



**Pacific Gas and
Electric Company**

Dennis Petersen
Station Director

Diablo Canyon Power Plant
P.O. Box 56
Avila Beach, CA 93424

805.545.4022
E-Mail:
Dennis.Petersen@pge.com

PG&E Letter DCL-22-017

U.S. Nuclear Regulatory Commission
ATTN: Document Control Desk
Washington, DC 20555-0001

10 CFR 50.36a(a)(2)

Docket No. 50-275, OL-DPR-80
Docket No. 50-323, OL-DPR-82
Diablo Canyon Units 1 and 2
2021 Annual Radioactive Effluent Release Report

Dear Commissioners and Staff:

Pacific Gas and Electric Company (PG&E) hereby submits the enclosed 2021 Annual Radioactive Effluent Release Report in accordance with 10 CFR 50.36a(a)(2) and Section 5.6.3 of the Diablo Canyon Power Plant (DCPP) Technical Specifications.

Enclosure 1 includes the DCPP 2021 Annual Radioactive Effluent Release Report, which describes the quantities of radioactive gaseous and liquid effluents released from the plant, and the solid radioactive waste shipments made during the period of January 1, 2021, through December 31, 2021.

Enclosure 2 is a compact disk containing meteorological data as described in Enclosure 1, Section VIII, "Meteorological Data."

PG&E makes no new or revised regulatory commitments (as defined by NEI 99-04) in this letter.

If you have any questions, please contact Mr. David Cortina, Manager Nuclear Environmental Services, at (805) 545-3517.

Sincerely,

Dennis Petersen

4/21/2022
Date

IE48

armb/50942686

Enclosures

cc: Diablo Distribution

cc/enc: Dr. Penny E. Borenstein, San Luis Obispo County Health Officer (w/o CD)

Nicholas A. Hernandez, Acting NRC Senior Resident Inspector

Matthew T. Keeling, Executive Officer, Central Coast Regional Water
Quality Control Board (w/o CD)

Samson S. Lee, NRC Project Manager

Bernice E. Minga, Institute of Nuclear Power Operations (w/o CD)

Scott A. Morris, NRC Region IV Administrator

Gonzalo L. Perez, Branch Chief, California Department of Public Health
(w/o CD)

Enclosure 1
PG&E Letter DCL-22-017

Diablo Canyon Power Plant
2021 Annual Radioactive Effluent Release Report

**DIABLO CANYON POWER PLANT
2021 ANNUAL RADIOACTIVE EFFLUENT RELEASE REPORT**

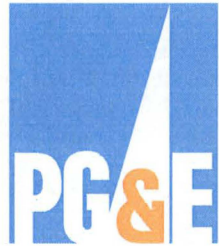

January 1, 2021- December 31, 2021



DIABLO CANYON POWER PLANT

Annual Radioactive Effluent Release Report January 1, 2021 through December 31, 2021

Table of Contents

	Introduction, Errata, and Executive Summary	5
I.	Supplemental Information	7
II.	Changes to Radwaste Management	14
III.	Changes to the Offsite Dose Calculation Manual (ODCM)	15
IV.	Land Use Census	15
V.	Gaseous and Liquid Effluent Release Report	16
	Table 1 - 2021 Gaseous Effluents – Summation of All Releases	17
	Table 2A - 2021 Gaseous Effluents – Nuclides Released – Ground Batch Mode	18
	Table 2B - 2021 Gaseous Effluents – Nuclides Released – Ground Continuous Mode	19
	Table 3 – 2021 Liquid Effluents – Summation of All Releases	20
	Table 4A – 2021 Liquid Effluents – Nuclides Released – Batch Mode	21
	Table 4B – 2021 Liquid Effluents – Nuclides Released – Continuous Mode	22
VI.	Solid Radwaste Shipments	23
VII.	Radiation Doses from Radioactive Effluents	25
	Atmospheric Release of Carbon-14 Due to Plant Operation and Associated Doses	26
	Radiation Doses from Radioactive Gaseous Effluents to Individuals Due to Consumption of Grazing Animals on Property Surrounding the Site	27
	Radiation Doses to Members of the Public in Unrestricted Areas Outside the Site Boundary Radiation Doses to Members of the Public from Activities Inside the Site Boundary	28
	Table 5A – 2021 Dose to Members of Public in Unrestricted Areas Due to Release of Gaseous Effluents – Airborne Noble Gas Doses – Units 1 and 2	31
	Table 5B – 2021 Dose to Members of Public in Unrestricted Areas Due to Release of Gaseous Effluents – Organ Dose from Non-Noble Gas – Unit 1	32
	Table 5C – 2021 Dose to Members of Public in Unrestricted Areas Due to Release of Gaseous Effluents – Organ Dose from Non-Noble Gas – Unit 2	33
	Table 6 – 2021 Dose to Members of Public in Unrestricted Areas Due to Release of Liquid Effluents – Organ & Whole Body Dose 2021 Appendix I Dose Assessment of Liquid Effluents	34
	Table 7A – 2021 Dose to Members of Public from Activities Inside the Site Boundary Due to Release of Gaseous Effluents – Airborne Noble Gas Doses - Units 1 and 2	35
	Table 7B - 2021 Dose to Members of Public from Activities Inside the Site Boundary Due to Release of Gaseous Effluents – Organ Dose from Non-Noble Gas - Unit 1	36
	Table 7C - 2021 Dose to Members of Public from Activities Inside the Site Boundary Due to Release of Gaseous Effluents – Organ Dose from Non-Noble Gas - Unit 2	37
	Table 7D - 2021 Dose to Members of Public from Activities Inside the Site Boundary Due to Release of Gaseous Effluents – Airborne Noble Gas Dose Evaluations – Unit 1 Airborne Iodine/Particulates/Tritium Dose Evaluations – Unit 1	38
	Table 7E - 2021 Dose to Members of Public from Activities Inside the Site Boundary Due to Release of Gaseous Effluents – Airborne Noble Gas Dose Evaluations – Unit 2 Airborne Iodine/Particulates/Tritium Dose Evaluations – Unit 2	39
VIII.	Meteorological Data	40

DIABLO CANYON POWER PLANT

**Annual Radioactive Effluent Release Report
January 1, 2021 through December 31, 2021**

Attachments

1. Diablo Canyon Power Plant Program Directive, CY2, "Radiological Monitoring and Controls Program," Revision 7B
2. Diablo Canyon Power Plant Interdepartmental Administrative Procedure, CY2.ID1, "Radioactive Effluent Controls Program," Revision 16
3. Diablo Canyon Power Plant Interdepartmental Administrative Procedure, RP1.ID11, "Environmental Radiological Monitoring Procedure," Revision 16
4. Diablo Canyon Power Plant Chemical Analysis Procedure (CAP), CAP A-8, "Off-Site Dose Calculations," Revision 42
5. Diablo Canyon Power Plant Departmental Administrative Procedure, RP2.DC2, "Radwaste Solidification Process Control Program," Revision 16
6. Diablo Canyon Power Plant Departmental Administrative Procedure, RP2.DC3, "Radwaste Dewatering Process Control Program," Revision 9
7. 2021 DCPD Land Use Census

DIABLO CANYON POWER PLANT

2021 Annual Radioactive Effluent Release Report

Introduction

The 2021 Annual Radioactive Effluent Release Report (ARERR) summarizes gaseous and liquid radiological effluent releases from Diablo Canyon Power Plant's (DCPP) Units 1 and 2. The report includes the dose due to release of radioactive liquid and gaseous effluents and summarizes solid radwaste shipments. The report contains information required by Units 1 and 2 Technical Specification (TS) 5.6.3 and is presented in the general format of Regulatory Guide (RG) 1.21, "Measuring, Evaluating, and Reporting Radioactivity in Solid Wastes and Releases of Radioactive Materials in Liquid and Gaseous Effluents from Light-Water Nuclear Power Plants," Revision 1, 1974, Appendix B, "Effluent and Waste Disposal Report." Procedure revisions that implement the Off-Site Dose Calculation Manual, programmatic support procedures and one compact disc containing meteorological data are attached.

In all cases, the doses associated with plant effluent releases during the report period were much less than the respective TS limits.

Errata

There are no errors to report for 2021.

Executive Summary

The radioactive effluent monitoring program for 2021 was conducted as described in the accompanying report. Results of the monitoring program reflect continued effort to maintain the release of radioactive effluents to the environment as low as reasonably achievable (ALARA). Results presented in this report were calculated in accordance with the DCPP Offsite Dose Calculation Manual (ODCM) and (when applicable) using the Canberra OpenEMS software.

In June 2009, the NRC provided revised guidance in Regulatory Guide 1.21, *Measuring, Evaluating and Reporting Radioactive Material in Liquid and Gaseous Effluents and Solid Waste, Revision 2*, establishing an updated approach for identifying principal radionuclides. Because the overall quantity of radioactive releases has steadily decreased due to improvements in power plant operations, carbon-14 (C-14) now qualifies as a "principal radionuclide" (anything greater than one percent of overall radioactivity in effluents) under federal regulations at many plants. In other words, C-14 has not increased, and C-14 is not a new nuclear plant emission. Instead, improvements in the mitigation of other isotopes have made C-14 more prominent. Section VII, Item B.3 provides more detail about C-14.

Executive Summary (continued)

Gaseous Effluents:

Three-year summary of all radioactive gaseous releases to the environment

Gaseous Waste	2021	2020	2019	Comments
Tritium (Ci)	34.8	43.5	73.2	1
C-14 (Ci)	19.6	19.7	19.5	2
Fission and Activation Gases (Ci)	0.37	0.34	1.09	
Total Particulates with half-lives >8 days (Ci)	N/D	5.91E-05	6.75E-05	
Gross Alpha (Ci)	4.02E-07	4.39E-07	4.99E-07	
Iodine (Ci)	N/D	N/D	N/D	
Calculated Gamma Air Dose (mRad)	1.66E-04	4.83E-04	1.56E-03	3
Calculated Beta Air Dose (mRad)	1.08E-04	1.82E-04	6.52E-04	3
Total Body Dose (mRem)	1.86E-03	2.19E-03	2.08E-03	4
Number of Refueling Outages	1	1	2	
Unit 1 Capacity Factor	99.2 %	92.1 %	90.1 %	
Unit 2 Capacity Factor	67.7 %	74.3 %	74.8 %	

Comments:

1. A major contributor to gaseous tritium activity is evaporation from the spent fuel pools. Factors contributing to the tritium activity in the pools are related to the type of fuel used (i.e., 18-month fuel) the core life, power output, and number of core cycles. Additionally, refueling outages contribute to gaseous tritium released.
2. C-14 activity released from the site has been estimated using reactor power in accordance with EPRI document "Estimation of Carbon-14 in Nuclear Power Plant Gaseous Effluents." C-14 production is proportional to the number of effective full power days and increases or decreases accordingly.
3. Beta and gamma air dose were calculated for the NW site boundary.
4. Total Body Dose was calculated for a full-time resident in the E sector at 7.43 km from the site. The Total Body Dose calculation includes both inhalation and ingestion dose from C-14 and non-noble gas organ dose.

Overall, the gaseous radioactivity releases from DCPD are well-controlled and maintained as low as reasonably achievable (ALARA). 2021 results from DCPD were well below all applicable limits for gaseous releases.

Executive Summary (continued)

Liquid Effluents:

Three-year summary of radioactive liquid releases to the environment

Liquid Waste	2021	2020	2019	Comments
Total Activity Excluding Tritium (Ci)	1.17E-02	6.87E-03	3.27E-02	1
Tritium Activity (Ci)	1080	2782	2214	2
Total Body Dose (mRem)	1.25E-04	3.36E-04	4.64E-04	3
Total Volume of Primary Liquid Waste Released (liters)	7.39E+06	9.91E+06	7.19E+06	

Comments:

1. Total activity can fluctuate based on the number of outages and if the fuel cycle is at the beginning, middle or end of the fuel cycle in proportion to reactor coolant dilution.
2. Tritium released values can vary from year to year based on two main factors. First, reactor coolant tritium production changes based on fuel burnup characteristics. Tritium activity increases following reactor startup, then plateaus mid-cycle, and begins to decline towards the end of cycle. Second, the tritium released value is dependent upon on how many outages there were during a calendar year. More liquid waste is processed and released during unit outages.
3. Due to DCP's location and its surrounding security exclusion area, there are no members of the public who can receive significant dose from the site's liquid effluents. Total body dose from liquid released during is calculated for a hypothetical receptor.

Direct Radiation

Due to the terrain surrounding the plant, DCP has no offsite direct radiation receptors with significant occupancy. Therefore, a bounding value for dose from direct radiation has been calculated for a receptor location that is onsite and close to both the sources and the nearest site boundary. Evaluation has been detailed in Section VII E.3. Note that calculated doses from direct radiation have all been well below 40 CFR 190 limit of 25 mrem/year.

Receptor	Sources of Direct Radiation	2021 (total)	2020 (total)	2019 (total)
Make-up Water Reverse Osmosis Operator	Warehouse A, ISFSI, Onsite Storage Casks, Old Steam Generator Storage Facility	4.9 mrem	4.8 mrem	4.5 mrem

Meteorological Data

During 2021, the DCP meteorological system achieved a greater than 90% mean recoverable data rate for the joint frequency parameters required by Regulatory Guide 1.23 for wind speed, wind direction and delta temperature.

Executive Summary (continued)

Monitors OOS > 30 Days

There were no Technical Specification/ODCM effluent radiation monitors out of service for greater than 30 days during 2021.

ODCM Changes

Changes made to the ODCM during 2021 have been described in Section III.

Solid Waste

Three-year summary of solid waste production:

Total Solid Waste	2021	2020	2019
Shipped (m ³)	77	44	118
Shipped (Ci)	158	152	313

Groundwater Tritium

Sampling and analysis of DCP Auxiliary Building roof drains, Auxiliary Building drywell, and the containment structure observation wells have historically identified detectable tritium activity. That tritium has been evaluated as most likely coming from the rain wash-out of gaseous tritium discharged via the plant vent. It is therefore accounted for in the plant vent release permit process, and rainwater tritium is accounted for per plant approved procedures. These practices will continue until new industry guidance is provided to account for this pathway in a different manner.

Refer to the 2021 Annual Radiological Environmental Operating Report for the data that has been evaluated to date for the sampling locations.

Conclusion

During 2021, the radioactive effluent monitoring program has been conducted in an appropriate manner to ensure the activity released and associated dose to the public has been maintained as low as reasonably achievable (ALARA).

Annual Radioactive Effluent Release Report

I. Supplemental Information

A. Regulatory Limits

1. Gaseous Effluents

a. Noble Gas Dose Rate Limit

The dose rate in areas at or beyond the site boundary due to radioactive noble gases released in gaseous effluents is limited to less than or equal to 500 millirem (mrem) per year to the total body and less than or equal to 3000 mrem per year to the skin. (Attachment 6 of CY2.ID1, "Radioactive Effluent Controls Program" [RECP])

b. Particulate and Iodine Dose Rate Limit

The dose rate in areas at or beyond the site boundary due to iodine-131, iodine-133, tritium, and all radionuclides in particulate form with half-lives greater than 8 days in gaseous effluents, is limited to less than or equal to 1500 mrem per year to any organ. (Attachment 6 of RECP)

c. Noble Gas Dose Limit

The air dose due to noble gases released in gaseous effluents from each reactor unit to areas at or beyond the site boundary is limited to the following:

Radiation Type	Calendar Quarter Limit (Attachment 7 of RECP)	Calendar Year Limit (Attachment 7 of RECP)
Gamma	5 millirad	10 millirad
Beta	10 millirad	20 millirad

d. Airborne Iodine, Tritium, and Particulate Dose Limit

The dose to an individual from iodine-131, iodine-133, tritium, and all radionuclides in particulate form with half-lives greater than 8 days in gaseous effluents released from each reactor unit to areas at or beyond the site boundary is limited to less than or equal to 7.5 mrem to any organ in any calendar quarter and less than or equal to 15 mrem to any organ during a calendar year. (Attachment 8 of RECP)

A. Regulatory Limits (continued)

2. Liquid Effluents

a. Concentration

With the exception of dissolved or entrained noble gases, the concentration of radioactive material released from the site in liquid form is limited to the concentrations specified in 10 CFR Part 20, Appendix B, Table 2, Column 2. For dissolved or entrained noble gases, the total specific activity is limited to 2×10^{-4} microcuries/milliliter ($\mu\text{Ci/ml}$). (Attachment 3 of RECP)

b. Dose

The dose or dose commitment to a member of the public from radioactive materials in liquid effluents released from each reactor unit to areas at or beyond the site boundary is limited to the following:

Dose Type	Calendar Quarter Limit (Attachment 4 of RECP)	Calendar Year Limit (Attachment 4 of RECP)
Total Body	1.5 millirem	3 millirem
Any Organ	5 millirem	10 millirem

3. Direct Radiation

a. Dose

The annual dose equivalent received by a member of the public as a result of exposures to planned discharges of non-radon, radioactive materials is limited in 40 CFR Part 190 to 25 millirem to the total body, 75 millirem to the thyroid, and 25 millirem to any other organ.

I. Supplemental Information

B. Maximum Permissible Concentrations

1. Gaseous Effluents

Maximum permissible concentrations are not used for determining allowable release rates for gaseous effluents at DCPP.

2. Liquid Effluents

Except for dissolved or entrained noble gases, the concentrations listed in 10 CFR 20, Appendix B, Table 2, Column 2, for radionuclides are used for determining the allowable release concentration at the point of discharge from the site for liquid effluents. For dissolved or entrained noble gases, the allowable release concentration for liquid effluents at the point of discharge is limited to 2×10^{-4} $\mu\text{Ci/ml}$ total activity.

I. Supplemental Information (continued)

C. Measurements and Approximations of Total Radioactivity

1. Gaseous Effluents

a. Fission and Activation Gases

A pair of radiation monitors equipped with beta scintillator detectors measure the gaseous radioactivity released from the plant vent. The readings from these monitors are correlated to the isotopic concentrations determined in grab samples that are analyzed in the laboratory using a germanium detector.

For plant vent noble gas releases, grab sample results are used to quantify releases. The individual batch release data are used to quantify the radioactivity discharged from the gas decay tanks and containment.

A noble gas grab sample is obtained from the plant vent and analyzed at least weekly. The isotopic mixture is assumed to remain constant between grab sample analyses.

Containment purges, gas decay tank releases, and air ejector discharges are released via the plant vent.

The gaseous radioactivity released from the steam generator blowdown tank vent is measured by analyzing liquid or steam condensate grab samples with a germanium detector. The ratio of unit masses of water flashing to steam and water entering the tank is used to calculate the activity. The isotopic concentrations are assumed to remain constant between grab samples.

Other potential pathways for releasing gaseous radioactivity are periodically monitored by collecting grab samples and analyzing these samples with a germanium detector system.

I. Supplemental Information (continued)

C. Measurements and Approximations of Total Radioactivity (continued)

1. Gaseous Effluents (continued)

b. Iodines and Particulates

Radioiodines released from the plant vent are measured through continuous sample collection on silver zeolite cartridges. The cartridges are changed at least weekly and analyzed with a germanium detector. The radioiodine releases are averaged over the period of cartridge sample collection.

Other potential pathways for releasing radioiodines are periodically measured by collecting samples using charcoal or silver zeolite cartridges and analyzing with a germanium detector.

Radioactive materials in particulate form released from the plant vent are measured through continuous sample collection on particulate filters. The filters are changed at least weekly and analyzed with a germanium detector. The particulate radioactivity is averaged over the period of particulate filter sample collection. Each filter is analyzed for alpha emitters using an internal proportional counter. Plant vent particulate filters collected during a quarter are used for the composite analysis for strontium-89 and -90, which is counted on an internal proportional counter after chemical separation.

Other potential pathways for releasing radioactive particulate are periodically monitored by collecting samples using particulate filters and analyzing these filters with a germanium detector.

c. Tritium

Tritium released from the plant vent is monitored by passing a measured volume of plant vent sample through a water column and determining the tritium increase in the water. An aliquot of the water is counted in a liquid scintillation spectrometer. The minimum routine sample frequency for tritium in the plant vent is weekly. The tritium concentration is assumed to remain constant between samples.

I. Supplemental Information (continued)

C. Measurements and Approximations of Total Radioactivity (continued)

1. Gaseous Effluents (continued)

d. Estimations of Overall Error

Sources of error considered for gaseous batch releases are: 1) calibration source; 2) calibration counting; 3) sampling; 4) sample counting; and 5) gas decay tank pressure gauge/containment exhaust fan flow rate.

Sources of error for continuous release are: 1) calibration source; 2) calibration counting; 3) sampling; 4) sample counting; 5) process monitor (RE-14) reading (fission gases only); and 6) plant vent exhaust fan flow rate.

$$\text{Total error} = (\sigma^2_1 + \sigma^2_2 + \sigma^2_3 + \dots + \sigma^2_i)^{1/2}$$

Where σ_i = error associated with each component.

2. Liquid Effluents

a. Batch Releases

Each tank of liquid radwaste is analyzed for principal gamma emitters using a germanium detector prior to release. A monthly prerelease analysis includes measurement of dissolved and entrained gases. Volume-proportional monthly and quarterly composites are prepared from aliquots of each tank volume discharged.

The monthly composite is analyzed for tritium using a liquid scintillation spectrometer and gross alpha radioactivity using an internal proportional counter.

The quarterly composite is analyzed for iron-55 using a liquid scintillation spectrometer and for strontium-89 and -90 using an internal proportional detector following chemical separations. The quarterly composite for discharges from the auxiliary building are also analyzed for nickel-63, uranium-233/234/235/236/238 and plutonium-238/239/240/241/242.

I. Supplemental Information (continued)

C. Measurements and Approximations of Total Radioactivity (continued)

2. Liquid Effluents (continued)

b. Continuous Releases

For continuous liquid releases from the steam generator blowdown tank and the turbine building sump oily water separator, daily grab samples are collected, and aliquots are proportioned to prepare weekly, monthly, and quarterly composites.

The oily water separator weekly composite is analyzed for principal gamma emitters. The steam generator blowdown tank weekly composite is analyzed for principal gamma emitters and iodine-131. These analyses are performed by gamma spectroscopy using germanium detectors.

The steam generator blowdown tank monthly composite is analyzed for tritium using a liquid scintillation spectrometer and for gross alpha using an internal proportional counter.

The steam generator blowdown tank quarterly composite is analyzed for iron-55 using a liquid scintillation spectrometer and for strontium-89 and strontium-90 using an internal proportional counter following chemical separation. The results for each of the composites are averaged over the period of the composite.

In addition, one grab sample of the steam generator blowdown tank is analyzed monthly for dissolved and entrained gases using a germanium detector. The results of this analysis are assumed to remain constant over the period of one month.

A grab sample of the steam generator blowdown is collected at least weekly and analyzed for gamma activity using a germanium detector. This analysis is used to monitor activity; however, it is not used in effluent calculations unless a significant change is detected.

Table 3, "Liquid Effluents - Summation of All Releases," Item G lists the "Dilution Water Volume During Period," in liters. Each value is calculated by multiplying the period(s) of operation for each circulating water pump by the respective pump flow rate.

I. Supplemental Information (continued)

C. Measurements and Approximations of Total Radioactivity (continued)

2. Liquid Effluents (continued)

c. Estimation of Overall Error

Sources of error considered for liquid releases are: 1) calibration source error; 2) calibration counting error; 3) sampling error; 4) sample counting error; and 5) volume of waste release error.

These sources of error are independent of one another. Therefore, the total error is calculated according to the following formula:

$$\text{Total error} = (\sigma^2_1 + \sigma^2_2 + \sigma^2_3 + \dots + \sigma^2_i)^{1/2}$$

Where σ_i = error associated with each component.

I. **Supplemental Information (continued)**

D. Batch Releases

1. Gaseous

a. Number of batch releases	139
b. Total time period for batch releases	1010 hours
c. Maximum time period for a batch release	72 hours
d. Average time period for a batch release	7.26 hours
e. Minimum time period for a batch release	0.25 hours

2. Liquid

a. Number of batch releases	603
b. Total time period for batch releases	2190 hours
c. Maximum time period for a batch release	120 hours
d. Average time period for a batch release	3.64 hours
e. Minimum time period for a batch release	0.33 hours
f. Average saltwater flow during batch releases	1.15E+06 gallons per minute (gpm)

E. Abnormal Release (Gaseous and Liquid)

No abnormal releases occurred during 2021.

F. Inoperable Effluent Monitoring Systems

There were no Technical Specification/ODCM effluent radiation monitors out of service for greater than 30 days during 2021.

II. Changes to Radwaste Management

A. Changes to Liquid, Gaseous and Solid Radwaste Treatment Systems

No major changes were made to the treatment systems during 2021.

B. Changes to the Radwaste Process Control Program

There were no changes to the Radwaste Process Control Program that was implemented by the following plant administrative procedures:

1. RP2.DC2, "Radwaste Solidification Process Control Program"
(See Attachment 5.)
2. RP2.DC3, "Radwaste Dewatering Process Control Program"
(See Attachment 6.)

III. Changes to the Offsite Dose Calculation Manual (ODCM)

A. General

The Diablo Canyon ODCM is made up of the following procedures:

- Nuclear Power Generation Program Directive Procedure, CY2, "Radiological Monitoring and Controls Program" (RMCP)
- Nuclear Power Generation Interdepartmental Administrative Procedure (IDAP), CY2.ID1, "Radioactive Effluent Controls Program" (RECP)"
- IDAP RP1.ID11, "Environmental Radiological Monitoring Procedure (ERMP)
- Diablo Canyon Power Plant Chemical Analysis Procedure, CAP A-8, "Off-Site Dose Calculation Procedure" (ODCP)

A copy of procedures that make up the ODCM are included (Attachment 1 through Attachment 4). If significant changes were made to an ODCM procedure, they are described below. Changes that were strictly editorial are not described.

B. CY2, "Radiological Monitoring and Controls Program" (RMCP)

1. No changes were made to the RMCP during 2021.
2. See Attachment 1.

C. CY2.ID1, "Radioactive Effluent Controls Program" (RECP)

1. No changes were made to the RECP during 2021.
2. See Attachment 2.

D. RP1.ID11, "Environmental Radiological Monitoring Procedure (ERMP)

1. No changes were made to RP1.ID11 during 2021.
2. See Attachment 3.

E. CAP A-8, "Off-Site Dose Calculations" Procedure (ODCP)

1. Revision 42 of CAP A-8 was revised in 2021 but issued in February of 2022. It implemented routine updates of atmospheric dispersion and deposition factors from 2021 and added details to High Alarm Setpoint Calculations.
2. See Attachment 4.

IV. Land Use Census

The 2021 DCPD Land Use Census is included as Attachment 7.

V. Gaseous and Liquid Effluent Release Report

Tables 1 and 2 describe 2021 releases of gaseous effluents.
Tables 3 and 4 describe 2021 releases of liquid effluents.

Table 1
2021 Gaseous Effluents -Summation of All Releases

	Units	1st Qtr	2nd Qtr	3rd Qtr	4th Qtr	Est Total Error, %
A. Fission & Activation Gases						
1. Total Release	Curies	2.83E-01	2.95E-02	3.00E-02	2.31E-02	24%
2. Average Release Rate for Period	μCi/sec	3.64E-02	3.75E-03	3.78E-03	2.90E-03	
B. Iodines						
1. Total Release	Curies	N/D	N/D	N/D	N/D	24%
2. Average Release Rate for Period	μCi/sec	N/D	N/D	N/D	N/D	
C. Particulates						
1. Total Release	Curies	N/D	N/D	N/D	N/D	24%
2. Average Release Rate for Period	μCi/sec	N/D	N/D	N/D	N/D	
3. Gross Alpha Radioactivity	Curies	3.28E-07	N/D	N/D	7.43E-08	
D. Tritium						
1. Total Release	Curies	1.22E+01	6.54E+00	7.29E+00	8.78E+00	13%
2. Average Release Rate for Period	μCi/sec	1.57E+00	8.31E-01	9.17E-01	1.10E+00	

NOTE: Where "N/D" is shown, the subject radionuclide was not detected at or above the "a posteriori" minimum detectable activity.

Table 2A
2021 Gaseous Effluents – Nuclides Released
Ground Batch Mode

	Units	1st Qtr	2nd Qtr	3rd Qtr	4th Qtr
Fission and Activation Gases					
Ar-41	Curies	1.55E-02	1.90E-02	2.72E-02	2.26E-02
Xe-133	Curies	2.65E-01	1.02E-02	2.81E-03	4.58E-04
Xe-133m	Curies	1.55E-04	8.45E-05	1.36E-05	N/D
Xe-135	Curies	2.51E-03	2.78E-04	N/D	N/D
Kr-85m	Curies	9.50E-05	2.81E-06	N/D	N/D
Kr-88	Curies	6.10E-05	N/D	N/D	N/D
Xe-131m	Curies	3.37E-05	N/D	N/D	N/D
Total	Curies	2.83E-01	2.95E-02	3.00E-02	2.31E-02

Iodines					
Total	Curies	N/D	N/D	N/D	N/D

Particulates					
Total	Curies	N/D	N/D	N/D	N/D

H-3					
Total	Curies	5.11E+00	2.92E-01	8.21E-02	1.02E-01

Gross Alpha					
Total	Curies	N/D	N/D	N/D	N/D

NOTE: Where "N/D" is shown, the subject radionuclide was not detected at or above the "a posteriori" minimum detectable activity.

Table 2B
2021 Gaseous Effluents – Nuclides Released
Ground Continuous Mode

	Units	1st Qtr	2nd Qtr	3rd Qtr	4th Qtr
Fission and Activation Gases					
Total	Curies	N/D	N/D	N/D	N/D
Iodines					
Total	Curies	N/D	N/D	N/D	N/D
Particulates					
Total	Curies	N/D	N/D	N/D	N/D
H-3					
Total	Curies	7.10E+00	6.24E+00	7.21E+00	8.68E+00
Gross Alpha					
Total	Curies	3.28E-07	N/D	N/D	7.43E-08

NOTE: Where "N/D" is shown, the subject radionuclide was not detected at or above the "a posteriori" minimum detectable activity.

Table 3
2021 Liquid Effluents - Summation of All Releases
Dilution Stream: Circ Water Discharge Structure

	Units	1st Qtr	2nd Qtr	3rd Qtr	4th Qtr	Est. Total Error %
A. Fission and Activation Products						
1. Total Release (not including tritium, gases, alpha)	Curies	3.22E-03	9.09E-04	2.96E-03	4.62E-03	124%
2. Average diluted concentration during period	µCi/ml	4.18E-12	1.17E-12	3.42E-12	5.54E-12	
3. Percent of Applicable Limit	%	6.28E-05	1.70E-05	2.73E-05	7.16E-05	
B. Tritium						
1. Total Release	Curies	3.15E+02	1.80E+02	5.39E+01	5.30E+02	13%
2. Average diluted concentration during period	µCi/ml	4.09E-07	2.32E-07	6.23E-08	6.36E-07	
3. Percent of Applicable Limit	%	4.09E-02	2.32E-02	6.23E-03	6.36E-02	
C. Dissolved & Entrained Gases						
1. Total Release	Curies	1.15E-04	1.07E-04	1.30E-05	2.19E-05	24%
2. Average diluted concentration during period	µCi/ml	1.49E-13	1.37E-13	1.51E-14	2.63E-14	
3. Percent of Applicable Limit	%	7.46E-07	6.85E-07	7.54E-08	1.31E-07	
D. Gross Alpha Radioactivity						
1. Total Release	Curies	N/D	N/D	N/D	N/D	61%
E. Primary Waste Volume Released (Pre-Dilution)						
1. Total Release	Liters	3.08E+06	1.67E+06	5.33E+05	2.11E+06	5%
F. Secondary Waste Volume Released (Pre-Dilution)						
1. Total Release	Liters	8.74E+07	8.96E+07	1.02E+08	1.12E+08	5%
G. Dilution Water Volume During Period						
1. Total Release	Liters	7.71E+11	7.78E+11	8.66E+11	8.33E+11	7%

NOTE: Where "N/D" is shown, the subject radionuclide was not detected at or above the "a posteriori" minimum detectable activity.

Table 4A

2021 Liquid Effluents – Nuclides Released

Batch Mode

Dilution Stream: Circ Water Discharge Structure

	Units	1st Qtr	2nd Qtr	3rd Qtr	4th Qtr
Fission and Activation Products					
Cr-51	Curies	3.52E-05	5.45E-07	N/D	N/D
Mn-54	Curies	3.48E-05	7.87E-06	1.59E-05	1.29E-05
Fe-55	Curies	N/D	N/D	1.63E-03	1.66E-03
Co-58	Curies	2.93E-04	9.14E-05	6.32E-05	1.70E-05
Co-60	Curies	1.09E-03	3.45E-04	6.09E-04	1.64E-03
Ni-63	Curies	4.19E-04	1.49E-04	3.23E-04	5.16E-04
Zn-65	Curies	N/D	N/D	N/D	4.26E-06
Br-84	Curies	N/D	1.87E-07	N/D	N/D
Zr-95	Curies	7.17E-06	1.67E-07	N/D	N/D
Nb-95	Curies	3.31E-05	3.26E-07	N/D	N/D
Mo-99	Curies	4.17E-07	N/D	N/D	N/D
Sb-124	Curies	5.18E-06	N/D	N/D	N/D
Sb-125	Curies	1.25E-03	3.15E-04	3.08E-04	7.60E-04
Cs-137	Curies	5.71E-05	N/D	N/D	N/D
Total	Curies	3.22E-03	9.09E-04	2.96E-03	4.62E-03

Dissolved & Entrained Gases

Xe-133	Curies	1.15E-04	1.07E-04	1.30E-05	2.19E-05
Total	Curies	1.15E-04	1.07E-04	1.30E-05	2.19E-05

H-3

Total	Curies	3.15E+02	1.80E+02	5.39E+01	5.30E+02
-------	--------	----------	----------	----------	----------

Gross Alpha

Total	Curies	N/D	N/D	N/D	N/D
-------	--------	-----	-----	-----	-----

NOTE: Where "N/D" is shown, the subject radionuclide was not detected at or above the "a posteriori" minimum detectable activity.

Table 4B
2021 Liquid Effluents – Nuclides Released
Continuous Mode
Dilution Stream: Circ Water Discharge Structure

	Units	1st Qtr	2nd Qtr	3rd Qtr	4th Qtr
Fission and Activation Products					
Total	Curies	N/D	N/D	N/D	N/D
Dissolved & Entrained Gases					
Total	Curies	N/D	N/D	N/D	N/D
H-3					
Total	Curies	N/D	N/D	N/D	N/D
Gross Alpha					
Total	Curies	N/D	N/D	N/D	N/D

NOTE: Where "N/D" is shown, the subject radionuclide was not detected at or above the "a posteriori" minimum detectable activity.

VI. Solid Radwaste Shipments

A. Solid Waste and Irradiated Fuel Shipment

(Refer to Section VI.B for irradiated fuel shipment and disposition.)

1. Type of Waste	Unit	12 Month Period	Est. Total Error, %
a. Spent Resins, Filter Sludges, Evaporator Bottoms, etc.	m ³	10.9	9.0
	Ci	158	
b. Dry Compressible Waste, Contaminated Equipment, etc.	m ³	67	9.0
	Ci	0.47	
c. Irradiated Components, Control Rods, etc.	m ³	N/A (none shipped)	N/A
	Ci		
d. Other	m ³	N/A (none shipped)	N/A
	Ci		

2. Estimate of Major Nuclide Composition (by type of waste)

a.

Spent Resins, Filter Sludges, Evaporator Bottoms, etc.		
Co-60	39.9	%
Fe-55	26.7	%
Ni-63	15.6	%
Mn-54	7.59	%
Zn-65	3.58	%
Co-58	2.27	%
Other nuclides	<5.0	%

b.

Dry Compressible Waste, Contaminated Equipment, etc.		
Nb-95	26.9	%
Fe-55	25.1	%
Zr-95	14.0	%
Co-60	9.83	%
Ni-63	7.14	%
Sb-125	6.73	%
Co-58	5.53	%
Other nuclides	<5.0	%

A. Solid Waste and Irradiated Fuel Shipment (continued)

3. Solid Waste Disposition

Number of Shipments	Mode of Transportation	Destination
3	Truck	WCS Compact cell Andrews, Tx
1	Truck	WCS Treatment Facility Andrews, Tx
1	Truck	Permafix Oak Ridge, Tn
1	Truck	Toxco Oak Ridge, Tn

4. Supplemental Information Required by former Technical Specification (TS) 6.9.1.6

Solidification Agent	Type of Container	Number of Containers	10 CFR 61 Waste Class	Shipping Type
None	IP-1	1	B	Type B
Cement	IP-1	1	A	IP2-LSA II
None	IP-1	1	A	IP2- LSA II
None	IP-1	8	NA	LSA

B. Irradiated Fuel Shipments (Disposition)

Number of Shipments	Mode of Transportation	Destination
None	N/A	N/A

VII. Radiation Doses from Radioactive Effluents

A. Radiation Doses from Radioactive Liquid Effluents

1. General Information

The radiation dose contributions to the total body and each individual organ due to releases of radioactive liquid effluents for the maximum exposed adult member of the public have been calculated in accordance with the methodology stated in the ODCP. Dose contributions listed in Table 6 show conformance to Attachment 4 of the RECP.

B. Radiation Doses from Radioactive Gaseous Effluents

1. General Information

The radiation dose to a hypothetical receptor at the site boundary from radioactive gaseous effluents due to plant operation has been calculated as described in the ODCP. The dose contribution related to operation of each unit has been calculated separately. (Table 5A)

In addition, doses to the most-affected individuals (critical receptors) identified in the 2021 DCCP Land Use Census were calculated. Doses from radioiodines, tritium, and particulates released in gaseous effluents with half-lives greater than eight days were determined in accordance with the methodology in the ODCP. (Tables 5B, 5C)

These calculations were performed using the methods described in NUREG-0133, "Preparation of Radiological Effluent Technical Specifications for Nuclear Power Plants," October 1978. Maximum doses for age groups, affected organs, and geographic locations for the report period show conformance to Attachments 6, 7, and 8 of the RECP.

2. Gaseous and Airborne Releases from Laboratory Exhausts

The radiation doses to the nearest offsite inhalation receptor (NW sector at 5.76 km) from two discharges other than the plant vent were also calculated for 2021. The discharges were the exhaust vent from the primary chemistry lab and the exhaust vent from the post-accident sampling system. The results are conservatively based on laboratory measurements of the isotopes in samples processed in the respective exhaust hoods and the associated discharge flows.

The inhalation doses in 2021 to the nearest offsite inhalation receptor from these two sources were:

Inhalation Receptor Location	Exhaust Vent Source	Total Gamma Air Dose (mrad)	Total Beta Air Dose (mrad)
NW – 5.76 km	Chemistry Lab	1.22E-07	4.39E-08
NW – 5.76 km	Post-accident Lab	9.31E-09	3.35E-09

VII. Radiation Doses from Radioactive Effluents(continued)

B. Radiation Doses from Radioactive Gaseous Effluents (continued)

3. Atmospheric Release of Carbon-14 Due to Plant Operation and Associated Doses

- a. In June, 2009, NRC revised guidance in RG 1.21, "Measuring, Evaluating and Reporting Radioactivity In Solid Wastes And Releases Of Radioactive Materials In Liquid And Gaseous Effluents From Light-Water-Cooled Nuclear Power Plants," Revision 2. That document stated that analytical methods for determining carbon-14 (C-14) had improved, and that coincidentally, radioactive effluents from commercial power plants had decreased to the point that C-14 was likely to be a principle radionuclide in gaseous effluents. Also, because the dose contribution of C-14 from liquid radioactive waste is much less than that contributed by gaseous radioactive waste, evaluation of C-14 in liquid radioactive waste is not required. However, NRC stated that licensees should evaluate whether C-14 is a principal radionuclide in gaseous releases from their facility.
- b. In order to aid the nuclear power industry in estimating C-14 production, the Electric Power Research Institute (EPRI) developed Technical Report 1021106, "Estimation of Carbon-14 in Nuclear Power Plant Gaseous Effluents," December 2010. DCPD uses the methods in that guidance to estimate the quantity of C-14 that is produced and released during the year.
- c. Calculated C-14 production during 2021, discharge parameters, and resulting dose to the nearest critical receptors from inhalation and ingestion of vegetation were calculated as listed below. (C-14 activities and related doses are not included in Tables 5, 6, and 7).

Year		2021	2020	2019
Unit capacity factors	U1	0.992	0.921	0.902
	U2	0.677	0.743	0.748
Total Ci C-14 produced	U1	12.0	11.3	10.5
	U2	8.0	8.8	9.4
Fractional release of C-14 produced as gas		0.98		
Fraction of C-14 chemical form assumed	Organic	0.70		
	Inorganic	0.30		
Curies C-14 released to atmosphere	U1	11.8	11.1	10.3
	U2	7.9	8.6	9.2
Dose to receptor in E sector at 7.43 km from C-14 inhalation and ingestion of C-14 in vegetation due to plant operation	Total body (mrem)	1.85E-3	2.04 E-3	1.84 E-3
	Bone (mrem)	9.29E-3	1.02E-2	9.23 E-3
Dose to receptor in NW sector at 5.76 km from C-14 inhalation due to plant operation	Total body (mrem)	5.09E-4	5.33 E-4	6.11 E-4
	Bone (mrem)	2.71E-3	2.84 E-3	3.26 E-3

VII. Radiation Doses from Radioactive Effluents (continued)

B. Radiation Doses from Radioactive Gaseous Effluents (continued)

4. Radiation Doses from Radioactive Gaseous Effluents to Individuals Due to Consumption of Grazing Animals on Property Surrounding the Site

The 2021 DCPD Land Use Census identified that during the year, residents of the area around the plant took deer for personal consumption. Cow meat from the surrounding property was reported to have been consumed by one resident during 2021.

In addition to field measurements of meat samples, doses to the respective offsite ingestion receptors from airborne tritium, particulates, and C-14 during 2021 due to plant operation and their consumption of meat were calculated.

Receptor Location	Meat Source	GI-LLI Dose (mrem) from airborne tritium and particulates ingested through meat	Total Body Dose (mrem) from airborne C-14 ingested through meat	Bone Dose (mrem) from airborne C-14 ingested through meat
		2021	2021	2021
NNE 5.19 km	Deer	5.12E-5	9.64E-5	4.82E-4
ENE 7.15 km		1.08E-5	3.77E-5	1.88E-4
NNW 2.42 km	Cow	2.65E-04	1.11E-3	5.56E-3

C. Evaluation for 40 CFR 190

The release of radioactivity in liquid and gaseous effluents resulted in doses that are small percentages of the TS limits as shown in Tables 5 and 6. In addition, the direct radiation from various sources, including the independent spent fuel storage installation (ISFSI), resulted in dose that was a fraction of 40 CFR 190 limits. (Refer to E.3 below.) The combined doses reported for 2021 from liquid and gaseous effluents and direct radiation show that DCPD complied with all 40 CFR 190 limits.

VII. Radiation Doses from Radioactive Effluents (continued)

D. Radiation Doses to Members of the Public in Unrestricted Areas Outside the Site Boundary

1. Gaseous Effluents

The radiation dose to members of the public in 2021 in unrestricted areas outside the site boundary due to the release of radioactive gaseous effluents has been evaluated as negligible. The factors evaluated were the distance of the nearest actual receptor for gaseous effluents and the source term for the 2021 reporting period. Specifically; the nearest evaluated resident is 5.76 km from the site. (Table 5B and Table 5C)

2. Liquid Effluents

The radiation dose to members of the public in 2021 near the site due to the release of radioactive liquid effluents has been evaluated as negligible. (Table 6)

E. Radiation Doses to Members of the Public from Activities Inside the Site Boundary

1. Gaseous Effluents

Dose to unmonitored personnel working at two specific locations inside the site boundary was evaluated. Because workers at both locations are on station for at least 40 hours/week, the results of the respective dose calculations bound the dose that could be incurred by any visiting Member of the Public inside the site boundary. (Table 7)

2. Liquid Effluents

Dose to Member(s) of the Public inside the site boundary due to liquid effluents was not evaluated. There were no opportunities for exposure inside the site boundary to dose from liquid effluents for any Member of the Public.

VII. Radiation Doses from Radioactive Effluents (continued)

E. Radiation Doses to Members of the Public from Activities Inside the Site Boundary (continued)

3. Direct Radiation (line-of-sight plus sky-shine)

Evaluation of dose from direct radiation to members of the public not associated with the nuclear fuel cycle and in unrestricted areas is required by 40 CFR 190. The respective dose limit is 25 mrem per year to the whole body. The 2021 Land Use Census did not identify any members of the public that live in an offsite location that can receive direct radiation from the DCPD site.

Therefore, instead of calculating dose to a hypothetical member of the public at the site boundary for 2021, the bounding dose from direct radiation was calculated for operators at the onsite makeup water treatment plant. This location was chosen because it is located near the northern site boundary and approximately 200 meters from both the ISFSI and the centerline between the Unit 1 and Unit 2 plant vent exhausts. There, the makeup water plant is exposed to radiation from onsite radioactive waste storage containers, Warehouse A (storage for contaminated tools and equipment), the Old Steam Generator Storage Facility (OSGSF), and the spent fuel casks inside the ISFSI.

The OSGSF has contained the following:

Year	Number	Material
2008	4	Unit 2 steam generators
2009	4	Unit 1 steam generators
2009	1	Unit 2 reactor head
2010	1	Unit 1 reactor head

The ISFSI spent fuel casks were loaded as follows:

Year	Casks	Year	Casks Loaded
2009	8	2016	12
2010	8	2017	0
2011	0	2018	9
2012	7	2019	0
2013	6	2020	0
2014	0	2021	0
2015	8	-	-

The makeup water operators have been estimated to spend a maximum of 2920 hours a year at their work location. This occupancy rating is much greater than any member of the public who might visit the site.

Because of the factors described, dose received by makeup water plant operators is considered bounding – a maximum greater than the dose that could be received by any real member of the public in the unrestricted area. The 2021 dose from direct radiation calculated for a makeup water operator as a receptor was 4.9 millirem. This value is approximately 1/5 of the 25 millirem limit from 40 CFR Part 190 that applies to members of the public unassociated with the nuclear fuel cycle due to activities inside the site boundary but outside the restricted area.

VII. Radiation Doses from Radioactive Effluents (continued)

F. Sub-surface Water Radioactive Contamination

Recent events at other nuclear plant sites have involved identification of equipment leaks containing low levels of radioactivity. In some cases, these leaks have resulted in radioactive contamination of ground water and storm water that may leave plant sites. Any plant equipment leaks that could result in such an event at DCPD are documented in the corrective action program (CAP). Analysis of samples of sub-surface water at DCPD has indicated the only radioactive isotope currently present is tritium. Currently, there is no evidence to point to plant system leakage as the source for this tritium.

Sampling and analysis of Auxiliary Building roof drains, Auxiliary Building drywell, and the containment structure observation wells have identified detectable tritium activity. This tritium has been evaluated as most likely coming from rain wash-out of gaseous tritium exiting the plant vent system. This tritium is accounted for in plant vent release permits, and rainwater tritium is accounted for per plant approved procedures.

Refer to the 2021 Annual Radiological Environmental Operating Report (DCL-22-025) for the data that has been evaluated to date for the sampling locations.

G. NEI 07-07 Voluntary Communication for Sub-surface Water

Section 2, "Communication," Objective 2.4, "Annual Reporting," of NEI 07-07 lists the acceptance criteria for annual reporting of "ground water" information, as follows:

1. Acceptance Criterion 2.4.b.i:

Reporting of on-site ground water sample results that are taken in support of the Groundwater Protection Initiative (GPI), but are not part of the ERMP program are reported in the ARERR required by 10 CFR 50.36a(a)(2).

- For 2021, there were no on-site ground water results for samples taken in support of the GPI that are not part of the ERMP program.

2. Acceptance Criterion 2.4.b.ii:

Reporting of on-site ground water "sample results for those long-term monitoring sample points that are not included in ERMP are reported in the ARERR."

- For 2021, there were no on-site ground water sample results for long term monitoring sample points not included in the ERMP.

3. Acceptance Criterion 2.4.c.i

Voluntary communications of the description of all spills or leaks, made per Objective 2.2 acceptance criterion, shall be included in the ARERR.

- For 2021, no voluntary communications were made per Objective 2.2.

4. Acceptance Criterion 2.4.c.ii:

Voluntary communications of all on-site or off-site ground water sample results that exceeded the ERMP reporting thresholds as described in the ODCM that were communicated per Objective 2.2 acceptance criterion b shall be included in the ARERR.

- For 2021, no voluntary communications were made per Objective 2.2.

Table 5A

**2021 Dose to Members of Public in Unrestricted Areas
Due to Release of Gaseous Effluents**

Airborne Noble Gas Doses- Unit 1

Receptor Name: 2021 Site Boundary NW 803m Child (hypothetical)

	1st Qtr		2nd Qtr		3rd Qtr		4th Qtr		Calendar Year	
	Dose (mrad)	% of ODCM Limit	Dose (mrad)	% of ODCM Limit	Dose (mrad)	% of ODCM Limit	Dose (mrad)	% of ODCM Limit	Dose (mrad)	% of ODCM Limit
Beta Air	8.32E-06	8.32E-05	7.96E-06	7.96E-05	8.24E-06	8.24E-05	7.33E-06	7.33E-05	3.19E-05	1.59E-04
Gamma Air	2.23E-05	4.46E-04	2.06E-05	4.13E-04	2.20E-05	4.41E-04	2.06E-05	4.11E-04	8.55E-05	8.55E-04

Airborne Noble Gas Doses - Unit 2

Receptor Name: 2021 Site Boundary NW 803m Child (hypothetical)

	1st Qtr		2nd Qtr		3rd Qtr		4th Qtr		Calendar Year	
	Dose (mrad)	% of ODCM Limit	Dose (mrad)	% of ODCM Limit	Dose (mrad)	% of ODCM Limit	Dose (mrad)	% of ODCM Limit	Dose (mrad)	% of ODCM Limit
Beta Air	5.44E-05	5.44E-04	5.83E-06	5.83E-05	9.01E-06	9.01E-05	6.63E-06	6.63E-05	7.59E-05	3.79E-04
Gamma Air	2.32E-05	4.65E-04	1.31E-05	2.62E-04	2.55E-05	5.10E-04	1.88E-05	3.76E-04	8.07E-05	8.07E-04

Table 5B

2021 Dose to Members of Public in Unrestricted Areas
Due to Release of Gaseous Effluents

Organ Dose – Non-Noble Gas

Unit 1

Receptor Name: 2021 Garden E 7.43 km Adult

	1st Qtr		2nd Qtr		3rd Qtr		4th Qtr		Calendar Year	
	Dose (mrem)	% of ODCM Limit	Dose (mrem)	% of ODCM Limit	Dose (mrem)	% of ODCM Limit	Dose (mrem)	% of ODCM Limit	Dose (mrem)	% of ODCM Limit
Bone	0.00E+00	0.00E+00	0.00E+00	0.00E+00	0.00E+00	0.00E+00	0.00E+00	0.00E+00	0.00E+00	0.00E+00
Liver	1.77E-05	2.36E-04	1.59E-05	2.12E-04	1.62E-05	2.16E-04	2.08E-05	2.78E-04	7.06E-05	4.71E-04
Total Body	1.77E-05	2.36E-04	1.59E-05	2.12E-04	1.62E-05	2.16E-04	2.08E-05	2.78E-04	7.06E-05	4.71E-04
Thyroid	1.77E-05	2.36E-04	1.59E-05	2.12E-04	1.62E-05	2.16E-04	2.08E-05	2.78E-04	7.06E-05	4.71E-04
Kidney	1.77E-05	2.36E-04	1.59E-05	2.12E-04	1.62E-05	2.16E-04	2.08E-05	2.78E-04	7.06E-05	4.71E-04
Lung	1.77E-05	2.36E-04	1.59E-05	2.12E-04	1.62E-05	2.16E-04	2.08E-05	2.78E-04	7.06E-05	4.71E-04
GI-Li	1.77E-05	2.36E-04	1.59E-05	2.12E-04	1.62E-05	2.16E-04	2.08E-05	2.78E-04	7.06E-05	4.71E-04

Receptor Name: 2021 Residence NW 5.76 km Adult

	1st Qtr		2nd Qtr		3rd Qtr		4th Qtr		Calendar Year	
	Dose (mrem)	% of ODCM Limit	Dose (mrem)	% of ODCM Limit	Dose (mrem)	% of ODCM Limit	Dose (mrem)	% of ODCM Limit	Dose (mrem)	% of ODCM Limit
Bone	0.00E+00	0.00E+00	0.00E+00	0.00E+00	0.00E+00	0.00E+00	0.00E+00	0.00E+00	0.00E+00	0.00E+00
Liver	2.04E-05	2.73E-04	1.84E-05	2.45E-04	1.87E-05	2.49E-04	2.40E-05	3.21E-04	8.15E-05	5.44E-04
Total Body	2.04E-05	2.73E-04	1.84E-05	2.45E-04	1.87E-05	2.49E-04	2.40E-05	3.21E-04	8.15E-05	5.44E-04
Thyroid	2.04E-05	2.73E-04	1.84E-05	2.45E-04	1.87E-05	2.49E-04	2.40E-05	3.21E-04	8.15E-05	5.44E-04
Kidney	2.04E-05	2.73E-04	1.84E-05	2.45E-04	1.87E-05	2.49E-04	2.40E-05	3.21E-04	8.15E-05	5.44E-04
Lung	2.04E-05	2.73E-04	1.84E-05	2.45E-04	1.87E-05	2.49E-04	2.40E-05	3.21E-04	8.15E-05	5.44E-04
GI-Li	2.04E-05	2.73E-04	1.84E-05	2.45E-04	1.87E-05	2.49E-04	2.40E-05	3.21E-04	8.15E-05	5.44E-04

Table 5C

2021 Dose to Members of Public in Unrestricted Areas

Due to Release of Gaseous Effluents

Organ Dose – Non-Noble Gas

Unit 2

Receptor Name: 2021 Garden E 7.43 km Adult

	1st Qtr		2nd Qtr		3rd Qtr		4th Qtr		Calendar Year	
	Dose (mrem)	% of ODCM Limit	Dose (mrem)	% of ODCM Limit	Dose (mrem)	% of ODCM Limit	Dose (mrem)	% of ODCM Limit	Dose (mrem)	% of ODCM Limit
Bone	0.00E+00	0.00E+00	0.00E+00	0.00E+00	0.00E+00	0.00E+00	0.00E+00	0.00E+00	0.00E+00	0.00E+00
Liver	2.27E-05	3.03E-04	5.74E-06	7.65E-05	7.94E-06	1.06E-04	8.24E-06	1.10E-04	4.47E-05	2.98E-04
Total Body	2.27E-05	3.03E-04	5.74E-06	7.65E-05	7.94E-06	1.06E-04	8.24E-06	1.10E-04	4.47E-05	2.98E-04
Thyroid	2.27E-05	3.03E-04	5.74E-06	7.65E-05	7.94E-06	1.06E-04	8.24E-06	1.10E-04	4.47E-05	2.98E-04
Kidney	2.27E-05	3.03E-04	5.74E-06	7.65E-05	7.94E-06	1.06E-04	8.24E-06	1.10E-04	4.47E-05	2.98E-04
Lung	2.27E-05	3.03E-04	5.74E-06	7.65E-05	7.94E-06	1.06E-04	8.24E-06	1.10E-04	4.47E-05	2.98E-04
GI-LI	2.27E-05	3.03E-04	5.74E-06	7.65E-05	7.94E-06	1.06E-04	8.24E-06	1.10E-04	4.47E-05	2.98E-04

Receptor Name: 2021 Residence NW 5.76 km Adult

	1st Qtr		2nd Qtr		3rd Qtr		4th Qtr		Calendar Year	
	Dose (mrem)	% of ODCM Limit	Dose (mrem)	% of ODCM Limit	Dose (mrem)	% of ODCM Limit	Dose (mrem)	% of ODCM Limit	Dose (mrem)	% of ODCM Limit
Bone	0.00E+00	0.00E+00	0.00E+00	0.00E+00	0.00E+00	0.00E+00	0.00E+00	0.00E+00	0.00E+00	0.00E+00
Liver	2.63E-05	3.50E-04	6.63E-06	8.84E-05	9.17E-06	1.22E-04	9.52E-06	1.27E-04	5.16E-05	3.44E-04
Total Body	2.63E-05	3.50E-04	6.63E-06	8.84E-05	9.17E-06	1.22E-04	9.52E-06	1.27E-04	5.16E-05	3.44E-04
Thyroid	2.63E-05	3.50E-04	6.63E-06	8.84E-05	9.17E-06	1.22E-04	9.52E-06	1.27E-04	5.16E-05	3.44E-04
Kidney	2.63E-05	3.50E-04	6.63E-06	8.84E-05	9.17E-06	1.22E-04	9.52E-06	1.27E-04	5.16E-05	3.44E-04
Lung	2.63E-05	3.50E-04	6.63E-06	8.84E-05	9.17E-06	1.22E-04	9.52E-06	1.27E-04	5.16E-05	3.44E-04
GI-LI	2.63E-05	3.50E-04	6.63E-06	8.84E-05	9.17E-06	1.22E-04	9.52E-06	1.27E-04	5.16E-05	3.44E-04

Table 6
2021 Dose to Members of Public in Unrestricted Areas
Due to Release of Liquid Effluents
Organ & Whole Body Dose

ReceptorName: 2021 Liquid / Adult

	1st Qtr		2nd Qtr		3rd Qtr		4th Qtr		Calendar Year	
	Dose (mrem)	% of ODCM Limit	Dose (mrem)	% of ODCM Limit	Dose (mrem)	% of ODCM Limit	Dose (mrem)	% of ODCM Limit	Dose (mrem)	% of ODCM Limit
Bone	1.26E-05	2.52E-04	5.33E-06	1.07E-04	5.07E-05	1.01E-03	6.05E-05	1.21E-03	1.29E-04	1.29E-03
Liver	3.14E-05	6.28E-04	2.09E-05	4.18E-04	3.50E-05	7.00E-04	8.21E-05	1.64E-03	1.69E-04	1.69E-03
Total Body	3.26E-05	2.17E-03	2.13E-05	1.42E-03	1.28E-05	8.53E-04	5.84E-05	3.89E-03	1.25E-04	4.17E-03
Thyroid	2.86E-05	5.71E-04	2.00E-05	4.00E-04	4.43E-06	8.86E-05	4.65E-05	9.30E-04	9.95E-05	9.95E-04
Kidney	2.87E-05	5.75E-04	2.00E-05	4.00E-04	4.45E-06	8.89E-05	4.73E-05	9.45E-04	1.00E-04	1.00E-03
Lung	2.87E-05	5.74E-04	2.00E-05	4.01E-04	2.08E-05	4.17E-04	6.44E-05	1.29E-03	1.34E-04	1.34E-03
GI-Li	9.61E-05	1.92E-03	3.05E-05	6.10E-04	3.24E-05	6.48E-04	9.58E-05	1.92E-03	2.55E-04	2.55E-03

2021 Appendix I Dose Assessment of Liquid Effluents

Liquid / Adult

	1st Qtr		2nd Qtr		3rd Qtr		4th Qtr		Calendar Year	
	Dose (mrem)	% of ODCM Limit	Dose (mrem)	% of ODCM Limit	Dose (mrem)	% of ODCM Limit	Dose (mrem)	% of ODCM Limit	Dose (mrem)	% of ODCM Limit
Total Body	3.26E-05	2.17E-03	2.13E-05	1.42E-03	1.28E-05	8.53E-04	5.84E-05	3.89E-03	1.25E-04	4.17E-03
GI-Li	9.61E-05	1.92E-03	3.05E-05	6.10E-04	3.24E-05	6.48E-04	9.58E-05	1.92E-03	2.55E-04	2.55E-03
Organ (non-TB) ODCM Limit	5 mrem		5 mrem		5 mrem		5 mrem		10 mrem	
TB ODCM Limit	1.5 mrem		1.5 mrem		1.5 mrem		1.5 mrem		3.0 mrem	

Table 7A

**2021 Dose to Members of Public from Activities Inside the Site Boundary
Due to Release of Gaseous Effluents**

2021 Airborne Noble Gas Doses Unit 1

Receptor Name: Administration Building SSE 146m Adult

	1st Qtr		2nd Qtr		3rd Qtr		4th Qtr		Calendar Year	
	Dose (mrad)	% of ODCM Limit	Dose (mrad)	% of ODCM Limit	Dose (mrad)	% of ODCM Limit	Dose (mrad)	% of ODCM Limit	Dose (mrad)	% of ODCM Limit
Beta Air	4.74E-06	4.74E-05	4.53E-06	4.53E-05	4.69E-06	4.69E-05	4.17E-06	4.17E-05	1.81E-05	9.07E-05
Gamma Air	1.27E-05	2.54E-04	1.18E-05	2.35E-04	1.25E-05	2.51E-04	1.17E-05	2.34E-04	4.87E-05	4.87E-04

Receptor Name: Makeup Water Plant NNE 270m Adult

	1st Qtr		2nd Qtr		3rd Qtr		4th Qtr		Calendar Year	
	Dose (mrad)	% of ODCM Limit	Dose (mrad)	% of ODCM Limit	Dose (mrad)	% of ODCM Limit	Dose (mrad)	% of ODCM Limit	Dose (mrad)	% of ODCM Limit
Beta Air	5.75E-06	5.75E-05	5.50E-06	5.50E-05	5.70E-06	5.70E-05	5.07E-06	5.07E-05	2.20E-05	1.10E-04
Gamma Air	1.54E-05	3.08E-04	1.43E-05	2.86E-04	1.52E-05	3.05E-04	1.42E-05	2.84E-04	5.91E-05	5.91E-04

2021 Airborne Noble Gas Doses Unit 2

Receptor Name: Administration Building SSE 146m Adult

	1st Qtr		2nd Qtr		3rd Qtr		4th Qtr		Calendar Year	
	Dose (mrad)	% of ODCM Limit	Dose (mrad)	% of ODCM Limit	Dose (mrad)	% of ODCM Limit	Dose (mrad)	% of ODCM Limit	Dose (mrad)	% of ODCM Limit
Beta Air	3.10E-05	3.10E-04	3.32E-06	3.32E-05	5.13E-06	5.13E-05	3.77E-06	3.77E-05	4.32E-05	2.16E-04
Gamma Air	1.32E-05	2.65E-04	7.47E-06	1.49E-04	1.45E-05	2.91E-04	1.07E-05	2.14E-04	4.59E-05	4.59E-04

Receptor Name: Makeup Water Plant NNE 270m Adult

	1st Qtr		2nd Qtr		3rd Qtr		4th Qtr		Calendar Year	
	Dose (mrad)	% of ODCM Limit	Dose (mrad)	% of ODCM Limit	Dose (mrad)	% of ODCM Limit	Dose (mrad)	% of ODCM Limit	Dose (mrad)	% of ODCM Limit
Beta Air	3.76E-05	3.76E-04	4.03E-06	4.03E-05	6.23E-06	6.23E-05	4.58E-06	4.58E-05	5.25E-05	2.62E-04
Gamma Air	1.61E-05	3.21E-04	9.07E-06	1.81E-04	1.76E-05	3.53E-04	1.30E-05	2.60E-04	5.58E-05	5.58E-04

Table 7B
2021 Dose to Members of Public from Activities Inside the Site Boundary
Due to Release of Gaseous Effluents
Organ Dose – Non-Noble Gas
Unit 1

Receptor Name: Administration Building SSE 146m Adult

	1st Qtr		2nd Qtr		3rd Qtr		4th Qtr		Calendar Year	
	Dose (mrem)	% of ODCM Limit	Dose (mrem)	% of ODCM Limit	Dose (mrem)	% of ODCM Limit	Dose (mrem)	% of ODCM Limit	Dose (mrem)	% of ODCM Limit
Bone	0.00E+00	0.00E+00	0.00E+00	0.00E+00	0.00E+00	0.00E+00	0.00E+00	0.00E+00	0.00E+00	0.00E+00
Liver	4.19E-04	5.59E-03	3.67E-04	4.90E-03	3.74E-04	4.99E-03	4.81E-04	6.41E-03	1.64E-03	1.09E-02
Total Body	4.19E-04	5.59E-03	3.67E-04	4.90E-03	3.74E-04	4.99E-03	4.81E-04	6.41E-03	1.64E-03	1.09E-02
Thyroid	4.19E-04	5.59E-03	3.67E-04	4.90E-03	3.74E-04	4.99E-03	4.81E-04	6.41E-03	1.64E-03	1.09E-02
Kidney	4.19E-04	5.59E-03	3.67E-04	4.90E-03	3.74E-04	4.99E-03	4.81E-04	6.41E-03	1.64E-03	1.09E-02
Lung	4.19E-04	5.59E-03	3.67E-04	4.90E-03	3.74E-04	4.99E-03	4.81E-04	6.41E-03	1.64E-03	1.09E-02
GI-Li	4.19E-04	5.59E-03	3.67E-04	4.90E-03	3.74E-04	4.99E-03	4.81E-04	6.41E-03	1.64E-03	1.09E-02

Receptor Name: Makeup Water Plant NNE 270m Adult

	1st Qtr		2nd Qtr		3rd Qtr		4th Qtr		Calendar Year	
	Dose (mrem)	% of ODCM Limit	Dose (mrem)	% of ODCM Limit	Dose (mrem)	% of ODCM Limit	Dose (mrem)	% of ODCM Limit	Dose (mrem)	% of ODCM Limit
Bone	0.00E+00	0.00E+00	0.00E+00	0.00E+00	0.00E+00	0.00E+00	0.00E+00	0.00E+00	0.00E+00	0.00E+00
Liver	5.03E-04	6.70E-03	4.46E-04	5.95E-03	4.54E-04	6.06E-03	5.84E-04	7.79E-03	1.99E-03	1.32E-02
Total Body	5.03E-04	6.70E-03	4.46E-04	5.95E-03	4.54E-04	6.06E-03	5.84E-04	7.79E-03	1.99E-03	1.32E-02
Thyroid	5.03E-04	6.70E-03	4.46E-04	5.95E-03	4.54E-04	6.06E-03	5.84E-04	7.79E-03	1.99E-03	1.32E-02
Kidney	5.03E-04	6.70E-03	4.46E-04	5.95E-03	4.54E-04	6.06E-03	5.84E-04	7.79E-03	1.99E-03	1.32E-02
Lung	5.03E-04	6.70E-03	4.46E-04	5.95E-03	4.54E-04	6.06E-03	5.84E-04	7.79E-03	1.99E-03	1.32E-02
GI-Li	5.03E-04	6.70E-03	4.46E-04	5.95E-03	4.54E-04	6.06E-03	5.84E-04	7.79E-03	1.99E-03	1.32E-02

Table 7C
2021 Dose to Members of Public from Activities Inside the Site Boundary
Due to Release of Gaseous Effluents
Organ Dose – Non-Noble Gas
Unit 2

Receptor Name: Administration Building SSE 146m Adult

	1st Qtr		2nd Qtr		3rd Qtr		4th Qtr		Calendar Year	
	Dose (mrem)	% of ODCM Limit	Dose (mrem)	% of ODCM Limit	Dose (mrem)	% of ODCM Limit	Dose (mrem)	% of ODCM Limit	Dose (mrem)	% of ODCM Limit
Bone	0.00E+00	0.00E+00	0.00E+00	0.00E+00	0.00E+00	0.00E+00	0.00E+00	0.00E+00	0.00E+00	0.00E+00
Liver	5.25E-04	7.00E-03	1.33E-04	1.77E-03	1.83E-04	2.45E-03	1.90E-04	2.54E-03	1.03E-03	6.88E-03
Total Body	5.25E-04	7.00E-03	1.33E-04	1.77E-03	1.83E-04	2.45E-03	1.90E-04	2.54E-03	1.03E-03	6.88E-03
Thyroid	5.25E-04	7.00E-03	1.33E-04	1.77E-03	1.83E-04	2.45E-03	1.90E-04	2.54E-03	1.03E-03	6.88E-03
Kidney	5.25E-04	7.00E-03	1.33E-04	1.77E-03	1.83E-04	2.45E-03	1.90E-04	2.54E-03	1.03E-03	6.88E-03
Lung	5.25E-04	7.00E-03	1.33E-04	1.77E-03	1.83E-04	2.45E-03	1.90E-04	2.54E-03	1.03E-03	6.88E-03
GI-Lli	5.25E-04	7.00E-03	1.33E-04	1.77E-03	1.83E-04	2.45E-03	1.90E-04	2.54E-03	1.03E-03	6.88E-03

Receptor Name: Makeup Water Plant NNE 270m Adult

	1st Qtr		2nd Qtr		3rd Qtr		4th Qtr		Calendar Year	
	Dose (mrem)	% of ODCM Limit	Dose (mrem)	% of ODCM Limit	Dose (mrem)	% of ODCM Limit	Dose (mrem)	% of ODCM Limit	Dose (mrem)	% of ODCM Limit
Bone	0.00E+00	0.00E+00	0.00E+00	0.00E+00	0.00E+00	0.00E+00	0.00E+00	0.00E+00	0.00E+00	0.00E+00
Liver	6.38E-04	8.50E-03	1.61E-04	2.15E-03	2.23E-04	2.97E-03	2.31E-04	3.08E-03	1.25E-03	8.35E-03
Total Body	6.38E-04	8.50E-03	1.61E-04	2.15E-03	2.23E-04	2.97E-03	2.31E-04	3.08E-03	1.25E-03	8.35E-03
Thyroid	6.38E-04	8.50E-03	1.61E-04	2.15E-03	2.23E-04	2.97E-03	2.31E-04	3.08E-03	1.25E-03	8.35E-03
Kidney	6.38E-04	8.50E-03	1.61E-04	2.15E-03	2.23E-04	2.97E-03	2.31E-04	3.08E-03	1.25E-03	8.35E-03
Lung	6.38E-04	8.50E-03	1.61E-04	2.15E-03	2.23E-04	2.97E-03	2.31E-04	3.08E-03	1.25E-03	8.35E-03
GI-Lli	6.38E-04	8.50E-03	1.61E-04	2.15E-03	2.23E-04	2.97E-03	2.31E-04	3.08E-03	1.25E-03	8.35E-03

Table 7D
2021 Dose to Members of Public from Activities Inside the Site Boundary
Due to Release of Gaseous Effluents

Airborne Noble Gas Dose Evaluations
Unit 1

Receptor Name: Administration Building SSE 146m Adult

	1st Qtr		2nd Qtr		3rd Qtr		4th Qtr		Calendar Year	
	Dose (mrad)	% of ODCM Limit	Dose (mrad)	% of ODCM Limit	Dose (mrad)	% of ODCM Limit	Dose (mrad)	% of ODCM Limit	Dose (mrad)	% of ODCM Limit
Beta Air	4.74E-06	4.74E-05	4.53E-06	4.53E-05	4.69E-06	4.69E-05	4.17E-06	4.17E-05	1.81E-05	9.07E-05
Gamma Air	1.27E-05	2.54E-04	1.18E-05	2.35E-04	1.25E-05	2.51E-04	1.17E-05	2.34E-04	4.87E-05	4.87E-04

Airborne Iodine / Particulates / Tritium Dose Evaluations
Unit 1

Receptor Name: Administration Building SSE 146m Adult

	1st Qtr		2nd Qtr		3rd Qtr		4th Qtr		Calendar Year	
	Dose (mrem)	% of ODCM Limit	Dose (mrem)	% of ODCM Limit	Dose (mrem)	% of ODCM Limit	Dose (mrem)	% of ODCM Limit	Dose (mrem)	% of ODCM Limit
Bone	0.00E+00	0.00E+00	0.00E+00	0.00E+00	0.00E+00	0.00E+00	0.00E+00	0.00E+00	0.00E+00	0.00E+00
Liver	4.19E-04	5.59E-03	3.67E-04	4.90E-03	3.74E-04	4.99E-03	4.81E-04	6.41E-03	1.64E-03	1.09E-02
Total Body	4.19E-04	5.59E-03	3.67E-04	4.90E-03	3.74E-04	4.99E-03	4.81E-04	6.41E-03	1.64E-03	1.09E-02
Thyroid	4.19E-04	5.59E-03	3.67E-04	4.90E-03	3.74E-04	4.99E-03	4.81E-04	6.41E-03	1.64E-03	1.09E-02
Kidney	4.19E-04	5.59E-03	3.67E-04	4.90E-03	3.74E-04	4.99E-03	4.81E-04	6.41E-03	1.64E-03	1.09E-02
Lung	4.19E-04	5.59E-03	3.67E-04	4.90E-03	3.74E-04	4.99E-03	4.81E-04	6.41E-03	1.64E-03	1.09E-02
GI-Li	4.19E-04	5.59E-03	3.67E-04	4.90E-03	3.74E-04	4.99E-03	4.81E-04	6.41E-03	1.64E-03	1.09E-02

Table 7E
2021 Dose to Members of Public from Activities Inside the Site Boundary
Due to Release of Gaseous Effluents

Airborne Noble Gas Dose Evaluations
Unit 2

Receptor Name: Administration Building SSE 146m Adult

	1st Qtr		2nd Qtr		3rd Qtr		4th Qtr		Calendar Year	
	Dose (mrad)	% of ODCM Limit	Dose (mrad)	% of ODCM Limit	Dose (mrad)	% of ODCM Limit	Dose (mrad)	% of ODCM Limit	Dose (mrad)	% of ODCM Limit
Beta Air	3.10E-05	3.10E-04	3.32E-06	3.32E-05	5.13E-06	5.13E-05	3.77E-06	3.77E-05	4.32E-05	2.16E-04
Gamma Air	1.32E-05	2.65E-04	7.47E-06	1.49E-04	1.45E-05	2.91E-04	1.07E-05	2.14E-04	4.59E-05	4.59E-04

Airborne Iodine / Particulates / Tritium Dose Evaluations
Unit 2

Receptor Name: Administration Building SSE 146m Adult

	1st Qtr		2nd Qtr		3rd Qtr		4th Qtr		Calendar Year	
	Dose (mrem)	% of ODCM Limit	Dose (mrem)	% of ODCM Limit	Dose (mrem)	% of ODCM Limit	Dose (mrem)	% of ODCM Limit	Dose (mrem)	% of ODCM Limit
Bone	0.00E+00	0.00E+00	0.00E+00	0.00E+00	0.00E+00	0.00E+00	0.00E+00	0.00E+00	0.00E+00	0.00E+00
Liver	5.25E-04	7.00E-03	1.33E-04	1.77E-03	1.83E-04	2.45E-03	1.90E-04	2.54E-03	1.03E-03	6.88E-03
Total Body	5.25E-04	7.00E-03	1.33E-04	1.77E-03	1.83E-04	2.45E-03	1.90E-04	2.54E-03	1.03E-03	6.88E-03
Thyroid	5.25E-04	7.00E-03	1.33E-04	1.77E-03	1.83E-04	2.45E-03	1.90E-04	2.54E-03	1.03E-03	6.88E-03
Kidney	5.25E-04	7.00E-03	1.33E-04	1.77E-03	1.83E-04	2.45E-03	1.90E-04	2.54E-03	1.03E-03	6.88E-03
Lung	5.25E-04	7.00E-03	1.33E-04	1.77E-03	1.83E-04	2.45E-03	1.90E-04	2.54E-03	1.03E-03	6.88E-03
GI-Li	5.25E-04	7.00E-03	1.33E-04	1.77E-03	1.83E-04	2.45E-03	1.90E-04	2.54E-03	1.03E-03	6.88E-03

VIII. Meteorological Data

A compact disc containing hour-by-hour wind speed, wind direction, atmospheric stability, and precipitation results for 2021 is included with this submittal.

Compact Disk Information

Folder Name	Sensitivity	File Size	Description
2021 PG&E Diablo Canyon Met Data	Non-SGI	1.5 Mb	Diablo Canyon Primary Meteorological Data

Attachment 1

**Diablo Canyon Power Plant Program Directive,
CY2, "Radiological Monitoring and Controls Program,"
Revision 7B**

Radiological Monitoring and Controls Program

11/22/16
Effective Date

QUALITY RELATED

Table of Contents

1.	PROGRAM OVERVIEW	1
2.	APPLICABILITY.....	2
3.	DEFINITIONS.....	3
4.	PROGRAM OBJECTIVES AND REQUIREMENTS	3
5.	RESPONSIBILITIES.....	7
6.	KEY IMPLEMENTING DOCUMENTS.....	8
7.	CLOSELY RELATED PROGRAMS	8
8.	RECORDS.....	9
9.	REFERENCES	9
10.	GRADED QA REQUIREMENTS FOR RADIOLOGICAL MONITORING AND CONTROLS PROGRAM.....	11

1. PROGRAM OVERVIEW

- 1.1 It is the policy of nuclear generation that the release of radioactive materials to the environment be in compliance with Federal regulations and be "As Low As Reasonably Achievable" (ALARA). The overall objectives are to protect the health and safety of the public from undue radiation exposure and to minimize the amount of radioactive effluents resulting from the operation of the plant.
- 1.2 This PD defines the overall policies and general requirements related to the Radiological Monitoring and Controls Program (RMCP). This includes the Radiological Environmental Monitoring Program (REMP), and the Radioactive Effluent Controls Program (RECP).

- 1.3 The scope of this PD is focused on the control of releases of radioactive material to the environment, and minimizing radiological impact on the general public. Radiation protection of plant workers and visitors within the restricted area of the plant is within the scope of RP1, "Radiation Protection."
- 1.4 Figure 1 illustrates the hierarchy of procedures associated with this PD.

Figure 1: CY2 Hierarchy of Procedures

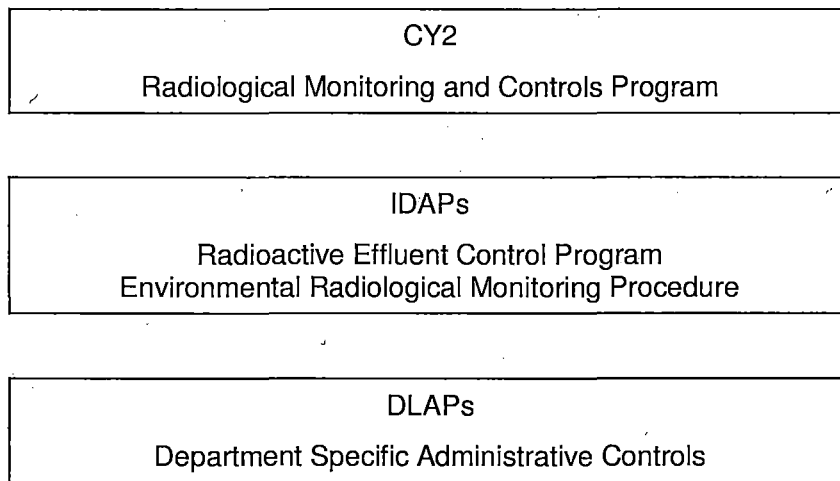

2. **APPLICABILITY**

This PD is applicable to all persons involved in radioactive effluent control, monitoring, and management activities. This includes all nuclear generation personnel, personnel matrixed to nuclear generation from other company organizations, personnel in other company organizations that are engaged in activities in support of nuclear generation, and contractor personnel that are working under nuclear generation supervision.

3. DEFINITIONS

- 3.1 ALARA (acronym for "as low as reasonably achievable"): A term that means making every reasonable effort to maintain exposures to radiation as far below the dose limits of 10 CFR 20 as is practical consistent with the purpose for which the licensed activity is undertaken, taking into account the state of technology, the economics of improvements in relation to state of technology, the economics of improvements in relation to benefits to the public health and safety, and in relation to utilization of nuclear energy and licensed materials in the public interest. The specific objectives of achieving ALARA effluents are based on those described in 10 CFR 50, Appendix I.
- 3.2 Environmental Radiological Monitoring Procedure (ERMP): Contains a description of sample locations, types of sample locations, methods and frequency of analysis, and reporting requirements.
- 3.3 Offsite Dose Calculation Procedure (ODCP): Contains the methodology and parameters used in the calculation of offsite doses due to radioactive gaseous and liquid effluents and in the calculation of gaseous and liquid effluent monitoring Alarm/Trip Setpoints.
- 3.4 Radiological Monitoring and Controls Program (RMCP): Contains the Radioactive Effluent Controls and Radiological Environmental Monitoring Programs required by Technical Specifications 5.5.1 and 5.5.4 and descriptions of the information that should be included in the Annual Radiological Environmental Operating and Annual Radioactive Effluent Release Reports required by Technical Specifications 5.6.2 and 5.6.3.

4. PROGRAM OBJECTIVES AND REQUIREMENTS

4.1 Program Objectives:

The nuclear generation radiological monitoring and controls program is established to meet the following objectives:

- 4.1.1 Ensure that systems, methods, and controls are established to meet applicable regulatory requirements and objectives for release of radioactive effluents.

Liquid and gaseous radioactive waste processing systems provide the means for controlling radioactive releases. It is also important to establish administrative controls with clear delineation of responsibilities to ensure that monitoring, measurement, and release activities are properly sequenced, authorized, and controlled.

4.2 Program Requirements

The basic requirement for the radiological monitoring and controls program shall be to maintain radioactive releases to the unrestricted areas surrounding the plant in conformance with applicable Federal regulations and ALARA. The following sections provide additional requirements for various elements of the program.

-
- 4.2.1 Changes to the RMCP (including ODCP, ERMP and RECP) shall be processed in accordance with the requirements of the plant Technical Specification Section 5.5.1.
- 4.2.2 Radiological Environmental Monitoring Program
- a. A Radiological Environmental Monitoring Program (REMP) shall be established and maintained to comply with the plant Technical Specification 5.5.1, Radiological Environmental Monitoring Program requirements. The program shall be provided to monitor the radiation and radionuclides in the environs of the plant, and shall address the following:
 1. Monitoring, sampling, analysis, and reporting of radiation and radionuclides in the environment in accordance with the methodology and parameters in the Environmental Radiological Monitoring Procedure (ERMP),
 2. A Land Use Census to ensure that changes in the use of areas at and beyond the site boundary are identified and that modifications to the monitoring program are made if required by the results of this census, and
 3. Participation in an Interlaboratory Comparison Program to ensure that independent checks on the precision and accuracy of the measurements of radioactive materials in the environmental sample matrices are performed as part of the quality assurance program for environmental monitoring.
- 4.2.3 Radioactive Effluent Control Program
- a. Monitoring requirements shall be established and maintained for all major and potentially significant paths for release of radioactive material during normal plant operation, including anticipated operational occurrences, to comply with Regulatory Guide 1.21, Revision 1, June 1974, requirements.
 - b. Procedures shall be established and maintained to define the methods and requirements for control of liquid and gaseous radioactive discharges within the limits of the plant Technical Specification Section 5.5.4. These procedures shall address the following:
 1. Limitations on the operability of radioactive liquid and gaseous monitoring instrumentation including surveillance requirements and setpoint determination in accordance with methodology in the Offsite Dose Calculation Procedure, (ODCP).
 2. Limitations on the concentrations of radioactive material released in liquid effluents to unrestricted areas conforming to 10 CFR Part 20, Appendix B, Table 2, Column 2.

3. Monitoring, sampling, and analysis of radioactive liquid and gaseous effluents in accordance with 10 CFR 20.1302 and with the methodology and parameters in the ODCP.
4. Limitations on the annual and quarterly doses or dose commitment to a member of the public from radioactive materials in liquid effluents released from each unit to unrestricted areas conforming to Appendix I to 10 CFR Part 50.
5. Determination of cumulative and projected dose contributions from radioactive effluents for the current calendar quarter and current calendar year in accordance with the methodology and parameters in the ODCP at least every 31 days.
6. Limitations on the operability and use of the liquid and gaseous effluent treatment systems to ensure that the appropriate portions of these systems are used to reduce releases of radioactivity when the projected doses in a 31-day period would exceed 2 percent of the guidelines for the annual dose or dose commitment conforming to Appendix I to 10 CFR Part 50.
7. Limitations on the dose rate resulting from radioactive material released in gaseous effluents from the site to areas at or beyond the site boundary shall be limited to the following:
 - a) For noble gases: Less than or equal to a dose rate of 500 mrem/yr to the whole body and less than or equal to a dose rate of 3000 mrem/yr to the skin.
 - b) For Iodine-131, for Iodine-133, for tritium, and for all radionuclides in particulate form with half-lives greater than 8 days: Less than or equal to a dose rate of 1500 mrem/yr to any organ.
8. Limitations on the annual and quarterly air doses resulting from noble gases released in gaseous effluents from each unit to areas beyond the site boundary conforming to Appendix I to 10 CFR Part 50.
9. Limitations on the annual and quarterly doses to members of the public from Iodine-131, Iodine-133, tritium, and all radionuclides in particulate form with half-lives greater than 8 days in gaseous effluents released from each unit to areas beyond the site boundary conforming to Appendix I to 10 CFR Part 50.
10. Limitations on the annual dose or dose commitment to any member of the public due to releases of radioactivity and to radiation from uranium fuel cycle sources conforming to 40 CFR Part 190.
11. The provisions of SR 3.0.2 and SR 3.0.3 are applicable to the Radioactive Effluent Controls Program Surveillance Frequency.

-
- c. Sampling and analysis methods associated with effluent monitoring activities shall be controlled in accordance with a department level administrative procedure that controls material and equipment used for analysis for the chemistry and radiochemistry programs.
 - d. Systems that are known pathways for radioactive releases shall be explicitly addressed. Periodic sampling of systems with the potential of becoming radioactively contaminated should also be addressed.
 - e. An onsite meteorological program shall be established and maintained in accordance with the requirements of Regulatory Guide 1.23, February 1972, to provide sufficient data for the performance of dose assessments.
 - f. The collection and processing of technical data required to support the Annual Radioactive Effluent Release Report and non-routine reports to the NRC to comply with the plant Technical Specification 5.6.3 shall be defined as part of this program. The processing of these reports shall be performed in accordance with XI1, "Regulatory Interface."

4.2.4 Offsite Dose Calculation Procedures

- a. Offsite Dose Calculation Procedures (ODCP) shall be established and maintained to define and control the methods for determining offsite doses. NRC Regulatory Guide 1.109, Revision 1, October 1977, as well as its interpretation through NUREG 0133, should be used as guidance for establishing acceptable methods. These procedures shall address the following:
 - 1. Methods for determining monitoring instrumentation alarm setpoints are addressed in accordance with a Department-Level Administrative Procedure (DLAP) under CY2.
 - 2. Methods for determining effluent concentrations.
 - 3. Methods for calculating doses to persons in unrestricted areas surrounding the plant from all exposure pathways.
- b. Changes to the ODCP shall be processed in accordance with the requirements of Technical Specification 5.5.1.

4.2.5 Environmental Radiological Monitoring Procedure

- a. An Environmental Radiological Monitoring Procedure (ERMP) shall be established and shall contain a description of sample locations, types of sample locations, methods and frequency of analysis, and reporting requirements.

4.2.6 Radwaste Treatment Systems

- a. Radwaste treatment systems shall be provided to control the processing and release of radioactive materials in gaseous and liquid effluent in compliance with Technical Specification requirements. The design of these systems shall be controlled in accordance with CF3, "Design Control," and the requirements of Regulatory Guide 1.143, Revision 1, October 1979.
- b. Approval of changes to the radwaste treatment systems shall be processed in accordance with the requirements of CF4, "Modification Control."

4.2.7 Quality Assurance Requirements

In addition to requirements specified in earlier sections and those requirements utilizing procedures in Section 6.2, the control program shall be subject to the quality assurance requirements specified in CY1, "Chemistry/Radiochemistry."

4.3 Support by the Company Departments

Departments outside of nuclear generation may be called upon to support nuclear generation activities associated with the Radioactive Monitoring Controls Program. The contract or agreement between nuclear generation and other departments shall ensure the support is performed in accordance with the requirements of this PD.

For example: Meteorological services may perform annual meteorological data reviews and calculate dispersion and deposition factors for use the radioactive effluents control program.

5. RESPONSIBILITIES

- 5.1 The Chief Nuclear Officer is responsible for establishing the policy and general requirements for the Radiological Monitoring and Controls Program, for providing management support and guidance for the program's implementation, and ensuring compliance with all regulatory requirements is maintained. The chief nuclear officer is also responsible for ensuring that support from reporting departments is provided for the Radiological Monitoring and Controls Program.
- 5.2 The Station Director is responsible for the overall development, implementation, and maintenance of the Radiological Monitoring and Controls Program in accordance with the requirements of this PD.
- 5.3 The operations director is responsible for the direct implementation of the Radiological Monitoring and Controls Program with the exception of the design of radwaste treatment and effluent monitoring systems.
- 5.4 The engineering director is responsible for maintaining the design bases for installed plant radwaste treatment and effluent monitoring systems, structures, and components and providing technical support to the plant for the operation and maintenance of these systems.

-
- 5.5 The quality verification director is responsible for auditing the Radiological Monitoring and Controls Program as outlined in Section 10.3.10.
- 5.6 The maintenance services director is responsible for maintaining the radiation monitoring systems and the hardware and software for the Rad Effluent program.

6. KEY IMPLEMENTING DOCUMENTS

6.1 Inter-Departmental Administrative Procedures (IDAPs)

Inter-Department Administrative Procedures shall be developed to address the following aspects of the Radiological Monitoring and Controls Program:

- 6.1.1 An IDAP shall be developed to define the requirements and responsibilities associated with the Radioactive Effluent Control Program.
- 6.1.2 An IDAP shall be developed to define the requirements and responsibilities associated with the Environmental Radiological Monitoring Procedure.

6.2 Department-Level Administrative Procedures (DLAPs)

Departments responsible for performing activities related to the Radioactive Effluent Control program shall develop DLAPs as appropriate to control program activities.

7. CLOSELY RELATED PROGRAMS

7.1 Interfaces

This section describes each of the principal interfaces and boundaries between this Program Directive and other management processes.

7.1.1 AD10, "Records"

"Records" provides for the retention of Radiological Monitoring and Controls Program records.

7.1.2 CF3, "Design Control"

"Design Control" addresses the implementation of design activities for installed radwaste treatment and effluent monitoring systems in accordance with the requirements of NRC Regulatory Guide 1.143, Revision 1.

7.1.3 CF4, "Modification Control"

"Modification Control" addresses the implementation of modification activities for installed effluent monitoring systems.

-
- 7.1.4 CY1, "Chemistry/Radiochemistry"
"Chemistry/Radiochemistry" addresses the methods for chemistry/radiochemistry sampling and analysis of liquid and gaseous radioactive effluents in support of this PD.
 - 7.1.5 CY2.ID1, "Radioactive Effluent Controls Program"
"Radioactive Effluent Controls Program" contains the general program requirements to ensure the requirements of 10 CFR Part 20 and 10 CFR Part 50, Appendix I, are met.
 - 7.1.6 OM7, "Problem Resolution"
"Problem Resolution" addresses deficiencies identified during the implementation of the radioactive effluent control program. OM7 also addresses evaluating nonconformances for reportability in accordance with Technical Specifications.
 - 7.1.7 TQ1, "Personnel Training and Qualification"
"Personnel Training and Qualification" identifies training and qualification requirements for personnel.
 - 7.1.8 XI1, "Regulatory Interface"
"Regulatory Interface" addresses the process for required reporting and communication with outside agencies.

8. RECORDS

None

9. REFERENCES

- 9.1 Diablo Canyon Nuclear Power Plant Facility Operating Licenses (Unit 1, Unit 2)
- 9.2 QA Commitments:
 - 9.2.1 FSAR Chapter 17.2
 - 9.2.2 Regulatory Guide 1.33, 2/78 (Rev. 2)
- 9.3 Regulatory Guides:
 - 9.3.1 Guide 1.109, Revision 1, October 1977, "Calculation of Annual Doses to Man From Routine Releases of Reactor Effluents for the Purpose of Evaluating Compliance with 10 CFR Part 50 Appendix I"
 - 9.3.2 Guide 1.143, Revision 1, October 1979, "Design Guidance for Radioactive Waste Management Systems, Structures, and Components Installed in Light-Water-Cooled Nuclear Power Plants"

-
- 9.3.3 Guide 1.21, Revision 1, June 1974, "Measuring, Evaluating, and Reporting Radioactivity in Solid Wastes and Releases of Radioactive Materials in Liquid and Gaseous Effluent from Light-Water-Cooled Nuclear Power Plants"
 - 9.3.4 Guide 1.23, February 1972, "Onsite Meteorological Programs"
 - 9.3.5 Guide 4.1, Revision 1, April 1975, "Programs for Monitoring Radioactivity in the Environs of Nuclear Power Plants"
 - 9.3.6 Guide 4.15, Revision 1, February 1979, "Quality Assurance For Radiological Monitoring Programs (Normal Operations) - Effluent Streams and the Environment"
 - 9.4 Title 10, Code of Federal Regulations:
 - 9.4.1 Part 20, "Standards for Protection Against Radiation"
 - 9.4.2 Part 50, Appendix I
 - 9.4.3 Part 50, Appendix A, GDC 60, 64
 - 9.4.4 Part 50.36a, "Technical Specifications on Effluents from Nuclear Power Reactors"
 - 9.5 Title 40, Code of Federal Regulations, "Environmental Radiation Protection Standards for Nuclear Power Operations"

10. GRADED QA REQUIREMENTS FOR RADIOLOGICAL MONITORING AND CONTROLS PROGRAM

The basis for these Graded QA requirements is to comply with the regulations of 10 CFR 20, 10 CFR 50, 40 CFR 190, the Technical Specifications and Regulatory Guides 1.21, and 4.15.

10.1 Graded Items

Radioactive Effluent monitoring instruments are classified as Category 2 or Category 3 items per Regulatory Guide 1.97, "Instrumentation for Light-Water-Cooled Nuclear Power Plants to Assess Plant and Environs Conditions During and Following an Accident." These instruments are used for detection and assessment of releases and possibly detection of containment breach with accomplishment of mitigation of the breach. These items fall under Graded QA requirements.

10.2 Graded Activities

10.2.1 Installed radiation monitors required per Technical Specification 3.3.3 for monitoring radioactive effluents during plant operations or accidents shall be calibrated at prescribed intervals.

10.2.2 Sampling and analysis of liquid and gaseous effluents shall be performed in accordance with CY1, "Chemistry/Radiochemistry."

10.2.3 Calculations, computer programs, and procedures for evaluating the dose associated with radioactive effluents shall be performed in accordance with approved quality related procedures.

10.3 Graded Requirements

10.3.1 Effluent releases shall be maintained ALARA and shall be performed in accordance with the requirements of this Program Directive to limit the concentrations, doses and doserates as specified in DCCP Technical Specification 5.5.4, NRC regulations 10 CFR 20, 10 CFR 50 Appendix I, and EPA regulation 40 CFR 190.

10.3.2 The Annual Radiological Environmental Operating Report shall be developed in accordance with Technical Specification 5.6.2.

10.3.3 The Annual Radioactive Effluent Release Report shall be developed in accordance with Technical Specification 5.6.3.

10.3.4 Records that support and document the Radiological Monitoring and Controls Program shall be controlled in accordance with AD10, "Records."

-
- 10.3.5 Personnel involved in direct implementation of chemistry/radiochemistry, operations, or radiation protection activities in support of the Radiological Monitoring and Controls Program are qualified in accordance with the requirements of TQ1, "Personnel Training and Qualification." In addition, personnel involved in direct implementation of activities in support of the Radiological Environmental Monitoring Program are qualified in accordance with the requirements of an interdepartmental administrative procedure for Environmental Radiological Monitoring (ERMP).
- 10.3.6 Notifications and reports to and correspondence with regulatory agencies shall be done in accordance with XI1, "Regulatory Interface."
- 10.3.7 Written plans, procedures and instructions for implementing Radiological Monitoring and Controls Program shall be prepared, processed, and controlled in accordance with AD1, "Administrative Control Program."
- 10.3.8 Procurement of quality-related equipment or services shall be in accordance with written procedures. Applicable regulatory requirements, design bases, and any other requirements necessary to assure adequate quality shall be included in or invoked by reference in documents for procurement of items or services. Test or acceptance requirements and documentation to be submitted by the supplier shall be identified in the procurement documents. Receipt inspection requirements, if required, shall be identified in the procurement documents.
- 10.3.9 Deficiencies identified during implementation of this program shall be documented and controlled in accordance with OM7, "Problem Resolution."
- 10.3.10 FSAR Chapter 17.18, "Audits," prescribes the audit frequency for various portions of the RMCP:
- a. The performance of activities required by the quality assurance program for the Radioactive Effluents Control Program shall be audited at least once per 24 months unless specified otherwise.
 - b. The Radiological Environmental Monitoring Program, implementing procedures, and program results shall be audited at least once per 24 months.
 - c. The Offsite Dose Calculation Procedure and its implementing procedures shall be audited at least once per 24 months.

Attachment 2

**Diablo Canyon Power Plant Interdepartmental Administrative Procedure,
CY2.ID1, "Radioactive Effluent Controls Program,"
Revision 16**

Radioactive Effluent Controls Program

05/26/20
Effective Date

QUALITY RELATED

Table of Contents

1.	SCOPE.....	1
2.	DISCUSSION.....	2
3.	DEFINITIONS.....	3
4.	RESPONSIBILITIES.....	3
5.	INSTRUCTIONS.....	4
5.1	Administrative Requirements.....	4
5.2	Reporting Requirements.....	5
5.3	Major Changes to Liquid, Gaseous, and Solid Radwaste Treatment Systems.....	8
6.	RECORDS.....	9
7.	REFERENCES.....	9

ATTACHMENTS:

1.	Radioactive Liquid Effluent Monitoring Instrumentation Operational Requirements.....	11
2.	Radioactive Gaseous Effluent Monitoring Instrumentation Operational Requirements.....	14
3.	Liquid Effluents - Concentration Operational Requirements.....	17
4.	Liquid Effluents - Dose Operational Requirements.....	22
5.	Liquid Radwaste Treatment System Dose Operational Requirements.....	23
6.	Gaseous Effluents - Dose Rate Operational Requirements.....	24
7.	Dose - Noble Gases Operational Requirements.....	27
8.	Iodine 131, Iodine 133, Tritium, and Radioactive Material in Particulate Form.....	28
9.	Gaseous Radwaste Treatment System Operational Requirements.....	30
10.	Total Dose Operational Requirements.....	31
11.	Radiological Environmental Monitoring Operational Requirements.....	33
12.	Land Use Census Operational Requirements.....	34
13.	High Alarm Setpoints - FB & CR Ventilation Systems Actuation Instrumentation.....	35

1. SCOPE

- 1.1 This procedure states the requirements of the Radioactive Effluent Controls Program (RECP). The program implements the requirements of 10 CFR Part 20 and 10 CFR Part 50 Appendix I for Diablo Canyon.^{T34939}

2. DISCUSSION

2.1 This procedure identifies the general requirements of Diablo Canyon's Radioactive Effluent Controls Program. These requirements are defined per Technical Specifications and NRC Generic Letter 89-01.^{Ref 7.24}

2.2 The following requirements from Technical Specification Section 5.5.1 (TS 5.5.1) apply:

2.2.1 The Off-site Dose Calculation Manual (ODCM) identifies the methods and parameters used for:

- a. Calculation of off-site doses resulting from radioactive gaseous and liquid effluents.
- b. Calculation of gaseous and liquid effluent monitoring alarm and trip setpoints.
- c. Conducting the radiological environmental monitoring program.

2.2.2 The ODCM also identifies the following:

- a. Radioactive effluent controls.
- b. Radiological environmental monitoring activities.
- c. Description of the information to be included in the Annual Radiological Environmental Operating Report (AREOR, TS 5.6.2).
- d. Description of the information to be included in the Annual Radioactive Effluent Release Report (ARERR, TS 5.6.3).

<p>NOTE: CAP A-8, "Off-Site Dose Calculations," provides guidance for specific methods and parameters used in the calculation of off-site doses resulting from discharge of radioactive gaseous and liquid effluents. CAP A-8 also provides guidance for calculation of gaseous and liquid effluent monitor alarm/trip setpoints. As such, CAP A-8 is incorporated into CY2.ID1 by reference.</p>
--

2.2.3 The Diablo Canyon ODCM is made up of the following procedures:

- CAP A-8, "Off-site Dose Calculations"
 - CY2.ID1, "Radioactive Effluent Controls Program"
 - RP1.ID11, "Environmental Radiological Monitoring Procedure"
 - CY2, "Radiological Monitoring and Controls Program"
- a. Changes to ODCM procedures are required to be processed per TS 5.5.1.

3. DEFINITIONS

- 3.1 ODCP: Offsite dose calculation procedure (CAP A-8).
- 3.2 Regulatory Guide (RG): Nuclear Regulatory Commission guidance document.
- 3.3 Shutdown: Taking the reactor sub-critical.
- 3.4 Startup: Taking the reactor critical.

4. RESPONSIBILITIES

- 4.1 Chemistry manager is responsible for:
 - 4.1.1 Ensuring the process for calculation of offsite doses is implemented in a manner that meets regulatory requirements.
 - 4.1.2 Preparing the ARERR.
 - 4.1.3 Providing recommendations to operations for pre-discharge processing of radioactive waste.
 - 4.1.4 Ensuring a comparison of the ARERR and the AREOR is performed.
 - 4.1.5 Ensuring offsite dose increases resulting from updates in the Land Use Census (LUC; provided per Attachment 12) are promptly determined and communicated to radiation protection.
- 4.2 Radiation protection manager is responsible for:
 - 4.2.1 Ensuring the annual LUC is performed and the results are provided to chemistry so that chemistry can update the dose requirements identified in Attachment 12.
 - 4.2.2 Ensuring the results of the annual LUC are included in the Annual Radiological Environmental Operating Report.
 - 4.2.3 Ensuring changes to the environmental radiological monitoring procedure (ERMP) are provided to chemistry for inclusion in the ARERR.
 - 4.2.4 Ensuring preparation, review, and approval of the Nonroutine Radiological Environmental Operating Report when required by Attachment 11.

5. INSTRUCTIONS**5.1 Administrative Requirements**

NOTE 1: It is the intent of the Radioactive Effluent Control Program (RECP) to monitor all significant release pathways from the power plant. A pathway is considered significant if evaluation shows activity from the path results in offsite dose greater than or equal to 10 percent of the total offsite dose from all RECP pathways.

NOTE 2: Minor releases from the power plant through known pathways occur due to maintenance activities. For example, containment air may escape to the environment when the equipment hatch or door is open. From a RECP release and dose perspective, minor releases are usually negligible and within the margin of error of the models for significant monitored pathways and the respective offsite doses.

5.1.1 Refer to attachments 1-12 for the operational requirements of the Radioactive Effluent Controls Program (RECP).

5.1.2 Ensure it is understood that operational requirements are implemented by Equipment Control Guidelines [(ECGs), as described in OP1.DC16], CAP A-8, and X11.ID2.

- a. The ECGs implement requirements related to equipment that have specific allowed outage times or operator actions.
- b. CAP A-8 includes the methodology and parameters used in the calculation of off-site doses resulting from radioactive gaseous and liquid effluents and in the calculation of gaseous and liquid effluent monitor alarm/trip setpoints.
- c. X11.ID2 implements the reporting requirements.

NOTE: Though not required per NRC RG 1.23, precipitation is typically measured at Diablo Canyon and included with the ARERR.

5.1.3 Check availability of measurements from the Diablo Canyon meteorology system is $\geq 90\%$ as required per NRC RG 1.23 (also called Safety Guide 23).^{Ref 7.10.8}

- a. This requirement may be satisfied by strip charts when digital records cannot be obtained.

- b. Meteorological parameters required by RG 1.23 for Diablo Canyon are:
 - 1. Wind speed
 - 2. Wind direction
 - 3. Temperature at two levels on the same tower (e.g., 10m and 60m)

5.2 Reporting Requirements

5.2.1 Annual Radioactive Effluent Release Report (ARERR)^{T21051}

- a. Ensure the ARERR covering the operation of the plant during the previous calendar year is submitted before May 1 of each year per 10 CFR 50.36a.
- b. Ensure the ARERR includes the following:
 - 1. Identification of any errors in the prior year's report, including corrected values and previously-reported values for comparison.
 - a) Ensure the word "errata" is used as part of error reporting. This is necessary to support word searching by the American Nuclear Insurers.
 - 2. A summary of the quantities of radioactive liquid and gaseous effluents and solid waste released from the units as outlined in RG 1.21 with data summarized on a quarterly basis following the format of Appendix B thereof.
 - 3. A summary of the quantities of solid wastes in the format of Table 3 in RG 1.21 Appendix B and supplemented with the following three additional categories:
 - a) Class of solid wastes (as defined by 10 CFR Part 61).
 - b) Type of container (e.g., LSA, Type A, Type B, Large Quantity).
 - c) Solidification agent or absorbent (e.g., cement, urea formaldehyde).
 - 4. A list and description of unplanned and/or abnormal releases of radioactive materials in gaseous and liquid effluents (as defined in CAP A-8) made during the reporting period from the site to unrestricted areas.
 - a) Ensure the word "abnormal" is used as part of annual discharge reporting. This is necessary to support word searching by the American Nuclear Insurers.

-
5. A description of changes to the ODCM as detailed in the following:^{T02694}
- a) Per Technical Specification 5.5.1, ensure changes to the following procedures made during the reporting period are included:
 - 1) CY2.ID1
 - 2) CY2
 - 3) RP1.ID11
 - 4) CAP A-8
 - b) An FSAR update may be used in lieu of the ARERR for communicating changes in the Radwaste Solidification Process Control Program to the NRC.
 - c) Though not part of the ODCM, changes to the following procedures are also included in the ARERR because solid radwaste disposition for each year is reported there.^{Ref 7.10.9}
 - 1) RP2.DC2, "Radwaste Solidification Process Control Program (PCP)"
 - 2) RP2.DC3, "Radwaste Dewatering Process Control Program"
 - d) If a change is made to any of the procedures listed in steps 5.2.1b.5.a) or 5.2.1b.5.c), include a copy of the current revision(s) for each procedure in the ARERR.
 - 1) When multiple changes to any one procedure are made during the reporting period, include a copy of each revision.

<p>NOTE: Revision bars are required by Tech Spec 5.5.1c. in all revisions of ODCM procedures that are submitted in the ARERR.^{Ref 7.10.11}</p>
--

- 2) Ensure revision bars are used to identify each ODCM procedure change submitted with the ARERR.^{Ref 7.10.11}
6. A listing of new locations for dose calculations or environmental monitoring identified by the LUC PER Attachment 12.
7. When inoperability of liquid or gaseous effluent monitoring instrumentation was not corrected within the time specified in attachments 1 and 2, include an explanation in the ARERR.
8. When liquid holdup tanks or gas storage tanks exceed the limits of ECG 19.1 or ECG 24.3, include a description of the events leading to the exceedance in the ARERR.

-
- c. If major changes to the liquid, gaseous, and solid radwaste treatment systems are not submitted as part of the annual FSAR update, ensure the ARERR includes a discussion of the changes including the following:
1. A summary of evaluation which concluded the change could be made per 10 CFR 50.59.
 2. A sufficiently detailed discussion of the evaluation basis such that it completely supports the change without requiring additional or supplemental information.
 3. A detailed description of the equipment, components, and processes involved and the interfaces with other plant systems.
 4. An evaluation of the change which shows the predicted releases of radioactive materials in liquid and gaseous effluents or quantity of solid waste that differ from those previously predicted in the license application and amendments thereto.
 5. An evaluation of the change which shows any expected maximum exposures to a member of the public in the unrestricted area (or to the general population) that differ from those previously estimated in the license application and respective amendments.
 6. A comparison of the predicted releases of radioactive materials in liquid and gaseous effluents and in solid waste to the actual releases for the period prior to when the changes are to be made.
 7. An estimate of the exposure to plant personnel as a result of the change.
- d. The licensee has the option of retaining the summary of required meteorological data on site in a file that shall be provided to the NRC upon request.
- e. Ensure the ARERR also includes the following:
1. An annual summary of hourly meteorological data collected over the previous year in either of the following forms:
 - a) An hour-by-hour listing (hard copy or electronic) of wind speed, wind direction, atmospheric stability, and precipitation (if measured).
 - b) Joint frequency distributions of wind speed, wind direction, and atmospheric stability.
 2. An assessment of the radiation doses due to the radioactive liquid and gaseous effluents released from the unit or station during the previous calendar year.

3. An assessment of the radiation doses from radioactive liquid and gaseous effluents to members of the public inside the site boundary due to their activities during the report period (see FSAR Figure 2.1-2).
4. All assumptions used in making assessments for steps 5.2.1e.2 and 5.2.1e.3 (e.g., specific activity, exposure time, and location).
 - a) Meteorological conditions concurrent with the time of release of radioactive materials in gaseous effluents (as determined by sampling frequency and measurement) shall be used for determining gaseous pathway doses.^{Ref 7.21/Ref 7.22}

NOTE: Acceptable methods for calculating the dose contribution from liquid and gaseous effluents for step 5.2.1e.5 are given in RG 1.109, Rev. 1, October 1977.

5. An assessment of radiation doses to the likely most exposed member of the public from reactor releases and other nearby uranium fuel cycle sources, including doses from primary effluent pathways and direct radiation, for the previous calendar year to show conformance with 40 CFR Part 190, "Environmental Radiation Protection Standards for Nuclear Power Operation."
 - f. Ensure the ARERR submittal for Diablo Canyon combines those sections common to both Unit 1 and Unit 2.

5.3 Major Changes to Liquid, Gaseous, and Solid Radwaste Treatment Systems

- 5.3.1 When major changes to the liquid, gaseous, and solid radwaste treatment systems can be made per 10 CFR 50.59, ensure the changes are implemented through the DCPD design control process.

6. RECORDS

- 6.1 Data sheets and records shall be maintained in the Records Management System (RMS) per CY1.DC1, "Analytical Data Processing Responsibilities."^{T04108}

7. REFERENCES

- 7.1 CAP A-5, "Liquid Radwaste Discharge Management"
- 7.2 CAP A-6, "Gaseous Radwaste Sampling and Analysis for Release"
- 7.3 CAP A-8, "Off-site Dose Calculations"
- 7.4 CF4.ID1, "Modification Request and Authorization"
- 7.5 CF6.ID1, "Setpoint Control Program"
- 7.6 CY2, "Radiological Monitoring and Controls Program"
- 7.7 OP1.DC16, "Control of Plant Equipment Not Required by the Technical Specifications"
- 7.8 RP1.ID11, "Environmental Radiological Monitoring Procedure"
- 7.9 XI1.ID2, "Regulatory Reporting Requirements and Reporting Process"
- 7.10 Action Requests/Notifications
- 7.10.1 A0581581, "Track LAR Revising Fuel Handling Requirements per TSTF-51"
- 7.10.2 A0619600, "Rad Effluent Sampling of Ni-63"
- 7.10.3 A0660441, "ODCM Change Identification Discrepancies"
- 7.10.4 A0702694, "Evaluate Detection Limit Differences for ECG and Procedures"
- 7.10.5 50453741, "Update CY2.ID1 for PCP"
- 7.10.6 50596176, "CY2.ID1 Needs Revision"
- 7.10.7 50624472, "DA-Vac Ops - Not Consistent w/FSAR"
- 7.10.8 50640298, "DA-RPI 2014: 90% of Met Tower Data not U"
- 7.10.9 50688029, "DA-QDEF - CY2.ID1 clarification"
- 7.10.10 50834457, "DA-Potential Risks Due to Sanitary Sewage"
- 7.10.11 50893145, "DA-QAAF - ODCM submission error"
- 7.10.12 51071944, "DA-QAAF - RM44A&B cal freq not per ODCM"

-
- 7.11 License Amendment Request 93-04
 - 7.12 License Amendment 67/66, January 22, 1992
 - 7.13 License Amendment 119/117, April 14, 1997
 - 7.14 License Amendment 184/186, January 3, 2006
 - 7.15 License Amendment 230/232, April 27, 2017
 - 7.16 10 CFR 20.1302
 - 7.17 10 CFR 50.36a
 - 7.18 10 CFR 50 Appendix I
 - 7.19 40 CFR 190
 - 7.20 Regulatory Guide 1.21, "Measuring, Evaluating, and Reporting Radioactivity in Solid Wastes and Releases of Radioactive Materials in Liquid and Gaseous Effluents from Light-Water-Cooled Nuclear Power Plants," Revision 1, June 1974
 - 7.21 Regulatory Guide 1.109, Revision 1, October 1977
 - 7.22 Regulatory Guide 1.111, "Methods for Estimating Atmospheric Transport and Dispersion of Gaseous Effluents in Routine Releases from Light-Water-Cooled Reactors," Revision 1, July 1977
 - 7.23 Regulatory Guide 1.23 (Safety Guide 23, Onsite Meteorological Programs), February 1972
 - 7.24 NRC Generic Letter 89-01, "Implementation of Programmatic Controls for Radiological Effluent Technical Specifications in the Administrative Controls Section of the Technical Specifications and the Relocation of Procedural Details of RETS to the Off-Site Dose Calculation Manual or to the Process Control Program"
 - 7.25 QA Commitments:
 - 7.25.1 FSAR Chapter 17.2
 - 7.25.2 Regulatory Guide 4.15, 2/79 (Rev. 1)

**Radioactive Liquid Effluent Monitoring
Instrumentation Operational Requirements**

Attachment 1: Page 1 of 3

1. Radioactive Liquid Effluent Monitoring Instrumentation (also covered by ECG 39.3)
 - a. Commitment for Operation
 - 1) Radioactive liquid effluent monitoring instrumentation channels shown in Table 1 shall be OPERABLE with their alarm and trip setpoints set to ensure the limits of Attachment 3 are not exceeded. The alarm and trip setpoints of these channels shall be determined per the methodology and parameters in the OFF-SITE DOSE CALCULATIONS (ODC).
 - 2) Applicability: At all times.
 - 3) Action
 - a) With a radioactive liquid effluent monitoring instrumentation channel alarm and trip setpoint less conservative than required by Attachment 3, immediately suspend release of radioactive liquid effluents monitored by the affected channel or declare the channel inoperable.
 - b) With less than the minimum number of radioactive liquid effluent monitoring instrumentation channels OPERABLE, take the ACTION shown in Table 1. Restore inoperable instrumentation to OPERABLE status within the time specified in the ACTION, or explain in the next Annual Radioactive Effluent Release Report why this inoperability was not corrected within the time specified.
 - b. Surveillance Requirements
 - 1) Each radioactive liquid effluent monitoring instrumentation channel shall be demonstrated OPERABLE by performance of the CHANNEL CHECK, SOURCE CHECK, CHANNEL CALIBRATION and CHANNEL FUNCTIONAL TEST at the frequencies shown in Table 2.
 - 2) At least one saltwater pump shall be determined operating and providing dilution to the discharge structure at least once per four hours whenever dilution is required to meet the limits of Attachment 3.
 - c. Bases:
 - 1) Radioactive liquid effluent instrumentation is provided to monitor and control, as applicable, the releases of radioactive materials in liquid effluents during actual or potential releases of liquid effluents. The alarm and trip setpoints for these instruments shall be calculated and adjusted per the methodology and parameters in the ODCP to ensure the alarm and trip will occur prior to exceeding the limits of 10 CFR Part 20. OPERABILITY and use of this instrumentation is consistent with the requirements of General Design Criteria (GDC): GDC 17, 1967; GDC 18, 1967; and GDC 70, 1967.

**Radioactive Liquid Effluent Monitoring
Instrumentation Operational Requirements**

Table 1: Radioactive Liquid Effluent Monitoring Instrumentation

Instrument	Minimum Channels OPERABLE	Action
2. Radioactivity Monitors Providing Alarm and Automatic Termination of Release		
a. Liquid Radwaste Effluent Line (RM-18)#	1	1
b. Steam Generator Blowdown Tank (RM-23)	1	2
3. Flow Rate Measurement Devices		
a. Liquid Radwaste Effluent Line (FIT-243)#	1	4
b. Steam Generator Blowdown Effluent Lines (FR-53)	1	4
c. Oily Water Separator Effluent Line (FR-251)#	1	4
4. Radioactivity Monitor Not Providing Automatic Termination of Release		
Oily Water Separator Effluent Line (RM-3)#	1	3

This radioactive liquid effluent monitoring instrumentation is common to both units.

Actions

- 1 With the number of channels OPERABLE less than required by the minimum channels OPERABLE requirement, effluent releases via this pathway may continue for up to 14 days provided that prior to initiating a release:
 - a. At least two independent samples are analyzed per Attachment 3.
 - b. At least two technically qualified members of the facility staff independently ensure correctness of the release rate calculations and discharge line valvings.
Otherwise, suspend release of radioactive effluents via this pathway.
- 2 With the number of channels OPERABLE less than required by the minimum channels OPERABLE requirement, effluent releases via this pathway may continue for up to 30 days provided grab samples are analyzed for radioactivity (beta or gamma) at a lower limit of detection of no more than 10^{-7} microcuries/ml.^{Ref 7.10.4}
 - a. At least once per 12 hours when the specific activity of the secondary coolant is greater than 0.01 microcuries/gram DOSE EQUIVALENT I-131, or
 - b. At least once per 24 hours when the specific activity of the secondary coolant is less than or equal to 0.01 microcuries/gram DOSE EQUIVALENT I-131.
- 3 With the number of channels OPERABLE less than required by the minimum channels OPERABLE requirement, effluent releases via this pathway may continue for up to 30 days provided that, at least once per 12 hours, grab samples are collected and analyzed for radioactivity (beta or gamma) at a lower limit of detection of no more than 10^{-7} microcuries/ml or transfer the oily water separator effluent to the Waste Holding and Treatment System or to portable tanks.
- 4 With the number of channels OPERABLE less than required by the minimum channels OPERABLE requirement, effluent releases via this pathway may continue for up to 30 days provided the flow rate is estimated at least once per four hours during actual releases. Pump performance curves may be used to estimate flow.

**Radioactive Liquid Effluent Monitoring
Instrumentation Operational Requirements**

Attachment 1: Page 3 of 3

Table 2: Radioactive Liquid Effluent Monitoring Instrumentation Surveillance Requirements

Instrument	Channel Check	Source Check	Channel Calibration	Channel Functional Test
1. Radioactivity Monitors Providing Alarm and Automatic Termination of Release				
a. Liquid Radwaste Effluent Line (RM-18)	D	P	R(3)	Q(1)
b. Steam Generator Blowdown Tank (RM-23)	D	M	R(3)	Q(1)
2. Flow Rate Measurement Devices				
a. Liquid Radwaste Effluent Line (FIT-243)	D(4)	N/A	R	Q
b. Steam Generator Blowdown Effluent Line (FR-53)	D(4)	N/A	R	Q
c. Oily Water Separator Effluent Line (FR-251)	Daily(4)	N/A	R	Q
3. Radioactivity Monitor Not Providing Automatic Termination of Release				
a. Oily Water Separator Effluent Line (RM-3)	D	M	R(3)	Q(2)

- (1) The CHANNEL FUNCTIONAL TEST shall also demonstrate that automatic isolation of this pathway and Control Room alarm annunciation occurs if any of the following conditions exist:
 - a. Instrument indicates measured levels above the alarm and trip setpoint (isolation and alarm)
 - b. Relay control circuit failure (isolation only)
 - c. Instrument indicates a downscale failure (alarm only)
 - d. Instrument controls not set in operate mode (alarm only)
- (2) The CHANNEL FUNCTIONAL TEST shall also demonstrate that control room alarm annunciation occurs if any of the following conditions exist:
 - a. Instrument indicates measured levels above the alarm setpoint
 - b. Circuit failure
 - c. Instrument indicates a downscale failure
 - d. Instrument controls not set in operate mode
- (3) The initial CHANNEL CALIBRATION shall be performed using one or more of the reference standards certified by the National Bureau of Standards (NBS) or using standards that have been obtained from suppliers that participate in measurement assurance activities with NBS. These standards shall permit calibrating the system over its intended range of energy and measurement range. For subsequent CHANNEL CALIBRATION, sources that have been related to the initial calibration shall be used.
- (4) CHANNEL CHECK shall consist of confirming indication of flow during periods of release. CHANNEL CHECK for FR-251 shall be made once per calendar day,* and for FIT-243 and FR-53 shall be made at least once per 24 hours on days on which continuous, periodic, or batch releases are made.
- (5) Frequency Notation

<u>Notation</u>	<u>Frequency</u>
D	At least once per 24 hours
Daily	At least once per calendar day*
M	At least once per 31 days
Q	At least once per 92 days
R	At least once per 18 months
P	Completed prior to each release
N/A	Not Applicable

* The frequency "once per calendar day" could result in two successive channel checks nearly 48 hours apart over a two day period. This frequency is different from and should not be confused with the frequency notation "D" (at least once per 24 hours) defined in Technical Specifications.

**Radioactive Gaseous Effluent Monitoring
Instrumentation Operational Requirements**

Attachment 2: Page 1 of 3

1. Radioactive Gaseous Effluent Monitoring Instrumentation (also covered by ECG 39.4)
 - a. Commitment for Operation
 - 1) The radioactive gaseous effluent monitoring instrumentation channels shown in Table 3 shall be OPERABLE with their alarm and trip setpoints set to ensure the limits of Attachment 6 is not exceeded. The alarm and trip setpoints of these channels meeting Attachment 6 shall be determined and adjusted per the methodology and parameters in the ODCP.
 - 2) Applicability: As shown in Table 3.
 - 3) Action
 - a) With a radioactive gaseous effluent monitoring instrumentation channel alarm and trip setpoint less conservative than required by the above commitment, immediately suspend the release of radioactive gaseous effluents monitored by the affected channel, or declare the channel inoperable.
 - b) With the number of OPERABLE radioactive gaseous effluent monitoring instrumentation channels less than the minimum channels OPERABLE, take the ACTION shown in Table 3. Restore the inoperable instrumentation to OPERABLE status within the time specified in the ACTION or explain in the next Annual Radioactive Effluent Release Report why this inoperability was not corrected within the time specified.
 - b. Surveillance Requirements
 - 1) Each radioactive gaseous effluent monitoring instrumentation channel shall be demonstrated OPERABLE by performance of the CHANNEL CHECK, SOURCE CHECK, CHANNEL CALIBRATION and CHANNEL FUNCTIONAL TEST at the frequencies shown in Table 4.
 - c. Bases
 - 1) Radioactive gaseous effluent instrumentation is provided to monitor and control, as applicable, the releases of radioactive materials in gaseous effluents during actual or potential releases of gaseous effluents. Alarm and trip setpoints for these instruments shall be calculated and adjusted per the methodology and parameters in the ODCP to ensure the alarm/trip will occur prior to exceeding the limits of NUREG 0133.
 - 2) OPERABILITY and use of this instrumentation is consistent with the requirements of General Design Criteria (GDC): GDC 17, 1967; GDC 18, 1967; and GDC 70, 1967. Sensitivity of any noble gas activity monitors used to show compliance with gaseous effluent release requirements of Attachment 7 shall be such that concentrations as low as 1×10^{-5} $\mu\text{Ci/ml}$ are measurable.

**Radioactive Gaseous Effluent Monitoring
Instrumentation Operational Requirements**

Attachment 2: Page 2 of 3

Table 3: Radioactive Gaseous Effluent Monitoring Instrumentation

Instrument	Minimum Channels OPERABLE	Applicability	Action
1. Gaseous Radwaste System Noble Gas Activity Monitor - Providing Alarm and Automatic Termination of Release (RM-22)	1	*	5
2. Plant Vent system			
a. Noble Gas Activity Monitor Providing Alarm (RM-14 or RM-14R)	1	*	7
b. Iodine Sampler	1	*	9
c. Particulate Sampler	1	*	9
d. Flow Rate Monitor (FR-12)	1	*	6
e. Iodine Sampler Flow Rate Monitor	1	*	6
3. Containment Purge System Noble Gas Activity Monitor - Providing Alarm and Automatic Termination of Release (RM-44A or 44B)	2 ⁽¹⁾	**	8

⁽¹⁾ Two channels required in MODES 1, 2, 3 and 4. Only one channel required during movement of recently irradiated fuel assemblies within containment.

* At all times.

** MODES 1-4; also MODE 6 during CORE ALTERATIONS or movement of irradiated fuel within containment.

- Action**
- 5 With the number of channels OPERABLE less than required by the minimum channels OPERABLE requirement, the contents of the tank(s) may be released to the environment for up to 14 days provided that prior to initiating the release both of the following conditions exist:
- At least two independent samples of the tank's contents are analyzed.
 - At least two technically qualified members of the facility staff independently ensure correctness of the release rate calculations and discharge valve lineup.
- If these conditions cannot both be met, then suspend release of radioactive effluents via this pathway.
- 6 With the number of channels OPERABLE less than required by the minimum channels OPERABLE requirement, effluent releases via this pathway may continue for up to 30 days provided the flow rate is estimated at least once per 4 hours.
- 7 With the number of channels OPERABLE less than required by the minimum channels OPERABLE requirement, effluent releases via this pathway may continue for up to 30 days provided grab samples are taken at least once per 12 hours and these samples are analyzed for radioactivity within 24 hours.
- 8 With the number of channels OPERABLE less than required by the minimum channels OPERABLE requirement, immediately suspend containment purging of radioactive effluents via this pathway.
- 9 With the number of channels OPERABLE less than required by the minimum channels OPERABLE requirement, effluent releases via the affected pathway may continue for up to 30 days provided samples are continuously collected with auxiliary sampling equipment as required in Attachment 6.

NOTE FOR ACTION 9: To respond to the low flow alarm, determine that a simple fix cannot be made and an auxiliary sampler is needed. Move the sampler in, hook up and ensure operation, a maximum of two hours is considered a reasonable time. Over two hours should be considered as exceeding the time limitation of the commitment for operation (ECG 39.4).

**Radioactive Gaseous Effluent Monitoring
Instrumentation Operational Requirements**

Attachment 2: Page 3 of 3

Table 4: Radioactive Gaseous Effluent Monitoring Instrumentation Surveillance Requirements

Instrument	Channel Check	Source Check	Channel Calibration	Channel Functional Test	MODES for Which Surveillance Is Required
1. Gaseous Radwaste System Noble Gas Activity Monitor - Providing Alarm and Automatic Termination of Release (RM-22)	P	P	R(3)	Q(1)	*
2. Plant Vent System					
a. Noble Gas Activity Monitor Providing Alarm (RM-14 or RM-14R)	D	M	R(3)	Q(2)	*
b. Iodine Sampler	W(4)	N/A	N/A	N/A	*
c. Particulate Sampler	W(4)	N/A	N/A	N/A	*
d. Flow Rate Monitor (FR-12)	D	N/A	R	Q	*
e. Iodine Sampler Flow Rate Monitor	D	N/A	R	Q	*
3. Containment Purge System Noble Gas Activity Monitor - Providing Alarm and Automatic Termination of Release (RM-44A or 44B)	D	P	R*(3)	Q(1)	**

* At all times.

** MODES 1-4; also MODE 6 during CORE ALTERATIONS or movement of irradiated fuel within containment.

- (1) The CHANNEL FUNCTIONAL TEST shall demonstrate that automatic isolation of this pathway and Control Room alarm annunciation occurs if any of the following conditions exist:
 - a. Instrument indicates measured levels above the Alarm/Trip Setpoint (isolation and alarm).
 - b. Instrument indicates a downscale failure (alarm only).
 - c. Instrument controls not set in operate mode (alarm only).
- (2) The CHANNEL FUNCTIONAL TEST shall also demonstrate that Control Room alarm annunciation occurs if any of the following conditions exist:
 - a. Instrument indicates measured levels above the alarm setpoint.
 - b. Circuit failure.
 - c. Instrument indicates a downscale failure.
 - d. Instrument controls not set in operate mode.
- (3) The initial CHANNEL CALIBRATION shall be performed using one or more of the reference standards certified by the National Bureau of Standards (NBS) or using standards obtained from suppliers that participate in measurement assurance activities with NBS. These standards shall permit calibrating the system over its intended range of energy and measurement range. For subsequent CHANNEL CALIBRATION, sources related to the initial calibration shall be used.
- (4) The CHANNEL CHECK shall consist of confirming the iodine cartridge and particulate filter are installed in the sample holders.
- (5) Frequency Notation

<u>Notation</u>	<u>Frequency</u>
D	At least once per 24 hours
W	At least once per 7 days
M	At least once per 31 days
Q	At least once per 92 days
R	At least once per 18 months
R*	At least once per 24 months ^{Ref 7.10.12/Ref 7.13}
P	Completed prior to each release
N/A	Not Applicable

Liquid Effluents - Concentration Operational Requirements

Attachment 3: Page 1 of 5

1. Liquid Effluents - Concentration

a. Commitment for Operation

- 1) Concentration of radioactive material released in liquid effluents to unrestricted areas (see FSAR Figure 2.1-2) shall be limited to the concentrations specified in 10 CFR Part 20, Appendix B, Table 2, Column 2 for radionuclides other than dissolved or entrained noble gases. For dissolved or entrained noble gases, the concentration shall be limited to 2×10^{-4} microcurie/ml total activity.
- 2) Applicability: At all times.
- 3) Action
 - a) With the concentration of radioactive material released in liquid effluents to unrestricted areas exceeding the above limits, immediately restore the concentration to within the above limits.

b. Surveillance Requirements

- 1) Radioactive liquid wastes shall be sampled and analyzed according to the sampling and analysis program in Attachment 3.
- 2) Results of the radioactivity analyses shall be used per the methodology and parameters in the ODCP to ensure concentrations at the point of release are maintained within the limits of Attachment 3

c. Bases

- 1) This regulatory commitment is provided to ensure that the concentration of radioactive materials released in liquid waste effluents to unrestricted areas will be less than concentration levels specified in 10 CFR Part 20, Appendix B, Table 2, Column 2. This limitation provides additional assurance that levels of radioactive materials in bodies of water in unrestricted areas will result in exposures within: (1) Section II.A design objectives of Appendix I, 10 CFR Part 50, to a member of the public, and (2) limits of 10 CFR 20.1301(e) to the population. Concentration limit for dissolved or entrained noble gases is based upon the assumption Xe-135 is the controlling radioisotope and its effluent concentration limit (ECL) in air (submersion) was converted to an equivalent concentration in water using methods described in International Commission on Radiological Protection (ICRP) Publication 2.
- 2) This regulatory commitment applies to the release of radioactive materials in liquid effluents from all units at the site.
- 3) Required detection capabilities for radioactive materials in liquid waste samples are tabulated in terms of the lower limits of detection (LLDs). Detailed discussion of LLD, and other detection limits can be found in Currie, L.A., "Lower Limit of Detection: Definition and Elaboration of a Proposed Position for Radiological Effluent and Environmental Measurements," NUREG/CR-4007 (September 1984), and in HASL Procedures Manual, HASL-300 (revised annually).

Liquid Effluents - Concentration Operational Requirements

Attachment 3: Page 2 of 5

Table 5: Radioactive Liquid Waste Sampling and Analysis Program

Liquid Release Type	Sampling Frequency	Minimum Analysis Frequency	Type of Activity Analysis	Lower Limit of Detection (LLD) ($\mu\text{Ci/ml}$) ⁽¹⁾
1. Batch Release Tanks ⁽⁴⁾ Liquid Radwaste System (LRW)	P Each Batch	P Each Batch	Principal Gamma Emitters ⁽⁶⁾	5×10^{-7} ⁽⁶⁾
			I-131	1×10^{-6}
	P One Batch/M	M	Dissolved and Entrained Gases (Gamma emitters)	1×10^{-5}
	P Each Batch	M Composite ⁽²⁾	H-3	1×10^{-5}
			Gross Alpha	1×10^{-7}
	P Each Batch	Q Composite ⁽²⁾	Sr-89, Sr-90	5×10^{-8}
			Fe-55	1×10^{-6}
			Ni-63	1×10^{-6}
			U-233, U-234, U-235, U-236, U-238 Pu-238, Pu-239, Pu-240, Pu-241, Pu-242	5×10^{-8}
	2. Batch Release Tanks Condensate Demineralizer Regenerant System (CDRS)	P Each Batch	P Each Batch	Principal Gamma Emitters ⁽⁶⁾
I-131				1×10^{-6}
P One Batch/M		M	Dissolved and Entrained Gases (Gamma emitters)	1×10^{-5}
P Each Batch		Q Composite ⁽²⁾	H-3	1×10^{-5}
			Sr-89, Sr-90	5×10^{-8}
			Fe-55	1×10^{-6}
P Each Batch		Q Composite ⁽²⁾	(only if primary-secondary LEAKAGE greater than 10 gpd) Gross Alpha, Ni-63, U-233, U-234, U-235, U-236, U-238, Pu-238, Pu-239, Pu-240, Pu-241, Pu-242	LLDs as for LRW system

Liquid Effluents - Concentration Operational Requirements

Table 5: Radioactive Liquid Waste Sampling and Analysis Program (continued)

Liquid Release Type	Sampling Frequency	Minimum Analysis Frequency	Type of Activity Analysis	Lower Limit of Detection (LLD) ($\mu\text{Ci/ml}$) ⁽¹⁾
3. Batch Release Tanks Waste Holding and Treatment (WHAT) System	P Each Batch	P Each Batch	Principal Gamma Emitters ⁽⁶⁾	5×10^{-7} ⁽⁶⁾
			H-3	1×10^{-5}
4. Continuous Releases ⁽⁵⁾ Steam Generator Blowdown Tank	D Grab Sample	W Composite ⁽³⁾	Principal Gamma Emitters ⁽⁶⁾	5×10^{-7} ⁽⁶⁾
			I-131	1×10^{-6}
	M Grab Sample	M	Dissolved and Entrained Gases (Gamma emitters)	1×10^{-5}
	D Grab Sample	M Composite ⁽³⁾	H-3	1×10^{-5}
			Gross Alpha	1×10^{-7}
	D Grab Sample	Q Composite ⁽³⁾	Sr-89, Sr-90	5×10^{-8}
Fe-55			1×10^{-6}	
5. Continuous Releases ⁽⁵⁾ Oily Water Separator Effluent	D Grab Sample	W Composite ⁽³⁾	Principal Gamma Emitters ⁽⁶⁾	5×10^{-7} ⁽⁶⁾
	as directed by chemistry supervision		H-3	1×10^{-5}
6. Continuous Releases ⁽⁵⁾ Waste Water (Sewage) Treatment Plant	M Grab Sample	M Grab Sample	Principal Gamma Emitters ⁽⁶⁾	5×10^{-7} ⁽⁶⁾
			H-3	1×10^{-5}

Liquid Effluents - Concentration Operational Requirements

Attachment 3: Page 4 of 5

- (1) LLD is defined, for the purposes of these specifications, as the smallest concentration of radioactive material in a sample that will yield a net count, above system background, that will be detected with 95% probability with only 5% probability of falsely concluding a blank observation represents a real signal.

For a particular measurement system, which may include radiochemical separation:

$$LLD = \frac{4.66s_b}{E * V * 2.22 \times 10^6 * Y * \exp(-\lambda\Delta t)}$$

Where:

- LLD = "a priori" lower limit of detection (microcuries per unit mass or volume)
s_b = standard deviation of background counting rate or of counting rate of a blank sample as appropriate (counts per minute)
E = counting efficiency (counts per disintegration)
V = sample size (units of mass or volume)
2.22 x 10⁶ = number of disintegrations per minute per microcurie
Y = fractional radiochemical yield, when applicable
λ = radioactive decay constant for the particular radionuclide (sec⁻¹)
Δt = elapsed time between midpoint of sample collection and time of counting (sec)

Typical values of E, V, Y, and Δt should be used in the calculation.

It should be recognized that the LLD is defined as an a priori (before the fact) limit representing the capability of a measurement system and not as a posterior (after the fact) limit for a particular measurement.

- (2) A composite sample is one in which the quantity of liquid sampled is proportional to the quantity of liquid waste discharged and in which the method of sampling employed results in a specimen representative of the liquids released.
- (3) To be representative of quantities and concentrations of radioactive materials in liquid effluents, samples shall be composited in proportion to the rate of flow of the effluent stream. Prior to analyses, all samples taken for the composite shall be thoroughly mixed in order for the composite sample to be representative of the effluent release.
- (4) A batch release is the discharge of liquid wastes of a discrete volume. Prior to sampling for analyses, each batch shall be isolated and thoroughly mixed by a method described in the ODCP to ensure representative sampling.
- (5) A continuous release is the discharge of liquid wastes of a nondiscrete volume (e.g., from a volume of system that has an input flow during the continuous release).

Liquid Effluents - Concentration Operational Requirements

Attachment 3: Page 5 of 5

- (6) LLD specification in (1) above applies to the following principal radionuclides: Mn-54, Fe-59, Co-58, Co-60, Zn-65, Mo-99, Cs-134, Cs-137, and Ce-141. Ce-144 shall also be measured but with an LLD of 5×10^{-6} . Inclusion in this list does not mean only these nuclides are to be considered. Other identifiable gamma peaks with those of the above nuclides shall also be analyzed and reported in the Annual Radioactive Effluent Release Report.

If two or more redundant sample and analysis results of the same discharge pathway indicate slight differences in low level isotopic mixture, the analysis resulting in higher calculated dose should be used. The isotopes chosen to represent the discharge shall be reported.

- (7) Frequency Notation:

<u>Notation</u>	<u>Frequency</u>
D	At least once per 24 hours
W	At least once per 7 days
M	At least once per 31 days
Q	At least once per 92 days
P	Completed prior to each release

Liquid Effluents - Dose Operational Requirements

Attachment 4: Page 1 of 1

1. Liquid Effluents - Dose

a. Commitment for Operation

- 1) Dose or dose commitment to a member of the public from radioactive materials in liquid effluents released from each unit to unrestricted areas (see FSAR Figure 2.1-2) shall be limited to the following:
 - a) During any calendar quarter to less than or equal to 1.5 mrem to the whole body and to less than or equal to 5 mrem to any organ.
 - b) During any calendar year to less than or equal to 3 mrem to the whole body and to less than or equal to 10 mrem to any organ.
- 2) Applicability: At all times.
- 3) Action
 - a) For calculated dose from release of radioactive materials in liquid effluents exceeding any of the above limits, prepare and submit to the Commission within 30 days, pursuant to 10 CFR 50.4, a special report that identifies cause(s) for exceeding limit(s) and defines corrective actions taken to reduce releases and proposed corrective actions to be taken to ensure subsequent releases will be in compliance with the above limits.

b. Surveillance Requirements

- 1) Cumulative dose contributions from liquid effluents for the current calendar quarter and the current calendar year shall be determined per the methodology and parameters in the ODCP at least once per 31 days.

c. Bases

- 1) This Regulatory Commitment is provided to implement the requirements of Sections II.A, III.A and IV.A of Appendix I, 10 CFR Part 50. Limiting condition for operation implements the guides set forth in Section II.A of Appendix I. Action statements provide required operating flexibility and implement the guides set forth in Section IV.A of Appendix I to ensure releases of radioactive material in liquid effluents to unrestricted areas will be kept as low as is reasonably achievable. Dose calculation methodology and parameters in the ODCP implement the requirements in Section III.A of Appendix I that conformance with the guides of Appendix I be shown by calculation procedures based on models and data, such that actual exposure of a member of the public through appropriate pathways is unlikely to be substantially underestimated.
- 2) The equations specified in the ODCP for calculating doses due to actual release rates of radioactive materials in liquid effluents are consistent with the methodology provided in RG 1.109, "Calculation of Annual Doses to Man from Routine Releases of Reactor Effluents for the Purpose of Evaluating Compliance with 10 CFR Part 50, Appendix I," Revision 1, October 1977 and RG 1.113, "Estimating Aquatic Dispersion of Effluents from Accidental and Routine Reactor Releases for the Purpose of Implementing Appendix I," April 1977.
- 3) This Regulatory Commitment applies to the release of radioactive materials in liquid effluents from each unit at the site. For units with shared radwaste treatment systems, liquid effluents from the shared system are to be proportioned among the units sharing that system.

**Liquid Radwaste Treatment System Dose
Operational Requirements**

Attachment 5: Page 1 of 1

1. Liquid Radwaste Treatment System

a. Commitment for Operation

NOTE: The Liquid Radwaste Treatment System is common to both units.

- 1) Liquid Radwaste Treatment System shall be OPERABLE and appropriate portions of the system shall be used to reduce radioactive materials in liquid wastes prior to their discharge when projected doses due to liquid effluent from each unit to unrestricted areas (see FSAR Figure 2.1-2) would exceed 0.06 mrem to whole body or 0.2 mrem to any organ in a 31-day period.
- 2) Applicability: At all times.
- 3) Action
 - a) If any portion of liquid radwaste treatment system is not in operation and radioactive liquid waste in excess of the above limits is being discharged without treatment, then prepare and submit to the Commission within 30 days a special report per 10 CFR 50.4 which includes the following information:
 - (1) Explanation of why liquid radwaste was being discharged without treatment, identification of any inoperable equipment or subsystems, and reason(s) for inoperability.
 - (2) Action(s) taken to restore inoperable equipment to OPERABLE status.
 - (3) Summary description of action(s) taken to prevent recurrence.

b. Surveillance Requirements

- 1) Doses due to liquid releases from each unit to unrestricted areas shall be projected at least once per 31 days in accordance with methodology and parameters in the ODCP when liquid radwaste treatment systems are not being fully utilized.
- 2) The installed liquid radwaste treatment system shall be considered OPERABLE by meeting attachments 3 and 4.

c. Bases

- 1) The OPERABILITY of the Liquid Radwaste Treatment System ensures that this system will be available for use whenever liquid effluents require treatment prior to release to the environment. The requirement that the appropriate portions of this system be used when specified provides assurance that the releases of radioactive materials in liquid effluents will be kept "as low as is reasonably achievable." This specification implements the requirements of 10 CFR 50.36a, General Design Criterion 60 of Appendix A to 10 CFR Part 50 and the design objective given in Section II.D of Appendix I to 10 CFR Part 50. The specified limits governing the use of appropriate portions of the Liquid Radwaste Treatment System were specified as a suitable fraction of the dose design objectives set forth in Section II.A of Appendix I, 10 CFR Part 50, for liquid effluents.
- 2) This Regulatory Commitment applies to release of radioactive materials in liquid effluents from each unit at the site. For units with shared radwaste treatment systems, the liquid effluents from the shared system are proportioned among units sharing that system.

**Gaseous Effluents - Dose Rate Operational
Requirements**

Attachment 6: Page 1 of 3

1. Gaseous Effluents - Dose Rate

a. Commitment for Operation

- 1) Dose rate due to radioactive materials released in gaseous effluents from the site to areas at or beyond the site boundary (see FSAR Figure 2.1-2) shall be limited to the following:
 - a) Noble gases: Less than or equal to 500 mrem/yr to the whole body and less than or equal to 3000 mrem/yr to the skin.
 - b) Iodine-131, Iodine-133, tritium, and all radionuclides in particulate form with half-lives greater than eight days: Less than or equal to 1500 mrem/yr to any organ.
- 2) Applicability: At all times.
- 3) Action
 - a) If dose rate(s) exceed the above limits, immediately decrease release rate to within limit(s).

b. Surveillance Requirements

- 1) Dose rate due to noble gases in gaseous effluents shall be determined to be within limits as described above and per methodology and procedures of ODCP.
- 2) Dose rate due to Iodine-131, Iodine-133, tritium, and all radionuclides in particulate form with half-lives greater than eight days in gaseous effluents shall be determined to be within the above limits per methodology and procedures described in the ODCP by obtaining representative samples and performing analyses per sampling and analysis program specified in Attachment 6.

c. Bases

- 1) This Regulatory Commitment is provided to ensure that dose at any time from gaseous effluents at and beyond the site boundary from all units on the site will be within the annual dose limits of NUREG 0133 to unrestricted areas. Annual dose limits are the doses associated with concentrations identified in 10 CFR Part 20, Appendix B, Table 2, Column 1. These limits provide reasonable assurance that radioactive material discharged in gaseous effluents will not result in exposure of a member of the public in an unrestricted area within or outside the site boundary to average concentrations exceeding the limits specified in Appendix B, Table 2 of 10 CFR Part 20 (10 CFR Part 20.1302(c)).
- 2) For members of the public who may at times be within the site boundary, the occupancy of members of the public will usually be sufficiently low to compensate for any increase in the atmospheric diffusion factor above that for the site boundary. Examples of calculations with appropriate occupancy factors for such members of the public shall be given in the ODCP. Release rate limits specified by NUREG 0133 presently restrict the corresponding gamma and beta dose rates above background to members of the public at or beyond the site boundary to less than or equal to 500 mrem/year to the whole body or to less than or equal to 3000 mrem/year to the skin. These release rate limits also restrict the corresponding thyroid dose rate above background to a child via the inhalation pathway at all times to less than or equal to 1500 mrem/year.

Gaseous Effluents - Dose Rate Operational Requirements

Attachment 6: Page 2 of 3

- 3) This Regulatory Commitment applies to the release of radioactive materials in gaseous effluents from all units at the site.
- 4) Required detection capabilities for radioactive material in gaseous waste samples are tabulated below in terms of lower limits of detection (LLDs). Detailed discussion of LLD, and other detection limits can be found in Currie, L.A., "Lower Limit of Detection: Definition and Elaboration of a Proposed Position for Radiological Effluent and Environmental Measurements," NUREG/CR-4007 (September 1984), and in the HASL Procedures Manual, HASL-300 (revised annually).

Table 6: Radioactive Gaseous Waste Sampling and Analysis Program

Gaseous Release Type	Sampling Frequency	Minimum Analysis Frequency	Type of Activity Analysis	Lower Limit of Detection (LLD) ($\mu\text{Ci}/\text{m}^3$) ⁽¹⁾
1. Waste Gas Decay Tank	P Each Tank Grab Sample	P Each Tank	Principal Gamma Emitters ⁽⁷⁾ (noble gases)	1×10^{-4}
2. Containment Purge	P Each Purge ⁽²⁾ Grab Sample	P Each Purge ⁽²⁾	Principal Gamma Emitters ⁽⁷⁾ (noble gases)	1×10^{-4}
			I-131, I-133	1×10^{-9}
			Principal Gamma Emitters (particulates)	1×10^{-9}
			H-3	1×10^{-6}
3. Plant Vent	M ⁽²⁾ Grab Sample	M ⁽²⁾	Principal Gamma Emitters ⁽⁷⁾ (noble gases)	1×10^{-4}
	W ^{(3) (5)} Grab Sample	W	H-3	1×10^{-6}
4. All Release Types as listed in 1., 2., 3., above, at the plant vent	Continuous ⁽⁶⁾	W ⁽⁴⁾ Charcoal Sample	I-131	1×10^{-12}
			I-133	1×10^{-10}
	Continuous ⁽⁶⁾	W ⁽⁴⁾ Particulate Sample	Principal Gamma Emitters ⁽⁷⁾	1×10^{-11}
	Continuous ⁽⁶⁾	M Composite Particulate Sample	Gross Alpha	1×10^{-11}
4. All Release Types as listed in 1., 2., 3., above, at the plant vent	Continuous ⁽⁶⁾	Q Composite Particulate Sample	Sr-89, Sr-90	1×10^{-11}
5. Steam Generator Blowdown Tank Vent	M ⁽⁸⁾	M ⁽⁸⁾	Principal Gamma Emitters ⁽⁷⁾ (noble gases)	1×10^{-4}
6. Main Condenser Nash Vacuum Pump Exhaust	24H ⁽¹⁰⁾	24H ⁽¹⁰⁾	Principal Gamma Emitters ⁽⁷⁾ (noble gases)	1×10^{-4}

Gaseous Effluents - Dose Rate Operational Requirements

Attachment 6: Page 3 of 3

- (1) LLD is defined for purposes of these specifications as the smallest concentration of radioactive material in a sample that will yield a net count above system background that will be detected with 95% probability and only 5% probability of falsely concluding a blank observation represents a real signal.

For a particular measurement system, which may include radiochemical separation:

$$LLD = \frac{4.66s_b}{E * V * 2.22 \times 10^6 * Y * \exp(-\lambda \Delta t)}$$

Where:

- LLD = "a priori" lower limit of detection (microcuries per unit mass or volume)
- s_b = standard deviation of the background counting rate or of the counting rate of a blank sample as appropriate (counts per minute)
- E = counting efficiency (counts per disintegration)
- V = sample size (units of mass or volume)
- 2.22×10^6 = number of disintegrations per minute per microcurie
- Y = fractional radiochemical yield, when applicable
- λ = radioactive decay constant for the particular radionuclide (sec^{-1})
- Δt = elapsed time between the midpoint of sample collection and the time of counting (sec)

Typical values of E, V, Y, and Δt should be used in the calculation.

It should be recognized that the LLD is defined as an a priori (before the fact) limit representing the capability of a measurement system and not as a posteriori (after the fact) limit for a particular measurement.

- (2) Sampling and analyses shall also be performed following shutdown, startup, or a power change exceeding 15% of the maximum rated THERMAL POWER within a 1-hour period, when either:
- a. Analysis shows that DOSE EQUIVALENT I-131 concentration in reactor coolant has increased more than a factor of 3.
 - b. Noble gas monitor shows that effluent activity has increased more than a factor of 3.
- (3) Tritium grab samples shall be taken a least once per 24 hours when refueling canal is flooded.
- (4) Samples shall be changed at least once per seven days and analyses shall be completed within 48 hours after changing or after removal from sampler. Sampling shall also be performed at least once per 24 hours for at least seven days following each shutdown, startup or THERMAL POWER change exceeding 15% of maximum rated THERMAL POWER within a 1-hour period and analyses shall be completed within 48 hours of changing. When samples collected for 24 hours are analyzed, the corresponding LLD's may be increased by a factor of 10.
- This requirement only applies when either:
- a. Analysis shows that DOSE EQUIVALENT I-131 concentration in reactor coolant has increased more than a factor of 3.
 - b. Noble gas monitor shows that effluent activity has increased more than a factor of 3.
- (5) Tritium grab samples shall be taken at least once per seven days whenever spent fuel is in the spent fuel pool from the ventilation exhaust from the spent fuel pool area.
- (6) The ratio of the sample flow rate to the sampled stream flow rate shall be known for the time period covered by each dose or dose rate calculation made per attachments 6, 7, and 8.
- (7) LLD specification (1) above applies to principal gamma emitters including the following radionuclides: Kr-87, Kr-88, Xe-133, Xe-133m, Xe-135, and Xe-138 in noble gas releases and Mn-54, Fe-59, Co-58, Co-60, Zn-65, Mo-99, I-131, Cs-134, Cs-137, Ce-141, and Ce-144 in iodine and particulate releases. Not only these nuclides are to be considered. Other identifiable gamma peaks with those of the above nuclides shall also be analyzed and reported in the Annual Radioactive Effluent Release Report.
- If two or more redundant sample and analysis results from the same discharge pathway indicate slight differences in low level isotopic mixture, analysis resulting in higher calculated dose should be used. The isotopes chosen to represent the discharge shall be reported.
- (8) Grab samples shall be taken and analyzed at least once per 31 days whenever there is flow through the steam generator blowdown tank. Releases of radioiodines shall be estimated based on secondary coolant concentration and partitioning factors during releases or shall be measured.
- (9) Frequency Notation

<u>Notation</u>	<u>Frequency</u>	<u>Notation</u>	<u>Frequency</u>
W	At least once per 7 days	P	Completed prior to each release
M	At least once per 31 days	24H	At least once per 24 hours
Q	At least once per 52 days		

- (10) When the main condenser vacuum pump is operating and being used to evacuate the main condenser.

Dose - Noble Gases Operational Requirements

Attachment 7: Page 1 of 1

1. Dose - Noble Gases

a. Commitment for Operation

- 1) Air dose due to noble gases released in gaseous effluents from each unit to areas at or beyond the site boundary (see FSAR Figure 2.1-2) shall be limited to the following:
 - a) During any calendar quarter: Less than or equal to 5 mrad for gamma radiation and less than or equal to 10 mrad for beta radiation, and
 - b) During any calendar year: Less than or equal to 10 mrad for gamma radiation and less than or equal to 20 mrad for beta radiation.
- 2) Applicability: At all times.
- 3) Action
 - a) If the calculated air dose from radioactive noble gases in gaseous effluents exceeds any of the above limits, prepare and submit a special report per 10 CFR 50.4 to the Commission within 30 days that identifies the cause(s) for exceeding the limit(s), defines corrective actions that have been taken to reduce the releases and proposed corrective actions to be taken to assure that subsequent releases will be in compliance with the above limits.

b. Surveillance Requirements

- 1) Cumulative dose contributions for the current calendar quarter and current calendar year for noble gases shall be determined per ODCP methodology and parameters at least once per 31 days.

c. Bases

- 1) This Regulatory Commitment is provided to implement requirements of Sections II.B, III.A and IV.A of Appendix I, 10 CFR Part 50. The limiting condition for operation implements guidance set forth in Section II.B of Appendix I. The required actions provide operational flexibility and implement guidance set forth in Section IV.A of Appendix I to assure that releases of radioactive material in gaseous effluents to unrestricted areas will be kept as low as is reasonably achievable. The surveillance requirements above implement Section III.A of Appendix I requirements such that conformance with the Appendix I guidance will be shown by calculation procedures based on models and data chosen to ensure that the actual exposure of a member of the public through respective pathways is not likely to be substantially underestimated.
- 2) Dose calculation methodology and parameters established in the ODCP for calculating doses due to actual release rates of radioactive noble gases in gaseous effluents are consistent with methodology provided in RG 1.109, "Calculation of Annual Doses to Man from Routine Releases of Reactor Effluents for the Purpose of Evaluating Compliance with 10 CFR Part 50, Appendix I," Revision 1, October 1977 and RG 1.111, "Methods for Estimating Atmospheric Transport and Dispersion of Gaseous Effluents in Routine Releases from Light-Water-Cooled Reactors," Revision 1, July 1977. ODCP equations provided for determining the air doses at and beyond the site boundary are based upon historical average atmospheric conditions.
- 3) This Regulatory Commitment applies to the release of radioactive materials in gaseous effluents from each unit at the site. For units with shared radwaste treatment systems, the gaseous effluents from the shared system are proportioned among the units sharing the system.

**Iodine 131, Iodine 133, Tritium, and Radioactive
Material in Particulate Form**

Attachment 8: Page 1 of 2

1. Dose - Iodine-131, Iodine-133, Tritium, and Radioactive Material in Particulate Form
 - a. Commitment for Operation
 - 1) Dose to a member of the public from Iodine-131, Iodine-133, tritium and all radionuclides in particulate form with half-lives greater than eight days in gaseous effluents released from each unit to areas at and beyond the site boundary (see Figure 2.1-2) shall be limited to the following:
 - a) During any calendar quarter: Less than or equal to 7.5 mrem to any organ.
 - b) During any calendar year: Less than or equal to 15 mrem to any organ.
 - 2) Applicability: At all times.
 - 3) Action
 - a) If the calculated dose from airborne release of Iodine-131, Iodine-133, tritium, and radionuclides in particulate form with half-lives greater than eight days exceed any of the above limits, prepare and submit to the Commission within 30 days a special report per 10 CFR 50.4 that identifies cause(s) for exceeding limit(s), defines corrective actions that have been taken to reduce releases and proposed actions to be taken to ensure that subsequent releases will be in compliance with the above limits.
 - b. Surveillance Requirements
 - 1) Cumulative dose contributions for the current calendar quarter and current calendar year for Iodine-131, Iodine-133, tritium, and radionuclides in particulate form with half-lives greater than 8 days shall be determined per ODCP methodology and parameters at least once per 31 days.
 - c. Bases
 - 1) This Regulatory Commitment is provided to implement the requirements of Sections II.C, III.A, and IV.A of Appendix I, 10 CFR Part 50. The limiting conditions for operation are the guides set forth in Section II.C of Appendix I. The required actions support the necessary operational flexibility and implement guidance set forth in Section IV.A of Appendix I to ensure that releases of radioactive materials in gaseous effluents to unrestricted areas will be kept as low as is reasonably achievable. ODCP calculation methods specified in the surveillance requirements implement Section III.A of Appendix I so that conformance with guidance of Appendix I will be shown by calculation procedures based on models and data chosen to ensure that the actual exposure of a member of the public through respective pathways is not likely to be substantially underestimated.
 - 2) ODCP calculation methodology and parameters for calculating doses due to actual release rates of subject materials are consistent with methodology provided in RG 1.109, "Calculation of Annual Doses to Man from Routine Releases of Reactor Effluents for the Purpose of Evaluating Compliance with 10 CFR Part 50, Appendix I," Revision 1, October 1977 and RG 1.111, "Methods for Estimating Atmospheric Transport and Dispersion of Gaseous Effluents in Routine Releases from Light-Water-Cooled Reactors," Revision 1, July 1977. These equations also provide for determining actual doses based upon historical average atmospheric conditions.

**Iodine 131, Iodine 133, Tritium, and Radioactive
Material in Particulate Form**

Attachment 8: Page 2 of 2

- 3) Release rate specifications for Iodine-131, Iodine-133, tritium, and radionuclides in particulate form with half-lives greater than 8 days are dependent upon actual radionuclide pathways to man in areas at and beyond the site boundary. The pathways addressed for development of calculations were: (1) individual inhalation of airborne radionuclides, (2) deposition of radionuclides onto green leafy vegetation with subsequent consumption by man, (3) deposition onto grassy areas where milk animals and meat-producing animals graze with consumption of the milk and meat by man, and (4) deposition on the ground with subsequent exposure of man.
- 4) This Regulatory Commitment applies to release of radioactive materials in gaseous effluents from each unit at the site. For units with shared radwaste treatment systems, gaseous effluents from the shared system are proportioned among units sharing that system.

Gaseous Radwaste Treatment System Operational Requirements

Attachment 9: Page 1 of 1

1. Gaseous Radwaste Treatment System

a. Commitment for Operation

- 1) Gaseous radwaste treatment system and ventilation exhaust treatment system shall be OPERABLE. Appropriate portions of these systems shall be used to reduce releases of radioactivity when the projected doses in 31 days due to gaseous effluent releases, from each unit to areas at and beyond site boundary (see FSAR Figure 2.1-2) would exceed 0.2 mrad to air from gamma radiation or 0.4 mrad to air from beta radiation or 0.3 mrem to any organ of a member of the public.
- 2) Applicability: At all times.
- 3) Action
 - a) If radioactive gaseous waste is being discharged without treatment and is in excess of the above limits, prepare and submit a special report per 10 CFR 50.4 to the Commission within 30 days that includes the following information:
 - (1) Identification of inoperable equipment or subsystems and reason for inoperability.
 - (2) Action(s) taken to restore inoperable equipment to OPERABLE status.
 - (3) Summary description of action(s) taken to prevent a recurrence.

b. Surveillance Requirements

- 1) Doses due to gaseous releases from each unit to areas at and beyond the site boundary shall be projected at least once per 31 days per ODCP methodology and parameters.
- 2) Installed ventilation exhaust treatment system and gaseous radwaste treatment system shall be considered OPERABLE when they meet conditions identified in attachments 6, 7, or 8.

c. Bases

- 1) Operability of gaseous radwaste treatment system and ventilation exhaust treatment system ensures that systems will be available for use whenever gaseous effluents require treatment prior to release to the environment. Requirement that appropriate portions of these systems be used when specified provides reasonable assurance that releases of radioactive materials in gaseous effluents will be kept as low as is reasonably achievable. This specification implements requirements of 10 CFR 50.36a, General Design Criterion 60 of Appendix A to 10 CFR Part 50 and the design objectives given in Section II.D of Appendix I to 10 CFR Part 50. The specified limits governing use of appropriate portions of the systems were specified as a suitable fraction of Sections II.B and II.C of Appendix I, 10 CFR Part 50 dose design objectives for gaseous effluents.
- 2) This Regulatory Commitment applies to release of radioactive materials in gaseous effluents from each unit at the site. For units with shared radwaste treatment systems, gaseous effluents from shared system are proportioned among units sharing that system.

Total Dose Operational Requirements

Attachment 10: Page 1 of 2

1. Total Dose

a. Commitment for Operation

- 1) Annual (calendar year) dose or dose commitment to any member of the public due to releases of radioactivity and radiation from uranium fuel cycle sources shall be limited to less than or equal to 25 mrem to the whole body or any organ. An exception is the thyroid, for which which annual dose shall be limited to less than or equal to 75 mrem.
- 2) Applicability: At all times.
- 3) Action
 - a) If calculated doses from release of radioactive materials in liquid or gaseous effluents exceed twice the limits of attachments 4, 7, or 8, calculations shall be made including direct radiation contributions from the units and from outside storage tanks to determine whether the above limits of Attachment 10 have been exceeded. If those limits are exceeded, prepare and submit to the Commission within 30 days a special report per 10 CFR 50.4 that defines the corrective action(s) to be taken to reduce subsequent releases and prevent recurrence of exceeding the above limits and also includes the schedule for achieving conformance with the above limits.
 - b) The special report has been defined in 10 CFR 20.2203(a) and shall include an analysis that estimates radiation exposure (dose) to a member of the public from uranium fuel cycle sources including all effluent pathway and direct radiation for the calendar year that includes the release(s) covered by this report. It shall also describe levels of radiation and concentrations of radioactive material involved, and cause(s) of exposure levels or concentrations. If estimated dose(s) exceed the above limits, and if the release condition resulting in violation of 40 CFR Part 190 has not already been corrected, then the special report shall include a request for a variance per provisions of 40 CFR Part 190. Submittal of special report is considered a timely request, and a variance is granted until staff action on the request is complete.

b. Surveillance Requirements

- 1) Cumulative dose contributions from liquid and gaseous effluents shall be determined per attachments 4, 7, and 8 and per ODCP methodology and parameters.
- 2) Cumulative dose contributions from direct radiation from the units and from outside storage tanks shall be determined per ODCP methodology and parameters. This requirement is applicable only under conditions set forth in action a) of Attachment 10.

c. Bases

- 1) This Regulatory Commitment is provided to meet 40 CFR Part 190 dose limitations that have been incorporated into 10 CFR Part 20 by 46 FR 18525. The specification requires preparation and submittal of a special report whenever calculated doses due to releases of radioactivity and radiation from uranium fuel cycle sources exceed 25 mrem to whole body or any organ except the thyroid. Dose to thyroid shall be limited to less than or equal to 75 mrem.

- 2) For sites containing up to four reactors, it is highly unlikely that resultant dose to a member of the public will exceed 40 CFR Part 190 dose limits if the individual reactors remain within twice the dose design objectives of Appendix I and if direct radiation doses from the units and from outside storage tanks are kept small. When a special report is prepared, it should describe a course of action resulting in limitation of the annual dose to a member of the public to within the 40 CFR Part 190 limits. For purposes of the special report, it may be assumed that dose commitment to the member of the public from other uranium fuel cycle sources is negligible, with the exception that dose contribution from other nuclear fuel cycle facilities at the same site or within a radius of 8 km must be considered.
- 3) If dose to any member of the public is estimated to exceed 40 CFR Part 190 requirements, then the special report with a request for a variance per provisions of 40 CFR 190.11 and 10 CFR 20.2203(a) is considered to be a timely request and fulfills the requirements of 40 CFR Part 190 until NRC staff action is completed. To be applicable, release conditions resulting in violation of 40 CFR Part 190 must not have not already been corrected. The variance only relates to the 40 CFR Part 190 limits and does not apply in any way to the other requirements for dose limitation of 10 CFR Part 20 as addressed in attachments 3 and 6. An individual is not considered a member of the public during any period in which he or she is engaged in carrying out any operation that is part of the nuclear fuel cycle.

**Radiological Environmental Monitoring
Operational Requirements**

Attachment 11: Page 1 of 1

1. Radiological Environmental Monitoring

a. Commitment for Operation

1) The Radiological Environmental Monitoring Program shall be conducted as specified in RP1.ID11, "Environmental Radiological Monitoring Procedure."

2) Applicability: At all times.

3) Action

a) If plant effluents are confirmed to contain a level of radioactivity that results in an environmental sampling medium at a specified location exceeding the "Reporting Levels for Nonroutine Operating Reports" in RP1.ID11 when averaged over any calendar quarter, prepare and submit a nonroutine radiological environmental operating report per 10 CFR 50.4 to the Commission within 30 days from the end of the quarter that identifies cause(s) for exceeding the limit(s) and defines corrective actions to be taken to reduce radioactive effluents so that the potential annual dose to a member of the public is less than the calendar year limits of attachments 4, 7, or 8.

b) When initial results show a limit may have been exceeded, confirmatory reanalysis of the original or a duplicate sample, or analysis of a new sample may be desirable. The results of the confirmatory analysis shall be completed at the earliest time consistent with the analysis and within 30 days. When more than one of the radionuclides from "Reporting Levels for Nonroutine Operating Reports" in RP1.ID11 are detected and when the following condition is met, this report shall be submitted:

$$\frac{\text{concentration}(1)}{\text{reporting level}(1)} + \frac{\text{concentration}(2)}{\text{reporting level}(2)} + \dots \geq 1.0$$

c) When radionuclides other than those in the "Reporting Levels for Nonroutine Operating Reports" in RP1.ID11 are detected and are the result of plant effluents, then a nonroutine radiological environmental operating report shall be submitted if the potential annual dose to a member of the public from all radionuclides is equal to or greater than the calendar year limits of attachments 4, 7, or 8. This report shall include an evaluation of any release conditions, environmental factors, or other aspects necessary to explain the anomalous result.

1. Land Use Census

- a. A land use census shall be conducted as specified in RP1.ID11, "Environmental Radiological Monitoring Procedure" (ERMP).
 - 1) Applicability: At all times.
 - 2) Action:
 - a) If the land use census identifies a location(s) at which a calculated dose or dose commitment greater than the doses calculated per Attachment 8, identify that new location(s) in the next annual radioactive effluent release report (ARERR).
 - b) If the land use census identifies a location(s) at which a calculated dose or dose commitment (via the same exposure pathway) is 20% greater than at a location from which samples are currently being obtained per Attachment 11, add that new location(s) within 30 days to the radiological environmental monitoring program described in the ERMP. The sampling location(s) (excluding the control station location) that has the lowest calculated dose or dose commitment(s) for the same exposure pathway may be deleted from this monitoring program after October 31 of the year in which this land use census was conducted. Submit in the next ARERR this change in the ERMP including a revised figure(s) and table(s) for the ERMP reflecting the new location(s) with information supporting the change in sampling locations.

**High Alarm Setpoints - FB & CR Ventilation
Systems Actuation Instrumentation**

Attachment 13: Page 1 of 2

1. Fuel Building Ventilation System (FBVS) Instrumentation, RE-58 and RE-59
 - a. RE-58 Nominal Setpoint ≤ 75 mrem/hr
 - 1) Bases
 - a) Fuel Handling Accident in Fuel Handling Building
 - (1) The basis for the RE-58 high alarm setpoint is to initiate actions to mitigate offsite dose consequences from airborne releases resulting from a fuel handling accident in the spent fuel pool area. Routing ventilation exhaust from the spent fuel pool area through the charcoal filter to strip halogens (principally iodine isotopes) is implemented to mitigate off-site dose consequences. The rerouting of the ventilation occurs automatically with an RE-58 high alarm. Receipt of the high alarm also signals personnel to evacuate the area.
 - (2) PG&E performed Calculation J-172, "High and Alert Alarm NSP for RE-58 and RE-59" (9000042190), to base the monitor response of RE-58 on the airborne radioactivity concentration in the fuel handling building following a release of the gap activity. The calculation used the gap activity mix and annual average X/Q from the Alternative Source Term (AST) fuel handling accident analysis (WECTEC Calculation 14078104-C-M-00011, "Site Boundary and Control Room Doses Following a Fuel Handling Accident in Containment or Fuel Handling Building Using Alternative Source Terms", [SAP No. 6024616-11]). Calculation J-172 analyzed the monitor sensitivity to the nuclide mix in the gap for both 72 hours after shutdown (value conservatively used in the AST fuel handling accident analyses) and 100 hours after shutdown (the ECG 42.1 minimum time requirement for reactor subcriticality prior to movement of irradiated fuel assemblies).
 - (3) The high alarm setpoint eliminates spurious ESF actuation while limiting the off-site consequences due to this accident. A less than or equal to 75 mrem/hr setpoint equates to a site boundary whole body dose rate of less than 1.57 mrem/hr for the duration of the accident, which is less than the 10CFR20 limit of 2 mrem/hr.
 - b) Inadvertent Criticality in the Spent Fuel Pool
 - (1) The high density spent fuel pool racks were redesigned to ensure that a K_{eff} equal to or less than 0.95 is maintained with the racks fully loaded with fuel of the highest anticipated reactivity in each of two regions, and flooded with unborated water at a temperature corresponding to the highest reactivity. PG&E submitted PG&E Letter No. DCL-85-30, "Re-racking of Spent Fuel Pools," on September 19, 1985. The results of the criticality analysis for normal and abnormal operations were evaluated in this report. LAR 85-13 (PG&E Letter No. DCL-85-333) was submitted on October 30, 1985, and summarized the results of the Spent Fuel Pool re-racking report. Postulated events that could potentially involve accidental criticality were examined and it was concluded that the limiting value for criticality (K_{eff} of 0.95) would not be exceeded. Therefore, an inadvertent criticality in the spent fuel pool is not considered a credible accident and an evaluation of the effect of raising the actuation setpoint on RE-58 was not required.
 - (2) Radiation monitor RE-59, which monitors the new fuel storage vault area, also provides indication of inadvertent criticality and changes in dose rate for radiation protection purposes.

**High Alarm Setpoints - FB & CR Ventilation
Systems Actuation Instrumentation**

Attachment 13: Page 2 of 2

- b. RE-59 Nominal Setpoint $\leq 15\text{mrem/hr}$
 - 1) Bases
 - a) In DCPD FSAR update in Chapter 12, Table 12.1-1, "Plant Zone Classifications," the fuel handling building areas in which RE-59 is located is classified as Zone III, "Controlled Access Requiring Short-Term Occupancy" per Design Criteria Memorandum DCM-T20.
 - b) Zone III design maximum dose rate is $\leq 15\text{mrem/hr}$. If radiation flux reaches this value, a high alarm will be actuated and ventilation mode will change as indicated above for RE-58 high alarm actuation.
2. Control Room Ventilation System (CRVS) Instrumentation, RS-25A and RS-26A
 - a. RS-25A/RS-26A Nominal Setpoint $\leq 1\text{ mrem/hr}$
 - 1) Bases
 - a) Design basis fuel handling accident analyses credit the Control Room (CR) normal intake radiation monitors to initiate CR ventilation system Mode 4 (filtered and pressurized ventilation) upon detection of high radiation levels at the CR normal air intakes. Credit for this design feature ensures the CR dose criteria in GDC 19 are met.
 - b) Per WECTEC Calculation 14078104-C-M-00011, "Site Boundary and Control Room Doses following a Fuel Handling Accident in Containment or Fuel Handling Building Using Alternative Source Terms" (SAP No. 6024616-11), the fuel handling accident dose consequence analysis is based on an "analytical limit" of 1 mrem/hr for the gamma radiation environment at the CR normal operation air intakes to initiate CRVS Mode 4. The actual monitor trip setpoint is lower to account for instrument loop uncertainty.
3. All setpoints are controlled by CF6.ID1, "Setpoint Control Program," and require a design change vehicle (request per CF4.ID1) to change. Actual field setpoints are set more conservatively to account for instrument errors.

Attachment 2

**Diablo Canyon Power Plant Interdepartmental Administrative Procedure,
CY2.ID1, "Radioactive Effluent Controls Program,"
Revision 16**

Radioactive Effluent Controls Program

05/26/20
Effective Date

QUALITY RELATED

Table of Contents

1.	SCOPE.....	1
2.	DISCUSSION.....	2
3.	DEFINITIONS.....	3
4.	RESPONSIBILITIES.....	3
5.	INSTRUCTIONS.....	4
5.1	Administrative Requirements.....	4
5.2	Reporting Requirements.....	5
5.3	Major Changes to Liquid, Gaseous, and Solid Radwaste Treatment Systems.....	8
6.	RECORDS.....	9
7.	REFERENCES.....	9

ATTACHMENTS:

1.	Radioactive Liquid Effluent Monitoring Instrumentation Operational Requirements.....	11
2.	Radioactive Gaseous Effluent Monitoring Instrumentation Operational Requirements.....	14
3.	Liquid Effluents - Concentration Operational Requirements.....	17
4.	Liquid Effluents - Dose Operational Requirements.....	22
5.	Liquid Radwaste Treatment System Dose Operational Requirements.....	23
6.	Gaseous Effluents - Dose Rate Operational Requirements.....	24
7.	Dose - Noble Gases Operational Requirements.....	27
8.	Iodine 131, Iodine 133, Tritium, and Radioactive Material in Particulate Form.....	28
9.	Gaseous Radwaste Treatment System Operational Requirements.....	30
10.	Total Dose Operational Requirements.....	31
11.	Radiological Environmental Monitoring Operational Requirements.....	33
12.	Land Use Census Operational Requirements.....	34
13.	High Alarm Setpoints - FB & CR Ventilation Systems Actuation Instrumentation.....	35

1. SCOPE

- 1.1 This procedure states the requirements of the Radioactive Effluent Controls Program (RECP). The program implements the requirements of 10 CFR Part 20 and 10 CFR Part 50 Appendix I for Diablo Canyon.^{T34939}

11/11/11

11/11/11

11/11/11

11/11/11

11/11/11

11/11/11

11/11/11

11/11/11

11/11/11

2. DISCUSSION

- 2.1 This procedure identifies the general requirements of Diablo Canyon's Radioactive Effluent Controls Program. These requirements are defined per Technical Specifications and NRC Generic Letter 89-01.^{Ref 7.24}
- 2.2 The following requirements from Technical Specification Section 5.5.1 (TS 5.5.1) apply:
- 2.2.1 The Off-site Dose Calculation Manual (ODCM) identifies the methods and parameters used for:
- a. Calculation of off-site doses resulting from radioactive gaseous and liquid effluents.
 - b. Calculation of gaseous and liquid effluent monitoring alarm and trip setpoints.
 - c. Conducting the radiological environmental monitoring program.
- 2.2.2 The ODCM also identifies the following:
- a. Radioactive effluent controls.
 - b. Radiological environmental monitoring activities.
 - c. Description of the information to be included in the Annual Radiological Environmental Operating Report (AREOR, TS 5.6.2).
 - d. Description of the information to be included in the Annual Radioactive Effluent Release Report (ARERR, TS 5.6.3).

<p>NOTE: CAP A-8, "Off-Site Dose Calculations," provides guidance for specific methods and parameters used in the calculation of off-site doses resulting from discharge of radioactive gaseous and liquid effluents. CAP A-8 also provides guidance for calculation of gaseous and liquid effluent monitor alarm/trip setpoints. As such, CAP A-8 is incorporated into CY2.ID1 by reference.</p>
--

- 2.2.3 The Diablo Canyon ODCM is made up of the following procedures:
- CAP A-8, "Off-site Dose Calculations"
 - CY2.ID1, "Radioactive Effluent Controls Program"
 - RP1.ID11, "Environmental Radiological Monitoring Procedure"
 - CY2, "Radiological Monitoring and Controls Program"
- a. Changes to ODCM procedures are required to be processed per TS 5.5.1.

3. DEFINITIONS

- 3.1 Broadleaf Vegetation: The leafy portion of plants such as lettuce, cabbage, spinach, or other similar leafy plants, typically used for human consumption.
- 3.2 Supplemental Sample: Samples that should be collected when available, but when they are not available, they are not subject to the substitution requirements listed in Attachment 1. These types of samples are specifically designated as "supplemental" in Attachment 1.

4. RESPONSIBILITIES

- 4.1 Radiation protection manager is responsible for:
- 4.1.1 Ensuring implementation of this procedure
 - 4.1.2 Approving the Annual Radiological Environmental Operating Report (AREOR) prior to its submittal to the NRC.
- 4.2 REMP program owner is responsible for:
- 4.2.1 Identifying and evaluating the significant pathways of radiological impact to man and biota (e.g., food vectors, recreational use, water use) and subsequent updating of the REMP.
 - 4.2.2 Ensuring the performance of the annual LUC and that the results are provided to chemistry so that chemistry can establish the dose requirements of CY2.ID1, "Radioactive Effluent Controls Program."
 - 4.2.3 Preparing the DCGP AREOR and the HB ISFSI Environmental (Env) TLD Monitoring Report.
 - 4.2.4 Ensuring changes to the ERMP are provided to chemistry for inclusion in the Annual Radiological Effluent Release Report (ARERR).
 - 4.2.5 Ensuring required REMP sampling and monitoring are performed.
 - 4.2.6 Ensuring environmental TLD programs are maintained.
 - 4.2.7 Implementing and communicating contracts with the REMP environmental lab vendor.

Attachment 3

**Diablo Canyon Power Plant Interdepartmental Administrative Procedure,
RP1.ID11, "Environmental Radiological Monitoring Procedure,"
Revision 16**

Environmental Radiological Monitoring Procedure

02/26/19
Effective Date

QUALITY RELATED

Table of Contents

1.	SCOPE.....	1
2.	DISCUSSION	2
3.	DEFINITIONS	3
4.	RESPONSIBILITIES	3
5.	INSTRUCTIONS	5
6.	RECORDS.....	10
7.	REFERENCES	10

ATTACHMENTS:

1.	Radiological Environmental Monitoring Program Matrix.....	11
2.	Environmental Detection Capabilities/Lower Limits of Detection (LLD) Matrix.....	15
3.	Reporting Levels for Radioactivity Concentration in Env Samples Matrix.....	17
4.	Distances and Directions to REMP Monitoring Stations Matrix.....	18
5.	Summary of Split-Sampling Program with State of California Matrix	21
6.	DCPP Onsite REMP Stations	22
7.	DCPP Offsite REMP Stations	23
8.	DCPP Offsite GIS REMP Stations	24
9.	AREOR Radiological Monitoring Program Summary Matrix.....	25

1. SCOPE

- 1.1 This procedure constitutes the Diablo Canyon Power Plant (DCPP) Environmental Radiological Monitoring Procedure (ERMP) and implements the requirements of the DCPP Radiological Environmental Monitoring Program (REMP) for DCPP per Technical Specification 5.5.1, 5.6.2, and the DCPP Independent Spent Fuel Storage Installation (ISFSI) Environmental Report, Section 6.2. This procedure is part of the DCPP Offsite Dose Calculation Manual (ODCM).
- 1.2 The Humboldt Bay (HB) ISFSI Environmental Thermoluminescent Dosimeter (TLD) monitoring and results are part of the HB ISFSI Technical Specification 5.1.2 requirement to provide monitoring in support of the requirements of 10CFR72.44(d)(2) and 10CFR72.126(c)(2). HB ISFSI radiological expertise and support are provided by the DCPP Radiation Protection Manager (RPM) and DCPP RP Department staff.
- 1.3 This procedure does not implement the administrative requirements for DCPP ground water protection. Refer to RP1.ID13, "DCPP Ground Water Protection Initiative (GPI) Program."
- 1.4 Changes to this procedure are processed per the requirements of DCPP Technical Specification Section 5.5.1.

2. DISCUSSION

- 2.1 The purpose of a REMP is to provide a basis for evaluating concentrations of radioactive materials and radiation levels in the environment from radiological releases once a reactor is operational.
- 2.2 This procedure describes the supplemental and minimum required program, including:
- Sample locations
 - Types of sample locations
 - Methods and frequency of analysis
 - Reporting requirements
 - Performance of land use census (LUC)
 - Participation in an interlaboratory comparison program
- 2.3 This procedure contains the state of California Department of Public Health (CDPH) split-sampling program.
- 2.4 The program described by this procedure provides measurements of radiation and of radioactive materials in those exposure pathways and for those nuclides that lead to the highest potential radiation exposures of members of the public resulting from plant operation.
- 2.4.1 This monitoring program implements section IV.B.2, IV.B.3, and IV.C of Appendix I to 10 CFR 50 and supplements the Radioactive Effluent Control Program.
- a. Guidance for this monitoring program is provided by the Radiological Assessment Branch Technical Position on Radiological Environmental Monitoring, revision 1, November, 1979. Due to DCPD site characteristics, some program requirements may vary from the Branch Technical Position on REMP (BTP 1979).
- 2.5 The Diablo Canyon ODCM is made up of the following procedures:
- 2.5.1 CY2, "Radiological Monitoring and Controls Program"
- 2.5.2 CY2.ID1, "Radioactive Effluent Controls Program"
- 2.5.3 RP1.ID11, "Environmental Radiological Monitoring Procedure"
- 2.5.4 CAP A-8, "Off-Site Dose Calculation Procedure"

-
- 4.2.8 Ensuring personnel responsible for the management and implementation of the DCPD REMP receive training on the changes to the REMP at least annually.
- a. Training consists of topics related to the changes in the plant's REMP procedures, industry events, any changes in technology that pertain to REMP sampling techniques or to the analysis of REMP samples and the nature and goals of the quality assurance program.
 - b. Proficiency of personnel who perform activities affecting the quality of the REMP may be maintained by retraining, reexamining, recertifying, or by periodic performance reviews as appropriate.
 - c. Initial training is provided on an as needed basis to new personnel responsible for quality related REMP activities.
- 4.3 REMP environmental lab vendor is responsible for:
- 4.3.1 Ensuring analysis is performed for the samples as required by the ERMP.
 - 4.3.2 Ensuring participation is maintained in an interlaboratory comparison program sufficient to satisfy step 5.3.1.
 - 4.3.3 Ensuring REMP sample results exceeding the criteria in Attachment 3 are communicated promptly to DCPD as per the contract.
 - 4.3.4 Ensuring communication with DCPD per the contract. Examples include:
 - Sample results not meeting the contract "a-priori" LLDs
 - Exceeding contract notification levels
 - Problems with lab REMP sample analyses
 - Problems with sample shipments
 - Interlaboratory comparison program issues
 - 4.3.5 Ensuring appropriate procedures are established and maintained for sample handling, sample analysis and all associated laboratory equipment.
 - 4.3.6 Ensuring qualifications and training of vendor lab personnel.
 - 4.3.7 Ensuring contract compliance.
- 4.4 DCPD licensing department is responsible for ensuring reports required by the ERMP are submitted to the appropriate recipients per XI1.ID2, "Regulatory Reporting Requirements and Reporting Process."

5. INSTRUCTIONS

5.1 Sampling and Monitoring^{T04341}

<p>NOTE: Sampling procedures for the REMP pathways and old steam generator storage facility (OSGSF) sump monitoring are controlled in the DCCP plant manual, Volume 7, "Radiation Protection-Radiation Control Procedures," "RCP EM" series of procedures.</p>

- 5.1.1 Environmental samples shall be collected and analyzed per Attachment 1 at the locations shown in attachments 4, 6, and 7.^{T35263}
- Analytical techniques used shall be such that the detection capabilities in Attachment 2 are routinely achieved.
 - Sampling frequencies specified in Attachment 1 may be allowed an extension of 25 percent (NUREG 1301, Page 16, Section 4.0.2).
- 5.1.2 The OSGSF inspection sumps shall be monitored quarterly to ensure there is no standing water in the sumps. If water is found.^{Ref 7.3.3}
- Initiate the corrective action process.
 - Perform isotopic analysis for plant related isotopes.
 - Disposition the water per plant protocols.
- 5.2 Land Use Census
- 5.2.1 The LUC satisfies the requirements of Section IV.B.3 of Appendix I to 10 CFR 50.
- Restricting the census to gardens of greater than 500 square feet provides assurance that significant exposure pathways via broadleaf vegetation will be identified and monitored as necessary.
 - The size of the garden is the minimum to produce the quantity of 26 kg/year of broadleaf assumed in Regulatory Guide 1.109 for consumption by a child.

-
- 5.2.2 A DCPD LUC shall be conducted at least once per year, during the growing season between February 15 and December 1.
- 5.2.3 The LUC shall determine the locations in each of the 16 meteorological sectors within a distance of 8 km (5 mi) for:^{Ref 7.3.1}
- a. The nearest milk animal.
 - b. The nearest residence.
 - c. The nearest garden of greater than 50 square meters (500 sq. ft.) producing broadleaf vegetation.
 1. Broadleaf vegetation sampling may be performed at the site boundary in a sector with the highest D/Q in lieu of the garden census portion of the LUC.
- 5.2.4 The LUC shall be conducted using that information which will provide the best results, which typically consists of discussions with landowners/tenants in conjunction with an aerial survey. Local agricultural authorities may also be consulted.
- 5.2.5 If the LUC identifies a location(s) that yields a calculated dose or dose commitment greater than the values currently being calculated per CY2.ID1, the new location(s) shall be identified in the next Annual Radioactive Effluent Release Report.
- 5.2.6 If the LUC identifies a location(s) that yields a calculated dose or dose commitment (via the same exposure pathway) 20 percent greater than at a location from which samples are currently being obtained per CY2.ID1, add the new location(s) within 30 days to the REMP given in this ERMP.
- a. Sampling location(s), excluding the control station location, having the lowest calculated dose or dose commitment(s), via the same exposure pathway, may be deleted from this monitoring program after October 31 of the year in which this LUC was conducted.
 - b. Documentation for a change in the ERMP shall be submitted in the next Annual Radioactive Effluent Release Report including a revised map(s) and table(s) for the ERMP reflecting the new location(s) with information supporting the change in sampling locations.
- 5.2.7 If the LUC identifies full time residency changes to a member-of-public within one mile of the site boundary, evaluate the potential impact on the NFPA 805 radioactive release calculations 9000041956 (M-1176A) and 9000041957 (M-1176B).

5.3 Cross-Check Programs

- 5.3.1 Participation in an interlaboratory comparison program shall be maintained.
- a. Participation should include each of the determinations (sample medium-radionuclide combination) as described in Attachment 1 to ensure independent checks on the precision and accuracy of the measurements of radioactive materials in the ERMP samples.
- 5.3.2 Participation in a split-sampling program with the State of California Department of Public Health (CDPH) as required by CDPH shall be maintained.
- a. Program consists of radiological analyses of duplicate (split) samples or replicate analyses of the same sample by both the REMP environmental lab vendor and CDPH.
 - b. Sample results from the REMP environmental lab vendor are available to CDPH in the AREOR or as requested by CDPH.
 - c. Sample types, analyses performed, and frequencies of collection are given in Attachment 5.

5.4 Annual Radiological Environmental Operating Report

- 5.4.1 An AREOR on the REMP shall be prepared annually and submitted to the NRC prior to May 1 of the following year per DCPD Tech Spec 5.6.2.
- 5.4.2 DCPD AREOR shall include:
- a. Summaries, interpretations, and an analysis of trends of the results of the REMP activities for the report period.
 - b. Comparison with preoperational studies, operational controls (as appropriate), and previous environmental surveillance reports.
 - c. Assessment of the observed impacts of the plant operation on the environment.
 - d. Results of the DCPD LUC.
 - e. Results of analyses of all radiological environmental samples and of all environmental radiation measurements taken during the period pursuant to the locations specified in tables and map(s) in this ERMP as well as summarized and tabulated results of these analyses and measurements in the format of Attachment 9 or equivalent.
 - f. Summary description of the REMP.
 - g. Legible maps covering all sampling locations keyed to a table giving distances and directions from the centerline of Unit One Reactor.

-
- h. Results of licensee or REMP analysis lab vendor participation in the interlaboratory comparison program and the corrective action taken if the specified program is not being performed as required.
 - i. Reason for not conducting the REMP as required, and discussion of all deviations from the sampling schedule of Attachment 1, including plans for preventing a recurrence.
 - j. Discussion of environmental sample measurements that exceed the reporting levels given in Attachment 3, but are not the result of plant effluents (i.e., demonstrated by comparison with a control station or with preoperational data).
 - k. Discussion of all analyses in which the LLD required by Attachment 2 was not achievable.
 - l. Signature approval of the AREOR by the DCPP RPM.
 - m. Results of the OSGSF quarterly sump monitoring for standing water in vault sumps. Report plant related isotopic activity detected and disposition of water.^{Ref 7.3.3}
 - n. Combined percent availability of REMP air samplers. This is done by reporting the percentage of actual runtime (as compared to available runtime) during the year for all REMP air samplers as a combined percentage.^{T31239}
 - o. Routine ground water radiological monitoring as performed for the industry NEI Ground Water Protection Initiative 07-07 (GPI):

5.4.3 The DCPP AREOR shall be distributed to the following agencies.^{Ref 7.3.2}

NOTE: The May 1st deadline for submittal applies to the NRC only.

- Nuclear Regulatory Commission (NRC)
- Chief, Radiological Health Branch, CA Dept of Public Health (CDPH)
- Executive Officer, Regional Water Quality Control Board, Central Coast
- Executive Officer, San Luis Obispo County Air Pollution Control District
- San Luis Obispo County Health Officer (Environmental Health Dept)

5.4.4 The HB ISFSI Radiation Protection (RP) Program is implemented by DCPP RP department staff.

- a. HB ISFSI Env TLD monitoring results shall be reported annually to the NRC.
- b. HB ISFSI Env TLD report should be a separate report from the DCPP AREOR.

5.5 Nonroutine Reports

5.5.1 Supplementary Report

- a. In the event some results are not available for inclusion with the report, the report shall be submitted noting and explaining the reasons for the missing results.
 1. Missing data shall be submitted as soon as possible in a supplementary report.

5.5.2 Nonroutine Radiological Environmental Operating Report

- a. If a measured radionuclide concentration resulting from plant effluents in an environmental sampling medium, averaged over any calendar quarter sampling period, exceeds the reporting level given in Attachment 3, or when radionuclides other than those in Attachment 3 are detected and are the result of plant effluents where the potential annual dose to a member of the public from all radionuclides is equal to or greater than the calendar year limits of Appendix I of 10 CFR 50, a nonroutine radiological environmental operating report shall be prepared per CY2.ID1.
 1. This report is not required if the measured level of radioactivity was not the result of plant effluents, however, in such an event, the condition shall be reported and described in the AREOR.

5.6 ERMP Changes^{T02694}

5.6.1 Notification of Sample Unavailability

<p>NOTE: The currently approved ERMP allows for substitution of milk and broadleaf vegetation sampling with additional air sampling in two sectors.</p>
--

- a. If milk or vegetation sampling is not being performed as required by Attachment 1, identify specific locations for obtaining replacement samples and add them within 30 days to the REMP given in the ERMP.
 1. Specific locations from which samples were unavailable may then be deleted from the monitoring program.
 2. Submit in the next Annual Radioactive Effluent Release Report documentation for a change in the ERMP including revised map(s) and table for the ERMP reflecting the new location(s) with supporting information identifying the cause of the unavailability of samples and justifying the selection of the new location(s) for obtaining samples.

6. RECORDS

- 6.1 Performance of the LUC shall be documented, including as a minimum the names of persons contacted and dates of contact. This documentation does not need to appear in the required reports, but should be entered into the records management system (RMS) per AD10.ID1, "Storage and Control of Quality Assurance Records."
- 6.2 Changes to the ERMP shall be retained in RMS per AD10.ID1, "Storage and Control of Quality Assurance Records."
- 6.3 REMP training shall be documented and recorded per plant protocols. Training records shall also be placed in RMS per AD10.ID1.

7. REFERENCES

- 7.1 Facilities and Environmental Standards, Radiologic Health Branch, Letter dated March 9, 1984
- 7.2 HBI-200, Humboldt Bay "ISFSI Conduct of Radiation Protection"
- 7.3 Corrective Actions:
 - 7.3.1 A0565194, "Request DCPD Biologist or Cal Poly AG Define Growing Season"
 - 7.3.2 A0619597, "Inconsistencies or Improvements to RP1.ID11"
 - 7.3.3 A0719469, "Establish Quarterly Monitoring of OSGSF"
 - 7.3.4 SAPN 50032742, "REMP Audit Dates and Numbers, Important Document Locations"

**Radiological Environmental Monitoring Program
Matrix**

Attachment 1: Page 1 of 4

Exposure Pathway and/or Sample Type	Number of Representative Samples and Sample Locations ¹	Sampling Stations	Collection Frequency	Type of Analysis	Required or Supplemental
1. Direct Radiation ²	Thirty-two routine monitoring stations containing thermo luminescent dosimeters (TLDs) such that at least two (2) phosphors are present at each station, placed as follows:				
	An inner ring of stations, one in each terrestrial meteorological sector in the general area of the SITE BOUNDARY;	0S1, 0S2, WN1, 1S1, 2S1, 3S1, 4S1, 5S1, 5S3, 6S1, 7S1, 8S1, 8S2, 9S1, and MT1	Quarterly	Gamma Dose	Required
	An outer ring of stations, one in each terrestrial meteorological sector in the 2.5 to 14 km range from the site; and	0B1, 1A1, 1C1, 2D1, 3D1, 4C1, 5C1, 6D1, and 7C1	Quarterly	Gamma Dose	Required
	One or two areas to serve as control stations; and	2F2, 4D1, 5F1	Quarterly	Gamma Dose	Required
	The balance of the stations to be placed in special interest areas such as population centers, nearby residences, or schools.	5F3, 7D1, 7D2, 7F1, and 7G2	Quarterly	Gamma Dose	Required
	A minimum of four stations around the ISFSI.	IS1, IS2, IS3, IS4, IS5, IS6, IS7, IS8	Quarterly	Gamma Dose	Required
2. Airborne Radioiodine	Samples from ≥ 4 stations: Three samples from close to the three SITE BOUNDARY locations (0S2, 8S1, & MT1) in different sectors. One sample from the vicinity of a community having the highest calculated annual average ground level D/Q (7D1).	0S2, 8S1, MT1, 7D1 5F1 (control)	Continuous sampler operation with sample collection weekly or more frequently if required by dust loading.	I-131 analysis	Required
	If food products are unavailable, additional air sampling will be done in the NNW (station 1S1) and SE (Station 8S2) sectors.	1S1 & 8S2	Continuous sampler operation with sample collection weekly or more frequently if required by dust loading.	I-131 analysis	Required
3. Airborne Particulate	Samples from ≥ 4 stations: Three samples from close to the three SITE BOUNDARY locations (0S2, 8S1, & MT1) in different sectors. One sample from the vicinity of a community having the highest calculated annual average ground level D/Q (7D1).	0S2, 8S1, MT1, 7D1 5F1 (control)	Continuous sampler operation with sample collection weekly or more frequently if required by dust loading.	Weekly gross beta radioactivity analysis following filter change ³ . Quarterly gamma isotopic analysis ⁴ of composite consisting of approx 12 filters (by location).	Required

**Radiological Environmental Monitoring Program
Matrix**

Attachment 1: Page 2 of 4

Exposure Pathway and/or Sample Type	Number of Representative Samples and Sample Locations ¹	Sampling Stations	Collection Frequency	Type of Analysis	Required or Supplemental
3. Airborne Particulate (continued)	If food products are unavailable, additional air sampling will be done in the NNW (station 1S1) and SE (Station 8S2) sectors.	1S1 & 8S2	Continuous sampler operation with sample collection weekly or more frequently if required by dust loading.	Weekly gross beta radioactivity analysis following filter change ³ . Quarterly gamma isotopic analysis ⁴ of composite consisting of approx 12 filters (by location).	Required
4. Airborne Carbon-14	Samples from 3 stations: One sample from each of the NW and SE sectors close to the site (0S2 and 8S1). One sample used as a control station (5F1).	0S2, 8S1 5F1 (control)	Continuous sampler operation with sample collection weekly or more frequently if required by dust loading.	C-14 analysis	Supplemental
5. Waterborne					
a. Surface Ocean Water	One sample from the plant Outfall, Diablo Cove, and an area not influenced by plant discharge.	OUT, DCM, and 7C2	Monthly (grab sample)	Gamma isotopic ⁴ and tritium analysis.	Required
	One sample from the plant Outfall, Diablo Cove, and an area not influenced by plant discharge.	OUT, DCM, and 7C2	Quarterly (grab sample)	Gross Beta, Total Sr 89/90, Fe-55, and Ni-63	Supplemental
b. Drinking Water	One sample from the plant drinking water, one sample from Diablo Creek (upstream of plant), and one control sample.	DW1 and 5S2; OEL (control)	Monthly (grab sample)	Gamma isotopic ⁴ , I-131, and tritium analysis.	Required
	One sample from the plant drinking water, one sample from Diablo Creek (upstream of plant), and one control sample.	DW1 and 5S2; OEL (control)	Quarterly (grab sample)	Gross Beta, Total Sr 89/90, Fe-55, and Ni-63	Supplemental
	One sample from Diablo Creek (downstream of plant) and one sample from Blanchard Spring.	WN2 and 1A2	Quarterly (grab sample)	Gamma isotopic ⁴ , tritium, I-131, gross beta, Total Sr 89/90, Fe-55, and Ni-63	Supplemental
c. Ground Water	One sample from wells located under or downgradient from the plant power block.	OW1, OW2, GW1, and GW2	Quarterly (grab sample, when available)	Gamma isotopic ⁴ , tritium, gross beta, Total Sr 89/90, Fe-55, and Ni-63	Supplemental
	One sample from a well located outside the plant power block (control sample).	WW2, 8S3	Quarterly (grab sample, when available)	Gamma isotopic ⁴ , tritium, gross beta, Total Sr 89/90, Fe-55, and Ni-63	Supplemental

Radiological Environmental Monitoring Program
Matrix

Attachment 1: Page 3 of 4

Exposure Pathway and/or Sample Type	Number of Representative Samples and Sample Locations ¹	Sampling Stations	Collection Frequency	Type of Analysis	Required or Supplemental
d. Sediment	One sample of offshore ocean sediment from Diablo Cove and Rattlesnake Canyon.	DCM and 7C2	Annual (grab sample)	Gamma isotopic ⁴	Required
	One sample of offshore ocean sediment from Diablo Cove and Rattlesnake Canyon.	DCM and 7C2	Annual (grab sample)	Total Sr 89/90, Fe-55, and Ni-63	Supplemental
	One sample from each of five local recreational beaches.	AVA, MDO, PMO, CYA, and CBA	Semi- Annual (grab sample)	Gamma isotopic ⁴ , Total Sr 89/90, Fe-55, and Ni-63	Supplemental
e. Marine Flora	One sample of kelp	DCM, PON, POS, and 7C2	Quarterly (when available)	Gamma isotopic ⁴	Supplemental
	One sample of intertidal algae	DCM and 7C2	Quarterly (when available)	Gamma isotopic ⁴	Supplemental
6. Ingestion					
a. Milk	Samples from milking animals in three locations within 5 km distance having the highest dose potential. If there are none, then one sample from milking animals in each of three areas between 5 to 8 km distance where doses are calculated to be greater than 1 mrem per year. One sample from milking animals at a control location 15 to 30 km distant and in the least prevalent wind direction. NOTE: The sample (5F2) should be taken monthly even if there are no indicator samples available.	5F2	Semimonthly when animals are on pasture; monthly at other times.	Gamma isotopic ⁴ and I-131 analysis.	Supplemental
b. Fish and Invertebrates	One sample of rock fish (family Sebastes) and one sample of perch (family Embiotocidae)	DCM and 7C2	Quarterly (grab sample)	Gamma isotopic ⁴ analysis on edible portions of each sample.	Required
	One sample of rock fish (family Sebastes) and one sample of perch (family Embiotocidae)	PON and POS	Quarterly (grab sample)	Gamma isotopic ⁴ analysis on edible portions of each sample.	Supplemental
	One sample of mussel (family Mytilus)	DCM and 7C2	Quarterly (grab sample)	Gamma isotopic ⁴ analysis on edible portions of each sample.	Required
	One sample of mussel (family Mytilus)	PON	Annual (A0584392) (grab sample)	Gamma isotopic ⁴ analysis on edible portions of each sample.	Supplemental
	One sample of mussel (family Mytilus)	POS	Quarterly (grab sample)	Gamma isotopic ⁴ analysis on edible portions of each sample.	Supplemental

**Radiological Environmental Monitoring Program
Matrix**

Attachment 1: Page 4 of 4

Exposure Pathway and/or Sample Type	Number of Representative Samples and Sample Locations ¹	Sampling Stations	Collection Frequency	Type of Analysis	Required or Supplemental
Fish and Invertebrates (continued)	One sample of locally harvested market fish.	7D3 or 2F1 (should alternate between locations)	Quarterly (grab sample)	Gamma isotopic ⁴ analysis on edible portions of each sample.	Supplemental
c. Broadleaf Vegetation ⁵	Three samples of broadleaf vegetation grown nearest off-site locations of highest calculated annual average ground level D/Q IF milk sampling is not performed.		Monthly (when available)	Gamma isotopic ⁴ analysis (that includes I-131) on edible portion.	Required (see notation #5)
	One sample of each of the similar broadleaf vegetation grown 15 to 30 km distant in the least prevalent wind direction IF milk sampling is not performed.		Monthly (when available)	Gamma isotopic ⁴ analysis (that includes I-131) on edible portion.	Required (see notation #5)
d. Vegetative Crops	One sample of broadleaf vegetation or vegetables or fruit.	5F2, 7C1, and 7G1	Monthly (when available)	Gamma isotopic ⁴ analysis on edible portion.	Supplemental
	One sample of broadleaf vegetation or vegetables or fruit.	3C1, 6C1, and 7E1	Quarterly (as provided by land owner)	Gamma isotopic ⁴ analysis on edible portion.	Supplemental
e. Meat	One sample of each species (cow, goat, sheep, deer, or pig) of edible meat portion slaughtered for personal consumption (not mass market).	BCM, BGM, BSM, JDM, JPM, ACM, ADM, APM	Quarterly (when available and provided by land owners within 8 km of plant site)	Gamma isotopic ⁴ analysis, and Total Sr 89/90 on edible portion.	Supplemental

- ¹ Deviations are permitted from the required sampling schedule if specimens are unobtainable due to circumstances such as hazardous conditions, seasonal unavailability, malfunction of automatic sampling equipment and other legitimate reasons. If specimens are unobtainable due to sampling equipment malfunction, effort shall be made to complete corrective action prior to the end of the next sampling period. All deviations from the sampling schedule shall be documented in the AREOR. It is recognized that, at times, it may not be possible or practicable to continue to obtain samples of the media of choice at the most desired location or time. In these instances, suitable specific alternative media and locations may be chosen for the particular pathway in question and appropriate substitutions made within 30 days in the REMP, and submitted in the next Annual Radioactive Effluent Release Report, including a revised map(s) and table for the ERMP reflecting the new location(s) with supporting information identifying the cause of the unavailability of samples for that pathway and justifying the selection of the new location(s) for obtaining samples.
- ² For the purposes of this table, a thermoluminescent dosimeter (TLD) is considered to be one phosphor. There are normally three calcium sulfate phosphors in an environmental TLD BADGE. Film badges shall not be used as dosimeters for measuring direct radiation. The DCP E-Plan is committed to placement of three TLD badges each quarter at each REMP TLD location to allow for monthly readout in case of an event.
- ³ Airborne particulate sample filters shall be analyzed for gross beta radioactivity 24 hours or more after sampling to allow for radon and thoron daughter decay. If gross beta activity in air particulate samples is greater than 10 times the yearly mean of control samples, gamma isotopic analysis shall be performed on the individual samples.
- ⁴ Gamma isotopic analysis means the identification and quantification of gamma-emitting radionuclides that may be attributable to the effluents from the facility.
- ⁵ If broadleaf vegetation food products are unavailable, additional air sampling as specified in Attachment 1, Parts 2 & 3 will be done in the NNW (Station 1S1) and SE (Station 8S2) sectors.

Note: The Branch Technical Position (Nov 79) states, "Any location from which milk can no longer be obtained may be dropped from the surveillance program after notifying the NRC in writing that they are no longer obtainable at that location". Although the milk sampling performed at 5F2 is outside the 5-mile radius and is supplemental to the REMP, this notification should take place if 5F2 milk sampling ceases.

Environmental Detection Capabilities/Lower
Limits of Detection (LLD) Matrix

Attachment 2: Page 1 of 2

NOTE 1: The gamma emitters and corresponding LLD values listed are derived from standard ODCM guidance for environmental samples as found in NUREG-1301, Table 4.12-1. This list does not mean that only these nuclides are to be considered. Other peaks that are identifiable, together with those of the following nuclides, are also analyzed and reported in the AREOR.

NOTE 2: Required detection capabilities for thermoluminescent dosimeters used for environmental measurements are per the recommendations of ANSI/HPS N13.37.

NOTE 3: The LLD is defined, for purposes of these specifications, as the a-priori analysis "process" that will yield a net count, above system background, that will be detected with 95 percent probability with only 5 percent probability of falsely concluding that a blank observation represents a "real" signal for the following concentration of radioactive material in a sample.

Analysis	Water (pCi/L)	Airborne Particulate or Gases (pCi/m ³)	Fish (pCi/kg, wet)	Milk (pCi/L)	Food Products (pCi/kg, wet)	Soil/Sediment (pCi/kg, dry) ^{N3}
Gross beta	4	0.01				
H-3	400 ^{N1}					11,000
Mn-54	15		130			150
Fe-59	30		260			300
Co-58	15		130			150
Co-60	15		130			150
Zn-65	30		260			300
Zr-95	30					300
Nb-95	15					150
I-131	1 ^{N2}	0.07		1	60	
Cs-134	15	0.05	130	15	60	150
Cs-137	18	0.06	150	18	80	180
Ba-140	60			60		600
La-140	15			15		150

^{N1} If no drinking water pathway exists, a value of 3,000 pCi/L may be used for tritium. All ground water wells should use the 400 pCi/L tritium value regardless of drinking water use.

^{N2} The LLD value of 1 pCi/L for I-131 is applicable only to sources used as drinking water. If no drinking water pathway exists, a value of 15 pCi/L may be used for I-131.

^{N3} The gamma emitters LLD values listed are derived from the Cs-134/137 10:1 ratio established in the environmental LLDs in NUREG-1301, Table 4.12-1.

Environmental Detection Capabilities/Lower
Limits of Detection (LLD) Matrix

Attachment 2: Page 2 of 2

1. For a particular measurement system, which may include radiochemical separation:

$$LLD = \frac{4.66s_b}{E \times V \times 2.22 \times Y \times \exp(-\lambda t)}$$

Where:

- LLD = the "a priori" the lower limit of detection as defined above (as pCi per unit mass or volume)
- S_b = the standard deviation of the background counting rate or of the counting rate of a blank sample as appropriate (as counts per minute)
- E = the counting efficiency (as counts per disintegration)
- V = the sample size (in units of mass or volume)
- 2.22 = the number of disintegrations per minute per picocurie
- Y = the fractional radiochemical yield (when applicable)
- λ = the radioactive decay constant for the particular radionuclide
- t = the elapsed time between sample collection (or end of the sample collection period) and time of counting
2. The value of S_b used in the calculation of the LLD for a detection system is based on the actual observed variance of the background counting rate or of the counting rate of the blank samples (as appropriate) rather than on an unverified theoretically predicted variance. In calculating the LLD for a radionuclide determined by gamma-ray spectrometry, the background includes the typical contributions of other radionuclides normally present in the samples (e.g., potassium-40 in milk samples).
 3. Analyses is performed in such a manner that the stated LLDs is achieved under routine conditions. Occasionally background fluctuations, unavoidably small sample sizes, the presence of interfering nuclides, or other uncontrollable circumstances may render these LLDs unachievable. In such cases, the contributing factors are identified and described in the AREOR.
 4. Use typical values of E, V, Y and t in the calculation. Recognize that the LLD is defined as a-priori (before the fact) limit representing the capability of a measurement system and not as a-posteriori (after the fact) limit for a particular measurement.

**Reporting Levels for Radioactivity Concentration
in Env Samples Matrix**

Attachment 3: Page 1 of 1

Analysis	Water (pCi/L)	Airborne Particulate or Gases (pCi/m ³)	Fish (pCi/kg, wet)	Milk (pCi/L)	Food Products (pCi/kg, wet)
H-3	20,000 ^{N1}				
Mn-54	1,000		30,000		
Fe-59	400		10,000		
Co-58	1,000		30,000		
Co-60	300		10,000		
Zn-65	300		20,000		
Zr-Nb-95	400				
I-131	2 ^{N2}	0.9		3	100
Cs-134	30	10	1,000	60	1,000
Cs-137	50	20	2,000	70	2,000
Ba-La-140	200			300	

^{N1} For drinking water samples. This is the 40 CFR 141 value. If no drinking water pathway exists, a value of 30,000 pCi/L may be used.

^{N2} If no drinking water pathway exists, a value of 20 pCi/L may be used.

**Distances and Directions to REMP Monitoring
Stations Matrix**

Attachment 4: Page 1 of 3

Station Code*	Station Name	Radial Direction (True Heading) (Degrees)	Radial Distance from Plant	
			Km	(Miles)
0S1	Exclusion Fence-Northwest Corner	320	0.16	(0.1)
0S2	North Gate	320	0.8	(0.5)
1S1	Wastewater Pond	330	0.64	(0.4)
2S1	Back Road-300 m North of Plant	0	0.32	(0.2)
3S1	Road NW of 230 kV Switchyard	23	0.64	(0.4)
4S1	Back Road Between Switchyards	43	0.8	(0.5)
5S1	500 kV Switchyard	58	0.64	(0.4)
5S2	Diablo Creek Weir	65	0.96	(0.6)
5S3	Microwave Tower Road	70	1.02	(0.7)
6S1	Microwave Tower	94	0.8	(0.5)
7S1	Overlook Road	112	0.48	(0.3)
8S1	Target Range	125	0.8	(0.5)
8S2	Southwest Site Boundary	128	1.76	(1.1)
8S3	DCSF96-1 (monitor well)	140	0.64	(0.4)
9S1	South Cove	167	0.64	(0.4)
MT1	Meteorological Tower	185	0.32	(0.2)
DCM	Diablo Cove Marine	249	0.44	(0.27)
WN1	Northwest Guard Shack	290	0.32	(0.2)
WN2	Diablo Creek Outlet	283	0.25	(0.15)
1A1	Crowbar Canyon	327	2.56	(1.6)
1A2	Blanchard Spring	331	2.4	(1.5)
0B1	Point Buchon	325	5.76	(3.6)
1C1	Montana de Oro Campground	336	7.52	(4.7)
3C1	Ranch Vegetation	20	7.16	(4.5)
4C1	Clark Valley Gravel Pit	45	9.28	(5.8)
5C1	Junction Prefumo/See Canyon Roads	64	7.52	(4.7)
6C1	Household Garden	98	7.24	(4.5)
7C1	Pecho Creek Ruins (Mello Farm)	120	6.56	(4.1)
7C2	Rattlesnake Canyon	124	7.52	(4.7)
2D1	Sunnyside School	10	11.04	(6.9)
3D1	Clark Valley	24	9.92	(6.2)
4D1	Los Osos Valley Road	36	12.16	(7.6)
6D1	Junction See/Davis Canyon Roads	89	13.4	(8.3)

**Distances and Directions to REMP Monitoring
Stations Matrix**

Attachment 4: Page 2 of 3

Station Code*	Station Name	Radial Direction (True Heading) (Degrees)	Radial Distance from Plant	
			Km	(Miles)
7D1	Avila Gate	118	10.56	(6.6)
7D2	Avila Beach	110	12.16	(7.6)
7D3	Avila Pier	120	11.0	(6.9)
7E1	Avila Valley Barn	103	13.94	(8.66)
2F1	Morro Bay (Commercial Landing)	0	17.44	(10.9)
2F2	Morro Bay Power Plant	358	17.9	(11.2)
5F1	SLO OEL	79	16.41	(10.2)
5F2	Cal Poly Farm	60	20.16	(12.6)
5F3	SLO County Health Department	70	20.32	(12.7)
7F1	Shell Beach	110	17.28	(10.8)
7G1	Arroyo Grande (Kawaoka Farm)	115	26.88	(16.8)
7G2	Oceano Substation	118	27.68	(17.3)
AVA	Avila Beach (near pier)	109	11.75	(7.3)
CBA	Cambria Moonstone Beach	330	45.86	(28.5)
CYA	Cayucos Beach (near pier)	350	26.87	(16.7)
DW1	Drinking Water, Plant Potable Water Sys	161	0.59	(0.37)
GW1	Ground Water Monitoring Well 1	271	0.15	(0.09)
GW2	Ground Water Monitoring Well 2	195	0.21	(0.13)
IS1 - IS8	ISFSI	59	0.38	(0.23)
MDO	Montana de Oro (Spooners Cove)	336	7.56	(4.7)
OW1	Observation Well 01	336	0.07	(0.046)
OW2	Observation Well 02	157	0.07	(0.045)
OEL	Offsite Emergency Lab	79	16.41	(10.2)
OUT	Plant Outfall	229	0.15	(0.01)
PMO	Pismo Beach (near pier)	113	20.76	(12.9)
PON	Pacific Ocean North of Diablo Cove	287	0.56	(0.35)
POS	Pacific Ocean South of Diablo Cove	176	0.7	(0.44)
WW2	Water Well 02	70	1.02	(0.63)

**Distances and Directions to REMP Monitoring
Stations Matrix**

Attachment 4: Page 3 of 3

* Station Code (XYZ):

X - First number (0-9) represents the radial sector in which the station is located:

- | | |
|---------------------|---------------------|
| 0 - Northwest | 5 - East-northeast |
| 1 - North-northwest | 6 - East |
| 2 - North | 7 - East-southeast |
| 3 - North-northeast | 8 - Southeast |
| 4 - Northeast | 9 - South-southeast |

Y - Letter (S, A-H) represents the distance from the plant:

- S - On-site
- A - 0-2 miles from plant (but off-site)
- B - 2-4 miles from plant
- C - 4-6 miles from plant
- D - 6-8 miles from plant
- E - 8-10 miles from plant
- F - 10-15 miles from plant
- G - 15-20 miles from plant
- H - Greater than 20 miles from plant

Z - Second number represents the station number within the zone.

* Station Codes exceptions:

The following stations do not follow the coding system:

- Diablo Cove Marine (DCM)
- Meteorological Tower (MT1)
- Northwest guard shack (WN1)
- Diablo Creek outlet (WN2)
- Pacific Ocean North (PON)
- Pacific Ocean South (POS)
- Offsite Emergency Lab (OEL)
- Plant outfall (OUT)
- Drinking water (DW1)
- Water Well 02 (WW2)
- Observation Well 01 (OW1)
- Observation Well 02 (OW2)
- Avila Beach (AVA)
- Montana de Oro - Spooners Cove (MDO)
- Pismo Beach (PMO)
- Cayucos Beach (CYA)
- Cambria - Moonstone Beach (CBA)
- Blanchard Cow Meat (BCM)
- Blanchard Goat Meat (BGM)
- Blanchard Sheep Meat (BSM)
- Johe Deer Meat (JDM)
- Johe Pig Meat (JPM)
- Andre Cow Meat (ACM)
- Andre Deer Meat (ADM)
- Andre Pig Meat (APM)
- ISFSI TLDs (IS1 - IS8)

Summary of Split-Sampling Program with State of California Matrix

Attachment 5: Page 1 of 1

Sample Type	Station No.	Frequency ^{N1}	Radioanalyses
Milk (supplemental)	5F2	Monthly	Gamma Isotopic (incl. I-131 and K-40)
Drinking Water	DW1	Monthly	Gamma Isotopic (incl. I-131), H-3
Outfall Water	OUT	Monthly	Gamma Isotopic, H-3
Diablo Creek	5S2	Monthly	Gamma Isotopic, H-3
Vegetative Crops (supplemental)	7G1	Quarterly	Gamma Isotopic
Fish or Invertebrate	DCM	Quarterly	Gamma Isotopic
Air Particulates and Radioiodine	5F1, 7D1 ^{N2}	Weekly & Quarterly	Gross Beta, I-131, Qtrly Gamma Isotopic (composite airborne particulate samples)
Sediment	DCM	Annually	Gamma Isotopic
Direct Radiation (TLD)	MT1, 1A1, 1C1, 4D1, 5F3, 5S1, 7D1, 7C1, 7F1, 8S2	Quarterly	Gamma Exposure (mR)
Kelp (supplemental)	DCM	Quarterly	Gamma Isotopic

^{N1} When available

^{N2} The California State CDPH air sampler used for correlation with DCPD 5F1 is located at the SLO County Health Dept on Johnson Avenue (near DCPD TLD station 5F3).

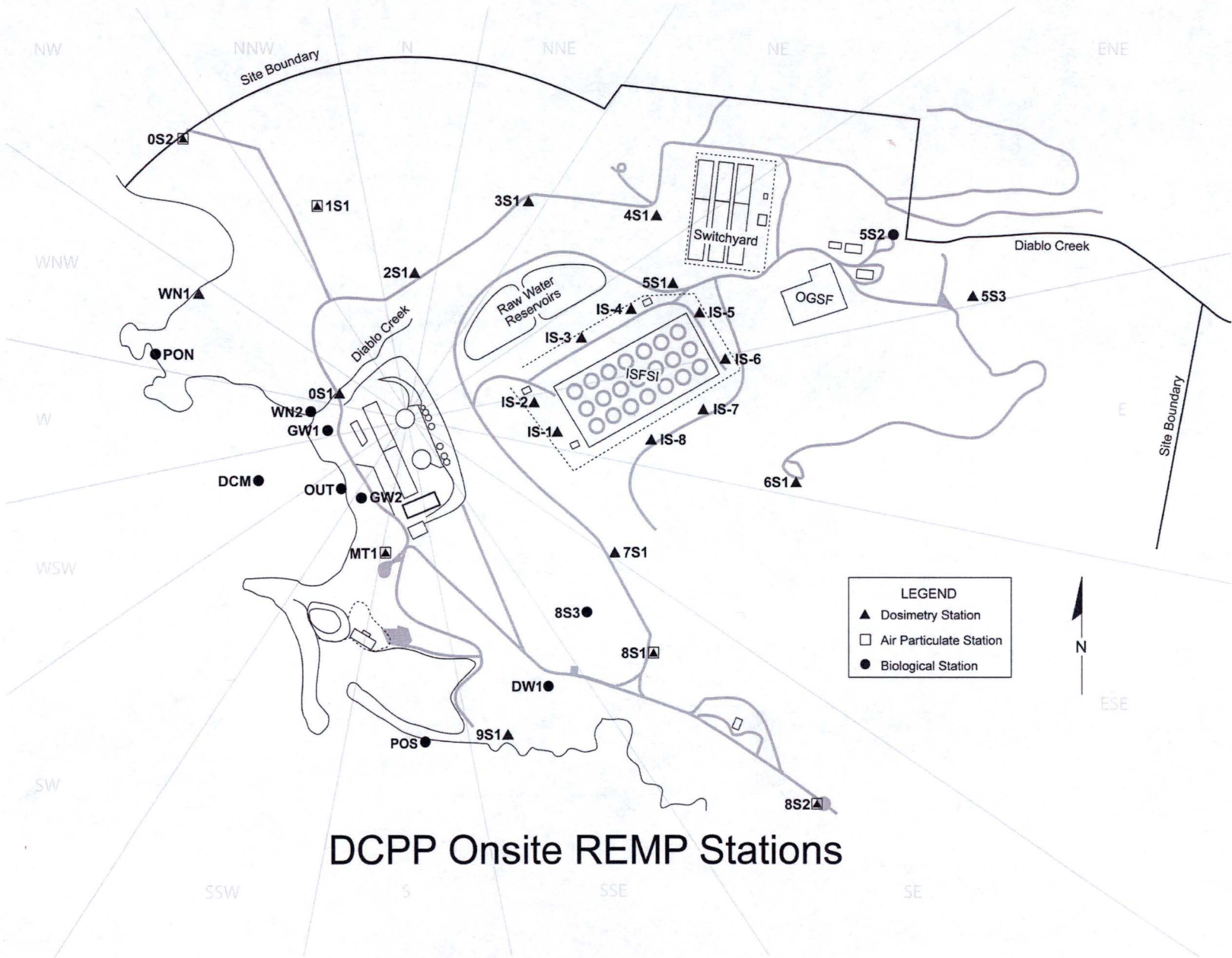

DCPD Onsite REMP Stations

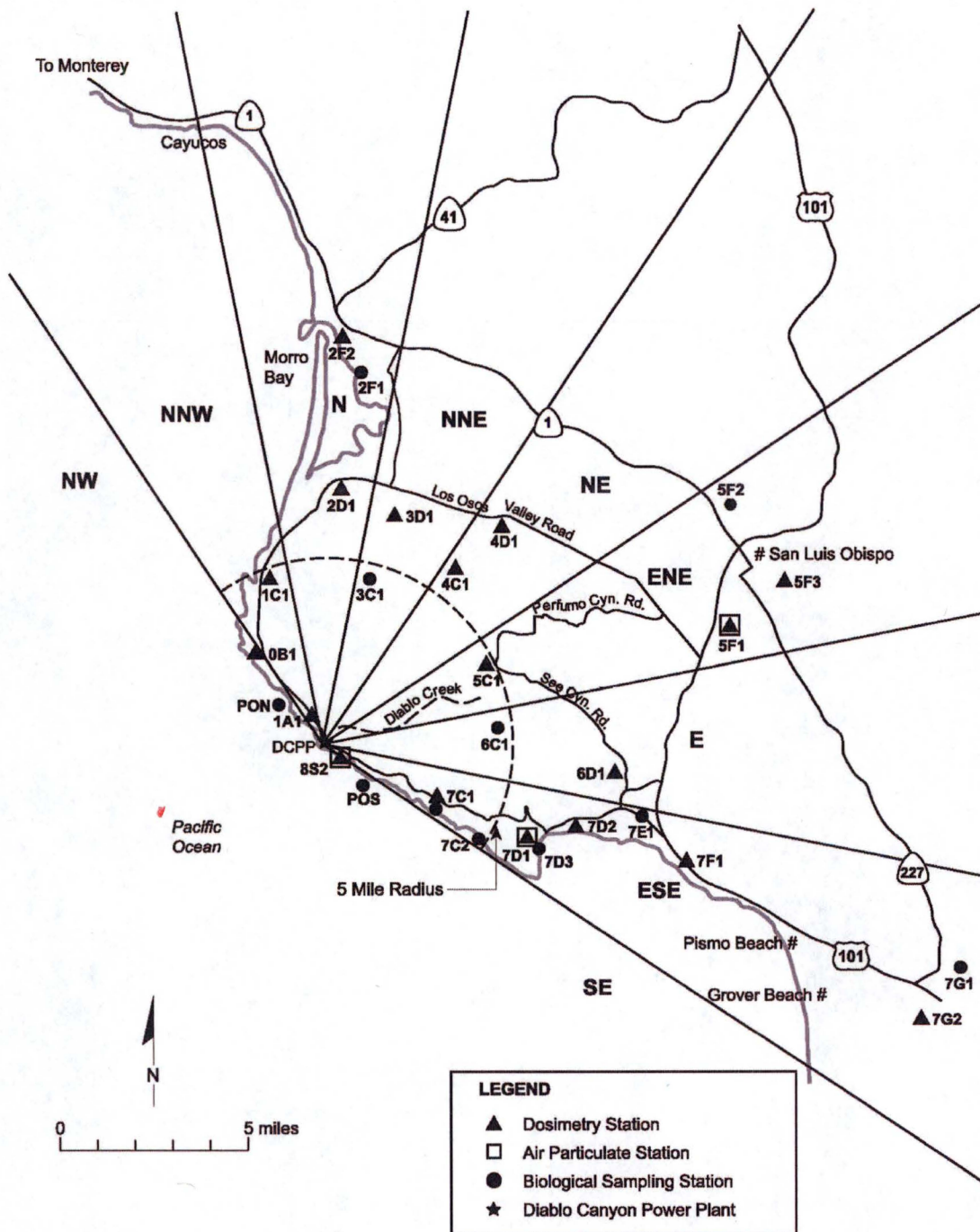

Units 1 and 2 Diablo Canyon off-site stations.

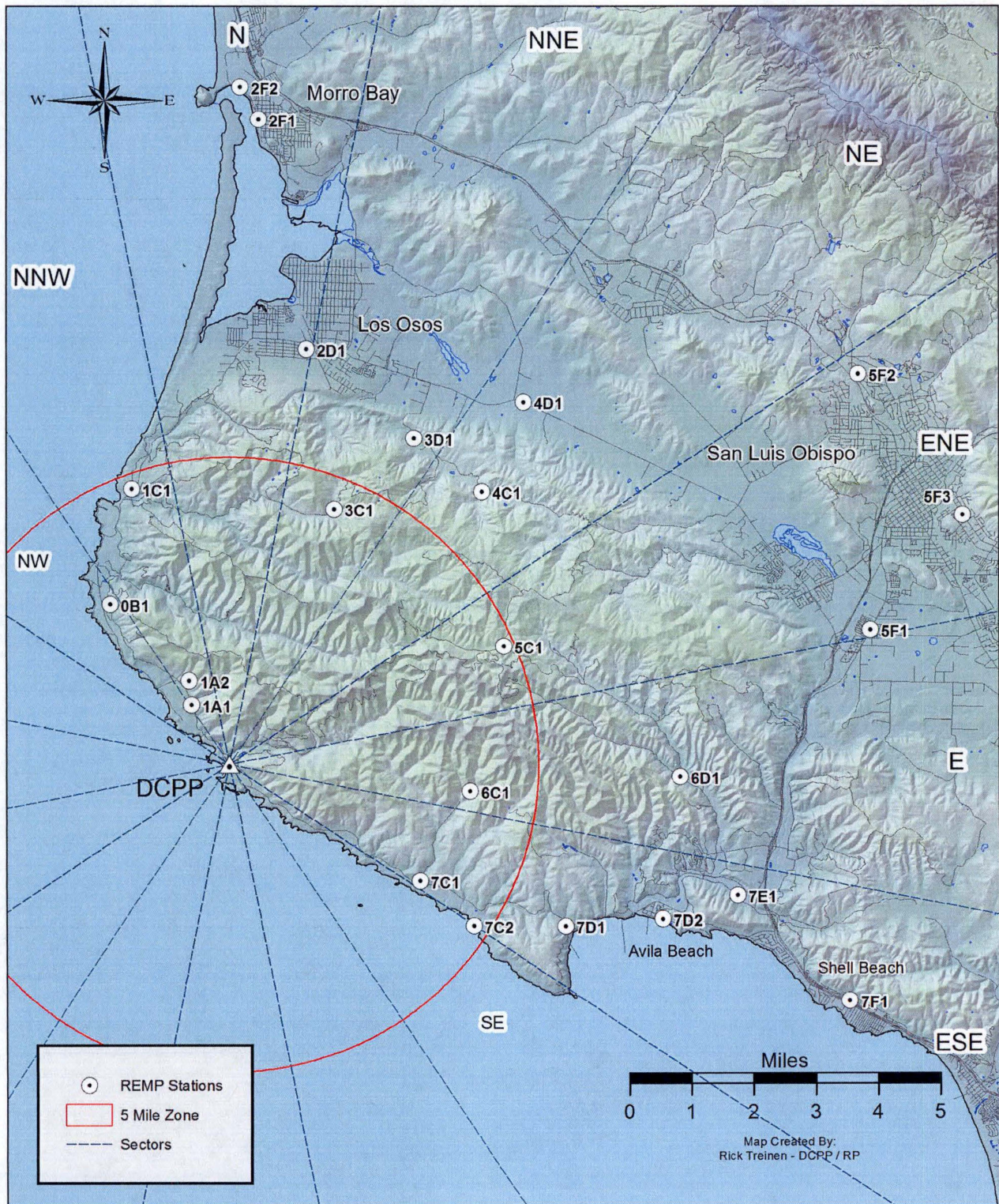

**AREOR Radiological Monitoring Program
Summary Matrix**

Attachment 9: Page 1 of 1

Name of Facility: _____ Docket No.: _____

Location of Facility: _____ Reporting Period: _____
(County, State)

Medium or Pathway Sampled (Unit of Measurement)	Type and Total Number of Analyses Performed	Lower Limit of Detection (LLD) ¹	Location with Highest Annual Mean		All Indicator Locations Mean ² Range ²	Control Locations Mean ² Range ²	Number of Reportable Occurrences
			Name, Distance and Direction	Mean ² Range ²			

¹ Unless indicated the LLDs specified in Attachment 2 were met.

² Mean and the range based upon detectable measurements only. Fraction of detectable measurements at specified locations is indicated in parentheses; e.g., (10/12) means that 10 out of 12 samples contained detectable activity.

Attachment 4

**Diablo Canyon Power Plant Chemical Analysis Procedure (CAP),
CAP A-8, "Off-Site Dose Calculations,"
Revision 42**

Off-Site Dose Calculations

02/07/22
Effective Date

QUALITY RELATED
REFERENCE USE

Table of Contents

1.	SCOPE.....	2
2.	DISCUSSION.....	2
3.	DEFINITIONS.....	5
4.	RESPONSIBILITIES.....	7
5.	INSTRUCTIONS.....	9
5.1	Procedure Revision Control.....	9
5.2	Liquid Effluent Dose Calculations.....	9
5.3	Liquid Effluent Dose Projections.....	11
5.4	Limiting Flowrate Calculation for Liquid Discharges.....	12
5.5	Liquid Effluent Concentration Limit (ECL) Calculations.....	14
5.6	Liquid Effluent Radiation Monitor Setpoint Calculations.....	16
5.7	Gaseous Effluents.....	22
5.8	Gaseous Dose Rate Calculations.....	24
5.9	Noble Gas Air Dose Calculations.....	26
5.10	Gaseous Effluent Dose to Critical Receptor from Iodines, Particulates, Tritium, and Carbon-14.....	27
5.11	Alternate Dose Calculations for Gaseous Effluents.....	30
5.12	Gaseous Effluent Dose Projections.....	30
5.13	Noble Gas Release Rate Limit and Expected Reading Calculations.....	31
5.14	Airborne Iodine, Particulate, and Tritium Release Rate Limit Calculation.....	34
5.15	Gaseous Effluent Radiation Monitor Setpoint Calculations.....	35
5.16	40 CFR 190 Nuclear Fuel Cycle Dose Calculations (Direct, Gas, Liquid, & Airborne).....	49
5.17	On-Site Dose to Unmonitored Individuals.....	53
5.18	Dose Projection Calculations.....	55
5.19	Actions Required for Unplanned Gaseous or Liquid Releases.....	57
6.	RECORDS.....	58
7.	REFERENCES.....	58
ATTACHMENTS:		
1.	LRW Composite Dose Factors.....	60
2.	Current Dose Receptor Information.....	63
3.	GRW Dose Parameters: Noble Gas Dose Factors.....	65
4.	GRW Dose Parameters: Child, Inhalation, Worst Case Organ.....	66
5.	GRW Dose Parameters: Ground Plane Dose Factors.....	67
6.	GRW Dose Parameters: Infant, Inhalation Pathway.....	68
7.	GRW Dose Parameters: Child, Inhalation Pathway.....	69
8.	GRW Dose Parameters: Teen, Inhalation Pathway.....	70
9.	GRW Dose Parameters: Adult, Inhalation Pathway.....	71

10.	GRW Dose Parameters: Child, Vegetation Pathway	72
11.	GRW Dose Parameters: Teen, Vegetation Pathway	73
12.	GRW Dose Parameters: Adult, Vegetation Pathway	74
13.	Liquid Discharges Monitored for Radioactivity.....	75
14.	Gaseous Releases Monitored for Radioactivity.....	76

1. SCOPE

- 1.1 This administrative procedure provides guidance for calculations related to radiological liquid and gaseous effluents for Diablo Canyon.

2. DISCUSSION

- 2.1 This procedure is used in support of CY2, "Radiological Monitoring and Controls Program," (RMCP) and CY2.ID1, "Radioactive Effluent Controls Program," (RECP) as they relate to routine radioactive liquid and gaseous releases from DCPD to the unrestricted area. Together with RP1.ID11, "Environmental Radiological Monitoring Program," and CAP A-8, these procedures form the Diablo Canyon Off-site Dose Calculation Manual.
- 2.2 Effluent discharge limits implemented by the RMCP are based on the dose commitment to a member of the general public from release of radionuclides through either direct or indirect exposure (e.g., submersion in a cloud of radioactive noble gases, radionuclides deposited on the ground, direct radiation from radionuclides stored on-site, inhalation or ingestion of radionuclides via a food pathway such as milk, meat, vegetable, fish, etc.).
- 2.2.1 Dose calculations in this procedure are based on models that make it unlikely to underestimate the actual exposure of an individual through relevant pathways.
- 2.3 40 CFR 190 Dose Calculations for Nuclear Fuel Cycle
- 2.3.1 Pathways
- 40 CFR 190, "Environmental Radiation Protection Standards for Nuclear Power Operations," is applicable to operations which are part of a nuclear fuel cycle which result in both of the following:
 - Radiation doses received by members of the public in the general environment
 - Radioactive materials introduced into the general environment
 - The total uranium fuel cycle dose to any member of the public are calculated by summing the following doses:
 - Direct radiation dose
 - Liquid effluent dose
 - Noble gas dose
 - Radioiodine, tritium, C-14, and particulate gaseous effluent dose
 - For DCPD, calculation of the dose contributions from liquid and gaseous effluents, as well as direct radiation from selected outside storage tanks, storage buildings, and the Independent Spent Fuel Storage Installation (ISFSI), are included.

-
- 2.3.2 40 CFR 190 Dose Limits
- a. The annual dose equivalent to any member of the public from planned discharges of radioactive materials to the general environment (and the radiation associated with these operations) shall not exceed the following:
- 25 millirem to the whole body
 - 75 millirem to the thyroid
 - 25 millirem to any other organ
- 2.4 The plant vent is the only significant path for gaseous radioactive waste (GRW) release to the environment during normal operation.
- 2.5 Calculated dose rates and real-time dose to the unrestricted area due to noble gases, gaseous iodines, and airborne particulates are based on discharge from the plant vent.
- 2.6 Miscellaneous gaseous effluent pathways include the following:
- SGBD tank vent
 - Chemistry lab fume hood (Aux Building 85')
 - Main condenser Nash vacuum pump^{REF 7.25}
- 2.6.1 These miscellaneous release sources are not continuously monitored but may have dose rates and dose calculated for their path to the unrestricted area.
- 2.7 The following describe the offsite dose exposure pathways for DCPD:
- 2.7.1 The inhalation and ground plane exposure pathways are considered to exist at all locations.
- 2.7.2 The grass-cow-milk, grass-cow-meat, grass-wild game-meat and vegetation pathways are considered based on their actual existence in the vicinity of the plant.
- 2.7.3 The dose pathways that have been shown to actually exist at DCPD are the ground plane, inhalation, and the vegetation pathways.
- 2.7.4 These dose pathways are reviewed yearly and updated based on the annual land use census survey to ensure that actual exposure to an individual will not be substantially underestimated.
- 2.7.5 The locations of the pathways and descriptions are listed in Attachment 2.
- 2.8 Equations for calculating gaseous effluent concentration limits, monitor high alarm setpoints, dose rates, and critical receptor doses are calculated using historical average atmospheric conditions according to the methods described in Reg. Guides 1.109 and 1.111, and NUREGs 0133 and 0472.
- 2.9 DCPD atmospheric dispersion (X/Q) and deposition (D/Q) factors are calculated using the methodology of Reg. Guide 1.111 as implemented by NUREG 2919 (computer code XOQDOQ).

- 2.10 DCPD atmospheric dispersion and deposition factors used in this procedure are based on the most recent five years of meteorological data, unless the most recent average differed by 10% or less from the previous average. In that case, no change is required. The current factors are listed in Attachment 2.
- 2.11 Gaseous effluent dose factors used in this procedure were generally based on NUREG 0133 methods. Inhalation dose conversion factors used in this procedure were based on those in Reg. Guide 1.109, Rev 1, Table E-9. Three exceptions are H-3, Sb-124, and Sb-125. Inhalation dose conversion factors for H-3, Sb-124, and Sb-125 were taken from NUREG/CR-4013.
- 2.12 The dose to an individual (critical receptor) due to radioiodines, tritium, carbon-14 (C-14), and particulates released in gaseous effluents with half-lives greater than 8 days is calculated based on NUREG 0133. This method makes use of the maximum individual concept described in Reg. Guide 1.109.

3. DEFINITIONS

- 3.1 Alert Alarm Setpoint (AASP): An administrative limit designed to provide early indication of increasing radiation monitor trends.
- 3.2 Allocation Factor (AF): A factor used in the DCPH high alarm setpoint (HASP) methodology that limits:
- 3.2.1 Effluent concentrations from simultaneous liquid discharges.
- 3.2.2 Noble gas effluent dose rate from simultaneous atmospheric releases.
- 3.3 Critical Receptor: An individual who receives the largest dose based on the combination of dose pathways that have been shown to actually exist.
- 3.3.1 The concept of critical receptor is introduced as a further refinement of the Maximum Individual.
- 3.3.2 The critical receptor concept is applied at that location where the combination of dispersion (X/Q), deposition (D/Q), existing pathways, occupancy time, receptor age group, and effluent source term indicates the maximum potential exposure.
- 3.4 Effluent Concentration Limit (ECL): The limit for liquid effluents entering the unrestricted area; limited to the concentrations listed in 10 CFR 20, Appendix B, Table 2, Column 2.
- 3.5 Expected Reading (ER): The anticipated monitor response based on the known release pathway concentration and the specific monitor response factors.
- 3.6 High Alarm Setpoint (HASP): An "administrative limit" set per CY2.DC1 to ensure radiation monitor release setpoints calculated do not exceed the liquid or gaseous effluent concentration limits of 10 CFR 20.
- 3.7 Long-term Gaseous Releases: A long-term gaseous releases is generally continuous and stable in release rate. For example, the effluent from a continuous ventilation system in its normal mode is a long-term gaseous release. Doses due to long-term releases are modeled using five-year historical average dispersion and deposition values PER Reg. Guides 1.109 and 1.111, and NUREGs 0133 and 0472.
- 3.8 Maximum Individual
- 3.8.1 The individual that receives the greatest dose due to food consumption, occupancy, and other usage parameters. This concept models those individuals within the local population with habits representing reasonable deviations from the average.
- 3.8.2 In all physiological and metabolic respects, the maximum individual is assumed to have those characteristics that represent the average for the age group of interest.
- 3.9 Safety Factor (SF): An administrative factor used in HASP calculations. The SF is set at 0.9 and provides for a HASP at 90% of the 10 CFR 20 concentration limits.

- 3.10 Short-term Gaseous Releases: Releases that occur for either of the following:
- 3.10.1 A total of 500 hours or less in a calendar year
 - 3.10.2 Not more than 150 hours in any quarter.
- 3.11 Tritium Correction Factor (TCF): A factor used in HASP calculations for liquid rad monitors that increases the setpoint over a background level that is typically high by assuming a constant, conservative tritium concentration in the liquid effluent. The TCF was originally developed when the results of HASP calculations for monitors that were intended for gamma-only liquids were barely over background. This condition was originally observed when DCPD recycled primary waste water using evaporators to reduce the overall volume of liquid waste discharged overboard. Continued use of evaporators resulted in buildup of tritium in plant systems where evaporator product was used as make-up. Although recycling primary waste water using evaporators was discontinued, including a TCF in liquid HASP calculations has been retained as a good practice.
- 3.12 Unplanned (Liquid or Gaseous) Release: An unexpected and potentially unmonitored release to the environment due to operational error or equipment malfunctions.

4. RESPONSIBILITIES

- 4.1 Chemistry and environmental operations manager is responsible for ensuring this off-site dose calculation procedure (ODCP) implements all CY2.ID1, "Radioactive Effluent Controls Program," (RECP) and DCP Technical Specification (TS) requirements related to calculating dose received in the unrestricted area around the site as a result of plant operation.
- 4.2 Chemistry engineering supervisor is responsible for ensuring the following:
- 4.2.1 The program implemented through this procedure is followed.
 - 4.2.2 That all RECP and TS requirements are satisfied by the Program.
- 4.3 Chemistry engineer assigned to radiological effluents is responsible for the following:
- 4.3.1 Correct and timely performance of calculations required by the procedure for each radioactive effluent released.
 - 4.3.2 Reviewing the results of calculations by spot-checking and maintaining an updated archive of post-release calculated doses to support preparation of the annual report.
 - 4.3.3 Providing oversight of the effluents program's ODCP by performing the following activities:
 - a. Confirming compliance with RECP or TS.
 - b. Providing technical support.
 - c. Recommending or designing improvements to the dose calculations and the effluent control program when appropriate.
 - d. Supporting long-term planning for radiological effluent-related activities and the associated dose calculations.
- 4.4 Digital systems group is responsible for:
- 4.4.1 Ensuring any non-vendor computer software that supports the program is maintained current and compatible with the procedure's calculation methods.
 - 4.4.2 Ensuring non-vendor computer hardware that supports the program is maintained operable at all times.
- 4.5 Vendor for dedicated, effluents-related software or hardware is responsible for:
- 4.5.1 Ensuring any vendor-supplied computer software that supports the program is maintained current and compatible with the procedure's calculation methods.
 - 4.5.2 Ensuring any vendor-supplied computer hardware that supports the program is maintained operable at all times.

- 4.6 PG&E meteorology group is responsible for providing results of annual recalculation of atmospheric dispersion and deposition factors.
- 4.7 DCPD Environmental Radiological Monitoring Program personnel are responsible for providing the annual Land Use Census including information on occupancy at receptor locations.

5. INSTRUCTIONS**5.1 Procedure Revision Control**

- 5.1.1 Ensure that changes to CAP A-8 are processed per the requirements of DCPD Technical Specification (TS) Section 5.5.1^{T02694} including use of revision bars to mark changes per TS 5.5.1c.^{Ref 7.27}

5.2 Liquid Effluent Dose Calculations**5.2.1 Division of Dose by DCPD Unit**

- a. Credit 50% each to Unit 1 and Unit 2 for effluent doses originating from the unit-common liquid radioactive waste (LRW) treatment system.

5.2.2 Contributions to Dose

- a. Calculate the dose contributions to the total body and each individual organ (bone, liver, thyroid, kidney, lung, and GI-LLI) of the maximum exposed individual (adult) due to consumption of saltwater fish and saltwater invertebrates for all radionuclides identified in liquid effluents released to unrestricted areas as shown in eq 1 and eq 2.^{T30837}

$$D_o = F_\ell \Delta t \sum_i A_{io} C_i e^{-\lambda_i t_m} \quad (\text{eq 1})$$

Where:

D_o = dose commitment to organ "o" (mrem)

Δt = time period for the release (hrs)

A_{io} = site-specific ingestion dose commitment factor to organ "o" due to radionuclide "i" (mrem/hr per $\mu\text{Ci/mL}$) defined in eq 3

C_i = concentration of radionuclide "i" in undiluted liquid effluent ($\mu\text{Ci/mL}$)

λ_i = decay constant of radionuclide "i"

t_m = time interval between end of sampling and midpoint of release

F_ℓ = near field average dilution factor during release period defined

$$\text{as: } \frac{\text{Waste flow}}{\text{Dilution flow} \times Z} \quad (\text{eq 2})$$

Where: Z = site-specific mixing effect of discharge structure.; specifically, it is the credit taken for dilution which occurs between the discharge structure and the body of water which contaminates fish or invertebrates in the liquid ingestion pathway. For DCPD, $Z = 5$.

- b. Calculate the site-specific ingestion dose commitment factor, A_{io} , as shown in eq 3:^{T30837}

$$A_{io} = k_o (U_F BF_i + U_I BI_i) DF_i \text{ (eq 3)}$$

Where:

k_o = conversion factor of $1.14E+05$ (pCi/ μ Ci x mL/L x yr/hr)

U_F = saltwater fish consumption rate (kg of fish/yr) (For DCP, $U_F = 21$ kg/yr; value is from NUREG 0133, Section 4.3.1.)

BF_i = saltwater bioaccumulation factor for radionuclide "i" in fish flesh (pCi/kg per pCi/L). [Values for BF_i are from Table A-1 of Regulatory (Reg.) Guide 1.109, except uranium and plutonium, which are from NUREG/CR-4013.]

U_I = saltwater invertebrate consumption rate (kg/yr) (For DCP, $U_I = 5$ kg/yr; value is from NUREG 0133, Section 4.3.1.)

BI_i = saltwater bioaccumulation factor for radionuclide "i" in invertebrate flesh (pCi/Kg per pCi/L) [Values for BI_i are from Table A-1 of Reg. Guide 1.109, except uranium and plutonium, which are from NUREG-4013.]

DF_i = adult ingestion dose conversion factor for radionuclide "i" (mrem/pCi ingested). Values from Reg. Guide 1.109, Table E-11, with exceptions as follows:

- H-3, Br-82, Sb-124, Sb-125, Pu-238, Pu-239, Pu-240, Pu-241 and Pu-242, ingestion dose conversion factors from EMP-155.
- As-76, Sn-113, Sn-117m and Sb-122 ingestion dose conversion factors calculated by ORNL using ICRP-2 methodology.
- U-233, U-234, U-235, U-236 and U-238 ingestion dose conversion factors from NUREG-0172.

1. Refer to Attachment 1 for site-specific values for A_{io} . (When necessary, these factors were corrected for ingrowth of daughter radionuclides following ingestion of the parent. All radionuclides treated in this manner are followed by "+D."^{Ref 7.8/Ref 7.10})

5.3 Liquid Effluent Dose Projections

NOTE: The purpose of dose projections is to determine whether appropriate treatment of liquid radioactive materials in relation to maintaining releases "as low as reasonably achievable" is necessary.

5.3.1 General

- a. At least once every 31 days, REFER TO Section 5.18 and calculate the projected liquid effluent dose contribution for each unit for the current calendar month, quarter, and year.

5.4 Limiting Flowrate Calculation for Liquid Discharges

NOTE: The maximum effluent flowrate through monitors RE-3, RE-18, and RE-23 is established to provide additional control over effluent releases. Maximum flow rates for releases from the Condensate Demineralizer Regeneration System waste tank and miscellaneous release points are also calculated.

5.4.1 Effluent Concentration Limit (ECL)-Based Calculation

- a. Calculate the maximum release rate from the effluent concentration and the 10 CFR 20 effluent concentration limits as shown in eq 4 and eq 5:

$$f = \frac{F(AF)(SF)(TCF)}{\sum_{i \neq H-3} \frac{C_i}{ECL_i}} \quad (\text{eq 4})$$

Where:

f = maximum operational undiluted liquid radwaste effluent discharge flowrate (gpm)

F = expected dilution flowrate (gpm)

AF = LRW source allocation factor from Table 1

SF = safety factor (0.9)

TCF = tritium correction factor defined in eq 11

C_i = concentration of isotopes "i" in the release mix, pre-dilution ($\mu\text{Ci/mL}$)

ECL_i = effluent concentration limit of radionuclide "i" ($\mu\text{Ci/mL}$)

- b. WHEN the term, $\sum_{i \neq H-3} \frac{C_i}{ECL_i}$ equals zero,
THEN calculate the limiting flowrate as shown in eq 5:

$$f = F (AF) (SF) (TCF) \quad (\text{eq 5})$$

(Other terms are as defined for eq 4.)

5.4.2 Lower Limit of Detection (LLD)-Based Calculation

- a. WHEN there is no primary-to-secondary leakage,
THEN assume the oily water separator and miscellaneous release points are not contaminated.

NOTE: While no activity may be present, eq 6 assumes a concentration equal to the lower limit of detection (LLD) for the nuclides listed in CY2.ID1, Attachment 3, Table 5.

- b. Calculate practical liquid discharge flowrate limits for uncontaminated pathways as shown in eq 6:

$$f = \frac{F(AF)(SF)}{4.3} \text{ (eq 6)}$$

Where:

f = maximum undiluted liquid radwaste effluent discharge flowrate (gpm)

F = expected dilution flowrate (gpm)

AF = LRW source allocation factor from Table 1

SF = safety factor (0.9)

4.3 = total ECL fraction as given by $\sum_i \frac{LLD_i}{ECL_i}$ (eq 7)

Where:

LLD_i = lower limit of detection for radionuclide "i" ($\mu\text{Ci/mL}$)
from CY2.ID1, Attachment 3, Table 5

ECL_i = effluent concentration limit for radionuclide "i"
($\mu\text{Ci/mL}$)

5.5 Liquid Effluent Concentration Limit (ECL) Calculations

5.5.1 Liquid ECL for Single Batch

- a. Calculate the ECL for the identified mixture of radionuclides in a batch of liquids as shown in eq 8:

$$ECL_i = \frac{\sum_{i=1}^n C_{ij}}{\sum_{i=1}^n \frac{C_{ij}}{ECL_{ij}}} \text{ (eq 8)}$$

Where:

ECL_j = unrestricted area total undiluted ECL for particular mixture "j" of identified radionuclides ($\mu\text{Ci/mL}$)

C_{ij} = concentration of radionuclide "i" ($\mu\text{Ci/mL}$) in mixture "j"

ECL_{ij} = ECL in unrestricted area water for radionuclide "i" in general ($\mu\text{Ci/mL}$) [Values from 10 CFR 20, Appendix B, Table 2, Column 2.]

5.5.2 Liquid ECL for Simultaneous Discharge of Multiple Batches

- a. Calculate the overall ECL for simultaneous discharges as shown in eq 9 and eq 10:

$$ECL_{\text{overall}} = \frac{\sum_{j=1}^n \Phi_j C_j}{\sum_{j=1}^n \frac{\Phi_j C_j}{ECL_j}} \quad (\text{eq 9})$$

Where:

ECL_{overall} = unrestricted area ECL for current radionuclide mixture for concurrent "j" discharges ($\mu\text{Ci/mL}$)

C_j = total activity concentration for individual stream "j" ($\mu\text{Ci/mL}$)

ECL_j = total ECL for individual mixture (or stream) "j" calculated as shown in eq 8 ($\mu\text{Ci/mL}$)

Φ_j = ratio of the flowrate for individual discharge pathway "j" to sum of all individual undiluted pathway flowrates is defined as:

$$\frac{f_j}{\sum_j f_j} \quad (\text{eq 10})$$

Where: f_j = undiluted effluent flowrate for pathway, "j"

5.6 Liquid Effluent Radiation Monitor Setpoint Calculations

5.6.1 General

NOTE: The alarm/trip setpoints for the liquid effluent radiation monitors are derived from the concentration limits in 10 CFR 20.1001-2404, Appendix B, Table 2, Column 2.

- a. Ensure that the effluent concentration limits in 10 CFR 20 are not exceeded by implementing alarm/trip setpoints for liquid effluent monitors as required by CY2.ID1, "Radioactive Effluents Control Program."^{T34939}
- b. Ensure that liquid effluent monitor setpoints take into account appropriate factors for dilution, dispersion, or decay of radioactive materials that may occur between the point of discharge and the unrestricted area boundary.

NOTE: The high alarm setpoint (HASP) should also be the maximum operational setpoint.

- c. Ensure that each liquid effluent monitor setpoint provided to Operations is less than or equal to the HASP calculated in this section.
- d. Ensure that liquid effluent monitor setpoint reviews and calculations are performed and documented as described in CY2.DC1, "Radiation Monitor System High Alarm Setpoint Control Program."
- e. WHEN alarm setpoints for RE-18 and/or RE-23 are changed, THEN notify Emergency Planning personnel to evaluate the change vs. applicable EAL threshold values in Emergency Plan Appendix D, "Emergency Action Level Technical Basis Manual," per OM10.ID2, "Emergency Plan Revision and Review."

5.6.2 Allocation and Safety Factors

- a. Ensure simultaneous releases do not exceed the liquid effluent concentration limits of 10 CFR 20 in the unrestricted area by implementing setpoints for liquid effluent monitors as necessary to meet site limits identified in CY2.ID1.^{T34939}

NOTE: The allocation factors (AFs) in Table 1 take into account that RE-3 and RE-18 are unit-common, while the RE-23 monitors are unit-specific.

- b. WHEN calculating high alarm setpoints (HASP), THEN use the allocation factors (AF) shown in Table 1 (adjusted as necessary to support operation) such that the sum of liquid release AFs for the site is less than or equal to 1.

Table 1: Typical Liquid Effluent Discharge Pathway Allocation Factors for the Site		
Discharge Pathway	Radiation Monitor	Allocation Factor
Oily Water Separator	RE-3	0.01
Liquid Radwaste System	RE-18	0.90
Steam Generator Blowdown (Unit 1)	RE-23 (U1)	0.04
Steam Generator Blowdown (Unit 2)	RE-23 (U2)	0.04
Miscellaneous	N/A	0.01

- c. WHEN calculating HASPs, THEN use a safety factor (SF) to make the setpoint more conservative.

5.6.3 Tritium Correction Factor (TCF)

- a. Ensure that liquid effluent concentrations released to the unrestricted areas do not exceed 10 CFR 20 limits by including a TCF (step 5.6.3b) in liquid HASPs.
- b. Calculate the TCF as shown in eq 11:

$$\text{TCF} = \left[1 - \left(\frac{C_{\text{H}_3} / \text{ECL}_{\text{H}_3}}{F/f} \right) \right] \text{ (eq 11)}$$

Where:

ECL_{H_3} = effluent concentration limit of tritium

C_{H_3} = tritium concentration in release mix, pre-dilution ($\mu\text{Ci/mL}$)
[Tritium concentration " C_{H_3} " is conservatively estimated.]

F = conservative dilution flowrate (gpm)

f = conservative undiluted effluent flowrate (gpm)

NOTE: The Oily Water Separator typically contains no radioactive material. Only when there is primary-to-secondary leakage does this become a liquid effluent discharge point.

5.6.4 Oily Water Separator (OWS) RE-3 HASP Calculation

a. Calculate the HASP for Oily Water Separator (OWS) RE-3 as shown in step 5.6.4a.1 (no primary-to-secondary leak) or step 5.6.4a.2 (measurable primary-to-secondary leak).

1. WHEN no significant primary-to-secondary leakage is taking place, OR when no activity has been identified in the OWS, THEN calculate the RE-3 HASP per eq 12:

$$\text{HASP}_{\text{RE-3}} = 3 \times \text{BKGD}_{\text{RE-3}} \text{ (eq 12)}$$

2. WHEN activity from primary-to-secondary leakage is present in the OWS, THEN calculate RE-3 HASP per eq 13:

$$\text{HASP}_{\text{RE-3}} = \text{BKGD}_{\text{RE-3}} + (\text{AF})(\text{SF}) \times \sum_{\gamma} k_{\gamma} C_{\gamma} \left[\frac{F/f}{\sum_{i \neq \text{H3}} C_i / \text{ECL}_i} \right] \times \text{TCF} \text{ (eq 13)}$$

Where:

$\text{HASP}_{\text{RE-3}}$ = high alarm setpoint for RE-3 (cpm)

$\text{BKGD}_{\text{RE-3}}$ = background reading for RE-3 (cpm)

AF = OWS allocation factor from Table 1

SF = safety factor for RE-3 (0.9)

k_{γ} = monitor response factor (cpm/ $\mu\text{Ci/mL}$)

C_{γ} = concentration of gamma emitting isotopes in release mix, pre-dilution ($\mu\text{Ci/mL}$)

F = dilution flowrate (gpm)

f = undiluted effluent flowrate (gpm)

C_i = concentration of radionuclide "i" in release mix, pre-dilution ($\mu\text{Ci/mL}$)

ECL_i = effluent concentration limit of radionuclide "i"

TCF = tritium correction factor defined in eq 11

$$\text{HASP}_{\text{RE-3(max)}} = 10[\log(\text{HASP}_{\text{RE-3(nom)}})+0.3] \quad (\text{eq 14})$$

$$\text{HASP}_{\text{RE-3(min)}} = 10[\log(\text{HASP}_{\text{RE-3(nom)}})-0.3] \quad (\text{eq 15})$$

5.6.5 Liquid Radwaste System (LRS) RE-18 HASP Calculation

- a. Calculate the HASP for Liquid Radwaste System (LRS) RE-18 per eq 16:

$$\text{HASP}_{\text{RE-18}} = \text{BKGD}_{\text{RE-18}} + (\text{AF})(\text{SF}) \times \sum_{\gamma} k_{\gamma} C_{\gamma} \left[\frac{F/f}{\sum_{i \neq \text{H3}} C_i / \text{ECL}_i} \right] \times \text{TCF} \quad (\text{eq 16})$$

Where:

$\text{HASP}_{\text{RE-18}}$ = high alarm setpoint for RE-18 (cpm)

$\text{BKGD}_{\text{RE-18}}$ = background reading for RE-18 (cpm)

AF = LRW source allocation factor from Table 1

SF = safety factor for RE-18 (0.9)

k_{γ} = monitor response factor (cpm/ $\mu\text{Ci/mL}$)

C_{γ} = concentration of gamma emitting isotopes in release mix, pre-dilution ($\mu\text{Ci/mL}$)

F = dilution flowrate (gpm)

f = undiluted effluent flowrate (gpm)

C_i = concentration of radionuclide "i" in release mix before dilution ($\mu\text{Ci/mL}$)

ECL_i = effluent concentration limit of radionuclide "i"

TCF = tritium correction factor defined in eq 11

$$\text{HASP}_{\text{RE-18(max)}} = 2 \times \text{HASP}_{\text{RE-18}} \quad (\text{eq 17})$$

$$\text{HASP}_{\text{RE-18(min)}} = 0.5 \times \text{HASP}_{\text{RE-18}} \quad (\text{eq 18})$$

5.6.6 Steam Generator Blowdown (SGBD) Tank RE-23 HASP Calculation

- a. Calculate the HASP for Steam Generator Blowdown (SGBD) Tank RE-23 per eq 19:

$$\text{HASP}_{\text{RE-23}} = \text{BKGD}_{\text{RE-23}} + (\text{AF})(\text{SF}) \times \sum_{\gamma} k_{\gamma} C_{\gamma} \left[\frac{F/f}{\sum_{i \neq \text{H3}} C_i / \text{ECL}_i} \right] \times \text{TCF} \quad (\text{eq 19})$$

Where:

$\text{HASP}_{\text{RE-23}}$ = high alarm setpoint for RE-23 (cpm)

$\text{BKGD}_{\text{RE-23}}$ = background reading for RE-23 (cpm)

AF = SGBD effluent system allocation factor for each unit from Table 1

SF = safety factor for RE-23 (0.9)

k_{γ} = monitor response factor (cpm/ $\mu\text{Ci/mL}$)

C_{γ} = concentration of gamma emitting isotopes in the release mix before dilution ($\mu\text{Ci/mL}$)

F = dilution flowrate (gpm)

f = undiluted effluent flowrate (gpm)

C_i = concentration of radionuclide "i" in the release mix, pre-dilution ($\mu\text{Ci/mL}$)

ECL_i = effluent concentration limit of radionuclide "i"

TCF = tritium correction factor defined in eq 11

5.7 Gaseous Effluents

5.7.1 Information Affecting Dose Calculation for Critical Receptors

NOTE 1: PG&E's meteorologists provide the annual report that includes 5-year averages factors for atmospheric dispersion (X/Q) or deposition (D/Q).

NOTE 2: The locations and occupancy for members of the public in the area immediately surrounding the plant are provided annually by the Environmental Radiological Monitoring Program in the Land Use Census.

- a. REFER TO Attachment 2 for current factors for atmospheric dispersion (X/Q) or deposition (D/Q).
- b. WHEN the latest 5-year average value of X/Q or D/Q changes from current Attachment 2 value by more than ten percent, OR a change in dose receptor location and/or occupancy requires designation of a new critical receptor, THEN ensure that Attachment 2 are updated.
- c. IF the latest 5-year average value for either X/Q or D/Q at NW Site Boundary is greater than the current Attachment 2 value by more than 10%, THEN initiate a notification for fire protection engineering (work center EMF) requesting evaluation of potential impact on NFPA 805 radioactive release calculations 9000041956 (M-1176A) and 9000041957 (M-1176B).

CAUTION: Failure to update dose receptor inputs by the first day of a new year can cause significant errors in the permit dose estimates until the tables are updated and the permits reprocessed.^{Ref 7.25}

- d. Ensure that by the first day of the calendar year that the gaseous receptor information in the effluent software is updated based on the current information in Attachment 2.

5.7.2 Gaseous Effluent Concentration Limits

NOTE: DCPD dose rate limits act to restrict the instantaneous concentrations of radionuclides in gaseous effluents at the site boundary at all times.

- a. Ensure that radiological effluent controls restrict the dose rates calculated at or beyond the site boundary due to radioactive gaseous effluents to the following:
 1. For noble gases:
 - a) Less than or equal to 500 mrem/yr to the total body
 - b) Less than or equal to 3000 mrem/yr to the skin
 2. For iodine-131, iodine-133, tritium, and for all radionuclides in particulate form with half-lives greater than 8 days:
 - a) Less than or equal to 1500 mrem/yr to any organ

5.8 Gaseous Dose Rate Calculations

5.8.1 Dose Rate to Total Body - Immersion in Noble Gas Cloud

- a. Calculate the dose rate to the total body due to immersion in a cloud of noble gases as shown in eq 20:

$$\left(\overline{\chi/Q}\right)_{\text{Max}} \sum_i K_i \dot{Q}_i \leq 500 \text{ mrem/year (eq 20)}$$

Where:

\dot{Q}_i = release rate of radionuclide "i" ($\mu\text{Ci/sec}$)
(Other terms are as previously defined.)

5.8.2 Dose Rate to Skin - Immersion in Noble Gas Cloud

- a. Calculate the dose rate to the skin due to immersion in a cloud of noble gases as shown in eq 21:

$$\left(\overline{\chi/Q}\right)_{\text{Max}} \left(\sum_i (L_i + 1.1M_i) \dot{Q}_i \right) \leq 3000 \text{ mrem/year (eq 21)}$$

(Where terms are as previously defined.)

5.8.3 Dose Rate to Organs - Iodines, Tritium, and Particulate

- a. Calculate the dose rate to organ "o" from radioiodines, tritium, and particulates released in gaseous effluents as shown in eq 22:

$$\left(\frac{\dot{\chi}}{Q}\right)_{\text{Max}} \left(\sum_i P_{i_o} \dot{Q}_i \right) \leq 1500 \text{ mrem/year (eq 22)}$$

Where:

$$P_{i_o} = K'(BR)DFA_{i_o}$$

Where:

$$K' = 10^6 \text{ pCi}/\mu\text{Ci}$$

BR = breathing rate of the child age group (m^3/yr) [The default value of $3700 \text{ m}^3/\text{yr}$ is from Reg. Guide 1.109, Table E-5.]

DFA_i = inhalation dose factor for organ "o" for child age group from radionuclide "i" (mrem/pCi) from Reg. Guide 1.109, Table E-9, with the following exceptions: H-3, Sb-124 and Sb-125 inhalation dose conversion factors from NUREG/CR4013. (Other terms are as previously defined. Values for P_{i_o} are listed in Attachment 4.)

5.9 Noble Gas Air Dose Calculations

5.9.1 Gamma Air Dose - Immersion in Noble Gas Cloud

- a. Calculate gamma air dose due to immersion in a cloud of noble gases as shown in eq 23:

$$D_{\text{ay}} = (3.17 \times 10^{-8}) (\overline{\chi/Q})_{\text{Max}} \left(\sum_i M_i \tilde{Q}_i \right) \text{ (eq 23)}$$

Where:

D_{ay} = gamma air dose (mrad)

3.17×10^{-8} = conversion constant yr/sec

M_i = gamma air dose factor for radionuclide "i" (mrad/yr per $\mu\text{Ci}/\text{m}^3$) from Attachment 3

\tilde{Q}_i = total release of noble gas radionuclide "i" (μCi)

(Other terms are as previously defined.)

5.9.2 Beta Air Dose - Immersion in Noble Gas Cloud

- a. Calculate the beta air dose due to immersion in a cloud of noble gases as shown in eq 24:

$$D_{\text{a}\beta} = (3.17 \times 10^{-8}) (\overline{\chi/Q})_{\text{Max}} \left(\sum_i N_i \tilde{Q}_i \right) \text{ (eq 24)}$$

Where:

$D_{\text{a}\beta}$ = beta air dose (mrad)

N_i = beta air dose factor for radionuclide "i" (mrad/yr per $\mu\text{Ci}/\text{m}^3$) from Attachment 3

(Other terms are as previously defined.)

5.10 Gaseous Effluent Dose to Critical Receptor from Iodines, Particulates, Tritium, and Carbon-14

5.10.1 Dose Factor Information - Gaseous Effluents

NOTE 1: Site-specific dose factors are calculated based on NUREG 0133. All dose conversion factors are taken from Reg. Guide 1.109, Rev 1, Tables E6-E14, except H-3, Sb-124 and Sb-125 dose conversion factors that are from NUREG/CR-4013.

NOTE 2: C-14 total release calculations are made per step 5.10.3a.

- a. REFER TO attachments 5 through 12 for site-specific dose factors when calculating eq 25.
 1. IF necessary to calculate a dose factor for use in an unusual circumstance,
THEN PERFORM the necessary calculation on a case-by-case basis,
AND document its use in the Corrective Action Program.

5.10.2 Total Body and Organ Dose - All Radionuclides

- a. Calculate the dose contributions to the total body and each individual organ (bone, liver, thyroid, kidney, lung, and GI-LLI) of the maximum exposed individual (critical receptor) due to radioactive gaseous effluent releases from all radionuclides identified in gaseous effluents released to unrestricted areas as shown in eq 25:

$$D_{apo} = (3.17 \times 10^{-8}) (\overline{W}_{CR}) \left(\sum_i R_{aipo} \tilde{Q}_i \right) \text{ (eq 25)}$$

Where:

D_{apo} = dose to critical receptor for age group "a," pathway "p," and organ "o" (mrem) [Dose due to C-14 may be reported separately from other isotopes within reports.]

\overline{W}_{CR} = critical receptor $\overline{\chi/Q}$ for immersion, inhalation, and all tritium and C-14 pathways (seconds/m³) from Attachment 2

= critical receptor $\overline{D/Q}$ for ground plane and all ingestion pathways (1/m²) from Attachment 2

R_{aipo} = site-specific dose factor for age group "a," radionuclide "i," pathway "p" and organ "j" (mrem/yr per $\mu\text{Ci}/\text{m}^3$ for inhalation, tritium, and C-14 pathways; mrem/yr per $\mu\text{Ci}/\text{sec m}^2$ for ground plane and ingestion pathways).

\tilde{Q}_i = total release of radionuclide "i" (μCi)

5.10.3 Carbon-14 Release Rate - Annual

NOTE: PER EPRI Technical Report 1021106, calculation of C-14 released includes factors for production and percent released in both gaseous and chemical form.^{Ref 7.20}

- a. Calculate the total C-14 release per unit per year as shown in eq 26 and eq 27:

$$\tilde{Q}_{C-14Tot} = \mu Ci_{C-14Rx} \times F_{cap} \times FR_{gas} \text{ (eq 26) (inhalation path)}$$

$$\tilde{Q}_{C-14CO2} = \mu Ci_{C-14Rx} \times F_{cap} \times FR_{gas} \times FF_{CO2} \text{ (eq 27) (ingestion path)}$$

Where:

$\tilde{Q}_{C-14Tot}$ = total C-14 released from unit in gaseous form during a calendar year (μCi)

$\tilde{Q}_{C-14CO2}$ = total C-14 released from unit in gaseous form as CO_2 during a calendar year (μCi)

μCi_{C-14Rx} = microcuries produced in the reactor per unit per effective full-power year [This value is calculated per Reference 7.20.]

F_{cap} = unit's operating capacity factor (≤ 1.0) during the year

FR_{gas} = fraction of produced C-14 assumed to be released in gaseous form based on site-specific values or values recommended by Reference 7.20. [This takes into consideration factors such as disposal of C-14 in solid radwaste.]

FF_{CO2} = fraction of produced C-14 assumed to be released in the gaseous, inorganic form (CO_2) based on site-specific values or values recommended by Reference 7.20.

5.11 Alternate Dose Calculations for Gaseous Effluents

5.11.1 Routine Gaseous Effluent Dose Assessment

- a. For routine gaseous effluent dose assessment, **PERFORM** calculations as described in Section 5.10.1. (These methods are based on NUREG 0133.)

5.11.2 New Pathway or Critical Receptor

- a. IF necessary to evaluate a new gaseous effluent dose pathway, a new critical receptor, or for another special purpose THEN the calculations described in Regulatory Guide 1.109 or the GASPAR computer code may be used.

5.12 Gaseous Effluent Dose Projections

5.12.1 Implementation

<p><u>NOTE:</u> The purpose of dose projections is to determine whether appropriate treatment of gaseous radioactive materials in relation to maintaining releases "as low as reasonably achievable" is necessary.</p>

- a. At least once every 31 days, **REFER TO** Section 5.18 and calculate the projected gaseous effluent dose contribution for each unit for the current calendar month, quarter, and year.

5.13 Noble Gas Release Rate Limit and Expected Reading Calculations

5.13.1 GRW Batch Release Noble Gas Percent Release Rate Limits (PRRLs)

- a. Calculate the PRRL for noble gas releases for each unit based on the 500 mrem/yr whole body dose rate limit as shown in eq 28:

$$\text{PRRL} = \frac{\left(\overline{\chi/Q}\right)_{\text{Max}} \left(\sum_i K_i \dot{Q}_i\right)}{(0.48)(500 \text{ mrem/yr})} \times 100\% \text{ (eq 28)}$$

Where:

$\left(\overline{\chi/Q}\right)_{\text{Max}}$ = maximum site boundary dispersion factor from Attachment 2, based on 5-year historical averages derived from the meteorological database

K_i = whole body dose factor (mrem/yr per $\mu\text{Ci}/\text{m}^3$) for radionuclide "i" from Attachment 3

\dot{Q}_i = total release rate of radionuclide "i" ($\mu\text{Ci}/\text{sec}$) from all sources discharged through this release point

0.48 = plant vent allocation factor for one unit from Table 2

500 mrem/yr = site noble gas dose rate limit

5.13.2 Noble Gas GRW Batch Release Expected Reading (ER)

- a. IF the ER exceeds the existing HASP setting,
THEN PERFORM one of the following before permitting the release:
1. Raise the HASP above the ER (per CY2.DC1).
 2. Ensure the release conditions (e.g., flowrate) are changed so that the ER is below the HASP.
- b. Calculate the ER for RE-22 as shown in eq 29:

$$ER_{RE-22} = BKGD_{RE-22} + \sum_i k_{RE-22i} C_{RE-22i} \quad (\text{eq 29})$$

Where:

ER_{RE-22} = expected reading on monitor RE-22 ($\mu\text{Ci/cc}$)

$BKGD_{RE-22}$ = RE-22 background

k_{RE-22i} = RE-22 response factor for radionuclide "i"

C_{RE-22i} = concentration of radionuclide "i" exposed to RE-22

- c. Calculate the ER for RE-44A/RE-44B as shown in eq 30:

$$ER_{RE-44} = BKGD_{RE-44} + (CCSP_{RE-44}) \sum_i k_{RE-44i} C_{RE-44i} \quad (\text{eq 30})$$

Where:

ER_{RE-44} = expected reading on monitor RE-44 ($\mu\text{Ci/cc}$)

$BKGD_{RE-44}$ = RE-44 background

$CCSP_{RE-44}$ = conversion constant setpoint for RE-44

k_{RE-44i} = RE-44 response factor for radionuclide "i"

C_{RE-44i} = concentration of radionuclide "i" exposed to RE-44

- d. Calculate the ER for RE-14/RE-14R as shown in eq 31:

$$ER_{RE-14} = BKGD_{RE-14} + (CCSP_{RE-14}) \left(\sum_i k_{RE-14i} C_{RE-14i} \right) \quad (\text{eq 31})$$

Where:

ER_{RE-14} = expected reading on monitor RE-14 ($\mu\text{Ci}/\text{cc}$)

$BKGD_{RE-14}$ = RE-14 background

$CCSP_{RE-14}$ = conversion constant setpoint for RE-14

k_{RE-14i} = RE-14 response factor for radionuclide "i"

C_{RE-14i} = concentration of radionuclide "i" exposed to RE-14

5.14 Airborne Iodine, Particulate, and Tritium Release Rate Limit Calculation

5.14.1 GRW Batch Release Iodine, Particulate, Tritium PRRL

NOTE 1: The PRRL for radioiodines, particulates, and tritium for each unit is calculated based on the 1500 mrem/yr organ dose rate limit.

NOTE 2: Site-specific dose factors are calculated based on NUREG 0133. All dose conversion factors are taken from Reg. Guide 1.109, Rev 1, Tables E6-E14, except H-3, Sb-124 and Sb-125 dose conversion factors that are from NUREG/CR-4013.

- a. Calculate the dose rate for the inhalation pathway for the child age group using the highest (worst case) organ dose factor for nuclide as shown in eq 32.

$$PRRL_o = \frac{(\overline{\chi/Q})_{\text{Max}} \sum_i P_i^w \dot{Q}_i}{(0.48)(1500 \text{ mrem/yr})} \times 100\% \text{ (eq 32)}$$

Where:

$(\overline{\chi/Q})_{\text{Max}}$ = maximum site boundary dispersion factor from Attachment 2, based on 5 year historical averages derived from the meteorological database

P_i^w = inhalation dose factor for radionuclide "i" (mrem/yr per $\mu\text{Ci}/\text{m}^3$) from Attachment 4 for child age group for worst case organ

\dot{Q}_i = release rate of radionuclide "i" ($\mu\text{Ci}/\text{sec}$)

0.48 = plant vent allocation factor for one unit from Table 2

1500 mrem/yr = site radioiodine, particulate, and tritium dose rate limit

5.15 Gaseous Effluent Radiation Monitor Setpoint Calculations

5.15.1 General

- a. Ensure that gaseous effluent monitor setpoints take into account appropriate factors for dilution or dispersion of radioactive materials that may occur between the point of discharge and the unrestricted area boundary.

NOTE: The high alarm setpoint (HASP) should also be the maximum operational setpoint.

- b. Ensure that each gaseous effluent monitor setpoint provided to Operations is less than or equal to the HASP calculated in this section.
- c. Ensure that gaseous effluent monitor setpoint reviews and calculations are performed and documented as described in CY2.DC1, "Radiation Monitor System High Alarm Setpoint Control Program."
- d. WHEN alarm setpoints for RE-14/14R are changed, THEN notify Emergency Planning personnel to evaluate the change vs. applicable EAL threshold values in Emergency Plan Appendix D, "Emergency Action Level Technical Basis Manual," per OM10.ID2, "Emergency Plan Revision and Review."

5.15.2 Allocation Factors

NOTE: DCPs annual dose rate limits for noble gases and radioiodines at or beyond the site boundary are identified in CY2.ID1. To ensure compliance, rad monitor alarm setpoint calculations are configured to ensure that the sum of the offsite dose rates resulting from simultaneous releases at the respective alarm setpoints is less than the applicable annual rate limit(s).

- a. Use the allocation factors (AFs) in the DCP high alarm setpoint (HASP) calculations with the following restrictions:
 - 1. The sum of the AFs for RE-14 (plant vent noble gas monitor), the SGBD tank vents, and miscellaneous gaseous release points from both units should be less than or equal to 1.
 - 2. AFs for RE-22 (waste gas decay tanks) and RE-44 (containment purge) may be adjusted based on operational requirements with the restriction that the sum of the AFs for RE-22 and RE-44 should be less than or equal to the AF for RE-14.
 - 3. Set the AFs for RE-24 (plant vent iodine monitor) and RE-28 (plant vent particulate monitor) both equal to the AF for RE-14.

Table 2: Typical Gaseous Effluent Discharge Pathway Allocation Factors for Unit 1 or Unit 2

Discharge Pathway	Radiation Monitor	Allocation Factor (AF)
Plant Vent - Noble gas monitor	RE-14	0.48
Plant Vent - Iodine monitor	RE-24	0.48
Plant Vent - Particulate monitor	RE-28	0.48
Waste Gas Decay Tank	RE-22	0.10
Containment Purge	RE-44	0.38
SGBD Tank Vent	N/A	0.01
Miscellaneous	N/A	0.01

5.15.3 Safety Factor

- a. Use a safety factor in HASP calculations to ensure the setpoint used by Operations is conservative.

5.15.4 Plant Vent Noble Gas RE-14/RE-14R HASP Calculation

NOTE: The HASP provides alarm function only. However, when RE-14 reaches an over-range condition, its processor will turn off RE-14 and turn on RE-87 (plant vent high range noble gas monitor). RE-14R does not have this over-range feature.

- a. Assume that the total body dose rate limit is most limiting, and calculate the HASP for RE-14/RE-14R using eq 33 :

$${}^{14}\text{Max}C_T(\text{NG}) = (\text{AF})(\text{SF}) \left(\frac{500}{(472)(F_{\text{pv}})(\overline{\chi/Q})_{\text{Max}} (294)} \right) \text{ (eq 33)}$$

Where:

${}^{14}\text{Max}C_T(\text{NG})$ = maximum allowable total concentration of noble gas in the plant vent ($\mu\text{Ci/cc}$)

AF = plant vent allocation factor for one unit from Table 2

SF = safety factor (0.9)

500 = site total body dose rate limit for instantaneous releases (mrem/yr)

472 = conversion constant to cc/sec from cfm

F_{pv} = total flowrate in the plant vent (cfm) [Maximum plant vent flowrate = 263,000 cfm]

$(\overline{\chi/Q})_{\text{Max}}$ = maximum site boundary dispersion factor from Attachment 2

294 = whole body dose factor (mrem/yr per $\mu\text{Ci/m}^3$) for Xe-133 from Attachment 3 [For plant vent HASP, release is assumed to be all Xe-133.]

$$\text{HASP}_{\text{RE-14}} = (1 - \text{Sig}_{\text{tot}}) \times {}^{14}\text{max}C_T(\text{NG}) + (\text{BKG-BRSUB}) \text{ (eq 34)}$$

$$\text{AASP}_{\text{RE-14}} = (0.3) \times (\text{HASP}_{\text{RE-14}}) \text{ (eq 35)}$$

Where:

$^{14}\text{max}C_{\text{T}}(\text{NG})$ = Maximum noble gas concentration

$\text{CCSP}_{\text{RE-14, Xe-133}}$ = conversion constant setpoint for RE-14
= $2.26\text{E-}8$ $\mu\text{Ci/cc/cpm}$

BKG = RE-14/RE-14R background cpm converted to $\mu\text{Ci/cc}$
using CCSP

BRSUB = Background subtraction setpoint, cpm converted to
 $\mu\text{Ci/cc}$ using CCSP (refer to Volume 9B for BRSUB in
cpm)

Sig_{tot} = Total channel error for isotopic mix (only Xe-133)
= 0.197 (where all s_i 's are in $\pm \%/100$)^{Ref 7.28}

5.15.5 Plant Vent Noble Gas RE-14/RE-14R Scaling Calculation

- a. Based on correlation of RE-14 readings to noble gas concentration during periods between samplings, scale the concentration of noble gas as shown in eq 36:

$$C_T = \frac{CPM_T}{CPM_S} \times C_S \text{ (eq 36)}$$

Where:

CPM_T = RE-14 time-weighted arithmetic mean (cpm)

CPM_S = RE-14 gross count rate at the time of sampling (cpm)

C_S = noble gas concentration corresponding to CPM_S , based on noble gas grab sample ($\mu\text{Ci/cc}$)

C_T = scaled concentration of noble gas ($\mu\text{Ci/cc}$)

5.15.6 Plant Vent Iodine RE-24/RE-24R HASP Calculation

NOTE: The eq 37 calculation assumes RE-24/24R respond only to I-131 as found in standard reactor coolant.

- a. Calculate the RE-24/RE-24R HASP as shown in eq 37, eq 38, and eq 39:

$${}^{24}\text{Max}C_T(I) = (AF)(SF)(f_{I-131}) \left(\frac{1500}{(472)(F_{pv})(\chi/Q)_{\text{Max}} \left(\sum_i P_i^w f_i \right)} \right) \quad (\text{eq 37})$$

Where:

${}^{24}\text{Max}C_T(I)$ = maximum allowable I-131 concentration in the plant vent ($\mu\text{Ci/cc}$)

AF = plant vent allocation factor for one unit from Table 2

SF = safety factor (0.9)

f_{I-131} = fraction of the total non-noble gas concentration due to I-131

defined as: $\frac{C_{I-131}}{\sum_i C_i}$ (eq 38)

1500 = site organ dose rate limit for I-131, for I-133, for tritium, and for all radioactive materials in particulate form with half-lives greater than 8 days (mrem/yr)

472 = conversion constant to cc/sec from cfm

F_{pv} = total flowrate in the plant vent (cfm) (maximum plant vent flowrate = 263,000 cfm)

$(\chi/Q)_{\text{Max}}$ = maximum site boundary dispersion factor from Attachment 2.

P_i^w = inhalation dose factor for radionuclide "i" (mrem/yr per $\mu\text{Ci/m}^3$) from Attachment 4 for child age group for worst case organ. Refer to step 2.11 for bases of Attachment 4 values.

f_i = fraction of total non-noble gas concentration (excluding tritium)

due to radionuclide "i" defined as: $\frac{C_i}{\sum_i C_i}$ (eq 39)

$$\text{HASP}_{\text{RE-24}} = (1 - \text{Sig}_{\text{tot}}) \times^{24\text{max}} C_{\text{T}} (\text{Iodine}) \text{ (eq 40)}$$

$$\text{AASP}_{\text{RE-24}} = (0.3) \times \text{HASP}_{\text{RE-24}} \text{ (eq 41)}$$

Where:

$$\begin{aligned} \text{CCSP}_{\text{RE-24, I-131}} &= \text{conversion constant setpoint for RE-24} \\ &= 1/k_i \text{ where } k_i = 3.4\text{E}+9 \text{ cpm/min/cfm-}\mu\text{Ci/cc} \\ &= 2.94\text{E}-10 \mu\text{Ci/cc-cfm/cpm/min} \end{aligned}$$

$$\begin{aligned} \text{Sig}_{\text{tot}} &= \text{Total channel error for isotopic mix} \\ &= 0.262 \text{ (where all } s_i\text{'s are in } \pm \% / 100 \text{)}^{\text{Ref 7.28}} \end{aligned}$$

5.15.7 Plant Vent Particulate RE-28/RE-28R HASP Calculation

- a. Assume RCS source term, and calculate the RE-28/RE-28R HASP as shown in eq 42 (and eq 43):

$${}^{28}\text{Max}C_T(\text{Part}) = (\text{AF})(\text{SF}) \left((0.05) \sum_{\text{Iodines}} f_{\text{Iodines}} + \sum_{\text{Particulates}} f_{\text{Particulates}} \right) \left(\frac{1500}{(472)(F_{\text{pv}}) \left(\frac{\chi}{Q} \right)_{\text{Max}} \left(\sum_i P_i^w f_i \right)} \right) \quad (\text{eq 42})$$

Where:

${}^{28}\text{Max}C_T(\text{Part})$ = maximum allowable particulate concentration in plant vent ($\mu\text{Ci}/\text{cc}$)

AF = plant vent allocation factor for one unit from Table 2

SF = safety factor (0.9)

0.05 = fraction of total iodine activity retained on the particulate filter (cross-talk)

f_{Iodines} = fraction of the total non-noble gas concentration due to iodines

$f_{\text{Particulates}}$ = fraction of total non-noble gas concentration due to particulates

1500 = site organ dose rate limit for I-131, I-133, tritium, and all particulate radioactive materials with half-lives greater than 8 days (mrem/yr)

472 = conversion constant to cc/sec from cfm

F_{pv} = total flow in plant vent (cfm) [Max plant vent flow = 263,000 cfm]

$\left(\frac{\chi}{Q} \right)_{\text{Max}}$ = maximum site boundary dispersion factor from Attachment 2

P_i^w = inhalation dose factor for radionuclide "i" (mrem/yr per $\mu\text{Ci}/\text{m}^3$) from Attachment 4 for child age group for worst case organ.
Refer to step 2.11 for bases of Attachment 4 values.

f_i = fraction of total non-noble gas concentration (excluding tritium) due to radionuclide "i" defined as: $\frac{C_i}{\sum_i C_i}$ (eq 43)

$$\text{HASP}_{\text{RE-28}} = (1 - \text{Sig}_{\text{tot}}) \times {}^{28\text{max}}C_{\text{T}}(\text{Part}) \quad (\text{eq 44})$$

$$\text{AASP}_{\text{RE-28}} = (0.3) \times (\text{HASP}_{\text{RE-28}}) \quad (\text{eq 45})$$

Where:

$\text{CCSP}_{\text{RE-28, Part}}$ = conversion constant setpoint for RE-28 $\mu\text{Ci}/\text{cc-cfm}/\text{cpm}/\text{min}$

$$= 1 / \left(\sum_i f_i \times E_i \right) \quad (\text{eq 46})$$

where E_i from CAP D-19, Att. 2 for RE-28 (Manufacturer's Theoretical "Tki" Factors)

$$\left(\sum f_i \right) = f_i / \left((0.05) \sum_{\text{Iodines}} f_{\text{Iodines}} + \sum_{\text{Particulates}} f_{\text{Particulates}} \right) \quad (\text{eq 47})$$

Sig_{tot} = Total channel error for isotopic mix
= 0.262 (where all s_i 's are $\pm \%/100$)^{Ref 7.28}

5.15.8 Waste Gas Decay Tank RE-22 HASP Calculation

NOTE: Radiation monitor RE-22 monitors waste gas decay tank (GDT) effluent releases and provides alarm and automatic release termination functions.

- a. Assuming the skin dose rate limit is most limiting, calculate the HASP for RE-22 as shown in eq 48:

$${}^{22}\text{Max}C_T(\text{NG}) = (\text{AF})(\text{SF}) \left(\frac{3000}{(472)(F_{\text{gdt}})(\overline{\chi/Q})_{\text{Max}} (1.34 \times 10^3)} \right) \quad (\text{eq 48})$$

Where:

${}^{22}\text{Max}C_T(\text{NG})$ = maximum allowable total concentration of noble gas in the GDT exhaust line ($\mu\text{Ci/cc}$)

AF = GDT allocation factor for one unit from Table 2

SF = safety factor (0.9)

3000 = site skin dose rate limit for instantaneous releases (mrem/yr)

472 = conversion constant to cc/sec from cfm

F_{gdt} = maximum flowrate for the GDT system (31 cfm)

$(\overline{\chi/Q})_{\text{Max}}$ = maximum site boundary dispersion factor from Attachment 2

1.34×10^3 = skin dose factor for Kr-85 ($\text{mrem/yr per } \mu\text{Ci/m}^3$) from Attachment 3

$$\text{HASP}_{\text{max}} = \text{BKGD}_{\text{RE-22}} + {}^{22}\text{Max}C_T(\text{NG}) \times \text{Response Factor} \quad (\text{eq 49})$$

$$\text{HASP}_{\text{nom}} = 10^{((\log \text{HASP}_{\text{max}}) - 0.3)} \quad (\text{eq 50})$$

Where:

BKGD = RE-22 background cpm converted to $\mu\text{Ci/cc}$

Response Factor RE-22_{Kr-85}, $\text{cpm}/\mu\text{Ci/cc} = 5.3\text{E}+3$

Dose Factor for Kr-85 $\text{mR/yr}/\mu\text{Ci/m}^3 = 1.34\text{E}+3$

5.15.9 Containment Purge Exhaust RE-44A/RE-44B HASP Calculation

NOTE 1: RE-44A/B monitor containment purge releases and provides alarm and automatic release termination functions.

NOTE 2: The Mode 6 design-basis accident involving RE-44 is a fuel handling accident in containment without particulate release to the air.

NOTE 3: The RE-44 HASP calculated in Section 5.15.9 is conservative because it is based on noble gas only. It bounds the TS limit for noble gas, iodine, and particulate activity in Mode 6.

- Use the more limiting of two RE-44A/B HASP setpoints calculated by eq 51 and eq 55 to limit noble gas dose rate for skin and total body exposure.
- Calculate RE-44A/B Limiting Concentration Based on Total Body Dose as shown in eq 51 (and eq 52):

$${}^{44A/B\text{Max}}C_T(\text{NG}) = (\text{AF})(\text{SF}) \left(\frac{500}{(472)(F_{\text{ct}}) \left(\overline{\chi/Q} \right)_{\text{Max}} \left(\sum K_i f_i \right)} \right) \quad (\text{eq 51})$$

Where:

${}^{44A/B\text{Max}}C_T(\text{NG})$ = maximum allowable noble gas concentration in containment purge exhaust line ($\mu\text{Ci/cc}$)

AF = containment purge allocation factor for one unit from Table 2

SF = safety factor (0.9)

500 = site instantaneous release total body dose rate limit (mrem/yr)

472 = conversion constant to cc/sec from cfm

F_{ct} = maximum flowrate in the containment purge system
[Maximum containment purge flowrate = 55,000 cfm]

$\left(\overline{\chi/Q} \right)_{\text{Max}}$ = dispersion factor for site boundary from Attachment 2

K_i = whole body dose factor (mrem/yr per $\mu\text{Ci/m}^3$) for radionuclide "i" from Attachment 3

f_i = fraction of concentration of individual noble gas radionuclide "i" in total mix of noble gas effluents in containment purge line defined as: $\frac{C_i}{\sum C_i}$ (eq 52)

$$HASP_{RE-44} = BKGD_{RE-44} + (1 - Sig_{tot}) \times {}^{44A/B} \text{ Total Body Dose } C_T(NG) \text{ (eq 53)}$$

$$AASP_{RE-44} = (0.3) \times ({}^{\text{TotalBodyDose}} HASP_{RE-44}) \text{ (eq 54)}$$

Where:

Sig_{tot} = Total channel error for isotopic mix
= 0.262 (where all s_i 's are in $\pm \%/100$)^{Ref 7.28}

$BKGD_{RE-44}$ = (BKG - BRSUB) X CCSP in $\mu\text{Ci/cc}$

BKG = RE-44 background cpm (from PPC) converted to $\mu\text{Ci/cc}$ using CCSP

BRSUB = Background subtraction setpoint, cpm converted to $\mu\text{Ci/cc}$ using CCSP (refer to Volume 9B for BSRUB in cpm)

$CCSP_{RE-44}$ from CAP D-19, Att. 2 in $\text{cpm}/\mu\text{Ci/cc}$ (Manufacturer's Theoretical "Tki" Factors)

1. GO TO step 5.15.9c and calculate eq 55 for comparison.

CAUTION: Skin dose should be calculated whenever the current RCS sample contains a significant fraction of Kr-85.

- c. Calculate the RE-44A/B Limiting Concentration Based on Skin Dose as shown in eq 55 (and eq 56):

$${}^{44A/B} \text{Max } C_T(NG) = (AF)(SF) \left(\frac{3000}{(472)(F_{ct}) \left(\frac{\lambda}{Q} \right)_{\text{Max}} \left(\sum_i (L_i + 1.1M_i) f_i \right)} \right) \text{ (eq 55)}$$

Where:

${}^{44A/B}M_{\max} C_T(\text{NG})$ = maximum allowable total concentration of noble gas in the plant vent ($\mu\text{Ci/cc}$)

AF = containment purge allocation factor for one unit from Table 2

SF = safety factor (0.9).

3000 = site skin dose rate limit for instantaneous releases (mrem/yr)

472 = conversion constant to cc/sec from cfm

F_{ct} = total flowrate in the containment purge system (cfm)
[Maximum containment purge flowrate = 55,000 cfm]

$(\chi/Q)_{\text{Max}}$ = dispersion factor for site boundary from Attachment 2

L_i = skin dose factor (mrem/yr per $\mu\text{Ci/m}^3$) for isotope "i" from Attachment 3

1.1 = conversion factor mrem/mrad; converts air dose to skin dose

M_i = gamma air dose factor (mrad/yr per $\mu\text{Ci/m}^3$) for radionuclide "i" from Attachment 3

f_i = fraction of concentration of individual noble gas radionuclide "i" in total mix of noble gas effluents in containment purge line defined

$$\text{as: } \frac{C_i}{\sum_i C_i} \text{ (eq 56)}$$

$$\text{HASP}_{\text{RE-44}} = \text{BKGD}_{\text{RE-44}} + (1 - \text{Sig}_{\text{tot}}) \times {}^{44\text{A/B}} \text{Skin Dose} C_{\text{T}}(\text{NG}) \quad (\text{eq 57})$$

$$\text{AASP}_{\text{RE-44}} = (0.3) \times ({}^{\text{Skin Dose}} \text{HASP}_{\text{RE-44}}) \quad (\text{eq 58})$$

Where:

Sig_{tot} = Total channel error for isotopic mix
= 0.262 (where all s_i 's are in $\pm \%/100$)^{Ref 7.28}

$\text{BKGD}_{\text{RE-44}}$ = (BKG - BRSUB) X CCSP in $\mu\text{Ci}/\text{cc}$

BKG = RE-44 background cpm (from PPC) converted to $\mu\text{Ci}/\text{cc}$ using CCSP

BRSUB = Background subtraction setpoint, cpm converted to $\mu\text{Ci}/\text{cc}$ using CCSP (refer to Volume 9B for BSRUB in cpm)

$\text{CCSP}_{\text{RE-44}}$ from CAP D-19, Att. 2 in $\text{cpm}/\mu\text{Ci}/\text{cc}$ (Manufacturer's Theoretical "Tki" Factors)

- d. Document the lesser of the results of eq 51 and eq 55 as the limiting concentration for the RE-44A/B HASP.

5.16 40 CFR 190 Nuclear Fuel Cycle Dose Calculations (Direct, Gas, Liquid, & Airborne)

5.16.1 Dose from Nuclear Fuel Cycle

- a. Calculate the sum of the doses to members of the public from the following:
 1. Direct radiation
 2. Liquid effluents
 3. Noble gas
 4. Airborne radioiodines, tritium, particulates, and C-14
- b. Ensure that the dose equivalent to any member of the public from planned discharges of radioactive materials to the environment and to radiation from DCPD operation do not exceed the following limits:
 - 25 millirem to the whole body
 - 75 millirem to the thyroid
 - 25 millirem to any other organ

NOTE: Direct radiation dose from outside storage tanks, storage buildings, and the ISFSI is typically calculated from area TLD data. It may also be calculated using direct survey measurements or using shielding code.

5.16.2 Direct Radiation Dose Calculation

- a. Ensure that direct radiation dose calculation is performed for appropriate receptor location(s) near the site including occupancy factor(s) based on land use census information.
- b. Calculate dose to the chosen receptor location from direct radiation using environmental TLD data as shown in eq 59 (and eq 60):

$$\dot{D}'_{\text{receptor}} = O_{\text{receptor}} \left(\frac{r_{\text{adj}}}{r_{\text{receptor}}} \right)^2 (D'_{\text{ro}})(B) \left(e^{-\mu_0 \times r_{\text{receptor}}} \right) \quad (\text{eq 59})$$

Where:

$\dot{D}'_{\text{receptor}}$ = dose rate at the receptor location (mrem)

O_{receptor} = occupancy factor for receptor at location

D'_{ro} = dose rate from the dosimetry reading (mrem)

r_{adj} = distance from the point source to the dosimetry (m)

r_{receptor} = distance from the point source to receptor location (m)

$$B = \text{buildup factor} = 1 + (\mu_s) r_{\text{receptor}} \left(\frac{\mu_a + \mu_s}{\mu_a} \right) \quad (\text{eq 60})$$

Where:

μ_a = total absorption coefficient

$$= 0.001 \times e^{(1.34 - (0.105 \times (\ln(10 \times \bar{E}) - 1.57)^2))} \times (273^\circ\text{K}/T^\circ\text{K})$$

μ_s = total Compton scatter coefficient

$$= 0.001 \times e^{(3.10 - (0.089 \times (\ln(10 \times \bar{E}) + 1.89)^2))} \times (273^\circ\text{K}/T^\circ\text{K})$$

μ_0 = total attenuation coefficient = $\mu_a + \mu_s$

\bar{E} = effective avg gamma energy per disintegration (MeV)

$T^\circ\text{K}$ = average absolute temperature (Kelvin)

5.16.3 Liquid and Gaseous Effluent Dose

- a. Calculate doses as follows:
 - Dose from liquid effluents per eq 1
 - Dose from radioiodines, tritium, and particulates in gaseous effluents per eq 25
- b. WHEN calculating the dose required by the radiological effluent controls, THEN use realistic assumptions for the liquid and gaseous effluent dose pathways that are based on the most recent land use census data and the current environmental monitoring information.
 1. WHEN they affect dose to the receptor, THEN use any or all of the following:
 - More realistic liquid dilution factors
 - Location and age of actual individuals
 - Site-specific food pathway parameters
 - Documentation of true food consumption
 - Other assumptions provided they are substantiated by census or direct measurement.

5.16.4 Noble Gas Dose

- a. Calculate the noble gas total body dose and noble gas skin dose contributions to the total uranium fuel cycle dose for a member of the public as shown in eq 61 and eq 62, respectively:

$$\text{Noble gas total body dose} = (3.17 \times 10^{-8}) \left(\overline{\chi/Q} \right)_R \left(\sum_i K_i \tilde{Q}_i \right) \quad (\text{eq 61})$$

$$\text{Noble gas skin dose} = (3.17 \times 10^{-8}) \left(\overline{\chi/Q} \right)_R \left(\sum_i (L_i + 1.1M_i) \tilde{Q}_i \right) \quad (\text{eq 62})$$

Where:

3.17×10^{-8} = conversion constant yr/sec

$\left(\overline{\chi/Q} \right)_R$ = maximum historical dispersion factor for the receptor of interest from Attachment 2, based on 5 year historical averages derived from the meteorological database

K_i = whole body dose factor for radionuclide "i" (mrem/yr per $\mu\text{Ci}/\text{m}^3$) from Attachment 3

L_i = skin dose factor for radionuclide "i" (mrem/yr per $\mu\text{Ci}/\text{m}^3$) from Attachment 3

1.1 = conversion factor mrem/mrad; converts air dose to skin dose

M_i = gamma air dose factor for radionuclide "i" (mrad/yr per $\mu\text{Ci}/\text{m}^3$) from Attachment 3

\tilde{Q}_i = total release of noble gas radionuclide "i" ($\mu\text{Ci}/\text{sec}$)

5.17 On-Site Dose to Unmonitored Individuals

NOTE 1: The 40CFR190 dose limits identified in Section 5.16 have been applied to Diablo Canyon employees that are not monitored for radiological exposure.

NOTE 2: Unmonitored, full-time employees at the locations in Table 3 are assumed to work 40 hours per week during 52 weeks each year. Any dose calculated for them represents an upper bound for individuals that visit the site for shorter periods.

NOTE 3: Exposure of unmonitored individuals due to radioactive liquid releases while on-site is highly unlikely and is therefore not addressed.

5.17.1 Using the guidance in this section, ensure that the 40 CFR Part 190 dose limits identified in Section 5.16 are considered for onsite, unmonitored individuals.

- a. IF AT ANY TIME an unmonitored individual at the site is determined to have received an annual dose >10 millirem, THEN initiate a tracking notification for evaluation and assign to radiation protection (work center ORE and the radiation protection manager). A courtesy notification may be initiated at a lower level.

5.17.2 Ensure that Table 3 reflects current information for unmonitored individuals that work closest to the plant.

Table 3: Information for Dose Calculation for On-site Unmonitored Individuals					
Location of On-Site Unmonitored Individual	Sector	Distance	Annual Occupancy Factor	X/Q	D/Q
Administration Building	SSE	146m	0.24	REFER TO Attachment 2	REFER TO Attachment 2
Make-up Water Plant	NNE	270m	0.24	REFER TO Attachment 2	REFER TO Attachment 2

5.17.3 Calculate dose from gaseous releases for the unmonitored onsite individuals in Table 3 using the following:

- a. Noble gas total body dose as shown in eq 61
- b. Noble gas skin dose as shown in eq 62
- c. Dose from radioiodines, tritium, C-14, and particulates as shown in eq 25.

NOTE: Based on Reg. Guide 1.111, modified X/Q and D/Q factors from eq 63 and eq 64, respectively, should provide reasonable dispersion and deposition estimates for distances as close as 200 meters from the plant.

- d. WHEN necessary to calculate an X/Q or D/Q values for an onsite location that is not already available, THEN use logarithmic extrapolation from the site boundary (SB) in the same sector to the on-site location of interest as shown in eq 63 and eq 64:

$$\log\left(\frac{X}{Q}\right)_{\text{on-site}} \approx \left(\frac{\log\left(\frac{X}{Q}\right)_{\text{SB}} - \log\left(\frac{X}{Q}\right)_{\text{loc}}}{\log(\text{dist})_{\text{SB}} - \log(\text{dist})_{\text{loc}}} \right) (\log(\text{dist})_{\text{on-site}} - \log(\text{dist})_{\text{SB}}) + \log\left(\frac{X}{Q}\right)_{\text{SB}} \quad (\text{eq 63})$$

$$\log\left(\frac{D}{Q}\right)_{\text{on-site}} \approx \left(\frac{\log\left(\frac{D}{Q}\right)_{\text{SB}} - \log\left(\frac{D}{Q}\right)_{\text{loc}}}{\log(\text{dist})_{\text{SB}} - \log(\text{dist})_{\text{loc}}} \right) (\log(\text{dist})_{\text{on-site}} - \log(\text{dist})_{\text{SB}}) + \log\left(\frac{D}{Q}\right)_{\text{SB}} \quad (\text{eq 64})$$

- 5.17.4 Calculate dose from direct radiation for unmonitored individuals in Table 3 from outside storage tanks, rad waste storage buildings, and the ISFSI using one or more of the following:
- Derivation from environmental TLD data (preferred)
 - Use of direct survey measurements
 - Calculation by shielding code
- 5.17.5 Ensure that dose calculation results obtained are reported in the Annual Radioactive Effluent Release Report.

5.18 Dose Projection Calculations

5.18.1 Dose Projection by Unit

- a. Calculate the projected dose from each unit per eq 65:

$$D_P = D_{P,U} + \frac{1}{2} D_{P,Com} \quad (\text{eq 65})$$

Where:

D_P = projected dose

$D_{P,U}$ = projected dose attributed to reactor unit, U

$D_{P,Com}$ = projected dose common to both reactor units

5.18.2 31-Day Dose Projection

- a. Calculate the 31-day projected dose as shown in eq 66:

$$D_P^M = 31 \left(\frac{D_A^{PM} + d_A^{CM} + d_P^{CB}}{T + t} \right) \quad (\text{eq 66})$$

Where:

D_P^M = projected dose for the next 31-day period

D_A^{PM} = previous month's actual dose

d_A^{CM} = current month actual dose to date

d_P^{CB} = projected dose from current batch release

T = number of days in the previous month

t = number of days into the present month

5.18.3 Quarterly Dose Projection

- a. Calculate the projected quarterly doses as shown in eq 67:

$$D_P^{CQ} = d_A^{CQ} + (92 - t) \left(\frac{D_A^{PQ} + d_A^{CQ} + d_P^{CB}}{T + t} \right) \text{ (eq 67)}$$

Where:

 D_P^{CQ} = projected dose for the current calendar quarter d_A^{CQ} = current quarter to date actual dose D_A^{PQ} = previous quarter's actual dose d_P^{CB} = projected dose from the current batch release

T = number of days in the previous quarter

t = number of days into the present quarter

5.18.4 Annual Dose Projection

- a. Calculate the projected annual doses as shown in eq 68:

$$D_P^{CY} = d_A^{CY} + (366 - t) \left(\frac{D_A^{PY} + d_A^{CY} + d_P^{CB}}{T + t} \right) \text{ (eq 68)}$$

Where:

 D_P^{CY} = projected dose for the current calendar year d_A^{CY} = current year to date actual dose D_A^{PY} = previous year's actual dose d_P^{CB} = projected dose from the current batch release

T = number of days in the previous year

t = number of days into the present year

5.19 Actions Required for Unplanned Gaseous or Liquid Releases

<p>NOTE: For purposes of classification only, unplanned gaseous release puffs through the plant vent may use one hour integrated resolution times.</p>

5.19.1 Unmonitored and Unplanned Release

- a. WHEN an unmonitored, unplanned release of contaminated gas or liquid occurs,
THEN PERFORM the following steps:
1. Write a report describing the event with a calculation of the percent of release rate limit listed in CY2.ID1 (if possible). This task is typically performed by the radiochemistry effluents engineer.
 2. Forward the report prepared in step 5.19.1a.1 to the Plant Safety Review Committee (PSRC) for review.
 3. Describe the release in the Annual Radioactive Effluent Release Report for the year in which the release occurred.

5.19.2 Monitored and Unplanned Release

- a. WHEN a monitored, unplanned gas or liquid release that exceeds 1% of the CY2.ID1 release rate limit occurs,
THEN PERFORM the following steps:
1. Write a report describing the event. This task is typically performed by the radiochemistry effluents engineer.
 2. Forward the event report prepared in step 5.19.2a.1 to PSRC for review.
 3. Describe the release in the Annual Radioactive Effluent Release Report for the year in which the release occurred.

6. RECORDS

6.1 Submit the basis documents generated per CAP A-8 for the following to the Records Management System (RMS) per CY1.DC1, "Analytical Data Processing Responsibilities":

- Meteorological parameters
- Abnormal discharges documentation
- Determination of release rate and dose parameters methodology
- Dose projections

7. REFERENCES

- 7.1 CAP A-5, "Liquid Radwaste Discharge Management"
- 7.2 CAP A-6, "Gaseous Radwaste Sampling and Analysis for Release"
- 7.3 CAP D-15, "Steam Generator Leak Rate Determination"
- 7.4 CAP D-19, "Correlation of Rad Monitors of Radioactivity"
- 7.5 CY2.DC1, "Radiation Monitoring System High Alarm Setpoint Control Program"
- 7.6 CY2.ID1, "Radioactive Effluent and Controls Program"
- 7.7 AR A0619600, "Rad Effluent Sampling of Ni-63"
- 7.8 AR A0619601, "Include Tc-99M In ODCM and ARER Reports"
- 7.9 License Amendment 67/66, January 22, 1992
- 7.10 NUREG-0172, "Age-Specific Radiation Dose Commitment Factors for a One-Year Chronic Intake," November 1977
- 7.11 NUREG 2919, "Computer Code XOQDOQ," Revision 2, September, 1982
- 7.12 NUREG No. 0133, "Preparation of Radiological Effluent Tech Specs for Nuclear Power Plants," October 1978
- 7.13 NUREG No. 0543, "Methods for Demonstrating LWR Compliance with the EPA Uranium Fuel Cycle Standard 40 CFR 190," January 1980
- 7.14 NUREG/CR-4013, "LADTAP II - Technical Reference and User Guide"
- 7.15 Regulatory Guide 1.109, "Calculation of Annual Doses to Man From Routine Releases of Reactor Effluents for the Purpose of Evaluating Compliance with 10 CFR 50, Appendix I," Rev. 0, March 1976

-
- 7.16 Regulatory Guide 1.109, "Calculation of Annual Doses to Man From Routine Releases of Reactor Effluents for the Purpose of Evaluating Compliance with 10 CFR 50, Appendix I," Rev. 1, October 1977
 - 7.17 Regulatory Guide, 1.111, "Methods for Estimating Atmospheric Transport and Dispersion of Gaseous Effluents in Routine Releases from Light-Water-Cooled Reactors," Rev. 1, July, 1977
 - 7.18 Review and Expansion of USNRC Regulatory Guide 1.109 Models for Computing Dose Conversion Factors, F.W. Boone and John M. Palms, Report No. EMP-155, February 1983
 - 7.19 "Radioactive Decay Data Tables," David C. Kocher. DOE/TIC-11026, 1981
 - 7.20 "Estimation of Carbon-14 in Nuclear Power Plant Gaseous Effluents," EPRI Technical Report 1021106, December 2010
 - 7.21 Meteorology Services Report Number 420DC-14.9, March 2014 (XOQDOQ data)
 - 7.22 "DRADCALC.xls Computer Program Verification and Validation Report", Revision 0, June 1997
 - 7.23 Notification 50660141, "Revise CAP A-8 Drawing"
 - 7.24 DCL-14-032, "2013 Annual Radiological Environmental Operating Report"
 - 7.25 SAPN 50624472, "DA-Vac PP Ops - Not Consistent w/FSAR"
 - 7.26 SAPN 50816085, "DA 2014 Rad Eff Rel Report - Corrections"
 - 7.27 SAPN 50893415, "DA-QAAF-ODCM submission error"
 - 7.28 Victoreen Document 958.365

LRW Composite Dose Factors

U1&2 Attachment 1: Page 1 of 3

LRW Composite Dose Factors, A_{10} , for Adults at a Saltwater Site to Organ "o" (mrem/hour per $\mu\text{Ci/mL}$) (1)							
Nuclide	Tot Body	Thyroid	Kidney	Lung	GI-LLI	Bone	Liver
H-3	1.61E-01	1.61E-01	1.61E-01	1.61E-01	1.61E-01	0.00E+00	1.61E-01
Na-24	4.57E-01	4.57E-01	4.57E-01	4.57E-01	4.57E-01	4.57E-01	4.57E-01
Cr-51	5.58E+00	3.34E+00	1.23E+00	7.40E+00	1.40E+03	0.00E+00	0.00E+00
Mn-54	1.35E+03	0.00E+00	2.10E+03	0.00E+00	2.16E+04	0.00E+00	7.06E+03
Mn-56	3.15E+01	0.00E+00	2.26E+02	0.00E+00	5.67E+03	0.00E+00	1.78E+02
Fe-55	8.23E+03	0.00E+00	0.00E+00	1.97E+04	2.03E+04	5.11E+04	3.53E+04
Fe-59	7.27E+04	0.00E+00	0.00E+00	5.30E+04	6.32E+05	8.06E+04	1.90E+05
Co-57	2.36E+02	0.00E+00	0.00E+00	0.00E+00	3.59E+03	0.00E+00	1.42E+02
Co-58	1.35E+03	0.00E+00	0.00E+00	0.00E+00	1.22E+04	0.00E+00	6.03E+02
Co-60	3.82E+03	0.00E+00	0.00E+00	0.00E+00	3.25E+04	0.00E+00	1.73E+03
Ni-63	1.67E+03	0.00E+00	0.00E+00	0.00E+00	7.18E+02	4.96E+04	3.44E+03
Ni-65	1.20E+01	0.00E+00	0.00E+00	0.00E+00	6.65E+02	2.02E+02	2.62E+01
Cu-64	1.01E+02	0.00E+00	5.40E+02	0.00E+00	1.83E+04	0.00E+00	2.14E+02
Zn-65	2.32E+05	0.00E+00	3.43E+05	0.00E+00	3.23E+05	1.61E+05	5.13E+05
Zn-69	4.56E+01	0.00E+00	4.26E+02	0.00E+00	9.85E+01	3.43E+02	6.56E+02
As-76	4.42E+01	0.00E+00	8.72E+01	0.00E+00	0.00E+00	0.00E+00	4.62E+01
Br-82	4.07E+00	0.00E+00	0.00E+00	0.00E+00	4.67E+00	0.00E+00	0.00E+00
Br-84	9.39E-02	0.00E+00	0.00E+00	0.00E+00	7.37E-07	0.00E+00	0.00E+00
Rb-86	2.91E+02	0.00E+00	0.00E+00	0.00E+00	1.23E+02	0.00E+00	6.24E+02
Rb-88	9.49E-01	0.00E+00	0.00E+00	0.00E+00	2.47E-11	0.00E+00	1.79E+00
Rb-89+D	8.34E-01	0.00E+00	0.00E+00	0.00E+00	6.89E-14	0.00E+00	1.19E+00
Sr-89+D	1.43E+02	0.00E+00	0.00E+00	0.00E+00	8.00E+02	4.99E+03	0.00E+00
Sr-90+D	2.83E+03	0.00E+00	0.00E+00	0.00E+00	3.55E+03	1.41E+05	0.00E+00
Sr-91+D	3.71E+00	0.00E+00	0.00E+00	0.00E+00	4.37E+02	9.18E+01	0.00E+00
Sr-92+D	1.51E+00	0.00E+00	0.00E+00	0.00E+00	6.90E+02	3.48E+01	0.00E+00
Y-90	1.63E-01	0.00E+00	0.00E+00	0.00E+00	6.42E+04	6.06E+00	0.00E+00
Y-91m+D	2.22E-03	0.00E+00	0.00E+00	0.00E+00	1.68E-01	5.73E-02	0.00E+00
Y-92	1.56E-02	0.00E+00	0.00E+00	0.00E+00	9.32E+03	5.32E-01	0.00E+00

(1) Dose factors are based on NUREG 0133 methodology.

LRW Composite Dose Factors

U1&2 Attachment 1: Page 2 of 3

LRW Composite Dose Factors, A_{10} , for Adults at a Saltwater Site to Organ "o" (mrem/hour per $\mu\text{Ci/mL}$) (1)							
Nuclide	Tot Body	Thyroid	Kidney	Lung	GI-LLI	Bone	Liver
Zr-95+D	3.46E+00	0.00E+00	8.02E+00	0.00E+00	1.62E+04	1.59E+01	5.11E+00
Zr-97+D	8.13E-02	0.00E+00	2.68E-01	0.00E+00	5.51E+04	8.81E-01	1.78E-01
Nb-95	1.34E+02	0.00E+00	2.46E+02	0.00E+00	1.51E+06	4.47E+02	2.49E+02
Mo-99+D	2.43E+01	0.00E+00	2.89E+02	0.00E+00	2.96E+02	0.00E+00	1.28E+02
Tc-101	1.88E-01	0.00E+00	3.46E-01	9.81E-03	5.77E-14	1.33E-02	1.92E-02
Ru-103+D	4.60E+01	0.00E+00	4.07E+02	0.00E+00	1.25E+04	1.07E+02	0.00E+00
Ru-105+D	3.51E+00	0.00E+00	1.15E+02	0.00E+00	5.44E+03	8.89E+00	0.00E+00
Ru-106+D	2.01E+02	0.00E+00	3.06E+03	0.00E+00	1.03E+05	1.59E+03	0.00E+00
Ag-110m+D	8.60E+02	0.00E+00	2.85E+03	0.00E+00	5.91E+05	1.56E+03	1.45E+03
Sn-113	3.53E+03	9.85E+02	0.00E+00	0.00E+00	0.00E+00	6.06E+04	1.66E+03
Sn-117m	8.76E+02	2.52E+02	0.00E+00	0.00E+00	0.00E+00	3.02E+03	3.41E+02
Sb-122	6.65E+00	3.09E-01	0.00E+00	1.18E+01	0.00E+00	2.19E+01	4.47E-01
Sb-124	1.09E+02	6.70E-01	0.00E+00	2.15E+02	7.84E+03	2.76E+02	5.22E+00
Sb-125	4.20E+01	1.79E-01	0.00E+00	1.36E+02	1.94E+03	1.77E+02	1.97E+00
Te-125m	2.91E+01	6.51E+01	8.82E+02	0.00E+00	8.66E+02	2.17E+02	7.86E+01
Te-129m+D	1.47E+02	3.20E+02	3.89E+03	0.00E+00	4.69E+03	9.31E+02	3.47E+02
Te-129	6.19E-01	1.95E+00	1.07E+01	0.00E+00	1.92E+00	2.54E+00	9.55E-01
Te-131m+D	5.71E+01	1.08E+02	6.94E+02	0.00E+00	6.80E+03	1.40E+02	6.85E+01
Te-131+D	5.03E-01	1.31E+00	6.99E+00	0.00E+00	2.26E-01	1.59E+00	6.66E-01
Te-132+D	1.24E+02	1.46E+02	1.27E+03	0.00E+00	6.24E+03	2.04E+02	1.32E+02
I-131+D	1.79E+02	1.02E+05	5.35E+02	0.00E+00	8.23E+01	2.18E+02	3.12E+02
I-132	9.96E+00	9.96E+02	4.54E+01	0.00E+00	5.35E+00	1.06E+01	2.85E+01
I-133+D	3.95E+01	1.90E+04	2.26E+02	0.00E+00	1.16E+02	7.45E+01	1.30E+02
I-134	5.40E+00	2.62E+02	2.40E+01	0.00E+00	1.32E-02	5.56E+00	1.51E+01
I-135+D	2.24E+01	4.01E+03	9.75E+01	0.00E+00	6.87E+01	2.32E+01	6.08E+01
Cs-134	1.33E+04	0.00E+00	5.27E+03	1.75E+03	2.85E+02	6.84E+03	1.63E+04
Cs-136	2.04E+03	0.00E+00	1.57E+03	2.16E+02	3.21E+02	7.16E+02	2.83E+03
Cs-137+D	7.85E+03	0.00E+00	4.07E+03	1.35E+03	2.32E+02	8.77E+03	1.20E+04
Cs-138	5.94E+00	0.00E+00	8.81E+00	8.70E-01	5.12E-05	6.07E+00	1.20E+01

(1) Dose factors are based on NUREG 0133 methodology.

LRW Composite Dose Factors

U1&2 Attachment 1: Page 3 of 3

LRW Composite Dose Factors, A_{10} , for Adults at a Saltwater Site to Organ "o" (mrem/hour per $\mu\text{Ci/mL}$) (1)							
Nuclide	Tot Body	Thyroid	Kidney	Lung	GI-LLI	Bone	Liver
Ba-139	2.30E-01	0.00E+00	5.23E-03	3.17E-03	1.39E+01	7.85E+00	5.59E-03
Ba-140+D	1.08E+02	0.00E+00	7.02E-01	1.18E+00	3.38E+03	1.64E+03	2.06E+00
Ba-141+D	1.29E-01	0.00E+00	2.68E-03	1.63E-03	1.80E-09	3.81E+00	2.88E-03
La-140	2.10E-01	0.00E+00	0.00E+00	0.00E+00	5.83E+04	1.57E+00	7.94E-01
La-142	9.13E-03	0.00E+00	0.00E+00	0.00E+00	2.68E+02	8.06E-02	3.67E-02
Ce-141	2.63E-01	0.00E+00	1.08E+00	0.00E+00	8.86E+03	3.43E+00	2.32E+00
Ce-143+D	4.94E-02	0.00E+00	1.97E-01	0.00E+00	1.67E+04	6.04E-01	4.46E+02
Ce-144+D	9.59E+00	0.00E+00	4.43E+01	0.00E+00	6.04E+04	1.79E+02	7.47E+01
Pr-144	9.64E-04	0.00E+00	4.44E-03	0.00E+00	2.73E-09	1.90E-02	7.87E-03
Nd-147+D	2.74E-01	0.00E+00	2.68E+00	0.00E+00	2.20E+04	3.96E+00	4.58E+00
Pu-238	2.07E+03	0.00E+00	8.87E+03	0.00E+00	8.85E+03	7.62E+04	9.66E+03
Pu-239	2.31E+03	0.00E+00	9.83E+03	0.00E+00	8.07E+03	8.79E+04	1.06E+04
Pu-240	2.31E+03	0.00E+00	9.82E+03	0.00E+00	8.23E+03	8.76E+04	1.05E+04
Pu-241+D	4.01E+01	0.00E+00	1.85E+02	0.00E+00	1.70E+02	1.90E+03	9.03E+01
Pu-242	2.23E+03	0.00E+00	9.46E+03	0.00E+00	7.91E+03	8.13E+04	1.02E+04
U-233+D	1.56E+03	0.00E+00	6.02E+03	0.00E+00	1.86E+03	2.58E+04	0.00E+00
U-234	1.53E+03	0.00E+00	5.90E+03	0.00E+00	1.82E+03	2.48E+04	0.00E+00
U-235+D	1.44E+03	0.00E+00	5.54E+03	0.00E+00	2.31E+03	2.37E+04	0.00E+00
U-236	1.47E+03	0.00E+00	5.66E+03	0.00E+00	1.71E+03	2.37E+04	0.00E+00
U-238+D	1.35E+03	0.00E+00	5.19E+03	0.00E+00	1.63E+03	2.27E+04	0.00E+00
W-187	2.68E+00	0.00E+00	0.00E+00	0.00E+00	2.51E+03	9.16E+00	7.66E+00
Np-239	1.91E-03	0.00E+00	1.08E-02	0.00E+00	7.11E+02	3.53E-02	3.47E-03

(1) Dose factors are based on NUREG 0133 methodology.

U1&2 Attachment 2: Page 1 of 2

Current Dose Receptor Information

Sector	Receptor Description	Distance (meters)	X/Q	Occupancy (Inhalation and Ground Plane, O_{InhGP})	$X/Q \times O_{InhGP}$	D/Q	Occupancy (Ingestion, O_{Ing})	$D/Q \times O_{Ing}$	Comments
N	Site Boundary	815	3.1E-06	N/A	N/A	7.2E-09	N/A	N/A	No consistent occupancy
NNE	Make-up Water Plant	270	2.0E-05	0.24	4.8E-06	2.9E-08	N/A	N/A	Close onsite receptor location; refer to step 5.17.2
NNE	Residence	5190	1.3E-07	0.3	3.9E-08	2.2E-10	N/A	N/A	Cabin - partial occupancy $((4 \times (10/30)) + ((2/7) \times 8)/30)/2$
NE	Residence	7950	4.2E-08	1.0	4.2E-08	8.2E-11	N/A	N/A	Full-time occupancy
ENE	Residence	7170	4.8E-08	1.0	4.8E-08	1.1E-10	N/A	N/A	Full-time occupancy
E	Residence + garden <500 sq ft	6011	7.2E-08	0.6	4.3E-08	2.5E-10	N/A	N/A	Partial occupancy (4 days/week all year)
	Residence + garden	7430	5.2E-08	1.0	<u>5.2E-08</u>	1.7E-10	1.0	<u>1.7E-10</u>	Full-time occupancy <u>Inhalation + Ground Plane + Ingestion Critical Receptor</u>
ESE	Oat hay farming	6540	1.5E-07	N/A	N/A	9.3E-10	N/A	N/A	No consistent occupancy
SE	Ocean Fishermen at Pecho Rock	4990	2.8E-07	0.06	1.7E-08	2.8E-09	N/A	N/A	Partial occupancy (Estimated 4 hrs/day and 4 months/year)
SSE	Administration Building	146	1.9E-05	0.24	4.6E-06	1.2E-07	N/A	N/A	Close onsite receptor location; refer to step 5.17.2
SSE	Ocean - Exclusion Zone Boundary	2345	1.0E-07	N/A	N/A	1.5E-09	N/A	N/A	Ocean- No consistent occupancy

Current Dose Receptor Information

Sector	Receptor Description	Distance (meters)	X/Q	Occupancy (Inhalation and Ground Plane, O_{InhGP})	$X/Q \times O_{InhGP}$	D/Q	Occupancy (Ingestion, O_{Ing})	$D/Q \times O_{Ing}$	Comments
S	Ocean - Exclusion Zone Boundary	2470	5.7E-08	N/A	N/A	2.8E-10	N/A	N/A	Ocean- No consistent occupancy
SSW	Ocean - Exclusion Zone Boundary	2455	8.8E-08	N/A	N/A	4.2E-10	N/A	N/A	Ocean- No consistent occupancy
SW	Ocean - Exclusion Zone Boundary	2325	1.7E-07	N/A	N/A	1.0E-09	N/A	N/A	Ocean- No consistent occupancy
W	Ocean - Exclusion Zone Boundary	1830	5.1E-07	N/A	N/A	1.1E-09	N/A	N/A	Ocean- No consistent occupancy
WNW	Ocean - Exclusion Zone Boundary	1572	1.3E-6	N/A	N/A	3.2E-09	N/A	N/A	Ocean- No consistent occupancy
NW	Highest site boundary dispersion value	803	5.9E-06	N/A	N/A	2.0E-08	N/A	N/A	<u>Gas effluent dose rates, PRRs, and HASPs evaluated at this location. NFPA 805 radioactive release calculations M-1167A and M-1167B also evaluated at this location.</u>
	Residence	5762	2.4E-07	0.7	<u>1.7E-7</u>	6.2E-10	N/A	N/A	5 days/week all year <u>Inhalation Critical Receptor</u>
NNW	Livestock Management Trailer	2417	7.4E-07	0.1	7.4E-8	2.0E-09	N/A	N/A	Partial occupancy 4 hrs/wk all year.

GRW Dose Parameters: Noble Gas Dose Factors

U1&2 Attachment 3: Page 1 of 1

GRW Dose Factors for Noble Gases (mrem/yr per $\mu\text{Ci}/\text{m}^3$) (1)				
Radionuclide	Whole Body Dose Factor, K_i	Skin Dose Factor, L_i	Gamma Air Dose Factor, M_i	Beta Air Dose Factor, N_i
Kr-83m	7.56E-02	-----	1.93E+01	2.88E+02
Kr-85m	1.17E+03	1.46E+03	1.23E+03	1.97E+03
Kr-85	1.61E+01	1.34E+03	1.72E+01	1.95E+03
Kr-87	5.92E+03	9.73E+03	6.17E+03	1.03E+04
Kr-88	1.47E+04	2.37E+03	1.52E+04	2.93E+03
Kr-89	1.66E+04	1.01E+04	1.73E+04	1.06E+04
Kr-90	1.56E+04	7.29E+03	1.63E+04	7.83E+03
Xe-131m	9.15E+01	4.76E+02	1.56E+02	1.11E+03
Xe-133m	2.51E+02	9.94E+02	3.27E+02	1.48E+03
Xe-133	2.94E+02	3.06E+02	3.53E+02	1.05E+03
Xe-135m	3.12E+03	7.11E+02	3.36E+03	7.39E+02
Xe-135	1.81E+03	1.86E+03	1.92E+03	2.46E+03
Xe-137	1.42E+03	1.22E+04	1.51E+03	1.27E+04
Xe-138	8.83E+03	4.13E+03	9.21E+03	4.75E+03
Ar-41	8.84E+03	2.69E+03	9.30E+03	3.28E+03

(1) From Table B-1 of Regulatory Guide 1.109 (Rev. 1, Oct. 1977)

Child Inhalation Pathway Dose Factors for Worst Case Organ

Radionuclide	P _w
H-3	6.40E+02
Cr-51	1.70E+04
Mn-54	1.58E+06
Fe-59	1.27E+06
Co-58	1.11E+06
Co-60	7.07E+06
Zn-65	9.95E+05
Rb-86	1.98E+05
Sr-89	2.16E+06
Y-90	2.68E+05
Sr-90	3.85E+07
Zr-95	2.23E+06
Nb-95	6.14E+05
Ru-103	6.62E+05
Ru-106	1.43E+07
Ag-110M	5.48E+06
Sb-124	3.24E+06
Sb-125	2.32E+06
Te-129M	1.76E+06
I-131	1.62E+07
I-133	3.85E+06
Cs-134	1.01E+06
Cs-136	1.71E+05
Cs-137	9.07E+05
Ba-140	1.74E+06
Ce-141	5.44E+05
Ce-144	1.20E+07
Nd-147	3.28E+05

GRW Dose Parameters: Ground Plane Dose Factors

U1&2 Attachment 5: Page 1 of 1

Ground Plane Dose Factors GRW Dose Parameters, $R_{i,GP}$, for Radioiodines, Radioactive Particulates, and any Radionuclide other than Noble Gas (IPT), Gaseous Effluents (GRW), any Age Group, Ground Plane Pathway (mrem/yr per $\mu\text{Ci}/(\text{sec m}^2)$) (1)							
Nuclide	Bone	Liver	T Body	Thyroid	Kidney	Lung	GI-LLI
H-3	0.00E+00	0.00E+00	0.00E+00	0.00E+00	0.00E+00	0.00E+00	0.00E+00
C-14	0.00E+00	0.00E+00	0.00E+00	0.00E+00	0.00E+00	0.00E+00	0.00E+00
Cr-51	4.65E+06	4.65E+06	4.65E+06	4.65E+06	4.65E+06	4.65E+06	4.65E+06
Mn-54	1.38E+09	1.38E+09	1.38E+09	1.38E+09	1.38E+09	1.38E+09	1.38E+09
Fe-59	2.73E+08	2.73E+08	2.73E+08	2.73E+08	2.73E+08	2.73E+08	2.73E+08
Co-58	3.80E+08	3.80E+08	3.80E+08	3.80E+08	3.80E+08	3.80E+08	3.80E+08
Co-60	2.15E+10	2.15E+10	2.15E+10	2.15E+10	2.15E+10	2.15E+10	2.15E+10
Zn-65	7.46E+08	7.46E+08	7.46E+08	7.46E+08	7.46E+08	7.46E+08	7.46E+08
Rb-86	8.98E+06	8.98E+06	8.98E+06	8.98E+06	8.98E+06	8.98E+06	8.98E+06
Sr-89	2.16E+04	2.16E+04	2.16E+04	2.16E+04	2.16E+04	2.16E+04	2.16E+04
Y-90	4.50E+03	4.50E+03	4.50E+03	4.50E+03	4.50E+03	4.50E+03	4.50E+03
Sr-90	0.00E+00	0.00E+00	0.00E+00	0.00E+00	0.00E+00	0.00E+00	0.00E+00
Zr-95	2.45E+08	2.45E+08	2.45E+08	2.45E+08	2.45E+08	2.45E+08	2.45E+08
Nb-95	1.37E+08	1.37E+08	1.37E+08	1.37E+08	1.37E+08	1.37E+08	1.37E+08
Ru-103	1.08E+08	1.08E+08	1.08E+08	1.08E+08	1.08E+08	1.08E+08	1.08E+08
Ru-106	4.20E+08	4.20E+08	4.20E+08	4.20E+08	4.20E+08	4.20E+08	4.20E+08
Ag-110M	3.45E+09	3.45E+09	3.45E+09	3.45E+09	3.45E+09	3.45E+09	3.45E+09
Sb-124	5.99E+08	5.99E+08	5.99E+08	5.99E+08	5.99E+08	5.99E+08	5.99E+08
Sb-125	2.34E+09	2.34E+09	2.34E+09	2.34E+09	2.34E+09	2.34E+09	2.34E+09
Te-129M	1.98E+07	1.98E+07	1.98E+07	1.98E+07	1.98E+07	1.98E+07	1.98E+07
I-131	1.72E+07	1.72E+07	1.72E+07	1.72E+07	1.72E+07	1.72E+07	1.72E+07
I-133	2.45E+06	2.45E+06	2.45E+06	2.45E+06	2.45E+06	2.45E+06	2.45E+06
Cs-134	6.90E+09	6.90E+09	6.90E+09	6.90E+09	6.90E+09	6.90E+09	6.90E+09
Cs-136	1.51E+08	1.51E+08	1.51E+08	1.51E+08	1.51E+08	1.51E+08	1.51E+08
Cs-137	1.03E+10	1.03E+10	1.03E+10	1.03E+10	1.03E+10	1.03E+10	1.03E+10
Ba-140	2.05E+07	2.05E+07	2.05E+07	2.05E+07	2.05E+07	2.05E+07	2.05E+07
Ce-141	1.37E+07	1.37E+07	1.37E+07	1.37E+07	1.37E+07	1.37E+07	1.37E+07
Ce-144	6.96E+07	6.96E+07	6.96E+07	6.96E+07	6.96E+07	6.96E+07	6.96E+07
Nd-147	8.39E+06	8.39E+06	8.39E+06	8.39E+06	8.39E+06	8.39E+06	8.39E+06

(1) Dose factors are based on NUREG 0133 methodology.

GRW Dose Parameters for Radioiodines, Radioactive Particulates, and any Radionuclide other than Noble Gas (IPT), Gaseous Effluents (GRW), Infant Age Group, Inhalation Pathway Organ "O" (mrem/yr per $\mu\text{Ci}/\text{m}^3$) $R_{i,\text{Inhal}}$ (1)							
Nuclide	Bone	Liver	T Body	Thyroid	Kidney	Lung	GI-LLI
H-3	0.00E+00	3.68E+02	3.68E+02	3.68E+02	3.68E+02	3.68E+02	3.68E+02
C-14	2.65E+04	5.31E+03	5.31E+03	5.31E+03	5.31E+03	5.31E+03	5.31E+03
Cr-51	0.00E+00	0.00E+00	8.95E+01	5.75E+01	1.32E+01	1.28E+04	3.57E+02
Mn-54	0.00E+00	2.53E+04	4.98E+03	0.00E+00	4.98E+03	1.00E+06	7.06E+03
Fe-59	1.36E+04	2.35E+04	9.48E+03	0.00E+00	0.00E+00	1.02E+06	2.48E+04
Co-58	0.00E+00	1.22E+03	1.82E+03	0.00E+00	0.00E+00	7.77E+05	1.11E+04
Co-60	0.00E+00	8.02E+03	1.18E+04	0.00E+00	0.00E+00	4.51E+06	3.19E+04
Zn-65	1.93E+04	6.26E+04	3.11E+04	0.00E+00	3.25E+04	6.47E+05	5.14E+04
Rb-86	0.00E+00	1.90E+05	8.82E+04	0.00E+00	0.00E+00	0.00E+00	3.04E+03
Sr-89	3.98E+05	0.00E+00	1.14E+04	0.00E+00	0.00E+00	2.03E+06	6.40E+04
Y-90	3.29E+03	0.00E+00	8.82E+01	0.00E+00	0.00E+00	2.69E+05	1.04E+05
Sr-90	1.55E+07	0.00E+00	3.12E+05	0.00E+00	0.00E+00	1.12E+07	1.31E+05
Zr-95	1.15E+05	2.79E+04	2.03E+04	0.00E+00	3.11E+04	1.75E+06	2.17E+04
Nb-95	1.57E+04	6.43E+03	3.78E+03	0.00E+00	4.72E+03	4.79E+05	1.27E+04
Ru-103	2.02E+03	0.00E+00	6.79E+02	0.00E+00	4.24E+03	5.52E+05	1.61E+04
Ru-106	8.68E+04	0.00E+00	1.09E+04	0.00E+00	1.07E+05	1.16E+07	1.64E+05
Ag-110M	9.98E+03	7.22E+03	5.00E+03	0.00E+00	1.09E+04	3.67E+06	3.30E+04
Sb-124	3.79E+04	5.56E+02	1.20E+04	1.01E+02	0.00E+00	2.65E+06	5.91E+04
Sb-125	5.17E+04	4.77E+02	1.09E+04	6.23E+01	0.00E+00	1.64E+06	1.47E+04
Te-129M	1.41E+04	6.09E+03	2.23E+03	5.47E+03	3.18E+04	1.68E+06	6.90E+04
I-131	3.79E+04	4.44E+04	1.96E+04	1.48E+07	5.18E+04	0.00E+00	1.06E+03
I-133	1.32E+04	1.92E+04	5.60E+03	3.56E+06	2.24E+04	0.00E+00	2.16E+03
Cs-134	3.96E+05	7.03E+05	7.45E+04	0.00E+00	1.90E+05	7.97E+04	1.33E+03
Cs-136	4.83E+04	1.35E+05	5.29E+04	0.00E+00	5.64E+04	1.18E+04	1.43E+03
Cs-137	5.49E+05	6.12E+05	4.55E+04	0.00E+00	1.72E+05	7.13E+04	1.33E+03
Ba-140	5.60E+04	5.60E+01	2.90E+03	0.00E+00	1.34E+01	1.60E+06	3.84E+04
Ce-141	2.77E+04	1.67E+04	1.99E+03	0.00E+00	5.25E+03	5.17E+05	2.16E+04
Ce-144	3.19E+06	1.21E+06	1.76E+05	0.00E+00	5.38E+05	9.84E+06	1.48E+05
Nd-147	7.94E+03	8.13E+03	5.00E+02	0.00E+00	3.15E+03	3.22E+05	3.12E+04

(1) Dose factors are based on NUREG 0133 methodology.

GRW Dose Parameters: Child, Inhalation Pathway

U1&2 Attachment 7: Page 1 of 1

GRW Dose Parameters for Radioiodines, Radioactive Particulates, and any Radionuclide other than Noble Gas (IPT), Gaseous Effluents (GRW), Child Age Group, Inhalation Pathway Organ "O" (mrem/yr per $\mu\text{Ci}/\text{m}^3$) $R_{i,\text{Inhal}}$ (1)							
Nuclide	Bone	Liver	T Body	Thyroid	Kidney	Lung	GI-LLI
H-3	0.00E+00	6.40E+02	6.40E+02	6.40E+02	6.40E+02	6.40E+02	6.40E+02
C-14	3.59E+04	6.73E+03	6.73E+03	6.73E+03	6.73E+03	6.73E+03	6.73E+03
Cr-51	0.00E+00	0.00E+00	1.54E+02	8.55E+01	2.43E+01	1.70E+04	1.08E+03
Mn-54	0.00E+00	4.29E+04	9.51E+03	0.00E+00	1.00E+04	1.58E+06	2.29E+04
Fe-59	2.07E+04	3.34E+04	1.67E+04	0.00E+00	0.00E+00	1.27E+06	7.07E+04
Co-58	0.00E+00	1.77E+03	3.16E+03	0.00E+00	0.00E+00	1.11E+06	3.44E+04
Co-60	0.00E+00	1.31E+04	2.26E+04	0.00E+00	0.00E+00	7.07E+06	9.62E+04
Zn-65	4.26E+04	1.13E+05	7.03E+04	0.00E+00	7.14E+04	9.95E+05	1.63E+04
Rb-86	0.00E+00	1.98E+05	1.14E+05	0.00E+00	0.00E+00	0.00E+00	7.99E+03
Sr-89	5.99E+05	0.00E+00	1.72E+04	0.00E+00	0.00E+00	2.16E+06	1.67E+05
Y-90	4.11E+03	0.00E+00	1.11E+02	0.00E+00	0.00E+00	2.62E+05	2.68E+05
Sr-90	3.85E+07	0.00E+00	7.66E+05	0.00E+00	0.00E+00	1.48E+07	3.43E+05
Zr-95	1.90E+05	4.18E+04	3.70E+04	0.00E+00	5.96E+04	2.23E+06	6.11E+04
Nb-95	2.35E+04	9.18E+03	6.55E+03	0.00E+00	8.62E+03	6.14E+05	3.70E+04
Ru-103	2.79E+03	0.00E+00	1.07E+03	0.00E+00	7.03E+03	6.62E+05	4.48E+04
Ru-106	1.36E+05	0.00E+00	1.69E+04	0.00E+00	1.84E+05	1.43E+07	4.29E+05
Ag-110M	1.69E+04	1.14E+04	9.14E+03	0.00E+00	2.12E+04	5.48E+06	1.00E+05
Sb-124	5.74E+04	7.40E+02	2.00E+04	1.26E+02	0.00E+00	3.24E+06	1.64E+05
Sb-125	9.84E+04	7.59E+02	2.07E+04	9.10E+01	0.00E+00	2.32E+06	4.03E+04
Te-129M	1.92E+04	6.85E+03	3.04E+03	6.33E+03	5.03E+04	1.76E+06	1.82E+05
I-131	4.81E+04	4.81E+04	2.73E+04	1.62E+07	7.88E+04	0.00E+00	2.84E+03
I-133	1.66E+04	2.03E+04	7.70E+03	3.85E+06	3.38E+04	0.00E+00	5.48E+03
Cs-134	6.51E+05	1.01E+06	2.25E+05	0.00E+00	3.30E+05	1.21E+05	3.85E+03
Cs-136	6.51E+04	1.71E+05	1.16E+05	0.00E+00	9.55E+04	1.45E+04	4.18E+03
Cs-137	9.07E+05	8.25E+05	1.28E+05	0.00E+00	2.82E+05	1.04E+05	3.62E+03
Ba-140	7.40E+04	6.48E+01	4.33E+03	0.00E+00	2.11E+01	1.74E+06	1.02E+05
Ce-141	3.92E+04	1.95E+04	2.90E+03	0.00E+00	8.55E+03	5.44E+05	5.66E+04
Ce-144	6.77E+06	2.12E+06	3.61E+05	0.00E+00	1.17E+06	1.20E+07	3.89E+05
Nd-147	1.08E+04	8.73E+03	6.81E+02	0.00E+00	4.81E+03	3.28E+05	8.21E+04

(1) Dose factors are based on NUREG 0133 methodology.

GRW Dose Parameters: Teen, Inhalation Pathway

U1&2 Attachment 8: Page 1 of 1

GRW Dose Parameters for Radioiodines, Radioactive Particulates, and any Radionuclide other than Noble Gas (IPT), Gaseous Effluents (GRW), Teen Age Group, Inhalation Pathway Organ "o" (mrem/yr per $\mu\text{Ci}/\text{m}^3$) $R_{i,\text{Inhal}}$ (1)							
Nuclide	Bone	Liver	T Body	Thyroid	Kidney	Lung	GI-LLI
H-3	0.00E+00	7.25E+02	7.25E+02	7.25E+02	7.25E+02	7.25E+02	7.25E+02
C-14	2.60E+04	4.87E+03	4.87E+03	4.87E+03	4.87E+03	4.87E+03	4.87E+03
Cr-51	0.00E+00	0.00E+00	1.35E+02	7.50E+01	3.07E+01	2.10E+04	3.00E+03
Mn-54	0.00E+00	5.11E+04	8.40E+03	0.00E+00	1.27E+04	1.98E+06	6.68E+04
Fe-59	1.59E+04	3.70E+04	1.43E+04	0.00E+00	0.00E+00	1.53E+06	1.78E+05
Co-58	0.00E+00	2.07E+03	2.78E+03	0.00E+00	0.00E+00	1.34E+06	9.52E+04
Co-60	0.00E+00	1.51E+04	1.98E+04	0.00E+00	0.00E+00	8.72E+06	2.59E+05
Zn-65	3.86E+04	1.34E+05	6.24E+04	0.00E+00	8.64E+04	1.24E+06	4.66E+04
Rb-86	0.00E+00	1.90E+05	8.40E+04	0.00E+00	0.00E+00	0.00E+00	1.77E+04
Sr-89	4.34E+05	0.00E+00	1.25E+04	0.00E+00	0.00E+00	2.42E+06	3.71E+05
Y-90	2.98E+03	0.00E+00	8.00E+01	0.00E+00	0.00E+00	2.93E+05	5.59E+05
Sr-90	3.31E+07	0.00E+00	6.66E+05	0.00E+00	0.00E+00	1.65E+07	7.65E+05
Zr-95	1.46E+05	4.58E+04	3.15E+04	0.00E+00	6.74E+04	2.69E+06	1.49E+05
Nb-95	1.86E+04	1.03E+04	5.66E+03	0.00E+00	1.00E+04	7.51E+05	9.68E+04
Ru-103	2.10E+03	0.00E+00	8.96E+02	0.00E+00	7.43E+03	7.83E+05	1.09E+05
Ru-106	9.84E+04	0.00E+00	1.24E+04	0.00E+00	1.90E+05	1.61E+07	9.60E+05
Ag-110M	1.38E+04	1.31E+04	7.99E+03	0.00E+00	2.50E+04	6.75E+06	2.73E+05
Sb-124	4.30E+04	7.94E+02	1.68E+04	9.76E+01	0.00E+00	3.85E+06	3.98E+05
Sb-125	7.38E+04	8.08E+02	1.72E+04	7.04E+01	0.00E+00	2.74E+06	9.92E+04
Te-129M	1.39E+04	6.58E+03	2.25E+03	4.58E+03	5.19E+04	1.98E+06	4.05E+05
I-131	3.54E+04	4.91E+04	2.64E+04	1.46E+07	8.40E+04	0.00E+00	6.49E+03
I-133	1.22E+04	2.05E+04	6.22E+03	2.92E+06	3.59E+04	0.00E+00	1.03E+04
Cs-134	5.02E+05	1.13E+06	5.49E+05	0.00E+00	3.75E+05	1.46E+05	9.76E+03
Cs-136	5.15E+04	1.94E+05	1.37E+05	0.00E+00	1.10E+05	1.78E+04	1.09E+04
Cs-137	6.70E+05	8.48E+05	3.11E+05	0.00E+00	3.04E+05	1.21E+05	8.48E+03
Ba-140	5.47E+04	6.70E+01	3.52E+03	0.00E+00	2.28E+01	2.03E+06	2.29E+05
Ce-141	2.84E+04	1.90E+04	2.17E+03	0.00E+00	8.88E+03	6.14E+05	1.26E+05
Ce-144	4.89E+06	2.02E+06	2.62E+05	0.00E+00	1.21E+06	1.34E+07	8.64E+05
Nd-147	7.86E+03	8.56E+03	5.13E+02	0.00E+00	5.02E+03	3.72E+05	1.82E+05

(1) Dose factors are based on NUREG 0133 methodology.

GRW Dose Parameters: Adult, Inhalation Pathway

U1&2 Attachment 9: Page 1 of 1

GRW Dose Parameters for Radioiodines, Radioactive Particulates, and any Radionuclide other than Noble Gas (IPT), Gaseous Effluents (GRW), Adult Age Group, Inhalation Pathway Organ "o" (mrem/yr per $\mu\text{Ci}/\text{m}^3$) $R_{i,\text{Inhal}}$ (1)							
Nuclide	Bone	Liver	T Body	Thyroid	Kidney	Lung	GI-LLI
H-3	0.00E+00	7.18E+02	7.18E+02	7.18E+02	7.18E+02	7.18E+02	7.18E+02
C-14	1.82E+04	3.41E+03	3.41E+03	3.41E+03	3.41E+03	3.41E+03	3.41E+03
Cr-51	0.00E+00	0.00E+00	1.00E+02	5.95E+01	2.28E+01	1.44E+04	3.32E+03
Mn-54	0.00E+00	3.96E+04	6.30E+03	0.00E+00	9.84E+03	1.40E+06	7.74E+04
Fe-59	1.18E+04	2.78E+04	1.06E+04	0.00E+00	0.00E+00	1.02E+06	1.88E+05
Co-58	0.00E+00	1.58E+03	2.07E+03	0.00E+00	0.00E+00	9.28E+05	1.06E+05
Co-60	0.00E+00	1.15E+04	1.48E+04	0.00E+00	0.00E+00	5.97E+06	2.85E+05
Zn-65	3.24E+04	1.03E+05	4.66E+04	0.00E+00	6.90E+04	8.64E+05	5.34E+04
Rb-86	0.00E+00	1.35E+05	5.90E+04	0.00E+00	0.00E+00	0.00E+00	1.66E+04
Sr-89	3.04E+05	0.00E+00	8.72E+03	0.00E+00	0.00E+00	1.40E+06	3.50E+05
Y-90	2.09E+03	0.00E+00	5.61E+01	0.00E+00	0.00E+00	1.70E+05	5.06E+05
Sr-90	2.87E+07	0.00E+00	5.77E+05	0.00E+00	0.00E+00	9.60E+06	7.22E+05
Zr-95	1.07E+05	3.44E+04	2.33E+04	0.00E+00	5.42E+04	1.77E+06	1.50E+05
Nb-95	1.41E+04	7.82E+03	4.21E+03	0.00E+00	7.74E+03	5.05E+05	1.04E+05
Ru-103	1.53E+03	0.00E+00	6.58E+02	0.00E+00	5.83E+03	5.05E+05	1.10E+05
Ru-106	6.91E+04	0.00E+00	8.72E+03	0.00E+00	1.34E+05	9.36E+06	9.12E+05
Ag-110M	1.08E+04	1.00E+04	5.94E+03	0.00E+00	1.97E+04	4.63E+06	3.02E+05
Sb-124	3.12E+04	5.89E+02	1.24E+04	7.55E+01	0.00E+00	2.48E+06	4.06E+05
Sb-125	5.34E+04	5.95E+02	1.26E+04	5.40E+01	0.00E+00	1.74E+06	1.01E+05
Te-129M	9.76E+03	4.67E+03	1.58E+03	3.44E+03	3.66E+04	1.16E+06	3.83E+05
I-131	2.52E+04	3.58E+04	2.05E+04	1.19E+07	6.13E+04	0.00E+00	6.28E+03
I-133	8.64E+03	1.48E+04	4.52E+03	2.15E+06	2.58E+04	0.00E+00	8.88E+03
Cs-134	3.73E+05	8.48E+05	7.28E+05	0.00E+00	2.87E+05	9.76E+04	1.04E+04
Cs-136	3.90E+04	1.46E+05	1.10E+05	0.00E+00	8.56E+04	1.20E+04	1.17E+04
Cs-137	4.78E+05	6.21E+05	4.28E+05	0.00E+00	2.22E+05	7.52E+04	8.40E+03
Ba-140	3.90E+04	4.90E+01	2.57E+03	0.00E+00	1.67E+01	1.27E+06	2.18E+05
Ce-141	1.99E+04	1.35E+04	1.53E+03	0.00E+00	6.26E+03	3.62E+05	1.20E+05
Ce-144	3.43E+06	1.43E+06	1.84E+05	0.00E+00	8.48E+05	7.78E+06	8.16E+05
Nd-147	5.27E+03	6.10E+03	3.65E+02	0.00E+00	3.56E+03	2.21E+05	1.73E+05

(1) Dose factors are based on NUREG 0133 methodology.

GRW Dose Parameters: Child, Vegetation Pathway

U1&2 Attachment 10: Page 1 of 1

GRW Dose Parameters for Radioiodines, Radioactive Particulates, and any Radionuclide other than Noble Gas (IPT), Gaseous Effluents (GRW), Child Age Group, Vegetation Pathway Organ "o" (mrem/yr per $\mu\text{Ci}/(\text{sec m}^2)$) $R_{i,\text{vegi}}$ (1)							
Nuclide	Bone	Liver	T Body	Thyroid	Kidney	Lung	GI-LLI
H-3 (2)	0.00E+00	2.29E+03	2.29E+03	2.29E+03	2.29E+03	2.29E+03	2.29E+03
C-14 (2)	3.50E+06	7.01E+05	7.01E+05	7.01E+05	7.01E+05	7.01E+05	7.01E+05
Cr-51	0.00E+00	0.00E+00	1.17E+05	6.49E+04	1.77E+04	1.18E+05	6.20E+06
Mn-54	0.00E+00	6.65E+08	1.77E+08	0.00E+00	1.86E+08	0.00E+00	5.58E+08
Fe-59	3.97E+08	6.42E+08	3.20E+08	0.00E+00	0.00E+00	1.86E+08	6.69E+08
Co-58	0.00E+00	6.45E+07	1.97E+08	0.00E+00	0.00E+00	0.00E+00	3.76E+08
Co-60	0.00E+00	3.78E+08	1.12E+09	0.00E+00	0.00E+00	0.00E+00	2.10E+09
Zn-65	8.12E+08	2.16E+09	1.35E+09	0.00E+00	1.36E+09	0.00E+00	3.80E+08
Rb-86	0.00E+00	4.54E+08	2.79E+08	0.00E+00	0.00E+00	0.00E+00	2.92E+07
Sr-89	3.59E+10	0.00E+00	1.03E+09	0.00E+00	0.00E+00	0.00E+00	1.39E+09
Y-90	2.31E+04	0.00E+00	6.18E+02	0.00E+00	0.00E+00	0.00E+00	6.57E+07
Sr-90	1.87E+12	0.00E+00	3.77E+10	0.00E+00	0.00E+00	0.00E+00	1.67E+10
Zr-95	3.86E+06	8.50E+05	7.56E+05	0.00E+00	1.22E+06	0.00E+00	8.86E+08
Nb-95	4.12E+05	1.61E+05	1.15E+05	0.00E+00	1.51E+05	0.00E+00	2.97E+08
Ru-103	1.53E+07	0.00E+00	5.89E+06	0.00E+00	3.86E+07	0.00E+00	3.96E+08
Ru-106	7.45E+08	0.00E+00	9.30E+07	0.00E+00	1.01E+09	0.00E+00	1.16E+10
Ag-110M	3.21E+07	2.17E+07	1.74E+07	0.00E+00	4.04E+07	0.00E+00	2.58E+09
Sb-124	3.52E+08	4.57E+06	1.23E+08	7.78E+05	0.00E+00	1.96E+08	2.20E+09
Sb-125	4.99E+08	3.85E+06	1.05E+08	4.62E+05	0.00E+00	2.78E+08	1.19E+09
Te-129M	8.40E+08	2.35E+08	1.30E+08	2.71E+08	2.47E+09	0.00E+00	1.02E+09
I-131	1.43E+08	1.44E+08	8.17E+07	4.75E+10	2.36E+08	0.00E+00	1.28E+07
I-133	3.52E+06	4.36E+06	1.65E+06	8.09E+08	7.26E+06	0.00E+00	1.76E+06
Cs-134	1.60E+10	2.63E+10	5.55E+09	0.00E+00	8.16E+09	2.93E+09	1.42E+08
Cs-136	8.18E+07	2.25E+08	1.46E+08	0.00E+00	1.20E+08	1.79E+07	7.90E+06
Cs-137	2.39E+10	2.29E+10	3.38E+09	0.00E+00	7.46E+09	2.68E+09	1.43E+08
Ba-140	2.77E+08	2.43E+05	1.62E+07	0.00E+00	7.90E+04	1.45E+05	1.40E+08
Ce-141	6.55E+05	3.27E+05	4.85E+04	0.00E+00	1.43E+05	0.00E+00	4.08E+08
Ce-144	1.27E+08	3.98E+07	6.78E+06	0.00E+00	2.21E+07	0.00E+00	1.04E+10
Nd-147	7.27E+04	5.89E+04	4.56E+03	0.00E+00	3.23E+04	0.00E+00	9.33E+07

- (1) Dose factors are based on NUREG 0133 methodology.
- (2) For tritium and carbon-14, the dose parameter units are mrem/yr per $\mu\text{Ci}/\text{m}^3$ for all pathways, and they shall be multiplied by X/Q.

GRW Dose Parameters for Radioiodines, Radioactive Particulates, and any Radionuclide other than Noble Gas (IPT), Gaseous Effluents (GRW), Teen Age Group, Vegetation Pathway Organ "o" (mrem/yr per $\mu\text{Ci}/(\text{sec m}^2)$) $R_{i,\text{vegi}}$ (1)							
Nuclide	Bone	Liver	T Body	Thyroid	Kidney	Lung	GI-LLI
H-3 (2)	0.00E+00	1.47E+03	1.47E+03	1.47E+03	1.47E+03	1.47E+03	1.47E+03
C-14 (2)	1.45E+06	2.91E+05	2.91E+05	2.91E+05	2.91E+05	2.91E+05	2.91E+05
Cr-51	0.00E+00	0.00E+00	6.16E+04	3.42E+04	1.35E+04	8.79E+04	1.03E+07
Mn-54	0.00E+00	4.54E+08	9.01E+07	0.00E+00	1.36E+08	0.00E+00	9.32E+08
Fe-59	1.79E+08	4.18E+08	1.61E+08	0.00E+00	0.00E+00	1.32E+08	9.89E+08
Co-58	0.00E+00	4.37E+07	1.01E+08	0.00E+00	0.00E+00	0.00E+00	6.02E+08
Co-60	0.00E+00	2.49E+08	5.60E+08	0.00E+00	0.00E+00	0.00E+00	3.24E+09
Zn-65	4.24E+08	1.47E+09	6.86E+08	0.00E+00	9.41E+08	0.00E+00	6.23E+08
Rb-86	0.00E+00	2.75E+08	1.29E+08	0.00E+00	0.00E+00	0.00E+00	4.06E+07
Sr-89	1.51E+10	0.00E+00	4.33E+08	0.00E+00	0.00E+00	0.00E+00	1.80E+09
Y-90	1.24E+04	0.00E+00	3.35E+02	0.00E+00	0.00E+00	0.00E+00	1.02E+08
Sr-90	9.22E+11	0.00E+00	1.84E+10	0.00E+00	0.00E+00	0.00E+00	2.11E+10
Zr-95	1.72E+06	5.44E+05	3.74E+05	0.00E+00	7.99E+05	0.00E+00	1.26E+09
Nb-95	1.93E+05	1.07E+05	5.90E+04	0.00E+00	1.04E+05	0.00E+00	4.58E+08
Ru-103	6.82E+06	0.00E+00	2.91E+06	0.00E+00	2.40E+07	0.00E+00	5.69E+08
Ru-106	3.09E+08	0.00E+00	3.90E+07	0.00E+00	5.97E+08	0.00E+00	1.48E+10
Ag-110M	1.52E+07	1.44E+07	8.73E+06	0.00E+00	2.74E+07	0.00E+00	4.03E+09
Sb-124	1.55E+08	2.85E+06	6.03E+07	3.51E+05	0.00E+00	1.35E+08	3.11E+09
Sb-125	2.14E+08	2.34E+06	5.01E+07	2.05E+05	0.00E+00	1.88E+08	1.67E+09
Te-129M	3.61E+08	1.34E+08	5.72E+07	1.17E+08	1.51E+09	0.00E+00	1.36E+09
I-131	7.68E+07	1.08E+08	5.78E+07	3.14E+10	1.85E+08	0.00E+00	2.13E+07
I-133	1.93E+06	3.28E+06	1.00E+06	4.58E+08	5.75E+06	0.00E+00	2.48E+06
Cs-134	7.10E+09	1.67E+10	7.75E+09	0.00E+00	5.31E+09	2.03E+09	2.08E+08
Cs-136	4.35E+07	1.71E+08	1.15E+08	0.00E+00	9.31E+07	1.47E+07	1.38E+07
Cs-137	1.01E+10	1.35E+10	4.69E+09	0.00E+00	4.59E+09	1.78E+09	1.92E+08
Ba-140	1.38E+08	1.69E+05	8.90E+06	0.00E+00	5.74E+04	1.14E+05	2.13E+08
Ce-141	2.83E+05	1.89E+05	2.17E+04	0.00E+00	8.89E+04	0.00E+00	5.40E+08
Ce-144	5.27E+07	2.18E+07	2.83E+06	0.00E+00	1.30E+07	0.00E+00	1.33E+10
Nd-147	3.67E+04	4.00E+04	2.39E+03	0.00E+00	2.35E+04	0.00E+00	1.44E+08

- (1) Dose factors are based on NUREG 0133 methodology.
- (2) For tritium and carbon-14, the dose parameter units are mrem/yr per $\mu\text{Ci}/\text{m}^3$ for all pathways, and they shall be multiplied by X/Q.

GRW Dose Parameters: Adult, Vegetation Pathway

U1&2 Attachment 12: Page 1 of 1

GRW Dose Parameters for Radioiodines, Radioactive Particulates, and any Radionuclide other than Noble Gas (IPT), Gaseous Effluents (GRW), Adult Age Group, Vegetation Pathway Organ "o" (mrem/yr per $\mu\text{Ci}/(\text{sec m}^2)$) $R_{i,\text{Vegi}}$ (1)							
Nuclide	Bone	Liver	T Body	Thyroid	Kidney	Lung	GI-LLI
H-3 (2)	0.00E+00	1.29E+03	1.29E+03	1.29E+03	1.29E+03	1.29E+03	1.29E+03
C-14 (2)	8.97E+05	1.79E+05	1.79E+05	1.79E+05	1.79E+05	1.79E+05	1.79E+05
Cr-51	0.00E+00	0.00E+00	4.64E+04	2.77E+04	1.02E+04	6.15E+04	1.17E+07
Mn-54	0.00E+00	3.13E+08	5.97E+07	0.00E+00	9.31E+07	0.00E+00	9.58E+08
Fe-59	1.26E+08	2.96E+08	1.13E+08	0.00E+00	0.00E+00	8.27E+07	9.87E+08
Co-58	0.00E+00	3.08E+07	6.90E+07	0.00E+00	0.00E+00	0.00E+00	6.24E+08
Co-60	0.00E+00	1.67E+08	3.69E+08	0.00E+00	0.00E+00	0.00E+00	3.14E+09
Zn-65	3.17E+08	1.01E+09	4.56E+08	0.00E+00	6.75E+08	0.00E+00	6.36E+08
Rb-86	0.00E+00	2.20E+08	1.03E+08	0.00E+00	0.00E+00	0.00E+00	4.34E+07
Sr-89	9.95E+09	0.00E+00	2.86E+08	0.00E+00	0.00E+00	0.00E+00	1.60E+09
Y-90	1.33E+04	0.00E+00	3.57E+02	0.00E+00	0.00E+00	0.00E+00	1.41E+08
Sr-90	6.95E+11	0.00E+00	1.40E+10	0.00E+00	0.00E+00	0.00E+00	1.75E+10
Zr-95	1.18E+06	3.77E+05	2.55E+05	0.00E+00	5.92E+05	0.00E+00	1.20E+09
Nb-95	1.43E+05	7.95E+04	4.27E+04	0.00E+00	7.86E+04	0.00E+00	4.83E+08
Ru-103	4.77E+06	0.00E+00	2.05E+06	0.00E+00	1.82E+07	0.00E+00	5.57E+08
Ru-106	1.93E+08	0.00E+00	2.44E+07	0.00E+00	3.72E+08	0.00E+00	1.25E+10
Ag-110M	1.05E+07	9.75E+06	5.79E+06	0.00E+00	1.92E+07	0.00E+00	3.98E+09
Sb-124	1.04E+08	1.96E+06	4.11E+07	2.52E+05	0.00E+00	8.08E+07	2.95E+09
Sb-125	1.37E+08	1.53E+06	3.25E+07	1.39E+05	0.00E+00	1.05E+08	1.50E+09
Te-129M	2.51E+08	9.37E+07	3.97E+07	8.62E+07	1.05E+09	0.00E+00	1.26E+09
I-131	8.07E+07	1.15E+08	6.62E+07	3.78E+10	1.98E+08	0.00E+00	3.05E+07
I-133	2.08E+06	3.62E+06	1.10E+06	5.32E+08	6.31E+06	0.00E+00	3.25E+06
Cs-134	4.67E+09	1.11E+10	9.08E+09	0.00E+00	3.59E+09	1.19E+09	1.94E+08
Cs-136	4.25E+07	1.68E+08	1.21E+08	0.00E+00	9.33E+07	1.28E+07	1.90E+07
Cs-137	6.36E+09	8.70E+09	5.70E+09	0.00E+00	2.95E+09	9.81E+08	1.68E+08
Ba-140	1.29E+08	1.61E+05	8.42E+06	0.00E+00	5.49E+04	9.24E+04	2.65E+08
Ce-141	1.97E+05	1.33E+05	1.51E+04	0.00E+00	6.19E+04	0.00E+00	5.09E+08
Ce-144	3.29E+07	1.38E+07	1.77E+06	0.00E+00	8.16E+06	0.00E+00	1.11E+10
Nd-147	3.37E+04	3.90E+04	2.33E+03	0.00E+00	2.28E+04	0.00E+00	1.87E+08

- (1) Dose factors are based on NUREG 0133 methodology.
- (2) For tritium and carbon-14, the dose parameter units are mrem/yr per $\mu\text{Ci}/\text{m}^3$ for all pathways, and they shall be multiplied by X/Q.

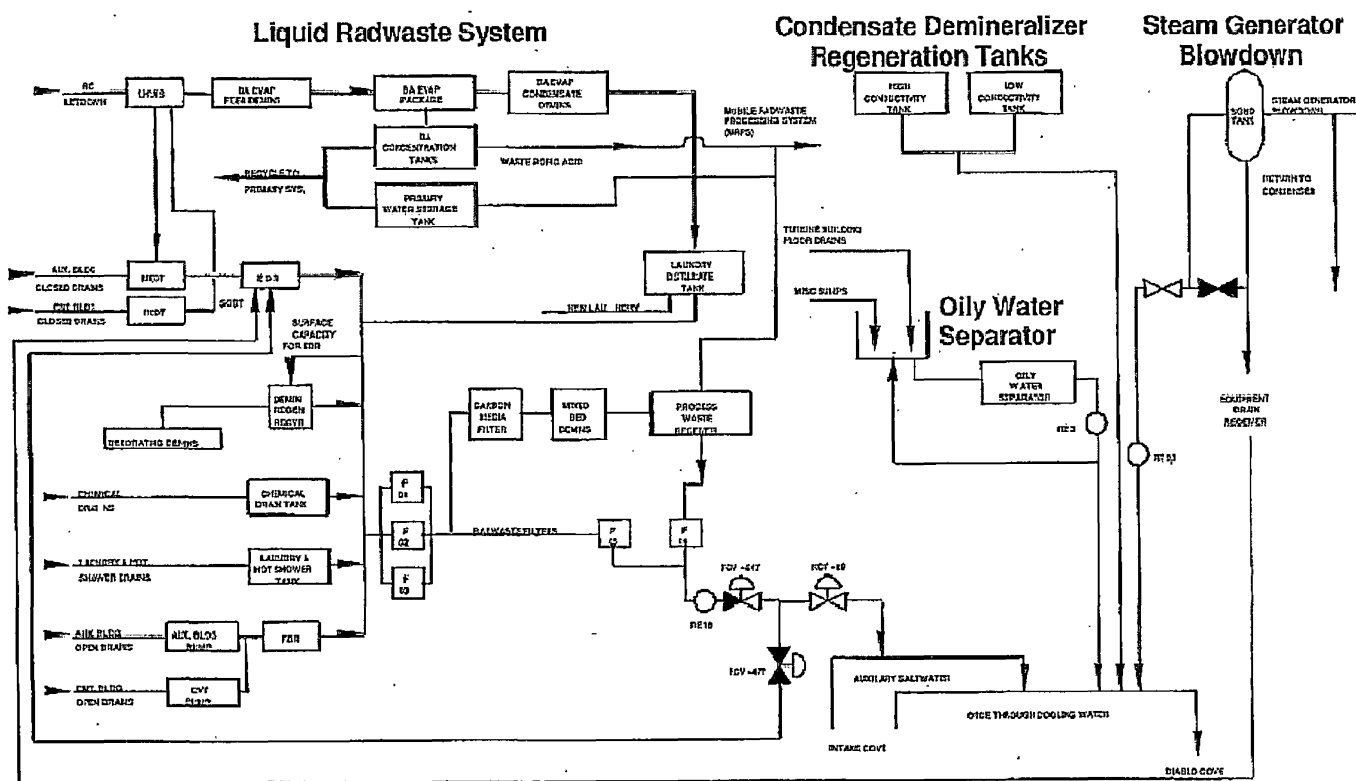

Gaseous Releases Monitored for Radioactivity

U1&2 Attachment 14: Page 1 of 1

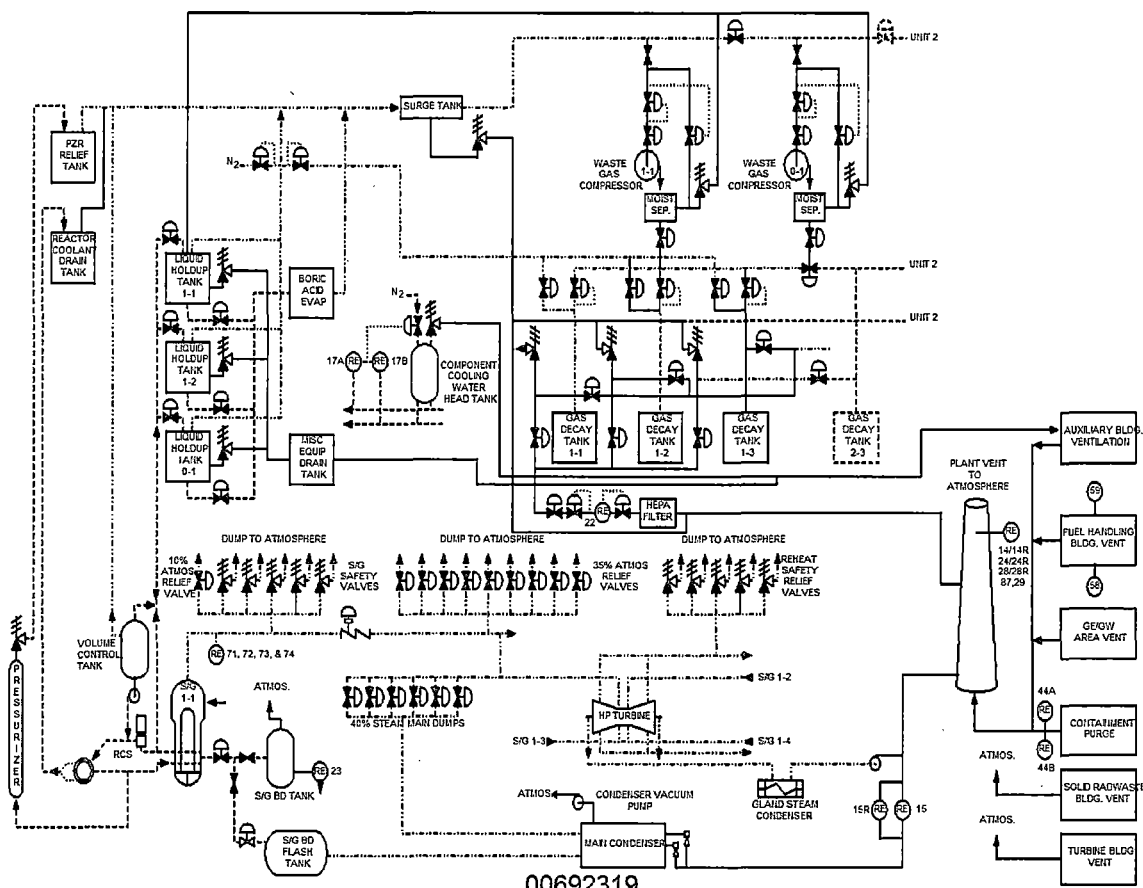

Attachment 5

**Diablo Canyon Power Plant Departmental Administrative Procedure,
RP2.DC2, "Radwaste Solidification Process Control Program,"
Revision 16**

Radwaste Solidification Process Control Program

01/11/16
Effective Date

QUALITY RELATED

Table of Contents

1.	SCOPE.....	1
2.	DISCUSSION	1
3.	DEFINITIONS.....	2
4.	RESPONSIBILITIES.....	2
5.	INSTRUCTIONS.....	3
5.1	General.....	3
5.2	Wet Waste.....	3
5.3	Oily Waste.....	6
5.4	Special Cases.....	6
5.5	Remedial Actions.....	6
5.6	Vendor Reports.....	7
5.7	Vendor Procedures.....	7
6.	RECORDS.....	8
7.	REFERENCES	8
8.	Major Change to the Solid Radwaste Treatment System Evaluation.....	9

ATTACHMENTS:

- Form 69-10350, Process Control Program (PCP) Specimen Monitoring, 12/10/15

1. SCOPE

- The purpose of the Radwaste Solidification Process Control Program (PCP) is to define the necessary program guidance used at the plant to ensure that activities to solidify wet radioactive waste for disposal, conform to the code of Federal and State regulations and the Waste Burial Site License criteria.

2. DISCUSSION

- Solidification is the conversion of wet radioactive wastes into a form that meets shipping and burial ground requirements.
- This procedure implements the requirements of 10 CFR 50.36a and General Design Criterion 60 of Appendix A to 10 CFR Part 50. The process parameters included in establishing the PROCESS CONTROL PROGRAM may include, but are not limited to, waste type, waste pH, waste/liquid/SOLIDIFICATION agent/catalyst ratios, waste oil content, waste principal chemical constituents, and mixing and curing times.

- 2.3 This procedure contains the individual procedures necessary to perform PCP sample solidifications.
- 2.4 Cement solidification will not be utilized to stabilize resin or floor drain sludges.
- 2.5 When access to a low level waste (LLW) disposal site is available, only NRC approved, or LLW disposal host state approved, or accepted binders may be used to solidify resin or floor drain sludges to meet waste form stability.
- 2.6 When access to a LLW disposal site is not available, only NRC approved binders or binders found to meet the NRC branch technical position (BTP) waste form test by the Conference of Radiation Control Program Directors (CRCPD) may be used to meet waste form stability for on-site storage and subsequent disposal.

3. DEFINITIONS

None

4. RESPONSIBILITIES

- 4.1 The Station Director has overall responsibility for the solid radioactive waste activities and approves changes to the PCP.
- 4.2 Radiation protection manager is responsible for implementing the requirements of this procedure.
- 4.3 Radwaste engineer is responsible for the developing and reviewing procedures relating to the requirements of this procedure.
- 4.4 Radwaste foreman is responsible for the implementing procedures relating to the requirements of this procedure.
- 4.5 Quality is responsible for ensuring compliance with the program requirements.

5. INSTRUCTIONS

5.1 General

<p>NOTE: It is the policy of the company to conscientiously apply emphasis and attention to those activities associated with generation, processing, packaging, storage and disposal of radioactive waste generated at the plant and to maintain a high level of assurance that radioactive waste forms meet or exceed the applicable federal and state regulations and the radioactive waste burial site license criteria.</p>
--

- 5.1.1 Changes to this program requires submission to the US NRC in the annual Radioactive Effluent Release report for the period in which the changes were made.
- 5.1.2 Any major change to the solid radwaste treatment system shall be reported to the US NRC in the annual Radioactive Effluent Release report for the period in which the change was approved.
 - a. The discussion of each system change shall contain the items listed in Section 8, "Major Change to the Solid Radwaste Treatment System Evaluation."
 - b. This information may be submitted as part of the annual FSAR update in lieu of the annual Radioactive Effluent Release report.

5.2 Wet Waste

5.2.1 Liquid/Wet Waste

- a. Liquid/wet wastes shall be processed to a condition meeting shipping and disposal criteria.
 - 1. These criteria include requirements for immobilization, stability and limits on free standing water (FSW).
 - 2. Specific instructions on processing and required FSW limits are contained in plant procedures and/or qualified vendor procedures.

5.2.2 Containers, Shipping Casks, and Packaging

- a. Solid radioactive waste shall be processed, packaged and shipped per plant procedures and/or qualified vendor procedures.
 - 1. These procedures provide specific instructions which ensure the container, shipping casks, and packaging methods comply with the applicable code of federal regulations, state regulations and the radioactive waste burial site license criteria.

5.2.3 Shipping and Disposal

- a. Solid radioactive waste shall be prepared, loaded and shipped to a federal and/or state licensed radioactive waste disposal facility (burial ground) per plant procedures and/or qualified vendor procedures.
 1. These procedures provide specific instructions which ensure the shipments meet the intended burial site license requirements as well as applicable federal and state regulations.

5.2.4 Specimen Samples

- a. Qualified vendor procedures, approved by the Station Director, shall provide written instructions on sampling, processing and handling waste for the determination of process parameters prior to the actual full scale solidification.
 1. These procedures contain the description of the laboratory mixing methods used for specimen sample solidification.

5.2.5 Solidification Process

- a. Qualified vendors used for radioactive waste solidification shall provide a Process Control program and written procedures.
 1. These procedures and changes thereto shall be approved by the Station Director prior to use.
 2. The vendors shall have an NRC topical report, CRCPD E-5 committee approval or submittal for state approval on the waste forms which will be solidified. These documents should include:
 - a) Description of the solidification process.
 - b) Type of solidification used.
 - c) Process control parameters.
 - d) Parameter boundary conditions.
 - e) Proper waste form properties.
 - f) Specific instructions to ensure the systems are operated within established process parameters.

5.2.6 Sampling Program for Solidification^{T32288}

- a. Vendors, utilized for radioactive waste solidification, shall include in their approved procedures, requirements to sample at least every tenth batch of the same waste type to ensure solidification and to provide actions to be taken if a sample fails to demonstrate solidification.
 - 1. After a test specimen failure, initial test specimens from three consecutive batches of that waste type must demonstrate solidification before testing requirements of every tenth batch can be resumed.
 - 2. Documentation of such sampling is to be accomplished by completing Form 69-10350, "Process Control Program (PCP) Specimen Monitoring."
 - 3. These forms will be maintained by radiation protection and in the Records Management System (RMS).
 - 4. These procedures and changes thereto shall be approved by the Station Director prior to use.

5.2.7 Demonstration of Waste Form Stability

- a. Vendors utilized to process wet wastes shall include in their procedures provisions to demonstrate that the solidification and/or FSW criteria in the federal and state regulations and the burial site license are met for the specific type of waste being processed.

5.2.8 Corrective Actions for Free Standing Water

- a. Vendors utilized to process wet wastes shall include in their approved procedures provisions for correcting processed waste in which free standing water in excess of the FSW criteria is detected.

5.2.9 Exothermic Processes

- a. Vendors utilized for radioactive waste solidification that use an exothermic solidification method shall include in their approved procedures:
 - 1. Waste/binder temperature monitoring to mitigate the consequence of adverse exothermic reactions which may occur in the full scale solidification but might not be noticeable in the specimen tests.
 - 2. Specific process control parameters that shall be met before capping the container.

5.3 Oily Waste

- 5.3.1 Oily wastes shall be shipped to off-site processor for treatment.
- a. These processors provide the proper methods to treat oily wastes to comply with federal and state regulations and applicable burial site license criteria.

5.4 Special Cases

<p>NOTE: Based upon previous industry experience, the plant foresees the potential for situations arising that may be beyond existing plant capabilities.</p>
--

- 5.4.1 Anticipating this possibility, provisions to accommodate such situations in a timely manner by using special techniques or processes are allowed. These special cases shall be controlled as follows:
- a. Implementing procedures shall be developed comparable to those used for normal plant solid waste activities based on the guidance of this PCP and incorporating the applicable provisions for process control and testing.
 - b. The implementing procedure shall receive Station Director approval prior to use.
 - c. Use of this provision and supporting information shall be included in the next annual Radioactive Effluent Release report to the NRC.

5.5 Remedial Actions

- 5.5.1 For waste forms which do not meet federal, state and burial site regulations and requirements, suspension of shipment of the inadequately processed waste and correction of the PCP, procedures or processing equipment shall be performed as necessary to prevent recurrence.
- 5.5.2 For waste forms not prepared per the PCP, testing of the waste to demonstrate shipping and burial site requirements shall be performed and appropriate administrative action taken to prevent recurrence.

5.6 Vendor Reports^{T32288}

- 5.6.1 The following is located in vendor binder TK 9400/ES-1 maintained by the RP radwaste engineer.
- a. US DOE Waste Form Report INEEL/EXT-04-01501, Low-Level Waste Form Qualification Testing of the NUKEM Macro encapsulation Cartridge Filters Waste Form, December 2005.
- 5.6.2 The following is located in vendor binder TK 94001 DTI-1 maintained by the RP radwaste engineer.
- a. US DOE Waste Form Report INEEL/EXT-04-01505, Low-Level Waste Form Qualification Testing of the Diversified Technologies Polymer Waste Form, January 2004.
 - b. US DOE Waste Form Report INEEL/EXT-04-01505 Addendum, Low-Level Waste Form Qualification Testing of the Diversified Technologies Polymer Waste Form - APS ENCAP Application, February 2009.
 - c. Topical Report DTI-VERI-100-NP-A, VERI™ (Vinyl Ester Resin In Situ) Solidification Process for Low-Level Radioactive Waste, Rev 1.
 - d. Topical Report DT-VERI-100-NP-A, Addendum 1, ENCAP Encapsulation Utilizing the VERI Solidification Process.
 - e. Topical Report DNS-RSS-200-NP, The Dow Waste Solidification Process for Low-Level Radioactive Waste (Docket Number WM-82).

5.7 Vendor Procedures

- 5.7.1 A roster of the currently approved vendor Process Control Program procedures is located in NPG Library/Radiation Protection/RadWaste/RW Vendor Waste Form Procedures.

6. **RECORDS**

6.1 Records of PCP specimen results and form 69-10350 shall be submitted to the Records Management System on a shipment basis by container per RCP RW-4.

7. **REFERENCES**

7.1 RP2.DC3, "Radwaste Dewatering Process Control Program"

7.2 Cement Encapsulation of Cartridge Filters to Provide Waste Form Stability Basis Document, Rev. 1, PG&E NRS Log 0087

7.3 Encapsulation of Cartridge Filters In Vinyl Ester Styrene (VES) to Provide Waste Form Stability Basis Document, Rev. 0, PG&E NRS Log 0072

7.4 NRC Information Notice 88-08, Chemical Reactions with Radioactive Waste Solidification Agents

7.5 NUREG 0472 and 0473

7.6 NUREG-0800, 11.4 US NRC Standard Review Plan Solid Waste Management Systems

7.7 Technical Position on Waste Form, Revision 1, US NRC, January 1991

7.8 Title 10 Code of Federal Regulations

8. Major Change to the Solid Radwaste Treatment System Evaluation

- 8.1 A summary of the evaluation that led to the determination that the change could be made per 10 CFR 50.59.
- 8.2 Sufficient detailed information to totally support the reason for the change without benefit of additional or supplemental information.
- 8.3 A detailed description of the equipment, components and processes involved and the interfaces with other plant systems.
- 8.4 An evaluation of the change which shows the predicted releases of radioactive materials in liquid and gaseous effluents and/or quantity of solid waste that differ from those previously predicted in the License application and amendments thereto.
- 8.5 An evaluation of the change which shows the expected maximum exposures to a MEMBER OF THE PUBLIC in the UNRESTRICTED AREA and to the general population that differ from those previously estimated in the License application and amendments thereto.
- 8.6 A comparison of the predicted releases of radioactive materials, in liquid and gaseous effluent and in solid waste, to the actual releases for the period prior to when the changes are to be made.
- 8.7 An estimate of the exposure to plant operating personnel as a result of the change.
- 8.8 Documentation of the fact that the change was reviewed and found acceptable.

Attachment 6

**Diablo Canyon Power Plant Departmental Administrative Procedure,
RP2.DC3, "Radwaste Dewatering Process Control Program,"
Revision 9**

Radwaste Dewatering Process Control Program

10/05/10
Effective Date

QUALITY RELATED

Table of Contents

1.	SCOPE	1
2.	DISCUSSION.....	1
3.	DEFINITIONS	1
4.	RESPONSIBILITIES	2
5.	INSTRUCTIONS	2
5.1	General.....	2
5.2	Required Specific Instructions for the Dewatering Procedures	3
5.3	General Control Parameters	3
5.4	Reports and HIC Certifications	4
6.	RECORDS	4
7.	REFERENCES	4

1. SCOPE

- 1.1 The purpose of the Radwaste Dewatering Process Control Program is to assure that the waste form resulting from the dewatering of vendor containers meets State and Federal regulations as well as Burial Site Criteria for Free Standing Water (FSW).
- 1.2 This Dewatering Process Control Program applies to all vendor dewatering liners and High Integrity Containers (HICs) containing ion exchange and filter media.

2. DISCUSSION

- 2.1 The dewatering system consists of a pump with necessary hoses for connection to the liner or HIC and to the plant interface piping. Liners or HICs supplied by a vendor are preassembled with a hub and/or lateral assembly for dewatering retention of media. Procedures for dewatering are dependent on the waste media to be dewatered and/or the container type.
- 2.2 These procedures, specific to the container and waste material, provide instruction for the pumping and settling time sequences as well as; pump rate, total times pumped, and acceptance criteria. Additional contingencies are provided for vessels or liners requiring further steps to meet acceptance criteria and the means of verification of compliance. Methods for recording container and dewatering data are included in the specific procedures.

3. DEFINITIONS

None

4. RESPONSIBILITIES

- 4.1 The Station Director shall approve changes to this program.
- 4.2 The radwaste engineer is responsible for developing and reviewing procedures relating to the requirements of this program.
- 4.3 The radwaste foreman is responsible for implementing the procedures relating to the requirements of this program.
- 4.4 Quality organization is responsible for verifying compliance with the quality requirements of the dewatering procedures.

5. INSTRUCTIONS**5.1 General**

- 5.1.1 In order to stabilize a dewatered wet waste an NRC approved HIC may be utilized.
- 5.1.2 Polyethylene HICs which are approved by the disposal site state may be used to provide waste stability provided they are disposed of in a concrete overpack as a compensatory measure for their structural deficiency.
- 5.1.3 Changes to the Dewatering Control Program which affect any waste form parameters (e.g., type of HIC) require submission to the US NRC in the annual Radioactive Effluent Release report for the period in which the changes were made.
- 5.1.4 Any container of dewatered ion exchange media placed in interim storage shall undergo a dewatering verification prior to shipment for disposal.
- 5.1.5 No NRC topical or vendor dewatering test report for spent cartridge filters currently exists. Spent cartridge filters may be loaded into HICs and dewatered for storage.
- a. These containers shall not be shipped for disposal prior to encapsulation of the contents or dewatering by an as yet to be determined verifiable process to meet free standing water criteria.
- 5.1.6 The Dewatering Control Program consists of:
- Dewatering test reports
 - HIC certifications
 - Dewatering procedures
- a. Changes to the Dewatering Control Program shall be approved by the Station Director.

5.2 Required Specific Instructions for the Dewatering Procedures

- 5.2.1 Pumping time cycles.
- 5.2.2 Pump rate.
- 5.2.3 Total time to be pumped.
- 5.2.4 Temperature monitoring.
- 5.2.5 Acceptance criteria of FSW.
- 5.2.6 Pressure monitoring when gas generation is suspected.^{T34960}
- 5.2.7 Documentation and records of dewatering activities.
- 5.2.8 These procedures shall also specify the type of container and waste media that may be dewatered.
 - a. Contingencies shall be provided for additional steps that may be necessary to meet FSW criteria.
- 5.2.9 A roster of the currently approved vendor dewatering procedures is located in NPG Library/Radiation Protection/RadWaste/RW Vendor Procedures.doc.

5.3 General Control Parameters

- 5.3.1 Carbon steel liners for direct disposal at Clive, UT shall not to be loaded with material that exceeds Class A after concentration averaging.
- 5.3.2 Waste temperature should be monitored to mitigate exothermic chemical reactions which are possible when dewatering organic ion exchange materials used for chemical decontamination.
- 5.3.3 At the end of the appropriate pump cycle a measurement of displaced liquid shall be made for containers sent directly to disposal.
- 5.3.4 Records shall be maintained for all dewatered containers prior to shipment.
 - a. Copies shall be delivered to the radwaste foreman for indexing with radwaste container paper work.

5.4 Reports and HIC Certifications

- 5.4.1 The following are located in vendor binder TK 9400/ES-1 maintained by the RP radwaste engineer.
- a. Test Report: Scientific Ecology Group, Inc. EN-005, Summary Test Report for Dewatering Tests on Durasil 70, DT-80 and other media Dewatering Testing, Rev. C.
 - b. State of South Carolina Department of Health and Environmental Control, Certificate of Compliance - High Integrity Container.
 1. Certification Number DHEC-PL-010
- 5.4.2 The following is located in vendor binder TK 94001/DTI-2 maintained by the RP radwaste engineer.
- a. Diversified Technologies, High Velocity Vacuum (HVV) Dewatering Test Report, Rev 1.
 - b. Diversified Technology Services, Process Control Parameters PCP-02, High Velocity Vacuum (HVV) Dewatering, Rev 0, 08/16/90.

6. RECORDS

- 6.1 Records of dewatering activities shall be submitted to the Records Management System by container per RCP RW-4.

7. REFERENCES

- 7.1 RCP RW-4, "Solid Radioactive Waste Shipment"
- 7.2 NRC Information Notice No. 83-14: Dewatered Spent Ion Exchange Resin Susceptibility to Exothermic Chemical Reaction
- 7.3 NRC Information Notice No. 89-27: Limitations on the Use of Waste Forms and High Integrity Containers for the Disposal of Low-Level Radioactive Waste
- 7.4 NRC Information Notice No. 90-50: Minimization of Methane Gas in Plant Systems and Radwaste Shipping Containers
- 7.5 Polyethylene HIC and Concrete Overpack Disposal Basis Document, Rev 1, PG&E NRS Log 0041

Attachment 7

2021 Diablo Canyon Power Plant Land Use Census

2021 DCPD Land Use Census

Diablo Canyon Power Plant (DCPP) was owned and operated by Pacific Gas & Electric (PG&E) Company. PG&E owned and provided environmental stewardship to approximately 14 miles of Pacific Ocean coastline and approximately 13,000 acres surrounding the 1,000 acre DCPD site boundary. The PG&E property extended roughly from Avila Beach to Montana de Oro State Park. DCPD was located approximately seven miles WNW of Avila Beach and approximately four miles SSE of Montana de Oro State Park.

DCPP Radiological Environmental Monitoring Program (REMP) personnel conducted a Land Use Census (LUC) in the vicinity of DCPD for 2021. The LUC was based on Nuclear Regulatory Commission (NRC) Regulatory Guide 4.8, "Environmental Technical Specifications for Nuclear Power Plants". The LUC also provided compliance with 10 CFR 50 Appendix I Section IV (B)(3); "Identify changes in the use of unrestricted areas (e.g., for agricultural purposes) to permit modifications in monitoring programs for evaluating doses to individuals from principal pathways of exposure".

DCPP Program Directive CY2, "Radiological Monitoring and Controls Program" required performance of a LUC. DCPD procedure RP1.ID11, "Environmental Radiological Monitoring Procedure", required identification of the nearest milk animal, nearest residence, and the nearest broadleaf producing garden greater than 50 square meters (500 square feet) in each of the landward meteorological sectors within a radial distance of 8 kilometers (5 miles) of the Unit One Containment (CTMT) structure. A LUC was conducted at least once per year during the growing season (between Feb 15 and Dec 1) for the Diablo Canyon environs.

The 2021 LUC was conducted via landowner telephone or email interviews. Interviews were conducted March 25th, 2021 through March 28th, 2021. Ten individual landowners or tenants were contacted.

Milk:

No milk animals were identified within the first 8 kilometers (5 miles) of any sector.

Residences:

The nearest residence, relative to all sectors, was a small trailer located in the NNW sector about 2.43 kilometers (1.51 miles) from the plant. One ranch worker occupied this BLANCHARD trailer approximately 5 days per year.

Eighteen structures were identified within the 8-kilometer (5-mile) radius of the site, which were confirmed or appear to have been occupied in 2021. Twenty-four abandoned structures were identified within the 8-kilometer (5-mile) radius of the site during the LUC.

The nearest residence in each sector was summarized in Table 8.

Gardens:

The LUC identified two household gardens greater than 50 square meters (500 square feet) that produced broadleaf vegetation. The READ garden (REMP station 3C1) was approximately ¼ acre and located in the NNE sector at 7.12 kilometers (4.42 miles). The KOONZE garden (REMP station 6C1) was approximately 500 square feet and located in the E sector at 7.46 kilometers (4.63 miles).

Additional Land Use:

It should be noted that the term "site-boundary" referred to the area within a radius of approximately 1.2 km (0.74 mi) from the Unit One CTMT structure. The area outside the "site-boundary" was also referred to as the "unrestricted area". Much of the area outside the site-boundary was routinely used for rotational cattle grazing by five separate cattle operations. For purposes of this land use census, the five cattle operations were called BLANCHARD, SINSHEIMER, READ, ANDRE, and MELLO.

BLANCHARD allowed cattle to graze within the DCPD environs in 2021. BLANCHARD did not graze any goats or sheep within 8 km (5 miles) of DCPD in 2021 due to drought conditions in San Luis Obispo County.

BLANCHARD's livestock were sold under the "Old Creek Ranch" label in SLO, Santa Cruz, and Santa Clara counties in 2021. "Old Creek Ranch" labeled meats were sampled quarterly by REMP personnel in 2021. The REMP station codes were BCM, BGM, and BSM (if available).

SINSHEIMER had about 100 cattle outside the site-boundary in the NNE sector. The cows were allowed to breed and about 90 yearling calves were sold to mass market in 2021. SINSHEIMER did not slaughter any cattle in 2021 for personal consumption.

READ had about 80 cows, 4 bulls, and 72 yearling calves outside the site-boundary in the NNE sector. About 72 yearling calves were sold to mass market in 2021. READ did not slaughter any cattle in 2021 for personal consumption.

ANDRE had about 50 cattle outside the site-boundary in the ENE sector. About 50 yearling calves were sold to mass market in 2021. ANDRE did not slaughter any cattle in 2021 for personal consumption.

MELLO managed about 400 cattle outside the site-boundary in the E, ESE, and SE sectors. A commercial cattle corporation owned these cattle and sold all of them to mass market in 2021. MELLO did not slaughter any cattle in 2021 for personal consumption.

Two landowners (JOHE and ANDRE) harvested wild game for personal consumption outside the site-boundary in the NNE, NE, and ENE sectors. This wild game consisted of approximately 2-4 deer per landowner.

There was a California State Park Ranger Office in the NNW sector at 7.48 kilometers (4.65 miles) from the site. Approximately three State Parks staff personnel occupy this office from 1000 to 1500 each day (365 days per year) normally, but the office had been closed due to the Covid-19 pandemic to possibly reopen when state and county protocols allowed.

There was a public campground (Islay Creek Campground) located in the NNW sector at Montana de Oro State Park at 7.31 kilometers (4.54 miles). This campground was near Spooner's Cove. Approximately 800,000 people visited Montana de Oro State Park via day-use permit. Approximately 22,000 people spend the night at Islay Creek Campground in a normal year, but the campground was closed due to the Covid-19 pandemic to reopen based on state and county protocol.

There was public access to hiking trails at the north end of the PG&E property in 2021.

The Point Buchon Trail was located at the north end of PG&E property and had about 18,000 visitors in 2021. The trail traversed about 3.4 miles of coastline from Coon Creek to Lion Rock overlook. The trail was open to the public for day hikes Thursday thru Monday from approximately 0800-1700. Two to three people from California Land Management occupied the trail head booth near Coon Creek during operational days from 0700 to 1730. This trail was originally opened to the public on July 13, 2007.

The Pecho Coast Trail was located at the south end of PG&E property and was closed to visitors in the beginning of 2021 because of the Covid-19 pandemic. The trail opened up for limited use in June of 2021. The trail was approximately 3.8 miles long and led from the Avila Beach DCPD entrance gate to the Point San Luis Lighthouse property. Pecho Coast Trail hikes were historically available on Wednesdays (about 20 people) and Saturdays (about 40 people). An extension of the trail up the coastline to Rattlesnake Canyon made the trail 8 miles roundtrip and is only usually available on Mondays (about 20 people each trip). This trail extension was improved in October 2017 to allow controlled vehicle access on the trail. Access was normally controlled (via web-site reservation permission only) and conducted by docents from approximately 0900 to 1500. This trail was just slightly outside the 5-mile radius of the DCPD site. This Pecho Coast Trail has been open for docent-guided hikes since 1993.

Five to ten Port San Luis Lighthouse keepers worked at the lighthouse grounds during the week in 2021. There were a pool of 70 total volunteers that worked at the lighthouse in 2021. The public visited the lighthouse on Wednesdays and Saturdays, work crews were on-site on Tuesdays through the year. On May 1st, 2021 public tours began again on the lighthouse grounds. Beginning in mid-June the lighthouse allowed full public occupancy on the grounds.

NEI 07-07 Groundwater Protection Initiative (GPI) Review:

There were no site construction activities or radioactive spills that warranted changes to GPI monitoring frequencies, monitoring locations, lab analytical capabilities, or analytical detection thresholds in 2021.

There were no changes in on-site or near site groundwater usage.

Groundwater beneath the site power block was not used as a source of drinking water.

Old Steam Generator Storage Facility (OSGSF):

The OSGSF vault was located within the site-boundary in the ENE sector (68.3 degrees) at 0.99 km (0.61 mi) from Unit One CTMT.

The following plant equipment was placed into the OSGSF for the duration of the Diablo Canyon Part 50 license on the dates indicated below.

Unit One old steam generators (4 total): 2/14/2009

Unit Two old steam generators (4 total): 3/2/2008

Unit One old reactor head (1 total): 10/23/2010

Unit Two old reactor head (1 total): 11/6/2009

Independent Spent Fuel Storage Installation (ISFSI):

The on-site dry cask ISFSI pad was located within the site-boundary in the ENE sector (58.47 degrees) at 0.36 km (0.22 mi) from Unit One CTMT.

DCPP loaded it's first ISFSI dry cask onto the pad on 6/23/2009.

There were no dry cask loading campaigns in 2021.

At the end of 2021, a total of 58 dry casks occupy the ISFSI pad.

Table 8 summarizes the nearest residence location in each meteorological sector.

The Land Use Figure shows the location of the residences and gardens in the vicinity of DCPP.

Table 8

Land Use Census 2021

**Distance in kilometers (and miles) from the center point of U-1 CTMT
Nearest Milk Animal, Residence, and Vegetable Garden**

22½ Degree (a) Radial Sector	Nearest Milk Animal	Nearest Residence km (mi)	Residence Azimuth Degree	Nearest Vegetable Garden km (mi)
NW	None	5.76 (3.58)	325.18	None
NNW	None	2.43 (1.51) ^(b)	332.01	None
N	None	None	—	None
NNE	None	5.18 (3.22)	21.43	7.12 (4.42) ^(c)
NE	None	7.94 (4.93)	35.33	None
ENE	None	7.15 (4.45)	63.84	None
E	None	5.96 (3.71)	89.89	7.46 (4.63) ^(d)
ESE	None	None	—	None
SE	None	None	—	None

Table Notation:

- (a) Sectors not shown were over water and contained no land (other than islets not used for the purposes indicated in this table) beyond the site-boundary.
- (b) BLANCHARD trailer was the residence used for critical receptor calculations.
- (c) The READ (REMP station 3C1) vegetable garden was located in the NNE sector and the 19.89 azimuth degree. There was also a limited use residence at this location.
- (d) The KOONZE (REMP station 6C1) vegetable garden was located in the E sector and the 97.26 azimuth degree. There was also a full-time residence at this location.

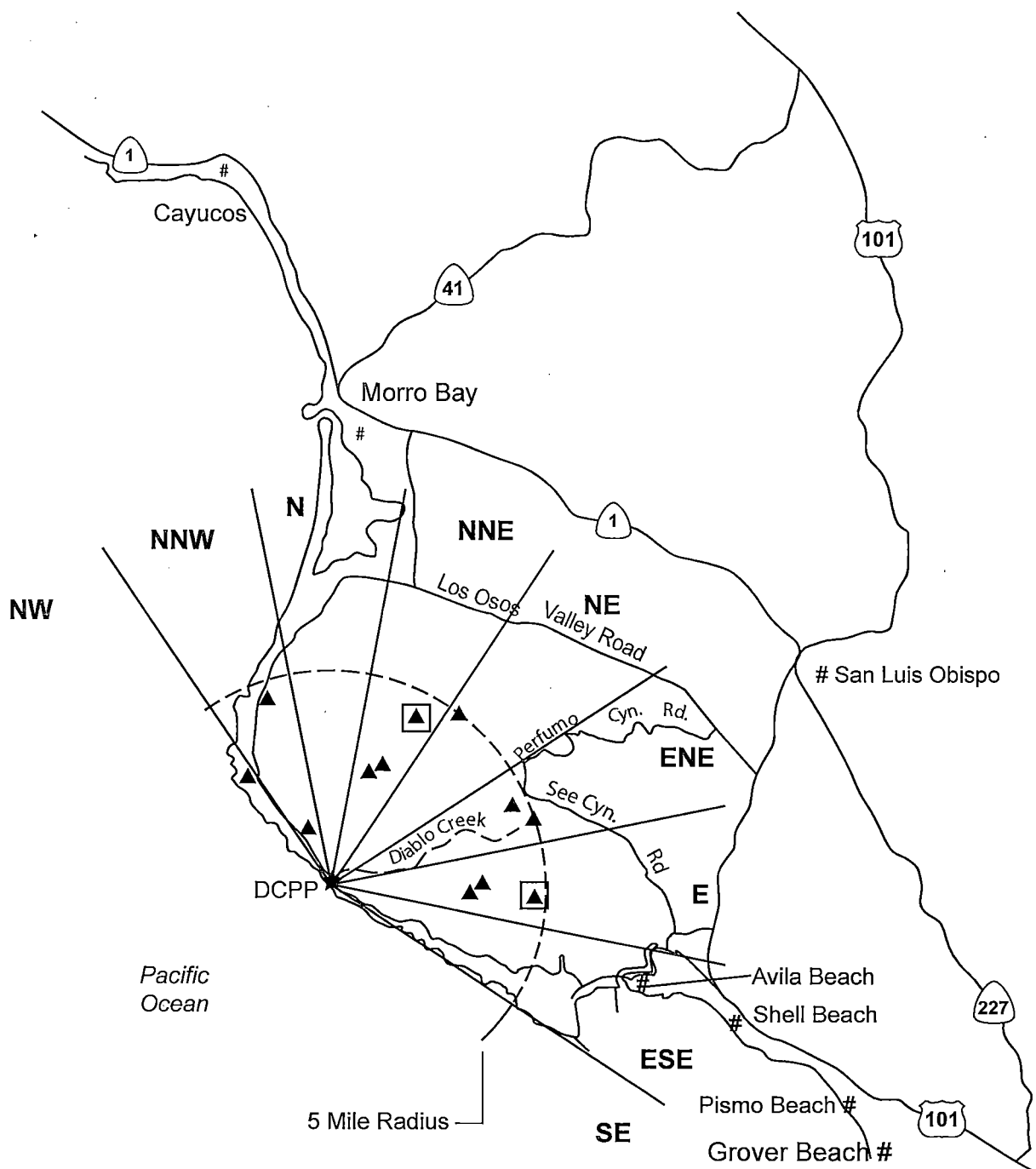

UNITS 1 AND 2
DIABLO CANYON SITE

□ Gardens or Farm

▲ Residences

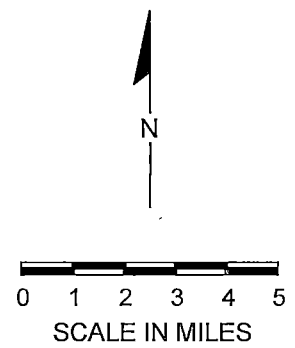

Units 1 and 2 Diablo Canyon Power Plant Land Use Census.

Diablo Canyon Power Plant
Meteorological Data

