

---

---

Loss of an Iridium-192 Source and  
Therapy Misadministration at  
Indiana Regional Cancer Center  
Indiana, Pennsylvania, on  
November 16, 1992

---

---

**U.S. Nuclear Regulatory Commission**



## AVAILABILITY NOTICE

### Availability of Reference Materials Cited in NRC Publications

Most documents cited in NRC publications will be available from one of the following sources:

1. The NRC Public Document Room, 2120 L Street, NW., Lower Level, Washington, DC 20555
2. The Superintendent of Documents, U.S. Government Printing Office, P.O. Box 37082, Washington, DC 20013-7082
3. The National Technical Information Service, Springfield, VA 22161

Although the listing that follows represents the majority of documents cited in NRC publications, it is not intended to be exhaustive.

Referenced documents available for inspection and copying for a fee from the NRC Public Document Room include NRC correspondence and internal NRC memoranda; NRC bulletins, circulars, information notices, inspection and investigation notices; licensee event reports; vendor reports and correspondence; Commission papers; and applicant and licensee documents and correspondence.

The following documents in the NUREG series are available for purchase from the GPO Sales Program: formal NRC staff and contractor reports, NRC-sponsored conference proceedings, international agreement reports, grant publications, and NRC booklets and brochures. Also available are regulatory guides, NRC regulations in the *Code of Federal Regulations*, and *Nuclear Regulatory Commission Issuances*.

Documents available from the National Technical Information Service include NUREG-series reports and technical reports prepared by other Federal agencies and reports prepared by the Atomic Energy Commission, forerunner agency to the Nuclear Regulatory Commission.

Documents available from public and special technical libraries include all open literature items, such as books, journal articles, and transactions. *Federal Register* notices, Federal and State legislation, and congressional reports can usually be obtained from these libraries.

Documents such as theses, dissertations, foreign reports and translations, and non-NRC conference proceedings are available for purchase from the organization sponsoring the publication cited.

Single copies of NRC draft reports are available free, to the extent of supply, upon written request to the Office of Administration, Distribution and Mail Services Section, U.S. Nuclear Regulatory Commission, Washington, DC 20555.

Copies of industry codes and standards used in a substantive manner in the NRC regulatory process are maintained at the NRC Library, 7920 Norfolk Avenue, Bethesda, Maryland, for use by the public. Codes and standards are usually copyrighted and may be purchased from the originating organization or, if they are American National Standards, from the American National Standards Institute, 1430 Broadway, New York, NY 10018.

---

---

Loss of an Iridium-192 Source and  
Therapy Misadministration at  
Indiana Regional Cancer Center  
Indiana, Pennsylvania, on  
November 16, 1992

---

---

Manuscript Completed: February 1993  
Date Published: February 1993

**U.S. Nuclear Regulatory Commission**  
**Washington, DC 20555**





## ABSTRACT

On December 1, 1992, the Indiana Regional Cancer Center reported to the U.S. Nuclear Regulatory Commission's (NRC) Region I that they believed a  $1.37 \text{ E}+11$  becquerel (3.7-curie) iridium-192 source from their Omnitron 2000 high dose rate remote brachytherapy afterloader had been found at a biohazard waste transfer station in Carnegie, Pennsylvania. After notifying the NRC, this cancer center, one of several operated by the licensee, Oncology Services Corporation, retrieved the source, and Region I dispatched an inspector and a supervisor to investigate the event. The source was first detected when it triggered radiation alarms at a waste incinerator facility in Warren, Ohio. The licensee informed the NRC that the source wire had apparently broken during treatment of a patient on November 16, 1992, leaving the source in the patient. On the basis of the seriousness of the incident, the NRC elevated its response to an Incident Investigation. The Incident Investigation Team initiated its investigation on December 3, 1992. The investigation team concluded that the patient received a serious misadministration and died on November 21, 1992, and that over 90 individuals were exposed to radiation from November 16 to December 1, 1992. In a press release dated January 26, 1993, the Indiana County Coroner stated that the cause of death listed in the official autopsy report was "Acute Radiational Exposure and Consequences Thereof." An almost identical source wire failure occurred with an afterloader in Pittsburgh, Pennsylvania, on December 7, 1992, but with minimal radiological consequences. This incident was included in the investigation. This report discusses the Omnitron 2000 high dose rate afterloader source-wire failure, the reasons why the failure was not detected by Indiana Regional Cancer Center, the potential consequences to the patient, the estimated radiological doses to workers and the public, and regulatory aspects associated with this incident.



# CONTENTS

Section	Page
Abstract . . . . .	iii
Executive Summary . . . . .	xiii
Team Members . . . . .	xxi
Acknowledgements . . . . .	xxii
Abbreviations . . . . .	xxiii
1 INTRODUCTION . . . . .	1-1
2 SEQUENCE OF EVENTS . . . . .	2-1
2.1 Patient Treatment Plan . . . . .	2-1
2.2 Indiana Regional Cancer Center Incident . . . . .	2-2
2.3 Greater Pittsburgh Cancer Center Incident . . . . .	2-12
3 OMNITRON 2000 HIGH DOSE RATE REMOTE AFTERLOADER SYSTEM . . . . .	3-1
3.1 Description of the Afterloader System . . . . .	3-1
3.2 Description of the Source Wire . . . . .	3-6
3.3 Description of the Omnitron 2000 Afterloader System Software . . . . .	3-8
3.4 Omnitron's Quality Assurance and Quality Control Program . . . . .	3-10
3.5 Training, Operating, and Emergency Procedures for the Omnitron 2000 High Dose Rate Afterloader . . . . .	3-11
4 EQUIPMENT PERFORMANCE . . . . .	4-1
4.1 Failure Analysis Pertaining to the Source Wire . . . . .	4-1
4.2 Immediate Cause of Wire Break . . . . .	4-9
4.3 Potential Root Cause of Wire Break . . . . .	4-10
4.4 Failure of Device To Detect Loss of Part of the Wire . . . . .	4-11
4.5 Performance of PrimAlert-10 . . . . .	4-11

## CONTENTS (continued)

Section	Page
5	HUMAN FACTORS ANALYSIS . . . . . 5-1
5.1	Organizational Factors . . . . . 5-1
5.2	Emergency Operating Procedures . . . . . 5-7
5.3	Training . . . . . 5-7
5.4	Quality Management Program for High Dose Rate Brachytherapy at the Indiana Regional Cancer Center . . . . . 5-8
6	RADIOLOGICAL DOSE EVALUATIONS . . . . . 6-1
6.1	Overview of Team's Methodology . . . . . 6-1
6.2	NRC's Medical Evaluation of the Dosimetry and Effect of Radiation on Patient A . . . . . 6-3
6.3	Evaluation of Radiation Doses for Occupational Workers at the Indiana Regional Cancer Center . . . . . 6-10
6.4	The Public . . . . . 6-14
6.5	Blood Studies . . . . . 6-38
7	LICENSEE AND VENDOR RESPONSE TO INCIDENT . . . . . 7-1
7.1	Misadministration . . . . . 7-1
7.2	Licensee Actions . . . . . 7-1
7.3	Vendor Actions . . . . . 7-8
8	REGULATORY OVERSIGHT . . . . . 8-1
8.1	High Dose Rate Afterloader Device Review by the Food and Drug Administration . . . . . 8-1
8.2	Source and Device Registration by the State of Louisiana . . . . . 8-1
8.3	NRC's Regulations and Guidance for Quality Assurance and Quality Control Programs for Sealed Source and Device Vendors . . . . . 8-2
8.4	NRC Licensing of Oncology Services Corporation . . . . . 8-3
8.5	NRC Inspection Program and Process . . . . . 8-4
8.6	NRC Regulatory Activities . . . . . 8-5
9	PRECURSORS . . . . . 9-1
9.1	High Dose Rate Remote Afterloader Incidents . . . . . 9-1
9.2	OmniTron 2000 Performance History . . . . . 9-2



## CONTENTS (continued)

Section	Page
10 FINDINGS AND CONCLUSIONS . . . . .	10-1
10.1 Radiological Consequences Were Serious to the Patient and Significant to Many Members of the Public. . . . .	10-1
10.2 Weaknesses in Oncology Services Corporation's Radiation Protection Program Were a Contributing Cause of the Seriousness of the Event and Radiation Exposure Consequences . . . . .	10-2
10.3 Weaknesses Existed in the Design and Testing of the Omnitron 2000 Remote Afterloader System and Its Source Wire . . . . .	10-3
10.4 Oncology Services Corporation and Indiana Regional Cancer Center Lacked Critical Safety Awareness with Respect to High Dose Rate Brachytherapy . . . . .	10-3
10.5 Overall Regulatory Oversight Was Weak . . . . .	10-4
10.6 No Regulatory Guidance Exists for Nonradioactive Waste Collectors. In Addition, Browning-Ferris Industries Failed To Follow Their Existing Radiation Control Policies . . . . .	10-5
Glossary . . . . .	G-1

## Appendices

Section	Page
A Incident Investigation Team Charter . . . . .	A-1
B Properties of Iridium-192 . . . . .	B-1
C Low Dose and High Dose Rate Brachytherapy . . . . .	C-1
D Oncology Services Corporation Materials License . . . . .	D-1
E Interviews and Meetings the Incident Investigation Team Conducted . . . . .	E-1

## CONTENTS (continued)

### Tables

Number	Page
A	Summary of Doses Received as a Result of an Iridium-192 Source Lost from November 16 to December 1, 1992 . . . . . xix
B	Summary of Collective Doses for All Locations . . . . . xx
4.1	Summary of Test Samples . . . . . 4-6
4.2	Summary of Tests Performed on Wire Samples . . . . . 4-8
6.1(a)	Normal Tissue Distances from Possible Source Location in Patient A . . . . . 6-7
6.1(b)	Normal Tissue Dose (cGy) Versus Possible Source Location in Patient A . . . . . 6-8
6.2	Tolerance of Different Tissues to Radiation Exposure . . . . . 6-9
6.3	Summary of Radiation Doses for Indiana Regional Cancer Center Occupational Workers . . . . . 6-13
6.4	Summary of Radiation Doses for Indiana Regional Cancer Center Nonoccupational Workers and Patients . . . . . 6-16
6.5	Summary of Radiation Doses for Adjacent Physician's Personnel and Patients . . 6-18
6.6	Summary of Radiation Doses for Ambulance Service Employees . . . . . 6-20
6.7	Schedule for Nursing Staff Assigned to Patient A Week of November 16-20, 1992 . . . . . 6-22
6.8	Summary of Whole Body Dose Estimates for SHM Nursing Home Staff . . . . . 6-26
6.9	Summary of Extremity Dose Estimates for Selected SHM Nursing Home Staff . 6-27
6.10	Summary of Radiation Doses for Relatives and Friends During November 16-20, 1992 . . . . . 6-29
6.11	Summary of Radiation Doses for SHM Residents During November 16-20, 1992 . . . . . 6-30

## CONTENTS (continued)

### Tables

Number	Page
6.12	Summary of Radiation Doses for SHM Nursing Home Residents While in Recreation Room During November 20-25, 1992 . . . . . 6-32
6.13	Summary of Whole Body Dose Estimates for BFI Employees . . . . . 6-36
6.14	Summary of Extremity Dose Estimates for Selected BFI Employees . . . . . 6-37
6.15	Comparison of Calculated Whole Body Doses with Cytogenetic Evaluation . . . 6-42
B.1	Calculated Dose Rate (mSv/hr) at Selected Distances for 3.3085 E+11 Bq (8.942-Ci) Iridium-192 Source Certified August 28, 1992 . . . B-4
B.2	Iridium-192 Dose Rates vs. Distance With and Without Berger Buildup Factors . . . . . B-6

### Figures

Number	Page
1.1	Indiana Regional Cancer Center, Indiana, Pennsylvania . . . . . 1-3
2.1	Isodose Graph for Initial High Dose Rate Patient Treatment Plan . . . . . 2-16
2.2	Summary of Initial High Dose Rate Treatment Plan . . . . . 2-17
2.3	Back of High Dose Rate Afterloader . . . . . 2-18
2.4	Front of High Dose Rate Afterloader . . . . . 2-18
2.5	Diagram of Indiana Regional Cancer Center . . . . . 2-19
2.6	Front of Scenery Hill Manor Nursing Home . . . . . 2-20
2.7	Soiled Utility Room with Biohazard Waste Container . . . . . 2-21
2.8	Waste Storage Room at Scenery Hill Manor Nursing Home . . . . . 2-22

## CONTENTS (continued)

### Figures

Number		Page
2.9	Browning-Ferris Industries Straight Truck Used To Collect Waste from Scenery Hill Manor Nursing Home . . . . .	2-23
2.10	Aerial Photograph of Browning-Ferris Industries Transfer Station in Carnegie, Pennsylvania . . . . .	2-24
2.11	BFI Tractor-Trailer [14.63-m (48-ft)] Long Showing Location of Source Container in the Trailer . . . . .	2-25
2.12	Route of Browning-Ferris Industries Semitruck 808 on November 25, 1992 . .	2-26
2.13	Diagram of Tractor-Trailer Route Carrying Iridium-192 Source at BFI-Warren on November 25, 1992 . . . . .	2-27
2.14	Boxes on Conveyor Feedline Adjacent to Radiation Monitor . . . . .	2-28
2.15	Console for Monitoring Radiation at Incinerator Conveyor Feedline . . . . .	2-28
2.16	Survey Meter Used at BFI-Warren . . . . .	2-29
2.17	Location of Where Manager and Supervisor Detected Radiation (~400 Feet) from BFI Trailer 808 . . . . .	2-30
2.18	BFI Truck Parking Lot, Carnegie, Pennsylvania . . . . .	2-31
2.19	Location of Isolated Biohazard Box Containing Source . . . . .	2-32
2.20	BFI Locking Recycle Container . . . . .	2-33
2.21	Interior of the BFI Waste Container Where Radioactive Source Was Stored . . .	2-33
2.22	Location of Radioactive Source Recycle Container at BFI-Carnegie . . . . .	2-34
3.1	Omnitron 2000 High Dose Rate Remote Afterloader . . . . .	3-12
3.2	Left Side of High Dose Rate Remote Afterloader, Indiana, Pennsylvania . . . .	3-13
3.3	Turret Drive Assembly, Indiana, Pennsylvania . . . . .	3-14

## CONTENTS (continued)

### Figures

Number		Page
3.4	Control Panel for High Dose Rate Remote Afterloader, Indiana, Pennsylvania . . . . .	3-15
3.5	Arrangement of the Computer Console Status Panel, Door Panel, System Printer, Linear Accelerator Controls, Computer Monitor, and Monitor for Patient Surveillance Camera . . . . .	3-16
3.6	Computer Console Status Panel of High Dose Rate Remote Afterloader System .	3-17
3.7	Door Status Panel of High Dose Rate Remote Afterloader System . . . . .	3-17
3.8	Connecting Catheter and Flexineedle Unassembled . . . . .	3-18
3.9	Iridium-192 Seed in Titanium/Nickel . . . . .	3-19
4.1	Source Wire—Possible Failure Areas . . . . .	4-14
4.2	Track Where Source Tip May Have Contacted Parts of the Afterloader . . . . .	4-15
4.3	Connecting Catheter and Flexineedle—Assembled . . . . .	4-16
4.4	Shipping Container for Iridium-192 Source . . . . .	4-17
4.5	Testing of a Sample Wire . . . . .	4-18
5.1	Oncology Services Corporation Organizational Chart . . . . .	5-10
6.1	Diagram of the Indiana Regional Cancer Center Showing Isodose Curves from the Iridium-192 Source on November 16, 1992 . . . . .	6-43
6.2	Location of Ambulance Staff and Patient A in Citizens' Ambulance . . . . .	6-44
6.3	Diagram of Room 4B at the Scenery Hill Manor Nursing Home Showing Isodose Curves from the Iridium-192 Source on November 16, 1992 . . . . .	6-45
6.4	Diagram of the SHM Nursing Home Soiled Utility Room Showing Isodose Curves from the Iridium-192 Source on November 20, 1992 . . . . .	6-46

## CONTENTS (continued)

### Figures

Number		Page
6.5	Diagram of Rooms Adjacent to Patient Room 4B Showing 1-Meter Isodose Curves from the Iridium-192 Source on November 16, 1992 . . . . .	6-47
6.6	Detailed Diagram of the Scenery Hill Manor Nursing Home Recreation Room Showing Isodose Curves from the Iridium-192 Source Located in the Outside Storage Room from November 20 to 25, 1992 . . . . .	6-48
6.7	Portable Radiation Survey Meter from BFI-Carnegie Straight Truck . . . . .	6-49
6.8	Aerial View of the Positions of Supervisor A, Safety Technician A, and Safety Technician B Around the Box Containing the Iridium-192 Source on December 1, 1992, Showing Isodose Curves in mSv per Hour . . . . .	6-50
7.1	Treatment Plan Catheter Location . . . . .	7-10
7.2	Actual Catheter Location . . . . .	7-10
B.1	Simplified Decay Scheme for Iridium-192 . . . . .	B-2
B.2	Microshield 3.13 Program Showing Point Source and Shields . . . . .	B-3

## EXECUTIVE SUMMARY

On November 16, 1992, an elderly patient was treated for anal carcinoma at the Indiana Regional Cancer Center (IRCC) in Indiana, Pennsylvania, using high dose rate (HDR) brachytherapy. The IRCC is one of ten cancer treatment centers using HDR units operated by the Oncology Services Corporation (OSC), the license holder. The patient died on the evening of November 21, 1992, five days after the treatment. Before the treatment, five catheters were placed in the tumor. During the treatment, an approximate  $1.6 \text{ E}+11$  becquerel (4.3-curie) iridium-192 source was placed at various positions in each catheter to irradiate the tumor by use of a remotely controlled Omnitron 2000 afterloader. The treatment was conducted in the same shielded facility in which linear accelerator treatments were conducted. This treatment was the first of a series of three 600-centigray (rad) treatments planned by the physician, and the five catheters were to remain in the patient for subsequent treatments.

After a trial run through the five catheters with a dummy wire, the iridium source wire was placed in four catheters without difficulty. After several unsuccessful attempts to insert the source wire and the dummy wire into a fifth catheter, the treatment was terminated. An area radiation monitor in the treatment area was observed in an alarm condition at various times when the source should have been retracted during the unsuccessful attempts to insert the source wire through the catheter. Although three technologists and the physician attending the patient were aware of the alarm condition, no one conducted a survey for radiation levels with the available portable radiation survey instrument. The only action taken was to check the control console of the HDR remote afterloader. Because the console indicator showed "safe," they believed the source to be fully retracted into the lead shield and assumed the area radiation monitor was malfunctioning. They were unaware the source wire had broken, leaving the source in one of the catheters in the patient. The staff at the IRCC stated they had experienced difficulties with the area radiation monitor that had alarmed after patient linear accelerator treatments and that a survey after a previous false alarm had shown no radiation was present.

Before the incident, breakage of the wire encapsulating the iridium source was not considered credible by the vendor or the licensee. Omnitron International, Inc.'s (Omnitron's), emergency procedures were directed toward emergency retraction of a wire with a source that was stuck out and required manual retraction. The only individual interviewed who stated he believed that wire breakage was credible was the medical physicist at the Greater Pittsburgh Cancer Center (GPCC), another facility operated by OSC.

OSC appears to have provided no systematic radiation safety training to the staff at the IRCC. Dependence was placed on the staff's previous formal training; training by Omnitron on the HDR remote afterloader, which included Omnitron emergency procedures but did not include radiation safety; and an expectation that either the medical director or the medical physicist at each site would provide radiation safety training. This expectation was neither met nor were steps taken to confirm it.

Given the conflict between the data provided by the area radiation monitor and the Omnitron 2000 control panel, and the lack of radiation safety training that should have conditioned the staff to respond properly to radiation alarms, the licensee staff failed to respond to the alarm. Instead, a technologist unplugged and reset the radiation monitor. The technologist should have responded by using the portable survey meter available at the control console for the afterloader. This meter would have identified the fact that the source had not returned to the afterloader shield.

The patient spent 50 minutes in the treatment room. After the patient was removed from the treatment room, one catheter was observed to be loose and it was removed. The patient was returned to the nursing home where the patient resided with four catheters, one containing the iridium-192 source, in the patient's body. The source remained in the patient's body for almost four days. The catheter with the source came loose on the fourth day and, eventually, the catheter fell out (early on the morning of November 20, 1992). It was placed in a medical biohazards bag (red-bag) in a storage room by nursing home personnel who did not know it contained the radioactive source.

Later, on the same day, the catheter containing the source was moved to another storage location at the nursing home and placed in a box with other red bags. From November 16 through November 25, 1992, numerous residents, employees, and visitors to the nursing home were unknowingly irradiated. The ambulance staff who returned the patient to the nursing home were irradiated along with employees and patients at the IRCC who were present for the approximately 10 minutes while the patient was outside the treatment room after the treatment.

On November 25, 1992, a driver for Browning-Ferris Industries (BFI) picked up the nursing home red-bag waste as part of the driver's normal rounds. The driver had an operable portable radiation survey meter but, contrary to company procedures, did not survey the waste from the nursing home. The nursing home waste along with other medical waste was taken to a BFI facility in Carnegie, Pennsylvania, where it was loaded onto a trailer. This trailer remained in Carnegie throughout the following day, which was Thanksgiving, and early on November 27, 1992, was driven to a BFI medical waste incinerator in Warren, Ohio. At the Warren facility, fixed radiation monitors identified radiation emanating from the trailer, and, on facility personnel direction, the trailer was returned to Carnegie the same day. It was left over the weekend and on Monday, November 30, 1992, the BFI staff searched the truck for the radiation source. They identified the box with the radiation source and looked at individual red bags to identify the origin of the waste. On December 1, 1992, BFI successfully identified a name found with the red-bag waste in the box, and traced it to the nursing home.

After being notified by BFI, the nursing home called the IRCC on December 1, 1992. The cancer center had not used the HDR afterloader after the single treatment on November 16, 1992. Upon being informed of the source discovery, the medical physicist determined that



no source was present in the HDR afterloader and informed the NRC Region I office of this fact. The physician and the medical physicist drove to Carnegie to retrieve the source.

A second Omnitron 2000 source wire broke at the GPCC on December 7, 1992. This failure was included in the scope of this investigation. This wire broke in the same approximate location as the first wire. The GPCC medical physicist who was conducting the treatment was aware of the first incident and immediately recognized the problem and promptly and appropriately intervened, thereby preventing significant dose consequences to the patient or the cancer center staff. Apparently, the patient stressed the wire by an arm movement when the source was being retracted.

The NRC issued a Bulletin on December 8, 1992, to all licensees authorized to use the Omnitron 2000 afterloader requesting that they ensure patients are surveyed immediately after completing each therapy treatment; provide for prompt surgical intervention, if needed, in the event a source does not retract into the shielded container after treatment; and ensure that training on routine and emergency procedures is provided to licensee staffs initially and semiannually. In addition, an NRC Information Notice was issued December 17, 1992, informing all NRC medical licensees of this incident, reminding them of NRC requirements for positive assurance that all implanted sources have been removed before patients are released after treatment and informing them of the information provided in the Bulletin.

The cause of the source wire failures was investigated by the vendor, Omnitron, and their consultant and by the NRC team and its consultant laboratory, Southwest Research Institute. The Food and Drug Administration (FDA), which has responsibilities for the HDR afterloader as a medical device, conducted an independent inspection. The team shared its data with the FDA. The FDA issued its Form 483 with 37 findings to Omnitron on January 11, 1993. These findings were primarily in the quality assurance and quality control (QA/QC) area. The NRC team also interacted with the State of Louisiana because certain of Omnitron's activities are also overseen by this Agreement State.

Although the team identified a number of weaknesses in Omnitron's QA/QC program in addition to concerns with the design and prototype testing of the source wire, the cause of the wire failure is not known with certainty at this time. The wire broke at the bottom section of the source-wire cavity. The vendor had not calculated the maximum allowable stress in the design. The wire is made from Nitinol, a shape-memory alloy of nickel and titanium in approximately equal atomic percentages. The vendor believes it has evidence to show that storage of the source wire in teflon, if moisture is present, causes degradation of the teflon with release of fluorine or hydrogen fluoride that causes degradation of the Nitinol wire. The NRC and its consultant are still evaluating this hypothesis and conducting further studies.

An NRC medical consultant, who is a radiation oncologist, assisted the team in evaluating the effect of the source on the patient. The medical consultant concluded that an analysis of the medical records and physical dosimetry would indicate that the massive radiation dose

was a probable contributing cause of death in this patient. The consultant added that even if the exact cause of death could be attributed to other causes such as cancer or heart disease, the extent of the radiation received would have soon caused death. The consultant stated the radiation accident would probably have eventually resulted in a fatality in a younger, healthier patient within days or weeks of an equivalent accident.

The licensee reported the prescribed dose at one centimeter was  $1.8 \text{ E}+03$  centigray (rad) to be delivered in three treatments and that the delivered dose was  $1.6 \text{ E}+06$  centigray (rad) to the same point, an overdose of about three orders of magnitude. The licensee stated the effect on the patient would be significant local tissue damage and possible significant tissue damage to organs outside the treatment area, depending upon the progression of radiation damage with time before the patient expired. The licensee stated the dose was of sufficient magnitude that it believed it was highly probable that the radiation exposure was at least a contributing factor to the patient's subsequent death. In a press release dated January 26, 1993, the Indiana County Coroner stated that the cause of death listed in the official autopsy report was "Acute Radiation Exposure and Consequences Thereof."

In addition to the patient, the team evaluated the radiation doses to 94 persons associated with the IRCC event. Exposures of individuals wearing film badges were taken from the badge reading. Except for the physician, all other exposures were derived by calculations based on time-motion studies. These data were based on interviews and records. Individuals visiting the patient were identified through interviews with nursing home staff and known visitors. Becoming aware of a previously unidentified visitor from a newspaper article, the team interviewed that person and placed an advertisement in the local Indiana, Pennsylvania, newspaper. The advertisement requested any individual who was concerned about having come into contact with radiation from the source and who had not been interviewed to contact the NRC. A collect telephone number was provided. This led to two additional contacts. Table A presents a summary of the whole body doses received by the 94 individuals specifically evaluated. Table B presents a summary of collective doses for all locations. Extremity (i.e., hands and forearm) doses were calculated for those individuals who were judged to have the highest exposures because of the proximity of their hands to the source when caring for the patient or searching for the source. The highest extremity dose was calculated to be between 0.73 to 1.6 sieverts (73 to 160 rem) to the hands of one of the Certified Nursing Assistants.

Further studies were conducted by blood counts and cytogenetic studies on selected individuals. Blood counts are simple to perform but have sensitivity limited to 0.75 to 1.5 sieverts (75 to 150 rem). Cytogenetic studies are more sensitive [0.2 sieverts (20 rem)] but are much more difficult to perform. Cytogenetic studies were performed for the NRC by the Radiation Emergency Assistance Center/Training Site at Oak Ridge. Individuals selected for cytogenetic studies were almost always those with the greatest calculated dose. Because the highest calculated doses were at about the limit of detection [0.2 sieverts (20 rem)], the team expected that the cytogenetic data would show if there were significant nonconservative errors in the calculated doses (i.e., measured doses were higher than calculated doses).

Cytogenetic results were consistent with calculated doses within the limits of accuracy of both techniques.

No occupational worker received a radiation dose above the NRC occupational limit of 0.0125 sieverts (1.25 rem). While members of the public received radiation doses above applicable limits, no one received a dose at which acute radiation injury or clinical signs are expected to occur.

In addition to the radiological consequences and the cause of the wire failure the team made a number of findings:

1. OSC had weaknesses in their radiation safety program that were a major contributing cause of the seriousness of the event and radiation exposure consequences. Some of these were a result of a rapid expansion in their HDR brachytherapy program from one facility to ten facilities in less than a year. The Radiation Safety Officer (RSO) failed to ensure that the staffs at all facilities received adequate radiation safety training and that all management instructions relating to HDR were being followed. Informal and unwritten procedures that may have been adequate when the licensee possessed one HDR unit under the direct control of the RSO were ineffective for the expanded program.
2. A number of weaknesses were found in the design and testing of the Omnitron 2000. Weaknesses were identified in the testing and validation of source-wire design, and in the design of certain safety features of the HDR afterloader. These could allow the undetected retraction and further use of a broken wire with no warning to the user. Although not contributing to this event, weaknesses were found in Omnitron's QA/QC program.
3. The safety culture at IRCC contributed significantly to the event. Technologists routinely ignored the PrimAlert-10 alarm. Its problems were worked around and not fixed. Technologists did not survey patients, the afterloader, or the treatment room following HDR treatments. No one was sure who was responsible for radiation safety training or the radiation safety program. The authorized user failed to wear a film badge on both occasions when the source was encountered.
4. Overall regulatory oversight was weak. NRC regulations do not directly address HDR brachytherapy to the extent that teletherapy and low dose rate brachytherapy are addressed. Licensing guidance for HDR has been unchanged since 1986 in spite of significant changes in medical regulations and other medical licensing guidance. Inspection guidance for medical licensees does not specifically address HDR brachytherapy. Although inspected by the NRC Region I office within a year of initial licensing, the inspection program does not require early reinspection in cases where licensees significantly expand the scope of their program through license amendments. The regulatory interaction between the NRC, the FDA, and the

involved Agreement States in the regulation and authorization of the Omnitron 2000 HDR afterloader is poorly defined.

5. NRC guidance for scrap dealers needs to be given to waste brokers and collectors. Discovery of the lost iridium-192 source by BFI may have prevented additional significant radiation exposures; however, subsequent actions taken by BFI employees led to their receiving unnecessary exposures when they moved and searched for the source. Assistance from radiation protection experts should have been sought.

**Table A Summary of Doses Received as a Result of an  
Iridium-192 Source Lost  
from November 16 to December 1, 1992**

<b>Dose Range (Sv)</b>	<b>Dose Range (rem)</b>	<b>Estimated Number of Individuals Exposed</b>
0.0 - 0.005	0.0 - 0.5	42
0.005 - 0.01	0.5 - 1	11
0.01 - 0.05	1 - 5	20
0.05 - 0.1	5 - 10	13
0.1 - 0.15	10 - 15	7
0.15 - 0.20	15 - 20	1
<b>TOTALS</b>		<b>94</b>

Table B Summary of Collective Doses for All Locations

Location	Estimated Number of Individuals Exposed	Dose Range (mSv)	Collective Dose (Person-Sv)	Dose Range (rem)	Collective Dose (Person-rem)
IRCC Clinic	6	1.1 - 8.6	0.027 <sup>a</sup>	0.1 - 0.86	2.66 <sup>a</sup>
IRCC-Other <sup>b</sup>	17	0.08 - 13.9	0.009 - 0.026	0.01 - 1.4	0.94 - 2.6
Ambulance	2	4.8 - 25.7	0.018 - 0.034	0.5 - 2.6	1.8 - 3.4
SHM-Staff	21	3.6 - 223	1.1 - 1.7	0.4 - 22.3	110 - 166
SHM-Visitors	7	21.9 - 166	0.21 - 0.46	2.2 - 16.6	21 - 46
SHM-Residents	22	11.2 - 205	0.35 - 0.73	0.2 - 20.5	35 - 73
BFI-Carnegie	19	0.004- 90	0.08 - 0.22	0.0004 - 9.0	8.3 - 22
<b>TOTALS</b>	<b>94</b>		<b>1.8 - 3.2</b>		<b>180 - 316</b>

<sup>a</sup> Established from film badge results

<sup>b</sup> IRCC Nonoccupational workers and individuals from the adjacent physician's office

## THE TEAM MEMBERS

Members of the NRC Incident Investigation Team for the loss of an iridium-192 source and therapy misadministration incident at Oncology Services Corporation's, Indiana Regional Cancer Center, on November 16, 1992, are as follows:

Dr. Carl J. Paperiello, Team Leader  
Dr. Mohamed M. Shanbaky, Assistant Team Leader  
Cynthia G. Jones  
Ronald L. Lloyd  
Alan L. Madison  
Penny A. Nessen  
Thomas W. Rich  
M. Marcia Karabelnikoff, Onsite Administrative Coordinator  
Cherie Siegel, Headquarters Administrative Coordinator  
June L. Garland, Secretary

Technical Editor: Juanita F. Beeson  
Visual Information Specialists: Lionel J. Watkins  
John Orban

## ACKNOWLEDGEMENTS

The team wishes to acknowledge the technical assistance provided by the following:

Daniel Flynn, M.D., Massachusetts General Hospital, Boston, Massachusetts,  
Medical Consultant

Robert J. Gastorf, University of Texas, MD Anderson Cancer Center, Contractor

Dr. Lee T. Ostrom, Idaho National Engineering Laboratory/EG&G Idaho, Contractor

George Simion, Idaho National Engineering Laboratory/EG&G Idaho, Contractor

Radiation Emergency Assistance Center/Training Site, Oak Ridge, Tennessee,  
Contractors

Southwest Research Institute, San Antonio, Texas, Contractors



## ABBREVIATIONS

ADO	adjacent doctor's office
AP	anterior-posterior
BFI	Browning-Ferris Industries
CAL	confirmatory action letter
CDRH	Center for Devices and Radiological Health, FDA
CFR	Code of Federal Regulations
CNA	certified nurse assistant
CTPS	Computerized Treatment Planning System
FDA	Food and Drug Administration, U.S.
GAO	Government Accounting Office, U.S.
GMP	Good Manufacturing Practices
GPCC	Greater Pittsburgh Cancer Center
GPN	graduate practical nurse
HDR	high dose rate
IIT	incident investigation team
IP	inspection procedure
IRCC	Indiana Regional Cancer Center
LED	light-emitting diode
LPN	licensed practical nurse
LS	lumbar-sacral
MC	manual chapter
NMSS	Nuclear Materials Safety and Safeguards (Office of)
NRC	Nuclear Regulatory Commission, U.S.
ORISE	Oak Ridge Institute for Sciences and Education
OSC	Oncology Services Corporation
QA	quality assurance
QC	quality control
QM	quality management

REAC/TS	Radiation Emergency Assistance Center/Training Site
RN	registered nurse
RSO	radiation safety officer
RTT	registered therapy technician
RTR	registered technologist radiographer
SHM	Scenery Hill Manor
S/N	serial number

## 1 INTRODUCTION

On November 16, 1992, an 82-year-old female cancer patient was undergoing radiation therapy at the Indiana Regional Cancer Center (IRCC) in Indiana, Pennsylvania (Figure 1), one of several operated by Oncology Services Corporation (OSC), an NRC licensee. The radiation therapy was to be administered by a high dose rate (HDR) afterloader with five connecting catheters. For that day's treatment, a dose of 6 Gy (600 rad) was to be administered through five catheters implanted as a single-plane perineal (rectal) implant encompassing the tumor. After a trial run through the five catheters with a dummy source, the iridium-192 source was placed in four catheters without difficulty. After several unsuccessful attempts to insert the source into the fifth catheter, the physician directed termination of the treatment. An area radiation monitor in the treatment room was observed in an alarm condition--flashing red light--at some point during the unsuccessful attempts to insert the source in the fifth catheter. Although three technologists and the physician were aware of the alarm, no one conducted a survey with the available portable survey meter to detect whether radioactivity was present. Believing that the area radiation monitor was malfunctioning, they reset the area radiation monitor and returned the patient to a local nursing home without performing any radiological surveys. The IRCC staff was unaware that the iridium-192 source had remained in the patient.

On December 1, 1992, the IRCC Medical Physicist notified NRC Region I that a  $1.37 \text{ E}+11$  Bq (3.7-Ci) iridium-192 sealed source was missing from the licensee's HDR afterloader. The Medical Physicist believed that a radioactive source that was discovered by Browning-Ferris Industries (BFI) at their nonradioactive medical waste incinerator facility in Warren, Ohio, and later returned to another BFI facility in Carnegie, Pennsylvania (BFI-Carnegie), could be the same source that was missing from the HDR afterloader at IRCC. Later on December 1, 1992, the IRCC retrieved the source from BFI-Carnegie and placed it in a shielded container at their cancer center. NRC Region I inspectors went to the IRCC to ascertain the facts surrounding the loss of the iridium-192 source.

Region I inspectors determined that BFI had collected the source in the medical waste from the local nursing home where the patient had resided and later died on November 21, 1992. The location of the source between the patient's treatment and death and its subsequent transportation exposed a number of individuals to radiation. In addition to the patient, those exposed were certain members of the licensee's staff, the ambulance staff, the nursing home staff and residents, BFI personnel, and other members of the general public. Consequently, the NRC chartered an Incident Investigation Team (the team) to comprehensively review this incident.

On December 7, 1992, a similar source-wire break on an Omnitron 2000 afterloader occurred at the Greater Pittsburgh Cancer Center (GPCC). The team also examined the events associated with this second incident.

The team's report of these two incidents is organized into the following sections and appendices:

Section 2 presents a chronology of events for the two source-wire-break incidents involving an HDR afterloader.

Section 3 describes Omnitron International, Inc.'s, 2000 HDR Afterloader System, which was used to treat patients in both incidents.

Section 4 discusses the performance of equipment involved in the IRCC incident, including the HDR afterloader system and a fixed radiation monitor, PrimAlert-10.

Section 5 analyzes the human factors that could have contributed to these incidents, including the organization and performance of the licensee.

Section 6 presents the team's methodology for calculating estimated and actual doses of radiation exposures to the staffs of the cancer centers, the nursing home, visitors to any of these organizations, BFI, and the public. It also presents the assessment of Patient A's dose as determined by NRC's Medical Consultant. In addition, cytogenetic results for those believed to have had the greatest exposure to the iridium-192 source are presented.

Section 7 presents the team's findings about each involved organization's response to the incident.

Section 8 discusses which Federal or State regulatory agencies are responsible for the materials, devices, or procedures involved in these two incidents and evaluates NRC regulations and guidance.

Section 9 briefly describes any precursors to these incidents.

Finally, Section 10 presents the team's findings and conclusions for these two incidents.

Appendix A is a copy of the team's Charter for investigating these incidents; Appendix B presents the properties of the iridium-192 source; Appendix C describes both conventional and HDR brachytherapy; Appendix D is a copy of the licensee's, OSC's, NRC license; and Appendix E lists the interviews and meetings the team conducted.

The facts and data in this report are current as of January 27, 1993.



Figure 1.1 Indiana Regional Cancer Center, Indiana, Pennsylvania



## 2 SEQUENCE OF EVENTS

This section describes the patient treatment plan, the sequence of events associated with the brachytherapy misadministration that occurred at the Indiana Regional Cancer Center (IRCC) on November 16, 1992, the transportation of the patient from IRCC to Scenery Hill Manor (SHM) nursing home, and the subsequent chronology of events at the SHM nursing home. It also describes the sequence of events involving the loss of the iridium-192 source from IRCC and events associated with the transportation, discovery, and retrieval of the source from the Browning-Ferris Industries (BFI) facility in Carnegie, Pennsylvania (BFI-Carnegie). This section also describes events associated with the second Omnitron International, Inc., (Omnitron) 2000 high dose rate (HDR) afterloader source-wire break at another Oncology Services Corporation (OSC) cancer center in Pittsburgh, Pennsylvania.

### 2.1 Patient Treatment Plan

On November 16, 1992, an 82-year-old female patient was treated for anal carcinoma at the IRCC in Indiana, Pennsylvania, using HDR brachytherapy. The total dose was to be administered in three fractions of 6 Gy (600 rad) each. The HDR treatment plan included the interstitial insertion of the HDR iridium-192 source into five catheters that were strategically implanted in the treatment site. The catheters were implanted on November 13, 1992, and a localization study (simulation) was performed to ascertain the location of the five catheters within the patient. Catheter placement is further discussed in Sections 6.2 and 7.2.

On November 16, 1992, before the patient was treated, Medical Physicist A generated an Omnitron HDR dosimetry drawing with 40 dosimetric points (Figure 2.1). The calculated source strength upon initiating the treatment was  $1.56 \text{ E}+11 \text{ Bq}$  (4.219 Ci). The dwell time calculations for the five implanted catheters were generated by computer (Figure 2.2). On November 16, 1992, at 9:35 a.m., the implanted catheters were connected to the HDR afterloader connecting catheters\* and patient treatment was initiated. Difficulties were encountered during the source wire insertion into implanted Catheter 5, and Physician A directed termination of treatment without treating the patient through implanted Catheter 5. The patient was disconnected from the HDR afterloader (Figures 2.3 and 2.4). After the patient was removed from the treatment room, one loose catheter was removed, and the other four catheters were left in the patient for subsequent treatments.

On the basis of the licensee's assumption that the fifth catheter was not treated, Medical Physicist A generated, on November 17, 1992, a second Omnitron dosimetry plan, including different dosimetric drawings and dwell time for each location within each catheter. The licensee's dosimetric calculation, considering that no dose had been administered through the

---

\* The connecting catheters are flexible tubes each with two connectors, one at each end. One end is connected to the HDR afterloader and the other end is connected to the implanted catheter (see Section 3.1.5 for further details).

fifth catheter, was 4.8 Gy (480 rad). The subsequent two fractions were adjusted to 6.6 Gy (660 rad) each to result in a total administered dose of 18 Gy (1800 rad).

## **2.2 Indiana Regional Cancer Center Incident**

This section describes the sequence of events that pertain to the brachytherapy misadministration and accidental loss and transport of an approximate  $1.56 \text{ E}+11 \text{ Bq}$  (4.2- Ci) HDR iridium-192 source from the IRCC to BFI, in Warren, Ohio, (BFI-Warren) between November 16 to December 1, 1992. Events preceding the actual loss of the source are also described to more fully explain the incident. Times are approximated.

### **Friday, November 13, 1992**

At a local hospital, five catheters were surgically inserted adjacent to the patient's rectum to prepare for an HDR treatment. The patient was taken to the IRCC where a simulation study was performed to ascertain the location of the catheters. The patient was subsequently returned to the SHM nursing home. Catheter numbers in this chronology are those taken from the HDR afterloader error log given to NRC by Omnitron.

### **Monday, November 16, 1992**

- 7:12 a.m.            The patient departed the nursing home in a local Citizens Ambulance Service ambulance to be transported to the IRCC.
- 7:30 a.m.            The patient arrived at the IRCC (Figure 2.5).
- 9:15 a.m.            Medical Physicist A completed the patient treatment plan.
- 9:20 a.m.            Physician A signed a printout of the patient treatment plan, indicating his approval of the plan.
- 9:30 a.m.            The patient was moved to the treatment room.
- 9:35 a.m.            Registered Therapy Technician A (RTT-A), in the presence of Medical Physicist A, connected the patient's five implanted catheters to the HDR afterloader connecting catheters.
- 9:40 a.m.            RTT-A successfully completed the insertion of the HDR dummy wire into the patient's five implanted catheters.
- 9:40 a.m.            Medical Physicist A left the IRCC for the day.
- 9:43 a.m.            RTT-A was present at the HDR afterloader computer console. Registered Technologist Radiographer (RTR) was observing the conduct



of patient treatment at the HDR computer console. The insertion of the HDR source wire into the patient's catheters was initiated by RTT-A. The computer log indicated the active source wire was successfully inserted into and retracted from the patient's implanted Catheters 1 through 4.

The following error messages were received on the HDR computer monitor for Channel 5:

- 9:59 a.m.
- Treatment halted due to Error Class 2: Error can be reset by console operator;
  - Error Code 1A: Active wire path constriction detected at 82.4 cm;
  - Treatment halted due to Error Class 2: Error can be reset by console operator;
  - Error Code 55: Console STOP pressed

RTT-A reset HDR computer error message. The following two messages were displayed on the HDR computer monitor:

- Treatment halted due to Error Class 2: Error can be reset by console operator;
- Error Code 6F: Attempt to treat with door open.

RTT-A entered the HDR treatment room and checked the implanted and connecting catheters. RTR entered the HDR treatment room to see to patient's needs. RTT-A and RTR then left the HDR treatment room. RTT-A reset HDR computer error message.

10:01 a.m. RTT-A attempted to insert the dummy wire into Catheter 5. The following two messages were displayed on the computer monitor:

- Treatment halted due to Error Class 2: Error can be reset by console operator;
- Error Code 2A: Dummy wire path constriction detected at 90.1 cm; Dummy wire check on Channel 5 failed.

RTT-A reset HDR computer error message.

10:02 a.m. RTT-A attempted to insert the dummy wire into Catheter 5. RTR was observing the conduct of patient treatment at the HDR computer console. The following messages were displayed on the HDR computer monitor:

- Treatment halted due to Error Class 2: Error can be reset by console operator;
- Error Code 2A: Dummy wire path constriction detected at 90.0 cm; Dummy wire check on Channel 5 failed.

RTT-A reset HDR computer error message. RTT-A entered the HDR treatment room, disconnected and reconnected Catheter 5 in an attempt to remove constriction. RTR and RTT-B entered the HDR treatment room to assist RTT-A. The three individuals then left the HDR treatment room.

10:07 a.m.

RTT-A attempted to insert the dummy wire into Catheter 5. RTR was observing the conduct of patient treatment at the HDR computer console. The HDR computer monitor indicated the following:

- Treatment halted due to Error Class 2: Error can be reset by console operator;
- Error Code 2A: Dummy path constriction detected at 90.0 cm; Dummy wire check on Channel 5 failed.

RTT-A reset HDR Computer error message.

10:08 a.m.

RTT-A attempted to insert the dummy wire into Catheter 5. RTR was observing the conduct of patient treatment at HDR computer console. The HDR computer monitor indicated the following:

- Treatment halted due to Error Class 2: Error can be reset by console operator;
- Error Code 2A: Dummy wire path constriction detected at 90.1 cm; Dummy wire check on Channel 5 failed.

RTR noticed the PrimAlert-10 red light alarm flashing, and RTR informed RTT-A and RTT-B. RTT-A was concerned that the wire was still out of the HDR. RTR was instructed to inform Physician A. RTR informed Physician A, who was in his office in the IRCC, of a problem with inserting the source in Catheter 5. RTT-A observed that the indicator light on the HDR computer monitor was green, indicating that the source was "safe" (see Section 3). RTR returned to the HDR treatment room—the door to the room was open—and entered the room but did not walk all the way to the patient. RTR also informed Physician A that the PrimAlert-10 red light alarm was flashing. Physician A, RTT-A, and RTT-B entered the room while the PrimAlert-10 was flashing. Physician A and RTT-A examined the Catheter 5 connection at the HDR afterloader but observed no source

wire. RTT-A disconnected the implanted catheter that he believed to be implanted Catheter 5 from the HDR afterloader connecting Catheter 5, and both Physician A and RTT-A examined the catheter connection at the patient and observed no wire. RTT-B left the HDR treatment room. RTT-A reconnected Catheter 5 to the patient and to the HDR afterloader. Physician A and RTT-A left the HDR treatment room. Physician A directed RTT-A to again try treating through Catheter 5. RTT-A reset the HDR computer error message. Physician A returned to his office.

10:10 a.m. RTT-A attempted to insert the dummy wire into Catheter 5. The following messages appeared on the monitor:

- Treatment halted due to Error Class 2: Error can be reset by console operator;
- Error Code 2A: Dummy wire path constriction detected at 90.1 cm; Dummy wire check on Channel 5 failed.

10:13 a.m. RTT-A attempted to insert dummy wire into Catheter 5. RTR was observing the conduct of patient treatment at the HDR computer console. The HDR computer monitor indicated the following:

- Treatment halted due to Error Class 2: Error can be reset by console operator;
- Error Code 2A: Dummy wire path constriction detected at 90.0 cm; Dummy wire check on Channel 5 failed.

RTT-A reset the computer error message.

10:14 a.m. RTT-A again attempted to insert the dummy wire into Catheter 5 but received the same computer error message previously received on the monitor.

10:16 a.m. RTT-B informed Physician A of the failure to insert the dummy wire into Catheter 5, and Physician A directed RTT-A to discontinue the treatment.

10:20 a.m. RTT-A disconnected the patient's implanted catheters from the HDR afterloader. RTT-A removed the patient from the HDR treatment room, and the patient was taken to the stretcher room (see Figure 2.5).

RTT-A unplugged and replugged the PrimAlert-10 power supply to reset the alarm sometime during the preceding events.

- 10:27 a.m. RTT-A informed Nurse A and Physician A that the stitches were loose on one of the patient's catheters, after which they went to the stretcher room to examine the patient.
- 10:28 a.m. The local ambulance was called to transport the patient from the clinic to the nursing home.
- 10:29 a.m. Physician A, assisted by Nurse A, removed the loose implanted catheter, which they assumed at that time to be Catheter 5. The local ambulance arrived at the clinic.
- 10:35 a.m. Patient A was transferred from the IRCC by ambulance to the SHM Nursing Home (Figure 2.6). IRCC Nurse A helped two ambulance assistants with placing the patient into the ambulance.
- 10:48 a.m. The ambulance arrived at the nursing home and Patient A was transferred to Room 4B.
- 10:56 a.m. The ambulance drivers left the nursing home.

**Tuesday, November 17, 1992**

- 3:00 p.m. Patient A requested that the second radiation therapy treatment scheduled for November 18 be canceled, owing to her inability to "tolerate the radiation therapy again." Staff at the SHM nursing home contacted the IRCC and rescheduled the treatment for Monday, November 23, 1992.

**Thursday, November 19, 1992**

- 7:00 p.m. Certified Nurse Assistant E (CNA-E) was performing perineum care and "removed a piece of gray-black tissue about 1-inch long that was stuck to one of the implants."

**Friday, November 20, 1992**

- 4:30 a.m. CNA-C noticed that one of the four remaining catheters (later determined to be the one containing the radioactive source) had become dislodged from the patient and protruded approximately 2.54 cm (1 inch) from the body.
- 6:15 a.m. During regular patient rounds, Licensed Practical Nurse B (LPN-B) and CNA-C discovered that the catheter that had been protruding earlier on the shift had fallen out of the patient onto the bedding.

LPN-B picked up the catheter containing the source, placed it in a red bag, which the nursing home uses for medical and biohazardous waste (typically referred to as "red-bag" waste), and transferred this small, red bag to a larger container for medical waste in the soiled utility room where red-bag waste is stored daily (Figure 2.7). LPN-B was unaware the catheter contained the iridium-192 source.

8:10 a.m. Registered Nurse-D (RN-D) called the IRCC to determine what method of disposal was needed for the catheter that had fallen out of the patient during the earlier shift. IRCC informed RN-D that what they had done was appropriate and that the catheter could be disposed of in the red-bag waste.

After discussing the situation with the IRCC, RN-D instructed Maintenance Man A to remove the large red bag of waste from the soiled utility room, which he normally does at 7:30 a.m., and transfer it to the outside waste storage room (see Figure 2.8).

8:30 a.m. Maintenance Man A took the large red bag of medical waste from inside the soiled utility room to the outside waste storage room, placed it inside a BFI cardboard box and locked the room.

The waste remained in this location for an additional 5 days, awaiting pickup by BFI from BFI-Carnegie, which usually occurs the last Wednesday of each month.

#### **Saturday, November 21, 1992**

11:10 p.m. Patient A dies. The remaining three catheters were subsequently removed and disposed of in red-bag waste.

#### **Wednesday, November 25, 1992**

4:30 a.m. BFI Driver A began picking up medical waste from the first of 22 stops for that day.

9:25 a.m. BFI Driver A arrived at his 12th stop, SHM Nursing home; picked up three boxes of red-bag waste from this facility; and placed it in a straight truck (Figure 2.9). Although BFI Driver A had a portable survey meter in the truck, he stated that he did not use it at the SHM nursing home. He continued with his regularly scheduled stops throughout the day, stopping at an additional 10 facilities before returning to BFI-Carnegie (Figure 2.10).

- 2:30 p.m. BFI Driver A arrived at BFI-Carnegie.
- 3:30 p.m. BFI Driver A unloaded all the boxes by himself from the straight truck onto BFI Trailer 808, which is a 14.6-meter (48-foot) trailer and left for the day. The box containing the source was one of the last ones to be loaded. The box was positioned in the rear left-hand corner of the trailer, approximately 1.8 meters (6 feet) off the floor (Figure 2.11).

#### **Thursday, November 26, 1992**

Because Thursday, November 26, 1992, was Thanksgiving Day, BFI scheduled no transfers to the BFI-Warren Medical Waste Incinerator, and the trailer remained on the site until November 27, 1992.

#### **Friday, November 27, 1992**

- 12:00 midnight BFI semitruck Driver B began his routes for the day.
- 6:15 a.m. BFI Driver B began a review of paperwork for his second tractor-trailer shipment (808) that day to BFI-Warren. As is customary, Driver B signed and dated all shipping manifests and checked the bottom and top latches at the back of the trailer before placing a padlock on the trailer.
- 6:30 a.m. BFI Driver B left BFI Carnegie via I-79, to I-680N, to I-80W to Hwy-46N, and on to Hwy-169N (Figure 2.12). He made no stops between Carnegie and Warren.
- 8:30 a.m. Driver B arrived at BFI-Warren, drove over to the unloading area (see Position A, Figure 2.13), disconnected Trailer 808, hooked up his cab to an empty trailer, drove to the front office, completed the paperwork for this shipment, and left BFI-Warren. Two fixed radiation monitors inside the facility alarmed, reading above their normal limits of 0.2  $\mu\text{Sv}$  (20  $\mu\text{rem}$ ) per hour. Employees working that shift began trying to locate the cause of the radiation alarms.
- 8:50 a.m. These employees notified both the Plant Manager and the Supervisor on the day shift who also began to attempt to find the source. They surveyed all packages on the conveyor belt (Figures 2.14 and 2.15) and those near the loading dock.

Because they could not determine the source of the radiation, they began reviewing their shipping records to determine what shipments they had received that morning. They identified two tractor-trailer

shipments, 806 and 808, that had arrived that morning at 4 a.m. and 8:30 a.m., respectively, from BFI-Carnegie.

After identifying the possible cause of the radiation alarms, both the Plant Manager and the Supervisor began to look for the source with their portable survey meters (Figure 2.16) outside of the parked trailers (Figure 2.17). When they came within approximately 121.9 meters (400 feet) of the trailer, both portable survey meters immediately alarmed and registered at their highest levels over 5  $\mu\text{Sv}$  (500  $\mu\text{rem}$ ) per hour.

9:45 a.m. Because the Plant Manager and the Supervisor could not determine which trailer had the radioactive material in it, they decided to drive one trailer at a time behind the main building, (see Figure 2.13), using it as a large concrete shield, to see if any of the portable survey meters alarmed as a trailer approached Position B in Figure 2.13.

Before the tractor-trailer drove behind the main building, the Plant Manager stood at Position C in Figure 2.13 of the facility with his portable survey meter turned on. At this location, there was no indication of radioactivity. As the tractor-trailer came from behind the building, however, the portable survey meter registered its highest level.

10:00 a.m. As soon as BFI-Warren identified the trailer containing the radioactive material, they parked it as far away on their property as they could from the main building and immediately called BFI-Carnegie to come pick up the trailer as soon as possible. The facility was fenced and secured.

2:30 p.m. BFI Driver C arrived at BFI-Warren to pick up the tractor-trailer from the Ohio facility, which was then driven to BFI-Carnegie. No radioactive material placards were placed on the tractor-trailer.

4:45 p.m. BFI Driver C arrived at BFI-Carnegie. Because it was growing late, the driver unhooked and parked the trailer in a back lot where it remained for the rest of the weekend in a fenced, secured area (Figure 2.18).

#### **Monday, November 30, 1992**

1:00 p.m. BFI-Carnegie Supervisor A and two safety assistants (Safety Technicians A and B) put gloves on and began to survey boxes from the trailer for radioactivity. When approaching the trailer, each safety

technician noticed that the portable survey meter registered its highest level [ $5 \mu\text{Sv}$  ( $500 \mu\text{rem}$ ) per hr].

- 2:30 p.m. After surveying approximately 40 boxes, they identified the box containing the radioactive material (Figure 2.19). Because the box containing the source had no generator identification labels on the outside, Safety Technicians A and B opened the box and began to go through individual medical red bags looking for information to enable them to identify the originator of the waste. Supervisor A left for an appointment offsite but requested that the safety technicians continue to search for the originator's identification.
- 3:00 p.m. One of the two safety technicians found a portion of a prescription in the waste that had an individual's name on it. With this information, they sealed up the box, placed it in a green recycle container (Figures 2.20 and 2.21), and locked it. They returned to their office with this information and began calling the list of facilities from which waste was picked up on November 25, 1992.
- 4:00 p.m. Safety Technician B began calling hospitals and nursing homes to see if any of these facilities could recognize the name they found.
- 5:00 p.m. After contacting approximately 15 facilities to identify the location of the individual on the prescription without success, they stopped for the day and went home.

#### **Tuesday, December 1, 1992**

- 8:30 a.m. Supervisor A reopened the trailer containing the other medical waste boxes and began to look for the other two containers that had arrived with the box containing the radioactive material.
- 9:30 a.m. Supervisor A and Safety Technicians A and B again went through the red bags in these two containers trying to find identifying information. This time, they were successful and found an individual's name associated with the SHM nursing home.
- 9:45 a.m. Immediately, Supervisor A called the SHM nursing home to inform them that radioactive material had been discovered in the waste that they had picked up from the home on November 25, 1992. The SHM nursing home staff informed BFI-Carnegie that they did not have any radioactive material at their facility, but they did identify a resident (Patient A) that had recently undergone cancer treatment therapy at IRCC.



- 10:00 a.m. The staff at the SHM nursing home immediately called the IRCC and spoke with Nurse A, who contacted Physician A. Physician A suspected a possible source loss.
- 11:00 a.m. Nurse A called Medical Physicist A in Johnstown, Pennsylvania, to notify him of the source loss. During the telephone conversation, Medical Physicist A asked RTT-B to evacuate the treatment vault, use remote control to extend the iridium-192 source into a connecting catheter, and observe the PrimAlert-10 radiation monitor to verify the presence of a radiation reading. RTT-B informed Medical Physicist A that the PrimAlert-10 did not detect any radiation levels.
- 11:40 a.m. Medical Physicist A arrived at the IRCC and verified the absence of the iridium-192 source by performing an autoradiograph of the source wire, monitoring the PrimAlert-10, and by performing portable survey meter measurements.
- 11:44 a.m. Medical Physicist A called BFI-Carnegie to inform them that they would arrive shortly to retrieve the radioactive material.
- 11:45 a.m. Medical Physicist A notified OSC's Radiation Safety Officer (RSO) in Harrisburg, Pennsylvania.
- 11:50 a.m. Medical Physicist A notified NRC, Region I.
- 3:15 p.m. Medical Physicist A and Physician A, arriving in separate vehicles at BFI-Carnegie, were met by Safety Technician A, who had previously supervised and participated in the unloading, identification, and subsequent isolation of the BFI box containing the radioactive material.

Upon approaching the green recycle container (Figure 2.22), Safety Technician A unlocked it and stood approximately 2 meters (6.6 feet) away with a portable survey meter turned on. Medical Physicist A also had a portable survey meter and noted that the radiation reading at about 1.5 to 1.8 meters (5 to 6 feet) away from the container was above 7.8 mSv (780 mrem) per hour.

Medical Physicist A placed the lead container in which the iridium-192 source was originally shipped on the ground next to the green recycle container. Wearing surgical gloves, Medical Physicist A lifted the box containing the source out of the recycle container, and both Medical Physicist A and Physician A opened the box and began taking plastic bags out. These plastic red bags were removed one at a time, and carried toward Medical Physicist A's portable survey meter located

approximately 4.6 meters (15 feet) away. The first two bags contained no radioactive material. The third bag contained radioactive material. Using long-handled [about 30 cm (11.8 inches)] forceps, Medical Physicist A opened the red bag and saw several smaller red bags inside. One contained three catheters and one contained a single catheter. The bag with the single catheter was surveyed and indicated the presence of radioactivity. Medical Physicist A quickly walked to the lead container and placed the single catheter containing the source inside.

Medical Physicist A estimated that it had taken approximately 70 seconds from the time they located the red bag containing the source to the time it took to secure the source in its protective shield.

After securing the source, Medical Physicist A placed the container inside his truck and secured its movement by placing rubber-covered sandbags around it. Medical Physicist A surveyed the source container; it read 0.35 mSv (35 mrem) per hour. In addition, he surveyed the cab of his truck and obtained a reading of 6  $\mu$ Sv (0.6 mrem) per hour.

- 3:45 p.m. Once the source was secured in place, Medical Physicist A transported it back to the IRCC for storage. No radioactive material placards were placed on the vehicle.
- 5:10 p.m. Medical Physicist A arrived at the IRCC and placed the container with the iridium-192 source in the Treatment Room.
- 5:12 p.m. Medical Physicist A surveyed the source with his survey instrument and obtained a reading of 0.35 mSv (35 mrem) per hour.

### **2.3 Greater Pittsburgh Cancer Center Incident**

On Monday, December 7, 1992, Medical Physicist B, from the Greater Pittsburgh Cancer Center (GPCC), reported that a 1.28 E+11 Bq (3.45-Ci) iridium-192 sealed source apparently broke off from the end of the source wire while being removed from a patient following a completed endobronchial HDR treatment. The system being used was an Omnitron 2000 HDR afterloader identical to the afterloader involved in the IRCC incident. Further, GPCC was operated by OSC, the same licensee that operated the IRCC at which the November 16, 1992, incident occurred.

The following is a chronology of events at the GPCC. Times are approximated.

**Monday, December, 7, 1992**

- 11:30 a.m. Medical Physicist B acquired keys from a locked cabinet and performed daily operational and safety checks on the HDR afterloader. These checks included positional accuracy (via x-ray films); emergency stops; functionality of the treatment room door and door interlock; PrimAlert-10 operability; afterloader and console indicator lights; and a survey of the treatment room, using a portable survey meter.
- 12:00 noon Operational and safety checks were completed.
- 2:30 p.m. Patient B arrived at the GPCC.
- The GPCC staff made simulation films to determine the correct extent of the treatment volume. The catheter path was determined to be clear by inserting a measurement wire.
- 3:10 p.m. Physician E approved the treatment plan.
- Patient B was moved to the treatment room and connected to the HDR afterloader. To reduce exposure to the source, Physicist B reduced the travel distance outside of the patient to 93.3 cm (36.7 inches), and the connecting catheter was secured by taping it to a 15.2 cm by 15.2 cm by 7.6 cm (6 inch x 6 inch x 3 inch) foam rubber pad, which was then taped to the patient's left arm.
- 3:45 p.m. Treatment commenced. Dummy wire verified that the catheter was clear.
- 3:50 p.m. Medical Physicist B initiated the HDR treatment.
- Patient B stirred slightly, coughed several times, and moved left arm slightly to reach for a paper tissue.
- Medical Physicist B noted that the treatment was completed and that the source wire was retracting.
- 3:52 p.m. The staff heard an audible alarm at the HDR afterloader and its console. Also, a visual alarm indicated on the console: "Emergency Condition, Manual Retract, Check Source Status."
- Medical Physicist B entered the treatment room carrying a portable survey meter and noted that the PrimAlert-10 was alarming, which indicated that the source had not retracted into the HDR afterloader.

Medical Physicist B also noted that the portable survey meter was pegged high on the X1 scale, further indicating that the source had not fully retracted.

Medical Physicist B noted that Patient B had raised left arm, which produced an approximate 45-degree angle in the catheter at the quick disconnect nearest the HDR afterloader. Concentrating his attention on that quick disconnect, Medical Physicist B observed "a piece of wire" in the catheter.

Assuming that this was the source wire, Medical Physicist B exited the treatment room, acquired a pair of scissors, reentered the treatment room, and cut the catheter approximately 20 to 30 cm (7.9 inches to 11.8 inches) from the quick disconnect. Medical Physicist B then removed the patient from the treatment room, assisted by Physician E.

Medical Physicist B and Physician E surveyed Patient B, using the same portable survey meter to verify that the source had not remained with the patient.

4:00 p.m.

Having obtained 10-inch (25.4-cm) forceps, Medical Physicist B, accompanied by RTT-C with the portable survey meter, reentered the treatment room to secure the source.

Using the forceps to hold the source, Medical Physicist B disconnected the remaining portion catheter from the HDR afterloader and then placed the source and catheter into the lead container previously stationed next to the HDR afterloader. The PrimAlert-10 stopped flashing red, and RTT-C noted that the survey meter also responded by indicating a drop in the radiation level.

Medical Physicist B placed the lead container in a shipping container, and stored it in a small room behind the treatment room. Medical Physicist B then surveyed the treatment room to verify that no further radioactivity existed.

4:05 p.m.

Medical Physicist B and RTT-C exited the treatment room, and the physicist, assisted by Physician E, once again surveyed Patient B and the implanted catheter that the physician had removed. They found no radioactivity.

4:24 p.m.

Medical Physicist B called Omnitron to notify their Senior Vice President of the incident.

4:50 p.m. Medical Physicist B notified the OSC RSO.

5:30 p.m. Medical Physicist B notified the NRC.

Calc Date: 09:09:22 November 16, 1992

Depth of cut (cm): 0.7

Angles from AP Plane:

X: 42.3 Y: 24.6 Z: 41.6

Matrix size (CM): 18.9

Plot Scale: 1.00

Site: Rectal

Comment:

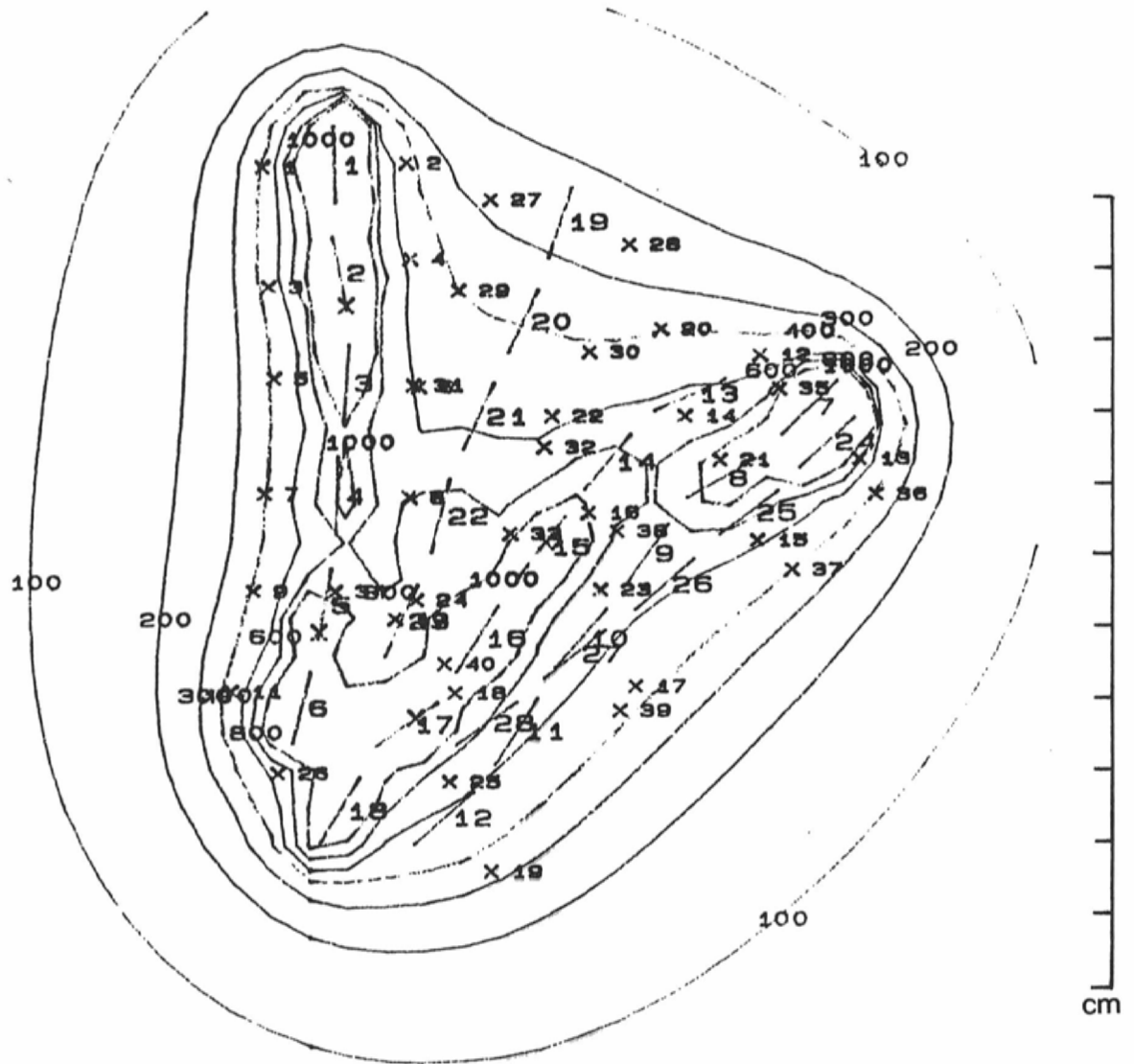

Figure 2.1 Isodose Graph for Initial High Dose Rate Patient Treatment Plan

Time of printout: 09:15:26 November 16, 1992  
 Time of plan: 09:09:22 November 16, 1992

Age: 82  
 Sex: F

The source 01-01-9282-001-082892-08942-08 was used in these calculations  
 The original calibration was: 8.942 Curies  
 The date of original calibration was: Friday August 28, 1992  
 The date used for these calculations was: Monday November 16, 1992  
 The half life used was: 73.83 days  
 The decay factor is: 0.4719  
 The present strength is: 4.219 Curies  
 The source description is: Omnitron  
 The sourcetype is: 1  
 Calculations are for a dose fraction 600.0 cGy

Total Doses to calculation points (cGy):

1	403.5	15	846.4	29	464.3
2	449.1	16	672.8	30	500.0
3	449.0	17	650.5	31	534.6
4	523.4	18	827.0	32	656.6
5	415.9	19	446.0	33	821.8
6	543.4	20	444.2	34	794.6
7	402.6	21	591.5	35	867.1
8	655.1	22	633.9	36	388.6
9	398.1	23	719.8	37	457.2
10	859.8	24	830.8	38	818.6
11	445.3	25	663.1	39	604.6
12	471.9	26	694.9	40	799.2
13	823.1	27	417.6		
14	610.8	28	415.2		

Mean dose: 600.0 cGy  
 Standard deviation: 162.6  
 per cent standard deviation: 27.1

I-rwell times:

Position	Cath#	Distance	seconds
1	1	90.0	49.2
2	1	88.4	42.9
3	1	86.8	26.8
4	1	85.2	26.8
5	1	83.6	16.5
6	1	82.0	45.9
7	2	90.0	24.7
8	2	88.4	25.4
9	2	86.8	16.3
10	2	85.2	26.8
11	2	83.6	29.0
12	2	82.0	45.7
13	3	90.0	28.3
14	3	88.4	26.8
15	3	86.8	22.6
16	3	85.2	26.8
17	3	83.6	26.8
18	3	82.0	29.0
19	4	90.0	45.9
20	4	88.4	26.8
21	4	86.8	27.6
22	4	85.2	22.6
23	4	83.6	8.5
24	5	90.0	29.1
25	5	88.4	28.3
26	5	86.8	26.8
27	5	85.2	29.2
28	5	83.6	15.5

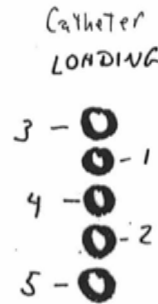

Physician approval signed Physics review initialed  
 The data presented by this plan must NOT be used clinically without approval of a qualified person

Figure 2.2 Summary of Initial High Dose rate Treatment Plan

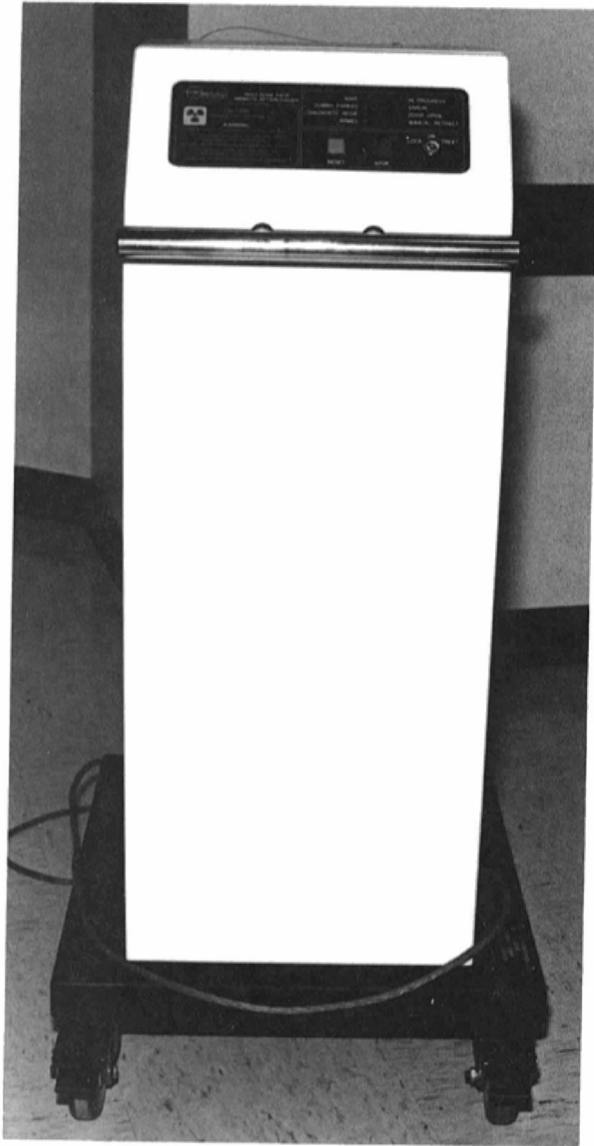

Figure 2.3 Back of High Dose Rate Afterloader

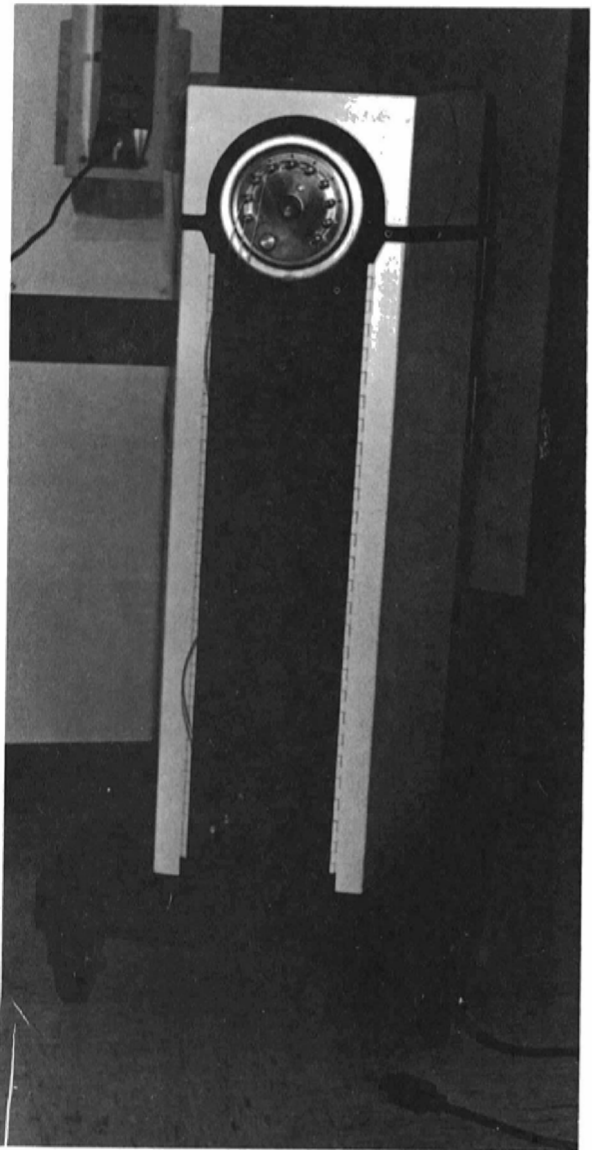

Figure 2.4 Front of High Dose Rate Afterloader



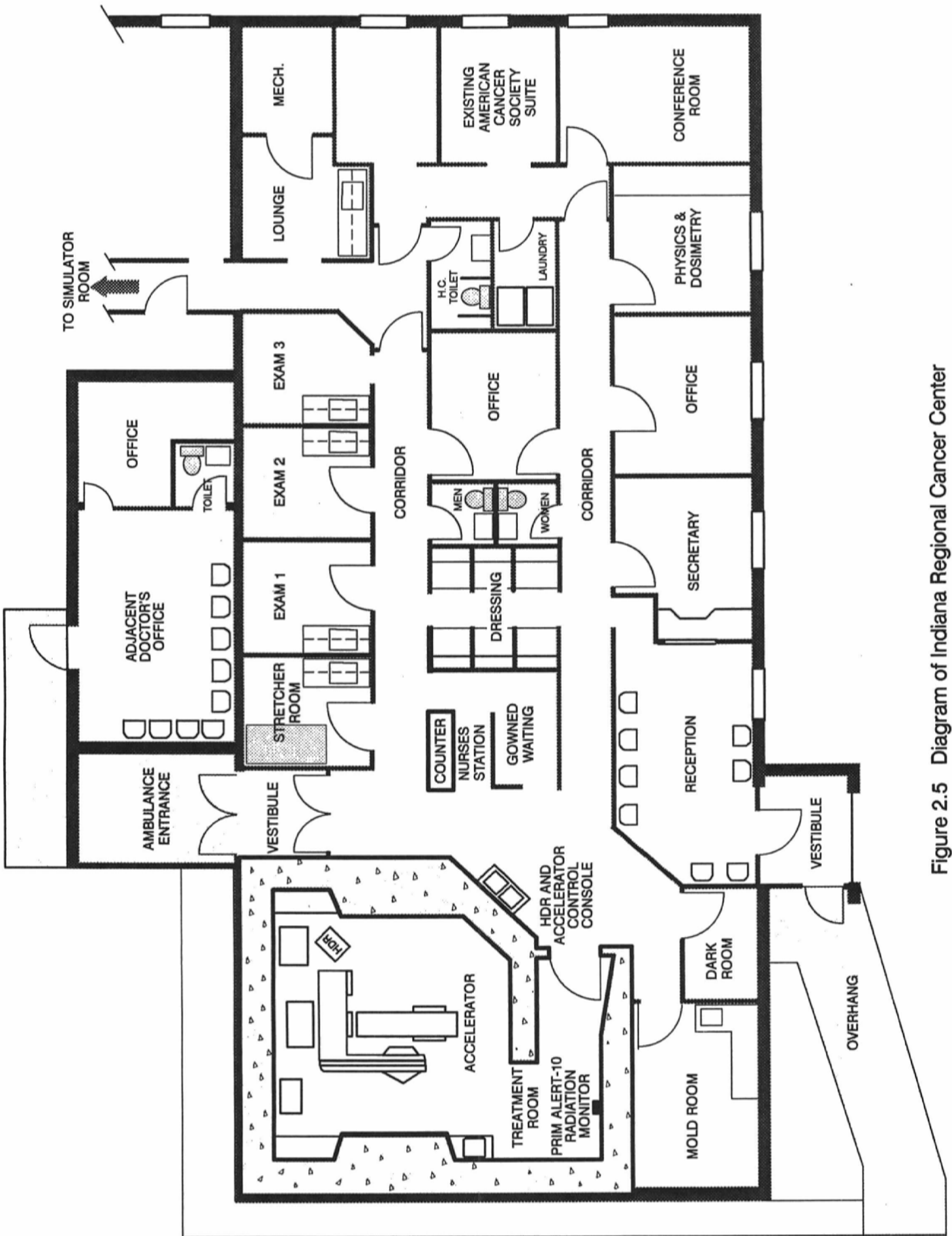

Figure 2.5 Diagram of Indiana Regional Cancer Center



Figure 2.6 Front of Scenery Hill Manor Nursing Home

Red-Bag Waste  
Containing Iridium-192  
Source on 11/20/92



Figure 2.7 Soiled Utility Room with Biohazard Waste Container

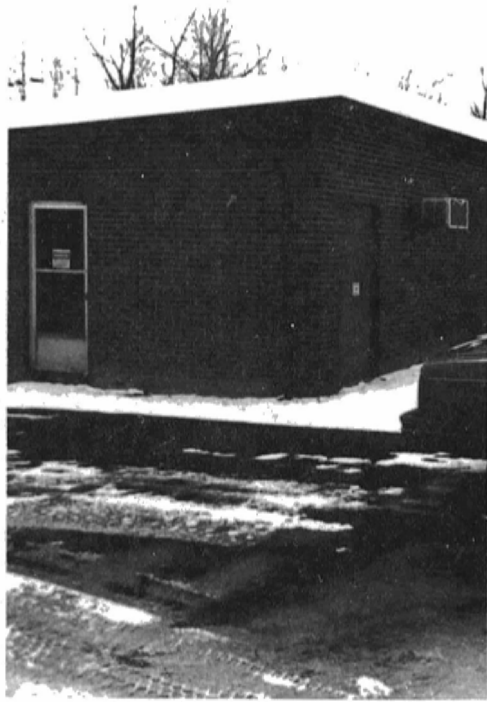

Figure 2.8 Waste Storage Room at Scenery Hill Manor Nursing Home



**Figure 2.9** Browning – Ferris Industries Straight Truck Used to Collect Waste from Scenery Hill Manor Nursing Home



Figure 2.10 Aerial Photograph of Browning - Ferris Industries Transfer Station in Carnegie, Pennsylvania

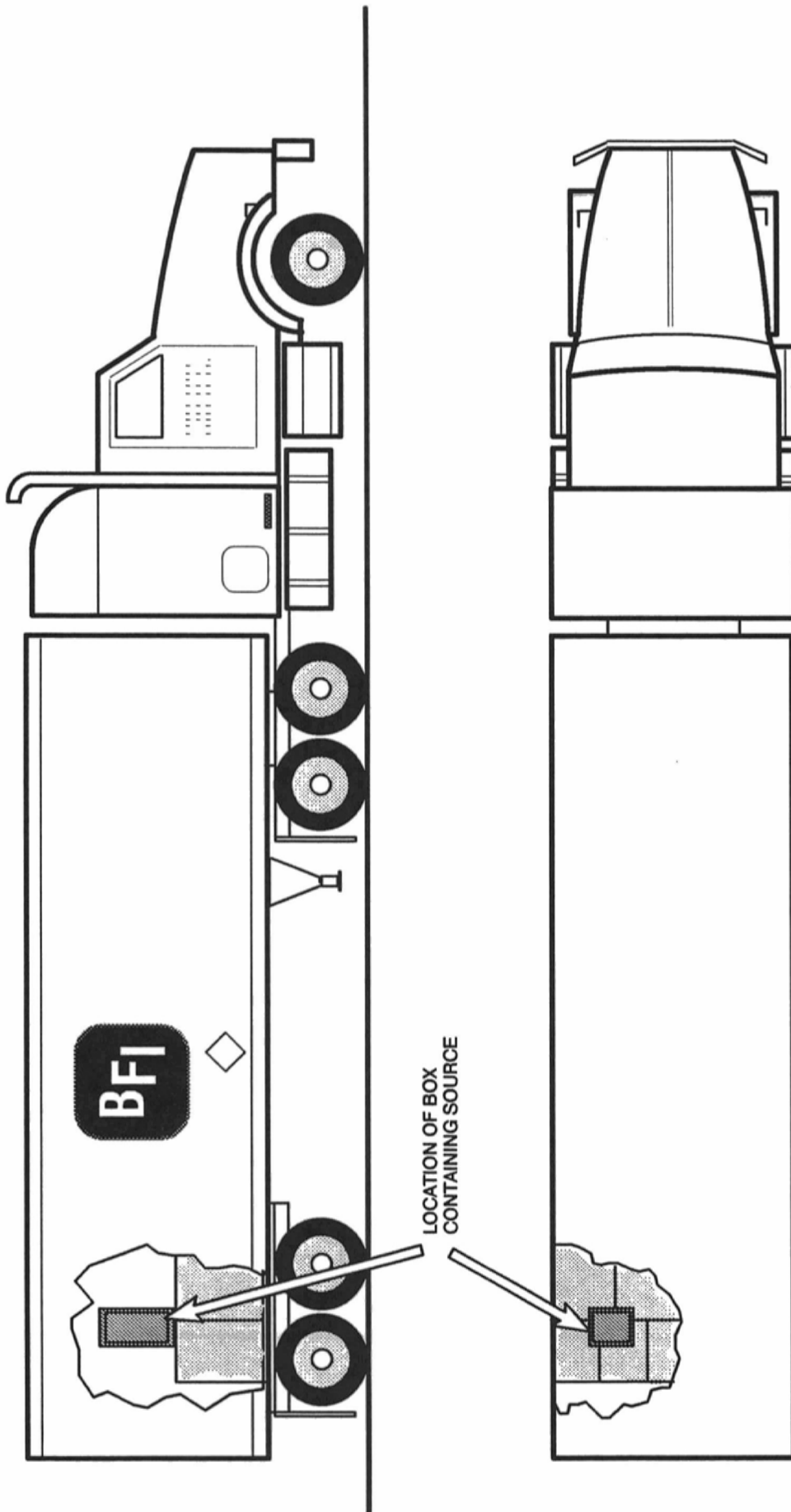

Fig. 2.11 BFI Tractor Trailer 14.63 m (48') Long Showing Location of Source Container in the Trailer.

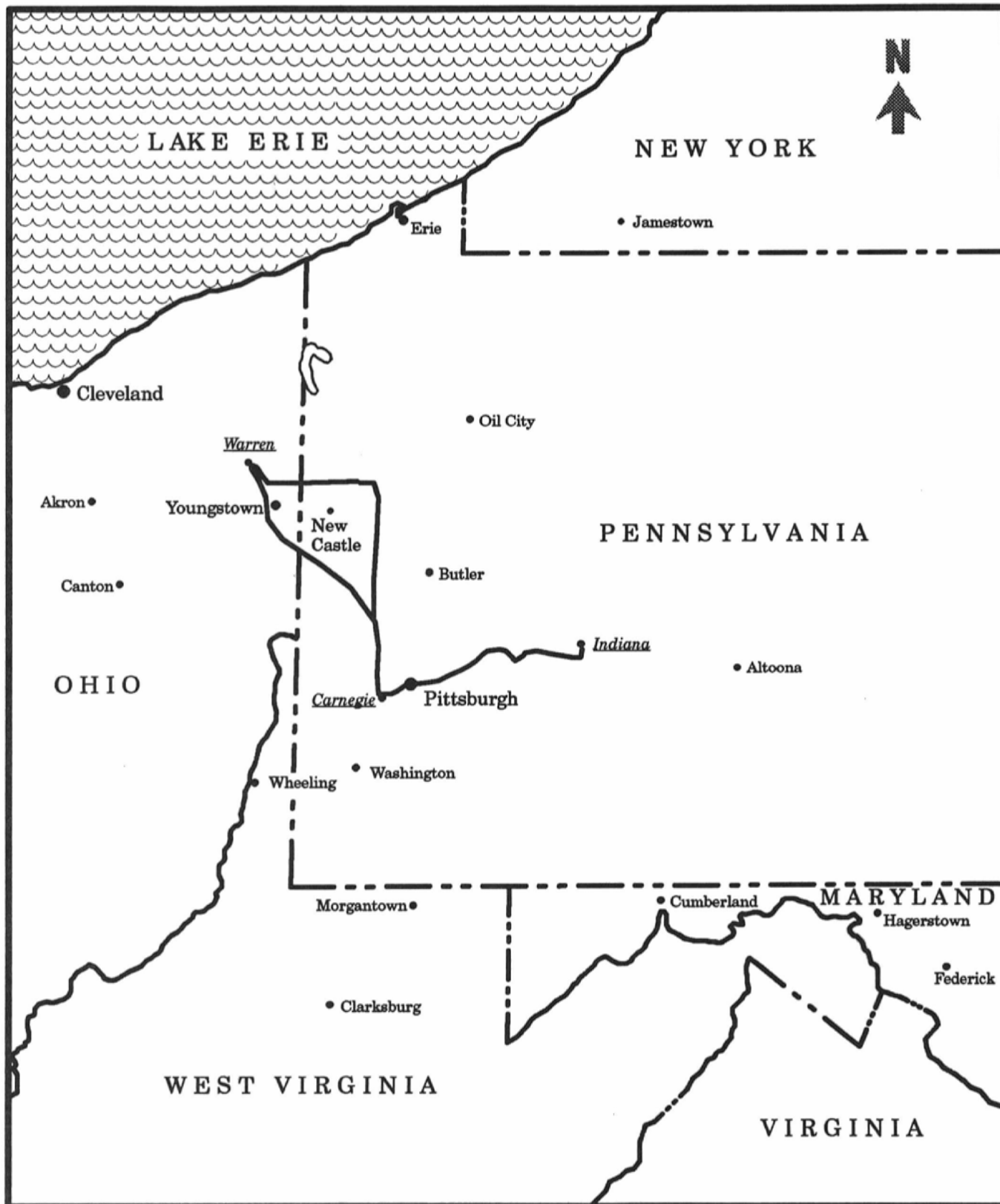

Figure 2.12 Route of Browning - Ferris Industries Semitruck 808 on November 25, 1992



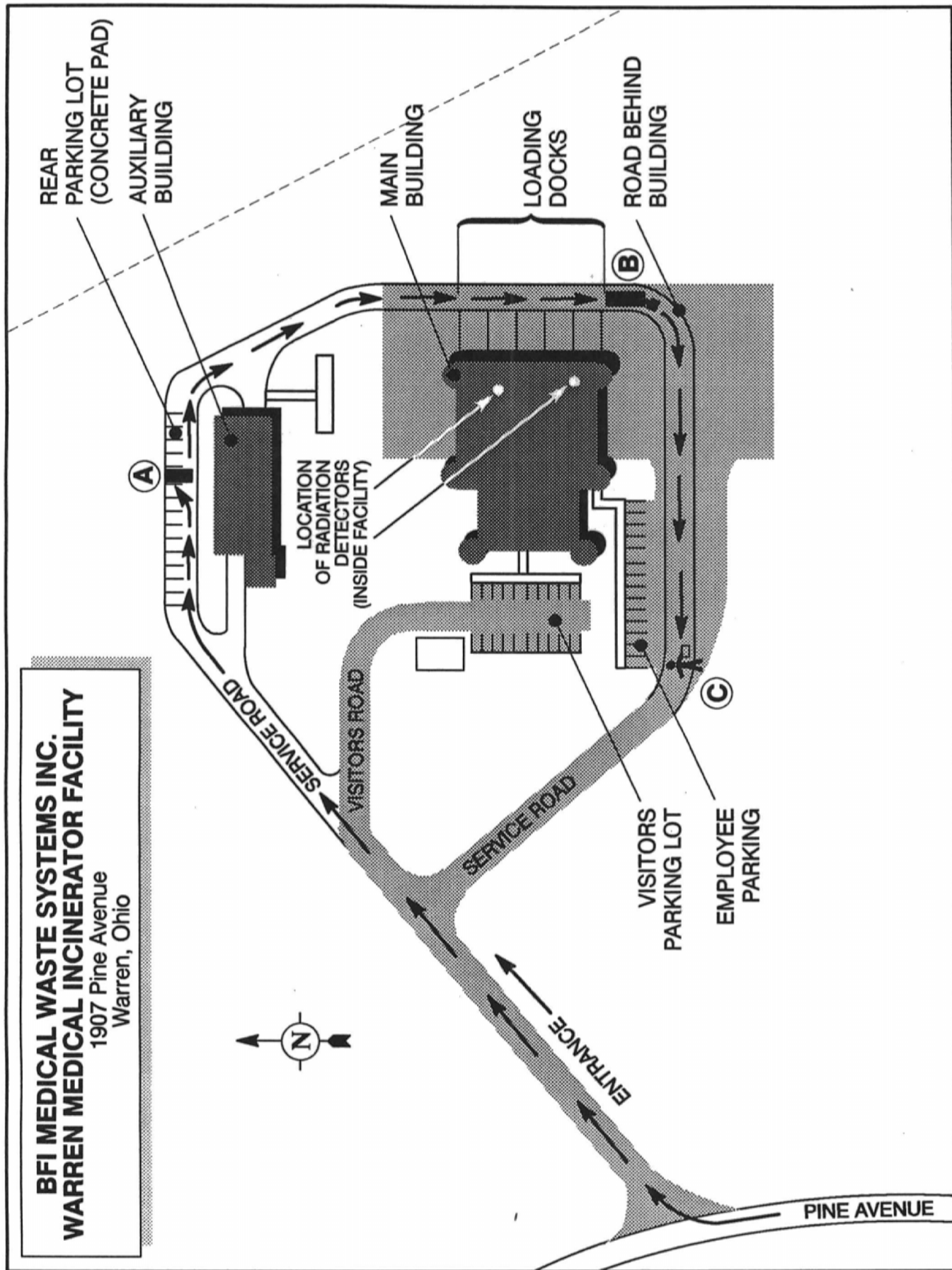

Figure 2.13 Diagram of Tractor-Trailer Route Carrying Iridium-192 Source at BFI-Warren on November 25, 1992

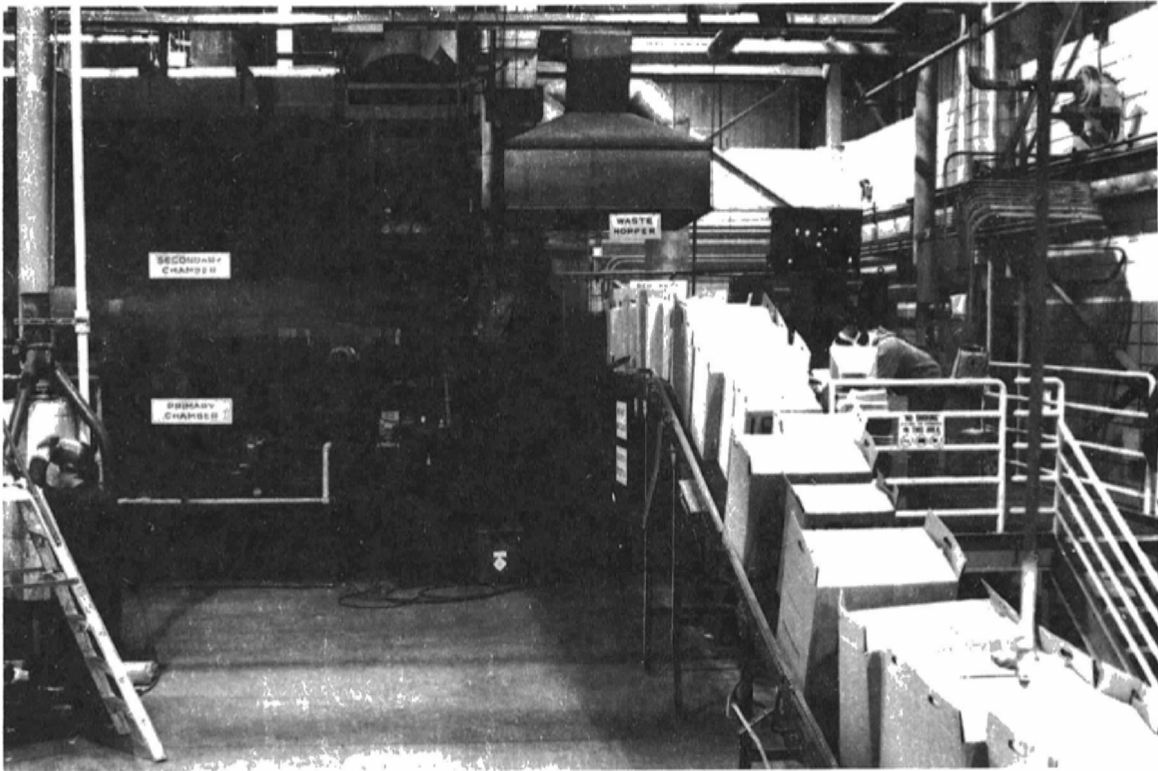

Figure 2.14 Boxes on Conveyor Feedline Adjacent to Radiation Monitor



Figure 2.15 Console for Monitoring Radiation at Incinerator Conveyor Feedline



Figure 2.16 Survey Meter Used at BFI – Warren



Figure 2.17 Location of Where Manager and Supervisor Detected Radiation (~ 400')  
from BFI Trailer 808



Figure 2.18 BFI Truck Parking Lot, Carnegie, Pennsylvania

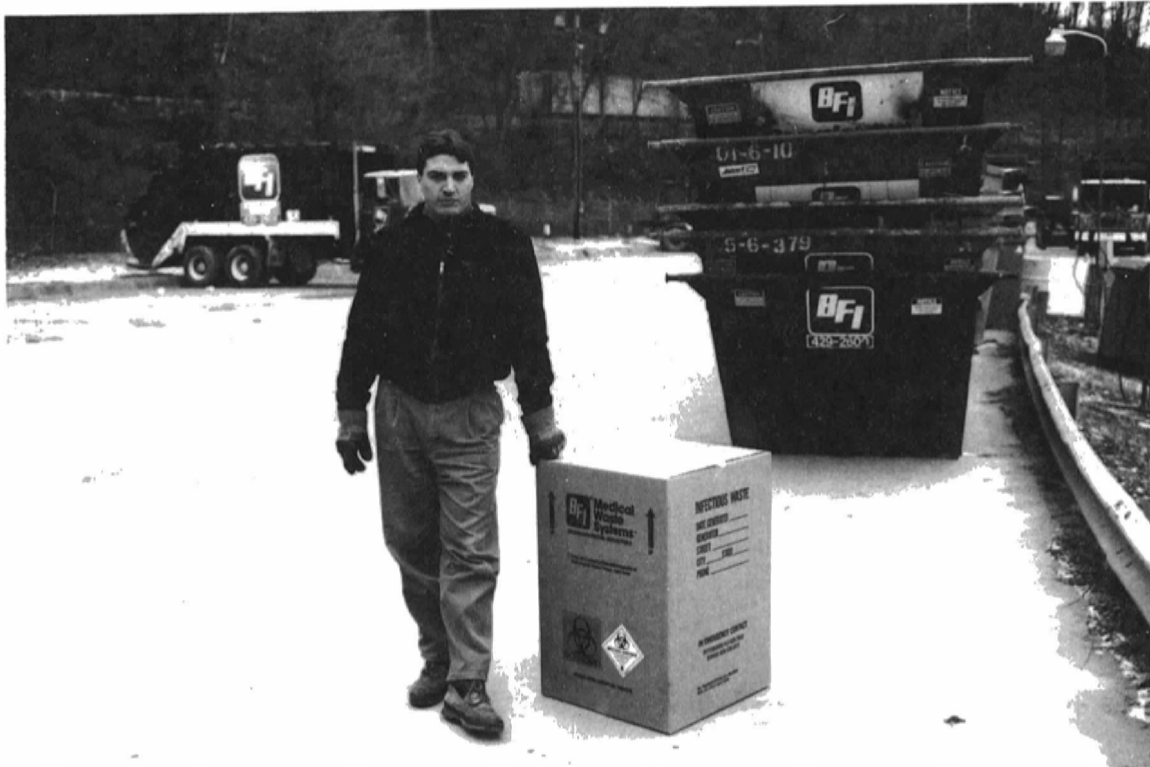

Figure 2.19 Location of Isolated Biohazard Box Containing Source



Figure 2.20 BFI Locking Recycle Container

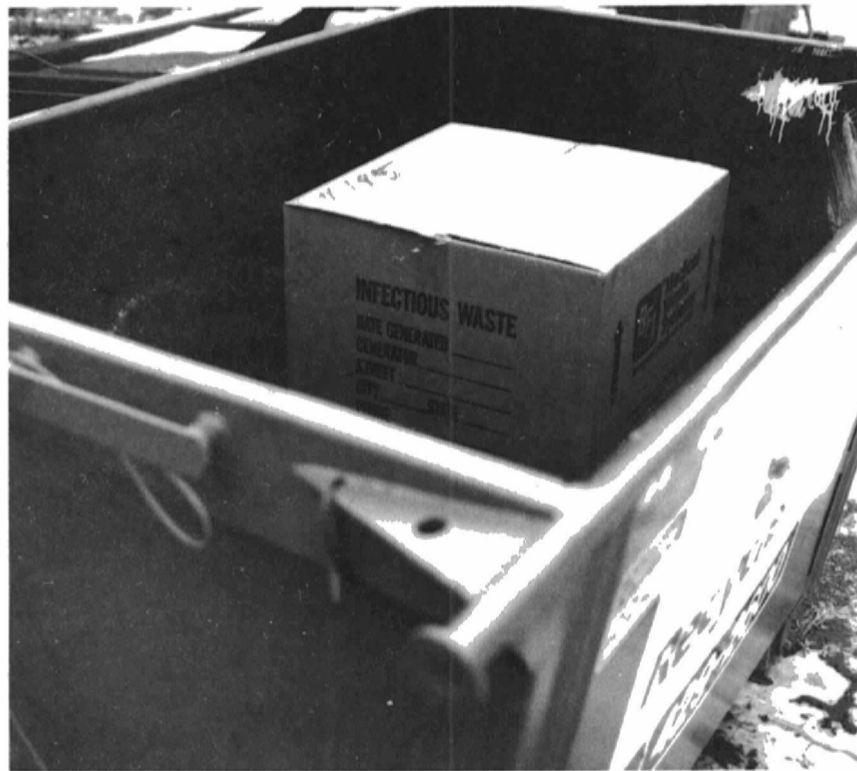

Figure 2.21 Interior of BFI Waste Container Where Radioactive Source Was Stored



Figure 2.22 Location of Radioactive Source Recycle Container at BFI – Carnegie



### **3 OMNITRON 2000 HIGH DOSE RATE REMOTE AFTERLOADER SYSTEM**

This section describes the Omnitron International, Inc.'s (Omnitron's) 2000 High Dose Rate (HDR) Remote Afterloader System; the nickel-titanium source wire; the HDR afterloader software; and the manufacturer's quality assurance and quality control (QA/QC) program. In addition, this section discusses the training, operating, and emergency procedures Omnitron gives to its customers.

The Incident Investigation Team (the team) obtained information from Omnitron's brochures and manuals; safety evaluations of the source and device (Registration Certificates); letters provided to the State of Louisiana to support the safety evaluations; and interviews with the persons involved. Additionally, the Food and Drug Administration (FDA) gave the NRC information they obtained from their investigation of the incident at the Indiana Regional Cancer Center (IRCC).

The scope of this investigation included only those mechanical or electrical components that could have contributed to the break in the wire and reflects the team's observations and review of documents and interviews with Omnitron personnel. The afterloader is operated by a computer; however, it is designed so that all low-level safety systems (e.g., hardware, interlocks, watchdog timers) are independent of the computer. The following description summarizes the overall operation of the afterloader, presenting specific details about the areas the team felt could have contributed to the wire break.

#### **3.1 Description of the Afterloader System**

This section discusses the main components of Omnitron's Model 2000 HDR afterloader system, which are the afterloader, the main console, the door status panel, the afterloader system safety features, and the implanted catheters and connecting catheters.

##### **3.1.1 High Dose Rate Afterloader**

The HDR afterloader (Figures 3.1 and 3.2) (see also Figures 2.3 and 2.4) contains the mechanical and electrical hardware necessary to execute a treatment. The afterloader contains a microcomputer that communicates with the main console through an RS-422 data link. The unit is approximately 107-cm high, 56-cm wide, and 61-cm deep (42-inches H x 22-inches W x 24-inches D) and weighs approximately 148 kg (325 pounds). Casters are mounted on the unit so that it is easy to move. The main components are the friction drive mechanisms, active and inactive wires, optical and mechanical switches, storage safe, treatment channel turret, stepping motors, emergency retract motors, backup power supply, and console interface card.

The turret (Figure 3.3) allows for connection of up to ten treatment channels. These channels are numbered on the turret head. Each treatment channel can have up to 20 dwell

positions with each position having dwell times of 0.1-second to 3-minute increments. For each channel, the source can be moved in 1.1-cm increments (the minimum) to a maximum treatment distance of 21 centimeters.

The implanted and connecting catheters are joined to the HDR afterloader by appropriate fittings. The turret rotates to allow the single active wire to extend and enter each implanted catheter for the desired treatment. The computer can determine the location of the turret by use of optical sensors and unique coding on the edge of the turret wheel.

The storage safe provides shielding for the tip of the source wire where the source is located. When the source wire is in the "safe" position (i.e., in the shielded position), the source is located within the center of the safe, and radiation levels at 1 meter (39.4 inches) from the surface of the device are below 0.001 mSv/hr (0.1 mR/hr).

Two independent drive systems are used in the afterloader. One drive system drives the source wire used for patient treatment and the other drives the dummy wire used to ensure that the catheter path is not constricted or obstructed. The dummy wire is also used during service and maintenance to ensure that the device is operating and functioning correctly.

Each drive system uses a pinch roller attached to a solenoid. When the solenoid is energized, the pinch roller puts pressure on the wire so that the wire comes in contact with the stepping motor's drive roller. The stepping motor moves the wire a predetermined distance (a step) for each signal sent from the computer to the motor. When the drive roller rotates, the wire travels through the guide tubes, owing to the friction between the wire, pinch roller, and drive roller.

An optical encoder mechanism is used for independent wire tracking and is located below the drive mechanism. Pinch rollers that are attached to solenoids are used for each system to keep pressure on the wire so that the wire is in contact with the optical encoder.

During a treatment, the appropriate motors and solenoids for the source-wire path or the dummy wire path are energized causing friction that allows movement of the wire and optical encoder roller.

As a stepping motor drives the source wire forward from the lead safe, a microswitch is tripped (the parked switch, which indicates the safe position, is located at the bottom of the source wire path) that resets a counter to zero (electric pulses are counted). As the wire travels, it reaches a microswitch (home position sensor) just before entering the turret and the distance is tracked by the pulses sent to the computer from the optical encoder.

The source wire travels past the first dwell position and then is pulled backwards, to remove any slack, to the first dwell position. The wire remains in this position for the prescribed dwell time and then travels to the next dwell position for that prescribed dwell time until all dwell positions and times have been completed. During each movement of the wire the

distance is recorded. After all dwell positions and times are completed, the wire is retracted. The number of pulses are counted during the retraction process until the home switch is deactivated. When the wire reaches the safe position, the solenoids are de-energized.

A computer controls the afterloader through an interface board in the computer and a signal multiplexer. Separate circuits on the interface board count the number of pulses in each direction. By using the optical encoders in combination with the stepping motors, the HDR can account for the slippage of the wire. In addition, timers are located on the interface board to time the stepping motors (used for error detection).

An emergency drive system is located in the afterloader that is separated from the main drive systems (stepping motors). The emergency drive system consists of a solenoid, pinch roller, and battery-operated dc motor. In the event of an emergency retract, the dc retract motor is energized and power is removed from the solenoids associated with the stepping motors and optical encoders, thus removing any friction forces caused by these systems. The dc motor continues to operate until the end of the source wire (opposite the source-end) contacts the parked switch.

The back of the afterloader contains a status panel, shown in Figure 3.4, which consists of the following.

- The "SAFE," green, light-emitting diode (LED) indicates that the end of the wire opposite the source end has been detected by the sensor (i.e., the parked switch is tripped).
- The "IN PROGRESS," amber, LED indicates that treatment has been initiated.
- The "DUMMY PARKED," green, LED indicates that the end of the wire has been detected by the sensors (i.e., parked switch is tripped).
- The "ERROR," red, LED indicates that an error has occurred. The error LED is lit whenever an error condition occurs. These error conditions can be caused by malfunctioning equipment, power failures, catheter restrictions, etc., and the cause of the error is displayed on the computer screen.
- The "DIAGNOSTIC MODE," amber, LED indicates that the system is undergoing diagnostics. Only Omnitron personnel are authorized and have access to this mode. Under this mode of operation, direct movement of the source and dummy wires can be controlled through the console.
- The "DOOR OPEN," red, LED indicates that the switch on the treatment room door has been tripped. Either the switch is broken or the door is open.

- The "ARMED," amber, LED indicates that the system is ready for treatment (i.e., passwords have been entered correctly, keylocks have been set, etc.).
- The "MANUAL RETRACT," red, LED indicates that both the ac stepping motors and the dc emergency retract motor failed to retract the wire, and, therefore, a manual retraction is necessary. If this condition occurs, the LED will be lit and an alarm on the console will sound.
- The "RESET," yellow push button has a hinged cover to prevent accidental activation. For resettable errors, pushing the button will erase the error message displayed on the computer console and turn off the "ERROR" LED. For nonresettable errors, a message will appear on the screen that Omnitron needs to be called to fix the error.
- The "STOP," red push button is used to stop treatment. If this button is pushed when the active wire is out, the active wire will automatically retract. Treatment information is saved, and, therefore, treatment can be resumed from the point where it was stopped when this button was pushed.
- A keyswitch is provided on the console to allow only authorized personnel to control the treatment.

A label containing a radiation symbol and warning appear on the HDR afterloader next to the status panel.

The afterloader is locked, preventing users from accessing the mechanical, electrical, and software maintenance portions of the HDR afterloader system. Entry can only be accessed by the manufacturer.

### **3.1.2 Main Console**

The main console consists of a microprocessor, color monitor, printer, disk drive, uninterruptable power supply, and treatment unit interface card (Figure 3.5). The microprocessor is a personal computer (PC) that operates the afterloader and performs first-level safety functions (e.g., dummy wire check, door interlock). The PC controls all wire movement signals and controls. It is used to enter patient data and the patient treatment plan, to initiate treatment, and to perform service diagnostics.

The computer console contains a status panel, shown in Figure 3.6, that consists of the same LEDs, controls, and keyswitch as those described in Section 3.1.1 for the afterloader.

The system printer provides hard copies of treatment printouts, treatment logging and diagnostic reports, and error messages.

Also provided with the control console is an uninterruptable power supply, which allows treatment to continue in the event of a power failure.

### **3.1.3 Door Status Panel**

The treatment room door status panel (Figure 3.7) provides additional indication to personnel performing the treatment as to the status of the HDR afterloader. This panel contains the error LEDs as described for the afterloader and control console, an emergency stop button to allow the user to halt treatment, and an alarm horn. The panel is installed in close proximity to the door of the treatment room.

### **3.1.4 Afterloader System Safety Features**

The manufacturer incorporated numerous safety features into the HDR afterloader system. The team observed the performance of those safety features incorporated into the HDR afterloader relevant to the constriction or obstruction of the source wire. Team members requested that Omnitron simulate the constriction condition that occurred at the IRCC with the active source wire. Team members observed that during a constriction in which the dc motor is energized, no audible alarms were activated. However, an error message did appear on the computer console for the entire duration of the wire retraction, and an error message indicating that a constriction occurred was reported to the error log. Other safety features are described in the manufacturer's manuals and brochures.

### **3.1.5 Patient Applicators and Treatment Tubes**

Implanted catheters, known as patient applicators or treatment applicators are inserted into the patient during a surgical operation. The active source encased in the cavity of the source wire will reside inside this catheter during treatment time. Typical implant catheters (applicators) include rigid needles, flexineedles, and custom applicators. The flexineedles must be used with appropriate accessories (e.g., needle obturator, treatment tubes).

In the HDR treatment of November 16, 1992, at the IRCC, five 10-cm flexineedles were used. Each of the 10-cm flexineedles has a 20-gauge polyester tubing needle shaft, a stainless tip, aluminum coupling, and a nylon suture button. The internal diameter of the 10-cm flexineedle is 0.813 millimeter (mm).

Connecting catheters are known as treatment tubes; these are the tubes between the HDR afterloader and the implanted catheter.

In the HDR treatment of November 16, 1992, at IRCC, five 80-cm connecting catheters were used. Each of the catheters was made of teflon tubing with aluminum coupling hardware. The nominal coupled length of the inside lumen of the 10-cm flexineedle connected to an 80-cm coupling catheter is 90.34 cm plus or minus 0.2 cm. Figure 3.8 represents a schematic of this arrangement.

## 3.2 Description of the Source Wire

The registration certificate for the source wire, Model SL-777 (Figure 3.9), was issued by the Louisiana Radiation Protection Division. The source wire is constructed of Nitinol (nickel-titanium alloy). The source wire was produced in the following way.

Originally the wire comes in a roll from the supplier of the Nitinol wire. Lengths of wire are cut from the roll (cut intentionally long) and sent to another company to produce a cavity in one end of the wire approximately 0.34 mm (0.014 inch) in diameter and 11-mm (0.43-inch) deep (wall thickness approximately 0.089 to 0.102 mm [0.0035 to 0.004 inch]). Previous production required a 13-mm cavity. Instructions are sent with the wire telling the company in which end of the wire to put the cavity.

The wire is sent with a traveler to another company where the cavity is x-rayed. At this time, the x-ray vendor assigns a serial number to the source wire. The wire and videotape of the x-ray are shipped back to Omnitron's Houston, Texas, office.

The wire is inspected at the Houston office for gross defects in material or workmanship and the wire's critical dimensions are checked. The wire is then sent with its traveler to Omnitron's source production facility in Edgerly, Louisiana.

At the Edgerly facility, the critical dimensions are again checked against what is stated on the traveler. If these dimensions are not the same, the discrepancy is either handled over the telephone, the wire is scrapped, or the wire is returned to Houston for rework. Once the personnel are satisfied with the wire, a sample piece of the wire is placed in the welding fixture located in the hot cell and a test weld is performed on a sample piece of the wire. The weld is inspected for an even-flow, uniform heat distribution (heat ring), and a "shiny" surface. If the weld is satisfactory, the remaining portion of the wire is cut to length. The wire is placed in the hot cell, and a weld is performed on the end opposite the cavity. All welds are performed, using a tungsten inert gas process. This weld is inspected as mentioned above, and if found to be satisfactory, the production continues.

Active iridium wires 5-mm (0.2-inch) long are received from the reactor and are placed in the hot cell. Two active iridium wires are placed in the source wire cavity and a 1-mm plug is placed on top. Previous production required a 3-mm (0.12-inch) plug. This 3-mm (0.12-inch) plug was the size used in the IRCC source wire. This end is welded to form a closure weld. The weld is inspected as previously described, and the outside diameter is measured. If the weld and outside diameter of the wire are acceptable, the wire is leak tested and placed in a transport container. The approximate dimensions of the finished wire are 2201 mm (86.7 inches) in length and 0.58 mm (0.023 inch) in diameter.

The transport container is moved to an HDR afterloader in the laboratory. The wire is loaded in the afterloader and cycled through the connecting catheters (1) to a wipe-test fixture where a wet and dry wipe are taken; (2) to a critical bend test fixture to ensure the source

wire will make the curves without failure; and (3) to a calibration station where the source is calibrated. The critical bend test consists of two curves, attached together to form a smooth "S" curve. The two radii of the test fixture were chosen to simulate actual patient treatment.

The finished wire is then packaged with the calibration and shipping papers and shipped to the customer. Omnitron staff install the source at the customer's site. Because of the source's half-life, it is replaced approximately every three months.

### 3.2.1 Prototype Testing Performed on Nickel-Titanium Source Wire.

Letters in support of the sealed source certification stated that the manufacturer subjected the source to the tests discussed in this section. Two prototype nickel-titanium wires were tested to the requirements of the International Organization for Standardization (ISO) 2919, "Sealed Radioactive Sources--Classification." This guidance does not provide specific tests for HDR afterloader brachytherapy sources. However, this guidance does provides specific tests, test procedures, and test equipment for other radioactive source usages (e.g., radiography, teletherapy, calibration). The classification of the source defines the testing conditions that the source has met.

Common practice has been to test brachytherapy wire sources to the same specifications as sealed sources used in medical interstitial and intracavitary appliances. The recommended tests for these sources are temperature, pressure, and impact. In addition, common practice has been to perform cycle and tensile tests on source wires where capsules are welded or swaged onto the end of the source as with radiography wires.

In a letter dated January 16, 1992, to the State of Louisiana Radiation Protection Division, Omnitron stated it subjected two prototype sources to the minimum classification recommended for the temperature, pressure, and impact tests. The prototype sources passed the tests in accordance with ISO 2919.

The manufacturer also subjected prototype sources to a bending fatigue test. Catheters connected to an afterloader were curved to represent pathways encountered during treatment. Different curved paths were used during the cycling of the source wire. The paths chosen and number of cycles tested for each path, as documented by Omnitron, are listed below:

<u>Pathway</u>	<u>Cycles</u>
4-cm (1.6-inch) radius followed by a 3.5-cm (1.4-inch) radius ("S" curve)	2500
2.5-cm (1-inch) radius (180° turn)	1
2.3-cm (0.91-inch) radius (180° turn)	1

2.2-cm (0.87-inch) radius (180° turn)	1
2.0-cm (0.79-inch) radius (180° turn)	21
1.5-cm (0.6-inch) radius (180° turn)	2

The wire was then subjected to 974 additional cycles, using the 4-cm (1.6-inch) radius followed by a 3.5-cm (1.4-inch) radius. The wire was subjected to a total of 3500 cycles.

With the use of a microscope (magnification 38 times), Omnitron reported that the source examination "showed wire tip, iridium encapsulation and body of wire to be in pristine condition. Dye penetrant test of tip and encapsulation area showed no material cracks."

An Omnitron corporate manager stated in an interview that the first production wire was tested to the breaking point and broke after 4000 cycles at the bottom of the cavity. However, the same manager's notes showed a break after 4070 cycles on one wire and 3490 cycles on another wire.

Omnitron performed no calculations to validate the design of the nickel-titanium source wire. Tensile or shear stresses were not calculated and no associated tests were performed on the wire. Through discussions with the vendor of the wire and Omnitron personnel, Omnitron decided that cycling testing simulating clinical situations would be the best way to test the source wire.

Further, Omnitron performed no metallurgical tests before the wire broke to validate the vendor's material certification. No metallurgical tests were performed after the cavity was produced to ensure that production of the cavity did not affect the overall integrity of the wire.

### **3.3 Description of the Omnitron 2000 Afterloader System Software**

Two groups of software programs were available with the Omnitron 2000 afterloader system: (1) the Computerized Treatment Planning System (CTPS) software used to develop a treatment plan (isodose computations) for a patient and (2) the software required to run afterloader functions.

The Omnitron 2000 HDR afterloader has a dedicated software system used in isodose computations. This software system, called the CTPS, was developed by a medical physics software company independent of Omnitron. Omnitron's medical physics personnel performed specific QA checks of the CTPS software before releasing it to its customers. The CTPS resides on a stand-alone computer hardware system and has a menu-driven interface. Treatment data is transferred to the Omnitron 2000 control console, via a standard 3.5-inch floppy disk drive. The CTPS also automatically corrects for the decay of the source. The CTPS has a full three-dimensional dose optimization feature that plans the HDR



brachytherapy doses delivered by the radioactive source. Dose histograms and three-dimensional wire frame displays are produced. Separate programs exist for entering patient data and for entering or editing iridium-192 radioactive source data.

The computer software installed on the Omnitron 2000 control console was developed by Omnitron, with the assistance of a consultant. The Omnitron 2000 computer console at IRCC used Version 3.0 of the software. This software has a menu-driven operator interface and is organized in a modular manner.

The operator must (1) have the Omnitron key in TREAT mode and (2) enter the Omnitron console program system Access Password before any access to patient or afterloader information is allowed. Some of the software programs in the afterloader console are only accessible to the Omnitron personnel.

The console and afterloader software were designed to monitor all major electrical and mechanical systems, detect the proper operation of these systems, and initiate any afterloader safety functions if necessary. The software is also designed to record and print out patient treatment information, treatment interruption causes (e.g., "Active wire path constriction detected at XX cm"), whether the detected condition can be reset by the HDR afterloader operator, and any device check failures detected (e.g., "Dummy wire check on Channel X failed").

The team identified the following features of the Omnitron 2000 hardware and software configuration.

1. The dummy wire executes programmed treatment to test for proper catheter routing, programming, and to ensure that no obstructions or kinks are in the catheters. For patient treatments requiring multiple catheters or applicators (similar to the 5-channel treatment of November 16), the operator can choose between having--
  - dummy wire checks of all programmed channels (i.e., catheters) before source wire treatment of each channel, or
  - dummy wire check of Channel 1 (one catheter), followed by the source wire entering that channel; dummy wire check of Channel 2, followed by the source wire entering that channel; and so on.
2. If the source wire jams while being extended or while being retracted from the device, one message is generated "Active wire path constriction detected at XX cm." However, the two conditions are acted upon differently by the afterloader. When the source wire jams while retracting and the pull force necessary to retract the wire exceeds that of the stepper motor upper limit, the emergency dc retract motor is engaged to retract the source wire. Otherwise, if no wire jam occurs, the stepping motor retracts the wire.

3. When the emergency dc motor engages, a message stating that the dc motor engaged is displayed momentarily (for approximately 10 seconds) on the console's screen, with no written information being stored in memory or printed out.
4. The software was configured so that when the emergency dc retract motor starts retracting the source wire, all devices that monitor and record the wire length information immediately disengage and all wire length information is lost. In addition, activation of the emergency dc retract motor is not recorded on the printout,
5. Following an emergency dc retract of the source wire, the afterloader operator is allowed to reset this error and restart treatment without taking any corrective actions.

### **3.4 Omnitron's Quality Assurance and Quality Control Program**

Omnitron International, Inc., located in Houston, Texas, was responsible for the overall QA/QC program. However, although not directly stated, Omnitron's source-wire fabrication facility, located in Edgerly, Louisiana, was responsible for the QA/QC of the source wire once it was received from the Houston office. Therefore, the team separately reviewed the QA/QC program pertaining to (1) the production of the HDR afterloader and the initial fabrication of the nickel-titanium wire and (2) the assembly of the source wire. Any part of Houston's QA/QC program that pertains to the source wire was considered during the review of the QA/QC program for the Edgerly facility. The NRC does not have specific regulations or guidance that relate to QA/QC programs for vendors of sealed sources and devices. The team used a draft NRC QA/QC guide to review Omnitron's QA/QC program. The team's findings were essentially the same as those reported in the FDA audits as noted below.

The Lafayette, Louisiana, office of the FDA performed an audit of Omnitron's Edgerly, Louisiana, facility during December 1992. Audit findings were presented to Omnitron on December 23, 1992, and documented on FDA Form 483. The inspection report findings included multiple Omnitron deficiencies relating to their (1) quality assurance program, (2) audits, (3) device history records, (4) reworking of components, (5) device master records, (6) written procedures for in-process and finished device testing, (7) cleaning and leak testing, (8) calibration of equipment, (9) validation of the work process, (10) wire receipt inspection, and (11) use of white-out on QA documents .

The Dallas, Texas, office of the FDA performed an audit of Omnitron's Houston, Texas, facility during December 1992 and January 1993. Audit findings were presented to Omnitron on January 11, 1992, and documented on a Form 483. The inspection report findings included multiple deficiencies relating to (1) their QA audits and design changes, (2) complaint file shortcomings, (3) medical device reporting, (4) software (afterloader and console) validation and testing, (4) manufacturing specifications and manufacturing process control, (5) device history records, and (6) component receipt inspection. Both FDA audits indicated a lack of procedures, component QA records, and tests. In addition, where

procedures, component QA records, and tests existed, numerous examples indicated that standard QA/QC practices were poorly implemented.

Findings documented in the recent FDA audits are similar to the overall team observations. On the basis of FDA audit findings at the Edgerly and Houston offices, the Texas Department of Health, assisted by Houston police, embargoed the Omnitron 2000 HDR afterloader on January 12, 1993. To have the embargo lifted, Omnitron must complete the corrective actions needed to resolve the issues raised during the FDA audits.

### **3.5 Training, Operating, and Emergency Procedures for the Omnitron 2000 High Dose Rate Afterloader**

Upon request, Omnitron provides a two-day, inhouse, or onsite, training course to customers. The course in its current form became available May 1, 1992. In addition, Omnitron provides training at the customer's facility before treatment of the first patient.

Omnitron chose four trainers on the basis of their knowledge and experience. They have not been formally trained or received training to become trainers. Omnitron had (1) no written policies or procedures on what training and experience is required before an individual can become a trainer and (2) no written procedures specifying who should be trained at the customer's facility. Typically, an individual responsible for training calls or writes the customer's facility and asks the responsible physicist who they feel should be trained. Typically, the responsible physicist and the person who will most likely perform the treatment are trained. The director of training told the team that Omnitron will periodically call the customers who have not had two people trained in order to schedule future courses for them.

Omnitron provides the customer with training and reference material. The material includes system specifications, applicator and accessory specifications, treatment planning, HDR software and hardware, an instruction manual, and a one-page emergency procedure. The objectives of the two-day training course are to teach the customer how to perform treatment planning and dose calibration, execute treatment using the HDR afterloader, use emergency procedures in the event of a source retract failure, and discuss uses of accessories and applicators. The emergency procedures, which are provided to the customer, do not address breakage of the wire. Training provided before treatment of the first patient consists of a review of the operation and safety features of the HDR afterloader. Basic radiation safety training is not provided.

According to Omnitron's Sr. Vice President of Research and Development, the safety features and error messages that appear on the console monitor screen are discussed as part of the training; however, these error messages are not addressed in Omnitron's written procedures. Errors that cannot be reset are not discussed in the training, and the customers are told to call Omnitron if an error of this type occurs.

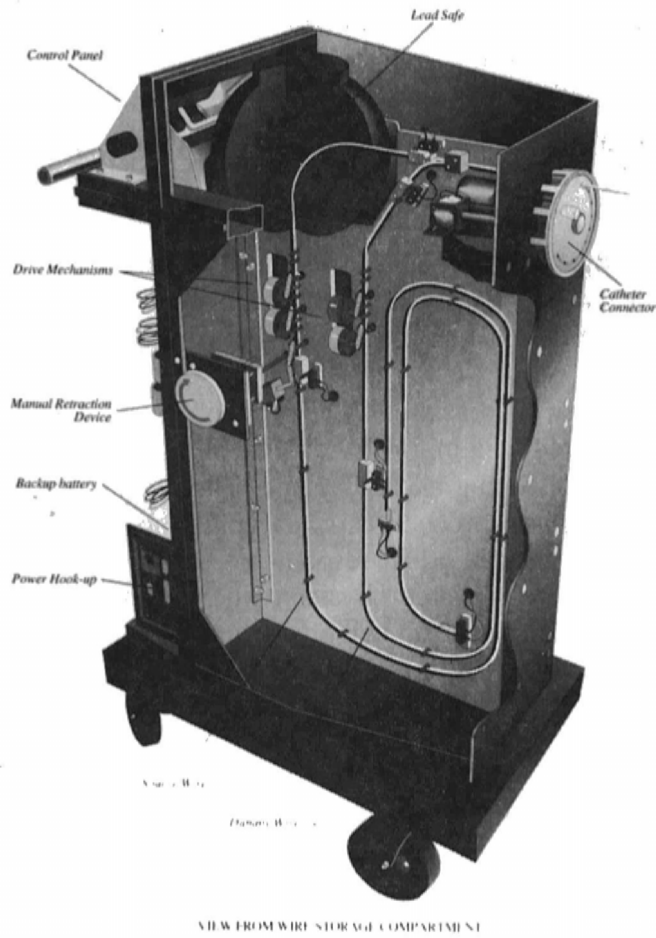

Figure 3.1 Omnitron 2000 High Dose Rate Remote Afterloader

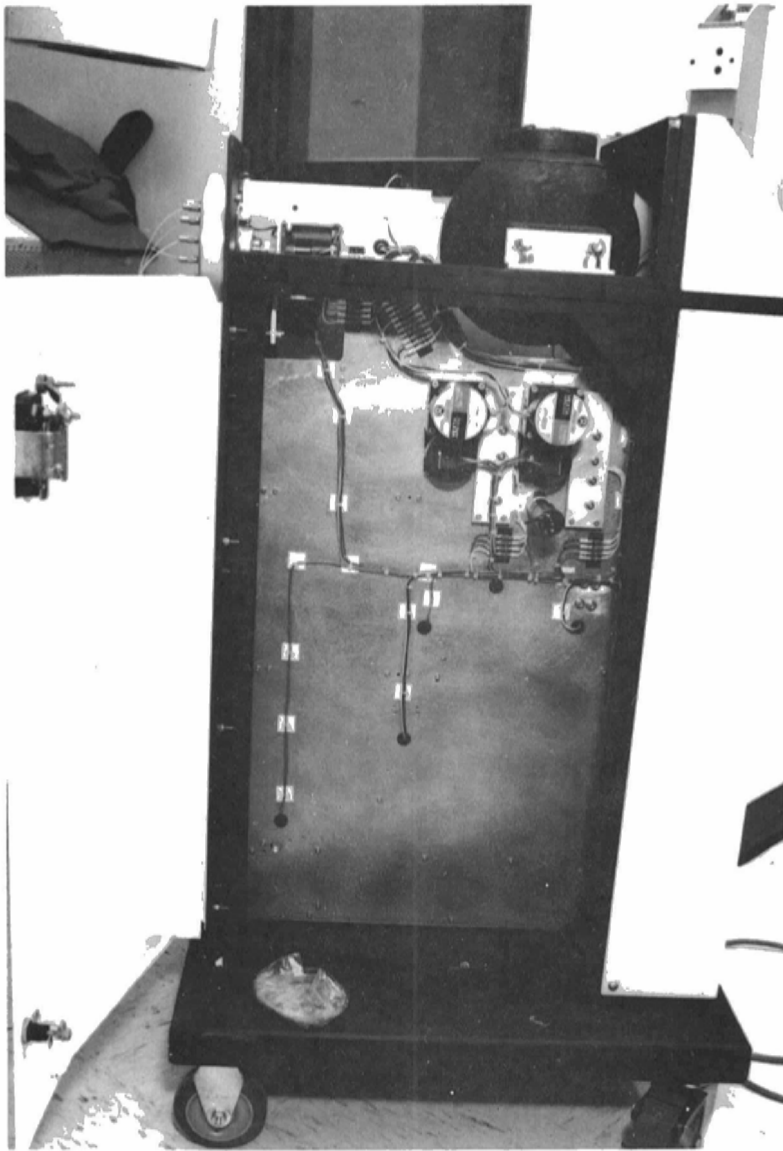

Figure 3.2 Left Side of High Dose Rate Remote Afterloader, Indiana, Pennsylvania

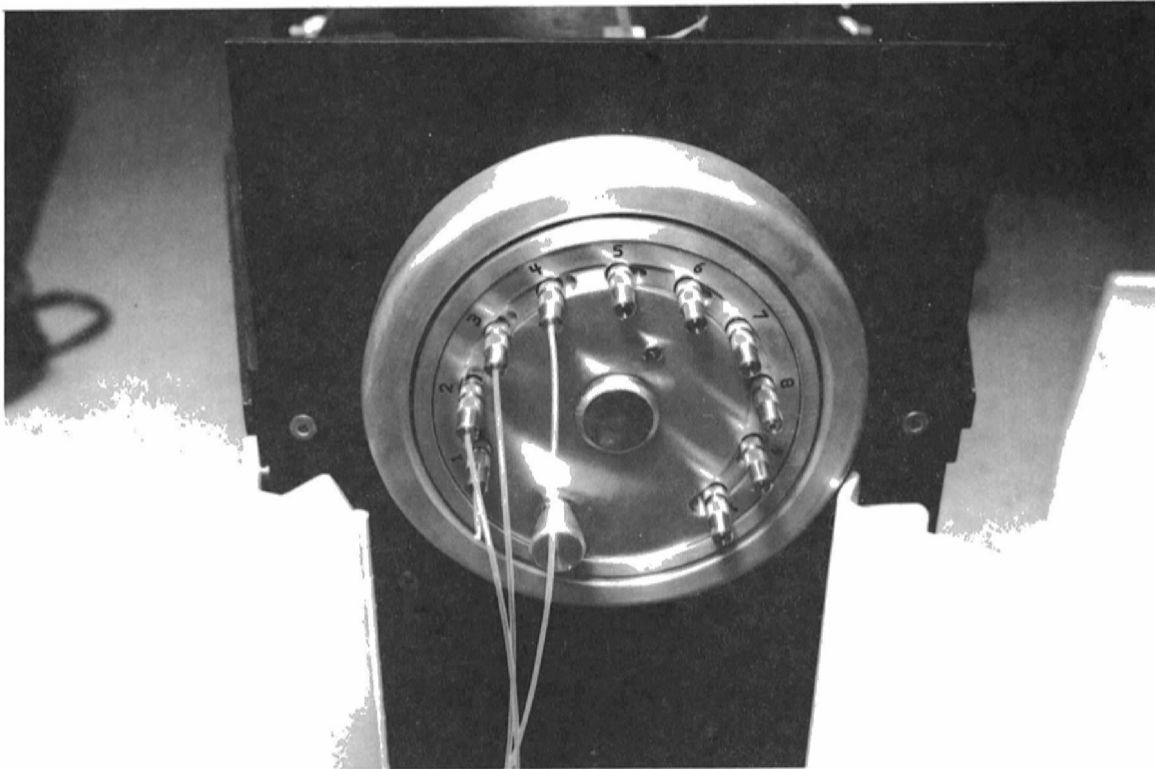

Figure 3.3 Turret Drive Assembly, Indiana, Pennsylvania



Figure 3.4 Control Panel for High Dose Rate Remote Afterloader, Indiana, Pennsylvania

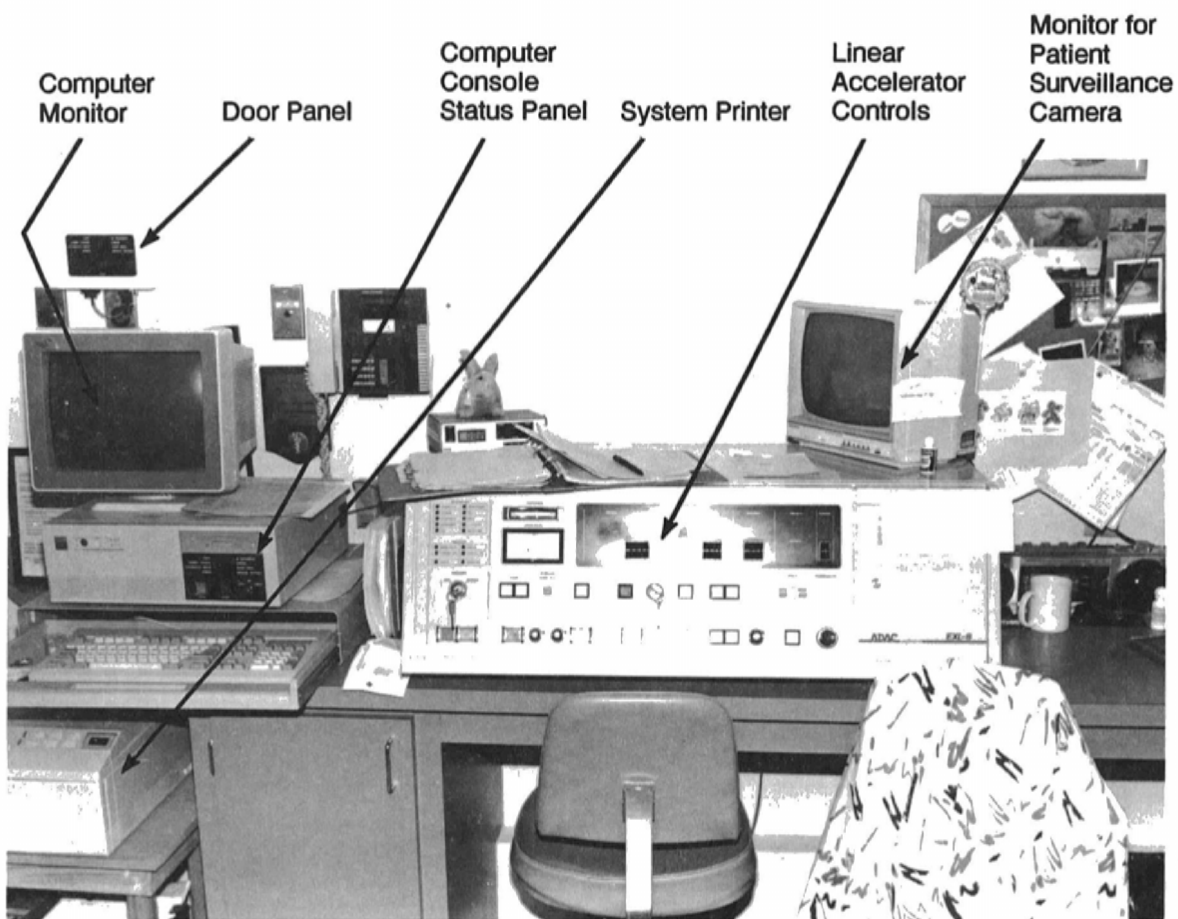

Figure 3.5 Arrangement of the Computer Console Status Panel, Door Panel System Printer, Linear Accelerator Controls, Computer Monitor, and Monitor for Patient Surveillance Camera





Figure 3.6 Computer Console Status Panel of High Dose Rate Remote Afterloader System

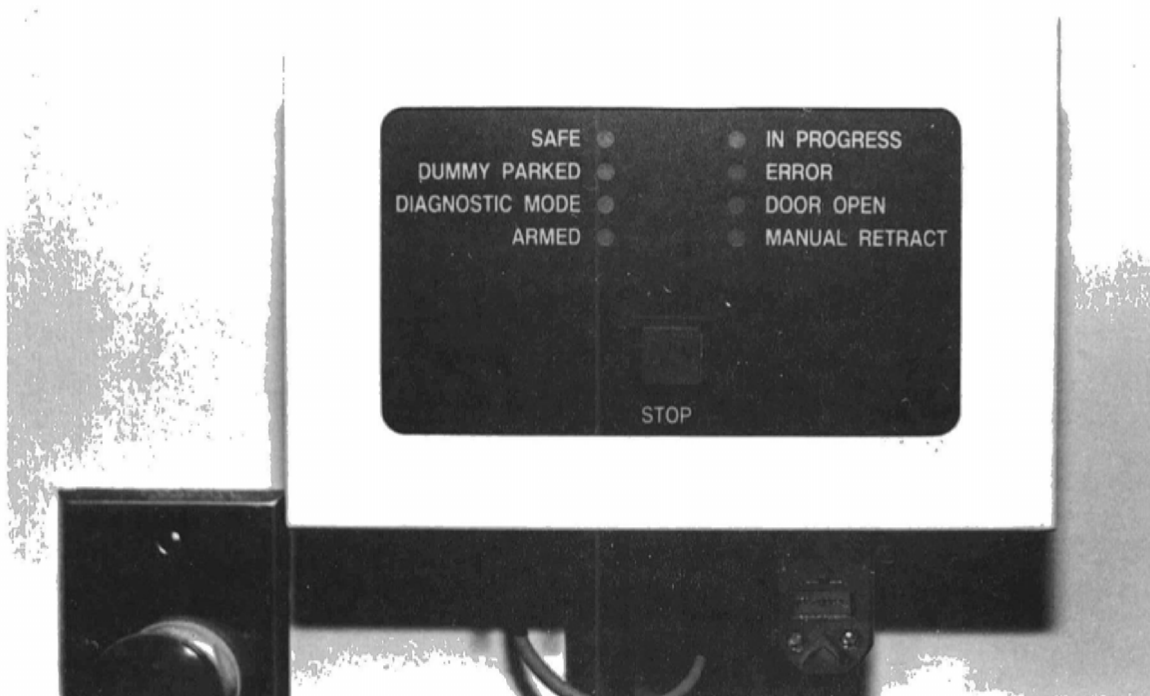
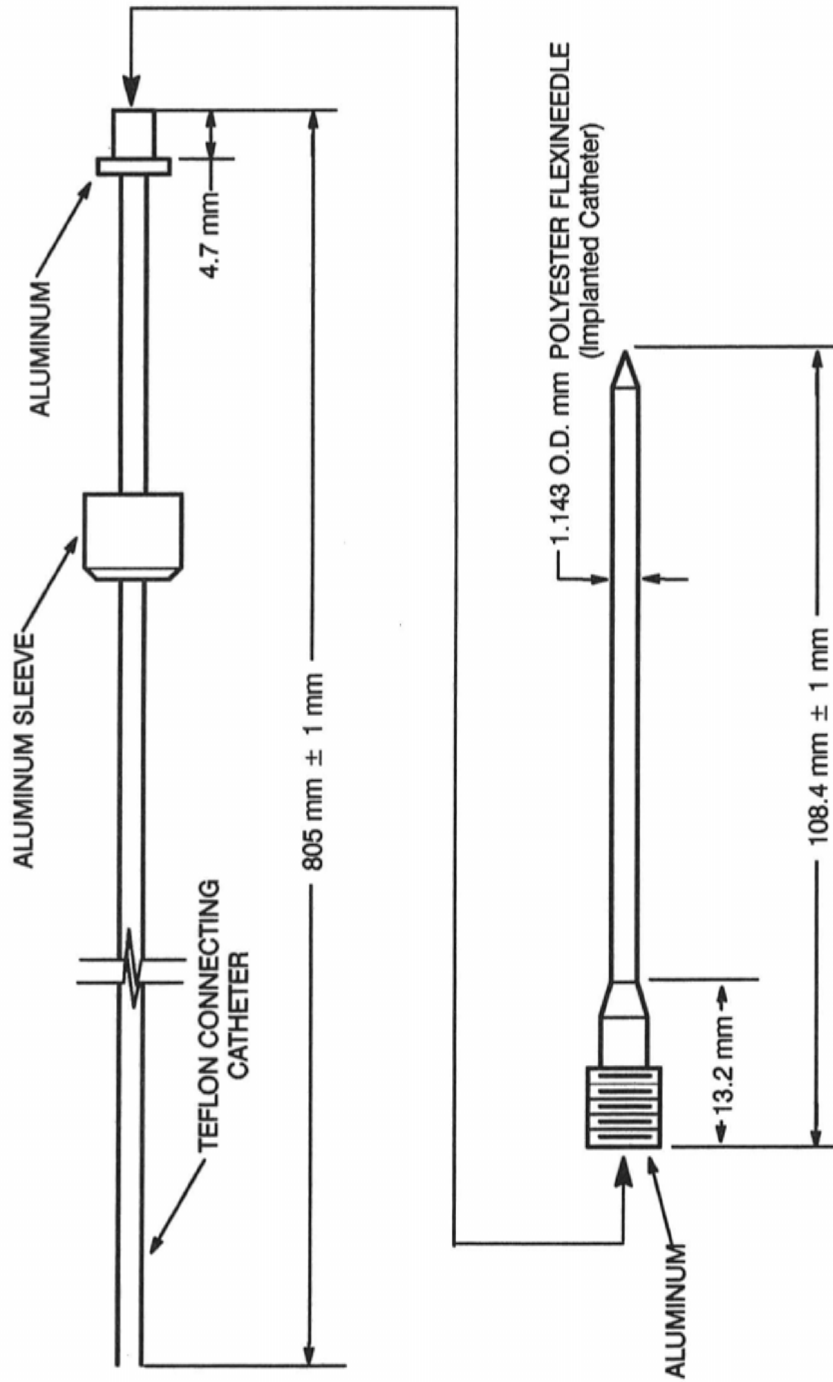

Figure 3.7 Door Status Panel of High Dose Rate Remote Afterloader System



NOTE: Drawing not to scale and all dimensions are approximate

Figure 3.8 Connecting Catheter and Flexineedle Unassembled

**Ir-192 Seed in Titanium/Nickel  
Model #SL -777**

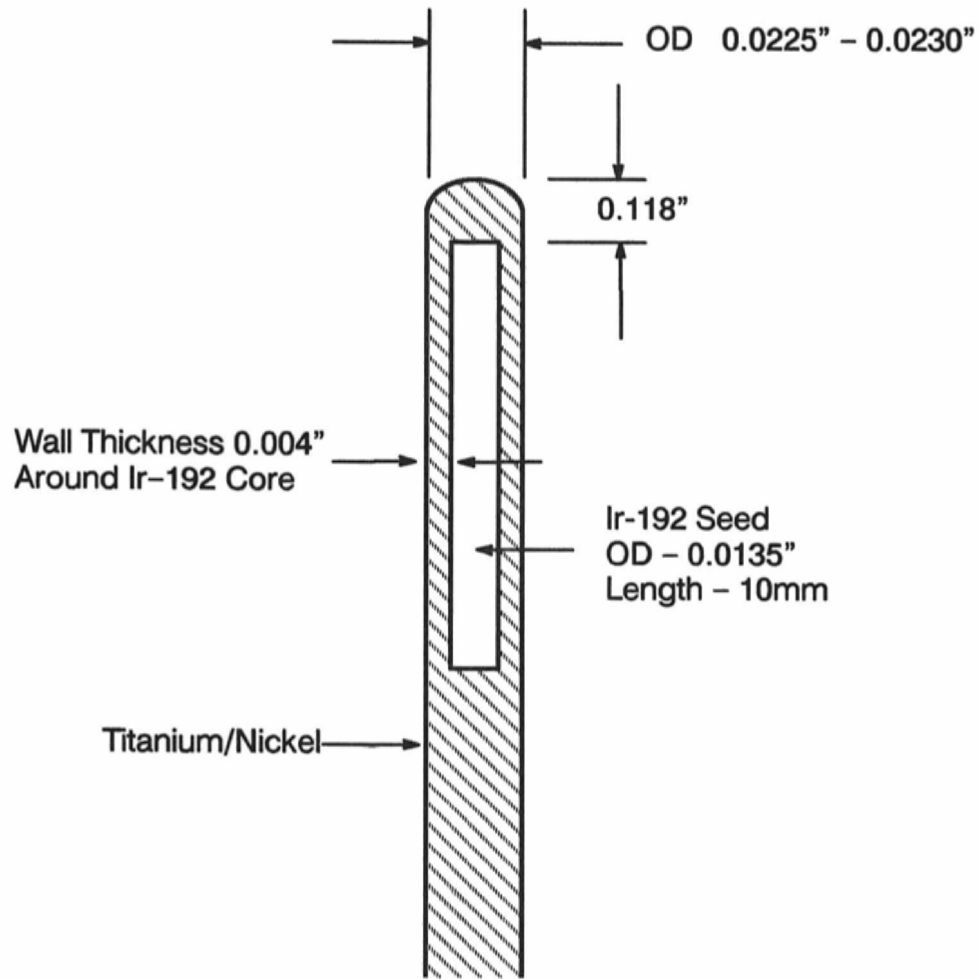

**Ir-192 Seed in Titanium/Nickel**

An Ir-192 Seed is encapsulated firmly inside a solid titanium/nickel wire.  
The overall length of the Ir-192 Seed is 10mm

The above composite has passed all ANSI requirements for sealed sources.

Figure 3.9 Iridium-192 Seed in Titanium/ Nickel  
(Reproduced from Registration  
Certificate LA-0760-S-102-S)



## **4 EQUIPMENT PERFORMANCE**

This section presents (1) the potential analysis of the source-wire breaks, (2) the immediate cause of the wire break, (3) the root cause of the wire break, (4) the failure of the high dose rate (HDR) afterloader system to detect the length of the broken wire, and (5) the performance of the PrimAlert-10 area radiation monitor.

The team obtained its knowledge of the source wire and HDR afterloader from Omnitron International, Inc.'s (Omnitron) brochures, visits to the HDR afterloader and source wire facilities, direct observation of the broken wire and afterloader, engineering reference material, material certification, prototype test results, and other information provided by Omnitron. Most of the testing was performed by Southwest Research Institute (SwRI), San Antonio, Texas, under an existing contract with the NRC. The team also reviewed the performance history of the PrimAlert-10 that was installed in the treatment room at the Indiana Regional Cancer Center (IRCC).

### **4.1 Failure Analysis Pertaining to the Source Wire**

This section describes the failure analysis performed on the broken source wire at IRCC, and the Greater Pittsburgh Cancer Center, (GPCC). It also includes an analysis of other sample wires used for testing purposes and describes (1) possible areas where the source wire failure may have occurred; (2) observations of equipment used during assembly, testing, and shipping that may have caused wire degradation; (3) description of the test samples; (4) the test performed of the samples; (5) observations of the test results; (6) implications of these observations; and (7) further testing.

#### **4.1.1 Possible Failure Areas**

On December 4, 1992, the quarantine of IRCC's Omnitron 2000 HDR afterloader was lifted by the NRC, and team members observed the disassembly of the device by Omnitron. The team asked Omnitron personnel specific questions pertaining to the source wire and afterloader.

Upon examination of the inactive portion of the source wire, it appeared that the wire broke just above the bottom of the cavity. The entire source wire length as specified on drawings and the associated traveler was 2201 mm (86.65 inches). The inactive portion of the wire was measured, and found to be approximately 2188 mm (86.14 inches). Therefore, the remaining portion of the source wire containing the iridium-192 source was approximately 13 mm (0.51 inch). The cavity produced in the end of the wire was also approximately 13 mm (0.51 inch) in depth.

The team took wipe samples of the active wire and inactive dummy wire and analyzed them on site to determine leakage of radioactivity from the source. The wipe samples were below the regulatory limit of 185 Bq (0.005  $\mu$ Ci) but were sent to Region I for analysis. The wipe

samples were divided between Omnitron and NRC, both having representative samples of the dummy and source wires. The results from the gamma spectroscopy test performed in NRC's Region I office indicated a photopeak having an energy corresponding to iridium-192 for both wires. However, the levels obtained were below the regulatory limits of 185 Bq (0.005  $\mu$ Ci).

To examine the HDR afterloader system for conditions that could damage or break the source wire, the afterloader was divided into six areas where the break of the wire could have occurred (Figure 4.1):

- **Area 1—Inside the afterloader:** The team examined the entire track where the source tip came in contact with parts of the afterloader (Figure 4.2). This track consisted of the lead-safe stainless-steel guide tubes, the home sensor, the "y" block, and the turret assembly. The team examined all the guide tubes for flattening, elongation, crimps, cracks, eccentricity and other signs of visible damage. These wipe samples previously mentioned were sent to SwRI for chemical analysis of the deposit material. The chemical analysis indicated that no lead was present in the deposit material. Minor wear of the source wire and machine components could have produced the small quantities of metallic elements found in the deposit material. Sulfur and silicon were present in small quantities, however, the origin of these elements has not been established. The home sensor was taken apart and examined; the "y" block was disassembled and inspected for wear; and the drive rollers, encoder, and corresponding pinch rollers were examined. The turret head assembly was not disassembled and inspected owing to a limited selection of available tools. No significant wear was observed on any of the accessible Area 1 components.
- **Area 2—Inside the turret connector:** The five turret connectors installed in the turret head (believed to be the five used in the November 16, 1992, treatment) were examined for significant wear (see Figure 3.3). The inside holes were not obstructed, no burs were noticed, and the holes appeared to be straight. The outside surface showed no signs of damage, and the connectors did not appear to be bent. No significant wear was observed on any Area 2 components.
- **Area 3—Inside the connecting catheter (see Figure 3.8):** Four of the five connecting catheters (believed to be used during the November 16, 1992, treatment) were examined for wear. All appeared to be in good condition with no visible signs of significant damage. A catheter that was believed to be the fifth connecting catheter (not connected at the time of the inspection) was also examined. The fifth catheter was cut, and there were some signs of visible damage. Damage to the catheter could have occurred after treatment.
- **Area 4—Inside the connecting catheter connector:** Area 4 consists of an aluminum fitting pressed onto the teflon catheter. An aluminum sleeve, which is threaded

inside, fits over the implant catheter and allows the connecting catheter to be fitted to the flexineedle (Figure 4.3 and see Figure 3.8). For damage to the source wire to occur in Area 4, a misalignment of the connecting catheter and flexineedle and/or an external force causing the source to bend would have had to occur. Misalignment was not noticed by either RTT-A or RTT-B and no constriction error was reported on the error log for the dummy wire as it passed this area during treatment.

- **Area 5—Inside the flexineedle connector:** A polyester tube containing a stainless steel tip was pressed into a threaded aluminum fitting to form the flexineedle. Because the break occurred near the bottom of the source-wire cavity and a constriction error occurred at 82.4 cm, the tip of the source would have had to be placed approximately 13 mm past the end of the fitting. (See Figures 3.8 and 4.3). The fitting supplies support to the wire, and when the wire is bent and retracting, places a stress point on the wire. The team was unable to examine the fitting for wear.
- **Area 6—Inside the flexineedle:** The actual break may have occurred within this area because the error log reported a constriction at 82.4 cm. The team does not believe that the break was caused by forces on the teflon tube because most of the needle was inside the patient. The flexineedle used in Patient A was disposed of and was not examined by the team.

#### 4.1.2 Observations of Equipment Used During Assembly, Testing, and Shipping.

On December 3, 1992, team members observed equipment at the Edgerly facility used in the manufacturing and assembly of the source wire to evaluate if the equipment could cause unnecessary stress or failure of the wire.

In reviewing the assembly procedures, the team noticed several areas that may subject the source wire to unnecessary stress. During loading and welding, part of the coiled nickel-titanium wire is unwound and inserted through a semicircular tube. The wire is clamped with rubber shoes attached to a pneumatic system. The other end is left in a coil and placed in a tray. During inspection of the weld, they rotate the wire 90 degrees by picking up the tray and rotating the tray 90 degrees, which forces the wire to rotate 90 degrees in the tube. If the pneumatic force holding the wire in place is not released, the wire would be subjected to torsional forces that could affect the reliability of the wire.

Omnitron stated that nitrogen was used to reduce moisture in their pneumatic systems. Sufficient amounts of nitrogen can cause embrittlement in titanium if the oxide layer is breached. During final inspection of each wire, Omnitron uses an afterloader to cycle the source wire to a calibration station, wipe test station, and critical bend test station (i.e., 3 full cycles). Team members examined the inside of the HDR afterloader and found signs of wear. Team members saw degradation and debris of the drive wheels and misaligned stainless steel guide tubes.

In examining the wipe station, the clamps used to hold the wire were not accurately aligned and contained some sharp edges. Cotton wads were placed on the clamps and the wire traveled through the cotton wads. When the team asked Omnitron if they ever inspected the cotton wads to see if they were worn, they stated that they never have. In addition, Omnitron stated that a wet wipe test and dry wipe test are performed on the wire. If the oxide coating on the wire were breached, hydrogen could cause embrittlement of the wire.

The failure of the wire did not directly occur because of the manufacturing equipment. If the wire break had occurred at the manufacturing facility, it probably would have been detected at the facility during the calibration or packaging of the source.

The potential for stresses or environmental conditions imposed on the source wire at the manufacturing facility contributing to the source wire failure has to be considered.

Omnitron noticed during disposal of returned source wires from their customers that some of the teflon tube lining on the inside of the wire shipping container (Figure 4.4) was degraded in the area where the active source contacted the teflon. In late September, Omnitron stated that they changed the design of the shipping container to use a stainless steel liner for the wire instead of a teflon liner. Omnitron conducted no tests to see if the degradation of the teflon affected the integrity of the source wire. Omnitron assumed that the degradation of the teflon was due to the radiation.

#### **4.1.3 Description of Test Samples**

As of January 7, 1992, nine samples of the nickel-titanium wire have been tested as indicated in Table 4.1. Some samples consist of more than one test specimen.

The following paragraphs briefly describe the samples as they were received by SwRI, tests performed by Omnitron and Omnitron observations of the failure analysis. Once the failure analysis has been completed, SwRI will provide the NRC with a more detailed report regarding the samples, tests performed, testing procedures, equipment used, and their observations and probable cause of failure.

**Sample 1** consisted of the broken active source wire (inactive portion) that was used during treatment at IRCC.

**Sample 2** consisted of the broken active source wire (inactive portion) that was used during treatment at GPCC.

**Sample 3** consisted of a sample, provided by Omnitron, of solid wire cut from a spool of nickel-titanium wire. All wires manufactured to date were cut from this spool of wire.



**Sample 4** consisted of a wire manufactured in the same manner as the active source wire except that nonradioactive iridium was placed inside the cavity. Omnitron used an afterloader and similar catheters to simulate the equipment used at IRCC.

According to Omnitron, they performed their test on Sample 4 in the following way and obtained test results before its shipment to SwRI. The afterloader was used to extend the wire to the approximate position where the source wire broke (bottom of cavity at end of flexineedle connector) at IRCC. The source was then bent over more than 90 degrees and the source was retracted. After eight attempts of the above procedure, Omnitron broke the sample by hand. The sample was observed to have permanent deformation to the source cavity, and the source wire broke at the bottom section of the cavity. The sample was sent to Omnitron's contractor in San Diego, California. Metallography was performed, and Omnitron's contractor stated that it "showed distinct necking of the material at the fracture point which is indicative of a ductile overload breakage."

**Sample 5** consisted of a wire that was manufactured in the same manner as the source wire except that nonradioactive iridium was placed in the cavity.

Omnitron stated that before shipping Sample 5, they performed the following test. The iridium was loaded into the cavity with 4 pounds of thrust, instead of the typical 1.8 pounds, to intentionally create hoop stress at the bottom of the cavity. The wire was placed in a pin vise held in the tailstock of a lathe. A flat plate was held in the lathe's chuck. The tip of the clamped wire was brought in contact with the flat plate and advanced slowly until the wire bent beyond 90 degrees from the axis of the lathe (Figure 4.5). The plate was then removed and the wire was examined under a microscope. Omnitron states that no permanent deformation or yielding of the material was observed.

**Sample 6** consisted of multiple specimens of nickel-titanium wire that was subjected to hydrofluoric acid. According to Omnitron, their contractor soaked the samples for 12 hours in 0.1 percent hydrofluoric solution at room temperature in different configurations (i.e., straight, 90°, and 180°). Omnitron stated in a facsimile dated January 9, 1993, that their contractor observed that oxide film on the nickel-titanium wire was attacked by the solution, and that the wires "showed brittle behavior, cracking with little deformation." In addition, "Metallographic examination showed no signs of pitting or significant corrosion or stress corrosion cracks...The experiment yielded samples with characteristics of hydrogen embrittlement." The samples were sent to SwRI for examination and analysis.

**Sample 7** was a source wire that was installed on June 30, 1992, at a customer's facility. It was used for 3 months and then stored on site for approximately 3 months. It was shipped back to Omnitron. According to Omnitron, on December 26, 1992, during removal of the wire from the shipping container in order to dispose of the source, their personnel observed that the source was not attached to the end of the wire but that it was in the bottom of the shipping container. The shipping container and wire were sent to SwRI for examination.

**Sample 8** was an active wire containing approximately  $3.5 \text{ E}+11 \text{ Bq}$  (9.5 Ci) of iridium-192. Omnitron stated that they performed the following test on Sample 8. The sample was stored in a shipping container lined with moist teflon. The wire was removed and bend tested by bending the wire 90 degrees in a 2.6-mm radius on December 23 and on December 26, 1992. On December 30, 1992, during the bend test, the wire broke after only being bent approximately 15 degrees. The wire was shipped to SwRI for examination and analysis.

**Sample 9** consisted of sample pieces of wire. Omnitron subjected one-half of each wire to a 0.1 percent hydrofluoric solution for varying amounts of time after which the samples were bend tested using the same procedure as that used for Sample 5. The samples were sent to SwRI for examination and analysis.

<b>Table 4.1 Summary of Test Samples</b>		
<b>Sample number</b>	<b>SwRI ID. number</b>	<b>Sample identification</b>
1	410	Indiana service failure
2	411	Pittsburgh service failure. (Received 12/12/92)
3	412	SwRI solid wire sample
4	413	First dummy wire (Omnitron contractor)
5	414	Second dummy wire (Omnitron-Houston)
6	415	Multiple HF immersion specimens (0.1%)
7	416	Returned source after 3 months of service (treatment) and approx. 3 months storage (Received 12/30/92)
8	417	Fractured wire from wet Teflon test with active source (performed in storage pig) (Received 01/05/93)
9	418	Multiple dilute HF immersion test specimens (labeled 24, 25, and 26) (Received 01/05/93)

#### 4.1.4 Testing performed at Southwest Research Institute

A summary of the tests performed on the different wire samples is summarized in Table 4.2.

#### **4.1.5 Summary of Observations of Tests Performed**

NRC's contractor, SwRI, made the following observations from the tests performed and their visual examinations of the samples.

- (1) No inherent material deficiencies. Composition, hardness, and transition temperature are within material specifications.
- (2) Two service failures, Samples 1 and 2, show similar features.
- (3) Failures occurred by brittle fracture in bending.
- (4) Fractures occurred consistently near bottom of cavity.
- (5) New and returned wires survived bending in Omnitron tests, presumably more severe than any clinical situation.
- (6) Material is subject to cracking and embrittlement in dilute hydrofluoric solutions.
- (7) Sample 7 completely disintegrated in storage pig (a lead container).
- (8) Sample wire 8 experienced brittle failure after wet teflon test with active source.
- (9) Sample wire failures have occurred in afterloader system service (Samples 1 and 2) and in storage facility (Samples 7 and 8).

#### **4.1.6 Implications of Observations to Date**

SwRI stated that their observations as listed in Section 4.1.5, implied the following:

- All factors to date point to failure caused by environmentally induced degradation of properties on nickel-titanium wire in the vicinity of the iridium source.
- The timing and location of initial properties degradation (in-storage versus in-service) are uncertain.
- Possible environmental factors include (1) moisture entrapment (condensation, etc.) (2) hydrogen fluoride from teflon deterioration, and (3) body fluids.

Table 4.2 Summary of Tests Performed on Wire Samples

Wire	Conditions	Metal- lography	Chem- istry	Hardness	Fracto- graphy	EDX	DSC	Comments
No. 1 Ind. wire	Service Failure	√*	x	*√	√	√	x	Two distinct fractures
No. 2 Pitts. wire	Service Failure	√	√	√	√	√	√	Two distinct fractures
No. 3 Bend test	Test Failure - Wire No. 1	x	x	x	√	x	x	No comment
No. 4 1st dummy	From San Diego	√*	x	√*	x	x	x	Fissures on cavity
No. 5 2nd dummy	From Houston	√	√	√	x	x	√	No internal fissures No fracture
No. 6 0.1% HF	Bend test failures	x	x	x	√	x	x	Very brittle
No. 7 Failed wire	3 mos. in service, 3 mos. in storage	x	x	x	√	√	x	Completely deteriorated
No. 8 Failed wire	Test failure- wet teflon & active source	x	x	x	√	√	x	No comment
No. 9 Dilute HF	Bend test failures	x	x	x	√	x	x	Cracks on the surface

√ = Test Result  
x = No test results  
\* = Performed in San Diego

#### **4.1.7 Ongoing Testing**

SwRI, Omnitron's Houston and Edgerly facility, and Omnitron's contractor are continuing to test and analyze the wire. They are testing to determine which, if any, environmental factors listed above caused the source wire to embrittle.

The data suggests that radiation deteriorates the teflon lining in the shipping container producing hydrofluoric acid that attacks the wire's protective surface, allowing hydrogen to embrittle the nickel titanium. Textbooks indicate that teflon degrades from radiation when oxygen is present. However, other environmental factors such as body fluids and moisture entrapment on the wire or within the shipping container are being considered.

Further examinations of the samples received are being analyzed. Chemical analysis of the material within the GPCC wire cavity is being conducted, as well as of material found in the bottom of the shipping container received from Omnitron. Microscopic fissures found within the inside cavity wall on one of the service wire failures is being studied. SwRI will keep NRC apprised of any new observations and will keep them abreast of all testing that is being performed. In addition, as mentioned before, SwRI will provide a more detailed report of the failure analysis once the failure analysis has been completed.

#### **4.2 Immediate Cause of Wire Break**

The nickel titanium source wire used in the Omnitron Model 2000 HDR afterloader in Indiana, Pennsylvania, was shipped from the Edgerly, Louisiana, facility on August 31, 1992.

According to the traveler the source wire had a "Pit at hole entrance .010 inch long." The source wire was reworked by shortening the tip area. The wire was reinspected and passed. All other inspection steps passed with no reported problems. The team reviewed the video tape containing the x-ray of the IRCC source wire. The team determined that sections of the source cavity had a minimum wall thickness of less than 0.089 mm (0.0035 inch). In addition, the team observed from the videotape that the cavity was off center through various portions of the wire.

SwRI and contractors working with Omnitron continue to test the wire. The definitive cause of the wire break is not final.

Test results to date indicate that the source may have been weakened from environmental factors (see Section 4.1.5). The weakest section of the wire is assumed to be at the bottom of the hole because of a void space surrounded by a thin wall and stress concentration produced by the hole. Also, if the source were bent, the torque generated within the cavity section would be most significant at the bottom of the hole. The known constriction distance (82.4 cm) places the cavity section of the wire in the vicinity of the flexineedle connector. During retraction, if the source wire was bent, it would be constricted against the end of the

connector. The resulting stress (bending moment and tensile force) acting on a weakened wire (embrittlement) may cause the wire to break. This effect could be exacerbated by the observed eccentricity of the source wire cavities.

The most likely hypothesis at this time is that the wire was subjected to environmentally induced embrittlement and that during treatment the source wire was bent (probably by the patient moving), causing a constriction at the flexineedle connector. The stresses generated by the bending moment and retraction of the wire (tensile stress) were significant enough to break the weakened source.

During the team's inspection of the afterloader and treatment log, the team determined that this source was cycled 65 times.

### **4.3 Potential Root Cause of Wire Break**

The potential root cause of the source wire breaks was weaknesses in design validation of the Nitinol source wires.

In particular, the team found that Omnitron before the incident—

- performed no engineering calculations on the source wires, especially in the area of the cavity;
- performed a bend fatigue test on two wires, but did not validate the test results by engineering calculations or proper evaluation of the results. The bend fatigue test consisted of smooth, full radii. During treatment, a patient, or equipment, could cause a sharp bend in the source, and Omnitron performed no tests to simulate this condition;
- failed to determine whether the operating environment of the equipment could affect the integrity of the source wire. Environmental embrittlement was not considered, although titanium alloys are subject to hydrogen embrittlement when their protective oxide film is breached. In the absence of this oxide film, other atoms such as carbon, oxygen, and nitrogen can embrittle the titanium;
- failed to perform tests to determine if the catheters would interfere with the integrity of the wire and,
- performed no test to ensure that the degradation of the teflon would not affect the integrity of the source wire. Although, before the incident, Omnitron was aware that there was a degradation of the teflon lining in their shipping container.

A more definitive root-cause evaluation needs to be performed once the immediate cause of the source wire failure is determined.

#### **4.4 Failure of Device To Detect Loss of Part of the Wire**

Omnitron states in its instruction manual for the Omnitron 2000 HDR afterloader that when the source wire is retracted in the safe position, the inactive tail of the source wire reaches a park switch sensor, indicating that the center of the source is located at the center of the lead safe. However, the park switch sensor for the source wire only detects the end of the source wire opposite the source end.

In addition, this manual states:

3. Applicator wire lengths are checked each time the wires are retracted into the machine to ensure the entire wire has been retrieved with no break.
  
7. Fail-safe retract system ensures that applicator wire has been fully retracted.

Omnitron stated that the length of the source wire is checked before the source wire is returned to the safe position (parked) to ensure that no length errors have occurred during treatment. This checking is done by comparing the wire position when the home sensor is activated during extension to the position when the home sensor is deactivated during retraction.

However, this design feature does not allow for a comparison against the physical length of the source wire (a known parameter). This design weakness was clearly demonstrated again on November 17, 1992, when Physicist A at IRCC reran the treatment sequence of the November 16 session. During the November 17 simulation, although the source had already detached from the wire, no errors were detected by the afterloader system because the source wire length leaving (as measured by the afterloader) was the same as the source wire length returned.

Omnitron stated that during a treatment, any source wire length errors are reported to the operator at the main console and will cause a manual retract alarm to sound. However, this design feature is only effective if the source wire is being retracted by the stepping motor. When the emergency dc retract motor is activated, all optical detection mechanisms disengage, and source wire length information is lost. In the November 16, 1992, incident at IRCC, the emergency dc retract motor returned the source wire back into the afterloader. The device configuration did not allow for the detection of the missing source.

#### **4.5 Performance of PrimAlert-10**

The IRCC possessed and used a PrimAlert-10 Area Alarm Monitor (Model Number 05-433, Serial Number C393) manufactured by Victoreen to detect the presence of radiation in the HDR remote afterloader and linear accelerator treatment room. The licensee indicated, as

discussed in Sections 2 and 5 of this report, that although the PrimAlert-10 alarmed, the staff did not heed the alarm because some staff members had experienced previous problems with this monitor. On the basis of this information, the NRC team investigated the performance of the PrimAlert-10 monitor.

The PrimAlert-10 uses an energy-compensated Geiger-Mueller (G.M.) detector to provide a means of monitoring the radiation levels in an area. The PrimAlert-10 monitor is activated when the radiation level exceeds a preset value. The alarm level [0.025 mGy (2.5 mrad) or 0.2 mGy (20 mrad) per hour] is selected by means of a slide switch on the front panel. When the selected alarm level is reached, a pair of bright red bulbs, [approximately 2.54 cm x 2.54 cm (1 inch x 1 inch)] on the face of the instrument flash a warning and continue to flash until the radiation level drops below the preset value or the monitor is reset by unplugging the power supply. This alarm responds—begins to flash—within 2 to 3 seconds after the radiation level exceeds the preset value.

The PrimAlert-10 continuously monitors the background radiation and provides visible proof that the instrument is functioning by a flashing green operation indicator light. The manufacturer's literature states that in high radiation fields, those over 1 Gy (100 rad) per hour, the unit will not jam and will continue to alarm.

The manufacturer suggests that battery and other operational checks be performed before each use to ensure that the instrument is functioning properly. These checks include placing a check source on the top of the front panel in the position indicated to check the alarm. The manufacturer also cautions that the instrument should be used only by persons who have been trained to properly interpret its readings and to appropriately follow the safety procedures required in the presence of radiation. From discussions with the IRCC staff, the team determined that the PrimAlert-10 was not checked with the check source before each use to ensure that the instrument was functioning properly. However, the PrimAlert-10 was observed to alarm as it should when the linear accelerator was on. In addition, they learned that although the IRCC staff had been trained to know that the alarming of the monitor indicated the presence of radiation, they did not understand the alarm setpoint (the preset value) and, as discussed in Section 5, did not have confidence in the alarm indicating a radiation level higher than the alarm setpoint.

On December 2, 1992, the Deputy IIT Team Leader witnessed a test of the PrimAlert-10, using a test source. On December 5, 1992, the IIT Team Leader also witnessed a test of the PrimAlert-10, using Physician A's strontium-90 eye applicator as a radiation source. Physician A conducted the test. These tests confirm that the PrimAlert-10 at IRCC would properly alarm in the presence of radiation.

The team contacted the manufacturer to investigate the performance of the PrimAlert-10 monitor. The team reviewed service data supplied by the manufacturer. The data showed that at the end of the G.M. detector life, the PrimAlert-10 will remain in the alarm mode. The data failed to show a history of intermittent spurious alarms. Further, the team



interviewed the IRCC staff and the staffs of two cancer centers not operated by Oncology Services Corporation (OSC). Inspectors from Region I obtained information from two other OSC facilities. The staff at the IRCC, one other OSC facility, and at the other cancer centers stated that the PrimAlert-10 monitor would sometimes alarm when radiation was not present. In addition, a separate OSC facility experienced a similar problem with a different manufacturer's monitor. Each of these facilities uses a linear accelerator.

The cause of these PrimAlert-10 monitors alarming without the presence of radiation has not been determined. However, an employee of a cancer center not managed by OSC stated that when the PrimAlert-10 monitor was moved further away from the accelerator in their treatment room, the problem with the PrimAlert-10 monitor alarming without the presence of radiation was alleviated. The staff at some of the cancer centers believe that accelerator ionizing radiation levels are so high that these levels may cause some type of radiation damage to a monitor. The NRC team suggested that nonionizing radiation or electromagnetic fields associated with the linear accelerator power source may cause a spurious alarm. Some portable radiation survey meters exhibit this characteristic. The team was unable to resolve this matter.

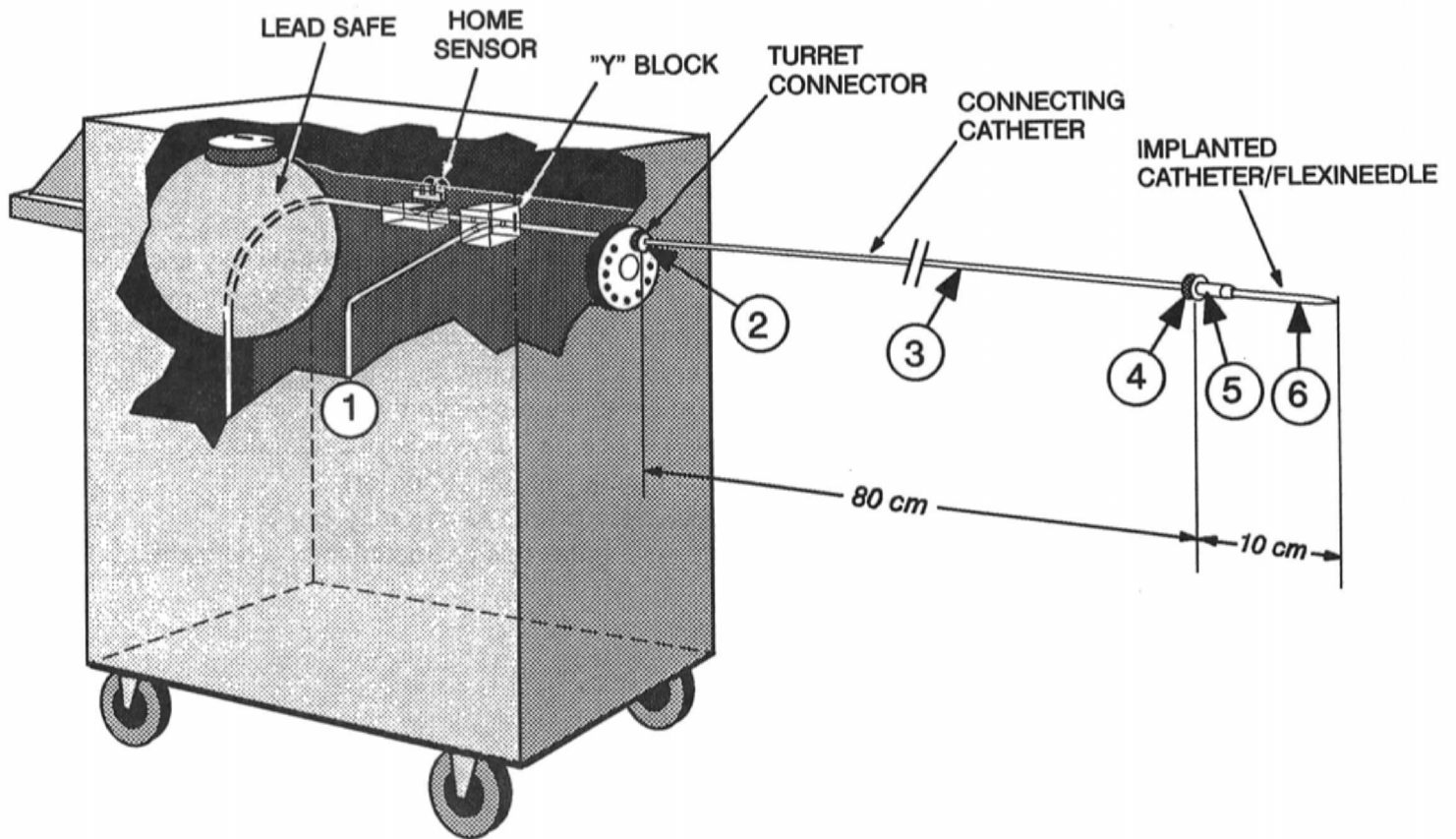

- ① Inside HDR Afterloader
- ② Turret connection (catheter connection)
- ③ Connecting catheter (teflon tube)
- ④ Connecting catheter connector
- ⑤ Flexineedle catheter connector
- ⑥ Flexineedle catheter

Figure 4.1 Source Wire – Possible Failure Areas

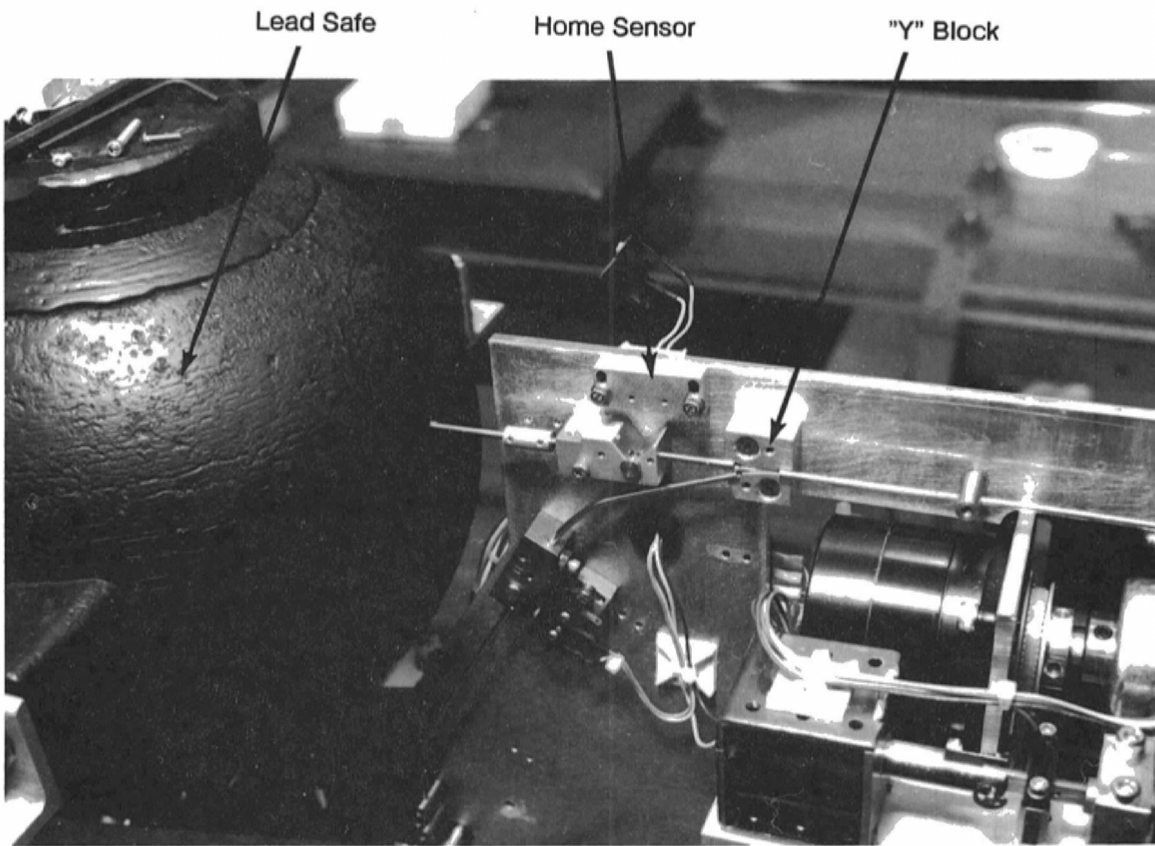
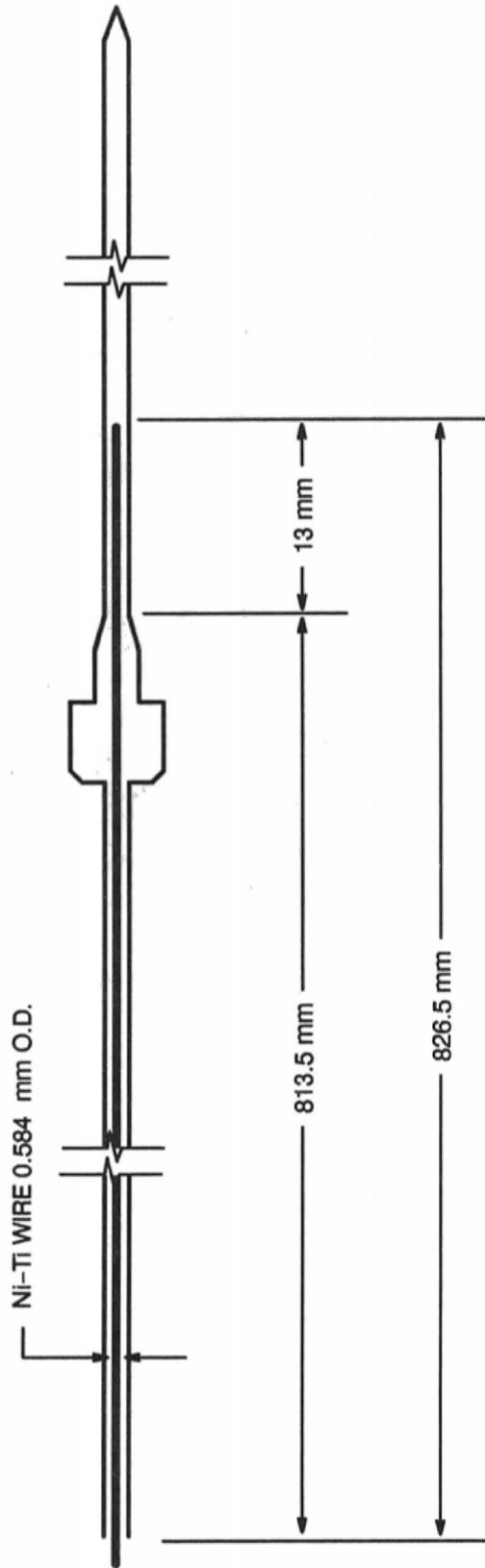

Figure 4.2 Track Where Source Tip May Have Contacted Parts of the Afterloader



NOTE: Drawing not to scale and all dimensions are approximate

Figure 4.3 Connecting Catheter and Flexineedle-Assembled



Figure 4.4 Shipping Container for Iridium-192 Source

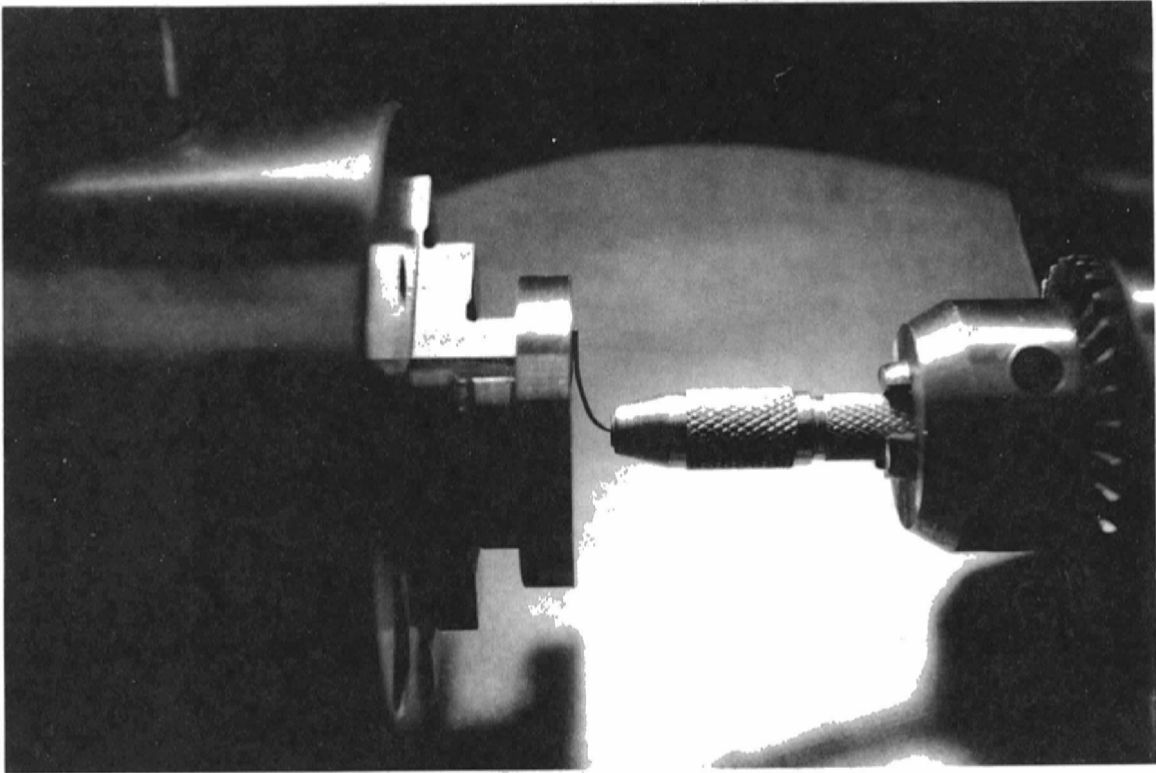

Figure 4.5 Testing of a Sample Wire

## 5 HUMAN FACTORS ANALYSIS

This section discusses the human factors associated with the two previously described source-wire-break incidents (see Section 2). Specifically, it discusses --

- the organizational factors for the licensee, Oncology Services Corporation (OSC); management oversight at the Indiana Regional Cancer Center (IRCC); a comparison of the safety cultures for OSC and IRCC and the Greater Pittsburgh Cancer Center (GPCC), and the physical arrangement of the treatment room and the HDR afterloader system at the two cancer centers; and
- the IRCC's emergency operating procedures, training, and the quality management program for HDR brachytherapy at IRCC.

### 5.1 Organizational Factors

#### 5.1.1 Organization of Oncology Services Corporation

The corporate headquarters of OSC is located in State College, Pennsylvania. OSC managed 10 cancer treatment centers that use HDR afterloader systems in five states, including six located in Pennsylvania that are licensed by NRC Region I. Figure 5.1 presents an organization chart for OSC. OSC also managed a number of other cancer centers that do not use HDR afterloaders. All OSC cancer centers used linear accelerators.

OSC corporate headquarters provided support to the cancer centers in clinical and quality assurance areas. The corporate Radiation Safety Officer (RSO) was located at the Harrisburg Cancer Center and was responsible for providing radiological safety oversight to the cancer centers, including radiological safety program development and implementation, radiological safety audits, and radiation safety training.

Physician C was the chief executive officer of the OSC. Physician B was their medical director and primarily dealt with the physicians at the various centers. Physician D was director of all brachytherapy programs. Managers in the corporate office developed policies and expected the various centers to develop the specific procedures needed to follow these policies.

Physician A was the Medical Director of the IRCC and had full authority in all clinical areas and medical care of patients. Physician A was an authorized medical user on OSC's NRC license.

Medical Physicist A was a contract employee who worked two evenings a week at the IRCC to perform treatment planning and review therapy quality control records. Medical Physicist A reported to Physician A and the RSO. During the day he worked at another hospital that had no affiliation with OSC.

Registered Therapy Technician RTT-B was the lead technologist at the IRCC and supervised the other technologists, RTT-A, and the registered technologist radiographer (RTR). As lead technologist, RTT-B assigned and scheduled work for other technologists. Nurse A reported to Physician A.

### 5.1.2 Management Oversight

**Indiana Regional Cancer Center.** As indicated in Section 5.1.1, the IRCC staff was headed by Physician A who contracted with OSC. Neither Physician A nor the full-time staff at the IRCC were aware of who the RSO was. Physician A was not certain whether he or the corporation had the responsibility of providing radiation safety training. Physician A stated that he was not aware of any formal radiation safety training that the corporation provided to the technologists and other center staff. During interviews, and after being informed by the team who the RSO was, the staff said that the RSO came to the IRCC about once a year.

The RSO stated that Medical Physicist A was responsible for conducting training at the IRCC. Medical Physicist A said he was not responsible for radiological safety training, and, indeed, the physicist's contract did not explicitly list radiological safety training as one of his duties. However, Medical Physicist A's contract listed technical supervision of technologists as a duty. This responsibility was limited to briefings on individual treatment plans, dosimetry, and/or technical aspects of patient treatment. The medical physicist's contract did not specifically list responsibility for HDR brachytherapy support although Medical Physicist A had verbally agreed with OSC to provide this support. The contract had not been updated to reflect this verbal agreement.

### 5.1.3 Safety Culture

The team identified the following overall differences in the safety culture of OSC, IRCC, and GPCC:

**OSC** staff, including corporate managers, believed that the source wire would not break.

**IRCC** staff believed that the source wire would not break. Therefore, the IRCC staff were neither conditioned nor prepared to appropriately respond to a source-wire-break incident. This was demonstrated by IRCC's inadequate response to the November 16 IRCC's incident (see Section 2).

Medical Physicist B at the **GPCC** told the team that after his August 1992 training he believed that a source wire break was a credible, "worst case scenario," accident. He responded appropriately during the source-break incident at the GPCC.



The **IRCC** technologists were not familiar with the operation of the portable survey meter.

Medical Physicist B at the **GPCC**, upon receiving constriction error messages on the computer screen and hearing the audible alarm, entered the treatment room with a portable survey meter. He performed appropriate radiological measurements and assessment and ascertained the location of the source inside the connecting catheter and responded accordingly.

The **IRCC** technologists and Physician A either noticed or were informed that the PrimAlert-10 was flashing red. The technologists stated that the PrimAlert-10 had alarmed multiple times without the presence of radiation in the treatment room, and, they, therefore, assumed the PrimAlert-10 was malfunctioning during the November 16, 1992, incident.

Medical Physicist B at **GPCC** upon receiving an audible alarm of an error and a visual alarm on the computer screen indicating "Emergency Condition, Manual Retract, Check Source Status," immediately entered the treatment room with a portable survey meter and observed that the PrimAlert-10 was flashing red. Medical Physicist B's assessment of the alarming PrimAlert-10 was that the source was not in its shielded configuration and the physicist confirmed this assessment with portable radiation survey meter measurements and responded accordingly.

The **IRCC** technologists had limited knowledge and experience working with radioactive materials. On the basis of their day-to-day experience working with a linear accelerator, they were conditioned to believe that by turning the linear accelerator off, no radiation would be present. This conditioning and the fact that the HDR afterloader indicated that the source was "safe" caused them to believe that the source was inside the machine and that the PrimAlert-10 alarm was spurious. After completing the dummy wire insertions, Medical Physicist A had left the **IRCC** and Physician A was not continuously present at the HDR console during patient treatment. **IRCC** staff had not received a copy of draft procedures: "Oncology Services Corporation, Department of Physics, HDR Treatment Manual."

Medical Physicist B at **GPCC** had prior extensive experience working with radioactive materials, including cobalt-60 teletherapy units and an HDR afterloader. Medical Physicist B performed planning and administration of HDR treatments and was continuously present at the HDR console during patient treatment. In addition, Physician E, who is an authorized user, was watching the patient surveillance camera during the treatment. OSC gave draft procedures, "Oncology Services Corporation, Department of Physics, HDR Treatment Manual," to **GPCC** before the **IRCC** event.

Specific aspects of OSC's, **IRCC**'s and **GPCC**'s safety culture were revealed during the team's personal observations and interviews of personnel.

### **Oncology Services Corporation:**

OSC staff believed that the source wire could not break. OSC's Physician D said he assumed the source wire was safe because the Federal Government had licensed it.

### **Indiana Regional Cancer Center:**

**Source Wire.** IRCC staff believed the source wire could not break and that if the machine malfunctioned the wire would be stuck outside the machine and would need to be manually retracted. The IRCC technologists knew that if the wire was stuck outside the HDR afterloader that it could be manually retracted by using the wheel on the unit or by just pulling the HDR afterloader away from the patient, effectively pulling the source wire out of the patient.

**Survey Meter.** A portable survey meter was positioned close to the HDR afterloader computer console. All of the technologists knew that the meter was there and that it detected radiation. None of the technologists routinely used the survey meter. From direct observation of technologists handling the survey meter, the team found that the technologists were not very familiar with its use. Medical Physicist A said he had shown the technologists how to use the survey meter but this was not documented.

**Alarm Response.** RTR noticed the PrimAlert-10 alarm upon the third entry into the treatment room. RTR notified the other two technologists (RTT-A and RTT-B), who assumed the PrimAlert-10 was not working properly rather than that the device was detecting radiation in the room. The PrimAlert-10 had previously alarmed when no radiation was present. Specifically, it would flash for no apparent reason, presumably indicating radiation in the treatment room. On one occasion, over a year before this November 16, 1992, incident, it had flashed all day. On this occasion, RTT-A brought a portable survey meter into the room, as suggested by Medical Physicist A, to ensure that no radiation was in the room. The survey meter detected no radiation, and the technologists concluded that the PrimAlert-10 was not working properly. The IRCC staff stated they believed that the malfunctioning PrimAlert-10 was sent for repair. The PrimAlert-10 vendor stated that the unit currently used at the IRCC had never been returned for service. Neither the IRCC staff nor the team could determine whether the PrimAlert-10 in the IRCC treatment room at the time of this incident was the instrument that caused confusion a year ago or whether it was a different instrument.

Since the PrimAlert-10 had malfunctioned in the past, the technologists assumed that, if the PrimAlert-10 flashes when the linear accelerator is not turned on or the HDR afterloader is not being used, the monitor was malfunctioning rather than that radiation was present in the treatment room. They, therefore, did not use a portable survey meter upon entering the room after the PrimAlert-10 alarmed on November 16, 1992. RTT-A resolved the problem with the flashing monitor by unplugging the PrimAlert-10 thereby allowing it to reset. RTT-A stated that this had occurred multiple times in the past.

The RTR had not had this mental conditioning because the RTR had not worked at the IRCC as long as the other technologists and because the staff at the other facility where the RTR worked believed their radiation monitors were reliable.

**HDR Afterloader Usage.** Physician B during an interview discussed the fact that most of the OSC facilities had been linear accelerator facilities until the HDR afterloader systems were brought on site. The IRCC received their HDR afterloader in late 1991 and did not begin using it until February 1992. The IRCC did not have a cobalt-60 teletherapy unit. When linear accelerators are turned off no radiation is present, therefore, the IRCC technologists were not used to dealing with a device that contained a radioactive isotope. This lack of experience was exacerbated by the fact that the IRCC staff had only performed about 30 treatments on 10 patients since February 1992.

RTT-A who treated the patient on November 16, 1992, did not know the activity of the source and did not appear to understand its potential radioactive hazard. RTT-A was unaware of the magnitude of exposure received on entering the treatment room if the HDR afterloader source was unshielded.

The IRCC staff believed that if the HDR afterloader failed, they would hear an alarm and see an indication on the HDR computer monitor of the failure. Medical Physicist A believed that if the HDR afterloader failed there would be all kinds of "bells and whistles." The HDR afterloader software is designed to produce visible error message indications on the computer console monitor during dc emergency retraction of the source wire but is not designed to produce any other record. This visible error message indication should have caused a portion of the upper half of the screen to flash red. However, the afterloader system gives no audible alarm for an emergency retraction. The IRCC technologists did not see the error message indications on the computer console monitor. The IRCC staff revealed that they were not very familiar with the error messages associated with the HDR afterloader because Omnitron had not supplied all the meanings of all the error messages to them.

IRCC technologists stated that they did not verify the operation of the treatment room door interlock associated with the HDR afterloader before operating the unit. Additionally, IRCC technologists stated they did not use a check source to verify the operability of the PrimAlert-10 area radiation monitor before HDR afterloader operation.

#### **Greater Pittsburgh Cancer Center:**

**Source Wire.** When Medical Physicist B received his training at the Omnitron facility in Houston, Texas, this physicist asked Omnitron to demonstrate how the HDR afterloader operated. This demonstration lasted about an hour, during which Medical Physicist B discussed the possibility of the wire breaking with the Omnitron representative. Physicist B, upon hearing of the HDR source-wire break at the IRCC, placed a shielded container near the HDR afterloader to be used to contain the source should the source wire break.

**Survey Meter.** Medical Physicist B entered the treatment room with a portable survey meter to check for radiation after hearing the audible alarm. When the portable survey meter indicated radiation, Medical Physicist B acted to protect the patient and to secure the source.

Medical Physicist B said that GPCC has an unwritten policy requiring surveys of the patient after every brachytherapy procedure. Further, OSC managers stated that corporate policy requires the staff to survey each patient with a portable survey meter upon completing treatment and before discharging the patient. Medical Physicist B surveyed the patient with a portable survey meter before the patient's release.

**Alarm Response.** During the GPCC incident, the HDR afterloader gave an audible alarm when the source wire was retracted. Medical Physicist B responded appropriately to this alarm and the alarming PrimAlert-10 and indicated that the PrimAlert-10 alarm stopped when the source was placed in the shielded container.

**HDR Afterloader Usage.** The GPCC had performed 36 HDR afterloader treatments in the 4 months they had possessed the afterloader. Medical Physicist B was the only person authorized to use the HDR afterloader at GPCC. He performed all the planning for the treatments and administered all except one of the treatment procedures. In addition, Physician E was present at the HDR computer console when the December 7, 1992, treatment was being conducted.

Medical Physicist B performed operational and safety checks on a daily basis before operating the HDR afterloader. These included testing the treatment room door interlock and the PrimAlert-10 via a check source.

#### **5.1.4 Physical Arrangement of the Treatment Room and HDR Afterloader System at the Indiana Regional Cancer Center**

At the time of the incident at the IRCC, RTT-A was operating the HDR treatment system from the computer console, and the RTR was also present in the area of the computer console.

Owing to the placement of the computer console and the patient surveillance camera monitor (Figure 3.5), it was difficult for one operator to watch both simultaneously. Additionally, the PrimAlert-10 was located inside the treatment room and was visible through a window in the treatment room door. Therefore, the operator would have to look away from the console and monitor to observe any alarm on the PrimAlert-10. Physician A was not present at the computer console during the treatment, and Medical Physicist A was off the site. In contrast, at the GPCC, Medical Physicist B was watching the computer console and Physician E was watching the patient surveillance camera monitor.

The control console panel may be positioned so that it is in as prominent a position as the computer monitor. The panel and the monitor need to be positioned so that when the console panel alarms, the operator would automatically direct attention to the error messages appearing on the computer monitor.

If the door alarm display panel is used for alarm information, the operator's attention is not automatically directed to error messages appearing on the computer monitor.

While the emergency dc motor is retracting the active source, no alarm is audible, and the error message only stays on the screen until the end of the active wire contacts the park switch. It normally takes approximately 10 seconds for the emergency motor to retract the source. Therefore, the saliency of the alarm indications may be less than optimal.

## **5.2 Emergency Operating Procedures**

Omnitron gave framed operating procedures to be used in an emergency involving the HDR afterloader to IRCC and GPCC. These procedures were not comprehensive and did not address the incidents that occurred at IRCC or GPCC or suggest an appropriate response to either incident. Each center had posted these procedures by the HDR afterloader console, but they were not used during the incident. The procedures did not provide instructions to workers as to "how to" perform any radiological safety functions, including radiological surveys and precautions.

## **5.3 Training**

### **5.3.1 Omnitron Provided Training at the Indiana Regional Cancer Center**

Omnitron provided the team a letter describing the training they had given the staff at the IRCC from which the following information is summarized:

Medical Physicist A had notified Omnitron that Medical Physicist A, RTT-B, and Physician A would be operating the HDR afterloader. On December 9 and 10, 1991, Trainer A from Omnitron trained Physician A, Medical Physicist A, and RTT-B. The training included --

- instruction in the use of the treatment planning computer to plan patient treatments,
- instruction in operation of the HDR afterloader system, a demonstration of the safety features and emergency procedures to be followed, a review of the equipment warranty, and support services that Omnitron provides, and
- a demonstration of the use of the various catheters provided with the system.

On February 27, 1992, Trainer A from Omnitron conducted a review of the operation and safety features of the system. The treatment of the first patient was to be conducted on

February 28, 1992. From the interviews, the team learned that Physician A, Medical Physicist A, and RTT-B had attended this review and that RTT-A and Nurse A were intermittently present when the review was being conducted.

### **5.3.2 Radiation Safety Training at the Indiana Regional Cancer Center**

RTT-A, RTT-B, and RTR stated that during their tenure at IRCC they had not received any formal radiation safety training. All informal training they received was conducted by Medical Physicist A. However, the team could not verify the content of this training. Two technologists stated that the radiation safety training at IRCC was not very good, but the team could not verify whether they had communicated this opinion to their managers. The RSO was under the impression that Medical Physicist A was responsible for training in radiation safety at the IRCC. Medical Physicist A said that the contract with OSC did not explicitly list radiation training or other types of training as one of his duties. The RSO did not consider it appropriate for the RSO to provide radiation safety training to someone with Physician A's qualifications and, further, stated that if Physician A needed this type of training, Physician A should not be approved by the NRC as an authorized user. NRC Region I Inspectors identified similar training weaknesses during a recent inspection at OSC cancer centers in Exton and Mahoning Valley Cancer Centers in Pennsylvania.

## **5.4 Quality Management Program for High Dose Rate Brachytherapy at the Indiana Regional Cancer Center**

OSC's RSO submitted the quality management (QM) program for HDR brachytherapy to the NRC on January 22, 1992. The licensee's QM program was two pages long and addressed the following 10 points:

1. The authorized user was to date and sign each prescription before treatment.
2. The patient's identity was to be verified.
3. The treatment setup was to be verified against the treatment plan before treatment.
4. The staff was required to ask questions concerning the treatment procedure before treatment if they were unsure what to do.
5. Radiographs were required to be taken with dummy sources to verify source positions before treatment.
6. Dose calculation checks were required before patient treatment. Two individuals were to verify input data for the HDR afterloader.
7. The physician was required to sign and date a written record after treatment, indicating the dose administered.

8. The staff was allowed to treat patients without checking the dose calculation before treatment if the delay in treatment would jeopardize the patient's health.
9. A 'radiological physicist' was to perform acceptance tests on each treatment planning or dose calculating computer program for use with the HDR afterloader system.
10. Periodic reviews were required of the QM program for HDR afterloader treatments.

The team noted that the QM program did not provide, and NRC QM requirements may not have required, guidance or any procedural requirements that could have, upon implementation, prevented the occurrence of this incident. The following problems do not appear to be addressed by the QM program:

- Patient left the treatment room with the source inside. The QM program did not address surveying the patient after treatment. If the program had required a patient survey and the staff had followed the program, the radioactive source left in the patient would have been detected and could have been removed before the patient left the cancer center.
- Identification of the implanted catheters was not accomplished. The QM program did not specifically address the need to identify these catheters and, apparently, the IRCC did not label them. Therefore, the implanted catheters could be incorrectly connected to the HDR afterloader.
- The correct emergency response to most error messages was unclear. The QM program did not specifically address how to respond to error messages from the HDR afterloader system.

# Lines of Authority

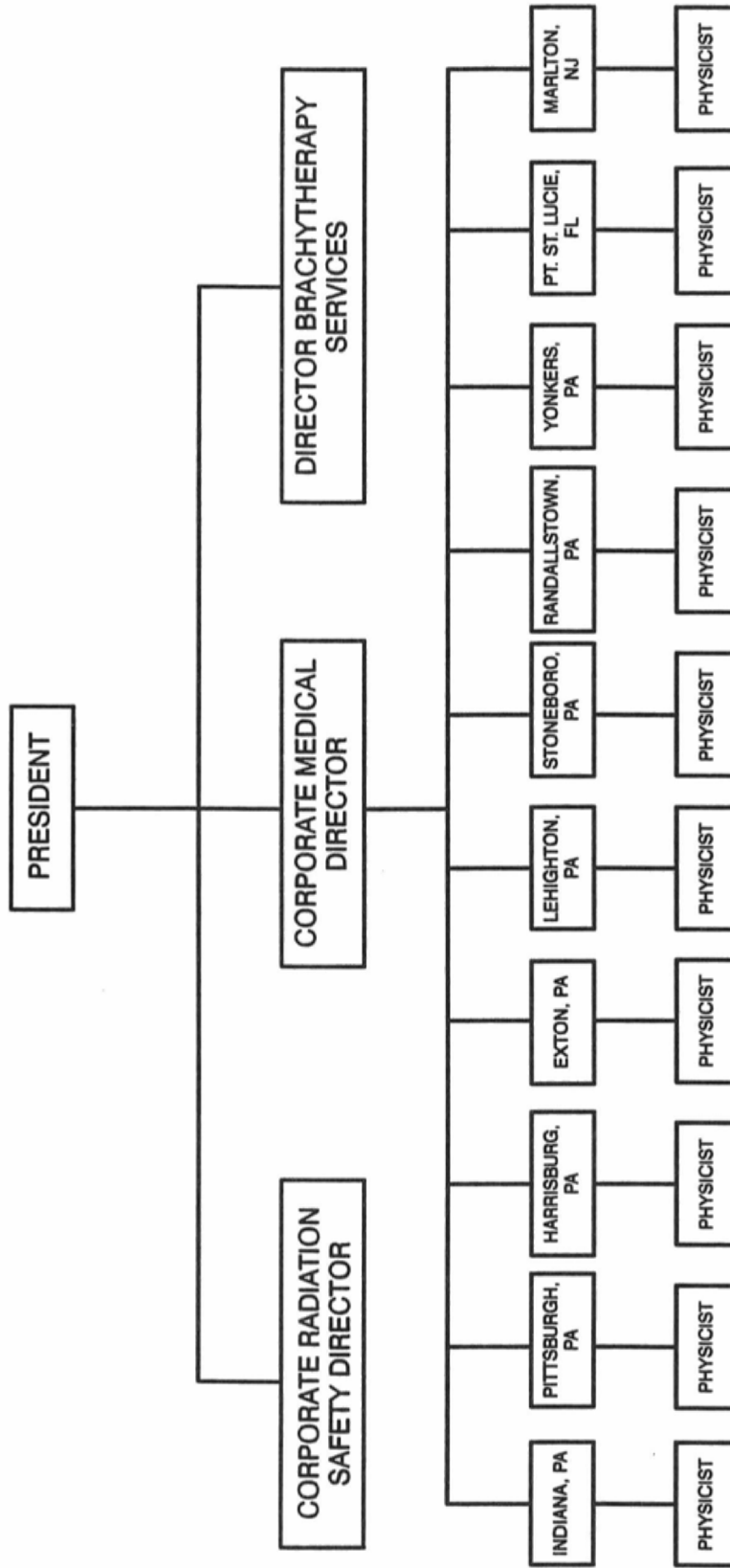

Figure 5.1 Oncology Services Corporation Organizational Chart



## 6 RADIOLOGICAL DOSE EVALUATIONS

The Incident Investigation Team (the team) estimated whole-body and extremity (i.e., hand, forearm) radiation doses for all persons who were known or postulated to have been exposed to radiation from the time the source wire broke at the Indiana Regional Cancer Center (IRCC) on November 16, 1992, until the time the source was eventually recovered at the Browning-Ferris Industries (BFI) in Carnegie, Pennsylvania (BFI-Carnegie) at 4 p.m. on December 1, 1992. The team performed contamination surveys of the IRCC, the Scenery Hill Manor (SHM) nursing home where the patient resided, and the ambulance used to transport the patient after the high dose rate (HDR) treatment. In addition, the Pennsylvania Department of Environmental Resources performed radiation surveys at the SHM nursing home. None of the surveys showed any indication of contamination. Because the source was not in its original shielded container after the source wire broke on November 16, 1992, and because Patient A's body provided little or no attenuation, all radiation dose estimates are based on the assumption that the source remained unshielded until its recovery on December 1, 1992 (see Appendix B).

### 6.1 Overview of Team's Methodology

Radiation doses to individuals (occupational and nonoccupational workers and the general public) were determined from data gathered from interviews with the following individuals:

- the IRCC staff;
- the Scenery Hill Manor (SHM) nursing home staff, residents and visitors;
- employees of Citizens Ambulance Service;
- employees at BFI-Carnegie facility, Pennsylvania;
- employees at BFI-Warren facility, Ohio; and
- other individuals who may have been near the source at any time from November 16 through December 1, 1992.

The team used data from personnel dosimeters worn by occupational workers and gathered information from individuals who were not wearing dosimeters to develop time and motion histories for those with possible exposures. The team used these histories to determine the time spent and the distances involved when in the vicinity of the source. For the purpose of this report, the words "exposure" and "dose" are exchangeable. To confirm the range of estimated radiation exposures to the nine individuals identified as having the highest potential for exposure, the team arranged for cytogenetic studies.

Radiation exposures that the team calculated for individuals who may have received radiation exposure from the iridium-192 source are described in detail in the following sections. Included in each section are the time, distance, shielding factors, and other assumptions that were used in supporting each calculated dose estimate. Each estimate of radiation exposure is presented as a dose range received by that individual based on interviews, re-enactments,

and measurements of probable or known source locations for each of the various facilities where the source was located between November 16 and December 1, 1992.

For a perspective on the magnitude of the range of doses determined from personnel dosimeter measurements, calculations, and cytogenetic studies, the values obtained can be compared to NRC regulatory limits (10 CFR Part 20), recommendations of international and national radiation protection advisory bodies, and normal exposures received by the public from natural background and man-made sources of radiation. The exposure estimates may also be compared with the maximum whole-body dose of 12.5 mSv (1.25 rem) per calendar quarter allowed by the NRC for occupationally exposed individuals. Current NRC regulations have an implied limit of 5 mSv (500 mrem) per year for members of the general public. This limit will become explicit and drop to 1 mSv (100 mrem) per year when the new 10 CFR Part 20 becomes effective on January 1, 1994.<sup>1</sup> This value is in accordance with the recent recommendations of the National Council on Radiation Protection and Measurements.

The estimated total effective dose equivalent rate for an average person's exposure from natural background radiation is 3 mSv (300 mrem) per year.<sup>2</sup> None of the above limits apply to or include natural background or radiation exposures prescribed by a physician. A dose that slightly exceeds the annual dose limit has little biological significance for the individual because any lifetime risk will be only slightly perturbed and can be readily offset by no exposure or reduced exposure to radiation in future years.<sup>3</sup> The biological significance of radiation exposure is discussed in References 3,4 ,5 , and 6 .

As described on the manufacturer's certification of calibration, the unshielded source was determined to be a sealed source containing iridium-192, Serial Number (S/N) 01-01-9282-001-082892-08942-08. This source was manufactured by Omnitron International, Inc. (Omnitron), on August 28, 1992. According to the manufacturer's calibration and leak-test certificate, the source activity was  $3.3085 \text{ E}+11$  Bq (8.942 Ci) on August 28, 1992. On November 16, 1992, when the wire containing the source broke, the source activity was  $1.579 \text{ E}+11$  Bq (4.267 Ci).

Iridium-192 decays with a half-life of 74.02 days by electron capture to osmium-192 (4.7 percent) and by the emission of 0.67 MeV and 0.54 MeV beta particles to platinum-192 (95.3 percent). Approximately 88 percent of the beta particles are absorbed by the source capsule and the remainder are absorbed by the plastic catheter. Therefore, the beta contribution presented little hazard to anyone during the handling and storage of the source in the transportation chain. Eighteen gamma photons are also emitted during the decay of iridium-192, with energies from 0.879 MeV to 0.133 MeV. Appendix B provides several tables that give the activity and dose rate for several distances from the unshielded source.

Because the majority of the gamma rays from iridium-192 are of relatively low energy (from 0.3 to 0.6 MeV), buildup in air results in approximately 5 percent of the exposure rate in air for distances greater than 1 meter. Therefore, the buildup factor cannot be ignored in these

calculations and is included in calculating the radiation dose estimates for each person exposed to the radiation source. Table B-2 in Appendix B calculates the total dose rate from 0.02 to 15 meters, taking into account the buildup of scattered radiation in air and compares the total dose rate to the level with no buildup. Buildup factors used in these evaluations are based on the Berger method (see Appendix B).

Radiation dose estimates for all individuals evaluated during the investigation were based on exposure rates that were calculated using MICROSHIELD<sup>7</sup>, Version 3.13, S/N 327.004, which is a microcomputer adaptation of the mainframe code ISOSHL<sup>8</sup>. This code was used to calculate the dose contribution for specific distances to occupied areas from an unshielded iridium-192 source. Correction factors for radioactive decay, attenuation in materials surrounding the source, and buildup, were included in these calculations. Because of the relatively large magnitude of certain errors associated with the analysis of radiation exposures to individuals, the dose equivalent, sievert (Sv), for gamma radiation is assumed to be essentially equal to the calculated absorbed dose, gray (Gy). Therefore, doses are reported in either units of Sv, cSv (one-hundredth of a sievert), and mSv (one-thousandth of a sievert), or Gy, cGy, and mGy. The team performed dose calculations by hand as a quality check on the MICROSHIELD results. For additional information about MICROSHIELD, see Appendix B.

## **6.2 NRC's Medical Evaluation of the Dosimetry and Effect of Radiation Dose on Patient A**

Radiation absorbed doses to normal healthy tissues and vital organs were calculated by NRC's Medical Consultant assuming a 92.75-hour exposure from a 1.56 E+11 Bq (4.22-Ci) iridium-192 stationary source located at the needle-tip of a 10-cm catheter. Values obtained from the Omnitron 2000 HDR afterloader printout for the half-life of iridium-192 (73.83 days) and decay time (80 days) were used for Patient A's dosimetry calculations. The source location was determined by using the anterior-posterior (AP) and lateral planning films, which had dummy source markers. The information in Section 6.2 was obtained from NRC's Medical Consultant's final report dated January 13, 1993. This section was reviewed and incorporates comments from the NRC Medical Consultant as of January 27, 1993.

### **6.2.1 Radiation Dosimetry on Patient A**

Doses to normal tissues were calculated separately, assuming that each of the five catheters contained the stationary source. The source is 1.0 cm long with a 0.3-cm dead space at the end. Therefore, the source location of the midpoint of the source in each catheter was taken as 0.8 cm from the end of the catheter as marked by the end of the dummy sources on the planning films. These points were translated to the premortem and postmortem patient computerized tomography (CAT) scans from the IRCC planning films. For the dose calculations presented in Tables 6.1(a) and 6.1(b), catheters were arbitrarily labeled A, B, C, D, and E from left to right on the IRCC planning films. Tables 6.1(a) and 6.1(b) provide the normal tissue distances and doses in cGy (rad) for major organs in the body. For

purposes of this report, 1 cGy (rad) is equal to 1 cSv (rem). Each of the five possible source location points was assigned an X,Y,Z coordinate and distances were calculated to a series of normal tissue and X,Y,Z coordinates. All possible source locations were in the posterior pelvis in the perirectal area just superior to the anus.

Physical dosimetry was performed using the Nucletron Planning System (NPS) in the HDR program mode. The following equation was used to adjust each of the calculation points for the actual activity, time, and radioactive decay:

$$D = \frac{T}{t} \frac{A}{a} dX$$

where D	=	Dose in tissue [cGy (rad)]
T	=	Total irradiation time in seconds (92.75 hours = 333,900 sec)
t	=	Dwell time of the NPS system to deliver 6000 cGy (rad) at 1.0 cm (979.9 sec)
A	=	Activity of the source in units of Ci [4.22 Ci (1.56 E+11 Bq)]
a	=	Activity in units of Ci for the NRC Medical Consultant's NPS system iridium-192 source on 01/05/93 [4.844 Ci (1.79 E+11 Bq)]
d	=	Decay factor (0.982, the decay of Ir-192, with a half-life of 74.02 days for 0.5 of the irradiation time)
X	=	Dose calculated at points of interest by the NPS system in units of cGy (rad)

The NPS uses the Van Kleffen, Star algorithm (1979) to correct for tissue absorption and scatter (buildup) in tissue. The majority of dose algorithms differ from each other as distances increase beyond 10 cm.

### 6.2.2 Radiation Effects on Patient A

Table 6.2 shows the tolerance of different tissues for total or partial organ irradiation. It should be emphasized that Table 6.2 is for fractionated radiation at the rate of 1000 cGy (rad) per week as might be given for external beam treatment. The tolerance doses would be much lower if the dose were given at a higher rate or all at one time. A similar comparison can be made between low dose rate (LDR) brachytherapy and HDR brachytherapy. The HDR doses are at rates that are high enough for the exposure to be shorter than the radiobiological normal tissue repair half-time of sublethal damage. This results in more normal tissue damage if the same dose is delivered by HDR as would have been delivered by

LDR. For this reason, in cancer treatment HDR doses are substantially less than LDR treatment doses for equivalent biological effect.

The radiation effects on normal tissue are dependent on a number of factors, including (1) total absorbed dose, (2) time over which a dose is administered, (3) the volume of tissue irradiated, and (4) the specific organ irradiated. Patients can experience acute radiation syndrome and severe bone marrow effects of radiation even though only a portion of the body is irradiated. For example, patients with ovarian cancer are sometimes treated with abdominal-pelvic radiation fields which cover the marrow of the lumbar-sacral (LS) spine and pelvis. Typical doses are 3000 cGy (rad) over six weeks time. Nausea, vomiting, and diarrhea are frequently seen side effects, in addition to bone marrow suppression. The most common limiting acute toxicity is blood-count depression (white blood cells platelets), which is due to bone-marrow injury. Patient A received approximately 2000 cGy (rad) minimum dose to the bone marrow of the LS spine region over a very short time (4 days). Because of this relatively short time, the effects on the bone marrow would be much greater than if Patient A would have received 3000 cGy (rad) over 6 weeks.

Bowel intolerance is another major dose-limiting factor in the treatment of tumors of the abdomen and pelvis. Acute small bowel reactions result in nausea, vomiting, painful abdominal cramps, and diarrhea. In the human, it is known that the small bowel mucosa denudes between 3-7 days following a large radiation dose. Superficial ulceration of bowel with denuding of the villi allow a pathway for bacterial invasion. With sufficient dose and volume of bowel irradiated, death due to the gastrointestinal (GI) syndrome can occur within 3-10 days with significant diarrhea leading to dehydration, with electrolyte loss. Patient A had already been irradiated to normal small bowel tolerance in 1991 when she had to be hospitalized several times due to severe chemo-radiation GI toxicity and related secondary infections.

In addition to the effects on the bone marrow, the intestine, and related infectious complications, the radiation effects on the rectum, the bladder, and the kidney are important in this case. Doses in the range of a half million to a million cSv (rem) should cause extensive necrosis in a few days and possible rectal perforation. If rectal perforation had not occurred by the time Patient A died in 5 days, it would have occurred later. Similar conclusions could be drawn on the effects on the bladder and perhaps also on the kidneys, which received lower doses.

The local HDR treatment that Patient A received on November 16, 1992, was an attempt to control the local cancer without causing additional irradiation to the small bowel and other normal tissues away from the anal tumor. Unfortunately, the HDR overdose was so massive, normal tissues higher and outside the pelvis were irradiated beyond normal tissue tolerance levels.

Within a few hours of Patient A's return to the SHM nursing home, Patient A's condition suddenly and dramatically deteriorated, starting with repeated episodes of nausea, vomiting,

and increased rectal pain. Observations after several days included a warm, reddened, swollen rectal area, diarrhea, tachycardia, fever, poor skin turgor suggesting dehydration, and finally a piece of grey-black tissue stuck to the catheter (which presumably contained the source) that fell out after 4 days. NRC's Medical Consultant concluded that the clinical deterioration of the patient coincided with the radiation accident. The sequence of symptoms and observations were consistent with a severe acute radiation syndrome.

Analysis of Patient A's medical records by NRC's Medical Consultant indicated that the massive radiation overdose was either a probable cause of death, or a probable contributing cause of death in Patient A. Some life-threatening effects including bone marrow suppression had not yet reached their peak. In addition, if Patient A had lived longer, she would have suffered within weeks, or months, with other severe, acute, or delayed effects, including new or additional episodes of bowel obstruction, bowel perforation, fistulae, strictures, and tissue necrosis along with delayed vital organ failure owing to the radiation dose having exceeded the expected normal tissue tolerance for that organ system. This radiation accident would probably have resulted in a fatality in a younger, healthier patient within days or weeks of an equivalent exposure. Based on analysis of the clinical records, the approximate location of the iridium-192 source in the pelvis, and the massive overexposure Patient A received, the effect of the radiation could contribute to her death in a number of ways, alone or in combination, within a 5-day period. Analysis of medical records and physical dosimetry would suggest that one likely mechanism of death from radiation for the range of possibilities would be acute GI injury with secondary sepsis, dehydration, and electrolyte imbalance.

### **6.2.3 Postmortem Examination**

A postmortem examination was conducted on December 21, 1992, at the request of the Indiana County Coroner on Patient A. In order to better understand the radiation effects and to pinpoint the exact location and distance of various critical organs from the source location in the pelvis, the Indiana County Coroner invited NRC's Medical Consultant to observe the autopsy. At the request of the Coroner, radiological contamination surveys were performed by NRC's Medical Consultant. No radioactive contamination externally or internally was found.

From the direct measurements taken from the body, the actual perineal needle puncture sites were found to be in general agreement with the diagrams provided by the IRCC. In addition, NRC's Medical Consultant stated that there appeared to be gross changes and tissue destruction consistent with radiation effect. In a press release dated January 26, 1993, the Indiana County Coroner stated that the cause of death listed in the official autopsy report was "Acute Radiational Exposure and Consequences Therof."

**Table 6.1(a) Normal Tissue Distances from Possible Source Location in Patient A**

	Source location in centimeters				
	A	B	C	D	E
	1. Rectum	1.5	1.5	1.5	1.5
2. Bladder (closest point)	4.7	6.0	3.0	2.2	2.2
3. Bladder (median point)	9.1	8.6	6.7	5.7	6.2
4. Small bowel (closest point)	8.5	9.3	7.3	6.0	6.3
5. Small bowel (median point)	15.5	15.2	12.7	11.4	11.4
6. Small bowel (furthest point)	23.9	23.7	22.5	22.1	22.2
7. LS spine/pelvis bone marrow (furthest point)	25.4	25.3	24.9	25.7	25.4
8. Right kidney (median point)	19.3	20.7	21.2	22.3	22.3
9. Left kidney (median point)	20.6	19.2	18.7	20.3	19.8
10. Liver (median point)	25.1	25.4	24.6	25.4	25.2
11. Right lung (median point)	38.6	39.2	39.0	39.8	39.5
12. Left lung (median point)	39.2	38.5	37.8	38.7	38.1
13. Heart (closest point)	30.4	29.7	28.8	29.6	29.1
14. Heart (left ventricle)	34.1	33.5	32.8	33.6	33.1
15. Brain	71.0	71.0	71.0	71.0	71.0

**Table 6.1(b) Normal Tissue Dose (cGy) Versus  
Possible Source Location in Patient A**

	Source location				
	A	B	C	D	E
1. Rectum	776,956	776,956	776,956	776,956	776,956
2. Bladder (closest point)	78,221	47,605	193,483	360,663	360,663
3. Bladder (median point)	20,142	22,667	37,979	52,857	44,520
4. Small bowel (closest point)	23,226	19,244	31,836	47,605	43,086
5. Small bowel (median point)	6,369	6,655	9,897	12,497	12,497
6. Small bowel (furthest point)	2,283	2,332	2,653	2,772	2,742
7. LS spine/pelvis bone marrow (furthest point)	1,956	1,976	2,058	1,898	1,956
8. Right kidney (median point)	3,842	3,250	3,068	2,712	2,712
9. Left kidney (median point)	3,289	3,889	4,139	3,406	3,616
10. Liver (median point)	2,017	1,956	2,122	1,956	1,996
11. Right lung (median point)	620	593	602	567	580
12. Left lung (median point)	593	625	660	616	645
13. Heart (closest point)	1,219	1,298	1,409	1,310	1,371
14. Heart (left ventricle)	887	932	989	925	964
15. Brain	86	86	86	86	86

Note: 1 cGy = 1 rad.



**Table 6.2 Tolerance of Different Tissues to Radiation Exposure\***

Organ	Type of damage	TD 5/5 (Gy)	TD 50/5 (Gy)	Total or partial organ irradiation (Field size or length)
Bone marrow	Aplasia, pancytopenia	2-5/30	4-5/40	Total/partial
Liver	Acute and chronic hepatitis	25/15	40/20	Partial/total
Bladder†	Contracture, fistula	-	80	Whole
Intestine	Ulcer, perforation, hemorrhage	45/50	55/65	400 cm <sup>2</sup> /100 cm <sup>2</sup>
Brain	Infarction, necrosis	50	60	Whole
Rectum†	Proctitis, ulcer, stricture, fistula	-	80	100 cm <sup>2</sup>
Heart	Pericarditis and pancarditis	45/70	55/80	50%/25%
Lung	Acute and chronic pneumonitis	30/15	50/25	100 cm <sup>2</sup> /total
Kidney	Acute and chronic nephrosclerosis	15/20	20/25	Total/partial

TD: tolerance dose (5/5 and 50/5 % and 50% of severe complications at 5 years) The alternatives in the last column refer to the alternative values of dose and to total or partial organ irradiation. For example, 2-5 Gy to the whole bone marrow results in 5% severe complications and 4-5 Gy gives 50%. For partial irradiation the doses are 30 Gy and 40 Gy. For purposes of this report,  
 † 1 Gy = 1 Sv.

Note: 1 Gy = 100 rads

\* Source: "Introduction to Radiobiology," by Maurice Tubiana, Jean Dutreix, and Andre Wambersie, Taylor & Francis, p. 138, London, England, 1990

† Source: "Radiation Biology and Radiation Pathology Syllabus," American College of Radiology, 1975

### **6.3 Evaluation of Radiation Doses for Occupational Workers at the Indiana Regional Cancer Center**

Employees at IRCC were exposed to the iridium-192 source during patient treatment, catheter manipulation, implanted catheter removal, and source retrieval. Employees at IRCC who may have received occupational doses of radiation were —

- Registered Therapy Technician (RTT)-A
- RTT-B
- Registered Technologist Radiographer (RTR)
- Nurse A
- Medical Physicist A
- Physician A

The evaluation of radiation exposure for each of these employees is based on the dosimeter reports and interviews with the IRCC staff. The results are presented in Table 6.3 and discussed in the following sections.

#### **6.3.1 Dose for RTT-A**

When the staff experienced difficulty inserting the source wire in the last of five catheters and when subsequent dummy wire insertions were unsuccessful, RTT-A entered the treatment room several times to attempt to straighten the connecting catheter. After several error messages appeared on the HDR afterloader computer screen, Physician A instructed RTT-A to disconnect the catheters from the patient and move the patient to the stretcher room with the assistance of the RTR. After moving the patient to the stretcher room, RTT-A returned to accelerator patient treatment duties. The team used RTT-A's dosimeter reading of 8.20 mSv (0.820 rem) for November 5 to December 4, 1992, as the dose received from exposure to the source. RTT-A's year-to-date exposure was 8.20 mSv (0.820 rem).

#### **6.3.2 Dose for RTT-B**

During the failures in dummy wire insertions previously mentioned, RTT-B entered the treatment room twice with RTT-A to attempt to straighten the connecting catheter. RTT-B then returned to paperwork duties.

The team used RTT-B's dosimeter reading of 1.10 mSv (0.110 rem) for November 5 to December 4, 1992, as the dose received from exposure to the source. RTT-B's year-to-date exposure was 1.10 mSv (0.110 rem).

#### **6.3.3 Dose for RTR**

The RTR entered the treatment room three times to see to the patient's needs and to assist RTT-A. After several error messages appeared on the computer screen, the RTR was

instructed to assist RTT-A in removing Patient A from the treatment room to the stretcher room. RTR then returned to accelerator patient treatment duties. The team used RTR's dosimeter reading of 1.40 mSv (0.140 rem) for November 5 to December 4, 1992, as the dose received from the exposure to the source. The RTR's year-to-date exposure was 1.50 mSv (0.150 rem).

#### **6.3.4 Dose for Nurse A**

After Patient A was removed from the treatment room and placed in the stretcher room, Nurse A and Physician A removed the implanted catheter found to have loose stitches. The team used Nurse A's dosimeter reading of 6.30 mSv (0.630 rem) for November 5 to December 4, 1992, as the dose received from the exposure to the source. Nurse A's year-to-date exposure was 6.30 mSv (0.630 rem).

#### **6.3.5 Dose for Medical Physicist A**

Medical Physicist A's only exposure to the source was during source retrieval. Medical Physicist A and Physician A retrieved the source from BFI-Carnegie. The team used Medical Physicist A's dosimeter reading of 1.20 mSv (0.120 rem) for November 5 to December 4, 1992, as the dose received from the exposure to the source. Medical Physicist A's year-to-date exposure was 1.90 mSv (0.190 rem).

#### **6.3.6 Estimated Dose for Physician A**

As described in the previous sections, Physician A was exposed to the source on three occasions:

1. When he entered the treatment room after another set of error messages with RTT-A and RTT-B to attempt to straighten the catheter. Physician A was estimated to have been 0.5 to 1.0 meters (20 to 39 inches) away from the source for 1 minute while in the treatment room.
2. When he removed the implanted catheter with Nurse A. Physician A was estimated to have been 0.5 to 1.0 meter (20 to 39 inches) away from the source for 3 minutes while in the stretcher room.
3. When he retrieved the source with Medical Physicist A. Physician A was estimated to have been 0.5 to 1.0 meter (20 to 39 inches) from the source for 1.2 minutes while at BFI-Carnegie.

Physician A stated that he did not wear his dosimeter during any of these possible exposures. The calculated doses from the above time and distance data give an estimated exposure from 1.82 to 7.21 mSv (182 to 721 mrem). The dose can also be estimated by summing the film badge doses received by individuals that participated with Physician A in each of the above

activities. This total would have been 8.60 mSv (0.860 rem). Therefore, the team is estimating the dose to Physician A to be the sum of each dose received by RTT-B, Nurse A, and Medical Physicist A, totaling 8.60 mSv (0.860 rem). Even with this more conservative approach, Physician A's dose is less than the NRC quarterly limit.

**Table 6.3 Summary of Radiation Doses for Indiana Regional Cancer Center Occupational Workers**

Exposed individuals	Activity causing radiation exposure	Range of distance from source (m)	Dose rate range* (mSv/hr)	Estimated exposure time (Minutes)	Total dose range (mSv)	Total dose range (mrem)
Physician A	Catheter manipulation and catheter removal on 11-16-92	0.5-1.0	21.0-83.2	4.0	1.82-7.21 (8.60) ‡	182-721 (860) ‡
	Source retrieval on 12-01-92	0.5-1.0	21.0-83.2	1.2		
RTT-A	Catheter manipulation and patient removal from treatment room	-	-	-	8.20 †	820 †
RTT-B	Catheter manipulation	-	-	-	1.10 †	110 †
RTR	Patient care and patient removal from treatment room	-	-	-	1.40 †	140 †
Medical Physicist A	Source retrieval	-	-	-	1.20 †	120 †
Nurse A	Catheter removal	-	-	-	6.30 †	630 †
				<b>TOTALS:</b>	Person-Sv 0.027	Person-rem 2.7

\* Rate from unshielded iridium-192 source containing 1.579 E+11 Bq (4.267 Ci) on November 16, 1992, using Microshield 3.13 with point-source geometry and Berger build-up factor. 1 mSv = 100 mrem

† Total dose reported from dosimeter reports

‡ Total dose reported from dosimeter reports for RTT-B + Nurse A + Medical Physicist A

## **6.4 The Public**

When the team arrived in Indiana, Pennsylvania, on December 2, 1992, NRC's medical consultant worked with the SHM nursing home staff to determine the number of employees who may have been exposed to the iridium-192 source. In addition, residents and visitors of SHM nursing home may have been exposed to the source while it remained at the nursing home from November 16 through 25, 1992.

BFI employees at both the Carnegie, Pennsylvania, and Warren, Ohio (BFI-Warren), sites were also exposed to radiation from the iridium-192 source while it remained at these two facilities from November 25 to December 1, 1992. These exposures, however, were much less than those encountered at SHM nursing home because of two major factors: (1) the distance from the source to the persons exposed was, on the average, much greater at the BFI facilities, and (2) the time spent near or around the source was relatively short, in most cases, less than a few hours.

In some isolated cases, however, an individual may have been exposed to the iridium-192 source any number of ways from November 16 to December 1, 1992, for example: (1) while visiting a resident other than Patient A at the nursing home; (2) while driving by or parking near the rear entrance of SHM nursing home when the source was in the outside storage area; (3) by driving past one of the BFI trucks as it carried the source during transit; or (4) possibly, standing near one of the BFI trucks as it drove by carrying the source. Even in the most conservative estimates for an individual inadvertently exposed to the source in these specific scenarios, the potential calculated dose to this person would be less than the allowable exposure to a member of the general public according to NRC regulations (10 CFR Part 20).

The estimated potential and actual radiation exposures are described in the following sections.

### **6.4.1 Nonoccupational Radiation Doses for Workers and Visitors to Indiana Regional Cancer Center**

The team estimated potential doses of nonoccupational radiation exposure for employees who were not involved with treating Patient A and visitors to the IRCC who were exposed to the iridium-192 source on November 16, 1992.

During the treatment, Patient A was in a shielded treatment room. After the IRCC staff experienced difficulty using the HDR afterloader to insert the source wire into the last catheter, Patient A was moved from the shielded room to the stretcher room (see Figure 6.1). Patient A remained in this room for 10 minutes awaiting the arrival of the ambulance service employees to transport Patient A to SHM nursing home. For this 10-minute period, all nonoccupational workers and visitors to IRCC were potentially exposed to the source. Table 6.4 depicts their range of distances from the source location in the stretcher room and,

hence, the range of potential doses received by those individuals who received nonoccupational exposures at IRCC. Depending on the estimated distance from the source, the calculated doses to these individuals ranged from as low as 0.04 mSv (4.0 mrem) to as high as 13.9 mSv (1.39 rem). Figure 6.1 shows isodose curves at the IRCC on November 16, 1992.

Table 6.4 Summary of Radiation Doses for Indiana Regional Cancer Center Nonoccupational Workers and Patients							
Exposed individuals	Activity causing radiation exposure	Range of distance from source (m)	Dose rate range* (mSv/hr)	Estimated exposure time (Minutes)	Total dose range* (mSv)	Total dose range* (mrem)	
Patient C	Waiting-GWA	6.2- 6.5	0.55- 0.60	10	0.09 - 0.10	9-10	
Patient D	Waiting-GWA	6.2- 6.5	0.55- 0.60	10	0.09 - 0.10	9-10	
Patient E	Waiting-GWA	6.2- 6.5	0.55- 0.60	10	0.09 - 0.10	9-10	
Patient F	Waiting-GWA	6.2- 6.5	0.55- 0.60	10	0.09 - 0.10	9-10	
Patient G	Waiting-GWA	6.2- 6.5	0.55- 0.60	10	0.09 - 0.10	9-10	
Patient H	Waiting-GWA	6.2- 6.5	0.55- 0.60	10	0.09 - 0.10	9-10	
Patient I	Waiting-GWA	6.2- 6.5	0.55- 0.60	10	0.09 - 0.10	9-10	
Patient J	Receiving care in exam room adjacent to S.R.	1.9- 4.7	1.02- 5.92	10	0.17 - 0.99	17-99	
Phlebotomist	Stood beside patient in T.R.	0.5- 1.0	21.0 -83.2	10	3.5 -13.9	350-1390	
Office Manager	Working in secretary office	6.4-10.0	0.24- 0.56	10	0.04 - 0.09	4-9	
Medical Secretary	Working in secretary office	6.4-10.0	0.24- 0.56	10	0.04 - 0.09	4-9	
Tumor Registrar	Working in secretary office	6.4-10.0	0.24- 0.56	10	0.04 - 0.09	4-9	
GWA = Gowned waiting area near stretcher room S.R. = Stretcher room T.R. = Treatment room				TOTALS:	Person-Sv	Person-rem	
					0.004-0.016	0.442-1.586	

\* Rate from unshielded iridium-192 source containing 1.579 E+11 Bq (4.267 Ci) on November 16, 1992, using Microshield 3.13 with point-source geometry and Berger build-up factor.  
1 mSv = 100 mrem



#### **6.4.2 Estimates of Possible Radiation Doses for Employees and Visitors to the Doctor's Office Adjacent to the IRCC Stretcher Room**

The team found that three employees of the adjacent doctor's office (ADO) and two patients visiting the ADO were potentially exposed to the source on November 16, 1992. The ADO is located southwest and adjacent to the IRCC stretcher room (see Figure 6.1). Using conservative estimates, the team estimated the exposure time for these individuals to be 10 minutes (the time Patient A spent in the IRCC stretcher room). The team estimated the distance the ADO employees and visitors spent near the source from the office's layout plan, which was supplied by the staff in the ADO, and the IRCC's blueprint of the building. As shown in Table 6.5, the maximum estimated exposure that these persons received was 4.3 mSv (430 mrem).

**Table 6.5 Summary of Radiation Doses for Adjacent Physician's Personnel and Patients**

Exposed individuals	Activity causing radiation exposure	Range of distance from source (m)	Dose rate range* (mSv/hr)	Estimated exposure time (minutes)	Total dose range (mSv)	Total dose range (mrem)
Patient K	Waiting for care adjacent to IRCC stretcher room	0.90-1.20	14.64-25.88	10	2.4 - 4.3	240 - 430
Patient L	Waiting for care adjacent to IRCC stretcher room	0.90-1.20	14.64-25.88	10	2.4 - 4.3	240 - 430
Administrative Aide A	Working in office near IRCC stretcher room	2.50-6.50	0.55- 3.46	10	0.09 - 0.58	9 - 58
Administrative Aide B	Working in office near IRCC stretcher Room	2.50-6.50	0.55- 3.46	10	0.09 - 0.58	9 - 58
Laboratory Employee	Working in lab near IRCC stretcher room	4.00-7.00	0.48- 1.39	10	0.08 - 0.23	8 - 23
				<b>TOTALS:</b>	<b>Person-Sv</b>	<b>Person-rem</b>
					0.005-0.010	0.51 - 1.00

\* Dose rate from unshielded iridium-192 source containing 1.579 E+11 Bq (4.267 Ci) on November 16, 1992, using Microshield 3.13 with point-source geometry and Berger build-up factor. 1mSv = 100 mrem

### **6.4.3 Estimates of Possible Radiation Doses for Citizens Ambulance Service Staff**

Two ambulance service employees were exposed to the iridium-192 source during transport of Patient A after Patient A received HDR treatment on November 16, 1992. The team measured probable distances that the ambulance service employees maintained from the source in Patient A and estimated the time spent at each distance based on the ambulance service's dispatch log. The team estimates that the ambulance aide received a dose in the range of 13.3 mSv (1.3 rem) to 25.7 mSv (2.6 rem), while the ambulance driver received from 4.8 mSv (0.48 rem) to 8.4 mSv (0.84 rem) (Table 6.6). The estimated dose range for the ambulance aide is higher because he spent the time in transit to SHM nursing home sitting across from Patient A approximately 58 cm (22.8 inches) away (Figure 6.2).

Table 6.6 Summary of Radiation Doses for Ambulance Service Employees

Exposed individual	Activity causing radiation exposure	Range of distance from source (m)	Dose rate range* (mSv/hr)	Estimated exposure time (Minutes)	Total dose range (mSv)	Total dose range (mrem)
Ambulance Driver	Loaded patient	0.80-1.10	17.39-32.69	6	4.8-8.4	480-840
	Drove ambulance	2.40-2.60	3.20- 3.75	13		
	Unloaded patient	0.80-1.10	17.39-32.69	8		
Ambulance Aide	Loaded patient	0.80-1.10	17.39-32.69	6	13.3-25.7	1330-2570
	Sat beside-transit	0.50-0.70	42.60-83.17	13		
	Unloaded patient	0.80-1.10	17.39-32.69	8		
				TOTAL:	Person-Sv	Person-rem
					0.02-0.03	1.81-3.41

\* Dose Rate from unshielded iridium-192 source containing 1.579 E+11 Bq (4.267 Ci) on November 16, 1992, using Microshield 3.13 with point-source geometry and Berger build-up factor. 1mSv = 100 mrem.

#### 6.4.4 Nursing Home

The SHM nursing home is a State-licensed, 58-bed nursing home offering skilled, intermediate, and respite care to the community of Indiana, Pennsylvania, located approximately 104.6 km (65 miles) east-northeast of Pittsburgh, Pennsylvania. On average, there are 45 occupants residing in the home at any given time.

The home employs three working shifts: 7 a.m. to 3 p.m.; 3 p.m. to 11 p.m.; and 11 p.m. to 7 a.m. For the first two shifts, three staff members are assigned to each resident: a registered nurse (RN) for treatment, a licensed practical nurse (LPN) for administering medication to residents, and a certified nurse assistant (CNA) as an aide. In those instances where a graduate practical nurse (GPN) was employed on a shift, an RN was still required to provide any medical treatment that a resident would need. For the evening shift (11 p.m. to 7 a.m.), only two staff members were assigned to a resident: an LPN and a CNA. Table 6.7 identifies the SHM nursing home staff assigned to Patient A the week of November 16 through 20, 1992.

**Table 6.7 Schedule for Nursing Staff Assigned to Patient A  
Week of November 16 - 20, 1992**

Date	Shift	Assigned employee	Estimated hours with Patient A
11/16/92	7:00 a.m.- 3:00 p.m.	RN A LPN A CNA A	1 1.3 2
	3:00 p.m. - 11:00 P.M.	RN B GPN A CNA B	1 1.3 2
	11:00 p.m. - 7:00 a.m.	LPN B CNA C	1.3 2
11/17/92	7:00 p.m. - 3:00 p.m.	RN B LPN C CNA D	1 1.3 2
	3:00 p.m. - 11:00 p.m.	RN C LPN A CNA E	1 1.3 2
	11:00 p.m. - 7:00 a.m.	LPN B CNA C	1.3 2
11/18/92	7:00 a.m. - 3:00 p.m.	RN A GPN A CNA A	1 1.3 2
	3:00 p.m. - 11:00 p.m.	RN C LPN D RN B (CNA duties)	1 1.3 2
	11:00 p.m. - 7:00 a.m.	LPN B CNA F	1.3 2
11/19/92	7:00 a.m. - 3:00 p.m.	RN B LPN C CNA G	1 1.3 2
	3:00 p.m. - 11:00 p.m.	RN C GPN A CNA E	1 1.3 2
	11:00 p.m. - 7:00 a.m.	LPN B CNA C	1.3 2
11/20/92*	7:00 a.m. - 3:00 p.m.	RN D GPN A CNA H	0.2 0.2 0.2

\* These time estimates assume that each of the three employees on duty for Patient A spent 10 minutes near the stored red-bag waste (0.8-1.0 meters) inside the soiled utility room where the source was kept until approximately 8:30 a.m. on November 20, 1992.

For purposes of estimating distances from the iridium-192 source for each of the three types of nursing staff (RNs, LPNs, and CNAs) as well as other SHM nursing home employees, the following information was based on interviews with the nursing staff and individuals involved with providing care to Patient A and nurse's notes about this resident from November 16 through 20, 1992:

- **Registered Nurses** These individuals were on the average between 1 to 1.3 meters (39.4 to 51.2 inches) away from Patient A when providing medication to Patient A. Some of those interviewed stated that the RNs at SHM nursing home spent approximately 10 to 15 minutes with Patient A every 2 hours ( $15 \text{ min}/2 \text{ hr} \times 8 \text{ hr/day} = 1 \text{ hr}$ ).
- **Licensed Practical Nurses** were on the average between 0.8 to 1.0 meters (31.5 to 39.4 inches) away when providing medication and checking vital signs of Patient A. Some of those interviewed stated that the GPN and LPNs at SHM nursing home spent approximately 20 minutes every 2 hours ( $20 \text{ min}/2 \text{ hr} \times 8 \text{ hr/day} = 1.3 \text{ hr}$ ) with Patient A.
- **Certified Nurse Assistants** were on the average between 0.75 to 0.9 meters (29.6 to 35.5 inches) away from Patient A while performing their daily duties. These duties include bed baths, perineum care, assistance with feeding, assistance with bed pan, and any other assistance necessary that Patient A requested. Some of those interviewed stated that the CNAs at the SHM nursing home spent approximately 15 to 30 minutes every 2 hours ( $30 \text{ min}/2 \text{ hr} \times 8 \text{ hr/day} = 2 \text{ hr}$ ), or as Patient A required assistance.

Because of the specific care that the CNA's provided to Patient A, these individuals were most likely to have received the highest extremity dose of any of the SHM nursing staff owing to either having their hand at close proximity to the source or by actually handling the catheter in which the source was dislodged. The radiation dose to the hand is usually limited by the magnitude of dose received by the skin because the hand does not include vital tissues such as blood-forming organs (i.e., active bone marrow). The maximum calculated dose to the hand (deep tissue) of an individual was 1.6 Gy (160 rad) (see Table 6.9). Because there was no beta contribution to these doses, it is reasonable to assume that the maximum dose to the skin of the hand was also 1.6 Gy (160 rad). In addition, Table 6.14 provides extremity dose estimates for BFI employees involved in this incident. This maximum dose was found to be below the threshold for early erythematous reactions of 2 Gy (200 rad). No skin damage is anticipated because the maximum dose was also well below the moist skin desquamation induced dose of approximately 11 Gy (1100 rad).<sup>9</sup>

- **Activities Director** was estimated to have been 4.1 to 9.1 meters (13.5 to 29.8 feet) away from the outside waste storage area (where the source was stored before shipping) when working in the Recreation Room. On the basis of discussions with

the Activities Director, the team determined that this individual spent approximately 5 hours per day in this room on November 20, 23, and 24. On November 25, when the medical waste containing the source was removed from the SHM nursing home, the team estimated from an interview with the Activities Director that the Director spent 1.5 hours at her desk that morning, which was approximately 9.1 meters (29.8 feet) away from the outside waste storage area where the source was stored November 20 through 25, 1992.

- **Dietician** was, on the average, 1.5 to 2.0 meters (59 to 78.7 inches) away when providing meals (or other information regarding the resident's diet) to Patient A. The team estimated that the dietician at SHM nursing home spent approximately 10 minutes each day with Patient A.

Figure 6.3 is a diagram of the dose rates at different distances for individuals who may have been in contact with Patient A from November 16 through 20, 1992.

- **Maintenance Man** was estimated to have been 0.4 to 0.5 meters (15.8 to 19.7 inches) away from the source when moving the red-bag waste from the inside soiled utility room (next to Room 9) to the outside waste storage room on November 20, 1992. Figure 6.4 shows the soiled utility room illustrating isodose curves from the iridium-192 source on November 20, 1992. The amount of time estimated to walk from the inside soiled utility room to the outside waste storage area, and then to place the red-bag waste in a BFI carton was approximately 5 minutes.

The amount of time the maintenance man spent thereafter in the outside waste storage room is 2 minutes each for the 7:30 a.m. and 3:30 p.m. pickup of red-bag waste. The estimated distance from the source during this period was between 0.5 to 0.75 meters (19.7 to 29.6 inches). The total time that the maintenance man spent inside the outside waste storage room after November 20 was [4 min/day x 5 days (11/21-11/25)] 20 minutes.

The team assessed the doses to two individuals known to be pregnant at the time of the incident on November 16, 1992. One of these individuals, CNA-I, was not assigned to Patient A during the week of November 16 through 20, 1993, but helped to assist other CNA's who were assigned to Patient A during this period. Blood samples were taken from this individual on two separate occasions during the incident investigation to verify the team's initial dose calculations for this individual. In addition, time-motion studies were performed to calculate an estimated dose. CNA I stated that she assisted other CNA's on November 17, but had spent most of her time with Patient A on November 20, 1992. Because the source was no longer in Patient A's body on November 20 and because the time she spent with Patient A before this date was relatively short, the team estimates that CNA-I received on average a dose of about 5 mSv (500 mrem).



In addition to CNA I, the Dietician was also known to be pregnant at the time of the incident. As described in Table 6.8, the Dietician received an average dose of about 5 mSv (500 mrem) for this time period. Current guidance provides a limit of 5 mSv (500 mrem) for the embryo-fetus.

Table 6.8 gives a summary of whole body dose estimates for SHM nursing staff during the week of November 16 through 20, 1992. Table 6.9 gives a summary of dose estimates for extremity (i.e., hand and forearm) exposures for SHM nursing staff the week of November 16 through 20, 1992.

**Table 6.8 Summary of Whole Body Dose Estimates for SHM Nursing Home Staff**

Exposed individuals	Activity causing radiation exposure	Range of distance from source (m)	Dose rate range* (mSv/hr)	Estimated exposure time (hours)	Total dose range (mSv)	Total dose range [rem]
RN A	Treatment	1.0 - 1.3	21.0-12.5	2	42 - 25	4.2 - 2.5
RN B	Treatment	1.0 - 1.3	21.0-12.5	3	137 - 89 (Total)	13.7 - 8.9 (Total)
	Aide (11/18)	0.75 - 0.9	37.1-25.8	2		
RN C	Treatment	1.0 - 1.3	21.0-12.5	3	63 - 38	6.3 - 3.8
RN D**	Near Utility room	0.8 - 1.0	32.6-21.0	0.17	5.5 - 3.6	0.55 - 0.36
GPN A	Medication	0.8 - 1.0	32.6-21.0	4.17	136 - 88	13.6 - 8.8
LPN A	Medication	0.8 - 1.0	32.6-21.0	2.67	87 - 56	8.7 - 5.6
LPN B	Medication	0.8 - 1.0	32.6-21.0	5.33	174 - 112	17.4 - 11.2
LPN C	Medication	0.8 - 1.0	32.6-21.0	2.67	87 - 56	8.7 - 5.6
LPN D	Medication	0.8 - 1.0	32.6-21.0	1.33	43 - 28	4.3 - 2.8
CNA A	Aide	0.75 - 0.9	37.1-25.8	4	148 - 103	14.8 - 10.3
CNA B	Aide	0.75 - 0.9	37.1-25.8	2	74 - 52	7.4 - 5.2
CNA C	Aide	0.75 - 0.9	37.1-25.8	6	223 - 155	22.3 - 15.5
CNA D	Aide	0.75 - 0.9	37.1-25.8	2	74 - 52	7.4 - 5.2
CNA E	Aide	0.75 - 0.9	37.1-25.8	4	148 - 103	14.8 - 10.3
CNA F	Aide	0.75 - 0.9	37.1-25.8	2	74 - 52	7.4 - 5.2
CNA G	Aide	0.75 - 0.9	37.1-25.8	2	74 - 52	7.4 - 5.2
CNA H**	Near Utility room	0.8 - 1.0	32.6-21.0	0.17	5.5 - 3.6	0.55 - 0.36
CNA I	Assisting CNAs 11/17/92	0.75 - 0.9	37.1-25.8	0.17	6.2 - 4.3	0.62 - 0.43
Maintenance Man A	Initial transfer of red-bag waste on 11/20/92	0.4 - 0.5	130-83.1	0.08	38 - 19 (Total)	3.8 - 1.9 (Total)
	Subsequent transfer of daily waste	0.5 - 0.75	83.1-37.1	0.33		
Dietician	Visits, residents rooms	1.5 - 2.0	9.4 - 5.3	0.67	6.3 - 3.6	0.63 - 0.36
Activities Director	Develops and participates in SHM activities 11/20, 11/23-24	4.1 - 9.1	1.32- 0.29	15	22 - 4.8 (Total)	2.2 - 0.48 (Total)
	Develops activities at desk 11/25	9.0 - 9.1	0.296-0.290	1.5		
					Person-Sv	Person-rem
<b>TOTALS</b>					1.67 - 1.10	167 - 110

\* Dose rate from an unshielded iridium-192 source containing 1.579 E+11 Bq [4.267 Ci] on November 16, 1992, using MICROSHIELD 3.13 with point-source geometry and Berger build-up factor.

\*\* These individuals spent approximately 10 minutes near (0.8 - 1.0 meters) the soiled utility room where the source was inadvertently placed on November 20, 1992.  
Note: 1 mSv = 100 mrem

**Table 6.9 Summary of Extremity Dose Estimates for Selected SHM Nursing Home Staff**

Exposed individuals	Activity causing radiation exposure	Range of distance from source <sup>†</sup> (m)	Dose rate range* (Sv/hr)	Total estimated exposure time (hours)	Total dose range (Sv)	Total dose range (rem)
LPN B**	Assisting CNA C (11/20)	0.10 - 0.20	2.1 - 0.51	0.17	0.36 - 0.09	36 - 8.7
CNA A	Aide	0.20 - 0.30	0.51 - 0.23	2	1.02 - 0.46	102 - 46
CNA B	Aide	0.20 - 0.30	0.51 - 0.23	1	0.51 - 0.23	51 - 23
CNA C**	Aide Aide (11/20)	0.20 - 0.30 0.15 - 0.20	0.51 - 0.23 0.92 - 0.51	2.83 0.17	1.6 - 0.74 (Total)	160 - 74 (Total)
CNA D	Aide	0.20 - 0.30	0.51 - 0.23	1	0.51 - 0.23	51 - 23
CNA E	Aide	0.20 - 0.30	0.51 - 0.23	2	1.02 - 0.46	102 - 46
CNA F	Aide	0.20 - 0.30	0.51 - 0.23	1	0.51 - 0.23	51 - 23
CNA G	Aide	0.20 - 0.30	0.51 - 0.23	1	0.51 - 0.23	51 - 23

† Ranges of distances for perineal care estimated from time-motion studies and personal interviews. Distances are approximated.  
 \* Dose rate from an unshielded iridium-192 source containing 1.579 E+11 Bq (4.267 Ci) on November 16, 1992, using MICROSHIELD 3.13 with point-source geometry and Berger build-up factor.  
 \*\* These individuals found the dislodged iridium-192 source in Patient A's bed on November 16, 1992.  
 Note: 1 Sv = 100 rem

In addition to the number of staff who were exposed to the radiation source during November 16 through 20, 1992, Patient A received seven different visitors (relatives and friends). Because there was no visitor log maintained at the entrance of the facility, the team cannot determine the exact number of visitors that may have entered the facility and traveled past Room 4B. Even if several visitors were to have been near this room, or in the hallway near Room 4B, the resulting exposures would have been relatively low due to the short period of time spent at these locations. Distances and estimated times of the hours visited were established through interviews with relatives, friends, and the SHM nursing home staff. In addition, the daily nurse's notes provided valuable information as to when visitors arrived and departed. Interviews with Relative A and Friend A gave the team specific information about the time each spent with Patient A and at what distance. Relative A stated that she spent approximately one-third of her time with Patient A at close proximity [between 0.5 to 1 meter (1.6 to 3.3 feet)]. Friend A stated that she spent approximately 2.5 hours with Patient A [estimated distance 0.75 to 1.5 meters (29.5 to 59 inches)]. Table 6.10 provides detailed information as to the dates, times of visitation, estimated distance from Patient A, and calculated doses while they were at the SHM nursing home.

The team estimated doses for several of the residents that were known to have been exposed to the source for the entire period of November 16, 1992, 11 a.m., through November 20, 1992, 6:15 a.m., (91.25 hours total) while the source remained inside Patient A. Isodose curves for the rooms adjacent to Patient A are shown in Figure 6.5. These estimated doses are summarized in Table 6.11. All of the residents listed in Table 6.11 except Residents K and M participated in several activities in the Recreation Room during November 20 through 25, 1992.

The team assumed that the residents in nearby rooms were exposed to the source while it remained inside Patient A for 91.25 hours. The highest of these doses, those for Residents B, C, and M, were verified independently by cytogenetic analysis (see Section 6.5.2).

**Table 6.10 Summary of Radiation Doses for Relatives and Friends  
During November 16 - 20, 1992**

Exposed individuals	Date visited	Range of distance from source (m)	Dose rate range* (mSv/hr)	Estimated exposure time (hours)	Total dose range (mSv)	Total dose range [rem]																																																								
Relative A	11/17/92	0.5 - 1.0	83.1-21.0	1.25	166 - 54.4 (Total)	16.6-5.4 (Total)																																																								
		1.0 - 1.5	21.0- 9.4	3.0			Relative B	11/16/92	1.0 - 1.2	21.0-14.6	2.0	42.0-29.2	4.2-2.9	Relative C	11/16/92 11/18/92	0.9 - 1.2	25.8-14.6	0.5	64.5-36.5 (Total)	6.4-3.6 (Total)	2.0	Relative D	11/16/92 11/18/92	1.2 - 1.5	14.6- 9.4	0.5	36.5-23.5 (Total)	3.6-2.4 (Total)	2.0	Relative E	11/18/92 11/19/92	1.0 - 1.2	21.0-14.6	0.75	31.5-21.9 (Total)	3.1-2.2 (Total)	0.75	Relative F	11/18/92 11/19/92	1.0 - 1.2	21.0-14.6	0.75	31.5-21.9 (Total)	3.1-2.2 (Total)	0.75	Friend A	11/19/92	0.75- 1.5	37.1-9.4	2.5	92.8-23.5	9.3-2.4						Person-Sv	Person-rem	<b>TOTALS</b>		
Relative B	11/16/92	1.0 - 1.2	21.0-14.6	2.0	42.0-29.2	4.2-2.9																																																								
Relative C	11/16/92 11/18/92	0.9 - 1.2	25.8-14.6	0.5	64.5-36.5 (Total)	6.4-3.6 (Total)																																																								
				2.0			Relative D	11/16/92 11/18/92	1.2 - 1.5	14.6- 9.4	0.5	36.5-23.5 (Total)	3.6-2.4 (Total)	2.0	Relative E	11/18/92 11/19/92	1.0 - 1.2	21.0-14.6	0.75	31.5-21.9 (Total)	3.1-2.2 (Total)	0.75	Relative F	11/18/92 11/19/92	1.0 - 1.2	21.0-14.6	0.75	31.5-21.9 (Total)	3.1-2.2 (Total)	0.75	Friend A	11/19/92	0.75- 1.5	37.1-9.4	2.5	92.8-23.5	9.3-2.4						Person-Sv	Person-rem	<b>TOTALS</b>					<b>0.46-0.21</b>	<b>46.3-21.1</b>											
Relative D	11/16/92 11/18/92	1.2 - 1.5	14.6- 9.4	0.5	36.5-23.5 (Total)	3.6-2.4 (Total)																																																								
				2.0			Relative E	11/18/92 11/19/92	1.0 - 1.2	21.0-14.6	0.75	31.5-21.9 (Total)	3.1-2.2 (Total)	0.75	Relative F	11/18/92 11/19/92	1.0 - 1.2	21.0-14.6	0.75	31.5-21.9 (Total)	3.1-2.2 (Total)	0.75	Friend A	11/19/92	0.75- 1.5	37.1-9.4	2.5	92.8-23.5	9.3-2.4						Person-Sv	Person-rem	<b>TOTALS</b>					<b>0.46-0.21</b>	<b>46.3-21.1</b>																			
Relative E	11/18/92 11/19/92	1.0 - 1.2	21.0-14.6	0.75	31.5-21.9 (Total)	3.1-2.2 (Total)																																																								
				0.75			Relative F	11/18/92 11/19/92	1.0 - 1.2	21.0-14.6	0.75	31.5-21.9 (Total)	3.1-2.2 (Total)	0.75	Friend A	11/19/92	0.75- 1.5	37.1-9.4	2.5	92.8-23.5	9.3-2.4						Person-Sv	Person-rem	<b>TOTALS</b>					<b>0.46-0.21</b>	<b>46.3-21.1</b>																											
Relative F	11/18/92 11/19/92	1.0 - 1.2	21.0-14.6	0.75	31.5-21.9 (Total)	3.1-2.2 (Total)																																																								
				0.75			Friend A	11/19/92	0.75- 1.5	37.1-9.4	2.5	92.8-23.5	9.3-2.4						Person-Sv	Person-rem	<b>TOTALS</b>					<b>0.46-0.21</b>	<b>46.3-21.1</b>																																			
Friend A	11/19/92	0.75- 1.5	37.1-9.4	2.5	92.8-23.5	9.3-2.4																																																								
					Person-Sv	Person-rem																																																								
<b>TOTALS</b>					<b>0.46-0.21</b>	<b>46.3-21.1</b>																																																								

\* Dose rate from an unshielded iridium-192 source containing 1.579 E+11 Bq (4.267 Ci) on November 16, 1992, using MICROSHIELD 3.13 with point-source geometry and Berger build-up factor.

Table 6.11 Summary of Radiation Doses for SHM Residents During November 16 - 20, 1992						
Exposed Individuals	Activity causing radiation exposure	Range of distance from source (m)	Dose rate range* (mSv/hr)	Estimated exposure time (hours)	Total dose range (mSv)	Total dose range (rem)
Resident B	In adjacent room	2.6 - 4.9	3.2 - 0.94	40	128 - 37.6	12.8-3.8
Resident C	In adjacent room	2.7 - 4.9	2.9 - 0.94	68	197 - 63.9	19.7-6.4
Resident D	Room down the hall	4.3 - 8.5	1.2 - 0.33	70	84.0-23.1	8.4-2.3
Resident E	Room down the hall	10.6 - 12.4	0.22 - 0.16	70	15.4-11.2	1.6-1.1
Resident F	Room across hall	6.7 - 7.2	0.52 - 0.45	61	31.7-27.5	3.2-2.8
Resident G	Room across hall	8.1 - 9.0	0.36 - 0.30	61	22.0-18.3	2.2-1.8
Resident H	Room across hall	6.7 - 7.2	0.52 - 0.45	76	39.5-34.2	4.0-3.4
Resident I	Room across hall	8.1 - 9.0	0.36 - 0.30	72	25.9-21.6	2.6-2.2
Resident J	Room across hall	8.7 - 11.4	0.32 - 0.19	76	24.3-14.4	2.4-1.4
Resident K	Room across hall	9.8 - 11.4	0.25 - 0.19	91.25	22.8-17.3	2.3-1.7
Resident L	In adjacent room	7.2 - 11.1	0.45 - 0.20	61	27.5-12.2	2.8-1.2
Resident M	Room near soiled utility room	11.4 - 15.5 (Distance from Room 4B)	0.19 - 0.11	91.25	90.9-57.3 (Total)	9.1-5.7 (Total)
		0.8 - 1.0 (Distance from soiled utility room)	32.7 - 21.0	2.25		
Resident N	Room near soiled utility room	11.4 - 16.1 (Distance from Room 4B)	0.19 - 0.10	60	23.4-13.8 (Total)	2.3-1.4 (Total)
		2.0 - 2.5 (Distance from soiled utility room)	5.35 - 3.46	2.25		
				<b>TOTALS</b>	<b>Person-Sv</b>	<b>Person-rem</b>
					<b>0.73-0.35</b>	<b>73.2-35.2</b>

\* Dose rate from an unshielded iridium-192 source containing 1.579 E+11 Bq [4.267 Ci] on November 16, 1992, using MICROSIELD 3.13 with point-source geometry and Berger build-up factor.

The SHM nursing home provides medical care and, in addition, a recreation room that offers residents a variety of diversions from which to choose; therefore, many of the residents in the home occupy the recreation room daily. On the basis of an interview with the Activities Director, who was responsible for developing and coordinating all activities at the SHM nursing home, and a review of the activities calendar for November 1992; the team developed Table 6.12 that describes the number of activities, the approximate number of residents in the Recreation Room for each activity, the estimated distance the residents were from the outside waste storage room (where the source was later stored), estimated total dose range for each resident that participated in each activity, and the total collective dose for each activity in the Recreation Room. Figure 6.6 shows the isodose curves for the Recreation Room for the iridium-192 source while located in the outside storage room from November 20 through 25, 1992.

Table 6.12 shows that the total collective dose for *each* activity ranged from 0.003 to 0.030 person-Sv (0.26 to 3.0 person-rem). Because there are no records of the residents who were participating in each activity, only the collective dose for each activity can be calculated. If it is assumed, however, that the same residents participated in all of the activities at the SHM nursing home during November 20 through 25, 1992, then the total dose for each of the residents would be between 8.32 to 3.36 mSv (832 to 336 mrem). The collective dose for the recreation room activities is the sum of the dose for each activity, or 0.15 to 0.06 person-Sv (15.0 to 5.9 person-rem).

The catheter containing the source remained in SHM's outside waste storage room until 9:25 a.m. on Wednesday, November 25, 1992, when BFI Driver A picked up all the red-bag waste (3 boxes) generated by the SHM nursing home.

**Table 6.12 Summary of Radiation Doses for SHM Nursing Home Residents While in Recreation Room During November 20 - 25, 1992**

Date	Time for activity (hr)	Activity	Estimated no. of residents	Ranges of distance from source (m)	Dose rate range <sup>a</sup> (mSv/hr)	Dose <sup>b</sup> range for each resident (mSv)	Total collective dose <sup>c</sup> for each activity (person-Sv)	Total collective dose <sup>c</sup> for each activity (person-rem)	
11/20/92	0.5	Reading	15	4.1-8.4	1.32-0.34	0.66-0.17	0.010-0.003	0.99-0.26	
11/20/92	1.0	Games	20	4.1-8.4	1.32-0.34	1.32-0.34	0.026-0.007	2.6 -0.68	
11/20/92	1.0	Church	20	4.1-6.1	1.32-0.62	1.32-0.62	0.026-0.012	2.6 -1.2	
11/22/92	1.5	Music	15	4.1-6.1	1.32-0.62	1.98-0.93	0.030-0.014	3.0 -1.4	
11/23/92	1.0	Exercise	20	4.1-6.1	1.32-0.62	1.32-0.62	0.026-0.012	2.6 -1.2	
11/23/92	1.0	Music	15	7.5-8.4	0.40-0.34	0.40-0.34	0.006-0.005	0.60-0.51	
11/24/92	1.0	Birthdays	20	4.1-8.4	1.32-0.34	1.32-0.34	0.026-0.007	2.6 -0.68	
11/25/92	1.0	Comedy <sup>d</sup>	N/A	N/A	N/A	N/A	N/A	N/A	
<b>TOTALS</b>							mSv <sup>e</sup>	Person-Sv	Person-rem
							8.32-3.36	0.15-0.06	15.0-5.9

<sup>a</sup> Dose rate from an unshielded iridium-192 source containing 1.521 E+11 Bq [4.110 Ci] on November 20, 1992, using MICROSHIELD 3.13 with point-source geometry and Berger build-up factor.  
<sup>b</sup> Time participating in activity (hours) multiplied by the dose rate (mSv/hour).  
<sup>c</sup> The collective dose equals the total dose (in mSv) multiplied by the number of residents participating in each activity.  
<sup>d</sup> Waste containing source was removed from SHM at 9:25 a.m. Wednesday, November 25, 1992, prior to comedy activity.  
<sup>e</sup> Total dose for each resident assuming that each resident went to all the activities listed above.

Note: 1 mSv = 100 mreem



#### **6.4.5 Browning-Ferris Industries Transit and Storage**

BFI is a waste management company that had two separate facilities involved in the transit and storage of the iridium-192 source. At the time of the incident, BFI had a firm policy that prohibits the acceptance of specific levels of radioactive material in biomedical waste. The policy set for the screening levels of medical waste is  $0.5 \mu\text{Sv}$  ( $50 \mu\text{rem}$ ) per hour. BFI has an informal agreement with the Ohio Environmental Protection Agency to report all received shipments above  $0.5 \mu\text{Sv}$  ( $50 \mu\text{rem}$ ) per hour.

For comparison purposes, the naturally occurring background radiation level at each of the BFI facilities—BFI-Carnegie and BFI-Warren—varies between  $0.07$  to  $0.15 \mu\text{Sv}$  ( $7$  to  $15 \mu\text{rem}$ ) per hour. BFI-Warren places a portable survey meter in each vehicle and fixed radiation monitors at each processing facility to sound an alarm at readings at or above  $0.2 \mu\text{Sv}$  ( $20 \mu\text{rem}$ ) per hour. Neither BFI-Carnegie nor BFI-Warren were authorized or permitted to handle radioactive material at any of the medical waste facilities and, thereby, established a strict policy to prohibit the entrance of any radioactive waste.

BFI employees are trained in the use and operation of portable survey meters. Each BFI-Carnegie straight truck (see Figure 2.9) that is used to pick up medical waste from generators is equipped with a portable survey meter similar to the one illustrated in Figure 6.7. In addition, all BFI-Carnegie straight-truck drivers are also required to wear radiation dosimeters (i.e., film badges) during work hours.

All BFI-Carnegie straight truck drivers are required to perform a radiation survey with their portable survey meters before accepting any waste on the truck. In addition, the drivers must sign a statement on the bottom of the shipping manifest that all packages at each location of pick-up have been surveyed with their portable survey meter. Contrary to BFI's policy, BFI Driver A, who was the driver of the straight truck that picked up waste at the SHM nursing home, stated that he did not use his survey instrument at the SHM nursing home on November 25, 1992.

Although the BFI-Carnegie policy states that (1) each straight-truck driver must survey all waste containers that are placed in the tractor-trailer, (2) survey the tractor-trailer before transportation of the waste, and (3) sign a statement on the manifest form stating that all these surveys have been completed, BFI-Carnegie Driver B was not supplied with a portable survey meter. Therefore, BFI Driver B could not have surveyed the tractor-trailer or boxes because he did not have a survey meter available. As a followup note, BFI has since purchased portable survey meters for each BFI tractor-trailer.

#### **6.4.6 Browning-Ferris Industries Search and Retrieval**

For purposes of estimating distances from the radioactive source for each of the BFI employees, the team developed the following information from interviews with employees

and time-motion studies at BFI-Carnegie regarding isolation of the box that contained the radioactive source:

- **BFI Driver A** drove the BFI-Carnegie straight truck on November 25, 1992. Because the SHM nursing home was his 12th stop of the day, the team estimated that the source was located approximately midway in the truck, or about 4.6 meters (15 feet) from the driver. The team estimated that for each stop the driver made after the SHM nursing home, he would be between 4.5 to 4.6 meters away from the box containing the source. For a brief period while he unloaded the truck (approximately 1 minute), he was estimated to be between 2 to 2.5 meters away from the box containing the radioactive source (10 stops x 1 min/stop = 10 minutes between 2 to 2.5 m). The total dose estimated for BFI Driver A is between 7.3 to 6.4 mSv (0.73 to 0.64 rem).

However, on January 15, 1993, BFI Driver A provided a statement to the team which stated that he was wearing a film badge on November 25, 1992. BFI Driver A's film badge report indicated that BFI Driver A received 1.7 mSv (0.17 rem) for this period. The team used the dosimetry report value of 1.7 mSv (0.17 rem) for the assigned dose to this individual.

Although BFI Driver A stated that he did not survey for radioactive material at the SHM nursing home, he did state that he surveyed for waste at 10 additional stops *after* picking up the waste at the home. Because of the high radioactivity of the source, the team finds it unlikely that the source was not detected, and that his film badge reading was not higher than 1.7 mSv (0.17 rem).

- **BFI Driver B** drove the tractor-trailer from BFI-Carnegie to BFI-Warren on November 27, 1992. Because the team determined that the container was the last loaded onto the trailer, it was approximately 12.2 meters (40 feet) from the driver during transit. Except for initially checking the shipment at the beginning of the trip, which took about 15 minutes at a distance of about 1.5 meters (4.9 feet) from the box containing the source, Driver B was between 12.0 to 12.2 meters away from the source for the duration of the trip.
- **BFI Driver C** drove the tractor-trailer from BFI-Warren to BFI-Carnegie on November 27, 1992 (see Figure 2.13). Because it had been determined that the trailer contained radioactive material, the driver stayed at the maximum distance away from this material while driving it back to BFI-Carnegie. The driver was estimated from the source to be between 12.0 to 12.2 meters (39 to 40 feet) during transit.
- **Medical Waste Supervisor A** spent approximately 1.5 hours at a distance between 0.75 to 1.5 meters (2.5 to 5 feet) away from the box while trying to determine which of the red bags contained the radioactive source. Once the source was located,

Supervisor A left for the day, and asked Safety Technicians A and B to continue searching through the box for identifying information.

- **Safety Tech A** spent approximately 1.5 hours within a distance of 0.75 to 1.25 meters (2.5 to 4.1 feet) and helped to identify the box containing the radioactive source. An additional 30 minutes was spent after the initial location of the box as Safety Technician A opened up the box and began to search through the red-bag waste [approximate distance during these 30 minutes was 0.5 to 0.75 meter (1.6 to 2.5 feet)]. In addition, this individual helped Medical Physicist A and Physician A when they retrieved the source from BFI-Carnegie on December 1, 1992.
- **Safety Tech B** spent approximately 1.5 hours within a distance of 0.75 to 1.25 meters (2.5 to 4.1 feet) and helped to identify the box containing the radioactive source. After the initial location of the box, Safety Technician B spent an additional 30 minutes at an approximate distance of 0.75 to 1.0 meters (2.5 to 3.3 feet) from the source holding the portable survey meter and searching through the red-bag waste.

Figure 6.8 shows the position of Supervisor A, Safety Technician A, and Safety Technician B around the box [78.7 cm by 53.3 cm by 53.3 cm (31 inches by 21 inches by 21 inches)] showing isodose curves in mSv per hour.

- **Other BFI Employees** (11 employees) worked on Saturday, November 28, 1992: three individuals in the maintenance shop, four in the main office, and four in the recyclery. The closest of these buildings, the container shop, is approximately 107 to 122 meters (350 to 400 feet) from the trailer containing the source. The exposure rate at this distance is between 0.0021 to 0.0016 mSv (0.21 to 0.16 mrem) per hour. Assuming that every worker was working in the container shop, each worker would receive a total dose of 0.017 to 0.013 mSv (1.7 to 1.3 mrem) for this 8-hour day. On November 29, 1992, only two people worked at BFI-Carnegie. These employees worked in the maintenance shop on this day. Assuming an 8-hour work day, at a distance of between 150 to 180 meters (490 to 590 feet), their total dose would have been 0.007 to 0.004 mSv (0.7 to 0.4 mrem). The total collective dose for November 28 and 29, 1992, would be 0.19 to 0.14 person-mSv (0.019 to 0.014 person-rem).

Table 6.13 summarizes the whole body dose estimates for BFI-Carnegie employees for November 25 through December 1, 1992. Table 6.14 summarizes the extremity doses for BFI-Carnegie employees for November 25 through December 1, 1992.

**Table 6.13 Summary of Whole Body Radiation Doses for BFI Employees**

Exposed individuals	Date & time	Activity causing radiation exposure	Range of distance from source (m)	Dose rate range* (mSv/hr)	Estimate of time for exposure (hours)	Total dose range (mSv)	Total dose range [rem]
Driver A	11/25/92 (9:45a.m.-3:30p.m.)	Loading and unloading straight truck	-	-	-	1.7†	0.170†
Driver B	11/27/92 (6:15a.m.-8:45a.m.)	Initial 15-min safety check	1.0 - 1.5	19.3- 8.7	0.25	5.2 - 2.5 (Total)	0.52 - 0.25 (Total)
		Driver from BFI-Carnegie to BFI-Warren	12.0 -12.2	0.16-0.15	2.5		
Driver C	11/27/92 (2:30p.m.-4:45p.m.)	Driver from BFI-Warren to BFI-Carnegie	12.0 -12.2	0.16-0.15	2.25	0.36- 0.34	0.036-0.034
Supervisor A	11/30/92 - 12/01/92	Unloading boxes	0.75- 1.5	34.2- 8.7	1.5	51.3- 13.0	5.1 -1.3
Safety Technician A	11/30/92	Locating source	0.75 -1.3	34.2-11.5	1.5	89.5- 34.3 (Total)	9.0 -3.4 (Total)
		Searching through red-bag waste	0.5 - 0.75	76.4-34.2	0.5		
Safety Technician B	11/30/92	Locating source	0.75 - 1.3	34.2-11.5	1.5	68.4- 26.9 (Total)	6.8 -2.7 (Total)
		Searching through red-bag waste	0.75 - 1.0	34.2-19.3	0.5		
Other BFI Employees	11/28/92	11 Workers at BFI-Carnegie	107 - 122	0.0021-0.0016	8	0.19-0.15 (Total Person-mSv for 11/28 and 11/29)	0.019-0.015 (Total Person-rem for 11/28 and 11/29)
	11/29/92	2 Workers at BFI-Carnegie	150 - 180	0.00089-0.00052	8		
						Person-Sv	Person-rem
<b>TOTALS</b>						<b>0.22-0.08</b>	<b>0.022-0.008</b>

† Total dose reported from dosimeter reports.

\* Dose rate from an unshielded Ir-192 source containing 1.451 E+11 Bq [3.922 Ci] on November 25, 1992, using MICROSIELD 3.13 with point-source geometry and Berger build-up factor.

Note: 1 mSv = 100 mrem

**Table 6.14 Summary of Extremity Dose Estimates For Selected BFI Employees**

Exposed individuals	Activity causing radiation exposure	Range of distance from source <sup>†</sup> (m)	Dose rate range* (Sv/hr)	Total estimated exposure time (hours)	Total dose range (Sv)	Total dose range (rem)
Safety Technician A	Searching through red-bag waste	0.10 - 0.25	1.9 - 0.30	0.5	0.95 - 0.15	95 - 15
Safety Technician B	Searching through red-bag waste	0.20 - 0.25	0.48 - 0.30	0.5	0.24 - 0.15	24 - 15

† Ranges of distances for this activity were estimated from time-motion studies and personal interviews. Distances are approximate.  
 \* Dose rate from an unshielded iridium-192 source containing 1.451 E+11 Bq (3.922 Ci) on November 25, 1992, using MICROSIELD 3.13 with point-source geometry and Berger build-up factor.  
 Note: 1 Sv = 100 rem

## 6.5 Blood Studies

When the NRC was notified of the incident on December 1, 1992, the NRC immediately consulted a Medical Consultant to help assess the extent of the radiation exposures to individuals at the SHM nursing home. On December 3, 1992, when the team arrived in Indiana, Pennsylvania, the NRC Medical Consultant contacted the SHM nursing home administrator to review all the medical records of Patient A. In addition, the NRC Medical Consultant worked with the Medical Director of the SHM nursing home to--

- interview most, if not all, the SHM nursing home employees, especially those in close contact with the patient, to see if they had been ill since the iridium-192 source was inside the facility (November 16 through 20, 1992);
- assess the SHM nursing home residents in the vicinity of Patient A's room (Room 4B) and any visitors who may have spent time in Room 4B between November 16 to 20, 1992; and
- ask all SHM nursing home employees, selected SHM nursing home residents, and relevant visitors to have blood counts done as a group during the following day at the SHM nursing home.

### 6.5.1 Blood Counts

NRC's Medical Consultant contacted REAC/TS in Oak Ridge, Tennessee, to request special prepackaged blood kits by overnight mail for blood studies of SHM nursing home employees. This allowed blood samples to be drawn and platelets to be analyzed at a local hospital and chromosome analysis of cultivated lymphocytes to be analyzed by REAC/TS.

On December 3, 1992, NRC's Medical Consultant supervised the drawing of blood samples at SHM nursing home between 2 p.m. and 4 p.m. (39 of 51 employees had blood samples taken). These samples were drawn by two laboratory technologists from a local hospital. Twelve of the SHM nursing home employees did not have their blood taken for analysis because they (1) had infrequent contact with Patient A at the SHM nursing home; (2) had not worked near Patient A for extended periods of time; or (3) had not been on duty the week of November 16 through 20, 1992.

Samples for possible cytogenetic studies were drawn at the same time and were carefully labelled, handled, and packaged. The NRC's Medical Consultant explained to the SHM nursing home Medical Director and RN B that the blood tests were precautionary only and they were asked to reassure their staff. The analogy was given of similar precautionary blood tests familiar to all health care workers, such as those tests that are taken to rule out tuberculosis or hepatitis exposures from patient care.

The results of the above tests, as stated by NRC's Medical Consultant, were as follows:

- No SHM nursing home employees or residents located near Patient A were known to be ill between November 16 through 20, 1992, or to have experienced any effects consistent with acute radiation syndrome;
- blood work consisting of complete blood count, differential count, and platelet counts were not consistent with a significant exposure to cause their depression.<sup>10</sup> Since the blood was drawn on December 3, 1992, and the exposure period was from November 16 through 20, 1992, sufficient time had elapsed to allow for depression of not only the lymphocytes, but also the neutrophils and platelets (see Reference 10).

All blood samples taken from the SHM nursing home staff were sent to REAC/TS for processing, but not for further analysis until further instructions from either NRC or NRC's Medical Consultant were given. All the initial 39 blood samples were hand-carried by an NRC contractor to the REAC/TS facility on December 3, 1992. This was done so that if any new information became available, such as depressed lymphocyte, neutrophil, or platelet counts, any of the blood samples could be analyzed for cytogenetics without losing time. In addition, as more time-motion studies and interviews were performed, the team selected additional persons to be judged at risk of higher exposures. In fact, an additional two individuals were later evaluated for cytogenetic analysis because of calculated high exposures. Of the 40 blood samples (total) taken from the SHM nursing home, eight (five employees and three residents) were sent to REAC/TS in Oak Ridge, Tennessee, for cytogenetic and independent analysis of dose distributions. An additional 10 blood samples were taken from relatives and visitors to Patient A.

In addition to the SHM nursing home employees, visitors, and friends who may have been near the source during this period, six BFI employees' blood samples were also taken for initial screening and analysis. The results of the time-motion studies and blood tests indicated that none of the BFI employees were exposed to an amount of radiation greater than the minimum detectable limit needed [approximately 20 cGy (rad)] for cytogenetic evaluation.

On December 23, 1992, a member of the public was identified and contacted about the amount of time spent at the SHM nursing home November 16 through 20, 1992. This individual stated that she had spent approximately 2.5 hours visiting with Patient A at very close proximity [between 0.75 to 1.5 meters (29.5 to 59 inches)] the evening of November 19, 1992. Because of this individual's close proximity to the resident, additional blood samples were taken from this person (Friend A) on January 7, 1993, and sent directly to REAC/TS for cytogenetic analysis. The results of these tests are provided in Table 6.15.

After the team became aware of this previously unidentified visitor, NRC placed an advertisement in the local newspaper on December 2, 1992, informing any person who was concerned about having coming into contact with radiation from the source and who had not

been interviewed to contact the NRC. A collect telephone number was provided. This lead to two additional contacts, the results of which are discussed in Table 6.10.

### 6.5.2 Cytogenetics

To confirm the range of estimated radiation exposure to the nine individuals identified as having the highest potential for exposure, the team arranged for cytogenetic evaluation of these individuals. Cytogenetic analysis is used to determine if any of the persons sustained any radiation-induced chromosome aberrations, a biological indicator of significant radiation exposure. Cytogenetic dosimetry is based on the premise that ionizing radiation induces identifiable chromosome aberrations in lymphocytes and that this induced frequency is strictly dependent on cellular dose.<sup>11</sup> The cytogenetic evaluation involved the examination of a randomly selected set of lymphocytes (white blood cells) to determine how many in each set exhibited radiation-induced chromosome aberrations.

The team arranged with the Oak Ridge Institute for Science and Education (ORISE), REAC/TS, Cytogenetics Laboratory in Oak Ridge, Tennessee, to supply "cytogenetics kits" for collecting two blood specimens for each person that was evaluated. For all of the individuals tested, the contracting physician arranged for blood specimens to be collected at the SHM nursing home. Of the 41 blood samples sent to REAC/TS, the team requested that nine of the blood samples be evaluated for cytogenetic analysis based on the team's initial dose calculations. Although the samples were collected at different times, REAC/TS stated that as long as the blood samples were taken within the first 6 weeks of the incident involving radiation exposure, no difference in the cytogenetic evaluation would be noted.

REAC/TS's procedure for cytogenetic evaluation involves sampling 500 first-division metaphases from blood lymphocyte cultures. REAC/TS reported to the team that the observed frequencies of dicentric chromosomes ranged from 1 to 4 dicentrics in the 500 metaphase samples from these cultures.<sup>12</sup> In persons who have had no radiation exposure other than background, an average of 1 dicentric per 500 cells scored is routinely observed in lymphocyte cultures. As an example, for a 90-percent confidence interval, an average of 5 dicentrics per 500 cells would indicate a cytogenetic dose estimate of approximately 20 cGy (rad), similarly, an average of 3 dicentrics per 500 cells would indicate a cytogenetic dose estimate of approximately 10 cGy (rad) (Reference 12).

The results of the cytogenetic analysis showed a total of 21 dicentric chromosomes in the 4,500 metaphases examined from these 9 persons (see Reference 12). The average frequency of dicentric chromosomes in >25,000 metaphases from 131 nonirradiated control persons examined at REAC/TS is 1.6 per thousand cells, which is virtually identical to the 1.8 per thousand reported by a recent REAC/TS report, "Chromosome Aberrations in Relation to Radiation Dose following Partial-Body Exposures in Three Populations."<sup>13</sup>

On the basis of these findings in a nonirradiated control subject, the team expected that about 1 dicentric per 500 metaphases would have been observed in persons having no radiation



exposures other than incidental chest x-rays or natural background exposures. Thus, in a sample of 4,500 metaphases, one would expect to see on average about 9 dicentric chromosomes. However, the team observed a total of 21 dicentrics, or 12 dicentrics in excess to those expected due to background. Thus, the data provides strong evidence that the group as a whole did indeed receive an exposure in excess of background with a cytogenetic dose estimate for the group of 7 rad, with 90 percent confidence intervals of 5 to 11 rad (see Reference 12).

The results from the cytogenetic studies (with 90% confidence intervals for the dose estimates) are shown in Table 6.15. The individuals identified in the table known to have been actually exposed to the iridium-192 source exhibited up to 4 dicentrics per 500 metaphases scored, which was in good agreement with the estimated radiation exposures from time-motion studies the team conducted for each person.

**Table 6.15 Comparison of Calculated Whole Body Doses with Cytogenetic Evaluations**

Individual	Metaphases scored	No. dicentric observed	Dose estimate †		90% Confidence interval (cGy)
			Based on time-motion studies (cGy)	Based on cytogenetic evaluation (cGy)	
SHM Dietician	500	1	0.6 - 0.4	0	<1-12
SHM Resident B	500	2	13 - 4	~6	<1-20
SHM Resident C	500	3	20 - 6	~10	3-25
SHM Resident M	500	3	9 - 6	~10	3-25
SHM CNA C	500	4	22-16	~16	6-29
SHM CNA E	500	2	15 - 10	~6	<3-20
SHM LPN B	500	3	17 - 11	~10	3-25
SHM Maintenance Man A	500	2	4 - 2	~6	<1-20
Friend A	500	1	9 - 2	0	<1-12

† Estimate of "equivalent" dose to whole body for iridium-192 gamma rays. For purposes of this report, 1 cGy = 1 cSv.  
 Note: 1 cGy = 1 rad

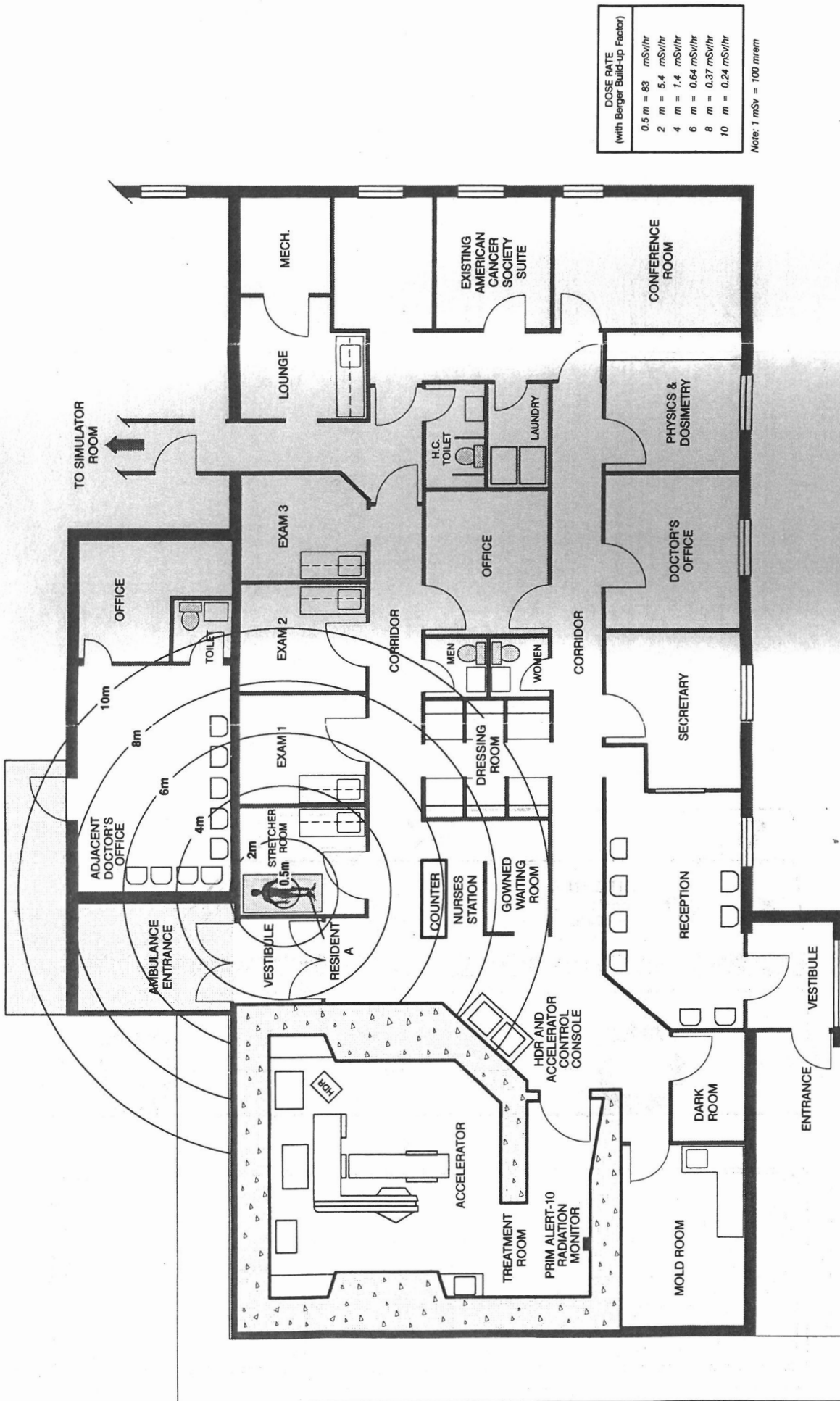
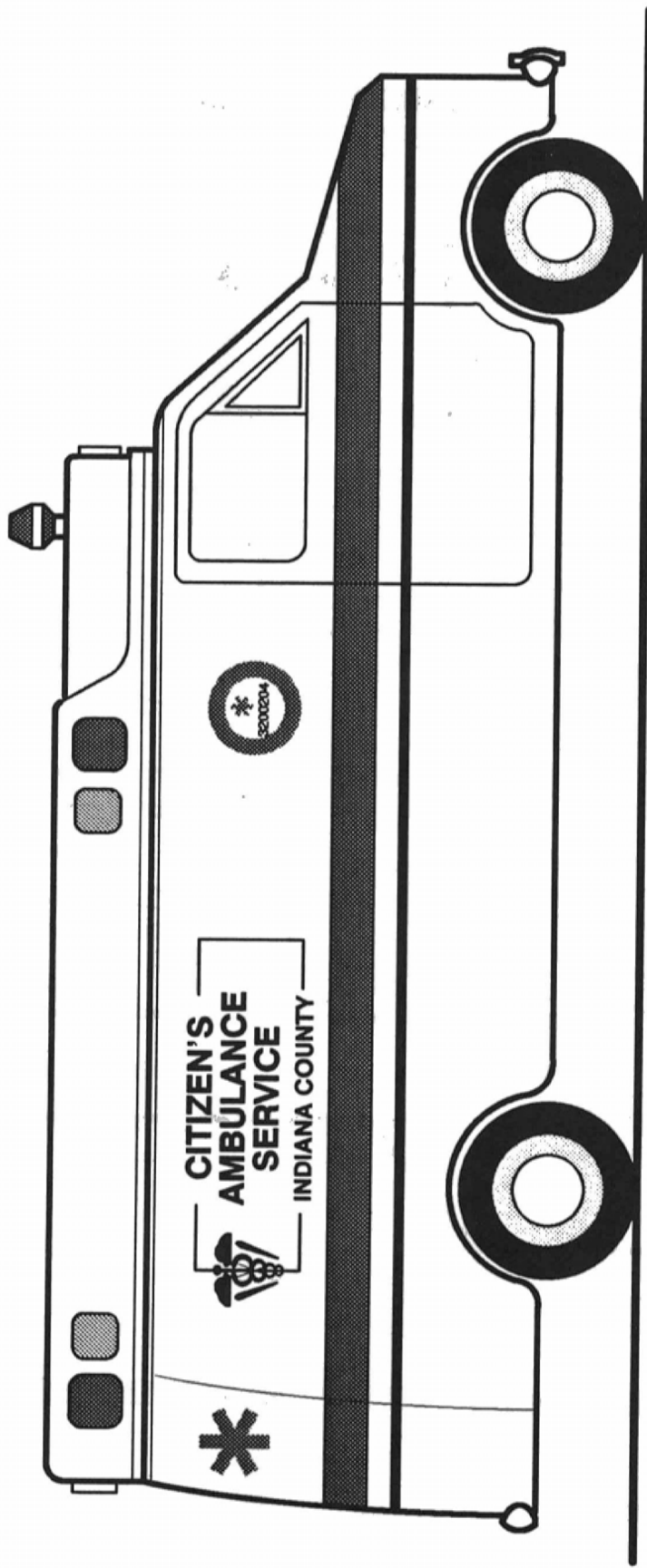

Figure 6.1 Diagram of the Indiana Regional Cancer Center Showing Isodose Curves from the Iridium-192 Source on November 16, 1992.

6-43

Section 6



Section 6

6-44

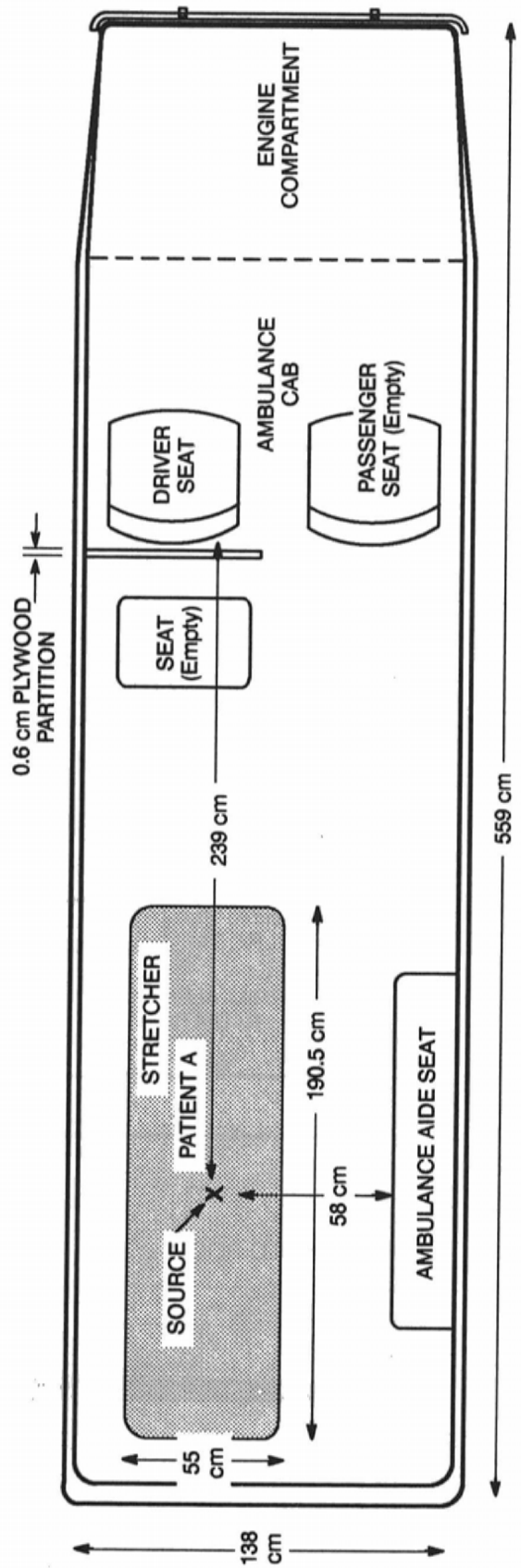

Figure 6.2 Location of Ambulance Staff and Patient A in Citizen's Ambulance

NUREG-1480

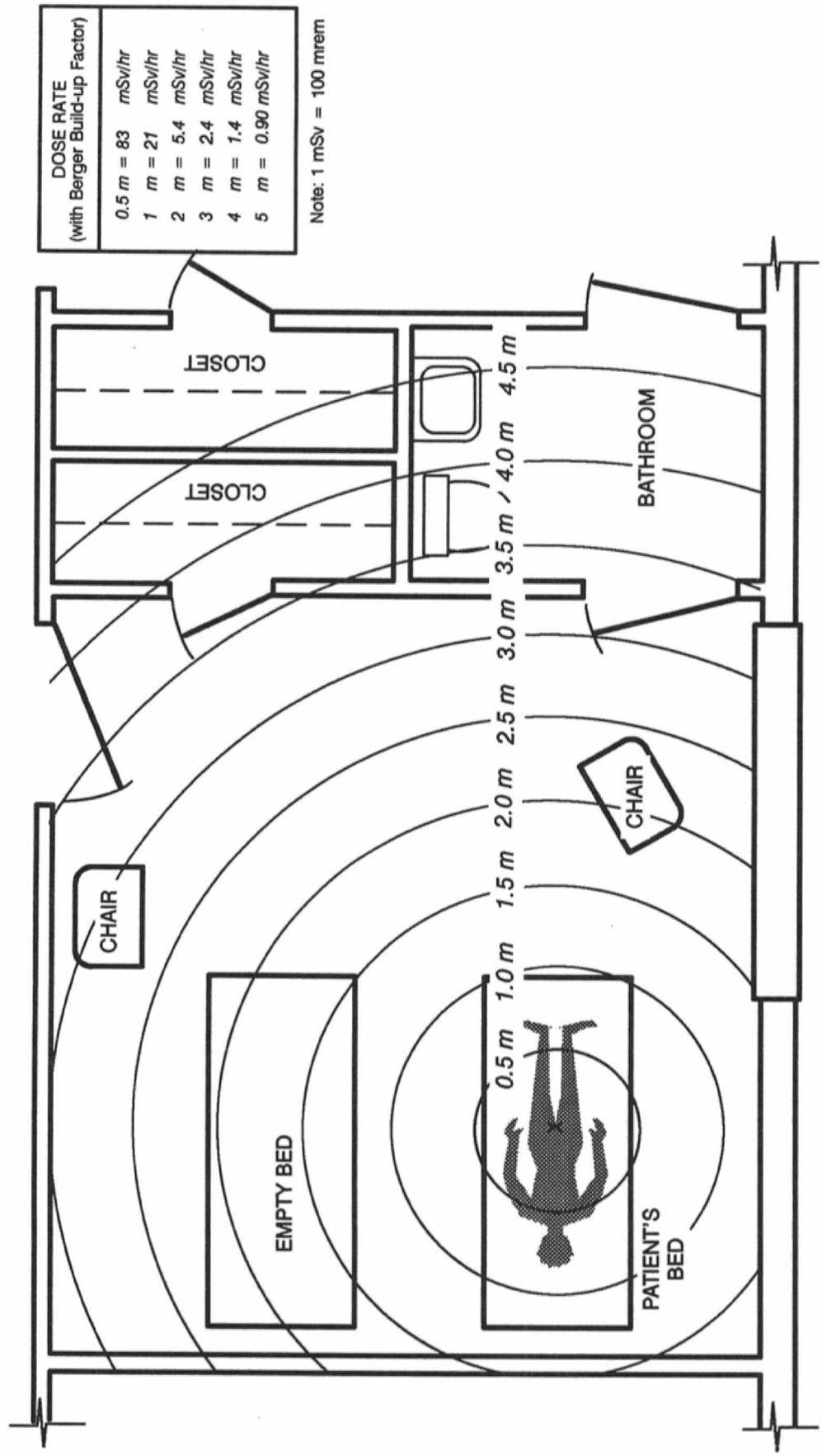

Figure 6.3 Diagram of Room 4B at the Scenery Hill Manor Nursing Home Showing Isodose Curves from the Iridium-192 Source on November 16, 1992

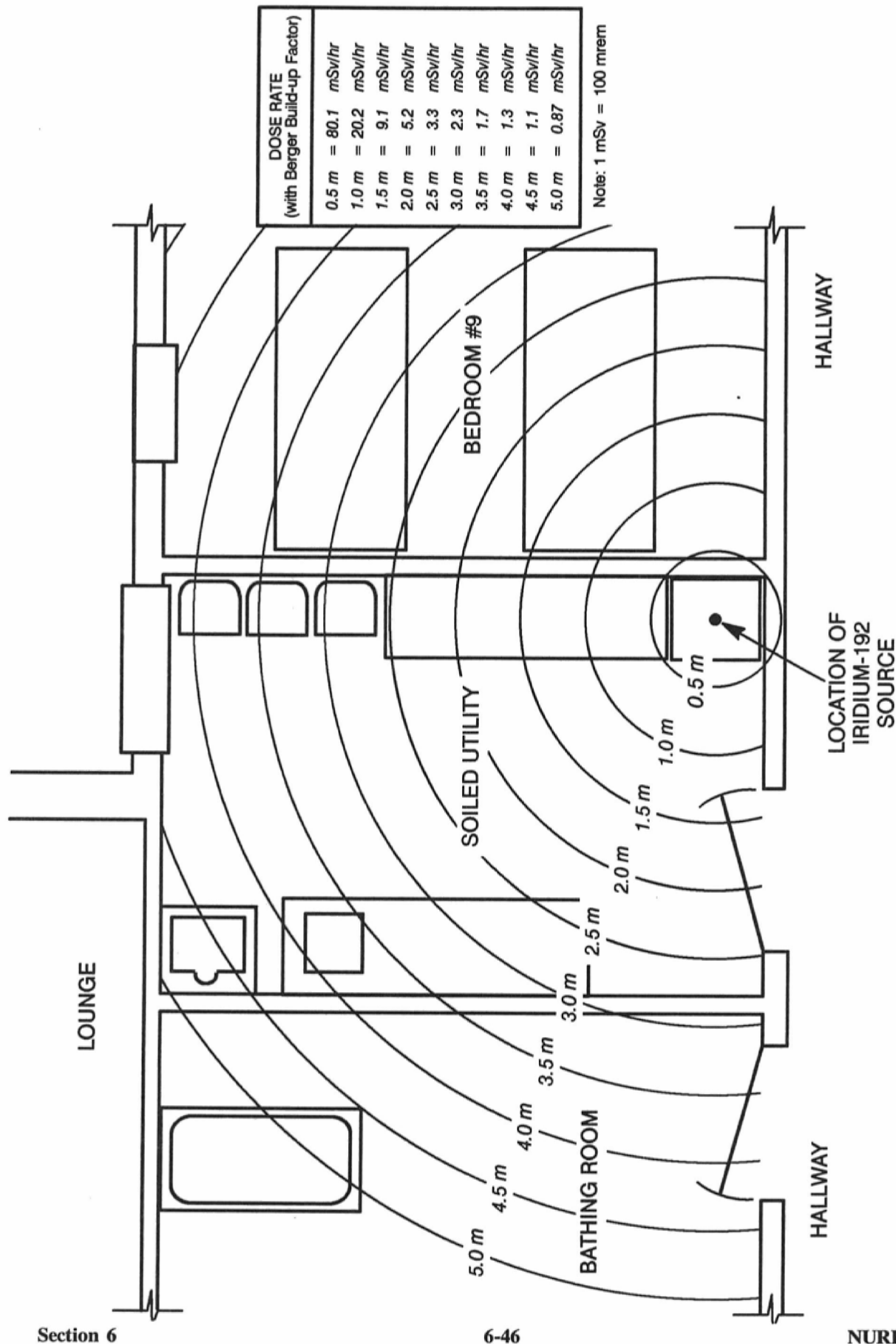

Figure 6.4 Diagram of the SHM Nursing Home Soiled Utility Room Showing Isodose Curves from the Iridium-192 Source on November 20, 1992

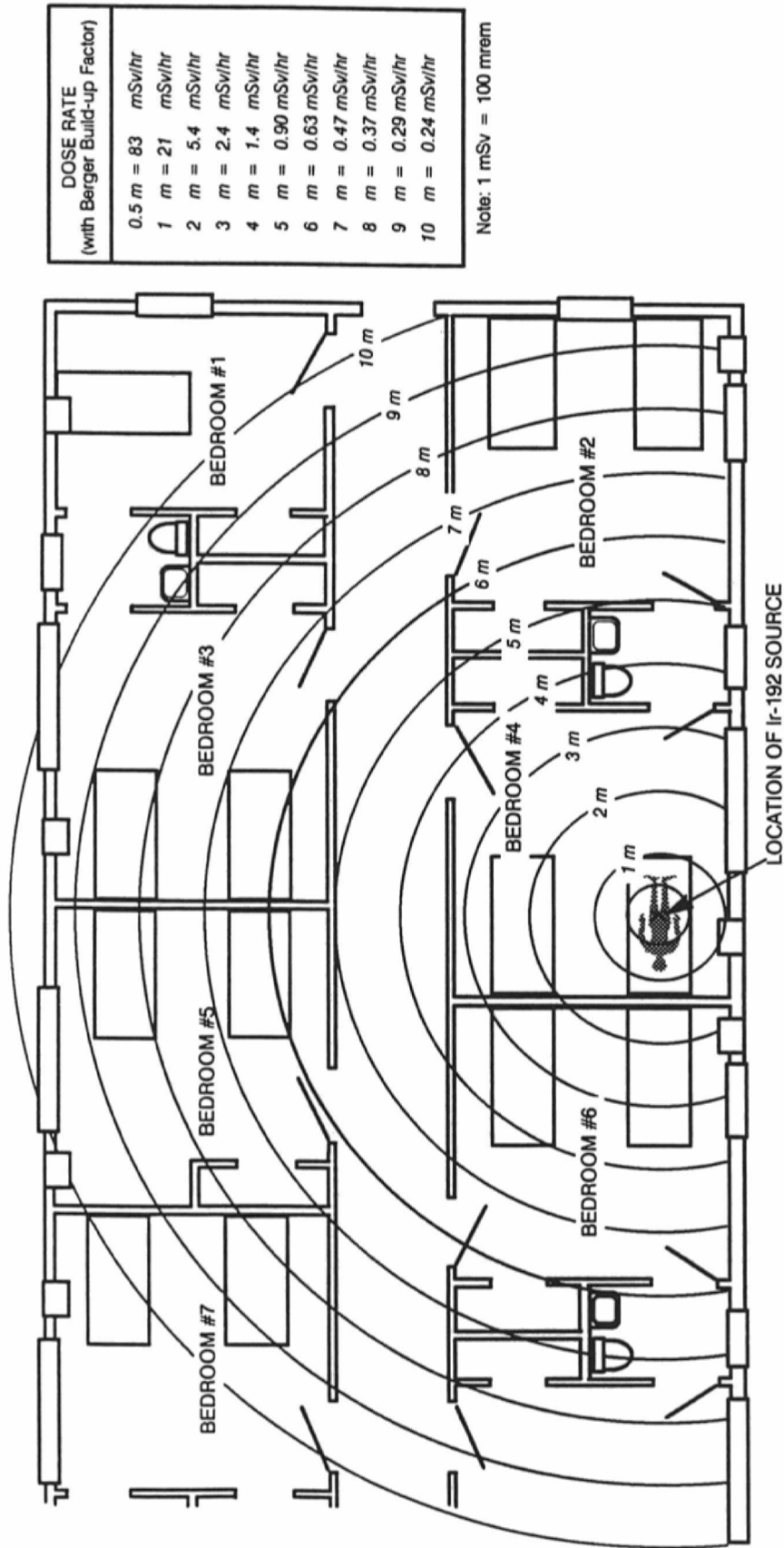

Figure 6.5 Diagram of Rooms Adjacent to Patient Room 4B Showing 1-Meter Isodose Curves from the Iridium-192 Source on November 16, 1992

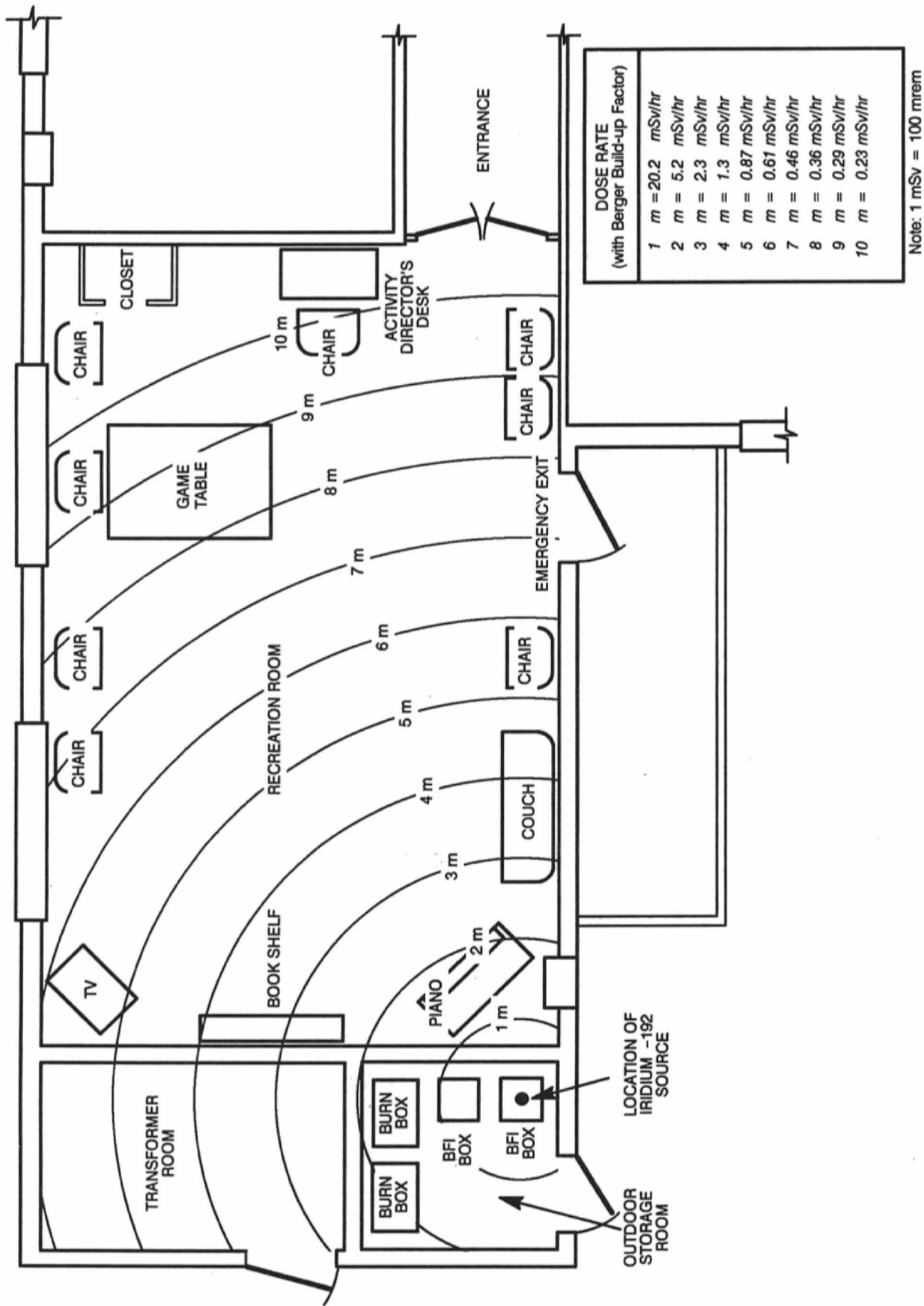

Figure 6.6 Detailed Diagram of the Scenery Hill Manor Nursing Home Recreation Room Showing Isodose Curves from the Iridium-192 Source Located in the Outside Storage Room from November 20 to 25, 1992





Figure 6.7 Portable Radiation Survey Meter from BFI-Carnegie Straight Truck

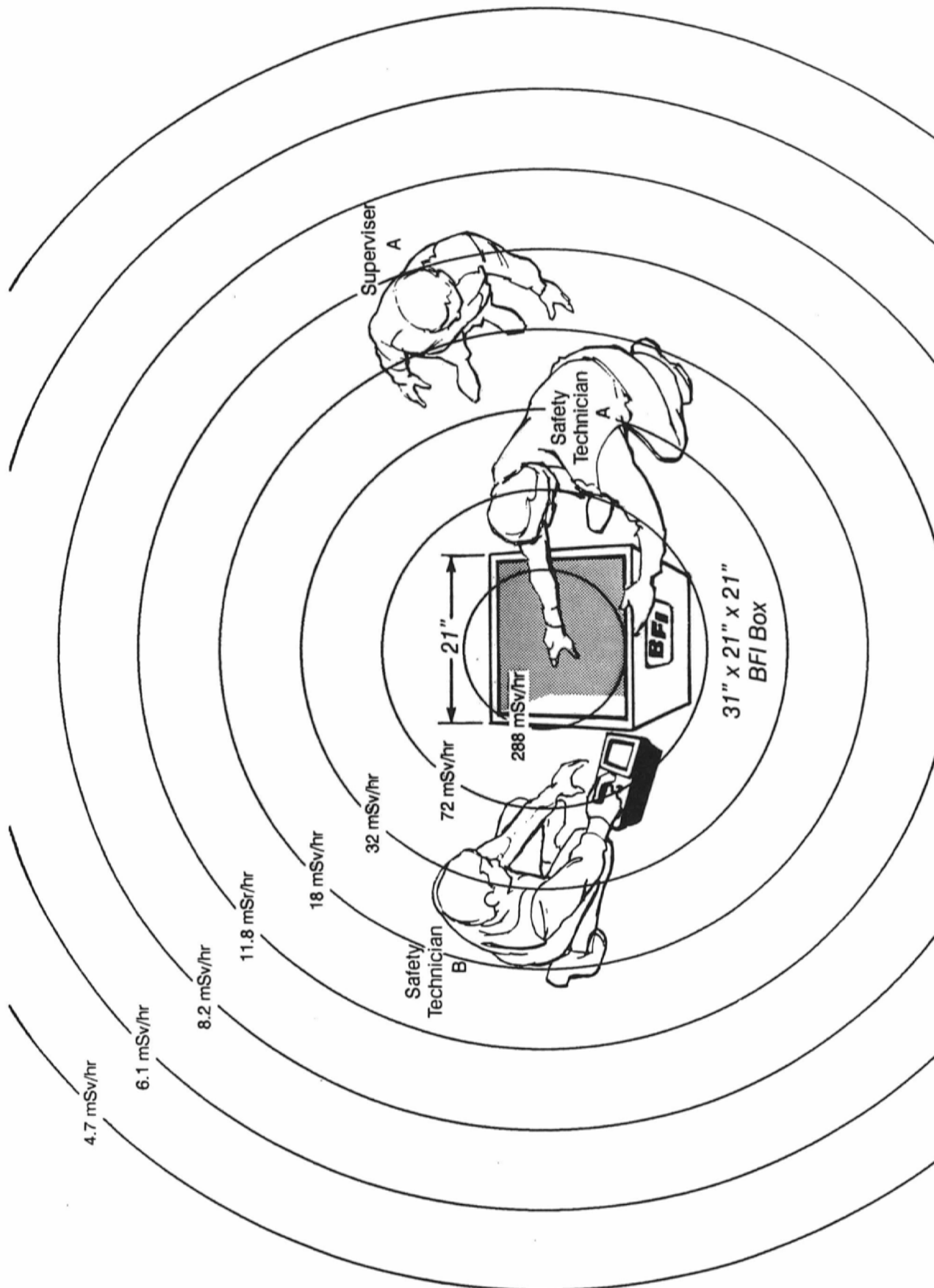

Figure 6.8 Aerial View of the Positions of Supervisor A, Safety Technician A, and Safety Technician B Around the Box Containing the Iridium-192 Source on December 1, 1992, Showing Isodose Curves in mSv per Hour

## References

1. U.S. Code of Federal Regulations, "Standards for Protection Against Radiation," Part 20, Chapter 1, Title 10, "Energy."
2. National Council on Radiation Protection and Measurements (NCRP), "Exposure of the Population in the United States and Canada from Natural Background Radiation," NCRP Report No. 94).
3. NCRP, "Recommendations on Limits for Exposure to Ionizing Radiation," NCRP Report No. 91, Bethesda, MD., 1987.
4. International Commission on Radiological Protection, "Limits for Intakes of Radionuclides by Workers," ICRP Publication 30, Supplement to Part 2, Pergamon Press, Oxford, England, 1980, pp. 511-518.
5. Casarett, Alison, "Radiation Biology," Prentice-Hall, Inc., Englewood Cliffs, N.J., 1968.
6. Tubiana, M., Dutreix, J., Wambersie, A., "Introduction to Radiobiology," Taylor and Francis, Philadelphia, PA, 1990.
7. Grove Engineering, Inc., "Microshield, Version 3.13," Rockville, Maryland, 1987.
8. Engle, R.L., et.al., June 1966. "ISOSHLD, A Computer Code for General Purpose Isotope Shielding Analysis," BNWL-2316, Richland, WA, U.S. Department of Energy.
9. International Commission on Radiological Protection, "The Biological Basis for Dose Limitation in the Skin," ICRP Publication 59, Pergamon Press, Oxford, England, 1992, p. 34.
10. Flynn, Daniel F., M.D. NRC Medical Consultant's Report on the November 16, 1992, HDR Brachytherapy Accident, Indiana, Pennsylvania, January 13, 1992.
11. Fry, Shirley A., MB, Bch, MPH, and Ricks, Robert C., MS, PhD., Proceedings of the Second International REAC/TS Conference on the Medical Basis for Radiation Accident Preparedness held October 20-22, 1988, p. 463.
12. Letter dated December 15, 1992, from L. Gayle Littlefield, PhD., Cytogenetics Laboratory, REAC/TS, to Cynthia Jones, IIT.
13. "Chromosome Aberrations in Relation to Radiation Dose Following Partial-body Exposures in Three Populations", R.A. Kleinerman, L.G. Littlefield, et. al., Radiation Research, Vol. 123, pp. 93-191, 1990.



## **7 LICENSEE AND VENDOR RESPONSE TO INCIDENT**

The following section briefly summarizes the licensee's actions related to the November 16, 1992, misadministration notification, reports to the NRC, licensee assessment of personnel radiation exposure, and assessment of patient's dose. This section also describes the licensee's initial corrective actions and the vendor's actions.

### **7.1 Misadministration**

As defined in NRC regulations Part 35 of Title 10, "Energy," U.S. Code of Federal Regulations (10 CFR Part 35), a brachytherapy misadministration would occur when the calculated administered dose differs from the prescribed dose by more than 20 percent of the prescribed dose. This incident far exceeded this criteria.

In this incident, Patient A received a severe medical misadministration. The physician intended to deliver a total dose of 1800 cGy (rad) to the tumor, delivered in three 600 cGy (rad) fractions. By the licensee's own calculations, the delivered dose to the same treatment point was in the order of 1,600,000 cGy (rad).

The NRC's medical consultant concluded that Patient A experienced a severe acute radiation syndrome from an overdose of radiation, which was a probable contributing cause of death.

### **7.2 Licensee Actions**

#### **7.2.1 Initial Event Notification**

The Medical Physicist A initially notified NRC's Region I Office on December 1, 1992, of a radiological incident involving the loss of a  $1.37 \text{ E}+11 \text{ Bq}$  (3.7-Ci) iridium-192 sealed source from the facility (Indiana Regional Cancer Center (IRCC)) in Indiana, Pennsylvania. The licensee reported that Browning-Ferris Industries (BFI) (a nonradioactive waste removal company) notified a local nursing home of the discovery of radioactive material in waste that BFI-Carnegie, a BFI facility in Carnegie, Pennsylvania, previously removed from the nursing home. Suspecting that the radioactive material may have originated from a nursing home resident that had previously undergone radiation therapy at the IRCC, the nursing home immediately notified the IRCC that BFI personnel had discovered radioactive material.

Knowing that a Scenery Hill Manor (SHM) nursing home resident had undergone high dose rate (HDR) treatment at the IRCC, Medical Physicist A performed radiological surveys, observed the PrimAlert-10, and performed an x-ray film autoradiograph evaluation of the HDR afterloader source wire to ascertain the location of the source. The licensee reported that the PrimAlert-10 did not alarm when the HDR afterloader was activated and the radiological surveys and the autoradiograph indicated the HDR afterloader iridium-192 source was missing.

Initial investigation of the incident and the licensee reports to the NRC indicated that the HDR afterloader was last used for patient treatment on November 16, 1992, when the patient was brought to the IRCC by local ambulance from the SHM nursing home for HDR treatment at the IRCC.

The licensee stated that the patient was returned to the SHM nursing home after HDR treatment at the IRCC and, apparently, the iridium-192 source became dislodged from the HDR afterloader and moved with the patient to the SHM nursing home. The licensee's initial report did not indicate how the iridium-192 source was dislodged, whether the source was still implanted in the patient or lost in the patient bedding/clothing material, or how the source was found in the waste at BFI-Carnegie. The licensee reported that the iridium-192 source was secured inside an enclosure at BFI-Carnegie. The licensee informed the NRC that plans were completed, with all appropriate radiological safety precautions, to retrieve the iridium-192 source from the BFI-Carnegie facility and return it to the IRCC. At approximately 4 p.m. on December 1, 1992, the licensee, IRCC, reported to the NRC that the iridium-192 source had been successfully retrieved and would be secured later at the IRCC.

Medical Physicist A stated that the source retrieval was completed in about 70 seconds. Forceps and a cylindrical container (similar to a 5-gallon drum) with a lead shield were used during source retrieval and transportation. The source container was surveyed by Medical Physicist A. The container was placed in the back of Medical Physicist A's truck for transport to IRCC. Dose rates on contact with the container's side and at 1 meter (3 feet) were recorded by Medical Physicist A as 0.35 mSv/hr (35 mrem/hr) and 0.03 mSv/hr (3 mrem/hr), respectively.

The NRC's independent survey of the source container at IRCC on December 2, 1992, confirmed the medical physicist's measured dose rates at contact and at 1 meter (3 feet) from the side of the container. However, the dose rate at contact with the top of the container was approximately 2 cSv (rem) per hour. Medical Physicist A resurveyed the top of the source container and measured approximately 2 cSv (rem) per hour. Medical Physicist A stated that he recalled inserting the source in its shielded location within the source container when the source was transported from BFI-Carnegie to the IRCC on December 1, 1992. The Medical Physicist added that it was possible that the source may have moved within the shielded container and that this would have contributed to the elevated dose rate on the container's top. Medical Physicist A stated that no radioactive material placarding was used on the source transport truck; however, the source container was well shielded and braced during transportation.

An Omnitron International, Inc. (Omnitron) representative opened the source container and pushed the source further into its shielded location. This reduced the dose rate at the top of the source container to 0.35 mSv/hr (35 mrem/hr). Medical Physicist A stated that the source container was placed in the HDR treatment room on the top of a table at the corner of

the room far from the accelerator treatment area with the top of the container facing up. Therefore, the dose to personnel or patients would have been minimal.

### 7.2.2 IRCC Incident Reports

On December 10, 1992, Physician A submitted a written report on the incident to the NRC Incident Investigation Team (the team) Leader. The report described the incident and the subsequent events, including (1) the BFI notification to the nursing home of radioactive material that was found, (2) the IRCC's discovery of the lost HDR afterloader source, (3) the IRCC's notification to NRC of the incident, (4) source retrieval activities by IRCC personnel, (5) radiation exposure to personnel, (6) patient exposure, and (7) IRCC actions taken to prevent recurrence of similar incidents.

The December report stated that on November 13, 1992, an 82-year-old female patient with anal canal carcinoma was surgically implanted with five catheters at a local hospital. Three days later, on November 16, 1992, the patient was brought by ambulance to IRCC. After being seen by Physician A, the patient was taken to the HDR treatment room and the patient's five implanted catheters were connected to the HDR afterloader under the supervision of Medical Physicist A. The licensee reported that no difficulty was encountered during the treatment using the first four catheters and no error messages were observed on the HDR computer monitor screen until the fifth and final catheter was entered by the source wire, at which point the treatment was interrupted and a message on the HDR computer monitor screen indicated that an obstruction had prevented entrance of the source wire into the fifth catheter. After retriial to treat the fifth catheter had failed, Physician A ordered the procedure to be terminated.

Although the December 10 report indicated that, at some point in the incident, one technologist mentioned that the PrimAlert-10 area radiation monitor light had been flashing red, Physician A did not observe, to his recollection, any flashing of the PrimAlert-10 monitor. However, Physician A informed the NRC staff on two separate occasions on December 2 and 3, 1992, that he noticed the PrimAlert-10 flashing red light. A licensee's consultant audit report, dated January 5, 1993, stated that Physician A, RTT-A, and RTT-B entered the treatment room and did not notice that the PrimAlert-10 light was flashing red, indicating that radiation levels were still elevated in the room. The licensee's consultant audit report stated that RTR did notice the PrimAlert-10 light flashing red and called it to the attention of the other three individuals. The consultant's report stated that the other three individuals chose to disregard it since it had flashed previously when there was no problem. This report adds that they unplugged the PrimAlert-10 and reconnected it later after the patient had been taken to an examination room.

The team learned from interviews with IRCC staff that they had informed Physician A before he had entered the HDR treatment room of the flashing of the PrimAlert-10 red light that they had observed when they first encountered difficulties inserting the source wire into the fifth catheter.

In the December 10, 1992, report, the IRCC stated that after termination of the patient treatment, Physician A and Nurse A examined the patient. Physician A stated, "This examination revealed that the fifth, most posterior catheter, was extruded approximately 2 cm from its desired position. Its suture was cut and the catheter and suture were removed."

The team review indicated that the treatment plan for Patient A required placement of the five implanted catheters as shown in Figure 7.1. Physician A and Medical Physicist A identified the implanted catheter placements as being the same as those shown in Figure 7.1. Physician A and Nurse A identified the location of the implanted catheter removed on November 16, 1992, as being the implanted catheter connected to Channel 5 in Figure 7.1. However, RTT-A, who had connected the implanted and connecting catheters to the HDR afterloader's turret head, identified the locations of the implanted catheters as that shown in Figure 7.2, which is the reverse of the treatment plan. This reversal of the connections made to the HDR afterloader's turret head places the implanted catheter connected to Channel 5 on top (see Figure 7.2). The SHM nursing home staff identified the top location as being the location of the implanted catheter that had extruded from Patient A on November 20, 1992, and had been subsequently removed and placed in SHM's nursing home outside waste storage room for BFI waste pickup.

Therefore, given RTT-A's description of the implanted catheter placement, and the SHM staff's recollection of the extruded implanted catheter location, the source was left in the implanted catheter attached to Channel 5 (top location in Figure 7.2), which remained in the patient until November 20, 1992, and was eventually recovered on December 1, 1992.

### **7.2.3 Licensee Dose Assessment Reports**

On December 23 and 24, 1992, IRCC and Oncology Services Corporation (OSC) submitted two reports to the NRC. The reports described the incident, the dose received by potentially exposed personnel, the patient dose, the licensee's corrective action, and the results of audits of the HDR therapy program at OSC centers. In a facsimile dated January 7, 1993, entitled "Supplement to Part 20 and 30 Reporting Requirements," the licensee provided additional information relevant to the chronology of events, the effect on patient and patient dosimetry, effects on other individuals exposed, action to prevent recurrence, and a preliminary "independent audit" report on the incident.

The licensee conducted interviews of personnel potentially exposed to radiation from the iridium-192 source. Also, blood samples of selected individuals were taken and blood counts were performed to identify personnel with potential high levels of radiation exposures (see Section 6). Section 6 also presents the team's calculations of doses for those that may have been or were exposed to the source.

IRCC's December 10, 1992, report indicated that dosimetric evaluations were done on potentially exposed personnel. IRCC reported that 16 SHM nursing home staff members had received radiation doses in the range of 1.5 to 102 mSv (0.15 to 10.2 rem). However, the



team's examination of the SHM nursing home staff exposure indicated that 21 identified workers had received doses in the range of between 4.0 to possibly as high as 223 mSv (0.4 to 22.3 rem). All calculated doses are given as a range of values.

IRCC reported that six persons visited the patient at the nursing home and that their estimated exposure ranged from 23 to 68 mSv (2.3 to 6.8 rem). The team's assessment of these individual exposures indicated that one person whose dose was estimated at 34 mSv (3.4 rem) by the licensee did not receive any exposure since their visit occurred after the catheter containing the source was removed. Also, the NRC's assessment of potential exposures of patient visitors at the nursing home indicated that seven visitors had received exposures in the range of 22 to 166 mSv (2.2 to 16.6 rem). The licensee's consultant who performed the dose calculation stated he assumed 14 cm or 2 half-value layers of tissue in the path of the radiation. The team's calculations show that the use of narrow beam attenuation factors without buildup is inappropriate (see Appendix B).

The licensee's reports did not address potential exposures to the nursing home residents. The NRC's assessment of potential exposure of the nursing home residents identified 13 individuals who received calculated doses in the range of 11 to 197 mSv (1.1 to 19.7 rem).

The licensee reported that the two ambulance service attendants' who transported the patient to the nursing home had a total exposure of 1.6 mSv (0.16 rem) each. The team's assessment of the two ambulance service attendants exposure indicated that the two individuals may have received exposures in the range of 4.8 to 25.7 mSv (480 to 2570 millirem). OSC or IRCC did not consider the location of the second attendant sitting near, about one-half meter, from the patient.

The licensee's report did not address potential exposure to individuals at an office adjacent to the IRCC. The team's assessment of the potential exposure of individuals in the adjacent office identified five individuals who may have received doses in the range of 0.08 to 4.3 mSv (8 to 430 mrem).

The licensee reported that six BFI individuals may have received doses in the range of 0.3 to 28 mSv (0.03 to 2.8 rem). The team's assessment indicated that these six individuals may have received doses in the range of 0.34 to 90 mSv (0.034 to 9.0 rem).

The licensee reported no occupational exposure that exceeded the NRC regulatory limit [12.5 mSv (1.25 rem) in a calendar quarter]. The dosimeter results indicated that exposures for the calendar quarter (up to December 1) for technologists RTT-A, RTT-B, and RTR were 8.2, 1.1, and 1.4 mSv (820, 110, and 140 mrem), respectively. The licensee estimated Nurse A's exposure to be 4.0 mSv (0.4 rem). The team noted Nurse A's film badge showed 6.3 mSv (0.63 rem). The licensee estimated the exposure of a laboratory technician, who spoke to the patient for about 10 minutes, to be 3.0 mSv (0.3 rem). The NRC's exposure estimate of 3.5 to 13.9 mSv (0.35 - 1.39 rem) for the laboratory technician (phlebotomist)

was based on an estimated time of 10 minutes at a distance of 0.5 to 1.0 meters (20 to 39 inches) from the patient.

The licensee estimated that Physician A's exposure as a result of both Patient A's examination on November 16 and the source retrieval on December 1, 1992, was 5.2 mSv (520 mrem). Physician A received an estimated 1.2 mSv (120 mrem) based on Medical Physicist A's whole-body dosimeter reading during source retrieval because they had worked together on December 1, 1992. Physician A did not use the assigned whole-body dosimeter either during Patient A's examination on November 16, 1992, at IRCC or during retrieval of the source on December 1, 1992, at the BFI-Carnegie facility. The team's assessment of Physician A's exposure of 8.60 mSv (860 mrem) was based on summing the exposure for Nurse A, RTT-B, and Medical Physicist A as indicated by their film badges.

#### **7.2.4 The Licensee's Assessment of Patient's Dose**

In the December 23, 1992, addendum to the December 10, 1992, report, the licensee stated that the patient dosimetry calculation indicated a minimum total body dose of 1.6 Gy (158 rad), a dose of 6.3 Gy (630 rad) to surface of a sphere with a 50-cm radius, and a minimum dose of 158 Gy (15759 rad) to surface of a sphere with a 10-cm radius. The licensee added that the mean or median total body dose probably lies between the 1.6-Gy (158-rad) and 6.3-Gy (632-rad) values, and may approach 4 Gy (400 rad).

Physician A stated in his December 10 report that although the 4-Gy (400-rad) dose, "is below the published LD50 dose (lethal dose to cause mortality in 50% of exposed population) of 5 Gy (500 rad), it is of sufficient magnitude that I believe that it is highly probable that the radiation exposure was at least a contributing factor to the patient's subsequent death." Physician A, disagreeing with NRC Bulletin 92-03, stated that it is not consistent with the facts as known in this case to state "that the patient either died as a result of exposure to radiation or that radiation exposure was a major contributor to her death," as was stated in NRC Bulletin 92-03, dated December 8, 1992. Physician A did not evaluate the doses to significant internal organs or the potential consequences of such doses.

The December 23, 1992, report was supplemented by information the team received from OSC on January 7, 1993. In a January 7, 1993, OSC facsimile, the licensee stated that one of the effects on the patient was significant local tissue damage. Possible significant tissue damage to organs outside the treatment area would depend on the progression of radiation damage over time before the patient expired. The prescribed dose at 1 cm was 18 Gy (1800 rad) to be delivered in three treatments. The licensee reported that the source remained in the patient for 92.7 hours resulting in the following doses based on a  $1.4 \text{ E}+11 \text{ Bq}$  (3.8-Ci) source and including the effects of tissue absorption and scatter. At 1 cm, the dose was  $1.6 \text{ E}+04 \text{ Gy}$  ( $1.6 \text{ E}+06 \text{ rad}$ ). The licensee reported that at 10 cm, the dose was 140 Gy ( $1.4 \text{ E}+04 \text{ rad}$ ). At 20 cm, the dose was 1.9 Gy (190 rad).

The team's independent dose assessment for patient organs, provided by the NRC's Medical Consultant, is described in Section 6.2.

#### **7.2.5 Corrective Actions**

The team reviewed the licensee's ongoing actions to prevent recurrence of similar incidents. Corrective actions were initiated by Physician A and by the Radiation Safety Officer (RSO).

In a written policy statement dated December 9, 1992, Physician A directed the staff to follow additional precautions for HDR brachytherapy treatments. These proposed precautions included additional continuous radiological measurements to be performed during HDR patient treatment by placing a diode detector probe near or over the center of the treatment location. Further, this detector will be used to verify that no radioactive material remains in the patient after each treatment. Also, immediately after each treatment, each patient will be surveyed again with a portable survey meter for radiation before leaving the clinic. Physician A added that all personnel involved in HDR treatment will be initially trained on appropriate radiation safety practices and trained semiannually thereafter. Improvements in the documentation of radiological survey, quality control verifications, and training will also be completed.

The RSO stated and reported to the NRC that in addition to the audit conducted by an independent contractor, he was performing an internal audit. The RSO also stated OSC had taken "extraordinary precautions" by suspending HDR treatments at many selected OSC centers. The HDR treatments will be conducted at certain OSC centers under the supervision of a physicist. In addition, the authorized physician will be required to be present at the HDR console while patient treatment is in progress. The RSO also stated that radiological safety training, including emergency drills and practical factors, will be provided to all personnel before initiating any additional HDR treatment at centers where HDR treatments have been suspended. Additional resources, including qualified physicists, will be hired to ensure that radiation safety training is provided and verified to be effective. In addition, radiological safety training and quality control verifications will be documented. The RSO stated that the center is devoting significant effort to ensuring that high quality patient care is provided and that operations are conducted safely by well-trained personnel.

The team's assessment of the OSC's corrective actions indicated that full implementation and verification of the effectiveness of these actions by the licensee may significantly contribute to enhancement of radiological safety at OSC Centers. These actions may provide greater assurance that HDR treatment would be conducted in a manner that precludes radiological consequences of potential radiological occurrences.

### 7.3 Vendor Actions

This section summarizes the actions taken by Omnitron the manufacturer of the Omnitron 2000 brachytherapy afterloader system associated with the incident that occurred at the IRCC on November 16, 1992.

OSC notified the NRC on December 1, 1992, about the event at its IRCC facility involving the Omnitron 2000 HDR afterloader. They also notified Omnitron that the radioactive source that had previously broken from the source wire had been secured and stored in a lead storage cask. The RSO and the Vice-President, Product Development, from Omnitron, arrived at IRCC's site in Indiana, Pennsylvania, on December 2, 1992. An NRC Region I inspection team also arrived at the IRCC facility on December 2, 1992. After obtaining approval of the NRC inspection team, the RSO surveyed the afterloader and storage cask for radioactive contamination. The RSO found trace levels of radioactive contamination. The HDR afterloader was then secured in a locked room in the clinic.

On the following day, December 3, 1992, Omnitron's Vice-President, Product Development, was allowed temporary access to the afterloader and the treatment console to retrieve and print out all information, including error messages, recorded from November 16, 1992, to December 3, 1992. The NRC team continuously monitored the Omnitron representatives' areas of access. Omnitron then supplied this information to the NRC team, and transmitted a copy to the Omnitron software developer. This information was transmitted to the software developer to preliminarily identify what caused the source to dislodge itself from the source wire and why this condition was not communicated to the technologists at the IRCC.

Physician E at the Greater Pittsburgh Cancer Center (GPCC) informed the team that he was not called by OSC but that a doctor from Texas, presumed to be from Omnitron, notified him of the event at IRCC before the GPCC incident on December 7, 1992.

On December 7 and 8, 1992, the vendor notified all Omnitron 2000 user sites by telephone about a second incident involving an active source dislodging from the guide wire. The users were told that Omnitron recommends that they temporarily not use their HDR afterloader systems until further information indicating reasons for the source-wire break is obtained. The users were also told that if they should choose to use the device, they should strictly adhere to all safety precautions indicated in the user manual and that the patients should be surveyed for radioactivity both before and after the HDR afterloader treatment.

During the investigation of the source-wire breaks (failures), initial observations indicated that dilute hydrogen fluoride solutions embrittle the nickel-titanium wire. This solution may have been generated in the teflon liner of the shipping container for the source. Omnitron noticed deterioration of the teflon liner and, as a result, made a design change in late September 1992, changing the teflon liner to a stainless steel liner. Because of this initial observation, Omnitron stated in a memorandum, dated January 8, 1993, that they contacted

customers using the old shipping container by telephone and told them not to use the source wire until their source wire is replaced.

Numbers represent placement of implanted catheters within the patient and correspond to the treatment channel number indicated on the turret head.

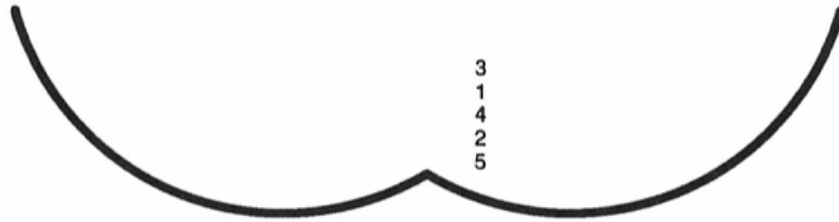

Figure 7.1 Treatment Plan Catheter Location

Numbers represent placement of implanted catheters within the patient and correspond to the treatment channel number indicated on the turret head.



Figure 7.2 Actual Catheter Location

## **8 REGULATORY OVERSIGHT**

### **8.1 High Dose Rate Afterloader Device Review by the Food and Drug Administration**

The team and one of its contractors prepared a description of the regulatory review process followed by the Food and Drug Administration (FDA) for the Omnitron International Inc.'s (Omnitron's) 2000 high dose rate (HDR) afterloader based on FDA's Omnitron file. This section was presented to the FDA to ensure its accuracy; however, the team has not received FDA's comments. Therefore, a description of the FDA's role has not been included in this report. Information on the case has been shared with the FDA who conducted their own inspection. The FDA stated they will furnish the NRC with an accurate description of their role, but it would not be furnished in time to be included in this report.

### **8.2 Source and Device Registration by the State of Louisiana**

Any device or sealed source that contains radioactive material must be evaluated and approved by the NRC or an Agreement State before the device or sealed source can be distributed. The manufacturer or distributor typically provides the information to the licensing authority on behalf of their customers (licensees) so that each customer does not have to provide this information.

In order to approve a sealed source or device for distribution, sufficient information pertaining to the design and construction, labeling, conditions of use, prototype testing, external radiation profiles, and quality assurance (QA) and quality control (QC) program must be submitted so that the reviewer can determine whether the device or sealed source is radiologically safe for use. If the license reviewer determines that the device or sealed source is adequate, then (1) the reviewer issues a certificate summarizing the information submitted, (2) lists the limitations placed on the device or sealed source, and (3) states their conclusion (i.e., a safety analysis) of the sealed source or device. The reviewer signs the document. The document is then independently reviewed by another individual. If this individual agrees with the reviewer's findings then the document is signed by this individual and the sealed source or device is approved for distribution.

Omnitron's office located in Lake Charles, Louisiana, submitted to the State of Louisiana information pertaining to the registration of the nickel-titanium source wire and the HDR afterloader. The nickel-titanium source wire was approved for use on March 9, 1992 (Registration Certificate LA-0760-S-102-S). The HDR afterloader was approved for use on March 26, 1991 (Registration Certificate LA-0760-D-101-S).

### **8.3 NRC's Regulations and Guidance for Quality Assurance and Quality Control Programs for Sealed Source and Device Vendors**

The NRC or an Agreement State must evaluate and approve a device or sealed source that contains radioactive material before the device or sealed source can be distributed. The NRC or Agreement State evaluates the manufacturer's and/or the distributor's QA/QC program as part of the overall evaluation.

The NRC does not have specific regulations or guidance that relate to QA/QC programs for vendors of sealed sources and devices. Section 32.210 of Title 10 of the Code of Federal Regulations (10 CFR 32.210) states that a manufacturer or distributor must include sufficient information pertaining to their QC program to "provide reasonable assurance that the radiation safety properties of the source or device are adequate to protect health and minimize danger to life and property." However, the regulation does not mention what the QC program must entail.

The NRC issued two regulatory guides, Regulatory Guide 10.10, "Guide for the Preparation of Applications for Radiation Safety Evaluation and Registration of Devices Containing Byproduct Material," March 1987, and Regulatory Guide 10.11, "Guide for the Preparation of Applications for Radiation Safety Evaluation and Registration of Sealed Sources Containing Byproduct Material," June 1987. These guides provide assistance to manufacturers and distributors of byproduct sealed sources and devices on how to file an application and on what information and documentation is required in their submittal.

The guidance states that part of the vendor's submittal should describe its "quality control program and procedures to be followed to ensure that each finished device (or sealed source) meets the specifications furnished to the NRC." However, the guidance does not give details on what is necessary for the QA/QC program. The guidance suggests using industry standards. In the team's review of the standards pertaining to the manufacturer of brachytherapy sources and devices (i.e., American National Standard Institute ANSI N542-1977, "Sealed Radioactive Sources, Classification"; ISO 22919-1980 (E), "Sealed Radioactive Sources, Classification"; American National Standard Institute, ANSI N44.1-1973, "Integrity and Test Specifications for Selected Brachytherapy Sources") no specific guidance for QA/QC was found. ISO-2919 was revised in September 1992. This revision mentions a QA program and provides an example of a QA program. The example references ISO-9000, "Quality Management and Quality Assurance Standards Guidelines for Selection and Use," which specifies areas that a QA/QC program should cover.

NRC has evaluated different guidance on QA/QC, such as military standards, ISO-9000, and FDA's GMP, to establish a QA/QC program for vendors of sealed sources and devices. The NRC completed a draft Quality Assurance Manual in October 1991. This draft manual has been used on several visits to vendors of sealed sources and devices in the United States and other countries. The draft QA manual outlines and explains the basic procedures,



policies, and practices needed in a QA/QC program. This manual was used as guidance for the review of Omnitron's QA/QC program.

#### **8.4 NRC Licensing of Oncology Services Corporation**

Oncology Services Corporation (OSC) is licensed by the NRC, as prescribed in 10 CFR Part 35 to use several types of HDR brachytherapy remote afterloaders to treat humans. The license was issued by NRC Region I. NRC's Office of Nuclear Materials Safety and Safeguards provides guidance for medical use programs in Regulatory Guide 10.8, "Guide for the Preparation of Applications for Medical Use," Revision 2, August 1987, and specific licensing guidance for brachytherapy remote afterloaders in Policy and Guidance Directive FC 86-4; "Information Required for Licensing Remote Afterloading Devices," issued on February 20, 1986.

Part 35, issued in substantially its current form on October 16, 1986, prescribes requirements for the medical use of byproduct material. Subpart G of Part 35, "Sources for Brachytherapy," provides specific requirements for brachytherapy; however, this subpart is mostly applicable to low dose rate brachytherapy application. Although the latest amendments to Part 35 became effective 6 months after FC 86-4, the regulations do not explicitly recognize HDR brachytherapy, and only some requirements in Subpart G are applicable to HDR brachytherapy. Regulatory Guide 10.8 provides guidance only for low dose rate brachytherapy. Because of the substantial changes to Part 35 in 1986, certain references to an earlier revision of Part 35 in FC 86-4 are inaccurate. These inaccuracies are not significant and appear to have no practical consequence. However, the licensing guidance in FC 86-4 is outdated and is not well integrated with NRC medical regulations or other NRC licensing guides.

The NRC issued original OSC License 37-28540-01 on August 3, 1990. This license authorized the use of one Gamma Med Iii remote afterloading brachytherapy system in Harrisburg, Pennsylvania. On November 2, 1990, the license was amended in its entirety to add additional users and locations and to permit the single Gamma Med system to be shipped from site to site. The IRCC was one of these sites.

License Amendment 2 was issued January 22, 1992. This amendment added several models of HDR afterloader brachytherapy systems to the license for use at several locations, including the IRCC. One of the models authorized for use was the Omnitron 2000 HDR remote afterloader.

Amendment 3 was issued August 19, 1992. This amendment was the version of the license in effect at the time of the incident. It added to the license authorization for a stand-alone HDR brachytherapy shielded facility at the existing Harrisburg facility.

## 8.5 NRC Inspection Program and Process

NRC Inspection Manual Chapter (MC) 2800 establishes the inspection program for medical licenses, including license priority and inspection frequency. Inspection Procedure (IP)-87100 provides inspection direction for several types of material inspections, including Nuclear Medicine and Medical Teletherapy. The field notes used by inspectors for teletherapy are included in Appendix A to IP-87100 and the field notes for Nuclear Medicine programs, including brachytherapy, in Appendix B to this IP. The section on brachytherapy in the field notes closely follows the requirements in 10 CFR Part 35, Subpart G. None of the guidance explicitly discusses HDR brachytherapy, and FC 86-4 is not referenced, although other NRC licensing guides are referenced in MC-2800. In addition, inspection guidance directs inspectors to review the licensee's license, the license conditions, and referenced applications.

MC-2800 requires an initial inspection within a year of initial licensing of a facility and routine inspections every 3 years for those facilities licensed for medical programs. Facilities licensed for teletherapy programs are to be inspected annually. The frequency for inspecting facilities licensed to use HDR brachytherapy is not explicitly addressed in this MC but is included in its guidance for medical programs. The inspection program guidance is silent for licenses authorizing (1) multiple places of use, (2) use where the Radiation Safety Officer (RSO) can not respond quickly, and (3) license amendments that greatly expand a licensee's scope of operations, including new locations of use after the initial inspection.

The initial inspection of OSC was conducted on September 4, 1991, about 1 year after its initial licensing. The inspection was conducted at the Harrisburg Cancer Center, which is the mailing address of the licensee as well as the routine work location of the RSO. At the time of the inspection, the licensee possessed only one HDR afterloader. The system was transported to other OSC facilities named in the license and stored as well as used in the Harrisburg facility. During this inspection, inspectors identified two Severity Level IV violations (Appendix C to 10 CFR Part 2). Both violations were of modest safety significance and were appropriately categorized. Neither was a precursor of the November 16, 1992, event. A routine reinspection was scheduled for September 1995 in accordance with MC-2800.

The two individuals conducting the inspection in 1991 were experienced and well-qualified inspectors. One was the Chief of the Region I Medical Licensing Section and the other was a senior inspector. Both had work experience in medical radiology in addition to their NRC experience. Their training in brachytherapy was limited to conventional low dose rate brachytherapy; one inspector had extensive work experience in low dose rate brachytherapy.

These inspectors found that the staff involved with the HDR afterloader at the Harrisburg facility had been trained. This finding was based on interviews with six Harrisburg staff members, including the RSO, the physician user, two medical physicists, a driver, and a

technologist. Those questioned were knowledgeable in both operating and emergency procedures. They were also knowledgeable in the areas specified in 10 CFR 19.12. Records of training and retraining were not reviewed and this was stated in the inspector's inspection notes. One inspector stated that, if correctly recalled, they had requested these records. The inspector does not recall why they did not review them. According to the inspector's statement, the inspector may have been distracted. Inspectors did not go to the IRCC during this inspection. The IRCC had no HDR afterloader at this time.

Section 12, Brachytherapy, of the NRC inspector's field notes was marked "HDR only." The inspector stated a belief that the requirements covered by this section (i.e., Subpart G of 10 CFR Part 35) were either not applicable or covered by other sections of the field notes. The inspector noted that operational and emergency procedures were covered by license conditions in lieu of 10 CFR 35.410 "Safety instructions." The inspector correctly notes that 10 CFR 35.415 "Safety precautions," are not applicable to HDR brachytherapy. The inspector believed the requirement in 10 CFR 35.404 to survey the patient immediately after removing the source was met by the area radiation monitor in the treatment room. The inspector stated that this belief was based on the licensee's commitment to comply with the guidance in FC 86-4, which provides for a room monitor to verify the location of a source.

The NRC has no policy on reinspection when a licensee significantly changes or increases the scope of its program by an amendment. At times a licensing visit is performed when such changes are requested.

## **8.6 NRC Regulatory Activities**

The NRC took several actions related to this event before the completion of this report.

1. Bulletin 92-03, issued December 8, informed licensees authorized to use the Omnitron 2000 HDR afterloader of the November 16, 1992, incident and requested that they implement three actions: First, the survey of all patients had to be completed immediately after completing each therapy treatment and before removing the patient from the therapy room. Second, procedures, staff, and equipment had to be available for prompt intervention should the source not retract into the shielded container at the conclusion of the treatment. Third, initial and semiannual training were needed on procedures for both the routine use of the afterloader and in the event of an emergency.
2. Information Notice 92-84, issued December 17, 1992, informed all NRC medical licensees of this incident and reminded them of the requirements for positive assurance that all implanted sources have been removed before patients have been released after treatment. It provided information similar to that in Bulletin 92-03.

3. On January 20, 1993, the NRC suspended the license of Oncology Services Corporation. The action was based on both the findings discussed in this report as well as the results of inspections at two other Oncology Service Corporation facilities that identified training problems similar to those identified by the team at IRCC performed by NRC Region I.

## 9 PRECURSORS

The following section presents a summary of all hardware-related brachytherapy device precursors that were identified as being similar to the malfunction of the Omnitron International Inc.'s (Omnitron's) 2000 high dose rate (HDR) brachytherapy afterloader unit at the Indiana Regional Cancer Center (IRCC).

### 9.1 High Dose Rate Remote Afterloader Incidents

For this report, an HDR incident precursor is defined as an event that involves malfunctioning (through breakage, rupture, unintended disconnection) of the source wire or guide tube of a brachytherapy remote afterloader.

From information provided by the Food and Drug Administration, NRC's Office of State Programs, and other NRC Offices, no Omnitron-specific malfunctioning events have been reported to NRC before December 1, 1992. The first Omnitron 2000 system was shipped to a user in February 1991.

To date, the team is aware of one incident involving HDR brachytherapy afterloaders (and sources) manufactured by a company other than Omnitron International, Inc. (Omnitron). However, other similar incidents may have occurred in the United States or in other countries of which the team is not aware.

The precursor, in August 1988, involved a Microselectron HDR afterloader manufactured by Nucletron. In this event, the top of a defective source capsule became detached during a treatment, allowing several high-activity iridium-192 seeds to fall out of the capsule. Several things are important to note. First, when the top of the source capsule separated from the capsule and the body of the capsule returned to the storage safe, the Nucletron device indicated a "safe condition" existed. Second, the PrimAlert-10 monitor in the room was flashing red and the radiation therapy technologists (RTTs) performing the treatment took this signal as an indication that radiation was present in the treatment room. The RTT's actions demonstrated their knowledge of radiation safety and emergency procedures. Third, the RTTs surveyed the patient for radiation after removing the patient from the treatment room.

Subsequent testing and examination performed by the source vendor (Mallinckrodt Diagnostica B.V.) indicated that an incomplete welded joint on the source end cap was the cause of the source failure. To prevent recurrence of this type of event, both the source vendor and Nucletron improved quality control procedures associated with the manufacture of the source. Nucletron has since changed the overall design of the source used in the Microselectron HDR afterloader.

## 9.2 Omnitron 2000 Performance History

Omnitron was founded in 1988, and its first HDR afterloader system was developed in 1989. Omnitron demonstrated it at an industry show and decided that the system needed some modifications and improvements. The first commercial unit was shipped in February 1991. Currently, 25 units with an active source wire installed are in service in the United States.

Omnitron's President stated that the afterloader's performance history has been excellent. Several individuals who work for Omnitron stated that they were unaware of any production source-wire breaks except for those at the IRCC and the Greater Pittsburgh Cancer Center.

A review of the complaint file provided to the team indicated that 41 complaints have been filed from 15 different customers. The most frequent complaints that required service are categorized as follows:

- Dummy wire fails to retract/park or constricted—7 complaints
- Printer problems—5 complaints
- Planning system problems—4 complaints
- HDR hardware problems—4 complaints
- Computer console hardware problems—2 complaints
- Software problems—2 complaints
- Source wire failed length check—1 complaint
- Contamination problem—1 complaint

The remaining 15 complaints were handled by calling the customer and working through the complaint with them by telephone.

When service calls are placed, or when routine maintenance is required, Omnitron representatives go to the customer's site and perform the required service. A service checklist was provided to the team by Omnitron's service manager. According to this service manager, the checklist is used and discarded after its use. The service checklist shows tests, inspections, and parts that are replaced during service.

The only service records that were saved are the actual service-order documents. These documents list the parts replaced, the service requested, the type of service, and other information. However, in reviewing these records, the team found little or no information explaining why the item was replaced or why the problem occurred.

## 10 FINDINGS AND CONCLUSIONS

The team has compiled the following list of principal findings and conclusions concerning the incident. Each major conclusion appears as a numbered section.

### 10.1 Radiological Consequences Were Serious to the Patient and Significant to Many Members of the Public.

Patient A at the Indiana Regional Cancer Center (IRCC) received a severe medical misadministration and subsequently died. The physician intended to deliver a total dose of 1800 cGy (rad) to the tumor delivered in three 600 cGy fractions. By the licensee's own calculations the delivered dose to the same treatment point was in the order of 1,600,000 cGy (rad). Radiation absorbed doses to normal tissues and vital organs were calculated by NRC's Medical Consultant assuming a 92.75-hour exposure from a  $1.56 \text{ E}+11 \text{ Bq}$  (4.22-Ci) iridium-192 source, which was the source strength as indicated on the Omnitron computer printout. Doses to the kidneys ranged from 27 to 41 Gy (2,712 to 4,139 rad), doses to the small bowel ranged from 64 Gy (6,369 rad) at the median point to 476 Gy (47,605 rad) to the closest point, and doses to the bladder ranged from 201 to 3,607 Gy (20,142 to 360,663 rad). As stated by NRC's Medical Consultant, doses in the half million to one million cSv (rem) range should cause extensive necrosis in a few days and possible rectal perforation. Therefore, the NRC's Medical Consultant concluded that Patient A experienced a severe acute radiation syndrome from an overdose of radiation, which was a probable contributing cause of death. In a press release dated January 26, 1993, the Indiana County Coroner stated that the cause of death listed in the official autopsy report was "Acute Radiational Exposure and Consequences Thereof."

Forty-nine nonoccupational workers and members of the public received exposures calculated to be in excess of 0.005 Sv (0.5 rem). Of these exposures, 21 were calculated to have exceeded 0.05 Sv (5 rem). The upper limit on exposures is calculated to be 0.15 to 0.25 Sv (15 to 25 rem). The calculations were based on reconstructions of activities and estimates of dwell times that result in uncertainties in individual exposures. All nine cytogenetic evaluations are in agreement with the above upper limit and generally consistent with calculated doses.

The NRC's medical consultant concluded there were no acute effects of radiation seen in the nursing home staff, other residents, visitors, or members of the general public.

Population groups receiving significant exposures included individuals at the IRCC; the adjacent physician's office; the staff, residents, and visitors at the SHM nursing home; the ambulance driver and aide; and BFI workers at Carnegie, Pennsylvania.

The evaluation of radiological doses submitted by the licensee were lower than the team's calculations in some cases by as much as a factor of 3. In addition, the licensee did not

calculate doses for any of the residents of the Scenery Hill Manor (SHM) nursing home, even though in several cases, these residents were known to have been exposed (later confirmed by cytogenetic evaluation) to the radiation source because of their close proximity to Patient A's room.

No occupational worker's exposure exceeded the 0.0125-Sv (1.25-rem) quarterly occupational limit.

The most conservative estimates for individuals not specifically evaluated in the report but inadvertently exposed to the source are less than 1 mSv (100 mrem). This is less than the current allowable exposure limit for a member of the general public.

The source, an iridium-192 wire, released essentially no radioactive material. No contamination was detected at the IRCC, in the ambulance or at the SHM nursing home. Traces, less than the NRC (185 Bq) 5-nanocurie limit, of iridium-192 were detected on the active and dummy source wires.

## **10.2 Weaknesses in Oncology Services Corporation's Radiation Protection Program Were a Contributing Cause of the Seriousness of the Event and Radiation Exposure Consequences.**

OSC's Radiation Protection Program was ineffective and incomplete. The corporation's Radiation Safety Officer (RSO) did not provide sufficient oversight to ensure that all personnel associated with operation of the HDR afterloader were properly trained in its use. The RSO did not ensure that all personnel were properly trained and knowledgeable in basic radiation safety. Further, the RSO was not aware of the IRCC's authorized user's practice of authorizing a technologist, who had not completed the Omnitron International, Inc.'s (Omnitron's) training course, to operate the unit.

Other than the operator's manual provided by Omnitron, approved written policies, procedures, and guidelines were not provided to OSC personnel. Practices followed at the Greater Pittsburgh Cancer Center (GPCC) that limited the consequences of their source-wire-break incident included surveying the patient and the afterloader following patient treatment, and having the medical physicist and the physician present at the console. These practices were not followed at IRCC. The lack of adequate emergency procedures and training contributed to the failure of the IRCC staff to respond to the PrimAlert-10 area radiation monitor alarm. The RSO was not aware of the PrimAlert-10 spurious alarms and the IRCC reaction to the alarms.

Further, owing to the lack of management oversight, guidance, and training, OSC personnel at the IRCC did not adequately respond during the recovery of the source, which resulted in apparent violations of Department of Transportation (DOT) regulations; unnecessary exposure to a nonoccupational worker; and inadequate and incomplete reports to the NRC concerning whole-body and organ doses received by the patient.



### **10.3 Weaknesses Existed in the Design and Testing of the Omnitron 2000 Remote Afterloader System and Its Source Wire.**

The two failures of the source wire in service in the Omnitron 2000 high dose rate (HDR) afterloader may be attributed to weaknesses in design of the source wire and the testing program to validate the design. Specifically, the manufacturer performed no engineering calculations for stress and fatigue of the wire before this event, particularly the source cavity. All breaks during testing and in service have occurred in the bottom section of the cavity. Although they performed prototype testing in accordance with ISO 2919, they performed no additional tests before this event to ensure that environmental conditions would not affect the integrity of the source wire, particularly, tests for environmental effects of radiation, moisture, and the presence of teflon within the shipping container. The material teflon has been known to have poor resistance to radiation in the presence of oxygen.

The HDR afterloader was not designed to positively verify that a source wire has fully retracted if the emergency dc motor is being used to retract the source. If a broken source wire is not initially detected by the HDR afterloader, the HDR afterloader is not designed to detect the broken source wire during subsequent use because it is not designed to measure and record the overall length of the wire.

Personnel performing treatment are briefly notified by an error message displayed on the computer monitor that an emergency dc retraction is occurring (i.e., an error message only appears on the screen for the short duration of the retraction). Once the source wire has retracted, the error message is cleared, and no other design features verify full retraction of the source wire or whether the emergency motor retracted the wire. The manufacturer established no program to recover and examine "spent" source wires to look for evidence of deterioration and confirm the adequacy of the source-wire design.

Although Omnitron's quality assurance and quality control (QA/QC) program was weak, the team identified no other deficiencies that could be directly related to the source-wire breaks.

### **10.4 Oncology Services Corporation and Indiana Regional Cancer Center Lacked Critical Safety Awareness with Respect to High Dose Rate Brachytherapy.**

The safety culture at the IRCC significantly contributed to the incident. A pervasive lack of critical radiation safety awareness existed within the IRCC organization. The authorized user was not wearing a film badge during both encounters with the source. Technologists routinely ignored the PrimAlert-10 alarm and habitually sought to override this alarm by unplugging the unit to reset it. No one at IRCC who operated the HDR afterloader ever verified the operation of safety interlocks associated with the unit before its use. Technologists did not survey patients, the afterloader, or the treatment room following HDR

treatment. The authorized user rarely observed operations and was not present at the console during treatment in this incident. The IRCC technologist who had not completed Omnitron training was allowed to perform unsupervised treatments.

Omnitron personnel believed and apparently had led most OSC personnel to believe that a source-wire break was not possible and, in fact, had not provided emergency procedures adequate to mitigate such an event. Consequently, IRCC personnel did not consider a source-wire break as a credible event.

These assumptions were exacerbated by the facts that the corporation's RSO rarely visited the site and did not audit radiation safety practices and that IRCC personnel were not aware of who was responsible for radiation management and training or who was listed as the RSO on the license.

## **10.5 Overall Regulatory Oversight Was Weak.**

The team identified regulatory oversight weaknesses in several areas although none directly caused this incident or increased the severity of the consequences. The weaknesses were in the areas of regulatory oversight of HDR afterloader users, the licensing and inspection of programs that expand significantly by amendment after initial licensing; and the overall regulation of vendors of devices that use licensed nuclear material.

HDR afterloader license applications for use of HDR afterloaders are reviewed using guidance provided by NMSS Policy and Guidance Directive FC 86-4, "Information Required for Licensing Remote Afterloading Devices." Except for Regulatory Guide 8.33, "Quality Management Program," HDR is not addressed specifically or FC 86-4 referenced in any other NRC regulation, licensing guide, or inspection procedure, most of which were issued after FC 86-4 was issued. Because the current effective 10 CFR Part 35, and its associated medical licensing guide, Regulatory Guide 10.8, Revision 2, were issued after FC 86-4, licensing guidance in FC 86-4 is not totally consistent with the general requirements of 10 CFR Part 35. Most importantly, FC 86-4 does not reference the patient survey requirements in 10 CFR 35.404(a), which require a survey with radiation survey instruments.

Some experienced NRC staff in the Regions were confused over the applicability of some 10 CFR Part 35 requirements to HDR brachytherapy. The NRC staff's medical inspection procedures are consistent with Part 35 requirements and the medical licensing guide but reference neither HDR nor FC 86-4. NMSS Headquarters managers stated they believed that NRC inspectors were not always enforcing the patient survey requirements of 10 CFR 35.404(a). Instead, some NRC inspectors and licensees believed area radiation monitors met the survey requirements of 10 CFR 35.404(a), which was the case at IRCC where patients were not surveyed after treatment.

NRC licensing and inspection guidance did not clearly focus on a program that rapidly expanded, as was the case with OSC, when License Amendment 2 was issued. This

amendment did not require special management controls to ensure the RSO could manage radiation safety training and control at remote facilities. The NRC inspection Manual Chapter 2800, while requiring an early initial inspection, allowed the next inspection to be set 4 years after the initial inspection, regardless of how significantly the scope of licensed activities changed after the initial inspection. Furthermore, even if the initial inspection had been conducted after the program expanded, a performance-based inspection at the Harrisburg facility alone would not have identified the training problem at other OSC facilities.

This investigation also revealed a number of weaknesses in the design and QA and QC program of the vendor. NRC issued two regulatory guides, Regulatory Guide 10.10, "Guide for the Preparation of Applications for Radiation Safety Evaluation and Registration of Devices Containing Byproduct Material," March 1987, and Regulatory Guide 10.11, "Guide for the Preparation of Applications for Radiation Safety Evaluation and Registration of Sealed Sources Containing Byproduct Material," June 1987. These guides provided assistance to manufacturers and distributors of byproduct sealed sources and devices on how to file an application, and what information and documentation were required in their submittal. However, the guidance did not provide details on what the QC program must include. Therefore, the team could find no applicable NRC requirements or guidelines against which details in a QC program could be measured.

The Food and Drug Administration (FDA) has authority over the vendors of medical devices such as the Omnitron 2000 afterloader. The source wires were also licensed as sealed sources by the State of Louisiana. The scope of the IIT did not include an evaluation of the adequacy of FDA or State regulatory activity related to the Omnitron 2000 afterloader. The regulatory interaction between the NRC, FDA, and the involved Agreement States in the regulation and authorization of the Omnitron 2000 HDR afterloader is poorly defined.

## **10.6 No Regulatory Guidance Exists for Nonradioactive Waste Collectors. In Addition, Browning-Ferris Industries Failed To Follow Their Existing Radiation Control Policies.**

No regulatory guidance exists for waste collectors, brokers, and recyclers similar to that developed by the steel industry. Browning-Ferris Industries (BFI) had an aggressive radiation monitoring program to ensure radioactive material was not disposed of inappropriately. Without this program, the source might never have been detected by the BFI-Warren facility, and further significant radiation exposures could have occurred. The radioactivity that BFI workers receive from medical facilities they serve is very low. In this incident, BFI workers encountered a significant radiological hazard for which they were not prepared and for which they had no regulatory guidance that described how to dispose of highly radioactive material.

The failure of the BFI-Carnegie waste pick-up Driver A to survey the waste at the nursing home on November 25, 1992, in accordance with BFI policy, resulted in the exposure of the driver and other BFI employees to significant levels of radiation. If BFI Driver A had surveyed the waste at the nursing home, exposures to all other BFI employees would have been avoided.

The return of the radioactive waste shipment to BFI-Carnegie, coupled with the search for the source of radiation and attempts to trace the material's origin by BFI employees who were neither trained nor equipped to handle a source of this magnitude, should have been avoided. The highest exposed BFI workers were among those who searched the trailer for the source on November 30, 1992. Once BFI-Warren determined that they had a highly radioactive shipment, further shipment violated DOT regulations. In addition, when BFI-Warren located the trailer containing the iridium-192 source, measures should have been taken to isolate the trailer and obtain professional radiological safety help to minimize radiation exposure to others.

## **GLOSSARY**



## GLOSSARY

**The description of the terms in this glossary do not provide definitions or legal interpretation of these terms. The description of the terms is intended for use in this report.**

**Absorbed dose** means the amount of ionizing radiation absorbed by an object or individual. The special name gray, symbol Gy, has been adopted for the System International (SI) unit of absorbed dose.

**Activity** means a measure of strength of a radioactive source, measured in units of becquerel (Bq) [curies (Ci)].

**Attenuation** means the reduction of radiation intensity as it passes through any material, for example, lead shielding.

**Autoradiograph** means the imaging of radioactive material on x-ray film by exposing the film to the radioactive material. Darkened areas on the film would indicate the presence and distribution of radioactive material.

**Background radiation** means radiation emitted from naturally occurring radioactive materials in the earth or from cosmic rays. The estimated total effective dose equivalent rate for a member of the public in the United States from various sources of natural background radiation is 3.0 mSv 300 (mrem) per year.

**Byproduct material** means radioactive material obtained as a byproduct from nuclear reactors. Iridium-192 is byproduct material.

**Becquerel** means a unit of activity equal to one disintegration per second. (Abbreviation Bq).

**Beta particle** means a charged particle emitted from the nucleus of an atom with a mass and charge equal in magnitude to that of the electron.

**Calibration** means a determination of variation from a standard, or accuracy of a measuring instrument to ascertain necessary correction factors.

**Chemical analysis** means the chemical analysis of bulk samples of a metal part by one or more of several wet chemical techniques to establish the bulk chemical composition of the material for comparison with applicable specifications.

**Curie** means a unit of activity equal to  $3.7 \text{ E}+10$  disintegrations per second (Abbreviated Ci).

**Collective dose** means the sum of the individual doses received in a given period of time by a specific population from exposure to a specified source of radiation.

**Counting efficiency** means a measure of the probability that a count will be recorded when radiation is incident on a detector.

**Cytogenetic evaluation** means an evaluation of blood cells to determine chromosomal aberrations induced by radiation exposure.

**Differential Scanning Calorimetry (DSC)** means a thermal analysis technique employed to identify phase transformations in materials as a function of temperature. Small specimens of the material to be analyzed are heated at a constant, predetermined rate in an inert gas environment. Instrumentation records the heat input required to maintain the predetermined heating rate and phase changes (endothermic or exothermic) that result in spikes in a heat input versus temperature plot.

**Dose equivalent** means the product of D, Q, and N at the point of interest where D is the absorbed dose, Q is the quality factor, and N is the product of all other modifying factors,

$$H = DQN$$

The special name sievert, symbol Sv, has been adopted for the SI unit of dose equivalent in the field of radiation protection. The older conventional unit of dose equivalent is rem ( $1 \text{ Sv} = 100 \text{ rem}$ ). An absorbed dose of 1 Gy (100 rad) from gamma rays results in approximately a dose equivalent of 1 Sv (100 rem).

**Dose rate** means the absorbed dose delivered per unit time.

**Dosimeter** means an instrument to detect and measure accumulated radiation exposure (i.e., film badge).

**Dwell time** means the amount of time a brachytherapy source remains at a specific location within an implant catheter.

**Electron capture** means a mode of radioactive decay involving the capture of an orbital electron by its nucleus.

**Electron volt** means a unit of energy equivalent to the energy gained by an electron passing through a potential difference of one volt.



**Endobronchial implant** means the insertion of brachytherapy source(s) into the bronchial tubes in the patient's lung.

**Energy dispersive x-ray spectroscopy (EDX or EDS)** means a procedure that provides for identification of the elemental composition of a material. In this procedure, an exciting radiation (electron beam or x-rays) is directed against the specimen in question. Characteristic x-rays are then emitted for each element present and these emitted x-rays are analyzed to identify the individual elements qualitatively or quantitatively.

**Exposure** means being exposed by ionizing radiation or to radioactive material.

**Fractography** means the process of examining the fracture surfaces of a failed component or test specimen in detail. Fractographic examinations are carried out at all levels of magnification from the visual level to high magnification (up to 10,000X) in the scanning electron microscope (SEM).

Fracture surface features can identify fracture initiation sites, directions of fracture, and certain mechanical and chronological aspects of the fracture. Fine-scale fracture surface features serve to identify the particular cracking mechanism involved in the fracture.

**Gamma ray** means short-wave length electromagnetic radiation of nuclear origin emitted from the nucleus.

**Geiger-Mueller Counter** means a highly sensitive, gas-filled radiation measuring device.

**Gray** means the SI unit of absorbed dose. One gray is equal to an absorbed dose of one Joule per kilogram (100 rads) (Gy).

**Hardness Measurements** means measurements made by indenting a material with a standard indenter and a known load. Hardness values are then determined by the depth of penetration or by the projected size of indentation. Hardness is considered as a unique mechanical property but it also provides for relative evaluation of other mechanical properties such as tensile strength.

**Hot cell** means a shielded box or enclosure for sorting, processing, manufacturing or testing radioactive materials that must be handled remotely.

**Interstitial** means the insertion of brachytherapy source(s) into spaces within a tissue.

**Intracavitary implant** means the insertion of brachytherapy source(s) into a body cavity.

**Ionization chamber** means an instrument designed to measure a quantity of ionizing radiation in terms of the charge of electricity associated with ions produced within a defined volume.

**Leak test** means a test on sealed sources to ensure that radioactive material is not being released.

**Metallography** means metallographic examinations that are performed by monitoring a sectioned specimen in a suitable plastic and grinding and polishing the section using successively finer grits (down to 0.05 microns). This specimen is then etched with a suitable reagent to enhance microstructural features. Examinations of the as-polished or polished and etched section in an optical microscope at magnifications up to 1000X provides for evaluation of the microstructure of the material and identification of microstructural defects and abnormalities.

**Micro - or milli** means those abbreviations commonly used in radiation protection. Several fractions of radiological units are --

**millisievert:** One-thousandth of a sievert (abbreviated msv)

**microsievert:** One-millionth of a sievert (abbreviated  $\mu$ Sv)

**Misadministration**, as it applies to brachytherapy, means the administration of a brachytherapy dose that involves the wrong patient, the wrong radioisotope, the wrong treatment site, a leaking source, an administered dose differing by more than 20 percent from the prescribed dose; or when a temporary source is not removed upon completion of the procedure.

**Occupational dose** means the dose received by an individual in a restricted area or in the course of employment in which the individual's assigned duties involve exposure to radiation and to radioactive material. Occupational dose not involve dose received from background radiation, as a patient from medical practices, from voluntary participation in medical research programs, or as a member of the general public.

**Public dose** means the dose received by a member of the public from exposure to radiation and to radioactive material released by a licensee, or to another source of radiation either within a licensee's controlled area or in unrestricted areas. It does not include occupational dose or dose received from background radiation, as a patient from medical practices, or from voluntary participation in medical research programs.

**Quality assurance (QA)** means the planned and systematic actions necessary to provide confidence that a firm or product will perform to establish specifications.

**Quality control (QC)** means the QC activities, including inspection and testing whose purpose is to provide a means to measure the characteristics of a firm or product to the required specifications.

**Quality factor** means the modifying factor that is used to derive dose equivalent from absorbed dose. The quality factor for gamma radiation emitted by iridium-192 is one.

**Quality management (QM) program** means licensee response to the requirements set forth in 10 CFR Part 35.32 that requires medical users of byproduct material to establish a QM program.

**Radiation Safety Officer** means the individual or the Radiation Safety Officer identified on an NRC licensee responsible for implementing the radiation safety program. The RSO ensures that radiation safety activities are being performed in accordance with approved procedures and regulatory requirements in the licensee's daily operations.

**Radioactive decay** means the disintegration of the nucleus of an unstable nuclide by spontaneous emission of charged particles and/or photons.

**Radioactive half-life** means the time required for a radioactive substance to lose 50 percent of its activity by decay.

**Radioactive source capsule or source** means the small sealed metal capsule containing the radioactive material that emit the gamma rays used in remote afterloading devices.

**Red-bag waste** means the common term used to describe medical biohazard waste.

**Remote afterloader** means a radiation therapy device used to insert and retract a radioactive source (or sources) from a patient via remote-controlled mechanism.

**Safety culture** means the beliefs, perceptions, and expectations that individuals have about the organization in which they work and about the values and consequences that will follow from once course of action or another. Consequently, culture highly influences behavior within the organization.

**Sealed source** means a radioactive source sealed in an impervious container that has sufficient mechanical strength to prevent contact with and dispersion of the radioactive material under the condition of use and wear for which it was designed.

**Sievert** means the SI unit of any of the quantities expressed as dose equivalent. The dose equivalent in sieverts is equal to the absorbed dose in grays multiplied by the quality factor (1 Sv = 100 rems).

**Time and motion study** means an evaluation of the proximity and duration that an individual was near a source of radiation for the purposes of estimating radiation exposure.

**Wipe test** means an evaluation of removable contamination on a surface or object, wherein an absorbent material such as paper is rubbed across a surface and subsequently analyzed for radioactivity in a counting instrument.

**Work traveler** means a document that accompanies and records the history of the source wire. Typical work travelers list the steps and operations performed on the wire, the status (pass/fail), who performed inspections on the wire, and the date operations or inspections were performed.

**Worst-case scenario** means a situation for which it is assumed that no designed or incidental shielding absorbed radiation from the source emitting it.

**APPENDIX A**

**INCIDENT INVESTIGATION TEAM CHARTER**





UNITED STATES  
NUCLEAR REGULATORY COMMISSION  
WASHINGTON, D. C. 20555

December 4, 1992

MEMORANDUM FOR: The Chairman  
Commissioner Rogers  
Commissioner Curtiss  
Commissioner Remick  
Commissioner de Planque

FROM: James M. Taylor  
Executive Director for Operations

SUBJECT: INVESTIGATION OF A LOSS OF AN IRIDIUM-192 SOURCE AND THERAPY  
MISADMINISTRATION AT ONCOLOGY SERVICES CORPORATION, INDIANA  
REGIONAL CANCER CENTER, INDIANA, PENNSYLVANIA

On December 1, 1992 at approximately 12:30 P.M. (EST), a medical physics consultant (physicist) with Oncology Services Corporation (OSC) informed Region I that a 3.7 curie, iridium-192 source was missing from the licensee's facility in Indiana, Pennsylvania where it was utilized in a high dose rate remote afterloading (HDR) brachytherapy device. The missing item was found by Browning Ferris Industries (BFI). BFI is a waste removal company. The physicist stated that BFI had contacted OSC to determine whether waste picked up from the nursing home, in the vicinity of OSC's Indiana, Pennsylvania site, may have originated from the OSC facility. Waste picked up in the area set off a radiation monitor alarm at BFI's facility in Warren, Ohio, which initiated the source recovery and followup actions. In this case the source was "found" before it was reported to be "missing."

The licensee's authorized physician user indicated that the HDR brachytherapy device was last used on November 16, 1992, to treat an 82 year old female patient from the Scenery Hill Nursing Home located near OSC's Indiana, Pennsylvania site. Region I was notified on December 1, 1992 that during a brachytherapy treatment of the nursing home patient, the radioactive source had somehow remained in the patient. The patient was subsequently returned to her nursing home where she died a few days later. Therefore, the potential existed for overexposure to the patient, as well as nursing home staff, other individuals and those involved in the inadvertent discovery and retrieval of the source (the dose rate at one meter is of the order of 2R/hour). There are potential generic implications regarding the design and operation of similar devices. Calls by the vendor to other licensees who possess the device, notifying them of the incident, are almost completed. Our current information is that there are 21 such devices in use.

Region I and NMSS dispatched teams to review the licensee's actions and to determine any generic issues. The NRC staff notified the Food and Drug Administration's (FDA's) Center for Devices of the incident. The FDA has primary Federal responsibility for medical devices and indicated its interest to participate in the investigation of the incident. Because of the potential for overexposure for multiple members of the public as well as clinic and

nursing home staff, the complexity of the event, the licensing of the therapy device vendor in an agreement state and the involvement of the FDA in the licensing process, I have requested AEOD to take the necessary actions to upgrade the current investigation activities to an NRC Incident Investigation Team (IIT). The IIT is to: (a) fact-find as to what happened, (b) identify the probable cause as to why it happened, and (c) make appropriate findings and conclusions which would form the basis for any necessary follow-on actions. The IIT charter is enclosed.

The team will report directly to me and is comprised of: Carl Paperiello, (Region III) IIT Leader; Mohamed Shanbaky (Region I), Assistant IIT Leader; Cynthia Jones (NMSS), Thomas Rich (NMSS) and other NRC staff which will be determined later. Contractor support will include Daniel Flynn, MD and additional technical expertise. Because of the limited number of technical experts able to investigate an event of this type, some team members have had previous inspection involvement at the facility. The IIT was selected on the bases of their knowledge and experience in the fields of medical physics, health physics, radiation oncology, human factors, and mechanical engineering. All team members are relieved of all normal duties while assigned to the IIT.

The licensee has agreed to preserve the equipment in an "as-found" state until the licensee and the team has had an opportunity to evaluate the event. The licensee's actions have been confirmed by the Region in a Confirmatory Action Letter which was issued on December 2, 1992.

The IIT report will constitute the single NRC fact-finding investigation report. It is expected that the IIT report will be issued within about 45 days from the time the team exits from the site.

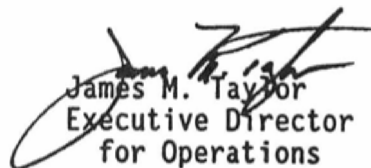
  
James M. Taylor  
Executive Director  
for Operations

Enclosure:  
Incident Investigation Team  
Charter

cc w/encl:  
SECY  
OGC  
ACRS  
OPA  
OSP  
OCA  
Regional Administrators



**Incident Investigation Team Charter**

**LOSS OF AN IRIDIUM-192 SOURCE AND THERAPY MISADMINISTRATION  
AT ONCOLOGY SERVICES CORPORATION,  
INDIANA REGIONAL CANCER CENTER, INDIANA, PA**

The scope of the investigation should include: incident chronology; source characterization; analysis of actual and potential dose consequences; human factors aspects; design and experience in operation of the equipment; event reporting and licensee response; and whether the NRC's regulatory process and activities, or the interface with state and other federal jurisdictions preceding the event, contributed to it. Within the framework of this overall scope the IIT should specifically:

With respect to the incident chronology: develop a detailed sequence of events associated with the therapy treatment, transport of the cancer patient, and transport and location of the source from the time it was used at the treatment center until its retrieval from the waste truck.

With respect to the source characterization: determine the manufacture type, radiation types and levels.

With respect to analysis of the actual and potential dose consequences: evaluate the dose received by the cancer patient as a result of the misadministration and the potential consequences; and reconstruct the projected exposure to individuals who were in proximity to the source either during the time it was in the cancer patient, or during storage, waste transport or retrieval.

With respect to the human factors aspects: evaluate training, surveys and supervision associated with the medical personnel's detection and response to the inadvertent retention of the source in the cancer patient.

With respect to the equipment: evaluate (1) the failure mechanism, (2) root causes of the failure, (3) its operating procedures, and (4) generic applicability of the failure or operation to other equipment.

With respect to event reporting and licensee response: evaluate the actions taken by the licensee to report to the NRC the loss of the source and potential overexposure(s) of individual(s); and the actions taken by the licensee to recover the source.

With respect to the NRC's regulatory process and activities: evaluate the regulatory controls concerning this type of event. Also, examine the interface with the involved Agreement States and other Federal jurisdictions.



**APPENDIX B**

**PROPERTIES OF IRIDIUM-192**



### Iridium-192\*

Atomic number: 77  
Atomic weight: 192  
Half life: 74.02 days

#### Betas

	<u>Probability per decay</u>	<u>Maximum (MeV)</u>	<u>Average (MeV)</u>
1.	.056500	.255950	.070800
2.	.414000	.536080	.161200
3.	.483000	.672420	.208900
4.	.004000	.844530	.275900
5.	.000987	.093000	.024933

#### Electrons

	<u>Probability per decay</u>	<u>Energy (MeV)</u>
1.	.031078	.006880
2.	.001594	.048300
3.	.005227	.131920
4.	.003649	.192830
5.	.001180	.202750
6.	.076020	.007240
7.	.003505	.051000
8.	.001192	.067951
9.	.001300	.122470
10.	.019237	.217560
11.	.017896	.230060
12.	.044658	.238110
13.	.008792	.282080
14.	.002867	.292660
15.	.007716	.294580
16.	.019470	.302630
17.	.002511	.305160
18.	.004839	.313210
19.	.001483	.315790
20.	.010236	.389680
21.	.002946	.454190
22.	.001509	.526020

#### Gammas & x-rays

	<u>Probability per decay</u>	<u>Energy (MeV)</u>
1.	.014625	.008910
2.	.011323	.061487
3.	.019555	.063001
4.	.008399	.071400
5.	.004674	.201310
6.	.032873	.205800
7.	.002615	.283260
8.	.007264	.374480
9.	.031628	.484580
10.	.003985	.489060
11.	.000797	.423070
12.	.040934	.009440
13.	.026350	.065022
14.	.045197	.066832
15.	.019675	.075700
16.	.001806	.136350
17.	.290150	.295960
18.	.296780	.308460
19.	.828530	.316510
20.	.006645	.416460
21.	.480550	.468070
22.	.045735	.588580
23.	.082024	.604410
24.	.053357	.612460
25.	.003016	.884510
26.	.000986	.871730

\* From Microshield 3.13

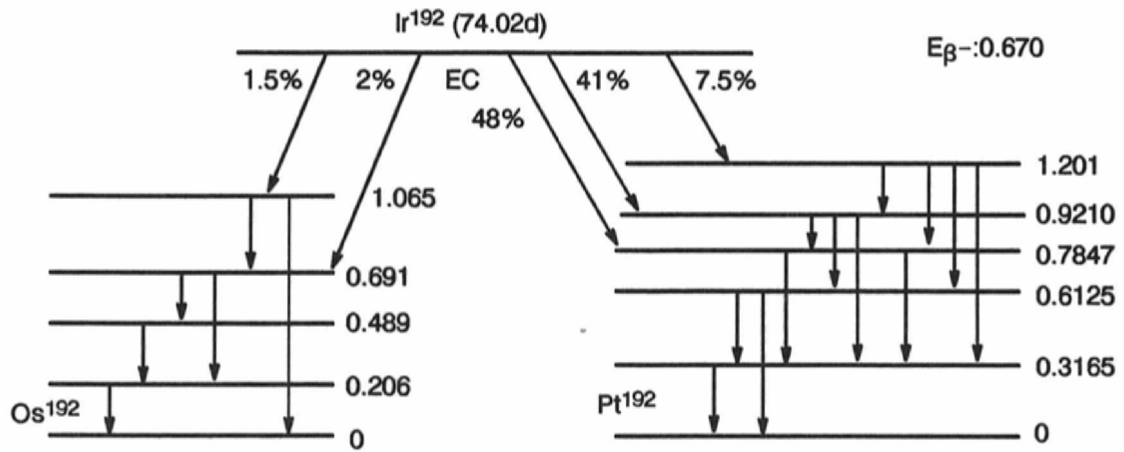
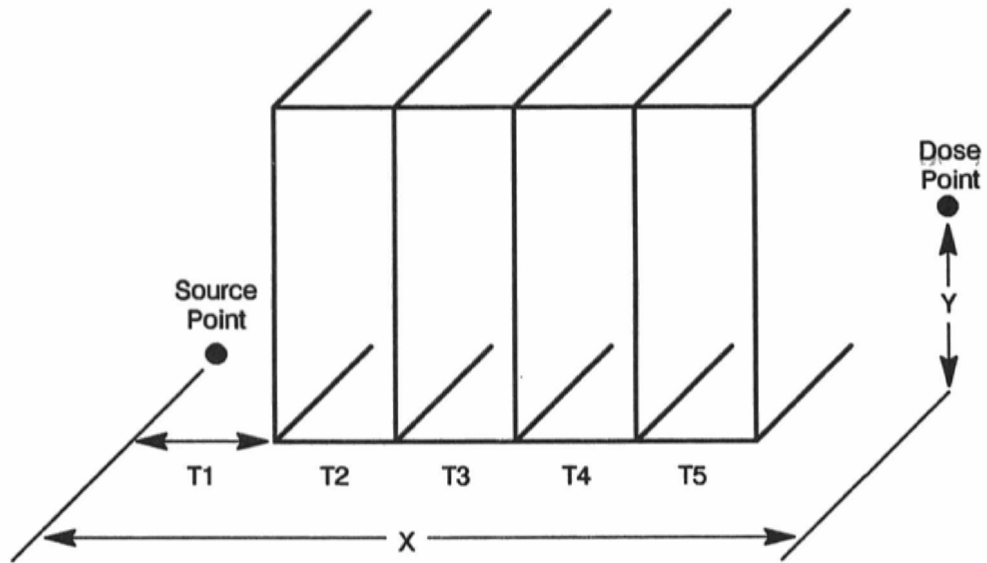

Figure B.1 Simplified Decay Scheme for Iridium-192



- X X is the horizontal distance from the source to the point of interest.
- Y Y is the vertical distance from the source to the point of interest.
- T Six Ts represent shield thicknesses. As many as five shields may be entered by the user. The sixth is reserved for a Microshield assigned air gap.

Figure B.2 Microshield 3.13 Program Showing Point Source and Shields

**Table B.1 Calculated Dose Rates (mSv/hr)\* at Selected Distances  
for 3.3085 E+11 Bq (8.942 Ci) Iridium-192 Source  
Certified August 28, 1992**

Date: Elapsed time (days): Activity (Bq): Activity [Ci]:	11/16/92 79 1.579 E+11 4.267	11/20/92 83 1.521 E+11 4.110	11/25/92 88 1.451 E+11 3.922	11/27/92 90 1.424 E+11 3.850	12/01/92 94 1.372 E+11 3.708
Distance: (m)	0.02	0.02	0.02	0.02	0.02
	5.146E+4	4.957E+4	4.730E+4	4.642E+4	4.472E+4
	3.310E+2	3.188E+2	3.042E+2	2.977E+2	2.876E+2
	8.317E+1	8.011E+1	7.644E+1	7.502E+1	7.227E+1
	3.715E+1	3.579E+1	3.415E+1	3.351E+1	3.228E+1
	2.100E+1	2.023E+1	1.930E+1	1.894E+1	1.825E+1
	9.427E+0	9.080E+0	8.665E+0	8.504E+0	8.192E+0
	5.354E+0	5.157E+0	4.921E+0	4.830E+0	4.652E+0
	3.459E+0	3.332E+0	3.179E+0	3.120E+0	3.006E+0
	2.424E+0	2.335E+0	2.228E+0	2.187E+0	2.106E+0
	1.797E+0	1.731E+0	1.652E+0	1.621E+0	1.562E+0
	1.388E+0	1.337E+0	1.276E+0	1.252E+0	1.206E+0
	1.106E+0	1.065E+0	1.017E+0	9.979E-1	9.612E-1
	9.036E-1	8.703E-1	8.305E-1	8.152E-1	7.852E-1
	4.176E-1	4.022E-1	3.838E-1	3.767E-1	3.629E-1
	2.432E-1	2.343E-1	2.235E-1	2.194E-1	2.114E-1
	1.147E-1	1.105E-1	1.054E-1	1.035E-1	9.966E-2

\* Dose rate from an unshielded iridium-192 source using Microshield 3.13 with point-source geometry and Berger build-up factor.  
1 mSv/hr = 100 mrem/hour



## **Build-Up Factor**

The build-up factor (B) is defined as the ratio of the actual dose rate (dose rate from primary plus scattered and secondary radiation) to the dose rate that is due to the primary radiation alone. The value of B is a function of radiation type and energy, attenuating medium and depth, and geometry (see Reference 1).

From the Microshield 3.13 computer code used in this report to calculate the dose rate to a point of interest, there are four methods available for buildup determination: no buildup, Taylor, geometric progression, and Berger (see Reference 2). The comparison of calculating dose rate with the Berger build-up factor versus no build-up is presented in Table B.2. If a substantial amount of shielding is present, buildup may contribute significantly to the calculated dose rate.

For this report, the Berger build-up factor was used since the Taylor build-up factor is not useful below a gamma ray energy of 2 MeV (see Reference 3). Also, Berger calculations are valid to about 10 mean free paths (10 times  $1/\mu$ ), which is approximately 730 m (2395 feet) of air, 0.9 m (2.95 feet) of water, or 0.4 m (1.31 feet) of concrete (see Reference 4).

**Table B.2 Iridium-192 Dose Rates vs. Distance  
With and Without Berger Buildup Factors**

Distance (meters)	Dose Rate in Air		
	With Berger buildup	With no buildup	<u>Dose Rate-Berger</u> <u>Dose Rate-None</u>
	mSv/hr*	mSv/hr*	
0.02	5.146E+4	5.143E+4	1.006
0.25	3.310E+2	3.283E+2	1.008
0.50	8.317E+1	8.182E+1	1.016
0.75	3.715E+1	3.626E+1	1.025
1.00	2.100E+1	2.033E+1	1.033
1.50	9.427E+0	8.984E+0	1.049
2.00	5.354E+0	5.023E+0	1.066
2.50	3.459E+0	3.196E+0	1.082
3.00	2.424E+0	2.206E+0	1.099
3.50	1.797E+0	1.611E+0	1.115
4.00	1.388E+0	1.226E+0	1.132
4.50	1.106E+0	9.632E-1	1.148
5.00	9.036E-1	7.756E-1	1.165
7.50	4.176E-1	3.346E-1	1.248
10.00	2.432E-1	1.827E-1	1.331
15.00	1.147E-1	7.652E-2	1.499

\* Dose rate from an unshielded iridium-192 source containing 1.579 E+11 Bq [4.267-Ci] on November 16, 1992, using Microshield 3.13 with point-source geometry.  
1 mSv/hr = 100 mrem/hour

## Build-up Contribution to Exposure Rate Calculations

As discussed in Section 7 of this report, the team concluded that (1) build-up factors were necessary to include in all exposure rate calculations and (2) there was very little attenuation owing to patient shielding. The following calculations illustrate these conclusions.

### Calculation

Material: Muscle

Density ( $\rho$ ): 1040 kilograms per cubic meter = 1.04 grams per cubic centimeter (g/cm<sup>3</sup>)  
(Reference 5)

Mass Attenuation Coefficient ( $\mu_m$ ) [from interpolation] = 0.1151 square centimeters per gram (cm<sup>2</sup>/g) for 320 keV gamma ray (Reference 5)

(Note: a 320 keV gamma ray was used since this is the most abundant Ir-192 gamma ray).

$$\begin{aligned}\text{Linear Attenuation Coefficient}(\mu_1) &= \mu_m \times \rho = 0.1151 \text{ cm}^2/\text{g} \times 1.04 \text{ g/cm}^3 \\ &= 0.1197 \text{ cm}^{-1}\end{aligned}$$

$$\text{Mean free path (mfp)} = 1/\mu_1 = 1/0.1197 \text{ cm}^{-1} = 8.354 \text{ cm}$$

$$\frac{X}{X_0} = B \exp(-\mu_1 d), \text{ where}$$

X	= Final exposure rate
X <sub>0</sub>	= Initial exposure rate
B	= Build-up factor
d	= Distance from the source (cm)
$\mu_1$	= Linear attenuation coefficient (cm <sup>-1</sup> )

a) If d = 10 cm:

$$\text{number of mfp's} = 10 \text{ cm}/8.354 \text{ cm} = 1.20$$

$$B \text{ (for 1.20 mfp's and a gamma ray energy of 300 keV)} = 3.35 \text{ (Reference 6)}$$

Using the Equation above,

$$\frac{X}{X_0} = 3.35 \exp(-0.1197 \text{ cm}^{-1} \times 10 \text{ cm}) = 1 \text{ (i.e., no attenuation)}$$

b) If  $d = 1$  cm:

number of mfp's =  $1 \text{ cm} / 8.354 \text{ cm} = 0.12$

B (for 0.10 mfp's and a gamma ray energy of 300 keV) = 1.12 (Reference 6)

$$\frac{X}{X_0} = 1.12 \exp(-0.1197 \text{ cm}^{-1} \times 1 \text{ cm}) = 1 \text{ (i.e., no attenuation)}$$

### Sample Hand Calculation (in SI units)

For correcting for radioactive decay of a source,

$$A_t = A_o B e^{-\ln 2 * t / T_{1/2}}$$

- where  $A_t$  = Corrected source activity (Bq) at time  $t$   
 $A_o$  = Source activity on August 28, 1992 ( $3.31 \text{ E}+11$  Bq)  
 $B$  = Dose Build-up factor  
 $t$  = Elapsed time in days since August 28, 1992  
 $T_{1/2}$  = Half-life of iridium-192 (74.02 days)

For calculating the exposure rate from a point source at a given distance,

$$\Gamma = 3.65 \times 10^{-9} \sum f_x E_x \frac{(C/kg) m^2}{MBq-hr}$$

- where  $\Gamma$  = Exposure rate in coulombs per kilogram (C/kg) per hour at 1 meter from an unshielded iridium-192 source of Activity,  $A_t$   
 $f_x$  = Probability of a gamma ray being emitted  
 $E_x$  = Gamma-ray energy in MeV

For iridium-192:

$$\Gamma = 3.5 \times 10^{-9} \frac{(C/kg) - m^2}{MBq-hr}$$

For calculating the exposure rate from iridium-192 for a specific time period,

$$E_d = \frac{\Gamma T}{d^2}$$

- where  $E_d$  = Exposure in sievert (Sv) at distance, d  
d = Distance in meters from the unshielded iridium-192 source  
T = Exposure time in hours  
 $\Gamma$  = Gamma constant

### Sample Hand Calculation (in English Units)

For correcting for radioactive decay of a source,

$$A_t = A_o B e^{-\ln 2 * t / T_{1/2}}$$

- where  $A_t$  = Corrected source activity (Ci) at time t  
 $A_o$  = Source activity on August 28, 1992 (8.942 Ci)  
B = Dose build-up factor  
t = Elapsed time in days since August 28, 1992  
 $T_{1/2}$  = Half-life of iridium-192 (74.02 days)

For calculating the exposure rate from a point source at a given distance,

$$\Gamma = 0.5 \sum f_x E_x \frac{R-m^2}{Ci-hr}$$

where  $\Gamma$  = Exposure rate in R per hour at 1 meter from an unshielded iridium-192 source of Activity,  $A_t$

$f_x$  = Probability of a gamma ray being emitted

$E_x$  = Gamma-ray energy in MeV

For iridium-192:

$$\Gamma = 0.48 \frac{R-m^2}{Ci-hr}$$

For calculating the exposure rate from iridium-192 for a specific time period,

$$E_d = \frac{\Gamma T}{d^2}$$

where  $E_d$  = Exposure in rem at distance,  $d$

$d$  = Distance in meters from the unshielded iridium-192 source

$T$  = Exposure time in hours

$\Gamma$  = Gamma constant (0.48 R-m<sup>2</sup>/Ci-hr)

## References

1. Attix, Frank Herbert, "Introduction to Radiological Physics and Radiation Dosimetry", John Wiley & Sons, Inc., 1986.
2. Microshield 3 Manual, Grove Engineering, Inc., Rockville, Maryland, 1987.
3. Taylor, J.J. and F.E. Obershain, USAEC Report WAPD-RM-213, Westinghouse Electric Corp., 1953.
4. Engineering Compendium on Radiation Shielding, Vol. 1, Shielding Fundamentals and Methods, Springer-Verlag, New York, 1968.
5. H.E. Johns and J.R. Cunningham, "The Physics of Radiology," Fourth Edition, Charles C. Thomas, Springfield, Illinois, 1983.
6. M.J. Berger, "Energy Deposition in Water by Photons from Point Isotropic Sources", MIRD/Pamphlet No. 2, J. Nucl. Medicine, Supplement No. 1, Feb. 1968.





**APPENDIX C**  
**LOW DOSE RATE AND HIGH DOSE RATE**  
**BRACHYTHERAPY**



## Appendix C

### Low Dose Rate and High Dose Rate Brachytherapy

Brachytherapy is a radiation therapy procedure for the treatment of cancer in which radioactive sources are placed near or in contact with a tumor. The prefix "brachy" means short as opposed to "tele" which means far. Thus, brachytherapy involves the use of a radioactive source at a short distance from the tumor while teletherapy involves the use of a radiation source at a long distance, usually greater than 80 centimeters (cm), from the tumor.

Each treatment method has its own advantages and safety problems. Teletherapy requires the shielding and protection of large sources. Typical sources are  $3.7 \text{ E}+14 \text{ Bq}$  (10,000 Ci) of cobalt-60. The output of these devices requires precise measurement. The dose at the treatment site is generally uniform over the volume of the tumor. The rooms in which they are used are heavily shielded with lead or concrete. Treatment times are in the order of minutes. Sources are relatively large sealed sources in large lead or depleted uranium cavities with heavy shields to block the radiation beam when the device is not being used. Problems encountered with these types of devices generally involve errors in output measurement or calculation, errors in treatment time, failure to shield the source at the end of the treatment, and exposure of the wrong part of the body.

One of the original uses of radium was brachytherapy. Today radium is rarely used. Principal sources in use today are cesium-137, iridium-192, cobalt-60, iodine-125, strontium-90, and palladium-103. Original treatment methods with radium did not depend on dose calculations. Instead, they were based on milligrams of radium at certain locations for specific periods of time. Treatment modes were based on physicians' clinical experience. Even today, certain brachytherapy sources are specified in milligram radium equivalents.

Because exposure rates vary with the inverse square of distance and because brachytherapy sources are either very close to or at the treatment site, the dose delivered is relatively nonuniform. When technology advanced, dose could be defined and measured, and systems were developed based on certain source distributions with a dose being specified at certain arbitrary points. Doses were derived from previous clinical practices that proved successful.

Brachytherapy sources are applied with intraluminal, interstitial, intracavitary, or intraoperative techniques. Usually catheters or applicators are placed in the patient to hold the radioactive sources before the sources are placed in the patient. Dummy sources placed in the catheters or applicators are located by x-rays to enable the physician to more accurately place the active sources and more accurately calculate dose. After the physician or technicians identify the proper location for the sources, the dummy sources are replaced by radioactive sources and the treatment begins. Low dose rate brachytherapy generally employs sources similar in strength to the original radium sources used. These sources are generally in the order of  $3.7 \text{ E}+09 \text{ Bq}$  (0.1 Ci). Sources are frequently loaded manually,

using forceps. If the physician is skillful and does not handle the sources by hand, the physician's exposure is usually within regulatory limits.

Typically, the sources remain in the patient for several days. The patient's room is isolated and nurses and other support staff are instructed to limit the amount of time spent in the room and, therefore, their exposure. Visitors are likewise limited. At the end of the treatment, the sources are removed, and surveying the patient with a radiation monitor at this point is critical for ensuring that no sources remain in the patient. It is also critical when returning sources to storage after their use to count them and ensure that none are lost. Brachytherapy sources are small and easy to lose. On occasion, a source will fall out of a patient during treatment. Sometimes semiconscious or agitated patients will remove sources inadvertently. Most low dose brachytherapy problems have resulted from sources being left in patients or being lost. NRC regulations require both the patient survey and the source count.

Remote afterloaders are devices for loading active sources into catheters or applicators by machine rather than manually. This protects the physician and other medical personnel from exposure to the source. The sources are stored in an internal lead shield and remotely removed from the shield and guided into the patient through catheters. For low dose rate remote brachytherapy, sources can be retracted when the nursing staff and other medical personnel provide bedside care for the patient. This reduces their exposure and this has significant As-Low-As-Is-Reasonably-Achievable (ALARA) value.

High dose rate brachytherapy combines remote afterloader technology with much higher source strengths in the order of  $3.7 \text{ E}+11 \text{ Bq}$  (10 Ci) or about two orders of magnitude greater than low dose rate brachytherapy. The technique is relatively new and it has two principal advantages. First, patients can avoid long hospitalizations in isolation. Treatment times are in the order of minutes. Second, small-diameter high-activity sources allow the treatment of certain sites (e.g., esophagus, bronchus, bile duct, brain) that could not be previously treated by brachytherapy.

However, high dose rate brachytherapy has its own special problems, some of which are similar to teletherapy. The high activity of the source requires the treatment to be conducted in a special shielded room. In addition, the source is not routinely observable. Treatment planning and timing must be much more sophisticated and must strongly depend on computer calculational techniques. Because of the newness of this technique, physicians place more reliance on dose calculations than on previous clinical practice. Emergency response is more difficult because if the source has to be retrieved, the dose rates involved are much higher than those encountered in low dose rate brachytherapy. Nevertheless, high dose rate brachytherapy is a medically important treatment modality.

**APPENDIX D**  
**ONCOLOGY SERVICES CORPORATION**  
**MATERIALS LICENSE**



**MATERIALS LICENSE**

Amendment No. 03

Pursuant to the Atomic Energy Act of 1954, as amended, the Energy Reorganization Act of 1974 (Public Law 93-438), and Title 10, Code of Federal Regulations, Chapter I, Parts 30, 31, 32, 33, 34, 35, 39, 40 and 70, and in reliance on statements and representations heretofore made by the licensee, a license is hereby issued authorizing the licensee to receive, acquire, possess, and transfer byproduct, source, and special nuclear material designated below; to use such material for the purpose(s) and at the place(s) designated below; to deliver or transfer such material to persons authorized to receive it in accordance with the regulations of the applicable Part(s). This license shall be deemed to contain the conditions specified in Section 183 of the Atomic Energy Act of 1954, as amended, and is subject to all applicable rules, regulations and orders of the Nuclear Regulatory Commission now or hereafter in effect and to any conditions specified below.

Licensee		In accordance with letter dated June 10, 1992,	
1. Oncology Services Corporation  2. 775 South Arlington Avenue Harrisburg, Pennsylvania 17109		3. License number 37-28540-01 is amended in its entirety to read as follows:	
		4. Expiration date August 31, 1995	
5. Docket or Reference No. 030-31765			
6. Byproduct, source, and/or special nuclear material	7. Chemical and/or physical form	8. Maximum amount that licensee may possess at any one time under this license	
A. Iridium 192	A. Sealed sources (Byk Mallinckrodt Model No. GM 252.20-001 or RTS Technology Model No. 722)	A. Not to exceed 11 curies per source and 132 curies total	
B. Iridium 192	B. Sealed sources (Byk Mallinckrodt Model No. GM 212.03-000 or RTS Technology Model No. 721)	B. Not to exceed 11 curies per source and 132 curies total	
C. Iridium 192	C. Sealed sources (Omnitron International Model SL-777)	C. Not to exceed 11 curies per source and 132 curies total	
D. Iridium 192	D. Sealed sources (Byk Mallinckrodt Model No. CI L BV)	D. Not to exceed 11 curies per source and 132 curies total	
9. Authorized use			
A. One source per device for use in an Isotopen-Technik Dr. Sauerwein GmbH Gamma Med Ili remote after loading brachytherapy device for the treatment of humans. One source per device in its shipping container as necessary to the replacement of the source in the irradiation device only.			
B. One source per device for use in an Isotopen-Technik Dr. Sauerwein GmbH Gamma Med 12i remote after loading brachytherapy device for the treatment of humans. One source per device in its shipping container as necessary to the replacement of the source in the irradiation device only.			
C. One source per device for use in an Omnitron 2000 remote after loading brachytherapy device for the treatment of humans. One source per device in its shipping container as necessary to the replacement of the source in the irradiation device only.			
D. One source per device for use in a Nucleotron MicroSelectron-HDR remote after loading brachytherapy device for the treatment of humans. One source per device in its shipping container as necessary to the replacement of the source in the irradiation device only.			

MATERIALS LICENSE  
SUPPLEMENTARY SHEET

License number	37-28540-01
Docket or Reference number	030-31765
Amendment No.	03

CONDITIONS

10. Location of use: Harrisburg Cancer Center, 775 South Arlington Avenue, Harrisburg, Pennsylvania; Life Care Center, R. D. #1, Sandy Lake Road, Stoneboro, Pennsylvania; Greater Pittsburgh Cancer Center, 1145 Bower Hill Road Suite 105, Pittsburgh, Pennsylvania; Exton Cancer Center, 460 Creamery Way, Suite B, Exton Pennsylvania; Indiana Regional Cancer Center 877 Hospital Road, Indiana, Pennsylvania; Mahoning Valley Cancer Center, 800 Mahoning Street, Suite E, Lehighton, Pennsylvania.
11. Radiation Safety Officer: David E. Cunningham, Ph.D.
12. Authorized Users:

<p>Abdurrahman Unal, M.D.</p> <p>Gilbert Lawrence, M.D.</p> <p>Norman Williams, M.D.</p> <p>Richard M. Yelovich, M.D.</p> <p>James E. Bauer, M.D.</p> <p>David J. Moylan, III, M.D.</p> <p>Bernard R. Rogers, M.D.</p> <p>Roger P. Tokars, M.D.</p>	<p><u>Material and Use:</u></p> <p>Iridium-192 in a brachytherapy remote after loader for the treatment of humans.</p> <p>Iridium-192 in a brachytherapy remote after loader for the treatment of humans.</p> <p>Iridium-192 in a brachytherapy remote after loader for the treatment of humans.</p> <p>Iridium-192 in a brachytherapy remote after loader for the treatment of humans.</p> <p>Iridium-192 in a brachytherapy remote after loader for the treatment of humans.</p> <p>Iridium-192 in a brachytherapy remote after loader for the treatment of humans.</p> <p>Iridium-192 in a brachytherapy remote after loader for the treatment of humans.</p>
---	--
13. The following shall be performed only by persons specifically licensed by the Commission or an Agreement State to perform such services:
  - A. Installation, relocation, or removal of high dose after loader units containing sources.
  - B. Any maintenance or repair operations on a high dose after loader unit involving work on any mechanism that could expose the source, reduce the shielding around the source, or compromise the safety of the unit and result in increased radiation levels.
  - C. David E. Cunningham, Ph.D., may perform those services listed in Condition 13.A. above, for which he has received specific training from a licensed manufacturer's representative.



MATERIALS LICENSE  
SUPPLEMENTARY SHEET

License number  
37-28540-01  
Docket or Reference number  
030-31765  
Amendment No. 03

(Continued)

CONDITIONS

14. Any changes made in the treatment room shielding, location of the high dose after loader (HDR) unit within the treatment room, or use of the unit that could result in increased radiation levels in areas outside the HDR treatment room shall be evaluated by a radiation survey and results reported to the Commission within 30 days following completion of the change(s).
15. The licensee may transport licensed material in accordance with the provisions of 10 CFR 71, "Packaging and Transportation of Radioactive Material."
16. Persons performing calibrations on high dose after loading units and establishing procedures for (and reviewing the results of) spot check measurements shall meet the training qualifications stated in 10 CFR 35.961(a).
17. Except as specifically provided otherwise in this license, the licensee shall conduct its program in accordance with the statements, representations, and procedures contained in the documents, including any enclosures, listed below. The Nuclear Regulatory Commission's regulations shall govern unless the statements, representations and procedures in the licensee's application and correspondence are more restrictive than the regulations.
  - A. Application dated June 1, 1990
  - B. Letter dated August 2, 1990
  - C. Letter dated October 1, 1990
  - D. Letter dated June 20, 1991
  - E. Letter dated July 9, 1991
  - F. Letter dated August 16, 1991
  - G. Paragraph 3 of Item 1 of the letter dated June 10, 1992

For the U.S. Nuclear Regulatory Commission  
Original Signed By:  
Pamela J. Henderson

Date AUG 19 1992

By Nuclear Materials Safety Branch  
Region I  
King of Prussia, Pennsylvania 19406



**APPENDIX E**  
**INTERVIEWS AND MEETINGS**  
**THE INCIDENT INVESTIGATION**  
**TEAM CONDUCTED**



## Interviews and Meetings the Incident Investigation Team Conducted

Date	Time	Meeting/Interview
12/03/92	3:20 p.m.	Entrance Meeting
12/04/92	1:38 p.m.	Interview of RTR Staff Technologist, Oncology Services Corporation (OSC) Indiana Regional Cancer Center (IRCC)
12/04/92	1:12 p.m.	Group Interview of Physician A, IRCC; Physician D, Director of Brachytherapy, OSC; and RSO, Director of Physics and Bioengineering, OSC, Harrisburg, Pennsylvania
12/04/92	10:20 a.m.	Interview of President, Omnitron International, Inc. (Omnitron)
12/04/92	10:16 a.m.	Interview of RTT-A, Staff Therapist, IRCC
12/04/92	12:08 p.m.	Interview of Medical Physicist A, Consulting Physicist, IRCC
12/04/92		Incident Investigation Team Media Briefing with Dr. Carl Paperiello, NRC, and NRC Medical Consultant
12/04/92	8:20 a.m.	Interview of RTT-B, Registered Radiation Therapy Technician, IRCC
12/04/92	8:25 a.m.	Interview of Nurse A, R.N., IRCC
12/05/92	8:00 a.m.	Interview of Medical Physicist A, Consulting Physicist, was continued on December 5, 1992
12/05/92	8:30 a.m.	Interview of CNA-C, Certified Nurses Aide, Scenery Hill Manor Nursing Home (SHM)
12/05/92	9:34 a.m.	Interview of Physician A, IRCC

**Interviews and Meetings the Incident  
Investigation Team Conducted (continued)**

<b>Date</b>	<b>Time</b>	<b>Meeting/Interview</b>
12/05/92	9:55 a.m.	Interview of LPN-B Licensed Practical Nurse, SHM Nursing Home, December 5, 1992
12/05/92	1:00 p.m.	Interview of Administrator, SHM Nursing Home
12/07/92	11:50 a.m.	Interview of Browing-Ferris Industries (BFI) Driver B, Tractor-Trailer Driver, BFI, Carnegie, Pennsylvania
12/07/92	10:30 a.m.	Interview of Supervisor A, Medical Supervisor, BFI, Carnegie, Pennsylvania
12/07/92	10:54 a.m.	Interview of Safety Technician B Assistant District Safety Manager, and Safety Technition A, District Safety Manager, BFI, Carnegie, Pennsylvania
12/08/92	10:17 a.m.	Interview of Medical Physicist B, Senior Radiological Physicist, Oncology Services Corporation, Greater Pittsburgh Cancer Center (GPCC)
12/08/92	12:35 p.m.	Interview of Physician E Medical Director, GPCC and Jefferson Radiation Oncology Center
12/08/92	2:21 p.m.	Interview of CNA-E, Certified Nursing Assistant, SHM Nursing Home
12/08/92	3:05 p.m.	Interview of RTT-C, Radiation Therapist, GPCC
12/08/92	3:07 p.m.	Interview of Maintenance Man A, SHM Nursing Home
12/08/92	10:30 p.m.	Interview of General Manger, Brachytherapy, BFI, Warren, Ohio

**Interviews and Meetings the Incident  
Investigation Team Conducted (continued)**

<b>Date</b>	<b>Time</b>	<b>Meeting/Interview</b>
12/09/92	9:30 a.m.	Interview of Physician D Director of Brachytherapy, OSC
12/09/92	11:45 a.m.	Interview of Physician C President and CEO, OSC, State College, Pennsylvania
12/09/92	2:37 p.m.	Interview of Physician B, Radiation Oncologist, Vice President and Medical Director, OSC, State College, Pennsylvania
12/09/92	4:15 p.m.	Interview of RN-D, Registered Nurse, SHM Nursing Home
12/16/92	2:00 p.m.	Group Interview of NRC Headquarters NMSS Staff: Richard E. Cunningham, Director, Division of Industrial & Medical Nuclear Safety; John E. Glenn, Chief, Medical Academic & Commercial Use Safety Branch; and Frederick Combs, Chief, Operations Branch
12/17/92	10:04 a.m.	Interview of RSO Director, Radiation Safety, OSC
12/17/92	1:00 p.m.	Interview of Service Manager, Omnitron International, Inc.  Interview of Senior V.P., Radiation Science, Omnitron
12/17/92	2:35 p.m.	Interim Exit Interview, Harrisburg Hotel, Harrisburg, Pennsylvania
12/17/92	2:35 p.m.	Interview of V.P., Product Development, Omnitron
12/17/92	4:15 p.m.	Interview of President, Omnitron International, Inc. (Omnitron)

**Interviews and Meetings the Incident  
Investigation Team Conducted (continued)**

---

<b>Date</b>	<b>Time</b>	<b>Meeting/Interview</b>
12/22/92	10:05 a.m.	Interview (via speakerphone) of Sales Representative for Omnitron
12/31/92	9:45 a.m.	Interview (via speakerphone) of Patient A's best friend
01/05/93	10:10 a.m.	Interview of RSO Director of Physics and Bioengineering, OSC, Harrisburg, Pennsylvania



NRC FORM 335 (2-89) NRCM 1102, 3201, 3202	U. S. NUCLEAR REGULATORY COMMISSION	1. REPORT NUMBER (Assigned by NRC, Add Vol., Supp., Rev., and Addendum Num- bers, if any.)				
<b>BIBLIOGRAPHIC DATA SHEET</b> (See Instructions on the reverse)		NUREG-1480				
2. TITLE AND SUBTITLE  Loss of an Iridium-192 Source and Therapy Misadministration at Indiana Regional Cancer Center Indiana, Pennsylvania, on November 16, 1992		3. DATE REPORT PUBLISHED  <table border="1" style="width: 100%;"> <tr> <td style="width: 50%;">MONTH</td> <td style="width: 50%;">YEAR</td> </tr> <tr> <td>February</td> <td>1993</td> </tr> </table>	MONTH	YEAR	February	1993
MONTH	YEAR					
February	1993					
5. AUTHOR(S)  Incident Investigation Team		4. FIN OR GRANT NUMBER   6. TYPE OF REPORT  Regulatory  7. PERIOD COVERED (Inclusive Dates)				
8. PERFORMING ORGANIZATION - NAME AND ADDRESS (If NRC, provide Division, Office or Region, U.S. Nuclear Regulatory Commission, and mailing address; if contractor, provide name and mailing address.)  U.S. Nuclear Regulatory Commission Washington, DC 20555						
9. SPONSORING ORGANIZATION - NAME AND ADDRESS (If NRC, type "Same as above"; if contractor, provide NRC Division, Office or Region, U.S. Nuclear Regulatory Commission, and mailing address.)  Same as above.						
10. SUPPLEMENTARY NOTES						
11. ABSTRACT (200 words or less)  On December 1, 1992, the Indiana Regional Cancer Center reported to the U.S. Nuclear Regulatory Commission's (NRC) Region I that they believed a 1.37 E + 11 becquerel (3.7-curie) iridium-192 source from their Omnitron 2000 high dose rate remote brachytherapy afterloader had been found at a biohazard waste transfer station in Carnegie, Pennsylvania. After notifying the NRC, this cancer center, one of several operated by the licensee, Oncology Services Corporation, retrieved the source, and Region I dispatched an inspector and a supervisor to investigate the event. The source was first detected when it triggered radiation alarms at a waste incinerator facility in Warren, Ohio. The licensee informed the NRC that the source wire had apparently broken during treatment of a patient on November 16, 1992, leaving the source in the patient. On the basis of the seriousness of the incident, the NRC elevated its response to an Incident Investigation. The Incident Investigation Team initiated its investigation on December 3, 1992. The investigation team concluded that the patient received a serious misadministration and died on November 21, 1992, and that over 90 individuals were exposed to radiation from November 16 to December 1, 1992. In a press release dated January 26, 1993, the Indiana County Coroner stated that the cause of death listed in the official autopsy report was 'Acute Radiational Exposure and Consequences Thereof.' An almost identical source-wire failure occurred with an afterloader in Pittsburgh, Pennsylvania, on December 7, 1992, but with minimal radiological consequences. This incident was included in the investigation. This report discusses the Omnitron 2000 high dose rate afterloader source-wire failure, the reasons why the failure was not detected by Indiana Regional Cancer Center, the potential consequences to the patient, the estimated radiological doses to workers and the public, and regulatory aspects associated with this incident.						
12. KEY WORDS/DESCRIPTORS (List words or phrases that will assist researchers in locating the report.)  cancer treatment cytogenetics delivered dose high dose rate remote afterloader iridium-192 radiation exposure radioactivity radioactive source regulation of medical devices regulation of nuclear materials therapy misadministration transportation of nuclear materials	13. AVAILABILITY STATEMENT Unlimited	14. SECURITY CLASSIFICATION (This Page) Unclassified (This Report) Unclassified				
15. NUMBER OF PAGES		16. PRICE				







Federal Recycling Program



**UNITED STATES  
NUCLEAR REGULATORY COMMISSION  
WASHINGTON, D.C. 20555-0001**

**OFFICIAL BUSINESS  
PENALTY FOR PRIVATE USE, \$300**

**SPECIAL FOURTH-CLASS RATE  
POSTAGE AND FEES PAID  
USNRC  
PERMIT NO. G-67**