



Paul M. Swift
Site Vice President

R.E. Ginna Nuclear Power Plant
1503 Lake Rd.
Ontario, NY 14519

315-791-5200 Office
www.exeloncorp.com
paul.swift@exeloncorp.com

May 15, 2020

U.S. Nuclear Regulatory Commission
ATTN: Document Control Desk
Washington, DC 20555-0001

R.E. Ginna Nuclear Power Plant
Renewed Facility Operating License No. DPR-18
NRC Docket No. 50-244

Independent Spent Fuel Storage Installation (ISFSI)
NRC Docket No. 72-67

Subject: 2019 Annual Radioactive Effluent Release Report and 2019 Annual Radiological Environmental Operating Report

Enclosed is the Annual Radioactive Effluent Release Report (ARERR) for 2019 for the R.E. Ginna Nuclear Power Plant and Independent Spent Fuel Storage Installation (ISFSI). This report is being submitted in accordance with 10 CFR 50.36a(a)(2) and Technical Specifications (TS) Sections 5.5.1.c and 5.6.3.

No (0) revisions to the Offsite Dose Calculation Manual (ODCM) and no (0) revisions to the Process Control Program (PCP) occurred during the 2019 reporting period. In the ARERR, ODCM revisions are described in Section 10.0 and PCP revisions are described in Section 11.0. Submitted as Appendices to the ARERR are (A) the Annual Report on the Meteorological Monitoring Program and, (B) a complete, legible copy of the entire ODCM, as required by TS 5.5.1.c (no annotations due to no changes during the reporting period).

Also enclosed is the Annual Radiological Environmental Operating Report (AREOR) for 2019, submitted in accordance with Technical Specification Section 5.6.2.

There are no regulatory commitments contained in this submittal. Should you have any other questions regarding this submittal, please contact George Wrobel at 585-315-0552.

Respectfully,

A handwritten signature in black ink that reads "Paul M. Swift".

Paul M. Swift
ps/jf

Attachments:

- 1) Annual Radioactive Effluent Release Report, January 1, 2019 – December 31, 2019

App. A, Annual Report on the Meteorological Monitoring Program at the Ginna Nuclear Power Plant [p.31 of PDF file]

App. B, Copy of the latest revision (36) of the ODCM in the reporting period (no annotations due to no changes) [p.77 of PDF file]

- 2) Annual Radiological Environmental Operating Report, January 1, 2019 – December 31, 2019 [p.197 of PDF file]

cc: NRC Regional Administrator, Region I (w/o)
NRC Project Manager, Ginna (w/o)
NRC Senior Resident Inspector, Ginna (w/o)

NYS Office of Emergency Management (electronic)
Division of Homeland Security and Emergency Services
1220 Washington Avenue
Building 22, Suite 101
Albany, NY 12226-2251
Attn.: Gary Machina

NYS Department of Public Service (electronic)
3 Empire State Plaza, 10th Floor
Albany, NY 12223
Attn.: Bridget Frymire

American Nuclear Insurers (electronic)
95 Glastonbury Blvd.
Glastonbury, CT 06033
Attn.: Edward Everett

NYS Division of Homeland Security and Emergency Services (electronic)
Attn: Radiological Preparedness Department
1220 Washington Avenue
Building 7A Suite 710
Albany, NY 12242

Tim Kohlmeier, Office of Emergency Management (electronic)
Monroe County Office of Emergency Management
1190 Scottsville Rd., Suite 200
Rochester, NY 14624

George Bastedo, Director, Office of Disaster Preparedness (electronic)
Wayne County Emergency Management
7376 Rt. 31, Suite 2000
Lyons, NY 14489-9174



**ANNUAL RADIOACTIVE EFFLUENT RELEASE
REPORT:
JANUARY 1, 2019 – DECEMBER 31, 2019**

MAY 2020



R.E. Ginna Nuclear Power Plant
1503 Lake Road
Ontario, New York 14519

TABLE OF CONTENTS

1.0	Introduction.....	1
2.0	Supplemental Information	1
2.1	Regulatory Limits	1
2.2	Effluent Concentration Limits	2
2.3	Release Rate Limits Based on Average Nuclide Energy	3
2.4	Measurements and Approximations of Total Radioactivity	3
2.5	Batch Releases	3
2.6	Abnormal Releases	4
3.0	Summary of Gaseous Radioactive Effluents	4
4.0	Summary of Liquid Radioactive Effluents	4
5.0	Solid Waste	4
6.0	Lower Limit of Detection	4
7.0	Radiological Impact	5
7.1	Total Dose	5
8.0	Meteorological Data	5
9.0	Land Use Census Changes	6
10.0	Changes to the Offsite Dose Calculation Manual	6
11.0	Changes to the Process Control Program.....	6
12.0	Major Changes to Radwaste Treatment Systems	7
13.0	Inoperable Monitors	7
14.0	Changes to Previous Annual Radioactive Effluent Release Reports	7
15.0	Groundwater Monitoring.....	7
16.0	Offsite Dose Due To ISFSI.....	8
17.0	Offsite Dose Due to Carbon-14	8
17.1	Gaseous Effluents	9
17.2	Liquid Effluents.....	9

LIST OF TABLES

Table 1A	Gaseous Effluents - Summation of all Releases	10
Table 1B	Gaseous Effluents – Continuous and Batch Releases.....	11
Table 2A	Liquid Effluents - Summation of all Releases	13
Table 2B	Liquid Effluents - Continuous and Batch Releases	14
Table 3	Solid Waste and Irradiated Fuel Shipments.....	16
Table 4A	Radiation Dose to Maximum Individual Receptor from Gaseous Effluents	19
Table 4B	Radiation Dose to Maximum Individual Receptor from Liquid Effluents	23
Table 5	Groundwater Monitoring Wells	24
Table 6	Offsite Dose Due to Carbon-14 in Gaseous and Liquid Effluents	27

Appendix A, Annual Report on the Meteorological Monitoring Program at the
Ginna Nuclear Power Plant

Appendix B, R.E. Ginna Nuclear Power Plant Offsite Dose Calculation Manual,
Revision 36

1.0 INTRODUCTION

R.E. Ginna Nuclear Power Plant (Ginna) has prepared this Annual Radioactive Effluent Release Report (ARERR) in accordance with the requirements of Technical Specification Section 5.6.3.

This report, covering the period from January 1, 2019 through December 31, 2019, provides a summary of the quantities of radioactive gaseous effluents, liquid effluents, and solid waste released from the plant presented in the format outlined in Appendix B of Regulatory Guide 1.21, Revision 1, June 1974.

All gaseous and liquid effluents discharged during this reporting period complied with the limits of the Ginna Technical Specifications as defined in the Offsite Dose Calculation Manual (ODCM). The ODCM is Ginna procedure CY-GY-170-300, *Offsite Dose Calculation Manual (ODCM) R.E. Ginna Nuclear Power Plant*.

2.0 SUPPLEMENTAL INFORMATION

2.1 Regulatory Limits

The ODCM limits applicable to the release of radioactive material in liquid and gaseous effluents are:

2.1.1 Fission and Activation Gases

The instantaneous dose rate, as calculated in the ODCM, due to noble gases released in gaseous effluents from the site shall be limited to a release rate that would yield ≤ 500 mrem/yr to the total body and ≤ 3000 mrem/yr to the skin if allowed to continue for a full year.

The air dose, as calculated in the ODCM, due to noble gases released in gaseous effluents from the site shall be limited to the following:

- (I) During any calendar quarter to ≤ 5 mrad for gamma radiation and to ≤ 10 mrad for beta radiation.
- (ii) During any calendar year to ≤ 10 mrad for gamma radiation and to ≤ 20 mrad for beta radiation.

2.1.2 Radioiodine, Tritium, and Particulates

The instantaneous dose rate, as calculated in the ODCM, due to radioactive materials released in gaseous effluents from the site as radioiodine species, radioactive materials in particulate form, and radionuclides other than noble gases with half-lives greater than eight days shall be limited to a release rate that would yield ≤ 1500 mrem/yr to any organ if allowed to continue for a full year.

Dose to an individual from radioiodine, radioactive materials in particulate form, and radionuclides other than noble gases with half-lives greater than eight days released with gaseous effluents is calculated in accordance with ODCM methodology. The dose to an individual shall be limited to:

- (i) During any calendar quarter to ≤ 7.5 mrem to any organ.
- (ii) During any calendar year to ≤ 15 mrem to any organ.

2.1.3 Liquid Effluents

The release of radioactive liquid effluents shall be such that the concentration in the circulating water discharge does not exceed 10 times the limits specified in Appendix B, Table II, Column 2 and notes thereto of 10 CFR 20, as explained in Section 4 of the ODCM. For dissolved or entrained noble gases the total activity due to dissolved or entrained noble gases shall not exceed $2E-04$ uCi/ml.

The dose or dose commitment to an individual from radioactive materials in liquid effluents released to unrestricted areas is calculated according to ODCM methodology and is limited to:

- (i) During any calendar quarter to ≤ 1.5 mrem to the total body and to ≤ 5 mrem to any organ, and
- (ii) During any calendar year to ≤ 3 mrem to the total body and to ≤ 10 mrem to any organ.

2.2 Effluent Concentration Limits (ECLs)

2.2.1 For gaseous effluents, effluent concentration limits (ECLs) are not directly used in release rate calculations since the applicable limits are stated in terms of dose rate at the unrestricted area boundary, in accordance with Technical Specification 5.5.4.g.

2.2.2 For liquid effluents, ECLs ten times those specified in 10 CFR 20, Appendix B, Table II, column 2, are used to calculate release rates and permissible concentrations at the unrestricted area boundary as permitted by Technical Specification 5.5.4.b. A value of $2E-04$ uCi/ml is used as the ECL for dissolved and entrained noble gases in liquid effluents.

2.3 Release Rate Limits Based on Average Nuclide Energy

The release rate limits for fission and activation gases from the R.E. Ginna Nuclear Power Plant are not based on the average energy of the radionuclide mixture in gaseous effluents; therefore, this value is not applicable. However, the 2019 average beta/gamma energy of the radionuclide mixture in fission and activation gases released from Ginna is available for review upon request.

2.4 Measurements and Approximations of Total Radioactivity

Gamma spectroscopy was the primary analysis method used to determine the radionuclide composition and concentration of gaseous and liquid effluents. Composite samples were analyzed for Fe-55, Ni-63, Sr-89, and Sr-90 by a contract laboratory. Tritium and alpha analyses were performed using liquid scintillation and gas flow proportional counting respectively.

The total radioactivity in effluent releases was determined from the measured concentration of each radionuclide present in a representative sample and the total volume of effluents released.

2.5 Batch Releases

2.5.1 Liquid

1. Number of batch releases:	6.00 E+01
2. Total time for batch releases (Minutes):	5.74 E+03
3. Maximum time for a batch release (Minutes):	2.35 E+02
4. Average time for batch releases (Minutes):	9.57 E+01
5. Minimum time for a batch release:	4.00 E+01
6. Average effluent release flowrate into the discharge canal (Liters per Minute):	3.60 E+02
7. Average dilution flowrate of discharge canal during effluent releases (Liters per Minute):	1.22 E+06

2.5.2 Gaseous

1. Number of batch releases:	2.00 E+01
2. Total time for batch releases (Minutes):	5.39 E+05
3. Maximum time for a batch release (Minutes):	4.46 E+04
4. Average time for batch releases (Minutes):	2.70 E+04
5. Minimum time for a batch release (Minutes):	6.00 E+01

2.6 Abnormal Releases

In 2019, there were two abnormal releases of gaseous effluents.

1. On 7/2/2019, a seal leak was noted on the 'B' waste gas compressor. This leaking gas compressor resulted in a lowering of 'A' Gas Decay Tank pressure of nine PSIG over five hours. As this release traveled through a monitored pathway, a release permit was conservatively generated to capture the release (see Issue Report 04261457 and Release Permit G-2019028).
2. On 9/16/2019, a lowering of vent header pressure of 0.25 PSIG was noted and there were no water transfers in progress or operations that would affect vent header pressure. The 'D' Gas Decay Tank (GDT) was in service and aligned to the vent header, pressure within the tank increased from 24 PSIG to 27 PSIG. As this potential release traveled through a monitored pathway, a release permit was conservatively generated to account for any issues associated with the 'B' waste gas compressor (see Issue Report 04279840 and Release Permit G-2019035).

3.0 SUMMARY OF GASEOUS RADIOACTIVE EFFLUENTS

The quantities of radioactive material released in gaseous effluents are summarized in Tables 1A and 1B. Plant Vent and Containment Vent releases are modeled as mixed mode and the Air Ejector is modeled as a ground level release.

4.0 SUMMARY OF LIQUID RADIOACTIVE EFFLUENTS

The quantities of radioactive material released in liquid effluents are summarized in tables 2A and 2B.

5.0 SOLID WASTE

The quantities of radioactive material released in shipments of solid waste transported from Ginna during the reporting period are summarized in Table 3. Principal nuclides were determined by gamma spectroscopy and non-gamma emitters were calculated from scaling factors determined by an independent laboratory from representative samples of that waste type. The majority of Dry Active Waste (DAW) is processed utilizing an off-site vendor that reduces the volume and then transports the waste to a permitted landfill for disposal.

6.0 LOWER LIMIT OF DETECTION

The required Lower Limit of Detection (LLD), as defined in Table 2-1 of the ODCM, was met on all effluent samples in 2019.

7.0 RADIOLOGICAL IMPACT

An assessment of doses to the hypothetical maximally exposed individual member of the public from gaseous and liquid effluents was performed for locations representing the maximum calculated dose in occupied sectors. Meteorological sectors to the north from NW through ENE are entirely over Lake Ontario, while the remaining meteorological sectors to the south (WNW through E) are over land. In all cases, doses were well below Technical Specification limits as defined in the ODCM. Doses were assessed based upon historical meteorological conditions considering the noble gas exposure, inhalation, ground plane exposure, and ingestion pathways. The ingestion pathways considered were the fruit, vegetable, fish, drinking water, goat's milk, cow's milk and cow meat pathways.

Results of this assessment are presented in Tables 4A and 4B. Population doses are inferred from the population density, distance from the plant, and drinking water source.

7.1 Total Dose

40 CFR 190 limits the total dose to members of the public due to radiation and radioactivity from uranium fuel cycle sources to:

- ≤ 25 mrem total body or any organ and;
- ≤ 75 mrem thyroid for a calendar year.

Using the maximum exposure and uptake pathways, the maximum liquid pathways, including C-14 dose, and the maximum direct radiation measurements at the site boundary, yield the following dose summaries to the hypothetical maximally exposed individual member of the public. The maximum total body dose is determined by summing the hypothetical maximum direct radiation dose exposure and the total body dose from gaseous and liquid pathways. Dose to any real member of the public should be conservatively bounded by these calculated doses:

- Maximum Annual Total Body Dose: $1.08E-03$ mRem
Sum of no detectable direct radiation dose, $1.07E-03$ (Total Body Liquid Dose), and $1.35E-05$ (Total Body Gas Dose).
- Maximum Annual Organ Dose: $4.91E-03$ mRem (Child, Thyroid)
- Maximum Annual Thyroid Dose: $4.91E-03$ mRem (Child)

8.0 METEOROLOGICAL DATA

The annual summary report of meteorological data collected during 2019 is included with this report, as Appendix A, Annual Report on the Meteorological Monitoring Program at the Ginna Nuclear Power Plant by Murray and Trettel, Incorporated.

9.0 LAND USE CENSUS CHANGES

In September 2019, Ginna staff conducted a Land Use Survey to identify the location of the nearest milk animal, the nearest residence, and the nearest garden greater than 500 square feet in each of the nine sectors within a five-mile radius of the power plant. The Land Use Survey is conducted in accordance with Ginna procedures (Reference #4). If changes are noted in the annual Land Use Survey, alterations to Ginna's REMP program would be made to ensure sampling practices cover these new areas of potential public exposure.

Over the past year, the following land use observations were made within a 5-mile radius of the power plant:

- The nearest residence remains in the SSE sector, approximately 610 meters from the reactor.
- Single-family home / senior housing subdivision / development construction was observed near the plant on LaFrank Drive (Ontario), and South of Route 104 near Tops Plaza (Ontario).
- Lake Front Estates and Summer Lake subdivisions continue to expand along with the southeast corner of Lake Road and Slocum Road.
- Other single-family home construction was observed sporadically within 5-miles of the plant.
- A new 120-acre commercial hydroponic farm has 25 acres of active production of "AGRI-GROW" tomatoes year-round at East end of Dean Parkway. (North of Route 104).
- Commercial fishing information was collected from the New York State Department of Environmental Conservation (NYSDEC) which shows activity only in the Eastern basin of Lake Ontario. Commercial fishing operations have not changed in the last five-years and no commercial fishing takes place within 5-miles of Ginna.
- No new agricultural land use was identified.
- No new food producing facilities were identified as the commercial hydroponic farm is not currently growing produce.
- No new milk producing animals were identified.

10.0 CHANGES TO THE OFFSITE DOSE CALCULATION MANUAL

There were no changes to the Offsite Dose Calculation Manual (ODCM) in 2019. The most recent revision of the ODCM (Revision 36) was made effective on 12/27/2018 and is included within this report as Appendix B.

11.0 CHANGES TO THE PROCESS CONTROL PROGRAM

There were no changes to the Process Control Program in 2019.

12.0 MAJOR CHANGES TO RADWASTE TREATMENT SYSTEMS

There were no changes to the Radwaste Treatment Systems during the reporting period.

13.0 INOPERABLE MONITORS

There was one occurrence in 2019 satisfying the requirement stated in Section 5.4 and Table 5-1, of the ODCM for weekly sample (cartridge) collection.

The surveillance of R-14A is redundant to R-10B. R-10B exhibited an extended run time on the filter due to R-14A being out of service which caused R-10B to not be changed. The filter on R-10B collected sample from 12/29/2018 – 1/8/2019, exceeding the weekly periodicity mandated by the ODCM. At no time did gaseous effluents leave the station in an unmonitored pathway. Both detectors were restored to operability on 1/8/2019.

14.0 CHANGES TO PREVIOUS ANNUAL RADIOACTIVE EFFLUENT RELEASE REPORTS

None.

15.0 GROUNDWATER MONITORING

In accordance Ginna's Chemistry procedures, environmental groundwater monitoring wells are sampled on a routine frequency. In 2019, Ginna staff collected and analyzed samples collected from a total of 14 groundwater monitoring wells:

- GW01: Warehouse Access Road (Control)
- GW03: Screenhouse West, South Well
- GW04: Screenhouse West, North Well
- GW05: Screenhouse East, South
- GW06: Screenhouse East, Middle
- GW07: Screenhouse East, North
- GW08: All Volatiles Treatment Building
- GW10: Technical Support Center, South
- GW11: Southeast of Contaminated Storage Building (CSB)
- GW12: West of Orchard Access Road
- GW13: North of Independent Spent Fuel Storage Installation (ISFSI)
- GW14: South of Canister Preparation Building
- GW15: West of Manor House
- GW16: Southeast of Manor House

Groundwater samples are analyzed for tritium to a detection limit of 500 pCi/L and for gamma emitting radionuclides to the environmental LLDs. The analytical results for groundwater monitoring well samples collected during 2019 are presented in Table 5.

16.0 OFFSITE DOSE DUE TO ISFSI

A review of direct radiation between the Ginna ISFSI facility and the nearest residents was conducted. Environmental TLD station 64 is the highest direct radiation dose offsite and is the basis for the maximum direct radiation dose reported in 7.1 A review of TLD stations 14, 15, 16 since fuel was first stored in the ISFSI in 2010 indicate no change in offsite direct radiation dose as measured by TLDs.

Ginna ISFSI design is such that effluent releases of noble gases are precluded.

17.0 OFFSITE DOSE DUE TO CARBON-14

A study of Carbon-14 in effluent releases from Ginna was conducted in 1982 by Charles Kunz of New York State Department of Health, Center for Laboratories and Research. Results of this study are used as the basis for current Carbon-14 production and releases at Ginna. Using the Carbon-14 releases measured in the Kunz study at 4.3 Curies, adjusted for power uprate from 490 MWe to 580 MWe, and adjusted for increased capacity factor and 18-month fuel cycles, leads to a conservative estimate of 6.8 Curies released in gaseous effluents in 2019. Kunz further determined the chemical form of the Carbon-14 at Ginna to be approximately 10% Carbon Dioxide (CO₂).

As a cross-check, the EPRI Carbon-14 Source Term Calculator was used to estimate Carbon-14 releases from Ginna, using Ginna specific reactor core data and reactor coolant chemistry to estimate the products of the activation reactions. The resulting estimate of 6.9 Curies per Equivalent Full Power Year (EFPY) agrees with the Kunz data, adjusted for current operating cycles.

17.1 Gaseous Effluents

Dose due to Carbon-14 in gaseous effluents was calculated using the following conditions:

- a. 6.8 Curies of C-14 were released to the atmosphere in 2019.
- b. There was no refueling outage in 2019. However, according to the Kunz study it has little or no impact on the C-14 effluents and was not considered in this report.
- c. 10% of the C-14 was in the chemical form of carbon dioxide (CO₂), which is the only dose contributor. The bulk of C-14 is released in the chemical form of methane (CH₄). Methane would exhibit high upward velocity due to its low density relative to air. Additionally, CH₄ does not have an uptake pathway for humans.
- d. Meteorological dispersion factor, (X/Q), at the site boundary to the hypothetical maximally exposed member of the public is 2.43E-07 sec/m³.
- e. Dose calculations and dose factors are from Regulatory Guide 1.109 methodology.
- f. Pathways considered were inhalation, milk consumption, and vegetation ingestion.
- g. The critical receptor is a child at the site boundary in the ESE direction.

See Table 6 for an estimate of Carbon-14 in gaseous effluents during 2019.

17.2 Liquid Effluents

Dose due to Carbon-14 in liquid effluents was calculated using the following conditions:

- a. The liquid waste processing system at Ginna has not been evaluated for efficiency of removal of Carbon-14. Therefore, no removal term was used in estimation of offsite dose.
- b. Average concentration of C-14 in wastewater as measured in the Kunz study was adjusted for current operating conditions and was 6.0E-07 uCi/cc.
- c. 9.12E+05 liters of liquid waste (with the potential to contain C-14) were released with a total dilution flow of 1.94E+12 liters.
- d. Average diluted concentration of C-14 released was 2.83E-13 uCi/cc.
- e. Liquid effluent dilution factor for potable water pathway is 200.
- f. Liquid effluent dilution factor for fish pathway is 1.
- g. Dose calculations and dose factors are from Regulatory Guide 1.109 methodology.
- h. The critical receptor is a child for the fish consumption pathway and the infant is the critical receptor for the potable water pathway.

See Table 6 for an estimate of Carbon-14 in liquid effluents during 2019.

TABLE 1A
EFFLUENT AND WASTE DISPOSAL ANNUAL REPORT
GASEOUS EFFLUENTS - SUMMATION OF ALL RELEASES

2019

Effluent Type	Units	1 st Quarter	2 nd Quarter	3 rd Quarter	4 th Quarter	Est. Total Error, %
A. Fission & Activation Gases						
1. Total release	Ci	4.60E-01	4.71E-01	3.12E-01	4.07E-01	1.50E+01
2. Average release rate for period	uCi/sec	5.84E-02	5.97E-02	3.96E-02	5.16E-02	
3. Percent of technical specification limit	%	9.27E-06	9.48E-06	6.29E-06	8.19E-06	
B. Iodines						
1. Total iodine-131	Ci	1.52E-05	1.33E-06	1.31E-07	0.00E+00	1.50E+01
2. Average release rate for period	uCi/sec	1.93E-06	1.69E-07	1.66E-08	0.00E+00	
3. Percent of technical specification limit	%	4.20E-03	3.67E-04	3.61E-05	0.00E+00	
C. Particulates						
1. Particulates with half-lives > 8days	Ci	0.00E+00	6.18E-08	0.00E+00	0.00E+00	1.50E+01
2. Average release rate for period	uCi/sec	0.00E+00	7.84E-09	0.00E+00	0.00E+00	
3. Percent of technical specification limit	%	0.00E+00	7.84E-14	0.00E+00	0.00E+00	
4. Gross alpha radioactivity	Ci	0.00E+00	0.00E+00	0.00E+00	0.00E+00	
D. Tritium						
1. Total release	Ci	2.03E+01	2.80E+01	3.15E+01	3.66E+01	9.20E+00
2. Average release rate for period	uCi/sec	2.57E+00	3.55E+00	4.00E+00	4.65E+00	
3. Percent of technical specification limit	%	3.01E-06	4.15E-06	4.68E-06	5.44E-06	

Notes: Isotopes for which no value is given were not identified in applicable releases.

TABLE 1B
EFFLUENT AND WASTE DISPOSAL ANNUAL REPORT
GASEOUS EFFLUENTS - CONTINUOUS AND BATCH RELEASES
 2019

Nuclides Released	Units	Continuous Mode				Batch Mode			
		1 st Quarter	2 nd Quarter	3 rd Quarter	4 th Quarter	1 st Quarter	2 nd Quarter	3 rd Quarter	4 th Quarter
1. Fission Gases									
Argon-41	Ci		6.53E-03			4.83E-02	5.11E-02	5.72E-02	1.01E-01
Krypton-85	Ci								
Krypton-85m	Ci								
Krypton-87	Ci								
Krypton-88	Ci								
Xenon-131m	Ci								
Xenon-133	Ci		2.35E-02			1.82E-01	1.54E-01	9.88E-02	1.03E-01
Xenon-133m	Ci								
Xenon-135	Ci								
Xenon-135m	Ci								
Xenon-138	Ci								
Total for period	Ci	0.00E+00	3.00E-02	0.00E+00	0.00E+00	2.30E-01	2.05E-01	1.57E-01	2.04E-01
2. Iodines									
Iodine-131	Ci					7.62E-06	6.67E-07	6.54E-08	
Iodine-132	Ci								
Iodine-133	Ci					5.28E-07	4.77E-07		
Iodine-135	Ci								
Total for period	Ci	0.00E+00	0.00E+00	0.00E+00	0.00E+00	8.15E-06	1.14E-06	6.54E-08	0.00E+00

TABLE 1B (Continued)
EFFLUENT AND WASTE DISPOSAL ANNUAL REPORT
GASEOUS EFFLUENTS - CONTINUOUS AND BATCH RELEASES
 2019

Nuclides Released	Units	Continuous Mode				Batch Mode			
		1 st Quarter	2 nd Quarter	3 rd Quarter	4 th Quarter	1 st Quarter	2 nd Quarter	3 rd Quarter	4 th Quarter
3. Particulates									
Strontium-89	Ci								
Strontium-90	Ci								
Cesium-137	Ci								
Cobalt-57	Ci						3.09E-08		
Cobalt-58	Ci								
Cobalt-60	Ci								
Unidentified	Ci								
Total for period	Ci	0.00E+00	0.00E+00	0.00E+00	0.00E+00	0.00E+00	3.09E-08	0.00E+00	0.00E+00
4. Tritium									
Hydrogen-3	Ci	1.01E+01	1.40E+01	1.57E+01	1.83E+01	3.90E-03	8.11E-03	4.64E-02	2.40E-02

Note: Isotopes for which no value is given were not identified in applicable releases.

TABLE 2A
EFFLUENT AND WASTE DISPOSAL ANNUAL REPORT
LIQUID EFFLUENTS - SUMMATION OF ALL RELEASES
 2019

Effluent Type	Units	1 st Quarter	2 nd Quarter	3 rd Quarter	4 th Quarter	Est. Total Error, %
A. Fission & Activation Products						
1. Total Release (not including tritium, gases, alpha)	Ci	1.04E-03	8.57E-04	4.34E-04	7.87E-05	9.90E+00
2. Average Diluted concentration	uCi/ml	2.79E-12	1.54E-12	8.43E-13	1.60E-13	
3. Percent of applicable limit	%	2.79E-05	1.54E-05	8.43E-06	1.60E-06	
B. Tritium						
1. Total Release	Ci	6.12E+01	4.34E+01	1.26E+02	4.08E+02	9.20E+00
2. Average Diluted Concentration	uCi/ml	1.64E-07	7.79E-08	2.44E-07	8.31E-07	
3. Percent of applicable limit	%	1.64E-03	7.79E-04	2.44E-03	8.31E-03	
C. Dissolved and Entrained Gases						
1. Total Release	Ci	0.00E+00	0.00E+00	0.00E+00	0.00E+00	
2. Average Diluted Concentration	uCi/ml	0.00E+00	0.00E+00	0.00E+00	0.00E+00	
3. Percent of applicable limit	%	0.00E+00	0.00E+00	0.00E+00	0.00E+00	
D. Gross Alpha Radioactivity						
1. Total release	Ci	0.00E+00	0.00E+00	0.00E+00	0.00E+00	
E. Vol. of Waste Released (prior to dilution)						
	Liters	1.10E+08	1.17E+08	1.22E+08	1.16E+08	
F. Vol. of Dilution Water Used During Period						
	Liters	3.72E+11	5.57E+11	5.15E+11	4.91E+11	

Note: Isotopes for which no value is given were not identified in applicable releases.

TABLE 2B
EFFLUENT AND WASTE DISPOSAL ANNUAL REPORT
LIQUID EFFLUENTS – CONTINUOUS AND BATCH RELEASES
 2019

Nuclides Released	Units	Continuous Mode				Batch Mode				
		1 st Quarter	2 nd Quarter	3 rd Quarter	4 th Quarter	1 st Quarter	2 nd Quarter	3 rd Quarter	4 th Quarter	
Fission & Activation Products										
Chromium-51	Ci									
Manganese-54	Ci									
Iron-55	Ci									
Iron-59	Ci									
Cobalt-57	Ci									
Cobalt-58	Ci					4.69E-04	1.44E-04			
Cobalt-60	Ci						2.41E-04			
Zinc-65	Ci									
Strontium-89	Ci									
Strontium-90	Ci									
Niobium-95	Ci									
Molybdenum-99	Ci									
Zirconium-95	Ci									
Silver-110m	Ci									
Antimony-122	Ci									
Tellurium-123m	Ci					5.69E-04	4.73E-04	4.34E-04	7.87E-05	
Antimony-124	Ci									
Antimony-125	Ci									
Iodine-131	Ci									
Iodine-132	Ci									
Tellurium-132	Ci									
Iodine-135	Ci									
Cesium-134	Ci									
Cesium-136	Ci									
Cesium-137	Ci									

TABLE 2B (Continued)
EFFLUENT AND WASTE DISPOSAL ANNUAL REPORT
LIQUID EFFLUENTS – CONTINUOUS AND BATCH RELEASES
 2019

Nuclides Released	Units	Continuous Mode				Batch Mode			
		1 st Quarter	2 nd Quarter	3 rd Quarter	4 th Quarter	1 st Quarter	2 nd Quarter	3 rd Quarter	4 th Quarter
Barium/Lanthanum-140	Ci								
Cerium-141	Ci								
Total (above)	Ci	0.00E+00	0.00E+00	0.00E+00	0.00E+00	1.04E-03	8.58E-04	4.34E-04	7.87E-05
Unidentified (from total above)	Ci	0.00E+00	0.00E+00	0.00E+00	0.00E+00	0.00E+00	0.00E+00	0.00E+00	0.00E+00
Tritium									
Hydrogen-3	Ci	0.00E+00	0.00E+00	0.00E+00	0.00E+00	6.12E+01	4.34E+01	1.26E+02	4.08E+01
Dissolved and Entrained Gases									
Xenon-133	Ci								
Xenon-135	Ci								

Note: Isotopes for which no value is given were not identified in applicable releases.

TABLE 3
EFFLUENT AND WASTE DISPOSAL ANNUAL REPORT
SOLID WASTE AND IRRADIATED FUEL SHIPMENTS

2019

A. SOLID WASTE SHIPPED OFFSITE FOR BURIAL OR DISPOSAL (Not Irradiated Fuel)

1. Type of Waste	Units	12 Month Period	Est. total Error (%)
A – Spent Resins, Filter Sludge, Evaporator Bottoms, Etc.	m ³	1.16E+01	2.5E+01
	Ci	5.70E+01	2.5E+01
B – Dry Active Waste (DAW), Contaminated Equipment, Etc.	m ³	1.45E+02	2.5E+01
	Ci	1.07E-02	2.5E+01
C – Irradiated Components, Control Rods, Etc.	m ³	None	N/A
	Ci		
D – Other: Sources, Filters	m ³	None	2.5E+01
	Ci	None	2.5E+01

Note: Estimated total error for solid waste shipped offsite not available.

TABLE 3 (Continued)
EFFLUENT AND WASTE DISPOSAL ANNUAL REPORT
SOLID WASTE AND IRRADIATED FUEL SHIPMENTS

2019

2. Estimate of Major Nuclide Composition by Type of Waste

Isotope	Unit	Class A	Class B	Class C	Type D
H-3	%	0.04	0.02		
Be-7	%	0.30			
C-14	%	0.56	0.38		
Mn-54	%	4.80	3.81		
Fe-55	%	6.89	7.68		
Co-57	%	0.17	0.25		
Co-58	%	15.55	1.01		
Co-60	%	18.42	23.59		
Ni-59	%	0.65	0.92		
Ni-63	%	40.44	56.72		
Zn-65	%	0.11	0.06		
Sr-90	%	0.09	0.09		
Zr-95	%	0.04	0.01		
Nb-95	%	0.08	0.02		
Tc-99	%	0.01	0.03		
Ag-110m	%	0.34	0.45		
Sn-113	%	0.26	0.04		
Sb-124	%	1.17	0.03		
Sb-125	%	4.74	2.90		
Cs-134	%		0.35		
Cs-137	%	5.21	1.63		
Pu-241	%	0.13	0.01		
Total	%	100.00	100.00		

Note: Isotopes for which no value is given were not identified in applicable releases.

TABLE 3 (Continued)
EFFLUENT AND WASTE DISPOSAL ANNUAL REPORT
SOLID WASTE AND IRRADIATED FUEL SHIPMENTS

2019

# of Shipments	Mode of Transportation	Type of Container	Solidification Agent	Processing Destination
2	Sole Use Truck	Metal Containers	None	Energy Solutions, Bear Creek
1	Sole Use Truck	High Integrity Container	None	Energy Solutions, Bear Creek
1	Sole Use Truck	High Integrity Container	None	Energy Solutions (Treatment Facility)

B. IRRADIATED FUEL SHIPMENTS (Disposition)

# of Shipments	Mode of Transportation	Destination
None	N/A	N/A

TABLE 4A
Radiation Dose to Maximum Individual Receptor from Gaseous Effluents
First Quarter 2019
(Units In milliRem)

	All Gamma Air	All Beta Air	Adult THYRD	Teen THYRD	Child THYRD	Infant THYRD
N	1.39E-06	9.47E-06	2.42E-04	2.99E-04	4.98E-04	6.34E-07
NNE	1.17E-06	7.94E-06	2.03E-04	2.51E-04	4.17E-04	5.32E-07
NE	1.35E-06	9.15E-06	2.34E-04	2.89E-04	4.81E-04	6.13E-07
ENE	1.71E-06	1.16E-05	2.97E-04	3.68E-04	6.11E-04	7.78E-07
E	3.11E-06	2.11E-05	5.40E-04	6.69E-04	1.11E-03	1.42E-06
ESE	3.96E-06	2.69E-05	6.87E-04	8.51E-04	1.41E-03	2.12E-03
SE	2.40E-06	1.63E-05	4.16E-04	5.15E-04	8.55E-04	1.09E-06
SSE	9.86E-07	6.70E-06	1.71E-04	2.12E-04	3.52E-04	4.49E-07
S	1.73E-06	1.17E-05	2.99E-04	3.71E-04	6.17E-04	7.86E-07
SSW	1.73E-06	1.17E-05	2.99E-04	3.71E-04	6.17E-04	7.86E-07
SW	1.73E-06	1.17E-05	2.99E-04	3.71E-04	6.17E-04	7.86E-07
WSW	1.84E-06	1.25E-05	3.19E-04	3.96E-04	6.58E-04	8.38E-07
W	1.17E-06	7.96E-06	2.03E-04	2.52E-04	4.19E-04	5.33E-07
WNW	9.90E-08	6.73E-07	1.72E-05	2.13E-05	3.54E-05	4.50E-08
NW	3.25E-07	2.21E-06	5.63E-05	6.98E-05	1.16E-04	1.48E-07
NNW	1.01E-06	6.89E-06	1.76E-04	2.18E-04	3.62E-04	4.61E-07
MAX.	3.96E-06	2.69E-05	6.87E-04	8.51E-04	1.41E-03	2.12E-03

Note: Shaded regions indicate areas over Lake Ontario.

TABLE 4A (Continued)
Radiation Dose to Maximum Individual Receptor from Gaseous Effluents
Second Quarter 2019
(Units In milliRem)

	All Gamma Air	All Beta Air	Adult THYRD	Teen THYRD	Child THYRD	Infant THYRD
N	1.62E-06	1.02E-06	1.85E-04	2.06E-04	2.90E-04	1.73E-04
NNE	1.36E-06	8.56E-07	1.55E-04	1.72E-04	2.43E-04	1.45E-04
NE	1.57E-06	9.86E-07	1.79E-04	1.99E-04	2.80E-04	1.67E-04
ENE	1.99E-06	1.25E-06	2.27E-04	2.53E-04	3.56E-04	2.13E-04
E	3.62E-06	2.28E-06	4.13E-04	4.59E-04	6.48E-04	3.87E-04
ESE	4.61E-06	2.90E-06	5.26E-04	5.85E-04	8.24E-04	4.92E-04
SE	2.79E-06	1.75E-06	3.18E-04	3.54E-04	4.99E-04	2.98E-04
SSE	1.15E-06	7.22E-07	1.31E-04	1.46E-04	2.05E-04	1.23E-04
S	2.01E-06	1.26E-06	2.29E-04	2.55E-04	3.59E-04	2.15E-04
SSW	2.01E-06	1.26E-06	2.29E-04	2.55E-04	3.59E-04	2.15E-04
SW	2.01E-06	1.26E-06	2.29E-04	2.55E-04	3.59E-04	2.15E-04
WSW	2.14E-06	1.35E-06	2.44E-04	2.72E-04	3.83E-04	2.29E-04
W	1.36E-06	8.58E-07	1.56E-04	1.73E-04	2.44E-04	1.46E-04
WNW	1.15E-07	7.25E-08	1.31E-05	1.46E-05	2.06E-05	1.23E-05
NW	3.78E-07	2.38E-07	4.31E-05	4.79E-05	6.76E-05	4.04E-05
NNW	1.18E-06	7.42E-07	1.35E-04	1.50E-04	2.11E-04	1.26E-04
MAX.	4.61E-06	2.90E-06	5.26E-04	5.85E-04	8.24E-04	4.92E-04

Note: Shaded regions indicate areas over Lake Ontario.

TABLE 4A (Continued)
Radiation Dose to Maximum Individual Receptor from Gaseous Effluents
Third Quarter 2019
(Units In milliRem)

	All Gamma Air	All Beta Air	Adult THYRD	Teen THYRD	Child THYRD	Infant THYRD
N	1.54E-06	7.92E-07	1.98E-04	2.17E-04	2.99E-04	1.35E-04
NNE	1.29E-06	6.64E-07	1.66E-04	1.82E-04	2.51E-04	1.13E-04
NE	1.49E-06	7.65E-07	1.91E-04	2.10E-04	2.89E-04	1.31E-04
ENE	1.89E-06	9.72E-07	2.43E-04	2.67E-04	3.67E-04	1.66E-04
E	3.43E-06	1.77E-06	4.43E-04	4.85E-04	6.68E-04	3.02E-04
ESE	4.37E-06	2.25E-06	5.63E-04	6.18E-04	8.50E-04	3.84E-04
SE	2.64E-06	1.36E-06	3.41E-04	3.74E-04	5.14E-04	2.32E-04
SSE	1.09E-06	5.60E-07	1.40E-04	1.54E-04	2.12E-04	9.56E-05
S	1.91E-06	9.81E-07	2.45E-04	2.69E-04	3.71E-04	1.67E-04
SSW	1.91E-06	9.81E-07	2.45E-04	2.69E-04	3.71E-04	1.67E-04
SW	1.91E-06	9.81E-07	2.45E-04	2.69E-04	3.71E-04	1.67E-04
WSW	2.03E-06	1.05E-06	2.62E-04	2.87E-04	3.95E-04	1.79E-04
W	1.29E-06	6.66E-07	1.67E-04	1.83E-04	2.52E-04	1.14E-04
WNW	1.09E-07	5.63E-08	1.41E-05	1.54E-05	2.13E-05	9.60E-06
NW	3.58E-07	1.85E-07	4.62E-05	5.06E-05	6.97E-05	3.15E-05
NNW	1.12E-06	5.76E-07	1.44E-04	1.58E-04	2.18E-04	9.83E-05
MAX.	4.37E-06	2.25E-06	5.63E-04	6.18E-04	8.50E-04	3.84E-04

Note: Shaded regions indicate areas over Lake Ontario.

TABLE 4A (Continued)
Radiation Dose to Maximum Individual Receptor from Gaseous Effluents
Fourth Quarter 2019
(Units In milliRem)

	All Gamma Air	All Beta Air	Adult THYRD	Teen THYRD	Child THYRD	Infant THYRD
N	2.64E-06	1.19E-06	2.29E-04	2.51E-04	3.45E-04	1.50E-04
NNE	2.21E-06	9.97E-07	1.92E-04	2.10E-04	2.89E-04	1.26E-04
NE	2.55E-06	1.15E-06	2.21E-04	2.42E-04	3.33E-04	1.45E-04
ENE	3.24E-06	1.46E-06	2.81E-04	3.08E-04	4.23E-04	1.85E-04
E	5.90E-06	2.66E-06	5.11E-04	5.60E-04	7.69E-04	3.36E-04
ESE	7.50E-06	3.38E-06	6.51E-04	7.13E-04	9.79E-04	4.27E-04
SE	4.54E-06	2.04E-06	3.94E-04	4.31E-04	5.92E-04	2.59E-04
SSE	1.87E-06	8.42E-07	1.62E-04	1.77E-04	2.44E-04	1.06E-04
S	3.27E-06	1.47E-06	2.84E-04	3.11E-04	4.27E-04	1.86E-04
SSW	3.27E-06	1.47E-06	2.84E-04	3.11E-04	4.27E-04	1.86E-04
SW	3.27E-06	1.47E-06	2.84E-04	3.11E-04	4.27E-04	1.86E-04
WSW	3.49E-06	1.57E-06	3.03E-04	3.31E-04	4.55E-04	1.99E-04
W	2.22E-06	1.00E-06	1.93E-04	2.11E-04	2.90E-04	1.26E-04
WNW	1.88E-07	8.45E-08	1.63E-05	1.78E-05	2.45E-05	1.07E-05
NW	6.15E-07	2.77E-07	5.33E-05	5.84E-05	8.03E-05	3.50E-05
NNW	1.92E-06	8.65E-07	1.67E-04	1.82E-04	2.51E-04	1.09E-04
MAX.	7.50E-06	3.38E-06	6.51E-04	7.13E-04	9.79E-04	4.27E-04

Note: Shaded regions indicate areas over Lake Ontario.

TABLE 4B
Radiation Dose to Maximum Individual Receptor
From Liquid Effluents for 2019
(Units in milliRem)

	Adult	Teen	Child	Infant
First Quarter				
T. Body	3.13E-04	2.41E-04	2.42E-04	6.53E-05
GI-LLI	5.48E-04	4.26E-04	3.09E-04	6.53E-05
Thyroid	3.21E-04	2.48E-04	2.51E-04	6.53E-05
Second Quarter				
T. Body	1.58E-04	1.22E-04	1.23E-04	3.26E-05
GI-LLI	3.02E-04	2.35E-04	1.63E-04	3.26E-05
Thyroid	1.62E-04	1.25E-04	1.27E-04	3.26E-05
Third Quarter				
T. Body	4.43E-04	3.38E-04	3.36E-04	9.43E-05
GI-LLI	5.60E-04	4.32E-04	3.71E-04	9.44E-05
Thyroid	4.48E-04	3.43E-04	3.42E-04	9.46E-05
Fourth Quarter				
T. Body	1.54E-04	1.17E-04	1.16E-04	3.29E-05
GI-LLI	1.75E-04	1.34E-04	1.23E-04	3.29E-05
Thyroid	1.55E-04	1.18E-04	1.17E-04	3.29E-05

**Table 5
Groundwater Monitoring Wells**

Location	Sample Date	Tritium (pCi/l)	Gamma ¹ (uCi/ml)
GW01: Warehouse Access Road (Control)	3/13/2019	< 460	< 6.95E-09
	6/26/2019	< 426	< 5.92E-09
	9/4/2019	< 431	< 6.97E-09
	12/13/2019	< 451	< 1.12E-08
GW03: Screenhouse West, South Well ²	1/27/2019	< 444	
	2/22/2019	< 453	
	3/14/2019	< 450	< 8.80E-09
	4/12/2019	< 404	
	5/24/2019	446	
	5/29/2019	579	
	6/27/2019	< 426	< 7.06E-09
	7/25/2019	< 413	
	8/16/2019	< 428	
	9/4/2019	< 439	< 1.02E-08
	10/25/2019	< 488	
	11/19/2019	< 459	
	12/13/2019	< 469	< 7.98E-09
GW04: Screenhouse West, North Well	3/14/2019	< 454	< 8.09E-09
	6/27/2019	< 428	< 6.86E-09
	9/4/2019	< 439	< 6.78E-09
	12/13/2019	< 482	< 6.33E-09
GW05: Screenhouse East, South (15.5')	3/14/2019	< 452	< 6.10E-09
	6/26/2019	< 427	< 8.44E-09
	9/4/2019	< 457	< 9.30E-09
	12/13/2019	< 484	< 8.43E-09
GW06: Screenhouse East, Middle (20.0')	3/14/2019	< 451	< 6.52E-09
	6/26/2019	< 425	< 6.52E-09
	9/4/2019	< 434	< 7.23E-09
	12/13/2019	< 483	< 8.59E-09
GW07: Screenhouse East, North (24.0')	3/14/2019	< 454	< 7.31E-09
	6/26/2019	< 423	< 6.61E-09
	9/4/2019	< 448	< 7.17E-09
	12/13/2019	< 486	< 7.17E-09

**Table 5 (Continued)
Groundwater Monitoring Wells**

Location	Sample Date	Tritium (pCi/l)	Gamma (uCi/ml)
GW08: All Volatiles Treatment Building ²	1/27/2019	< 443	
	2/22/2019	< 449	
	3/14/2019	< 454	< 9.62E-09
	4/12/2019	< 409	
	5/24/2019	542	
	5/29/2019	521	
	6/27/2019	< 424	< 8.21E-09
	7/25/2019	< 430	
	8/16/2019	< 429	
	9/4/2019	< 425	< 1.14E-08
	10/25/2019	< 486	
	11/19/2019	< 462	
	12/13/2019	< 483	< 1.12E-08
GW10: Technical Support Center, South	3/14/2019	< 457	< 6.85E-09
	6/26/2019	< 426	< 8.46E-09
	9/4/2019	< 424	< 1.88E-09
	12/13/2019	603	< 9.61E-09
GW11: Southeast of Contaminated Service Building (CSB)	3/14/2019	< 449	< 9.89E-09
	6/26/2019	< 427	< 6.19E-09
	9/4/2019	< 448	< 8.20E-09
	12/13/2019	< 479	< 8.13E-09
GW12: West of Orchard Access Road	3/13/2019	< 453	< 6.85E-09
	6/26/2019	< 418	< 9.77E-09
	9/4/2019	< 422	< 7.33E-09
	12/13/2019	< 487	< 9.35E-09
GW13: North of Independent Spent Fuel Storage Installation (ISFSI)	3/14/2019	< 458	< 7.38E-09
	6/26/2019	< 427	< 6.21E-09
	9/4/2019	< 426	< 7.98E-09
	12/13/2019	< 488	< 7.92E-09
GW14: South of Canister Preparation Building	3/14/2019	< 454	< 1.05E-08
	6/26/2019	< 422	< 6.30E-09
	9/4/2019	< 430	< 9.36E-09
	12/13/2019	< 480	< 7.50E-09

**Table 5 (Continued)
Groundwater Monitoring Wells**

Location	Sample Date	Tritium (pCi/l)	Gamma (uCi/ml)
GW15: West of Manor House	3/13/2019	< 454	< 6.71E-09
	6/26/2019	< 425	< 7.68E-09
	9/4/2019	< 419	< 7.42E-09
	12/13/2019	< 485	< 9.98E-09
GW16: Southeast of Manor House	3/13/2019	< 456	< 8.12E-09
	6/26/2019	< 427	< 7.95E-09
	9/4/2019	< 422	< 8.35E-09
	12/13/2019	< 487	< 9.01E-09

¹ Gamma analysis is performed on a quarterly basis for groundwater monitoring well results.

² Groundwater monitoring wells GW03 and GW08 are sampled monthly due to their location being important for early detection of any tritium within the environment.

TABLE 6
Offsite Dose Due to Carbon-14 in Gaseous and Liquid Effluents

MAXIMUM DOSE VALUES DUE TO C-14 IN GASEOUS EFFLUENTS IN 2019		
Organ	Age Group	mRem/yr
NRC Reg. Guide 1.109, Annual Bone Dose	Child	1.94E-02
NRC Reg. Guide 1.109, Annual Total Body/Organ Dose	Child	3.86E-03

MAXIMUM DOSE VALUES DUE TO C-14 IN LIQUID EFFLUENTS IN 2019		
Organ	Age	mRem/yr
NRC Reg. Guide 1.109, Annual Bone Dose	Child	1.08E-04
NRC Reg. Guide 1.109, Annual Total Body/Organ Dose	Child	2.16E-05

Annual Report
On the
Meteorological Monitoring Program
At the
Ginna Nuclear Power Plant

2019

prepared for

Exelon Nuclear
Warrenville, IL 60555

by

Murray and Trettel, Incorporated
600 First Bank Drive, Suite A
Palatine, IL 60067
(847) 963-9000
e-mail: mt@weathercommand.com
web : <http://www.weathercommand.com>

For Exelon Use Only

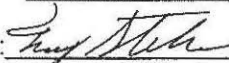
Reviewed By: 

Date: 2/27/2020

Table of Contents

<u>Section</u>	<u>Description</u>	<u>Page</u>
	List of Tables	ii
1	Introduction	1
2	Summary	2
3	Data Acquisition.....	3
4	Data Analysis.....	4
5	Results.....	7

List of Tables

<u>Number</u>	<u>Description</u>	<u>Page</u>
1	Instrument Locations	3
2	Data Loggers	3
3	Wind Direction Classes	5
4	Wind Speed Classes	5
5	Atmospheric Stability Classes	6
6	D/Q Plant Vent Release	8
7	X/Q Plant Vent Release	9
8	D/Q Containment Vent Release	10
9	X/Q Containment Vent Release	11
10	D/Q Air Ejector Release	12
11	X/Q Air Ejector Release	13
12	Special X/Q and D/Q Release.....	14
13	Data Recovery Summary	16
14	Precipitation Totals	18
15	Annual Joint Frequency Tables	20

1. Introduction

The purpose of the meteorological program being conducted at the Ginna Plant site is to provide information sufficient to assess the local weather conditions and to determine the degree of atmospheric dispersion of airborne radioactive effluent from the station.

The meteorological tower is 300 ft. high and is instrumented at three levels. Wind speed and direction, and ambient temperature are measured at 33 ft., 150 ft., and 250 ft. Differential temperatures, referenced to 33 ft., are measured at 150 ft. and 250 ft. Precipitation is measured at ground level.

Joint frequency stability wind rose tables of wind direction, wind speed, and stability are routinely tabulated from hourly measurements. The annual tables are included in this report.

Descriptions of the instruments and data computers are given in Section 3 (Data Acquisition) of this report. Data reduction and processing are described in Section 4 (Data Analysis). The results given in Section 5 of this report include X/Q and D/Q data results and site meteorology.

2. Summary

The Ginna Plant meteorological monitoring program produced 96,197 hours of valid data out of a possible 96,360 priority parameter hours during 2019, which represents an overall data recovery rate of 99.8%. Priority parameters are all parameters except precipitation.

The stability wind rose tables included in this report have been generated using the 33 ft. wind data with the 150-33 ft. differential temperature data, the 150 ft. wind data with the 150-33 ft differential temperature data and the 250 ft. wind data with the 250-33 ft. differential temperature data.

3. Data Acquisition

Wind speed and direction are measured with Climatronics F460 wind sensors. The wind speed sensors have a starting speed of 0.5 mph (0.22 mps), a range of 0 to 100 mph (0 to 44.7 mps), and a system accuracy of ± 1.0 mph at 100 mph (± 0.45 mps at 44.7 mps). The wind direction sensors have a threshold speed of 0.5 mph (0.22 mps), a range of 0 to 540°, and a system accuracy of $\pm 5^\circ$.

Ambient and differential temperature are measured with the Climatronics 100093 system. Ambient temperature is measured within the range of -20 to 120°F (-28.9 to 48.9°C) with an accuracy of $\pm 0.5^\circ\text{F}$ ($\pm 0.3^\circ\text{C}$). Differential temperature is measured within the range of -10 to 20°F (-5.6 to 11.1°C) with an accuracy of $\pm 0.18^\circ\text{F}$ ($\pm 0.10^\circ\text{C}$). Precipitation is measured with a Climatronics tipping bucket rain gauge and is measured in increments of one one-hundredth of an inch with a system accuracy of $\pm 0.01''$ ($\pm 0.25\text{mm}$).

The meteorological data are collected and stored by Campbell Scientific CR3000 and CR850 data loggers. The data loggers measure the analog voltages of the instruments and record the digital equivalent within the range of 0 to +5 volts. Data are obtained from the Campbell Scientific CR850 by a direct dial telephone hookup to an in-house computer system.

Table 1

Instrument Locations

<u>Measurement</u>	<u>Sensor Type</u>	<u>Location</u>	<u>Elevation</u>
Wind Speed	Climatronics 100075 F460	Tower	250 ft.
Wind Direction	Climatronics 100076 F460	Tower	250 ft.
Differential Temperature	Climatronics 100093	Tower	250 ft.
Wind Speed	Climatronics 100075 F460	Tower	150 ft.
Wind Direction	Climatronics 100076 F460	Tower	150 ft.
Differential Temperature	Climatronics 100093	Tower	150 ft.
Wind Speed	Climatronics 100075 F460	Tower	33 ft.
Wind Direction	Climatronics 100076 F460	Tower	33 ft.
Ambient Temperature	Climatronics 100093	Tower	33 ft.
Precipitation	Climatronics 100097-1 Tipping Bucket Rain Gage	Meteorological shelter roof	Ground

Table 2

Data Loggers

<u>Measurement</u>	<u>Logger Type</u>	<u>Sampling Frequency</u>
Winds, Temperatures, and Precipitation	Campbell Scientific CR3000 (A & B) and CR850	1 sec.
Winds, Temperatures, and Precipitation	Johnson Yokogawa Corp. Digital Recorder	10 sec.

4. Data Analysis

The meteorological data are collected via modem connection to a Campbell Scientific CR850 data logger. Data are sampled once per second. The data are then stored in the meteorological data base and hourly listings of the data are generated. The data listings are examined by qualified personnel and any apparent problems are brought to the attention of the Project Manager or Environmental Meteorologist and the Instrument Maintenance staff.

Hourly values of wind speed, wind direction, ambient temperature, differential temperature, and precipitation are obtained through measurements taken at the site. The standard deviation of wind direction (σ) is derived. The wind direction variation is described in terms of the standard deviation of the direction about the mean direction. The MIDAS computer derives an hourly value of wind σ .

The data base files are edited approximately once a week. Missing values are replaced with back up data values, when available. Invalid data are deleted from the data base.

When an hourly value is missing or invalid, the numeral 999 is entered into the computer data file in the appropriate location.

A professional meteorologist reviews the data, calibration findings, equipment maintenance reports, and other information and determines which data are valid. Only the valid data are retained in the data base.

Joint frequency stability wind rose tables of hourly data measured at the site are generated. These tables indicate the prevailing wind direction, wind speed, and stability classes measured during the period of observation as well as the joint frequencies of occurrence of the wind direction, wind speed, and stability classes. The values are also used as input to the atmospheric transport and diffusion models. Wind direction, wind speed, and stability classes are given in Tables 3, 4, and 5.

Table 3Wind Direction Classes

IF	348.75°	<	WD	<	11.25°	THEN	Class is	N
IF	11.25°	<	WD	≤	33.75°	THEN	Class is	NNE
IF	33.75°	<	WD	≤	56.25°	THEN	Class is	NE
IF	56.25°	<	WD	≤	78.75°	THEN	Class is	ENE
IF	78.75°	<	WD	≤	101.25°	THEN	Class is	E
IF	101.25°	<	WD	≤	123.75°	THEN	Class is	ESE
IF	123.75°	<	WD	≤	146.25°	THEN	Class is	SE
IF	146.25°	<	WD	≤	168.75°	THEN	Class is	SSE
IF	168.75°	<	WD	≤	191.25°	THEN	Class is	S
IF	191.25°	<	WD	≤	213.75°	THEN	Class is	SSW
IF	213.75°	<	WD	≤	236.25°	THEN	Class is	SW
IF	236.25°	<	WD	≤	258.75°	THEN	Class is	WSW
IF	258.75°	<	WD	≤	281.25°	THEN	Class is	W
IF	281.25°	<	WD	≤	303.75°	THEN	Class is	WNW
IF	303.75°	<	WD	≤	326.25°	THEN	Class is	NW
IF	326.25°	<	WD	≤	348.75°	THEN	Class is	NNW

Table 4Wind Speed Classes

IF		<	WS	<	0.50 m/s	THEN	Class is	1
IF	0.50 m/s	<	WS	≤	1.0 m/s	THEN	Class is	2
IF	1.1 m/s	<	WS	≤	1.5 m/s	THEN	Class is	3
IF	1.6 m/s	<	WS	≤	2.0 m/s	THEN	Class is	4
IF	2.1 m/s	<	WS	≤	3.0 m/s	THEN	Class is	5
IF	3.1 m/s	<	WS	≤	4.0 m/s	THEN	Class is	6
IF	4.1 m/s	<	WS	≤	5.0 m/s	THEN	Class is	7
IF	5.1 m/s	<	WS	≤	6.0 m/s	THEN	Class is	8
IF	6.1 m/s	<	WS	≤	8.0 m/s	THEN	Class is	9
IF	8.1 m/s	<	WS	≤	10.0 m/s	THEN	Class is	10
IF	10.0 m/s	<	WS			THEN	Class is	11

Table 5Atmospheric Stability Classes

Class	Differential Temperature Interval (in °C/100m) ⁽¹⁾	Differential Temperature Interval (in °F over the 150-33ft. range) ⁽²⁾	Differential Temperature Interval (in °F over the 250-33ft. range) ⁽²⁾
Extremely Unstable	$\Delta T \leq -1.9$	$\Delta T \leq -1.2$	$\Delta T \leq -2.3$
Moderately Unstable	$-1.9 < \Delta T \leq -1.7$	$-1.2 < \Delta T \leq -1.1$	$-2.3 < \Delta T \leq -2.1$
Slightly Unstable	$-1.7 < \Delta T \leq -1.5$	$-1.1 < \Delta T \leq -1.0$	$-2.1 < \Delta T \leq -1.8$
Neutral	$-1.5 < \Delta T \leq -0.5$	$-1.0 < \Delta T \leq -0.3$	$-1.8 < \Delta T \leq -0.6$
Slightly Stable	$-0.5 < \Delta T \leq 1.5$	$-0.3 < \Delta T \leq 1.0$	$-0.6 < \Delta T \leq 1.8$
Moderately Stable	$1.5 < \Delta T \leq 4.0$	$1.0 < \Delta T \leq 2.6$	$1.8 < \Delta T \leq 4.8$
Extremely Stable	$4.0 < \Delta T$	$2.6 < \Delta T$	$4.8 < \Delta T$

⁽¹⁾ from ANSI/ANS 2.5⁽²⁾ ANSI/ANS 2.5 intervals scaled for instrument heights on the Ginna meteorological tower

5. Results

5.1 X/Q and D/Q

The ground and mixed mode values for X/Q and D/Q can be found in tables 4-9.

The following program was used to calculate X/Q and D/Q values:

1. XOQDOQ: Computer Program for the Meteorological Evaluation of Routine Effluent Releases at Nuclear Power Stations (NUREG/CR-2919).

The program is based on the theory that material released to the atmosphere will be normally distributed (Gaussian) about the plume centerline. A straight-line trajectory is assumed between the point of release and all receptors.

The program implements the assumptions outlined in Section C of NRC Regulatory Guide 1.111. In evaluating routine releases from nuclear power plants, it primarily is designed to calculate annual relative effluent concentrations, X/Q values and annual average relative deposition, D/Q values.

Table 6

D/Q PLANT VENT 2019

Page 8

DIRECTION	804m	1609m	2416m	3218m	4022m	4827m	5632m	6436m	7240m	8045m
D/Q										
N	3.11E-09	1.52E-09	9.03E-10	5.90E-10	4.17E-10	3.12E-10	2.43E-10	1.95E-10	1.60E-10	1.34E-10
NNE	1.58E-09	7.39E-10	4.32E-10	2.83E-10	2.01E-10	1.51E-10	1.18E-10	9.47E-11	7.79E-11	6.52E-11
NE	2.57E-09	1.21E-09	7.11E-10	4.63E-10	3.27E-10	2.44E-10	1.90E-10	1.53E-10	1.26E-10	1.05E-10
ENE	4.12E-09	2.13E-09	1.27E-09	8.29E-10	5.84E-10	4.36E-10	3.39E-10	2.72E-10	2.23E-10	1.87E-10
E	4.02E-09	2.17E-09	1.31E-09	8.56E-10	6.04E-10	4.51E-10	3.53E-10	2.83E-10	2.35E-10	1.94E-10
ESE	8.32E-09	4.01E-09	1.88E-09	1.20E-09	8.54E-10	6.32E-10	4.84E-10	4.02E-10	3.39E-10	2.95E-10
SE	7.60E-09	2.62E-09	1.34E-09	8.35E-10	5.72E-10	4.22E-10	3.68E-10	2.97E-10	2.82E-10	2.50E-10
SSE	2.66E-09	9.25E-10	5.36E-10	3.52E-10	2.49E-10	1.84E-10	1.63E-10	1.88E-10	1.39E-10	1.20E-10
S	1.58E-09	6.15E-10	3.26E-10	2.13E-10	1.53E-10	1.30E-10	1.17E-10	1.08E-10	9.49E-11	7.87E-11
SSW	1.64E-09	6.94E-10	4.11E-10	2.64E-10	1.87E-10	1.39E-10	1.16E-10	1.15E-10	1.04E-10	9.31E-11
SW	3.80E-09	1.48E-09	7.82E-10	5.15E-10	3.55E-10	2.83E-10	2.30E-10	1.85E-10	1.60E-10	1.49E-10
WSW	5.46E-09	1.99E-09	1.04E-09	6.65E-10	4.60E-10	3.43E-10	2.67E-10	2.16E-10	1.87E-10	1.61E-10
W	3.44E-09	1.43E-09	7.73E-10	5.05E-10	3.58E-10	2.69E-10	2.11E-10	1.70E-10	1.40E-10	1.17E-10
WNW	5.30E-10	3.53E-10	2.30E-10	1.57E-10	1.15E-10	8.74E-11	6.90E-11	5.58E-11	4.60E-11	3.85E-11
NW	1.02E-09	6.03E-10	3.79E-10	2.56E-10	1.85E-10	1.40E-10	1.10E-10	8.88E-11	7.32E-11	6.14E-11
NNW	3.00E-09	1.49E-09	8.87E-10	5.79E-10	4.08E-10	3.05E-10	2.38E-10	1.91E-10	1.57E-10	1.31E-10

DIRECTION	804m	1609m	2416m	3218m	4022m	4827m	5632m	6436m	7240m	8045m
X/Q										
N	1.25E-07	1.18E-07	9.99E-08	8.13E-08	6.69E-08	5.61E-08	4.79E-08	4.16E-08	3.66E-08	3.25E-08
NNE	7.67E-08	7.67E-08	7.01E-08	6.00E-08	5.11E-08	4.39E-08	3.82E-08	3.37E-08	3.00E-08	2.69E-08
NE	9.67E-08	1.03E-07	9.46E-08	8.11E-08	6.92E-08	5.97E-08	5.20E-08	4.59E-08	4.10E-08	3.69E-08
ENE	1.49E-07	1.34E-07	1.10E-07	8.91E-08	7.34E-08	6.18E-08	5.30E-08	4.62E-08	4.08E-08	3.65E-08
E	1.47E-07	1.29E-07	1.03E-07	8.26E-08	6.76E-08	5.67E-08	5.12E-08	4.45E-08	4.13E-08	3.50E-08
ESE	1.83E-07	2.01E-07	1.05E-07	8.69E-08	8.48E-08	7.33E-08	5.54E-08	5.38E-08	4.82E-08	4.31E-08
SE	1.32E-07	8.83E-08	7.74E-08	6.38E-08	5.43E-08	5.23E-08	4.63E-08	4.15E-08	3.92E-08	3.55E-08
SSE	9.89E-08	7.23E-08	6.61E-08	6.53E-08	5.69E-08	4.85E-08	4.35E-08	4.42E-08	3.49E-08	3.11E-08
S	4.75E-08	5.70E-08	3.98E-08	4.00E-08	3.49E-08	3.47E-08	3.10E-08	2.78E-08	2.42E-08	2.09E-08
SSW	4.79E-08	4.49E-08	5.41E-08	5.05E-08	4.18E-08	3.64E-08	3.30E-08	3.23E-08	3.00E-08	2.75E-08
SW	6.94E-08	6.69E-08	5.98E-08	5.87E-08	4.67E-08	4.40E-08	4.09E-08	3.51E-08	3.10E-08	2.91E-08
WSW	1.04E-07	8.08E-08	6.26E-08	6.33E-08	4.80E-08	4.24E-08	3.54E-08	3.11E-08	2.85E-08	2.52E-08
W	1.02E-07	1.05E-07	7.95E-08	6.87E-08	5.91E-08	5.13E-08	4.51E-08	4.00E-08	3.59E-08	3.25E-08
WNW	1.95E-08	3.91E-08	4.12E-08	3.73E-08	3.28E-08	2.88E-08	2.55E-08	2.27E-08	2.05E-08	1.86E-08
NW	3.27E-08	5.12E-08	4.84E-08	4.15E-08	3.53E-08	3.03E-08	2.63E-08	2.32E-08	2.06E-08	1.85E-08
NNW	1.07E-07	9.63E-08	7.81E-08	6.24E-08	5.08E-08	4.24E-08	3.61E-08	3.13E-08	2.75E-08	2.45E-08

DIRECTION	804m	1609m	2416m	3218m	4022m	4827m	5632m	6436m	7240m	8045m
D/Q										
N	1.53E-08	4.87E-09	2.44E-09	1.49E-09	1.01E-09	7.30E-10	5.56E-10	4.39E-10	3.56E-10	2.96E-10
NNE	1.04E-08	3.33E-09	1.67E-09	1.02E-09	6.89E-10	5.00E-10	3.81E-10	3.01E-10	2.44E-10	2.03E-10
NE	1.52E-08	4.82E-09	2.41E-09	1.47E-09	9.92E-10	7.20E-10	5.49E-10	4.34E-10	3.52E-10	2.92E-10
ENE	1.82E-08	5.76E-09	2.88E-09	1.75E-09	1.18E-09	8.58E-10	6.53E-10	5.16E-10	4.19E-10	3.47E-10
E	1.69E-08	5.36E-09	2.68E-09	1.63E-09	1.10E-09	8.01E-10	6.15E-10	4.88E-10	4.00E-10	3.32E-10
ESE	1.96E-08	6.28E-09	3.13E-09	1.90E-09	1.29E-09	9.34E-10	7.13E-10	5.64E-10	4.69E-10	4.07E-10
SE	1.21E-08	3.80E-09	1.90E-09	1.15E-09	7.81E-10	6.06E-10	4.86E-10	3.85E-10	3.12E-10	2.58E-10
SSE	5.10E-09	1.61E-09	8.00E-10	4.92E-10	4.11E-10	3.04E-10	2.31E-10	1.83E-10	1.48E-10	1.22E-10
S	3.02E-09	9.54E-10	4.76E-10	2.95E-10	2.55E-10	1.90E-10	1.44E-10	1.14E-10	9.20E-11	7.61E-11
SSW	3.39E-09	1.20E-09	5.99E-10	3.98E-10	2.93E-10	2.30E-10	1.75E-10	1.38E-10	1.12E-10	9.24E-11
SW	6.48E-09	2.26E-09	1.13E-09	6.83E-10	4.63E-10	3.94E-10	3.09E-10	2.44E-10	1.97E-10	1.63E-10
WSW	9.91E-09	3.16E-09	1.58E-09	9.57E-10	6.49E-10	4.72E-10	3.61E-10	2.87E-10	2.36E-10	1.98E-10
W	1.07E-08	3.44E-09	1.69E-09	1.03E-09	6.99E-10	5.08E-10	3.88E-10	3.07E-10	2.50E-10	2.08E-10
WNW	4.04E-09	1.34E-09	6.81E-10	4.17E-10	2.84E-10	2.07E-10	1.58E-10	1.26E-10	1.03E-10	8.60E-11
NW	5.50E-09	1.81E-09	9.21E-10	5.63E-10	3.83E-10	2.79E-10	2.13E-10	1.69E-10	1.38E-10	1.15E-10
NNW	1.20E-08	3.82E-09	1.91E-09	1.16E-09	7.87E-10	5.71E-10	4.35E-10	3.43E-10	2.79E-10	2.31E-10

DIRECTION	804m	1609m	2416m	3218m	4022m	4827m	5632m	6436m	7240m	8045m
X/Q										
N	1.28E-06	4.72E-07	2.68E-07	1.80E-07	1.33E-07	1.04E-07	8.41E-08	7.03E-08	6.00E-08	5.21E-08
NNE	1.03E-06	3.96E-07	2.30E-07	1.56E-07	1.16E-07	9.10E-08	7.42E-08	6.21E-08	5.32E-08	4.63E-08
NE	1.54E-06	5.73E-07	3.31E-07	2.25E-07	1.67E-07	1.31E-07	1.07E-07	8.93E-08	7.64E-08	6.65E-08
ENE	1.53E-06	5.59E-07	3.22E-07	2.18E-07	1.62E-07	1.27E-07	1.03E-07	8.68E-08	7.44E-08	6.48E-08
E	1.34E-06	4.93E-07	2.85E-07	1.94E-07	1.45E-07	1.14E-07	9.51E-08	8.00E-08	7.04E-08	5.99E-08
ESE	9.76E-07	4.23E-07	2.19E-07	1.53E-07	1.24E-07	9.93E-08	7.67E-08	6.78E-08	5.85E-08	5.09E-08
SE	5.38E-07	2.33E-07	1.57E-07	1.15E-07	8.98E-08	7.75E-08	6.43E-08	5.45E-08	4.73E-08	4.09E-08
SSE	4.85E-07	2.04E-07	1.36E-07	1.10E-07	8.55E-08	6.74E-08	5.54E-08	4.60E-08	3.88E-08	3.34E-08
S	2.49E-07	1.54E-07	8.64E-08	7.08E-08	5.49E-08	4.55E-08	3.66E-08	3.02E-08	2.55E-08	2.19E-08
SSW	2.56E-07	1.38E-07	1.16E-07	9.35E-08	7.06E-08	5.65E-08	4.69E-08	3.97E-08	3.35E-08	2.88E-08
SW	3.42E-07	2.00E-07	1.31E-07	1.05E-07	7.70E-08	6.45E-08	5.40E-08	4.47E-08	3.80E-08	3.29E-08
WSW	4.89E-07	2.41E-07	1.43E-07	1.13E-07	8.09E-08	6.56E-08	5.29E-08	4.46E-08	3.90E-08	3.39E-08
W	1.06E-06	4.38E-07	2.54E-07	1.79E-07	1.37E-07	1.10E-07	9.07E-08	7.70E-08	6.66E-08	5.86E-08
WNW	5.70E-07	2.38E-07	1.48E-07	1.05E-07	8.01E-08	6.43E-08	5.33E-08	4.54E-08	3.93E-08	3.46E-08
NW	6.59E-07	2.59E-07	1.54E-07	1.06E-07	7.99E-08	6.32E-08	5.19E-08	4.38E-08	3.76E-08	3.29E-08
NNW	9.74E-07	3.56E-07	2.03E-07	1.37E-07	1.02E-07	7.94E-08	6.46E-08	5.41E-08	4.63E-08	4.03E-08

DIRECTION	804m	1609m	2416m	3218m	4022m	4827m	5632m	6436m	7240m	8045m
D/Q										
N	1.69E-08	5.33E-09	2.66E-09	1.61E-09	1.09E-09	7.89E-10	6.00E-10	4.73E-10	3.83E-10	3.17E-10
NNE	1.18E-08	3.73E-09	1.86E-09	1.13E-09	7.62E-10	5.52E-10	4.20E-10	3.31E-10	2.68E-10	2.22E-10
NE	1.70E-08	5.37E-09	2.68E-09	1.62E-09	1.10E-09	7.96E-10	6.05E-10	4.77E-10	3.86E-10	3.19E-10
ENE	2.02E-08	6.37E-09	3.18E-09	1.93E-09	1.30E-09	9.44E-10	7.18E-10	5.65E-10	4.58E-10	3.79E-10
E	1.91E-08	6.01E-09	3.00E-09	1.82E-09	1.23E-09	8.90E-10	6.77E-10	5.33E-10	4.32E-10	3.57E-10
ESE	2.16E-08	6.80E-09	3.39E-09	2.06E-09	1.39E-09	1.01E-09	7.66E-10	6.03E-10	4.88E-10	4.04E-10
SE	1.34E-08	4.22E-09	2.11E-09	1.28E-09	8.63E-10	6.26E-10	4.76E-10	3.75E-10	3.03E-10	2.51E-10
SSE	6.23E-09	1.96E-09	9.79E-10	5.94E-10	4.01E-10	2.91E-10	2.21E-10	1.74E-10	1.41E-10	1.17E-10
S	3.84E-09	1.21E-09	6.04E-10	3.66E-10	2.48E-10	1.80E-10	1.37E-10	1.08E-10	8.71E-11	7.20E-11
SSW	4.65E-09	1.47E-09	7.31E-10	4.44E-10	3.00E-10	2.17E-10	1.65E-10	1.30E-10	1.05E-10	8.72E-11
SW	8.29E-09	2.62E-09	1.30E-09	7.91E-10	5.35E-10	3.87E-10	2.95E-10	2.32E-10	1.88E-10	1.55E-10
WSW	1.18E-08	3.71E-09	1.85E-09	1.12E-09	7.58E-10	5.49E-10	4.18E-10	3.29E-10	2.66E-10	2.20E-10
W	1.39E-08	4.39E-09	2.19E-09	1.33E-09	8.98E-10	6.51E-10	4.95E-10	3.90E-10	3.16E-10	2.61E-10
WNW	6.27E-09	1.98E-09	9.86E-10	5.98E-10	4.04E-10	2.93E-10	2.23E-10	1.76E-10	1.42E-10	1.18E-10
NW	7.40E-09	2.33E-09	1.16E-09	7.05E-10	4.77E-10	3.45E-10	2.63E-10	2.07E-10	1.68E-10	1.39E-10
NNW	1.34E-08	4.24E-09	2.11E-09	1.28E-09	8.66E-10	6.28E-10	4.77E-10	3.76E-10	3.04E-10	2.52E-10

DIRECTION	804m	1609m	2416m	3218m	4022m	4827m	5632m	6436m	7240m	8045m
X/Q										
N	1.95E-06	6.70E-07	3.67E-07	2.41E-07	1.75E-07	1.34E-07	1.08E-07	8.94E-08	7.57E-08	6.54E-08
NNE	1.65E-06	5.74E-07	3.15E-07	2.07E-07	1.50E-07	1.16E-07	9.30E-08	7.70E-08	6.53E-08	5.64E-08
NE	2.30E-06	8.03E-07	4.43E-07	2.92E-07	2.12E-07	1.64E-07	1.32E-07	1.09E-07	9.26E-08	8.01E-08
ENE	2.42E-06	8.37E-07	4.62E-07	3.05E-07	2.22E-07	1.71E-07	1.38E-07	1.15E-07	9.72E-08	8.41E-08
E	2.28E-06	7.89E-07	4.36E-07	2.88E-07	2.09E-07	1.62E-07	1.30E-07	1.08E-07	9.16E-08	7.92E-08
ESE	1.63E-06	5.50E-07	2.98E-07	1.95E-07	1.40E-07	1.08E-07	8.61E-08	7.11E-08	6.01E-08	5.18E-08
SE	1.19E-06	4.03E-07	2.21E-07	1.45E-07	1.05E-07	8.11E-08	6.52E-08	5.40E-08	4.58E-08	3.96E-08
SSE	1.00E-06	3.39E-07	1.85E-07	1.21E-07	8.69E-08	6.67E-08	5.34E-08	4.42E-08	3.73E-08	3.22E-08
S	6.42E-07	2.18E-07	1.19E-07	7.79E-08	5.63E-08	4.33E-08	3.47E-08	2.87E-08	2.43E-08	2.10E-08
SSW	8.49E-07	2.84E-07	1.55E-07	1.02E-07	7.34E-08	5.64E-08	4.53E-08	3.75E-08	3.17E-08	2.74E-08
SW	1.02E-06	3.38E-07	1.83E-07	1.19E-07	8.60E-08	6.60E-08	5.28E-08	4.36E-08	3.68E-08	3.18E-08
WSW	1.19E-06	3.94E-07	2.13E-07	1.39E-07	1.00E-07	7.68E-08	6.15E-08	5.08E-08	4.30E-08	3.71E-08
W	2.39E-06	8.25E-07	4.56E-07	3.01E-07	2.19E-07	1.69E-07	1.36E-07	1.13E-07	9.61E-08	8.31E-08
WNW	1.43E-06	4.99E-07	2.78E-07	1.84E-07	1.34E-07	1.04E-07	8.40E-08	6.98E-08	5.94E-08	5.14E-08
NW	1.30E-06	4.48E-07	2.47E-07	1.63E-07	1.18E-07	9.12E-08	7.34E-08	6.08E-08	5.16E-08	4.46E-08
NNW	1.55E-06	5.31E-07	2.91E-07	1.91E-07	1.39E-07	1.07E-07	8.57E-08	7.10E-08	6.02E-08	5.19E-08

Table 12

Direction	Distance to Nearest Residence (m)	Air Ejector		Containment Vent		Plant Vent	
		X/Q (sec/m ³)	D/Q (m ⁻²)	X/Q (sec/m ³)	D/Q (m ⁻²)	X/Q (sec/m ³)	D/Q (m ⁻²)
E	1170	1.27E-06	1.03E-08	7.70E-07	9.17E-09	1.41E-07	2.98E-09
ESE	1660	5.24E-07	6.45E-09	4.03E-07	5.96E-09	1.91E-07	3.81E-09
SE	840	1.11E-06	1.25E-08	5.08E-07	1.13E-08	1.23E-07	7.14E-09
SSE	610	1.56E-06	9.69E-09	6.06E-07	7.77E-09	8.78E-08	3.44E-09
S	1500	2.43E-07	1.37E-09	1.60E-07	1.08E-09	5.54E-08	6.86E-10
SSW	620	1.31E-06	7.06E-09	3.53E-07	5.01E-09	5.40E-08	2.15E-09
SW	740	1.16E-06	9.49E-09	3.79E-07	7.38E-09	7.18E-08	4.22E-09
WSW	900	9.89E-07	9.80E-09	4.27E-07	8.28E-09	8.74E-08	4.90E-09
W	1330	1.10E-06	6.07E-09	5.47E-07	4.76E-09	1.02E-07	1.84E-09

Direction	Distance to Nearest Milk Producing Animal (m)	Air Ejector		Containment Vent		Plant Vent	
		X/Q (sec/m ³)	D/Q (m ⁻²)	X/Q (sec/m ³)	D/Q (m ⁻²)	X/Q (sec/m ³)	D/Q (m ⁻²)
ESE	8240	5.01E-08	3.87E-10	4.93E-08	3.90E-10	4.18E-08	2.87E-10

Direction	Distance to Nearest Garden (m)	Air Ejector		Containment Vent		Plant Vent	
		X/Q (sec/m ³)	D/Q (m ⁻²)	X/Q (sec/m ³)	D/Q (m ⁻²)	X/Q (sec/m ³)	D/Q (m ⁻²)
E	610	3.55E-06	2.97E-08	2.03E-06	2.62E-08	1.56E-07	4.90E-09
ESE	430	4.43E-06	5.76E-08	2.54E-06	5.22E-08	3.50E-07	1.56E-08
SSE	660	1.37E-06	8.56E-09	5.65E-07	6.93E-09	8.91E-08	3.13E-09

5.2 Instrument Maintenance

In January and February, at the Primary Tower, the 150' A wind direction lost a tailpiece. All invalid data was replaced with the 150' B wind direction. The issue was fixed February 20.

In June, a calibration of the Primary Tower and Backup Tower was performed.

In July, at the Backup Tower, the cable, crossarm and wind direction were replaced.

No other problems were encountered with the equipment, and at the end of the year, no problems were evident at the site.

5.3 Data Recovery

The record of data recovery for the year is summarized in Table 12.

Table 12

Ginna Site
Data Recovery Summary
2019

<u>Measurement</u>	<u>Elevation</u>	<u>Recovered Hours</u>	<u>Recovered Percent</u>	<u>Lost Hours</u>	<u>Percent Changed</u>
Wind Speed	33 ft.	8754	99.9	6	0.1
Wind Speed	150 ft.	8711	99.4	49	0.6
Wind Speed	250 ft.	8700	99.3	60	0.7
Wind Direction	33 ft.	8754	99.9	6	0.1
Wind Direction	150 ft.	8754	99.9	6	8.4
Wind Direction	250 ft.	8754	99.9	6	0.2
Ambient Temperature	33 ft.	8754	99.9	6	0.1
Ambient Temperature	150 ft.	8754	99.9	6	0.1
Ambient Temperature	250 ft.	8754	99.9	6	0.1
Differential Temperature	150-33 ft.	8754	99.9	6	0.3
Differential Temperature	250-33 ft.	8754	99.9	6	0.7
Precipitation	10 ft.	8754	99.9	6	0.2
AVERAGE*			99.8		

* average of priority parameters (all except precipitation)

	<u>Valid Hours</u>	<u>Recovered Percent</u>	<u>Lost Hours</u>
Lower Level Joint Frequency %	8754	99.9	6
Middle Level Joint Frequency %	8711	99.4	49
Upper Level Joint Frequency %	8700	99.3	60

5.4 Stability Wind Rose Data

The annual stability wind roses are given at the end of this report. Wind speed classes have been altered to reflect the sensor threshold.

For the year, winds measured at 33 ft. most frequently came from the west southwest (10.61%) and most frequently fell into the 2.1-3.0 m/s wind speed class (23%). Calms (wind speeds at or below the sensor threshold) were measured 0.00% of the time and speeds greater than 10.0 m/s were measured (2.72%) of the time. Winds measured at 150 ft. most frequently came from the west northwest (11.%) and most frequently fell into the 6.1-8.0 m/s wind speed class (18.6%). Calms were measured 0.00% of the time and speeds greater than 10.0 m/s were measured (10.67%) of the time. Winds measured at 250 ft. most frequently came from the west northwest (11.85%) and most frequently fell into the 6.1-8.1 m/s wind speed class (22.08%). Calms were measured 0.00% of the time and speeds greater than 10.0 m/s were measured (16.19%) of the time.

Stability based on the 150-33 ft. differential temperature most frequently fell into the neutral classification (35.24%) and stability based on the 250-33 ft. differential temperature most frequently fell into the neutral classification (43.01%).

5.5 Precipitation

Table 13
Precipitation Totals (Inches) - 2019
Ginna Site

<u>Month</u>	<u>Total</u>
January	2.18
February	1.89
March	1.32
April	2.74
May	4.41
June	4.11
July	1.48
August	3.74
September	3.37
October	5.13
November	1.77
December	3.96
 TOTAL:	 36.10*

*Indicates some precipitation missing.

2019

Joint Frequency Tables

Joint Frequency Distribution

Site:: Ginna Primary

Period:: Months Jan - Dec for years 2019 - 2019

All Stabilities

Elevations:: Winds 33ft Stability 150ft

Wind Direction Sector	Wind Speed Range (m/s)											Total
	<0.50	0.5-1.0	1.1-1.5	1.6-2.0	2.1-3.0	3.1-4.0	4.1-5.0	5.1-6.0	6.1-8.0	8.1-10.0	>10.00	
N	1	18	33	38	60	32	5	5	3	0	0	195
NNE	0	12	34	36	83	45	26	24	22	8	5	295
NE	1	18	27	54	75	57	38	45	39	44	28	426
ENE	1	12	41	74	150	108	101	93	65	31	29	705
E	0	15	28	68	129	116	77	40	23	1	0	497
ESE	0	9	22	33	72	37	8	3	0	0	0	184
SE	0	8	20	28	92	63	23	10	6	0	0	250
SSE	1	8	27	33	96	79	71	51	79	19	10	474
S	0	25	49	62	139	157	127	99	115	31	8	812
SSW	0	25	77	162	293	204	97	48	14	0	0	920
SW	0	21	70	146	326	166	79	47	16	0	3	874
WSW	1	13	27	50	146	145	132	114	167	83	51	929
W	0	12	30	28	98	157	160	109	176	49	24	843
WNW	2	11	22	40	153	149	141	128	122	73	77	918
NW	1	17	26	51	77	43	37	29	39	11	3	334
NNW	0	17	17	20	24	15	3	2	0	0	0	98
Tot	8	241	550	923	2013	1573	1125	847	886	350	238	8754

Hours of Calm	0
Hours of Variable Direction	0
Hours of Valid Data	8754
Hours of Missing Data . . .	6
Hours in Period	8760

Joint Frequency Distribution

Site:: Ginna Primary

Period:: Months Jan - Dec for years 2019 - 2019

Stability Class A Extremely Unstable based on Lapse Rate

Elevations:: Winds 33ft Stability 150ft

Wind Direction Sector	Wind Speed Range (m/s)											Total
	<0.50	0.5-1.0	1.1-1.5	1.6-2.0	2.1-3.0	3.1-4.0	4.1-5.0	5.1-6.0	6.1-8.0	8.1-10.0	>10.00	
N	0	0	0	7	6	9	1	3	2	0	0	28
NNE	0	0	1	1	11	6	6	3	9	6	5	48
NE	0	0	0	0	4	19	20	20	20	36	28	147
ENE	0	0	0	4	28	34	45	63	48	28	29	279
E	0	0	0	0	0	3	0	7	9	1	0	20
ESE	0	0	0	0	0	2	0	0	0	0	0	2
SE	0	0	1	0	1	5	1	1	0	0	0	9
SSE	0	0	0	0	2	7	1	4	5	1	0	20
S	0	0	0	0	3	11	7	4	3	1	0	29
SSW	0	0	1	0	5	10	2	0	0	0	0	18
SW	0	0	0	3	4	15	11	2	0	0	0	35
WSW	0	0	0	0	0	4	3	3	3	0	0	13
W	0	0	0	0	3	6	9	6	5	2	0	31
WNW	0	0	0	1	47	65	55	50	33	14	11	276
NW	0	0	0	12	29	16	23	10	14	3	2	109
NNW	0	0	0	9	4	11	3	0	0	0	0	27
Tot	0	0	3	37	147	223	187	176	151	92	75	1091

Hours of Calm 0
 Hours of Variable Direction 0
 Hours of Valid Data 1091
 Hours of Missing Data 6
 Hours in Period 8760

Joint Frequency Distribution

Site:: Ginna Primary

Period:: Months Jan - Dec for years 2019 - 2019

Stability Class B Moderately Unstable based on Lapse Rate

Elevations:: Winds 33ft Stability 150ft

Wind Direction Sector	Wind Speed Range (m/s)										Total	
	<0.50	0.5-1.0	1.1-1.5	1.6-2.0	2.1-3.0	3.1-4.0	4.1-5.0	5.1-6.0	6.1-8.0	8.1-10.0		>10.00
N	0	0	1	5	7	10	1	0	1	0	0	25
NNE	0	0	2	3	19	6	4	9	12	1	0	56
NE	0	0	0	4	8	8	3	9	9	5	0	46
ENE	0	0	3	3	16	21	21	15	12	2	0	93
E	0	0	0	0	3	13	16	11	6	0	0	49
ESE	0	0	0	0	0	3	0	0	0	0	0	3
SE	0	0	0	1	0	3	1	2	2	0	0	9
SSE	0	0	0	1	6	9	5	3	6	1	0	31
S	0	0	0	2	6	4	5	2	2	4	0	25
SSW	0	0	1	2	5	5	4	1	0	0	0	18
SW	0	0	0	0	10	11	7	3	0	0	0	31
WSW	0	0	0	0	6	7	8	4	8	1	0	34
W	0	0	0	2	2	3	5	4	11	4	0	31
WNW	0	0	1	6	9	11	14	13	11	9	11	85
NW	0	0	0	4	3	4	4	7	10	5	0	37
NNW	0	0	2	0	0	2	0	0	0	0	0	4
Tot	0	0	10	33	100	120	98	83	90	32	11	577

Hours of Calm 0
 Hours of Variable Direction 0
 Hours of Valid Data 577
 Hours of Missing Data 6
 Hours in Period 8760

Joint Frequency Distribution

Site:: Ginna Primary

Period:: Months Jan - Dec for years 2019 - 2019

Stability Class C Slightly Unstable based on Lapse Rate

Elevations:: Winds 33ft Stability 150ft

Wind Direction Sector	Wind Speed Range (m/s)											Total
	<0.50	0.5-1.0	1.1-1.5	1.6-2.0	2.1-3.0	3.1-4.0	4.1-5.0	5.1-6.0	6.1-8.0	8.1-10.0	>10.00	
N	0	0	0	4	9	6	2	0	0	0	0	21
NNE	0	0	1	3	10	13	5	4	1	0	0	37
NE	0	0	2	2	13	8	6	8	4	1	0	44
ENE	0	0	2	3	11	6	6	3	2	1	0	34
E	0	0	0	2	10	6	14	2	2	0	0	36
ESE	0	0	0	1	1	3	0	0	0	0	0	5
SE	0	0	0	0	3	2	2	0	0	0	0	7
SSE	0	0	1	0	1	3	2	2	7	1	0	17
S	0	0	0	0	6	4	3	0	5	2	0	20
SSW	0	0	0	1	10	5	0	3	0	0	0	19
SW	0	0	0	0	6	5	3	2	2	0	0	18
WSW	0	0	1	2	1	4	3	4	4	3	0	22
W	0	0	0	0	3	10	8	4	7	1	0	33
WNW	0	0	0	2	4	3	4	7	7	11	14	52
NW	0	0	0	3	1	3	1	4	3	2	0	17
NNW	0	0	2	1	2	1	0	0	0	0	0	6
Tot	0	0	9	24	91	82	59	43	44	22	14	388

Hours of Calm 0
 Hours of Variable Direction 0
 Hours of Valid Data 388
 Hours of Missing Data 6
 Hours in Period 8760

Joint Frequency Distribution

Site:: Ginna Primary

Period:: Months Jan - Dec for years 2019 - 2019

Stability Class D Neutral based on Lapse Rate

Elevations:: Winds 33ft Stability 150ft

Wind Direction Sector	Wind Speed Range (m/s)											Total
	<0.50	0.5-1.0	1.1-1.5	1.6-2.0	2.1-3.0	3.1-4.0	4.1-5.0	5.1-6.0	6.1-8.0	8.1-10.0	>10.00	
N	1	9	17	15	34	6	1	2	0	0	0	85
NNE	0	4	18	20	30	15	8	5	0	0	0	100
NE	0	6	5	24	28	20	9	6	4	1	0	103
ENE	0	3	12	15	41	26	16	8	1	0	0	122
E	0	2	5	22	51	52	38	14	3	0	0	187
ESE	0	0	3	8	38	20	6	3	0	0	0	78
SE	0	2	4	7	36	40	17	7	4	0	0	117
SSE	0	1	3	13	26	40	48	35	49	14	10	239
S	0	2	12	16	35	51	58	36	56	19	8	293
SSW	0	3	4	14	49	46	21	16	8	0	0	161
SW	0	1	7	10	46	64	30	27	9	0	2	196
WSW	0	2	3	6	26	56	74	70	139	75	51	502
W	0	5	8	7	31	64	83	65	140	42	24	469
WNW	1	3	7	10	25	29	40	42	62	37	40	296
NW	1	0	13	14	21	19	9	7	11	1	1	97
NNW	0	7	9	5	16	1	0	2	0	0	0	40
Tot	3	50	130	206	533	549	458	345	486	189	136	3085

Hours of Calm 0
 Hours of Variable Direction 0
 Hours of Valid Data 3085
 Hours of Missing Data 6
 Hours in Period 8760

Joint Frequency Distribution

Site:: Ginna Primary

Period:: Months Jan - Dec for years 2019 - 2019

Stability Class E Slightly Stable based on Lapse Rate

Elevations:: Winds 33ft Stability 150ft

Wind Direction Sector	Wind Speed Range (m/s)											Total
	<0.50	0.5-1.0	1.1-1.5	1.6-2.0	2.1-3.0	3.1-4.0	4.1-5.0	5.1-6.0	6.1-8.0	8.1-10.0	>10.00	
N	0	8	13	5	3	1	0	0	0	0	0	30
NNE	0	7	10	8	12	5	3	2	0	1	0	48
NE	1	5	5	10	13	1	0	2	0	1	0	38
ENE	1	3	10	23	25	13	11	4	1	0	0	91
E	0	7	11	31	37	27	6	6	3	0	0	128
ESE	0	1	12	21	26	7	2	0	0	0	0	69
SE	0	4	8	10	37	12	2	0	0	0	0	73
SSE	0	3	3	8	35	18	15	7	12	2	0	103
S	0	5	10	16	54	68	50	57	49	5	0	314
SSW	0	6	22	18	90	92	65	28	6	0	0	327
SW	0	11	23	30	138	69	28	13	5	0	1	318
WSW	0	7	15	22	64	70	44	33	13	4	0	272
W	0	4	13	15	50	71	54	30	13	0	0	250
WNW	1	8	10	13	44	31	24	15	8	2	1	157
NW	0	11	11	9	8	0	0	1	1	0	0	41
NNW	0	4	2	2	1	0	0	0	0	0	0	9
Tot	3	94	178	241	637	485	304	198	111	15	2	2268

Hours of Calm	0
Hours of Variable Direction	0
Hours of Valid Data	2268
Hours of Missing Data	6
Hours in Period	8760

Joint Frequency Distribution

Site:: Ginna Primary

Period:: Months Jan - Dec for years 2019 - 2019

Stability Class F Moderately Stable based on Lapse Rate

Elevations:: Winds 33ft Stability 150ft

Wind Direction Sector	Wind Speed Range (m/s)											Total
	<0.50	0.5-1.0	1.1-1.5	1.6-2.0	2.1-3.0	3.1-4.0	4.1-5.0	5.1-6.0	6.1-8.0	8.1-10.0	>10.00	
N	0	1	2	2	1	0	0	0	0	0	0	6
NNE	0	0	2	1	1	0	0	1	0	0	0	5
NE	0	4	9	7	5	1	0	0	2	0	0	28
ENE	0	4	8	8	13	5	1	0	0	0	0	39
E	0	4	9	4	17	6	2	0	0	0	0	42
ESE	0	5	6	2	3	2	0	0	0	0	0	18
SE	0	2	4	6	13	1	0	0	0	0	0	26
SSE	0	3	10	6	18	2	0	0	0	0	0	39
S	0	9	11	8	19	19	4	0	0	0	0	70
SSW	0	8	17	33	51	38	5	0	0	0	0	152
SW	0	7	26	48	72	2	0	0	0	0	0	155
WSW	1	2	6	15	39	4	0	0	0	0	0	67
W	0	2	4	2	8	3	1	0	0	0	0	20
WNW	0	0	3	3	13	9	4	1	1	0	0	34
NW	0	3	2	7	12	1	0	0	0	0	0	25
NNW	0	3	1	1	0	0	0	0	0	0	0	5
Tot	1	57	120	153	285	93	17	2	3	0	0	731

Hours of Calm 0
 Hours of Variable Direction 0
 Hours of Valid Data 731
 Hours of Missing Data 6
 Hours in Period 8760

Joint Frequency Distribution

Site:: Ginna Primary

Period:: Months Jan - Dec for years 2019 - 2019

Stability Class G Extremely Stable based on Lapse Rate

Elevations:: Winds 33ft Stability 150ft

Wind Direction Sector	Wind Speed Range (m/s)											Total
	<0.50	0.5-1.0	1.1-1.5	1.6-2.0	2.1-3.0	3.1-4.0	4.1-5.0	5.1-6.0	6.1-8.0	8.1-10.0	>10.00	
N	0	0	0	0	0	0	0	0	0	0	0	0
NNE	0	1	0	0	0	0	0	0	0	0	0	1
NE	0	3	6	7	4	0	0	0	0	0	0	20
ENE	0	2	6	18	16	3	1	0	1	0	0	47
E	0	2	3	9	11	9	1	0	0	0	0	35
ESE	0	3	1	1	4	0	0	0	0	0	0	9
SE	0	0	3	4	2	0	0	0	0	0	0	9
SSE	1	1	10	5	8	0	0	0	0	0	0	25
S	0	9	16	20	16	0	0	0	0	0	0	61
SSW	0	8	32	94	83	8	0	0	0	0	0	225
SW	0	2	14	55	50	0	0	0	0	0	0	121
WSW	0	2	2	5	10	0	0	0	0	0	0	19
W	0	1	5	2	1	0	0	0	0	0	0	9
WNW	0	0	1	5	11	1	0	0	0	0	0	18
NW	0	3	0	2	3	0	0	0	0	0	0	8
NNW	0	3	1	2	1	0	0	0	0	0	0	7
Tot	1	40	100	229	220	21	2	0	1	0	0	614

Hours of Calm 0
 Hours of Variable Direction 0
 Hours of Valid Data 614
 Hours of Missing Data 6
 Hours in Period 8760

Joint Frequency Distribution

Site:: Ginna Primary

Period:: Months Jan - Dec for years 2019 - 2019

All Stabilities

Elevations:: Winds 150ft Stability 150ft

Wind Direction Sector	Wind Speed Range (m/s)											Total
	<0.50	0.5-1.0	1.1-1.5	1.6-2.0	2.1-3.0	3.1-4.0	4.1-5.0	5.1-6.0	6.1-8.0	8.1-10.0	>10.00	
N	0	3	16	20	32	27	8	14	25	15	11	171
NNE	0	13	15	22	37	24	24	18	23	22	9	207
NE	0	9	22	29	55	45	32	32	47	37	61	369
ENE	0	9	12	25	93	101	73	61	77	38	34	523
E	0	13	18	34	116	119	147	107	64	2	0	620
ESE	1	6	18	20	58	81	52	32	11	0	0	279
SE	0	4	7	12	69	91	85	39	19	3	0	329
SSE	0	4	8	14	48	60	94	89	144	95	42	598
S	1	5	9	15	51	73	109	135	205	99	50	752
SSW	0	8	12	13	41	64	97	117	152	20	2	526
SW	0	6	10	19	47	103	210	190	131	38	4	758
WSW	0	9	10	13	56	90	142	149	207	111	112	899
W	1	8	16	20	60	65	110	115	161	140	152	848
WNW	0	4	8	21	65	81	76	91	217	158	238	959
NW	0	10	20	16	61	44	41	31	95	82	196	596
NNW	0	10	15	33	49	28	32	27	42	22	19	277
Tot	3	121	216	326	938	1096	1332	1247	1620	882	930	8711

Hours of Calm 0
 Hours of Variable Direction 0
 Hours of Valid Data 8711
 Hours of Missing Data 49
 Hours in Period 8760

Joint Frequency Distribution

Site:: Ginna Primary

Period:: Months Jan - Dec for years 2019 - 2019

Stability Class A Extremely Unstable based on Lapse Rate

Elevations:: Winds 150ft Stability 150ft

Wind Direction Sector	Wind Speed Range (m/s)											Total
	<0.50	0.5-1.0	1.1-1.5	1.6-2.0	2.1-3.0	3.1-4.0	4.1-5.0	5.1-6.0	6.1-8.0	8.1-10.0	>10.00	
N	0	0	0	0	4	4	0	2	5	7	4	26
NNE	0	0	0	0	4	2	2	3	6	10	7	34
NE	0	0	0	0	4	10	11	15	20	23	57	140
ENE	0	0	0	1	14	30	28	49	55	34	31	242
E	0	0	0	0	1	6	19	17	14	1	0	58
ESE	0	0	0	0	0	2	0	0	0	0	0	2
SE	0	0	0	1	0	1	4	1	1	0	0	8
SSE	0	0	0	0	0	3	7	2	4	5	3	24
S	0	0	0	0	2	4	7	9	3	2	0	27
SSW	0	0	0	0	2	3	8	0	0	0	0	13
SW	0	0	0	2	3	4	10	12	5	0	0	36
WSW	0	0	0	0	1	1	4	4	4	3	0	17
W	0	0	0	0	1	1	3	1	3	1	1	11
WNW	0	0	0	0	5	14	27	31	59	34	47	217
NW	0	0	0	0	21	22	16	16	40	22	57	194
NNW	0	0	0	0	13	4	2	1	10	4	6	40
Tot	0	0	0	4	75	111	148	163	229	146	213	1089

Hours of Calm 0
 Hours of Variable Direction 0
 Hours of Valid Data 1089
 Hours of Missing Data 49
 Hours in Period 8760

Joint Frequency Distribution

Site:: Ginna Primary

Period:: Months Jan - Dec for years 2019 - 2019

Stability Class B Moderately Unstable based on Lapse Rate

Elevations:: Winds 150ft Stability 150ft

Wind Direction Sector	Wind Speed Range (m/s)											Total
	<0.50	0.5-1.0	1.1-1.5	1.6-2.0	2.1-3.0	3.1-4.0	4.1-5.0	5.1-6.0	6.1-8.0	8.1-10.0	>10.00	
N	0	0	0	0	7	2	0	2	8	1	4	24
NNE	0	0	2	1	12	3	1	2	9	4	1	35
NE	0	0	2	4	3	8	3	4	14	9	1	48
ENE	0	0	0	3	10	13	15	7	8	2	0	58
E	0	0	0	0	1	8	22	21	15	1	0	68
ESE	0	0	0	0	1	1	1	0	0	0	0	3
SE	0	0	0	0	0	2	4	3	2	1	0	12
SSE	0	0	0	2	4	3	6	4	4	6	1	30
S	0	0	0	1	4	4	3	3	4	1	4	24
SSW	0	0	0	1	5	5	4	0	3	0	0	18
SW	0	0	0	0	0	8	9	6	6	0	0	29
WSW	0	0	0	0	2	4	4	7	10	6	1	34
W	0	0	0	2	3	1	0	2	4	3	3	18
WNW	0	0	0	2	5	6	8	3	20	13	26	83
NW	0	0	0	0	3	3	0	0	4	11	32	53
NNW	0	0	1	4	5	4	0	1	5	7	1	28
Tot	0	0	5	20	65	75	80	65	116	65	74	565

Hours of Calm 0
 Hours of Variable Direction 0
 Hours of Valid Data 565
 Hours of Missing Data 49
 Hours in Period 8760

Joint Frequency Distribution

Site:: Ginna Primary

Period:: Months Jan - Dec for years 2019 - 2019

Stability Class C Slightly Unstable based on Lapse Rate

Elevations:: Winds 150ft Stability 150ft

Wind Direction Sector	Wind Speed Range (m/s)											Total
	<0.50	0.5-1.0	1.1-1.5	1.6-2.0	2.1-3.0	3.1-4.0	4.1-5.0	5.1-6.0	6.1-8.0	8.1-10.0	>10.00	
N	0	0	0	1	2	3	3	4	4	2	0	19
NNE	0	0	1	2	5	5	4	6	2	2	0	27
NE	0	0	0	1	8	6	3	6	7	2	0	33
ENE	0	0	0	3	6	6	6	1	5	0	1	28
E	0	1	0	1	6	6	13	7	3	0	0	37
ESE	0	0	0	0	0	4	1	1	0	0	0	6
SE	0	0	0	0	4	0	4	2	0	0	0	10
SSE	0	0	1	1	1	2	1	2	5	7	1	21
S	0	0	0	0	1	6	4	2	1	2	2	18
SSW	0	0	0	0	4	5	4	0	3	0	0	16
SW	0	0	0	0	4	2	3	2	4	3	0	18
WSW	0	0	0	0	1	2	4	3	4	5	3	22
W	0	0	0	1	1	1	4	3	6	4	0	20
WNW	0	0	0	0	0	3	4	6	7	9	27	56
NW	0	0	0	1	3	1	1	1	0	3	18	28
NNW	0	0	0	3	2	1	2	1	4	6	4	23
Tot	0	1	2	14	48	53	61	47	55	45	56	382

Hours of Calm 0
 Hours of Variable Direction 0
 Hours of Valid Data 382
 Hours of Missing Data 49
 Hours in Period 8760

Joint Frequency Distribution

Site:: Ginna Primary

Period:: Months Jan - Dec for years 2019 - 2019

Stability Class D Neutral based on Lapse Rate

Elevations:: Winds 150ft Stability 150ft

Wind Direction Sector	Wind Speed Range (m/s)											Total
	<0.50	0.5-1.0	1.1-1.5	1.6-2.0	2.1-3.0	3.1-4.0	4.1-5.0	5.1-6.0	6.1-8.0	8.1-10.0	>10.00	
N	0	0	8	9	6	15	5	4	5	3	2	57
NNE	0	1	6	12	10	11	8	5	3	4	0	60
NE	0	1	11	15	22	13	11	6	6	2	1	88
ENE	0	2	4	6	27	30	7	2	6	2	0	86
E	0	1	2	10	33	35	39	27	21	0	0	168
ESE	0	1	4	6	21	20	24	14	8	0	0	98
SE	0	1	2	3	32	40	33	17	13	2	0	143
SSE	0	0	0	3	16	22	31	32	82	57	30	273
S	0	0	1	9	21	17	42	47	68	35	33	273
SSW	0	1	6	4	14	19	28	20	16	7	2	117
SW	0	1	2	4	11	26	35	49	46	17	3	194
WSW	0	1	1	2	10	21	39	52	112	77	103	418
W	0	3	2	4	12	10	31	47	94	117	142	462
WNW	0	1	4	5	10	19	14	27	60	58	121	319
NW	0	3	7	5	14	6	11	9	32	32	79	198
NNW	0	2	6	11	15	16	18	15	16	4	8	111
Tot	0	19	66	108	274	320	376	373	588	417	524	3065

Hours of Calm 0
 Hours of Variable Direction 0
 Hours of Valid Data 3065
 Hours of Missing Data 49
 Hours in Period 8760

Joint Frequency Distribution

Site:: Ginna Primary

Period:: Months Jan - Dec for years 2019 - 2019

Stability Class E Slightly Stable based on Lapse Rate

Elevations:: Winds 150ft Stability 150ft

Wind Direction Sector	Wind Speed Range (m/s)											Total
	<0.50	0.5-1.0	1.1-1.5	1.6-2.0	2.1-3.0	3.1-4.0	4.1-5.0	5.1-6.0	6.1-8.0	8.1-10.0	>10.00	
N	0	0	4	5	5	3	0	2	3	2	1	25
NNE	0	7	4	3	4	1	9	2	2	2	1	35
NE	0	4	4	6	10	4	2	0	0	1	1	32
ENE	0	5	2	10	21	11	14	1	2	0	0	66
E	0	2	6	15	29	34	30	24	8	0	0	148
ESE	0	0	9	9	14	23	16	13	2	0	0	86
SE	0	0	0	3	13	27	22	12	2	0	0	79
SSE	0	0	3	4	14	12	33	34	38	20	7	165
S	1	0	3	4	10	25	31	55	106	59	11	305
SSW	0	2	3	4	10	15	33	68	89	13	0	237
SW	0	2	0	5	20	21	87	79	65	18	1	298
WSW	0	3	5	4	20	22	35	55	77	20	5	246
W	0	1	5	5	17	22	36	46	50	15	6	203
WNW	0	1	2	4	26	22	19	20	61	42	15	212
NW	0	2	4	4	14	5	9	5	17	12	10	82
NNW	0	4	4	7	7	2	8	7	6	1	0	46
Tot	1	33	58	92	234	249	384	423	528	205	58	2265

Hours of Calm 0
 Hours of Variable Direction 0
 Hours of Valid Data 2265
 Hours of Missing Data 49
 Hours in Period 8760

Joint Frequency Distribution

Site:: Ginna Primary

Period:: Months Jan - Dec for years 2019 - 2019

Stability Class F Moderately Stable based on Lapse Rate

Elevations:: Winds 150ft Stability 150ft

Wind Direction Sector	Wind Speed Range (m/s)											Total
	<0.50	0.5-1.0	1.1-1.5	1.6-2.0	2.1-3.0	3.1-4.0	4.1-5.0	5.1-6.0	6.1-8.0	8.1-10.0	>10.00	
N	0	1	3	3	5	0	0	0	0	0	0	12
NNE	0	0	1	0	1	1	0	0	1	0	0	4
NE	0	2	1	2	5	2	1	1	0	0	1	15
ENE	0	2	4	0	9	7	2	1	1	0	1	27
E	0	7	4	4	24	12	13	4	1	0	0	69
ESE	1	1	4	3	3	20	3	1	1	0	0	37
SE	0	2	2	3	7	12	6	4	1	0	0	37
SSE	0	2	2	0	4	4	7	12	9	0	0	40
S	0	1	1	0	6	8	9	12	21	0	0	58
SSW	0	3	0	3	2	11	12	21	32	0	0	84
SW	0	2	5	2	2	26	49	29	4	0	0	119
WSW	0	1	0	3	3	20	29	24	0	0	0	80
W	1	1	1	2	11	13	16	10	4	0	0	59
WNW	0	2	2	3	11	11	3	3	10	2	2	49
NW	0	2	4	4	6	2	3	0	1	0	0	22
NNW	0	1	2	6	5	0	2	2	1	0	0	19
Tot	2	30	36	38	104	149	155	124	87	2	4	731

Hours of Calm 0
 Hours of Variable Direction 0
 Hours of Valid Data 731
 Hours of Missing Data 49
 Hours in Period 8760

Joint Frequency Distribution

Site:: Ginna Primary

Period:: Months Jan - Dec for years 2019 - 2019

Stability Class G Extremely Stable based on Lapse Rate

Elevations:: Winds 150ft Stability 150ft

Wind Direction Sector	Wind Speed Range (m/s)											Total
	<0.50	0.5-1.0	1.1-1.5	1.6-2.0	2.1-3.0	3.1-4.0	4.1-5.0	5.1-6.0	6.1-8.0	8.1-10.0	>10.00	
N	0	2	1	2	3	0	0	0	0	0	0	8
NNE	0	5	1	4	1	1	0	0	0	0	0	12
NE	0	2	4	1	3	2	1	0	0	0	0	13
ENE	0	0	2	2	6	4	1	0	0	0	1	16
E	0	2	6	4	22	18	11	7	2	0	0	72
ESE	0	4	1	2	19	11	7	3	0	0	0	47
SE	0	1	3	2	13	9	12	0	0	0	0	40
SSE	0	2	2	4	9	14	9	3	2	0	0	45
S	0	4	4	1	7	9	13	7	2	0	0	47
SSW	0	2	3	1	4	6	8	8	9	0	0	41
SW	0	1	3	6	7	16	17	13	1	0	0	64
WSW	0	4	4	4	19	20	27	4	0	0	0	82
W	0	3	8	6	15	17	20	6	0	0	0	75
WNW	0	0	0	7	8	6	1	1	0	0	0	23
NW	0	3	5	2	0	5	1	0	1	2	0	19
NNW	0	3	2	2	2	1	0	0	0	0	0	10
Tot	0	38	49	50	138	139	128	52	17	2	1	614

Hours of Calm 0
 Hours of Variable Direction 0
 Hours of Valid Data 614
 Hours of Missing Data 49
 Hours in Period 8760

Joint Frequency Distribution

Site:: Ginna Primary

Period:: Months Jan - Dec for years 2019 - 2019

All Stabilities

Elevations:: Winds 250ft Stability 250ft

Wind Direction Sector	Wind Speed Range (m/s)											Total
	<0.50	0.5-1.0	1.1-1.5	1.6-2.0	2.1-3.0	3.1-4.0	4.1-5.0	5.1-6.0	6.1-8.0	8.1-10.0	>10.00	
N	0	7	18	27	33	24	12	12	26	19	11	189
NNE	0	5	13	17	46	29	21	12	28	24	9	204
NE	0	9	19	34	64	68	50	37	60	48	58	447
ENE	2	9	24	39	110	103	113	61	56	33	26	576
E	1	6	17	35	91	61	101	100	86	5	0	503
ESE	2	7	11	18	48	40	50	57	56	8	0	297
SE	0	3	7	9	31	48	77	68	92	25	5	365
SSE	0	3	5	7	19	38	45	64	168	153	139	641
S	1	1	2	8	38	37	50	74	156	129	94	590
SSW	0	8	8	10	29	30	46	69	147	125	20	492
SW	0	3	6	16	26	46	69	137	280	92	17	692
WSW	0	6	10	12	35	41	87	138	277	152	154	912
W	0	4	10	9	44	68	68	114	195	125	258	895
WNW	0	7	7	10	58	78	66	72	173	176	383	1030
NW	0	6	8	24	51	50	42	29	87	84	208	589
NNW	0	5	11	20	59	34	32	26	33	27	26	273
Tot	6	89	176	295	782	795	929	1070	1920	1225	1408	8695

Hours of Calm	5
Hours of Variable Direction	0
Hours of Valid Data	8700
Hours of Missing Data	60
Hours in Period	8760

Joint Frequency Distribution

Site:: Ginna Primary

Period:: Months Jan - Dec for years 2019 - 2019

Stability Class A Extremely Unstable based on Lapse Rate

Elevations:: Winds 250ft Stability 250ft

Wind Direction Sector	Wind Speed Range (m/s)										Total	
	<0.50	0.5-1.0	1.1-1.5	1.6-2.0	2.1-3.0	3.1-4.0	4.1-5.0	5.1-6.0	6.1-8.0	8.1-10.0		>10.00
N	0	0	0	0	0	0	0	0	0	0	2	2
NNE	0	0	0	0	0	0	0	0	0	2	4	6
NE	0	0	0	0	0	0	4	5	9	12	30	60
ENE	0	0	0	0	0	4	11	8	9	12	13	57
E	0	0	0	0	0	0	0	0	0	0	0	0
ESE	0	0	0	0	0	0	0	0	0	0	0	0
SE	0	0	0	0	0	0	1	1	1	0	0	3
SSE	0	0	0	0	0	0	1	0	0	0	0	1
S	0	0	0	0	0	0	0	0	0	0	0	0
SSW	0	0	0	0	0	0	0	0	0	0	0	0
SW	0	0	0	0	0	0	0	0	0	0	0	0
WSW	0	0	0	0	0	0	0	0	0	0	0	0
W	0	0	0	0	0	0	0	0	0	0	0	0
WNW	0	0	0	0	2	4	3	7	17	10	5	48
NW	0	0	0	0	3	12	11	8	11	7	20	72
NNW	0	0	0	0	2	2	1	0	0	1	5	11
Tot	0	0	0	0	7	22	32	29	47	44	79	260

Hours of Calm 0
 Hours of Variable Direction 0
 Hours of Valid Data 260
 Hours of Missing Data 60
 Hours in Period 8760

Joint Frequency Distribution

Site:: Ginna Primary

Period:: Months Jan - Dec for years 2019 - 2019

Stability Class B Moderately Unstable based on Lapse Rate

Elevations:: Winds 250ft Stability 250ft

Wind Direction Sector	Wind Speed Range (m/s)											Total
	<0.50	0.5-1.0	1.1-1.5	1.6-2.0	2.1-3.0	3.1-4.0	4.1-5.0	5.1-6.0	6.1-8.0	8.1-10.0	>10.00	
N	0	0	0	0	0	1	0	0	0	3	0	4
NNE	0	0	0	0	0	0	0	0	0	0	1	1
NE	0	0	0	0	0	0	4	5	2	6	17	34
ENE	0	0	0	0	0	2	4	4	10	5	3	28
E	0	0	0	0	0	0	0	0	0	0	0	0
ESE	0	0	0	0	0	0	0	0	0	0	0	0
SE	0	0	0	0	0	0	0	0	0	0	0	0
SSE	0	0	0	0	0	0	1	0	0	0	0	1
S	0	0	0	0	0	0	1	1	0	0	0	2
SSW	0	0	0	0	0	0	1	0	0	0	0	1
SW	0	0	0	0	0	1	0	1	1	0	0	3
WSW	0	0	0	0	0	0	0	0	0	0	0	0
W	0	0	0	0	0	0	0	1	1	0	0	2
WNW	0	0	0	0	0	1	5	1	5	3	6	21
NW	0	0	0	0	3	2	1	1	6	1	10	24
NNW	0	0	0	0	3	5	0	0	0	1	1	10
Tot	0	0	0	0	6	12	17	14	25	19	38	131

Hours of Calm 0
 Hours of Variable Direction 0
 Hours of Valid Data 131
 Hours of Missing Data 60
 Hours in Period 8760

Joint Frequency Distribution

Site:: Ginna Primary

Period:: Months Jan - Dec for years 2019 - 2019

Stability Class C Slightly Unstable based on Lapse Rate

Elevations:: Winds 250ft Stability 250ft

Wind Direction Sector	Wind Speed Range (m/s)											Total
	<0.50	0.5-1.0	1.1-1.5	1.6-2.0	2.1-3.0	3.1-4.0	4.1-5.0	5.1-6.0	6.1-8.0	8.1-10.0	>10.00	
N	0	0	0	0	2	0	0	0	3	3	1	9
NNE	0	0	0	0	0	3	3	4	3	6	1	20
NE	0	0	0	0	2	7	3	6	10	8	3	39
ENE	0	0	0	1	3	4	28	8	12	8	1	65
E	0	0	0	0	0	0	0	3	1	0	0	4
ESE	0	0	0	0	0	0	2	0	0	0	0	2
SE	0	0	0	0	0	0	1	3	1	0	0	5
SSE	0	0	0	0	0	4	4	1	5	4	2	20
S	0	0	0	0	0	2	4	1	2	1	2	12
SSW	0	0	0	0	0	1	4	2	0	0	0	7
SW	0	0	0	0	0	1	2	5	0	0	0	8
WSW	0	0	0	0	0	1	2	1	1	1	0	6
W	0	0	0	0	0	0	1	1	3	2	0	7
WNW	0	0	0	0	1	3	2	4	14	9	14	47
NW	0	0	0	0	2	4	1	4	8	11	21	51
NNW	0	0	0	0	3	5	0	1	5	4	0	18
Tot	0	0	0	1	13	35	57	44	68	57	45	320

Hours of Calm 0
 Hours of Variable Direction 0
 Hours of Valid Data 320
 Hours of Missing Data 60
 Hours in Period 8760

Joint Frequency Distribution

Site:: Ginna Primary

Period:: Months Jan - Dec for years 2019 - 2019

Stability Class D Neutral based on Lapse Rate

Elevations:: Winds 250ft Stability 250ft

Wind Direction Sector	Wind Speed Range (m/s)											Total
	<0.50	0.5-1.0	1.1-1.5	1.6-2.0	2.1-3.0	3.1-4.0	4.1-5.0	5.1-6.0	6.1-8.0	8.1-10.0	>10.00	
N	0	0	7	13	15	16	10	10	22	9	6	108
NNE	0	0	8	11	22	18	12	6	21	12	2	112
NE	0	1	10	20	33	38	25	15	36	19	3	200
ENE	0	0	3	12	45	48	40	23	17	6	8	202
E	0	1	0	10	19	20	44	53	62	4	0	213
ESE	0	2	3	0	15	15	17	19	19	6	0	96
SE	0	0	0	4	19	18	39	37	35	14	4	170
SSE	0	0	1	3	5	11	18	26	64	72	76	276
S	1	0	1	5	26	19	24	27	50	20	34	207
SSW	0	1	2	4	15	13	15	26	31	4	2	113
SW	0	1	1	5	13	18	34	46	72	33	7	230
WSW	0	1	1	1	9	11	33	49	113	108	139	465
W	0	1	1	3	8	7	13	39	93	84	230	479
WNW	0	1	1	3	11	15	19	25	64	78	225	442
NW	0	1	3	9	12	8	13	8	48	42	141	285
NNW	0	1	2	7	21	10	24	20	20	17	20	142
Tot	1	11	44	110	288	285	380	429	767	528	897	3740

Hours of Calm 0
 Hours of Variable Direction 0
 Hours of Valid Data 3740
 Hours of Missing Data 60
 Hours in Period 8760

Joint Frequency Distribution

Site:: Ginna Primary

Period:: Months Jan - Dec for years 2019 - 2019

Stability Class E Slightly Stable based on Lapse Rate

Elevations:: Winds 250ft Stability 250ft

Wind Direction Sector	Wind Speed Range (m/s)											Total
	<0.50	0.5-1.0	1.1-1.5	1.6-2.0	2.1-3.0	3.1-4.0	4.1-5.0	5.1-6.0	6.1-8.0	8.1-10.0	>10.00	
N	0	2	5	7	8	3	1	1	1	2	2	32
NNE	0	4	2	1	16	5	5	1	3	3	0	40
NE	0	3	6	5	15	12	6	4	2	3	4	60
ENE	0	2	11	15	44	25	19	13	4	1	0	134
E	0	1	8	13	36	16	35	33	16	1	0	159
ESE	0	2	5	7	11	10	14	17	23	1	0	90
SE	0	0	5	1	4	17	20	13	33	6	1	100
SSE	0	1	2	2	9	13	10	26	70	54	59	246
S	0	1	0	0	5	8	9	34	79	83	57	276
SSW	0	5	4	2	6	7	17	28	76	71	13	229
SW	0	0	4	5	8	18	17	56	133	48	10	299
WSW	0	1	4	4	15	17	16	45	113	43	15	273
W	0	2	4	3	16	28	24	40	60	35	27	239
WNW	0	4	2	1	25	33	20	24	55	58	101	323
NW	0	2	5	6	14	18	10	6	13	19	10	103
NNW	0	2	4	5	13	6	6	4	8	3	0	51
Tot	0	32	71	77	245	236	229	345	689	431	299	2654

Hours of Calm 1
 Hours of Variable Direction 0
 Hours of Valid Data 2655
 Hours of Missing Data 60
 Hours in Period 8760

Joint Frequency Distribution

Site:: Ginna Primary

Period:: Months Jan - Dec for years 2019 - 2019

Stability Class F Moderately Stable based on Lapse Rate

Elevations:: Winds 250ft Stability 250ft

Wind Direction Sector	Wind Speed Range (m/s)											Total
	<0.50	0.5-1.0	1.1-1.5	1.6-2.0	2.1-3.0	3.1-4.0	4.1-5.0	5.1-6.0	6.1-8.0	8.1-10.0	>10.00	
N	0	0	4	4	5	2	1	1	0	2	0	19
NNE	0	1	1	3	4	2	1	1	1	1	1	16
NE	0	2	2	7	11	8	7	0	1	0	1	39
ENE	0	5	6	6	8	14	10	4	4	0	1	58
E	1	3	5	8	23	14	15	5	6	0	0	80
ESE	0	2	2	4	12	8	9	10	10	1	0	58
SE	0	2	0	2	3	6	5	8	13	4	0	43
SSE	0	1	2	1	3	4	2	5	19	16	2	55
S	0	0	0	1	2	6	4	6	13	19	1	52
SSW	0	1	0	3	5	3	6	4	25	35	3	85
SW	0	2	1	4	2	4	11	17	50	8	0	99
WSW	0	0	2	3	2	5	22	34	43	0	0	111
W	0	1	3	2	8	16	16	21	28	3	1	99
WNW	0	1	0	3	10	18	13	5	15	16	25	106
NW	0	1	0	5	8	0	4	2	0	2	1	23
NNW	0	1	2	6	14	5	1	0	0	1	0	30
Tot	1	23	30	62	120	115	127	123	228	108	36	973

Hours of Calm 3
 Hours of Variable Direction 0
 Hours of Valid Data 976
 Hours of Missing Data 60
 Hours in Period 8760

Joint Frequency Distribution

Site:: Ginna Primary

Period:: Months Jan - Dec for years 2019 - 2019

Stability Class G Extremely Stable based on Lapse Rate

Elevations:: Winds 250ft Stability 250ft

Wind Direction Sector	Wind Speed Range (m/s)											Total
	<0.50	0.5-1.0	1.1-1.5	1.6-2.0	2.1-3.0	3.1-4.0	4.1-5.0	5.1-6.0	6.1-8.0	8.1-10.0	>10.00	
N	0	5	2	3	3	2	0	0	0	0	0	15
NNE	0	0	2	2	4	1	0	0	0	0	0	9
NE	0	3	1	2	3	3	1	2	0	0	0	15
ENE	2	2	4	5	10	6	1	1	0	1	0	32
E	0	1	4	4	13	11	7	6	1	0	0	47
ESE	2	1	1	7	10	7	8	11	4	0	0	51
SE	0	1	2	2	5	7	11	6	9	1	0	44
SSE	0	1	0	1	2	6	9	6	10	7	0	42
S	0	0	1	2	5	2	8	5	12	6	0	41
SSW	0	1	2	1	3	6	3	9	15	15	2	57
SW	0	0	0	2	3	4	5	12	24	3	0	53
WSW	0	4	3	4	9	7	14	9	7	0	0	57
W	0	0	2	1	12	17	14	12	10	1	0	69
WNW	0	1	4	3	9	4	4	6	3	2	7	43
NW	0	2	0	4	9	6	2	0	1	2	5	31
NNW	0	1	3	2	3	1	0	1	0	0	0	11
Tot	4	23	31	45	103	90	87	86	96	38	14	617

Hours of Calm 1
 Hours of Variable Direction 0
 Hours of Valid Data 618
 Hours of Missing Data 60
 Hours in Period 8760

OFFSITE DOSE CALCULATION MANUAL (ODCM)

R.E. GINNA NUCLEAR POWER PLANT

No document summarizing changes is included, because there have been no ODCM changes since the last annual submittal.

TABLE OF CONTENTS

1.0 Operability and Surveillance Requirements	4
2.0 Definitions	5
3.0 List of Acronyms	10
4.0 RADIOACTIVE LIQUID EFFLUENTS	12
4.1 Concentration (10 CFR 20)	12
4.2 Dose (10 CFR 50 Appendix I)	14
4.3 Total Dose (40 CFR 190)	16
4.4 Liquid Effluents Release Points	22
4.5 Liquid Effluents Monitor Setpoints	23
4.6 Liquid Effluent Release Concentrations	26
4.7 Liquid Effluent Dose	27
5.0 RADIOACTIVE GASEOUS EFFLUENTS.....	31
5.1 DELETED	31
5.2 Dose Rate	32
5.3 Dose (10 CFR 50, Appendix I)	34
5.4 Total Dose (40 CFR 190)	38
5.5 Gaseous Effluent Release Points	43
5.6 Gaseous Effluent Monitor Setpoints	44
5.7 Gaseous Effluent Dose Rate	50
5.8 Gaseous Effluent Doses	52
6.0 RADIOACTIVE EFFLUENT MONITORING INSTRUMENTATION.....	58
6.1 Liquid Effluent Monitors	58
6.2 Gaseous Effluent Monitors	64
6.3 Radiation Accident Monitoring Instrumentation	71
6.4 Area Radiation Monitors	75
7.0 RADWASTE TREATMENT	77
7.1 Liquid Radwaste Treatment System	77
7.2 Gaseous Radwaste Treatment System	80
7.3 Solid Radwaste System	83
7.4 Configuration Changes	84
7.5 Process Control Program	85

8.0 RADIOLOGICAL ENVIRONMENTAL MONITORING	86
8.1 Monitoring Program.....	86
8.2 Environmental Monitor Sample Locations	92
8.3 Land Use Census.....	110
8.4 Interlaboratory Comparison Program	112
9.0 REPORTING REQUIREMENTS	113
9.1 Annual Radiological Environmental Operating Report.....	113
9.2 Annual Radioactive Effluent Release Report.....	115
9.3 Special Reports.....	117
10.0 REFERENCES.....	119

FIGURES

Figure 7-1	Liquid Radwaste Treatment Systems Effluent Paths and Controls	79
Figure 7-2	Gaseous Radwaste Treatment Systems Effluent Paths and Controls	82
Figure 8-1	Location of Onsite Air Monitors and Dosimeters	96
Figure 8-2	Location of Farms for Milk Samples and Ontario Water District Intake	97
Figure 8-3	Location of Offsite Dosimeters.....	98
Figure 8-4	Location of Offsite Air Monitors.....	99

TABLES

Table 4-1	Radioactive Liquid Waste Sampling and Analysis Program	18
Table 5-1	Radioactive Gaseous Waste Sampling and Analysis Program.....	40
Table 5-2	Meteorological Data and Locations of Receptors for Set point Calculations	48
Table 5-3	Dose Factors to the Child for Noble Gases and Daughters	55
Table 5-4	Dose Parameters for Radionuclides and Radioactive Particulate, Gaseous Effluents.....	56
Table 5-5	Pathway Dose Factors Due to Radionuclides Other Than Noble Gases	57
Table 6.1-1	Radioactive Liquid Effluent Monitoring Instrumentation.....	60
Table 6.1-2	Radioactive Liquid Effluent Monitoring SURVEILLANCE REQUIREMENTS	62
Table 6.2-1	Radioactive Gaseous Effluent Monitoring Instrumentation	66
Table 6.2-2	Radioactive Gaseous Effluent Monitoring SURVEILLANCE REQUIREMENTS ..	69
Table 6.3-1	Radiation Accident Monitoring Instrumentation	72
Table 6.3-2	Radiation Accident Monitoring SURVEILLANCE REQUIREMENTS	74
Table 6-4	Area Radiation Monitor SURVEILLANCE REQUIREMENTS	76
Table 8-1	Radiological Environmental Monitoring Program	88
Table 8-2	Location, Direction, and Distances to Sample Points	93
Table 8-3	Detection Capabilities for Environmental Sample Analysis Lower Limit of Detection (LLD).....	100
Table 8-4	Reporting Levels for Radioactivity Concentrations in Environmental Samples ..	102
Table 8-5	D/Q and X/Q 5 year Average 2011-2015 Plant Vent.....	104
Table 8-6	D/Q and X/Q 5 year Average 2011-2015 Containment Vent	106
Table 8-7	D/Q and X/Q 5 year Average 2011-2015 Air Ejector Vent.....	108
Table 9-1	Radiological Environmental Monitoring Program Summary	118

1.0 OPERABILITY and SURVEILLANCE REQUIREMENTS

The OPERABILITY requirements in this manual follow the same LCO applicabilities as the Improved Technical Specifications with the exception of:

- a. LCO 3.0.3 which relates to the failure to meet a Required Action and the associated plant shutdown actions;
- b. LCO 3.0.4 which relates to changing MODES with inoperable equipment; and
- c. LCO 3.0.6 which deals solely with ITS LCOs on support/supported system inoperabilities.

The failure to meet any Required Action for which no additional ACTIONS are provided shall result in continued efforts to meet the specified Required Action. A plant shutdown to exit the MODE of Applicability is not required unless directed by plant management.

This does not endorse the practice of failing to meet specified Required Actions.

The SURVEILLANCE REQUIREMENTS in this manual follow the same SR applicabilities as the Improved Technical Specifications with the exception of:

- a. SR 3.0.4 which relates to changing MODES with incomplete surveillances.

2.0 DEFINITIONS

The defined terms of this section appear in capitalized type and are applicable throughout these controls. Terms used in these controls and not defined herein have the same definition as listed in the Technical Specifications and/or the Technical Requirements Manual. If a conflict in definition exists, the definition in the Technical Specifications takes precedence.

2.1 ACTION

ACTION shall be that part of a Control that prescribes required actions to be taken under designated conditions, within specified completion times.

2.2 CHANNEL CALIBRATION

A CHANNEL CALIBRATION shall be the adjustment, as necessary, of the channel such that it responds within the required range and accuracy to known values of input. The CHANNEL CALIBRATION shall encompass the entire channel including the sensors and alarm, interlock display, and/or trip functions and may be performed by any series of sequential, overlapping, or total channel steps such that the entire channel is calibrated.

2.3 CHANNEL CHECK

A CHANNEL CHECK shall be the qualitative assessment of channel behavior during operation by observation. This determination shall include, where possible, comparison of the channel indication and/or status with other indications and/or status derived from independent instrument channels measuring the same parameter.

2.4 DOSE EQUIVALENT I-131

DOSE EQUIVALENT I-131 shall be that concentration of I-131 (microCurie/gram) which alone would produce the same thyroid dose as the quantity and isotopic mixture of I-131, I-132, I-133, I-134, and I-135 actually present. The thyroid dose conversion factors used for this calculation shall be those listed in ICRP 30, Supplement to Part 1, Pages 192-212, table entitled, "Committed Dose Equivalent in Target Organs or Tissues per Intake of Unit Activity" (Reference 10).

2.5 FREQUENCY NOTATION

The FREQUENCY NOTATION specified for the performance of Surveillance Requirements shall correspond to the intervals defined as follows:

NOTATION	FREQUENCY
S	At least once per 12 hours
D	At least once per 24 hours
W	At least once per 7 days
M	At least once per 31 days
Q	At least once per 92 days
SA	At least once per 184 days
R	At least once per 18 months
S/U	Prior to each reactor startup
N/A	Not applicable
P	Completed prior to each release
6Y	At least once per 6 years

2.6 FUNCTIONAL TEST

A FUNCTIONAL TEST shall be the injection of a simulated signal into the channel as close to the sensor as practicable to verify OPERABILITY of alarm, interlock display and/or trip functions. The FUNCTIONAL TEST shall include adjustments, as necessary, of the alarm, interlock display and/or Trip Setpoints such that the setpoints are within the required range and accuracy.

2.7 LOWER LIMIT OF DETECTION

The LOWER LIMIT OF DETECTION (LLD) is the smallest concentration of radioactive material in a sample that will yield a net count above system background that will be detected with 95% probability with only 5% probability of falsely concluding that a blank observation represents a "real" signal. The LLD is defined as a *priori* (before the fact) limit representing the capability of a measurement system and not as a *posteriori* (after the fact) limit for a particular measurement, the minimum detectable activity (MDA).

2.8 MEMBER(S) OF THE PUBLIC

MEMBER(S) OF THE PUBLIC shall include all persons who are not occupationally associated with the plant. This category does not include employees of the licensee, its contractors, or vendors. Also excluded from this category are persons who enter the site to service equipment or to make deliveries. This category does include persons who use portions of the site for recreational, occupational, or other purposes not associated with the plant.

2.9 OFFSITE DOSE CALCULATION MANUAL

The OFFSITE DOSE CALCULATION MANUAL (ODCM) shall contain the methodology and parameters used in the calculation of offsite doses resulting

from radioactive gaseous and liquid effluents, in the calculation of gaseous and liquid effluent monitoring Alarm/Trip Setpoints, and in the conduct of the Radiological Environmental Monitoring Program (REMP). The ODCM shall also contain descriptions of the Radioactive Effluent Controls and Radiological Environmental Monitoring Program and descriptions of the information that shall be included in the Annual Radiological Environmental Operating Report and the Annual Radioactive Effluent Release Report, as required by Technical Specification 5.5.1.

2.10 OPERABLE - OPERABILITY

A system, subsystem, train, component, or device shall be OPERABLE or have OPERABILITY when it is capable of performing its specified function(s) and when all necessary attendant instrumentation, controls, electric power, cooling or seal water, lubrication or other auxiliary equipment that are required for the system, subsystem, train, component, or device to perform its function(s) are also capable of performing their related support function(s).

2.11 OPERATIONAL MODE - MODE

An OPERATIONAL MODE (i.e., MODE) shall correspond to any one inclusive combination of core reactivity condition, power level, and average reactor coolant temperature specified in Table 1.1-1 of Technical Specifications.

2.12 PURGE - PURGING

PURGE or PURGING shall be any controlled process of discharging air or gas from a confinement to maintain temperature, pressure, humidity, concentration, or other operating condition, in such a manner that replacement air or gas is required to purify the confinement.

2.13 RATED THERMAL POWER (RTP)

RTP shall be a total reactor core heat transfer rate to the reactor coolant of 1775 MWt.

2.14 SITE BOUNDARY

The SITE BOUNDARY shall be that line beyond which the land is neither owned, nor leased, nor otherwise controlled by the licensee.

2.15 SOURCE CHECK

A SOURCE CHECK shall be the qualitative assessment of channel response when the channel sensor is exposed to a source of increased radioactivity.

2.16 SURVEILLANCE REQUIREMENT

SURVEILLANCE REQUIREMENTS shall be met during the OPERATIONAL MODES or other conditions specified for individual CONTROLS unless otherwise stated in an individual SURVEILLANCE REQUIREMENT. Each SURVEILLANCE REQUIREMENT shall be performed within the specified time interval with:

1. A maximum allowable extension not to exceed 25% of the surveillance interval, but
2. The combined time interval for any three consecutive surveillance intervals shall not exceed 3.25 times the specified surveillance interval.

2.17 THERMAL POWER

THERMAL POWER shall be the total reactor core heat transfer rate to the reactor coolant.

2.18 UNRESTRICTED AREA

An UNRESTRICTED AREA shall be any area at or beyond the SITE BOUNDARY access to which is not controlled by the licensee for purposes of protection of individuals from exposure to radiation and radioactive materials, or any area within the SITE BOUNDARY used for residential quarters or for industrial, commercial, institutional, and/or recreational purposes.

2.19 VENTILATION EXHAUST TREATMENT SYSTEM

A VENTILATION EXHAUST TREATMENT SYSTEM shall be any system designed and installed to reduce gaseous radioiodine or radioactive material in particulate form in effluents by passing ventilation or vent exhaust gases through charcoal adsorbers and/or HEPA filters for the purpose of removing iodines or particulates from the gaseous exhaust stream prior to the release to the environment. Such a system is not considered to have any effect on noble gas effluents. Engineered Safety Features Atmospheric Cleanup Systems are not considered to be VENTILATION EXHAUST TREATMENT SYSTEM components.

2.20 VENTING

VENTING shall be the controlled process of discharging air or gas from a confinement to maintain temperature, pressure, humidity, concentration, or other operating condition, in such a manner that replacement air or gas is not provided or required during VENTING. Vent, used in system names, does not imply a venting process.

2.21 WASTE GAS HOLDUP SYSTEM

A WASTE GAS HOLDUP SYSTEM shall be any system designed and installed to reduce radioactive gaseous effluents by collecting Reactor Coolant System offgases and providing for delay or holdup for the purpose of reducing the total radioactivity prior to release to the environment.

3.0 LIST OF ACRONYMS

D	Frequency Notation noting a surveillance frequency requirement of at least once per 24 hours.
D/Q	Deposition parameter
E	East
ENE	East-Northeast
ESE	East-Southeast
HCWT	High Conductivity Waste Tank
ICRP	International Commission on Radiological Protection
LLD	Lower Limit of Detection
M	Frequency Notation noting a surveillance frequency requirement at least once per 31 days.
MDA	Minimum Detectable Activity
N	North
N.A.	Not Applicable
N/A	Not Applicable
NE	Northeast
NIST	National Institute for Standards and Technology
NNE	North-Northeast
NNW	North-Northwest
NW	Northwest
ODCM	Offsite Dose Calculation Manual
P	Frequency Notation noting a surveillance frequency requirement of being performed prior to each release.
PCP	Process Control Program
Q	Frequency Notation noting a surveillance frequency requirement at least once per 92 days.
R	Frequency Notation noting a surveillance frequency requirement at least once per 18 months.

REMP	Radiological Environmental Monitoring Program
RTP	Rated Thermal Power
SA	Frequency Notation noting a surveillance frequency requirement at least once 184 days.
SE	Southeast
S	Frequency Notation noting a surveillance frequency requirement of at least once per 12 hours.
S	South
SSE	South-Southeast
SSW	South-Southwest
S/U	Frequency Notation noting a surveillance frequency requirement of being performed prior to
SW	Southwest
W	Frequency Notation noting a surveillance frequency requirement at least once per 7 days.
W	West
WNW	West-Northwest
WSW	West-Southwest
X/Q	Dispersion parameter
6Y	At least once per 6 years.

4.0 RADIOACTIVE LIQUID EFFLUENTS

4.1 CONCENTRATION (10 CFR 20)

4.1.1 CONTROLS:

1. The release of radioactive liquid effluents shall be such that the concentration in the circulating water discharge does not exceed ten times the concentration values specified in Appendix B, Table 2, Column 2 to 10 CFR Part 20.1001 - 20.2402. For dissolved or entrained noble gases, the total activity due to dissolved or entrained noble gases shall not exceed $2.0E-04$ $\mu\text{Ci/ml}$.

4.1.2 APPLICABILITY: At all times.

4.1.3 ACTION:

If the concentration of radioactive material in the circulating water discharge exceeds ten times the concentration values of Appendix B, Table 2, Column 2 of 10 CFR 20, measures shall be initiated to restore the concentration to within these limits immediately.

4.1.4 ACTION:

If the concentration when averaged over one hour exceeds ten times the applicable concentrations specified in Appendix B of 10CFR Part 20, Table 2, Column 2, at the point of entry to receiving waters, submit to the commission a special report within 30 days.

4.1.5 SURVEILLANCE REQUIREMENTS:

1. Radioactive liquid wastes shall be sampled and analyzed according to the sampling and analysis program of Table 4-1. The results of pre-release analyses shall be used with the calculational methods in Section 4.6 to assure that the concentration at the point of release is limited to the values in Section 4.1.1 (Radioactive Liquid Effluents - Controls).

4.1.6 BASES:

This control is provided to ensure that the concentration of radioactive materials released in liquid waste effluents to UNRESTRICTED AREAS will be less than the concentration levels specified in 10 CFR 20, Appendix B, Table 2, Column 2. This limitation provides additional assurance that the levels of radioactive materials in bodies of water in UNRESTRICTED AREAS will result in exposures within (1) the Section II.A design objectives of Appendix I, 10 CFR 50, to a MEMBER OF THE PUBLIC, and (2) the limits of Appendix B, 10 CFR 20, to the population. The concentration limit for dissolved or entrained noble gases is based upon the assumption that Xe-135 is the controlling radioisotope and its MPC in air

(submersion) was converted to an equivalent concentration in water using the methods described in International Commission on Radiological Protection (ICRP) Publication 2.

4.2 DOSE (10 CFR 50 APPENDIX I)

4.2.1 CONTROLS:

1. The dose or dose commitment to a MEMBER OF THE PUBLIC from radioactive materials in liquid effluents released to UNRESTRICTED AREAS shall be limited:
 - A. during any calendar quarter to ≤ 1.5 mrem to the total body and to ≤ 5 mrem to any organ, and
 - B. during any calendar year to ≤ 3 mrem to the total body and to ≤ 10 mrem to any organ.

4.2.2 APPLICABILITY: At all times.

4.2.3 ACTION:

Whenever the calculated dose resulting from the release of radioactive materials in liquid effluents exceeds any of the above limits, a Special Report shall be submitted to the Commission within thirty days which includes the following information:

1. identification of the cause for exceeding the dose limit;
2. corrective actions taken and/or to be taken to reduce the releases of radioactive material in liquid effluents to assure that subsequent releases will remain within the above limits;
3. The results of the radiological analyses of the nearest public drinking water source, and an evaluation of the radiological impact due to licensee releases on finished drinking water with regard to the requirements of 40 CFR 141, Safe Drinking Water Act.

4.2.4 ACTION:

During any month when the calculated dose to a MEMBER OF THE PUBLIC exceeds 1/48 the annual limit (0.06 mrem to the total body or 0.2 mrem to any organ), projected cumulative dose contributions from liquid effluents shall be determined for that month and at least once every 31 days for the next 3 months.

4.2.5 SURVEILLANCE REQUIREMENTS:

Post-release analyses of samples composited from batch releases shall be performed in accordance with Table 4-1. The results of the post-release analyses shall be used with the calculational methods in Section 1.6 to assure that the dose commitments from liquids are limited to the values in Section 4.2.1 (Dose - Controls).

4.2.6 BASES:

This control is provided to implement the requirements of Sections II.A, III.A, and IV.A of Appendix I, 10 CFR 50. This control implements the guides set forth in Section II.A of Appendix I. The ACTION statements provide the required operating flexibility and at the same time implement the guides set forth in Section IV.A of Appendix I to assure that the releases of radioactive material in liquid effluents to UNRESTRICTED AREAS will be kept "as low as reasonably achievable". Also, with Lake Ontario drinking water supplies potentially affected by plant operations, there is reasonable assurance that the operation of the plant will not result in radionuclide concentrations in the finished drinking water that are in excess of the requirements of 40 CFR 141. The dose calculation methodology and parameters in the ODCM implement the requirements in Section III.A of Appendix I that conformance with the guides of Appendix I be shown by calculational models and data, such that the actual exposure of a MEMBER OF THE PUBLIC appropriate pathways is unlikely to be substantially underestimated. The equations specified in the ODCM for calculating the doses due to the actual release rates of radioactive materials in liquid effluents are consistent with the methodology provided in Regulatory Guide 1.109, "Calculation of Annual Doses to Man from Routine Releases of Reactor Effluents for the Purpose of Evaluating Compliance with 10 CFR 50, Appendix I", Revision 1, October 1977, and Regulatory Guide 1.113, "Estimating Aquatic Dispersion of Effluents from Accidental and Routine Reactor Releases for the Purpose of Implementing Appendix I", April 1977.

4.3 TOTAL DOSE (40 CFR PART 190)

4.3.1 CONTROLS:

The annual (calendar year) dose or dose commitment to any MEMBER OF THE PUBLIC due to releases of radioactivity and to radiation from uranium fuel cycle sources shall be limited to less than or equal to 25 mrem to the whole body or any organ, except the thyroid, which shall be limited to less than or equal to 75 mrem.

4.3.2 APPLICABILITY: At all times.

4.3.3 ACTION:

With the calculated doses from the release of radioactive materials in liquid effluents exceeding twice the limits of Section 4.2.1 (Dose - Controls), prepare and submit to the Commission within 30 days a Special Report that defines the corrective actions to be taken to reduce subsequent releases to prevent recurrence of exceeding the above limits and include scheduling for achieving conformance with the above limits. Calculations which include direct radiation contributions from the unit and from any radwaste storage shall be performed to determine total dose to a member of the public. This Special Report, as defined in 10 CFR 20.405(c) shall include an analysis that estimates the radiation exposure (dose) to a MEMBER OF THE PUBLIC from uranium fuel cycle sources, including all effluent pathways and direct radiation, for the calendar year that includes the releases covered by this report. It shall also describe levels of radiation and concentrations of radioactive material involved, and the cause of the exposure levels or concentrations. If the estimated dose(s) exceeds the above limits, and if the release condition resulting in violation of 40 CFR 190 has not already been corrected, the Special Report shall include a request for a variance in accordance with the provisions of 40 CFR 190. Submittal of the report is considered a timely request, and a variance is granted until staff action on the request is complete.

4.3.4 SURVEILLANCE REQUIREMENTS:

1. Cumulative dose contributions from liquid and gaseous effluents for the current calendar quarter and the current calendar year shall be determined in accordance with SURVEILLANCE REQUIREMENT S.1.2.1 at least once every 31 days, in accordance with the methodology and parameters of Section 1.7 of the ODCM.
2. Cumulative dose contributions from direct radiation from the unit and from radwaste storage shall be determined from environmental dosimeter data at least quarterly.

4.3.5 BASES:

This control is provided to meet the dose limitations of 40 CFR 190 that have been incorporated into 10 CFR 20 by 46FR18525. The specification requires the preparation and submittal of a Special Report whenever the calculated doses due to releases of radioactivity and to radiation from uranium fuel cycle sources exceed 25 mrems to the whole body or any organ, except the thyroid, which shall be limited to less than or equal to 75 mrems. It is highly unlikely that the resultant dose to a MEMBER OF THE PUBLIC will exceed the dose limits of 40 CFR 190 if the plant remains within twice the dose design objectives of Appendix I, and if direct radiation doses are kept small. The Special Report will describe a course of action that should result in the limitation of the annual dose to a MEMBER OF THE PUBLIC to within the 40 CFR 190 limits. For the purposes of the Special Report, it may be assumed that the dose contributions from other uranium fuel cycle sources is negligible. If the dose to any MEMBER OF THE PUBLIC is estimated to exceed the requirements of 40 CFR 190, the Special Report with a request for a variance, (provided the release conditions resulting in violation of 40 CFR 190 have not already been corrected), in accordance with the provisions of 40 CFR 190.11 and 10 CFR 20.405c, is considered to be a timely request and fulfills the requirements of 40 CFR 190 until NRC staff action is completed. The variance only relates to the limits of 40 CFR 190, and does not apply in any way to the other requirements for dose limitation of 10 CFR 20, as addressed in Section 4.1.1 (Radioactive Liquid Effluents - Controls) and Section 5.2.1 (Dose Rate - Controls). An individual is not considered a MEMBER OF THE PUBLIC during any period in which he/she is engaged in carrying out any operation that is part of the nuclear fuel cycle.

Table 4-1

Radioactive Liquid Waste Sampling and Analysis Program

Liquid Release Type	Sampling Frequency	Minimum Analysis Frequency	Type of Activity Analysis	Lower Limit of Detection (LLD) ($\mu\text{Ci/ml}$) (a)
Batch Release (b)				
Batch Waste Release Tanks	P Each Batch	P Each Batch	Principal Gamma and I-131	5.0E-07 1.0E-06
	P One Batch/M	M	Dissolved and Entrained Gases (Gamma Emitters)	1.0E-05
	P Each Batch	M Composite (c)	H-3 Gross Alpha	1.0E-05 1.0E-07
	P Each Batch	Q Composite (c)	Sr-89 Sr-90 Fe-55	5.0E-08 1.0E-06
Continuous Release (e)				
Retention Tank	Continuous (e)	W Composite (c)	Principal Gamma and I-131	5.0E-07 1.0E-06
	Continuous (e)	W Composite (c)	Dissolved and Entrained Gasses (Gamma Emitters)	1.0E-05
	Continuous (e)	M Composite (c)	H-3 Gross Alpha	1.0E-05 1.0E-07
	Continuous (e)	Q Composite (c)	Sr-89 Sr-90 Fe-55	5.0E-08 1.0E-06
Service Water (CV Fan and SFP Hx lines)	M or S Grab (f)	M or S Grab (f)	Principal Gamma and I-131	5.0E-07 1.0E-06
	(f)	(f)	Dissolved and Entrained Gasses (Gamma Emitters)	1.0E-05
	(f)	(f)	H-3 Gross Alpha	1.0E-05 1.0E-07
	(f)	(f)	Sr-89 Sr-90 Fe-55	5.0E-08 1.0E-06

Table 4-1

Table Notation

- (a) The LLD is the smallest concentration of radioactive material in a sample that will yield a net count above system background that will be detected with 95% probability with only 5% probability of falsely concluding that a blank observation represents a "real" signal. The LLD is defined as an *a priori* (before the fact) limit representing the capability of a measurement system and not as an *a posteriori* (after the fact) limit for a particular measurement, the minimum detectable activity (MDA).

For a particular measurement system (which may include radiochemical separation):

$$LLD = \frac{(4.66)(S_b)}{(Y)(E)(V)(2.22 \times 10^6) [\exp(-\lambda t)]}$$

Where:

- LLD = the lower limit of detection as defined above as μCi per unit mass or volume
- S_b = the standard deviation of the background counting rate or of the counting rate of a blank sample as appropriate as counts per disintegration
- V = the sample size in units of mass or volume
- E = the counting efficiency
- Y = the fractional radiochemical yield when applicable 2.22×10^6 is the number of disintegrations per minute per μCi
- λ = the decay constant
- t = the time elapsed since sample time

The value of S_b used in the calculation of the LLD for a particular measurement system shall be based on the actual observed variance of the background counting rate or the counting rate of the blank samples, as appropriate, rather than on an unverified theoretically predicted variance. In calculating the LLD for a radionuclide determined by gamma-ray spectrometry, the background shall include the typical contribution of other radionuclides normally present in the samples. Typical values of E, V, and Y should be used in the calculation.

The background count rate is calculated from the background counts that are determined to be within +/- one FWHM energy band about the energy of the gamma ray peak used for the quantitative analysis for this radionuclide.

(b) A batch release is the discharge of liquid wastes of a discrete volume. Prior to sampling for analysis, each batch shall be isolated then thoroughly mixed according to the following:

- A & B Monitor Tanks shall be mixed by recirculating for at least 2 hours.
- The High Conductivity Waste Tank (HCWT) shall be mixed by running the pump and air blower for at least 10 minutes. HCWT isolation does not include periodic pumpdown of the AVT sample sink sump.
- Steam Generator batch releases during shutdown cannot be adequately mixed by recirculating. A sample shall be taken during mid-release and analyzed.
- The outside Condensate Storage Tank cannot be adequately mixed by recirculating. A sample shall be taken during mid-release and analyzed.
- The sludge lance trailer shall be mixed by recirculating for at least 30 minutes.

(c) A composite sample is one in which the quantity of liquid sampled is proportional to the quantity of liquid waste discharged and in which the method of sampling employed results in a specimen which is representative of the liquids released. Decay corrections are calculated from the midpoint of the sampling period.

(d) The principal gamma emitters for which the LLD specification will apply are exclusively the following radionuclides:

Mn-54, Fe-59, Co-58, Co-60, Zn-65, Cs-134, Cs-137 and Ce-141 (Ce-141 shall be measured to a LLD of 5.0E-06).

This list does not mean that only these nuclides are to be detected and reported. Other nuclides which are measurable and identifiable, together with the above nuclides, shall also be identified and reported. Nuclides which are below the LLD for the analyses should be reported as less than the LLD and should not be reported as being present at the LLD level. The less than values should not be used in the required dose calculations.

(e) A continuous release is the discharge of liquid wastes of a non-discrete volume; e.g., from a volume or system that has an input flow during the continuous release. Decay corrections will be calculated based on all samples collected during the release.

- (f) Service water samples shall be taken and analyzed once per 12 hours if alarm setpoint is reached on continuous monitor. Service water sample frequency for H-3, gross alpha, Sr-89, Sr-90, and Fe-55 will be increased to produce a composite whenever principal gamma emitters are detected. The analysis frequency will be monthly for H-3 and gross alpha, and quarterly for Sr-89, Sr-90, and Fe-55 whenever principal gamma emitters are detected.

4.4 LIQUID EFFLUENTS RELEASE POINTS

There are three normal release points for liquid radioactive effluents from the plant that empty into the discharge canal. These are the Radwaste Treatment Discharge, Retention Tank discharge and the All Volatile Treatment Discharge. Each of these is a monitored release line that can be isolated before the release reaches the discharge canal. There is also a release point for the service water lines used for cooling the heat exchangers that is a monitored release line but is not isolatable. If there is an alarm on the service water monitor, it is necessary to sample each heat exchanger separately to determine which has a leak and then isolate the affected heat exchanger. The pressure of the service water system flow would normally force water from the clean service water side into the contaminated side of the heat exchanger. Dilution of liquid effluent is provided by the discharge canal. The discharge canal flow is nominally $1.7E+05$ gpm for each circulating water pump. During operating periods, two circulating water pumps are in operation. During shutdown periods, one circulating water pump is operated. If neither circulating water pump is operable, dilution is provided by operation of one to three service water pumps which provide nominally $5.3E+03$ gpm each.

4.5 LIQUID EFFLUENTS MONITOR SETPOINTS

Alarm and/or trip setpoints for radiation monitors on each liquid effluent line are required. Precautions, limitations and setpoints applicable to the operation of Ginna Station liquid effluent monitors are provided in plant procedure P-9 *RADIATION MONITORING SYSTEM*. Setpoint values are calculated to assure that alarm and trip actions occur prior to exceeding ten times the effluent concentration of Appendix B, Table 2, Column 2 of 10 CFR 20.1001 - 20.2402 at the release point to the unrestricted area. For added conservatism, liquid effluent release rates are administratively set so that only fractions of the applicable maximum effluent concentrations can be reached in the discharge canal.

The Calculated alarm and trip action setpoints for each radioactive liquid effluent line monitor and flow determination must satisfy the following equation:

$$\frac{cf}{F+f} \leq C$$

Equation (1)

Where:

- C = the effluent concentration which implements ten times 10 CFR 20 limit for unrestricted areas, in $\mu\text{Ci/ml}$.
- c = the setpoint of the radioactivity monitor measuring the radioactivity concentration in the discharge line prior to dilution and subsequent release, in $\mu\text{Ci/ml}$.
- F = the dilution water flow as determined prior to the release point, in volume per unit time.
- f = the liquid waste flow as measured at the discharge point, in volume per unit time, in the same units as F.

Liquid effluent batch releases from Ginna Station are discharged through a liquid waste disposal monitor. The liquid waste stream (f) is diluted by (F) in the plant discharge canal before it enters Lake Ontario.

The limiting batch release concentration (c) corresponding to the liquid waste monitor setpoint is calculated from the above expression. Since the value of (f) is very small in comparison to (F), and tritium cannot be accounted for, the expression becomes:

$$c \leq \frac{CF}{f} \times 0.4 (1 - TCF)$$

Equation (2)

Where:

- C = 10 x the allowable concentration of Cs-137 as given in Appendix B, Table 2, Column 2 of 10 CFR 20, 1×10^{-5} . This value is normally more restrictive than the calculated mixed isotopic release concentration. A weighted average, excluding Sb-125, from 1998 data indicated a release concentration of 1.15×10^{-5} $\mu\text{Ci/ml}$. (See DA-RP-99-078). This should be reviewed as an annual basis, and the more conservative value between the two be utilized.
- F = the dilution flow assuming operation of only 1 circulating water pump (170,000 gpm).
- c = the limiting batch release concentration corresponding to the liquid monitor setpoint
- f = the maximum waste effluent discharge rate through the designated pathway.
- 0.4 = a conservatism based on the possibility of 2 liquid discharges occurring simultaneously, minus 0.2 (Total Instrumental Uncertainty)
eg: (limit - 0.2 TIU/2)
- TCF = the Tritium Correction Factor, based on the maximum concentration of diluted RCS H-3, divided by H-3 E.C.L. The maximum UFSAR RCS tritium concentration is $3.5 \mu\text{Ci/ml}$. The monitor setpoint against gamma emitters must be reduced proportional to the ratio of tritium in the waste stream, to which the monitor will not respond.

The limiting release concentration (c) is then converted to a set-point count rate by the use of the monitor calibration factor determined per the individual monitor calibration procedure. The expression becomes:

$$\text{Setpoint (cpm)} = \frac{c (\mu\text{Ci/ml})}{\text{Cal Factor } (\mu\text{Ci/ml/cpm})}$$

Equation (3)

Example (Liquid Radwaste Monitor R-18):

Assuming, for example, that the maximum pump effluent discharge rate (f) is 90 gpm and the RCS tritium concentration is 3 $\mu\text{Ci/ml}$, then the limiting batch release concentration (c) would be determined as follows:

$$c (\mu\text{Ci/ml}) \leq \frac{1E-05 (\mu\text{Ci/ml}) \times 170,000 (\text{gpm})}{90 \text{ gpm}} \times 0.4 \times \left[1 - \frac{3}{1E-2} \right]$$

$$c \leq 6.39E-3 (\mu\text{Ci/ml})$$

The monitor R-18 alarm and trip setpoint (in cpm) is then determined utilizing the monitor calibration factor calculated in plant procedure CPI-MON-R18. Assuming a calibration factor of

$$1.2E-8 \frac{(\mu\text{Ci/ml})}{\text{cpm}}$$

and a limiting batch release concentration determined above, the alarm and trip setpoint for monitor R-18 would be:

$$\frac{6.39E-3 (\mu\text{Ci/ml})}{1.2E-8 \frac{\mu\text{Ci/ml}}{\text{cpm}}} = 5.33E+05 \text{ cpm} \quad \text{above background}$$

The setpoint values for the containment Fan Cooler monitor (R-16), Spent Fuel Pit Heat Exchanger Service Water Monitors (R-20A and R-20B), Steam Generator Blowdown Monitor

(R-19), the Retention Tank Monitor (R-21, and the All volatile Treatment Waste Discharge Monitor (R-22) are calculated in a similar manner using equation (2), substituting appropriate values of (f) and the corresponding calibration factor.

Effluent Monitor Warning alarm setpoints are set at one-half of the trip setpoint. With all calculations equal this is a warning that 20% of the release limit has been reached at a single release point.

4.6 LIQUID EFFLUENT RELEASE CONCENTRATIONS

Liquid batch releases are controlled individually and each batch release is authorized based upon sample analysis and the existing dilution flow in the discharge canal. Plant procedures establish the methods for sampling and analysis of each batch prior to release. A release rate limit is calculated for each batch based upon analysis, dilution flow and all procedural conditions being met before it is authorized for release. The waste effluent stream entering the discharge canal is continuously monitored and the release will be automatically terminated if the preselected monitor setpoint is exceeded. A release may continue subject to grab sample analysis and monitoring in accordance with Table 6.1-1.

The equation used to calculate activity is:

Gamma Spectroscopy

$$\mu\text{Ci/gm Act.} = \frac{\text{peak area counts} - \text{bkgd counts}}{(\text{C Time})(\text{Eff})(\text{Vol})(\text{Decay})(3.7 \text{ E} + 04)}$$

Equation (4)

4.7 LIQUID EFFLUENT DOSE

The dose contribution received by the maximally exposed individual from the ingestion of Lake Ontario fish and drinking water is determined using the following methodology. These calculations will assume a near field dilution factor of 1.0 in evaluating the fish pathway dose, and an average annual dilution factor of 200 between the plant discharge and the Ontario Water District drinking water intake located approximately 2220 meters northeast (53 degrees) of the discharge canal. The average annual dilution factor of 200 was derived from the drift and dispersion study documented in reference 10.4.

Dose contributions from shoreline recreation, boating and swimming have been shown to be negligible in the Appendix I dose analysis, reference 10.5, and do not need to be routinely evaluated. Shoreline sediment samples downstream from the plant will be collected at least semi-annually for the Radiological Environmental Monitoring Program, as a conservatism. Presence of radioactivity above background will result in calculation of dose contribution from these pathways. There is no known human consumption of shellfish from Lake Ontario; therefore, this pathway is not taken into consideration in dose calculations.

The dose contribution to an individual will be determined to ensure that it complies with the specification of Section 4.2.1 (Dose - Controls). Offsite receptor doses will be determined for the limiting age group and organ, unless census data show that actual offsite individuals are the limiting age group.

The following expression is used to calculate ingestion pathway dose contributions for the total release period from all radionuclides identified in liquid effluents released to unrestricted areas:

$$D_{\tau} = \sum_i \left[A_{i\tau} \sum_j \Delta t_j C_{ij} F_j \right]$$

Equation (5)

Where:

D_{τ} = the cumulative dose commitment to the total body or any organ, t , from the liquid effluents for the summation of the total time period in mrem.

\sum_i is for total number of hours of release.

Δt_j = the length of the j th time period over which C_{ij} and F_j are averaged for all liquid releases in hours.

- C_{ij} = the average concentration of radionuclide i in undiluted liquid effluent during time period t_j from any liquid release in $\mu\text{Ci/ml}$.
- $A_{i\tau}$ = the site-related ingestion dose commitment factor to the total body or any organ, τ , for each identified principal gamma and beta emitter in mrem/hr per $\mu\text{Ci/ml}$. See equation (6).
- F_j = the discharge canal dilution factor for C_{ij} during any liquid effluent release, defined as the ratio of the maximum undiluted liquid waste flow during release to unrestricted receiving waters. The dilution factor will depend on the number of circulation pumps operating and, during icing conditions, the percentage opening of the recirculating gate. Reference curves are presented in plant procedure CH-RETS-LIQ-RELEASE.

$$A_{i\tau} = k_o (U_w / D_w + U_F BF_i) DF_{i\tau}$$

Equation (6)

Where:

- $A_{i\tau}$ = the site-related ingestion dose commitment factor to the total body or to any organ, τ , for each identified principal gamma and beta emitter in mrem/hr per $\mu\text{Ci/ml}$.
- k_o = the units conversion factor, $1.14\text{E}+05 = 1.0\text{E}+06 \text{ pCi}/\mu\text{Ci} \times 1.0\text{E}+03 \text{ ml/kg} \div 8760 \text{ hr/yr}$
- U_w = a receptor person's water consumption by age group from Table E-5 of Regulatory Guide 1.109
- D_w = the dilution factor from the near field area of the release point to potable water intake. The site specific dilution factor is 200. This factor is 1.0 for the fish ingestion pathway.
- U_F = a receptor person's fish consumption by age group from Table E-5 of Regulatory Guide 1.109
- BF_i = a bioaccumulation factor for nuclide, i , in fish in pCi/kg per pCi/L , from Table A-1 of Regulatory Guide 1.109

$DF_{i\tau}$ is the dose conversion factor for the ingestion of nuclide, i , for a receptor person in pre-selected organ, t , in mrem/pCi, from Tables E-11, E-12, E-13, E-14 of Regulatory Guide 1.109

The monthly dose contribution from releases for which radionuclide concentrations are determined by periodic composite sample analysis may be approximated by assuming an average monthly concentration based on the previous monthly or quarterly composite analysis. However, in the Annual Radioactive Effluent Release Report the calculated dose contributions from these radionuclides shall be based on the actual composite analysis.

Example:

Computing the dose to the whole body via the fish and drinking water pathways, assuming an initial Cs-137 discharge concentration of $3.0E-04$ $\mu\text{Ci/ml}$:

Given the following discharge factors for example, where:

$\Delta t_i = 1$ hour, the duration of the release

$C_{ij} = 3.0E-04$ $\mu\text{Ci/ml}$

$F_j = \frac{\text{liquid waste flow}}{(\text{dilution flow})(z)} = \frac{20 \text{ gpm}}{170,000 \text{ gpm}} = 1.2E-04$

$z = \text{Near field dilution} = 1.0$ for Ginna

$D_w = 200$

and, taking the following values from Regulatory Guide 1.109 which concern the critical receptor, which is considered to be the child in this case:

$U_w = 510$ l/year

$U_f = 6.9$ kg/year

$BF_i = 2000$ pCi/kg per pCi/l

$DF_i = 4.62E-05$ mrem/pCi

Then, the site-related ingestion dose commitment factor, $A_{i\tau}$, is calculated as follows:

$$A_{iT} \frac{\text{mrem/hr}}{\mu\text{Ci/ml}} = k_o (U_w/D_w + U_F BF_i) DF_i$$

$$= 1.14 E+05 \left[\frac{510}{200} + (6.9)(2000) \right] 4.62 E-05$$

$$A_{iT} = 7.27 E+04 \text{ mrem/hr per } \mu\text{Ci/ml}$$

And, the whole body dose to the child is then:

$$D_T \text{ mrem} = (A_{iT}) (\Delta t_j) (C_j) (F_j)$$

$$= (7.27 E+04)(1)(3.0 E-04)(1.2 E-04)$$

$$D_T = 2.6 E-03 \text{ mrem to the whole body from Cs-137}$$

The dose contribution from any other isotopes would then need to be calculated and all the isotopic contributions summed.

5.0 RADIOACTIVE GASEOUS EFFLUENTS

5.1 DELETED

5.2 DOSE RATE

5.2.1 CONTROLS

The instantaneous dose rate due to radioactive materials released in gaseous effluents from the site to areas at or beyond the SITE BOUNDARY shall be limited to the following values:

1. The dose rate for noble gases shall be ≤ 500 mrem/yr to the total body and ≤ 3000 mrem/yr to the skin, and
2. The dose rate for I-131, I-133, tritium, and for all radioactive materials in particulate form with half-lives greater than 8 days shall be ≤ 1500 mrem/yr to any organ.

5.2.2 APPLICABILITY: At all times.

Note: For unplanned release of gaseous wastes, compliance with Section 5.2.1 (Dose Rate - Controls) may be calculated using annual average X/Q. Compliance with Section 5.2.1 (Dose Rate - Controls) shall be determined by considering the applicable ventilation system flow rates. These flow rates shall be determined at the frequency required by Table 6.2-2.

5.2.3 ACTION:

If the calculated dose rate of radioactive materials released in gaseous effluents from the site exceeds the limits of Section 5.2.1 (Dose Rate - Controls), measures shall be initiated to restore releases to within limits. The effluent continuous monitors listed in Table 6.2-1 that have provisions for the automatic termination of gas decay tank, shutdown purge or mini-purge releases, shall be used to limit releases within the values established in Section 5.2.1 (Dose Rate - Controls) when monitor setpoint values are exceeded.

5.2.4 SURVEILLANCE REQUIREMENTS:

1. The dose rate due to noble gases in gaseous effluents shall be determined to be within the above limits in accordance with the methodology and parameters of Section 5.7 of the ODCM.
2. The dose rate due to radioactive materials, other than noble gases, in gaseous effluents shall be determined to be within the above limits in accordance with the methodology and parameters of Section 5.7 of the ODCM by obtaining representative samples and performing analyses in accordance with the sampling and analysis program specified in Table 5-1.

5.2.5 BASES:

This control is provided to ensure that the dose at any time at and beyond the SITE BOUNDARY from gaseous effluents will be within the annual dose limits of 10 CFR 20, Appendix B, Table 2, Column 1. These limits provide reasonable assurance that radioactive material discharged in gaseous effluents will not result in the exposure of a MEMBER OF THE PUBLIC in an UNRESTRICTED AREA, either within or outside the SITE BOUNDARY, to annual average concentrations exceeding the limits specified in Appendix B, Table 2 of 10 CFR 20. For MEMBERS OF THE PUBLIC who may at times be within the SITE BOUNDARY, the occupancy of the MEMBER OF THE PUBLIC will usually be sufficiently low to compensate for any increase in the atmospheric diffusion factor above that for the SITE BOUNDARY. Examples of calculations for such MEMBERS OF THE PUBLIC, with the appropriate occupancy factors, shall be given in the ODCM. The specified release rate limits restrict, at all times, the corresponding gamma and beta dose rates above background to a MEMBER OF THE PUBLIC at or beyond the SITE BOUNDARY to less than or equal to 500 mrems/year to the whole body or to less than or equal to 3000 mrems/year to the skin. These release rate limits also restrict, at all times, the corresponding thyroid dose rate above background to a child via the inhalation pathway to less than or equal to 1500 mrems/year.

5.3 DOSE (10 CFR 50, Appendix I)

5.3.1 CONTROLS:

The dose due to noble gases released in gaseous effluents to areas at or beyond the SITE BOUNDARY shall be limited to the following:

1. During any calendar quarter to ≤ 5 mrad for gamma radiation and to ≤ 10 mrad for beta radiation.
2. During any calendar year to ≤ 10 mrad for gamma radiation and to ≤ 20 mrad for beta radiation.

5.3.2 APPLICABILITY: At all times

5.3.3 ACTION:

Whenever the calculated dose to a MEMBER OF THE PUBLIC resulting from noble gases exceeds the limits of Section 5.3.1 (Dose - Controls), a Special Report shall be submitted to the Commission within 30 days which includes the following information:

1. Identification of the cause for exceeding the dose limit.
2. Corrective actions taken and/or to be taken to reduce releases of radioactive material in gaseous effluents to assure that subsequent releases will be within the above limits.

5.3.4 ACTION:

During any month when the calculated dose to a MEMBER OF THE PUBLIC exceeds 1/48th the annual limits of Section 5.3.1 (Dose - Controls), (0.2 mrad gamma or 0.4 mrad beta), projected cumulative dose contributions from gaseous effluents shall be determined for that month and at least once every 31 days for the next 3 months.

5.3.5 SURVEILLANCE REQUIREMENTS:

Cumulative dose contributions for the current calendar quarter and current calendar year for noble gases shall be determined in accordance with the methodology and parameters of Section 2.8 of the ODCM at least once every 31 days.

5.3.6 BASES:

This control is provided to implement the requirements of Sections II.B, III.A, and IV.A of Appendix I, 10 CFR 50. The control implements the guides set forth in Section I.B of Appendix I. The ACTION statements provide the required operating

flexibility and at the same time implement the guides set forth in Section IV.A of Appendix I to assure that the release of radioactive material in gaseous effluents to UNRESTRICTED AREAS will be kept "as low as reasonably achievable". The SURVEILLANCE REQUIREMENTS implement the requirements in Section III.A of Appendix I that conformance with the guides of Appendix I be shown by calculational procedures based on models and data such that the actual exposure of a MEMBER OF THE PUBLIC through appropriate pathways is unlikely to be substantially underestimated. The dose calculation methodology and parameters established in the ODCM for calculating the doses due to the actual release rates of radioactive noble gases in gaseous effluents are consistent with the methodology provided in Regulatory Guide 1.109, "Calculation of Annual Doses to Man from Routine Releases of Reactor Effluents for the Purpose of Evaluating Compliance with 10 CFR 50, Appendix I", Revision I, October 1977 and Regulatory Guide 1.111, "Methods for Estimating Atmospheric Dispersion of Gaseous Effluents in Routine Releases from Light-Water Cooled Reactors", Revision I, July 1977. The ODCM equations for determining air doses at the SITE BOUNDARY are based on historical average atmospheric conditions.

5.3.7 CONTROLS:

The dose to a MEMBER OF THE PUBLIC from I-131, I-133, tritium, and for all radioactive materials in particulate form with half-lives greater than eight days released with gaseous effluents from the site shall be limited to the following:

1. during any calendar quarter to ≤ 7.5 mrem to any organ.
2. during any calendar year to ≤ 15 mrem to any organ.

5.3.8 APPLICABILITY: At all times.

5.3.9 ACTION:

Whenever the calculated dose to a MEMBER OF THE PUBLIC resulting from radionuclides other than noble gases exceeds the limits of Section 5.3.7 (Controls), a Special Report shall be submitted to the Commission within 30 days which includes the following information:

1. Identification of the cause for exceeding the dose limit.
2. Corrective actions taken and/or to be taken to reduce releases of radioactive material in gaseous effluents to assure that subsequent releases will be within the above limits.

5.3.10 ACTION:

During any month when the calculated dose to a MEMBER OF THE PUBLIC exceeds 1/48th the annual limit of Section 5.3.7 (Controls), (0.3 mrem), projected

cumulative dose contributions from gaseous effluents shall be determined for that month and at least once every 31 days for the next 3 months.

5.3.11 SURVEILLANCE REQUIREMENTS

Cumulative dose contributions for the current calendar quarter and current calendar year for Iodine-131, Iodine-133, tritium, and radionuclides in particulate form with half-lives greater than 8 days shall be determined in accordance with methodology and parameters of Section 5.8 of the ODCM at least once every 31 days.

5.3.12 BASES:

This control is provided to implement the requirements of Sections II.C, III.A, and IV.A of Appendix I, 10 CFR 50. The control implements the guides set forth in Section II.C of Appendix I. The ACTION statements provide the required operating flexibility and at the same time implement the guides set forth in Section IV.A of Appendix I to assure that the release of radioactive material in gaseous effluents to UNRESTRICTED AREAS will be kept "as low as reasonably achievable". The SURVEILLANCE REQUIREMENTS implement the requirements in Section III.A of Appendix I that conformance with the guides of Appendix I be shown by calculational procedures based on models and data such that the actual exposure of a MEMBER OF THE PUBLIC through appropriate pathways is unlikely to be substantially underestimated. The dose calculation methodology and parameters established in the ODCM for calculating the doses due to the actual release rates of the subject materials in gaseous effluents are consistent with the methodology provided in Regulatory Guide 1.109, "Calculation of Annual Doses to Man from Routine Releases of Reactor Effluents for the Purpose of Evaluating Compliance with 10 CFR 50, Appendix I", Revision I, October 1977 and Regulatory Guide 1.111, "Methods for Estimating Atmospheric Dispersion of Gaseous Effluents in Routine Releases from Light-Water Cooled Reactors", Revision I, July 1977. These equations also provide for determining the actual doses based upon the historical average atmospheric conditions. The release rate controls for Iodine-131, Iodine-133, tritium, and radionuclides in particulate form with half-lives greater than 8 days are dependent upon the existing radionuclide pathways to man in the areas at or beyond the SITE BOUNDARY. The pathways examined in development of the calculations were:

1. Individual inhalation of airborne radionuclides
2. Deposition of radionuclides onto green leafy vegetation with subsequent consumption by man
3. Deposition of radionuclides onto grassy areas where milk animals and meat producing animals graze, followed by human consumption of that milk and meat

4. Deposition of radionuclides on the ground followed by subsequent human exposure

5.4 TOTAL DOSE (40 CFR 190)

5.4.1 CONTROLS:

The annual (calendar year) dose or dose commitment to any MEMBER OF THE PUBLIC due to releases of radioactivity and to radiation from uranium fuel cycle sources shall be limited to less than or equal to 25 mrem to the whole body or any organ, except the thyroid, which shall be limited to less than or equal to 75 mrem.

5.4.2 APPLICABILITY: At all times.

5.4.3 ACTION:

With the calculated doses from the release of radioactive materials in gaseous effluents exceeding twice the limits of Sections 5.3.1 and 5.3.7 (Controls), prepare and submit to the Commission within 30 days a Special Report that defines the corrective actions to be taken to reduce subsequent releases to prevent recurrence of exceeding the above limits and include scheduling for achieving conformance with the above limits. Calculations which include direct radiation contributions from the unit and from any radwaste storage shall be performed to determine total dose to a MEMBER OF THE PUBLIC. This Special Report, as defined in 10 CFR 20.405(c) shall include an analysis that estimates the radiation exposure (dose) to a MEMBER OF THE PUBLIC from uranium fuel cycle sources, including all effluent pathways and direct radiation, for the calendar year that includes the releases covered by this report. It shall also describe levels of radiation and concentrations of radioactive material involved, and the cause of the exposure levels or concentrations. If the estimated dose(s) exceeds the above limits, and if the release condition resulting in violation of 40 CFR 190 has not already been corrected, the Special Report shall include a request for a variance in accordance with the provisions of 40 CFR 190. Submittal of the report is considered a timely request, and a variance is granted until staff action on the request is complete.

5.4.4 ACTION:

This report shall include an analysis which demonstrates that radiation exposure to all MEMBERS OF THE PUBLIC from the plant are less than the 40 CFR 190 limits. Otherwise, the report shall request a variance from the commission to permit releases to exceed 40 CFR Part 190. Submittal of the report is considered a timely request by the NRC, and a variance is granted until staff action on the request is complete.

5.4.5 SURVEILLANCE REQUIREMENTS:

1. Cumulative dose contributions from liquid and gaseous effluents shall be determined in accordance with Sections 5.3.5 and 5.3.11 (Surveillance Requirements) at least once every 31 days, in accordance with the methodology and parameters of Section 2.8 of the ODCM.

2. Cumulative dose contributions from direct radiation from the unit and from radwaste storage including ISFSI, shall be determined from environmental dosimeter data at least quarterly.

5.4.6 BASES:

This control is provided to meet the dose limitations of 40 CFR 190 that have been incorporated into 10 CFR 20 by 46FR18525. The specification requires the preparation and submittal of a Special Report whenever the calculated doses due to releases of radioactivity and to radiation from uranium fuel cycle sources exceed 25 mrem to the whole body or any organ, except the thyroid, which shall be limited to less than or equal to 75 mrem. It is highly unlikely that the resultant dose to a MEMBER OF THE PUBLIC will exceed the dose limits of 40 CFR 190 if the plant remains within twice the dose design objectives of Appendix I, and if direct radiation doses are kept small. Cumulative direct radiation dose from environmental dosimeters shall be used to ensure that dose limits of 10CFR72.104 are met. The Special Report will describe a course of action that should result in the limitation of the annual dose to a MEMBER OF THE PUBLIC to within the 40 CFR 190 limits. For the purposes of the Special Report, it may be assumed that the dose contributions from other uranium fuel cycle sources is negligible. If the dose to any MEMBER OF THE PUBLIC is estimated to exceed the requirements of 40 CFR 190, the Special Report with a request for a variance, (provided the release conditions resulting in violation of 40 CFR 190 have not already been corrected), in accordance with the provisions of 40 CR 190.11 and 10 CFR 20.405c, is considered to be a timely request and fulfills the requirements of 40 CFR 190 until NRC staff action is completed. The variance only relates to the limits of 40 CFR 190, and does not apply in any way to the other requirements for dose limitation of 10 CFR 20, as addressed in Section 4.1.1 (Radioactive Liquid Effluents - Controls) and Section 5.2.1 (Dose Rate - Controls). An individual is not considered a MEMBER OF THE PUBLIC during any period in which he/she is engaged in carrying out any operation that is part of the nuclear fuel cycle.

Table 5-1

Radioactive Gaseous Waste Sampling and Analysis Program

Gaseous Release Type	Sampling Frequency	Minimum Analysis Frequency	Type of Activity Analysis	Lower Limit of Detection (LLD) ($\mu\text{Ci/cc}$) (a)
Containment Purge	P Each Purge (b,c) Grab Sample	P	Principal Gamma Emitters (e) H-3	1.0E-04 1.0E-06
Auxiliary Building Ventilation	M (b) Grab Sample	M (b)	Principal Gamma Emitters (e) H-3	1.0E-04 1.0E-06
All Release Types as listed above	Continuous (d)	W (b,i) Charcoal Sample	I-131 I-133	1.0E-12 1.0E-10
	Continuous (d)	W (b,i) Particulate Sample	Principal Gamma Emitters (e)	1.0E-11
	Continuous (d)	M Composite Particulate Sample	Gross Alpha	1.0E-11
	Continuous (d)	Q Composite Particulate Sample	Sr-89 Sr-90	1.0E-11
Air Ejector	M (b,f) Grab Sample	M (b, f)	Principal Gamma Emitters (e) I-131 (h) H-3 (g)	1.0E-04 1.0E-12 1.0E-06
All Release Types listed above	Continuous (d)	Noble Gas Monitor	Beta or Gamma	1.0E-06
Gas Decay Tank	P Each Tank Grab Sample	P Each Tank	Principal Gamma Emitters (e)	1.0E-04

Table 5-1**Table Notation**

- (a) The lower limit of detection (LLD) is defined in Table Notation (a) of Table 4-1.
- (b) Analyses shall also be performed when the monitor on the continuous sampler reaches its setpoint.
- (c) Tritium grab samples shall be taken at least three times per week when the reactor cavity is flooded.
- (d) The ratio of the sample flow rate to the sampled stream flow rate shall be known for the time period covered by each dose or dose rate calculation made in accordance with Sections 5.2.1, 5.3.1, and 5.3.7 (Controls).
- (e) The principal gamma emitters for which the LLD specification will apply are exclusively the following radionuclides:
- Kr-85m, Xe-133, Xe-133m and Xe-135 for gaseous emissions
 - I-131, Mn-54, Fe-59, Co-58, Co-60, Zn-65, Mo-99, Cs-134, Cs-137, Ce-141 and Ce-144 for particulate emissions.

This list does not mean that only these nuclides are to be detected and reported. Other nuclides which are measurable and identifiable, together with the above nuclides, shall also be identified and reported. Nuclides which are below the LLD for the analyses should not be reported as being present at the LLD level for that nuclide. When unusual circumstances result in LLDs higher than required, the reasons shall be documented in the Annual Radioactive Effluent Release Report.

- (f) Air ejector samples are not required during cold or refueling shutdowns.
- (g) Air ejector tritium sample is not required if the secondary coolant activity is less than $1.0\text{E-}04$ $\mu\text{Ci/gm}$.
- (h) Air ejector iodine samples shall be taken and analyzed weekly if the secondary coolant activity exceeds $1.0\text{E-}04$ $\mu\text{Ci/gm}$.
- (i) Analyses shall be completed within 48 hours after changing, or after removal from sampler. Sampling shall also be performed at least once per 24 hours for at least 7 days following each shutdown, startup, or THERMAL POWER change exceeding 15% RATED THERMAL POWER within a 1-hour period and analyses shall be completed within 48 hours of changing. When samples collected for 24 hours are analyzed, the corresponding LLDs may be increased by a factor of 10. This requirement for increased sample frequency does not apply if: (1) analysis shows that the DOSE EQUIVALENT I-131 concentration in the reactor coolant has not increased more than a factor of 3; and (2) the noble gas monitor shows that effluent

activity has not increased more than a factor of 3.

5.5 GASEOUS EFFLUENT RELEASE POINTS

There are three release points continuously monitored for noble gases, containment vent, plant vent and air ejector. The containment vent and plant vent are also continuously monitored for radioiodines and particulates. Since the air ejector is a steam release point, continuous radioiodine and particulate monitoring is not required when the secondary coolant activity is less than $1.0\text{E-}04$ $\mu\text{Ci/gm}$. Flow rates through the vents are measured periodically. During shutdown, temporary trailers may be brought on site that also require monitoring and characterization of their releases, such as the CO_2 decon trailer.

Quarterly plant measurements of one week duration for the particulate and iodine released in the steam by the air ejector demonstrate that sampling this pathway for particulate and iodine is not necessary since these releases are less than 0.1% of the Plant Vent. The releases are correlated to blowdown activity for determining activity in steam releases. During shutdown and startup, special systems are in use that may release small amounts of radioactivity in steam releases. This is accounted for by using operational data and activity in the source of the steam. Grab samples are obtained when practicable.

If an unmonitored release point is identified, a calculation is performed to determine the radioactivity that is released. The calculation includes a conservative estimate of source term if sample data is not available, and a conservative estimate of flow rate and duration if measurement of flow and duration are not available. If the release is continuous, it is included in the monthly report that accounts for releases from the site for calculating doses to the general public.

5.6 GASEOUS EFFLUENT MONITOR SETPOINTS

Alarm and/or trip setpoints for specified radiation monitors are required on each noble gas effluent line from the plant. Precautions, limitations and setpoints applicable to the operation of Ginna Station gaseous effluent monitors are provided in plant procedure P-9. Setpoints are conservatively established for each ventilation noble gas monitor so that dose rates in unrestricted areas corresponding to 10 CFR Part 50 Appendix I limits will not be exceeded. Setpoints shall be determined so that dose rates from releases of noble gases will comply with Section 5.2.1 (Dose Rate - Controls).(1). Table 5-2 provides the gaseous and particulate meteorological assumption used in development of the P-9 setpoints.

The calculated alarm and trip action setpoints for each radioactive gaseous effluent monitor must satisfy the following equation:

$$c_v \leq \frac{\sum_i Q_{iv}}{f(k)(K)}$$

Equation (7)

Where:

c_v = setpoint in cpm

Q_{iv} = release rate limit by specific nuclide (i) in $\mu\text{Ci}/\text{sec}$ from vent (v)

f = discharge flow rate in cfm

k = units conversion factor in $\text{cc}/\text{sec}/\text{cfm}$

K = calibration factor in $\mu\text{Ci}/\text{cc}/\text{cpm}$

The general methodology for establishing plant ventilation monitor setpoints is based upon a vent concentration limit in $\mu\text{Ci}/\text{cc}$ derived from site specific meteorology and vent release characteristics.

Additional radiation monitor alarm and/or trip setpoints are calculated for radiation monitors measuring radioiodines, radioactive materials in particulate form and to radionuclides other than noble gases. Setpoints are determined to assure that dose rates from the release of these effluents shall comply with Section 5.2.1 (Dose Rate - Controls)(2)

The release rate limit for noble gases shall be calculated by the following equation for total body dose:

$$Q_{iv} [\mu Ci/sec] \leq \sum_i Q_{iv} \frac{500 \text{ mrem/yr}}{(X/Q)_v \sum_i K_i Q_{iv}}$$

Equation (8)

Note: An occupancy factor of 1 is assumed. This may be modified following reviews of the area in question and by the following equation for skin doses:

$$Q_v [\mu Ci/sec] \leq \sum_i Q_{iv} \frac{3000 \text{ mrem/yr}}{(X/Q)_v \sum_i (L_i + 1.1 M_i) Q_{iv}}$$

Equation (9)

Where:

Q_{iv} = the release rate of radionuclide (i) from vent (v) which results in a dose rate of 500 mrem/yr to the whole body or 3000 mrem/yr to the skin of the critical receptor in $\mu Ci/sec$.

K_i = the total body dose factor due to gamma emissions for each identified noble gas radionuclide in mrem/yr per $\mu Ci/m^3$ from Table 5-3.

L_i = the skin dose factor due to beta emissions for each identified noble gas radionuclide in mrem/yr per $\mu Ci/m^3$ from Table 5-3.

M_i = the air dose factor due to gamma emissions for each identified noble gas radionuclide in mrad/yr per $\mu Ci/m^3$ from Table 5-3. Unit conversion constant of 1.1 mrem/mrad converts air dose to skin dose.

$(X/Q)_v$ = the highest calculated annual average dispersion parameter for estimating the dose to the critical offsite receptor from vent release point (v) in sec/m^3 . The $(X/Q)_v$ is calculated by the method described in Regulatory Guide 1.111.

Noble gas monitor setpoints are conservatively set according to procedure P-9, *RADIATION MONITORING SYSTEM*, to correspond to fractions of the applicable 10 CFR Part 20 dose limits for unrestricted areas. Fractions are small enough to

assure the timely detection of any simultaneous discharges from multiple release points before the combined downwind site boundary concentration could exceed allowable limits. Additional conservatism is provided by basing these setpoints upon instantaneous downwind concentrations. Release rates during the remainder of a given year, combined with any infrequent releases at setpoint levels, would result in only a very small fraction of the 10 CFR Part 20 annual limits.

Historically, xenon-133 has been the principal fission product noble gas released from all vents and is appropriate for use as the reference isotope for establishing monitor setpoints. The whole-body dose will be limiting, and the Xe-133 release rate limit is calculated by substituting the appropriate values into equation (8). After the release rate limit for Xe-133 is determined for each vent, the corresponding vent concentration limits are calculated based on applicable vent flow rates. During periods of high make-up water usage, argon-41 from air saturated make-up water becomes the principle radiogas of concern and may be used as the reference isotope for establishing setpoints. Calibration factors in $\mu\text{Ci}/\text{cc}$ per cpm are used to convert limiting vent concentrations to count rates.

Example: Plant Vent Monitor, R-14

Using Xe-133 as the controlling isotope for the setpoint and assuming a measured activity of $2.66\text{E}-04$ $\mu\text{Ci}/\text{cc}$ and a ratemeter reading of 4750 cpm above background, the efficiency can be calculated, using a measured vent flow of $7.45\text{E}+04$ cfm, K_i from Table 5-3 of $2.94\text{E}+02$ and a $(X/Q)_v$ for the site boundary of $2.7\text{E}-06$, the Release Rate Limit is calculated and then the setpoint determined.

$$\text{Xe-133 efficiency} = \frac{\text{Activity}}{\text{Net ratemeter reading}}$$

$$\text{Xe-133 efficiency} = \frac{2.66 \text{ E} - 04}{4750} = 5.67 \text{ E} - 08 \frac{\mu\text{Ci}/\text{cc}}{\text{cpm}}$$

Using Equation 8:

$$Q_{iv} \leq \frac{500}{(2.94 \text{ E} + 02)(2.7 \text{ E} - 06)} \leq 6.3 \text{ E} + 05 \mu\text{Ci}/\text{sec}$$

$$\text{Release Rate Limit } Q_{iv} \leq \frac{500 \text{ mrem}/\text{yr}}{(K_i)(X/Q)_v}$$

Using Equation 7:

$$\text{Setpoint } c \leq \frac{Q_{iv}}{(f)(k)(K)}$$

$$c \leq \frac{6.3 \text{ E} + 05 \text{ uCi/sec}}{(7.45 \text{ E} + 04 \text{ cfm}) \left(472 \frac{\text{cc/sec}}{\text{cfm}} \right) \left(5.67 \text{ E} - 08 \frac{\text{uCi/cc}}{\text{cpm}} \right)}$$

$$c \leq 3.2 \text{ E} + 05 \text{ cpm}$$

Per procedure P-9, R-14 is set at 0.4 of this value or 1.28E+05 cpm for normal operation. 40% of the release rate limit is a conservatism based on the possibility of two release points simultaneously at their setpoints for a total of 80% of the release rate limit.

Effluent Monitor Warning alarm setpoints are set at one-half of the trip setpoint. With all calculations equal this is a warning that 20% of the release limit has been reached at a single release point.

Table 5-2

Meteorological Data and Locations of Receptors for Set Point Calculations

Process Monitors					
Monitor (Radioisotope)	Geographic Location (Dist./Direction)	Release Point (vent)	X/Q (sec/m ³)	D/Q (m ⁻²)	Flow (cfm)
R-10A (Radioiodine)	0.5 - 1-mile E	Containment		1.99E-8	12,520
R-10B (Radioiodine)	0.5 - 1-mile ESE	Plant		7.41E-9	81,650
R-11 (Cs-137)	0.5 - 1-mile E	Containment		1.99E-8	12,520
R-12 (Xe-133)	0.5 - 1-mile NNE	Containment	2.15E-6		12,520
R-13 (Cs-137)	0.5 - 1-mile ESE	Plant		7.41E-9	81,650
R-14 (Xe-133)	0.5 - 1-mile ESE	Plant	2.43E-7		81,650
R-15 (Xe-133)	0.5-1-mile NNE	Air Ejector	3.01E-6		720
Accident Monitors					
Monitor (Radioisotope)	Geographic Location (Dist./Direction)	Release Point (vent)	X/Q (sec/m ³)	D/Q (m ⁻²)	Flow (cfm)
R-12A (Radioiodine)	0.5-1-mile E	Containment		1.99E-8	12,520
R-12A (Particulate Cs-137)	0.5-1-mile E	Containment		1.99E-8	12,520
R-12A (Noble Gas Xe-133)	0.5-1-mile NNE	Containment	2.15E-6		12,520
R-14A (Radioiodine)	0.5-1-mile ESE	Plant		7.41E-9	81,650
R-14A (Particulate Cs-137)	0.5-1-mile ESE	Plant		7.41E-9	81,650
R-14A (Noble Gas Xe-133)	0.5-1-mile ESE	Plant	2.43E-7		81,650
R-48 (RCS Accident Mix)	0.5-1-mile NNE	Air Ejector	3.01E-6		720

**Table 5-2
(continued...)**

Further details found in procedure P-9.

I-131, I-133, H-3 and particulates with half lives greater than 8 days utilizes the following equation:

$$Q_{iv} \leq \frac{1500 \text{ mrem/year}}{(D/Q)_v P_i}$$

For Noble Gases:

$$Q_{iv} \leq \frac{500 \text{ mrem/year}}{(X/Q)_v K_i}$$

P_i = Food and ground pathways in m^2 mrem/year per $\mu\text{Ci}/\text{sec}$

K_i = mrem/year per $\mu\text{Ci}/m^3$

Q_{iv} = Release rate in units of $\mu\text{Ci}/\text{sec}$

5.7 GASEOUS EFFLUENT DOSE RATE

Gaseous effluent monitor setpoints as described in Section 5.6 of this manual are established at concentrations which permit some margin for corrective action to be taken before exceeding offsite dose rates corresponding to 10 CFR Part 20 limitations. Plant procedures establish the methods for sampling and analysis for continuous ventilation releases and for containment purge releases. Plant procedures also establish the methods for sampling and analysis prior to gas decay tank releases. The instantaneous dose rate in unrestricted areas due to unplanned releases of airborne radioactive materials may be calculated using annual average X/Q's. Dose rates shall be determined using the following expressions:

For noble gases:

$$D_v = \sum_i \left[(L_i + 1.1 M_i) (X/Q)_v Q_{iv} \right] \leq 3000 \text{ mrem/yr}$$

Equation (11)

Total gamma and beta dose to the skin

$$D_v = \sum_i \left[K_i (X/Q)_v Q_{iv} \right] \leq 500 \text{ mrem/yr}$$

Equation (12)

total body dose

For I-131, I-133, tritium and all radioactive materials in particulate form with half-lives greater than 8 days:

$$D_v = \sum_i P_i W_v Q_{iv} \leq 1500 \text{ mrem/yr to critical organ}$$

Equation (13)

Where:

K_i = the total body dose factor due to gamma emissions for each identified noble gas radionuclide (i) in mrem/yr per $\mu\text{Ci}/\text{m}^3$ from Table 5-2.

L_i = the skin dose factor due to beta emissions for each identified noble gas radionuclide (i) in mrem/yr per $\mu\text{Ci}/\text{m}^3$ from Table 5-3.

- M_i = the air dose factor due to gamma emissions for each identified noble gas radionuclide (i) in mrad/yr per $\mu\text{Ci}/\text{m}^3$ from Table 5-3. Unit conversion constant of 1.1 mrem/mrad converts air dose to skin dose.
- P_i = the dose parameter for radionuclide (i) other than noble gases for the inhalation pathway, in mrem/yr per $\mu\text{Ci}/\text{m}^3$. The dose factors are based on the critical individual organ and the child age group. P_i is further defined as: $P_i = (10^6 \text{pCi/uCi})(\text{BR})(\text{DFA}_i)$ where BR is the breathing rate for a child in m^3/yr and DFA_i is the dose factor for the child in mrem/pCi.
- $(X/Q)_v$ = the highest calculated annual average relative concentration for any area at or beyond the unrestricted area boundary in sec/m^3 .
- W_v = the highest annual average dispersion parameter for estimating the dose to the critical receptor in sec/m^3 for the inhalation pathway and in m^{-2} for the food and ground pathways.
- Q_{iv} = the release rate of radionuclide (i) from vent (v) in $\mu\text{Ci}/\text{sec}$.

5.8 GASEOUS EFFLUENT DOSES

The air dose in unrestricted areas due to noble gases released in gaseous effluents from the site shall be determined using the following expressions:

During any calendar year, for gamma air dose:

$$D_{v\gamma} = 3.17 E-08 \sum_i \left[M_i (X/Q)_v Q_{iv} \right] \leq 10 \text{ mrad}$$

Equation (14)

During any calendar quarter, for gamma air dose:

$$D_{v\gamma} = 3.17 E-08 \sum_i \left[M_i (X/Q)_v Q_{iv} \right] \leq 5 \text{ mrad}$$

Equation (14A)

During any calendar year for beta air dose:

$$D_{v\beta} = 3.17 E-08 \sum_i \left[N_i (X/Q)_v Q_{iv} \right] \leq 20 \text{ mrad}$$

(Equation 15)

During any calendar quarter, for beta air dose:

$$D_{v\beta} = 3.17 E-08 \sum_i \left[N_i (X/Q)_v Q_{iv} \right] \leq 10 \text{ mrad}$$

(Equation 15A)

Where:

M_i = the air dose factor due to gamma emissions for each identified noble gas radionuclide in mrad/yr per $\mu\text{Ci}/\text{m}^3$ from Table 5-3

N_i = the air dose factor due to beta emissions for each identified noble gas radionuclide in mrad/yr per $\mu\text{Ci}/\text{m}^3$ from Table 5-3

$(X/Q)_V$ = for vent releases. The highest calculated annual average relative concentration for any area at or beyond the unrestricted area boundary in sec/m^3 .

D_γ = the total gamma air dose from gaseous effluents in mrad.

D_β = the total beta air dose from gaseous effluents in mrad.

Q_{iV} = the release of noble gas radionuclides, i, in gaseous effluents from vents in μCi . Releases shall be cumulative over the time period.

$3.17\text{E}-08$ = the inverse of the number of seconds in a year

The dose to an individual from I-131, I-133, tritium and all radioactive materials in particulate form with half-lives greater than 8 days in gaseous effluents released from the site to unrestricted areas shall be determined using the following expression:

dose during any calendar year:

$$D_I = 3.17 \text{ E} - 08 \sum_i \left[R_i W_v Q_{iv} \right] \leq 15 \text{ mrem}$$

Equation (16)

dose during any calendar quarter:

$$D_I = 3.17 \text{ E} - 08 \sum_i \left[R_i W_v Q_{iv} \right] \leq 7.5 \text{ mrem}$$

(Equation 16A)

Where:

D_I = the total dose from I-131, I-133, tritium and all radioactive materials in particulate form with half-lives greater than 8 days in gaseous effluents in mrem.

R_i = the dose factor for each identified radionuclide (i) in m^{-2} mrem/yr per $\mu\text{Ci}/\text{sec}$ or mrem/ yr per $\mu\text{Ci}/\text{m}^3$ from Table 5-5.

W_v = the annual average dispersion parameter for estimating the dose to an individual at the critical location in sec/m^3 for the inhalation pathway and in

m^{-2} for the food and ground pathways.

Q_{iv} = the release of I-131, I-133, tritium and all radioactive materials in particulate form in gaseous effluents with half-lives greater than 8 days in μCi . Releases shall be cumulative over the desired time period as appropriate.

Table 5-3
Dose Factors to the Child For Noble Gases and Daughters*

Radio-nuclides	Total Body Dose Factor K_i (mrem/yr per $\mu\text{Ci}/\text{m}^3$)	Skin Dose Factor L_i (mrem/yr per $\mu\text{Ci}/\text{m}^3$)	Gamma Air Dose Factor M_i (mrad/yr per $\mu\text{Ci}/\text{m}^3$)	Beta Air Dose Factor N_i (mrad/yr per $\mu\text{Ci}/\text{m}^3$)
Kr-83m	7.56E-02**	----	1.93E+01	2.88E+02
Kr-85m	1.17E+03	1.46E+03	1.23E+03	1.97E+03
Kr-85	1.61E+01	1.34E+03	1.72E+01	1.95E+03
Kr-87	5.92E+03	9.73E+03	6.17E+03	1.03E+04
Kr-88	1.47E+04	2.37E+03	1.52E+04	2.93E+03
Kr-89	1.66E+04	1.01E+04	1.73E+04	1.06E+04
Kr-90	1.56E+04	7.29E+03	1.63E+04	7.83E+03
Xe-131m	9.15E+01	4.76E+02	1.56E+02	1.11E+03
Xe-133	2.94E+02	3.06E+02	3.53E+02	1.05E+03
Xe-133m	2.51E+02	9.94E+02	3.27E+02	1.48E+03
Xe-135m	3.12E+03	7.11E+02	3.36E+03	7.39E+02
Xe-135	1.81E+03	1.86E+03	1.92E+03	2.46E+03
Xe-137	1.42E+03	1.22E+04	1.51E+03	1.27E+04
Xe-138	8.83E+03	4.13E+03	9.21E+03	4.75E+03
Ar-41	8.84E+03	2.69E+03	9.30E+03	3.28E+03
<p>* The listed dose factors are for radionuclides that may be detected in gaseous effluents. These dose factors for noble gases and daughter nuclides are taken from Table B-1 of Regulatory Guide 1.109 (Reference 3). A semi-infinite cloud is assumed.</p> <p>** $7.56\text{E}-02 = 7.56 \times 10^{-2}$</p>				

Table 5-4

Dose Parameters for Radionuclides and Radioactive Particulate, Gaseous Effluents*

Radio-nuclides	P _i Inhalation Pathways (mrem/yr per $\mu\text{Ci}/\text{m}^3$)	P _i Food & Ground Pathways ($\text{m}^2 \times$ mrem/yr per $\mu\text{Ci}/\text{sec}$)	Radio-nuclides	P _i Inhalation Pathways (mrem/yr per $\mu\text{Ci}/\text{m}^3$)	P _i Food & Ground Pathways ($\text{m}^2 \times$ mrem/yr per $\mu\text{Ci}/\text{sec}$)
H-3	6.5E+02	2.4E+03	Cd-115m	7.0E+04	4.8E+07
C-14	8.9E+03	1.3E+09	Sn-126	1.2E+06	1.1E+09
Cr-51	3.6E+02	1.1E+07	Sb-125	1.5E+04	1.1E+09
Mn-54	2.5E+04	1.1E+09	Te-127m	3.8E+04	7.4E+10
Fe-59	2.4E+04	7.0E+08	Te-129m	3.2E+04	1.3E+09
Co-58	1.1E+04	5.7E+08	Te-132	1.0E+03	7.2E+07
Co-60	3.2E+04	4.6E+09	Cs-134	7.0E+05	5.3E+10
Zn-65	6.3E+04	1.7E+10	Cs-136	1.3E+05	5.4E+09
Rb-86	1.9E+05	1.6E+10	Cs-137	6.1E+05	4.7E+10
Sr-89	4.0E+05	1.0E+10	Ba-140	5.6E+04	2.4E+08
Sr-90	4.1E+07	9.5E+10	Ce-141	2.2E+04	8.7E+07
Y-91	7.0E+04	1.9E+09	Ce-144	1.5E+05	6.5E+08
Zr-95	2.2E+04	3.5E+08	Np-239	2.5E+04	2.5E+06
Nb-95	1.3E+04	3.6E+08	I-131	1.5E+07	1.1E+12
Mo-99	2.6E+02	3.3E+08	I-133	3.6E+06	9.6E+09
Ru-103	1.6E+04	3.4E+10	Unidentified	4.1E+07	9.5E+10
Ru-106	1.6E+05	4.4E+11	----	----	----
Ag-110m	3.3E+04	1.5E+10	----	----	----

* The listed dose parameters are for radionuclides that may be detected in gaseous effluents. These and additional dose parameters for isotopes not included in Table 5-4 may be calculated using the methodology described in NUREG-0133, Section 5.2.1 (Reference 2).

Table 5-5
Pathway Dose Factors Due to Radionuclides Other Than Noble Gases *

Radio-nuclides	Inhalation Pathway R_i (mrem/yr per $\mu\text{Ci}/\text{m}^3$)	Meat Pathway R_i ($\text{m}^2 \times \text{mrem}/\text{yr}$ per $\mu\text{Ci}/\text{sec}$)	Ground Plane Pathway R_i ($\text{m}^2 \times \text{mrem}/\text{yr}$ per $\mu\text{Ci}/\text{sec}$)	Cow-Milk-Child Pathway R_i ($\text{m}^2 \times \text{mrem}/\text{yr}$ per $\mu\text{Ci}/\text{sec}$)	Leafy Vegetables Pathway R_i ($\text{m}^2 \times \text{mrem}/\text{yr}$ per $\mu\text{Ci}/\text{sec}$)
H-3	1.12E+03	2.33E+02	0	2.38E+03	2.47E+02
Cr-51	1.70E+04	4.98E+05	5.31E+06	5.75E+06	1.63E+06
Mn-54	1.57E+06	7.60E+06	1.56E+09	3.70E+07	5.38E+07
Fe-59	1.27E+06	6.49E+08	3.09E+08	4.01E+08	1.10E+08
Co-58	1.10E+06	9.49E+07	4.27E+08	7.01E+07	4.55E+07
Co-60	7.06E+06	3.61E+08	2.44E+10	2.25E+08	1.54E+08
Zn-65	9.94E+05	1.05E+09	8.28E+08	1.99E+10	2.24E+08
Sr-89	2.15E+06	4.89E+08	2.42E+04	1.28E+10	5.39E+09
Sr-90	1.01E+08	1.01E+10	0	1.19E+10	9.85E+10
Zr-95	2.23E+06	6.09E+08	2.73E+08	8.76E+05	1.13E+08
I-131	1.62E+07	2.60E+09	1.01E+07	4.95E+11	2.08E+10
I-133	3.84E+06	6.45E+01	1.43E+06	4.62E+09	3.88E+08
Cs-134	1.01E+06	1.42E+09	7.70E+09	6.37E+10	1.96E+09
Cs-136	1.71E+05	5.06E+07	1.64E+08	6.61E+09	1.60E+08
Cs-137	9.05E+05	1.27E+09	1.15E+10	5.75E+10	1.80E+09
Ba-140	1.74E+06	5.00E+07	2.26E+07	2.75E+08	2.03E+08
Ce-141	5.43E+05	1.45E+07	1.48E+07	1.43E+07	8.99E+07

* Additional dose factors for isotopes not included in Table 5-5 may be calculated using the methodology described in NUREG-0133, Section 5.3.1(reference 2).

6.0 RADIOACTIVE EFFLUENT MONITORING INSTRUMENTATION

6.1 LIQUID EFFLUENT MONITORS

6.1.1 CONTROLS

The radioactive liquid effluent monitoring instrumentation channels shown in Table 6.1-1 shall be OPERABLE with their Alarm/Trip setpoints set to ensure that the limits of Section 4.1.1 (Radioactive Liquid Effluents - Controls) are not exceeded. The Alarm/Trip setpoints of these channels shall be determined and adjusted in accordance with the methodology and parameters in the ODCM.

6.1.2 APPLICABILITY: At all times.

Note: The Radioactive Effluent Monitoring Instrumentation may be removed from service for short periods of time without the instrumentation being considered inoperable for monthly/quarterly testing. Preventative/ corrective maintenance or calibrations require instrumentation to be declared inoperable.

6.1.3 ACTION:

With a radioactive liquid effluent monitoring instrumentation channel Alarm/ Trip setpoint less conservative than required by the above control, immediately suspend the release of radioactive liquid effluents monitored by the affected channel, or declare the channel inoperable, or change the setpoint so it is acceptably conservative.

6.1.4 ACTION:

With less than the minimum number of radioactive liquid effluent monitoring instrumentation channels OPERABLE, take the ACTION shown in Table 6.1-1. Restore the minimum number of instrumentation channels to OPERABLE status within 30 days or explain in the next Annual Radioactive Effluent Release Report, pursuant to Section 6.2 of the ODCM, why this inoperability was not corrected in a timely manner.

6.1.5 SURVEILLANCE REQUIREMENTS

Each radioactive liquid effluent monitoring instrumentation channel shall be demonstrated OPERABLE by performance of the CHANNEL CHECK, SOURCE CHECK, CHANNEL CALIBRATION, and CHANNEL FUNCTIONAL TEST at the frequencies shown in Table 6.1-2.

6.1.6 BASES

The radioactive liquid effluent instrumentation is provided to monitor and control, as applicable, the releases of radioactive materials in liquid effluents during actual or potential releases of liquid effluents. The Alarm/Trip setpoints for these instruments shall be calculated and adjusted in accordance with the methodology and parameters in the ODCM to ensure that the Alarm/Trip will occur prior to exceeding the limits of 10 CFR 20.

The OPERABILITY and use of this instrumentation is consistent with the requirements of General Design Criteria 60, 63 and 64 of Appendix A to 10 CFR 50.

Table 6.1-1

Radioactive Liquid Effluent Monitoring Instrumentation

Gross Activity Monitors (Liquid)	Minimum Channels OPERABLE	Action
a. Containment Fan Coolers (R-16)	1	1
b. Liquid Radwaste (R-18)	1	2
c. Steam Generator Blowdown (R-19)	1(a)	3
d. Spent Fuel Pool Heat Exchanger (R-20A, R-20B)	1	1
e. Turbine Building Floor Drains (R-21)	1	1
f. High Conductivity Waste (R-22)	1	2

**Table 6.1-1
Table Notation**

(a) Not required when steam generator blowdown is being recovered, i.e. not released.

Action 1 If the number of OPERABLE channels is less than required by the Minimum Channels OPERABLE requirement, effluent releases via this pathway may continue provided that at least once per 24 hours grab samples are analyzed for isotopic concentration or gross radioactivity (beta or gamma) at a lower limit of detection (LLD) of at most $1.0E-07$ $\mu\text{Ci/gm}$.

Action 2 If the number of OPERABLE channels is less than required by the minimum Channels OPERABLE requirement, effluent releases from the tank may continue, provided that prior to initiating a release:

Note: When counting 2 independent samples for agreement, doubling the acceptance criterion for low ($< 6.0E-05$ $\mu\text{Ci/ml}$) activity samples from 10% to 20% results in a consequence at the release point of $< 1\%$. The expanded acceptable criterion for low activity samples is employed to compensate for increased impact of sampling and counting error on acceptance.

1. At least two independent samples of the tank's contents, taken at least 60 minutes apart, are analyzed and agree within 10% of total activity, (20% if total activity minus noble gases $< 6.0E-05$ $\mu\text{Ci/ml}$), and
2. At least two technically qualified members of the Facility Staff independently review and approve the analytical results, and
3. At least two technically qualified members of the Facility Staff independently verify the discharge line valving.

Action 3 When Steam Generator Blowdown is being released (not recycled) and the number of channels OPERABLE is less than required by the Minimum Channels OPERABLE requirement, effluent releases via this pathway may continue provided grab samples are analyzed for isotopic concentration at a lower limit of detection (LLD) of at most $1.0E-07$ $\mu\text{Ci/gram}$:

1. At least once per 8 hours when the concentration of the secondary coolant is > 0.01 $\mu\text{Ci/gram}$ (DOSE EQUIVALENT I-131).
2. At least once per 24 hours when the concentration of the secondary coolant is ≤ 0.01 $\mu\text{Ci/gram}$ (DOSE EQUIVALENT I-131).

Table 6.1-2

Radioactive Liquid Effluent Monitoring SURVEILLANCE REQUIREMENTS

Gross Activity Monitor (Liquid)	Channel Check	Source Check	Functional Test	Channel Calibration
a. Containment Fan Coolers (R-16)	D(e)	M(c)	Q(b)	R(d)
b. Liquid Radwaste (R-18)	D(e)	M(c)	Q(a)	R(d)
c. Steam Generator Blowdown (R-19)	D(e)	M(c)	Q(a)	R(d)
d. Spent Fuel Pool Heat Exchanger (R-20A, R-20B)	D(e)	M(c)	Q(b)	R(d)
e. Retention Tank (R-21)	D(e)	M(c)	Q(a)	R(d)
f. High Conductivity Waste (R-22)	D(e)	M(c)	Q(a)	R(d)
g. Dilution Flow Rate Determination	N.A.	N.A.	N.A.	R(f)

Table 6.1-2**Table Notation**

- (a) The FUNCTIONAL Test shall also demonstrate that automatic isolation of this pathway and control room alarm will occur if any of the following conditions exist:
 - 1. Instrument indicates measured levels above the alarm and/or trip setpoint.
 - 2. Power failure. (Verified in same functional test as Alarm/Trip setpoint due to normally energized relay)

- (b) The FUNCTIONAL Test shall also demonstrate that control room alarm occurs if any of the following conditions exist.
 - 1. Instrument indicates measured levels above the alarm setpoint.
 - 2. Power failure. (Verified in same functional test as Alarm setpoint due to normally energized relay)

- (c) This check may require the use of an external source due to high background in the sample chamber.

- (d) Source used for the CHANNEL CALIBRATION shall be traceable to the National Institute for Standards and Technology (NIST) or shall be obtained from suppliers (e.g., Analytics) that provide sources traceable to other officially designated standards agencies.

- (e) Applies only during releases via this pathway.

- (f) Flow rate for the discharge canal dilution, which is applied to all liquid effluent pathways, shall be determined at the frequency specified.

6.2 GASEOUS EFFLUENT MONITORS

6.2.1 CONTROLS

The radioactive gaseous effluent monitoring instrumentation channels shown in Table 6.2-1 shall be OPERABLE with their Alarm/Trip setpoints set to ensure that the limits of Control Section 5.2.1 (Dose Rate - Controls) are not exceeded. The Alarm/ Trip setpoints of these channels meeting Control Section 5.2.1 (Dose Rate - Controls) shall be determined and adjusted in accordance with the methodology and parameters in the ODCM.

6.2.2 APPLICABILITY: As shown in Table 6.2-1

Note: The Radioactive Effluent Monitoring Instrumentation may be removed from service for short periods of time without the instrumentation being considered inoperable for weekly grab filter or cartridge changes or monthly/quarterly testing, with the exception of the R-10A, R-11, R-12 skid. Preventative/corrective maintenance, calibrations, and moving filter replacements require instrumentation to be declared inoperable.

6.2.3 ACTION:

With a radioactive gaseous effluent monitoring instrumentation channel Alarm/Trip setpoint less conservative than required by the above specification, immediately declare the channel inoperable.

6.2.4 ACTION:

With less than the minimum number of radioactive gaseous effluent monitoring instrumentation channels OPERABLE, take the ACTION shown in Table 6.2-1. Restore the minimum number of instrumentation channels to OPERABLE status within 30 days or, if not, explain in the next Annual Radioactive Effluent Release Report, pursuant to Section 6.2 of the ODCM, why this inoperability was not corrected in a timely manner.

6.2.5 SURVEILLANCE REQUIREMENTS

Each radioactive gaseous effluent monitoring instrumentation channel shall be demonstrated OPERABLE by performance of the CHANNEL CHECK, SOURCECHECK, CHANNEL CALIBRATION, and CHANNEL FUNCTIONAL TEST at the frequencies shown in Table 6.2-2.

6.2.6 BASES

The radioactive gaseous effluent instrumentation is provided to monitor and control, as applicable, the releases of radioactive materials in gaseous effluents during actual or potential releases of gaseous effluents. The Alarm/Trip setpoints

for these instruments shall be calculated and adjusted in accordance with the methodology and parameters in the ODCM to ensure that the Alarm/Trip will occur prior to exceeding the limits of 10 CFR 20. The OPERABILITY and use of this instrumentation is consistent with the requirements of General Design Criteria 60, 63, and 64 of Appendix A to 10 CFR 50.

Table 6.2-1

Radioactive Gaseous Effluent Monitoring Instrumentation

Plant Ventilation (a)(h)		Minimum Channels OPERABLE	Action
a.	Iodine sampler (R-10B or R-14AIODN)	1 (i)	1
b.	Particulate Sampler (R-13 or R-14APART)	1 (i)	1
c.	Noble Gas Activity (R-14 or R-14AGAS)	1 (b)	2
d.	Containment Noble Gas Activity (R-12) or Containment Particulate Sampler (R-11)	1 (d,e)	3
Containment Purge (c)(h)		Minimum Channels OPERABLE	Action
a.	Iodine Sampler (R-10A or R-12AIODN)	1 (i)	1
b.	Particulate Sampler (R-11 or R-12APART)	1 (f)	5
c.	Noble Gas Activity (R-12 or R-12AGAS)	1 (f)	5
Air Ejector Monitor (g)(h)		Minimum Channels OPERABLE	Action
Noble Gas Activity (R-15 or R-47)		1	4

Table 6.2-1**Table Notation**

- (a) Required at all times.
- (b) Only radiation monitor R-14 has an isolation signal. If R-14AGAS is being used to monitor batch gas releases, the contents of the tank(s) may be released to the environment provided that prior to initiating the release:
 - 1. At least two independent samples of the tank's contents are analyzed, and
 - 2. At least two technically qualified members of the facility staff independently verify the release rate calculations and discharge valve lineup.
- (c) Required in MODES 5 and 6.
- (d) The mini-purge system allows the release of Containment atmosphere through the plant vent. 10 CFR 100 type releases via mini-purge are limited by an isolation signal generated from Safety Injection. 10 CFR 20 releases through the mini-purge are considered to be similar to other plant ventilation releases and are monitored by R-14, R-13 and R-10B. R-14A may be used as a substitute for R-14 since automatic isolation is available from the R-11 or R-12 monitors if the activity in Containment increases. Therefore, either R-11 or R-12 is required to sample Containment during a mini-purge release. Automatic isolation of mini-purge for 10 CFR part 20 type releases is considered unnecessary due to the low flow associated with mini-purge, the continuous monitoring from R-11 or R-12 and the original measurement before the purge begins. To ensure the Containment sample monitored by R-11 or R-12 is representative of the containment atmosphere, at least one containment recirculation fan is required to be in operation during mini-purge operation.
- (e) If the R-10A, R-11, R-12 skid is not OPERABLE, it is possible to substitute the R-10B, R-13, R-14 skid when the R-14A skid is OPERABLE. The setpoints for the R-10A, R-11, R-12 skid would be used. There would be no automatic containment isolation capability from the radioactive effluent monitoring instrumentation when using R-10B, R-13, R-14 skid for containment leakage measurements. This cannot be used if Containment Ventilation Isolation is required.
- (f) If containment ventilation isolation instrumentation is required by LCO 3.3.5 for core alteration or movement of irradiated fuel in containment, R-12A skid cannot be used in place of the R-10A, R-11, R-12 skid.
- (g) Required only when Air Ejector is operating.
- (h) Gaseous effluent monitors are not considered inoperable due to changes in ventilation flow. Reduced flow in the ventilation makes the monitor setpoint more conservative.

- (i) Minimum channels OPERABLE for Plant Vent Iodine, Plant Vent Particulate, and Containment Purge Iodine, refers to the sample collection system - not the radiation monitor.

- Action 1** If the number of OPERABLE channels is less than required by the Minimum Channels OPERABLE requirement, effluent releases via this pathway may continue provided iodine and particulate samples are continuously collected with alternate sampling equipment as required in Table 6.2-1. This should be completed within one hour.
- Action 2** If the number of OPERABLE channels is less than required by the Minimum Channels OPERABLE requirement, continuous effluent releases via this pathway may continue provided grab samples are taken and analyzed for isotopic activity at least once per 8 hours. No batch gas releases are to be made with operable channels less than required minimum channels operable.
- Action 3** If the number of OPERABLE channels is less than required by the Minimum Channels OPERABLE requirement, or at least one containment recirc fan cooler is not in operation, within 1 hour terminate any mini-purge release in process.
- Action 4** If the number of OPERABLE Channels is less than required by the Minimum Channels OPERABLE requirement and the Secondary Activity is $\leq 1.0E-04 \mu\text{Ci/gm}$, effluent releases may continue via this pathway provided grab samples are analyzed for isotopic concentration at least once per 24 hours. If the secondary activity is $> 1.0E-04 \mu\text{Ci/gm}$, effluent releases via this pathway may continue for up to 31 days provided grab samples are taken every 8 hours and analyzed within 24 hours.
- Action 5** If the number of OPERABLE channels is less than required by the Minimum Channels Operable requirement, terminate the purge within 1 hour. Also refer to LCO 3.3.5 if core alterations or movement of irradiated fuel in containment is in progress.

Table 6.2-2

Radioactive Gaseous Effluent Monitoring SURVEILLANCE REQUIREMENTS

Plant Ventilation		Channel Check	Source Check	Functional Test	Channel Calibration
a.	Iodine Sampler (R-10B)	W(e)	N.A.	N.A.	R(c)
b.	Iodine Sampler (R-14AIODN)	W(e)	N.A.	N.A.	R(c)
c.	Particulate Sampler (R-13)	W(e)	N.A.	N.A.	R(c)
d.	Particulate Sampler (R-14APART)	W(e)	N.A.	N.A.	R(c)
e.	Noble Gas Activity (R-14)	D(e)	M	Q(a)	R(c)
f.	Noble Gas Activity (R-14AGAS)	D(e)	M	Q(b)	R(c)
g.	Flow Rate Determination	N.A.	N.A.	N.A.	R(d)
Containment Purge					
Containment Purge		Channel Check	Source Check	Functional Test	Channel Calibration
a.	Iodine Sampler (R-10A)	W(e)	N.A.	N.A.	R(c)
b.	Iodine Sampler (R-12AIODN)	W(e)	N.A.	N.A.	R(c)
c.	Particulate Sampler (R-11)	W(e)	M	Q(a)	R(c)
d.	Particulate Sampler (R-12APART)	W(e)	M	Q(b)	R(c)
e.	Noble Gas Activity (R-12)	D(e)	M	Q(a)	R(c)
f.	Noble Gas Activity (R-12AGAS)	D(e)	M	Q(b)	R(c)
g.	Flow Rate Determination	N.A.	N.A.	N.A.	6Y(d)
Air Ejector Monitor					
Air Ejector Monitor		Channel Check	Source Check	Functional Test	Channel Calibration
a.	Noble Gas Activity (R-15)	D(e)	M	Q(b)	R(c)
b.	Noble Gas Activity (R-47)	D(e)	M	Q(b)	R(c)
c.	Flow Rate Determination	N.A.	N.A.	N.A.	R(f)

Table 6.2-2**Table Notation**

- (a) The FUNCTIONAL TEST shall also demonstrate that automatic isolation of this pathway and control room alarm occur if any of the following conditions exist:
 - 1. Instrument indicates measured levels above the alarm and/or trip setpoint.
 - 2. Power failure. (Verified in same functional test as Alarm/Trip Setpoint due to normally energized relay)

- (b) The FUNCTIONAL TEST shall also demonstrate that control room alarm occurs if any of the following conditions exist:
 - 1. Instrument indicates measured levels above the alarm setpoint.
 - 2. Power failure. (Verified in same functional test as Alarm Setpoint due to normally energized relay)

- (c) Source used for the Channel Calibration shall be traceable to the National Institute for Standards and Technology (NIST) or shall be obtained from suppliers (e.g., Amersham) that provide sources traceable to other officially designated standards agencies.

- (d) Flow rate for main plant ventilation exhaust and containment purge exhaust are calculated by the flow capacity of ventilation exhaust fans in service and shall be determined at the frequency specified.

- (e) Applies only during releases via this pathway.

- (f) Flow rate of the Air Ejector vent shall be determined with the plant in operation, at the frequency specified.

6.3 RADIATION ACCIDENT MONITORING INSTRUMENTATION

6.3.1 CONTROLS:

The radiation accident monitoring instrumentation channels shown in Table 6.3-1 shall be OPERABLE according to the following schedule:

6.3.2 APPLICABILITY:

1. Containment Purge (R-12A) - Modes 5 and 6 when the purge flanges are removed.
2. Plant Vent (R-14A) - All modes
3. Air Ejector (R-47 and R-48) - When air ejector is operating
4. A Main Steam Line (R-31) - Modes 1, 2, and 3
5. B Main Steam Line (R-32) - Modes 1, 2, and 3

Note: The Radiation Accident Monitoring Instrumentation may be removed from service for short periods of time without the instrumentation being considered inoperable for weekly grab filter or cartridge changes. Preventative maintenance and calibrations require instrumentation to be declared inoperable.

6.3.4 ACTION:

With less than the minimum number of radiation accident monitoring instrumentation channels OPERABLE, take the ACTION shown in Table 6.3-1.

6.3.5 SURVEILLANCE REQUIREMENTS:

1. Each radiation accident monitoring instrumentation channel shall be demonstrated OPERABLE by performance of the CHANNEL CHECK and CHANNEL CALIBRATION at the frequencies shown in Table 6.3-2.

6.3.6 BASES:

Radiation accident monitoring instrumentation is provided to monitor, as applicable, the releases of radioactive materials in gaseous effluents during actual or potential releases of gaseous effluents. The Alarm setpoints for these instruments shall be calculated and adjusted in accordance with the methodology and parameters in the ODCM to ensure that the Alarm will occur prior to exceeding the limits of 10 CFR 20. The OPERABILITY and use of this instrumentation is consistent with the requirements of General Design Criteria 60, 63, and 64 of Appendix A to 10 CFR 50.

Table 6.3-1

Radiation Accident Monitoring Instrumentation

Instrument		Minimum Channels Operable	Action
a.	Containment Purge Beta Particulate (R-12APART)	1(a)	1
	Containment Purge Iodine (R-12AIODN)	1(a)	1
	Containment Purge Gas (R-12AGAS)	1(a)	1
b.	Plant Vent Beta Particulate (R-14APART)	1	1
	Plant Vent Iodine (R-14AIODN)	1	1
	Plant Vent Gas (R-14AGAS)	1	1
c.	Air Ejector Low-range Gas (R-47)	1	1,2
	Air Ejector/Gland Seal Exhaust High-range Gas (R-48)	1	1
d.	A Main Steam Line (R-31)	1	1
e.	B Main Steam Line (R-32)	1	1

Table 6.3-1**Table Notation**

- (a) Only when the shutdown purge flanges are removed; otherwise, instrumentation kept in STANDBY mode.

Action 1 With the number of OPERABLE channels less than required by the Minimum Channels OPERABLE requirements, either restore the inoperable channel(s) to OPERABLE status within 30 days of the event, or if not restored, prepare and submit, within the following 14 days, a Special Report to the Commission outlining the action taken, the cause of the inoperability and the plans and schedule for restoring the system to OPERABLE status. If the channel(s) is inoperable greater than 7 days but less than 30 days, report the cause of the inoperability and the actions taken in the Annual Radioactive Effluent Release Report.

Action 2 R-47 is relied upon to trend and quantify primary-to-secondary leakage. If R-47 is not OPERABLE with the air ejector in service, then enter procedures CH-RETS-RMS-INOP and CH-360.

Table 6.3-2

Radiation Accident Monitoring Surveillance Requirements

Radiation Accident Monitoring Instrumentation	Channel Check	Channel Calibration
a. Containment Purge (R-12A)	M	R(a)
b. Plant Vent (R-14A)	M	R(a)
c. Air Ejector (R-47)	M	R(a)
d. Air Ejector/Gland Seal Exhaust (R-48)	M	R(a)
e. A Main Steam Line (R-31)	M	R(a)
f. B Main Steam Line (R-32)	M	R(a)
(a) Source used for the CHANNEL CALIBRATION shall be traceable to the National Institute for Standards and Technology (NIST) or shall be obtained from suppliers (e.g., Analytics) that provide sources traceable to other officially designated standards agencies.		

6.4 AREA RADIATION MONITORS

6.4.1 SURVEILLANCE REQUIREMENTS:

CHANNEL CALIBRATION, CHANNEL CHECK, and a FUNCTIONAL TEST of the area radiation monitors shall be performed as specified in Table 6-4.

Table 6-4

Area Radiation Monitor Surveillance Requirements

Instrument		Channel Check	Functional Test	Channel Calibration
a.	Control Room R-1	D	Q	R
b.	Containment R-2	D	Q	R
c.	Radiochemistry Lab R-3	D	Q	R
d.	Charging Pump Room R-4	D	Q	R
e.	Spent Fuel Pool R-5	D	Q	R
f.	Nuclear Sample Room R-6	D	Q	R
g.	Incore Detector Area R-7	D	Q	R
h.	Drumming Station R-8	D	Q	R
i.	Letdown Line Monitor R-9	D	Q	R
j.	Component Cooling Water Heat Exchanger * R-17	D	Q	R
k.	AVT D Mixed Bed R-26	N.A.	Q	N.A.
l.	Nuclear Sample Room Wide Range Monitor R-33	N.A.	Q	N.A.
m.	Containment Spray Pump Wide Range Area Monitor R-34	N.A.	Q	N.A.
n.	PASS Panel Wide Range Area Monitor R-35	N.A.	Q	N.A.
<p>* While not an area monitor by strict definition, it serves as an indicator of internal leakage and provides an isolation signal for the component cooling system.</p>				

7.0 RADWASTE TREATMENT

7.1 LIQUID RADWASTE TREATMENT SYSTEM

7.1.1 CONTROLS:

The Liquid Radwaste Treatment System shall be OPERABLE and appropriate portions of the system shall be used to reduce releases of radioactivity when the projected doses due to the liquid effluent to UNRESTRICTED AREAS would exceed 0.06 mrem to the whole body or 0.2 mrem to any organ in a 31 day period.

7.1.2 APPLICABILITY: At all times.

7.1.3 ACTION:

With radioactive liquid waste being discharged without treatment and in excess of the above limits and any portion of the Liquid Radwaste Treatment System which could reduce the radioactive liquid waste discharged not in operation, prepare and submit to the Commission within 30 days a Special Report that includes the following information:

1. Explanation of why liquid radwaste was being discharged without treatment, identification of any inoperable equipment or subsystems, and the reason for the inoperability.
2. Action(s) taken to return the inoperable equipment to OPERABLE status, and
3. Summary description of action(s) taken to prevent recurrence.

7.1.4 SURVEILLANCE REQUIREMENTS:

1. Doses due to liquid releases to UNRESTRICTED AREAS shall be projected at least once per 31 days in accordance with the methodology and parameters in the ODCM when Liquid Radwaste Treatment Systems are not being fully utilized.
2. The installed Liquid Radwaste Treatment System shall be considered OPERABLE by meeting Section 4.1.1 (Radioactive Liquid Effluents - Controls) and Section 4.2.1 (Dose - Controls).

7.1.5 BASES:

The OPERABILITY of the Liquid Radwaste Treatment System ensures that this system will be available for use whenever liquid effluents require treatment prior to release to the environment. The requirement that the appropriate portions of this system be used when specified provides assurance that the releases of radioactive materials in liquid effluents will be kept "as low as is reasonably achievable". This specification implements the requirements of 10 CFR 50.36a,

General Design Criterion 60 of Appendix A to 10 CFR 50, and the design objective given in Section II.D of Appendix I to 10 CFR 50. The specified limits governing the use of the appropriate portions of the Liquid Radwaste Treatment System were specified as a suitable fraction of the dose design objectives set forth in Section II.A of Appendix A to 10 CFR 50 for liquid effluents.

Figure 7-1

Liquid Radwaste Treatment Systems Effluent Paths and Controls

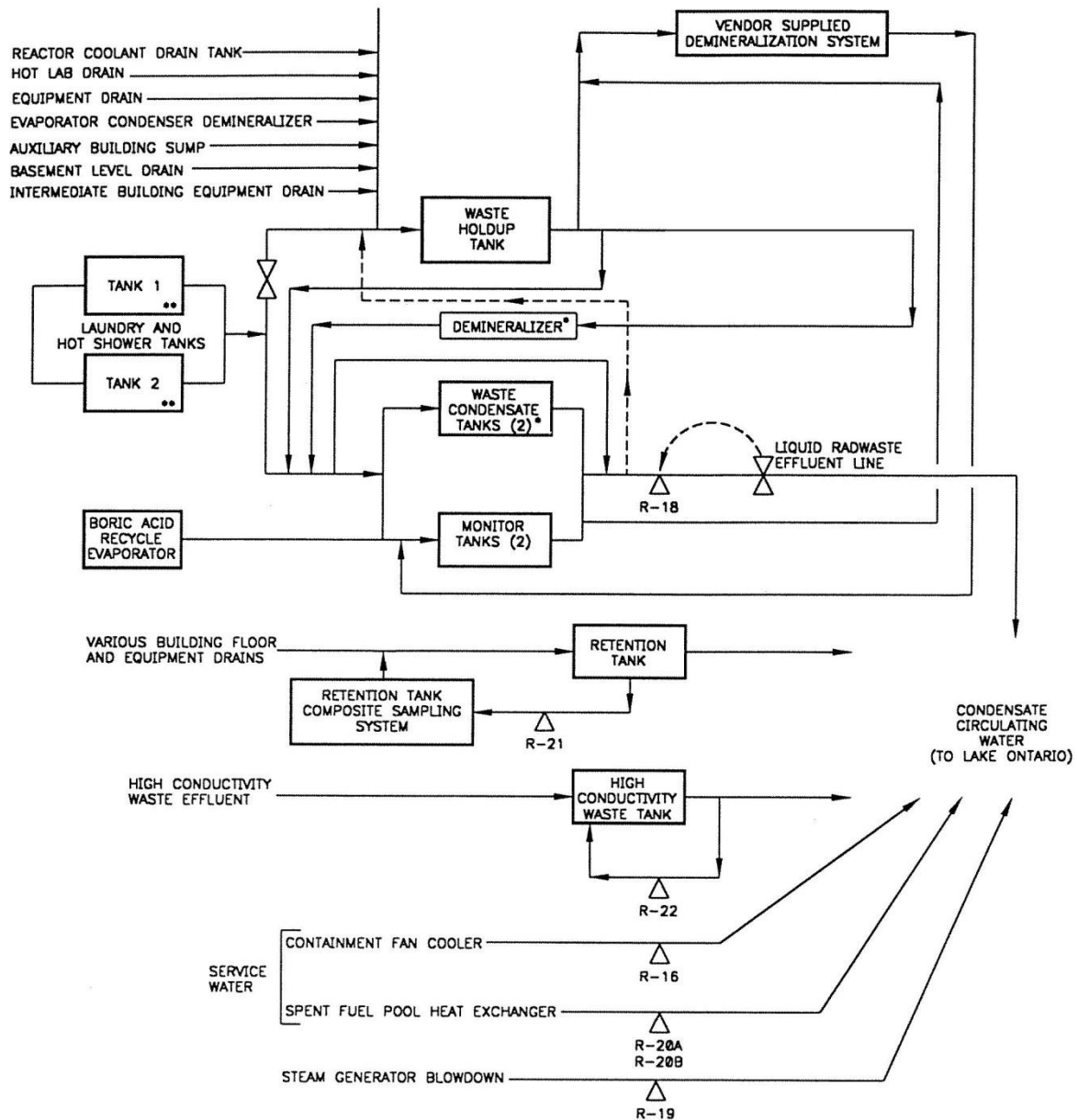

- USE OF THE DEMINERALIZER AND WASTE CONDENSATE TANKS WAS DISCONTINUED IN 1990.
- USE OF THE LAUNDRY WAS DISCONTINUED IN 1994.

7.2 GASEOUS RADWASTE TREATMENT SYSTEM

7.2.1 CONTROLS

The Gaseous Radwaste Treatment System and the Ventilation Exhaust Treatment System shall be OPERABLE and appropriate portions of these systems shall be used to reduce releases of radioactivity when the projected doses in 31 days due to gaseous effluent releases to areas at and beyond the SITE BOUNDARY would exceed:

1. 0.2 mrad to air from gamma radiation, or
2. 0.4 mrad to air from beta radiation, or
3. 0.3 mrem to any organ of a MEMBER OF THE PUBLIC

7.2.2 APPLICABILITY: At all times.

7.2.3 ACTION:

With radioactive gaseous waste being discharged without treatment and in excess of the above limits, prepare and submit to the Commission within 30 days a Special Report that includes the following information:

1. Explanation of why gaseous radwaste was being discharged without treatment, identification of any inoperable equipment or subsystems, and the reason for the inoperability,
2. Action(s) taken to restore the inoperable equipment to OPERABLE status, and
3. Summary description of action(s) taken to prevent recurrence.

7.2.4 SURVEILLANCE REQUIREMENTS:

1. Doses due to gaseous releases to areas at and beyond the SITE BOUNDARY shall be projected at least once per 31 days in accordance with the methodology and parameters in the ODCM when Gaseous Radwaste Treatment Systems are not being fully utilized.
2. The installed GASEOUS RADWASTE TREATMENT SYSTEM and VENTILATION EXHAUST TREATMENT SYSTEM shall be considered OPERABLE by meeting Sections 5.2.1, 5.3.1, and 5.3.7 (Controls).

7.2.5 BASES:

The OPERABILITY of the Gaseous Radwaste Treatment System and the Ventilation Exhaust Treatment System ensures that the systems will be available for use whenever gaseous effluents require treatment prior to release to the environment. The requirement that the appropriate portions of these systems be used, when specified, provides reasonable assurance that the releases of radioactive materials in gaseous effluents will be kept "as low as is reasonably achievable". This Control implements the requirements of 10 CFR 50.36a,

General Design Criterion 60 of Appendix A to 10 CFR 50, and the design objectives given in Section II.D of Appendix I to 10 CFR 50. The specified limits governing the use of appropriate portions of the systems were specified as a suitable fraction of the dose design objectives set forth in Sections II.B and II.C of Appendix I to 10 CFR 50, for gaseous effluents.

Figure 7-2

Gaseous Radwaste Treatment Systems Effluent Paths and Controls

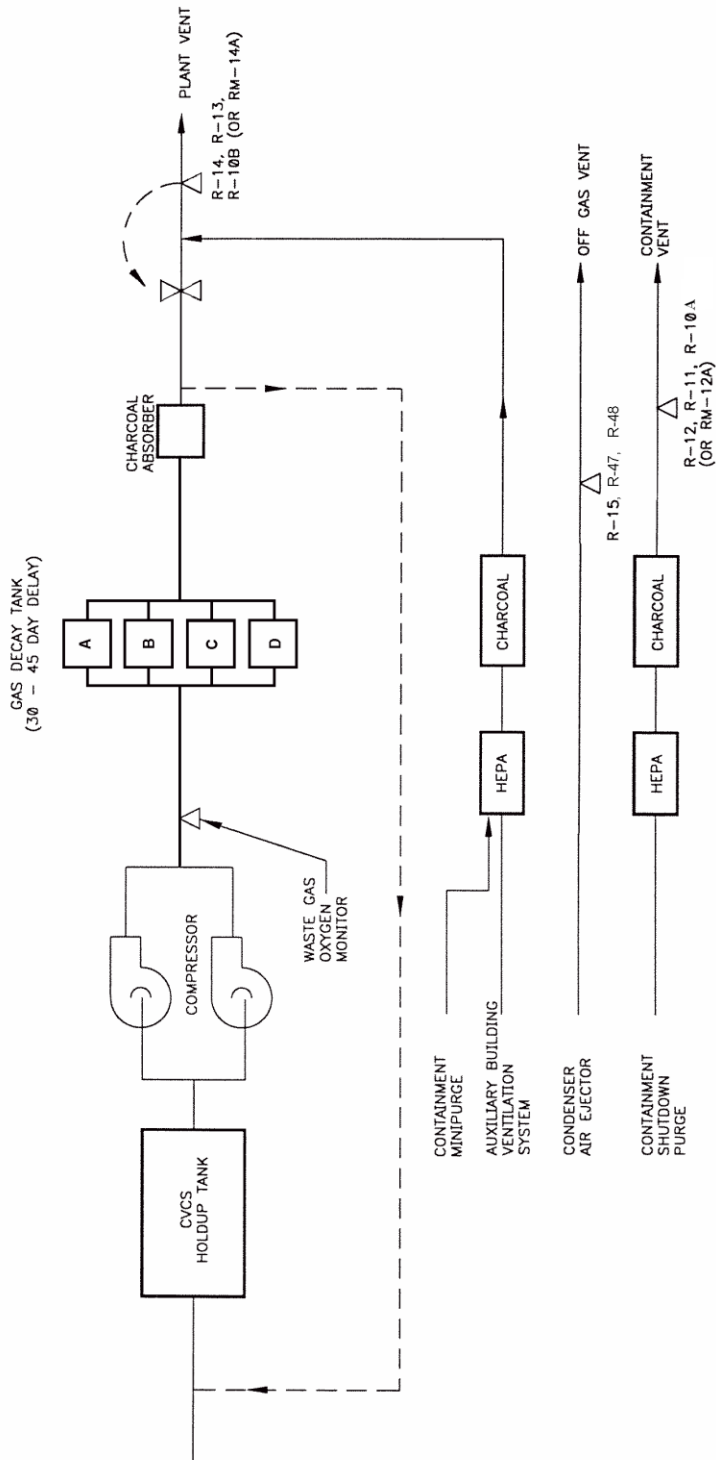

7.3 SOLID RADWASTE SYSTEM

7.3.1 CONTROLS:

1. The solid radwaste system shall be used as applicable in accordance with the Process Control Program for the solidification and packaging of radioactive waste to ensure meeting the requirements of 10 CFR 71 prior to shipment of radioactive wastes from the site.

7.3.2 APPLICABILITY: At all times.

7.3.3 ACTION:

If the packaging requirements of 10 CFR 71 are not satisfied, suspend shipments of deficiently packaged solid radioactive wastes from the site until appropriate corrective measures have been taken.

7.4 CONFIGURATION CHANGES

7.4.1 CONTROLS:

Major changes to the Radioactive Waste Treatment Systems, (Liquid, Solid, and Gaseous), shall be reported to the Commission by the inclusion of a suitable discussion or by reference to a suitable discussion of each change in the Annual Radioactive Effluent Release Report for the period in which the changes were made. Major changes to Radioactive Waste Treatment Systems, (Liquid, Gaseous and Solid), shall include the following:

1. Changes in process equipment, components and structures from those in use (e.g., deletion of evaporators and installation of demineralizers);
2. Changes in the design of Radioactive Waste Treatment Systems that could significantly alter the characteristics and/or quantities of effluents released;
3. Changes in system design which may invalidate the accident analysis (e.g., changes in tank capacity that would alter the curies released).

Note: The Radioactive Waste Treatment Systems, are those systems used to minimize the total activity released from the site.

Note: Changing the filters used, replacement resins or minor modifications (pipe or valve dimensions or manufacturers) due to maintenance activities would not be considered a major change.

7.4.2 APPLICABILITY: At all times.

7.4.2 ACTION:

The discussion of each change shall contain:

1. a summary, in accordance with 10 CFR 50.59, of the evaluation that led to the determination that the change could be made;
2. sufficient detailed information to support the reason for the change;
3. a detailed description of the equipment, components and processes involved and the interfaces with other plant systems;
4. an evaluation of the change which shows the predicted releases of radioactive materials in liquid and gaseous effluents from those previously predicted;
5. an evaluation of the change which shows the expected maximum exposures to individuals in all UNRESTRICTED AREAS and to the MEMBERS OF THE PUBLIC from those previously estimated;
6. documentation of the fact that the change was reviewed and found acceptable by the Plant Operations Review Committee.

7.5 PROCESS CONTROL PROGRAM

- a. The Process Control Program (PCP) shall be a document outlining the method of processing wet or dry solid wastes and for solidification of liquid wastes. It shall include the process parameters and evaluation methods used to assure meeting the requirements of 10 CFR Part 71 prior to shipment of containers of radioactive waste from the site.
- b. Licensee may make changes to the PCP and shall submit to the Commission with the Radioactive Effluent Release Report for the period in which any change(s) is made a copy of the new PCP and a summary containing:
 1. sufficiently detailed information to support the rationale for the change;
 2. a determination that the change will not reduce the overall conformance of the solidified waste product to existing criteria for solid wastes; and
 3. documentation of the fact that the change has been reviewed and found acceptable by the onsite review function.
- c. Licensee initiated changes shall become effective after review and acceptance by the Plant Operation Review Committee.

8.0 RADIOLOGICAL ENVIRONMENTAL MONITORING

8.1 MONITORING PROGRAM

8.1.1 CONTROLS:

The Radiological Environmental Monitoring Program (REMP) shall be conducted as specified in Table 8-1 at the locations given in Figures 8-1, 8-2, 8-3 and 8-4.

8.1.2 APPLICABILITY: At all times.

8.1.3 ACTION:

1. If the radiological environmental monitoring program is not conducted as specified in Table 8-1, prepare and submit to the Commission, in the Annual Radiological Environmental Operating Report, a description of the reasons for not conducting the program as required and the plans for preventing a recurrence. Deviations are permitted from the required sampling schedule if specimens are unobtainable due to hazardous conditions, seasonal availability, or to malfunction of automatic sampling equipment. If the latter, efforts shall be made to complete corrective action prior to the end of the next sampling period. Sampling periods for this specification are usually of one week duration. If continuous water sampling equipment is out of service, the 120 minute aliquot sampling period does not mean that grab samples must be taken every 120 minutes, but one grab sample once each week is sufficient until the automatic sampling equipment is restored to service.
2. If the level of radioactivity as a result of plant effluents in an environmental sampling medium at one or more of the locations specified exceeds the reporting levels of Table 8-4 when averaged over any calendar quarter, prepare and submit to the Commission within 30 days from receipt of the laboratory analysis a Special Report that identifies the cause(s) for exceeding the limit(s) and defines the corrective actions to be taken to reduce radioactive effluents so that the potential annual dose* to a MEMBER OF THE PUBLIC is less than the calendar year limits of Sections 4.2.1, 5.3.1, and 5.3.7 (Controls).

When more than one of the radionuclides in Table 8-4 are detected in the sampling medium, this report shall be submitted if:

$$\frac{\text{concentration (1)}}{\text{limit level (1)}} + \frac{\text{concentration (2)}}{\text{limit level (2)}} + \Rightarrow > 1.0$$

When radionuclides other than those in Table 8-4 are detected and are the result of plant effluents, this report shall be submitted if the potential annual dose to a MEMBER OF THE PUBLIC from all radionuclides is greater than

the calendar year limit of Sections 4.2.1, 5.3.1, and 5.3.7 (Controls). This report is not required if the measured level of radioactivity was not the result of plant effluents; however, in such an event, the condition shall be reported and described in the Annual Radiological Environmental Operating Report.

The methodology and parameters used to estimate the potential annual dose to a MEMBER OF THE PUBLIC shall be indicated in this report.

4. With milk or fresh leafy vegetable samples unavailable from one or more of the sampling locations indicated on Figure 8-2, a discussion shall be included in the Annual Radiological Environmental Operating Report which identifies the cause for the unavailability of samples and identifies locations for obtaining replacement samples. In selecting replacement samples, consider the implications of collecting samples outside the normal REMP ingestion pathway. In particular, recognize that perennial vegetation from relatively undisturbed areas is likely to have higher concentrations of Cs-137 than vegetation grown in soil that is regularly disturbed by cultivation and harvesting activities. If a milk or leafy vegetable sample location becomes unavailable, the location from which samples were unavailable may then be deleted provided that a comparable location is added to the radiological environmental monitoring program as described in the ODCM, unless no other sample location is available.

8.1.4 SURVEILLANCE REQUIREMENTS:

The radiological environmental samples shall be collected pursuant to Table 8-1 from the specific locations given in the table and figure(s) given in the ODCM, and shall be analyzed pursuant to the requirements of Table 8-1 and the detection capabilities required by Table 8-3.

8.1.5 BASES:

The REMP required by this Control provides representative measurements of radiation and of radioactive materials in those exposure pathways and for those radionuclides that lead to the highest potential radiation exposures to MEMBERS OF THE PUBLIC resulting from plant operation. This monitoring program implements Section IV.B.2 of Appendix I to 10 CFR 50, and thereby supplements the RETS by verifying that the measurable concentrations of radioactive materials and levels of radiation are not higher than expected on the basis of the effluent measurements and the modeling of the environmental exposure pathways. Guidance for this monitoring program is provided by the Radiological Assessment Branch Technical Position on Environmental Monitoring, Revision 1, November 1979.

Table 8-1

Radiological Environmental Monitoring Program

EXPOSURE PATHWAY AND/OR SAMPLE	NUMBER OF SAMPLES & SAMPLE LOCATIONS (a)	SAMPLING AND COLLECTION FREQUENCY	TYPE AND FREQUENCY OF ANALYSIS
1. AIRBORNE a. Radioiodine b. Particulate	5 indicator (Samplers 2,4,7,9,11) 1 control (Sampler 8) 9 indicator 3 control	Continuous operation of sampler with sample collection at least weekly (a) Same as above	Radioiodine canister. Analyze within 7 days of collection for I-131. Particulate sampler. Analyze for gross beta radioactivity \geq 24 hours following filter change.(c) Perform gamma isotopic analysis on each sample for which gross beta activity is > 10 times the mean of offsite samples. Perform gamma isotopic analysis on composite (by location) sample at least once per 92 days.(d)
2. DIRECT RADIATION (b)	30 indicator 9 control (11 placed greater than 5 miles from plant site)	Dosimeters at least quarterly	Gamma dose quarterly.
3. WATERBORNE a. Surface (e) b. Drinking c. Shoreline Sediment	1 control (Shoremont) 1 indicator (Condenser Water Discharge) 1 indicator (Ontario Water District Intake) 1 control (Shoremont) 1 indicator (Ontario Water District - Bear Creek)	Composite* sample collected over a period of \leq 31 days.(f) Same as above (f) Semi-annually	Gross beta and gamma isotopic analysis of each composite sample. Tritium analysis of one composite sample at least once per 92 days. (d) Same as above Gamma isotopic analysis of each sample (d)
* Composite sample to be collected by collecting an aliquot at intervals not exceeding 2 hours.			

EXPOSURE PATHWAY AND/OR SAMPLE	NUMBER OF SAMPLES & SAMPLE LOCATIONS (a)	SAMPLING AND COLLECTION FREQUENCY	TYPE AND FREQUENCY OF ANALYSIS
<p>4. INGESTION</p> <p>a. Milk</p> <p>b. Fish</p> <p>c. Food Products</p>	<p>2 Supplemental (June through October)</p> <p>2 Supplemental (November through May)</p> <p>4 control 4 indicator (Off shore at Ginna)</p> <p>1 control 1 indicator (On site)</p> <p>1 control 1 indicator (Nearest offsite garden within 5 miles in the highest D/Q meteorological sector or onsite garden)</p>	<p>At least once per 15 days</p> <p>At least once per 31 days</p> <p>Twice during fishing season including at least four species</p> <p>Annual at time of harvest. Sample from two of the following:</p> <ol style="list-style-type: none"> 1. apples 2. cherries 3. Other crops grown on site by contract farmer <p>At time of harvest. One sample of:</p> <ol style="list-style-type: none"> 1. broad leaf vegetation* 2. other vegetable 	<p>Gamma isotopic and I-131 analysis of each sample.(d,g)</p> <p>Gamma isotopic and I-131 analysis of each sample.(d,g)</p> <p>Gamma isotopic analysis on edible portions of each sample.(d,g)</p> <p>Gamma isotopic analysis on edible portion of each sample.(d,g)</p> <p>Gamma isotopic analysis on edible portion of each sample.(d,g)</p>
<p>* leaves from 3 different plant species composited</p>			

Table 8-1**Table Notation**

- (a) Specific parameters of distance and direction sector from the centerline of the reactor, and additional description where pertinent, shall be provided for each and every sample location in Table 8-2 in a table and figures in the ODCM. Deviations are permitted from the required sampling schedule if specimens are unobtainable due to circumstances such as hazardous conditions, seasonal unavailability, inclement weather, and malfunction of automatic sampling equipment. If specimens are unavailable due to sampling equipment malfunction, effort shall be made to complete corrective action prior to the end of the next sampling period. All deviations from the sampling schedule shall be documented in the next Annual Radiological Environmental Operating Report. It is recognized that, at times, it may not be possible or practicable to continue to obtain samples of the media of choice at the most desired location or time. In these instances suitable alternative media and locations may be chosen for the particular pathway in question and appropriate substitutions made within 30 days in the radiological environmental monitoring program as described in the ODCM. Submit in the next Annual Radioactive Effluent Release Report documentation for a change in the ODCM including a revised figure(s) and table for the ODCM reflecting the new location(s) with supporting information identifying the cause of the unavailability of samples for the pathway and justifying the selection of the new location(s) for obtaining samples.
- (b) One or more instruments, such as a pressurized ion chamber, for measuring and recording dose rate continuously may be used in place of, or in addition to, integrating dosimeters. For the purposes of this table, a dosimeter is considered to be one phosphor; two or more phosphors in one packet are considered to be two or more dosimeters. Film badges shall not be used for measuring direct radiation. The 39 stations is not an absolute number. The number of direct radiation monitoring stations may be reduced according to geographical limitations; e.g., some sectors may be over water so that the number of dosimeters may be reduced accordingly. The frequency of analysis or readout for dosimetry systems will depend upon the characteristics of the specific system used and should be selected to obtain optimum dose information with minimal fading.
- (c) Airborne particulate sample filters shall be analyzed for gross beta radioactivity 24 or more hours after sampling to allow for radon and thoron daughter decay. If gross beta activity in air particulate samples is greater than 10 times the yearly mean of control samples, gamma isotopic analysis shall be performed on the individual samples.
- (d) Gamma isotopic analysis means the identification and quantification of gamma-emitting radionuclides that may be attributable to the effluents from the facility.

- (e) The "control sample" shall be taken at a distance beyond significant influence of the discharge. The "indicator sample" shall be taken in an area beyond but near the mixing zone.
- (f) A composite sample is one in which the quantity (aliquot) of liquid sampled is proportional to the quantity of flowing liquid and in which the method of sampling employed results in a specimen that is representative of the liquid flow. In this program composite sample aliquots shall be collected at time intervals that are very short (e.g., hourly) relative to the compositing period (e.g., monthly) in order to assure obtaining a representative sample.
- (g) The dose shall be calculated for the maximum organ and age group, using the methodology and parameters in the OCDM.

8.2 ENVIRONMENTAL MONITOR SAMPLE LOCATIONS

All sample locations are specified on Table 8-2, a list of direction and distance to sample points. Indicator and control samples required by the environmental program are noted by an I or a C.

Figure 8-1 shows the onsite* sample locations for airborne particulates, radioiodine and direct radiation. Also indicated on Figure 8-1 is the onsite vegetable garden, as well as the placement of post-accident dosimeters, locations 2 -7 and 13 -24. Dosimeter locations 2, 4,5,6, 7 are co-located with the air monitor samplers. The onsite garden is located in the SE sector near the closest resident who is the real maximally exposed individual, rather than in the ESE sector which has the highest D/Q.

Figure 8-2 gives the location of the milk herds near the plant. On this map is also included the Ontario Water District intake pumping station where lake water is sampled prior to treatment.

Figure 8-3 shows the offsite control locations for direct radiation as measured by dosimeters.

Figure 8-4 shows the offsite sample locations for airborne particulates, and radioiodine. Sample stations 9 and 11 are situated near population centers, Webster and Williamson, located approximately 7 miles from the Ginna Site. Dosimeter locations 8 - 12 are co-located with air monitor samplers.

- * Onsite refers to the area surrounding the Ginna Plant bounded by Ginna property lines. Offsite refers to the area beyond the immediate Ginna property.
- ** Air Sampler #3 was relocated in 2018 for reliable electric power source. TLD#3 remains in its original location for consistency of direct radiation trending.

Table 8-2

Location, Direction, and Distances to Sample Points

Air Sample Locations					
Station	Type	Coordinates (Latitude, N)	Coordinates (Longitude, W)	Direction (degrees)	Distance (meters)
2	I	43.27798	77.30450	84	360
3	I	43.27667	77.30646	120	220
4	I	43.27561	77.30600	134	320
5	I	43.27602	77.30913	186	180
6	I	43.27614	77.31198	236	300
7	I	43.27724	77.31177	259	240
8	C	43.22860	77.54403	254	19840
9	I	43.21872	77.42007	234	11150
10	C	43.16360	77.32606	186	12730
11	I	43.22327	77.18756	122	11540
12	C	43.26818	76.99870	92	25170
13	I	43.27091	77.31103	193	770
Water Sample Locations					
Station	Type	Coordinates (Latitude, N)	Coordinates (Longitude, W)	Direction (degrees)	Distance (meters)
Shoremont	C	43.27561	77.64368	270	27150
Ontario Water District Intake	I	43.28963	77.28704	53	2220
Circulation Water Intake	S	43.28725	77.30928	358	1070
Circulation Water Discharge	I	43.27861	77.30857	13	110
Deer Creek	S	Points down- stream from Outfall 006	Points downstream from Outfall 006	N/A	N/A
Milk Sample Locations					
Station	Type	Coordinates (Latitude, N)	Coordinates (Longitude, W)	Direction (degrees)	Distance (meters)
Farm A	S	43.24196	77.21978	119	8240
Farm B	S	43.17035	77.12589	129	19030

Produce Samples					
Description	Type	Coordinates (Latitude, N)	Coordinates (Longitude, W)	Direction (degrees)	Distance (meters)
Onsite Gardens	I	43.27278	77.30413	145	660
		43.27627	77.30389	111	430
		43.27727	77.30140	94	610
Purchased from farms > 10 miles	C	--	--	--	--
Fish Samples			Sediment Samples		
Description	Type	Description	Type		
Discharge Plume	I	OWD Shoreline	I		
Lake Ontario > 10 miles West of Ginna	C	Shoremont (> 10 miles)	C		
		Lake Ontario Benthic	S		
Dosimeter Sample Locations					
Station	Type	Coordinates (Latitude, N)	Coordinates (Longitude, W)	Direction (degrees)	Distance (meters)
2	I	43.27798	77.30450	84	360
3	I	43.27643	77.30366	108	440
4	I	43.27561	77.30600	134	320
5	I	43.27602	77.30913	186	180
6	I	43.27614	77.31198	236	300
7	I	43.27724	77.31177	259	240
8	C	43.22860	77.54403	254	19840
9	I	43.21872	77.42007	234	11150
10	C	43.16360	77.32606	186	12730
11	I	43.22327	77.18756	122	11540
12	C	43.26818	76.99870	92	25170
13	I	43.27889	77.31157	303	260
14	I	43.28032	77.31886	290	860
15	I	43.27708	77.32016	266	920
16	I	43.27310	77.31993	241	1030

Dosimeter Sample Locations (Continued)					
Station	Type	Coordinates (Latitude, N)	Coordinates (Longitude, W)	Direction (degrees)	Distance (meters)
17	I	43.27347	77.31162	206	510
18	I	43.27122	77.31082	192	730
19	I	43.27346	77.30868	178	460
20	I	43.27202	77.30650	163	650
21	I	43.27279	77.30408	144	660
22	I	43.27284	77.29960	125	920
23	I	43.27564	77.29969	107	780
24	I	43.27797	77.29993	87	730
25	C	43.23026	77.46891	248	14000
26	C	43.18249	77.43311	224	14600
27	C	43.16017	77.37563	203	14120
28	C	43.14851	77.18617	145	17450
29	C	43.23817	77.14423	108	14050
30	C	43.23687	77.05909	103	20760
31	I	43.26868	77.39841	262	7330
32	I	43.25309	77.37582	243	6070
33	I	43.22451	77.37458	222	7950
34	I	43.22582	77.34687	208	6520
35	I	43.21207	77.33044	193	7490
36	I	43.22840	77.30405	176	5480
37	I	43.22933	77.28251	158	5770
38	I	43.23135	77.25186	138	6910
39	I	43.25321	77.23025	113	6930
40	I	43.28071	77.22961	87	6440
63	I	43.27892	77.32344	228	740
64	I	43.27320	77.31571	277	1190

Table 8-2 Notes:

Latitude and longitude coordinates are based on World Geodetic System of 1984 (WGS84) datum.

Directions and Distance are noted from the centerline of thereactor

I = Indicator Sample

C = Control or background sample

S = Supplemental sample

Figure 8-1

Location of Onsite Air Monitors and Dosimeters

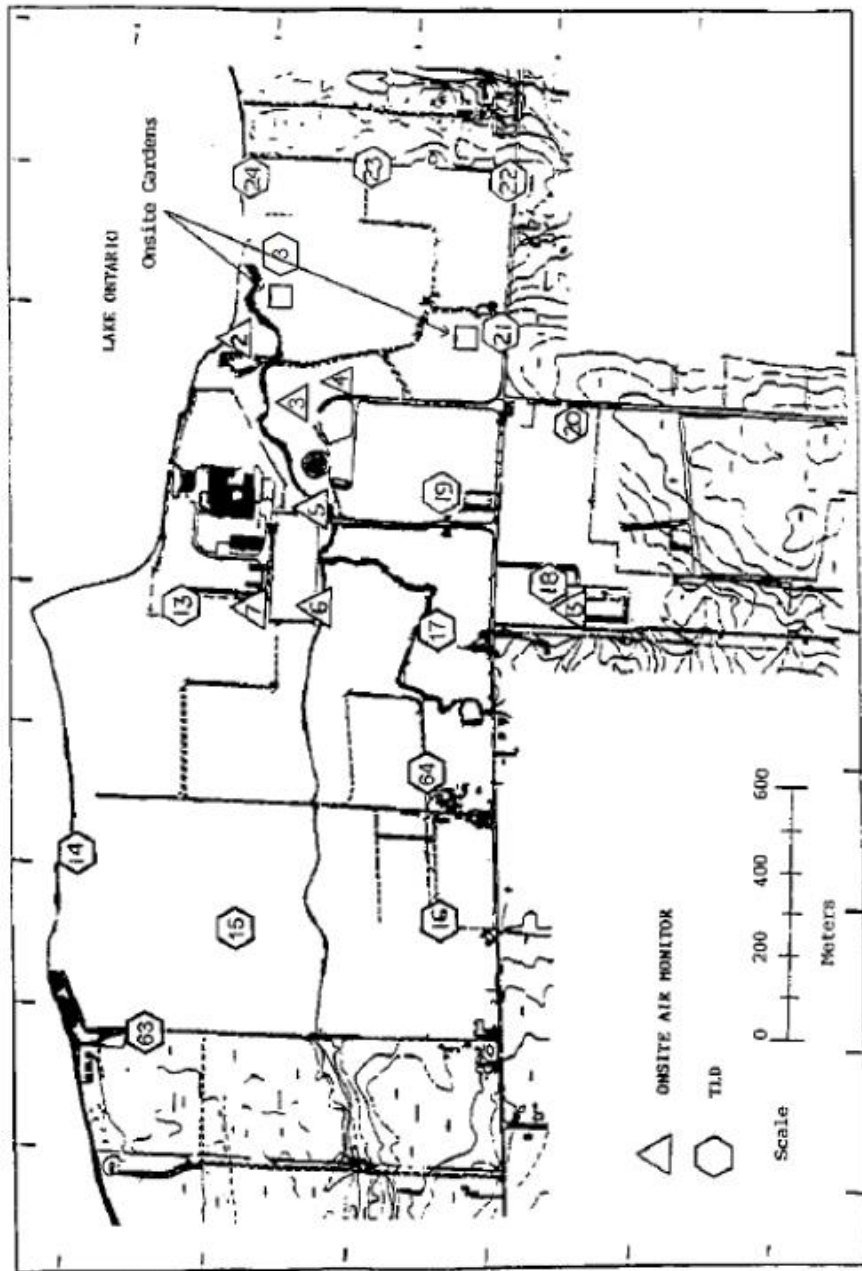

Figure 8-2

Location of Farms for Milk Samples and Ontario Water District Intake

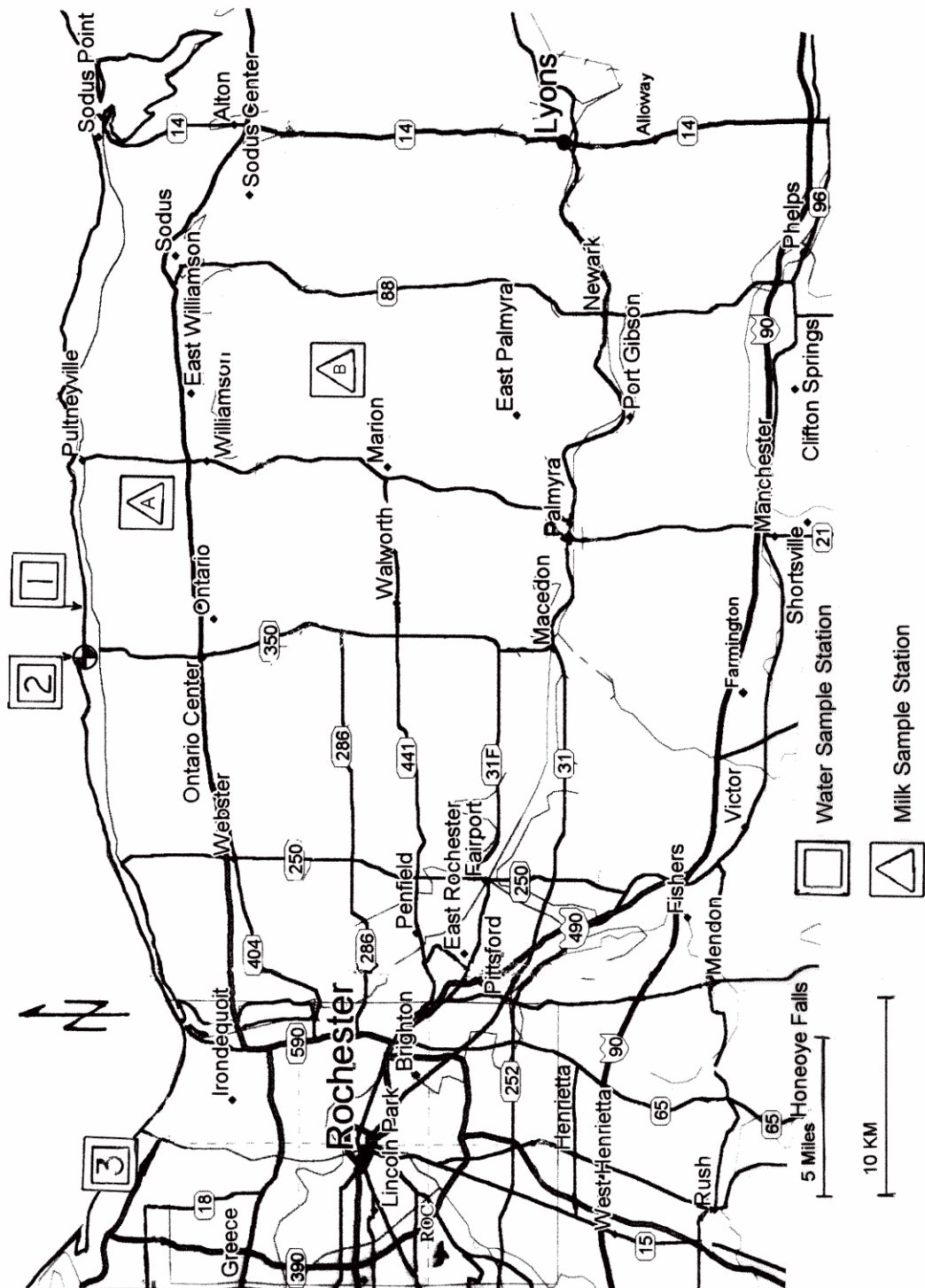

Figure 8-3
Location of Offsite Dosimeters

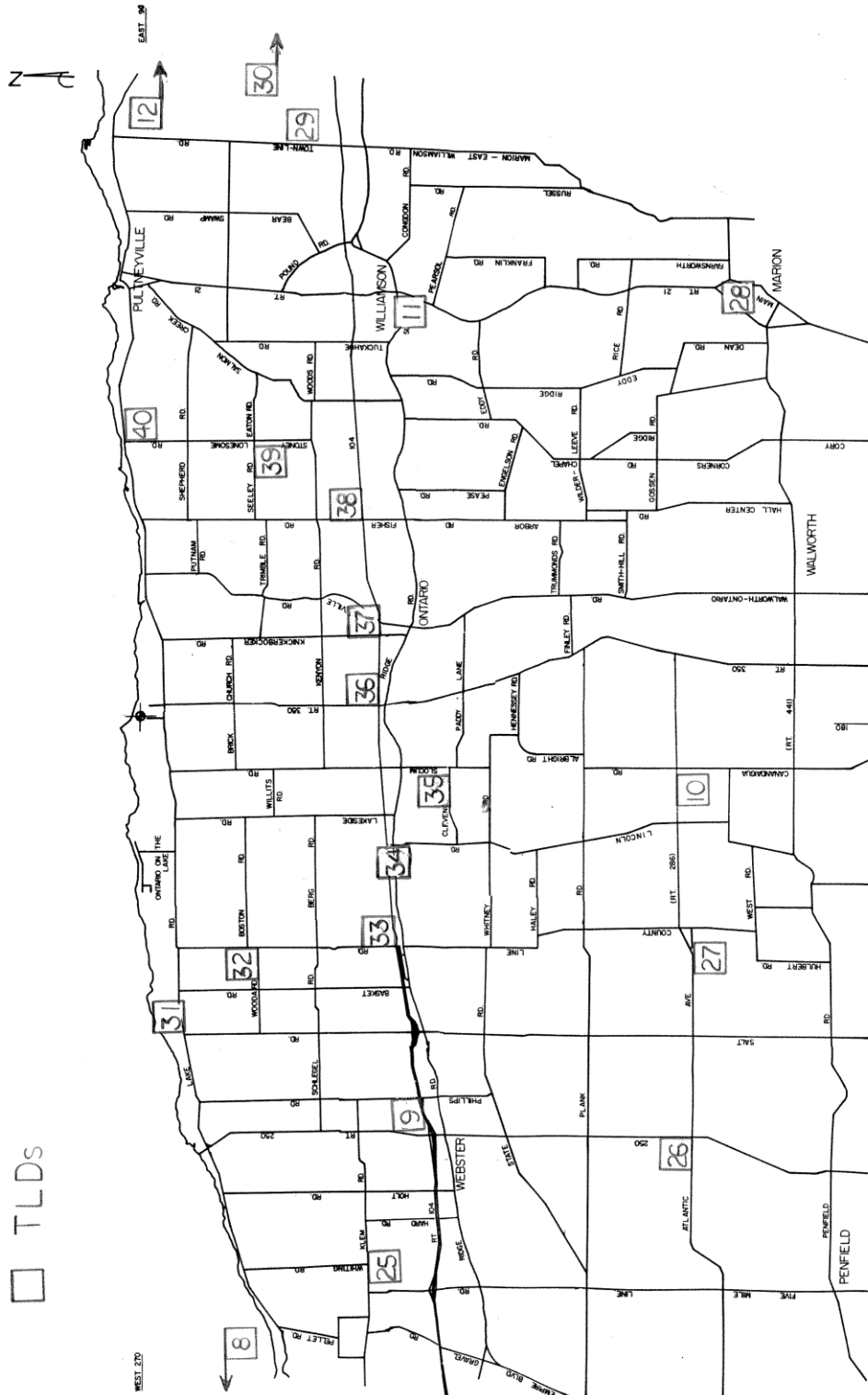

Figure 8-4

Location of Offsite Air Monitors

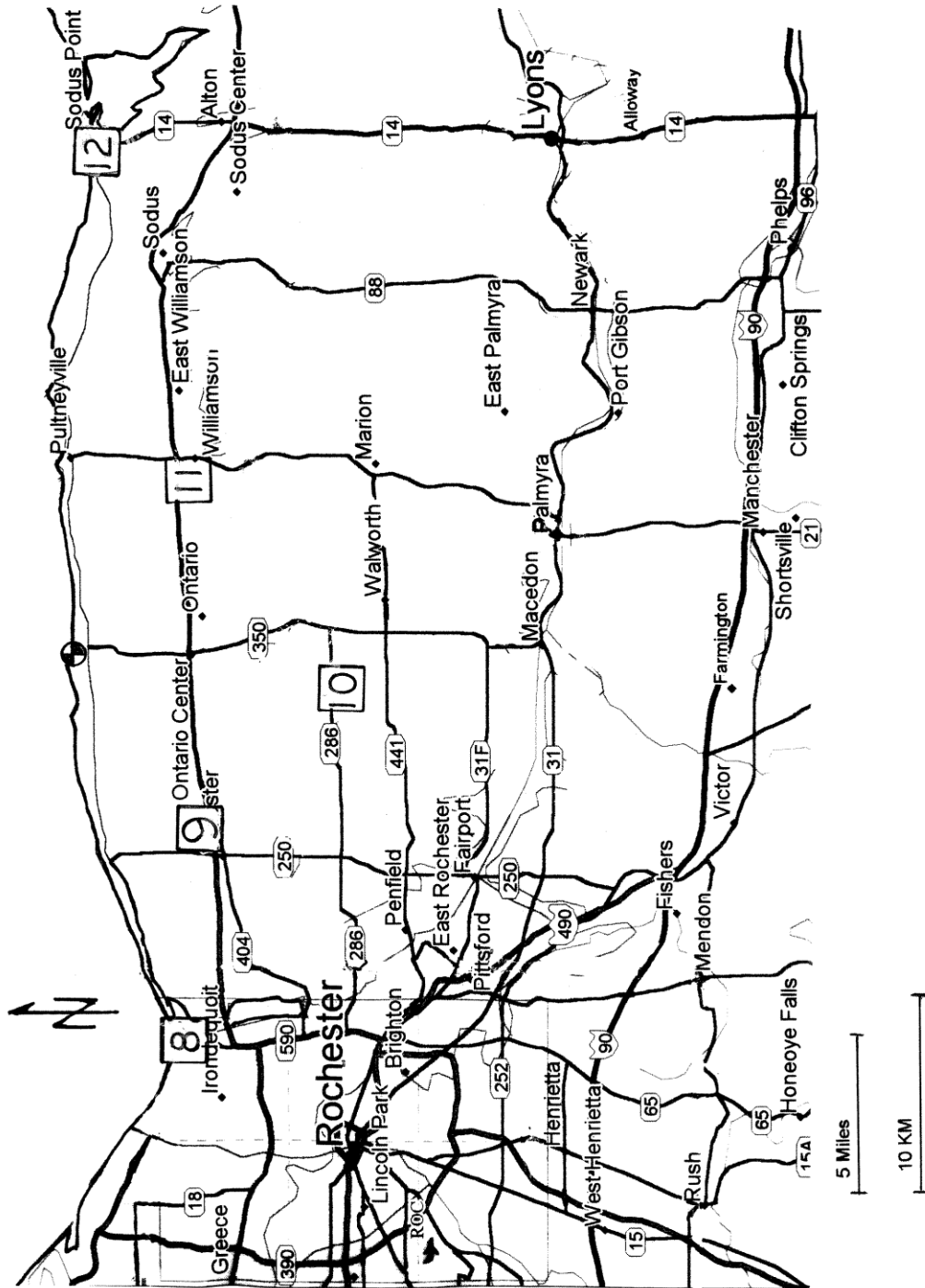

Table 8-3

**Detection Capabilities for Environmental Sample Analysis
Lower Limit of Detection (LLD)**

Analysis	Water (pCi/l)	Airborne Particulate Or Gas (pCi/m³)	Fish (pCi/kg) wet	Milk (pCi/l)	Food Products (pCi/kg) wet	Shoreline Sediment (pCi/kg) dry
gross beta	4(a)	1.0E-02				
3-H	2000 (1000)(a)					
54-Mn	15		130			
59-Fe	30		260			
58, 60-Co	15		130			
65-Zn	30		260			
95-Zr-Nb	15(b)					
131-I	1	7.0E-02		1	60	
134, 137-Cs	15(10)(a), 18	1.0E-02	130	15	60	150
140-Ba-La	15(b)			15(b)		

Table 8-3

Table Notation

- (a) LLD for drinking water
- (b) Total for parent and daughter

The LLD shall be calculated as described in Notation (a) to Table 4-1

Table 8-4

**Reporting Levels for Radioactivity Concentrations
in Environmental Samples**

Analysis	Water (pCi/l)	Airbourne Particulate or Gas (pCi/m³)	Fish (pCi/kg,wet)	Milk (pCi/l)	Broad Leaf Vegetables (pCi/kg, wet)
H-3	2.0E+04				
Mn-54	1000		3.0E+04		
Fe-59	400		1.0E+04		
Co-58	1000		3.0E+04		
Co-60	300		1.0E+04		
Zn-65	300		2.0E+04		
Zr-Nb-95	400(a)				
I-131	2	0.9		3	1.0E+02
Cs-134	30	10	1.0E+03	60	1.0E+03
Cs-137	50	20	2.0E+03	70	2.0E+03
Ba-La-140	200(a)			300	

Table 8-4

Table Notation

(a) Total for parent and daughter

Decay correction in analysis of environmental samples is taken from the end of the sampling time not from the midpoint of the sample period.

Table 8-5
D/Q and X/Q 5 Year Average 1995 - 1999
Plant Vent

Distance to section boundary in meters:										
Direction	804m	1609m	2416m	3218m	4022m	4827m	5632m	6436m	7240m	8045m
D/Q										
N	1.74E-09	8.20E-10	5.54E-10	3.36E-10	2.45E-10	1.85E-10	1.41E-10	1.13E-10	1.01E-10	3.86E-10
NNE	1.18E-09	6.28E-10	3.99E-10	2.75E-10	2.02E-10	1.53E-10	1.29E-10	9.54E-11	8.50E-11	2.26E-10
NE	1.74E-09	1.84E-09	6.26E-10	3.86E-10	2.83E-10	2.14E-10	1.64E-10	1.32E-10	1.09E-10	9.17E-11
ENE	2.99E-09	1.43E-09	8.56E-10	5.76E-10	4.25E-10	3.14E-10	2.39E-10	1.91E-10	1.58E-10	1.32E-10
E	5.11E-09	2.20E-09	1.23E-09	7.96E-10	5.69E-10	4.17E-10	5.09E-10	6.34E-10	4.74E-10	4.00E-10
ESE	7.41E-09	3.19E-09	1.67E-09	1.13E-09	9.34E-10	9.18E-10	7.27E-10	5.16E-10	4.26E-10	3.54E-10
SE	4.14E-09	1.93E-09	9.91E-10	7.32E-10	7.05E-10	5.40E-10	4.00E-10	3.05E-10	2.52E-10	2.09E-10
SSE	1.32E-09	6.71E-10	3.72E-10	2.68E-10	2.58E-10	1.88E-10	1.38E-10	2.76E-10	8.94E-11	7.48E-11
S	2.15E-09	1.29E-09	7.37E-10	6.54E-10	4.95E-10	3.58E-10	2.61E-10	2.02E-10	1.67E-10	1.39E-10
SSW	2.57E-09	1.48E-09	8.43E-10	5.50E-10	4.00E-10	3.95E-10	2.87E-10	2.22E-10	1.83E-10	1.52E-10
SW	2.88E-09	1.53E-09	8.50E-10	5.66E-10	4.79E-10	4.41E-10	3.20E-10	2.49E-10	2.05E-10	1.71E-10
WSW	2.21E-09	1.18E-09	6.93E-10	4.73E-10	3.57E-10	3.04E-10	4.38E-10	3.39E-10	2.80E-10	2.33E-10
W	9.54E-10	5.40E-10	3.27E-10	2.21E-10	1.61E-10	1.20E-10	1.76E-10	2.71E-10	2.25E-10	1.87E-10
WNW	1.29E-10	9.58E-11	6.87E-11	4.91E-11	1.18E-10	2.83E-11	2.23E-11	1.82E-11	1.51E-11	1.27E-11
NW	4.80E-10	3.03E-10	2.03E-10	1.41E-10	1.05E-10	8.01E-11	6.25E-11	5.05E-11	4.20E-11	3.52E-11
NNW	1.37E-09	7.06E-10	4.40E-10	3.01E-10	2.21E-10	1.73E-10	1.29E-10	1.03E-10	8.59E-11	7.19E-11

Direction	804m	1609m	2416m	3218m	4022m	4827m	5632m	6436m	7240m	8045m
X/Q										
N	8.56E-08	9.42E-08	9.19E-08	8.10E-08	6.99E-08	6.15E-08	5.38E-08	5.41E-08	6.17E-08	1.20E-07
NNE	7.17E-08	8.06E-08	8.23E-08	7.45E-08	7.21E-08	5.83E-08	5.28E-08	4.81E-08	6.98E-08	1.33E-07
NE	8.27E-08	9.48E-08	9.36E-08	8.33E-08	7.23E-08	6.94E-08	5.63E-08	5.05E-08	4.57E-08	4.18E-08
ENE	1.05E-07	1.16E-07	1.06E-07	8.89E-08	7.41E-08	6.26E-08	5.35E-08	4.66E-08	4.13E-08	3.70E-08
E	1.91E-07	1.81E-07	1.53E-07	1.16E-07	9.09E-08	7.32E-08	8.82E-08	7.67E-08	6.51E-08	5.61E-08
ESE	2.43E-07	2.13E-07	1.70E-07	1.35E-07	1.11E-07	9.27E-08	7.19E-08	5.86E-08	4.96E-08	4.27E-08
SE	1.47E-07	1.38E-07	1.15E-07	1.12E-07	9.67E-08	7.43E-08	5.79E-08	5.33E-08	5.21E-08	3.44E-08
SSE	6.06E-08	6.56E-08	5.66E-08	5.38E-08	4.55E-08	3.40E-08	2.64E-08	2.16E-08	1.83E-08	1.58E-08
S	1.06E-07	1.49E-07	1.27E-07	9.80E-08	7.10E-08	5.27E-08	4.09E-08	3.34E-08	2.83E-08	2.42E-08
SSW	1.06E-07	1.59E-07	1.54E-07	1.04E-07	7.61E-08	6.96E-08	5.35E-08	4.35E-08	3.68E-08	3.16E-08
SW	1.06E-07	1.39E-07	1.43E-07	1.18E-07	1.01E-07	9.76E-08	7.60E-08	6.22E-08	5.27E-08	4.53E-08
WSW	1.13E-07	1.40E-07	1.33E-07	1.23E-07	1.20E-07	1.30E-07	1.47E-07	1.20E-07	1.02E-07	8.78E-08
W	7.19E-08	1.07E-07	9.56E-08	7.99E-08	6.66E-08	5.67E-08	9.77E-08	9.14E-08	7.77E-08	6.68E-08
WNW	6.07E-09	1.64E-08	1.96E-08	1.87E-08	1.68E-08	1.49E-08	1.33E-08	1.20E-08	1.08E-08	9.88E-09
NW	1.99E-08	3.49E-08	3.64E-08	3.24E-08	2.80E-08	2.42E-08	2.11E-08	1.86E-08	1.66E-08	1.50E-08
NNW	6.23E-08	6.98E-08	6.67E-08	5.74E-08	4.86E-08	4.15E-08	3.58E-08	3.20E-08	2.80E-08	2.53E-08

Table 8-6
D/Q and X/Q 5 Year Average 1995 – 1999
Containment Vent

Distance to section boundary in meters:										
Direction	804m	1609m	2416m	3218m	4022m	4827m	5632m	6436m	7240m	8045m
D/Q										
N	1.88E-08	5.95E-09	2.88E-09	1.85E-09	1.31E-09	9.45E-10	6.86E-10	5.31E-10	4.42E-10	3.90E-10
NNE	1.86E-08	5.88E-09	2.85E-09	1.83E-09	1.29E-09	9.35E-10	6.79E-10	5.25E-10	4.39E-10	3.90E-10
NE	1.99E-08	6.30E-09	3.05E-09	1.96E-09	1.38E-09	1.00E-09	7.27E-10	5.62E-10	4.64E-10	3.86E-10
ENE	1.98E-08	6.28E-09	3.04E-09	1.95E-09	1.38E-09	1.08E-09	7.24E-10	5.60E-10	4.62E-10	3.84E-10
E	1.99E-08	6.30E-09	3.05E-09	1.96E-09	1.38E-09	1.00E-09	7.41E-10	5.75E-10	4.75E-10	3.95E-10
ESE	1.78E-08	5.66E-09	2.74E-09	1.77E-09	1.27E-09	9.19E-10	6.67E-10	5.16E-10	4.11E-10	3.54E-10
SE	1.01E-08	3.23E-09	1.57E-09	1.05E-09	7.51E-10	5.43E-10	3.94E-10	3.05E-10	2.52E-10	2.09E-10
SSE	3.66E-09	1.18E-09	5.75E-10	3.92E-10	2.85E-10	2.06E-10	1.50E-10	1.16E-10	9.56E-11	7.94E-11
S	6.65E-09	2.14E-09	1.07E-09	7.06E-10	4.99E-10	3.60E-10	2.62E-10	2.02E-10	1.67E-10	1.39E-10
SSW	7.05E-09	2.28E-09	1.17E-09	7.53E-10	5.35E-10	3.95E-10	2.87E-10	2.22E-10	1.83E-10	1.52E-10
SW	7.77E-09	2.50E-09	1.22E-09	7.94E-10	5.98E-10	4.43E-10	3.22E-10	2.49E-10	2.05E-10	1.71E-10
WSW	1.04E-08	3.32E-09	1.61E-09	1.04E-09	7.44E-10	5.64E-10	4.39E-10	3.39E-10	2.80E-10	2.33E-10
W	8.42E-09	2.68E-09	1.30E-09	8.33E-10	5.89E-10	4.27E-10	3.46E-10	2.72E-10	2.25E-10	1.87E-10
WNW	2.68E-09	1.18E-09	4.16E-10	2.67E-10	1.89E-10	1.36E-10	9.92E-11	7.67E-11	6.34E-11	5.27E-11
NW	5.20E-09	1.66E-09	8.05E-10	5.16E-10	3.65E-10	2.64E-10	1.92E-10	1.48E-10	1.23E-10	1.02E-10
NNW	1.13E-08	3.58E-09	1.74E-09	1.12E-09	7.88E-10	5.70E-10	4.14E-10	3.20E-10	2.65E-10	2.20E-10

Direction	804m	1609m	2416m	3218m	4022m	4827m	5632m	6436m	7240m	8045m
X/Q										
N	1.73E-06	6.24E-07	3.58E-07	2.44E-07	1.52E-07	1.42E-07	1.15E-07	9.67E-08	9.34E-08	9.86E-08
NNE	2.15E-06	7.57E-07	4.37E-07	3.01E-07	2.26E-07	1.78E-07	1.46E-07	1.24E-07	1.26E-07	1.48E-07
NE	1.94E-06	7.00E-07	3.99E-07	2.70E-07	2.00E-07	1.55E-07	1.25E-07	1.05E-07	9.02E-08	7.88E-08
ENE	1.20E-06	4.40E-07	2.46E-07	1.64E-07	1.19E-07	9.14E-08	7.26E-08	6.03E-08	5.17E-08	4.50E-08
E	1.05E-06	3.91E-07	2.18E-07	1.44E-07	1.03E-07	7.84E-08	6.58E-08	5.39E-08	4.59E-08	3.96E-08
ESE	8.27E-07	3.15E-07	1.83E-07	1.24E-07	8.99E-08	6.76E-08	5.27E-08	4.32E-08	3.67E-08	3.16E-08
SE	5.82E-07	2.44E-07	1.56E-07	1.17E-07	8.36E-08	6.27E-08	4.88E-08	4.00E-08	3.39E-08	2.92E-08
SSE	3.27E-07	1.42E-07	8.76E-08	6.27E-08	4.44E-08	3.31E-08	2.57E-08	2.09E-08	1.77E-08	1.52E-08
S	5.09E-07	2.29E-07	1.40E-07	8.96E-08	6.92E-08	4.71E-08	3.65E-08	2.98E-08	2.52E-08	2.16E-08
SSW	4.64E-07	2.44E-07	1.61E-07	1.03E-07	7.31E-08	5.49E-08	4.27E-08	3.49E-08	2.95E-08	2.54E-08
SW	4.99E-07	2.52E-07	1.95E-07	1.36E-07	1.00E-07	7.59E-08	5.94E-08	4.87E-08	4.13E-08	3.56E-08
WSW	9.88E-07	3.99E-07	2.57E-07	1.99E-07	1.61E-07	1.37E-07	1.11E-07	9.16E-08	7.79E-08	6.73E-08
W	9.24E-07	3.62E-07	2.15E-07	1.49E-07	1.10E-07	8.62E-08	8.29E-08	6.83E-08	5.82E-08	5.03E-08
WNW	3.25E-07	1.26E-07	7.51E-08	5.22E-08	3.92E-08	3.08E-08	2.51E-08	2.11E-08	1.83E-08	1.60E-08
NW	5.27E-07	1.98E-07	1.14E-07	7.80E-08	5.78E-08	4.50E-08	3.62E-08	3.03E-08	2.62E-08	2.29E-08
NNW	9.39E-07	3.46E-07	1.98E-07	1.34E-07	9.89E-08	7.65E-08	6.13E-08	5.12E-08	4.41E-08	3.85E-08

Table 8-7
D/Q and X/Q 5 Year Average 1995 - 1999
Air Ejector

Distance to section boundary in meters:										
Direction	804m	1609m	2416m	3218m	4022m	4827m	5632m	6436m	7240m	8045m
D/Q										
N	2.02E-08	6.38E-09	3.09E-09	1.98E-09	1.40E-09	1.01E-09	7.34E-10	5.68E-10	4.69E-10	3.90E-10
NNE	2.07E-08	6.55E-09	3.17E-09	2.03E-09	1.44E-09	1.04E-09	7.54E-10	5.83E-10	4.81E-10	4.00E-10
NE	2.11E-08	6.66E-09	3.22E-09	2.07E-09	1.46E-09	1.06E-09	7.67E-10	5.93E-10	4.89E-10	4.07E-10
ENE	2.05E-08	6.49E-09	3.14E-09	2.01E-09	1.42E-09	1.03E-09	7.47E-10	5.77E-10	4.77E-10	3.96E-10
E	2.04E-08	6.46E-09	3.13E-09	2.01E-09	1.42E-09	1.02E-09	7.43E-10	5.75E-10	4.75E-10	3.95E-10
ESE	1.84E-08	5.80E-09	2.81E-09	1.80E-09	1.27E-09	9.19E-10	6.67E-10	5.16E-10	4.26E-10	3.54E-10
SE	1.08E-08	3.43E-09	1.66E-09	1.06E-09	7.51E-10	5.43E-10	3.94E-10	3.05E-10	2.52E-10	2.09E-10
SSE	4.12E-09	1.30E-09	6.30E-10	4.04E-10	2.85E-10	2.06E-10	1.50E-10	1.16E-10	9.56E-11	7.94E-11
S	7.19E-09	2.27E-09	1.10E-09	7.06E-10	4.99E-10	3.60E-10	2.62E-10	2.02E-10	1.67E-10	1.39E-10
SSW	7.89E-09	2.49E-09	1.21E-09	7.74E-10	5.47E-10	3.95E-10	2.87E-10	2.22E-10	1.83E-10	1.52E-10
SW	8.85E-09	2.80E-09	1.35E-09	8.68E-10	6.13E-10	4.43E-10	3.22E-10	2.49E-10	2.05E-10	1.71E-10
WSW	1.21E-08	3.82E-09	1.85E-09	1.18E-09	8.37E-10	6.05E-10	4.39E-10	3.39E-10	2.80E-10	2.33E-10
W	9.68E-09	3.06E-09	1.48E-09	9.49E-10	6.71E-10	4.85E-10	3.52E-10	2.72E-10	2.25E-10	1.87E-10
WNW	3.28E-09	1.04E-09	5.54E-10	3.22E-10	2.51E-10	1.64E-10	1.19E-10	9.22E-11	7.62E-11	6.33E-11
NW	5.88E-09	1.86E-09	8.99E-10	5.77E-10	4.07E-10	2.94E-10	2.14E-10	1.65E-10	1.37E-10	1.13E-10
NNW	1.22E-08	3.84E-09	1.86E-09	1.19E-09	8.43E-10	6.09E-10	4.42E-10	3.42E-10	2.82E-10	2.35E-10

Direction	804m	1609m	2416m	3218m	4022m	4827m	5632m	6436m	7240m	8045m
X/Q										
N	2.34E-06	8.13E-07	4.56E-07	3.06E-07	2.24E-07	1.72E-07	1.37E-07	1.13E-07	9.72E-08	8.43E-08
NNE	3.01E-06	1.02E-06	5.81E-07	3.94E-07	2.91E-07	2.25E-07	1.80E-07	1.49E-07	1.28E-07	1.11E-07
NE	2.48E-06	8.70E-07	4.88E-07	3.27E-07	2.40E-07	1.84E-07	1.47E-07	1.21E-07	1.04E-07	9.01E-08
ENE	1.51E-06	5.37E-07	2.94E-07	1.92E-07	1.39E-07	1.05E-07	8.25E-08	6.79E-08	5.79E-08	5.01E-08
E	1.28E-06	4.52E-07	2.44E-07	1.58E-07	1.13E-07	8.50E-08	6.65E-08	5.46E-08	4.65E-08	4.01E-08
ESE	9.59E-07	3.28E-07	1.75E-07	1.13E-07	8.09E-08	6.08E-08	4.75E-08	3.90E-08	3.31E-08	2.85E-08
SE	7.73E-07	2.65E-07	1.42E-07	9.20E-08	6.57E-08	4.95E-08	3.87E-08	7.93E-05	2.70E-08	2.33E-08
SSE	4.47E-07	1.54E-07	8.18E-08	5.27E-08	3.75E-08	2.80E-08	2.18E-08	1.79E-08	1.52E-08	1.68E-08
S	6.59E-07	2.27E-07	1.21E-07	7.75E-08	5.49E-08	4.11E-08	3.20E-08	2.61E-08	2.21E-08	1.90E-08
SSW	6.43E-07	2.22E-07	1.19E-07	7.73E-08	5.52E-08	4.16E-08	3.25E-08	2.67E-08	2.26E-08	1.95E-08
SW	7.75E-07	2.65E-07	1.45E-07	9.61E-08	6.96E-08	5.31E-08	4.19E-08	3.46E-08	2.95E-08	2.55E-08
WSW	1.49E-06	5.11E-07	2.86E-07	1.91E-07	1.40E-07	1.08E-07	8.58E-08	7.11E-08	6.08E-08	5.27E-08
W	1.29E-06	4.52E-07	2.51E-07	1.67E-07	1.22E-07	9.30E-08	7.37E-08	6.09E-08	5.21E-08	4.51E-08
WNW	5.27E-07	1.88E-07	1.05E-07	6.99E-08	5.10E-08	3.91E-08	3.10E-08	2.56E-08	2.19E-08	1.90E-08
NW	7.90E-07	2.79E-07	1.54E-07	1.02E-07	7.39E-08	5.63E-08	4.45E-08	3.67E-08	3.14E-08	2.71E-08
NNW	1.28E-06	4.51E-07	2.49E-07	1.64E-07	1.19E-07	9.06E-08	7.15E-08	5.90E-08	5.04E-08	4.36E-08

8.3 LAND USE CENSUS

8.3.1. CONTROL

A Land Use Census shall be conducted annually between June 1 and October 1, and shall identify within a distance of 5 miles the location in each of the 16 meteorological sectors of the nearest milk animal, the nearest residence, and the nearest garden of greater than 500 square feet producing broad leaf vegetation. (In lieu of a garden census, broad leaf vegetation sampling of at least three different kinds of vegetation may be performed in an onsite garden located in the meteorological sector with the highest average annual growing season deposition parameter (D/Q) OR another location with a higher D/Q than the location of the maximally exposed individual.)

8.3.2 APPLICABILITY: At all Times.

8.3.3 ACTION:

- With a Land Use Census identifying a location(s) that yields a calculated dose or dose commitment greater than the values currently being calculated in Section 5.3.11 (Surveillance Requirements) of the ODCM, identify the new location(s) in the next Annual Radioactive Effluent Release Report.
- With a Land Use Census identifying a location(s) that yields a calculated dose or dose commitment (via the same exposure pathway) 20% greater than at a location from which samples are currently being obtained in accordance with Section 8.1.1 (Radiological Environmental Monitoring - Controls), add the new location(s) within 30 days to the REMP described in the ODCM, if permission from the owner to collect samples can be obtained and sufficient sample volume is available. The sampling location(s), excluding Control location(s), having the lowest calculated dose or dose commitment(s), via the same exposure pathway, may be deleted from this monitoring program after October 31 of the year in which this Land Use Census was conducted. Submit in the next Annual Radioactive Effluent Release Report documentation for a change in the ODCM including a revised figure(s) and table(s) for the ODCM reflecting the new location(s) with information supporting the change in sampling location(s).

8.3.4 SURVEILLANCE REQUIREMENTS

The Land Use Census shall be conducted between June 1 and October 1 of each year using a method that will best provide the necessary information such as by door-to-door survey, vehicular survey, aerial survey, or by consulting local agricultural authorities. The results of the Land Use Census shall be included in the Annual Radiological Environmental Operating Report pursuant to Section 9.1 of the ODCM.

8.3.5 BASES:

This specification is provided to ensure that changes in the use of areas at or beyond the SITE BOUNDARY are identified and that modifications to the REMP given in the ODCM are made if required by the results of this census. Information from methods such as the door-to door survey, vehicular survey, aerial survey, or from consulting with local agricultural authorities shall be used. This census satisfies the requirements of Section IV.B.3 of Appendix I to 10 CFR 50. Restricting the census to gardens of greater than 500 square feet provides assurance that significant exposure pathways via leafy vegetables will be identified and monitored, since a garden of this size is the minimum required to produce the quantity (26 kg/year) of leafy vegetables assumed in Regulatory Guide 1.109 for consumption by a child. To determine this minimum garden size, the following assumptions were made: (1) 20% of the garden was used for growing broad leaf vegetation (i.e., similar to lettuce and cabbage), and (2) there was a vegetation yield of 2 kg/m².

8.4 INTERLABORATORY COMPARISON PROGRAM

8.4.1 CONTROL

Analyses shall be performed on all radioactive materials supplied as part of an Interlaboratory Comparison Program, that correspond to samples required by the REMP, and that has been approved by the Commission, if such a program exists.

8.4.2 APPLICABILITY: At all times.

8.4.3 ACTION:

With analyses not performed as required above, report the corrective actions taken to prevent recurrence to the Commission in the Annual Radiological Environmental Operating Report pursuant to Section 8.4.1 (Interlaboratory Comparison Program – Control) of the ODCM.

8.4.4 SURVEILLANCE REQUIREMENTS

The Interlaboratory Comparison Program is described in and implemented by procedure CH-QC-INTERLAB. A summary of the results obtained as part of the above required Interlaboratory Comparison Program shall be included in the Annual Radiological Environmental Operating Report pursuant to Section 8.4.1 (Interlaboratory Comparison Program – Control) of the ODCM.

8.4.5 BASES:

The requirement for participation in an approved Interlaboratory Comparison Program is provided to ensure that independent checks on the precision and accuracy of the measurements of radioactive materials in environmental sample matrices are performed as part of the Quality Assurance program for environmental monitoring in order to demonstrate that the results are valid for the purposes of Section IV.B.2 of Appendix I to 10 CFR 50.

9.0 REPORTING REQUIREMENTS

9.1 Annual Radiological Environmental Operating Report

An Annual Radiological Environmental Operating Report covering the operation of the unit during the previous calendar year shall be submitted prior to May 15 of each year. The Annual Radiological Environmental Operating Report shall include summaries, interpretations, and analysis of trends of the results of the radiological environmental surveillance activities for the report period, including a comparison with background (control) samples and previous environmental surveillance reports and an assessment of the observed impacts of the plant operation on the environment. The report shall also include the results of the Land Use Census as required.

This report shall include any new location(s) identified by the Land Use Census which yield a calculated dose or dose commitment greater than those forming the basis of Section 8.1.1 (Radiological Environmental Monitoring - Controls). The report shall also contain a discussion which identifies the causes of the unavailability of milk or leafy vegetable samples and identifies locations for obtaining replacement samples in accordance with Section 8.1.1 (Radiological Environmental Monitoring - Controls).

The Annual Radiological Environmental Operating Report shall include the results of analysis of all radiological environmental samples and of all environmental radiation measurements taken during the period pursuant to the locations specified in the tables and figures of Section 5.0 of the ODCM, the summarized and tabulated results of these analyses and measurements shall be in the format of Table 9-1, derived from the Radiological Assessment Branch Technical Position, Revision 1, November 1979. In the event that some results are not available for inclusion with the report, the report shall be submitted noting and explaining the reasons for the missing results. The missing data shall be submitted as soon as possible in a supplementary report.

The report shall also include the following:

- a. a summary description of the radiological environmental monitoring program including a map of all sampling locations keyed to a table giving distances and directions from the reactor centerline; and
- b. the results of the licensee participation in an Interlaboratory Comparison Program, and the corrective actions taken if the specified program is not being performed as required by Section 8.4.1 (Interlaboratory Comparison Program – Control).
- c. a discussion of all deviations from the sampling schedule specified in Table 8-1.

- d. a discussion of any environmental sample measurements that exceed the reporting levels but are not the result of plant effluents, as required in the second ACTION of Section 8.1.3.
- e. a discussion of all analyses in which the required LLD was not achievable.

9.2 ANNUAL RADIOACTIVE EFFLUENT RELEASE REPORT

The Radioactive Effluent Release Report covering the operation of the unit during the previous calendar year of operation shall be submitted prior to May 15 each year. This report shall include a summary, on a quarterly basis, of the quantities of radioactive liquid and gaseous effluents and solid waste released as outlined in Regulatory Guide 1.21, Revision 1, with data summarized on a quarterly basis following the format of the Appendix thereof. For solid wastes, the format for Table 3 in Appendix B shall be supplemented with three additional categories: classes of solid wastes (as defined by 10 CFR 61), type of container (e.g. LSA, Type A, Type B, etc.) and solidification agent or absorbent (e.g., Portland cement).

The Radioactive Effluent Release Report shall include an assessment of radiation doses from the radioactive liquid and gaseous effluents released from the unit during each of the previous four calendar quarters as outlined in Regulatory Guide 1.21, Revision 1. In addition, the site boundary maximum noble gas gamma air and beta air doses shall be evaluated. The assessment of radiation doses shall be performed in accordance with Controls 1.2 and 2.3. This same report shall include an annual summary of hourly meteorological data collected over the previous calendar year. The Radioactive Effluent Release Report shall include a discussion which identifies the circumstances which prevented any required detection limits for effluent sample analyses being met. This report shall also include an assessment of the radiation doses from radioactive gaseous and liquid effluents to MEMBERS OF THE PUBLIC due to their activities inside the SITE BOUNDARY during the report period. The assessment of radiation doses shall be performed in accordance with the methodology and parameters in the ODCM.

The Annual Radioactive Effluent Release Report shall also include an assessment of radiation doses to the likely maximum exposed MEMBER OF THE PUBLIC from reactor operation, including doses from effluent releases and direct radiation, for the previous calendar year to demonstrate compliance with 40 CFR 190.

This report shall include a list and description of unplanned releases from the site to UNRESTRICTED AREAS of radioactive materials in gaseous and liquid effluents made during the reporting period.

This report shall include any changes made during the reporting period to the Offsite Dose Calculation Manual (ODCM). Licensee may make changes to this ODCM and shall submit to the Commission, with the Radioactive Effluent Release Report for the period in which any change(s) is made, a copy of the new ODCM and a summary containing:

- a. sufficiently detailed information to support the rationale for the change;
- b. a determination that the change will not reduce the accuracy or reliability of dose calculations or setpoint determinations; and
- c. documentation of the fact that the change has been reviewed and found acceptable by the Plant Operations Review Committee.

Licensee initiated changes shall become effective after review and acceptance by the Plant Operations Review Committee on a date specified by the licensee.

This report shall include any changes made during the reporting period to the Process Control Program (PCP). This report shall include a discussion of any major changes to the radioactive waste treatment systems.

The Radiological Environmental Operating Report and the Annual Radioactive Effluent Release Report will be prepared and submitted to the U.S. Nuclear Regulatory Commission, Document Control Desk, Washington, D.C. 20555 and a copy to the Regional Administrator of the USNRC, Region I.

9.3 SPECIAL REPORTS

Guidance is given for each of these reports in the applicable Control. The following general guidelines are included here for calculating dose to an exposed individual or the MEMBERS OF THE PUBLIC for preparation of Special Reports:

- a. The maximally exposed real MEMBER OF THE PUBLIC will generally be the same individual considered in the ODCM.
- b. Dose contributions to the maximally exposed individual need only be considered to be those resulting from the Ginna plant itself. All other uranium fuel cycle facilities or operations are of sufficient distance to contribute a negligible portion of the individual's dose.
- c. For determining the total dose to the maximally exposed individual from the major gaseous and liquid effluent pathways and from direct radiation, dose evaluation techniques used in preparing the Special Report will be those described in the ODCM, or other applicable methods where appropriate.
- d. The contribution from direct radiation may be estimated by effluent dispersion modeling or calculated from the results of the environmental monitoring program for direct radiation.

Table 9-1

Radiological Environmental Monitoring Program Summary

R.E. GINNA NUCLEAR POWER PLANT Docket No. 50-244 WAYNE, NEW YORK							
Pathway Sampled Unit Of Measurement	Type And Total Number Of Analyses	LLD	Indicator Locations Mean (a) Range	Location With Highest Annual Mean		Control Locations Mean (a) Range	
				Name, Distance And Direction	Mean (a) Range		
Air: Particulate (pCi/Cu.M.) Iodine	Gross Beta						
	Gamma Scan						
	Gamma Scan						
Direct Radiation: Dosimetry (mrem/quarter)	Gamma						
Water: Drinking (pCi/liter) Surface (pCi/liter) Shoreline Sediment	Gross Beta						
	Gamma Scan						
	Iodine						
	Gross Beta						
	Gamma Scan						
	Iodine						
	Gamma Scan						
Milk: (pCi/liter)	Iodine						
	Gamma Scan						
Fish:	Gamma Scan						
Vegetation:	Gamma Scan						
(a) Mean and range based on detectable measurements only. Fraction of detectable measurements at specified locations in parentheses.							

10.0 REFERENCES

- 10.1 R. E. Ginna Nuclear Power Plant Unit No. 1, Appendix A to Operating License No.DPR-18, Technical Specifications, Rochester Gas and Electric Corporation, Docket 50-244
- 10.2 USNRC, Preparation of Radiological Effluent Technical Specifications for Nuclear Power Plants, NUREG-0133 (October, 1978).
- 10.3 USNRC, Calculation of Annual Doses to Man from Routine Releases of Reactor Effluents for the Purpose of Evaluating Compliance with 10 CFR Part 50, Appendix I, Regulatory Guide 1.109, Revision 1 (October 1977).
- 10.4 "R.E. Ginna Nuclear Power Plant Tracer Dilution Study for the Town of Ontario Municipal Drinking Water Intake," HydroQual, Inc. (May 28, 2010).
- 10.5 R. E. Ginna Nuclear Power Plant, Calculations to Demonstrate Compliance with the Design Objectives of 10 CFR Part 50, Appendix I, Rochester Gas and Electric Corporation, (June, 1977).
- 10.6 USNRC, Methods for Estimating Atmospheric Transport and dispersion of Gaseous Effluents in Routine Releases from Light-Water-Cooled Reactors, Regulatory Guide 1.111, Revision 1 (July, 1977).
- 10.7 R. E. Ginna Nuclear Power Plant, Incident Evaluation, Ginna Steam Generator Tube Failure Incident January 25, 1982, Rochester Gas and Electric Corporation, (April 12, 1982).
- 10.8 Pelletier, C. A., et. al., Sources of Radioiodine at Pressurized Water Reactors, EPRI NP-939 (November 1978).
- 10.9 NUREG-1301, Offsite Dose Calculation Manual Guidance: Standard Radiological Effluent Controls for pressurized Water Reactors.
- 10.10 International Commission on Radiological Protection, Publication 30 Supplement to Part I, "Limits for Intake of Radionuclides by Workers" (July 1978).

- 10.11 International Commission on Radiological Protection (ICRP) Publication 2, "Permissible Dose For Internal Radiation," 1959.
- 10.12 Nuclear Regulatory Commission Reg. Guide 1.21, "Measuring, Evaluating, and Reporting Radioactive Material in Liquid and Gaseous Effluents and Solid Waste," Revision 1, June 1974.
- 10.13 Nuclear Regulatory Commission Regulatory Guide 1.113, "Estimating Aquatic Dispersion of Effluents from Accidental and Routine Reactor Releases for the Purpose of Implementing Appendix I," Revision 1, April 1977.
- 10.14 Title 10 Code of Federal Regulation Part 20 (10 CFR 20), Standards for Protection Against Radiation.
- 10.15 Title 10 Code of Federal Regulation Part 61 (10 CFR 61), Licensing Requirements for Land Disposal of Radioactive Waste.
- 10.16 Title 10 Code of Federal Regulation Part 71 (10 CFR 71), Packaging and Transportation of Radioactive Material.
- 10.17 Title 40 Code of Federal Regulation Part 141 (40 CFR 141), National Primary Drinking Water Standards.
- 10.18 Title 40 Code of Federal Regulation Part 190 (40 CFR 190), Environmental Radiation Protection Standards for Nuclear Power Operations.



**ANNUAL RADIOLOGICAL
ENVIRONMENTAL OPERATING REPORT:
JANUARY 1, 2019 – DECEMBER 31, 2019**

MAY 2020



R.E. Ginna Nuclear Power Plant
1503 Lake Road
Ontario, New York 14519

TABLE OF CONTENTS

LIST OF FIGURES	ii
LIST OF TABLES	iii
1. EXECUTIVE SUMMARY	1
2. INTRODUCTION.....	2
2.1 Station Description.....	2
2.2 Program Description and Background.....	2
2.3 Program Objectives.....	2
3. PROGRAM DESCRIPTION	3
3.1 Sample Collection and Analysis	3
3.2 Data Interpretation.....	3
3.3 Quality Assurance Program	3
3.4 Land Use Survey	4
3.5 Program Exceptions	5
3.6 Corrections to Previous Reports.....	5
4. RESULTS AND DISCUSSIONS	6
4.1 Aquatic Environment	6
4.1.a Surface and Drinking Water.....	6
4.1.b Aquatic Organisms.....	7
4.1.c Shoreline Sediment	7
4.2 Atmospheric Environment	7
4.2.a Air Iodine	8
4.2.b Air Particulate Filters	8
4.3 Terrestrial Environment	8
4.3.a Vegetation	9
4.3.b Milk.....	9
4.4 Direct Radiation	9
4.5 Groundwater.....	10
4.6 Summary and Conclusion	11
5. REFERENCES.....	11
Appendix A REMP Sample Locations	15
Appendix B REMP Analytical Results.....	24
Appendix C Quality Assurance Program	53
Appendix D Land Use Survey	66
Appendix E Interpretations and Graphical Representations.....	70

LIST OF FIGURES

Figure	Title	Page
A-1	Map of New York State and Lake Ontario Showing Location of R.E. Ginna Nuclear Power Plant	20
A-2	Onsite Sample Locations	21
A-3	Offsite Sample Locations (TLDs and milk farms within 5 miles).....	22
A-4	Water Sample, Milk Farms and TLD Locations.....	23
E-1	E-Series 1, Table B-1 (Gross Beta Values for Surface and Drinking Water).....	72
E-2	E-Series 2, Table B-5 / B-6 (Beta in Air Particulates).....	76
E-3	E-Series 3, Table B-12 (Direct Radiation).....	81
E-4	E-Series 4, Table B-13 (Tritium in Groundwater).....	94

LIST OF TABLES

Table	Title	Page
1	Synopsis of R.E. Ginna Nuclear Power Plant Radiological Environmental Monitoring Program.....	12
2	Annual Summary of Radioactivity in the Environs of the R.E. Ginna Nuclear Power Plant	13
A-1	Locations of Environmental Sampling Stations for the R.E. Ginna Nuclear Plant.....	17
B-1	Concentration of Tritium, Gamma Emitters and Gross Beta in Surface and Drinking Water	26
B-2	Concentration of Gamma Emitters in the Flesh of Edible Fish	29
B-3	Concentration of Gamma Emitters in Sediment.....	30
B-4	Concentration of Iodine-131 in Filtered Air (Charcoal Cartridges).....	31
B-5	Concentration of Beta Emitters in Air Particulates – Onsite Samples	34
B-6	Concentration of Beta Emitters in Air Particulates - Offsite Samples	38
B-7	Concentration of Gamma Emitters in Air Particulates.....	40
B-8	Concentration of Gamma Emitters in Vegetation Samples.....	42
B-9	Concentration of Gamma Emitters (including I-131) in Milk	43
B-10	Typical MDA Ranges for Gamma Spectrometry.....	44
B-11	Typical LLDs for Gamma Spectrometry	45
B-12	Direct Radiation	46
B-13	Groundwater Monitoring Wells	50
C-1	Results of Participation in Cross Check Programs.....	55
C-2	Results of Quality Assurance Program	58
C-3	Teledyne Brown Engineering’s Typical MDAs for Gamma Spectrometry	65
D-1	Land Use Survey Distances.....	68

1. EXECUTIVE SUMMARY

The Radiological Environmental Monitoring Program (REMP) is a comprehensive surveillance program, which is implemented to assess the impact of site operations on the environment and compliance with 10 CFR 50 Appendix I and 40 CFR 190. Samples are collected from the aquatic and terrestrial pathways applicable to the site. The aquatic pathways include Lake Ontario fish, surface waters, groundwater, and lakeshore sediment. The terrestrial pathways include airborne particulate and radioiodine, milk, food products, and direct radiation.

Results of the monitoring program for the 2019 operational period for R.E. Ginna Nuclear Power Plant are included in this report. This report presents a synopsis of the REMP (Table 1), summary of the detectable activity analytical results (Table 2), sampling locations (Appendix A), compilation of the analytical data (Appendix B), results of the Quality Assurance Program (Appendix C), and results of the Land Use Survey (Appendix D). Interpretation of the data and conclusions are presented in the body of this report.

The results of the REMP verify that the effluent releases did not impact the environment with a measurable concentration of radioactive materials and/or levels of radiation that are higher than expected. The 2019 results for all pathways sampled were consistent with the previous five-year historical results and exhibited no adverse trends. The results of the REMP continue to demonstrate that the operation of the plant does not result in a measurable dose to a member of the general population, or adversely impact the environment as a result of radiological effluents. The program continues to demonstrate that the dose to a member of the public, as a result of the operation of R.E. Ginna Nuclear Power Plant, remains significantly below the federally required dose limits specified in 10 CFR 20 and 40 CFR 190.

2. INTRODUCTION

2.1 Station Description

R.E. Ginna Nuclear Power Plant (Ginna), owned by Exelon Generation, is an operating nuclear generating facility consisting of one pressurized water reactor. Ginna achieved criticality in September 1969 and commenced commercial operation in July 1970. The location of the plant in relation to local metropolitan areas is depicted in Appendix A, Figure A-1.

2.2 Program Description and Background

The Annual Radiological Environmental Operating Report (AREOR) is published in accordance with Section 8.0 of the Offsite Dose Calculation Manual (ODCM, Ref. 1) and the Plant's Technical Specifications (Ref. 2). This report describes the REMP, and its implementation as required by the ODCM. The environmental surveillance data collected during this reporting period were compared with that generated in previous periods whenever possible to evaluate the environmental radiological impact of the R.E. Ginna Nuclear Power Plant. Results of the monitoring program for the pre-operational and previous operational periods through 2018 have been reported in a series of previously released documents.

The REMP is implemented to measure radioactivity in the aquatic and terrestrial pathways. The aquatic pathways include Lake Ontario fish, surface waters, groundwater, and lakeshore sediment. Measurement results of the samples representing these pathways contained only natural background radiation or low concentrations of Cs-137 resulting from past atmospheric nuclear weapons testing. Terrestrial pathways monitored included airborne particulate and radioiodine, milk, food products, and direct radiation.

2.3 Program Objectives

The objectives of the REMP for the R.E. Ginna Nuclear Power Plant are:

- a. Measure and evaluate the effects of plant operation on the environment.
- b. Monitor background radiation levels in the environs of the Ginna site.
- c. Demonstrate compliance with the environmental conditions and requirements of applicable state and federal regulations, including the ODCM and 40 CFR 190.
- d. Provide information by which the general public can evaluate environmental aspects of the operation of R.E. Ginna Nuclear Power Plant.

3. PROGRAM DESCRIPTION

3.1 Sample Collection and Analysis

The locations of the individual sampling stations are listed in Table A-1 and shown in Figures A-2 and A-3. All samples were collected and analyzed by Exelon personnel or its contractors in accordance with Ginna procedures (Ref. 3).

During 2019, 1350 samples were collected for analysis by gross beta counting, tritium, and/or gamma spectroscopy. These included 89 surface water samples, 18 fish samples, 5 sediment samples, 623 air particulate samples, 311 air iodine samples, 28 vegetation samples, 38 milk samples, 74 groundwater samples, and 164 dosimeter measurements. Deviations from the REMP sampling schedule are described in section 3.5. This monitoring program satisfied the minimum number of samples required by the ODCM for all pathways.

Ginna Chemistry personnel collected all REMP samples. Analysis was performed at either Ginna's onsite laboratory (groundwater samples), Environmental Dosimetry Company in Sterling Massachusetts (direct radiation samples), or Exelon Industrial Services – Ft. Smallwood Environmental Laboratory in Baltimore, Maryland (surface and drinking water, aquatic organisms, shoreline sediment, air particulate filters, air iodine, and vegetation samples). A summary of the content of the REMP and the results of the data collected for indicator and control locations are provided in Tables 1 and 2.

3.2 Data Interpretation

Many results in environmental monitoring occur at or below the minimum detectable activity (MDA). In this report, all results below the relevant MDA are reported as being "not detected." Typical MDA values are listed in Appendix B, Table B-10.

3.3 Quality Assurance Program

Appendix C provides a summary of Exelon Industrial Services (EIS) – Ft. Smallwood Environmental Laboratory's quality assurance program for 2019. It consists of Table C-1, which represents a compilation of the results of the EIS – Ft. Smallwood Environmental Laboratory's participation in an inter-comparison program with Environmental Resource Associates (ERA) located in Arvada, Colorado and Analytics, Inc. located in Atlanta, Georgia and Eckert and Ziegler Analytics, Inc. (EZA) located in Atlanta, Georgia. Table C-2 compiles the results of the Exelon Industrial Services Ft. Smallwood Laboratory's participation in a split sample program with Teledyne Brown Engineering located in Knoxville, Tennessee. Table C-3 identifies a list of typical MDAs achieved by Teledyne Brown for Gamma Spectroscopy.

All the EIS – Ft. Smallwood Environmental Laboratory results contained in Table C-1 agree with the inter-comparison laboratory results within the range of $\pm 2 \sigma$ (standard deviation) between the analytical values or agree with the ranges established in the NRC Resolution Test Criteria.

All the results contained in Table C-2 agree within the range of $\pm 2 \sigma$ of each other with their respective Ft. Smallwood Environmental Laboratory original, replicate and/or Teledyne Brown Engineering's split laboratory samples.

3.4 Land Use Survey

In September 2019, Ginna staff conducted a Land Use Survey to identify the location of the nearest milk animal, the nearest residence, and the nearest garden greater than 500 square feet in each of the nine sectors within a five-mile radius of the power plant. The Land Use Survey is conducted in accordance with Ginna procedures (Ref. 4). If changes are noted in the annual Land Use Survey, alterations to Ginna's REMP program would be made to ensure sampling practices cover these new areas of potential public exposure. The position of the nearest residence and garden and animals producing milk for human consumption in each sector is provided in Appendix D, Table D-1.

Over the past year, the following land use observations were made within a 5-mile radius of the power plant:

- The nearest residence remains in the SSE sector, approximately 610 meters from the reactor.
- Single-family home / senior housing subdivision / development construction was observed near the plant on LaFrank Drive (Ontario), and South of Route 104 near Tops Plaza (Ontario).
- Lake Front Estates and Summer Lake subdivisions continue to expand along with the southeast corner of Lake Road and Slocum Road.
- Other single-family home construction was observed sporadically within 5-miles of the plant.
- A new 120-acre commercial hydroponic farm has 25 acres of active production of "AGRI-GROW" tomatoes year-round at East end of Dean Parkway. (North of Route 104).
- Commercial fishing information was collected from the New York State Department of Environmental Conservation (NYSDEC) which shows activity only in the Eastern basin of Lake Ontario. Commercial fishing operations have not changed in the last five-years and no commercial fishing takes place within 5-miles of Ginna.
- No new agricultural land use was identified.
- No new food producing facilities were identified as the commercial hydroponic farm is not currently growing produce.
- No new milk producing animals were identified.

3.5 Program Exceptions

The reportable items in the Annual Environmental Radiological Operating Report under procedure CHA-RETS-VARIATION are as follows:

- On 4/18/19, during a review of REMP data at the vendor laboratory EIS, a radioiodine cartridge was counted prior to clearing the source check on the counting apparatus leading to a false-positive result. After acknowledging the error, the sample was recounted and both counts showed no I-131 activity. The peaks identified on the initial count were artifacts from the source check. Although no exception to the REMP program resulted from this laboratory practice, the issue has been included in this report.
- On 7/9/19, when collecting the Webster Water Authority weekly supplemental sample, it was noted that only 4L of sample were collected in the compositor and the source of water was off. Flow was inadvertently terminated by Webster Water Authority workers. According to the sample volume collected (4L), this represents a sample period of four days (7/2/19 – 7/6/19). The Webster Water Authority sample is a supplementary sample to the Ginna REMP program, and no compensatory sampling was performed during that week. Sample was restored to normal collection the following week and no further conditions adverse to quality existed.
- On 8/13/19, when performing the weekly exchange of air filters at Environmental Sample Station (ES11, Williamson; RG&E Substation 207), it was noted the air sampler was off. The ground fault circuit interrupter (GFCI) was unsuccessfully reset and the sampling unit was not running. For the sample period of 8/6/2019 – 8/13/2019, the sampler collected a total of 38.2 m³ (1,500 ft³) during 24.9 hours of runtime. This volume does not meet the Lower Limit of Detection (LLD) requirements. Sample collection returned to normal collection the following week and no further conditions adverse to quality existed.
- On 11/4/19, when collecting the Webster Water Authority weekly supplemental sample, it was noted that only 1L of sample was collected in the compositor and the source of the water was off. This collection volume is less than the required minimum of 4L of sample volume. There were no issues with the collection equipment and the source of the low sample volume was determined to be the source water for the sampler being inadvertently terminated by Webster Water Authority workers. The Webster Water Authority sample is a supplementary sample to the Ginna REMP program, and no compensatory sampling was performed during that week. Sample was restored to normal collection the following week and no further conditions adverse to quality existed.

3.6 Corrections to Previous Reports

There are no corrections necessary to any previously submitted Annual Radiological Environmental Operating Report (AREOR).

4. RESULTS AND DISCUSSIONS

All environmental samples collected during the year were analyzed in accordance with Exelon analytical procedures (Ref. 5). The analytical results for this reporting period are presented in Appendix B and the detectable activity results are also summarized in Table 2. For discussion purposes, the analytical results are divided into five categories: Aquatic Environment, the Atmospheric Environment, the Terrestrial Environment, Direct Radiation, and Groundwater.

4.1 Aquatic Environment

The aquatic environment surrounding the plant was monitored by analyzing samples of surface and drinking water, Lake Ontario fish, and shoreline sediment. These samples were obtained from various sampling locations near the plant.

4.1.a Surface and Drinking Water

Monthly composite samples are collected from Lake Ontario at an upstream control location (Monroe County Water Authority - Shoremont) and a downstream indicator location (Ontario Water District Plant - OWD) and analyzed for gross beta activity (Table B-1). A supplemental sample is also collected at the upstream location of the Webster Water Authority. A grab sample of Deer Creek is collected and analyzed monthly for gross beta activity (Table B-1). Lake Ontario is a primary indicator for sampling due to the close proximity to the station as well as the Lake providing recreational activities which could be a means of public exposure. Additionally, liquid releases from the station enter Lake Ontario waters, which leads to sampling of this environment, in all its forms, to be a priority.

In 2019, the gross beta averages for the upstream Lake Ontario monitoring locations (controls) and downstream Lake Ontario monitoring locations (indicators) were 2.09 pCi/Liter and 2.10 pCi/Liter, respectively. Gross beta analysis of the monthly composite samples showed no statistically significant difference in activity between the control and indicator locations that would indicate plant related activity higher than background.

The average gross beta concentration seen in the Mill Creek samples (control) and the Deer Creek (indicator) samples were 3.81 pCi/Liter and 3.73 pCi/Liter, respectively. Results from Deer Creek (indicator) and Mill Creek (control) are higher than other surface water samples within the REMP program due to naturally occurring radiological daughter products from radon within the soil being introduced into the samples. These naturally occurring radiological daughter products would exist in this environ at these same levels even if Ginna had never been built. Gross beta analysis of the samples showed no statistically significant difference in activity between the control and indicator locations that would indicate plant related activity higher than background.

Gamma isotopic analysis is performed on each monthly composite sample. These are listed in Table B-1 and are separated by source of sample. During 2019, no sample results indicated detection of gamma activity above MDA.

Tritium analysis was performed on all water samples on a monthly basis. Composites are made from the monthly samples and a portion filtered to remove interferences for analysis by beta scintillation. During 2019, no surface water or drinking water sample results indicated detectable tritium activity.

4.1.b Aquatic Organisms

Indicator fish are caught in the vicinity of the Discharge Canal and analyzed for radioactivity from liquid effluent releases from the plant. The fish are filleted to represent that portion which would normally be eaten and represents the likely pathway for human exposure. Additional fish are caught more than 15 miles away to be used as control samples and are prepared in the same manner.

At a minimum, four different edible species of fish are analyzed during each half-year from the indicator and background locations. Fish are caught by R.E. Ginna Nuclear Power Plant Chemistry personnel and are analyzed by gamma spectroscopy after being held for periods typically less than two weeks to keep the LLD value for the shorter half-life isotopes realistic. Detection limits could also be affected by small mass samples, (< 2000 grams), in some species. gamma isotopic concentrations (pCi/kilogram wet) are listed in Table B-2.

During 2019, none of the indicator samples indicated activity other than naturally occurring radionuclides.

4.1.c Shoreline Sediment

Samples of shoreline sediment are taken upstream (Town of Greece near Slater Creek) and downstream (Near the Ontario Water District) of R.E. Ginna Nuclear Power Plant. The control sample is typical of the lake bottom, rich in mollusk shells and rocky particulate. These samples are analyzed for radionuclides that a member of the public would be expected to encounter during swimming and wading activities. Similarly, indicator samples are collected at the Bear Creek boat dock as this is another recreational area accessible to the public.

Results of the gamma isotopic analysis for sediment are included in Table B-3. During 2019, all sediment samples indicated that gamma emitters were below detection limits.

4.2 Atmospheric Environment

Radioactive particles in air are collected by drawing approximately one standard cubic foot per minute (SCFM) through a two-inch diameter particulate filter. The volume of air sampled is measured by a dry gas meter and corrected for the pressure drop across the filter. The filters are changed weekly and allowed to decay for three days prior to counting to eliminate

most of the natural radioactivity such as the short half-life decay products of radon. The decay period is used to give a more sensitive measurement of long-lived man-made radioactivity.

A ring of six sampling stations is located on the plant site from 180 to 440 meters from the reactor centerline near the point of the maximum annual average ground level concentration, one additional sampling location is located on-site at 770 meters, and two others offsite at approximately seven miles. In addition, there are three sampling stations located approximately seven to 16 miles from the site that serve as control stations. The arrangement of air sampling stations in concentric rings around the station would ensure the environment would be appropriately monitored if a radiological release were to occur. See Figure A-2 and Figure A-4.

4.2.a Air Iodine

Radioiodine cartridges are placed at six locations. These cartridges are changed and analyzed each week. No positive analytical results were found on any sample. A list of values for these cartridges is given in Table B-4.

4.2.b Air Particulate Filters

The major airborne species released as gaseous effluents are noble gases and tritium. Most of this activity is released in a gaseous form; however, some radioiodine is released as airborne particulate and some of the particulate activity is due to short lived noble gas decay products. Tables B-5 provides a list of gross beta analysis values for the on-site sample stations. Table B-6 is a list of gross beta analysis values for the off-site sample stations.

Based on the weekly comparisons, there was no statistical difference between the control and indicator radioactive particulate concentrations. The average for the control samples (i.e., offsite sampling locations) was 0.021 pCi/m³ and the averages for the indicator samples (i.e., onsite sampling locations) was 0.021 pCi/m³ for the period of January to December 2019. Maximum weekly concentrations for all control stations and all indicator stations were 0.038 pCi/m³ and 0.039 pCi/m³, respectively.

The particulate filters from each sampling location were saved and a 13-week composite was made. A gamma isotopic analysis was performed for each sampling location and corrected for decay. No positive analytical results were found on any sample. The results of these analyses are listed in Tables B-7.

4.3 Terrestrial Environment

Crops are grown on the plant property in a location with a highest off-site meteorological deposition parameter, and samples of the produce are collected at harvest time for analysis. Control samples are purchased from farms greater than 10 miles from the plant.

4.3.a Vegetation

There was no indication in the vegetation samples of activity greater than naturally occurring background levels. Both onsite (indicator) and offsite (control) vegetation samples are rinsed prior to sampling as this is the expected behavior to be exhibited by a member of the public prior to consuming any produce. Analyses revealed that there was no difference in the radiological activity observed in the indicator and control sampling locations. Gamma isotopic data is provided in Table B-8.

4.3.b Milk

Although there are no indicator dairy herds located within five miles from the plant, Ginna has elected to continue sampling the milk pathway as a supplemental sample to satisfy this potential exposure pathway to a member of the public. This pathway is specific to gaseous radiological releases from Ginna station that could deposit onto the grazing pastures of dairy farms. When these grazing cows are milked, any potential radiological exposure received by the cow could enter the human pathway.

In 2019, milk samples were collected monthly during November through May from the indicator farm and biweekly during June through October. Samples are collected twice as frequently in the summer as the likelihood of cows grazing and not consuming stored feed is higher during this time. A control farm sample is taken for each monthly sample and once during each biweekly period. The milk is analyzed for Iodine-131 and also analyzed by gamma spectroscopy.

During 2019, no samples indicated I-131 activity above detection levels. There was no difference in the radiological activity observed in the indicator and control sampling locations. Table B-9 provides a listing of all samples collected and analytical results.

4.4 Direct Radiation

Thermoluminescent Dosimeter (TLDs / Dosimeters) are placed as part of the environmental monitoring program. 41 dosimeter badges are currently placed in four rings around the plant. These rings range from less than 1,000 feet to 15 miles and have been dispersed to give indications in each of the nine land-based sectors around the plant should an excessive release occur from the plant. Badges are changed and read after approximately three months exposure. Each direct radiation sampling location is described in Table A-1 and identified in Figure A-2.

In 2019, Ginna adopted Exelon procedure CY-AA-170-1001, “Environmental Dosimetry Performance Specifications, Testing, and Data Analysis,” which included new methodology for determining dose attributable to facility operations. As part of this methodology, the direct radiation dose to the general public is now determined in accordance with the Environmental Protection Agency (EPA) guidance 40 CFR 190, “Environmental Radiation Protection Standards for Nuclear Power Operations.” This methodology incorporates the concepts established in ANSI/HPS N13.37, “Environmental Dosimetry” as established in NRC Regulatory Guide 4.13, “Environmental Dosimetry - Performance, Specifications, Testing, and Data Analysis.”

In accordance with the measures set forth in this new methodology for reporting ambient gamma radiation, Ginna evaluated the last 5 years of TLD data to establish a background dose and baseline dose for each TLD location in the REMP. Detectable Facility Dose is now classified as any normalized net dose above the baseline (i.e. “background”) and is reported both quarterly and annually for each location. Therefore, the mean dose for both “Indicator” and “Control” locations will no longer be reported.

This new methodology of reporting Quarterly and Annual Normalized Net Dose for each location is reported in Table B-12, “Direct Radiation.” No locations showed a net positive normalized dose in 2019, meaning that Ginna had no statistically significant dose contributions for operations in 2019.

4.5 Groundwater

Groundwater monitoring wells have been established in close proximity to the station and are routinely sampled by Ginna personnel. In 2019, Ginna staff collected and analyzed samples collected from a total of 14 groundwater monitoring wells:

- GW01: Warehouse Access Road (Control)
- GW03: Screenhouse West, South Well
- GW04: Screenhouse West, North Well
- GW05: Screenhouse East, South (15.5’)
- GW06: Screenhouse East, Middle (20.0’)
- GW07: Screenhouse East, North (24.0’)
- GW08: All Volatiles Treatment Building
- GW10: Technical Support Center, South
- GW11: Contaminated Storage Building, SE (24.0’)
- GW12: West of Orchard Access Road
- GW13: North of Independent Spent Fuel Storage Installation (ISFSI)
- GW14: South of Canister Preparation Building
- GW15: West of Manor House
- GW16: Southeast of Manor House

Tritium is sampled for at nuclear facilities due to the migration capabilities of tritium. Essentially, tritium, when in an aqueous form, flows like water and can be found in surface water, groundwater, and atmospheric environs due to evaporative processes found in nature. Nuclear stations place a sensitivity on detecting tritium in the environment as it is an efficient marker to show if radioactivity has been introduced off-site. Groundwater samples are analyzed for tritium to a detection limit of 500 pCi/L, and for gamma emitting radionuclides to the environmental LLDs. The analytical results for groundwater monitoring well samples collected during 2019 are presented in table B-13.

In 2019, supplemental low-level tritium analysis was performed on select groundwater samples. This low-level study (which analyzed samples to a detection limit of 200 pCi/L), some positive detections were made ranging from 446 – 603 pCi/L. These positive results are within agreement with our gaseous tritium recapture experiences detailed in E-Series 4 at the end of this report.

4.6 Summary and Conclusion

Operation of the R.E. Ginna Nuclear Power Plant produced radioactivity and ambient radiation levels significantly below the limits of the ODCM and 40 CFR 190. The analytical results from the Radiological Environmental Monitoring Program indicate the operation of the R.E. Ginna Nuclear Power Plant had no measurable radiological impact on the environment or measurable build-up of plant-related radionuclides in the environment. The results also indicate operation of the plant did not result in a measurable radiation dose to the general population above natural background levels.

Additionally, the 2019 results are consistent with data for the past seven years and exhibited no detectable increases or adverse trends. Further explanation on REMP data can be found in Appendix E.

5. REFERENCES

1. Procedure CY-GI-170-300, Offsite Dose Calculation Manual (ODCM) R.E. Ginna Nuclear Power Plant, Revision 36 (Effective Date: 12/27/2018)
2. R.E. Ginna Nuclear Power Plant, Technical Specification 5.6.2; Annual Radiological Environmental Operating Report.
3. Procedure CY-AA-170-100, Radiological Environmental Monitoring Program.
4. Procedure CH-ENV-LAND-USE, Land Use Census; Completed September 2019.
5. Exelon Industrial Services – Ft. Smallwood Environmental Laboratory Procedures Manual, General Services Department.

Table 1

Synopsis of R.E. Ginna Nuclear Power Plant Radiological Environmental Monitoring Program

Sample Type	Sampling Frequency ¹	Number of Locations	Number Collected	Analysis	Analysis Frequency ¹	Number Analyzed
Aquatic Environment						
Surface & Drinking Water	M/C	7	89 89 89	Gamma Gross Beta Tritium	MC/M MC/M M/Q	89 89 89
Fish ²	A	4	18	Gamma	A	18
Shoreline Sediment	SA	2	5	Gamma	SA	5
Groundwater	M/Q	14	74 74	Tritium Gamma	M/Q M/Q	74 74
Atmospheric Environment						
Air Iodine ³	W	6	311	I-131	W	311
Air Particulates ⁴	W	12	623 48	Gross Beta Gamma	W QC	623 48
Direct Radiation Ambient Radiation	Q	41	164	TLD	Q	164
Terrestrial Environment						
Milk ⁵	M/BW	2	38	Gamma	M/BW	38
Vegetation ⁶	M	4	28	Gamma	M	28

¹ W=Weekly, BW=BiWeekly (15 days), M=Monthly (31 days), Q=Quarterly (92 days), SA=Semiannual, A=Annual, C=Composite

² Twice during fishing season including at least four species.

³ The collection device contains activated charcoal.

⁴ Beta counting is performed \geq 24 hours following filter change. Gamma spectroscopy performed on quarterly composite of weekly samples.

⁵ Bi-Weekly during growing season.

⁶ Annual at time of harvest. Samples include broad leaf vegetation.

Table 2

**Annual Summary of Radioactivity in the Environs of the
R.E. Ginna Nuclear Power Plant**

Medium or Pathway Sampled (Unit of Measurement)	Type and Total Number of Analyses Performed	Lower Limit of Detection (LLD)	Indicator Locations Mean (F)/Range ¹	Location with Highest Annual Mean Name/Distance & Direction ²	Highest Annual Mean (F) / Range ¹	Control Locations Mean (F)/Range
Aquatic Environment						
Surface & Drinking Water (pCi/L)	Gamma (84) Tritium (84)	2.3 (Cs-137) 2000	-- (48/48) -- (48/48)	-- --	-- (12/12) -- (12/12)	-- (24/24) -- (24/24)
Surface & Drinking Water, (pCi/L)	Gross Beta (89)	0.5	2.48 (51/51) (1.38 - 6.71)	Mill Creek -- SW	3.81 (12/12) (1.93 - 7.10)	2.92 (25/25) (1.42 - 7.10)
Sediment (pCi/kg)	Gamma (5)	17 (Cs-137)	-- (3/3) --(3/3)	--	-- (3/3) --(3/3)	-- (2/2) --(2/2)
Fish (pCi/kg)	Gamma (18)	15 (Cs-137)	-- (8/8) --(8/8)	--	-- (8/8) -- (8/8)	-- (10/10) -- (10/10)
Groundwater ³ (pCi/L)	Tritium (74) Gamma (56)	500 2.3 (Cs-137)	538 (5/70) -- (56/56)	GW10 (0.067 km E)	602 (1/4) (602)	-- (4/4) -- (4/4)
Direct Radiation						
Ambient Radiation (mR/91 days)	Dosimeters (164)	--	12.2 (128/128) (9.3-21.0)	Env. Station 13 0.77 km SSW	19.5 (4/4) (17.6-21.0)	11.0 (36/36) (9.3-13.1)

Table 2
Annual Summary of Radioactivity in the Environs of the
R.E. Ginna Nuclear Power Plant

Medium or Pathway Sampled (Unit of Measurement)	Type and Total Number of Analyses Performed	Lower Limit of Detection (LLD)	Indicator Locations Mean (F)/Range ¹	Location with Highest Annual Mean Name/Distance & Direction ²	Highest Annual Mean (F) / Range ¹	Control Locations Mean (F)/Range
Atmospheric Environment						
Air Iodine (10 ⁻² pCi/m ³)	I-131 (311)	0.002	-- (259/259) -- (259/259)	--	-- (52/52) -- (52/52)	-- (52/52) -- (52/52)
Air Particulates (10 ⁻² pCi/m ³)	Gross Beta (623)	0.5	2.1 (467/467) (1.0 – 3.9)	Env. Station 3 - 0.44 km ESE	2.2 (52/52) (1.2 – 3.8)	2.1 (156/156) (1.1 – 3.8)
Air Particulates (10 ⁻³ pCi/m ³)	Gamma (48)	1.8 (Cs-137)	-- (36/36) -- (36/36)	--	-- (4/4) -- (4/4)	-- (12/12) -- (12/12)
Terrestrial Environment						
Milk (pCi/L)	Gamma (38)	0.01 (I-131)	-- (19/19) -- (19/19)	--	-- (19/19) -- (19/19)	-- (19/19) -- (19/19)
Vegetation (pCi/L)	Gamma (28)	27 (Cs-137)	-- (20/20) -- (20/20)	--	-- (8/8) -- (8/8)	-- (8/8) -- (8/8)

¹ Mean and range based upon detectable measurements only. Fraction (F) of detectable measurements at specified location is indicated in parentheses

² From the center point of the containment building.

³ Most of the groundwater sample results for calculations were less-than detectable numerical values.

-- No detectable activity at specified location.

APPENDIX A

REMP Sample Locations

Summary of Appendix A Content

Appendix A contains information concerning the environmental samples which were collected during this operating period.

Sample locations and specific information about individual locations for Ginna are provided in Table A-1.

Figure A-1 shows the location of the R.E. Ginna Nuclear Power Plant in relation to New York State and Lake Ontario. Figures A-2, A-3, and A-4 show the locations of the power plant sampling sites in relation to the plant site at different degrees of detail.

TABLE OF CONTENTS - SAMPLING LOCATIONS

Table	Title	Page
A-1	Locations of Environmental Sampling Stations for the R.E Ginna Nuclear Power Plant ...	17

Figure	Title	Page
A-1	Map of New York State and Lake Ontario Showing Location of R.E. Ginna Nuclear Power Plant	20
A-2	Onsite Sample Locations.....	21
A-3	Offsite Sample Locations (TLDs and milk farms within 5 miles).....	22
A-4	Water Sample, Milk Farms and TLD Locations	23

TABLE A-1
Locations of Environmental Sampling Stations
for the R.E. Ginna Nuclear Plant

Station	Description	Distance		Direction
		Meters	Miles	Sector
Air Samplers				
2	Manor House Yard	360	0.22	E
3	North of Training Center Parking Lot	220	0.14	ESE
4	East of Training Center Parking Lot	320	0.20	SE
5	Creek Bridge	180	0.11	SSE
6	Onsite-SW side of plant parking lot	300	0.19	SW
7	Onsite-utility pole along West plant fence	240	0.15	WSW
8	Seabreeze	19840	12.33	WSW
9	Webster	11150	6.93	SW
10	Walworth	12730	7.91	S
11	Williamson	11540	7.17	ESE
12	Sodus Point	25170	15.64	E
13	Substation 13	770	0.48	SSW
Direct Radiation				
2	Onsite-Manor House Yard	360	0.22	E
3	Onsite-In field approximately 200 ft SE of station #2	440	0.27	ESE
4	Onsite- East of Training Center Parking Lot	320	0.19	SE
5	Onsite-Between creek and plant entry road	180	0.11	SSE
6	Onsite-SW side of plant parking lot	300	0.19	SW
7	Onsite-utility pole along West plant fence	240	0.15	WSW
8	Topper Drive-Irondequoit, Seabreeze Substation #51	19840	12.33	WSW
9	Phillips Road-Webster, intersection with Highway #104, Substation #74	11150	6.93	SW
10	Atlantic Avenue-Walworth, Substation #230	12730	7.91	S
11	W. Main Street-Williamson, Substation #207	11540	7.17	ESE
12	12 Seaman Avenue-Sodus Point-Off Lake Road by Sewer district, Substation #209	25170	15.64	E
13	Onsite - South of Meteorological Tower	260	0.16	WNW
14	NW corner of field along lake shore	860	0.53	WNW
15	Field access road, west of orchard, approximately 3000' West of plant	920	0.57	W
16	SW Corner of orchard, approximately 3000' West of plant, approximately 200' North of Lake Road	1030	0.64	WSW
17	Utility pole in orchard, approximately 75" North of Lake Road	510	0.32	SSW
18	Substation 13A fence, North Side	730	0.45	SSW
19	On NW corner of house 100' East of plant access road	460	0.29	S
20	Approximately 150' West of Ontario Center Road and approximately 170' South of Lake Road	650	0.40	SSE

Station	Description	Distance		Direction
		Meters	Miles	Sector
21	North side of Lake Road, approximately 200' East of Ontario Center Road	660	0.41	SE
22	North side of Lake Road, SE, property corner	920	0.57	SE
23	East property line, midway between Lake Road and Lake shore	780	0.49	ESE
24	Lake shore near NE corner of property	730	0.45	E
25	Substation #73, Klem Road, adjacent to 897 Klem Road	14000	8.70	WSW
26	Service Center, Plank Road, West of 250	14600	9.07	SW
27	Atlantic Avenue at Knollwood Drive utility pole, North side of road	14120	8.77	SSW
28	Substation #193, Marion, behind Stanton Ag. Service, North Main Street	17450	10.84	SE
29	Substation #208, Town Line Road (CR-118), 1000 ' North of Route 104	14050	8.73	ESE
30	District Office, Sodus, on pole, West side of bldg.	20760	12.90	ESE
31	Lake Road, pole 20' North of road, 500' East of Salt Road	7330	4.56	W
32	Woodard Road at County Line Road, pole @ Northwest corner.	6070	3.77	WSW
33	County Line Road at RR tracks, pole approximately 100' East along tracks	7950	4.94	SW
34	Pole at Route 104, Lincoln Road, SW Corner.	6520	4.05	SSW
35	Transmission Right of Way, North of Clevenger Road on pole.	7490	4.65	SSW
36	Substation #205, Route 104, East of Ontario Center Road, North side of fence.	5480	3.41	S
37	Railroad Avenue, pole at 2048	5770	3.59	SSE
38	Fisher Road at RR Tracks, pole East of road	6910	4.29	SE
39	Seeley Road, Pole South side 100' West of intersection with Stony Lonesome Road	6930	4.31	ESE
40	Lake Road at Stoney Lonesome Road, pole at SE corner	6440	4.00	E
63	Westside of warehouse access road	740	0.46	SW
64	Westside of direct road, adjacent to orchard	1190	0.74	W
Fish				
	Lake Ontario Discharge Plume	2200	1.37	ENE
	Russell Station	25600	15.9	W

Produce (Vegetation)				
Indicator and background samples of various produce are collected from gardens grown on company property and purchased from farms >10 miles from the plant.				
Station	Description	Distance		Direction
		Meters	Miles	Sector
	Onsite Supplemental Garden (E)	610	0.38	E
	Onsite Supplemental Garden (ESE)	430	0.27	ESE
	Onsite Supplemental Garden (SSE)	660	0.41	SSE
Water				
	Shoremont/MCWA	27150	16.87	W
	Ontario Water District	2220	1.38	ENE
	Circ Water Intake	1070	0.66	N
	Circ Water Discharge	110	0.07	NNE
	Deer Creek	Points downstream of Outfall 006	Points downstream of Outfall 006	ESE
Sediment				
	Lake Ontario Discharge Plume	2200	1.37	ENE
	Russell Station	25600	15.91	W
	Benthic	1070	0.66	N
Milk				
	Field Craft Farm, Williamson (Indicator)	8240	5.12	ESE
	Schultz Farm, S. Sodus (Control)	19030	11.82	SE

Figure A-1

Map of New York State and Lake Ontario Showing Location of R.E. Ginna Nuclear Power Plant

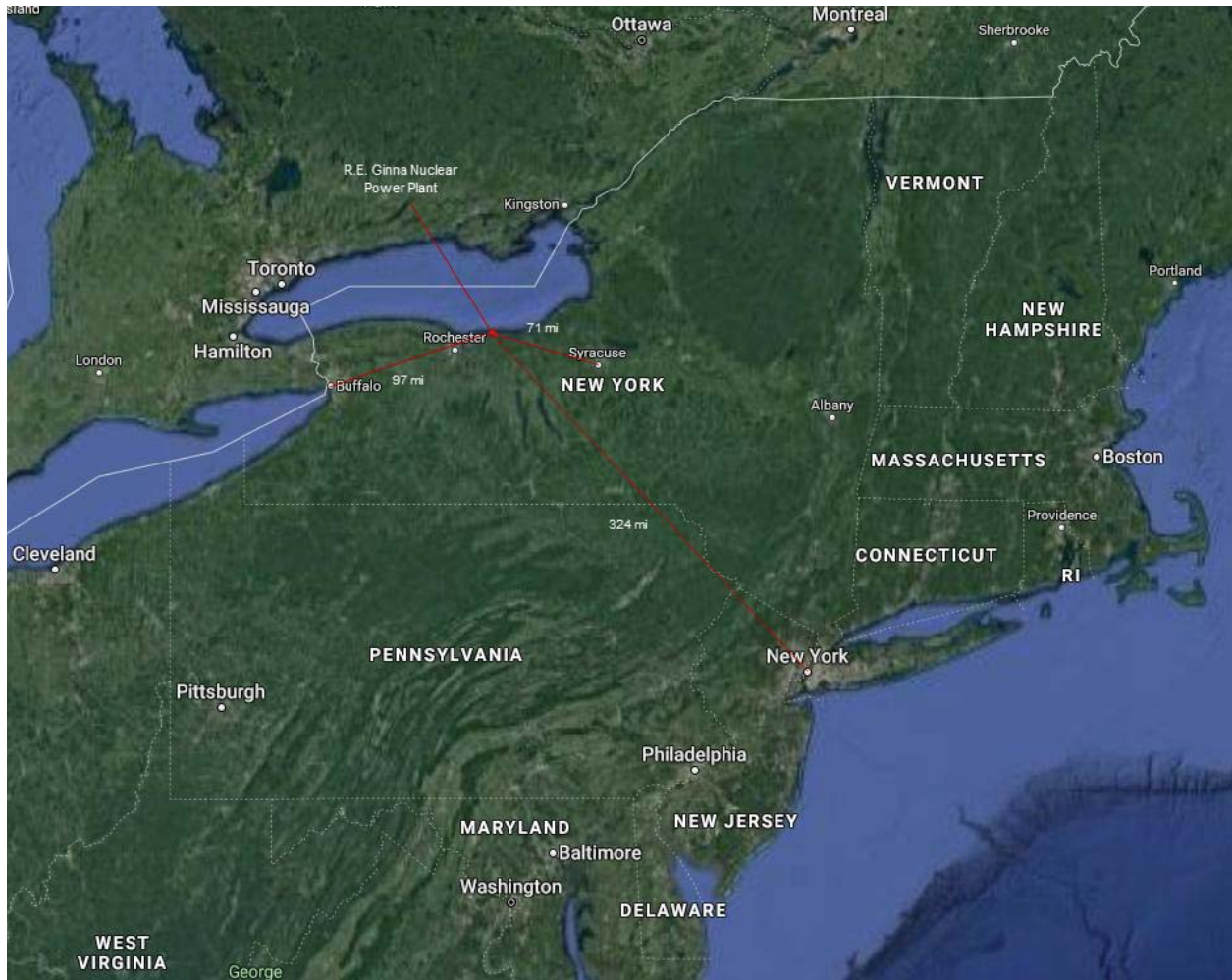

Figure A-2
Onsite Sample Locations

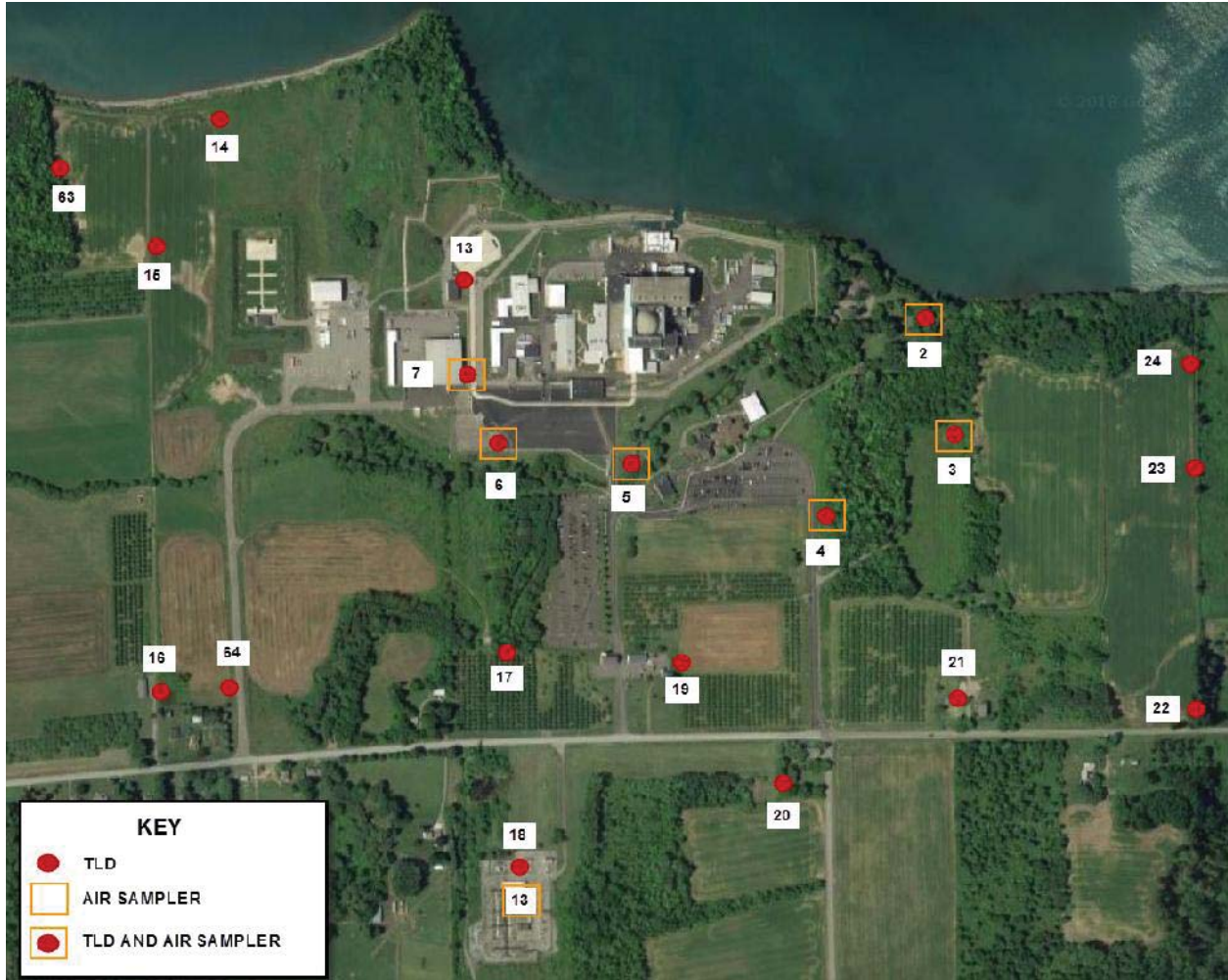

Figure A-3
Offsite Sample Locations (TLDs and Milk Farms within 5 Miles)

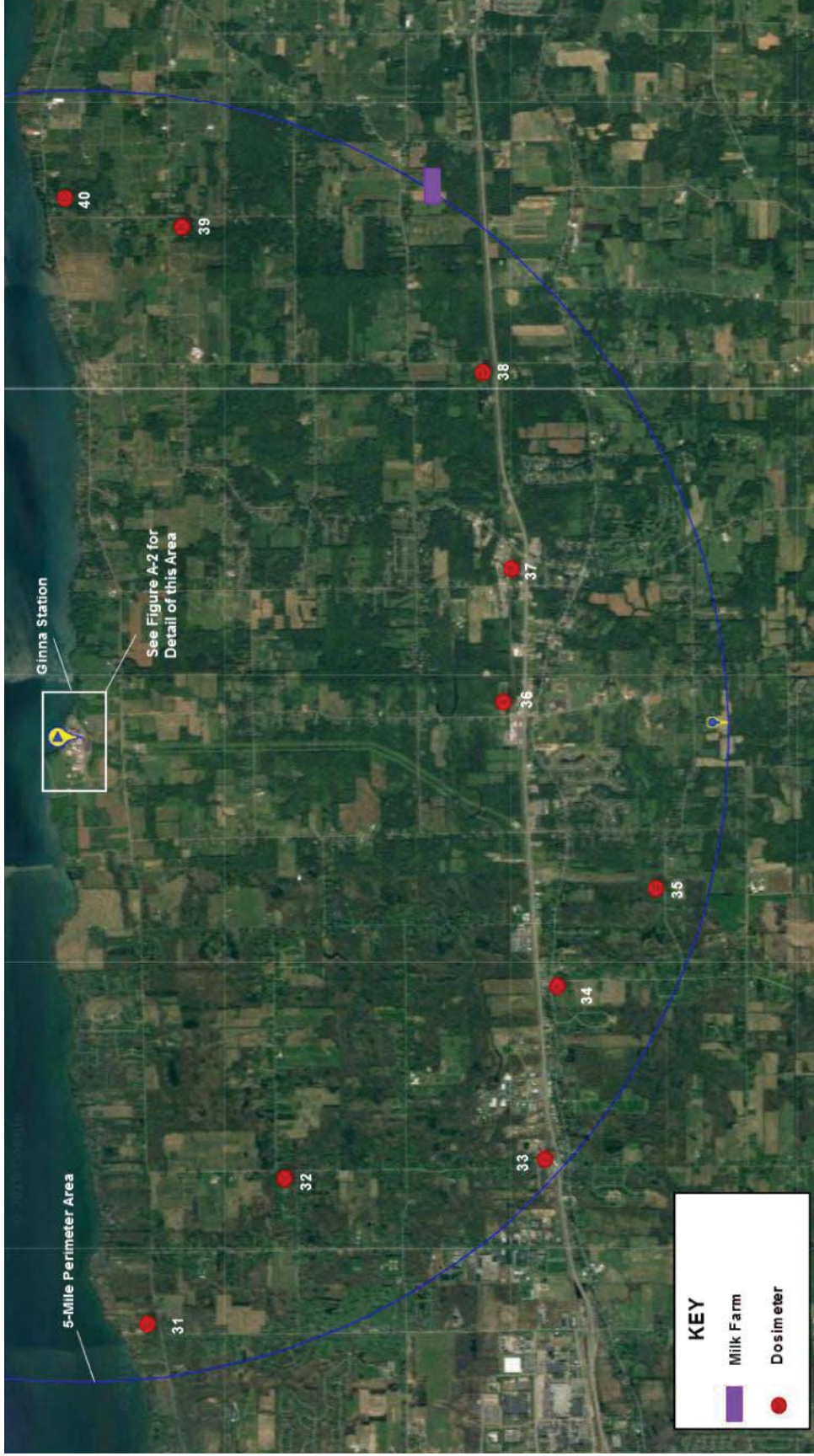
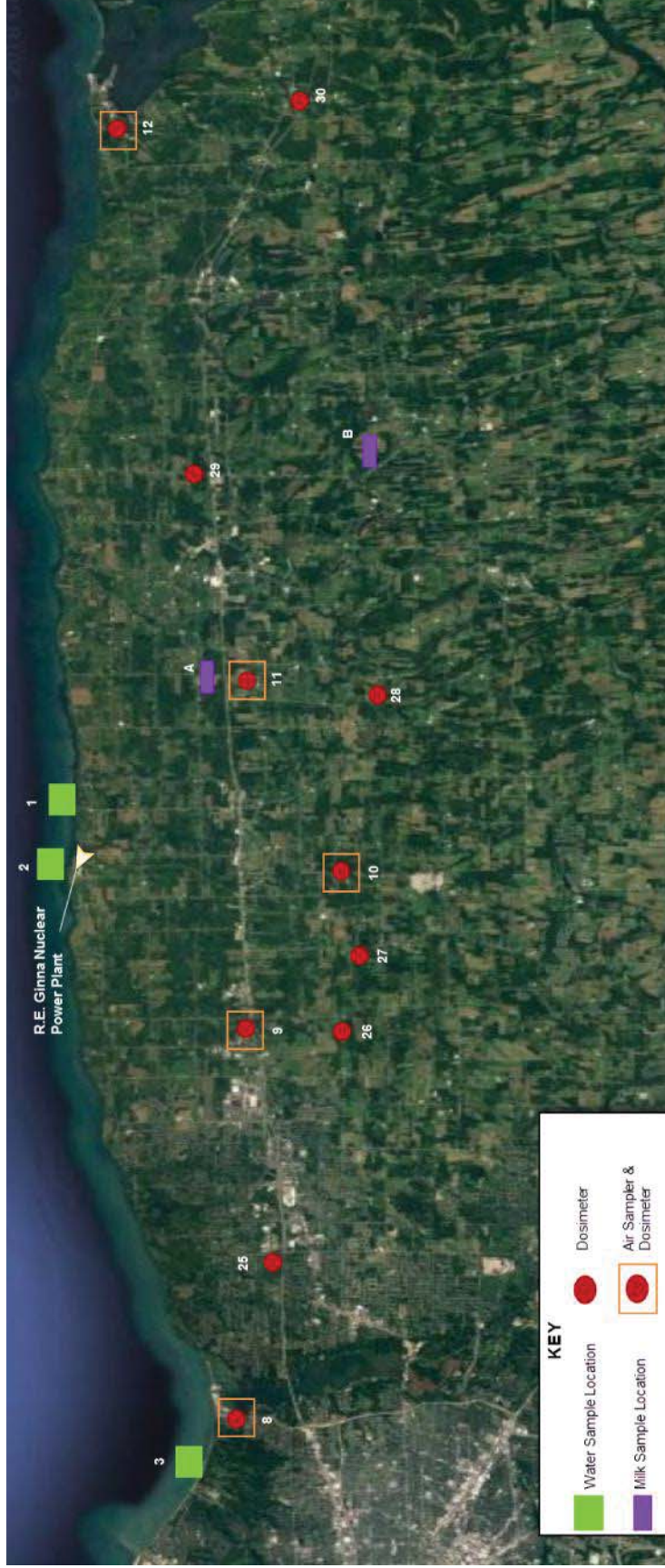

Figure A-4
Water Sample, Milk Farms and TLD Locations



APPENDIX B

REMP Analytical Results

Summary of Appendix B Content

Appendix B is a presentation of the analytical results for the R.E. Ginna Nuclear Power Plant radiological environmental monitoring programs.

TABLE OF CONTENTS - ANALYTICAL RESULTS

Table	Title	Page
B-1	Concentration of Tritium, Gamma Emitters and Gross Beta in Surface and Drinking Water	26
B-2	Concentration of Gamma Emitters in the Flesh of Edible Fish	29
B-3	Concentration of Gamma Emitters in Sediment.....	30
B-4	Concentration of Iodine-131 in Filtered Air (Charcoal Cartridges).....	31
B-5	Concentration of Beta Emitters in Air Particulates – Onsite Samples	34
B-6	Concentration of Beta Emitters in Air Particulates - Offsite Samples	38
B-7	Concentration of Gamma Emitters in Air Particulates.....	40
B-8	Concentration of Gamma Emitters in Vegetation Samples.....	42
B-9	Concentration of Gamma Emitters (including I-131) in Milk	43
B-10	Typical MDA Ranges for Gamma Spectrometry.....	44
B-11	Typical LLDs for Gamma Spectrometry	45
B-12	Direct Radiation	46
B-13	Groundwater Monitoring Wells	50

Table B-1

**Concentration of Tritium, Gamma Emitters and Gross Beta in Surface and Drinking Water
(Results in units of pCi/L +/- 2σ)**

Sample Code	Sample Date	Cs-137	Tritium	Gamma Emitters ²	Gross Beta
CIRC-IN					
Circulating Water					
Inlet - N	1/7/2019	< 2.3	< 961	*	2.14 +/- 0.67
	2/4/2019	< 2.3	< 999	*	2.29 +/- 0.67
	3/4/2019	< 2.3	< 984	*	3.60 +/- 0.74
	4/1/2019	< 2.3	< 993	*	2.77 +/- 0.71
	4/29/2019				2.21 +/- 0.67
	5/28/2019	< 2.3	< 989	*	1.61 +/- 0.65
	6/24/2019	< 2.3	< 952	*	2.08 +/- 0.65
	7/22/2019	< 2.3	< 951	*	2.22 +/- 0.65
	8/19/2019	< 2.3	< 959	*	2.45 +/- 0.65
	9/16/2019	< 2.3	< 965	*	3.40 +/- 0.70
	10/14/2019	< 2.3	< 959	*	1.88 +/- 0.61
	11/11/2019	< 2.3	< 966	*	1.45 +/- 0.65
	12/9/2019	< 2.3	< 971	*	1.78 +/- 0.64
CIRC-OUT					
Circulating Water					
Outlet - N	1/7/2019	< 2.3	< 965	*	1.38 +/- 0.62
	2/4/2019	< 2.3	< 985	*	2.48 +/- 0.68
	3/4/2019	< 2.3	< 981	*	1.95 +/- 0.63
	4/1/2019	< 2.3	< 993	*	1.68 +/- 0.64
	4/29/2019				2.01 +/- 0.66
	5/28/2019	< 2.3	< 989	*	1.66 +/- 0.65
	6/24/2019	< 2.3	< 946	*	1.98 +/- 0.65
	7/22/2019	< 2.3	< 957	*	1.73 +/- 0.62
	8/19/2019	< 2.3	< 962	*	2.01 +/- 0.61
	9/16/2019	< 2.3	< 969	*	1.53 +/- 0.57
	10/14/2019	< 2.3	< 956	*	2.27 +/- 0.54
	11/11/2019	< 2.3	< 963	*	1.81 +/- 0.67
	12/9/2019	< 2.3	< 971	*	2.13 +/- 0.66
DC					
Deer Creek - ESE					
	1/3/2019	< 2.3	< 979	*	3.74 +/- 0.80
	2/19/2019	< 2.3	< 990	*	3.18 +/- 0.76
	3/13/2019	< 2.3	< 993	*	2.51 +/- 0.68
	4/22/2019	< 2.3	< 999	*	2.43 +/- 1.21
	5/14/2019	< 2.3	< 1000	*	2.70 +/- 1.27
	6/10/2019	< 2.3	< 961	*	4.19 +/- 1.33
	7/10/2019	< 2.3	< 963	*	2.70 +/- 1.13
	8/5/2019	< 2.3	< 963	*	6.71 +/- 1.68 ³
	9/3/2019	< 2.3	< 973	*	5.10 +/- 1.55
	10/2/2019	< 2.3	< 970	*	2.99 +/- 1.41
	11/4/2019	< 2.3	< 947	*	5.00 +/- 1.71
	12/4/2019	< 2.3	< 978	*	3.48 +/- 1.55

Table B-1

**Concentration of Tritium, Gamma Emitters and Gross Beta in Surface and Drinking Water
(Results in units of pCi/L +/- 2σ)**

Sample Code	Sample Date	Cs-137	Tritium	Gamma Emitters ²	Gross Beta
MCWA					
Monroe County					
Water/Shoremont,					
Greece – W ¹					
	1/7/2019	< 2.3	< 967	*	2.25 +/- 0.68
	2/4/2019	< 2.3	< 971	*	2.86 +/- 0.71
	3/4/2019	< 2.3	< 968	*	2.36 +/- 0.66
	4/1/2019	< 2.3	< 991	*	3.12 +/- 0.73
	4/29/2019	< 2.3	< 995	*	2.10 +/- 0.67
	5/28/2019				1.42 +/- 0.64
	6/24/2019	< 2.3	< 949	*	2.25 +/- 0.67
	7/22/2019	< 2.3	< 958	*	2.13 +/- 0.64
	8/19/2019	< 2.3	< 955	*	1.56 +/- 0.58
	9/16/2019	< 2.3	< 969	*	1.56 +/- 0.57
	10/14/2019	< 2.3	< 969	*	2.17 +/- 0.64
	11/11/2019	< 2.3	< 970	*	1.59 +/- 0.66
	12/9/2019	< 2.3	< 970	*	1.84 +/- 0.64
ML					
Mill Creek – SW ¹					
	1/3/2019	< 2.3	< 978	*	3.78 +/- 0.80
	2/19/2019	< 2.3	< 987	*	2.66 +/- 0.72
	3/13/2019	< 2.3	< 998	*	2.64 +/- 0.70
	4/22/2019	< 2.3	< 998	*	2.60 +/- 0.94
	5/13/2019	< 2.3	< 998	*	1.93 +/- 1.21
	6/10/2019	< 2.3	< 957	*	3.71 +/- 1.29
	7/10/2019	< 2.3	< 962	*	2.34 +/- 1.39
	8/5/2019	< 2.3	< 960	*	7.10 +/- 1.70 ³
	9/3/2019	< 2.3	< 971	*	4.04 +/- 1.44
	10/2/2019	< 2.3	< 978	*	5.19 +/- 1.57
	11/4/2019	< 2.3	< 931	*	5.76 +/- 1.76
	12/2/2019	< 2.3	< 981	*	3.99 +/- 1.57
W					
Webster					
(Supplemental)					
	1/7/2019	< 2.3	< 964	*	1.58 +/- 0.63
	2/4/2019	< 2.3	< 965	*	1.29 +/- 0.60
	3/4/2019	< 2.3	< 973	*	2.06 +/- 0.64
	4/1/2019	< 2.3	< 989	*	1.92 +/- 0.65
	4/29/2019	< 2.3	< 981	*	1.75 +/- 0.64
	5/28/2019				1.72 +/- 0.66
	6/24/2019	< 2.3	< 950	*	1.88 +/- 0.64
	7/22/2019	< 2.3	< 958	*	2.02 +/- 0.64
	8/19/2019	< 2.3	< 953	*	2.03 +/- 0.62
	9/16/2019	< 2.3	< 971	*	2.78 +/- 0.66
	10/14/2019	< 2.3	< 958	*	2.11 +/- 0.63
	11/11/2019	< 2.3	< 966	*	1.32 +/- 0.54
	12/9/2019	< 2.3	< 966	*	1.99 +/- 0.65

Table B-1

**Concentration of Tritium, Gamma Emitters and Gross Beta in Surface and Drinking Water
(Results in units of pCi/L +/- 2σ)**

Sample Code	Sample Date	Cs-137	Tritium	Gamma Emitters ²	Gross Beta
OWD Ontario Water District - NE	1/7/2019	< 2.3	< 964	*	2.03 +/- 0.67
	2/4/2019	< 2.3	< 984	*	3.45 +/- 0.74
	3/4/2019	< 2.3	< 979	*	2.44 +/- 0.67
	4/1/2019	< 2.3	< 995	*	1.92 +/- 0.65
	4/29/2019	< 2.3	< 986	*	1.55 +/- 0.63
	5/28/2019				1.84 +/- 0.67
	6/24/2019	< 2.3	< 953	*	2.16 +/- 0.66
	7/22/2019	< 2.3	< 951	*	1.73 +/- 0.62
	8/19/2019	< 2.3	< 954	*	2.12 +/- 0.62
	9/16/2019	< 2.3	< 972	*	2.24 +/- 0.62
	10/14/2019	< 2.3	< 957	*	2.00 +/- 0.63
	11/11/2019	< 2.3	< 966	*	1.76 +/- 0.67
	12/9/2019	< 2.3	< 966	*	2.20 +/- 0.67

¹ Control Location

² All Non-Natural Gamma Emitters < MDA.

³ The cause of the elevated Gross Beta analysis for Deer Creek and Mill Creek in August 2019 is due to seasonal stagnation of the creek allowing for accumulation of natural beta emitters in the low water level.

Table B-2

**Concentration of Gamma Emitters in the Flesh of Edible Fish
(Results in units of pCi/kg (wet) +/- 2σ)**

Sample Code	Sample Date	Sample Type	Gamma Emitters (Cs-137)
CONTROL ¹	6/21/2019	Rainbow Trout	*
Local Sites	6/21/2019	Chinook Salmon	*
GREECE ¹	6/14/2019	Freshwater Drum	*
Control	6/26/2019	Largemouth Bass	*
	6/28/2019	Brown Trout	*
	6/28/2019	Lake Trout	*
HAMLIN ¹	9/30/2019	Chinook Salmon	*
Control	9/30/2019	Bowfin	*
	9/30/2019	Largemouth Bass	*
	9/30/2019	Carp	*
NORTH	1/4/2019	Lake Trout	*
North Sector	1/16/2019	Brown Trout	*
	1/17/2019	Rainbow Trout	*
	6/14/2019	Smallmouth Bass	*
	11/8/2019	Lake Trout	*
	11/13/2019	White Sucker Fish	*
	11/22/2019	Brown Trout	*
	12/6/2019	Carp	*

¹ Control Locations include Greece, NY and Irondequoit, NY.

Table B-3

**Concentration of Gamma Emitters in Sediment
(Results in units of pCi/kg (wet) +/- 2 σ)**

Sample Code	Sample Date	Gamma Emitters (Cs-137)
EAST - Shoreline	5/6/2019	*
East Sector	8/26/2019	*
	10/7/2019	*
Greece ¹ - Shoreline	5/6/2019	*
Control	8/6/2019	*

¹ Control Location

Table B-4

Concentration of Iodine-131 in Filtered Air (Charcoal Cartridges)
(Results in units of 10^{-2} pCi/m³ +/- 2 σ)

Start Date	Stop Date	STATION-02 Manor House Yard	STATION-04 Training Center Parking Lot	STATION-07 West Fence Line	STATION-08 ¹ Seabreeze	STATION-09 Webster	STATION-11 Williamson
1/2/2019	1/8/2019	< 0.002	< 0.002	< 0.002	< 0.002	< 0.002	< 0.002
1/8/2019	1/15/2019	< 0.002	< 0.002	< 0.002	< 0.002	< 0.002	< 0.002
1/15/2019	1/22/2019	< 0.002	< 0.002	< 0.002			
1/15/2019	1/23/2019				< 0.002	< 0.002	< 0.002
1/22/2019	1/28/2019	< 0.002	< 0.002	< 0.002			
1/23/2019	1/29/2019				< 0.002	< 0.002	< 0.002
1/28/2019	2/4/2019	< 0.002	< 0.002	< 0.002			
1/29/2019	2/5/2019				< 0.002	< 0.002	< 0.002
2/4/2019	2/11/2019	< 0.002	< 0.002	< 0.002			
2/5/2019	2/13/2019				< 0.002	< 0.002	< 0.002
2/11/2019	2/19/2019	< 0.002	< 0.002	< 0.002			
2/13/2019	2/20/2019				< 0.002	< 0.002	< 0.002
2/19/2019	2/25/2019	< 0.002	< 0.002	< 0.002			
2/20/2019	2/26/2019				< 0.002	< 0.002	< 0.002
2/25/2019	3/4/2019	< 0.002	< 0.002	< 0.002			
2/26/2019	3/5/2019				< 0.002	< 0.002	< 0.002
3/4/2019	3/11/2019	< 0.002	< 0.002	< 0.002			
3/5/2019	3/12/2019				< 0.002	< 0.002	
3/5/2019	3/13/2019						< 0.002
3/11/2019	3/18/2019	< 0.002	< 0.002	< 0.002			
3/13/2019	3/19/2019						< 0.002
3/12/2019	3/19/2019				< 0.002	< 0.002	
3/18/2019	3/25/2019	< 0.002	< 0.002	< 0.002			
3/19/2019	3/27/2019				< 0.002	< 0.002	< 0.002
3/25/2019	4/1/2019	< 0.002	< 0.002	< 0.002			
3/27/2019	4/2/2019				< 0.002	< 0.002	< 0.002
4/1/2019	4/9/2019	< 0.002	< 0.002	< 0.002			
4/2/2019	4/9/2019				< 0.002	< 0.002	< 0.002
4/9/2019	4/15/2019	< 0.002	< 0.002	< 0.002			
4/9/2019	4/16/2019				< 0.002	< 0.002	< 0.002
4/15/2019	4/22/2019	< 0.002	< 0.002	< 0.002			
4/16/2019	4/23/2019				< 0.002	< 0.002	< 0.002
4/22/2019	4/29/2019	< 0.002	< 0.002	< 0.002			
4/23/2019	4/30/2019				< 0.002	< 0.002	< 0.002
4/29/2019	5/6/2019	< 0.002	< 0.002	< 0.002			
4/30/2019	5/7/2019				< 0.002	< 0.002	< 0.002
5/6/2019	5/13/2019	< 0.002	< 0.002	< 0.002			
5/7/2019	5/14/2019				< 0.002	< 0.002	< 0.002
5/13/2019	5/20/2019	< 0.002	< 0.002	< 0.002			
5/14/2019	5/21/2019				< 0.002	< 0.002	< 0.002
5/20/2019	5/28/2019	< 0.002	< 0.002	< 0.002			
5/21/2019	5/29/2019				< 0.002	< 0.002	< 0.002

Table B-4

Concentration of Iodine-131 in Filtered Air (Charcoal Cartridges)
(Results in units of 10^{-2} pCi/m³ +/- 2σ)

Start Date	Stop Date	STATION-02 Manor House Yard	STATION-04 Training Center Parking Lot	STATION-07 West Fence Line	STATION-08 ¹ Seabreeze	STATION-09 Webster	STATION-11 Williamson
5/28/2019	6/3/2019	< 0.002	< 0.002	< 0.002			
5/29/2019	6/4/2019				< 0.002	< 0.002	< 0.002
6/3/2019	6/10/2019	< 0.002	< 0.002	< 0.002			
6/4/2019	6/11/2019				< 0.002	< 0.002	< 0.002
6/10/2019	6/18/2019	< 0.002	< 0.002	< 0.002			
6/11/2019	6/18/2019				< 0.002	< 0.002	< 0.002
6/18/2019	6/24/2019	< 0.002	< 0.002	< 0.002	< 0.002	< 0.002	< 0.002
6/24/2019	7/2/2019	< 0.002	< 0.002	< 0.002			
6/25/2019	7/3/2019				< 0.002	< 0.002	< 0.002
7/2/2019	7/9/2019	< 0.002	< 0.002	< 0.002			
7/3/2019	7/10/2019				< 0.002	< 0.002	< 0.002
7/9/2019	7/16/2019	< 0.002	< 0.002	< 0.002			
7/10/2019	7/16/2019				< 0.002	< 0.002	< 0.002
7/16/2019	7/22/2019	< 0.002	< 0.002	< 0.002			
7/16/2019	7/24/2019				< 0.002	< 0.002	< 0.002
7/22/2019	7/29/2019	< 0.002	< 0.002	< 0.002			
7/24/2019	7/30/2019				< 0.002	< 0.002	< 0.002
7/29/2019	8/5/2019	< 0.002	< 0.002	< 0.002			
7/30/2019	8/6/2019				< 0.002	< 0.002	< 0.002
8/5/2019	8/13/2019	< 0.002	< 0.002	< 0.002			
8/6/2019	8/13/2019				< 0.002	< 0.002	²
8/13/2019	8/19/2019	< 0.002	< 0.002	< 0.002			
8/14/2019	8/21/2019						< 0.002
8/13/2019	8/21/2019				< 0.002	< 0.002	
8/19/2019	8/26/2019	< 0.002	< 0.002	< 0.002			
8/21/2019	8/27/2019				< 0.002	< 0.002	< 0.002
8/26/2019	9/3/2019	< 0.002	< 0.002	< 0.002			
8/27/2019	9/4/2019				< 0.002	< 0.002	< 0.002
9/3/2019	9/11/2019	< 0.002	< 0.002	< 0.002			
9/4/2019	9/12/2019				< 0.002	< 0.002	< 0.002
9/11/2019	9/16/2019	< 0.002	< 0.002	< 0.002			
9/12/2019	9/17/2019				< 0.002	< 0.002	< 0.002
9/16/2019	9/23/2019	< 0.002	< 0.002	< 0.002			
9/17/2019	9/24/2019				< 0.002	< 0.002	< 0.002
9/23/2019	10/1/2019	< 0.002	< 0.002	< 0.002			
9/24/2019	10/1/2019				< 0.002	< 0.002	< 0.002
10/1/2019	10/7/2019	< 0.002	< 0.002	< 0.002			
10/1/2019	10/8/2019				< 0.002	< 0.002	< 0.002
10/7/2019	10/14/2019	< 0.002	< 0.002	< 0.002			
10/8/2019	10/15/2019				< 0.002	< 0.002	< 0.002
10/14/2019	10/22/2019	< 0.002	< 0.002	< 0.002			
10/15/2019	10/22/2019				< 0.002	< 0.002	< 0.002
10/22/2019	10/28/2019	< 0.002	< 0.002	< 0.002			
10/22/2019	10/29/2019				< 0.002	< 0.002	< 0.002

Table B-4

Concentration of Iodine-131 in Filtered Air (Charcoal Cartridges)
(Results in units of 10^{-2} pCi/m³ +/- 2 σ)

Start Date	Stop Date	STATION-02 Manor House Yard	STATION-04 Training Center Parking Lot	STATION-07 West Fence Line	STATION-08 ¹ Seabreeze	STATION-09 Webster	STATION-11 Williamson
10/28/2019	11/4/2019	< 0.002	< 0.002	< 0.002			
10/29/2019	11/5/2019				< 0.002	< 0.002	< 0.002
11/4/2019	11/11/2019	< 0.002	< 0.002	< 0.002			
11/5/2019	11/12/2019				< 0.002	< 0.002	< 0.002
11/11/2019	11/18/2019	< 0.002	< 0.002	< 0.002			
11/12/2019	11/19/2019				< 0.002	< 0.002	< 0.002
11/18/2019	11/25/2019	< 0.002	< 0.002	< 0.002			
11/19/2019	11/26/2019				< 0.002	< 0.002	< 0.002
11/25/2019	12/2/2019	< 0.002	< 0.002	< 0.002			
11/26/2019	12/3/2019				< 0.002	< 0.002	< 0.002
12/2/2019	12/9/2019	< 0.002	< 0.002	< 0.002			
12/3/2019	12/10/2019				< 0.002	< 0.002	< 0.002
12/9/2019	12/18/2019	< 0.002	< 0.002	< 0.002			
12/10/2019	12/18/2019				< 0.002	< 0.002	< 0.002
12/18/2019	12/26/2019	< 0.002	< 0.002	< 0.002	< 0.002	< 0.002	< 0.002
12/26/2019	1/2/2020	< 0.002	< 0.002	< 0.002	< 0.002	< 0.002	< 0.002

¹Control Location

²Sampler Malfunction / Low Flow

Table B-5
Concentration of Beta Emitters in Air Particulates – Onsite Samples
(Results in units of 10^{-2} pCi/m³ +/- 2 σ Uncertainty)

Start Date	Stop Date	STATION-02 Manor House Yard	STATION-03 East Field	STATION-04 Training Center Parking Lot	STATION-05 Creek Bridge	STATION-06 Main Parking Lot	STATION-07 West Fence Line	STATION-13 Substation 13
1/2/2019	1/8/2019	3.0 +/- 0.2	3.1 +/- 0.2	3.0 +/- 0.1	2.9 +/- 0.2	3.1 +/- 0.2	3.0 +/- 0.2	2.7 +/- 0.1
1/8/2019	1/15/2019	1.7 +/- 0.1	2.1 +/- 0.1	1.7 +/- 0.1	1.7 +/- 0.1	1.8 +/- 0.2	1.9 +/- 0.1	1.6 +/- 0.1
1/15/2019	1/22/2019	1.7 +/- 0.1	2.1 +/- 0.1	1.8 +/- 0.1	1.8 +/- 0.1	1.9 +/- 0.2	1.8 +/- 0.1	
1/15/2019	1/23/2019							1.7 +/- 0.1
1/22/2019	1/28/2019	2.2 +/- 0.1	2.5 +/- 0.1	2.3 +/- 0.1	2.4 +/- 0.1	2.5 +/- 0.2	2.5 +/- 0.2	2.2 +/- 0.1
1/23/2019	1/29/2019							
1/28/2019	2/4/2019	2.7 +/- 0.1	3.1 +/- 0.1	2.6 +/- 0.1	2.8 +/- 0.1	2.9 +/- 0.2	3.2 +/- 0.2	2.9 +/- 0.1
1/29/2019	2/5/2019							
2/4/2019	2/11/2019	1.8 +/- 0.1	2.1 +/- 0.1	1.8 +/- 0.1	1.9 +/- 0.1	1.9 +/- 0.2	1.9 +/- 0.1	1.5 +/- 0.1
2/5/2019	2/13/2019							
2/11/2019	2/19/2019	2.3 +/- 0.1	2.5 +/- 0.1	2.4 +/- 0.1	2.3 +/- 0.1	2.5 +/- 0.2	2.4 +/- 0.1	2.5 +/- 0.1
2/13/2019	2/20/2019							
2/19/2019	2/25/2019	2.6 +/- 0.1	2.8 +/- 0.2	2.5 +/- 0.1	2.7 +/- 0.2	2.6 +/- 0.2	2.7 +/- 0.2	2.6 +/- 0.1
2/20/2019	2/26/2019							
2/25/2019	3/4/2019	2.6 +/- 0.1	2.8 +/- 0.1	2.6 +/- 0.1	2.4 +/- 0.1	2.6 +/- 0.2	2.9 +/- 0.1	2.5 +/- 0.1
2/26/2019	3/5/2019							
3/4/2019	3/11/2019	2.6 +/- 0.1	2.5 +/- 0.1	2.4 +/- 0.1	2.5 +/- 0.1	2.6 +/- 0.2	2.5 +/- 0.1	2.6 +/- 0.1
3/5/2019	3/12/2019							
3/11/2019	3/18/2019	3.6 +/- 0.2	3.8 +/- 0.2	3.5 +/- 0.1	3.7 +/- 0.2	3.8 +/- 0.2	3.8 +/- 0.2	3.1 +/- 0.1
3/12/2019	3/19/2019							
3/18/2019	3/25/2019	2.1 +/- 0.1	2.3 +/- 0.1	2.1 +/- 0.1	2.2 +/- 0.1	2.2 +/- 0.2	2.4 +/- 0.1	1.9 +/- 0.1
3/19/2019	3/26/2019							

Table B-5
Concentration of Beta Emitters in Air Particulates – Onsite Samples
(Results in units of 10^{-2} pCi/m³ +/- 2 σ Uncertainty)

Start Date	Stop Date	STATION-02 Manor House Yard	STATION-03 East Field	STATION-04 Training Center Parking Lot	STATION-05 Creek Bridge	STATION-06 Main Parking Lot	STATION-07 West Fence Line	STATION-13 Substation 13
3/25/2019	4/1/2019	1.8 +/- 0.1	1.8 +/- 0.1	1.7 +/- 0.1	1.6 +/- 0.1	1.8 +/- 0.2	1.8 +/- 0.1	1.7 +/- 0.1
3/26/2019	4/2/2019							
4/1/2019	4/9/2019	1.9 +/- 0.1	2.1 +/- 0.1	1.9 +/- 0.1	1.9 +/- 0.1	1.9 +/- 0.2	2.0 +/- 0.1	1.9 +/- 0.1
4/2/2019	4/9/2019							
4/9/2019	4/15/2019	1.3 +/- 0.1	1.2 +/- 0.1	1.3 +/- 0.1	1.2 +/- 0.1	1.3 +/- 0.2	1.3 +/- 0.1	1.2 +/- 0.1
4/9/2019	4/16/2019							
4/15/2019	4/22/2019	1.2 +/- 0.1	2.0 +/- 0.2	1.4 +/- 0.1	1.4 +/- 0.1	1.5 +/- 0.2	1.3 +/- 0.1	1.2 +/- 0.1
4/16/2019	4/23/2019							
4/22/2019	4/29/2019	1.3 +/- 0.1	1.2 +/- 0.1	1.2 +/- 0.1	1.3 +/- 0.1	1.4 +/- 0.2	1.5 +/- 0.1	1.2 +/- 0.1
4/23/2019	4/30/2019							1.3 +/- 0.1
4/29/2019	5/6/2019							
4/30/2019	5/7/2019	1.5 +/- 0.1	1.6 +/- 0.1	1.6 +/- 0.1	1.6 +/- 0.1	1.5 +/- 0.2	1.6 +/- 0.1	1.5 +/- 0.1
5/6/2019	5/13/2019	1.4 +/- 0.1	1.5 +/- 0.1	1.4 +/- 0.1	1.5 +/- 0.1	1.8 +/- 0.2	1.5 +/- 0.1	1.0 +/- 0.1
5/7/2019	5/14/2019							
5/13/2019	5/20/2019	1.6 +/- 0.1	1.7 +/- 0.1	1.4 +/- 0.1	1.7 +/- 0.1	1.7 +/- 0.2	1.7 +/- 0.1	1.5 +/- 0.1
5/14/2019	5/21/2019							
5/20/2019	5/28/2019	1.3 +/- 0.1	1.4 +/- 0.1	1.4 +/- 0.1	1.4 +/- 0.1	1.4 +/- 0.1	1.4 +/- 0.1	1.6 +/- 0.1
5/21/2019	5/29/2019							
5/28/2019	6/3/2019							
5/29/2019	6/4/2019	1.4 +/- 0.1	1.5 +/- 0.1	1.5 +/- 0.1	1.7 +/- 0.1	1.6 +/- 0.2	1.5 +/- 0.1	1.6 +/- 0.1
6/3/2019	6/10/2019	1.7 +/- 0.1	1.7 +/- 0.1	1.7 +/- 0.1	1.8 +/- 0.1	1.6 +/- 0.2	1.7 +/- 0.1	1.8 +/- 0.1
6/4/2019	6/11/2019							
6/10/2019	6/18/2019	1.3 +/- 0.1	1.4 +/- 0.1	1.4 +/- 0.1	1.3 +/- 0.1	1.4 +/- 0.1	1.4 +/- 0.1	1.7 +/- 0.1
6/11/2019	6/18/2019							
6/18/2019	6/24/2019	1.6 +/- 0.1	1.5 +/- 0.1	1.4 +/- 0.1	1.7 +/- 0.1	1.2 +/- 0.1	1.4 +/- 0.1	1.8 +/- 0.1
6/18/2019	6/25/2019							

Table B-5
Concentration of Beta Emitters in Air Particulates – Onsite Samples
(Results in units of 10^{-2} pCi/m³ +/- 2 σ Uncertainty)

Start Date	Stop Date	STATION-02 Manor House Yard	STATION-03 East Field	STATION-04 Training Center Parking Lot	STATION-05 Creek Bridge	STATION-06 Main Parking Lot	STATION-07 West Fence Line	STATION-13 Substation 13
6/24/2019	7/2/2019	1.9 +/- 0.1	2.2 +/- 0.1	2.0 +/- 0.1	2.0 +/- 0.1	1.6 +/- 0.1	2.1 +/- 0.1	2.1 +/- 0.1
6/25/2019	7/3/2019							
7/2/2019	7/9/2019	2.1 +/- 0.1	2.3 +/- 0.1	2.0 +/- 0.1	2.2 +/- 0.2	1.7 +/- 0.1	2.3 +/- 0.2	2.1 +/- 0.1
7/3/2019	7/10/2019							
7/9/2019	7/16/2019	1.5 +/- 0.1	1.6 +/- 0.1	1.5 +/- 0.1	1.6 +/- 0.1	1.3 +/- 0.1	1.8 +/- 0.2	1.7 +/- 0.2
7/10/2019	7/16/2019							
7/16/2019	7/22/2019	1.9 +/- 0.1	1.9 +/- 0.2	1.8 +/- 0.1	1.8 +/- 0.2	1.4 +/- 0.1	1.9 +/- 0.2	2.1 +/- 0.1
7/16/2019	7/23/2019							
7/22/2019	7/29/2019	2.6 +/- 0.2	2.5 +/- 0.2	2.5 +/- 0.1	2.6 +/- 0.2	2.1 +/- 0.1	2.9 +/- 0.2	2.9 +/- 0.2
7/23/2019	7/30/2019							
7/29/2019	8/5/2019	1.9 +/- 0.1	2.2 +/- 0.2	2.0 +/- 0.1	2.1 +/- 0.2	1.6 +/- 0.1	2.2 +/- 0.2	2.0 +/- 0.1
7/30/2019	8/6/2019							
8/5/2019	8/13/2019	2.3 +/- 0.1	2.1 +/- 0.2	2.2 +/- 0.1	2.3 +/- 0.1	1.8 +/- 0.1	2.4 +/- 0.2	2.3 +/- 0.2
8/6/2019	8/13/2019							
8/13/2019	8/19/2019	2.7 +/- 0.2	2.7 +/- 0.2	2.4 +/- 0.1	2.6 +/- 0.2	2.0 +/- 0.1	2.7 +/- 0.2	2.6 +/- 0.2
8/13/2019	8/20/2019							
8/19/2019	8/26/2019	1.7 +/- 0.1	1.6 +/- 0.2	1.6 +/- 0.1	1.8 +/- 0.1	1.4 +/- 0.1	1.9 +/- 0.2	1.7 +/- 0.1
8/20/2019	8/27/2019							
8/26/2019	9/3/2019	1.8 +/- 0.1	1.9 +/- 0.2	1.9 +/- 0.1	1.8 +/- 0.1	1.5 +/- 0.1	2.0 +/- 0.1	2.3 +/- 0.1
8/27/2019	9/4/2019							
9/3/2019	9/11/2019	2.0 +/- 0.1	2.1 +/- 0.2	2.0 +/- 0.1	2.2 +/- 0.1	1.8 +/- 0.1	2.2 +/- 0.2	2.0 +/- 0.1
9/4/2019	9/12/2019							
9/11/2019	9/16/2019	1.9 +/- 0.2	2.1 +/- 0.3	1.8 +/- 0.2	2.0 +/- 0.2	1.6 +/- 0.1	2.0 +/- 0.2	1.9 +/- 0.2
9/12/2019	9/17/2019							
9/16/2019	9/23/2019	3.6 +/- 0.2	3.6 +/- 0.2	3.5 +/- 0.2	3.5 +/- 0.2	3.0 +/- 0.1	3.8 +/- 0.2	3.8 +/- 0.2
9/17/2019	9/24/2019							

Table B-5
Concentration of Beta Emitters in Air Particulates – Onsite Samples
(Results in units of 10^{-2} pCi/m³ +/- 2 σ Uncertainty)

Start Date	Stop Date	STATION-02 Manor House Yard	STATION-03 East Field	STATION-04 Training Center Parking Lot	STATION-05 Creek Bridge	STATION-06 Main Parking Lot	STATION-07 West Fence Line	STATION-13 Substation 13
9/24/2019	10/1/2019							2.8 +/- 0.2
9/23/2019	10/1/2019	2.6 +/- 0.1	2.6 +/- 0.2	2.5 +/- 0.1	2.7 +/- 0.2	2.2 +/- 0.1	2.7 +/- 0.2	
10/1/2019	10/7/2019	1.8 +/- 0.1	1.6 +/- 0.2	1.7 +/- 0.1	1.8 +/- 0.2	1.5 +/- 0.1	1.9 +/- 0.2	
10/1/2019	10/8/2019							1.9 +/- 0.1
10/7/2019	10/14/2019	2.7 +/- 0.2	2.9 +/- 0.2	2.5 +/- 0.1	2.6 +/- 0.2	2.3 +/- 0.1	2.9 +/- 0.2	
10/8/2019	10/15/2019							2.6 +/- 0.2
10/14/2019	10/22/2019	1.9 +/- 0.1	2.0 +/- 0.2	1.8 +/- 0.1	2.1 +/- 0.1	1.7 +/- 0.1	2.1 +/- 0.1	
10/15/2019	10/22/2019							2.1 +/- 0.1
10/22/2019	10/28/2019	1.5 +/- 0.1	1.8 +/- 0.2	1.6 +/- 0.1	1.6 +/- 0.1	1.4 +/- 0.1	1.7 +/- 0.2	
10/22/2019	10/29/2019							1.7 +/- 0.1
10/28/2019	11/4/2019							2.3 +/- 0.2
10/29/2019	11/5/2019	2.0 +/- 0.1	2.0 +/- 0.2	1.8 +/- 0.1	2.0 +/- 0.2	1.7 +/- 0.1	2.1 +/- 0.2	
11/4/2019	11/11/2019	2.1 +/- 0.1	2.1 +/- 0.2	1.9 +/- 0.1	2.0 +/- 0.1	1.6 +/- 0.1	2.2 +/- 0.2	
11/5/2019	11/12/2019							2.0 +/- 0.1
11/11/2019	11/18/2019	1.6 +/- 0.1	1.8 +/- 0.2	1.5 +/- 0.1	1.7 +/- 0.1	1.4 +/- 0.1	1.7 +/- 0.1	
11/12/2019	11/19/2019							1.8 +/- 0.1
11/18/2019	11/25/2019	2.4 +/- 0.1	2.4 +/- 0.2	2.0 +/- 0.1	2.1 +/- 0.2	2.0 +/- 0.1	2.3 +/- 0.2	
11/19/2019	11/26/2019							2.8 +/- 0.2
11/25/2019	12/2/2019	2.0 +/- 0.1	2.1 +/- 0.2	2.0 +/- 0.1	2.1 +/- 0.1	1.8 +/- 0.1	2.1 +/- 0.1	
11/26/2019	12/3/2019							2.0 +/- 0.1
12/2/2019	12/9/2019	2.1 +/- 0.1	2.1 +/- 0.2	1.8 +/- 0.1	2.0 +/- 0.1	1.8 +/- 0.1	2.2 +/- 0.2	
12/3/2019	12/10/2019							2.3 +/- 0.1
12/9/2019	12/18/2019	1.8 +/- 0.1	1.9 +/- 0.2	1.5 +/- 0.1	1.9 +/- 0.1	1.7 +/- 0.1	1.8 +/- 0.1	
12/10/2019	12/18/2019							1.9 +/- 0.1
12/18/2019	12/26/2019	3.7 +/- 0.2	3.8 +/- 0.2	3.3 +/- 0.1	3.6 +/- 0.2	3.1 +/- 0.1	3.7 +/- 0.2	
12/26/2019	1/2/2020	3.3 +/- 0.2	3.6 +/- 0.2	3.2 +/- 0.2	3.4 +/- 0.2	3.1 +/- 0.1	3.3 +/- 0.2	
								3.8 +/- 0.2

Table B-6

**Concentration of Beta Emitters in Air Particulates - Offsite Samples
(Results in units of 10^{-2} pCi/m³ +/- 2 σ Uncertainty)**

Start Date	Stop Date	STATION-08 ¹ Seabreeze	STATION-09 Webster	STATION-10 ¹ Walworth	STATION-11 Williamson	STATION-12 ¹ Sodus Point
1/2/2019	1/8/2019	3.2 +/- 0.2	2.8 +/- 0.2	2.9 +/- 0.2	2.8 +/- 0.2	2.8 +/- 0.1
1/8/2019	1/15/2019	2.0 +/- 0.1	1.7 +/- 0.1	1.9 +/- 0.1	1.8 +/- 0.1	1.8 +/- 0.1
1/15/2019	1/22/2019					
1/15/2019	1/23/2019	1.9 +/- 0.1	1.9 +/- 0.1	1.9 +/- 0.1	1.8 +/- 0.1	1.9 +/- 0.1
1/22/2019	1/29/2019					2.6 +/- 0.1
1/23/2019	1/29/2019	2.8 +/- 0.2	2.4 +/- 0.1	2.8 +/- 0.2	2.7 +/- 0.2	
1/29/2019	2/5/2019	3.1 +/- 0.2	2.6 +/- 0.1	3.0 +/- 0.2	2.9 +/- 0.2	3.1 +/- 0.1
2/5/2019	2/13/2019	1.7 +/- 0.1	1.5 +/- 0.1	1.6 +/- 0.1	1.4 +/- 0.1	1.5 +/- 0.1
2/13/2019	2/20/2019	2.9 +/- 0.2	2.6 +/- 0.1	2.5 +/- 0.1	2.4 +/- 0.1	2.6 +/- 0.1
2/20/2019	2/26/2019	2.9 +/- 0.2	2.8 +/- 0.2	3.0 +/- 0.2	2.7 +/- 0.2	2.8 +/- 0.1
2/26/2019	3/5/2019	2.7 +/- 0.2	2.6 +/- 0.1	2.5 +/- 0.1	2.4 +/- 0.1	2.7 +/- 0.1
3/5/2019	3/12/2019	3.0 +/- 0.2	2.9 +/- 0.1	3.1 +/- 0.2		
3/5/2019	3/13/2019				3.1 +/- 0.1	3.1 +/- 0.1
3/13/2019	3/19/2019				2.8 +/- 0.2	2.8 +/- 0.1
3/12/2019	3/19/2019	3.3 +/- 0.2	3.0 +/- 0.1	3.2 +/- 0.2		
3/19/2019	3/26/2019					1.9 +/- 0.1
3/19/2019	3/27/2019	2.1 +/- 0.1	1.9 +/- 0.1	1.9 +/- 0.1	1.9 +/- 0.1	
3/26/2019	4/2/2019					1.8 +/- 0.1
3/27/2019	4/2/2019	2.1 +/- 0.2	1.8 +/- 0.1	2.1 +/- 0.1	1.9 +/- 0.1	
4/2/2019	4/9/2019	2.2 +/- 0.1	2.1 +/- 0.1	2.2 +/- 0.1	2.0 +/- 0.1	2.1 +/- 0.1
4/9/2019	4/16/2019	1.3 +/- 0.1	1.4 +/- 0.1	1.4 +/- 0.1	1.3 +/- 0.1	1.3 +/- 0.1
4/16/2019	4/23/2019	1.4 +/- 0.1	1.4 +/- 0.1	1.4 +/- 0.1	1.3 +/- 0.1	1.1 +/- 0.1
4/23/2019	4/30/2019	1.6 +/- 0.1	1.4 +/- 0.1	1.6 +/- 0.1	2.0 +/- 0.2	1.4 +/- 0.1
4/30/2019	5/7/2019	1.8 +/- 0.1	1.7 +/- 0.1	1.8 +/- 0.1	1.9 +/- 0.2	1.5 +/- 0.1
5/7/2019	5/14/2019	1.2 +/- 0.1	1.1 +/- 0.1	1.2 +/- 0.1	1.5 +/- 0.2	1.1 +/- 0.1
5/14/2019	5/21/2019	1.8 +/- 0.1	1.7 +/- 0.1	1.8 +/- 0.1	2.0 +/- 0.2	1.6 +/- 0.1
5/21/2019	5/29/2019	1.4 +/- 0.1	1.5 +/- 0.1	1.5 +/- 0.1	1.6 +/- 0.2	1.3 +/- 0.1
5/29/2019	6/4/2019	1.6 +/- 0.1	1.5 +/- 0.1	1.7 +/- 0.1	1.8 +/- 0.2	1.5 +/- 0.1
6/4/2019	6/11/2019	1.9 +/- 0.1	1.7 +/- 0.1	1.9 +/- 0.1	2.0 +/- 0.2	1.7 +/- 0.1
6/11/2019	6/18/2019	1.6 +/- 0.1	1.5 +/- 0.1	1.6 +/- 0.1	1.7 +/- 0.2	1.5 +/- 0.1
6/18/2019	6/25/2019	1.6 +/- 0.1	1.8 +/- 0.1	1.7 +/- 0.1	2.0 +/- 0.2	1.7 +/- 0.1
6/25/2019	7/3/2019	2.2 +/- 0.1	2.1 +/- 0.1	2.0 +/- 0.1	2.0 +/- 0.2	2.2 +/- 0.1
7/3/2019	7/10/2019	2.1 +/- 0.1	2.1 +/- 0.2	2.1 +/- 0.1	2.1 +/- 0.2	2.2 +/- 0.1
7/10/2019	7/16/2019	1.7 +/- 0.1	1.7 +/- 0.2	1.7 +/- 0.1	1.6 +/- 0.3	1.7 +/- 0.1
7/16/2019	7/23/2019					1.9 +/- 0.1
7/16/2019	7/24/2019	1.9 +/- 0.1	1.8 +/- 0.1	1.8 +/- 0.1	1.9 +/- 0.2	
7/23/2019	7/30/2019					2.9 +/- 0.2
7/24/2019	7/30/2019	3.0 +/- 0.2	3.2 +/- 0.2	2.8 +/- 0.2	3.1 +/- 0.3	

Table B-6

**Concentration of Beta Emitters in Air Particulates - Offsite Samples
(Results in units of 10^{-2} pCi/m³ +/- 2 σ Uncertainty)**

Start Date	Stop Date	STATION-08 ¹ Seabreeze	STATION-09 Webster	STATION-10 ¹ Walworth	STATION-11 Williamson	STATION-12 ¹ Sodus Point
7/30/2019	8/6/2019	2.0 +/- 0.1	2.0 +/- 0.2	1.9 +/- 0.1	2.0 +/- 0.2	1.9 +/- 0.1
8/6/2019	8/13/2019	2.4 +/- 0.1	2.3 +/- 0.2	2.2 +/- 0.1	²	2.3 +/- 0.1
8/13/2019	8/20/2019					2.4 +/- 0.1
8/14/2019	8/21/2019				2.6 +/- 0.2	
8/13/2019	8/21/2019	2.6 +/- 0.1	2.7 +/- 0.2	2.4 +/- 0.1		
8/20/2019	8/27/2019					1.6 +/- 0.1
8/21/2019	8/27/2019	1.4 +/- 0.1	1.4 +/- 0.2	1.4 +/- 0.1	1.4 +/- 0.2	
8/27/2019	9/4/2019	2.2 +/- 0.1	2.3 +/- 0.1	2.0 +/- 0.1	2.2 +/- 0.1	2.0 +/- 0.1
9/4/2019	9/12/2019	2.1 +/- 0.1	2.0 +/- 0.1	1.9 +/- 0.1	2.0 +/- 0.1	2.0 +/- 0.1
9/12/2019	9/17/2019	2.0 +/- 0.2	1.9 +/- 0.2	1.6 +/- 0.1	1.7 +/- 0.2	1.7 +/- 0.2
9/17/2019	9/24/2019	3.6 +/- 0.2	3.4 +/- 0.2	3.5 +/- 0.2	3.6 +/- 0.2	3.5 +/- 0.2
9/24/2019	10/1/2019	2.9 +/- 0.1	2.8 +/- 0.2	2.8 +/- 0.1	2.9 +/- 0.2	2.7 +/- 0.1
10/1/2019	10/8/2019	2.0 +/- 0.1	1.8 +/- 0.1	1.9 +/- 0.1	2.0 +/- 0.1	1.8 +/- 0.1
10/8/2019	10/15/2019	2.5 +/- 0.1	2.5 +/- 0.2	2.4 +/- 0.1	2.6 +/- 0.2	2.6 +/- 0.1
10/15/2019	10/22/2019	2.0 +/- 0.1	2.1 +/- 0.1	2.0 +/- 0.1	2.2 +/- 0.2	2.0 +/- 0.1
10/22/2019	10/29/2019	1.7 +/- 0.1	1.6 +/- 0.1	1.7 +/- 0.1	1.8 +/- 0.1	1.8 +/- 0.1
10/29/2019	11/5/2019	2.0 +/- 0.1	2.2 +/- 0.2	1.9 +/- 0.1	2.1 +/- 0.2	2.0 +/- 0.1
11/5/2019	11/12/2019	1.9 +/- 0.1	1.7 +/- 0.1	2.0 +/- 0.1	1.9 +/- 0.1	1.8 +/- 0.1
11/12/2019	11/19/2019	1.5 +/- 0.1	1.6 +/- 0.1	1.6 +/- 0.1	1.7 +/- 0.1	1.6 +/- 0.1
11/19/2019	11/26/2019	2.6 +/- 0.1	2.5 +/- 0.2	2.5 +/- 0.1	2.4 +/- 0.2	2.7 +/- 0.1
11/26/2019	12/3/2019	1.8 +/- 0.1	1.7 +/- 0.1	1.8 +/- 0.1	1.8 +/- 0.1	1.8 +/- 0.1
12/3/2019	12/10/2019	2.1 +/- 0.1	1.7 +/- 0.1	2.0 +/- 0.1	2.0 +/- 0.1	2.1 +/- 0.1
12/10/2019	12/18/2019	1.9 +/- 0.1	1.7 +/- 0.1	1.8 +/- 0.1	1.7 +/- 0.1	1.9 +/- 0.1
12/18/2019	12/26/2019	3.7 +/- 0.1	3.6 +/- 0.2	3.6 +/- 0.1	3.7 +/- 0.2	3.8 +/- 0.2
12/26/2019	1/2/2020	3.5 +/- 0.2	3.2 +/- 0.2	3.3 +/- 0.1	3.2 +/- 0.2	3.0 +/- 0.2

¹Control Location

²Sampler Malfunction / Low Flow. See Section 3.5 for additional information.

Table B-7

**Concentration of Gamma Emitters in Air Particulates
(Results in units of 10^{-3} pCi/m³ +/- 2σ)**

Location	Description	Sample Date	Gamma Emitters	
			(Cs-137)	(I-131)
STATION-02	Manor House Yard	1/2/2019	< 1.8	< 0.002
		4/1/2019	< 1.8	< 0.002
		7/2/2019	< 1.8	< 0.002
		10/1/2019	< 1.8	< 0.002
STATION-03	North of Training Center Parking Lot	1/2/2019	< 1.8	< 0.002
		4/1/2019	< 1.8	< 0.002
		7/2/2019	< 1.8	< 0.002
		10/1/2019	< 1.8	< 0.002
STATION-04	Training Center Parking Lot	1/2/2019	< 1.8	< 0.002
		4/1/2019	< 1.8	< 0.002
		7/2/2019	< 1.8	< 0.002
		10/1/2019	< 1.8	< 0.002
STATION-05	Creek Bridge	1/2/2019	< 1.8	< 0.002
		4/1/2019	< 1.8	< 0.002
		7/2/2019	< 1.8	< 0.002
		10/1/2019	< 1.8	< 0.002
STATION-06	Main Parking Lot	1/2/2019	< 1.8	< 0.002
		4/1/2019	< 1.8	< 0.002
		7/2/2019	< 1.8	< 0.002
		10/1/2019	< 1.8	< 0.002
STATION-07	West Fence Line	1/2/2019	< 1.8	< 0.002
		4/1/2019	< 1.8	< 0.002
		7/2/2019	< 1.8	< 0.002
		10/1/2019	< 1.8	< 0.002
STATION-08 ¹	Seabreeze	1/2/2019	< 1.8	< 0.002
		4/2/2019	< 1.8	< 0.002
		7/3/2019	< 1.8	< 0.002
		10/1/2019	< 1.8	< 0.002
STATION-09	Webster	1/2/2019	< 1.8	< 0.002
		4/2/2019	< 1.8	< 0.002
		7/3/2019	< 1.8	< 0.002
		10/1/2019	< 1.8	< 0.002
STATION-10 ¹	Walworth	1/2/2019	< 1.8	< 0.002
		4/2/2019	< 1.8	< 0.002
		7/3/2019	< 1.8	< 0.002
		10/1/2019	< 1.8	< 0.002

Table B-7 (Continued)

**Concentration of Gamma Emitters in Air Particulates
(Results in units of 10^{-3} pCi/m³ +/- 2 σ)**

Location	Description	Sample Date	Gamma Emitters	
			(Cs-137)	(I-131)
STATION-11	Williamson	1/2/2019	< 1.8	< 0.002
		4/2/2019	< 1.8	< 0.002
		7/3/2019	< 1.8	< 0.002
		10/1/2019	< 1.8	< 0.002
STATION-12 ¹	Sodus Point	1/2/2019	< 1.8	< 0.002
		4/2/2019	< 1.8	< 0.002
		7/3/2019	< 1.8	< 0.002
		10/1/2019	< 1.8	< 0.002
STATION-13	Substation 13	1/2/2019	< 1.8	< 0.002
		4/2/2019	< 1.8	< 0.002
		7/3/2019	< 1.8	< 0.002
		10/1/2019	< 1.8	< 0.002

¹ Control Location

Table B-8

**Concentration of Gamma Emitters in Vegetation Samples
(Results in units of pCi/kg (wet) +/- 2σ)**

Sample Code	Sample Date	Sample Type	Gamma Emitters	
			(Cs-137)	(I-131)
CONTROL¹				
Local Sites in				
Control Sectors	7/11/2019	Zucchini	< 27	< 20
	7/13/2019	Greens	< 27	< 20
	9/19/2019	Apples	< 27	< 20
	9/19/2019	Grapes	< 27	< 20
	9/19/2019	Onion (root)	< 27	< 20
	9/19/2019	Pears	< 27	< 20
	9/19/2019	Tomato	< 27	< 20
	9/19/2019	Tuber (potato)	< 27	< 20
EAST				
East Sector	7/11/2019	Greens	< 27	< 20
	7/16/2019	Zucchini	< 27	< 20
	8/5/2019	Tuber (potato)	< 27	< 20
	8/27/2019	Onion (root)	< 27	< 20
	8/27/2019	Tomato	< 27	< 20
	9/19/2019	Pears	< 27	< 20
ESE				
East South East Sector	7/11/2019	Greens	< 27	< 20
	7/22/2019	Raspberries	< 27	< 20
	7/24/2019	Tomato	< 27	< 20
	8/5/2019	Tuber (potato)	< 27	< 20
	8/5/2019	Zucchini	< 27	< 20
	9/3/2019	Onion (root)	< 27	< 20
	9/19/2019	Grapes	< 27	< 20
SSE				
South South East Garden	7/10/2019	Greens	< 27	< 20
	7/16/2019	Zucchini	< 27	< 20
	8/5/2019	Onion (root)	< 27	< 20
	8/27/2019	Tomato	< 27	< 20
	8/27/2019	Tuber (potato)	< 27	< 20

¹ Control Location

Table B-9

**Concentration of Gamma Emitters (including I-131) in Milk
(Results in units of pCi/Liter +/- 2σ)**

Sample Code	Sample Date	Cs-137	Gamma Emitters (I-131)
FARM_A			
(FIELD CRAFT)			
ESE Supplemental	1/14/2019	< 0.4	< 0.01
	2/11/2019	< 0.4	< 0.01
	3/11/2019	< 0.4	< 0.01
	4/8/2019	< 0.4	< 0.01
	5/6/2019	< 0.4	< 0.01
	5/20/2019	< 0.4	< 0.01
	6/3/2019	< 0.4	< 0.01
	6/17/2019	< 0.4	< 0.01
	7/1/2019	< 0.4	< 0.01
	7/15/2019	< 0.4	< 0.01
	7/29/2019	< 0.4	< 0.01
	8/12/2019	< 0.4	< 0.01
	8/26/2019	< 0.4	< 0.01
	9/9/2019	< 0.4	< 0.01
	9/23/2019	< 0.4	< 0.01
	10/7/2019	< 0.4	< 0.01
	10/21/2019	< 0.4	< 0.01
	11/18/2019	< 0.4	< 0.01
	12/16/2019	< 0.4	< 0.01
FARM_B			
(SCHULTZ¹)			
South Sodus Control	1/14/2019	< 0.4	< 0.01
	2/11/2019	< 0.4	< 0.01
	3/11/2019	< 0.4	< 0.01
	4/8/2019	< 0.4	< 0.01
	5/6/2019	< 0.4	< 0.01
	5/20/2019	< 0.4	< 0.01
	6/3/2019	< 0.4	< 0.01
	6/17/2019	< 0.4	< 0.01
	7/1/2019	< 0.4	< 0.01
	7/15/2019	< 0.4	< 0.01
	7/29/2019	< 0.4	< 0.01
	8/12/2019	< 0.4	< 0.01
	8/26/2019	< 0.4	< 0.01
	9/9/2019	< 0.4	< 0.01
	9/23/2019	< 0.4	< 0.01
	10/7/2019	< 0.4	< 0.01
	10/21/2019	< 0.4	< 0.01
	11/18/2019	< 0.4	< 0.01
	12/16/2019	< 0.4	< 0.01

¹ Control Location

Table B-10

Typical MDA Ranges for Gamma Spectrometry

Selected Nuclides	Air Particulates (10 ⁻² pCi/m ³)	Surface Water, Drinking Water (pCi/L)	Fish (pCi/kg) Wet	Ground-water (pCi/L)	Milk (pCi/L)	Oysters (pCi/kg)	Shoreline Sediment (pCi/kg) Dry	Soil (pCi/kg) Dry	Vegetation (pCi/kg) Wet
Na-22	0.03 - 0.47	3.1 - 5.1	9.6 - 25.7	3.6 - 5.2	5 - 7.3	5.9 - 23.6	27.1 - 74.8	33.9 - 90.3	11.1 - 32.3
K-40	0.16 - 8.09	32.2 - 58.8	69.2 - 212	41.4 - 63	40.4 - 61.7	70.8 - 204	300 - 749	308 - 744	91.8 - 270
Cr-51	1.31 - 11.0	27.6 - 43.3	74 - 267	29.4 - 39.8	36.9 - 52.5	25.8 - 285	477 - 1303	507 - 1486	29.2 - 327
Mn-54	0.03 - 0.52	3 - 4.6	6.9 - 36.2	3.2 - 4.8	3.9 - 5.6	9.4 - 21.7	27.0 - 69.9	32.7 - 82.6	8.9 - 28.2
Co-58	0.05 - 0.73	3.1 - 4.7	8.6 - 38.6	3.2 - 4.8	4.1 - 5.7	7.4 - 30	38.6 - 96.8	38.1 - 109	8.2 - 30.5
Fe-59	0.21 - 2.35	6.8 - 10.4	26.8 - 97.6	7.1 - 10.8	10.1 - 14.3	14.3 - 87.1	96.7 - 271	100 - 283	18.5 - 73.9
Co-60	0.03 - 0.48	3.1 - 4.7	10.2 - 33.3	3.3 - 4.9	4.5 - 6.5	10 - 21.9	26.2 - 72	31.1 - 82.5	10.1 - 29.8
Zn-65	0.08 - 1.33	6.5 - 10.3	22.5 - 82.3	7.2 - 12	10.1 - 15.2	23.1 - 54	81 - 196	86.9 - 240	22.2 - 68.2
Nb-95	0.14 - 1.07	3.4 - 5.3	9 - 33.5	3.6 - 5.2	4.5 - 6.2	5.3 - 31.1	64.7 - 155	62.1 - 183	6.9 - 38.9
Zr-95	0.10 - 1.01	5.3 - 8.2	15.1 - 42.8	5.8 - 8	7.1 - 9.6	10.2 - 38.9	66.7 - 166	77.4 - 192	14.2 - 53.7
Ru-106	0.30 - 396	25.8 - 40.9	65.3 - 170	28.6 - 40.8	33.6 - 47.6	42.7 - 159	226 - 560	292 - 699	77.4 - 236
Ag-110m	0.03 - 0.43	2.9 - 4.5	7.8 - 20.2	3.2 - 4.5	3.7 - 5.2	5.1 - 18.3	26.7 - 65.1	35.2 - 90	8.3 - 26.4
I-131 ¹	1.85 - 137	1.7 - 10.5	0 - 466	5.1 - 8.8	0.4 - 11.1	0 - 1046	294 - 4372	0 - 3833	0 - 583
Cs-134	0.03 - 0.40	2.9 - 4.4	7.7 - 30.1	3.2 - 4.6	3.6 - 5.3	8.5 - 21.4	41.6 - 66.6	44.5 - 84.4	10.2 - 27.5
Cs-137	0.03 - 0.43	3.2 - 4.9	7.7 - 36.6	3.5 - 5	4 - 5.7	9.7 - 21.4	42 - 59.7	40.6 - 87.2	11.2 - 29.3
Ba-140	1.01 - 17.2	5.1 - 14.2	0 - 145	5.8 - 9.7	7.8 - 28	0 - 199	274 - 1006	44.9 - 1198	0 - 175
La-140	1.01 - 17.2	6.1 - 10.6	0 - 142.5	5.8 - 9.7	6.3 - 10.9	0 - 199	274 - 1006	45.0 - 1198	0 - 174
Ce-144	0.12 - 2.05	16.2 - 30.9	39.4 - 110	19.8 - 26.6	22.7 - 37.2	27.3 - 112	128 - 314	187 - 435	42 - 127

¹ This MDA range for I-131 on a charcoal cartridge is typically 3.94 x 10⁻³ to 6.10 x 10⁻² pCi/m³

Table B-11
Typical LLDs for Gamma Spectrometry

Selected Nuclides	Air Particulates 10 ⁻³ pCi/m ³	Surface Water, Drinking Water pCi/L	Fish pCi/kg (wet)	Groundwater pCi/L	Oysters pCi/kg (wet)	Precipitation pCi/L	Soil pCi/kg (dry)	Vegetation pCi/kg (wet)
Na-22	2.9	2.9	22	2.9	6	22	24	35
Cr-51	12	17	88	17	30	88	110	162
Mn-54	2.1	2.4	17	2.4	5	17	18	27
Co-58	2	2.4	16	2.4	5	16	17	25
Fe-59	4.6	5.2	37	5.2	11	37	38	60
Co-60	2.7	2.8	22	2.8	6	22	21	33
Zn-65	2.8	5.6	23	5.6	12	23	54	66
Nb-95	1.9	2.2	15	2.2	4	15	18	25
Zr-95	3.3	3.8	27	3.8	8	27	29	44
Ru-106	17	20	135	20	39	135	146	223
Ag-110m	1.8	2.1	14	2.1	4	14	16	25
Te-129m	20	26	149	26	50	149	180	265
I-131	1.5*	2**	11	2	4**	11	14	20
Cs-134	1.9	2.2	15	2.2	4	15	20	24
Cs-137	1.8	2.3	15	2.3	5	15	17	27
Ba-140	6.1	7.3	48	7.3	5	48	54	80
La-140	3.4	4.1	26	4.1	5	26	25	41
Ce-144	5.5	12	43	12	20	43	75	101

* The LLD for I-131 measured on a charcoal cartridge is 2.0 x 10⁻³ pCi/m³
** The LLD for Low Level I-131 measured in drinking water and milk is 0.3 pCi/L

Table B-12
Direct Radiation
2019 Quarterly Dose (mrem/ 91 days)

TLD	2019												Location Quarterly Baseline, B _Q (mrem)	Quarterly Standard Deviation, S _Q (mrem)	CV _Q	QTRLY Value +3 SDs	Quarterly Facility Dose, F _Q (mrem)
	mrem / 91 Days																
	1st QTR		2nd QTR		3rd QTR		4th QTR		AVG	MAX							
2	12.4 ± 0.4	13.0 ± 0.6	11.8 ± 0.7	13.6 ± 0.5	12.7	13.6	0.07	15.54	12.7	0.94	0.07	15.54	ND				
3	12.4 ± 0.5	13.5 ± 0.7	12.5 ± 0.6	14.0 ± 0.7	13.1	14.0	0.08	16.20	13.0	1.07	0.08	16.20	ND				
4	11.1 ± 0.6	12.3 ± 0.8	11.1 ± 0.4	13.1 ± 0.7	11.9	13.1	0.08	14.80	11.8	0.98	0.08	14.80	ND				
5	12.3 ± 0.4	13.2 ± 1.0	12.7 ± 0.6	13.6 ± 0.9	12.9	13.6	0.07	15.64	12.8	0.95	0.07	15.64	ND				
6	9.7 ± 0.4	10.1 ± 0.8	9.8 ± 0.4	10.3 ± 0.4	10.0	10.3	0.11	13.22	9.9	1.09	0.11	13.22	ND				
7	11.6 ± 0.4	11.8 ± 0.8	11.6 ± 0.4	12.4 ± 0.5	11.8	12.4	0.11	15.89	11.8	1.35	0.11	15.89	ND				
8 ¹	11.4 ± 0.6	11.4 ± 0.6	11.3 ± 0.5	12.6 ± 0.7	11.7	12.6	0.09	14.34	11.4	0.98	0.09	14.34	ND				
9	10.4 ± 0.6	11.2 ± 0.6	11.0 ± 0.7	12.0 ± 0.8	11.1	12.0	0.08	13.59	11.1	0.84	0.08	13.59	ND				
10 ¹	10.3 ± 0.3	10.8 ± 0.7	10.0 ± 0.4	11.9 ± 0.6	10.7	11.9	0.08	12.95	10.4	0.85	0.08	12.95	ND				
11	10.5 ± 0.8	10.6 ± 0.7	10.6 ± 0.5	11.6 ± 0.5	10.8	11.6	0.08	13.38	10.7	0.89	0.08	13.38	ND				
12 ¹	11.6 ± 0.6	12.4 ± 0.6	11.8 ± 0.4	13.1 ± 0.7	12.2	13.1	0.08	14.69	12.0	0.91	0.08	14.69	ND				
13	19.0 ± 0.9	20.3 ± 1.1	17.6 ± 0.6	21.0 ± 1.0	19.5	21.0	0.13	24.26	17.4	2.28	0.13	24.26	ND				
14	11.4 ± 0.4	12.5 ± 0.6	11.7 ± 0.4	13.3 ± 0.6	12.2	13.3	0.09	15.60	12.3	1.11	0.09	15.60	ND				
15	12.1 ± 0.4	13.4 ± 0.7	12.7 ± 0.6	15.0 ± 0.6	13.3	15.0	0.07	16.28	13.3	1.00	0.07	16.28	ND				
16	12.6 ± 0.6	13.2 ± 0.6	12.9 ± 0.7	13.8 ± 0.6	13.1	13.8	0.07	15.65	12.9	0.91	0.07	15.65	ND				
17	11.8 ± 0.4	12.9 ± 0.6	11.8 ± 0.6	13.4 ± 0.6	12.5	13.4	0.09	15.53	12.3	1.06	0.09	15.53	ND				
18	10.4 ± 0.6	10.1 ± 0.5	9.7 ± 0.6	11.6 ± 0.7	10.5	11.6	0.10	13.48	10.5	1.01	0.10	13.48	ND				
19	10.6 ± 0.5	10.1 ± 0.7	9.7 ± 0.7	10.7 ± 0.5	10.3	10.7	0.08	12.94	10.4	0.84	0.08	12.94	ND				
20	12.3 ± 0.5	11.9 ± 0.6	11.6 ± 0.5	13.8 ± 1.0	12.4	13.8	0.08	15.45	12.3	1.04	0.08	15.45	ND				
21	11.5 ± 0.7	12.5 ± 0.9	11.8 ± 0.7	13.3 ± 0.5	12.3	13.3	0.08	15.05	12.2	0.95	0.08	15.05	ND				
22	11.8 ± 0.4	10.8 ± 0.7	10.7 ± 0.4	12.4 ± 0.5	11.4	12.4	0.08	13.75	11.1	0.89	0.08	13.75	ND				
23	11.9 ± 0.6	13.0 ± 0.9	12.5 ± 0.4	14.4 ± 0.9	13.0	14.4	0.08	15.86	12.7	1.06	0.08	15.86	ND				
24	12.0 ± 0.5	12.8 ± 0.6	12.1 ± 0.7	14.0 ± 0.9	12.7	14.0	0.08	15.61	12.6	0.99	0.08	15.61	ND				
25 ¹	10.8 ± 0.5	11.0 ± 0.6	10.1 ± 0.4	12.0 ± 0.6	11.0	12.0	0.09	13.77	10.9	0.97	0.09	13.77	ND				
26 ¹	9.4 ± 0.4	9.8 ± 0.6	9.3 ± 0.4	11.6 ± 0.6	10.0	11.6	0.10	13.69	10.6	1.03	0.10	13.69	ND				

Table B-12
Direct Radiation
2019 Quarterly Dose (mrem/ 91 days)

TLD	2019												Location Quarterly Baseline, B _Q (mrem)	Quarterly Standard Deviation, S _Q (mrem)	CV _Q	QTRLY Value +3 SDs	Quarterly Facility Dose, F _Q (mrem)
	mrem / 91 Days																
	1st QTR		2nd QTR		3rd QTR		4th QTR		AVG	MAX							
27 ¹	10.3 ± 0.5	11.1 ± 0.5	11.1 ± 0.4	11.3 ± 0.6	11.3 ± 0.6	11.1 ± 0.4	11.3 ± 0.6	11.0	11.3	11.1	11.1	12.2	10.9	0.97	0.09	14.02	ND
28 ¹	10.6 ± 0.3	11.3 ± 0.6	10.4 ± 0.4	12.2 ± 0.6	12.2 ± 0.6	10.4 ± 0.4	12.2 ± 0.6	11.1	12.2	11.1	11.1	12.2	10.8	0.97	0.09	13.87	ND
29 ¹	10.7 ± 0.5	11.3 ± 0.6	10.4 ± 0.4	12.2 ± 0.8	12.2 ± 0.8	10.4 ± 0.4	12.2 ± 0.8	11.1	12.2	11.1	11.1	12.2	10.8	0.97	0.09	13.71	ND
30 ¹	9.7 ± 0.5	9.9 ± 0.6	9.3 ± 0.3	10.7 ± 0.5	10.7 ± 0.5	9.3 ± 0.3	10.7 ± 0.5	9.9	10.7	9.9	9.9	10.7	9.8	0.92	0.09	12.57	ND
31	12.3 ± 0.6	12.5 ± 0.8	12.6 ± 0.5	13.6 ± 0.8	13.6 ± 0.8	12.6 ± 0.5	13.6 ± 0.8	12.8	13.6	12.8	12.8	13.6	12.7	1.07	0.08	15.94	ND
32	10.6 ± 0.4	11.4 ± 0.9	10.3 ± 0.5	11.9 ± 0.7	11.9 ± 0.7	10.3 ± 0.5	11.9 ± 0.7	11.1	11.9	11.1	11.1	11.9	11.0	0.94	0.09	13.78	ND
33	10.1 ± 0.4	10.4 ± 0.6	9.9 ± 0.6	11.5 ± 0.7	11.5 ± 0.7	9.9 ± 0.6	11.5 ± 0.7	10.5	11.5	10.5	10.5	11.5	10.5	1.01	0.10	13.53	ND
34	12.9 ± 0.8	13.5 ± 0.7	12.1 ± 0.6	14.1 ± 0.9	14.1 ± 0.9	12.1 ± 0.6	14.1 ± 0.9	13.1	14.1	13.1	13.1	14.1	13.1	0.96	0.07	16.02	ND
35	11.9 ± 0.7	12.6 ± 0.6	12.6 ± 0.5	13.2 ± 0.5	13.2 ± 0.5	12.6 ± 0.5	13.2 ± 0.5	12.6	13.2	12.6	12.6	13.2	12.7	1.16	0.09	16.13	ND
36	10.3 ± 0.7	10.9 ± 0.7	10.2 ± 0.5	12.4 ± 0.6	12.4 ± 0.6	10.2 ± 0.5	12.4 ± 0.6	10.9	12.4	10.9	10.9	12.4	11.0	0.94	0.09	13.78	ND
37	9.8 ± 0.6	10.6 ± 0.8	10.1 ± 0.4	11.4 ± 0.5	11.4 ± 0.5	10.1 ± 0.4	11.4 ± 0.5	10.5	11.4	10.5	10.5	11.4	10.3	1.01	0.10	13.35	ND
38	12.4 ± 0.5	12.6 ± 0.8	12.2 ± 0.4	13.4 ± 0.9	13.4 ± 0.9	12.2 ± 0.4	13.4 ± 0.9	12.7	13.4	12.7	12.7	13.4	12.4	1.00	0.08	15.42	ND
39	11.4 ± 0.4	12.6 ± 1.1	11.7 ± 0.7	13.2 ± 0.8	13.2 ± 0.8	11.7 ± 0.7	13.2 ± 0.8	12.2	13.2	12.2	12.2	13.2	12.2	1.10	0.09	15.50	ND
40	10.4 ± 1.1	11.4 ± 0.6	10.5 ± 0.8	11.6 ± 0.6	11.6 ± 0.6	10.5 ± 0.8	11.6 ± 0.6	11.0	11.6	11.0	11.0	11.6	10.7	0.84	0.08	13.21	ND
63	12.3 ± 0.6	13.1 ± 1.0	12.1 ± 0.5	14.1 ± 0.6	14.1 ± 0.6	12.1 ± 0.5	14.1 ± 0.6	12.9	14.1	12.9	12.9	14.1	12.6	1.02	0.08	15.67	ND
64	13.4 ± 0.5	14.3 ± 0.8	13.0 ± 0.8	14.7 ± 0.8	14.7 ± 0.8	13.0 ± 0.8	14.7 ± 0.8	13.9	14.7	13.9	13.9	14.7	13.8	1.11	0.08	17.19	ND

1 - Control Location

Table B-12
Direct Radiation

2019 Annual Dose (mrem/ year)

TLD	2019 (mrem)	Annual Baseline, B _A (mrem)	Annual Standard Deviation, S _A (mrem)	CV _A	YRLY Values +3 SDs	Annual Facility Dose, F _A
2	50.7	50.9	1.03	0.02	53.95	ND
3	52.4	52.0	1.28	0.02	55.85	ND
4	47.5	47.4	0.85	0.02	49.93	ND
5	51.8	51.2	1.22	0.02	54.89	ND
6	39.9	39.8	0.87	0.02	42.41	ND
7	47.2	47.4	3.70	0.08	58.49	ND
8 ¹	46.7	45.6	0.81	0.02	48.00	ND
9	44.6	44.3	0.63	0.01	46.16	ND
10 ¹	43.0	41.5	0.95	0.02	44.40	ND
11	43.2	42.9	0.89	0.02	45.54	ND
12 ¹	48.8	47.9	0.85	0.02	50.45	ND
13	77.9	69.7	7.68	0.11	92.76	ND
14	49.0	49.0	1.32	0.03	52.99	ND
15	53.3	53.2	0.85	0.02	55.72	ND
16	52.5	51.7	1.17	0.02	55.18	ND
17	49.9	49.4	0.95	0.02	52.21	ND
18	41.8	41.8	0.43	0.01	43.11	ND
19	41.1	41.6	0.97	0.02	44.55	ND
20	49.4	49.4	0.90	0.02	52.05	ND
21	49.0	48.7	1.29	0.03	52.59	ND
22	45.7	44.3	1.13	0.03	47.69	ND
23	51.8	50.7	1.02	0.02	53.77	ND
24	50.9	50.6	1.25	0.02	54.30	ND
25 ¹	43.9	43.4	0.89	0.02	46.08	ND
26 ¹	40.2	42.4	2.37	0.06	49.46	ND

Table B-12
Direct Radiation

2019 Annual Dose (mrem/ year)

TLD	2019 (mrem)	Annual Baseline, B _A (mrem)	Annual Standard Deviation, S _A (mrem)	CV _A	YRLY Values +3 SDs	Annual Facility Dose, F _A
27 ¹	43.9	44.5	1.58	0.04	49.21	ND
28 ¹	44.6	43.5	0.93	0.02	46.31	ND
29 ¹	44.6	43.1	1.17	0.03	46.64	ND
30 ¹	39.5	39.2	0.78	0.02	41.56	ND
31	51.0	50.9	1.71	0.03	56.03	ND
32	44.2	43.8	1.02	0.02	46.91	ND
33	42.0	42.0	1.26	0.03	45.76	ND
34	52.5	52.6	1.35	0.03	56.63	ND
35	50.3	50.6	1.93	0.04	56.41	ND
36	43.7	43.9	1.09	0.02	47.15	ND
37	41.9	41.3	0.79	0.02	43.63	ND
38	50.7	49.6	1.03	0.02	52.74	ND
39	48.9	48.8	0.80	0.02	51.20	ND
40	43.8	42.8	0.79	0.02	45.16	ND
63	51.5	50.4	1.49	0.03	54.86	ND
64	55.5	55.4	1.33	0.02	59.37	ND

1 - Control Location

TABLE B-13
Groundwater Monitoring Wells

Location	Sample Date	Tritium (pCi/l)	Gamma ¹ (uCi/ml)
GW01: Warehouse Access Road (Control)	3/13/2019	< 460	< 6.95E-09
	6/26/2019	< 426	< 5.92E-09
	9/4/2019	< 431	< 6.97E-09
	12/13/2019	< 451	< 1.12E-08
GW03: Screenhouse West, South Well ²	1/27/2019	< 444	
	2/22/2019	< 453	
	3/14/2019	< 450	< 8.80E-09
	4/12/2019	< 404	
	5/24/2019	446	
	5/29/2019	579	
	6/27/2019	< 426	< 7.06E-09
	7/25/2019	< 413	
	8/16/2019	< 428	
	9/4/2019	< 439	< 1.02E-08
	10/25/2019	< 488	
	11/19/2019	< 459	
	12/13/2019	< 469	< 7.98E-09
GW04: Screenhouse West, North Well	3/14/2019	< 454	< 8.09E-09
	6/27/2019	< 428	< 6.86E-09
	9/4/2019	< 439	< 6.78E-09
	12/13/2019	< 482	< 6.33E-09
GW05: Screenhouse East, South (15.5')	3/14/2019	< 452	< 6.10E-09
	6/26/2019	< 427	< 8.44E-09
	9/4/2019	< 457	< 9.30E-09
	12/13/2019	< 484	< 8.43E-09
GW06: Screenhouse East, Middle (20.0')	3/14/2019	< 451	< 6.52E-09
	6/26/2019	< 425	< 6.52E-09
	9/4/2019	< 434	< 7.23E-09
	12/13/2019	< 483	< 8.59E-09
GW07: Screenhouse East, North (24.0')	3/14/2019	< 454	< 7.31E-09
	6/26/2019	< 423	< 6.61E-09
	9/4/2019	< 448	< 7.17E-09
	12/13/2019	< 486	< 7.17E-09

TABLE B-13 (Continued)
Groundwater Monitoring Wells

Location	Sample Date	Tritium (pCi/l)	Gamma (uCi/ml)
GW08: All Volatiles Treatment Building ²	1/27/2019	< 443	
	2/22/2019	< 449	
	3/14/2019	< 454	< 9.62E-09
	4/12/2019	< 409	
	5/24/2019	542	
	5/29/2019	521	
	6/27/2019	< 424	< 8.21E-09
	7/25/2019	< 430	
	8/16/2019	< 429	
	9/4/2019	< 425	< 1.14E-08
	10/25/2019	< 486	
	11/19/2019	< 462	
	12/13/2019	< 483	< 1.12E-08
GW10: Technical Support Center, South	3/14/2019	< 457	< 6.85E-09
	6/26/2019	< 426	< 8.46E-09
	9/4/2019	< 424	< 1.88E-09
	12/13/2019	603	< 9.61E-09
GW11: Southeast of Contaminated Service Building (CSB)	3/14/2019	< 449	< 9.89E-09
	6/26/2019	< 427	< 6.19E-09
	9/4/2019	< 448	< 8.20E-09
	12/13/2019	< 479	< 8.13E-09
GW12: West of Orchard Access Road	3/13/2019	< 453	< 6.85E-09
	6/26/2019	< 418	< 9.77E-09
	9/4/2019	< 422	< 7.33E-09
	12/13/2019	< 487	< 9.35E-09
GW13: North of Independent Spent Fuel Storage Installation (ISFSI)	3/14/2019	< 458	< 7.38E-09
	6/26/2019	< 427	< 6.21E-09
	9/4/2019	< 426	< 7.98E-09
	12/13/2019	< 488	< 7.92E-09
GW14: South of Canister Preparation Building	3/14/2019	< 454	< 1.05E-08
	6/26/2019	< 422	< 6.30E-09
	9/4/2019	< 430	< 9.36E-09
	12/13/2019	< 480	< 7.50E-09

TABLE B-13 (Continued)
Groundwater Monitoring Wells

Location	Sample Date	Tritium (pCi/l)	Gamma (uCi/ml)
GW15: West of Manor House	3/13/2019	< 454	< 6.71E-09
	6/26/2019	< 425	< 7.68E-09
	9/4/2019	< 419	< 7.42E-09
	12/13/2019	< 485	< 9.98E-09
GW16: Southeast of Manor House	3/13/2019	< 456	< 8.12E-09
	6/26/2019	< 427	< 7.95E-09
	9/4/2019	< 422	< 8.35E-09
	12/13/2019	< 487	< 9.01E-09

¹Gamma analysis is performed on a quarterly basis for groundwater monitoring well results.

² Groundwater monitoring wells GW03 and GW08 are sampled monthly due to their location being important for early detection of any tritium within the environment.

APPENDIX C

Quality Assurance Program

Summary of Appendix C Content:

Appendix C is a summary of Exelon Industrial Services (EIS) laboratory's quality assurance program. It consists of Table C-1 which is a compilation of the results of the EIS laboratory's participation in an interlaboratory comparison program with Environmental Resource Associates (ERA) located in Arvada, Colorado and Eckert and Ziegler Analytics, Inc. (EZA) located in Atlanta, Georgia. It also includes Table C-2, which is a compilation of the results of the EIS laboratory's participation in a split sample program with Teledyne Brown Engineering located in Knoxville, Tennessee. Finally, Table C-3, is a list of the power plant's ODCM required LLDs, all of which are achieved by both EIS laboratory and Teledyne Brown Engineering for the analyses reported.

All the EIS laboratory's results contained in Table C-1, inter-comparison results, are in full agreement when they were evaluated using the NRC Resolution Test Criteria[1]. The EIS laboratory's results are provided with their analytical uncertainties of 2 sigma. When evaluating with the NRC Resolution Test a one sigma uncertainty is used to determine Pass or Fail and noted accordingly.

The EIS laboratory results contained in Table C-2 are inter-comparison results for routine samples analyzed for replicate and split analyses and evaluated for beta and non-natural gamma emitters. The EIS laboratory's results are provided with their analytical uncertainties of 2 sigma. When evaluating with the NRC Resolution Test a one sigma uncertainty is used to determine Pass or Fail and noted accordingly. In the event there are no non-natural isotopes detected, the samples are reported <MDA and designated as Pass.

All the results contained in Table C-2 agree with their respective EIS laboratory original, replicate and/or Teledyne Brown Engineering's split laboratory samples, except for the comparisons of Beta emitters in a particulate sample with poor resolution at A2 collected on 06/10/19 and one sample involving Cs-137 results for a bottom sediment sample at WBS2 collected on 6/25/19.

The original and replicate analysis of the air particulate sample from A2 collected on 06/10/19 failed the NRC Resolution test criteria due to low volume collected resulting from a power outage to the air sampler. Poor resolution of these results is attributed to the low volume collected resulting in insufficient counting statistics. A nonconformance was issued on this event and recorded in the corrective action program.

In the bottom sediment sample, WBS2 collected on 6/25/19, the original and replicate analysis do pass NRC Resolution test criteria however the result does not agree within the required resolution for the split lab result. These minor discrepancies, which have been observed in previous reporting periods, are most probably due to counting statistics and/or the non-homogeneous nature of this type of sample.

All air particulate samples contain beta emitters and are reported with a 2-sigma uncertainty. The original and replicate analyses are evaluated for agreement using the NRC Resolution Test Criteria 1. These samples must be composited for further analysis and this precludes them from being split for analysis of beta emitters. Filters and other samples whose nature generally preclude sample splitting are marked "***" in the Split Analysis column.

[1] NRC Inspection Manual, Inspection Procedure 84750, March 15, 1994

TABLE OF CONTENTS - ANALYTICAL RESULTS

Table	Title	Page
C-1	Results of Participation in Cross Check Program.....	55
C-2	Results of Quality Assurance Program.....	58
C-3	Teledyne Brown Engineering’s Typical MDAs for Gamma Spectrometry	65

TABLE C-1
Results of Participation in Cross Check Program

Sample Date	Sample Type and Units	Isotope Observed	Reported Laboratory's Results	Cross Check Lab Results
3/14/2019	Air Iodine - pCi	I-131	73.0 ± 11.0	75.6
3/14/2019	Milk - pCi/L	Fe-59	149 ± 25.0	159
		Mn-54	141 ± 16.0	143
		Co-60	262 ± 16.0	299
		Co-58	128 ± 17.0	143
		Cr-51	227 ± 101.0	293
		Ce-141	101 ± 20.0	117
		Cs-137	184 ± 18.0	196
		Cs-134	138 ± 10.0	160
		I-131	92.0 ± 36.0	89.5
		Zn-65	177 ± 32.0	220
3/14/2019	Water - pCi/L	Gross Beta	26.4 ± 4.84	28.8
4/8/2019	Water - pCi/L	I-131	25.3 ± 8.0	28.4
		Ba-133	23.0 ± 2.7	24.1
		Cs-137	34.4 ± 3.4	33.1
		Cs-134	10.8 ± 1.7	12.1
		Zn-65	88.0 ± 9.3	89.2
		Co-60	11.3 ± 1.8	11.5
4/8/2019	Water - pCi/L	Gross Beta	28.8 ± 2.09	29.9
6/6/2019	Air Iodine - pCi	Cs-134	80.9 ± 4.4	93
		Zn-65	185 ± 18.0	164
		Co-60	139 ± 7.0	131
		Co-58	77.7 ± 7.4	74.1
		Fe-59	121 ± 13.0	93.5
		Mn-54	142 ± 8.9	126
		Cs-137	119 ± 7.7	111
		Cr-51	222 ± 50.6	223
Ce-141	97.7 ± 7.7	88.3		
6/6/2019	Water	Mn-54	214 ± 17.6	207
		Fe-59	154 ± 22.5	154
		Co-58	115 ± 15.6	122
		Co-60	216 ± 12.8	216
		Zn-65	257 ± 31.6	270
		I-131	115 ± 77.0	89.1
		Cs-134	139 ± 8.8	153
		Cs-137	186 ± 15.7	184
		Ce-141	142 ± 22.7	145
		Cr-51	327 ± 117	368
6/6/2019	Water - pCi/L	Gross Beta	199 ± 4.2	199
9/12/2019	Air Filter - pCi/m ³	Gross Beta	271 ± 3.42	221

TABLE C-1 – Continued
Results of Participation in Cross Check Program

Sample Date	Sample Type and Units	Isotope Observed	Reported Laboratory's Results	Cross Check Lab Results
9/16/2019	Air Iodine - pCi	Am-241	28.4 ± 9.9	32
		Cs-137	440 ± 20.0	437
		Cs-134	60.7 ± 5.2	59
		Zn-65	381 ± 31.0	364
		Co-60	57.5 ± 6.1	58.4
10/4/2019	Water - pCi/L	Cs-137	80.3 ± 7.2	78.7
		Ba-133	37.2 ± 5.4	43.8
		Cs-134	52.2 ± 4.2	55.9
		Zn-65	39.3 ± 10.0	34
		I-131	25.4 ± 8.3	23.9
		Co-60	54.8 ± 5.1	53.4
12/5/2019	Air Filter – pCi (Det 2)	Mn-54	170 ± 13.0	155
		Fe-59	124 ± 14.3	104
		Co-58	117 ± 11.7	107
		Co-60	139 ± 9.1	138
		Zn-65	194 ± 24.8	190
		Cs-134	123 ± 7.4	135
		Cs-137	128 ± 11.6	121
		Ce-141	98.5 ± 6.4	99.1
		Cr-51	246 ± 46.6	288
		12/5/2019	Air Filter – pCi (Det 3)	Mn-54
Fe-59	122 ± 10.8			104
Co-58	111 ± 8.9			107
Co-60	148 ± 7.9			138
Zn-65	203 ± 20.9			190
Cs-134	128 ± 5.7			135
Cs-137	128 ± 8.9			121
Ce-141	95.7 ± 7.0			99.1
Cr-51	257 ± 40.6			288
12/5/2019	Air Filter – pCi (Det 4)			Mn-54
		Fe-59	132 ± 10.3	104
		Co-58	102 ± 7.3	107
		Co-60	146 ± 7.2	138
		Zn-65	195 ± 17.3	190
		Cs-134	122 ± 4.9	135
		Cs-137	122 ± 7.6	121
		Ce-141	102 ± 6.1	99.1
		Cr-51	299 ± 29.9	288

TABLE C-1 – Continued

Results of Participation in Cross Check Program

Sample Date	Sample Type and Units	Isotope Observed	Reported Laboratory's Results	Cross Check Lab Results
12/5/2019	Air Iodine – pCi (Det 4)	I-131	79.2 ± 5.7	88.2
		(Det 2)	79.0 ± 6.3	88.2
		(Det 3)	79.1 ± 6.0	88.2
12/5/2019	Milk pCi/L (DET 2)	I-131	100 ± 16.9	94.5
		Ce-141	82.4 ± 15.9	83
		Cr-51	271 ± 76.7	241
		Cs-134	112 ± 11.9	113
		Cs-137	123 ± 17.9	102
		Co-58	84.9 ± 14.6	89.9
		Mn-54	128 ± 17.4	130
		Fe-59	95.5 ± 20.2	87.1
		Zn-65	148 ± 34.3	159
		Co-60	119 ± 13.3	115
12/5/2019	Milk pCi/L (DET 3)	I-131	99.3 ± 15.0	94.5
		Ce-141	80.7 ± 12.5	83
		Cr-51	228 ± 63.0	241
		Cs-134	103 ± 9.6	113
		Cs-137	109 ± 12.2	102
		Co-58	102 ± 12.2	89.9
		Mn-54	141 ± 15.2	130
		Fe-59	102 ± 15.7	87.1
		Zn-65	166 ± 28.4	159
		Co-60	111 ± 10.8	115
12/5/2019	Milk pCi/L (DET 4)	I-131	104 ± 13.5	94.5
		Ce-141	78.3 ± 12.7	83
		Cr-51	235 ± 68.0	241
		Cs-134	114 ± 8.3	113
		Cs-137	105 ± 13.2	102
		Co-58	92.0 ± 11.4	89.9
		Mn-54	143 ± 13.8	130
		Fe-59	104 ± 14.9	87.1
		Zn-65	164 ± 27.2	159
		Co-60	123 ± 10.2	115
12/5/2019	Water - pCi/L	Gross Beta	260 ± 4.76	269

¹ See discussion at the beginning of the Appendix

TABLE C-2

Results of Quality Assurance Program

Sample Type and Location	Sample Date	Type of Analysis	Result ² Units	Original Analysis	Replicate Analysis	Split Analysis
Air Iodine - A1	1/7/2019	I-131	pCi/m ³	<MDA	<MDA	**
Air Iodine - A2	1/7/2019	I-131	pCi/m ³	<MDA	<MDA	**
Air Iodine - A3	1/7/2019	I-131	pCi/m ³	<MDA	<MDA	**
Air Iodine - A4	1/7/2019	I-131	pCi/m ³	<MDA	<MDA	**
Air Iodine - A5	1/7/2019	I-131	pCi/m ³	<MDA	<MDA	**
Air Iodine - SFA1	1/7/2019	I-131	pCi/m ³	<MDA	<MDA	**
Air Filter - A1	2/11/2019	Gross Beta	pCi/m ³	2.3 ± 0.1	2.3 ± 0.1	**
Air Filter - A2	2/11/2019	Gross Beta	pCi/m ³	2.4 ± 0.1	2.3 ± 0.1	**
Air Filter - A3	2/11/2019	Gross Beta	pCi/m ³	2.1 ± 0.1	2.1 ± 0.1	**
Air Filter - A4	2/11/2019	Gross Beta	pCi/m ³	2.1 ± 0.1	2.2 ± 0.1	**
Air Filter - A5	2/11/2019	Gross Beta	pCi/m ³	2.4 ± 0.1	2.3 ± 0.1	**
Air Filter - SFA1	2/11/2019	Gross Beta	pCi/m ³	2.2 ± 0.1	2.2 ± 0.1	**
Air Filter - SFA2	2/11/2019	Gross Beta	pCi/m ³	2.3 ± 0.1	2.2 ± 0.1	**
Air Filter - SFA3	2/11/2019	Gross Beta	pCi/m ³	2.5 ± 0.1	2.2 ± 0.1	**
Air Filter - SFA4	2/11/2019	Gross Beta	pCi/m ³	2.2 ± 0.1	2.4 ± 0.1	**
Air Iodine - A1	2/11/2019	I-131	pCi/m ³	<MDA	<MDA	**
Air Iodine - A2	2/11/2019	I-131	pCi/m ³	<MDA	<MDA	**
Air Iodine - A3	2/11/2019	I-131	pCi/m ³	<MDA	<MDA	**
Air Iodine - A4	2/11/2019	I-131	pCi/m ³	<MDA	<MDA	**
Air Iodine - A5	2/11/2019	I-131	pCi/m ³	<MDA	<MDA	**
Air Iodine - SFA1	2/11/2019	I-131	pCi/m ³	<MDA	<MDA	**
Air Filter - A1	3/4/2019	Gross Beta	pCi/m ³	1.7 ± 0.1	1.7 ± 0.1	**
Air Filter - A2	3/4/2019	Gross Beta	pCi/m ³	1.8 ± 0.1	2.0 ± 0.1	**
Air Filter - A3	3/4/2019	Gross Beta	pCi/m ³	1.6 ± 0.1	1.7 ± 0.1	**
Air Filter - A4	3/4/2019	Gross Beta	pCi/m ³	1.6 ± 0.1	1.8 ± 0.1	**
Air Filter - A5	3/4/2019	Gross Beta	pCi/m ³	1.8 ± 0.1	1.9 ± 0.1	**
Air Filter - SFA1	3/4/2019	Gross Beta	pCi/m ³	1.7 ± 0.1	1.6 ± 0.1	**
Air Filter - SFA2	3/4/2019	Gross Beta	pCi/m ³	1.5 ± 0.1	1.6 ± 0.1	**
Air Filter - SFA3	3/4/2019	Gross Beta	pCi/m ³	1.7 ± 0.1	1.7 ± 0.1	**
Air Filter - SFA4	3/4/2019	Gross Beta	pCi/m ³	1.7 ± 0.1	1.6 ± 0.1	**

TABLE C-2 - Continued
Results of Quality Assurance Program

Sample Type and Location	Sample Date	Type of Analysis	Result ² Units	Original Analysis	Replicate Analysis	Split Analysis
Air Iodine - A1	3/4/2019	I-131	pCi/m ³	<MDA	<MDA	**
Air Iodine - A2	3/4/2019	I-131	pCi/m ³	<MDA	<MDA	**
Air Iodine - A3	3/4/2019	I-131	pCi/m ³	<MDA	<MDA	**
Air Iodine - A4	3/4/2019	I-131	pCi/m ³	<MDA	<MDA	**
Air Iodine - A5	3/4/2019	I-131	pCi/m ³	<MDA	<MDA	**
Air Iodine - SFA1	3/4/2019	I-131	pCi/m ³	<MDA	<MDA	**
Air Filter - A1	4/8/2019	Gross Beta	pCi/m ³	2.1 ± 0.1	2.1 ± 0.1	**
Air Filter - A2	4/8/2019	Gross Beta	pCi/m ³	1.9 ± 0.1	1.9 ± 0.1	**
Air Filter - A3	4/8/2019	Gross Beta	pCi/m ³	2.0 ± 0.1	2.0 ± 0.1	**
Air Filter - A4	4/8/2019	Gross Beta	pCi/m ³	1.8 ± 0.1	1.8 ± 0.1	**
Air Filter - A5	4/8/2019	Gross Beta	pCi/m ³	2.0 ± 0.1	2.0 ± 0.1	**
Air Filter - SFA1	4/8/2019	Gross Beta	pCi/m ³	1.7 ± 0.1	1.9 ± 0.1	**
Air Filter - SFA2	4/8/2019	Gross Beta	pCi/m ³	1.6 ± 0.1	1.6 ± 0.1	**
Air Filter - SFA3	4/8/2019	Gross Beta	pCi/m ³	1.9 ± 0.1	1.8 ± 0.1	**
Air Filter - SFA4	4/8/2019	Gross Beta	pCi/m ³	1.9 ± 0.1	1.9 ± 0.1	**
Air Iodine - A1	4/15/2019	I-131	pCi/m ³	<MDA	<MDA	**
Air Iodine - A2	4/15/2019	I-131	pCi/m ³	<MDA	<MDA	**
Shoreline Sediment-WB1	4/29/2019	Gamma	pCi/kg	<MDA	<MDA	<MDA
Air Filter - A1	5/7/2019	Gross Beta	pCi/m ³	1.2 ± 0.1	1.1 ± 0.1	**
Air Filter - A2	5/7/2019	Gross Beta	pCi/m ³	1.2 ± 0.1	1.2 ± 0.1	**
Air Filter - A3	5/7/2019	Gross Beta	pCi/m ³	1.3 ± 0.1	1.2 ± 0.1	**
Air Filter - A4	5/7/2019	Gross Beta	pCi/m ³	1.2 ± 0.1	1.3 ± 0.1	**
Air Filter - A5	5/7/2019	Gross Beta	pCi/m ³	1.3 ± 0.1	1.2 ± 0.1	**
Air Filter - SFA1	5/7/2019	Gross Beta	pCi/m ³	1.2 ± 0.1	1.3 ± 0.1	**
Air Filter - SFA2	5/7/2019	Gross Beta	pCi/m ³	1.1 ± 0.1	1.1 ± 0.1	**
Air Filter - SFA3	5/7/2019	Gross Beta	pCi/m ³	1.2 ± 0.1	1.1 ± 0.1	**
Air Filter - SFA4	5/7/2019	Gross Beta	pCi/m ³	1.0 ± 0.1	1.0 ± 0.1	**
Air Iodine - A1	6/3/2019	I-131	pCi/m ³	<MDA	<MDA	**
Air Iodine - A2	6/3/2019	I-131	pCi/m ³	<MDA	<MDA	**
Air Iodine - A3	6/3/2019	I-131	pCi/m ³	<MDA	<MDA	**
Air Iodine - A4	6/3/2019	I-131	pCi/m ³	<MDA	<MDA	**
Air Iodine - A5	6/3/2019	I-131	pCi/m ³	<MDA	<MDA	**
Air Iodine - SFA1	6/3/2019	I-131	pCi/m ³	<MDA	<MDA	**

TABLE C-2 - Continued
Results of Quality Assurance Program

Sample Type and Location	Sample Date	Type of Analysis	Result ² Units	Original Analysis	Replicate Analysis	Split Analysis
Air Filter - A1	6/10/2019	Gross Beta	pCi/m ³	1.8 ± 0.1	1.7 ± 0.1	**
Air Filter - A2	6/10/2019	Gross Beta	pCi/m ³	1.6 ± 0.4	0.9 ± 0.3	**
Air Filter - A3	6/10/2019	Gross Beta	pCi/m ³	1.7 ± 0.1	1.7 ± 0.1	**
Air Filter - A4	6/10/2019	Gross Beta	pCi/m ³	1.7 ± 0.1	1.8 ± 0.1	**
Air Filter - A5	6/10/2019	Gross Beta	pCi/m ³	1.8 ± 0.1	1.7 ± 0.1	**
Air Filter - SFA1	6/10/2019	Gross Beta	pCi/m ³	1.8 ± 0.1	1.8 ± 0.1	**
Air Filter - SFA2	6/10/2019	Gross Beta	pCi/m ³	1.6 ± 0.1	1.6 ± 0.1	**
Air Filter - SFA3	6/10/2019	Gross Beta	pCi/m ³	1.7 ± 0.1	1.7 ± 0.1	**
Air Filter - SFA4	6/10/2019	Gross Beta	pCi/m ³	1.6 ± 0.1	1.5 ± 0.1	**
Soil – SFS2	6/12/2019	GAMMA	pCi/kg	<MDA	<MDA	<MDA
Soil - SFS5	6/12/2019	Cs-137	pCi/kg	96.3 ± 25.1	75.2 ± 21.3	<MDA
Oysters – IA3	6/25/2019	GAMMA	pCi/kg	<MDA	<MDA	<MDA
Oysters – IA6	6/25/2019	GAMMA	pCi/kg	<MDA	<MDA	<MDA
Bottom sed.-WBS2 ¹	6/25/2019	Cs-137	pCi/kg	91.4 ± 79.2	149 ± 72.3	341 ± 189
Bottom sed.- WBS4	6/25/2019	Cs-137	pCi/kg	113 ± 73.8	<MDA	<MDA
Air Filter - A1	7/1/2019	GAMMA	pCi/m ³	<MDA	<MDA	<MDA
Air Filter - A2	7/1/2019	GAMMA	pCi/m ³	<MDA	<MDA	<MDA
Air Filter - A3	7/1/2019	GAMMA	pCi/m ³	<MDA	<MDA	<MDA
Air Filter - A4	7/1/2019	GAMMA	pCi/m ³	<MDA	<MDA	<MDA
Air Filter - A5	7/1/2019	GAMMA	pCi/m ³	<MDA	<MDA	<MDA
Air Filter - SFA1	7/1/2019	GAMMA	pCi/m ³	<MDA	<MDA	<MDA
Air Filter - SFA2	7/1/2019	GAMMA	pCi/m ³	<MDA	<MDA	<MDA
Air Filter - SFA3	7/1/2019	GAMMA	pCi/m ³	<MDA	<MDA	<MDA
Air Filter - SFA4	7/1/2019	GAMMA	pCi/m ³	<MDA	<MDA	<MDA
Gamma field– DR5	7/1/2019	TLD	mR/Qtr	12.1 ± 0.7	10.8 ± 1.3	**
Gamma field– DR6	7/1/2019	TLD	mR/Qtr	10.3 ± 0.7	10.0 ± 0.9	**
Gamma field– DR7	7/1/2019	TLD	mR/Qtr	10.2 ± 0.6	10.0 ± 1.1	**
Gamma field– DR8	7/1/2019	TLD	mR/Qtr	13.3 ± 1.2	12.8 ± 1.2	**
Gamma field– DR9	7/1/2019	TLD	mR/Qtr	10.3 ± 0.9	10.4 ± 0.7	**
Gamma field- DR10	7/1/2019	TLD	mR/Qtr	10.6 ± 1.1	10.7 ± 1.7	**
Gamma field- DR11	7/1/2019	TLD	mR/Qtr	10.6 ± 0.4	10.4 ± 0.6	**

TABLE C-2 - Continued
Results of Quality Assurance Program

Sample Type and Location	Sample Date	Type of Analysis	Result Units	Original Analysis	Replicate Analysis	Split Analysis
Gamma field-SFDR14	7/1/2019	TLD	mR/Qtr	40.9 ± 2.8	46.4 ± 5.1	**
Gamma field - SFDR15	7/1/2019	TLD	mR/Qtr	20.1 ± 2.8	24.0 ± 6.8	**
Gamma field – DR23	7/1/2019	TLD	mR/Qtr	14.6 ± 1.1	13.5 ± 1.1	**
Air Iodine - A1	7/15/2019	I-131	pCi/m ³	<MDA	<MDA	**
Air Iodine - A2	7/15/2019	I-131	pCi/m ³	<MDA	<MDA	**
Air Iodine - A3	7/15/2019	I-131	pCi/m ³	<MDA	<MDA	**
Chard - IB5	7/22/2019	Cs-137	pCi/kg	18.6 ± 13.9	<MDA	18.2 ± 5.6
Cabbage – IB4	7/22/2019	GAMMA	pCi/kg	<MDA	<MDA	<MDA
Collards – IB10	7/22/2019	GAMMA	pCi/kg	<MDA	<MDA	<MDA
Cabbage – IB12	7/22/2019	GAMMA	pCi/kg	<MDA	<MDA	<MDA
Air Filter - A1	8/5/2019	Gross Beta	pCi/m ³	2.7 ± 0.2	2.4 ± 0.2	**
Air Filter - A2	8/5/2019	Gross Beta	pCi/m ³	2.8 ± 0.2	2.6 ± 0.2	**
Air Filter - A3	8/5/2019	Gross Beta	pCi/m ³	2.6 ± 0.2	2.6 ± 0.2	**
Air Filter - A4	8/5/2019	Gross Beta	pCi/m ³	2.5 ± 0.2	2.5 ± 0.2	**
Air Filter - A5	8/5/2019	Gross Beta	pCi/m ³	2.4 ± 0.2	2.4 ± 0.2	**
Air Filter - SFA1	8/5/2019	Gross Beta	pCi/m ³	2.7 ± 0.2	2.6 ± 0.2	**
Air Filter - SFA2	8/5/2019	Gross Beta	pCi/m ³	2.5 ± 0.2	2.4 ± 0.2	**
Air Filter - SFA3	8/5/2019	Gross Beta	pCi/m ³	2.6 ± 0.2	2.5 ± 0.2	**
Air Filter - SFA4	8/5/2019	Gross Beta	pCi/m ³	2.4 ± 0.2	2.5 ± 0.2	**
Air Iodine - A1	8/12/2019	I-131	pCi/m ³	<MDA	<MDA	**
Air Iodine - A2	8/12/2019	I-131	pCi/m ³	<MDA	<MDA	**
Air Iodine - A3	8/12/2019	I-131	pCi/m ³	<MDA	<MDA	**
Span. Mack.- IA5	8/12/2019	Gamma	pCi/kg	<MDA	<MDA	<MDA
Spot - IA1	8/12/2019	Gamma	pCi/kg	<MDA	<MDA	<MDA
Span. Mack.- IA2	8/12/2019	Gamma	pCi/kg	<MDA	<MDA	<MDA
Air Iodine - A1	9/9/2019	I-131	pCi/m ³	<MDA	<MDA	**
Air Iodine - A2	9/9/2019	I-131	pCi/m ³	<MDA	<MDA	**
Air Iodine - A3	9/9/2019	I-131	pCi/m ³	<MDA	<MDA	**
Air Iodine - A4	9/9/2019	I-131	pCi/m ³	<MDA	<MDA	**
Air Iodine - A5	9/9/2019	I-131	pCi/m ³	<MDA	<MDA	**
Air Iodine - SFA1	9/9/2019	I-131	pCi/m ³	<MDA	<MDA	**

TABLE C-2 - Continued
Results of Quality Assurance Program

Sample Type and Location	Sample Date	Type of Analysis	Result Units	Original Analysis	Replicate Analysis	Split Analysis
Water – WA2	9/27/2019	Gamma	pCi/L	<MDA	<MDA	<MDA
Water – WA1	9/27/2019	Gamma	pCi/L	<MDA	<MDA	<MDA
Air Filter - A1	10/1/2019	GAMMA	pCi/m ³	<MDA	<MDA	<MDA
Air Filter - A2	10/1/2019	GAMMA	pCi/m ³	<MDA	<MDA	<MDA
Air Filter - A3	10/1/2019	GAMMA	pCi/m ³	<MDA	<MDA	<MDA
Air Filter - A4	10/1/2019	GAMMA	pCi/m ³	<MDA	<MDA	<MDA
Air Filter - A5	10/1/2019	GAMMA	pCi/m ³	<MDA	<MDA	<MDA
Air Filter - SFA1	10/1/2019	GAMMA	pCi/m ³	<MDA	<MDA	<MDA
Air Filter - SFA2	10/1/2019	GAMMA	pCi/m ³	<MDA	<MDA	<MDA
Air Filter - SFA3	10/1/2019	GAMMA	pCi/m ³	<MDA	<MDA	<MDA
Air Filter - SFA4	10/1/2019	GAMMA	pCi/m ³	<MDA	<MDA	<MDA
Air Filter - A1	10/7/2019	Gross Beta	pCi/m ³	2.0 ± 0.1	2.1 ± 0.2	**
Air Filter - A2	10/7/2019	Gross Beta	pCi/m ³	1.9 ± 0.1	1.8 ± 0.1	**
Air Filter - A3	10/7/2019	Gross Beta	pCi/m ³	2.1 ± 0.1	2.1 ± 0.2	**
Air Filter - A4	10/7/2019	Gross Beta	pCi/m ³	2.1 ± 0.1	2.0 ± 0.1	**
Air Filter - A5	10/7/2019	Gross Beta	pCi/m ³	2.1 ± 0.1	2.1 ± 0.2	**
Air Filter - SFA1	10/7/2019	Gross Beta	pCi/m ³	2.2 ± 0.2	1.9 ± 0.1	**
Air Filter - SFA2	10/7/2019	Gross Beta	pCi/m ³	1.9 ± 0.1	1.9 ± 0.1	**
Air Filter - SFA3	10/7/2019	Gross Beta	pCi/m ³	2.0 ± 0.1	2.0 ± 0.2	**
Air Filter - SFA4	10/7/2019	Gross Beta	pCi/m ³	2.0 ± 0.1	1.8 ± 0.1	**
Air Iodine - A1	10/7/2019	I-131	pCi/m ³	<MDA	<MDA	**
Air Iodine - A2	10/7/2019	I-131	pCi/m ³	<MDA	<MDA	**
Air Iodine - A3	10/7/2019	I-131	pCi/m ³	<MDA	<MDA	**
Air Iodine - A4	10/7/2019	I-131	pCi/m ³	<MDA	<MDA	**
Air Iodine - A5	10/7/2019	I-131	pCi/m ³	<MDA	<MDA	**
Air Iodine - SFA1	10/7/2019	I-131	pCi/m ³	<MDA	<MDA	**
Oysters – IA3	10/23/2019	GAMMA	pCi/kg	<MDA	<MDA	<MDA
Oysters – IA6	10/23/2019	GAMMA	pCi/kg	<MDA	<MDA	<MDA

TABLE C-2 - Continued
Results of Quality Assurance Program

Sample Type and Location	Sample Date	Type of Analysis	Result Units	Original Analysis	Replicate Analysis	Split Analysis
Air Filter - A1	11/4/2019	Gross Beta	pCi/m ³	1.6 ± 0.1	1.6 ± 0.1	**
Air Filter - A2	11/4/2019	Gross Beta	pCi/m ³	1.4 ± 0.1	1.4 ± 0.1	**
Air Filter - A3	11/4/2019	Gross Beta	pCi/m ³	1.4 ± 0.1	1.3 ± 0.1	**
Air Filter - A4	11/4/2019	Gross Beta	pCi/m ³	1.4 ± 0.1	1.4 ± 0.1	**
Air Filter - A5	11/4/2019	Gross Beta	pCi/m ³	1.5 ± 0.1	1.7 ± 0.1	**
Air Filter - SFA1	11/4/2019	Gross Beta	pCi/m ³	1.5 ± 0.1	1.5 ± 0.1	**
Air Filter - SFA2	11/4/2019	Gross Beta	pCi/m ³	1.5 ± 0.1	1.4 ± 0.1	**
Air Filter - SFA3	11/4/2019	Gross Beta	pCi/m ³	1.4 ± 0.1	1.4 ± 0.1	**
Air Filter - SFA4	11/4/2019	Gross Beta	pCi/m ³	1.6 ± 0.1	1.3 ± 0.1	**
Air Iodine - A1	11/4/2019	I-131	pCi/m ³	<MDA	<MDA	**
Air Iodine - A2	11/4/2019	I-131	pCi/m ³	<MDA	<MDA	**
Air Iodine - A3	11/4/2019	I-131	pCi/m ³	<MDA	<MDA	**
Air Iodine - A4	11/4/2019	I-131	pCi/m ³	<MDA	<MDA	**
Air Iodine - A5	11/4/2019	I-131	pCi/m ³	<MDA	<MDA	**
Air Iodine - SFA1	11/4/2019	I-131	pCi/m ³	<MDA	<MDA	**
Vegetation– SFB2	11/18/2019	Gamma	pCi/kg	<MDA	<MDA	<MDA
Vegetation - SFB5	11/18/2019	Cs-137	pCi/kg	<MDA	<MDA	19.5 ± 8.9
Water – WA1	12/2/2019	Gamma	pCi/L	<MDA	<MDA	<MDA
Water – WA2	12/2/2019	Gamma	pCi/L	<MDA	<MDA	<MDA
Air Iodine - A1	12/9/2019	I-131	pCi/m ³	<MDA	<MDA	**
Air Iodine - A2	12/9/2019	I-131	pCi/m ³	<MDA	<MDA	**
Air Iodine - A3	12/9/2019	I-131	pCi/m ³	<MDA	<MDA	**
Air Iodine - A4	12/9/2019	I-131	pCi/m ³	<MDA	<MDA	**
Air Iodine - A5	12/9/2019	I-131	pCi/m ³	<MDA	<MDA	**
Air Iodine - SFA1	12/9/2019	I-131	pCi/m ³	<MDA	<MDA	**

TABLE C-2 - Continued
Results of Quality Assurance Program

Sample Type and Location	Sample Date	Type of Analysis	Result Units	Original Analysis	Replicate Analysis	Split Analysis
Gamma field – DR05	1/21/2020	TLD	mR/Qtr	15.3 ± 1.6	15.1 ± 1.0	**
Gamma field – DR06	1/21/2020	TLD	mR/Qtr	13.6 ± 0.8	13.2 ± 0.5	**
Gamma field – DR07	1/21/2020	TLD	mR/Qtr	13.6 ± 1.0	13.9 ± 1.2	**
Gamma field – DR08	1/21/2020	TLD	mR/Qtr	18.2 ± 1.0	18.2 ± 1.8	**
Gamma field – DR09	1/21/2020	TLD	mR/Qtr	13.6 ± 1.4	13.5 ± 1.1	**
Gamma field - DR10	1/21/2020	TLD	mR/Qtr	13.7 ± 0.7	14.6 ± 3.7	**
Gamma field - DR11	1/21/2020	TLD	mR/Qtr	14.3 ± 1.0	14.1 ± 0.9	**
Gamma field - SFDR14	1/21/2020	TLD	mR/Qtr	76.1 ± 40.2	83.0 ± 55.5	**
Gamma field - SFDR15	1/21/2020	TLD	mR/Qtr	31.7 ± 6.0	33.9 ± 5.8	**
Gamma field – DR23	1/21/2020	TLD	mR/Qtr	21.9 ± 2.1	20.3 ± 1.0	**

¹ See discussion at the beginning of the Appendix.

** The nature of these samples precluded splitting them with an independent laboratory.

Table C-3

Teledyne Brown Engineering's Typical MDAs for Gamma Spectrometry

Selected Nuclides	Bay Water pCi/l	Fish pCi/kg	Shellfish pCi/kg	Sediment pCi/kg	Vegetation pCi/kg	Particulates 10 ⁻³ pCi/m ³
H-3	175	--	--	--	--	--
Na-22	1	8	3	12	6	5
Cr-51	12	105	4	104	50	63
Mn-54	1	9	3	12	5	4
Co-58	1	9	4	9	4	5
Fe-59	3	28	9	24	10	12
Co-60	1	9	4	12	5	6
Zn-65	2	20	8	25	10	9
Nb-95	1	12	7	14	6	9
Zr-95	2	18	8	20	9	9
Ru-106	9	75	30	90	41	40
Ag-110m	1	10	10	10	5	4
Te-129m	16	131	60	162	79	95
I-131	4	65	30	35	22	74
Cs-134	1	8	4	10	5	4
Cs-137	1	9	4	10	5	4
BaLa-140	3	32	15	25	14	36
Ce-144	7	40	16	54	26	18

APPENDIX D

Land Use Survey

Summary of Appendix D Content:

Appendix D contains the results of a Land Use Survey conducted around R.E. Ginna Nuclear Power Plant during this operating period. A discussion of the results is included in Section 3.4 of this report.

TABLE OF CONTENTS - LAND USE SURVEY

Table	Title	Page
D-1	Land Use Survey Distances.....	68

TABLE D-1
Land Use Survey Distances

Sector (Direction in Degrees)	Distance to Nearest Residence	Distance to Nearest Garden (Latitude N, Longitude W)	Distance to Milk Producing Animals (Latitude N, Longitude W)
E (94)	1170 m	610 m Onsite Supplemental Garden (43.27727, 77.30140)	N/A
ESE (111)	1660 m	430 m Onsite Garden (43.27627, 77.30389)	N/A
ESE (119)	840 m	N/A	8240 m (43.24196, 77.21978)
SSE (145)	610 m	660 m Onsite Supplemental Garden (43.27278, 77.30413)	N/A
S	1500 m	N/A	N/A
SSW	620 m	N/A	N/A
SW	740 m	N/A	N/A
WSW	900 m	N/A	N/A
W	1330 m	N/A	N/A

Discussion

A Land Use Survey was conducted to identify, within five miles, the location of the nearest milk animal, the nearest residence, and the nearest garden greater than 500 square feet in each of the nine sectors over land. The position of the nearest residence and garden and animals producing milk for human consumption in each sector out to five miles is given in the above Table D-1.

Changes from Previous Years:

- The nearest residence remains in the SSE sector, approximately 610 meters from the reactor.
- Single-family home / senior housing subdivision / development construction was observed near the plant on LaFrank Drive (Ontario), and South of Route 104 near Tops Plaza (Ontario).
- Lake Front Estates and Summer Lake subdivisions continue to expand along with the southeast corner of Lake Road and Slocum Road.
- Other single-family home construction was observed sporadically within 5-miles of the plant.
- A new 120-acre commercial hydroponic farm has 25-acres of active production of “AGRI-GROW” tomatoes year-round at East end of Dean Parkway (North of Route 104)
- Commercial fishing information was collected from the New York State Department of Environmental Conservation (NYSDEC) which shows activity only in the Eastern basin of Lake Ontario. Commercial fishing operations have not changed in the last five-years and no commercial fishing takes place within 5-miles of Ginna.
- No new agricultural land use was identified.
- No new food producing facilities were identified as the commercial hydroponic farm is not currently growing produce.
- No new milk producing animals were identified.

Milk Animal Locations

- Schultz Farm – 450 Boston Road, Ontario NY
- Field Craft Farm (supplemental sample) – 6747 Salmon Creek Road, Williamson NY
- No new milk producing animals were identified in the 2019 survey.

APPENDIX E

Interpretations and Graphical Representations

Summary of Appendix E Content:

To better illustrate that the continued operation of the R.E. Ginna Nuclear Power Plant (Ginna) has no statistically significant impact on the surrounding environment, Appendix E contains the results of the last eight years of Radiological Environment Monitoring Program (REMP) data. Where applicable (when analytical results produced a measured numerical value), trends have been produced to show values that have been observed in the various environs surrounding Ginna. A discussion of these results will accompany each series of trends to enhance understanding of the REMP program.

**TABLE OF CONTENTS –
INTERPRETATIONS AND GRAPHICAL REPRESENTATIONS**

Table	Title	Page
E-1	E-Series 1, Table B-1 (Gross Beta Values for Surface and Drinking Water).....	72
E-2	E-Series 2, Table B-5 / Table B-6 (Beta in Air Particulates).....	76
E-3	E-Series 3, Table B-12 (Direct Radiation).....	81
E-4	E-Series 4, Table B-13 (Tritium in Groundwater).....	94

E-Series 1

Table B-1 (Gross Beta Values for Surface and Drinking Water)

Ginna's Offsite Dose Calculation Manual (ODCM) is written in accordance with specifications contained within 10 CFR 20 and the Branch Technical Position document published by the NRC in 1979. This document specifies Gross Beta in Surface Water samples to be detected to a Lower Limit of Detection (LLD) of 4 pCi/l. Since that time, detection capabilities have improved which allow values to be measured lower than the required 4 pCi/l.

The trends below include the Gross Beta averages (from 2012-2019) for Ginna's surface water samples (Circ – In, Circ – Out, MCWA, Deer Creek, Mill Creek, OWD, and Webster). An elevated Gross Beta result inconsistent with the trend would indicate radionuclides in the sample which would require further analysis. From 2012 through 2019, no such results have been measured within Ginna's REMP program.

Results from Deer Creek (indicator) and Mill Creek (control) are higher than other surface water samples within the REMP program due to naturally occurring radiological daughter products within the soil being introduced into the samples. It is worth noting that these naturally occurring radiological daughter products would exist in this environ at these same levels even if Ginna had never been built. These samples are obtained to evaluate the potential for public exposure due to the surface water (Mill Creek, Circ-In, Circ-Out, and Deer Creek) and drinking water pathway (Monroe County Water Authority, Webster Water Authority, and Ontario Water District). These locations are chosen as a member of the public is most likely to encounter water which has left Ginna property via these sample streams.

Trend "B-1 Control and Indicator Averages (2012-2019) shows the relationship between the control samples (Mill Creek, MCWA, and Webster Water Authority) and the indicator samples (Circ-In, Circ-Out, Deer Creek, and OWD). This trend illustrates that there is no statistically significant difference between control and indicator samples for Gross Beta in Surface water from 2012-2019.

B-1 Control and Indicator Averages (2012-2019)



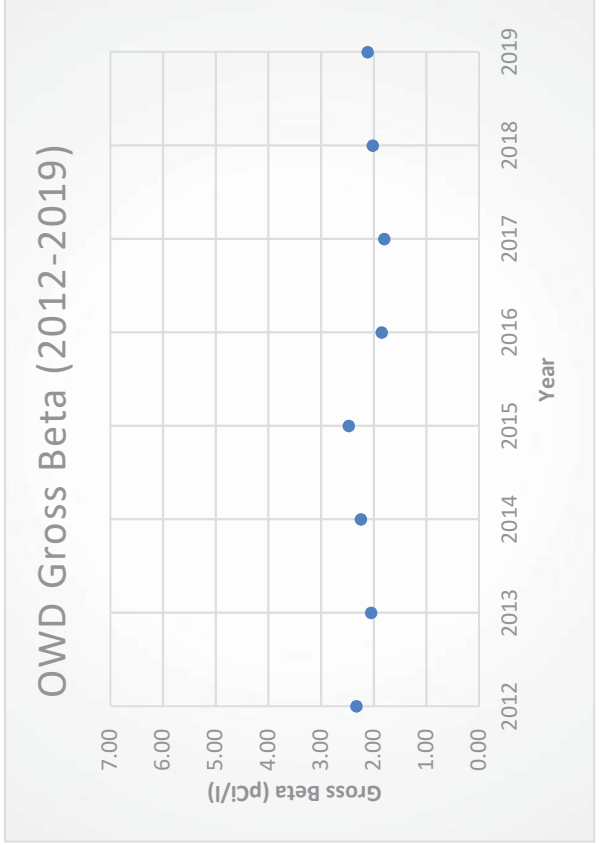
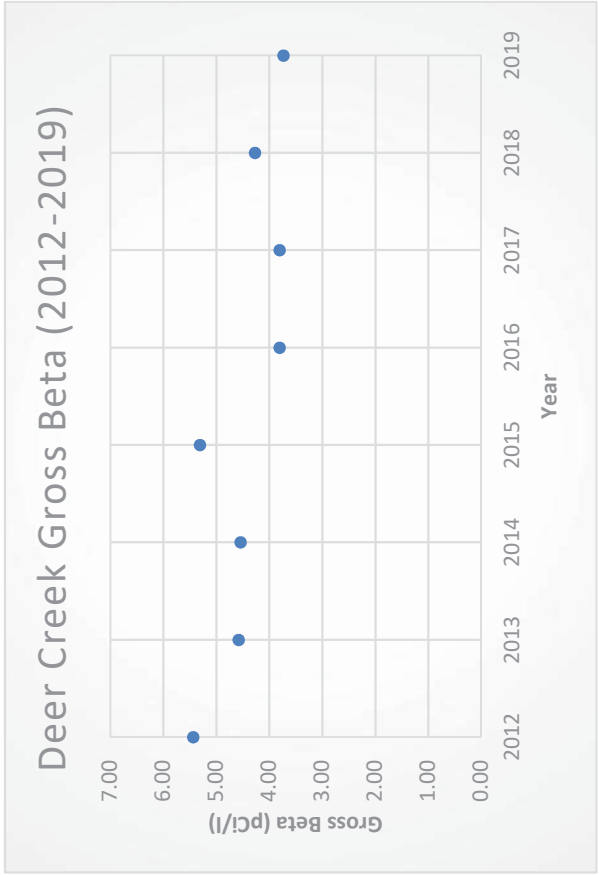
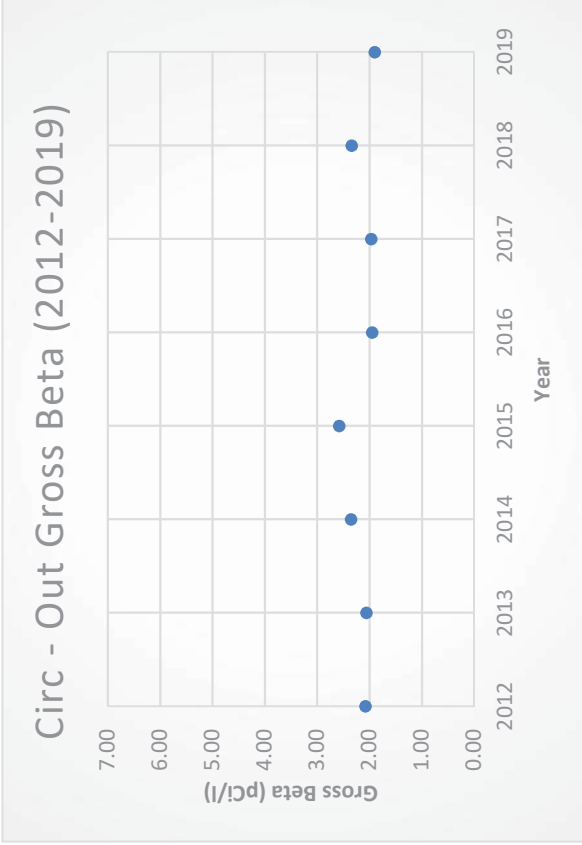
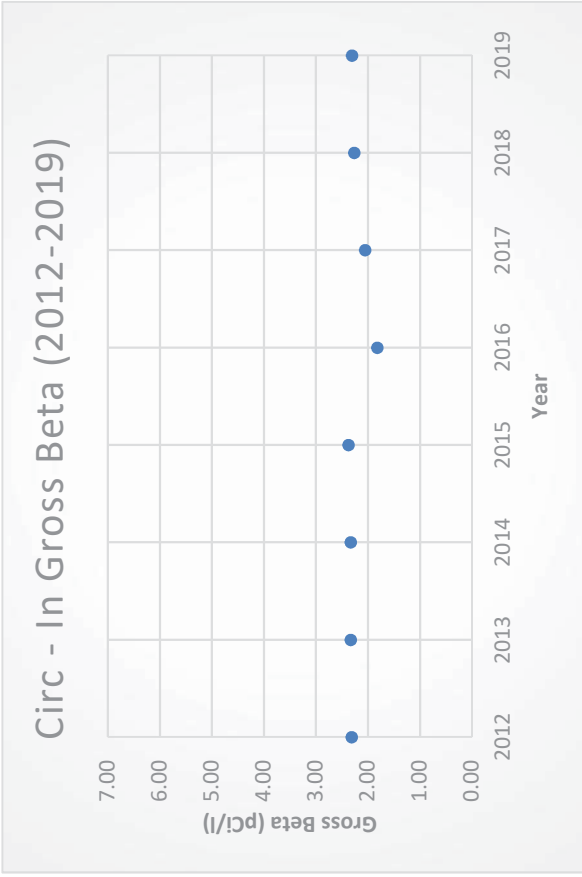

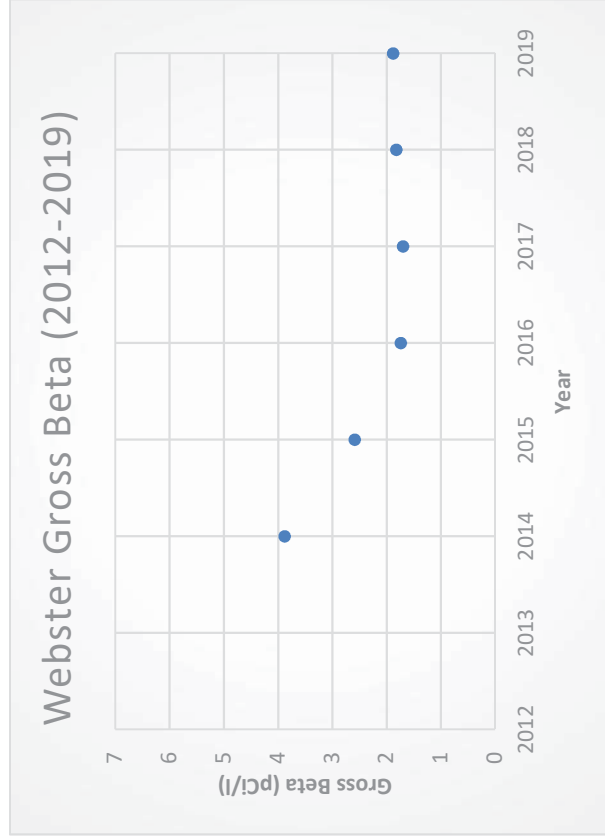
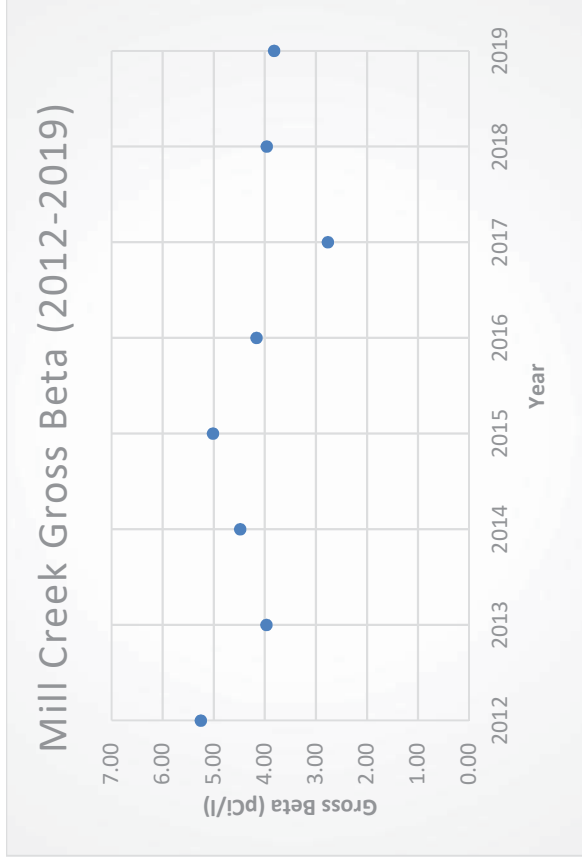
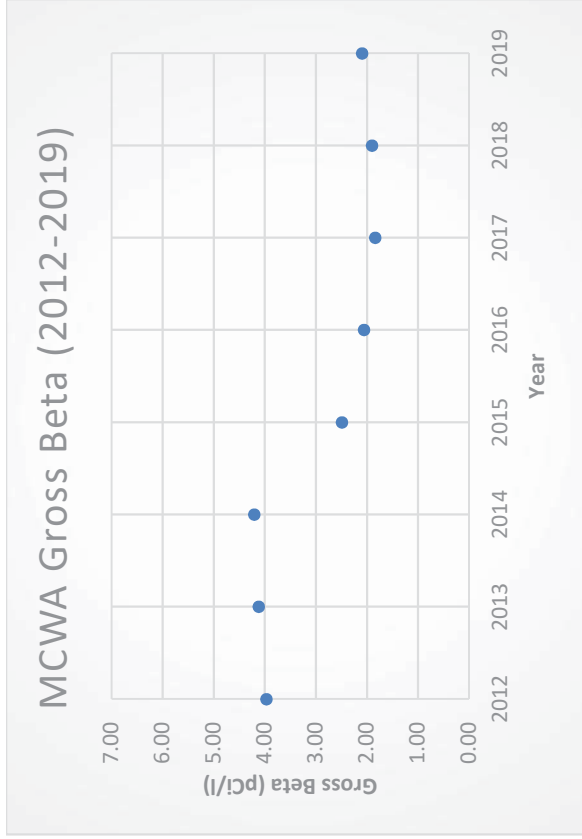

E-Series 2

Table B-5 / Table B-6 (Beta in Air Particulates)

Ginna's Offsite Dose Calculation Manual (ODCM) is written in accordance with specifications contained within 10 CFR 20 and the Branch Technical Position document published by the NRC in 1979. This document specifies Gross Beta in Air Particulate samples to be detected to a Lower Limit of Detection (LLD) of 1.0×10^{-2} pCi/m³. Accordingly, analyses performed as part of the REMP at Ginna satisfy this requirement.

The trends below include the Gross Beta averages (from 2012-2019) for Ginna's air particulate samples (Station-02 through Station-13). An elevated Gross Beta result inconsistent with the trend would indicate radionuclides in the sample which would require further analysis. From 2012 through 2019, no such results have been measured within Ginna's REMP program.

Sampling locations (Station-02 through Station-13) are noted below, and their classification as either a control or an indicator. These locations were selected to show areas where breathable air, which has the potential to be in communication with air released from Ginna, could lead to public exposure. Some locations (such as Station-08, Seabreeze and Station-12, Sodus Point) are sampled due to recreational activities in the area and their associated sensitivity.

- Station-02 – Manor House Yard, Ginna Property (Indicator)
- Station-03 – North of Training Center Parking Lot, Ginna Property (Indicator)
- Station-04 – East of Training Center Parking Lot, Ginna Property (Indicator)
- Station-05 – Bridge Near Deer Creek, Ginna Property (Indicator)
- Station-06 – Southwest of Plant Parking Lot, Ginna Property (Indicator)
- Station-07 – Utility Pole West of Parking Lot, Ginna Property (Indicator)
- Station-08 – Seabreeze (Control)
- Station-09 – Webster (Indicator)
- Station-10 – Walworth (Control)
- Station-11 – Williamson (Indicator)
- Station-12 – Sodus Point (Control)
- Station-13 – Substation 13 (Indicator)

Trend "B-5 / B-6 Control and Indicator Averages (2012 – 2019)" shows the relationship between the control samples (Station-08, Station-10, and Station-12) and the indicator samples (Station-02, Station-03, Station-04, Station-05, Station-06, Station-07, Station-09, and Station-11). This trend illustrates that there is no statistically significant difference between control and indicator samples for Gross Beta in Air Particulates from 2012-2019.

B-5 / B-6 Control and Indicator Averages (2012-2019)

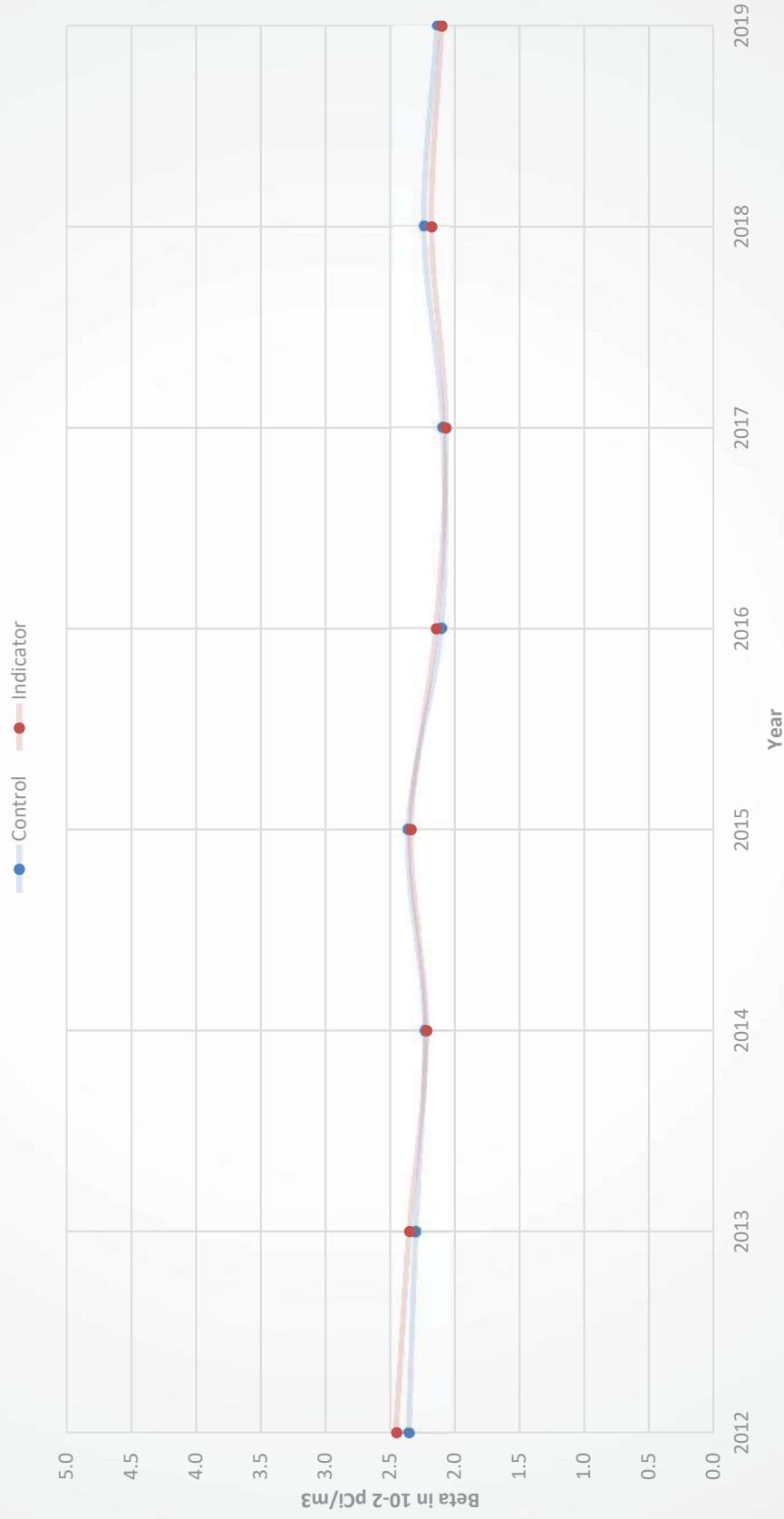

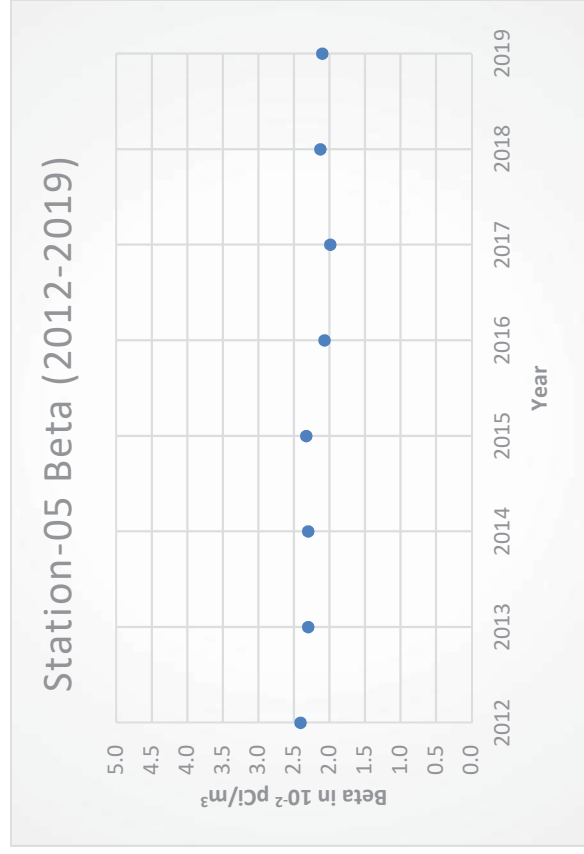
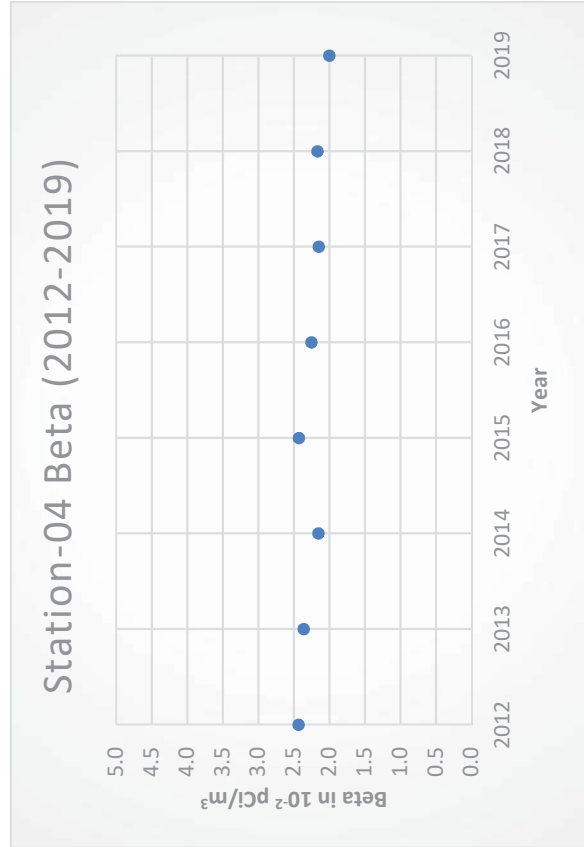
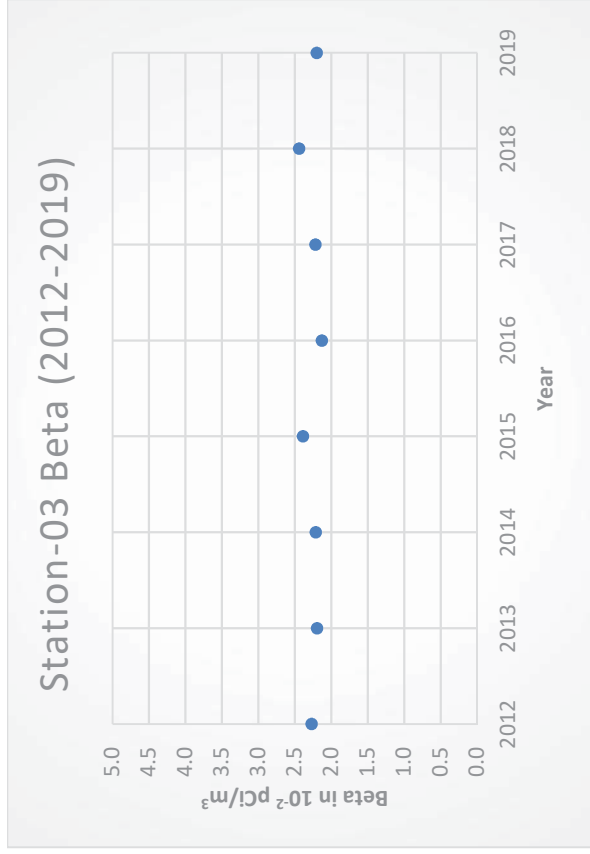
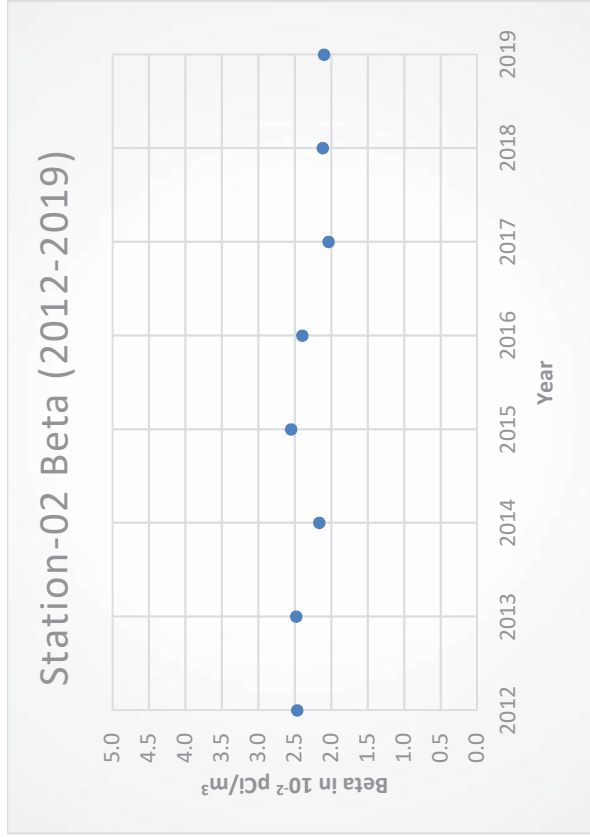

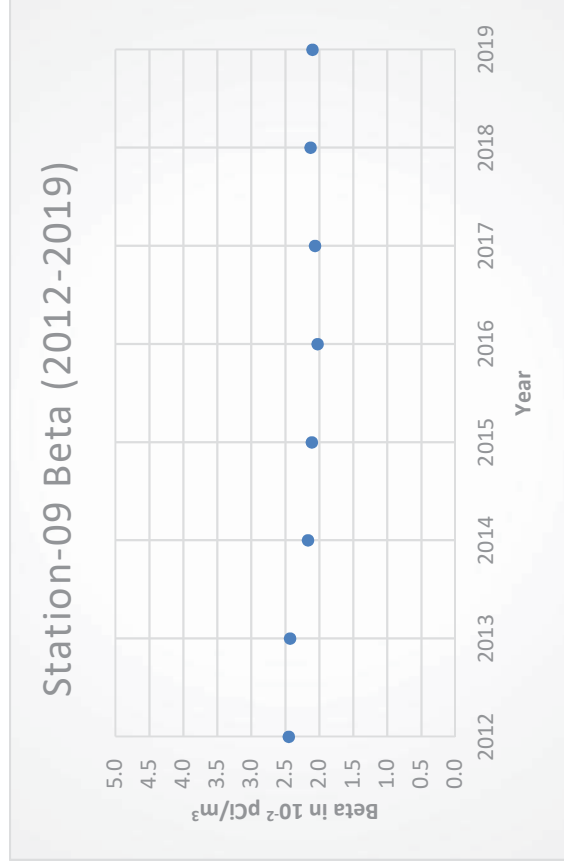
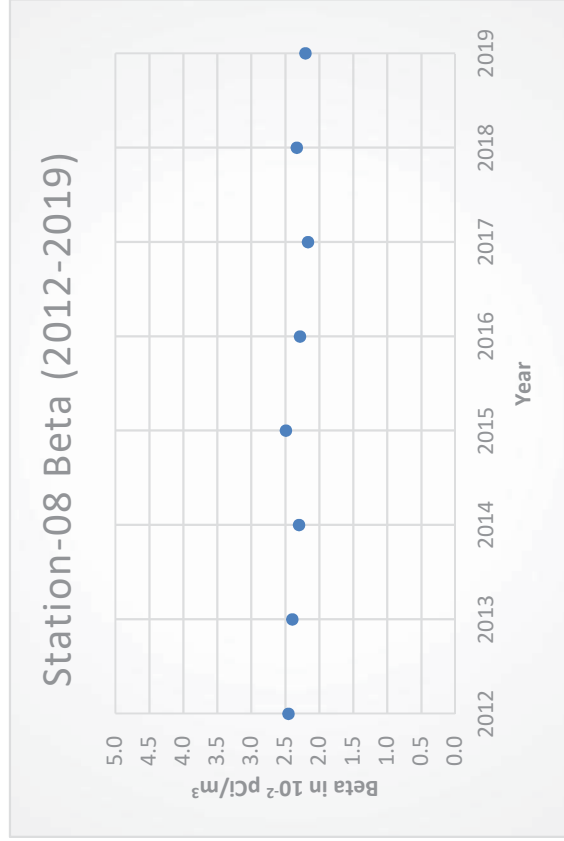
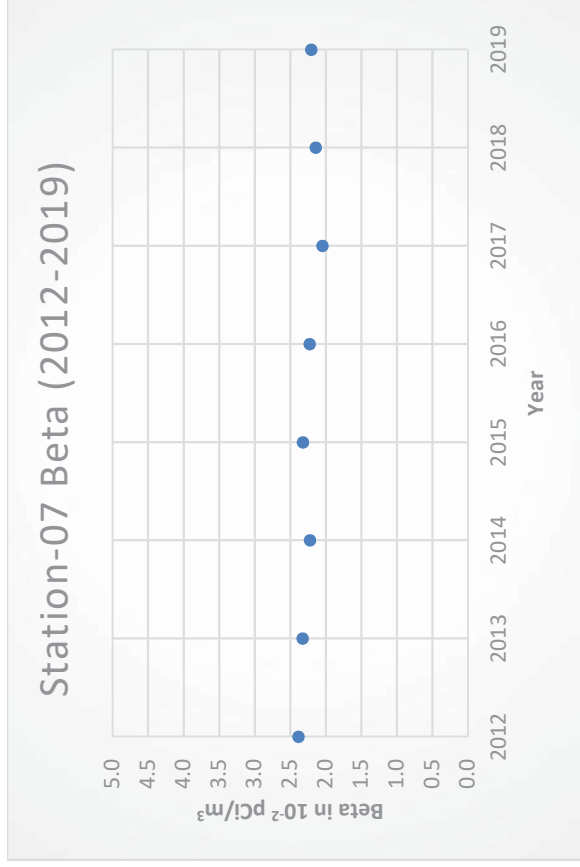
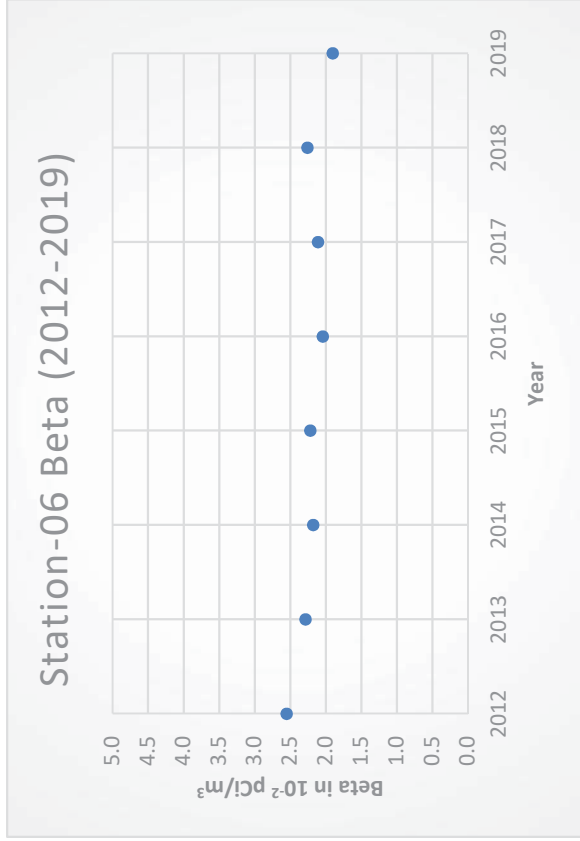

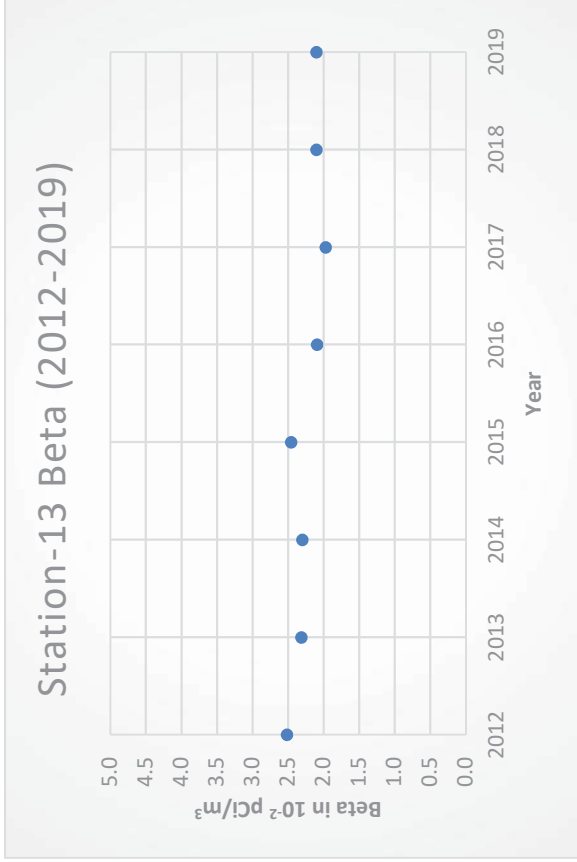
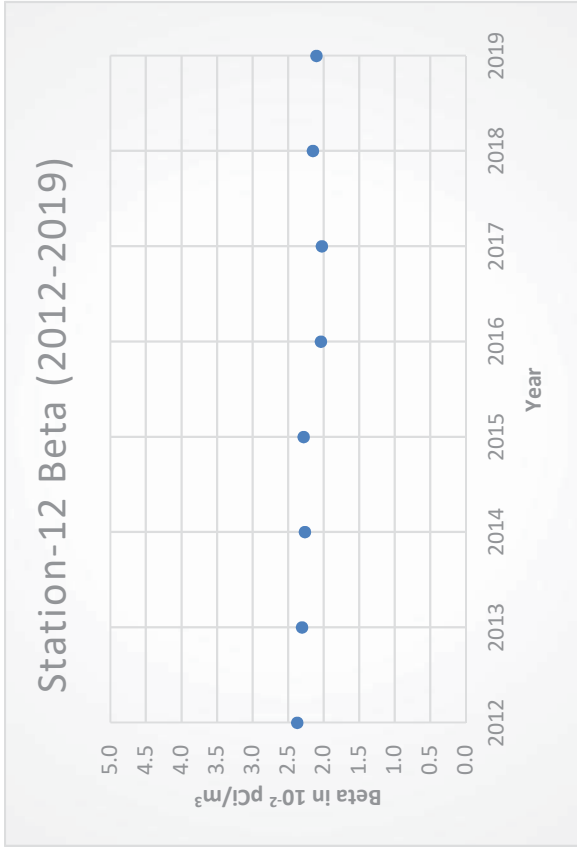
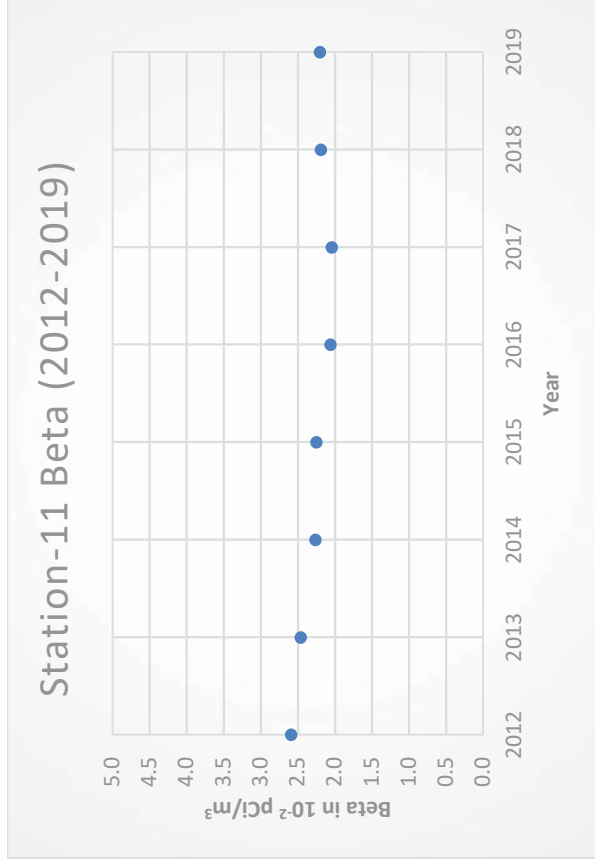
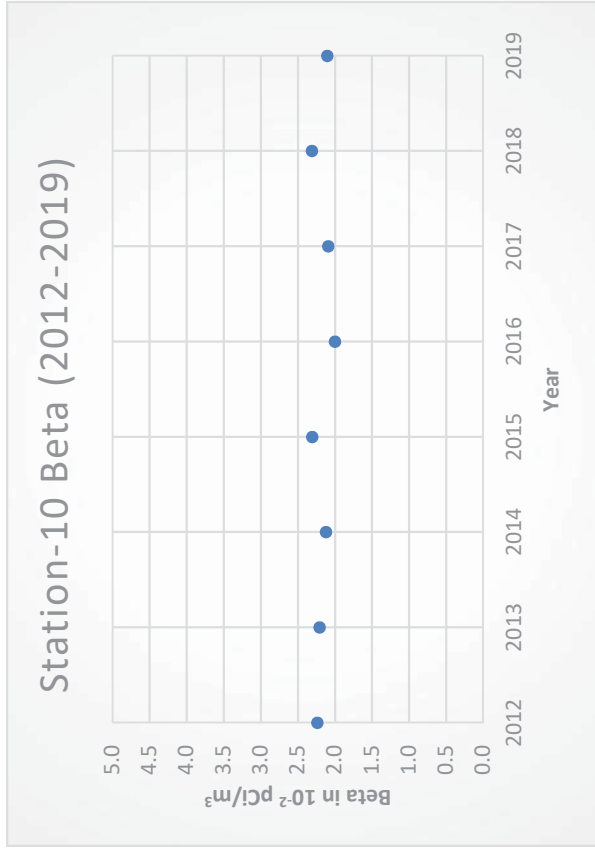

E-Series 3

Table B-12 (Direct Radiation)

In 2019, Ginna adopted Exelon procedure CY-AA-170-1001, “Environmental Dosimetry Performance Specifications, Testing, and Data Analysis,” which included new methodology for determining dose attributable to facility operations. As part of this methodology, the direct radiation dose to the general public is now determined in accordance with the Environmental Protection Agency (EPA) guidance 40 CFR 190, “Environmental Radiation Protection Standards for Nuclear Power Operations.” This methodology incorporates the concepts established in ANSI/HPS N13.37, “Environmental Dosimetry” as established in NRC Regulatory Guide 4.13, “Environmental Dosimetry - Performance, Specifications, Testing, and Data Analysis.”

The values below have been maintained and include the average quarterly exposure (in millirem) for Ginna’s direct radiation monitoring locations. This quarterly average is averaged for the year to facilitate trending.

Direct radiation is the measurement that a member of the public would experience due to being near a source of radioactivity, such as a nuclear power plant in addition to natural sources. These natural sources are present throughout the environment (examples include being near bedrock rich in granite, being in the presence of the sun, radon gas emerging from layers of earth, etc.) and the direct radiation measurement Ginna collects is to determine if there is any statistically significant additional exposure from the operations of the nuclear facility.

Trend “B-12 Control and Indicator Averages (2012-2019)” shows the relationship between the control samples (TL-08, TL-10, TL-12, TL-25 – TL-30) and the indicator samples (TL-02 – TL 07, TL-11, TL-13 – TL-24, TL-31 – TL-40, TL-63, and TL-64). This trend illustrates that there is no statistically significant difference between control and indicator samples for direct radiation exposure in millirem from 2012-2019.

B-12 Control and Indicator Averages (2012-2019)

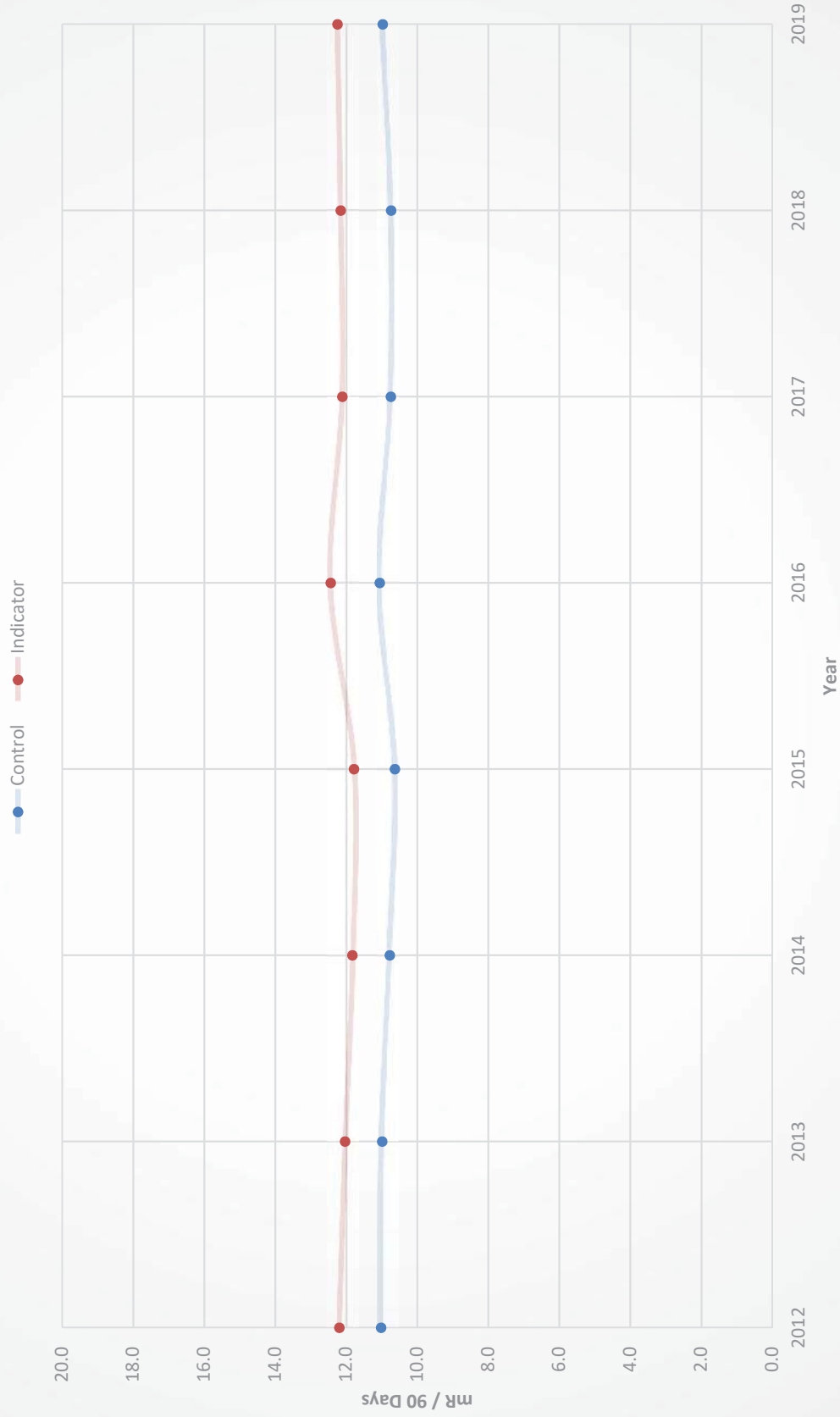

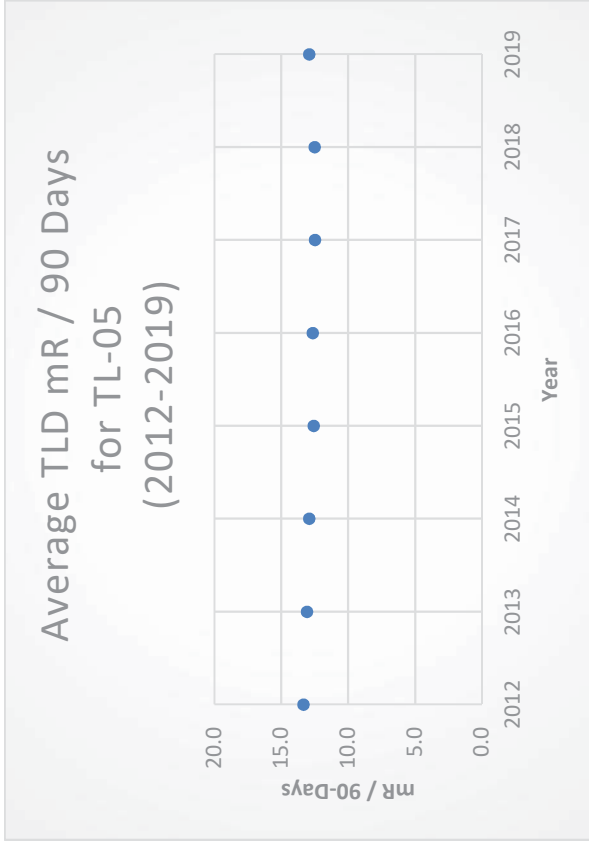
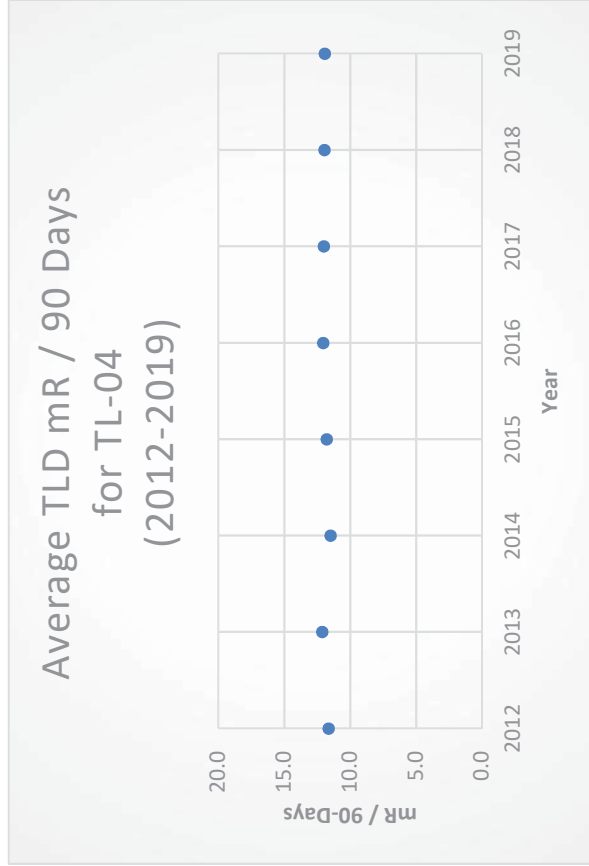
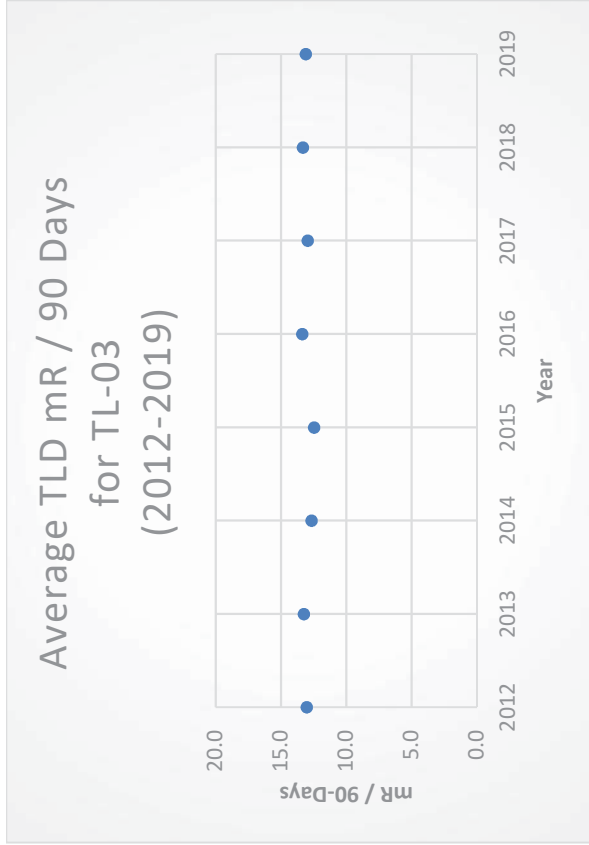
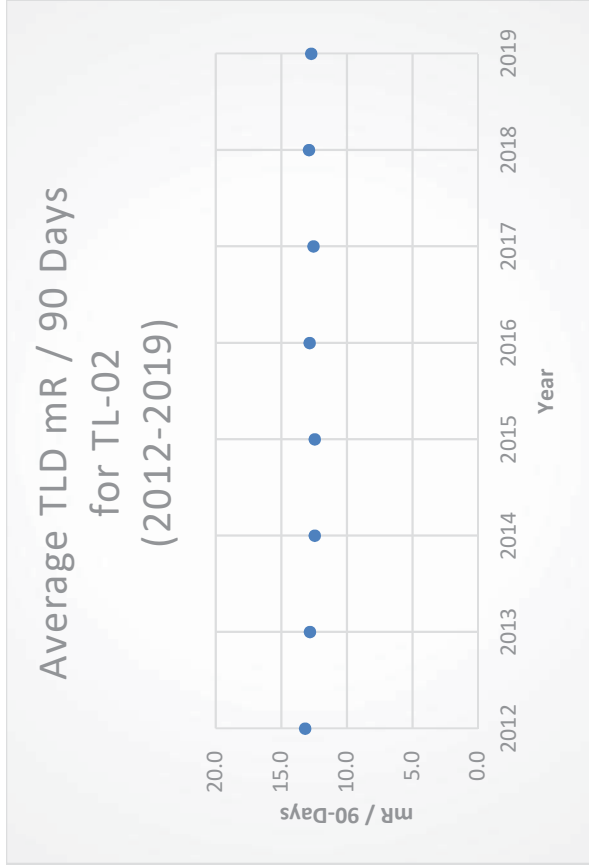

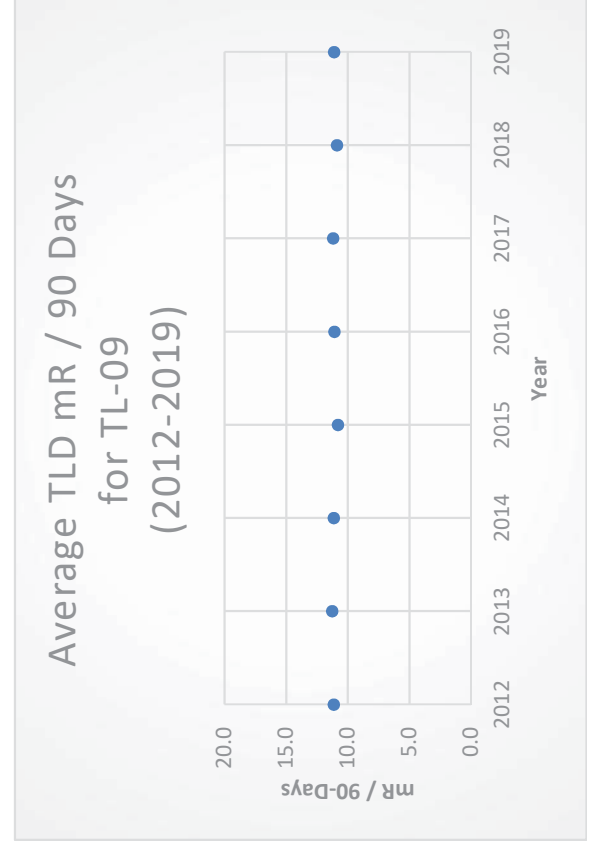
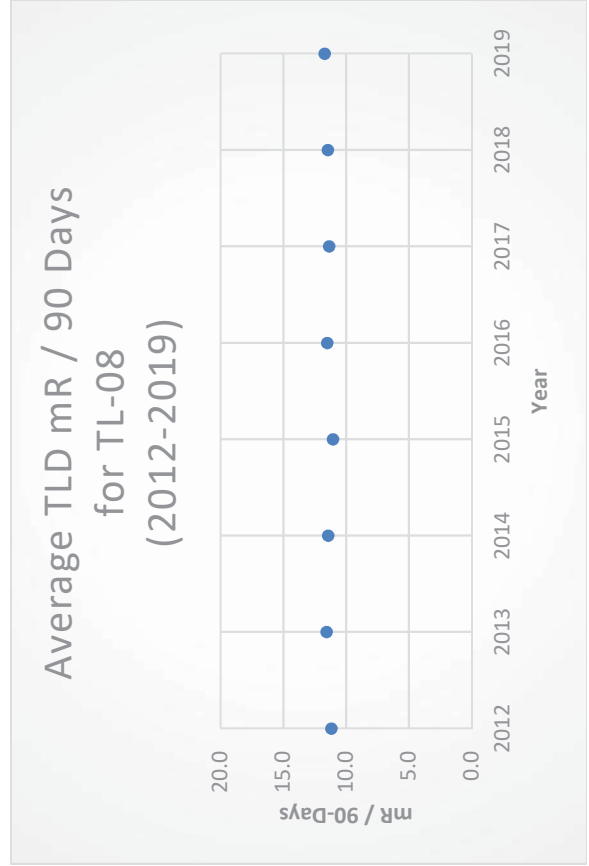
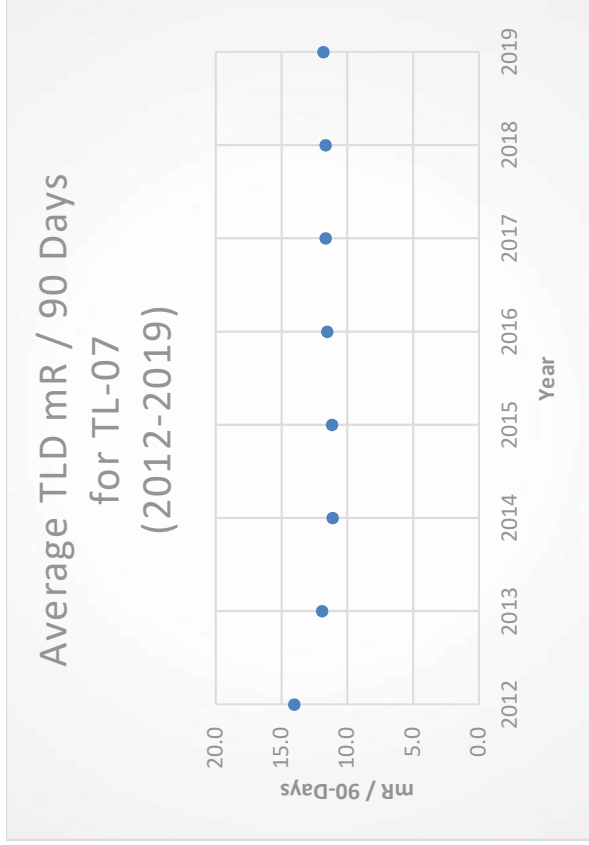
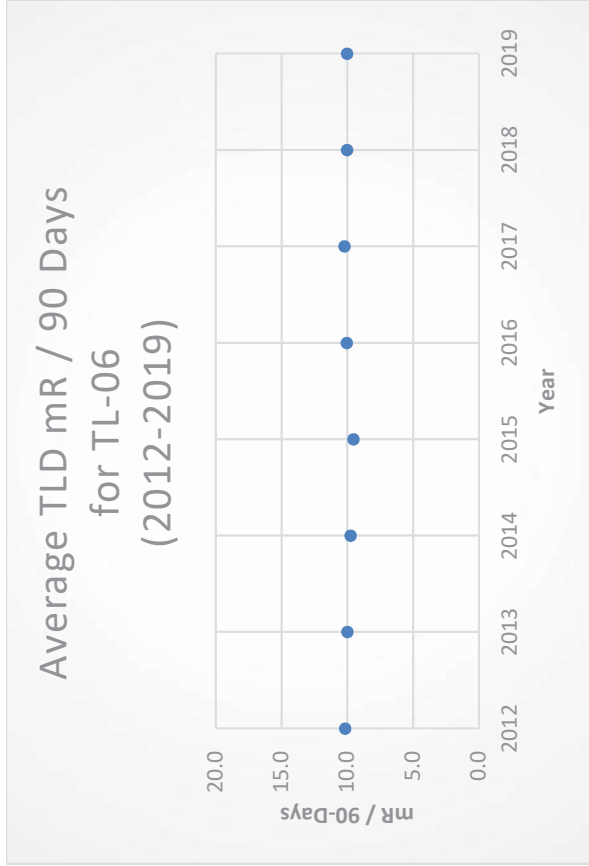

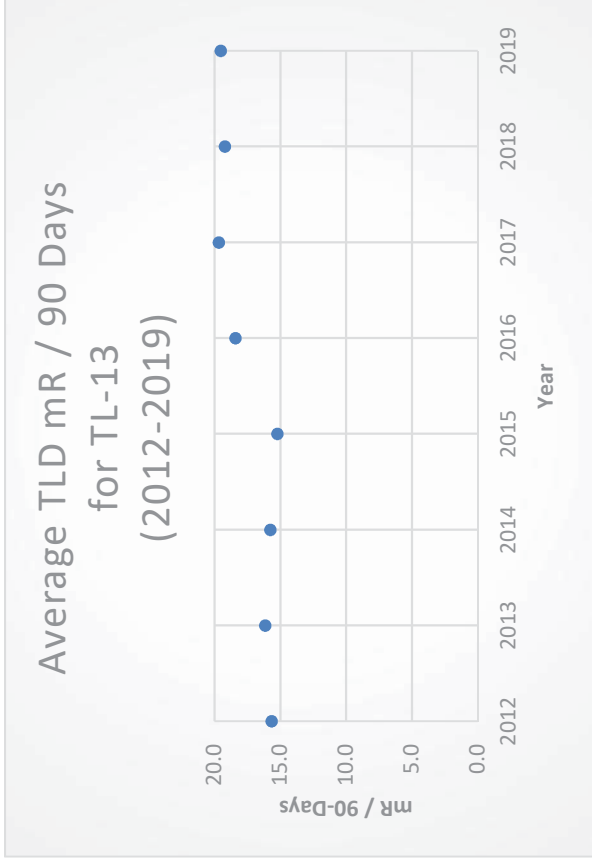
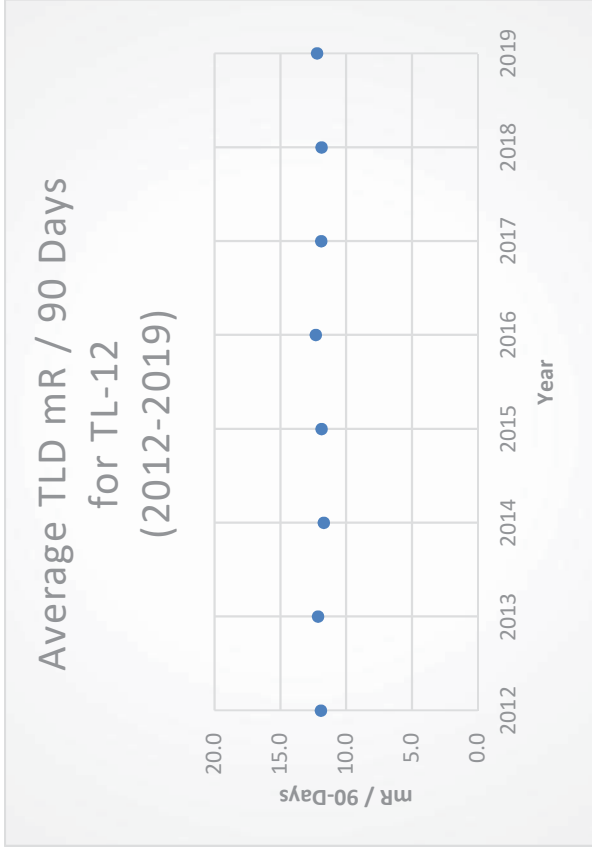
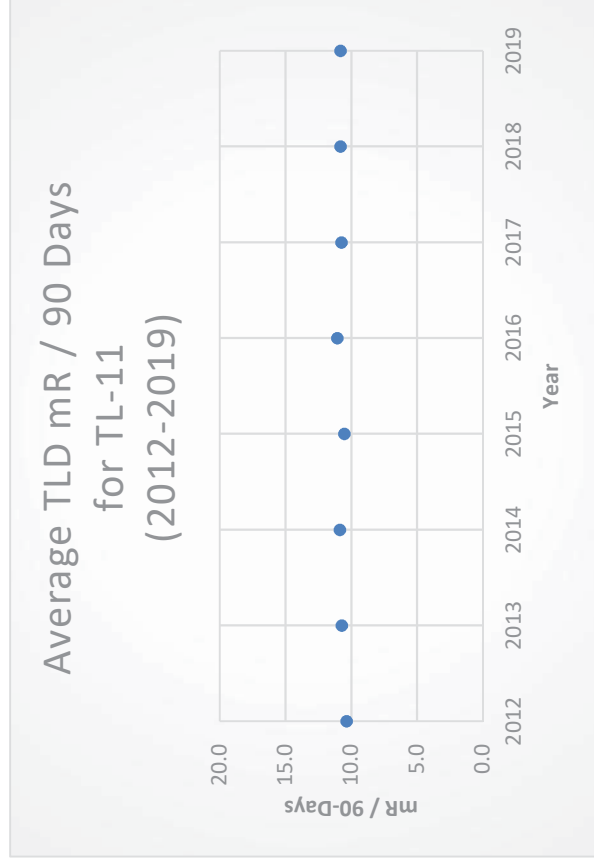
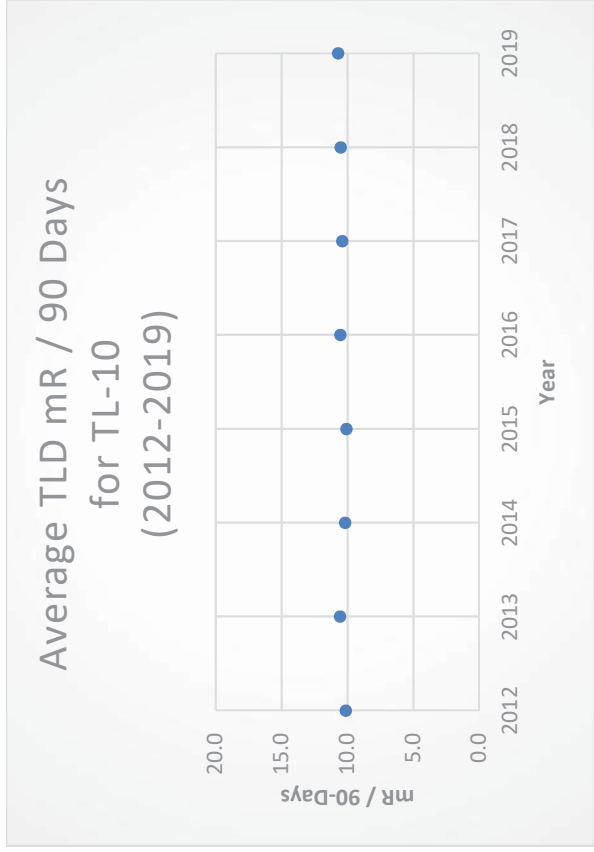

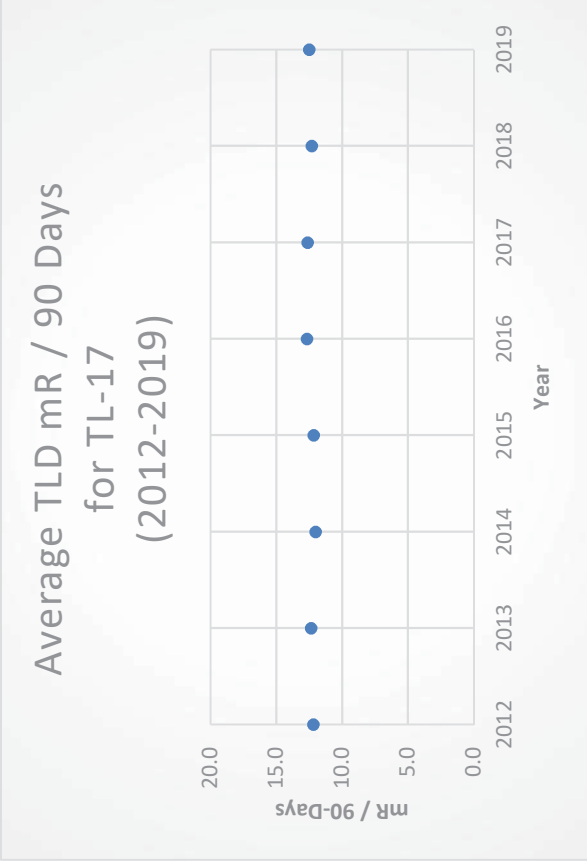
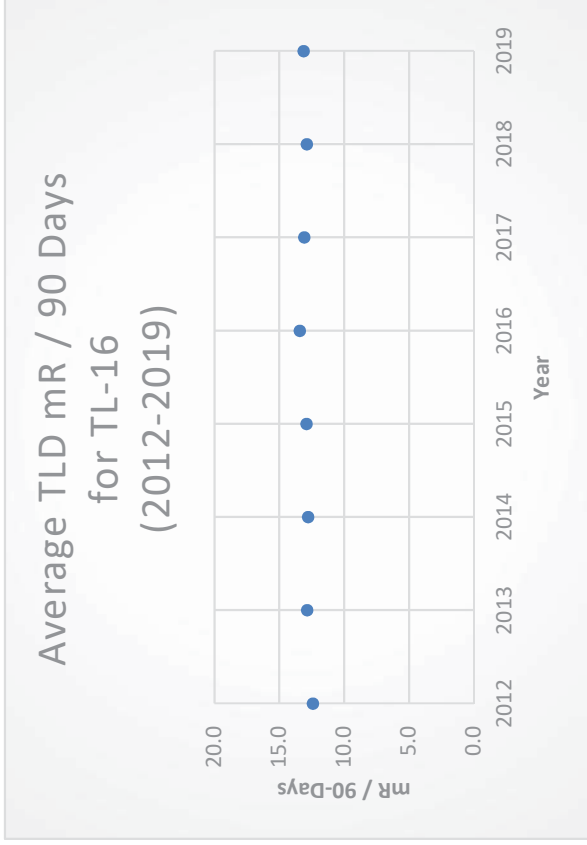
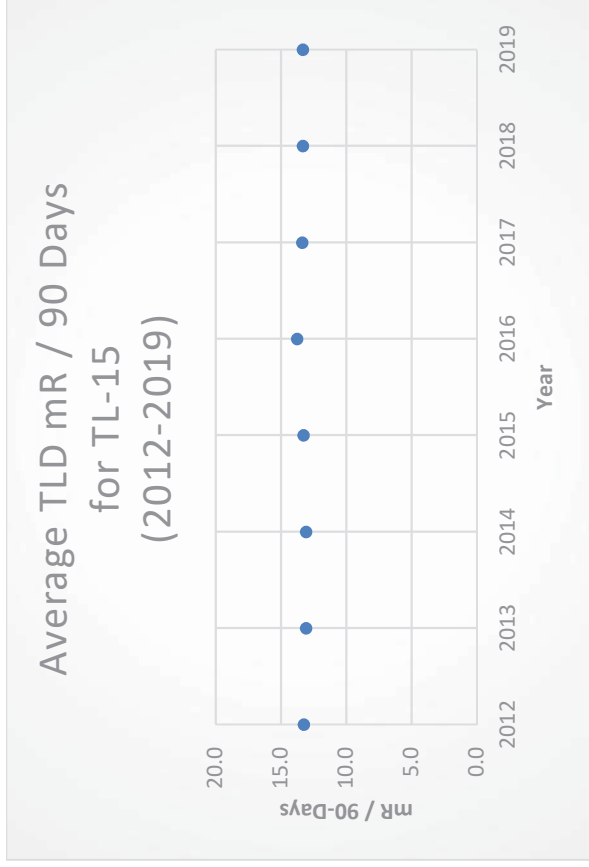
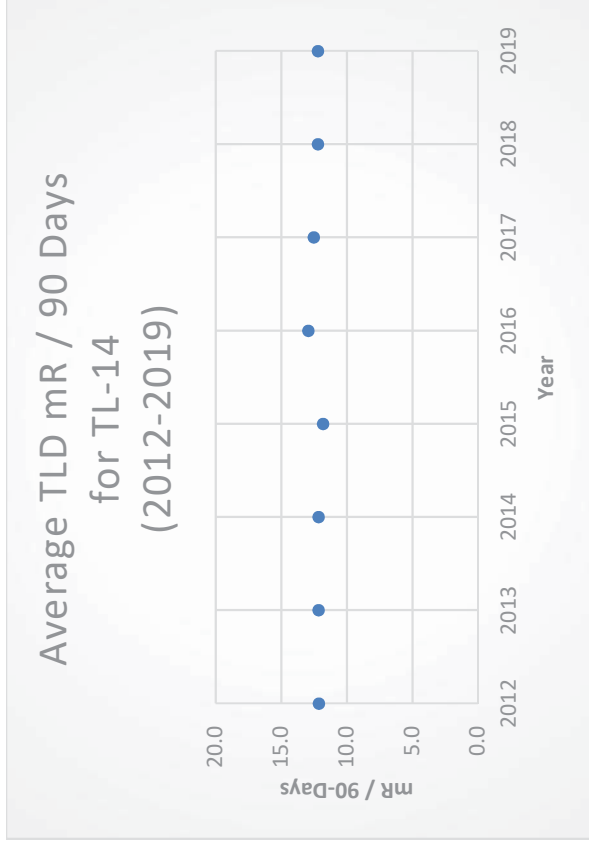

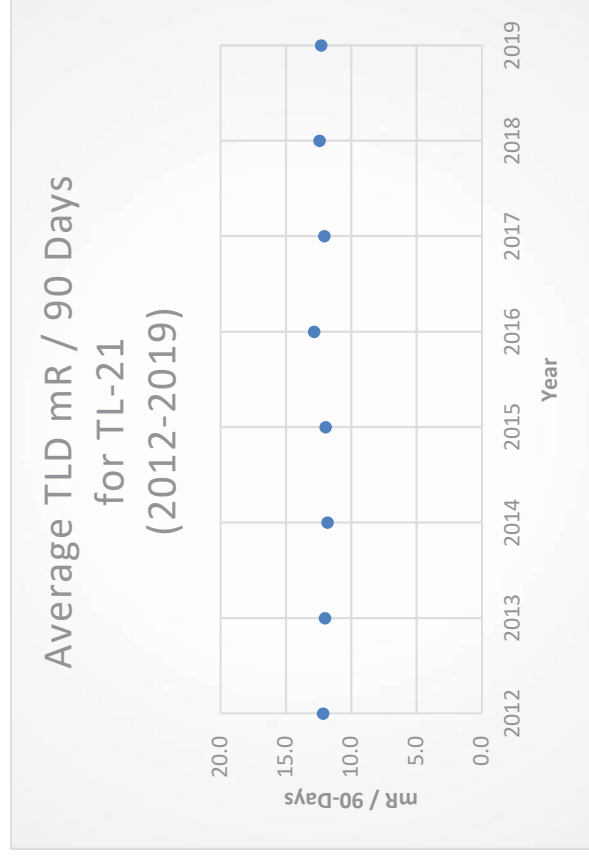
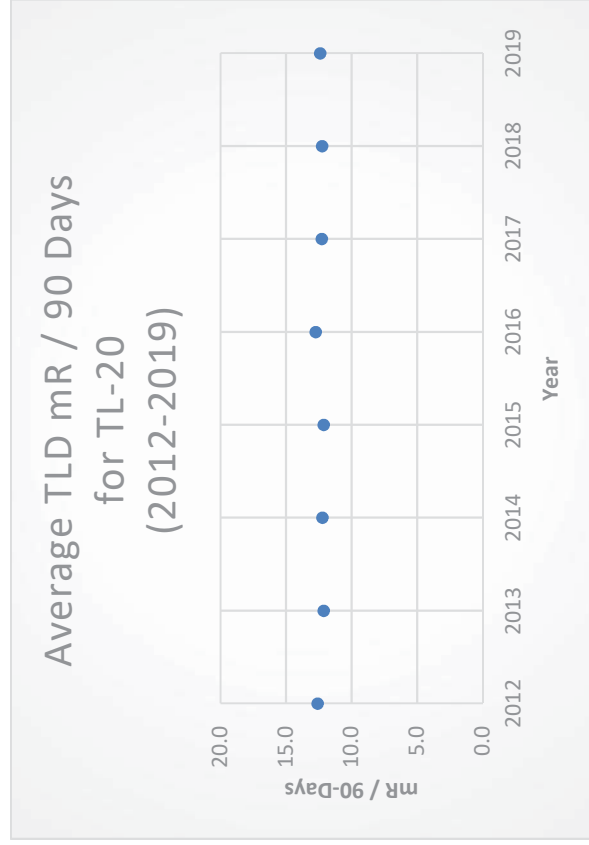
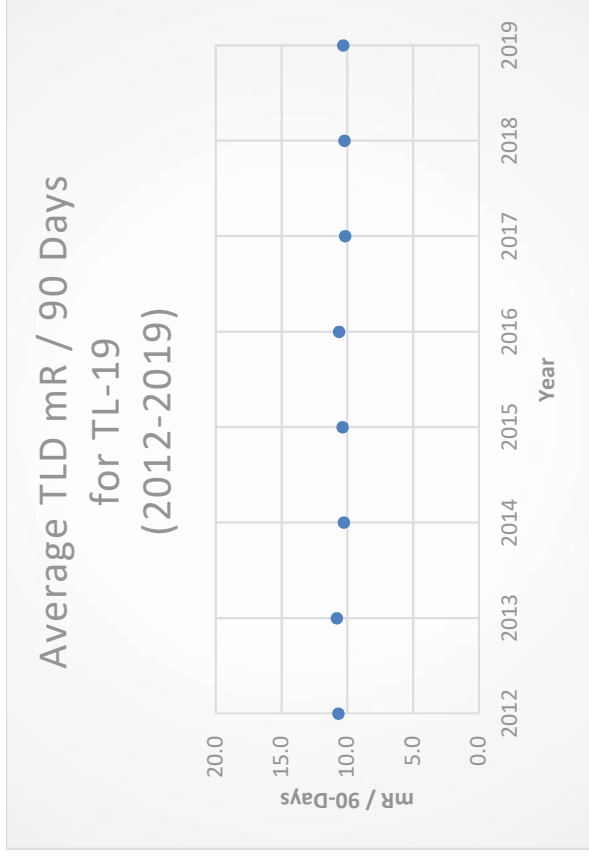
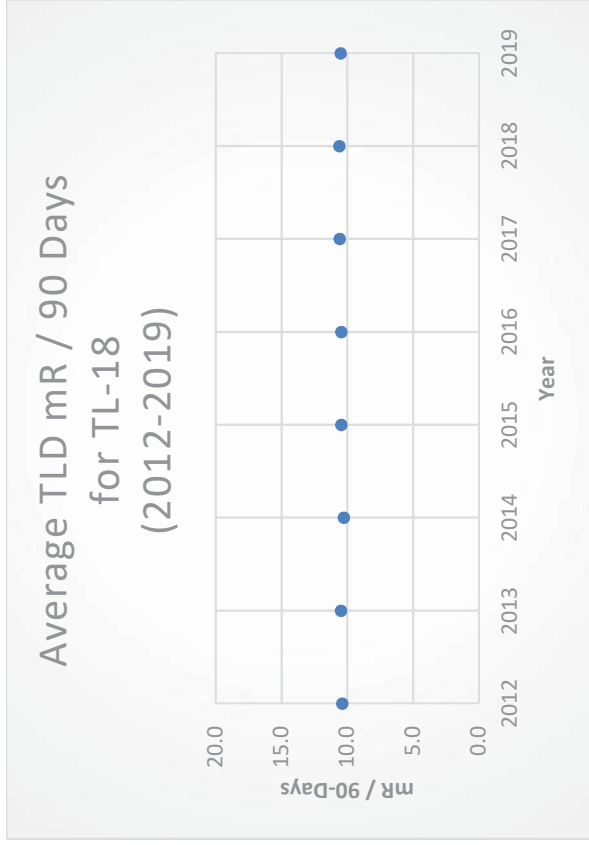

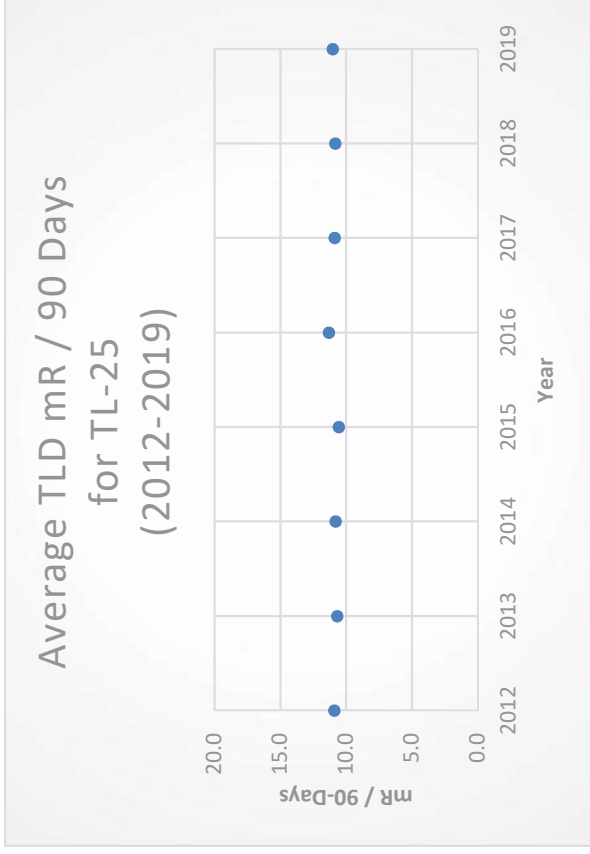
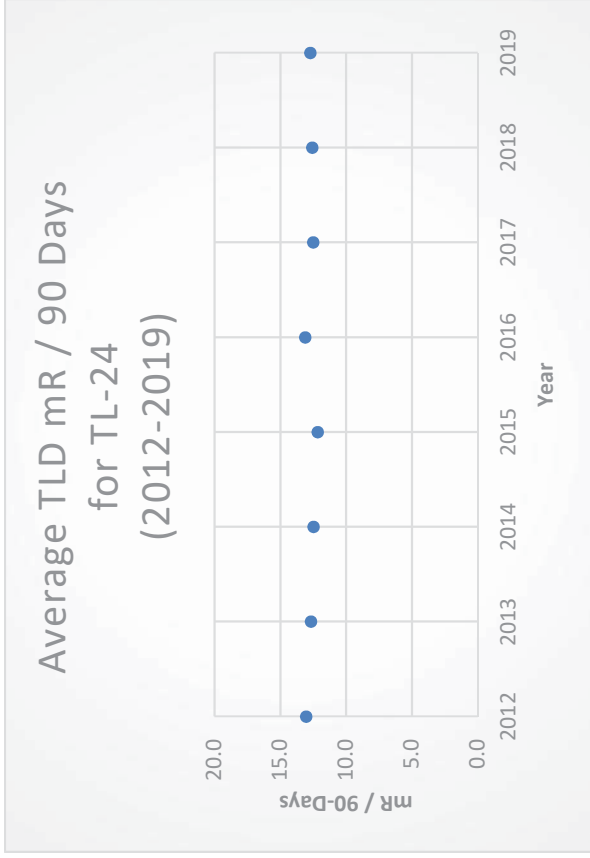
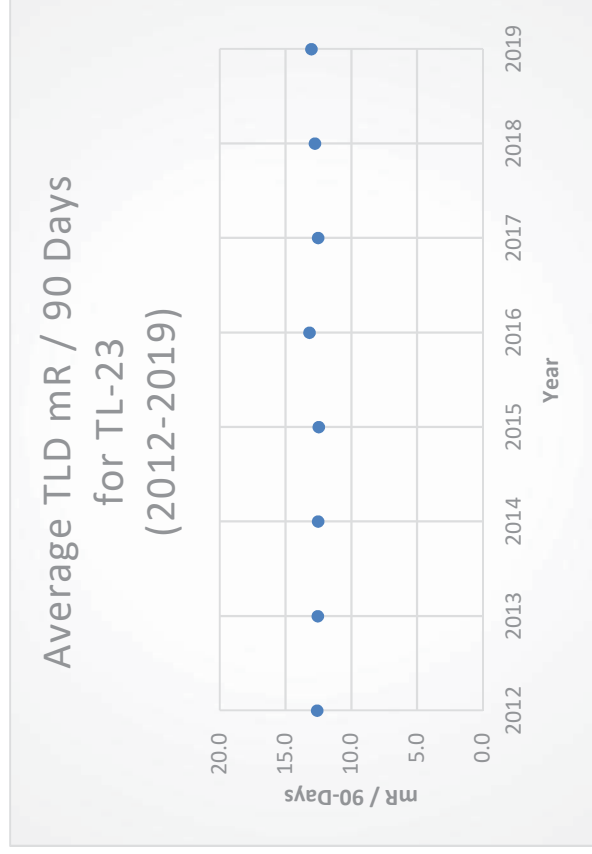
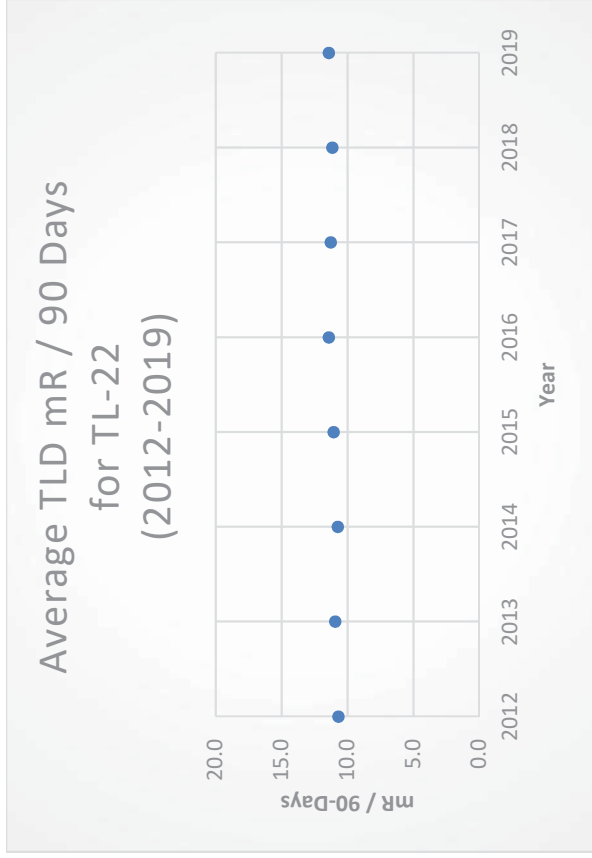

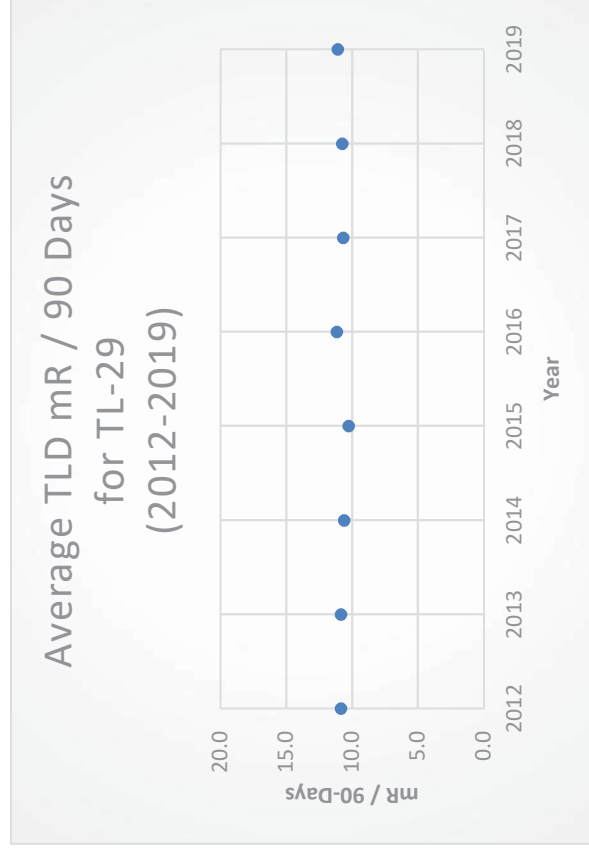
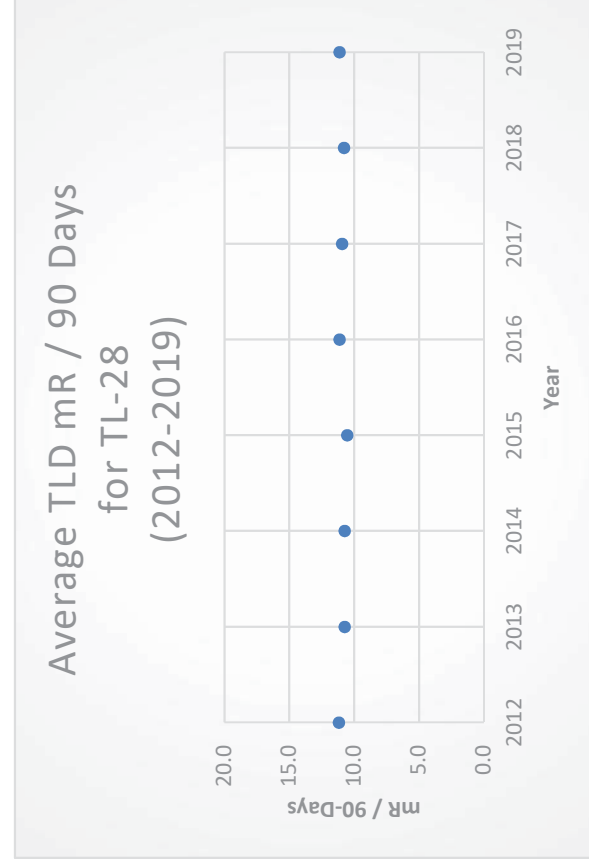
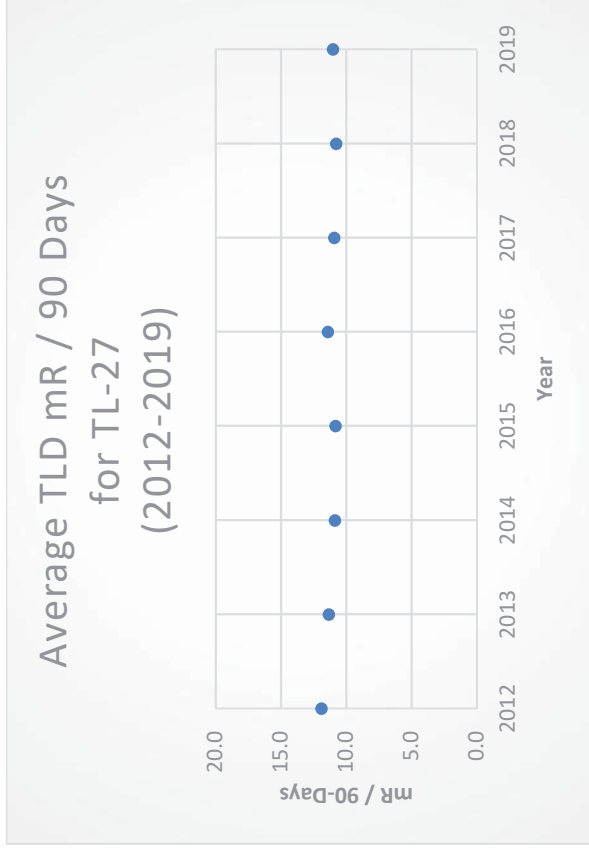
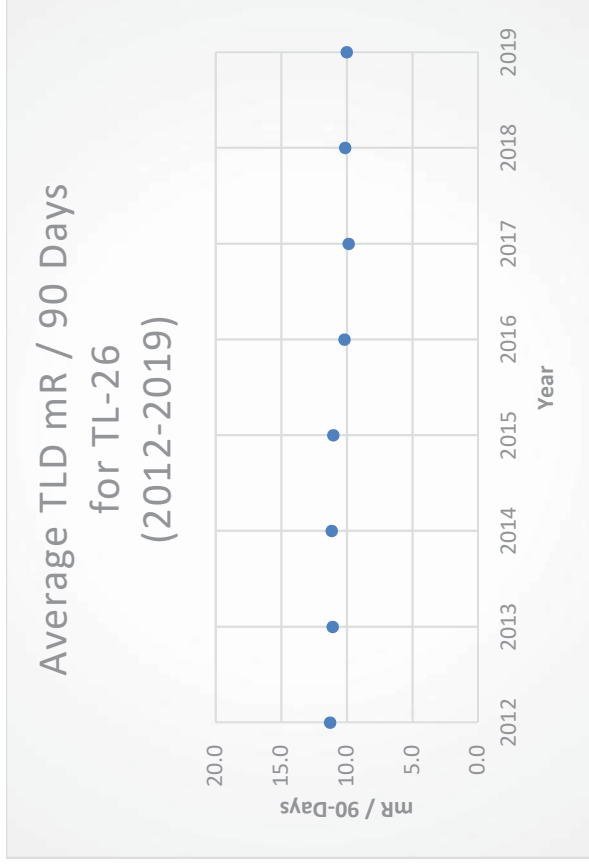

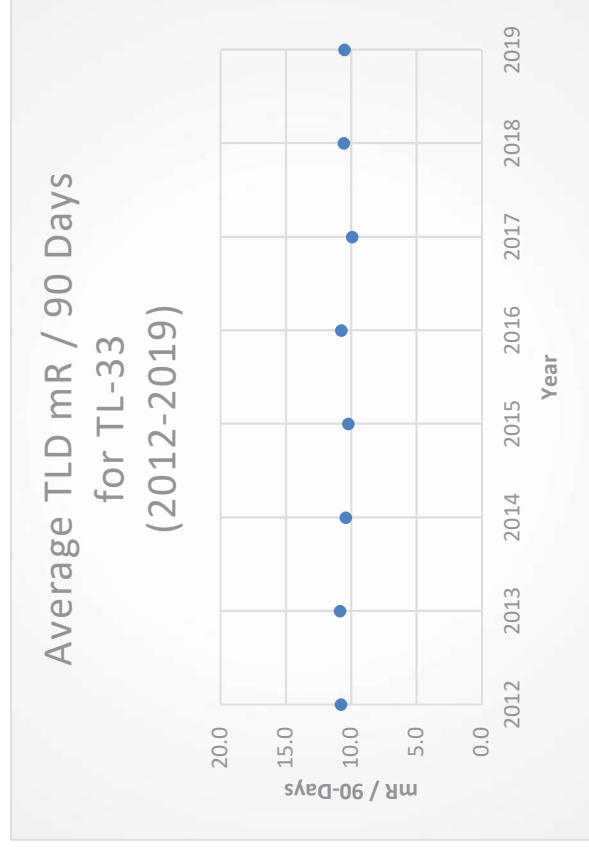
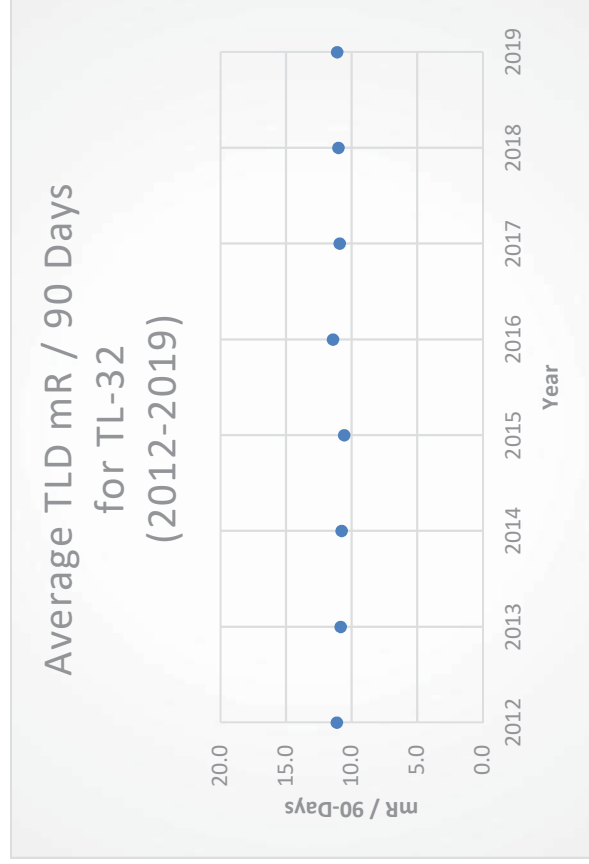
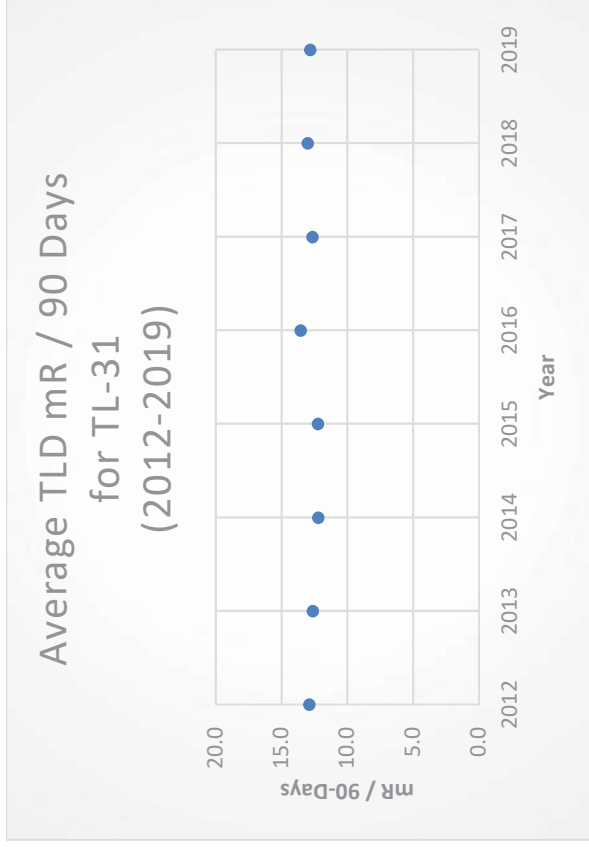
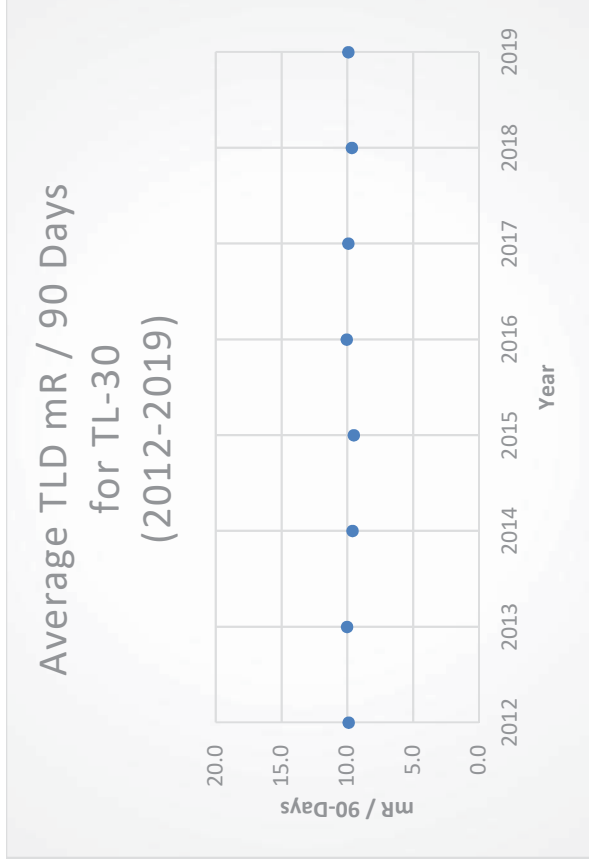

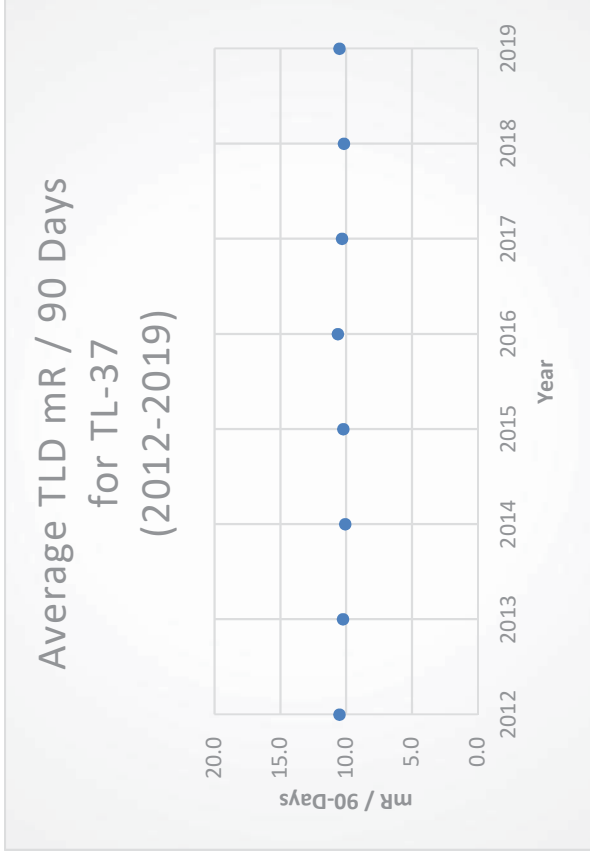
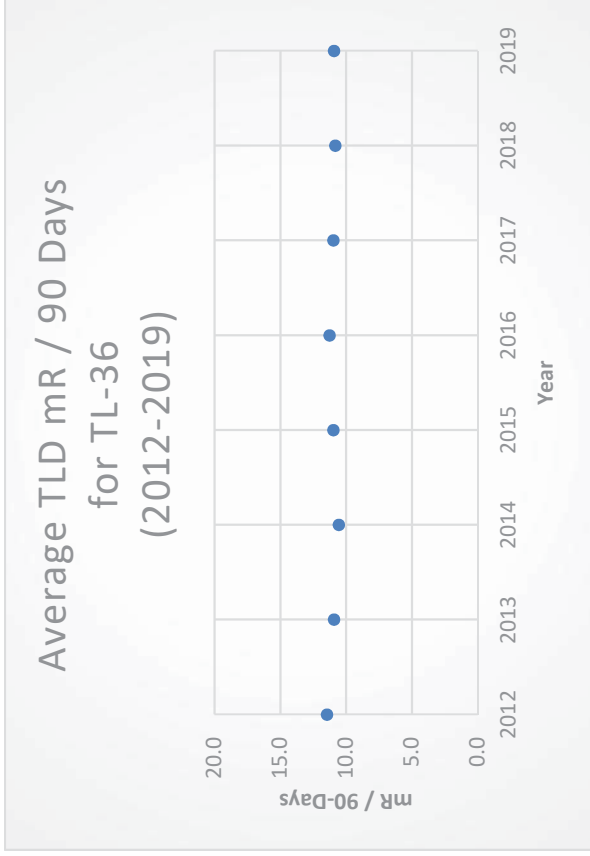
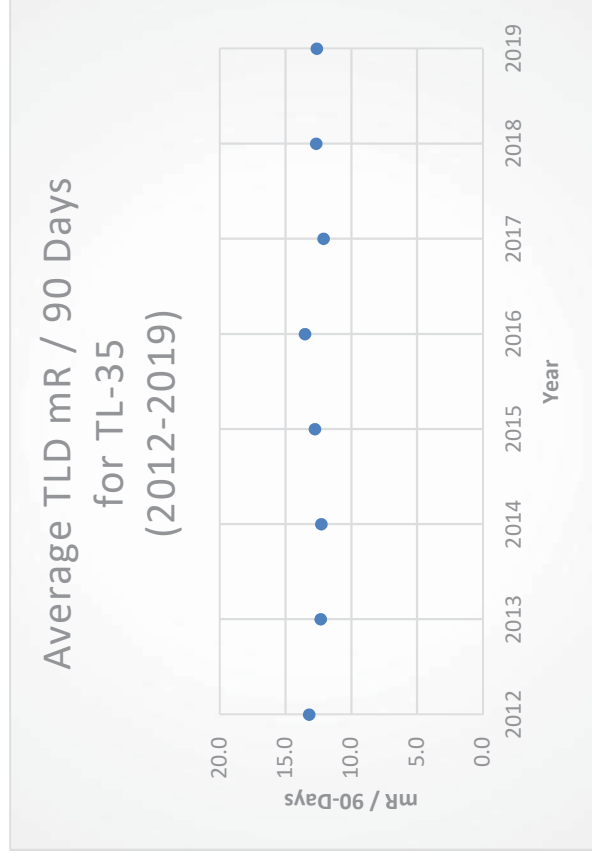
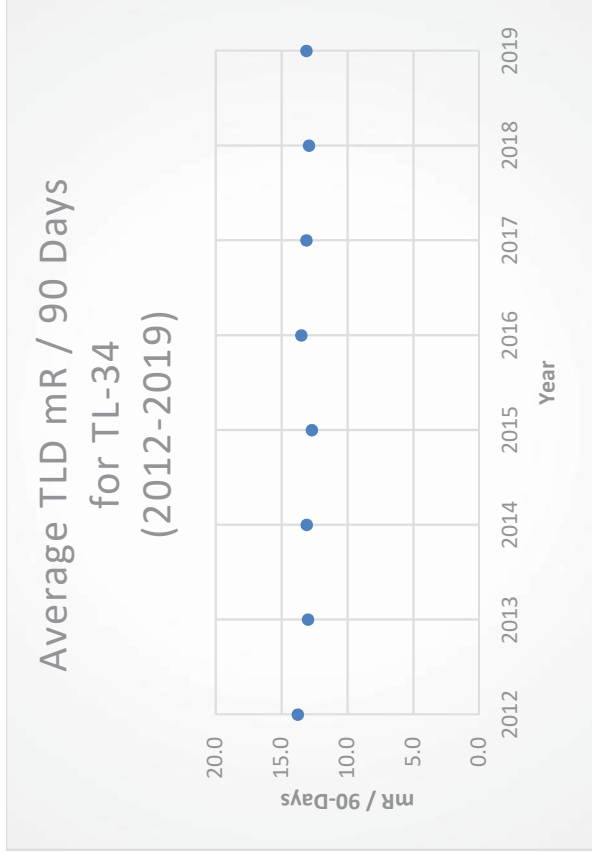

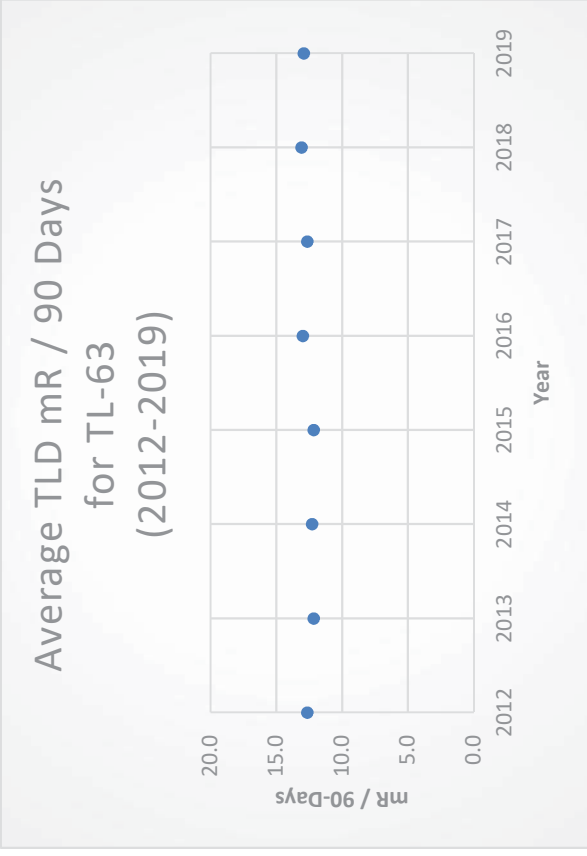
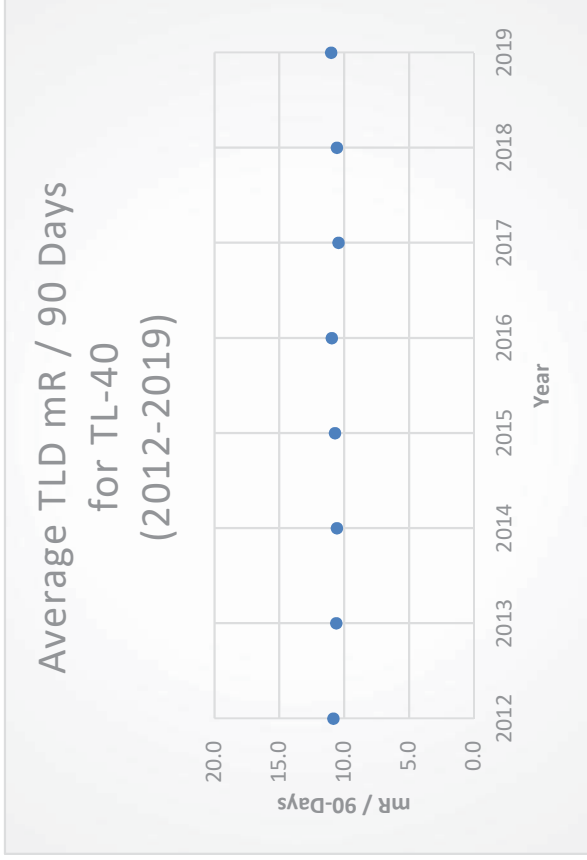
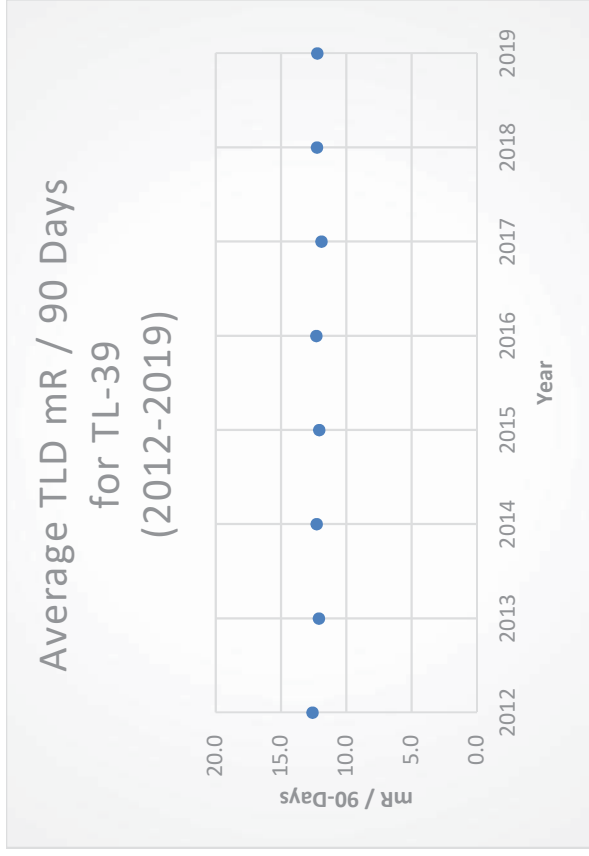
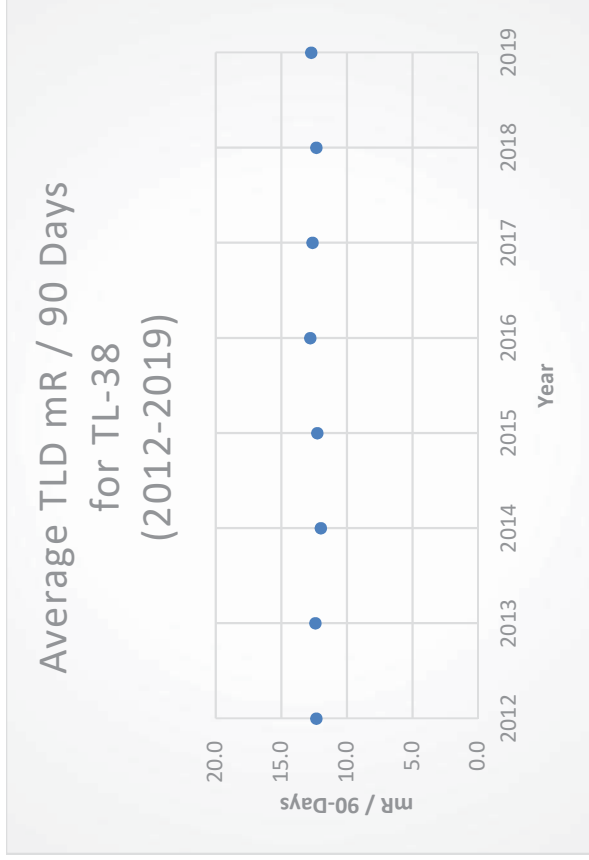

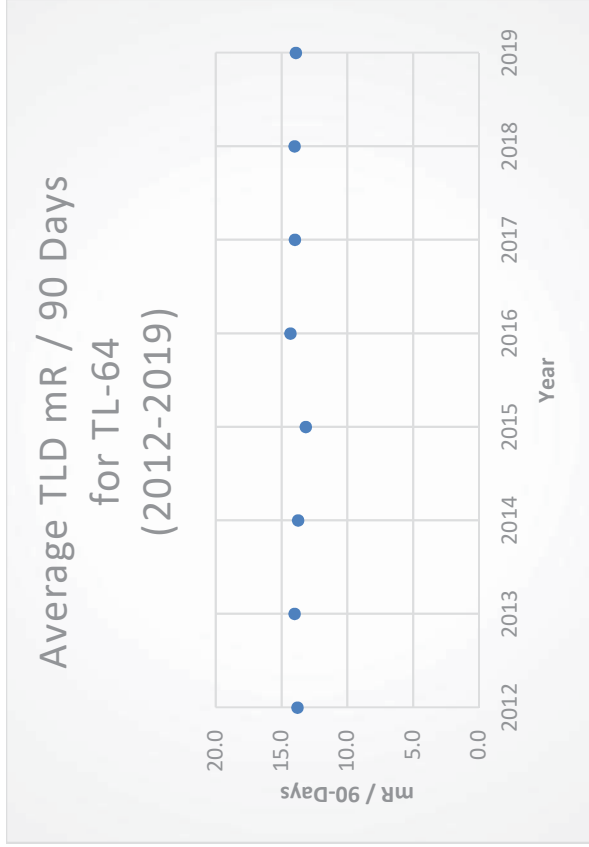

E-Series 4

Table B-13 (Tritium in Groundwater)

Ginna's Offsite Dose Calculation Manual (ODCM) is written in accordance with specifications contained within 10 CFR 20 and the Branch Technical Position document published by the NRC in 1979. This document specifies Tritium and Gamma in Groundwater samples to be detected to a Lower Limit of Detection (LLD) of 2,000 pCi/l. Since that time, detection capabilities have improved which allow values to be measured lower than the required 2,000 pCi/l and Ginna measures tritium concentration down to an LLD of 500 pCi/l and certain vendor laboratories down to an LLD of 200 pCi/l.

The trends below include the tritium averages (from 2012-2019) for Ginna's groundwater samples (GW01, GW03 – GW08, GW-10 – GW16). A tritium value of greater than 20,000 pCi/l (20,000 pCi/l value from Environmental Protection Agency EPA standards) would indicate radionuclides in the sample which would require further analysis and offsite reporting. From 2012 through 2019, no such results have been received from Ginna's REMP program.

Tritium (H-3) is a radioactive form of Hydrogen and, when detected in the environment at high-levels (greater than 2,000 pCi/l, can be an indication that plant effluents may have been introduced into the environment. Tritium is sampled for at nuclear facilities due to its exposure capabilities for members of the public. Essentially, Tritium, when in an aqueous form, flows like water and can be found in surface water, groundwater, and atmospheric environs due to evaporative processes found in nature. Nuclear stations place a sensitivity on detecting Tritium in the environment as it is an efficient marker to show if radioactivity has been introduced off-site.

All results shown below are less-than values (< LLD) excluding the sample result for groundwater monitoring well GW04 from 1/30/2013 (2,520 pCi/l). This value was the result of atmospheric recapture of gaseous tritium which accumulated in snow located around the facility. As this snow melted during this sampling period, this recaptured tritium was introduced into the groundwater and captured via our groundwater sampling program. This value of 2,520 pCi/l is roughly 8-times lower than the reportable limit of 20,000 pCi/l. This recapture phenomenon was also experienced for the GW10 sample collected on 12/13/2019 (result of 603 pCi/L).

Additionally, groundwater monitoring well GW14 on 3/11/2014 was counted to an LLD of 2,000 pCi/l rather than the LLD of 500 pCi/l. Actual result was a less than value of < 1,950 pCi/l. Subsequent samples were collected to ensure there was no detectable tritium in the environment and these samples returned values of less than 500 pCi/l.

Ginna groundwater monitoring well GW01 (West of the station) is the control location for sampling and due to the sampling frequencies of this program, it is difficult to graphically compare the control samples against the indicator samples. Since 2012, the average tritium concentration in control samples was < 451 pCi/l whereas the average tritium concentration in indicator samples (Groundwater Monitoring Well GW-03 – GW08, GW10-GW16) was < 454 pCi/l. This result demonstrates that there is no statistically significant difference between control and indicator samples for Ginna's groundwater samples for the REMP.

Tritium in Groundwater Well GW01

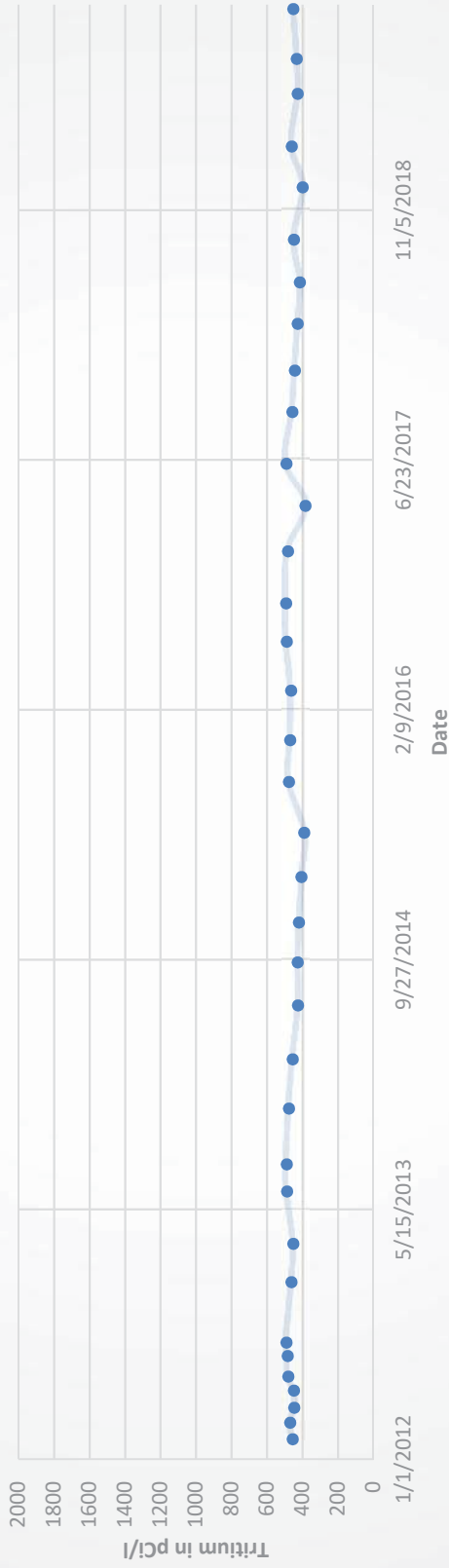

Tritium in Groundwater Well GW03

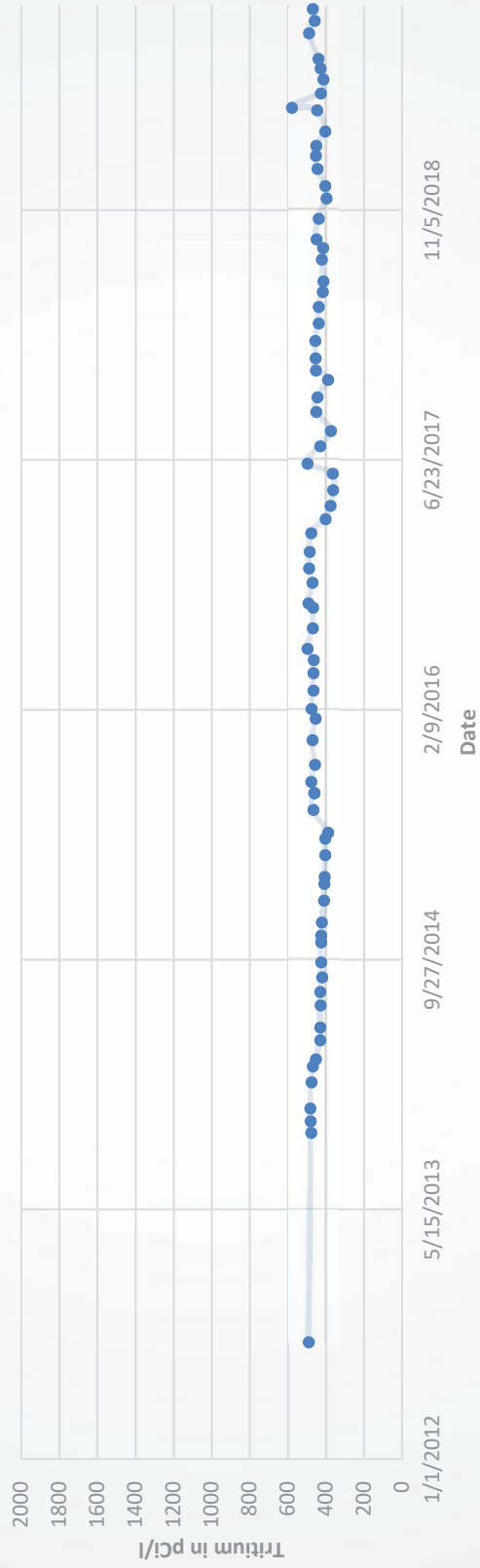

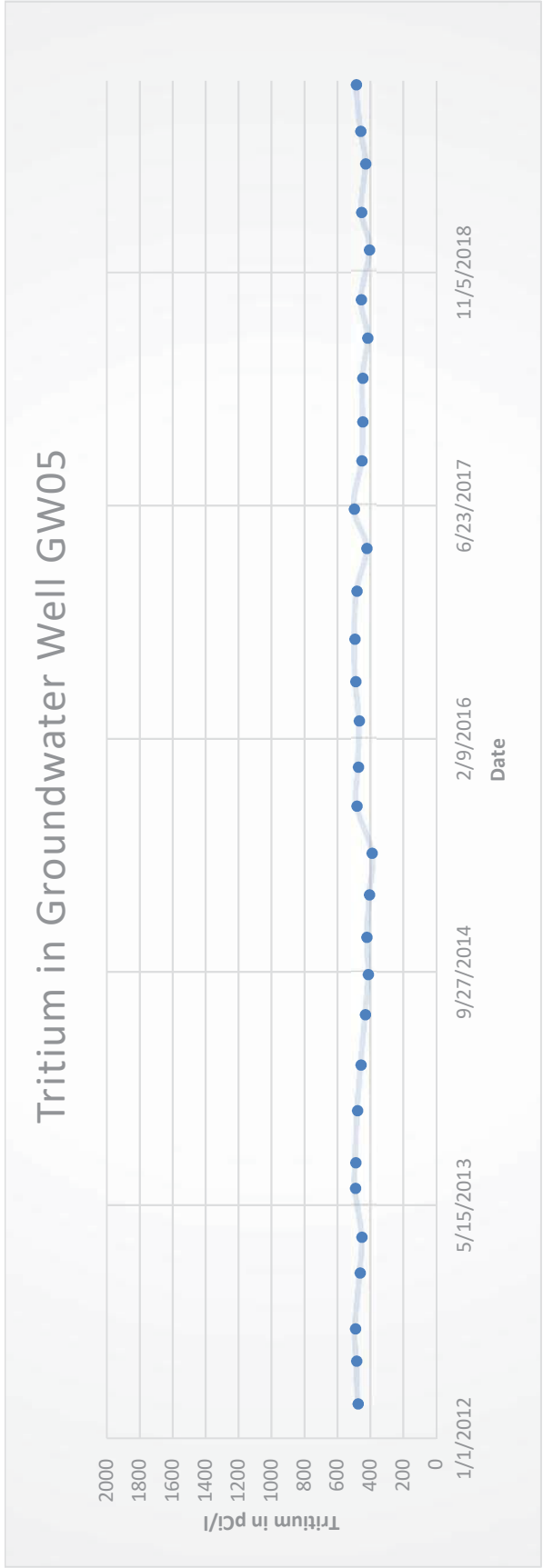
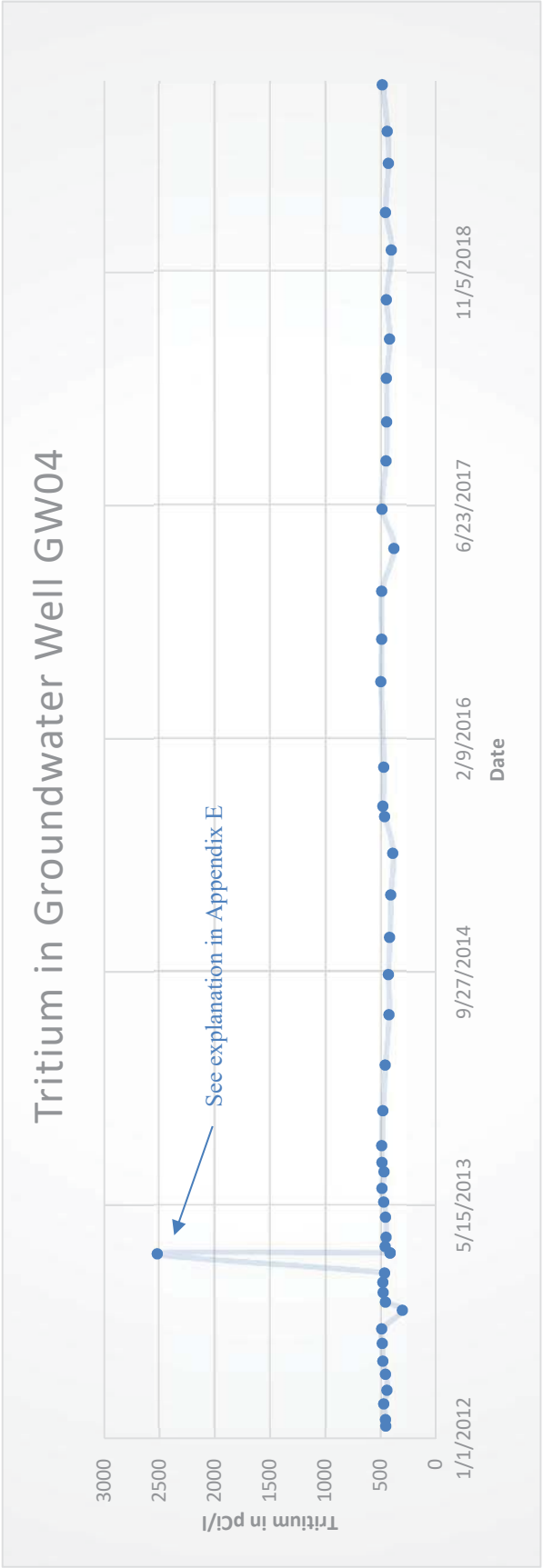

Tritium in Groundwater Well GW06

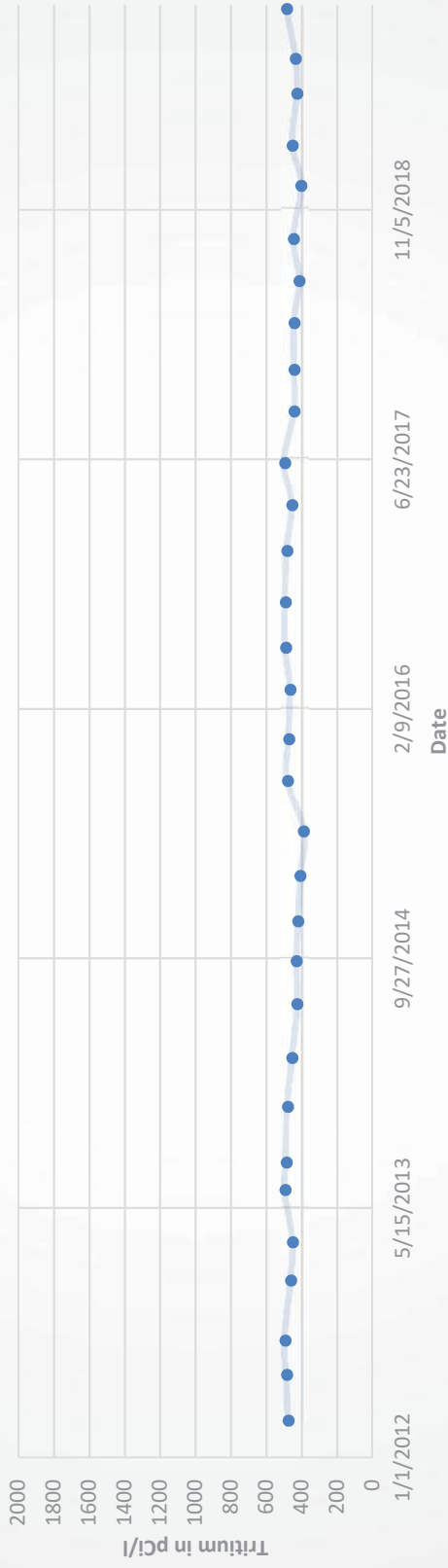

Tritium in Groundwater Well GW07

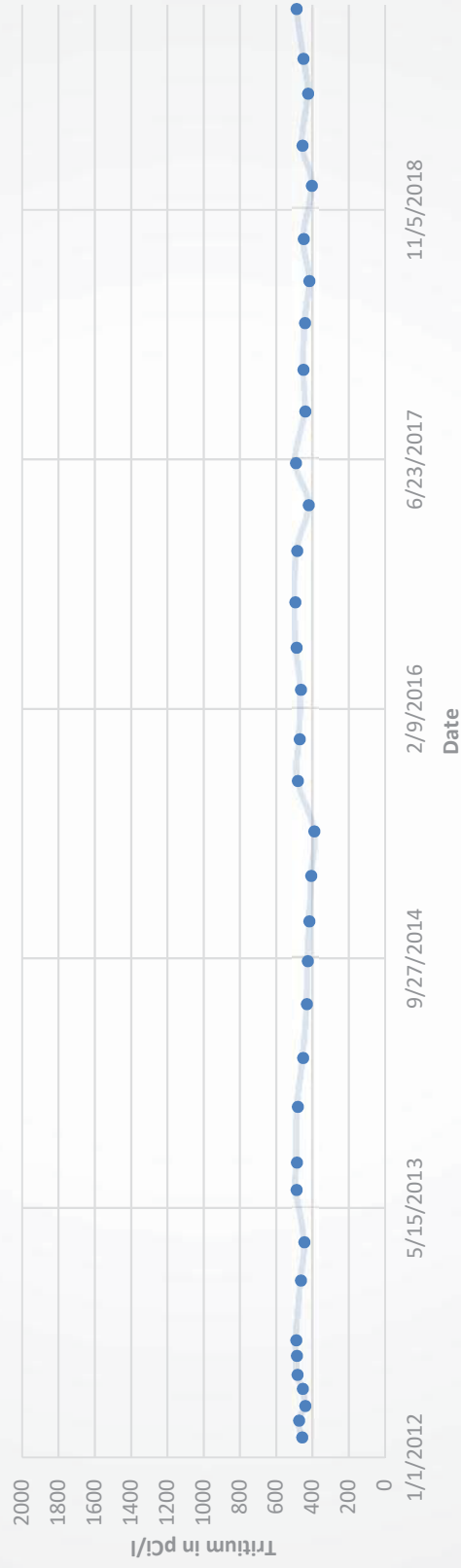

Tritium in Groundwater Well GW08

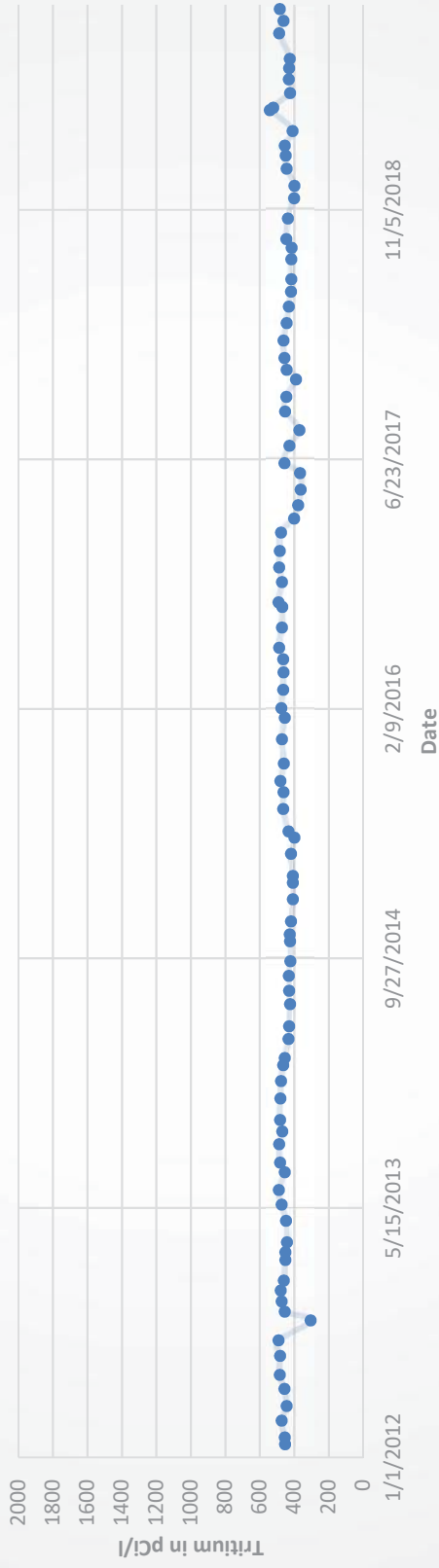

Tritium in Groundwater Well GW10

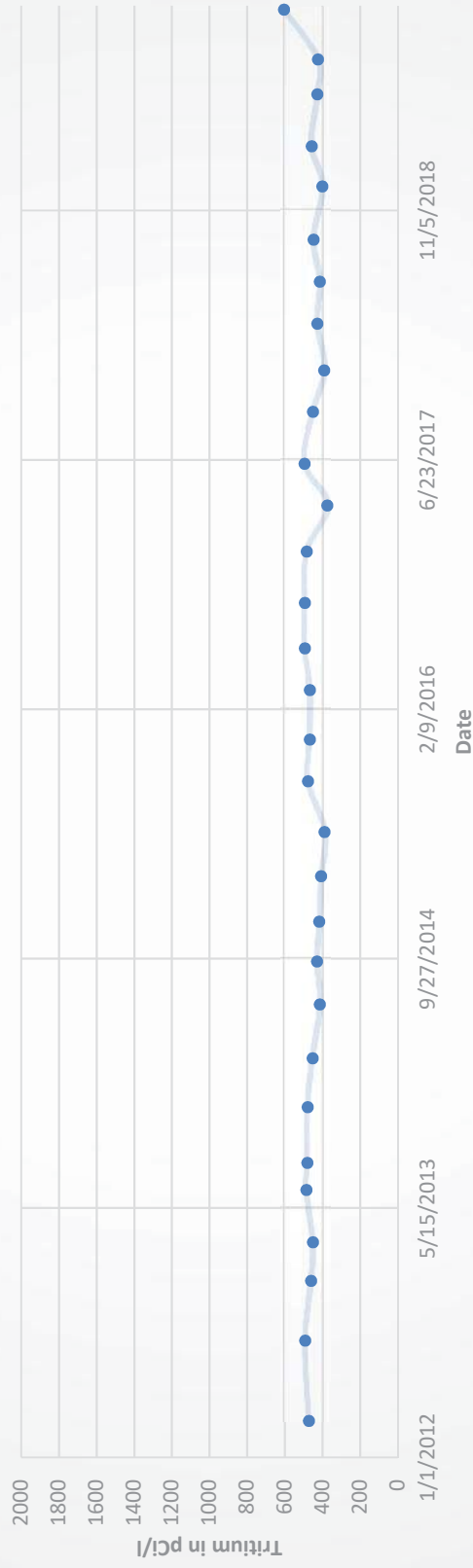

Tritium in Groundwater Well GW11

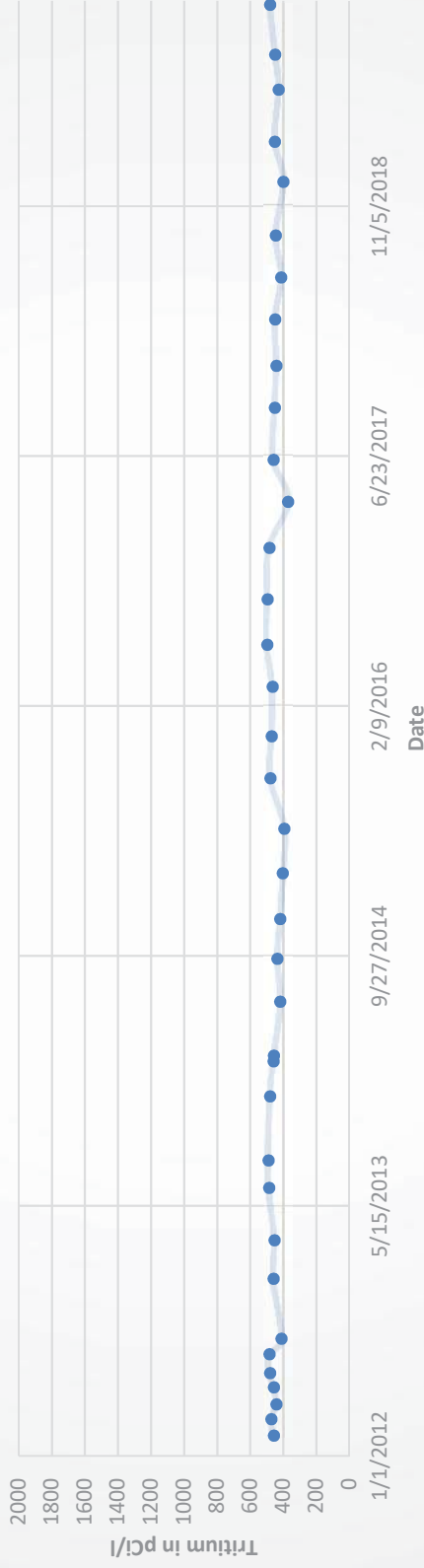

Tritium in Groundwater Well GW12

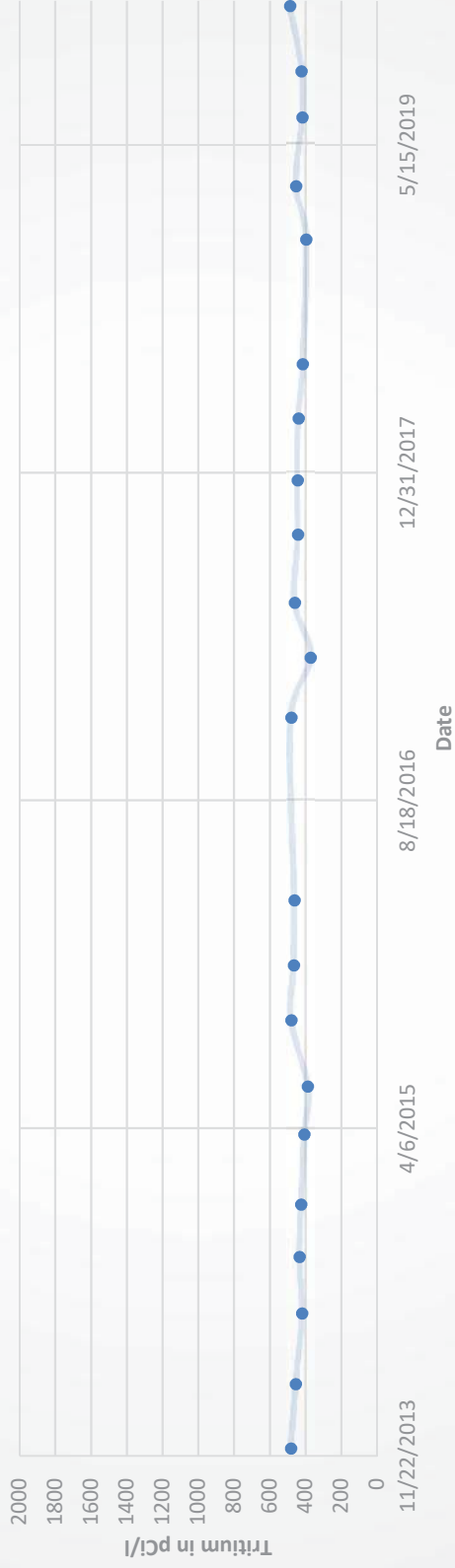

Tritium in Groundwater Well GW13

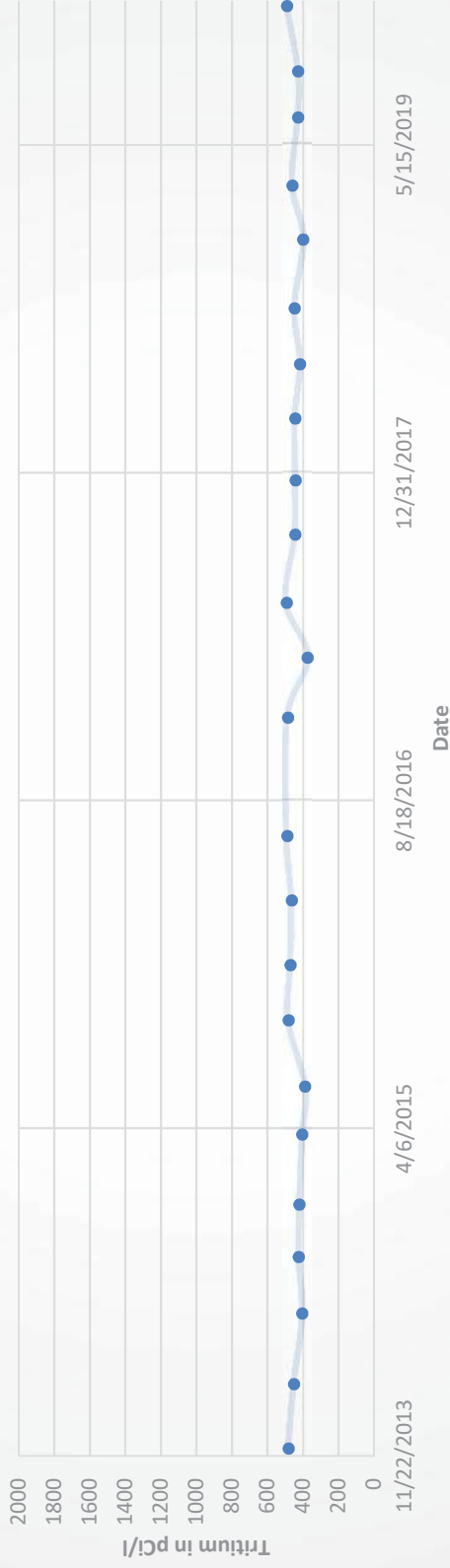

Tritium in Groundwater Well GW14

