



Annual Radioactive Effluent Release Report
(ARERR)
2019
Oyster Creek Nuclear Generating Station

ANNUAL RADIOACTIVE EFFLUENT RELEASE REPORT

**January 1, 2019 through December 31, 2019
HOLTEC DECOMMISSIONING INTERNATIONAL
OYSTER CREEK NUCLEAR GENERATING
STATION**

**DOCKET NO. 50-219 (Oyster Creek Nuclear Generating Station)
DOCKET NO. 72-15 (Independent Spent Fuel Storage Facility)**

**Submitted to
The United States Nuclear Regulatory Commission Pursuant to
Renewed Facility Operating License DPR-16**

TABLE OF CONTENTS

- I. EXECUTIVE SUMMARY..... 4
 - 1. Understanding Radiation..... 6
 - 2. Sources of Radiation 10
 - 3. Exposure Pathways..... 11
 - 4. Radiation Risk 12
 - 5. Annual Reports..... 14
 - 6. Introduction..... 15
- II. SUPPLEMENTAL INFORMATION (MAIN BODY OF REG GUIDE 1.21 REPORT)..... 17
 - 1. Abnormal Releases and Abnormal Discharges (e.g., leaks and spills) 17
 - 2. Non Routine, Planned Discharges..... 17
 - 3. Radioactive Waste Treatment System Changes..... 17
 - 4. Annual Land-Use Census Changes 17
 - 5. Effluent Monitor Instrument Inoperability 17
 - 6. Offsite Dose Calculation Manual Changes..... 17
 - 7. Process Control Program Changes..... 17
 - 8. Errata/Corrections to Previous ARERRs 17
 - 9. Other..... 18
- III. Appendices..... 18

I. EXECUTIVE SUMMARY

The 2019 Oyster Creek Nuclear Generating Station Annual Radioactive Effluent Release Report (ARERR) is attached. The format of this report has been modified following the adoption of Regulatory Guide 1.21, Revision 2, reporting format and updated reporting tables. There have also been some simplifications to the reporting which is the result of the new reporting format and physical changes to the station (system, structure and source term reductions) as decommissioning was initiated in 2019, including transfer of the station and decommissioning license from Exelon Generation Company, LLC to Oyster Creek Environmental Protection, LLC (OCEP) as the licensed owner and Holtec Decommissioning International, LLC (HDI) as the licensed operator.

Report Format Changes

- Radioactive waste and effluent tables used are from the latest revision to Regulatory Guide 1.21, revision 2, "Measuring, Evaluating, and Reporting Radioactive Material in Liquid and Gaseous Effluents and Solid Waste"
- Meteorological Data is not reported here, per revision 2 to Regulatory Guide 1.21. This information is readily available at the station for review upon request.

Effluents are strictly monitored to ensure that radioactivity released to the environment is as low as reasonably achievable (ALARA) and does not exceed regulatory limits. Effluent control includes the operation of monitoring systems, in-plant and environmental sampling and analyses programs, quality assurance programs for the effluent and environmental programs, and procedures covering all aspects of effluent and environmental monitoring.

Both radiological environmental and effluent monitoring indicate that the operation of Oyster Creek Nuclear Generating Station (OCNGS) does not result in significant radiation exposure to the people or the environment surrounding OCNGS and is well below the applicable levels set by the Nuclear Regulatory Commission (NRC) and the Environmental Protection Agency (EPA). This is especially true now that Oyster Creek has entered its decommissioning phase.

On July 1st 2019, the licensed operator of the Oyster Creek Nuclear Generating Station (permanently shut down effective September 26, 2018), was transferred from Exelon Generation Company, LLC to Holtec Decommissioning International (LLC). Exelon had determined that transitioning operational nuclear plants to decommissioning nuclear plants targeted for permanent shutdown was not aligned with its core objectives and actively sought buyers who would assume ownership and complete decommissioning and license termination for the Oyster Creek Nuclear Generating Station. With permanent shutdown and transfer of the spent fuel from the reactor vessel to the Spent Fuel Pool (all fission reactions would be terminated at this point), certain elements of the effluent and environmental programs would change over time. One of these changes was the emergent need to process and dispense of the water inventory accumulated in plant systems. To that end, on-site processing (cleaning) of plant water for overboard discharges was re-introduced to the site in January 2019 with revision 9 to the ODCM. With revision 9 to the Off-Site Dose Calculation Manual (ODCM) and the restoration of liquid discharges, the site formally re-instituted processing, treating and permitted discharging of processed waste water from plant systems to the main condenser outfall. Levels of radioactivity in this water were detectable, but at low concentrations that were a small fraction of the federal limits.

2019 OYSTER CREEK ANNUAL RADIOACTIVE EFFLUENT RELEASE REPORT (ARERR)

The off-site dose impact from these liquid effluent discharges is summarized below, and was found to be a small fraction of the federal dose limits. Additional changes included the termination of gaseous releases from the Turbine and Reactor Buildings, and removal of these ground level release points and pathways from the ODCM in January of 2019.

Tritium identified in groundwater monitoring wells was remediated by installing a remediation well (Well 73) in the effective center of the affected wells, and drawing that tritiated water out and pumping it to the condenser intake structure where it was subsequently discharged to the main condenser outfall. At that outfall, the water was sampled and analyzed and found to be below the ODCM lower limit of detection (<LLD). This approach was utilized in lieu of natural attenuation of low levels of tritium in groundwater for two reasons: one was to accomplish remediation on a more accelerated timetable, and the other was to ensure that the water removed was channeled through a process that permitted tracking and accounting for potential off-site impact to a member of the public.

Exelon and the State of New Jersey Department of Environmental Protection (NJDEP) agreed to this approach, which Holtec continued until remediation was determined complete in the fourth quarter of 2019 and the project was terminated as a continuous discharge. ODCM revision 10 permits restoration of this process as batch or continuous releases if surrounding well sample results indicate tritium levels warrant remediation.

Well 73 was initially installed and put into service in 2010 to address low levels of tritium identified in groundwater. Well 73 and supporting equipment and piping were installed to pump groundwater to the intake structure at the inlet of the main circulating water pumps. Provisions were established for both batch and continuous releases of groundwater. When tritium was detectable, the concentrations were quantified and resulting off-site doses (which were negligible) were calculated and reported in the Annual Radioactive Effluent Release Reports (ARERR) issued each year.

Well 73 water had contained low levels of tritium at one point, but no radioactivity was detectable in 2019 as levels were below the ODCM Lower Limit of Detection (LLD). In 2019, there were no gamma emitters identified in remediation Well 73 sampled water. Nearby wells (monitored monthly), which feed remediation Well 73 showed residual levels of tritium below the ODCM LLD, but no detectable gamma emitters using state of the art analytical equipment on-site and vendor labs.

Continuous releases occurred for approximately 277 days from January 1, 2019 through October 4, 2019 with a total of 2.60E+07 gallons of groundwater pumped with no detectable radioactivity identified in the form of either gamma emitters or hard to detect radionuclides, and no off-site dose impact.

There were no abnormal gaseous or liquid releases in 2019.

The maximum calculated organ dose (Child Gi-LLI) from tritium and particulates to any individual due to gaseous effluents was 2.53E-05 mrem, which was approximately 1.69E-04 percent of the annual limit of 1.50E+01 mrem. The majority of organ dose from gaseous effluents was due to Co-60. With permanent power cessation in September 2018, no C-14 was produced in 2019, and neither noble gases or iodine were produced or detected in any gaseous effluents. There was no maximum calculated gamma air dose in the UNRESTRICTED AREA due to a lack of noble gas production or presence in gaseous or liquid effluents. For comparison, the background radiation

dose averages approximately 620 mrem per year to the average person in the United States; the 40 CFR 190 dose limit is 25 mrem per year to a member of the public from all uranium cycle sources.

The Independent Spent Fuel Storage Installation (ISFSI) is a facility storing spent fuel canisters (containing spent nuclear fuel) that are immersed in a blanket of inert N₂ gas prior to being welded shut and then inserted into heavy concrete and steel rebar over packs for shielding and canister protection. As these are sealed containers, no radioactive effluents or material is released from these containers. Based on off-site (at the controlled area boundary along Route 9) Optically Stimulated Luminescence Dosimeter (OSLD) readings and accounting for occupancy, dose to a member of the public due to direct radiation from the ISFSI was less than 1 mrem in 2019. The location used to assign the direct dose component for the 40 CFR 190 dose is that assigned to warehouse workers in the warehouse located at the back site; beyond the site protected area boundary and staffed by members of the public. The occupancy factor for this location assumes a 40-hour work week and some attenuation from the warehouse building structure using guidance provided in Reg Guide 1.109. This location presents the highest direct dose to a member of the public, and is summarized in Table A-5.

Joint Frequency Tables of real time meteorological data, per Stability Classification Category, as well as for all stability classes, are available on-site, but no longer included in this report with the site's adoption of Reg Guide 1.21, revision 2, June 2009 in Revision 10 to the ODCM in December of 2019. All data was collected from the on-site Meteorological Facility. Data recoveries for the 380-foot data and the 33-foot data were 99.1% on average, with the exception of precipitation, which was 100 percent recovery. The Defueled Safety Analysis Report (DSAR) commits to Regulatory Guide (RG) 1.23 for Meteorological Facility data recovery. RG 1.23 requires data recovery of at least 90% on an annual basis.

BACKGROUND

The nuclear power industry uses terms and concepts that may be unfamiliar to all readers of this report. This section of the report is intended to help the reader better understand some of these terms and concepts. In this section, we will discuss radiation and exposure pathways. This section is intended only to give a basic understanding of these subjects to hopefully allow the reader to better understand the data provided within the report.

Every nuclear power station is required to submit two reports annually, the Annual Radioactive Effluents Release Report (ARERR) and the Annual Radiological Environmental Operating Report (AREOR). The following information is provided in both reports for Oyster Creek Nuclear Station.

1. Understanding Radiation

Radiation is simply defined as the process of emitting radiant energy in the form of waves or particles. Radiation can be categorized as ionizing or non-ionizing radiation. If the radiation has enough energy to displace electrons from an atom it is termed ionizing radiation. Typically, you will see a warning sign where there is a potential to be exposed to man-made ionizing radiation. These signs normally have the trefoil symbol on a yellow background.



Example Radiological warning signs

People do not always recognize non-ionizing radiation as a form of radiation, such as light, heat given off from a stove, radiowaves and microwaves. In our report we focus on the ionizing radiation that is produced at a nuclear power plant though it is important to note that ionizing radiation comes from many sources. In fact, the amount of ionizing radiation an average person is exposed to due to operation of a nuclear power plant is a very small fraction of the total ionizing radiation they will be exposed to in their lifetime and will be discussed later.

From this point forward we will only be discussing ionizing radiation but we will just use the term radiation.

Since this report discusses radiation in different forms and different pathways we first need to understand where the radiation comes from that we report. Radiation comes from atoms. So, what are atoms and how does radiation come from atoms?

You may have seen a Periodic Table of the Elements:

Group →	1	2	3	4	5	6	7	8	9	10	11	12	13	14	15	16	17	18
↓ Period	The Periodic Table of the Elements																	
1	1 H																	2 He
2	3 Li	4 Be											5 B	6 C	7 N	8 O	9 F	10 Ne
3	11 Na	12 Mg											13 Al	14 Si	15 P	16 S	17 Cl	18 Ar
4	19 K	20 Ca	21 Sc	22 Ti	23 V	24 Cr	25 Mn	26 Fe	27 Co	28 Ni	29 Cu	30 Zn	31 Ga	32 Ge	33 As	34 Se	35 Br	36 Kr
5	37 Rb	38 Sr	39 Y	40 Zr	41 Nb	42 Mo	43 Tc	44 Ru	45 Rh	46 Pd	47 Ag	48 Cd	49 In	50 Sn	51 Sb	52 Te	53 I	54 Xe
6	55 Cs	56 Ba		72 Hf	73 Ta	74 W	75 Re	76 Os	77 Ir	78 Pt	79 Au	80 Hg	81 Tl	82 Pb	83 Bi	84 Po	85 At	86 Rn
7	87 Fr	88 Ra		104 Rf	105 Db	106 Sg	107 Bh	108 Hs	109 Mt	110 Ds	111 Rg	112 Cn	113 Nh	114 Fl	115 Mc	116 Lv	117 Ts	118 Og
Lanthanides		57 La	58 Ce	59 Pr	60 Nd	61 Pm	62 Sm	63 Eu	64 Gd	65 Tb	66 Dy	67 Ho	68 Er	69 Tm	70 Yb	71 Lu		
Actinides		89 Ac	90 Th	91 Pa	92 U	93 Np	94 Pu	95 Am	96 Cm	97 Bk	98 Cf	99 Es	100 Fm	101 Md	102 No	103 Lr		

This table lists all the elements found on earth. An atom is the smallest part of an element that maintains the characteristics of that element. An atom is made up of three parts, protons, neutrons and electrons.

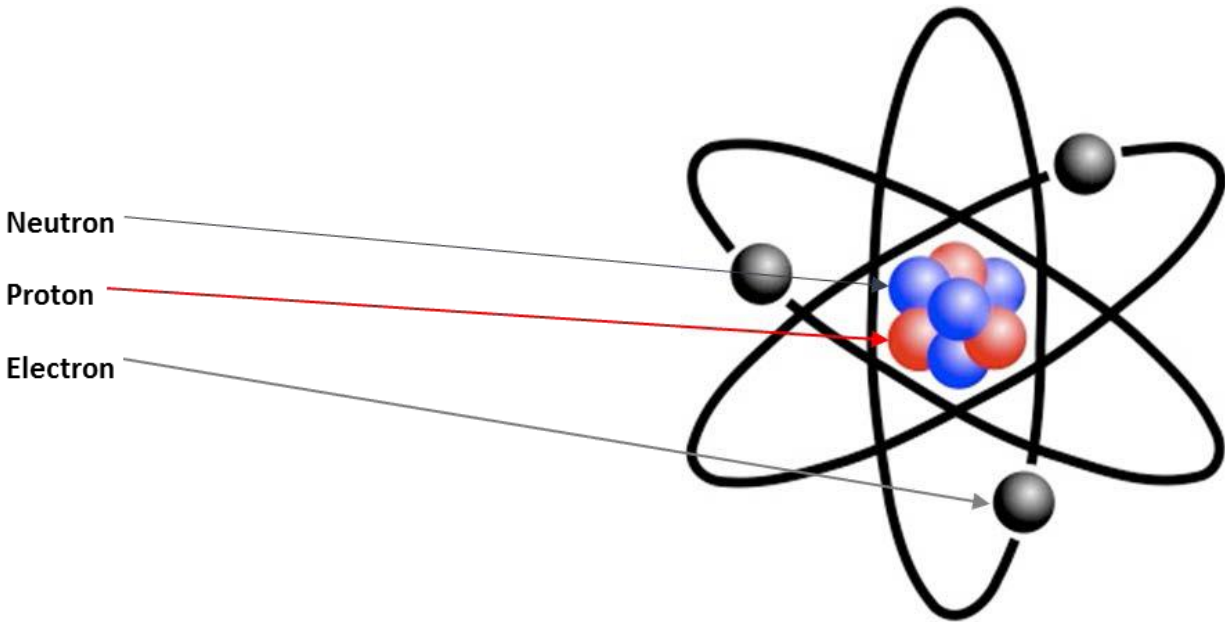

The number of protons in an atom determines the element. A hydrogen atom will always have one proton while an oxygen atom will always have eight protons. The protons are clustered

with the neutrons at the center of the atom and this is called the nucleus. Orbiting around the nucleus are the relatively small electrons. Neutrons do not have an electrical charge; protons have a positive charge while electrons have a negative charge. In an electrically neutral atom, the negative and positive charges are balanced. Atoms of the same element that have a different number of neutrons in their nucleus are called isotopes.

Isotopes are atoms that have the same number of protons but different number of neutrons. They all have the same chemical properties and many isotopes are nonradioactive or stable while other isotopes may be unstable and are radioactive. Radioactive isotopes can be called a radionuclide, a radioisotope or simply called a radioactive atom. A radionuclide usually contains an excess amount of energy in the nucleus usually due to a deficit or excess of neutrons in the nucleus.

There are two basic ways radionuclides are produced at a nuclear power plant. The first way is a direct result of the fission process and the radionuclides created through this process are termed fission products. Fission occurs when a very large atom, such as U-235 (Uranium-235) and Pu-239 (Plutonium-239) absorbs a neutron into its nucleus making the atom unstable. In this instance the atom can actually split into smaller atoms. This splitting of the atom is called fission. When fission occurs, there is also a large amount of energy released from the atom in the form of heat which is what is used to produce the steam that will spin the turbines to produce electricity at a nuclear power plant.

The second way a radionuclide is produced at a nuclear power plant is through a process called activation and the radionuclides produced in this method are termed activation products. Water passes through the core where the fission process is occurring. This water is used to both produce

the steam to turn the turbines and to cool the reactor. Though the water passing through the core is considered to be very pure water, there is always some other material within the water. This material typically comes from the material used in the plant's construction. As the water passes through the core, the material is exposed to the fission process and the radiation within the core can react with the material causing it to become unstable, creating a radionuclide. The atoms in the water itself can become activated and create radionuclides.

Over time, radioactive atoms will reach a stable state and no longer be radioactive. To do this they must release the excess energy. The release of excess energy can be in different forms and is called radioactive decay and the energy released is called radiation. The time it takes for a radionuclide to become stable is measured in units called half-lives. A half-life is the amount of time it takes for half of the original radioactivity to decay. Each radionuclide has a specific half-life. Some half-lives can be very long and are measured in years while others may be very short and are measured in seconds.

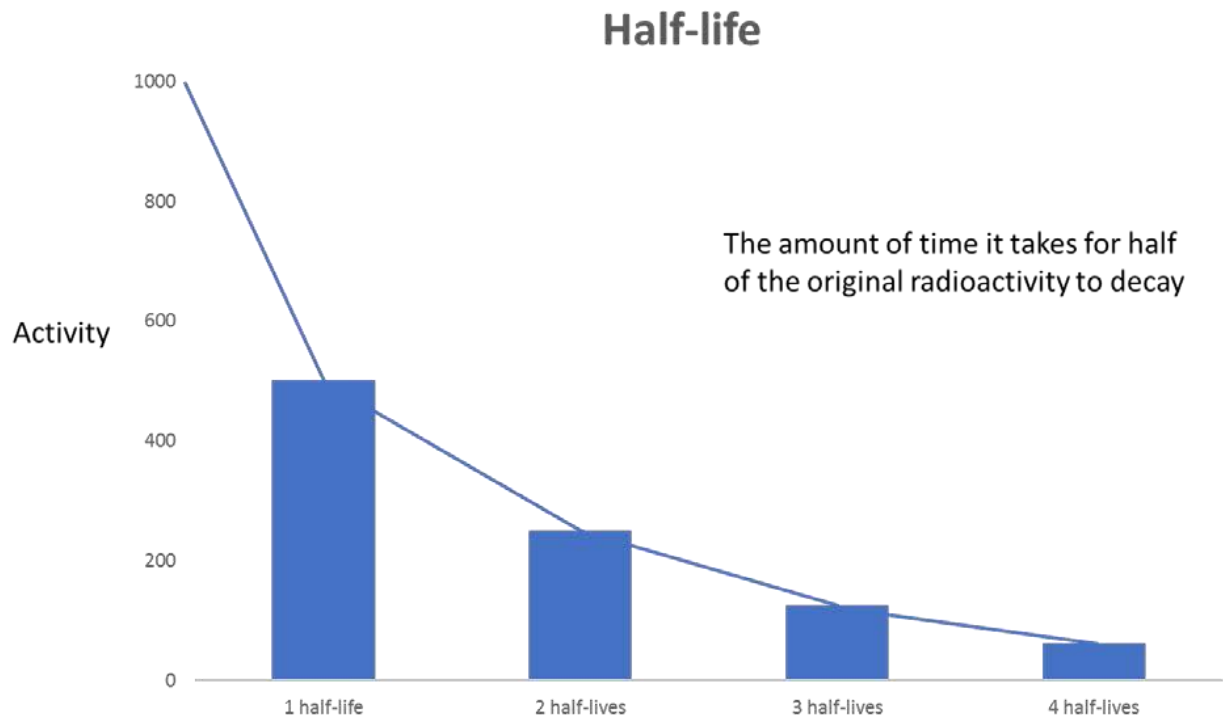

In this report you will see radionuclides listed such as K-40 (potassium-40) and Co-60 (cobalt- 60). The letter(s) represents the element and the number represents the specific isotope of that element and is the number of neutrons and protons in the nucleus of that radionuclide. You may hear the term naturally occurring radionuclide which refers to radionuclides that naturally occur in nature such as K-40. There are man-made radionuclides such as Co-60 that we are concerned with since these man-made radionuclides result as a by-product when generating electricity at a nuclear power plant. There are other ways man-made radionuclides are produced, such as detonating nuclear weapons, and this is important to note since nuclear weapons testing deposited these man-made radionuclides into the environment and some are still present today. There is a discussion in the AREOR for the radionuclides Cs-137, Sr-89 and Sr-90. The reason we only see some of the radionuclides today is due to the fact that some of the radionuclides released into the environment had relatively short half-lives and all the atoms have decayed to a stable state while other

radionuclides have relatively long half- lives and will be measurable in the environment for years to come.

2. Sources of Radiation

People are exposed to radiation every day of their lives and have been since the dawn of mankind. Some of this radiation is naturally occurring while some is man-made. There are many factors that will determine the amount of radiation an individual will be exposed to such as where you live, medical treatments, etc. Below are examples of some of the typical sources of radiation an individual is exposed to in a year.

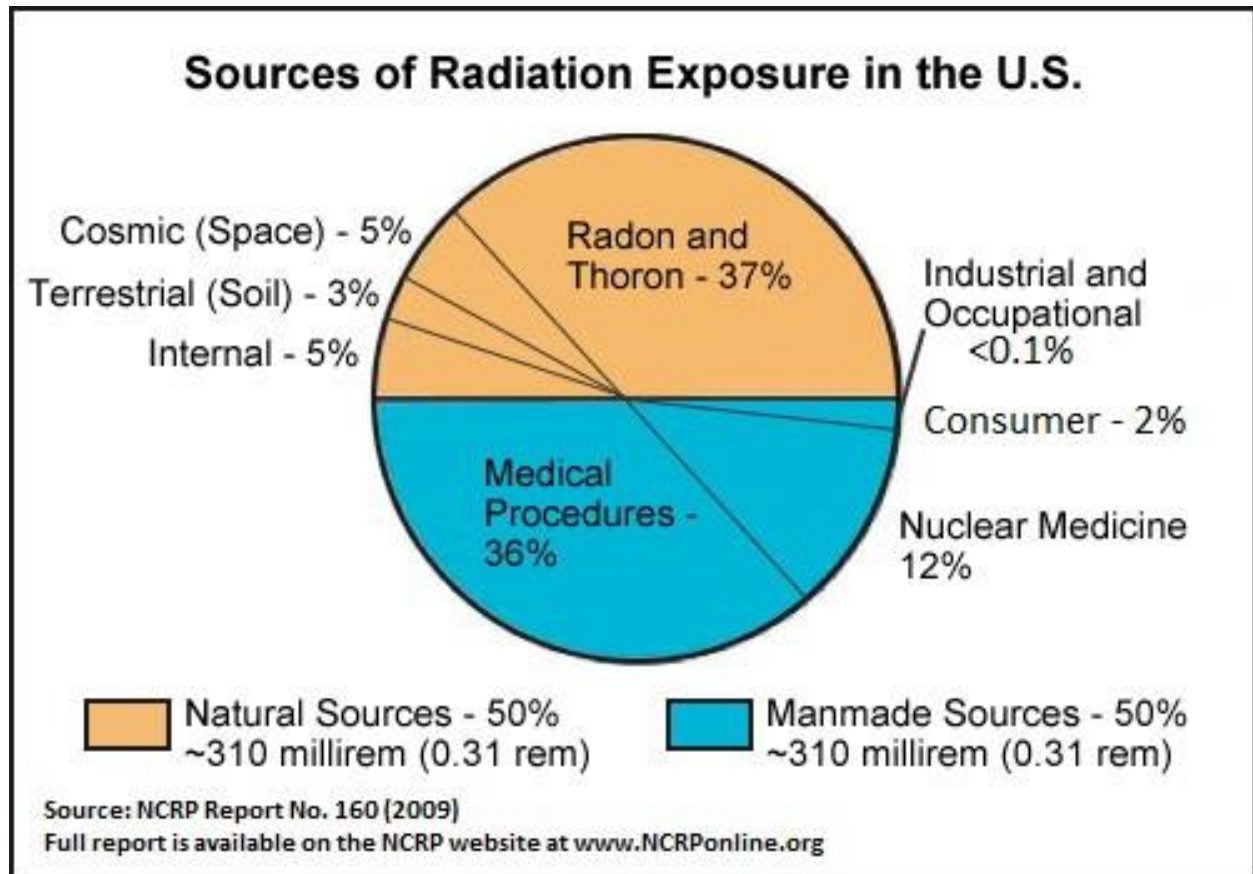

Adapted with permission of the National Council on Radiation Protection and Measurements, <http://NCRPonline.org>

As you can see from the graph, the largest natural source of radiation is due to Radon. That is because essentially all air contains Radon. Cosmic and Internal make up the next largest natural sources of radiation. Cosmic radiation comes from the sun and stars and there are multiple factors which can impact the amount of cosmic radiation you are exposed to such as the elevation at which you live and the amount of air travel you take a year. The internal natural source of radiation mainly comes from two sources. Technically, all organic material is slightly radioactive due to C-14 (Carbon-14), including humans and the food we eat. C-14 makes up a percentage of the carbon in all organic material. Another contributor to the internal natural source is K-40 (Potassium-40). Potassium is present in many of the foods we eat, such as brazil nuts, bananas, carrots and red meat. The smallest natural source listed is terrestrial. Soil and rocks contain radioactive materials such as Radium and Uranium. The amount of terrestrial radiation you are exposed to depends on where you live. The map below shows terrestrial exposure levels across the United States. The

radiation released from nuclear power plants is included in the Industrial and Occupational slice and is listed as <0.1%.

Terrestrial Gamma-Ray Exposure at 1m above ground

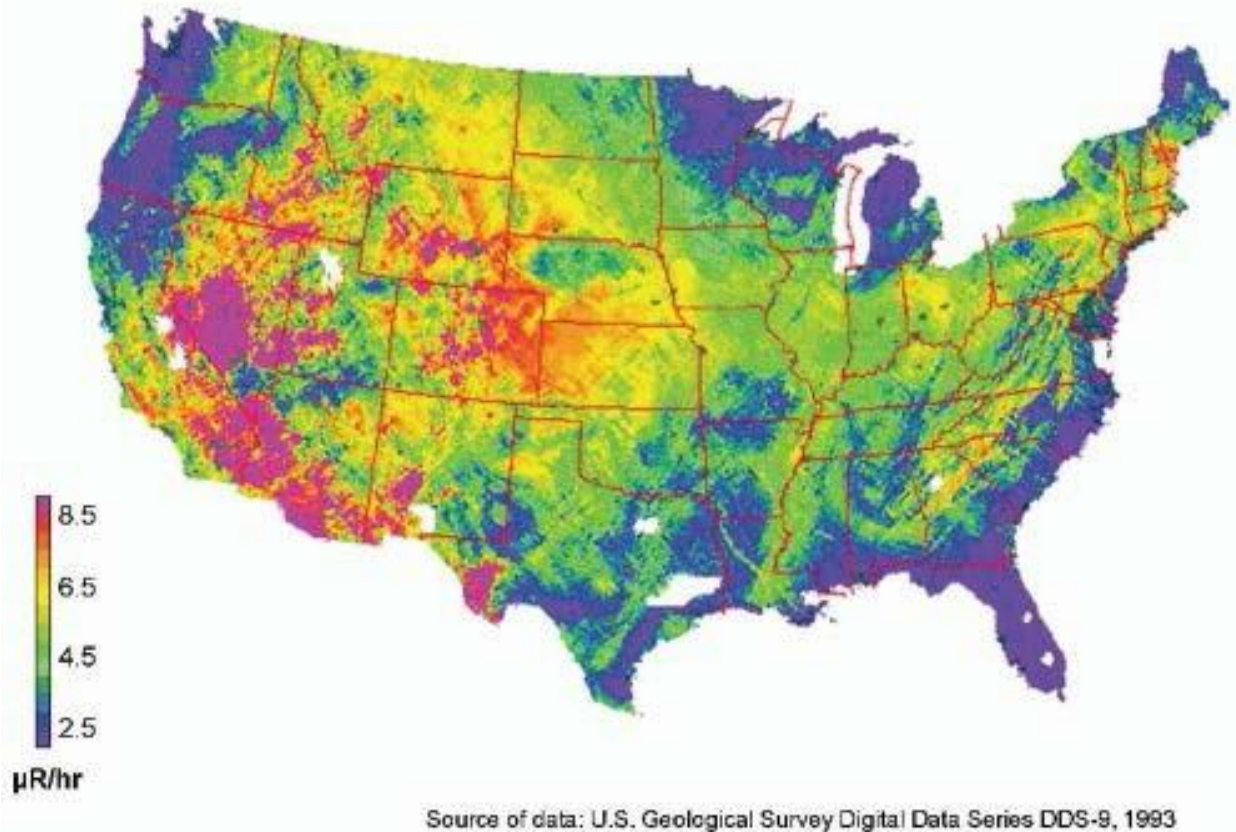

3. Exposure Pathways

Radiological exposure pathways define the methods by which people may become exposed to radioactive material. The major pathways of concern are those which could cause the highest calculated radiation dose. These projected pathways are determined from the type and amount of radioactive material released into the environment and how the environment is used. The way radioactive material is transported in the environment includes consideration of physical factors, such as the hydrological (water) and meteorological (weather) characteristics of the area. An annual average of the water flow, wind speed, and wind direction are used to evaluate how the radionuclides will be distributed in an area for gaseous or liquid releases. An important factor in evaluating the exposure pathways is the use of the environment. Many factors are considered such as dietary intake of residents, recreational use of the area, and the locations of homes and farms in the area.

The external and internal exposure pathways considered are shown in the picture below. The release of radioactive gaseous effluents involves pathways such as external whole-body exposure, deposition of radioactive material on plants, deposition on soil, inhalation by animals destined for human consumption, and inhalation by humans. The release of radioactive material in

liquid effluents involves pathways such as drinking water, fish, and direct exposure from the water at the shoreline while swimming.

Although radionuclides can reach humans by many different pathways, some result in more dose than others. The critical pathway is the exposure route that will provide, for a specific radionuclide, the greatest dose to a population, or to a specific group of the population called the critical group. The critical group may vary depending on the radionuclides involved, the age and diet of the group, or other cultural factors. The dose may be delivered to the whole body or to a specific organ. The organ receiving the greatest fraction of the dose is called the critical organ.

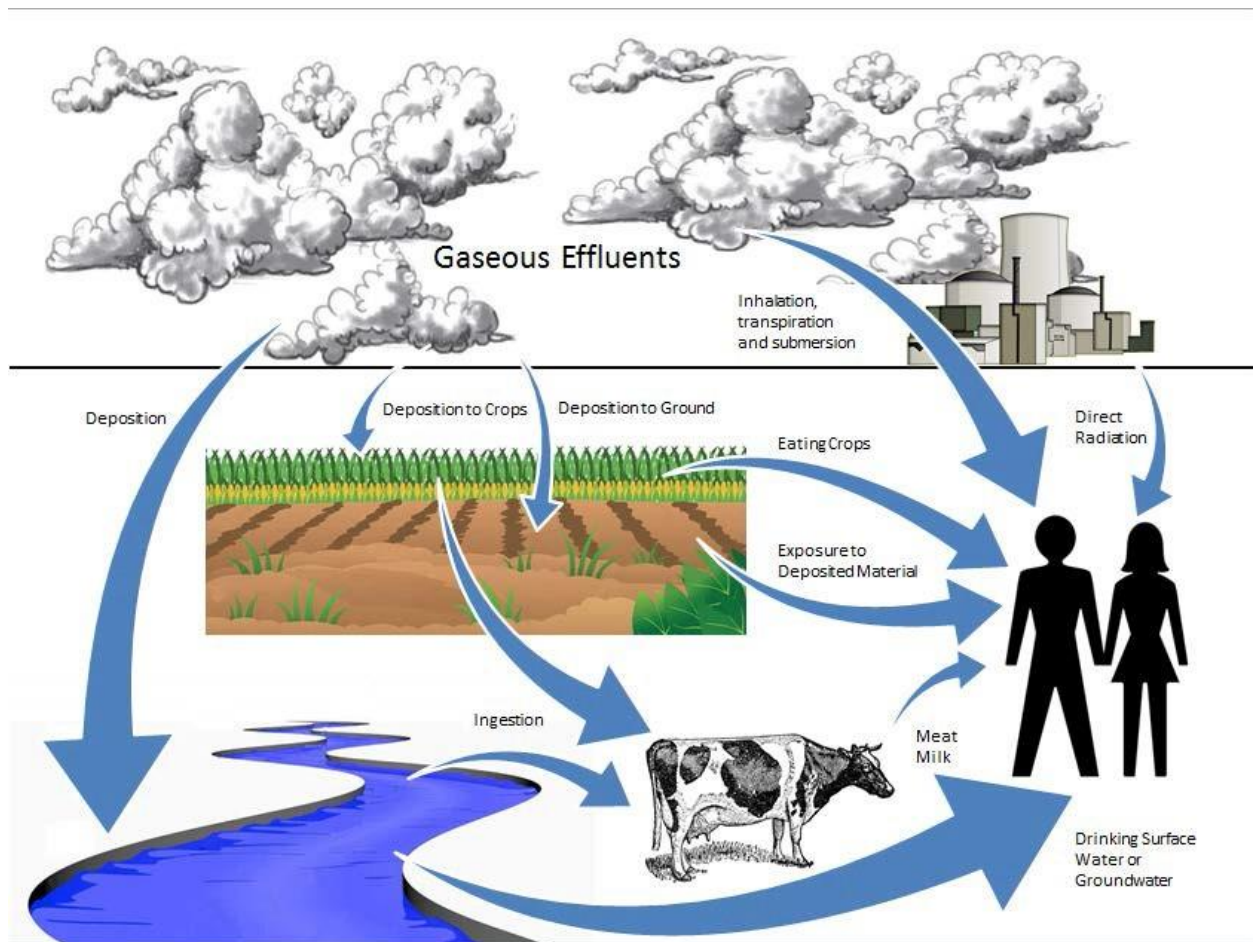

This simple diagram demonstrates some potential exposure pathways from Oyster Creek Nuclear Generating Station.

4. Radiation Risk

U.S. radiation protection standards are based on the premise that any radiation exposure carries some risk. There is a risk whether the radiation exposure is due to man-made sources or natural sources. There have been many studies performed trying to determine the level of risk. The following graph is an example of one study that tries to relate risk from many different factors. This graph represents risk as "Days of Lost Life Expectancy". All the categories are averaged over the entire population except Male Smokers, Female Smokers and individuals that are overweight. Those risks are only for people that fall into those categories. The category for Nuclear Power is a

government estimate based on all radioactivity releases from nuclear power, including accidents and wastes.

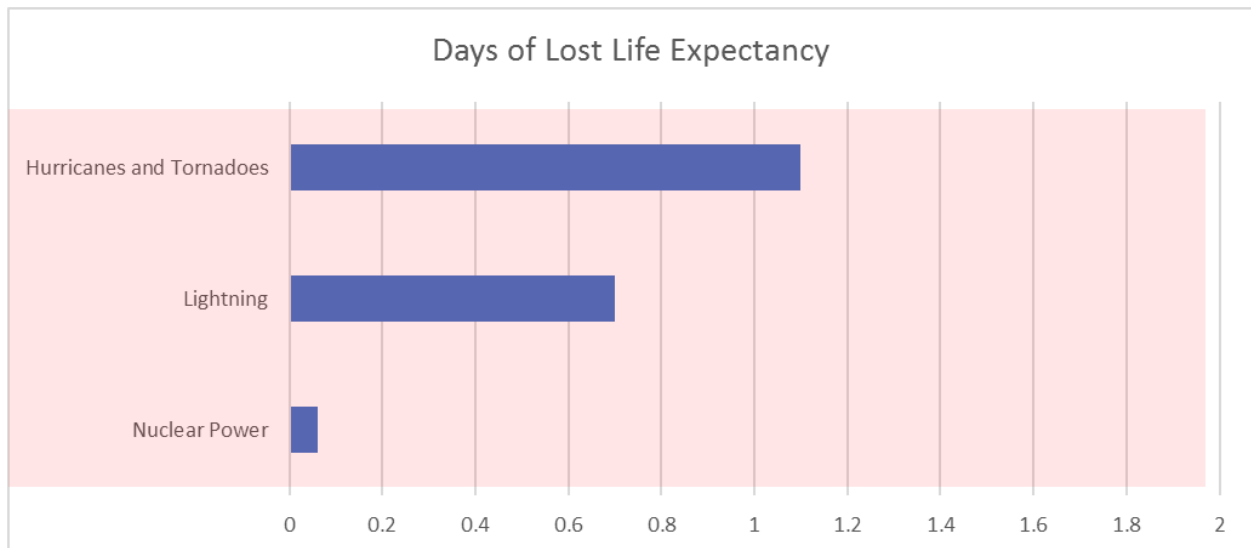
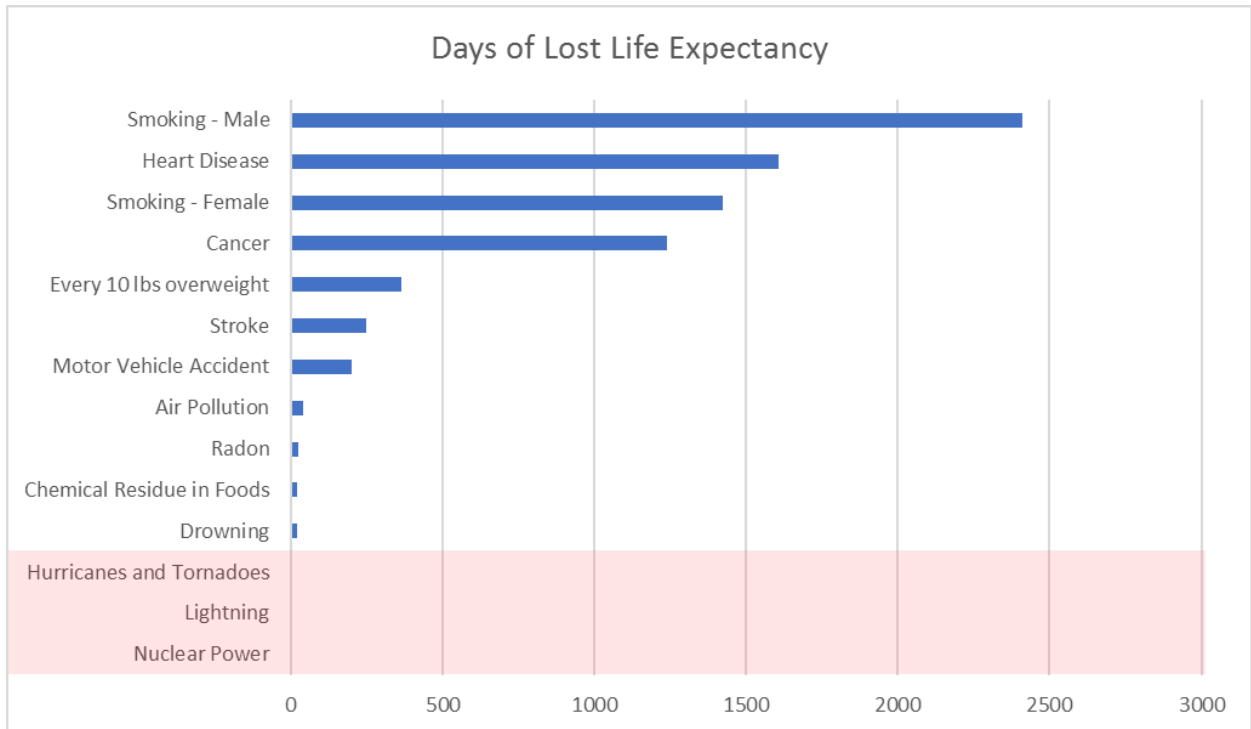

Adapted from the article by Bernard L. Cohen, Ph.D. in the Journal of American Physicians and Surgeons Volume 8 Number 2 Summer 2003.

The full article can be found at <http://www.jpands.org/vol8no2/cohen.pdf>

5. Annual Reports

All nuclear power plants are required to perform sampling of both the potential release paths from the plant and the potential exposure pathways in the environment. The results of this sampling are required to be reported annually to the Nuclear Regulatory Commission (NRC) and made available to the public. There are two reports generated annually, the Annual Radioactive Effluents Release Report (ARERR) and the Annual Radiological Environmental Operating Report (AREOR). The ARERR summarizes all the effluents released from the plant and quantifies the doses to the public from these effluents. The AREOR summarizes the results of the samples obtained in the environment looking at all the potential exposure pathways by sampling different media such as air, vegetation, direct radiation, etc. These two reports are related in that the results should be aligned. The AREOR should validate that the effluent program is accurate. The ARERR and AREOR together ensure Nuclear Power Plants are operating in a manner that adequately protects the public.

In the reports there are four different but interrelated units for measuring radioactivity, exposure, absorbed dose, and dose equivalent. Together, they are used to properly capture both the amount of radiation and its effects on humans.

- Radioactivity refers to the amount of ionizing radiation released by a material. The units of measure for radioactivity used within the AREOR and ARERR are the curie (Ci). Small fractions of the Ci often have a prefix, such as μCi that means 1/1,000,000. That means there are 1,000,000 μCi in one Ci.
- Exposure describes the amount of radiation traveling through the air. The units of measure for exposure used within the AREOR and ARERR are the roentgen (R). Traditionally direct radiation monitors placed around the site are measured in milliroentgen (mR), 1/1,000 of one R.
- Absorbed dose describes the amount of radiation absorbed by an object or person. The units of measure for absorbed dose used within the AREOR and ARERR are the rad. Noble gas air doses are reported by the site are measured in milli-rad (mrad), 1/1,000 of one rad.
- Dose equivalent (or effective dose) combines the amount of radiation absorbed and the health effects of that type of radiation. The units used within the AREOR and ARERR are the roentgen equivalent man (rem). Regulations require doses to the whole body, specific organ, and direct radiation to be reported in millirem (mrem), 1/1,000 of one rem.

Typically releases from nuclear power plants are so low that the samples taken in the environment are below the detection levels required to be met by all nuclear power plants. There are some radionuclides identified in the environment during the routine sampling, but this is typically background radiation from nuclear weapons testing and events such as Chernobyl and these radionuclides are discussed in the AREOR.

Each report lists the types of samples that are collected, and the analyses performed. Different types of media may be used at one sample location looking for specific radionuclides. For example, at our gaseous effluent release points we use different media to collect samples for particulates, iodines, noble gases and tritium. There are also examples where a sample collected on one media is analyzed differently depending on the radionuclide for which the sample is being analyzed.

These annual reports, and much more information related to nuclear power, are available on the NRC website at www.nrc.gov.

6. Introduction

In accordance with the reporting requirements of Technical Specification 6.9.1.a applicable during the reporting period, this report summarizes the effluent release data for OCGS for the period January 1, 2019 through December 31, 2019. This submittal complies with the format described in Regulatory Guide 1.21, "Measuring, Evaluating and Reporting Radioactivity in Solid Wastes and Releases of Radioactive Materials in Liquid and Gaseous Effluents from Light-Water-Cooled Nuclear Power Plants." Revision 2, June 2009.

Meteorological data is reported in the format specified in Regulatory Guide 1.23, Revision 1, "Meteorological Monitoring Programs for Nuclear Power Plants", is not included in this report, but is available on-site upon request.

All vendor results were received and included in the report calculations. Therefore, the 2019 report is complete.

Regulatory Limits:

	Limit	Units	Receptor	ODCM and 10 CFR 50, Appendix I Design Objective Limits
1. Noble Gases:				
a.	≤ 500	mrem/yr	Total Body	ODCM Control 3.11.2.1
	≤ 3000	mrem/yr	Skin	
b.	≤ 5	mrad/qtr	Air Gamma	Quarterly air dose limits ODCM Control 3.11.2.2
	≤ 10	mrad/qtr	Air Beta	
c.	≤ 10	mrad/yr	Air Gamma	Yearly air dose limits ODCM Control 3.11.2.2
	≤ 20	mrad/yr	Air Beta	
d.	< 5	mrem/yr	Total Body (Gamma)	10 CFR 50, Appendix I, Section II.B.2(b)
	< 15	mrem/yr	Skin (Beta)	
2. Iodines, Tritium, Particulates with Half Life > 8 days:				
a.	≤ 1500	mrem/yr	Any Organ	ODCM Control 3.11.2.1
b.	≤ 7.5	mrem/qtr	Any Organ	Quarterly dose limits ODCM Control 3.11.2.3
c.	≤ 15	mrem/yr	Any Organ	Yearly dose limits ODCM Control 3.11.2.3
3. Liquid Effluents:				
a.	Concentration 10 CFR 20, Appendix B, Table 2 Column 2			ODCM Control 3.11.1.1
b.	≤ 1.5	mrem/qtr	Total Body	Quarterly dose limits ODCM Control 3.11.1.2
	≤ 5	mrem/qtr	Any Organ	
c.	≤ 3	mrem/yr	Total Body	Yearly dose limits ODCM Control 3.11.1.2
	≤ 10	mrem/yr	Any Organ	

II. SUPPLEMENTAL INFORMATION (MAIN BODY OF REG GUIDE 1.21 REPORT)

Oyster Creek Nuclear Generating Station, Holtec Decommissioning International, LLC

1. Abnormal Releases and Abnormal Discharges (e.g., leaks and spills)

There were no Abnormal Releases or Abnormal Discharges (e.g., spills or leaks of radioactive material) during the decommissioning the Oyster Creek Nuclear Generating Station in 2019.

2. Non Routine, Planned Discharges

There were no non routine, planned radioactive discharges (e.g., pumping of leaks and spills for remediation, results of ground water monitoring to quantify effluent releases to the offsite environment) for remediation resulting in releases off-site. There was no off-site impact.

3. Radioactive Waste Treatment System Changes

There were no physical changes to the Waste Water Treatment System or Waste Processing in 2019 at Oyster Creek.

4. Annual Land-Use Census Changes

A search for new gardens, farms and orchards within a 10 kilometer radius of the site was performed with no changes or additions identified. The annual resident survey was also completed with no changes to the previous year's results identified. As a result, no changes to the Oyster Creek Nuclear Generating Station Off-site Dose Calculation Manual (ODCM) were needed as a result of changes to the Land Use Census.

5. Effluent Monitor Instrument Inoperability

There were no Oyster Creek Nuclear Generating Station process radiation monitors out of service for more than 30 days in 2019. As part of Revision 9 to the ODCM, the Turbine Building and Reactor Building ground level release points and pathways were terminated by taking those systems and their respective Radiation Monitor systems, out of service. Effluent releases from the Turbine and Reactor Buildings have been terminated.

6. Offsite Dose Calculation Manual Changes

There were two revisions made to the ODCM in 2019. Revision 9 was issued in January of 2019 and Revision 10 was approved and issued in December 2019. The summaries and bases for these two revisions, as well as a full copy of the revision in effect as of December 31, 2019, Revision 10, are attached (provided in Appendix D).

7. Process Control Program Changes

There were no changes to the process control program in 2019.

8. Errata/Corrections to Previous ARERRs

There are no Errata/corrections to previous ARERRs.

9. Other

Other supplemental information are narrative descriptions of other information that is provided to the U.S. Nuclear Regulatory Commission, e.g., the ARERR for ISFSIs.

a. Processed liquid radioactive waste with subsequent over boarding of these 23,000 gallon batch releases from Tank T-2B was implemented to deal with the water inventory present upon permanent plant shutdown and the transition to decommissioning. Termination of gaseous effluent releases from the Turbine and Reactor Buildings was also terminated with this revision to the ODCM in January of 2019 (revision 9). The December 2019 revision eliminated noble gas and iodine monitoring, compressed the direct radiation monitoring inner and outer dosimeter rings, added open air demolition and construction dewatering. Additionally, Revision 10 to the ODCM included the flexibility to utilize 10 year meteorological averages and alternative off-site dose calculation software as long as the modelling specified to in Reg Guide 1.109 is adhered to.

b. The ISFSI facility is located within the Oyster Creek Site and Controlled Area Boundaries. The termination of power operations has reduced the ambient dose rates on-site increasing the relative significance of the contributions from the ISFSI pad for direct radiation and the expansion of on-site storage for spent fuel pending a permanent repository will increase its relevance further once spent fuel is moved to the ISFSI pad extension to accommodate decommissioning. As the spent fuel canisters are sealed and the contents blanketed in an inert gas, the ISFSI facility does not release liquid or gaseous effluents, and the direct radiation component, including skyshine, is the only radiological impact attributable to the ISFSI operations.

c. There were forty nine (49) liquid batch releases completed between January and December, 2019. Gaseous releases were elevated only and continuous from the Main Stack. There were no elevated continuous, ground level continuous or ground level batch releases of gaseous effluents in 2019. Inputs to the Main Stack include gaseous effluents from the Turbine Building, Reactor Building, and New and Old Radwaste Buildings. In 2019, the Main Stack was monitored for noble gas emissions (continuously), tritium releases (quarterly grab samples), particulate activity (weekly filter collections) and radioactive iodine (weekly charcoal canister change outs). In 2019, the only gaseous effluents released from the Main Stack were particulates and tritium. No noble gas or iodine was detected during the year, and in combination with the Design Basis Accident Calculation one year post permanent shutdown, provided the basis for removing noble gas and iodine emissions from the ODCM.

III. Appendices

Appendix A – Effluent, Waste Disposal, and Dose Tables

Appendix B – Error Estimation

Appendix C – Errata

Appendix D – ODCM Revisions

Appendix E – Revisions to the Process Control Program (PCP)

Appendix A – Effluent, Waste Disposal, and Dose Tables

Table A-1: Gaseous Effluents - Summation of All Releases

Summation of All Releases	Units	Quarter 1	Quarter 2	Quarter 3	Quarter 4	Total	Uncertainty ⁴
Fission and Activation Gases	Ci	<LLD ¹	<LLD	<LLD	<LLD	<LLD	± 25%
Average Release Rate	µCi/s	N/A	N/A	N/A	N/A	N/A	
% of Limit	%	N/A ²	N/A	N/A	N/A	N/A	
Iodines (Halogens)	Ci	<LLD	<LLD	<LLD	<LLD	<LLD	± 18%
Average Release Rate	µCi/s	N/A	N/A	N/A	N/A	N/A	
% of Limit	%	N/A	N/A	N/A	N/A	N/A	
Particulates	Ci	<LLD	<LLD	1.18E-05	<LLD	1.18E-05	± 18%
Average Release Rate ³	µCi/s	N/A	N/A	1.48E-06	N/A	3.73E-07	
% of Limit*	%	N/A	N/A	2.69E-04	N/A	1.35E-04	
Tritium	Ci	2.01E-01	4.45E-01	3.39E-01	2.77E-01	1.26E+00	± 23%
Average Release Rate	µCi/s	2.59E-02	5.66E-02	4.26E-02	3.49E-02	4.00E-02	
% of Limit*	%	2.11E-05	4.08E-05	1.87E-05	3.03E-05	5.54E-05	
Gross Alpha	Ci	<LLD	<LLD	<LLD	<LLD	<LLD	± 24%

*% of WB Dose Limit is the criteria used and the actual whole-body dose for the period is compared to that respective limit reported here, in accordance with NUREG 1301, and the Oyster Creek Station ODCM

<LLD¹ Not Detected: Radionuclides in these categories (Noble Gases, Iodine's, Halogens) are not expected at this stage in decommissioning, but the analytical equipment used to quantify these would identify them, if present, so these are listed as not detected at the lower limit of detection (LLD)

N/A² Not Applicable: Release Rate and % of Limit requires detection of the radionuclides in this class to calculate release rates and compare to limits

³ Average release rate is not based on the actual minutes of all batch discharges; it is based on an average of 91 days per quarter as calculated by SEEDS as this is more conservative in this scenario

⁴ Error Estimates are calculated in Appendix B

2019 OYSTER CREEK ANNUAL RADIOACTIVE EFFLUENT RELEASE REPORT (ARERR)

Table A-1D: Gaseous Effluents - Elevated Release - Continuous Mode

Fission and Activation Gases	Units	Quarter 1	Quarter 2	Quarter 3	Quarter 4	Total
Noble Gases not Detected	Ci	<LLD ¹	<LLD	<LLD	<LLD	<LLD

Iodines/Halogens	Units	Quarter 1	Quarter 2	Quarter 3	Quarter 4	Total
Iodines and Halogens not Detected	Ci	<LLD ¹	<LLD	<LLD	<LLD	<LLD

Particulates	Units	Quarter 1	Quarter 2	Quarter 3	Quarter 4	Total
Co-60	Ci	<LLD ¹	<LLD	1.18E-05	<LLD	1.18E-05
Total	Ci	<LLD ¹	<LLD	1.18E-05	<LLD	1.18E-05

Tritium	Ci	2.01E-01	4.45E-01	3.39E-01	2.77E-01	1.26E+00
----------------	----	----------	----------	----------	----------	----------

Gross Alpha	Ci	<LLD ¹	<LLD	<LLD	<LLD	<LLD
--------------------	----	-------------------	------	------	------	------

<LLD¹- Not Detected: Samples and analyzed for, but not detected at concentrations at or above the lower limit of detection (LLD).

Radionuclides in these categories (Noble Gases, Iodines, & Halogens) are no longer created by fission or released as the plant shutdown permanently in 2018. However, if any of these were present, the analytical equipment used to quantify airborne radionuclides would identify them, so these are listed as not detected.

Table A-1A. Gaseous Effluents—Ground-Level Release—Batch Mode
There were no Ground Level Batch Gaseous Releases from Oyster Creek Station

Table A-1B. Gaseous Effluents—Ground-Level Release—Continuous Mode
There were no Ground Level Continuous Gaseous Releases from Oyster Creek Station

Table A-1C. Gaseous Effluents—Elevated Release—Batch Mode
There were no Elevated Batch Gaseous Releases from Oyster Creek Station

Table A-1E. Gaseous Effluents—Mixed Mode Release—Batch Mode
There were no Mixed Mode Batch Gaseous Releases from Oyster Creek Station

Table A-1F. Gaseous Effluents—Mixed Mode Release—Continuous Mode
There were no Mixed Mode Continuous Gaseous Releases from Oyster Creek Station

2019 OYSTER CREEK ANNUAL RADIOACTIVE EFFLUENT RELEASE REPORT (ARERR)

Table A-2: Liquid Effluents - Summation of All Releases

Summation of All Liquid Releases	Units	Quarter 1	Quarter 2	Quarter 3	Quarter 4	Total	Uncertainty ⁵
Fission and Activation Products (excluding tritium, gases, and gross alpha)	Ci	1.76E-02	6.73E-03	9.63E-04	6.05E-04	2.60E-02	±15%
Average Concentration ²	µCi/ml	2.41E-08	1.30E-07	3.02E-08	2.40E-08	3.08E-08	
% of Limit ³	%	7.10E-01	2.18E+00	1.02E+00	8.01E-01	8.63E-01	
Tritium	Ci	1.06E+00	2.25E+00	8.67E-01	8.64E-01	5.03E+00	± 15%
Average Concentration	µCi/ml	1.44E-06	4.34E-05	2.71E-05	3.43E-05	5.99E-06	
% of Limit ³	%	1.44E-01	4.34E+00	2.71E+00	3.43E+00	5.99E-01	
Dissolved and Entrained Gases	Ci	<LLD ¹	<LLD	<LLD	<LLD	<LLD	± 15%
Average Concentration	µCi/ml	<LLD ¹	<LLD	<LLD	<LLD	<LLD	
% of Limit ³	%	N/A ⁴	N/A	N/A	N/A	N/A	
Gross Alpha	Ci	<LLD ¹	<LLD	<LLD	<LLD	<LLD	± 22%
Average Concentration	µCi/ml	N/A	N/A	N/A	N/A	N/A	
Volume of Primary System Liquid Effluent (Before Dilution)	Liters	0.00E+00	0.00E+00	0.00E+00	0.00E+00	0.00E+00	
Dilution Water Used for Above	Liters	0.00E+00	0.00E+00	0.00E+00	0.00E+00	0.00E+00	
Volume of Secondary or Balance-of-Plant Liquid Effluent (e.g., low-activity or unprocessed) (Before Dilution)	Liters	1.13E+06	1.57E+06	8.68E+05	6.88E+05	4.26E+06	
Dilution Water Used for Above Average Stream Flow	Liters	7.31E+08	5.03E+07	3.11E+07	2.45E+07	8.37E+08	
Flow	m ³ /s	4.06E+00	2.02E-01	2.26E-01	2.24E-01	1.24E+00	

<LLD ¹ Not Detected: Radionuclides were sampled for and not detected in liquid discharges in 2019 and are therefore reported as less than the lower limit of detection (<LLD)

² Average concentration is the concentration of the effluent at the point of discharge to the canal

³ Percent of limit uses the concentration limit in the 10 CFR 20 Appendix B Table 2, Column 2 ECL for liquid effluent, and the sum of fractions when more than radionuclide is involved as for F & A products

⁴ N/A: Not Applicable

⁵ Error Estimates are calculated in Appendix B

Table A-2A: Liquid Effluents - Batch Mode

Fission and Activation Products	Units	Quarter 1	Quarter 2	Quarter 3	Quarter 4¹	Total
Mn-54	Ci	6.78E-04	6.75E-04	5.70E-06	<LLD	1.36E-03
Co-58	Ci	4.17E-05	<LLD	<LLD	<LLD	4.17E-05
Co-60	Ci	1.51E-02	3.19E-03	9.47E-04	6.05E-04	1.99E-02
Zn-65	Ci	7.57E-05	<LLD	<LLD	<LLD	7.57E-05
Cs-137	Ci	1.02E-04	1.52E-05	1.03E-05	<LLD	1.27E-04
Fe-55	Ci	1.62E-03	2.85E-03	<LLD	<LLD	4.47E-03
Totals	Ci	1.76E-02	6.73E-03	9.63E-04	6.05E-04	2.60E-02

Dissolved and Entrained Gases	Units	Quarter 1	Quarter 2	Quarter 3	Quarter 4	Total
(List Others)	Ci	<LLD	<LLD	<LLD	<LLD	<LLD
Totals	Ci	<LLD	<LLD	<LLD	<LLD	<LLD

Tritium	Ci	1.06E+00	2.25E+00	8.67E-01	8.64E-01	5.03E+00
----------------	----	----------	----------	----------	----------	----------

Gross Alpha	Ci	<LLD	<LLD	<LLD	<LLD	<LLD
--------------------	----	------	------	------	------	------

¹ NLD: No liquid discharges were made in the 4th quarter, and therefore there were no samples collected or analyzed for permitted liquid discharges

<LLD: Less than the Lower Limit of Detection

Table A-2B: Liquid Effluents - Continuous Mode

There were no Continuous Liquid Releases from Oyster Creek Station in 2019 containing detectable radionuclides, though these are permitted per the Oyster Creek ODCM

Table A-3: Low-Level Waste¹

Resins, Filters, and Evaporator Bottoms	Volume		Curies Shipped
Waste Class	ft ³	m ³	Ci
A	2.41E+03	6.83E+01	3.79E+01
B	0.00E+00	0.00E+00	0.00E+00
C	0.00E+00	0.00E+00	0.00E+00
ALL	2.41E+03	6.83E+01	3.79E+01

Major Nuclides for the Above Table: **H-3 (2.93%)**, C-14, **Mn-54 (2.77%)**, **Fe-55 (1.71%)**, **Co-60 (81.3%)**, **Ni-63 (4.05%)**, Zn-65, Sr-90, Tc-99, I-129, **Cs-137 (6.02%)**, Pu-238, Pu-239, Pu-240, Pu-241, Am-241, Cm-243, Cm-244

Dry Active Waste	Volume		Curies Shipped
Waste Class	ft ³	m ³	Ci
A	6.20E+03	1.76E+02	3.02E-01
B	0.00E+00	0.00E+00	0.00E+00
C	0.00E+00	0.00E+00	0.00E+00
ALL	6.20E+03	1.76E+02	3.02E-01

Major Nuclides for the Above Table: H-3, C-14, **Mn-54 (3.03%)**, **Fe-55 (56.29%)**, **Co-60 (34.81%)**, Ni-59, **Ni-63 (2.18%)**, Sr-90, Tc-99, I-129, **Cs-137 (2.50%)**, Pu-238, Pu-239, Pu-240, Pu-241, Am-241, Cm-242, Cm-243, Cm-244

Irradiated Components	Volume		Curies Shipped
Waste Class	ft ³	m ³	Ci
A	0.00E+00	0.00E+00	0.00E+00
B	0.00E+00	0.00E+00	0.00E+00
C	0.00E+00	0.00E+00	0.00E+00
ALL	0.00E+00	0.00E+00	0.00E+00

Major Nuclides for the Above Table: N/A

¹ All radionuclides comprising >1.0 % are bolded and the percentages listed in parenthesis

Table A-3: Low-Level Waste¹ (continued)

Other Waste	Volume		Curies Shipped
Waste Class	ft ³	m ³	Ci
A	3.60E+02	1.02E+01	9.30E-02
B	0.00E+00	0.00E+00	0.00E+00
C	0.00E+00	0.00E+00	0.00E+00
ALL	3.60E+02	1.02E+01	9.30E-02

Major Nuclides for the Above Table: H-3, C-14, **Mn-54 (2.99%)**, **Fe-55 (56.26%)**, **Co-60 (34.89%)**, Ni-59, **Ni-63 (2.20%)**, Sr-90, Nb-94, Tc-99, I-129, **Cs-137 (2.51%)**, Pu-238, Pu-239, Pu-240, Pu-241, Am-241, Cm-242, Cm-243, Cm-243

Sum of All Low-Level Waste Shipped from Site	Volume		Curies Shipped
Waste Class	ft ³	m ³	Ci
A	8.97E+03	2.54E+02	3.83E+01
B	0.00E+00	0.00E+00	0.00E+00
C	0.00E+00	0.00E+00	0.00E+00
ALL	8.97E+03	2.54E+02	3.83E+01

Major Nuclides for the Above Table: **H-3 (2.90%)**, C-14, **Mn-54 (2.77%)**, **Fe-55 (2.28%)**, **Co-60 (80.82%)**, Ni-59, **Ni-63 (4.03%)**, Zn-65, Sr-90, Tc-99, I-129, **Cs-137 (5.99%)**, Pu-238, Pu-239, Pu-240, Pu-241, Am-241, Cm-242, Cm-243, Cm-244

¹ All radionuclides comprising >1.0 % are bolded and the percentages listed in parenthesis

Waste Carrier Details

Number of Shipments	Mode of Transportation	Destination
3	Hittman Transport Co.	Barnwell Disposal Facility Operated by Energy Solutions, LLC
2	Hittman Transport Co.	Energy Solutions Services, Inc. Gallaher Road Facility
1	Hittman Transport Co.	Barnwell Processing Facility 16043 Dunbarton Boulevard
9	Hittman Transport Co.	Energy Solutions Services 1560 Bear Creek Road

Table A-4: Dose Assessments, 10 CFR Part 50, Appendix I

	Quarter 1	Quarter 2	Quarter 3	Quarter 4	Yearly
Liquid Effluent Dose Limit, Total Body	1.5 mrem	1.5 mrem	1.5 mrem	1.5 mrem	3 mrem
Total Body Dose ¹	1.03E-01	8.99E-02	9.11E-03	5.87E-03	2.08E-01
% of Limit	6.87E+00	5.99E+00	6.07E-01	3.91E-01	6.93E-01
Liquid Effluent Dose Limit, Any Organ	5 mrem	5 mrem	5 mrem	5 mrem	10 mrem
Organ Dose-Teen Liver	5.48E-01	4.70E-01	4.61E-02	2.94E-02	1.09E+00
% of Limit ²	1.10E+01	9.40E+00	9.21E-01	5.88E-01	1.09E+01
Gaseous Effluent Dose Limit, Gamma ³ Air	5 mrad	5 mrad	5 mrad	5 mrad	10 mrad
Gamma Air Dose	0.00E+00	0.00E+00	0.00E+00	0.00E+00	0.00E+00
% of Limit	0.00E+00	0.00E+00	0.00E+00	0.00E+00	0.00E+00
Gaseous Effluent Dose Limit, Beta Air ³	10 mrad	10 mrad	10 mrad	10 mrad	20 mrad
Beta Air Dose	0.00E+00	0.00E+00	0.00E+00	0.00E+00	0.00E+00
% of Limit	0.00E+00	0.00E+00	0.00E+00	0.00E+00	0.00E+00
Gaseous Effluent Dose Limit, Any Organ (Iodine, Tritium, Particulates with >8-day half-life)	7.5 mrem	7.5 mrem	7.5 mrem	7.5 mrem	15 mrem
Gaseous Effluent Organ Dose – Child GI-LLI (Iodine, Tritium, Particulates with > 8 - Day half-life)	1.58E-06	3.06E-06	2.16E-05	2.27E-06	2.53E-05
% of Limit	2.11E-05	4.08 E-05	2.88 E-04	3.03 E-05	1.69 E-04

¹ Highest Total Body dose varies from quarter to quarter between age groups, depending on the mix of radionuclides in the effluent stream, but the highest is reported for each quarter

² Highest organ dose varies from quarter to quarter depending on the mix of radionuclides in the effluent stream, but the highest is reported for each quarter

³ Dose to air (mrad) is applied to noble gas emissions only – noble gases are no longer created by fission at Oyster Creek or released from site following under normal decommissioning conditions

Table A-5: EPA 40 CFR Part 190 Individual in the Unrestricted Area

Dose Limit	Whole Body ¹	Thyroid ¹	Any other organ ¹
	25 mrem	75 mrem	25 mrem
Gaseous Effluent Dose	2.45E-05	2.53E-05	2.53E-05
Liquid Effluent Dose	2.08E-01	1.09E+00	1.09E+00
Liquid Effluent Dose Well 73	0.00E+00	0.00E+00	0.00E+00
Direct Dose Member of Public	5.86E+00	5.86E+00	5.86E+00
Total Dose	6.07E+00	6.95E+00	6.95E+00
% of Limit	2.43E+01	9.27E+00	2.78E+01

¹ The 40CFR190 dose is the sum of internal exposure (consumption of food stuffs and water), inhalation and direct radiation in the highest X/Q sector at the site boundary for gaseous releases

Per ODCM Administrative Control 6.2, an assessment of radiation doses to the likely most exposed MEMBER OF THE PUBLIC from nearby uranium fuel cycle sources (including doses from primary effluent pathways and direct radiation) for the previous calendar year must be made to show conformance with 40 CFR Part 190

Gaseous

Nearest member of the public was SE sector at 937 meters for gaseous effluents. Actual 2019 meteorology and measured gaseous effluent releases were used. All significant pathways were assumed to be present.

Direct Dose

For direct dose, the highest dose measured with OSLDs at the site boundary where a member of the public could gain non-challenged access is on Route 9 at OSLD location 66. Using occupancy factors presented in Technical Support Document OC-19-008, “2019 ISFSI Pad Full Projection”, the most conservative occupancy factor of 5.7% was utilized. Annual Dose at this location was < 1.0 mrem. This is a location where numerous members of the public take advantage of the nature trail for biking and walking along Route 9. The highest dose to a member of the public, assigned for comparison to federal limits, is for members of the public working at the warehouse beyond and west of the site and protected area boundary. This dose of 5.86 mrem is the dose of record assigned and is a fraction of the federal limit as summarized in Table A-5 above.

Liquid

Liquid effluent doses are calculated at the discharge canal (the Route 9 Bridge) where a member of the public can catch fish or crab. The dose model includes human consumption of fish, shellfish and and exposure to shoreline deposition dose pathways.

40 CFR Part 190 Compliance

For reporting direct dose to a member of the public, Dosimetry measurements (minus average of control stations, occupancy and assumed structure shielding) measured direct radiation for the nearest member of the public (OC-TLD-55). The nearest member of the public for direct radiation is considered an individual that works in the warehouse west of the site.

Nearest resident was at SE sector at 937 meters.

Appendix B – Error Estimation

Estimates of Total Error

Total Estimated Error determination for each release pathway is estimated in accordance with procedure CY-AA-170-2100, “Estimated Errors of Effluent Measurements”.

Appendix C – Errata

No Errata to Previously Issued ARERRs

Appendix D – ODCM REVISIONS

Revision 9 and Revision 10 to the ODCM were issued in 2019

ODCM Revision 9 Change Summary Matrix

Administrative Changes - Determination A

Technical Changes Overboard Discharge– Determination B

Item No.	(old) Rev. 8 page No.	(new) Rev. 9 page No.	Determination Identifier	Description of Change
1	1 - 138	1 - 137	A	Revise header to revision 9. Revise footer revision month and year date to 012019.
2	1	1	A	Revise PORC to SRC.
3	6	6	B	Add Figure D-1-1d Overboard Discharge.
4	16	16	A	Rephrase Control 3.3.3.10 to clarify alarm/trip point operability.
5	17	17	A & B	Format numbering. Added Overboard Discharge to Flow Rate Measurement Devices.
6	19	19	A & B	Format numbering. Added surveillance requirement for overboard discharge.
7	20	20	B	Added description of verification for overboard discharge and frequency.
8	27	27	B	Add Ni-63 to batch waste release tank quarterly composite analysis.
9	121	121	B	Revise Figure D-1-1b Liquid Radwaste Treatment – High Purity and Equipment Drain System to reflect overboard discharge configuration.
10	123	123	B	Add Figure D-1-1d Overboard Discharge.
11	123 - 138	123 -137	A	Format page number following addition of Figure D-1-1d and eliminating blank pages.
12	125	125	B	Delete hardened vent path from Figure D-2-2 Ventilation System. It does not apply to a facility in the permanently defueled condition.

ODCM Revision 10 Change Summary Matrix

Administrative Changes - Determination A (Editorial)

Technical Changes - Determination B (Technical)

1. Removed Low Range Noble Gas Monitor from service in RAGEMS 1
2. Removed Iodine Gas sampling from RAGEMS 1
3. Removed noble gas, noble gas and gas monitor controls, bases and surveillances, and dose and set point calculations.
4. Removed iodine charcoal sampler from controls, surveillances and table notations.
5. Effluent (Stack Gas) Flow and Sample Flow surveillances remain as Particulates will continue to be sampled continuously, and quarterly tritium grab samples can continue if SFP evaporation tritium release estimates are not used to quantify Gaseous Tritium releases from the Stack.

Note, the justification for changes 1-4 is that at one year post permanent shutdown, noble gas and iodine radionuclide creation through fission reactions have ceased, and the inventory present at permanent shutdown has decayed to levels that are no longer detectable using state of the art sampling and analyses. Additionally, and looking at a worst case scenario, a design basis accident (DBA), as described in revision 10 ODCM Reference 35, identifies an off-site dose impact from a DBA of 0.4 mrem to a member of the public with a dropped fuel canister on the Refuel Floor, assuming a Ground Level release from the Reactor Building under accident conditions. Under normal and expected operations, Reactor Building exhaust is channeled to the Main Stack, which is an elevated release. The off-site dose resulting from a release of Kr-85 trapped, then released, from the design basis accident damaged fuel gaps is 100 fold lower when using the maximum X/Q for a main stack release of noble gas (on the order of 0.004 mrem). Both conditions (ground level and/or elevated releases of Kr-85 under DBA conditions) result in an insignificant off site dose to a member of the public well below defueled EALs.

6. Hi Range is not addressed in ODCM but is included in DEP EAL's – removal of the high range noble gas monitor involves an EP change to the EALs using a 50.54.q review – Not part of the ODCM, but should be removed as EALs will never be reached from a DBA dropped fuel canister. No ODCM Revision Impact. Recommend removal of Hi-range monitor by this process as it will not respond to levels predicted in the DBA.
7. Added Use of 10 Year Meteorological Averages vs. real time meteorological data as an option. Will require replacement software for SEEDS or manual calculation of off-site airborne dose for the annual ARERR as SEEDS cannot utilize averaged data.
8. Adoption of R.G. 1.21, Revision 2 to simplify annual reports and more accurately reflect current practices. (eliminates need to report meteorological data in the ARERR and permits reporting all 4 quarters of releases in one table, vs. semi-annual reporting required in revision 1.
9. Added Construction Dewatering sampling, release criteria and release pathway to simplify removal of accumulated precipitation, surface run-off and ground water infiltration into subsurface structures where core samples, survey gridding and surveys need to be completed. Normally, with any licensed material identified in the volume, it would have to be pumped to a tank, processed and discharged as a batch tank release.

This approach provides considerable flexibility as the principal gamma emitter and H-3 levels anticipated in these basement structures. Presumes limited water processing capabilities in later stages of decommissioning.

10. Added equivalent dose modelling software permissible in addition to SEEDS as SEEDS can no longer be used in the absence of real time meteorological data. Alternates include NRC Dose Code, Open EMS, RETDAS. Any code utilizing the methodology of R.G. 1.109 is acceptable.
11. Added Open Air Demolition monitoring criteria for different stages. These are principally all ground level releases monitored at the source and require sampling at or near the source and assumptions on the plume of release, providing effluent like monitoring and calculation of off-site airborne dose.
12. Added LLDs for Gamma emitters, hard to detects (HTDs) and H-3 to LLD Tables for Construction Dewatering and Open Air Demolition.
13. Added Alternative method for monitoring H-3 stack releases (SFP evaporation) using make up water to the spent fuel pool.
14. REMP Sample Location Maps Recreated to conform with reduced sample locations, and symbols added to illustrate the sample media collected at each location.
15. Removed all AP and TLD REMP samples, except controls, beyond 3 miles from the site. Retained all remaining sample media as most are related to the newly added liquid effluent discharge pathway, with the SFP processing and discharge expected in 2021.
16. Reduced AP sampling frequency from weekly to bi-weekly with the removal of iodine canisters (weekly required for iodine with an 8 day T1/2). Reduces samples collected and analyzed to half, without a significant increase in filter dust loading. (NUREG 1302)
17. Synchronized all sample flow meters (liquid and gaseous) to a 24 month calibration surveillance frequency as the basis for doing this had been established by engineering, but the change was never incorporated into the ODCM.
18. Reduced drinking water and surface water sampling frequency from weekly and composited monthly, to monthly and composited quarterly. This is in line with frequencies at other decommissioning plants where the liquid effluent receiving water is not fresh water, and is not the drinking water supply. Surface water sampling at a seawater plant is only required when it is utilized for recreational activities (NUREG 1302).
19. Removed flow calibration surveillance for groundwater discharge pump. The system is set up as a temporary system versus a permanent installation and will only be utilized when GW well sample results warrant it. The ability to pump groundwater to the intake remains in the ODCM to be used on an as needed basis.

Item No.	(old) Rev. 9 page No.	(new) Rev. 10 page	Determination Identifier	Description of Change
1	1 - 137	1 - 118	A	Revise header to revision 10. Revise footer revision month and year date to 12/31/19.
2	2-7	2-7	A	Revisions to the TOC to reflect removal of Noble Gas and Iodine effluent releases from site, including dose factors, exposure pathways, and example calculations.

3	1-137	1-118	A	Editorial changes including spelling and grammatical errors for all pages identified individually. Editorial clean up from previous revisions eliminating extra spaces, adding spaces and hyphens where needed, table column line ups, improving consistency of equations and examples, bolding, capitalization, etc.
4	9,10	9,10	B	Identified the RAGEMS 1 noble gas low range monitor as removed from service as noble gas, if released, is too low to detect in definition 1.16. Added a Construction Dewatering Definition/description. Definition 1.6-5 to maintain numbering.
5	12	11,12	B	Identified RAGEMS removed from service as noble gases other than potential trace levels below the Monitor LLD are possible.
6	13	12	B	Added other comparable computer codes, other than SEEDs, to calculate off site dose that utilize the methodology of R.G. 1.109. Added Open Air Demolition Monitoring Definition/description. Definition 1.15-5 to maintain numbering sequence.
7	19	19	B	Deleted Ground Water discharge pump flow monitor calibration surveillance. As results have been <LLD since decommissioning started, pumping to the intake will only be restored if sample results indicate remediation is necessary. If groundwater results indicate remediation is necessary, a calibrated pump will be used for the period needed to remediate, but as it will no longer be a permanent installation, recalibration is not required. Changed Reactor Building Service Water (RBSW) radiation monitor calibration surveillance from 18 months to 24 months to bring it in line with the overboard discharge flow monitor calibration post permanent shutdown and post permanent defueling.
8	22	22	B	Updated Table 3.3.3.11-1 to reflect the removal of RAGEMS low range noble gas monitor from service. Basis for removal is insignificant off site impact from DBA – see reference 36. Effluent and Sample flow instrumentation are the only remaining instrumentation gaseous surveillances that remain.
9	23	23	B	Removed Action 124 from Table notation with RAGEMS 1 low range noble gas monitor removed from Service.
10	24	24	B	Removed RAGEMS low range noble gas monitor and Iodine Sampler Surveillances from Table 4.3.3.11-1. Extended flow sample measuring device calibration frequency to 24 months in alignment with stack flow monitor and in accordance with Engineering's technical evaluation document recommending extending this surveillance to 24 months from 18.
11	25	25	B	Removed Table 4.33.11-1 notations pertaining to RAGEMS 1 low range noble gas monitor and Iodine Sampler.
12	26	26	B	Updated Control 3.11.1.1 to reflect removal of entrained noble gases.
13	27	27,28	B	Removed entrained noble gas LLD, added LLDs for Gamma emitters, HTDs and H-3 for Construction Dewatering – added to the Table 4.11.1.1.1-11. Removed Iodine -131
14	28	30	B	Added Table notation h. for alternate use of composite sampler in lieu of shiftly grab sample for continuous Construction Dewatering.
15	32	33	B	Removed control for noble gas and iodine dose limits. Removed associated surveillances for control 3.11.2.1. For dose due to gaseous effluents, added alternative method to sample and quantify tritium releases and associated off site dose. Same for Surveillance. Added description to surveillance 4.11.2.1.1 for gaseous tritium.

16	33	34,35	B	Removed monthly noble gas grab sample and weekly iodine charcoal sample collection, and continuous monitoring for noble gas from Table 4.11.2.1.2-1, and added Open Air Demolition requirements to same table.
17	35	37	B	Modified notation b., Removed Noble Gas Table notations c., for Table 4.11.2.1.2-1, notation f.added alternative H-3 stack measurement methodology, and added notation I for Open Air Demolition.
18	36	37	B	Deleted Control 3.11.2.2 and Surveillance 4.11.2.2 for Noble Gas Dose Limits, as neither is in site gaseous effluent streams one year after permanent defueling. Removed reference to Noble gas and iodine from Control 3.11.2.3 and surveillance 4.11.2.3
18.5	37	38	B	Removed references to radioiodine in these control 3.11.2.3 and surveillance.
19	41-44	42- 46	B	Removed off site AP sampling of Iodine from Table 3.12.1-1 and from drinking water and milk and vegetation. Reduced outer ring from 5 miles to 3 miles.
20	47	48	B	Notation 1. Clarified Gaseous release point, elevated, and continued relevance once the stack is OOS post fuel transfer and pool processing and discharge with open air demolition releases at ground level. Deleted reference to radioiodine.
21	48	49	B	Removed reference to I-131 from notation 7 of Table 3.12.1-1
22	49	50	B	Removed Reporting Level for I-131 in table 3.12.1-2 and reference to it in column header. Removed notation **.
23	50,52	51, 53	B	Repeated same for LLD table 3.12.1-2, and notations. Corrected Ba-140 LLD set as 60 pCi/L in rev 9 to 15 pCi/L as specified in NUREG 1302.
24	55	56	B	Control 3.12.4 – Clarified use of 10 year meteorological averages and basis. Left option to revert to real time monitoring using site met tower in the event the strategy is reversed..
25	56,57	57,58,59	B	Liquid Effluents Concentration Bases – deleted reference to Noble gas and entrained noble gases. Also deleted reference to Circulation water as it no longer exists. Removed reference to Stack monitoring and replaced with Stack sampling. Added Bases and requirements for Construction Dewatering.
26	58,59	60	B	Added bases for alternative gaseous tritium monitoring. Deleted Bases for gaseous Noble Gas Dose. Deleted reference to iodine in Dose for gaseous Radionuclides.
27	64	65	B	Clarified required content of ARERR in terms of Met Data per RG 1.21 revision 2, and that the dose from the license terminated and decommissioned nuclear site did not need to include the residual dose left behind (<25 mrem/year) as decommissioned plant are not included in 40CFR 190's description of the uranium cycle. Revised reference R.G 1.21 revision 1, June 1974, to revision 2, June 2009 to be consistent with reference section in ODCM.
28	66-69	67-69	B	Deleted the need to include entrained noble gas and iodine in liquid effluent monitor set point determination. Updated equation for Liquid Effluent monitor set point with subscripts where needed.

29	75	71,73	B	Cleaned up shoreline dose equation for consistency. 2.0 Gaseous Effluents; deleted reference to RAGEMS low range noble gas monitor and Standby Gas Treatment as both are no longer in service.
30	76	73	B	Deleted all reference to Gaseous Effluent Monitor Set point Determination as noble gases are no longer released at detectable levels as a result of fission cessation, and any trace amounts released through a DBA would not be detected as the levels are too low. Removed all reference to Iodine and radioiodine. Left Example for calculating dose previously with iodine as example, but changed it to Ni-63, as the example can be used for other radionuclides. DELETED 2.2.1 Plant Vent (RBV) – no longer in service
30.5	83	74-76	B	Revised example 2.3.2.2 from an exposure to iodine 131 to Nickel 63. Expanded on acceptable off site dose calculation software.
31	84-87	77,80,81	B	Deleted section 2.4, Noble gas dose calculation examples Deleted Reference to Radioiodine.
32	104-109	89-90	B	Appendix A – Deleted Tables A-1, A-2, A-3 & A-5, and removed reference to noble gas in Table A-4.
33		90	B	deleted reference to Iodine in Table A=4
34	117	97	B	Revised reference R.G 1.21 revision 1, June 1974, to revision 2, June 2009. Updated references listed as just Reg Guide to full reference with title and issue date.
35	118	100	B	Added 2 references – 10 year met averaged data white paper and DBA calculation for one year post S/D conditions.
36	127-132	109-114	B	Appendix E, REMP Sample type and Location. All TLDs and Air samplers beyond 3 miles from site were eliminated except for controls. All other food pathways were retained as the majority were related to the liquid effluent pathway reintroduced in Revision 9. All sampling of iodine was removed. Particulate AP sampling extended to bi-weekly from weekly with cancellation of Iodine sampling, Revised surface and drinking water sampling from weekly with monthly compositing to monthly sampling with quarterly compositing which is more in line with other decommissioning plants, and permissible as the site is not a fresh water plant, nor is the receiving water for liquid effluents the drinking water supply for residents within 3 miles (NUREG 1302)
37	134-136	115-117	B	Figures E-1 to E-3 were redone to reflect the updated sample locations. Note – Figure E-3 had some issues when printed and needs to be re-added. Error occurred when word version was pdf's – will correct. Figure E-2 depicts collapsing of outer ring from 5 miles to 3 miles under 1 year post S/D decommissioning conditions.

OFFSITE DOSE CALCULATION MANUAL

FOR

OYSTER CREEK GENERATING STATION

Revision of this document requires SRC approval and changes are controlled by
CY-AA-170-3100

TABLE OF CONTENTS

INTRODUCTION

PART 1 - RADIOLOGICAL EFFLUENT CONTROLS

1.0 DEFINITIONS

3/4 CONTROLS AND SURVEILLANCE REQUIREMENTS

3/4.0 APPLICABILITY

3/4.3 INSTRUMENTATION

3/4.3.3.10 RADIOACTIVE LIQUID EFFLUENT MONITORING
INSTRUMENTATION

3/4.3.3.11 RADIOACTIVE GASEOUS EFFLUENT MONITORING
INSTRUMENTATION

3/4.11 RADIOACTIVE EFFLUENTS

3/4.11.1 LIQUID EFFLUENTS

3/4.11.1.1 CONCENTRATION

3/4.11.1.2 DOSE

3/4.11.1.3 LIQUID WASTE TREATMENT SYSTEM

3/4.11.2 GASEOUS EFFLUENTS

3/4.11.2.1 DOSE RATE

3/4.11.2.3 DOSE - TRITIUM, AND RADIONUCLIDES IN PARTICULATE
FORM

3/4.11.4 TOTAL DOSE

3/4.12 RADIOLOGICAL ENVIRONMENTAL MONITORING

3/4.12.1 MONITORING PROGRAM

3/4.12.2 LAND USE CENSUS

3/4.12.3 INTERLABORATORY COMPARISON PROGRAM

3/4.12.4 METEOROLOGICAL AVERAGES AND REAL TIME MONITORING
PROGRAM

BASES FOR SECTIONS 3.0 AND 4.0

3/4.3 INSTRUMENTATION

- 3/4.3.3.10 RADIOACTIVE LIQUID EFFLUENT MONITORING
INSTRUMENTATION
- 3/4.3.3.11 RADIOACTIVE GASEOUS EFFLUENT MONITORING
INSTRUMENTATION

3/4.11 RADIOACTIVE EFFLUENTS

- 3/4.11.1 LIQUID EFFLUENTS
 - 3/4.11.1.1 CONCENTRATION
 - 3/4.11.1.2 DOSE
 - 3/4.11.1.3 LIQUID RADWASTE TREATMENT
- 3/4.11.2 GASEOUS EFFLUENTS
 - 3/4.11.2.1 DOSE RATES
 - 3/4.11.2.3 DOSE - TRITIUM, AND RADIONUCLIDES IN PARTICULATE
FORM
- 3/4.11.4 TOTAL DOSE

3/4.12 RADIOLOGICAL ENVIRONMENTAL MONITORING

- 3/4.12.1 MONITORING PROGRAM
- 3/4.12.2 LAND USE CENSUS
- 3/4.12.3 INTERLABORATORY COMPARISON PROGRAM

5.0 DESIGN FEATURES / SITE MAP

6.0 ADMINISTRATIVE CONTROLS

- 6.1 ANNUAL RADIOLOGICAL ENVIRONMENTAL OPERATING
REPORT (AREOR)
- 6.2 ANNUAL RADIOACTIVE EFFLUENT RELEASE REPORT (ARERR)
- 6.3 RESPONSIBILITIES

PART II – CALCULATIONAL METHODOLOGIES

- 1.0 LIQUID EFFLEUNTS
- 1.1 RADIATION MONITORING INSTRUMENTATION AND CONTROLS
- 1.2 LIQUID EFFLUENT MONITOR SETPOINT DETERMINATION
 - 1.2.1 LIQUID EFFLUENT MONITORS
 - 1.2.2 SAMPLE RESULT SET POINTS
 - 1.2.3 ASSUMED DISTRIBUTION SET POINTS
- 1.3 BATCH RELEASES
- 1.4 CONTINUOUS RELEASES
- 1.5 LIQUID EFFLUENT DOSE CALCULATION – 10 CFR 50
 - 1.5.1 MEMBER OF THE PUBLIC DOSE – LIQUID EFFLUENTS
 - 1.5.2 SHORELINE DEPOSIT DOSE
 - 1.5.3 SHORELINE DOSE EXAMPLE 1
 - 1.5.3.1 SHORELINE DOSE EXAMPLE 2
 - 1.5.4 INGESTION DOSE – LIQUID
 - 1.5.5 INGESTION DOSE CALCULATION EXAMPLE 1
 - 1.5.5.1 INGESTION DOSE CALCULATION EXAMPLE 2
 - 1.5.6 PROJECTED DOSE – LIQUID
- 1.6 REPRESENTATIVE SAMPLES
- 2.0 GASEOUS EFFLUENTS
- 2.1 RADIATION MONITORING INSTRUMENTATION AND CONTROLS
- 2.2. GASEOUS EFFLUENT MONITOR SET POINT DETERMINATION
 - 2.2.1 PLANT VENT
 - 2.2.2 OTHER RELEASE POINTS
 - 2.2.3 RADIONUCLIDE MIX FOR SET POINTS
- 2.3 GASEOUS EFFLUENT INSTANTANEOUS DOSE RATE CALCULATIONS 10 CFR 20
 - 2.3.1 DELETED
 - 2.3.2 SITE BOUNDARY DOSE RATE – PARTICULATES
 - 2.3.2.1 METHOD – SITE BOUNDARY DOSE RATE – PARTICULATES
 - 2.3.2.2 EXAMPLE PARTICULATES DOSE RATE CALCULATION
- 2.4 DELETED

2.4 PARTICULATE AND OTHER RADIONUCLIDES DOSE CALCULATIONS –
10 CFR 50

- 2.5.1 INHALATION OF TRITIUM, PARTICULATES, AND OTHER RADIONUCLIDES
- 2.5.2 EXAMPLE CALCULATION - INHALATION OF TRITIUM, PARTICULATES, AND OTHER RADIONUCLIDES
- 2.5.3 INGESTION OF PARTICULATES AND OTHER RADIONUCLIDES
- 2.5.3.1 CONCENTRATION OF THE RADIONUCLIDE IN ANIMAL FORAGE AND VEGETATION – OTHER THAN TRITIUM
- 2.5.3.2 EXAMPLE CALCULATION OF CONCENTRATION OF THE RADIONUCLIDE IN ANIMAL FORAGE AND VEGETATION – OTHER THAN TRITIUM
- 2.5.3.3 CONCENTRATION OF TRITIUM IN ANIMAL FORAGE AND VEGETATION
- 2.5.3.4 EXAMPLE CALCULATION OF CONCENTRATION OF TRITIUM IN ANIMAL FORAGE AND VEGETATION
- 2.5.3.5 CONCENTRATION OF THE RADIONUCLIDE IN MILK AND MEAT
- 2.5.3.6 EXAMPLE CALCULATION OF CONCENTRATION OF THE RADIONUCLIDE IN MILK AND MEAT
- 2.5.3.7 DOSE FROM CONSUMPTION OF MILK, MEAT, AND VEGETABLES
- 2.5.3.8 EXAMPLE CALCULATION – DOSE FROM CONSUMPTION OF MILK, MEAT, AND VEGETABLES

- 2.5.4 GROUND PLANE DEPOSITION IRRADIATION
- 2.5.4.1 GROUND PLANE CONCENTRATION
- 2.5.4.2 EXAMPLE GROUND PLANE CONCENTRATION CALCULATION
- 2.5.4.3 GROUND PLANE DOSE
- 2.5.4.4 EXAMPLE GROUND PLANE DOSE

2.6 PROJECTED DOSES - GASEOUS

3.0 TOTAL DOSE TO MEMBERS OF THE PUBLIC – 40 CFR 190

- 3.1 EFFLUENT DOSE CALCULATIONS
- 3.2 DIRECT EXPOSURE DOSE DETERMINATION

4.0 RADIOLOGICAL ENVIRONMENTAL MONITORING PROGRAM

APPENDIX A – LOCATIONS ASSOCIATED WITH MAXIMUM EXPOSURE OF A MEMBER OF THE PUBLIC

- Table A-1: DELETED
- Table A-2: DELETED
- Table A-3: DELETED
- Table A-4: Locations Associated with Maximum Exposure of a Member of The Public
- Table A-5: DELETED

APPENDIX B – MODELING PARAMETERS

- Table B-1: OCGS Usage Factors for Individual Dose Assessment
- Table B-2: Monthly Average Absolute Humidity g/m³

APPENDIX C – REFERENCES

- Table C-1: REFERENCES

APPENDIX D – SYSTEM DRAWINGS

- Figure D-1-1a: Liquid Radwaste Treatment Chem Waste and Floor Drain System
- Figure D-1-1b: Liquid Radwaste Treatment – High Purity and Equipment Drain System
- Figure D-1-1c: Groundwater Release System
- Figure D-1-1d: Overboard Discharge
- Figure D-1-2: Solid Radwaste Processing System
- Figure D-2-2: Ventilation System

APPENDIX E – RADIOLOGICAL ENVIRONMENTAL MONITORING PROGRAM – SAMPLE
TYPE AND LOCATION

Table E-1:	REMP Sample Locations
Figure E-1:	Oyster Creek Generating Station REMP Sample Locations within a 1 Mile Radius
Figure E-2:	Oyster Creek Generating Station REMP Sample Locations within a 1 to 3 Mile Radius
Figure E-3:	Oyster Creek Generating Station REMP Sample Locations Out to a 25 Mile Radius
Figure E-4:	Area Plot Plan of Site

OYSTER CREEK GENERATING STATION OFFSITE DOSE CALCULATION MANUAL

INTRODUCTION

The Oyster Creek Offsite Dose Calculation Manual (ODCM) is an implementing document to the Oyster Creek Technical Specifications. The previous Limiting Conditions for Operations that were contained in the Radiological Effluent Technical Specifications (RETS) are now included in the ODCM as Radiological Effluent Controls (REC). The ODCM contains two parts: Part I – Radiological Effluent Controls, and Part II – Calculational Methodologies.

Part I includes the following:

- The Radiological Effluent Controls and the Radiological Environmental Monitoring Programs required by Technical Specification 6.8.4.
- Descriptions of the information that should be included in the Annual Radioactive Effluent Release Report and the Annual Radiological Environmental Operating Report required by Technical Specifications 6.9.1.a and 6.9.1.b, respectively.

Part II describes methodologies and parameters used for:

- The calculation of radioactive liquid effluent monitoring instrumentation alarm/trip set points; and
- The calculation of radioactive liquid and gaseous concentrations, dose rates, cumulative yearly doses, and projected doses.

Part II also contains a list and graphical description of the specific sample locations for the radiological environmental monitoring program (REMP), and the liquid and gaseous waste treatment systems and discharge points.

PART I - RADIOLOGICAL EFFLUENT CONTROLS

1.0 DEFINITIONS

The following terms are defined so that uniform interpretation of these CONTROLS may be achieved. The defined terms appear in capitalized type and are applicable throughout these CONTROLS.

1.1 OPERABLE – OPERABILITY

A system, subsystem, train, component or device shall be OPERABLE or have OPERABILITY when it can perform its specified function(s). Implicit in the definition shall be the assumption that all necessary attendant instrumentation, controls, normal and emergency electrical power sources, cooling or seal water, lubrication or other auxiliary equipment that are required for the system, subsystem, train, component or device to perform its function(s) are also capable of performing their related support function(s).

A verification of OPERABILITY is an administrative check, by examination of appropriate plant records (logs, surveillance test records) to determine that a system, subsystem, train, component or device is not inoperable. Such verification does not preclude the demonstration (testing) of a given system, subsystem, train, component or device to determine OPERABILITY.

1.2 ACTION

ACTION shall be that part of a CONTROL that prescribes remedial measures required under designated conditions.

1.3 CHANNEL CALIBRATION

A CHANNEL CALIBRATION shall be the adjustment, as necessary, of the channel output such that it responds, with acceptable range and accuracy, to known values of the parameter that the channel monitors. The CHANNEL CALIBRATION shall encompass the entire channel, including equipment actuation alarm, or trip.

1.4 CHANNEL CHECK

A CHANNEL CHECK shall be a qualitative determination of acceptable operability by observation of channel behavior during operation. This determination shall include, where possible, comparison of the channel with other independent channels measuring the same variable.

1.5 CHANNEL FUNCTIONAL TEST

CHANNEL FUNCTIONAL TEST shall be the injection of a simulated signal into the channel to verify its proper response including, where applicable, alarm and/or trip initiating actions.

1.6 CONTROL

The Limiting Conditions for Operation (LCOs) that were contained in the Radiological Effluent Technical Specifications were transferred to the OFFSITE DOSE CALCULATION MANUAL (ODCM) and were renamed CONTROLS. This is to distinguish between those LCOs that were retained in the Technical Specifications and those LCOs or CONTROLS that were transferred to the ODCM.

1.6-5 CONSTRUCTION DEWATERING

The evacuation of accumulated precipitation, surface water runoff and groundwater infiltration from subsurface basement structures directly to receiving waters or tanks for treatment and discharge. This process supports collection of core samples, survey gridding, performance of radiation surveys and other demolition and decommissioning activities. With low to no detectable levels of radionuclide concentrations expected (typically leached from the concrete and metal surfaces in subsurface structures) this water can be discharged directly to the intake, 30-inch header or within the vicinity of the service water discharge to preserve liquid effluent dose modelling assumptions. In all cases, a liquid discharge permit must be completed in accordance with station procedures, the requirements of Control 3.11.1.1 and the station's NJDES permit. The pathway is nearly identical to that for direct discharge of well groundwater, except for the source location (building structure basements versus remediation wells) and flexibility in selecting discharge locations (intake, 30-inch header, or within the vicinity of the Service Water Discharge point) to the extent these do not challenge liquid effluent discharge off site dose calculation assumptions.

1.7 FREQUENCY NOTATION

The FREQUENCY NOTATION specified for the performance of Surveillance Requirements shall correspond to the intervals defined in Table 1.1.

1.8 SOURCE CHECK

SOURCE CHECK shall be the qualitative assessment of channel response when the channel sensor is exposed to a source of increased radioactivity.

1.9 OFFSITE DOSE CALCULATION MANUAL (ODCM)

The OFFSITE DOSE CALCULATION MANUAL (ODCM) shall contain the methodology and parameters used in the calculation of offsite doses due to

radioactive gaseous and liquid effluents, in the calculation of liquid effluent monitoring Alarm/Trip Set points, and in the conduct of the Radiological Environmental Monitoring Program. The ODCM shall also contain (1) the Radioactive Effluent Controls and Radiological Environmental Monitoring Programs required by Technical Specification Section 6.8.4 and (2) descriptions of the information that should be included in the Annual Radioactive Effluent Release Report (ARERR) and Annual Radiological Environmental Operating Report (AREOR) required by Technical Specification Sections 6.9.1.a and 6.9.1.b, respectively.

1.10 DOSE CONVERSION FACTOR (DCF)

The direct removal of gaseous and particulate species on land or water surfaces. DEPOSITION is expressed as a quantity of material per unit area (e.g. m^{-2}).

1.11 DOSE CONVERSION FACTOR (DCF)

A parameter calculated by the methods of internal dosimetry, which indicates the committed dose equivalent (to the whole body or organ) per unit activity inhaled or ingested. This parameter is specific to the isotope and the dose pathway. DOSE CONVERSION FACTORS are commonly tabulated in units of mrem/hr per picocurie/ m^3 in air or water. They can be found in Reg Guide 1.109 appendices.

1.12 EFFLUENT CONCENTRATION (EC)

The liquid and air concentration levels which, if inhaled or ingested continuously over the course of a year, would produce a total effective dose equivalent of 0.05 rem. LEC refers to LIQUID EFFLUENT CONCENTRATION.

1.13 ELEVATED RELEASE (STACK)

An airborne effluent plume whose release point is higher than twice the height of the nearest adjacent solid structure and well above any building wake effects to be essentially unentrained. Regulatory Guide 1.111 is the basis of the definition of an ELEVATED RELEASE. Elevated releases generally will not produce any significant ground level concentrations within the first few hundred yards of the source. ELEVATED RELEASES generally have less dose consequence to the public due to the greater dispersion of the plume downwind and greater downwind distance to the ground concentration maximum compared to ground releases. All main stack releases at the OCGS are ELEVATED RELEASES.

1.14 FINITE PLUME MODEL

Atmospheric dispersion and dose assessment model which is based on the assumption that the horizontal and vertical dimensions of an effluent plume are not necessarily large compared to the distance that gamma rays can travel in air. It is more realistic than the semi-infinite plume model because it considers the finite dimensions of the plume, the radiation build-up factor, and the air

attenuation of the gamma rays coming from the cloud. This model can estimate the dose to a receptor who is not submerged in the radioactive cloud. It is particularly useful in evaluating doses from an elevated plume or when the receptor is near the effluent source.

1.15 GROUND LEVEL RELEASE

An airborne effluent plume which contacts the ground essentially at the point of release either from a source located at ground elevation or from a source well above the ground elevation which has significant building wake effects to cause the plume to be entrained in the wake and driven to the ground elevation. GROUND LEVEL RELEASES are treated differently than ELEVATED RELEASES in that the X/Q calculation results in significantly higher concentrations at the ground elevation near the release point.

1.15-5 OPEN AIR DEMOLITION EFFLUENT MONITORING

Open Air Demolition Monitoring is the particulate sampling of concrete and demolition dust leaving structures undergoing demolition activities at exit points and openings in structures (overhead doors, personnel floors, equipment hatches, etc.). The sampler is positioned at the opening and run continuously while work is performed. To quantify plant related activity in effluents leaving the openings, exit air velocity out of the structure is quantified daily/shiftly (handheld anemometer, e.g.) is used with the opening dimensions to calculate the effluent concentration and rate of release to project off site dose assuming a ground level release. These are established at each opening of structure undergoing internal demolition and component removal with known levels of radioactivity present and fixed/loose contamination. The same method is used to quantify effluents generated from the demolition of structures and walls and moving debris piles by positioning the REMP like air particulate samplers in the vicinity of the activity.

1.16 RAGEMS (RADIATION GAS EMISSIONS MONITORING SYSTEM)

A plant system that monitors gaseous effluent releases from monitored points. The RAGEMS system for the main stack (RAGEMS I) monitored noble gas (no longer produced with the cessation of fission reactions) during routine operations. RAGEMS noble gas low range monitor has been removed from service as it will no longer respond to trace levels of residual noble gas trapped in the gaps of fuel elements.

1.17 SEMI-INFINITE PLUME MODEL

Dose assessment model with the following assumptions. The ground is considered to be an infinitely large flat plate and the receptor is located at the origin of a hemispherical cloud of infinite radius. The radioactive cloud is limited to the space above the ground plane. The semi-infinite plume model is limited to immersion dose calculations.

1.18 SOURCE TERM

The activity release rate, or concentration of an actual release or potential release. The common units for the source term are curies, curies per second, and curies per cubic centimeter, or multiples thereof (e.g., micro curies).

1.19 X/Q - ("CHI over Q")

The dispersion factor of a gaseous release in the environment calculated by a point source Gaussian dispersion model. Normal units of X/Q are sec/m³. The X/Q is used to determine environmental atmospheric concentrations by multiplying the source term, represented by Q (in units of μCi/sec or Ci/sec). Thus, the plume dispersion, X/Q (seconds/cubic meter) multiplied by the source term, Q (μCi/seconds) yields an environmental concentration, X (μCi/m³). X/Q is a function of many parameters including wind speed, stability class, release point height, building size, and release velocity.

1.20 SEEDS (Simplified Effluent Environmental Dosimetry System)

A routine effluent dosimetry computer program that uses Regulatory Guides 1.109 and 1.111 methodologies. Equivalent codes, that utilize the same methodologies are acceptable alternatives, e.g., NRC Dose Code for Windows, RETDAS or Open EMS.

TABLE 1.1: SURVEILLANCE FREQUENCY NOTATION *

<u>NOTATION</u>	<u>FREQUENCY</u>
S	At least once per 12 hours.
D	At least once per 24 hours.
3X	At least 3 times per 7 days
W	At least once per 7 days.
M	At least once per 31 days.
Q	At least once per 92 days.
SA	At least once per 184 days.
A	At least once per 366 days.
18m	At least once per 18 months (550 days).
24m	At least once per 24 months (733 days).
P	Prior to each radioactive release.
N.A.	Not applicable.

* Each surveillance requirement shall be performed within the specified time interval with a maximum allowable extension not to exceed 25% of the surveillance interval.

3/4 CONTROLS AND SURVEILLANCE REQUIREMENTS

3/4.0 APPLICABILITY

CONTROLS

- 3.0.1 Compliance with the CONTROLS contained in the succeeding CONTROLS is required during the OPERATIONAL CONDITIONS or other conditions specified therein; except that upon failure to meet the CONTROL, the associated ACTION requirements shall be met.
- 3.0.2 Noncompliance with a CONTROL shall exist when the requirements of the CONTROL and associated ACTION requirements are not met within the specified time intervals. If the CONTROL is restored prior to expiration of the specified time intervals, completion of the ACTION requirements is not required.
- 3.0.4 Entry into an OPERATIONAL CONDITION or other specified condition may be made in accordance with ACTION requirements when conformance to them permits continued operation of the facility for an unlimited period of time. This provision shall not prevent passage through or to OPERATIONAL CONDITIONS as required to comply with ACTION requirements. Exceptions to these requirements are stated in the individual CONTROLS.
- 3.0.5 Equipment removed from service or declared inoperable to comply with ACTIONS may be returned to service under administrative control solely to perform testing to demonstrate its OPERABILITY or the OPERABILITY of other equipment. This is an exception to CONTROL 3.0.2 for the system returned to service under administrative control to perform the testing required to demonstrate OPERABILITY.

3 /4.0 APPLICABILITY

SURVEILLANCE REQUIREMENTS

- 4.0.1 Surveillance Requirements shall be met during the OPERATIONAL CONDITIONS or other conditions specified for individual CONTROLS unless otherwise stated in an individual Surveillance Requirement.
- 4.0.2 Each Surveillance Requirement shall be performed within the specified surveillance interval with a maximum allowable extension not to exceed 25 percent of the specified surveillance interval.
- 4.0.3 Failure to perform a Surveillance Requirement within the allowed surveillance interval, defined by CONTROL 4.0.2, shall constitute a failure to meet the OPERABILITY requirements for a CONTROL. The time limits of the ACTION requirements are applicable at the time it is identified that a Surveillance Requirement has not been performed. The ACTION requirements may be delayed for up to 24 hours to permit the completion of the surveillance when the allowed outage time limits of the ACTION requirements are less than 24 hours. Surveillance Requirements do not have to be performed on inoperable equipment.
- 4.0.4 Entry into an OPERATIONAL CONDITION or other specified applicable condition shall not be made unless the Surveillance Requirement(s) associated with the CONTROLS have been performed within the applicable surveillance interval or as otherwise specified. This provision shall not prevent passage through or to OPERATIONAL CONDITIONS as required to comply with ACTION requirements.

3/4.3 INSTRUMENTATION

3/4.3.3.10 RADIOACTIVE LIQUID EFFLUENT MONITORING INSTRUMENTATION

CONTROLS

3.3.3.10 In accordance with Oyster Creek Technical Specifications 6.8.4.a.1, the radioactive liquid effluent monitoring instrumentation channels shown in Table 3.3.3.10-1 shall be OPERABLE that required Alarm/Trip points are set to ensure that the limits of CONTROL 3.11.1.1 are not exceeded. The Alarm/Trip set points of these channels shall be determined and adjusted in accordance with the methodology and parameters in the ODCM Part II section 1.2.1.

APPLICABILITY: During all liquid releases via these pathways.

ACTION:

- a. With a radioactive liquid effluent monitoring instrumentation channel Alarm/Trip set point less conservative than required by the above CONTROL, immediately suspend the release of radioactive liquid effluents monitored by the affected channel, or declare the channel inoperable, or change the set point so it is acceptably conservative or provide for manual initiation of the Alarm/Trip function(s).
- b. With less than the minimum number of radioactive liquid effluent monitoring instrumentation channels OPERABLE, take the ACTION shown in Table 3.3.3.10-1. Make every reasonable effort to return the instrument to OPERABLE status within 30 days and, if unsuccessful, explain in the next Radioactive Effluent Release Report pursuant to Technical Specification 6.9.1.a why the inoperability was not corrected in a timely manner.
- c. The provisions of CONTROL 3.0.4 are not applicable. Report all deviations in the Radioactive Effluent Release Report.

SURVEILLANCE REQUIREMENTS

4.3.3.10 Each radioactive liquid effluent monitoring instrumentation channel shall be demonstrated OPERABLE by performance of the CHANNEL CHECK, SOURCE CHECK, CHANNEL CALIBRATION, and CHANNEL FUNCTIONAL TEST at the Frequencies shown in Table 4.3.3.10-1.

TABLE 3.3.3.10-1: RADIOACTIVE LIQUID EFFLUENT MONITORING INSTRUMENTATION

INSTRUMENT	MINIMUM CHANNELS OPERABLE	ACTION
1. RADIOACTIVITY MONITORS PROVIDING ALARM BUT NOT PROVIDING AUTOMATIC TERMINATION OF RELEASE		
a. Reactor Building Service Water System Effluent Line	1	112
2. FLOW RATE MEASUREMENT DEVICES		
b. Overboard Discharge	1	115

TABLE 3.3.3.10-1 (Continued)

TABLE NOTATIONS

- ACTION 112 With no channels OPERABLE, effluent releases via this pathway may continue provided that, at least once per 24 hours, grab samples are collected and analyzed for radioactivity at a limit of detection specified by Table 4.11.1.1.1-1.
- ACTION 115 With no channel OPERABLE, effluent releases via this pathway may continue provided the flow rate is estimated at least once per 4 hours during actual releases. Pump performance curves may be used to estimate flow. Secure effluent release via this pathway when flow rate cannot be estimated in the specified time.

TABLE 4.3.3.10-1: RADIOACTIVE LIQUID EFFLUENT MONITORING INSTRUMENTATION SURVEILLANCE REQUIREMENTS^a

<u>INSTRUMENT</u>	<u>CHANNEL CHECK</u>	<u>SOURCE CHECK</u>	<u>CHANNEL CALIBRATION</u>	<u>CHANNEL FUNCTIONAL TEST</u>
1. RADIOACTIVITY MONITORS PROVIDING ALARM BUT NOT PROVIDING AUTOMATIC TERMINATION OF RELEASE				
a. Reactor Building Service Water System Effluent Line	D	M	24m ^e	Q ^d
2. FLOW RATE MEASUREMENT DEVICES				
b. Overboard Discharge	D ^{f,g}	N/A	24m ^f	N/A

TABLE 4.3.3.10-1 (Continued)

TABLE NOTATIONS

- a. Instrumentation shall be OPERABLE and in service except that a channel may be taken out of service for the purpose of a check, calibration, test or maintenance without declaring it to be inoperable.

- d. The **CHANNEL FUNCTIONAL TEST** shall also demonstrate that Control Room alarm annunciation occurs if any of the following conditions exists:
 - 1. Instrument indicates measured levels above the alarm set point.
 - 2. Instrument indicates a downscale failure.
 - 3. Instrument controls not set in operate mode.
 - 4. Instrument electrical power loss.

- e. The **CHANNEL CALIBRATION** shall be performed according to established calibration procedures.

- f. While actively discharging through this pathway.

- g. CHANNEL CHECK shall consist of verifying indication of flow during periods of release. CHANNEL CHECK shall be made at least once per 24 hours on days on which batch releases are made.

3/4.3 INSTRUMENTATION

3/4.3.3.11 RADIOACTIVE GASEOUS EFFLUENT MONITORING INSTRUMENTATION

CONTROLS

3.3.3.11 DELETED

APPLICABILITY: DELETED

ACTION:

- a. DELETED.
- b. With less than the minimum number of radioactive gaseous effluent sampling flow instrumentation channels OPERABLE, take the ACTION shown in Table 3.3.3.11-1. Exert best efforts to return the instrument to OPERABLE status within 30 days and, if unsuccessful, explain in the next Radioactive Effluent Release Report pursuant to Technical Specification 6.9.1.a why this inoperability was not corrected in a timely manner.
- c. The provisions of CONTROLS 3.0.4 are not applicable. Report all deviations in the Radioactive Effluent Release Report.

SURVEILLANCE REQUIREMENTS

4.3.3.11 Each radioactive gaseous effluent flow instrumentation channel shall be demonstrated OPERABLE by performance of the CHANNEL CHECK, CHANNEL CALIBRATION, and CHANNEL FUNCTIONAL TEST operations at the frequencies shown in Table 4.3.3.11-1.

TABLE 3.3.3.11-1: RADIOACTIVE GASEOUS EFFLUENT MONITORING INSTRUMENTATION

INSTRUMENT	MINIMUM CHANNELS OPERABLE ^a	APPLICABILITY	ACTION
2. STACK MONITORING SYSTEM			
c. Particulate Sampler	1	b	127
d. Effluent Flow Measuring Device	1	b	122
e. Sample Flow Measuring Device	1	b	128

TABLE 3.3.3.11-1 (Continued)

TABLE NOTATIONS

- a. Channels shall be OPERABLE and in service as indicated except that a channel may be taken out of service for a check, calibration, test maintenance or sample media change without declaring the channel to be inoperable.
 - b. During releases via this pathway
- ACTION 122 With no channel OPERABLE, effluent releases via this pathway may continue provided the flow rate is estimated whenever the exhaust fan combination in this system is changed.
- ACTION 127 With no channel OPERABLE, effluent releases via this pathway may continue provided the required sampling is initiated with auxiliary sampling equipment as soon as reasonable after discovery of inoperable primary sampler(s).
- ACTION 128 With no channel OPERABLE, effluent releases via the sampled pathway may continue provided the sampler air flow is estimated and recorded at least once per day.

TABLE 4.3.3.11-1: RADIOACTIVE GASEOUS EFFLUENT MONITORING INSTRUMENTATION SURVEILLANCE REQUIREMENTS

<u>INSTRUMENT</u>	<u>CHANNEL CHECK</u>	<u>SOURCE CHECK</u>	<u>CHANNEL CALIBRATION</u>	<u>CHANNEL FUNCTIONAL TEST</u>	<u>MODES IN WHICH SURVEILLANCE REQUIRED^a</u>
2. MAIN STACK MONITORING SYSTEM					
c. Particulate Sampler	W	N.A.	N.A.	N.A.	b
d. Effluent Flow Measuring Device	3X	N.A.	24m	Q	b
e. Sample Flow Measuring Device	3X	N.A.	24m	Q	b

TABLE 4.3.3.11-1 (Continued)

TABLE NOTATIONS

- a. Instrumentation shall be OPERABLE and in service except that a channel may be taken out of service for a check calibration, test or maintenance without declaring it to be inoperable.
- b. During releases via this pathway.

3/4.11 RADIOACTIVE EFFLUENTS

3/4.11.1 LIQUID EFFLUENTS

3/4.11.1.1 CONCENTRATION

CONTROLS

3.11.1.1 In accordance with the Oyster Creek Technical Specifications 6.8.4.a.2 and 3, the concentration of radioactive material in liquid effluent in the discharge canal at the Route 9 bridge (See Figure E-4) shall not exceed the concentrations specified in 10 CFR Part 20, Appendix B, Table 2, Column 2.

APPLICABILITY: At all times.

ACTION:

- a. In the event the concentration of radioactive material in liquid effluent released into the offsite area beyond the Route 9 bridge exceeds either of the concentration limits above, reduce the release rate without delay to bring the concentration below the limit.
- b. The provisions of CONTROLS 3.0.4 are not applicable.

SURVEILLANCE REQUIREMENTS

4.11.1.1.1 Radioactive liquid wastes shall be sampled and analyzed according to the sampling and analysis program in Table 4.11.1.1.1-1.

Alternately, pre-release analysis of batches(es) of radioactive liquid waste may be by gross beta or gamma counting provided a maximum concentration limit of 1E-8 $\mu\text{Ci/ml}$ in the discharge canal at the Route 9 bridge is applied.

4.11.1.1.2 The results of the radioactivity analyses shall be used in accordance with the methodology and parameters in the ODCM Part II Section 1.2 to assure that the concentrations at the point of release are maintained within the limits of CONTROL 3.11.1.1 and 3.11.1.2.

4.11.1.1.3 The alarm or trip set point of each radioactivity monitoring channel in Table 3.3.3.10-1 shall be determined on the basis of sampling and analyses results obtained according to Table 4.11.1.1.1-1 and the set point method in ODCM Part II 1.2.1 and set to alarm or trip before exceeding the limits of CONTROL 3.11.1.1.

TABLE 4.11.1.1.1-1: RADIOACTIVE LIQUID WASTE SAMPLING AND ANALYSIS PROGRAM

Liquid Release Type	Sampling Frequency	Minimum Analysis Frequency	Type of Activity Analysis	Lower Limit Detection ^a (LLD) (μCi/ml)
1. Batch Waste Release Tanks	P Each Batch ^b	P ^c Each Batch	Principal Gamma Emitters	5E-07
			H-3	1E-05
	P Each Batch ^b	M Composite ^d	H-3	1E-05
			Gross Alpha	1E-07
			Sr-89, Sr-90	5E-08
			Fe-55, Ni-63	1E-06
1.1. Construction Dewatering Release Path a. Batch	Batch ^b	P ^c	Principal Gamma Emitters	5E-07
			H-3	1E-05
			Gross Alpha	1E-07
			Sr-89, Sr-90	5E-08
			Fe-55, Ni-63	1E-06
1.2. Construction Dewatering Release Path a. Continuous	Continuous	S ^{h,e}	Principal Gamma Emitters	5E-07
			H-3	1E-05
	Q	Q	Gross Alpha	1E-07
			Sr-89, Sr-90	5E-08
			Fe-55, Ni-63	1E-06

TABLE 4.11.1.1.1-1: RADIOACTIVE LIQUID WASTE SAMPLING AND ANALYSIS PROGRAM (Continued)

Liquid Release Type	Sampling Frequency	Minimum Analysis Frequency	Type of Activity Analysis	Lower Limit Detection ^a (LLD) ($\mu\text{Ci/ml}$)
2. Continuous Release a. Reactor Building Service Water Effluent	W Grab Sample ^e	W	Principal Gamma Emitters	5E-07
	(note f)	M Composite ^g	H-3	1E-05
			Gross Alpha	1E-07
3. Groundwater Release Path a. Continuous	Continuous	Q	Principal Gamma Emitters	5E-07
			H-3	1E-05
	Q	Q	Gross Alpha	1E-07
			Sr-89, Sr-90	5E-08
			Fe-55, Ni-63	1E-06
b. Batch Release Tank	P Each Batch ^b	P Each Batch	Principal Gamma Emitters	5E-07
			H-3	1E-05
	P Each Batch ^b	Q Composite ^d	Gross Alpha	1E-07
			Sr-89, Sr-90	5E-08
			Fe-55, Ni-63	1E-06

TABLE 4.11.1.1-1 (CONTINUED)

TABLE NOTATIONS

- a. The Lower Limit of Detection (LLD) is defined, for purposes of these specifications, as the smallest concentration of radioactive material in a sample that will yield a net count, above system background, that will be detected with 95 percent probability with only 5 percent probability of falsely concluding that a blank observation represents a “real” signal.

The LLD is applicable to the capability of a measurement system under typical conditions and not as a limit for the measurement of a particular sample in the radioactive liquid waste sampling and analyses program.

For a particular measurement system, which may include radiochemical separation:

$$LLD = \frac{4.66 * S_b}{E * V * 2.22E6 * Y * \exp(-\lambda\Delta t)}$$

Where:

LLD is the lower limit of detection as defined above (microcurie per unit mass or volume),

S_b is the standard deviation of the background counting rate or of the counting rate of a blank sample as appropriate (counts per minute),

E is the counting efficiency,

V is the sample size (units of mass or volume),

2.22E+6 is the number of disintegrations per minute per microcurie,

Y is the fractional radiochemical yield, when applicable,

λ is the radioactive decay constant for the particular radionuclide, and

Δt is the elapsed time between the end of the sample collection and the time of counting.

Analyses shall be performed in such a manner that the stated LLDs will be achieved under routine conditions with typical values of E, V, Y, and t for the radionuclides Mn-54, Fe-59, Co-58, Co-60, Zn-65, Mo-99, Ce-141, Cs-134, Cs-137; and an LLD of 5E-6 μ Ci/ml should typically be achieved for Ce-144.

TABLE 4.11.1.1.1-1 (CONTINUED)

TABLE NOTATIONS

Occasionally, background fluctuations, interfering radionuclides, or other uncontrollable circumstances may render these LLD's unachievable.

When calculating the LLD for a radionuclide determined by gamma ray spectrometry, the background may include the typical contributions of other radionuclides normally present in the sample. The background count rate of a semiconductor detector (e.g. HPGe) is determined from background counts that are determined to be within the full width of the specific energy band used for the quantitative analysis for the radionuclide.

The principal gamma emitters for which the LLD specification will apply are exclusively the following radionuclides: Mn-54, Fe-59, Co-58, Co-60, Zn-65, Mo-99, Cs-134, Cs-137, Ce-141, and Ce-144. This list does not mean that only these nuclides are to be detected and reported. Other peaks that are measurable and identifiable, together with the above nuclides, shall be identified and reported. The LLD for Ce-144 is $5E-6$ $\mu\text{Ci}/\text{mL}$ whereas the LLD for Mo-99 and the other gamma emitters is $5E-7$ $\mu\text{Ci}/\text{mL}$. Nuclides that are below the LLD for the analysis should not be reported.

- b. A batch release is the discharge of liquid wastes of a discrete volume. Before sampling for analysis, each batch should be thoroughly mixed.
- c. In the event a gross radioactivity analysis is performed in lieu of an isotopic analysis before a batch is discharged, a sample will be analyzed for principal gamma emitters afterwards.
- d. A composite sample is one in which the quantity of liquid sampled is proportional to the quantity of liquid waste discharged and in which the method of sampling employed results in a specimen which is representative of the liquids released.
- e. Analysis may be performed after release.
- f. In the event a grab sample contains more than $5E-7$ $\mu\text{Ci}/\text{mL}$ of principal gamma emitters or in the event the Reactor Building Service Water radioactivity monitor indicates more than $5E-7$ $\mu\text{Ci}/\text{mL}$ radioactivity in the effluent, as applicable, sample the elevated activity effluent daily until analysis confirms the activity concentration in the effluent does not exceed $5E-7$ $\mu\text{Ci}/\text{mL}$. In addition, a composite sample must be made up for further analysis for all samples taken when the activity was $> 5E-7$ $\mu\text{Ci}/\text{mL}$.
- g. A composite sample is produced combining grab samples, each having a defined volume, collected routinely from the sump or stream being sampled
- h. For Continuous Construction Dewatering, a composite sampler may be used in lieu of shiftly grab samples collected a frequency of once per shift when there is continuous groundwater, surface and/or precipitation infiltration to the subsurface structure requiring continuous discharge. For Continuous Discharges, the first set of three representative samples are collected and analyzed prior to initiating the discharge. Single shiftly samples after the first three are collected during each subsequent shift until the discharge is complete.

3/ 4.11 RADIOACTIVE EFFLUENTS

3/ 4.11.1.2 DOSE

CONTROLS

- 3.11.1.2 In accordance with Oyster Creek Technical Specifications 6.8.4.a.4 and 5, the dose or dose commitment to a member of the public from radioactive materials in liquid effluents released to unrestricted areas (see Figure E-4) shall be limited:
- a. During any calendar quarter to less than or equal to 1.5 mrem to the Total Body and to less than or equal to 5 mrem to any body organ, and
 - b. During any calendar year to less than or equal to 3 mrem to the Total Body and to less than or equal to 10 mrem to any body organ.

APPLICABILITY: At all times.

ACTION:

- a. With the calculated dose from the release of radioactive materials in liquid effluents exceeding any of the above limits, prepare and submit to the Commission within 30 days from the end of the quarter a report that identifies the cause(s) for exceeding the limit(s) and defines the corrective actions that have been taken and/or will be taken to reduce the releases and the proposed corrective actions to be taken to assure that subsequent releases will be in compliance with the above limits.
- b. The provisions of CONTROL 3.0.4 are not applicable.

SURVEILLANCE REQUIREMENTS

- 4.11.1.2 Cumulative dose contributions from liquid effluents for the current calendar quarter and the current calendar year shall be determined in accordance with the methodology and parameters in the ODCM Part II Section 1.5 at least once per 31 days in accordance with Technical Specification 6.8.4.a.5.

3/4.11 RADIOACTIVE EFFLUENTS

3/4.11.1.3 LIQUID WASTE TREATMENT SYSTEM

CONTROLS

3.11.1.3 In accordance with the Oyster Creek Technical Specifications 6.8.4.a.6, the liquid radwaste treatment system shall be OPERABLE and appropriate portions of the system shall be used to reduce releases of radioactivity when projected doses due to the liquid effluent to unrestricted areas (see Figure E-4) would exceed 0.06 mrem to the Total Body or 0.2 mrem to any organ in a 31 day period.

APPLICABILITY: At all times.

ACTION:

- a. With radioactive liquid waste being discharged without treatment and in excess of the above, prepare and submit to the Commission within 30 days a report that includes the following information:
 1. Explanation of why liquid radwaste was being discharged without treatment, identification of any inoperable equipment or subsystems, and the reason for the inoperability,
 2. Action(s) taken to restore the inoperable equipment to OPERABLE status, and
 3. Summary description of action(s) taken to prevent a recurrence.
- b. The provisions of CONTROL 3.0.4 are not applicable.

SURVEILLANCE REQUIREMENTS

- 4.11.1.3.1 Doses due to liquid releases to unrestricted areas shall be projected at least once per 31 days in accordance with the methodology and parameters in the ODCM Part II Section 1.5 in accordance with Technical Specifications 6.8.4.a.5.
- 4.11.1.3.2 The installed liquid radwaste treatment system shall be demonstrated OPERABLE by meeting CONTROLS 3.11.1.1, 3.11.1.2, and 3.11.1.3.

3/4.11 RADIOACTIVE EFFLUENTS

3/4.11.2 GASEOUS EFFLUENTS

3/4.11.2.1 DOSE RATE

CONTROLS

3.11.2.1 In accordance with the Oyster Creek Technical Specifications 6.8.4.a.5 and 7, the dose rate due to radioactive materials released in gaseous effluents in the unrestricted area (see Figure E-4) shall be limited to the following:

- b. For tritium, and for all radionuclides in particulate form with half-lives greater than 8 days: Less than or equal to 1500 mrem/yr to any body organ.

APPLICABILITY: At all times.

ACTION:

- a. With the dose rate(s) exceeding the above limits, immediately restore the release rate to within the above limit(s).

SURVEILLANCE REQUIREMENTS

4.11.2.1.2 The dose rate due to tritium, and all radionuclides in particulate form with half-lives greater than 8 days in gaseous effluents shall be determined to be within the above limits in accordance with the methodology and parameters in the ODCM Part II Section 2.3.2 by obtaining representative samples and performing analyses in accordance with the sampling and analysis program specified in Table 4.11.2.1.2-1. Note: Tritium is currently sampled by desiccant once per quarter and the total curies released and resulting concentration are projected from that single sample over the entire quarter. Alternatively, and where evaporation of spent fuel pool (SFP) water is currently the only source of gaseous tritium remaining on site, the total curies of tritium released via the main stack may be estimated using the tritium spent fuel pool concentration from the higher of the previous or current months' sample identified in the volume, assuming all make up volume for that month replaces the volume evaporated from the SFP.

4.11.2.1.3 Dose rates due to tritium, Sr-89, Sr-90, and alpha-emitting radionuclides are averaged over no more than 3 months and the dose rate due to other radionuclides is averaged no more than 31 days.

TABLE 4.11.2.1.2-1: RADIOACTIVE GASEOUS WASTE SAMPLING AND ANALYSIS PROGRAM

Gaseous Release Type	Sampling Frequency	Minimum Analysis Frequency	Type of Activity Analysis	Lower Limit Detection ^a (LLD) (μCi/ml)
1. Stack	Q Grab Sample ^{f,g}	Q	H-3	1E-06
	Continuous ^f	W Particulate Sample	Principal Gamma Emitters ^b (particulates)	1E-11
	Continuous ^f	M ^e Composite Particulate Sample	Gross Alpha	1E-11
	Continuous	Q ^e Composite Particulate Sample	Sr-89, Sr-90	1E-11
2. Open Air Demolition				
Releases from inside Structures	Continuous ^{f,i}	W ⁱ Particulate Sample	Principal Gamma Emitters ^b (particulates)	1E-11
	Continuous ^f	M ^e Composite Particulate Sample	Gross Alpha	1E-11
	Continuous	Q ^e Composite Particulate Sample	Sr-89, Sr-90	1E-11

TABLE 4.11.2.1.2-1: RADIOACTIVE GASEOUS WASTE SAMPLING AND ANALYSIS PROGRAM
(Continued)

Gaseous Release Type	Sampling Frequency	Minimum Analysis Frequency	Type of Activity Analysis	Lower Limit Detection ^a (LLD) (μCi/ml)
Open Air Demolition				
3. Outdoor Releases at Demolition Location and the Land Based Compass Points Outside the Protected Area	Continuous ^{f,i}	W ⁱ Particulate Sample	Principal Gamma Emitters ^b (particulates)	1E-11
	Continuous ^f	M ^e Composite Particulate Sample	Gross Alpha	1E-11
	Continuous	Q ^e Composite Particulate Sample	Sr-89, Sr-90	1E-11

TABLE 4.11.2.1.2-1 (Continued)

TABLE NOTATIONS

- a. The Lower Limit of Detection (LLD) is defined, for purposes of these specifications, as the smallest concentration of radioactive material in a sample that will yield a net count, above system background, that will be detected with 95 percent probability with only 5 percent probability of falsely concluding that a blank observation represents a "real" signal.

The LLD is applicable to the capability of a measurement system under typical conditions and not as a limit for the measurement of a particular sample in the radioactive liquid waste sampling and analyses program.

For a particular measurement system which may include radiochemical separation:

$$LLD = \frac{4.66 * S_b}{E * V * 2.22E6 * Y * \exp(-\lambda \Delta t)}$$

Where:

LLD is the lower limit of detection as defined above (microcurie per unit mass or volume),

S_b is the standard deviation of the background counting rate or of the counting rate of a blank sample as appropriate (counts per minute),

E is the counting efficiency,

V is the sample size (units of mass or volume),

2.22E+6 is the number of disintegrations per minute per microcurie,

Y is the fractional radiochemical yield, when applicable,

λ is the radioactive decay constant for the particular radionuclide, and

Δt is the elapsed time between the end of the sample collection and the time of counting.

Analyses shall be performed in such a manner that the stated LLD's will be achieved under routine conditions with typical values of E, V, Y, and t for the radionuclides Mn-54, Fe-59, Co-58, Co-60, Zn-65, Cs-134, Cs-137, and Ce-141. Occasionally background fluctuations or other uncontrollable circumstances may render these LLD's unachievable.

When calculating the LLD for a radionuclide determined by gamma ray spectrometry, the background may include the typical contributions of other radionuclides normally present in the samples. The background count rate of a HPGe detector is determined from background counts that are determined to be within the full width of the specific energy band used for the quantitative analysis for that radionuclide

TABLE 4.11.2.1.2-1 (Continued)

TABLE NOTATIONS

- b. The principal gamma emitters for which the LLD specification applies exclusively are the following radionuclides: Mn-54, Fe-59, Co-58, Co-60, Zn-65, Mo-99, Cs-134, Cs-137, Ce-141, and Ce-144 for particulate emissions. This list does not mean that only these nuclides are to be considered. Other gamma peaks that are identifiable, together with those of the above nuclides, shall also be analyzed and reported in the Annual Radioactive Effluent Release Report consistent with CONTROL 3.11.2.1. The LLD for Mo-99 and Ce-144 is $1\text{E}-10$ $\mu\text{Ci/ml}$ whereas the LLD for other principal gamma emitting particulates is $1\text{E}-11$ $\mu\text{Ci/ml}$. Radionuclides which are below the LLD for the analysis should not be reported.
- e. A composite particulate sample shall include an equal fraction of at least one particulate sample collected during each week of the compositing period.
- f. In the event a sample is collected for 24 hours or less, the LLD may be increased by a factor of 10.
- g. Tritium is currently sampled by desiccant once per quarter and the total curies released and resulting concentration are projected from that single sample over the entire quarter to calculate off site dose. Alternatively, and where evaporation of spent fuel pool (SFP) water is currently the only source of gaseous tritium remaining on site, the total curies of tritium released via the main stack may be estimated using the tritium spent fuel pool concentration from the higher of the previous or current months' sample assuming all make up volume for that month replaces the volume evaporated from the SFP.
- i. In the event dust loading on the filter is excessive in Open Air Demolition, filter changeout may need to be increased to daily or shiftly. Open Air Demolition is in effect after the Main Stack is removed from service. Sampling would be accomplished using samplers equivalent in flow and operation to those used for offsite REMP sampling.

3/4.11 RADIOACTIVE EFFLUENTS

3/4.11 RADIOACTIVE EFFLUENTS

3/4.11.2.3 DOSE - TRITIUM, AND RADIONUCLIDES IN PARTICULATE FORM

CONTROLS

3.11.2.3 In accordance with Oyster Creek Technical Specification 6.8.4.a.5 and 9, the dose to a member of the public from tritium, and all radionuclides in particulate form with half-lives greater than 8 days in gaseous effluents released in the unrestricted area (see Figure E-4) shall be limited to the following:

- a. During any calendar quarter: Less than or equal to 7.5 mrem to any body organ and,
- b. During any calendar year: Less than or equal to 15 mrem to any body organ.

APPLICABILITY: At all times.

ACTION:

- a. With the calculated dose from the release of radionuclides in particulate form with half-lives greater than 8 days, in gaseous effluents exceeding any of the above limits, prepare and submit to the Commission within 30 days a report that identifies the cause(s) for exceeding the limit and defines the corrective actions that have been taken to reduce the releases and the proposed corrective actions to be taken to assure that subsequent releases will be in compliance with the above limits.
- b. The provisions of CONTROLS 3.0.4 are not applicable.

SURVEILLANCE REQUIREMENTS

4.11.2.3 Cumulative dose contributions for the current calendar quarter and current calendar year for tritium, and radionuclides in particulate form with half-lives greater than 8 days shall be determined in accordance with the methodology and parameters in the ODCM Part II Section 2.5 at least once per 31 days in accordance with Technical Specification 6.8.4.a.5.

3/4.11 RADIOACTIVE EFFLUENTS

3/4.11.4 TOTAL DOSE

CONTROLS

3.11.4.1 In accordance with Oyster Creek Technical Specifications 6.8.4.a.10, the annual (calendar year) dose commitment to any MEMBER OF THE PUBLIC due to radioactive material in the effluent and direct radiation from the OCGS in the unrestricted area shall be limited to less than or equal to 75 mrem to the thyroid or less than or equal to 25 mrem to the total body or any other organ.

APPLICABILITY: At all times

ACTION:

- a. With the calculated doses from the release of radioactive materials in liquid or gaseous effluents exceeding twice the limits of CONTROLS 3.11.1.2a, 3.11.1.2b, 3.11.2.2a, 3.11.2.2b, 3.11.2.3a, or 3.11.2.3b, perform an assessment to determine whether the limits of CONTROL 3.11.4.1 have been exceeded. If such is the case, prepare and submit to the Commission within 30 days a report that defines the corrective action to be taken to reduce subsequent releases to prevent recurrence of exceeding the above limits and includes the schedule for achieving conformance with the above limits. This report shall include information specified in 10CFR20.2203. If the estimated dose(s) exceeds the above limits, and if the release condition resulting in violation of 40 CFR Part 190 has not already been corrected, the report shall include a request for a variance in accordance with the provisions of 40 CFR Part 190. Submittal of the report is considered a timely request, and a variance is granted until staff action on the request is complete.
- b. The provisions of CONTROLS 3.0.4 are not applicable.

SURVEILLANCE REQUIREMENTS

- 4.11.4.1 Cumulative dose contributions from liquid and gaseous effluents shall be determined in accordance with SURVEILLANCE REQUIREMENT 4.11.1.2, 4.11.2.2, 4.11.2.3, and in accordance with the methodology and parameters in the ODCM Part II Section 3.0 at least once per year.
- 4.11.4.2 Cumulative dose contributions from direct radiation from the facility shall be determined in accordance with the methodology and parameters in the ODCM Part II Section 3.2. This requirement is applicable only under conditions set forth in CONTROL 3.11.4.1, ACTION a.

3/4.12 RADIOLOGICAL ENVIRONMENTAL MONITORING

3/4.12.1 MONITORING PROGRAM

CONTROLS

3.12.1. In accordance with Oyster Creek Technical Specifications 6.8.4.b, the radiological environmental monitoring program shall be conducted as specified in Table 3.12.1-1. For specific sample locations see Table E-1. Revisions to the non-ODCM required portions of the program may be implemented at any time. Non-ODCM samples are those taken in addition to the minimum required samples listed in Table 3.12.1-1.

APPLICABILITY: At all times.

ACTION:

- a. With the radiological environmental monitoring program not being conducted as specified in Table 3.12.1-1, prepare and submit to the Commission, in the Annual Radiological Environmental Operating Report required by Technical Specification 6.9.1.b, a description of the reasons for not conducting the program as required and the plans for preventing a recurrence.
- b. With the level of radioactivity as the result of plant effluents in an environmental sampling medium at a specified location exceeding the reporting levels of Table 3.12.1-2 when averaged over any calendar quarter, prepare and submit to the Commission within 60 days of the end of the quarter a report that identifies the cause(s) for exceeding the limit(s) and defines the corrective actions to be taken to reduce radioactive effluents so that the potential annual dose* to a member of the public is less than the calendar year limits of CONTROLS 3.11.1.2, 3.11.2.2, and 3.11.2.3. When more than one of the radionuclides in Table 3.12.1-2 are detected in the sampling medium, this report shall be submitted if:

$$\frac{\text{concentration (1)}}{\text{reporting level (1)}} + \frac{\text{concentration (2)}}{\text{reporting level (2)}} + \dots \geq 1.0$$

When radionuclides other than those in Table 3.12.1-2 are detected and are the result of plant effluents, this report shall be submitted if the potential annual dose* to a member of the public from all radionuclides is equal to or greater than the calendar year limits of CONTROLS 3.11.1.2, 3.11.2.2, and 3.11.2.3. This report is not required if the measured level of radioactivity was not the result of plant effluents; however, in such an event, the condition shall be reported and described in the Annual Radiological Environmental Operating Report pursuant to Section 6.1.2.1.

*The methodology used to estimate the potential annual dose to a member of the public shall be indicated in this report.

3/4.12 RADIOLOGICAL ENVIRONMENTAL MONITORING

3/4.12.1 MONITORING PROGRAM

CONTROLS (Continued)

ACTION: (Continued)

- c. If garden vegetation samples are unobtainable due to any legitimate reason, it is NOT ACCEPTABLE to substitute vegetation from other sources. The missed sample will be documented in the annual report, with no further actions necessary. If a permanent sampling location becomes unavailable, follow Table 3.12.1-1 Table Notation (1) to replace the location.
- d. The provisions of CONTROLS 3.0.4 are not applicable.

SURVEILLANCE REQUIREMENTS

- 4.12.1 The radiological environmental monitoring samples shall be collected pursuant to Table 3.12.1-1 from the specific locations given in Table E-1, and shall be analyzed pursuant to the requirements of Table 3.12.1-1, and the detection capabilities required by Table 4.12.1-1.

TABLE 3.12.1-1: RADIOLOGICAL ENVIRONMENTAL MONITORING PROGRAM

<u>EXPOSURE PATHWAY AND/OR SAMPLE</u>	<u>NUMBER OF REPRESENTAIVE SAMPLES AND SAMPLE LOCATIONS⁽¹⁾</u>	<u>SAMPLING AND COLLECTION FREQUENCY</u>	<u>TYPE AND FREQUENCY OF ANALYSIS</u>
1. DIRECT RADIATION ⁽²⁾	<p>Routine monitoring stations with two or more dosimeters placed as follows:</p> <p>An inner ring of stations one in each meteorological sector in the general area of the site boundary (At least 16 locations);</p> <p>An outer ring of stations, one in each land-based meteorological sector in the approximately 2 to 5 km range from the site (At least 16 locations); and</p> <p>At least 3 stations to be placed in special interest areas such as population centers, nearby residences, schools, and in one or two areas to serve as control stations.</p>	Quarterly	Gamma dose quarterly

TABLE 3.12.1-1(Cont'd)

RADIOLOGICAL ENVIRONMENTAL MONITORING PROGRAM

<u>EXPOSURE PATHWAY AND/OR SAMPLE</u>	<u>NUMBER OF REPRESENTATIVE SAMPLES AND SAMPLE LOCATIONS⁽¹⁾</u>	<u>SAMPLING AND COLLECTION FREQUENCY</u>	<u>TYPE AND FREQUENCY OF ANALYSIS</u>
2. AIRBORNE Particulates	<p>Samples from 7 locations:</p> <p>Three samples from close to the site boundary in different sectors of the highest calculated annual average ground-level D/Q</p> <p>One sample from the vicinity of a community having the highest calculated annual average ground-level D/Q; and</p> <p>One sample from a control location, as for example 15-30 km distant and in the least prevalent wind direction ⁽⁶⁾</p>	<p>Continuous sampler operation with sample collection bi-weekly or more frequently if required by dust loading</p>	<p><u>Particulate Sampler</u> Gross beta radioactivity analysis following filter change⁽³⁾;</p> <p>Gamma isotopic analysis⁽⁴⁾ of composites (by location) quarterly</p>

TABLE 3.12.1-1(Cont'd)

RADIOLOGICAL ENVIRONMENTAL MONITORING PROGRAM

<u>EXPOSURE PATHWAY AND/OR SAMPLE</u>	<u>NUMBER OF REPRESENTATIVE SAMPLES AND SAMPLE LOCATIONS⁽¹⁾</u>	<u>SAMPLING AND COLLECTION FREQUENCY</u>	<u>TYPE AND FREQUENCY OF ANALYSIS</u>
3. WATERBORNE			
a. Surface	One sample upstream One sample downstream	Grab sample monthly, composite quarterly.	Gamma isotopic and tritium analysis ⁽⁴⁾
b. Ground ⁽⁵⁾	Samples from one or two sources if likely to be affected	Grab sample quarterly	Gamma isotopic and tritium analysis ⁽⁴⁾
c. Drinking	1 sample of each of 1 to 3 of the nearest water supplies that could be affected by its discharge	Grab sample monthly Composite quarterly	Gross beta monthly, gamma isotopic and tritium analysis quarterly ⁽⁴⁾⁽⁷⁾ ;
	One sample from a background location		
d. Sediment	One sample from downstream area with existing or potential recreational value	Semiannually	Gamma isotopic analysis ⁽⁴⁾ semiannually

TABLE 3.12.1-1(Cont'd)

RADIOLOGICAL ENVIRONMENTAL MONITORING PROGRAM

<u>EXPOSURE PATHWAY AND/OR SAMPLE</u>	<u>NUMBER OF REPRESENTATIVE SAMPLES AND SAMPLE LOCATIONS⁽¹⁾</u>	<u>SAMPLING AND COLLECTION FREQUENCY</u>	<u>TYPE AND FREQUENCY OF ANALYSIS</u>
4. INGESTION a. Milk ⁽⁶⁾	No milking animals If milk animals are identified: Samples from milking animals in three locations within 5km having the highest dose potential. If there are none, then one sample from milking animals in each of three areas between 5 and 8 km distant where doses are calculated to be greater than 1 mrem per year. One sample from milking animal at a control location 15 to 30 km distant and in the least prevalent wind direction	Semimonthly when on pasture; Monthly at other times	Gamma isotopic ⁽⁴⁾ Semimonthly when animals are on pasture; monthly at other times

TABLE 3.12.1-1(Cont'd)

RADIOLOGICAL ENVIRONMENTAL MONITORING PROGRAM

<u>EXPOSURE PATHWAY AND/OR SAMPLE</u>	<u>NUMBER OF REPRESENTATIVE SAMPLES AND SAMPLE LOCATIONS⁽¹⁾</u>	<u>SAMPLING AND COLLECTION FREQUENCY</u>	<u>TYPE AND FREQUENCY OF ANALYSIS</u>
b. Fish	One sample of available species consumed by man in plant discharge canal	Semiannually, when available	Gamma isotopic analysis ⁽⁴⁾ on edible portions
	One sample of available species consumed by man not influenced by plant discharge		
c. Clams	One sample of available species consumed by man within the influence of the facility discharge.	Semiannually, when available	Gamma isotopic analysis ⁽⁴⁾ on edible portions.
	One sample of available species consumed by man not influenced by plant discharge.		

TABLE 3.12.1-1(Cont'd)

RADIOLOGICAL ENVIRONMENTAL MONITORING PROGRAM

<u>EXPOSURE PATHWAY AND/OR SAMPLE</u>	<u>NUMBER OF REPRESENTATIVE SAMPLES AND SAMPLE LOCATIONS⁽¹⁾</u>	<u>SAMPLING AND COLLECTION FREQUENCY</u>	<u>TYPE AND FREQUENCY OF ANALYSIS</u>
d. Vegetation ⁽⁸⁾	<p>3 samples of broad leaf vegetation grown nearest each of two different offsite locations of highest predicted annual average combined elevated and ground level release D/Q</p> <p>One sample of each of the similar broad leaf vegetation grown at least 15 to 30 km (9.3-18.6 miles) distant in the least prevalent wind direction.</p>	Monthly during growing season	Gamma isotopic analysis ⁽⁴⁾ on edible portion.

TABLE 3.12.1-1 (Continued)

TABLE NOTATIONS

- 1 Specific parameters of distance and direction sector from the centerline of the reactor, and additional description where pertinent, are provided for each and every sample location in Table 3.12.1-1 and Table E-1. Currently gaseous releases are from the Main Stack – an elevated release point on site. Once the spent fuel is transferred to the ISFSI and the spent fuel pool water is processed and released as a liquid effluent, the Main Stack will be removed from service and any and all releases will be from Open Air Demolition. For this reason, the point of release from the site used to describe distance and direction from this point to all environmental sample locations will remain unchanged. Deviations are permitted from the required sampling schedule if specimens are unobtainable due to circumstances such as hazardous conditions, seasonal unavailability, malfunction of automatic sampling equipment, and other legitimate reasons. If specimens are unobtainable due to sampling equipment malfunction, effort shall be made to complete corrective action prior to the end of the next sampling period. All deviations from the sampling schedule shall be documented in the Annual Radiological Environmental Operating Report pursuant to CONTROL 6.1.2.4. It is recognized that, at times, it may not be possible or practicable to continue to obtain samples of the media of choice at the most desired location or time. In these instances, suitable specific alternative media and locations may be chosen for the particular pathway in question and appropriate substitutions made within 30 days in the Radiological Environmental Monitoring Program given in the ODCM. Pursuant to Technical specification 6.19, submit in the next Radioactive Effluent Release Report documentation for a change in the ODCM including revised figure(s) and table for the ODCM reflecting the new location(s) with supporting information identifying the cause of the unavailability of samples for the pathway and justifying the selection of the new location(s) for obtaining samples. This applies to changes/deletions/additions of permanent sampling locations. This does not apply to one-time deviations from the sampling schedule. In those cases, it is NOT ACCEPTABLE to substitute sample media from other sources. The missed sample will be documented in the annual report, with no further actions necessary.
- 2 One or more instruments, such as pressurized ion chamber, for measuring and recording dose rate continuously may be used in place of, or in addition to, integrating dosimeters. The number of direct radiation monitoring stations has been reduced from the NUREG 1302 recommendation due to geographical limitations; e.g., some sectors are over water and some sectors cannot be reached due to lack of highway access, therefore the number of dosimeters has been reduced accordingly.
- 3 Airborne particulate sample filters shall be analyzed for gross beta radioactivity 24 hours or more after sampling to allow for radon and thoron daughter decay. If gross beta activity in air particulate is greater than ten times the yearly mean of control samples, gamma isotopic analysis shall be performed on the individual samples.
- 4 Gamma isotopic analysis means the identification and quantification of gamma-emitting radionuclides that may be attributable to the effluents from the facility.

- 5 Groundwater samples shall be taken when this source is tapped for drinking or irrigation purposes in areas where the hydraulic gradient or recharge properties are suitable for contamination. Extensive studies of geology and groundwater in the vicinity of the OCGS (Reference 21 and 31) have demonstrated that there is no plausible pathway for effluents from the facility to contaminate offsite groundwater, including the local drinking water supplies. Samples of groundwater, including local drinking water wells, are collected in order to provide assurance to the public that these water resources are not impacted.
- 6 The purpose of this sample is to obtain background information. If it is not practical to establish control locations in accordance with the distance and wind direction criteria, other sites which provide valid background data may be substituted .
- 7 If garden vegetation samples are unobtainable due to any legitimate reason (see (1) above), it is NOT ACCEPTABLE to substitute vegetation from other sources. The missed sample will be documented in the annual report, with no further actions necessary.

TABLE 3.12.1-2: REPORTING LEVELS FOR RADIOACTIVITY CONCENTRATIONS IN ENVIRONMENTAL SAMPLES - REPORTING LEVELS

Analysis	Potable, Surface and Ground Water(pCi/l)	Airborne Particulate (pCi/m ³)	Fish (pCi/Kg, wet)	Milk (pCi/l)	Vegetation (pCi/Kg, wet)
H-3	20000*				
Mn-54	1000		30000		
Fe-59	400		10000		
Co-58	1000		30000		
Co-60	300		10000		
Zn-65	300		20000		
Zr-Nb-95	400				
Cs-134	30	10	1000	60	1000
Cs-137	50	20	2000	70	2000
Ba-La-140	200			300	

*For drinking water samples (this is the 40 CFR Part 141 value).
If no drinking water pathway exists, a value of 30,000 pCi/L may be used.

TABLE 4.12.1-1: DETECTION CAPABILITIES FOR ENVIRONMENTAL SAMPLE ANALYSIS^{(1),(2)} - LOWER LIMITS OF DETECTION (LLD)⁽³⁾

Analysis	Potable, Surface and Ground Water (pCi/l)	Air Particulate (pCi/m ³)	Vegetation (pCi/Kg, wet)	Sediment (pCi/Kg, dry)	Fish, Clams and Crabs (pCi/Kg, wet)
Gross Beta	4	0.01			
H-3	2000 ⁽⁴⁾				
Mn-54	15				130
Fe-59	30				260
Co-58, 60	15				130
Zn-65	30				260
Zr-95	30				
Nb-95	15				
Cs-134	15				
Cs-137	18	0.05 ⁽⁵⁾	60	150	130
La-140	15 ⁽⁶⁾	0.06 ⁽⁵⁾	80	180	150
Ba-140	15 ⁽⁶⁾				

TABLE 4.12.1-1 (Continued)

TABLE NOTATIONS

1. This list does not mean that only these nuclides are to be considered. Other peaks that are identifiable, together with those of the above nuclides, shall also be analyzed and reported in the Annual Radiological Environmental Operating Report pursuant to CONTROL 6.1.2.3.
2. Required detection capabilities for dosimeters used for environmental measurements shall be in accordance with the recommendations of Regulatory Guide 4.13.
3. The LLD is defined, for purposes of these CONTROLS as the smallest concentration of radioactive material in a sample that will yield a net count, above system background, that will be detected with 95% probability with only 5% probability of falsely concluding that a blank observation represents a "real" signal.

For a particular measurement system, which may include radiochemical separation:

$$LLD = \frac{4.66 * Sb}{E * V * 2.22 * Y * \exp(-\lambda\Delta t)}$$

Where:

LLD is the "a priori" lower limit of detection as defined above, as picocuries per unit mass or volume,

Sb is the standard deviation of the background counting rate or of the counting rate of a blank sample as appropriate, as counts per minute,

E is the counting efficiency, as counts per disintegration,

V is the sample size in units of mass or volume,

2.22 is the number of disintegrations per minute per Pico curie,

Y is the fractional radiochemical yield, when applicable,

λ is the radioactive decay constant for the particular radionuclide (sec^{-1}), and

Δt for environmental samples is the elapsed time between sample collection, or end of the sample collection period, and time of counting (sec).

Typical values of E, V, Y, and Δt should be used in the calculation.

TABLE 4.12.1-1 (Continued)

TABLE NOTATIONS

It should be recognized that the LLD is defined as an a priori (before the fact) limit representing the capability of a measurement system and not as an a posteriori (after the fact) limit for a particular measurement. Analyses shall be performed in such a manner that the stated LLDs will be achieved under routine conditions. Occasionally, background fluctuations, unavoidable small sample sizes, the presence of interfering nuclides, or other uncontrollable circumstances may render these LLDs unachievable. In such cases, the contributing factors shall be identified and described in the Annual Radiological Environmental Operating Report pursuant Technical Specification 6.9.1.b and Control 6.1.2.6.4.

4. If no drinking water pathway exists, a value of 3000 pCi/L for tritium may be used.
5. For the air particulate sample
6. Ba-140 and La-140 are in equilibrium

3/4.12 RADIOLOGICAL ENVIRONMENTAL MONITORING

3/4.12.2 LAND USE CENSUS

CONTROLS

3.12.2 A land use census shall be conducted and shall identify within a distance of 5 miles the location in each of the 16 meteorological sectors of the nearest milk animal, the nearest residence and the nearest garden* of greater than 500 ft² producing broad leaf vegetation. The census shall also identify within a distance of 3 miles the location in each of the 16 meteorological sectors all milk animal and all gardens greater than 500 square feet producing broadleaf vegetation.

APPLICABILITY: At all times.

ACTION:

- a. With a land use census identifying a location(s) that yields a calculated dose or dose commitment greater than the values currently being calculated in SURVEILLANCE REQUIREMENT 4.11.2.3, identify the new location(s) in the next Radioactive Effluent Release Report, pursuant to Control 6.2.2.4.
- b. With a land use census identifying a location(s) that yields a calculated dose or dose commitment (via the same exposure pathway) 20 percent greater than at a location from which samples are currently being obtained in accordance with CONTROL 3.12.1, add the new location(s) to the radiological environmental monitoring program within 30 days. The sampling location(s), excluding the control station location, having the lowest calculated dose or dose commitment(s), via the same exposure pathway, may then be deleted from this monitoring. Pursuant to CONTROL 6.2.2.4, identify the new location(s) in the next Radioactive Effluent Release Report and also include in the report a revised figure(s) and table for the ODCM reflecting the new location(s).
- c. The provisions of CONTROLS 3.0.4 are not applicable.

SURVEILLANCE REQUIREMENTS

4.12.2 The land use census shall be conducted during the growing season at least once per 12 months using that information that will provide the best results, such as by door-to-door survey, visual survey, aerial survey, or by consulting local agriculture authorities. The results of the land use census shall be included in the Annual Radiological Environmental Operating Report pursuant to CONTROL 6.1.2.2.

*Broad leaf vegetation sampling of at least three different kinds of vegetation may be performed at the site boundary in each of two different direction sectors with the highest predicted elevated release D/Q's in lieu of the garden census. Controls for broadleaf vegetation sampling in Table 3.12.1-1, Part 4.c shall be followed, including analysis of control samples.

3/4.12 RADIOLOGICAL ENVIRONMENTAL MONITORING

3/4.12.3 INTERLABORATORY COMPARISON PROGRAM

CONTROLS

3.12.3 Analyses shall be performed on radioactive materials supplied as part of an interlaboratory comparison program which has been approved by the Commission.

APPLICABILITY: At all times.

ACTION:

- a. With analyses not being performed as required above, report the reason and corrective actions taken to prevent a recurrence to the Commission in the Annual Radiological Environmental Operating Report pursuant to CONTROL 6.1.2.6.3.
- b. The provisions of CONTROLS 3.0.4 are not applicable.

SURVEILLANCE REQUIREMENTS

4.12.3 A summary of the results obtained as part of the above-required Interlaboratory Comparison Program shall be included in the Annual Radiological Environmental Operating Report pursuant to CONTROL 6.1.2.6.3.

3 /4 .12 RADIOLOGICAL ENVIRONMENTAL MONITORING

3/4.12.4 METEOROLOGICAL MONITORING PROGRAM

CONTROLS

3.12.4 Ten Year Averaged Meteorological Data shall be used during decommissioning in lieu of real time meteorological data. However, if the decision is made to revert to real time meteorological data at any point during the decommissioning, the meteorological monitoring instrumentation channels shown in Table 3.12.4.-1 shall be OPERABLE, or a suitable substitute meteorological tower at a National Oceanic and Atmospheric Administration (NOAA) facility, local airport or equivalent location may be substituted to acquire the required meteorological data to calculate offsite dose from gaseous effluents.

APPLICABILITY: At all times.

ACTION:

- a. With less than the minimum required instrumentation channels OPERABLE for more than 7 days, initiate an Issue Report outlining the cause of the malfunction and the plans for restoring the instrumentation to OPERABLE status.
- b. The provisions of CONTROLS 3.0.4 are not applicable.

TABLE 3.12.4-1

METEOROLOGICAL MONITORING INSTRUMENTATION

INSTRUMENT	ELEVATION	MINIMUM INSTRUMENT OPERABLE
1. Wind Speed		
a.	380 feet	1
b.	150 feet	1
c.	33 feet	1
2. Wind Direction		
a.	380 feet	1
b.	150 feet	1
c.	33 feet	1
3. ΔT		
a.	380-33	1
b.	150-33	1

BASES FOR SECTIONS 3.0 AND 4.0

CONTROLS AND SURVEILLANCE REQUIREMENTS

NOTE: The BASES contained in the succeeding pages summarize the reasons for the CONTROLS of Sections 3.0 and 4.0, but are not considered a part of these CONTROLS.

3/4.3 INSTRUMENTATION

BASES

3/4.3.3.10 RADIOACTIVE LIQUID EFFLUENT MONITORING INSTRUMENTATION

The radioactive liquid effluent instrumentation is provided to monitor and control, as applicable, the releases of radioactive materials in liquid effluents during actual or potential releases of liquid effluents. The reactor service water system discharge line radioactivity monitor initiates an alarm in the Control Room when the alarm set point is exceeded. The alarm/trip set points for these instruments shall be calculated and adjusted in accordance with the methodology and parameters in the ODCM to ensure that the alarm/trip will occur prior to exceeding the limits of 10 CFR Part 20. The OPERABILITY and use of this instrumentation is consistent with the requirements of General Design Criteria 60, 63, and 64 of Appendix A to 10 CFR Part 50.

3/4.3.3.11 RADIOACTIVE GASEOUS EFFLUENT SAMPLING INSTRUMENTATION

The radioactive gaseous effluent instrumentation is provided to sample, as applicable, the releases of radioactive materials in gaseous effluents during actual or potential releases of gaseous effluents. The OPERABILITY and use of this instrumentation is consistent with the requirements of General Design Criteria 60, 63, and 64 of Appendix A to 10 CFR Part 50.

3/4.11 RADIOACTIVE EFFLUENTS

BASES

3/4.11.1 LIQUID EFFLUENTS

3/4.11.1.1 CONCENTRATION

This CONTROL is provided to ensure that the concentration of radioactive materials released in liquid waste effluents to unrestricted areas will be less than the concentration levels specified in 10 CFR Part 20, Appendix B, Table 2, Column 2. This limitation provides additional assurance that the levels of radioactive materials in bodies of water in unrestricted areas will result in exposures within (1) the Section II.A design objectives of Appendix I, 10 CFR Part 50, to a member of the public and (2) the limits of 10 CFR Part 20.106(a) to the population.

The value 1E-8 is the limit for unidentified gross gamma or beta releases as per 10 CFR 20 Appendix B, Table 2, Column 2 "any single radionuclide...other than alpha or spontaneous fission ...half-life greater than 2 hours". This provides operational flexibility while providing reasonable assurance that dose will remain less than 0.1 rem/yr.

The required detection capabilities for radioactive materials in liquid waste samples are tabulated in terms of the lower limits of detection (LLDs). Detailed discussion of the LLD, and other detection limits can be found in references 25, 26, and 27.

Weekly grab samples for Service Water Effluent are composited for monthly tritium and gross alpha analysis and quarterly Sr-89/90 and Fe-55 analysis if activity is detected.

While discharging groundwater via the continuous release pathway, the grab sample will be analyzed quarterly for principal gamma emitters and tritium. A quarterly grab sample is analyzed for gross alpha, Sr-89/90, Fe-55, and Ni-63.

While discharging groundwater via the batch release mode pathway, a grab sample is collected from each tank and analyzed for principal gamma emitters and tritium, a composite sample is analyzed quarterly for gross alpha, Sr-89/90, Fe-55, and Ni-63.

In the process of decommissioning, evacuation of precipitation, surface water and groundwater infiltration to subsurface structures becomes necessary to support remediation, gridding and survey of these structures in support of Final Status Survey (FSS) and the License Termination Plan (LTP).

Direct discharge of this Construction Dewatering volume to the intake canal, 30" service water header, or to the discharge canal within the vicinity of the 30" header (a practice that maintains liquid effluent discharge off site dose modelling assumptions) shall be completed in accordance with concentration and dose controls 3.11.1.1, 3.11.1.2, 3.11.1.3 and the Oyster Creek Nuclear Generating Station's NJPDES

permit. Filtration of any discharge of construction dewatering is an acceptable form of treatment, when required or deemed appropriate.

3/4.11.1.2 DOSE

This CONTROL is provided to implement the requirements of Sections II.A, III.A, and IV.A of Appendix I, 10 CFR Part 50. The CONTROL implements the guides set forth in Section II.A of Appendix I. The ACTION statements provide the required operating flexibility and at the same time implement the guides set forth in Section IV.A of Appendix I to assure that the releases of radioactive material in liquid effluents to unrestricted areas will be kept "as low as is reasonably achievable." The dose calculation methodology and parameters in the ODCM implement the requirements in Section III.A of Appendix I that conformance with the guides of Appendix I be shown by calculational procedures based on models and data, such that the actual exposure of a member of the public through appropriate pathways is unlikely to be substantially underestimated. The equations specified in the ODCM for calculating the doses due to the actual release rates of radioactive materials in liquid effluents are consistent with the methodology provided in Regulatory Guide 1.109 and Regulatory Guide 1.113.

3/4.11.1.3 LIQUID RADWASTE TREATMENT

The OPERABILITY of a liquid radwaste treatment system ensures that this system will be available for use whenever liquid effluents require treatment prior to their release to the environment. The requirement that the appropriate portions of this system be used, when specified, provides assurance that the releases of radioactive materials in liquid effluents will be kept "as low as is reasonably achievable". This CONTROL implements the requirements of General Design Criterion 60 of Appendix A to 10 CFR Part 50 and the design objective given in Section II.D of Appendix I to 10 CFR Part 50. The specified limits governing the use of appropriate portions of the liquid radwaste treatment system were specified as a suitable fraction of the dose design objectives set forth in Section II.A of Appendix I, 10 CFR Part 50, for liquid effluents. Figure D-1-1a, Liquid Radwaste Treatment Chem Waste and Floor Drain System and Figure D-1-1b, Liquid Radwaste Treatment – High Purity and Equipment Drain System provides details of the Liquid Radwaste Treatment system.

3/4.11.2 GASEOUS EFFLUENTS

3/4.11.2.1 DOSE RATE

This CONTROL is provided to ensure that the dose at any time at and beyond the site boundary from gaseous effluents will be within the annual dose limits of 10 CFR Part 20 to unrestricted areas. The annual dose limits are the doses associated with the concentrations of 10 CFR Part 20, Appendix B, Table 2, Column 1. These limits provide reasonable assurance that radioactive material discharged in gaseous effluents will not result in the exposure of a member of the public in an unrestricted area either within or outside the site boundary, to annual average concentrations exceeding the limits specified in Appendix B, Table 2 of 10 CFR Part 20. For members of the public who may at times be within the site boundary, the occupancy of the

individual will usually be sufficiently low to compensate for any increase in the atmospheric diffusion factor above that for the site boundary. Examples of calculations for such members of the public with the appropriate occupancy factors shall be given in the ODCM. The specified release rate limits restrict, at all times, the corresponding gamma and beta dose rates above background to a member of the public at or beyond the site boundary to less than or equal to 500 mrem/year to the total body or to less than or equal to 3000 mrem/yr to the skin. These release rate limits also restrict, at all times, the corresponding thyroid dose rate above background to a child via the inhalation pathway to less than or equal to 1500 mrem/year.

The required detection capabilities for radioactive materials in liquid waste samples are tabulated in terms of the lower limits of detection (LLDs). Detailed discussion of the LLD, and other detection limits can be found in references 25, 26 and 27.

Tritium is sampled quarterly for gaseous effluents. Based on the consistency of the data from the quarterly sampling, the sampling frequency is adequate. Alternatively, calculation of tritium in gaseous effluents may be accomplished by assuming that all water evaporated from the spent fuel pool and quantified by tracking monthly make up volumes to the SFP and monthly tritium concentration analysis of SPF water.

3/4.11.2.3 DOSE - TRITIUM, AND RADIONUCLIDES IN PARTICULATE FORM

This CONTROL is provided to implement the requirements of Section II.C, III.A and IV.A of Appendix I, 10 CFR Part 50. The CONTROLS are the guides set forth in Section II.C of Appendix I. The ACTION statements provide the required operating flexibility and at the same time implement the guides set forth in Section IV.A of Appendix I to assure that the releases of radioactive material in gaseous effluents to unrestricted areas will be kept "as low as is reasonably achievable." The ODCM calculational methods specified in SURVEILLANCE REQUIREMENTS implement the requirements in Section III.A of Appendix I that conformance with the guides of Appendix I be shown by calculational procedures based on models and data such that the actual exposure of a member of the public through appropriate pathways is unlikely to be substantially underestimated. The ODCM calculational methodology and parameters for calculating the doses due to the actual release rates of the subject materials are consistent with the methodology provided in Regulatory Guide 1.109, and Regulatory Guide 1.111. These equations also provide for determining the actual doses based upon the historical average atmospheric conditions. The release rate controls for tritium, and radionuclides in particulate form with half-life greater than 8 days are dependent on the existing radionuclide pathways to man, in the areas at and beyond the site boundary. The pathways that were examined in the development of these calculations were: 1) individual inhalation of airborne radionuclides, 2) deposition of radionuclides onto green leafy vegetation with subsequent consumption by man, 3) deposition onto grassy areas where milk animals and meat producing animals graze with consumption of the milk and meat by man, and 4) deposition on the ground with subsequent exposure of man.

3/4.11.4 TOTAL DOSE

This CONTROL is provided to meet the dose limitations of 40 CFR Part 190 that have now been incorporated into 10 CFR Part 20 by 46 FR 18525. The CONTROL requires the preparation and submittal of a report whenever the calculated doses from plant radioactive effluents exceed 25 mrem to the total body or any organ, except the thyroid, which shall be limited to less than or equal to 75 mrem. It is highly unlikely that the resultant dose to a member of the public will exceed the dose limits of 40 CFR Part 190 if the doses remain within twice the dose design objectives of Appendix I, and if direct radiation doses from the unit, including outside storage no, etc. are kept small. The report will describe a course of action that should result in the limitation of the annual dose to a member of the public to within the 40 CFR Part 190 limits. For purposes of the report, it may be assumed that the dose commitment to the member of the public from other uranium fuel cycle sources is negligible. If the dose to any member of the public is estimated to exceed the requirements of 40 CFR Part 190, the report with a request for a variance (provided the release conditions resulting in violation of 40 CFR Part 190 have not already been corrected), in accordance with the provisions of 40 CFR Part 190 and 10 CFR Part 20, is considered to be a timely request and fulfills the requirements of 40 CFR Part 190 until NRC staff action is completed. The variance only relates to the limits of 40 CFR Part 190, and does not apply in any way to the other requirements for dose limitation of 10 CFR Part 20, as addressed in CONTROLS 3.11.1.1 and 3.11.2.1. An individual is not considered a member of the public during any period in which he/she is engaged in carrying out any operation that is part of the nuclear fuel cycle.

3/4.12 RADIOLOGICAL ENVIRONMENTAL MONITORING

BASES

3/4.12.1 MONITORING PROGRAM

The Radiological Environmental Monitoring Program (REMP) required by this CONTROL provides representative measurements of radiation and of radioactive materials in those exposure pathways and for those radionuclides that lead to the highest potential radiation exposures of members of the public resulting from the station operation. This monitoring program implements Section IV.B.2 of Appendix I to 10 CFR Part 50 and thereby supplements the radiological effluent monitoring program by verifying that the measurable concentrations of radioactive materials and levels of radiation are not higher than expected on the basis of the effluent measurements and the modeling of the environmental exposure pathways. Guidance for this monitoring program is provided by the Radiological Assessment Branch Position on Environmental Monitoring, Revision 1, November 1979.

The required detection capabilities for environmental sample analyses are tabulated in terms of the lower limits of detection (LLDs). The LLDs required by Table 4.12.1-1 are considered optimum for routine environmental measurements in industrial laboratories. It should be recognized that the LLD is defined as an a priori (before the fact) limit representing the capability of a measurement system and not as an a posteriori (after the fact) limit for a particular measurement.

Detailed discussion of the LLD, and other detection limits in references 25, 26, and 27.

Site-specific research, which included the installation of a groundwater monitoring well network, has demonstrated that the groundwater pathway is not a potential pathway to man from the OCGS. The surface water into which the OCGS discharges is a marine estuary containing saline water that is not used as drinking water or irrigation water by man.

3/4.12.2 LAND USE CENSUS

This CONTROL is provided to ensure that changes in the use of areas at and beyond the site boundary are identified and that modifications to the radiological environmental monitoring program are made if required by the results of this census. The best information from the door-to-door survey, from aerial survey, from visual survey or consulting with local agricultural authorities shall be used. This census satisfies the requirements of Section IV.B.3 of Appendix I to 10 CFR Part 50. Restricting the census to gardens of greater than 50 m² (500 ft²) provides assurance that significant exposure pathways via leafy vegetables will be identified and monitored since a garden of this size is the minimum required to produce the quantity (26 kg/year) of leafy vegetables assumed in Regulatory Guide 1.109 for consumption by a child. To determine this minimum garden size, the following assumptions were made: 1) 20% of the garden was used for growing broad leaf vegetation (i.e., similar to lettuce and cabbage), and 2) a vegetation yield of 2 kg/m².

3/4.12 RADIOLOGICAL ENVIRONMENTAL MONITORING

BASES

3/4.12.3 INTERLABORATORY COMPARISON PROGRAM

The requirement for participation in an approved Interlaboratory Comparison Program is provided to ensure that independent checks on the precision and accuracy of the measurements of radioactive material in environmental sample matrices are performed as part of the quality assurance program for environmental monitoring in order to demonstrate that the results are valid for the purposes of Section IV.B.2 of Appendix I to 10 CFR Part 50.5.0

5.0 DESIGN FEATURES / SITE MAP

- 5.1 Site map which will allow identification of structures and release points shall be as shown in Figure E-4.

6.0 ADMINISTRATIVE CONTROLS

6.1 ANNUAL RADIOLOGICAL ENVIRONMENTAL OPERATING REPORT (AREOR)

6.1.1 In accordance with Oyster Creek Technical Specifications 6.9.1.b, a routine radiological environmental operating report covering the operation of the unit during the previous calendar year shall be submitted prior to May 1 of the following year.

6.1.2 The Annual Radiological Environmental Operating Reports shall include:

6.1.2.1 Summaries, interpretations, and an analysis of trends of the results of the radiological environmental surveillance activities (Radiological Environmental Monitoring Program – REMP) for the report period. This will include a comparison with preoperational studies, with operational controls (as appropriate), and with previous environmental surveillance reports, and an assessment of the observed impacts of the plant operation on the environment.

6.1.2.2 The reports shall also include the results of land use censuses required by CONTROL 3.12.2. If harmful effects or evidence of irreversible damage are detected by the monitoring, the report shall provide an analysis of the problem and a planned course of action to alleviate the problem.

6.1.2.3 The Annual Radiological Environmental Operating Reports shall include summarized and tabulated results similar in format to that in Regulatory Guide 4.8, December 1975 of all the radiological environmental samples taken during the report period.

6.1.2.4 Deviations from the sampling program identified in CONTROL 3.12.1 shall be reported.

6.1.2.5 In the event that some individual results are not available for inclusion with the report, the report shall be submitted noting and explaining the reasons for the missing results. The missing data shall be submitted as soon as possible in a supplementary report.

6.1.2.6 The reports shall also include the following:

- a. A summary description of the Radiological Environmental Monitoring Program (REMP);
- b. Map(s), covering sampling locations, keyed to a table giving distances and directions from the stack;
- c. The results of licensee participation in the Interlaboratory Comparison Program, as required by CONTROL 3.12.3;
- d. Identification of environmental samples analyzed when the analysis instrumentation was not capable of meeting the detection capabilities in Table 4.12.1-1.
- e. The Annual GWPP report as an attachment

6.2 ANNUAL ROUTINE RADIOACTIVE EFFLUENT RELEASE REPORT (ARERR)

- 6.2.1 Routine radioactive effluent release reports covering the operation of the unit shall be submitted prior to May 1 of each year and in accordance with the requirements of 10CFR50.36a and section IV.B.1 of 10CFR 50 Appendix I.
- 6.2.2 The Radioactive Effluent Release Report shall include:
- 6.2.2.1 A summary of the quantities of radioactive liquid and gaseous effluents and solid waste released from the unit as outlined in Regulatory Guide 1.21. "Measuring, Evaluating, and Reporting Radioactivity in Solid Wastes and Releases of Radioactive Materials in Liquid and Gaseous Effluents from Light-Water-Cooled Nuclear Power Plants," Revision 2, June 2009, with data summarized on a quarterly basis following the format of Appendix B thereof.
- 6.2.2.2 Ten year averaged or an annual summary of hourly meteorological data collected over the previous year is available upon request and is *not* included in the ARERR in accordance with reference 5. Ten year averaged meteorological data (2009 to 2018) may be found in reference 34 and includes data required in accordance with reference 6.
- 6.2.2.3 An assessment of the radiation doses due to the radioactive liquid and gaseous effluents released from the unit or station during the previous calendar year. The historical annual average meteorology or the meteorological conditions concurrent with the time of release of radioactive materials in gaseous effluents (as determined by sampling frequency and measurement) shall be used for determining the gaseous pathway doses. The assessment of radiation doses shall be performed in accordance with this OFFSITE DOSE CALCULATION MANUAL (ODCM).
- 6.2.2.4 Identify those radiological environmental sample parameters and locations where it is not possible or practicable to continue to obtain samples of the media of choice at the most desired location or time. In addition, the cause of the unavailability of samples for the pathway and the new location(s) for obtaining replacement samples should be identified. The report should also include a revised figure(s) and table(s) for the ODCM reflecting the new location(s).
- 6.2.2.5 An assessment of radiation doses to the likely most exposed member of the public from reactor releases and other nearby uranium fuel cycle sources (including doses from primary effluent pathways and direct radiation) for the previous calendar year to show conformance with 40 CFR Part 190, Environmental Radiation Protection Standards for Nuclear Power Operation. The assessment of radiation doses shall be performed in accordance with this ODCM Part II Sections 1.5, 2.4, 2.5 and 3.2. When assessing dose to a member of the public upon completion of FSS and license termination, dose from the ISFSI does not include the projected 1000 year dose from the decommissioned site as this component is not identified as part of the uranium cycle per 40CFR190.

- 6.2.2.6 The Annual Radioactive Effluent Release Report (ARERR) shall include the following information for each class of solid waste (as defined by 10 CFR Part 61) shipped offsite during the report period (see Figure D-1-2):
 - a. Total volume shipped,
 - b. Total curie quantity (specify whether determined by measurement or estimate),
 - c. Principal radionuclides (specify whether determined by measurement or estimate),
 - d. Type of waste (e.g., dewatered spent resin, compacted dry waste, evaporator bottoms).
- 6.2.2.7 Unplanned releases from the site to unrestricted areas of radioactive materials in gaseous and liquid effluents on a quarterly basis.
- 6.2.2.8 Changes to the PROCESS CONTROL PROGRAM (PCP).
- 6.2.2.9 Changes to the ODCM in the form of a complete, legible copy of the ODCM.
- 6.3 RESPONSIBILITIES:
 - 6.3.1 Chemistry / Radwaste - Responsible for:
 - 6.3.1.1 Implementing approval.
 - 6.3.1.2 Compliance with specifications regarding routine dose assessment.
 - 6.3.1.3 Radiological Environmental Monitoring Program
 - 6.3.1.4 Technical consultation and review
 - 6.3.2 Operations - Responsible for compliance with specifications regarding operation of the OCGS.
 - 6.3.3 Engineering - Responsible for compliance with specifications regarding set point determination and implementation
 - 6.3.4 Radiological Engineering - Responsible for technical consultation and review.

PART II - CALCULATIONAL METHODOLOGIES

1.0 LIQUID EFFLUENTS

1.1 RADIATION MONITORING INSTRUMENTATION AND CONTROLS

The liquid effluent monitoring instrumentation and controls at Oyster Creek for controlling and monitoring normal radioactive material releases in accordance with the Oyster Creek Radiological Effluent Technical Specifications are summarized as follows:

Reactor Building Service Water Effluent - The Reactor Building Service Water Effluent Line Monitor provides an alarm function only for releases into the environment.

Liquid radioactive waste flow diagrams are presented in Figures D-1-1a, D-1-1b, and D-1-1c.

1.2 LIQUID EFFLUENT MONITOR SET POINT DETERMINATION

Per the requirements of CONTROL 3.3.3.10, alarm set points shall be established for the liquid monitoring instrumentation to ensure that the release concentration limits of CONTROL 3.11.1.1 are met (i.e., the concentration of radioactive material released in liquid effluents to unrestricted areas at the U.S. Route 9 bridge over the discharge canal shall not exceed the concentrations specified in 10 CFR 20 Appendix B Table 2, Column 2, for radionuclides).

1.2.1 LIQUID EFFLUENT MONITOR

The set points for the liquid effluent monitor at the Oyster Creek Generating Station are determined by the following equation:

$$S = \frac{A}{FLEC} g \frac{F_2}{F_1} + BKG$$

Where:

S = radiation monitor alarm set point (cpm)

A = activity concentration ($\mu\text{Ci/ml}$) of sample in laboratory: $A = \sum C_i$

g = the primary conversion factor for the instrument – the ratio of effluent radiation monitor counting rate to laboratory activity concentration in a sample of liquid (cpm per $\mu\text{Ci/mL}$).

F₁ = flow in the batch release line (e.g. gal/min). Value not greater than the discharge line flow alarm maximum set point.

F₂ = flow in the discharge canal (e.g. gal/min). Value not less than the discharge canal minimum flow.

- BKG = Monitoring instrument background (cpm)
- FLEC = fraction or multiple of unrestricted area LEC in aqueous effluent based on sample analysis. FLEC is the ratio between the LEC_i and C_i. FLEC is unitless. For example: LEC for Co-60 is 3E-6 μCi/mL. If the concentration in an expected release is 6E-6 μCi/mL; then FLEC is 6E-6/3E-6 = 2.
The term $\frac{A}{FLEC}$ represents the count rate of a solution having the same nuclide distribution as the sample and the LEC of that mixture.
- C_i = concentration of radionuclide i in effluent, i.e., in a liquid radwaste sample tank, in reactor building service water (μCi/mL).
- LEC_i = the unrestricted area liquid effluent concentration (LEC) of radionuclide i, i.e., 10 CFR 20, Appendix B, Table 2, Column 2 quantity for radionuclide i (μCi/mL).
In the event gross radioactivity analysis alone is used to determine the radioactivity in an effluent stream or batch, FLEC is C/1E-8 (see 4.11.1.1.1),

Where:

- C = the gross radioactivity concentration in effluent (μCi/mL).
- 1E-8 = the unrestricted area LEC for unidentified radionuclides (μCi/mL) from 4.11.1.1.1.
If the gross activity concentration, C, is below the lower limit of detection for gross activity, the value, 1E-8 μCi/mL, or the equivalent counting rate (cpm/mL) may be substituted for the factor $\frac{A}{FLEC}$

$$\frac{A}{FLEC} = 1E-8 \text{ } \mu\text{Ci/mL}$$

1.2.2 SAMPLE RESULT SET POINTS

Usually, when the concentration of specific radionuclides is determinable in a sample(s), i.e., greater than the LLD, the alarm/trip set point of each liquid effluent radioactivity monitor is based upon the measurement of radioactive material in a batch of liquid to be released or in a continuous aqueous discharge.

1.2.3 ASSUMED DISTRIBUTION SET POINTS

Alternatively, a radionuclide distribution that represents the distribution expected to be in the effluent if the concentration were high enough to be detectable, i.e., greater than the LLD, may be assumed. The representative distribution may be based upon past measurements of the effluent stream or upon a computed distribution.

1.3 BATCH RELEASES

A sample of each batch of liquid radwaste is analyzed for principal gamma emitters or for gross beta or gross gamma activity before release. The result of the analyses are used to calculate the total activity released or the trip set point of the radioactivity monitor on the liquid radwaste effluent line to apply to release of the batch.

1.4 CONTINUOUS RELEASES

The Reactor Building Service Water Effluent is sampled and analyzed weekly for principal gamma emitters. Results of analyses for the preceding week or for a period as long as the preceding 3 months are used to calculate the alarm/trip set point of the corresponding effluent radioactivity monitor in order to determine a representative value. In each case, whether batch or continuous, the monitor alarm/trip set point may be set at lower activity concentration than the calculated set point.

1.5 LIQUID EFFLUENT DOSE CALCULATION - 10 CFR 50

Doses resulting from the release of particulates must be calculated to show compliance with Appendix I of 10CFR50. Calculations will be performed at least monthly for all liquid effluents as stated in SURVEILLANCE REQUIREMENT 4.11.1.2 and SURVEILLANCE REQUIREMENT 4.11.1.3.1 to verify that the dose to members of the public is maintained below the limits specified in CONTROL 3.11.1.2

The maximum dose to an individual from tritium, and radioactive particulates with half-lives of greater than eight days in liquid effluents released to unrestricted areas is determined as described in Reg. Guide 1.109. Environmental pathways that tritium, and particulates in liquid effluent follow to the maximally exposed member of the public are assumed to be: exposure to shoreline deposits, ingestion of fish, and ingestion of shellfish. To assess compliance with CONTROL 3.11.1.2, the dose due to tritium, and particulates in liquid effluent is calculated to a person at the Route 9 bridge who consumes fish and shellfish harvested at that location.

1.5.1 MEMBER OF THE PUBLIC DOSE - LIQUID EFFLUENTS

CONTROL 3.11.1.2 limits the dose or dose commitment to members of the public from radioactive materials in liquid effluents from Oyster Creek Generating Station to those listed in Table 1.5.1-1.

TABLE 1.5.1-1 LIQUID PATHWAY DOSE LIMITS

<u>During Any Calendar Quarter</u>	<u>During Any Calendar Year</u>
≤ 1.5 mrem to total body	≤ 3.0 mrem to total body
≤ 5.0 mrem to any organ	≤ 10.0 mrem to any organ

Per the SURVEILLANCE REQUIREMENTS of 4.11.1.2, the following calculation methods shall be used for determining the dose or dose commitment due to the liquid radioactive effluents from Oyster Creek. Applicable liquid pathways to man for Oyster

Creek include shoreline exposure, and ingestion of saltwater fish and shellfish. The receptor location is provided in Table A-4.

1.5.2 SHORELINE DEPOSIT DOSE

The shoreline exposure pathway dose is calculated generally in the form (based on Reg. Guide 1.109):

$$Rapj = 110000 \frac{UapWM}{F} \sum_i QiTiDaipj(1 - \exp(-\lambda iTb))$$

Where:

- 110000 = a conversion factor to convert from Ci y⁻¹ ft³ s⁻¹ to pCi L⁻¹ and account for a proportionality constant used in the sediment radioactivity model (100 L m⁻² d⁻¹)
- Rapj = the annual dose to organ j (including the total body), through pathway p, to age group a
- Uap = the age dependent usage factor for the specific pathway. Usage factors for shoreline exposure are residence time on the shoreline (h y⁻¹). Usage factors are provided in Reg. Guide 1.109 Table E-5. Usage factors specifically selected for Oyster Creek are presented in Table B-1.
- W = the shore width factor. This adjusts the infinite plane gamma or beta dose factors for the finite size and shape of the shoreline. A factor of 0.1 is used for the discharge canal bank.
- M = the recirculation factor of 1.2 to account for recirculation of discharge water back into the intake.
- F = the flow rate in the discharge canal (ft³ s⁻¹)
- Qi = the activity of the ith isotope in the release in curies
- Ti = the half-life of the ith isotope in days
- Daipj = the age a, isotope i, pathway p, and organ j, specific dose conversion factor. Pathway, isotope, age, and organ specific dose factors are obtained from Regulatory Guide 1.109 Appendix E, Tables E-6 through E-14 (mrem h⁻¹ pCi⁻¹ m²)
- λi = the decay constant of the ith isotope in years
- Tb = the long-term buildup time, assumed to be 30 years

Note: λi and Tb can use any time units as long as they are both the same. No transit delay (Tp from Reg. Guide 1.109) is assumed.

1.5.3 SHORELINE DOSE EXAMPLE

Dilution flow rate is 5,000 gpm = 11.14 ft³ s⁻¹
Discharge 30,000 gal of water at 4.20 x 10⁻⁸ μCi mL⁻¹ ⁶⁰Co
Calculate teen shoreline whole body dose

$$U_{ap} \equiv 67 \text{ hour in a year (teenager)}$$

$$F \equiv 5,000 \text{ gpm} = 11.14 \text{ ft}^3 \text{ s}^{-1}$$

$$Q_i \equiv 4.20 \times 10^{-8} \mu\text{Ci mL}^{-1} \times 30,000 \text{ gal} \times 3.785 \times 10^3 \text{ mL gal}^{-1} \\ \times 10^{-6} \text{ Ci } \mu\text{Ci}^{-1} = 4.77 \times 10^{-6} \text{ Ci}$$

$$T_i \equiv 5.271 \text{ y} \times 365.25 \text{ d y}^{-1} = 1.93 \times 10^3 \text{ d}$$

$$Da_{ipj} \equiv 1.70 \times 10^{-8} \text{ mrem h}^{-1} \text{ pCi}^{-1} \text{ m}^2 \text{ (Regulatory Guide 1.109 Table E-6)}$$

$$1 - \exp^{-\lambda T_i} \equiv (1 - \exp^{-0.131 \times 30}) = 0.98$$

$$Rapj = 110000 \frac{67 \times 0.1 \times 1.2}{11.14} \sum_i^n 4.77 E - 6 \times 1930 \times 1.70 E - 8 \times 0.98$$

$$\mathbf{Rapj = 1.2 \times 10^{-5} \text{ mrem teen shoreline whole body dose}}$$

1.5.4 INGESTION DOSE - LIQUID

Ingestion dose pathway calculations are like those for the shoreline dose, with minor changes in constants, removal of the shore width factor, and inclusion of the bioaccumulation factor:

$$Rapj = 1100 \frac{U_{ap} M}{F} \sum_i Q_i B_{ip} Da_{ipj}$$

Where:

B_{ip} = the stable element bioaccumulation factor for pathway p for the ith isotope
(pCi kg⁻¹ pCi⁻¹ L)

No transit delay is assumed

Pathway, isotope, age, and organ specific dose factors are obtained from Regulatory Guide 1.109 Appendix E Tables E-7 through E-14. Bioaccumulation factors are provided in Reg. Guide 1.109 Table A-1. Usage factors are provided in Reg. Guide 1.109 Table E-5. Usage factors specifically selected for Oyster Creek are presented in Table B-1.

The radionuclides included in the periodic dose assessment per the requirements of CONTROL 3/4.11.1.2 are those as identified by gamma spectral analysis of the liquid waste samples collected and analyzed per the requirements of CONTROL 3/4.11.1.1, Table 4.11.1.1.1-1.

Radionuclides requiring radiochemical analysis (e.g., Sr-89 and Sr-90) will be added to the dose analysis at a frequency consistent with the required minimum analysis frequency of Table 4.11.1.1.1-1.

1.5.5 INGESTION DOSE CALCULATION EXAMPLE

Dilution flow rate is 5,000 gpm = 11.14 ft³ s⁻¹
Discharge 30,000 gal of water at 4.20 x 10⁻⁸ μCi mL⁻¹ ⁶⁰Co
Calculate adult GI-LLI dose from saltwater fish ingestion

$$U_{ap} \equiv 21 \text{ kg y}^{-1} \text{ (adult)}$$

$$F \equiv 5,000 \text{ gpm} = 11.14 \text{ ft}^3 \text{ s}^{-1}$$

$$Q_i \equiv 4.20 \times 10^{-8} \text{ } \mu\text{Ci mL}^{-1} \times 30,000 \text{ gal} \times 3.785 \times 10^3 \text{ mL gal}^{-1} \times 10^{-6} \text{ Ci } \mu\text{Ci}^{-1}$$

$$= 4.77 \times 10^{-6} \text{ Ci}$$

$$B_{ip} \equiv 100 \text{ pCi kg}^{-1} \text{ pCi}^{-1} \text{ L (Regulatory Guide 1.109 Table A-1)}$$

$$D_{aipj} \equiv 4.02 \times 10^{-5} \text{ mrem pCi}^{-1} \text{ (Regulatory Guide 1.109 Table E-11)}$$

$$R_{apj} = 1100 \frac{21 \times 1.2}{11.14} \sum_i^n 4.77 \times 10^{-6} \times 100 \times 4.02 \times 10^{-5}$$

R_{apj} = 4.8 x 10⁻⁵ mrem adult GI-LLI dose from saltwater fish ingestion

1.5.6 PROJECTED DOSE – LIQUID

The projected doses in a 31-day period are equal to the calculated doses from the current 31-day period.

1.6 REPRESENTATIVE SAMPLES

A sample should be representative of the bulk stream or volume of effluent from which it is taken. Prior to sampling, large volumes of liquid waste should be mixed in as short a time interval as practicable to assure that any sediments or particulate solids are distributed uniformly in the waste mixture. Recirculation pumps for liquid waste tanks (collection or sample test tanks) should be capable of recirculating at a rate of not less than two tank volumes in eight hours. Minimum recirculation times and methods of recirculation are controlled by specific plant procedures.

2.0 GASEOUS EFFLUENTS

2.1 RADIATION MONITORING INSTRUMENTATION AND CONTROLS

The gaseous effluent monitoring instrumentation and controls at Oyster Creek for controlling and monitoring normal radioactive material releases in accordance with the Radiological Effluent CONTROLS are summarized as follows:

(1) Main Stack

The main stack receives normal ventilation flow from the reactor building, new radwaste, old radwaste, and normal ventilation flow from portions of the turbine building. Reactor building and turbine building flow is not normally processed or filtered. Flow from the 'new' and 'old' radwaste buildings is HEPA filtered. Releases through the main stack are sampled for particulates and tritium. The main stack is an elevated release point.

Gaseous radioactive waste flow diagram is presented in Figure D-2-2.

2.2 GASEOUS EFFLUENT MONITOR SET POINT DETERMINATION

2.2.1 PLANT VENT - DELETED

2.3.2 SITE BOUNDARY DOSE RATE - PARTICULATES

2.3.2.1 METHOD - SITE BOUNDARY DOSE RATE - PARTICULATES

The dose rate OFFSITE due to the airborne release of tritium, and particulates with half-lives greater than 8 days is limited to no more than 1500 mrem/yr to any organ in CONTROL 3.11.2.1b. Evaluation of compliance with CONTROL 3.11.2.1b is based on the sampling and analyses specified in TABLE 4.11.2.1.2-1. Since the dose rate cannot be resolved within less than the sample integration or compositing time, the contribution of each radionuclide to the calculated dose rate will be averaged no more than 3 months for H-3, Sr-89, Sr-90, and alpha-emitting radionuclides and no more than 31 days for other radionuclides. These are their usual sample integration or compositing times. The equation used to assess compliance of tritium, and radioactive particulate releases with the dose rate limit is:

$$DR_p = 1E6 \sum_e \sum_i^n RaDFAijaQei \frac{\overline{X}}{Qe}$$

Where:

1E6 = conversion pCi/μCi

DR_p = the average dose rate to an organ via exposure pathway, p (mrem/yr).

- DFA_{ija} = inhalation dose factors due to intake of radionuclide i, to organ j age group a (mrem/pCi) from Reg. Guide 1.109 Appendix E.
- R_a = age group dependent inhalation respiratory rate (usage factor) m³/yr from Table B-1
- $\frac{\overline{X}}{Q_e}$ = annual average relative airborne concentration at an offsite location due to a release from either the Stack or a vent, i.e. release point, e (sec/m³) from Table 2.3.2.1-1.
- Q_{ei} = release rate of radionuclide i from release point, e during the period of interest (μCi/sec).

For real-time meteorology and on an annual average basis, the location of the maximum ground-level concentration originating from a vent release will differ from the maximum ground-level concentration from a stack release. When assessing compliance with CONTROL 3.11.2.1b for tritium and particulate, the air dispersion (X/Q) values are provided in Table 2.3.2.1-1.

TABLE 2.3.2.1-1 LOCATION OF MAXIMUM EXPOSURE RE BY INHALATION

Discharge Point	Receptor Location		Atm. Dispersion (sec/m ³)
	Sector	Distance (m)	
Ground Level or Vent	ENE	338	4.59 E-5
Stack	SE	937	1.25 E-8
Alternatively, inhalation exposure to effluent from the stack may be evaluated at the closest hypothetical individual located at:			
Stack	SE	805	1.29 E-8

Alternatively, an approved computer code (e.g., "SEEDS" or "Open EMS") that implements the methods of Regulatory Guide 1.109, may be used.

2.3.2.2 EXAMPLE PARTICULATES DOSE RATE CALCULATION

Calculate the child bone dose rate from a release of 100 μCi/hr of Ni-63 from a ground level release:

$$DR_p = 1E6 \sum_e \sum_i^n R_a D F A_{ija} Q_{ei} \frac{\overline{X}}{Q_e}$$

- R_a = 3700 m³/yr
DFA_{ija} = 2.22 E-4 mrem/pCi
Q_{ei} = 0.028 μCi/sec [100μCi/hr /3600 sec/hr = 0.02778]
X/Q_e = 4.59 E-5 sec/m³

$$DRp = 1E6 \sum_1^n 3700 * 2.22E-4 * 0.028 * 4.59E-5$$

$$DRp = 1.05 \text{ mrem/ yr}$$

2.4 DELETED

2.5 PARTICULATE AND OTHER RADIONUCLIDES DOSE CALCULATIONS - 10 CFR 50

Doses resulting from the release of particulates must be calculated to show compliance with Appendix I of 10CFR50. Calculations will be performed at least monthly for all gaseous effluents as stated in SURVEILLANCE REQUIREMENT 4.11.2.2 and SURVEILLANCE REQUIREMENT 4.11.2.3 to verify that the dose to air is kept below the limits specified in CONTROL 3.11.2.2 and the dose to members of the public is maintained below the limits specified in CONTROL 3.11.2.3.

The maximum dose to an individual from tritium, and radioactive particulates with half-lives of greater than eight days in gaseous effluents released to unrestricted areas is determined as described in Reg. Guide 1.109. Environmental pathways that tritium, and particulates in airborne effluent follow to the maximally exposed member of the public as determined by the annual land use survey and reference meteorology will be evaluated. The seasonality of exposure pathways may be considered. For instance, if the most exposed receptor has a garden, fresh and stored vegetables are assumed to be harvested and eaten during April through October. Fresh vegetables need not be considered as an exposure pathway during November through March. To assess compliance with CONTROL 3.11.2.3, the dose due to tritium, and particulates in airborne effluent is calculated to a person residing 972 meters ESE of the OCGS for ground-level or vent and 937 meters SE of the OCGS for stack. Reference atmospheric dispersion and deposition factors are given in Table 2.5-1.

TABLE 2.5-1 DISPERSION FOR 10CFR50 DOSES

Discharge Point	Dispersion X/Q (sec/m ³)	Deposition D/Q(1/m ²)
Ground Level or Vent	5.13 E-6	1.68 E-8
Stack	1.25 E-8	2.39 E-9

The environmental pathways of exposure to be evaluated are: inhalation, irradiation from ground deposition, and ingestion of milk (cow and goat are treated separately), meat, and vegetables. Eight organs are considered: Bone, Liver, Total Body, Thyroid, Kidney, Lung, GI-LLI (Gastro-Intestinal tract / Lower Large Intestine), and Skin. Four different age groups are considered: Infants, Children, Teens, and Adults. Doses are calculated to a 'receptor' – a person who inhales the airborne activity and resides in a location with ground deposition, and eats and drinks the foodstuffs produced. The maximally exposed individual is conservatively assumed to reside at the location of the highest sum of the

inhalation and ground plane doses, while eating and drinking foodstuffs transported from the locations that are highest for those pathways. Receptor locations are provided in Table A-4.

Alternatively, an approved computer code (e.g., "SEEDS", NRC Dose Code", "RETDAS" or "Open EMS") that implements the requirements of Reg Guide 1.109 may be used.

2.5.1 INHALATION OF TRITIUM, PARTICULATES, AND OTHER RADIONUCLIDES

Dose from the inhalation pathway is generally in the form:

$$D_{ja} = RaT \sum_i \frac{X}{Q} Q_i D_{FAija} \text{Exp}(-\lambda_i Tr)$$

Where:

D_{ja} = the dose to the organ j (of eight) of age group a (of four)

Ra = the respiration rate for age group a from Table B-1

T = the duration of the release in fraction of a year

$\frac{X}{Q}$ = The atmospheric dispersion to the point of interest (the 'receptor') in sec/m^3 from
Table 2.5-1

Q_i = The release rate of radionuclide i (pCi/sec)

D_{FAija} = The inhalation dose conversion factor (mrem per pCi) for radionuclide i to organ j of age group a from Reg. Guide 1.109 Appendix E.

λ_i = decay constant of isotope i: $0.693/\text{Half-life in years}$

Tr = plume transit time from release to receptor in years

λ_i and Tr may be in any time units as long as they are the same

Note that a 'depleted X/Q' (dX/Q) is applicable to particulates only, which accounts for the natural settling and lack of surface reflection of particulates to estimate the downwind concentration accounting for these removal processes. Depleted X/Q will be slightly smaller than the X/Q. This is not used in the ODCM for simplicity. Using the X/Q is therefore slightly conservative compared to the dX/Q .

2.5.2 EXAMPLE CALCULATION - INHALATION OF TRITIUM, PARTICULATES, AND OTHER RADIONUCLIDES

Calculate the dose to child lung from inhalation from a ground level release of 100 μCi of Co-60 in 10 hours. Plume transit decay time is ignored ($\exp(-\lambda_i T_r)=1$).

$$D_{ja} = RaT \sum_i \frac{X}{Q} Q_i D_{FAi} a_j$$

D_{ja} = the dose to the organ j (of eight) of age group a (of four)

Ra = 3700 m^3/yr

T = 0.00114 yrs [10 hrs / 8760 hrs / yr]

$\frac{X}{Q}$ = 5.13 $\text{E}-6$ sec/ m^3

Q_i = 2.78E3 pCi/sec [100 μCi * 1E6 pCi/ μCi / (10 hrs*3600 sec / hr)]
 $D_{FAi} a_j$ = 1.91E-3 mrem / pCi

$$D_{ja} = 3700 * 0.00114 * 5.13E-6 * 2.78E3 * 1.91E-3$$

$$D_{ja} = 1.15E-4 \text{ mrem}$$

2.5.3 INGESTION OF PARTICULATES AND OTHER RADIONUCLIDES

Dose from the ingestion pathways is more complex and is broken out here into multiple steps.

2.5.3.1 CONCENTRATION OF THE RADIONUCLIDE IN ANIMAL FORAGE AND VEGETATION – OTHER THAN TRITIUM

The concentration of a radionuclide in a foodstuff (other than tritium – see section 2.5.3.3 for tritium) is dependent on the atmospheric deposition, the biological uptake into the food, various decay times (plume travel, harvest to table, etc.) and is generally of the form:

$$C_{iv} = \frac{D}{Q} Q_i \left\{ \frac{r(1 - \text{EXP}(-\lambda_i T_e))}{Y_v \lambda_i} + \frac{B_{iv}(1 - \text{EXP}(-\lambda_i T_b))}{P \lambda_i} \right\} \text{EXP}(-\lambda_i T_h) \text{EXP}(-\lambda_i T_r)$$

Where:

C_{iv} = the concentration (pCi/kg) of radionuclide i in vegetation

Q_i = the release rate of isotope i in pCi/hr

- $\frac{D}{Q}$ = The atmospheric deposition to the point of interest (the 'receptor') in 1/m² from Table 2.5-1.
- r = the retention coefficient for deposition onto vegetation surfaces (0.2 for particulates)
- λ_i = the decay constant of radionuclide i; 0.693/half-life in hours
- λ_{Ei} = the effective removal constant which is the sum of $\lambda_i + \lambda_w$ where λ_w is the weathering constant, 0.0021/hr
- Te = duration of crop exposure during the growing season in hours. This is not the entire duration of the growing season, and is different for leafy vegetable and fruit/grain/vegetables. Provided in Table E-15 of Reg. Guide 1.109 or Table B-1.
- Yv = agricultural yield Kg of vegetation per m², typically 0.7 kg/m²
- Biv = soil uptake concentration factor for transfer of the radionuclide i from the soil to the vegetation through normal root uptake processes in pCi/kg in vegetation per pCi/Kg in soil. Values are provided in Reg. Guide 1.109 Table E-1.
- Tb = the length of time the soil is exposed to contaminated inputs – nominally 30 years (2.63E5 hr)
- P = effective soil density in kg/m² normally 240 kg/m²
- Th = holdup time, the time the foodstuff is in transit between harvest and consumption in hours
- Tr = plume transit time from release to receptor in hours

2.5.3.2 EXAMPLE CALCULATION OF CONCENTRATION OF THE RADIONUCLIDE IN ANIMAL FORAGE AND VEGETATION – OTHER THAN TRITIUM.

Calculate the forage and vegetation concentration from a ground level release of 100 μ Ci of Co-60 in 10 hours (plume transit time is ignored $T_r=0$, $EXP(-\lambda_i T_r)=1$):

$$C_{iv} = \frac{D}{Q} Q_i \left\{ \frac{r(1 - EXP(-\lambda_{Ei} T_e))}{Y_v \lambda_{Ei}} + \frac{B_{iv}(1 - EXP(-\lambda_i T_b))}{P \lambda_i} \right\} EXP(-\lambda_i T_h) EXP(-\lambda_i T_r)$$

- D/Q = 1.67E-8 m²
- Q_i = 1E7 pCi/hr [100 μ Ci * 1E6 pCi/ μ Ci / 10 hr]
- r = 0.2
- λ_i = 1.5E-5/hr [0.693 / (5.27yr * 8760 hr/yr)]
- λ_{Ei} = 2.12E-3 /hr [1.5E-5 + 0.0021]
- Te = 720 hr [grass-cow-milk-man pathway value]
- Yv = 0.7 kg/m²

Biv = 9.4E-3
Tb = 2.63E5 hr
P = 240 kg/m²
Th = 24.1 hours

$$C_{iv} = 1.67E-8 * 1E7 \left\{ \frac{0.2 * (1 - EXP(-2.12E-3 * 720))}{0.7 * 2.12E-3} + \frac{9.4E-3 * (1 - EXP(-1.5E-5 * 2.63E5))}{240 * 1.5E-5} \right\} EXP(-1.5E-5 * 0)$$

$$C_{iv} = 1.67E-8 * 1E7 \left\{ \frac{0.2 * (1 - EXP(-1.53))}{1.48E-3} + \frac{9.4E-3 * (1 - EXP(-3.95))}{3.6E-3} \right\} EXP(-0)$$

$$C_{iv} = 1.67E-1 \left\{ \frac{105.9}{2.56} + \right\} * 1$$

$$C_{iv} = 18.0 pCi / Kg$$

2.5.3.3 CONCENTRATION OF TRITIUM IN ANIMAL FORAGE AND VEGETATION

Since tritium is assumed to be released as tritiated water (HTO), the concentration of tritium in a foodstuff is dependent on atmospheric dispersion like a gas, rather than particulate deposition as for other radionuclides for foodstuff uptake. Further, the concentration of tritium in food is assumed to be based on equilibrium between the concentration of the tritium in the atmospheric water and the concentration of tritium in the water in the food. Concentration of tritium in vegetation can be calculated generally in the form (a plume transit decay term: EXP(-λiTr) is ignored since plume travel times are very short compared to the half-life):

$$C_{tv} = 1000Q_t \frac{X}{Q} * 0.75 * \frac{0.5}{H}$$

Where:

C_{tv} = the concentration (pCi/kg) of tritium in vegetation

1000 = g per kg

Q_t = the release rate of the tritium in pCi/ sec

- X/Q = the atmospheric dispersion at the vegetation point, sec/m³ from Table 2.5-1
- 0.75 = the fraction of vegetation that is water
- 0.5 = the effective ratio between the atmospheric water concentration and the vegetation concentration
- H = the absolute humidity g/m³. Absolute humidity is seasonally dependent, varying from as little as 1 in the winter to as much as 20 in the summer. Monthly average values derived from historical data are provided in Table B-2.

2.5.3.4 EXAMPLE CALCULATION OF CONCENTRATION OF TRITIUM IN ANIMAL FORAGE AND VEGETATION.

Calculate the forage and vegetation concentration from a ground level release of 100 μCi of H-3 in 10 hours. Plume transit decay time is ignored (exp(-λiTr)=1):

$$C_{tv} = 1000Q_t \frac{X}{Q} * 0.75 * \frac{0.5}{H}$$

- Qt = 2778 pCi/sec [100uCi * 1E6 pCi/uCi / (10hrs*3600sec/hr)]
- X/Q = 5.13E-6 sec/m³
- H = 5 g/m³ (assumed for this example)

$$C_{tv} = 2778 * 1000 * 5.13E - 6 * 0.75 * \frac{0.5}{5}$$

$$C_{tv} = 1.07 \text{ pCi / kg}$$

2.5.3.5 CONCENTRATION OF THE RADIONUCLIDE IN MILK AND MEAT

Meat and milk animals are assumed to eat both pasture grass and stored feed. During a fraction of the year, they may be assumed to be exclusively on stored feed, outside of the growing season. If using annual average release, the fraction of stored and fresh feed must be accounted for with fractions, otherwise (as in this ODCM), the fresh pasture pathway is turned on or off depending on the growing season. The concentration of a radionuclide in the animal feed is calculated as follows:

$$C_{iv} = F_p C_{is} + (1 - F_p) C_{is} (1 - F_s) + C_{ip} F_s (1 - F_p)$$

Where:

- Fp = the growing season pasture factor: 1 if not growing season, 0 if in growing season
- Fs = the fraction of the daily feed from fresh pasture from Table B-1 or Exhibit E-15 from Reg. Guide 1.109.

Cip = the concentration in the fresh pasture feed (Civ from section 2.5.3.2 with Th = 0 for immediate consumption)

Cis = the concentration in stored feed (Civ from section 2.5.3.2 with Th = 90 days)

The concentration in the milk is then based on this feed concentration:

$$C_{im} = F_m C_{iv} Q_f \text{EXP}(-\lambda_i T_f)$$

Where:

Cim = the concentration in milk pCi/l

Fm = the transfer coefficient of intake to concentration in the milk (d/l) from Reg. Guide 1.109 Table E-1.

Qf = feed intake rate Kg/d from Reg. Guide 1.109 Table E-3.

λ_i = radionuclide i decay constant in 1/days

Tf = transport time from milk production to consumption (2 days for milk)

The Goat milk pathway may be similarly evaluated:

$$C_{im} = F_g C_{iv} Q_f \text{EXP}(-\lambda_i T_f)$$

Where:

Fg = the transfer coefficient of intake to concentration in the milk (d/l) for goats from Reg. Guide 1.109 Table E-2.

And for meat:

$$C_{if} = F_f C_{iv} Q_f \text{EXP}(-\lambda_i T_s)$$

Where:

Ff = the transfer coefficient of intake to concentration in the meat d/kg from Reg. Guide 1.109 Table E-1.

Ts = the transport time from slaughter to consumption (20 days)

2.5.3.6 EXAMPLE CALCULATION OF CONCENTRATION OF THE RADIONUCLIDE IN MILK AND MEAT

Calculate the concentration in cow milk from a ground level release of 100 μCi of Co-60 in 10 hours. Plume transit decay time is ignored ($\text{exp}(-\lambda_i T_r)=1$):

$$C_{iv} = F_p C_{is} + (1 - F_p) C_{is} (1 - F_s) + C_{ip} F_s (1 - F_p)$$

Assume animals are on pasture and receive half of their food from stored feed.

C _{ip}	= 18.0 pCi/kg as previously calculated in section 2.5.3.2
F _p	= 0
F _s	= 0.5

C_{is} is calculated by applying a 90-day decay term to the C_{ip} value previously calculated, since the previous decay correction was for 0 time as shown in 2.5.3.2.

$$C_{is} = 18.0 * (\exp(-0.693 * 90 / (5.27 * 365)))$$

$$C_{is} = 17.4 \text{ pCi / kg}$$

C_{iv} is then:

$$C_{iv} = 0 * 17.4 + (1 - 0) 17.4 * (1 - 0.5) + 18.0 * 0.5 * (1 - 0)$$

$$C_{iv} = 17.7 \text{ pCi / kg}$$

The concentration in milk is given by:

$$C_{im} = F_m C_{iv} Q_f \text{EXP}(-\lambda_i T_f)$$

F _m	= 1.0E-3 d/l
Q _f	= 50 Kg/d
λ _i	= 3.6E-4/d [0.693 / (5.27 yrs*365 days/yr)]

$$C_{im} = 1.0E - 3 * 17.7 * 50 * \text{EXP}(-3.6E - 4 * 2)$$

$$C_{im} = 0.88 \text{ pCi / l}$$

The concentration in meat given by:

$$C_{if} = F_f C_{iv} Q_f \text{EXP}(-\lambda_i T_s)$$

F _f	= 1.3E-2 d/kg
Q _f	= 50 Kg/d
λ _i	= 3.6E-4/d

$$C_{if} = 1.3E - 2 * 17.7 * 50 * \text{EXP}(-3.6E - 4 * 20)$$

$$C_{if} = 11.5 \text{ pCi / kg}$$

2.5.3.7 DOSE FROM CONSUMPTION OF MILK, MEAT, AND VEGETABLES

The environmental pathway ingestion dose is the sum of the milk, meat, and vegetation ingestion pathways. There are two separate pathways for vegetation: fresh leafy vegetables and a combination of fruits, non-leafy vegetables, and grains. These differ only in the decay and buildup processes applied to account for the environmental exposure, and transportation delay decay represented by T_e and T_h as shown in section 2.5.3.1. For long half-life isotopes (e.g. Co-60) the decay differences have little impact on the dose.

Dose from the environmental ingestion pathways is generally of the form:

$$D_{ja} = T \sum_i DF_{Iija} [U_{av} F_g C_{iv} + U_{am} C_{im} + U_{af} C_{if} + U_{al} F_l C_{il}]$$

Where:

D_{ja} = the dose to organ j of age group a - mrem

T = fraction of year of release duration

DF_{Iija} = the ingestion dose factor for isotope i to organ j for age group a - mrem/pCi from Reg. Guide 1.109 Appendix E

U_{av} = Ingestion rate (usage factor) for non-leafy vegetables, grains, and fruits for age group a from Reg. Guide 1.109 Table E-5 or Table B-1.

F_g = the fraction of vegetables, grains, and fruits from the location of interest: 0.76 in Reg. Guide 1.109.

C_{iv} = the concentration of isotope i in the vegetables, fruits, and grains calculated from section 2.5.3.2.

U_{am} = Ingestion rate (usage factor) for milk for age group a : from Table B-1 or Reg. Guide 1.109 Table E-5.

C_{im} = the concentration of isotope i in milk calculated from section 2.5.3.5.

U_{af} = the ingestion rate for meat for age group a : from Table B-1 or Reg. Guide 1.109 Table E-5.

C_{if} = the concentration of isotope i in meat calculated from section 2.5.3.2.

U_{al} = the ingestion rate for leafy vegetables for age group a : from Table B-1 or Reg. Guide 1.109 Table E-5.

F_l = the fraction of annual leafy vegetable ingestion from the location of interest: 1.0 in Reg. Guide 1.109.

C_{il} = concentration of isotope i in the leafy vegetables for direct human consumption: C_{iv} calculated from section 2.5.3.2 with $T_h=0$.

2.5.3.8 EXAMPLE CALCULATION - DOSE FROM CONSUMPTION OF MILK, MEAT, AND VEGETABLES

Calculate the ingestion dose to child whole body from a ground level release of 100 μCi of Co-60 in 10 hours. Plume transit decay time is ignored ($\exp(-\lambda_i T_r)=1$):

$$D_{ja} = T \sum_i DFI_{ija} [U_{av} F_g C_{iv} + U_{am} C_{im} + U_{af} C_{if} + U_{al} F_l C_{il}]$$

Where:

T	= 0.00114 yr [10hrs / 8760 hrs/yr]
DFI _{ija}	= 1.56E-5 mrem/pCi
U _{av}	= 520
F _g	= 0.76
C _{iv}	= 17.6 [18.0*EXP(- λ *60) using 60 day delay for ingestion]
U _{am}	= 330
C _{im}	= 0.88
U _{af}	= 41
C _{if}	= 11.5
U _{al}	= 26
F _l	= 1
C _{il}	= 17.7

$$D_{ja} = .00114 \sum_i 1.56E - 5 [520 * 0.76 * 17.6 + 330 * 0.88 + 41 * 11.5 + 26 * 1 * 17.7]$$

$$D_{ja} = .00114 \sum_i 1.56E - 5 [6956 + 290 + 472 + 460]$$

$$D_{ja} = 1.45E - 4 \text{ mrem} : \text{child} : \text{whole body}$$

2.5.4 GROUND PLANE DEPOSITION IRRADIATION

Dose from ground plane deposition is estimated by determining the surface activity resulting from the release.

2.5.4.1 GROUND PLANE CONCENTRATION

The ground surface activity is estimated as:

$$C_{ig} = \frac{D}{Q} \frac{Q_i}{\lambda_i} (1 - \text{EXP}(-\lambda_i T_b))$$

Where:

C_{ig} = ground plane concentration of radionuclide i in pCi/m²

$\frac{D}{Q}$ = local atmospheric release deposition factor in 1/m² from Table 2.5-1

- Qi = release rate in pCi/sec
- λ_i = radiological decay constant in 1/sec
- Tb = long term buildup time 30 years (9.46E8 sec)

Note: Qi, λ_i and Tb can utilize any time units as long as they are all the same

2.5.4.2 EXAMPLE GROUND PLANE CONCENTRATION CALCULATION

Calculate the ground plane concentration from a 100 μ Ci release of Co-60 over 10 hours from a ground level release point.

$$C_{ig} = \frac{D}{Q} \frac{Q_i}{\lambda_i} (1 - EXP(-\lambda_i T_b))$$

- $\frac{D}{Q}$ = 1.67E-8 /m²
- Qi = 2778 pCi/sec [100 μ Ci/10hrs/3600sec/hr]
- λ_i = 4.17E-9/sec [0.693/(5.27yr*8760hr/yr*3600sec/hr)]
- Tb = 9.46E8 sec

$$C_{ig} = 1.67E-8 \frac{2778}{4.17E-9} (1 - EXP(-4.17E-9 * 9.46E8))$$

$$C_{ig} = 1.09E4 pCi / m^2$$

2.5.4.3 GROUND PLANE DOSE

Annual dose from the ground plane deposition is of the form:

$$D_{jg} = 8760 * T * S_f \sum_i C_{ig} D_{FGij}$$

Where:

- D_{jg} = the annual dose (mrem) from ground plane pathway (g) to the total body or skin (j)
- 8760 = hours in a year
- T = fraction of year release is in progress
- S_f = shielding factor accounting for shielding from dwelling from Table B-1
- D_{FGij} = Ground plane dose factor for skin or total body (j) for radionuclide i from Table E-6 of Reg. Guide 1.109 in mrem/hr / pCi/m².

2.5.4.4 EXAMPLE GROUND PLANE DOSE

Calculate the ground plane Total Body dose from a 100 μCi release of Co-60 over 10 hours from a ground level release point.

$$D_{jg} = 8760 * T * S_f \sum_i C_{ig} D_{FGij}$$

T	= 0.00114 [10/8760]
S _f	= 0.7
D _{FGij}	= 1.7E-8
C _{ig}	= 1.09E4

$$D_{jg} = 8760 * 0.00114 * 0.7 \sum_i 1.09E4 * 1.7E-8$$

$$D_{jg} = 1.30E-3 \text{ mrem Total Body}$$

2.6 PROJECTED DOSES – GASEOUS

The projected doses in a 31-day period are equal to the calculated doses from the current 31-day period.

3.0 TOTAL DOSE TO MEMBERS OF THE PUBLIC - 40 CFR 190

The Annual Radiological Effluent Release Report (ARERR) submitted by May 1st of each year shall include an assessment of the radiation dose to the likely most exposed member of the public for reactor releases and other nearby uranium fuel cycle sources (including dose contributions from effluents and direct radiation from on-site sources). For the likely most exposed member of the public near Oyster Creek, the sources of exposure need only consider the Oyster Creek Generating Station. No other fuel cycle facilities would contribute significantly to the member of the public dose for the Oyster Creek vicinity, however, both plant operation and ISFSI sources must be included in the dose assessment.

To assess compliance with CONTROL 3.11.4, calculated organ and total body doses from effluents from liquid pathways and atmospheric releases as well as any dose from direct radiation will be summed.

As appropriate for demonstrating/evaluating compliance with the limits of CONTROL 3.11.4 (40 CFR 190), the results of the Radiological Environmental Monitoring Program (REMP) may be used for providing data on actual measured levels of radiation and / or radioactive material and resultant dose to the member of the public in the actual pathways of exposure.

3.1 EFFLUENT DOSE CALCULATIONS

For purposes of implementing the surveillance requirements of CONTROL 3/4.11.4 and the reporting requirements of Technical Specification 6.9.1.a (ARERR), dose calculations for the Oyster Creek Generating Station may be performed using the calculation methods contained within the ODCM; the conservative controlling pathways and locations from the ODCM or the actual pathways and locations as identified by the land use census (CONTROL 3/4.12.1) may be used. Average annual meteorological dispersion parameters provided in reference 34, herein or meteorological conditions concurrent with the release period under evaluation may be used.

3.2 DIRECT EXPOSURE DOSE DETERMINATION

Any potentially significant direct exposure contribution to offsite individual doses may be evaluated based on the results of environmental measurements (e.g., dosimeter) and/or by the use of radiation transport and shielding calculation methodologies.

4.0 RADIOLOGICAL ENVIRONMENTAL MONITORING PROGRAM

The operational phase of the Radiological Environmental Monitoring Program (REMP) is conducted in accordance with the requirements of CONTROL 3.12.1. The objectives of the program are:

- To determine whether any significant increases occur in the concentration of radionuclides in the critical pathways of exposure in the vicinity of Oyster Creek
- To determine if the operation of the Oyster Creek Generating Station has resulted in any increase in the inventory of long-lived radionuclides in the environment;
- To detect any changes in the ambient gamma radiation levels; and
- To verify that OCGS operations have no detrimental effects on the health and safety of the public or on the environment.

The REMP sample locations are presented in Appendix E.

**APPENDIX A - LOCATIONS ASSOCIATED WITH MAXIMUM EXPOSURE OF A
MEMBER OF THE PUBLIC**

Table A-4 Locations Associated with Maximum Exposure of a Member of the Public*

<u>Effluent</u>	<u>Distance</u> (meters)	<u>Location</u>	<u>Direction</u> (to)
Liquid		U.S. Route 9 Bridge at Discharge Canal	
Airborne Particulates	937		SE
Tritium	937		SE
Irradiation by OCGS		Site Boundary	All

Note: the nearby resident experiencing the maximum exposure to airborne effluent from the Station is located 937 meters SE of the OCGS. The nearby resident (part-time) experiencing the maximum exposure to gamma radiation directly from the Station is located 618 meters WSW of the OCGS. The most exposed member of the public is assumed to be exposed by irradiation from the OCGS, by inhaling airborne effluent, by irradiation by the airborne effluent, by irradiation, by radionuclides deposited onto the ground, by irradiation by shoreline deposits, and by eating fish and shellfish caught in the discharge canal.

*The age group of the most exposed member of the public is based on Reg. Guide 1.109, Revision 1.

APPENDIX B - MODELING PARAMETERS

Table B-1- OCGS Usage Factors For Individual Dose Assessment

<u>Effluent Ingestion Parameters</u>	<u>Usage Factor</u>
Fraction Of Produce From Local Garden	7.6E-1
Soil Density In Plow Layer (Kg/m ²)	2.4E+2
Fraction Of Deposited Activity Retained On Vegetation	2.5E-1
Shielding Factor For Residential Structures	7.0E-1
Period Of Buildup Of Activity In Soil (hr)	1.31E+5
Period of Pasture Grass Exposure to Activity (hr)	7.2E+2
Period Of Crop Exposure to Activity (hr)	1.44E+3
Delay Time For Ingestion Of Stored Feed By Animals (hr)	2.16E+3
Delay Time For Ingestion Of Leafy Vegetables By Man (hr)	2.4E+1
Delay Time For Ingestion Of Other Vegetables By Man (hr)	1.44E+3
Transport Time Milk-Man (hr)	4.8E+1
Time Between Slaughter and Consumption of Meat Animal (hr)	4.8E+2
Grass Yield Wet Weight (Kg/m ²)	7.0E-1
Other Vegetation Yield Wet-Weight (Kg/m ²)	2.0
Weathering Rate Constant For Activity on Veg. (hr ⁻¹)	2.1E-3
Milk Cow Feed Consumption Rate (Kg/day)	5.0E+1
Goat Feed Consumption Rate (Kg/day)	6.0
Beef Cattle Feed Consumption Rate (Kg/day)	5.0E+1
Milk Cow Water Consumption Rate (L/day)	6.0E+1
Goat Water Consumption Rate (L/day)	8.0
Beef Cattle Water Consumption Rate (L/day)	5.0E+1
Environmental Transit Time For Water Ingestion (hr)	1.2E+1
Environmental Transit Time For Fish Ingestion (hr)	2.4E+1
Environmental Transit Time For Shore Exposure (hr)	0
Environmental Transit Time For Invertebrate Ingestion (hr)	2.4E+1

Table B-1(Continued)
OCGS Usage Factors for Individual Dose Assessment

<u>Effluent Ingestion Parameters</u>	<u>Usage Factor</u>
Water Ingestion (L/yr)	
a. Adult	7.3E+2
b. Teen	5.1E+2
c. Child	5.1E+2
d. Infant	3.3E+2
Shore Exposure (hr/yr)	
a. Adult	1.2E+1
b. Teen	6.7E+1
c. Child	1.4E+1
d. Infant	0
Salt Water Sport Fish Ingestion (Kg/yr)	
a. Adult	2.1E+1
b. Teen	1.6E+1
c. Child	6.9
d. Infant	0
Salt Water Commercial Fish Ingestion (Kg/yr)	
a. Adult	2.1E+1
b. Teen	1.6E+1
c. Child	6.9
d. Infant	0
Salt Water Invertebrate Ingestion (Kg/yr)	
a. Adult	5.0
b. Teen	3.8
c. Child	1.7
d. Infant	0
Irrigated Leafy Vegetable Ingestion (Kg/yr)	
a. Adult	6.4E+1
b. Teen	4.2E+1
c. Child	2.6E+1
d. Infant	0

Table B-1 (Continued)
OCGS Usage Factors for Individual Dose Assessment

<u>Effluent Ingestion Parameters</u>	<u>Usage Factor</u>
Irrigated Other Vegetable Ingestion (Kg/yr)	
a. Adult	5.2E+2
b. Teen	6.3E+2
c. Child	5.2E+2
d. Infant	0
Irrigated Root Vegetable Ingestion (Kg/yr)	
a. Adult	5.2E+2
b. Teen	6.3E+2
c. Child	5.2E+2
d. Infant	0
Irrigated Cow and Goat Milk Ingestion (L/yr)	
a. Adult	3.1E+2
b. Teen	4.0E+2
c. Child	3.3E+2
d. Infant	3.3E+2
Irrigated Beef Ingestion (Kg/yr)	
a. Adult	1.1E+2
b. Teen	6.5E+1
c. Child	4.1E+1
d. Infant	0
Inhalation (m ³ /yr)	
a. Adult	8.0E+3
b. Teen	8.0E+3
c. Child	3.7E+3
d. Infant	1.4E+3
Cow and Goat Milk Ingestion (L/yr)	
a. Adult	3.1E+2
b. Teen	4.0E+2
c. Child	3.3E+2
d. Infant	3.3E+2
Meat Ingestion (Kg/yr)	
a. Adult	1.1E+2
b. Teen	6.5E+1
c. Child	4.1E+1
d. Infant	0

Table B-1 (Continued)
OCGS Usage Factors for Individual Dose Assessment

<u>Effluent Ingestion Parameters</u>	<u>Usage Factor</u>
Leafy Vegetable Ingestion (Kg/yr)	
a. Adult	6.4E+1
b. Teen	4.2E+1
c. Child	2.6E+1
d. Infant	0
Fruits, Grains, & Other Vegetable Ingestion (Kg/yr)	
a. Adult	5.2E+2
b. Teen	6.3E+2
c. Child	5.2E+2
d. Infant	0

Table B-2 Monthly Average Absolute Humidity g/m³
(derived from historical climatological data)

<u>Month</u>	<u>Average Absolute Humidity (g/m³)</u>
January	3.3
February	3.3
March	4.5
April	6.1
May	9.4
June	12.8
July	15.2
August	15.6
September	12.4
October	7.9
November	5.9
December	3.8

APPENDIX C - REFERENCES

Table C-1 - REFERENCES

- 1) Oyster Creek Updated Final Safety Analysis Report
- 2) Oyster Creek Facility Description and Safety Analysis Report
- 3) Oyster Creek Operating License and Technical Specifications
- 4) NUREG 1302 "Offsite Dose Calculation Manual Guidance: Standard Radiological Effluent Controls for Boiling Water Reactors" – Generic Letter 89-10, Supplement No. 1, April 1991
- 5) Reg Guide 1.21 "Measuring, Evaluating, and Reporting Radioactivity in Solid Wastes and Releases of Radioactive Materials in Liquid and Gaseous Effluents from Light-Water-Cooled Nuclear Power Plants" Rev.2, June 2009
- 6) Reg Guide 1.23, "Meteorological Monitoring Programs for Nuclear Power Plants", Revision 1, March 2007
- 7) Reg Guide 1.97, "Instrumentation for Light-Water Cooled Nuclear Power Plants to Assess Plant and Environs Conditions During and Following an Accident", Revision 3, May 1983
- 8) Reg Guide 1.109 "Calculation of Annual Doses to Man from Routine Releases of Reactor Effluents for the Purpose of Evaluating Compliance With 10 CFR 50, Appendix I", Rev 1, October 1977
- 9) Reg Guide 1.111 "Methods for Estimating Atmospheric Transport and Dispersion of Gaseous Effluents in Routine Releases From Light-Water-Cooled Reactors", Rev.1, July 1977
- 10) Reg Guide 4.8 "Environmental Technical Specifications for Nuclear Power Plants"
- 11) NRC Radiological Assessment Branch Technical Position, Rev 1, November 1979 (Appendix A to NUREG1302)
- 12) NUREG-0016, "Calculation of Releases of Radioactive Materials in Gaseous Liquid Effluents from Boiling Water Reactors (BWR-GALE Code)", Revision 1, January 1979
- 13) NUREG-0133, "Preparation of Radiological Effluent Technical Specifications for Nuclear Power Plants", October 1987
- 14) Licensing Application, Amendment 13, Meteorological Radiological Evaluation for the Oyster Creek Nuclear Power Station Site.
- 15) Licensing Application, Amendment 11, Question IV-8.

- 16) Evaluation of the Oyster Creek Nuclear Generating Station to Demonstrate Conformance to the Design Objectives of 10CFR50, Appendix I, May, 1976, Tables 3-10
- 17) XOQDOQ Output Files for Oyster Creek Meteorology, Murray and Trettle, Inc.
- 18) Hydrological Information and Liquid Dilution Factors Determination to Conform with Appendix I Requirements: Oyster Creek, correspondence from T. Potter, Pickard, Lowe and Garrick, Inc. to Oyster Creek, July 1976.
- 19) Carpenter, J. J. "Recirculation and Effluent Distribution for Oyster Creek Site", Pritchard-Carpenter Consultants, Baltimore, Maryland, 1964.
- 20) Nuclear Regulatory Commission, Generic Letter 89-01, "Implementation of Programmatic Controls for Radiological Effluent Technical Specifications in the Administrative Controls Section and Relocation of the Procedural Details of RETS to the ODCM or PCP", January 1989.
- 21) Ground Water Monitoring System (Final Report), Woodward-Clyde Consultants, March 1984.
- 22) Meteorology and Atomic Energy, Department of Energy, 1981.
- 23) SEEDS Code Documentation through V & V of Version 98.8F (Radiological Engineering Calculation No. 2820-99-005, Dated 3/23/99)
- 24) Lynch, Giuliano, and Associates, Inc., Drawing Entitled, "Minor Subdivision, Lots 4 and 4.01 Block 1001", signed 13 Sep 99.
- 25) Currie, L. A., "Lower Limit of Detection: Definition and Elaboration of a Proposed Position for Radiological Effluent and Environmental Measurements" .
- 26) NUREG/CR-4007, "Lower Limit of Detection: Definition and Elaboration of a Proposed Position for Radiological Effluent and Environmental Measurements", September 1984
- 27) HASL Procedures Manual, HASL-300 (revised annually).
- 28) Regulatory Guide 1.113, "Estimating Aquatic Dispersion of Effluents from Accidental and Routine Reactor Releases for the Purposes of Implementing Appendix I," April 1977
- 29) Reg Guide 4.13, "Environmental Dosimetry – Performance Specifications, Testing, and Data Analysis", Revision 2, June 2019
- 30) 10CFR20, Appendix B, Table 2, Annual Limits on Intake (ALIs) and Derived Air Concentrations (DACs) of Radionuclides for Occupational Exposure; Effluent Concentrations; Concentrations for Release to Sewerage

- 31) Conestoga Rovers and Associates, Hydrogeologic Investigation Report, Fleet wide Assessment, Oyster Creek Generating Station, Forked River, New Jersey, Ref. No. 045136(18), September 2006.
- 32) Letter date April 23, 2013 from Murray and Trettel, Incorporated
- 33) Letter dated January 10, 2013 titled "Meteorology and Dose Factor Update – ODCM Revision 6"
- 34) Radiation Protection/Chemistry White Paper, "Oyster Creek Site 10 Year Averaged Meteorological Data Utilized in the Calculation of Off Dose to a Member of the Public, (2009-2018), Rev. 0, November 14, 2019"
- 35) Calculation C-1302-226-E310-460, "EAB, LPZ, and CR Doses due to Fuel Handling Accident (FHA) – Post Cessation of Power Operations, Revision 0, EC No. 618695, August, 9, 2017.

APPENDIX D – SYSTEM DRAWINGS

FIGURE D-1-1a: LIQUID RADWASTE TREATMENT CHEM WASTE AND FLOOR DRAIN SYSTEM

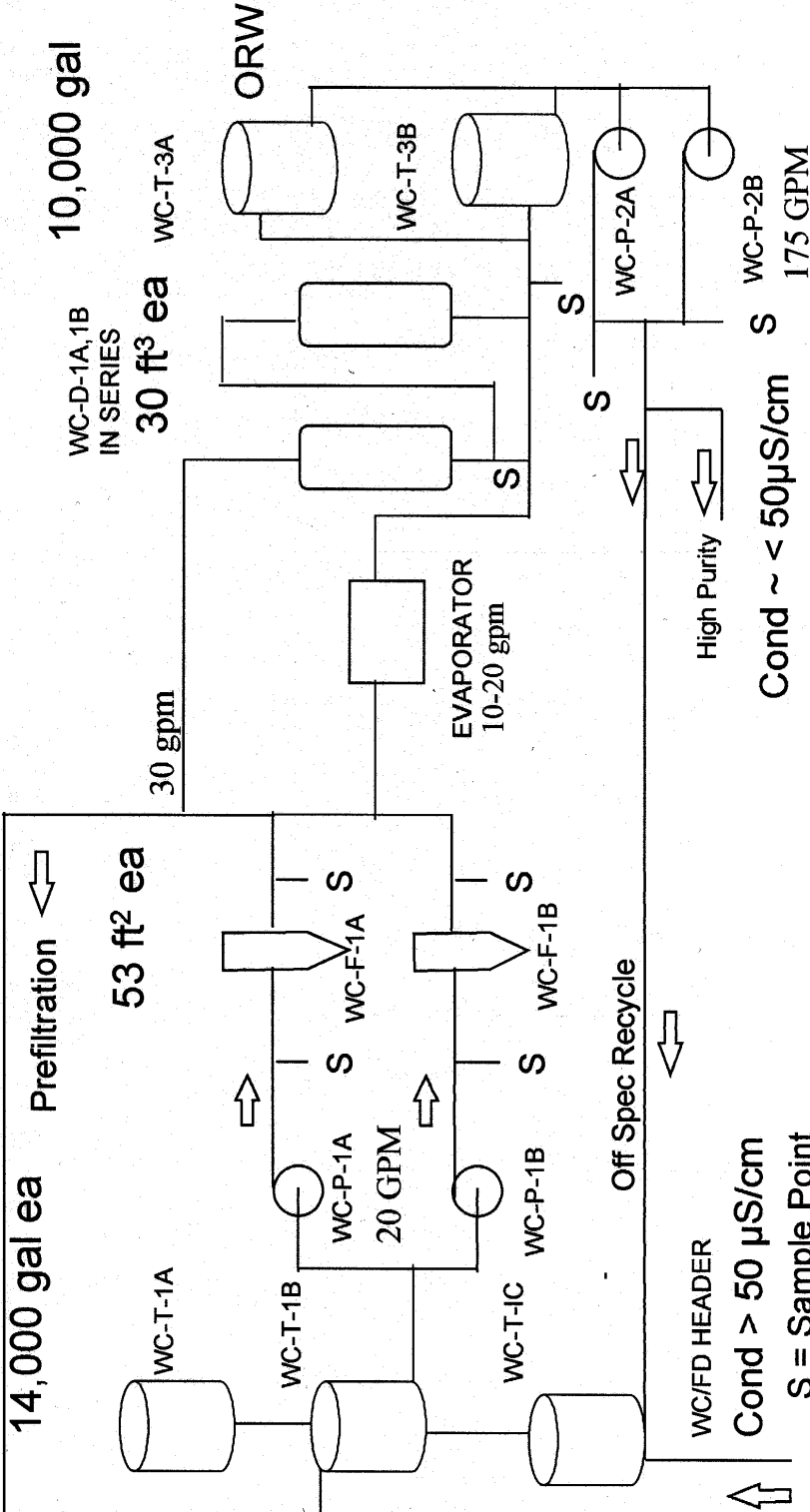

FIGURE D-1-1b: LIQUID RADWASTE TREATMENT - HIGH PURITY AND EQUIPMENT DRAIN SYSTEM

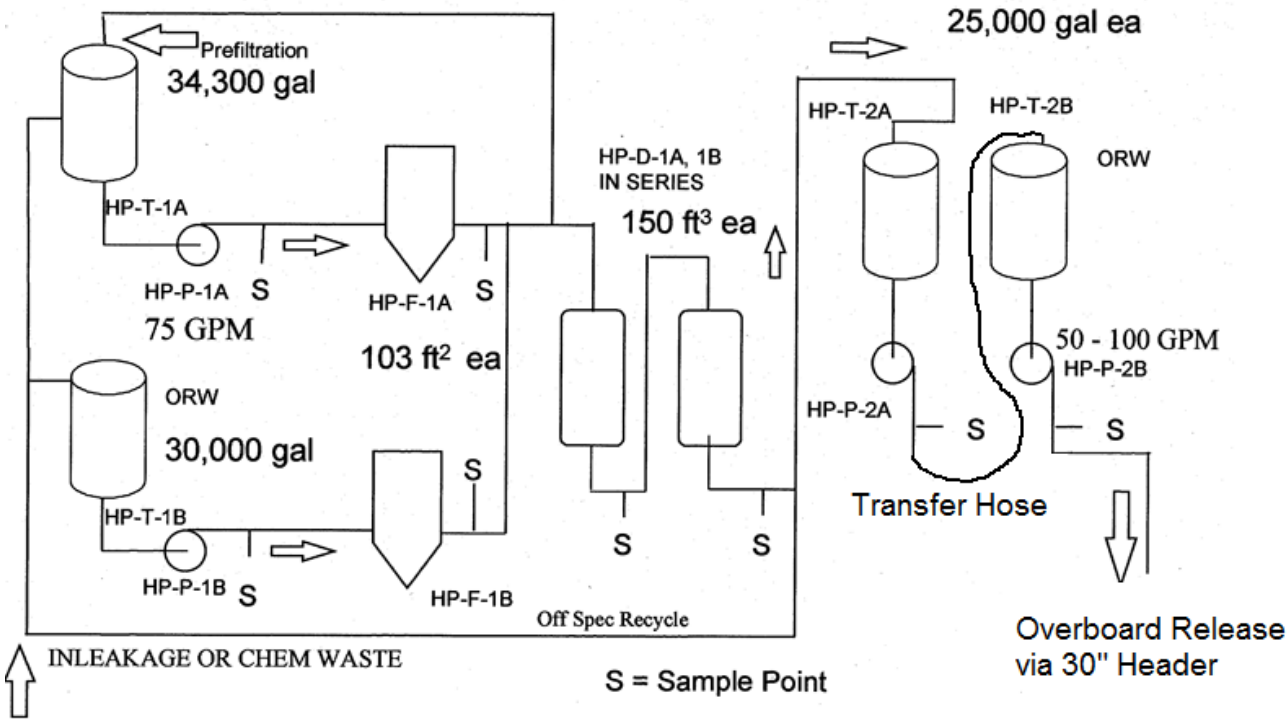

FIGURE D-1-1c: GROUNDWATER RELEASE SYSTEM

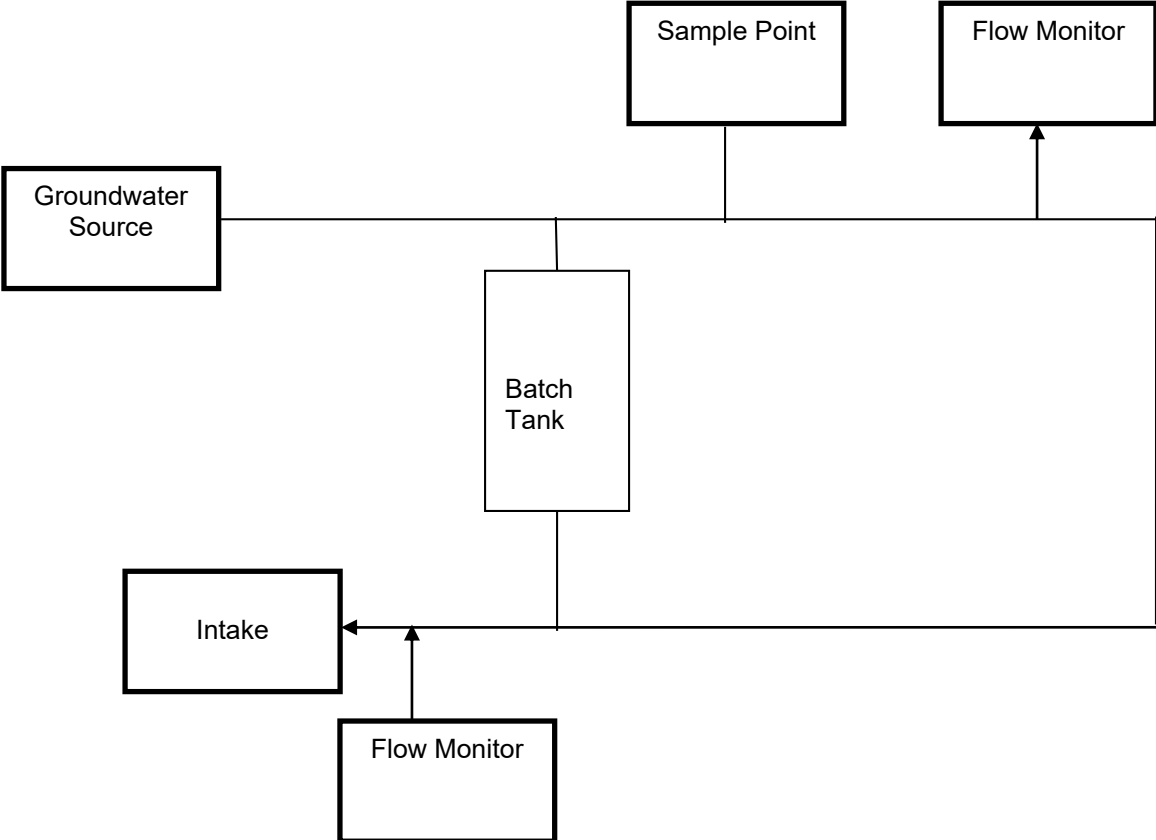

FIGURE D-1-1d: OVERBOARD DISCHARGE

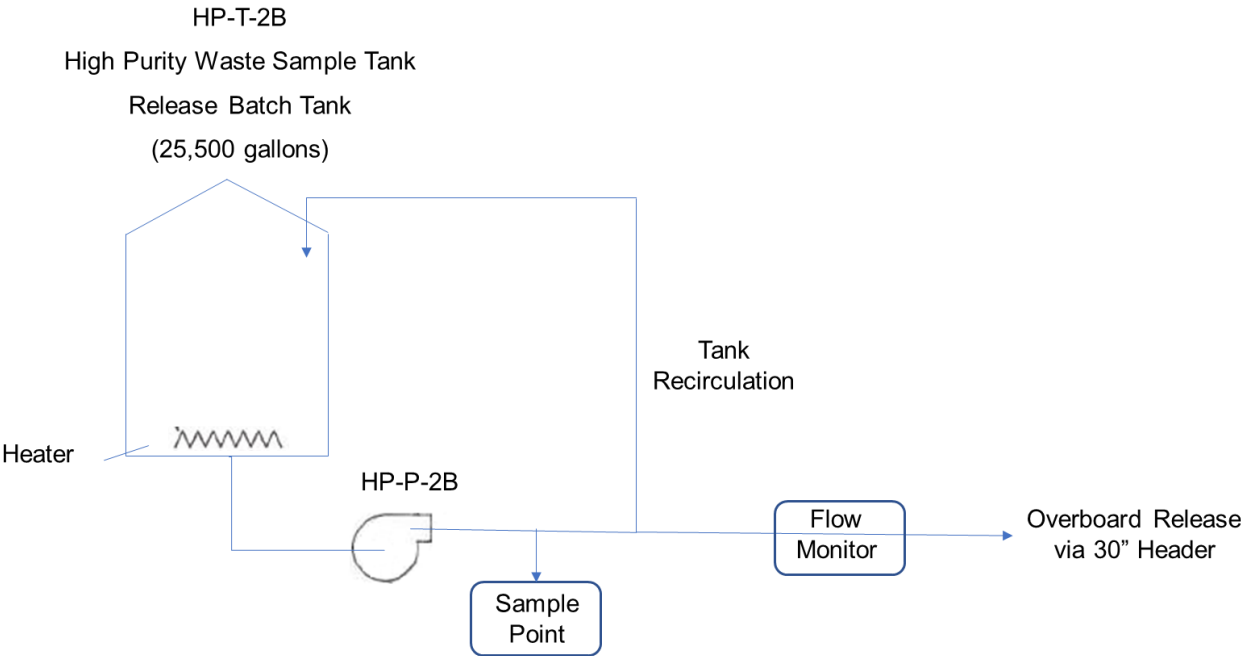

FIGURE D-1-2: SOLID RADWASTE PROCESSING SYSTEM

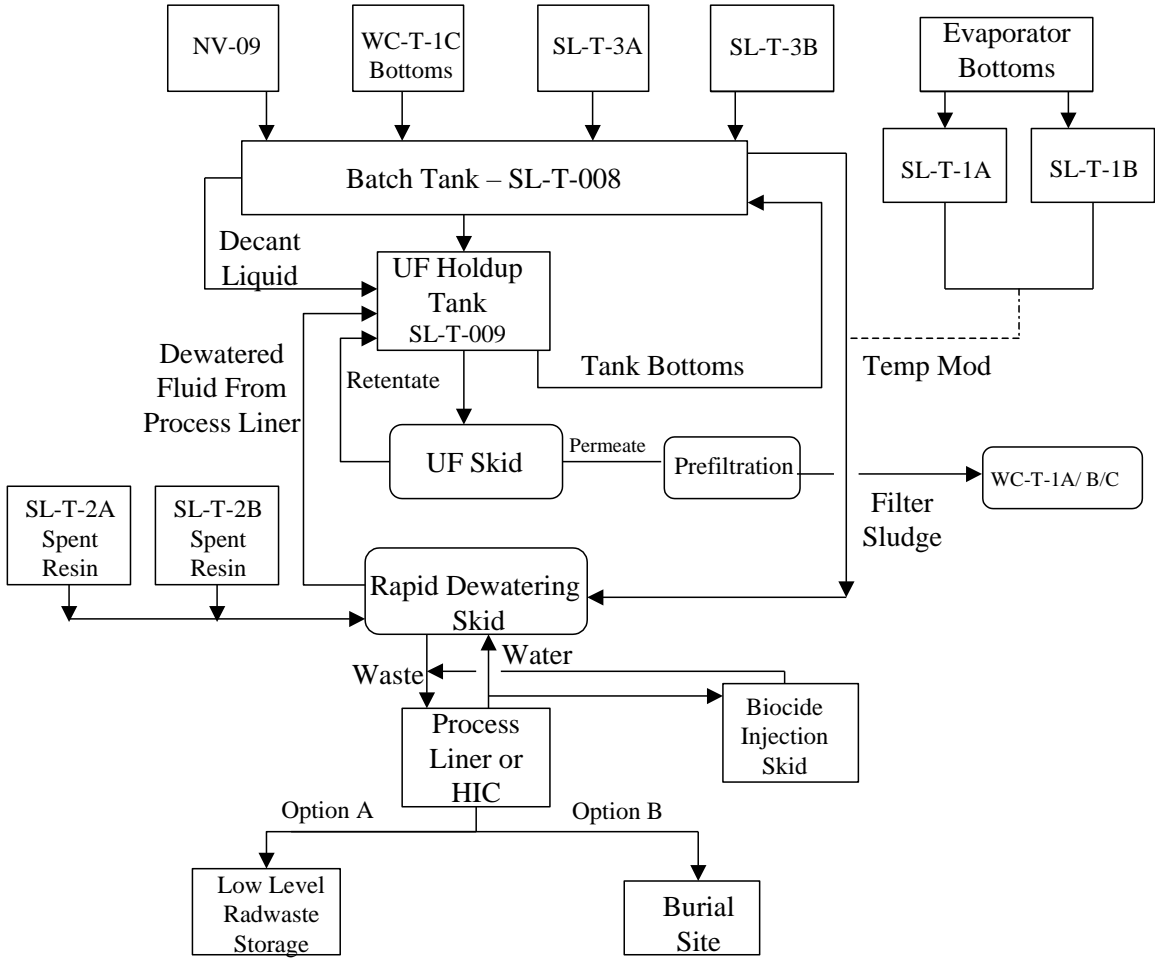
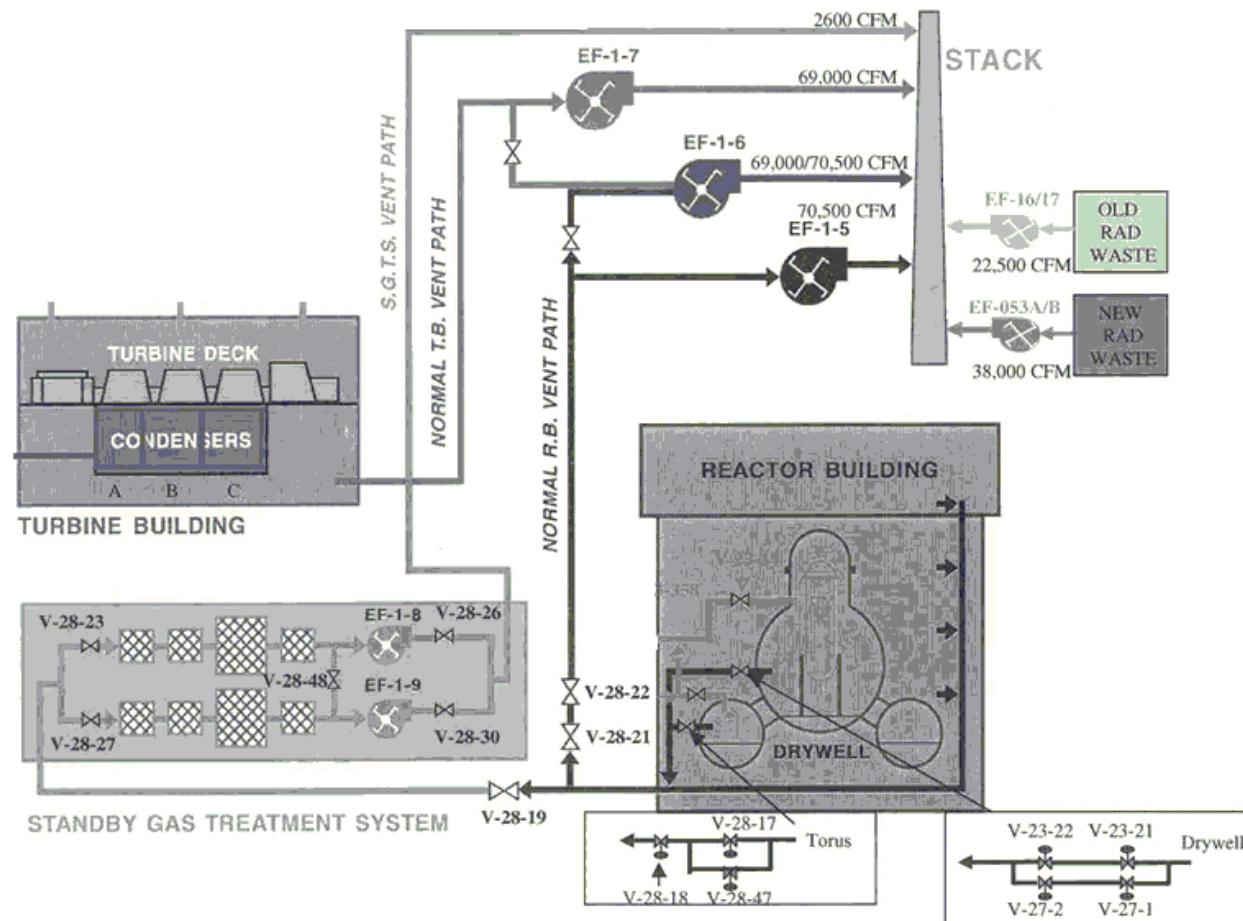

FIGURE D-2-2: VENTILATION SYSTEM



APPENDIX E - RADIOLOGICAL ENVIRONMENTAL MONITORING PROGRAM - SAMPLE TYPE AND LOCATION

All sampling locations and specific information about the individual locations are given in Table E-1. Figures E-1, E-2 and E-3 show the locations of sampling stations with respect to the site. Figure E-4 shows the site layout.

TABLE E-1: REMP SAMPLE LOCATIONS⁽¹⁾

1. Direct Radiation

DOS - Inner Ring at or near site boundary

<u>Code</u>	<u>(miles)</u>	<u>(degrees)</u>	<u>Description</u>
1	0.4	219	SW of site at OCGS Fire Pond, Forked River, NJ
51	0.4	358	North of site, on the access road to Forked River Site, Forked River, NJ
52	0.3	333	NNW of site, on the access road to Forked River Site, Forked River, NJ
53	0.3	309	NW of site, at sewage lift station on the access road to the Forked River Site, Forked River, NJ
54	0.3	288	WNW of site, on the access road to Forked River Site, Forked River, NJ
55	0.3	263	West of site, on Southern Area Stores security fence, west of OCGS Switchyard, Forked River, NJ
56	0.3	249	WSW of site, on utility pole east of Southern Area Stores, west of the OCGS Switchyard, Forked River, NJ
57	0.2	206	SSW of site, on Southern Area Stores access road, Forked River, NJ
58	0.2	188	South of site, on Southern Area Stores access road, Forked River, NJ
59	0.3	166	SSE of site, on Southern Area Stores access road, Waretown, NJ
61	0.3	104	ESE of site, on Route 9 south of OCGS Main Entrance, Forked River, NJ
62	0.2	83	East of site, on Route 9 at access road to OCGS Main Gate, Forked River, NJ
63	0.2	70	ENE of site, on Route 9, between main gate and OCGS North Gate access road, Forked River, NJ
64	0.3	42	NE of site, on Route 9 North at entrance to Finninger Farm, Forked River, NJ
65	0.4	19	NNE of site, on Route 9 at Intake Canal Bridge, Forked River, NJ
66	0.4	133	SE of site, east of Route 9 and south of the OCGS Discharge Canal, inside fence, Waretown, NJ
112	0.2	178	S of site, along Southern access road, Lacey Township, NJ
113	0.3	90	E of site, along Rt. 9 North, Lacey Township, NJ
T1	0.4	219	SW of site, at OCGS Fire Pond, Lacey Township, NJ

TABLE E-1: REMP SAMPLE LOCATIONS (CONTINUED)

1. Direct Radiation (Continued)

<u>Code</u>	<u>(miles)</u>	<u>(degrees)</u>	<u>Description</u>
DOS - Outer Ring at 2–5 km			
6	2.1	13	NNE of site, Lane Place, behind St. Pius Church, Forked River, NJ
8	2.3	177	South of site, Route 9 at the Waretown Substation, Waretown, NJ
9	2.5	230	WSW of site, where Route 532 and the Garden State Parkway meet, Waretown, NJ
22	1.6	145	SE of site, on Long John Silver Way, Skippers Cove, Waretown, NJ
68	1.3	266	West of site, on Garden State Parkway North at mile marker 71.7, Lacey Township, NJ
73	1.8	108	ESE of site, on Bay Parkway, Sands Point Harbor, Waretown, NJ
74	1.8	88	East of site, Orlando Drive and Penguin Court, Forked River, NJ
75	2.0	71	ENE of site, Beach Blvd. and Maui Drive, Forked River, NJ
78	1.8	2	North of site, 1514 Arient Road, Forked River, NJ
79	2.9	160	SSE of site, Hightide Drive and Bonita Drive, Waretown, NJ

TABLE E-1: REMP SAMPLE LOCATIONS (CONTINUED)

1. Direct Radiation (continued)

DOS - Outer Ring at 2-5 km (continued).

<u>Code</u>	<u>(miles)</u>	<u>(degrees)</u>	<u>Description</u>
98	1.6	318	NW of site, on Garden State Parkway at mile marker 73.0, Lacey Township, NJ
99	1.5	310	NW of site, on Garden State Parkway at mile marker 72.8, Lacey Township, NJ
100	1.4	43	NE of site, Yacht Basin Plaza South off Lakdeside Dr., Lacey Township, NJ
101	1.7	49	NE of site, end of Lacey Rd., East, Lacey Township, NJ
102	1.6	344	NNW of site, end of Sheffield Dr., Barnegat Pines, Lacey Township, NJ
103	2.4	337	NNW of site, Llewellyn Parkway, Barnegat Pines, Lacey Township, NJ
104	1.8	221	SW of site, Rt. 532 West, before Garden State Parkway, Ocean Township, NJ
106	1.2	288	WNW of site, Garden State Parkway North, beside mile marker 72.2 Lacey Township, NJ
107	1.3	301	WNW of Site, Garden State Parkway North, beside mile marker 72.5, Lacey Township, NJ
109	1.2	141	SE of site, Lighthouse Dr., Waretown, Ocean Township, NJ
110	1.5	127	SE of site, Tiller Drive and Admiral Way, Waretown, Ocean Township, NJ

DOS - Special Interest

71	1.6	164	SSE of site, on Route 532 at the Waretown Municipal Building, Waretown, NJ
72	1.9	25	NNE of site, on Lacey Road at Knights of Columbus Hall, Forked River, NJ
81	3.5	201	SSW of site, on Rose Hill Road at intersection with Barnegat Boulevard, Barnegat, NJ

DOS - Background

C	24.7	313	NW of site, JCP&L office in rear parking lot, Cookstown, NJ
---	------	-----	---

TABLE E-1: REMP SAMPLE LOCATIONS (CONTINUED)

2. Airborne - Particulates

APT - At or near site boundary in highest D/Q Sectors

<u>Code</u>	<u>(miles)</u>	<u>(degrees)</u>	<u>Description</u>
20	0.7	95	East of site, on Finninger Farm on south side of access road, Forked River, NJ
66	0.4	133	SE of site, east of Route 9 and south of the OCGS Discharge Canal, inside fence, Waretown, NJ
111	0.3	64	ENE of site, Finninger Farm property along access road, Lacey Township, NJ
APT -Special Interest			
71	1.6	164	SSE of site, on Route 532 at the Waretown Municipal Building, Waretown, NJ
72	1.9	25	NNE of site, on Lacey Road at Knights of Columbus Hall, Forked River, NJ
73	1.8	108	ESE of site, on Bay Parkway, Sands Point Harbor, Waretown, NJ

3. Waterborne

SWA - Surface

23	3.6	64	ENE of site, Barnegat Bay off Stouts Creek, approximately 400 yards SE of "Flashing Light 1"
24	2.1	101	East of site, Barnegat Bay, approximately 250 yards SE of "Flashing Light 3"
33	0.4	123	ESE of site, east of Route 9 Bridge in OCGS Discharge Canal

SWA - Background

94	20.0	198	SSW of site, in Great Bay/Little Egg Harbor
----	------	-----	---

GW - Ground

W-3C	0.4	112	ESE of site on Finninger Farm adjacent to Station 35, Lacey Township, NJ
MW-24-3A	0.8	97	E of site on Finninger Farm on South side of access road, Lacey Township, NJ

TABLE E-1: REMP SAMPLE LOCATIONS (CONTINUED)

3. Waterborne (continued)

<u>Code</u>	<u>(miles)</u>	<u>(degrees)</u>	<u>Description</u>
DW - Drinking			
1S	0.1	209	On-site southern domestic well at OCGS, Forked River, NJ
1N	0.2	349	On-site northern domestic well at OCGS, Forked River, NJ
38	1.6	197	SSW of Site, on Route 532, at Ocean Township MUA Pumping Station, Waretown, NJ
114	0.8	267	Well at Bldg 25 on Forked River site
DW - Background			
37	2.2	18	NNE of Site, off Boox Road at Lacey MUA Pumping Station, Forked River, NJ
AQS - Sediment			
23	3.6	64	ENE of site, Barnegat Bay off Stouts Creek, approximately 400 yards SE of "Flashing Light 1"
24	2.1	101	East of site, Barnegat Bay, approximately 250 yards SE of "Flashing Light 3"
33	0.4	123	ESE of site, east of Route 9 Bridge in OCGS Discharge Canal
94	20.0	198	Control -SSW of site, in Great Bay/Little Egg Harbor

4. Ingestion

FISH - Fish

93	0.1	242	WSW of site, OCGS Discharge Canal between Pump Discharges and Route 9, Forked River, NJ
----	-----	-----	---

FISH - Background

94	20.0	198	SSW of site, in Great Bay/Little Egg Harbor
----	------	-----	---

CLAM - Clams

23	3.6	64	ENE of site, Barnegat Bay off Stouts Creek, approximately 400 yards SE of "Flashing Light 1"
24	2.1	101	East of site, Barnegat Bay, approximately 250 yards SE of "Flashing Light 3"

CLAM - Background

94	20.0	198	SSW of site, in Great Bay/Little Egg Harbor
----	------	-----	---

TABLE E-1: REMP SAMPLE LOCATIONS (CONTINUED)

4. Ingestion (continued)

<u>Code</u>	<u>(miles)</u>	<u>(degrees)</u>	<u>Description</u>
CRAB - Crabs			
33	0.4	123	ESE of site, east of Route 9 Bridge in OCGS Discharge Canal
93	0.1	242	WSW of site, OCGS Discharge Canal between Pump Discharges and Route 9, Forked River, NJ
VEG - Vegetation			
35	0.4	111	ESE of site, east of Route 9 and north of the OCGS Discharge Canal, Forked River, NJ
66	0.4	133	SE of site, east of Route 9 and south of the OCGS Discharge Canal, inside fence, Waretown, NJ
115	0.3	96	East of Site, on Finninger Farm
VEG - Background			
36	23.1	319	NW of site, at "U-Pick" Farm, New Egypt, NJ

SAMPLE MEDIUM IDENTIFICATION KEY

APT = Air Particulate	SWA = Surface Water	DOS = Dosimeter
	AQS = Aquatic Sediment	FISH = Fish
	CLAM = Clams	CRAB =Crab
VEG = Vegetables	DW = Drinking Water	GW = Ground Water

(1) Samples may not be collected from some locations listed in this table, as long as the minimum number of samples listed in Table 3.12.1-1 is collected.

FIGURE E-1

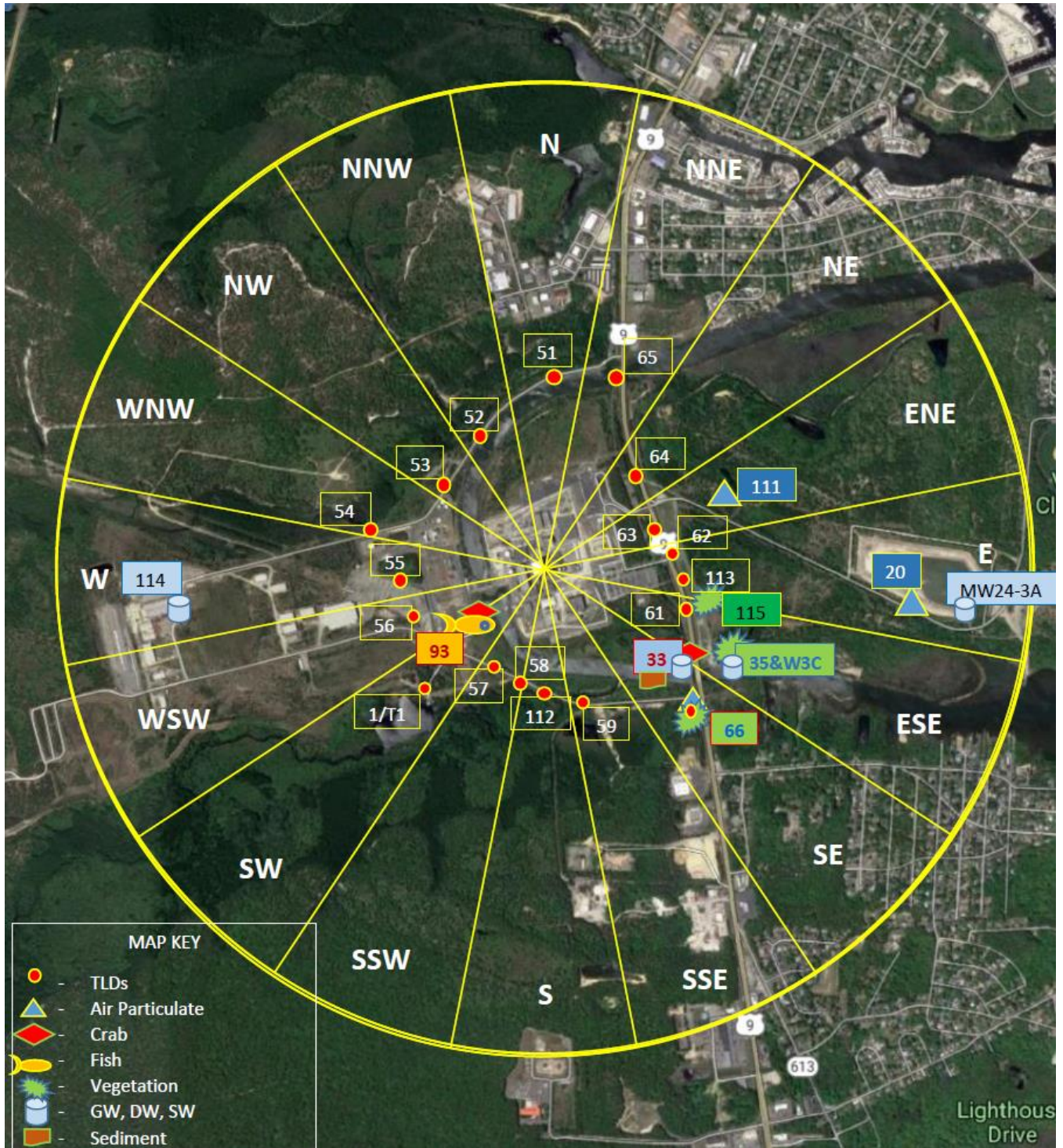

Oyster Creek Nuclear Station
 REMP Sample Locations
 Within a 1 Mile Radius

FIGURE E-2



Oyster Creek Nuclear Station
 REMP Sample Locations
 Within a 1 to 3 Mile Radius

FIGURE E-3

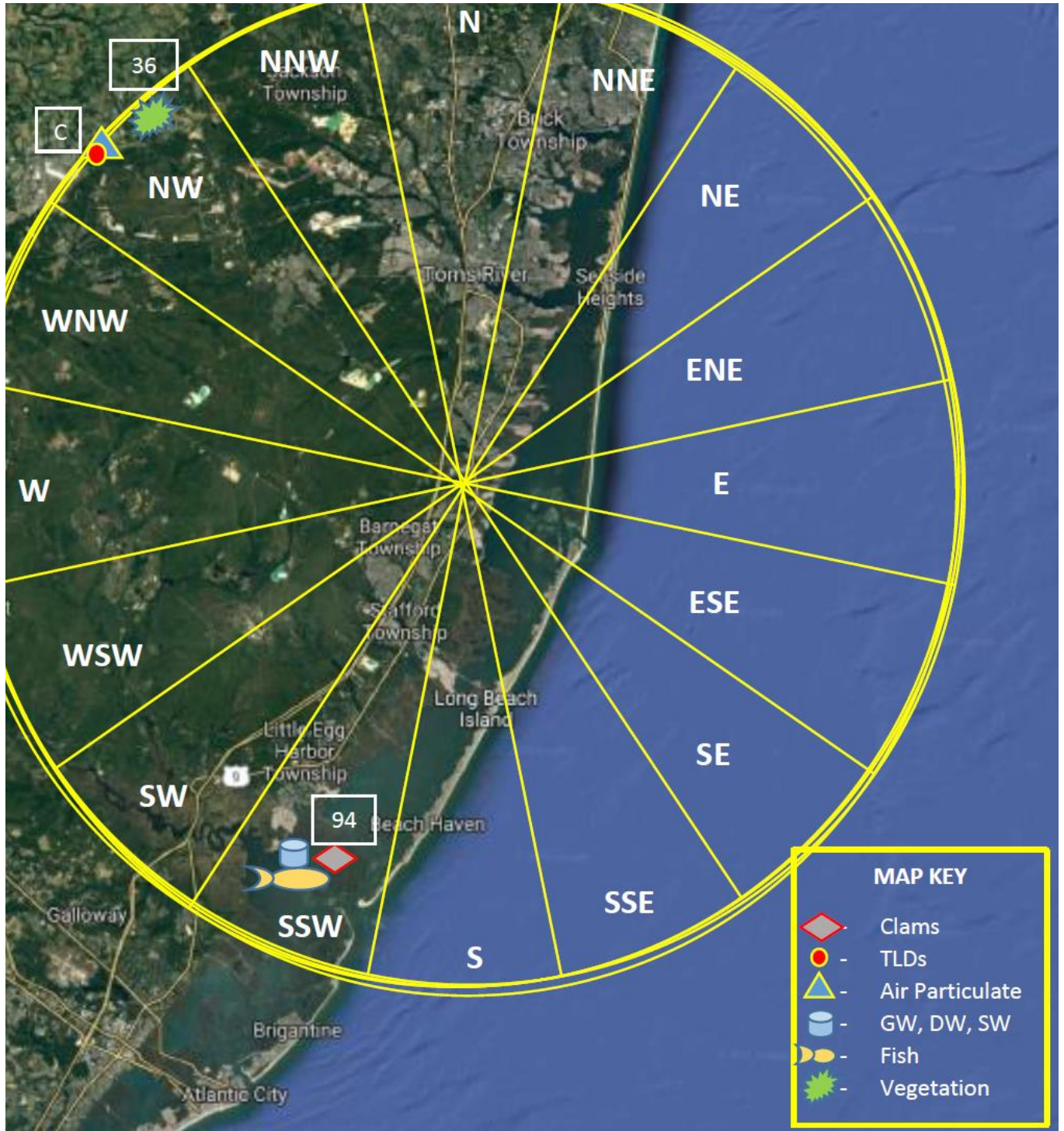

Oyster Creek Nuclear Station
 REMP Sample Locations
 25 Mile Radius – Control Sample Locations

FIGURE E-4

**AREA PLOT PLAN OF SITE
 SITE MAP DEFINING UNRESTRICTED AREAS AND SITE BOUNDARY FOR RADIOACTIVE
 GASEOUS AND LIQUID EFFLUENTS**

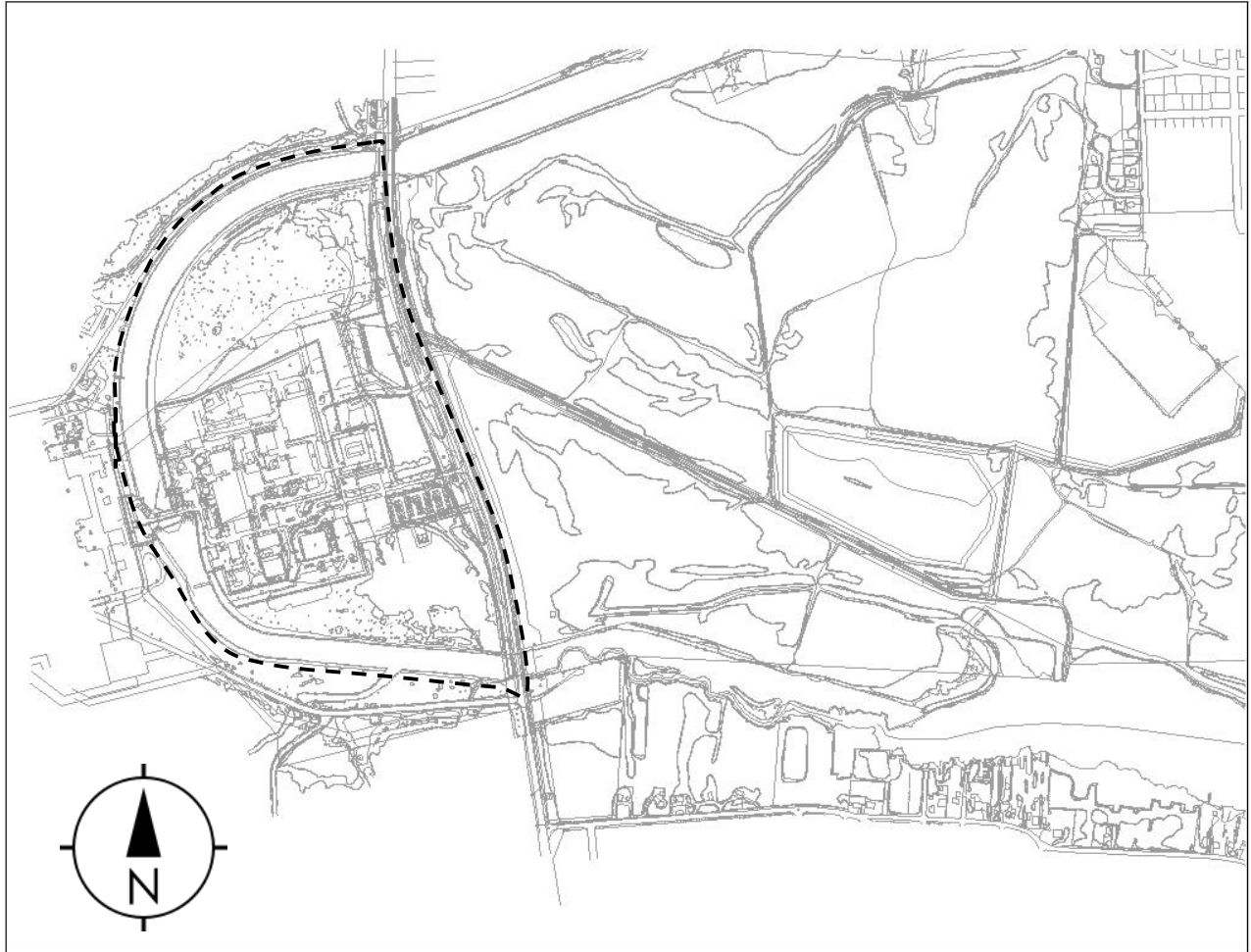

Site Boundary Distances

Sector	Distance in meters	Sector	Distance in meters
S	348	N	584
SSW	291	NNE	621
SW	229	NE	373
WSW	260	ENE	338
W	239	E	360
WNW	284	ESE	491
NW	364	SE	544
NNW	474	SSE	395

Appendix E – Revisions to the Process Control Program (PCP)

Process Control Program (PCP) Changes – None in 2019