

DAVIS-BESSE

OFFSITE DOSE CALCULATION MANUAL

Revision 35

Approval:



PORC Chairman

10/9/18

Date



General Plant Manager, Nuclear

10/9/18

Date

ODCM REV. 35 - LIST OF CHANGES

Page No.
44
63
65

TABLE OF CONTENTS

1.0	INTRODUCTION.....	1
2.0	LIQUID EFFLUENTS.....	2
2.1	Radiation Monitoring Instrumentation and Controls	2
2.1.1	Required Monitors	3
2.1.2	Non-Required Monitors	4
2.2	Sampling and Analysis of Liquid Effluents	4
2.2.1	Batch Releases	5
2.2.2	Continuous Releases	5
2.2.3	Condensate Demineralizer Backwash.....	6
2.2.4	Borated Water Storage Tank.....	7
2.3	Liquid Effluent Monitor Setpoints	8
2.3.1	Concentration Limits.....	8
2.3.2	Basic Setpoint Equation	8
2.3.3	Liquid Radwaste Effluent Line Monitor Setpoint Calculations (RE-1770A & B, RE-1878A & B).....	8
2.3.4	Storm Sewer Drain Monitor (RE-4686).....	11
2.3.5	Alarm Setpoints for the Non-Required Radiation Monitors	11
2.3.6	Alarm Response - Evaluating Actual Release Conditions	12
2.4	Liquid Effluent Dose Calculation - 10 CFR 50	13
2.4.1	Dose Limits to MEMBERS OF THE PUBLIC.....	13
2.4.2	MEMBER OF THE PUBLIC DOSE - Liquid Effluents.	14
2.4.3	Simplified Liquid Effluent Dose Calculation	15
2.4.4	Contaminated TBS/SSD System - Dose Calculation.	16
2.5	Liquid Effluent Dose Projections.....	17
3.0	GASEOUS EFFLUENTS	34
3.1	Radiation Monitoring Instrumentation and Controls	34
3.1.1	Alarm and Automatic Release Termination.....	35
3.1.2	Alarm Only	36
3.2	Sampling and Analysis of Gaseous Effluents	37
3.2.1	Batch Releases.	37
3.2.2	Continuous Release.....	37
3.2.3	Releases Resulting from Primary-to-Secondary System Leakage	38

TABLE OF CONTENTS (Continued)

(3.0 GASEOUS EFFLUENTS - continued)

3.3	Gaseous Effluent Monitor Setpoint Determination.....	39
3.3.1	Total Effective Dose Equivalent Limits	39
3.3.2	Release Rate Limits.....	39
3.3.3	Individual Release Radiation Monitor Setpoints.....	40
3.3.4	Conservative, Generic Radiation Monitor Setpoints.....	41
3.3.5	Release Flow Rate Evaluation for Batch Releases.....	41
3.4	Unrestricted Area Boundary Dose Rate Calculation - Noble Gas	43
3.5	Unrestricted Area Boundary Dose Rate Calculation - Radioiodine, Tritium, and Particulates	44
3.5.1	Dose Rate Calculation	44
3.5.2	Simplified Dose Rate Evaluation for Radioiodine, Tritium and Particulates.	44
3.6	Quantifying Activity Released	45
3.6.1	Quantifying Noble Gas Activity Released Using a Grab Sample or RE-4598	45
3.6.2	Quantifying Noble Gas Activity Released While RE-4598 AA and BA, Channel C, Are Inoperable	46
3.6.3	Quantifying Radioiodine, Tritium, and Particulate Activity Released	46
3.6.4	Quantifying Ground Level Releases Activity	47
3.7	Noble Gas Dose Calculations - 10 CFR 50.....	49
3.7.1	UNRESTRICTED AREA Dose - Limits	49
3.7.2	Dose Calculations - Noble Gases	49
3.7.3	Simplified Dose Calculation for Noble Gases	50
3.8	Radioiodine, Tritium and Particulate Dose Calculations - 10 CFR 50	51
3.8.1	UNRESTRICTED AREA Dose Limits	51
3.8.2	Critical Pathway	52
3.8.3	Dose Calculations - Radioiodine, Tritium and Particulates	52
3.8.4	Simplified Dose Calculation for Radioiodine, Tritium and Particulates	53
3.9	Gaseous Effluent Dose Projection	54
4.0	SPECIAL DOSE ANALYSES	104
4.1	Doses to the Public due to activities inside the UNRESTRICTED AREA BOUNDARY	104

TABLE OF CONTENTS (Continued)

(4.0)	SPECIAL DOSE ANALYSES - continued)	
4.2	Doses to MEMBERS OF THE PUBLIC - 40 CFR 190.....	106
4.2.1	Effluent Dose Calculations.....	108
4.2.2	Direct Exposure Dose Determination - Onsite Sources.	109
4.2.3	Dose Assessment Based on Radiological Environmental Monitoring Data	109
4.2.4	Use of Environmental TLD for Assessing Doses Due to Noble Gas Releases.....	111
5.0	ASSESSMENT OF LAND USE CENSUS DATA	113
5.1	Land Use Census Requirements.....	113
5.1.1	Data Compilation.	114
5.1.2	Relative Dose Significance	114
5.1.3	Data Evaluation.....	114
5.2	Land Use Census to Support Realistic Dose Assessment	115
6.0	RADIOLOGICAL ENVIRONMENTAL MONITORING PROGRAM.....	116
6.1	Program Description	116
6.1.1	General	116
6.1.2	Program Deviations.....	116
6.1.3	Unavailability of Milk or Broad Leaf Vegetation Samples	116
6.1.4	Seasonal Unavailability, Equipment Malfunctions, Safety Concerns	117
6.1.5	Sample Analysis	117
6.2	Reporting Levels	117
6.2.1	General	117
6.2.2	Exceedance of Reporting Levels.....	117
6.3	Interlaboratory Comparison Program	118
7.0	ADMINISTRATIVE CONTROLS	131
7.1	Annual Radiological Environmental Operating Report	131
7.2	Radioactive Effluent Release Report	131
7.3	Licensee Event Reports.....	133
7.4	Major Changes to Radioactive Liquid and Gaseous Waste Treatment Systems	133

TABLE OF CONTENTS (Continued)

(7.0 ADMINISTRATIVE CONTROLS - continued)

7.5	Definitions.....	134
7.5.1	Batch Release.....	134
7.5.2	Composite Sample	134
7.5.3	Gaseous Radwaste Treatment System	134
7.5.4	Lower Limit of Detection (LLD).	134
7.5.5	Member of the Public	135
7.5.6	Purge-Purging	135
7.5.7	Unrestricted Area Boundary	135
7.5.8	Source Check	135
7.5.9	Unrestricted Area	135
7.5.10	Ventilation Exhaust Treatment System	135
7.5.11	Venting	135

APPENDICES

APPENDIX A -	Technical Basis for Simplified Dose Calculations, Liquid Effluent Releases.	A-1
APPENDIX B -	Technical Basis for Effective Dose Factors Gaseous Effluent Releases.....	B-1
APPENDIX C -	Radiological Environmental Monitoring Program, Sample Location Maps	C-1
APPENDIX D -	ODCM Subsections Related to Station Procedures	D-1

LIST OF TABLES

Table 2-1 -	Radioactive Liquid Effluent Monitoring Instrumentation	19
Table 2-2 -	Radioactive Liquid Effluent Monitoring Instrumentation Verification Requirements	21
Table 2-3 -	Radioactive Liquid Waste Sampling and Analysis Program	23
Table 2-4 -	Limiting Radionuclide Concentrations in Secondary Side Clean-up Resins for Allowable Discharges to Onsite Settling Basin.	26
Table 2-5 -	Radionuclide Concentration Limits for the BWST.....	27
Table 2-6 -	Liquid Ingestion Dose Commitment Factors	28
Table 2-7 -	Bioaccumulation Factors	30

TABLE OF CONTENTS

	<u>Page</u>
 LIST OF TABLES	
Table 2-8 - Liquid Pathway Dose Commitment Factors for Release to the Training Center Pond	31
Table 3-1 - Radioactive Gaseous Effluent Monitoring Instrumentation.....	56
Table 3-2 - Radioactive Gaseous Effluent Monitoring Instrumentation Verification Requirements	58
Table 3-3 - Radioactive Gaseous Waste Sampling and Analysis Program	60
Table 3-4 - Land Use Census Summary	63
Table 3-5 - Dose Factors for Noble Gases	64
Table 3-6 - Exposure Pathways, Controlling Parameters, and Atmospheric Dispersion for Dose Calculations.	65
Table 3-7 - Inhalation Pathway Dose Factors`	66
Table 3-8 - Grass - Cow - Milk Pathway Dose Factors.....	74
Table 3-9 - Grass - Goat - Milk Pathway Dose Factors.....	82
Table 3-10 - Grass - Cow - Meat Pathway Dose Factors	90
Table 3-11- Vegetation Pathway Dose Factors	96
Table 3-12- Ground Plane Pathway Dose Factors	102
Table 4-1 - Recommended Exposure Rates in Lieu of Site Specific Data.	112
Table 6-1 - Radiological Environmental Monitoring Program.....	119
Table 6-2 - Required Sampling Locations.....	124
Table 6-3 - Lower Limits of Detection.....	127
Table 6-4 - Reporting Levels for Radioactivity Concentrations in Environmental Samples.	130
Table B-1 - Default Noble Gas Radionuclide Distribution of Gaseous Effluents	B-5
Table B-2 - Effective Dose Factors - Noble Gas Effluents	B-6

LIST OF FIGURES

Figure 2-1 -	Liquid Radioactive Effluent Monitoring and Processing Diagram...	33
Figure 3-1 -	Gaseous Radioactive Effluent Monitoring and Ventilation Systems Diagram	103

1.0 INTRODUCTION

The Davis-Besse Offsite Dose Calculation Manual (ODCM) describes the methodology and parameters used in:

- 1) determining the radioactive material release rates and cumulative releases;
- 2) calculating the radioactive liquid and gaseous effluent monitoring instrumentation alarm/trip setpoints; and
- 3) calculating the corresponding dose rates and cumulative quarterly and yearly doses.

The ODCM also describes and provides requirements for the Radiological Environmental Monitoring Program. Sampling locations, media and collection frequencies, and analytical requirements are specified. The methodology provided in this manual is acceptable for use in demonstrating compliance with concentration limits of 10 CFR 20.1302; the cumulative dose criteria of 10 CFR 50, Appendix I; 40 CFR 190; and the Davis-Besse Technical Specifications (TS) 5.5.3.

The exposure pathway and dose modeling presented provides estimates (e.g., calculational results) that are conservative (i.e., higher than actual exposures in the environment). This conservatism does not invalidate the modeling since the main purpose of these calculations is for demonstrating "As Low As is Reasonably Achievable" (ALARA) for radioactive effluents. In using these models for evaluation and controlling actual effluents, further simplification and conservatism may be applied. For purposes of demonstrating compliance with the EPA environmental dose standard for the Uranium Fuel Cycle (40 CFR 190), more realistic dose assessment modeling may be used. Other approved methodologies (LADTAP, GASPAR, XOQDOQ) also may be used to assess dose from radioactive effluents.

The ODCM will be maintained for use as a reference guide and training document of accepted methodologies and calculations. Changes to the ODCM calculational methodologies and parameters will be made as necessary to ensure reasonable conservatism in keeping with the principles of 10 CFR 50, Appendix I, Section III and IV. Questions about the ODCM should be directed to the Manager, Site Chemistry.

Changes to the ODCM shall be in accordance with TS 5.5.1.

NOTE: Throughout this document, words appearing all capitalized denote definitions specified in Section 7.5 of this manual, or common acronyms.

Section 2.0 describes equipment for monitoring and controlling liquid effluents, sampling requirements, and dose evaluation methods. Section 3.0 provides similar information on gaseous effluent controls, sampling, and dose evaluation. Section 4.0 describes special dose analyses required for Regulatory Guide 1.21, Annual Effluent Reporting and EPA Environmental Dose Standard of 40 CFR 190. Section 5.0 describes the role of the annual land use census in identifying the controlling pathways and locations of exposure for assessing the potential offsite doses. Section 6.0 describes the Radiological Environmental Monitoring Program. Section 7.0 describes the environmental, effluent and reporting requirements, procedural requirements for major changes to liquid and gaseous radwaste systems, and definitions.

2.0 LIQUID EFFLUENTS

2.1 RADIATION MONITORING INSTRUMENTATION AND CONTROLS

This section summarizes information on the liquid effluent radiation monitoring instrumentation and controls. More detailed information is provided in the Davis-Besse USAR, Section 11.2, Liquid Waste Systems, and associated design drawings from which this summary was derived. Location and control function of the monitors are displayed in Figure 2-1.

The radioactive liquid effluent instrumentation is provided to monitor and control, as applicable, releases of radioactivity in liquid effluents during actual or potential releases. The radioactive liquid effluent monitoring instrumentation channels listed in Table 2-1 shall be FUNCTIONAL with their alarm/trip setpoints set to ensure the limits specified in Section 2.3.1 are not exceeded.

Each radioactive liquid effluent monitoring instrumentation channel shall be demonstrated FUNCTIONAL by the performance of the CHANNEL CHECK, SOURCE CHECK, CHANNEL CALIBRATION, and CHANNEL FUNCTIONAL TEST operations at the frequencies shown in Table 2-2. Each of these operations shall be performed within the specified time interval with a maximum allowable extension not to exceed 25 percent of the specified interval.

NOTE: The monitors indicated in 2.1.1 a), b), and c) are nonfunctional if verifications are not performed or setpoints are less conservative than required.

With a radioactive liquid effluent monitoring instrumentation channel alarm/trip setpoint less conservative than required, without delay suspend the release of radioactive liquid effluents monitored by the affected channel, or declare the channel nonfunctional, or change the setpoint so it is acceptably conservative.

With less than the required number of radioactive liquid effluent monitoring instrumentation channels FUNCTIONAL, take the actions described in Table 2-1. Exert best efforts to return the instruments to FUNCTIONAL status within 30 days and, if unsuccessful, explain in the next Radioactive Effluent Release Report, (Section 7.2), why the nonfunctionality was not corrected in a timely manner.

2.1.1 Required Monitors

This section describes the monitoring required during liquid releases and the backup sampling required when monitors are nonfunctional.

a) Alarm and Automatic Release Termination

i. Clean Radwaste Effluent Monitors (RE-1770 A & B)

Discharges from the Clean Radwaste Monitor Tanks (2) are monitored by redundant radiation monitoring systems (RE-1770 A & B). These monitors detect gross gamma activity in the effluent prior to mixing in the Collection Box. Measurements from each detector read out on the Victoreen panel in the Control Room. Each monitoring system is capable of initiating an alarm and an automatic termination of the release by closing Clean Liquid Radwaste Discharge Flow Control valve (WC-1771). The method for determining setpoints for the alarms is discussed in Section 2.3.

- ##### ii. Miscellaneous Radwaste Effluent Monitors (RE-1878 A & B)
- Discharges from the Miscellaneous Liquid Waste Monitor Tank and the Detergent Waste Drain Tank are monitored by redundant radiation monitoring systems (RE-1878 A & B). These monitors detect gross gamma activity in the effluent line prior to mixing in the Collection Box. Measurements from each detector read out on the Victoreen panel in the Control Room. Each monitor is separately capable of initiating an alarm and automatic termination of the release by closing Miscellaneous Waste Discharge Isolation valve (WM-1876). Setpoint determination for the alarms is discussed in Section 2.3.

b) Alarm (only)

i. Storm Sewer Drain Line (RE-4686)

The monitor on the Storm Sewer Drain effluent line detects abnormal radionuclide concentrations in the storm sewer effluent. This monitor is located near the end of the storm sewer drain pipe, upstream of the final discharge point into the Training Center Pond. The most probable source of any non-naturally occurring radioactive material in the storm sewer would be from the secondary system.

To eliminate this potential source of radioactivity, the Turbine Building Sump effluent is normally directed to the onsite Settling Basins. In this configuration, the source of radioactivity in the Storm Sewer Drain line is from Turbine Building drains that are not routed to the Turbine Building Sump, or from Storm Sewer drains. Evaluation of the alarm setpoint for RE-4686 is discussed in Section 2.3.4.

c) Flow Rate Measuring Devices

i. Clean Radwaste Effluent Line

Flow Indicator (FI) 1700 A & B
Flow Totalizer (FQI) 1700 A & B

ii. Miscellaneous Radwaste Effluent Line

Flow Indicator (FI) 1887 A & B
Flow Totalizer (FQI) 1887 A & B

iii. Dilution Flow to the Collection Box

Computer Point F201 consists of four points:

- F147 Cooling Tower Blowdown
- F890 Service Water Outflow
- F200 Collection Box Dilution Flow
- F886 Unit Dilution Pump Flow

2.1.2 Non-Required Monitors

Additional monitors, although not required by the ODCM, have been installed to monitor radioactive material in liquid. The monitors are:

- Component Cooling Water System (CCWS) (RE-1412 & 1413)-monitors the CCWS return lines. High alarm redirects the vent path to the Miscellaneous Waste Drain Tank,
- Service Water System (SWS) (RE-8432) offline detector monitors the SWS outlet prior to discharge to the Collection Box, and
- Intake Forebay (RE-8434) monitors the station intake water from intake forebay.

2.2 SAMPLING AND ANALYSIS OF LIQUID EFFLUENTS

As a minimum, radioactive liquid wastes shall be sampled and analyzed according to the sampling and analysis program of Table 2-3. Table 2-3 identifies three potential sources of liquid radioactive effluents. A fourth potential release point from the Turbine Building Sump is discussed in Section 2.2.2.

The results of the radioactivity analyses shall be used in accordance with the methodology and parameters of this section to ensure that the concentrations at the point of release are maintained within the limits of 10 CFR 20.1302.

2.2.1 Batch Releases

BATCH RELEASE is defined as the discharge of liquid waste of a discrete volume. The releases from the Clean Waste Monitor Tanks 1-1 and 1-2, the Miscellaneous Liquid Waste Monitor Tank, and the Detergent Waste Drain Tank are classified as BATCH RELEASES. The following sampling and analysis requirements shall be met for all releases from these tanks.

- Prior to each release, analysis of a representative grab sample for principal gamma emitters.
- Once per month, as a minimum, analysis of one sample from a BATCH RELEASE for dissolved and entrained gases (see note below).
- Once per month, analysis of a COMPOSITE SAMPLE of all releases that month for tritium and gross alpha activity. Samples contributed to the composite are to be proportional to the quantity of liquid discharged.
- Once per quarter, analysis of a COMPOSITE SAMPLE of all releases that quarter for Strontium (Sr)-89, Sr-90, and Iron (Fe)-55.

NOTE: Identification of noble gases that are principal gamma-emitting radionuclides are included as a part of the gamma spectral analysis performed on all liquid radwaste effluents. Therefore, the Table 2-3 requirement for sampling and analysis of one batch per month for noble gases need not be performed as a separate program.

2.2.2 Continuous Releases

Releases from the Turbine Building Sump (TBS) and Storm Sewer Drains (SSD) are classified as continuous releases.

Because the Turbine Building Sump discharges may contain minute concentrations of radionuclides due to primary-to-secondary system leakage, the Turbine Building Sump discharges are routed to the onsite Settling Basins instead of the SSD line. Screenwash water from the Screenwash Catch Basin is also routed to the North Settling Basin. Overflow from the Settling Basins is pumped to the Collection Box where it is mixed with dilution flow and released to Lake Erie. Releases via this pathway are monitored by weekly analysis for principal gamma-emitting radionuclides and tritium, and by quarterly analysis of composite samples for Fe-55, Sr-89 and Sr-90.

Discharges to the Storm Sewer Drains are from Turbine Building drains that are not routed to the TBS and from storm drains. The Storm Sewer discharges to the Training Center Pond with the overflow discharging to the Toussaint River. For conservatism, it is assumed that radioactive material released to the Training Center Pond is ultimately discharged to Lake Erie (unless actions are taken to prevent this occurrence).

Grab samples are collected weekly from the Settling Basins and analyzed by gamma spectroscopy. If activity is identified, additional controls are enacted to ensure that the release concentrations are maintained below Effluent Concentration Limits and that the cumulative releases are a small fraction of the dose limits of Section 2.4.1. The following actions will be considered for controlling any radioactive material releases via the TBS and SSD:

- Increase the sampling frequency of the TBS and SSD until the source of the contamination is identified.
- Perform gamma spectral analysis on each sample for principal gamma emitters.
- Compare the measured radionuclide concentrations in the sample with Effluent Concentration (EC) equation 2-2 to ensure releases are within the limits.
- Based on the measured concentrations, a re-evaluation of the alarm setpoint for the SSD monitor (RE-4686) may be performed as specified in Section 2.3.4.
- Consider each sample representative of the releases that have occurred since the previous sample. Determine the volume of liquid released from the Turbine Building Sump based on the Turbine Building Sump pump run times and flow rates.
- Determine the total radioactive material released from the sample analysis and the calculated volume released. Determine cumulative doses in accordance with Section 2.4.

2.2.3 Condensate Demineralizer Backwash

Discharges from the Condensate Demineralizer Backwash Receiving Tank (BRT) to the South Settling Basin are sampled in accordance with Table 2-3. Samples are collected prior to each release of the resin/water slurry and separated into the liquid phase (transfer water) and solid phase (resin). These samples are separately analyzed for principal gamma emitters. FirstEnergy Nuclear Operating Company (FENOC) has imposed guidelines on concentrations of radionuclides that may be discharged to the onsite settling basin. These guidelines are presented in Table 2-4.

The radioactive material contamination in the condensate demineralizer backwash will be contained on the powdered resin; soluble or suspended radioactive material associated with the water phase is not expected. The resin and the water are analyzed separately thus allowing for a determination of the amounts retained onsite in the Settling Basin (the resin) and the amounts released to Lake Erie as an effluent (the decant).

The BRT receives the spent resin from the Condensate Polishing System. Low-level radioactive material contamination of the spent resin is periodically expected due to minor leaks in the steam generators and the leaching of residual activity in the secondary system.

During primary-to-secondary leakage, activity levels will be elevated and typically above the limits imposed for acceptable discharge to the basin. Under these conditions, the powdered resins are retained within the plant and processed as solid radwaste for offsite transport and disposal at a licensed radioactive waste disposal site. If within the criteria of Table 2-4, the BRT may be discharged to the onsite settling basin with the approval of the Manager – Site Chemistry.

2.2.4 Borated Water Storage Tank

The Borated Water Storage Tank (BWST) is an unprotected outdoor liquid storage tank and therefore is part the Explosive Gas and Storage Tank Radioactivity Monitoring Program (TS 5.5.11.b as implemented by TRM 8.7.4).

The quantity of radioactive material stored in the BWST shall be limited to ensure that an uncontrolled release of the tank contents would result in concentrations less than the limits of 10 CFR 20, Appendix B, Table 2, Column 2 at the nearest potable water supply and the nearest surface water supply in an unrestricted area.

The concentration of radionuclides in the BWST shall be determined to be within the applicable limits by analyzing a representative sample of the tank contents at least once per 7 days when radioactive materials are being added to the tank.

The method for limiting the BWST radionuclide concentration to meet the criteria above is described below.

- 1) Determine the limiting fraction of each radionuclide present in a liquid sample from the tank. This is the sample concentration in $\mu\text{Ci/ml}$ divided by the limiting activity from Table 2-5.
- 2) Sum the limiting fractions of each radionuclide in the sample. This sum should be less than one (1) to meet the limiting criteria for offsite dose rates via the liquid pathway.

If the sum of the limiting fractions of radionuclides in the BWST is equal to or exceeds one (1), then suspend all additions of radioactive material to the tank, reduce tank contents to within the limits, and describe the events leading to this condition in the next Radioactive Effluent Release Report. (TRM 8.7.4 requirements)

The values in Table 2-5 were calculated specifically for the BWST.

2.3 LIQUID EFFLUENT MONITOR SETPOINTS

2.3.1 Concentration Limits

The concentrations of radioactive material released in liquid effluents to UNRESTRICTED AREAS shall be limited to the concentrations specified in 10 CFR Part 20.1302 for radionuclides other than dissolved or entrained noble gases. For dissolved or entrained noble gases, the concentration shall be limited to 2.0E-04 $\mu\text{Ci/ml}$. If the concentration of radioactive material released in liquid effluents to UNRESTRICTED AREAS exceeds these limits, then without delay restore the concentrations to within these limits.

This limitation provides additional assurance that the levels of radioactive material in bodies of water outside the site should not result in exposures exceeding the Section II.A design objective of Appendix I, 10 CFR Part 50, to an individual, and the limits of 10 CFR Part 20.1302 to the population.

The concentration limit for noble gases is based upon the assumption that Xe-135 is the controlling radioisotope and its Effluent Concentration in air (submersion) was converted to an equivalent concentration in water using the methods described in International Commission on Radiological Protection (ICRP) Publication 2.

2.3.2 Basic Setpoint Equation

During the release of liquid radioactive effluents, radiation monitor setpoints shall be established to alarm and trip prior to exceeding the limits specified above. To meet this requirement, the alarm/trip setpoint for liquid effluent monitors measuring the radioactivity concentration prior to dilution is derived in Section 2.3.3.

2.3.3 Liquid Radwaste Effluent Line Monitor Setpoint Calculations (RE-1770A & B, RE-1878A & B)

The Liquid Radwaste Effluent Line Monitors provide alarm and automatic termination of releases prior to exceeding the Effluent Concentrations (EC) of 10 CFR 20.1302 at the UNRESTRICTED AREA. As required by Table 2-3 and as discussed in Section 2.2.1, a sample of the liquid radwaste to be discharged is collected and analyzed by gamma spectroscopy to identify principal gamma-emitting radionuclides. A maximum release rate from the tank is determined for the release based on the radionuclide concentrations and the available dilution flow rate.

The maximum release rate is inversely proportional to the ratio of the radionuclide concentrations to their EC values. This ratio of measured concentration to EC values is referred to as the EC fraction (ECF) and is calculated by the equation:

$$\text{ECF} = \sum_i \frac{C_i}{\text{EC}_i} \quad (2-2)$$

where:

- ECF = sum of the fractions of the unrestricted area EC for a mixture of radionuclides,
- C_i = concentration of each radionuclide i measured in tank prior to release ($\mu\text{Ci/ml}$), and
- EC_i = unrestricted area EC ($\mu\text{Ci/ml}$) for each radionuclide i from 10 CFR Part 20.1302. For dissolved and entrained noble gases an EC value of $2.0\text{E-}04 \mu\text{Ci/ml}$ shall be used.

Based on the ECF, the minimum dilution factor (MDF) for the conduct of the release is established at 3.33 times larger than actually required. This safety factor (SF) provides conservatism, accounting for variations in monitor response and flow rates and also for the presence of radionuclides that may not be detected by the monitors (i.e., non-gamma emitters). The following equation is used for calculating the required minimum dilution factor:

$$\text{MDF} = \text{ECF}/\text{SF} \quad (2-3)$$

where:

- MDF = minimum required dilution factor,
- SF = 0.3 administrative safety factor.

The maximum release rate from the tank is then calculated by dividing the available dilution flow rate (ADF) at the Collection Box by the MDF as calculated by equation (2-4).

$$\text{MAX RR} = 0.9 (\text{ADF}/\text{MDF}) \quad (2-4)$$

where:

- MAX RR = maximum allowable release rate (gal/min),
- 0.9 = administrative conservatism factor, and
- ADF = available dilution flow rate at the Collection Box as measured by Computer Point F201 (gal/min).

NOTE: Equations (2-3) and (2-4) are valid only for $\text{ECF} > 1$. For $\text{ECF} \leq 1$, the waste tank concentration is below the limits of 10 CFR Part 20.1302 without dilution, and MAX RR may take on any value within discharge pump capacity.

If MAX RR is greater than the maximum discharge pump capacity, then the pump capacity should be used in establishing the actual release rate (RR) for the radwaste discharge. For releases from the Miscellaneous Waste Monitor Tank and Detergent Waste Drain Tank, the discharge pump capacity is 100 gpm; for the Clean Waste Monitor Tank, this value is 140 gpm.

Since the actual release rate from the tank is derived such that 10 CFR 20.1302 limits will not be exceeded given the radionuclide concentration in the tank and the available dilution flow, setpoints must be established to ensure:

- 1) radionuclide concentration released from the tank does not increase above the concentration detected in the sample,
- 2) available dilution flow does not decrease, and
- 3) actual release rate from the tank does not increase above the calculated value.

The setpoints for the predilution radiation monitor (RE-1770 A & B, or RE-1878 A & B) are determined as follows:

$$\text{Alert Alarm SP} = [2 * R * \Sigma (C_i * \text{SEN}_i)] + \text{Bkg} \quad (2-5)$$

$$\text{High Alarm SP} = [3 * R * \Sigma (C_i * \text{SEN}_i)] + \text{Bkg} \quad (2-6)$$

where:

SP = setpoint of the radiation monitor (cpm),

C_i = concentration of radionuclide i as measured by gamma spectroscopy (μCi/ml),

SEN_i = monitor sensitivity for radionuclide i based on calibration curve (cpm per μCi/ml),

Bkg = background reading of the radiation monitor (cpm), and

R = MAX RR / actual release rate

The Cs-137 sensitivity may be used in lieu of the sensitivity values for individual radionuclides. The Cs-137 sensitivity provides a reasonably conservative monitor response correlation for radionuclides of interest in reactor effluents. Coupled with the safety factor SF in equation (2-3), this assumption simplifies the evaluation without invalidating the overall conservatism of the setpoint determination.

The high flow setpoint should be set equal to the MAX RR calculated in equation (2-4) or discharge pump capacity (whichever is smaller). The low flow setpoint for dilution flow rate should be set at 0.9 times the available dilution flow rate.

2.3.4 Storm Sewer Drain Monitor (RE-4686)

The setpoint for the SSD radiation monitor, RE-4686, shall be established to ensure the concentration in the effluent does not exceed the limits of 10 CFR 20.1302. The SSD is not normally radioactively contaminated by other than naturally-occurring radionuclides. Therefore, the setpoint for this monitor has been established at a practical level to provide an early indication of any abnormal conditions without causing spurious alarm due to fluctuations in background.

Since discharge is to the Training Center Pond, exceeding the RE-4686 setpoint does not necessarily mean Section 2.3.1 concentration limits have been exceeded at UNRESTRICTED AREAS. The verification of compliance with the limits on concentration should be based on actual samples of the effluent from the pond to the Toussaint River and Lake Erie. (Refer to Section 2.3.6).

2.3.5 Alarm Setpoints for the Non-Required Radiation Monitors

a) Component Cooling Water System (CCWS) (RE-1412 & 1413)

The monitors RE-1412 and 1413 provide indication of a breach in the CCWS integrity that would allow reactor coolant water to enter and contaminate the system. Therefore, the alarm setpoint is established to prevent incurring a spurious alarm due to background fluctuations. The setpoint is controlled in accordance with the Radiation Monitor Setpoint Manual.

b) Service Water System (SWS) (RE-8432)

No radioactive material is expected to be contained within the SWS during normal operations. Therefore, the high alarm setpoint is established to prevent incurring a spurious alarm due to background fluctuations. The setpoint is controlled in accordance with the Radiation Monitor Setpoint Manual.

c) Intake Forebay Monitor (RE-8434)

The high alarm setpoint is established to prevent incurring a spurious alarm due to background fluctuations. Although highly unlikely, a verified alarm from this system would indicate a possible contamination of the station intake water. The setpoint is controlled in accordance with the Radiation Monitor Setpoint Manual.

2.3.6 Alarm Response - Evaluating Actual Release Conditions

Liquid release rates are controlled and alarm setpoints are established to ensure that releases do not exceed the concentration limits of Section 2.3.1 (i.e., 10 CFR 20 ECs at the discharge to Lake Erie). However, if any of the monitors (RE-1770 A & B, RE-1878 A & B, or RE-4686) alarm during a liquid release, it becomes necessary to re-evaluate the release conditions to determine compliance with the limits. After an alarm, the following actual release conditions should be determined:

- verify radiation monitor alarm setpoint to ensure consistency with the setpoint evaluation for the release;
- re-sample and re-analyze the source of the release
- re-determine the release rate and the dilution water flow.

Based on available data, the following equation may be used for evaluating the actual release conditions:

$$\sum \frac{C_i}{EC_i} * \frac{RR}{DF + RR} \leq 1 \quad (2-7)$$

where:

- C_i = measured concentration of radionuclide i in the effluent stream prior to dilution ($\mu\text{Ci/ml}$),
- EC_i = the Effluent Concentration for radionuclide i from Appendix B, Table II, Column 2 of 10 CFR 20 or $2.0\text{E-}04 \mu\text{Ci/ml}$ for dissolved or entrained noble gases ($\mu\text{Ci/ml}$),
- RR = actual release rate of the liquid effluent at the time of the alarm (gal/min), and
- DF = actual dilution water flow at the time of the release alarm (gal/min).

If the value calculated by equation 2-7 is less than or equal to 1, then the release did not exceed the limits of 10 CFR 20.1302.

2.4 LIQUID EFFLUENT DOSE CALCULATION - 10 CFR 50

2.4.1 Dose Limits to MEMBERS OF THE PUBLIC

The limits for dose or dose commitment to MEMBERS OF THE PUBLIC from radioactive materials in liquid effluents from Davis-Besse are:

- during any calendar quarter:
 - ≤ 1.5 mrem to total body
 - ≤ 5.0 mrem to any organ

- during any calendar year:
 - ≤ 3.0 mrem to total body
 - ≤ 10.0 mrem to any organ

With the calculated dose from the release of radioactive materials in liquid effluents exceeding any of the above limits, prepare and submit to the Commission within 60 days, pursuant to Section 7.3, a Licensee Event Report that identifies the cause(s) for exceeding the limit(s) and defines the corrective actions that have been taken to reduce the releases and the proposed corrective actions to be taken to assure that subsequent releases will be in compliance with the above limits.

Cumulative dose contributions from liquid effluents for the current calendar quarter and the current calendar year shall be determined in accordance with the methodology and parameters in the ODCM at least once per 31 days.

This requirement is provided to implement the requirements of Sections II.A, III.A and IV.A of Appendix I, 10 CFR Part 50.

This action provides the required operating flexibility and at the same time implements the guides set forth in Section IV.A of Appendix I, 10 CFR Part 50 to assure that the releases of radioactive material in liquid effluents will be kept "as low as is reasonably achievable."

NOTE: For fresh water sites with drinking water supplies which can be potentially affected by plant operations, there is reasonable assurance that the operation of the facility will not result in radionuclide concentrations in the finished drinking water that are in excess of the requirements of 40 CFR 141. The dose calculations in the ODCM implement the requirements of Section III.A of Appendix I, 10 CFR Part 50. Conformance with the guides of Appendix I is to be shown by calculational procedures based on models and data such that the actual exposure of an individual through appropriate pathways is unlikely to be substantially underestimated. The equations specified in the ODCM for calculating the doses due to the actual release rates of radioactive materials in liquid effluents are consistent with the methodology provided in Regulatory Guide 1.109, "Calculation of Annual Doses to Man from Routine Releases of Reactor Effluents for the Purpose of Evaluating Compliance with 10 CFR Part 50, Appendix I," Revision 1, October 1977.

2.4.2 MEMBER OF THE PUBLIC DOSE - Liquid Effluents

The calculation of the potential doses to MEMBERS OF THE PUBLIC is a function of the radioactive material releases to the lake, the subsequent transport and dilution in the exposure pathways, and the resultant individual uptake. At Davis-Besse, the combined fish consumption and drinking water pathway has been modeled to provide a conservative dose assessment for exposures to MEMBERS OF THE PUBLIC. For the fish pathway, it has been conservatively assumed that the maximum exposed individual consumes 21 kg per year of fish taken in the immediate vicinity of the Davis-Besse discharge to the lake. For the drinking water pathway, the conservative modeling is based on an individual drinking 730 liters per year of water from the Carroll Township Water Intake located 3.0 miles to the NW of the site discharge.

The equation for assessing the maximum potential dose to MEMBERS OF THE PUBLIC from liquid radwaste releases from Davis-Besse is:

$$D_o = \frac{1.67E - 02 * VOL}{DF * Z} * \sum (C_i * A_{io}) \quad (2-8)$$

where:

- D_o = dose or dose commitment to organ "o" including total body (mrem),
- A_{io} = site-specific ingestion dose commitment factor to the total body or any organ "o" for radionuclide "i" given in Table 2-6 (mrem/hr per μ Ci/ml),
- C_i = average concentration of radionuclide i in undiluted liquid effluent representative of the volume VOL (μ Ci/ml),
- VOL = total volume of undiluted liquid effluent released (gal),
- DF = average dilution water flow rate during release period (gal/min) (typically 20,000 gpm),
- Z = 10 (near field dilution factor)*
- 1.67E-02 = 1 hr/60 min.

* Near field dilution factor and dilution to Carroll Township water intake is based on USAR Section 11.2.7.2 and a study performed by Stone & Webster for Toledo Edison entitled "Aquatic Dilution Factors within 50 Miles of the Davis-Besse Unit 1 Nuclear Power Plant", June 1980.

The site-specific ingestion dose/dose commitment factors (A_{io}) represent a composite dose factor for the fish and drinking water pathway. The site-specific dose factor is based on the NRC's generic maximum individual consumption rates. Values of A_{io} are presented in Table 2-6. These values were derived in accordance with the guidance of NUREG-0133 using the following equation:

$$A_{io} = 1.14E+05 (U_w / D_w + U_F * BF_i) DF_i \quad (2-9)$$

where:

U_F = 21 kg/yr adult fish consumption,

U_w = 730 liters/yr adult water consumption,

D_w = 175 additional dilution from the near field to the Carroll Township water intake (net dilution of 1750),

BF_i = bioaccumulation factor for radionuclide "i" in fish from Table 2-7 (pCi/kg per pCi/l),

DF_i = dose conversion factor for nuclide "i" for adults in organ "o" from Table E-11 of Regulatory Guide 1.109 and Table 4 of NUREG 0172 (mrem/pCi), and

$$1.14E+05 = 10^6 (\text{pCi}/\mu\text{Ci}) * 10^3 (\text{ml}/\text{kg}) / 8760 (\text{hr}/\text{yr}).$$

The radionuclides included in the periodic dose assessment required by Section 2.4.1 are those identified by gamma spectral analysis of the liquid waste samples collected and analyzed per the requirements of Table 2-3. In keeping with the NUREG-0133 guidance, the adult age group represents the maximum exposed individual age group. Evaluation of doses for other age groups is not required for demonstrating compliance with the dose criteria of Section 2.4.1. The dose analysis for radionuclides requiring radiochemical analysis will be performed after receipt of results of the analysis of the composite samples. In keeping with the required analytical frequencies of Table 2-3, tritium dose analyses will be performed at least monthly; Sr-89, Sr-90 and Fe-55 dose analyses will be performed at least quarterly.

2.4.3 Simplified Liquid Effluent Dose Calculation

In lieu of the individual radionuclide dose assessment presented in Section 2.4.2, the following simplified dose calculation may be used for demonstrating compliance with the dose limits required by Section 2.4.1. Radionuclides included in this dose calculation should be those measured in the grab sample of the release (principal gamma emitters measured by gamma spectroscopy). H-3 should not be included in this analysis. Refer to Appendix A for the derivation of this simplified method.

Total Body

$$D_{tb} = \frac{9.67E+02 * VOL}{DF} * \Sigma C_i \quad (2-10)$$

$$D_{max} = \frac{1.18E+03 * VOL}{DF} * \Sigma C_i \quad (2-11)$$

where:

- C_i = average concentration of radionuclide i excluding H-3 in undiluted liquid effluent representative of the release volume ($\mu\text{Ci/ml}$),
- VOL = volume of liquid effluent released (gal),
- DF = average dilution water flow rate during release period (gal/min),
- D_{tb} = conservatively evaluated total body dose (mrem),
- D_{max} = conservatively evaluated maximum organ dose (mrem),
- $9.67E+02$ = $0.0167 \text{ (hr/min)} * 5.79E+05 \text{ (mrem/hr per } \mu\text{Ci/ml, Cs-134 total body dose factor from Table 2-6) / 10}$ (near field dilution), and
- $1.18E+03$ = $0.0167 \text{ (hr/min)} * 7.09E+05 \text{ (mrem/hr per } \mu\text{Ci/ml, Cs-134 liver dose factor from Table 2-6) / 10}$ (near field dilution).

2.4.4 Contaminated TBS/SSD System - Dose Calculation

All non-naturally occurring radioactivity released from the SSD must be included in the evaluation of the cumulative dose to a MEMBER OF THE PUBLIC. Although the discharges are via the Training Center Pond to Pool 3, and then to the Toussaint River (instead of directly to Lake Erie), the modeling of equation (2-8) remains reasonably conservative for determining a hypothetical maximum individual dose. The following assumptions should be applied for the dose assessment of any radioactive material releases from the SSD into the Training Center Pond and subsequently to the Toussaint River:

- If no additional controls are taken, then it should be assumed that any radioactive material released to the Training Center Pond will ultimately be discharged to the lake environment;
- If actions are taken to limit any release, then the assessment of dose should be made based on an evaluation of actual releases; and
- The dilution flow should consider additional dilution of the SSD discharge from other sources into the Training Center Pond prior to release to the river.

2.5 LIQUID EFFLUENT DOSE PROJECTIONS

10 CFR 50.36a requires licensees to maintain and operate the radwaste system to ensure releases are maintained ALARA. This Section implements the requirements of 10 CFR Part 50.36a, General Design Criterion 60 of Appendix A to 10 CFR Part 50 and design objective Section II.D of Appendix I to 10 CFR Part 50. Based on a cost analysis of treating liquid radwaste, the specified limits governing the use of appropriate portions of the liquid radwaste treatment system were specified as the dose design objectives as set forth in Section II.A of Appendix I, 10 CFR Part 50, for liquid effluents. This requirement is implemented through this ODCM.

The liquid radioactive waste processing system shall be used to reduce the radioactive material levels in the liquid waste prior to release when the projected doses in any 31-day period would exceed:

- 0.06 mrem to the total body, or
- 0.20 mrem to any organ.

This dose criteria for processing is established at one quarter of the design objective rate (i.e., 1/4 of 3 mrem/yr total body and 10 mrem/yr any organ over a 31-day projection).

With radioactive liquid waste being discharged without treatment and in excess of the above limits, prepare and submit to the Commission within 60 days, pursuant to Section 7.3, a Licensee Event Report that includes the following information:

- explanation of why liquid radwaste was being discharged without treatment, identification of any nonfunctional equipment or subsystems, and the reason for the nonfunctionality;
- action(s) taken to restore the nonfunctional equipment to FUNCTIONAL status; and
- summary description of action(s) taken to prevent a recurrence.

In any month in which radioactive liquid effluent is being discharged without treatment, doses due to liquid releases to UNRESTRICTED AREAS shall be projected at least once per 31 days in accordance with the methodology and parameters in the ODCM.

The following equations may be used for the dose projection calculation:

$$D_{\text{tbp}} = D_{\text{tb}} (31 / d) \quad (2-12)$$

$$D_{\text{maxp}} = D_{\text{max}} (31 / d) \quad (2-13)$$

where:

- D_{tbp} = the 31-day total body dose projection (mrem),
- D_{tb} = the cumulative total body dose for current calendar month including release under consideration as determined by equation (2-8) or (2-10) (mrem),
- D_{maxp} = the 31-day maximum organ dose projection (mrem),
- D_{max} = the maximum organ dose for current calendar month including release under consideration as determined by equation (2-8) or (2-11) (mrem),
- d = the number of days into current month, and
- 31 = the number of days in projection.

Table 2-1
RADIOACTIVE LIQUID EFFLUENT MONITORING INSTRUMENTATION

<u>INSTRUMENT</u>	<u>REQUIRED CHANNELS</u>	<u>APPLICABILITY</u>	<u>ACTION</u>
1. Gross Radioactivity Monitors Providing Alarms and Automatic Termination of Release			
a. Liquid Radwaste Effluent Line (either Miscellaneous (RE 1878A, B) or Clean (RE 1770A, B), but not both simultaneously)*	1	(1)	A
2. Flow Rate Measurement Devices			
a. Liquid Radwaste Effluent Line	1	(1)	B
b. Dilution Flow to Collection Box	1	(1)	B
c. FE 4687 Storm Sewer	1	(1)	B
3. Gross Beta or Gamma Radioactivity Monitors Providing Alarm But Not Providing Automatic Termination of Release			
a. Storm Sewer Drain (RE 4686)	1	(1)	C

* Only one release (either MWMT or CWMT) at a time can be in progress.

Table 2-1 (continued)

TABLE NOTATION

(1) During radioactive releases via this pathway

ACTION A With less than the number of required channels FUNCTIONAL, effluent releases may be resumed, provided that prior to initiating a release:

1. At least two independent samples are analyzed in accordance with Table 2-3 for analyses performed with each batch;
2. At least two independent verification of the release rate calculations are performed;
3. At least two independent verifications of the discharge valving are performed;

Otherwise, suspend release of radioactive effluents via this pathway.

ACTION B With less than the number of required channels FUNCTIONAL, effluent releases via this pathway may continue provided the flow rate is estimated at least once per 4 hours during actual releases. Pump curves may be used to estimate flow.

ACTION C With less than the number of required channels FUNCTIONAL, or if high alarm is locked in on RE, effluent releases via this pathway may continue provided that during effluent releases, grab samples are collected, at least once per 12 hours, and analyzed, at least once per 12 hours, for gross radioactivity (beta or gamma) at a lower limit of detection no greater than $1.0E-07$ $\mu\text{Ci/ml}$ or a gamma isotopic analysis meeting the LLD Requirement of Table 2-3.

Table 2-2
RADIOACTIVE LIQUID EFFLUENT MONITORING
INSTRUMENTATION VERIFICATION REQUIREMENTS

<u>INSTRUMENT</u>	<u>CHANNEL CHECK</u>	<u>SOURCE CHECK</u>	<u>CHANNEL CALIBRATION</u>	<u>CHANNEL FUNCTIONAL _ TEST</u>
1. Gross Beta or Gamma Radioactivity Monitors Providing Alarm and Automatic Isolation, if applicable.				
a. Liquid Radwaste Effluents Lines	D ⁽¹⁾	P	E ⁽³⁾	Q ⁽²⁾
b. Storm Sewer Discharge Line	D ⁽⁴⁾	M	E ₍₃₎	Q ⁽²⁾
2. Flow Rate Monitors				
a. Liquid Radwaste Effluent Lines	D ⁽⁴⁾	N/A	E	Q
b. Dilution Flow to Collection Box	D ⁽⁴⁾	N/A	E	Q
c. Storm Sewer		N/A		

Table 2-2 (continued)

TABLE NOTATION

- (1) During releases via this pathway.
- (2) If applicable, the CHANNEL FUNCTIONAL TEST shall also demonstrate that automatic isolation of this pathway and control room alarm annunciation occurs if the instrument indicates measured levels above the alarm/trip setpoint.
- (3) The initial CHANNEL CALIBRATION for radioactivity measurement instrumentation shall be performed using one or more of the reference standards certified by the National Institute of Standards and Technology (NIST) or using standards that have been obtained from suppliers that participate in measurement assurance activities with NIST. These standards should permit calibrating the system over its intended range of energy and rate capabilities. For subsequent CHANNEL CALIBRATION, sources that have been related to the initial calibration should be used, at intervals of at least once per eighteen months. For high range monitoring instrumentation, where calibration with a radioactive source is impractical, an electronic calibration may be substituted for the radiation source calibration.
- (4) CHANNEL CHECK shall consist of verifying indication of flow during periods of release. CHANNEL CHECK shall be made at least once daily on any day on which continuous, periodic, or BATCH RELEASES are made.

- (D) At least once per 24 hours.
- (M) At least once per 31 days.
- (P) Prior to each release.
- (E) At least once per 18 month (550 days).
- (Q) At least once per 92 days.
- (R) At least once per 24 months (730 days)

Table 2-3

RADIOACTIVE LIQUID WASTE SAMPLING AND ANALYSIS PROGRAM

Liquid Release Type		Sampling Frequency	Minimum Analysis Frequency	Type of Activity Analysis	Lower Limit of Detection (LLD) ($\mu\text{Ci/ml}$) ^a
A.	Batch Waste Release Tanks ^d	P	P	Principal Gamma Emitters ^f	5.0E-07 ^b
		Each Batch	Each Batch	I-131 ^f	1.0E-06
		P	M	Dissolved and Entrained Gases	1.0E-05
		One Batch/M	M	H-3	1.0E-05
		P	Composite ^c	Gross Alpha	1.0E-07
		Each Batch	Composite ^c	Sr-89, Sr-90	5.0E-08
B.	Storm Sewer Drain	P	Q	Fe-55	1.0E-06
		Each Batch	Composite ^c	Principal Gamma Emitters ^f	5.0E-07 ^b
		Continuously monitored	S ^e	I-131 ^f	1.0E-06
C.	Condensate Demineralizer Backwash	P	P	Principal Gamma Emitters ^f	5.0E-07 ^b
		Each Batch when discharged to the settling basin	Each Batch when discharged to the settling basin	I-131 ^f	1.0E-06

Table 2-3 (continued)

TABLE NOTATION

- a. The LLD is the smallest concentration of radioactive material in a sample that will be detected with 95% probability with 5% probability of falsely concluding that a blank observation represents a "real" signal.

For a particular measurement system (which may include radiochemical separation):

$$LLD = \frac{4.66 s_b}{E * V * 2.22 * Y * \exp(-\lambda\Delta t)}$$

where

LLD is the lower limit of detection as defined above (as pCi per unit mass or volume);

S_b is the standard deviation of the background counting rate or of the counting rate of a blank sample as appropriate (as counts per minute);

E is the counting efficiency (as counts per transformation);

V is the sample size (in units of mass or volume);

2.22 is the number of transformations per minute per picocurie;

Y is the fractional radiochemical yield (when applicable);

λ is the radioactive decay constant for the particular radionuclide;

Δt for plant effluents is the elapsed time between the midpoint of sample collection and time of counting.

It should be recognized that the LLD is defined as an a priori (before the fact) limit representing the capability of a measurement system and not as an a posteriori (after the fact) limit for a particular measurement.

- b. The principal gamma emitters for which the LLD specification will apply are exclusively the following radionuclides: Mn-54, Fe-59, Co-58, Co-60, Zn-65, Mo-99, Cs-134, Cs-137, and Ce-141. For Ce-144, the LLD is 2.0E-06 μ Ci/ml. Other peaks which are measured and identified shall also be reported.

Nuclides which are below the LLD for the analysis should not be reported as being present at the LLD level. When unusual circumstances result in LLDs higher than required, the reasons shall be documented in the Radioactive Effluent Release Report.

- c. A COMPOSITE SAMPLE is one in which the method of sampling employed results is a specimen which is representative of the liquids released.

Table 2-3 (continued)

TABLE NOTATION

- d. A BATCH RELEASE is the discharge of liquid wastes of a discrete volume.
- e. When the monitor is out of service or monitor is locked in high alarm, a grab sample shall be taken and analyzed once every 12 hours if there is flow from the Storm Sewer line.
- f. If an isotopic analysis is unavailable, gross beta or gamma measurement of BATCH RELEASE may be substituted provided the concentration released to the UNRESTRICTED AREA does not exceed $1.0E-07 \mu\text{Ci/ml}$ and a COMPOSITE SAMPLE is analyzed for principal gamma emitters when instrumentation is available.
- g. Frequency notation:
 - P - Prior to each release.
 - M - At least once per 31 days.
 - Q - At least once per 92 days.
 - S - At least once per 12 hours (when the monitor is nonfunctional or high alarm is locked in).

Table 2-4

Limiting Radionuclide Concentrations* In Secondary-Side
Clean-Up Resins for Allowable Discharges to Onsite Settling Basin

Radionuclide	Limiting Concentration** ($\mu\text{Ci}/\text{cm}^3$)
Cr-51	3.3E-02
Mn-54	6.2E-05
Fe-59	5.1E-04
Co-58	3.0E-04
Co-60	5.4E-06
Y-91	2.1E-03
Zr-95	4.1E-04
Nb-95	1.0E-03
Mo-99	7.8E-03***
Ru-103	1.0E-03
Ru-106	1.6E-05
Ag-110m	1.6E-05
Te-125m	5.4E-05
Te-127m	1.5E-05
Te-129m	6.2E-05
Te-131m	3.1E-03***
Te-132	3.5E-03***
I-131	1.1E-04
I-133	3.8E-04
I-135	1.5E-03
Cs-134	1.1E-05
Cs-136	2.3E-03***
Cs-137	1.0E-05
Ba-140	3.1E-03***
La-140	3.5E-03***
Ce-141	5.8E-03
Ce-144	4.1E-05
Pr-143	1.9E-02

* Concentration limits based on the study, Disposal of Low-Level Radioactively Contaminated Secondary-Side Clean-up Resins in the On-site Settling Basins at the Davis-Besse Nuclear Power Station, J. Stewart Bland, May 1983. The limits represent a hypothetical maximum individual dose of less than 1 mrem per year due to an inadvertent release to the offsite environment. The allowable release limits as presented in Table 2 of the above reference report have been reduced by a factor of 10 for added conservatism - representing a hypothetical dose of less than 0.1 mrem.

** With more than one radionuclide identified in a resin batch, the evaluation for acceptable discharge to the onsite settling basin shall be based on the "sum of the fractions" rule as follows: Determine for each identified radionuclide the ratio between the measured concentration and the limiting concentration; the sum of these ratios for all radionuclides should be less than one (1) for discharge to the basin.

*** Limits updated due to changes in 10CFR20, Appendix B, Table 2, Column 2 values.

Table 2-5

Radionuclide Concentration Limits for the BWST

Isotope	Maximum Permissible Concentration, $\mu\text{Ci/ml}$
H-3	1.35E+00
Cr-51	6.76E-01
Mn-54	4.06E-02
Fe-59	1.35E-02
Co-57	8.12E-02
Co-58	2.70E-02
Co-60	4.06E-03
Zn-65	6.76E-03
Rb-88	5.40E-01
Sr-89	1.08E-02
Sr-90	6.76E-04
Sr-91	2.70E-02
Sr-92	5.40E-02
Y-90	9.46E-03
Y-91	1.08E-02
Y-93	2.70E-02
Zr-95	2.70E-02
Zr-97	1.22E-02
Nb-95	4.06E-02
Nb-97	4.06E-01
Mo-99	2.70E-02
Tc-99m	1.35E+00
Ru-103	4.06E-02
Ru-106	4.06E-03
Ag-110m	8.12E-03
Sn-113	4.06E-02
Te-123m	1.35E-02
Sb-124	9.46E-03
Sb-125	4.06E-02
Te-132	1.22E-02
I-131	1.35E-03
I-132	1.35E-01
I-133	9.46E-03
I-134	5.40E-01
I-135	4.06E-02
Cs-134	1.22E-03
Cs-136	8.12E-03
Cs-137	1.35E-03
Cs-138	5.40E-01
Ba-139	2.70E-01
Ba-140	1.08E-02
La-140	1.22E-02
Ce-141	4.06E-02
Ce-144	4.06E-03

Table 2-6
 Davis-Besse Site-Specific Liquid Ingestion Dose Commitment Factors, A₁₀
 (mrem/hr per μCi/ml)

<u>Nuclide</u>	<u>Bone</u>	<u>Liver</u>	<u>T.Body</u>	<u>Thyroid</u>	<u>Kidney</u>	<u>Lung</u>	<u>GI-LLI</u>
H-3	0.00E+01	2.76E-01	2.76E-01	2.76E-01	2.76E-01	2.76E-01	2.76E-01
C-14	3.13E+04	6.26E+03	6.26E+03	6.26E+03	6.26E+03	6.26E+03	6.26E+03
Na-24	4.08E+02	4.08E+02	4.08E+02	4.08E+02	4.08E+02	4.08E+02	4.08E+02
P-32	1.39E+06	8.62E+04	5.36E+04	0.00E+01	0.00E+01	0.00E+01	1.56E+05
Cr-51	0.00E+01	0.00E+01	1.27E+00	7.62E-01	2.81E-01	1.69E+00	3.21E+02
Mn-54	0.00E+01	4.38E+03	8.35E+02	0.00E+01	1.30E+03	0.00E+01	1.34E+04
Mn-56	0.00E+01	1.10E+02	1.95E+01	0.00E+01	1.40E+02	0.00E+01	3.52E+03
Fe-55	6.60E+02	4.56E+02	1.06E+02	0.00E+01	0.00E+01	2.54E+02	2.61E+02
Fe-59	1.04E+03	2.45E+03	9.38E+02	0.00E+01	0.00E+01	6.84E+02	8.16E+03
Co-57	0.00E+01	2.10E+01	3.50E+01	0.00E+01	0.00E+01	0.00E+01	5.34E+02
Co-58	0.00E+01	8.95E+01	2.01E+02	0.00E+01	0.00E+01	0.00E+01	1.81E+03
Co-60	0.00E+01	2.57E+02	5.67E+02	0.00E+01	0.00E+01	0.00E+01	4.83E+03
Ni-63	3.12E+04	2.16E+03	1.05E+03	0.00E+01	0.00E+01	0.00E+01	4.51E+02
Ni-65	1.27E+02	1.65E+01	7.51E+00	0.00E+01	0.00E+01	0.00E+01	4.17E+02
Cu-64	0.00E+01	1.00E+01	4.70E+00	0.00E+01	2.52E+01	0.00E+01	8.53E+02
Zn-65	2.32E+04	7.37E+04	3.33E+04	0.00E+01	4.93E+04	0.00E+01	4.64E+04
Zn-69	4.93E+01	9.43E+01	6.56E+00	0.00E+01	6.13E+01	0.00E+01	1.42E+01
Zn-69m	8.14E+02	1.95E+03	1.79E+02	0.00E+01	1.18E+03	0.00E+01	1.19E+05
Br-82	0.00E+01	0.00E+01	2.27E+03	0.00E+01	0.00E+01	0.00E+01	2.61E+03
Br-83	0.00E+01	0.00E+01	4.04E+01	0.00E+01	0.00E+01	0.00E+01	5.82E+01
Br-84	0.00E+01	0.00E+01	5.24E+01	0.00E+01	0.00E+01	0.00E+01	4.11E-04
Br-85	0.00E+01	0.00E+01	2.15E+00	0.00E+01	0.00E+01	0.00E+01	0.00E+01
Rb-86	0.00E+01	1.01E+05	4.71E+04	0.00E+01	0.00E+01	0.00E+01	1.99E+04
Rb-88	0.00E+01	2.90E+02	1.54E+02	0.00E+01	0.00E+01	0.00E+01	4.00E-09
Rb-89	0.00E+01	1.92E+02	1.35E+02	0.00E+01	0.00E+01	0.00E+01	1.12E-11
Sr-89	2.23E+04	0.00E+01	6.39E+02	0.00E+01	0.00E+01	0.00E+01	3.57E+03
Sr-90	5.48E+05	0.00E+01	1.34E+05	0.00E+01	0.00E+01	0.00E+01	1.58E+04
Sr-91	4.10E+02	0.00E+01	1.66E+01	0.00E+01	0.00E+01	0.00E+01	1.95E+03
Sr-92	1.55E+02	0.00E+01	6.72E+00	0.00E+01	0.00E+01	0.00E+01	3.08E+03
Y-90	5.80E-01	0.00E+01	1.56E-02	0.00E+01	0.00E+01	0.00E+01	6.15E+03
Y-91m	5.48E-03	0.00E+01	2.12E-04	0.00E+01	0.00E+01	0.00E+01	1.61E-02
Y-91	8.51E+00	0.00E+01	2.27E-01	0.00E+01	0.00E+01	0.00E+01	4.68E+03
Y-92	5.10E-02	0.00E+01	1.49E-03	0.00E+01	0.00E+01	0.00E+01	8.93E+02
Y-93	1.62E-01	0.00E+01	4.46E-03	0.00E+01	0.00E+01	0.00E+01	5.13E+03
Zr-95	2.55E-01	8.17E-02	5.53E-02	0.00E+01	1.28E-01	0.00E+01	2.59E+02
Zr-97	1.41E-02	2.84E-03	1.30E-03	0.00E+01	4.29E-03	0.00E+01	8.79E+02
Nb-95	4.47E+02	2.48E+02	1.34E+02	0.00E+01	2.46E+02	0.00E+01	1.51E+06
Nb-97	3.75E+00	9.48E-01	3.46E-01	0.00E+01	1.11E+00	0.00E+01	3.50E+03
Mo-99	0.00E+01	1.05E+02	2.00E+01	0.00E+01	2.38E+02	0.00E+01	2.44E+02
Tc-99m	8.99E-03	2.54E-02	3.23E-01	0.00E+01	3.86E-01	1.24E-02	1.50E+01
Tc-101	9.24E-03	1.33E-02	1.31E-01	0.00E+01	2.40E-01	6.80E-03	4.00E-14
Ru-103	4.52E+00	0.00E+01	1.95E+00	0.00E+01	1.72E+01	0.00E+01	5.27E+02
Ru-105	3.76E-01	0.00E+01	1.48E-01	0.00E+01	4.86E+00	0.00E+01	2.30E+02

Table 2-6 (Continued)
 Davis-Besse Site-Specific Liquid Ingestion Dose Commitment Factors, A₁₀
 (mrem/hr per μCi/ml)

<u>Nuclide</u>	<u>Bone</u>	<u>Liver</u>	<u>T.Body</u>	<u>Thyroid</u>	<u>Kidney</u>	<u>Lung</u>	<u>GI-LLI</u>
Ru-106	6.71E+01	0.00E+01	8.50E+00	0.00E+01	1.30E+02	0.00E+01	4.35E+03
Rh-103m	0.00E+01	0.00E+01	0.00E+01	0.00E+01	0.00E+01	0.00E+01	0.00E+01
Rh-106	0.00E+01	0.00E+01	0.00E+01	0.00E+01	0.00E+01	0.00E+01	0.00E+01
Ag-110m	9.57E-01	8.85E-01	5.26E-01	0.00E+01	1.74E+00	0.00E+01	3.61E+02
Sb-124	8.03E+00	1.52E-01	3.19E+00	1.95E-02	0.00E+01	6.26E+00	2.28E+02
Sb-125	5.14E+00	5.74E-02	1.22E+00	5.22E-03	0.00E+01	3.96E+00	5.65E+01
Te-125m	2.57E+03	9.30E+02	3.44E+02	7.72E+02	1.04E+04	0.00E+01	1.03E+04
Te-127m	6.49E+03	2.32E+03	7.90E+02	1.66E+03	2.63E+04	0.00E+01	2.17E+04
Te-127	1.05E+02	3.78E+01	2.28E+01	7.81E+01	4.29E+02	0.00E+01	8.32E+03
Te-129m	1.10E+04	4.11E+03	1.74E+03	3.78E+03	4.60E+04	0.00E+01	5.55E+04
Te-129	3.01E+01	1.13E+01	7.33E+00	2.31E+01	1.26E+02	0.00E+01	2.27E+01
Te-131m	1.66E+03	8.11E+02	6.75E+02	1.28E+03	8.21E+03	0.00E+01	8.05E+04
Te-131	1.89E+01	7.88E+00	5.96E+00	1.55E+01	8.27E+01	0.00E+01	2.67E+00
Te-132	2.41E+03	1.56E+03	1.47E+03	1.72E+03	1.50E+04	0.00E+01	7.39E+04
I-130	2.75E+01	8.11E+01	3.20E+01	6.88E+03	1.27E+02	0.00E+01	6.99E+01
I-131	1.51E+02	2.16E+02	1.24E+02	7.10E+04	3.71E+02	0.00E+01	5.71E+01
I-132	7.39E+00	1.98E+01	6.91E+00	6.91E+02	3.15E+01	0.00E+01	3.71E+00
I-133	5.17E+01	8.99E+01	2.74E+01	1.32E+04	1.57E+02	0.00E+01	8.08E+01
I-134	3.86E+00	1.05E+01	3.75E+00	1.82E+02	1.67E+01	0.00E+01	9.13E-03
I-135	1.61E+01	4.22E+01	1.56E+01	2.78E+03	6.77E+01	0.00E+01	4.77E+01
Cs-134	2.98E+05	7.09E+05	5.79E+05	0.00E+01	2.29E+05	7.61E+04	1.24E+04
Cs-136	3.12E+04	1.23E+05	8.86E+04	0.00E+01	6.85E+04	9.39E+03	1.40E+04
Cs-137	3.82E+05	5.22E+05	3.42E+05	0.00E+01	1.77E+05	5.89E+04	1.01E+04
Cs-138	2.64E+02	5.22E+02	2.59E+02	0.00E+01	3.84E+02	3.79E+01	2.23E-03
Ba-139	9.75E-01	6.95E-04	2.85E-02	0.00E+01	6.49E-04	3.94E-04	1.73E+00
Ba-140	2.04E+02	2.56E-01	1.34E+01	0.00E+01	8.71E-02	1.47E-01	4.20E+02
Ba-141	4.73E-01	3.58E-04	1.60E-02	0.00E+01	3.33E-04	2.03E-04	2.23E-10
Ba-142	2.14E-01	2.20E-04	1.35E-02	0.00E+01	1.86E-04	1.25E-04	3.02E-19
La-140	1.51E-01	7.60E-02	2.01E-02	0.00E+01	0.00E+01	0.00E+01	5.58E+03
La-142	7.72E-03	3.51E-03	8.75E-04	0.00E+01	0.00E+01	0.00E+01	2.56E+01
Ce-141	2.69E-02	1.82E-02	2.06E-03	0.00E+01	8.44E-03	0.00E+01	6.94E+01
Ce-143	4.73E-03	3.50E+00	3.87E-04	0.00E+01	1.54E-03	0.00E+01	1.31E+02
Ce-144	1.40E+00	5.85E-01	7.52E-02	0.00E+01	3.47E-01	0.00E+01	4.73E+02
Pr-143	5.55E-01	2.23E-01	2.75E-02	0.00E+01	1.28E-01	0.00E+01	2.43E+03
Pr-144	1.82E-03	7.54E-04	9.23E-05	0.00E+01	4.25E-04	0.00E+01	2.61E-10
Nd-147	3.79E-01	4.39E-01	2.62E-02	0.00E+01	2.56E-01	0.00E+01	2.11E+03
W-187	2.96E+02	2.47E+02	8.65E+01	0.00E+01	0.00E+01	0.00E+01	8.10E+04
Np-239	2.91E-02	2.86E-03	1.57E-03	0.00E+01	8.91E-03	0.00E+01	5.86E+02

Table 2-7

Bioaccumulation Factors (BFi)
(pCi/kg per pCi/liter)*

<u>Element</u>	<u>Freshwater Fish</u>
H	9.0E-01
C	4.6E+03
Na	1.0E+02
P	3.0E+03
Cr	2.0E+02
Mn	4.0E+02
Fe	1.0E+02
Co	5.0E+01
Ni	1.0E+02
Cu	5.0E+01
Zn	2.0E+03
Br	4.2E+02
Rb	2.0E+03
Sr	3.0E+01
Y	2.5E+01
Zr	3.3E+00
Nb	3.0E+04
Mo	1.0E+01
Tc	1.5E+01
Ru	1.0E+01
Rh	1.0E+01
Ag	2.3E+00
Sb	1.0E+00
Te	4.0E+02
I	1.5E+01
Cs	2.0E+03
Ba	4.0E+00
La	2.5E+01
Ce	1.0E+00
Pr	2.5E+01
Nd	2.5E+01
W	1.2E+03
Np	1.0E+01

* Values in this Table are taken from Regulatory Guide 1.109 except for phosphorus which is adapted from NUREG/CR-1336 and silver and antimony which are taken from UCRL 50564, Rev. 1, October 1972.

Table 2-8
 Davis-Besse Site-Specific Liquid Pathway Dose Commitment Factors, $A_{shore,1}$
 For Releases to the Training Center Pond
 (mrem/hr per $\mu\text{Ci/ml}$)

<u>Nuclide</u>	<u>Bone</u>	<u>Liver</u>	<u>T.Body</u>	<u>Thyroid</u>	<u>Kidney</u>	<u>Lung</u>	<u>GI-LLI</u>
H-3	0.00E+00	0.00E+00	0.00E+00	0.00E+00	0.00E+00	0.00E+00	0.00E+00
C-14	0.00E+00	0.00E+00	0.00E+00	0.00E+00	0.00E+00	0.00E+00	0.00E+00
Na-24	2.10E+00	2.10E+00	2.10E+00	2.10E+00	2.10E+00	2.10E+00	2.10E+00
P-32	0.00E+00	0.00E+00	0.00E+00	0.00E+00	0.00E+00	0.00E+00	0.00E+00
Cr-51	1.38E+00	1.38E+00	1.38E+00	1.38E+00	1.38E+00	1.38E+00	1.38E+00
Mn-54	4.02E+02	4.02E+02	4.02E+02	4.02E+02	4.02E+02	4.02E+02	4.02E+02
Mn-56	1.08E-02	1.08E-02	1.08E-02	1.08E-02	1.08E-02	1.08E-02	1.08E-02
Fe-55	0.00E+00	0.00E+00	0.00E+00	0.00E+00	0.00E+00	0.00E+00	0.00E+00
Fe-59	8.18E+01	8.18E+01	8.18E+01	8.18E+01	8.18E+01	8.18E+01	8.18E+01
Co-57	9.49E+01	9.49E+01	9.49E+01	9.49E+01	9.49E+01	9.49E+01	9.49E+01
Co-58	1.14E+02	1.14E+02	1.14E+02	1.14E+02	1.14E+02	1.14E+02	1.14E+02
Co-60	6.43E+03	6.43E+03	6.43E+03	6.43E+03	6.43E+03	6.43E+03	6.43E+03
Ni-63	0.00E+00	0.00E+00	0.00E+00	0.00E+00	0.00E+00	0.00E+00	0.00E+00
Ni-65	3.28E-03	3.28E-03	3.28E-03	3.28E-03	3.28E-03	3.28E-03	3.28E-03
Cu-64	9.50E-02	9.50E-02	9.50E-02	9.50E-02	9.50E-02	9.50E-02	9.50E-02
Zn-65	2.23E+02	2.23E+02	2.23E+02	2.23E+02	2.23E+02	2.23E+02	2.23E+02
Zn-69	0.00E+00	0.00E+00	0.00E+00	0.00E+00	0.00E+00	0.00E+00	0.00E+00
Br-82	9.08E+00	9.08E+00	9.08E+00	9.08E+00	9.08E+00	9.08E+00	9.08E+00
Br-83	4.58E-05	4.58E-05	4.58E-05	4.58E-05	4.58E-05	4.58E-05	4.58E-05
Br-84	9.29E-09	9.29E-09	9.29E-09	9.29E-09	9.29E-09	9.29E-09	9.29E-09
Br-85	0.00E+00	0.00E+00	0.00E+00	0.00E+00	0.00E+00	0.00E+00	0.00E+00
Rb-86	2.64E+00	2.64E+00	2.64E+00	2.64E+00	2.64E+00	2.64E+00	2.64E+00
Rb-88	5.52E-15	5.52E-15	5.52E-15	5.52E-15	5.52E-15	5.52E-15	5.52E-15
Rb-89	2.00E-16	2.00E-16	2.00E-16	2.00E-16	2.00E-16	2.00E-16	2.00E-16
Sr-89	6.43E-03	6.43E-03	6.43E-03	6.43E-03	6.43E-03	6.43E-03	6.43E-03
Sr-90	0.00E+00	0.00E+00	0.00E+00	0.00E+00	0.00E+00	0.00E+00	0.00E+00
Sr-91	2.77E-01	2.77E-01	2.77E-01	2.77E-01	2.77E-01	2.77E-01	2.77E-01
Sr-92	1.08E-02	1.08E-02	1.08E-02	1.08E-02	1.08E-02	1.08E-02	1.08E-02
Y-90	1.18E-03	1.18E-03	1.18E-03	1.18E-03	1.18E-03	1.18E-03	1.18E-03
Y-91m	1.39E-06	1.39E-06	1.39E-06	1.39E-06	1.39E-06	1.39E-06	1.39E-06
Y-91	3.21E-01	3.21E-01	3.21E-01	3.21E-01	3.21E-01	3.21E-01	3.21E-01
Y-92	5.11E-03	5.11E-03	5.11E-03	5.11E-03	5.11E-03	5.11E-03	5.11E-03
Y-93	2.46E-02	2.46E-02	2.46E-02	2.46E-02	2.46E-02	2.46E-02	2.46E-02
Zr-95	7.41E+01	7.41E+01	7.41E+01	7.41E+01	7.41E+01	7.41E+01	7.41E+01
Zr-97	5.38E-01	5.38E-01	5.38E-01	5.38E-01	5.38E-01	5.38E-01	5.38E-01
Nb-95	4.05E+01	4.05E+01	4.05E+01	4.05E+01	4.05E+01	4.05E+01	4.05E+01
Nb-97	1.14E-04	1.14E-04	1.14E-04	1.14E-04	1.14E-04	1.14E-04	1.14E-04
Mo-99	1.07E+00	1.07E+00	1.07E+00	1.07E+00	1.07E+00	1.07E+00	1.07E+00
Tc-99m	1.37E-02	1.37E-02	1.37E-02	1.37E-02	1.37E-02	1.37E-02	1.37E-02
Tc-101	3.33E-18	3.33E-18	3.33E-18	3.33E-18	3.33E-18	3.33E-18	3.33E-18
Ru-103	3.24E+01	3.24E+01	3.24E+01	3.24E+01	3.24E+01	3.24E+01	3.24E+01
Ru-105	2.93E-02	2.93E-02	2.93E-02	2.93E-02	2.93E-02	2.93E-02	2.93E-02
Ru-106	1.26E+02	1.26E+02	1.26E+02	1.26E+02	1.26E+02	1.26E+02	1.26E+02

Table 2-8 (Continued)

Davis-Besse Site-Specific Liquid Pathway Dose Commitment Factors, $A_{shore,I}$
 For Releases to the Training Center Pond
 (mrem/hr per $\mu\text{Ci/ml}$)

<u>Nuclide</u>	<u>Bone</u>	<u>Liver</u>	<u>T.Body</u>	<u>Thyroid</u>	<u>Kidney</u>	<u>Lung</u>	<u>GI-LLI</u>
Rh-103m	0.00E+00	0.00E+00	0.00E+00	0.00E+00	0.00E+00	0.00E+00	0.00E+00
Rh-106	0.00E+00	0.00E+00	0.00E+00	0.00E+00	0.00E+00	0.00E+00	0.00E+00
Ag-110m	1.04E+03	1.04E+03	1.04E+03	1.04E+03	1.04E+03	1.04E+03	1.04E+03
Sb-124	3.13E+02	3.13E+02	3.13E+02	3.13E+02	3.13E+02	3.13E+02	3.13E+02
Sb-125	1.26E+03	1.26E+03	1.26E+03	1.26E+03	1.26E+03	1.26E+03	1.26E+03
Te-125m	4.62E-01	4.62E-01	4.62E-01	4.62E-01	4.62E-01	4.62E-01	4.62E-01
Te-127m	2.74E-02	2.74E-02	2.74E-02	2.74E-02	2.74E-02	2.74E-02	2.74E-02
Te-127	3.71E-04	3.71E-04	3.71E-04	3.71E-04	3.71E-04	3.71E-04	3.71E-04
Te-129m	5.94E+00	5.94E+00	5.94E+00	5.94E+00	5.94E+00	5.94E+00	5.94E+00
Te-129	5.62E-06	5.62E-06	5.62E-06	5.62E-06	5.62E-06	5.62E-06	5.62E-06
Te-131m	1.82E+00	1.82E+00	1.82E+00	1.82E+00	1.82E+00	1.82E+00	1.82E+00
Te-131	1.97E-11	1.97E-11	1.97E-11	1.97E-11	1.97E-11	1.97E-11	1.97E-11
Te-132	1.14E+00	1.14E+00	1.14E+00	1.14E+00	1.14E+00	1.14E+00	1.14E+00
I-130	8.48E-01	8.48E-01	8.48E-01	8.48E-01	8.48E-01	8.48E-01	8.48E-01
I-131	4.95E+00	4.95E+00	4.95E+00	4.95E+00	4.95E+00	4.95E+00	4.95E+00
I-132	1.00E-02	1.00E-02	1.00E-02	1.00E-02	1.00E-02	1.00E-02	1.00E-02
I-133	4.99E-01	4.99E-01	4.99E-01	4.99E-01	4.99E-01	4.99E-01	4.99E-01
I-134	1.07E-05	1.07E-05	1.07E-05	1.07E-05	1.07E-05	1.07E-05	1.07E-05
I-135	2.22E-01	2.22E-01	2.22E-01	2.22E-01	2.22E-01	2.22E-01	2.22E-01
Cs-134	2.02E+03	2.02E+03	2.02E+03	2.02E+03	2.02E+03	2.02E+03	2.02E+03
Cs-136	4.35E+01	4.35E+01	4.35E+01	4.35E+01	4.35E+01	4.35E+01	4.35E+01
Cs-137	3.08E+03	3.08E+03	3.08E+03	3.08E+03	3.08E+03	3.08E+03	3.08E+03
Cs-138	2.00E-08	2.00E-08	2.00E-08	2.00E-08	2.00E-08	2.00E-08	2.00E-08
Ba-139	7.96E-05	7.96E-05	7.96E-05	7.96E-05	7.96E-05	7.96E-05	7.96E-05
Ba-140	5.99E+00	5.99E+00	5.99E+00	5.99E+00	5.99E+00	5.99E+00	5.99E+00
Ba-141	1.08E-14	1.08E-14	1.08E-14	1.08E-14	1.08E-14	1.08E-14	1.08E-14
Ba-142	7.48E-23	7.48E-23	7.48E-23	7.48E-23	7.48E-23	7.48E-23	7.48E-23
La-140	4.66E+00	4.66E+00	4.66E+00	4.66E+00	4.66E+00	4.66E+00	4.66E+00
La-142	9.95E-04	9.95E-04	9.95E-04	9.95E-04	9.95E-04	9.95E-04	9.95E-04
Ce-141	4.04E+00	4.04E+00	4.04E+00	4.04E+00	4.04E+00	4.04E+00	4.04E+00
Ce-143	5.41E-01	5.41E-01	5.41E-01	5.41E-01	5.41E-01	5.41E-01	5.41E-01
Ce-144	2.08E+01	2.08E+01	2.08E+01	2.08E+01	2.08E+01	2.08E+01	2.08E+01
Pr-143	0.00E+00	0.00E+00	0.00E+00	0.00E+00	0.00E+00	0.00E+00	0.00E+00
Pr-144	1.58E-16	1.58E-16	1.58E-16	1.58E-16	1.58E-16	1.58E-16	1.58E-16
Nd-147	2.44E+00	2.44E+00	2.44E+00	2.44E+00	2.44E+00	2.44E+00	2.44E+00
W-187	4.99E-01	4.99E-01	4.99E-01	4.99E-01	4.99E-01	4.99E-01	4.99E-01
Np-239	4.41E-01	4.41E-01	4.41E-01	4.41E-01	4.41E-01	4.41E-01	4.41E-01

Figure 2-1

Liquid Radioactive Effluent Monitoring and Processing Diagram

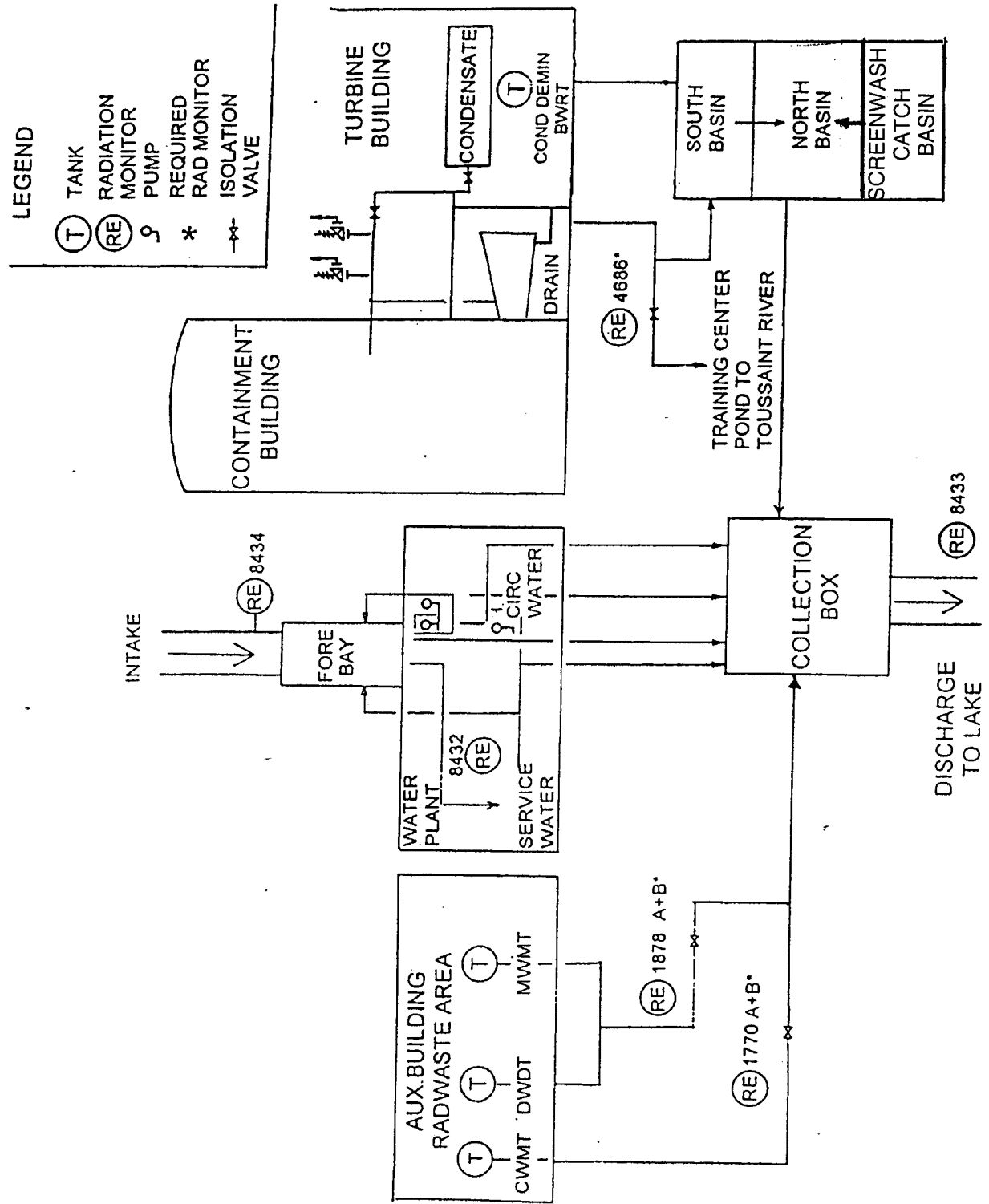

LEGEND

- (T) TANK
- (RE) RADIATION MONITOR
- ⊕ PUMP
- * REQUIRED RAD MONITOR
- ISOLATION VALVE

3.0 GASEOUS EFFLUENTS

3.1 RADIATION MONITORING INSTRUMENTATION AND CONTROLS

This Section specifies the gaseous effluent monitoring instrumentation required at Davis-Besse for controlling and monitoring radioactive effluents. Location and control function of these monitors are displayed in Figure 3-1. More information is provided in the Davis-Besse USAR, Section 11.3, Gaseous Waste System.

The radioactive gaseous effluent monitoring instrumentation channels shown in Table 3-1 shall be FUNCTIONAL with their alarm/trip setpoints set to ensure that the limits of Section 3.3 are not exceeded. The alarm/trip setpoints of these channels shall be determined and adjusted in accordance with the methodology and parameters in Section 3.3.

With a radioactive gaseous effluent monitoring instrumentation channel alarm/trip setpoint less conservative than required, without delay suspend the release of radioactive gaseous effluents monitored by the affected channel, or declare the channel nonfunctional, or change the setpoint so it is acceptably conservative.

With less than the required number of radioactive gaseous effluent monitoring instrumentation channels FUNCTIONAL, take the actions shown in Table 3-1. Exert best efforts to return the instruments to FUNCTIONAL status within 30 days and, if unsuccessful, explain in the next Radioactive Effluent Release Report (Section 7.2) why the non-functionality was not corrected in a timely manner.

Each radioactive gaseous effluent monitoring instrumentation channel shall be demonstrated FUNCTIONAL by performance of the CHANNEL CHECK, SOURCE CHECK, CHANNEL CALIBRATION and CHANNEL FUNCTIONAL TEST operations at the frequencies shown in Table 3-2. Each of these operations shall be performed within the specified time interval with a maximum allowable extension not to exceed 25 percent of the specified interval.

NOTE: The monitors specified in Table 3-2 are nonfunctional if verifications are not performed or setpoints are less conservative than required.

The radioactive gaseous effluent instrumentation is provided to monitor and control, as applicable, the releases of radioactive materials in gaseous effluents during actual or potential releases. The alarm/trip setpoints for these instruments shall be calculated in accordance with methods in Section 3.3 to ensure that the alarm/trip will occur prior to exceeding the limits of 10 CFR Part 20. The FUNCTIONALITY and use of this instrumentation is consistent with the requirements of General Design Criteria 60, 63 and 64 of Appendix A to 10 CFR Part 50.

3.1.1 Alarm and Automatic Release Termination

a) Waste Gas Decay System Monitor (RE-1822 A&B)

The radioactive waste gas discharge line is continuously monitored by two offline detectors, each measuring gross activity. The monitors' control function will terminate the waste discharge prior to exceeding the release rate limits of Section 3.3.2. Table 3-1 requires that the Waste Gas Decay System contain as a minimum the following instrumentation:

- noble gas activity monitor (RE-1822 A or B), and
- effluent system flow rate measuring device (FT-1821 or 1821 A).

If both noble gas monitors are declared nonfunctional, then the contents of the tank may be released provided that prior to the release:

- at least two independent gas samples are collected and analyzed by gamma spectroscopy for principal gamma emitters (noble gases),
- at least two independent verifications of the release rate calculations are performed, and
- at least two independent verifications of the discharge valve line-up are performed.

If the flow rate device is nonfunctional, effluent releases may continue provided that the flow rate is estimated at least once per 12 hours. Flow rates may be estimated based on fan curves or discharge valve header positioning.

b) Containment Purge Exhaust Filter Monitor (RE-5052 A,B&C)

This detector monitors the containment atmosphere for radioactivity during Containment VENT or PURGE. The noble gas activity monitor (Channel C) is required by Table 3-1. It provides an automatic termination of the release prior to exceeding the release rate limits of Section 3.3.2. Although not required in order to comply with Table 3.1, Channels A and B provide indications of increasing levels of particulate and radioiodine releases and terminate the release if their high alarm setpoint is exceeded.

3.1.2 Alarm Only

a) Station Vent Monitor (RE-4598 AA, BA)

The Station Vent is designed as the final release point for all gaseous radioactive effluents. Three separate channels (A, B, and C) are provided for each monitoring system. Channel A is a Silicon alpha beta particle monitor viewing a fixed particulate filter. Channel B is a Sodium Iodide detector viewing a fixed charcoal cartridge sampler. Channel C is a Silicon detector viewing a fixed air volume measuring for noble gases. Only the Channel C radiation detector is required by Table 3.1.

The Channel A and Channel B detectors provide information on potential particulate and radioiodine releases, respectively. However, those monitors experience wide variations in response due, in part, to the much more abundant noble gases in the effluent stream relative to the particulate or radioiodines being sampled. Therefore, while Channels A and B provide useful information for identifying particulate and radioiodine releases, they are not required by Table 3.1 for quantifying the release rate. Refer to Section 3.5.

The following sampling and/or monitoring instrumentation on the Station Vent is required by Table 3-1:

- noble gas activity monitor (Channel C),
- particulate sampler filter,
- iodine sampler cartridge,
- sampler flow rate measuring device, and
- unit vent total Flow Indicating Transmitter (FIT- computer points F883 or F885).

The hydrogen purge line serves as a Containment pressure relief route to the Station Vent. A separate radiation monitor on this line is not required. Any release through the hydrogen purge line will be monitored by the Station Vent monitor, RE-4598.

b) Waste Gas System Oxygen Monitors (AE 5984 and 6570)

The Waste Gas System is provided with two oxygen monitors (with an alarm function) as required by Table 3-1 to alert operators in the unlikely event of oxygen leakage into the waste gas header. The concentration of oxygen is limited to less than or equal to 2% by volume whenever the hydrogen concentration exceeds 4% by volume. An oxygen concentration above the specified limit will actuate a local and control room alarm (TS 5.5.11.a as implemented by TRM 8.7.5).

3.2 SAMPLING AND ANALYSIS OF GASEOUS EFFLUENTS

Radioactive gaseous wastes shall be sampled and analyzed in accordance with Table 3-3. This sampling and analysis ensures that the dose rates and doses from gaseous effluents remain below the release rate limits of Section 3.3.2, and the dose limits of Sections 3.7.1 and 3.8.1.

3.2.1 Batch Releases

Table 3-3 requires that a grab gas sample be collected and analyzed prior to each BATCH RELEASE from the Waste Gas Decay Tanks (WGDT) or a Containment PURGE. The analysis shall include the identification of all principal gamma emitters (noble gas) and tritium. Although not required by Table 3-3, Containment Pressure releases, Integrated Leak Rate Tests of Containment, and other tank venting operations are batch releases and shall be sampled similarly.

The results of the sample analysis are used to establish the acceptable release rate in accordance with Section 3.3.5. This evaluation is necessary to ensure compliance with the limits of Section 3.3.2.

3.2.2 Continuous Release

All releases from the Station Vent are required to be continuously sampled for radioactivity. As specified in Table 3-3, the following minimum samples and analyses are required:

- once per week, analysis of an absorption media (e.g., charcoal cartridge) for I-131,
- once per week, analysis of a filter sample for all principal gamma emitters (particulate radioactive material),
- once per month, analysis of a grab gas sample for all principal gamma emitters (noble gas) and tritium,
- once per month, analysis of a composite of the particulate samples of all releases for that month for gross alpha activity,
- once per quarter, analysis of a composite of the particulate samples for all releases for that quarter for Sr-89 and 90, and
- continuous monitoring for noble gases (gross beta and gamma activity).

3.2.3 Releases Resulting from Primary-to-Secondary System Leakage

Due to secondary coolant system contamination, there are several additional gaseous release points to consider:

- The Atmospheric Vent Valves (AVVs) weepage - continuous ground level release
- Main Steam System Relief Valves (MSSVs) - batch ground level release
- Auxiliary Feed Pump Turbines (AFPTs) - batch ground level release
- Auxiliary Steam System Relief Valves (235#, 15#, 50#, 5# Relief Valves) - batch ground level release
- Auxiliary Boiler Relief Valve - batch ground level release

Steam may be released via any of these points due to improper valve seating. Steam may be released via the MSSVs and AVVs if the plant trips, or via the AVVs during a condenser outage. Steam is released through the AFPTs during their operation. Steam may be released due to overpressurization of the Auxiliary Steam System via the relief valves on the various steam headers.

For secondary coolant system release pathways, the following minimum samples and analyses are required:

- once per week, analysis of a secondary system off-gas sample for principal gamma emitters (noble gases) and tritium;
- once per week, analysis of condensate sample for principal gamma emitters (iodines and particulates) and tritium;
- once per quarter, analysis of a composite of condensate samples for strontium-89 and strontium-90.

To supplement the above requirements, the moisture separator drain tank liquid may be analyzed for principal gamma emitters (iodines and particulants)

Liquid samples are analyzed from Condensate during normal operations, and from the Auxiliary Boiler during Modes 5 and 6. For Auxiliary Steam System Relief lifts that occur when the Auxiliary Boiler is the source of Auxiliary Steam, liquid samples from the Auxiliary Boiler are analyzed for principal gamma emitters (iodines and particulates) and tritium.

If only one steam generator has a primary-to-secondary leak, then radionuclides other than tritium are released through the valves on the leaking steam generator's main steam line. Demineralizing and gas stripping remove some radionuclides from the condensate prior to its return to the steam generator as feedwater. However, these processes do not remove tritium.

3.3 GASEOUS EFFLUENT MONITOR SETPOINT DETERMINATION

3.3.1 Total Effective Dose Equivalent Limits

10 CFR 20.1301 limits the total effective dose equivalent, (TEDE), to individual members of the public from all licensed operations to 100 mrem in a year. At Davis-Besse, the total effective dose equivalent due to radioactive materials released in gaseous effluents at the boundary of the unrestricted area shall be limited to 50 mrem in a year.

3.3.2 Release Rate Limits

All releases of gaseous radioactive effluents are designed to occur via the Station Vent. Station Vent alarm setpoints shall be established to ensure the release rate of noble gas, iodine and particulate effluent does not exceed any 10 CFR limit at or beyond the site boundary. For batch and intermittent releases (e.g. containment purges, etc.), compliance may be demonstrated by ensuring that:

Noble gas: A dose rate less than or equal to 500 mrem/year to the total body, and a dose rate less than or equal to 3000 mrem/year to the skin,

And

Iodine 131, Iodine 133, Tritium, and all radionuclides in particulate form with half-lives greater than 8 days: A dose rate less than or equal to 1500 mrem/year to any organ.

Should dose rate(s) exceed the above limits, without delay restore the release rate to within the above limit(s).

These requirements ensure that the total effective dose equivalent at the UNRESTRICTED AREA BOUNDARY from gaseous effluents will be within the annual dose limits of 10 CFR Part 20 for individual members of the public.

For INDIVIDUAL MEMBERS OF THE PUBLIC who may at times be within the UNRESTRICTED AREA BOUNDARY, the occupancy of that MEMBER OF THE PUBLIC will be sufficiently low to compensate for any increase in the atmospheric diffusion factor above that for the UNRESTRICTED AREA BOUNDARY.

3.3.3 Individual Release Radiation Monitor Setpoints

Although generic radiation monitor setpoints are normally used at Davis-Besse (see Section 3.3.4), setpoints may be established from a sample analysis of the applicable source (i.e., Station Vent, Waste Gas Decay Tanks, or Containment atmosphere), and the following equations:

$$SP_{TB} = \frac{\sum C_i * 500}{472 * \chi / Q_{NG} * VF * \sum (C_i * K_i)} \quad (3-1)$$

$$SP_S = \frac{\sum C_i * 3000}{472 * \chi / Q_{NG} * VF * \sum (C_i * (L_i + 1.1 M_i))} \quad (3-2)$$

where:

- SP_{TB} = monitor setpoint corresponding to the release rate limit for the total body dose rate of 500 mrem per year ($\mu\text{Ci/ml}$),
- SP_S = monitor setpoint corresponding to the release rate limit for the skin dose rate of 3000 mrem per year ($\mu\text{Ci/ml}$),
- 500 = total body dose rate limit (mrem/yr),
- 3000 = skin dose rate limit (mrem/yr),
- χ/Q_{NG} = atmospheric χ/Q value for direct exposure to noble gas at the UNRESTRICTED AREA BOUNDARY given in Table 3-6 (sec/m^3),
- VF = ventilation system flow rate for the applicable release point and monitor ($\text{ft}^3/\text{minute}$),
- C_i = concentration of noble gas radionuclide "i" as determined by gamma spectral analysis of grab sample ($\mu\text{Ci/ml}$),
- K_i = total body dose conversion factor for radionuclide "i" (mrem/yr per $\mu\text{Ci/m}^3$) from Table 3-5,
- L_i = beta skin dose conversion factor for radionuclide "i" (mrem/yr per $\mu\text{Ci/m}^3$) from Table 3-5,
- M_i = gamma air dose conversion factor for radionuclide "i" (mrad/yr per $\mu\text{Ci/m}^3$) from Table 3-5,
- 1.1 = mrem skin dose per mrad gamma air dose (mrem/mrad), and
- 472 = $28,317 (\text{ml/ft}^3) * 1/60 (\text{min/sec})$.

The lesser value of SP_{TB} or SP_S is used to establish the monitor setpoint.

The Station Vent monitor (RE-4598) efficiencies and read outs are in $\mu\text{Ci/ml}$; however, the Containment Purge Exhaust Monitor (RE-5052) and the WGDT monitor (RE-1822) efficiencies and readouts are in counts per minute. Therefore, for RE-5052 and RE-1822, the setpoints in $\mu\text{Ci/ml}$ must be corrected to an equivalent monitor counts per minute. The monitor calibration curves are used for determining specific radionuclide efficiencies (cpm per $\mu\text{Ci/ml}$).

Normally, the monitor for Xe-133 efficiency is used in lieu of the efficiency values for the individual radionuclides. Xe-133 is used because it is the predominant inert gas found in station gaseous releases. The use of Xe-133 efficiency provides a conservative value for alarm setpoint determination.

3.3.4 Conservative, Generic Radiation Monitor Setpoints

Normally, generic alarm setpoints are established instead of those determined by individual radionuclide analysis. This approach eliminates the need to adjust the setpoint periodically to reflect minor changes in radionuclide distribution or release flow rate. Therefore, the more restrictive setpoint is based on the total body dose rate limit and may be calculated using equation (3-1). Again, Xe-133 monitor efficiency is used for conservatism. Xe-133 is used because it is the predominant inert gas in station gaseous releases. The alarm setpoints are controlled for RE-4598, RE-5052, and RE-1822 in accordance with the Radiation Monitor Setpoint Manual.

3.3.5 Release Flow Rate Evaluation For Batch Releases

To comply with the release rate limits of Section 3.3.2, each batch release shall be evaluated for maximum release flow rate prior to being released. Based on noble gas concentration, and the radioiodine, particulate, and tritium concentration in the sample as collected in accordance with Table 3-3, the allowable release rate is determined based on equations (3-3), (3-4) and (3-5). The smallest value of RR_{tb} , RR_S or RR_{INH} is used as the maximum allowable release flow rate.

To determine RR_{INH} exactly, a separate RR_{INH} must be calculated for every organ in every age group (28 values of RR_{INH}). The smallest of these 28 is the RR_{INH} which is compared to RR_{tb} and RR_S to determine maximum allowable release rate. A conservative shortcut is to calculate RR_{INH} once by using the largest inhalation dose factor (R_{io} from Table 3-7) for any organ of any age group for each nuclide released. The largest dose factors in the inhalation pathway are usually for the teen lung.

$$RR_{tb} = \frac{500}{472 * \chi / Q_{NG} * \Sigma(K_i * CNG_i)} \quad (3-3)$$

$$RR_S = \frac{3000}{472 * \chi / Q_{NG} * \Sigma((L_i + 1.1 M_i) * CNG_i)} \quad (3-4)$$

$$RR_{INH} = \frac{1500}{472 * \chi / Q_{INH} * \Sigma(R_{io} * CINH_i) * DF_{IP}} \quad (3-5)$$

where:

- RR_{tb} = allowable release flow rate so as not to exceed a total body dose rate of 500 mrem/yr ($\text{ft}^3/\text{minute}$),
- RR_s = allowable release flow rate so as not to exceed a skin dose rate of 3000 mrem/yr ($\text{ft}^3/\text{minute}$),
- RR_{INH} = allowable release flow rate so as not to exceed an inhalation dose rate of 1500 mrem/yr (ft^3/min),
- 500 = total body dose rate limit at the UNRESTRICTED AREA BOUNDARY (mrem/yr),
- 3000 = skin dose rate limit at the UNRESTRICTED AREA BOUNDARY (mrem/yr),
- 1500 = inhalation dose rate limit at the UNRESTRICTED AREA BOUNDARY (mrem/yr),
- 472 = $28317 \text{ (ml/ft}^3) * 1/60 \text{ (min/sec)}$,
- χ/Q_{NG} = atmospheric χ/Q value for direct exposure to noble gas at the UNRESTRICTED AREA BOUNDARY given in Table 3-6 (sec/m^3),
- χ/Q_{INH} = atmospheric χ/Q value for inhalation at the UNRESTRICTED AREA BOUNDARY given in Table 3-6 (sec/m^3),
- K_i = total body dose conversion factor for radionuclide "i" (mrem/yr per $\mu\text{Ci/m}^3$) from Table 3-5,
- L_i = beta skin dose conversion factor for radionuclide "i" (mrem/yr per $\mu\text{Ci/m}^3$) from Table 3-5,
- M_i = gamma air dose conversion factor for radionuclide "i" (mrad/yr per $\mu\text{Ci/m}^3$) from Table 3-5,
- R_{io} = dose factor for radionuclide_i to organ "o" of age group_a given in Table 3-7 (mrem/yr per $\mu\text{Ci/m}^3$),
- CNG_i = concentration of noble gas radionuclide "i" analyzed in grab samples,
- $CINH_i$ = concentration of tritium, radioiodine, or particulate radionuclide "i" analyzed in grab samples, and
- DF_{IP} = 0.01 which is a removal factor of 100 for radioiodines and particulates when the effluent is processed through an absolute filter (do not use for tritium).

The actual release rate may be set lower than the maximum allowable release rate to provide an additional assurance that the release rate limits of Section 3.3.2 are not exceeded.

3.4 UNRESTRICTED AREA BOUNDARY DOSE RATE CALCULATION - NOBLE GAS

If an effluent noble gas monitor exceeds the alarm setpoint, then an evaluation of compliance with the release rate limits of Section 3.3.2 must be performed using actual release conditions. This evaluation requires collecting a sample of the effluent to establish actual radionuclide concentrations and monitor response.

The following equations may be used for evaluating compliance with the release rate limit of Section 3.3.2 for noble gases:

$$D_{tb} = 472 * \chi / Q_{NG} * VF * \Sigma(K_i * C_i) \quad (3-6)$$

$$D_s = 472 * \chi / Q_{NG} * VF * \Sigma((L_i + 1.1 M_i) * C_i) \quad (3-7)$$

where:

- D_{tb} = total body dose rate (mrem/yr),
- D_s = skin dose rate (mrem/yr),
- χ/Q_{NG} = atmospheric χ/Q for direct exposure to noble gases at the UNRESTRICTED AREA BOUNDARY given in Table 3-6 (sec/m³),
- VF = ventilation system flow rate (ft³/min),
- C_i = concentration of radionuclide "i" as measured in sample (μ Ci/ml),
- K_i = total body dose conversion factor for noble gas radionuclide "i" (mrem/yr per μ Ci/m³) from Table 3-5,
- L_i = beta skin dose conversion factor for noble gas radionuclide "i" (mrem/yr per μ Ci/m³) from Table 3-5,
- M_i = gamma air dose conversion factor for noble gas radionuclide "i" (mrad/yr per μ Ci/m³) from Table 3-5,
- 1.1 = mrem skin dose per mrad gamma air dose (mrem/mrad), and
- 472 = 28,317 (ml/ft³) * 1/60 (min/sec).

3.5 UNRESTRICTED AREA BOUNDARY DOSE RATE CALCULATION - RADIOIODINE, TRITIUM, AND PARTICULATES

3.5.1 Dose Rate Calculation

Section 3.3.2 limits the dose rate to ≤ 1500 mrem/yr to any organ for gaseous releases of I-131, tritium and all particulates with half-lives greater than 8 days. To demonstrate compliance with this limit, an evaluation is performed in accordance with Table 3-3 (nominally once per 7 days). The following equation may be used for the dose rate evaluation:

$$D_o = \chi / Q_{INH} * \Sigma(R_{io} * Q_i) \quad (3-8)$$

where:

D_o = dose rate to organ "o" over the sampling time period (mrem/yr)

χ/Q_{INH} = atmospheric χ/Q value for inhalation at the UNRESTRICTED AREA BOUNDARY given in Table 3-6 (sec/m³),

R_{io} = dose factor to organ_O from radionuclide "i" for the controlling age group via the inhalation pathway (mrem/yr per $\mu\text{Ci}/\text{m}^3$) from Table 3-7, and

Q_i = average release rate over the appropriate sampling period and analysis frequency for radionuclide "i" ($\mu\text{Ci}/\text{sec}$).

3.5.2 Simplified Dose Rate Evaluation for Radioiodine, Tritium and Particulates

It is conservative to evaluate dose rates by applying the I-131 dose factor to the collective releases for all measured radionuclides. By substituting 1500 mrem/yr for the dose rate to organ "o" in Equation (3-8) and solving for Q_i , an allowable release rate can be determined. Based on the annual average meteorological dispersion (see Table 3-6) and the I-131 dose factor for the most limiting potential pathway, age group and organ (inhalation, child, thyroid - $R_{io} = 1.62\text{E}+07$ mrem/yr per $\mu\text{Ci}/\text{m}^3$), the allowable release rate is 26.5 $\mu\text{Ci}/\text{sec}$. An added conservatism factor of 0.8 has been included in this calculation to account for any potential dose contribution from other radioactive particulate material.

For a 7-day period, which is the nominal sampling and analysis frequency, the cumulative release would be 16.0 Ci. Therefore, as long as the total radioiodine, tritium, and particulate releases in any 7-day period do not exceed 16.0 Ci, no additional analyses are needed to verify compliance with the Section 3.3.2 limits on allowable release rate.

3.6 QUANTIFYING ACTIVITY RELEASED

NRC Regulatory Guide 1.21 requires reporting the quantities of individual radionuclides released in gaseous effluents. Therefore, these quantities shall be determined.

3.6.1 Quantifying Noble Gas Activity Released Using a Grab Sample or RE-4598

The quantification of continuous noble gas effluents is based on sampling and analysis of the Station Vent effluent. The monitor, RE-4598, provides a measurement of gross radioactive material concentration in the effluent. As required by Table 3-3, a gas sample is collected at least monthly from the Station Vent. And, as discussed in Section 3.2.2, this sample is analyzed by gamma spectroscopy to identify principal gamma emitting radionuclides (noble gases). The results of the analysis are used to determine the quantities of radionuclides released. This simplified approach reasonably quantifies the continuous release provided that no atypical levels have been observed (e.g., alert setpoint being exceeded).

Based on the actual grab sample analysis, the release quantities are determined by using the following equation:

$$Q_i = 28,317 * VF * T * C_i * 1E-06 \quad (3-9)$$

where:

$$\begin{aligned} Q_i &= \text{total activity released of radionuclide}_i \text{ (Ci),} \\ 28,317 &= \text{milliliters per ft}^3, \\ VF &= \text{ventilation system flow rate (ft}^3\text{/min),} \\ T &= \text{release duration (min),} \\ 1E-06 &= \text{Ci per } \mu\text{Ci, and} \\ C_i &= \text{concentration of radionuclide "i" as measured in the grab sample} \\ &\quad (\mu\text{Ci/ml}). \end{aligned}$$

As an alternative method, the average noble gas reading for the release period can be used to quantify individual noble gas radionuclides released provided a normal isotopic mixture of gases is present by using the following equation:

$$Q_i = 28,317 * \frac{A_i}{\Sigma A_i} * C * VF * T \quad (3-10)$$

where:

$$\begin{aligned} Q_i &= \text{total activity released of radionuclide "i" (}\mu\text{Ci),} \\ 28,317 &= \text{milliliters per ft}^3, \end{aligned}$$

- A_i = activity concentration of radionuclide "i" from the gamma spectral analysis of a grab sample from the release point ($\mu\text{Ci/ml}$),
- C = average gross activity concentration over the release period as measured by the noble gas monitor excluding any BATCH RELEASES ($\mu\text{Ci/ml}$),
- VF = ventilation system flow rate (ft^3/min), and
- T = release duration (min).

3.6.2 Quantifying Noble Gas Activity Released While RE-4598AA and BA, Channel C Are Inoperable

With both Station Vent radiation monitors inoperable (i.e., RE-4598 AA and BA, Channel C), the alarm functions are also nonfunctional. The once-per-8 hours grab samples provide for continued quantification of releases in accordance with Table 3-1 requirements. Analysis of grab samples provides the radionuclide concentrations in the effluent. The flow measurement device (or flow rate estimate) and the release duration provide the total volume released. With these, the total amount of radioactive material released can be determined by using equation 3-9.

3.6.3 Quantifying Radioiodine, Tritium, and Particulate Activity Released

For radioiodine and particulates:

$$Q_i = \frac{A_i * \lambda_i * t * v * 1E-06}{(1 - e^{-\lambda_i t}) * s * 0.72} \quad (3-11)$$

where:

- Q_i = total activity released of radionuclide_i (Ci),
- A_i = activity of radionuclide_i measured on filter media (μCi),
- λ_i = decay constant of radionuclide_i (hr^{-1}),
- t = release duration (hr),
- v = total vent system flow for sampling period (cc),
- $1E-06$ = Ci per μCi ,
- s = total flow through sampler (cc), and
- 0.72 = isokinetic flow correction factor for normal range station vent skid RE 4598 AA or BA filter media.

For Tritium:

$$Q = \frac{C * W * V * 1E - 06}{0.9 * S} \quad (3-12)$$

where:

- Q = total activity of tritium released (Ci),
- C = tritium concentration in gas washing bottle ($\mu\text{Ci/ml}$),
- W = volume of water added to gas washing bottle (ml),
- V = total vent system flow for release period (cc),
- 1E-06 = Ci per μCi ,
- 0.9 = efficiency for collection of tritium, and
- S = total sample volume through gas washing bottle (cc).

3.6.4 Quantifying Ground Level Releases Activity

The ground level releases listed in Section 3.2.3 do not exhaust through Station Vent nor are directly sampled for activity. The condensate sample is used to calculate the postulated iodine and particulates activities and a portion of the tritium and noble gas activity. The off-gas sample supplement the tritium and noble gas activities released (due to partitioning factors, over 99.9% of iodines and particulates are in the condensate and moisture separator drain tank liquid). The results of the sampling program are used to indirectly quantify the activity released as follows:

$$Q_i = T[(M * 7.564)(C_{ic} + 0.065 * P * C_{im}) + (F * 28317 * C_{is} * M / M_c)]$$

where:

- Q_i = total activity released of radionuclide i (μCi),
- T = duration of release (min),
- M = mass flow rate of release (lbs/hr),
- M_c = mass flow rate of condensate (lbs/hr),
- 7.564 = $\frac{1}{60}$ hr/min * (3785 cc/8.34 lbs),
- C_{ic} = concentration of radionuclide in condensate ($\mu\text{Ci/cc}$),

- 0.065 = mass flow rate ratio of moisture separator drain to condensate,
- P = fraction of moisture separator drain flow routed to feedwater,
- C_{im} = concentration of radionuclide in moisture separator drain ($\mu\text{Ci/cc}$),
- F = flowrate of off-gas system (ft^3/min),
- 28317 = cc per ft^3
- C_{is} = concentration of radionuclide, in off-gas sample ($\mu\text{Ci/cc}$)

3.7 NOBLE GAS DOSE CALCULATIONS - 10 CFR 50

3.7.1 UNRESTRICTED AREA Dose - Limits

Cumulative dose contributions for the current calendar quarter and current calendar year for noble gases shall be determined in accordance with the methodology and parameters in this Section or the methodology used in GASPAR II (NUREG/CR-4653) at least once per 31 days. This periodic assessment of releases of noble gases is to evaluate compliance with the quarterly dose limits and calendar year limits.

The air dose due to noble gases released in gaseous effluents to areas at and beyond the UNRESTRICTED AREA BOUNDARY shall be limited to the following:

- during any calendar quarter: less than or equal to 5 mrad for gamma radiation and less than or equal to 10 mrad for beta radiation, and
- during any calendar year: less than or equal to 10 mrad for gamma radiation and less than or equal to 20 mrad for beta radiation.

With the calculated air dose from radioactive noble gases in gaseous effluents exceeding any of the above limits, prepare and submit to the Commission within 60 days, pursuant to Section 7.3, a Licensee Event Report that identifies the cause(s) for exceeding the limit(s) and defines the corrective actions that have been taken to reduce the releases and the proposed corrective actions to be taken to assure that subsequent releases will be in compliance with the above limits.

This specification is provided to implement the requirements of Section II.B, III.A and IV.A of Appendix I, 10 CFR Part 50. The limits specified above provide the required operating flexibility and at the same time implement the guides set forth in Section IV.A of Appendix I to assure that the releases of radioactive material in gaseous effluents will be kept "as low as is reasonably achievable." This Section implements the requirements of Section III.A of Appendix I that conformance with the guides of Appendix I to be shown by calculational procedures based on models and data such that the actual exposure of an individual through the appropriate pathways is unlikely to be substantially underestimated. The dose calculations established for calculating the doses due to the actual release rates of radioactive noble gases in gaseous effluents are consistent with the methodology provided in Regulatory Guide 1.109, "Calculation of Annual Doses to Man from Routine Releases of Reactor Effluents for the Purpose of Evaluating Compliance with 10 CFR Part 50, Appendix I," Revision 1, October 1977 and Regulatory Guide 1.111, "Methods for Estimating Atmospheric Transport and Dispersion of Gaseous Effluents in Routine Releases from Light-Water-Cooled Reactors," Revision 1, July 1977.

3.7.2 Dose Calculations - Noble Gases

The following equations may be used to calculate the gamma-air and beta-air doses:

$$D_{\lambda} = 3.17E - 08 * \chi / Q_{NG} * \Sigma (M_i * Q_i) \quad (3-13)$$

$$D_{\beta} = 3.17E - 08 * \chi / Q_{NG} * \Sigma (N_i * Q_i) \quad (3-14)$$

where:

- $D\lambda$ = air dose due to gamma emissions for noble gas radionuclides (mrad),
- $D\beta$ = air dose due to beta emissions for noble gas radionuclides (mrad),
- χ/Q_{NG} = atmospheric χ/Q value for direct exposure to noble gas at the UNRESTRICTED AREA BOUNDARY given in Table 3-6 (sec/m³),
- Q_i = cumulative release of noble gas radionuclide "i" over the period of interest (μ Ci),
- M_i = air dose factor due to gamma emissions from noble gas radionuclide "i" (mrad/yr per μ Ci/m³) from Table 3-5,
- N_i = air dose factor due to beta emissions from noble gas radionuclide "i" (mrad/yr per μ Ci/m³) from Table 3-5, and
- $3.17E-08 = 1/3.15E+07$ (yr/sec).

3.7.3 Simplified Dose Calculation for Noble Gases

In lieu of the individual noble gas radionuclide dose assessment presented above, the following simplified equations may be used for verifying compliance with the dose limits of Section 3.7.1. (Refer to Appendix B for the derivation and justification of this simplified method.)

$$D\lambda = 2.0 * 3.17E - 08 * \chi / Q_{NG} * M_{eff} * \Sigma Q_i \quad (3-15)$$

and

$$D\beta = 2.0 * 3.17E - 08 * \chi / Q_{NG} * N_{eff} * \Sigma Q_i \quad (3-16)$$

where:

- M_{eff} = 5.7E+02, effective gamma-air dose factor from Appendix B (mrad/yr per μ Ci/m³),
- N_{eff} = 1.1E+03, effective beta-air dose factor from Appendix B (mrad/yr per μ Ci/m³), and
- 2.0 = conservatism factor to account for potential variability in the radionuclide distribution.

3.8 RADIOIODINE, TRITIUM AND PARTICULATE DOSE CALCULATIONS - 10 CFR 50

3.8.1 UNRESTRICTED AREA Dose Limits

A periodic assessment is required to evaluate compliance with the quarterly dose limit and the calendar year limit to any organ. Cumulative dose contributions for the current calendar quarter and current calendar year for I-131, tritium, and radionuclides in particulate form with half-lives greater than 8 days shall be determined in accordance with the methodology and parameters in this Section or the methodology used in GASPAR II (NREG/CR-4653) at least once per 31 days.

The dose to a MEMBER OF THE PUBLIC from I-131, tritium and all radionuclides in particulate form with half-lives greater than 8 days in gaseous effluents released to areas at and beyond the UNRESTRICTED AREA BOUNDARY shall be limited to the following:

- During any calendar quarter: less than or equal to 7.5 mrem to any organ, and
- During any calendar year: less than or equal to 15 mrem to any organ.

With the calculated dose from the release of iodine-131, tritium and radionuclides in particulate form with half-lives greater than 8 days in gaseous effluents exceeding any of the above limits, prepare and submit to the Commission within 60 days, pursuant to Section 7.3, a Licensee Event Report that identifies the cause(s) for exceeding the limit and defines the corrective actions that have been taken to reduce the releases and the proposed corrective actions to be taken to assure that subsequent releases will be in compliance with the above limits.

This requirement is provided to implement the requirements of Section II.C, III.A, and IV.A of Appendix I, 10 CFR Part 50. The limits are the guides set forth in Section II.C of Appendix I. The actions specified provide the required operating flexibility and at the same time implement the guides set forth in Section IV.A of Appendix I to assure that the releases of radioactive materials in gaseous effluents will be kept "as low as is reasonably achievable." The ODCM calculational methods specified in this Section implement the requirements in Section III.A of Appendix I that conformance with the guides of Appendix I be shown by calculational procedure based on models and data such that the actual exposure of an individual through appropriate pathways is unlikely to be substantially underestimated. The ODCM methods for calculating the doses due to the actual release rates of the subject materials are consistent with the methodology provided in Regulatory Guide 1.109, "Calculating of Annual Doses to Man from Routine Releases of Reactor Effluents for the Purpose of Evaluating Compliance with 10 CFR 50, Appendix I", Revision 1, October 1977 and Regulatory Guide 1.111, "Methods for Estimating Atmospheric Transport and Dispersion of Gaseous Effluents in Routine Releases from Light-Water-Cooled Reactors," Revision 1, July 1977.

The release rate specifications for radioiodines and radioactive material in particulate form are dependent on the existing radionuclide pathways to man in the UNRESTRICTED AREA. The pathways which are examined in the development of these calculations are:

- individual inhalation of airborne radionuclides,
- deposition of radionuclides into green leafy vegetation with subsequent consumption by man,
- deposition onto grassy areas where milk animals and meat-producing animals graze with consumption of the milk and meat by man, and
- deposition on the ground with subsequent exposure of man.

3.8.2 Critical Pathway

The critical pathway is that exposure pathway, age group, organ, and receptor location for which the maximum dose is calculated due to a given gaseous release of radionuclides. Determination of the critical pathway is made as part of the Annual Land Use Census. As part of this process, the maximum exposure pathway is determined for each directional sector in the area surrounding Davis-Besse. The maximum exposure pathways for each sector are listed in Table 3-4. The critical pathway is chosen from among the maximum pathways for each sector and is listed in Table 3-6.

Only the dose via the critical pathway identified in Table 3-6 need be evaluated for compliance with the dose limits of Section 3.8.1. Dose shall be calculated to the organ with the highest dose factor for the controlling age group to determine the maximum organ dose. The dose factors for organs of the various age groups are listed by exposure pathway in Tables 3-7 through 3-12. The meteorological dispersion values used (Table 3-6) may be those derived from current Land Use Census or those created by XOQDOQ.

3.8.3 Dose Calculations - Radioiodine, Tritium and Particulates

The following equation may be used to evaluate the maximum organ dose due to releases of iodine-131, tritium and particulates with half-lives greater than 8 days:

$$D_{aop} = 3.17E - 08 * W * ICF * SF * \Sigma (R_{io} * Q_i) \quad (3-17)$$

Where:

- | | | |
|-----------|---|---|
| D_{aop} | = | dose or dose commitment to organ "o" via controlling pathway "p" and age group "a" as identified in Table 3-6 (mrem), |
| W | = | atmospheric dispersion factor to the controlling location as identified in Table 3-6 |
| W | = | χ/Q , dispersion factor for inhalation pathway and H-3 dose contribution via all pathways (sec/m ³) |
| W | = | D/Q, deposition factor for vegetation, milk and ground plane exposure pathways (m ⁻²), |

- R_{io} = dose factor for radionuclide "i" to organ "o" of age group "a" via pathway "p" as identified in Table 3-7, 3-8, 3-9, 3-10, 3-11, or 3-12 depending on the pathway specified (mrem/yr per $\mu\text{Ci}/\text{m}^3$) or (m^2 - mrem/yr per $\mu\text{Ci}/\text{sec}$),
- Q_i = cumulative release over the period of interest for radionuclide "i" (μCi),
- ICF = elemental iodine correction factor which may be used in calculating doses from radioiodines via the vegetation, milk, and ground plane exposure pathways = 0.5,
- SF = seasonal correction factor which may be used for milk and vegetation pathways = 0.5, and
- $3.17\text{E}-08$ = $1/3.15\text{E}+07$ (yr/sec).

The dose factors in Tables 3-7 through 3-12 are derived in accordance with NUREG-0133. The elemental iodine correction factor in equation (3-17) is referenced in Regulatory Guide 1.109.

3.8.4 Simplified Dose Calculation for Radioiodine, Tritium and Particulates

In lieu of the individual radionuclide dose assessment presented in equation (3-17) the following simplified dose calculation may be used for verifying compliance with the dose limits of Section 3.8.1:

$$D_{\max} = 3.17\text{E}-08 * W * \text{ICF} * \text{SF} * R_{\text{I-131}} * \Sigma Q_i \quad (3-18)$$

where:

- D_{\max} = maximum organ dose (mrem),
- $R_{\text{I-131}}$ = I-131 dose factor for the thyroid for the controlling pathway identified in Table 3-6, and
- ΣQ_i = sum of the activities of all radioiodines, tritium and particulates (μCi).

The ground plane exposure and inhalation pathways need not be considered when the simplified method is used because of the negligible contribution of these pathways to the total thyroid dose. It is recognized that for some particulate radionuclides (e.g., Co-60 and Cs-137), the ground exposure pathway may represent a higher dose contribution than either the vegetation or milk pathway. However, use of the I-131 thyroid dose factor for all radionuclides will maximize the organ dose calculation, especially considering that no other radionuclide has a higher dose factor for any organ via any pathway than I-131 for the thyroid via the vegetable or milk pathway.

3.9 GASEOUS EFFLUENT DOSE PROJECTION

As with liquid effluents, gaseous effluents require processing if the projected dose exceeds specified limits. This requirement implements the requirements of 10 CFR 50.36a on maintaining and using the appropriate radwaste processing equipment to keep releases ALARA.

The GASEOUS RADWASTE TREATMENT SYSTEM (i.e., Waste Gas Decay Tank) shall be used to reduce noble gas levels prior to discharge when the projected air dose due to gaseous effluent releases to areas at and beyond the UNRESTRICTED AREA BOUNDARY would exceed 0.2 mrad for gamma radiation and 0.4 mrad for beta radiation in a 31 day period (i.e., one quarter of the design objective rate).

The VENTILATION EXHAUST TREATMENT SYSTEM shall be used to reduce radioiodine and particulate effluents, prior to their discharge, when the projected dose due to gaseous effluents releases to areas at or beyond the UNRESTRICTED AREA BOUNDARY would exceed 0.3 mrem to any organ in a 31-day period. Figure 3-1 presents the gaseous effluent release points and the GASEOUS RADWASTE and VENTILATION EXHAUST TREATMENT SYSTEMS applicable for reducing effluents prior to release.

With the gaseous waste being discharged without treatment and in excess of the limits, prepare and submit to the commission within 60 days, pursuant to Section 7.3 a Licensee Event Report that includes the following information:

- Explanation of why gaseous radwaste was being discharged without treatment, identification of any nonfunctional equipment or subsystems, and the reasons for the nonfunctionality,
- Actions taken to restore the nonfunctional equipment to FUNCTIONAL status, and
- Summary description of action(s) taken to prevent a recurrence.

The requirements that the appropriate portions of these systems be used, when specified, provides reasonable assurance that the releases of radioactive materials in gaseous effluents will be kept "as low as is reasonably achievable." This requirement implements the requirements of 10 CFR Part 50.36a, General Design Criterion 60 of Appendix A to 10 CFR Part 50. The specified limits governing the use of appropriate portions of the systems were specified as a suitable fraction of the dose design objectives set forth in Sections II.B and II.C of Appendix I, 10 CFR Part 50, for gaseous effluents.

If the GASEOUS RADWASTE and VENTILATION EXHAUST TREATMENT SYSTEMS are not being used, dose projections shall be performed at least once per 31 days using the following equations:

$$D\lambda_p = D\lambda * (31 / d) \quad (3-19)$$

$$D\beta_p = D\beta * (31 / d) \quad (3-20)$$

$$D_{\max p} = D_{\max} * (31 / d) \quad (3-21)$$

where:

- $D\lambda_p$ = projected 31-day gamma-air dose (mrad),
- $D\lambda$ = gamma-air dose for current calendar quarter (mrad),
- $D\beta_p$ = projected 31-day beta-air dose (mrad),
- $D\beta$ = beta-air dose for current calendar quarter (mrad),
- D_{maxp} = projected 31-day maximum organ dose (mrem),
- D_{max} = maximum organ dose for current calendar quarter as determined by equation (3-17) or (3-18) (mrem),
- d = number of days accounted for by current calendar quarter dose, and
- 31 = number of days in projection.

Table 3-1

RADIOACTIVE GASEOUS EFFLUENT MONITORING INSTRUMENTATION

<u>INSTRUMENT</u>	<u>REQUIRED CHANNELS</u>	<u>APPLICABILITY</u>	<u>PARAMETER</u>	<u>ACTION</u>
1. Waste Gas Decay System (provides automatic isolation)				
a. Noble Gas Activity Monitor (RE 1822A, B)	1	(1)	Radioactivity Measurement	A
b. Effluent System Flow Rate Measuring Device	1	(1)	System Flow Rate Measurement	B
2. Waste Gas System (provides alarm function)				
a. Oxygen Monitor (AE 5984, AE6570)	1	(2)	% Oxygen	D
3. Containment Purge Monitoring System (provides automatic isolation)				
a. Noble Gas Activity Monitor (RE 5052C)	1	(1)	Radioactivity measurement	C
4. Station Vent Stack (provides alarm function) (RE 4598AA,BA)				
a. Noble Gas Activity Monitor	1	(1)	Radioactivity Measurement	C*
b. Iodine Sampler Cartridge	1	(1)	Verify Presence of Cartridge	E*
c. Particulate Sampler Filter	1	(1)	Verify Presence of Filter	E*
d. Effluent System Flow Rate Measuring Device	1	(1)	System Flow Rate Measurement	B*
e. Sampler Flow Rate Measuring Device	1	(1)	Sampler Flow Rate Measurement	B*

*This requirement is not applicable for routine replacement of sampling media or routine test.

Table 3-1 (Continued)

TABLE NOTATION

(1) During radioactive waste gas releases via this pathway.

(2) During additions to the waste gas surge tank

ACTION A With less than the number of required channels FUNCTIONAL, the contents of the tank may be released to the environment provided that prior to initiating the release:

1. At least two independent samples are analyzed in accordance with Table 3-3 for analyses performed with each batch;
2. At least two independent verifications of the release rate calculations are performed;
3. At least two independent verifications of the discharge valving are performed.

ACTION B With less than the number of required channels FUNCTIONAL, effluent releases via this pathway may continue provided the flow rate is estimated at least once per 12 hours.

ACTION C With less than the number of required channels FUNCTIONAL, effluent releases via this pathway may continue provided grab samples are taken at least once per 8 hours and analyzed in accordance with applicable procedures.

ACTION D With less than the number of required channels FUNCTIONAL, additions to the waste gas surge tank may continue provided another method for ascertaining oxygen concentrations, such as grab sample analysis, is implemented to provide measurements at least once per four (4) hours during degassing and daily during other operations.

ACTION E With less than the number of required channels FUNCTIONAL, effluent releases via this pathway may continue provided samples are continuously collected with auxiliary sampling equipment, as required in Table 3-3 (this requirement is not applicable for routine replacement of sampling media or routine testing).

Table 3-2

RADIOACTIVE GASEOUS EFFLUENT MONITORING INSTRUMENTATION
VERIFICATION REQUIREMENTS

<u>INSTRUMENT</u>	<u>CHANNEL CHECK</u>	<u>SOURCE CHECK</u>	<u>CHANNEL CALIBRATION</u>	<u>CHANNEL FUNCTIONAL TEST</u>
1. Waste Gas Decay System				
a. Noble Gas Activity Monitor (RE 1822A,B)	P ⁽¹⁾	P	E ⁽⁵⁾	Q ⁽³⁾
b. Effluent System Flow Rate	P ⁽¹⁾	N/A	E	Q
2. Containment Purge Vent System				
a. Noble Gas Activity Monitor (RE 5052C)	D ⁽¹⁾	P ⁽⁷⁾ ;M ⁽⁸⁾	E ⁽⁵⁾	Q ⁽³⁾
3. Station Vent Stack				
a. Noble Gas Activity Monitor (RE 4598AA,BA)	D ⁽¹⁾	M	E ⁽⁵⁾	Q ⁽⁴⁾
b. Iodine Sampler	W ⁽¹⁾	N/A	N/A	N/A
c. Particulate Sampler	W ⁽¹⁾	N/A	N/A	N/A
d. System Effluent Flow Rate Measurement Device	D ⁽¹⁾	N/A	R	N/A
e. Sampler Flow Rate Measurement Device	W ⁽¹⁾	N/A	E	N/A

Table 3-2 (Continued)

TABLE NOTATION

- (1) During radioactive waste gas releases via this pathway.
- (2) During additions to the waste gas surge tank.
- (3) The CHANNEL FUNCTIONAL TEST shall also demonstrate that automatic isolation of this pathway and control room alarm annunciation occurs if the instrument indicates measured levels above the alarm/trip setpoint.
- (4) The CHANNEL FUNCTIONAL TEST shall also demonstrate that control room alarm annunciation occurs if the instrument indicates measured levels above the alarm/trip setpoint.
- (5) The initial CHANNEL CALIBRATION for radioactivity measurement instrumentation shall be performed using one or more reference standards certified by the National Institute of Standards and Technology or using standards that have been obtained from suppliers that participate in measurement assurance activities with NIST. These standards should permit calibrating the system over its intended range of energy and rate capabilities. For subsequent CHANNEL CALIBRATION, sources that have been related to the initial calibration should be used, at intervals of at least once per eighteen months. For high range monitoring instrumentation, where calibration with a radioactive source is impractical, an electronic calibration may be substituted for the radiation source calibration.
- (6) The CHANNEL CALIBRATION shall include the use of standard gas samples containing a nominal:
 - 1. One volume percent oxygen, balance nitrogen; and
 - 2. Four volume percent oxygen, balance nitrogen.
- (7) During containment purges.
- (8) When used in a continuous mode.

- P Prior to each release.
- E At least once per 18 months (550 days).
- Q At least once per 92 days.
- D At least once per 24 hours.
- M At least once per 31 days.
- W At least once per 7 days.
- R At least once per 24 months (730 days)

Table 3-3

RADIOACTIVE GASEOUS WASTE SAMPLING AND ANALYSIS PROGRAM

Gaseous Release Type	Sampling Frequency	Minimum Analysis Frequency	Type of Activity Analysis	Lower Limit of Detection (LLD) ($\mu\text{Ci/ml}$) ^a
Waste Gas Decay	P Each Release	P Each Release	Principal Gamma Emitters ^C	1.0E-04
	Grab Sample		H-3	1.0E-06
Containment Purge	P Each Purge	P Each Purge	Principal Gamma Emitters ^C	1.0E-04
	Grab Sample		H-3	1.0E-06
Station Vent Stack	M Grab Sample	M	Principal Gamma Emitters ^C	1.0E-04
			H-3	1.0E-06
	Continuous ^b	W Charcoal Sample	I-131, I-133	1.0E-12
	Continuous ^b	W Particulate Sample	Principal Gamma Emitters ^C	1.0E-11
	Continuous ^b	M Composite Particulate Sample	Gross Alpha	1.0E-11
	Continuous ^b	Q Composite Particulate Sample	Sr-89, Sr-90	1.0E-11
	Continuous ^b	Noble Gas Monitor	Noble Gases Gross Beta or Gamma	1.0E-06

Table 3-3 (Continued)

TABLE NOTATION

- a. The LLD is the smallest concentration of radioactive material in a sample that will be detected with 95% probability with 5% probability of falsely concluding that a blank observation represents a "real" signal.

For a particular measurement system (which may include radio-chemical separation):

$$LLD = \frac{4.66 s_b}{E * V * 2.22 * Y * \exp(-\lambda\Delta t)}$$

where

LLD is the lower limit of detection as defined above (as pCi per unit mass or volume);

s_b is the standard deviation of the background counting rate or of the counting rate of a blank sample as appropriate (as counts per minute);

E is the counting efficiency (as counts per transformation);

V is the sample size (in units of mass or volume);

2.22 is the number of transformations per minute per picocurie;

Y is the fractional radiochemical yield (when applicable);

λ is the radioactive decay constant for the particular radionuclide;

Δt for plant effluents is the elapsed time between the midpoint of sample collection and time of counting.

It should be recognized that the LLD is defined as an a priori (before the fact) limit representing the capability of a measurement system and not as a a posteriori (after the fact) limit for a particular measurement.

- b. The ratio of the sample flow rate to the sampled stream flow rate shall be known for the time period covered by each dose or dose rate calculation made in accordance with Sections 3.3.1 and 3.8.

Table 3-3 (Continued)

TABLE NOTATION

- c. The principal gamma emitters for which the LLD specification will apply are exclusively the following radionuclides: Kr-87, Kr-88, Xe-133, Xe-133m, Xe-135, and Xe-138 for gaseous emissions and Mn-54, Fe-59, Co-58, Co-60, Zn-65, Mo-99, Cs-134, Cs-137, Ce-141 and Ce-144 for particulate emissions. This list does not mean that only these nuclides are to be detected and reported. Other peaks which are measured and identified, together with the above nuclides, shall also be identified and reported. Nuclides which are below the LLD for the analyses should be reported as "less than" the nuclide's LLD and should not be reported as being present at the LLD level for the nuclide. The "less than" values shall not be used in the required dose calculations. When unusual circumstances result in LLDs higher than required, the reasons shall be documented in the Radioactive Effluent Release Report.

Frequency notation:

P - Prior to each release.

M - At least once per 31 days.

W - At least once per 7 days.

Q - At least once per 92 days.

Table 3-4

Land Use Census Summary

Exposure Pathway Locations and Atmospheric Dispersion Parameters

<u>Sector</u>	<u>Distance (miles)</u>	<u>Exposure Pathway</u>	<u>Controlling Age Group</u>	<u>χ/Q (sec/m³)</u>	<u>D/Q (m⁻²)</u>
N	0.55	inhalation	child	1.56E-06	1.34E-08
NNE	0.55	inhalation	child	2.09E-06	2.34E-08
NE	0.56	inhalation	child	1.43E-06	2.32E-08
ENE*	-	-	-	-	-
E*	-	-	-	-	-
ESE*	-	-	-	-	-
SE	4.94	inhalation	child	9.69E-09	1.53E-10
SSE	1.82	vegetation	child	4.58E-08	8.31E-10
S	3.10	vegetation	child	1.76E-08	2.66E-10
SSW**	0.70	vegetation	child	2.23E-07	4.33E-09
SW	3.50	vegetation	child	2.42E-08	3.62E-10
WSW	4.00	vegetation	child	2.66E-08	3.68E-10
W	0.97	vegetation	child	3.28E-07	4.56E-09
WNW	0.94	inhalation	child	2.84E-07	2.94E-09
NW	0.93	inhalation	child	2.90E-07	2.55E-09
NNW	0.80	inhalation	child	4.83E-07	3.78E-09

* Since these sectors are located over marsh areas and Lake Erie with no receptors, no ingestion or inhalation pathways are present.

** This is a new location identified during the 2018 Land Use Census.

Note: The meteorological dispersion factors are taken from the Chesapeake Nuclear Services report, Davis-Besse Nuclear Power Station Meteorological and Atmospheric Dispersion Report, November 2017.

Table 3-5
Dose Factors for Noble Gases*

<u>Nuclide</u>	Total Body Gamma Dose Factor K_i (mrem/yr per $\mu\text{Ci}/\text{m}^3$)	Skin Beta Dose Factor L_i (mrem/yr per $\mu\text{Ci}/\text{m}^3$)	Gamma Air Dose Factor M_i (mrad/yr per $\mu\text{Ci}/\text{m}^3$)	Beta Air Dose Factor N_i (mrad/yr per $\mu\text{Ci}/\text{m}^3$)
Kr-83m	7.56E-02	--	1.93E+01	2.88E+02
Kr-85m	1.17E+03	1.46E+03	1.23E+03	1.97E+03
Kr-85	1.61E+01	1.34E+03	1.72E+01	1.95E+03
Kr-87	5.92E+03	9.73E+03	6.17E+03	1.03E+04
Kr-88	1.47E+04	2.37E+03	1.52E+04	2.93E+03
Kr-89	1.66E+04	1.01E+04	1.73E+04	1.06E+04
Kr-90	1.56E+04	7.29E+03	1.63E+04	7.83E+03
Xe-131m	9.15E+01	4.76E+02	1.56E+02	1.11E+03
Xe-133m	2.51E+02	9.94E+02	3.27E+02	1.48E+03
Xe-133	2.94E+02	3.06E+02	3.53E+02	1.05E+03
Xe-135m	3.12E+03	7.11E+02	3.36E+03	7.39E+02
Xe-135	1.81E+03	1.86E+03	1.92E+03	2.46E+03
Xe-137	1.42E+03	1.22E+04	1.51E+03	1.27E+04
Xe-138	8.83E+03	4.13E+03	9.21E+03	4.75E+03
Ar-41	8.84E+03	2.69E+03	9.30E+03	3.28E+03

* Dose factors taken from NRC Regulatory Guide 1.109

Table 3-6
Exposure Pathways, Controlling Parameters, and Atmospheric Dispersion
for Dose Calculations

Exposure Pathway	Receptor Location	Controlling Age Group	Atmospheric Dispersion		Use
			χ/Q (sec/m ³)	D/Q (m ⁻²)	
noble gases direct exposure	UNRESTRICTED AREA BOUNDARY NNE		⁽³⁾ 3.10E-06	N/A	(a)
inhalation	UNRESTRICTED AREA BOUNDARY NNE	child	⁽⁴⁾ 2.80E-06	N/A	(a)
(critical pathway) garden	0.97 miles W	child	⁽¹⁾ 3.28E-07	⁽¹⁾ 4.56E-09	(b), (c)
Variable Dispersion Factors			⁽²⁾ Variable	⁽²⁾ Variable	(c), (d)

- (a) To calculate allowable release rates (Sections 3.3 through 3.8)
- (b) To reflect results of Land Use Census
- (c) To screen individual releases for dose and/or calculate 31 day dose
- (d) To calculate annual dose and/or calculate 31 day dose

NOTES:

1. Meteorological dispersion values have been taken from the Chesapeake Nuclear Services report, Davis-Besse Nuclear Power Station Meteorological and Atmospheric Dispersion Report, November 2017.
2. Meteorological dispersion values generated using XOQDOQ (NUREG/CR-2919) for input into GASP. Meteorological data may be historic or real time.
3. The noble gas, direct exposure χ/Q s are based on the 2.26 day decayed, undepleted values.
4. The inhalation pathway χ/Q s are based on the 8 day decayed, depleted values.

Table 3-7
 R_{i0} Inhalation Pathway Dose Factors - ADULT
(mrem/yr per $\mu\text{Ci}/\text{m}^3$)

<u>Nuclide</u>	<u>Bone</u>	<u>Liver</u>	<u>Thyroid</u>	<u>Kidney</u>	<u>Lung</u>	<u>GI-LLI</u>	<u>T.Body</u>
H-3	-	1.26E+3	1.26E+3	1.26E+3	1.26E+3	1.26E+3	1.26E+3
C-14	1.82E+4	3.41E+3	3.41E+3	3.41E+3	3.41E+3	3.41E+3	3.41E+3
Na-24	1.02E+4	1.02E+4	1.02E+4	1.02E+4	1.02E+4	1.02E+4	1.02E+4
P-32	1.32E+6	7.71E+4	-	-	-	8.64E+4	5.01E+4
Cr-51	-	-	5.95E+1	2.28E+1	1.44E+4	3.32E+3	1.00E+2
Mn-54	-	3.96E+4	-	9.84E+3	1.40E+6	7.74E+4	6.30E+3
Mn-56	-	1.24E+0	-	1.30E+0	9.44E+3	2.02E+4	1.83E-1
Fe-55	2.46E+4	1.70E+4	-	-	7.21E+4	6.03E+3	3.94E+3
Fe-59	1.18E+4	2.78E+4	-	-	1.02E+6	1.88E+5	1.06E+4
Co-57	-	6.92E+2	-	-	3.70E+5	3.14E+4	6.71E+2
Co-58	-	1.58E+3	-	-	9.28E+5	1.06E+5	2.07E+3
Co-60	-	1.15E+4	-	-	5.97E+6	2.85E+5	1.48E+4
Ni-63	4.32E+5	3.14E+4	-	-	1.78E+5	1.34E+4	1.45E+4
Ni-65	1.54E+0	2.10E-1	-	-	5.60E+3	1.23E+4	9.12E-2
Cu-64	-	1.46E+0	-	4.62E+0	6.78E+3	4.90E+4	6.15E-1
Zn-65	3.24E+4	1.03E+5	-	6.90E+4	8.64E+5	5.34E+4	4.66E+4
Zn-69	3.38E-2	6.51E-2	-	4.22E-2	9.20E+2	1.63E+1	4.52E-3
Br-82	-	-	-	-	-	1.04E+4	1.35E+4
Br-83	-	-	-	-	-	2.32E+2	2.41E+2
Br-84	-	-	-	-	-	1.64E-3	3.13E+2
Br-85	-	-	-	-	-	-	1.28E+1
Rb-86	-	1.35E+5	-	-	-	1.66E+4	5.90E+4
Rb-88	-	3.87E+2	-	-	-	3.34E-9	1.93E+2
Rb-89	-	2.56E+2	-	-	-	-	1.70E+2
Sr-89	3.04E+5	-	-	-	1.40E+6	3.50E+5	8.72E+3
Sr-90	9.92E+7	-	-	-	9.60E+6	7.22E+5	6.10E+6
Sr-91	6.19E+1	-	-	-	3.65E+4	1.91E+5	2.50E+0
Sr-92	6.74E+0	-	-	-	1.65E+4	4.30E+4	2.91E-1
Y-90	2.09E+3	-	-	-	1.70E+5	5.06E+5	5.61E+1
Y-91m	2.61E-1	-	-	-	1.92E+3	1.33E+0	1.02E-2
Y-91	4.62E+6	-	-	-	1.70E+6	3.85E+5	1.24E+4
Y-92	1.03E+1	-	-	-	1.57E+4	7.35E+4	3.02E-1
Y-93	9.44E+1	-	-	-	4.85E+4	4.22E+5	2.61E+0
Zr-95	1.07E+5	3.44E+4	-	5.42E+4	1.77E+6	1.50E+5	2.33E+4
Zr-97	9.68E+1	1.96E+1	-	2.97E+1	7.87E+4	5.23E+5	9.04E+0
Nb-95	1.41E+4	7.82E+3	-	7.74E+3	5.05E+5	1.04E+5	4.21E+3
Nb-97	2.22E-1	5.62E-2	-	6.54E-2	2.40E+3	2.42E+2	2.05E-2
Mo-99	-	1.21E+2	-	2.91E+2	9.12E+4	2.48E+5	2.30E+1
Tc-99m	1.03E-3	2.91E-3	-	4.42E-2	7.64E+2	4.16E+3	3.70E-2
Tc-101	4.18E-5	6.02E-5	-	1.08E-3	3.99E+2	-	5.90E-4

Table 3-7
R₁₀' Inhalation Pathway Dose Factors - ADULT (Continued)
(mrem/yr per μCi/m³)

<u>Nuclide</u>	<u>Bone</u>	<u>Liver</u>	<u>Thyroid</u>	<u>Kidney</u>	<u>Lung</u>	<u>GI-LLI</u>	<u>T.Body</u>
Ru-103	1.53E+3	-	-	5.83E+3	5.05E+5	1.10E+5	6.58E+2
Ru-105	7.90E-1	-	-	1.02E+0	1.10E+4	4.82E+4	3.11E-1
Ru-106	6.91E+4	-	-	1.34E+5	9.36E+6	9.12E+5	8.72E+3
Rh-103m	-	-	-	-	-	-	-
Rh-106	-	-	-	-	-	-	-
Ag-110m	1.08E+4	1.00E+4	-	1.97E+4	4.63E+6	3.02E+5	5.94E+3
Sb-124	3.12E+4	5.89E+2	7.55E+1	-	2.48E+6	4.06E+5	1.24E+4
Sb-125	5.34E+4	5.95E+2	5.40E+1	-	1.74E+6	1.01E+5	1.26E+4
Te-125m	3.42E+3	1.58E+3	1.05E+3	1.24E+4	3.14E+5	7.06E+4	4.67E+2
Te-127m	1.26E+4	5.77E+3	3.29E+3	4.58E+4	9.60E+5	1.50E+5	1.57E+3
Te-127	1.40E+0	6.42E-1	1.06E+0	5.10E+0	6.51E+3	5.74E+4	3.10E-1
Te-129m	9.76E+3	4.67E+3	3.44E+3	3.66E+4	1.16E+6	3.83E+5	1.58E+3
Te-129	4.98E-2	2.39E-2	3.90E-2	1.87E-1	1.94E+3	1.57E+2	1.24E-2
Te-131m	6.99E+1	4.36E+1	5.50E+1	3.09E+2	1.46E+5	5.56E+5	2.90E+1
Te-131	1.11E-2	5.95E-3	9.36E-3	4.37E-2	1.39E+3	1.84E+1	3.59E-3
Te-132	2.60E+2	2.15E+2	1.90E+2	1.46E+3	2.88E+5	5.10E+5	1.62E+2
I-130	4.58E+3	1.34E+4	1.14E+6	2.09E+4	-	7.69E+3	5.28E+3
I-131	2.52E+4	3.58E+4	1.19E+7	6.13E+4	-	6.28E+3	2.05E+4
I-132	1.16E+3	3.26E+3	1.14E+5	5.18E+3	-	4.06E+2	1.16E+3
I-133	8.64E+3	1.48E+4	2.15E+6	2.58E+4	-	8.88E+3	4.52E+3
I-134	6.44E+2	1.73E+3	2.98E+4	2.75E+3	-	1.01E+0	6.15E+2
I-135	2.68E+3	6.98E+3	4.48E+5	1.11E+4	-	5.25E+3	2.57E+3
Cs-134	3.73E+5	8.48E+5	-	2.87E+5	9.76E+4	1.04E+4	7.28E+5
Cs-136	3.90E+4	1.46E+5	-	8.56E+4	1.20E+4	1.17E+4	1.10E+5
Cs-137	4.78E+5	6.21E+5	-	2.22E+5	7.52E+4	8.40E+3	4.28E+5
Cs-138	3.31E+2	6.21E+2	-	4.80E+2	4.86E+1	1.86E-3	3.24E+2
Ba-139	9.36E-1	6.66E-4	-	6.22E-4	3.76E+3	8.96E+2	2.74E-2
Ba-140	3.90E+4	4.90E+1	-	1.67E+1	1.27E+6	2.18E+5	2.57E+3
Ba-141	1.00E-1	7.53E-5	-	7.00E-5	1.94E+3	1.16E-7	3.36E-3
Ba-142	2.63E-2	2.70E-5	-	2.29E-5	1.19E+3	-	1.66E-3
La-140	3.44E+2	1.74E+2	-	-	1.36E+5	4.58E+5	4.58E+1
La-142	6.83E-1	3.10E-1	-	-	6.33E+3	2.11E+3	7.72E-2
Ce-141	1.99E+4	1.35E+4	-	6.26E+3	3.62E+5	1.20E+5	1.53E+3
Ce-143	1.86E+2	1.38E+2	-	6.08E+1	7.98E+4	2.26E+5	1.53E+1
Ce-144	3.43E+6	1.43E+6	-	8.48E+5	7.78E+6	8.16E+5	1.84E+5
Pr-143	9.36E+3	3.75E+3	-	2.16E+3	2.81E+5	2.00E+5	4.64E+2
Pr-144	3.01E-2	1.25E-2	-	7.05E-3	1.02E+3	2.15E-8	1.53E-3
Nd-147	5.27E+3	6.10E+3	-	3.56E+3	2.21E+5	1.73E+5	3.65E+2
W-187	8.48E+0	7.08E+0	-	-	2.90E+4	1.55E+5	2.48E+0
Np-239	2.30E+2	2.26E+1	-	7.00E+1	3.76E+4	1.19E+5	1.24E+1

Table 3-7
R₁₀' Inhalation Pathway Dose Factors - TEENAGER
(mrem/yr per μCi/m³)

<u>Nuclide</u>	<u>Bone</u>	<u>Liver</u>	<u>Thyroid</u>	<u>Kidney</u>	<u>Lung</u>	<u>GI-LLI</u>	<u>T.Body</u>
H-3	-	1.27E+3	1.27E+3	1.27E+3	1.27E+3	1.27E+3	1.27E+3
C-14	2.60E+4	4.87E+3	4.87E+3	4.87E+3	4.87E+3	4.87E+3	4.87E+3
Na-24	1.38E+4	1.38E+4	1.38E+4	1.38E+4	1.38E+4	1.38E+4	1.38E+4
P-32	1.89E+6	1.10E+5	-	-	-	9.28E+4	7.16E+4
Cr-51	-	-	7.50E+1	3.07E+1	2.10E+4	3.00E+3	1.35E+2
Mn-54	-	5.11E+4	-	1.27E+4	1.98E+6	6.68E+4	8.40E+3
Mn-56	-	1.70E+0	-	1.79E+0	1.52E+4	5.74E+4	2.52E-1
Fe-55	3.34E+4	2.38E+4	-	-	1.24E+5	6.39E+3	5.54E+3
Fe-59	1.59E+4	3.70E+4	-	-	1.53E+6	1.78E+5	1.43E+4
Co-57	-	6.92E+2	-	-	5.86E+5	3.14E+4	9.20E+2
Co-58	-	2.07E+3	-	-	1.34E+6	9.52E+4	2.78E+3
Co-60	-	1.51E+4	-	-	8.72E+6	2.59E+5	1.98E+4
Ni-63	5.80E+5	4.34E+4	-	-	3.07E+5	1.42E+4	1.98E+4
Ni-65	2.18E+0	2.93E-1	-	-	9.36E+3	3.67E+4	1.27E-1
Cu-64	-	2.03E+0	-	6.41E+0	1.11E+4	6.14E+4	8.48E-1
Zn-65	3.86E+4	1.34E+5	-	8.64E+4	1.24E+6	4.66E+4	6.24E+4
Zn-69	4.83E-2	9.20E-2	-	6.02E-2	1.58E+3	2.85E+2	6.46E-3
Br-82	-	-	-	-	-	-	1.82E+4
Br-83	-	-	-	-	-	-	3.44E+2
Br-84	-	-	-	-	-	-	4.33E+2
Br-85	-	-	-	-	-	-	1.83E+1
Rb-86	-	1.90E+5	-	-	-	1.77E+4	8.40E+4
Rb-88	-	5.46E+2	-	-	-	2.92E-5	2.72E+2
Rb-89	-	3.52E+2	-	-	-	3.38E-7	2.33E+2
Sr-89	4.34E+5	-	-	-	2.42E+6	3.71E+5	1.25E+4
Sr-90	1.08E+8	-	-	-	1.65E+7	7.65E+5	6.68E+6
Sr-91	8.80E+1	-	-	-	6.07E+4	2.59E+5	3.51E+0
Sr-92	9.52E+0	-	-	-	2.74E+4	1.19E+5	4.06E-1
Y-90	2.98E+3	-	-	-	2.93E+5	5.59E+5	8.00E+1
Y-91m	3.70E-1	-	-	-	3.20E+3	3.02E+1	1.42E-2
Y-91	6.61E+5	-	-	-	2.94E+6	4.09E+5	1.77E+4
Y-92	1.47E+1	-	-	-	2.68E+4	1.65E+5	4.29E-1
Y-93	1.35E+2	-	-	-	8.32E+4	5.79E+5	3.72E+0
Zr-95	1.46E+5	4.58E+4	-	6.74E+4	2.69E+6	1.49E+5	3.15E+4
Zr-97	1.38E+2	2.72E+1	-	4.12E+1	1.30E+5	6.30E+5	1.26E+1
Nb-95	1.86E+4	1.03E+4	-	1.00E+4	7.51E+5	9.68E+4	5.66E+3
Nb-97	3.14E-1	7.78E-2	-	9.12E-2	3.93E+3	2.17E+3	2.84E-2
Mo-99	-	1.69E+2	-	4.11E+2	1.54E+5	2.69E+5	3.22E+1
Tc-99m	1.38E-3	3.86E-3	-	5.76E-2	1.15E+3	6.13E+3	4.99E-2
Tc-101	5.92E-5	8.40E-5	-	1.52E-3	6.67E+2	8.72E-7	8.24E-4

Table 3-7
 R_{io}' Inhalation Pathway Dose Factors - TEENAGER (Continued)
 (mrem/yr per μCi/m³)

<u>Nuclide</u>	<u>Bone</u>	<u>Liver</u>	<u>Thyroid</u>	<u>Kidney</u>	<u>Lung</u>	<u>GI-LLI</u>	<u>T.Body</u>
Ru-103	2.10E+3	-	-	7.43E+3	7.83E+5	1.09E+5	8.96E+2
Ru-105	1.12E+0	-	-	1.41E+0	1.82E+4	9.04E+4	4.34E-1
Ru-106	9.84E+4	-	-	1.90E+5	1.61E+7	9.60E+5	1.24E+4
Rh-103m	-	-	-	-	-	-	-
Rh-106	-	-	-	-	-	-	-
Ag-110m	1.38E+4	1.31E+4	-	2.50E+4	6.75E+6	2.73E+5	7.99E+3
Sb-124	4.30E+4	7.94E+2	9.76E+1	-	3.85E+6	3.98E+5	1.68E+4
Sb-125	7.38E+4	8.08E+2	7.04E+1	-	2.74E+6	9.92E+4	1.72E+4
Te-125m	4.88E+3	2.24E+3	1.40E+3	-	5.36E+5	7.50E+4	6.67E+2
Te-127m	1.80E+4	8.16E+3	4.38E+3	6.54E+4	1.66E+6	1.59E+5	2.18E+3
Te-127	2.01E+0	9.12E-1	1.42E+0	7.28E+0	1.12E+4	8.08E+4	4.42E-1
Te-129m	1.39E+4	6.58E+3	4.58E+3	5.19E+4	1.98E+6	4.05E+5	2.25E+3
Te-129	7.10E-2	3.38E-2	5.18E-2	2.66E-1	3.30E+3	1.62E+3	1.76E-2
Te-131m	9.84E+1	6.01E+1	7.25E+1	4.39E+2	2.38E+5	6.21E+5	4.02E+1
Te-131	1.58E-2	8.32E-3	1.24E-2	6.18E-2	2.34E+3	1.51E+1	5.04E-3
Te-132	3.60E+2	2.90E+2	2.46E+2	1.95E+3	4.49E+5	4.63E+5	2.19E+2
I-130	6.24E+3	1.79E+4	1.49E+6	2.75E+4	-	9.12E+3	7.17E+3
I-131	3.54E+4	4.91E+4	1.46E+7	8.40E+4	-	6.49E+3	2.64E+4
I-132	1.59E+3	4.38E+3	1.51E+5	6.92E+3	-	1.27E+3	1.58E+3
I-133	1.22E+4	2.05E+4	2.92E+6	3.59E+4	-	1.03E+4	6.22E+3
I-134	8.88E+2	2.32E+3	3.95E+4	3.66E+3	-	2.04E+1	8.40E+2
I-135	3.70E+3	9.44E+3	6.21E+5	1.49E+4	-	6.95E+3	3.49E+3
Cs-134	5.02E+5	1.13E+6	-	3.75E+5	1.46E+5	9.76E+3	5.49E+5
Cs-136	5.15E+4	1.94E+5	-	1.10E+5	1.78E+4	1.09E+4	1.37E+5
Cs-137	6.70E+5	8.48E+5	-	3.04E+5	1.21E+5	8.48E+3	3.11E+5
Cs-138	4.66E+2	8.56E+2	-	6.62E+2	7.87E+1	2.70E-1	4.46E+2
Ba-139	1.34E+0	9.44E-4	-	8.88E-4	6.46E+3	6.45E+3	3.90E-2
Ba-140	5.47E+4	6.70E+1	-	2.28E+1	2.03E+6	2.29E+5	3.52E+3
Ba-141	1.42E-1	1.06E-4	-	9.84E-5	3.29E+3	7.46E-4	4.74E-3
Ba-142	3.70E-2	3.70E-5	-	3.14E-5	1.91E+3	-	2.27E-3
La-140	4.79E+2	2.36E+2	-	-	2.14E+5	4.87E+5	6.26E+1
La-142	9.60E-1	4.25E-1	-	-	1.02E+4	1.20E+4	1.06E-1
Ce-141	2.84E+4	1.90E+4	-	8.88E+3	6.14E+5	1.26E+5	2.17E+3
Ce-143	2.66E+2	1.94E+2	-	8.64E+1	1.30E+5	2.55E+5	2.16E+1
Ce-144	4.89E+6	2.02E+6	-	1.21E+6	1.34E+7	8.64E+5	2.62E+5
Pr-143	1.34E+4	5.31E+3	-	3.09E+3	4.83E+5	2.14E+5	6.62E+2
Pr-144	4.30E-2	1.76E-2	-	1.01E-2	1.75E+3	2.35E-4	2.18E-3
Nd-147	7.86E+3	8.56E+3	-	5.02E+3	3.72E+5	1.82E+5	5.13E+2
W-187	1.20E+1	9.76E+0	-	-	4.74E+4	1.77E+5	3.43E+0
Np-239	3.38E+2	3.19E+1	-	1.00E+2	6.49E+4	1.32E+5	1.77E+1

Table 3-7
 R_{io} Inhalation Pathway Dose Factors - CHILD
 (mrem/yr per μCi/m³)

<u>Nuclide</u>	<u>Bone</u>	<u>Liver</u>	<u>Thyroid</u>	<u>Kidney</u>	<u>Lung</u>	<u>GI-LLI</u>	<u>T.Body</u>
H-3	-	1.12E+3	1.12E+3	1.12E+3	1.12E+3	1.12E+3	1.12E+3
C-14	3.59E+4	6.73E+3	6.73E+3	6.73E+3	6.73E+3	6.73E+3	6.73E+3
Na-24	1.61E+4	1.61E+4	1.61E+4	1.61E+4	1.61E+4	1.61E+4	1.61E+4
P-32	2.60E+6	1.14E+5	-	-	-	4.22E+4	9.88E+4
Cr-51	-	-	8.55E+1	2.43E+1	1.70E+4	1.08E+3	1.54E+2
Mn-54	-	4.29E+4	-	1.00E+4	1.58E+6	2.29E+4	9.51E+3
Mn-56	-	1.66E+0	-	1.67E+0	1.31E+4	1.23E+5	3.12E-1
Fe-55	4.74E+4	2.52E+4	-	-	1.11E+5	2.87E+3	7.77E+3
Fe-59	2.07E+4	3.34E+4	-	-	1.27E+6	7.07E+4	1.67E+4
Co-57	-	9.03E+2	-	-	5.07E+5	1.32E+4	1.07E+3
Co-58	-	1.77E+3	-	-	1.11E+6	3.44E+4	3.16E+3
Co-60	-	1.31E+4	-	-	7.07E+6	9.62E+4	2.26E+4
Ni-63	8.21E+5	4.63E+4	-	-	2.75E+5	6.33E+3	2.80E+4
Ni-65	2.99E+0	2.96E-1	-	-	8.18E+3	8.40E+4	1.64E-1
Cu-64	-	1.99E+0	-	6.03E+0	9.58E+3	3.67E+4	1.07E+0
Zn-65	4.26E+4	1.13E+5	-	7.14E+4	9.95E+5	1.63E+4	7.03E+4
Zn-69	6.70E-2	9.66E-2	-	5.85E-2	1.42E+3	1.01E+4	8.92E-3
Br-82	-	-	-	-	-	-	2.09E+4
Br-83	-	-	-	-	-	-	4.74E+2
Br-84	-	-	-	-	-	-	5.48E+2
Br-85	-	-	-	-	-	-	2.53E+1
Rb-86	-	1.98E+5	-	-	-	7.99E+3	1.14E+5
Rb-88	-	5.62E+2	-	-	-	1.72E+1	3.66E+2
Rb-89	-	3.45E+2	-	-	-	1.89E+0	2.90E+2
Sr-89	5.99E+5	-	-	-	2.16E+6	1.67E+5	1.72E+4
Sr-90	1.01E+8	-	-	-	1.48E+7	3.43E+5	6.44E+6
Sr-91	1.21E+2	-	-	-	5.33E+4	1.74E+5	4.59E+0
Sr-92	1.31E+1	-	-	-	2.40E+4	2.42E+5	5.25E-1
Y-90	4.11E+3	-	-	-	2.62E+5	2.68E+5	1.11E+2
Y-91m	5.07E-1	-	-	-	2.81E+3	1.72E+3	1.84E-2
Y-91	9.14E+5	-	-	-	2.63E+6	1.84E+5	2.44E+4
Y-92	2.04E+1	-	-	-	2.39E+4	2.39E+5	5.81E-1
Y-93	1.86E+2	-	-	-	7.44E+4	3.89E+5	5.11E+0
Zr-95	1.90E+5	4.18E+4	-	5.96E+4	2.23E+6	6.11E+4	3.70E+4
Zr-97	1.88E+2	2.72E+1	-	3.89E+1	1.13E+5	3.51E+5	1.60E+1
Nb-95	2.35E+4	9.18E+3	-	8.62E+3	6.14E+5	3.70E+4	6.55E+3
Nb-97	4.29E-1	7.70E-2	-	8.55E-2	3.42E+3	2.78E+4	3.60E-2
Mo-99	-	1.72E+2	-	3.92E+2	1.35E+5	1.27E+5	4.26E+1
Tc-99m	1.78E-3	3.48E-3	-	5.07E-2	9.51E+2	4.81E+3	5.77E-2
Tc-101	8.10E-5	8.51E-5	-	1.45E-3	5.85E+2	1.63E+1	1.08E-3

Table 3-7
 R_{i0} , Inhalation Pathway Dose Factors - CHILD (continued)
(mrem/yr per $\mu\text{Ci}/\text{m}^3$)

<u>Nuclide</u>	<u>Bone</u>	<u>Liver</u>	<u>Thyroid</u>	<u>Kidney</u>	<u>Lung</u>	<u>GI-LLI</u>	<u>T.Body</u>
Ru-103	2.79E+3	-	-	7.03E+3	6.62E+5	4.48E+4	1.07E+3
Ru-105	1.53E+0	-	-	1.34E+0	1.59E+4	9.95E+4	5.55E-1
Ru-106	1.36E+5	-	-	1.84E+5	1.43E+7	4.29E+5	1.69E+4
Rh-103m	-	-	-	-	-	-	-
Rh-106	-	-	-	-	-	-	-
Ag-110m	1.69E+4	1.14E+4	-	2.12E+4	5.48E+6	1.00E+5	9.14E+3
Sb-124	5.74E+4	7.40E+2	1.26E+2	-	3.24E+6	1.64E+5	2.00E+4
Sb-125	9.84E+4	7.59E+2	9.10E+1	-	2.32E+6	4.03E+4	2.07E+4
Te-125m	6.73E+3	2.33E+3	1.92E+3	-	4.77E+5	3.38E+4	9.14E+2
Te-127m	2.49E+4	8.55E+3	6.07E+3	6.36E+4	1.48E+6	7.14E+4	3.02E+3
Te-127	2.77E+0	9.51E-1	1.96E+0	7.07E+0	1.00E+4	5.62E+4	6.11E-1
Te-129m	1.92E+4	6.85E+3	6.33E+3	5.03E+4	1.76E+6	1.82E+5	3.04E+3
Te-129	9.77E-2	3.50E-2	7.14E-2	2.57E-1	2.93E+3	2.55E+4	2.38E-2
Te-131m	1.34E+2	5.92E+1	9.77E+1	4.00E+2	2.06E+5	3.08E+5	5.07E+1
Te-131	2.17E-2	8.44E-3	1.70E-2	5.88E-2	2.05E+3	1.33E+3	6.59E-3
Te-132	4.81E+2	2.72E+2	3.17E+2	1.77E+3	3.77E+5	1.38E+5	2.63E+2
I-130	8.18E+3	1.64E+4	1.85E+6	2.45E+4	-	1E+3	8.44E+3
I-131	4.81E+4	4.81E+4	1.62E+7	7.88E+4	-	2.84E+3	2.73E+4
I-132	2.12E+3	4.07E+3	1.94E+5	6.25E+3	-	3.20E+3	1.88E+3
I-133	1.66E+4	2.03E+4	3.85E+6	3.38E+4	-	5.48E+3	7.70E+3
I-134	1.17E+3	2.16E+3	5.07E+4	3.30E+3	-	9.55E+2	9.95E+2
I-135	4.92E+3	8.73E+3	7.92E+5	1.34E+4	-	4.44E+3	4.14E+3
Cs-134	6.51E+5	1.01E+6	-	3.30E+5	1.21E+5	3.85E+3	2.25E+5
Cs-136	6.51E+4	1.71E+5	-	9.55E+4	1.45E+4	4.18E+3	1.16E+5
Cs-137	9.07E+5	8.25E+5	-	2.82E+5	1.04E+5	3.62E+3	1.28E+5
Cs-138	6.33E+2	8.40E+2	-	6.22E+2	6.81E+1	2.70E+2	5.55E+2
Ba-139	1.84E+0	9.84E-4	-	8.62E-4	5.77E+3	5.77E+4	5.37E-2
Ba-140	7.40E+4	6.48E+1	-	2.11E+1	1.74E+6	1.02E+5	4.33E+3
Ba-141	1.96E-1	1.09E-4	-	9.47E-5	2.92E+3	2.75E+2	6.36E-3
Ba-142	5.00E-2	3.60E-5	-	2.91E-5	1.64E+3	2.74E+0	2.79E-3
La-140	6.44E+2	2.25E+2	-	-	1.83E+5	2.26E+5	7.55E+1
La-142	1.30E+0	4.11E-1	-	-	8.70E+3	7.59E+4	1.29E-1
Ce-141	3.92E+4	1.95E+4	-	8.55E+3	5.44E+5	5.66E+4	2.90E+3
Ce-143	3.66E+2	1.99E+2	-	8.36E+1	1.15E+5	1.27E+5	2.87E+1
Ce-144	6.77E+6	2.12E+6	-	1.17E+6	1.20E+7	3.89E+5	3.61E+5
Pr-143	1.85E+4	5.55E+3	-	3.00E+3	4.33E+5	9.73E+4	9.14E+2
Pr-144	5.96E-2	1.85E-2	-	9.77E-3	1.57E+3	1.97E+2	3.00E-3
Nd-147	1.08E+4	8.73E+3	-	4.81E+3	3.28E+5	8.21E+4	6.81E+2
W-187	1.63E+1	9.66E+0	-	-	4.11E+4	9.10E+4	4.33E+0
Np-239	4.66E+2	3.34E+1	-	9.73E+1	5.81E+4	6.40E+4	2.35E+1

Table 3-7 (continued)
 R_{iO} , Inhalation Pathway Dose Factors - INFANT
(mrem/yr per $\mu\text{Ci}/\text{m}^3$)

<u>Nuclide</u>	<u>Bone</u>	<u>Liver</u>	<u>Thyroid</u>	<u>Kidney</u>	<u>Lung</u>	<u>GI-LLI</u>	<u>T.Body</u>
H-3	-	6.47E+2	6.47E+2	6.47E+2	6.47E+2	6.47E+2	6.47E+2
C-14	2.65E+4	5.31E+3	5.31E+3	5.31E+3	5.31E+3	5.31E+3	5.31E+3
Na-24	1.06E+4	1.06E+4	1.06E+4	1.06E+4	1.06E+4	1.06E+4	1.06E+4
P-32	2.03E+6	1.12E+5	-	-	-	1.61E+4	7.74E+4
Cr-51	-	-	5.75E+1	1.32E+1	1.28E+4	3.57E+2	8.95E+1
Mn-54	-	2.53E+4	-	4.98E+3	1.00E+6	7.06E+3	4.98E+3
Mn-56	-	1.54E+0	-	1.10E+0	1.25E+4	7.17E+4	2.21E-1
Fe-55	1.97E+4	1.17E+4	-	-	8.69E+4	1.09E+3	3.33E+3
Fe-59	1.36E+4	2.35E+4	-	-	1.02E+6	2.48E+4	9.48E+3
Co-57	-	6.51E+2	-	-	3.79E+5	4.86E+3	6.41E+2
Co-58	-	1.22E+3	-	-	7.77E+5	1.11E+4	1.82E+3
Co-60	-	8.02E+3	-	-	4.51E+6	3.19E+4	1.18E+4
Ni-63	3.39E+5	2.04E+4	-	-	2.09E+5	2.42E+3	1.16E+4
Ni-65	2.39E+0	2.84E-1	-	-	8.12E+3	5.01E+4	1.23E-1
Cu-64	-	1.88E+0	-	3.98E+0	9.30E+3	1.50E+4	7.74E-1
Zn-65	1.93E+4	6.26E+4	-	3.25E+4	6.47E+5	5.14E+4	3.11E+4
Zn-69	5.39E-2	9.67E-2	-	4.02E-2	1.47E+3	1.32E+4	7.18E-3
Br-82	-	-	-	-	-	-	1.33E+4
Br-83	-	-	-	-	-	-	3.81E+2
Br-84	-	-	-	-	-	-	4.00E+2
Br-85	-	-	-	-	-	-	2.04E+1
Rb-86	-	1.90E+5	-	-	-	3.04E+3	8.82E+4
Rb-88	-	5.57E+2	-	-	-	3.39E+2	2.87E+2
Rb-89	-	3.21E+2	-	-	-	6.82E+1	2.06E+2
Sr-89	3.98E+5	-	-	-	2.03E+6	6.40E+4	1.14E+4
Sr-90	4.09E+7	-	-	-	1.12E+7	1.31E+5	2.59E+6
Sr-91	9.56E+1	-	-	-	5.26E+4	7.34E+4	3.46E+0
Sr-92	1.05E+1	-	-	-	2.38E+4	1.40E+5	3.91E-1
Y-90	3.29E+3	-	-	-	2.69E+5	1.04E+5	8.82E+1
Y-91m	4.07E-1	-	-	-	2.79E+3	2.35E+3	1.39E-2
Y-91	5.88E+5	-	-	-	2.45E+6	7.03E+4	1.57E+4
Y-92	1.64E+1	-	-	-	2.45E+4	1.27E+5	4.61E-1
Y-93	1.50E+2	-	-	-	7.64E+4	1.67E+5	4.07E+0
Zr-95	1.15E+5	2.79E+4	-	3.11E+4	1.75E+6	2.17E+4	2.03E+4
Zr-97	1.50E+2	2.56E+1	-	2.59E+1	1.10E+5	1.40E+5	1.17E+1
Nb-95	1.57E+4	6.43E+3	-	4.72E+3	4.79E+5	1.27E+4	3.78E+3
Nb-97	3.42E-1	7.29E-2	-	5.70E-2	3.32E+3	2.69E+4	2.63E-2
Mo-99	-	1.65E+2	-	2.65E+2	1.35E+5	4.87E+4	3.23E+1
Tc-99m	1.40E-3	2.88E-3	-	3.11E-2	8.11E+2	2.03E+3	3.72E-2
Tc-101	6.51E-5	8.23E-5	-	9.79E-4	5.84E+2	8.44E+2	8.12E-4

Table 3-7 (continued)
 R_{i0} , Inhalation Pathway Dose Factors - INFANT (continued)
(mrem/yr per $\mu\text{Ci}/\text{m}^3$)

<u>Nuclide</u>	<u>Bone</u>	<u>Liver</u>	<u>Thyroid</u>	<u>Kidney</u>	<u>Lung</u>	<u>GI-LLI</u>	<u>T.Body</u>
Ru-103	2.02E+3	-	-	4.24E+3	5.52E+5	1.61E+4	6.79E+2
Ru-105	1.22E+0	-	-	8.99E-1	1.57E+4	4.84E+4	4.10E-1
Ru-106	8.68E+4	-	-	1.07E+5	1.16E+7	1.64E+5	1.09E+4
Rh-103m	-	-	-	-	-	-	-
Rh-106	-	-	-	-	-	-	-
Ag-110m	9.98E+3	7.22E+3	-	1.09E+4	3.67E+6	3.30E+4	5.00E+3
Sb-124	3.79E+4	5.56E+2	1.01E+2	-	2.65E+6	5.91E+4	1.20E+4
Sb-125	5.17E+4	4.77E+2	6.23E+1	-	1.64E+6	1.47E+4	1.09E+4
Te-125m	4.76E+3	1.99E+3	1.62E+3	-	4.47E+5	1.29E+4	6.58E+2
Te-127m	1.67E+4	6.90E+3	4.87E+3	3.75E+4	1.31E+6	2.73E+4	2.07E+3
Te-127	2.23E+0	9.53E-1	1.85E+0	4.86E+0	1.03E+4	2.44E+4	4.89E-1
Te-129m	1.41E+4	6.09E+3	5.47E+3	3.18E+4	1.68E+6	6.90E+4	2.23E+3
Te-129	7.88E-2	3.47E-2	6.75E-2	1.75E-1	3.00E+3	2.63E+4	1.88E-2
Te-131m	1.07E+2	5.50E+1	8.93E+1	2.65E+2	1.99E+5	1.19E+5	3.63E+1
Te-131	1.74E-2	8.22E-3	1.58E-2	3.99E-2	2.06E+3	8.22E+3	5.00E-3
Te-132	3.72E+2	2.37E+2	2.79E+2	1.03E+3	3.40E+5	4.41E+4	1.76E+2
I-130	6.36E+3	1.39E+4	1.60E+6	1.53E+4	-	1.99E+3	5.57E+3
I-131	3.79E+4	4.44E+4	1.48E+7	5.18E+4	-	1.06E+3	1.96E+4
I-132	1.69E+3	3.54E+3	1.69E+5	3.95E+3	-	1.90E+3	1.26E+3
I-133	1.32E+4	1.92E+4	3.56E+6	2.24E+4	-	2.16E+3	5.60E+3
I-134	9.21E+2	1.88E+3	4.45E+4	2.09E+3	-	1.29E+3	6.65E+2
I-135	3.86E+3	7.60E+3	6.96E+5	8.47E+3	-	1.83E+3	2.77E+3
Cs-134	3.96E+5	7.03E+5	-	1.90E+5	7.97E+4	1.33E+3	7.45E+4
Cs-136	4.83E+4	1.35E+5	-	5.64E+4	1.18E+4	1.43E+3	5.29E+4
Cs-137	5.49E+5	6.12E+5	-	1.72E+5	7.13E+4	1.33E+3	4.55E+4
Cs-138	5.05E+2	7.81E+2	-	4.10E+2	6.54E+1	8.76E+2	3.98E+2
Ba-139	1.48E+0	9.84E-4	-	5.92E-4	5.95E+3	5.10E+4	4.30E-2
Ba-140	5.60E+4	5.60E+1	-	1.34E+1	1.60E+6	3.84E+4	2.90E+3
Ba-141	1.57E-1	1.08E-4	-	6.50E-5	2.97E+3	4.75E+3	4.97E-3
Ba-142	3.98E-2	3.30E-5	-	1.90E-5	1.55E+3	6.93E+2	1.96E-3
La-140	5.05E+2	2.00E+2	-	-	1.68E+5	8.48E+4	5.15E+1
La-142	1.03E+0	3.77E-1	-	-	8.22E+3	5.95E+4	9.04E-2
Ce-141	2.77E+4	1.67E+4	-	5.25E+3	5.17E+5	2.16E+4	1.99E+3
Ce-143	2.93E+2	1.93E+2	-	5.64E+1	1.16E+5	4.97E+4	2.21E+1
Ce-144	3.19E+6	1.21E+6	-	5.38E+5	9.84E+6	1.48E+5	1.76E+5
Pr-143	1.40E+4	5.24E+3	-	1.97E+3	4.33E+5	3.72E+4	6.99E+2
Pr-144	4.79E-2	1.85E-2	-	6.72E-3	1.61E+3	4.28E+3	2.41E-3
Nd-147	7.94E+3	8.13E+3	-	3.15E+3	3.22E+5	3.12E+4	5.00E+2
W-187	1.30E+1	9.02E+0	-	-	3.96E+4	3.56E+4	3.12E+0
Np-239	3.71E+2	3.32E+1	-	6.62E+1	5.95E+4	2.49E+4	1.88E+1

Table 3-8
 R_{io} Grass - Cow - Milk Pathway Dose Factors - ADULT
(mrem/yr per $\mu\text{Ci}/\text{m}^3$) for H-3 and C-14
($\text{m}^2 * \text{mrem}/\text{yr}$ per $\mu\text{Ci}/\text{sec}$) for others

<u>Nuclide</u>	<u>Bone</u>	<u>Liver</u>	<u>Thyroid</u>	<u>Kidney</u>	<u>Lung</u>	<u>GI-LLI</u>	<u>T.Body</u>
H-3	-	7.63E+2	7.63E+2	7.63E+2	7.63E+2	7.63E+2	7.63E+2
C-14	3.63E+5	7.26E+4	7.26E+4	7.26E+4	7.26E+4	7.26E+4	7.26E+4
Na-24	2.54E+6	2.54E+6	2.54E+6	2.54E+6	2.54E+6	2.54E+6	2.54E+6
P-32	1.71E+10	1.06E+9	-	-	-	1.92E+9	6.60E+8
Cr-51	-	-	1.71E+4	6.30E+3	3.80E+4	7.20E+6	2.86E+4
Mn-54	-	8.40E+6	-	2.50E+6	-	2.57E+7	1.60E+6
Mn-56	-	4.23E-3	-	5.38E-3	-	1.35E-1	7.51E-4
Fe-55	2.51E+7	1.73E+7	-	-	9.67E+6	9.95E+6	4.04E+6
Fe-59	2.98E+7	7.00E+7	-	-	1.95E+7	2.33E+8	2.68E+7
Co-57	-	1.28E+6	-	-	-	3.25E+7	2.13E+6
Co-58	-	4.72E+6	-	-	-	9.57E+7	1.06E+7
Co-60	-	1.64E+7	-	-	-	3.08E+8	3.62E+7
Ni-63	6.73E+9	4.66E+8	-	-	-	9.73E+7	2.26E+8
Ni-65	3.70E-1	4.81E-2	-	-	-	1.22E+0	2.19E-2
Cu-64	-	2.41E+4	-	6.08E+4	-	2.05E+6	1.13E+4
Zn-65	1.37E+9	4.36E+9	-	2.92E+9	-	2.75E+9	1.97E+9
Zn-69	-	-	-	-	-	-	-
Br-82	-	-	-	-	-	3.72E+7	3.25E+7
Br-83	-	-	-	-	-	1.49E-1	1.03E-1
Br-84	-	-	-	-	-	-	-
Br-85	-	-	-	-	-	-	-
Rb-86	-	2.59E+9	-	-	-	5.11E+8	1.21E+9
Rb-88	-	-	-	-	-	-	-
Rb-89	-	-	-	-	-	-	-
Sr-89	1.45E+9	-	-	-	-	2.33E+8	4.16E+7
Sr-90	4.68E+10	-	-	-	-	1.35E+9	1.15E+10
Sr-91	3.13E+4	-	-	-	-	1.49E+5	1.27E+3
Sr-92	4.89E-1	-	-	-	-	9.68E+0	2.11E-2
Y-90	7.07E+1	-	-	-	-	7.50E+5	1.90E+0
Y-91m	-	-	-	-	-	-	-
Y-91	8.60E+3	-	-	-	-	4.73E+6	2.30E+2
Y-92	5.42E-5	-	-	-	-	9.49E-1	1.58E-6
Y-93	2.33E-1	-	-	-	-	7.39E+3	6.43E-3
Zr-95	9.46E+2	3.03E+2	-	4.76E+2	-	9.62E+5	2.05E+2
Zr-97	4.26E-1	8.59E-2	-	1.30E-1	-	2.66E+4	3.93E-2
Nb-95	8.25E+4	4.59E+4	-	4.54E+4	-	2.79E+8	2.47E+4
Nb-97	-	-	-	-	-	5.47E-9	-
Mo-99	-	2.52E+7	-	5.72E+7	-	5.85E+7	4.80E+6
Tc-99m	3.25E+0	9.19E+0	-	1.40E+2	4.50E+0	5.44E+3	1.17E+2
Tc-101	-	-	-	-	-	-	-

Table 3-8
 R_{10} Grass - Cow - Milk Pathway Dose Factors - ADULT (continued)
(mrem/yr per $\mu\text{Ci}/\text{m}^3$) for H-3 and C-14
($\text{m}^2 * \text{mrem}/\text{yr}$ per $\mu\text{Ci}/\text{sec}$) for others

<u>Nuclide</u>	<u>Bone</u>	<u>Liver</u>	<u>Thyroid</u>	<u>Kidney</u>	<u>Lung</u>	<u>GI-LLI</u>	<u>T.Body</u>
Ru-103	1.02E+3	-	-	3.89E+3	-	1.19E+5	4.39E+2
Ru-105	8.57E-4	-	-	1.11E-2	-	5.24E-1	3.38E-4
Ru-106	2.04E+4	-	-	3.94E+4	-	1.32E+6	2.58E+3
Rh-103m	-	-	-	-	-	-	-
Rh-106	-	-	-	-	-	-	-
Ag-110m	5.83E+7	5.39E+7	-	1.06E+8	-	2.20E+10	3.20E+7
Sb-124	2.57E+7	4.86E+5	6.24E+4	-	2.00E+7	7.31E+8	1.02E+7
Sb-125	2.04E+7	2.28E+5	2.08E+4	-	1.58E+7	2.25E+8	4.86E+6
Te-125m	1.63E+7	5.90E+6	4.90E+6	6.63E+7	-	6.50E+7	2.18E+6
Te-127m	4.58E+7	1.64E+7	1.17E+7	1.86E+8	-	1.54E+8	5.58E+6
Te-127	6.72E+2	2.41E+2	4.98E+2	2.74E+3	-	5.30E+4	1.45E+2
Te-129m	6.04E+7	2.25E+7	2.08E+7	2.52E+8	-	3.04E+8	9.57E+6
Te-129	-	-	-	-	-	-	-
Te-131m	3.61E+5	1.77E+5	2.80E+5	1.79E+6	-	1.75E+7	1.47E+5
Te-131	-	-	-	-	-	-	-
Te-132	2.39E+6	1.55E+6	1.71E+6	1.49E+7	-	7.32E+7	1.45E+6
I-130	4.26E+5	1.26E+6	1.07E+8	1.96E+6	-	1.08E+6	4.96E+5
I-131	2.96E+8	4.24E+8	1.39E+11	7.27E+8	-	1.12E+8	2.43E+8
I-132	1.64E-1	4.37E-1	1.53E+1	6.97E-1	-	8.22E-2	1.53E-1
I-133	3.97E+6	6.90E+6	1.01E+9	1.20E+7	-	6.20E+6	2.10E+6
I-134	-	-	-	-	-	-	-
I-135	1.39E+4	3.63E+4	2.40E+6	5.83E+4	-	4.10E+4	1.34E+4
Cs-134	5.65E+9	1.34E+10	-	4.35E+9	1.44E+9	2.35E+8	1.10E+10
Cs-136	2.61E+8	1.03E+9	-	5.74E+8	7.87E+7	1.17E+8	7.42E+8
Cs-137	7.38E+9	1.01E+10	-	3.43E+9	1.14E+9	1.95E+8	6.61E+9
Cs-138	-	-	-	-	-	-	-
Ba-139	4.70E-8	-	-	-	-	8.34E-8	1.38E-9
Ba-140	2.69E+7	3.38E+4	-	1.15E+4	1.93E+4	5.54E+7	1.76E+6
Ba-141	-	-	-	-	-	-	-
Ba-142	-	-	-	-	-	-	-
La-140	4.49E+0	2.26E+0	-	-	-	1.66E+5	5.97E-1
La-142	-	-	-	-	-	3.03E-8	-
Ce-141	4.84E+3	3.27E+3	-	1.52E+3	-	1.25E+7	3.71E+2
Ce-143	4.19E+1	3.09E+4	-	1.36E+1	-	1.16E+6	3.42E+0
Ce-144	3.58E+5	1.50E+5	-	8.87E+4	-	1.21E+8	1.92E+4
Pr-143	1.59E+2	6.37E+1	-	3.68E+1	-	6.96E+5	7.88E+0
Pr-144	-	-	-	-	-	-	-
Nd-147	9.42E+1	1.09E+2	-	6.37E+1	-	5.23E+5	6.52E+0
W-187	6.56E+3	5.48E+3	-	-	-	1.80E+6	1.92E+3
Np-239	3.66E+0	3.60E-1	-	1.12E+0	-	7.39E+4	1.98E-1

Table 3-8 (continued)
 R_{i0} , Grass - Cow - Milk Pathway Dose Factors - TEENAGER
(mrem/yr per $\mu\text{Ci}/\text{m}^3$) for H-3 and C-14
($\text{m}^2 * \text{mrem}/\text{yr}$ per $\mu\text{Ci}/\text{sec}$) for others

<u>Nuclide</u>	<u>Bone</u>	<u>Liver</u>	<u>Thyroid</u>	<u>Kidney</u>	<u>Lung</u>	<u>GI-LLI</u>	<u>T.Body</u>
H-3	-	9.94E+2	9.94E+2	9.94E+2	9.94E+2	9.94E+2	9.94E+2
C-14	6.70E+5	1.34E+5	1.34E+5	1.34E+5	1.34E+5	1.34E+5	1.34E+5
Na-24	4.44E+6	4.44E+6	4.44E+6	4.44E+6	4.44E+6	4.44E+6	4.44E+6
P-32	3.15E+10	1.95E+9	-	-	-	2.65E+9	1.22E+9
Cr-51	-	-	2.78E+4	1.10E+4	7.13E+4	8.40E+6	5.00E+4
Mn-54	-	1.40E+7	-	4.17E+6	-	2.87E+7	2.78E+6
Mn-56	-	7.51E-3	-	9.50E-3	-	4.94E-1	1.33E-3
Fe-55	4.45E+7	3.16E+7	-	-	2.00E+7	1.37E+7	7.36E+6
Fe-59	5.20E+7	1.21E+8	-	-	3.82E+7	2.87E+8	4.68E+7
Co-57	-	2.25E+6	-	-	-	4.19E+7	3.76E+6
Co-58	-	7.95E+6	-	-	-	1.10E+8	1.83E+7
Co-60	-	2.78E+7	-	-	-	3.62E+8	6.26E+7
Ni-63	1.18E+10	8.35E+8	-	-	-	1.33E+8	4.01E+8
Ni-65	6.78E-1	8.66E-2	-	-	-	4.70E+0	3.94E-2
Cu-64	-	4.29E+4	-	1.09E+5	-	3.33E+6	2.02E+4
Zn-65	2.11E+9	7.31E+9	-	4.68E+9	-	3.10E+9	3.41E+9
Zn-69	-	-	-	-	-	-	-
Br-82	-	-	-	-	-	-	5.64E+7
Br-83	-	-	-	-	-	-	1.91E-1
Br-84	-	-	-	-	-	-	-
Br-85	-	-	-	-	-	-	-
Rb-86	-	4.73E+9	-	-	-	7.00E+8	2.22E+9
Rb-88	-	-	-	-	-	-	-
Rb-89	-	-	-	-	-	-	-
Sr-89	2.67E+9	-	-	-	-	3.18E+8	7.66E+7
Sr-90	6.61E+10	-	-	-	-	1.86E+9	1.63E+10
Sr-91	5.75E+4	-	-	-	-	2.61E+5	2.29E+3
Sr-92	8.95E-1	-	-	-	-	2.28E+1	3.81E-2
Y-90	1.30E+2	-	-	-	-	1.07E+6	3.50E+0
Y-91m	-	-	-	-	-	-	-
Y-91	1.58E+4	-	-	-	-	6.48E+6	4.24E+2
Y-92	1.00E-4	-	-	-	-	2.75E+0	2.90E-6
Y-93	4.30E-1	-	-	-	-	1.31E+4	1.18E-2
Zr-95	1.65E+3	5.22E+2	-	7.67E+2	-	1.20E+6	3.59E+2
Zr-97	7.75E-1	1.53E-1	-	2.32E-1	-	4.15E+4	7.06E-2
Nb-95	1.41E+5	7.80E+4	-	7.57E+4	-	3.34E+8	4.30E+4
Nb-97	-	-	-	-	-	6.34E-8	-
Mo-99	-	4.56E+7	-	1.04E+8	-	8.16E+7	8.69E+6
Tc-99m	5.64E+0	1.57E+1	-	2.34E+2	8.73E+0	1.03E+4	2.04E+2
Tc-101	-	-	-	-	-	-	-

Table 3-8 (continued)
 R_{i0} , Grass - Cow - Milk Pathway Dose Factors - TEENAGER (continued)
(mrem/yr per $\mu\text{Ci}/\text{m}^3$) for H-3 and C-14
($\text{m}^2 \cdot \text{mrem}/\text{yr}$ per $\mu\text{Ci}/\text{sec}$) for others

<u>Nuclide</u>	<u>Bone</u>	<u>Liver</u>	<u>Thyroid</u>	<u>Kidney</u>	<u>Lung</u>	<u>GI-LLI</u>	<u>T.Body</u>
Ru-103	1.81E+3	-	-	6.40E+3	-	1.52E+5	7.75E+2
Ru-105	1.57E-3	-	-	1.97E-2	-	1.26E+0	6.08E-4
Ru-106	3.75E+4	-	-	7.23E+4	-	1.80E+6	4.73E+3
Rh-103m	-	-	-	-	-	-	-
Rh-106	-	-	-	-	-	-	-
Ag-110m	9.63E+7	9.11E+7	-	1.74E+8	-	2.56E+10	5.54E+7
Sb-124	4.59E+7	8.46E+5	1.04E+5	-	4.01E+7	9.25E+8	1.79E+7
Sb-125	3.65E+7	3.99E+5	3.49E+4	-	3.21E+7	2.84E+8	8.54E+6
Te-125m	3.00E+7	1.08E+7	8.39E+6	-	-	8.86E+7	4.02E+6
Te-127m	8.44E+7	2.99E+7	2.01E+7	3.42E+8	-	2.10E+8	1.00E+7
Te-127	1.24E+3	4.41E+2	8.59E+2	5.04E+3	-	9.61E+4	2.68E+2
Te-129m	1.11E+8	4.10E+7	3.57E+7	4.62E+8	-	4.15E+8	1.75E+7
Te-129	-	-	-	1.67E-9	-	2.18E-9	-
Te-131m	6.57E+5	3.15E+5	4.74E+5	3.29E+6	-	2.53E+7	2.63E+5
Te-131	-	-	-	-	-	-	-
Te-132	4.28E+6	2.71E+6	2.86E+6	2.60E+7	-	8.58E+7	2.55E+6
I-130	7.49E+5	2.17E+6	1.77E+8	3.34E+6	-	1.67E+6	8.66E+5
I-131	5.38E+8	7.53E+8	2.20E+11	1.30E+9	-	1.49E+8	4.04E+8
I-132	2.90E-1	7.59E-1	2.56E+1	1.20E+0	-	3.31E-1	2.72E-1
I-133	7.24E+6	1.23E+7	1.72E+9	2.15E+7	-	9.30E+6	3.75E+6
I-134	-	-	-	-	-	-	-
I-135	2.47E+4	6.35E+4	4.08E+6	1.00E+5	-	7.03E+4	2.35E+4
Cs-134	9.81E+9	2.31E+10	-	7.34E+9	2.80E+9	2.87E+8	1.07E+10
Cs-136	4.45E+8	1.75E+9	-	9.53E+8	1.50E+8	1.41E+8	1.18E+9
Cs-137	1.34E+10	1.78E+10	-	6.06E+9	2.35E+9	2.53E+8	6.20E+9
Cs-138	-	-	-	-	-	-	-
Ba-139	8.69E-8	-	-	-	-	7.75E-7	2.53E-9
Ba-140	4.85E+7	5.95E+4	-	2.02E+4	4.00E+4	7.49E+7	3.13E+6
Ba-141	-	-	-	-	-	-	-
Ba-142	-	-	-	-	-	-	-
La-140	8.06E+0	3.96E+0	-	-	-	2.27E+5	1.05E+0
La-142	-	-	-	-	-	2.23E-7	-
Ce-141	8.87E+3	5.92E+3	-	2.79E+3	-	1.69E+7	6.81E+2
Ce-143	7.69E+1	5.60E+4	-	2.51E+1	-	1.68E+6	6.25E+0
Ce-144	6.58E+5	2.72E+5	-	1.63E+5	-	1.66E+8	3.54E+4
Pr-143	2.92E+2	1.17E+2	-	6.77E+1	-	9.61E+5	1.45E+1
Pr-144	-	-	-	-	-	-	-
Nd-147	1.81E+2	1.97E+2	-	1.16E+2	-	7.11E+5	1.18E+1
W-187	1.20E+4	9.78E+3	-	-	-	2.65E+6	3.43E+3
Np-239	6.99E+0	6.59E-1	-	2.07E+0	-	1.06E+5	3.66E-1

Table 3-8 (continued)
 R_{i0} , Grass - Cow - Milk Pathway Dose Factors - CHILD
(mrem/yr per $\mu\text{Ci}/\text{m}^3$) for H-3 and C-14
($\text{m}^2 * \text{mrem}/\text{yr}$ per $\mu\text{Ci}/\text{sec}$) for others

<u>Nuclide</u>	<u>Bone</u>	<u>Liver</u>	<u>Thyroid</u>	<u>Kidney</u>	<u>Lung</u>	<u>GI-LLI</u>	<u>T.Body</u>
H-3	-	1.57E+3	1.57E+3	1.57E+3	1.57E+3	1.57E+3	1.57E+3
C-14	1.65E+6	3.29E+5	3.29E+5	3.29E+5	3.29E+5	3.29E+5	3.29E+5
Na-24	9.23E+6	9.23E+6	9.23E+6	9.23E+6	9.23E+6	9.23E+6	9.23E+6
P-32	7.77E+10	3.64E+9	-	-	-	2.15E+9	3.00E+9
Cr-51	-	-	5.66E+4	1.55E+4	1.03E+5	5.41E+6	1.02E+5
Mn-54	-	2.09E+7	-	5.87E+6	-	1.76E+7	5.58E+6
Mn-56	-	1.31E-2	-	1.58E-2	-	1.90E+0	2.95E-3
Fe-55	1.12E+8	5.93E+7	-	-	3.35E+7	1.10E+7	1.84E+7
Fe-59	1.20E+8	1.95E+8	-	-	5.65E+7	2.03E+8	9.71E+7
Co-57	-	3.84E+6	-	-	-	3.14E+7	7.77E+6
Co-58	-	1.21E+7	-	-	-	7.08E+7	3.72E+7
Co-60	-	4.32E+7	-	-	-	2.39E+8	1.27E+8
Ni-63	2.96E+10	1.59E+9	-	-	-	1.07E+8	1.01E+9
Ni-65	1.66E+0	1.56E-1	-	-	-	1.91E+1	9.11E-2
Cu-64	-	7.55E+4	-	1.82E+5	-	3.54E+6	4.56E+4
Zn-65	4.13E+9	1.10E+10	-	6.94E+9	-	1.93E+9	6.85E+9
Zn-69	-	-	-	-	-	2.14E-9	-
Br-82	-	-	-	-	-	-	1.15E+8
Br-83	-	-	-	-	-	-	4.69E-1
Br-84	-	-	-	-	-	-	-
Br-85	-	-	-	-	-	-	-
Rb-86	-	8.77E+9	-	-	-	5.64E+8	5.39E+9
Rb-88	-	-	-	-	-	-	-
Rb-89	-	-	-	-	-	-	-
Sr-89	6.62E+9	-	-	-	-	2.56E+8	1.89E+8
Sr-90	1.12E+11	-	-	-	-	1.51E+9	2.83E+10
Sr-91	1.41E+5	-	-	-	-	3.12E+5	5.33E+3
Sr-92	2.19E+0	-	-	-	-	4.14E+1	8.76E-2
Y-90	3.22E+2	-	-	-	-	9.15E+5	8.61E+0
Y-91m	-	-	-	-	-	-	-
Y-91	3.91E+4	-	-	-	-	5.21E+6	1.04E+3
Y-92	2.46E-4	-	-	-	-	7.10E+0	7.03E-6
Y-93	1.06E+0	-	-	-	-	1.57E+4	2.90E-2
Zr-95	3.84E+3	8.45E+2	-	1.21E+3	-	8.81E+5	7.52E+2
Zr-97	1.89E+0	2.72E-1	-	3.91E-1	-	4.13E+4	1.61E-1
Nb-95	3.18E+5	1.24E+5	-	1.16E+5	-	2.29E+8	8.84E+4
Nb-97	-	-	-	-	-	1.45E-6	-
Mo-99	-	8.29E+7	-	1.77E+8	-	6.86E+7	2.05E+7
Tc-99m	1.29E+1	2.54E+1	-	3.68E+2	1.29E+1	1.44E+4	4.20E+2
Tc-101	-	-	-	-	-	-	-

Table 3-8 (continued)
 R_{i0} , Grass - Cow - Milk Pathway Dose Factors - CHILD (continued)
(mrem/yr per $\mu\text{Ci}/\text{m}^3$) for H-3 and C-14
($\text{m}^2 * \text{mrem}/\text{yr}$ per $\mu\text{Ci}/\text{sec}$) for others

<u>Nuclide</u>	<u>Bone</u>	<u>Liver</u>	<u>Thyroid</u>	<u>Kidney</u>	<u>Lung</u>	<u>GI-LLI</u>	<u>T.Body</u>
Ru-103	4.29E+3	-	-	1.08E+4	-	1.11E+5	1.65E+3
Ru-105	3.82E-3	-	-	3.36E-2	-	2.49E+0	1.39E-3
Ru-106	9.24E+4	-	-	1.25E+5	-	1.44E+6	1.15E+4
Rh-103m	-	-	-	-	-	-	-
Rh-106	-	-	-	-	-	-	-
Ag-110m	2.09E+8	1.41E+8	-	2.63E+8	-	1.68E+10	1.13E+8
Sb-124	1.09E+8	1.41E+8	2.40E+5	-	6.03E+7	6.79E+8	3.81E+7
Sb-125	8.70E+7	1.41E+6	8.06E+4	-	4.85E+7	2.08E+8	1.82E+7
Te-125m	7.38E+7	2.00E+7	2.07E+7	-	-	7.12E+7	9.84E+6
Te-127m	2.08E+8	5.60E+7	4.97E+7	5.93E+8	-	1.68E+8	2.47E+7
Te-127	3.06E+3	8.25E+2	2.12E+3	8.71E+3	-	1.20E+5	6.56E+2
Te-129m	2.72E+8	7.61E+7	8.78E+7	8.00E+8	-	3.32E+8	4.23E+7
Te-129	-	-	-	2.87E-9	-	6.12E-8	-
Te-131m	1.60E+6	5.53E+5	1.14E+6	5.35E+6	-	2.24E+7	5.89E+5
Te-131	-	-	-	-	-	-	-
Te-132	1.02E+7	4.52E+6	6.58E+6	4.20E+7	-	4.55E+7	5.46E+6
I-130	1.75E+6	3.54E+6	3.90E+8	5.29E+6	-	1.66E+6	1.82E+6
I-131	1.30E+9	1.31E+9	4.34E+11	2.15E+9	-	1.17E+8	7.46E+8
I-132	6.86E-1	1.26E+0	5.85E+1	1.93E+0	-	1.48E+0	5.80E-1
I-133	1.76E+7	2.18E+7	4.04E+9	3.63E+7	-	8.77E+6	8.23E+6
I-134	-	-	-	-	-	-	-
I-135	5.84E+4	1.05E+5	9.30E+6	1.61E+5	-	8.00E+4	4.97E+4
Cs-134	2.26E+10	3.71E+10	-	1.15E+10	4.13E+9	2.00E+8	7.83E+9
Cs-136	1.00E+9	2.76E+9	-	1.47E+9	2.19E+8	9.70E+7	1.79E+9
Cs-137	3.22E+10	3.09E+10	-	1.01E+10	3.62E+9	1.93E+8	4.55E+9
Cs-138	-	-	-	-	-	-	-
Ba-139	2.14E-7	-	-	-	-	1.23E-5	6.19E-9
Ba-140	1.17E+8	1.03E+5	-	3.34E+4	6.12E+4	5.94E+7	6.84E+6
Ba-141	-	-	-	-	-	-	-
Ba-142	-	-	-	-	-	-	-
La-140	1.93E+1	6.74E+0	-	-	-	1.88E+5	2.27E+0
La-142	-	-	-	-	-	2.51E-6	-
Ce-141	2.19E+4	1.09E+4	-	4.78E+3	-	1.36E+7	1.62E+3
Ce-143	1.89E+2	1.02E+5	-	4.29E+1	-	1.50E+6	1.48E+1
Ce-144	1.62E+6	5.09E+5	-	2.82E+5	-	1.33E+8	8.66E+4
Pr-143	7.23E+2	2.17E+2	-	1.17E+2	-	7.80E+5	3.59E+1
Pr-144	-	-	-	-	-	-	-
Nd-147	4.45E+2	3.60E+2	-	1.98E+2	-	5.71E+5	2.79E+1
W-187	2.91E+4	1.72E+4	-	-	-	2.42E+6	7.73E+3
Np-239	1.72E+1	1.23E+0	-	3.57E+0	-	9.14E+4	8.68E-1

Table 3-8 (continued)
 R_{i0} , Grass - Cow - Milk Pathway Dose Factors - INFANT
(mrem/yr per $\mu\text{Ci}/\text{m}^3$) for H-3 and C-14
($\text{m}^2 * \text{mrem}/\text{yr}$ per $\mu\text{Ci}/\text{sec}$) for others

<u>Nuclide</u>	<u>Bone</u>	<u>Liver</u>	<u>Thyroid</u>	<u>Kidney</u>	<u>Lung</u>	<u>GI-LLI</u>	<u>T.Body</u>
H-3	-	2.38E+3	2.38E+3	2.38E+3	2.38E+3	2.38E+3	2.38E+3
C-14	3.23E+6	6.89E+5	6.89E+5	6.89E+5	6.89E+5	6.89E+5	6.89E+5
Na-24	1.61E+7	1.61E+7	1.61E+7	1.61E+7	1.61E+7	1.61E+7	1.61E+7
P-32	1.60E+11	9.42E+9	-	-	-	2.17E+9	6.21E+9
Cr-51	-	-	1.05E+5	2.30E+4	2.05E+5	4.71E+6	1.61E+5
Mn-54	-	3.89E+7	-	8.63E+6	-	1.43E+7	8.83E+6
Mn-56	-	3.21E-2	-	2.76E-2	-	2.91E+0	5.53E-3
Fe-55	1.35E+8	8.72E+7	-	-	4.27E+7	1.11E+7	2.33E+7
Fe-59	2.25E+8	3.93E+8	-	-	1.16E+8	1.88E+8	1.55E+8
Co-57	-	8.95E+6	-	-	-	3.05E+7	1.46E+7
Co-58	-	2.43E+7	-	-	-	6.05E+7	6.06E+7
Co-60	-	8.81E+7	-	-	-	2.10E+8	2.08E+8
Ni-63	3.49E+10	2.16E+9	-	-	-	1.07E+8	1.21E+9
Ni-65	3.51E+0	3.97E-1	-	-	-	3.02E+1	1.81E-1
Cu-64	-	1.88E+5	-	3.17E+5	-	3.85E+6	8.69E+4
Zn-65	5.55E+9	1.90E+10	-	9.23E+9	-	1.61E+10	8.78E+9
Zn-69	-	-	-	-	-	7.36E-9	-
Br-82	-	-	-	-	-	-	1.94E+8
Br-83	-	-	-	-	-	-	9.95E-1
Br-84	-	-	-	-	-	-	-
Br-85	-	-	-	-	-	-	-
Rb-86	-	2.22E+10	-	-	-	5.69E+8	1.10E+10
Rb-88	-	-	-	-	-	-	-
Rb-89	-	-	-	-	-	-	-
Sr-89	1.26E+10	-	-	-	-	2.59E+8	3.61E+8
Sr-90	1.22E+11	-	-	-	-	1.52E+9	3.10E+10
Sr-91	2.94E+5	-	-	-	-	3.48E+5	1.06E+4
Sr-92	4.65E+0	-	-	-	-	5.01E+1	1.73E-1
Y-90	6.80E+2	-	-	-	-	9.39E+5	1.82E+1
Y-91m	-	-	-	-	-	-	-
Y-91	7.33E+4	-	-	-	-	5.26E+6	1.95E+3
Y-92	5.22E-4	-	-	-	-	9.97E+0	1.47E-5
Y-93	2.25E+0	-	-	-	-	1.78E+4	6.13E-2
Zr-95	6.83E+3	1.66E+3	-	1.79E+3	-	8.28E+5	1.18E+3
Zr-97	3.99E+0	6.85E-1	-	6.91E-1	-	4.37E+4	3.13E-1
Nb-95	5.93E+5	2.44E+5	-	1.75E+5	-	2.06E+8	1.41E+5
Nb-97	-	-	-	-	-	3.70E-6	-
Mo-99	-	2.12E+8	-	3.17E+8	-	6.98E+7	4.13E+7
Tc-99m	2.69E+1	5.55E+1	-	5.97E+2	2.90E+1	1.61E+4	7.15E+2
Tc-101	-	-	-	-	-	-	-

Table 3-8 (continued)
 R_{i0} , Grass - Cow - Milk Pathway Dose Factors - INFANT (continued)
(mrem/yr per $\mu\text{Ci}/\text{m}^3$) for H-3 and C-14
($\text{m}^2 * \text{mrem}/\text{yr}$ per $\mu\text{Ci}/\text{sec}$) for others

<u>Nuclide</u>	<u>Bone</u>	<u>Liver</u>	<u>Thyroid</u>	<u>Kidney</u>	<u>Lung</u>	<u>GI-LLI</u>	<u>T.Body</u>
Ru-103	8.69E+3	-	-	1.81E+4	-	1.06E+5	2.91E+3
Ru-105	8.06E-3	-	-	5.92E-2	-	3.21E+0	2.71E-3
Ru-106	1.90E+5	-	-	2.25E+5	-	1.44E+6	2.38E+4
Rh-103m	-	-	-	-	-	-	-
Rh-106	-	-	-	-	-	-	-
Ag-110m	3.86E+8	2.82E+8	-	4.03E+8	-	1.46E+10	1.86E+8
Sb-124	2.09E+8	3.08E+6	5.56E+5	-	1.31E+8	6.46E+8	6.49E+7
Sb-125	1.49E+8	1.45E+6	1.87E+5	-	9.38E+7	1.99E+8	3.07E+7
Te-125m	1.51E+8	5.04E+7	5.07E+7	-	-	7.18E+7	2.04E+7
Te-127m	4.21E+8	1.40E+8	1.22E+8	1.04E+9	-	1.70E+8	5.10E+7
Te-127	6.50E+3	2.18E+3	5.29E+3	1.59E+4	-	1.36E+5	1.40E+3
Te-129m	5.59E+8	1.92E+8	2.15E+8	1.40E+9	-	3.34E+8	8.62E+7
Te-129	2.08E-9	-	1.75E-9	5.18E-9	-	1.66E-7	-
Te-131m	3.38E+6	1.36E+6	2.76E+6	9.35E+6	-	2.29E+7	1.12E+6
Te-131	-	-	-	-	-	-	-
Te-132	2.10E+7	1.04E+7	1.54E+7	6.51E+7	-	3.85E+7	9.72E+6
I-130	3.60E+6	7.92E+6	8.88E+8	8.70E+6	-	1.70E+6	3.18E+6
I-131	2.72E+9	3.21E+9	1.05E+12	3.75E+9	-	1.15E+8	1.41E+9
I-132	1.42E+0	2.89E+0	1.35E+2	3.22E+0	-	2.34E+0	1.03E+0
I-133	3.72E+7	5.41E+7	9.84E+9	6.36E+7	-	9.16E+6	1.58E+7
I-134	-	-	1.01E-9	-	-	-	-
I-135	1.21E+5	2.41E+5	2.16E+7	2.69E+5	-	8.74E+4	8.80E+4
Cs-134	3.65E+10	6.80E+10	-	1.75E+10	7.18E+9	1.85E+8	6.87E+9
Cs-136	1.96E+9	5.77E+9	-	2.30E+9	4.70E+8	8.76E+7	2.15E+9
Cs-137	5.15E+10	6.02E+10	-	1.62E+10	6.55E+9	1.88E+8	4.27E+9
Cs-138	-	-	-	-	-	-	-
Ba-139	4.55E-7	-	-	-	-	2.88E-5	1.32E-8
Ba-140	2.41E+8	2.41E+5	-	5.73E+4	1.48E+5	5.92E+7	1.24E+7
Ba-141	-	-	-	-	-	-	-
Ba-142	-	-	-	-	-	-	-
La-140	4.03E+1	1.59E+1	-	-	-	1.87E+5	4.09E+0
La-142	-	-	-	-	-	5.21E-6	-
Ce-141	4.33E+4	2.64E+4	-	8.15E+3	-	1.37E+7	3.11E+3
Ce-143	4.00E+2	2.65E+5	-	7.72E+1	-	1.55E+6	3.02E+1
Ce-144	2.33E+6	9.52E+5	-	3.85E+5	-	1.33E+8	1.30E+5
Pr-143	1.49E+3	5.59E+2	-	2.08E+2	-	7.89E+5	7.41E+1
Pr-144	-	-	-	-	-	-	-
Nd-147	8.82E+2	9.06E+2	-	3.49E+2	-	5.74E+5	5.55E+1
W-187	6.12E+4	4.26E+4	-	-	-	2.50E+6	1.47E+4
Np-239	3.64E+1	3.25E+0	-	6.49E+0	-	9.40E+4	1.84E+0

Table 3-9
 R_{io}' Grass - Goat - Milk Pathway Dose Factors - ADULT
 (mrem/yr per $\mu\text{Ci}/\text{m}^3$) for H-3 and C-14
 ($\text{m}^2 * \text{mrem}/\text{yr}$ per $\mu\text{Ci}/\text{sec}$) for others

<u>Nuclide</u>	<u>Bone</u>	<u>Liver</u>	<u>Thyroid</u>	<u>Kidney</u>	<u>Lung</u>	<u>GI-LLI</u>	<u>T.Body</u>
H-3	-	1.56E+3	1.56E+3	1.56E+3	1.56E+3	1.56E+3	1.56E+3
C-14	3.63E+5	7.26E+4	7.26E+4	7.26E+4	7.26E+4	7.26E+4	7.26E+4
Na-24	3.05E+5	3.05E+5	3.05E+5	3.05E+5	3.05E+5	3.05E+5	3.05E+5
P-32	2.05E+10	1.27E+9	-	-	-	2.30E+9	7.92E+8
Cr-51	-	-	2.05E+3	7.56E+2	4.56E+3	8.64E+5	3.43E+3
Mn-54	-	1.01E+6	-	3.00E+5	-	3.08E+6	1.92E+5
Mn-56	-	5.08E-4	-	6.46E-4	-	1.65E-2	9.01E-5
Fe-55	3.31E+5	2.28E+5	-	-	1.28E+5	1.31E+5	5.33E+4
Fe-59	3.93E+5	9.24E+5	-	-	2.57E+5	3.08E+6	3.54E+5
Co-57	-	1.54E+5	-	-	-	3.90E+6	2.56E+5
Co-58	-	5.66E+5	-	-	-	1.15E+7	1.27E+6
Co-60	-	1.97E+6	-	-	-	3.70E+7	3.34E+6
Ni-63	8.08E+8	5.59E+7	-	-	-	1.17E+7	2.71E+7
Ni-65	4.44E-2	5.77E-3	-	-	-	1.46E-1	2.63E-3
Cu-64	-	2.69E+3	-	6.79E+3	-	2.79E+5	1.26E+3
Zn-65	1.64E+8	5.23E+8	-	3.50E+8	-	3.30E+8	2.36E+8
Zn-69	-	-	-	-	-	-	-
Br-82	-	-	-	-	-	4.46E+6	3.90E+6
Br-83	-	-	-	-	-	1.79E-2	1.24E-2
Br-84	-	-	-	-	-	-	-
Br-85	-	-	-	-	-	-	-
Rb-86	-	3.11E+8	-	-	-	6.13E+7	1.45E+8
Rb-88	-	-	-	-	-	-	-
Rb-89	-	-	-	-	-	-	-
Sr-89	3.04E+9	-	-	-	-	4.89E+8	8.74E+7
Sr-90	9.83E+10	-	-	-	-	2.84E+9	2.42E+10
Sr-91	6.57E+4	-	-	-	-	3.13E+5	2.67E+3
Sr-92	1.03E+0	-	-	-	-	2.03E+1	4.43E-2
Y-90	8.48E+0	-	-	-	-	9.00E+4	2.28E-1
Y-91m	-	-	-	-	-	-	-
Y-91	1.03E+3	-	-	-	-	5.71E+5	2.76E+1
Y-92	6.50E-6	-	-	-	-	1.14E-1	1.90E-7
Y-93	2.80E-2	-	-	-	-	8.87E+2	7.72E-4
Zr-95	1.15E+2	3.64E+1	-	5.71E+1	-	1.15E+5	2.46E+1
Zr-97	5.11E-2	1.03E-2	-	1.56E-2	-	3.19E+3	4.72E-3
Nb-95	9.90E+3	5.51E+3	-	5.34E+3	-	3.35E+7	2.96E+3
Nb-97	-	-	-	-	-	6.56E-10	-
Mo-99	-	3.02E+6	-	6.96E+6	-	7.02E+6	5.76E+5
Tc-99m	3.90-1	1.10E+0	-	1.68E+1	5.40E-1	6.53E+2	1.40E+1
Tc-101	-	-	-	-	-	-	-

Table 3-9
 R_{10} Grass - Goat - Milk Pathway Dose Factors - ADULT (continued)
(mrem/yr per $\mu\text{Ci}/\text{m}^3$) for H-3 and C-14
($\text{m}^2 * \text{mrem}/\text{yr}$ per $\mu\text{Ci}/\text{sec}$) for others

<u>Nuclide</u>	<u>Bone</u>	<u>Liver</u>	<u>Thyroid</u>	<u>Kidney</u>	<u>Lung</u>	<u>GI-LLI</u>	<u>T.Body</u>
Ru-103	1.22E+2	-	-	4.67E+2	-	1.43E+4	5.27E+1
Ru-105	1.03E-4	-	-	1.33E-3	-	6.29E-2	4.06E-5
Ru-106	2.45E+3	-	-	4.73E+3	-	1.58E+5	3.10E+2
Rh-103m	-	-	-	-	-	-	-
Rh-106	-	-	-	-	-	-	-
Ag-110m	6.70E+6	6.47E+6	-	1.27E+7	-	2.64E+9	3.84E+6
Sb-124	3.08E+6	5.83E+4	7.49E+3	-	2.40E+6	8.77E+7	1.22E+6
Sb-125	2.45E+6	2.74E+4	2.50E+3	-	1.90E+6	2.70E+7	5.83E+5
Te-125m	1.96E+6	7.08E+5	5.88E+5	7.96E+6	-	7.80E+6	2.62E+5
Te-127m	5.50E+6	1.97E+6	1.40E+6	2.23E+7	-	1.85E+7	6.70E+5
Te-127	8.06E+1	2.89E+1	5.80E+1	3.29E+2	-	6.36E+3	1.74E+1
Te-129m	7.25E+6	2.70E+6	2.50E+6	3.02E+7	-	3.65E+7	1.15E+6
Te-129	-	-	-	-	-	-	-
Te-131m	4.33E+4	2.12E+4	3.36E+4	2.15E+5	-	2.10E+6	1.76E+4
Te-131	-	-	-	-	-	-	-
Te-132	2.87E+5	1.96E+5	2.05E+5	1.79E+6	-	8.78E+6	1.74E+5
I-130	5.11E+5	1.51E+6	1.28E+8	2.35E+6	-	1.30E+6	5.95E+5
I-131	3.55E+8	5.01E+8	1.67E+11	8.72E+8	-	1.34E+8	2.92E+8
I-132	1.97E-1	5.24E-1	1.84E+1	8.36E-1	-	9.86E-2	1.84E-1
I-133	4.76E+6	8.28E+6	1.21E+9	1.44E+7	-	7.44E+6	2.52E+6
I-134	-	-	-	-	-	-	-
I-135	1.67E+4	4.36E+4	2.88E+6	6.70E+4	-	4.92E+4	1.61E+4
Cs-134	1.70E+10	4.02E+10	-	1.31E+10	4.32E+9	7.05E+8	3.30E+10
Cs-136	7.83E+8	3.09E+9	-	1.72E+9	2.36E+8	3.31E+8	2.23E+9
Cs-137	2.21E+10	3.03E+10	-	1.03E+10	3.42E+9	5.85E+8	1.98E+10
Cs-138	-	-	-	-	-	-	-
Ba-139	5.64E-9	-	-	-	-	1.00E-8	1.66E-10
Ba-140	3.23E+6	4.06E+3	-	1.38E+3	2.32E+3	6.65E+6	2.11E+5
Ba-141	-	-	-	-	-	-	-
Ba-142	-	-	-	-	-	-	-
La-140	5.39E-1	2.71E-1	-	-	-	1.99E+4	7.16E-2
La-142	-	-	-	-	-	3.64E-9	-
Ce-141	5.81E+2	3.92E+2	-	1.82E+2	-	1.50E+6	4.45E+1
Ce-143	5.03E+0	3.71E+3	-	1.62E+0	-	1.39E+5	4.10E-1
Ce-144	4.30E+4	1.80E+4	-	1.06E+4	-	1.45E+7	2.30E+3
Pr-143	1.91E+1	7.64E+0	-	4.42E+0	-	8.35E+4	9.46E-1
Pr-144	-	-	-	-	-	-	-
Nd-147	1.13E+1	1.31E+1	-	7.64E+0	-	6.28E+4	6.74E-1
W-187	7.87E+2	6.58E+2	-	-	-	2.16E+5	2.30E+2
Np-239	4.39E-1	4.32E-2	-	1.34E-1	-	8.87E+3	2.38E-2

Table 3-9 (continued)
 R_{IO}: Grass - Goat - Milk Pathway Dose Factors - TEENAGER
 (mrem/yr per μCi/m³) for H-3 and C-14
 (m² * mrem/yr per μCi/sec) for others

<u>Nuclide</u>	<u>Bone</u>	<u>Liver</u>	<u>Thyroid</u>	<u>Kidney</u>	<u>Lung</u>	<u>GI-LLI</u>	<u>T.Body</u>
H-3	-	2.03E+3	2.03E+3	2.03E+3	2.03E+3	2.03E+3	2.03E+3
C-14	6.70E+5	1.34E+5	1.34E+5	1.34E+5	1.34E+5	1.34E+5	1.34E+5
Na-24	5.33E+5	5.33E+5	5.33E+5	5.33E+5	5.33E+5	5.33E+5	5.33E+5
P-32	3.78E+10	2.34E+9	-	-	-	3.18E+9	1.46E+9
Cr-51	-	-	3.34E+3	1.32E+3	8.56E+3	1.01E+6	6.00E+3
Mn-54	-	1.68E+6	-	5.00E+5	-	3.44E+6	3.34E+5
Mn-56	-	9.01E-4	-	1.14E-3	-	5.93E-2	1.60E-4
Fe-55	5.79E+5	4.11E+5	-	-	2.60E+5	1.78E+5	9.57E+4
Fe-59	6.76E+5	1.57E+6	-	-	4.97E+5	3.73E+6	6.08E+5
Co-57	-	2.70E+5	-	-	-	5.03E+6	4.51E+5
Co-58	-	9.54E+5	-	-	-	1.32E+7	2.20E+6
Co-60	-	3.34E+6	-	-	-	4.34E+7	7.51E+6
Ni-63	1.42E+9	1.00E+8	-	-	-	1.60E+7	4.81E+7
Ni-65	8.14E-2	1.04E-2	-	-	-	5.64E-1	4.73E-3
Cu-64	-	4.78E+3	-	1.21E+4	-	3.71E+5	2.25E+3
Zn-65	2.53E+8	8.77E+8	-	5.62E+8	-	3.72E+8	4.09E+8
Zn-69	-	-	-	-	-	-	-
Br-82	-	-	-	-	-	-	6.77E+6
Br-83	-	-	-	-	-	-	2.29E-2
Br-84	-	-	-	-	-	-	-
Br-85	-	-	-	-	-	-	-
Rb-86	-	5.68E+8	-	-	-	8.40E+7	2.66E+8
Rb-88	-	-	-	-	-	-	-
Rb-89	-	-	-	-	-	-	-
Sr-89	5.61E+9	-	-	-	-	6.68E+8	1.61E+8
Sr-90	1.39E+11	-	-	-	-	3.91E+9	3.42E+10
Sr-91	1.20E+5	-	-	-	-	5.48E+5	4.81E+3
Sr-92	1.88E+0	-	-	-	-	4.79E+1	8.00E-2
Y-90	1.56E+1	-	-	-	-	1.28E+5	4.20E-1
Y-91m	-	-	-	-	-	-	-
Y-91	1.90E+3	-	-	-	-	7.78E+5	5.09E+1
Y-92	1.20E-5	-	-	-	-	3.30E-1	3.48E-7
Y-93	5.16E-2	-	-	-	-	1.57E+3	1.42E-3
Zr-95	1.98E+2	6.26E+1	-	9.20E+1	-	1.44E+5	4.31E+1
Zr-97	9.30E-2	1.84E-2	-	2.78E-2	-	4.98E+3	8.47E-3
Nb-95	1.69E+4	936E+3	-	9.08E+3	-	4.01E+7	5.16E+3
Nb-97	-	-	-	-	-	7.61E-9	-
Mo-99	-	5.47E+6	-	1.25E+7	-	9.79E+6	1.04E+6
Tc-99m	6.77E-1	1.88E+0	-	2.81E+1	1.05E+0	1.24E+3	2.45E+1
Tc-101	-	-	-	-	-	-	-

Table 3-9 (continued)
R₁₀, Grass - Goat - Milk Pathway Dose Factors - TEENAGER (continued)
(mrem/yr per μCi/m³) for H-3 and C-14
(m²* mrem/yr per μCi/sec) for others

<u>Nuclide</u>	<u>Bone</u>	<u>Liver</u>	<u>Thyroid</u>	<u>Kidney</u>	<u>Lung</u>	<u>GI-LLI</u>	<u>T.Body</u>
Ru-103	2.17E+2	-	-	7.68E+2	-	1.82E+4	9.30E+1
Ru-105	1.88E-4	-	-	2.36E-3	-	1.51E-1	7.30E-5
Ru-106	4.50E+3	-	-	8.68E+3	-	2.16+E5	5.68E+2
Rh-103m	-	-	-	-	-	-	-
Rh-106	-	-	-	-	-	-	-
Ag-110m	1.16E+7	1.09E+7	-	2.09E+7	-	3.07E+9	6.65E+6
Sb-124	5.51E+6	1.02E+5	1.25E+4	-	4.81E+6	1.11E+8	2.15E+6
Sb-125	4.38E+6	4.79E+4	4.19E+3	-	3.85E+6	3.41E+7	1.02E+6
Te-125m	3.60E+6	1.30E+6	1.01E+6	-	-	1.06E+7	4.82E+5
Te-127m	1.01E+7	3.59E+6	2.41E+6	4.10E+7	-	2.52E+7	1.20E+6
Te-127	1.49E+2	5.29E+1	1.03E+2	6.05E+2	-	1.15E+4	3.22E+1
Te-129m	1.33E+7	4.92E+6	4.28E+6	5.54E+7	-	4.98E+7	2.10E+6
Te-129	-	-	-	2.00E-10	-	2.62E-10	-
Te-131m	7.88E+4	3.78E+4	5.69E+4	3.95E+5	-	3.04E+6	3.16E+4
Te-131	-	-	-	-	-	-	-
Te-132	5.14E+5	3.25E+5	3.43E+5	3.12E+6	-	1.03E+7	3.06E+5
I-130	8.99E+5	2.60E+6	2.12E+8	4.01E+6	-	2.00E+6	1.04E+6
I-131	6.46E+8	9.04E+8	2.64E+11	1.56E+9	-	1.79E+8	4.85E+8
I-132	3.48E-1	9.11E-1	3.07E+1	1.44E+0	-	3.97E-1	3.26E-1
I-133	8.69E+6	1.48E+7	2.06E+9	2.58E+7	-	1.12E+7	4.50E+6
I-134	-	-	-	-	-	-	-
I-135	2.96E+4	7.62E+4	4.90E+6	1.20E+5	-	8.44E+4	2.82E+4
Cs-134	2.94E+10	6.93E+10	-	2.20E+10	8.40E+9	8.61E+8	3.21E+10
Cs-136	1.34E+9	5.25E+9	-	2.86E+9	4.50E+8	4.23E+8	3.54E+9
Cs-137	4.02E+10	5.34E+10	-	1.82E+10	7.05E+9	7.59E+8	1.86E+10
Cs-138	-	-	-	-	-	-	-
Ba-139	1.04E-8	-	-	-	-	9.30E-8	3.04E-10
Ba-140	5.82E+6	7.14E+3	-	2.42E+3	4.80E+3	6.99E+6	3.76E+5
Ba-141	-	-	-	-	-	-	-
Ba-142	-	-	-	-	-	-	-
La-140	9.67E-1	4.75E-1	-	-	-	2.72E+4	1.26E-1
La-142	-	-	-	-	-	2.68E-8	-
Ce-141	1.06E+3	7.10E+2	-	3.35E+2	-	2.03E+6	8.17E+1
Ce-143	9.23E+0	6.72E+3	-	3.01E+0	-	2.02E+5	7.50E-1
Ce-144	7.90E+4	3.26E+4	-	1.96E+4	-	1.99E+7	4.25E+3
Pr-143	3.50E+1	1.40E+1	-	8.12E+0	-	1.15E+5	1.74E+0
Pr-144	-	-	-	-	-	-	-
Nd-147	2.17E+1	2.36E+1	-	1.39E+1	-	8.53E+4	1.42E+0
W-187	1.44E+3	1.17E+3	-	-	-	3.18E+5	4.12E+2
Np-239	8.39E-1	7.91E-2	-	2.48E-1	-	1.27E+4	4.39E-2

Table 3-9 (continued)
 R_{io}: Grass - Goat - Milk Pathway Dose Factors - CHILD
 (mrem/yr per μCi/m³) for H-3 and C-14
 (m² * mrem/yr per μCi/sec) for others

<u>Nuclide</u>	<u>Bone</u>	<u>Liver</u>	<u>Thyroid</u>	<u>Kidney</u>	<u>Lung</u>	<u>GI-LLI</u>	<u>T.Body</u>
H-3	-	3.20E+3	3.20E+3	3.20E+3	3.20E+3	3.20E+3	3.20E+3
C-14	1.65E+6	3.29E+5	3.29E+5	3.29E+5	3.29E+5	3.29E+5	3.29E+5
Na-24	1.11E+6	1.11E+6	1.11E+6	1.11E+6	1.11E+6	1.11E+6	1.11E+6
P-32	9.32E+10	4.37E+9	-	-	-	2.58E+9	3.60E+9
Cr-51	-	-	6.79E+3	1.86E+3	1.24E+4	6.49E+5	1.22E+4
Mn-54	-	2.51E+6	-	7.04E+5	-	2.11E+6	6.70E+5
Mn-56	-	1.57E-3	-	1.90E-3	-	2.28E-1	3.54E-4
Fe-55	1.46E+6	7.71E+5	-	-	4.36E+5	1.43E+5	2.39E+5
Fe-59	1.56E+6	2.54E+6	-	-	7.34E+5	2.64E+6	1.26E+6
Co-57	-	4.61E+5	-	-	-	3.77E+6	9.32E+5
Co-58	-	1.45E+6	-	-	-	8.50E+6	4.46E+6
Co-60	-	5.18E+6	-	-	-	2.87E+7	1.52E+7
Ni-63	3.55E+9	1.91E+8	-	-	-	1.28E+7	1.21E+8
Ni-65	1.99E-1	1.82E-2	-	-	-	2.29E+0	1.09E-2
Cu-64	-	8.41E+3	-	2.03E+4	-	3.94E+5	5.08E+3
Zn-65	4.96E+8	1.32E+9	-	8.33E+8	-	2.32E+8	8.22E+8
Zn-69	-	-	-	-	-	2.57E-10	-
Br-82	-	-	-	-	-	-	1.38E+7
Br-83	-	-	-	-	-	-	5.63E-2
Br-84	-	-	-	-	-	-	-
Br-85	-	-	-	-	-	-	-
Rb-86	-	1.05E+9	-	-	-	6.77E+7	6.47E+8
Rb-88	-	-	-	-	-	-	-
Rb-89	-	-	-	-	-	-	-
Sr-89	1.39E+10	-	-	-	-	5.38E+8	3.97E+8
Sr-90	2.35E+11	-	-	-	-	3.17E+9	5.94E+10
Sr-91	2.96E+5	-	-	-	-	6.55E+5	1.12E+4
Sr-92	4.60E+0	-	-	-	-	8.69E+1	1.84E-1
Y-90	3.86E+1	-	-	-	-	1.10E+5	1.03E+0
Y-91m	-	-	-	-	-	-	-
Y-91	4.69E+3	-	-	-	-	6.25E+5	1.25E+2
Y-92	2.95E-5	-	-	-	-	8.52E-1	8.44E-7
Y-93	1.27E-1	-	-	-	-	1.88E+3	3.48E-3
Zr-95	4.61E+2	1.01E+2	-	1.45E+2	-	1.06E+5	9.02E+1
Zr-97	2.27E-1	3.26E-2	-	4.69E-2	-	4.96E+3	1.93E-2
Nb-95	3.82E+4	1.49E+4	-	1.39E+4	-	2.75E+7	1.06E+4
Nb-97	-	-	-	-	-	1.74E-7	-
Mo-99	-	9.95E+6	-	2.12E+7	-	8.23E+6	2.46E+6
Tc-99m	1.55E+0	3.05E+0	-	4.42E+1	1.55E+0	1.73E+3	5.04E+1
Tc-101	-	-	-	-	-	-	-

Table 3-9 (continued)
 R_{10} , Grass - Goat - Milk Pathway Dose Factors - CHILD (continued)
(mrem/yr per $\mu\text{Ci}/\text{m}^3$) for H-3 and C-14
($\text{m}^2 * \text{mrem}/\text{yr}$ per $\mu\text{Ci}/\text{sec}$) for others

<u>Nuclide</u>	<u>Bone</u>	<u>Liver</u>	<u>Thyroid</u>	<u>Kidney</u>	<u>Lung</u>	<u>GI-LLI</u>	<u>T.Body</u>
Ru-103	5.15E+2	-	-	1.30E+3	-	1.33E+4	1.98E+2
Ru-105	4.58E-4	-	-	4.03E-3	-	2.99E-1	1.67E-4
Ru-106	1.11E+4	-	-	1.50E+4	-	1.73E+5	1.38E+3
Rh-103m	-	-	-	-	-	-	-
Rh-106	-	-	-	-	-	-	-
Ag-110m	2.51E+7	1.69E+7	-	2.76E+7	-	2.02E+9	1.36E+7
Sb-124	1.31E+7	1.69E+7	2.88E+4	-	7.24E+6	8.15E+7	4.57E+6
Sb-125	1.04E+7	1.69E+5	9.67E+3	-	5.82E+6	2.50E+7	2.18E+6
Te-125m	8.86E+6	2.40E+6	2.49E+6	-	-	8.54E+6	1.18E+6
Te-127m	2.50E+7	6.72E+6	5.96E+6	7.12E+7	-	2.02E+7	2.96E+6
Te-127	3.67E+2	9.90E+1	2.54E+2	1.04E+3	-	1.44E+4	7.87E+1
Te-129m	3.26E+7	9.13E+6	1.05E+7	9.60E+7	-	3.98E+7	5.08E+6
Te-129	-	-	-	3.44E-10	-	7.34E-9	-
Te-131m	1.92E+5	6.64E+4	1.37E+5	6.42E+5	-	2.69E+6	7.07E+4
Te-131	-	-	-	-	-	-	-
Te-132	1.22E+6	5.42E+5	7.90E+5	5.04E+6	-	5.46E+6	6.55E+5
I-130	2.11E+6	4.25E+6	4.68E+8	6.35E+6	-	1.99E+6	2.18E+6
I-131	1.56E+9	1.57E+9	5.21E+11	2.58E+9	-	1.40E+8	8.95E+8
I-132	8.23E-1	1.51E+0	7.02E+1	2.32E+0	-	1.78E+0	6.96E-1
I-133	2.11E+7	2.62E+7	4.85E+9	4.36E+7	-	1.05E+7	9.88E+6
I-134	-	-	-	-	-	-	-
I-135	7.01E+4	1.26E+5	1.12E+7	1.93E+5	-	9.60E+4	5.96E+4
Cs-134	6.78E+10	1.13E+11	-	3.45E+10	1.24E+10	6.00E+8	2.35E+10
Cs-136	3.00E+9	8.28E+9	-	4.41E+9	6.57E+8	2.91E+8	5.37E+9
Cs-137	9.66E+10	9.27E+10	-	3.03E+10	1.09E+10	5.79E+8	1.36E+10
Cs-138	-	-	-	-	-	-	-
Ba-139	2.57E-8	-	-	-	-	1.48E-6	7.45E-10
Ba-140	1.40E+7	1.24E+4	-	4.01E+3	7.34E+3	7.13E+6	8.21E+5
Ba-141	-	-	-	-	-	-	-
Ba-142	-	-	-	-	-	-	-
La-140	2.32E+0	8.09E-1	-	-	-	2.26E+4	2.72E-1
La-142	-	-	-	-	-	3.01E-7	-
Ce-141	2.63E+3	1.31E+3	-	5.74E+2	-	1.63E+6	1.84E+2
Ce-143	2.27E+1	1.22E+4	-	5.15E+0	-	1.80E+5	1.78E+0
Ce-144	1.94E+5	6.11E+4	-	3.38E+4	-	1.60E+7	1.04E+4
Pr-143	8.68E+1	2.60E+1	-	1.40E+1	-	9.36E+4	4.31E+0
Pr-144	-	-	-	-	-	-	-
Nd-147	5.34E+1	4.32E+1	-	2.38E+1	-	6.83E+4	3.35E+0
W-187	3.49E+3	2.06E+3	-	-	-	2.96E+5	9.28E+2
Np-239	2.06E+0	1.48E-1	-	4.28E-1	-	1.10E+4	1.04E-1

Table 3-9 (continued)
 R_{10} , Grass - Goat - Milk Pathway Dose Factors - INFANT
(mrem/yr per $\mu\text{Ci}/\text{m}^3$) for H-3 and C-14
($\text{m}^2 * \text{mrem}/\text{yr}$ per $\mu\text{Ci}/\text{sec}$) for others

<u>Nuclide</u>	<u>Bone</u>	<u>Liver</u>	<u>Thyroid</u>	<u>Kidney</u>	<u>Lung</u>	<u>GI-LLI</u>	<u>T.Body</u>
H-3	-	4.86E+3	4.86E+3	4.86E+3	4.86E+3	4.86E+3	4.86E+3
C-14	3.23E+6	6.89E+5	6.89E+5	6.89E+5	6.89E+5	6.89E+5	6.89E+5
Na-24	1.93E+6	1.93E+6	1.93E+6	1.93E+6	1.93E+6	1.93E+6	1.93E+6
P-32	1.92E+11	1.13E+10	-	-	-	2.60E+9	7.45E+9
Cr-51	-	-	1.26E+4	2.76E+3	2.46E+4	5.65E+5	1.93E+4
Mn-54	-	4.67E+6	-	1.04E+6	-	1.72E+6	1.06E+6
Mn-56	-	3.85E-3	-	3.31E-3	-	3.49E-1	6.64E-4
Fe-55	1.76E+6	1.13E+6	-	-	5.55E+5	1.44E+5	3.03E+5
Fe-59	2.93E+6	5.11E+6	-	-	1.51E+6	2.44E+6	2.02E+6
Co-57	-	1.07E+6	-	-	-	3.66E+6	1.75E+6
Co-58	-	2.92E+6	-	-	-	7.26E+6	7.27E+6
Co-60	-	1.06E+7	-	-	-	2.52E+7	2.50E+7
Ni-63	4.19E+9	2.59E+8	-	-	-	1.28E+7	1.45E+8
Ni-65	4.21E-1	4.76E-2	-	-	-	3.62E+0	2.17E-2
Cu-64	-	2.09E+4	-	3.53E+4	-	4.29E+5	9.68E+3
Zn-65	6.66E+8	2.28E+9	-	1.11E+9	-	1.93E+9	1.05E+9
Zn-69	-	-	-	-	-	8.83E-10	-
Br-82	-	-	-	-	-	-	2.33E+7
Br-83	-	-	-	-	-	-	1.19E-1
Br-84	-	-	-	-	-	-	-
Br-85	-	-	-	-	-	-	-
Rb-86	-	2.66E+9	-	-	-	6.83E+7	1.32E+9
Rb-88	-	-	-	-	-	-	-
Rb-89	-	-	-	-	-	-	-
Sr-89	2.65E+10	-	-	-	-	5.44E+8	7.58E+8
Sr-90	2.56E+11	-	-	-	-	3.19E+9	6.51E+10
Sr-91	6.17E+5	-	-	-	-	7.31E+5	2.23E+4
Sr-92	9.76E+0	-	-	-	-	1.05E+2	3.63E-1
Y-90	8.16E+1	-	-	-	-	1.13E+5	2.18E+0
Y-91m	-	-	-	-	-	-	-
Y-91	8.80E+3	-	-	-	-	6.31E+5	2.34E+2
Y-92	6.26E-5	-	-	-	-	1.20E+0	1.76E-6
Y-93	2.70E-1	-	-	-	-	2.14E+3	7.36E-3
Zr-95	8.20E+2	1.99E+2	-	2.15E+2	-	9.94E+4	1.42E+2
Zr-97	4.79E-1	8.22E-2	-	8.29E-2	-	5.24E+3	3.76E-2
Nb-95	7.12E+4	2.93E+4	-	2.10E+4	-	2.47E+7	1.69E+4
Nb-97	-	-	-	-	-	4.44E-7	-
Mo-99	-	2.54E+7	-	3.80E+7	-	8.38E+6	4.96E+6
Tc-99m	3.23E+0	6.66E+0	-	7.16E+1	3.48E+0	1.93E+3	8.58E+1
Tc-101	-	-	-	-	-	-	-

Table 3-9 (continued)
 R_{i0} : Grass - Goat - Milk Pathway Dose Factors - INFANT (continued)
(mrem/yr per $\mu\text{Ci}/\text{m}^3$) for H-3 and C-14
($\text{m}^2 * \text{mrem}/\text{yr}$ per $\mu\text{Ci}/\text{sec}$) for others

<u>Nuclide</u>	<u>Bone</u>	<u>Liver</u>	<u>Thyroid</u>	<u>Kidney</u>	<u>Lung</u>	<u>GI-LLI</u>	<u>T.Body</u>
Ru-103	1.04E+3	-	-	2.17E+3	-	1.27E+4	3.49E+2
Ru-105	9.67E-4	-	-	7.10E-3	-	3.85E-1	3.25E-4
Ru-106	2.28E+4	-	-	2.70E+4	-	1.73E+5	2.86E+3
Rh-103m	-	-	-	-	-	-	-
Rh-106	-	-	-	-	-	-	-
Ag-110m	4.63E+7	3.38E+7	-	4.84E+7	-	1.75E+9	2.23E+7
Sb-124	2.51E+7	3.70E+5	6.67E+4	-	1.57E+7	7.75E+7	7.79E+6
Sb-125	1.79E+7	1.74E+5	2.24E+4	-	1.13E+7	2.39E+7	3.68E+6
Te-125m	1.81E+7	6.05E+6	6.08E+6	-	-	8.62E+6	2.45E+6
Te-127m	5.05E+7	1.68E+7	1.46E+7	1.25E+8	-	2.04E+7	6.12E+6
Te-127	7.80E+2	2.62E+2	6.35E+2	1.91E+3	-	1.63E+4	1.68E+2
Te-129m	6.71E+7	2.30E+7	2.58E+7	1.68E+8	-	4.01E+7	1.03E+7
Te-129	2.50E-10	-	2.10E-10	6.22E-10	-	1.99E-8	-
Te-131m	4.06E+5	1.63E+5	3.31E+5	1.12E+6	-	2.75E+6	1.34E+5
Te-131	-	-	-	-	-	-	-
Te-132	2.52E+6	1.25E+6	1.85E+6	7.81E+6	-	4.62E+6	1.17E+6
I-130	4.32E+6	9.50E+6	1.07E+9	1.04E+7	-	2.04E+6	3.82E+6
I-131	3.26E+9	3.85E+9	1.26E+12	4.50E+9	-	1.38E+8	1.69E+9
I-132	1.70E+0	3.47E+0	1.62E+2	3.86E+0	-	2.81E+0	1.24E+0
I-133	4.46E+7	6.49E+7	1.18E+10	7.63E+7	-	1.10E+7	1.90E+7
I-134	-	-	1.21E-9	-	-	-	-
I-135	1.45E+5	2.89E+5	2.59E+7	3.23E+5	-	1.05E+5	1.06E+5
Cs-134	1.10E+11	2.04E+11	-	5.25E+10	2.15E+10	5.55E+8	2.06E+10
Cs-136	5.88E+9	1.73E+10	-	6.90E+9	1.41E+9	2.63E+8	6.45E+9
Cs-137	1.54E+11	1.81E+11	-	4.86E+10	1.96E+10	5.64E+8	1.28E+10
Cs-138	-	-	-	-	-	-	-
Ba-139	5.46E-8	-	-	-	-	3.46E-6	1.58E-9
Ba-140	2.89E+7	2.89E+4	-	6.88E+3	1.78E+4	7.10E+6	1.49E+6
Ba-141	-	-	-	-	-	-	-
Ba-142	-	-	-	-	-	-	-
La-140	4.84E+0	1.91E+0	-	-	-	2.24E+4	4.91E-1
La-142	-	-	-	-	-	6.25E-7	-
Ce-141	5.20E+3	3.17E+3	-	9.78E+2	-	1.64E+6	3.73E+2
Ce-143	4.80E+1	3.18E+4	-	9.26E+0	-	1.86E+5	3.62E+0
Ce-144	2.80E+5	1.14E+5	-	4.62E+4	-	1.60E+7	1.56E+4
Pr-143	1.79E+2	6.71E+1	-	2.50E+1	-	9.47E+4	8.89E+0
Pr-144	-	-	-	-	-	-	-
Nd-147	1.06E+2	1.09E+2	-	4.19E+1	-	6.89E+4	6.66E+0
W-187	7.34E+3	5.11E+3	-	-	-	3.00E+5	1.76E+3
Np-239	4.67E+0	3.90E-1	-	7.79E-1	-	1.13E+4	2.21E-1

Table 3-10
 R_{10} , Grass - Cow - Meat Pathway Dose Factors - ADULT
(mrem/yr per $\mu\text{Ci}/\text{m}^3$) for H-3 and C-14
($\text{m}^2 * \text{mrem}/\text{yr}$ per $\mu\text{Ci}/\text{sec}$) for others

<u>Nuclide</u>	<u>Bone</u>	<u>Liver</u>	<u>Thyroid</u>	<u>Kidney</u>	<u>Lung</u>	<u>GI-LLI</u>	<u>T.Body</u>
H-3	-	3.25E+2	3.25E+2	3.25E+2	3.25E+2	3.25E+2	3.25E+2
C-14	3.33E+5	6.66E+4	6.66E+4	6.66E+4	6.66E+4	6.66E+4	6.66E+4
Na-24	1.84E-3	1.84E-3	1.84E-3	1.84E-3	1.84E-3	1.84E-3	1.84E-3
P-32	4.65E+9	2.89E+8	-	-	-	5.23E+8	1.80E+8
Cr-51	-	-	4.22E+3	1.56E+3	9.38E+3	1.78E+6	7.07E+3
Mn-54	-	9.15E+6	-	2.72E+6	-	2.80E+7	1.75E+6
Mn-56	-	-	-	-	-	-	-
Fe-55	2.93E+8	2.02E+8	-	-	1.13E+8	1.16E+8	4.72E+7
Fe-59	2.67E+8	6.27E+8	-	-	1.75E+8	2.09E+9	2.40E+8
Co-57	-	5.64E+6	-	-	-	1.43E+8	9.37E+6
Co-58	-	1.83E+7	-	-	-	3.70E+8	4.10E+7
Co-60	-	7.52E+7	-	-	-	1.41E+9	1.66E+8
Ni-63	1.89E+10	1.31E+9	-	-	-	2.73E+8	6.33E+8
Ni-65	-	-	-	-	-	-	-
Cu-64	-	2.95E-7	-	7.45E-7	-	2.52E-5	1.39E-7
Zn-65	3.56E+8	1.13E+9	-	7.57E+8	-	7.13E+8	5.12E+8
Zn-69	-	-	-	-	-	-	-
Br-82	-	-	-	-	-	1.44E+3	1.26E+3
Br-83	-	-	-	-	-	-	-
Br-84	-	-	-	-	-	-	-
Br-85	-	-	-	-	-	-	-
Rb-86	-	4.87E+8	-	-	-	9.60E+7	2.27E+8
Rb-88	-	-	-	-	-	-	-
Rb-89	-	-	-	-	-	-	-
Sr-89	3.01E+8	-	-	-	-	4.84E+7	8.65E+6
Sr-90	1.24E+10	-	-	-	-	3.59E+8	3.05E+9
Sr-91	-	-	-	-	-	1.38E-9	-
Sr-92	-	-	-	-	-	-	-
Y-90	1.07E+2	-	-	-	-	1.13E+6	2.86E+0
Y-91m	-	-	-	-	-	-	-
Y-91	1.13E+6	-	-	-	-	6.24E+8	3.03E+4
Y-92	-	-	-	-	-	-	-
Y-93	-	-	-	-	-	2.08E-7	-
Zr-95	1.88E+6	6.04E+5	-	9.48E+5	-	1.91E+9	4.09E+5
Zr-97	1.83E-5	3.69E-6	-	5.58E-6	-	1.14E+0	1.69E-6
Nb-95	2.29E+6	1.28E+6	-	1.26E+6	-	7.75E+9	6.86E+5
Nb-97	-	-	-	-	-	-	-
Mo-99	-	1.09E+5	-	2.46E+5	-	2.52E+5	2.07E+4
Tc-99m	-	-	-	-	-	-	-
Tc-101	-	-	-	-	-	-	-

Table 3-10
 R_{iO} , Grass - Cow - Meat Pathway Dose Factors - ADULT (continued)
(mrem/yr per $\mu\text{Ci}/\text{m}^3$) for H-3 and C-14
($\text{m}^2 * \text{mrem}/\text{yr}$ per $\mu\text{Ci}/\text{sec}$) for others

<u>Nuclide</u>	<u>Bone</u>	<u>Liver</u>	<u>Thyroid</u>	<u>Kidney</u>	<u>Lung</u>	<u>GI-LLI</u>	<u>T.Body</u>
Ru-103	1.06E+8	-	-	4.03E+8	-	1.23E+10	4.55E+7
Ru-105	-	-	-	-	-	-	-
Ru-106	2.80E+9	-	-	5.40E+9	-	1.81E+11	3.54E+8
Rh-103m	-	-	-	-	-	-	-
Rh-106	-	-	-	-	-	-	-
Ag-110m	6.69E+6	6.19E+6	-	1.22E+7	-	2.52E+9	3.67E+6
Sb-124	1.98E+7	3.74E+5	4.80E+4	-	1.54E+7	5.62E+8	7.85E+6
Sb-125	1.91E+7	2.13E+5	1.94E+4	-	1.47E+7	2.10E+8	4.54E+6
Te-125m	3.59E+8	1.30E+8	1.08E+8	1.46E+9	-	1.43E+9	4.81E+7
Te-127m	1.12E+9	3.99E+8	2.85E+8	4.53E+9	-	3.74E+9	1.36E+8
Te-127	-	-	-	1.09E-9	-	2.10E-8	-
Te-129m	1.14E+9	4.27E+8	3.93E+8	4.77E+9	-	5.76E+9	1.81E+8
Te-129	-	-	-	-	-	-	-
Te-131m	4.51E+2	2.21E+2	3.50E+2	2.24E+3	-	2.19E+4	1.84E+2
Te-131	-	-	-	-	-	-	-
Te-132	1.40E+6	9.07E+5	1.00E+6	8.73E+6	-	4.29E+7	8.51E+5
I-130	2.35E-6	6.94E-6	5.88E-4	1.08E-5	-	5.98E-6	2.74E-6
I-131	1.08E+7	1.54E+7	5.05E+9	2.64E+7	-	4.07E+6	8.83E+6
I-132	-	-	-	-	-	-	-
I-133	4.30E-1	7.47E-1	1.10E+2	1.30E+0	-	6.72E-1	2.28E-1
I-134	-	-	-	-	-	-	-
I-135	-	-	-	-	-	-	-
Cs-134	6.57E+8	1.56E+9	-	5.06E+8	1.68E+8	2.74E+7	1.28E+9
Cs-136	1.18E+7	4.67E+7	-	2.60E+7	3.56E+6	5.30E+6	3.36E+7
Cs-137	8.72E+8	1.19E+9	-	4.05E+8	1.35E+8	2.31E+7	7.81E+8
Cs-138	-	-	-	-	-	-	-
Ba-139	-	-	-	-	-	-	-
Ba-140	2.88E+7	3.61E+4	-	1.23E+4	2.07E+4	5.92E+7	1.89E+6
Ba-141	-	-	-	-	-	-	-
Ba-142	-	-	-	-	-	-	-
La-140	3.60E-2	1.81E-2	-	-	-	1.33E+3	4.79E-3
La-142	-	-	-	-	-	-	-
Ce-141	1.40E+4	9.48E+3	-	4.40E+3	-	3.62E+7	1.08E+3
Ce-143	2.09E-2	1.55E+1	-	6.80E-3	-	5.78E+2	1.71E-3
Ce-144	1.46E+6	6.09E+5	-	3.61E+5	-	4.93E+8	7.83E+4
Pr-143	2.13E+4	8.54E+3	-	4.93E+3	-	9.33E+7	1.06E+3
Pr-144	-	-	-	-	-	-	-
Nd-147	7.08E+3	8.18E+3	-	4.78E+3	-	3.93E+7	4.90E+2
W-187	2.16E-2	1.81E-2	-	-	-	5.92E+0	6.32E-3
Np-239	2.56E-1	2.51E-2	-	7.84E-2	-	5.15E+3	1.39E-2

Table 3-10 (continued)
 R_{io}, Grass - Cow - Meat Pathway Dose Factors - TEENAGER
 (mrem/yr per μCi/m³) for H-3 and C-14
 (m² * mrem/yr per μCi/sec) for others

<u>Nuclide</u>	<u>Bone</u>	<u>Liver</u>	<u>Thyroid</u>	<u>Kidney</u>	<u>Lung</u>	<u>GI-LLI</u>	<u>T.Body</u>
H-3	-	1.94E+2	1.94E+2	1.94E+2	1.94E+2	1.94E+2	1.94E+2
C-14	2.81E+5	5.62E+4	5.62E+4	5.62E+4	5.62E+4	5.62E+4	5.62E+4
Na-24	1.47E-3	1.47E-3	1.47E-3	1.47E-3	1.47E-3	1.47E-3	1.47E-3
P-32	3.93E+9	2.44E+8	-	-	-	3.30E+8	1.52E+8
Cr-51	-	-	3.14E+3	1.24E+3	8.07E+3	9.50E+5	5.65E+3
Mn-54	-	6.98E+6	-	2.08E+6	-	1.43E+7	1.38E+6
Mn-56	-	-	-	-	-	-	-
Fe-55	2.38E+8	1.69E+8	-	-	1.07E+8	7.30E+7	3.93E+7
Fe-59	2.13E+8	4.98E+8	-	-	1.57E+8	1.18E+9	1.92E+8
Co-57	-	4.53E+6	-	-	-	8.45E+7	7.59E+6
Co-58	-	1.41E+7	-	-	-	1.94E+8	3.25E+7
Co-60	-	5.83E+7	-	-	-	7.60E+8	1.31E+8
Ni-63	1.52E+10	1.07E+9	-	-	-	1.71E+8	5.15E+8
Ni-65	-	-	-	-	-	-	-
Cu-64	-	2.41E-7	-	6.10E-7	-	1.87E-5	1.13E-7
Zn-65	2.50E+8	8.69E+8	-	5.56E+8	-	3.68E+8	4.05E+8
Zn-69	-	-	-	-	-	-	-
Br-82	-	-	-	-	-	-	9.98E+2
Br-83	-	-	-	-	-	-	-
Br-84	-	-	-	-	-	-	-
Br-85	-	-	-	-	-	-	-
Rb-86	-	4.06E+8	-	-	-	6.01E+7	1.91E+8
Rb-88	-	-	-	-	-	-	-
Rb-89	-	-	-	-	-	-	-
Sr-89	2.54E+8	-	-	-	-	3.03E+7	7.29E+6
Sr-90	8.05E+9	-	-	-	-	2.26E+8	1.99E+9
Sr-91	-	-	-	-	-	1.10E-9	-
Sr-92	-	-	-	-	-	-	-
Y-90	8.98E+1	-	-	-	-	7.40E+5	2.42E+0
Y-91m	-	-	-	-	-	-	-
Y-91	9.56E+5	-	-	-	-	3.92E+8	2.56E+4
Y-92	-	-	-	-	-	-	-
Y-93	-	-	-	-	-	1.69E-7	-
Zr-95	1.51E+6	4.76E+5	-	6.99E+5	-	1.10E+9	3.27E+5
Zr-97	1.53E-5	3.02E-6	-	4.58E-6	-	8.18E-1	1.39E-6
Nb-95	1.79E+6	9.94E+5	-	9.64E+5	-	4.25E+9	5.47E+5
Nb-97	-	-	-	-	-	-	-
Mo-99	-	8.98E+4	-	2.06E+5	-	1.61E+5	1.71E+4
Tc-99m	-	-	-	-	-	-	-
Tc-101	-	-	-	-	-	-	-

Table 3-10 (continued)
 R_{io}, Grass - Cow - Meat Pathway Dose Factors - TEENAGER (continued)
 (mrem/yr per $\mu\text{Ci}/\text{m}^3$) for H-3 and C-14
 ($\text{m}^2 * \text{mrem}/\text{yr}$ per $\mu\text{Ci}/\text{sec}$) for others

<u>Nuclide</u>	<u>Bone</u>	<u>Liver</u>	<u>Thyroid</u>	<u>Kidney</u>	<u>Lung</u>	<u>GI-LLI</u>	<u>T.Body</u>
Ru-103	8.60E+7	-	-	3.03E+8	-	7.18E+9	3.68E+7
Ru-105	-	-	-	-	-	-	-
Ru-106	2.36E+9	-	-	4.55E+9	-	1.13E+11	2.97E+8
Rh-103m	-	-	-	-	-	-	-
Rh-106	-	-	-	-	-	-	-
Ag-110m	5.06E+6	4.79E+6	-	9.14E+6	-	1.35E+9	2.91E+6
Sb-124	1.62E+7	2.98E+5	3.67E+4	-	1.41E+7	3.26E+8	6.31E+6
Sb-125	1.56E+7	1.71E+5	1.49E+4	-	1.37E+7	1.22E+8	3.66E+6
Te-125m	3.03E+8	1.09E+8	8.47E+7	-	-	8.94E+8	4.05E+7
Te-127m	9.41E+8	3.34E+8	2.24E+8	3.82E+9	-	2.35E+9	1.12E+8
Te-127	-	-	-	-	-	1.75E-8	-
Te-129m	9.58E+8	3.56E+8	3.09E+8	4.01E+9	-	3.60E+9	1.52E+8
Te-129	-	-	-	-	-	-	-
Te-131m	3.76E+2	1.80E+2	2.71E+2	1.88E+3	-	1.45E+4	1.50E+2
Te-131	-	-	-	-	-	-	-
Te-132	1.15E+6	7.26E+5	7.66E+5	6.97E+6	-	2.30E+7	6.84E+5
I-130	1.89E-6	5.48E-6	4.47E-4	8.44E-6	-	4.21E-6	2.19E-6
I-131	8.95E+6	1.25E+7	3.66E+9	2.16E+7	-	2.48E+6	6.73E+6
I-132	-	-	-	-	-	-	-
I-133	3.59E-1	6.10E-1	8.51E+1	1.07E+0	-	4.61E-1	1.86E-1
I-134	-	-	-	-	-	-	-
I-135	-	-	-	-	-	-	-
Cs-134	5.23E+8	1.23E+9	-	3.91E+8	1.49E+8	1.53E+7	5.71E+8
Cs-136	9.22E+6	3.63E+7	-	1.97E+7	3.11E+6	2.92E+6	2.44E+7
Cs-137	7.24E+8	9.63E+8	-	3.28E+8	1.27E+8	1.37E+7	3.36E+8
Cs-138	-	-	-	-	-	-	-
Ba-139	-	-	-	-	-	-	-
Ba-140	2.38E+7	2.91E+4	-	9.88E+3	1.96E+4	3.67E+7	1.53E+6
Ba-141	-	-	-	-	-	-	-
Ba-142	-	-	-	-	-	-	-
La-140	2.96E-2	1.45E-2	-	-	-	8.35E+2	3.87E-3
La-142	-	-	-	-	-	-	-
Ce-141	1.18E+4	7.86E+3	-	3.70E+3	-	2.25E+7	9.03E+2
Ce-143	1.76E-2	1.28E+1	-	5.74E-3	-	3.85E+2	1.43E-3
Ce-144	1.23E+6	5.08E+5	-	3.04E+5	-	3.09E+8	6.60E+4
Pr-143	1.79E+4	7.15E+3	-	4.16E+3	-	5.90E+7	8.92E+2
Pr-144	-	-	-	-	-	-	-
Nd-147	6.24E+3	6.79E+3	-	3.98E+3	-	2.45E+7	4.06E+2
W-187	1.81E-2	1.48E-2	-	-	-	3.99E+0	5.17E-3
Np-239	2.23E-1	2.11E-2	-	6.61E-2	-	3.39E+3	1.17E-2

Table 3-10 (continued)
 R_{io}, Grass - Cow - Meat Pathway Dose Factors - CHILD
 (mrem/yr per μCi/m³) for H-3 and C-14
 (m² * mrem/yr per μCi/sec) for others

<u>Nuclide</u>	<u>Bone</u>	<u>Liver</u>	<u>Thyroid</u>	<u>Kidney</u>	<u>Lung</u>	<u>GI-LLI</u>	<u>T.Body</u>
H-3	-	2.34E+2	2.34E+2	2.34E+2	2.34E+2	2.34E+2	2.34E+2
C-14	5.29E+5	1.06E+5	1.06E+5	1.06E+5	1.06E+5	1.06E+5	1.06E+5
Na-24	2.34E-3	2.34E-3	2.34E-3	2.34E-3	2.34E-3	2.34E-3	2.34E-3
P-32	7.41E+9	3.47E+8	-	-	-	2.05E+8	2.86E+8
Cr-51	-	-	4.89E+3	1.34E+3	8.93E+3	4.67E+5	8.81E+3
Mn-54	-	7.99E+6	-	2.24E+6	-	6.70E+6	2.13E+6
Mn-56	-	-	-	-	-	-	-
Fe-55	4.57E+8	2.42E+8	-	-	1.37E+8	4.49E+7	7.51E+7
Fe-59	3.78E+8	6.12E+8	-	-	1.77E+8	6.37E+8	3.05E+8
Co-57	-	5.92E+6	-	-	-	4.85E+7	1.20E+7
Co-58	-	1.65E+7	-	-	-	9.60E+7	5.04E+7
Co-60	-	6.93E+7	-	-	-	3.84E+8	2.04E+8
Ni-63	2.91E+10	1.56E+9	-	-	-	1.05E+8	9.91E+8
Ni-65	-	-	-	-	-	-	-
Cu-64	-	3.24E-7	-	7.82E-7	-	1.52E-5	1.96E-7
Zn-65	3.75E+8	1.00E+9	-	6.30E+8	-	1.76E+8	6.22E+8
Zn-69	-	-	-	-	-	-	-
Br-82	-	-	-	-	-	-	1.56E+3
Br-83	-	-	-	-	-	-	-
Br-84	-	-	-	-	-	-	-
Br-85	-	-	-	-	-	-	-
Rb-86	-	5.76E+8	-	-	-	3.71E+7	3.54E+8
Rb-88	-	-	-	-	-	-	-
Rb-89	-	-	-	-	-	-	-
Sr-89	4.82E+8	-	-	-	-	1.86E+7	1.38E+7
Sr-90	1.04E+10	-	-	-	-	1.40E+8	2.64E+9
Sr-91	-	-	-	-	-	1.01E-9	-
Sr-92	-	-	-	-	-	-	-
Y-90	1.70E+2	-	-	-	-	4.84E+5	4.55E+0
Y-91m	-	-	-	-	-	-	-
Y-91	1.81E+6	-	-	-	-	2.41E+8	4.83E+4
Y-92	-	-	-	-	-	-	-
Y-93	-	-	-	-	-	1.55E-7	-
Zr-95	2.68E+6	5.89E+5	-	8.43E+5	-	6.14E+8	5.24E+5
Zr-97	2.84E-5	4.10E-6	-	5.89E-6	-	6.21E-1	2.42E-6
Nb-95	3.09E+6	1.20E+6	-	1.13E+6	-	2.23E+9	8.61E+5
Nb-97	-	-	-	-	-	-	-
Mo-99	-	1.25E+5	-	2.67E+5	-	1.03E+5	3.09E+4
Tc-99m	-	-	-	-	-	-	-
Tc-101	-	-	-	-	-	-	-

Table 3-10 (continued)
R_{io}, Grass - Cow - Meat Pathway Dose Factors - CHILD (continued)
(mrem/yr per μCi/m³) for H-3 and C-14
(m² * mrem/yr per μCi/sec) for others

<u>Nuclide</u>	<u>Bone</u>	<u>Liver</u>	<u>Thyroid</u>	<u>Kidney</u>	<u>Lung</u>	<u>GI-LLI</u>	<u>T.Body</u>
Ru-103	1.56E+8	-	-	3.92E+8	-	4.02E+9	5.98E+7
Ru-105	-	-	-	-	-	-	-
Ru-106	4.44E+9	-	-	5.99E+9	-	6.90E+10	5.54E+8
Rh-103m	-	-	-	-	-	-	-
Rh-106	-	-	-	-	-	-	-
Ag-110m	8.40E+6	5.67E+6	-	1.06E+7	-	6.75E+8	4.53E+6
Sb-124	2.93E+7	3.80E+5	6.46E+4	-	1.62E+7	1.83E+8	1.03E+7
Sb-125	2.85E+7	2.19E+5	2.64E+4	-	1.59E+7	6.80E+7	5.96E+6
Te-125m	5.69E+8	1.54E+8	1.60E+8	-	-	5.49E+8	7.59E+7
Te-127m	1.77E+9	4.78E+8	4.24E+8	5.06E+9	-	1.44E+9	2.11E+8
Te-127	-	-	-	1.21E-9	-	1.66E-8	-
Te-129m	1.81E+9	5.04E+8	5.82E+8	5.30E+9	-	2.20E+9	2.80E+8
Te-129	-	-	-	-	-	-	-
Te-131m	7.00E+2	2.42E+2	4.98E+2	2.34E+3	-	9.82E+3	2.58E+2
Te-131	-	-	-	-	-	-	-
Te-132	2.09E+6	9.27E+5	1.35E+6	8.60E+6	-	9.33E+6	1.12E+6
I-130	3.39E-6	6.85E-6	7.54E-4	1.02E-5	-	3.20E-6	3.53E-6
I-131	1.66E+7	1.67E+7	5.52E+9	2.74E+7	-	1.49E+6	9.49E+6
I-132	-	-	-	-	-	-	-
I-133	6.68E-1	8.26E-1	1.53E+2	1.38E+0	-	3.33E-1	3.12E-1
I-134	-	-	-	-	-	-	-
I-135	-	-	-	-	-	-	-
Cs-134	9.22E+8	1.51E+9	-	4.69E+8	1.68E+8	8.15E+6	3.19E+8
Cs-136	1.59E+7	4.37E+7	-	2.33E+7	3.47E+6	1.54E+6	2.83E+7
Cs-137	1.33E+9	1.28E+9	-	4.16E+8	1.50E+8	7.99E+6	1.88E+8
Cs-138	-	-	-	-	-	-	-
Ba-139	-	-	-	-	-	-	-
Ba-140	4.39E+7	3.85E+4	-	1.25E+4	2.29E+4	2.22E+7	2.56E+6
Ba-141	-	-	-	-	-	-	-
Ba-142	-	-	-	-	-	-	-
La-140	5.41E-2	1.89E-2	-	-	-	5.27E+2	6.38E-3
La-142	-	-	-	-	-	-	-
Ce-141	2.22E+4	1.11E+4	-	4.84E+3	-	1.38E+7	1.64E+3
Ce-143	3.30E-2	1.79E+1	-	7.51E-3	-	2.62E+2	2.59E-3
Ce-144	2.32E+6	7.26E+5	-	4.02E+5	-	1.89E+8	1.24E+5
Pr-143	3.39E+4	1.02E+4	-	5.51E+3	-	3.66E+7	1.68E+3
Pr-144	-	-	-	-	-	-	-
Nd-147	1.17E+4	9.48E+3	-	5.20E+3	-	1.50E+7	7.34E+2
W-187	3.36E-2	1.99E-2	-	-	-	2.79E+0	8.92E-3
Np-239	4.20E-1	3.02E-2	-	8.73E-2	-	2.23E+3	2.12E-2

Table 3-11
 R_{io}, Vegetation Pathway Dose Factors - ADULT
 (mrem/yr per μCi/m³) for H-3 and C-14
 (m² * mrem/yr per μCi/sec) for others

<u>Nuclide</u>	<u>Bone</u>	<u>Liver</u>	<u>Thyroid</u>	<u>Kidney</u>	<u>Lung</u>	<u>GI-LLI</u>	<u>T.Body</u>
H-3	-	2.26E+3	2.26E+3	2.26E+3	2.26E+3	2.26E+3	2.26E+3
C-14	8.97E+5	1.79E+5	1.79E+5	1.79E+5	1.79E+5	1.79E+5	1.79E+5
Na-24	2.76E+5	2.76E+5	2.76E+5	2.76E+5	2.76E+5	2.76E+5	2.76E+5
P-32	1.40E+9	8.73E+7	-	-	-	1.58E+8	5.42E+7
Cr-51	-	-	2.79E+4	1.03E+4	6.19E+4	1.17E+7	4.66E+4
Mn-54	-	3.11E+8	-	9.27E+7	-	9.54E+8	5.94E+7
Mn-56	-	1.61E+1	-	2.04E+1	-	5.13E+2	2.85E+0
Fe-55	2.09E+8	1.45E+8	-	-	8.06E+7	8.29E+7	3.37E+7
Fe-59	1.27E+8	2.99E+8	-	-	8.35E+7	9.96E+8	1.14E+8
Co-57	-	1.17E+7	-	-	-	2.97E+8	1.95E+7
Co-58	-	3.09E+7	-	-	-	6.26E+8	6.92E+7
Co-60	-	1.67E+8	-	-	-	3.14E+9	3.69E+8
Ni-63	1.04E+10	7.21E+8	-	-	-	1.50E+8	3.49E+8
Ni-65	6.15E+1	7.99E+0	-	-	-	2.03E+2	3.65E+0
Cu-64	-	9.27E+3	-	2.34E+4	-	7.90E+5	4.35E+3
Zn-65	3.17E+8	1.01E+9	-	6.75E+8	-	6.36E+8	4.56E+8
Zn-69	8.75E-6	1.67E-5	-	1.09E-5	-	2.51E-6	1.16E-6
Br-82	-	-	-	-	-	1.73E+6	1.51E+6
Br-83	-	-	-	-	-	4.63E+0	3.21E+0
Br-84	-	-	-	-	-	-	-
Br-85	-	-	-	-	-	-	-
Rb-86	-	2.19E+8	-	-	-	4.32E+7	1.02E+8
Rb-88	-	-	-	-	-	-	-
Rb-89	-	-	-	-	-	-	-
Sr-89	9.96E+9	-	-	-	-	1.60E+9	2.86E+8
Sr-90	6.05E+11	-	-	-	-	1.75E+10	1.48E+11
Sr-91	3.20E+5	-	-	-	-	1.52E+6	1.29E+4
Sr-92	4.27E+2	-	-	-	-	8.46E+3	1.85E+1
Y-90	1.33E+4	-	-	-	-	1.41E+8	3.56E+2
Y-91m	5.83E-9	-	-	-	-	1.71E-8	-
Y-91	5.13E+6	-	-	-	-	2.82E+9	1.37E+5
Y-92	9.01E-1	-	-	-	-	1.58E+4	2.63E-2
Y-93	1.74E+2	-	-	-	-	5.52E+6	4.80E+0
Zr-95	1.19E+6	3.81E+5	-	5.97E+5	-	1.21E+9	2.58E+5
Zr-97	3.33E+2	6.73E+1	-	1.02E+2	-	2.08E+7	3.08E+1
Nb-95	1.42E+5	7.91E+4	-	7.81E+4	-	4.80E+8	4.25E+4
Nb-97	2.90E-6	7.34E-7	-	8.56E-7	-	2.71E-3	2.68E-7
Mo-99	-	6.25E+6	-	1.41E+7	-	1.45E+7	1.19E+6
Tc-99m	3.06E+0	8.66E+0	-	1.32E+2	4.24E+0	5.12E+3	1.10E+2
Tc-101	-	-	-	-	-	-	-

Table 3-11 (continued)
 R_{io}, Vegetation Pathway Dose Factors - ADULT (continued)
 (mrem/yr per μCi/m³) for H-3 and C-14
 (m² * mrem/yr per μCi/sec) for others

<u>Nuclide</u>	<u>Bone</u>	<u>Liver</u>	<u>Thyroid</u>	<u>Kidney</u>	<u>Lung</u>	<u>GI-LLI</u>	<u>T.Body</u>
Ru-103	4.80E+6	-	-	1.83E+7	-	5.61E+8	2.07E+6
Ru-105	5.39E+1	-	-	6.96E+2	-	3.30E+4	2.13E+1
Ru-106	1.93E+8	-	-	3.72E+8	-	1.25E+10	2.44E+7
Rh-103m	-	-	-	-	-	-	-
Rh-106	-	-	-	-	-	-	-
Ag-110m	1.06E+7	9.76E+6	-	1.92E+7	-	3.98E+9	5.80E+6
Sb-124	1.04E+8	1.96E+6	2.52E+5	-	8.08E+7	2.95E+9	4.11E+7
Sb-125	1.36E+8	1.52E+6	1.39E+5	-	1.05E+8	1.50E+9	3.25E+7
Te-125m	9.66E+7	3.50E+7	2.90E+7	3.93E+8	-	3.86E+8	1.29E+7
Te-127m	3.49E+8	1.25E+8	8.92E+7	1.42E+9	-	1.17E+9	4.26E+7
Te-127	5.76E+3	2.07E+3	4.27E+3	2.35E+4	-	4.54E+5	1.25E+3
Te-129m	2.55E+8	9.50E+7	8.75E+7	1.06E+9	-	1.28E+9	4.03E+7
Te-129	6.65E-4	2.50E-4	5.10E-4	2.79E-3	-	5.02E-4	1.62E-4
Te-131m	9.12E+5	4.46E+5	7.06E+5	4.52E+6	-	4.43E+7	3.72E+5
Te-131	-	-	-	-	-	-	-
Te-132	4.29E+6	2.77E+6	3.06E+6	2.67E+7	-	1.31E+8	2.60E+6
I-130	3.96E+5	1.17E+6	9.90E+7	1.82E+6	-	1.01E+6	4.61E+5
I-131	8.09E+7	1.16E+8	3.79E+10	1.98E+8	-	3.05E+7	6.63E+7
I-132	5.74E+1	1.54E+2	5.38E+3	2.45E+2	-	2.89E+1	5.38E+1
I-133	2.12E+6	3.69E+6	5.42E+8	6.44E+6	-	3.31E+6	1.12E+6
I-134	1.06E-4	2.88E-4	5.00E-3	4.59E-4	-	2.51E-7	1.03E-4
I-135	4.08E+4	1.07E+5	7.04E+6	1.71E+5	-	1.21E+5	3.94E+4
Cs-134	4.66E+9	1.11E+10	-	3.59E+9	1.19E+9	1.94E+8	9.07E+9
Cs-136	4.20E+7	1.66E+8	-	9.24E+7	1.27E+7	1.89E+7	1.19E+8
Cs-137	6.36E+9	8.70E+9	-	2.95E+9	9.81E+8	1.68E+8	5.70E+9
Cs-138	-	-	-	-	-	-	-
Ba-139	2.95E-2	2.10E-5	-	1.96E-5	1.19E-5	5.23E-2	8.64E-4
Ba-140	1.29E+8	1.62E+5	-	5.49E+4	9.25E+4	2.65E+8	8.43E+6
Ba-141	-	-	-	-	-	-	-
Ba-142	-	-	-	-	-	-	-
La-140	1.97E+3	9.92E+2	-	-	-	7.28E+7	2.62E+2
La-142	1.40E-4	6.35E-5	-	-	-	4.64E-1	1.58E-5
Ce-141	1.96E+5	1.33E+5	-	6.17E+4	-	5.08E+8	1.51E+4
Ce-143	1.00E+3	7.42E+5	-	3.26E+2	-	2.77E+7	8.21E+1
Ce-144	3.29E+7	1.38E+7	-	8.16E+6	-	1.11E+10	1.77E+6
Pr-143	6.34E+4	2.54E+4	-	1.47E+4	-	2.78E+8	3.14E+3
Pr-144	-	-	-	-	-	-	-
Nd-147	3.34E+4	3.86E+4	-	2.25E+4	-	1.85E+8	2.31E+3
W-187	3.82E+4	3.19E+4	-	-	-	1.05E+7	1.12E+4
Np-239	1.42E+3	1.40E+2	-	4.37E+2	-	2.87E+7	7.72E+1

Table 3-11 (continued)
 R_{io} , Vegetation Pathway Dose Factors - TEENAGER
(mrem/yr per $\mu\text{Ci}/\text{m}^3$) for H-3 and C-14
($\text{m}^2 * \text{mrem}/\text{yr}$ per $\mu\text{Ci}/\text{sec}$) for others

<u>Nuclide</u>	<u>Bone</u>	<u>Liver</u>	<u>Thyroid</u>	<u>Kidney</u>	<u>Lung</u>	<u>GI-LLI</u>	<u>T.Body</u>
H-3	-	2.59E+3	2.59E+3	2.59E+3	2.59E+3	2.59E+3	2.59E+3
C-14	1.45E+6	2.91E+5	2.91E+5	2.91E+5	2.91E+5	2.91E+5	2.91E+5
Na-24	2.45E+5	2.45E+5	2.45E+5	2.45E+5	2.45E+5	2.45E+5	2.45E+5
P-32	1.61E+9	9.96E+7	-	-	-	1.35E+8	6.23E+7
Cr-51	-	-	3.44E+4	1.36E+4	8.85E+4	1.04E+7	6.20E+4
Mn-54	-	4.52E+8	-	1.35E+8	-	9.27E+8	8.97E+7
Mn-56	-	1.45E+1	-	1.83E+1	-	9.54E+2	2.58E+0
Fe-55	3.25E+8	2.31E+8	-	-	1.46E+8	9.98E+7	5.38E+7
Fe-59	1.81E+8	4.22E+8	-	-	1.33E+8	9.98E+8	1.63E+8
Co-57	-	1.79E+7	-	-	-	3.34E+8	3.00E+7
Co-58	-	4.38E+7	-	-	-	6.04E+8	1.01E+8
Co-60	-	2.49E+8	-	-	-	3.24E+9	5.60E+8
Ni-63	1.61E+10	1.13E+9	-	-	-	1.81E+8	5.45E+8
Ni-65	5.73E+1	7.32E+0	-	-	-	3.97E+2	3.33E+0
Cu-64	-	8.40E+3	-	2.12E+4	-	6.51E+5	3.95E+3
Zn-65	4.24E+8	1.47E+9	-	9.41E+8	-	6.23E+8	6.86E+8
Zn-69	8.19E-6	1.56E-5	-	1.02E-5	-	2.88E-5	1.09E-6
Br-82	-	-	-	-	-	-	1.33E+6
Br-83	-	-	-	-	-	-	3.01E+0
Br-84	-	-	-	-	-	-	-
Br-85	-	-	-	-	-	-	-
Rb-86	-	2.73E+8	-	-	-	4.05E+7	1.28E+8
Rb-88	-	-	-	-	-	-	-
Rb-89	-	-	-	-	-	-	-
Sr-89	1.51E+10	-	-	-	-	1.80E+9	4.33E+8
Sr-90	7.51E+11	-	-	-	-	2.11E+10	1.85E+11
Sr-91	2.99E+5	-	-	-	-	1.36E+6	1.19E+4
Sr-92	3.97E+2	-	-	-	-	1.01E+4	1.69E+1
Y-90	1.24E+4	-	-	-	-	1.02E+8	3.34E+2
Y-91m	5.43E-9	-	-	-	-	2.56E-7	-
Y-91	7.87E+6	-	-	-	-	3.23E+9	2.11E+5
Y-92	8.47E-1	-	-	-	-	2.32E+4	2.45E-2
Y-93	1.63E+2	-	-	-	-	4.98E+6	4.47E+0
Zr-95	1.74E+6	5.49E+5	-	8.07E+5	-	1.27E+9	3.78E+5
Zr-97	3.09E+2	6.11E+1	-	9.26E+1	-	1.65E+7	2.81E+1
Nb-95	1.92E+5	1.06E+5	-	1.03E+5	-	4.55E+8	5.86E+4
Nb-97	2.69E-6	6.67E-7	-	7.80E-7	-	1.59E-2	2.44E-7
Mo-99	-	5.74E+6	-	1.31E+7	-	1.03E+7	1.09E+6
Tc-99m	2.70E+0	7.54E+0	-	1.12E+2	4.19E+0	4.95E+3	9.77E+1
Tc-101	-	-	-	-	-	-	-

Table 3-11 (continued)
 R_{io} , Vegetation Pathway Dose Factors - TEENAGER (continued)
(mrem/yr per $\mu\text{Ci}/\text{m}^3$) for H-3 and C-14
($\text{m}^2 * \text{mrem}/\text{yr}$ per $\mu\text{Ci}/\text{sec}$) for others

<u>Nuclide</u>	<u>Bone</u>	<u>Liver</u>	<u>Thyroid</u>	<u>Kidney</u>	<u>Lung</u>	<u>GI-LLI</u>	<u>T.Body</u>
Ru-103	6.87E+6	-	-	2.42E+7	-	5.74E+8	2.94E+6
Ru-105	5.00E+1	-	-	6.31E+2	-	4.04E+4	1.94E+1
Ru-106	3.09E+8	-	-	5.97E+8	-	1.48E+10	3.90E+7
Rh-103m	-	-	-	-	-	-	-
Rh-106	-	-	-	-	-	-	-
Ag-110m	1.52E+7	1.44E+7	-	2.74E+7	-	4.04E+9	8.74E+6
Sb-124	1.55E+8	2.85E+6	3.51E+5	-	1.35E+8	3.11E+9	6.03E+7
Sb-125	2.14E+8	2.34E+6	2.04E+5	-	1.88E+8	1.66E+9	5.00E+7
Te-125m	1.48E+8	5.34E+7	4.14E+7	-	-	4.37E+8	1.98E+7
Te-127m	5.51E+8	1.96E+8	1.31E+8	2.24E+9	-	1.37E+9	6.56E+7
Te-127	5.43E+3	1.92E+3	3.74E+3	2.20E+4	-	4.19E+5	1.17E+3
Te-129m	3.67E+8	1.36E+8	1.18E+8	1.54E+9	-	1.38E+9	5.81E+7
Te-129	6.22E-4	2.32E-4	4.45E-4	2.61E-3	-	3.40E-3	1.51E-4
Te-131m	8.44E+5	4.05E+5	6.09E+5	4.22E+6	-	3.25E+7	3.38E+5
Te-131	-	-	-	-	-	-	-
Te-132	3.90E+6	2.47E+6	2.60E+6	2.37E+7	-	7.82E+7	2.32E+6
I-130	3.54E+5	1.02E+6	8.35E+7	1.58E+6	-	7.87E+5	4.09E+5
I-131	7.70E+7	1.08E+8	3.14E+10	1.85E+8	-	2.13E+7	5.79E+7
I-132	5.18E+1	1.36E+2	4.57E+3	2.14E+2	-	5.91E+1	4.87E+1
I-133	1.97E+6	3.34E+6	4.66E+8	5.86E+6	-	2.53E+6	1.02E+6
I-134	9.59E-5	2.54E-4	4.24E-3	4.01E-4	-	3.35E-6	9.13E-5
I-135	3.68E+4	9.48E+4	6.10E+6	1.50E+5	-	1.05E+5	3.52E+4
Cs-134	7.09E+9	1.67E+10	-	5.30E+9	2.02E+9	2.08E+8	7.74E+9
Cs-136	4.29E+7	1.69E+8	-	9.19E+7	1.45E+7	1.36E+7	1.13E+8
Cs-137	1.01E+10	1.35E+10	-	4.59E+9	1.78E+9	1.92E+8	4.69E+9
Cs-138	-	-	-	-	-	-	-
Ba-139	2.77E-2	1.95E-5	-	1.84E-5	1.34E-5	2.47E-1	8.08E-4
Ba-140	1.38E+8	1.69E+5	-	5.75E+4	1.14E+5	2.13E+8	8.91E+6
Ba-141	-	-	-	-	-	-	-
Ba-142	-	-	-	-	-	-	-
La-140	1.80E+3	8.84E+2	-	-	-	5.08E+7	2.35E+2
La-142	1.28E-4	5.69E-5	-	-	-	1.73E+0	1.42E-5
Ce-141	2.82E+5	1.88E+5	-	8.86E+4	-	5.38E+8	2.16E+4
Ce-143	9.37E+2	6.82E+5	-	3.06E+2	-	2.05E+7	7.62E+1
Ce-144	5.27E+7	2.18E+7	-	1.30E+7	-	1.33E+10	2.83E+6
Pr-143	7.12E+4	2.84E+4	-	1.65E+4	-	2.34E+8	3.55E+3
Pr-144	-	-	-	-	-	-	-
Nd-147	3.63E+4	3.94E+4	-	2.32E+4	-	1.42E+8	2.36E+3
W-187	3.55E+4	2.90E+4	-	-	-	7.84E+6	1.02E+4
Np-239	1.38E+3	1.30E+2	-	4.09E+2	-	2.10E+7	7.24E+1

Table 3-11 (continued)
 R_{io} , Vegetation Pathway Dose Factors - CHILD
(mrem/yr per $\mu\text{Ci}/\text{m}^3$) for H-3 and C-14
($\text{m}^2 * \text{mrem}/\text{yr}$ per $\mu\text{Ci}/\text{sec}$) for others

<u>Nuclide</u>	<u>Bone</u>	<u>Liver</u>	<u>Thyroid</u>	<u>Kidney</u>	<u>Lung</u>	<u>GI-LLI</u>	<u>T.Body</u>
H-3	-	4.01E+3	4.01E+3	4.01E+3	4.01E+3	4.01E+3	4.01E+3
C-14	3.50E+6	7.01E+5	7.01E+5	7.01E+5	7.01E+5	7.01E+5	7.01E+5
Na-24	3.83E+5	3.83E+5	3.83E+5	3.83E+5	3.83E+5	3.83E+5	3.83E+5
P-32	3.37E+9	1.58E+8	-	-	-	9.30E+7	1.30E+8
Cr-51	-	-	6.54E+4	1.79E+4	1.19E+5	6.25E+6	1.18E+5
Mn-54	-	6.61E+8	-	1.85E+8	-	5.55E+8	1.76E+8
Mn-56	-	1.90E+1	-	2.29E+1	-	2.75E+3	4.28E+0
Fe-55	8.00E+8	4.24E+8	-	-	2.40E+8	7.86E+7	1.31E+8
Fe-59	4.01E+8	6.49E+8	-	-	1.88E+8	6.76E+8	3.23E+8
Co-57	-	2.99E+7	-	-	-	2.45E+8	6.04E+7
Co-58	-	6.47E+7	-	-	-	3.77E+8	1.98E+8
Co-60	-	3.78E+8	-	-	-	2.10E+9	1.12E+9
Ni-63	3.95E+10	2.11E+9	-	-	-	1.42E+8	1.34E+9
Ni-65	1.05E+2	9.89E+0	-	-	-	1.21E+3	5.77E+0
Cu-64	-	1.11E+4	-	2.68E+4	-	5.20E+5	6.69E+3
Zn-65	8.12E+8	2.16E+9	-	1.36E+9	-	3.80E+8	1.35E+9
Zn-69	1.51E-5	2.18E-5	-	1.32E-5	-	1.38E-3	2.02E-6
Br-82	-	-	-	-	-	-	2.04E+6
Br-83	-	-	-	-	-	-	5.55E+0
Br-84	-	-	-	-	-	-	-
Br-85	-	-	-	-	-	-	-
Rb-86	-	4.52E+8	-	-	-	2.91E+7	2.78E+8
Rb-88	-	-	-	-	-	-	-
Rb-89	-	-	-	-	-	-	-
Sr-89	3.59E+10	-	-	-	-	1.39E+9	1.03E+9
Sr-90	1.24E+12	-	-	-	-	1.67E+10	3.15E+11
Sr-91	5.50E+5	-	-	-	-	1.21E+6	2.08E+4
Sr-92	7.28E+2	-	-	-	-	1.38E+4	2.92E+1
Y-90	2.30E+4	-	-	-	-	6.56E+7	6.17E+2
Y-91m	9.94E-9	-	-	-	-	1.95E-5	-
Y-91	1.87E+7	-	-	-	-	2.49E+9	5.01E+5
Y-92	1.56E+0	-	-	-	-	4.51E+4	4.46E-2
Y-93	3.01E+2	-	-	-	-	4.48E+6	8.25E+0
Zr-95	3.90E+6	8.58E+5	-	1.23E+6	-	8.95E+8	7.64E+5
Zr-97	5.64E+2	8.15E+1	-	1.17E+2	-	1.23E+7	4.81E+1
Nb-95	4.10E+5	1.59E+5	-	1.50E+5	-	2.95E+8	1.14E+5
Nb-97	4.90E-6	8.85E-7	-	9.82E-7	-	2.73E-1	4.13E-7
Mo-99	-	7.83E+6	-	1.67E+7	-	6.48E+6	1.94E+6
Tc-99m	4.65E+0	9.12E+0	-	1.33E+2	4.63E+0	5.19E+3	1.51E+2
Tc-101	-	-	-	-	-	-	-

Table 3-11 (continued)
 R_{io} , Vegetation Pathway Dose Factors - CHILD (continued)
(mrem/yr per $\mu\text{Ci}/\text{m}^3$) for H-3 and C-14
($\text{m}^2 * \text{mrem}/\text{yr}$ per $\mu\text{Ci}/\text{sec}$) for others

<u>Nuclide</u>	<u>Bone</u>	<u>Liver</u>	<u>Thyroid</u>	<u>Kidney</u>	<u>Lung</u>	<u>GI-LLI</u>	<u>T.Body</u>
Ru-103	1.55E+7	-	-	3.89E+7	-	3.99E+8	5.94E+6
Ru-105	9.17E+1	-	-	8.06E+2	-	5.98E+4	3.33E+1
Ru-106	7.45E+8	-	-	1.01E+9	-	1.16E+10	9.30E+7
Rh-103m	-	-	-	-	-	-	-
Rh-106	-	-	-	-	-	-	-
Ag-110m	3.22E+7	2.17E+7	-	4.05E+7	-	2.58E+9	1.74E+7
Sb-124	3.52E+8	4.57E+6	7.78E+5	-	1.96E+8	2.20E+9	1.23E+8
Sb-125	4.99E+8	3.85E+6	4.62E+5	-	2.78E+8	1.19E+9	1.05E+8
Te-125m	3.51E+8	9.50E+7	9.84E+7	-	-	3.38E+8	4.67E+7
Te-127m	1.32E+9	3.56E+8	3.16E+8	3.77E+9	-	1.07E+9	1.57E+8
Te-127	1.00E+4	2.70E+3	6.93E+3	2.85E+4	-	3.91E+5	2.15E+3
Te-129m	8.54E+8	2.39E+8	2.75E+8	2.51E+9	-	1.04E+9	1.33E+8
Te-129	1.15E-3	3.22E-4	8.22E-4	3.37E-3	-	7.17E-2	2.74E-4
Te-131m	1.54E+6	5.33E+5	1.10E+6	5.16E+6	-	2.16E+7	5.68E+5
Te-131	-	-	-	-	-	-	-
Te-132	6.98E+6	3.09E+6	4.50E+6	2.87E+7	-	3.11E+7	3.73E+6
I-130	6.21E+5	1.26E+6	1.38E+8	1.88E+6	-	5.87E+5	6.47E+5
I-131	1.43E+8	1.44E+8	4.76E+10	2.36E+8	-	1.28E+7	8.18E+7
I-132	9.20E+1	1.69E+2	7.84E+3	2.59E+2	-	1.99E+2	7.77E+1
I-133	3.59E+6	4.44E+6	8.25E+8	7.40E+6	-	1.79E+6	1.68E+6
I-134	1.70E-4	3.16E-4	7.28E-3	4.84E-4	-	2.10E-4	1.46E-4
I-135	6.54E+4	1.18E+5	1.04E+7	1.81E+5	-	8.98E+4	5.57E+4
Cs-134	1.60E+10	2.63E+10	-	8.14E+9	2.92E+9	1.42E+8	5.54E+9
Cs-136	8.06E+7	2.22E+8	-	1.18E+8	1.76E+7	7.79E+6	1.43E+8
Cs-137	2.39E+10	2.29E+10	-	7.46E+9	2.68E+9	1.43E+8	3.38E+9
Cs-138	-	-	-	-	-	-	-
Ba-139	5.11E-2	2.73E-5	-	2.38E-5	1.61E-5	2.95E+0	1.48E-3
Ba-140	2.77E+8	2.43E+5	-	7.90E+4	1.45E+5	1.40E+8	1.62E+7
Ba-141	-	-	-	-	-	-	-
Ba-142	-	-	-	-	-	-	-
La-140	3.23E+3	1.13E+3	-	-	-	3.15E+7	3.81E+2
La-142	2.32E-4	7.40E-5	-	-	-	1.47E+1	2.32E-5
Ce-141	1.23E+5	6.14E+4	-	2.69E+4	-	7.66E+7	9.12E+3
Ce-143	1.73E+3	9.36E+5	-	3.93E+2	-	1.37E+7	1.36E+2
Ce-144	1.27E+8	3.98E+7	-	2.21E+7	-	1.04E+10	6.78E+6
Pr-143	1.48E+5	4.46E+4	-	2.41E+4	-	1.60E+8	7.37E+3
Pr-144	-	-	-	-	-	-	-
Nd-147	7.16E+4	5.80E+4	-	3.18E+4	-	9.18E+7	4.49E+3
W-187	6.47E+4	3.83E+4	-	-	-	5.38E+6	1.72E+4
Np-239	2.55E+3	1.83E+2	-	5.30E+2	-	1.36E+7	1.29E+2

Table 3-12
 R_{io}, Ground Plane Pathway Dose Factors
 (m² * mrem/yr per μCi/sec)

<u>Nuclide</u>	<u>Any Organ</u>	<u>Nuclide</u>	<u>Any Organ</u>
-		Rh-103m	-
C-14	-	Rh-106	-
Na-24	1.21E+7	Ag-110m	3.47E+9
P-32	-	Te-125m	1.55E+6
Cr-51	4.68E+6	Te-127m	9.17E+4
Mn-54	1.34E+9	Te-127	3.00E+3
Mn-56	9.05E+5	Te-129m	2.00E+7
Fe-55	-	Te-129	2.60E+4
Fe-59	2.75E+8	Te-131m	8.03E+6
Co-58	3.82E+8	Te-131	2.93E+4
Co-60	2.16E+10	Te-132	4.22E+6
Ni-63	-	I-130	5.53E+6
Ni-65	2.97E+5	I-131	1.72E+7
Cu-64	6.09E+5	I-132	1.24E+6
Zn-65	7.45E+8	I-133	2.47E+6
Zn-69	-	I-134	4.49E+5
Br-83	4.89E+3	I-135	2.56E+6
Br-84	2.03E+5	Cs-134	6.75E+9
Br-85	-	Cs-136	1.49E+8
Rb-86	8.98E+6	Cs-137	1.04E+10
Rb-88	3.29E+4	Cs-138	3.59E+5
Rb-89	1.21E+5	Ba-139	1.06E+5
Sr-89	2.16E+4	Ba-140	2.05E+7
Sr-90	-	Ba-141	4.18E+4
Sr-91	2.19E+6	Ba-142	4.49E+4
Sr-92	7.77E+5	La-140	1.91E+7
Y-90	4.48E+3	La-142	7.36E+5
Y-91m	1.01E+5	Ce-141	1.36E+7
Y-91	1.08E+6	Ce-143	2.32E+6
Y-92	1.80E+5	Ce-144	6.95E+7
Y-93	1.85E+5	Pr-143	-
Zr-95	2.48E+8	Pr-144	1.83E+3
Zr-97	2.94E+6	Nd-147	8.40E+6
Nb-95	1.36E+8	W-187	2.36E+6
Mo-99	4.05E+6	Np-239	1.71E+6
Tc-99m	1.83E+5		
Tc-101	2.04E+4		
Ru-103	1.09E+8		
Ru-105	6.36E+5		
Ru-106	4.21E+8		

Figure 3-1
Gaseous Radioactive Effluent Monitoring and Ventilation Systems Diagram

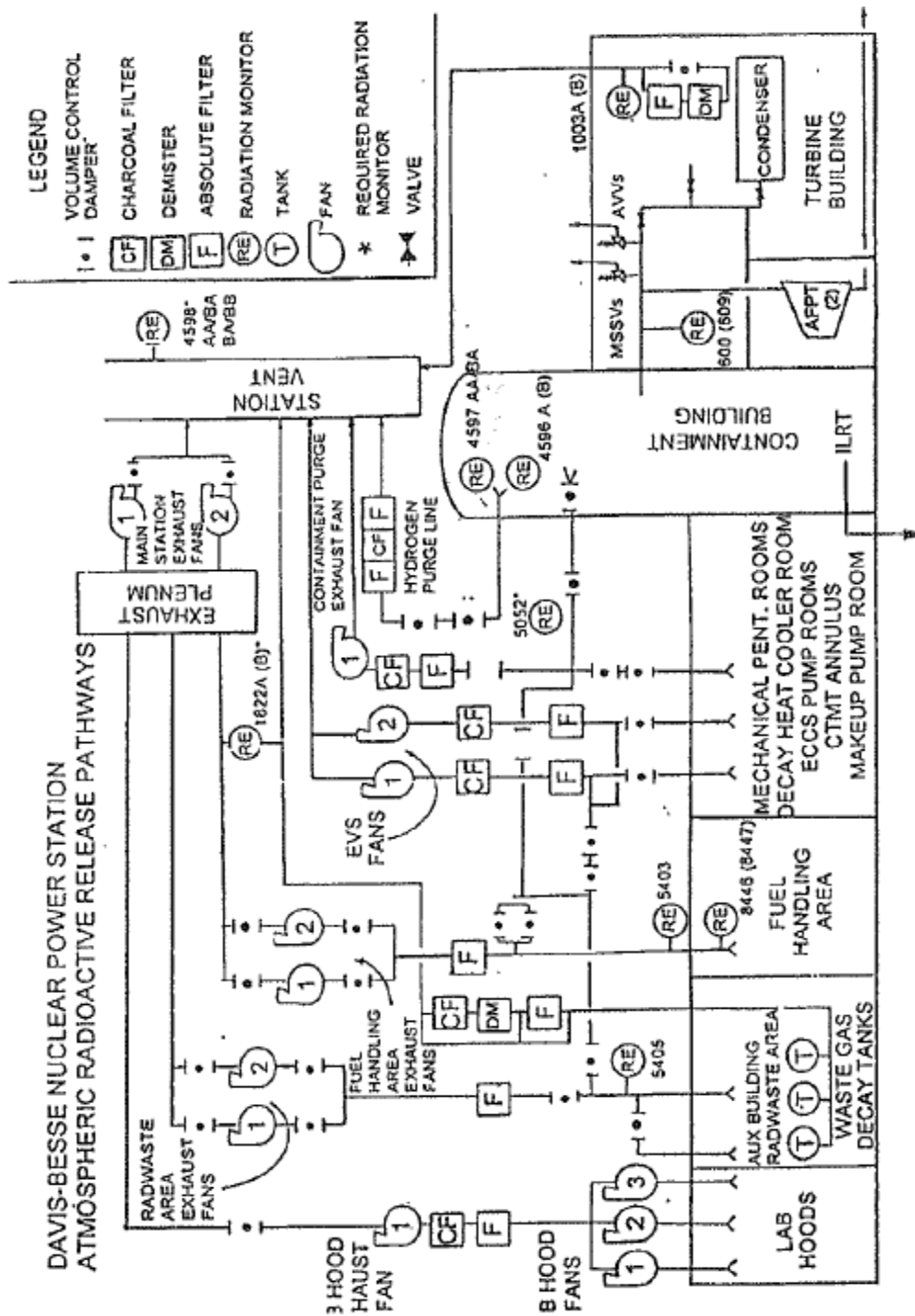

4.0 SPECIAL DOSE ANALYSES

4.1 DOSES TO THE PUBLIC DUE TO ACTIVITIES INSIDE THE UNRESTRICTED AREA BOUNDARY

In accordance with Section 7.2, the Radioactive Effluent Release Report shall include an assessment of radiation doses from radioactive liquid and gaseous effluents to MEMBERS OF THE PUBLIC due to their activities inside the UNRESTRICTED AREA BOUNDARY.

In special instances MEMBERS OF THE PUBLIC are permitted access to the radiologically restricted area within the Davis-Besse station. Tours for the public are conducted with the assurance that no individual will receive an appreciable dose (i.e., small fraction of the 40 CFR 190 dose standards).

The Wellness Center, located inside the DBNPS Controlled Area and therefore within the UNRESTRICTED AREA BOUNDARY, is also accessible to MEMBERS OF THE PUBLIC. Considering the frequency and duration of visits, the resultant dose would be a fraction of the calculated maximum UNRESTRICTED AREA BOUNDARY unrestricted area dose. The dose from airborne effluents and the direct "shine" from the Independent Spent Fuel Storage Installation (ISFSI) and the Old Steam Generator Storage Facility (OSGSF) are considered. The direct "shine" from normal Plant operation and the OSGSF is negligible. This combination is considered the controlling factor when evaluating doses to MEMBERS OF THE PUBLIC from activities inside the UNRESTRICTED AREA BOUNDARY.

For purposes of assessing the dose to MEMBERS OF THE PUBLIC in accordance with Technical Specification 5.6.2 and ODCM Section 7.2, the following exposure assumptions may be used:

- Exposure time for maximum exposed visitor user of the Wellness Center of 250 hours (1 h/day, 5 day/wk, 50 wk/yr).*
- For noble gas direct exposure, default use of the maximum UNRESTRICTED AREA BOUNDARY dispersion from table 3-6.
- For Inhalation Pathway, default use of the maximum UNRESTRICTED AREA BOUNDARY dispersion from Table 3-6.
- For Direct "Shine" from the ISFSI, default use of the maximum dose rate for a completed (full) ISFSI, and a distance of 950 feet.

Additional locations within the Unrestricted Area boundary with periodic public access include the pavilion and associated pond area and the Training Center pond. Considering the assumptions above for the Wellness Center, any potential doses to Members of the public from activities at the pavilion and associated pond will be less than those assessed for the Wellness Center. The assumed exposure time of 67 h/y for activities at the pavilion and on-site fishing is a fraction of the 250 h/y assumed for the Wellness Center. The pavilion and associated pond area are located in the southwest sector relative to the reactor, and this is not a prevailing wind direction. Therefore, the dispersion factor will be lower for the pavilion area than for the Wellness Center.

* Based on a maximum conservative estimate.

Extrapolating from historical meteorological data*, the annual average dispersion (considered ground level) for the Wellness Center, is approximately $2E-05 \text{ sec/m}^3$. The Wellness Center is controlling and poses the highest potential dose to Members of the Public from activities inside the Unrestricted Area boundary from a dose modeling standpoint.

For purposes of evaluating any direct exposure component, the Wellness Center is closer to the Borated Water Storage Tank and the ISFSI than are the pavilion and associated pond area or the Training Center pond. The evaluation of the direct exposure component at the Wellness Center remains conservative. The Pavilion and associated pond area and the Training Center Pond are located closer to the OSGSF than is the Wellness Center, however, direct exposure at these locations is still considered negligible.

The equations in Section 4.2 may be used for calculating the potential dose to a MEMBER OF THE PUBLIC for activities inside the UNRESTRICTED AREA BOUNDARY. Based on these assumptions, this dose would be at least a factor of 35 less than the maximum UNRESTRICTED AREA BOUNDARY air dose as calculated in Section 3.7.

Public access is periodically allowed to areas on-site for the purposes of recreational activities. During company sponsored events, Members of the Public may be allowed to fish at the Training Center pond. However, since the pond communicates with a release path of potential liquid effluents from the plant, the potential dose to individuals during these activities has been evaluated. Fishing is only allowed under a "catch-and-release" program; therefore, the fish pathway is not considered applicable. For the Training Center pond, releases via the Storm Sewer Drains could pose an exposure pathway from shoreline deposition. In the past, releases to the pond have been negligible, with radioactivity levels ranging from non-detectable to very low levels of tritium and cesium. Therefore, based on historical effluents, a significant exposure pathway does not exist. If releases were to occur, this pathway would be evaluated.

* Chesapeake Nuclear Services report, Davis-Besse Nuclear Power Station Meteorological and Atmospheric Dispersion Report, November 2017.

The following equation, adapted from Regulatory Guide 1.109, provides a conservative estimate for this calculation:

$$D_{shore,o} = \frac{1.67E-02 * VOL}{DF} * \sum C_i * A_{shore,i}$$

where:

$D_{shore,o}$ = dose to total body or any organ from shoreline exposure (mrem)

VOL = volume of undiluted liquid effluent to the pond (gal)

DF = dilution flow, average flow from the SSD to the pond during the time period of measurable levels being released to the pond (gal/min)

C_i = concentration of radionuclide i in SSD to the pond

$A_{shore,i}$ = site-specific shoreline dose conversion factor for the total body and any organ (mrem/h per μ Ci/ml, from Table 2-8)

1.67E-02 = conversion factor (hour per minute)

Table 28 provides the $A_{shore,i}$ values that were calculated using Regulatory Guide 1.109 modeling.

4.2 DOSES TO MEMBERS OF THE PUBLIC - 40 CFR 190

As required by and ODCM Section 7.2, the Radioactive Effluent Release Report shall also include an assessment of the radiation dose to the likely most exposed MEMBER OF THE PUBLIC for reactor releases and other nearby uranium fuel cycle sources (including dose contributions from effluents and direct radiation from onsite sources). For the likely most exposed MEMBER OF THE PUBLIC in the vicinity of the Davis-Besse site, the sources of exposure need consider only the radioactive effluents and direct exposure contribution from Davis-Besse. No other fuel cycle facilities contribute significantly to the cumulative dose to a MEMBER OF THE PUBLIC in the immediate vicinity of the site. Fermi-2 is the closest fuel cycle facility located about 20 miles to the NNW. Due to environmental dispersion, any routine releases from Fermi-2 would contribute insignificantly to the potential doses in the vicinity of Davis-Besse.

The correlation of measured plant effluents with pathway modeling of this ODCM provide the primary method for demonstrating/evaluating compliance with the limits specified below (40 CFR 190). However, as appropriate, the results of the environmental monitoring program may be used to provide additional data on actual measured levels of radioactive material in the actual pathways of exposure. ODCM Section 4.2.3 discusses the methodology for correlating measured levels of radioactive material in environmental pathway samples with potential doses. Also, results of the Land Use Census may be used to determine actual exposure pathways and locations.

The annual (calendar year) dose or dose commitment to any MEMBER OF THE PUBLIC due to releases of radioactivity and to radiation from uranium fuel cycle sources shall be limited to less than or equal to 25 mrem to the total body or any organ, except the thyroid, which shall be limited to less than or equal to 75 mrem.

With the calculated doses from the releases of radioactive materials in liquid or gaseous effluents exceeding twice the limits of Sections 2.4.1, 3.7.1, and 3.8.1, evaluations should be made including direct radiation contributions from the reactor unit, from the Old Steam Generator Storage Facility (OSGSF) and from outside storage tanks to determine whether the above limits of this Section have been exceeded. If such is the case, prepare and submit to the Commission within 60 days, pursuant to Section 7.3, a Licensee Event Report that defines the corrective action to be taken to reduce subsequent releases to prevent recurrence of exceeding the above limits and includes the schedule for achieving conformance with the above limits. This report, as defined in 10 CFR Part 20.2203, shall include an analysis that estimates the radiation exposure (dose) to a MEMBER OF THE PUBLIC from uranium fuel cycle sources, including all effluent pathways and direct radiation, for the calendar year that includes the release(s) covered by this report. It shall also describe levels of radiation and concentrations of radioactive material involved, and the cause of the exposure levels or concentrations. If the estimated dose(s) exceeds the above limits, and if the release condition resulting in violation of 40 CFR Part 190 has not already been corrected, the report shall include a request for a variance in accordance with the provisions of 40 CFR Part 190. Submittal of the report is considered a timely request, and a variance is granted until staff action on the request is complete.

This requirement is provided to meet the dose limitations of 40 CFR Part 190 that have been incorporated into 10 CFR Part 20 by 46 FR 18525. The requirement requires the preparation and submittal of a report whenever the calculated doses from plant generated radioactive effluents and direct radiation exceed 25 mrem to the total body or any organ, except the thyroid, which shall be limited to less than or equal to 75 mrem.

It is highly unlikely that the resultant dose to a MEMBER OF THE PUBLIC will exceed the dose limits of 40 CFR Part 190 if the reactor remains within twice the dose design objectives of Appendix I, and if direct radiation doses from the reactor and outside storage tanks are kept small. The report will describe a course of action that should result in the limitation of the annual dose to a MEMBER OF THE PUBLIC to within the 40 CFR Part 190 limits. For the purposes of the report, it may be assumed that the dose commitment to the MEMBER OF THE PUBLIC from other uranium fuel cycle sources is negligible, with the exception that the dose contributions from other nuclear fuel cycle facilities at the same site or within a radius of 8 km must be considered. If a dose to any MEMBER OF THE PUBLIC is estimated to exceed the requirements of 40 CFR 190, the report with a request for variance (provided the release conditions resulting in violation of 40 CFR Part 190 have not already been corrected), in accordance with the provisions of 40 CFR Part 190.11 and 10 CFR Part 20.405c, is considered to be a timely request and fulfills the requirements of 40 CFR Part 190 until NRC staff action is completed. The variance only relates to the limits of 40 CFR Part 190, and does not apply in any way to the other dose requirements for dose limitation of 10 CFR Part 20, as addressed in Sections 2.2 and 3.3.1. An individual is not considered a MEMBER OF THE PUBLIC during any period in which he/she is engaged in carrying out any operation that is a part of the nuclear fuel cycle.

4.2.1 Effluent Dose Calculations

For purposes of implementing the above requirements of determining the cumulative dose contribution from liquid and gaseous effluents in accordance with Sections 2 and 3 and the reporting requirements of Section 7, dose calculations for Davis-Besse may be performed using the calculational methods contained within this ODCM; the conservative controlling pathways and locations of Table 3-6 or the actual pathways and locations as identified by the Land Use Census may be used. Liquid pathway doses may be calculated using equations in ODCM Section 2.4. Doses due to releases of radioiodines, tritium and particulates are calculated based on equations in Section 3.8.

The following equations may be used for calculating the dose to MEMBERS OF THE PUBLIC from releases of noble gases:

$$D_{tb} = 3.17E - 08 * \frac{U}{8760} * \chi / Q * \Sigma (K_i * Q_i) \quad (4-1)$$

and

$$D_s = 3.17E - 08 * U * \chi / Q * \Sigma ((L_i + 1.1 M_i) * Q_i) \quad (4-2)$$

where:

D_{tb}	=	total body dose due to gamma emissions for noble gas radionuclides (mrem)
D_s	=	skin dose due to gamma and beta emissions for noble gas radionuclides (mrem)
U	=	duration of exposure (hr/yr, default values in Table 4-1)
χ/Q	=	atmospheric dispersion to the offsite location (sec/m ³)
Q_i	=	cumulative release of noble gas radionuclide i over the period of interest (μ Ci)
K_i	=	total body dose factor due to gamma emissions from noble gas radionuclide i from Table 3-5 (mrem/yr per μ Ci/m ³)
L_i	=	skin dose factor due to beta emissions from noble gas radionuclide i from Table 3-5 (mrem/yr per μ Ci/m ³)
M_i	=	gamma air dose factor for noble gas radionuclide i from Table 3-5 (mrad/yr per μ Ci/m ³)
8760	=	hours per year
1.1	=	mrem skin dose per mrad gamma air dose (mrem/mrad)
3.17E-08	=	1/3.15E+07 yr/sec

Average annual meteorological dispersion parameters or meteorological conditions concurrent with the release period under evaluation may be used (e.g., quarterly averages or year-specific annual averages).

4.2.2 Direct Exposure Dose Determination - Onsite Sources

Any potentially significant direct exposure contribution from onsite sources to offsite individual doses may be evaluated based on the results of the environmental measurements (e.g., TLD, ion chamber measurements) or by the use of a radiation transport and shielding calculational method. Only during atypical conditions will there exist any potential for significant onsite sources at Davis-Besse that would yield potentially significant offsite doses to a MEMBER OF THE PUBLIC. However, should a situation exist whereby the direct exposure contribution is potentially significant, onsite measurements, offsite measurements and calculational techniques will be used for determination of dose for assessing 40 CFR 190 compliance.

The following simplified method may be used for evaluating the direct dose based on onsite or site boundary measurements:

$$D_{L,\theta} = D_{B,\theta} \frac{(X_{B,\theta})^2}{(X_{L,\theta})^2} \quad (4-3)$$

where:

- $D_{B,\theta}$ = direct radiation dose measured at location B (onsite or site boundary) in sector θ
- $D_{L,\theta}$ = extrapolated dose at location L in same sector θ
- $X_{L,\theta}$ = distance to the location L from the radiation source
- $X_{B,\theta}$ = distance to location B from the radiation source

4.2.3 Dose Assessment Based on Radiological Environmental Monitoring Data

Normally, the assessment of potential doses to MEMBERS OF THE PUBLIC must be calculated based on the measured radioactive effluents at the plant. The resultant levels of radioactive material in the offsite environment are so minute as to be undetectable. The calculational methods as presented in this ODCM are used for modeling the transport in the environment and the resultant exposure to offsite individuals.

The results of the radiological environmental monitoring program can provide input into the overall assessment of impact of plant operations and radioactive effluents. With measured levels of plant related radioactive material in principal pathways of exposure, a quantitative assessment of potential exposures can be performed. With the monitoring program not identifying any measurable levels, the data provides a qualitative assessment - a confirmatory demonstration of the negligible impact.

Dose modeling can be simplified into three basic parameters that can be applied in using environmental monitoring data for dose assessment.

$$D = C * U * DF \quad (4-4)$$

where:

- D = dose or dose commitment
- C = concentration in the exposure media, such as air concentration for the inhalation pathway, or fish, vegetation or milk concentration for the ingestion pathway
- U = individual exposure to the pathway, such as hr/yr for direct exposure, kg/yr for ingestion pathway
- DF = dose conversion factor to convert from an exposure or uptake to an individual dose or dose commitment

The applicability of each of these basic modeling parameters to the use of environmental monitoring data for dose assessment is addressed below:

Concentration - C

The main value of using environmental sampling data to assess potential doses to individuals is that the data represents actual measured levels of radioactive material in the exposure pathways. This eliminates one main uncertainty in the modeling - the release from the plant and the transport to the environmental exposure medium.

Environmental samples are collected on a routine frequency (e.g., weekly airborne particulate samples, monthly vegetable samples, annual fish samples). To determine the annual average concentration in the environmental medium for use in assessing cumulative dose for the year, an average concentration should be determined based on the sampling frequency and measured levels.

$$\bar{C}_i = \Sigma (C_i * t) / 365 \quad (4-5)$$

where:

- \bar{C}_i = average concentration in the sampling medium for the year
- C_i = concentration of each radionuclide i measured in the individual sampling medium
- t = period of time that the measured concentration is considered representative of the sampling medium (typically equal to the sampling frequency; e.g., 7 days for weekly samples, 30 days for monthly samples).

If the concentration in the sampling medium is below the detection capabilities (i.e., less than lower limits of detection -LLD), a value of zero should be used for C_i ($C_i = 0$).

Exposure - U

Default exposure values (U) as recommended in Regulatory Guide 1.109 are presented in Table 4-1. These values should be used only when specific data applicable to the environmental pathway being evaluated is unavailable.

Also, the routine radiological environmental monitoring program is designed to sample/monitor the environmental media that would provide early indications of any measurable levels in the environment but not necessarily levels to which any individual is exposed. For example, sediment samples are collected in the area of the liquid discharge: typically, no individuals are directly exposed. To apply the measured levels of radioactivity in samples that are not directly applicable to exposure to real individuals, the approach recommended is to correlate the location and measured levels to actual locations of exposure. Hydrological or atmospheric dilution factors can be used to provide reasonable correlations of concentrations (and doses) at other locations. The other alternative is to conservatively assume a hypothetical individual at the sampling location. Doses that are calculated in this manner should be presented as hypothetical and very conservatively determined - actual exposure would be much less. Samples collected from nearby wells or actual water supply intake (e.g., Port Clinton) should be used for estimating the potential drinking water doses. Other water samples collected, such as near field dilution area, are not applicable to this pathway.

Dose Factors - DF

The dose factors are used to convert the intake of the radioactive material to an individual dose commitment. Values of the dose factors are presented in NRC Regulatory Guide 1.109. The use of the Regulatory Guide 1.109 values applicable to the exposure pathway and maximum exposed individual is referenced in Table 4-1.

4.2.4 Use of Environmental TLD for Assessing Doses Due to Noble Gas Releases

Thermoluminescent dosimeters (TLD) are routinely used to assess the direct exposure component of radiation doses in the environment. However, because routine releases of radioactive material (noble gases) are so low, the resultant direct exposure doses are also very low. A study* performed for the NRC concluded that it is possible to determine a plant contribution to the natural background radiation levels (direct exposure) of around 10 mrem per year (by optimum methods and high precision data). Therefore, for routine releases from nuclear power plants the use of TLD is mainly confirmatory - ensuring actual exposures are within the expected natural background variation.

For releases of noble gases, environmental modeling using plant measured releases and atmospheric transport models as presented in this ODCM represents the best method of assessing potential environmental doses. However, any observed variations in TLD measurements outside the norm should be evaluated.

* NUREG/CR-0711, Evaluation of Methods for the Determination of X- and Gamma-Ray Exposure Attributable to a Nuclear Facility Using Environmental TLD Measurements, Gail dePlanque, June 1979, USNRC.

Table 4-1

Recommended Exposure Rates in Lieu of Site Specific Data*

<u>Exposure Pathway</u>	<u>Maximum Exposed Age Group</u>	<u>Exposure Rates</u>	<u>Table Reference for Dose Factors from RG 1.109</u>
<u>Liquid Releases</u>			
Fish	Adult	21 kg/y	E-11
Drinking Water	Adult	730 l/y	E-11
Bottom Sediment	Teen	67 h/y	E-6
<u>Atmospheric Releases</u>			
Inhalation	Teen	8,000 m ³ /y	E-8
Direct Exposure	All	6,100 h/y**	N/A (ODCM Table 3-5)
Leafy Vegetables	Child	26 kg/y	E-13
Fruits, Vegetables & Grain	Teen	630 kg/y	E-12
Milk	Infant	330 l/y	E-14

* Adapted from Regulatory Guide 1.109, Table E-5

** Net exposure of 6,100 h/y is based on the total 8760 hours per year adjusted by a 0.7 shielding factor as recommended in Regulatory Guide 1.109.

5.0 ASSESSMENT OF LAND USE CENSUS DATA

A Land Use Census (LUC) is conducted annually in the vicinity of the Davis-Besse site. This census fulfills two main purposes: 1) meet requirements of the Radiological Environmental Monitoring Program (as required by 10 CFR 50, Appendix I, Section IV.B.3) for identifying controlling location/pathway for dose assessment of ODCM Section 3.8.1; and 2) provide data on actual exposure pathways for assessing realistic doses to MEMBERS OF THE PUBLIC.

5.1 LAND USE CENSUS REQUIREMENTS

A land use census shall be conducted during the growing season at least once per twelve months using that information that will provide the best results, such as by a door-to-door survey, aerial survey, or by consulting local agricultural authorities. The Land Use Census shall identify within a distance of 8 km (5 miles) the location, in each of the 16 meteorological sectors, of the nearest milk animal, the nearest residence and the nearest garden of greater than 50 m² (500 ft²) producing broad leaf vegetation. This requirement is provided to ensure that changes in the use of UNRESTRICTED AREAS are identified and that modifications to the monitoring program are made if required by the results of this census. This census satisfies the requirements of Section IV.B.3 of Appendix I to 10 CFR Part 50. Restricting the census to gardens of greater than 50 m² (500 ft²) provides assurance that significant exposure pathways via leafy vegetables will be identified and monitored. A garden of this size is the minimum required to produce the quantity (26 kg/year) of leafy vegetables assumed in Regulatory Guide 1.109 for consumption by a child. To determine this minimum garden size, the following assumptions were made: (1) 20% of the garden was used for growing broad leaf vegetation (i.e., similar to lettuce and cabbage), and (2) a vegetation yield of 2 kg/m².

The data from the Land Use Census is used for updating the location/pathway for dose assessment and for updating the Radiological Environmental Monitoring Program. The results of the Land Use Census shall be included in the Annual Radiological Environmental Operating Report pursuant to Section 7.1.

With a Land Use Census identifying a location(s) that yields a calculated dose or dose commitment greater than the values currently being calculated in Sections 3.8.1, identify the new locations(s) in the next Radioactive Effluent Release Report, pursuant to Section 7.2. With a Land Use Census identifying a locations(s) that yields a calculated dose or dose commitment (via the same exposure pathway) 20 percent greater than that at a location from which samples are currently being obtained in accordance with Section 6.1, add the new locations(s) if practical (and readily obtainable) to the Radiological Environmental Monitoring Program within 30 days. The sampling locations(s), excluding the control station location, having a lower calculated dose or dose commitment(s), via the same exposure pathway, may be deleted from this monitoring program. Identify the new location(s) in the next Radioactive Effluent Release Report and also include in the report a revised figure(s) and table for the ODCM reflecting the new location(s).

The following guidelines shall be used for assessing the results from the Land Use Census to ensure compliance with this Section.

5.1.1 Data Compilation

- A. Locations and pathways of exposure as identified by the Land Use Census will be compiled for comparison with the current locations as presented in Table 3-4.
- B. Changes from the previous year's census will be identified. Also, any location/pathway not currently included in the Radiological Environmental Monitoring Program (Table 6-2) will be identified.
- C. Historical, annual average meteorological dispersion parameters (χ/Q , D/Q) for any new location (i.e., location not previously identified and/or evaluated) will be determined. All locations should be evaluated against the same historical meteorological data set.

5.1.2 Relative Dose Significance

- A. For all new locations, the relative dose significance will be determined by applicable pathways of exposure.
- B. Relative dose calculations should be based on a generic radionuclide distribution (e.g., Davis-Besse USAR gaseous effluent source term or past year actual effluents). An I-131 source term dose may be used for assessment of the maximum organ ingestion pathway dose because of its overwhelming contribution to the total dose relative to the other particulates.
- C. The pathway dose equations of the ODCM should be used.

5.1.3 Data Evaluation

- A. The controlling location used in the ODCM Table 3-4 will be verified. If any location/pathway(s) is identified with a higher relative dose, this location/pathway(s) should replace the previously identified controlling location/pathway in Table 3-4. If the previously identified controlling pathway is no longer present, the current controlling location/pathway should be determined.
- B. Any changes in either the controlling location/pathway(s) of the ODCM dose calculations (Section 3.7 and Table 3-4) or the Radiological Environmental Monitoring Program (ODCM Section 6.0 and Table 6-2) shall be reported to NRC in accordance with ODCM Section 5.1 and 7.2.

5.2 LAND USE CENSUS TO SUPPORT REALISTIC DOSE ASSESSMENT

The Land Use Census (LUC) provides data needed to support the special dose analyses of Section 4.0. Activities inside the UNRESTRICTED AREA BOUNDARY should be periodically reviewed for dose assessment as required by Section 4.1. Assessment of realistic doses to MEMBERS OF THE PUBLIC is required by Section 4.0 for demonstrating compliance with the EPA Environmental Dose Standard, 40 CFR 190 (Section 4.2).

Even though not a part of the LUC, to support these dose assessments, areas within the UNRESTRICTED AREA BOUNDARY that are accessible to the public; and (b) use of Lake Erie water on and near the site are evaluated. The scope of the evaluation includes the following:

- Assessment of areas onsite that are accessible to MEMBERS OF THE PUBLIC. Particular attention should be given to assessing exposure times for visits to the Davis-Besse Administration Building and Wellness Center. Data should be used for updating Table 4-1.
- Data on Lake Erie use should be obtained from local and state officials. Reasonable efforts shall be made to identify individual irrigation and potable water users, and industrial and commercial water users whose source is Lake Erie. This data is used to verify the pathways of exposure used in Section 2.4.

6.0 RADIOLOGICAL ENVIRONMENTAL MONITORING PROGRAM

The Radiological Environmental Monitoring Program (REMP) provides measurements of radiation and of radioactive materials in those exposure pathways and for those radionuclides which lead to the higher potential radiation exposures of individuals resulting from the station operations. The sampling and analysis program described in this Section was developed to provide representative measurements of radiation and radioactive materials resulting from station operation in the principal pathways of exposure of MEMBERS OF THE PUBLIC. This monitoring program implements Sections IV.B.2 of Appendix I to 10 CFR Part 50 and thereby supplements the radiological effluent controls by verifying that the measurable concentrations of radioactive materials and levels of radiation are not higher than expected on the basis of the effluent measurements and the modeling of the environmental exposure pathways. Guidance for the development of this monitoring program is provided by the Radiological Assessment Branch Technical Position on Environmental Monitoring.

6.1 PROGRAM DESCRIPTION

6.1.1 General

The REMP shall be conducted as specified in Table 6-1. This table describes the minimum environmental media to be sampled, the sample collection frequencies, the number of representative samples required, the characteristics of the sampling locations, and the type and frequency of sample analysis. Table 6-2 provides a detailed listing of the sample locations for Davis-Besse which satisfy the requirements of Table 6-1. Maps for each site listed in Table 6-2 are contained in Appendix C. The specific locations used to satisfy the requirements of Table 6-1 may be changed as deemed appropriate by the Manager – Site Chemistry. The changes shall be reported in the Annual Radiological Environmental Operating Report and the Radiological Effluent Release Report as required by Sections 7.1 and 7.2, respectively. If the changes are to be permanent, Table 6-2 and Appendix C shall be updated.

Note: For the purpose of implementing Section 5.1, sampling locations will be modified, to reflect the findings of the Land Use Census as described in ODCM Section 5.1.

6.1.2 Program Deviations

With the REMP not being conducted as specified in Table 6-1, prepare and submit to the Commission, in the Annual Radiological Environmental Operating Report required by Section 7.1, a description of the reasons for not conducting the program as required and plans for preventing a recurrence.

6.1.3 Unavailability of Milk or Broad Leaf Vegetation Samples

With milk or fresh leafy vegetable samples unavailable from one or more of the sample locations required by Table 6-1, identify locations for obtaining replacement samples and if practical add them to the REMP within 30 days. The locations from which samples were unavailable may then be deleted from the monitoring program. In lieu of a Licensee Event Report and pursuant to Section 7.2, identify the cause of the unavailability of samples and identify and the new locations(s) for obtaining replacement samples in the next Radiological Effluent Release Report and also include in the report a revised figure(s) and table for the ODCM reflecting the new locations(s).

6.1.4 Seasonal Unavailability, Equipment Malfunctions, Safety Concerns

With specimens unobtainable due to hazardous conditions, seasonal unavailability, malfunction of automatic sampling equipment and other legitimate reasons, every effort will be made to complete corrective action prior to the end of the next sampling period. All deviations from the sampling schedule will be documented in the Annual Radiological Environmental Operating report pursuant to Section 7.1.

6.1.5 Sample Analysis

REMP samples shall be analyzed pursuant to the requirements of Table 6-1 and the detection capabilities required by Table 6-3. Cumulative potential dose contributions for the current calendar year from radionuclides detected in environmental samples shall be determined in accordance with the methodology and parameters in this ODCM.

6.2 REPORTING LEVELS

6.2.1 General

The reporting levels are based on the design objective doses of 10 CFR 50, Appendix I (i.e., levels of radioactive material in the sampling media corresponding to potential annual doses of 3 mrem, total body or 10 mrem, maximum organ from liquid pathways; or 5 mrem, total body, or 15 mrem, maximum organ for gaseous effluent pathways - the annual limits of Sections 2.4.1, 3.7.1 and 3.8.1). These potential doses are modeled on the maximum exposure or consumption rates of NRC Regulatory Guide 1.109.

The evaluation of potential doses should be based solely on radioactive material resulting from plant operation.

6.2.2 Exceedance of Reporting Levels

With the level of radioactivity as the result of plant effluents in an environmental sampling medium at a specified location exceeding the reporting levels of Table 6-4 when averaged over any calendar quarter, prepare and submit to the Commission within 60 days, pursuant to Section 7.3, a Licensee Event report that identifies the cause(s) for exceeding the limit(s) and defines the corrective actions to be taken to reduce radioactive effluents so that the potential annual dose to MEMBER OF THE PUBLIC is less than the calendar year limits of Sections 2.4.1, 3.7.1 and 3.8.1. When more than one of the radionuclides in Table 6-3 are detected in the sampling medium, this report shall be submitted if:

$$\frac{\text{concentration (1)}}{\text{reporting level (1)}} + \frac{\text{concentration (2)}}{\text{reporting level (2)}} + \dots \geq 1.0.$$

When radionuclides other than those in Table 6-4 are detected and are the result of plant effluents, this report shall be submitted if the potential annual dose to a MEMBER OF THE PUBLIC is equal to or greater than the calendar year limits of Sections 2.4.1, 3.7.1 and 3.8.1. The method described in Section 4.2.3 may be used for assessing the potential dose and required reporting for radionuclides other than those listed in Table 6-4.

A Licensee Event Report is not required if the measured level of radioactivity was not the result of plant effluents; however, in such an event, the condition shall be reported and described in the Annual Radiological Environmental Operating Report.

6.3 INTERLABORATORY COMPARISON PROGRAM

Analyses shall be performed on radioactive materials supplied as part of an Interlaboratory Comparison Program that has been approved by the Commission. The requirement for participating in an approved Interlaboratory Comparison Program is provided to ensure that independent checks on the precision and accuracy of the measurements of radioactive material in environmental sample matrices are performed as part of the quality assurance program for environmental monitoring in order to demonstrate that the results are reasonably valid for the purposes of Section IV.B.2 of Appendix I to 10 CFR Part 50.

A summary of the results obtained as part of the required Interlaboratory Comparison Program shall be included in the Annual Radiological Environmental Operating Report pursuant to Section 7.1. With analyses not being performed as required, report the corrective actions taken to prevent a recurrence to the Commission in the Annual Radiological Environmental Operating Report pursuant to Section 7.1.

Table 6-1
RADIOLOGICAL ENVIRONMENTAL MONITORING PROGRAM

<u>Exposure Pathway and/or Sample</u>	<u>Number of Representative Samples and Sample Locations^a</u>	<u>Collection Frequency</u>	<u>Type and Frequency of Analysis</u>
1. DIRECT RADIATION ^b	<p>27 routine monitoring stations either with two or more dosimeters or with one instrument for measuring and recording dose rate continuously, placed as follows:</p> <p>an inner ring of stations, generally one in each meteorological sector in the general area of the UNRESTRICTED AREA BOUNDARY;</p> <p>an outer ring of stations, one in each meteorological sector in the 6 to 8 km range from the site, excluding the sectors over Lake Erie;</p> <p>the balance of the stations to be placed in special interest areas such as population centers, nearby residences, schools, and in 1 or 2 areas to serve as control stations.</p>	Quarterly	Gamma dose quarterly

Table 6-1 (Continued)

RADIOLOGICAL ENVIRONMENTAL MONITORING PROGRAM

Exposure Pathway and/or Sample	Number of Representative Samples and Sample Locations ^a	Collection Frequency	Type and Frequency of Analysis	
2. AIRBORNE	<p>Radioiodine and Particulates</p> <p>Samples from 5 locations, placed as follows:</p> <p>3 samples from close to the UNRESTRICTED AREA BOUNDARY, in different sectors, generally from areas of higher calculated annual average groundlevel D/Q.</p> <p>*1 sample from the vicinity of a nearby community, generally in the area of higher calculated annual average groundlevel D/Q.</p> <p>1 sample from a control location, 15-30 km from the site.</p>	Continuous sampler operation with sample collection weekly, or more frequent if required by dust loading.	Radioiodine Canister: I-131 analysis weekly. Particulate Sampler: Gross beta radioactivity analysis following filter change; ^c Gamma isotopic analysis of composite (by location) quarterly.	
3. WATERBORNE	a. Surface (untreated water)	2 samples	Weekly composite sample (Indicator location should be a composite)	Tritium and gamma isotopic ^d analysis of composite sample monthly.
	b. Ground	Sample from one source only if likely to be affected ^e	Quarterly	Gamma isotopic ^d and tritium analysis quarterly.

*NOTE: A nearby community may be considered as a large group of residences in a close proximity to the Plant.

Table 6-1 (Continued)

RADIOLOGICAL ENVIRONMENTAL MONITORING PROGRAM

Exposure Pathway and/or Sample	Number of Representative Samples and Sample Locations ^a	Collection Frequency	Type and Frequency of Analysis
c. Drinking (Treated water)	1 sample from the nearest source. 1 sample from a control location.	Weekly composite sample.	Gross beta on monthly composite. Tritium and gamma isotopic analysis on quarterly composite. I-131 analysis on each composite when the dose calculated for the consumption of the water is greater than 1 mrem per year.
d. Sediment from Shoreline	1 sample from area with existing or potential recreational value.	Semiannually	Gamma isotopic analyzed semi-annually.
4. INGESTION			
a. Milk	If available, samples from animals up to 2 locations within 8 km distance having the highest dose potential. 1 sample from milking animals at a control location 15-30 km distant and generally in a less prevalent wind direction.	Semimonthly when animals are on pasture, monthly at other times	Gamma isotopic ^d and I-131 analysis semi- monthly when animals are on pasture; monthly at other times.
b. Fish	1 sample each of 2 commercially and/or recreationally important species in vicinity of site. 1 sample of same species in areas not influenced by plant discharge.	1 sample in season.	Gamma isotopic analysis on edible portions.

Table 6-1 (Continued)
 RADIOLOGICAL ENVIRONMENTAL MONITORING PROGRAM

<u>Exposure Pathway and/or Sample</u>	<u>Number of Representative Samples and Sample Locations^a</u>	<u>Collection Frequency</u>	<u>Type and Frequency of Analysis</u>
c. Food Products (Broad leaf vegetation)	Samples of up to 3 different kinds of broad leaf vegetation grown in two different offsite locations of higher predicted annual average ground-level D/Q if milk sampling is not performed.	Monthly when available.	Gamma isotopic ^d and I-131 analysis.
	1 sample of each of the similar broad leaf vegetations grown 15-30 km distant in a less prevalent wind direction if milk sampling is not performed.	Monthly when available.	Gamma isotopic ^d and I-131 analysis.

Table 6-1 (Continued)

TABLE NOTATION

^aSpecific parameters of distance and direction sector from the centerline of the reactor, and additional description (where pertinent) are provided for each and every sample location in Table 6-2. Refer to NUREG-0133, "Preparation of Radiological Effluent Technical Specifications for Nuclear Power Plants", October 1978, and to Radiological Assessment Branch Technical Position, Revision 1, November 1979. It is recognized that, at times, it may not be possible or practicable to continue to obtain samples of the media of choice at the most desired location or time. In these instances suitable alternative media and locations may be chosen for the particular pathway in question and appropriate substitutions made within 30 days in the Radiological Environmental Monitoring Program. In lieu of a Licensee Event Report and pursuant to Technical Specification 5.6.1 and Section 7.2, identify the cause of the unavailability of samples for that pathway and identify the new location(s) for obtaining replacement samples in the next Radioactive Effluent Release Report. Also, include in the report a revised figure(s) and table for the ODCM reflecting the new location(s).

^bOne or more instruments, such as a pressurized ion chamber, for measuring and recording dose rate continuously may be used in place of, or in addition to, integrating dosimeters. For the purposes of this table, a thermoluminescent dosimeter (TLD) is considered to be one phosphor; two or more phosphors in a packet are considered as two or more dosimeters. Film badges shall not be used as dosimeters for measuring direct radiation. The number of direct radiation monitoring stations may be reduced according to geographical limitations; e.g., at an ocean site, some sectors will be over water so that the number of dosimeters may be reduced accordingly. The frequency of analysis or readout for TLD systems will depend upon the characteristics of the specific system used and should be selected to obtain optimum dose information with minimal fading.

^cAirborne particulate sample filters shall be analyzed for gross beta radioactivity 24 hours or more after sampling to allow for radon and thoron daughter decay. If gross beta activity in air particulate samples is greater than ten times the yearly mean of control samples, then gamma isotopic analysis shall be performed on the individual samples.

^dGamma isotopic analysis means the identification and quantification of gamma emitting radionuclides that may be attributable to the effluents from the facility.

^eGroundwater samples shall be taken when this source is tapped for drinking or irrigation purposes in areas where the hydraulic gradient or recharge properties are suitable for contamination.

Table 6-2

Required Sampling Locations

Location	Samples Collected	Appendix C Page Reference	Type of Location*	Location Description
T-1	AI/AP, TLD	C-4	I	UNRESTRICTED AREA BOUNDARY, 0.6 mile ENE of Station.
T-2	AI/AP, TLD	C-5	I	UNRESTRICTED AREA BOUNDARY, 0.9 mile E of Station.
T-3	AI/AP, TLD	C-6	I	UNRESTRICTED AREA BOUNDARY, 1.4 miles ESE of Station near mouth of Toussaint River.
T-4	TLD	C-7	I	UNRESTRICTED AREA BOUNDARY, 0.8 mile S of Station.
T-5	TLD	C-8	I	Main entrance to site, 0.5 mile W of Station.
T-6	TLD	C-9	I	UNRESTRICTED AREA BOUNDARY, 0.5 mile NNE of Station.
T-7	AI/AP, TLD	C-10	I	Sand Beach, 0.9 mile NW of Station.
T-8	TLD	C-11	I	Farm, 2.7 miles WSW of Station.
T-10	TLD	C-12	I	UNRESTRICTED AREA BOUNDARY, 0.5 mile SSW of Station.
T-11	AI/AP, TLD SWT/SWU	C-13	C	All samples are collected at the Ottawa County Regional Water Intake Facility, 9.5 miles SE of Plant except for Treated Water Sample, which is collected at the Ottawa County Regional Water Treatment Plant, 9.1 miles SE of Plant.
T-12	TLD	C-14	C	Toledo Water Treatment Plant, 20.7 miles WNW of Station.
T-227	BLV	C-15	I	Roving BLV site within 5 miles of Station.
T-19	BLV	C-16	I	Garden, 1.0 mile W of Station
T-22	SWT/SWU	C-17	I	Carroll Township Water Treatment Plant, SWU collected 2.1 miles W of station and SWT from REMP Lab DBAB Annex

* I = Indicator locations; C = Control locations.

Table 6-2

Required Sampling Locations

Location	Samples Collected	Appendix C Page Reference	Type of Location*	Location Description
T-27	SED	C-18	C	Crane Creek State Park, 5.3 miles WNW of Station.
T-33	FIS	C-19	I	Lake Erie within a 5-mile radius from Station.
T-35	FIS	C-20	C	Lake Erie, greater than a 10-mile radius from Station.
T-37	BLV	C-21	C	Farm, 13 miles SW of Station.
T-40	TLD	C-22	I	UNRESTRICTED AREA BOUNDARY, 0.7 mile SE of Station.
T-41	TLD	C-23	I	UNRESTRICTED AREA BOUNDARY, 0.6 mile SSE of Station.
T-42	TLD	C-24	I	UNRESTRICTED AREA BOUNDARY, 0.8 mile SW of Station.
T-44	TLD	C-25	I	UNRESTRICTED AREA BOUNDARY, 0.5 mile WSW of Station.
T-46	TLD	C-26	I	UNRESTRICTED AREA BOUNDARY, 0.5 mile NW of Station.
T-47	TLD	C-27	I	UNRESTRICTED AREA BOUNDARY, 0.5 mile N of Station.
T-48	TLD	C-28	I	UNRESTRICTED AREA BOUNDARY, 0.5 mile NE of Station.
T-50	TLD	C-29	I	Erie Industrial Park Water Treatment Plant, 4.5 mile SE of Station.
T-52	TLD	C-30	I	Farm, 3.7 miles S of Station.
T-54	TLD	C-31	I	Farm, 4.8 miles SW of Station.
T-55	TLD	C-32	I	Farm, 4.0 miles W. of Station.
T-67	TLD	C-33	I	UNRESTRICTED AREA BOUNDARY, 0.3 mile NNW of Station.

* I = Indicator locations; C = Control locations.

Table 6-2

Required Sampling Locations

Location	Samples Collected	Appendix C Page Reference	Type of Location*	Location Description
T-68	TLD	C-34	I	UNRESTRICTED AREA BOUNDARY, 0.5 miles WNW of station
T-91	TLD	C-35	I	Siren Post No. 204, 2.5 miles SSE of Station.
T-112	TLD	C-36	I	State Route 2 and Thompson Road, 1.5 miles SSW of Station.
T-151	TLD	C-37	I	State Route 2 and Humphrey Road, 1.8 miles WNW of Station.

* I = Indicator locations; C = Control locations.

Table 6-3
LOWER LIMITS OF DETECTION (LLD)^a

Analysis	Water (pCi/1)	Airborne Particulate or Gas (pCi/m ³)	Fish (pCi/kg. wet)	Milk (pCi/1)	Food Products (pCi/kg, wet)	Sediment (pCi/kg, dry)
Gross Beta	4 ^b	1.0E-02				
³ H	2000 ^{c*}					
⁵⁴ Mn	15		130			
⁵⁹ Fe	30		260			
^{58, 60} Co	15		130			
⁶⁵ Zn	30		260			
⁹⁵ Zr	15					
¹³¹ I	1 ^d	7.0E-02		1	60	
^{134, 137} Cs	15(10 ^b),18	6.0E-02	130	15	60	150
¹⁴⁰ Ba - La	15			15		

NOTE: This list does not mean that only these nuclides are to be detected and reported. Other peaks which are measurable and identifiable, together with the above nuclides, shall be identified and reported.

* If no drinking water pathway exists, a value of 3000 pCi/L may be used.

Table 6-3 (Continued)

TABLE NOTATION

- a. The LLD is the smallest concentration of radioactive material in a sample that will be detected with 95% probability (with 5% probability of falsely concluding that a blank observation represents a "real" signal).

For a particular measurement system (which may include radiochemical separation):

$$LLD = \frac{4.66 s_b}{E * V * 2.22 * Y * \exp(-\lambda\Delta t)}$$

where:

LLD is the lower limit of detection as defined above (pCi per unit mass or volume),

s_b is the standard deviation of the background counting rate or of the counting rate of a blank sample as appropriate (counts per minute),

E is the counting efficiency (counts per transformation),

V is the sample size (in units of mass or volume),

2.22 is the number of transformations per minute per picocurie,

Y is the fractional radiochemical yield (when applicable),

λ is the radioactive decay constant for the particular radionuclide,

Δt is the elapsed time between end of the sample collection period and time of counting.

Typical values of E, V, Y and Δt should be used in the calculations.

The LLD is defined as an a priori (before the fact) limit representing the capability of a measurement system and not as a a posteriori (after the fact) limit for a particular measurement.

Analyses shall be performed in such a manner that the stated LLDs will be achieved under routine conditions. Occasionally background fluctuations, unavoidable small sample sizes, the presence of interfering nuclides, or uncontrollable circumstances may render these LLDs unachievable. In such cases, the contributing factors will be identified and described in the Annual Radiological Environmental Operating Report.

For more complete discussion of the LLD and other detection limits, see the following:

- (1) HASL Procedures Manual, HASL-300 (revised annually).
- (2) Currie, L. A., "Limits for Qualitative Detection and Quantitative Determination - Application to Radiochemistry" Anal. Chem. 40, 586-93 (1968).

Table 6-3 (Continued)

TABLE NOTATION

- (3) Hartwell, J. K., "Detection Limits for Radioisotopic Counting Techniques", Atlantic Richfield Hanford Company Report ARH-2537 (June 22, 1972).
- b. LLD for drinking water.
- c. If no drinking water pathway exists, a value of 3000 pCi/liter may be used.
- d. LLD only when specific analysis for I-131 required.

Table 6-4
REPORTING LEVELS FOR RADIOACTIVITY CONCENTRATIONS IN ENVIRONMENTAL SAMPLES

Analysis	Reporting Levels				
	Water (pCi/L)	Airborne Particulate or Gas (pCi/m ³)	Fish (pCi/kg. wet)	Milk (pCi/l)	Vegetables (pCi/kg, wet)
H-3	2.0E+04*				
Mn-54	1.0E+03		3.0E+04		
Fe-59	4.0E+02		1.0E+04		
Co-58	1.0E+03		3.0E+04		
Co-60	3.0E+02		1.0E+04		
Zn-65	3.0E+02		2.0E+04		
Zr-Nb-95	4.0E+02				
I-131	2.0E+00	9.0E-01		3.0E+00	1.0E+02
Cs-134	3.0E+01	1.0E+01	1.0E+03	6.0E+01	1.0E+03
Cs-137	5.0E+01	2.0E+01	2.0E+03	7.0E+02	2.0E+03
Ba-La-140	2.0E+02			3.0E+02	

* For drinking water samples, this is the 40 CFR 141 value. If no drinking water pathway exists, a value of 30,000 pCi/liter may be used.

7.0 ADMINISTRATIVE CONTROLS

7.1 ANNUAL RADIOLOGICAL ENVIRONMENTAL OPERATING REPORT

Routine Radiological Environmental Operating reports covering the operation of the unit during the previous calendar year shall be submitted by May 15 of each year.

The Annual Radiological Environmental Operating Report shall include summaries, interpretations, and an analysis of trends of the results of the radiological environmental verification activities for the report period, including a comparison with the preoperational studies, with operational controls, as appropriate, and with previous environmental surveillance reports and an assessment of the observed impacts of the plant operation on the environment. The reports shall also include the results of land use censuses as required in Section 5.1.

The Annual Radiological Environmental Operating Reports shall include the summarized and tabulated results of analysis of radiological environmental samples and of radiation measurements taken during the period pursuant to the locations specified in Sections 6.1 and Appendix C of this ODCM. In the event that some results are not available for inclusion with the report, the report shall be submitted noting and explaining the reasons for the missing results. The missing data shall be submitted as soon as possible in a supplementary report.

The reports shall also include the following: a summary description of the radiological environmental monitoring program; at least two legible maps covering all sampling locations keyed to a table giving distances and directions from the centerline of one reactor; the results of licensee participation in the Interlaboratory Comparison Program, required by Section 6.3; and discussions of all analyses in which the LLD required by Table 6-3 was not achievable.

7.2 RADIOACTIVE EFFLUENT RELEASE REPORT

Radioactive Effluent Release Reports covering the operation of the unit during the previous calendar year shall be submitted by May 15 of each year.

The Radioactive Effluent Release Reports (RERR) shall include a summary of the quantities of radioactive liquid and gaseous effluents and solid waste released from the unit as outlined in Regulatory Guide 1.21, "Measuring, Evaluating, and Reporting Radioactivity in Solid Wastes and Releases of Radioactive Materials in Liquid and Gaseous Effluents from Light-Water-Cooled Nuclear Power Plants," Revision 1, June 1974, with data summarized on a quarterly basis following the format of Appendix B thereof.

The RERR shall include an annual summary of hourly meteorological data collected over the previous year. This annual summary may be either in the form of an hour-by-hour listing of wind speed, wind direction, atmospheric stability, and precipitation (if measured), or in the form of joint frequency distributions of wind speed, wind direction, and atmospheric stability. This same report shall include an assessment of the radiation doses due to the radioactive liquid and gaseous effluents released from the unit or station during the previous calendar year. This same report shall also include an assessment of the radiation doses from radioactive liquid and gaseous effluents to MEMBERS OF THE PUBLIC due to their activities inside the UNRESTRICTED AREA BOUNDARY during the reporting period. All assumptions used in making these assessments, i.e., specific activity, exposure time, and location, shall be included in these reports. The assessment of radiation doses shall be performed in accordance with the methodology and parameters in this ODCM.

The RERR shall also include an assessment of radiation doses to the likely most exposed MEMBER OF THE PUBLIC from reactor releases and other nearby uranium fuel cycle sources, including doses from primary effluent pathways and direct radiation, for the previous calendar year to show conformance with 40 CFR Part 190, "Environmental Radiation Protection Standards for Nuclear Power Operation."

The RERR shall include the following information for each class of solid waste (as defined by 10 CFR Part 61) shipped offsite during the report period:

- a. container volume,
- b. total curie quantity (specify whether determined by measurement or estimate),
- c. principal radionuclides (specify whether determined by measurement or estimate),
- d. source of waste and processing employed (e.g., dewatered spent resin, compressed dry waste, evaporator bottoms).
- e. type of container (e.g., Type A, Type 3, Large Quantity), and
- f. solidification agent or absorbent (e.g., cement, urea formaldehyde).

The RERR shall include a list and description of unplanned releases from the site to UNRESTRICTED AREAS of radioactive materials in gaseous and liquid effluents made during the reporting period.

The RERR shall include any changes made during the reporting period to the PROCESS CONTROL PROGRAM (PCP) and to the ODCM, as well as a listing of new locations for dose calculations and pursuant to Section 5.1.

The RERR shall include any radionuclide activity limits for the BWST which have been exceeded during the reporting period, a description of the event leading to the limit being exceeded and action taken to return it to within the limits.

7.3 LICENSEE EVENT REPORTS

Licensee Event Reports shall be submitted to the U. S. Nuclear Regulatory Commission (NRC) in accordance with 10 CFR 50.4 within the time period specified for each report. These reports shall be submitted covering the activities identified below pursuant to the requirements of the applicable reference:

- a. dose or dose commitment exceedences to a MEMBER OF THE PUBLIC from radioactive materials in liquid effluents released to UNRESTRICTED AREAS (Section 2.4.1),
- b. the discharge of radioactive liquid waste without treatment and in excess of the limits in Section 2,
- c. the calculated air dose from radioactive gases exceeding the limits in Section 3.7.1,
- d. the calculated dose from the release of iodine-131, tritium, and radionuclides in particulate form with half-lives greater than 8 days, in gaseous effluents exceeding the limits of Section 3.8.1,
- e. the discharge of radioactive gaseous waste without treatment and in excess of the limits in Section 3.9,
- f. the calculated doses from the release of radioactive materials in liquid or gaseous effluents exceeding the limits of Section 4.2, and
- g. the level of radioactivity as the result of plant effluents in an environmental sampling medium exceeding the reporting levels of Table 6-4 (Section 6.2.2).

7.4 MAJOR CHANGES TO RADIOACTIVE LIQUID AND GASEOUS WASTE TREATMENT SYSTEMS

Licensee initiated major changes to the radioactive waste systems (liquid and gaseous):

1. Shall be reported to the Commission in the update to the Safety Analysis Report. The discussion of each change shall contain:
 - a. a summary of the evaluation that led to the determination that the change could be made in accordance with 10 CFR Part 50.59;
 - b. sufficient detailed information to totally support the reason for the change without benefit of additional or supplemental information;
 - c. a detailed description of the equipment, components and processes involved and the interfaces with other plant systems;
 - d. an evaluation of the change which shows the predicted releases of radioactive materials in liquid or gaseous effluents and/or quantity of solid waste that differ from those previously predicted in the license application and amendments thereto;

- e. an evaluation of the change which shows the expected maximum exposures to individuals in the UNRESTRICTED AREA and the general population that differ from those previously estimated in the license application and amendments thereto;
 - f. a comparison of the predicted releases of radioactive materials in liquid and gaseous effluents to the actual releases for the period prior to when the changes are to be made;
 - g. an estimate of the exposure to plant operating personnel as a result of the change; and
 - h. documentation of the fact that the change was reviewed and found acceptable by the Plant Operations Review Committee.
2. Shall become effective upon review and acceptance by the Plant Operations Review Committee.

7.5 DEFINITIONS

- 7.5.1 BATCH RELEASE - The discharge of liquid wastes of a discrete volume.
- 7.5.2 COMPOSITE SAMPLE - A sample in which the method of sampling employed results in a specimen which is representative of the liquids released.
- 7.5.3 GASEOUS RADWASTE TREATMENT SYSTEM - The GASEOUS RADWASTE TREATMENT SYSTEM is a system that is designed and installed to reduce radioactive gaseous effluents by collecting primary coolant system off gases and providing for decay for the purpose of reducing the total radioactivity prior to release to the environment.
- 7.5.4 LOWER LIMIT OF DETECTION (LLD) - The LLD is the smallest concentration of radioactive material in a sample that will be detected with 95% probability, with 5% probability of falsely concluding that a blank observation represents a "real" signal.

For a particular measurement system (which may include radiochemical separation):

$$LLD = \frac{4.66 S_b}{E * V * 2.22 * Y * \exp(-\lambda \Delta t)}$$

where

LLD is the lower limit of detection as defined above (as pCi per unit mass or volume);

S_b is the standard deviation of the background counting rate or of the counting rate of a blank sample as appropriate (as counts per minute);

E is the counting efficiency (as counts per transformations);

V is the sample size (in units of mass or volume);

2.22 is the number of transformations per minute per picocurie;

Y is the fractional radiochemical yield (when applicable);

λ is the radioactive decay constant for the particular radionuclide; and

Δt for plant effluents is the elapsed time between the midpoint of sample collection and time of counting.

It should be recognized that the LLD is defined as an a priori (before the fact) limit representing the capability of a measurement system and not as an a posteriori (after the fact) limit for a particular measurement.

- 7.5.5 **MEMBER OF THE PUBLIC - MEMBER(S) OF THE PUBLIC** shall include all persons who are not occupationally associated with the plant. This category does not include employees of the utility, its contractors, or vendors. Also excluded from this category are persons who enter the site to service equipment or to make deliveries. This category does include persons who use portions of the site for recreation, occupational, or other purposes not associated with the plant.
- 7.5.6 **PURGE-PURGING - PURGE OR PURGING** is the controlled process of discharging air or gas from a confinement to maintain temperature, pressure, humidity, concentration or other operating condition, in such a manner that replacement air or gas is required to purify the confinement.
- 7.5.7 **UNRESTRICTED AREA BOUNDARY** - The **UNRESTRICTED AREA BOUNDARY** shall be that line beyond which the land is neither owned, nor leased, nor otherwise controlled by the licensee.
- 7.5.8 **SOURCE CHECK - A SOURCE CHECK** shall be the observation of channel upscale response when the channel sensor is exposed to a radioactive or LED source.
- 7.5.9 **UNRESTRICTED AREA** - An **UNRESTRICTED AREA** shall be any area at or beyond the **UNRESTRICTED AREA BOUNDARY**, access to which is not controlled by the licensee for purposes of protection of individuals from exposure to radiation or radioactive materials, or any area within the **UNRESTRICTED AREA BOUNDARY** used for residential quarters or for industrial, commercial, institutional, and/or recreational purposes. The definition of **UNRESTRICTED AREA** used in implementing the Radiological Effluent Technical Specifications has been expanded over that in 10 CFR 100.3(a), but the unrestricted area does not include areas over water bodies. The concept of unrestricted areas, established at or beyond the **UNRESTRICTED AREA BOUNDARY**, is utilized in the Technical Specifications and the ODCM to keep levels of radioactive materials in liquid and gaseous effluents as low as is reasonably achievable, pursuant to 10 CFR 50.36a.
- 7.5.10 **VENTILATION EXHAUST TREATMENT SYSTEM - A VENTILATION EXHAUST TREATMENT SYSTEM** is a system that is designed and installed to reduce radioactive material in particulate form in effluents by passing ventilation or vent exhaust gases through HEPA filters for the purpose of removing particulates from the gaseous exhaust stream prior to release to the environment. Engineered Safety Feature (ESF) atmospheric cleanup systems are not considered to be **VENTILATION EXHAUST TREATMENT SYSTEM** components.
- 7.5.11 **VENTING - VENTING** is the controlled process of discharging air or gas from a confinement to maintain temperature, pressure, humidity, concentration or other operating condition, in such a manner that replacement air or gas is not provided or required during **VENTING**. Vent, used in system names, does not imply a **VENTING** process.

NOTES:

1. The following terms are defined in Section 1.1 of the Technical Specifications: CHANNEL CALIBRATION, CHANNEL CHECK, CHANNEL FUNCTIONAL TEST, OPERABLE-OPERABILITY.
2. The following terms are defined in Section 7.1 of the Technical Requirements Manual: FUNCTIONAL-FUNCTIONALITY.

APPENDIX A
Technical Basis for Simplified Dose Calculations
Liquid Effluent Releases

APPENDIX A
Technical Basis for Simplified Dose Calculations
Liquid Effluent Releases

Overview

To simplify the dose calculation process, it is conservative to identify a controlling, dose-significant radionuclide and to use its dose conversion factor in the dose calculations. Using the total release (i.e., the cumulative activity of all radionuclides) and this single dose conversion factor as inputs to a one-step dose assessment yields a dose calculation method which is both simple and conservative.

Cs-134 is the controlling nuclide for the total body dose. It has the highest total body dose conversion factor for all the radionuclides listed in Table 2-6. Therefore, the use of its dose conversion factor in the simplified dose assessment method for evaluating the total body dose is demonstrably conservative.

The selection of the maximum organ dose conversion factor for use in the simplified calculation requires consideration of the prevalence of the radionuclides in the effluents. An examination of the Table 2-6 factor will show that the Nb-95 dose factor for the GI-LLI represents the highest value (1.51E+06 mrem/hr per $\mu\text{Ci/ml}$); and the P-32 bone factor (1.39E+06) is similarly high. However, neither of these two radionuclides are of significance in the Davis-Besse effluents. Nb-95 is not typically measured in the liquid effluents and P-32 analyses are not even performed. (NRC has categorically determined that P-32 is not a significant radionuclide in liquid effluents from nuclear power plants and does not require the special radiochemical analyses needed for identification and quantification.) The next highest dose conversion factor is for Cs-134, liver, with a value of 7.09E+05 mrem/hr per $\mu\text{Ci/ml}$. Cs-134 is a prevalent radionuclide in the liquid effluents from Davis-Besse. Therefore, it is recommended that the Cs-134 liver dose conversion factor be used for the simplified maximum organ dose assessment.

Simplified Method

For evaluating compliance with the dose limits of Section 2.4.1, the following simplified equations may be used:

Total Body

$$D_{\text{tb}} = \frac{1.67\text{E} - 02 * \text{VOL}}{\text{DF} * Z} * A_{(\text{Cs-134, tb})} * \Sigma C_i \quad (\text{A-1})$$

where:

D_{tb} = dose to the total body (mrem)

VOL = volume of liquid effluents released (gal)

DF = average Collection Box release flow (gal/min)

Z = 10, near field dilution

$A_{(Cs-134,tb)}$ = $5.79E+05$ mrem/hr per $\mu\text{Ci/ml}$, the total body ingestion dose factor for Cs-134

ΣC_i = total concentration of all radionuclides ($\mu\text{Ci/ml}$)

$1.67E-02$ = 1 hr/60 min

Substituting the values for Z and the Cs-134 total body dose conversion factor, the equation simplifies to:

$$D_{tb} = \frac{9.67E + 02 * VOL}{DF} * \Sigma C_i \quad (A-2)$$

Maximum Organ

$$D_{max} = \frac{1.67E - 02 * VOL}{DF * Z} * A_{(Cs-134,liver)} * \Sigma C_i \quad (A-3)$$

where:

D_{max} = maximum organ dose (mrem)

$A_{(Cs-134,liver)}$ = $7.09E+05$ mrem/hr per $\mu\text{Ci/ml}$, the liver ingestion dose factor for Cs-134

Substituting the values for Z and the Cs-134 liver dose conversion factor, the equation simplifies to:

$$D_{max} = \frac{1.18E + 03 * VOL}{DF} * \Sigma C_i \quad (A-4)$$

Tritium should not be included in the simplified analysis dose assessment for liquid releases. The potential dose resulting from normal reactor releases of H-3 is relatively negligible. But, its relatively higher abundance would yield resulting simplified doses that would be overly conservative and unrealistic. Excluding tritium has essentially no impact on the conservative use of this recommended simplified method. Furthermore, the release of tritium is a function of operating history and is essentially unrelated to radwaste system operations.

APPENDIX B
Technical Basis for Effective Dose Factors
Gaseous Radwaste Effluents

APPENDIX B
 Technical Basis for Effective Dose Factors
 Gaseous Radwaste Effluents

Overview

Dose evaluations for releases of gaseous radioactive effluents may be simplified by the use of an effective dose factor rather than radionuclide-specific dose factors. These effective dose factors are applied to the total radioactive release to approximate the various doses in the environment; i.e., the total body, gamma-air, and beta-air doses. The effective dose factors are based on the typical radionuclide distribution in the gaseous radioactive effluents. The approach provides a reasonable estimate of the actual doses since under normal operating conditions, minor variations are expected in the radionuclide distribution.

Determination of Effective Dose Factors

Effective dose factors are calculated by equations (B-1) through (B-4).

$$K_{\text{eff}} = \Sigma(K_i * f_i) \quad (\text{B-1})$$

where:

- K_{eff} = the effective total body dose factor due to gamma emissions from all noble gases released (mrem/yr per $\mu\text{Ci}/\text{m}^3$),
- K_i = the total body dose factor due to gamma emissions from each noble gas radionuclide i released, from Table 3-5 (mrem/yr per $\mu\text{Ci}/\text{m}^3$), and
- f_i = the fractional abundance of noble gas radionuclide i relative to the total noble gas activity.

$$(L + 1.1 M)_{\text{eff}} = \Sigma((L_{i_i} + 1.1M_i) * f_i) \quad (\text{B-2})$$

where:

- $(L+1.1M)_{\text{eff}}$ = the effective skin dose factor due to beta and gamma emissions from all noble gases released (mrem/yr per $\mu\text{Ci}/\text{m}^3$), and
- $(L_i+1.1M_i)$ = the skin dose factor due to beta and gamma emissions from each noble gas radionuclide i released, from Table 3-5 (mrem/yr per $\mu\text{Ci}/\text{m}^3$).

$$M_{\text{eff}} = \Sigma(M_i * f_i) \quad (\text{B-3})$$

where:

M_{eff} = the effective air dose factor due to gamma emissions from all noble gases released (mrad/yr per $\mu\text{Ci}/\text{m}^3$), and

M_i = the air dose factor due to gamma emissions from each noble gas radionuclide i released, from Table 3-5 (mrad/yr per $\mu\text{Ci}/\text{m}^3$).

$$N_{\text{eff}} = \sum(N_i * f_i) \quad (\text{B-4})$$

where:

N_{eff} = the effective air dose factor due to beta emissions from all noble gases released (mrad/yr per $\mu\text{Ci}/\text{m}^3$), and

N_i = the air dose factor due to beta emissions from each noble gas radionuclide i released, from Table 3-5 (mrad/yr per $\mu\text{Ci}/\text{m}^3$).

Normally, past radioactive effluent data would be used for the determination of the effective dose factors. However, the releases of noble gases from Davis-Besse have been exceedingly insignificant. Therefore, in order to ensure overall conservatism in the modeling, the USAR estimate of radionuclide concentrations at the UNRESTRICTED AREA BOUNDARY (summarized in Table B-1) has been used as the initial typical distribution. The effective dose factors derived from this distribution are presented in Table B-2.

Application

To provide an additional degree of conservatism, a factor of 2.0 is introduced into the dose calculation when the effective dose factor is used. This conservatism provides additional assurance that the evaluation of doses by the use of a single effective dose factor will not significantly underestimate any actual doses in the environment.

For evaluating compliance with the dose limits of Technical Specification 5.5.3.e and 5.5.3.h, the following simplified equations may be used:

$$D\lambda = 2.0 * 3.17\text{E} - 08 * \chi / Q * M_{\text{eff}} * \Sigma Q_i \quad (\text{B-5})$$

and

$$D\beta = 2.0 * 3.17\text{E} - 08 * \chi / Q * N_{\text{eff}} * \Sigma Q_i \quad (\text{B-6})$$

where:

$D\lambda$ = air dose due to gamma emissions for the cumulative release of all noble gases (mrad),

$D\beta$ = air dose due to beta emissions for the cumulative release of all noble gases (mrad),

χ/Q = atmospheric dispersion to the controlling unrestricted area boundary (sec/m³),

M_{eff} = 5.7E+02, effective gamma-air dose factor (mrad/yr per $\mu\text{Ci}/\text{m}^3$),

N_{eff} = 1.1E+03, effective beta-air dose factor (mrad/yr per $\mu\text{Ci}/\text{m}^3$),

Q_i = cumulative release for all noble gas radionuclides (μCi),

3.17E-08 = conversion factor (yr/sec), and

2.0 = conservatism factor to account for the variability in the effluent data.

Combining the constants, the dose calculation equations simplify to:

$$D\lambda = 3.61E - 05 * \chi / Q * \Sigma Q_i \quad (\text{B-5})$$

and

$$D\beta = 7.20E - 05 * \chi / Q * \Sigma Q_i \quad (\text{B-6})$$

The effective dose factors are used for the purpose of facilitating the timely assessment of radioactive effluent releases, particularly during periods when the computer or ODCM software may be unavailable to perform a detailed dose assessment.

Table B-1
 Default Noble Gas Radionuclide Distribution*
 of Gaseous Effluents

<u>Nuclide</u>	Fraction of Total ($A_i / \sum A_i$)			
	<u>Containment Vessel Purge</u>	<u>Station Vent</u>	<u>Waste Gas Decay Tank</u>	<u>Total</u>
Ar-41	0.0003	0.004	0.004	0.003
Kr-85	0.12	0.012	0.034	0.06
Xe-131m	0.02	0.009	0.008	0.017
Xe-133m	0.005	0.011	0.011	0.008
Xe-133	0.86	0.94	0.92	0.83
Xe-135m	--	0.004	0.0034	0.06
Xe-135	<u>0.002</u>	<u>0.02</u>	<u>0.02</u>	<u>0.021</u>
Total	<u>1.0</u>	<u>1.0</u>	<u>1.0</u>	<u>1.0</u>

NOTE:

** Data adapted from Davis-Besse USAR Section 11.3, Table 11.3-13 and Table 11.3-14. Kr-83m, Kr-85m, Kr-87, Kr-88 and Xe-138 have been excluded because of their negligible fractional abundance (i.e., < 1%).

Table B-2
Effective Dose Factors - Noble Gas Effluents

Isotope	Fractional Abundance	Total Body Dose Factor K_{eff} (mrem/yr per $\mu\text{Ci}/\text{m}^3$)	Skin Dose Factor (L+1.1 M_{eff}) (mrem/yr per $\mu\text{Ci}/\text{m}^3$)	Gamma Air Dose Factor M_{eff} (mrad/yr per $\mu\text{Ci}/\text{m}^3$)	Beta Air Dose Factor N_{eff} (mrad/yr per $\mu\text{Ci}/\text{m}^3$)
Ar-41	0.003	2.65E+01	3.87E+01	2.79E+01	9.84E+00
Kr-85	0.06	9.96E-01	8.15E+01	1.03E+00	1.17E+02
Xe-131m	0.017	1.55E+00	1.10E+01	2.65E+00	1.88E+01
Xe-133m	0.008	2.00E+00	1.08E+01	2.61E+00	1.18E+01
Xe-133	0.83	2.44E+02	5.76E+02	2.93E+02	8.72E+02
Xe-135m	0.06	1.87E+02	2.64E+02	2.02E+02	4.43E+01
Xe-135	0.02	3.62E+01	7.94E+02	4.03E+01	5.16E+01
TOTAL	1.0	4.98E+02	9.89E+02	5.69E+02	1.12E+03

APPENDIX C
Radiological Environmental Monitoring Program
Sample Location Maps

Sampling locations (excepting those on the site periphery)
 Davis-Besse Nuclear Power Station, Unit No. 1.

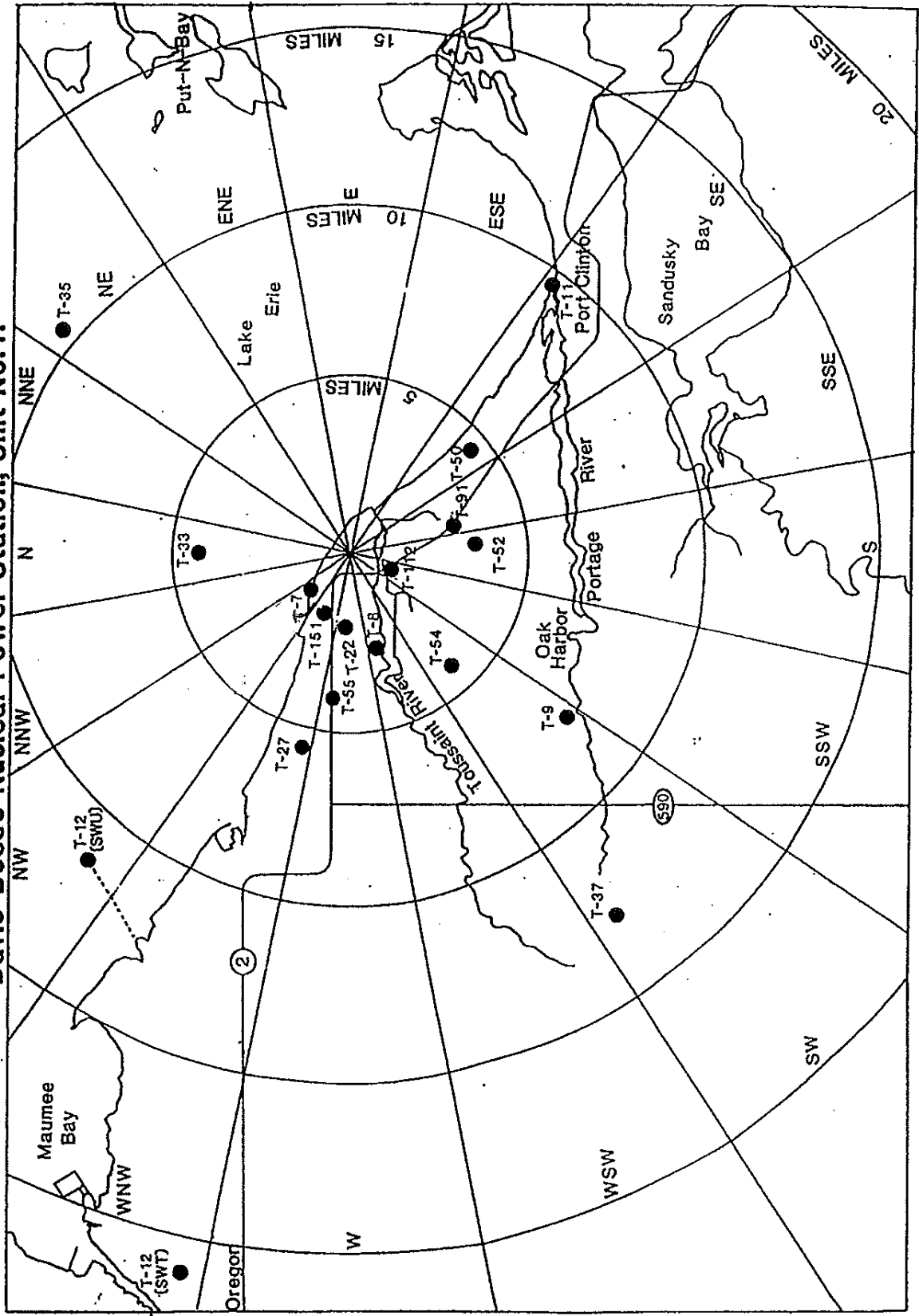

Sampling locations on the site periphery of the Davis-Besse Nuclear Power Station, Unit No. 1.

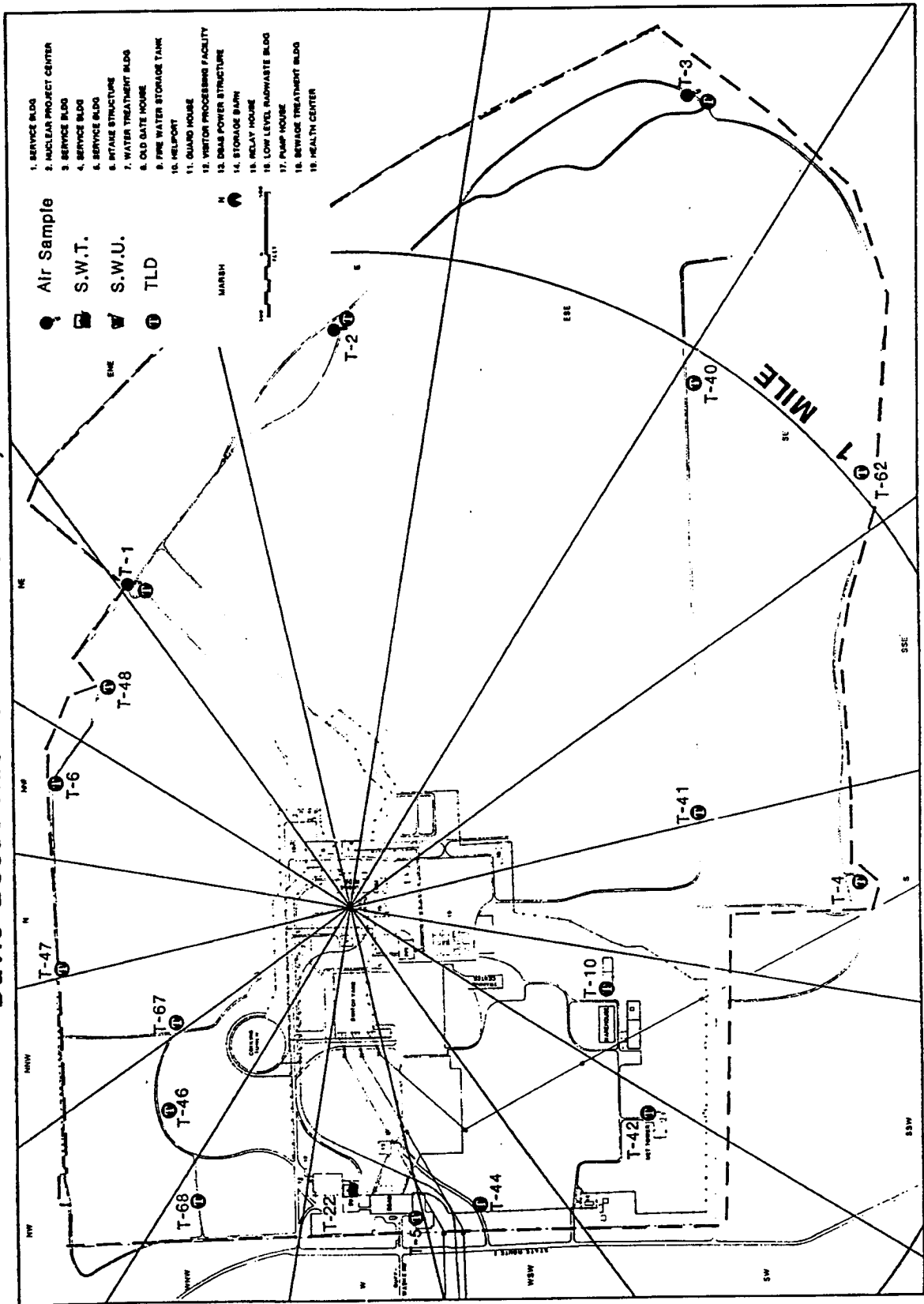

ENVIRONMENTAL MONITORING

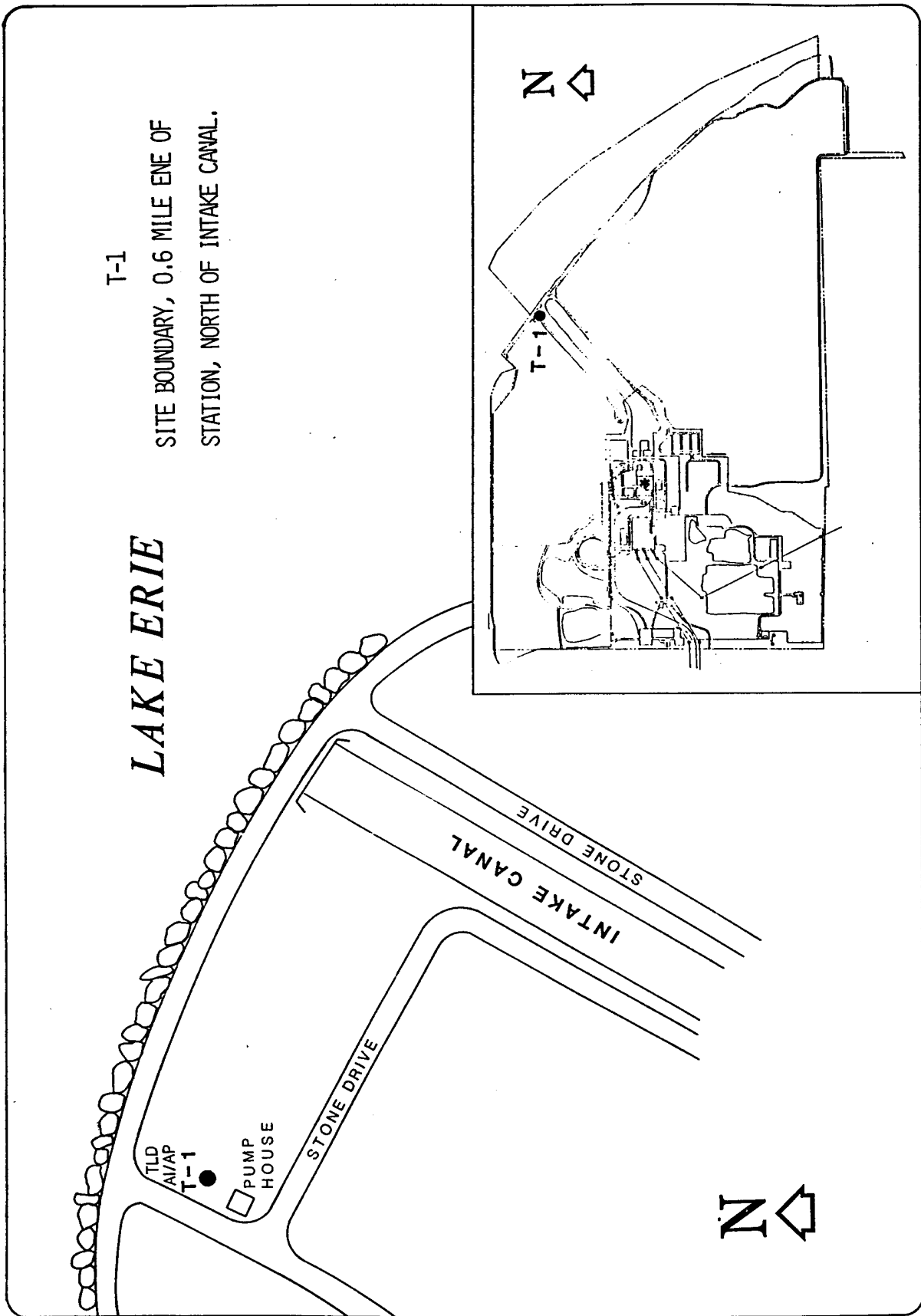

T-1
 SITE BOUNDARY, 0.6 MILE ENE OF
 STATION, NORTH OF INTAKE CANAL.

LAKE ERIE

TLD
 A1/AP
 T-1

PUMP
 HOUSE

STONE DRIVE

INTAKE CANAL

STONE DRIVE

T-1



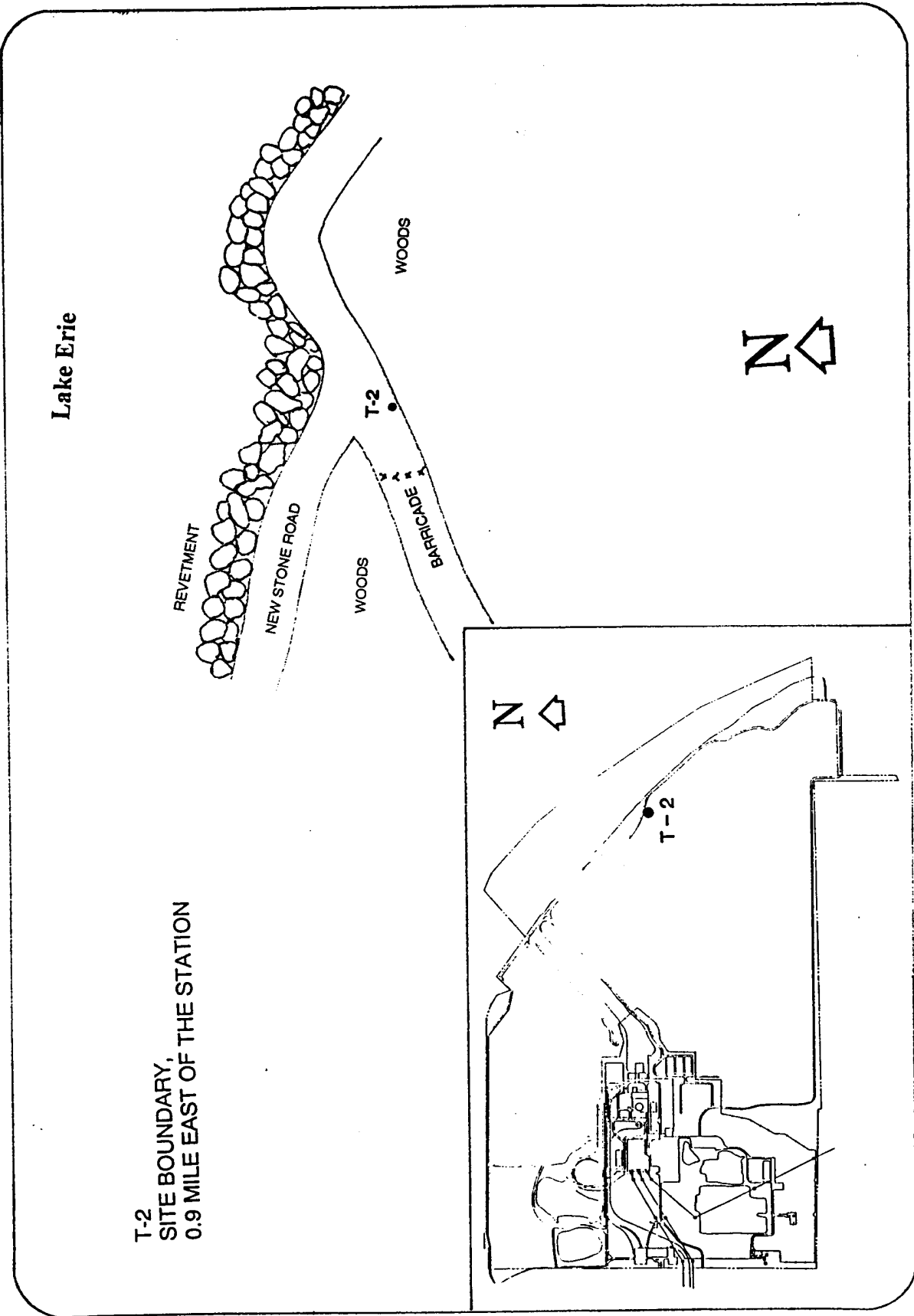

T-2
SITE BOUNDARY,
0.9 MILE EAST OF THE STATION

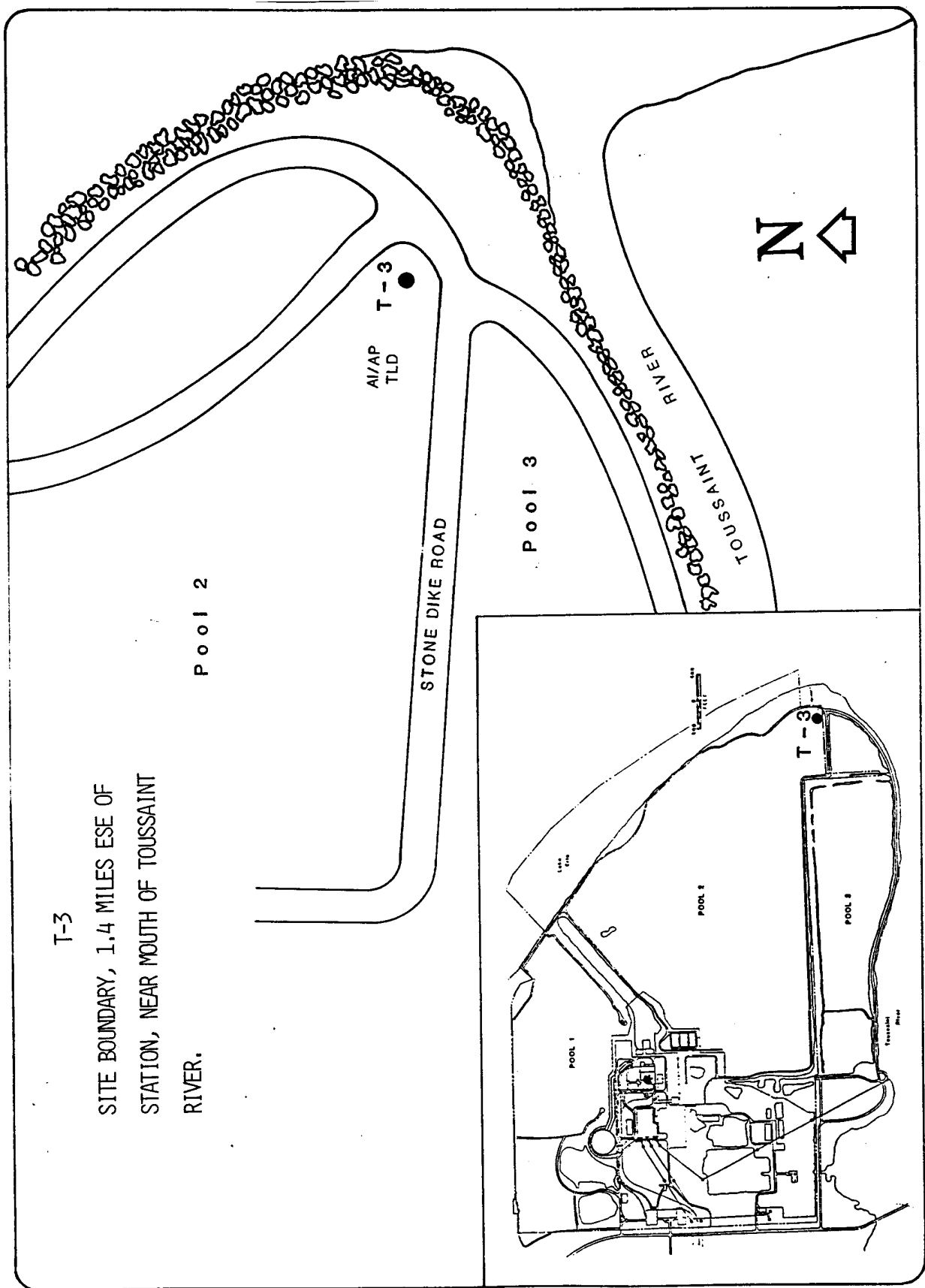

T-3
 SITE BOUNDARY, 1.4 MILES ESE OF
 STATION, NEAR MOUTH OF TOUSSAINT
 RIVER.

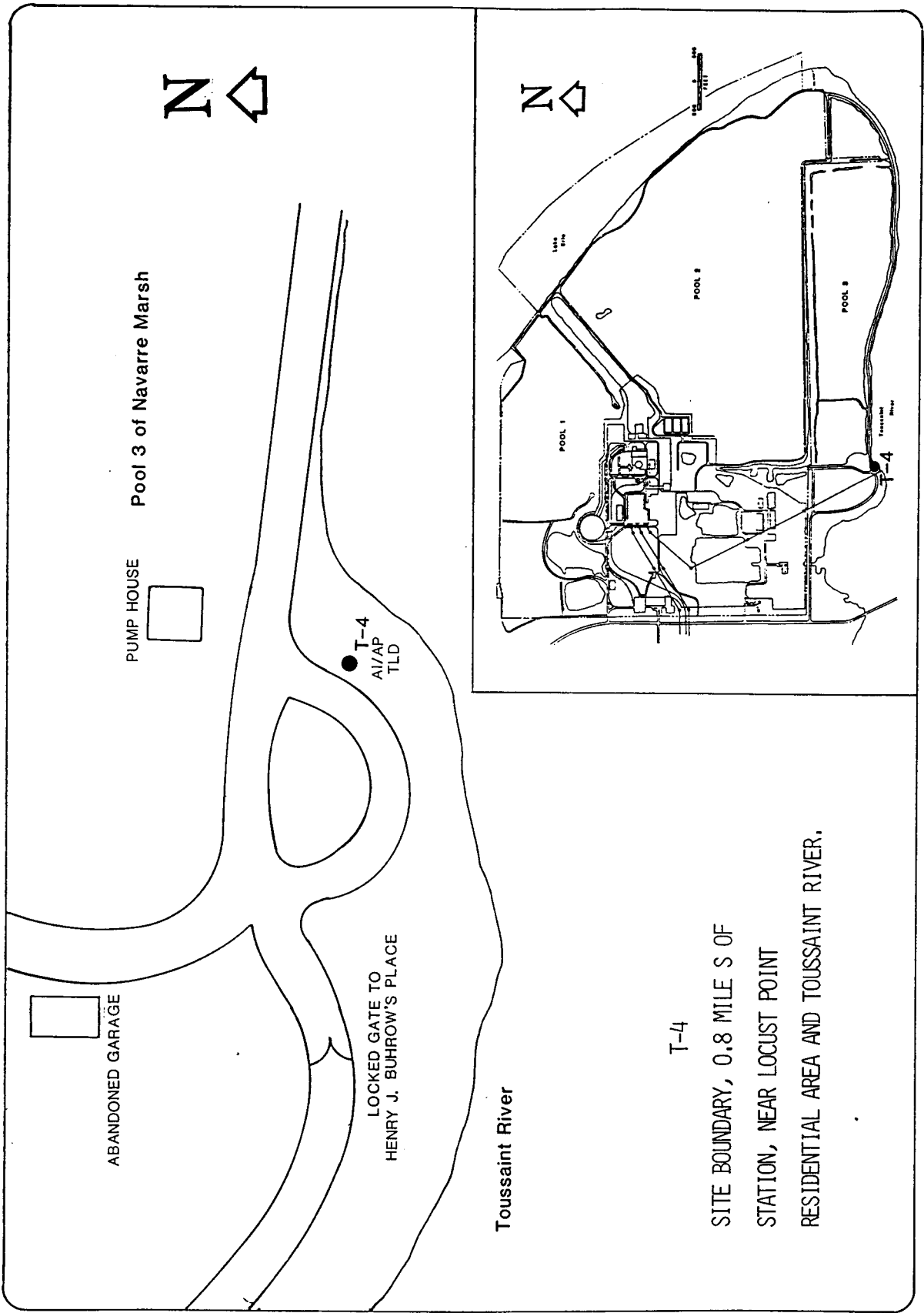

Toussaint River

T-4

SITE BOUNDARY, 0.8 MILE S OF
STATION, NEAR LOCUST POINT
RESIDENTIAL AREA AND TOUSSAINT RIVER.

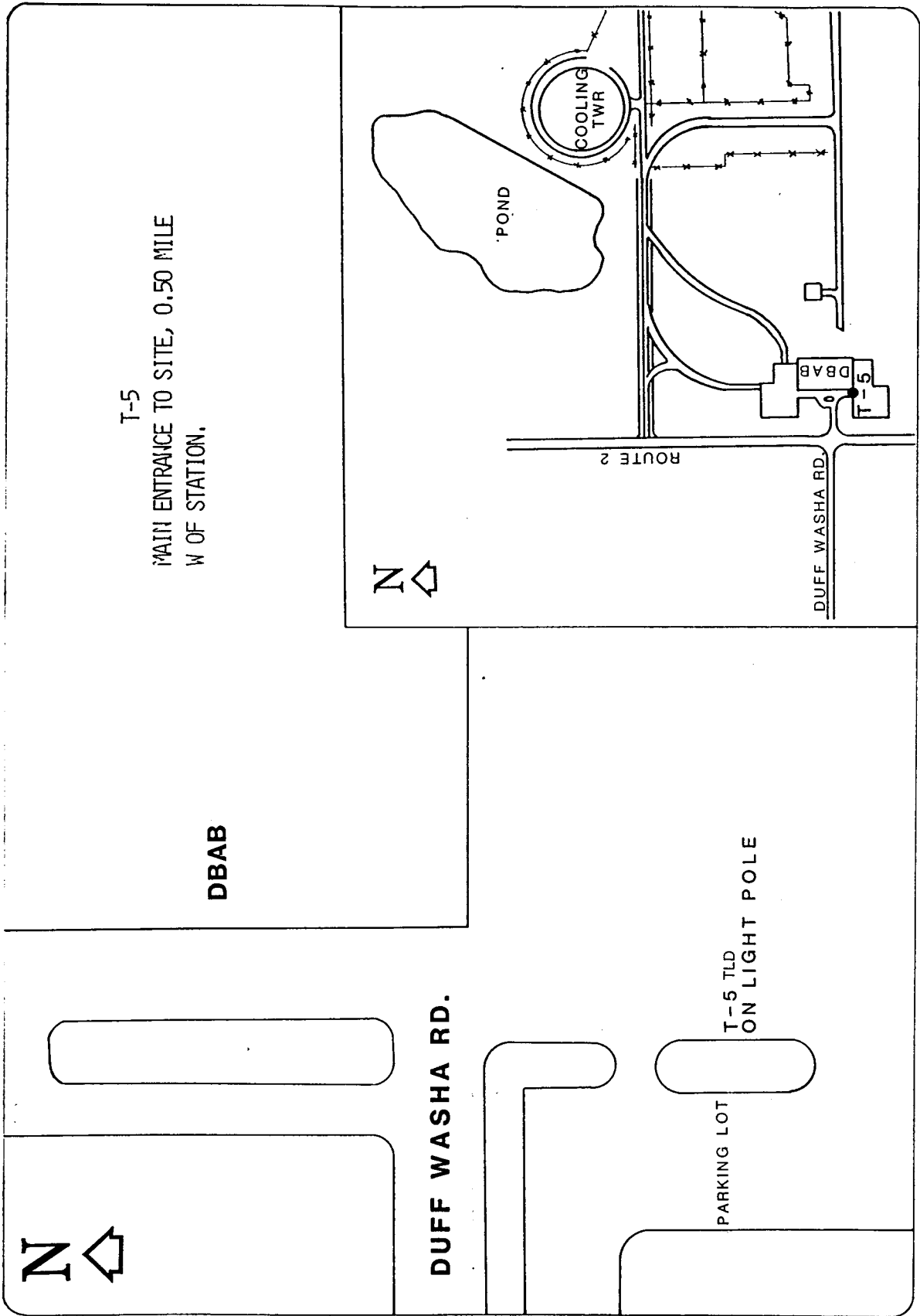

T-5
 MAIN ENTRANCE TO SITE, 0.50 MILE
 W OF STATION.

DBAB

DUFF WASHA RD.

T-5 TLD
 ON LIGHT POLE

PARKING LOT

POND

COOLING
 TWR

ROUTE 2

DUFF WASHA RD.

DBAB

T-5

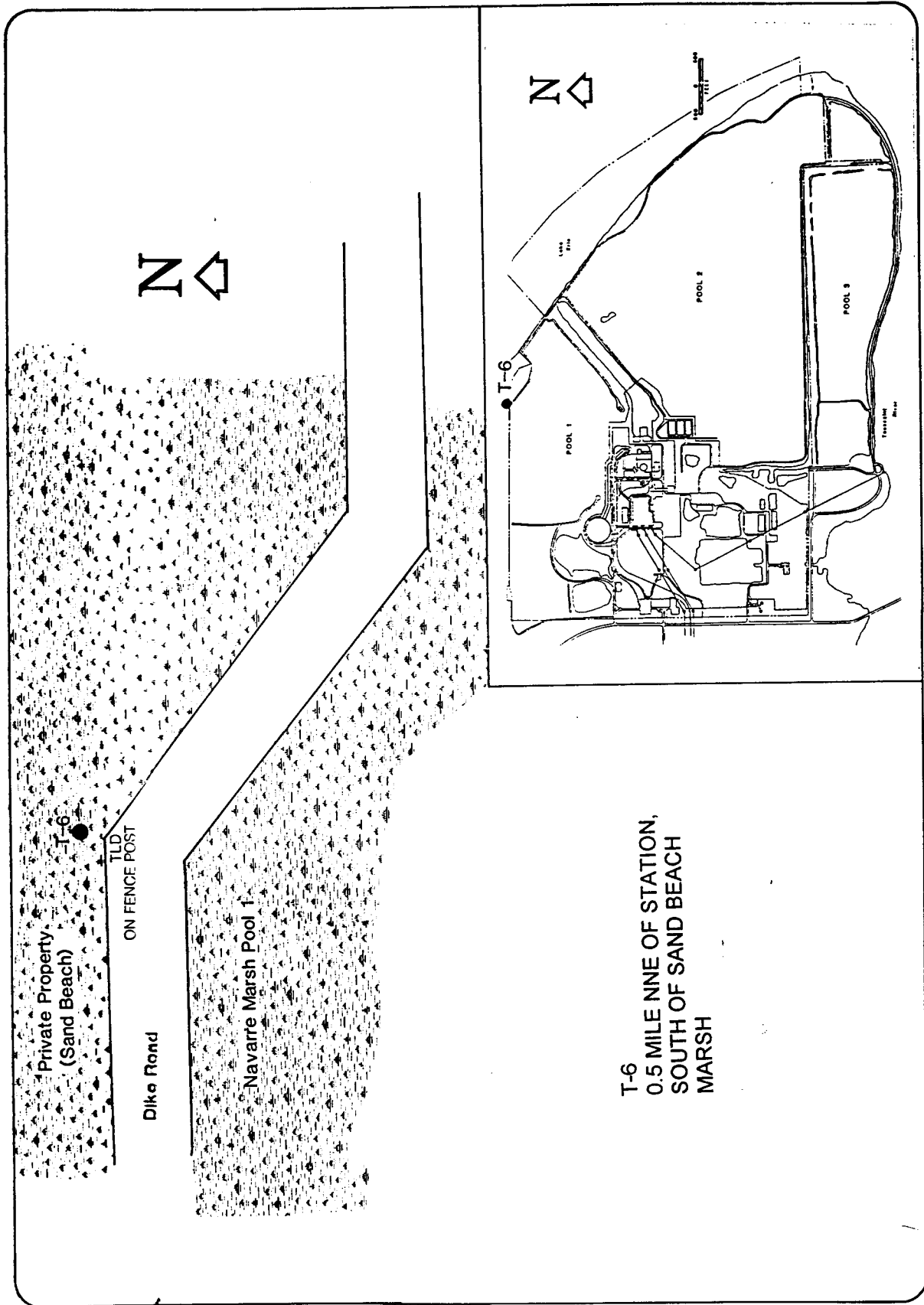

T-6
 0.5 MILE NNE OF STATION,
 SOUTH OF SAND BEACH
 MARSH

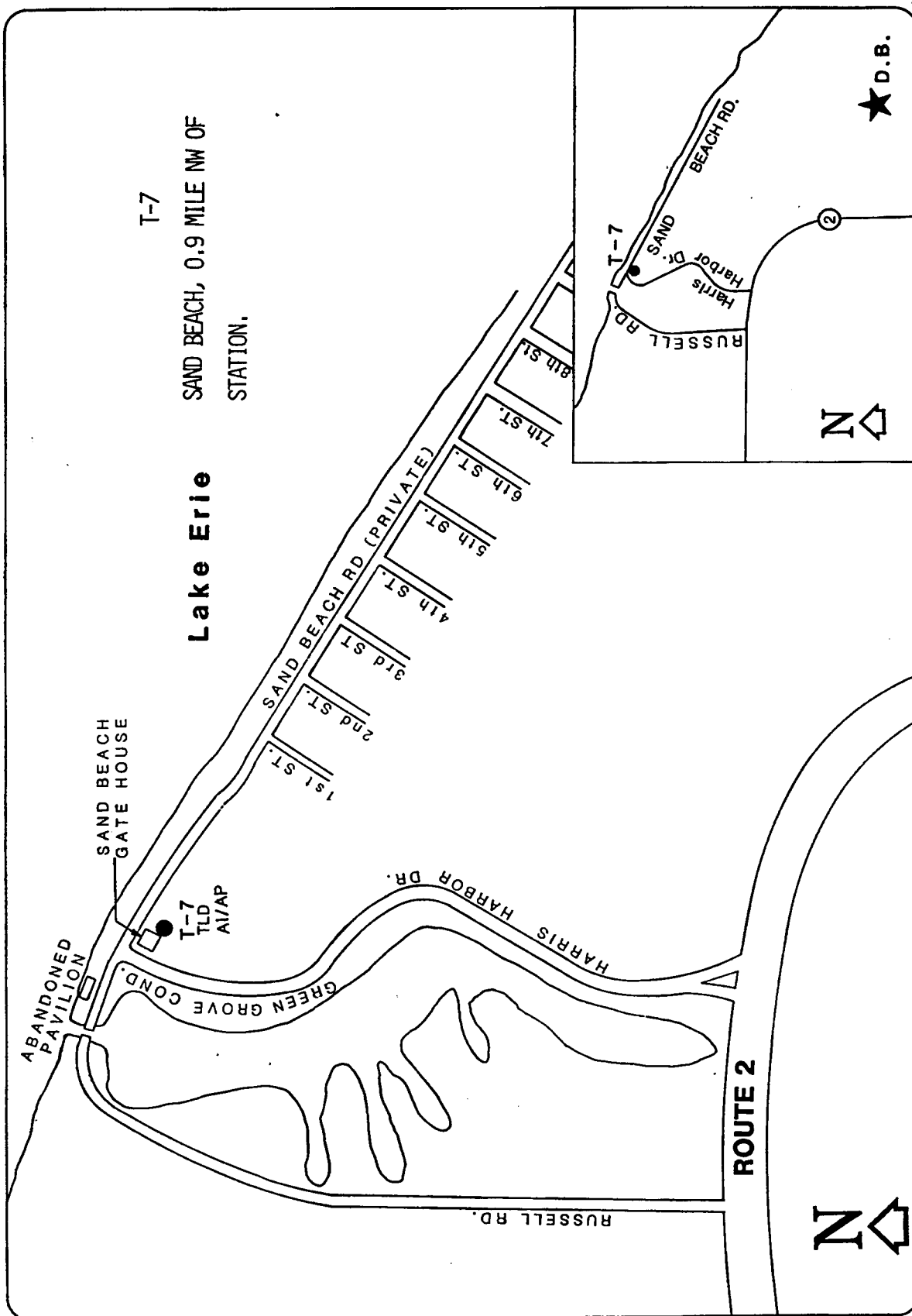

T-8
EARL MOORE FARM, 2.7 MILES WSW
OF STATION.

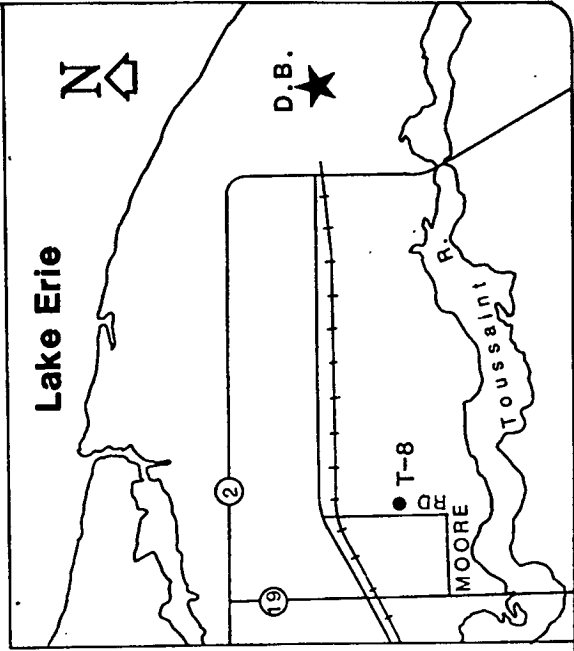
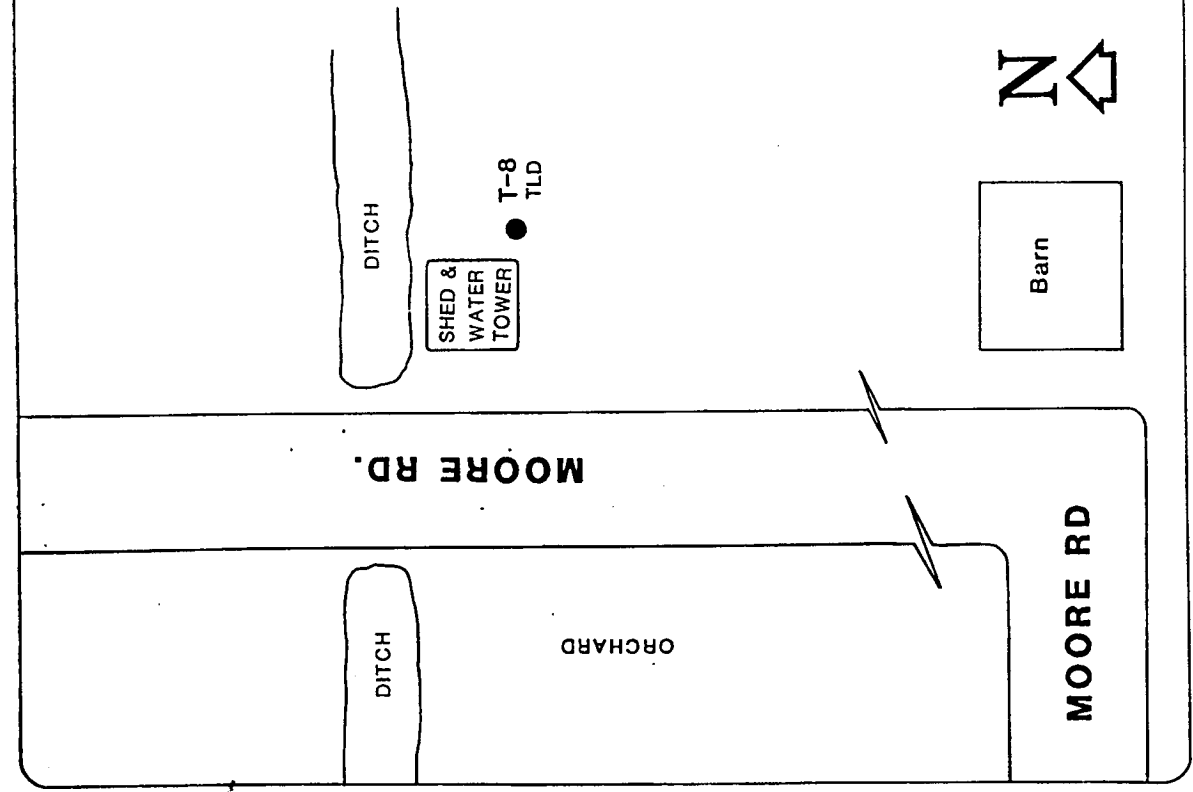

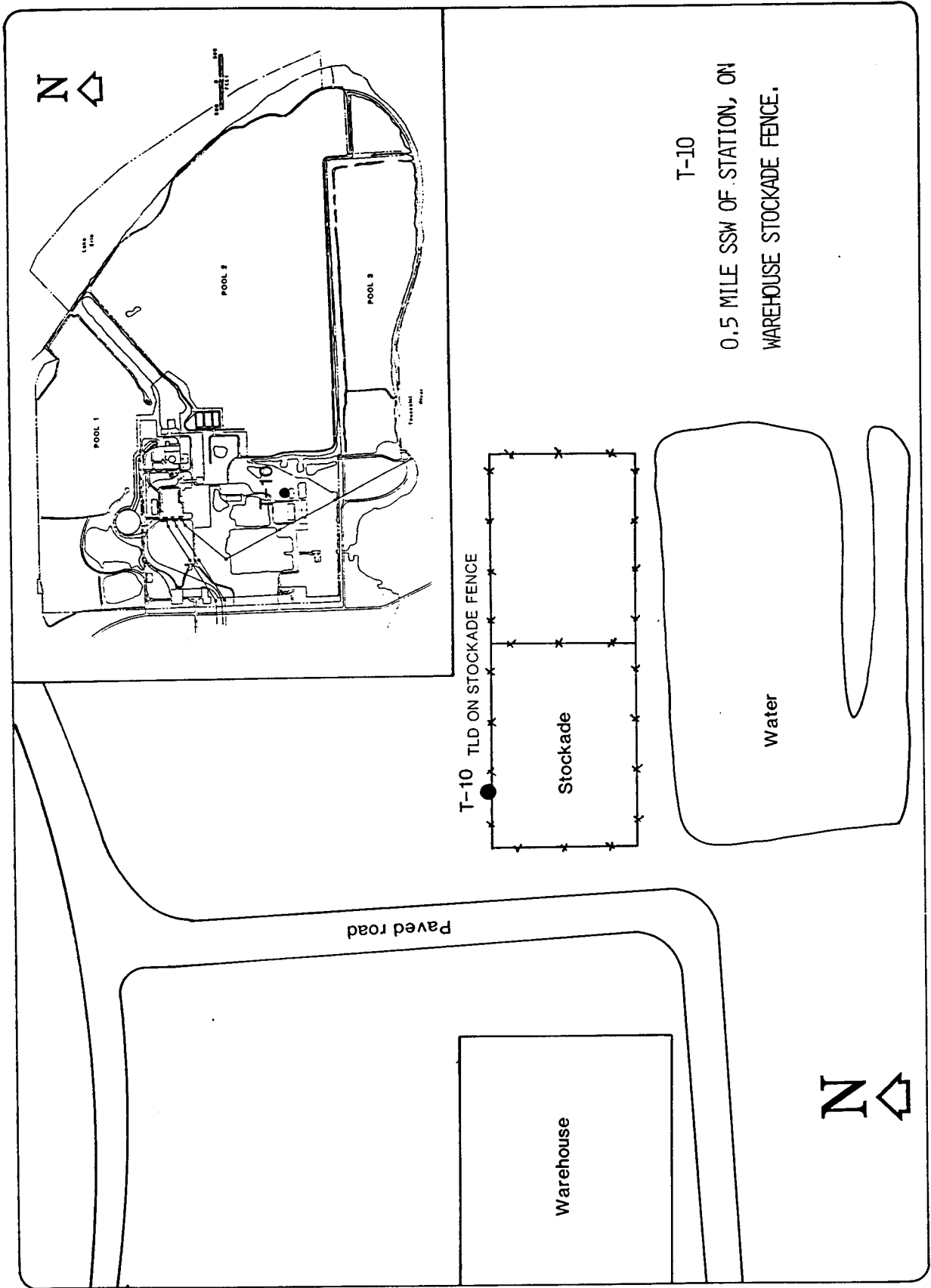

T-10
 0.5 MILE SSW OF STATION, ON
 WAREHOUSE STOCKADE FENCE.

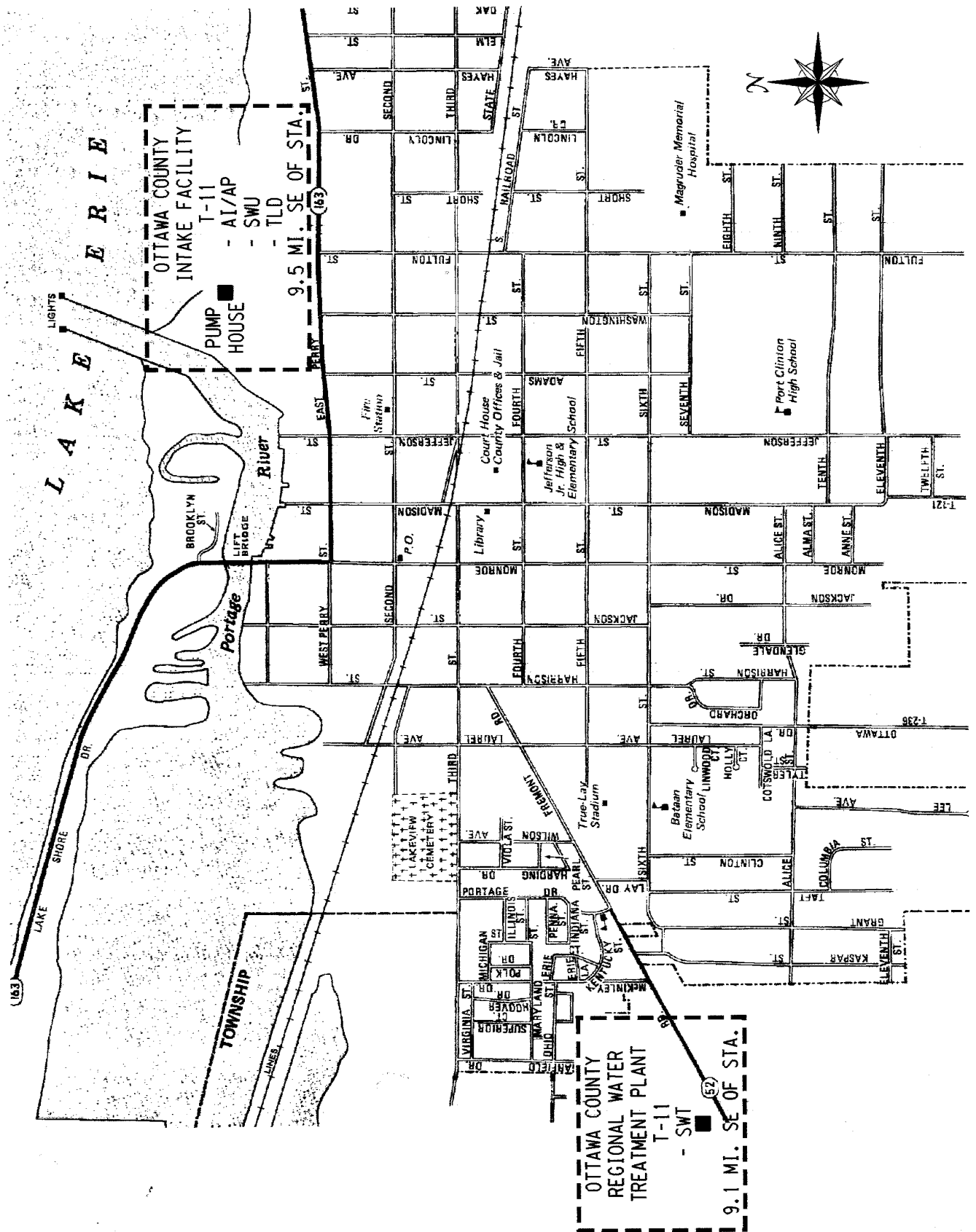

T-12

TOLEDO WATER TREATMENT PLANT, 23.5
MILES WNW OF STATION.

* SWT SAMPLES TAKEN
INSIDE PLANT

* SWU SAMPLES COLLECTED
AT INTAKE CRIB, 11.3 MILES
NW OF STATION IN LAKE ERIE

TO COLLINS PARK YORK ST.

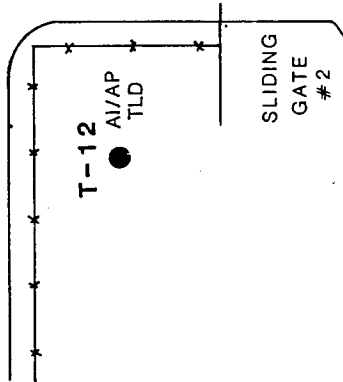
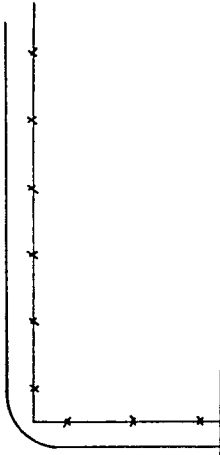

T-12
AI/AP
TLD

SLIDING
GATE
#2

TOLEDO WATER
TREATMENT PLANT
600 COLLINS PARK
OREGON, OHIO
* WATER SAMPLES

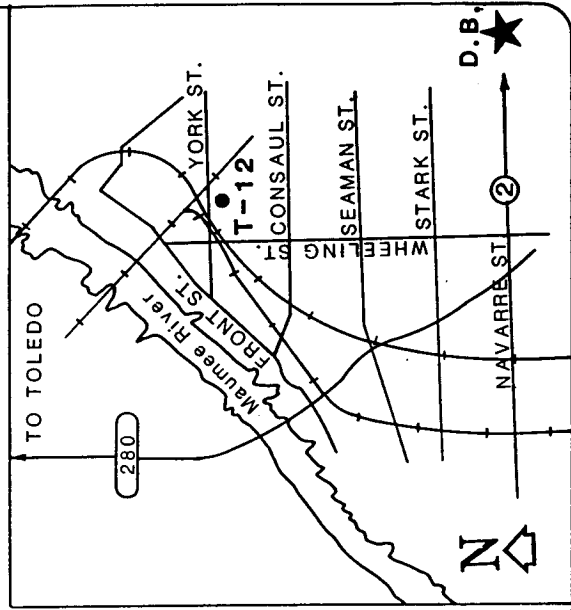

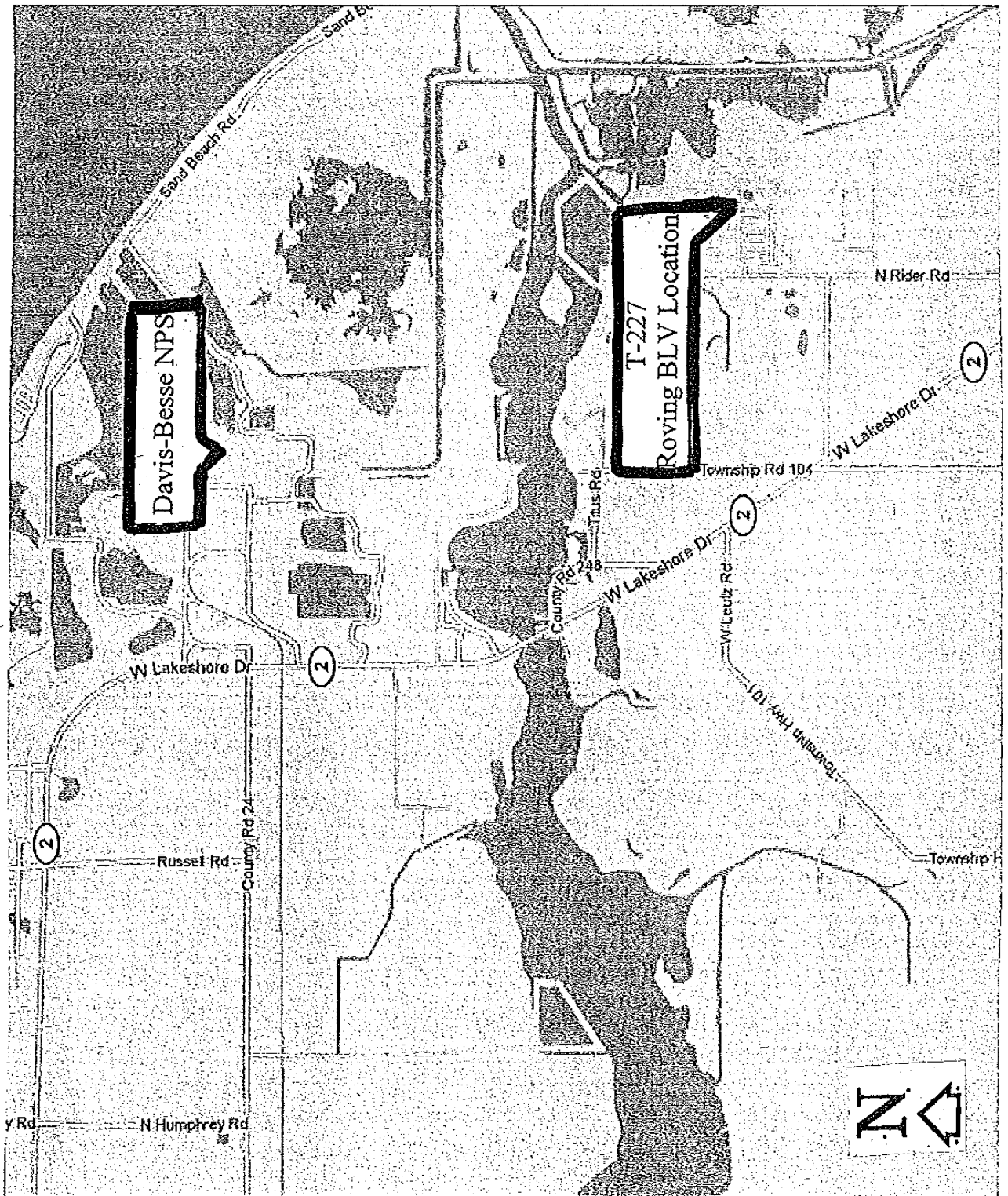

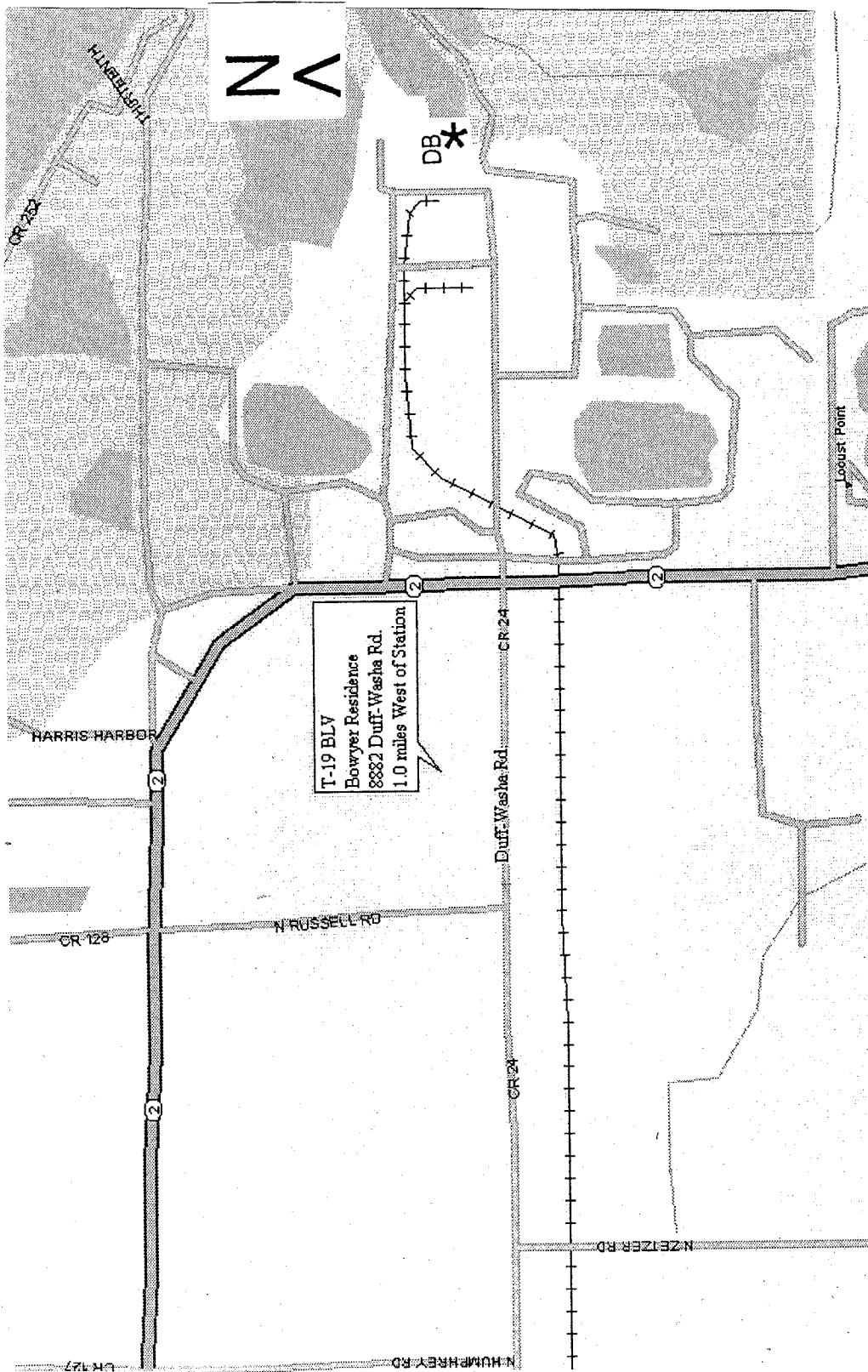

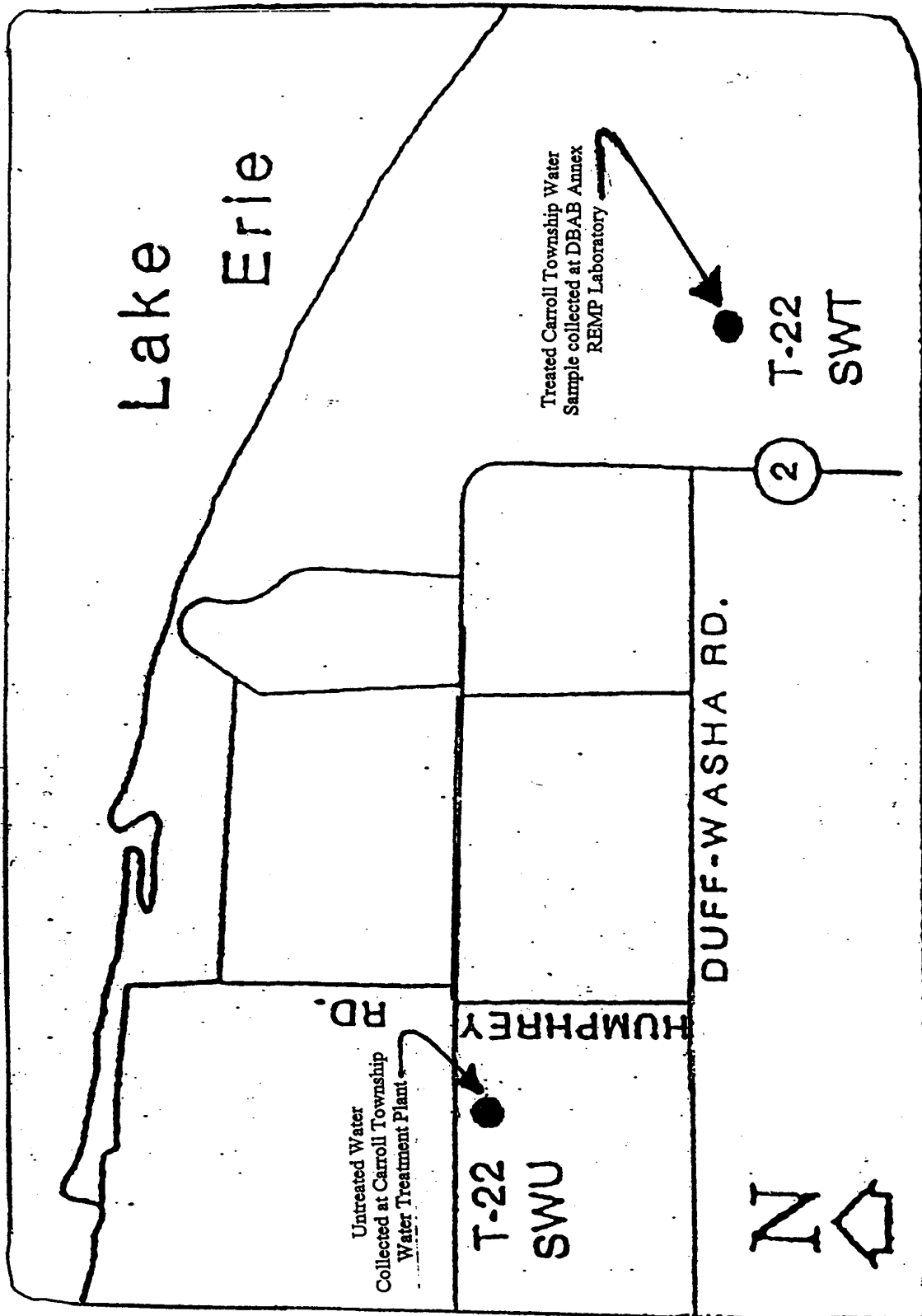

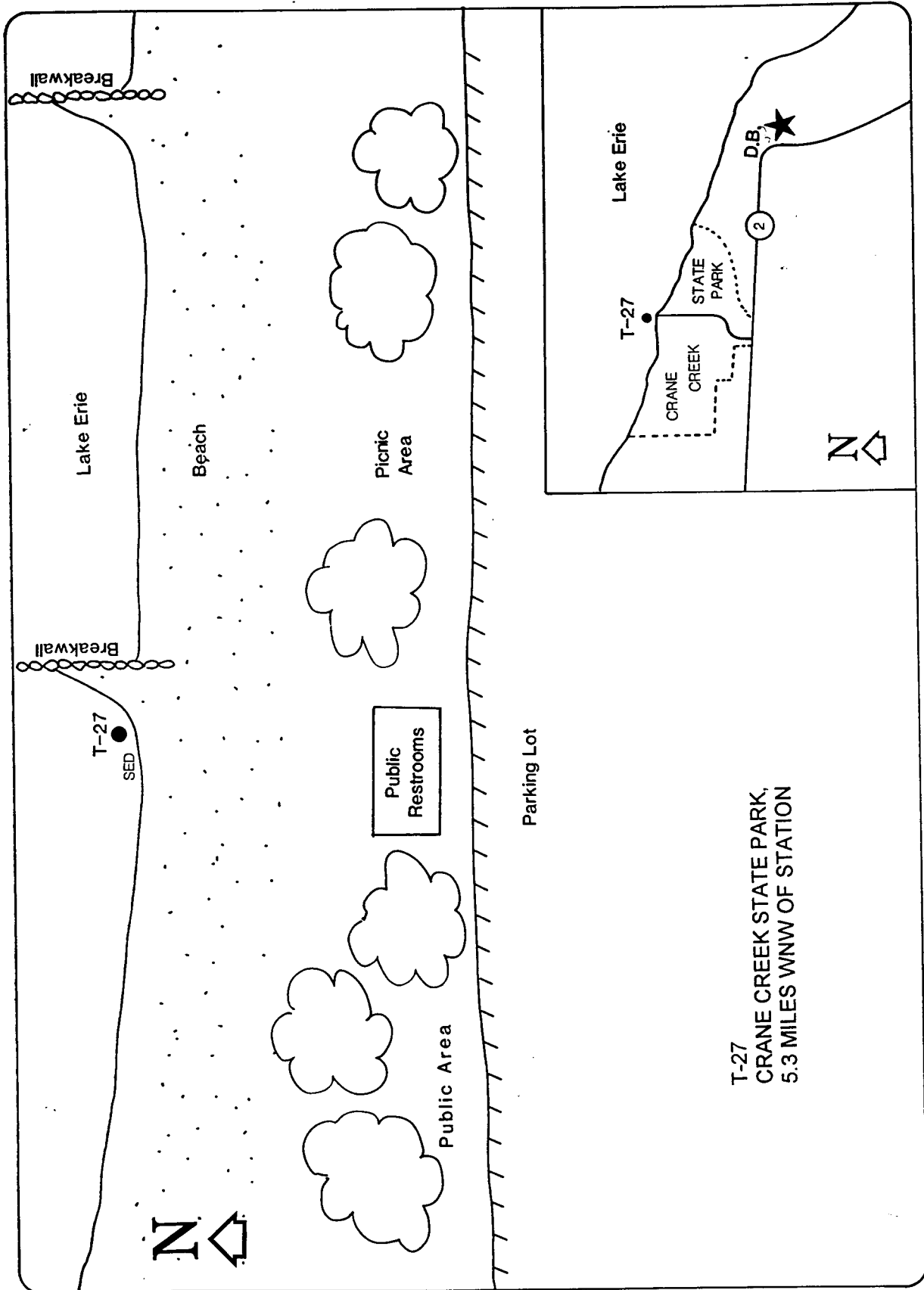

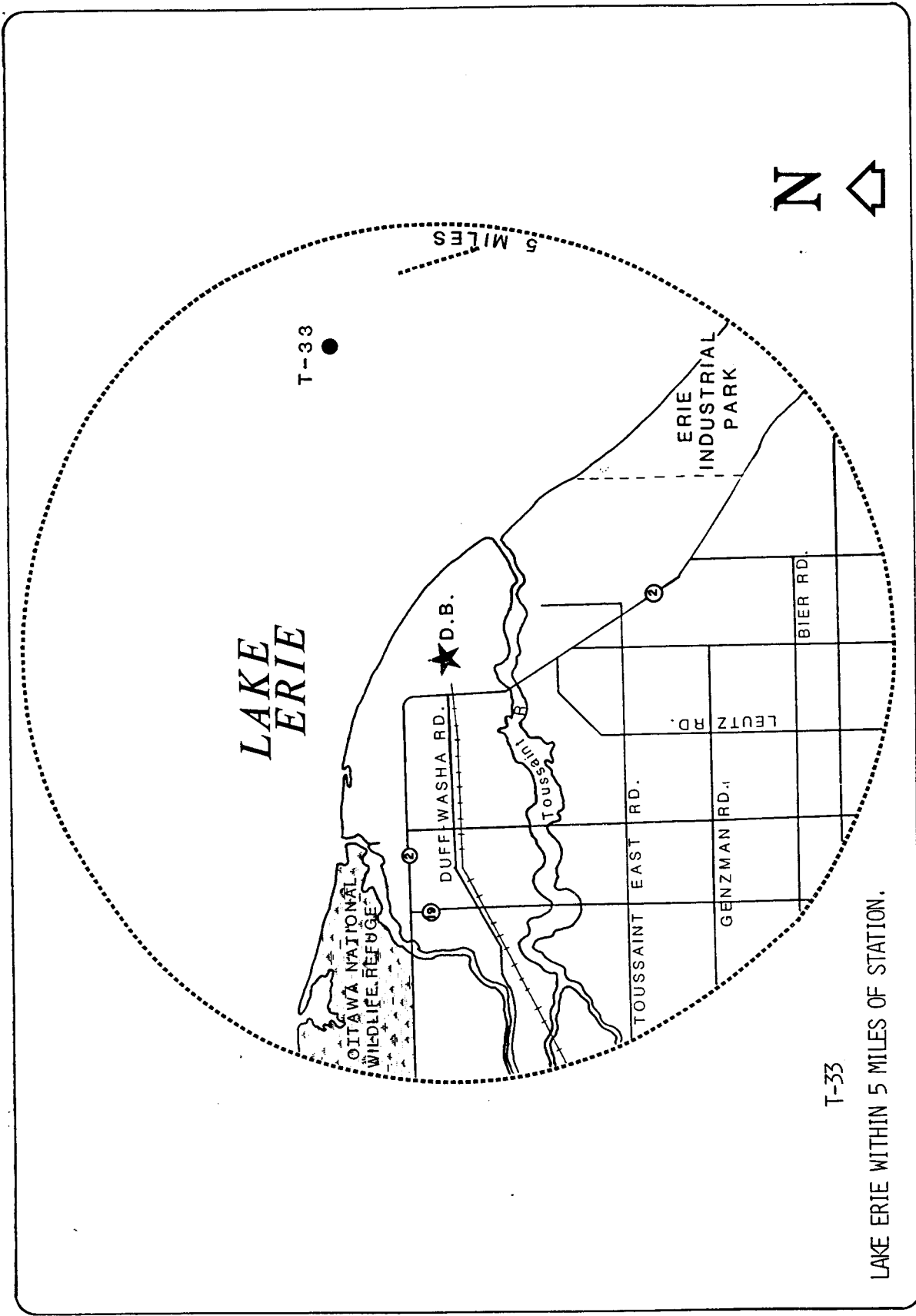

T-33

LAKE ERIE WITHIN 5 MILES OF STATION.

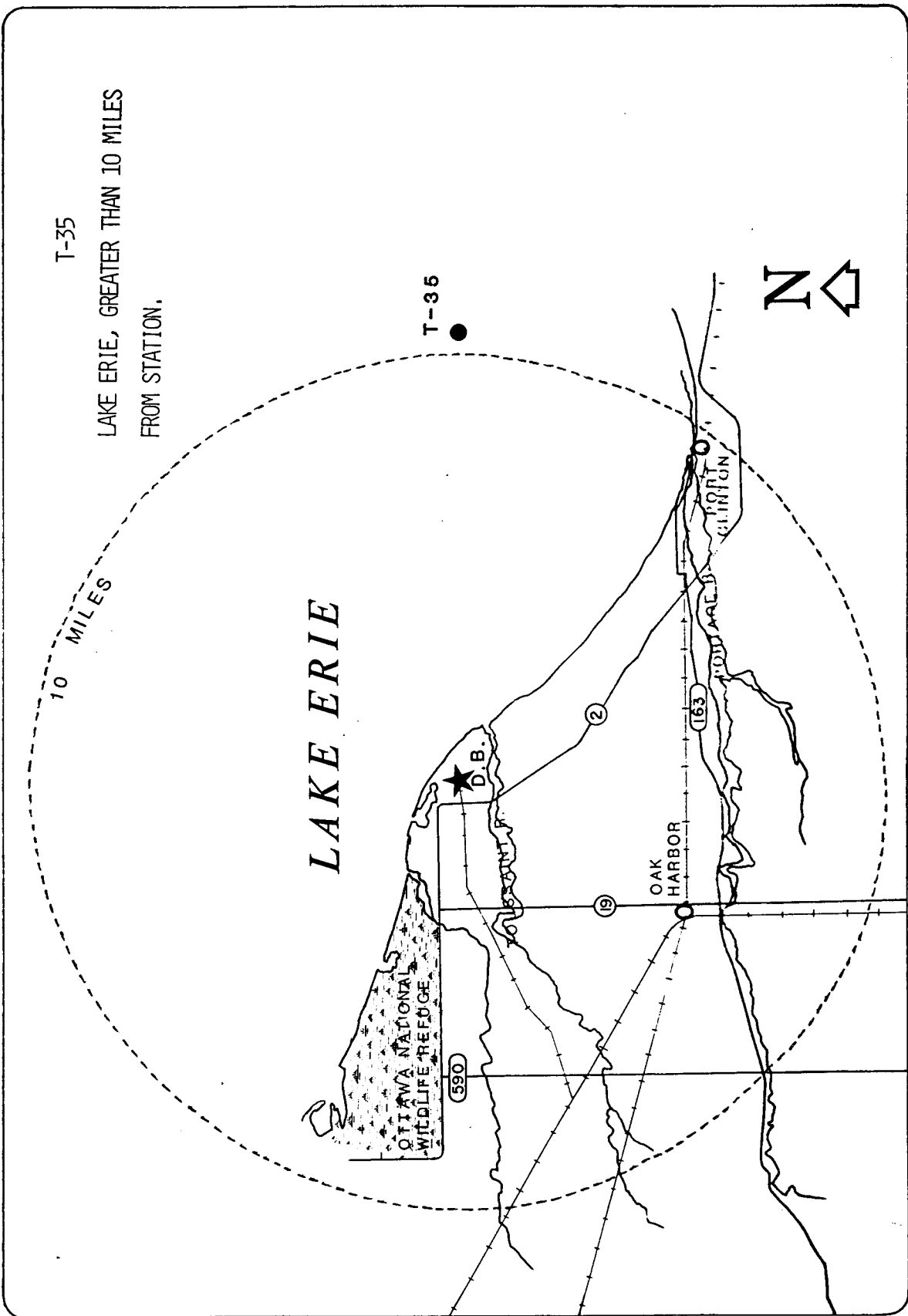

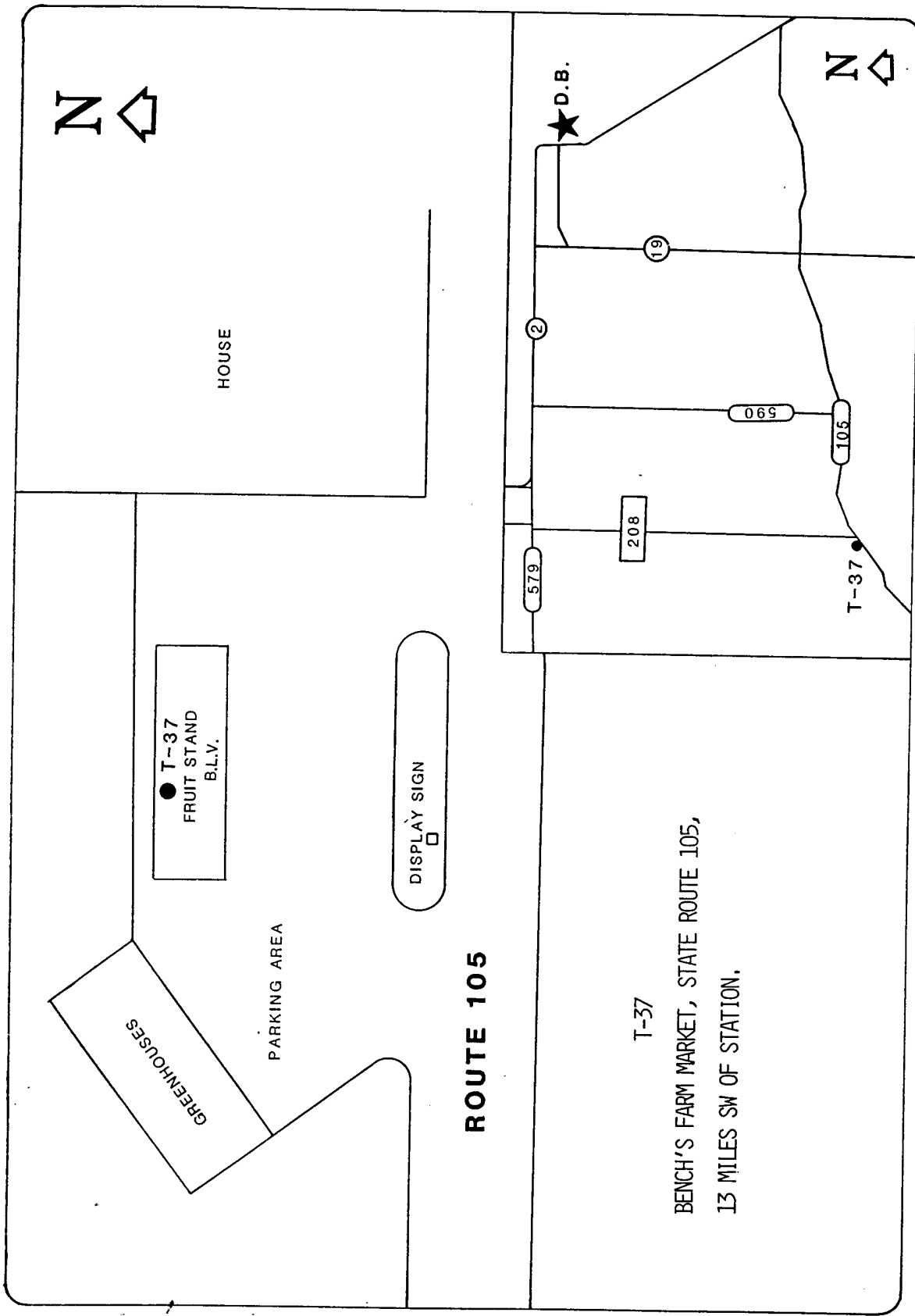

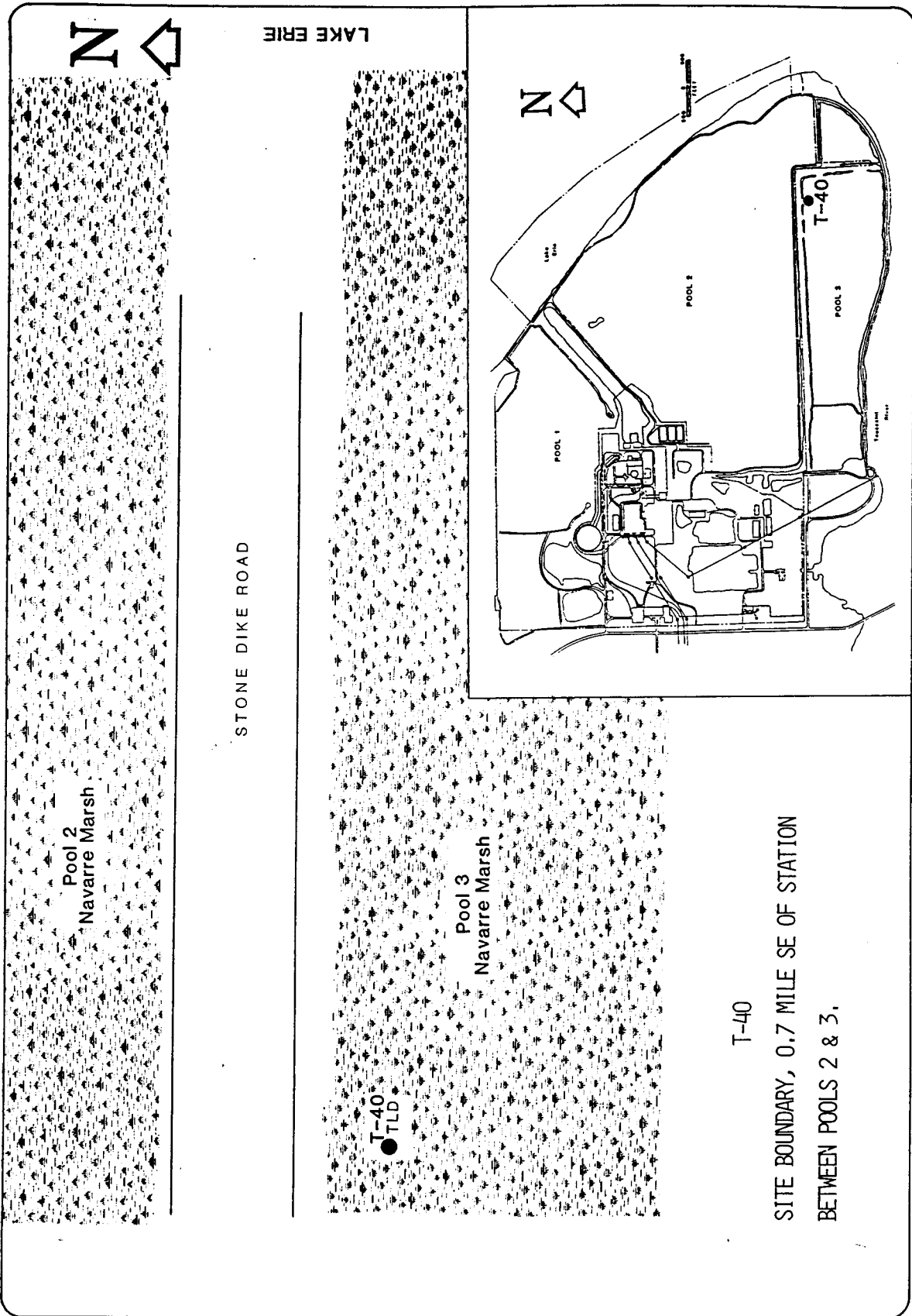

N



Pool 2
Navarre Marsh

STONE DIKE ROAD

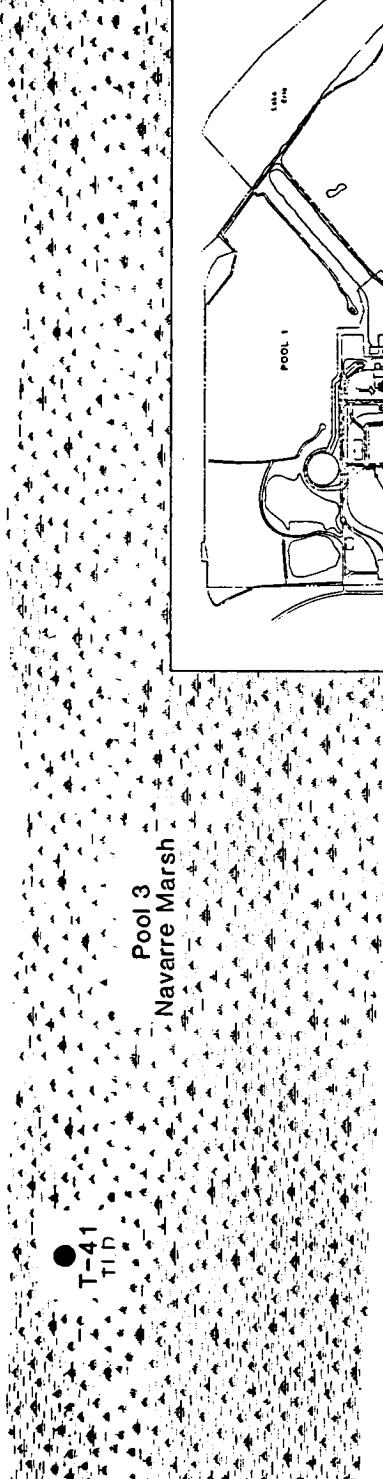

T-41
TID

Pool 3
Navarre Marsh

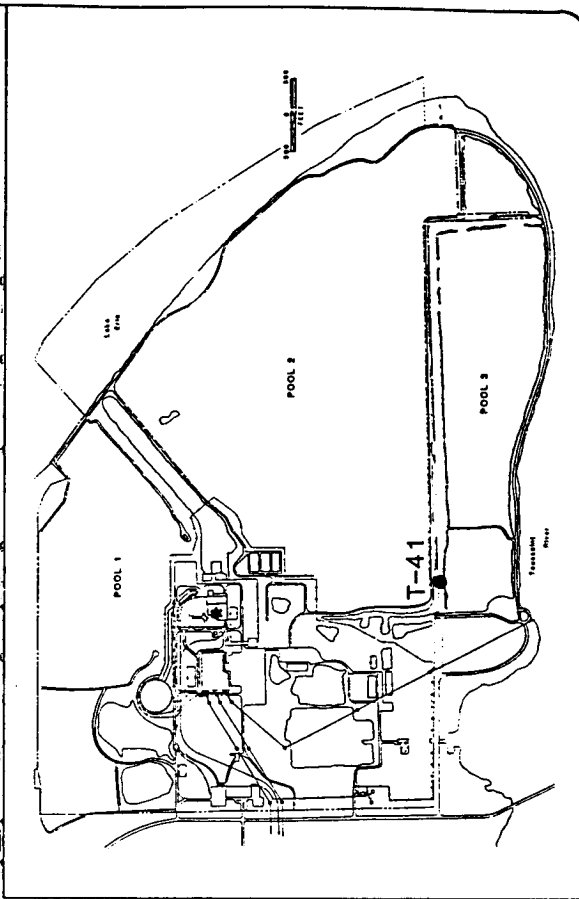

T-41

SITE BOUNDARY, 0.6 MILE SSE OF STATION
BETWEEN POOLS 2 & 3.

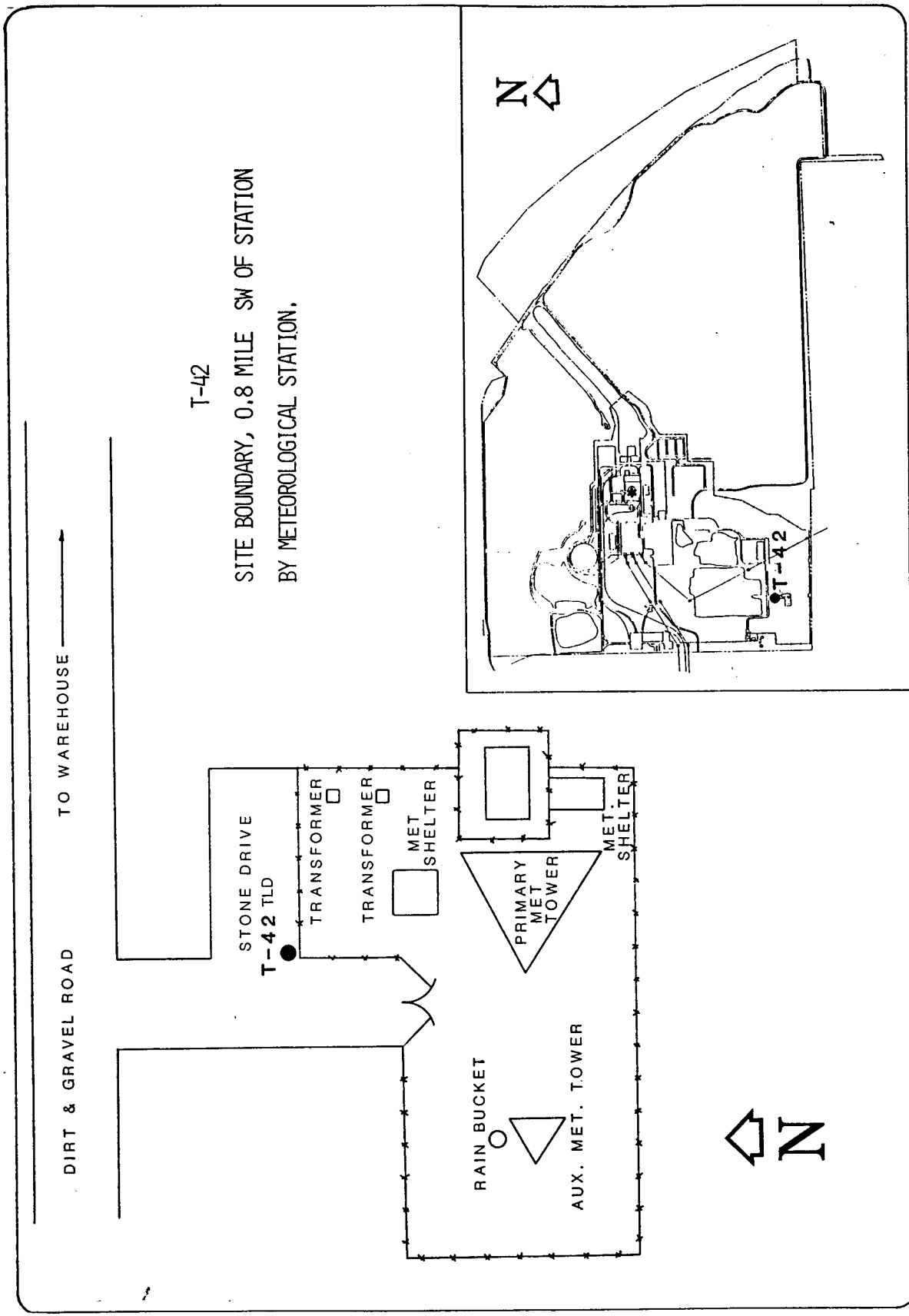

T-42
 SITE BOUNDARY, 0.8 MILE SW OF STATION
 BY METEOROLOGICAL STATION.

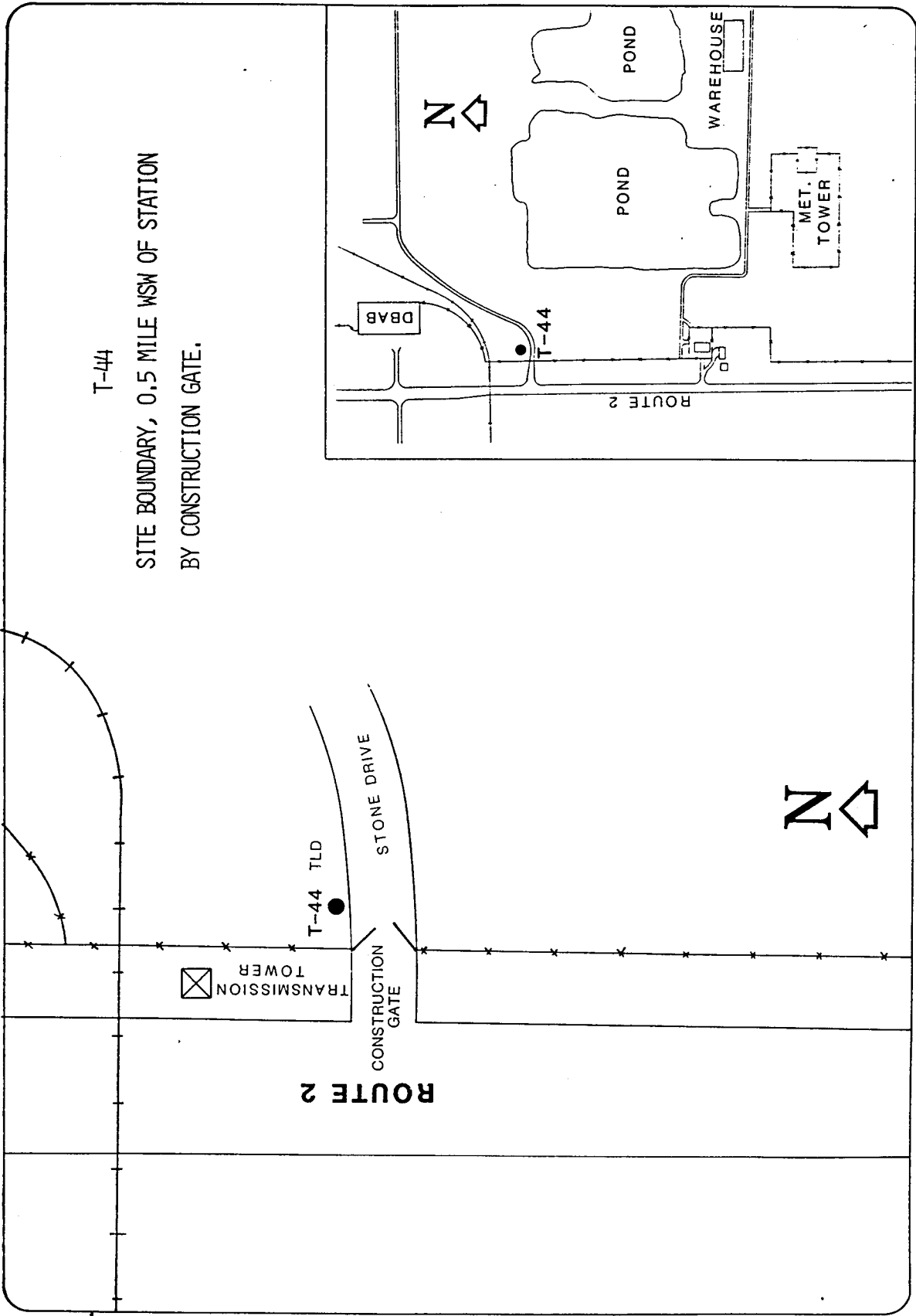

T-44
 SITE BOUNDARY, 0.5 MILE WSW OF STATION
 BY CONSTRUCTION GATE.

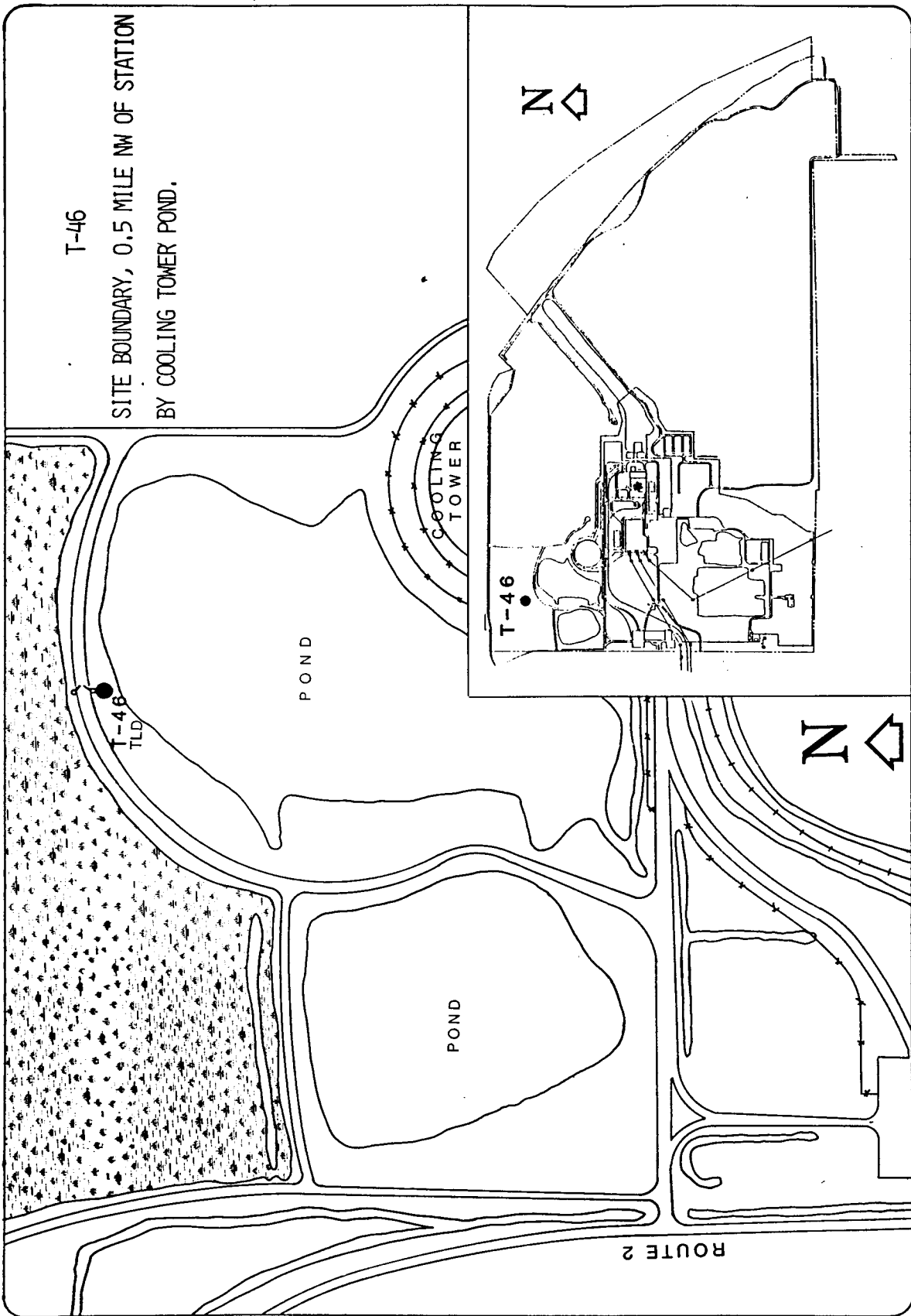

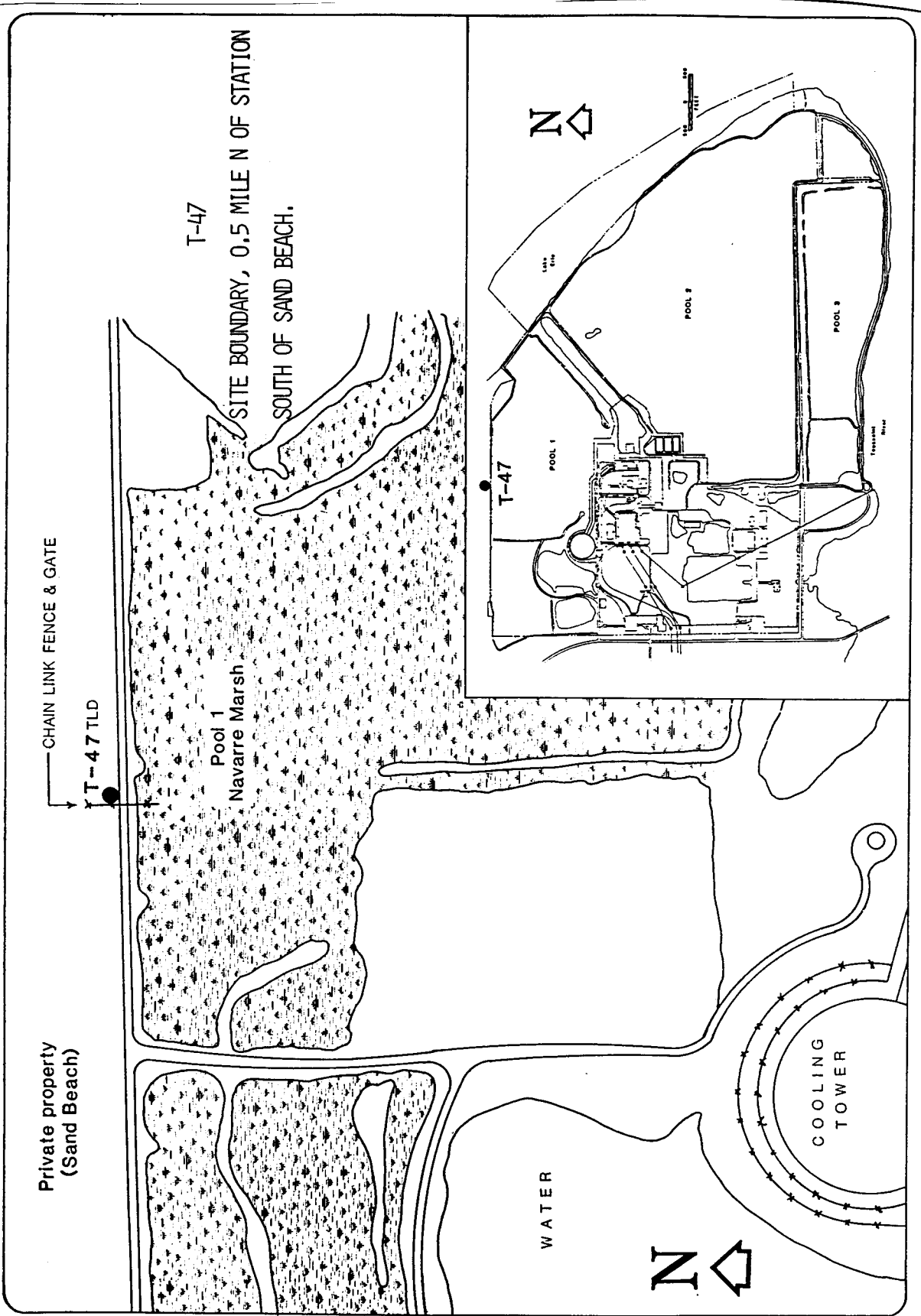

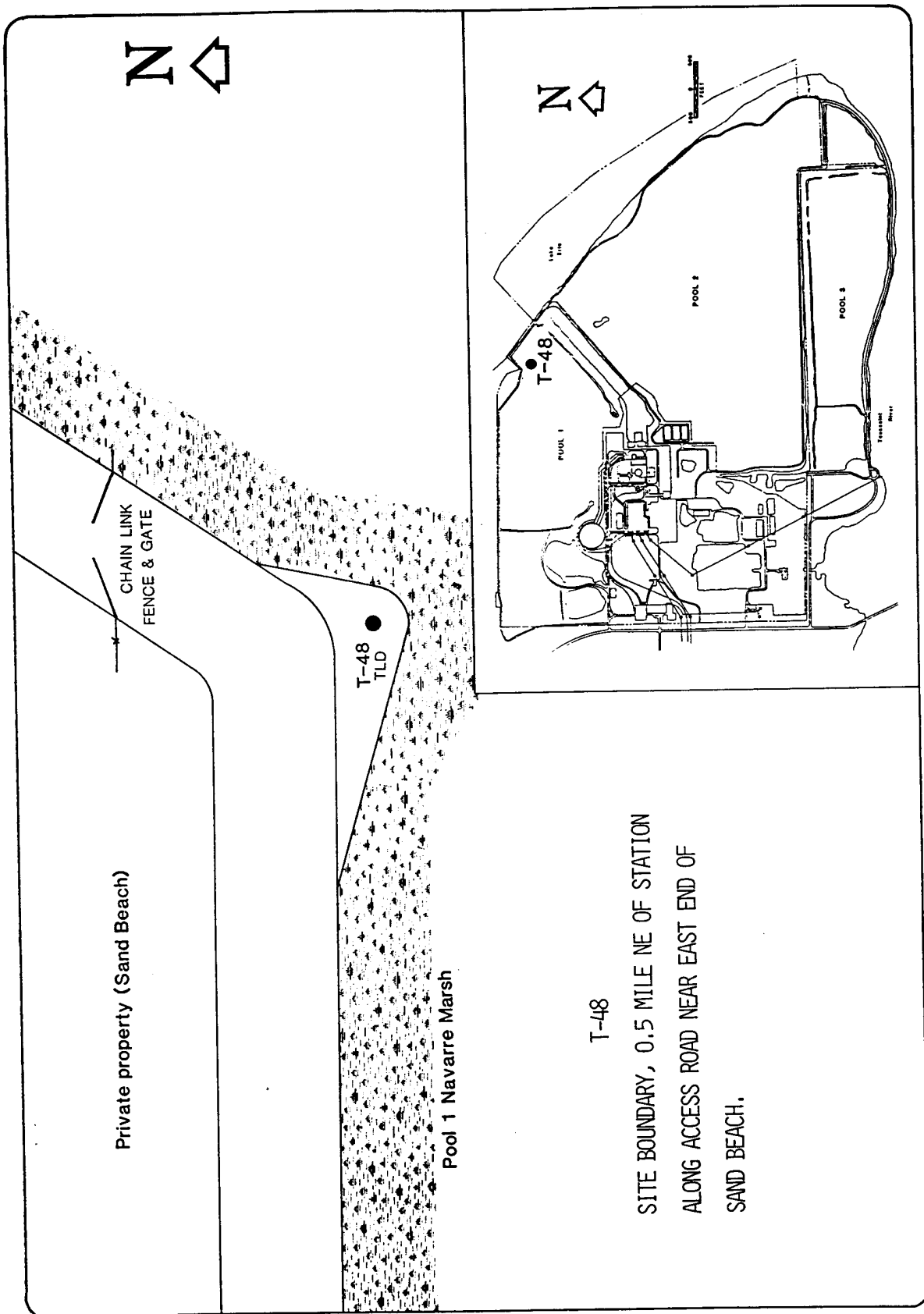

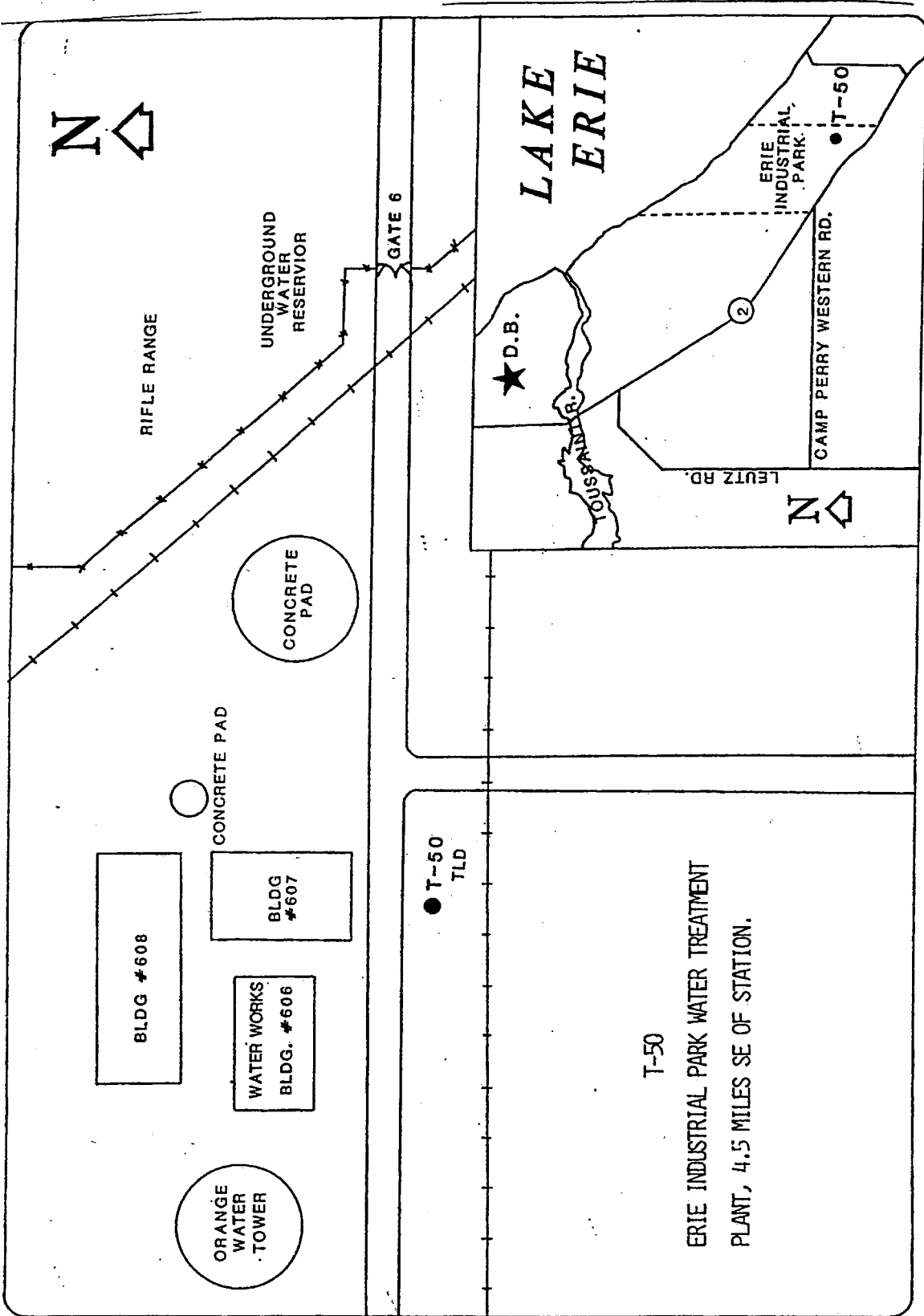

T-52



TLD is mounted on fence post in orchard

CAMP PERRY WESTERN RD.

STONE DRIVE



STONE DRIVE

HOUSE (7898)

BARN & GARAGE

T-52 (TLD)

Miller Farm, 3.7 miles South
of Station on Camp Perry
Western Road.

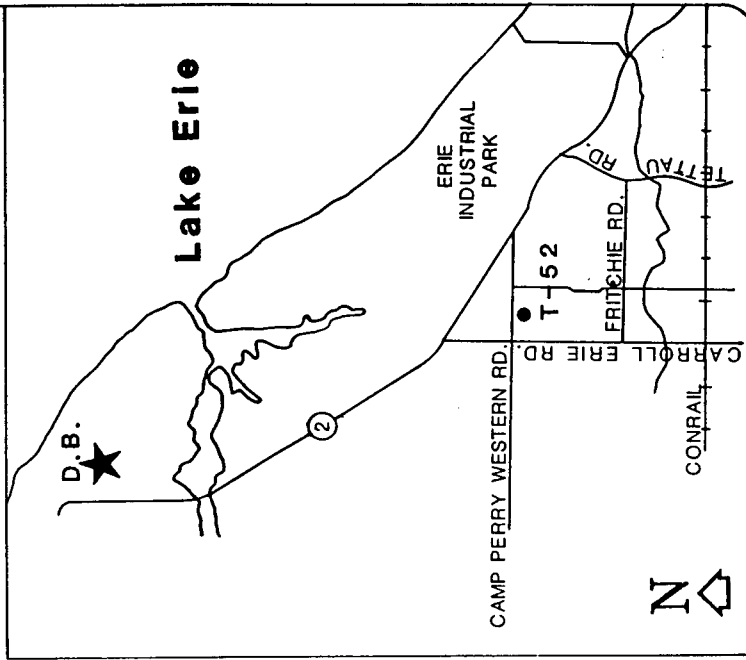

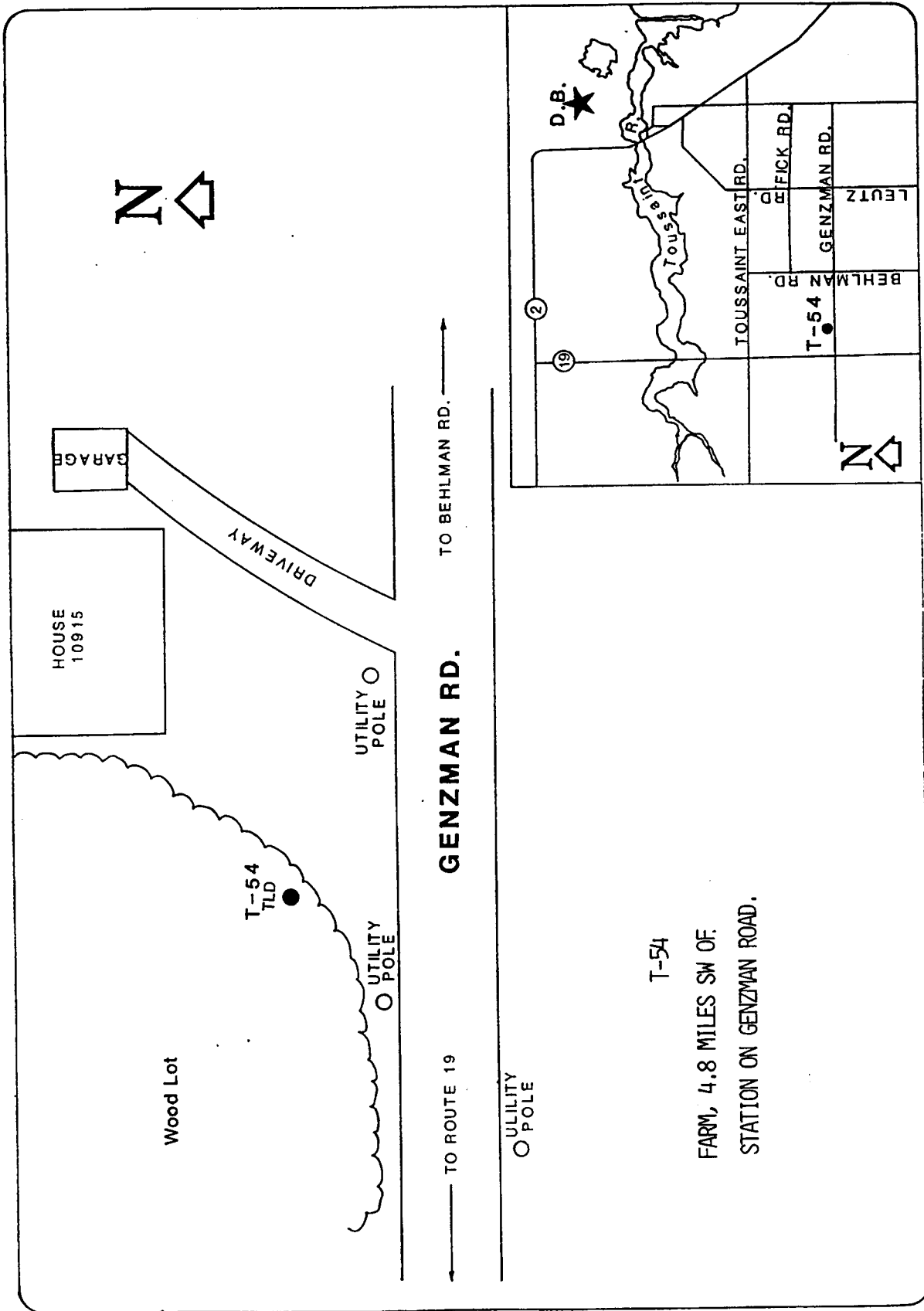

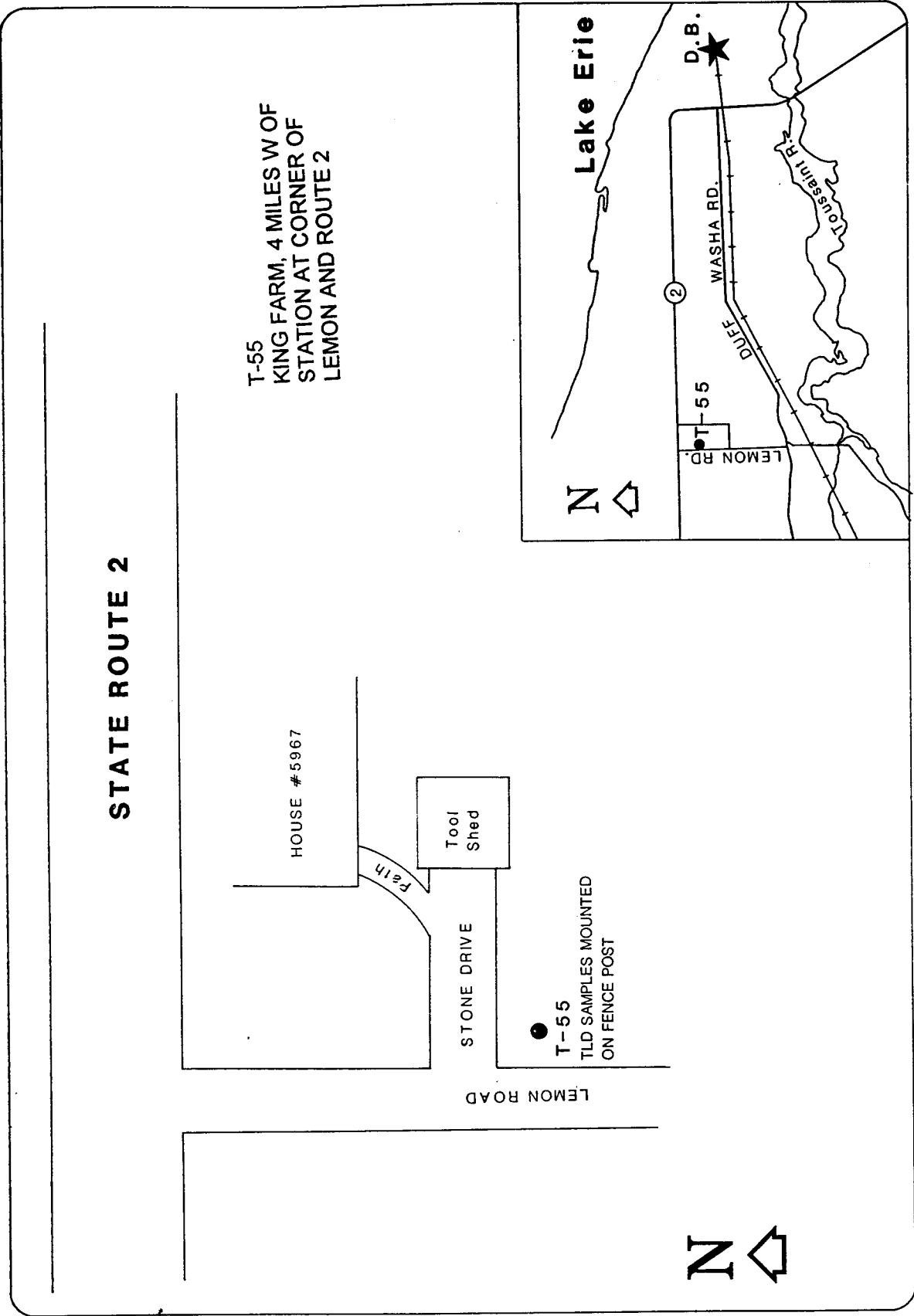

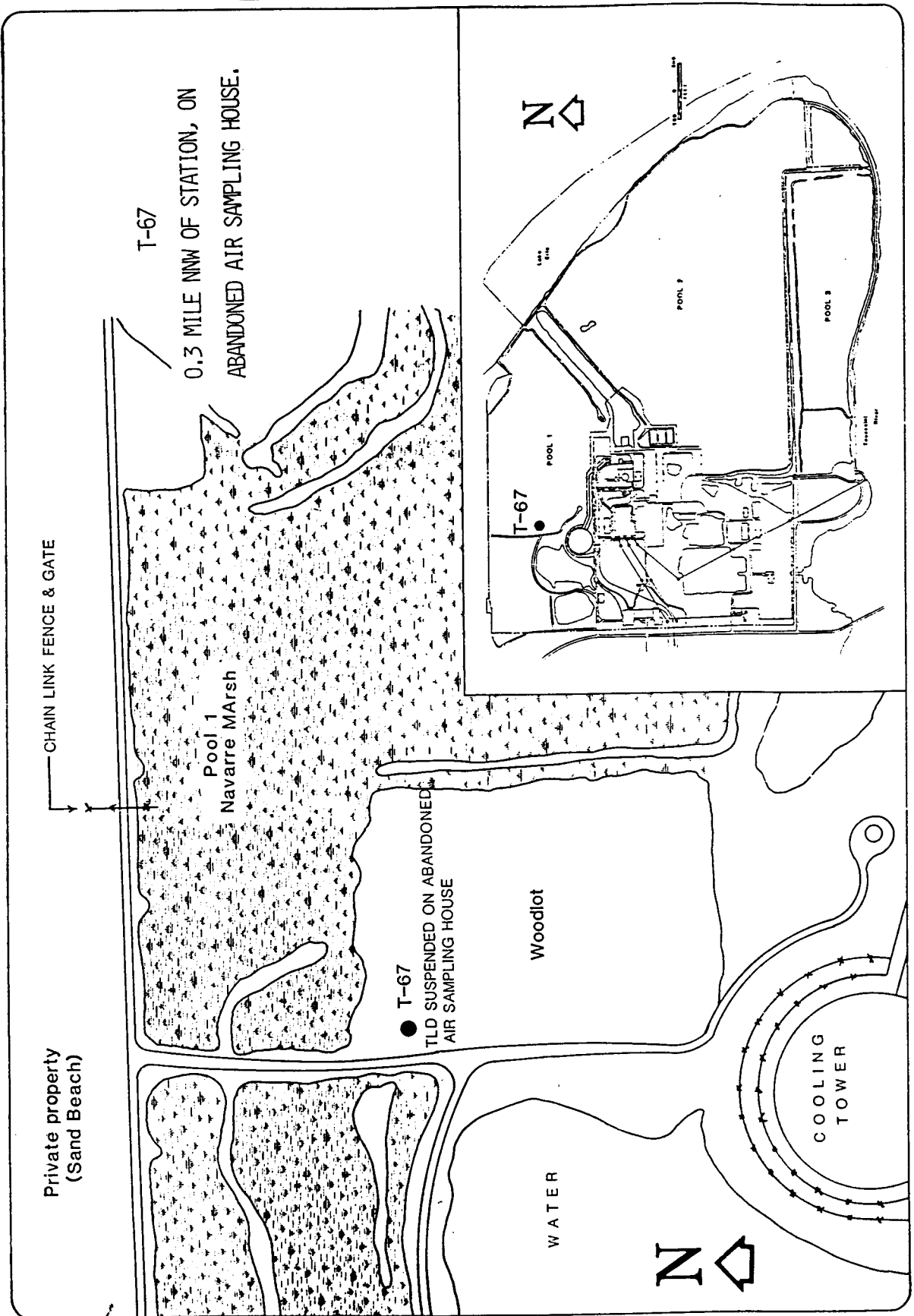

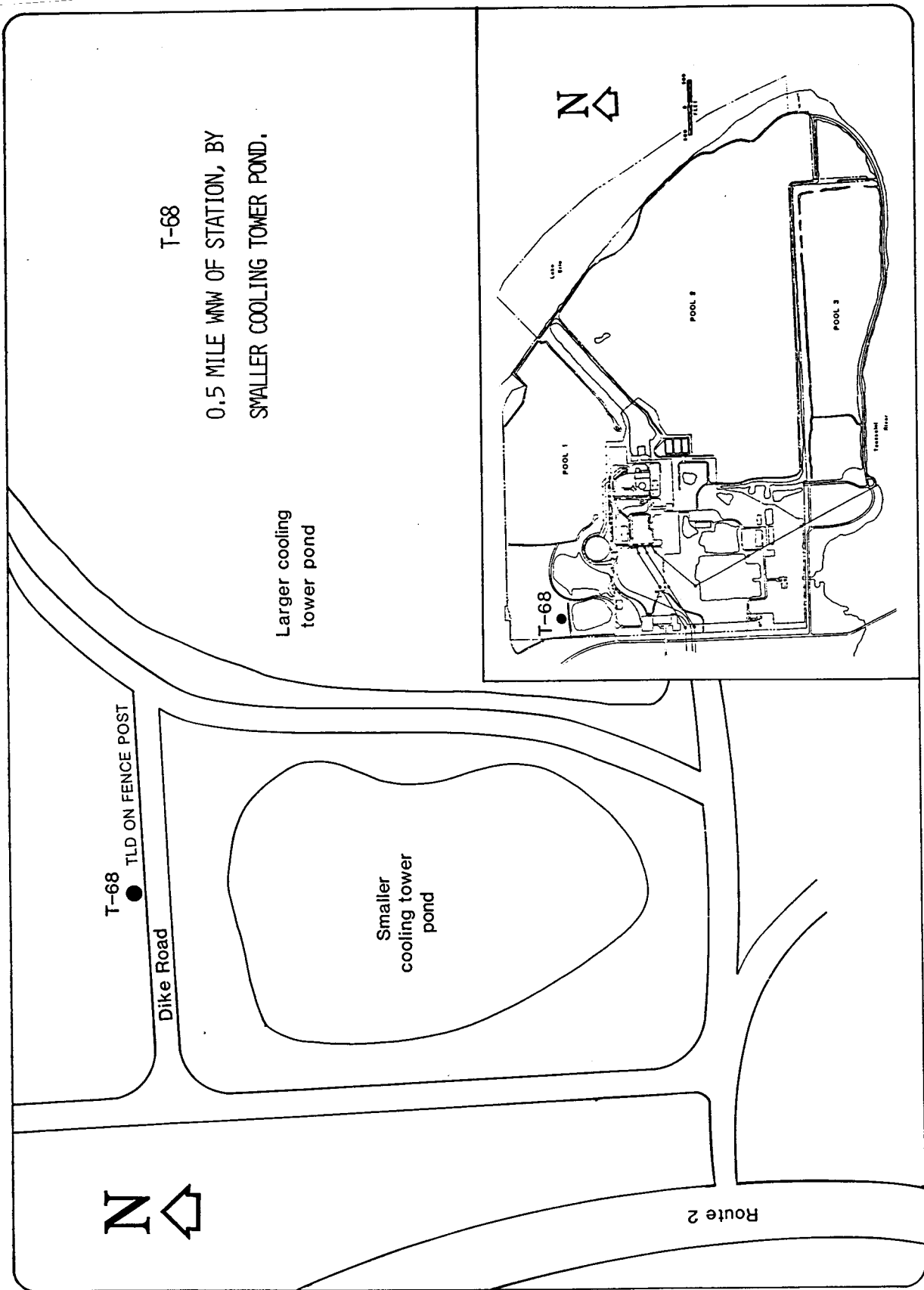

T-68
 0.5 MILE NNW OF STATION, BY
 SMALLER COOLING TOWER POND.

Larger cooling
 tower pond

Smaller
 cooling tower
 pond

T-68 ● TLD ON FENCE POST

Dike Road

Route 2

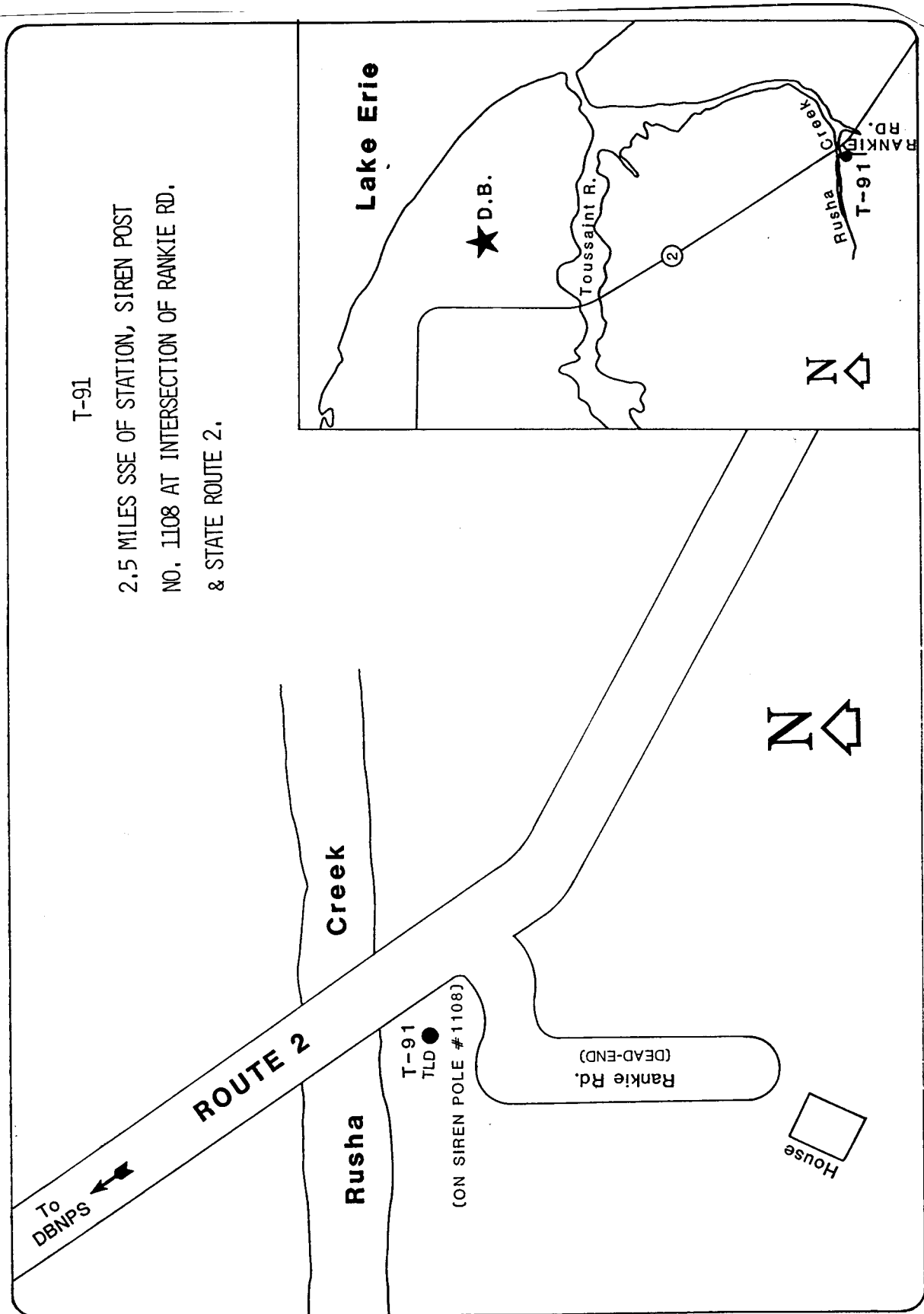

T-91

2.5 MILES SSE OF STATION, SIREN POST
NO. 1108 AT INTERSECTION OF RANKIE RD.
& STATE ROUTE 2.

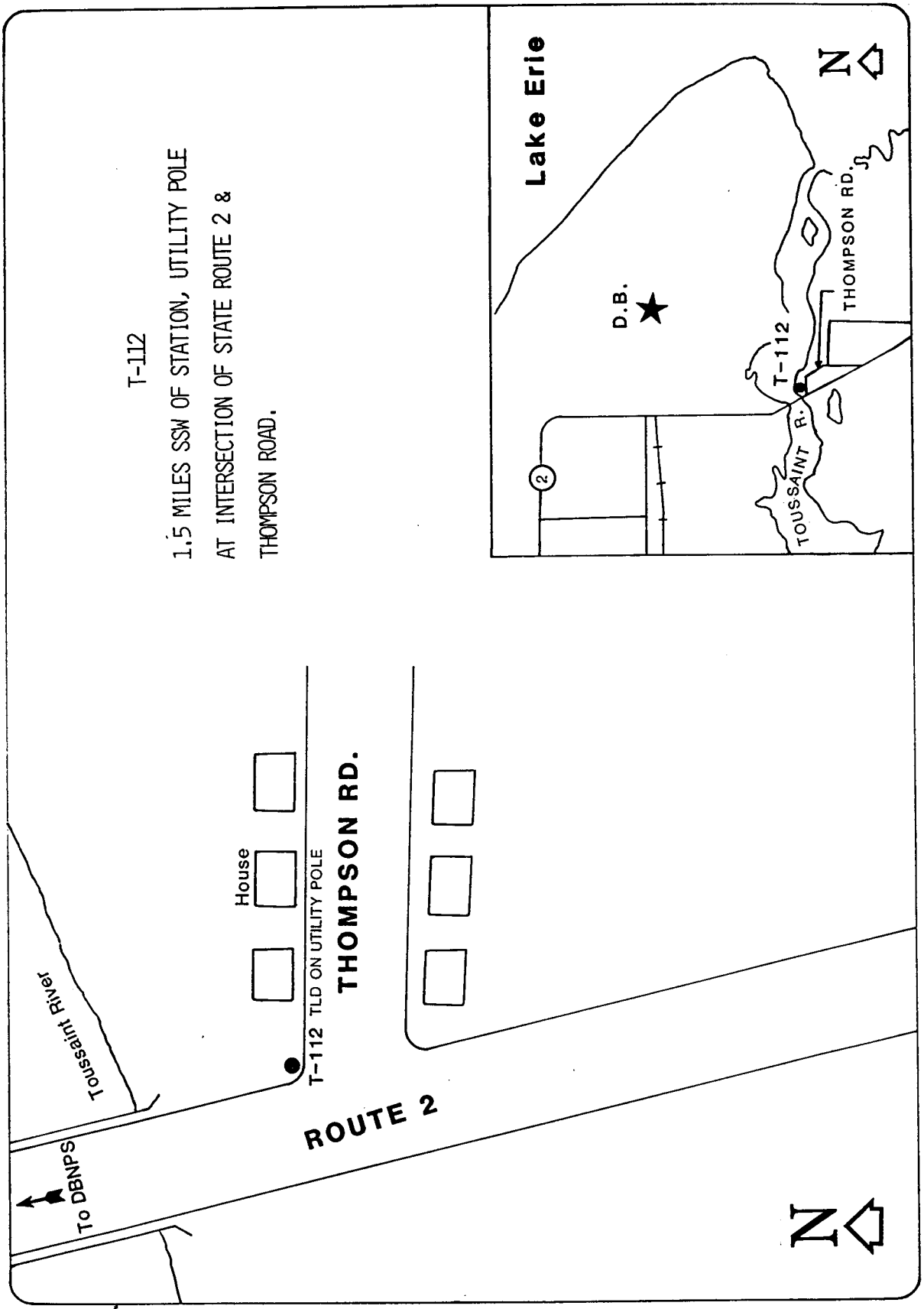

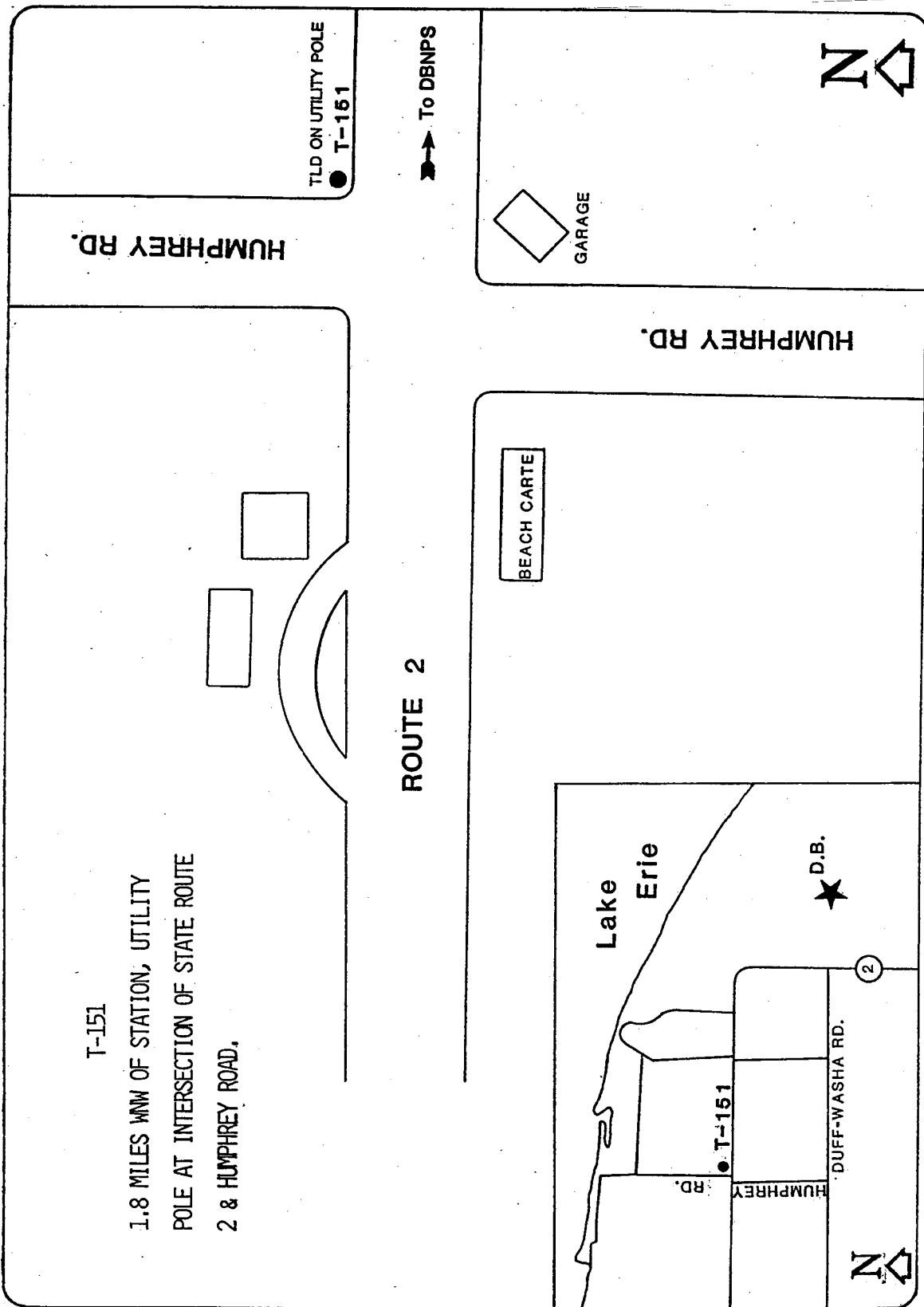

APPENDIX D
ODCM Subsections Related to Station Procedures

APPENDIX D
ODCM Subsections Related To Station Procedures

OVERVIEW

To ensure required alteration changes to the ODCM and implementing procedures are completed, the following ODCM subsections and the implementing procedures may be referenced as an aid.

2.0 LIQUID EFFLUENTS

2.1.1.a.i Clean Radwaste Effluent Monitors (RE-1770A & B)

DB-SC-03200 - Shift Channel Check of the Radiation Monitor System
DB-SC-03221 - Quarterly Functional Test of RE 1770A and/or RE 1770B, Clean
Liquid Waste System Discharge Radiation Monitors
DB-MI-03401 - Channel Calibration of RE-1770A & B, RE-1878A & B, RE-4686
Liquid Process and RE-1822A & B Waste Gas System Outlet
Radiation Monitors (UDR)
DB-OP-03011 - Radioactive Liquid Batch Release

2.1.1.a.ii Miscellaneous Radwaste Effluent Monitors (RE 1878A & B)

DB-SC-03200 - Shift Channel Check of the Radiation Monitor System
DB-SC-03222 - Quarterly Functional Test of RE 1878A and/or RE1878B,
Miscellaneous Waste System Outlet Radiation Elements
DB-MI-03401 - Channel Calibration of RE-1770A & B, RE-1878A & B, RE-4686
Liquid Process and RE-1822A & B Waste Gas System Outlet
Radiation Monitors (UDR)
DB-OP-03011 - Radioactive Liquid Batch Release

2.1.1.b.i Storm Sewer Drain line (RE-4686)

DB-SC-03200 - Shift Channel Check of the Radiation Monitor System
DB-SC-03224 - Quarterly Functional Test of RE 4686, Turbine Building/ Storm
Sewer Discharge Radiation Monitor
DB-SC-03231 - Monthly Check Source Test of RE 4686, Turbine Building/ Storm
Sewer Discharge Radiation Monitor
DB-MI-03401 - Channel Calibration of RE-1770A&B, RE-1878A & B, RE-4686
Liquid Process and RE-1822A & B Waste Gas System Outlet
Radiation Monitors (UDR)

2.1.1.c.i Flow Indicator (FI) 1700 A&B

DB-MI-03423 - Channel Functional Test of 69D-ISF1700A Clean Waste Outlet 1.5”
Flow
DB-MI-03424 - Channel Calibration of 69D-ISF1700A Clean Waste Outlet 1.5” Flow
DB-MI-03425 - Channel Functional Test of 69D-ISF1700B Clean Waste Outlet 3.0”
Flow
DB-MI-03426 - Channel Calibration of 69D-ISF1700B Clean Waste Outlet 3.0” Flow

Flow Totalizer (FQI) 1700 A&B

DB-MI-03424 - Channel Calibration of 69D-ISF1700A Clean Waste Outlet 1.5" Flow
DB-MI-03426 - Channel Calibration of 69D-ISF1700B Clean Waste Outlet 3.0" Flow

2.1.1.c.ii

Flow Indicator (FI) 1887 A&B

DB-MI-03432 - Channel Calibration of 71C-ISF1887A Miscellaneous Waste Outlet
1.5" Flow
DB-MI-03434 - Channel Calibration of 71C-ISF1887B Miscellaneous Waste Outlet
3.0" Flow

Flow Totalizer (FQI) 1887 A&B

DB-MI-03432 - Channel Calibration of 71C-ISF1887A Miscellaneous Waste Outlet
1.5" Flow
DB-MI-03434 - Channel Calibration of 71C-ISF1887B Miscellaneous Waste Outlet
3.0" Flow

2.1.1.c.iii

F145(FT-840)

DB-MI-03422 – Channel Functional/Calibration of 41C-ISF840, Cooling Tower
Blowdown Flow

F890 Service Water Outflow (FT-2729)

DB-MI-03435 - Channel Functional Test of 20A-ISF2729, Service Water Outlet Flow
to Collection Box

F200 Collection Box Dilution Flow (FT2799)

DB-MI-03437 - Channel Functional Test of 20A-ISF2799, Cooling Tower Makeup
Pumps to Collection Box Flow

F886 Unit Dilution Pump Flow (FT3611)

DB-MI-03439 – Channel Functional Test of 20A-ISF3611 Dilution Pump Discharge
Flow

2.1.2

Non Required Monitors

Component Cooling Water System (RE-1412 & RE-1413)

DB-SC-04178 - Quarterly Functional Test of RE 1412, Component Cooling Water Return Line to CC Pump 2 Radiation Monitor

DB-SC-04179 - Quarterly Functional Test of RE 1413, Component Cooling Water Return Line to CC Pump 1 Radiation Monitor

DB-SC-04187 - Daily Check of the Radiation Monitoring System

DB-MI-04501 - Channel Calibration of RE-1412 and RE-1413 Process Radiation Monitors

Service Water System (RE-8432)

DB-SC-04162 - Quarterly Functional Test of RE 8432, Service Water Discharge Radiation Monitor

DB-SC-04187 - Daily Check of the Radiation Monitoring System

DB-MI-04559 - Channel Calibration of RE-1998 (Failed Fuel), RE-8432, and RE-8434 Process Radiation Monitors (UDR)

Intake Forebay (RE-8434)

DB-SC-04164 - Quarterly Functional Test of RE 8434, Station Intake Forebay Radiation Monitor

DB-SC-04187 - Daily Check of the Radiation Monitoring System

DB-MI-04559 - Channel Calibration of RE-1998 (Failed Fuel), RE-8432, and RE-8434 Process Radiation Monitors (UDR)

2.2 Sampling and Analysis of Liquid Effluents

2.2.1 Batch Releases

Prior to Release (Grab sample of principal Gamma Emitters)

DB-OP-03011 - Radioactive Liquid Batch Release

Once Per Month (Dissolved and Entrained Gases)

DB-OP-03011 - Radioactive Liquid Batch Release

Once Per month (Composite Sample of H-3 and alpha activity)

DB-CN-03012 - Liquid Releases, Monthly Monitoring Analysis

Once Per Quarter (Composite sample of Sr-89, Sr-90 and Fe-55)

DB-CN-03013 - Liquid Releases, Quarterly Monitoring Analysis

2.2.2 Continuous Releases

North Settling Basin

DB-CN-04039 - North Settling Basin Weekly Sampling and Analysis

DB-CN-04040 - North Settling Basin Quarterly Analysis

Turbine Building Sump and Storm Sewer Drain

DB-CN-12005 - Storm Sewer Monitor (RE 4686) Inoperable/In Alarm

- 2.2.4 Borated Water Storage Tank
DB-CH-03004 - Borated Water Storage Tank Analysis

- 2.3.3 Liquid Radwaste Effluent Monitor Set Point Calculation - (RE1770A/B & RE 1878A/B)
DB-OP-03011 - Radioactive Liquid Batch Release

- 2.3.4 Storm Sewer Drain Monitor (RE-4686) Setpoint
DB-HP-10000 - Radiation Monitor Setpoint Control

- 2.3.5 Alarm Setpoints for the Non-Required Radiation Monitors
Component Cooling Water System (RE-8412, RE-8413)
Service Water System (RE-8432)
DB-HP-10000 - Radiation Monitor Setpoint Control

- 2.3.6 Alarm Response - Evaluating Actual Release Conditions
DB-OP-03011 - Radioactive Liquid Batch Release
RETSCode

- 2.4 Liquid Effluent Dose Calculation – 10 CFR - 50
DB-CN-03001 - Liquid and Gaseous Radioactive Dose Commitment
DB-OP-03011 - Radioactive Liquid Batch Release
DB-CN-03023 - Annual Land Use Census

- 2.5 Liquid Dose Projections
DB-OP-03011 - Radioactive Liquid Batch Release
DB-CN-03001 - Liquid and Gaseous Radioactive Dose Commitment

3.0 GASEOUS EFFLUENTS

3.1.1 Alarm and Automatic Release Termination

Waste Gas Decay System Monitor (RE 1822A & B)

- DB-SC-03200 - Shift Channel Check of the Radiation Monitor System
- DB-SC-03225 - Quarterly Functional Test of RE 1822A and/or RE 1822B, Waste Gas System Discharge to Station Vent Radiation Monitors
- DB-MI-03401 - Channel Calibration of RE-1770A & B, RE-1878A & B, RE-4686 Liquid Process and RE-1822A & B Waste Gas System Outlet Digital Radiation Monitors
- DB-OP-03012 - Radioactive Gaseous Batch Release

Containment Purge Exhaust Filter Monitor (RE 5052A, B and C)

- DB-SC-03200 - Shift Channel Check of the Radiation Monitor System
- DB-SC-03227 - Quarterly Functional Test of RE 5052A, B, and C, CTMT Purge Exhaust Radiation Monitor
- DB-SC-03228 - Monthly Check Source Test of RE 5052C, CTMT Purge Exhaust Radiation Monitor (Noble Gas Activity Channel).
- DB-MI-03415 - Channel Calibration of RE-5052C, Containment Purge Exhaust Fan Inlet Digital Process Radiation Monitor
- DB-MI-03428 - Channel Calibration of 72C-ISF1821 Waste Gas System Outlet 1.0" Flow
- DB-MI-04503 - Channel Calibration of RE-5052A, RE-5327A & C, RE-5328A & C, RE-5403A & C, and RE5405A & C Process Radiation Monitors
- DB-MI-04514 - Channel Calibration of RE-5052B, RE-5327B, RE-5328B, RE-5403B, and RE-5405B Process Radiation Monitors
- DB-RE-04503 - Channel Calibration of RE-1003B, RE-5052A, RE-5403A & C Analog Process Radiation Monitors
- DB-RE-04514 - Channel Calibration of RE-1003A, RE-5052B, and RE-5405B Digital Process Radiation Monitor

Gaseous Flow Measurement Devices (FT-1821)

- DB-MI-03428 - Channel Calibration of 72C-ISF1821 Waste System Gas Outlet 1.0" Flow
- DB-SP-03419 – Waste Gas System Flow Transmitters Quarterly Channel Functional Test

3.1.2 Alarm Only

Station Vent Monitor (RE 4598AA & BA)

- DB-SC-03200 - Shift Channel Check of the Radiation Monitor System
- DB-SC-03216 - Quarterly Functional Test of RE 4598AA, Station Vent Normal Range Radiation Monitor
- DB-SC-03218 - Quarterly Functional Test of RE 4598BA, Station Vent Normal Range Radiation Monitor
- DB-SC-03229 - Monthly Check Source Test of RE 4598AA, Station Vent Normal Range Radiation Monitor (Noble Gas Activity Channel)
- DB-SC-03230 - Monthly Check Source Test of RE 4598BA Station Vent Normal Range Radiation Monitor (Noble Gas Activity Channel)
- DB-MI-03413 - Channel Calibration of RE4598AA and RE4598BA Station Vent Normal Range Radiation Monitors

3.2 Sample and Analysis of Gaseous Effluents

3.2.1 Batch Releases

Prior to Batch Release

DB-OP-03012 - Radioactive Gaseous Batch Release

3.2.2 Continuous Releases

Once per week, analysis of an adsorption media for (I-131)

DB-CN-03008 - Station Vent Releases, Weekly Radiological Monitoring, Sampling and Analysis of RE 4598AA

DB-CN-03009 - Station Vent Releases, Weekly Radiological Monitoring Sampling and Analysis of RE 4598BA

Once per week, analysis for principal gamma emitters (Particulate Radioactive Material)

DB-CN-03008 - Station Vent Releases, Weekly Radiological Monitoring Sampling and Analysis of RE 4598AA

DB-CN-03009 - Station Vent Releases, Weekly Radiological Monitoring Sampling and Analysis of RE 4598BA

Once per month, grab gas sample analysis for (Noble Gas and Tritium)

DB-CN-03008 - Station Vent Releases, Weekly Radiological Monitoring Sampling and Analysis of RE 4598AA

DB-CN-03009 - Station Vent Releases, Weekly Radiological Monitoring Sampling and Analysis of RE 4598BA

Once per month, composite analysis for (Gross Alpha Activity)

DB-CN-03010 - Station Vent Releases, Monthly Radiological Monitoring Analysis

Once per quarter, composite analysis for particulates Sr-89 and Sr-90

DB-CN-03011 - Station Vent Releases, Quarterly Radiological Monitoring Analysis

Continuous monitoring for Noble Gas (Gross Beta and Gamma activity)

DB-OP-06131 - Gaseous Radioactive Waste System

DB-OP-06412 - Process and Area Radiation Monitor

3.2.3 Release Resulting from Primary to Secondary System Leakage

Once per week, analysis of a secondary system off - gas for gamma emitters (noble gases) and tritium.

DB-CH-04005 - Weekly Condenser Air Activity Sampling and Analysis

Once per week, analysis of condensate sample for principle gamma emitters (Iodines and particulates) and tritium.

DB-CH-06901 - Radiochemistry Test Requirements

Once per quarter, composite analysis of the condensate for particulates Sr-89 and Sr-90

DB-CN-04038 - Radioactive Strontium Determination in Condensate

Auxiliary Steam System Relief lifts when Auxiliary Boiler is the Source of Auxiliary Steam.

DB-CH-06901 - Radiochemistry Test Requirements
DB-CN-10102 - Calculating Radioactive Release Data
RETSCode

- 3.3.2 Release Rate Limits
 - DB-OP-03012 - Radioactive Gaseous Batch Release
- 3.3.3 Individual Release Radiation Monitor Setpoints
 - DB-OP-03012 - Radioactive Gaseous Batch Release
 - DB-HP-10000 - Radiation Monitor Setpoint Control
- 3.6.4 Quantifying Ground Level Releases Activity
 - DB-CN-10102 - Calculating Radioactive Release Data
- 3.7.1 Unrestricted Area Dose Limits
 - DB-CN-03001 - Liquid and Gaseous Radioactive Release Dose Commitment
 - DB-CN-03011 - Station Vent Releases, Quarterly Radiological Monitoring Analysis
- 5.0 Assessment of Land Use Census Data
 - DB-CN-03023 - Annual Land Use Census
- 6.0 Radiological Environmental Program
 - DB-CN-00013 - Review and Evaluation of REMP Sample Analysis Results
 - DB-CN-00014 - Annual Radiological Environmental Operating Report Preparation and Submittal
 - DB-CN-00015 - Radiological Environmental Monitoring Program
 - DB-CN-03004 - Radiological Monitoring Quarterly, Semiannual and Annual Sampling
 - DB-CN-03005 - Radiological Monitoring Weekly, Semimonthly, and Monthly Sampling
 - DB-HP-04022 - Preparation of Quarterly Report of REMP Sample Analysis Results
 - DB-CN-10101 - REMP Enhancement Sampling
- 7.1 Annual Radiological Environmental Operating Report
 - DB-CN-00012 - Preparation of Radioactive Effluent Release Report
 - DB-CN-00014 - Annual Radiological Environmental Operating Report Preparation and Submittal
 - DB-CN-03001 - Liquid and Gaseous Radioactive Dose Commitment
 - DB-CN-04025 - Quarterly Radioactive Release Data Calculations
 - DB-CN-10102 - Calculating Radioactive Release Data
 - DB-CN-10106 - Processing Changes to the ODCM