



TS 6.9.1.8
TS 6.14.1.c

LG-19-038

April 30, 2019

U. S. Nuclear Regulatory Commission
Attn: Document Control Desk
Washington, DC 20555-0001

Limerick Generating Station, Unit 1 and 2
Renewed Facility Operating License Nos. NPF-39 and NPF-85
NRC Docket Nos. 50-352 and 50-353 and 72-065

Subject: Annual Radioactive Effluent Release Report No. 44

In accordance with Section 6.9.1.8 of the Limerick Generating Station (LGS) Technical Specifications (TS) and Section 6.2 of the Offsite Dose Calculation Manual (ODCM), Attachment 1 is the Annual Radioactive Effluent Release Report No. 44, 2018 Limerick Generating Station.

In accordance with Section 6.14.1.c of the LGS TS, a copy of the ODCM is submitted with the Annual Radioactive Effluent Release Report if the ODCM was revised during the period. The ODCM was revised twice from January 1, 2018 to December 31, 2018, both revisions are included.

Limerick has reviewed the Dosimeter of Legal Record (DLR) data for the nearest residence from the ISFSI modules currently loaded. In 2018 the dose to the nearest resident from the ISFSI was 0.00 mrem.

There are no commitments contained in this letter.

If you have any questions or require additional information, please contact Orlando Credendino at 610-718-2701.

Respectfully,

A handwritten signature in black ink that reads "R. Libra".

Richard W. Libra
Vice President-Limerick Generating Station
Exelon Generation Company, LLC

- Attachment 1: Annual Radioactive Effluent Release Report No. 44, 2018 Limerick
Generating Station
- Attachment 2: Limerick Generating Station Units 1 and 2 Offsite Dose Calculation Manual
Revision 30
- Attachment 3: Limerick Generating Station Units 1 and 2 Offsite Dose Calculation Manual
Revision 31

cc: D. Lew, Administrator, Region I, USNRC (w/attachment)
S. Rutenkroger, LGS USNRC Senior Resident Inspector (w/attachment)
H. Anagnostopoulos, Inspector Region I, USNRC (w/attachment)

Document Control Desk, (w/attachment)
Director, Division of Spent Fuel Management,
Office of Nuclear Material Safety and Safeguards U.S. NRC,
Washington, DC 20555-0001

E. Thorton-Jones (w/attachment)
U.S. Environmental Protection Agency,
Center for Waste Management, Radiation Protection Division,
Office of Radiation and Indoor Air,
1200 Pennsylvania Avenue, NW., Washington, DC 20460-0001;
Mail Code: 6608J



Exelon Generation®



**Annual Radioactive Effluent Release Report
No. 44**

2018

Limerick Generating Station

SITE: LIMERICK GENERATING STATION – UNITS 1 & 2
LICENSEE: EXELON GENERATION COMPANY, LLC

ANNUAL RADIOACTIVE EFFLUENT RELEASE REPORT

NO. 44

January 1, 2018 through December 31, 2018

EXELON GENERATION COMPANY, LLC

LIMERICK GENERATING STATION
UNITS NO. 1 AND 2

DOCKET NO. 50-352 (Unit 1)

DOCKET NO. 50-353 (Unit 2)

DOCKET NO. 72-065 (ISFSI)

Submitted to
The United States Nuclear Regulatory Commission
Pursuant to
Renewed Facility Operating License:

SITE: LIMERICK GENERATING STATION – UNITS 1 & 2
LICENSEE: EXELON GENERATION COMPANY, LLC

(Page Intentionally Left Blank)

Table of Contents

1. Preface.....	1
2. Introduction	6
3. Supplemental Information	7
A. Regulatory Limits	7
B. Effluent Concentration Limits	8
C. Average Energy (E)	8
D. Measurements and Approximations of Total Radioactivity	8
E. Batch Releases	10
F. Abnormal Releases	10
G. Insignificant Releases.....	12
H. Spills	12
I. Revisions to the ODCM	13
J. Radioactive Effluent Monitoring Instrumentation Out of Service for More Than 30 Days.....	13
K. Program Deviations	13
L. Independent Spent Fuel Storage Installation (ISFSI).....	13
M. Annual Land Use Census Changes	13
4. Radiological Impact to Man and Compliance to 40 CFR 190 Limits	14
A. Dose to Members of the Public at or Beyond Site Boundary	14
B. Dose to Members of the Public Inside the Site Boundary	15
Appendix A Effluent and Waste Disposal Summary.....	17
Appendix B Solid Waste and Irradiated Fuel Shipments.....	27
Appendix C Meteorological Data	31

SITE: LIMERICK GENERATING STATION – UNITS 1 & 2
LICENSEE: EXELON GENERATION COMPANY, LLC

1. Preface

The following sections of the preface are meant to help define key concepts, provide clarity, and give context to the readers of this report.

Annual Reports

The Nuclear Regulatory Commission (NRC) is the federal agency who has the role to protect public health and safety related to nuclear energy. Nuclear Power Plants have made many commitments to the NRC to ensure the safety of the public. As part of these commitments, they provide two reports annually to specifically address how the station’s operation impacts the environment of the local community. Then the NRC reviews these reports and makes them available to the public. The names of the reports are the Annual Radioactive Effluent Release Report (ARERR) and the Annual Radiological Environmental Operating Report (AREOR).

The ARERR reports the results of the sampling from the effluent release paths at the station and analyzed for radioactivity. An effluent is a liquid or gaseous waste, containing plant-related radioactive material emitted at the boundary of the facility.

The AREOR reports the results of the samples obtained in the environment surrounding the station and analyzed for radioactivity. Environmental samples include air, water, vegetation, and other sample types that are identified as potential pathways radioactivity can reach humans.

Graphic 1. Examples of Gaseous and Liquid Effluent Pathways

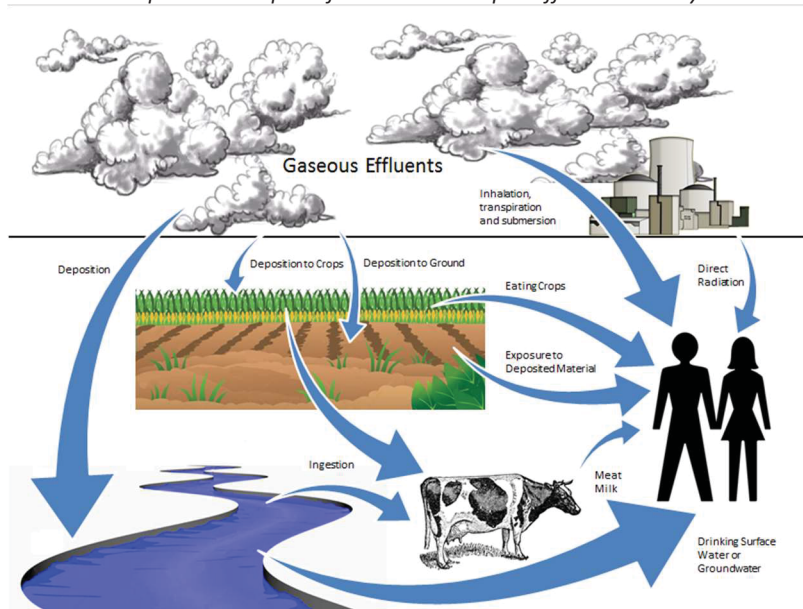

Graphic 1 demonstrates some potential exposure pathways from Limerick Generating Station. The ARERR and AREOR together ensure Nuclear Power Plants are operating in a manner that is within established regulatory commitments meant to adequately protect the public.

Understanding Radiation

Generally, radiation is defined as emitted energy in the form of waves or particles. If radiation has enough energy to displace electrons from an atom it is termed “ionizing”, otherwise it is “non-ionizing”. Non-ionizing radiation includes light, heat given off from a stove, radiowaves and microwaves. Ionizing radiation occurs in atoms, particles too small for the eye to see. So, what are atoms and how does radiation come from them?

Graphic 2. Types of Radiation, from NASA Hubblesite

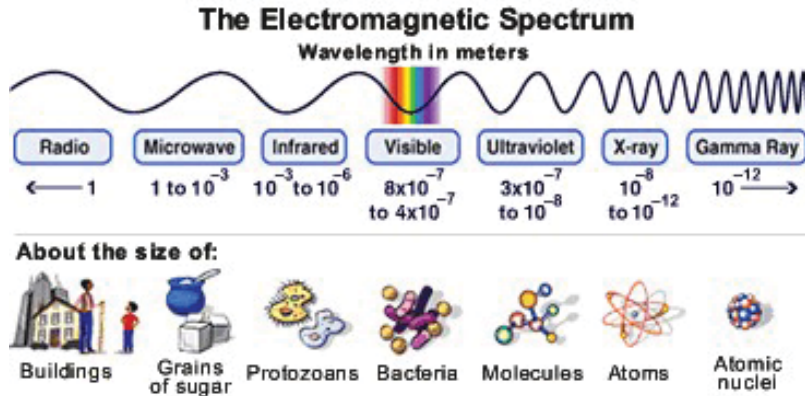

An atom is the smallest part of an element that maintains the characteristics of that element. Atoms are made up of three parts: protons, neutrons, and electrons.

Graphic 3. Structure of an Atom

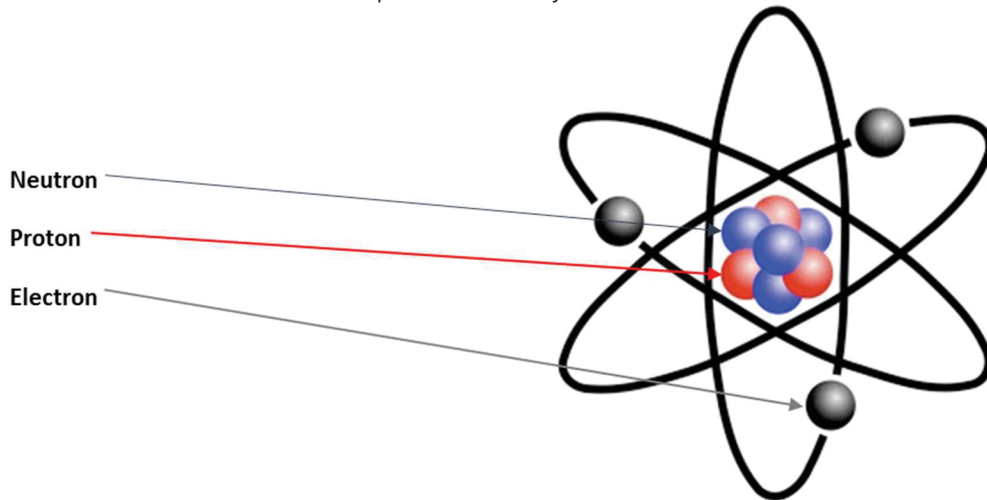

The number of protons in an atom determines the element. For example, a hydrogen atom will always have one proton while an oxygen atom will always have eight protons. The protons are clustered with the neutrons forming the nucleus at the center of the atom. Orbiting around the nucleus are the relatively small electrons.

Isotopes are atoms that have the same number of protons but different numbers of neutrons. Different isotopes of an element will all have the same chemical properties and many isotopes are radioactive while other isotopes are not radioactive. A radioactive isotope can emit radiation because it contains excess energy in its nucleus. Radioactive atoms and isotopes are also referred to as radionuclides and radioisotopes.

There are two basic ways that radionuclides are produced at a nuclear power plant. The first is fission, which creates radionuclides that are called *fission products*. Fission occurs when a very large atom, such as Uranium-235 (U-235) or Plutonium-239 (Pu-239), absorbs a neutron into its nucleus making the atom unstable. The unstable atom can then split into smaller atoms. When fission occurs there is a large

amount of energy released in the form of heat. A nuclear power plant uses the heat generated to boil water that spins turbines to produce electricity.

The second way a radionuclide is produced at a nuclear power plant is through a process called activation. The radionuclides produced in this method are termed *activation products*. Pure water that passes over the fissioning atoms is used to cool the reactor and also produce steam to turn the turbines. Although this water is considered to be very pure, there are always some contaminants within the water from material used in the plant's construction and operation. These contaminants are exposed to the fission process and may become activation products. The atoms in the water itself can also become activated and create radionuclides.

Over time, radioactive atoms will reach a stable state and no longer be radioactive. To do this they must release their excess energy. This release of excess energy is called radioactive decay. The time it takes for a radionuclide to become stable is measured in units called half-lives. A half-life is the amount of time it takes for half of the original radioactivity to decay. Each radionuclide has a specific half-life. Some half-lives can be very long and measured in years while others may be very short and measured in seconds.

Graphic 4. Radioactive Decay Half-Life

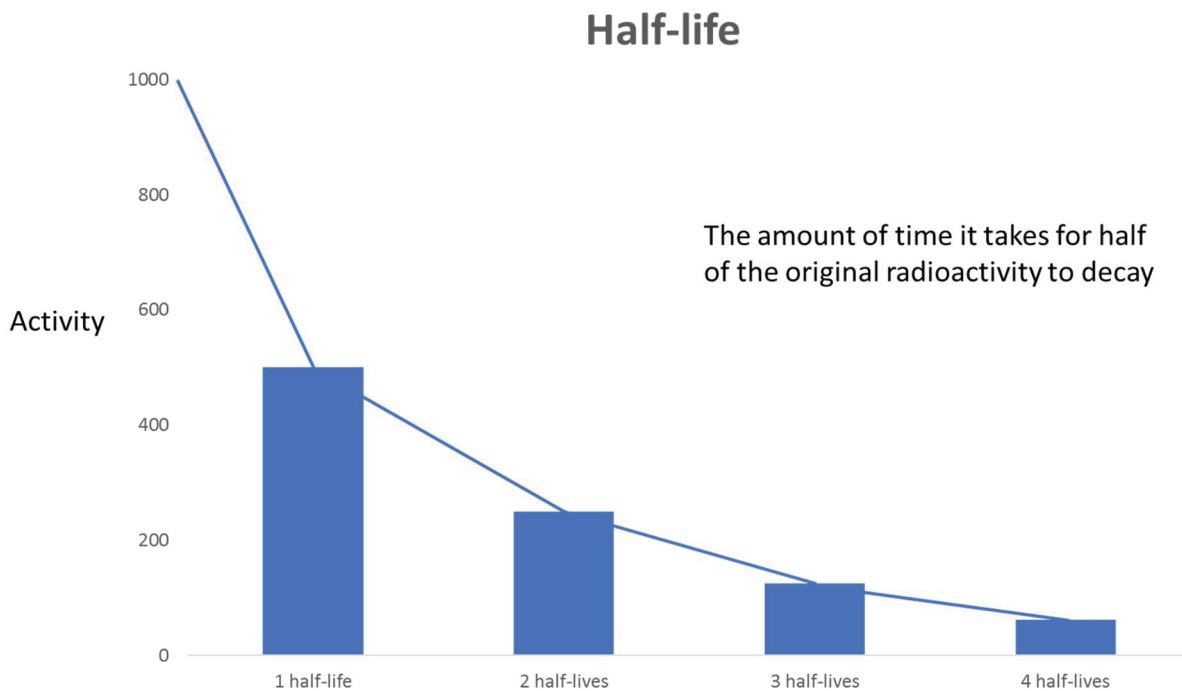

In the annual reports you will see both man made and naturally occurring radionuclides listed, for example Potassium-40 (K-40, natural) and Cobalt-60 (Co-60, man-made). We are mostly concerned about man-made radionuclides because they can be produced as by-products when generating electricity at a nuclear power plant. It is important to note that there are also other ways man-made radionuclides are produced, such as detonating nuclear weapons. Weapons testing has deposited some of the same man-made radionuclides into the environment as those generated by nuclear power, and some are still present today because of long half-lives.

Measuring Radiation

There are four different but interrelated units for measuring radioactivity, exposure, absorbed dose, and dose equivalent. Together, they are used to scientifically report the amount of radiation and its effects on humans.

- Radioactivity refers to the amount of ionizing radiation released by a material. The units of measure for radioactivity used within the AREOR and ARERR are the Curie (Ci). Small fractions of the Ci often have a prefix, such as the microCurie (μCi), which means 1/1,000,000 of a Curie.

SITE: LIMERICK GENERATING STATION – UNITS 1 & 2
LICENSEE: EXELON GENERATION COMPANY, LLC

- Exposure describes the amount of radiation traveling through the air. The units of measure for exposure used within the AREOR and ARERR are the Roentgen (R). Traditionally direct radiation monitors placed around the site are measured milliRoentgen (mR), 1/1,000 of one R.
- Absorbed dose describes the amount of radiation absorbed by an object or person. The units of measure for absorbed dose used within the AREOR and ARERR are the rad. Noble gas air doses are reported by the site are measured in millirad (mrad), 1/1,000 of one rad.
- Dose equivalent (or effective dose) combines the amount of radiation absorbed and the health effects of that type of radiation. The units used within the AREOR and ARERR are the Roentgen equivalent man (rem). Regulations require doses to the whole body, specific organ, and direct radiation to be reported in millirem (mrem), 1/1,000 of one rem.

Sources of Radiation

People are exposed to radiation every day of their lives and have been since the dawn of mankind. Some of this radiation is naturally occurring while some is man-made. There are many factors that will determine the amount of radiation individuals will be exposed to such as where they live, medical treatments, etc. The average person in the United States is exposed to approximately 620 mrem each year. 310 mrem comes from natural sources and 310 from man-made sources. The Graphic 5 shows what the typical sources of radiation are for an individual over a calendar year:

Graphic 5. Sources of Radiation Exposure in the U.S., from NCRP Report No. 160

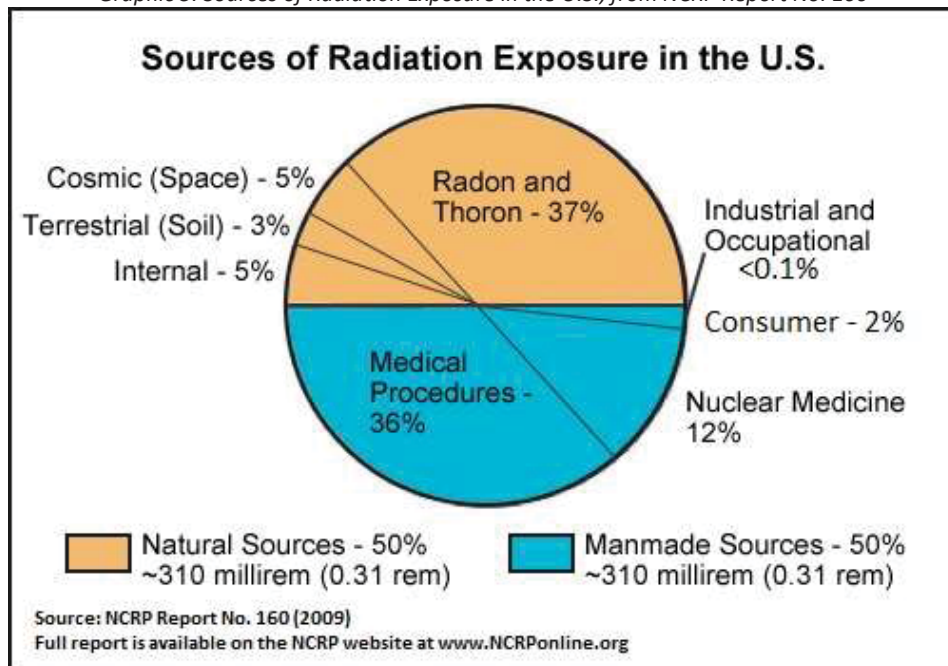

The radiation from a nuclear power plant is included in the chart as part of the “Industrial and Occupational” fraction, <0.1%. The largest natural source of radiation is from radon, because radon gas travels in the air we breathe. Perhaps you know someone who had a CT scan at a hospital to check his or her bones, brain, or heart. CT scans are included in the chart as “Medical Procedures”, which make up the next largest fraction. Graphic 6 on the following page shows some of the common doses humans receive from radiation every year.

Graphic 6 .Relative Doses from Radiation Sources, from EPA Radiation Doses and Sources

RELATIVE DOSES FROM RADIATION SOURCES

All doses from the National Council on Radiation Protection & Measurements, Report No. 160 (unless otherwise denoted)

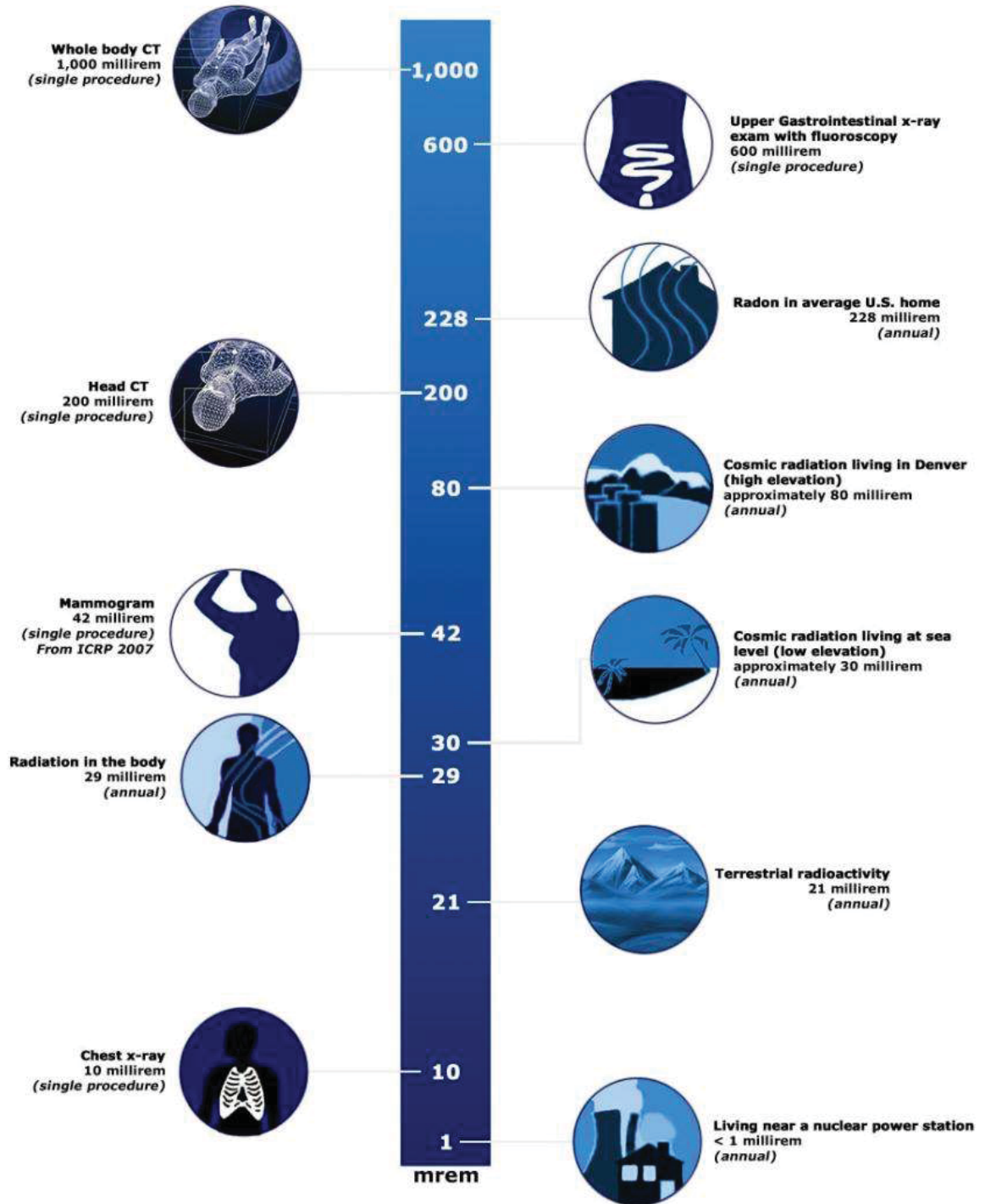

Radiation Risk

Current science suggests there is some risk from any exposure to radiation. However, it is very hard to tell whether cancers or deaths can be attributed to very low doses of radiation or by something else. U.S. radiation protection standards are based on the premise that any radiation exposure carries some risk.

The following graph is an example of one study that tries to relate risk from many different factors. This graph represents risk as “Days of Lost Life Expectancy”. All the categories are averaged over the entire population except Male Smokers, Female Smokers, and individuals that are overweight. Those risks are only for people that fall into those categories. The category for Nuclear Power is a government estimate based on all radioactivity releases from nuclear power, including accidents and wastes.

Graphic 7. Days of Lost Life Expectancy, Adapted from the Journal of American Physicians and Surgeons Volume 8 Number 2 Summer 2003

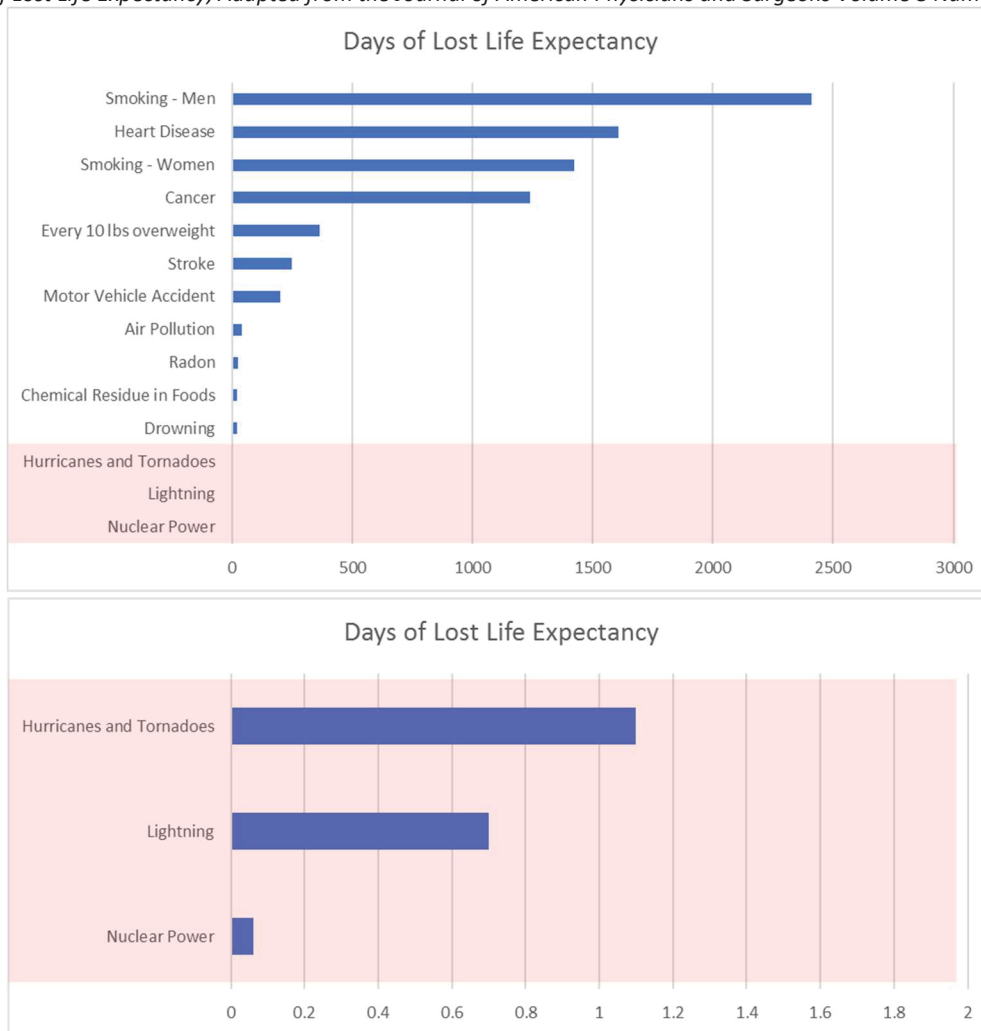

2. Introduction

In accordance with the reporting requirements of Technical Specification 6.9.1.8 applicable during the reporting period, this report summarizes the effluent release data for Limerick Generating Station Units 1 and 2 for the period January 1, 2018 through December 31, 2018. This submittal complies with the format described in Regulatory Guide 1.21, "Measuring, Evaluating and Reporting Radioactivity in Solid Wastes and Releases of Radioactive Materials in Liquid and Gaseous Effluents from Light-Water Cooled Nuclear Power Plants", Revision 1, June, 1974.

Meteorological data was reported in the format specified in Regulatory Guide 1.23, Revision 1, "Meteorological Monitoring Programs for Nuclear Power Plants".

All vendor results were received and included in the report calculations. Therefore, the 2018 report is complete.

3. Supplemental Information

A. Regulatory Limits

	Limit	Units	Receptor	ODCM and 10 CFR 50, Appendix I Design Objective Limits
1. Noble Gases:				
a.	≤ 500 ≤ 3000	mrem/Yr mrem/Yr	Total Body Skin	ODCM Control 3.2.2.1.a
b.	≤ 10 ≤ 20	mRad mRad	Air Gamma Air Beta	Quarterly air dose limits ODCM Control 3.2.2.2.a
c.	≤ 20 ≤ 40	mRad mRad	Air Gamma Air Beta	Yearly air dose limits ODCM Control 3.2.2.2.b
d.	≤ 10 ≤ 30	mrem mrem	Total Body (Gamma) Skin (Beta)	10 CFR 50, Appendix I, Section II.B.2(b) (limits listed here are based on two unit operation)
2. Iodines, Tritium, Particulates with Half Life > 8 days:				
a.	≤ 1500	mrem/Yr	Any Organ	ODCM Control 3.2.2.1.b
b.	≤ 15	mrem	Any Organ	Quarterly dose limits ODCM Control 3.2.2.3.a
c.	≤ 30	mrem	Any Organ	Yearly dose limits ODCM Control 3.2.2.3.b
3. Liquid Effluents				
a.	10 times the concentration limits in 10 CFR 20, Appendix B, Table 2 Col. 2			ODCM Control 3.2.1.1
b.	≤ 3 ≤ 10	mrem mrem	Total Body Any Organ	Quarterly dose limits ODCM Control 3.2.1.2.a
c.	≤ 6 ≤ 20	mrem mrem	Total Body Any Organ	Yearly dose limits ODCM Control 3.2.1.2.b
4. 40 CFR 190, 10 CFR 72.104				
	≤ 25 ≤ 75	mrem mrem	Total Body or Organ Thyroid	Yearly dose limits ODCM Control 3.2.3

B. Effluent Concentration Limits

Gaseous dose rates rather than effluent concentrations are used to calculate permissible release rates for gaseous releases. The maximum permissible dose rates for gaseous releases are defined in Offsite Dose Calculation Manual (ODCM) Controls 3.2.2.1.a and 3.2.2.1.b as 500 mrem/yr (Total Body), 3000 mrem/yr (Skin), and 1500 mrem/yr (Organ).

The Effluent Concentration Limit (ECL) specified in 10 CFR 20, Appendix B, Table 2, Column 2 for identified nuclides, were used to calculate permissible release rates and concentrations for liquid release per the Limerick ODCM Control 3.2.1.1. The total activity concentration for all dissolved or entrained gases was limited to $< 2E-04 \mu\text{Ci/ml}$.

C. Average Energy (\bar{E})

The Limerick ODCM limits the instantaneous dose equivalent rates due to the release of noble gases to less than or equal to 500 mrem/year to the total body and less than or equal to 3000 mrem/year to the skin. The average beta and gamma energies (E) of the radionuclide mixture in releases of fission and activation gases as described in Regulatory Guide 1.21, "Measuring, Evaluating, and Reporting Radioactivity in Solid Wastes and Releases of Radioactive Materials in Liquid and Gaseous Effluents from Light-Water-Cooled Nuclear Power Plants," may be used to calculate doses in lieu of more sophisticated software. The Limerick radioactive effluent program employs the methodologies presented in U.S. NRC Regulatory Guide 1.109 "Calculation of Annual Doses to Man from Routine Releases of Reactor Effluents for the Purpose of Evaluating Compliance with 10 CFR Part 50, Appendix I," Revision 1, October 1977 and NUREG-0133, "Preparation of Radiological Effluent Technical Specifications for Nuclear Power Plants, October 1978. Therefore, average energies are not applicable to Limerick.

D. Measurements and Approximations of Total Radioactivity

1. Fission and Activation Gases

The method used for Gamma Isotopic Analysis is the Canberra Gamma Spectroscopy System with a gas Marinelli beaker. Airborne effluent gaseous activity was continuously monitored and recorded in accordance with ODCM Table 4.2-2. Additional vent grab samples were taken from the North Stack, Unit 1 South Stack, and Unit 2 South Stack and analyzed at least monthly to determine the isotopic mixture of noble gas activity released for the month. The data from the noble gas radiation monitors were analyzed to report net noble gas effluent activity. When no activity was found in the grab isotopic analysis, the isotopic mixture was assumed to be that evaluated in the UFSAR (Section 11.5, Table 11.5-4). If activity was found in the grab isotopic analysis, the isotopic mixture for the Noble Gas Monitor was determined from that isotopic mixture.

Each month a monitor background was determined at the time of the noble gas grab sample and used to determine net radiation monitor activity. When no isotopic activity was identified in the grab noble gas sample, the noble gas radiation monitor 15-minute average data for one-hour prior to and one-hour post noble gas grab sampling were used to determine monitor background for the month. The mean plus two standard deviations was used as background for each Noble Gas Monitor. When activity was identified the background determination was made from the last month that no activity was found.

2. Particulates and Iodines

The method used for Gamma Isotopic Analysis is the Canberra Gamma Spectroscopy System with a particulate filter (47 mm) or charcoal cartridge, respectively. Particulate and iodine activity was continuously sampled and analyzed in accordance with ODCM Table 4.2-2. Charcoal and particulate samples are taken from the North Stack, Unit 1 South Stack, Unit 2 South Stack and Hot Maintenance Shop exhausts and analyzed at least weekly to determine the total activity released from the plant.

3. Carbon-14 in gaseous effluents

Gaseous releases of Carbon-14 were estimated based upon a study by EPRI (EPRI 1021106, Estimation of Carbon-14 in Nuclear Power Plant Gaseous Effluents). The principal production reaction leading to the release of C-14 during plant operation is the O-17(n,α) C-14 nuclear reaction in reactor coolant. Carbon-14 is also produced by neutron activation of N-14 in the BWR drywell and dissolved nitrogen in the reactor coolant, however these sources are a small fraction of that produced by the O-17(n,α) C-14 reaction and can be neglected since reactor coolant normally contains less than 0.1 ppm by weight nitrogen and the neutron flux in the drywell is low. Most of the C-14 produced in a BWR is released in a gaseous form by the off-gas system, primarily in the form of ¹⁴CO .

An Exelon fleet-wide spreadsheet was developed using the production factors from the EPRI report. The spreadsheet requires site specific inputs of total reactor power ratings (7030) MWth and Equivalent Full Power Operation days. Using this method, total C-14 released was estimated at 33.06 Curies (Ci). Ninety-five percent or 31.41 Ci was in the form of ¹⁴CO₂, which was the chemical form necessary to be incorporated in the dose pathways of vegetation, meat and milk. Only inhalation pathway uses the full C-14 release value in estimating dose.

To simplify the dose calculations for C-14, the total release value was used in calculating dose via the offsite effluent pathways. Using the total C-14 release value results in a conservative five percent overestimation of dose via the vegetation, meat and milk pathways. In addition, releases of C-14 were assumed to occur only through the North Vent, which is common to both units. The North Vent has the most conservative X/Q factors for calculating dose.

4. Liquid Effluents

Each batch of liquid effluent was sampled and analyzed for gamma isotopic activity in accordance with ODCM Table 4.2-1 prior to release. The total activity of each released batch was determined by multiplying each nuclide's concentration by the total volume discharged and then summing. The total activity released during a quarter was then determined by summing the activity content of all batch releases discharged during the quarter.

5. Tritium in Liquid and Gaseous Effluents

Liquid effluents are analyzed for tritium using a Liquid Scintillation Counter.

Gaseous effluents are analyzed for tritium by passing air from stack effluents through two bubblers in series. An aliquot of the water from each bubbler was analyzed using a Liquid Scintillation Counter.

The monthly liquid radwaste composite was analyzed for tritium using a Liquid Scintillation Counter.

6. Composite Samples

Particulate air samples were composited monthly and analyzed for gross alpha, Sr-89, Sr-90, and Ni-63. Liquid radwaste samples were composited monthly and quarterly and analyzed for gross alpha (monthly) and Fe-55, Sr-89 and Sr-90 (quarterly). These composites were submitted to an offsite vendor laboratory for analysis.

7. Lower Limit of Detection (LLD)

The ODCM required lower limit of detection for airborne and liquid releases as follows:

Airborne:	LLD
Gross Alpha, Sr-89, Sr-90	1E-11 uCi/cc
H-3	1E-06 uCi/cc
I-131	1E-12 uCi/cc
Principal Gamma Emitters (Mn-54, Fe-59, Co-58, Co-60, Zn-65, Mo-99, I-131, Cs-134, Cs-137, Ce-141, Ce-144)	1E-11 uCi/cc
Noble Gas (Kr-87, Kr-88, Xe-133, Xe-133m, Xe-135, Xe-135m, Xe-138)	1E-04 uCi/cc

SITE: LIMERICK GENERATING STATION – UNITS 1 & 2
 LICENSEE: EXELON GENERATION COMPANY, LLC

Liquid:	LLD
Principal Gamma Emitters (Mn-54, Fe-59, Co-58, Co-60, Zn-65, Mo-99, Cs-134, Cs-137, Ce-141, Ce-144)	5E-07 uCi/ml
I-131	1E-06 uCi/ml
Entrained Gases (Kr-87, Kr-88, Xe-133, Xe-133m, Xe-135, Xe-135m, Xe-138)	1E-05 uCi/ml
H-3	1E-05 uCi/ml
Gross Alpha	1E-07 uCi/ml
Sr-89, Sr-90	5E-08 uCi/ml
Fe-55	1E-06 uCi/ml

8. Estimated Total Error Present

Procedure CY-AA-170-2100, Estimated Errors of Effluent Measurements, provides the methodology to obtain an overall estimate of the error associated with radioactive effluents. The sum of errors used in this report was documented in IR 138895-02.

E. Batch Releases

Liquid	Qtr 1	Qtr 2	Qtr 3	Qtr 4	Total
Number of Batch Releases	7.00E+00	1.70E+01	6.00E+00	2.00E+00	3.20E+01
Total time period for batch releases (min)	1.13E+03	2.25E+03	2.92E+04	2.10E+02	3.27E+04
Maximum time period for batch release (min)	3.30E+02	2.00E+02	2.83E+04	2.00E+02	2.83E+04
Average time period for batch release (min)	1.61E+02	1.33E+02	4.86E+03	1.05E+02	1.02E+03
Minimum time period for batch release (min)	7.00E+01	8.30E+01	2.50E+01	1.00E+01	1.00E+01
Average stream flow (Schuylkill River) during periods of release of effluents into a flowing stream (LPM)	5.16E+06	3.77E+06	5.07E+06	1.33E+06	4.96E+06
Average Blowdown Flowrate (LPM)	1.99E+04	2.19E+04	1.89E+04	1.89E+04	1.92E+04

Gaseous	Qtr 1	Qtr 2	Qtr 3	Qtr 4	Total
Number of Batch Releases	1.00E+00	0.00E+00	0.00E+00	1.00E+00	2.00E+00
Total time period for batch releases (min)	1.03E+04	0.00E+00	0.00E+00	1.44E+04	2.47E+04
Maximum time period for batch release (min)	1.03E+04	0.00E+00	0.00E+00	1.44E+04	1.44E+04
Average time period for batch release (min)	1.03E+04	0.00E+00	0.00E+00	1.44E+04	1.24E+04
Minimum time period for batch release (min)	1.03E+04	0.00E+00	0.00E+00	1.44E+04	1.03E+04

F. Abnormal Releases

1. Liquid	Qtr 1	Qtr 2	Qtr 3	Qtr 4	Total
Number of Releases	3.00E+00	5.00E+00	6.00E+00	2.00E+00	1.60E+01
Total Activity Released (Ci)	2.10E-02	4.06E-04	5.68E-04	1.24E-04	2.21E-02

2. Gaseous	Qtr 1	Qtr 2	Qtr 3	Qtr 4	Total
Number of Releases	1.00E+00	0.00E+00	0.00E+00	1.00E+00	2.00E+00
Total Activity Released (Ci)	2.49E-04	0.00E+00	0.00E+00	1.61E-04	4.11E-04

All the liquid abnormal releases being reported were released through the drain system to the on-site holding pond. The on-site holding pond is a body of water that is ultimately released through the permitted

SITE: LIMERICK GENERATING STATION – UNITS 1 & 2
 LICENSEE: EXELON GENERATION COMPANY, LLC

discharge point. The on-site holding pond is sampled daily for gamma emitters and an aliquot is saved to create a monthly composite which is ran for tritium. All the samples taken from the on-site holding pond were less than detectable for gamma and tritium activity. Though the on-site holding pond provides a large volume of water for dilution, for the purposes of reporting these abnormal releases we do not use the on-site holding pond dilution to calculate the activity released and only use the normal dilution from the blowdown line and the river. The concentrations released from all abnormal releases represent a small fraction of the Total Body and Organ Dose limits and have been included as part of Appendix A in Table 2A.

- Each unit has one Underground Normal Waste Holding Tank (UGNWHT) which is an isolated tank that is released in batches to the on-site Holding Pond, and ultimately released through the permitted discharge point. There were eleven instances when tritium was identified in very low activity levels in these UGNWHTs. In all these instances the tritium values were less than the drinking water limit of 2.00E-05 uCi/ml. Tritium was identified in the Unit 1 UGNWHT on two occasions and on nine occasions in the Unit 2 UGNWHT in 2018. The table below lists each occasion. The Unit 2 UGNWHT was seeing much higher volume than usual during the period tritium was identified and it wasn't realized by the Chemistry Department until after the samples had been disposed that the extra volume entering the Unit 2 UGNWHT was from a chiller unit that is chemically treated with a chemical that is known to produce false positive tritium results. Since the samples were disposed, analysis for this chemical could not be performed to verify its presence so all the positive tritium results are reported. Summary of all UGNWHTs in IR 04149552 Assignment 2.

Unit	Date	Tritium Activity uCi/ml
1	1/25/18	7.51E-06
1	12/6/18	1.95E-06
2	4/9/18	3.70E-06
2	5/30/18	8.29E-06
2	6/1/18	1.48E-06
2	6/18/18	4.09E-06
2	6/25/18	3.86E-06
2	7/4/18	1.87E-06
2	7/17/18	3.35E-06
2	7/24/18	3.14E-06
2	8/27/18	4.67E-06

- Tritium was identified in the Unit 2 Condensate Storage Tank (CST) dike from a sample taken on March 8, 2018 at a concentration of 1.45E-06 uCi/ml. The water is released through the normal waste system to the on-site holding pond. This dike collects rain water and is periodically drained. The potential sources of tritium in the dike are recapture of previously released tritium in rain water, CST tank and piping leaks and auxiliary heating system leaks if contaminated. The CST tank and piping were inspected, no leaks were identified (IR 04124444).
- Tritium was identified in samples from barrels taken March 24, 2018 with a maximum concentration of 2.39E-03 uCi/ml from water leaking from the exterior wall of the condenser area for Unit 1 where there is a seal in the exterior wall that is leaking. The barrels were pumped down a green drain to the on-site holding pond (IR 4089765).
- Tritium was identified in a sample from the Unit 2 Reactor Fuel Floor intake plenum area taken August 10, 2018 at a concentration of 5.88E-06 uCi/ml. The water was released through a drain to the on-site holding pond. The potential sources for positive tritium results in this plenum area is from the heating and cooling coils. The heating coils use auxiliary steam and if the auxiliary heating system becomes contaminated there is a potential for leaks in the heating coils to provide a source of tritium. The cooling coils are cooled with Drywell Closed Cooling Water (DWCCW). The DWCCW is chemically treated with a chemical known to produce false positive tritium results. If there are leaks in the cooling coils, then there is a source for positive tritium results (IR 04175184).
- Tritium was identified in a manhole from a sample taken on August 29, 2018 at a concentration of 3.07E-06 uCi/ml. This water was pumped down a storm drain to the on-site holding pond. The source of tritium is from tritium in the groundwater at the station from previously identified spills/leaks (IR 04175187).

SITE: LIMERICK GENERATING STATION – UNITS 1 & 2
 LICENSEE: EXELON GENERATION COMPANY, LLC

- Tritium was identified in 2 drums of contaminated water that were inappropriately disposed down a drain in the plant that goes to the on-site holding pond on December 26, 2018 at a concentration of 1.40E-06 uCi/ml. A third drum of contaminated water was also inappropriately disposed of down the drain that did not contain tritium but Co-60 was identified at a concentration of 3.64E-08 uCi/ml (IR 04206155).
- Tritium was identified in the Aux Boiler Deaerator and Feedwater and released via the Aux Boiler Deaerator Vent during quarters 1 and 4. The source of the tritium was identified as leak by of two isolation valves where the auxiliary steam contacts nuclear steam. The water from the leak by entered the auxiliary steam condensate return system back to the deaerator. This water was rerouted to the radwaste system. The concentrations released represent a small fraction of the Total Body and Organ Dose limits and have been included as part of Appendix A in Table 1A (IR 04127076 and IR 04199408).

G. Insignificant Releases

In January of 2016 new pathways were identified and classified as a less significant Effluent Pathway. Gaseous effluents from the Main Turbine and Reactor Feed Pump Turbine lubrication oil vapor extractor exhaust vents to the Turbine Building roof. These pathways are not continuously monitored. Tritium analysis was performed in January and December 2016 of the water vapor exiting the vent and of nearby standing water. The tritium in the water is the result of condensation and direct deposition from the discharge of the entrained water vapor from the exhaust vents. This condensation does occur year-round but increases during seasonally cold weather.

The lube oil exhaust vents and associated systems were operating as designed to remove accumulated water from the lubricating and seal oil for the various turbine systems. The water was discharged as entrained vapor out the Turbine Building roof vent and a portion of it condensed on lower temperature surfaces. This water includes tritium, as the source is from the primary system. (IR 2606991)

Based on Regulatory Guide 1.21, Rev 2, Measuring, Evaluating, and Reporting Radioactive Material in Liquid and Gaseous Effluents and Solid Waste these release pathways are considered less significant. A significant release point is any location, from which radioactive material is released, that contributes greater than 1 percent of the activity discharged from all the release points for a particular type of effluent considered. Regulatory Guide 1.109 lists the three types of effluent as (1) liquid effluents, (2) noble gases discharged to the atmosphere, and (3) all other radionuclides discharged to the atmosphere. As such, the percentage of U1 and U2 MTLO exhaust vent activity in 2018 is relatively small compared to the total activity released of all other radionuclides from the site in 2018. This percentage is calculated below.

Vent	Tritium Concentration, uCi/cc	Site Gaseous Annual Release from all other Radionuclides, Ci	Percentage of Activity Relative to Total Release from the Site
		2018	2018
U1 MTLO extractor exhaust vent	1.30E-08	5.33E+01	5.08E-01%
U2 MTLO extractor exhaust vent	1.02E-08		4.00E-01%
U1 and U2 RFPT extractor exhaust vent	<LLD		N/A

H. Spills

There were no spills to ground containing radioactive material in 2018. However, the Power Block Foundation Sump, which collects groundwater around the reactor buildings, turbine building and rad waste building, had identified tritium in the third and fourth quarter samples and analysis of potentially contaminated systems (IRs 04157321 and 04166840). The maximum activity of 1.94E-06 uCi/ml was recorded. The source of the tritium is groundwater movement from the previously identified and reported leaks/spills.

I. Revisions to the ODCM

Revision 30 of the ODCM was issued in May 2018. The summary of changes and a complete copy of ODCM revision 30 is being included with this annual report.

Revision 31 of the ODCM was issued in May 2018. The summary of changes and a complete copy of ODCM revision 31 is being included with this annual report.

J. Radioactive Effluent Monitoring Instrumentation Out of Service for More Than 30 Days

There was no radioactive effluent monitoring instrumentation out of service for more than 30 Days in 2018.

K. Program Deviations

During compensatory sampling at the North Stack Radiation Monitor there was an eight-hour period that the required continuous particulate and iodine sampling was invalid due to a failure of the sampling equipment. With the North Stack Radiation Monitor system declared inoperable, compensatory sampling was started in accordance with the Offsite Dose Calculation Manual (ODCM). The compensatory sampling required is that a noble gas sample be obtained once every twelve hours and continuous particulate and iodine sampling is obtained. The Chemistry Technicians set up a gas Marinelli and particulate and iodine filters in series. A sample pump was used to pull the sample through the Marinelli and particulate and iodine filters. Though the noble gas sample is required per the ODCM once every twelve hours, the station administratively obtains the noble gas sample every eight hours to ensure the compensatory requirements are met. When the Chemistry Technician arrived at the North Stack to swap out the gas Marinelli, they discovered that the vacuum on the Marinelli from the sample pump had caused the Marinelli to implode. With the Marinelli damaged, air was being drawn in from the room and not from the sample line through the iodine and particulate filter making those samples invalid. The technician removed the damaged Marinelli and obtained the required Marinelli sample with a new Marinelli and restarted the iodine and particulate sampling with new filters. The compensatory sampling required is that a noble gas sample be obtained once every twelve hours and continuous particulate and iodine sampling is obtained. The Chemistry Technicians set up a gas Marinelli and particulate and iodine filters in series. A sample pump was used to pull the sample through the Marinelli and particulate and iodine filters. Though the noble gas sample is required per the ODCM once every twelve hours, the station administratively obtains the noble gas sample every eight hours to ensure the compensatory requirements are met. When the Chemistry Technician arrived at the North Stack to swap out the gas Marinelli, they discovered that the vacuum on the Marinelli from the sample pump had caused the Marinelli to implode. With the Marinelli damaged, air was being drawn in from the room and not from the sample line through the iodine and particulate filter making those samples invalid. The technician removed the damaged Marinelli and obtained the required Marinelli sample and restarted the iodine and particulate sampling with new filters. A review of particulate/iodine sample results from the samples obtained prior to the eight-hour period there was no sampling and a review of the particulate/iodine sample results from the samples obtained after the missing sampling was performed. There were no particulate/iodine nuclides identified in either the pre or post samples as is typical for this sample point. A review of plant operation during this eight-hour period identified no activities were performed that would have impacted these sample results. (IR 04124028)

L. Independent Spent Fuel Storage Installation (ISFSI)

An Independent Spent Fuel Storage Installation (ISFSI) was placed in service starting July 21, 2008. Direct radiation exposure was determined using dosimetry measurements (minus background levels) obtained from the Radiological Environmental Monitoring Program for the nearest residence to the Independent Spent Fuel Storage Installation (ISFSI). In 2018 the dose to the nearest resident from the ISFSI was 0.00 mrem.

M. Annual Land Use Census Changes

The 2018 Land Use Survey identified differences in locations for gardens and meat animals. The gardens identified in sectors NE, and SW are newly identified and closer than in 2017. There were new locations for

SITE: LIMERICK GENERATING STATION – UNITS 1 & 2
LICENSEE: EXELON GENERATION COMPANY, LLC

meat animals identified in sectors N, S, SSW and WSW and are closer than in 2017. There were no changes in the nearest residences and dairy farms from 2017.

4. Radiological Impact to Man and Compliance to 40 CFR 190 Limits

A. Dose to Members of the Public at or Beyond Site Boundary

Per ODCM Control 6.2, the Annual Radioactive Effluent Release Report shall include an assessment of the radiation doses to the hypothetically highest exposed MEMBER OF THE PUBLIC from reactor releases and other nearby uranium fuel cycle sources. The ODCM does not require population doses to be calculated. For purposes of this calculation the following assumptions were made:

- Long term annual average meteorology X/Q and D/Q and actual gaseous effluent releases were used.
- Gamma air dose, Beta air dose, Total Body and Skin doses were attributed to noble gas releases.
- Critical organ and age group dose attributed to iodine, particulate, carbon-14 and tritium releases.
- 100 percent occupancy factor was assumed.
- Dosimetry measurements (minus background levels) obtained from the Radiological Environmental Monitoring Program for the nearest residence to the Independent Spent Fuel Storage Installation (ISFSI) was used to determine direct radiation exposure.
- The highest doses from the critical organ and critical age group for each release pathway was summed and added to the net dosimetry measurement from nearest residence to the ISFSI for 40CFR190 compliance.

Gaseous Releases (Table 1):

The critical age-organ group was the child-bone. Calculated dose was 1.28E+00 mrem, which represents 4.26E+00 percent of the allowable limits. Carbon-14 represented 100.0% or 1.28E+00 mrem of the total dose.

Liquid Releases (Table 1):

The critical age-organ was the adult-liver. Calculated total body dose was 4.90E-04 mrem and organ dose was 6.59E-04 mrem.

40 CFR 190 Compliance (Table 2):

The maximum calculated dose to a real individual would not exceed 2.90E-01 mrem (total body), 1.29E+00 mrem (organ), or 2.90E-01 mrem (thyroid).

All doses calculated were well below all ODCM and 40 CFR Part 190 limits to a real individual.

Table 1 Summary of Gaseous and Liquid Effluent Doses to Members of the Public at the Highest Dose Receptors

Maximum Individual Noble Gas	Applicable Dose	Estimated Dose	Age Group	% of Applicable Limit	Limit	Unit
Nearest Residence	Gamma Air Dose	3.45E-03	All	1.73E-02	20	mRad
Nearest Residence	Beta Air Dose	2.13E-03	All	5.33E-03	40	mRad
Nearest Residence	Total Body	3.25E-03	All	3.25E-02	10	mrem
Nearest Residence	Skin	5.35E-03	All	1.78E-02	30	mrem
Iodine, Particulate, C-14 & Tritium						
Vegetation Pathway	Bone	1.28E+00	Child	4.26E+00	30	mrem
Liquid						
LGS Outfall	Total Body	4.90E-04	Teen	8.16E-03	6	mrem
LGS Outfall	Liver	6.59E-04	Adult	3.29E-03	20	mrem

Table 2 Summary of Gaseous and Liquid Effluent Doses to Members of the Public for 40CFR190 Compliance

40 CFR 190 Compliance								
	Gaseous Effluents		Liquid Effluents	Net Direct Radiation	Total	% of Applicable Limit	Limit	Unit
	Noble Gas	Particulate, Iodine, C-14 & Tritium						
Total Body Dose	3.25E-02	2.57E-01	4.90E-04	0.00E+00	2.90E-01	1.16E+00	25	mrem
Organ Dose	5.35E-03	1.28E+00	6.59E-04	0.00E+00	1.29E+00	5.14E+00	25	mrem
Thyroid Dose	3.25E-02	2.57E-01	2.92E-04	0.00E+00	2.90E-01	3.86E-01	75	mrem

B. Dose to Members of the Public Inside the Site Boundary

ODCM Control 6.2 also requires that the Annual Effluent Release Report shall include an assessment of the radiation doses from radioactive liquid and gaseous effluents to members of the public due to activities inside the Site Boundary during the report period. MEMBER OF THE PUBLIC shall include all persons not occupationally associated with the plant. This category does not include employees of the utility or contractors. Also excluded from this category are persons who enter the site to service equipment or to make deliveries. This category does include persons who use portions of the site for recreational, occupational education, or other purposes not associated with the plant. A MEMBER OF THE PUBLIC may receive up to 100 mrem in a year (10CFR20.1301). Areas within the site boundary, where radiation dose of this type could occur include the Limerick Information Center on Longview Road, Frick's Lock on the south shore of the Schuylkill River, and the railroad track that runs along the north shore of the Schuylkill River. The radiation doses to Members of the Public have been estimated using methodology stated in the ODCM. The maximum gaseous dose to members of the public at these locations is based on the following assumptions:

- Long term annual average meteorology and actual effluent releases for the sectors encompassing the Railroad Tracks (W), Information Center, and Frick's Lock.
- Dose is from ground plane and inhalation only. No ingestion dose is included.
- The maximum expected occupancy factor is 25% of a working year at all locations.

The maximum calculated dose for activities on site was 3.53E-02 mrem at the Rail Road Tracks in the West sector (Table 3). All Doses calculated were a small fraction of the 10 CFR 20.1301 limits.

SITE: LIMERICK GENERATING STATION – UNITS 1 & 2
 LICENSEE: EXELON GENERATION COMPANY, LLC

Table 3 Summary of Gaseous Radiation Doses to Members of the Public for Activities on Site

Location	Sector	Approx. Distance (meters)	X/Q s/m ³	D/Q 1/m ²	Total Body Dose, mrem ⁽¹⁾		Organ Dose, mrem ⁽¹⁾	Total
					Noble Gas	Iodine, Particulate, C-14 & H-3	Iodine, Particulate, C-14 & H-3	
R.R. Tracks	W	225	2.66E-06	2.36E-08	3.84E-03	5.36E-03	2.62E-02	3.54E-02
Info. Center	ESE	884	7.32E-07	9.27E-09	1.06E-03	1.50E-03	7.24E-03	9.80E-03
Frick's Lock	WSW	450	5.58E-07	4.78E-09	8.06E-04	1.12E-03	5.50E-03	7.43E-03

(1) The limit for sum of the Total Body Dose and Organ Dose = 100 mrem (ref. 10 CFR 20.1301)

SITE: LIMERICK GENERATING STATION – UNITS 1 & 2
LICENSEE: EXELON GENERATION COMPANY, LLC

Appendix A Effluent and Waste Disposal Summary

SITE: LIMERICK GENERATING STATION – UNITS 1 & 2
LICENSEE: EXELON GENERATION COMPANY, LLC

(Page Intentionally Left Blank)

SITE: LIMERICK GENERATING STATION – UNITS 1 & 2
LICENSEE: EXELON GENERATION COMPANY, LLC

LIST OF TABLES

	PAGE
TABLE 1A GASEOUS EFFLUENTS – SUMMATION OF ALL RELEASES	21
TABLE 1B-1 GASEOUS EFFLUENTS—MIXED-LEVEL RELEASE – BATCH MODE	22
TABLE 1B-2 GASEOUS EFFLUENTS – MIXED-LEVEL RELEASE – CONTINUOUS MODE	23
TABLE 2A LIQUID EFFLUENTS – SUMMATION OF ALL RELEASES	24
TABLE 2A-1 LIQUID EFFLUENTS – BATCH MODE	25
TABLE 2A-2 LIQUID EFFLUENTS – CONTINUOUS MODE	26

SITE: LIMERICK GENERATING STATION – UNITS 1 & 2
LICENSEE: EXELON GENERATION COMPANY, LLC

(Page Intentionally Left Blank)

TABLE 1A GASEOUS EFFLUENTS - SUMMATION OF ALL RELEASES

PERIOD 2018

A. Fission And Activation Gasses	Units	Qtr 1	Qtr 2	Qtr 3	Qtr 4	Total	Uncertainty (%)
Total Release	Ci	1.75E+01	1.27E+01	1.03E+01	2.44E+01	6.48E+01	36.6
Average Release Rate for Period	uCi/sec	2.25E+00	1.62E+00	1.30E+00	3.07E+00	2.06E+00	
Dose - Gamma Air Dose	mrad	8.94E-04	7.36E-04	5.47E-04	1.28E-03	3.45E-03	
- Beta Air Dose	mrad	5.55E-04	4.50E-04	3.38E-04	7.90E-04	2.13E-03	
Percent of ODCM Limit - Gamma Air Dose	%	8.94E-03	7.36E-03	5.47E-03	1.28E-02	1.73E-02	
- Beta Air Dose	%	2.78E-03	2.25E-03	1.69E-03	3.95E-03	5.33E-03	
B. Radioiodines	Units	Qtr 1	Qtr 2	Qtr 3	Qtr 4	Total	Uncertainty (%)
Total I-131	Ci	1.03E-05	< LLD	< LLD	< LLD	1.03E-05	20.4
Average Release Rate for Period	uCi/sec	1.33E-06	< LLD	< LLD	< LLD	3.27E-07	
Percent of ODCM Limit	%	*	*	*	*	*	
C. Particulates	Units	Qtr 1	Qtr 2	Qtr 3	Qtr 4	Total	Uncertainty (%)
Total Release	Ci	1.14E-05	4.07E-05	< LLD	< LLD	5.21E-05	22.6
Average Release Rate for Period	uCi/sec	1.47E-06	5.18E-06	< LLD	< LLD	1.65E-06	
Percent of ODCM Limit	%	*	*	*	*	*	
D. Gross Alpha	Units	Qtr 1	Qtr 2	Qtr 3	Qtr 4	Total	Uncertainty (%)
Total Release	Ci	< LLD	< LLD	< LLD	< LLD	< LLD	22.6
Average Release Rate for Period	uCi/sec	< LLD	< LLD	< LLD	< LLD	< LLD	
Percent of ODCM Limit	%	*	*	*	*	*	
E. Tritium (H-3)	Units	Qtr 1	Qtr 2	Qtr 3	Qtr 4	Total	Uncertainty (%)
Total Release	Ci	1.01E+01	9.74E-01	7.50E-01	7.17E+00	1.90E+01	15.7
Average Release Rate for Period	uCi/sec	1.30E+00	1.24E-01	9.43E-02	9.02E-01	6.03E-01	
Percent of ODCM Limit	%	*	*	*	*	*	
F. Carbon-14	Units	Qtr 1	Qtr 2	Qtr 3	Qtr 4	Total	
Total Release	Ci	7.10E+00	9.35E+00	1.06E+01	7.21E+00	3.42E+01	
Average Release Rate for Period	uCi/sec	9.12E-01	1.19E+00	1.33E+00	9.07E-01	1.09E+00	
Percent of ODCM Limit	%	*	*	*	*	*	
G. Iodine 131 & 133, Particulate, C-14 & H-3	Units	Qtr 1	Qtr 2	Qtr 3	Qtr 4	Total	
Organ Dose	mrem	2.65E-01	3.49E-01	3.96E-01	2.69E-01	1.28E+00	
Percent of ODCM Limit	%	1.77E+00	2.33E+00	2.64E+00	1.79E+00	4.26E+00	

* ODCM Limit for combined Iodine, Carbon-14, Tritium and particulate only, which is shown in Item G.

SITE: LIMERICK GENERATING STATION – UNITS 1 & 2
 LICENSEE: EXELON GENERATION COMPANY, LLC

TABLE 1B–1 GASEOUS EFFLUENTS—MIXED-LEVEL RELEASE—BATCH MODE

PERIOD 2018

Fission And Activation Gasses	Units	Qtr 1	Qtr 2	Qtr 3	Qtr 4	Total
Ar-41	Ci	< LLD	N/A	N/A	< LLD	< LLD
Kr-85	Ci	< LLD	N/A	N/A	< LLD	< LLD
Kr-85m	Ci	< LLD	N/A	N/A	< LLD	< LLD
Kr-87	Ci	< LLD	N/A	N/A	< LLD	< LLD
Kr-88	Ci	< LLD	N/A	N/A	< LLD	< LLD
Xe-133	Ci	< LLD	N/A	N/A	< LLD	< LLD
Xe-135	Ci	< LLD	N/A	N/A	< LLD	< LLD
Xe-135m	Ci	< LLD	N/A	N/A	< LLD	< LLD
Xe-138	Ci	< LLD	N/A	N/A	< LLD	< LLD
Total	Ci	< LLD	N/A	N/A	< LLD	< LLD
Radioiodines	Units	Qtr 1	Qtr 2	Qtr 3	Qtr 4	Total
I-131	Ci	< LLD	N/A	N/A	< LLD	< LLD
I-133	Ci	< LLD	N/A	N/A	< LLD	< LLD
I-135	Ci	< LLD	N/A	N/A	< LLD	< LLD
Total	Ci	< LLD	N/A	N/A	< LLD	< LLD
Particulates	Units	Qtr 1	Qtr 2	Qtr 3	Qtr 4	Total
Cr-51	Ci	< LLD	N/A	N/A	< LLD	< LLD
Mn-54	Ci	< LLD	N/A	N/A	< LLD	< LLD
Co-58	Ci	< LLD	N/A	N/A	< LLD	< LLD
Co-60	Ci	< LLD	N/A	N/A	< LLD	< LLD
Zn-65	Ci	< LLD	N/A	N/A	< LLD	< LLD
Sr-89	Ci	< LLD	N/A	N/A	< LLD	< LLD
Sr-90	Ci	< LLD	N/A	N/A	< LLD	< LLD
Mo-99	Ci	< LLD	N/A	N/A	< LLD	< LLD
Ag-110m	Ci	< LLD	N/A	N/A	< LLD	< LLD
Cs-134	Ci	< LLD	N/A	N/A	< LLD	< LLD
Cs-137	Ci	< LLD	N/A	N/A	< LLD	< LLD
Ba-140	Ci	< LLD	N/A	N/A	< LLD	< LLD
La-140	Ci	< LLD	N/A	N/A	< LLD	< LLD
Ce-141	Ci	< LLD	N/A	N/A	< LLD	< LLD
Ce-144	Ci	< LLD	N/A	N/A	< LLD	< LLD
Total	Ci	< LLD	N/A	N/A	< LLD	< LLD
H-3	Ci	2.494E-04	N/A	N/A	1.612E-04	4.105E-04
Gross Alpha	Ci	N/A	N/A	N/A	N/A	N/A
C-14	Ci	N/A	N/A	N/A	N/A	N/A

TABLE 1B–2 GASEOUS EFFLUENTS – MIXED-LEVEL RELEASE - CONTINUOUS MODE

PERIOD 2018

Fission And Activation Gasses	Units	Qtr 1	Qtr 2	Qtr 3	Qtr 4	Total
Kr-85m	Ci	3.02E-01	2.24E-01	1.79E-01	4.23E-01	1.13E+00
Kr-85	Ci	1.59E-02	1.39E-01	3.89E-02	6.41E-02	2.58E-01
Kr-87	Ci	3.06E-01	2.51E-01	1.87E-01	4.36E-01	1.18E+00
Kr-88	Ci	3.11E-01	3.01E-01	2.01E-01	4.59E-01	1.27E+00
Ar-41	Ci	1.24E+00	7.79E-01	7.04E-01	1.70E+00	4.42E+00
Xe-131m	Ci	3.99E-04	3.48E-03	9.74E-04	1.61E-03	6.45E-03
Xe-133m	Ci	0.00E+00	0.00E+00	0.00E+00	0.00E+00	0.00E+00
Xe-133	Ci	6.47E+00	4.06E+00	3.66E+00	8.81E+00	2.30E+01
Xe-135m	Ci	4.61E+00	3.19E+00	2.68E+00	6.38E+00	1.69E+01
Xe-135	Ci	3.44E+00	2.62E+00	2.06E+00	4.84E+00	1.30E+01
Xe-138	Ci	7.76E-01	1.13E+00	5.88E-01	1.27E+00	3.76E+00
Total	Ci	1.75E+01	1.27E+01	1.03E+01	2.44E+01	6.49E+01
Radioiodines	Units	Qtr 1	Qtr 2	Qtr 3	Qtr 4	Total
I-131	Ci	1.03E-05	< LLD	< LLD	< LLD	1.03E-05
I-133	Ci	< LLD	< LLD	< LLD	< LLD	< LLD
I-135	Ci	< LLD	< LLD	< LLD	< LLD	< LLD
Total	Ci	1.03E-05	< LLD	< LLD	< LLD	1.03E-05
Particulates	Units	Qtr 1	Qtr 2	Qtr 3	Qtr 4	Total
Cr-51	Ci	< LLD	< LLD	< LLD	< LLD	< LLD
Mn-54	Ci	< LLD	< LLD	< LLD	< LLD	< LLD
Co-58	Ci	< LLD	< LLD	< LLD	< LLD	< LLD
Co-60	Ci	1.14E-05	4.07E-05	< LLD	< LLD	5.21E-05
Ni-63	Ci	< LLD	< LLD	< LLD	< LLD	< LLD
Zn-65	Ci	< LLD	< LLD	< LLD	< LLD	< LLD
Sr-89	Ci	< LLD	< LLD	< LLD	< LLD	< LLD
Sr-90	Ci	< LLD	< LLD	< LLD	< LLD	< LLD
Mo-99	Ci	< LLD	< LLD	< LLD	< LLD	< LLD
Cs-134	Ci	< LLD	< LLD	< LLD	< LLD	< LLD
Cs-137	Ci	< LLD	< LLD	< LLD	< LLD	< LLD
Ba-140	Ci	< LLD	< LLD	< LLD	< LLD	< LLD
La-140	Ci	< LLD	< LLD	< LLD	< LLD	< LLD
Ce-141	Ci	< LLD	< LLD	< LLD	< LLD	< LLD
Ce-144	Ci	< LLD	< LLD	< LLD	< LLD	< LLD
Total	Ci	1.14E-05	4.07E-05	< LLD	< LLD	5.21E-05
H-3	Ci	1.01E+01	9.74E-01	7.50E-01	7.17E+00	1.90E+01
Gross Alpha	Ci	< LLD	< LLD	< LLD	< LLD	< LLD
C-14	Ci	7.10E+00	9.35E+00	1.06E+01	7.21E+00	3.43E+01

TABLE 2A LIQUID EFFLUENTS – SUMMATION OF ALL RELEASES

PERIOD 2018

Fission and Activation Products Excluding Tritium, Gasses & Alpha	Units	Qtr 1	Qtr 2	Qtr 3	Qtr 4	Total	Uncertainty (%)
Total Release	Ci	1.01E-03	4.96E-04	0.00E+00	7.56E-09	1.51E-03	21.1
Average Concentration	uCi/ml	4.47E-08	9.87E-09	0.00E+00	1.89E-12	2.40E-09	
Dose - Whole Body	mrem	3.05E-04	1.85E-04	1.55E-08	8.33E-07	4.90E-04	
- Organ	mrem	4.51E-04	2.10E-04	1.55E-08	8.29E-07	6.59E-04	
% of ODCM Limit - Whole Body Dose*	%	1.02E-02	6.15E-03	5.18E-07	2.78E-05	8.16E-03	
- Organ Dose*	%	4.51E-03	2.10E-03	1.55E-07	8.29E-06	3.29E-03	
Tritium	Units	Qtr 1	Qtr 2	Qtr 3	Qtr 4	Total	Uncertainty (%)
Total Release	Ci	1.15E+00	5.49E+00	5.68E-04	1.24E-04	6.64E+00	6.4
Average Concentration	uCi/ml	5.06E-05	1.09E-04	1.03E-09	3.11E-08	1.06E-05	
% of ODCM Limit - ECL	%	5.06E-01	1.09E+00	1.03E-05	3.11E-04	1.06E-01	
Dissolved and Entrained Gases	Units	Qtr 1	Qtr 2	Qtr 3	Qtr 4	Total	Uncertainty (%)
Total Release	Ci	0.00E+00	9.32E-06	0.00E+00	0.00E+00	9.32E-06	21.1
Average Concentration	uCi/ml	0.00E+00	1.86E-10	0.00E+00	0.00E+00	1.48E-11	
% of ODCM Limit - ECL	%	N/A	9.30E-05	N/A	N/A	7.40E-06	
Gross Alpha	Units	Qtr 1	Qtr 2	Qtr 3	Qtr 4	Total	Uncertainty (%)
Total Release	Ci	< LLD	< LLD	< LLD	<LLD	< LLD	23.0
Average Concentration	uCi/ml	< LLD	< LLD	< LLD	<LLD	<LLD	
Volume of Waste Released	Units	Qtr 1	Qtr 2	Qtr 3	Qtr 4	Total	Uncertainty (%)
Total	Liters	2.54E+05	9.62E+05	1.31E+05	1.96E+04	1.37E+06	5.0
Volume of Dilution Water used during period	Units	Qtr 1	Qtr 2	Qtr 3	Qtr 4	Total	Uncertainty (%)
Total	Liters	2.24E+07	4.93E+07	5.52E+08	3.98E+06	6.28E+08	5.0

* Percent of limit includes gases and tritium.

TABLE 2A–1 LIQUID EFFLUENTS - BATCH MODE

PERIOD 2018

Fission and Activation Products	Units	Qtr 1	Qtr 2	Qtr 3	Qtr 4	Total
NA-24	Ci	< LLD	3.13E-05	< LLD	< LLD	3.13E-05
Cr-51	Ci	< LLD	7.85E-05	< LLD	< LLD	7.85E-05
Mn-54	Ci	< LLD	3.37E-05	< LLD	< LLD	3.37E-05
Fe-55	Ci	6.61E-04	< LLD	< LLD	< LLD	6.61E-04
Co-58	Ci	< LLD	4.31E-05	< LLD	< LLD	4.31E-05
Fe-59	Ci	< LLD	< LLD	< LLD	< LLD	< LLD
Co-60	Ci	9.66E-05	2.59E-04	< LLD	7.56E-09	3.55E-04
Zn-65	Ci	5.27E-05	4.85E-05	< LLD	< LLD	1.01E-04
Zn-69m	Ci	< LLD	1.06E-06	< LLD	< LLD	1.06E-06
Sr-89	Ci	< LLD	< LLD	< LLD	< LLD	< LLD
Sr-90	Ci	< LLD	< LLD	< LLD	< LLD	< LLD
Zr-95	Ci	< LLD	< LLD	< LLD	< LLD	< LLD
Nb-95	Ci	< LLD	< LLD	< LLD	< LLD	< LLD
Nb-97	Ci	1.21E-05	< LLD	< LLD	< LLD	1.21E-05
Mo-99	Ci	< LLD	< LLD	< LLD	< LLD	< LLD
Tc-99m	Ci	< LLD	< LLD	< LLD	< LLD	< LLD
Ag-110m	Ci	3.19E-05	< LLD	< LLD	< LLD	3.19E-05
Sb-122	Ci	< LLD	6.90E-06	< LLD	< LLD	6.90E-06
Sb-124	Ci	1.64E-05	1.95E-06	< LLD	< LLD	1.83E-05
Sb-125	Ci	8.97E-05	< LLD	< LLD	< LLD	8.97E-05
I-131	Ci	< LLD	< LLD	< LLD	< LLD	< LLD
Cs-134	Ci	< LLD	< LLD	< LLD	< LLD	< LLD
Cs-137	Ci	5.31E-05	< LLD	< LLD	< LLD	5.31E-05
Ba-140	Ci	< LLD	< LLD	< LLD	< LLD	< LLD
La-140	Ci	< LLD	< LLD	< LLD	< LLD	< LLD
Ce-141	Ci	< LLD	< LLD	< LLD	< LLD	< LLD
Total	Ci	N/A	8.41E-04	1.33E-03	2.13E-04	2.38E-03
Dissolved and Entrained Gases	Units	Qtr 1	Qtr 2	Qtr 3	Qtr 4	Total
Kr-87	Ci	< LLD	< LLD	< LLD	< LLD	< LLD
Kr-88	Ci	< LLD	< LLD	< LLD	< LLD	< LLD
Xe-133	Ci	< LLD	< LLD	< LLD	< LLD	< LLD
Xe-133m	Ci	< LLD	< LLD	< LLD	< LLD	< LLD
Xe-135	Ci	< LLD	9.32E-06	< LLD	< LLD	9.32E-06
Xe-135m	Ci	< LLD	< LLD	< LLD	< LLD	< LLD
Xe-138	Ci	< LLD	< LLD	< LLD	< LLD	< LLD
Total	Ci	< LLD	1.08E-05	< LLD	< LLD	1.46E-05
H-3	Ci	1.15E+00	5.49E+00	5.68E-04	1.24E-04	6.64E+00
Gross Alpha	Ci	< LLD	< LLD	< LLD	< LLD	< LLD

SITE: LIMERICK GENERATING STATION – UNITS 1 & 2
 LICENSEE: EXELON GENERATION COMPANY, LLC

TABLE 2A-2 LIQUID EFFLUENTS - CONTINUOUS MODE

PERIOD 2018

Fission and Activation Products	Units	Qtr 1	Qtr 2	Qtr 3	Qtr 4	Total
Cr-51	Ci	N/A	N/A	N/A	N/A	N/A
Mn-54	Ci	N/A	N/A	N/A	N/A	N/A
Fe-55	Ci	N/A	N/A	N/A	N/A	N/A
Co-58	Ci	N/A	N/A	N/A	N/A	N/A
Fe-59	Ci	N/A	N/A	N/A	N/A	N/A
Co-60	Ci	N/A	N/A	N/A	N/A	N/A
Zn-65	Ci	N/A	N/A	N/A	N/A	N/A
Sr-89	Ci	N/A	N/A	N/A	N/A	N/A
Sr-90	Ci	N/A	N/A	N/A	N/A	N/A
Zr-95	Ci	N/A	N/A	N/A	N/A	N/A
Nb-95	Ci	N/A	N/A	N/A	N/A	N/A
Mo-99	Ci	N/A	N/A	N/A	N/A	N/A
Tc-99m	Ci	N/A	N/A	N/A	N/A	N/A
Ag-110m	Ci	N/A	N/A	N/A	N/A	N/A
I-131	Ci	N/A	N/A	N/A	N/A	N/A
Cs-134	Ci	N/A	N/A	N/A	N/A	N/A
Cs-137	Ci	N/A	N/A	N/A	N/A	N/A
Ba-140	Ci	N/A	N/A	N/A	N/A	N/A
La-140	Ci	N/A	N/A	N/A	N/A	N/A
Ce-141	Ci	N/A	N/A	N/A	N/A	N/A
Total	Ci	N/A	N/A	N/A	N/A	N/A
Dissolved and Entrained Gases	Units	Qtr 1	Qtr 2	Qtr 3	Qtr 4	Total
Xe-131m	Ci	N/A	N/A	N/A	N/A	N/A
Xe-133	Ci	N/A	N/A	N/A	N/A	N/A
Xe-135	Ci	N/A	N/A	N/A	N/A	N/A
Total	Ci	N/A	N/A	N/A	N/A	N/A
H-3	Ci	N/A	N/A	N/A	N/A	N/A
Gross Alpha	Ci	N/A	N/A	N/A	N/A	N/A

SITE: LIMERICK GENERATING STATION – UNITS 1 & 2
LICENSEE: EXELON GENERATION COMPANY, LLC

Appendix B
Solid Waste and Irradiated
Fuel Shipments

SITE: LIMERICK GENERATING STATION – UNITS 1 & 2
LICENSEE: EXELON GENERATION COMPANY, LLC

(Page Intentionally Left Blank)

A. Solid waste shipped offsite for burial or disposal (not irradiated fuel) 1/1/18 – 12/31/18

1. Type of waste

Type of waste	Unit	12 Month Period	Estimated Error %
a. Spent resin, filters sludges, evaporator bottoms, etc	m ³	152.42	25%
	Ci	1319.71	
b. Dry compressible waste, contaminated equipment, etc.	m ³	119.64	25%
	Ci	1.78	
c. Irradiated components, control rods, etc.	m ³	None	N/A
	Ci	None	
d. Other (Describe)	m ³	None	N/A
	Ci	None	

2. Estimate of Major Nuclide Composition (By Waste Type)

Category A – Spent Resin, Filters, Sludges, Evaporator Bottoms, etc.

Isotope	Waste Class A Curies *	Percent Abundance
C-14	2.88E+00	0.22%
Mn-54	7.12E+01	5.40%
Fe-55	5.81E+02	44.02%
Co-60	4.91E+02	37.21%
Ni-59	3.83E-02	0.01%
Ni-63	1.37E+01	1.04%
Zn-65	1.29E+02	9.77%
Sr-90	2.80E-02	0.00%
Cs-137	3.19E+00	0.24%
Ce-144	1.24E+00	0.09%
Cs-134	6.09E-02	0.01%
H-3	5.69E-01	0.04%
Co-58	2.58E+01	1.95%
TOTALS	1.32E+03	100.00%

* Activity is estimated

SITE: LIMERICK GENERATING STATION – UNITS 1 & 2
 LICENSEE: EXELON GENERATION COMPANY, LLC

Category B – Dry Compressible Waste, Contaminated Equipment, etc.

Isotope	Waste Class A Curies *	Percent Abundance
C-14	9.92E-03	0.56%
Ce-144	3.06E-03	0.17%
Co-58	1.91E-03	0.11%
Co-60	8.12E-01	45.73%
Cr-51	3.54E-03	0.20%
Cs-137	2.93E-03	0.16%
Fe-55	7.39E-01	41.62%
H-3	3.47E-04	0.02%
Mn-54	6.72E-02	3.79%
Ni-63	8.58E-02	4.83%
Zn-65	4.99E-02	2.81%
TOTALS	1.78E+00	100.00%

* Activity is estimated

3. Solid Waste (Disposition)

Number of Shipments	Mode of Transportation	Destination
18	Truck	Energy Solutions Bear Creek Operations Facility to Energy Solutions / Clive
26	Truck	Limerick Gen. Sta. to Energy Solutions / Clive

Comments:

34 Shipments were made from Limerick to Energy Solution Processing Facility for processing
 No solidifications were performed

Category A – 21 shipments Type A LSA
 Category A - 5 shipments > Type A LSA
 Category A - 2 shipment Type B
 Category B - 32 shipments Type A LSA
 Category C - No shipments made
 Category D - No shipments made

B. Irradiated Fuel Shipments (disposition)

Number of Shipments	Mode of Transportation	Destination
0	N/A	N/A

C. Changes to the Process Control Program

There were no revisions to RW-AA-100, "Process Control Program for Radioactive Wastes" in 2018.

SITE: LIMERICK GENERATING STATION – UNITS 1 & 2
LICENSEE: EXELON GENERATION COMPANY, LLC

Appendix C Meteorological Data

SITE: LIMERICK GENERATING STATION – UNITS 1 & 2
LICENSEE: EXELON GENERATION COMPANY, LLC

(Page Intentionally Left Blank)

SITE: LIMERICK GENERATING STATION – UNITS 1 & 2
LICENSEE: EXELON GENERATION COMPANY, LLC

LIST OF TABLES

	PAGE
Table D – 1 Wind Speed by Direction Measured at 30 Feet for Various Stability Classes for the Limerick Generating Station, January – March, 2018	33
Table D – 2 Wind Speed by Direction Measured at 175 Feet for Various Stability Classes for the Limerick Generating Station, January – March, 2018	40
Table D – 3 Wind Speed by Direction Measured at 30 Feet for Various Stability Classes for the Limerick Generating Station, April - June, 2018	47
Table D – 4 Wind Speed by Direction Measured at 175 Feet for Various Stability Classes for the Limerick Generating Station, April - June, 2018	54
Table D – 5 Wind Speed by Direction Measured at 30 Feet for Various Stability Classes for the Limerick Generating Station, July - September, 2018	61
Table D – 6 Wind Speed by Direction Measured at 175 Feet for Various Stability Classes for the Limerick Generating Station, July - September, 2018	68
Table D – 7 Wind Speed by Direction Measured at 30 Feet for Various Stability Classes for the Limerick Generating Station, October - December, 2018	75
Table D – 8 Wind Speed by Direction Measured at 175 Feet for Various Stability Classes for the Limerick Generating Station, October - December, 2018	82
Table D – 9 Wind Speed by Direction Measured at 30 Feet for Various Stability Classes for the Limerick Generating Station, January - December, 2018	89
Table D – 10 Wind Speed by Direction Measured at 175 Feet for Various Stability Classes for the Limerick Generating Station, January - December, 2018	91
Table D – 11 Annual x/Q undepleted and D/Q values for the North Stack, Limerick Generating Station, 2018	93
Table D – 12 Annual x/Q undepleted and D/Q values for the South Stack, Limerick Generating Station, 2018	95

SITE: LIMERICK GENERATING STATION – UNITS 1 & 2
LICENSEE: EXELON GENERATION COMPANY, LLC

(Page Intentionally Left Blank)

SITE: LIMERICK GENERATING STATION – UNITS 1 & 2
 LICENSEE: EXELON GENERATION COMPANY, LLC

Table D – 1 Wind Speed by Direction Measured at 30 Feet for Various Stability Classes for the Limerick Generating Station, January – March, 2018

Limerick Tower 1

Period of Record: January - March 2018
 Stability Class - Extremely Unstable - 171Ft-26Ft Delta-T (F)
 Winds Measured at 30 Feet

Wind Direction	1-3	4-7	8-12	13-18	19-24	> 24	Total
N	0	0	0	0	0	0	0
NNE	0	0	0	0	0	0	0
NE	0	0	0	0	0	0	0
ENE	0	0	0	0	0	0	0
E	0	0	0	0	0	0	0
ESE	0	0	0	0	0	0	0
SE	0	0	0	0	0	0	0
SSE	0	0	0	0	0	0	0
S	0	1	0	0	0	0	1
SSW	0	5	1	0	0	0	6
SW	0	7	4	0	0	0	11
WSW	0	1	4	0	0	0	5
W	0	0	3	0	0	0	3
WNW	0	0	0	0	0	0	0
NW	0	0	0	0	0	0	0
NNW	0	0	0	0	0	0	0
Variable	0	0	0	0	0	0	0
Total	0	14	12	0	0	0	26

Hours of calm in this stability class: 0
 Hours of missing wind measurements in this stability class: 0
 Hours of missing stability measurements in all stability classes: 9

SITE: LIMERICK GENERATING STATION – UNITS 1 & 2
 LICENSEE: EXELON GENERATION COMPANY, LLC

Table D – 1 Wind Speed by Direction Measured at 30 Feet for Various Stability Classes for the Limerick Generating Station, January – March, 2018

Limerick Tower 1

Period of Record: January - March 2018
 Stability Class - Moderately Unstable - 171Ft-26Ft Delta-T (F)
 Winds Measured at 30 Feet

Wind Direction	Wind Speed (in mph)						Total
	1-3	4-7	8-12	13-18	19-24	> 24	
N	0	0	0	0	0	0	0
NNE	0	0	0	0	0	0	0
NE	0	0	0	0	0	0	0
ENE	0	0	2	0	0	0	2
E	0	1	1	0	0	0	2
ESE	0	0	2	0	0	0	2
SE	0	0	2	0	0	0	2
SSE	0	1	0	0	0	0	1
S	0	1	0	0	0	0	1
SSW	0	4	0	0	0	0	4
SW	0	5	1	0	0	0	6
WSW	0	4	2	0	0	0	6
W	0	0	3	0	0	0	3
WNW	0	0	0	1	0	0	1
NW	0	1	1	0	0	0	2
NNW	0	0	0	0	0	1	1
Variable	0	0	0	0	0	0	0
Total	0	17	14	1	0	1	33

Hours of calm in this stability class: 0
 Hours of missing wind measurements in this stability class: 0
 Hours of missing stability measurements in all stability classes: 9

SITE: LIMERICK GENERATING STATION – UNITS 1 & 2
 LICENSEE: EXELON GENERATION COMPANY, LLC

Table D – 1 Wind Speed by Direction Measured at 30 Feet for Various Stability Classes for the Limerick Generating Station, January – March, 2018

Limerick Tower 1

Period of Record: January - March 2018
 Stability Class - Slightly Unstable - 171Ft-26Ft Delta-T (F)
 Winds Measured at 30 Feet

Wind Direction	Wind Speed (in mph)						Total
	1-3	4-7	8-12	13-18	19-24	> 24	
N	0	1	1	0	0	0	2
NNE	0	0	2	0	0	0	2
NE	0	0	0	0	0	0	0
ENE	0	4	0	0	0	0	4
E	0	1	0	0	0	0	1
ESE	0	3	1	0	0	0	4
SE	0	2	0	0	0	0	2
SSE	0	2	1	0	0	0	3
S	0	3	0	0	0	0	3
SSW	0	7	0	0	0	0	7
SW	0	3	1	0	0	0	4
WSW	0	3	1	0	0	0	4
W	0	2	8	6	0	0	16
WNW	0	2	1	4	0	0	7
NW	0	2	7	3	0	0	12
NNW	0	0	1	2	0	0	3
Variable	0	0	0	0	0	0	0
Total	0	35	24	15	0	0	74

Hours of calm in this stability class: 0
 Hours of missing wind measurements in this stability class: 0
 Hours of missing stability measurements in all stability classes: 9

SITE: LIMERICK GENERATING STATION – UNITS 1 & 2
 LICENSEE: EXELON GENERATION COMPANY, LLC

Table D – 1 Wind Speed by Direction Measured at 30 Feet for Various Stability Classes for the Limerick Generating Station, January – March, 2018

Limerick Tower 1

Period of Record: January - March 2018
 Stability Class - Neutral - 171Ft-26Ft Delta-T (F)
 Winds Measured at 30 Feet

Wind Direction	Wind Speed (in mph)						Total
	1-3	4-7	8-12	13-18	19-24	> 24	
N	8	20	28	5	0	0	61
NNE	3	15	9	0	0	0	27
NE	12	30	13	0	0	0	55
ENE	13	37	12	0	0	0	62
E	11	31	12	0	0	0	54
ESE	6	7	4	0	0	0	17
SE	6	10	3	0	0	0	19
SSE	5	9	1	0	0	0	15
S	5	20	0	0	0	0	25
SSW	10	40	5	0	0	0	55
SW	10	23	2	0	0	0	35
WSW	9	16	3	0	0	0	28
W	16	15	24	18	0	0	73
WNW	14	28	77	33	5	0	157
NW	6	34	128	85	15	0	268
NNW	3	12	58	50	9	1	133
Variable	0	0	0	0	0	0	0
Total	137	347	379	191	29	1	1084

Hours of calm in this stability class: 2
 Hours of missing wind measurements in this stability class: 4
 Hours of missing stability measurements in all stability classes: 9

SITE: LIMERICK GENERATING STATION – UNITS 1 & 2
 LICENSEE: EXELON GENERATION COMPANY, LLC

Table D – 1 Wind Speed by Direction Measured at 30 Feet for Various Stability Classes for the Limerick Generating Station, January – March, 2018

Limerick Tower 1

Period of Record: January - March 2018
 Stability Class - Slightly Stable - 171Ft-26Ft Delta-T (F)
 Winds Measured at 30 Feet

Wind Direction	Wind Speed (in mph)						Total
	1-3	4-7	8-12	13-18	19-24	> 24	
N	9	12	2	0	0	0	23
NNE	14	19	0	0	0	0	33
NE	22	14	0	0	0	0	36
ENE	15	7	0	0	0	0	22
E	13	15	5	0	0	0	33
ESE	11	7	1	0	0	0	19
SE	4	8	1	0	0	0	13
SSE	4	20	5	1	0	0	30
S	12	24	9	1	0	0	46
SSW	14	20	9	0	0	0	43
SW	24	23	0	0	0	0	47
WSW	15	15	0	0	0	0	30
W	22	44	12	0	0	0	78
WNW	13	44	23	0	0	0	80
NW	14	53	25	1	2	0	95
NNW	11	10	6	0	2	0	29
Variable	0	0	0	0	0	0	0
Total	217	335	98	3	4	0	657

Hours of calm in this stability class: 4
 Hours of missing wind measurements in this stability class: 3
 Hours of missing stability measurements in all stability classes: 9

SITE: LIMERICK GENERATING STATION – UNITS 1 & 2
 LICENSEE: EXELON GENERATION COMPANY, LLC

Table D – 1 Wind Speed by Direction Measured at 30 Feet for Various Stability Classes for the Limerick Generating Station, January – March, 2018

Limerick Tower 1

Period of Record: January - March 2018
 Stability Class - Moderately Stable - 171Ft-26Ft Delta-T (F)
 Winds Measured at 30 Feet

Wind Direction	Wind Speed (in mph)						Total
	1-3	4-7	8-12	13-18	19-24	> 24	
N	4	0	0	0	0	0	4
NNE	9	2	0	0	0	0	11
NE	11	1	0	0	0	0	12
ENE	8	4	0	0	0	0	12
E	9	2	0	0	0	0	11
ESE	5	1	0	0	0	0	6
SE	6	0	0	0	0	0	6
SSE	0	3	0	0	0	0	3
S	4	2	0	0	0	0	6
SSW	7	3	0	0	0	0	10
SW	2	1	0	0	0	0	3
WSW	4	2	0	0	0	0	6
W	10	3	0	0	0	0	13
WNW	7	1	0	0	0	0	8
NW	6	6	0	0	0	0	12
NNW	8	0	1	0	0	0	9
Variable	0	0	0	0	0	0	0
Total	100	31	1	0	0	0	132

Hours of calm in this stability class: 3
 Hours of missing wind measurements in this stability class: 0
 Hours of missing stability measurements in all stability classes: 9

SITE: LIMERICK GENERATING STATION – UNITS 1 & 2
 LICENSEE: EXELON GENERATION COMPANY, LLC

Table D – 1 Wind Speed by Direction Measured at 30 Feet for Various Stability Classes for the Limerick Generating Station, January – March, 2018

Limerick Tower 1

Period of Record: January - March 2018
 Stability Class - Extremely Stable - 171Ft-26Ft Delta-T (F)
 Winds Measured at 30 Feet

Wind Direction	Wind Speed (in mph)						Total
	1-3	4-7	8-12	13-18	19-24	> 24	
N	3	0	0	0	0	0	3
NNE	11	0	0	0	0	0	11
NE	7	0	0	0	0	0	7
ENE	4	0	0	0	0	0	4
E	8	0	0	0	0	0	8
ESE	3	0	0	0	0	0	3
SE	1	0	0	0	0	0	1
SSE	0	0	0	0	0	0	0
S	0	0	0	0	0	0	0
SSW	3	0	0	0	0	0	3
SW	2	0	0	0	0	0	2
WSW	4	2	0	0	0	0	6
W	15	3	0	0	0	0	18
WNW	16	3	0	0	0	0	19
NW	23	7	0	0	0	0	30
NNW	9	0	0	0	0	0	9
Variable	0	0	0	0	0	0	0
Total	109	15	0	0	0	0	124

Hours of calm in this stability class: 5
 Hours of missing wind measurements in this stability class: 0
 Hours of missing stability measurements in all stability classes: 9

SITE: LIMERICK GENERATING STATION – UNITS 1 & 2
 LICENSEE: EXELON GENERATION COMPANY, LLC

Table D – 2 Wind Speed by Direction Measured at 175 Feet for Various Stability Classes for the Limerick Generating Station, January – March, 2018

Limerick Tower 1
 Period of Record: January - March 2018
 Stability Class - Extremely Unstable - 171Ft-26Ft Delta-T (F)
 Winds Measured at 175 Feet

Wind Direction	Wind Speed (in mph)						Total
	1-3	4-7	8-12	13-18	19-24	> 24	
N	0	0	0	0	0	0	0
NNE	0	0	0	0	0	0	0
NE	0	0	0	0	0	0	0
ENE	0	0	0	0	0	0	0
E	0	0	0	0	0	0	0
ESE	0	0	0	0	0	0	0
SE	0	0	0	0	0	0	0
SSE	0	0	0	0	0	0	0
S	0	0	2	0	0	0	2
SSW	0	0	11	2	0	0	13
SW	0	0	2	4	0	0	6
WSW	0	0	1	3	0	0	4
W	0	0	0	1	0	0	1
WNW	0	0	0	0	0	0	0
NW	0	0	0	0	0	0	0
NNW	0	0	0	0	0	0	0
Variable	0	0	0	0	0	0	0
Total	0	0	16	10	0	0	26

Hours of calm in this stability class: 0
 Hours of missing wind measurements in this stability class: 0
 Hours of missing stability measurements in all stability classes: 9

SITE: LIMERICK GENERATING STATION – UNITS 1 & 2
 LICENSEE: EXELON GENERATION COMPANY, LLC

Table D – 2 Wind Speed by Direction Measured at 175 Feet for Various Stability Classes for the Limerick Generating Station, January – March, 2018

Limerick Tower 1

Period of Record: January - March 2018
 Stability Class - Moderately Unstable - 171Ft-26Ft Delta-T (F)
 Winds Measured at 175 Feet

Wind Direction	Wind Speed (in mph)						Total
	1-3	4-7	8-12	13-18	19-24	> 24	
N	0	0	0	0	0	0	0
NNE	0	0	0	0	0	0	0
NE	0	0	0	0	0	0	0
ENE	0	0	2	0	0	0	2
E	0	0	3	0	0	0	3
ESE	0	0	1	0	0	0	1
SE	0	0	2	0	0	0	2
SSE	0	0	0	0	0	0	0
S	0	1	1	0	0	0	2
SSW	0	0	7	1	0	0	8
SW	0	2	4	0	0	0	6
WSW	0	0	1	0	1	0	2
W	0	0	1	2	0	0	3
WNW	0	0	0	1	0	0	1
NW	0	0	2	0	0	1	3
NNW	0	0	0	0	0	0	0
Variable	0	0	0	0	0	0	0
Total	0	3	24	4	1	1	33

Hours of calm in this stability class: 0
 Hours of missing wind measurements in this stability class: 0
 Hours of missing stability measurements in all stability classes: 9

SITE: LIMERICK GENERATING STATION – UNITS 1 & 2
 LICENSEE: EXELON GENERATION COMPANY, LLC

Table D – 2 Wind Speed by Direction Measured at 175 Feet for Various Stability Classes for the Limerick Generating Station, January – March, 2018

Limerick Tower 1

Period of Record: January - March 2018
 Stability Class - Slightly Unstable - 171Ft-26Ft Delta-T (F)
 Winds Measured at 175 Feet

Wind Direction	Wind Speed (in mph)						Total
	1-3	4-7	8-12	13-18	19-24	> 24	
N	0	0	3	0	0	0	3
NNE	0	0	1	0	0	0	1
NE	0	0	1	0	0	0	1
ENE	0	2	2	0	0	0	4
E	0	1	1	0	0	0	2
ESE	0	1	0	0	0	0	1
SE	0	3	0	0	0	0	3
SSE	0	1	1	1	0	0	3
S	0	3	4	0	0	0	7
SSW	0	1	4	1	0	0	6
SW	0	1	3	0	0	0	4
WSW	0	0	2	2	0	0	4
W	0	2	0	6	8	2	18
WNW	0	1	3	2	2	0	8
NW	0	0	3	3	1	0	7
NNW	0	0	0	0	2	0	2
Variable	0	0	0	0	0	0	0
Total	0	16	28	15	13	2	74

Hours of calm in this stability class: 0
 Hours of missing wind measurements in this stability class: 0
 Hours of missing stability measurements in all stability classes: 9

SITE: LIMERICK GENERATING STATION – UNITS 1 & 2
 LICENSEE: EXELON GENERATION COMPANY, LLC

Table D – 2 Wind Speed by Direction Measured at 175 Feet for Various Stability Classes for the Limerick Generating Station, January – March, 2018

Limerick Tower 1

Period of Record: January - March 2018
 Stability Class - Neutral - 171Ft-26Ft Delta-T (F)
 Winds Measured at 175 Feet

Wind Direction	Wind Speed (in mph)						Total
	1-3	4-7	8-12	13-18	19-24	> 24	
N	3	5	31	4	1	0	44
NNE	4	13	16	3	0	0	36
NE	6	21	30	4	0	0	61
ENE	9	18	27	1	0	0	55
E	9	11	28	3	0	0	51
ESE	10	8	3	0	0	0	21
SE	0	5	5	0	0	0	10
SSE	3	7	12	0	0	0	22
S	3	15	37	7	0	0	62
SSW	4	16	28	4	0	0	52
SW	2	11	5	1	0	0	19
WSW	1	5	12	6	0	0	24
W	6	20	17	32	21	6	102
WNW	3	17	58	106	44	10	238
NW	1	7	34	71	51	19	183
NNW	3	1	26	45	24	5	104
Variable	0	0	0	0	0	0	0
Total	67	180	369	287	141	40	1084

Hours of calm in this stability class: 1
 Hours of missing wind measurements in this stability class: 5
 Hours of missing stability measurements in all stability classes: 9

SITE: LIMERICK GENERATING STATION – UNITS 1 & 2
 LICENSEE: EXELON GENERATION COMPANY, LLC

Table D – 2 Wind Speed by Direction Measured at 175 Feet for Various Stability Classes for the Limerick Generating Station, January – March, 2018

Limerick Tower 1

Period of Record: January - March 2018
 Stability Class - Slightly Stable - 171Ft-26Ft Delta-T (F)
 Winds Measured at 175 Feet

Wind Direction	Wind Speed (in mph)						Total
	1-3	4-7	8-12	13-18	19-24	> 24	
N	3	11	14	0	0	0	28
NNE	8	10	21	0	0	0	39
NE	3	8	11	0	0	0	22
ENE	5	13	2	0	0	0	20
E	11	10	12	4	0	0	37
ESE	6	8	10	0	0	0	24
SE	5	7	2	1	0	0	15
SSE	2	11	26	9	2	0	50
S	2	5	21	16	3	0	47
SSW	4	17	18	19	1	0	59
SW	4	16	11	1	0	0	32
WSW	0	8	13	2	0	0	23
W	4	13	40	11	0	0	68
WNW	6	13	72	29	0	0	120
NW	2	8	28	15	1	4	58
NNW	3	4	6	4	0	0	17
Variable	0	0	0	0	0	0	0
Total	68	162	307	111	7	4	659

Hours of calm in this stability class: 1
 Hours of missing wind measurements in this stability class: 4
 Hours of missing stability measurements in all stability classes: 9

SITE: LIMERICK GENERATING STATION – UNITS 1 & 2
 LICENSEE: EXELON GENERATION COMPANY, LLC

Table D – 2 Wind Speed by Direction Measured at 175 Feet for Various Stability Classes for the Limerick Generating Station, January – March, 2018

Limerick Tower 1

Period of Record: January - March 2018
 Stability Class - Moderately Stable - 171Ft-26Ft Delta-T (F)
 Winds Measured at 175 Feet

Wind Direction	Wind Speed (in mph)						Total
	1-3	4-7	8-12	13-18	19-24	> 24	
N	2	1	0	0	0	0	3
NNE	1	1	3	0	0	0	5
NE	1	3	0	0	0	0	4
ENE	2	4	1	0	0	0	7
E	2	4	1	0	0	0	7
ESE	3	4	0	0	0	0	7
SE	4	3	2	0	0	0	9
SSE	1	4	2	0	0	0	7
S	3	6	2	1	0	0	12
SSW	2	4	1	0	0	0	7
SW	3	3	7	0	0	0	13
WSW	0	2	4	0	0	0	6
W	1	7	5	0	0	0	13
WNW	1	8	6	0	0	0	15
NW	2	4	4	1	0	0	11
NNW	1	4	4	0	0	0	9
Variable	0	0	0	0	0	0	0
Total	29	62	42	2	0	0	135

Hours of calm in this stability class: 0
 Hours of missing wind measurements in this stability class: 0
 Hours of missing stability measurements in all stability classes: 9

SITE: LIMERICK GENERATING STATION – UNITS 1 & 2
 LICENSEE: EXELON GENERATION COMPANY, LLC

Table D – 2 Wind Speed by Direction Measured at 175 Feet for Various Stability Classes for the Limerick Generating Station, January – March, 2018

Limerick Tower 1

Period of Record: January - March 2018
 Stability Class - Extremely Stable - 171Ft-26Ft Delta-T (F)
 Winds Measured at 175 Feet

Wind Direction	Wind Speed (in mph)						Total
	1-3	4-7	8-12	13-18	19-24	> 24	
N	0	4	1	0	0	0	5
NNE	2	1	0	0	0	0	3
NE	1	1	0	0	0	0	2
ENE	1	3	0	0	0	0	4
E	1	2	0	0	0	0	3
ESE	6	0	0	0	0	0	6
SE	0	2	0	0	0	0	2
SSE	1	0	0	0	0	0	1
S	2	0	0	0	0	0	2
SSW	1	3	0	0	0	0	4
SW	7	5	4	1	0	0	17
WSW	2	6	1	0	0	0	9
W	3	5	6	0	0	0	14
WNW	2	18	15	1	0	0	36
NW	3	6	7	0	0	0	16
NNW	4	1	0	0	0	0	5
Variable	0	0	0	0	0	0	0
Total	36	57	34	2	0	0	129

Hours of calm in this stability class: 0
 Hours of missing wind measurements in this stability class: 0
 Hours of missing stability measurements in all stability classes: 9

SITE: LIMERICK GENERATING STATION – UNITS 1 & 2
 LICENSEE: EXELON GENERATION COMPANY, LLC

Table D – 3 Wind Speed by Direction Measured at 30 Feet for Various Stability Classes for the Limerick Generating Station, April – June, 2018

Limerick Tower 1

Period of Record: April - June 2018
 Stability Class - Extremely Unstable - 171Ft-26Ft Delta-T (F)
 Winds Measured at 30 Feet

Wind Direction	Wind Speed (in mph)						Total
	1-3	4-7	8-12	13-18	19-24	> 24	
N	0	0	0	0	0	0	0
NNE	1	1	0	0	0	0	2
NE	0	0	0	0	0	0	0
ENE	1	1	0	0	0	0	2
E	1	2	0	0	0	0	3
ESE	1	3	0	0	0	0	4
SE	0	3	1	0	0	0	4
SSE	0	0	0	0	0	0	0
S	0	2	2	0	0	0	4
SSW	1	7	7	0	0	0	15
SW	0	5	5	0	0	0	10
WSW	0	1	7	0	0	0	8
W	0	1	4	0	0	0	5
WNW	0	1	1	2	0	0	4
NW	1	0	0	0	0	0	1
NNW	1	0	0	0	0	0	1
Variable	0	0	0	0	0	0	0
Total	7	27	27	2	0	0	63

Hours of calm in this stability class: 0
 Hours of missing wind measurements in this stability class: 6
 Hours of missing stability measurements in all stability classes: 8

SITE: LIMERICK GENERATING STATION – UNITS 1 & 2
 LICENSEE: EXELON GENERATION COMPANY, LLC

Table D – 3 Wind Speed by Direction Measured at 30 Feet for Various Stability Classes for the Limerick Generating Station, April – June, 2018

Limerick Tower 1
 Period of Record: April - June 2018
 Stability Class - Moderately Unstable - 171Ft-26Ft Delta-T (F)
 Winds Measured at 30 Feet

Wind Direction	Wind Speed (in mph)						Total
	1-3	4-7	8-12	13-18	19-24	> 24	
N	2	2	2	0	0	0	6
NNE	0	0	0	0	0	0	0
NE	0	3	0	0	0	0	3
ENE	1	5	0	0	0	0	6
E	0	5	1	0	0	0	6
ESE	0	2	1	0	0	0	3
SE	1	0	2	1	0	0	4
SSE	0	0	0	0	0	0	0
S	0	2	2	0	0	0	4
SSW	1	4	2	0	0	0	7
SW	2	7	2	0	0	0	11
WSW	3	9	3	0	0	0	15
W	2	7	5	1	0	0	15
WNW	2	6	7	2	0	0	17
NW	1	1	8	4	0	0	14
NNW	1	0	2	0	0	0	3
Variable	0	0	0	0	0	0	0
Total	16	53	37	8	0	0	114

Hours of calm in this stability class: 0
 Hours of missing wind measurements in this stability class: 2
 Hours of missing stability measurements in all stability classes: 8

SITE: LIMERICK GENERATING STATION – UNITS 1 & 2
 LICENSEE: EXELON GENERATION COMPANY, LLC

Table D – 3 Wind Speed by Direction Measured at 30 Feet for Various Stability Classes for the Limerick Generating Station, April – June, 2018

Limerick Tower 1

Period of Record: April - June 2018
 Stability Class - Slightly Unstable - 171Ft-26Ft Delta-T (F)
 Winds Measured at 30 Feet

Wind Direction	Wind Speed (in mph)						Total
	1-3	4-7	8-12	13-18	19-24	> 24	
N	2	4	3	2	0	0	11
NNE	4	3	0	0	0	0	7
NE	4	3	0	0	0	0	7
ENE	10	11	1	0	0	0	22
E	5	16	2	1	0	0	24
ESE	2	5	1	0	0	0	8
SE	0	1	1	0	0	0	2
SSE	2	0	0	0	0	0	2
S	3	1	1	0	0	0	5
SSW	1	7	3	1	0	0	12
SW	1	6	1	0	0	0	8
WSW	4	11	7	0	0	0	22
W	4	12	7	1	0	0	24
WNW	4	8	5	5	0	0	22
NW	0	8	10	7	0	0	25
NNW	0	3	7	2	0	0	12
Variable	0	0	0	0	0	0	0
Total	46	99	49	19	0	0	213

Hours of calm in this stability class: 1
 Hours of missing wind measurements in this stability class: 1
 Hours of missing stability measurements in all stability classes: 8

SITE: LIMERICK GENERATING STATION – UNITS 1 & 2
 LICENSEE: EXELON GENERATION COMPANY, LLC

Table D – 3 Wind Speed by Direction Measured at 30 Feet for Various Stability Classes for the Limerick Generating Station, April – June, 2018

Limerick Tower 1

Period of Record: April - June 2018
 Stability Class - Neutral - 171Ft-26Ft Delta-T (F)
 Winds Measured at 30 Feet

Wind Direction	Wind Speed (in mph)						Total
	1-3	4-7	8-12	13-18	19-24	> 24	
N	15	39	9	2	0	0	65
NNE	13	28	5	0	0	0	46
NE	14	28	1	0	0	0	43
ENE	24	69	10	1	0	0	104
E	17	53	45	38	2	0	155
ESE	7	20	17	2	0	0	46
SE	5	6	2	3	0	0	16
SSE	15	17	2	0	0	0	34
S	16	15	2	0	0	0	33
SSW	9	17	9	0	0	0	35
SW	18	17	2	0	0	0	37
WSW	14	24	5	0	0	0	43
W	11	22	19	8	0	0	60
WNW	16	15	43	14	8	2	98
NW	13	29	52	36	0	0	130
NNW	6	33	20	1	0	0	60
Variable	0	0	0	0	0	0	0
Total	213	432	243	105	10	2	1005

Hours of calm in this stability class: 1
 Hours of missing wind measurements in this stability class: 13
 Hours of missing stability measurements in all stability classes: 8

SITE: LIMERICK GENERATING STATION – UNITS 1 & 2
 LICENSEE: EXELON GENERATION COMPANY, LLC

Table D – 3 Wind Speed by Direction Measured at 30 Feet for Various Stability Classes for the Limerick Generating Station, April – June, 2018

Limerick Tower 1

Period of Record: April - June 2018
 Stability Class - Slightly Stable - 171Ft-26Ft Delta-T (F)
 Winds Measured at 30 Feet

Wind Direction	Wind Speed (in mph)						Total
	1-3	4-7	8-12	13-18	19-24	> 24	
N	6	9	0	0	0	0	15
NNE	15	11	0	0	0	0	26
NE	14	14	0	0	0	0	28
ENE	8	9	0	0	0	0	17
E	7	6	4	0	0	0	17
ESE	7	3	2	0	0	0	12
SE	7	6	0	0	0	0	13
SSE	7	12	0	0	0	0	19
S	14	28	3	0	0	0	45
SSW	20	23	1	0	0	0	44
SW	18	26	2	0	0	0	46
WSW	15	11	1	0	0	0	27
W	16	11	3	0	0	0	30
WNW	14	18	7	0	0	0	39
NW	17	19	11	0	0	0	47
NNW	10	7	0	0	0	0	17
Variable	0	0	0	0	0	0	0
Total	195	213	34	0	0	0	442

Hours of calm in this stability class: 7
 Hours of missing wind measurements in this stability class: 15
 Hours of missing stability measurements in all stability classes: 8

SITE: LIMERICK GENERATING STATION – UNITS 1 & 2
 LICENSEE: EXELON GENERATION COMPANY, LLC

Table D – 3 Wind Speed by Direction Measured at 30 Feet for Various Stability Classes for the Limerick Generating Station, April – June, 2018

Limerick Tower 1

Period of Record: April - June 2018
 Stability Class - Moderately Stable - 171Ft-26Ft Delta-T (F)
 Winds Measured at 30 Feet

Wind Direction	Wind Speed (in mph)						Total
	1-3	4-7	8-12	13-18	19-24	> 24	
N	12	1	0	0	0	0	13
NNE	4	2	0	0	0	0	6
NE	6	0	0	0	0	0	6
ENE	6	0	0	0	0	0	6
E	11	3	0	0	0	0	14
ESE	4	1	0	0	0	0	5
SE	3	1	0	0	0	0	4
SSE	2	0	0	0	0	0	2
S	2	1	0	0	0	0	3
SSW	4	1	0	0	0	0	5
SW	6	1	0	0	0	0	7
WSW	11	2	0	0	0	0	13
W	17	2	0	0	0	0	19
WNW	23	7	0	0	0	0	30
NW	8	3	0	0	0	0	11
NNW	6	1	0	0	0	0	7
Variable	0	0	0	0	0	0	0
Total	125	26	0	0	0	0	151

Hours of calm in this stability class: 3
 Hours of missing wind measurements in this stability class: 6
 Hours of missing stability measurements in all stability classes: 8

SITE: LIMERICK GENERATING STATION – UNITS 1 & 2
 LICENSEE: EXELON GENERATION COMPANY, LLC

Table D – 3 Wind Speed by Direction Measured at 30 Feet for Various Stability Classes for the Limerick Generating Station, April – June, 2018

Limerick Tower 1

Period of Record: April - June 2018
 Stability Class - Extremely Stable - 171Ft-26Ft Delta-T (F)
 Winds Measured at 30 Feet

Wind Direction	Wind Speed (in mph)						Total
	1-3	4-7	8-12	13-18	19-24	> 24	
N	7	0	0	0	0	0	7
NNE	16	0	0	0	0	0	16
NE	9	0	0	0	0	0	9
ENE	13	0	0	0	0	0	13
E	7	1	0	0	0	0	8
ESE	1	0	0	0	0	0	1
SE	3	0	0	0	0	0	3
SSE	1	0	0	0	0	0	1
S	0	1	0	0	0	0	1
SSW	2	1	0	0	0	0	3
SW	0	0	0	0	0	0	0
WSW	6	0	0	0	0	0	6
W	11	0	0	0	0	0	11
WNW	18	0	0	0	0	0	18
NW	15	0	0	0	0	0	15
NNW	11	0	0	0	0	0	11
Variable	0	0	0	0	0	0	0
Total	120	3	0	0	0	0	123

Hours of calm in this stability class: 8
 Hours of missing wind measurements in this stability class: 2
 Hours of missing stability measurements in all stability classes: 8

SITE: LIMERICK GENERATING STATION – UNITS 1 & 2
 LICENSEE: EXELON GENERATION COMPANY, LLC

Table D – 4 Wind Speed by Direction Measured at 175 Feet for Various Stability Classes for the Limerick Generating Station, April – June, 2018

Limerick Tower 1

Period of Record: April - June 2018
 Stability Class - Extremely Unstable - 171Ft-26Ft Delta-T (F)
 Winds Measured at 175 Feet

Wind Direction	Wind Speed (in mph)						Total
	1-3	4-7	8-12	13-18	19-24	> 24	
N	0	0	0	0	0	0	0
NNE	1	2	0	0	0	0	3
NE	0	0	0	0	0	0	0
ENE	0	1	1	0	0	0	2
E	0	4	0	0	0	0	4
ESE	0	2	1	0	0	0	3
SE	0	0	3	0	0	0	3
SSE	0	1	0	0	0	0	1
S	0	0	10	2	0	0	12
SSW	0	3	8	6	2	0	19
SW	0	0	3	5	2	0	10
WSW	0	0	1	2	1	0	4
W	0	0	1	5	0	0	6
WNW	0	0	1	0	0	0	1
NW	0	0	0	0	0	0	0
NNW	1	0	0	0	0	0	1
Variable	0	0	0	0	0	0	0
Total	2	13	29	20	5	0	69

Hours of calm in this stability class: 0
 Hours of missing wind measurements in this stability class: 0
 Hours of missing stability measurements in all stability classes: 8

SITE: LIMERICK GENERATING STATION – UNITS 1 & 2
 LICENSEE: EXELON GENERATION COMPANY, LLC

Table D – 4 Wind Speed by Direction Measured at 175 Feet for Various Stability Classes for the Limerick Generating Station, April – June, 2018

Limerick Tower 1
 Period of Record: April - June 2018
 Stability Class - Moderately Unstable - 171Ft-26Ft Delta-T (F)
 Winds Measured at 175 Feet

Wind Direction	Wind Speed (in mph)						Total
	1-3	4-7	8-12	13-18	19-24	> 24	
N	0	2	1	1	0	0	4
NNE	0	0	0	0	0	0	0
NE	0	5	0	0	0	0	5
ENE	1	3	1	0	0	0	5
E	0	3	3	1	0	0	7
ESE	0	1	1	1	0	0	3
SE	1	0	0	2	0	0	3
SSE	0	0	0	0	0	0	0
S	0	1	1	3	1	0	6
SSW	0	3	4	2	0	0	9
SW	1	10	6	2	0	0	19
WSW	0	3	6	1	0	0	10
W	1	4	4	2	2	0	13
WNW	0	2	6	8	3	0	19
NW	1	1	1	5	0	0	8
NNW	4	0	0	1	0	0	5
Variable	0	0	0	0	0	0	0
Total	9	38	34	29	6	0	116

Hours of calm in this stability class: 0
 Hours of missing wind measurements in this stability class: 0
 Hours of missing stability measurements in all stability classes: 8

SITE: LIMERICK GENERATING STATION – UNITS 1 & 2
 LICENSEE: EXELON GENERATION COMPANY, LLC

Table D – 4 Wind Speed by Direction Measured at 175 Feet for Various Stability Classes for the Limerick Generating Station, April – June, 2018

Limerick Tower 1

Period of Record: April - June 2018
 Stability Class - Slightly Unstable - 171Ft-26Ft Delta-T (F)
 Winds Measured at 175 Feet

Wind Direction	Wind Speed (in mph)						Total
	1-3	4-7	8-12	13-18	19-24	> 24	
N	0	4	1	4	1	0	10
NNE	3	6	1	0	0	0	10
NE	4	3	1	0	0	0	8
ENE	5	9	5	0	0	0	19
E	4	9	11	1	0	0	25
ESE	1	4	2	0	0	0	7
SE	0	0	1	1	0	0	2
SSE	1	0	0	0	0	0	1
S	1	4	2	1	2	0	10
SSW	0	3	3	4	0	0	10
SW	0	7	5	2	1	0	15
WSW	2	9	8	3	0	0	22
W	3	9	6	9	0	0	27
WNW	1	4	11	3	8	0	27
NW	1	2	3	5	0	0	11
NNW	0	2	3	6	0	0	11
Variable	0	0	0	0	0	0	0
Total	26	75	63	39	12	0	215

Hours of calm in this stability class: 0
 Hours of missing wind measurements in this stability class: 0
 Hours of missing stability measurements in all stability classes: 8

SITE: LIMERICK GENERATING STATION – UNITS 1 & 2
 LICENSEE: EXELON GENERATION COMPANY, LLC

Table D – 4 Wind Speed by Direction Measured at 175 Feet for Various Stability Classes for the Limerick Generating Station, April – June, 2018

Limerick Tower 1

Period of Record: April - June 2018
 Stability Class - Neutral - 171Ft-26Ft Delta-T (F)
 Winds Measured at 175 Feet

Wind Direction	Wind Speed (in mph)						Total
	1-3	4-7	8-12	13-18	19-24	> 24	
N	5	35	21	3	0	0	64
NNE	5	25	8	5	0	0	43
NE	8	33	10	0	0	0	51
ENE	9	44	42	5	2	0	102
E	10	23	44	50	28	2	157
ESE	5	19	16	4	0	0	44
SE	3	12	2	3	0	0	20
SSE	6	12	20	1	0	0	39
S	10	14	10	3	2	0	39
SSW	9	16	15	13	0	0	53
SW	4	17	18	3	0	0	42
WSW	6	15	12	4	1	0	38
W	7	10	13	18	13	3	64
WNW	5	16	38	52	10	8	129
NW	3	7	28	45	3	0	86
NNW	3	19	22	4	0	0	48
Variable	0	0	0	0	0	0	0
Total	98	317	319	213	59	13	1019

Hours of calm in this stability class: 0
 Hours of missing wind measurements in this stability class: 0
 Hours of missing stability measurements in all stability classes: 8

SITE: LIMERICK GENERATING STATION – UNITS 1 & 2
 LICENSEE: EXELON GENERATION COMPANY, LLC

Table D – 4 Wind Speed by Direction Measured at 175 Feet for Various Stability Classes for the Limerick Generating Station, April – June, 2018

Limerick Tower 1

Period of Record: April - June 2018
 Stability Class - Slightly Stable - 171Ft-26Ft Delta-T (F)
 Winds Measured at 175 Feet

Wind Direction	Wind Speed (in mph)						Total
	1-3	4-7	8-12	13-18	19-24	> 24	
N	3	5	9	0	0	0	17
NNE	1	8	10	0	0	0	19
NE	3	9	8	0	0	0	20
ENE	6	11	3	0	0	0	20
E	4	10	2	4	0	0	20
ESE	3	7	4	1	0	0	15
SE	3	4	2	0	0	0	9
SSE	1	15	14	1	0	0	31
S	5	15	29	11	0	0	60
SSW	3	16	28	14	0	0	61
SW	2	25	16	2	2	0	47
WSW	3	11	3	1	0	0	18
W	0	9	9	3	1	0	22
WNW	4	16	18	12	0	0	50
NW	5	16	11	6	0	0	38
NNW	4	9	4	0	0	0	17
Variable	0	0	0	0	0	0	0
Total	50	186	170	55	3	0	464

Hours of calm in this stability class: 0
 Hours of missing wind measurements in this stability class: 0
 Hours of missing stability measurements in all stability classes: 8

SITE: LIMERICK GENERATING STATION – UNITS 1 & 2
 LICENSEE: EXELON GENERATION COMPANY, LLC

Table D – 4 Wind Speed by Direction Measured at 175 Feet for Various Stability Classes for the Limerick Generating Station, April – June, 2018

Limerick Tower 1

Period of Record: April - June 2018
 Stability Class - Moderately Stable - 171Ft-26Ft Delta-T (F)
 Winds Measured at 175 Feet

Wind Direction	Wind Speed (in mph)						Total
	1-3	4-7	8-12	13-18	19-24	> 24	
N	3	5	2	0	0	0	10
NNE	1	4	2	1	0	0	8
NE	1	1	0	0	0	0	2
ENE	3	0	0	0	0	0	3
E	3	1	2	0	0	0	6
ESE	2	3	2	0	0	0	7
SE	3	3	0	0	0	0	6
SSE	4	3	1	0	0	0	8
S	1	4	1	0	0	0	6
SSW	0	8	2	1	0	0	11
SW	0	5	2	0	0	0	7
WSW	0	9	2	0	0	0	11
W	2	7	3	1	0	0	13
WNW	2	13	17	0	0	0	32
NW	5	15	3	0	0	0	23
NNW	3	3	1	0	0	0	7
Variable	0	0	0	0	0	0	0
Total	33	84	40	3	0	0	160

Hours of calm in this stability class: 0
 Hours of missing wind measurements in this stability class: 0
 Hours of missing stability measurements in all stability classes: 8

SITE: LIMERICK GENERATING STATION – UNITS 1 & 2
 LICENSEE: EXELON GENERATION COMPANY, LLC

Table D – 4 Wind Speed by Direction Measured at 175 Feet for Various Stability Classes for the Limerick Generating Station, April – June, 2018

Limerick Tower 1

Period of Record: April – June 2018
 Stability Class - Extremely Stable - 171Ft-26Ft Delta-T (F)
 Winds Measured at 175 Feet

Wind Direction	Wind Speed (in mph)						Total
	1-3	4-7	8-12	13-18	19-24	> 24	
N	2	6	1	0	0	0	9
NNE	0	4	0	0	0	0	4
NE	1	0	0	0	0	0	1
ENE	2	1	0	0	0	0	3
E	0	2	0	0	0	0	2
ESE	2	1	0	0	0	0	3
SE	2	2	0	0	0	0	4
SSE	4	1	0	0	0	0	5
S	3	3	1	0	0	0	7
SSW	0	2	2	0	0	0	4
SW	4	5	0	0	0	0	9
WSW	4	6	1	0	0	0	11
W	6	14	2	0	0	0	22
WNW	5	6	15	0	0	0	26
NW	3	6	2	0	0	0	11
NNW	5	7	0	0	0	0	12
Variable	0	0	0	0	0	0	0
Total	43	66	24	0	0	0	133

Hours of calm in this stability class: 0
 Hours of missing wind measurements in this stability class: 0
 Hours of missing stability measurements in all stability classes: 8

SITE: LIMERICK GENERATING STATION – UNITS 1 & 2
 LICENSEE: EXELON GENERATION COMPANY, LLC

Table D – 5 Wind Speed by Direction Measured at 30 Feet for Various Stability Classes for the Limerick Generating Station, July – September, 2018

Limerick Tower 1

Period of Record: July - September 2018
 Stability Class - Extremely Unstable - 171Ft-26Ft Delta-T (F)
 Winds Measured at 30 Feet

Wind Direction	Wind Speed (in mph)						Total
	1-3	4-7	8-12	13-18	19-24	> 24	
N	5	2	0	0	0	0	7
NNE	2	1	0	0	0	0	3
NE	1	1	0	0	0	0	2
ENE	0	1	0	0	0	0	1
E	1	1	0	0	0	0	2
ESE	0	0	0	0	0	0	0
SE	0	0	0	0	0	0	0
SSE	0	1	2	0	0	0	3
S	0	1	0	0	0	0	1
SSW	0	7	0	0	0	0	7
SW	1	6	0	0	0	0	7
WSW	3	9	0	0	0	0	12
W	6	0	0	0	0	0	6
WNW	3	1	0	0	0	0	4
NW	2	1	0	0	0	0	3
NNW	5	1	0	0	0	0	6
Variable	0	0	0	0	0	0	0
Total	29	33	2	0	0	0	64

Hours of calm in this stability class: 0
 Hours of missing wind measurements in this stability class: 0
 Hours of missing stability measurements in all stability classes: 14

SITE: LIMERICK GENERATING STATION – UNITS 1 & 2
 LICENSEE: EXELON GENERATION COMPANY, LLC

Table D – 5 Wind Speed by Direction Measured at 30 Feet for Various Stability Classes for the Limerick Generating Station, July – September, 2018

Limerick Tower 1

Period of Record: July - September 2018
 Stability Class - Moderately Unstable - 171Ft-26Ft Delta-T (F)
 Winds Measured at 30 Feet

Wind Direction	Wind Speed (in mph)						Total
	1-3	4-7	8-12	13-18	19-24	> 24	
N	2	0	0	0	0	0	2
NNE	1	0	0	0	0	0	1
NE	1	0	0	0	0	0	1
ENE	2	4	0	0	0	0	6
E	1	4	2	0	0	0	7
ESE	0	5	1	0	0	0	6
SE	0	1	0	0	0	0	1
SSE	0	3	2	0	0	0	5
S	1	2	0	0	0	0	3
SSW	2	8	1	0	0	0	11
SW	4	12	0	0	0	0	16
WSW	4	19	0	0	0	0	23
W	4	12	0	0	0	0	16
WNW	3	6	0	0	0	0	9
NW	0	2	1	0	0	0	3
NNW	2	0	0	0	0	0	2
Variable	0	0	0	0	0	0	0
Total	27	78	7	0	0	0	112

Hours of calm in this stability class: 0
 Hours of missing wind measurements in this stability class: 0
 Hours of missing stability measurements in all stability classes: 14

SITE: LIMERICK GENERATING STATION – UNITS 1 & 2
 LICENSEE: EXELON GENERATION COMPANY, LLC

Table D – 5 Wind Speed by Direction Measured at 30 Feet for Various Stability Classes for the Limerick Generating Station, July – September, 2018

Limerick Tower 1

Period of Record: July - September 2018
 Stability Class - Slightly Unstable - 171Ft-26Ft Delta-T (F)
 Winds Measured at 30 Feet

Wind Direction	Wind Speed (in mph)						Total
	1-3	4-7	8-12	13-18	19-24	> 24	
N	5	4	0	0	0	0	9
NNE	4	2	0	0	0	0	6
NE	6	5	1	0	0	0	12
ENE	6	13	4	0	0	0	23
E	1	6	3	0	0	0	10
ESE	1	9	0	0	0	0	10
SE	1	1	2	0	0	0	4
SSE	2	2	1	0	0	0	5
S	1	3	0	0	0	0	4
SSW	9	6	1	0	0	0	16
SW	10	10	0	0	0	0	20
WSW	9	12	0	0	0	0	21
W	11	14	0	0	0	0	25
WNW	8	12	1	0	0	0	21
NW	4	15	3	0	0	0	22
NNW	2	8	0	0	0	0	10
Variable	0	0	0	0	0	0	0
Total	80	122	16	0	0	0	218

Hours of calm in this stability class: 1
 Hours of missing wind measurements in this stability class: 0
 Hours of missing stability measurements in all stability classes: 14

SITE: LIMERICK GENERATING STATION – UNITS 1 & 2
 LICENSEE: EXELON GENERATION COMPANY, LLC

Table D – 5 Wind Speed by Direction Measured at 30 Feet for Various Stability Classes for the Limerick Generating Station, July – September, 2018

Limerick Tower 1

Period of Record: July - September 2018
 Stability Class - Neutral - 171Ft-26Ft Delta-T (F)
 Winds Measured at 30 Feet

Wind Direction	Wind Speed (in mph)						Total
	1-3	4-7	8-12	13-18	19-24	> 24	
N	34	20	14	0	0	0	68
NNE	18	36	3	0	0	0	57
NE	35	41	2	0	0	0	78
ENE	34	68	11	2	0	0	115
E	25	51	26	1	0	0	103
ESE	14	18	28	3	0	0	63
SE	15	18	25	0	0	0	58
SSE	9	16	6	0	0	0	31
S	10	17	3	0	0	0	30
SSW	16	35	1	0	0	0	52
SW	33	23	0	0	0	0	56
WSW	27	20	0	0	0	0	47
W	24	23	4	0	0	0	51
WNW	29	34	8	0	0	0	71
NW	22	23	17	0	0	0	62
NNW	17	22	19	0	0	0	58
Variable	0	0	0	0	0	0	0
Total	362	465	167	6	0	0	1000

Hours of calm in this stability class: 8
 Hours of missing wind measurements in this stability class: 0
 Hours of missing stability measurements in all stability classes: 14

SITE: LIMERICK GENERATING STATION – UNITS 1 & 2
 LICENSEE: EXELON GENERATION COMPANY, LLC

Table D – 5 Wind Speed by Direction Measured at 30 Feet for Various Stability Classes for the Limerick Generating Station, July – September, 2018

Limerick Tower 1

Period of Record: July - September 2018
 Stability Class - Slightly Stable - 171Ft-26Ft Delta-T (F)
 Winds Measured at 30 Feet

Wind Direction	Wind Speed (in mph)						Total
	1-3	4-7	8-12	13-18	19-24	> 24	
N	18	6	2	0	0	0	26
NNE	21	3	1	0	0	0	25
NE	19	8	0	0	0	0	27
ENE	12	7	0	0	0	0	19
E	7	8	3	0	0	0	18
ESE	7	10	2	0	0	0	19
SE	11	3	1	0	0	0	15
SSE	4	4	0	0	0	0	8
S	19	10	0	0	0	0	29
SSW	21	18	1	0	0	0	40
SW	32	5	0	0	0	0	37
WSW	33	4	0	0	0	0	37
W	39	23	0	0	0	0	62
WNW	31	14	0	0	0	0	45
NW	22	13	0	0	0	0	35
NNW	18	7	0	0	0	0	25
Variable	0	0	0	0	0	0	0
Total	314	143	10	0	0	0	467

Hours of calm in this stability class: 11
 Hours of missing wind measurements in this stability class: 0
 Hours of missing stability measurements in all stability classes: 14

SITE: LIMERICK GENERATING STATION – UNITS 1 & 2
 LICENSEE: EXELON GENERATION COMPANY, LLC

Table D – 5 Wind Speed by Direction Measured at 30 Feet for Various Stability Classes for the Limerick Generating Station, July – September, 2018

Limerick Tower 1

Period of Record: July - September 2018
 Stability Class - Moderately Stable - 171Ft-26Ft Delta-T (F)
 Winds Measured at 30 Feet

Wind Direction	Wind Speed (in mph)						Total
	1-3	4-7	8-12	13-18	19-24	> 24	
N	13	0	0	0	0	0	13
NNE	13	3	0	0	0	0	16
NE	5	0	0	0	0	0	5
ENE	8	0	0	0	0	0	8
E	3	0	0	0	0	0	3
ESE	3	0	0	0	0	0	3
SE	4	1	0	0	0	0	5
SSE	1	0	0	0	0	0	1
S	2	0	0	0	0	0	2
SSW	7	0	0	0	0	0	7
SW	10	0	0	0	0	0	10
WSW	10	3	0	0	0	0	13
W	19	0	0	0	0	0	19
WNW	25	2	0	0	0	0	27
NW	22	3	0	0	0	0	25
NNW	18	0	0	0	0	0	18
Variable	0	0	0	0	0	0	0
Total	163	12	0	0	0	0	175

Hours of calm in this stability class: 51
 Hours of missing wind measurements in this stability class: 0
 Hours of missing stability measurements in all stability classes: 14

SITE: LIMERICK GENERATING STATION – UNITS 1 & 2
 LICENSEE: EXELON GENERATION COMPANY, LLC

Table D – 5 Wind Speed by Direction Measured at 30 Feet for Various Stability Classes for the Limerick Generating Station, July – September, 2018

Limerick Tower 1

Period of Record: July - September 2018
 Stability Class - Extremely Stable - 171Ft-26Ft Delta-T (F)
 Winds Measured at 30 Feet

Wind Direction	Wind Speed (in mph)						Total
	1-3	4-7	8-12	13-18	19-24	> 24	
N	4	0	0	0	0	0	4
NNE	5	0	0	0	0	0	5
NE	5	0	0	0	0	0	5
ENE	3	0	0	0	0	0	3
E	1	0	0	0	0	0	1
ESE	2	0	0	0	0	0	2
SE	1	0	0	0	0	0	1
SSE	0	0	0	0	0	0	0
S	0	0	0	0	0	0	0
SSW	2	0	0	0	0	0	2
SW	4	0	0	0	0	0	4
WSW	3	0	0	0	0	0	3
W	3	0	0	0	0	0	3
WNW	6	0	0	0	0	0	6
NW	8	0	0	0	0	0	8
NNW	6	0	0	0	0	0	6
Variable	0	0	0	0	0	0	0
Total	53	0	0	0	0	0	53

Hours of calm in this stability class: 34
 Hours of missing wind measurements in this stability class: 0
 Hours of missing stability measurements in all stability classes: 14

SITE: LIMERICK GENERATING STATION – UNITS 1 & 2
 LICENSEE: EXELON GENERATION COMPANY, LLC

Table D – 6 Wind Speed by Direction Measured at 175 Feet for Various Stability Classes for the Limerick Generating Station, July – September, 2018

Limerick Tower 1
 Period of Record: July - September 2018
 Stability Class - Extremely Unstable - 171Ft-26Ft Delta-T (F)
 Winds Measured at 175 Feet

Wind Direction	Wind Speed (in mph)						Total
	1-3	4-7	8-12	13-18	19-24	> 24	
N	4	2	0	0	0	0	6
NNE	1	4	1	0	0	0	6
NE	0	1	0	0	0	0	1
ENE	0	1	0	0	0	0	1
E	1	1	0	0	0	0	2
ESE	0	0	0	0	0	0	0
SE	0	0	0	0	0	0	0
SSE	1	0	1	1	1	0	4
S	0	0	2	0	0	0	2
SSW	0	4	6	0	0	0	10
SW	2	2	7	0	0	0	11
WSW	1	2	1	0	0	0	4
W	5	0	0	0	0	0	5
WNW	2	1	0	0	0	0	3
NW	3	0	0	0	0	0	3
NNW	1	4	1	0	0	0	6
Variable	0	0	0	0	0	0	0
Total	21	22	19	1	1	0	64

Hours of calm in this stability class: 0
 Hours of missing wind measurements in this stability class: 0
 Hours of missing stability measurements in all stability classes: 14

SITE: LIMERICK GENERATING STATION – UNITS 1 & 2
 LICENSEE: EXELON GENERATION COMPANY, LLC

Table D – 6 Wind Speed by Direction Measured at 175 Feet for Various Stability Classes for the Limerick Generating Station, July – September, 2018

Limerick Tower 1
 Period of Record: July - September 2018
 Stability Class - Moderately Unstable - 171Ft-26Ft Delta-T (F)
 Winds Measured at 175 Feet

Wind Direction	Wind Speed (in mph)						Total
	1-3	4-7	8-12	13-18	19-24	> 24	
N	1	1	0	0	0	0	2
NNE	0	1	0	0	0	0	1
NE	0	1	0	0	0	0	1
ENE	1	3	3	0	0	0	7
E	0	2	3	2	0	0	7
ESE	0	2	2	0	0	0	4
SE	0	1	0	0	0	0	1
SSE	0	3	0	2	0	0	5
S	0	4	2	0	0	0	6
SSW	1	8	3	2	0	0	14
SW	1	11	10	1	0	0	23
WSW	0	8	4	0	0	0	12
W	1	10	6	0	0	0	17
WNW	1	5	1	0	0	0	7
NW	1	0	0	0	0	0	1
NNW	1	1	1	0	0	0	3
Variable	0	0	0	0	0	0	0
Total	8	61	35	7	0	0	111

Hours of calm in this stability class: 1
 Hours of missing wind measurements in this stability class: 0
 Hours of missing stability measurements in all stability classes: 14

SITE: LIMERICK GENERATING STATION – UNITS 1 & 2
 LICENSEE: EXELON GENERATION COMPANY, LLC

Table D – 6 Wind Speed by Direction Measured at 175 Feet for Various Stability Classes for the Limerick Generating Station, July – September, 2018

Limerick Tower 1
 Period of Record: July - September 2018
 Stability Class - Slightly Unstable - 171Ft-26Ft Delta-T (F)
 Winds Measured at 175 Feet

Wind Direction	Wind Speed (in mph)						Total
	1-3	4-7	8-12	13-18	19-24	> 24	
N	2	3	2	0	0	0	7
NNE	4	4	1	0	0	0	9
NE	2	8	3	0	0	0	13
ENE	1	8	12	1	0	0	22
E	1	9	1	3	0	0	14
ESE	1	3	5	0	0	0	9
SE	0	1	0	2	0	0	3
SSE	0	0	3	1	0	0	4
S	1	8	2	0	0	0	11
SSW	3	11	5	1	0	0	20
SW	5	8	5	1	0	0	19
WSW	1	11	5	0	0	0	17
W	1	18	8	0	0	0	27
WNW	5	13	7	0	0	0	25
NW	2	3	2	0	0	0	7
NNW	2	5	5	0	0	0	12
Variable	0	0	0	0	0	0	0
Total	31	113	66	9	0	0	219

Hours of calm in this stability class: 0
 Hours of missing wind measurements in this stability class: 0
 Hours of missing stability measurements in all stability classes: 14

SITE: LIMERICK GENERATING STATION – UNITS 1 & 2
 LICENSEE: EXELON GENERATION COMPANY, LLC

Table D – 6 Wind Speed by Direction Measured at 175 Feet for Various Stability Classes for the Limerick Generating Station, July – September, 2018

Limerick Tower 1

Period of Record: July - September 2018
 Stability Class - Neutral - 171Ft-26Ft Delta-T (F)
 Winds Measured at 175 Feet

Wind Direction	Wind Speed (in mph)						Total
	1-3	4-7	8-12	13-18	19-24	> 24	
N	15	16	23	3	0	0	57
NNE	16	36	16	1	0	0	69
NE	16	48	26	3	1	0	94
ENE	7	58	51	4	1	0	121
E	8	23	25	19	1	0	76
ESE	6	13	36	12	2	0	69
SE	4	12	11	26	1	0	54
SSE	5	13	13	7	0	0	38
S	7	15	21	6	0	0	49
SSW	9	23	31	9	0	0	72
SW	12	21	16	0	0	0	49
WSW	6	18	14	0	0	0	38
W	7	24	22	7	0	0	60
WNW	12	18	30	3	0	0	63
NW	6	14	17	2	0	0	39
NNW	11	13	29	5	0	0	58
Variable	0	0	0	0	0	0	0
Total	147	365	381	107	6	0	1006

Hours of calm in this stability class: 2
 Hours of missing wind measurements in this stability class: 0
 Hours of missing stability measurements in all stability classes: 14

SITE: LIMERICK GENERATING STATION – UNITS 1 & 2
 LICENSEE: EXELON GENERATION COMPANY, LLC

Table D – 6 Wind Speed by Direction Measured at 175 Feet for Various Stability Classes for the Limerick Generating Station, July – September, 2018

Limerick Tower 1

Period of Record: July - September 2018
 Stability Class - Slightly Stable - 171Ft-26Ft Delta-T (F)
 Winds Measured at 175 Feet

Wind Direction	Wind Speed (in mph)						Total
	1-3	4-7	8-12	13-18	19-24	> 24	
N	15	9	8	3	0	0	35
NNE	7	12	3	0	0	0	22
NE	4	18	6	0	0	0	28
ENE	1	14	3	0	0	0	18
E	4	4	7	3	0	0	18
ESE	1	4	14	0	0	0	19
SE	4	3	7	1	0	0	15
SSE	6	6	6	0	0	0	18
S	2	13	19	3	0	0	37
SSW	2	26	30	3	0	0	61
SW	4	24	6	0	0	0	34
WSW	2	19	7	0	0	0	28
W	6	14	19	0	0	0	39
WNW	5	27	18	1	0	0	51
NW	6	14	7	0	0	0	27
NNW	5	17	6	0	0	0	28
Variable	0	0	0	0	0	0	0
Total	74	224	166	14	0	0	478

Hours of calm in this stability class: 0
 Hours of missing wind measurements in this stability class: 0
 Hours of missing stability measurements in all stability classes: 14

SITE: LIMERICK GENERATING STATION – UNITS 1 & 2
 LICENSEE: EXELON GENERATION COMPANY, LLC

Table D – 6 Wind Speed by Direction Measured at 175 Feet for Various Stability Classes for the Limerick Generating Station, July – September, 2018

Limerick Tower 1

Period of Record: July - September 2018
 Stability Class - Moderately Stable - 171Ft-26Ft Delta-T (F)
 Winds Measured at 175 Feet

Wind Direction	Wind Speed (in mph)						Total
	1-3	4-7	8-12	13-18	19-24	> 24	
N	8	6	1	0	0	0	15
NNE	4	2	3	0	0	0	9
NE	3	1	0	0	0	0	4
ENE	4	0	0	0	0	0	4
E	4	0	0	0	0	0	4
ESE	1	1	1	0	0	0	3
SE	3	1	0	0	0	0	4
SSE	4	0	0	0	0	0	4
S	1	2	1	0	0	0	4
SSW	3	11	7	0	0	0	21
SW	4	17	4	0	0	0	25
WSW	6	6	1	0	0	0	13
W	8	17	0	0	0	0	25
WNW	10	32	14	0	0	0	56
NW	3	22	2	0	0	0	27
NNW	1	5	0	0	0	0	6
Variable	0	0	0	0	0	0	0
Total	67	123	34	0	0	0	224

Hours of calm in this stability class: 2
 Hours of missing wind measurements in this stability class: 0
 Hours of missing stability measurements in all stability classes: 14

SITE: LIMERICK GENERATING STATION – UNITS 1 & 2
 LICENSEE: EXELON GENERATION COMPANY, LLC

Table D – 6 Wind Speed by Direction Measured at 175 Feet for Various Stability Classes for the Limerick Generating Station, July – September, 2018

Limerick Tower 1

Period of Record: July - September 2018
 Stability Class - Extremely Stable - 171Ft-26Ft Delta-T (F)
 Winds Measured at 175 Feet

Wind Direction	Wind Speed (in mph)						Total
	1-3	4-7	8-12	13-18	19-24	> 24	
N	3	1	0	0	0	0	4
NNE	2	0	0	0	0	0	2
NE	4	0	0	0	0	0	4
ENE	1	0	0	0	0	0	1
E	2	1	0	0	0	0	3
ESE	2	1	0	0	0	0	3
SE	2	4	0	0	0	0	6
SSE	1	0	0	0	0	0	1
S	3	1	3	0	0	0	7
SSW	3	0	0	0	0	0	3
SW	2	3	0	0	0	0	5
WSW	2	3	0	0	0	0	5
W	3	10	0	0	0	0	13
WNW	4	14	0	0	0	0	18
NW	2	6	0	0	0	0	8
NNW	3	1	0	0	0	0	4
Variable	0	0	0	0	0	0	0
Total	39	45	3	0	0	0	87

Hours of calm in this stability class: 0
 Hours of missing wind measurements in this stability class: 0
 Hours of missing stability measurements in all stability classes: 14

SITE: LIMERICK GENERATING STATION – UNITS 1 & 2
 LICENSEE: EXELON GENERATION COMPANY, LLC

Table D – 7 Wind Speed by Direction Measured at 30 Feet for Various Stability Classes for the Limerick Generating Station, October – December, 2018

Limerick Tower 1

Period of Record: October – December 2018
 Stability Class - Extremely Unstable - 171Ft-26Ft Delta-T (F)
 Winds Measured at 30 Feet

Wind Direction	Wind Speed (in mph)						Total
	1-3	4-7	8-12	13-18	19-24	> 24	
N	0	0	0	0	0	0	0
NNE	0	0	0	0	0	0	0
NE	0	0	0	0	0	0	0
ENE	1	0	0	0	0	0	1
E	0	3	0	0	0	0	3
ESE	0	0	0	0	0	0	0
SE	0	0	0	0	0	0	0
SSE	0	0	0	0	0	0	0
S	0	0	0	0	0	0	0
SSW	0	3	0	0	0	0	3
SW	0	4	2	0	0	0	6
WSW	0	1	1	0	0	0	2
W	0	0	0	0	0	0	0
WNW	0	0	0	0	0	0	0
NW	0	0	0	0	0	0	0
NNW	0	0	0	0	0	0	0
Variable	0	0	0	0	0	0	0
Total	1	11	3	0	0	0	15

Hours of calm in this stability class: 0
 Hours of missing wind measurements in this stability class: 0
 Hours of missing stability measurements in all stability classes: 3

SITE: LIMERICK GENERATING STATION – UNITS 1 & 2
 LICENSEE: EXELON GENERATION COMPANY, LLC

Table D – 7 Wind Speed by Direction Measured at 30 Feet for Various Stability Classes for the Limerick Generating Station, October – December, 2018

Limerick Tower 1

Period of Record: October – December 2018
 Stability Class - Moderately Unstable - 171Ft-26Ft Delta-T (F)
 Winds Measured at 30 Feet

Wind Direction	Wind Speed (in mph)						Total
	1-3	4-7	8-12	13-18	19-24	> 24	
N	0	0	1	0	0	0	1
NNE	0	0	0	0	0	0	0
NE	0	0	0	0	0	0	0
ENE	0	0	0	0	0	0	0
E	1	1	0	0	0	0	2
ESE	0	0	0	0	0	0	0
SE	0	0	0	0	0	0	0
SSE	0	0	0	0	0	0	0
S	0	3	0	0	0	0	3
SSW	0	2	0	0	0	0	2
SW	0	3	0	0	0	0	3
WSW	0	3	0	0	0	0	3
W	0	1	3	0	0	0	4
WNW	0	1	0	0	0	0	1
NW	0	0	0	0	0	0	0
NNW	0	0	0	0	0	0	0
Variable	0	0	0	0	0	0	0
Total	1	14	4	0	0	0	19

Hours of calm in this stability class: 0
 Hours of missing wind measurements in this stability class: 0
 Hours of missing stability measurements in all stability classes: 3

SITE: LIMERICK GENERATING STATION – UNITS 1 & 2
 LICENSEE: EXELON GENERATION COMPANY, LLC

Table D – 7 Wind Speed by Direction Measured at 30 Feet for Various Stability Classes for the Limerick Generating Station, October – December, 2018

Limerick Tower 1

Period of Record: October – December 2018
 Stability Class - Slightly Unstable - 171Ft-26Ft Delta-T (F)
 Winds Measured at 30 Feet

Wind Direction	Wind Speed (in mph)						Total
	1-3	4-7	8-12	13-18	19-24	> 24	
N	0	0	0	0	0	0	0
NNE	0	0	0	0	0	0	0
NE	0	0	0	0	0	0	0
ENE	0	0	0	0	0	0	0
E	0	2	0	0	0	0	2
ESE	1	0	1	0	0	0	2
SE	0	0	0	0	0	0	0
SSE	0	0	0	0	0	0	0
S	0	1	0	0	0	0	1
SSW	2	4	0	0	0	0	6
SW	2	0	0	0	0	0	2
WSW	2	3	2	0	0	0	7
W	0	3	6	0	0	0	9
WNW	1	10	1	4	1	0	17
NW	0	3	7	2	0	0	12
NNW	0	2	1	0	0	0	3
Variable	0	0	0	0	0	0	0
Total	8	28	18	6	1	0	61

Hours of calm in this stability class: 0
 Hours of missing wind measurements in this stability class: 0
 Hours of missing stability measurements in all stability classes: 3

SITE: LIMERICK GENERATING STATION – UNITS 1 & 2
 LICENSEE: EXELON GENERATION COMPANY, LLC

Table D – 7 Wind Speed by Direction Measured at 30 Feet for Various Stability Classes for the Limerick Generating Station, October – December, 2018

Limerick Tower 1

Period of Record: October – December 2018
 Stability Class - Neutral - 171Ft-26Ft Delta-T (F)
 Winds Measured at 30 Feet

Wind Direction	Wind Speed (in mph)						Total
	1-3	4-7	8-12	13-18	19-24	> 24	
N	16	26	6	0	0	0	48
NNE	11	14	3	0	0	0	28
NE	16	15	6	0	0	0	37
ENE	11	32	29	1	0	0	73
E	17	42	20	1	0	0	80
ESE	12	14	9	0	0	0	35
SE	13	6	2	1	0	0	22
SSE	11	13	1	1	0	0	26
S	15	23	1	0	0	0	39
SSW	11	26	1	0	0	0	38
SW	10	9	1	0	0	0	20
WSW	17	24	1	0	0	0	42
W	15	28	31	4	0	0	78
WNW	12	57	92	60	8	0	229
NW	13	40	105	58	4	0	220
NNW	12	20	27	8	0	0	67
Variable	0	0	0	0	0	0	0
Total	212	389	335	134	12	0	1082

Hours of calm in this stability class: 1
 Hours of missing wind measurements in this stability class: 0
 Hours of missing stability measurements in all stability classes: 3

SITE: LIMERICK GENERATING STATION – UNITS 1 & 2
 LICENSEE: EXELON GENERATION COMPANY, LLC

Table D – 7 Wind Speed by Direction Measured at 30 Feet for Various Stability Classes for the Limerick Generating Station, October – December, 2018

Limerick Tower 1

Period of Record: October – December 2018
 Stability Class - Slightly Stable - 171Ft-26Ft Delta-T (F)
 Winds Measured at 30 Feet

Wind Direction	Wind Speed (in mph)						Total
	1-3	4-7	8-12	13-18	19-24	> 24	
N	19	6	0	0	0	0	25
NNE	14	5	0	0	0	0	19
NE	20	5	0	0	0	0	25
ENE	15	13	4	0	0	0	32
E	10	10	4	0	0	0	24
ESE	12	4	1	4	0	0	21
SE	7	10	3	1	0	0	21
SSE	6	8	2	0	0	0	16
S	5	18	7	0	0	0	30
SSW	21	26	8	0	0	0	55
SW	23	20	0	0	0	0	43
WSW	23	17	2	0	0	0	42
W	32	46	8	0	0	0	86
WNW	30	81	14	1	0	0	126
NW	21	31	19	1	0	0	72
NNW	18	14	0	0	0	0	32
Variable	0	0	0	0	0	0	0
Total	276	314	72	7	0	0	669

Hours of calm in this stability class: 13
 Hours of missing wind measurements in this stability class: 0
 Hours of missing stability measurements in all stability classes: 3

SITE: LIMERICK GENERATING STATION – UNITS 1 & 2
 LICENSEE: EXELON GENERATION COMPANY, LLC

Table D – 7 Wind Speed by Direction Measured at 30 Feet for Various Stability Classes for the Limerick Generating Station, October – December, 2018

Limerick Tower 1

Period of Record: October – December 2018
 Stability Class - Moderately Stable - 171Ft-26Ft Delta-T (F)
 Winds Measured at 30 Feet

Wind Direction	Wind Speed (in mph)						Total
	1-3	4-7	8-12	13-18	19-24	> 24	
N	9	0	0	0	0	0	9
NNE	8	0	0	0	0	0	8
NE	9	0	0	0	0	0	9
ENE	4	1	0	0	0	0	5
E	2	1	0	0	0	0	3
ESE	4	0	1	0	0	0	5
SE	4	0	0	0	0	0	4
SSE	1	0	0	0	0	0	1
S	4	1	0	0	0	0	5
SSW	8	2	0	0	0	0	10
SW	8	0	0	0	0	0	8
WSW	12	5	0	0	0	0	17
W	26	4	0	0	0	0	30
WNW	26	9	0	0	0	0	35
NW	19	3	0	0	0	0	22
NNW	9	0	0	0	0	0	9
Variable	0	0	0	0	0	0	0
Total	153	26	1	0	0	0	180

Hours of calm in this stability class: 9
 Hours of missing wind measurements in this stability class: 0
 Hours of missing stability measurements in all stability classes: 3

SITE: LIMERICK GENERATING STATION – UNITS 1 & 2
 LICENSEE: EXELON GENERATION COMPANY, LLC

Table D – 7 Wind Speed by Direction Measured at 30 Feet for Various Stability Classes for the Limerick Generating Station, October – December, 2018

Limerick Tower 1

Period of Record: October – December 2018
 Stability Class - Extremely Stable - 171Ft-26Ft Delta-T (F)
 Winds Measured at 30 Feet

Wind Direction	Wind Speed (in mph)						Total
	1-3	4-7	8-12	13-18	19-24	> 24	
N	10	0	0	0	0	0	10
NNE	13	0	0	0	0	0	13
NE	14	0	0	0	0	0	14
ENE	5	0	0	0	0	0	5
E	1	0	0	0	0	0	1
ESE	4	0	0	0	0	0	4
SE	0	0	0	0	0	0	0
SSE	3	0	0	0	0	0	3
S	0	0	0	0	0	0	0
SSW	1	0	0	0	0	0	1
SW	2	0	0	0	0	0	2
WSW	2	0	0	0	0	0	2
W	14	1	0	0	0	0	15
WNW	18	1	0	0	0	0	19
NW	26	0	0	0	0	0	26
NNW	15	0	0	0	0	0	15
Variable	0	0	0	0	0	0	0
Total	128	2	0	0	0	0	130

Hours of calm in this stability class: 26
 Hours of missing wind measurements in this stability class: 0
 Hours of missing stability measurements in all stability classes: 3

SITE: LIMERICK GENERATING STATION – UNITS 1 & 2
 LICENSEE: EXELON GENERATION COMPANY, LLC

Table D – 8 Wind Speed by Direction Measured at 175 Feet for Various Stability Classes for the Limerick Generating Station, October – December, 2018

Limerick Tower 1

Period of Record: October – December 2018
 Stability Class - Extremely Unstable - 171Ft-26Ft Delta-T (F)
 Winds Measured at 175 Feet

Wind Direction	Wind Speed (in mph)						Total
	1-3	4-7	8-12	13-18	19-24	> 24	
N	0	0	0	0	0	0	0
NNE	0	0	0	0	0	0	0
NE	0	0	0	0	0	0	0
ENE	0	0	0	0	0	0	0
E	0	0	2	0	0	0	2
ESE	0	0	0	0	0	0	0
SE	0	0	0	0	0	0	0
SSE	0	0	0	0	0	0	0
S	0	0	1	0	0	0	1
SSW	0	2	2	1	0	0	5
SW	0	0	2	2	0	0	4
WSW	0	0	0	0	0	0	0
W	0	0	0	0	0	0	0
WNW	0	0	0	0	0	0	0
NW	0	0	0	0	0	0	0
NNW	0	0	0	0	0	0	0
Variable	0	0	0	0	0	0	0
Total	0	2	7	3	0	0	12

Hours of calm in this stability class: 0
 Hours of missing wind measurements in this stability class: 3
 Hours of missing stability measurements in all stability classes: 3

SITE: LIMERICK GENERATING STATION – UNITS 1 & 2
 LICENSEE: EXELON GENERATION COMPANY, LLC

Table D – 8 Wind Speed by Direction Measured at 175 Feet for Various Stability Classes for the Limerick Generating Station, October – December, 2018

Limerick Tower 1
 Period of Record: October – December 2018
 Stability Class - Moderately Unstable - 171Ft-26Ft Delta-T (F)
 Winds Measured at 175 Feet

Wind Direction	Wind Speed (in mph)						Total
	1-3	4-7	8-12	13-18	19-24	> 24	
N	0	0	0	1	0	0	1
NNE	0	0	0	0	0	0	0
NE	0	0	0	0	0	0	0
ENE	0	0	0	0	0	0	0
E	0	0	1	0	0	0	1
ESE	0	0	0	0	0	0	0
SE	0	0	0	0	0	0	0
SSE	0	0	0	0	0	0	0
S	0	1	1	0	0	0	2
SSW	0	2	2	0	0	0	4
SW	0	0	2	0	0	0	2
WSW	0	0	2	1	0	0	3
W	0	0	2	2	0	0	4
WNW	0	0	0	0	0	0	0
NW	0	0	0	0	0	0	0
NNW	0	0	0	0	0	0	0
Variable	0	0	0	0	0	0	0
Total	0	3	10	4	0	0	17

Hours of calm in this stability class: 0
 Hours of missing wind measurements in this stability class: 2
 Hours of missing stability measurements in all stability classes: 3

SITE: LIMERICK GENERATING STATION – UNITS 1 & 2
 LICENSEE: EXELON GENERATION COMPANY, LLC

Table D – 8 Wind Speed by Direction Measured at 175 Feet for Various Stability Classes for the Limerick Generating Station, October – December, 2018

Limerick Tower 1

Period of Record: October – December 2018
 Stability Class - Slightly Unstable - 171Ft-26Ft Delta-T (F)
 Winds Measured at 175 Feet

Wind Direction	Wind Speed (in mph)						Total
	1-3	4-7	8-12	13-18	19-24	> 24	
N	0	0	0	0	0	0	0
NNE	0	0	0	0	0	0	0
NE	0	0	0	0	0	0	0
ENE	0	0	0	0	0	0	0
E	0	0	2	0	0	0	2
ESE	0	0	1	0	0	0	1
SE	0	0	0	0	0	0	0
SSE	0	0	0	0	0	0	0
S	0	1	1	0	0	0	2
SSW	0	3	2	1	0	0	6
SW	0	2	1	1	0	0	4
WSW	0	0	2	2	0	0	4
W	0	0	6	5	0	2	13
WNW	0	2	5	5	0	2	14
NW	0	1	0	2	2	0	5
NNW	0	1	1	0	0	0	2
Variable	0	0	0	0	0	0	0
Total	0	10	21	16	2	4	53

Hours of calm in this stability class: 0
 Hours of missing wind measurements in this stability class: 8
 Hours of missing stability measurements in all stability classes: 3

SITE: LIMERICK GENERATING STATION – UNITS 1 & 2
 LICENSEE: EXELON GENERATION COMPANY, LLC

Table D – 8 Wind Speed by Direction Measured at 175 Feet for Various Stability Classes for the Limerick Generating Station, October – December, 2018

Limerick Tower 1

Period of Record: October – December 2018
 Stability Class - Neutral - 171Ft-26Ft Delta-T (F)
 Winds Measured at 175 Feet

Wind Direction	Wind Speed (in mph)						Total
	1-3	4-7	8-12	13-18	19-24	> 24	
N	2	15	16	1	0	0	34
NNE	4	7	11	1	0	0	23
NE	6	15	13	9	1	0	44
ENE	6	17	30	17	0	0	70
E	3	15	38	10	0	0	66
ESE	5	11	8	9	0	0	33
SE	6	8	2	3	0	0	19
SSE	2	3	10	2	1	0	18
S	10	16	19	1	0	0	46
SSW	2	8	14	7	0	0	31
SW	4	17	11	4	0	0	36
WSW	2	5	11	2	0	0	20
W	10	11	32	49	19	5	126
WNW	4	12	70	93	50	15	244
NW	7	10	33	69	29	4	152
NNW	2	7	13	16	2	0	40
Variable	0	0	0	0	0	0	0
Total	75	177	331	293	102	24	1002

Hours of calm in this stability class: 0
 Hours of missing wind measurements in this stability class: 81
 Hours of missing stability measurements in all stability classes: 3

SITE: LIMERICK GENERATING STATION – UNITS 1 & 2
 LICENSEE: EXELON GENERATION COMPANY, LLC

Table D – 8 Wind Speed by Direction Measured at 175 Feet for Various Stability Classes for the Limerick Generating Station, October – December, 2018

Limerick Tower 1

Period of Record: October – December 2018
 Stability Class - Slightly Stable - 171Ft-26Ft Delta-T (F)
 Winds Measured at 175 Feet

Wind Direction	Wind Speed (in mph)						Total
	1-3	4-7	8-12	13-18	19-24	> 24	
N	11	7	4	1	0	0	23
NNE	9	8	3	0	0	0	20
NE	8	13	3	0	0	0	24
ENE	6	20	11	1	0	0	38
E	8	10	13	4	0	0	35
ESE	2	2	6	2	4	0	16
SE	2	4	2	3	1	0	12
SSE	1	10	6	3	0	0	20
S	1	8	26	16	0	0	51
SSW	4	18	28	12	0	0	62
SW	4	13	14	7	0	0	38
WSW	3	9	17	3	0	0	32
W	1	18	52	11	0	0	82
WNW	4	20	75	29	2	0	130
NW	2	9	19	10	1	0	41
NNW	6	13	14	1	0	0	34
Variable	0	0	0	0	0	0	0
Total	72	182	293	103	8	0	658

Hours of calm in this stability class: 0
 Hours of missing wind measurements in this stability class: 24
 Hours of missing stability measurements in all stability classes: 3

SITE: LIMERICK GENERATING STATION – UNITS 1 & 2
 LICENSEE: EXELON GENERATION COMPANY, LLC

Table D – 8 Wind Speed by Direction Measured at 175 Feet for Various Stability Classes for the Limerick Generating Station, October – December, 2018

Limerick Tower 1

Period of Record: October – December 2018
 Stability Class - Moderately Stable - 171Ft-26Ft Delta-T (F)
 Winds Measured at 175 Feet

Wind Direction	Wind Speed (in mph)						Total
	1-3	4-7	8-12	13-18	19-24	> 24	
N	0	5	1	0	0	0	6
NNE	3	3	0	0	0	0	6
NE	1	1	1	0	0	0	3
ENE	2	4	0	0	0	0	6
E	3	3	3	0	0	0	9
ESE	3	0	0	2	0	0	5
SE	4	2	0	0	0	0	6
SSE	4	2	0	0	0	0	6
S	1	4	6	0	0	0	11
SSW	1	3	2	0	0	0	6
SW	0	7	4	0	0	0	11
WSW	1	5	6	2	0	0	14
W	0	18	15	2	0	0	35
WNW	3	18	17	2	0	0	40
NW	0	6	5	0	0	0	11
NNW	3	7	1	0	0	0	11
Variable	0	0	0	0	0	0	0
Total	29	88	61	8	0	0	186

Hours of calm in this stability class: 0
 Hours of missing wind measurements in this stability class: 3
 Hours of missing stability measurements in all stability classes: 3

SITE: LIMERICK GENERATING STATION – UNITS 1 & 2
 LICENSEE: EXELON GENERATION COMPANY, LLC

Table D – 8 Wind Speed by Direction Measured at 175 Feet for Various Stability Classes for the Limerick Generating Station, October – December, 2018

Limerick Tower 1

Period of Record: October – December 2018
 Stability Class - Extremely Stable - 171Ft-26Ft Delta-T (F)
 Winds Measured at 175 Feet

Wind Direction	Wind Speed (in mph)						Total
	1-3	4-7	8-12	13-18	19-24	> 24	
N	0	0	0	0	0	0	0
NNE	3	0	0	0	0	0	3
NE	1	4	0	0	0	0	5
ENE	9	2	0	0	0	0	11
E	11	2	0	0	0	0	13
ESE	8	3	0	0	0	0	11
SE	0	0	0	0	0	0	0
SSE	3	1	0	0	0	0	4
S	1	2	0	0	0	0	3
SSW	2	7	1	0	0	0	10
SW	2	5	0	0	0	0	7
WSW	2	8	2	0	0	0	12
W	4	15	7	0	0	0	26
WNW	5	16	9	0	0	0	30
NW	2	12	1	0	0	0	15
NNW	2	3	0	0	0	0	5
Variable	0	0	0	0	0	0	0
Total	55	80	20	0	0	0	155

Hours of calm in this stability class: 0
 Hours of missing wind measurements in this stability class: 1
 Hours of missing stability measurements in all stability classes: 3

SITE: LIMERICK GENERATING STATION – UNITS 1 & 2
 LICENSEE: EXELON GENERATION COMPANY, LLC

Table D – 9 Wind Speed by Direction Measured at 30 Feet for Various Stability Classes for the Limerick Generating Station, January - December, 2018

SPEED CLASS		Limerick Tower 1 30 ft. Wind Speed and Direction																January-December, 2018 171Ft-26Ft Delta-T (F)									
		WIND DIRECTION CLASSES								WIND DIRECTION CLASSES								STABILITY CLASSES					STABILITY CLASSES				
		N	NNE	NE	E	ESE	SE	SSE	S	SSW	SW	WSW	W	WNW	NW	NNW	TOTAL	EU	MU	SU	N	SS	MS	ES	TOTAL		
EU	0.00	0.00	0.00	0.00	0.00	0.00	0.00	0.00	0.00	0.00	0.00	0.00	0.00	0.00	0.00	0.00	0.00	0.00	0.00	0.00	0.00	0.00	0.00	0.00	0.00		
1 MU	0.00	0.00	0.00	0.00	0.00	0.00	0.00	0.00	0.00	0.00	0.00	0.00	0.00	0.00	0.00	0.00	0.00	0.00	0.00	0.00	0.00	0.00	0.00	0.00	0.00		
9 SU	0.00	0.00	0.00	0.00	0.00	0.00	0.00	0.00	0.00	0.00	0.00	0.00	0.00	0.01	0.00	0.00	0.00	0.01	0.00	0.01	0.00	0.00	0.00	0.00	0.00		
- N	0.00	0.00	0.00	0.02	0.00	0.00	0.00	0.00	0.00	0.00	0.00	0.00	0.00	0.25	0.22	0.11	0.60	0.00	0.01	0.60	0.05	0.00	0.00	0.00	0.00		
2 SS	0.00	0.00	0.00	0.00	0.00	0.00	0.00	0.00	0.00	0.00	0.00	0.00	0.00	0.00	0.02	0.02	0.05	0.00	0.00	0.00	0.00	0.00	0.00	0.00	0.00		
4 MS	0.00	0.00	0.00	0.00	0.00	0.00	0.00	0.00	0.00	0.00	0.00	0.00	0.00	0.00	0.00	0.00	0.00	0.00	0.00	0.00	0.00	0.00	0.00	0.00	0.00		
ES	0.00	0.00	0.00	0.00	0.00	0.00	0.00	0.00	0.00	0.00	0.00	0.00	0.00	0.00	0.00	0.00	0.00	0.00	0.00	0.00	0.00	0.00	0.00	0.00	0.00		
EU	0.00	0.00	0.00	0.00	0.00	0.00	0.00	0.00	0.00	0.00	0.00	0.00	0.00	0.00	0.00	0.00	0.00	0.00	0.00	0.00	0.00	0.00	0.00	0.00	0.66		
G MU	0.00	0.00	0.00	0.00	0.00	0.00	0.00	0.00	0.00	0.00	0.00	0.00	0.00	0.00	0.00	0.01	0.01	0.00	0.01	0.00	0.00	0.00	0.00	0.00	0.00		
T SU	0.00	0.00	0.00	0.00	0.00	0.00	0.00	0.00	0.00	0.00	0.00	0.00	0.00	0.00	0.00	0.00	0.00	0.00	0.00	0.00	0.00	0.00	0.00	0.00	0.00		
N	0.00	0.00	0.00	0.00	0.00	0.00	0.00	0.00	0.00	0.00	0.00	0.00	0.00	0.02	0.00	0.01	0.04	0.00	0.00	0.04	0.00	0.00	0.00	0.00	0.00		
2 SS	0.00	0.00	0.00	0.00	0.00	0.00	0.00	0.00	0.00	0.00	0.00	0.00	0.00	0.00	0.00	0.00	0.00	0.00	0.00	0.00	0.00	0.00	0.00	0.00	0.00		
4 MS	0.00	0.00	0.00	0.00	0.00	0.00	0.00	0.00	0.00	0.00	0.00	0.00	0.00	0.00	0.00	0.00	0.00	0.00	0.00	0.00	0.00	0.00	0.00	0.00	0.00		
ES	0.00	0.00	0.00	0.00	0.00	0.00	0.00	0.00	0.00	0.00	0.00	0.00	0.00	0.00	0.00	0.00	0.00	0.00	0.00	0.00	0.00	0.00	0.00	0.00	0.00		
TOT	5.09	4.35	4.96	6.68	7.01	3.53	2.59	2.46	3.82	5.88	5.44	5.77	9.09	13.08	13.80	6.43	99.96	1.98	3.27	6.67	49.13	26.32	7.54	5.06	99.96		

Wind Direction by Stability

STABILITY CLASS	EU	MU	SU	N	SS	MS	ES	TOTAL	STABILITY CLASS	EU	MU	SU	N	SS	MS	ES	TOTAL
Extremely Unstable	0.08	0.06	0.02	0.05	0.09	0.05	0.05	0.40	0.37	0.40	0.32	0.16	0.09	0.05	0.08	1.98	
Moderately Unstable	0.11	0.01	0.05	0.16	0.20	0.13	0.08	0.42	0.28	0.42	0.55	0.45	0.33	0.22	0.07	3.27	
Slightly Unstable	0.26	0.18	0.22	0.58	0.44	0.28	0.09	0.40	0.48	0.40	0.64	0.87	0.79	0.84	0.33	6.67	
Neutral	2.85	1.86	2.51	4.17	4.62	1.90	1.35	1.25	2.12	1.75	1.88	3.09	6.54	8.01	3.74	49.13	
Slightly Stable	1.05	1.21	1.37	1.06	1.08	0.84	0.73	0.86	1.77	2.04	1.60	3.01	3.41	2.93	1.21	26.32	
Moderately Stable	0.46	0.49	0.38	0.37	0.22	0.22	0.22	0.33	0.38	0.33	0.58	0.95	1.19	0.82	0.51	7.54	
Extremely Stable	0.28	0.53	0.41	0.29	0.21	0.12	0.06	0.05	0.01	0.09	0.20	0.55	0.73	0.93	0.48	5.06	

Wind Direction by Wind Speed

WIND SPEED CLASS	N	NNE	NE	E	ESE	SE	SSE	S	SSW	SW	WSW	W	WNW	NW	NNW	TOTAL	WIND SPEED CLASS	C	A	M
< 3.5 mph	0.00	0.00	0.00	0.00	0.00	0.00	0.00	0.00	0.00	0.00	0.00	0.00	0.00	0.00	0.00	0.04	3.6 - 7.5 mph	3.6	7.5	mph
3.6 - 7.5 mph	2.39	2.36	2.71	2.40	1.87	1.26	1.08	0.86	1.33	2.03	2.61	2.71	3.73	3.10	2.21	36.41	7.6 - 12.5 mph	7.6	12.5	mph
7.6 - 12.5 mph	1.79	1.71	1.98	3.37	3.12	1.32	0.91	1.31	2.12	3.25	2.54	2.60	3.26	4.25	3.50	38.67	12.6 - 18.5 mph	12.6	18.5	mph
12.6 - 18.5 mph	0.80	0.27	0.27	0.86	1.51	0.85	0.53	0.27	0.35	0.59	0.27	0.46	1.65	3.30	4.64	18.29	> 24.5 mph	18.6	24.5	mph
18.6 - 24.5 mph	0.11	0.00	0.00	0.05	0.48	0.11	0.07	0.02	0.01	0.01	0.00	0.45	1.48	2.32	0.74	5.85				
> 24.5 mph	0.00	0.00	0.00	0.00	0.00	0.00	0.00	0.00	0.00	0.00	0.00	0.00	0.26	0.25	0.13	0.66				
	0.00	0.00	0.00	0.00	0.00	0.00	0.00	0.00	0.00	0.00	0.00	0.00	0.02	0.00	0.02	0.05				

SITE: LIMERICK GENERATING STATION – UNITS 1 & 2
 LICENSEE: EXELON GENERATION COMPANY, LLC

Table D – 10 Wind Speed by Direction Measured at 175 Feet for Various Stability Classes for the Limerick Generating Station, January - December, 2018

Limerick Tower 1
 175 ft. Wind Speed and Direction

January-December, 2018
 171Ft--26Ft Delta-T (F)

SPEED CLASS	WIND DIRECTION CLASSES										TOTAL	STABILITY CLASSES										TOTAL		
	N	NNE	NE	E	ESE	SE	SSE	S	SSW	SW		WSW	W	WNW	NW	NNW	EU	MU	SU	N	SS		MS	ES
EU	0.00	0.00	0.00	0.00	0.00	0.00	0.01	0.00	0.02	0.02	0.01	0.00	0.00	0.00	0.00	0.07	0.07							
1 MU	0.00	0.00	0.00	0.00	0.00	0.00	0.00	0.01	0.00	0.00	0.01	0.00	0.00	0.00	0.00	0.08	0.08							
9 SU	0.01	0.00	0.00	0.00	0.00	0.00	0.00	0.00	0.00	0.01	0.00	0.00	0.09	0.12	0.03	0.31	0.31	0.31						
- N	0.01	0.00	0.02	0.03	0.02	0.01	0.01	0.02	0.00	0.00	0.01	0.62	1.21	0.97	0.30	3.59	3.59	3.59						
2 SS	0.00	0.00	0.00	0.00	0.05	0.01	0.02	0.03	0.01	0.02	0.00	0.01	0.02	0.00	0.00	0.21	0.21	0.21	0.21					
4 MS	0.00	0.00	0.00	0.00	0.00	0.00	0.00	0.00	0.00	0.00	0.00	0.00	0.00	0.00	0.00	0.00	0.00	0.00	0.21					
ES	0.00	0.00	0.00	0.00	0.00	0.00	0.00	0.00	0.00	0.00	0.00	0.00	0.00	0.00	0.00	0.00	0.00	0.00	0.00	0.00	0.00	0.00	4.26	
EU	0.00	0.00	0.00	0.00	0.00	0.00	0.00	0.00	0.00	0.00	0.00	0.00	0.00	0.00	0.00	0.00	0.00							
G MU	0.00	0.00	0.00	0.00	0.00	0.00	0.00	0.00	0.00	0.00	0.00	0.00	0.00	0.01	0.00	0.01	0.01							
T SU	0.00	0.00	0.00	0.00	0.00	0.00	0.00	0.00	0.00	0.00	0.00	0.05	0.02	0.00	0.00	0.07	0.07	0.07						
N	0.00	0.00	0.00	0.02	0.00	0.00	0.00	0.00	0.00	0.00	0.00	0.16	0.38	0.27	0.06	0.90	0.90	0.90	0.90					
2 SS	0.00	0.00	0.00	0.00	0.00	0.00	0.00	0.00	0.00	0.00	0.00	0.00	0.00	0.05	0.00	0.05	0.05							
4 MS	0.00	0.00	0.00	0.00	0.00	0.00	0.00	0.00	0.00	0.00	0.00	0.00	0.00	0.00	0.00	0.00	0.00	0.05						
ES	0.00	0.00	0.00	0.00	0.00	0.00	0.00	0.00	0.00	0.00	0.00	0.00	0.00	0.00	0.00	0.00	0.00	0.00	0.05					
TOT	4.51	3.97	4.63	6.71	3.67	2.42	3.38	5.89	7.46	5.99	4.52	9.99	16.10	9.21	5.20	100.00	1.99	3.23	6.53	47.87	26.30	8.21	5.87	100.00

Wind Direction by Stability

N	NNE	NE	E	ESE	SE	SSE	S	SSW	SW	WSW	W	WNW	NW	NNW	TOTAL	-STABILITY CLASSES-
0.07	0.10	0.01	0.03	0.09	0.03	0.06	0.20	0.55	0.36	0.14	0.14	0.05	0.03	0.08	1.99	Extremely Unstable
0.08	0.01	0.07	0.16	0.21	0.09	0.07	0.19	0.41	0.58	0.31	0.43	0.31	0.14	0.09	3.23	Moderately Unstable
0.23	0.23	0.26	0.52	0.50	0.21	0.09	0.35	0.49	0.49	0.55	0.99	0.86	0.35	0.31	6.53	Slightly Unstable
2.32	1.99	2.91	4.05	4.08	1.94	1.20	1.36	2.28	1.70	1.40	4.10	7.85	5.36	2.91	47.87	Neutral
1.20	1.16	1.09	1.12	1.28	0.86	0.59	1.39	2.27	1.76	1.18	2.46	4.09	1.91	1.12	26.30	Slightly Stable
0.40	0.33	0.15	0.23	0.30	0.26	0.29	0.38	0.52	0.65	0.51	1.00	1.67	0.84	0.38	8.21	Moderately Stable
0.21	0.14	0.14	0.22	0.24	0.27	0.14	0.22	0.24	0.44	0.43	0.87	1.28	0.58	0.30	5.87	Extremely Stable

Wind Direction by Wind Speed

N	NNE	NE	E	ESE	SE	SSE	S	SSW	SW	WSW	W	WNW	NW	NNW	TOTAL	-WIND SPEED CLASSES-
0.00	0.00	0.00	0.00	0.00	0.00	0.00	0.00	0.00	0.00	0.00	0.00	0.00	0.00	0.00	0.00	C A L M
0.95	0.92	0.85	0.94	1.04	0.78	0.54	0.58	0.66	0.78	0.51	0.92	0.98	0.70	0.79	12.56	< 3.5 mph
1.67	1.76	2.26	2.75	1.75	1.14	0.90	1.70	2.54	2.76	1.96	2.97	3.40	1.97	1.48	32.07	3.6 - 7.5 mph
1.62	1.16	1.32	2.28	2.35	1.32	0.48	1.34	2.62	1.96	1.62	3.21	5.89	2.47	1.60	34.30	7.6 - 12.5 mph
0.24	0.13	0.19	0.34	1.21	0.36	0.49	0.33	0.82	0.43	0.40	1.93	4.04	2.72	0.95	15.78	12.6 - 18.5 mph
0.02	0.00	0.02	0.03	0.34	0.07	0.02	0.05	0.09	0.06	0.03	0.75	1.39	1.02	0.33	4.26	18.6 - 24.5 mph
0.00	0.00	0.00	0.00	0.02	0.00	0.00	0.00	0.00	0.00	0.00	0.21	0.41	0.33	0.06	1.02	> 24.5 mph

SITE: LIMERICK GENERATING STATION – UNITS 1 & 2
 LICENSEE: EXELON GENERATION COMPANY, LLC

Table D – 11 Annual x/Q and D/Q values for the North Stack, Limerick Generating Station, 2018

Limerick Generating Station
 x/Q and D/Q values

North Stack - Flow = 316000 cfm

Stack ID	Location	Direction	Range (m)	X/Q (s/m ³) Undepleted	D/Q (1/m ²)
N	Site Boundary	S	762	1.17E-07	1.19E-09
N	Site Boundary	SSW	762	7.94E-08	6.10E-10
N	Site Boundary	SW	884	7.15E-08	5.96E-10
N	Site Boundary	WSW	854	1.44E-07	1.30E-09
N	Site Boundary	W	854	2.06E-07	2.31E-09
N	Site Boundary	WNW	793	9.67E-08	1.01E-09
N	Site Boundary	NW	762	6.74E-08	7.90E-10
N	Site Boundary	NNW	884	5.89E-08	5.49E-10
N	Site Boundary	N	884	9.33E-08	7.98E-10
N	Site Boundary	NNE	793	1.63E-07	1.72E-09
N	Site Boundary	NE	793	1.19E-07	1.35E-09
N	Site Boundary	ENE	793	1.28E-07	1.35E-09
N	Site Boundary	E	762	2.72E-07	3.30E-09
N	Site Boundary	ESE	762	5.12E-07	6.93E-09
N	Site Boundary	SE	762	6.23E-07	9.02E-09
N	Site Boundary	SSE	1006	1.51E-07	2.13E-09
N	RR-Inf-Lck-NG	S	300	5.02E-07	4.47E-09
N	RR-Inf-Lck-NG	SSW	225	5.88E-07	3.32E-09
N	RR-Inf-Lck-NG	SW	225	6.48E-07	3.75E-09
N	RR-Inf-Lck-NG	WSW	345	5.62E-07	4.50E-09
N	RR-Inf-Lck-NG	W	225	1.76E-06	1.59E-08
N	RR-Inf-Lck-NG	WNW	345	3.44E-07	3.32E-09
N	RR-Inf-Lck-NG	NW	450	1.38E-07	1.56E-09
N	RR-Inf-Lck-NG	ESE	884	4.22E-07	5.58E-09
N	RR-Inf-Lck-NG	WSW	450	3.51E-07	3.06E-09
N	RR-Inf-Lck-NG	NNE	682	1.89E-07	2.05E-09
N	Inhalation	N	948	8.74E-08	7.34E-10
N	Inhalation	NNE	825	1.57E-07	1.65E-09
N	Inhalation	NE	1057	9.78E-08	9.95E-10
N	Inhalation	ENE	985	1.12E-07	1.08E-09
N	Inhalation	E	873	2.39E-07	2.79E-09
N	Inhalation	ESE	1047	3.46E-07	4.69E-09
N	Inhalation	SE	1202	3.53E-07	4.71E-09
N	Inhalation	SSE	1647	9.28E-08	1.17E-09
N	Inhalation	S	1325	6.23E-08	7.10E-10
N	Inhalation	SSW	1543	3.88E-08	3.83E-10
N	Inhalation	SW	991	6.18E-08	5.44E-10
N	Inhalation	WSW	1158	1.00E-07	1.01E-09
N	Inhalation	W	1106	1.50E-07	1.70E-09

SITE: LIMERICK GENERATING STATION – UNITS 1 & 2
 LICENSEE: EXELON GENERATION COMPANY, LLC

Table D – 11 Annual x/Q and D/Q values for the North Stack, Limerick Generating Station, 2018

Limerick Generating Station
 x/Q and D/Q values

North Stack - Flow = 316000 cfm

Stack ID	Location	Direction	Range (m)	X/Q (s/m ³) Undepleted	D/Q (1/m ²)
N	Inhalation	WNW	1123	6.40E-08	6.78E-10
N	Inhalation	NW	1103	4.49E-08	5.30E-10
N	Inhalation	NNW	1539	4.86E-08	3.44E-10
N	Vegetation	N	1016	8.25E-08	6.81E-10
N	Vegetation	NNE	3779	1.70E-07	3.28E-10
N	Vegetation	NE	4100	1.79E-07	2.44E-10
N	Vegetation	ENE	2512	1.31E-07	4.58E-10
N	Vegetation	E	2398	1.92E-07	8.41E-10
N	Vegetation	ESE	1047	3.46E-07	4.69E-09
N	Vegetation	SE	2176	2.22E-07	2.27E-09
N	Vegetation	SSE	2107	8.53E-08	8.57E-10
N	Vegetation	S	1860	5.44E-08	5.47E-10
N	Vegetation	SSW	1747	3.90E-08	3.46E-10
N	Vegetation	SW	1926	5.02E-08	3.97E-10
N	Vegetation	WSW	1374	8.65E-08	9.42E-10
N	Vegetation	W	2708	9.72E-08	6.70E-10
N	Vegetation	WNW	3664	4.20E-08	2.02E-10
N	Vegetation	NW	2499	3.70E-08	2.31E-10
N	Vegetation	NNW	1973	5.01E-08	2.66E-10
N	Meat	N	7551	6.75E-08	8.30E-11
N	Meat	NNE	4090	2.00E-07	3.18E-10
N	Meat	NE	4890	2.24E-07	2.20E-10
N	Meat	ENE	2271	1.32E-07	5.13E-10
N	Meat	ESE	3738	2.01E-07	8.46E-10
N	Meat	SE	3323	1.55E-07	1.15E-09
N	Meat	SSE	2492	8.28E-08	6.90E-10
N	Meat	S	3722	7.36E-08	2.71E-10
N	Meat	SSW	3167	7.34E-08	2.18E-10
N	Meat	SW	7055	2.16E-07	2.08E-10
N	Meat	WSW	1413	8.50E-08	9.35E-10
N	Meat	W	4305	9.72E-08	4.08E-10
N	Meat	NNW	3677	4.86E-08	1.29E-10
N	Cow	N	7551	6.75E-08	8.30E-11
N	Cow	S	6740	1.16E-07	1.36E-10
N	Cow	SSW	3167	7.34E-08	2.18E-10
N	Cow	WSW	4321	1.17E-07	3.43E-10

SITE: LIMERICK GENERATING STATION – UNITS 1 & 2
 LICENSEE: EXELON GENERATION COMPANY, LLC

Table D – 12 Annual x/Q and D/Q values for the South Stack, Limerick Generating Station, 2018

Limerick Generating Station
 x/Q and D/Q values

South Stack - Flow = 187000 cfm

Stack ID	Location	Direction	Range (m)	X/Q (s/m ³) Undepleted	D/Q (1/m ²)
S	Site Boundary	S	762	6.33E-08	7.59E-10
S	Site Boundary	SSW	762	3.49E-08	3.52E-10
S	Site Boundary	SW	884	3.05E-08	3.63E-10
S	Site Boundary	WSW	854	7.03E-08	8.25E-10
S	Site Boundary	W	854	1.11E-07	1.47E-09
S	Site Boundary	WNW	793	5.36E-08	7.34E-10
S	Site Boundary	NW	762	3.46E-08	5.90E-10
S	Site Boundary	NNW	884	3.46E-08	3.88E-10
S	Site Boundary	N	884	5.25E-08	5.44E-10
S	Site Boundary	NNE	793	9.71E-08	1.30E-09
S	Site Boundary	NE	793	7.03E-08	1.05E-09
S	Site Boundary	ENE	793	6.92E-08	1.31E-09
S	Site Boundary	E	762	1.54E-07	2.49E-09
S	Site Boundary	ESE	762	2.71E-07	4.67E-09
S	Site Boundary	SE	762	3.34E-07	5.58E-09
S	Site Boundary	SSE	1006	8.73E-08	1.49E-09
S	RR-Inf-Lck-NG	S	300	2.67E-07	2.52E-09
S	RR-Inf-Lck-NG	SSW	225	2.47E-07	1.66E-09
S	RR-Inf-Lck-NG	SW	225	2.62E-07	1.80E-09
S	RR-Inf-Lck-NG	WSW	345	2.63E-07	2.43E-09
S	RR-Inf-Lck-NG	W	225	9.02E-07	8.50E-09
S	RR-Inf-Lck-NG	WNW	345	1.83E-07	1.88E-09
S	RR-Inf-Lck-NG	NW	450	6.37E-08	8.84E-10
S	RR-Inf-Lck-NG	ESE	884	2.33E-07	3.97E-09
S	RR-Inf-Lck-NG	WSW	450	1.64E-07	1.68E-09
S	RR-Inf-Lck-NG	NNE	682	1.04E-07	1.50E-09
S	Inhalation	N	948	5.16E-08	5.09E-10
S	Inhalation	NNE	825	9.61E-08	1.66E-09
S	Inhalation	NE	1057	7.21E-08	8.14E-10
S	Inhalation	ENE	985	7.74E-08	1.11E-09
S	Inhalation	E	873	1.49E-07	2.23E-09
S	Inhalation	ESE	1047	2.09E-07	3.35E-09
S	Inhalation	SE	1202	2.24E-07	3.81E-09
S	Inhalation	SSE	1647	7.04E-08	9.69E-10
S	Inhalation	S	1325	4.27E-08	5.64E-10
S	Inhalation	SSW	1543	2.68E-08	3.12E-10
S	Inhalation	SW	991	2.75E-08	3.54E-10
S	Inhalation	WSW	1158	5.60E-08	7.40E-10
S	Inhalation	W	1106	8.80E-08	1.19E-09

SITE: LIMERICK GENERATING STATION – UNITS 1 & 2
 LICENSEE: EXELON GENERATION COMPANY, LLC

Table D – 12 Annual x/Q and D/Q values for the South Stack, Limerick Generating Station, 2018

Limerick Generating Station
 x/Q and D/Q values

South Stack - Flow = 187000 cfm

Stack ID	Location	Direction	Range (m)	X/Q (s/m ³) Undepleted	D/Q (1/m ²)
S	Inhalation	WNW	1123	4.00E-08	4.87E-10
S	Inhalation	NW	1103	2.80E-08	4.55E-10
S	Inhalation	NNW	1539	4.40E-08	2.87E-10
S	Vegetation	N	1016	5.13E-08	4.81E-10
S	Vegetation	NNE	3779	1.80E-07	3.25E-10
S	Vegetation	NE	4100	1.93E-07	2.49E-10
S	Vegetation	ENE	2512	1.41E-07	4.89E-10
S	Vegetation	E	2398	1.99E-07	8.20E-10
S	Vegetation	ESE	1047	2.09E-07	3.35E-09
S	Vegetation	SE	2176	1.94E-07	1.96E-09
S	Vegetation	SSE	2107	7.56E-08	7.45E-10
S	Vegetation	S	1860	4.75E-08	4.78E-10
S	Vegetation	SSW	1747	3.08E-08	2.90E-10
S	Vegetation	SW	1926	4.55E-08	3.60E-10
S	Vegetation	WSW	1374	5.59E-08	7.50E-10
S	Vegetation	W	2708	9.44E-08	6.35E-10
S	Vegetation	WNW	3664	4.32E-08	1.87E-10
S	Vegetation	NW	2499	3.73E-08	2.09E-10
S	Vegetation	NNW	1973	4.98E-08	2.31E-10
S	Meat	N	7551	6.98E-08	8.09E-11
S	Meat	NNE	4090	2.12E-07	3.03E-10
S	Meat	NE	4890	2.37E-07	2.21E-10
S	Meat	ENE	2271	1.42E-07	5.48E-10
S	Meat	ESE	3738	2.07E-07	7.75E-10
S	Meat	SE	3323	1.47E-07	1.03E-09
S	Meat	SSE	2492	7.86E-08	6.79E-10
S	Meat	S	3722	7.92E-08	2.81E-10
S	Meat	SSW	3167	7.89E-08	2.02E-10
S	Meat	SW	7055	2.28E-07	2.24E-10
S	Meat	WSW	1413	5.63E-08	7.55E-10
S	Meat	W	4305	1.01E-07	3.85E-10
S	Meat	NNW	3677	5.14E-08	1.33E-10
S	Cow	N	7551	6.98E-08	8.09E-11
S	Cow	S	6740	1.25E-07	1.38E-10
S	Cow	SSW	3167	7.89E-08	2.02E-10
S	Cow	WSW	4321	1.25E-07	3.64E-10

SITE: LIMERICK GENERATING STATION – UNITS 1 & 2
LICENSEE: EXELON GENERATION COMPANY, LLC

(Page Intentionally Left Blank)

Attachment 2

Limerick Generating Station Units 1 and 2

Offsite Dose Calculation Manual

Revision 30

This page is intentionally left blank

Change Summary Matrix for ODCM Revision 30

Determination A – T.S. to ODCM Relocation of the Main Condenser Offgas Radiation Monitor

Item No.	TS Or ODCM Rev 29 Page	Rev 30 Page	Determination Identifier	Description of Change
1.	ODCM 6-8	6-8	A	Update of the Table of Contents Reason: Relocation of information from TS to ODCM
2.	Unit 1; 3/4 11-16 Unit 2; 3/4 11-16	50	A	Surveillance Requirements (4.11.2.6.1) Reason: Relocating from TS to ODCM
3.	Unit 1; 3/4 3-103 Unit 2; 3/4 3-103	51	A	Limiting Conditions (3.3.7.12) with Surveillance Requirements (4.3.7.12) Reason: Relocating from TS to ODCM
4.	Unit 1; 3/4 3-104 Unit 2; 3/4 3 104	52	A	Table (3.3.7.12-1) OFFGAS MONITORING INSTRUMENTATION (4a) Reason: Relocating from TS to ODCM
5.	Unit 1; 3/4 3-105 Unit 2; 3/4 3-105	53	A	TABLE NOTATIONS (**) & ACTION STATEMENT (115) for Table 3.3.7.12-1 Reason: Relocating from TS to ODCM
6.	Unit 1; 3/4 3-107 Unit 2; 3/4 3-107	54	A	TABLE (4.3.7.12-1) OFFGAS MONITORING INSTRUMENTATION SURVEILLANCE REQUIRMENTS (4a) Reason: Relocating from TS to ODCM
7.	Unit 1; 3/4 3-108 Unit 2; 3/4 3-108	55	A	TABLE NOTATIONS (**,1,2) for Table 4.3.7.12-1 Reason: Relocating from TS to ODCM
8.	Unit 1; 3/4 3-7 Unit 2; 3/4 3-7	84	A	3.3.7.12 OFFGAS MONITORING INSTRUMENTATION Reason: Relocating from TS to ODCM

This page is intentionally left blank

LIMERICK GENERATING STATION

UNITS 1 AND 2

OFFSITE DOSE CALCULATION MANUAL

Revision 30

EXELON NUCLEAR

DOCKET NOS. 50-352 AND 50-353

(This Manual cannot be changed without PORC and Plant Manager Approval)

Limerick Generating Station
Offsite Dose Calculation Manual

PURPOSE:

The OFFSITE DOSE CALCULATION MANUAL (ODCM) shall contain the methodology and parameters used in the calculation of offsite doses resulting from radioactive gaseous and liquid effluent, in the calculation of gaseous and liquid effluent monitoring alarm/trip setpoints, and in the conduct of the Radiological Environmental Monitoring Program.

SCOPE:

The ODCM shall also contain the Radioactive Effluent Controls Programs, the Meteorological Monitoring Program, the Radiological Environmental Monitoring Program required by Tech. Spec. Section 6.8.4 and the descriptions of the information that should be included in the Annual Radiological Environmental Operating and Annual Radioactive Effluent Release Reports required by Tech Spec. Sections 6.9.1.7 and 6.9.1.8, respectively.

Change Matrix

The following details the linkage between the Revision 21 of the ODCM and the current revision of the ODCM regarding the renumbering of the various sections. The purpose of this section is to permit a cross-reference from the old to new revision of the ODCM for procedures and surveillance tests. Changes to procedures to address the new numbering will occur as the procedures are revised on their normal revision process cycle.

Revision 21 – Old	Current Revision
Part I	
1.0 Definitions Table I1-1 Figure I2.2-1a Figure I2.2-1b	1.0 Definitions Table 1-1 Figure 1-1 Figure 1-2
2.0 Bases	Bases
	3.0 Applicability 3.0.1 3.0.2 3.0.3 3.0.4 4.0 Surveillance Requirement 4.0.1 4.0.2 4.0.3 4.0.4
3.1 Meteorology 3.1-1 Table I3.1-1 Table I3.1-2 Table I3.1-3 Figure I3.1-1	3.3.4 Meteorology 4.3.4 Table 3.3-3 Table 4.3-2 Figure 3.3-1
3.2.1 Radioactive Liquid Effluent Monitoring Instrumentation 3.2.1-1 Table I3.2-1 Table I3.2-2	3.1.1 Radioactive Liquid Effluent Monitoring Instrumentation 4.1.1 Table 3.1-1 Table 4.1-1
3.2.2 Concentration in Liquid Effluents 3.2.2-1 3.2.2-2 Table I3.2-3	3.2.1.1 Concentration Liquid Effluents 4.2.1.1.1 4.2.1.1.2 Table 4.2-1
3.2.3 Dose due to Liquid Effluents 3.2.3-1	3.2.1.2 Dose Liquid Effluents 4.2.1.2

Revision 21 – Old	Current Revision
Part I	
3.2.4 Liquid Radwaste Treatment System 3.2.4-1	3.2.1.3 Liquid Radwaste Treatment System 4.2.1.3.1 4.2.1.3.2
3.3.1 Radioactive Gaseous Effluent Monitoring Instrumentation 3.3.1-1 Table I3.3-1 Table I3.3-2	3.1.2 Radioactive Gaseous Effluent Monitoring Instrumentation 4.1.2 Table 3.1-2 Table 4.1-2
3.3.2 Site Boundary Dose Rate 3.3.2-1 3.3.2-2 Table I3.3-3	3.2.2.1 Dose Rate 4.2.2.1.1 4.2.2.1.2 Table 4.2-2
3.3.3 Dose – Noble Gas 3.3.3-1	3.2.2.2 Dose – Noble Gas 4.2.2.2
3.3.4 Dose – Iodine-133, tritium and radionuclides in particulate forms 3.3.4-1	3.2.2.3 Dose – Iodine-131, Iodine-133, tritium and radionuclides in particulate forms 4.2.2.3
None	3.2.2.4 Gaseous Radwaste Treatment System
3.3.5 Ventilation Exhaust Treatment System 3.3.5-1 —	3.2.2.5 Ventilation Exhaust Treatment System 4.2.2.5.1 4.2.2.5.2
3.3.6 Venting or Purging 3.3.6-1 3.3.6-2	3.2.2.7 Venting or Purging 4.2.2.7.1 4.2.2.7.2
3.3.7 Total Dose 3.3.7-1 3.3.7-2	3.2.3 Total Dose 4.2.3.1 4.2.3.2
3.3.8 Dose – Incineration of Radioactive Waste Oil 3.3.8-1 3.3.8-2	3.2.2.6 Incineration of Radioactive Waste Oil 4.2.2.6.1 4.2.2.6.2
3.4.1 Radiological Environmental Monitoring Program 3.4.1-1 Table I3.4-1 REMP Table I3.4-2 Reporting Levels Table I3.4-3 Lower Limit of Detection	3.3.1 Radiological Environmental Monitoring Program 4.3.1 Table 3.3-1 REMP Table 3.3-2 Reporting Levels Table 4.3-1 Lower Limit of Detection
3.4.2 Land Use Census 3.4.2-1	3.3.2 Land Use Census 4.3.2

Revision 21 – Old	Current Revision
Part I	
3.4.3 Interlaboratory Comparison Program 3.4.3-1	3.3.3 Interlaboratory Comparison Program 4.3.3
— 3.5 Annual Radiological Environmental Operating Report 3.6 Annual Radioactive Effluent Release Report 3.7 Major Changes to Radioactive Waste Treatment Systems	6.0 Administrative Controls 6.1 Annual Radiological Environmental Operating Report 6.2 Annual Radioactive Effluent Release Report 6.3 Major Changes to Radioactive Waste Treatment Systems
Part II	
1.4 Liquid Effluent Dose Projection	1.3.2 Liquid Effluent Dose Projection
Appendix A Technical Specification/ODCM Matrix	Deleted
Appendix B - Radiological Environmental Monitoring Program – Sample Type, Location and Analysis	Appendix A - Radiological Environmental Monitoring Program – Sample Type, Location and Analysis
Appendix C – ODCM Revision Process	Part I, Section 6.4 Changes to the ODCM

TABLE OF CONTENTS

PART I - RADIOLOGICAL EFFLUENT CONTROLS	11
1.0 DEFINITIONS	12
3.0 APPLICABILITY	18
3.1 INSTRUMENTATION	20
3.1.1 RADIOACTIVE LIQUID EFFLUENT MONITORING INSTRUMENTATION	20
3.1.2 RADIOACTIVE GASEOUS EFFLUENT MONITORING INSTRUMENTATION	25
3.2 RADIOACTIVE EFFLUENTS	31
3.2.1 LIQUID EFFLUENTS	31
3.2.1.1 CONCENTRATION	31
3.2.1.2 DOSE	35
3.2.1.3 LIQUID RADWASTE TREATMENT SYSTEM	36
3.2.2 GASEOUS EFFLUENTS	37
3.2.2.1 DOSE RATE	37
3.2.2.2 DOSE - NOBLE GASES	41
3.2.2.3 DOSE - IODINE-131, IODINE-133, TRITIUM, AND RADIONUCLIDES IN PARTICULATE FORM	42
3.2.2.4 GASEOUS RADWASTE (OFFGAS) TREATMENT SYSTEM	43
3.2.2.5 VENTILATION EXHAUST TREATMENT SYSTEM	44
3.2.2.7 MARK II CONTAINMENT	46
3.2.3 TOTAL DOSE	47
3.3 RADIOLOGICAL ENVIRONMENTAL MONITORING	48
3.3.1 MONITORING PROGRAM	48
3.3.2 LAND USE CENSUS	61
3.3.3 INTERLABORATORY COMPARISON PROGRAM	62
3.3.4 METEOROLOGICAL MONITORING INSTRUMENTATION	63
INSTRUMENTATION: OFFGAS MONITORING INSTRUMENTATION	67
RADIOACTIVE EFFLUENTS: MAIN CONDENSER	72
BASES	73
6.0 ADMINISTRATIVE CONTROLS	83
6.1 ANNUAL RADIOLOGICAL ENVIRONMENTAL OPERATING REPORT	83
6.2 ANNUAL RADIOACTIVE EFFLUENT RELEASE REPORT	84
6.3 MAJOR CHANGES TO RADIOACTIVE WASTE TREATMENT SYSTEMS	86

6.4	CHANGES TO THE ODCM	87
	PART II - CALCULATION METHODOLOGIES	88
1.0	LIQUID EFFLUENTS	89
1.1	RADIATION MONITORING INSTRUMENTATION AND CONTROLS	89
1.2	LIQUID EFFLUENT MONITOR SETPOINT DETERMINATION	90
1.2.1	Radwaste Discharge Monitor and Discharge Flow Rate	90
1.2.2	Service Water and RHR Service Water Radiation Monitor	93
1.3	LIQUID EFFLUENT DOSE CALCULATIONS - 10 CFR 50	94
1.3.1	Dose to Members of the Public	94
1.3.2	Liquid Effluent Dose Projection	97
2.0	GASEOUS EFFLUENTS	99
2.1	RADIATION MONITORING INSTRUMENTATION AND CONTROLS	99
2.2	GASEOUS EFFLUENT MONITOR SETPOINT DETERMINATION	99
2.2.1	North Vent Noble Gas Effluent Monitors	100
2.2.2	South Vent Noble Gas Effluent Monitors	102
2.2.3	Noble Gas Effluent Fractional Contribution	103
2.2.4	Noble Gas Effluent Default Setpoints	104
2.2.5	WRAM Noble Gas Effluent Monitor	106
2.3	GASEOUS EFFLUENT DOSE EVALUATIONS	108
2.3.1	Site Boundary Dose Rate - Noble Gases	108
2.3.2	Site Boundary Dose Rate - Radioiodine and Particulates	109
2.3.3	Noble Gas Air Dose	110
2.3.4	Radioiodine and Particulate Dose Calculations	111
2.3.6	Gaseous Effluent Dose Projection	117
3.0	ANNUAL DOSE EVALUATION	118
4.0	SPECIAL DOSE ANALYSIS	118
4.1	TOTAL DOSES TO MEMBERS OF THE PUBLIC	118
4.2	DOSES DUE TO ACTIVITIES INSIDE THE SITE BOUNDARY	119
5.0	RADIOLOGICAL ENVIRONMENTAL MONITORING PROGRAM	120
5.1	SAMPLING PROGRAM	120
5.2	INTERLABORATORY COMPARISON PROGRAM	120
	REFERENCES	334

LIST OF TABLES

PART I

1-1	Surveillance Frequency Notation	15
3.1-1	Radioactive Liquid Effluent Monitoring Instrumentation	21
4.1-1	Radioactive Liquid Effluent Monitoring Instrumentation Surveillance Requirements	23
3.1-2	Radioactive Gaseous Effluent Monitoring Instrumentation	26
4.1-2	Radioactive Gaseous Effluent Monitoring Instrumentation Surveillance Requirements	29
4.2-1	Radioactive Liquid Waste Sampling and Analysis Program	32
4.2-2	Radioactive Gaseous Waste Sampling and Analysis Program	38
3.3-1	Radiological Environmental Monitoring Program	50
3.3-2	Reporting Levels for Radioactivity Concentrations In Environmental Samples	57
4.3-1	Detection Capabilities For Environmental Sample Analysis	58
3.3-3	Meteorological Monitoring Instrumentation	64
4.3-2	Meteorological Monitoring Instrumentation Surveillance Requirements	65

PART II

II1-1	Decay Constants For Nuclides Of Interest	122
II1-2	Bioaccumulation Factors For Freshwater Fish	126
II1-3	Ingestion Dose Factors for Adult (D_{aipj})	127
II1-4	Ingestion Dose Factors for Teen (D_{aipj})	131
II1-5	Ingestion Dose Factors for Child (D_{aipj})	135
II1-6	Ingestion Dose Factors for Infant (D_{aipj})	139
II1-7	Dose Factors for Standing on Contaminated Ground (D_{aipj})	143
II1-8	Aquatic Pathway Usage Factors (U_{ap})	147
II1-9	Adult Drinking Water A_{iT} Factors	148
II1-10	Adult Freshwater Fish A_{iT} Factors	152
II1-11	Adult Shoreline A_{iT} Factors	156
II1-12	Teen Drinking Water A_{iT} Factors	160
II1-13	Teen Freshwater Fish A_{iT} Factors	164
II1-14	Teen Shoreline A_{iT} Factors	168
II1-15	Child Drinking Water A_{iT} Factors	172
II1-16	Child Freshwater Fish A_{iT} Factors	176
II1-17	Child Shoreline A_{iT} Factors	180
II1-18	Infant Drinking Water A_{iT} Factors	184

II1-19	Infant Freshwater Fish A _{ir} Factors	188
II1-20	Infant Shoreline A _{ir} Factors	192
II1-21	Assumptions Used In Limerick Liquid Effluent Dose Evaluations	196
II2-1	Dose Factors for Noble Gases	197
II2-2	R _i Dose Factors Age: Adult Pathway: Inhalation	198
II2-3	R _i Dose Factors Age: Teen Pathway: Inhalation	202
II2-4	R _i Dose Factors Age: Child Pathway: Inhalation	206
II2-5	R _i Dose Factors Age: Infant Pathway: Inhalation	210
II2-6	R _i Dose Factors Age: Adult Pathway: Ground	214
II2-7	R _i Dose Factors Age: Teen Pathway: Ground	218
II2-8	R _i Dose Factors Age: Child Pathway: Ground	222
II2-9	R _i Dose Factors Age: Infant Pathway: Ground	226
II2-10	R _i Dose Factors Age: Adult Pathway: Vegetation	230
II2-11	R _i Dose Factors Age: Teen Pathway: Vegetation	234
II2-12	R _i Dose Factors Age: Child Pathway: Vegetation	238
II2-13	R _i Dose Factors Age: Infant Pathway: Vegetation	242
II2-14	R _i Dose Factors Age: Adult Pathway: Meat	246
II2-15	R _i Dose Factors Age: Teen Pathway: Meat	250
II2-16	R _i Dose Factors Age: Child Pathway: Meat	254
II2-17	R _i Dose Factors Age: Infant Pathway: Meat	258
II2-18	R _i Dose Factors Age: Adult Pathway: Cow Milk	262
II2-19	R _i Dose Factors Age: Teen Pathway: Cow Milk	266
II2-20	R _i Dose Factors Age: Child Pathway: Cow Milk	270
II2-21	R _i Dose Factors Age: Infant Pathway: Cow Milk	274
II2-22	R _i Dose Factors Age: Adult Pathway: Goat Milk	278
II2-23	R _i Dose Factors Age: Teen Pathway: Goat Milk	282
II2-24	R _i Dose Factors Age: Child Pathway: Goat Milk	286
II2-25	R _i Dose Factors Age: Infant Pathway: Goat Milk	290
II2-26	Stable Element Transfer Data	294
II2-27	Inhalation Dose Factors For Adult (D _{aijp})	298

II2-28	Inhalation Dose Factors For Teenager (D_{aipj})	302
II2-29	Inhalation Dose Factors For Child (D_{aipj})	306
II2-30	Inhalation Dose Factors For Infant (D_{aipj})	310
II2-31	Assumptions Used In Limerick Gaseous Effluent R_i Evaluation	314
II2-32	Nearest Gaseous Effluent Dose Receptor Distances	316
A-1	ODCM – Limerick Generating Station Radiological Environmental Monitoring Program	328

LIST OF FIGURES

PART I

1-1	Map Detailing the Restricted Area Boundary for Radioactive Gaseous And Liquid Effluents	16
1-2	Map Detailing Low Population Areas for Radioactive Gaseous and Liquid Effluents	17
3.3-1	Meteorological Tower Locations	66

PART II

II1.3.1-1	LGS Dilution Vs River Flow (Station Outfall)	318
II1.3.1-2	LGS Dilution Vs River Flow (Pennsylvania American Water Company)	319
II1.3.1-3	LGS Dilution Vs River Flow (Phoenixville)	320
II1.3.1-4	LGS Dilution Vs River Flow (Aqua America)	321
II1.3.1-5	LGS Dilution Vs River Flow (Crew Course)	322
II1-1	Liquid Effluent Flow Diagram	323
II2-1	Gaseous Effluent Flow Diagram - North Stack	324
II2-2	Gaseous Effluent Flow Diagram - South Stack	325
II2-3	Gaseous Effluent Flow Diagram - Hot Maintenance Shop	326
A-1	Environmental Sampling Location on Site or Near the Limerick Generating Station	331
A-2	Environmental Sampling Locations at Distances Less Than Five Miles from the Limerick Generating Station	332
A-3	Environmental Sampling Locations at Distances Greater Than Five Miles from the Limerick Generating Station	333

PART I

RADIOLOGICAL EFFLUENT CONTROLS

1.0 DEFINITIONS

The following terms are taken from LGS Unit 1/Unit 2 Tech Specs, unless otherwise noted:

1.1 ACTION

ACTION shall be that part of a specification, which prescribes remedial measures, required under designated conditions.

1.2 CHANNEL CALIBRATION

A CHANNEL CALIBRATION shall be the adjustment, as necessary, of the channel output such that it responds with the necessary range and accuracy to known values of the parameter which the channel monitors. The CHANNEL CALIBRATION shall encompass the entire channel including the sensor and alarm and/or trip functions, and shall include the CHANNEL FUNCTION TEST. The CHANNEL CALIBRATION may be performed by any series of sequential, overlapping or total channel steps such that the entire channel is calibrated.

1.3 CHANNEL CHECK

A CHANNEL CHECK shall be the qualitative assessment of channel behavior during operation by observation. This determination shall include, where possible, comparison of the channel indication and/or status with other indications and/or status derived from independent instrument channels measuring the same parameter.

1.4 CHANNEL FUNCTIONAL TEST

A CHANNEL FUNCTIONAL TEST shall be:

- a. Analog channels - the injection of a simulated signal into the channel as close to the sensor as practicable to verify OPERABILITY including alarm and/or trip functions and channel failure trips.
- b. Bistable channels - the injection of a simulated signal into the sensor to verify OPERABILITY including alarm and/or trip functions.

The CHANNEL FUNCTIONAL TEST may be performed by any series of sequential, overlapping or total channel steps such that the entire channel is tested.

1.0 DEFINITIONS

1.5 CONTROLLED AREA

CONTROLLED AREA means an area, outside of a restricted area but inside the site boundary, access to which can be limited by the licensee for any reason. The CONTROLLED AREA equals the RESTRICTED AREA. By definition Limerick does not have a CONTROLLED AREA.

1.6 DOSE EQUIVALENT I-131

DOSE EQUIVALENT I-131 shall be that concentration of I-131, microcuries per gram, which alone would produce the same inhalation committed effective dose equivalent (CEDE) as the quantity and isotopic mixture of I-131, I-132, I-133, I-134, and I-135 actually present. The inhalation committed effective dose equivalent (CEDE) conversion factors used for this calculation shall be those listed in Table 2.1 of Federal Guidance Report 11, Limiting Values of Radionuclide Intake and Air Concentration and Dose Conversion Factors for Inhalation, Submersion, and Ingestion," ORNL, 1989, as described in Regulatory Guide 1.183. The factors in the column headed "effective" yield doses corresponding to the CEDE.

1.7 FREQUENCY NOTATION

The FREQUENCY NOTATION specified for the performance of Surveillance Requirements shall correspond to the intervals defined in Table 1-1.

1.8 MEMBER(S) OF THE PUBLIC

MEMBER(S) OF THE PUBLIC means any individual except when that individual is receiving an occupational dose.

1.9 OPERABLE - OPERABILITY

A system, subsystem, train, component or device shall be OPERABLE or have OPERABILITY when it is capable of performing its specified function(s) and when all necessary attendant instrumentation, controls, electrical power, cooling or seal water, lubrication or other auxiliary equipment that are required for the system, subsystem, train, component or device to perform its function(s) are also capable of performing their related support function(s).

1.10 OPERATIONAL CONDITION - CONDITION

An OPERATIONAL CONDITION, i.e., CONDITION, shall be any one inclusive combination of mode switch position and average reactor coolant temperature as defined in the Technical Specifications.

1.0 DEFINITIONS

1.11 PURGE - PURGING

PURGE or PURGING shall be the controlled process of discharging air or gas from a confinement to maintain temperature, pressure, humidity, concentration or other operating condition, in such a manner that replacement air or gas is required to purify the confinement.

1.12 RATED THERMAL POWER

See current LGS Tech Spec definition.

1.13 REPORTABLE EVENT

A REPORTABLE EVENT shall be any of those conditions specified in Section 50.73 of 10 CFR Part 50 or 10 CFR 72.75.

1.14 RESTRICTED AREA

The RESTRICTED AREA means an area, access to which is limited by the licensee for the purpose of protecting individuals against undue risks from exposure to radiation and radioactive materials (Figure 1-1). Per UFSAR 2.1.1.3 the RESTRICTED AREA extends to the SITE BOUNDARY.

1.15 SITE BOUNDARY

The SITE BOUNDARY shall be that line beyond which the land or property is not owned, leased, or otherwise controlled by the licensee (Figure 1-1).

1.16 SOURCE CHECK

A SOURCE CHECK shall be the qualitative assessment of channel response when the channel sensor is exposed to a radioactive source.

1.17 THERMAL POWER

THERMAL POWER shall be the total reactor core heat transfer rate to the reactor coolant.

1.18 UNRESTRICTED AREA

UNRESTRICTED AREA means an area, access to which is neither limited nor controlled by the licensee.

1.19 VENTILATION EXHAUST TREATMENT SYSTEM

A VENTILATION EXHAUST TREATMENT SYSTEM shall be any system designed and installed to reduce gaseous radioiodine or radioactive material in particulate form in effluents by passing ventilation or vent exhaust gases through charcoal absorbers and/or HEPA filters for the purpose of removing iodines or particulates from the gaseous exhaust stream prior to the release to the environment (such a system is not considered to have any effect on noble gas effluents). Engineered Safety Feature (ESF) atmospheric cleanup systems are

1.0 DEFINITIONS

not considered to be VENTILATION EXHAUST TREATMENT SYSTEM components.

1.20 VENTING

VENTING shall be the controlled process of discharging air or gas from a confinement to maintain temperature, pressure, humidity, concentration or other operating condition, in such a manner that replacement air or gas is not provided or required during VENTING. Vent, used in system names, does not imply a VENTING process.

TABLE 1-1SURVEILLANCE FREQUENCY NOTATION

<u>NOTATION</u>	<u>FREQUENCY</u>
S (Shift)	At least once per 12 hours.
D (Daily)	At least once per 24 hours.
W (Weekly)	At least once per 7 days.
M (Monthly)	At least once per 31 days.
Q (Quarterly)	At least once per 92 days.
SA (Semi-annual)	At least once per 184 days.
A (Annual)	At least once per 366 days.
E	At least once per 18 months (550 days).
R	At least once per 24 months (731 days).
S/U	Prior to each reactor startup.
P	Prior to each radioactive release.
N.A.	Not applicable

1.0 DEFINITIONS

FIGURE 1-1

MAP DETAILING THE RESTRICTED AREA BOUNDARY FOR RADIOACTIVE GASEOUS AND LIQUID EFFLUENTS

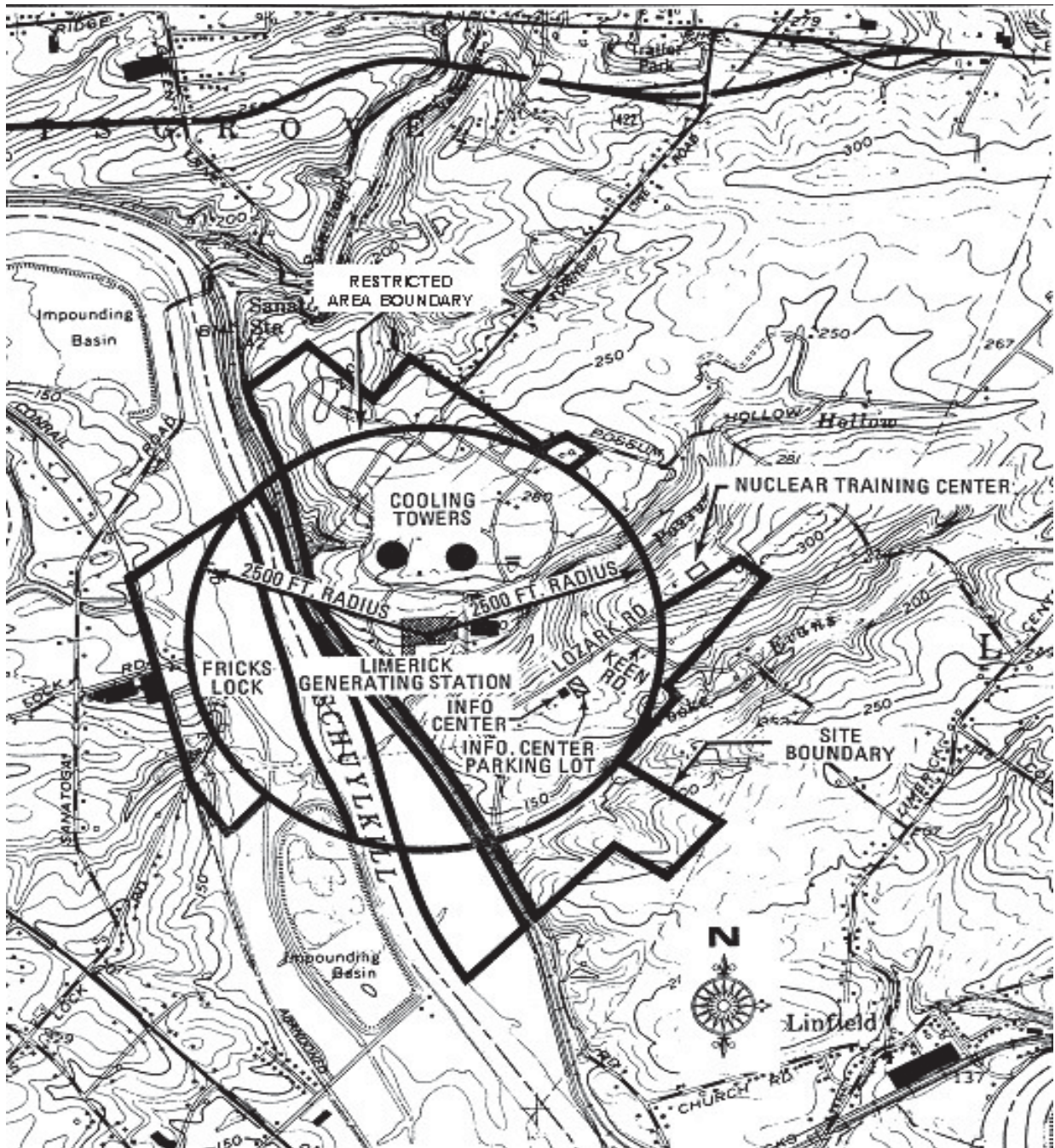

1.0 DEFINITIONS

FIGURE 1-2

MAP DETAILING LOW POPULATION AREAS FOR RADIOACTIVE GASEOUS AND LIQUID EFFLUENTS

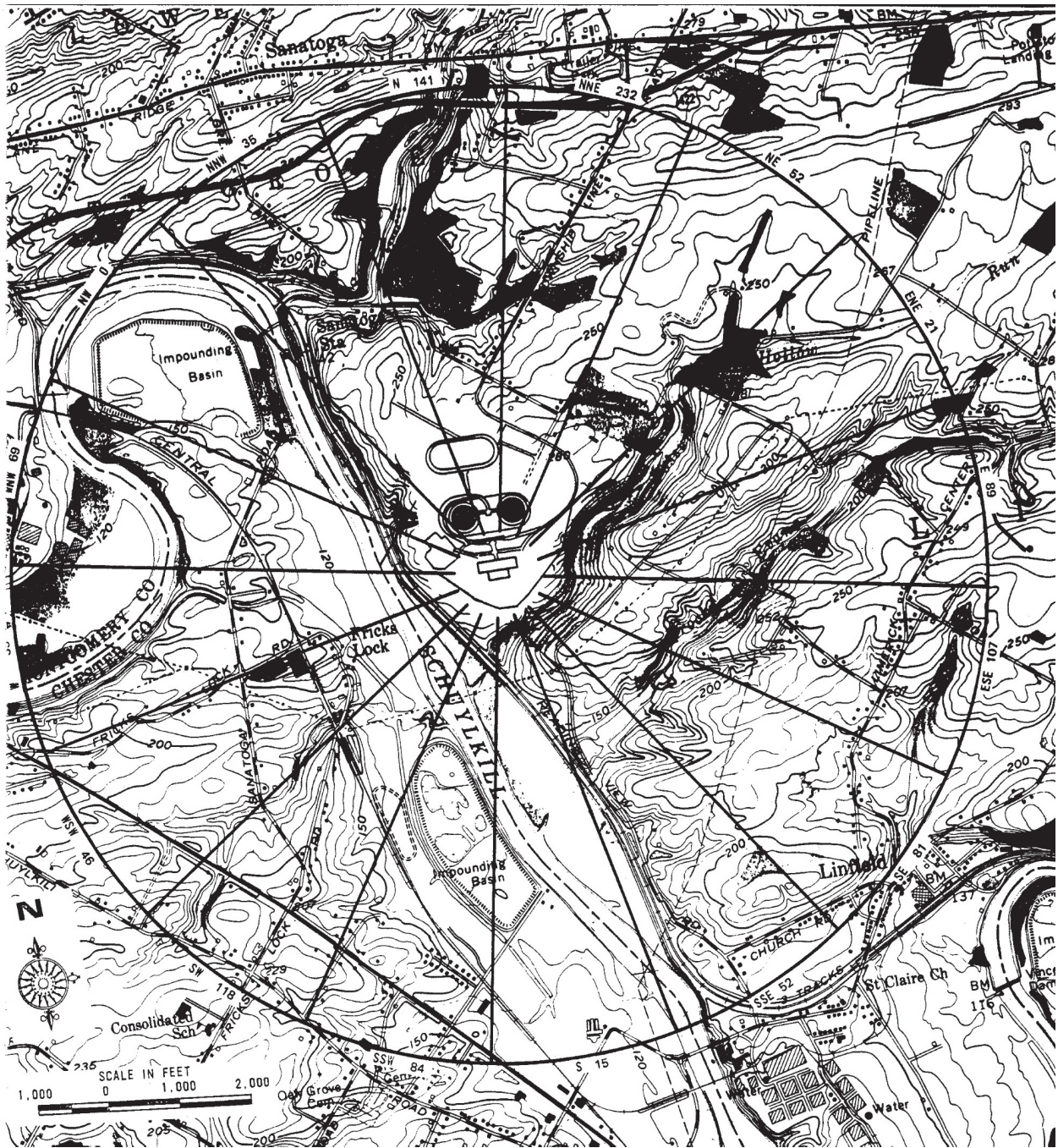

3/4 CONTROLS AND SURVEILLANCE REQUIREMENTS

3/4.0 APPLICABILITY

CONTROLS

- 3.0.1 Compliance with the Controls contained in the succeeding controls is required during the OPERATIONAL CONDITIONS or other conditions specified therein; except that upon failure to meet the Control, the associated ACTION requirements shall be met.
- 3.0.2 Noncompliance with a Control shall exist when the requirements of the Control and associated ACTION requirements are not met within the specified time intervals. If the Control is restored prior to expiration of the specified time intervals, completion of the ACTION requirements is not required.
- 3.0.3 When a Control is not met, except as provide in the associated ACTION requirements, within 1 hour action shall be initiated to place the unit in an
- At least STARTUP within the next 6 hours
 - At least HOT SHUTDOWN within the following 6 hours, and
 - At least COLD SHUTDOWN within the subsequent 24 hours.
- Where corrective measures are completed that permit operation under the ACTION requirements, the ACTION may be taken in accordance with the specified time limits as measured from the time of failure to meet the Control. Exceptions to these requirements are stated in the individual controls.
- This control is not applicable in OPERATIONAL CONDITIONS 4 or 5.
- 3.0.4 When a Limiting Condition for Operation is not met, entry into an OPERATIONAL CONDITION or other specified condition in the Applicability shall only be made:
- When the associated ACTION requirements to be entered permit continued operation in the OPERATIONAL CONDITION or other specified condition in the Applicability for an unlimited period of time; or
 - After performance of a risk assessment addressing inoperable systems and components, consideration of the results, determination of the acceptability of entering the OPERATIONAL CONDITION or other specified condition in the Applicability, and establishment of risk management actions, if appropriate; exceptions to this Control are stated in the individual Controls; or
 - When an allowance is stated in the individual value, parameter, or other Control.

3/4 CONTROLS AND SURVEILLANCE REQUIREMENTS

3/4.0 APPLICABILITY

SURVEILLANCE REQUIREMENTS

- 4.0.1 Surveillance Requirements shall be met during the OPERATIONAL CONDITIONS or other specified conditions in the Applicability for individual Controls, unless otherwise stated in the Surveillance Requirement. Failure to meet a Surveillance, whether such failure is experienced during the performance of the Surveillance or between performances of the Surveillance, shall be failure to meet the Control. Failure to perform a Surveillance within the specified Surveillance time interval and allowed extension per Surveillance Requirement 4.0.2, shall be failure to meet the Control except as provided in Surveillance Requirement 4.0.3. Surveillances do not have to be performed on inoperable equipment or variables outside specified limits.
- 4.0.2 Each Surveillance Requirement shall be performed within the specified surveillance time interval with a maximum allowable extension not to exceed 25% of the surveillance interval.
- 4.0.3 If it is discovered that a Surveillance was not performed within its specified Surveillance time interval and allowed extension per Surveillance Requirement 4.0.2, then compliance with the requirement to declare the Control not met may be delayed, from the time of discovery, up to 24 hours or up to the limit of the specified Surveillance time interval, whichever is greater. This delay period is permitted to allow performance of the Surveillance. A risk evaluation shall be performed for any Surveillance delayed greater than 24 hours and the risk impact shall be managed.
- If the Surveillance is not performed within the delay period, the Control must immediately be declared not met, and the applicable ACTION requirements must be entered.
- When the Surveillance is performed within the delay period and the Surveillance is not met, the Control must immediately be declared not met, and the applicable ACTION requirements must be entered.
- 4.0.4 Entry into an OPERATIONAL CONDITION or other specified condition in the Applicability of a Control shall only be made when the Control's Surveillance Requirements have been met within their Surveillance time interval, except as provided in Surveillance Requirement 4.0.3. When a Control is not met due to its Surveillance Requirements not having been met, entry into an OPERATIONAL CONDITION or other specified condition in the Applicability shall only be made in accordance with Control 3.0.4.

3/4.1 INSTRUMENTATION

3/4.1.1 RADIOACTIVE LIQUID EFFLUENT MONITORING INSTRUMENTATION CONTROLS

3.1.1 The radioactive liquid effluent monitoring instrumentation channels shown in Table 3.1-1 shall be OPERABLE with their Alarm/Trip Setpoints set to ensure that the limits of Control 3.2.1.1 are not exceeded. The Alarm/Trip Setpoints* of these channels shall be determined and adjusted in accordance with the methodology and parameters in ODCM Part II, Section 1.2.

APPLICABILITY: As shown in Table 3.1-1

ACTION:

- a. With a radioactive liquid effluent monitoring instrumentation channel Alarm/Trip Setpoint less conservative than required by the above control, immediately suspend the release of radioactive liquid effluents monitored by the affected channel, or declare the channel inoperable, or change the setpoint so it is acceptably conservative.
- b. With less than the minimum number of radioactive liquid effluent monitoring instrumentation channels OPERABLE, take the ACTION shown in Table 3.1-1. Restore the inoperable instrumentation to OPERABLE status within 30 days and, if unsuccessful explain in the next Annual Radioactive Effluent Release Report pursuant to CONTROL 6.2 why this inoperability was not corrected in a timely manner.
- c. The provisions of Controls 3.0.3 and 3.0.4 are not applicable. Report all deviations in the Annual Radioactive Effluent Release Report.

SURVEILLANCE REQUIREMENTS

4.1.1 Each radioactive liquid effluent monitoring instrumentation channel shall be demonstrated OPERABLE by performance of the CHANNEL CHECK, SOURCE CHECK, CHANNEL CALIBRATION and CHANNEL FUNCTIONAL TEST operations at the frequencies shown in Table 4.1-1.

* Excluding the flow rate measuring devices which are not determined and adjusted in accordance with the ODCM.

TABLE 3.1-1RADIOACTIVE LIQUID EFFLUENT MONITORING INSTRUMENTATION

INSTRUMENT	MINIMUM CHANNELS OPERABLE	APPLICABILITY	ACTION
1. Gross Radioactivity Monitors Providing Automatic Termination of Release			
a. Liquid Radwaste Effluent Line	1	***	100
b. A/B RHR Service Water Effluent Line *	1/loop	**	101
2. Gross Radioactivity Monitors Not Providing Automatic Termination of Release			
a. Service Water Effluent Line	1	**	101
3. Flow Rate Measurement Devices			
a. Liquid Radwaste Effluent Line	1	***	102
b. Discharge Line	1	***	102

* Termination of the release is accomplished by auto trip of the RHRSW pumps and remote manual closure of isolation valves.

** While system pumps are in operation.

*** During a liquid effluent release.

TABLE 3.1-1 (Continued)ACTION STATEMENTS

- Action 100 - With the number of channels OPERABLE less than required by the Minimum Channels requirement, effluent releases via this pathway may continue provided that prior to initiating a release:
- At least two independent samples are analyzed in accordance with SURVEILLANCE REQUIREMENT 4.2.1.1.1, and
 - At least two technically qualified members of the facility staff independently verify the release rate calculations and discharge line valving.
- Otherwise, suspend release of radioactive effluents via this pathway.
- Action 101 - With the number of channels OPERABLE less than required by the Minimum Channels OPERABLE requirement, effluent releases via this pathway may continue provided that, at least once per 12 hours, grab samples are collected and analyzed for radioactivity at a lower limit of detection (LLD) of no more than $1E-7$ uCi/ml.
- If the A or B RHRSW Process Rad Monitor should become inoperable, sampling is required at least once every twelve (12) hours at a sample point common with the inoperable A and/or B RHRSW Process Rad Monitor(s). If a monitor is inoperable but will still continuously sample and annunciate on high activity, i.e. rad monitor bypass switch placed in "Bypass", Chemistry sampling is not required as the continuous monitor sampling complies with the periodic sampling requirement.
- Action 102 - With the number of channels OPERABLE less than required by the Minimum Channels requirement, effluent releases via this pathway may continue provided the flow rate is estimated at least once per 4 hours during actual releases. Pump performance curves generated in place may be used to estimate flow.

TABLE 4.1-1

RADIOACTIVE LIQUID EFFLUENT MONITORING INSTRUMENTATION SURVEILLANCE REQUIREMENTS

INSTRUMENT		CHANNEL CHECK	SOURCE CHECK	CHANNEL CALIBRATION	CHANNEL FUNCTIONAL TEST
1.	Gross Radioactivity Monitors Providing Automatic Termination of Release				
	a. Liquid Radwaste Effluent Line	D*	D*	R(3)	Q(1)
	b. RHR Service Water System Effluent Line	D	M	R(3)	Q(1)
2.	Gross Radioactivity Monitored Not Providing Automatic Termination of Release				
	a. Service Water System Effluent Line	D	M	R(3)	Q(2)
3.	Flow Rate Measurement Devices				
	a. Liquid Radwaste Effluent Line	D(4)	N.A.	R	Q
	b. Discharge Line	D(4)	N.A.	R	Q

* Daily when in use

TABLE 4.1-1 (Continued)TABLE NOTATIONS

- (1) The CHANNEL FUNCTIONAL TEST shall also demonstrate that automatic isolation of this pathway and control room alarm annunciation will occur if any of the following conditions exists:
 1. Instrument indicates measured levels above the alarm/trip setpoint.
 2. Circuit failure.
 3. Instrument indicates a downscale failure.

- (2) The CHANNEL FUNCTIONAL TEST shall also demonstrate that control room alarm annunciation occurs if any of the following conditions exists:
 1. Instrument indicates measured levels above the alarm setpoint.
 2. Circuit failure.
 3. Instrument indicates a downscale failure.

- (3) The initial CHANNEL CALIBRATION shall be performed using reference standards certified by the National Institute of Standards and Technology (NIST) obtained from suppliers that participate in measurement assurance activities with NIST. These standards shall permit calibrating the system over its intended range of energy and measurements range. For subsequent CHANNEL CALIBRATION, sources that have been related to the initial calibration shall be used.

- (4) CHANNEL CHECK shall consist of verifying indication of flow during periods of release. CHANNEL CHECK shall be made at least once per 24 hours on days on which batch releases are made.

3/4.1 INSTRUMENTATION

3/4.1.2 RADIOACTIVE GASEOUS EFFLUENT MONITORING INSTRUMENTATION CONTROLS

3.1.2 The radioactive gaseous effluents monitoring instrumentation channels in Table 3.1-2 shall be OPERABLE with their Alarm/Trip Setpoints set to ensure that the limits of Control 3.2.2.1 are not exceeded. The alarm/trip setpoints of the applicable channels shall be determined in accordance with the methodology and parameters in ODCM Part II, Section 2.2.

APPLICABILITY: As shown in Table 3.1-2.

ACTION:

- a. With a radioactive gaseous effluent monitoring instrumentation channel Alarm/Trip Setpoints less conservative than required by the above control, immediately suspend the release of radioactive gaseous effluents monitored by the affected channel, or declare the channel inoperable, or change the setpoint so it is acceptably conservative.
- b. With less than the minimum number of radioactive gaseous effluent monitoring instrumentation channels OPERABLE, take the ACTION shown in Table 3.1-2. Restore the inoperable instrumentation to OPERABLE status within 30 days and, if unsuccessful, explain in the next Annual Radioactive Effluent Release Report pursuant to Control 6.2 why this inoperability was not corrected in a timely manner.
- c. The provisions of Controls 3.0.3 and 3.0.4 are not applicable. Report all deviations in the Annual Radioactive Effluent Release Report.

SURVEILLANCE REQUIREMENTS

4.1.2 Each radioactive gaseous effluent monitoring instrumentation channel shall be demonstrated OPERABLE by performance of the CHANNEL CHECK, SOURCE CHECK, CHANNEL CALIBRATION AND CHANNEL FUNCTIONAL TEST operations at the frequencies shown in Table 4.1-2.

TABLE 3.1-2

RADIOACTIVE GASEOUS EFFLUENT MONITORING INSTRUMENTATION

INSTRUMENT	MINIMUM CHANNELS OPERABLE	APPLICABILITY	ACTION
1. SOUTH STACK EFFLUENT MONITORING SYSTEM			
a. Noble Gas Activity Monitor	1	*	111
b. Iodine Sampler	1	*	112
c. Particulate Sampler	1	*	112
d. Effluent System Flow Rate Monitor	1	*	113
e. Sampler Flow Rate Monitor	1	*	116
2. NORTH STACK EFFLUENT MONITORING SYSTEM +			
a. Noble Gas Activity Monitor	1	*	114
b. Iodine Sampler	1	*	112
c. Particulate Sampler	1	*	112
d. Effluent System Flow Rate Monitor	1	*	113
e. Sampler Flow Rate Monitor	1	*	116
3. HOT MAINTENANCE SHOP VENTILATION EXHAUST RADIATION MONITOR			
a. Iodine Sampler	1	**	115
b. Particulate Sampler	1	**	115
c. Effluent System Flow Rate Monitor	1	**	113
d. Sampler Flow Rate Monitor	1	**	116

TABLE NOTATIONS

- + The (A or B) North Stack Normal Range Radiation Monitors OR the Wide Range Accident Monitor (Low Range) may be used to satisfy requirements for the North Stack Effluent Monitoring System.
- * At all times.
- ** During operation of the hot maintenance shop ventilation system.

TABLE 3.1-2 (Continued)
TABLE NOTATIONS
ACTION STATEMENTS

ACTION 111 – (SS Noble Gas)	<p>With the number of channels OPERABLE less than required by the Minimum Channels OPERABLE requirement, effluent releases via this pathway may continue provided grab samples are taken at least once per 12 hours and these samples are analyzed for radioactivity within 24 hours.</p> <p><u>IF</u> monitor readings are available from local computer output, <u>THEN</u> GRAB SAMPLES ARE NOT REQUIRED. Obtain monitor readings at least once per 12 hours.</p>
ACTION 112 – (NS and SS Iodine & Part.)	<p>With the number of channels OPERABLE less than required by the Minimum Channels OPERABLE requirement, effluent releases via the affected pathway may continue provided samples are continuously collected with auxiliary sampling equipment as required in Table 4.2-2.</p> <p><u>IF</u> replacing particulate and iodine filter media for weekly analysis as required by Table 4.2-2, <u>THEN</u> auxiliary sampling equipment is not required if the interruption of sample collection will not exceed one (1) hour.</p>
ACTION 113 – (Effluent Flow Rate)	<p>With the number of channels OPERABLE less than required by the Minimum Channels OPERABLE requirement, effluent releases via NS, SS or HMS may continue provided the Effluent System flow rate is estimated by adding the nominal flow rates indicated in P&ID M-26 for each in-service fan. This shall be documented in the MCR operations Shift Log at least once per 4 hours.</p>
ACTION 114 – (NS Noble Gas)	<p>With the number of channels OPERABLE less than required by the Minimum Channels OPERABLE requirement, effluent releases via this pathway may continue provided grab samples are taken at least once per 12 hours and these samples are analyzed for radioactivity within 24 hours. The Mechanical Vacuum Pumps may not be operated while in this action statement.</p> <p><u>IF</u> monitor readings are available from local computer output, <u>THEN</u> GRAB SAMPLES ARE NOT REQUIRED. Obtain monitor readings at least once per 12 hours.</p>

ACTION 115 –
(HMS)

With the number of channels OPERABLE less than required by the Minimum Channels OPERABLE requirement, then secure Hot Maintenance Shop Ventilation.

IF replacing particulate and iodine filter media for weekly analysis as required by Table 4.2-2,

THEN Hot Maintenance Shop Ventilation may remain in service if the interruption of sample collection will **not** exceed one (1) hour.

ACTION 116 –
(Sample Flow Rate)

With the number of channels OPERABLE less than required by the Minimum Channels OPERABLE requirement, the sample pump shall be documented in service by recording the air pump local flow indicator value in the MCR operations Shift Log at least once per 8 hours.

TABLE 4.1-2

RADIOACTIVE GASEOUS EFFLUENT MONITORING INSTRUMENTATION SURVEILLANCE REQUIREMENTS

INSTRUMENT	CHANNEL CHECK	SOURCE CHECK	CHANNEL CALIBR.	CHANNEL FUNCT. TEST	MODES IN WHICH SURVEILLANCE IS REQUIRED
1. SOUTH STACK EFFLUENT MONITORING SYSTEM					
a. Noble Gas Activity Monitor	D	M	R(2)	Q(1)	*
b. Iodine Sampler	W(3)	N.A.	N.A.	N.A.	*
c. Particulate Sampler	W(3)	N.A.	N.A.	N.A.	*
d. Effluent System Flow Rate Monitor	D	N.A.	R	Q	*
e. Sampler Flow Rate Monitor	D	N.A.	R	Q	*
2. NORTH STACK EFFLUENT MONITORING SYSTEM +					
a. Noble Gas Activity Monitor	D	M	R(2)	Q(1)	*
b. Iodine Sampler	W(3)	N.A.	N.A.	N.A.	*
c. Particulate Sampler	W(3)	N.A.	N.A.	N.A.	*
d. Effluent System Flow Rate Monitor	D	N.A.	R	Q	*
e. Sampler Flow Rate Monitor	D	N.A.	R	Q	*
3. HOT MAINTENANCE SHOP VENTILATION EXHAUST RADIATION MONITOR					
a. Iodine Sampler	W(3)	N.A.	N.A.	N.A.	**
b. Particulate Sampler	W(3)	N.A.	N.A.	N.A.	**
c. Effluent System Flow Rate Monitor	D	N.A.	R	Q	**
d. Sampler Flow Rate Monitor	D	N.A.	R	Q	**

TABLE NOTATIONS

- + The (A or B) Wide Range Accident Monitor (WRAM) surveillance is specified in Technical Specification 3.3.7.5.
 * At all times.
 ** During operation of the hot maintenance shop ventilation exhaust system.

TABLE 4.1-2 (Continued)TABLE NOTATIONS

- (1) The CHANNEL FUNCTIONAL TEST shall also demonstrate that control room alarm annunciation occurs if any of the following conditions exists:
 1. Instruments indicate measured levels above the alarm/trip setpoint.
 2. Circuit failure.
 3. Instrument indicates a downscale failure.
 4. Instrument controls not set in operate mode.
- (2) The initial CHANNEL CALIBRATION shall be performed using one or more of the reference standards certified by the National Institute of Standards and Testing (NIST) or using standards that have been obtained from suppliers that participate in measurement assurance activities with NIST. These standards shall permit calibrating the system over its intended range of energy and measurement range. For subsequent CHANNEL CALIBRATION, sources that are traceable to the initial calibration shall be used.
- (3) The iodine cartridges and particulate filters will be changed and analyzed at least once per 7 days.

3/4.2 RADIOACTIVE EFFLUENTS

3/4.2.1 LIQUID EFFLUENTS

3/4.2.1.1 CONCENTRATION

CONTROLS

- 3.2.1.1 The concentration of radioactive material released in liquid effluents to UNRESTRICTED AREAS (see Figures 1-1 and 1-2) shall be limited to 10 times the effluent concentration limits (ECL) specified in 10 CFR Part 20, Appendix B, Table 2, Column 2 for radionuclides other than dissolved or entrained noble gases. For dissolved or entrained noble gases, the concentration shall be limited to 2E-4 microcuries/ml total activity (NUREG 0133, Section 2).

APPLICABILITY: At all times.

ACTION:

- a. With the concentration of radioactive material released in liquid effluents to UNRESTRICTED AREAS exceeding the above limits, immediately restore the concentration to within the above limits or terminate the release.
- b. The provisions of Controls 3.0.3 and 3.0.4 are not applicable.

SURVEILLANCE REQUIREMENTS

- 4.2.1.1.1 Radioactive liquid wastes shall be sampled and analyzed according to the sampling and analysis program of Table 4.2-1.
- 4.2.1.1.2 The results of the radioactivity analyses shall be used in accordance with the methodology and parameters in ODCM Part II, Section 1.2 to assure that the concentrations at the point of release are maintained within the limits of Control 3.2.1.1.

TABLE 4.2-1

RADIOACTIVE LIQUID WASTE SAMPLING AND ANALYSIS PROGRAM

Liquid Release Type	Sampling Frequency	Minimum Analysis Frequency	Type of Activity Analysis	Lower Limit of Detection (LLD) ^a (uCi/ml)
A. Batch Waste Release Tanks ^b	P Each Batch	P Each Batch	Principal Gamma Emitters ^c	5E-7
1. Floor Drain Sample Tank			I-131	1E-6
2. Equip. Drain Sample Tanks			Dissolved and Entrained Gases (Gamma Emitters) ^c	1E-5
3. Laundry Drain Sample Tank		M Composite ^d	H-3 Gross Alpha	1E-5 1E-7
		Q Composite ^d	Sr-89, Sr-90 Fe-55	5E-8 1E-6
B. Continuous Release ^e	W Grab Sample	W	Principal Gamma Emitters ^c	5E-7
1. RHR Service Water System Effluent Line ^f			I-131	1E-6
			Dissolved and Entrained Gases (Gamma Emitters) ^c	1E-5
2. Service Water System Effluent Line ^f		M Composite ^d	H-3 Gross Alpha	1E-5 1E-7
		Q Composite ^d	Sr-89, Sr-90 Fe-55	5E-8 1E-6

TABLE 4.2-1 (Continued)TABLE NOTATIONS

- a. The LLD is defined as the smallest concentration of radioactive material in a sample that will yield a net count, above system background, that will be detected with 95% probability with only 5% probability of falsely concluding that a blank observation represents a "real" signal.

For a measurement system, which may include radiochemical separation:

$$\text{LLD (Composite)} = \frac{(2.71 + 4.66\sigma_B) (\lambda\Delta t_2)}{E \cdot V \cdot 2.22E6 \cdot Y \cdot [\exp(-\lambda\Delta t_1)] (1-\exp(-\lambda\Delta t_2))}$$

$$\text{LLD (Grab Samples)} = \frac{(2.71 + 4.66 \sigma_B)}{E \cdot V \cdot 2.22E6 \cdot Y (\exp - \lambda\Delta t_1)}$$

Where:

- 2.71 is a statistical term to properly calculate the LLD as the background approaches zero (see reference 17). When background is greater than 70 counts the factor is not necessary for the calculation.
- LLD is the a priori lower limit of detection as defined above (as microcuries per unit mass or volume). The LLD for composite samples contains a correction to account for the decay of radionuclides during the collection time $\{(\lambda\Delta t_2) / [\exp(-\lambda\Delta t_1)](1-\exp(-\lambda\Delta t_2))\}$.
- σ_B is the standard deviation of the background counting rate or of the counting rate of blank sample as appropriate (as counts per minute),
- E is the counting efficiency, as counts per disintegration,
- V is the sample size, in units of mass or volume,
- 2.22E6 is the number of disintegrations per minute per microcurie,
- Y is the fractional radiochemical yield, when applicable,
- λ is the radioactive decay constant for the particular radionuclide,
- Δt_1 for the plant effluents is the elapsed time between the end of the sample collection and the start of sample count.
- Δt_2 for the plant effluents is the elapsed time between the start and the end of sample collection.

TABLE 4.2-1 (Continued)TABLE NOTATIONS

It should be recognized that the LLD is defined as an a priori (before the fact) limit representing the capability of a measurement system and not as an after the fact limit for a particular measurement.

- b. A batch release is the discharge of liquid wastes of a discrete volume. Prior to sampling for analyses, each batch shall be isolated, and then thoroughly mixed to assure representative sampling.
- c. The principal gamma emitters for which the LLD specification applies include the following radionuclides: Mn-54, Fe-59, Co-58, Co-60, Zn-65, Mo-99, Cs-134, Cs-137, Ce-141 and Ce-144. The dissolved and entrained noble gases (gamma emitters) for which the LLD specification applies include the following radionuclides: Kr-87, Kr-88, Xe-133, Xe-133m, Xe-135, Xe-135m, Xe-138. This list does not mean that only these nuclides are to be considered. Other gamma peaks that are identifiable, together with those of the above nuclides, shall also be analyzed and reported in the Annual Radioactive Effluent Release Report pursuant to Administrative Control 6.2.
- d. The term "Composite Sample" means a combination of individual samples obtained at regular intervals over a time period. Either the volume of each individual sample is proportional to discharge flow rates, or the sampling interval (for constant volume samples) is proportional to flow rates over the time period used to produce the composite.
- e. A continuous release is the discharge of liquid wastes of non-discrete volume, e.g. from a volume of a system that has an input flow during the continuous release.
- f. Whenever effluent releases are in excess of the monitor's setpoint.

3/4.2 RADIOACTIVE EFFLUENTS

3/4.2.1 LIQUID EFFLUENTS

3/4.2.1.2 DOSE

CONTROLS

- 3.2.1.2 The dose or dose commitment to a MEMBER OF THE PUBLIC from radioactive materials in liquid effluents released from the site to UNRESTRICTED AREAS (See Figure 1-1) shall be limited:
- a. During any calendar quarter to less than or equal to 3 mrem to the total body and to less than or equal to 10 mrem to any organ, and
 - b. During any calendar year to less than or equal to 6 mrem to the total body and to less than or equal to 20 mrem to any organ.

APPLICABILITY: At all times.

ACTION:

- a. With the calculated dose from the release of radioactive materials in liquid effluents exceeding any of the above limits, Initiate a Special Report that identifies the cause(s) for exceeding the limit(s) and defines the corrective actions that have been taken to reduce the releases and the proposed corrective actions to be taken to assure that subsequent releases will be in compliance with the above limits. This Special Report shall also include: (1) the results of the radiological analyses of the drinking water source, and (2) the radiological impact on finished drinking water supplies with regard to the requirements of 40 CFR Part 141, Safe Drinking Water Act.*
- b. The provisions of Controls 3.0.3 and 3.0.4 are not applicable.

SURVEILLANCE REQUIREMENTS

- 4.2.1.2 Cumulative dose contributions from liquid effluents for the current calendar quarter and the current calendar year shall be determined at least once per 31 days.

* The requirements of Action A. (1) and (2) are applicable only if drinking water supply is taken from the receiving water body within 3 miles of the plant discharge. In the case of river-sited plants this is 3 miles downstream only.

3/4.2 RADIOACTIVE EFFLUENTS

3/4.2.1 LIQUID EFFLUENTS

3/4.2.1.3 LIQUID RADWASTE TREATMENT SYSTEM

CONTROLS

3.2.1.3 The liquid radwaste treatment system shall be IN SERVICE and appropriate portions of the system shall be used to reduce the radioactive materials in liquid waste prior to their discharge when the projected doses due to the liquid effluent, from the site, to UNRESTRICTED AREAS (See Figure 1-1) would exceed 0.12 mrem to the total body or 0.4 mrem to any organ in a 31-day period.

APPLICABILITY: At all times.

ACTION:

- a. With radioactive liquid waste being discharged without treatment and in excess of the above limits and any portion of the Liquid Radwaste Treatment System not in operation initiate a Special Report that includes the following information:
 1. Explanation of what liquid radwaste was being discharged without treatment, identification of any inoperable equipment or subsystems, and the reason for the inoperability.
 2. Action(s) taken to restore the inoperable equipment to OPERABLE status, and
 3. Summary description of action(s) taken to prevent a recurrence.
- b. The provisions of Controls 3.0.3 and 3.0.4 are not applicable.

SURVEILLANCE REQUIREMENTS

- 4.2.1.3.1 Dose due to liquid releases from the site to UNRESTRICTED AREAS shall be projected at least once per 31 days, in accordance with the methodology and parameters in the ODCM when Liquid Radwaste Treatment Systems are not being fully utilized.
- 4.2.1.3.2 The installed Liquid Radwaste Treatment System shall be considered OPERABLE by meeting Controls 3.2.1.1 and 3.2.1.2

3/4.2 RADIOACTIVE EFFLUENTS

3/4.2.2 GASEOUS EFFLUENTS

3/4.2.2.1 DOSE RATE

CONTROLS

- 3.2.2.1 The dose rate due to radioactive materials released in gaseous effluents from the site to areas at or beyond the SITE BOUNDARY (See Figure 1-1) shall be limited to:
- a. For noble gases: less than or equal to 500 mrem/yr to the total body and less than or equal to 3000 mrem/yr to the skin, and
 - b. For iodine-131, iodine-133, tritium, and for all radionuclides in particulate form with half-lives greater than 8 days: less than or equal to 1500 mrem/yr to any organ (Inhalation pathway only).

APPLICABILITY: At all times.

ACTION:

- a. With the dose rate(s) exceeding the above limits, immediately restore the release rate to within the above limits.
- b. The provisions of Controls 3.0.3 and 3.0.4 are not applicable.

SURVEILLANCE REQUIREMENTS

- 4.2.2.1.1 The dose rate due to noble gases in gaseous effluents shall be determined to be within the above limits in accordance with the methodology and parameters in the ODCM.
- 4.2.2.1.2 The dose rate due to iodine-131, iodine-133, tritium, and all radionuclides in particulate form with half-lives greater than 8 days in gaseous effluents shall be determined to be within the above limits in accordance with the methodology and parameters in the ODCM by obtaining representative samples and performing analyses in accordance with the sampling and analysis program specified in Table 4.2-2.

TABLE 4.2-2

RADIOACTIVE GASEOUS WASTE SAMPLING AND ANALYSIS PROGRAM

Gaseous Release Point	Sampling Frequency	Minimum Analysis Frequency	Type of Activity Analysis	Lower Limit of Detection (LLD) ^a
A. North Stack/ South Stack	M ^b Grab Smpl.	M ^b	Noble Gas	1E-4 uCi/cc
			H-3	1E-6 uCi/cc
	Continuous ^d	W ^c Char. Smpl. Part. Smpl.	I-131	1E-12 uCi/cc
			Principal Gamma Emitters ^e	1E-11 uCi/cc
			Gross Alpha	1E-11 uCi/cc
			Sr-89, Sr-90	1E-11 uCi/cc
Continuous ^d	Continuous Noble Gas Monitor	Noble Gas Beta or Gamma	1E-6 (Based on Xe-133)	
B. Hot Mainten. Shop Vent Exhaust ^f	Continuous ^d	W Char. Smpl.	I-131	1E-12 uCi/cc
			Principal Gamma Emitters ^e	1E-11 uCi/cc
		M Comp. Part. Sample	Gross Alpha	1E-11 uCi/cc
			Sr-89, Sr-90	1E-11 uCi/cc

TABLE 4.2-2 (Continued)TABLE NOTATIONS

- a. The LLD is defined, as the smallest concentration of radioactive material in a sample that will yield a net count, above system background, that will be detected with 95% probability with only 5% probability of falsely concluding that a blank observation represents a "real" signal. It should be recognized that the LLD is defined as an a priori (before the fact) limit representing the capability of a measurement system and not as an after the fact limit for a particular measurement.

For a particular measurement system, (which may include radiochemical separation):

$$\text{LLD (Composite)} = \frac{(2.71 + 4.66\sigma_B)(\lambda\Delta t_2)}{E \cdot V \cdot 2.22E6 \cdot Y \cdot [\exp(-\lambda\Delta t_1)](1-\exp(-\lambda\Delta t_2))}$$

$$\text{LLD (Grab Samples)} = \frac{(2.71 + 4.66\sigma_B)}{E \cdot V \cdot 2.22E6 \cdot Y \cdot (\exp -\lambda\Delta t_1)}$$

Where:

- 2.71 is a statistical term to properly calculate the LLD as the background approaches zero (see reference 17). When background is greater than 70 counts the factor is not necessary for the calculation.
- LLD is the a priori lower limit of detection as defined above (uCi/cc or uCi/ml). The LLD for composite samples contains a correction to account for the decay of radionuclides during the collection time $\{(\lambda\Delta t_2)/[\exp(-\lambda\Delta t_1)](1-\exp(-\lambda\Delta t_2))\}$,
- σ_B is the standard deviation of the background counting rate or of the counting rate of blank sample as appropriate (as cpm), shall be based on the actual observed variance of the background counting rate or of the counting rate of the blank samples (as appropriate) rather than on an unverified theoretically predicted variance.
- E is the counting efficiency, as counts per disintegration,
- V is the sample size, in units of cc or ml,
- 2.22E6 is the number of dpm/uCi
- Y is the fractional radiochemical yield, when applicable,
- λ is the radioactive decay constant for the particular radionuclide, and
- Δt_1 for the plant effluents is the elapsed time between the end of the sample collection and the start of sample count.
- Δt_2 for the plant effluents is the elapsed time between the start and the end of sample collection.

TABLE 4.2-2 (Continued)TABLE NOTATIONS

- b. Sampling and analyses shall also be performed following shutdown, startup, or a THERMAL POWER change exceeding 15% of the RATED THERMAL POWER within a 1-hour period. This requirement does not apply if (1) analysis show that the DOSE EQUIVALENT I-131 concentration in the primary coolant has not increased more than a factor of 3; and (2) the main condenser offgas pre-treatment radioactivity monitor shows that effluent activity has not increased more than a factor of 3.
- c. Samples shall be changed at least once per 7 days and analyses shall be completed within 48 hours after changing, or after removal from sampler. Sampling shall also be performed at least once per 24 hours for at least 7 days following each shutdown, startup or THERMAL POWER change exceeding 15% of RATED THERMAL POWER in 1 hour and analyses completed within 48 hours of changing. When samples collected for 24 hours are analyzed, the corresponding LLDs may be increased by a factor of 10. This requirement does not apply if (1) analysis shows that the DOSE EQUIVALENT I-131 concentration in the primary coolant has not increased more than a factor of 3; and (2) the noble gas monitor shows that effluent activity has not increased more than a factor of 3.
- d. The ratio of the sample flow rate to the sampled stream flow rate shall be known for the time period covered by each dose or dose rate calculation made in accordance with Controls 3.2.2.1, 3.2.2.2, and 3.2.2.3.
- e. The principal gamma emitters for which the LLD specification applies include the following radionuclides: Kr-87, Kr-88, Xe-133, Xe-133m, Xe-135, Xe-135m and Xe-138 for gaseous emissions and Mn-54, Fe-59, Co-58, Co-60, Zn-65, Mo-99, I-131, Cs-134, Cs-137, Ce-141 and Ce-144 for particulate emissions. This list does not mean that only these nuclides are to be considered. Other gamma peaks which are identifiable, together with the above nuclides, shall also be analyzed and reported in the Annual Radioactive Effluent Release Report, pursuant to Administrative Control 6.2.
- f. Required for the hot maintenance shop ventilation exhaust only during operation of the hot maintenance shop ventilation exhaust system.

3/4.2 RADIOACTIVE EFFLUENTS

3/4.2.2 GASEOUS EFFLUENTS

3/4.2.2.2 DOSE - NOBLE GASES

CONTROLS

- 3.2.2.2 The air dose due to noble gases released in gaseous effluents, from the site to areas at and beyond the SITE BOUNDARY (See Figure 1-1) shall be limited to the following:
- a. During any calendar quarter: less than or equal to 10 mrad for gamma radiation and less than or equal to 20 mrad for beta radiation, and
 - b. During any calendar year: less than or equal to 20 mrad for gamma radiation and less than or equal to 40 mrad for beta radiation.

APPLICABILITY: At all times.

ACTION:

- a. With the calculated air dose from radioactive noble gases in gaseous effluents exceeding any of the above limits, initiate a Special Report that identifies the cause(s) for exceeding the limit(s) and defines the corrective actions that have been taken to reduce the releases and the proposed corrective actions to be taken to assure that subsequent releases will be in compliance with the above limits.
- b. The provisions of Controls 3.0.3 and 3.0.4 are not applicable.

SURVEILLANCE REQUIREMENTS

- 4.2.2.2 Cumulative dose contributions for the current quarter and current calendar year for noble gases shall be determined in accordance with the methodology and parameters in the ODCM at least once per 31 days.

3/4.2 RADIOACTIVE EFFLUENTS

3/4.2.2 GASEOUS EFFLUENTS

3/4.2.2.3 DOSE – IODINE-131, IODINE-133, TRITIUM, AND RADIOACTIVE MATERIAL IN PARTICULATE FORM

CONTROLS

3.2.2.3 The dose to a MEMBER OF THE PUBLIC from iodine-131, iodine-133, tritium and all radionuclides in particulate form with half-lives greater than 8 days in gaseous effluents released from the site to areas at or beyond the SITE BOUNDARY (See Figure 1-1) shall be limited to the following:

- a. During any calendar quarter: less than or equal to 15 mrem to any organ and,
- b. During any calendar year: less than or equal to 30 mrem to any organ.

APPLICABILITY: At all times.

ACTION:

- a. With the calculated dose from the release of iodine-131, iodine-133, tritium and all radionuclides in particulate form with half-lives greater than 8 days in gaseous effluents exceeding any of the above limits, initiate a Special Report that identifies the cause(s) for exceeding the limit and defines the corrective actions that have been taken to reduce the releases and the proposed corrective actions to be taken to assure that subsequent releases will be in compliance with the above limits.
- b. The provisions of Controls 3.0.3 and 3.0.4 are not applicable.

SURVEILLANCE REQUIREMENTS

4.2.2.3 Cumulative dose contributions for the current calendar quarter and current calendar year for iodine-131, iodine-133, tritium and radionuclides in particulate form with half-lives greater than 8 days shall be determined in accordance with the methodology and parameters in the ODCM at least once per 31 days.

3/4.2 RADIOACTIVE EFFLUENTS

3/4.2.2 GASEOUS EFFLUENTS

3/4.2.2.4 GASEOUS RADWASTE (OFFGAS) TREATMENT SYSTEM

CONTROLS

3.2.2.4 Section is not applicable. See UFSAR Chapter 11.3.

3/4.2 RADIOACTIVE EFFLUENTS3/4.2.2 GASEOUS EFFLUENTS3/4.2.2.5 VENTILATION EXHAUST TREATMENT SYSTEMCONTROLS

3.2.2.5 The VENTILATION EXHAUST TREATMENT SYSTEM shall be OPERABLE and appropriate portions of the system shall be used to reduce releases of radioactivity when the projected doses in 31 days due to gaseous effluent releases, from the site to areas at and beyond the SITE BOUNDARY (See Figure 1-1) would exceed

- a. 0.4 mrad to air from gamma radiation, or
- b. 0.8 mrad to air from beta radiation, or
- c. 0.6 mrem to any organ of a MEMBER OF THE PUBLIC.

APPLICABILITY: At all times.

ACTION:

- a. With gaseous waste being discharged without treatment, and in excess of the above limits, initiate a Special Report that includes the following information:
 1. Identification of any inoperable equipment or subsystems, and the reason for the inoperability.
 2. Action(s) taken to restore the inoperable equipment to OPERABLE status, and
 3. Summary description of action(s) taken to prevent a recurrence.
- b. The provisions of Controls 3.0.3 and 3.0.4 are not applicable.

SURVEILLANCE REQUIREMENTS

- 4.2.2.5.1 Doses due to gaseous releases from the site to areas at and beyond the SITE BOUNDARY shall be projected at least once per 31 days in accordance with the methodology and parameters in the ODCM, when the Ventilation Exhaust Treatment System is not being fully utilized.
- 4.2.2.5.2 The installed VENTILATION EXHAUST TREATMENT SYSTEM shall be considered OPERABLE by meeting Controls 3.2.2.1, and either 3.2.2.2 or 3.2.2.3

3/4.2 RADIOACTIVE EFFLUENTS

3/4.2.2 GASEOUS EFFLUENTS

3/4.2.2.6 Not Used

CONTROLS

3.2.2.6 Section is not applicable.

3/4.2 RADIOACTIVE EFFLUENTS3/4.2.2 GASEOUS EFFLUENTS3/4.2.2.7 MARK II CONTAINMENTCONTROLS

3.2.2.7 The VENTING or PURGING of the Mark II containment drywell shall be through the Standby Gas Treatment System.

APPLICABILITY: Whenever the drywell is vented or purged. *

ACTION:

- a. With the requirements of the above control not satisfied, suspend all VENTING and PURGING of the drywell.
- b. The provisions of Controls 3.0.3 and 3.0.4 are not applicable.

SURVEILLANCE REQUIREMENTS

4.2.2.7.1 The containment drywell shall be determined to be aligned for VENTING or PURGING through the Standby Gas Treatment System within 4 hours prior to start of and at least once per 12 hours during VENTING or PURGING of the containment.

4.2.2.7.2 Prior to use of the purge system through the standby gas treatment system assure that:

- a. Both standby gas treatment system trains are OPERABLE whenever the purge system is in use, and
- b. Whenever the purge system is in use, only one of the standby gas treatment system trains shall be used to prevent damage to both trains should a LOCA occur (LCO 3.6.5.3 ACTION a applies during this configuration).

* Except after Containment is deinerted and purged **OR** for the one inch/two inch vent valves to the Reactor Enclosure Equipment Compartment Exhaust Filters when used for containment pressure control and nitrogen make-up operations.

3/4.2 RADIOACTIVE EFFLUENTS

3/4.2.3 TOTAL DOSE

CONTROLS

- 3.2.3 The annual (calendar year) dose or dose commitment to any MEMBER OF THE PUBLIC, due to releases of radioactivity and radiation, from uranium fuel cycle sources shall be limited to less than or equal to 25 mrem to the total body or any organ, except the thyroid, which shall be limited to less than or equal to 75 mrem.

APPLICABILITY: At all times.

ACTION:

- a. With the calculated doses from the release of radioactive materials in liquid or gaseous effluents exceeding the limits of Controls 3.2.1.2.a., 3.2.1.2.b., 3.2.2.2.a., 3.2.2.2.b., 3.2.2.3.a., or 3.2.2.3.b calculations shall be made including direct radiation contributions from the reactor units (including outside storage tanks, etc.) to determine whether the above limits of Control 3.2.3 have been exceeded. If such is the case, initiate a Special Report that defines the corrective action to be taken to reduce subsequent releases to prevent recurrence of exceeding the above limits and includes the schedule for achieving conformance with the above limits. This Report, as defined in 10 CFR 20.2203, shall include an analysis that estimates the radiation exposure (dose) to a MEMBER OF THE PUBLIC from the uranium fuel cycle sources, including all effluent pathways and direct radiation, for the calendar year that includes the release(s) covered by this report. It shall also describe levels of radiation and concentration of radioactive material involved, and the cause of the exposure levels or concentrations. If the estimated dose(s) exceeds the above limits, and if the release condition resulting in violation of 40 CFR Part 190 or 10 CFR 72.104 has not already been corrected, the Special Report shall include a request for a variance in accordance with the provisions of 40 CFR Part 190 or 10 CFR 72.104. Submittal of the report is considered a timely request, and a variance is granted until staff action on the request is complete.
- b. The provisions of Controls 3.0.3 and 3.0.4 are not applicable.

SURVEILLANCE REQUIREMENTS

- 4.2.3.1 Cumulative dose contributions from liquid and gaseous effluents shall be determined in accordance with Surveillance Requirements 4.2.1.2, 4.2.2.2, and 4.2.2.3, and in accordance with the methodology and parameters in the ODCM.
- 4.2.3.2 Cumulative dose contributions from direct radiation from the units (including outside storage tanks, ISFSI, etc.) shall be determined in accordance with the methodology and parameters in the ODCM. This requirement is applicable only under conditions set forth in Action a. of Control 3.2.3.

3/4.3 RADIOLOGICAL ENVIRONMENTAL MONITORING

3/4.3.1 MONITORING PROGRAM

CONTROLS

3.3.1 The Radiological Environmental Monitoring Program shall be conducted as specified in Table 3.3-1.

APPLICABILITY: At all times.

ACTION:

- a. With the Radiological Environmental Monitoring Program not being conducted as specified in Table 3.3-1, prepare and submit to the Commission, in the Annual Radiological Environmental Operating Report required by Administrative Control 6.1, a description of the reasons for not conducting the program as required and the plans for preventing a recurrence.
- b. With the level of radioactivity as the result of plant effluents in an environmental sampling medium at a specified location exceeding the reporting levels of Table 3.3-2 when averaged over any calendar quarter, initiate a Special Report that identifies the cause(s) for exceeding the limit(s) and defines the corrective actions to be taken to reduce radioactive effluents so that the potential annual dose to a MEMBER OF THE PUBLIC is less than the calendar year limits of Controls 3.2.1.2, 3.2.2.2, or 3.2.2.3. When more than one of the radionuclides in Table 3.3-2 are detected in the sampling medium, this report shall be submitted if:

$$\frac{\text{concentration (1)}}{\text{reporting level (1)}} + \frac{\text{concentration (2)}}{\text{reporting level (2)}} + \dots \geq 1.0$$

When radionuclides other than those in Table 3.3-2 are detected and are the result of plant effluents, a Special Report shall be initiated if the potential annual dose* to a MEMBER OF THE PUBLIC is equal to or greater than the calendar year limits of Controls 3.2.1.2, 3.2.2.2, or 3.2.2.3. A Special Report is not required if the measured level of radioactivity was not the result of plant effluents; however, in such an event, the condition shall be reported and described in the Annual Radiological Environmental Operating Report required by Administrative Control 6.1.

- * The methodology and parameters used to estimate the potential annual dose to a MEMBER OF THE PUBLIC shall be indicated in this report.

3/4.3 RADIOLOGICAL ENVIRONMENTAL MONITORING

3/4.3.1 MONITORING PROGRAM

CONTROLS

ACTION (Continued)

- c. With milk or fresh leafy vegetable samples unavailable from one or more of the sample locations required by Table 3.3-1, identify locations for obtaining replacement samples and add them to the radiological environmental monitoring program within 30 days. The specific locations from which samples were unavailable may then be deleted from the monitoring program. Pursuant to Technical Specification 6.14, submit as a part of or concurrent with the Annual Radioactive Effluent Release Report, a complete, legible copy of the entire ODCM, including a revised figure(s) and table for the ODCM reflecting the new location(s).
- d. The provisions of Controls 3.0.3 and 3.0.4 are not applicable.

SURVEILLANCE REQUIREMENTS

- 4.3.1 The radiological environmental monitoring samples shall be collected pursuant to Table 3.3-1 from the specific locations given in the table and figure(s) in the ODCM and shall be analyzed pursuant to the requirements of Table 3.3-1, with the detection capabilities required by the Table 4.3-1.

TABLE 3.3-1

RADIOLOGICAL ENVIRONMENTAL MONITORING PROGRAM*

EXPOSURE PATHWAY AND/OR SAMPLE	NUMBER OF REPRESENTATIVE SAMPLES AND SAMPLE LOCATION ^(a)	SAMPLING AND COLLECTION FREQ.	TYPE AND FREQUENCY OF ANALYSIS
1. DIRECT RADIATION ^b	40 routine monitoring stations either with two or more dosimeters or with one instrument for measuring and recording dose rate continuously placed as follows: <ol style="list-style-type: none"> (1) An inner ring of stations, one in each meteorological sector, in the general area of the SITE BOUNDARY: (2) An outer ring of stations, one in each meteorological sector, in the 3-9 mile range from the site; (3) The balance of the stations placed in special interest areas such as population centers, nearby residences, schools and in 1 or 2 areas to serve as control stations. 	Quarterly	Gamma dose quarterly.

* The number, media, frequency, and location of samples may vary from site to site. This table presents an acceptable minimum program for a site at which each entry is applicable. Local site characteristics must be examined to determine if pathways not covered by this table may significantly contribute to an individual's dose and should be included in the sample program.

TABLE 3.3-1 (Continued)

RADIOLOGICAL ENVIRONMENTAL MONITORING PROGRAM

EXPOSURE PATHWAY AND/OR SAMPLE	NUMBER OF REPRESENTATIVE SAMPLES AND SAMPLE LOCATION ^(a)	SAMPLING AND COLLECTION FREQ.	TYPE AND FREQUENCY OF ANALYSIS
2. AIRBORNE Radioiodine and Particulates	<p>Samples from 5 locations: 3 samples from close to the 3 SITE BOUNDARY locations (in different sectors) of the highest calculated annual average ground-level D/Q.</p> <p>1 sample from the vicinity community having one of the highest calculated annual ground level D/Q.</p> <p>1 sample from a control location, as for example 15-30 km distant and in the least prevalent wind direction.</p>	Continuous sampler operation with sample collection weekly, or more frequently if required by dust loading.	<p><u>Radioiodine canisters:</u> I-131 analysis weekly</p> <p><u>Particulate Sampler:</u> Gross beta radio activity analysis following filter change:^c Gamma isotopic analysis^d of composite (by location) at least quarterly</p>

TABLE 3.3-1 (Continued)

RADIOLOGICAL ENVIRONMENTAL MONITORING PROGRAM

EXPOSURE PATHWAY AND/OR SAMPLE	NUMBER OF REPRESENTATIVE SAMPLES AND SAMPLE LOCATION ^(a)	SAMPLING AND COLLECTION FREQ.	TYPE AND FREQUENCY OF ANALYSIS
3. WATERBORNE			
a. Surface ^e	1 sample upstream 1 sample downstream	Composite sample over 1- month period ^f .	Gamma isotopic analysis ^d monthly. Composite for tritium analysis quarterly.
b. Ground	Samples from 1 or 2 sources only if likely to be affected ^g	Quarterly.	Gamma isotopic ^d and tritium analysis
c. Drinking	1 sample of each on 1 to 3 of the nearest water supplies that could be affected by its discharge. 1 sample from a control location	Composite sample over 2- week period ^f when I-131 analysis is performed; monthly composite otherwise.	I-131 analysis on each composite when the dose calculated for the consumption of the water is greater than 1 mrem per year. ^h Composite for gross beta and gamma isotopic ^d analysis monthly. Composite for tritium analysis quarterly.
d. Sediment from shoreline	1 sample from downstream area with existing or potential recreational value.	Semiannually.	Gamma isotopic analysis ^d semiannually.

TABLE 3.3-1 (Continued)

RADIOLOGICAL ENVIRONMENTAL MONITORING PROGRAM

EXPOSURE PATHWAY AND/OR SAMPLE	NUMBER OF REPRESENTATIVE SAMPLES AND SAMPLE LOCATION ^(a)	SAMPLING AND COLLECTION FREQ.	TYPE AND FREQUENCY OF ANALYSIS
4. INGESTION a. Milk	Samples from milking animals in 3 locations within 5 km distance having the highest dose potential. If there are none, then 1 sample from milking animals in each of 3 areas between 5 to 8 km distance where dose are calculated to be greater than 1 mrem per year. ^h 1 sample from milking animals at a control location (15-30 km distance) and in the least prevalent wind direction.	Semimonthly when animals are on pasture, monthly at other times.	Gamma isotopic ^d and I-131 analysis semimonthly when animals are on pasture (April 1 - Oct. 1); monthly at other times.
b. Fish and Invertebrates	1 sample of each commercially and recreationally important species in vicinity of plant discharge area. 1 sample of same species in area not influenced by plant discharge.	Sample in season, or semiannually if they are not seasonal.	Gamma isotopic ^d analysis on edible portions.

TABLE 3.3-1 (Continued)

RADIOLOGICAL ENVIRONMENTAL MONITORING PROGRAM

EXPOSURE PATHWAY AND/OR SAMPLE	NUMBER OF REPRESENTATIVE SAMPLES AND SAMPLE LOCATION ^(a)	SAMPLING AND COLLECTION FREQ.	TYPE AND FREQUENCY OF ANALYSIS
4. INGESTION (Continued) c. Food Products	1 sample of each principal class of food products from any area that is irrigated by water in which liquid plant wastes have been discharged	At time of harvest ⁱ	Gamma isotopic ^d and I-131 analysis.
	Samples of 3 different kinds of broad leaf vegetation grown nearest each of 2 different offsite locations of highest predicted annual average ground level D/Q if milk sampling is not performed.	Monthly during the growing season	Gamma isotopic ^d and I-131 analysis.
	1 sample of each of the similar broad leaf vegetation grown 15-30 km distance in the least prevalent wind direction if milk sampling is not performed.	Monthly during the growing season	Gamma isotopic ^d and I-131 analysis.

TABLE 3.3-1 (Continued)TABLE NOTATIONS

- a. Specific parameters of distance and direction sector from the centerline of the two reactors and additional description where pertinent, shall be provided for each and every sample location in Table 3.3-1 in a table and figure(s) in the ODCM. Deviations are permitted from the required sampling schedule if specimens are unobtainable due to hazardous conditions, seasonal unavailability, malfunction of automatic sampling equipment and other legitimate reasons. If specimens are unobtainable due to sampling equipment malfunction, every effort shall be made to complete corrective action prior to the end of the next sampling period. All deviations from the sampling schedule shall be documented in the Annual Radiological Environmental Operating Report pursuant to Administrative Control 6.1. It is recognized that, at times, it may not be possible or practicable to continue to obtain samples of the media of choice at the most desired location or time. In these instances suitable alternative media and locations may be chosen for the particular pathway in question and appropriate substitutions made within 30 days in the radiological environmental monitoring program. Pursuant to Technical Specification 6.14, submit as a part of or concurrent with the next Annual Radioactive Effluent Release Report a complete legible copy of the ODCM including a revised figure(s) and table for the ODCM reflecting the new location(s).
- b. One or more instruments, such as a pressurized ion chamber, for measuring and recording dose rate continuously may be used in place of, or in addition to, integrating dosimeters. For the purpose of this table, a dosimeter (OSL, TLD, or similar) is considered to be one element; two or more elements in a packet are considered as two or more dosimeters. Film badges shall not be used as dosimeters for measuring direct radiation.
- c. Airborne particulate sample filters shall be analyzed for gross beta radioactivity 24 hours or more after sampling to allow for radon and thoron daughter decay. If gross beta activity in air particulate samples is greater than 10 times the yearly mean of control samples, gamma isotopic analysis shall be performed on the individual samples.
- d. Gamma isotopic analysis means the identification and quantification of gamma-emitting radionuclides that may be attributable to the effluents from the facility.
- e. The "upstream sample" shall be taken at a distance beyond significant influence of the discharge. The "downstream sample" shall be taken in an area beyond but near the mixing zone.

TABLE 3.3-1 (Continued)TABLE NOTATIONS (Continued)

- f. A composite sample is one in which the quantity (aliquot) of liquid sampled is proportional to the quantity of flowing liquid and in which the method of sampling employed results in a specimen that is representative of the liquid flow. In this program composite sample aliquots shall be collected at time intervals that are very short (e.g., hourly) relative to the compositing period (e.g., monthly) in order to assure obtaining a representative sample.
- g. Groundwater samples shall be taken when this source is tapped for drinking or irrigation purposes in areas where the hydraulic gradient or recharge properties are suitable for contamination.
- h. The dose shall be calculated for the maximum organ and age group using the methodology and parameters in the ODCM.
- i. If harvest occurs more than once a year, sampling shall be performed during each discrete harvest. If harvest occurs continuously, sampling shall be monthly. Attention shall be paid to including samples of tuberous and root food products.

TABLE 3.3-2
REPORTING LEVELS FOR RADIOACTIVITY CONCENTRATIONS IN ENVIRONMENTAL SAMPLES

Reporting Levels

ANALYSIS	WATER (pCi/l)	AIRBORNE PARTICULATE or GASES(pCi/m ³)	FISH (pCi/kg, wet)	MILK (pCi/l)	FOOD PRODUCTS (pCi/kg, wet)
H-3	20,000*				
Mn-54	1,000		30,000		
Fe-59	400		10,000		
Co-58	1,000		30,000		
Co-60	300		10,000		
Zn-65	300		20,000		
Zr-Nb-95	400***				
I-131	2**	0.9		3	100
Cs-134	30	10	1,000	60	1,000
Cs-137	50	20	2,000	70	2,000
Ba-La-140	200***			300	

* For drinking water samples. This is a 40 CFR Part 141 value. If no drinking pathway exists, a value of 30,000 pCi/l may be used.

** If no drinking water pathway exists, a value of 20 pCi/l may be used

*** Total for parent and daughter.

TABLE 4.3-1
DETECTION CAPABILITIES FOR ENVIRONMENTAL SAMPLE ANALYSIS^{(a) (b)}

Lower limit of Detection (LLD)^(c)

ANALYSIS	WATER (pCi/l)	AIRBORNE PARTICULATE or GASES (pCi/m ³)	FISH (pCi/kg, wet)	MILK (pCi/l)	FOOD PRODUCTS (pCi/kg, wet)	SEDIMENT (pCi/kg, dry)
Gross Beta	4	0.01				
H-3	2,000*					
Mn-54	15		130			
Fe-59	30		260			
Co-58	15		130			
Co-60	15		130			
Zn-65	30		260			
Zr-95	30					
Nb-95	15					
I-131	1**	0.07		1	60	
Cs-134	15	0.05	130	15	60	150
Cs-137	18	0.06	150	18	80	180
Ba-140	60			60		
La-140	15			15		

* If no drinking water pathway exists, a value of 3000 pCi/l may be used.

** If no drinking water pathway exists, a value of 15 pCi/l may be used.

TABLE 4.3-1 (Continued)TABLE NOTATIONS

- (a) This list does not mean that only these nuclides are to be considered. Other peaks that are identifiable at 95% confidence level, together with those of the above nuclides, shall also be analyzed and reported in the Annual Radiological Environmental Operating report pursuant to Administrative Control 6.1.
- (b) Required detection capabilities for thermoluminescent dosimeters used for environmental measurements are given in Regulatory Guide 4.13.
- (c) The LLD is defined, for purposes of these controls, as the smallest concentration of radioactive material in a sample that will yield a net count (above system background) that will be detected with 95% probability with only 5% probability of falsely concluding that a blank observation represents a "real" signal.

For a particular measurement system (which may include radiochemical separation):

$$LLD = \frac{4.66 s_b}{E \cdot V \cdot 2.22 \cdot Y \cdot \exp(-\lambda \Delta t)}$$

Where:

- LLD is the a priori lower limit of detection as defined above (as picocuries per unit mass or volume),
- s_b is the standard deviation of the background counting rate or of the counting rate of blank sample as appropriate (as counts per minute),
- E is the counting efficiency (as counts per disintegration),
- V is the sample size (in units of mass or volume),
- 2.22 is the number of disintegrations per minute per picocurie,
- Y is the fractional radiochemical yield (when applicable),
- λ is the radioactive decay constant for the particular radionuclide, and
- Δt for the environmental samples is the elapsed time between sample collection (or end of the sample collection period) and time of counting.

Typical values of E, V, Y and Δt should be used in the calculation

TABLE 4.3-1 (Continued)TABLE NOTATIONS (Continued)

It should be recognized that the LLD is defined as an a priori (before the fact) limit representing the capability of a measurement system and not as an after the fact limit for a particular measurement. Analyses shall be performed in such a manner that the stated LLDs will be achieved under routine conditions. Occasionally background fluctuations, unavoidably small sample sizes, the presence of interfering nuclides, or other uncontrollable circumstances may render these LLDs unachievable. In such cases, the contributing factors shall be identified and described in the Annual Radiological Environmental Operating Report pursuant to Administrative Control 6.1.

3/4.3 RADIOLOGICAL ENVIRONMENTAL MONITORING

3/4.3.2 LAND USE CENSUS

CONTROLS

- 3.3.2 A land use census shall be conducted and shall identify within a distance of 8 km (5 miles) the location (in each of the 16 meteorological sectors) of the nearest milk animal, the nearest residence and the nearest garden* of greater than 50 m² (500 ft²) producing broad leaf vegetation.

APPLICABILITY: At all times.

ACTION:

- a. With a land use census identifying a location(s) that yields a calculation dose or dose commitment greater than the values currently being calculated in Control 3.2.2.3, identify the new location(s) in the next Annual Radioactive Effluent Release Report, pursuant to Administrative Control 6.2.
- b. With a land use census identifying a location(s) that yields a calculated dose or dose commitment (via the same exposure pathway) 20% greater than at a location from which samples are currently being obtained in accordance with Control 3.2.2.3, add the new location(s) to the radiological environmental monitoring program within 30 days. The sampling location(s), excluding the control station location, having the lowest calculated dose or dose commitment(s) (via the same exposure pathway) may be deleted from this monitoring program after October 31 of the year in which this land use census was conducted. Pursuant to Technical Specification 6.14, submit as a part of or concurrent with in the next Annual Radioactive Effluent Release Report a complete, legible copy of the entire ODCM including a revised figure(s) and table(s) for the ODCM reflecting the new location(s).
- c. The provisions of Controls 3.0.3 and 3.0.4 are not applicable.

SURVEILLANCE REQUIREMENTS

- 4.3.2 The land use census shall be conducted during the growing season at least once per 12 months using that information that will provide the best results, such as by a door-to-door survey, aerial survey, or by consulting local agriculture authorities. The results of the land use census are included in the Annual Radiological Environmental Operating Report pursuant to Administrative Control 6.1.

* Broad leaf vegetation sampling of at least 3 different kinds of vegetation may be performed at the SITE BOUNDARY in each of 2 different direction sectors with the highest predicted D/Qs in lieu of the garden census. Controls for broad leaf vegetation sampling in Table 3.3-1 item 4.c. shall be followed, including analysis of control samples.

3/4.3 RADIOLOGICAL ENVIRONMENTAL MONITORING

3/4.3.3 INTERLABORATORY COMPARISON PROGRAM

CONTROLS

3.3.3 In accordance with LGS Technical Specification 6.8.4.f, analyses shall be performed on radioactive materials supplied as part of an Interlaboratory Comparison Program traceable to NIST, that correspond to samples required by Table 3.3-1.

APPLICABILITY: At all times.

ACTION:

- a. With analyses not being performed as required above, report the corrective actions taken to prevent a recurrence to the Commission in the Annual Radiological Environmental Operating Report pursuant to Administrative Control 6.1.
- b. The provisions of Controls 3.0.3 and 3.0.4 are not applicable.

SURVEILLANCE REQUIREMENTS

4.3.3 The Interlaboratory Comparison Program shall be described in the ODCM. A summary of the results shall be included in the Annual Radiological Environmental Operating Report pursuant to Administrative Control 6.1

3/4.3 RADIOLOGICAL ENVIRONMENTAL MONITORING

3/4.3.4 METEOROLOGICAL MONITORING INSTRUMENTATION

CONTROLS

3.3.4 The meteorological monitoring instrumentation channels shown in Table 3.3-3 shall be OPERABLE.

APPLICABILITY: At all times.

ACTION:

- a. With less than the minimum required instrumentation channels OPERABLE for more than 7 days, initiate an Issue Report outlining the cause of the malfunction and the plans for restoring the instrumentation to OPERABLE status.
- b. The provisions of Controls 3.0.3 and 3.0.4 are not applicable.

SURVEILLANCE REQUIREMENTS

4.3.4 Each of the above required meteorological monitoring instrumentation channels shall be demonstrated OPERABLE by the performance of the CHANNEL CHECK and CHANNEL CALIBRATION operations at the frequencies shown in Table 4.3-2.

TABLE 3.3-3METEOROLOGICAL MONITORING INSTRUMENTATION

INSTRUMENT		TOWER 1 (PRIMARY)	TOWER 2 (BACKUP)	MINIMUM INSTRUMENT OPERABLE
1.	Wind Speed			
	a. Elevation 1	30 feet	159 feet	1
	b. Elevation 2	175 feet	304 feet	1
2.	Wind Direction			
	a. Elevation 1	30 feet	159 feet	1
	b. Elevation 2	175 feet	304 feet	1
3.	Air Temperature Difference (ΔT)			
	a. Elevations	266 feet	300 feet	
		26 feet	26 feet	1

TABLE 4.3-2

METEOROLOGICAL MONITORING INSTRUMENTATION SURVEILLANCE
REQUIREMENTS

INSTRUMENT	CHANNEL CHECK	CHANNEL CALIBRATION
1. Wind Speed		
a. Elevation 1 (Tower 1 and Tower 2)	D	SA
b. Elevation 2 (Tower 1 and Tower 2)	D	SA
2. Wind Direction		
a. Elevation 1 (Tower 1 and Tower 2)	D	SA
b. Elevation 2 (Tower 1 and Tower 2)	D	SA
3. Air Temperature Difference (ΔT)		
a. Elevations 266 - 26 ft (Tower 1)	D	SA
b. Elevations 300 - 26 ft (Tower 2)	D	SA

NOTE:

The meteorological towers shall be located as shown on Figure 3.3-1.

Figure 3.3-1

METEOROLOGICAL TOWER LOCATIONS

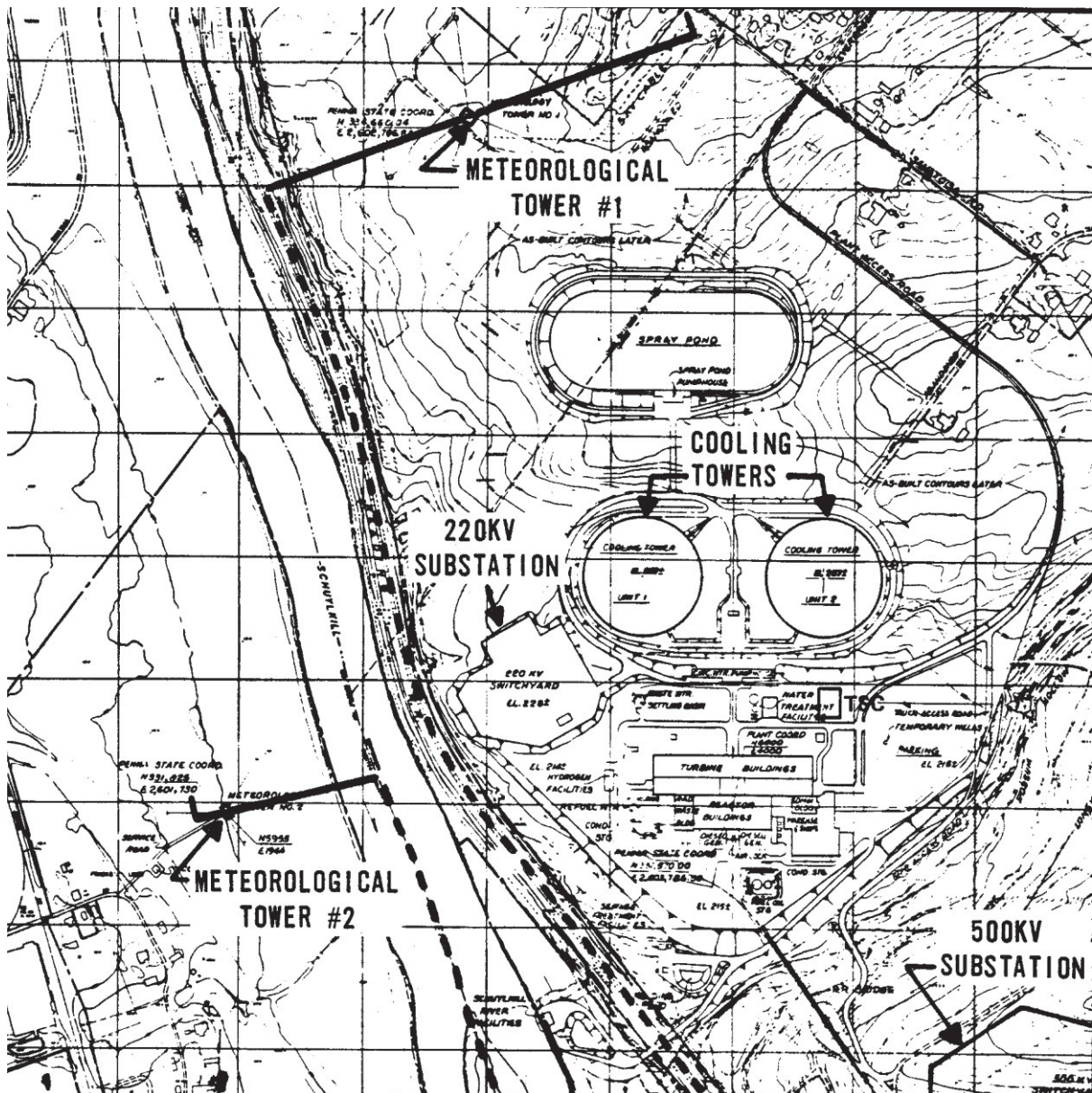

INSTRUMENTATION

OFFGAS MONITORING INSTRUMENTATION

LIMITED CONDITION FOR OPERATION

3.3.7.12 The offgas monitoring instrumentation channels shown in Table 3.3.7.12-1 shall be OPERABLE with their alarm/trip setpoints set to ensure that the limits of Specification 3.11.2.6 respectively, are not exceeded.

APPLICABILITY: As shown in Table 3.3.7.12-1

ACTION:

- a. With an offgas monitoring instrumentation channel alarm/trip setpoint less conservative than required by the above Specification, declare the channel inoperable, and take the ACTION shown in Table 3.3.7.12-1.
- b. With less than the minimum number of offgas monitoring instrumentation channels OPERABLE, take the ACTION shown in Table 3.3.7.12-1. Restore the inoperable instrumentation to OPERABLE status within the time specified in the ACTION or explain why this inoperability was not corrected in a timely manner in the next Annual Radioactive Effluent Release Report.
- c. The provisions of Specification 3.0.3 are not applicable.

SURVEILLANCE REQUIREMENTS

4.3.7.12 Each offgas monitoring instrumentation channel shall be demonstrated OPERABLE by performance of the CHANNEL CHECK, SOURCE CHECK, CHANNEL CALIBRATION, and CHANNEL FUNCTIONAL TEST operations at the frequencies specified in the Surveillance Frequency Control Program unless otherwise noted in Table 4.3.7.12

TABLE 3.3.7.12-1OFFGAS MONITORING INSTRUMENTATION

<u>INSTRUMENT</u>	<u>MINIMUM CHANNELS OPERABLE</u>	<u>APPLICABILITY</u>	<u>ACTION</u>
4. MAIN CONDENSER OFFGAS PRE-TREATMENT RADIOACTIVITY MONITOR			
a. Nobel Gas Activity Monitor	1	**	115

TABLE 3.3.7.12-1 (Continued)

TABLE NOTATIONS

** During operation of the main condenser steam jet air ejector and offgas Treatment system.

ACTION STATEMENTS

ACTION 115 - With the number of channels OPERABLE less than required by the Minimum Channels OPERABLE requirement, releases to the environment may continue for up to 72 hours provided that the North Stack Effluent Noble Gas Activity Monitor is OPERABLE; otherwise, be in at least HOT SHUTDOWN within 12 hours.

TABLE 4.3.7.12-1OFFGAS MONITORING INSTRUMENTATION SURVEILLANCE REQUIREMENTS

<u>INSTRUMENT</u>	<u>CHANNEL CHECK (5)</u>	<u>SOURCE CHECK (5)</u>	<u>CHANNEL CALIBRATION (5)</u>	<u>CHANNEL FUNCTIONAL TEST (5)</u>	<u>MODES IN WHICH SURVEILLANCE IS REQUIRED</u>
4. MAIN CONDENSER OFFGAS PRE-TREATMENT RADIOACTIVITY MONITOR (STEAM JET AIR EJECTOR)					
a. Noble gas activity monitor			(2)	(1)	**

TABLE 4.3.7.12-1 (Continued)TABLE NOTATIONS

- ** During operation of the main condenser steam jet air ejector and offgas treatment system.
- (1) The CHANNEL FUNCTIONAL TEST shall also demonstrate that control room alarm annunciation occurs if any of the following conditions exists:
1. Instrument indicates measured levels above the alarm/trip setpoint.
 2. Circuit failure.
 3. Instrument indicates a downscale failure.
 4. Instrument controls not set in operate mode.
- (2) The initial CHANNEL CALIBRATION shall be performed using one or more of the reference standards certified by the National Institute of Standards and Technology (NIST), previously National Bureau of Standards, or using standards that have been obtained from suppliers that participate in measurement assurance activities with NIST. These standards shall permit calibrating the system over its intended range of energy and measurement range. For subsequent CHANNEL CALIBRATION, sources that have been related to the initial calibration shall be used.
- (5) Frequencies are specified in the Surveillance Frequency Control Program unless otherwise noted in the table.

RADIOACTIVE EFFLUENTS

MAIN CONDENSER

LIMITING CONDITION FOR OPERATION

SURVEILLANCE REQUIREMENTS

- 4.11.2.6.1 The rate of the sum of the activities of noble gases at the recombiner after-condenser discharge shall be continuously monitored in accordance with Specification 3.3.7.12.

3/4.0 CONTROLS

BASES

GENERAL

It is expected that releases of radioactive material in effluents will be kept at small fractions of the limits specified in Section 20.1302 of 10 CFR, Part 20. At the same time, the licensee is permitted the flexibility of operation, compatible with consideration of health and safety, to assure that the public is provided a dependable source of power even under unusual operating conditions which may temporarily result in releases higher than such small fractions, but still within the limits specified in Section 20.1302 of 10 CFR, Part 20. It is expected that in using this operational flexibility under unusual operating conditions the licensee will exert his best efforts to keep levels of radioactive material in effluents as low as practicable.

MAPS DEFINING UNRESTRICTED AREAS AND SITE BOUNDARY FOR RADIOACTIVE GASEOUS AND LIQUID EFFLUENTS

Information regarding radioactive gaseous and liquid effluents, which will allow identification of structures and release points as well as definition of UNRESTRICTED AREAS within the SITE BOUNDARY that are accessible to MEMBER(S) OF THE PUBLIC, shall be as shown in Technical Specifications Figures 5.1.3-1a and 5.1.3-1b.

The exclusion area and low population zone shall be as shown in Figures 1-1 and 1-2.

10 CFR 20

Per Technical Specification Section 6.8.4.d, the Radioactive Effluent Controls Program must conform with limitations specified in 10 CFR 50.36a, 10 CFR Part 50, Appendix I, 10 times the ECL limits of 10 CFR Part 20, Appendix B, Table 2, Column 2 and 40 CFR 190. (See Reference 14)

3/4.0 CONTROLS

BASES

3/4.0 APPLICABILITY

Compliance with the controls is required during the OPERATIONAL CONDITIONS or other conditions specified therein; except that upon failure to meet the controls, the associated ACTION requirements shall be met.

Non compliance with a Control shall exist when the requirements of the control and associated ACTION requirements are not performed within the specified time intervals. If the control is restored prior to expiration of the specified time intervals, completion of the ACTION requirements is not required.

There are no actions in the ODCM which would require an operational condition change.

There are no restrictions on changing operating conditions in any of the controls on the ODCM.

Surveillance Requirements shall be met during the OPERATIONAL CONDITIONS or other conditions specified for individual controls unless otherwise stated in an individual Surveillance Requirement.

Each Surveillance Requirement shall be performed within the specified interval with a maximum allowable extension not to exceed 25% of the surveillance interval.

Failure to perform a Surveillance Requirement within the allowed surveillance interval defined by Surveillance Requirement 4.0.2.a, shall constitute noncompliance with the OPERABILITY requirements for a control. The time limits of the ACTION requirements are applicable at the time it is identified that a Surveillance Requirement has not been performed. The ACTION requirements may be delayed for up to 24 hours to permit the completion of the surveillance when the allowable outage time limits of the ACTION requirements are less than 24 hours. Surveillance requirements do not have to be performed on inoperable equipment.

The associated bases from the LGS Technical Specifications apply to this section.

3/4.1 INSTRUMENTATION

BASES

3/4.1.1 RADIOACTIVE LIQUID EFFLUENT MONITORING INSTRUMENTATION

The radioactive liquid effluent instrumentation is provided to monitor and control, as applicable, the releases of radioactive materials in liquid effluents during actual or potential releases of liquid effluents. The alarm/trip setpoints for these instruments shall be calculated in accordance with the procedures in the ODCM Part II to ensure that the alarm/trip will occur prior to exceeding the limits of 10 CFR Part 20. The OPERABILITY and use of this instrumentation is consistent with the requirements of General Design Criteria 60, 63, and 64 of Appendix A to 10 CFR Part 50.

3/4.1.2 RADIOACTIVE GASEOUS EFFLUENT MONITORING INSTRUMENTATION

The radioactive gaseous effluent instrumentation is provided to monitor and control, as applicable, the releases of radioactive materials in gaseous effluents during actual or potential releases of gaseous effluents. The alarm/trip setpoints for these instruments shall be calculated in accordance with the procedures in the ODCM Part II to ensure that the alarm/trip will occur prior to exceeding the limits of 10 CFR Part 20. The OPERABILITY and use of this instrumentation is consistent with the requirements of General Design Criteria 60, 63, and 64 of Appendix A to 10 CFR Part 50.

3/4.3.7.12 OFFGAS MONITORING INSTRUMENTATION

The instrumentation includes provisions for monitoring the concentration of noble gases in the off gas system.

3/4.2 RADIOACTIVE EFFLUENTS

BASES

3/4.2.1 LIQUID EFFLUENTS

3/4.2.1.1 CONCENTRATION

This control is provided to ensure that the concentration of radioactive materials released in liquid waste effluents to areas at and beyond the UNRESTRICTED AREAS will be less than 10 times the effluent concentration limits (ECL) specified in 10 CFR Part 20, Appendix B, Table 2, Column 2. This instantaneous limitation provides additional assurance that the levels of radioactive materials in bodies of water in areas at and beyond the SITE BOUNDARY will result in exposures within (1) the Section II.A design objectives of Appendix I, 10 CFR Part 50, to a MEMBER OF THE PUBLIC, and (2) the limits of 10 CFR 20.1302 to the population. The concentration limits for dissolved or entrained noble gases are based upon the assumption that Xe-135 is the controlling radioisotope and its ECL in air (submersion) was converted to an equivalent concentration in water using the methods described in the International Commission on Radiological Protection (ICRP) Publication 2.

The required detection capabilities for radioactive materials in liquid waste samples are tabulated in terms of the lower limits of detection (LLDs). Detailed discussion of the LLD, and other detection limits can be found in HASL Procedures Manual, HASL-300 (revised annually); Currie, L.A., "Limits for Qualitative Detection and Quantitative Determination - Application to Radiochemistry"; Anal. Chem. 40, 586-93 (1968); and Hartwell, J.K., "Detection Limits for Radioanalytical Counting Techniques", Atlantic Richfield Hanford Company Report ARH-SA-215 (June, 1975).

3/4.2.1.2 DOSE

This Control is provided to implement the requirements of Sections II.A, III.A, and IV.A of Appendix I, 10 CFR Part 50. Control 3.2.1.2 implements the guidance set forth in Section II.A of Appendix I and provides the required operating flexibility and at the same time implement the guides set forth in Section IV.A of Appendix I to assure that the releases of radioactive material in liquid effluents will be kept "as low as reasonably achievable". Also, for fresh water sites with drinking water supplies which can be potentially affected by plant operations, there is reasonable assurance that the operation of the facility will not result in radionuclide concentrations in the finished drinking water that are in excess of the requirements of 40 CFR Part 141. The Surveillance Requirement 4.2.1.2 implement the requirements in Section III.A of Appendix I that conformance with the guidance of Appendix I be shown by calculational procedures based on models and data, such that the actual exposure of a MEMBER OF THE PUBLIC through appropriate pathways is unlikely to be substantially underestimated. The equations specified in the ODCM for calculating the doses due to the actual release rates of radioactive materials in liquid effluents are

3/4.2 RADIOACTIVE EFFLUENTS

BASES

consistent with the methodology provided in NUREG-0133, "Preparation of Radiological Effluent Technical Specifications for Nuclear Power Plants" and Regulatory Guide 1.113, "Estimating Aquatic Dispersion of Effluents from Accidental and Routine Reactor Releases for the Purpose of Implementing Appendix I," April, 1977.

This control applies to the release of radioactive materials in liquid effluents from the site.

3/4.2.1.3 LIQUID RADWASTE TREATMENT SYSTEM

The requirement that the appropriate portions of this system be used when specified provides assurance that the releases of radioactive materials in liquid effluents will be kept "as low as reasonably achievable". Control 3.2.1.3 implements the requirements of 10 CFR 50.35a, General Design Criterion 60 of Appendix A to 10 CFR Part 50 and the design objective given in Section II.D of Appendix I to 10 CFR Part 50. The specified limits governing the use of appropriate portions of the liquid radwaste treatment system were specified as a suitable fraction of the dose design objectives set forth in Section II.A of Appendix I, 10 CFR Part 50, for liquid effluents.

3/4.2.2 GASEOUS EFFLUENTS

3/4.2.2.1 DOSE RATE

This control is provided to ensure that the dose from radioactive materials in gaseous effluents at and beyond the SITE BOUNDARY will be within the annual dose limits of 10 CFR Part 20 to UNRESTRICTED AREAS. The annual dose limits are the doses associated with the concentrations of 10 CFR Part 20, Appendix B, Table 2, Column 1. These limits provide reasonable assurance that radioactive material discharged in gaseous effluents will not result in the exposure of a MEMBER OF THE PUBLIC, either within or outside the SITE BOUNDARY, to annual average concentrations exceeding the limits specified in Appendix B, Table 2 of 10 CFR Part 20. For MEMBERS OF THE PUBLIC who may at times be within the SITE BOUNDARY, the occupancy factor for that MEMBER OF THE PUBLIC will usually be sufficiently low to compensate for any increase in the atmospheric diffusion factor for above that for the SITE BOUNDARY. Examples of calculations for such MEMBERS OF THE PUBLIC, with the appropriate occupancy factors, are given in the ODCM. The specified release rate limits restrict, at all times, the corresponding gamma and beta dose rates above background to a MEMBER OF THE PUBLIC at or beyond the SITE BOUNDARY to less than or equal to 500 mrem/year to the total body or to less than or equal to 3000 mrem/year to the skin. These release rate limits also restrict, at all times, the corresponding thyroid dose rate above background to a child via the inhalation pathway to less than or equal to 1500 mrem/year.

3/4.2 RADIOACTIVE EFFLUENTS

BASES

This Control applies to the release of radioactive materials in gaseous effluents from all reactors at the site.

The required detection capability for radioactive materials in gaseous waste samples are tabulated in terms of the lower limits of detection (LLDs). Detailed discussion of the LLD, and other detection limits can be found in HASL Procedures Manual, HASL-300 (revised annually); Currie, L.A., "Limits for Qualitative Detection and Quantitative Determination - Application to Radiochemistry"; Anal. Chem. 40, 586-93 (1986); and Hartwell, J.K., "Detection Limits for Radioanalytical Counting Techniques." Atlantic Richfield Hanford Company Report ARH-SA-215 (June 1975).

3/4.2.2.2 DOSE - NOBLE GASES

This control is provided to implement the requirements of Sections II.B, III.A, and IV.A of Appendix I, 10 CFR Part 50. Control 3.2.2.2 implements the guidance set forth in Section II.B of Appendix I and provides the required operating flexibility to implement the guides set forth in Section IV.A of Appendix I to assure that the releases of radioactive material in gaseous effluents will be kept "as low as reasonably achievable". The Surveillance Requirement 4.2.2.2 implement the requirements in Section III.A of Appendix I that conformance with the guides of Appendix I be shown by calculational procedures based on appropriate pathways is unlikely to be substantially underestimated. The dose calculation established in the ODCM for calculating the doses due to the actual release rates of radioactive noble gases in gaseous effluents are consistent with the methodology provided in NUREG-0133, "Preparation of Radiological Effluent Technical Specifications for Nuclear Power Plants" and Regulatory Guide 1.111, "Methods for Estimating Atmospheric Transport and Dispersion of Gaseous Effluents in Routing Releases from Light-Water Cooled Reactors," Revision 1, July 1977 with site specific dispersion curves and deposition methodology.

The ODCM equations provided for determining the air doses at and beyond the SITE BOUNDARY are based upon the historical average atmospheric conditions.

3/4.2.2.3 DOSE - IODINE-131, IODINE-133, TRITIUM, AND RADIONUCLIDES IN PARTICULATE FORM

This control is provided to implement the requirements of Sections II.C, III.A, and IV.A of Appendix I, 10 CFR Part 50. Control 3.2.2.3 implements the guidance set forth in Section II.C of Appendix I and provides the required operating flexibility to implement the guides set forth in Section IV.A of Appendix I to assure that the releases of radioactive materials in gaseous effluents will be kept "as low as is reasonably achievable." The ODCM calculational methods specified in the Surveillance Requirements 4.2.2.3 implement the

3/4.2 RADIOACTIVE EFFLUENTS

BASES

requirements in Section III.A of Appendix I, that conformance with the guides of Appendix I be shown by calculational procedures based on models and data, such that the actual exposure of a MEMBER OF THE PUBLIC through appropriate pathways is unlikely to be substantially underestimated. The ODCM calculational methods for calculating the doses due to the actual release rates of the subject materials are consistent with the methodology provided in NUREG-0133, "Preparation of Radiological Effluent Technical Specifications for Nuclear Power Plants" and Regulatory Guide 1.111, "Methods for Estimating Atmospheric Transport and Dispersion of Gaseous Effluents in Routine Releases from Light-Water-Cooled Reactors," Revision 1, July 1977 with site specific dispersion curves and deposition methodology. These equations also provide for determining the actual doses based upon the historical average atmospheric conditions. The release rate specifications for iodine-131, iodine-133, tritium, and radionuclides in particulate form with half-lives greater than 8 days are dependent on the existing radionuclides pathways to man in areas at and beyond the SITE BOUNDARY. The pathways which were examined in the development of these calculations were: (1) individual inhalation of airborne radionuclides, (2) deposition of radionuclides onto green leafy vegetation with subsequent consumption by man, (3) deposition onto grassy areas where milk animals and meat-producing animals graze with consumption of the milk and meat by man, and (4) deposition on the ground with subsequent exposure of man.

3/4.2.2.4 AND 3/4.2.2.5 GASEOUS RADWASTE TREATMENT SYSTEM AND VENTILATION EXHAUST TREATMENT SYSTEM

The requirement that the appropriate portions of this system be used, when specified, provides reasonable assurance that the releases of radioactive materials in gaseous effluents will be kept "as low as is reasonably achievable." Controls 3.2.2.4 and 3.2.2.5 implements the requirements of 10 CFR 50.36a, General Design Criteria 60 of Appendix A to 10 CFR Part 50, and the design objectives given in Section II.D of Appendix I to 10 CFR Part 50. The specified limits governing the use of appropriate portions of the systems were specified as a suitable fraction of the dose design objectives set forth in Section II.B and II.C of Appendix I, 10 CFR Part 50, for gaseous effluents.

3/4.2.2.7 MARK II CONTAINMENT

This control provides reasonable assurance that releases from drywell venting or purging operations will not exceed the annual dose limits of 10 CFR Part 20 for areas at or beyond the UNRESTRICTED AREAS.

3/4.2 RADIOACTIVE EFFLUENTS

BASES

3/4.2.3 TOTAL DOSE

This control is provided to meet the dose limitations of 40 CFR Part 190 that have been incorporated into 10 CFR Part 20 by 46 CFR 18525, as well as the dose limitations specific to Independent Spent Fuel Storage Installation (ISFSI) operations in accordance with 10 CFR 72.104. Over the long term, as more storage modules containing dry shielded canisters of spent fuel are placed on the ISFSI pad, it is expected that ISFSI operations will become the prominent contributor to the dose limits in this section. ISFSI dose contribution is in the form of direct radiation as no liquid or gas releases are expected to occur from the ISFSI canisters. The LGS 10 CFR 72.212 Report prepared in accordance with 10 CFR 72 requirements assumes a certain array of storage modules exists on the pad. The dose contribution from this array of casks combination with historical uranium fuel cycle operations prior to ISFSI operations was analyzed to be within the 40 CFR 190 and 10 CFR 72.104 limits. Control 3.2.3 requires the preparation and submittal of a Special Report whenever the calculated doses due to releases of radioactivity and to radiation from uranium fuel cycle sources exceed 25 mrem to the whole body or any organ, except the thyroid, which shall be limited to less than or equal to 75 mrem. For sites containing up to four reactors, it is highly unlikely that the resultant dose to a MEMBER OF THE PUBLIC will exceed the dose limits of 40 CFR Part 190 if the individual reactors remain within twice the dose design objectives of Appendix I, and if direct radiation does from the units (including outside storage tanks, etc.) are kept small.

The Special Report will describe a course of action that should result in the limitation of the annual dose to a MEMBER OF THE PUBLIC to within the 40 CFR Part 190 limits. For the purposes of the Special Report, it may be assumed that the dose commitment to the MEMBER OF THE PUBLIC from other uranium fuel cycle sources is negligible, with the exception that dose contributions from other nuclear fuel cycle facilities at the same site or within a radius of 5 miles must be considered. If the dose to any MEMBER OF THE PUBLIC is estimated to exceed the requirements of 40 CFR Part 190 or 10 CFR 72.104, the Special Report with a request for a variance (provided the release condition resulting in violation of 40 CFR Part 190 or 10 CFR 72.104 have not already been corrected), in accordance with the provisions of 40 CFR 190.11, or 10 CFR 72.104 and 10 CFR 20.2203, is considered to be a timely request and fulfills the requirements of 40 CFR Part 190 or 10 CFR 72.104 until NRC staff action is completed. The variance only relates to the limits of 40 CFR Part 190 or 10 CFR 72.104, and does not apply in any way to the other requirements for dose limitation of 10 CFR Part 20, as addressed in Controls 3.2.1.1 and 3.2.2.1. An individual is not considered a MEMBER OF THE PUBLIC during any period in which he/she is engaged in carrying out any operation that is part of the nuclear fuel cycle.

3/4.3 RADIOLOGICAL ENVIRONMENTAL MONITORING BASES

3/4.3.1 MONITORING PROGRAM

The Radiological Environmental Monitoring Program (REMP) required by this control provides representative measurements of radiation and of radioactive materials in those exposure pathways and for those radionuclides that lead to the highest potential radiation exposures of MEMBER OF THE PUBLIC resulting from the station operation. This monitoring program implements Section IV.B.2 of Appendix I to 10 CFR Part 50 and thereby supplements the radiological effluent monitoring program by verifying that the measurable concentrations of radioactive materials and levels of radiation are not higher than expected on the basis of the effluent measurements and modeling of the environmental exposure pathways.

The required detection capabilities for environmental sample analyses are tabulated in terms of the lower limits of detection (LLDs). The LLDs required by Table 4.3-1 are considered optimum for routine environmental measurements in industrial laboratories. It should be recognized that the LLD is defined as an a priori (before the fact) limit representing the capability of a measurement system and not an after the fact limit for a particular measurement.

Detailed discussion of the LLD, and other detection limits, can be found in HASL Procedures Manual, HASL-300 (revised annually); Currie L.A., "Limits for Qualitative Detection and Quantitative Determination - Application to Radiochemistry," Anal. Chem. 40, 586-93 (1968), and Hartwell, J.K., "Detection Limits for Radioanalytical Counting Techniques", Atlantic Richfield Hanford Company Report ARH-SA-215 (June, 1975).

3/4.3.2 LAND USE CENSUS

This control is provided to ensure that changes in the use of areas at and beyond the SITE BOUNDARY are identified and that modifications to the monitoring program are made if required by the results of the census. The best information from the door-to-door survey, aerial survey or consulting with local agricultural authorities or any combination of these methods shall be used. This census satisfies the requirements of Section IV.B.3 of Appendix I to 10 CFR Part 50. Restricting the census to gardens of greater than 500 square feet provides assurance that significant exposure pathways via leafy vegetables will be identified and monitored since a garden of this size is the minimum required to produce the quantity (26 Kg/year) of leafy vegetables assumed in Regulatory Guide 1.109 for consumption by a child. To determine this minimum garden size, the following assumptions were used: (1) that 20% of the garden was used for growing broad leafy vegetation (i.e. similar to lettuce and cabbage), and (2) a vegetation yield of 2 kg/Square meter.

3/4.3 RADIOLOGICAL ENVIRONMENTAL MONITORING BASES

3/4.3.3 INTERLABORATORY COMPARISON PROGRAM

The requirement for participation in an Interlaboratory Comparison Program ensures that independent checks on the precision and accuracy of the measurements of radioactive material in environmental sample matrices are performed as part of the quality assurance program for environmental monitoring in order to demonstrate that the results are reasonably valid for the purpose of Section IV.B.2 of Appendix I to 10 CFR Part 50.

3/4.3.4 METEOROLOGICAL MONITORING INSTRUMENTATION

The OPERABILITY of the meteorological monitoring instrumentation ensures that sufficient meteorological data is available for estimating potential radiation doses to the public as a result of routine or accidental release of radioactive materials to the atmosphere. This capability is required to evaluate the need for initiating measures to protect the health and safety of the public. This instrumentation is consistent with the recommendations of Regulatory Guide 1.23 "Onsite Meteorological Programs," February, 1972.

Site data compiled since January 1972 provide correlation between Elevation 1 (Tower 1) and Elevation 1 (Tower 2), and between Elevation 2 (Tower 1) and Elevation 2 (Tower 2). This correlation serves as justification for the use of the appropriate Tower 2 instrument as a back-up to the Tower 1 instrument as shown in Table 3.3-3.

6.0 ADMINISTRATIVE CONTROLS

6.1 ANNUAL RADIOLOGICAL ENVIRONMENTAL OPERATING REPORT

- 6.1 Routine Annual Radiological Environmental Operating Report covering the operation of Unit 1 and Unit 2 during the previous calendar year shall be submitted prior to May 1 for each year. The initial report was submitted prior to May 1 of the year following initial criticality (1984). A single report is submitted for a multiple unit station. The Annual Radiological Environmental Operating Report shall include summaries, interpretations, and an analysis of trends of the results report period, including a comparison (as appropriate), with preoperational studies, operational controls and previous environmental surveillance reports and an assessment of the observed impacts of the plant operation on the environment. The reports shall also include the results of land use census required by Control 3.3.2. The Annual Radiological Environmental Operating Report shall include the results of all radiological environmental samples and of all environmental radiation measurements taken during the report period pursuant to the locations specified in the tables and figures in the OFFSITE DOSE CALCULATION MANUAL, as well as summarized and tabulated results of these analyses and measurements in the format of the table in NUREG 1302. In the event that some individual results are not available for inclusion with the report, the report shall be submitted noting and explaining the reasons for the missing results. The missing data shall be submitted as soon as possible in a supplementary report. The report shall also include the following: a summary description of the radiological environmental monitoring program and at least two legible maps. One map shall cover stations near the SITE BOUNDARY; a second shall include the more detailed distant stations. Covering all sampling locations keyed to a table giving distances and directions from the centerline of the reactor plant; the results of licensee participation in the Interlaboratory Comparison Program, required by Control 3.3.3 discussion of all deviations from the Sampling Schedule of Table 3.3-1; and discussion of all analyses in which the LLD required by Table 4.3-1 was not achievable.

The Annual Radiological Environmental Monitoring Report shall include a summary of Special Reports detailing level of radioactivity as the result of plant effluents in an environmental sampling medium exceed the reporting levels of Table 3.3-2.

6.0 ADMINISTRATIVE CONTROLS6.2 ANNUAL RADIOACTIVE EFFLUENT RELEASE REPORT

6.2 A Routine Annual Radioactive Effluent Release Report covering the operation of Unit 1 and Unit 2 during the previous year shall be submitted in accordance with Tech Spec section 6.9.1.8. The period of the first report shall begin with the date of initial criticality. A single unit submittal is made for the 2-unit station. The submittal combines those sections that are common to all units at the station. The Annual Radioactive Effluent Release Report shall include a summary of the quantities of radioactive liquid and gaseous effluents and solid waste released from the facility as outlined in Regulatory Guide 1.21, "Measuring, Evaluation, and Reporting Radioactivity in Solid Wastes and Releases of Radioactive Materials in Liquid and Gaseous Effluents from Light-Water-Cooled Nuclear Power Plants," Revision 1, June 1974, with data summarized on a quarterly basis following the format of Appendix B with the following exception: (1) Gaseous dose rates rather than effluent concentrations are used to calculate permissible release rates for gaseous releases. (2) ODCM Control 3.2.2.1 limits the dose equivalent rates due to the release of noble gases to less than or equal to 500 mrem per year to the total body and less than or equal to 3000 mrem per year to the skin. Therefore, the average beta and gamma energies (\bar{E}) of the radionuclide mixture in releases of fission and activation gases are not applicable. (3) Achieving doses of less than the limits of 10 CFR Part 50, Appendix I demonstrate that Limerick's gaseous effluents are ALARA. Therefore, calculations of total body doses to the population out to 50 miles from gaseous effluents are not performed.

The Annual Radioactive Effluent Release Report shall include an annual summary of hourly meteorological data collected over the previous year. This annual summary may be either in the form of an hour-by-hour listing on magnetic tape of wind speed, wind direction and atmospheric stability, and precipitation (if measured), or in the form of joint frequency distributions of wind speed, wind direction, atmospheric stability. The licensee has the option of retaining this summary of required meteorological data on site in a file that shall be provided to the NRC upon request. This same report shall include an assessment of the radiation doses due to the radioactive liquid and gaseous effluents released from both units during the previous calendar year. This same report shall also include an assessment of the radiation doses from radioactive liquid and gaseous effluents to MEMBER OF THE PUBLIC due to their activities inside the SITE BOUNDARY (Figures 1-1 and 1-2) during the report period. All assumptions used in making these assessments shall be included in these reports. The assessment of radiation doses shall be performed in accordance with the methodology and parameters of the OFFSITE DOSE CALCULATION MANUAL (ODCM).

The Annual Radioactive Effluent Release Report shall also include an assessment of radiation doses to the hypothetically highest exposed MEMBER OF THE PUBLIC from reactor releases, ISFSI and other nearby uranium fuel cycle sources (including doses from primary effluent pathways and direct radiation) for the previous calendar

6.0 ADMINISTRATIVE CONTROLS6.2 ANNUAL RADIOACTIVE EFFLUENT RELEASE REPORT

year to show conformance with 40 CFR Part 190, Environmental Radiation Protection Standards for Nuclear Power Operation. Dose contribution from liquid and gaseous effluents is calculated based on NUREG-0133 methodology.

The Annual Radioactive Effluent Release Reports includes the following information for each type of solid waste (as defined in 10 CFR Part 61) shipped offsite during the report period:

1. Total volume, activity and estimated total % error for each waste type:
 - a. Spent resins filter sludges, evaporator bottoms, etc.
 - b. Dry compressible waste, contaminated equipment, etc.
 - c. Irradiated components, control rods, etc.
 - d. Others (describe).
2. Activity and percentage of each principle radionuclide (>1%), for each individual waste type as defined in 1. (a-d) above.
3. The disposition of solid waste shipments (identify the number of shipments, the mode of transport, and the destination).
4. The disposition of irradiated fuel shipments (identify the number of shipments, the mode of transport, and the destination).

The Annual Radioactive Effluent Release Report includes a list and description of unplanned releases from the site to UNRESTRICTED AREAS of radioactive material in gaseous and liquid effluents made during the reporting period.

Changes made during the reporting period to procedure RW-AA-100 (formerly the PROCESS CONTROL PROGRAM) and to the ODCM, as well as a listing of new locations for dose calculations and/or environmental monitoring identified by the land use census pursuant to Control 3.3.2. shall be submitted in the form of a complete, legible copy of the entire ODCM as part of or concurrent with the Annual Radiological Effluent Release Report for the period of the report in which any change to the ODCM was made.

The Annual Radioactive Effluent Release Report shall include an explanation as to why the inoperability of liquid or gaseous effluent monitoring instrumentation was not corrected within the time specified in Controls 3.1.1 or 3.1.2, respectively;

The Annual Radioactive Effluent Release Report shall include a summary of Special Reports detailing why discharge of liquid radwaste or gaseous radwaste without treatment exceeded the time specified in Controls 3.2.1.3 or 3.2.2.4, respectively.

The Annual Radioactive Effluent Release Report shall include a summary of Special Reports for exceeding the calculated doses from the release of radioactive materials in liquid or gaseous effluents exceeding the limits of Controls 3.2.1.2.a., 3.2.1.2.b., 3.2.2.2.a., 3.2.2.2.b., 3.2.2.3.a., 3.2.2.3.b., 3.2.2.5.a., 3.2.2.5.b., 3.2.2.5.c., and 3.2.3.

6.0 ADMINISTRATIVE CONTROLS

6.3 MAJOR CHANGES TO RADIOACTIVE WASTE TREATMENT SYSTEMS

- 6.3 Licensee-initiated major changes to the radioactive waste systems (liquid, gaseous, and solid):
- a. Shall be reported to the Commission in the Annual Radioactive Effluent Release Report for the period in which the change was made effective. The discussion of each change shall contain:
1. A summary of the evaluation that led to the determination that the change could be made in accordance with 10 CFR 50.59;
 2. Sufficient detailed information to totally support the reason for the change without benefit of additional or supplemental information;
 3. A detailed description of the equipment, components, and processes involved and the interface with other plant systems;
 4. An evaluation of the change which shows the predicted releases of radioactive materials in liquid and gaseous effluents and/or quantity of solid waste that differ from those previously predicted in the license application and amendments thereto;
 5. An evaluation of the change which shows the expected maximum exposures to individual in the UNRESTRICTED AREA and to the general population that differ from those previously estimated in the license application and amendments thereto;
 6. A comparison of the predicted releases of radioactive materials, in liquid and gaseous effluents and in solid waste, to the actual releases for the period prior to when the changes are to be made; and
 7. An estimate of the exposure to plant operating personnel as a result of the change.

6.0 ADMINISTRATIVE CONTROLS

6.4 CHANGES TO THE ODCM

6.4 Licensee-initiated changes to the Offsite Dose Calculational Manual:

- a. Shall contain the program elements described in Technical Specifications 6.8.4.d, e and f.
- b. Shall be revised in accordance with the requirements described in Technical Specification 6.14.
- c. Shall be revised per applicable procedures detailing other requirements for making changes to the ODCM.
- d. Shall be reviewed and accepted by PORC and signed by the Plant Manager prior to implementation.

PART II

CALCULATION METHODOLOGIES

CALCULATION METHODOLOGIES

1.0 LIQUID EFFLUENTS

1.1 RADIATION MONITORING INSTRUMENTATION AND CONTROLS

The liquid effluent monitoring instrumentation and controls at Limerick for controlling and monitoring normal radioactive material releases in accordance with the Limerick ODCM Controls are summarized as follows:

- 1) Liquid Radwaste System: The liquid radwaste discharge monitor (RISH-63-0K604) provides an alarm and automatic termination of radioactive material releases from the liquid radwaste system as required by ODCM Control 3.1.1. Additional design features of the liquid radwaste system which prevent inadvertent releases to the environment include 1) redundant discharge valves, 2) single discharge line with loop seal and siphon breaker to eliminate probability of inadvertent discharges, 3) Low Cooling Tower Blowdown flow interlock which isolates the radwaste discharge line.
- 2) Service Water System: The Service Water discharge monitor (RISH-10-1K605 AND RISH-10-2K605) provides an alarm upon indication of activity in the service water system as required by ODCM Control 3.1.1. While the service water system is not a normal release pathway, the monitor provides an indication of potential problems due to excessive leakage of the heat exchangers. In addition, the service water side of the fuel pool heat exchangers is kept at a higher pressure than the shell side to prevent potential radioactive contamination of the service water.
- 3) RHR Service Water System: The RHR Service Water Radiation (RHRSW) Monitors (RISH-12-0K619A, RISH-12-0K619B) provide alarm and automatic termination* of radioactive material release from the RHRSW system, as required by ODCM Control 3.1.1. The Residual Heat Removal (RHR) Service Water System provides water from the Emergency Service Water (ESW) spray pond to the RHR heat exchangers. In post accident conditions, RHR Service Water can supply water for vessel and containment flooding. While the RHRSW system is not a normal release pathway, the monitors provide indication of potential problems due to excessive leakage of the heat exchangers.

*Termination of the release is accomplished by auto trip of the RHRSW pumps and remote manual closure of isolation valves.

CALCULATION METHODOLOGIES

1.2 LIQUID EFFLUENT MONITOR SETPOINT DETERMINATION

Per the requirements of ODCM Control 3.1.1, alarm setpoints shall be established for the liquid effluent monitoring instrumentation to ensure that the release concentration limits of ODCM Control 3.2.1.1 are met. The concentration of radioactive material released in liquid effluents to UNRESTRICTED AREAS shall be limited to 10 times the effluent concentration limits specified in 10 CFR 20, Appendix B, Table 2, Column 2, for radionuclides other than noble gases and $2.0E-04$ $\mu\text{Ci/ml}$ for dissolved or entrained noble gases (NUREG 0133).

1.2.1 Radwaste Discharge Monitor and Discharge Flow Rate – RISH-63-0K604

The setpoint for the liquid radwaste discharge monitor is determined by equation 1-1. The radwaste discharge monitor high-high alarm/isolation setpoint is calculated with each tank release based on isotopes detected in the liquid radwaste sample tank to be released ($\sum C_{iY}$), the default minimum cooling tower blowdown of 5,000 gallons per minute (CTBD), the radwaste discharge flow rate of 255 gpm and the maximum tank volume in gallons.

The flow rate determination is calculated for each release and determined by equation 1-2.

The ECL fraction calculated includes, in the concentration mix (dissolved and entrained noble gases), the most recent results the quarterly composite for SR-89, SR-90 and Fe-55, and the monthly composite for H-3 and gross alpha.

If the calculated setpoint is less than the existing setpoint, the setpoint will be reduced to the new value or the tank will be returned for more processing. If the calculated setpoint is greater than the existing setpoint, the setpoint may remain at the lower value or be increased to the higher calculated value.

The actual setpoint may be reduced to a value less than the calculated setpoint at the discretion of supervision.

CALCULATION METHODOLOGIES

1.2.1.1 Setpoint Determination – RISH-63-0K604

The setpoints for the liquid radwaste discharge monitor is determined by the following equations:

$$\text{Hi-Hi Setpoint} = CPM_{(LRD)} \leq \left[1 - \frac{(S)(RR)[\sum(C_{i\beta})/ECL_{i\beta}]}{(RR+CTBD)} \right] \left[\frac{(\sum C_{i\gamma})(RR+CTBD)}{(S)(E)(RR)(\sum C_{i\gamma}/ECL_{i\gamma})} \right] + BKG_{(LRD)} \quad (1-1)$$

$$\text{Hi Setpoint} = (F)(\text{Hi-Hi Setpoint}) + BKG_{(LRD)} \quad (1-1a)$$

where:

- $CPM_{(LRD)}$ = calculated liquid radwaste discharge monitor (RISH-63-0K604) count rate attributable to the gamma emitting radionuclide, cpm
- $\sum C_{i\gamma}$ = the sum of the concentration of the identified gamma emitting nuclides ($\mu\text{Ci/ml}$),
- CTBD = the required minimum cooling tower blowdown rate during discharge (gpm),
- RR = average liquid radwaste discharge flow (gpm),
- $BKG_{(LRD)}$ = background count rate of liquid radwaste discharge monitor (CPM),
- E = the gross detection efficiency of the liquid radwaste discharge monitor ($\mu\text{Ci/ml/cpm}$), and
- S = 2; margin of safety factor to assure that the release is terminated prior to 10 CFR 20 limits being exceeded. Included in this factor are errors associated with monitor uncertainty, sampling uncertainty, flow rate uncertainty, and the contribution of other release paths (Service Water and RHRSW) which are not normally contaminated.
- F = 0.75 (a factor less than 1 that is used to calculate the Hi-Setpoint)
- $\sum C_{i\gamma}/ECL_{i\gamma}$ = the effective gamma ECL ratio for the mixture of radionuclides in the liquid radwaste discharge line (unitless).

where:

- $C_{i\gamma}$ = the concentration of each identified gamma emitting radionuclide 'i' in the liquid effluent (undiluted) ($\mu\text{Ci/ml}$)
- $ECL_{i\gamma}$ = the ECL value for radionuclide 'i' corresponding to 10 times the ECL limit from 10 CFR 20 Appendix B, Table 2, Column 2 (dissolved and entrained noble gases ECL = $2.0\text{E-4 } \mu\text{Ci/ml}$)

CALCULATION METHODOLOGIES

$\sum C_{i\beta} / ECL_{i\beta}$ = the effective nongamma ECL ratio for the mixture of radionuclides in the liquid radwaste discharge line (unitless)

where:

$C_{i\beta}$ = the concentration of each identified nongamma radionuclide ' i ' in the liquid effluent (undiluted) ($\mu\text{Ci/ml}$)
* (See note below)

$ECL_{i\beta}$ = the ECL value for radionuclide ' i ' corresponding to 10 times the ECL limit from 10 CFR 20, Appendix B, Table 2, Column 2

* **NOTE:** The concentration mix must include the most recent sample data for H-3, Sr-89, Sr-90, Fe-55 and gross alpha.

EXAMPLE:

Given the following information:

Tank Discharge Rate: 255 gpm

Cooling Tower Blowdown: 5000 gpm

Monitor Efficiency: 3.66E-09

Radwaste sample activity:

Nuclide	Activity uCi/ml	10 x ECL	Pre Dilution ECL Fraction
H-3	3.19E-03	1.00E-02	3.19E-01
Mn-54	9.00E-08	3.00E-04	3.00E-04
Co-60	7.00E-08	3.00E-05	2.33E-03
Cs-137	1.10E-07	1.00E-05	1.10E-02
Total Beta	3.19E-03		3.19E-01
Total Gamma	2.70E-07		1.36E-02

$$5.402E + 04 \leq \left[1 - \frac{(2)(255)[(3.19E-01)]}{(255+5000)} \right] \left[\frac{(2.70E-07)(255+5000)}{(2)(3.66E-09)(255)(1.36E-02)} \right] + 0.00$$

1.2.1.2 Flow Rate Determination

The maximum liquid radwaste tank flow rate discharge to the river is determined by the following equation:

CALCULATION METHODOLOGIES

$$FLOW_{(LRD)} \leq \frac{CTBD}{S \left| \sum (C_i / ECL_i) - 1 \right|} \quad (1-2)$$

where:

$FLOW_{(LRD)}$ = flow limit for radwaste discharge line (gpm).

CTBD = required minimum cooling tower blowdown flow during discharge (gpm).

S = 2; margin of safety factor to assure that the release does not exceed 10 CFR 20 limits.

$\sum(C_i/ECL_i)$ = the effective ECL ratio for the mixture of radionuclides in the liquid radwaste discharge line (unitless) for $\sum(C_i/ECL_i) > 1$. If $\sum(C_i/ECL_i) < 1$, then no flow rate determination is necessary.

where:

C_i = the concentration of each identified radionuclide ' i ' in the liquid effluent (undiluted) ($\mu\text{Ci/ml}$)* (See note below)

ECL_i = the ECL value for radionuclide ' i ' corresponding to 10 times the ECL limit from 10 CFR 20 Appendix B, Table 2, Column 2, (dissolved and entrained noble gases $ECL = 2E-4 \mu\text{Ci/ml}$).

* **NOTE:** The concentration mix must include the most recent sample data for H-3, Sr-89, Sr-90, Fe-55, gross alpha and dissolved and entrained noble gases.

1.2.2 Service Water Radiation Monitor – RISH-010-1K605, -2K605 RHR Service Water Monitor – RISH-012-0K619A, -0K619B

The High-High radiation setpoints for the Service Water and the RHR Service Water monitors are set at 10 times the Cs 137 Effluent Concentration Limits (ECL) of $1.0E-06 \mu\text{Ci/mL}$. Considering the radionuclides predominant in the Limerick reactors (e.g., Co-58, Co-60, Fe-59, Mn-54, Zn-65 and Cr-51), the use of a setpoint based on the Cs-137 Effluent Concentration Limit (ECL) is reasonable due to the following parameters:

- 1) High photon abundance (85%),
- 2) Spectrum midrange photon energy (0.662 MeV)
- 3) Conservative magnitude of the applicable ECL limit ($1.0E-05 \mu\text{Ci/ml}$)

CALCULATION METHODOLOGIES

The Service Water and the RHR Service Water maximum Radiation Monitor (High-High) setpoint is determined by the following equation to meet the requirements of ODCM Control 3.2.1.1.

The High Setpoint shall be administratively controlled to a value that is less than the High-High setpoint.

1.2.2.1 Setpoint Determination

The setpoints for the Service Water and RHR Service Water Radiation Monitors are determined by the following equations:

$$\text{Hi-Hi Setpoint} = \text{CPM} = (10 * ECL_{Cs-137})(CF) + (0.5)B \quad (1-3)$$

$$\text{Hi Setpoint} = (F)(\text{Hi-Hi Setpoint}) \quad (1-4)$$

where:

CPM = calculated maximum radiation monitor (RISH-010-1K605, -2K605, RISH-012-0K619A, -0K619B) count rate, cpm

10 = 10 times the ECL limit from 10 CFR 20 Appendix B, Table 2, Column 2 to maintain the 500 mrem/yr instantaneous release limits

ECL_{Cs-137} = ECL limit for Cs-137 (1.0E-06 $\mu\text{Ci/ml}$)

CF = monitor calibration factor - in cpm/ $\mu\text{Ci/ml}$

B = Background count rate (cpm)

F = a factor less than 1 that is used to calculate the Hi-Setpoint.

$$F_{\text{Service Water}} = 0.75$$

$$F_{\text{RHR Service Water}} = 0.50$$

1.3 LIQUID EFFLUENT DOSE CALCULATION - 10 CFR 50

1.3.1 Dose to Members of the Public

Control 3.2.1.2 limits the dose or dose commitment to MEMBERS OF THE PUBLIC from radioactive materials in liquid effluents from Limerick Generating Station to:

During any Calendar Quarter	During any Calendar Year
≤ 3 mrem to total body	≤ 6 mrem to total body
≤ 10 mrem to any organ.	≤ 20 mrem to any organ

CALCULATION METHODOLOGIES

Per Surveillance Requirement 4.2.1.2 the cumulative dose contribution from liquid effluents for the current calendar quarter and calendar year shall be determined at least once per 31 days in accordance with the following calculation methods. The results are accumulated to give the quarterly doses and the quarterly results are accumulated to give the annual doses.

Receptor Location	Dist. (mi)	Pathways		
		Potable Water	Fish	Shoreline
LGS Outfall	0		X	X
PA. American Water	2.5	X	X	X
Phoenixville Water	9.0	X	X	X
Aqua America	13.6	X		X
Crew Course	37.8			X

Software currently used at the Limerick Generating Station calculates doses from liquid releases based upon the methodology presented in NUREG-0133.

The NUREG-0133 methodology is based upon that presented in Reg. Guide 1.109, but has been simplified. Comparisons between the two methodologies indicate the doses calculated by NUREG-0133 are approximately 3 to 5% higher than those calculated using Reg. Guide 1.109 methodology.

1.3.1.1 Aquatic Pathway - NUREG-0133

$$D_{\tau} = \frac{\sum_i \left[A_{i\tau} \sum_{\ell=1}^m \Delta t_{\ell} C_{i\ell} F_{\ell} \right]}{D_w} \quad (1-5)$$

where:

- D_{τ} = The cumulative dose commitment to the total body or any organ, τ , from liquid effluents for the total time period $\sum_{\ell=1}^m \Delta t_{\ell}$, in mrem.
- Δt_{ℓ} = The length of the ℓ th time period over which $C_{i\ell}$ and F_{ℓ} are averaged for the liquid release, in hours.
- $C_{i\ell}$ = The average concentration of radionuclide, i , in undiluted liquid effluent during time period Δt_{ℓ} , from any liquid release,

CALCULATION METHODOLOGIES

(determined by the effluent sampling analysis program, ODCM Part I, Table 4.2-1, in uCi/ml).

F_ℓ = The near field average dilution factor for C_{i_ℓ} during any liquid effluent release. Defined as the ratio of the maximum undiluted liquid waste flow during the release to the average flow through the discharge pathway (minimum factor is 0.04853) defined by the following:

$$F_\ell = \frac{(\text{tank volume}_{\text{gallons}})}{(\text{tank volume}_{\text{gallons}}) + (\text{Cooling Tower Dilution}_{\text{gallons}})} \quad (1-6)$$

D_w = The dilution factor at point of exposure or at point of withdrawal of drinking water (dimensionless). Values are based on average daily river flow. D_w factors are calculated in equations 1-7 through 1-11.

$$\text{LGS Outfall} \quad 0.685 + 0.026 * \text{rflow} \quad (1-7)$$

$$\text{American Water} \quad 0.237 * \text{rflow}^{1.17} \quad (1-8)$$

$$\text{Phoenixville Water} \quad 0.121 * \text{rflow}^{0.973} \quad (1-9)$$

$$\text{Aqua America} \quad 0.089 * \text{rflow}^{0.993} \quad (1-10)$$

$$\text{Phil. Crew Course} \quad 0.076 * \text{rflow}^{0.996} \quad (1-11)$$

where:

rflow is river flow in ft³/sec.

$A_{i\tau}$ = The site specific ingestion dose commitment factor to the total body or organ, τ , for each radionuclide and pathway listed in Table II1-10 through Table II1-17 in mrem-mL per uCi-hr. $A_{i\tau}$ for each pathway and age group are calculated using the following equations:

Drinking Water

$$A_{i\tau} = k_0 * U_w * D_{aipj} * RC * e^{(-\lambda_i t_p^D)} \quad (1-12)$$

Freshwater Fish

$$A_{i\tau} = k_0 * U_F * BF_i * D_{aipj} * RC * e^{(-\lambda_i t_p^F)} \quad (1-13)$$

Shoreline

$$A_{i\tau} = k_{0S} * U_s * W * T_i * D_{aipj} * RC \left(e^{-\lambda_i t_p^S} \right) \left(1 - e^{-\lambda_i T_b} \right) \quad (1-14)$$

where:

$$k_0 = 114155, \text{ units conversion factor } (1.0 \text{ E6 pCi/uCi} * 1000 \text{ ml/L} / 8760 \text{ hr/yr}). \text{ Note for fish units are g/kg.}$$

CALCULATION METHODOLOGIES

k_{0S}	=	11416000, units conversion factor to account for the proportionality constant used in the sediment radioactivity model. (100 L/kg-hr kg/m ² hr/day * 1000 ml/L * 1.0E6 pCi/uCi/8760 hr/yr).
U	=	usage factor per pathway – Table II1-8.
D_{aipj}	=	dose conversion factor for nuclide, i , for total body or any organ, τ , in mrem/pCi, from Tables II1-3 through II1-7.
BF_i	=	bioaccumulation factor for nuclide, i , in fresh water fish, pCi/kg per pCi/L, from Table II1-2.
RC	=	reconcentration factor as indicated in Table II1-21.
W	=	shoreline width factor (dimensionless) as indicated in Table II1-21.
T_i	=	radioactive half-life of nuclide ' i ' (days) from Table II1-1.
λ_i	=	radioactive decay constant of nuclide ' i ' (hr ⁻¹) from Table II1-1.
t_p^D	=	delay time for water pathway in hours to allow for nuclide decay during transport through the water purification plant and the water distribution system as indicated in Table II1-21.
t_p^F	=	delay time for fish pathway to allow for nuclide decay during transport through the food chain, as well as during food preparation as indicated in Table II1-21.
t_p^S	=	delay time in hours for shoreline pathway as indicated in Table II1-21. Zero hours are assumed as shoreline activities can occur at the outfall.
T_b	=	time period during which sediment is exposed to contaminated water as indicated in Table II1-21.

1.3.2 Liquid Effluent Dose Projections

Control 3.2.1.3 requires that the liquid radwaste treatment system shall be operable and appropriate portions of the systems used to reduce the radioactive materials in liquid waste prior to their discharge when the projected doses due to the liquid effluent to UNRESTRICTED AREAS would exceed:

0.12 mrem to the total body

or

0.4 mrem to any organ.

Dose projections are made at least once per 31-days when liquid radwaste treatment systems are not being fully utilized using the following equations:

$$D_{tbp} = (D_{tb}/d) * 31 \text{ days} \quad (1-15)$$

$$D_{maxp} = (D_{max}/d) * 31 \text{ days} \quad (1-16)$$

CALCULATION METHODOLOGIES

where:

- D_{tbp} = the total body dose projection for the current 31-day period (mrem).
- D_{tb} = the total body dose to date for the current calendar quarter as determined by equation 1-5 (mrem).
- D_{maxp} = the maximum organ dose projection for the current 31-day period (mrem).
- D_{max} = the maximum organ dose to date for the current calendar quarter as determined by equations 1-5 (mrem).
- d = the actual number of days in the current calendar quarter at the end of the release (days).
- 31 days = the number of days of concern

CALCULATION METHODOLOGIES

2.0 GASEOUS EFFLUENTS

2.1 RADIATION MONITORING INSTRUMENTATION AND CONTROLS

The gaseous effluent monitoring instrumentation and controls at Limerick for controlling and monitoring radioactive material releases in accordance with the ODCM Part I are summarized as follows:

- 1) North Vent (Common): The plant gaseous discharges via this vent are monitored by two Particulate, Iodine and Gas (PIG) monitors (RY26-075A and RY26-075B) in parallel and by the Wide Range Accident Monitor (WRAM) (RY26-076). The PIGS have separate Particulate, Iodine, and Gas sampling and monitoring channels but the Controls require only particulate and iodine sampling and noble gas monitoring. The WRAM has extended range (via three channels) noble gas monitoring and particulate and iodine sampling capability. In addition, the WRAM provides an isolation (Group 6A) of the large Drywell Purge and Vent valves.
- 2) South Vent (one per unit): The plant gaseous discharges via each South Vent are monitored by two redundant PIG monitors (RY26-285A,B). As is the case of the North Vent, each PIG has separate particulate, iodine, and gas sampling and monitoring channels but the Controls require only particulate and iodine sampling with gas monitoring.
- 3) Hot Maintenance Shop (Common): Due to the composition of the radioactive materials in the effluent steam (i.e., very low potential for noble gas), this release point is sampled by a particulate and iodine (P&I) monitor (RY26-025). The P&I monitor has a separate particulate and iodine sampling and monitoring channels but Controls require only particulate and iodine sampling.

2.2 GASEOUS EFFLUENT MONITOR SETPOINT DETERMINATION

Control 3.1.2 requires that an alarm setpoint be established for the noble gas effluent monitoring channels (RY26-075A(B), RY26-185A(B), RY26-285A(B), and RY26-076) to ensure that the release rate of radioactive materials does not exceed the limits of Control 3.2.2.1.a, which corresponds to a dose rate at the SITE BOUNDARY of 500 mrem/yr to the total body or 3000 mrem/yr to the skin. Control limits are expressed in terms of dose rate, while the instruments that monitor effluents produce data in units of concentration or release rate. It is therefore necessary to identify the isotopes and calculate the corresponding release rate that will result in the dose rate limit being reached at the site

CALCULATION METHODOLOGIES

boundary. This calculation is made more complex by the use of multiple release points at LGS.

Calculation Bases

The alarm setpoint calculation is performed whenever the default Hi-Hi setpoint alarms based on analytical results of grab samples from the appropriate release point. The concentration of each identified radionuclide in the grab samples is determined, and the data is used to perform a setpoint calculation for that nuclide mix and release point.

The highest calculated annual average concentration (χ/Q) for an area at or beyond the site boundary (Table II2-31) is used in the setpoint calculation.

Maximum flow rates through the North and South vents are used in alarm setpoint calculations. This is necessary since flow can vary. By using maximum values, any flow less than the maximum will assure that the monitor will alarm before release rate limits are exceeded.

The fractional contribution of noble gas is calculated for each release point. The fractional contribution to the whole body and skin dose rates due to noble gases for the north stack and south stack vents are calculated by taking the product of this fraction and the limiting release rate. A comparison of the release rate for whole body and skin dose rates due to noble gas release is made to determine if the whole body or skin dose limit will be most restrictive. It is expected that the whole body limit will always be most restrictive, but the comparison is necessary to assure compliance with Control 3.2.2.1. The sum of the contributions from each release point, independently calculated for noble gases, will equal the maximum instantaneous release rate allowed from the site.

2.2.1 North Vent Noble Gas Effluent Monitors (RY26-075A-3, RY26-075B-3, and RY26-076-2)

The North Vent Noble Gas Effluent monitor high-high setpoint is calculated whenever the default Hi-Hi setpoint alarms based on the grab sample results performed in accordance with Table 4.2-2. If any calculated alarm setpoint is less than the existing monitor setpoint, the setpoint will be reduced to the new value. If the calculated setpoint value is greater than the existing value, the setpoint may remain at the lower value or be increased to the new value.

2.2.1.1 Setpoint Determination

The High-High setpoint is calculated per equation 2-1 or 2-2. The High-High setpoint for the North Vent Noble Gas Effluent Monitor is set at or below the lesser of the $NVSP(Hi-Hi)_{NGWB}$ OR $NVSP(Hi-Hi)_{NGSK}$ value (equations 2-1 or 2-2).

CALCULATION METHODOLOGIES

$$NSVP(HI-HI)_{NGWB} \leq \frac{[VF_{NVNG}][500][\Sigma Ci_{NV}]}{[3.471E+9]\Sigma[(Ci_{NV})(Ki)]} \quad (2-1)$$

$$NVSP(Hi - Hi)_{NGSK} \leq \frac{[VF_{NVNG}][3000][\Sigma Ci_{NV}]}{[3.471E+9]\Sigma[(Ci_{NV})(Li + 1.11Mi)]} \quad (2-2)$$

The High Setpoint shall be administratively controlled to a value that is less than the High-High Setpoint.

$$Hi \text{ Setpoint} = (F)(Hi-Hi \text{ Setpoint}) \quad (2-2a)$$

where:

NVSP (Hi-Hi)_{NGSK} = north vent high-high setpoint - noble gas skin ($\mu\text{Ci}/\text{cc}$).

NVSP (Hi-Hi)_{NGWB} = north vent high-high setpoint - noble gas whole body ($\mu\text{Ci}/\text{cc}$).

VF_{NVNG} = fractional contribution to site boundary noble gas dose rate from the North Vent. (unitless).

500 = total body dose rate limit (mrem/yr)

3000 = skin dose rate limit (mrem/yr)

ΣCi_{NV} = total noble gas activity from North Vent grab sample ($\mu\text{Ci}/\text{cc}$)

F = 0.289855 (a factor less than 1 that is used to calculate the Hi-Setpoint)

3.471E+9 = conversion factor, units are $\frac{(pCi)(cc)}{(\mu Ci)(m^3)}$

$$\left(\frac{1.1E-5 \text{ sec}}{m^3}\right) \left(\frac{1.0E+6 pCi}{\mu Ci}\right) \left(\frac{668,450 \text{ ft}^3}{\text{min}}\right) \left(\frac{1 \text{ min}}{60 \text{ sec}}\right) \left(\frac{2.832E+4 \text{ cc}}{\text{ft}^3}\right) \quad (2-3)$$

where:

1.1E-5 sec/ m^3 = highest annual average χ/Q (NE Sector)

1E+6 pCi/ μCi = units conversion

668,450 cfm = maximum North Vent flow rate for two unit operation

1 min/60 sec = units conversion

CALCULATION METHODOLOGIES

C_{inv}	$2.832E+4$ cc/ft ³	=	units conversion
		=	concentration of noble gas nuclide ' i ' as determined by radioanalysis of North Vent grab sample (μ Ci/cc).
K_i		=	total body dose conversion factor for noble gas nuclide ' i ' (mrem/yr per pCi/m ³ , from ODCM Table II2-1).
L_i		=	beta skin dose conversion factor noble gas nuclide ' i ' (mrem/yr per pCi/m ³ , from ODCM Table II2-1).
M_i		=	gamma air dose conversion factor for noble gas nuclide ' i ' (mrad/yr per pCi/m ³ , From ODCM Table II2-1).
1.11		=	the average ratio of tissue to air energy absorption coefficients (mrem/mrad) (Ref: Regulatory Guide 1.109, Section 2.0).

2.2.2 South Vent Noble Gas Effluent Monitors (RY26-185A-3, RY26-185B-3, RY26-285A-3, and RY26-285B-3)

Each unit's South Vent Noble Gas Effluent monitor High-High setpoint is calculated whenever the default Hi-Hi setpoint alarms based on the grab sample results performed in accordance with ODCM Part I, Table 4.2-2. If any calculated alarm setpoint is less than the existing monitor setpoint, the setpoint will be reduced to the new value. If the calculated setpoint value is greater than the existing value, the setpoint may remain at the lower value, or be increased to the new value.

2.2.2.1 Setpoint determination

The High-High setpoint for the South Vent Noble Gas Effluent Monitor is set at the lesser of the SVSP(Hi-Hi)_{NGWB} and SVSP(Hi-Hi)_{NGSK} value. SVSP(Hi-Hi)_{NGWB} and SVSP(Hi-Hi)_{NGSK} are calculated for each unit's South Vent.

The High-High setpoint is calculated per equation 2-4 or 2-5.

$$SVSP(HI-HI)_{NGWB} \leq \frac{[VF_{SVNG}][500][\sum C_{isv}]}{[1.2149E + 9]\sum[(C_{isv})(K_i)]} \quad (2-4)$$

$$SVSP(HI-HI)_{NGSK} \leq \frac{[VF_{SVNG}][3000][\sum C_{isv}]}{[1.2149E + 9]\sum[(C_{isv})(L_i + 1.11M_i)]} \quad (2-5)$$

The High Setpoint shall be administratively controlled to a value that is less than the High-High Setpoint.

CALCULATION METHODOLOGIES

$$\text{Hi Setpoint} = (F)(\text{Hi-Hi Setpoint}) \quad (2-5a)$$

where:

SVSP(Hi-Hi) _{NGWB}	= south vent high-high setpoint - noble gas whole body ($\mu\text{Ci/cc}$)
SVSP(Hi-Hi) _{NGSK}	= south vent high-high setpoint - noble gas skin ($\mu\text{Ci/cc}$)
VF _{SVNG}	= fractional contribution to site boundary noble gas dose rate from the Unit's South Vent. (unitless)
500	= total body dose rate limit (mrem/yr)
3000	= skin dose rate limit (mrem/yr)
F	= 0.5 (a factor less than 1 that is used to calculate the Hi-Setpoint)
$\sum C_{isv}$	= total noble gas activity from each unit South Vent grab sample ($\mu\text{Ci/cc}$).
C_{isv}	= concentration of noble gas nuclide ' i ' determined by radioanalysis of South Vent grab sample ($\mu\text{Ci/cc}$)
K_i	= total body dose conversion factor for noble gas nuclide ' i ' (mrem/yr per pCi/m ³ , from ODCM Table II2-1).
L_i	= beta skin dose conversion factor noble gas nuclide ' i ' (mrem/yr per pCi/m ³ , From ODCM Table II2-1).
M_i	= gamma air dose conversion factor for noble gas nuclide ' i ' (mrad/yr per pCi/m ³ , From ODCM Table II2-1).
1.11	= the average ratio of tissue to air energy absorption coefficients (mrem/mrad) (Ref: Regulatory Guide 1.109, Section 2.0)
1.2149E+9	= conversion factor units are in $\frac{(pCi)(cc)}{(\mu Ci)(m^3)}$

$$\left(\frac{1.1E-5 \text{ sec}}{m^3} \right) \left(\frac{1.0E+6 \text{ pCi}}{\mu Ci} \right) \left(\frac{2.34E+5 \text{ ft}^3}{\text{min}} \right) \left(\frac{1 \text{ min}}{60 \text{ sec}} \right) \left(\frac{2.832E+4 \text{ cc}}{\text{ft}^3} \right) \quad (2-6)$$

where:

1.1E-5 sec/m ³	= highest annual average χ/Q (NE Sector)
1E+6 pCi/ μCi	= units conversion
2.34E+5 ft ³ /m	= maximum South Vent flow rate
1/60 min/sec	= units conversion
2.832E+4 cc/ft ³	= units conversion

2.2.3 Noble Gas Effluent Fractional Contribution

The three release points will be partitioned such that the sum does not exceed 100 percent of the limit (500 mrem/yr whole body noble gas, 3000 mrem/yr skin noble

CALCULATION METHODOLOGIES

gas.) The default fraction will be set at 80 percent for the North Vent, 10 percent for the Unit-1 South Vent and 10 percent for the Unit-2 South Vent. These percentages can vary should operational concentrations warrant such change. However, the sum of the percentages shall be equal to or less than 100%. The following relationship shall be met:

$$VF_{NVNG} + VF_{1SVNG} + VF_{2SVNG} \leq 1 \quad (2-7)$$

where:

VF_{NVNG}	= fractional contribution to site boundary noble gas total body dose rate from the North Vent (unitless).
VF_{1SVNG}	= fractional contribution to site boundary noble gas total body dose rate from the Unit 1 South Vent (unitless).
VF_{2SVNG}	= fractional contribution to site boundary noble gas total body dose rate from the Unit 2 South Vent (unitless).

2.2.4 Noble Gas Effluent Default Setpoint

This methodology may be used when grab sample results from either the North Vent or the South Vent do not identify any radionuclides. This methodology is based on expected release concentration ratios as outlined in Section 11.3 of the Limerick UFSAR.

2.2.4.1 North Vent Noble Gas Monitors (RY26-075A-3 and RY26-075B-3). The default High-High setpoint for the North Vent Noble Gas Effluent Monitor is set at or below the $NVSP(Hi-Hi)_{NGD}$ value.

$$NVSP(Hi-Hi)_{NGD} \leq \frac{[8.00E-1][500][1.31E-6]}{[3.471E+9][4.37E-9]} \quad (2-8)$$

$$NVSP(Hi-Hi)_{NGD} \leq 3.45E-5 \text{ } \mu\text{Ci/cc}$$

where:

$NVSP(Hi-Hi)_{NGD}$	= default north vent high-high setpoint - noble gas whole body ($\mu\text{Ci/cc}$)
8.00E-1	= default fractional contribution to site boundary noble gas total body dose rate from the North Vent (unitless) .
500	= total body dose rate limit (mrem/yr).
1.31E-6	= total noble gas concentration from North Vent ($\mu\text{Ci/cc}$).
Ref:	a) based on UFSAR Table 11.3-1.
	b) based on maximum North Vent flow of 668,450 cfm.

CALCULATION METHODOLOGIES

- 3.471E+9 = conversion factor, units are in $\frac{(pCi)(cc)}{(\mu Ci)(m^3)}$. See Equation 2-3.
- 4.37E-9 = summation of the north vent concentration of noble gas nuclide 'i' multiplied by the corresponding whole body dose factor. Units are in $\frac{(\mu Ci)(mrem)(m^3)}{(cc)(yr)(pCi)}$
- Ref: a) based on UFSAR Table 11.3-1.
 b) based on maximum North Vent flow of 668,450 cfm.
 c) ODCM Table II2-1.

2.2.4.2 South Vent Noble Gas Monitors (RY26-185A-3, RY26-285A-3, RY26-185B-3, and RY26-285B-3). The default High-High setpoint for each Unit's South Vent Noble Gas Effluent Monitor is set at or below the SVSP(Hi-Hi)_{NGD} value.

$$SVSP(Hi - Hi)_{NGD} \leq \frac{[1.00E - 1][500][1.02E - 7]}{[1.2149E + 9][2.71E - 10]} \quad (2-9)$$

$$SVSP(Hi-Hi)_{NGD} \leq 1.54E-5 \mu Ci/cc$$

where:

- SVSP(Hi-Hi)_{NGD} = default south vent setpoint - noble gas ($\mu Ci/cc$).
- 1.00E-1 = default fractional contribution to site boundary noble gas total body dose rate from the South Vent (unitless).
- 500 = total body dose rate limit (mrem/yr).
- 1.02E-7 = total noble gas concentration from South Vent ($\mu Ci/cc$).
- Ref: a) Based on UFSAR Table 11.3-1.
 b) Based on maximum South Vent flow of 234,000 cfm.
- 1.2149E+9 = conversion factor, units are in $\frac{(pCi)(cc)}{(\mu Ci)(m^3)}$. See Equation 2-6.
- 2.71E-10 = summation of the south vent concentration of noble gas nuclide 'i' multiplied by the corresponding whole body dose factor.

CALCULATION METHODOLOGIES

Units are in $\frac{(\mu Ci)(mrem)(m^3)}{(cc)(yr)(pCi)}$

- Ref: a) Based on UFSAR Table 11.3-1.
 b) Based on maximum South Vent flow of 234,000 cfm.
 c) ODCM Table II2-1.

2.2.5 Wide Range Accident Monitor Noble Gas Effluent Monitor (RIX-26-076-4)

The Wide Range Accident Monitor (WRAM) noble gas total effluent channel displays the North Vent noble gas release rate. This monitor has Main Control Room Annunciation as well as a group 6A isolation function on the primary containment purge and vent valves. The isolation setpoint value of $\leq 2.1 \mu Ci/cc$ specified in Technical Specification Table 3.3.2-2 is based on the accident dose limits for containment purge during an accident (Ref: UFSAR Section 1.13). For routine operations the total effluent high and high-high setpoints are based upon the methodology of Sections II 2.2.5.1 and II 2.2.5.2. The setpoint units are in microcuries per second using the two-unit maximum North Vent flow rate of 668,450 scfm. The total effluent channel High-High setpoint is set at a value less than or equal to ten times the High setpoint (not to exceed the $2.1 \mu Ci/cc$ equivalent using the two-unit maximum North Vent flow rate). These values are always more conservative than the Technical Specification Table 3.3.2-2 required value of $\leq 2.1 \mu Ci/cc$.

If the calculated setpoint value is less than the existing monitor setpoint, the setpoint will be reduced to the new value. If the calculated setpoint is greater than the existing value, the setpoint may remain at the lower value, or be increased to the new value.

2.2.5.1 Routine Operations High Setpoint Determination

For routine operations, the High setpoint for the WRAM Noble Gas Total Effluent Channel is set at or below the lesser of the $NVSP(Hi-Hi)_{NGWB}$ or $NVSP(Hi-Hi)_{NGSK}$ value when activity is detected. When no activity is detected, the High setpoint is set at or below the $NVSP(Hi-Hi)_{NGD}$. This setpoint is calculated to ensure compliance with Control 3.2.2.1.a.

The setpoint values are converted from $\mu Ci/cc$ to $\mu Ci/sec$ using the maximum two-unit North Vent flow rate:

$$WRAM(Hi)_{WB} = [NVSP(Hi-Hi)_{NGWB \text{ OR } NGD}] [3.155E+8] \quad (2-10)$$

CALCULATION METHODOLOGIES

$$\text{WRAM}(\text{Hi})_{\text{SK}} = [\text{NVSP}(\text{Hi-Hi})_{\text{NGSK}}] [3.155\text{E}+8] \quad (2-11)$$

where:

$\text{WRAM}(\text{Hi})_{\text{WB}}$ = WRAM total effluent channel north vent high setpoint - noble gas whole body ($\mu\text{Ci}/\text{sec}$).

$\text{WRAM}(\text{Hi})_{\text{SK}}$ = WRAM total effluent channel north vent high setpoint - noble gas skin ($\mu\text{Ci}/\text{sec}$).

$\text{NVSP}(\text{Hi-Hi})_{\text{NGWB}}$ or NGD = North Vent high-high setpoint - noble gas whole body ($\mu\text{Ci}/\text{cc}$) from equation 2-1 or 2-8.

$\text{NVSP}(\text{Hi-Hi})_{\text{NGSK}}$ = North Vent high-high setpoint - noble gas skin ($\mu\text{Ci}/\text{cc}$) from equation 2-2.

$3.155\text{E}+8$ = conversion factor (cc/sec).

$$= \left(\frac{668,450 \text{ sft}^3}{\text{min}} \right) \left(\frac{1 \text{ min}}{60 \text{ sec}} \right) \left(\frac{2.832\text{E}+4 \text{ cc}}{\text{ft}^3} \right) \quad (2-12)$$

2.2.5.2 Routine Operations High-High Setpoint Determination

For routine operations, the High-High setpoint for the WRAM Noble Gas total effluent channel is set at or below ten times the lesser of the routine operations $\text{WRAM}(\text{Hi})_{\text{WB}}$ or $\text{WRAM}(\text{Hi})_{\text{SK}}$ value.

$$\text{WRAM}(\text{Hi-Hi})_{\text{WB}} = [\text{WRAM}(\text{Hi})_{\text{WB}}] [10] \quad (2-13)$$

$$\text{WRAM}(\text{Hi-Hi})_{\text{SK}} = [\text{WRAM}(\text{Hi})_{\text{SK}}] [10] \quad (2-14)$$

where:

$\text{WRAM}(\text{Hi-Hi})_{\text{WB}}$ = WRAM total effluent channel north vent high-high setpoint noble gas whole body ($\mu\text{Ci}/\text{sec}$).

$\text{WRAM}(\text{Hi-Hi})_{\text{SK}}$ = WRAM total effluent channel north vent high-high setpoint noble gas skin ($\mu\text{Ci}/\text{sec}$).

$\text{WRAM}(\text{Hi})_{\text{WB}}$ = WRAM total effluent channel north vent high setpoint - noble gas whole body ($\mu\text{Ci}/\text{sec}$) from equation 2-10.

$\text{WRAM}(\text{Hi})_{\text{SK}}$ = WRAM total effluent channel north vent setpoint - noble gas skin ($\mu\text{Ci}/\text{sec}$) from equation 2-11.

10 = multiplication factor to calculate high-high value (unitless)

CALCULATION METHODOLOGIES

2.3 GASEOUS EFFLUENT DOSE EVALUATION

Dose calculations are performed based on limiting sector average annual meteorological dispersion parameters. For the noble gas dose calculation, effluent release data are based on grab sample analysis for radionuclide composition and weekly stack effluent radiation monitor readings. For the iodine and particulate dose calculations, the effluent release radionuclide composition and release activity are based on weekly continuous samples.

The quarterly and annual dose calculations are a summation of the applicable dose results for the period of interest.

2.3.1 Site Boundary Dose Rate - Noble Gases (10CFR20 Limits)

Control 3.2.2.1.a limits the dose rate in gaseous effluents from the site to areas at or beyond the SITE BOUNDARY due to noble gas releases to ≤ 500 mrem/yr total body and ≤ 3000 mrem/yr skin. Radiation monitor alarm setpoints are established to ensure that these release limits are not exceeded.

Simultaneous releases from the North and South Vents are considered in evaluating compliance with the release rate limits of Control 3.2.2.1.a. following any releases exceeding the alarm setpoints. Monitor indications (readings) are averaged over time periods not to exceed 60 minutes.

NOTE: For administrative purposes, more conservative alarm setpoints than those required to meet 10 CFR 20 Dose Rate limits are imposed. However, conditions exceeding these more limiting alarm setpoints do not necessarily indicate radioactive material release rates exceeding the dose limits of Control 3.2.2.1.a. Provided actual releases do not result in radiation monitor indications exceeding values based on the dose rate limits of Control 3.2.2.1.a., no further analyses are required for demonstrating compliance with the limits of Control 3.2.2.1.a. In the event of a noble gas effluent release exceeding the setpoint value specified in ODCM Part II, Sections 2.2.1 or 2.2.2, the site boundary dose rate from the release is calculated using the methodology stated below. This methodology is based on worst sector annual average meteorological dispersion but, if further refinement is required to meet the requirements of Control 3.2.2.1.a, actual meteorological data from the time period of concern may be used to calculate actual meteorological dispersion.

CALCULATION METHODOLOGIES

$$D_{TB} = \chi/Q (1E + 6) \left[\sum_{i=1}^n (\dot{Q}_i K_i) \right] \quad (2-15)$$

$$D_{\gamma} = \chi/Q (1E + 6) \left[\sum_{i=1}^n (L_i + 1.1M_i) \dot{Q}_i \right] \quad (2-16)$$

where:

D_{TB}	= total body plume dose rate (mrem/yr).
D_{γ}	= skin plume dose rate (mrem/yr).
χ/Q	= highest annual average relative concentration (sec/m ³) at site boundary (see Table II2-31).
\dot{Q}_i	= The release rate of noble gas nuclide ' i ' from all vent releases averaged over one hour (uCi/sec).
K_i	= total body dose factor for noble gas nuclide ' i ' in units of mrem/yr per pCi/m ³ . Values are listed in ODCM Table II2-1.
L_i	= skin dose factor for the beta contribution for noble gas nuclide ' i ' in units of mrem/yr per pCi/m ³ . Values are listed in ODCM Table II2-1.
1.1	= the ratio of tissue to air absorption coefficients over the range of photons of interest. This ratio converts dose (mrad) to dose equivalent (mrem).
M_i	= gamma air dose factor for noble gas nuclide ' i ' in units of mrad/yr per pCi/m ³ . Values are listed in ODCM Table II2-1.
1E+6	= units conversion pCi/μCi.

2.3.2 Site Boundary Dose Rate - Radioiodine and Particulates (10CFR20 Limits)

Control 3.2.2.1.b limits the dose rate to ≤1500 mrem/yr to any organ (inhalation pathways only) for I-131, I-133, Tritium, and all radionuclides in particulate form with half-lives greater than 8 days in gaseous effluents.

Simultaneous releases from the North and South Vents are considered in evaluating compliance with the release rate limits of Control 3.2.2.1.b. Release activity is based upon the results of the weekly continuous sample analysis performed in accordance with ODCM Part I, Table 4.2-2.

CALCULATION METHODOLOGIES

$$D_{IH} = \chi/Q \sum_{i=1}^n P_i \dot{Q}_i \quad (2-17)$$

where:

D_{IH} = inhalation dose rate (mrem/yr).
 χ/Q = highest average annual χ/Q (sec/m³) (see Table II2-31).

P_i = dose factor for radionuclides other than noble gases for the inhalation pathway only (mrem/yr per $\mu\text{Ci}/\text{m}^3$). Values are listed in ODCM Table II2-2 through Table II2-5.

$$P_i = k' (BR) (D_{aipj}) \quad (2-17a)$$

where:

k' = 1.0E+6 unit conversion pCi/uCi.
 BR = breathing rate from Table II2-31.
 D_{aipj} = Inhalation Dose Factor Table II2-27 through Table II2-30.

\dot{Q}_i = The release rate of radionuclide ' i ' other than noble gases from all vent releases ($\mu\text{Ci}/\text{s}$).

2.3.3 Noble Gas Air Doses (10CFR50, Appendix I Limits)

Control 3.2.2.2 limits the air dose due to noble gases released in gaseous effluents (from both reactor units) to areas at or beyond the SITE BOUNDARY to:

- ≤ 10 mrad gamma for any quarter
- ≤ 20 mrad beta for any quarter
- ≤ 20 mrad gamma during any calendar year
- ≤ 40 mrad beta during any calendar year

As required by Surveillance Requirement 4.2.2.2, these doses are calculated at least once per 31 days using the results of the most recent grab samples for isotopic composition performed in accordance with ODCM Part I, Table 4.2-2. The dose calculation is performed using the most limiting average annual meteorological dispersion values. The quarterly and annual doses are based on the summation of the applicable dose results for the period of interest. The dose calculations are performed in accordance with the methodology below.

CALCULATION METHODOLOGIES

$$D_{\gamma AIR} = (3.17E - 8)(1.00E + 6) \chi / Q \sum_{i=1}^n M_i Q_i \quad (2-18)$$

$$D_{\beta AIR} = (3.17E - 8)(1.00E + 6) \chi / Q \sum_{i=1}^n N_i Q_i \quad (2-19)$$

where:

$D_{\gamma AIR}$	= gamma air dose from noble gas releases in mrad.
$D_{\beta AIR}$	= beta air dose from noble gas release in mrad.
3.17E-8	= units conversion [year/sec].
1.00E+6	= units conversion $\rho Ci/uCi$.
χ/Q	= highest average annual relative concentration in sec/m^3 (see Table II2-31).
Q_i	= release of noble gas radionuclides ' i ' from all vents in uCi . Releases shall be cumulative over the period of interest.
M_i	= gamma air dose factor for noble gas nuclide ' i ' in units of mrad/yr per pCi/m^3 . Values are listed in ODCM Table II2-1.
N_i	= beta air dose factor for noble gas nuclide ' i ' in units of mrad/yr per pCi/m^3 . Values are listed in ODCM Table II2-1.

2.3.4 Radioiodine and Particulate Dose Calculations (10CFR50, Appendix I Limits)

Control 3.2.2.3 limits the dose (from both reactor units) to a MEMBER OF THE PUBLIC from I-131, I-133, Tritium, and all radionuclides in particulate form with half-lives greater than 8 days in gaseous effluents released to areas at or beyond the SITE BOUNDARY to:

≤ 15 mrem to any organ during any calendar quarter

≤ 30 mrem to any organ during any calendar year

As required by Surveillance Requirement 4.2.2.3, these doses are calculated at least once per 31 days using the results of the weekly continuous sample analysis performed in accordance with ODCM Part I, Table 4.2-2. The dose calculation is performed using the most limiting average annual meteorological dispersion values for the appropriate dose receptor pathway (e.g. milk pathway SSE sector 2.5 miles, etc.). The quarterly and annual doses are based on the summation of

CALCULATION METHODOLOGIES

the applicable dose results determined during the period of interest. The dose calculations are performed in accordance with the methodology below. Total organ dose is the maximum organ dose obtained by the summation of the organ dose from each pathway.

2.3.4.1 Ground Pathway

$$D_{GPAR} = 3.17E-8 \left[D/Q \sum_{i=1}^n R_i Q_i \right] \quad (2-20)$$

where:

D_{GPAR} = dose from ground pathway due to release of particulates and iodines (mrem).

3.17E-8 = units conversion (year/sec).

D/Q = highest average annual deposition ($1/m^2$) (see Table II2-31).

Q_i = release of nuclide 'i' from all vents in uCi. Releases shall be cumulative over the time period of interest.

R_i = dose factor for organ type, age group, and pathway (for radionuclides other than noble gas); dose factors are calculated based on the methodology given in NUREG-0133. - Values of R_i are provided in ODCM Table II2-6 through Table II2-9 and calculated per the following equation:

$$R_i = (k')(k'')(SF) * D_{aipj} \left[(1 - e^{-\lambda_i t}) / \lambda_i \right] \quad (2-20a)$$

where:

$R_i^G [D/Q]$ = m^2 -mrem/yr per uCi/sec.

k' = $1E+06$ pCi/uCi.

k'' = 8760 hr/yr.

SF = shielding factor (see Table II2-31).

D_{aipj} = dose factor for standing on contaminated ground (see Table II1-7).

λ_i = decay constant for nuclide i in seconds (see Table II1-1).

t = period of buildup in soil in seconds (see Table II2-31).

CALCULATION METHODOLOGIES

2.3.4.2 Vegetation, Meat and Cow Milk or Goat Milk Pathway

$$D_{V\text{PAR}} = 3.17E-8 \left[\chi/Q \sum_{i=1}^2 R_i Q_i + D/Q \sum_{i=3}^n R_i Q_i \right] \quad (2-21)$$

where:

$D_{V\text{PAR}}$	=	dose from vegetation, meat, cow milk, and goat milk, pathways due to releases of particulates, iodines, and tritium (mrem).
3.17E-8	=	units conversion (year/sec).
$i = 1, 2$	=	^3H , ^{14}C .
$i = 3 \text{ thru } n$	=	all other isotopes (particulate and iodine).
Q_i	=	the release of nuclide 'i' from all vents in uCi. Releases shall be cumulative over the time period of interest.
χ/Q	=	highest average annual χ/Q (sec/m ³) (see Table II2-31).
D/Q	=	highest average annual deposition rate (1/m ²) (see Table II2-31).
R_i	=	dose factor for organ type, age group, and pathway (for radionuclides other than noble gas); dose factors are calculated based on the methodology given in NUREG-0133. - Values of R_i are provided in ODCM Table II2-10 through Table II2-25 and calculated per the following equations.

Vegetation Pathway R_i

$$R_i^V = (k') \frac{(r)}{Y_v (\lambda_i + \lambda_w)} * D_{a\text{ipj}} * \left[U_a^L * (f_L) e^{-\lambda_i t_L} + U_a^S * (f_g) e^{-\lambda_i t_h} \right] \quad (2-21a)$$

where:

R_i^V	=	m ² -mrem/yr per uCi/sec
k'	=	1.0 E+6 pCi/uCi
r	=	fraction of deposited particulates retained on vegetation (Table II2-31).
Y_v	=	vegetation area density kg/m ² (Table II2-31).
λ_i	=	decay constant for the ith radionuclide, in sec ⁻¹ (Table II1-1).
λ_w	=	decay constant for removal of activity on leaf and plant surfaces by weathering, in sec ⁻¹ (Table II2-31).
$D_{a\text{ipj}}$	=	ingestion dose factor, in mrem/pCi (Table II1-3 through Table II1-6).

CALCULATION METHODOLOGIES

U_a^L	=	consumption rate of fresh leafy vegetation by the receptor in age group (a), in kg/yr (Table II-2-31).
f_L	=	fraction of the annual intake of fresh leafy vegetation grown locally (dimensionless) (Table II-2-31).
t_L	=	average time between harvest of leafy vegetation and its consumption, in seconds (Table II-2-31).
U_a^S	=	consumption rate of stored vegetation by the receptor in age group (a), in kg/yr (Table II-2-31).
f_g	=	fraction of the annual intake of stored vegetation grown locally (dimensionless) (Table II-2-31).
t_h	=	average time between harvest of stored vegetation and its consumption, in seconds (Table II-2-31).

The concentrations of tritium and carbon-14 in vegetation are based on their airborne concentrations rather than their deposition. Therefore, the R_i is based on $[x/Q]$ as follows:

$$R_{H-3}^V = (k') * (k'') * \left[U_a^L * (f_L) + U_a^S * (f_g) \right] * D_{aij} * \left[0.75 * (0.5/H) \right] \quad (2-21b)$$

$$R_{C-14}^V = (k') * (k'') * \left[U_a^L * (f_L) + U_a^S * (f_g) \right] * D_{aij} * p \left[0.11 * 0.16 \right] \quad (2-21c)$$

where:

R_{H-3}^V	=	mrem/yr per uCi/m ³ .
R_{C-14}^V	=	mrem/yr per uCi/m ³ .
k''	=	1E+3, constant of unit conversion (gm/kg).
H	=	absolute humidity of the atmosphere, in gm/m ³ (Table II-2-31).
0.75	=	fraction of total feed that is water.
0.5	=	ratio of the specific activity of the feed grass water to the atmospheric water.
P	=	fractional equilibrium ratio (4400 hrs/8760 hrs). The ratio of the total annual release time (for C-14) atmospheric releases) to the total annual time during photosynthesis occurs (taken to be 4400 hrs), under the condition that the value of p should never exceed unity. For continuous C-14 releases, p is taken to be unity.
0.11	=	the fraction of total plant mass that is natural carbon, dimensionless.
0.16	=	the concentration of natural carbon in the atmosphere, in g/m ³

CALCULATION METHODOLOGIES

All other values as previously defined above.

Cow Milk / Goat Milk / Meat Pathway

$$R_i^M = (k') \frac{(Q_F * U_{AP})}{(\lambda_i + \lambda_w)} * (F_m) * (r) * D_{aipj} * \left[\frac{f_p f_s}{Y_p} + \frac{(1 - f_p f_s) e^{-\lambda_i t_h}}{Y_s} \right] e^{-\lambda_i t_f} \quad (2-21d)$$

where:

R_i^M	=	m ² -mrem/yr per uCi/sec.
k'	=	1.0E+6 pCi/uCi.
Q_F	=	cow/goat consumption rate kg/day (wet weight) (Table II2-31).
U_{AP}	=	receptor's milk consumption rate or meat consumption rate for age (a), in liters/yr or kg/yr (Table II2-31).
λ_i	=	decay constant for the ith radionuclide, in sec ⁻¹ (Table II1-1).
λ_w	=	decay constant for removal of activity on leaf and plant surfaces by weathering, in sec ⁻¹ (Table II2-31).
F_m	=	stable element transfer coefficients in days/liter or days/kg (Table II2-26).
r	=	fraction of deposited particulates retained on vegetation (Table II2-31).
D_{aipj}	=	ingestion dose factor, in mrem/pCi (Table II1-3 through Table II1-6).
f_p	=	fraction of the year that the cow/goat is on pasture (dimensionless) (Table II2-31).
f_s	=	fraction of the cow/goat feed that is pasture grass while the animal is on pasture (dimensionless) (Table II2-31).
Y_p	=	agricultural productivity by unit area of pasture feed grass, in kg/m ² (Table II2-31).
Y_s	=	agricultural productivity by unit area of stored feed, in kg/m ² (Table II2-31).
$T_{h(milk)}$	=	transport time from pasture to harvest, to milk animal, to milk, to receptor, in sec (Table II2-31).
$T_{f(milk)}$	=	transport time from pasture to milk animal, to milk, to receptor, in sec (Table II2-31).
$T_{h(meat)}$	=	transport time from crop field to ingestion receptor, in sec (Table II2-31).
$T_{f(meat)}$	=	transport time from pasture to ingestion receptor, in sec (Table II2-31).

The concentrations of tritium and carbon-14 in milk and meat are based on their airborne concentration rather than their deposition. Therefore, the R_i is based on $[x/Q]$ as follows:

$$R_{H-3}^M = (k') * (k''') * F_m * Q_F * U_{ap} * D_{aipj} * [0.75 * (0.5 / H)] \quad (2-21e)$$

$$R_{C-14}^M = (k') * (k''') * F_m * Q_F * U_{ap} * D_{aipj} * p * [0.11 / 0.16] \quad (2-21f)$$

where:

R_{H-3}^M	=	mrem/yr per uCi/m ³
R_{C-14}^M	=	mrem/yr per uCi/m ³

CALCULATION METHODOLOGIES

All other values as previously defined above.

2.3.4.3 Inhalation Pathway

$$D_{IPAR} = 3.17E-8 \left[\chi/Q \sum R_i Q_i \right] \quad (2-22)$$

where:

- D_{IPAR} = dose from inhalation pathway due to release of particulates, iodines, and tritium (mrem).
 $3.17E-8$ = units conversion (year/sec).
 Q_i = the release of nuclide ' i ' from all vents in uCi. Releases shall be cumulative over the time period of interest.
 χ/Q = highest average annual χ/Q (sec/m³) (see Table II2-31).
 R_i = dose factor for organ type, age group, and pathway (for radionuclides other than noble gas); dose factors are calculated based on the methodology given in NUREG-0133. - values of R_i are provided in ODCM Table II2-2 through Table II2-5 and calculated from the following equation.

$$R_i^I = k' (BR) (D_{aipj}) \quad (2-22a)$$

where:

- R_i^I = mrem/yr per uCi/m³.
 k' = 1.0E+6 unit conversion pCi/uCi.
 BR = breathing rate from Table II2-31.
 D_{aipj} = Inhalation Dose Factor Table II2-27 through Table II2-30.

2.3.5 Intentionally left blank.

CALCULATION METHODOLOGIES

2.3.6 Gaseous Effluent Dose Projection

Control 3.2.2.5 requires the VENTILATION EXHAUST TREATMENT SYSTEM be used to reduce radioactive material levels prior to discharge when projected doses from both units to areas at and beyond the SITE BOUNDARY would exceed in a 31 day period:

- a. 0.4 mrad to air from gamma radiation, or
- b. 0.8 mrad to air from beta radiation, or
- c. 0.6 mrem to any organ of a MEMBER OF THE PUBLIC

A dose projection is performed at least once per 31-days by the following equations:

$$D_{\text{max}_{\text{gamma}}} = (D_{\text{maxg}} / d) * 31 \quad (2-23)$$

$$D_{\text{max}_{\text{beta}}} = (D_{\text{maxb}} / d) * 31 \quad (2-24)$$

$$D_{\text{max}_{\text{organ}}} = (D_{\text{maxo}} / d) * 31 \quad (2-25)$$

where:

$D_{\text{max}_{\text{gamma}}}$	=	maximum gamma air dose projection for current 31-day period (mrad)
$D_{\text{max}_{\text{beta}}}$	=	maximum beta air dose projection for current 31-day period (mrad)
$D_{\text{max}_{\text{organ}}}$	=	maximum organ dose projection for current 31-day period (mrem)
D_{maxg}	=	maximum gamma air dose to date for current calendar quarter as obtained by equation (2-18).
D_{maxb}	=	maximum beta air dose to date for current calendar quarter as obtained by equation (2-19).
D_{maxo}	=	maximum organ dose to date for current calendar quarter as determined by summing the organ dose obtained from equations (2-20), (2-21) and (2-22) (mrem).
d	=	number of days in current calendar quarter at the end of the release.
31	=	the number of days of concern.

CALCULATION METHODOLOGIES

3.0 ANNUAL DOSE EVALUATION

The assessment of radiation doses for the Annual Radioactive Effluent Release Report (ARERR) shall be performed utilizing the methodology provided in NUREG-0133, Preparation of Radiological Effluent Technical Specifications for Nuclear Power Plants, October 1978. Any deviations from the methodology provided NUREG-0133 shall be documented in the Annual Radioactive Effluent Release Report.

The meteorological conditions concurrent with the time of release of radioactive materials (as determined by sampling frequency of measurement) or approximate methods shall be used as input to the dose model.

4.0 SPECIAL DOSE ANALYSIS

4.1 TOTAL DOSE TO MEMBERS OF THE PUBLIC

Control 3.2.3 requires that the annual dose or dose commitment to any MEMBER OF THE PUBLIC, due to releases of radioactivity and radiation, from the uranium fuel cycle shall be limited to:

- ≤ 25 mrem whole body or any organ except thyroid
- ≤ 75 mrem thyroid

Surveillance Requirement 4.2.3.2 requires that cumulative dose contributions from direct radiation from operations be evaluated when the calculated dose from the release of radioactive materials in liquid or gaseous effluents exceed the limits of Controls 3.2.1.2.a, 3.2.1.2.b, 3.2.2.2.a, 3.2.2.2.b, 3.2.2.3.a, or 3.2.2.3.b. The direct radiation contribution shall be determined by the methodology described below. This methodology calculates the direct radiation contribution, which then must be added to the dose or dose commitment determined in accordance with ODCM Part II, Sections 1.3.1, 2.3.3, and 2.3.4 to determine total dose from all pathways. This evaluation of direct radiation contribution is in accordance with ANSI/ANS 6.6.1-1979 Section 7. The error using this method is estimated to be approximately 8%. The following evaluation is performed for each receptor of concern.

$$D_{WB} = D_{1EFFL-WB} + (D_{TD} - D_{XBKG}) \quad (4-1)$$

$$D_O = D_{1EFFL-O} + (D_{TD} - D_{XBKG}) \quad (4-2)$$

$$D_T = D_{1EFFL-T} + (D_{TD} - D_{XBKG}) \quad (4-3)$$

CALCULATION METHODOLOGIES

where:

D_{WB}	=	cumulative total body dose contribution from direct radiation, liquid and gaseous effluents at the appropriate receptors (mrem).
D_O	=	cumulative organ dose contribution from direct radiation, liquid and gaseous effluents at the appropriate receptors (mrem).
D_T	=	cumulative thyroid dose contribution from direct radiation, liquid and gaseous effluents at the appropriate receptors (mrem).
D_{TD}	=	total dose at receptor of interest as evaluated by dosimetry measurement (mrem).

NOTE: If there is not a dosimetry location at the actual receptor location, a more conservative location will be used to evaluate Total Dose.

NOTE: Due to the statistics of radiation measurements and to the conservative nature of effluent calculations it is plausible the $D_{TD} - D_{XBKG}$ may yield a negative value. In this situation the value for $D_{TD} - D_{XBKG}$ shall be reported as zero (0).

D_{XBKG}	=	Background dose as evaluated by dosimetry at background sites (mrem).
$D_{1EFFL-TB}$	=	effluent contribution to total body dose (as evaluated in ODCM Part II, Sections 1.3.1, 2.3.3, and 2.3.4).
$D_{1EFFL-O}$	=	effluent contribution to organ dose (as evaluated in ODCM Part II, Sections 1.3.1, 2.3.3, and 2.3.4).
$D_{1EFFL-T}$	=	effluent contribution to thyroid dose (as evaluated in ODCM Part II, Sections 1.3.1, 2.3.3, and 2.3.4).

4.2 DOSES DUE TO ACTIVITIES INSIDE THE SITE BOUNDARY

In accordance with Administrative Control 6.2, the Annual Radioactive Effluent Release Report shall include an assessment of radiation dose from radioactive liquid and gaseous effluents to MEMBERS OF THE PUBLIC due to their activities inside the SITE BOUNDARY.

There are three locations within the SITE BOUNDARY that are accessible to MEMBERS OF THE PUBLIC for activities unrelated to the operation of Limerick Station. These locations are: 1) the railroad tracks which run along the river within the SITE BOUNDARY; 2) the Limerick Information Center, on Longview Road next to the 500kv substation; and 3) Fricks Lock. Of these three locations, the railroad tracks are the closest to the plant confines. Sectors and distances of these locations are provided below:

CALCULATION METHODOLOGIES

<u>Sector</u>	<u>Distance to Location (m)</u>
<u>Railroad Tracks:</u>	
S	300
SSW	225
SW	225
WSW	225
W	225
WNW	345
NW	450
<u>Information Center:</u>	
ESE	884
<u>Fricks Lock:</u>	
WSW	450

Annual doses will be calculated in accordance with NUREG-0133 methodology, as appropriate and assume an occupancy factor of 0.25. The maximum dose calculated will be reported in the Annual Radioactive Effluent Release Report.

5.0 RADIOLOGICAL ENVIRONMENTAL MONITORING PROGRAM

5.1 SAMPLING PROGRAM

The operational phase of the Radiological Environmental Monitoring Program (REMP) is conducted in accordance with the requirements of Control 3.3.1. The objectives of the program are:

- To provide data on measurable levels of radiation and radioactive materials in the site environs.
- To evaluate the relationship between quantities of radioactive materials released from LGS and resultant radiation doses to individuals from principal pathways of exposure.

The sampling requirements (type of samples, collection frequency, and analysis) and sample locations are presented in Appendix A.

5.2 INTERLABORATORY COMPARISON PROGRAM

Control 3.3.3 requires analyses be performed on radioactive material supplied as part of an Interlaboratory Comparison.

Participation in an NIST traceable Interlaboratory Comparison Program provides a check on the preciseness of measurements of radioactive material in environmental samples. A summary of the Interlaboratory Comparison Program results is provided in the Annual Radiological Environmental Operating Report pursuant to Administrative Control 6.1.

TABLES

TABLE II-1

DECAY CONSTANTS FOR NUCLIDES OF INTEREST¹

NUCLIDE	KOCHER		DECAY CONSTANT		DECAY CONSTANT		DECAY CONSTANT	
	T _{1/2}		T _{1/2}	HR ⁻¹	T _{1/2}	SEC ⁻¹	T _{1/2}	DAYS ⁻¹
	T _{1/2}	HOURS			SECONDS		DAYS	
H-3	1.228E+01	Y	1.076E+05	6.439E-06	3.875E+08	1.789E-09	4.485E+03	1.545E-04
C-14	5.730E+03	Y	5.023E+07	1.380E-08	1.808E+11	3.833E-12	2.093E+06	3.312E-07
NA-22	2.602E+00	Y	2.281E+04	3.039E-05	8.211E+07	8.441E-09	9.504E+02	7.293E-04
NA-24	1.500E+01	H	1.500E+01	4.621E-02	5.400E+04	1.284E-05	6.250E-01	1.109E+00
P-32	1.429E+01	D	3.430E+02	2.021E-03	1.235E+06	5.614E-07	1.429E+01	4.851E-02
CA-41	1.030E+05	Y	9.029E+08	7.677E-10	3.250E+12	2.132E-13	3.762E+07	1.842E-08
SC-46	8.383E+01	D	2.012E+03	3.445E-04	7.243E+06	9.570E-08	8.383E+01	8.268E-03
CR-51	2.770E+01	D	6.649E+02	1.042E-03	2.394E+06	2.896E-07	2.770E+01	2.502E-02
MN-54	3.127E+02	D	7.505E+03	9.236E-05	2.702E+07	2.566E-08	3.127E+02	2.217E-03
FE-55	2.700E+00	Y	2.367E+04	2.929E-05	8.521E+07	8.135E-09	9.862E+02	7.029E-04
MN-56	2.579E+00	H	2.579E+00	2.688E-01	9.283E+03	7.467E-05	1.074E-01	6.452E+00
CO-57	2.709E+02	D	6.502E+03	1.066E-04	2.341E+07	2.961E-08	2.709E+02	2.559E-03
CO-58	7.080E+01	D	1.699E+03	4.079E-04	6.117E+06	1.133E-07	7.080E+01	9.790E-03
FE-59	4.463E+01	D	1.071E+03	6.471E-04	3.856E+06	1.798E-07	4.463E+01	1.553E-02
CO-60	5.271E+00	Y	4.621E+04	1.500E-05	1.663E+08	4.167E-09	1.925E+03	3.600E-04
NI-59	7.500E+04	Y	6.575E+08	1.054E-09	2.367E+12	2.929E-13	2.739E+07	2.530E-08
NI-63	1.001E+02	Y	8.775E+05	7.899E-07	3.159E+09	2.194E-10	3.656E+04	1.896E-05
CU-64	1.270E+01	H	1.270E+01	5.457E-02	4.572E+04	1.516E-05	5.292E-01	1.310E+00
NI-65	2.520E+00	H	2.520E+00	2.751E-01	9.072E+03	7.641E-05	1.050E-01	6.601E+00
ZN-65	2.444E+02	D	5.866E+03	1.182E-04	2.112E+07	3.283E-08	2.444E+02	2.836E-03
ZN-69M	1.376E+01	H	1.376E+01	5.039E-02	4.952E+04	1.400E-05	5.732E-01	1.209E+00
ZN-69	9.267E-01	H	9.267E-01	7.480E-01	3.336E+03	2.078E-04	3.861E-02	1.795E+01
SE-79	6.500E+04	Y	5.698E+08	1.216E-09	2.051E+12	3.379E-13	2.374E+07	2.920E-08
BR-82	3.530E+01	H	3.530E+01	1.964E-02	1.271E+05	5.454E-06	1.471E+00	4.713E-01
BR-83	2.390E+00	H	2.390E+00	2.900E-01	8.604E+03	8.056E-05	9.958E-02	6.960E+00
BR-84	5.300E-01	H	5.300E-01	1.308E+00	1.908E+03	3.633E-04	2.208E-02	3.139E+01
BR-85	4.778E-02	H	4.778E-02	1.451E+01	1.720E+02	4.030E-03	1.991E-03	3.482E+02
RB-86	1.866E+01	D	4.478E+02	1.548E-03	1.612E+06	4.299E-07	1.866E+01	3.715E-02
RB-87	4.730E+10	Y	4.146E+14	1.672E-15	1.493E+18	4.644E-19	1.728E+13	4.012E-14
RB-88	2.967E-01	H	2.967E-01	2.336E+00	1.068E+03	6.490E-04	1.236E-02	5.607E+01
RB-89	2.573E-01	H	2.573E-01	2.694E+00	9.264E+02	7.482E-04	1.072E-02	6.465E+01
SR-89	5.055E+01	D	1.213E+03	5.713E-04	4.368E+06	1.587E-07	5.055E+01	1.371E-02
SR-90	2.860E+01	Y	2.507E+05	2.765E-06	9.025E+08	7.680E-10	1.045E+04	6.635E-05
Y-90	6.410E+01	H	6.410E+01	1.081E-02	2.308E+05	3.004E-06	2.671E+00	2.595E-01
SR-91	9.500E+00	H	9.500E+00	7.296E-02	3.420E+04	2.027E-05	3.958E-01	1.751E+00
Y-91M	8.285E-01	H	8.285E-01	8.366E-01	2.983E+03	2.324E-04	3.452E-02	2.008E+01
Y-91	5.851E+01	D	1.404E+03	4.936E-04	5.055E+06	1.371E-07	5.851E+01	1.185E-02
SR-92	2.710E+00	H	2.710E+00	2.558E-01	9.756E+03	7.105E-05	1.129E-01	6.139E+00
Y-92	3.540E+00	H	3.540E+00	1.958E-01	1.274E+04	5.439E-05	1.475E-01	4.699E+00
Y-93	1.010E+01	H	1.010E+01	6.863E-02	3.636E+04	1.906E-05	4.208E-01	1.647E+00
NB-93M	1.460E+01	Y	1.280E+05	5.416E-06	4.607E+08	1.504E-09	5.333E+03	1.300E-04
NB-95	3.506E+01	D	8.414E+02	8.238E-04	3.029E+06	2.288E-07	3.506E+01	1.977E-02

TABLE II-1

DECAY CONSTANTS FOR NUCLIDES OF INTEREST¹

NUCLIDE	KOCHER		DECAY CONSTANT		DECAY CONSTANT		DECAY CONSTANT	
	T _{1/2}		T _{1/2} HOURS	HR ⁻¹	T _{1/2} SECONDS	SEC ⁻¹	T _{1/2} DAYS	DAYS ⁻¹
NB-97	1.202E+00	H	1.202E+00	5.768E-01	4.326E+03	1.602E-04	5.007E-02	1.384E+01
ZR-93	1.530E+06	Y	1.341E+10	5.168E-11	4.828E+13	1.436E-14	5.588E+08	1.240E-09
ZR-95	6.402E+01	D	1.536E+03	4.511E-04	5.531E+06	1.253E-07	6.402E+01	1.083E-02
ZR-97	1.690E+01	H	1.690E+01	4.101E-02	6.084E+04	1.139E-05	7.042E-01	9.844E-01
MO-93	3.500E+03	Y	3.068E+07	2.259E-08	1.105E+11	6.276E-12	1.278E+06	5.422E-07
MO-99	6.602E+01	H	6.602E+01	1.050E-02	2.377E+05	2.916E-06	2.751E+00	2.520E-01
TC-99	2.130E+05	Y	1.867E+09	3.712E-10	6.722E+12	1.031E-13	7.780E+07	8.910E-09
TC-99M	6.020E+00	H	6.020E+00	1.151E-01	2.167E+04	3.198E-05	2.508E-01	2.763E+00
TC-101	2.367E-01	H	2.367E-01	2.929E+00	8.520E+02	8.136E-04	9.861E-03	7.029E+01
RU-103	3.935E+01	D	9.444E+02	7.340E-04	3.400E+06	2.039E-07	3.935E+01	1.761E-02
RU-105	4.440E+00	H	4.440E+00	1.561E-01	1.598E+04	4.337E-05	1.850E-01	3.747E+00
RU-106	3.682E+02	D	8.837E+03	7.844E-05	3.181E+07	2.179E-08	3.682E+02	1.883E-03
RH-105	3.536E+01	H	3.536E+01	1.960E-02	1.273E+05	5.445E-06	1.473E+00	4.705E-01
PD-107	6.500E+06	Y	5.698E+10	1.216E-11	2.051E+14	3.379E-15	2.374E+09	2.920E-10
PD-109	1.345E+01	H	1.345E+01	5.152E-02	4.843E+04	1.431E-05	5.605E-01	1.237E+00
AG-110M	2.499E+02	D	5.996E+03	1.156E-04	2.159E+07	3.211E-08	2.499E+02	2.774E-03
AG-111	7.460E+00	D	1.790E+02	3.871E-03	6.445E+05	1.075E-06	7.460E+00	9.292E-02
CD-113M	1.370E+01	Y	1.201E+05	5.772E-06	4.323E+08	1.603E-09	5.004E+03	1.385E-04
CD-115M	4.460E+01	D	1.070E+03	6.476E-04	3.853E+06	1.799E-07	4.460E+01	1.554E-02
SN-123	1.292E+02	D	3.101E+03	2.235E-04	1.116E+07	6.209E-08	1.292E+02	5.365E-03
SN-125	9.640E+00	D	2.314E+02	2.996E-03	8.329E+05	8.322E-07	9.640E+00	7.190E-02
SN-126	1.000E+05	Y	8.766E+08	7.907E-10	3.156E+12	2.196E-13	3.653E+07	1.898E-08
SB-124	6.020E+01	D	1.445E+03	4.798E-04	5.201E+06	1.333E-07	6.020E+01	1.151E-02
SB-125	2.770E+00	Y	2.428E+04	2.855E-05	8.741E+07	7.929E-09	1.012E+03	6.851E-04
SB-126	1.240E+01	D	2.976E+02	2.329E-03	1.071E+06	6.470E-07	1.240E+01	5.590E-02
SB-127	3.850E+00	D	9.240E+01	7.502E-03	3.326E+05	2.084E-06	3.850E+00	1.800E-01
TE-125M	5.800E+01	D	1.392E+03	4.980E-04	5.011E+06	1.383E-07	5.800E+01	1.195E-02
TE-127M	1.090E+02	D	2.616E+03	2.650E-04	9.418E+06	7.360E-08	1.090E+02	6.359E-03
TE-127	9.350E+00	H	9.350E+00	7.413E-02	3.366E+04	2.059E-05	3.896E-01	1.779E+00
TE-129M	3.360E+01	D	8.064E+02	8.596E-04	2.903E+06	2.388E-07	3.360E+01	2.063E-02
TE-129	1.160E+00	H	1.160E+00	5.975E-01	4.176E+03	1.660E-04	4.833E-02	1.434E+01
TE-133M	9.233E-01	H	9.233E-01	7.507E-01	3.324E+03	2.085E-04	3.847E-02	1.802E+01
TE-134	6.967E-01	H	6.967E-01	9.949E-01	2.508E+03	2.764E-04	2.903E-02	2.388E+01
I-129	1.570E+07	Y	1.376E+11	5.036E-12	4.955E+14	1.399E-15	5.734E+09	1.209E-10
I-130	1.236E+01	H	1.236E+01	5.608E-02	4.450E+04	1.558E-05	5.150E-01	1.346E+00
I-131	8.040E+00	D	1.930E+02	3.592E-03	6.947E+05	9.978E-07	8.040E+00	8.621E-02
TE-131M	3.000E+01	H	3.000E+01	2.310E-02	1.080E+05	6.418E-06	1.250E+00	5.545E-01
TE-131	4.167E-01	H	4.167E-01	1.664E+00	1.500E+03	4.621E-04	1.736E-02	3.993E+01
I-132	2.300E+00	H	2.300E+00	3.014E-01	8.280E+03	8.371E-05	9.583E-02	7.233E+00
TE-132	7.820E+01	H	7.820E+01	8.864E-03	2.815E+05	2.462E-06	3.258E+00	2.127E-01
I-133	2.080E+01	H	2.080E+01	3.332E-02	7.488E+04	9.257E-06	8.667E-01	7.998E-01
CS-134M	2.900E+00	H	2.900E+00	2.390E-01	1.044E+04	6.639E-05	1.208E-01	5.736E+00
CS-134	2.062E+00	Y	1.808E+04	3.835E-05	6.507E+07	1.065E-08	7.531E+02	9.203E-04

TABLE II-1

DECAY CONSTANTS FOR NUCLIDES OF INTEREST¹

NUCLIDE	KOCHER		DECAY CONSTANT		DECAY CONSTANT		DECAY CONSTANT	
	T _{1/2}		T _{1/2} HOURS	HR ⁻¹	T _{1/2} SECONDS	SEC ⁻¹	T _{1/2} DAYS	DAYS ⁻¹
I-134	8.767E-01	H	8.767E-01	7.907E-01	3.156E+03	2.196E-04	3.653E-02	1.898E+01
I-135	6.610E+00	H	6.610E+00	1.049E-01	2.380E+04	2.913E-05	2.754E-01	2.517E+00
CS-135	2.300E+06	Y	2.016E+10	3.438E-11	7.258E+13	9.550E-15	8.401E+08	8.251E-10
CS-136	1.316E+01	D	3.158E+02	2.195E-03	1.137E+06	6.096E-07	1.316E+01	5.267E-02
CS-137	3.017E+01	Y	2.645E+05	2.621E-06	9.521E+08	7.280E-10	1.102E+04	6.290E-05
CS-138	5.367E-01	H	5.367E-01	1.292E+00	1.932E+03	3.588E-04	2.236E-02	3.100E+01
CS-139	1.567E-01	H	1.567E-01	4.424E+00	5.640E+02	1.229E-03	6.528E-03	1.062E+02
BA-139	1.385E+00	H	1.385E+00	5.005E-01	4.986E+03	1.390E-04	5.771E-02	1.201E+01
BA-140	1.279E+01	D	3.069E+02	2.258E-03	1.105E+06	6.273E-07	1.279E+01	5.420E-02
LA-140	4.022E+01	H	4.022E+01	1.723E-02	1.448E+05	4.787E-06	1.676E+00	4.136E-01
BA-141	3.045E-01	H	3.045E-01	2.276E+00	1.096E+03	6.323E-04	1.269E-02	5.463E+01
LA-141	3.940E+00	H	3.940E+00	1.759E-01	1.418E+04	4.887E-05	1.642E-01	4.222E+00
CE-141	3.250E+01	D	7.800E+02	8.887E-04	2.808E+06	2.468E-07	3.250E+01	2.133E-02
BA-142	1.783E-01	H	1.783E-01	3.887E+00	6.420E+02	1.080E-03	7.431E-03	9.328E+01
LA-142	1.590E+00	H	1.590E+00	4.359E-01	5.724E+03	1.211E-04	6.625E-02	1.046E+01
CE-143	3.300E+01	H	3.300E+01	2.100E-02	1.188E+05	5.835E-06	1.375E+00	5.041E-01
PR-143	1.356E+01	D	3.254E+02	2.130E-03	1.172E+06	5.916E-07	1.356E+01	5.112E-02
CE-144	2.843E+02	D	6.823E+03	1.016E-04	2.456E+07	2.822E-08	2.843E+02	2.438E-03
PR-144	2.880E-01	H	2.880E-01	2.407E+00	1.037E+03	6.685E-04	1.200E-02	5.776E+01
ND-147	1.098E+01	D	2.635E+02	2.630E-03	9.487E+05	7.306E-07	1.098E+01	6.313E-02
PM-147	2.623E+00	Y	2.300E+04	3.014E-05	8.279E+07	8.373E-09	9.582E+02	7.234E-04
PM-148M	4.130E+01	D	9.912E+02	6.993E-04	3.568E+06	1.943E-07	4.130E+01	1.678E-02
PM-148	5.370E+00	D	1.289E+02	5.378E-03	4.640E+05	1.494E-06	5.370E+00	1.291E-01
PM-149	5.308E+01	H	5.308E+01	1.306E-02	1.911E+05	3.627E-06	2.212E+00	3.134E-01
PM-151	2.840E+01	H	2.840E+01	2.441E-02	1.022E+05	6.780E-06	1.183E+00	5.858E-01
SM-151	9.000E+01	Y	7.889E+05	8.786E-07	2.840E+09	2.441E-10	3.287E+04	2.109E-05
SM-153	4.670E+01	H	4.670E+01	1.484E-02	1.681E+05	4.123E-06	1.946E+00	3.562E-01
EU-152	1.360E+01	Y	1.192E+05	5.814E-06	4.292E+08	1.615E-09	4.967E+03	1.395E-04
EU-154	8.800E+00	Y	7.714E+04	8.985E-06	2.777E+08	2.496E-09	3.214E+03	2.157E-04
EU-155	4.960E+00	Y	4.348E+04	1.594E-05	1.565E+08	4.428E-09	1.812E+03	3.826E-04
EU-156	1.519E+01	D	3.646E+02	1.901E-03	1.312E+06	5.281E-07	1.519E+01	4.563E-02
TB-160	7.230E+01	D	1.735E+03	3.995E-04	6.247E+06	1.110E-07	7.230E+01	9.587E-03
HO-166M	1.200E+03	Y	1.052E+07	6.589E-08	3.787E+10	1.830E-11	4.383E+05	1.581E-06
W-181	1.210E+02	D	2.903E+03	2.388E-04	1.045E+07	6.633E-08	1.210E+02	5.731E-03
W-185	7.510E+01	D	1.802E+03	3.846E-04	6.489E+06	1.068E-07	7.510E+01	9.230E-03
W-187	2.383E+01	H	2.383E+01	2.909E-02	8.579E+04	8.080E-06	9.929E-01	6.981E-01
NP-239	2.355E+00	D	5.652E+01	1.226E-02	2.035E+05	3.407E-06	2.355E+00	2.943E-01
U-232	7.200E+01	Y	6.312E+05	1.098E-06	2.272E+09	3.051E-10	2.630E+04	2.636E-05
U-233	1.592E+05	Y	1.396E+09	4.967E-10	5.024E+12	1.380E-13	5.815E+07	1.192E-08
U-234	2.445E+05	Y	2.143E+09	3.234E-10	7.716E+12	8.983E-14	8.930E+07	7.762E-09
U-235	7.038E+08	Y	6.170E+12	1.124E-13	2.221E+16	3.121E-17	2.571E+11	2.696E-12
U-236	2.342E+07	Y	2.053E+11	3.377E-12	7.389E+14	9.381E-16	8.552E+09	8.105E-11
U-237	6.750E+00	D	1.620E+02	4.279E-03	5.832E+05	1.189E-06	6.750E+00	1.027E-01

TABLE II-1

DECAY CONSTANTS FOR NUCLIDES OF INTEREST¹

NUCLIDE	KOCHER		DECAY CONSTANT		DECAY CONSTANT		DECAY CONSTANT	
	T _{1/2}		T _{1/2} HOURS	HR ⁻¹	T _{1/2} SECONDS	SEC ⁻¹	T _{1/2} DAYS	DAYS ⁻¹
U-238	4.468E+09	Y	3.917E+13	1.770E-14	1.410E+17	4.916E-18	1.632E+12	4.247E-13
NP-237	2.140E+06	Y	1.876E+10	3.695E-11	6.753E+13	1.026E-14	7.816E+08	8.868E-10
NP-238	2.117E+00	D	5.081E+01	1.364E-02	1.829E+05	3.790E-06	2.117E+00	3.274E-01
PU-238	8.775E+01	Y	7.692E+05	9.011E-07	2.769E+09	2.503E-10	3.205E+04	2.163E-05
PU-239	2.413E+04	Y	2.115E+08	3.277E-09	7.615E+11	9.102E-13	8.814E+06	7.864E-08
PU-240	6.569E+03	Y	5.758E+07	1.204E-08	2.073E+11	3.344E-12	2.399E+06	2.889E-07
PU-241	1.440E+01	Y	1.262E+05	5.491E-06	4.544E+08	1.525E-09	5.260E+03	1.318E-04
PU-242	3.758E+05	Y	3.294E+09	2.104E-10	1.186E+13	5.845E-14	1.373E+08	5.050E-09
PU-244	8.260E+07	Y	7.241E+11	9.573E-13	2.607E+15	2.659E-16	3.017E+10	2.297E-11
AM-241	4.322E+02	Y	3.789E+06	1.830E-07	1.364E+10	5.082E-11	1.579E+05	4.391E-06
AM-242M	1.520E+02	Y	1.332E+06	5.202E-07	4.797E+09	1.445E-10	5.552E+04	1.249E-05
AM-243	7.380E+03	Y	6.469E+07	1.071E-08	2.329E+11	2.976E-12	2.696E+06	2.571E-07
CM-242	1.632E+02	D	3.917E+03	1.770E-04	1.410E+07	4.916E-08	1.632E+02	4.247E-03
CM-243	2.850E+01	Y	2.498E+05	2.774E-06	8.994E+08	7.707E-10	1.041E+04	6.659E-05
CM-244	1.811E+01	Y	1.588E+05	4.366E-06	5.715E+08	1.213E-09	6.615E+03	1.048E-04
CM-245	8.500E+03	Y	7.451E+07	9.303E-09	2.682E+11	2.584E-12	3.105E+06	2.233E-07
CM-246	4.750E+03	Y	4.164E+07	1.665E-08	1.499E+11	4.624E-12	1.735E+06	3.995E-07
CM-247	1.560E+07	Y	1.367E+11	5.069E-12	4.923E+14	1.408E-15	5.698E+09	1.216E-10
CM-248	3.390E+05	Y	2.972E+09	2.333E-10	1.070E+13	6.479E-14	1.238E+08	5.598E-09
CF-252	2.639E+00	Y	2.313E+04	2.996E-05	8.328E+07	8.323E-09	9.639E+02	7.191E-04

1. Kocher, David C., "Radioactive Decay Data Tables," DOE/TIC-11026,138 (1981).

TABLE II-2

BIOACCUMULATION FACTORS FOR FRESHWATER FISH (pCi/kg per pCi/liter)¹

NUCLIDE	FISH	NUCLIDE	FISH	NUCLIDE	FISH	NUCLIDE	FISH
H-3	9.0E-01	ZR-93	3.3E+00	I-131	1.5E+01	W-187	1.2E+03
C-14	4.6E+03	ZR-95	3.3E+00	I-132	1.5E+01	U-232	2.0E+00
NA-22	1.0E+02	ZR-97	3.3E+00	I-133	1.5E+01	U-233	2.0E+00
NA-24	1.0E+02	NB-93M	3.0E+04	I-134	1.5E+01	U-234	2.0E+00
P-32 ²	3.0E+03 ²	NB-95	3.0E+04	I-135	1.5E+01	U-235	2.0E+00
CA-41	4.0E+01	NB-97	3.0E+04	CS-134M	2.0E+03	U-236	2.0E+00
SC-46	2.0E+00	MO-93	1.0E+01	CS-134	2.0E+03	U-237	2.0E+00
CR-51	2.0E+02	MO-99	1.0E+01	CS-135	2.0E+03	U-238	2.0E+00
MN-54	4.0E+02	TC-99M	1.5E+01	CS-136	2.0E+03	NP-237	1.0E+01
MN-56	4.0E+02	TC-99	1.5E+01	CS-137	2.0E+03	NP-238	1.0E+01
FE-55	1.0E+02	TC-101	1.5E+01	CS-138	2.0E+03	NP-239	1.0E+01
FE-59	1.0E+02	RU-103	1.0E+01	CS-139	2.0E+03	PU-238	3.5E+00
CO-57	5.0E+01	RU-105	1.0E+01	BA-139	4.0E+00	PU-239	3.5E+00
CO-58	5.0E+01	RU-106	1.0E+01	BA-140	4.0E+00	PU-240	3.5E+00
CO-60	5.0E+01	RH-105	1.0E+01	BA-141	4.0E+00	PU-241	3.5E+00
NI-59	1.0E+02	PD-107	1.0E+01	BA-142	4.0E+00	PU-242	3.5E+00
NI-63	1.0E+02	PD-109	1.0E+01	LA-140	2.5E+01	PU-244	3.5E+00
NI-65	1.0E+02	AG-110M	2.5E+00	LA-141	2.5E+01	AM-241	2.5E+01
CU-64	5.0E+01	AG-111	2.5E+00	LA-142	2.5E+01	AM-242M	2.5E+01
ZN-65	2.0E+03	CD-113M	2.0E+02	CE-141	1.0E+00	AM-243	2.5E+01
ZN-69M	2.0E+03	CD-115M	2.0E+02	CE-143	1.0E+00	CM-242	2.5E+01
ZN-69	2.0E+03	SN-123	3.0E+03	CE-144	1.0E+00	CM-243	2.5E+01
SE-79	1.7E+02	SN-125	3.0E+03	PR-143	2.5E+01	CM-244	2.5E+01
BR-82	4.2E+02	SN-126	3.0E+03	PR-144	2.5E+01	CM-245	2.5E+01
BR-83	4.2E+02	SB-124	1.0E+00	ND-147	2.5E+01	CM-246	2.5E+01
BR-84	4.2E+02	SB-125	1.0E+00	PM-147	2.5E+01	CM-247	2.5E+01
BR-85	4.2E+02	SB-126	1.0E+00	PM-148M	2.5E+01	CM-248	2.5E+01
RB-86	2.0E+03	SB-127	1.0E+00	PM-148	2.5E+01	CF-252	2.5E+01
RB-87	2.0E+03	TE-125M	4.0E+02	PM-149	2.5E+01		
RB-88	2.0E+03	TE-127M	4.0E+02	PM-151	2.5E+01		
RB-89	2.0E+03	TE-127	4.0E+02	SM-151	2.5E+01		
SR-89	3.0E+01	TE-129M	4.0E+02	SM-153	2.5E+01		
SR-90	3.0E+01	TE-129	4.0E+02	EU-152	2.5E+01		
SR-91	3.0E+01	TE-131M	4.0E+02	EU-154	2.5E+01		
SR-92	3.0E+01	TE-131	4.0E+02	EU-155	2.5E+01		
Y-90	2.5E+01	TE-132	4.0E+02	EU-156	2.5E+01		
Y-91M	2.5E+01	TE-133M	4.0E+02	TB-160	2.5E+01		
Y-91	2.5E+01	TE-134	4.0E+02	HO-166M	2.5E+01		
Y-92	2.5E+01	I-129	1.5E+01	W-181	1.2E+03		
Y-93	2.5E+01	I-130	1.5E+01	W-185	1.2E+03		

1 NUREG/CR-4013, LADTAP II, Technical Reference and User Guide, Table 3.1

2 Letter LTR 881209L001, from R.J. Clark, U.S.N.R.C., to G.A. Hunger, Philadelphia Electric Co., December 9, 1988, transmitting evaluation of Limerick ODCM.

TABLE II-3

 INGESTION DOSE FACTORS FOR ADULT (D_{aipj})
 mrem/pCi

NUCLIDE	BONE	LIVER	T BODY	THYROID	KIDNEY	LUNG	GI-LLI	SKIN
H-3	0.00E+00	5.99E-08	5.99E-08	5.99E-08	5.99E-08	5.99E-08	5.99E-08	0.00E+00
C-14	2.84E-06	5.68E-07	5.68E-07	5.68E-07	5.68E-07	5.68E-07	5.68E-07	0.00E+00
NA-22	1.74E-05	1.74E-05	1.74E-05	1.74E-05	1.74E-05	1.74E-05	1.74E-05	0.00E+00
NA-24	1.70E-06	1.70E-06	1.70E-06	1.70E-06	1.70E-06	1.70E-06	1.70E-06	0.00E+00
P-32	1.93E-04	1.20E-05	7.46E-06	0.00E+00	0.00E+00	0.00E+00	2.17E-05	0.00E+00
CA-41	1.85E-04	0.00E+00	2.00E-05	0.00E+00	0.00E+00	0.00E+00	1.84E-07	0.00E+00
SC-46	5.51E-09	1.07E-08	3.11E-09	0.00E+00	9.99E-09	0.00E+00	5.21E-05	0.00E+00
CR-51	0.00E+00	0.00E+00	2.66E-09	1.59E-09	5.86E-10	3.53E-09	6.69E-07	0.00E+00
MN-54	0.00E+00	4.57E-06	8.72E-07	0.00E+00	1.36E-06	0.00E+00	1.40E-05	0.00E+00
MN-56	0.00E+00	1.15E-07	2.04E-08	0.00E+00	1.46E-07	0.00E+00	3.67E-06	0.00E+00
FE-55	2.75E-06	1.90E-06	4.43E-07	0.00E+00	0.00E+00	1.06E-06	1.09E-06	0.00E+00
FE-59	4.34E-06	1.02E-05	3.91E-06	0.00E+00	0.00E+00	2.85E-06	3.40E-05	0.00E+00
CO-57	0.00E+00	1.75E-07	2.91E-07	0.00E+00	0.00E+00	0.00E+00	4.44E-06	0.00E+00
CO-58	0.00E+00	7.45E-07	1.67E-06	0.00E+00	0.00E+00	0.00E+00	1.51E-05	0.00E+00
CO-60	0.00E+00	2.14E-06	4.72E-06	0.00E+00	0.00E+00	0.00E+00	4.02E-05	0.00E+00
NI-59	9.76E-06	3.35E-06	1.63E-06	0.00E+00	0.00E+00	0.00E+00	6.90E-07	0.00E+00
NI-63	1.30E-04	9.01E-06	4.36E-06	0.00E+00	0.00E+00	0.00E+00	1.88E-06	0.00E+00
NI-65	5.28E-07	6.86E-08	3.13E-08	0.00E+00	0.00E+00	0.00E+00	1.74E-06	0.00E+00
CU-64	0.00E+00	8.33E-08	3.91E-08	0.00E+00	2.10E-07	0.00E+00	7.10E-06	0.00E+00
ZN-65	4.84E-06	1.54E-05	6.96E-06	0.00E+00	1.03E-05	0.00E+00	9.70E-06	0.00E+00
ZN-69M	1.70E-07	4.08E-07	3.73E-08	0.00E+00	2.47E-07	0.00E+00	2.49E-05	0.00E+00
ZN-69	1.03E-08	1.97E-08	1.37E-09	0.00E+00	1.28E-08	0.00E+00	2.96E-09	0.00E+00
SE-79	0.00E+00	2.63E-06	4.39E-07	0.00E+00	4.55E-06	0.00E+00	5.38E-07	0.00E+00
BR-82	0.00E+00	0.00E+00	2.26E-06	0.00E+00	0.00E+00	0.00E+00	2.59E-06	0.00E+00
BR-83	0.00E+00	0.00E+00	4.02E-08	0.00E+00	0.00E+00	0.00E+00	5.79E-08	0.00E+00
BR-84	0.00E+00	0.00E+00	5.21E-08	0.00E+00	0.00E+00	0.00E+00	4.09E-13	0.00E+00
BR-85	0.00E+00	0.00E+00	2.14E-09	0.00E+00	0.00E+00	0.00E+00	0.00E+00	0.00E+00
RB-86	0.00E+00	2.11E-05	9.83E-06	0.00E+00	0.00E+00	0.00E+00	4.16E-06	0.00E+00
RB-87	0.00E+00	1.23E-05	4.28E-06	0.00E+00	0.00E+00	0.00E+00	5.76E-07	0.00E+00
RB-88	0.00E+00	6.05E-08	3.21E-08	0.00E+00	0.00E+00	0.00E+00	8.36E-19	0.00E+00
RB-89	0.00E+00	4.01E-08	2.82E-08	0.00E+00	0.00E+00	0.00E+00	2.33E-21	0.00E+00
SR-89	3.08E-04	0.00E+00	8.84E-06	0.00E+00	0.00E+00	0.00E+00	4.94E-05	0.00E+00
SR-90	8.71E-03	0.00E+00	1.75E-04	0.00E+00	0.00E+00	0.00E+00	2.19E-04	0.00E+00
SR-91	5.67E-06	0.00E+00	2.29E-07	0.00E+00	0.00E+00	0.00E+00	2.70E-05	0.00E+00
SR-92	2.15E-06	0.00E+00	9.30E-08	0.00E+00	0.00E+00	0.00E+00	4.26E-05	0.00E+00
Y-90	9.62E-09	0.00E+00	2.58E-10	0.00E+00	0.00E+00	0.00E+00	1.02E-04	0.00E+00
Y-91M	9.09E-11	0.00E+00	3.52E-12	0.00E+00	0.00E+00	0.00E+00	2.67E-10	0.00E+00
Y-91	1.41E-07	0.00E+00	3.77E-09	0.00E+00	0.00E+00	0.00E+00	7.76E-05	0.00E+00
Y-92	8.45E-10	0.00E+00	2.47E-11	0.00E+00	0.00E+00	0.00E+00	1.48E-05	0.00E+00
Y-93	2.68E-09	0.00E+00	7.40E-11	0.00E+00	0.00E+00	0.00E+00	8.50E-05	0.00E+00
ZR-93	4.18E-08	2.34E-09	1.09E-09	0.00E+00	8.87E-09	0.00E+00	2.43E-06	0.00E+00
ZR-95	3.04E-08	9.75E-09	6.60E-09	0.00E+00	1.53E-08	0.00E+00	3.09E-05	0.00E+00
ZR-97	1.68E-09	3.39E-10	1.55E-10	0.00E+00	5.12E-10	0.00E+00	1.05E-04	0.00E+00
NB-93M	2.55E-08	8.32E-09	2.05E-09	0.00E+00	9.57E-09	0.00E+00	3.84E-06	0.00E+00
NB-95	6.22E-09	3.46E-09	1.86E-09	0.00E+00	3.42E-09	0.00E+00	2.10E-05	0.00E+00
NB-97	5.22E-11	1.32E-11	4.82E-12	0.00E+00	1.54E-11	0.00E+00	4.87E-08	0.00E+00

TABLE II-3

 INGESTION DOSE FACTORS FOR ADULT (D_{aipj})
 mrem/pCi

NUCLIDE	BONE	LIVER	T BODY	THYROID	KIDNEY	LUNG	GI-LLI	SKIN
MO-93	0.00E+00	7.51E-06	2.03E-07	0.00E+00	2.13E-06	0.00E+00	1.22E-06	0.00E+00
MO-99	0.00E+00	4.31E-06	8.20E-07	0.00E+00	9.76E-06	0.00E+00	9.99E-06	0.00E+00
TC-99M	2.47E-10	6.98E-10	8.89E-09	0.00E+00	1.06E-08	3.42E-10	4.13E-07	0.00E+00
TC-99	1.25E-07	1.86E-07	5.02E-08	0.00E+00	2.34E-06	1.58E-08	6.08E-06	0.00E+00
TC-101	2.54E-10	3.66E-10	3.59E-09	0.00E+00	6.59E-09	1.87E-10	1.10E-21	0.00E+00
RU-103	1.85E-07	0.00E+00	7.97E-08	0.00E+00	7.06E-07	0.00E+00	2.16E-05	0.00E+00
RU-105	1.54E-08	0.00E+00	6.08E-09	0.00E+00	1.99E-07	0.00E+00	9.42E-06	0.00E+00
RU-106	2.75E-06	0.00E+00	3.48E-07	0.00E+00	5.31E-06	0.00E+00	1.78E-04	0.00E+00
RH-105	1.21E-07	8.85E-08	5.83E-08	0.00E+00	3.76E-07	0.00E+00	1.41E-05	0.00E+00
PD-107	0.00E+00	1.47E-07	9.40E-09	0.00E+00	1.32E-06	0.00E+00	9.11E-07	0.00E+00
PD-109	0.00E+00	1.77E-07	3.99E-08	0.00E+00	1.01E-06	0.00E+00	1.96E-05	0.00E+00
AG-110M	1.60E-07	1.48E-07	8.79E-08	0.00E+00	2.91E-07	0.00E+00	6.04E-05	0.00E+00
AG-111	5.81E-08	2.43E-08	1.21E-08	0.00E+00	7.84E-08	0.00E+00	4.46E-05	0.00E+00
CD-113M	0.00E+00	3.18E-06	1.02E-07	0.00E+00	3.50E-06	0.00E+00	2.56E-05	0.00E+00
CD-115M	0.00E+00	1.84E-06	5.87E-08	0.00E+00	1.46E-06	0.00E+00	7.74E-05	0.00E+00
SN-123	3.11E-05	5.15E-07	7.59E-07	4.38E-07	0.00E+00	0.00E+00	6.33E-05	0.00E+00
SN-125	8.33E-06	1.68E-07	3.78E-07	1.39E-07	0.00E+00	0.00E+00	1.04E-04	0.00E+00
SN-126	8.45E-05	1.67E-06	2.40E-06	4.92E-07	0.00E+00	0.00E+00	2.43E-05	0.00E+00
SB-124	2.80E-06	5.29E-08	1.11E-06	6.79E-09	0.00E+00	2.18E-06	7.95E-05	0.00E+00
SB-125	1.79E-06	2.00E-08	4.26E-07	1.82E-09	0.00E+00	1.38E-06	1.97E-05	0.00E+00
SB-126	1.15E-06	2.34E-08	4.15E-07	7.04E-09	0.00E+00	7.05E-07	9.40E-05	0.00E+00
SB-127	2.58E-07	5.65E-09	9.90E-08	3.10E-09	0.00E+00	1.53E-07	5.90E-05	0.00E+00
TE-125M	2.68E-06	9.71E-07	3.59E-07	8.06E-07	1.09E-05	0.00E+00	1.07E-05	0.00E+00
TE-127M	6.77E-06	2.42E-06	8.25E-07	1.73E-06	2.75E-05	0.00E+00	2.27E-05	0.00E+00
TE-127	1.10E-07	3.95E-08	2.38E-08	8.15E-08	4.48E-07	0.00E+00	8.68E-06	0.00E+00
TE-129M	1.15E-05	4.29E-06	1.82E-06	3.95E-06	4.80E-05	0.00E+00	5.79E-05	0.00E+00
TE-129	3.14E-08	1.18E-08	7.65E-09	2.41E-08	1.32E-07	0.00E+00	2.37E-08	0.00E+00
TE-131M	1.73E-06	8.46E-07	7.05E-07	1.34E-06	8.57E-06	0.00E+00	8.40E-05	0.00E+00
TE-131	1.97E-08	8.23E-09	6.22E-09	1.62E-08	8.63E-08	0.00E+00	2.79E-09	0.00E+00
TE-133M	4.62E-08	2.70E-08	2.60E-08	3.91E-08	2.67E-07	0.00E+00	9.26E-09	0.00E+00
TE-134	3.24E-08	2.12E-08	1.30E-08	2.83E-08	2.05E-07	0.00E+00	3.59E-11	0.00E+00
TE-132	2.52E-06	1.63E-06	1.53E-06	1.80E-06	1.57E-05	0.00E+00	7.71E-05	0.00E+00
I-129	3.27E-06	2.81E-06	9.21E-06	7.23E-03	6.04E-06	0.00E+00	4.44E-07	0.00E+00
I-130	7.56E-07	2.23E-06	8.80E-07	1.89E-04	3.48E-06	0.00E+00	1.92E-06	0.00E+00
I-131	4.16E-06	5.95E-06	3.41E-06	1.95E-03	1.02E-05	0.00E+00	1.57E-06	0.00E+00
I-132	2.03E-07	5.43E-07	1.90E-07	1.90E-05	8.65E-07	0.00E+00	1.02E-07	0.00E+00
I-133	1.42E-06	2.47E-06	7.53E-07	3.63E-04	4.31E-06	0.00E+00	2.22E-06	0.00E+00
I-134	1.06E-07	2.88E-07	1.03E-07	4.99E-06	4.58E-07	0.00E+00	2.51E-10	0.00E+00
I-135	4.43E-07	1.16E-06	4.28E-07	7.65E-05	1.86E-06	0.00E+00	1.31E-06	0.00E+00
CS-134M	2.13E-08	4.48E-08	2.29E-08	0.00E+00	2.43E-08	3.83E-09	1.58E-08	0.00E+00
CS-134	6.22E-05	1.48E-04	1.21E-04	0.00E+00	4.79E-05	1.59E-05	2.59E-06	0.00E+00
CS-135	1.95E-05	1.80E-05	7.99E-06	0.00E+00	6.81E-06	2.04E-06	4.21E-07	0.00E+00
CS-136	6.51E-06	2.57E-05	1.85E-05	0.00E+00	1.43E-05	1.96E-06	2.92E-06	0.00E+00
CS-137	7.97E-05	1.09E-04	7.14E-05	0.00E+00	3.70E-05	1.23E-05	2.11E-06	0.00E+00
CS-138	5.52E-08	1.09E-07	5.40E-08	0.00E+00	8.01E-08	7.91E-09	4.65E-13	0.00E+00
CS-139	3.41E-08	5.08E-08	1.85E-08	0.00E+00	4.07E-08	3.70E-09	1.10E-30	0.00E+00
BA-139	9.70E-08	6.91E-11	2.84E-09	0.00E+00	6.46E-11	3.92E-11	1.72E-07	0.00E+00

TABLE II-3

 INGESTION DOSE FACTORS FOR ADULT (D_{aipj})
 mrem/pCi

NUCLIDE	BONE	LIVER	T BODY	THYROID	KIDNEY	LUNG	GI-LLI	SKIN
BA-140	2.03E-05	2.55E-08	1.33E-06	0.00E+00	8.67E-09	1.46E-08	4.18E-05	0.00E+00
BA-141	4.71E-08	3.56E-11	1.59E-09	0.00E+00	3.31E-11	2.02E-11	2.22E-17	0.00E+00
BA-142	2.13E-08	2.19E-11	1.34E-09	0.00E+00	1.85E-11	1.24E-11	3.00E-26	0.00E+00
LA-140	2.50E-09	1.26E-09	3.33E-10	0.00E+00	0.00E+00	0.00E+00	9.25E-05	0.00E+00
LA-141	3.19E-10	9.90E-11	1.62E-11	0.00E+00	0.00E+00	0.00E+00	1.18E-05	0.00E+00
LA-142	1.28E-10	5.82E-11	1.45E-11	0.00E+00	0.00E+00	0.00E+00	4.25E-07	0.00E+00
CE-141	9.36E-09	6.33E-09	7.18E-10	0.00E+00	2.94E-09	0.00E+00	2.42E-05	0.00E+00
CE-143	1.65E-09	1.22E-06	1.35E-10	0.00E+00	5.37E-10	0.00E+00	4.56E-05	0.00E+00
CE-144	4.88E-07	2.04E-07	2.62E-08	0.00E+00	1.21E-07	0.00E+00	1.65E-04	0.00E+00
PR-143	9.20E-09	3.69E-09	4.56E-10	0.00E+00	2.13E-09	0.00E+00	4.03E-05	0.00E+00
PR-144	3.01E-11	1.25E-11	1.53E-12	0.00E+00	7.05E-12	0.00E+00	4.33E-18	0.00E+00
ND-147	6.29E-09	7.27E-09	4.35E-10	0.00E+00	4.25E-09	0.00E+00	3.49E-05	0.00E+00
PM-147	7.54E-08	7.09E-09	2.8E-09	0.00E+00	1.34E-08	0.00E+00	8.93E-06	0.00E+00
PM-148M	3.07E-08	7.95E-09	6.08E-09	0.00E+00	1.20E-08	0.00E+00	6.74E-05	0.00E+00
PM-148	7.17E-09	1.19E-09	5.99E-10	0.00E+00	2.25E-09	0.00E+00	9.35E-05	0.00E+00
PM-149	1.52E-09	2.15E-10	8.78E-11	0.00E+00	4.06E-10	0.00E+00	4.03E-05	0.00E+00
PM-151	6.97E-10	1.17E-10	5.91E-11	0.00E+00	2.09E-10	0.00E+00	3.22E-05	0.00E+00
SM-151	6.90E-08	1.19E-08	2.85E-09	0.00E+00	1.33E-08	0.00E+00	5.25E-06	0.00E+00
SM-153	8.57E-10	7.15E-10	5.22E-11	0.00E+00	2.31E-10	0.00E+00	2.55E-05	0.00E+00
EU-152	1.95E-07	4.44E-08	3.90E-08	0.00E+00	2.75E-07	0.00E+00	2.56E-05	0.00E+00
EU-154	6.15E-07	7.56E-08	5.38E-08	0.00E+00	3.62E-07	0.00E+00	5.48E-05	0.00E+00
EU-155	8.60E-08	1.22E-08	7.87E-09	0.00E+00	5.63E-08	0.00E+00	9.60E-06	0.00E+00
EU-156	1.37E-08	1.06E-08	1.71E-09	0.00E+00	7.08E-09	0.00E+00	7.26E-05	0.00E+00
TB-160	4.70E-08	0.00E+00	5.86E-09	0.00E+00	1.94E-08	0.00E+00	4.33E-05	0.00E+00
HO-166M	2.70E-07	8.43E-08	6.40E-08	0.00E+00	1.26E-07	0.00E+00	2.56E-05	0.00E+00
W-181	9.91E-09	3.23E-09	3.46E-10	0.00E+00	0.00E+00	0.00E+00	3.68E-07	0.00E+00
W-185	4.05E-07	1.35E-07	1.42E-08	0.00E+00	0.00E+00	0.00E+00	1.56E-05	0.00E+00
W-187	1.03E-07	8.61E-08	3.01E-08	0.00E+00	0.00E+00	0.00E+00	2.82E-05	0.00E+00
U-232	4.13E-03	0.00E+00	2.95E-04	0.00E+00	4.47E-04	0.00E+00	6.78E-05	0.00E+00
U-233	8.71E-04	0.00E+00	5.28E-05	0.00E+00	2.03E-04	0.00E+00	6.27E-05	0.00E+00
U-234	8.36E-04	0.00E+00	5.17E-05	0.00E+00	1.99E-04	0.00E+00	6.14E-05	0.00E+00
U-235	8.01E-04	0.00E+00	4.86E-05	0.00E+00	1.87E-04	0.00E+00	7.81E-05	0.00E+00
U-236	8.01E-04	0.00E+00	4.96E-05	0.00E+00	1.91E-04	0.00E+00	5.76E-05	0.00E+00
U-237	5.52E-08	0.00E+00	1.47E-08	0.00E+00	2.27E-07	0.00E+00	1.94E-05	0.00E+00
U-238	7.67E-04	0.00E+00	4.54E-05	0.00E+00	1.75E-04	0.00E+00	5.50E-05	0.00E+00
NP-237	1.26E-03	8.96E-05	5.54E-05	0.00E+00	4.12E-04	0.00E+00	7.94E-05	0.00E+00
NP-238	1.37E-08	3.69E-10	2.13E-10	0.00E+00	1.25E-09	0.00E+00	3.43E-05	0.00E+00
NP-239	1.19E-09	1.17E-10	6.45E-11	0.00E+00	3.65E-10	0.00E+00	2.40E-05	0.00E+00
PU-238	6.30E-04	7.98E-05	1.71E-05	0.00E+00	7.32E-05	0.00E+00	7.30E-05	0.00E+00
PU-239	7.25E-04	8.71E-05	1.91E-05	0.00E+00	8.11E-05	0.00E+00	6.66E-05	0.00E+00
PU-240	7.24E-04	8.70E-05	1.91E-05	0.00E+00	8.10E-05	0.00E+00	6.78E-05	0.00E+00
PU-241	1.57E-05	7.45E-07	3.32E-07	0.00E+00	1.53E-06	0.00E+00	1.40E-06	0.00E+00
PU-242	6.72E-04	8.39E-05	1.84E-05	0.00E+00	7.81E-05	0.00E+00	6.53E-05	0.00E+00
PU-244	7.84E-04	9.61E-05	2.11E-05	0.00E+00	8.95E-05	0.00E+00	9.73E-05	0.00E+00
AM-241	7.55E-04	7.05E-04	5.41E-05	0.00E+00	4.07E-04	0.00E+00	7.42E-05	0.00E+00
AM-242M	7.61E-04	6.63E-04	5.43E-05	0.00E+00	4.05E-04	0.00E+00	9.34E-05	0.00E+00
AM-243	7.54E-04	6.90E-04	5.30E-05	0.00E+00	3.99E-04	0.00E+00	8.70E-05	0.00E+00

TABLE II-3

INGESTION DOSE FACTORS FOR ADULT (D_{aipj})
mrem/pCi

NUCLIDE	BONE	LIVER	T BODY	THYROID	KIDNEY	LUNG	GI-LLI	SKIN
CM-242	2.06E-05	2.19E-05	1.37E-06	0.00E+00	6.22E-06	0.00E+00	7.92E-05	0.00E+00
CM-243	5.99E-04	5.49E-04	3.75E-05	0.00E+00	1.75E-04	0.00E+00	7.81E-05	0.00E+00
CM-244	4.56E-04	4.27E-04	2.87E-05	0.00E+00	1.34E-04	0.00E+00	7.55E-05	0.00E+00
CM-245	9.38E-04	8.17E-04	5.76E-05	0.00E+00	2.69E-04	0.00E+00	7.04E-05	0.00E+00
CM-246	9.30E-04	8.16E-04	5.75E-05	0.00E+00	2.68E-04	0.00E+00	6.91E-05	0.00E+00
CM-247	9.07E-04	8.04E-04	5.67E-05	0.00E+00	2.64E-04	0.00E+00	9.09E-05	0.00E+00
CM-248	7.54E-03	6.63E-03	4.67E-04	0.00E+00	2.18E-03	0.00E+00	1.47E-03	0.00E+00
CF-252	2.61E-04	0.00E+00	6.29E-06	0.00E+00	0.00E+00	0.00E+00	2.88E-04	0.00E+00

NUREG/CR-4653, GASPAR II, Technical Reference and User Guide

TABLE II-4

INGESTION DOSE FACTORS FOR TEEN (D_{aipj})
mrem/pCi

NUCLIDE	BONE	LIVER	T BODY	THYROID	KIDNEY	LUNG	GI-LLI	SKIN
H-3	0.00E+00	6.04E-08	6.04E-08	6.04E-08	6.04E-08	6.04E-08	6.04E-08	0.00E+00
C-14	4.06E-06	8.12E-07	8.12E-07	8.12E-07	8.12E-07	8.12E-07	8.12E-07	0.00E+00
NA-22	2.34E-05	2.34E-05	2.34E-05	2.34E-05	2.34E-05	2.34E-05	2.34E-05	0.00E+00
NA-24	2.30E-06	2.30E-06	2.30E-06	2.30E-06	2.30E-06	2.30E-06	2.30E-06	0.00E+00
P-32	2.76E-04	1.71E-05	1.07E-05	0.00E+00	0.00E+00	0.00E+00	2.32E-05	0.00E+00
CA-41	1.97E-04	0.00E+00	2.13E-05	0.00E+00	0.00E+00	0.00E+00	1.95E-07	0.00E+00
SC-46	7.24E-09	1.41E-08	4.18E-09	0.00E+00	1.35E-08	0.00E+00	4.80E-05	0.00E+00
CR-51	0.00E+00	0.00E+00	3.60E-09	2.00E-09	7.89E-10	5.14E-09	6.05E-07	0.00E+00
MN-54	0.00E+00	5.90E-06	1.17E-06	0.00E+00	1.76E-06	0.00E+00	1.21E-05	0.00E+00
MN-56	0.00E+00	1.58E-07	2.81E-08	0.00E+00	2.00E-07	0.00E+00	1.04E-05	0.00E+00
FE-55	3.78E-06	2.68E-06	6.25E-07	0.00E+00	0.00E+00	1.70E-06	1.16E-06	0.00E+00
FE-59	5.87E-06	1.37E-05	5.29E-06	0.00E+00	0.00E+00	4.32E-06	3.24E-05	0.00E+00
CO-57	0.00E+00	2.38E-07	3.99E-07	0.00E+00	0.00E+00	0.00E+00	4.44E-06	0.00E+00
CO-58	0.00E+00	9.72E-07	2.24E-06	0.00E+00	0.00E+00	0.00E+00	1.34E-05	0.00E+00
CO-60	0.00E+00	2.81E-06	6.33E-06	0.00E+00	0.00E+00	0.00E+00	3.66E-05	0.00E+00
NI-59	1.32E-05	4.66E-06	2.24E-06	0.00E+00	0.00E+00	0.00E+00	7.31E-07	0.00E+00
NI-63	1.77E-04	1.25E-05	6.00E-06	0.00E+00	0.00E+00	0.00E+00	1.99E-06	0.00E+00
NI-65	7.49E-07	9.57E-08	4.36E-08	0.00E+00	0.00E+00	0.00E+00	5.19E-06	0.00E+00
CU-64	0.00E+00	1.15E-07	5.41E-08	0.00E+00	2.91E-07	0.00E+00	8.92E-06	0.00E+00
ZN-65	5.76E-06	2.00E-05	9.33E-06	0.00E+00	1.28E-05	0.00E+00	8.47E-06	0.00E+00
ZN-69M	2.40E-07	5.66E-07	5.19E-08	0.00E+00	3.44E-07	0.00E+00	3.11E-05	0.00E+00
ZN-69	1.47E-08	2.80E-08	1.96E-09	0.00E+00	1.83E-08	0.00E+00	5.16E-08	0.00E+00
SE-79	0.00E+00	3.73E-06	6.27E-07	0.00E+00	6.50E-06	0.00E+00	5.70E-07	0.00E+00
BR-82	0.00E+00	0.00E+00	3.04E-06	0.00E+00	0.00E+00	0.00E+00	0.00E+00	0.00E+00
BR-83	0.00E+00	0.00E+00	5.74E-08	0.00E+00	0.00E+00	0.00E+00	0.00E+00	0.00E+00
BR-84	0.00E+00	0.00E+00	7.22E-08	0.00E+00	0.00E+00	0.00E+00	0.00E+00	0.00E+00
BR-85	0.00E+00	0.00E+00	3.05E-09	0.00E+00	0.00E+00	0.00E+00	0.00E+00	0.00E+00
RB-86	0.00E+00	2.98E-05	1.40E-05	0.00E+00	0.00E+00	0.00E+00	4.41E-06	0.00E+00
RB-87	0.00E+00	1.75E-05	6.11E-06	0.00E+00	0.00E+00	0.00E+00	6.11E-07	0.00E+00
RB-88	0.00E+00	8.52E-08	4.54E-08	0.00E+00	0.00E+00	0.00E+00	7.30E-15	0.00E+00
RB-89	0.00E+00	5.50E-08	3.89E-08	0.00E+00	0.00E+00	0.00E+00	8.43E-17	0.00E+00
SR-89	4.40E-04	0.00E+00	1.26E-05	0.00E+00	0.00E+00	0.00E+00	5.24E-05	0.00E+00
SR-90	1.02E-02	0.00E+00	2.04E-04	0.00E+00	0.00E+00	0.00E+00	2.33E-04	0.00E+00
SR-91	8.07E-06	0.00E+00	3.21E-07	0.00E+00	0.00E+00	0.00E+00	3.66E-05	0.00E+00
SR-92	3.05E-06	0.00E+00	1.30E-07	0.00E+00	0.00E+00	0.00E+00	7.77E-05	0.00E+00
Y-90	1.37E-08	0.00E+00	3.69E-10	0.00E+00	0.00E+00	0.00E+00	1.13E-04	0.00E+00
Y-91M	1.29E-10	0.00E+00	4.93E-12	0.00E+00	0.00E+00	0.00E+00	6.09E-09	0.00E+00
Y-91	2.01E-07	0.00E+00	5.39E-09	0.00E+00	0.00E+00	0.00E+00	8.24E-05	0.00E+00
Y-92	1.21E-09	0.00E+00	3.50E-11	0.00E+00	0.00E+00	0.00E+00	3.32E-05	0.00E+00
Y-93	3.83E-09	0.00E+00	1.05E-10	0.00E+00	0.00E+00	0.00E+00	1.17E-04	0.00E+00
ZR-93	5.53E-08	2.73E-09	1.49E-09	0.00E+00	9.65E-09	0.00E+00	2.58E-09	0.00E+00
ZR-95	4.12E-08	1.30E-08	8.94E-09	0.00E+00	1.91E-08	0.00E+00	3.00E-05	0.00E+00
ZR-97	2.37E-09	4.69E-10	2.16E-10	0.00E+00	7.11E-10	0.00E+00	1.27E-04	0.00E+00
NB-93M	3.44E-08	1.13E-08	2.83E-09	0.00E+00	1.32E-08	0.00E+00	4.07E-06	0.00E+00
NB-95	8.22E-09	4.56E-09	2.51E-09	0.00E+00	4.42E-09	0.00E+00	1.95E-05	0.00E+00

TABLE II-4

INGESTION DOSE FACTORS FOR TEEN (D_{aipj})
mrem/pCi

NUCLIDE	BONE	LIVER	T BODY	THYROID	KIDNEY	LUNG	GI-LLI	SKIN
NB-97	7.37E-11	1.83E-11	6.68E-12	0.00E+00	2.14E-11	0.00E+00	4.37E-07	0.00E+00
MO-93	0.00E+00	1.06E-05	2.90E-07	0.00E+00	3.04E-06	0.00E+00	1.29E-06	0.00E+00
MO-99	0.00E+00	6.03E-06	1.15E-06	0.00E+00	1.38E-05	0.00E+00	1.08E-05	0.00E+00
TC-99M	3.32E-10	9.26E-10	1.20E-08	0.00E+00	1.38E-08	5.14E-10	6.08E-07	0.00E+00
TC-99	1.79E-07	2.63E-07	7.17E-08	0.00E+00	3.34E-06	2.72E-08	6.44E-06	0.00E+00
TC-101	3.60E-10	5.12E-10	5.03E-09	0.00E+00	9.26E-09	3.12E-10	8.75E-17	0.00E+00
RU-103	2.55E-07	0.00E+00	1.09E-07	0.00E+00	8.99E-07	0.00E+00	2.13E-05	0.00E+00
RU-105	2.18E-08	0.00E+00	8.46E-09	0.00E+00	2.75E-07	0.00E+00	1.76E-05	0.00E+00
RU-106	3.92E-06	0.00E+00	4.94E-07	0.00E+00	7.56E-06	0.00E+00	1.88E-04	0.00E+00
RH-105	1.73E-07	1.25E-07	8.20E-08	0.00E+00	5.31E-07	0.00E+00	1.59E-05	0.00E+00
PD-107	0.00E+00	2.08E-07	1.34E-08	0.00E+00	1.88E-06	0.00E+00	9.66E-07	0.00E+00
PD-109	0.00E+00	2.51E-07	5.70E-08	0.00E+00	1.45E-06	0.00E+00	2.53E-05	0.00E+00
AG-110M	2.05E-07	1.94E-07	1.18E-07	0.00E+00	3.70E-07	0.00E+00	5.45E-05	0.00E+00
AG-111	8.29E-08	3.44E-08	1.73E-08	0.00E+00	1.12E-07	0.00E+00	4.80E-05	0.00E+00
CD-113M	0.00E+00	4.51E-06	1.45E-07	0.00E+00	4.99E-06	0.00E+00	2.71E-05	0.00E+00
CD-115M	0.00E+00	2.60E-06	8.39E-08	0.00E+00	2.08E-06	0.00E+00	8.23E-05	0.00E+00
SN-123	4.44E-05	7.29E-07	1.08E-06	5.84E-07	0.00E+00	0.00E+00	6.71E-05	0.00E+00
SN-125	1.19E-05	2.37E-07	5.37E-07	1.86E-07	0.00E+00	0.00E+00	1.12E-04	0.00E+00
SN-126	1.16E-04	2.16E-06	3.30E-06	5.69E-07	0.00E+00	0.00E+00	2.58E-05	0.00E+00
SB-124	3.87E-06	7.13E-08	1.51E-06	8.78E-09	0.00E+00	3.38E-06	7.80E-05	0.00E+00
SB-125	2.48E-06	2.71E-08	5.80E-07	2.37E-09	0.00E+00	2.18E-06	1.93E-05	0.00E+00
SB-126	1.59E-06	3.25E-08	5.71E-07	8.99E-09	0.00E+00	1.14E-06	9.41E-05	0.00E+00
SB-127	3.63E-07	7.76E-09	1.37E-07	4.08E-09	0.00E+00	2.47E-07	6.16E-05	0.00E+00
TE-125M	3.83E-06	1.38E-06	5.12E-07	1.07E-06	0.00E+00	0.00E+00	1.13E-05	0.00E+00
TE-127M	9.67E-06	3.43E-06	1.15E-06	2.30E-06	3.92E-05	0.00E+00	2.41E-05	0.00E+00
TE-127	1.58E-07	5.60E-08	3.40E-08	1.09E-07	6.40E-07	0.00E+00	1.22E-05	0.00E+00
TE-129M	1.63E-05	6.05E-06	2.58E-06	5.26E-06	6.82E-05	0.00E+00	6.12E-05	0.00E+00
TE-129	4.48E-08	1.67E-08	1.09E-08	3.20E-08	1.88E-07	0.00E+00	2.45E-07	0.00E+00
TE-131M	2.44E-06	1.17E-06	9.76E-07	1.76E-06	1.22E-05	0.00E+00	9.39E-05	0.00E+00
TE-131	2.79E-08	1.15E-08	8.72E-09	2.15E-08	1.22E-07	0.00E+00	2.29E-09	0.00E+00
TE-132	3.49E-06	2.21E-06	2.08E-06	2.33E-06	2.12E-05	0.00E+00	7.00E-05	0.00E+00
TE-133M	6.44E-08	3.66E-08	3.56E-08	5.11E-08	3.62E-07	0.00E+00	1.48E-07	0.00E+00
TE-134	4.47E-08	2.87E-08	3.00E-08	3.67E-08	2.74E-07	0.00E+00	1.66E-09	0.00E+00
I-129	4.66E-06	3.92E-06	6.54E-06	4.77E-03	7.01E-06	0.00E+00	4.57E-07	0.00E+00
I-130	1.03E-06	2.98E-06	1.19E-06	2.43E-04	4.59E-06	0.00E+00	2.29E-06	0.00E+00
I-131	5.85E-06	8.19E-06	4.40E-06	2.39E-03	1.41E-05	0.00E+00	1.62E-06	0.00E+00
I-132	2.79E-07	7.30E-07	2.62E-07	2.46E-05	1.15E-06	0.00E+00	3.18E-07	0.00E+00
I-133	2.01E-06	3.41E-06	1.04E-06	4.76E-04	5.98E-06	0.00E+00	2.58E-06	0.00E+00
I-134	1.46E-07	3.87E-07	1.39E-07	6.45E-06	6.10E-07	0.00E+00	5.10E-09	0.00E+00
I-135	6.10E-07	1.57E-06	5.82E-07	1.01E-04	2.48E-06	0.00E+00	1.74E-06	0.00E+00
CS-134M	2.94E-08	6.09E-08	3.13E-08	0.00E+00	3.39E-08	5.95E-09	4.05E-08	0.00E+00
CS-134	8.37E-05	1.97E-04	9.14E-05	0.00E+00	6.26E-05	2.39E-05	2.45E-06	0.00E+00
CS-135	2.78E-05	2.55E-05	5.96E-06	0.00E+00	9.73E-06	3.52E-06	4.46E-07	0.00E+00
CS-136	8.59E-06	3.38E-05	2.27E-05	0.00E+00	1.84E-05	2.90E-06	2.72E-06	0.00E+00
CS-137	1.12E-04	1.49E-04	5.19E-05	0.00E+00	5.07E-05	1.97E-05	2.12E-06	0.00E+00
CS-138	7.76E-08	1.49E-07	7.45E-08	0.00E+00	1.10E-07	1.28E-08	6.76E-11	0.00E+00
CS-139	4.87E-08	7.17E-08	2.63E-08	0.00E+00	5.79E-08	6.34E-09	3.33E-23	0.00E+00

TABLE II-4

INGESTION DOSE FACTORS FOR TEEN (D_{aipj})
mrem/pCi

NUCLIDE	BONE	LIVER	T BODY	THYROID	KIDNEY	LUNG	GI-LLI	SKIN
BA-139	1.39E-07	9.78E-11	4.05E-09	0.00E+00	9.22E-11	6.74E-11	1.24E-06	0.00E+00
BA-140	2.84E-05	3.48E-08	1.83E-06	0.00E+00	1.18E-08	2.34E-08	4.38E-05	0.00E+00
BA-141	6.71E-08	5.01E-11	2.24E-09	0.00E+00	4.65E-11	3.43E-11	1.43E-13	0.00E+00
BA-142	2.99E-08	2.99E-11	1.84E-09	0.00E+00	2.53E-11	1.99E-11	9.18E-20	0.00E+00
LA-140	3.48E-09	1.71E-09	4.55E-10	0.00E+00	0.00E+00	0.00E+00	9.82E-05	0.00E+00
LA-141	4.55E-10	1.40E-10	2.31E-11	0.00E+00	0.00E+00	0.00E+00	2.48E-05	0.00E+00
LA-142	1.79E-10	7.95E-11	1.98E-11	0.00E+00	0.00E+00	0.00E+00	2.42E-06	0.00E+00
CE-141	1.33E-08	8.88E-09	1.02E-09	0.00E+00	4.18E-09	0.00E+00	2.54E-05	0.00E+00
CE-143	2.35E-09	1.71E-06	1.91E-10	0.00E+00	7.67E-10	0.00E+00	5.14E-05	0.00E+00
CE-144	6.96E-07	2.88E-07	3.74E-08	0.00E+00	1.72E-07	0.00E+00	1.75E-04	0.00E+00
PR-143	1.31E-08	5.23E-09	6.52E-10	0.00E+00	3.04E-09	0.00E+00	4.31E-05	0.00E+00
PR-144	4.30E-11	1.76E-11	2.18E-12	0.00E+00	1.01E-11	0.00E+00	4.74E-14	0.00E+00
ND-147	9.38E-09	1.02E-08	6.11E-10	0.00E+00	5.99E-09	0.00E+00	3.68E-05	0.00E+00
PM-147	1.05E-07	9.96E-09	4.06E-09	0.00E+00	1.90E-08	0.00E+00	9.47E-06	0.00E+00
PM-148M	4.14E-08	1.05E-08	8.21E-09	0.00E+00	1.59E-08	0.00E+00	6.61E-05	0.00E+00
PM-148	1.02E-08	1.66E-09	8.36E-10	0.00E+00	3.00E-09	0.00E+00	9.90E-05	0.00E+00
PM-149	2.17E-09	3.05E-10	1.25E-10	0.00E+00	5.81E-10	0.00E+00	4.49E-05	0.00E+00
PM-151	9.87E-10	1.63E-10	8.25E-11	0.00E+00	2.93E-10	0.00E+00	3.66E-05	0.00E+00
SM-151	8.73E-08	1.68E-08	3.94E-09	0.00E+00	1.84E-08	0.00E+00	5.70E-06	0.00E+00
SM-153	1.22E-09	1.01E-09	7.43E-11	0.00E+00	3.30E-10	0.00E+00	2.85E-05	0.00E+00
EU-152	2.45E-07	5.90E-08	5.20E-08	0.00E+00	2.74E-07	0.00E+00	2.17E-05	0.00E+00
EU-154	7.91E-07	1.02E-07	7.19E-08	0.00E+00	4.56E-07	0.00E+00	5.39E-05	0.00E+00
EU-155	1.74E-07	1.68E-08	1.04E-08	0.00E+00	6.57E-08	0.00E+00	9.63E-05	0.00E+00
EU-156	1.92E-08	1.44E-08	2.35E-09	0.00E+00	9.69E-09	0.00E+00	7.36E-05	0.00E+00
TB-160	6.47E-08	0.00E+00	8.07E-09	0.00E+00	2.56E-08	0.00E+00	4.19E-05	0.00E+00
HO-166M	3.57E-07	1.10E-07	7.96E-08	0.00E+00	1.61E-07	0.00E+00	2.71E-05	0.00E+00
W-181	1.42E-08	4.58E-09	4.79E-10	0.00E+00	0.00E+00	0.00E+00	3.90E-07	0.00E+00
W-185	5.79E-07	1.91E-07	2.02E-08	0.00E+00	0.00E+00	0.00E+00	1.65E-05	0.00E+00
W-187	1.46E-07	1.19E-07	4.17E-08	0.00E+00	0.00E+00	0.00E+00	3.22E-05	0.00E+00
U-232	5.89E-03	0.00E+00	4.21E-04	0.00E+00	6.38E-04	0.00E+00	7.19E-05	0.00E+00
U-233	1.24E-03	0.00E+00	7.54E-05	0.00E+00	2.90E-04	0.00E+00	6.65E-05	0.00E+00
U-234	1.19E-03	0.00E+00	7.39E-05	0.00E+00	2.85E-04	0.00E+00	6.51E-05	0.00E+00
U-235	1.14E-03	0.00E+00	6.94E-05	0.00E+00	2.67E-04	0.00E+00	8.28E-05	0.00E+00
U-236	1.14E-03	0.00E+00	7.09E-05	0.00E+00	2.73E-04	0.00E+00	6.11E-05	0.00E+00
U-237	7.89E-08	0.00E+00	2.10E-08	0.00E+00	3.24E-07	0.00E+00	2.09E-05	0.00E+00
U-238	1.09E-03	0.00E+00	6.49E-05	0.00E+00	2.50E-04	0.00E+00	5.83E-05	0.00E+00
NP-237	1.33E-03	9.55E-05	5.85E-05	0.00E+00	4.33E-04	0.00E+00	8.41E-05	0.00E+00
NP-238	1.95E-08	5.22E-10	3.04E-10	0.00E+00	1.79E-09	0.00E+00	3.83E-05	0.00E+00
NP-239	1.76E-09	1.66E-10	9.22E-11	0.00E+00	5.21E-10	0.00E+00	2.67E-05	0.00E+00
PU-238	6.70E-04	8.58E-05	1.82E-05	0.00E+00	7.80E-05	0.00E+00	7.73E-05	0.00E+00
PU-239	7.65E-04	9.29E-05	2.01E-05	0.00E+00	8.57E-05	0.00E+00	7.06E-05	0.00E+00
PU-240	7.64E-04	9.27E-05	2.01E-05	0.00E+00	8.56E-05	0.00E+00	7.19E-05	0.00E+00
PU-241	1.75E-05	8.40E-07	3.69E-07	0.00E+00	1.71E-06	0.00E+00	1.48E-06	0.00E+00
PU-242	7.09E-04	8.94E-05	1.94E-05	0.00E+00	8.25E-05	0.00E+00	6.92E-05	0.00E+00
PU-244	8.28E-04	1.02E-04	2.22E-05	0.00E+00	9.45E-05	0.00E+00	1.03E-04	0.00E+00
AM-241	7.98E-04	7.53E-04	5.75E-05	0.00E+00	4.31E-04	0.00E+00	7.87E-05	0.00E+00
AM-242M	8.07E-04	7.11E-04	5.80E-05	0.00E+00	4.30E-04	0.00E+00	9.90E-05	0.00E+00

TABLE II-4

INGESTION DOSE FACTORS FOR TEEN (D_{aipj})
mrem/pCi

NUCLIDE	BONE	LIVER	T BODY	THYROID	KIDNEY	LUNG	GI-LLI	SKIN
AM-243	7.96E-04	7.35E-04	5.62E-05	0.00E+00	4.22E-04	0.00E+00	9.23E-05	0.00E+00
CM-242	2.94E-05	3.10E-05	1.95E-06	0.00E+00	8.89E-06	0.00E+00	8.40E-05	0.00E+00
CM-243	6.50E-04	6.03E-04	4.09E-05	0.00E+00	1.91E-04	0.00E+00	8.28E-05	0.00E+00
CM-244	5.04E-04	4.77E-04	3.19E-05	0.00E+00	1.49E-04	0.00E+00	8.00E-05	0.00E+00
CM-245	9.90E-04	8.71E-04	6.10E-05	0.00E+00	2.85E-04	0.00E+00	7.46E-05	0.00E+00
CM-246	9.82E-04	8.70E-04	6.09E-05	0.00E+00	2.84E-04	0.00E+00	7.33E-05	0.00E+00
CM-247	9.57E-04	8.57E-04	6.00E-05	0.00E+00	2.80E-04	0.00E+00	9.63E-05	0.00E+00
CM-248	7.95E-03	7.06E-03	4.95E-04	0.00E+00	2.31E-03	0.00E+00	1.55E-03	0.00E+00
CF-252	3.47E-04	0.00E+00	8.37E-06	0.00E+00	0.00E+00	0.00E+00	3.05E-04	0.00E+00

NUREG/CR-4653, GASPAR II, Technical Reference and User Guide

TABLE II-5

 INGESTION DOSE FACTORS FOR CHILD (D_{aipj})
 mrem/pCi

NUCLIDE	BONE	LIVER	T BODY	THYROID	KIDNEY	LUNG	GI-LLI	SKIN
H-3	0.00E+00	1.16E-07	1.16E-07	1.16E-07	1.16E-07	1.16E-07	1.16E-07	0.00E+00
C-14	1.21E-05	2.42E-06	2.42E-06	2.42E-06	2.42E-06	2.42E-06	2.42E-06	0.00E+00
NA-22	5.88E-05	5.88E-05	5.88E-05	5.88E-05	5.88E-05	5.88E-05	5.88E-05	0.00E+00
NA-24	5.80E-06	5.80E-06	5.80E-06	5.80E-06	5.80E-06	5.80E-06	5.80E-06	0.00E+00
P-32	8.25E-04	3.86E-05	3.18E-05	0.00E+00	0.00E+00	0.00E+00	2.28E-05	0.00E+00
CA-41	3.47E-04	0.00E+00	3.79E-05	0.00E+00	0.00E+00	0.00E+00	1.90E-07	0.00E+00
SC-46	1.97E-08	2.70E-08	1.04E-08	0.00E+00	2.39E-08	0.00E+00	3.95E-05	0.00E+00
CR-51	0.00E+00	0.00E+00	8.90E-09	4.94E-09	1.35E-09	9.02E-09	4.72E-07	0.00E+00
MN-54	0.00E+00	1.07E-05	2.85E-06	0.00E+00	3.00E-06	0.00E+00	8.98E-06	0.00E+00
MN-56	0.00E+00	3.34E-07	7.54E-08	0.00E+00	4.04E-07	0.00E+00	4.84E-05	0.00E+00
FE-55	1.15E-05	6.10E-06	1.89E-06	0.00E+00	0.00E+00	3.45E-06	1.13E-06	0.00E+00
FE-59	1.65E-05	2.67E-05	1.33E-05	0.00E+00	0.00E+00	7.74E-06	2.78E-05	0.00E+00
CO-57	0.00E+00	4.93E-07	9.98E-07	0.00E+00	0.00E+00	0.00E+00	4.04E-06	0.00E+00
CO-58	0.00E+00	1.80E-06	5.51E-06	0.00E+00	0.00E+00	0.00E+00	1.05E-05	0.00E+00
CO-60	0.00E+00	5.29E-06	1.56E-05	0.00E+00	0.00E+00	0.00E+00	2.93E-05	0.00E+00
NI-59	4.02E-05	1.07E-05	6.82E-06	0.00E+00	0.00E+00	0.00E+00	7.10E-07	0.00E+00
NI-63	5.38E-04	2.88E-05	1.83E-05	0.00E+00	0.00E+00	0.00E+00	1.94E-06	0.00E+00
NI-65	2.22E-06	2.09E-07	1.22E-07	0.00E+00	0.00E+00	0.00E+00	2.56E-05	0.00E+00
CU-64	0.00E+00	2.45E-07	1.48E-07	0.00E+00	5.92E-07	0.00E+00	1.15E-05	0.00E+00
ZN-65	1.37E-05	3.65E-05	2.27E-05	0.00E+00	2.30E-05	0.00E+00	6.41E-06	0.00E+00
ZN-69M	7.10E-07	1.21E-06	1.43E-07	0.00E+00	7.03E-07	0.00E+00	3.94E-05	0.00E+00
ZN-69	4.38E-08	6.33E-08	5.85E-09	0.00E+00	3.84E-08	0.00E+00	3.99E-06	0.00E+00
SE-79	0.00E+00	8.43E-06	1.87E-06	0.00E+00	1.37E-05	0.00E+00	5.53E-07	0.00E+00
BR-82	0.00E+00	0.00E+00	7.55E-06	0.00E+00	0.00E+00	0.00E+00	0.00E+00	0.00E+00
BR-83	0.00E+00	0.00E+00	1.71E-07	0.00E+00	0.00E+00	0.00E+00	0.00E+00	0.00E+00
BR-84	0.00E+00	0.00E+00	1.98E-07	0.00E+00	0.00E+00	0.00E+00	0.00E+00	0.00E+00
BR-85	0.00E+00	0.00E+00	9.12E-09	0.00E+00	0.00E+00	0.00E+00	0.00E+00	0.00E+00
RB-86	0.00E+00	6.70E-05	4.12E-05	0.00E+00	0.00E+00	0.00E+00	4.31E-06	0.00E+00
RB-87	0.00E+00	3.95E-05	1.83E-05	0.00E+00	0.00E+00	0.00E+00	5.92E-07	0.00E+00
RB-88	0.00E+00	1.90E-07	1.32E-07	0.00E+00	0.00E+00	0.00E+00	9.32E-09	0.00E+00
RB-89	0.00E+00	1.17E-07	1.04E-07	0.00E+00	0.00E+00	0.00E+00	1.02E-09	0.00E+00
SR-89	1.32E-03	0.00E+00	3.77E-05	0.00E+00	0.00E+00	0.00E+00	5.11E-05	0.00E+00
SR-90	2.56E-02	0.00E+00	5.15E-04	0.00E+00	0.00E+00	0.00E+00	2.29E-04	0.00E+00
SR-91	2.40E-05	0.00E+00	9.06E-07	0.00E+00	0.00E+00	0.00E+00	5.30E-05	0.00E+00
SR-92	9.03E-06	0.00E+00	3.62E-07	0.00E+00	0.00E+00	0.00E+00	1.71E-04	0.00E+00
Y-90	4.11E-08	0.00E+00	1.10E-09	0.00E+00	0.00E+00	0.00E+00	1.17E-04	0.00E+00
Y-91M	3.82E-10	0.00E+00	1.39E-11	0.00E+00	0.00E+00	0.00E+00	7.48E-07	0.00E+00
Y-91	6.02E-07	0.00E+00	1.61E-08	0.00E+00	0.00E+00	0.00E+00	8.02E-05	0.00E+00
Y-92	3.60E-09	0.00E+00	1.03E-10	0.00E+00	0.00E+00	0.00E+00	1.04E-04	0.00E+00
Y-93	1.14E-08	0.00E+00	3.13E-10	0.00E+00	0.00E+00	0.00E+00	1.70E-04	0.00E+00
ZR-93	1.67E-07	6.25E-09	4.45E-09	0.00E+00	2.42E-08	0.00E+00	2.37E-06	0.00E+00
ZR-95	1.16E-07	2.55E-08	2.27E-08	0.00E+00	3.65E-08	0.00E+00	2.66E-05	0.00E+00
ZR-97	6.99E-09	1.01E-09	5.96E-10	0.00E+00	1.45E-09	0.00E+00	1.53E-04	0.00E+00
NB-93M	1.05E-07	2.62E-08	8.61E-09	0.00E+00	2.83E-08	0.00E+00	3.95E-06	0.00E+00
NB-95	2.25E-08	8.76E-09	6.26E-09	0.00E+00	8.23E-09	0.00E+00	1.62E-05	0.00E+00

TABLE II-5

 INGESTION DOSE FACTORS FOR CHILD (D_{aipj})
 mrem/pCi

NUCLIDE	BONE	LIVER	T BODY	THYROID	KIDNEY	LUNG	GI-LLI	SKIN
NB-97	2.17E-10	3.92E-11	1.83E-11	0.00E+00	4.35E-11	0.00E+00	1.21E-05	0.00E+00
MO-93	0.00E+00	2.41E-05	8.65E-07	0.00E+00	6.35E-06	0.00E+00	1.22E-06	0.00E+00
MO-99	0.00E+00	1.33E-05	3.29E-06	0.00E+00	2.84E-05	0.00E+00	1.10E-05	0.00E+00
TC-99M	9.23E-10	1.81E-09	3.00E-08	0.00E+00	2.63E-08	9.19E-10	1.03E-06	0.00E+00
TC-99	5.35E-07	5.96E-07	2.14E-07	0.00E+00	7.02E-06	5.27E-08	6.25E-06	0.00E+00
TC-101	1.07E-09	1.12E-09	1.42E-08	0.00E+00	1.91E-08	5.92E-10	3.56E-09	0.00E+00
RU-103	7.31E-07	0.00E+00	2.81E-07	0.00E+00	1.84E-06	0.00E+00	1.89E-05	0.00E+00
RU-105	6.45E-08	0.00E+00	2.34E-08	0.00E+00	5.67E-07	0.00E+00	4.21E-05	0.00E+00
RU-106	1.17E-05	0.00E+00	1.46E-06	0.00E+00	1.58E-05	0.00E+00	1.82E-04	0.00E+00
RH-105	5.14E-07	2.76E-07	2.36E-07	0.00E+00	1.10E-06	0.00E+00	1.71E-05	0.00E+00
PD-107	0.00E+00	4.72E-07	4.01E-08	0.00E+00	3.95E-06	0.00E+00	9.37E-07	0.00E+00
PD-109	0.00E+00	5.67E-07	1.70E-07	0.00E+00	3.04E-06	0.00E+00	3.35E-05	0.00E+00
AG-110M	5.39E-07	3.64E-07	2.91E-07	0.00E+00	6.78E-07	0.00E+00	4.33E-05	0.00E+00
AG-111	2.48E-07	7.76E-08	5.12E-08	0.00E+00	2.34E-07	0.00E+00	4.75E-05	0.00E+00
CD-113M	0.00E+00	1.02E-05	4.34E-07	0.00E+00	1.05E-05	0.00E+00	2.63E-05	0.00E+00
CD-115M	0.00E+00	5.89E-06	2.51E-07	0.00E+00	4.38E-06	0.00E+00	8.01E-05	0.00E+00
SN-123	1.33E-04	1.65E-06	3.24E-06	1.75E-06	0.00E+00	0.00E+00	6.52E-05	0.00E+00
SN-125	3.55E-05	5.35E-07	1.59E-06	5.55E-07	0.00E+00	0.00E+00	1.10E-04	0.00E+00
SN-126	3.33E-04	4.15E-06	9.46E-06	1.14E-06	0.00E+00	0.00E+00	2.50E-05	0.00E+00
SB-124	1.11E-05	1.44E-07	3.89E-06	2.45E-08	0.00E+00	6.16E-06	6.94E-05	0.00E+00
SB-125	7.16E-06	5.52E-08	1.50E-06	6.63E-09	0.00E+00	3.99E-06	1.71E-05	0.00E+00
SB-126	4.40E-06	6.73E-08	1.58E-06	2.58E-08	0.00E+00	2.10E-06	8.87E-05	0.00E+00
SB-127	1.06E-06	1.64E-08	3.68E-07	1.18E-08	0.00E+00	4.60E-07	5.97E-05	0.00E+00
TE-125M	1.14E-05	3.09E-06	1.52E-06	3.20E-06	0.00E+00	0.00E+00	1.10E-05	0.00E+00
TE-127M	2.89E-05	7.78E-06	3.43E-06	6.91E-06	8.24E-05	0.00E+00	2.34E-05	0.00E+00
TE-127	4.71E-07	1.27E-07	1.01E-07	3.26E-07	1.34E-06	0.00E+00	1.84E-05	0.00E+00
TE-129M	4.87E-05	1.36E-05	7.56E-06	1.57E-05	1.43E-04	0.00E+00	5.94E-05	0.00E+00
TE-129	1.34E-07	3.74E-08	3.18E-08	9.56E-08	3.92E-07	0.00E+00	8.34E-06	0.00E+00
TE-131M	7.20E-06	2.49E-06	2.65E-06	5.12E-06	2.41E-05	0.00E+00	1.01E-04	0.00E+00
TE-131	8.30E-08	2.53E-08	2.47E-08	6.35E-08	2.51E-07	0.00E+00	4.36E-07	0.00E+00
TE-132	1.01E-05	4.47E-06	5.40E-06	6.51E-06	4.15E-05	0.00E+00	4.50E-05	0.00E+00
TE-133M	1.87E-07	7.56E-08	9.37E-08	1.45E-07	7.18E-07	0.00E+00	5.77E-06	0.00E+00
TE-134	1.29E-07	5.80E-08	7.74E-08	1.02E-07	5.37E-07	0.00E+00	5.89E-07	0.00E+00
I-129	1.39E-05	8.53E-06	7.62E-06	5.58E-03	1.44E-05	0.00E+00	4.29E-07	0.00E+00
I-130	2.92E-06	5.90E-06	3.04E-06	6.50E-04	8.82E-06	0.00E+00	2.76E-06	0.00E+00
I-131	1.72E-05	1.73E-05	9.83E-06	5.72E-03	2.84E-05	0.00E+00	1.54E-06	0.00E+00
I-132	8.00E-07	1.47E-06	6.76E-07	6.82E-05	2.25E-06	0.00E+00	1.73E-06	0.00E+00
I-133	5.92E-06	7.32E-06	2.77E-06	1.36E-03	1.22E-05	0.00E+00	2.95E-06	0.00E+00
I-134	4.19E-07	7.78E-07	3.58E-07	1.79E-05	1.19E-06	0.00E+00	5.16E-07	0.00E+00
I-135	1.75E-06	3.15E-06	1.49E-06	2.79E-04	4.83E-06	0.00E+00	2.40E-06	0.00E+00
CS-134M	8.44E-08	1.25E-07	8.16E-08	0.00E+00	6.59E-08	1.09E-08	1.58E-07	0.00E+00
CS-134	2.34E-04	3.84E-04	8.10E-05	0.00E+00	1.19E-04	4.27E-05	2.07E-06	0.00E+00
CS-135	8.30E-05	5.78E-05	5.93E-06	0.00E+00	2.04E-05	6.81E-06	4.33E-07	0.00E+00
CS-136	2.35E-05	6.46E-05	4.18E-05	0.00E+00	3.44E-05	5.13E-06	2.27E-06	0.00E+00
CS-137	3.27E-04	3.13E-04	4.62E-05	0.00E+00	1.02E-04	3.67E-05	1.96E-06	0.00E+00
CS-138	2.28E-07	3.17E-07	2.01E-07	0.00E+00	2.23E-07	2.40E-08	1.46E-07	0.00E+00
CS-139	1.45E-07	1.61E-07	7.74E-08	0.00E+00	1.21E-07	1.22E-08	1.45E-11	0.00E+00

TABLE II-5

 INGESTION DOSE FACTORS FOR CHILD (D_{aipj})
 mrem/pCi

NUCLIDE	BONE	LIVER	T BODY	THYROID	KIDNEY	LUNG	GI-LLI	SKIN
BA-139	4.14E-07	2.21E-10	1.20E-08	0.00E+00	1.93E-10	1.30E-10	2.39E-05	0.00E+00
BA-140	8.31E-05	7.28E-08	4.85E-06	0.00E+00	2.37E-08	4.34E-08	4.21E-05	0.00E+00
BA-141	2.00E-07	1.12E-10	6.51E-09	0.00E+00	9.69E-11	6.58E-10	1.14E-07	0.00E+00
BA-142	8.74E-08	6.29E-11	4.88E-09	0.00E+00	5.09E-11	3.70E-11	1.14E-09	0.00E+00
LA-140	1.01E-08	3.53E-09	1.19E-09	0.00E+00	0.00E+00	0.00E+00	9.84E-05	0.00E+00
LA-141	1.36E-09	3.17E-10	6.88E-11	0.00E+00	0.00E+00	0.00E+00	7.05E-05	0.00E+00
LA-142	5.24E-10	1.67E-10	5.23E-11	0.00E+00	0.00E+00	0.00E+00	3.31E-05	0.00E+00
CE-141	3.97E-08	1.98E-08	2.94E-09	0.00E+00	8.68E-09	0.00E+00	2.47E-05	0.00E+00
CE-143	6.99E-09	3.79E-06	5.49E-10	0.00E+00	1.59E-09	0.00E+00	5.55E-05	0.00E+00
CE-144	2.08E-06	6.52E-07	1.11E-07	0.00E+00	3.61E-07	0.00E+00	1.70E-04	0.00E+00
PR-143	3.93E-08	1.18E-08	1.95E-09	0.00E+00	6.39E-09	0.00E+00	4.24E-05	0.00E+00
PR-144	1.29E-10	3.99E-11	6.49E-12	0.00E+00	2.11E-11	0.00E+00	8.59E-08	0.00E+00
ND-147	2.79E-08	2.26E-08	1.75E-09	0.00E+00	1.24E-08	0.00E+00	3.58E-05	0.00E+00
PM-147	3.18E-07	2.27E-08	1.22E-08	0.00E+00	4.01E-08	0.00E+00	9.19E-06	0.00E+00
PM-148M	1.03E-07	2.05E-08	2.05E-08	0.00E+00	3.04E-08	0.00E+00	5.78E-05	0.00E+00
PM-148	3.02E-08	3.63E-09	2.35E-09	0.00E+00	6.17E-09	0.00E+00	9.70E-05	0.00E+00
PM-149	6.49E-09	6.90E-10	3.74E-10	0.00E+00	1.22E-09	0.00E+00	4.71E-05	0.00E+00
PM-151	2.92E-09	3.55E-10	2.31E-10	0.00E+00	6.02E-10	0.00E+00	4.03E-05	0.00E+00
SM-151	2.56E-07	3.81E-08	1.20E-08	0.00E+00	3.94E-08	0.00E+00	5.53E-06	0.00E+00
SM-153	3.65E-09	2.27E-09	2.19E-10	0.00E+00	6.91E-10	0.00E+00	3.02E-05	0.00E+00
EU-152	6.15E-07	1.12E-07	1.33E-07	0.00E+00	4.73E-07	0.00E+00	1.84E-05	0.00E+00
EU-154	2.30E-06	2.07E-07	1.89E-07	0.00E+00	9.09E-07	0.00E+00	4.81E-05	0.00E+00
EU-155	4.82E-07	3.47E-08	2.72E-08	0.00E+00	1.30E-07	0.00E+00	8.69E-05	0.00E+00
EU-156	5.62E-08	3.01E-08	6.23E-09	0.00E+00	1.94E-08	0.00E+00	6.83E-05	0.00E+00
TB-160	1.66E-07	0.00E+00	2.06E-08	0.00E+00	4.94E-08	0.00E+00	3.68E-05	0.00E+00
HO-166M	1.08E-06	2.26E-07	1.91E-07	0.00E+00	3.22E-07	0.00E+00	2.63E-05	0.00E+00
W-181	4.23E-08	1.04E-08	1.43E-09	0.00E+00	0.00E+00	0.00E+00	3.79E-07	0.00E+00
W-185	1.73E-06	4.32E-07	6.05E-08	0.00E+00	0.00E+00	0.00E+00	1.61E-05	0.00E+00
W-187	4.29E-07	2.54E-07	1.14E-07	0.00E+00	0.00E+00	0.00E+00	3.57E-05	0.00E+00
U-232	1.76E-02	0.00E+00	1.26E-03	0.00E+00	1.34E-03	0.00E+00	6.98E-05	0.00E+00
U-233	3.72E-03	0.00E+00	2.25E-04	0.00E+00	6.10E-04	0.00E+00	6.45E-05	0.00E+00
U-234	3.57E-03	0.00E+00	2.21E-04	0.00E+00	5.98E-04	0.00E+00	6.32E-05	0.00E+00
U-235	3.42E-03	0.00E+00	2.07E-04	0.00E+00	5.61E-04	0.00E+00	8.03E-05	0.00E+00
U-236	3.42E-03	0.00E+00	2.12E-04	0.00E+00	5.73E-04	0.00E+00	5.92E-05	0.00E+00
U-237	2.36E-07	0.00E+00	6.27E-08	0.00E+00	6.81E-07	0.00E+00	2.08E-05	0.00E+00
U-238	3.27E-03	0.00E+00	1.94E-04	0.00E+00	5.24E-04	0.00E+00	5.66E-05	0.00E+00
NP-237	2.23E-03	1.47E-04	9.79E-05	0.00E+00	6.05E-04	0.00E+00	8.16E-05	0.00E+00
NP-238	5.83E-08	1.18E-09	9.08E-10	0.00E+00	3.76E-09	0.00E+00	4.04E-05	0.00E+00
NP-239	5.25E-09	3.77E-10	2.65E-10	0.00E+00	1.09E-09	0.00E+00	2.79E-05	0.00E+00
PU-238	1.19E-03	1.38E-04	3.16E-05	0.00E+00	1.15E-04	0.00E+00	7.50E-05	0.00E+00
PU-239	1.29E-03	1.38E-04	3.31E-05	0.00E+00	1.22E-04	0.00E+00	6.85E-05	0.00E+00
PU-240	1.28E-03	1.43E-04	3.31E-05	0.00E+00	1.22E-04	0.00E+00	6.98E-05	0.00E+00
PU-241	3.87E-05	1.58E-06	8.04E-07	0.00E+00	2.96E-06	0.00E+00	1.44E-06	0.00E+00
PU-242	1.19E-03	1.38E-04	3.19E-05	0.00E+00	1.17E-04	0.00E+00	6.71E-05	0.00E+00
PU-244	1.39E-03	1.58E-03	3.65E-05	0.00E+00	1.35E-04	0.00E+00	1.00E-04	0.00E+00
AM-241	1.36E-03	1.17E-03	1.02E-04	0.00E+00	6.23E-04	0.00E+00	7.64E-05	0.00E+00
AM-242M	1.40E-03	1.12E-03	1.04E-04	0.00E+00	6.30E-04	0.00E+00	9.61E-05	0.00E+00

TABLE II-5

INGESTION DOSE FACTORS FOR CHILD (D_{aipj})
mrem/pCi

NUCLIDE	BONE	LIVER	T BODY	THYROID	KIDNEY	LUNG	GI-LLI	SKIN
AM-243	1.34E-03	1.13E-03	9.83E-05	0.00E+00	6.06E-04	0.00E+00	8.95E-05	0.00E+00
CM-242	8.78E-05	7.01E-05	5.84E-06	0.00E+00	1.87E-05	0.00E+00	8.16E-05	0.00E+00
CM-243	1.28E-03	1.04E-03	8.24E-05	0.00E+00	3.08E-04	0.00E+00	8.03E-05	0.00E+00
CM-244	1.08E-03	8.74E-04	6.93E-05	0.00E+00	2.54E-04	0.00E+00	7.77E-05	0.00E+00
CM-245	1.67E-03	1.34E-03	1.05E-04	0.00E+00	4.11E-04	0.00E+00	7.24E-05	0.00E+00
CM-246	1.65E-03	1.34E-03	1.05E-04	0.00E+00	4.10E-04	0.00E+00	7.11E-05	0.00E+00
CM-247	1.61E-03	1.32E-03	1.03E-04	0.00E+00	4.04E-04	0.00E+00	9.35E-05	0.00E+00
CM-248	1.34E-02	1.09E-02	8.52E-04	0.00E+00	3.33E-03	0.00E+00	1.51E-03	0.00E+00
CF-252	1.05E-03	0.00E+00	2.54E-05	0.00E+00	0.00E+00	0.00E+00	2.96E-04	0.00E+00

NUREG/CR-4653, GASPAR II, Technical Reference and User Guide

TABLE II1-6

 INGESTION DOSE FACTORS FOR INFANT (D_{aipj})
 mrem/pCi

NUCLIDE	BONE	LIVER	T BODY	THYROID	KIDNEY	LUNG	GI-LLI	SKIN
H-3	0.00E+00	1.76E-07	1.76E-07	1.76E-07	1.76E-07	1.76E-07	1.76E-07	0.00E+00
C-14	2.37E-05	5.06E-06	5.06E-06	5.06E-06	5.06E-06	5.06E-06	5.06E-06	0.00E+00
NA-22	9.83E-05	9.83E-05	9.83E-05	9.83E-05	9.83E-05	9.83E-05	9.83E-05	0.00E+00
NA-24	1.01E-05	1.01E-05	1.01E-05	1.01E-05	1.01E-05	1.01E-05	1.01E-05	0.00E+00
P-32	1.70E-03	1.00E-04	6.59E-05	0.00E+00	0.00E+00	0.00E+00	2.30E-05	0.00E+00
CA-41	3.74E-04	0.00E+00	4.08E-05	0.00E+00	0.00E+00	0.00E+00	1.91E-07	0.00E+00
SC-46	3.75E-08	5.41E-08	1.69E-08	0.00E+00	3.56E-08	0.00E+00	3.53E-05	0.00E+00
CR-51	0.00E+00	0.00E+00	1.41E-08	9.20E-09	2.01E-09	1.79E-08	4.11E-07	0.00E+00
MN-54	0.00E+00	1.99E-05	4.51E-06	0.00E+00	4.41E-06	0.00E+00	7.31E-06	0.00E+00
MN-56	0.00E+00	8.18E-07	1.41E-07	0.00E+00	7.03E-07	0.00E+00	7.43E-05	0.00E+00
FE-55	1.39E-05	8.98E-06	2.40E-06	0.00E+00	0.00E+00	4.39E-06	1.14E-06	0.00E+00
FE-59	3.08E-05	5.38E-05	2.12E-05	0.00E+00	0.00E+00	1.59E-05	2.57E-05	0.00E+00
CO-57	0.00E+00	1.15E-06	1.87E-06	0.00E+00	0.00E+00	0.00E+00	3.92E-06	0.00E+00
CO-58	0.00E+00	3.60E-06	8.98E-06	0.00E+00	0.00E+00	0.00E+00	8.97E-06	0.00E+00
CO-60	0.00E+00	1.08E-05	2.55E-05	0.00E+00	0.00E+00	0.00E+00	2.57E-05	0.00E+00
NI-59	4.73E-05	1.45E-05	8.17E-06	0.00E+00	0.00E+00	0.00E+00	7.16E-07	0.00E+00
NI-63	6.34E-04	3.92E-05	2.20E-05	0.00E+00	0.00E+00	0.00E+00	1.95E-06	0.00E+00
NI-65	4.70E-06	5.32E-07	2.42E-07	0.00E+00	0.00E+00	0.00E+00	4.05E-05	0.00E+00
CU-64	0.00E+00	6.09E-07	2.82E-07	0.00E+00	1.03E-06	0.00E+00	1.25E-05	0.00E+00
ZN-65	1.84E-05	6.31E-05	2.91E-05	0.00E+00	3.06E-05	0.00E+00	5.33E-05	0.00E+00
ZN-69M	1.50E-06	3.06E-06	2.79E-07	0.00E+00	1.24E-06	0.00E+00	4.24E-05	0.00E+00
ZN-69	9.33E-08	1.68E-07	1.25E-08	0.00E+00	6.98E-08	0.00E+00	1.37E-05	0.00E+00
SE-79	0.00E+00	2.10E-05	3.90E-06	0.00E+00	2.43E-05	0.00E+00	5.58E-07	0.00E+00
BR-82	0.00E+00	0.00E+00	1.27E-05	0.00E+00	0.00E+00	0.00E+00	0.00E+00	0.00E+00
BR-83	0.00E+00	0.00E+00	3.63E-07	0.00E+00	0.00E+00	0.00E+00	0.00E+00	0.00E+00
BR-84	0.00E+00	0.00E+00	3.82E-07	0.00E+00	0.00E+00	0.00E+00	0.00E+00	0.00E+00
BR-85	0.00E+00	0.00E+00	1.94E-08	0.00E+00	0.00E+00	0.00E+00	0.00E+00	0.00E+00
RB-86	0.00E+00	1.70E-04	8.40E-05	0.00E+00	0.00E+00	0.00E+00	4.35E-06	0.00E+00
RB-87	0.00E+00	8.88E-05	3.52E-05	0.00E+00	0.00E+00	0.00E+00	5.98E-07	0.00E+00
RB-88	0.00E+00	4.98E-07	2.73E-07	0.00E+00	0.00E+00	0.00E+00	4.85E-07	0.00E+00
RB-89	0.00E+00	2.86E-07	1.97E-07	0.00E+00	0.00E+00	0.00E+00	9.74E-08	0.00E+00
SR-89	2.51E-03	0.00E+00	7.20E-05	0.00E+00	0.00E+00	0.00E+00	5.16E-05	0.00E+00
SR-90	2.83E-02	0.00E+00	5.74E-04	0.00E+00	0.00E+00	0.00E+00	2.31E-04	0.00E+00
SR-91	5.00E-05	0.00E+00	1.81E-06	0.00E+00	0.00E+00	0.00E+00	5.92E-05	0.00E+00
SR-92	1.92E-05	0.00E+00	7.13E-07	0.00E+00	0.00E+00	0.00E+00	2.07E-04	0.00E+00
Y-90	8.69E-08	0.00E+00	2.33E-09	0.00E+00	0.00E+00	0.00E+00	1.20E-04	0.00E+00
Y-91M	8.10E-10	0.00E+00	2.76E-11	0.00E+00	0.00E+00	0.00E+00	2.70E-06	0.00E+00
Y-91	1.13E-06	0.00E+00	3.01E-08	0.00E+00	0.00E+00	0.00E+00	8.10E-05	0.00E+00
Y-92	7.65E-09	0.00E+00	2.15E-10	0.00E+00	0.00E+00	0.00E+00	1.46E-04	0.00E+00
Y-93	2.43E-08	0.00E+00	6.62E-10	0.00E+00	0.00E+00	0.00E+00	1.92E-04	0.00E+00
ZR-93	1.93E-07	9.19E-09	5.54E-09	0.00E+00	2.71E-08	0.00E+00	2.39E-06	0.00E+00
ZR-95	2.06E-07	5.02E-08	3.56E-08	0.00E+00	5.41E-08	0.00E+00	2.50E-05	0.00E+00
ZR-97	1.48E-08	2.54E-09	1.16E-09	0.00E+00	2.56E-09	0.00E+00	1.62E-04	0.00E+00
NB-93M	1.23E-07	3.33E-08	1.04E-08	0.00E+00	3.25E-08	0.00E+00	3.98E-06	0.00E+00
NB-95	4.20E-08	1.73E-08	1.00E-08	0.00E+00	1.24E-08	0.00E+00	1.46E-05	0.00E+00

TABLE II-6

 INGESTION DOSE FACTORS FOR INFANT (D_{aipj})
 mrem/pCi

NUCLIDE	BONE	LIVER	T BODY	THYROID	KIDNEY	LUNG	GI-LLI	SKIN
NB-97	4.59E-10	9.79E-11	3.53E-11	0.00E+00	7.65E-11	0.00E+00	3.09E-05	0.00E+00
MO-93	0.00E+00	5.65E-05	1.82E-06	0.00E+00	1.13E-05	0.00E+00	1.21E-06	0.00E+00
MO-99	0.00E+00	3.40E-05	6.63E-06	0.00E+00	5.08E-05	0.00E+00	1.12E-05	0.00E+00
TC-99M	1.92E-09	3.96E-09	5.10E-08	0.00E+00	4.26E-08	2.07E-09	1.15E-06	0.00E+00
TC-99	1.08E-06	1.46E-06	4.55E-07	0.00E+00	1.23E-05	1.42E-07	6.31E-06	0.00E+00
TC-101	2.27E-09	2.86E-09	2.83E-08	0.00E+00	3.40E-08	1.56E-09	4.86E-07	0.00E+00
RU-103	1.48E-06	0.00E+00	4.95E-07	0.00E+00	3.08E-06	0.00E+00	1.80E-05	0.00E+00
RU-105	1.36E-07	0.00E+00	4.58E-08	0.00E+00	1.00E-06	0.00E+00	5.41E-05	0.00E+00
RU-106	2.41E-05	0.00E+00	3.01E-06	0.00E+00	2.85E-05	0.00E+00	1.83E-04	0.00E+00
RH-105	1.09E-06	7.13E-07	4.79E-07	0.00E+00	1.98E-06	0.00E+00	1.77E-05	0.00E+00
PD-107	0.00E+00	1.19E-06	8.45E-08	0.00E+00	6.79E-06	0.00E+00	9.46E-07	0.00E+00
PD-109	0.00E+00	1.50E-06	3.62E-07	0.00E+00	5.51E-06	0.00E+00	3.68E-05	0.00E+00
AG-110M	9.96E-07	7.27E-07	4.81E-07	0.00E+00	1.04E-06	0.00E+00	3.77E-05	0.00E+00
AG-111	5.20E-07	2.02E-07	1.07E-07	0.00E+00	4.22E-07	0.00E+00	4.82E-05	0.00E+00
CD-113M	0.00E+00	1.77E-05	6.52E-07	0.00E+00	1.34E-05	0.00E+00	2.66E-05	0.00E+00
CD-115M	0.00E+00	1.42E-05	4.93E-07	0.00E+00	7.41E-06	0.00E+00	8.09E-05	0.00E+00
SN-123	2.49E-04	3.89E-06	6.50E-06	3.91E-06	0.00E+00	0.00E+00	6.58E-05	0.00E+00
SN-125	7.41E-05	1.38E-06	3.29E-06	1.36E-06	0.00E+00	0.00E+00	1.11E-04	0.00E+00
SN-126	5.53E-04	7.26E-06	1.80E-05	1.91E-06	0.00E+00	0.00E+00	2.52E-05	0.00E+00
SB-124	2.14E-05	3.15E-07	6.63E-06	5.68E-08	0.00E+00	1.34E-05	6.60E-05	0.00E+00
SB-125	1.23E-05	1.19E-07	2.53E-06	1.54E-08	0.00E+00	7.12E-06	1.64E-05	0.00E+00
SB-126	8.06E-06	1.58E-07	2.91E-06	6.19E-08	0.00E+00	5.07E-06	8.35E-05	0.00E+00
SB-127	2.23E-06	3.98E-08	6.90E-07	2.84E-08	0.00E+00	1.15E-06	5.91E-05	0.00E+00
TE-125M	2.33E-05	7.79E-06	3.15E-06	7.84E-06	0.00E+00	0.00E+00	1.11E-05	0.00E+00
TE-127M	5.85E-05	1.94E-05	7.08E-06	1.69E-05	1.44E-04	0.00E+00	2.36E-05	0.00E+00
TE-127	1.00E-06	3.35E-07	2.15E-07	8.14E-07	2.44E-06	0.00E+00	2.10E-05	0.00E+00
TE-129M	1.00E-04	3.43E-05	1.54E-05	3.84E-05	2.50E-04	0.00E+00	5.97E-05	0.00E+00
TE-129	2.84E-07	9.79E-08	6.63E-08	2.38E-07	7.07E-07	0.00E+00	2.27E-05	0.00E+00
TE-131M	1.52E-05	6.12E-06	5.05E-06	1.24E-05	4.21E-05	0.00E+00	1.03E-04	0.00E+00
TE-131	1.76E-07	6.50E-08	4.94E-08	1.57E-07	4.50E-07	0.00E+00	7.11E-06	0.00E+00
TE-132	2.08E-05	1.03E-05	9.61E-06	1.52E-05	6.44E-05	0.00E+00	3.81E-05	0.00E+00
TE-133M	3.91E-07	1.79E-07	1.71E-07	3.45E-07	1.22E-06	0.00E+00	1.93E-05	0.00E+00
TE-134	2.67E-07	1.34E-07	1.38E-07	2.39E-07	9.03E-07	0.00E+00	3.06E-06	0.00E+00
I-129	2.86E-05	2.12E-05	1.55E-05	1.36E-02	2.51E-05	0.00E+00	4.24E-07	0.00E+00
I-130	6.00E-06	1.32E-05	5.30E-06	1.48E-03	1.45E-05	0.00E+00	2.83E-06	0.00E+00
I-131	3.59E-05	4.23E-05	1.86E-05	1.39E-02	4.94E-05	0.00E+00	1.51E-06	0.00E+00
I-132	1.66E-06	3.37E-06	1.20E-06	1.58E-04	3.76E-06	0.00E+00	2.73E-06	0.00E+00
I-133	1.25E-05	1.82E-05	5.33E-06	3.31E-03	2.14E-05	0.00E+00	3.08E-06	0.00E+00
I-134	8.69E-07	1.78E-06	6.33E-07	4.15E-05	1.99E-06	0.00E+00	1.84E-06	0.00E+00
I-135	3.64E-06	7.24E-06	2.64E-06	6.49E-04	8.07E-06	0.00E+00	2.62E-06	0.00E+00
CS-134M	1.76E-07	2.93E-07	1.48E-07	0.00E+00	1.13E-07	2.60E-08	2.32E-07	0.00E+00
CS-134	3.77E-04	7.03E-04	7.10E-05	0.00E+00	1.81E-04	7.42E-05	1.91E-06	0.00E+00
CS-135	1.33E-04	1.21E-04	6.30E-06	0.00E+00	3.44E-05	1.31E-05	4.37E-07	0.00E+00
CS-136	4.59E-05	1.35E-04	5.04E-05	0.00E+00	5.38E-05	1.10E-05	2.05E-06	0.00E+00
CS-137	5.22E-04	6.11E-04	4.33E-05	0.00E+00	1.64E-04	6.64E-05	1.91E-06	0.00E+00
CS-138	4.81E-07	7.82E-07	3.79E-07	0.00E+00	3.90E-07	6.09E-08	1.25E-06	0.00E+00

TABLE II-6

 INGESTION DOSE FACTORS FOR INFANT (D_{aipj})
 mrem/pCi

NUCLIDE	BONE	LIVER	T BODY	THYROID	KIDNEY	LUNG	GI-LLI	SKIN
CS-139	3.10E-07	4.24E-07	1.62E-07	0.00E+00	2.19E-07	3.30E-08	2.66E-08	0.00E+00
BA-139	8.81E-07	5.84E-10	2.55E-08	0.00E+00	3.51E-10	3.54E-10	5.58E-05	0.00E+00
BA-140	1.71E-04	1.71E-07	8.81E-06	0.00E+00	4.06E-08	1.05E-07	4.20E-05	0.00E+00
BA-141	4.25E-07	2.91E-10	1.34E-08	0.00E+00	1.75E-10	1.77E-10	5.19E-06	0.00E+00
BA-142	1.84E-07	1.53E-10	9.06E-09	0.00E+00	8.81E-11	9.26E-11	7.59E-07	0.00E+00
LA-140	2.11E-08	8.32E-09	2.14E-09	0.00E+00	0.00E+00	0.00E+00	9.77E-05	0.00E+00
LA-141	2.89E-09	8.38E-10	1.46E-10	0.00E+00	0.00E+00	0.00E+00	9.61E-05	0.00E+00
LA-142	1.10E-09	4.04E-10	9.67E-11	0.00E+00	0.00E+00	0.00E+00	6.86E-05	0.00E+00
CE-141	7.87E-08	4.80E-08	5.65E-09	0.00E+00	1.48E-08	0.00E+00	2.48E-05	0.00E+00
CE-143	1.48E-08	9.82E-06	1.12E-09	0.00E+00	2.86E-09	0.00E+00	5.73E-05	0.00E+00
CE-144	2.98E-06	1.22E-06	1.67E-07	0.00E+00	4.93E-07	0.00E+00	1.71E-04	0.00E+00
PR-143	8.13E-08	3.04E-08	4.03E-09	0.00E+00	1.13E-08	0.00E+00	4.29E-05	0.00E+00
PR-144	2.74E-10	1.06E-10	1.38E-11	0.00E+00	3.84E-11	0.00E+00	4.93E-06	0.00E+00
ND-147	5.53E-08	5.68E-08	3.48E-09	0.00E+00	2.19E-08	0.00E+00	3.60E-05	0.00E+00
PM-147	3.88E-07	3.27E-08	1.59E-08	0.00E+00	4.88E-08	0.00E+00	9.27E-06	0.00E+00
PM-148M	1.65E-07	4.18E-08	3.28E-08	0.00E+00	4.80E-08	0.00E+00	5.44E-05	0.00E+00
PM-148	6.32E-08	9.13E-09	4.60E-09	0.00E+00	1.09E-08	0.00E+00	9.74E-05	0.00E+00
PM-149	1.38E-08	1.81E-09	7.90E-10	0.00E+00	2.20E-09	0.00E+00	4.86E-05	0.00E+00
PM-151	6.18E-09	9.01E-10	4.56E-10	0.00E+00	1.07E-09	0.00E+00	4.17E-05	0.00E+00
SM-151	2.90E-07	6.67E-08	1.44E-08	0.00E+00	4.53E-08	0.00E+00	5.58E-06	0.00E+00
SM-153	7.72E-09	5.97E-09	4.58E-10	0.00E+00	1.25E-09	0.00E+00	3.12E-05	0.00E+00
EU-152	6.74E-07	1.79E-07	1.51E-07	0.00E+00	5.02E-07	0.00E+00	1.59E-05	0.00E+00
EU-154	2.64E-06	3.67E-07	2.20E-07	0.00E+00	9.95E-07	0.00E+00	4.58E-05	0.00E+00
EU-155	5.42E-07	6.25E-08	3.23E-08	0.00E+00	1.40E-07	0.00E+00	8.37E-05	0.00E+00
EU-156	1.14E-07	7.06E-08	1.12E-08	0.00E+00	3.26E-08	0.00E+00	6.67E-05	0.00E+00
TB-160	2.59E-07	0.00E+00	3.24E-08	0.00E+00	7.37E-08	0.00E+00	3.45E-05	0.00E+00
HO-166M	1.25E-06	2.69E-07	2.13E-07	0.00E+00	3.57E-07	0.00E+00	2.66E-05	0.00E+00
W-181	8.85E-08	2.72E-08	3.04E-09	0.00E+00	0.00E+00	0.00E+00	3.82E-07	0.00E+00
W-185	3.62E-06	1.13E-06	1.29E-07	0.00E+00	0.00E+00	0.00E+00	1.62E-05	0.00E+00
W-187	9.03E-07	6.28E-07	2.17E-07	0.00E+00	0.00E+00	0.00E+00	3.69E-05	0.00E+00
U-232	2.42E-02	0.00E+00	2.16E-03	0.00E+00	2.37E-03	0.00E+00	7.04E-05	0.00E+00
U-233	5.08E-03	0.00E+00	3.87E-04	0.00E+00	1.08E-03	0.00E+00	6.51E-05	0.00E+00
U-234	4.88E-03	0.00E+00	3.80E-04	0.00E+00	1.06E-03	0.00E+00	6.37E-05	0.00E+00
U-235	4.67E-03	0.00E+00	3.56E-04	0.00E+00	9.93E-04	0.00E+00	8.10E-05	0.00E+00
U-236	4.67E-03	0.00E+00	3.64E-04	0.00E+00	1.01E-03	0.00E+00	5.98E-05	0.00E+00
U-237	4.95E-07	0.00E+00	1.32E-07	0.00E+00	1.23E-06	0.00E+00	2.11E-05	0.00E+00
U-238	4.47E-03	0.00E+00	3.33E-04	0.00E+00	9.28E-04	0.00E+00	5.71E-05	0.00E+00
NP-237	2.40E-03	1.59E-04	1.05E-04	0.00E+00	6.34E-04	0.00E+00	8.23E-05	0.00E+00
NP-238	1.24E-07	3.12E-09	1.92E-09	0.00E+00	6.81E-09	0.00E+00	4.17E-05	0.00E+00
NP-239	1.11E-08	9.93E-10	5.61E-10	0.00E+00	1.98E-09	0.00E+00	2.87E-05	0.00E+00
PU-238	1.28E-03	1.50E-04	3.40E-05	0.00E+00	1.21E-04	0.00E+00	7.57E-05	0.00E+00
PU-239	1.38E-03	1.55E-04	3.54E-05	0.00E+00	1.28E-04	0.00E+00	6.91E-05	0.00E+00
PU-240	1.38E-03	1.55E-04	3.54E-05	0.00E+00	1.28E-04	0.00E+00	7.04E-05	0.00E+00
PU-241	4.25E-05	1.76E-06	8.82E-07	0.00E+00	3.17E-06	0.00E+00	1.45E-06	0.00E+00
PU-242	1.28E-03	1.49E-04	3.41E-05	0.00E+00	1.23E-04	0.00E+00	6.77E-05	0.00E+00
PU-244	1.49E-03	1.71E-04	3.91E-05	0.00E+00	1.41E-04	0.00E+00	1.01E-04	0.00E+00

TABLE II1-6

INGESTION DOSE FACTORS FOR INFANT (D_{aipj})
mrem/pCi

NUCLIDE	BONE	LIVER	T BODY	THYROID	KIDNEY	LUNG	GI-LLI	SKIN
AM-241	1.46E-03	1.27E-03	1.09E-04	0.00E+00	6.55E-04	0.00E+00	7.70E-05	0.00E+00
AM-242M	1.51E-03	1.22E-03	1.13E-04	0.00E+00	6.64E-04	0.00E+00	9.69E-05	0.00E+00
AM-243	1.44E-03	1.23E-03	1.06E-04	0.00E+00	6.36E-04	0.00E+00	9.03E-05	0.00E+00
CM-242	1.37E-04	1.27E-04	9.10E-06	0.00E+00	2.62E-05	0.00E+00	8.23E-05	0.00E+00
CM-243	1.40E-03	1.15E-03	8.98E-05	0.00E+00	3.27E-04	0.00E+00	8.10E-05	0.00E+00
CM-244	1.18E-03	9.70E-04	7.59E-05	0.00E+00	2.71E-04	0.00E+00	7.84E-05	0.00E+00
CM-245	1.79E-03	1.45E-03	1.13E-04	0.00E+00	4.32E-04	0.00E+00	7.30E-05	0.00E+00
CM-246	1.77E-03	1.45E-03	1.13E-04	0.00E+00	4.31E-04	0.00E+00	7.17E-05	0.00E+00
CM-247	1.73E-03	1.43E-03	1.11E-04	0.00E+00	4.24E-04	0.00E+00	9.43E-05	0.00E+00
CM-248	1.43E-02	1.18E-02	9.16E-04	0.00E+00	3.50E-03	0.00E+00	1.52E-03	0.00E+00
CF-252	1.22E-03	0.00E+00	2.95E-05	0.00E+00	0.00E+00	0.00E+00	2.99E-04	0.00E+00

NUREG/CR-4653, GASPAR II, Technical Reference and User Guide

TABLE II-7

DOSE FACTORS FOR STANDING ON CONTAMINATED GROUND (D_{aipj})(mrem/hr per pCi/m²)

NUCLIDE	BONE	LIVER	T BODY	THYROID	KIDNEY	LUNG	GI-LLI	SKIN
H-3	0.00E+00	0.00E+00	0.00E+00	0.00E+00	0.00E+00	0.00E+00	0.00E+00	0.00E+00
C-14	0.00E+00	0.00E+00	0.00E+00	0.00E+00	0.00E+00	0.00E+00	0.00E+00	0.00E+00
NA-22	1.60E-08	1.60E-08	1.60E-08	1.60E-08	1.60E-08	1.60E-08	1.60E-08	1.80E-08
NA-24	2.50E-08	2.50E-08	2.50E-08	2.50E-08	2.50E-08	2.50E-08	2.50E-08	2.90E-08
P-32	0.00E+00	0.00E+00	0.00E+00	0.00E+00	0.00E+00	0.00E+00	0.00E+00	0.00E+00
CA-41	3.41E-09	3.41E-09	3.41E-09	3.41E-09	3.41E-09	3.41E-09	3.41E-09	4.01E-09
SC-46	1.30E-08	1.30E-08	1.30E-08	1.30E-08	1.30E-08	1.30E-08	1.30E-08	1.50E-08
CR-51	2.20E-10	2.20E-10	2.20E-10	2.20E-10	2.20E-10	2.20E-10	2.20E-10	2.60E-10
MN-54	5.80E-09	5.80E-09	5.80E-09	5.80E-09	5.80E-09	5.80E-09	5.80E-09	6.80E-09
MN-56	1.10E-08	1.10E-08	1.10E-08	1.10E-08	1.10E-08	1.10E-08	1.10E-08	1.30E-08
FE-55	0.00E+00	0.00E+00	0.00E+00	0.00E+00	0.00E+00	0.00E+00	0.00E+00	0.00E+00
FE-59	8.00E-09	8.00E-09	8.00E-09	8.00E-09	8.00E-09	8.00E-09	8.00E-09	9.40E-09
CO-57	9.10E-10	9.10E-10	9.10E-10	9.10E-10	9.10E-10	9.10E-10	9.10E-10	1.00E-09
CO-58	7.00E-09	7.00E-09	7.00E-09	7.00E-09	7.00E-09	7.00E-09	7.00E-09	8.20E-09
CO-60	1.70E-08	1.70E-08	1.70E-08	1.70E-08	1.70E-08	1.70E-08	1.70E-08	2.00E-08
NI-59	0.00E+00	0.00E+00	0.00E+00	0.00E+00	0.00E+00	0.00E+00	0.00E+00	0.00E+00
NI-63	0.00E+00	0.00E+00	0.00E+00	0.00E+00	0.00E+00	0.00E+00	0.00E+00	0.00E+00
NI-65	3.70E-09	3.70E-09	3.70E-09	3.70E-09	3.70E-09	3.70E-09	3.70E-09	4.30E-09
CU-64	1.50E-09	1.50E-09	1.50E-09	1.50E-09	1.50E-09	1.50E-09	1.50E-09	1.70E-09
ZN-65	4.00E-09	4.00E-09	4.00E-09	4.00E-09	4.00E-09	4.00E-09	4.00E-09	4.60E-09
ZN-69M	2.90E-09	2.90E-09	2.90E-09	2.90E-09	2.90E-09	2.90E-09	2.90E-09	3.40E-09
ZN-69	0.00E+00	0.00E+00	0.00E+00	0.00E+00	0.00E+00	0.00E+00	0.00E+00	0.00E+00
SE-79	0.00E+00	0.00E+00	0.00E+00	0.00E+00	0.00E+00	0.00E+00	0.00E+00	0.00E+00
BR-82	1.90E-08	1.90E-08	1.90E-08	1.90E-08	1.90E-08	1.90E-08	1.90E-08	2.20E-08
BR-83	6.40E-11	6.40E-11	6.40E-11	6.40E-11	6.40E-11	6.40E-11	6.40E-11	9.30E-11
BR-84	1.20E-08	1.20E-08	1.20E-08	1.20E-08	1.20E-08	1.20E-08	1.20E-08	1.40E-08
BR-85	0.00E+00	0.00E+00	0.00E+00	0.00E+00	0.00E+00	0.00E+00	0.00E+00	0.00E+00
RB-86	6.30E-10	6.30E-10	6.30E-10	6.30E-10	6.30E-10	6.30E-10	6.30E-10	7.20E-10
RB-87	0.00E+00	0.00E+00	0.00E+00	0.00E+00	0.00E+00	0.00E+00	0.00E+00	0.00E+00
RB-88	3.50E-09	3.50E-09	3.50E-09	3.50E-09	3.50E-09	3.50E-09	3.50E-09	4.00E-09
RB-89	1.50E-08	1.50E-08	1.50E-08	1.50E-08	1.50E-08	1.50E-08	1.50E-08	1.80E-08
SR-89	5.60E-13	5.60E-13	5.60E-13	5.60E-13	5.60E-13	5.60E-13	5.60E-13	6.50E-13
SR-90	0.00E+00	0.00E+00	0.00E+00	0.00E+00	0.00E+00	0.00E+00	0.00E+00	0.00E+00
SR-91	7.10E-09	7.10E-09	7.10E-09	7.10E-09	7.10E-09	7.10E-09	7.10E-09	8.30E-09
SR-92	9.00E-09	9.00E-09	9.00E-09	9.00E-09	9.00E-09	9.00E-09	9.00E-09	1.00E-08
Y-90	2.20E-12	2.20E-12	2.20E-12	2.20E-12	2.20E-12	2.20E-12	2.20E-12	2.60E-12
Y-91M	3.80E-09	3.80E-09	3.80E-09	3.80E-09	3.80E-09	3.80E-09	3.80E-09	4.40E-09
Y-91	2.40E-11	2.40E-11	2.40E-11	2.40E-11	2.40E-11	2.40E-11	2.40E-11	2.70E-11
Y-92	1.60E-09	1.60E-09	1.60E-09	1.60E-09	1.60E-09	1.60E-09	1.60E-09	1.90E-09
Y-93	5.70E-10	5.70E-10	5.70E-10	5.70E-10	5.70E-10	5.70E-10	5.70E-10	7.80E-10
ZR-93	0.00E+00	0.00E+00	0.00E+00	0.00E+00	0.00E+00	0.00E+00	0.00E+00	0.00E+00
ZR-95	5.00E-09	5.00E-09	5.00E-09	5.00E-09	5.00E-09	5.00E-09	5.00E-09	5.80E-09
ZR-97	5.50E-09	5.50E-09	5.50E-09	5.50E-09	5.50E-09	5.50E-09	5.50E-09	6.40E-09
NB-93M	8.20E-13	8.20E-13	8.20E-13	8.20E-13	8.20E-13	8.20E-13	8.20E-13	1.00E-10

TABLE II-7

DOSE FACTORS FOR STANDING ON CONTAMINATED GROUND (D_{aipj})(mrem/hr per pCi/m²)

NUCLIDE	BONE	LIVER	T BODY	THYROID	KIDNEY	LUNG	GI-LLI	SKIN
NB-95	5.10E-09	5.10E-09	5.10E-09	5.10E-09	5.10E-09	5.10E-09	5.10E-09	6.00E-09
NB-97	4.60E-09	4.60E-09	4.60E-09	4.60E-09	4.60E-09	4.60E-09	4.60E-09	5.40E-09
MO-93	2.29E-11	2.29E-11	2.29E-11	2.29E-11	2.29E-11	2.29E-11	2.29E-11	9.32E-10
MO-99	1.90E-09	1.90E-09	1.90E-09	1.90E-09	1.90E-09	1.90E-09	1.90E-09	2.20E-09
TC-99M	9.60E-10	9.60E-10	9.60E-10	9.60E-10	9.60E-10	9.60E-10	9.60E-10	1.10E-09
TC-99	0.00E+00	0.00E+00	0.00E+00	0.00E+00	0.00E+00	0.00E+00	0.00E+00	0.00E+00
TC-101	2.70E-09	2.70E-09	2.70E-09	2.70E-09	2.70E-09	2.70E-09	2.70E-09	3.00E-09
RU-103	3.60E-09	3.60E-09	3.60E-09	3.60E-09	3.60E-09	3.60E-09	3.60E-09	4.20E-09
RU-105	4.50E-09	4.50E-09	4.50E-09	4.50E-09	4.50E-09	4.50E-09	4.50E-09	5.10E-09
RU-106	1.50E-09	1.50E-09	1.50E-09	1.50E-09	1.50E-09	1.50E-09	1.50E-09	1.80E-09
RH-105	6.60E-10	6.60E-10	6.60E-10	6.60E-10	6.60E-10	6.60E-10	6.60E-10	7.70E-10
PD-107	0.00E+00	0.00E+00	0.00E+00	0.00E+00	0.00E+00	0.00E+00	0.00E+00	0.00E+00
PD-109	3.50E-11	3.50E-11	3.50E-11	3.50E-11	3.50E-11	3.50E-11	3.50E-11	4.00E-11
AG-110M	1.80E-08	1.80E-08	1.80E-08	1.80E-08	1.80E-08	1.80E-08	1.80E-08	2.10E-08
AG-111	1.80E-10	1.80E-10	1.80E-10	1.80E-10	1.80E-10	1.80E-10	1.80E-10	2.10E-10
CD-113M	2.30E-12	2.30E-12	2.30E-12	2.30E-12	2.30E-12	2.30E-12	2.30E-12	2.60E-12
CD-115M	0.00E+00	0.00E+00	0.00E+00	0.00E+00	0.00E+00	0.00E+00	0.00E+00	0.00E+00
SN-123	0.00E+00	0.00E+00	0.00E+00	0.00E+00	0.00E+00	0.00E+00	0.00E+00	6.46E-08
SN-125	5.70E-10	5.70E-10	5.70E-10	5.70E-10	5.70E-10	5.70E-10	5.70E-10	6.60E-10
SN-126	9.00E-09	9.00E-09	9.00E-09	9.00E-09	9.00E-09	9.00E-09	9.00E-09	1.00E-08
SB-124	1.30E-08	1.30E-08	1.30E-08	1.30E-08	1.30E-08	1.30E-08	1.30E-08	1.50E-08
SB-125	3.10E-09	3.10E-09	3.10E-09	3.10E-09	3.10E-09	3.10E-09	3.10E-09	3.50E-09
SB-126	8.90E-09	8.90E-09	8.90E-09	8.90E-09	8.90E-09	8.90E-09	8.90E-09	1.00E-08
SB-127	5.70E-09	5.70E-09	5.70E-09	5.70E-09	5.70E-09	5.70E-09	5.70E-09	6.60E-09
TE-125M	3.50E-11	3.50E-11	3.50E-11	3.50E-11	3.50E-11	3.50E-11	3.50E-11	4.80E-11
TE-127M	1.10E-12	1.10E-12	1.10E-12	1.10E-12	1.10E-12	1.10E-12	1.10E-12	1.30E-12
TE-127	1.00E-11	1.00E-11	1.00E-11	1.00E-11	1.00E-11	1.00E-11	1.00E-11	1.10E-11
TE-129M	7.70E-10	7.70E-10	7.70E-10	7.70E-10	7.70E-10	7.70E-10	7.70E-10	9.00E-10
TE-129	7.10E-10	7.10E-10	7.10E-10	7.10E-10	7.10E-10	7.10E-10	7.10E-10	8.40E-10
TE-131M	8.40E-09	8.40E-09	8.40E-09	8.40E-09	8.40E-09	8.40E-09	8.40E-09	9.90E-09
TE-131	2.20E-09	2.20E-09	2.20E-09	2.20E-09	2.20E-09	2.20E-09	2.20E-09	2.60E-06
TE-132	1.70E-09	1.70E-09	1.70E-09	1.70E-09	1.70E-09	1.70E-09	1.70E-09	2.00E-09
TE-133M	1.50E-08	1.50E-08	1.50E-08	1.50E-08	1.50E-08	1.50E-08	1.50E-08	1.70E-08
TE-134	1.00E-09	1.00E-09	1.00E-09	1.00E-09	1.00E-09	1.00E-09	1.00E-09	1.20E-09
I-129	4.50E-10	4.50E-10	4.50E-10	4.50E-10	4.50E-10	4.50E-10	4.50E-10	7.50E-10
I-130	1.40E-08	1.40E-08	1.40E-08	1.40E-08	1.40E-08	1.40E-08	1.40E-08	1.70E-08
I-131	2.80E-09	2.80E-09	2.80E-09	2.80E-09	2.80E-09	2.80E-09	2.80E-09	3.40E-09
I-132	1.70E-08	1.70E-08	1.70E-08	1.70E-08	1.70E-08	1.70E-08	1.70E-08	2.00E-08
I-133	3.70E-09	3.70E-09	3.70E-09	3.70E-09	3.70E-09	3.70E-09	3.70E-09	4.50E-09
I-134	1.60E-08	1.60E-08	1.60E-08	1.60E-08	1.60E-08	1.60E-08	1.60E-08	1.90E-08
I-135	1.20E-08	1.20E-08	1.20E-08	1.20E-08	1.20E-08	1.20E-08	1.20E-08	1.40E-08
CS-134M	6.20E-10	6.20E-10	6.20E-10	6.20E-10	6.20E-10	6.20E-10	6.20E-10	7.30E-10
CS-134	1.20E-08	1.20E-08	1.20E-08	1.20E-08	1.20E-08	1.20E-08	1.20E-08	1.40E-08
CS-135	0.00E+00	0.00E+00	0.00E+00	0.00E+00	0.00E+00	0.00E+00	0.00E+00	0.00E+00

TABLE II-7

DOSE FACTORS FOR STANDING ON CONTAMINATED GROUND (D_{aipj})(mrem/hr per pCi/m²)

NUCLIDE	BONE	LIVER	T BODY	THYROID	KIDNEY	LUNG	GI-LLI	SKIN
CS-136	1.50E-08	1.50E-08	1.50E-08	1.50E-08	1.50E-08	1.50E-08	1.50E-08	1.70E-08
CS-137	4.20E-09	4.20E-09	4.20E-09	4.20E-09	4.20E-09	4.20E-09	4.20E-09	4.90E-09
CS-138	2.10E-08	2.10E-08	2.10E-08	2.10E-08	2.10E-08	2.10E-08	2.10E-08	2.40E-08
CS-139	6.30E-09	6.30E-09	6.30E-09	6.30E-09	6.30E-09	6.30E-09	6.30E-09	7.20E-09
BA-139	2.40E-09	2.40E-09	2.40E-09	2.40E-09	2.40E-09	2.40E-09	2.40E-09	2.70E-09
BA-140	2.10E-09	2.10E-09	2.10E-09	2.10E-09	2.10E-09	2.10E-09	2.10E-09	2.40E-09
BA-141	4.30E-09	4.30E-09	4.30E-09	4.30E-09	4.30E-09	4.30E-09	4.30E-09	4.90E-09
BA-142	7.90E-09	7.90E-09	7.90E-09	7.90E-09	7.90E-09	7.90E-09	7.90E-09	9.00E-09
LA-140	1.50E-08	1.50E-08	1.50E-08	1.50E-08	1.50E-08	1.50E-08	1.50E-08	1.70E-08
LA-141	2.50E-10	2.50E-10	2.50E-10	2.50E-10	2.50E-10	2.50E-10	2.50E-10	2.80E-10
LA-142	1.50E-08	1.50E-08	1.50E-08	1.50E-08	1.50E-08	1.50E-08	1.50E-08	1.80E-08
CE-141	5.50E-10	5.50E-10	5.50E-10	5.50E-10	5.50E-10	5.50E-10	5.50E-10	6.20E-10
CE-143	2.20E-09	2.20E-09	2.20E-09	2.20E-09	2.20E-09	2.20E-09	2.20E-09	2.50E-09
CE-144	3.20E-10	3.20E-10	3.20E-10	3.20E-10	3.20E-10	3.20E-10	3.20E-10	3.70E-10
PR-143	0.00E+00	0.00E+00	0.00E+00	0.00E+00	0.00E+00	0.00E+00	0.00E+00	0.00E+00
PR-144	2.00E-10	2.00E-10	2.00E-10	2.00E-10	2.00E-10	2.00E-10	2.00E-10	2.30E-10
ND-147	1.00E-09	1.00E-09	1.00E-09	1.00E-09	1.00E-09	1.00E-09	1.00E-09	1.20E-09
PM-147	0.00E+00	0.00E+00	0.00E+00	0.00E+00	0.00E+00	0.00E+00	0.00E+00	0.00E+00
PM-148M	1.41E-08	1.41E-08	1.41E-08	1.41E-08	1.41E-08	1.41E-08	1.41E-08	8.16E-08
PM-148	4.60E-09	4.60E-09	4.60E-09	4.60E-09	4.60E-09	4.60E-09	4.60E-09	5.30E-09
PM-149	2.50E-11	2.50E-11	2.50E-11	2.50E-11	2.50E-11	2.50E-11	2.50E-11	2.90E-11
PM-151	2.20E-09	2.20E-09	2.20E-09	2.20E-09	2.20E-09	2.20E-09	2.20E-09	2.30E-09
SM-151	4.80E-11	4.80E-11	4.80E-11	4.80E-11	4.80E-11	4.80E-11	4.80E-11	2.10E-10
SM-153	2.70E-10	2.70E-10	2.70E-10	2.70E-10	2.70E-10	2.70E-10	2.70E-10	3.00E-10
EU-152	7.37E-09	7.37E-09	7.37E-09	7.37E-09	7.37E-09	7.37E-09	7.37E-09	8.53E-09
EU-154	7.80E-09	7.80E-09	7.80E-09	7.80E-09	7.80E-09	7.80E-09	7.80E-09	9.00E-09
EU-155	3.81E-10	3.81E-10	3.81E-10	3.81E-10	3.81E-10	3.81E-10	3.81E-10	4.33E-10
EU-156	7.60E-09	7.60E-09	7.60E-09	7.60E-09	7.60E-09	7.60E-09	7.60E-09	8.70E-09
TB-160	8.60E-09	8.60E-09	8.60E-09	8.60E-09	8.60E-09	8.60E-09	8.60E-09	1.00E-08
HO-166M	8.90E-09	8.90E-09	8.90E-09	8.90E-09	8.90E-09	8.90E-09	8.90E-09	1.00E-08
W-181	2.10E-12	2.10E-12	2.10E-12	2.10E-12	2.10E-12	2.10E-12	2.10E-12	2.80E-12
W-185	0.00E+00	0.00E+00	0.00E+00	0.00E+00	0.00E+00	0.00E+00	0.00E+00	0.00E+00
W-187	3.10E-09	3.10E-09	3.10E-09	3.10E-09	3.10E-09	3.10E-09	3.10E-09	3.60E-09
U-232	2.59E-12	2.59E-12	2.59E-12	2.59E-12	2.59E-12	2.59E-12	2.59E-12	2.69E-11
U-233	2.30E-09	2.30E-09	2.30E-09	2.30E-09	2.30E-09	2.30E-09	2.30E-09	2.80E-09
U-234	6.32E-13	6.32E-13	6.32E-13	6.32E-13	6.32E-13	6.32E-13	6.32E-13	1.59E-10
U-235	3.20E-09	3.20E-09	3.20E-09	3.20E-09	3.20E-09	3.20E-09	3.20E-09	4.00E-09
U-236	2.10E-14	2.10E-14	2.10E-14	2.10E-14	2.10E-14	2.10E-14	2.10E-14	1.80E-11
U-237	1.00E-09	1.00E-09	1.00E-09	1.00E-09	1.00E-09	1.00E-09	1.00E-09	1.30E-09
U-238	1.10E-10	1.10E-10	1.10E-10	1.10E-10	1.10E-10	1.10E-10	1.10E-10	1.50E-10
NP-237	1.40E-09	1.40E-09	1.40E-09	1.40E-09	1.40E-09	1.40E-09	1.40E-09	1.60E-09
NP-238	2.80E-09	2.80E-09	2.80E-09	2.80E-09	2.80E-09	2.80E-09	2.80E-09	3.20E-09
NP-239	9.50E-10	9.50E-10	9.50E-10	9.50E-10	9.50E-10	9.50E-10	9.50E-10	1.10E-09
PU-238	1.30E-12	1.30E-12	1.30E-12	1.30E-12	1.30E-12	1.30E-12	1.30E-12	1.80E-11

TABLE II-7

DOSE FACTORS FOR STANDING ON CONTAMINATED GROUND (D_{aipj})(mrem/hr per pCi/m²)

NUCLIDE	BONE	LIVER	T BODY	THYROID	KIDNEY	LUNG	GI-LLI	SKIN
PU-239	7.90E-13	7.90E-13	7.90E-13	7.90E-13	7.90E-13	7.90E-13	7.90E-13	7.70E-12
PU-240	1.30E-12	1.30E-12	1.30E-12	1.30E-12	1.30E-12	1.30E-12	1.30E-12	1.80E-11
PU-241	4.60E-12	4.60E-12	4.60E-12	4.60E-12	4.60E-12	4.60E-12	4.60E-12	6.80E-12
PU-242	1.10E-12	1.10E-12	1.10E-12	1.10E-12	1.10E-12	1.10E-12	1.10E-12	1.60E-11
PU-244	8.95E-10	8.95E-10	8.95E-10	8.95E-10	8.95E-10	8.95E-10	8.95E-10	9.62E-10
AM-241	1.80E-10	1.80E-10	1.80E-10	1.80E-10	1.80E-10	1.80E-10	1.80E-10	2.60E-10
AM-242M	2.60E-11	2.60E-11	2.60E-11	2.60E-11	2.60E-11	2.60E-11	2.60E-11	1.80E-10
AM-243	1.30E-09	1.30E-09	1.30E-09	1.30E-09	1.30E-09	1.30E-09	1.30E-09	1.50E-09
CM-242	5.50E-12	5.50E-12	5.50E-12	5.50E-12	5.50E-12	5.50E-12	5.50E-12	2.30E-11
CM-243	2.30E-09	2.30E-09	2.30E-09	2.30E-09	2.30E-09	2.30E-09	2.30E-09	2.90E-09
CM-244	2.90E-12	2.90E-12	2.90E-12	2.90E-12	2.90E-12	2.90E-12	2.90E-12	1.80E-11
CM-245	9.50E-10	9.50E-10	9.50E-10	9.50E-10	9.50E-10	9.50E-10	9.50E-10	1.20E-09
CM-246	1.00E-12	1.00E-12	1.00E-12	1.00E-12	1.00E-12	1.00E-12	1.00E-12	1.50E-11
CM-247	2.20E-09	2.20E-09	2.20E-09	2.20E-09	2.20E-09	2.20E-09	2.20E-09	2.60E-09
CM-248	5.23E-09	5.23E-09	5.23E-09	5.23E-09	5.23E-09	5.23E-09	5.23E-09	6.81E-09
CF-252	6.60E-08	6.60E-08	6.60E-08	6.60E-08	6.60E-08	6.60E-08	6.60E-08	7.20E-08

NUREG/CR-4653, GASPAR II, Technical Reference and User Guide

TABLE II-8

AQUATIC PATHWAY USAGE FACTORS (U_{ap})

Pathway	Infant	Child	Teen	Adult
Fish (kg/yr)	-	6.9 ^a	16 ^a	21 ^a
Potable Water (l/yr)	330 ^a	510 ^a	510 ^a	730 ^a
Shoreline Recreation (hr/yr)	-	90 ^b	600 ^b	600 ^b

Ref: ^a Regulatory Guide 1.109, Rev 1, Table E-5

^b EROL Table 5.2.A-3

TABLE II-9
ADULT DRINKING WATER A₁₇ FACTORS

mrem-ml per uCi-hr

NUCLIDE	BONE	LIVER	T BODY	THYROID	KIDNEY	LUNG	GI-LLI	SKIN
H-3	0.00E+00	4.99E+00	4.99E+00	4.99E+00	4.99E+00	4.99E+00	4.99E+00	0.00E+00
C-14	2.37E+02	4.73E+01	4.73E+01	4.73E+01	4.73E+01	4.73E+01	4.73E+01	0.00E+00
NA-22	1.45E+03	1.45E+03	1.45E+03	1.45E+03	1.45E+03	1.45E+03	1.45E+03	0.00E+00
NA-24	8.14E+01	8.14E+01	8.14E+01	8.14E+01	8.14E+01	8.14E+01	8.14E+01	0.00E+00
P-32	1.57E+04	9.76E+02	6.07E+02	0.00E+00	0.00E+00	0.00E+00	1.77E+03	0.00E+00
CA-41	1.54E+04	0.00E+00	1.67E+03	0.00E+00	0.00E+00	0.00E+00	1.53E+01	0.00E+00
SC-46	4.57E-01	8.88E-01	2.58E-01	0.00E+00	8.29E-01	0.00E+00	4.32E+03	0.00E+00
CR-51	0.00E+00	0.00E+00	2.19E-01	1.31E-01	4.82E-02	2.91E-01	5.51E+01	0.00E+00
MN-54	0.00E+00	3.80E+02	7.26E+01	0.00E+00	1.13E+02	0.00E+00	1.17E+03	0.00E+00
MN-56	0.00E+00	3.81E-01	6.75E-02	0.00E+00	4.83E-01	0.00E+00	1.21E+01	0.00E+00
FE-55	2.29E+02	1.58E+02	3.69E+01	0.00E+00	0.00E+00	8.83E+01	9.08E+01	0.00E+00
FE-59	3.59E+02	8.43E+02	3.23E+02	0.00E+00	0.00E+00	2.36E+02	2.81E+03	0.00E+00
CO-57	0.00E+00	1.46E+01	2.42E+01	0.00E+00	0.00E+00	0.00E+00	3.70E+02	0.00E+00
CO-58	0.00E+00	6.18E+01	1.38E+02	0.00E+00	0.00E+00	0.00E+00	1.25E+03	0.00E+00
CO-60	0.00E+00	1.78E+02	3.93E+02	0.00E+00	0.00E+00	0.00E+00	3.35E+03	0.00E+00
NI-59	8.13E+02	2.79E+02	1.36E+02	0.00E+00	0.00E+00	0.00E+00	5.75E+01	0.00E+00
NI-63	1.08E+04	7.51E+02	3.63E+02	0.00E+00	0.00E+00	0.00E+00	1.57E+02	0.00E+00
NI-65	1.62E+00	2.11E-01	9.61E-02	0.00E+00	0.00E+00	0.00E+00	5.34E+00	0.00E+00
CU-64	0.00E+00	3.61E+00	1.69E+00	0.00E+00	9.09E+00	0.00E+00	3.07E+02	0.00E+00
ZN-65	4.03E+02	1.28E+03	5.79E+02	0.00E+00	8.57E+02	0.00E+00	8.07E+02	0.00E+00
ZN-69M	7.74E+00	1.86E+01	1.70E+00	0.00E+00	1.12E+01	0.00E+00	1.13E+03	0.00E+00
ZN-69	1.08E-04	2.08E-04	1.44E-05	0.00E+00	1.35E-04	0.00E+00	3.12E-05	0.00E+00
SE-79	0.00E+00	2.19E+02	3.66E+01	0.00E+00	3.79E+02	0.00E+00	4.48E+01	0.00E+00
BR-82	0.00E+00	0.00E+00	1.49E+02	0.00E+00	0.00E+00	0.00E+00	1.71E+02	0.00E+00
BR-83	0.00E+00	0.00E+00	1.03E-01	0.00E+00	0.00E+00	0.00E+00	1.49E-01	0.00E+00
BR-84	0.00E+00	0.00E+00	6.64E-07	0.00E+00	0.00E+00	0.00E+00	5.21E-12	0.00E+00
BR-85	0.00E+00	0.00E+00	4.40E-77	0.00E+00	0.00E+00	0.00E+00	0.00E+00	0.00E+00
RB-86	0.00E+00	1.73E+03	8.04E+02	0.00E+00	0.00E+00	0.00E+00	3.40E+02	0.00E+00
RB-87	0.00E+00	1.03E+03	3.57E+02	0.00E+00	0.00E+00	0.00E+00	4.80E+01	0.00E+00
RB-88	0.00E+00	3.36E-12	1.78E-12	0.00E+00	0.00E+00	0.00E+00	4.64E-23	0.00E+00
RB-89	0.00E+00	3.06E-14	2.15E-14	0.00E+00	0.00E+00	0.00E+00	1.78E-27	0.00E+00
SR-89	2.55E+04	0.00E+00	7.32E+02	0.00E+00	0.00E+00	0.00E+00	4.09E+03	0.00E+00
SR-90	7.26E+05	0.00E+00	1.46E+04	0.00E+00	0.00E+00	0.00E+00	1.82E+04	0.00E+00
SR-91	1.97E+02	0.00E+00	7.95E+00	0.00E+00	0.00E+00	0.00E+00	9.37E+02	0.00E+00
SR-92	8.32E+00	0.00E+00	3.60E-01	0.00E+00	0.00E+00	0.00E+00	1.65E+02	0.00E+00
Y-90	7.04E-01	0.00E+00	1.89E-02	0.00E+00	0.00E+00	0.00E+00	7.47E+03	0.00E+00
Y-91M	3.31E-07	0.00E+00	1.28E-08	0.00E+00	0.00E+00	0.00E+00	9.71E-07	0.00E+00

TABLE II-9
ADULT DRINKING WATER A_{1T} FACTORS

mrem-ml per uCi-hr

NUCLIDE	BONE	LIVER	T BODY	THYROID	KIDNEY	LUNG	GI-LLI	SKIN
Y-91	1.17E+01	0.00E+00	3.12E-01	0.00E+00	0.00E+00	0.00E+00	6.43E+03	0.00E+00
Y-92	6.72E-03	0.00E+00	1.96E-04	0.00E+00	0.00E+00	0.00E+00	1.18E+02	0.00E+00
Y-93	9.80E-02	0.00E+00	2.71E-03	0.00E+00	0.00E+00	0.00E+00	3.11E+03	0.00E+00
ZR-93	3.48E+00	1.95E-01	9.08E-02	0.00E+00	7.39E-01	0.00E+00	2.03E+02	0.00E+00
ZR-95	2.52E+00	8.08E-01	5.47E-01	0.00E+00	1.27E+00	0.00E+00	2.56E+03	0.00E+00
ZR-97	8.56E-02	1.73E-02	7.90E-03	0.00E+00	2.61E-02	0.00E+00	5.35E+03	0.00E+00
NB-93M	2.12E+00	6.93E-01	1.71E-01	0.00E+00	7.97E-01	0.00E+00	3.20E+02	0.00E+00
NB-95	5.13E-01	2.85E-01	1.53E-01	0.00E+00	2.82E-01	0.00E+00	1.73E+03	0.00E+00
NB-97	4.29E-06	1.08E-06	3.96E-07	0.00E+00	1.27E-06	0.00E+00	4.00E-03	0.00E+00
MO-93	0.00E+00	6.26E+02	1.69E+01	0.00E+00	1.78E+02	0.00E+00	1.02E+02	0.00E+00
MO-99	0.00E+00	3.17E+02	6.02E+01	0.00E+00	7.17E+02	0.00E+00	7.34E+02	0.00E+00
TC-99M	5.17E-03	1.46E-02	1.86E-01	0.00E+00	2.22E-01	7.16E-03	8.64E+00	0.00E+00
TC-99	1.04E+01	1.55E+01	4.18E+00	0.00E+00	1.95E+02	1.32E+00	5.07E+02	0.00E+00
TC-101	1.15E-17	1.66E-17	1.63E-16	0.00E+00	2.99E-16	8.50E-18	5.00E-29	0.00E+00
RU-103	1.53E+01	0.00E+00	6.58E+00	0.00E+00	5.83E+01	0.00E+00	1.78E+03	0.00E+00
RU-105	1.97E-01	0.00E+00	7.78E-02	0.00E+00	2.55E+00	0.00E+00	1.21E+02	0.00E+00
RU-106	2.29E+02	0.00E+00	2.90E+01	0.00E+00	4.42E+02	0.00E+00	1.48E+04	0.00E+00
RH-105	7.97E+00	5.83E+00	3.84E+00	0.00E+00	2.48E+01	0.00E+00	9.29E+02	0.00E+00
PD-107	0.00E+00	1.23E+01	7.83E-01	0.00E+00	1.10E+02	0.00E+00	7.59E+01	0.00E+00
PD-109	0.00E+00	7.95E+00	1.79E+00	0.00E+00	4.54E+01	0.00E+00	8.80E+02	0.00E+00
AG-110M	1.33E+01	1.23E+01	7.31E+00	0.00E+00	2.42E+01	0.00E+00	5.03E+03	0.00E+00
AG-111	4.62E+00	1.93E+00	9.63E-01	0.00E+00	6.24E+00	0.00E+00	3.55E+03	0.00E+00
CD-113M	0.00E+00	2.65E+02	8.50E+00	0.00E+00	2.92E+02	0.00E+00	2.13E+03	0.00E+00
CD-115M	0.00E+00	1.52E+02	4.85E+00	0.00E+00	1.21E+02	0.00E+00	6.40E+03	0.00E+00
SN-123	2.58E+03	4.28E+01	6.31E+01	3.64E+01	0.00E+00	0.00E+00	5.26E+03	0.00E+00
SN-125	6.70E+02	1.35E+01	3.04E+01	1.12E+01	0.00E+00	0.00E+00	8.36E+03	0.00E+00
SN-126	7.04E+03	1.39E+02	2.00E+02	4.10E+01	0.00E+00	0.00E+00	2.03E+03	0.00E+00
SB-124	2.32E+02	4.38E+00	9.20E+01	5.63E-01	0.00E+00	1.81E+02	6.59E+03	0.00E+00
SB-125	1.49E+02	1.67E+00	3.55E+01	1.52E-01	0.00E+00	1.15E+02	1.64E+03	0.00E+00
SB-126	9.32E+01	1.90E+00	3.36E+01	5.70E-01	0.00E+00	5.71E+01	7.62E+03	0.00E+00
SB-127	1.96E+01	4.30E-01	7.54E+00	2.36E-01	0.00E+00	1.17E+01	4.49E+03	0.00E+00
TE-125M	2.22E+02	8.04E+01	2.97E+01	6.68E+01	9.03E+02	0.00E+00	8.86E+02	0.00E+00
TE-127M	5.62E+02	2.01E+02	6.85E+01	1.44E+02	2.28E+03	0.00E+00	1.89E+03	0.00E+00
TE-127	3.77E+00	1.35E+00	8.15E-01	2.79E+00	1.53E+01	0.00E+00	2.97E+02	0.00E+00
TE-129M	9.48E+02	3.54E+02	1.50E+02	3.26E+02	3.96E+03	0.00E+00	4.78E+03	0.00E+00
TE-129	2.01E-03	7.56E-04	4.90E-04	1.54E-03	8.46E-03	0.00E+00	1.52E-03	0.00E+00
TE-131M	1.09E+02	5.34E+01	4.45E+01	8.46E+01	5.41E+02	0.00E+00	5.31E+03	0.00E+00
TE-131	3.51E-09	1.47E-09	1.11E-09	2.89E-09	1.54E-08	0.00E+00	4.97E-10	0.00E+00

TABLE II-9
ADULT DRINKING WATER A_{IT} FACTORS

mrem-ml per uCi-hr

NUCLIDE	BONE	LIVER	T BODY	THYROID	KIDNEY	LUNG	GI-LLI	SKIN
TE-132	1.89E+02	1.22E+02	1.15E+02	1.35E+02	1.18E+03	0.00E+00	5.78E+03	0.00E+00
TE-133M	4.71E-04	2.75E-04	2.65E-04	3.99E-04	2.72E-03	0.00E+00	9.44E-05	0.00E+00
TE-134	1.76E-05	1.15E-05	7.07E-06	1.54E-05	1.12E-04	0.00E+00	1.95E-08	0.00E+00
I-129	2.73E+02	2.34E+02	7.68E+02	6.03E+05	5.03E+02	0.00E+00	3.70E+01	0.00E+00
I-130	3.21E+01	9.48E+01	3.74E+01	8.04E+03	1.48E+02	0.00E+00	8.16E+01	0.00E+00
I-131	3.32E+02	4.75E+02	2.72E+02	1.56E+05	8.14E+02	0.00E+00	1.25E+02	0.00E+00
I-132	4.55E-01	1.22E+00	4.26E-01	4.26E+01	1.94E+00	0.00E+00	2.28E-01	0.00E+00
I-133	7.93E+01	1.38E+02	4.21E+01	2.03E+04	2.41E+02	0.00E+00	1.24E+02	0.00E+00
I-134	6.69E-04	1.82E-03	6.50E-04	3.15E-02	2.89E-03	0.00E+00	1.58E-06	0.00E+00
I-135	1.05E+01	2.75E+01	1.01E+01	1.81E+03	4.40E+01	0.00E+00	3.10E+01	0.00E+00
CS-134M	1.01E-01	2.12E-01	1.08E-01	0.00E+00	1.15E-01	1.81E-02	7.48E-02	0.00E+00
CS-134	5.18E+03	1.23E+04	1.01E+04	0.00E+00	3.99E+03	1.32E+03	2.16E+02	0.00E+00
CS-135	1.63E+03	1.50E+03	6.66E+02	0.00E+00	5.68E+02	1.70E+02	3.51E+01	0.00E+00
CS-136	5.28E+02	2.09E+03	1.50E+03	0.00E+00	1.16E+03	1.59E+02	2.37E+02	0.00E+00
CS-137	6.64E+03	9.08E+03	5.95E+03	0.00E+00	3.08E+03	1.02E+03	1.76E+02	0.00E+00
CS-138	8.54E-07	1.69E-06	8.36E-07	0.00E+00	1.24E-06	1.22E-07	7.20E-12	0.00E+00
CS-139	2.49E-23	3.71E-23	1.35E-23	0.00E+00	2.97E-23	2.70E-24	8.03E-46	0.00E+00
BA-139	1.99E-02	1.42E-05	5.83E-04	0.00E+00	1.33E-05	8.05E-06	3.53E-02	0.00E+00
BA-140	1.65E+03	2.07E+00	1.08E+02	0.00E+00	7.03E-01	1.18E+00	3.39E+03	0.00E+00
BA-141	5.38E-12	4.06E-15	1.82E-13	0.00E+00	3.78E-15	2.31E-15	2.53E-21	0.00E+00
BA-142	9.84E-21	1.01E-23	6.19E-22	0.00E+00	8.55E-24	5.73E-24	1.39E-38	0.00E+00
LA-140	1.69E-01	8.54E-02	2.26E-02	0.00E+00	0.00E+00	0.00E+00	6.27E+03	0.00E+00
LA-141	3.22E-03	9.99E-04	1.63E-04	0.00E+00	0.00E+00	0.00E+00	1.19E+02	0.00E+00
LA-142	5.70E-05	2.59E-05	6.46E-06	0.00E+00	0.00E+00	0.00E+00	1.89E-01	0.00E+00
CE-141	7.72E-01	5.22E-01	5.92E-02	0.00E+00	2.42E-01	0.00E+00	2.00E+03	0.00E+00
CE-143	1.07E-01	7.90E+01	8.74E-03	0.00E+00	3.48E-02	0.00E+00	2.95E+03	0.00E+00
CE-144	4.06E+01	1.70E+01	2.18E+00	0.00E+00	1.01E+01	0.00E+00	1.37E+04	0.00E+00
PR-143	7.47E-01	3.00E-01	3.70E-02	0.00E+00	1.73E-01	0.00E+00	3.27E+03	0.00E+00
PR-144	7.19E-16	2.98E-16	3.65E-17	0.00E+00	1.68E-16	0.00E+00	1.03E-22	0.00E+00
ND-147	5.08E-01	5.87E-01	3.51E-02	0.00E+00	3.43E-01	0.00E+00	2.82E+03	0.00E+00
PM-147	6.28E+00	5.91E-01	2.39E-01	0.00E+00	1.12E+00	0.00E+00	7.44E+02	0.00E+00
PM-148M	2.54E+00	6.57E-01	5.02E-01	0.00E+00	9.92E-01	0.00E+00	5.57E+03	0.00E+00
PM-148	5.60E-01	9.30E-02	4.68E-02	0.00E+00	1.76E-01	0.00E+00	7.30E+03	0.00E+00
PM-149	1.08E-01	1.53E-02	6.26E-03	0.00E+00	2.89E-02	0.00E+00	2.87E+03	0.00E+00
PM-151	4.33E-02	7.27E-03	3.67E-03	0.00E+00	1.30E-02	0.00E+00	2.00E+03	0.00E+00
SM-151	5.75E+00	9.92E-01	2.37E-01	0.00E+00	1.11E+00	0.00E+00	4.37E+02	0.00E+00
SM-153	5.98E-02	4.99E-02	3.64E-03	0.00E+00	1.61E-02	0.00E+00	1.78E+03	0.00E+00
EU-152	1.62E+01	3.70E+00	3.25E+00	0.00E+00	2.29E+01	0.00E+00	2.13E+03	0.00E+00

TABLE II-9
ADULT DRINKING WATER A_{1T} FACTORS

mrem-ml per uCi-hr

NUCLIDE	BONE	LIVER	T BODY	THYROID	KIDNEY	LUNG	GI-LLI	SKIN
EU-154	5.12E+01	6.30E+00	4.48E+00	0.00E+00	3.02E+01	0.00E+00	4.57E+03	0.00E+00
EU-155	7.17E+00	1.02E+00	6.56E-01	0.00E+00	4.69E+00	0.00E+00	8.00E+02	0.00E+00
EU-156	1.12E+00	8.63E-01	1.39E-01	0.00E+00	5.77E-01	0.00E+00	5.91E+03	0.00E+00
TB-160	3.90E+00	0.00E+00	4.86E-01	0.00E+00	1.61E+00	0.00E+00	3.59E+03	0.00E+00
HO-166M	2.25E+01	7.02E+00	5.33E+00	0.00E+00	1.05E+01	0.00E+00	2.13E+03	0.00E+00
W-181	8.23E-01	2.68E-01	2.88E-02	0.00E+00	0.00E+00	0.00E+00	3.06E+01	0.00E+00
W-185	3.36E+01	1.12E+01	1.18E+00	0.00E+00	0.00E+00	0.00E+00	1.29E+03	0.00E+00
W-187	6.05E+00	5.06E+00	1.77E+00	0.00E+00	0.00E+00	0.00E+00	1.66E+03	0.00E+00
U-232	3.44E+05	0.00E+00	2.46E+04	0.00E+00	3.72E+04	0.00E+00	5.65E+03	0.00E+00
U-233	7.26E+04	0.00E+00	4.40E+03	0.00E+00	1.69E+04	0.00E+00	5.23E+03	0.00E+00
U-234	6.97E+04	0.00E+00	4.31E+03	0.00E+00	1.66E+04	0.00E+00	5.12E+03	0.00E+00
U-235	6.68E+04	0.00E+00	4.05E+03	0.00E+00	1.56E+04	0.00E+00	6.51E+03	0.00E+00
U-236	6.68E+04	0.00E+00	4.13E+03	0.00E+00	1.59E+04	0.00E+00	4.80E+03	0.00E+00
U-237	4.37E+00	0.00E+00	1.16E+00	0.00E+00	1.80E+01	0.00E+00	1.54E+03	0.00E+00
U-238	6.39E+04	0.00E+00	3.78E+03	0.00E+00	1.46E+04	0.00E+00	4.58E+03	0.00E+00
NP-237	1.05E+05	7.47E+03	4.62E+03	0.00E+00	3.43E+04	0.00E+00	6.62E+03	0.00E+00
NP-238	9.69E-01	2.61E-02	1.51E-02	0.00E+00	8.84E-02	0.00E+00	2.43E+03	0.00E+00
NP-239	8.56E-02	8.42E-03	4.64E-03	0.00E+00	2.63E-02	0.00E+00	1.73E+03	0.00E+00
PU-238	5.25E+04	6.65E+03	1.42E+03	0.00E+00	6.10E+03	0.00E+00	6.08E+03	0.00E+00
PU-239	6.04E+04	7.26E+03	1.59E+03	0.00E+00	6.76E+03	0.00E+00	5.55E+03	0.00E+00
PU-240	6.03E+04	7.25E+03	1.59E+03	0.00E+00	6.75E+03	0.00E+00	5.65E+03	0.00E+00
PU-241	1.31E+03	6.21E+01	2.77E+01	0.00E+00	1.27E+02	0.00E+00	1.17E+02	0.00E+00
PU-242	5.60E+04	6.99E+03	1.53E+03	0.00E+00	6.51E+03	0.00E+00	5.44E+03	0.00E+00
PU-244	6.53E+04	8.01E+03	1.76E+03	0.00E+00	7.46E+03	0.00E+00	8.11E+03	0.00E+00
AM-241	6.29E+04	5.87E+04	4.51E+03	0.00E+00	3.39E+04	0.00E+00	6.18E+03	0.00E+00
AM-242M	6.34E+04	5.52E+04	4.52E+03	0.00E+00	3.37E+04	0.00E+00	7.78E+03	0.00E+00
AM-243	6.28E+04	5.75E+04	4.42E+03	0.00E+00	3.33E+04	0.00E+00	7.25E+03	0.00E+00
CM-242	1.71E+03	1.82E+03	1.14E+02	0.00E+00	5.17E+02	0.00E+00	6.59E+03	0.00E+00
CM-243	4.99E+04	4.57E+04	3.12E+03	0.00E+00	1.46E+04	0.00E+00	6.51E+03	0.00E+00
CM-244	3.80E+04	3.56E+04	2.39E+03	0.00E+00	1.12E+04	0.00E+00	6.29E+03	0.00E+00
CM-245	7.82E+04	6.81E+04	4.80E+03	0.00E+00	2.24E+04	0.00E+00	5.87E+03	0.00E+00
CM-246	7.75E+04	6.80E+04	4.79E+03	0.00E+00	2.23E+04	0.00E+00	5.76E+03	0.00E+00
CM-247	7.56E+04	6.70E+04	4.73E+03	0.00E+00	2.20E+04	0.00E+00	7.58E+03	0.00E+00
CM-248	6.28E+05	5.53E+05	3.89E+04	0.00E+00	1.82E+05	0.00E+00	1.23E+05	0.00E+00
CF-252	2.17E+04	0.00E+00	5.24E+02	0.00E+00	0.00E+00	0.00E+00	2.40E+04	0.00E+00

TABLE II1-10

ADULT FRESHWATER FISH A_{IT} FACTORS

mrem-ml peruCi-hr

NUCLIDE	BONE	LIVER	T BODY	THYROID	KIDNEY	LUNG	GI-LLI	SKIN
H-3	0.00E+00	1.29E-01	1.29E-01	1.29E-01	1.29E-01	1.29E-01	1.29E-01	0.00E+00
C-14	3.13E+04	6.26E+03	6.26E+03	6.26E+03	6.26E+03	6.26E+03	6.26E+03	0.00E+00
NA-22	4.17E+03	4.17E+03	4.17E+03	4.17E+03	4.17E+03	4.17E+03	4.17E+03	0.00E+00
NA-24	1.34E+02	1.34E+02	1.34E+02	1.34E+02	1.34E+02	1.34E+02	1.34E+02	0.00E+00
P-32	1.32E+06	8.22E+04	5.11E+04	0.00E+00	0.00E+00	0.00E+00	1.49E+05	0.00E+00
CA-41	1.77E+04	0.00E+00	1.92E+03	0.00E+00	0.00E+00	0.00E+00	1.76E+01	0.00E+00
SC-46	2.62E-02	5.09E-02	1.48E-02	0.00E+00	4.75E-02	0.00E+00	2.48E+02	0.00E+00
CR-51	0.00E+00	0.00E+00	1.24E+00	7.43E-01	2.74E-01	1.65E+00	3.13E+02	0.00E+00
MN-54	0.00E+00	4.37E+03	8.34E+02	0.00E+00	1.30E+03	0.00E+00	1.34E+04	0.00E+00
MN-56	0.00E+00	1.74E-01	3.09E-02	0.00E+00	2.21E-01	0.00E+00	5.55E+00	0.00E+00
FE-55	6.59E+02	4.55E+02	1.06E+02	0.00E+00	0.00E+00	2.54E+02	2.61E+02	0.00E+00
FE-59	1.02E+03	2.41E+03	9.23E+02	0.00E+00	0.00E+00	6.73E+02	8.03E+03	0.00E+00
CO-57	0.00E+00	2.09E+01	3.48E+01	0.00E+00	0.00E+00	0.00E+00	5.31E+02	0.00E+00
CO-58	0.00E+00	8.84E+01	1.98E+02	0.00E+00	0.00E+00	0.00E+00	1.79E+03	0.00E+00
CO-60	0.00E+00	2.56E+02	5.66E+02	0.00E+00	0.00E+00	0.00E+00	4.82E+03	0.00E+00
NI-59	2.34E+03	8.03E+02	3.91E+02	0.00E+00	0.00E+00	0.00E+00	1.65E+02	0.00E+00
NI-63	3.12E+04	2.16E+03	1.05E+03	0.00E+00	0.00E+00	0.00E+00	4.51E+02	0.00E+00
NI-65	1.72E-01	2.23E-02	1.02E-02	0.00E+00	0.00E+00	0.00E+00	5.67E-01	0.00E+00
CU-64	0.00E+00	2.69E+00	1.26E+00	0.00E+00	6.79E+00	0.00E+00	2.30E+02	0.00E+00
ZN-65	2.31E+04	7.36E+04	3.33E+04	0.00E+00	4.92E+04	0.00E+00	4.64E+04	0.00E+00
ZN-69M	2.43E+02	5.84E+02	5.34E+01	0.00E+00	3.53E+02	0.00E+00	3.56E+04	0.00E+00
ZN-69	7.89E-07	1.51E-06	1.05E-07	0.00E+00	9.81E-07	0.00E+00	2.27E-07	0.00E+00
SE-79	0.00E+00	1.07E+03	1.79E+02	0.00E+00	1.85E+03	0.00E+00	2.19E+02	0.00E+00
BR-82	0.00E+00	0.00E+00	1.42E+03	0.00E+00	0.00E+00	0.00E+00	1.63E+03	0.00E+00
BR-83	0.00E+00	0.00E+00	3.84E-02	0.00E+00	0.00E+00	0.00E+00	5.53E-02	0.00E+00
BR-84	0.00E+00	0.00E+00	1.23E-12	0.00E+00	0.00E+00	0.00E+00	9.62E-18	0.00E+00
BR-85	0.00E+00	0.00E+00	1.31E-151	0.00E+00	0.00E+00	0.00E+00	0.00E+00	0.00E+00
RB-86	0.00E+00	9.75E+04	4.54E+04	0.00E+00	0.00E+00	0.00E+00	1.92E+04	0.00E+00
RB-87	0.00E+00	5.90E+04	2.05E+04	0.00E+00	0.00E+00	0.00E+00	2.76E+03	0.00E+00
RB-88	0.00E+00	1.29E-22	6.83E-23	0.00E+00	0.00E+00	0.00E+00	1.78E-33	0.00E+00
RB-89	0.00E+00	1.62E-26	1.14E-26	0.00E+00	0.00E+00	0.00E+00	9.39E-40	0.00E+00
SR-89	2.18E+04	0.00E+00	6.27E+02	0.00E+00	0.00E+00	0.00E+00	3.50E+03	0.00E+00
SR-90	6.26E+05	0.00E+00	1.26E+04	0.00E+00	0.00E+00	0.00E+00	1.57E+04	0.00E+00
SR-91	7.08E+01	0.00E+00	2.86E+00	0.00E+00	0.00E+00	0.00E+00	3.37E+02	0.00E+00
SR-92	3.34E-01	0.00E+00	1.44E-02	0.00E+00	0.00E+00	0.00E+00	6.61E+00	0.00E+00
Y-90	4.45E-01	0.00E+00	1.19E-02	0.00E+00	0.00E+00	0.00E+00	4.72E+03	0.00E+00
Y-91M	1.04E-11	0.00E+00	4.02E-13	0.00E+00	0.00E+00	0.00E+00	3.05E-11	0.00E+00

TABLE II1-10

ADULT FRESHWATER FISH A₁₇ FACTORS

mrem-ml peruCi-hr

NUCLIDE	BONE	LIVER	T BODY	THYROID	KIDNEY	LUNG	GI-LLI	SKIN
Y-91	8.35E+00	0.00E+00	2.23E-01	0.00E+00	0.00E+00	0.00E+00	4.60E+03	0.00E+00
Y-92	4.61E-04	0.00E+00	1.35E-05	0.00E+00	0.00E+00	0.00E+00	8.07E+00	0.00E+00
Y-93	3.09E-02	0.00E+00	8.54E-04	0.00E+00	0.00E+00	0.00E+00	9.81E+02	0.00E+00
ZR-93	3.31E-01	1.85E-02	8.62E-03	0.00E+00	7.02E-02	0.00E+00	1.92E+01	0.00E+00
ZR-95	2.38E-01	7.63E-02	5.17E-02	0.00E+00	1.20E-01	0.00E+00	2.42E+02	0.00E+00
ZR-97	4.97E-03	1.00E-03	4.58E-04	0.00E+00	1.51E-03	0.00E+00	3.10E+02	0.00E+00
NB-93M	1.83E+03	5.98E+02	1.47E+02	0.00E+00	6.88E+02	0.00E+00	2.76E+05	0.00E+00
NB-95	4.39E+02	2.44E+02	1.31E+02	0.00E+00	2.41E+02	0.00E+00	1.48E+06	0.00E+00
NB-97	3.65E-06	9.23E-07	3.37E-07	0.00E+00	1.08E-06	0.00E+00	3.40E-03	0.00E+00
MO-93	0.00E+00	1.80E+02	4.87E+00	0.00E+00	5.11E+01	0.00E+00	2.92E+01	0.00E+00
MO-99	0.00E+00	8.03E+01	1.53E+01	0.00E+00	1.82E+02	0.00E+00	1.86E+02	0.00E+00
TC-99M	5.60E-04	1.58E-03	2.02E-02	0.00E+00	2.40E-02	7.76E-04	9.37E-01	0.00E+00
TC-99	4.49E+00	6.69E+00	1.81E+00	0.00E+00	8.41E+01	5.68E-01	2.19E+02	0.00E+00
TC-101	2.71E-33	3.91E-33	3.84E-32	0.00E+00	7.04E-32	2.00E-33	1.18E-44	0.00E+00
RU-103	4.36E+00	0.00E+00	1.88E+00	0.00E+00	1.66E+01	0.00E+00	5.09E+02	0.00E+00
RU-105	8.71E-03	0.00E+00	3.44E-03	0.00E+00	1.13E-01	0.00E+00	5.33E+00	0.00E+00
RU-106	6.58E+01	0.00E+00	8.33E+00	0.00E+00	1.27E+02	0.00E+00	4.26E+03	0.00E+00
RH-105	1.81E+00	1.33E+00	8.73E-01	0.00E+00	5.63E+00	0.00E+00	2.11E+02	0.00E+00
PD-107	0.00E+00	3.52E+00	2.25E-01	0.00E+00	3.16E+01	0.00E+00	2.18E+01	0.00E+00
PD-109	0.00E+00	1.23E+00	2.78E-01	0.00E+00	7.03E+00	0.00E+00	1.36E+02	0.00E+00
AG-110M	8.80E-01	8.14E-01	4.83E-01	0.00E+00	1.60E+00	0.00E+00	3.32E+02	0.00E+00
AG-111	2.92E-01	1.22E-01	6.08E-02	0.00E+00	3.94E-01	0.00E+00	2.24E+02	0.00E+00
CD-113M	0.00E+00	1.52E+03	4.89E+01	0.00E+00	1.68E+03	0.00E+00	1.23E+04	0.00E+00
CD-115M	0.00E+00	8.69E+02	2.77E+01	0.00E+00	6.89E+02	0.00E+00	3.65E+04	0.00E+00
SN-123	2.22E+05	3.68E+03	5.43E+03	3.13E+03	0.00E+00	0.00E+00	4.53E+05	0.00E+00
SN-125	5.58E+04	1.12E+03	2.53E+03	9.30E+02	0.00E+00	0.00E+00	6.96E+05	0.00E+00
SN-126	6.08E+05	1.20E+04	1.73E+04	3.54E+03	0.00E+00	0.00E+00	1.75E+05	0.00E+00
SB-124	6.64E+00	1.25E-01	2.63E+00	1.61E-02	0.00E+00	5.17E+00	1.88E+02	0.00E+00
SB-125	4.29E+00	4.79E-02	1.02E+00	4.36E-03	0.00E+00	3.31E+00	4.72E+01	0.00E+00
SB-126	2.61E+00	5.30E-02	9.41E-01	1.60E-02	0.00E+00	1.60E+00	2.13E+02	0.00E+00
SB-127	5.17E-01	1.13E-02	1.98E-01	6.21E-03	0.00E+00	3.06E-01	1.18E+02	0.00E+00
TE-125M	2.54E+03	9.20E+02	3.40E+02	7.64E+02	1.03E+04	0.00E+00	1.01E+04	0.00E+00
TE-127M	6.45E+03	2.31E+03	7.86E+02	1.65E+03	2.62E+04	0.00E+00	2.16E+04	0.00E+00
TE-127	1.78E+01	6.39E+00	3.85E+00	1.32E+01	7.25E+01	0.00E+00	1.40E+03	0.00E+00
TE-129M	1.08E+04	4.03E+03	1.71E+03	3.71E+03	4.51E+04	0.00E+00	5.44E+04	0.00E+00
TE-129	1.78E-05	6.69E-06	4.34E-06	1.37E-05	7.48E-05	0.00E+00	1.34E-05	0.00E+00
TE-131M	9.53E+02	4.66E+02	3.88E+02	7.38E+02	4.72E+03	0.00E+00	4.63E+04	0.00E+00
TE-131	8.65E-17	3.61E-17	2.73E-17	7.11E-17	3.79E-16	0.00E+00	1.22E-17	0.00E+00

TABLE II1-10

ADULT FRESHWATER FISH A₁₇ FACTORS

mrem-ml peruCi-hr

NUCLIDE	BONE	LIVER	T BODY	THYROID	KIDNEY	LUNG	GI-LLI	SKIN
TE-132	1.95E+03	1.26E+03	1.19E+03	1.40E+03	1.22E+04	0.00E+00	5.98E+04	0.00E+00
TE-133M	6.63E-07	3.88E-07	3.73E-07	5.61E-07	3.83E-06	0.00E+00	1.33E-07	0.00E+00
TE-134	1.32E-09	8.66E-10	5.31E-10	1.16E-09	8.38E-09	0.00E+00	1.47E-12	0.00E+00
I-129	1.18E+02	1.01E+02	3.31E+02	2.60E+05	2.17E+02	0.00E+00	1.60E+01	0.00E+00
I-130	7.08E+00	2.09E+01	8.24E+00	1.77E+03	3.26E+01	0.00E+00	1.80E+01	0.00E+00
I-131	1.37E+02	1.96E+02	1.12E+02	6.43E+04	3.36E+02	0.00E+00	5.18E+01	0.00E+00
I-132	5.27E-03	1.41E-02	4.94E-03	4.94E-01	2.25E-02	0.00E+00	2.65E-03	0.00E+00
I-133	2.29E+01	3.99E+01	1.22E+01	5.87E+03	6.97E+01	0.00E+00	3.59E+01	0.00E+00
I-134	2.19E-08	5.94E-08	2.13E-08	1.03E-06	9.45E-08	0.00E+00	5.18E-11	0.00E+00
I-135	1.29E+00	3.37E+00	1.24E+00	2.22E+02	5.40E+00	0.00E+00	3.80E+00	0.00E+00
CS-134M	3.29E-01	6.93E-01	3.54E-01	0.00E+00	3.76E-01	5.92E-02	2.44E-01	0.00E+00
CS-134	2.98E+05	7.09E+05	5.80E+05	0.00E+00	2.29E+05	7.62E+04	1.24E+04	0.00E+00
CS-135	9.35E+04	8.63E+04	3.83E+04	0.00E+00	3.27E+04	9.78E+03	2.02E+03	0.00E+00
CS-136	2.96E+04	1.17E+05	8.41E+04	0.00E+00	6.50E+04	8.92E+03	1.33E+04	0.00E+00
CS-137	3.82E+05	5.23E+05	3.42E+05	0.00E+00	1.77E+05	5.90E+04	1.01E+04	0.00E+00
CS-138	9.13E-12	1.80E-11	8.93E-12	0.00E+00	1.32E-11	1.31E-12	7.69E-17	0.00E+00
CS-139	1.25E-44	1.87E-44	6.80E-45	0.00E+00	1.50E-44	1.36E-45	4.04E-67	0.00E+00
BA-139	5.65E-06	4.03E-09	1.65E-07	0.00E+00	3.76E-09	2.28E-09	1.00E-05	0.00E+00
BA-140	1.84E+02	2.32E-01	1.21E+01	0.00E+00	7.88E-02	1.33E-01	3.80E+02	0.00E+00
BA-141	8.48E-25	6.41E-28	2.86E-26	0.00E+00	5.96E-28	3.64E-28	4.00E-34	0.00E+00
BA-142	6.28E-42	6.45E-45	3.95E-43	0.00E+00	5.45E-45	3.65E-45	8.84E-60	0.00E+00
LA-140	9.91E-02	4.99E-02	1.32E-02	0.00E+00	0.00E+00	0.00E+00	3.67E+03	0.00E+00
LA-141	2.80E-04	8.70E-05	1.42E-05	0.00E+00	0.00E+00	0.00E+00	1.04E+01	0.00E+00
LA-142	2.19E-07	9.97E-08	2.48E-08	0.00E+00	0.00E+00	0.00E+00	7.28E-04	0.00E+00
CE-141	2.20E-02	1.49E-02	1.68E-03	0.00E+00	6.90E-03	0.00E+00	5.68E+01	0.00E+00
CE-143	2.39E-03	1.77E+00	1.95E-04	0.00E+00	7.78E-04	0.00E+00	6.60E+01	0.00E+00
CE-144	1.17E+00	4.88E-01	6.27E-02	0.00E+00	2.89E-01	0.00E+00	3.95E+02	0.00E+00
PR-143	5.24E-01	2.10E-01	2.60E-02	0.00E+00	1.21E-01	0.00E+00	2.29E+03	0.00E+00
PR-144	1.48E-28	6.15E-29	7.53E-30	0.00E+00	3.47E-29	0.00E+00	2.13E-35	0.00E+00
ND-147	3.54E-01	4.09E-01	2.45E-02	0.00E+00	2.39E-01	0.00E+00	1.96E+03	0.00E+00
PM-147	4.52E+00	4.25E-01	1.72E-01	0.00E+00	8.03E-01	0.00E+00	5.35E+02	0.00E+00
PM-148M	1.81E+00	4.69E-01	3.58E-01	0.00E+00	7.07E-01	0.00E+00	3.97E+03	0.00E+00
PM-148	3.78E-01	6.27E-02	3.16E-02	0.00E+00	1.19E-01	0.00E+00	4.93E+03	0.00E+00
PM-149	6.66E-02	9.42E-03	3.85E-03	0.00E+00	1.78E-02	0.00E+00	1.77E+03	0.00E+00
PM-151	2.33E-02	3.90E-03	1.97E-03	0.00E+00	6.97E-03	0.00E+00	1.07E+03	0.00E+00
SM-151	4.14E+00	7.13E-01	1.71E-01	0.00E+00	7.97E-01	0.00E+00	3.15E+02	0.00E+00
SM-153	3.60E-02	3.00E-02	2.19E-03	0.00E+00	9.70E-03	0.00E+00	1.07E+03	0.00E+00
EU-152	1.17E+01	2.66E+00	2.34E+00	0.00E+00	1.65E+01	0.00E+00	1.53E+03	0.00E+00

TABLE II1-10

ADULT FRESHWATER FISH A₁₇ FACTORS

mrem-ml peruCi-hr

NUCLIDE	BONE	LIVER	T BODY	THYROID	KIDNEY	LUNG	GI-LLI	SKIN
EU-154	3.68E+01	4.53E+00	3.22E+00	0.00E+00	2.17E+01	0.00E+00	3.28E+03	0.00E+00
EU-155	5.15E+00	7.31E-01	4.71E-01	0.00E+00	3.37E+00	0.00E+00	5.75E+02	0.00E+00
EU-156	7.84E-01	6.07E-01	9.79E-02	0.00E+00	4.05E-01	0.00E+00	4.16E+03	0.00E+00
TB-160	2.79E+00	0.00E+00	3.48E-01	0.00E+00	1.15E+00	0.00E+00	2.57E+03	0.00E+00
HO-166M	1.62E+01	5.05E+00	3.84E+00	0.00E+00	7.55E+00	0.00E+00	1.53E+03	0.00E+00
W-181	2.83E+01	9.24E+00	9.90E-01	0.00E+00	0.00E+00	0.00E+00	1.05E+03	0.00E+00
W-185	1.15E+03	3.85E+02	4.05E+01	0.00E+00	0.00E+00	0.00E+00	4.45E+04	0.00E+00
W-187	1.47E+02	1.23E+02	4.31E+01	0.00E+00	0.00E+00	0.00E+00	4.04E+04	0.00E+00
U-232	1.98E+04	0.00E+00	1.41E+03	0.00E+00	2.14E+03	0.00E+00	3.25E+02	0.00E+00
U-233	4.18E+03	0.00E+00	2.53E+02	0.00E+00	9.73E+02	0.00E+00	3.01E+02	0.00E+00
U-234	4.01E+03	0.00E+00	2.48E+02	0.00E+00	9.54E+02	0.00E+00	2.94E+02	0.00E+00
U-235	3.84E+03	0.00E+00	2.33E+02	0.00E+00	8.97E+02	0.00E+00	3.74E+02	0.00E+00
U-236	3.84E+03	0.00E+00	2.38E+02	0.00E+00	9.16E+02	0.00E+00	2.76E+02	0.00E+00
U-237	2.39E-01	0.00E+00	6.36E-02	0.00E+00	9.82E-01	0.00E+00	8.39E+01	0.00E+00
U-238	3.68E+03	0.00E+00	2.18E+02	0.00E+00	8.39E+02	0.00E+00	2.64E+02	0.00E+00
NP-237	3.02E+04	2.15E+03	1.33E+03	0.00E+00	9.88E+03	0.00E+00	1.90E+03	0.00E+00
NP-238	2.37E-01	6.38E-03	3.68E-03	0.00E+00	2.16E-02	0.00E+00	5.93E+02	0.00E+00
NP-239	2.13E-02	2.09E-03	1.15E-03	0.00E+00	6.52E-03	0.00E+00	4.29E+02	0.00E+00
PU-238	5.29E+03	6.70E+02	1.43E+02	0.00E+00	6.14E+02	0.00E+00	6.12E+02	0.00E+00
PU-239	6.08E+03	7.31E+02	1.60E+02	0.00E+00	6.80E+02	0.00E+00	5.59E+02	0.00E+00
PU-240	6.07E+03	7.30E+02	1.60E+02	0.00E+00	6.80E+02	0.00E+00	5.69E+02	0.00E+00
PU-241	1.32E+02	6.25E+00	2.79E+00	0.00E+00	1.28E+01	0.00E+00	1.17E+01	0.00E+00
PU-242	5.64E+03	7.04E+02	1.54E+02	0.00E+00	6.55E+02	0.00E+00	5.48E+02	0.00E+00
PU-244	6.58E+03	8.06E+02	1.77E+02	0.00E+00	7.51E+02	0.00E+00	8.16E+02	0.00E+00
AM-241	4.52E+04	4.23E+04	3.24E+03	0.00E+00	2.44E+04	0.00E+00	4.45E+03	0.00E+00
AM-242M	4.56E+04	3.97E+04	3.25E+03	0.00E+00	2.43E+04	0.00E+00	5.60E+03	0.00E+00
AM-243	4.52E+04	4.14E+04	3.18E+03	0.00E+00	2.39E+04	0.00E+00	5.21E+03	0.00E+00
CM-242	1.23E+03	1.31E+03	8.18E+01	0.00E+00	3.71E+02	0.00E+00	4.73E+03	0.00E+00
CM-243	3.59E+04	3.29E+04	2.25E+03	0.00E+00	1.05E+04	0.00E+00	4.68E+03	0.00E+00
CM-244	2.73E+04	2.56E+04	1.72E+03	0.00E+00	8.03E+03	0.00E+00	4.52E+03	0.00E+00
CM-245	5.62E+04	4.90E+04	3.45E+03	0.00E+00	1.61E+04	0.00E+00	4.22E+03	0.00E+00
CM-246	5.57E+04	4.89E+04	3.45E+03	0.00E+00	1.61E+04	0.00E+00	4.14E+03	0.00E+00
CM-247	5.44E+04	4.82E+04	3.40E+03	0.00E+00	1.58E+04	0.00E+00	5.45E+03	0.00E+00
CM-248	4.52E+05	3.97E+05	2.80E+04	0.00E+00	1.31E+05	0.00E+00	8.81E+04	0.00E+00
CF-252	1.56E+04	0.00E+00	3.77E+02	0.00E+00	0.00E+00	0.00E+00	1.72E+04	0.00E+00

TABLE II1-11

ADULT SHORELINE A₁₇ FACTORS

mrem-ml per uCi-hr

NUCLIDE	BONE	LIVER	T BODY	THYROID	KIDNEY	LUNG	GI-LLI	SKIN
H-3	0.00E+00	0.00E+00	0.00E+00	0.00E+00	0.00E+00	0.00E+00	0.00E+00	0.00E+00
C-14	0.00E+00	0.00E+00	0.00E+00	0.00E+00	0.00E+00	0.00E+00	0.00E+00	0.00E+00
NA-22	2.08E+04	2.08E+04	2.08E+04	2.08E+04	2.08E+04	2.08E+04	2.08E+04	2.34E+04
NA-24	2.14E+01	2.14E+01	2.14E+01	2.14E+01	2.14E+01	2.14E+01	2.14E+01	2.48E+01
P-32	0.00E+00	0.00E+00	0.00E+00	0.00E+00	0.00E+00	0.00E+00	0.00E+00	0.00E+00
CA-41	2.96E+04	2.96E+04	2.96E+04	2.96E+04	2.96E+04	2.96E+04	2.96E+04	3.48E+04
SC-46	1.49E+03	1.49E+03	1.49E+03	1.49E+03	1.49E+03	1.49E+03	1.49E+03	1.72E+03
CR-51	8.35E+00	8.35E+00	8.35E+00	8.35E+00	8.35E+00	8.35E+00	8.35E+00	9.87E+00
MN-54	2.48E+03	2.48E+03	2.48E+03	2.48E+03	2.48E+03	2.48E+03	2.48E+03	2.91E+03
MN-56	1.62E+00	1.62E+00	1.62E+00	1.62E+00	1.62E+00	1.62E+00	1.62E+00	1.91E+00
FE-55	0.00E+00	0.00E+00	0.00E+00	0.00E+00	0.00E+00	0.00E+00	0.00E+00	0.00E+00
FE-59	4.89E+02	4.89E+02	4.89E+02	4.89E+02	4.89E+02	4.89E+02	4.89E+02	5.75E+02
CO-57	3.38E+02	3.38E+02	3.38E+02	3.38E+02	3.38E+02	3.38E+02	3.38E+02	3.71E+02
CO-58	6.79E+02	6.79E+02	6.79E+02	6.79E+02	6.79E+02	6.79E+02	6.79E+02	7.95E+02
CO-60	4.32E+04	4.32E+04	4.32E+04	4.32E+04	4.32E+04	4.32E+04	4.32E+04	5.08E+04
NI-59	0.00E+00	0.00E+00	0.00E+00	0.00E+00	0.00E+00	0.00E+00	0.00E+00	0.00E+00
NI-63	0.00E+00	0.00E+00	0.00E+00	0.00E+00	0.00E+00	0.00E+00	0.00E+00	0.00E+00
NI-65	5.32E-01	5.32E-01	5.32E-01	5.32E-01	5.32E-01	5.32E-01	5.32E-01	6.19E-01
CU-64	1.09E+00	1.09E+00	1.09E+00	1.09E+00	1.09E+00	1.09E+00	1.09E+00	1.23E+00
ZN-65	1.34E+03	1.34E+03	1.34E+03	1.34E+03	1.34E+03	1.34E+03	1.34E+03	1.54E+03
ZN-69M	2.28E+00	2.28E+00	2.28E+00	2.28E+00	2.28E+00	2.28E+00	2.28E+00	2.67E+00
ZN-69	0.00E+00	0.00E+00	0.00E+00	0.00E+00	0.00E+00	0.00E+00	0.00E+00	0.00E+00
SE-79	0.00E+00	0.00E+00	0.00E+00	0.00E+00	0.00E+00	0.00E+00	0.00E+00	0.00E+00
BR-82	3.83E+01	3.83E+01	3.83E+01	3.83E+01	3.83E+01	3.83E+01	3.83E+01	4.43E+01
BR-83	8.73E-03	8.73E-03	8.73E-03	8.73E-03	8.73E-03	8.73E-03	8.73E-03	1.27E-02
BR-84	3.63E-01	3.63E-01	3.63E-01	3.63E-01	3.63E-01	3.63E-01	3.63E-01	4.24E-01
BR-85	0.00E+00	0.00E+00	0.00E+00	0.00E+00	0.00E+00	0.00E+00	0.00E+00	0.00E+00
RB-86	1.61E+01	1.61E+01	1.61E+01	1.61E+01	1.61E+01	1.61E+01	1.61E+01	1.84E+01
RB-87	0.00E+00	0.00E+00	0.00E+00	0.00E+00	0.00E+00	0.00E+00	0.00E+00	0.00E+00
RB-88	5.93E-02	5.93E-02	5.93E-02	5.93E-02	5.93E-02	5.93E-02	5.93E-02	6.77E-02
RB-89	2.20E-01	2.20E-01	2.20E-01	2.20E-01	2.20E-01	2.20E-01	2.20E-01	2.64E-01
SR-89	3.88E-02	3.88E-02	3.88E-02	3.88E-02	3.88E-02	3.88E-02	3.88E-02	4.50E-02
SR-90	0.00E+00	0.00E+00	0.00E+00	0.00E+00	0.00E+00	0.00E+00	0.00E+00	0.00E+00
SR-91	3.85E+00	3.85E+00	3.85E+00	3.85E+00	3.85E+00	3.85E+00	3.85E+00	4.50E+00
SR-92	1.39E+00	1.39E+00	1.39E+00	1.39E+00	1.39E+00	1.39E+00	1.39E+00	1.55E+00
Y-90	8.05E-03	8.05E-03	8.05E-03	8.05E-03	8.05E-03	8.05E-03	8.05E-03	9.51E-03
Y-91M	1.80E-01	1.80E-01	1.80E-01	1.80E-01	1.80E-01	1.80E-01	1.80E-01	2.08E-01

TABLE II1-11

ADULT SHORELINE A₁₇ FACTORS

mrem-ml per uCi-hr

NUCLIDE	BONE	LIVER	T BODY	THYROID	KIDNEY	LUNG	GI-LLI	SKIN
Y-91	1.92E+00	1.92E+00	1.92E+00	1.92E+00	1.92E+00	1.92E+00	1.92E+00	2.16E+00
Y-92	3.23E-01	3.23E-01	3.23E-01	3.23E-01	3.23E-01	3.23E-01	3.23E-01	3.84E-01
Y-93	3.29E-01	3.29E-01	3.29E-01	3.29E-01	3.29E-01	3.29E-01	3.29E-01	4.50E-01
ZR-93	0.00E+00	0.00E+00	0.00E+00	0.00E+00	0.00E+00	0.00E+00	0.00E+00	0.00E+00
ZR-95	4.39E+02	4.39E+02	4.39E+02	4.39E+02	4.39E+02	4.39E+02	4.39E+02	5.09E+02
ZR-97	5.31E+00	5.31E+00	5.31E+00	5.31E+00	5.31E+00	5.31E+00	5.31E+00	6.17E+00
NB-93M	4.16E+00	4.16E+00	4.16E+00	4.16E+00	4.16E+00	4.16E+00	4.16E+00	5.08E+02
NB-95	2.45E+02	2.45E+02	2.45E+02	2.45E+02	2.45E+02	2.45E+02	2.45E+02	2.88E+02
NB-97	3.16E-01	3.16E-01	3.16E-01	3.16E-01	3.16E-01	3.16E-01	3.16E-01	3.70E-01
MO-93	1.98E+02	1.98E+02	1.98E+02	1.98E+02	1.98E+02	1.98E+02	1.98E+02	8.06E+03
MO-99	7.16E+00	7.16E+00	7.16E+00	7.16E+00	7.16E+00	7.16E+00	7.16E+00	8.29E+00
TC-99M	3.30E-01	3.30E-01	3.30E-01	3.30E-01	3.30E-01	3.30E-01	3.30E-01	3.78E-01
TC-99	0.00E+00	0.00E+00	0.00E+00	0.00E+00	0.00E+00	0.00E+00	0.00E+00	0.00E+00
TC-101	3.65E-02	3.65E-02	3.65E-02	3.65E-02	3.65E-02	3.65E-02	3.65E-02	4.05E-02
RU-103	1.94E+02	1.94E+02	1.94E+02	1.94E+02	1.94E+02	1.94E+02	1.94E+02	2.26E+02
RU-105	1.14E+00	1.14E+00	1.14E+00	1.14E+00	1.14E+00	1.14E+00	1.14E+00	1.29E+00
RU-106	7.57E+02	7.57E+02	7.57E+02	7.57E+02	7.57E+02	7.57E+02	7.57E+02	9.08E+02
RH-105	1.33E+00	1.33E+00	1.33E+00	1.33E+00	1.33E+00	1.33E+00	1.33E+00	1.55E+00
PD-107	0.00E+00	0.00E+00	0.00E+00	0.00E+00	0.00E+00	0.00E+00	0.00E+00	0.00E+00
PD-109	2.69E-02	2.69E-02	2.69E-02	2.69E-02	2.69E-02	2.69E-02	2.69E-02	3.07E-02
AG-110M	6.16E+03	6.16E+03	6.16E+03	6.16E+03	6.16E+03	6.16E+03	6.16E+03	7.19E+03
AG-111	1.84E+00	1.84E+00	1.84E+00	1.84E+00	1.84E+00	1.84E+00	1.84E+00	2.15E+00
CD-113M	1.13E+01	1.13E+01	1.13E+01	1.13E+01	1.13E+01	1.13E+01	1.13E+01	1.28E+01
CD-115M	0.00E+00	0.00E+00	0.00E+00	0.00E+00	0.00E+00	0.00E+00	0.00E+00	0.00E+00
SN-123	0.00E+00	0.00E+00	0.00E+00	0.00E+00	0.00E+00	0.00E+00	0.00E+00	1.14E+04
SN-125	7.53E+00	7.53E+00	7.53E+00	7.53E+00	7.53E+00	7.53E+00	7.53E+00	8.72E+00
SN-126	7.80E+04	7.80E+04	7.80E+04	7.80E+04	7.80E+04	7.80E+04	7.80E+04	8.67E+04
SB-124	1.07E+03	1.07E+03	1.07E+03	1.07E+03	1.07E+03	1.07E+03	1.07E+03	1.24E+03
SB-125	4.29E+03	4.29E+03	4.29E+03	4.29E+03	4.29E+03	4.29E+03	4.29E+03	4.84E+03
SB-126	1.51E+02	1.51E+02	1.51E+02	1.51E+02	1.51E+02	1.51E+02	1.51E+02	1.70E+02
SB-127	3.01E+01	3.01E+01	3.01E+01	3.01E+01	3.01E+01	3.01E+01	3.01E+01	3.48E+01
TE-125M	2.78E+00	2.78E+00	2.78E+00	2.78E+00	2.78E+00	2.78E+00	2.78E+00	3.81E+00
TE-127M	1.64E-01	1.64E-01	1.64E-01	1.64E-01	1.64E-01	1.64E-01	1.64E-01	1.94E-01
TE-127	5.34E-03	5.34E-03	5.34E-03	5.34E-03	5.34E-03	5.34E-03	5.34E-03	5.87E-03
TE-129M	3.54E+01	3.54E+01	3.54E+01	3.54E+01	3.54E+01	3.54E+01	3.54E+01	4.14E+01
TE-129	4.70E-02	4.70E-02	4.70E-02	4.70E-02	4.70E-02	4.70E-02	4.70E-02	5.56E-02
TE-131M	1.44E+01	1.44E+01	1.44E+01	1.44E+01	1.44E+01	1.44E+01	1.44E+01	1.70E+01
TE-131	5.23E-02	5.23E-02	5.23E-02	5.23E-02	5.23E-02	5.23E-02	5.23E-02	6.18E+01

TABLE II1-11

ADULT SHORELINE A₁₇ FACTORS

mrem-ml per uCi-hr

NUCLIDE	BONE	LIVER	T BODY	THYROID	KIDNEY	LUNG	GI-LLI	SKIN
TE-132	7.59E+00	7.59E+00	7.59E+00	7.59E+00	7.59E+00	7.59E+00	7.59E+00	8.93E+00
TE-133M	7.91E-01	7.91E-01	7.91E-01	7.91E-01	7.91E-01	7.91E-01	7.91E-01	8.96E-01
TE-134	3.98E-02	3.98E-02	3.98E-02	3.98E-02	3.98E-02	3.98E-02	3.98E-02	4.77E-02
I-129	3.90E+03	3.90E+03	3.90E+03	3.90E+03	3.90E+03	3.90E+03	3.90E+03	6.50E+03
I-130	9.88E+00	9.88E+00	9.88E+00	9.88E+00	9.88E+00	9.88E+00	9.88E+00	1.20E+01
I-131	3.08E+01	3.08E+01	3.08E+01	3.08E+01	3.08E+01	3.08E+01	3.08E+01	3.74E+01
I-132	2.23E+00	2.23E+00	2.23E+00	2.23E+00	2.23E+00	2.23E+00	2.23E+00	2.63E+00
I-133	4.39E+00	4.39E+00	4.39E+00	4.39E+00	4.39E+00	4.39E+00	4.39E+00	5.34E+00
I-134	8.01E-01	8.01E-01	8.01E-01	8.01E-01	8.01E-01	8.01E-01	8.01E-01	9.51E-01
I-135	4.53E+00	4.53E+00	4.53E+00	4.53E+00	4.53E+00	4.53E+00	4.53E+00	5.28E+00
CS-134M	1.03E-01	1.03E-01	1.03E-01	1.03E-01	1.03E-01	1.03E-01	1.03E-01	1.21E-01
CS-134	1.24E+04	1.24E+04	1.24E+04	1.24E+04	1.24E+04	1.24E+04	1.24E+04	1.44E+04
CS-135	0.00E+00	0.00E+00	0.00E+00	0.00E+00	0.00E+00	0.00E+00	0.00E+00	0.00E+00
CS-136	2.70E+02	2.70E+02	2.70E+02	2.70E+02	2.70E+02	2.70E+02	2.70E+02	3.06E+02
CS-137	2.77E+04	2.77E+04	2.77E+04	2.77E+04	2.77E+04	2.77E+04	2.77E+04	3.23E+04
CS-138	6.43E-01	6.43E-01	6.43E-01	6.43E-01	6.43E-01	6.43E-01	6.43E-01	7.35E-01
CS-139	5.63E-02	5.63E-02	5.63E-02	5.63E-02	5.63E-02	5.63E-02	5.63E-02	6.44E-02
BA-139	1.90E-01	1.90E-01	1.90E-01	1.90E-01	1.90E-01	1.90E-01	1.90E-01	2.13E-01
BA-140	3.68E+01	3.68E+01	3.68E+01	3.68E+01	3.68E+01	3.68E+01	3.68E+01	4.20E+01
BA-141	7.47E-02	7.47E-02	7.47E-02	7.47E-02	7.47E-02	7.47E-02	7.47E-02	8.52E-02
BA-142	8.04E-02	8.04E-02	8.04E-02	8.04E-02	8.04E-02	8.04E-02	8.04E-02	9.16E-02
LA-140	3.44E+01	3.44E+01	3.44E+01	3.44E+01	3.44E+01	3.44E+01	3.44E+01	3.90E+01
LA-141	5.62E-02	5.62E-02	5.62E-02	5.62E-02	5.62E-02	5.62E-02	5.62E-02	6.30E-02
LA-142	1.36E+00	1.36E+00	1.36E+00	1.36E+00	1.36E+00	1.36E+00	1.36E+00	1.63E+00
CE-141	2.45E+01	2.45E+01	2.45E+01	2.45E+01	2.45E+01	2.45E+01	2.45E+01	2.76E+01
CE-143	4.14E+00	4.14E+00	4.14E+00	4.14E+00	4.14E+00	4.14E+00	4.14E+00	4.71E+00
CE-144	1.25E+02	1.25E+02	1.25E+02	1.25E+02	1.25E+02	1.25E+02	1.25E+02	1.44E+02
PR-143	0.00E+00	0.00E+00	0.00E+00	0.00E+00	0.00E+00	0.00E+00	0.00E+00	0.00E+00
PR-144	3.29E-03	3.29E-03	3.29E-03	3.29E-03	3.29E-03	3.29E-03	3.29E-03	3.78E-03
ND-147	1.50E+01	1.50E+01	1.50E+01	1.50E+01	1.50E+01	1.50E+01	1.50E+01	1.81E+01
PM-147	0.00E+00	0.00E+00	0.00E+00	0.00E+00	0.00E+00	0.00E+00	0.00E+00	0.00E+00
PM-148M	7.98E+02	7.98E+02	7.98E+02	7.98E+02	7.98E+02	7.98E+02	7.98E+02	4.62E+03
PM-148	3.38E+01	3.38E+01	3.38E+01	3.38E+01	3.38E+01	3.38E+01	3.38E+01	3.90E+01
PM-149	7.57E-02	7.57E-02	7.57E-02	7.57E-02	7.57E-02	7.57E-02	7.57E-02	8.79E-02
PM-151	3.57E+00	3.57E+00	3.57E+00	3.57E+00	3.57E+00	3.57E+00	3.57E+00	3.73E+00
SM-151	3.79E+02	3.79E+02	3.79E+02	3.79E+02	3.79E+02	3.79E+02	3.79E+02	1.66E+03
SM-153	7.20E-01	7.20E-01	7.20E-01	7.20E-01	7.20E-01	7.20E-01	7.20E-01	8.00E-01
EU-152	3.61E+04	3.61E+04	3.61E+04	3.61E+04	3.61E+04	3.61E+04	3.61E+04	4.18E+04

TABLE II1-11

ADULT SHORELINE A₁₇ FACTORS

mrem-ml per uCi-hr

NUCLIDE	BONE	LIVER	T BODY	THYROID	KIDNEY	LUNG	GI-LLI	SKIN
EU-154	2.96E+04	2.96E+04	2.96E+04	2.96E+04	2.96E+04	2.96E+04	2.96E+04	3.41E+04
EU-155	9.17E+02	9.17E+02	9.17E+02	9.17E+02	9.17E+02	9.17E+02	9.17E+02	1.04E+03
EU-156	1.58E+02	1.58E+02	1.58E+02	1.58E+02	1.58E+02	1.58E+02	1.58E+02	1.81E+02
TB-160	8.52E+02	8.52E+02	8.52E+02	8.52E+02	8.52E+02	8.52E+02	8.52E+02	9.90E+02
HO-166M	7.66E+04	7.66E+04	7.66E+04	7.66E+04	7.66E+04	7.66E+04	7.66E+04	8.61E+04
W-181	3.48E-01	3.48E-01	3.48E-01	3.48E-01	3.48E-01	3.48E-01	3.48E-01	4.64E-01
W-185	0.00E+00	0.00E+00	0.00E+00	0.00E+00	0.00E+00	0.00E+00	0.00E+00	0.00E+00
W-187	4.22E+00	4.22E+00	4.22E+00	4.22E+00	4.22E+00	4.22E+00	4.22E+00	4.90E+00
U-232	2.00E+01	2.00E+01	2.00E+01	2.00E+01	2.00E+01	2.00E+01	2.00E+01	2.07E+02
U-233	1.99E+04	1.99E+04	1.99E+04	1.99E+04	1.99E+04	1.99E+04	1.99E+04	2.43E+04
U-234	5.48E+00	5.48E+00	5.48E+00	5.48E+00	5.48E+00	5.48E+00	5.48E+00	1.38E+03
U-235	2.77E+04	2.77E+04	2.77E+04	2.77E+04	2.77E+04	2.77E+04	2.77E+04	3.47E+04
U-236	1.82E-01	1.82E-01	1.82E-01	1.82E-01	1.82E-01	1.82E-01	1.82E-01	1.56E+02
U-237	9.25E+00	9.25E+00	9.25E+00	9.25E+00	9.25E+00	9.25E+00	9.25E+00	1.20E+01
U-238	9.54E+02	9.54E+02	9.54E+02	9.54E+02	9.54E+02	9.54E+02	9.54E+02	1.30E+03
NP-237	1.21E+04	1.21E+04	1.21E+04	1.21E+04	1.21E+04	1.21E+04	1.21E+04	1.39E+04
NP-238	8.12E+00	8.12E+00	8.12E+00	8.12E+00	8.12E+00	8.12E+00	8.12E+00	9.28E+00
NP-239	3.06E+00	3.06E+00	3.06E+00	3.06E+00	3.06E+00	3.06E+00	3.06E+00	3.55E+00
PU-238	1.02E+01	1.02E+01	1.02E+01	1.02E+01	1.02E+01	1.02E+01	1.02E+01	1.42E+02
PU-239	6.85E+00	6.85E+00	6.85E+00	6.85E+00	6.85E+00	6.85E+00	6.85E+00	6.67E+01
PU-240	1.13E+01	1.13E+01	1.13E+01	1.13E+01	1.13E+01	1.13E+01	1.13E+01	1.56E+02
PU-241	2.32E+01	2.32E+01	2.32E+01	2.32E+01	2.32E+01	2.32E+01	2.32E+01	3.43E+01
PU-242	9.54E+00	9.54E+00	9.54E+00	9.54E+00	9.54E+00	9.54E+00	9.54E+00	1.39E+02
PU-244	7.76E+03	7.76E+03	7.76E+03	7.76E+03	7.76E+03	7.76E+03	7.76E+03	8.34E+03
AM-241	1.53E+03	1.53E+03	1.53E+03	1.53E+03	1.53E+03	1.53E+03	1.53E+03	2.21E+03
AM-242M	2.13E+02	2.13E+02	2.13E+02	2.13E+02	2.13E+02	2.13E+02	2.13E+02	1.48E+03
AM-243	1.13E+04	1.13E+04	1.13E+04	1.13E+04	1.13E+04	1.13E+04	1.13E+04	1.30E+04
CM-242	1.23E+00	1.23E+00	1.23E+00	1.23E+00	1.23E+00	1.23E+00	1.23E+00	5.14E+00
CM-243	1.49E+04	1.49E+04	1.49E+04	1.49E+04	1.49E+04	1.49E+04	1.49E+04	1.88E+04
CM-244	1.62E+01	1.62E+01	1.62E+01	1.62E+01	1.62E+01	1.62E+01	1.62E+01	1.00E+02
CM-245	8.23E+03	8.23E+03	8.23E+03	8.23E+03	8.23E+03	8.23E+03	8.23E+03	1.04E+04
CM-246	8.65E+00	8.65E+00	8.65E+00	8.65E+00	8.65E+00	8.65E+00	8.65E+00	1.30E+02
CM-247	1.91E+04	1.91E+04	1.91E+04	1.91E+04	1.91E+04	1.91E+04	1.91E+04	2.25E+04
CM-248	4.53E+04	4.53E+04	4.53E+04	4.53E+04	4.53E+04	4.53E+04	4.53E+04	5.90E+04
CF-252	8.70E+04	8.70E+04	8.70E+04	8.70E+04	8.70E+04	8.70E+04	8.70E+04	9.49E+04

TABLE II1-12

TEEN DRINKING WATER A₁₇ FACTORS

mrem-ml per uCi-hr

NUCLIDE	BONE	LIVER	T BODY	THYROID	KIDNEY	LUNG	GI-LLI	SKIN
H-3	0.00E+00	3.52E+00	3.52E+00	3.52E+00	3.52E+00	3.52E+00	3.52E+00	0.00E+00
C-14	2.36E+02	4.73E+01	4.73E+01	4.73E+01	4.73E+01	4.73E+01	4.73E+01	0.00E+00
NA-22	1.36E+03	1.36E+03	1.36E+03	1.36E+03	1.36E+03	1.36E+03	1.36E+03	0.00E+00
NA-24	7.69E+01	7.69E+01	7.69E+01	7.69E+01	7.69E+01	7.69E+01	7.69E+01	0.00E+00
P-32	1.57E+04	9.72E+02	6.08E+02	0.00E+00	0.00E+00	0.00E+00	1.32E+03	0.00E+00
CA-41	1.15E+04	0.00E+00	1.24E+03	0.00E+00	0.00E+00	0.00E+00	1.14E+01	0.00E+00
SC-46	4.20E-01	8.18E-01	2.42E-01	0.00E+00	7.83E-01	0.00E+00	2.78E+03	0.00E+00
CR-51	0.00E+00	0.00E+00	2.07E-01	1.15E-01	4.54E-02	2.96E-01	3.48E+01	0.00E+00
MN-54	0.00E+00	3.43E+02	6.80E+01	0.00E+00	1.02E+02	0.00E+00	7.04E+02	0.00E+00
MN-56	0.00E+00	3.65E-01	6.50E-02	0.00E+00	4.63E-01	0.00E+00	2.41E+01	0.00E+00
FE-55	2.20E+02	1.56E+02	3.64E+01	0.00E+00	0.00E+00	9.89E+01	6.75E+01	0.00E+00
FE-59	3.39E+02	7.91E+02	3.06E+02	0.00E+00	0.00E+00	2.50E+02	1.87E+03	0.00E+00
CO-57	0.00E+00	1.38E+01	2.32E+01	0.00E+00	0.00E+00	0.00E+00	2.58E+02	0.00E+00
CO-58	0.00E+00	5.63E+01	1.30E+02	0.00E+00	0.00E+00	0.00E+00	7.76E+02	0.00E+00
CO-60	0.00E+00	1.64E+02	3.68E+02	0.00E+00	0.00E+00	0.00E+00	2.13E+03	0.00E+00
NI-59	7.68E+02	2.71E+02	1.30E+02	0.00E+00	0.00E+00	0.00E+00	4.26E+01	0.00E+00
NI-63	1.03E+04	7.28E+02	3.49E+02	0.00E+00	0.00E+00	0.00E+00	1.16E+02	0.00E+00
NI-65	1.61E+00	2.05E-01	9.36E-02	0.00E+00	0.00E+00	0.00E+00	1.11E+01	0.00E+00
CU-64	0.00E+00	3.48E+00	1.64E+00	0.00E+00	8.80E+00	0.00E+00	2.70E+02	0.00E+00
ZN-65	3.35E+02	1.16E+03	5.42E+02	0.00E+00	7.44E+02	0.00E+00	4.92E+02	0.00E+00
ZN-69M	7.63E+00	1.80E+01	1.65E+00	0.00E+00	1.09E+01	0.00E+00	9.89E+02	0.00E+00
ZN-69	1.08E-04	2.06E-04	1.44E-05	0.00E+00	1.35E-04	0.00E+00	3.80E-04	0.00E+00
SE-79	0.00E+00	2.17E+02	3.65E+01	0.00E+00	3.78E+02	0.00E+00	3.32E+01	0.00E+00
BR-82	0.00E+00	0.00E+00	1.40E+02	0.00E+00	0.00E+00	0.00E+00	0.00E+00	0.00E+00
BR-83	0.00E+00	0.00E+00	1.03E-01	0.00E+00	0.00E+00	0.00E+00	0.00E+00	0.00E+00
BR-84	0.00E+00	0.00E+00	6.42E-07	0.00E+00	0.00E+00	0.00E+00	0.00E+00	0.00E+00
BR-85	0.00E+00	0.00E+00	4.38E-77	0.00E+00	0.00E+00	0.00E+00	0.00E+00	0.00E+00
RB-86	0.00E+00	1.70E+03	8.00E+02	0.00E+00	0.00E+00	0.00E+00	2.52E+02	0.00E+00
RB-87	0.00E+00	1.02E+03	3.56E+02	0.00E+00	0.00E+00	0.00E+00	3.56E+01	0.00E+00
RB-88	0.00E+00	3.30E-12	1.76E-12	0.00E+00	0.00E+00	0.00E+00	2.83E-19	0.00E+00
RB-89	0.00E+00	2.94E-14	2.08E-14	0.00E+00	0.00E+00	0.00E+00	4.50E-23	0.00E+00
SR-89	2.54E+04	0.00E+00	7.29E+02	0.00E+00	0.00E+00	0.00E+00	3.03E+03	0.00E+00
SR-90	5.94E+05	0.00E+00	1.19E+04	0.00E+00	0.00E+00	0.00E+00	1.36E+04	0.00E+00
SR-91	1.96E+02	0.00E+00	7.79E+00	0.00E+00	0.00E+00	0.00E+00	8.88E+02	0.00E+00
SR-92	8.25E+00	0.00E+00	3.52E-01	0.00E+00	0.00E+00	0.00E+00	2.10E+02	0.00E+00
Y-90	7.01E-01	0.00E+00	1.89E-02	0.00E+00	0.00E+00	0.00E+00	5.78E+03	0.00E+00
Y-91M	3.28E-07	0.00E+00	1.25E-08	0.00E+00	0.00E+00	0.00E+00	1.55E-05	0.00E+00

TABLE II1-12

TEEN DRINKING WATER A₁₇ FACTORS

mrem-ml per uCi-hr

NUCLIDE	BONE	LIVER	T BODY	THYROID	KIDNEY	LUNG	GI-LLI	SKIN
Y-91	1.16E+01	0.00E+00	3.12E-01	0.00E+00	0.00E+00	0.00E+00	4.77E+03	0.00E+00
Y-92	6.72E-03	0.00E+00	1.94E-04	0.00E+00	0.00E+00	0.00E+00	1.84E+02	0.00E+00
Y-93	9.79E-02	0.00E+00	2.68E-03	0.00E+00	0.00E+00	0.00E+00	2.99E+03	0.00E+00
ZR-93	3.22E+00	1.59E-01	8.67E-02	0.00E+00	5.62E-01	0.00E+00	1.50E+02	0.00E+00
ZR-95	2.39E+00	7.53E-01	5.18E-01	0.00E+00	1.11E+00	0.00E+00	1.74E+03	0.00E+00
ZR-97	8.43E-02	1.67E-02	7.69E-03	0.00E+00	2.53E-02	0.00E+00	4.52E+03	0.00E+00
NB-93M	2.00E+00	6.58E-01	1.65E-01	0.00E+00	7.68E-01	0.00E+00	2.37E+02	0.00E+00
NB-95	4.74E-01	2.63E-01	1.45E-01	0.00E+00	2.55E-01	0.00E+00	1.12E+03	0.00E+00
NB-97	4.23E-06	1.05E-06	3.83E-07	0.00E+00	1.23E-06	0.00E+00	2.51E-02	0.00E+00
MO-93	0.00E+00	6.17E+02	1.69E+01	0.00E+00	1.77E+02	0.00E+00	7.51E+01	0.00E+00
MO-99	0.00E+00	3.10E+02	5.90E+01	0.00E+00	7.08E+02	0.00E+00	5.54E+02	0.00E+00
TC-99M	4.85E-03	1.35E-02	1.75E-01	0.00E+00	2.02E-01	7.52E-03	8.89E+00	0.00E+00
TC-99	1.04E+01	1.53E+01	4.17E+00	0.00E+00	1.94E+02	1.58E+00	3.75E+02	0.00E+00
TC-101	1.14E-17	1.62E-17	1.60E-16	0.00E+00	2.94E-16	9.90E-18	2.78E-24	0.00E+00
RU-103	1.47E+01	0.00E+00	6.29E+00	0.00E+00	5.19E+01	0.00E+00	1.23E+03	0.00E+00
RU-105	1.95E-01	0.00E+00	7.57E-02	0.00E+00	2.46E+00	0.00E+00	1.57E+02	0.00E+00
RU-106	2.28E+02	0.00E+00	2.87E+01	0.00E+00	4.40E+02	0.00E+00	1.09E+04	0.00E+00
RH-105	7.96E+00	5.75E+00	3.77E+00	0.00E+00	2.44E+01	0.00E+00	7.32E+02	0.00E+00
PD-107	0.00E+00	1.21E+01	7.80E-01	0.00E+00	1.09E+02	0.00E+00	5.62E+01	0.00E+00
PD-109	0.00E+00	7.87E+00	1.79E+00	0.00E+00	4.55E+01	0.00E+00	7.94E+02	0.00E+00
AG-110M	1.19E+01	1.13E+01	6.86E+00	0.00E+00	2.15E+01	0.00E+00	3.17E+03	0.00E+00
AG-111	4.61E+00	1.91E+00	9.61E-01	0.00E+00	6.22E+00	0.00E+00	2.67E+03	0.00E+00
CD-113M	0.00E+00	2.63E+02	8.44E+00	0.00E+00	2.90E+02	0.00E+00	1.58E+03	0.00E+00
CD-115M	0.00E+00	1.50E+02	4.85E+00	0.00E+00	1.20E+02	0.00E+00	4.75E+03	0.00E+00
SN-123	2.58E+03	4.23E+01	6.27E+01	3.39E+01	0.00E+00	0.00E+00	3.90E+03	0.00E+00
SN-125	6.68E+02	1.33E+01	3.02E+01	1.04E+01	0.00E+00	0.00E+00	6.29E+03	0.00E+00
SN-126	6.75E+03	1.26E+02	1.92E+02	3.31E+01	0.00E+00	0.00E+00	1.50E+03	0.00E+00
SB-124	2.24E+02	4.13E+00	8.74E+01	5.08E-01	0.00E+00	1.96E+02	4.52E+03	0.00E+00
SB-125	1.44E+02	1.58E+00	3.38E+01	1.38E-01	0.00E+00	1.27E+02	1.12E+03	0.00E+00
SB-126	9.00E+01	1.84E+00	3.23E+01	5.09E-01	0.00E+00	6.45E+01	5.33E+03	0.00E+00
SB-127	1.93E+01	4.13E-01	7.29E+00	2.17E-01	0.00E+00	1.31E+01	3.28E+03	0.00E+00
TE-125M	2.22E+02	7.99E+01	2.96E+01	6.19E+01	0.00E+00	0.00E+00	6.54E+02	0.00E+00
TE-127M	5.61E+02	1.99E+02	6.67E+01	1.33E+02	2.27E+03	0.00E+00	1.40E+03	0.00E+00
TE-127	3.78E+00	1.34E+00	8.13E-01	2.61E+00	1.53E+01	0.00E+00	2.92E+02	0.00E+00
TE-129M	9.39E+02	3.49E+02	1.49E+02	3.03E+02	3.93E+03	0.00E+00	3.53E+03	0.00E+00
TE-129	2.01E-03	7.48E-04	4.88E-04	1.43E-03	8.42E-03	0.00E+00	1.10E-02	0.00E+00
TE-131M	1.08E+02	5.16E+01	4.31E+01	7.77E+01	5.38E+02	0.00E+00	4.14E+03	0.00E+00
TE-131	3.48E-09	1.43E-09	1.09E-09	2.68E-09	1.52E-08	0.00E+00	2.85E-10	0.00E+00

TABLE II1-12

TEEN DRINKING WATER A₁₇ FACTORS

mrem-ml per uCi-hr

NUCLIDE	BONE	LIVER	T BODY	THYROID	KIDNEY	LUNG	GI-LLI	SKIN
TE-132	1.83E+02	1.16E+02	1.09E+02	1.22E+02	1.11E+03	0.00E+00	3.66E+03	0.00E+00
TE-133M	4.59E-04	2.61E-04	2.54E-04	3.64E-04	2.58E-03	0.00E+00	1.05E-03	0.00E+00
TE-134	1.70E-05	1.09E-05	1.14E-05	1.39E-05	1.04E-04	0.00E+00	6.31E-07	0.00E+00
I-129	2.71E+02	2.28E+02	3.81E+02	2.78E+05	4.08E+02	0.00E+00	2.66E+01	0.00E+00
I-130	3.06E+01	8.85E+01	3.53E+01	7.22E+03	1.36E+02	0.00E+00	6.80E+01	0.00E+00
I-131	3.26E+02	4.57E+02	2.45E+02	1.33E+05	7.86E+02	0.00E+00	9.03E+01	0.00E+00
I-132	4.37E-01	1.14E+00	4.10E-01	3.85E+01	1.80E+00	0.00E+00	4.98E-01	0.00E+00
I-133	7.84E+01	1.33E+02	4.06E+01	1.86E+04	2.33E+02	0.00E+00	1.01E+02	0.00E+00
I-134	6.44E-04	1.71E-03	6.13E-04	2.84E-02	2.69E-03	0.00E+00	2.25E-05	0.00E+00
I-135	1.01E+01	2.60E+01	9.63E+00	1.67E+03	4.10E+01	0.00E+00	2.88E+01	0.00E+00
CS-134M	9.72E-02	2.01E-01	1.04E-01	0.00E+00	1.12E-01	1.97E-02	1.34E-01	0.00E+00
CS-134	4.87E+03	1.15E+04	5.32E+03	0.00E+00	3.64E+03	1.39E+03	1.43E+02	0.00E+00
CS-135	1.62E+03	1.48E+03	3.47E+02	0.00E+00	5.66E+02	2.05E+02	2.60E+01	0.00E+00
CS-136	4.87E+02	1.92E+03	1.29E+03	0.00E+00	1.04E+03	1.64E+02	1.54E+02	0.00E+00
CS-137	6.52E+03	8.67E+03	3.02E+03	0.00E+00	2.95E+03	1.15E+03	1.23E+02	0.00E+00
CS-138	8.39E-07	1.61E-06	8.06E-07	0.00E+00	1.19E-06	1.38E-07	7.31E-10	0.00E+00
CS-139	2.48E-23	3.66E-23	1.34E-23	0.00E+00	2.95E-23	3.23E-24	1.70E-38	0.00E+00
BA-139	1.99E-02	1.40E-05	5.81E-04	0.00E+00	1.32E-05	9.67E-06	1.78E-01	0.00E+00
BA-140	1.61E+03	1.97E+00	1.04E+02	0.00E+00	6.69E-01	1.33E+00	2.48E+03	0.00E+00
BA-141	5.35E-12	4.00E-15	1.79E-13	0.00E+00	3.71E-15	2.74E-15	1.14E-17	0.00E+00
BA-142	9.65E-21	9.65E-24	5.94E-22	0.00E+00	8.17E-24	6.42E-24	2.96E-32	0.00E+00
LA-140	1.65E-01	8.10E-02	2.15E-02	0.00E+00	0.00E+00	0.00E+00	4.65E+03	0.00E+00
LA-141	3.21E-03	9.87E-04	1.63E-04	0.00E+00	0.00E+00	0.00E+00	1.75E+02	0.00E+00
LA-142	5.57E-05	2.47E-05	6.16E-06	0.00E+00	0.00E+00	0.00E+00	7.53E-01	0.00E+00
CE-141	7.66E-01	5.12E-01	5.88E-02	0.00E+00	2.41E-01	0.00E+00	1.46E+03	0.00E+00
CE-143	1.06E-01	7.74E+01	8.64E-03	0.00E+00	3.47E-02	0.00E+00	2.33E+03	0.00E+00
CE-144	4.05E+01	1.67E+01	2.17E+00	0.00E+00	1.00E+01	0.00E+00	1.02E+04	0.00E+00
PR-143	7.43E-01	2.97E-01	3.70E-02	0.00E+00	1.73E-01	0.00E+00	2.45E+03	0.00E+00
PR-144	7.17E-16	2.94E-16	3.64E-17	0.00E+00	1.68E-16	0.00E+00	7.91E-19	0.00E+00
ND-147	5.29E-01	5.75E-01	3.45E-02	0.00E+00	3.38E-01	0.00E+00	2.08E+03	0.00E+00
PM-147	6.11E+00	5.80E-01	2.36E-01	0.00E+00	1.11E+00	0.00E+00	5.51E+02	0.00E+00
PM-148M	2.39E+00	6.06E-01	4.74E-01	0.00E+00	9.18E-01	0.00E+00	3.82E+03	0.00E+00
PM-148	5.57E-01	9.06E-02	4.56E-02	0.00E+00	1.64E-01	0.00E+00	5.40E+03	0.00E+00
PM-149	1.08E-01	1.52E-02	6.22E-03	0.00E+00	2.89E-02	0.00E+00	2.23E+03	0.00E+00
PM-151	4.29E-02	7.08E-03	3.58E-03	0.00E+00	1.27E-02	0.00E+00	1.59E+03	0.00E+00
SM-151	5.08E+00	9.78E-01	2.29E-01	0.00E+00	1.07E+00	0.00E+00	3.32E+02	0.00E+00
SM-153	5.94E-02	4.92E-02	3.62E-03	0.00E+00	1.61E-02	0.00E+00	1.39E+03	0.00E+00
EU-152	1.43E+01	3.43E+00	3.03E+00	0.00E+00	1.60E+01	0.00E+00	1.26E+03	0.00E+00

TABLE II1-12

TEEN DRINKING WATER A₁₇ FACTORS

mrem-ml per uCi-hr

NUCLIDE	BONE	LIVER	T BODY	THYROID	KIDNEY	LUNG	GI-LLI	SKIN
EU-154	4.60E+01	5.94E+00	4.19E+00	0.00E+00	2.65E+01	0.00E+00	3.14E+03	0.00E+00
EU-155	1.01E+01	9.78E-01	6.05E-01	0.00E+00	3.82E+00	0.00E+00	5.61E+03	0.00E+00
EU-156	1.09E+00	8.19E-01	1.34E-01	0.00E+00	5.51E-01	0.00E+00	4.19E+03	0.00E+00
TB-160	3.75E+00	0.00E+00	4.68E-01	0.00E+00	1.48E+00	0.00E+00	2.43E+03	0.00E+00
HO-166M	2.08E+01	6.40E+00	4.63E+00	0.00E+00	9.37E+00	0.00E+00	1.58E+03	0.00E+00
W-181	8.24E-01	2.66E-01	2.78E-02	0.00E+00	0.00E+00	0.00E+00	2.26E+01	0.00E+00
W-185	3.36E+01	1.11E+01	1.17E+00	0.00E+00	0.00E+00	0.00E+00	9.56E+02	0.00E+00
W-187	6.00E+00	4.89E+00	1.71E+00	0.00E+00	0.00E+00	0.00E+00	1.32E+03	0.00E+00
U-232	3.43E+05	0.00E+00	2.45E+04	0.00E+00	3.71E+04	0.00E+00	4.19E+03	0.00E+00
U-233	7.22E+04	0.00E+00	4.39E+03	0.00E+00	1.69E+04	0.00E+00	3.87E+03	0.00E+00
U-234	6.93E+04	0.00E+00	4.30E+03	0.00E+00	1.66E+04	0.00E+00	3.79E+03	0.00E+00
U-235	6.64E+04	0.00E+00	4.04E+03	0.00E+00	1.55E+04	0.00E+00	4.82E+03	0.00E+00
U-236	6.64E+04	0.00E+00	4.13E+03	0.00E+00	1.59E+04	0.00E+00	3.56E+03	0.00E+00
U-237	4.36E+00	0.00E+00	1.16E+00	0.00E+00	1.79E+01	0.00E+00	1.16E+03	0.00E+00
U-238	6.35E+04	0.00E+00	3.78E+03	0.00E+00	1.46E+04	0.00E+00	3.39E+03	0.00E+00
NP-237	7.74E+04	5.56E+03	3.41E+03	0.00E+00	2.52E+04	0.00E+00	4.90E+03	0.00E+00
NP-238	9.64E-01	2.58E-02	1.50E-02	0.00E+00	8.85E-02	0.00E+00	1.89E+03	0.00E+00
NP-239	8.84E-02	8.34E-03	4.63E-03	0.00E+00	2.62E-02	0.00E+00	1.34E+03	0.00E+00
PU-238	3.90E+04	5.00E+03	1.06E+03	0.00E+00	4.54E+03	0.00E+00	4.50E+03	0.00E+00
PU-239	4.45E+04	5.41E+03	1.17E+03	0.00E+00	4.99E+03	0.00E+00	4.11E+03	0.00E+00
PU-240	4.45E+04	5.40E+03	1.17E+03	0.00E+00	4.98E+03	0.00E+00	4.19E+03	0.00E+00
PU-241	1.02E+03	4.89E+01	2.15E+01	0.00E+00	9.95E+01	0.00E+00	8.62E+01	0.00E+00
PU-242	4.13E+04	5.20E+03	1.13E+03	0.00E+00	4.80E+03	0.00E+00	4.03E+03	0.00E+00
PU-244	4.82E+04	5.94E+03	1.29E+03	0.00E+00	5.50E+03	0.00E+00	6.00E+03	0.00E+00
AM-241	4.65E+04	4.38E+04	3.35E+03	0.00E+00	2.51E+04	0.00E+00	4.58E+03	0.00E+00
AM-242M	4.70E+04	4.14E+04	3.38E+03	0.00E+00	2.50E+04	0.00E+00	5.76E+03	0.00E+00
AM-243	4.63E+04	4.28E+04	3.27E+03	0.00E+00	2.46E+04	0.00E+00	5.37E+03	0.00E+00
CM-242	1.71E+03	1.80E+03	1.13E+02	0.00E+00	5.16E+02	0.00E+00	4.88E+03	0.00E+00
CM-243	3.78E+04	3.51E+04	2.38E+03	0.00E+00	1.11E+04	0.00E+00	4.82E+03	0.00E+00
CM-244	2.93E+04	2.78E+04	1.86E+03	0.00E+00	8.67E+03	0.00E+00	4.66E+03	0.00E+00
CM-245	5.76E+04	5.07E+04	3.55E+03	0.00E+00	1.66E+04	0.00E+00	4.34E+03	0.00E+00
CM-246	5.72E+04	5.07E+04	3.55E+03	0.00E+00	1.65E+04	0.00E+00	4.27E+03	0.00E+00
CM-247	5.57E+04	4.99E+04	3.49E+03	0.00E+00	1.63E+04	0.00E+00	5.61E+03	0.00E+00
CM-248	4.63E+05	4.11E+05	2.88E+04	0.00E+00	1.34E+05	0.00E+00	9.02E+04	0.00E+00
CF-252	2.02E+04	0.00E+00	4.87E+02	0.00E+00	0.00E+00	0.00E+00	1.78E+04	0.00E+00

TABLE II1-13

TEEN FRESHWATER FISH A_{IT} FACTORS

mrem-ml per uCi-hr

NUCLIDE	BONE	LIVER	T BODY	THYROID	KIDNEY	LUNG	GI-LLI	SKIN
H-3	0.00E+00	9.93E-02	9.93E-02	9.93E-02	9.93E-02	9.93E-02	9.93E-02	0.00E+00
C-14	3.41E+04	6.82E+03	6.82E+03	6.82E+03	6.82E+03	6.82E+03	6.82E+03	0.00E+00
NA-22	4.27E+03	4.27E+03	4.27E+03	4.27E+03	4.27E+03	4.27E+03	4.27E+03	0.00E+00
NA-24	1.39E+02	1.39E+02	1.39E+02	1.39E+02	1.39E+02	1.39E+02	1.39E+02	0.00E+00
P-32	1.44E+06	8.93E+04	5.59E+04	0.00E+00	0.00E+00	0.00E+00	1.21E+05	0.00E+00
CA-41	1.44E+04	0.00E+00	1.56E+03	0.00E+00	0.00E+00	0.00E+00	1.42E+01	0.00E+00
SC-46	2.62E-02	5.11E-02	1.51E-02	0.00E+00	4.89E-02	0.00E+00	1.74E+02	0.00E+00
CR-51	0.00E+00	0.00E+00	1.28E+00	7.13E-01	2.81E-01	1.83E+00	2.16E+02	0.00E+00
MN-54	0.00E+00	4.30E+03	8.53E+02	0.00E+00	1.28E+03	0.00E+00	8.82E+03	0.00E+00
MN-56	0.00E+00	1.82E-01	3.24E-02	0.00E+00	2.31E-01	0.00E+00	1.20E+01	0.00E+00
FE-55	6.90E+02	4.89E+02	1.14E+02	0.00E+00	0.00E+00	3.10E+02	2.12E+02	0.00E+00
FE-59	1.06E+03	2.46E+03	9.51E+02	0.00E+00	0.00E+00	7.77E+02	5.83E+03	0.00E+00
CO-57	0.00E+00	2.17E+01	3.63E+01	0.00E+00	0.00E+00	0.00E+00	4.04E+02	0.00E+00
CO-58	0.00E+00	8.79E+01	2.03E+02	0.00E+00	0.00E+00	0.00E+00	1.21E+03	0.00E+00
CO-60	0.00E+00	2.57E+02	5.78E+02	0.00E+00	0.00E+00	0.00E+00	3.34E+03	0.00E+00
NI-59	2.41E+03	8.51E+02	4.09E+02	0.00E+00	0.00E+00	0.00E+00	1.34E+02	0.00E+00
NI-63	3.23E+04	2.28E+03	1.10E+03	0.00E+00	0.00E+00	0.00E+00	3.63E+02	0.00E+00
NI-65	1.86E-01	2.37E-02	1.08E-02	0.00E+00	0.00E+00	0.00E+00	1.29E+00	0.00E+00
CU-64	0.00E+00	2.83E+00	1.33E+00	0.00E+00	7.17E+00	0.00E+00	2.20E+02	0.00E+00
ZN-65	2.10E+04	7.29E+04	3.40E+04	0.00E+00	4.66E+04	0.00E+00	3.09E+04	0.00E+00
ZN-69M	2.62E+02	6.17E+02	5.66E+01	0.00E+00	3.75E+02	0.00E+00	3.39E+04	0.00E+00
ZN-69	8.58E-07	1.63E-06	1.14E-07	0.00E+00	1.07E-06	0.00E+00	3.01E-06	0.00E+00
SE-79	0.00E+00	1.16E+03	1.95E+02	0.00E+00	2.02E+03	0.00E+00	1.77E+02	0.00E+00
BR-82	0.00E+00	0.00E+00	1.46E+03	0.00E+00	0.00E+00	0.00E+00	0.00E+00	0.00E+00
BR-83	0.00E+00	0.00E+00	4.18E-02	0.00E+00	0.00E+00	0.00E+00	0.00E+00	0.00E+00
BR-84	0.00E+00	0.00E+00	1.29E-12	0.00E+00	0.00E+00	0.00E+00	0.00E+00	0.00E+00
BR-85	0.00E+00	0.00E+00	1.43E-151	0.00E+00	0.00E+00	0.00E+00	0.00E+00	0.00E+00
RB-86	0.00E+00	1.05E+05	4.93E+04	0.00E+00	0.00E+00	0.00E+00	1.55E+04	0.00E+00
RB-87	0.00E+00	6.39E+04	2.23E+04	0.00E+00	0.00E+00	0.00E+00	2.23E+03	0.00E+00
RB-88	0.00E+00	1.38E-22	7.36E-23	0.00E+00	0.00E+00	0.00E+00	1.18E-29	0.00E+00
RB-89	0.00E+00	1.69E-26	1.19E-26	0.00E+00	0.00E+00	0.00E+00	2.59E-35	0.00E+00
SR-89	2.38E+04	0.00E+00	6.81E+02	0.00E+00	0.00E+00	0.00E+00	2.83E+03	0.00E+00
SR-90	5.59E+05	0.00E+00	1.12E+04	0.00E+00	0.00E+00	0.00E+00	1.28E+04	0.00E+00
SR-91	7.68E+01	0.00E+00	3.05E+00	0.00E+00	0.00E+00	0.00E+00	3.48E+02	0.00E+00
SR-92	3.61E-01	0.00E+00	1.54E-02	0.00E+00	0.00E+00	0.00E+00	9.19E+00	0.00E+00
Y-90	4.83E-01	0.00E+00	1.30E-02	0.00E+00	0.00E+00	0.00E+00	3.98E+03	0.00E+00
Y-91M	1.12E-11	0.00E+00	4.29E-13	0.00E+00	0.00E+00	0.00E+00	5.30E-10	0.00E+00

TABLE II1-13

TEEN FRESHWATER FISH A₁₇ FACTORS

mrem-ml per uCi-hr

NUCLIDE	BONE	LIVER	T BODY	THYROID	KIDNEY	LUNG	GI-LLI	SKIN
Y-91	9.07E+00	0.00E+00	2.43E-01	0.00E+00	0.00E+00	0.00E+00	3.72E+03	0.00E+00
Y-92	5.03E-04	0.00E+00	1.45E-05	0.00E+00	0.00E+00	0.00E+00	1.38E+01	0.00E+00
Y-93	3.37E-02	0.00E+00	9.23E-04	0.00E+00	0.00E+00	0.00E+00	1.03E+03	0.00E+00
ZR-93	3.33E-01	1.65E-02	8.98E-03	0.00E+00	5.82E-02	0.00E+00	1.56E+01	0.00E+00
ZR-95	2.46E-01	7.75E-02	5.33E-02	0.00E+00	1.14E-01	0.00E+00	1.79E+02	0.00E+00
ZR-97	5.34E-03	1.06E-03	4.87E-04	0.00E+00	1.60E-03	0.00E+00	2.86E+02	0.00E+00
NB-93M	1.88E+03	6.19E+02	1.55E+02	0.00E+00	7.23E+02	0.00E+00	2.23E+05	0.00E+00
NB-95	4.42E+02	2.45E+02	1.35E+02	0.00E+00	2.37E+02	0.00E+00	1.05E+06	0.00E+00
NB-97	3.93E-06	9.75E-07	3.56E-07	0.00E+00	1.14E-06	0.00E+00	2.33E-02	0.00E+00
MO-93	0.00E+00	1.94E+02	5.30E+00	0.00E+00	5.55E+01	0.00E+00	2.36E+01	0.00E+00
MO-99	0.00E+00	8.56E+01	1.63E+01	0.00E+00	1.96E+02	0.00E+00	1.53E+02	0.00E+00
TC-99M	5.74E-04	1.60E-03	2.07E-02	0.00E+00	2.38E-02	8.88E-04	1.05E+00	0.00E+00
TC-99	4.90E+00	7.21E+00	1.96E+00	0.00E+00	9.15E+01	7.45E-01	1.76E+02	0.00E+00
TC-101	2.93E-33	4.17E-33	4.10E-32	0.00E+00	7.54E-32	2.54E-33	7.12E-40	0.00E+00
RU-103	4.58E+00	0.00E+00	1.96E+00	0.00E+00	1.61E+01	0.00E+00	3.82E+02	0.00E+00
RU-105	9.39E-03	0.00E+00	3.65E-03	0.00E+00	1.19E-01	0.00E+00	7.58E+00	0.00E+00
RU-106	7.15E+01	0.00E+00	9.01E+00	0.00E+00	1.38E+02	0.00E+00	3.43E+03	0.00E+00
RH-105	1.97E+00	1.43E+00	9.36E-01	0.00E+00	6.06E+00	0.00E+00	1.81E+02	0.00E+00
PD-107	0.00E+00	3.80E+00	2.45E-01	0.00E+00	3.43E+01	0.00E+00	1.76E+01	0.00E+00
PD-109	0.00E+00	1.33E+00	3.02E-01	0.00E+00	7.69E+00	0.00E+00	1.34E+02	0.00E+00
AG-110M	8.59E-01	8.13E-01	4.94E-01	0.00E+00	1.55E+00	0.00E+00	2.28E+02	0.00E+00
AG-111	3.17E-01	1.32E-01	6.62E-02	0.00E+00	4.29E-01	0.00E+00	1.84E+02	0.00E+00
CD-113M	0.00E+00	1.65E+03	5.30E+01	0.00E+00	1.82E+03	0.00E+00	9.90E+03	0.00E+00
CD-115M	0.00E+00	9.35E+02	3.02E+01	0.00E+00	7.48E+02	0.00E+00	2.96E+04	0.00E+00
SN-123	2.42E+05	3.97E+03	5.89E+03	3.18E+03	0.00E+00	0.00E+00	3.66E+05	0.00E+00
SN-125	6.07E+04	1.21E+03	2.74E+03	9.48E+02	0.00E+00	0.00E+00	5.71E+05	0.00E+00
SN-126	6.36E+05	1.18E+04	1.81E+04	3.12E+03	0.00E+00	0.00E+00	1.41E+05	0.00E+00
SB-124	6.99E+00	1.29E-01	2.73E+00	1.59E-02	0.00E+00	6.10E+00	1.41E+02	0.00E+00
SB-125	4.53E+00	4.95E-02	1.06E+00	4.33E-03	0.00E+00	3.98E+00	3.52E+01	0.00E+00
SB-126	2.75E+00	5.61E-02	9.86E-01	1.55E-02	0.00E+00	1.97E+00	1.63E+02	0.00E+00
SB-127	5.54E-01	1.18E-02	2.09E-01	6.22E-03	0.00E+00	3.77E-01	9.40E+01	0.00E+00
TE-125M	2.76E+03	9.96E+02	3.70E+02	7.72E+02	0.00E+00	0.00E+00	8.16E+03	0.00E+00
TE-127M	7.02E+03	2.49E+03	8.35E+02	1.67E+03	2.85E+04	0.00E+00	1.75E+04	0.00E+00
TE-127	1.95E+01	6.91E+00	4.19E+00	1.34E+01	7.89E+01	0.00E+00	1.50E+03	0.00E+00
TE-129M	1.17E+04	4.33E+03	1.85E+03	3.76E+03	4.88E+04	0.00E+00	4.38E+04	0.00E+00
TE-129	1.94E-05	7.21E-06	4.71E-06	1.38E-05	8.12E-05	0.00E+00	1.06E-04	0.00E+00
TE-131M	1.02E+03	4.91E+02	4.10E+02	7.39E+02	5.12E+03	0.00E+00	3.94E+04	0.00E+00
TE-131	9.33E-17	3.85E-17	2.92E-17	7.19E-17	4.08E-16	0.00E+00	7.66E-18	0.00E+00

TABLE II-13

TEEN FRESHWATER FISH A₁₇ FACTORS

mrem-ml per uCi-hr

NUCLIDE	BONE	LIVER	T BODY	THYROID	KIDNEY	LUNG	GI-LLI	SKIN
TE-132	2.06E+03	1.31E+03	1.23E+03	1.38E+03	1.25E+04	0.00E+00	4.13E+04	0.00E+00
TE-133M	7.05E-07	4.00E-07	3.90E-07	5.59E-07	3.96E-06	0.00E+00	1.62E-06	0.00E+00
TE-134	1.39E-09	8.94E-10	9.34E-10	1.14E-09	8.53E-09	0.00E+00	5.17E-11	0.00E+00
I-129	1.28E+02	1.07E+02	1.79E+02	1.31E+05	1.92E+02	0.00E+00	1.25E+01	0.00E+00
I-130	7.35E+00	2.13E+01	8.49E+00	1.73E+03	3.27E+01	0.00E+00	1.63E+01	0.00E+00
I-131	1.47E+02	2.06E+02	1.11E+02	6.01E+04	3.54E+02	0.00E+00	4.07E+01	0.00E+00
I-132	5.52E-03	1.44E-02	5.19E-03	4.87E-01	2.28E-02	0.00E+00	6.29E-03	0.00E+00
I-133	2.47E+01	4.20E+01	1.28E+01	5.86E+03	7.36E+01	0.00E+00	3.18E+01	0.00E+00
I-134	2.30E-08	6.09E-08	2.19E-08	1.01E-06	9.59E-08	0.00E+00	8.02E-10	0.00E+00
I-135	1.35E+00	3.47E+00	1.29E+00	2.23E+02	5.48E+00	0.00E+00	3.85E+00	0.00E+00
CS-134M	3.47E-01	7.18E-01	3.69E-01	0.00E+00	4.00E-01	7.01E-02	4.77E-01	0.00E+00
CS-134	3.05E+05	7.19E+05	3.34E+05	0.00E+00	2.28E+05	8.72E+04	8.94E+03	0.00E+00
CS-135	1.02E+05	9.32E+04	2.18E+04	0.00E+00	3.55E+04	1.29E+04	1.63E+03	0.00E+00
CS-136	2.98E+04	1.17E+05	7.87E+04	0.00E+00	6.38E+04	1.01E+04	9.43E+03	0.00E+00
CS-137	4.09E+05	5.44E+05	1.90E+05	0.00E+00	1.85E+05	7.20E+04	7.74E+03	0.00E+00
CS-138	9.78E-12	1.88E-11	9.39E-12	0.00E+00	1.39E-11	1.61E-12	8.52E-15	0.00E+00
CS-139	1.36E-44	2.01E-44	7.37E-45	0.00E+00	1.62E-44	1.78E-45	9.33E-60	0.00E+00
BA-139	6.17E-06	4.34E-09	1.80E-07	0.00E+00	4.09E-09	2.99E-09	5.50E-05	0.00E+00
BA-140	1.97E+02	2.41E-01	1.27E+01	0.00E+00	8.17E-02	1.62E-01	3.03E+02	0.00E+00
BA-141	9.20E-25	6.87E-28	3.07E-26	0.00E+00	6.38E-28	4.70E-28	1.96E-30	0.00E+00
BA-142	6.71E-42	6.71E-45	4.13E-43	0.00E+00	5.68E-45	4.47E-45	2.06E-53	0.00E+00
LA-140	1.05E-01	5.16E-02	1.37E-02	0.00E+00	0.00E+00	0.00E+00	2.97E+03	0.00E+00
LA-141	3.05E-04	9.38E-05	1.55E-05	0.00E+00	0.00E+00	0.00E+00	1.66E+01	0.00E+00
LA-142	2.34E-07	1.04E-07	2.58E-08	0.00E+00	0.00E+00	0.00E+00	3.16E-03	0.00E+00
CE-141	2.38E-02	1.59E-02	1.82E-03	0.00E+00	7.47E-03	0.00E+00	4.54E+01	0.00E+00
CE-143	2.59E-03	1.89E+00	2.11E-04	0.00E+00	8.46E-04	0.00E+00	5.67E+01	0.00E+00
CE-144	1.27E+00	5.25E-01	6.81E-02	0.00E+00	3.13E-01	0.00E+00	3.19E+02	0.00E+00
PR-143	5.68E-01	2.27E-01	2.83E-02	0.00E+00	1.32E-01	0.00E+00	1.87E+03	0.00E+00
PR-144	1.61E-28	6.60E-29	8.17E-30	0.00E+00	3.78E-29	0.00E+00	1.78E-31	0.00E+00
ND-147	4.02E-01	4.37E-01	2.62E-02	0.00E+00	2.57E-01	0.00E+00	1.58E+03	0.00E+00
PM-147	4.79E+00	4.54E-01	1.85E-01	0.00E+00	8.67E-01	0.00E+00	4.32E+02	0.00E+00
PM-148M	1.86E+00	4.71E-01	3.69E-01	0.00E+00	7.14E-01	0.00E+00	2.97E+03	0.00E+00
PM-148	4.09E-01	6.66E-02	3.36E-02	0.00E+00	1.20E-01	0.00E+00	3.97E+03	0.00E+00
PM-149	7.24E-02	1.02E-02	4.17E-03	0.00E+00	1.94E-02	0.00E+00	1.50E+03	0.00E+00
PM-151	2.51E-02	4.14E-03	2.10E-03	0.00E+00	7.45E-03	0.00E+00	9.30E+02	0.00E+00
SM-151	3.99E+00	7.67E-01	1.80E-01	0.00E+00	8.40E-01	0.00E+00	2.60E+02	0.00E+00
SM-153	3.90E-02	3.23E-02	2.38E-03	0.00E+00	1.06E-02	0.00E+00	9.11E+02	0.00E+00
EU-152	1.12E+01	2.69E+00	2.37E+00	0.00E+00	1.25E+01	0.00E+00	9.91E+02	0.00E+00

TABLE II-13

TEEN FRESHWATER FISH A₁₇ FACTORS

mrem-ml per uCi-hr

NUCLIDE	BONE	LIVER	T BODY	THYROID	KIDNEY	LUNG	GI-LLI	SKIN
EU-154	3.61E+01	4.66E+00	3.28E+00	0.00E+00	2.08E+01	0.00E+00	2.46E+03	0.00E+00
EU-155	7.94E+00	7.67E-01	4.75E-01	0.00E+00	3.00E+00	0.00E+00	4.40E+03	0.00E+00
EU-156	8.38E-01	6.28E-01	1.03E-01	0.00E+00	4.23E-01	0.00E+00	3.21E+03	0.00E+00
TB-160	2.93E+00	0.00E+00	3.65E-01	0.00E+00	1.16E+00	0.00E+00	1.89E+03	0.00E+00
HO-166M	1.63E+01	5.02E+00	3.63E+00	0.00E+00	7.35E+00	0.00E+00	1.24E+03	0.00E+00
W-181	3.09E+01	9.98E+00	1.04E+00	0.00E+00	0.00E+00	0.00E+00	8.50E+02	0.00E+00
W-185	1.26E+03	4.15E+02	4.39E+01	0.00E+00	0.00E+00	0.00E+00	3.58E+04	0.00E+00
W-187	1.59E+02	1.30E+02	4.55E+01	0.00E+00	0.00E+00	0.00E+00	3.51E+04	0.00E+00
U-232	2.15E+04	0.00E+00	1.54E+03	0.00E+00	2.33E+03	0.00E+00	2.63E+02	0.00E+00
U-233	4.53E+03	0.00E+00	2.75E+02	0.00E+00	1.06E+03	0.00E+00	2.43E+02	0.00E+00
U-234	4.35E+03	0.00E+00	2.70E+02	0.00E+00	1.04E+03	0.00E+00	2.38E+02	0.00E+00
U-235	4.16E+03	0.00E+00	2.54E+02	0.00E+00	9.75E+02	0.00E+00	3.02E+02	0.00E+00
U-236	4.16E+03	0.00E+00	2.59E+02	0.00E+00	9.97E+02	0.00E+00	2.23E+02	0.00E+00
U-237	2.60E-01	0.00E+00	6.92E-02	0.00E+00	1.07E+00	0.00E+00	6.89E+01	0.00E+00
U-238	3.98E+03	0.00E+00	2.37E+02	0.00E+00	9.13E+02	0.00E+00	2.13E+02	0.00E+00
NP-237	2.43E+04	1.74E+03	1.07E+03	0.00E+00	7.91E+03	0.00E+00	1.54E+03	0.00E+00
NP-238	2.57E-01	6.87E-03	4.00E-03	0.00E+00	2.36E-02	0.00E+00	5.04E+02	0.00E+00
NP-239	2.39E-02	2.26E-03	1.25E-03	0.00E+00	7.09E-03	0.00E+00	3.63E+02	0.00E+00
PU-238	4.28E+03	5.48E+02	1.16E+02	0.00E+00	4.99E+02	0.00E+00	4.94E+02	0.00E+00
PU-239	4.89E+03	5.94E+02	1.28E+02	0.00E+00	5.48E+02	0.00E+00	4.51E+02	0.00E+00
PU-240	4.88E+03	5.93E+02	1.28E+02	0.00E+00	5.47E+02	0.00E+00	4.60E+02	0.00E+00
PU-241	1.12E+02	5.37E+00	2.36E+00	0.00E+00	1.09E+01	0.00E+00	9.46E+00	0.00E+00
PU-242	4.53E+03	5.72E+02	1.24E+02	0.00E+00	5.27E+02	0.00E+00	4.42E+02	0.00E+00
PU-244	5.29E+03	6.52E+02	1.42E+02	0.00E+00	6.04E+02	0.00E+00	6.58E+02	0.00E+00
AM-241	3.64E+04	3.44E+04	2.63E+03	0.00E+00	1.97E+04	0.00E+00	3.59E+03	0.00E+00
AM-242M	3.68E+04	3.25E+04	2.65E+03	0.00E+00	1.96E+04	0.00E+00	4.52E+03	0.00E+00
AM-243	3.63E+04	3.36E+04	2.57E+03	0.00E+00	1.93E+04	0.00E+00	4.21E+03	0.00E+00
CM-242	1.34E+03	1.41E+03	8.87E+01	0.00E+00	4.04E+02	0.00E+00	3.82E+03	0.00E+00
CM-243	2.97E+04	2.75E+04	1.87E+03	0.00E+00	8.72E+03	0.00E+00	3.78E+03	0.00E+00
CM-244	2.30E+04	2.18E+04	1.46E+03	0.00E+00	6.80E+03	0.00E+00	3.65E+03	0.00E+00
CM-245	4.52E+04	3.98E+04	2.79E+03	0.00E+00	1.30E+04	0.00E+00	3.41E+03	0.00E+00
CM-246	4.48E+04	3.97E+04	2.78E+03	0.00E+00	1.30E+04	0.00E+00	3.35E+03	0.00E+00
CM-247	4.37E+04	3.91E+04	2.74E+03	0.00E+00	1.28E+04	0.00E+00	4.40E+03	0.00E+00
CM-248	3.63E+05	3.22E+05	2.26E+04	0.00E+00	1.05E+05	0.00E+00	7.08E+04	0.00E+00
CF-252	1.58E+04	0.00E+00	3.82E+02	0.00E+00	0.00E+00	0.00E+00	1.39E+04	0.00E+00

TABLE II1-14

TEEN SHORELINE A₁₇ FACTORS

mrem-ml per uCi-hr

NUCLIDE	BONE	LIVER	T BODY	THYROID	KIDNEY	LUNG	GI-LLI	SKIN
H-3	0.00E+00	0.00E+00	0.00E+00	0.00E+00	0.00E+00	0.00E+00	0.00E+00	0.00E+00
C-14	0.00E+00	0.00E+00	0.00E+00	0.00E+00	0.00E+00	0.00E+00	0.00E+00	0.00E+00
NA-22	2.08E+04	2.08E+04	2.08E+04	2.08E+04	2.08E+04	2.08E+04	2.08E+04	2.34E+04
NA-24	2.14E+01	2.14E+01	2.14E+01	2.14E+01	2.14E+01	2.14E+01	2.14E+01	2.48E+01
P-32	0.00E+00	0.00E+00	0.00E+00	0.00E+00	0.00E+00	0.00E+00	0.00E+00	0.00E+00
CA-41	2.96E+04	2.96E+04	2.96E+04	2.96E+04	2.96E+04	2.96E+04	2.96E+04	3.48E+04
SC-46	1.49E+03	1.49E+03	1.49E+03	1.49E+03	1.49E+03	1.49E+03	1.49E+03	1.72E+03
CR-51	8.35E+00	8.35E+00	8.35E+00	8.35E+00	8.35E+00	8.35E+00	8.35E+00	9.87E+00
MN-54	2.48E+03	2.48E+03	2.48E+03	2.48E+03	2.48E+03	2.48E+03	2.48E+03	2.91E+03
MN-56	1.62E+00	1.62E+00	1.62E+00	1.62E+00	1.62E+00	1.62E+00	1.62E+00	1.91E+00
FE-55	0.00E+00	0.00E+00	0.00E+00	0.00E+00	0.00E+00	0.00E+00	0.00E+00	0.00E+00
FE-59	4.89E+02	4.89E+02	4.89E+02	4.89E+02	4.89E+02	4.89E+02	4.89E+02	5.75E+02
CO-57	3.38E+02	3.38E+02	3.38E+02	3.38E+02	3.38E+02	3.38E+02	3.38E+02	3.71E+02
CO-58	6.79E+02	6.79E+02	6.79E+02	6.79E+02	6.79E+02	6.79E+02	6.79E+02	7.95E+02
CO-60	4.32E+04	4.32E+04	4.32E+04	4.32E+04	4.32E+04	4.32E+04	4.32E+04	5.08E+04
NI-59	0.00E+00	0.00E+00	0.00E+00	0.00E+00	0.00E+00	0.00E+00	0.00E+00	0.00E+00
NI-63	0.00E+00	0.00E+00	0.00E+00	0.00E+00	0.00E+00	0.00E+00	0.00E+00	0.00E+00
NI-65	5.32E-01	5.32E-01	5.32E-01	5.32E-01	5.32E-01	5.32E-01	5.32E-01	6.19E-01
CU-64	1.09E+00	1.09E+00	1.09E+00	1.09E+00	1.09E+00	1.09E+00	1.09E+00	1.23E+00
ZN-65	1.34E+03	1.34E+03	1.34E+03	1.34E+03	1.34E+03	1.34E+03	1.34E+03	1.54E+03
ZN-69M	2.28E+00	2.28E+00	2.28E+00	2.28E+00	2.28E+00	2.28E+00	2.28E+00	2.67E+00
ZN-69	0.00E+00	0.00E+00	0.00E+00	0.00E+00	0.00E+00	0.00E+00	0.00E+00	0.00E+00
SE-79	0.00E+00	0.00E+00	0.00E+00	0.00E+00	0.00E+00	0.00E+00	0.00E+00	0.00E+00
BR-82	3.83E+01	3.83E+01	3.83E+01	3.83E+01	3.83E+01	3.83E+01	3.83E+01	4.43E+01
BR-83	8.73E-03	8.73E-03	8.73E-03	8.73E-03	8.73E-03	8.73E-03	8.73E-03	1.27E-02
BR-84	3.63E-01	3.63E-01	3.63E-01	3.63E-01	3.63E-01	3.63E-01	3.63E-01	4.24E-01
BR-85	0.00E+00	0.00E+00	0.00E+00	0.00E+00	0.00E+00	0.00E+00	0.00E+00	0.00E+00
RB-86	1.61E+01	1.61E+01	1.61E+01	1.61E+01	1.61E+01	1.61E+01	1.61E+01	1.84E+01
RB-87	0.00E+00	0.00E+00	0.00E+00	0.00E+00	0.00E+00	0.00E+00	0.00E+00	0.00E+00
RB-88	5.93E-02	5.93E-02	5.93E-02	5.93E-02	5.93E-02	5.93E-02	5.93E-02	6.77E-02
RB-89	2.20E-01	2.20E-01	2.20E-01	2.20E-01	2.20E-01	2.20E-01	2.20E-01	2.64E-01
SR-89	3.88E-02	3.88E-02	3.88E-02	3.88E-02	3.88E-02	3.88E-02	3.88E-02	4.50E-02
SR-90	0.00E+00	0.00E+00	0.00E+00	0.00E+00	0.00E+00	0.00E+00	0.00E+00	0.00E+00
SR-91	3.85E+00	3.85E+00	3.85E+00	3.85E+00	3.85E+00	3.85E+00	3.85E+00	4.50E+00
SR-92	1.39E+00	1.39E+00	1.39E+00	1.39E+00	1.39E+00	1.39E+00	1.39E+00	1.55E+00
Y-90	8.05E-03	8.05E-03	8.05E-03	8.05E-03	8.05E-03	8.05E-03	8.05E-03	9.51E-03
Y-91M	1.80E-01	1.80E-01	1.80E-01	1.80E-01	1.80E-01	1.80E-01	1.80E-01	2.08E-01

TABLE II1-14

TEEN SHORELINE A₁₇ FACTORS

mrem-ml per uCi-hr

NUCLIDE	BONE	LIVER	T BODY	THYROID	KIDNEY	LUNG	GI-LLI	SKIN
Y-91	1.92E+00	1.92E+00	1.92E+00	1.92E+00	1.92E+00	1.92E+00	1.92E+00	2.16E+00
Y-92	3.23E-01	3.23E-01	3.23E-01	3.23E-01	3.23E-01	3.23E-01	3.23E-01	3.84E-01
Y-93	3.29E-01	3.29E-01	3.29E-01	3.29E-01	3.29E-01	3.29E-01	3.29E-01	4.50E-01
ZR-93	0.00E+00	0.00E+00	0.00E+00	0.00E+00	0.00E+00	0.00E+00	0.00E+00	0.00E+00
ZR-95	4.39E+02	4.39E+02	4.39E+02	4.39E+02	4.39E+02	4.39E+02	4.39E+02	5.09E+02
ZR-97	5.31E+00	5.31E+00	5.31E+00	5.31E+00	5.31E+00	5.31E+00	5.31E+00	6.17E+00
NB-93M	4.16E+00	4.16E+00	4.16E+00	4.16E+00	4.16E+00	4.16E+00	4.16E+00	5.08E+02
NB-95	2.45E+02	2.45E+02	2.45E+02	2.45E+02	2.45E+02	2.45E+02	2.45E+02	2.88E+02
NB-97	3.16E-01	3.16E-01	3.16E-01	3.16E-01	3.16E-01	3.16E-01	3.16E-01	3.70E-01
MO-93	1.98E+02	1.98E+02	1.98E+02	1.98E+02	1.98E+02	1.98E+02	1.98E+02	8.06E+03
MO-99	7.16E+00	7.16E+00	7.16E+00	7.16E+00	7.16E+00	7.16E+00	7.16E+00	8.29E+00
TC-99M	3.30E-01	3.30E-01	3.30E-01	3.30E-01	3.30E-01	3.30E-01	3.30E-01	3.78E-01
TC-99	0.00E+00	0.00E+00	0.00E+00	0.00E+00	0.00E+00	0.00E+00	0.00E+00	0.00E+00
TC-101	3.65E-02	3.65E-02	3.65E-02	3.65E-02	3.65E-02	3.65E-02	3.65E-02	4.05E-02
RU-103	1.94E+02	1.94E+02	1.94E+02	1.94E+02	1.94E+02	1.94E+02	1.94E+02	2.26E+02
RU-105	1.14E+00	1.14E+00	1.14E+00	1.14E+00	1.14E+00	1.14E+00	1.14E+00	1.29E+00
RU-106	7.57E+02	7.57E+02	7.57E+02	7.57E+02	7.57E+02	7.57E+02	7.57E+02	9.08E+02
RH-105	1.33E+00	1.33E+00	1.33E+00	1.33E+00	1.33E+00	1.33E+00	1.33E+00	1.55E+00
PD-107	0.00E+00	0.00E+00	0.00E+00	0.00E+00	0.00E+00	0.00E+00	0.00E+00	0.00E+00
PD-109	2.69E-02	2.69E-02	2.69E-02	2.69E-02	2.69E-02	2.69E-02	2.69E-02	3.07E-02
AG-110M	6.16E+03	6.16E+03	6.16E+03	6.16E+03	6.16E+03	6.16E+03	6.16E+03	7.19E+03
AG-111	1.84E+00	1.84E+00	1.84E+00	1.84E+00	1.84E+00	1.84E+00	1.84E+00	2.15E+00
CD-113M	1.13E+01	1.13E+01	1.13E+01	1.13E+01	1.13E+01	1.13E+01	1.13E+01	1.28E+01
CD-115M	0.00E+00	0.00E+00	0.00E+00	0.00E+00	0.00E+00	0.00E+00	0.00E+00	0.00E+00
SN-123	0.00E+00	0.00E+00	0.00E+00	0.00E+00	0.00E+00	0.00E+00	0.00E+00	1.14E+04
SN-125	7.53E+00	7.53E+00	7.53E+00	7.53E+00	7.53E+00	7.53E+00	7.53E+00	8.72E+00
SN-126	7.80E+04	7.80E+04	7.80E+04	7.80E+04	7.80E+04	7.80E+04	7.80E+04	8.67E+04
SB-124	1.07E+03	1.07E+03	1.07E+03	1.07E+03	1.07E+03	1.07E+03	1.07E+03	1.24E+03
SB-125	4.29E+03	4.29E+03	4.29E+03	4.29E+03	4.29E+03	4.29E+03	4.29E+03	4.84E+03
SB-126	1.51E+02	1.51E+02	1.51E+02	1.51E+02	1.51E+02	1.51E+02	1.51E+02	1.70E+02
SB-127	3.01E+01	3.01E+01	3.01E+01	3.01E+01	3.01E+01	3.01E+01	3.01E+01	3.48E+01
TE-125M	2.78E+00	2.78E+00	2.78E+00	2.78E+00	2.78E+00	2.78E+00	2.78E+00	3.81E+00
TE-127M	1.64E-01	1.64E-01	1.64E-01	1.64E-01	1.64E-01	1.64E-01	1.64E-01	1.94E-01
TE-127	5.34E-03	5.34E-03	5.34E-03	5.34E-03	5.34E-03	5.34E-03	5.34E-03	5.87E-03
TE-129M	3.54E+01	3.54E+01	3.54E+01	3.54E+01	3.54E+01	3.54E+01	3.54E+01	4.14E+01
TE-129	4.70E+02	4.70E+02	4.70E+02	4.70E+02	4.70E+02	4.70E+02	4.70E+02	5.56E+02
TE-131M	1.44E+01	1.44E+01	1.44E+01	1.44E+01	1.44E+01	1.44E+01	1.44E+01	1.70E+01
TE-131	5.23E-02	5.23E-02	5.23E-02	5.23E-02	5.23E-02	5.23E-02	5.23E-02	6.18E+01

TABLE II1-14

TEEN SHORELINE A₁₇ FACTORS

mrem-ml per uCi-hr

NUCLIDE	BONE	LIVER	T BODY	THYROID	KIDNEY	LUNG	GI-LLI	SKIN
TE-132	7.59E+00	7.59E+00	7.59E+00	7.59E+00	7.59E+00	7.59E+00	7.59E+00	8.93E+00
TE-133M	7.91E-01	7.91E-01	7.91E-01	7.91E-01	7.91E-01	7.91E-01	7.91E-01	8.96E-01
TE-134	3.98E-02	3.98E-02	3.98E-02	3.98E-02	3.98E-02	3.98E-02	3.98E-02	4.77E-02
I-129	3.90E+03	3.90E+03	3.90E+03	3.90E+03	3.90E+03	3.90E+03	3.90E+03	6.50E+03
I-130	9.88E+00	9.88E+00	9.88E+00	9.88E+00	9.88E+00	9.88E+00	9.88E+00	1.20E+01
I-131	3.08E+01	3.08E+01	3.08E+01	3.08E+01	3.08E+01	3.08E+01	3.08E+01	3.74E+01
I-132	2.23E+00	2.23E+00	2.23E+00	2.23E+00	2.23E+00	2.23E+00	2.23E+00	2.63E+00
I-133	4.39E+00	4.39E+00	4.39E+00	4.39E+00	4.39E+00	4.39E+00	4.39E+00	5.34E+00
I-134	8.01E-01	8.01E-01	8.01E-01	8.01E-01	8.01E-01	8.01E-01	8.01E-01	9.51E-01
I-135	4.53E+00	4.53E+00	4.53E+00	4.53E+00	4.53E+00	4.53E+00	4.53E+00	5.28E+00
CS-134M	1.03E-01	1.03E-01	1.03E-01	1.03E-01	1.03E-01	1.03E-01	1.03E-01	1.21E-01
CS-134	1.24E+04	1.24E+04	1.24E+04	1.24E+04	1.24E+04	1.24E+04	1.24E+04	1.44E+04
CS-135	0.00E+00	0.00E+00	0.00E+00	0.00E+00	0.00E+00	0.00E+00	0.00E+00	0.00E+00
CS-136	2.70E+02	2.70E+02	2.70E+02	2.70E+02	2.70E+02	2.70E+02	2.70E+02	3.06E+02
CS-137	2.77E+04	2.77E+04	2.77E+04	2.77E+04	2.77E+04	2.77E+04	2.77E+04	3.23E+04
CS-138	6.43E-01	6.43E-01	6.43E-01	6.43E-01	6.43E-01	6.43E-01	6.43E-01	7.35E-01
CS-139	5.63E-02	5.63E-02	5.63E-02	5.63E-02	5.63E-02	5.63E-02	5.63E-02	6.44E-02
BA-139	1.90E-01	1.90E-01	1.90E-01	1.90E-01	1.90E-01	1.90E-01	1.90E-01	2.13E-01
BA-140	3.68E+01	3.68E+01	3.68E+01	3.68E+01	3.68E+01	3.68E+01	3.68E+01	4.20E+01
BA-141	7.47E-02	7.47E-02	7.47E-02	7.47E-02	7.47E-02	7.47E-02	7.47E-02	8.52E-02
BA-142	8.04E-02	8.04E-02	8.04E-02	8.04E-02	8.04E-02	8.04E-02	8.04E-02	9.16E-02
LA-140	3.44E+01	3.44E+01	3.44E+01	3.44E+01	3.44E+01	3.44E+01	3.44E+01	3.90E+01
LA-141	5.62E-02	5.62E-02	5.62E-02	5.62E-02	5.62E-02	5.62E-02	5.62E-02	6.30E-02
LA-142	1.36E+00	1.36E+00	1.36E+00	1.36E+00	1.36E+00	1.36E+00	1.36E+00	1.63E+00
CE-141	2.45E+01	2.45E+01	2.45E+01	2.45E+01	2.45E+01	2.45E+01	2.45E+01	2.76E+01
CE-143	4.14E+00	4.14E+00	4.14E+00	4.14E+00	4.14E+00	4.14E+00	4.14E+00	4.71E+00
CE-144	1.25E+02	1.25E+02	1.25E+02	1.25E+02	1.25E+02	1.25E+02	1.25E+02	1.44E+02
PR-143	0.00E+00	0.00E+00	0.00E+00	0.00E+00	0.00E+00	0.00E+00	0.00E+00	0.00E+00
PR-144	3.29E-03	3.29E-03	3.29E-03	3.29E-03	3.29E-03	3.29E-03	3.29E-03	3.78E-03
ND-147	1.50E+01	1.50E+01	1.50E+01	1.50E+01	1.50E+01	1.50E+01	1.50E+01	1.81E+01
PM-147	0.00E+00	0.00E+00	0.00E+00	0.00E+00	0.00E+00	0.00E+00	0.00E+00	0.00E+00
PM-148M	7.98E+02	7.98E+02	7.98E+02	7.98E+02	7.98E+02	7.98E+02	7.98E+02	4.62E+03
PM-148	3.38E+01	3.38E+01	3.38E+01	3.38E+01	3.38E+01	3.38E+01	3.38E+01	3.90E+01
PM-149	7.57E-02	7.57E-02	7.57E-02	7.57E-02	7.57E-02	7.57E-02	7.57E-02	8.79E-02
PM-151	3.57E+00	3.57E+00	3.57E+00	3.57E+00	3.57E+00	3.57E+00	3.57E+00	3.73E+00
SM-151	3.79E+02	3.79E+02	3.79E+02	3.79E+02	3.79E+02	3.79E+02	3.79E+02	1.66E+03
SM-153	7.20E-01	7.20E-01	7.20E-01	7.20E-01	7.20E-01	7.20E-01	7.20E-01	8.00E-01
EU-152	3.61E+04	3.61E+04	3.61E+04	3.61E+04	3.61E+04	3.61E+04	3.61E+04	4.18E+04

TABLE II1-14

TEEN SHORELINE A₁₇ FACTORS

mrem-ml per uCi-hr

NUCLIDE	BONE	LIVER	T BODY	THYROID	KIDNEY	LUNG	GI-LLI	SKIN
EU-154	2.96E+04	2.96E+04	2.96E+04	2.96E+04	2.96E+04	2.96E+04	2.96E+04	3.41E+04
EU-155	9.17E+02	9.17E+02	9.17E+02	9.17E+02	9.17E+02	9.17E+02	9.17E+02	1.04E+03
EU-156	1.58E+02	1.58E+02	1.58E+02	1.58E+02	1.58E+02	1.58E+02	1.58E+02	1.81E+02
TB-160	8.52E+02	8.52E+02	8.52E+02	8.52E+02	8.52E+02	8.52E+02	8.52E+02	9.90E+02
HO-166M	7.66E+04	7.66E+04	7.66E+04	7.66E+04	7.66E+04	7.66E+04	7.66E+04	8.61E+04
W-181	3.48E-01	3.48E-01	3.48E-01	3.48E-01	3.48E-01	3.48E-01	3.48E-01	4.64E-01
W-185	0.00E+00	0.00E+00	0.00E+00	0.00E+00	0.00E+00	0.00E+00	0.00E+00	0.00E+00
W-187	4.22E+00	4.22E+00	4.22E+00	4.22E+00	4.22E+00	4.22E+00	4.22E+00	4.90E+00
U-232	2.00E+01	2.00E+01	2.00E+01	2.00E+01	2.00E+01	2.00E+01	2.00E+01	2.07E+02
U-233	1.99E+04	1.99E+04	1.99E+04	1.99E+04	1.99E+04	1.99E+04	1.99E+04	2.43E+04
U-234	5.48E+00	5.48E+00	5.48E+00	5.48E+00	5.48E+00	5.48E+00	5.48E+00	1.38E+03
U-235	2.77E+04	2.77E+04	2.77E+04	2.77E+04	2.77E+04	2.77E+04	2.77E+04	3.47E+04
U-236	1.82E-01	1.82E-01	1.82E-01	1.82E-01	1.82E-01	1.82E-01	1.82E-01	1.56E+02
U-237	9.25E+00	9.25E+00	9.25E+00	9.25E+00	9.25E+00	9.25E+00	9.25E+00	1.20E+01
U-238	9.54E+02	9.54E+02	9.54E+02	9.54E+02	9.54E+02	9.54E+02	9.54E+02	1.30E+03
NP-237	1.21E+04	1.21E+04	1.21E+04	1.21E+04	1.21E+04	1.21E+04	1.21E+04	1.39E+04
NP-238	8.12E+00	8.12E+00	8.12E+00	8.12E+00	8.12E+00	8.12E+00	8.12E+00	9.28E+00
NP-239	3.06E+00	3.06E+00	3.06E+00	3.06E+00	3.06E+00	3.06E+00	3.06E+00	3.55E+00
PU-238	1.02E+01	1.02E+01	1.02E+01	1.02E+01	1.02E+01	1.02E+01	1.02E+01	1.42E+02
PU-239	6.85E+00	6.85E+00	6.85E+00	6.85E+00	6.85E+00	6.85E+00	6.85E+00	6.67E+01
PU-240	1.13E+01	1.13E+01	1.13E+01	1.13E+01	1.13E+01	1.13E+01	1.13E+01	1.56E+02
PU-241	2.32E+01	2.32E+01	2.32E+01	2.32E+01	2.32E+01	2.32E+01	2.32E+01	3.43E+01
PU-242	9.54E+00	9.54E+00	9.54E+00	9.54E+00	9.54E+00	9.54E+00	9.54E+00	1.39E+02
PU-244	7.76E+03	7.76E+03	7.76E+03	7.76E+03	7.76E+03	7.76E+03	7.76E+03	8.34E+03
AM-241	1.53E+03	1.53E+03	1.53E+03	1.53E+03	1.53E+03	1.53E+03	1.53E+03	2.21E+03
AM-242M	2.13E+02	2.13E+02	2.13E+02	2.13E+02	2.13E+02	2.13E+02	2.13E+02	1.48E+03
AM-243	1.13E+04	1.13E+04	1.13E+04	1.13E+04	1.13E+04	1.13E+04	1.13E+04	1.30E+04
CM-242	1.23E+00	1.23E+00	1.23E+00	1.23E+00	1.23E+00	1.23E+00	1.23E+00	5.14E+00
CM-243	1.49E+04	1.49E+04	1.49E+04	1.49E+04	1.49E+04	1.49E+04	1.49E+04	1.88E+04
CM-244	1.62E+01	1.62E+01	1.62E+01	1.62E+01	1.62E+01	1.62E+01	1.62E+01	1.00E+02
CM-245	8.23E+03	8.23E+03	8.23E+03	8.23E+03	8.23E+03	8.23E+03	8.23E+03	1.04E+04
CM-246	8.65E+00	8.65E+00	8.65E+00	8.65E+00	8.65E+00	8.65E+00	8.65E+00	1.30E+02
CM-247	1.91E+04	1.91E+04	1.91E+04	1.91E+04	1.91E+04	1.91E+04	1.91E+04	2.25E+04
CM-248	4.53E+04	4.53E+04	4.53E+04	4.53E+04	4.53E+04	4.53E+04	4.53E+04	5.90E+04
CF-252	8.70E+04	8.70E+04	8.70E+04	8.70E+04	8.70E+04	8.70E+04	8.70E+04	9.49E+04

TABLE II1-15

CHILD DRINKING WATER A_{IT} FACTORS

mrem-ml per uCi-hr

NUCLIDE	BONE	LIVER	T BODY	THYROID	KIDNEY	LUNG	GI-LLI	SKIN
H-3	0.00E+00	6.75E+00	6.75E+00	6.75E+00	6.75E+00	6.75E+00	6.75E+00	0.00E+00
C-14	7.04E+02	1.41E+02	1.41E+02	1.41E+02	1.41E+02	1.41E+02	1.41E+02	0.00E+00
NA-22	3.42E+03	3.42E+03	3.42E+03	3.42E+03	3.42E+03	3.42E+03	3.42E+03	0.00E+00
NA-24	1.94E+02	1.94E+02	1.94E+02	1.94E+02	1.94E+02	1.94E+02	1.94E+02	0.00E+00
P-32	4.69E+04	2.19E+03	1.81E+03	0.00E+00	0.00E+00	0.00E+00	1.30E+03	0.00E+00
CA-41	2.02E+04	0.00E+00	2.21E+03	0.00E+00	0.00E+00	0.00E+00	1.11E+01	0.00E+00
SC-46	1.14E+00	1.57E+00	6.03E-01	0.00E+00	1.39E+00	0.00E+00	2.29E+03	0.00E+00
CR-51	0.00E+00	0.00E+00	5.12E-01	2.84E-01	7.76E-02	5.19E-01	2.71E+01	0.00E+00
MN-54	0.00E+00	6.22E+02	1.66E+02	0.00E+00	1.74E+02	0.00E+00	5.22E+02	0.00E+00
MN-56	0.00E+00	7.72E-01	1.74E-01	0.00E+00	9.34E-01	0.00E+00	1.12E+02	0.00E+00
FE-55	6.69E+02	3.55E+02	1.10E+02	0.00E+00	0.00E+00	2.01E+02	6.58E+01	0.00E+00
FE-59	9.53E+02	1.54E+03	7.68E+02	0.00E+00	0.00E+00	4.47E+02	1.61E+03	0.00E+00
CO-57	0.00E+00	2.87E+01	5.80E+01	0.00E+00	0.00E+00	0.00E+00	2.35E+02	0.00E+00
CO-58	0.00E+00	1.04E+02	3.19E+02	0.00E+00	0.00E+00	0.00E+00	6.08E+02	0.00E+00
CO-60	0.00E+00	3.08E+02	9.08E+02	0.00E+00	0.00E+00	0.00E+00	1.71E+03	0.00E+00
NI-59	2.34E+03	6.23E+02	3.97E+02	0.00E+00	0.00E+00	0.00E+00	4.13E+01	0.00E+00
NI-63	3.13E+04	1.68E+03	1.07E+03	0.00E+00	0.00E+00	0.00E+00	1.13E+02	0.00E+00
NI-65	4.76E+00	4.48E-01	2.62E-01	0.00E+00	0.00E+00	0.00E+00	5.49E+01	0.00E+00
CU-64	0.00E+00	7.41E+00	4.48E+00	0.00E+00	1.79E+01	0.00E+00	3.48E+02	0.00E+00
ZN-65	7.96E+02	2.12E+03	1.32E+03	0.00E+00	1.34E+03	0.00E+00	3.73E+02	0.00E+00
ZN-69M	2.26E+01	3.85E+01	4.55E+00	0.00E+00	2.24E+01	0.00E+00	1.25E+03	0.00E+00
ZN-69	3.22E-04	4.66E-04	4.31E-05	0.00E+00	2.83E-04	0.00E+00	2.94E-02	0.00E+00
SE-79	0.00E+00	4.91E+02	1.09E+02	0.00E+00	7.98E+02	0.00E+00	3.22E+01	0.00E+00
BR-82	0.00E+00	0.00E+00	3.47E+02	0.00E+00	0.00E+00	0.00E+00	0.00E+00	0.00E+00
BR-83	0.00E+00	0.00E+00	3.07E-01	0.00E+00	0.00E+00	0.00E+00	0.00E+00	0.00E+00
BR-84	0.00E+00	0.00E+00	1.76E-06	0.00E+00	0.00E+00	0.00E+00	0.00E+00	0.00E+00
BR-85	0.00E+00	0.00E+00	1.31E-76	0.00E+00	0.00E+00	0.00E+00	0.00E+00	0.00E+00
RB-86	0.00E+00	3.83E+03	2.35E+03	0.00E+00	0.00E+00	0.00E+00	2.46E+02	0.00E+00
RB-87	0.00E+00	2.30E+03	1.07E+03	0.00E+00	0.00E+00	0.00E+00	3.45E+01	0.00E+00
RB-88	0.00E+00	7.37E-12	5.12E-12	0.00E+00	0.00E+00	0.00E+00	3.61E-13	0.00E+00
RB-89	0.00E+00	6.25E-14	5.55E-14	0.00E+00	0.00E+00	0.00E+00	5.45E-16	0.00E+00
SR-89	7.63E+04	0.00E+00	2.18E+03	0.00E+00	0.00E+00	0.00E+00	2.95E+03	0.00E+00
SR-90	1.49E+06	0.00E+00	3.00E+04	0.00E+00	0.00E+00	0.00E+00	1.33E+04	0.00E+00
SR-91	5.82E+02	0.00E+00	2.20E+01	0.00E+00	0.00E+00	0.00E+00	1.29E+03	0.00E+00
SR-92	2.44E+01	0.00E+00	9.79E-01	0.00E+00	0.00E+00	0.00E+00	4.62E+02	0.00E+00
Y-90	2.10E+00	0.00E+00	5.62E-02	0.00E+00	0.00E+00	0.00E+00	5.98E+03	0.00E+00
Y-91M	9.71E-07	0.00E+00	3.53E-08	0.00E+00	0.00E+00	0.00E+00	1.90E-03	0.00E+00

TABLE II-15

CHILD DRINKING WATER A₁₇ FACTORS

mrem-ml per uCi-hr

NUCLIDE	BONE	LIVER	T BODY	THYROID	KIDNEY	LUNG	GI-LLI	SKIN
Y-91	3.48E+01	0.00E+00	9.32E-01	0.00E+00	0.00E+00	0.00E+00	4.64E+03	0.00E+00
Y-92	2.00E-02	0.00E+00	5.72E-04	0.00E+00	0.00E+00	0.00E+00	5.78E+02	0.00E+00
Y-93	2.91E-01	0.00E+00	8.00E-03	0.00E+00	0.00E+00	0.00E+00	4.34E+03	0.00E+00
ZR-93	9.72E+00	3.64E-01	2.59E-01	0.00E+00	1.41E+00	0.00E+00	1.38E+02	0.00E+00
ZR-95	6.72E+00	1.48E+00	1.31E+00	0.00E+00	2.11E+00	0.00E+00	1.54E+03	0.00E+00
ZR-97	2.49E-01	3.59E-02	2.12E-02	0.00E+00	5.16E-02	0.00E+00	5.45E+03	0.00E+00
NB-93M	6.11E+00	1.53E+00	5.01E-01	0.00E+00	1.65E+00	0.00E+00	2.30E+02	0.00E+00
NB-95	1.30E+00	5.05E-01	3.61E-01	0.00E+00	4.74E-01	0.00E+00	9.34E+02	0.00E+00
NB-97	1.25E-05	2.25E-06	1.05E-06	0.00E+00	2.50E-06	0.00E+00	6.95E-01	0.00E+00
MO-93	0.00E+00	1.40E+03	5.04E+01	0.00E+00	3.70E+02	0.00E+00	7.10E+01	0.00E+00
MO-99	0.00E+00	6.83E+02	1.69E+02	0.00E+00	1.46E+03	0.00E+00	5.65E+02	0.00E+00
TC-99M	1.35E-02	2.65E-02	4.39E-01	0.00E+00	3.85E-01	1.34E-02	1.51E+01	0.00E+00
TC-99	3.11E+01	3.47E+01	1.25E+01	0.00E+00	4.09E+02	3.07E+00	3.64E+02	0.00E+00
TC-101	3.40E-17	3.55E-17	4.51E-16	0.00E+00	6.06E-16	1.88E-17	1.13E-16	0.00E+00
RU-103	4.22E+01	0.00E+00	1.62E+01	0.00E+00	1.06E+02	0.00E+00	1.09E+03	0.00E+00
RU-105	5.77E-01	0.00E+00	2.09E-01	0.00E+00	5.07E+00	0.00E+00	3.76E+02	0.00E+00
RU-106	6.81E+02	0.00E+00	8.49E+01	0.00E+00	9.19E+02	0.00E+00	1.06E+04	0.00E+00
RH-105	2.37E+01	1.27E+01	1.09E+01	0.00E+00	5.06E+01	0.00E+00	7.87E+02	0.00E+00
PD-107	0.00E+00	2.75E+01	2.33E+00	0.00E+00	2.30E+02	0.00E+00	5.46E+01	0.00E+00
PD-109	0.00E+00	1.78E+01	5.33E+00	0.00E+00	9.54E+01	0.00E+00	1.05E+03	0.00E+00
AG-110M	3.13E+01	2.12E+01	1.69E+01	0.00E+00	3.94E+01	0.00E+00	2.52E+03	0.00E+00
AG-111	1.38E+01	4.31E+00	2.85E+00	0.00E+00	1.30E+01	0.00E+00	2.64E+03	0.00E+00
CD-113M	0.00E+00	5.94E+02	2.53E+01	0.00E+00	6.11E+02	0.00E+00	1.53E+03	0.00E+00
CD-115M	0.00E+00	3.40E+02	1.45E+01	0.00E+00	2.53E+02	0.00E+00	4.63E+03	0.00E+00
SN-123	7.72E+03	9.58E+01	1.88E+02	1.02E+02	0.00E+00	0.00E+00	3.79E+03	0.00E+00
SN-125	1.99E+03	3.00E+01	8.93E+01	3.12E+01	0.00E+00	0.00E+00	6.18E+03	0.00E+00
SN-126	1.94E+04	2.42E+02	5.51E+02	6.64E+01	0.00E+00	0.00E+00	1.46E+03	0.00E+00
SB-124	6.43E+02	8.34E+00	2.25E+02	1.42E+00	0.00E+00	3.57E+02	4.02E+03	0.00E+00
SB-125	4.17E+02	3.21E+00	8.73E+01	3.86E-01	0.00E+00	2.32E+02	9.95E+02	0.00E+00
SB-126	2.49E+02	3.81E+00	8.95E+01	1.46E+00	0.00E+00	1.19E+02	5.02E+03	0.00E+00
SB-127	5.64E+01	8.73E-01	1.96E+01	6.28E-01	0.00E+00	2.45E+01	3.18E+03	0.00E+00
TE-125M	6.60E+02	1.79E+02	8.80E+01	1.85E+02	0.00E+00	0.00E+00	6.37E+02	0.00E+00
TE-127M	1.68E+03	4.52E+02	1.99E+02	4.01E+02	4.78E+03	0.00E+00	1.36E+03	0.00E+00
TE-127	1.13E+01	3.04E+00	2.42E+00	7.80E+00	3.20E+01	0.00E+00	4.40E+02	0.00E+00
TE-129M	2.81E+03	7.84E+02	4.36E+02	9.05E+02	8.24E+03	0.00E+00	3.42E+03	0.00E+00
TE-129	6.00E-03	1.67E-03	1.42E-03	4.28E-03	1.75E-02	0.00E+00	3.73E-01	0.00E+00
TE-131M	3.18E+02	1.10E+02	1.17E+02	2.26E+02	1.06E+03	0.00E+00	4.46E+03	0.00E+00
TE-131	1.03E-08	3.15E-09	3.08E-09	7.91E-09	3.13E-08	0.00E+00	5.43E-08	0.00E+00

TABLE II1-15

CHILD DRINKING WATER A_{IT} FACTORS

mrem-ml per uCi-hr

NUCLIDE	BONE	LIVER	T BODY	THYROID	KIDNEY	LUNG	GI-LLI	SKIN
TE-132	5.29E+02	2.34E+02	2.83E+02	3.41E+02	2.17E+03	0.00E+00	2.36E+03	0.00E+00
TE-133M	1.33E-03	5.39E-04	6.68E-04	1.03E-03	5.12E-03	0.00E+00	4.11E-02	0.00E+00
TE-134	4.90E-05	2.20E-05	2.94E-05	3.88E-05	2.04E-04	0.00E+00	2.24E-04	0.00E+00
I-129	8.09E+02	4.97E+02	4.44E+02	3.25E+05	8.38E+02	0.00E+00	2.50E+01	0.00E+00
I-130	8.67E+01	1.75E+02	9.03E+01	1.93E+04	2.62E+02	0.00E+00	8.20E+01	0.00E+00
I-131	9.59E+02	9.65E+02	5.48E+02	3.19E+05	1.58E+03	0.00E+00	8.59E+01	0.00E+00
I-132	1.25E+00	2.30E+00	1.06E+00	1.07E+02	3.52E+00	0.00E+00	2.71E+00	0.00E+00
I-133	2.31E+02	2.86E+02	1.08E+02	5.31E+04	4.76E+02	0.00E+00	1.15E+02	0.00E+00
I-134	1.85E-03	3.43E-03	1.58E-03	7.90E-02	5.25E-03	0.00E+00	2.28E-03	0.00E+00
I-135	2.89E+01	5.21E+01	2.46E+01	4.61E+03	7.99E+01	0.00E+00	3.97E+01	0.00E+00
CS-134M	2.79E-01	4.13E-01	2.70E-01	0.00E+00	2.18E-01	3.60E-02	5.22E-01	0.00E+00
CS-134	1.36E+04	2.23E+04	4.71E+03	0.00E+00	6.92E+03	2.48E+03	1.20E+02	0.00E+00
CS-135	4.83E+03	3.37E+03	3.45E+02	0.00E+00	1.19E+03	3.96E+02	2.52E+01	0.00E+00
CS-136	1.33E+03	3.66E+03	2.37E+03	0.00E+00	1.95E+03	2.91E+02	1.29E+02	0.00E+00
CS-137	1.90E+04	1.82E+04	2.69E+03	0.00E+00	5.94E+03	2.14E+03	1.14E+02	0.00E+00
CS-138	2.47E-06	3.43E-06	2.17E-06	0.00E+00	2.41E-06	2.60E-07	1.58E-06	0.00E+00
CS-139	7.39E-23	8.21E-23	3.95E-23	0.00E+00	6.17E-23	6.22E-24	7.39E-27	0.00E+00
BA-139	5.94E-02	3.17E-05	1.72E-03	0.00E+00	2.77E-05	1.87E-05	3.43E+00	0.00E+00
BA-140	4.71E+03	4.13E+00	2.75E+02	0.00E+00	1.34E+00	2.46E+00	2.39E+03	0.00E+00
BA-141	1.60E-11	8.93E-15	5.19E-13	0.00E+00	7.73E-15	5.25E-14	9.09E-12	0.00E+00
BA-142	2.82E-20	2.03E-23	1.57E-21	0.00E+00	1.64E-23	1.19E-23	3.68E-22	0.00E+00
LA-140	4.78E-01	1.67E-01	5.63E-02	0.00E+00	0.00E+00	0.00E+00	4.66E+03	0.00E+00
LA-141	9.59E-03	2.24E-03	4.85E-04	0.00E+00	0.00E+00	0.00E+00	4.97E+02	0.00E+00
LA-142	1.63E-04	5.20E-05	1.63E-05	0.00E+00	0.00E+00	0.00E+00	1.03E+01	0.00E+00
CE-141	2.29E+00	1.14E+00	1.69E-01	0.00E+00	5.00E-01	0.00E+00	1.42E+03	0.00E+00
CE-143	3.16E-01	1.71E+02	2.48E-02	0.00E+00	7.19E-02	0.00E+00	2.51E+03	0.00E+00
CE-144	1.21E+02	3.79E+01	6.45E+00	0.00E+00	2.10E+01	0.00E+00	9.89E+03	0.00E+00
PR-143	2.23E+00	6.70E-01	1.11E-01	0.00E+00	3.63E-01	0.00E+00	2.41E+03	0.00E+00
PR-144	2.15E-15	6.65E-16	1.08E-16	0.00E+00	3.52E-16	0.00E+00	1.43E-12	0.00E+00
ND-147	1.57E+00	1.27E+00	9.87E-02	0.00E+00	6.99E-01	0.00E+00	2.02E+03	0.00E+00
PM-147	1.85E+01	1.32E+00	7.10E-01	0.00E+00	2.33E+00	0.00E+00	5.35E+02	0.00E+00
PM-148M	5.95E+00	1.18E+00	1.18E+00	0.00E+00	1.76E+00	0.00E+00	3.34E+03	0.00E+00
PM-148	1.65E+00	1.98E-01	1.28E-01	0.00E+00	3.37E-01	0.00E+00	5.29E+03	0.00E+00
PM-149	3.23E-01	3.43E-02	1.86E-02	0.00E+00	6.07E-02	0.00E+00	2.34E+03	0.00E+00
PM-151	1.27E-01	1.54E-02	1.00E-02	0.00E+00	2.61E-02	0.00E+00	1.75E+03	0.00E+00
SM-151	1.49E+01	2.22E+00	6.99E-01	0.00E+00	2.29E+00	0.00E+00	3.22E+02	0.00E+00
SM-153	1.78E-01	1.11E-01	1.07E-02	0.00E+00	3.37E-02	0.00E+00	1.47E+03	0.00E+00
EU-152	3.58E+01	6.52E+00	7.74E+00	0.00E+00	2.75E+01	0.00E+00	1.07E+03	0.00E+00

TABLE II1-15

CHILD DRINKING WATER A_{IT} FACTORS

mrem-ml per uCi-hr

NUCLIDE	BONE	LIVER	T BODY	THYROID	KIDNEY	LUNG	GI-LLI	SKIN
EU-154	1.34E+02	1.21E+01	1.10E+01	0.00E+00	5.29E+01	0.00E+00	2.80E+03	0.00E+00
EU-155	2.81E+01	2.02E+00	1.58E+00	0.00E+00	7.57E+00	0.00E+00	5.06E+03	0.00E+00
EU-156	3.20E+00	1.71E+00	3.55E-01	0.00E+00	1.10E+00	0.00E+00	3.89E+03	0.00E+00
TB-160	9.62E+00	0.00E+00	1.19E+00	0.00E+00	2.86E+00	0.00E+00	2.13E+03	0.00E+00
HO-166M	6.29E+01	1.32E+01	1.11E+01	0.00E+00	1.87E+01	0.00E+00	1.53E+03	0.00E+00
W-181	2.46E+00	6.04E-01	8.30E-02	0.00E+00	0.00E+00	0.00E+00	2.20E+01	0.00E+00
W-185	1.00E+02	2.50E+01	3.51E+00	0.00E+00	0.00E+00	0.00E+00	9.33E+02	0.00E+00
W-187	1.76E+01	1.04E+01	4.68E+00	0.00E+00	0.00E+00	0.00E+00	1.47E+03	0.00E+00
U-232	1.02E+06	0.00E+00	7.34E+04	0.00E+00	7.80E+04	0.00E+00	4.06E+03	0.00E+00
U-233	2.17E+05	0.00E+00	1.31E+04	0.00E+00	3.55E+04	0.00E+00	3.76E+03	0.00E+00
U-234	2.08E+05	0.00E+00	1.29E+04	0.00E+00	3.48E+04	0.00E+00	3.68E+03	0.00E+00
U-235	1.99E+05	0.00E+00	1.21E+04	0.00E+00	3.27E+04	0.00E+00	4.68E+03	0.00E+00
U-236	1.99E+05	0.00E+00	1.23E+04	0.00E+00	3.34E+04	0.00E+00	3.45E+03	0.00E+00
U-237	1.31E+01	0.00E+00	3.47E+00	0.00E+00	3.77E+01	0.00E+00	1.15E+03	0.00E+00
U-238	1.90E+05	0.00E+00	1.13E+04	0.00E+00	3.05E+04	0.00E+00	3.30E+03	0.00E+00
NP-237	1.30E+05	8.56E+03	5.70E+03	0.00E+00	3.52E+04	0.00E+00	4.75E+03	0.00E+00
NP-238	2.88E+00	5.83E-02	4.49E-02	0.00E+00	1.86E-01	0.00E+00	2.00E+03	0.00E+00
NP-239	2.64E-01	1.89E-02	1.33E-02	0.00E+00	5.48E-02	0.00E+00	1.40E+03	0.00E+00
PU-238	6.93E+04	8.03E+03	1.84E+03	0.00E+00	6.70E+03	0.00E+00	4.37E+03	0.00E+00
PU-239	7.51E+04	8.03E+03	1.93E+03	0.00E+00	7.10E+03	0.00E+00	3.99E+03	0.00E+00
PU-240	7.45E+04	8.33E+03	1.93E+03	0.00E+00	7.10E+03	0.00E+00	4.06E+03	0.00E+00
PU-241	2.25E+03	9.20E+01	4.68E+01	0.00E+00	1.72E+02	0.00E+00	8.38E+01	0.00E+00
PU-242	6.93E+04	8.03E+03	1.86E+03	0.00E+00	6.81E+03	0.00E+00	3.91E+03	0.00E+00
PU-244	8.09E+04	9.20E+04	2.13E+03	0.00E+00	7.86E+03	0.00E+00	5.82E+03	0.00E+00
AM-241	7.92E+04	6.81E+04	5.94E+03	0.00E+00	3.63E+04	0.00E+00	4.45E+03	0.00E+00
AM-242M	8.15E+04	6.52E+04	6.05E+03	0.00E+00	3.67E+04	0.00E+00	5.59E+03	0.00E+00
AM-243	7.80E+04	6.58E+04	5.72E+03	0.00E+00	3.53E+04	0.00E+00	5.21E+03	0.00E+00
CM-242	5.10E+03	4.07E+03	3.39E+02	0.00E+00	1.09E+03	0.00E+00	4.74E+03	0.00E+00
CM-243	7.45E+04	6.05E+04	4.80E+03	0.00E+00	1.79E+04	0.00E+00	4.67E+03	0.00E+00
CM-244	6.29E+04	5.09E+04	4.03E+03	0.00E+00	1.48E+04	0.00E+00	4.52E+03	0.00E+00
CM-245	9.72E+04	7.80E+04	6.11E+03	0.00E+00	2.39E+04	0.00E+00	4.22E+03	0.00E+00
CM-246	9.61E+04	7.80E+04	6.11E+03	0.00E+00	2.39E+04	0.00E+00	4.14E+03	0.00E+00
CM-247	9.37E+04	7.68E+04	6.00E+03	0.00E+00	2.35E+04	0.00E+00	5.44E+03	0.00E+00
CM-248	7.80E+05	6.35E+05	4.96E+04	0.00E+00	1.94E+05	0.00E+00	8.79E+04	0.00E+00
CF-252	6.11E+04	0.00E+00	1.48E+03	0.00E+00	0.00E+00	0.00E+00	1.72E+04	0.00E+00

TABLE II1-16

CHILD FRESHWATER FISH A_{IT} FACTORS

mrem-ml per uCi-hr

NUCLIDE	BONE	LIVER	T BODY	THYROID	KIDNEY	LUNG	GI-LLI	SKIN
H-3	0.00E+00	8.22E-02	8.22E-02	8.22E-02	8.22E-02	8.22E-02	8.22E-02	0.00E+00
C-14	4.38E+04	8.77E+03	8.77E+03	8.77E+03	8.77E+03	8.77E+03	8.77E+03	0.00E+00
NA-22	4.63E+03	4.63E+03	4.63E+03	4.63E+03	4.63E+03	4.63E+03	4.63E+03	0.00E+00
NA-24	1.51E+02	1.51E+02	1.51E+02	1.51E+02	1.51E+02	1.51E+02	1.51E+02	0.00E+00
P-32	1.86E+06	8.69E+04	7.16E+04	0.00E+00	0.00E+00	0.00E+00	5.13E+04	0.00E+00
CA-41	1.09E+04	0.00E+00	1.19E+03	0.00E+00	0.00E+00	0.00E+00	5.99E+00	0.00E+00
SC-46	3.08E-02	4.22E-02	1.62E-02	0.00E+00	3.73E-02	0.00E+00	6.17E+01	0.00E+00
CR-51	0.00E+00	0.00E+00	1.37E+00	7.59E-01	2.07E-01	1.39E+00	7.25E+01	0.00E+00
MN-54	0.00E+00	3.36E+03	8.96E+02	0.00E+00	9.43E+02	0.00E+00	2.82E+03	0.00E+00
MN-56	0.00E+00	1.66E-01	3.75E-02	0.00E+00	2.01E-01	0.00E+00	2.41E+01	0.00E+00
FE-55	9.05E+02	4.80E+02	1.49E+02	0.00E+00	0.00E+00	2.72E+02	8.89E+01	0.00E+00
FE-59	1.28E+03	2.07E+03	1.03E+03	0.00E+00	0.00E+00	6.00E+02	2.16E+03	0.00E+00
CO-57	0.00E+00	1.94E+01	3.92E+01	0.00E+00	0.00E+00	0.00E+00	1.59E+02	0.00E+00
CO-58	0.00E+00	7.02E+01	2.15E+02	0.00E+00	0.00E+00	0.00E+00	4.09E+02	0.00E+00
CO-60	0.00E+00	2.08E+02	6.14E+02	0.00E+00	0.00E+00	0.00E+00	1.15E+03	0.00E+00
NI-59	3.17E+03	8.43E+02	5.37E+02	0.00E+00	0.00E+00	0.00E+00	5.59E+01	0.00E+00
NI-63	4.24E+04	2.27E+03	1.44E+03	0.00E+00	0.00E+00	0.00E+00	1.53E+02	0.00E+00
NI-65	2.38E-01	2.24E-02	1.31E-02	0.00E+00	0.00E+00	0.00E+00	2.74E+00	0.00E+00
CU-64	0.00E+00	2.60E+00	1.57E+00	0.00E+00	6.29E+00	0.00E+00	1.22E+02	0.00E+00
ZN-65	2.15E+04	5.73E+04	3.57E+04	0.00E+00	3.61E+04	0.00E+00	1.01E+04	0.00E+00
ZN-69M	3.34E+02	5.69E+02	6.72E+01	0.00E+00	3.30E+02	0.00E+00	1.85E+04	0.00E+00
ZN-69	1.10E-06	1.59E-06	1.47E-07	0.00E+00	9.67E-07	0.00E+00	1.00E-04	0.00E+00
SE-79	0.00E+00	1.13E+03	2.50E+02	0.00E+00	1.83E+03	0.00E+00	7.40E+01	0.00E+00
BR-82	0.00E+00	0.00E+00	1.56E+03	0.00E+00	0.00E+00	0.00E+00	0.00E+00	0.00E+00
BR-83	0.00E+00	0.00E+00	5.37E-02	0.00E+00	0.00E+00	0.00E+00	0.00E+00	0.00E+00
BR-84	0.00E+00	0.00E+00	1.53E-12	0.00E+00	0.00E+00	0.00E+00	0.00E+00	0.00E+00
BR-85	0.00E+00	0.00E+00	1.84E-151	0.00E+00	0.00E+00	0.00E+00	0.00E+00	0.00E+00
RB-86	0.00E+00	1.02E+05	6.25E+04	0.00E+00	0.00E+00	0.00E+00	6.54E+03	0.00E+00
RB-87	0.00E+00	6.22E+04	2.88E+04	0.00E+00	0.00E+00	0.00E+00	9.33E+02	0.00E+00
RB-88	0.00E+00	1.33E-22	9.22E-23	0.00E+00	0.00E+00	0.00E+00	6.51E-24	0.00E+00
RB-89	0.00E+00	1.55E-26	1.38E-26	0.00E+00	0.00E+00	0.00E+00	1.35E-28	0.00E+00
SR-89	3.08E+04	0.00E+00	8.79E+02	0.00E+00	0.00E+00	0.00E+00	1.19E+03	0.00E+00
SR-90	6.05E+05	0.00E+00	1.22E+04	0.00E+00	0.00E+00	0.00E+00	5.41E+03	0.00E+00
SR-91	9.84E+01	0.00E+00	3.72E+00	0.00E+00	0.00E+00	0.00E+00	2.17E+02	0.00E+00
SR-92	4.60E-01	0.00E+00	1.85E-02	0.00E+00	0.00E+00	0.00E+00	8.72E+00	0.00E+00
Y-90	6.24E-01	0.00E+00	1.67E-02	0.00E+00	0.00E+00	0.00E+00	1.78E+03	0.00E+00
Y-91M	1.43E-11	0.00E+00	5.21E-13	0.00E+00	0.00E+00	0.00E+00	2.81E-08	0.00E+00

TABLE II-16

CHILD FRESHWATER FISH A_{IT} FACTORS

mrem-ml per uCi-hr

NUCLIDE	BONE	LIVER	T BODY	THYROID	KIDNEY	LUNG	GI-LLI	SKIN
Y-91	1.17E+01	0.00E+00	3.13E-01	0.00E+00	0.00E+00	0.00E+00	1.56E+03	0.00E+00
Y-92	6.45E-04	0.00E+00	1.85E-05	0.00E+00	0.00E+00	0.00E+00	1.86E+01	0.00E+00
Y-93	4.32E-02	0.00E+00	1.19E-03	0.00E+00	0.00E+00	0.00E+00	6.45E+02	0.00E+00
ZR-93	4.34E-01	1.62E-02	1.16E-02	0.00E+00	6.29E-02	0.00E+00	6.16E+00	0.00E+00
ZR-95	2.98E-01	6.56E-02	5.84E-02	0.00E+00	9.39E-02	0.00E+00	6.84E+01	0.00E+00
ZR-97	6.79E-03	9.81E-04	5.79E-04	0.00E+00	1.41E-03	0.00E+00	1.49E+02	0.00E+00
NB-93M	2.48E+03	6.19E+02	2.03E+02	0.00E+00	6.69E+02	0.00E+00	9.33E+04	0.00E+00
NB-95	5.21E+02	2.03E+02	1.45E+02	0.00E+00	1.91E+02	0.00E+00	3.75E+05	0.00E+00
NB-97	4.99E-06	9.01E-07	4.20E-07	0.00E+00	9.99E-07	0.00E+00	2.78E-01	0.00E+00
MO-93	0.00E+00	1.90E+02	6.81E+00	0.00E+00	5.00E+01	0.00E+00	9.61E+00	0.00E+00
MO-99	0.00E+00	8.14E+01	2.01E+01	0.00E+00	1.74E+02	0.00E+00	6.73E+01	0.00E+00
TC-99M	6.88E-04	1.35E-03	2.24E-02	0.00E+00	1.96E-02	6.85E-04	7.68E-01	0.00E+00
TC-99	6.32E+00	7.04E+00	2.53E+00	0.00E+00	8.29E+01	6.23E-01	7.38E+01	0.00E+00
TC-101	3.76E-33	3.93E-33	4.99E-32	0.00E+00	6.71E-32	2.08E-33	1.25E-32	0.00E+00
RU-103	5.66E+00	0.00E+00	2.17E+00	0.00E+00	1.42E+01	0.00E+00	1.46E+02	0.00E+00
RU-105	1.20E-02	0.00E+00	4.35E-03	0.00E+00	1.05E-01	0.00E+00	7.82E+00	0.00E+00
RU-106	9.20E+01	0.00E+00	1.15E+01	0.00E+00	1.24E+02	0.00E+00	1.43E+03	0.00E+00
RH-105	2.53E+00	1.36E+00	1.16E+00	0.00E+00	5.41E+00	0.00E+00	8.41E+01	0.00E+00
PD-107	0.00E+00	3.72E+00	3.16E-01	0.00E+00	3.11E+01	0.00E+00	7.38E+00	0.00E+00
PD-109	0.00E+00	1.30E+00	3.89E-01	0.00E+00	6.95E+00	0.00E+00	7.66E+01	0.00E+00
AG-110M	9.74E-01	6.58E-01	5.26E-01	0.00E+00	1.22E+00	0.00E+00	7.82E+01	0.00E+00
AG-111	4.09E-01	1.28E-01	8.45E-02	0.00E+00	3.86E-01	0.00E+00	7.84E+01	0.00E+00
CD-113M	0.00E+00	1.61E+03	6.84E+01	0.00E+00	1.65E+03	0.00E+00	4.14E+03	0.00E+00
CD-115M	0.00E+00	9.14E+02	3.89E+01	0.00E+00	6.79E+02	0.00E+00	1.24E+04	0.00E+00
SN-123	3.13E+05	3.88E+03	7.62E+03	4.11E+03	0.00E+00	0.00E+00	1.53E+05	0.00E+00
SN-125	7.81E+04	1.18E+03	3.50E+03	1.22E+03	0.00E+00	0.00E+00	2.42E+05	0.00E+00
SN-126	7.87E+05	9.81E+03	2.24E+04	2.69E+03	0.00E+00	0.00E+00	5.91E+04	0.00E+00
SB-124	8.64E+00	1.12E-01	3.03E+00	1.91E-02	0.00E+00	4.80E+00	5.40E+01	0.00E+00
SB-125	5.64E+00	4.34E-02	1.18E+00	5.22E-03	0.00E+00	3.14E+00	1.35E+01	0.00E+00
SB-126	3.28E+00	5.01E-02	1.18E+00	1.92E-02	0.00E+00	1.56E+00	6.61E+01	0.00E+00
SB-127	6.97E-01	1.08E-02	2.42E-01	7.76E-03	0.00E+00	3.03E-01	3.93E+01	0.00E+00
TE-125M	3.55E+03	9.62E+02	4.73E+02	9.96E+02	0.00E+00	0.00E+00	3.42E+03	0.00E+00
TE-127M	9.05E+03	2.44E+03	1.07E+03	2.16E+03	2.58E+04	0.00E+00	7.33E+03	0.00E+00
TE-127	2.50E+01	6.75E+00	5.37E+00	1.73E+01	7.13E+01	0.00E+00	9.78E+02	0.00E+00
TE-129M	1.50E+04	4.20E+03	2.33E+03	4.85E+03	4.41E+04	0.00E+00	1.83E+04	0.00E+00
TE-129	2.50E-05	6.97E-06	5.92E-06	1.78E-05	7.30E-05	0.00E+00	1.55E-03	0.00E+00
TE-131M	1.30E+03	4.51E+02	4.80E+02	9.27E+02	4.36E+03	0.00E+00	1.83E+04	0.00E+00
TE-131	1.20E-16	3.65E-17	3.56E-17	9.16E-17	3.62E-16	0.00E+00	6.29E-16	0.00E+00

TABLE II1-16

CHILD FRESHWATER FISH A₁₇ FACTORS

mrem-ml per uCi-hr

NUCLIDE	BONE	LIVER	T BODY	THYROID	KIDNEY	LUNG	GI-LLI	SKIN
TE-132	2.57E+03	1.14E+03	1.38E+03	1.66E+03	1.06E+04	0.00E+00	1.15E+04	0.00E+00
TE-133M	8.82E-07	3.57E-07	4.42E-07	6.84E-07	3.39E-06	0.00E+00	2.72E-05	0.00E+00
TE-134	1.73E-09	7.79E-10	1.04E-09	1.37E-09	7.21E-09	0.00E+00	7.91E-09	0.00E+00
I-129	1.64E+02	1.01E+02	9.00E+01	6.59E+04	1.70E+02	0.00E+00	5.07E+00	0.00E+00
I-130	8.98E+00	1.81E+01	9.35E+00	2.00E+03	2.71E+01	0.00E+00	8.49E+00	0.00E+00
I-131	1.86E+02	1.88E+02	1.07E+02	6.20E+04	3.08E+02	0.00E+00	1.67E+01	0.00E+00
I-132	6.83E-03	1.25E-02	5.77E-03	5.82E-01	1.92E-02	0.00E+00	1.48E-02	0.00E+00
I-133	3.14E+01	3.89E+01	1.47E+01	7.22E+03	6.48E+01	0.00E+00	1.57E+01	0.00E+00
I-134	2.84E-08	5.28E-08	2.43E-08	1.21E-06	8.07E-08	0.00E+00	3.50E-08	0.00E+00
I-135	1.67E+00	3.00E+00	1.42E+00	2.66E+02	4.61E+00	0.00E+00	2.29E+00	0.00E+00
CS-134M	4.29E-01	6.35E-01	4.15E-01	0.00E+00	3.35E-01	5.54E-02	8.03E-01	0.00E+00
CS-134	3.68E+05	6.04E+05	1.27E+05	0.00E+00	1.87E+05	6.72E+04	3.26E+03	0.00E+00
CS-135	1.31E+05	9.11E+04	9.34E+03	0.00E+00	3.21E+04	1.07E+04	6.82E+02	0.00E+00
CS-136	3.51E+04	9.65E+04	6.25E+04	0.00E+00	5.14E+04	7.67E+03	3.39E+03	0.00E+00
CS-137	5.15E+05	4.93E+05	7.28E+04	0.00E+00	1.61E+05	5.78E+04	3.09E+03	0.00E+00
CS-138	1.24E-11	1.72E-11	1.09E-11	0.00E+00	1.21E-11	1.30E-12	7.93E-12	0.00E+00
CS-139	1.75E-44	1.95E-44	9.35E-45	0.00E+00	1.46E-44	1.47E-45	1.75E-48	0.00E+00
BA-139	7.93E-06	4.23E-09	2.30E-07	0.00E+00	3.69E-09	2.49E-09	4.58E-04	0.00E+00
BA-140	2.48E+02	2.17E-01	1.45E+01	0.00E+00	7.07E-02	1.30E-01	1.26E+02	0.00E+00
BA-141	1.18E-24	6.62E-28	3.85E-26	0.00E+00	5.73E-28	3.89E-27	6.74E-25	0.00E+00
BA-142	8.46E-42	6.09E-45	4.72E-43	0.00E+00	4.93E-45	3.58E-45	1.10E-43	0.00E+00
LA-140	1.32E-01	4.60E-02	1.55E-02	0.00E+00	0.00E+00	0.00E+00	1.28E+03	0.00E+00
LA-141	3.93E-04	9.16E-05	1.99E-05	0.00E+00	0.00E+00	0.00E+00	2.04E+01	0.00E+00
LA-142	2.95E-07	9.40E-08	2.94E-08	0.00E+00	0.00E+00	0.00E+00	1.86E-02	0.00E+00
CE-141	3.06E-02	1.53E-02	2.27E-03	0.00E+00	6.69E-03	0.00E+00	1.90E+01	0.00E+00
CE-143	3.33E-03	1.80E+00	2.61E-04	0.00E+00	7.57E-04	0.00E+00	2.64E+01	0.00E+00
CE-144	1.63E+00	5.12E-01	8.72E-02	0.00E+00	2.84E-01	0.00E+00	1.34E+02	0.00E+00
PR-143	7.35E-01	2.21E-01	3.65E-02	0.00E+00	1.20E-01	0.00E+00	7.93E+02	0.00E+00
PR-144	2.08E-28	6.45E-29	1.05E-29	0.00E+00	3.41E-29	0.00E+00	1.39E-25	0.00E+00
ND-147	5.16E-01	4.18E-01	3.24E-02	0.00E+00	2.29E-01	0.00E+00	6.62E+02	0.00E+00
PM-147	6.26E+00	4.47E-01	2.40E-01	0.00E+00	7.89E-01	0.00E+00	1.81E+02	0.00E+00
PM-148M	1.99E+00	3.97E-01	3.97E-01	0.00E+00	5.89E-01	0.00E+00	1.12E+03	0.00E+00
PM-148	5.23E-01	6.28E-02	4.07E-02	0.00E+00	1.07E-01	0.00E+00	1.68E+03	0.00E+00
PM-149	9.34E-02	9.93E-03	5.38E-03	0.00E+00	1.76E-02	0.00E+00	6.78E+02	0.00E+00
PM-151	3.20E-02	3.89E-03	2.53E-03	0.00E+00	6.60E-03	0.00E+00	4.42E+02	0.00E+00
SM-151	5.04E+00	7.50E-01	2.36E-01	0.00E+00	7.76E-01	0.00E+00	1.09E+02	0.00E+00
SM-153	5.03E-02	3.13E-02	3.02E-03	0.00E+00	9.53E-03	0.00E+00	4.16E+02	0.00E+00
EU-152	1.21E+01	2.21E+00	2.62E+00	0.00E+00	9.31E+00	0.00E+00	3.62E+02	0.00E+00

TABLE II1-16

CHILD FRESHWATER FISH A_{IT} FACTORS

mrem-ml per uCi-hr

NUCLIDE	BONE	LIVER	T BODY	THYROID	KIDNEY	LUNG	GI-LLI	SKIN
EU-154	4.53E+01	4.08E+00	3.72E+00	0.00E+00	1.79E+01	0.00E+00	9.47E+02	0.00E+00
EU-155	9.49E+00	6.83E-01	5.35E-01	0.00E+00	2.56E+00	0.00E+00	1.71E+03	0.00E+00
EU-156	1.06E+00	5.66E-01	1.17E-01	0.00E+00	3.65E-01	0.00E+00	1.28E+03	0.00E+00
TB-160	3.24E+00	0.00E+00	4.02E-01	0.00E+00	9.63E-01	0.00E+00	7.18E+02	0.00E+00
HO-166M	2.13E+01	4.45E+00	3.76E+00	0.00E+00	6.34E+00	0.00E+00	5.18E+02	0.00E+00
W-181	3.98E+01	9.77E+00	1.34E+00	0.00E+00	0.00E+00	0.00E+00	3.56E+02	0.00E+00
W-185	1.62E+03	4.05E+02	5.67E+01	0.00E+00	0.00E+00	0.00E+00	1.51E+04	0.00E+00
W-187	2.02E+02	1.19E+02	5.36E+01	0.00E+00	0.00E+00	0.00E+00	1.68E+04	0.00E+00
U-232	2.77E+04	0.00E+00	1.98E+03	0.00E+00	2.11E+03	0.00E+00	1.10E+02	0.00E+00
U-233	5.86E+03	0.00E+00	3.54E+02	0.00E+00	9.61E+02	0.00E+00	1.02E+02	0.00E+00
U-234	5.62E+03	0.00E+00	3.48E+02	0.00E+00	9.42E+02	0.00E+00	9.96E+01	0.00E+00
U-235	5.39E+03	0.00E+00	3.26E+02	0.00E+00	8.84E+02	0.00E+00	1.27E+02	0.00E+00
U-236	5.39E+03	0.00E+00	3.34E+02	0.00E+00	9.03E+02	0.00E+00	9.33E+01	0.00E+00
U-237	3.35E-01	0.00E+00	8.91E-02	0.00E+00	9.68E-01	0.00E+00	2.96E+01	0.00E+00
U-238	5.15E+03	0.00E+00	3.06E+02	0.00E+00	8.25E+02	0.00E+00	8.92E+01	0.00E+00
NP-237	1.76E+04	1.16E+03	7.71E+02	0.00E+00	4.77E+03	0.00E+00	6.43E+02	0.00E+00
NP-238	3.31E-01	6.70E-03	5.16E-03	0.00E+00	2.13E-02	0.00E+00	2.29E+02	0.00E+00
NP-239	3.08E-02	2.21E-03	1.56E-03	0.00E+00	6.40E-03	0.00E+00	1.64E+02	0.00E+00
PU-238	3.28E+03	3.80E+02	8.71E+01	0.00E+00	3.17E+02	0.00E+00	2.07E+02	0.00E+00
PU-239	3.56E+03	3.80E+02	9.13E+01	0.00E+00	3.36E+02	0.00E+00	1.89E+02	0.00E+00
PU-240	3.53E+03	3.94E+02	9.13E+01	0.00E+00	3.36E+02	0.00E+00	1.92E+02	0.00E+00
PU-241	1.07E+02	4.36E+00	2.22E+00	0.00E+00	8.16E+00	0.00E+00	3.97E+00	0.00E+00
PU-242	3.28E+03	3.80E+02	8.79E+01	0.00E+00	3.23E+02	0.00E+00	1.85E+02	0.00E+00
PU-244	3.83E+03	4.36E+03	1.01E+02	0.00E+00	3.72E+02	0.00E+00	2.76E+02	0.00E+00
AM-241	2.68E+04	2.30E+04	2.01E+03	0.00E+00	1.23E+04	0.00E+00	1.50E+03	0.00E+00
AM-242M	2.76E+04	2.21E+04	2.05E+03	0.00E+00	1.24E+04	0.00E+00	1.89E+03	0.00E+00
AM-243	2.64E+04	2.23E+04	1.94E+03	0.00E+00	1.19E+04	0.00E+00	1.76E+03	0.00E+00
CM-242	1.72E+03	1.37E+03	1.15E+02	0.00E+00	3.67E+02	0.00E+00	1.60E+03	0.00E+00
CM-243	2.52E+04	2.05E+04	1.62E+03	0.00E+00	6.06E+03	0.00E+00	1.58E+03	0.00E+00
CM-244	2.13E+04	1.72E+04	1.36E+03	0.00E+00	5.00E+03	0.00E+00	1.53E+03	0.00E+00
CM-245	3.29E+04	2.64E+04	2.07E+03	0.00E+00	8.09E+03	0.00E+00	1.43E+03	0.00E+00
CM-246	3.25E+04	2.64E+04	2.07E+03	0.00E+00	8.07E+03	0.00E+00	1.40E+03	0.00E+00
CM-247	3.17E+04	2.60E+04	2.03E+03	0.00E+00	7.96E+03	0.00E+00	1.84E+03	0.00E+00
CM-248	2.64E+05	2.15E+05	1.68E+04	0.00E+00	6.56E+04	0.00E+00	2.97E+04	0.00E+00
CF-252	2.07E+04	0.00E+00	5.00E+02	0.00E+00	0.00E+00	0.00E+00	5.82E+03	0.00E+00

TABLE II1-17

CHILD SHORELINE A_{IT} FACTORS

mrem-ml per uCi-hr

NUCLIDE	BONE	LIVER	T BODY	THYROID	KIDNEY	LUNG	GI-LLI	SKIN
H-3	0.00E+00	0.00E+00	0.00E+00	0.00E+00	0.00E+00	0.00E+00	0.00E+00	0.00E+00
C-14	0.00E+00	0.00E+00	0.00E+00	0.00E+00	0.00E+00	0.00E+00	0.00E+00	0.00E+00
NA-22	3.12E+03	3.12E+03	3.12E+03	3.12E+03	3.12E+03	3.12E+03	3.12E+03	3.51E+03
NA-24	3.21E+00	3.21E+00	3.21E+00	3.21E+00	3.21E+00	3.21E+00	3.21E+00	3.72E+00
P-32	0.00E+00	0.00E+00	0.00E+00	0.00E+00	0.00E+00	0.00E+00	0.00E+00	0.00E+00
CA-41	4.43E+03	4.43E+03	4.43E+03	4.43E+03	4.43E+03	4.43E+03	4.43E+03	5.21E+03
SC-46	2.24E+02	2.24E+02	2.24E+02	2.24E+02	2.24E+02	2.24E+02	2.24E+02	2.58E+02
CR-51	1.25E+00	1.25E+00	1.25E+00	1.25E+00	1.25E+00	1.25E+00	1.25E+00	1.48E+00
MN-54	3.73E+02	3.73E+02	3.73E+02	3.73E+02	3.73E+02	3.73E+02	3.73E+02	4.37E+02
MN-56	2.43E-01	2.43E-01	2.43E-01	2.43E-01	2.43E-01	2.43E-01	2.43E-01	2.87E-01
FE-55	0.00E+00	0.00E+00	0.00E+00	0.00E+00	0.00E+00	0.00E+00	0.00E+00	0.00E+00
FE-59	7.34E+01	7.34E+01	7.34E+01	7.34E+01	7.34E+01	7.34E+01	7.34E+01	8.62E+01
CO-57	5.07E+01	5.07E+01	5.07E+01	5.07E+01	5.07E+01	5.07E+01	5.07E+01	5.57E+01
CO-58	1.02E+02	1.02E+02	1.02E+02	1.02E+02	1.02E+02	1.02E+02	1.02E+02	1.19E+02
CO-60	6.47E+03	6.47E+03	6.47E+03	6.47E+03	6.47E+03	6.47E+03	6.47E+03	7.62E+03
NI-59	0.00E+00	0.00E+00	0.00E+00	0.00E+00	0.00E+00	0.00E+00	0.00E+00	0.00E+00
NI-63	0.00E+00	0.00E+00	0.00E+00	0.00E+00	0.00E+00	0.00E+00	0.00E+00	0.00E+00
NI-65	7.98E-02	7.98E-02	7.98E-02	7.98E-02	7.98E-02	7.98E-02	7.98E-02	9.28E-02
CU-64	1.63E-01	1.63E-01	1.63E-01	1.63E-01	1.63E-01	1.63E-01	1.63E-01	1.85E-01
ZN-65	2.01E+02	2.01E+02	2.01E+02	2.01E+02	2.01E+02	2.01E+02	2.01E+02	2.31E+02
ZN-69M	3.42E-01	3.42E-01	3.42E-01	3.42E-01	3.42E-01	3.42E-01	3.42E-01	4.00E-01
ZN-69	0.00E+00	0.00E+00	0.00E+00	0.00E+00	0.00E+00	0.00E+00	0.00E+00	0.00E+00
SE-79	0.00E+00	0.00E+00	0.00E+00	0.00E+00	0.00E+00	0.00E+00	0.00E+00	0.00E+00
BR-82	5.74E+00	5.74E+00	5.74E+00	5.74E+00	5.74E+00	5.74E+00	5.74E+00	6.65E+00
BR-83	1.31E-03	1.31E-03	1.31E-03	1.31E-03	1.31E-03	1.31E-03	1.31E-03	1.90E-03
BR-84	5.45E-02	5.45E-02	5.45E-02	5.45E-02	5.45E-02	5.45E-02	5.45E-02	6.35E-02
BR-85	0.00E+00	0.00E+00	0.00E+00	0.00E+00	0.00E+00	0.00E+00	0.00E+00	0.00E+00
RB-86	2.42E+00	2.42E+00	2.42E+00	2.42E+00	2.42E+00	2.42E+00	2.42E+00	2.76E+00
RB-87	0.00E+00	0.00E+00	0.00E+00	0.00E+00	0.00E+00	0.00E+00	0.00E+00	0.00E+00
RB-88	8.89E-03	8.89E-03	8.89E-03	8.89E-03	8.89E-03	8.89E-03	8.89E-03	1.02E-02
RB-89	3.30E-02	3.30E-02	3.30E-02	3.30E-02	3.30E-02	3.30E-02	3.30E-02	3.97E-02
SR-89	5.82E-03	5.82E-03	5.82E-03	5.82E-03	5.82E-03	5.82E-03	5.82E-03	6.75E-03
SR-90	0.00E+00	0.00E+00	0.00E+00	0.00E+00	0.00E+00	0.00E+00	0.00E+00	0.00E+00
SR-91	5.78E-01	5.78E-01	5.78E-01	5.78E-01	5.78E-01	5.78E-01	5.78E-01	6.75E-01
SR-92	2.09E-01	2.09E-01	2.09E-01	2.09E-01	2.09E-01	2.09E-01	2.09E-01	2.32E-01
Y-90	1.21E-03	1.21E-03	1.21E-03	1.21E-03	1.21E-03	1.21E-03	1.21E-03	1.43E-03
Y-91M	2.70E-02	2.70E-02	2.70E-02	2.70E-02	2.70E-02	2.70E-02	2.70E-02	3.12E-02

TABLE II1-17

CHILD SHORELINE A_{IT} FACTORS

mrem-ml per uCi-hr

NUCLIDE	BONE	LIVER	T BODY	THYROID	KIDNEY	LUNG	GI-LLI	SKIN
Y-91	2.89E-01	2.89E-01	2.89E-01	2.89E-01	2.89E-01	2.89E-01	2.89E-01	3.25E-01
Y-92	4.85E-02	4.85E-02	4.85E-02	4.85E-02	4.85E-02	4.85E-02	4.85E-02	5.76E-02
Y-93	4.93E-02	4.93E-02	4.93E-02	4.93E-02	4.93E-02	4.93E-02	4.93E-02	6.75E-02
ZR-93	0.00E+00	0.00E+00	0.00E+00	0.00E+00	0.00E+00	0.00E+00	0.00E+00	0.00E+00
ZR-95	6.58E+01	6.58E+01	6.58E+01	6.58E+01	6.58E+01	6.58E+01	6.58E+01	7.63E+01
ZR-97	7.96E-01	7.96E-01	7.96E-01	7.96E-01	7.96E-01	7.96E-01	7.96E-01	9.26E-01
NB-93M	6.24E-01	6.24E-01	6.24E-01	6.24E-01	6.24E-01	6.24E-01	6.24E-01	7.61E+01
NB-95	3.67E+01	3.67E+01	3.67E+01	3.67E+01	3.67E+01	3.67E+01	3.67E+01	4.32E+01
NB-97	4.73E-02	4.73E-02	4.73E-02	4.73E-02	4.73E-02	4.73E-02	4.73E-02	5.56E-02
MO-93	2.97E+01	2.97E+01	2.97E+01	2.97E+01	2.97E+01	2.97E+01	2.97E+01	1.21E+03
MO-99	1.07E+00	1.07E+00	1.07E+00	1.07E+00	1.07E+00	1.07E+00	1.07E+00	1.24E+00
TC-99M	4.95E-02	4.95E-02	4.95E-02	4.95E-02	4.95E-02	4.95E-02	4.95E-02	5.67E-02
TC-99	0.00E+00	0.00E+00	0.00E+00	0.00E+00	0.00E+00	0.00E+00	0.00E+00	0.00E+00
TC-101	5.47E-03	5.47E-03	5.47E-03	5.47E-03	5.47E-03	5.47E-03	5.47E-03	6.08E-03
RU-103	2.91E+01	2.91E+01	2.91E+01	2.91E+01	2.91E+01	2.91E+01	2.91E+01	3.40E+01
RU-105	1.71E-01	1.71E-01	1.71E-01	1.71E-01	1.71E-01	1.71E-01	1.71E-01	1.94E-01
RU-106	1.13E+02	1.13E+02	1.13E+02	1.13E+02	1.13E+02	1.13E+02	1.13E+02	1.36E+02
RH-105	2.00E-01	2.00E-01	2.00E-01	2.00E-01	2.00E-01	2.00E-01	2.00E-01	2.33E-01
PD-107	0.00E+00	0.00E+00	0.00E+00	0.00E+00	0.00E+00	0.00E+00	0.00E+00	0.00E+00
PD-109	4.03E-03	4.03E-03	4.03E-03	4.03E-03	4.03E-03	4.03E-03	4.03E-03	4.61E-03
AG-110M	9.24E+02	9.24E+02	9.24E+02	9.24E+02	9.24E+02	9.24E+02	9.24E+02	1.08E+03
AG-111	2.76E-01	2.76E-01	2.76E-01	2.76E-01	2.76E-01	2.76E-01	2.76E-01	3.22E-01
CD-113M	1.70E+00	1.70E+00	1.70E+00	1.70E+00	1.70E+00	1.70E+00	1.70E+00	1.92E+00
CD-115M	0.00E+00	0.00E+00	0.00E+00	0.00E+00	0.00E+00	0.00E+00	0.00E+00	0.00E+00
SN-123	0.00E+00	0.00E+00	0.00E+00	0.00E+00	0.00E+00	0.00E+00	0.00E+00	1.72E+03
SN-125	1.13E+00	1.13E+00	1.13E+00	1.13E+00	1.13E+00	1.13E+00	1.13E+00	1.31E+00
SN-126	1.17E+04	1.17E+04	1.17E+04	1.17E+04	1.17E+04	1.17E+04	1.17E+04	1.30E+04
SB-124	1.61E+02	1.61E+02	1.61E+02	1.61E+02	1.61E+02	1.61E+02	1.61E+02	1.86E+02
SB-125	6.43E+02	6.43E+02	6.43E+02	6.43E+02	6.43E+02	6.43E+02	6.43E+02	7.26E+02
SB-126	2.27E+01	2.27E+01	2.27E+01	2.27E+01	2.27E+01	2.27E+01	2.27E+01	2.55E+01
SB-127	4.51E+00	4.51E+00	4.51E+00	4.51E+00	4.51E+00	4.51E+00	4.51E+00	5.22E+00
TE-125M	4.17E-01	4.17E-01	4.17E-01	4.17E-01	4.17E-01	4.17E-01	4.17E-01	5.72E-01
TE-127M	2.46E-02	2.46E-02	2.46E-02	2.46E-02	2.46E-02	2.46E-02	2.46E-02	2.91E-02
TE-127	8.01E-04	8.01E-04	8.01E-04	8.01E-04	8.01E-04	8.01E-04	8.01E-04	8.81E-04
TE-129M	5.32E+00	5.32E+00	5.32E+00	5.32E+00	5.32E+00	5.32E+00	5.32E+00	6.21E+00
TE-129	7.05E-03	7.05E-03	7.05E-03	7.05E-03	7.05E-03	7.05E-03	7.05E-03	8.34E-03
TE-131M	2.16E+00	2.16E+00	2.16E+00	2.16E+00	2.16E+00	2.16E+00	2.16E+00	2.54E+00
TE-131	7.85E-03	7.85E-03	7.85E-03	7.85E-03	7.85E-03	7.85E-03	7.85E-03	9.28E+00

TABLE II1-17

CHILD SHORELINE A_{IT} FACTORS

mrem-ml per uCi-hr

NUCLIDE	BONE	LIVER	T BODY	THYROID	KIDNEY	LUNG	GI-LLI	SKIN
TE-132	1.14E+00	1.14E+00	1.14E+00	1.14E+00	1.14E+00	1.14E+00	1.14E+00	1.34E+00
TE-133M	1.19E-01	1.19E-01	1.19E-01	1.19E-01	1.19E-01	1.19E-01	1.19E-01	1.34E-01
TE-134	5.96E-03	5.96E-03	5.96E-03	5.96E-03	5.96E-03	5.96E-03	5.96E-03	7.16E-03
I-129	5.85E+02	5.85E+02	5.85E+02	5.85E+02	5.85E+02	5.85E+02	5.85E+02	9.75E+02
I-130	1.48E+00	1.48E+00	1.48E+00	1.48E+00	1.48E+00	1.48E+00	1.48E+00	1.80E+00
I-131	4.63E+00	4.63E+00	4.63E+00	4.63E+00	4.63E+00	4.63E+00	4.63E+00	5.62E+00
I-132	3.35E-01	3.35E-01	3.35E-01	3.35E-01	3.35E-01	3.35E-01	3.35E-01	3.94E-01
I-133	6.59E-01	6.59E-01	6.59E-01	6.59E-01	6.59E-01	6.59E-01	6.59E-01	8.01E-01
I-134	1.20E-01	1.20E-01	1.20E-01	1.20E-01	1.20E-01	1.20E-01	1.20E-01	1.43E-01
I-135	6.79E-01	6.79E-01	6.79E-01	6.79E-01	6.79E-01	6.79E-01	6.79E-01	7.92E-01
CS-134M	1.54E-02	1.54E-02	1.54E-02	1.54E-02	1.54E-02	1.54E-02	1.54E-02	1.81E-02
CS-134	1.86E+03	1.86E+03	1.86E+03	1.86E+03	1.86E+03	1.86E+03	1.86E+03	2.17E+03
CS-135	0.00E+00	0.00E+00	0.00E+00	0.00E+00	0.00E+00	0.00E+00	0.00E+00	0.00E+00
CS-136	4.06E+01	4.06E+01	4.06E+01	4.06E+01	4.06E+01	4.06E+01	4.06E+01	4.60E+01
CS-137	4.16E+03	4.16E+03	4.16E+03	4.16E+03	4.16E+03	4.16E+03	4.16E+03	4.85E+03
CS-138	9.65E-02	9.65E-02	9.65E-02	9.65E-02	9.65E-02	9.65E-02	9.65E-02	1.10E-01
CS-139	8.45E-03	8.45E-03	8.45E-03	8.45E-03	8.45E-03	8.45E-03	8.45E-03	9.66E-03
BA-139	2.85E-02	2.85E-02	2.85E-02	2.85E-02	2.85E-02	2.85E-02	2.85E-02	3.20E-02
BA-140	5.52E+00	5.52E+00	5.52E+00	5.52E+00	5.52E+00	5.52E+00	5.52E+00	6.31E+00
BA-141	1.12E-02	1.12E-02	1.12E-02	1.12E-02	1.12E-02	1.12E-02	1.12E-02	1.28E-02
BA-142	1.21E-02	1.21E-02	1.21E-02	1.21E-02	1.21E-02	1.21E-02	1.21E-02	1.37E-02
LA-140	5.17E+00	5.17E+00	5.17E+00	5.17E+00	5.17E+00	5.17E+00	5.17E+00	5.85E+00
LA-141	8.43E-03	8.43E-03	8.43E-03	8.43E-03	8.43E-03	8.43E-03	8.43E-03	9.45E-03
LA-142	2.04E-01	2.04E-01	2.04E-01	2.04E-01	2.04E-01	2.04E-01	2.04E-01	2.45E-01
CE-141	3.67E+00	3.67E+00	3.67E+00	3.67E+00	3.67E+00	3.67E+00	3.67E+00	4.14E+00
CE-143	6.22E-01	6.22E-01	6.22E-01	6.22E-01	6.22E-01	6.22E-01	6.22E-01	7.06E-01
CE-144	1.87E+01	1.87E+01	1.87E+01	1.87E+01	1.87E+01	1.87E+01	1.87E+01	2.16E+01
PR-143	0.00E+00	0.00E+00	0.00E+00	0.00E+00	0.00E+00	0.00E+00	0.00E+00	0.00E+00
PR-144	4.93E-04	4.93E-04	4.93E-04	4.93E-04	4.93E-04	4.93E-04	4.93E-04	5.67E-04
ND-147	2.26E+00	2.26E+00	2.26E+00	2.26E+00	2.26E+00	2.26E+00	2.26E+00	2.71E+00
PM-147	0.00E+00	0.00E+00	0.00E+00	0.00E+00	0.00E+00	0.00E+00	0.00E+00	0.00E+00
PM-148M	1.20E+02	1.20E+02	1.20E+02	1.20E+02	1.20E+02	1.20E+02	1.20E+02	6.93E+02
PM-148	5.08E+00	5.08E+00	5.08E+00	5.08E+00	5.08E+00	5.08E+00	5.08E+00	5.85E+00
PM-149	1.14E-02	1.14E-02	1.14E-02	1.14E-02	1.14E-02	1.14E-02	1.14E-02	1.32E-02
PM-151	5.35E-01	5.35E-01	5.35E-01	5.35E-01	5.35E-01	5.35E-01	5.35E-01	5.59E-01
SM-151	5.68E+01	5.68E+01	5.68E+01	5.68E+01	5.68E+01	5.68E+01	5.68E+01	2.48E+02
SM-153	1.08E-01	1.08E-01	1.08E-01	1.08E-01	1.08E-01	1.08E-01	1.08E-01	1.20E-01
EU-152	5.42E+03	5.42E+03	5.42E+03	5.42E+03	5.42E+03	5.42E+03	5.42E+03	6.27E+03

TABLE II1-17

CHILD SHORELINE A_{IT} FACTORS

mrem-ml per uCi-hr

NUCLIDE	BONE	LIVER	T BODY	THYROID	KIDNEY	LUNG	GI-LLI	SKIN
EU-154	4.43E+03	4.43E+03	4.43E+03	4.43E+03	4.43E+03	4.43E+03	4.43E+03	5.11E+03
EU-155	1.38E+02	1.38E+02	1.38E+02	1.38E+02	1.38E+02	1.38E+02	1.38E+02	1.56E+02
EU-156	2.37E+01	2.37E+01	2.37E+01	2.37E+01	2.37E+01	2.37E+01	2.37E+01	2.72E+01
TB-160	1.28E+02	1.28E+02	1.28E+02	1.28E+02	1.28E+02	1.28E+02	1.28E+02	1.49E+02
HO-166M	1.15E+04	1.15E+04	1.15E+04	1.15E+04	1.15E+04	1.15E+04	1.15E+04	1.29E+04
W-181	5.22E-02	5.22E-02	5.22E-02	5.22E-02	5.22E-02	5.22E-02	5.22E-02	6.96E-02
W-185	0.00E+00	0.00E+00	0.00E+00	0.00E+00	0.00E+00	0.00E+00	0.00E+00	0.00E+00
W-187	6.33E-01	6.33E-01	6.33E-01	6.33E-01	6.33E-01	6.33E-01	6.33E-01	7.35E-01
U-232	2.99E+00	2.99E+00	2.99E+00	2.99E+00	2.99E+00	2.99E+00	2.99E+00	3.11E+01
U-233	2.99E+03	2.99E+03	2.99E+03	2.99E+03	2.99E+03	2.99E+03	2.99E+03	3.64E+03
U-234	8.22E-01	8.22E-01	8.22E-01	8.22E-01	8.22E-01	8.22E-01	8.22E-01	2.07E+02
U-235	4.16E+03	4.16E+03	4.16E+03	4.16E+03	4.16E+03	4.16E+03	4.16E+03	5.20E+03
U-236	2.73E-02	2.73E-02	2.73E-02	2.73E-02	2.73E-02	2.73E-02	2.73E-02	2.34E+01
U-237	1.39E+00	1.39E+00	1.39E+00	1.39E+00	1.39E+00	1.39E+00	1.39E+00	1.80E+00
U-238	1.43E+02	1.43E+02	1.43E+02	1.43E+02	1.43E+02	1.43E+02	1.43E+02	1.95E+02
NP-237	1.82E+03	1.82E+03	1.82E+03	1.82E+03	1.82E+03	1.82E+03	1.82E+03	2.08E+03
NP-238	1.22E+00	1.22E+00	1.22E+00	1.22E+00	1.22E+00	1.22E+00	1.22E+00	1.39E+00
NP-239	4.60E-01	4.60E-01	4.60E-01	4.60E-01	4.60E-01	4.60E-01	4.60E-01	5.32E-01
PU-238	1.53E+00	1.53E+00	1.53E+00	1.53E+00	1.53E+00	1.53E+00	1.53E+00	2.12E+01
PU-239	1.03E+00	1.03E+00	1.03E+00	1.03E+00	1.03E+00	1.03E+00	1.03E+00	1.00E+01
PU-240	1.69E+00	1.69E+00	1.69E+00	1.69E+00	1.69E+00	1.69E+00	1.69E+00	2.34E+01
PU-241	3.48E+00	3.48E+00	3.48E+00	3.48E+00	3.48E+00	3.48E+00	3.48E+00	5.14E+00
PU-242	1.43E+00	1.43E+00	1.43E+00	1.43E+00	1.43E+00	1.43E+00	1.43E+00	2.08E+01
PU-244	1.16E+03	1.16E+03	1.16E+03	1.16E+03	1.16E+03	1.16E+03	1.16E+03	1.25E+03
AM-241	2.29E+02	2.29E+02	2.29E+02	2.29E+02	2.29E+02	2.29E+02	2.29E+02	3.31E+02
AM-242M	3.20E+01	3.20E+01	3.20E+01	3.20E+01	3.20E+01	3.20E+01	3.20E+01	2.21E+02
AM-243	1.69E+03	1.69E+03	1.69E+03	1.69E+03	1.69E+03	1.69E+03	1.69E+03	1.95E+03
CM-242	1.84E-01	1.84E-01	1.84E-01	1.84E-01	1.84E-01	1.84E-01	1.84E-01	7.71E-01
CM-243	2.24E+03	2.24E+03	2.24E+03	2.24E+03	2.24E+03	2.24E+03	2.24E+03	2.83E+03
CM-244	2.43E+00	2.43E+00	2.43E+00	2.43E+00	2.43E+00	2.43E+00	2.43E+00	1.51E+01
CM-245	1.23E+03	1.23E+03	1.23E+03	1.23E+03	1.23E+03	1.23E+03	1.23E+03	1.56E+03
CM-246	1.30E+00	1.30E+00	1.30E+00	1.30E+00	1.30E+00	1.30E+00	1.30E+00	1.95E+01
CM-247	2.86E+03	2.86E+03	2.86E+03	2.86E+03	2.86E+03	2.86E+03	2.86E+03	3.38E+03
CM-248	6.80E+03	6.80E+03	6.80E+03	6.80E+03	6.80E+03	6.80E+03	6.80E+03	8.86E+03
CF-252	1.31E+04	1.31E+04	1.31E+04	1.31E+04	1.31E+04	1.31E+04	1.31E+04	1.42E+04

TABLE II1-18

INFANT DRINKING WATER A₁₇ FACTORS

mrem-ml per uCi-hr

NUCLIDE	BONE	LIVER	T BODY	THYROID	KIDNEY	LUNG	GI-LLI	SKIN
H-3	0.00E+00	6.63E+00	6.63E+00	6.63E+00	6.63E+00	6.63E+00	6.63E+00	0.00E+00
C-14	8.93E+02	1.91E+02	1.91E+02	1.91E+02	1.91E+02	1.91E+02	1.91E+02	0.00E+00
NA-22	3.70E+03	3.70E+03	3.70E+03	3.70E+03	3.70E+03	3.70E+03	3.70E+03	0.00E+00
NA-24	2.19E+02	2.19E+02	2.19E+02	2.19E+02	2.19E+02	2.19E+02	2.19E+02	0.00E+00
P-32	6.25E+04	3.68E+03	2.42E+03	0.00E+00	0.00E+00	0.00E+00	8.46E+02	0.00E+00
CA-41	1.41E+04	0.00E+00	1.54E+03	0.00E+00	0.00E+00	0.00E+00	7.20E+00	0.00E+00
SC-46	1.41E+00	2.03E+00	6.34E-01	0.00E+00	1.34E+00	0.00E+00	1.32E+03	0.00E+00
CR-51	0.00E+00	0.00E+00	5.25E-01	3.42E-01	7.48E-02	6.66E-01	1.53E+01	0.00E+00
MN-54	0.00E+00	7.49E+02	1.70E+02	0.00E+00	1.66E+02	0.00E+00	2.75E+02	0.00E+00
MN-56	0.00E+00	1.22E+00	2.11E-01	0.00E+00	1.05E+00	0.00E+00	1.11E+02	0.00E+00
FE-55	5.23E+02	3.38E+02	9.04E+01	0.00E+00	0.00E+00	1.65E+02	4.29E+01	0.00E+00
FE-59	1.15E+03	2.01E+03	7.92E+02	0.00E+00	0.00E+00	5.94E+02	9.61E+02	0.00E+00
CO-57	0.00E+00	4.33E+01	7.04E+01	0.00E+00	0.00E+00	0.00E+00	1.47E+02	0.00E+00
CO-58	0.00E+00	1.35E+02	3.37E+02	0.00E+00	0.00E+00	0.00E+00	3.36E+02	0.00E+00
CO-60	0.00E+00	4.07E+02	9.60E+02	0.00E+00	0.00E+00	0.00E+00	9.68E+02	0.00E+00
NI-59	1.78E+03	5.46E+02	3.08E+02	0.00E+00	0.00E+00	0.00E+00	2.70E+01	0.00E+00
NI-63	2.39E+04	1.48E+03	8.29E+02	0.00E+00	0.00E+00	0.00E+00	7.35E+01	0.00E+00
NI-65	6.53E+00	7.39E-01	3.36E-01	0.00E+00	0.00E+00	0.00E+00	5.62E+01	0.00E+00
CU-64	0.00E+00	1.19E+01	5.52E+00	0.00E+00	2.02E+01	0.00E+00	2.45E+02	0.00E+00
ZN-65	6.92E+02	2.37E+03	1.09E+03	0.00E+00	1.15E+03	0.00E+00	2.01E+03	0.00E+00
ZN-69M	3.09E+01	6.30E+01	5.74E+00	0.00E+00	2.55E+01	0.00E+00	8.73E+02	0.00E+00
ZN-69	4.44E-04	8.00E-04	5.95E-05	0.00E+00	3.32E-04	0.00E+00	6.52E-02	0.00E+00
SE-79	0.00E+00	7.91E+02	1.47E+02	0.00E+00	9.15E+02	0.00E+00	2.10E+01	0.00E+00
BR-82	0.00E+00	0.00E+00	3.78E+02	0.00E+00	0.00E+00	0.00E+00	0.00E+00	0.00E+00
BR-83	0.00E+00	0.00E+00	4.21E-01	0.00E+00	0.00E+00	0.00E+00	0.00E+00	0.00E+00
BR-84	0.00E+00	0.00E+00	2.20E-06	0.00E+00	0.00E+00	0.00E+00	0.00E+00	0.00E+00
BR-85	0.00E+00	0.00E+00	1.80E-76	0.00E+00	0.00E+00	0.00E+00	0.00E+00	0.00E+00
RB-86	0.00E+00	6.29E+03	3.11E+03	0.00E+00	0.00E+00	0.00E+00	1.61E+02	0.00E+00
RB-87	0.00E+00	3.35E+03	1.33E+03	0.00E+00	0.00E+00	0.00E+00	2.25E+01	0.00E+00
RB-88	0.00E+00	1.25E-11	6.85E-12	0.00E+00	0.00E+00	0.00E+00	1.22E-11	0.00E+00
RB-89	0.00E+00	9.88E-14	6.80E-14	0.00E+00	0.00E+00	0.00E+00	3.36E-14	0.00E+00
SR-89	9.39E+04	0.00E+00	2.69E+03	0.00E+00	0.00E+00	0.00E+00	1.93E+03	0.00E+00
SR-90	1.07E+06	0.00E+00	2.16E+04	0.00E+00	0.00E+00	0.00E+00	8.70E+03	0.00E+00
SR-91	7.85E+02	0.00E+00	2.84E+01	0.00E+00	0.00E+00	0.00E+00	9.29E+02	0.00E+00
SR-92	3.36E+01	0.00E+00	1.25E+00	0.00E+00	0.00E+00	0.00E+00	3.62E+02	0.00E+00
Y-90	2.88E+00	0.00E+00	7.71E-02	0.00E+00	0.00E+00	0.00E+00	3.97E+03	0.00E+00
Y-91M	1.33E-06	0.00E+00	4.54E-08	0.00E+00	0.00E+00	0.00E+00	4.44E-03	0.00E+00

TABLE II-18

INFANT DRINKING WATER A₁₇ FACTORS

mrem-ml per uCi-hr

NUCLIDE	BONE	LIVER	T BODY	THYROID	KIDNEY	LUNG	GI-LLI	SKIN
Y-91	4.23E+01	0.00E+00	1.13E+00	0.00E+00	0.00E+00	0.00E+00	3.03E+03	0.00E+00
Y-92	2.75E-02	0.00E+00	7.73E-04	0.00E+00	0.00E+00	0.00E+00	5.25E+02	0.00E+00
Y-93	4.02E-01	0.00E+00	1.09E-02	0.00E+00	0.00E+00	0.00E+00	3.17E+03	0.00E+00
ZR-93	7.27E+00	3.46E-01	2.09E-01	0.00E+00	1.02E+00	0.00E+00	9.00E+01	0.00E+00
ZR-95	7.72E+00	1.88E+00	1.33E+00	0.00E+00	2.03E+00	0.00E+00	9.37E+02	0.00E+00
ZR-97	3.41E-01	5.85E-02	2.67E-02	0.00E+00	5.90E-02	0.00E+00	3.73E+03	0.00E+00
NB-93M	4.63E+00	1.25E+00	3.92E-01	0.00E+00	1.22E+00	0.00E+00	1.50E+02	0.00E+00
NB-95	1.57E+00	6.45E-01	3.73E-01	0.00E+00	4.63E-01	0.00E+00	5.45E+02	0.00E+00
NB-97	1.70E-05	3.64E-06	1.31E-06	0.00E+00	2.84E-06	0.00E+00	1.15E+00	0.00E+00
MO-93	0.00E+00	2.13E+03	6.86E+01	0.00E+00	4.26E+02	0.00E+00	4.56E+01	0.00E+00
MO-99	0.00E+00	1.13E+03	2.20E+02	0.00E+00	1.69E+03	0.00E+00	3.72E+02	0.00E+00
TC-99M	1.82E-02	3.75E-02	4.83E-01	0.00E+00	4.03E-01	1.96E-02	1.09E+01	0.00E+00
TC-99	4.07E+01	5.50E+01	1.71E+01	0.00E+00	4.63E+02	5.35E+00	2.38E+02	0.00E+00
TC-101	4.66E-17	5.87E-17	5.81E-16	0.00E+00	6.98E-16	3.20E-17	9.98E-15	0.00E+00
RU-103	5.53E+01	0.00E+00	1.85E+01	0.00E+00	1.15E+02	0.00E+00	6.72E+02	0.00E+00
RU-105	7.87E-01	0.00E+00	2.65E-01	0.00E+00	5.79E+00	0.00E+00	3.13E+02	0.00E+00
RU-106	9.07E+02	0.00E+00	1.13E+02	0.00E+00	1.07E+03	0.00E+00	6.89E+03	0.00E+00
RH-105	3.25E+01	2.12E+01	1.43E+01	0.00E+00	5.90E+01	0.00E+00	5.27E+02	0.00E+00
PD-107	0.00E+00	4.48E+01	3.18E+00	0.00E+00	2.56E+02	0.00E+00	3.56E+01	0.00E+00
PD-109	0.00E+00	3.04E+01	7.35E+00	0.00E+00	1.12E+02	0.00E+00	7.47E+02	0.00E+00
AG-110M	3.75E+01	2.73E+01	1.81E+01	0.00E+00	3.91E+01	0.00E+00	1.42E+03	0.00E+00
AG-111	1.87E+01	7.26E+00	3.85E+00	0.00E+00	1.52E+01	0.00E+00	1.73E+03	0.00E+00
CD-113M	0.00E+00	6.67E+02	2.46E+01	0.00E+00	5.05E+02	0.00E+00	1.00E+03	0.00E+00
CD-115M	0.00E+00	5.31E+02	1.84E+01	0.00E+00	2.77E+02	0.00E+00	3.02E+03	0.00E+00
SN-123	9.36E+03	1.46E+02	2.44E+02	1.47E+02	0.00E+00	0.00E+00	2.47E+03	0.00E+00
SN-125	2.69E+03	5.02E+01	1.20E+02	4.94E+01	0.00E+00	0.00E+00	4.03E+03	0.00E+00
SN-126	2.08E+04	2.73E+02	6.78E+02	7.20E+01	0.00E+00	0.00E+00	9.49E+02	0.00E+00
SB-124	8.02E+02	1.18E+01	2.48E+02	2.13E+00	0.00E+00	5.02E+02	2.47E+03	0.00E+00
SB-125	4.63E+02	4.48E+00	9.53E+01	5.80E-01	0.00E+00	2.68E+02	6.18E+02	0.00E+00
SB-126	2.95E+02	5.79E+00	1.07E+02	2.27E+00	0.00E+00	1.86E+02	3.06E+03	0.00E+00
SB-127	7.68E+01	1.37E+00	2.38E+01	9.78E-01	0.00E+00	3.96E+01	2.03E+03	0.00E+00
TE-125M	8.73E+02	2.92E+02	1.18E+02	2.94E+02	0.00E+00	0.00E+00	4.16E+02	0.00E+00
TE-127M	2.20E+03	7.29E+02	2.66E+02	6.35E+02	5.41E+03	0.00E+00	8.86E+02	0.00E+00
TE-127	1.55E+01	5.18E+00	3.33E+00	1.26E+01	3.78E+01	0.00E+00	3.25E+02	0.00E+00
TE-129M	3.73E+03	1.28E+03	5.74E+02	1.43E+03	9.32E+03	0.00E+00	2.23E+03	0.00E+00
TE-129	8.23E-03	2.84E-03	1.92E-03	6.89E-03	2.05E-02	0.00E+00	6.58E-01	0.00E+00
TE-131M	4.34E+02	1.75E+02	1.44E+02	3.54E+02	1.20E+03	0.00E+00	2.94E+03	0.00E+00
TE-131	1.42E-08	5.24E-09	3.98E-09	1.27E-08	3.63E-08	0.00E+00	5.73E-07	0.00E+00

Rev. 30

Page 185 of 335

05/2018

TABLE II1-18

INFANT DRINKING WATER A₁₇ FACTORS

mrem-ml per uCi-hr

NUCLIDE	BONE	LIVER	T BODY	THYROID	KIDNEY	LUNG	GI-LLI	SKIN
TE-132	7.04E+02	3.49E+02	3.25E+02	5.15E+02	2.18E+03	0.00E+00	1.29E+03	0.00E+00
TE-133M	1.80E-03	8.25E-04	7.88E-04	1.59E-03	5.62E-03	0.00E+00	8.90E-02	0.00E+00
TE-134	6.57E-05	3.30E-05	3.39E-05	5.88E-05	2.22E-04	0.00E+00	7.53E-04	0.00E+00
I-129	1.08E+03	7.99E+02	5.84E+02	5.12E+05	9.46E+02	0.00E+00	1.60E+01	0.00E+00
I-130	1.15E+02	2.54E+02	1.02E+02	2.84E+04	2.79E+02	0.00E+00	5.44E+01	0.00E+00
I-131	1.30E+03	1.53E+03	6.71E+02	5.02E+05	1.78E+03	0.00E+00	5.45E+01	0.00E+00
I-132	1.68E+00	3.41E+00	1.22E+00	1.60E+02	3.81E+00	0.00E+00	2.76E+00	0.00E+00
I-133	3.16E+02	4.60E+02	1.35E+02	8.36E+04	5.40E+02	0.00E+00	7.78E+01	0.00E+00
I-134	2.48E-03	5.08E-03	1.81E-03	1.18E-01	5.68E-03	0.00E+00	5.25E-03	0.00E+00
I-135	3.90E+01	7.75E+01	2.83E+01	6.95E+03	8.64E+01	0.00E+00	2.80E+01	0.00E+00
CS-134M	3.77E-01	6.27E-01	3.17E-01	0.00E+00	2.42E-01	5.56E-02	4.96E-01	0.00E+00
CS-134	1.42E+04	2.65E+04	2.67E+03	0.00E+00	6.82E+03	2.79E+03	7.19E+01	0.00E+00
CS-135	5.01E+03	4.56E+03	2.37E+02	0.00E+00	1.30E+03	4.93E+02	1.65E+01	0.00E+00
CS-136	1.68E+03	4.95E+03	1.85E+03	0.00E+00	1.97E+03	4.04E+02	7.52E+01	0.00E+00
CS-137	1.97E+04	2.30E+04	1.63E+03	0.00E+00	6.18E+03	2.50E+03	7.19E+01	0.00E+00
CS-138	3.37E-06	5.47E-06	2.65E-06	0.00E+00	2.73E-06	4.26E-07	8.75E-06	0.00E+00
CS-139	1.02E-22	1.40E-22	5.34E-23	0.00E+00	7.22E-23	1.09E-23	8.78E-24	0.00E+00
BA-139	8.18E-02	5.42E-05	2.37E-03	0.00E+00	3.26E-05	3.29E-05	5.18E+00	0.00E+00
BA-140	6.27E+03	6.27E+00	3.23E+02	0.00E+00	1.49E+00	3.85E+00	1.54E+03	0.00E+00
BA-141	2.19E-11	1.50E-14	6.92E-13	0.00E+00	9.03E-15	9.14E-15	2.68E-10	0.00E+00
BA-142	3.84E-20	3.20E-23	1.89E-21	0.00E+00	1.84E-23	1.93E-23	1.58E-19	0.00E+00
LA-140	6.46E-01	2.55E-01	6.56E-02	0.00E+00	0.00E+00	0.00E+00	2.99E+03	0.00E+00
LA-141	1.32E-02	3.82E-03	6.66E-04	0.00E+00	0.00E+00	0.00E+00	4.38E+02	0.00E+00
LA-142	2.22E-04	8.14E-05	1.95E-05	0.00E+00	0.00E+00	0.00E+00	1.38E+01	0.00E+00
CE-141	2.93E+00	1.79E+00	2.11E-01	0.00E+00	5.52E-01	0.00E+00	9.24E+02	0.00E+00
CE-143	4.33E-01	2.88E+02	3.28E-02	0.00E+00	8.37E-02	0.00E+00	1.68E+03	0.00E+00
CE-144	1.12E+02	4.59E+01	6.28E+00	0.00E+00	1.85E+01	0.00E+00	6.43E+03	0.00E+00
PR-143	2.99E+00	1.12E+00	1.48E-01	0.00E+00	4.15E-01	0.00E+00	1.58E+03	0.00E+00
PR-144	2.96E-15	1.14E-15	1.49E-16	0.00E+00	4.14E-16	0.00E+00	5.32E-11	0.00E+00
ND-147	2.02E+00	2.07E+00	1.27E-01	0.00E+00	7.99E-01	0.00E+00	1.31E+03	0.00E+00
PM-147	1.46E+01	1.23E+00	5.99E-01	0.00E+00	1.84E+00	0.00E+00	3.49E+02	0.00E+00
PM-148M	6.16E+00	1.56E+00	1.23E+00	0.00E+00	1.79E+00	0.00E+00	2.03E+03	0.00E+00
PM-148	2.23E+00	3.22E-01	1.62E-01	0.00E+00	3.85E-01	0.00E+00	3.44E+03	0.00E+00
PM-149	4.44E-01	5.83E-02	2.54E-02	0.00E+00	7.09E-02	0.00E+00	1.57E+03	0.00E+00
PM-151	1.74E-01	2.53E-02	1.28E-02	0.00E+00	3.01E-02	0.00E+00	1.17E+03	0.00E+00
SM-151	1.09E+01	2.51E+00	5.42E-01	0.00E+00	1.71E+00	0.00E+00	2.10E+02	0.00E+00
SM-153	2.43E-01	1.88E-01	1.44E-02	0.00E+00	3.94E-02	0.00E+00	9.84E+02	0.00E+00
EU-152	2.54E+01	6.74E+00	5.69E+00	0.00E+00	1.89E+01	0.00E+00	5.99E+02	0.00E+00

Rev. 30

Page 186 of 335

05/2018

TABLE II-18

INFANT DRINKING WATER A₁₇ FACTORS

mrem-ml per uCi-hr

NUCLIDE	BONE	LIVER	T BODY	THYROID	KIDNEY	LUNG	GI-LLI	SKIN
EU-154	9.94E+01	1.38E+01	8.29E+00	0.00E+00	3.75E+01	0.00E+00	1.73E+03	0.00E+00
EU-155	2.04E+01	2.35E+00	1.22E+00	0.00E+00	5.27E+00	0.00E+00	3.15E+03	0.00E+00
EU-156	4.20E+00	2.60E+00	4.12E-01	0.00E+00	1.20E+00	0.00E+00	2.46E+03	0.00E+00
TB-160	9.71E+00	0.00E+00	1.21E+00	0.00E+00	2.76E+00	0.00E+00	1.29E+03	0.00E+00
HO-166M	4.71E+01	1.01E+01	8.02E+00	0.00E+00	1.34E+01	0.00E+00	1.00E+03	0.00E+00
W-181	3.32E+00	1.02E+00	1.14E-01	0.00E+00	0.00E+00	0.00E+00	1.43E+01	0.00E+00
W-185	1.36E+02	4.24E+01	4.84E+00	0.00E+00	0.00E+00	0.00E+00	6.07E+02	0.00E+00
W-187	2.40E+01	1.67E+01	5.77E+00	0.00E+00	0.00E+00	0.00E+00	9.81E+02	0.00E+00
U-232	9.12E+05	0.00E+00	8.14E+04	0.00E+00	8.93E+04	0.00E+00	2.65E+03	0.00E+00
U-233	1.91E+05	0.00E+00	1.46E+04	0.00E+00	4.07E+04	0.00E+00	2.45E+03	0.00E+00
U-234	1.84E+05	0.00E+00	1.43E+04	0.00E+00	3.99E+04	0.00E+00	2.40E+03	0.00E+00
U-235	1.76E+05	0.00E+00	1.34E+04	0.00E+00	3.74E+04	0.00E+00	3.05E+03	0.00E+00
U-236	1.76E+05	0.00E+00	1.37E+04	0.00E+00	3.80E+04	0.00E+00	2.25E+03	0.00E+00
U-237	1.77E+01	0.00E+00	4.72E+00	0.00E+00	4.40E+01	0.00E+00	7.55E+02	0.00E+00
U-238	1.68E+05	0.00E+00	1.25E+04	0.00E+00	3.50E+04	0.00E+00	2.15E+03	0.00E+00
NP-237	9.04E+04	5.99E+03	3.96E+03	0.00E+00	2.39E+04	0.00E+00	3.10E+03	0.00E+00
NP-238	3.97E+00	9.98E-02	6.14E-02	0.00E+00	2.18E-01	0.00E+00	1.33E+03	0.00E+00
NP-239	3.61E-01	3.23E-02	1.82E-02	0.00E+00	6.44E-02	0.00E+00	9.33E+02	0.00E+00
PU-238	4.82E+04	5.65E+03	1.28E+03	0.00E+00	4.56E+03	0.00E+00	2.85E+03	0.00E+00
PU-239	5.20E+04	5.84E+03	1.33E+03	0.00E+00	4.82E+03	0.00E+00	2.60E+03	0.00E+00
PU-240	5.20E+04	5.84E+03	1.33E+03	0.00E+00	4.82E+03	0.00E+00	2.65E+03	0.00E+00
PU-241	1.60E+03	6.63E+01	3.32E+01	0.00E+00	1.19E+02	0.00E+00	5.46E+01	0.00E+00
PU-242	4.82E+04	5.61E+03	1.28E+03	0.00E+00	4.63E+03	0.00E+00	2.55E+03	0.00E+00
PU-244	5.61E+04	6.44E+03	1.47E+03	0.00E+00	5.31E+03	0.00E+00	3.80E+03	0.00E+00
AM-241	5.50E+04	4.78E+04	4.11E+03	0.00E+00	2.47E+04	0.00E+00	2.90E+03	0.00E+00
AM-242M	5.69E+04	4.60E+04	4.26E+03	0.00E+00	2.50E+04	0.00E+00	3.65E+03	0.00E+00
AM-243	5.42E+04	4.63E+04	3.99E+03	0.00E+00	2.40E+04	0.00E+00	3.40E+03	0.00E+00
CM-242	5.15E+03	4.77E+03	3.42E+02	0.00E+00	9.85E+02	0.00E+00	3.09E+03	0.00E+00
CM-243	5.27E+04	4.33E+04	3.38E+03	0.00E+00	1.23E+04	0.00E+00	3.05E+03	0.00E+00
CM-244	4.44E+04	3.65E+04	2.86E+03	0.00E+00	1.02E+04	0.00E+00	2.95E+03	0.00E+00
CM-245	6.74E+04	5.46E+04	4.26E+03	0.00E+00	1.63E+04	0.00E+00	2.75E+03	0.00E+00
CM-246	6.67E+04	5.46E+04	4.26E+03	0.00E+00	1.62E+04	0.00E+00	2.70E+03	0.00E+00
CM-247	6.52E+04	5.39E+04	4.18E+03	0.00E+00	1.60E+04	0.00E+00	3.55E+03	0.00E+00
CM-248	5.39E+05	4.45E+05	3.45E+04	0.00E+00	1.32E+05	0.00E+00	5.73E+04	0.00E+00
CF-252	4.59E+04	0.00E+00	1.11E+03	0.00E+00	0.00E+00	0.00E+00	1.13E+04	0.00E+00

TABLE II-19

INFANT FRESHWATER FISH A_{IT} FACTORS

mrem-ml per uCi-hr

NUCLIDE	BONE	LIVER	T BODY	THYROID	KIDNEY	LUNG	GI-LLI	SKIN
H-3	0.00E+00	0.00E+00	0.00E+00	0.00E+00	0.00E+00	0.00E+00	0.00E+00	0.00E+00
C-14	0.00E+00	0.00E+00	0.00E+00	0.00E+00	0.00E+00	0.00E+00	0.00E+00	0.00E+00
NA-22	0.00E+00	0.00E+00	0.00E+00	0.00E+00	0.00E+00	0.00E+00	0.00E+00	0.00E+00
NA-24	0.00E+00	0.00E+00	0.00E+00	0.00E+00	0.00E+00	0.00E+00	0.00E+00	0.00E+00
P-32	0.00E+00	0.00E+00	0.00E+00	0.00E+00	0.00E+00	0.00E+00	0.00E+00	0.00E+00
CA-41	0.00E+00	0.00E+00	0.00E+00	0.00E+00	0.00E+00	0.00E+00	0.00E+00	0.00E+00
SC-46	0.00E+00	0.00E+00	0.00E+00	0.00E+00	0.00E+00	0.00E+00	0.00E+00	0.00E+00
CR-51	0.00E+00	0.00E+00	0.00E+00	0.00E+00	0.00E+00	0.00E+00	0.00E+00	0.00E+00
MN-54	0.00E+00	0.00E+00	0.00E+00	0.00E+00	0.00E+00	0.00E+00	0.00E+00	0.00E+00
MN-56	0.00E+00	0.00E+00	0.00E+00	0.00E+00	0.00E+00	0.00E+00	0.00E+00	0.00E+00
FE-55	0.00E+00	0.00E+00	0.00E+00	0.00E+00	0.00E+00	0.00E+00	0.00E+00	0.00E+00
FE-59	0.00E+00	0.00E+00	0.00E+00	0.00E+00	0.00E+00	0.00E+00	0.00E+00	0.00E+00
CO-57	0.00E+00	0.00E+00	0.00E+00	0.00E+00	0.00E+00	0.00E+00	0.00E+00	0.00E+00
CO-58	0.00E+00	0.00E+00	0.00E+00	0.00E+00	0.00E+00	0.00E+00	0.00E+00	0.00E+00
CO-60	0.00E+00	0.00E+00	0.00E+00	0.00E+00	0.00E+00	0.00E+00	0.00E+00	0.00E+00
NI-59	0.00E+00	0.00E+00	0.00E+00	0.00E+00	0.00E+00	0.00E+00	0.00E+00	0.00E+00
NI-63	0.00E+00	0.00E+00	0.00E+00	0.00E+00	0.00E+00	0.00E+00	0.00E+00	0.00E+00
NI-65	0.00E+00	0.00E+00	0.00E+00	0.00E+00	0.00E+00	0.00E+00	0.00E+00	0.00E+00
CU-64	0.00E+00	0.00E+00	0.00E+00	0.00E+00	0.00E+00	0.00E+00	0.00E+00	0.00E+00
ZN-65	0.00E+00	0.00E+00	0.00E+00	0.00E+00	0.00E+00	0.00E+00	0.00E+00	0.00E+00
ZN-69M	0.00E+00	0.00E+00	0.00E+00	0.00E+00	0.00E+00	0.00E+00	0.00E+00	0.00E+00
ZN-69	0.00E+00	0.00E+00	0.00E+00	0.00E+00	0.00E+00	0.00E+00	0.00E+00	0.00E+00
SE-79	0.00E+00	0.00E+00	0.00E+00	0.00E+00	0.00E+00	0.00E+00	0.00E+00	0.00E+00
BR-82	0.00E+00	0.00E+00	0.00E+00	0.00E+00	0.00E+00	0.00E+00	0.00E+00	0.00E+00
BR-83	0.00E+00	0.00E+00	0.00E+00	0.00E+00	0.00E+00	0.00E+00	0.00E+00	0.00E+00
BR-84	0.00E+00	0.00E+00	0.00E+00	0.00E+00	0.00E+00	0.00E+00	0.00E+00	0.00E+00
BR-85	0.00E+00	0.00E+00	0.00E+00	0.00E+00	0.00E+00	0.00E+00	0.00E+00	0.00E+00
RB-86	0.00E+00	0.00E+00	0.00E+00	0.00E+00	0.00E+00	0.00E+00	0.00E+00	0.00E+00
RB-87	0.00E+00	0.00E+00	0.00E+00	0.00E+00	0.00E+00	0.00E+00	0.00E+00	0.00E+00
RB-88	0.00E+00	0.00E+00	0.00E+00	0.00E+00	0.00E+00	0.00E+00	0.00E+00	0.00E+00
RB-89	0.00E+00	0.00E+00	0.00E+00	0.00E+00	0.00E+00	0.00E+00	0.00E+00	0.00E+00
SR-89	0.00E+00	0.00E+00	0.00E+00	0.00E+00	0.00E+00	0.00E+00	0.00E+00	0.00E+00
SR-90	0.00E+00	0.00E+00	0.00E+00	0.00E+00	0.00E+00	0.00E+00	0.00E+00	0.00E+00
SR-91	0.00E+00	0.00E+00	0.00E+00	0.00E+00	0.00E+00	0.00E+00	0.00E+00	0.00E+00
SR-92	0.00E+00	0.00E+00	0.00E+00	0.00E+00	0.00E+00	0.00E+00	0.00E+00	0.00E+00
Y-90	0.00E+00	0.00E+00	0.00E+00	0.00E+00	0.00E+00	0.00E+00	0.00E+00	0.00E+00
Y-91M	0.00E+00	0.00E+00	0.00E+00	0.00E+00	0.00E+00	0.00E+00	0.00E+00	0.00E+00

TABLE II1-19

INFANT FRESHWATER FISH A_{17} FACTORS

mrem-ml per uCi-hr

NUCLIDE	BONE	LIVER	T BODY	THYROID	KIDNEY	LUNG	GI-LLI	SKIN
Y-91	0.00E+00	0.00E+00	0.00E+00	0.00E+00	0.00E+00	0.00E+00	0.00E+00	0.00E+00
Y-92	0.00E+00	0.00E+00	0.00E+00	0.00E+00	0.00E+00	0.00E+00	0.00E+00	0.00E+00
Y-93	0.00E+00	0.00E+00	0.00E+00	0.00E+00	0.00E+00	0.00E+00	0.00E+00	0.00E+00
ZR-93	0.00E+00	0.00E+00	0.00E+00	0.00E+00	0.00E+00	0.00E+00	0.00E+00	0.00E+00
ZR-95	0.00E+00	0.00E+00	0.00E+00	0.00E+00	0.00E+00	0.00E+00	0.00E+00	0.00E+00
ZR-97	0.00E+00	0.00E+00	0.00E+00	0.00E+00	0.00E+00	0.00E+00	0.00E+00	0.00E+00
NB-93M	0.00E+00	0.00E+00	0.00E+00	0.00E+00	0.00E+00	0.00E+00	0.00E+00	0.00E+00
NB-95	0.00E+00	0.00E+00	0.00E+00	0.00E+00	0.00E+00	0.00E+00	0.00E+00	0.00E+00
NB-97	0.00E+00	0.00E+00	0.00E+00	0.00E+00	0.00E+00	0.00E+00	0.00E+00	0.00E+00
MO-93	0.00E+00	0.00E+00	0.00E+00	0.00E+00	0.00E+00	0.00E+00	0.00E+00	0.00E+00
MO-99	0.00E+00	0.00E+00	0.00E+00	0.00E+00	0.00E+00	0.00E+00	0.00E+00	0.00E+00
TC-99M	0.00E+00	0.00E+00	0.00E+00	0.00E+00	0.00E+00	0.00E+00	0.00E+00	0.00E+00
TC-99	0.00E+00	0.00E+00	0.00E+00	0.00E+00	0.00E+00	0.00E+00	0.00E+00	0.00E+00
TC-101	0.00E+00	0.00E+00	0.00E+00	0.00E+00	0.00E+00	0.00E+00	0.00E+00	0.00E+00
RU-103	0.00E+00	0.00E+00	0.00E+00	0.00E+00	0.00E+00	0.00E+00	0.00E+00	0.00E+00
RU-105	0.00E+00	0.00E+00	0.00E+00	0.00E+00	0.00E+00	0.00E+00	0.00E+00	0.00E+00
RU-106	0.00E+00	0.00E+00	0.00E+00	0.00E+00	0.00E+00	0.00E+00	0.00E+00	0.00E+00
RH-105	0.00E+00	0.00E+00	0.00E+00	0.00E+00	0.00E+00	0.00E+00	0.00E+00	0.00E+00
PD-107	0.00E+00	0.00E+00	0.00E+00	0.00E+00	0.00E+00	0.00E+00	0.00E+00	0.00E+00
PD-109	0.00E+00	0.00E+00	0.00E+00	0.00E+00	0.00E+00	0.00E+00	0.00E+00	0.00E+00
AG-110M	0.00E+00	0.00E+00	0.00E+00	0.00E+00	0.00E+00	0.00E+00	0.00E+00	0.00E+00
AG-111	0.00E+00	0.00E+00	0.00E+00	0.00E+00	0.00E+00	0.00E+00	0.00E+00	0.00E+00
CD-113M	0.00E+00	0.00E+00	0.00E+00	0.00E+00	0.00E+00	0.00E+00	0.00E+00	0.00E+00
CD-115M	0.00E+00	0.00E+00	0.00E+00	0.00E+00	0.00E+00	0.00E+00	0.00E+00	0.00E+00
SN-123	0.00E+00	0.00E+00	0.00E+00	0.00E+00	0.00E+00	0.00E+00	0.00E+00	0.00E+00
SN-125	0.00E+00	0.00E+00	0.00E+00	0.00E+00	0.00E+00	0.00E+00	0.00E+00	0.00E+00
SN-126	0.00E+00	0.00E+00	0.00E+00	0.00E+00	0.00E+00	0.00E+00	0.00E+00	0.00E+00
SB-124	0.00E+00	0.00E+00	0.00E+00	0.00E+00	0.00E+00	0.00E+00	0.00E+00	0.00E+00
SB-125	0.00E+00	0.00E+00	0.00E+00	0.00E+00	0.00E+00	0.00E+00	0.00E+00	0.00E+00
SB-126	0.00E+00	0.00E+00	0.00E+00	0.00E+00	0.00E+00	0.00E+00	0.00E+00	0.00E+00
SB-127	0.00E+00	0.00E+00	0.00E+00	0.00E+00	0.00E+00	0.00E+00	0.00E+00	0.00E+00
TE-125M	0.00E+00	0.00E+00	0.00E+00	0.00E+00	0.00E+00	0.00E+00	0.00E+00	0.00E+00
TE-127M	0.00E+00	0.00E+00	0.00E+00	0.00E+00	0.00E+00	0.00E+00	0.00E+00	0.00E+00
TE-127	0.00E+00	0.00E+00	0.00E+00	0.00E+00	0.00E+00	0.00E+00	0.00E+00	0.00E+00
TE-129M	0.00E+00	0.00E+00	0.00E+00	0.00E+00	0.00E+00	0.00E+00	0.00E+00	0.00E+00
TE-129	0.00E+00	0.00E+00	0.00E+00	0.00E+00	0.00E+00	0.00E+00	0.00E+00	0.00E+00
TE-131M	0.00E+00	0.00E+00	0.00E+00	0.00E+00	0.00E+00	0.00E+00	0.00E+00	0.00E+00
TE-131	0.00E+00	0.00E+00	0.00E+00	0.00E+00	0.00E+00	0.00E+00	0.00E+00	0.00E+00

TABLE II1-19

INFANT FRESHWATER FISH A_{17} FACTORS

mrem-ml per uCi-hr

NUCLIDE	BONE	LIVER	T BODY	THYROID	KIDNEY	LUNG	GI-LLI	SKIN
TE-132	0.00E+00	0.00E+00	0.00E+00	0.00E+00	0.00E+00	0.00E+00	0.00E+00	0.00E+00
TE-133M	0.00E+00	0.00E+00	0.00E+00	0.00E+00	0.00E+00	0.00E+00	0.00E+00	0.00E+00
TE-134	0.00E+00	0.00E+00	0.00E+00	0.00E+00	0.00E+00	0.00E+00	0.00E+00	0.00E+00
I-129	0.00E+00	0.00E+00	0.00E+00	0.00E+00	0.00E+00	0.00E+00	0.00E+00	0.00E+00
I-130	0.00E+00	0.00E+00	0.00E+00	0.00E+00	0.00E+00	0.00E+00	0.00E+00	0.00E+00
I-131	0.00E+00	0.00E+00	0.00E+00	0.00E+00	0.00E+00	0.00E+00	0.00E+00	0.00E+00
I-132	0.00E+00	0.00E+00	0.00E+00	0.00E+00	0.00E+00	0.00E+00	0.00E+00	0.00E+00
I-133	0.00E+00	0.00E+00	0.00E+00	0.00E+00	0.00E+00	0.00E+00	0.00E+00	0.00E+00
I-134	0.00E+00	0.00E+00	0.00E+00	0.00E+00	0.00E+00	0.00E+00	0.00E+00	0.00E+00
I-135	0.00E+00	0.00E+00	0.00E+00	0.00E+00	0.00E+00	0.00E+00	0.00E+00	0.00E+00
CS-134M	0.00E+00	0.00E+00	0.00E+00	0.00E+00	0.00E+00	0.00E+00	0.00E+00	0.00E+00
CS-134	0.00E+00	0.00E+00	0.00E+00	0.00E+00	0.00E+00	0.00E+00	0.00E+00	0.00E+00
CS-135	0.00E+00	0.00E+00	0.00E+00	0.00E+00	0.00E+00	0.00E+00	0.00E+00	0.00E+00
CS-136	0.00E+00	0.00E+00	0.00E+00	0.00E+00	0.00E+00	0.00E+00	0.00E+00	0.00E+00
CS-137	0.00E+00	0.00E+00	0.00E+00	0.00E+00	0.00E+00	0.00E+00	0.00E+00	0.00E+00
CS-138	0.00E+00	0.00E+00	0.00E+00	0.00E+00	0.00E+00	0.00E+00	0.00E+00	0.00E+00
CS-139	0.00E+00	0.00E+00	0.00E+00	0.00E+00	0.00E+00	0.00E+00	0.00E+00	0.00E+00
BA-139	0.00E+00	0.00E+00	0.00E+00	0.00E+00	0.00E+00	0.00E+00	0.00E+00	0.00E+00
BA-140	0.00E+00	0.00E+00	0.00E+00	0.00E+00	0.00E+00	0.00E+00	0.00E+00	0.00E+00
BA-141	0.00E+00	0.00E+00	0.00E+00	0.00E+00	0.00E+00	0.00E+00	0.00E+00	0.00E+00
BA-142	0.00E+00	0.00E+00	0.00E+00	0.00E+00	0.00E+00	0.00E+00	0.00E+00	0.00E+00
LA-140	0.00E+00	0.00E+00	0.00E+00	0.00E+00	0.00E+00	0.00E+00	0.00E+00	0.00E+00
LA-141	0.00E+00	0.00E+00	0.00E+00	0.00E+00	0.00E+00	0.00E+00	0.00E+00	0.00E+00
LA-142	0.00E+00	0.00E+00	0.00E+00	0.00E+00	0.00E+00	0.00E+00	0.00E+00	0.00E+00
CE-141	0.00E+00	0.00E+00	0.00E+00	0.00E+00	0.00E+00	0.00E+00	0.00E+00	0.00E+00
CE-143	0.00E+00	0.00E+00	0.00E+00	0.00E+00	0.00E+00	0.00E+00	0.00E+00	0.00E+00
CE-144	0.00E+00	0.00E+00	0.00E+00	0.00E+00	0.00E+00	0.00E+00	0.00E+00	0.00E+00
PR-143	0.00E+00	0.00E+00	0.00E+00	0.00E+00	0.00E+00	0.00E+00	0.00E+00	0.00E+00
PR-144	0.00E+00	0.00E+00	0.00E+00	0.00E+00	0.00E+00	0.00E+00	0.00E+00	0.00E+00
ND-147	0.00E+00	0.00E+00	0.00E+00	0.00E+00	0.00E+00	0.00E+00	0.00E+00	0.00E+00
PM-147	0.00E+00	0.00E+00	0.00E+00	0.00E+00	0.00E+00	0.00E+00	0.00E+00	0.00E+00
PM-148M	0.00E+00	0.00E+00	0.00E+00	0.00E+00	0.00E+00	0.00E+00	0.00E+00	0.00E+00
PM-148	0.00E+00	0.00E+00	0.00E+00	0.00E+00	0.00E+00	0.00E+00	0.00E+00	0.00E+00
PM-149	0.00E+00	0.00E+00	0.00E+00	0.00E+00	0.00E+00	0.00E+00	0.00E+00	0.00E+00
PM-151	0.00E+00	0.00E+00	0.00E+00	0.00E+00	0.00E+00	0.00E+00	0.00E+00	0.00E+00
SM-151	0.00E+00	0.00E+00	0.00E+00	0.00E+00	0.00E+00	0.00E+00	0.00E+00	0.00E+00
SM-153	0.00E+00	0.00E+00	0.00E+00	0.00E+00	0.00E+00	0.00E+00	0.00E+00	0.00E+00
EU-152	0.00E+00	0.00E+00	0.00E+00	0.00E+00	0.00E+00	0.00E+00	0.00E+00	0.00E+00

TABLE II-19

INFANT FRESHWATER FISH A_{17} FACTORS

mrem-ml per uCi-hr

NUCLIDE	BONE	LIVER	T BODY	THYROID	KIDNEY	LUNG	GI-LLI	SKIN
EU-154	0.00E+00	0.00E+00	0.00E+00	0.00E+00	0.00E+00	0.00E+00	0.00E+00	0.00E+00
EU-155	0.00E+00	0.00E+00	0.00E+00	0.00E+00	0.00E+00	0.00E+00	0.00E+00	0.00E+00
EU-156	0.00E+00	0.00E+00	0.00E+00	0.00E+00	0.00E+00	0.00E+00	0.00E+00	0.00E+00
TB-160	0.00E+00	0.00E+00	0.00E+00	0.00E+00	0.00E+00	0.00E+00	0.00E+00	0.00E+00
HO-166M	0.00E+00	0.00E+00	0.00E+00	0.00E+00	0.00E+00	0.00E+00	0.00E+00	0.00E+00
W-181	0.00E+00	0.00E+00	0.00E+00	0.00E+00	0.00E+00	0.00E+00	0.00E+00	0.00E+00
W-185	0.00E+00	0.00E+00	0.00E+00	0.00E+00	0.00E+00	0.00E+00	0.00E+00	0.00E+00
W-187	0.00E+00	0.00E+00	0.00E+00	0.00E+00	0.00E+00	0.00E+00	0.00E+00	0.00E+00
U-232	0.00E+00	0.00E+00	0.00E+00	0.00E+00	0.00E+00	0.00E+00	0.00E+00	0.00E+00
U-233	0.00E+00	0.00E+00	0.00E+00	0.00E+00	0.00E+00	0.00E+00	0.00E+00	0.00E+00
U-234	0.00E+00	0.00E+00	0.00E+00	0.00E+00	0.00E+00	0.00E+00	0.00E+00	0.00E+00
U-235	0.00E+00	0.00E+00	0.00E+00	0.00E+00	0.00E+00	0.00E+00	0.00E+00	0.00E+00
U-236	0.00E+00	0.00E+00	0.00E+00	0.00E+00	0.00E+00	0.00E+00	0.00E+00	0.00E+00
U-237	0.00E+00	0.00E+00	0.00E+00	0.00E+00	0.00E+00	0.00E+00	0.00E+00	0.00E+00
U-238	0.00E+00	0.00E+00	0.00E+00	0.00E+00	0.00E+00	0.00E+00	0.00E+00	0.00E+00
NP-237	0.00E+00	0.00E+00	0.00E+00	0.00E+00	0.00E+00	0.00E+00	0.00E+00	0.00E+00
NP-238	0.00E+00	0.00E+00	0.00E+00	0.00E+00	0.00E+00	0.00E+00	0.00E+00	0.00E+00
NP-239	0.00E+00	0.00E+00	0.00E+00	0.00E+00	0.00E+00	0.00E+00	0.00E+00	0.00E+00
PU-238	0.00E+00	0.00E+00	0.00E+00	0.00E+00	0.00E+00	0.00E+00	0.00E+00	0.00E+00
PU-239	0.00E+00	0.00E+00	0.00E+00	0.00E+00	0.00E+00	0.00E+00	0.00E+00	0.00E+00
PU-240	0.00E+00	0.00E+00	0.00E+00	0.00E+00	0.00E+00	0.00E+00	0.00E+00	0.00E+00
PU-241	0.00E+00	0.00E+00	0.00E+00	0.00E+00	0.00E+00	0.00E+00	0.00E+00	0.00E+00
PU-242	0.00E+00	0.00E+00	0.00E+00	0.00E+00	0.00E+00	0.00E+00	0.00E+00	0.00E+00
PU-244	0.00E+00	0.00E+00	0.00E+00	0.00E+00	0.00E+00	0.00E+00	0.00E+00	0.00E+00
AM-241	0.00E+00	0.00E+00	0.00E+00	0.00E+00	0.00E+00	0.00E+00	0.00E+00	0.00E+00
AM-242M	0.00E+00	0.00E+00	0.00E+00	0.00E+00	0.00E+00	0.00E+00	0.00E+00	0.00E+00
AM-243	0.00E+00	0.00E+00	0.00E+00	0.00E+00	0.00E+00	0.00E+00	0.00E+00	0.00E+00
CM-242	0.00E+00	0.00E+00	0.00E+00	0.00E+00	0.00E+00	0.00E+00	0.00E+00	0.00E+00
CM-243	0.00E+00	0.00E+00	0.00E+00	0.00E+00	0.00E+00	0.00E+00	0.00E+00	0.00E+00
CM-244	0.00E+00	0.00E+00	0.00E+00	0.00E+00	0.00E+00	0.00E+00	0.00E+00	0.00E+00
CM-245	0.00E+00	0.00E+00	0.00E+00	0.00E+00	0.00E+00	0.00E+00	0.00E+00	0.00E+00
CM-246	0.00E+00	0.00E+00	0.00E+00	0.00E+00	0.00E+00	0.00E+00	0.00E+00	0.00E+00
CM-247	0.00E+00	0.00E+00	0.00E+00	0.00E+00	0.00E+00	0.00E+00	0.00E+00	0.00E+00
CM-248	0.00E+00	0.00E+00	0.00E+00	0.00E+00	0.00E+00	0.00E+00	0.00E+00	0.00E+00
CF-252	0.00E+00	0.00E+00	0.00E+00	0.00E+00	0.00E+00	0.00E+00	0.00E+00	0.00E+00

TABLE II1-20

INFANT SHORELINE A₁₇ FACTORS

mrem-ml per uCi-hr

NUCLIDE	BONE	LIVER	T BODY	THYROID	KIDNEY	LUNG	GI-LLI	SKIN
H-3	0.00E+00	0.00E+00	0.00E+00	0.00E+00	0.00E+00	0.00E+00	0.00E+00	0.00E+00
C-14	0.00E+00	0.00E+00	0.00E+00	0.00E+00	0.00E+00	0.00E+00	0.00E+00	0.00E+00
NA-22	0.00E+00	0.00E+00	0.00E+00	0.00E+00	0.00E+00	0.00E+00	0.00E+00	0.00E+00
NA-24	0.00E+00	0.00E+00	0.00E+00	0.00E+00	0.00E+00	0.00E+00	0.00E+00	0.00E+00
P-32	0.00E+00	0.00E+00	0.00E+00	0.00E+00	0.00E+00	0.00E+00	0.00E+00	0.00E+00
CA-41	0.00E+00	0.00E+00	0.00E+00	0.00E+00	0.00E+00	0.00E+00	0.00E+00	0.00E+00
SC-46	0.00E+00	0.00E+00	0.00E+00	0.00E+00	0.00E+00	0.00E+00	0.00E+00	0.00E+00
CR-51	0.00E+00	0.00E+00	0.00E+00	0.00E+00	0.00E+00	0.00E+00	0.00E+00	0.00E+00
MN-54	0.00E+00	0.00E+00	0.00E+00	0.00E+00	0.00E+00	0.00E+00	0.00E+00	0.00E+00
MN-56	0.00E+00	0.00E+00	0.00E+00	0.00E+00	0.00E+00	0.00E+00	0.00E+00	0.00E+00
FE-55	0.00E+00	0.00E+00	0.00E+00	0.00E+00	0.00E+00	0.00E+00	0.00E+00	0.00E+00
FE-59	0.00E+00	0.00E+00	0.00E+00	0.00E+00	0.00E+00	0.00E+00	0.00E+00	0.00E+00
CO-57	0.00E+00	0.00E+00	0.00E+00	0.00E+00	0.00E+00	0.00E+00	0.00E+00	0.00E+00
CO-58	0.00E+00	0.00E+00	0.00E+00	0.00E+00	0.00E+00	0.00E+00	0.00E+00	0.00E+00
CO-60	0.00E+00	0.00E+00	0.00E+00	0.00E+00	0.00E+00	0.00E+00	0.00E+00	0.00E+00
NI-59	0.00E+00	0.00E+00	0.00E+00	0.00E+00	0.00E+00	0.00E+00	0.00E+00	0.00E+00
NI-63	0.00E+00	0.00E+00	0.00E+00	0.00E+00	0.00E+00	0.00E+00	0.00E+00	0.00E+00
NI-65	0.00E+00	0.00E+00	0.00E+00	0.00E+00	0.00E+00	0.00E+00	0.00E+00	0.00E+00
CU-64	0.00E+00	0.00E+00	0.00E+00	0.00E+00	0.00E+00	0.00E+00	0.00E+00	0.00E+00
ZN-65	0.00E+00	0.00E+00	0.00E+00	0.00E+00	0.00E+00	0.00E+00	0.00E+00	0.00E+00
ZN-69M	0.00E+00	0.00E+00	0.00E+00	0.00E+00	0.00E+00	0.00E+00	0.00E+00	0.00E+00
ZN-69	0.00E+00	0.00E+00	0.00E+00	0.00E+00	0.00E+00	0.00E+00	0.00E+00	0.00E+00
SE-79	0.00E+00	0.00E+00	0.00E+00	0.00E+00	0.00E+00	0.00E+00	0.00E+00	0.00E+00
BR-82	0.00E+00	0.00E+00	0.00E+00	0.00E+00	0.00E+00	0.00E+00	0.00E+00	0.00E+00
BR-83	0.00E+00	0.00E+00	0.00E+00	0.00E+00	0.00E+00	0.00E+00	0.00E+00	0.00E+00
BR-84	0.00E+00	0.00E+00	0.00E+00	0.00E+00	0.00E+00	0.00E+00	0.00E+00	0.00E+00
BR-85	0.00E+00	0.00E+00	0.00E+00	0.00E+00	0.00E+00	0.00E+00	0.00E+00	0.00E+00
RB-86	0.00E+00	0.00E+00	0.00E+00	0.00E+00	0.00E+00	0.00E+00	0.00E+00	0.00E+00
RB-87	0.00E+00	0.00E+00	0.00E+00	0.00E+00	0.00E+00	0.00E+00	0.00E+00	0.00E+00
RB-88	0.00E+00	0.00E+00	0.00E+00	0.00E+00	0.00E+00	0.00E+00	0.00E+00	0.00E+00
RB-89	0.00E+00	0.00E+00	0.00E+00	0.00E+00	0.00E+00	0.00E+00	0.00E+00	0.00E+00
SR-89	0.00E+00	0.00E+00	0.00E+00	0.00E+00	0.00E+00	0.00E+00	0.00E+00	0.00E+00
SR-90	0.00E+00	0.00E+00	0.00E+00	0.00E+00	0.00E+00	0.00E+00	0.00E+00	0.00E+00
SR-91	0.00E+00	0.00E+00	0.00E+00	0.00E+00	0.00E+00	0.00E+00	0.00E+00	0.00E+00
SR-92	0.00E+00	0.00E+00	0.00E+00	0.00E+00	0.00E+00	0.00E+00	0.00E+00	0.00E+00
Y-90	0.00E+00	0.00E+00	0.00E+00	0.00E+00	0.00E+00	0.00E+00	0.00E+00	0.00E+00
Y-91M	0.00E+00	0.00E+00	0.00E+00	0.00E+00	0.00E+00	0.00E+00	0.00E+00	0.00E+00
Y-91	0.00E+00	0.00E+00	0.00E+00	0.00E+00	0.00E+00	0.00E+00	0.00E+00	0.00E+00

TABLE II1-20

INFANT SHORELINE A₁₇ FACTORS

mrem-ml per uCi-hr

NUCLIDE	BONE	LIVER	T BODY	THYROID	KIDNEY	LUNG	GI-LLI	SKIN
Y-92	0.00E+00	0.00E+00	0.00E+00	0.00E+00	0.00E+00	0.00E+00	0.00E+00	0.00E+00
Y-93	0.00E+00	0.00E+00	0.00E+00	0.00E+00	0.00E+00	0.00E+00	0.00E+00	0.00E+00
ZR-93	0.00E+00	0.00E+00	0.00E+00	0.00E+00	0.00E+00	0.00E+00	0.00E+00	0.00E+00
ZR-95	0.00E+00	0.00E+00	0.00E+00	0.00E+00	0.00E+00	0.00E+00	0.00E+00	0.00E+00
ZR-97	0.00E+00	0.00E+00	0.00E+00	0.00E+00	0.00E+00	0.00E+00	0.00E+00	0.00E+00
NB-93M	0.00E+00	0.00E+00	0.00E+00	0.00E+00	0.00E+00	0.00E+00	0.00E+00	0.00E+00
NB-95	0.00E+00	0.00E+00	0.00E+00	0.00E+00	0.00E+00	0.00E+00	0.00E+00	0.00E+00
NB-97	0.00E+00	0.00E+00	0.00E+00	0.00E+00	0.00E+00	0.00E+00	0.00E+00	0.00E+00
MO-93	0.00E+00	0.00E+00	0.00E+00	0.00E+00	0.00E+00	0.00E+00	0.00E+00	0.00E+00
MO-99	0.00E+00	0.00E+00	0.00E+00	0.00E+00	0.00E+00	0.00E+00	0.00E+00	0.00E+00
TC-99M	0.00E+00	0.00E+00	0.00E+00	0.00E+00	0.00E+00	0.00E+00	0.00E+00	0.00E+00
TC-99	0.00E+00	0.00E+00	0.00E+00	0.00E+00	0.00E+00	0.00E+00	0.00E+00	0.00E+00
TC-101	0.00E+00	0.00E+00	0.00E+00	0.00E+00	0.00E+00	0.00E+00	0.00E+00	0.00E+00
RU-103	0.00E+00	0.00E+00	0.00E+00	0.00E+00	0.00E+00	0.00E+00	0.00E+00	0.00E+00
RU-105	0.00E+00	0.00E+00	0.00E+00	0.00E+00	0.00E+00	0.00E+00	0.00E+00	0.00E+00
RU-106	0.00E+00	0.00E+00	0.00E+00	0.00E+00	0.00E+00	0.00E+00	0.00E+00	0.00E+00
RH-105	0.00E+00	0.00E+00	0.00E+00	0.00E+00	0.00E+00	0.00E+00	0.00E+00	0.00E+00
PD-107	0.00E+00	0.00E+00	0.00E+00	0.00E+00	0.00E+00	0.00E+00	0.00E+00	0.00E+00
PD-109	0.00E+00	0.00E+00	0.00E+00	0.00E+00	0.00E+00	0.00E+00	0.00E+00	0.00E+00
AG-110M	0.00E+00	0.00E+00	0.00E+00	0.00E+00	0.00E+00	0.00E+00	0.00E+00	0.00E+00
AG-111	0.00E+00	0.00E+00	0.00E+00	0.00E+00	0.00E+00	0.00E+00	0.00E+00	0.00E+00
CD-113M	0.00E+00	0.00E+00	0.00E+00	0.00E+00	0.00E+00	0.00E+00	0.00E+00	0.00E+00
CD-115M	0.00E+00	0.00E+00	0.00E+00	0.00E+00	0.00E+00	0.00E+00	0.00E+00	0.00E+00
SN-123	0.00E+00	0.00E+00	0.00E+00	0.00E+00	0.00E+00	0.00E+00	0.00E+00	0.00E+00
SN-125	0.00E+00	0.00E+00	0.00E+00	0.00E+00	0.00E+00	0.00E+00	0.00E+00	0.00E+00
SN-126	0.00E+00	0.00E+00	0.00E+00	0.00E+00	0.00E+00	0.00E+00	0.00E+00	0.00E+00
SB-124	0.00E+00	0.00E+00	0.00E+00	0.00E+00	0.00E+00	0.00E+00	0.00E+00	0.00E+00
SB-125	0.00E+00	0.00E+00	0.00E+00	0.00E+00	0.00E+00	0.00E+00	0.00E+00	0.00E+00
SB-126	0.00E+00	0.00E+00	0.00E+00	0.00E+00	0.00E+00	0.00E+00	0.00E+00	0.00E+00
SB-127	0.00E+00	0.00E+00	0.00E+00	0.00E+00	0.00E+00	0.00E+00	0.00E+00	0.00E+00
TE-125M	0.00E+00	0.00E+00	0.00E+00	0.00E+00	0.00E+00	0.00E+00	0.00E+00	0.00E+00
TE-127M	0.00E+00	0.00E+00	0.00E+00	0.00E+00	0.00E+00	0.00E+00	0.00E+00	0.00E+00
TE-127	0.00E+00	0.00E+00	0.00E+00	0.00E+00	0.00E+00	0.00E+00	0.00E+00	0.00E+00
TE-129M	0.00E+00	0.00E+00	0.00E+00	0.00E+00	0.00E+00	0.00E+00	0.00E+00	0.00E+00
TE-129	0.00E+00	0.00E+00	0.00E+00	0.00E+00	0.00E+00	0.00E+00	0.00E+00	0.00E+00
TE-131M	0.00E+00	0.00E+00	0.00E+00	0.00E+00	0.00E+00	0.00E+00	0.00E+00	0.00E+00
TE-131	0.00E+00	0.00E+00	0.00E+00	0.00E+00	0.00E+00	0.00E+00	0.00E+00	0.00E+00
TE-132	0.00E+00	0.00E+00	0.00E+00	0.00E+00	0.00E+00	0.00E+00	0.00E+00	0.00E+00

TABLE II1-20

INFANT SHORELINE A₁₇ FACTORS

mrem-ml per uCi-hr

NUCLIDE	BONE	LIVER	T BODY	THYROID	KIDNEY	LUNG	GI-LLI	SKIN
TE-133M	0.00E+00	0.00E+00	0.00E+00	0.00E+00	0.00E+00	0.00E+00	0.00E+00	0.00E+00
TE-134	0.00E+00	0.00E+00	0.00E+00	0.00E+00	0.00E+00	0.00E+00	0.00E+00	0.00E+00
I-129	0.00E+00	0.00E+00	0.00E+00	0.00E+00	0.00E+00	0.00E+00	0.00E+00	0.00E+00
I-130	0.00E+00	0.00E+00	0.00E+00	0.00E+00	0.00E+00	0.00E+00	0.00E+00	0.00E+00
I-131	0.00E+00	0.00E+00	0.00E+00	0.00E+00	0.00E+00	0.00E+00	0.00E+00	0.00E+00
I-132	0.00E+00	0.00E+00	0.00E+00	0.00E+00	0.00E+00	0.00E+00	0.00E+00	0.00E+00
I-133	0.00E+00	0.00E+00	0.00E+00	0.00E+00	0.00E+00	0.00E+00	0.00E+00	0.00E+00
I-134	0.00E+00	0.00E+00	0.00E+00	0.00E+00	0.00E+00	0.00E+00	0.00E+00	0.00E+00
I-135	0.00E+00	0.00E+00	0.00E+00	0.00E+00	0.00E+00	0.00E+00	0.00E+00	0.00E+00
CS-134M	0.00E+00	0.00E+00	0.00E+00	0.00E+00	0.00E+00	0.00E+00	0.00E+00	0.00E+00
CS-134	0.00E+00	0.00E+00	0.00E+00	0.00E+00	0.00E+00	0.00E+00	0.00E+00	0.00E+00
CS-135	0.00E+00	0.00E+00	0.00E+00	0.00E+00	0.00E+00	0.00E+00	0.00E+00	0.00E+00
CS-136	0.00E+00	0.00E+00	0.00E+00	0.00E+00	0.00E+00	0.00E+00	0.00E+00	0.00E+00
CS-137	0.00E+00	0.00E+00	0.00E+00	0.00E+00	0.00E+00	0.00E+00	0.00E+00	0.00E+00
CS-138	0.00E+00	0.00E+00	0.00E+00	0.00E+00	0.00E+00	0.00E+00	0.00E+00	0.00E+00
CS-139	0.00E+00	0.00E+00	0.00E+00	0.00E+00	0.00E+00	0.00E+00	0.00E+00	0.00E+00
BA-139	0.00E+00	0.00E+00	0.00E+00	0.00E+00	0.00E+00	0.00E+00	0.00E+00	0.00E+00
BA-140	0.00E+00	0.00E+00	0.00E+00	0.00E+00	0.00E+00	0.00E+00	0.00E+00	0.00E+00
BA-141	0.00E+00	0.00E+00	0.00E+00	0.00E+00	0.00E+00	0.00E+00	0.00E+00	0.00E+00
BA-142	0.00E+00	0.00E+00	0.00E+00	0.00E+00	0.00E+00	0.00E+00	0.00E+00	0.00E+00
LA-140	0.00E+00	0.00E+00	0.00E+00	0.00E+00	0.00E+00	0.00E+00	0.00E+00	0.00E+00
LA-141	0.00E+00	0.00E+00	0.00E+00	0.00E+00	0.00E+00	0.00E+00	0.00E+00	0.00E+00
LA-142	0.00E+00	0.00E+00	0.00E+00	0.00E+00	0.00E+00	0.00E+00	0.00E+00	0.00E+00
CE-141	0.00E+00	0.00E+00	0.00E+00	0.00E+00	0.00E+00	0.00E+00	0.00E+00	0.00E+00
CE-143	0.00E+00	0.00E+00	0.00E+00	0.00E+00	0.00E+00	0.00E+00	0.00E+00	0.00E+00
CE-144	0.00E+00	0.00E+00	0.00E+00	0.00E+00	0.00E+00	0.00E+00	0.00E+00	0.00E+00
PR-143	0.00E+00	0.00E+00	0.00E+00	0.00E+00	0.00E+00	0.00E+00	0.00E+00	0.00E+00
PR-144	0.00E+00	0.00E+00	0.00E+00	0.00E+00	0.00E+00	0.00E+00	0.00E+00	0.00E+00
ND-147	0.00E+00	0.00E+00	0.00E+00	0.00E+00	0.00E+00	0.00E+00	0.00E+00	0.00E+00
PM-147	0.00E+00	0.00E+00	0.00E+00	0.00E+00	0.00E+00	0.00E+00	0.00E+00	0.00E+00
PM-148M	0.00E+00	0.00E+00	0.00E+00	0.00E+00	0.00E+00	0.00E+00	0.00E+00	0.00E+00
PM-148	0.00E+00	0.00E+00	0.00E+00	0.00E+00	0.00E+00	0.00E+00	0.00E+00	0.00E+00
PM-149	0.00E+00	0.00E+00	0.00E+00	0.00E+00	0.00E+00	0.00E+00	0.00E+00	0.00E+00
PM-151	0.00E+00	0.00E+00	0.00E+00	0.00E+00	0.00E+00	0.00E+00	0.00E+00	0.00E+00
SM-151	0.00E+00	0.00E+00	0.00E+00	0.00E+00	0.00E+00	0.00E+00	0.00E+00	0.00E+00
SM-153	0.00E+00	0.00E+00	0.00E+00	0.00E+00	0.00E+00	0.00E+00	0.00E+00	0.00E+00
EU-152	0.00E+00	0.00E+00	0.00E+00	0.00E+00	0.00E+00	0.00E+00	0.00E+00	0.00E+00
EU-154	0.00E+00	0.00E+00	0.00E+00	0.00E+00	0.00E+00	0.00E+00	0.00E+00	0.00E+00

TABLE II1-20

INFANT SHORELINE A₁₇ FACTORS

mrem-ml per uCi-hr

NUCLIDE	BONE	LIVER	T BODY	THYROID	KIDNEY	LUNG	GI-LLI	SKIN
EU-155	0.00E+00	0.00E+00	0.00E+00	0.00E+00	0.00E+00	0.00E+00	0.00E+00	0.00E+00
EU-156	0.00E+00	0.00E+00	0.00E+00	0.00E+00	0.00E+00	0.00E+00	0.00E+00	0.00E+00
TB-160	0.00E+00	0.00E+00	0.00E+00	0.00E+00	0.00E+00	0.00E+00	0.00E+00	0.00E+00
HO-166M	0.00E+00	0.00E+00	0.00E+00	0.00E+00	0.00E+00	0.00E+00	0.00E+00	0.00E+00
W-181	0.00E+00	0.00E+00	0.00E+00	0.00E+00	0.00E+00	0.00E+00	0.00E+00	0.00E+00
W-185	0.00E+00	0.00E+00	0.00E+00	0.00E+00	0.00E+00	0.00E+00	0.00E+00	0.00E+00
W-187	0.00E+00	0.00E+00	0.00E+00	0.00E+00	0.00E+00	0.00E+00	0.00E+00	0.00E+00
U-232	0.00E+00	0.00E+00	0.00E+00	0.00E+00	0.00E+00	0.00E+00	0.00E+00	0.00E+00
U-233	0.00E+00	0.00E+00	0.00E+00	0.00E+00	0.00E+00	0.00E+00	0.00E+00	0.00E+00
U-234	0.00E+00	0.00E+00	0.00E+00	0.00E+00	0.00E+00	0.00E+00	0.00E+00	0.00E+00
U-235	0.00E+00	0.00E+00	0.00E+00	0.00E+00	0.00E+00	0.00E+00	0.00E+00	0.00E+00
U-236	0.00E+00	0.00E+00	0.00E+00	0.00E+00	0.00E+00	0.00E+00	0.00E+00	0.00E+00
U-237	0.00E+00	0.00E+00	0.00E+00	0.00E+00	0.00E+00	0.00E+00	0.00E+00	0.00E+00
U-238	0.00E+00	0.00E+00	0.00E+00	0.00E+00	0.00E+00	0.00E+00	0.00E+00	0.00E+00
NP-237	0.00E+00	0.00E+00	0.00E+00	0.00E+00	0.00E+00	0.00E+00	0.00E+00	0.00E+00
NP-238	0.00E+00	0.00E+00	0.00E+00	0.00E+00	0.00E+00	0.00E+00	0.00E+00	0.00E+00
NP-239	0.00E+00	0.00E+00	0.00E+00	0.00E+00	0.00E+00	0.00E+00	0.00E+00	0.00E+00
PU-238	0.00E+00	0.00E+00	0.00E+00	0.00E+00	0.00E+00	0.00E+00	0.00E+00	0.00E+00
PU-239	0.00E+00	0.00E+00	0.00E+00	0.00E+00	0.00E+00	0.00E+00	0.00E+00	0.00E+00
PU-240	0.00E+00	0.00E+00	0.00E+00	0.00E+00	0.00E+00	0.00E+00	0.00E+00	0.00E+00
PU-241	0.00E+00	0.00E+00	0.00E+00	0.00E+00	0.00E+00	0.00E+00	0.00E+00	0.00E+00
PU-242	0.00E+00	0.00E+00	0.00E+00	0.00E+00	0.00E+00	0.00E+00	0.00E+00	0.00E+00
PU-244	0.00E+00	0.00E+00	0.00E+00	0.00E+00	0.00E+00	0.00E+00	0.00E+00	0.00E+00
AM-241	0.00E+00	0.00E+00	0.00E+00	0.00E+00	0.00E+00	0.00E+00	0.00E+00	0.00E+00
AM-242M	0.00E+00	0.00E+00	0.00E+00	0.00E+00	0.00E+00	0.00E+00	0.00E+00	0.00E+00
AM-243	0.00E+00	0.00E+00	0.00E+00	0.00E+00	0.00E+00	0.00E+00	0.00E+00	0.00E+00
CM-242	0.00E+00	0.00E+00	0.00E+00	0.00E+00	0.00E+00	0.00E+00	0.00E+00	0.00E+00
CM-243	0.00E+00	0.00E+00	0.00E+00	0.00E+00	0.00E+00	0.00E+00	0.00E+00	0.00E+00
CM-244	0.00E+00	0.00E+00	0.00E+00	0.00E+00	0.00E+00	0.00E+00	0.00E+00	0.00E+00
CM-245	0.00E+00	0.00E+00	0.00E+00	0.00E+00	0.00E+00	0.00E+00	0.00E+00	0.00E+00
CM-246	0.00E+00	0.00E+00	0.00E+00	0.00E+00	0.00E+00	0.00E+00	0.00E+00	0.00E+00
CM-247	0.00E+00	0.00E+00	0.00E+00	0.00E+00	0.00E+00	0.00E+00	0.00E+00	0.00E+00
CM-248	0.00E+00	0.00E+00	0.00E+00	0.00E+00	0.00E+00	0.00E+00	0.00E+00	0.00E+00
CF-252	0.00E+00	0.00E+00	0.00E+00	0.00E+00	0.00E+00	0.00E+00	0.00E+00	0.00E+00

TABLE II1-21

ASSUMPTIONS USED IN LIMERICK LIQUID EFFLUENT DOSE EVALUATION

Symbol	Description	Value	Reference(1)
T _b	Period of buildup of activity in sediment(hr)	2.192E+05	RG 1.109 Appendix A Equation A-4 adjusted for license renewal (25 years)
t _p ^D	Envtl transit time for water ingestion (hr)	1.200E+01	A-2 ⁽²⁾
t _p ^F	Envtl transit time for fish ingestion (hr)	2.400E+01	A-3 ⁽²⁾
t _p ^S	Envtl transit time for shore exposure (hr)	0.000E+00	Site Specific
U _{ap}	Water ingestion (1/yr) adult	7.300E+02	E-5
U _{ap}	Water ingestion (1/yr) teen	5.100E+02	E-5
U _{ap}	Water ingestion (1/yr) child	5.100E+02	E-5
U _{ap}	Water ingestion (1/yr) infant	3.300E+02	E-5
U _{ap}	Shore exposure (hr/yr) adult	6.000E+02	Site Specific
U _{ap}	Shore exposure (hr/yr) teen	6.000E+02	Site Specific
U _{ap}	Shore exposure (hr/yr) child	9.000E+01	Site Specific
U _{ap}	Shore exposure (hr/yr) infant	0.000E+00	Site Specific
U _{ap}	Fresh water fish ingestion (kg/yr) adult	2.100E+01	E-5
U _{ap}	Fresh water fish ingestion (kg/yr) teen	1.600E+01	E-5
U _{ap}	Fresh water fish ingestion (kg/yr) child	6.900E+00	E-5
U _{ap}	Fresh water fish ingestion (kg/yr) infant	0.000E+00	E-5
RC	Reconcentration Factor	1.000E+00	Site Specific
W	Shoreline Width Factor (dimensionless)	2.000E-01	A-2 ⁽³⁾

- 1) The References refer to tables contained in Regulatory Guide 1.109 unless otherwise specified.
- 2) Equation A-2 and A-3 from Reg. Guide 1.109, Appendix A.
- 3) Table A-2 from Reg. Guide 1.109, Appendix A.

TABLE II2-1

DOSE FACTORS FOR NOBLE GAS

From Table B-1 of Reg. Guide 1.109

RADIONUCLIDE	TOTAL BODY DOSE FACTOR KI (MREM/YR PER PCI/M ³)	BETA SKIN DOSE FACTOR LI (MREM/YR PER PCI/M ³)	GAMMA AIR DOSE FACTOR MI (MRAD/YR PER PCI/M ³)	BETA AIR DOSE FACTOR NI (MRAD/YR PER PCI/M ³)
AR-41	8.84E-03	2.69E-03	9.30E-03	3.28E-03
KR-83M	7.56E-08	-----	1.93E-05	2.88E-04
KR-85M	1.17E-03	1.46E-03	1.23E-03	1.97E-03
KR-85	1.61E-05	1.34E-03	1.72E-05	1.95E-03
KR-87	5.92E-03	9.73E-03	6.17E-03	1.03E-02
KR-88	1.47E-02	2.37E-03	1.52E-02	2.93E-03
KR-89	1.66E-02	1.01E-02	1.73E-02	1.06E-02
KR-90	1.56E-02	7.29E-03	1.63E-02	7.83E-03
XE-131M	9.15E-05	4.76E-04	1.56E-04	1.11E-03
XE-133M	2.51E-04	9.94E-04	3.27E-04	1.48E-03
XE-133	2.94E-04	3.06E-04	3.53E-04	1.05E-03
XE-135M	3.12E-03	7.11E-04	3.36E-03	7.39E-04
XE-135	1.81E-03	1.86E-03	1.92E-03	2.46E-03
XE-137	1.42E-03	1.22E-02	1.51E-03	1.27E-02
XE-138	8.83E-03	4.13E-03	9.21E-03	4.75E-03

TABLE II-2

R_i / P_i DOSE FACTORS AGE: ADULT PATHWAY: INHALATIONmrem/yr per $\mu\text{Ci}/\text{m}^3$

NUCLIDE	BONE	LIVER	T BODY	THYROID	KIDNEY	LUNG	GI-LLI	SKIN
H-3	0.00E+00	7.18E+02	7.18E+02	7.18E+02	7.18E+02	7.18E+02	7.18E+02	0.00E+00
C-14	1.82E+04	3.41E+03	3.41E+03	3.41E+03	3.41E+03	3.41E+03	3.41E+03	0.00E+00
NA-22	1.04E+05	1.04E+05	1.04E+05	1.04E+05	1.04E+05	1.04E+05	1.04E+05	0.00E+00
NA-24	1.02E+04	1.02E+04	1.02E+04	1.02E+04	1.02E+04	1.02E+04	1.02E+04	0.00E+00
P-32	1.32E+06	7.71E+04	5.01E+04	0.00E+00	0.00E+00	0.00E+00	8.64E+04	0.00E+00
CA-41	3.06E+05	0.00E+00	3.30E+04	0.00E+00	0.00E+00	3.06E+04	2.29E+03	0.00E+00
SC-46	4.41E+05	8.56E+05	2.49E+05	0.00E+00	7.99E+05	0.00E+00	2.58E+05	0.00E+00
CR-51	0.00E+00	0.00E+00	1.00E+02	5.95E+01	2.28E+01	1.44E+04	3.32E+03	0.00E+00
MN-54	0.00E+00	3.96E+04	6.30E+03	0.00E+00	9.84E+03	1.40E+06	7.74E+04	0.00E+00
MN-56	0.00E+00	1.24E+00	1.83E-01	0.00E+00	1.30E+00	9.44E+03	2.02E+04	0.00E+00
FE-55	2.46E+04	1.70E+04	3.94E+03	0.00E+00	0.00E+00	7.21E+04	6.03E+03	0.00E+00
FE-59	1.18E+04	2.78E+04	1.06E+04	0.00E+00	0.00E+00	1.02E+06	1.88E+05	0.00E+00
CO-57	0.00E+00	6.92E+02	6.71E+02	0.00E+00	0.00E+00	3.70E+05	3.14E+04	0.00E+00
CO-58	0.00E+00	1.58E+03	2.07E+03	0.00E+00	0.00E+00	9.28E+05	1.06E+05	0.00E+00
CO-60	0.00E+00	1.15E+04	1.48E+04	0.00E+00	0.00E+00	5.97E+06	2.85E+05	0.00E+00
NI-59	3.25E+04	1.17E+04	5.42E+03	0.00E+00	0.00E+00	6.56E+04	4.89E+03	0.00E+00
NI-63	4.32E+05	3.14E+04	1.45E+04	0.00E+00	0.00E+00	1.78E+05	1.34E+04	0.00E+00
NI-65	1.54E+00	2.10E-01	9.12E-02	0.00E+00	0.00E+00	5.60E+03	1.23E+04	0.00E+00
CU-64	0.00E+00	1.46E+00	6.15E-01	0.00E+00	4.62E+00	6.78E+03	4.90E+04	0.00E+00
ZN-65	3.24E+04	1.03E+05	4.66E+04	0.00E+00	6.90E+04	8.64E+05	5.34E+04	0.00E+00
ZN-69M	8.16E+00	1.96E+01	1.79E+00	0.00E+00	1.18E+01	1.90E+04	1.37E+05	0.00E+00
ZN-69	3.38E-02	6.51E-02	4.52E-03	0.00E+00	4.22E-02	9.20E+02	1.63E+01	0.00E+00
SE-79	0.00E+00	3.06E+03	4.87E+02	0.00E+00	4.55E+03	3.58E+05	2.66E+04	0.00E+00
BR-82	0.00E+00	0.00E+00	1.35E+04	0.00E+00	0.00E+00	0.00E+00	1.04E+04	0.00E+00
BR-83	0.00E+00	0.00E+00	2.41E+02	0.00E+00	0.00E+00	0.00E+00	2.32E+02	0.00E+00
BR-84	0.00E+00	0.00E+00	3.13E+02	0.00E+00	0.00E+00	0.00E+00	1.64E-03	0.00E+00
BR-85	0.00E+00	0.00E+00	1.28E+01	0.00E+00	0.00E+00	0.00E+00	0.00E+00	0.00E+00
RB-86	0.00E+00	1.35E+05	5.90E+04	0.00E+00	0.00E+00	0.00E+00	1.66E+04	0.00E+00
RB-87	0.00E+00	7.89E+04	2.57E+04	0.00E+00	0.00E+00	0.00E+00	2.30E+03	0.00E+00
RB-88	0.00E+00	3.87E+02	1.93E+02	0.00E+00	0.00E+00	0.00E+00	3.34E-09	0.00E+00
RB-89	0.00E+00	2.56E+02	1.70E+02	0.00E+00	0.00E+00	0.00E+00	9.28E-12	0.00E+00
SR-89	3.04E+05	0.00E+00	8.72E+03	0.00E+00	0.00E+00	1.40E+06	3.50E+05	0.00E+00
SR-90	2.87E+07	0.00E+00	5.77E+05	0.00E+00	0.00E+00	9.60E+06	7.22E+05	0.00E+00
SR-91	6.19E+01	0.00E+00	2.50E+00	0.00E+00	0.00E+00	3.65E+04	1.91E+05	0.00E+00
SR-92	6.74E+00	0.00E+00	2.91E-01	0.00E+00	0.00E+00	1.65E+04	4.30E+04	0.00E+00
Y-90	2.09E+03	0.00E+00	5.61E+01	0.00E+00	0.00E+00	1.70E+05	5.06E+05	0.00E+00
Y-91M	2.61E-01	0.00E+00	1.02E-02	0.00E+00	0.00E+00	1.92E+03	1.33E+00	0.00E+00
Y-91	4.62E+05	0.00E+00	1.24E+04	0.00E+00	0.00E+00	1.70E+06	3.85E+05	0.00E+00
Y-92	1.03E+01	0.00E+00	3.02E-01	0.00E+00	0.00E+00	1.57E+04	7.35E+04	0.00E+00

TABLE II-2

R_i / P_i DOSE FACTORS AGE: ADULT PATHWAY: INHALATIONmrem/yr per $\mu\text{Ci}/\text{m}^3$

NUCLIDE	BONE	LIVER	T BODY	THYROID	KIDNEY	LUNG	GI-LLI	SKIN
Y-93	9.44E+01	0.00E+00	2.61E+00	0.00E+00	0.00E+00	4.85E+04	4.22E+05	0.00E+00
ZR-93	4.18E+05	2.34E+04	1.10E+04	0.00E+00	8.88E+04	1.70E+05	1.21E+04	0.00E+00
ZR-95	1.07E+05	3.44E+04	2.33E+04	0.00E+00	5.42E+04	1.77E+06	1.50E+05	0.00E+00
ZR-97	9.68E+01	1.96E+01	9.04E+00	0.00E+00	2.97E+01	7.87E+04	5.23E+05	0.00E+00
NB-93M	2.48E+05	8.08E+04	1.99E+04	0.00E+00	9.28E+04	2.49E+05	1.90E+04	0.00E+00
NB-95	1.41E+04	7.82E+03	4.21E+03	0.00E+00	7.74E+03	5.05E+05	1.04E+05	0.00E+00
NB-97	2.22E-01	5.62E-02	2.05E-02	0.00E+00	6.54E-02	2.40E+03	2.42E+02	0.00E+00
MO-93	0.00E+00	9.36E+03	2.54E+02	0.00E+00	2.84E+03	4.09E+05	3.03E+04	0.00E+00
MO-99	0.00E+00	1.21E+02	2.30E+01	0.00E+00	2.91E+02	9.12E+04	2.48E+05	0.00E+00
TC-99M	1.03E-03	2.91E-03	3.70E-02	0.00E+00	4.42E-02	7.64E+02	4.16E+03	0.00E+00
TC-99	2.50E+02	3.71E+02	1.00E+02	0.00E+00	4.68E+03	8.08E+05	6.03E+04	0.00E+00
TC-101	4.18E-05	6.02E-05	5.90E-04	0.00E+00	1.08E-03	3.99E+02	1.09E-11	0.00E+00
RU-103	1.53E+03	0.00E+00	6.58E+02	0.00E+00	5.83E+03	5.05E+05	1.10E+05	0.00E+00
RU-105	7.90E-01	0.00E+00	3.11E-01	0.00E+00	1.02E+00	1.10E+04	4.82E+04	0.00E+00
RU-106	6.91E+04	0.00E+00	8.72E+03	0.00E+00	1.34E+05	9.36E+06	9.12E+05	0.00E+00
RH-105	7.39E+00	5.38E+00	3.54E+00	0.00E+00	2.29E+01	1.93E+04	8.72E+04	0.00E+00
PD-107	0.00E+00	6.62E+02	4.70E+01	0.00E+00	5.26E+03	7.58E+04	5.65E+03	0.00E+00
PD-109	0.00E+00	3.70E+00	9.28E-01	0.00E+00	1.88E+01	1.48E+04	1.22E+05	0.00E+00
AG-110M	1.08E+04	1.00E+04	5.94E+03	0.00E+00	1.97E+04	4.63E+06	3.02E+05	0.00E+00
AG-111	3.40E+02	1.42E+02	7.10E+01	0.00E+00	4.59E+02	1.86E+05	2.23E+05	0.00E+00
CD-113M	0.00E+00	1.23E+06	3.98E+04	0.00E+00	1.37E+06	1.66E+06	1.27E+05	0.00E+00
CD-115M	0.00E+00	1.97E+05	6.36E+03	0.00E+00	1.58E+05	1.41E+06	3.84E+05	0.00E+00
SN-123	2.42E+05	5.34E+03	7.86E+03	4.54E+03	0.00E+00	2.30E+06	3.14E+05	0.00E+00
SN-125	9.28E+03	2.50E+02	5.62E+02	2.07E+02	0.00E+00	5.90E+05	5.45E+05	0.00E+00
SN-126	1.26E+06	3.34E+04	4.80E+04	9.84E+03	0.00E+00	9.36E+06	1.27E+05	0.00E+00
SB-124	3.12E+04	5.89E+02	1.24E+04	7.55E+01	0.00E+00	2.48E+06	4.06E+05	0.00E+00
SB-125	5.34E+04	5.95E+02	1.26E+04	5.40E+01	0.00E+00	1.74E+06	1.01E+05	0.00E+00
SB-126	3.60E+03	7.30E+01	1.30E+03	2.20E+01	0.00E+00	7.66E+05	4.81E+05	0.00E+00
SB-127	2.64E+02	5.78E+00	1.02E+02	3.18E+00	0.00E+00	1.64E+05	3.02E+05	0.00E+00
TE-125M	3.42E+03	1.58E+03	4.67E+02	1.05E+03	1.24E+04	3.14E+05	7.06E+04	0.00E+00
TE-127M	1.26E+04	5.77E+03	1.57E+03	3.29E+03	4.58E+04	9.60E+05	1.50E+05	0.00E+00
TE-127	1.40E+00	6.42E-01	3.10E-01	1.06E+00	5.10E+00	6.51E+03	5.74E+04	0.00E+00
TE-129M	9.76E+03	4.67E+03	1.58E+03	3.44E+03	3.66E+04	1.16E+06	3.83E+05	0.00E+00
TE-129	4.98E-02	2.39E-02	1.24E-02	3.90E-02	1.87E-01	1.94E+03	1.57E+02	0.00E+00
TE-131M	6.99E+01	4.36E+01	2.90E+01	5.50E+01	3.09E+02	1.46E+05	5.56E+05	0.00E+00
TE-131	1.11E-02	5.95E-03	3.59E-03	9.36E-03	4.37E-02	1.39E+03	1.84E+01	0.00E+00
TE-132	2.60E+02	2.15E+02	1.62E+02	1.90E+02	1.46E+03	2.88E+05	5.10E+05	0.00E+00
TE-133M	5.79E-02	4.32E-02	3.34E-02	5.02E-02	2.99E-01	4.41E+03	6.12E+01	0.00E+00
TE-134	3.07E-02	2.58E-02	1.26E-02	2.75E-02	1.74E-01	3.47E+03	2.38E-01	0.00E+00

TABLE II-2

R_i / P_i DOSE FACTORS AGE: ADULT PATHWAY: INHALATIONmrem/yr per $\mu\text{Ci}/\text{m}^3$

NUCLIDE	BONE	LIVER	T BODY	THYROID	KIDNEY	LUNG	GI-LLI	SKIN
I-129	1.98E+04	1.69E+04	5.53E+04	4.43E+07	3.62E+04	0.00E+00	1.78E+03	0.00E+00
I-130	4.58E+03	1.34E+04	5.28E+03	1.14E+06	2.09E+04	0.00E+00	7.69E+03	0.00E+00
I-131	2.52E+04	3.58E+04	2.05E+04	1.19E+07	6.13E+04	0.00E+00	6.28E+03	0.00E+00
I-132	1.16E+03	3.26E+03	1.16E+03	1.14E+05	5.18E+03	0.00E+00	4.06E+02	0.00E+00
I-133	8.64E+03	1.48E+04	4.52E+03	2.15E+06	2.58E+04	0.00E+00	8.88E+03	0.00E+00
I-134	6.44E+02	1.73E+03	6.15E+02	2.98E+04	2.75E+03	0.00E+00	1.01E+00	0.00E+00
I-135	2.68E+03	6.98E+03	2.57E+03	4.48E+05	1.11E+04	0.00E+00	5.25E+03	0.00E+00
CS-134M	1.27E+02	2.56E+02	1.38E+02	0.00E+00	1.46E+02	2.34E+01	6.34E+01	0.00E+00
CS-134	3.73E+05	8.48E+05	7.28E+05	0.00E+00	2.87E+05	9.76E+04	1.04E+04	0.00E+00
CS-135	1.17E+05	1.03E+05	4.79E+04	0.00E+00	4.09E+04	1.26E+04	1.69E+03	0.00E+00
CS-136	3.90E+04	1.46E+05	1.10E+05	0.00E+00	8.56E+04	1.20E+04	1.17E+04	0.00E+00
CS-137	4.78E+05	6.21E+05	4.28E+05	0.00E+00	2.22E+05	7.52E+04	8.40E+03	0.00E+00
CS-138	3.31E+02	6.21E+02	3.24E+02	0.00E+00	4.80E+02	4.86E+01	1.86E-03	0.00E+00
CS-139	2.05E+02	2.90E+02	1.11E+02	0.00E+00	2.44E+02	2.27E+01	4.39E-21	0.00E+00
BA-139	9.36E-01	6.66E-04	2.74E-02	0.00E+00	6.22E-04	3.76E+03	8.96E+02	0.00E+00
BA-140	3.90E+04	4.90E+01	2.57E+03	0.00E+00	1.67E+01	1.27E+06	2.18E+05	0.00E+00
BA-141	1.00E-01	7.53E-05	3.36E-03	0.00E+00	7.00E-05	1.94E+03	1.16E-07	0.00E+00
BA-142	2.63E-02	2.70E-05	1.66E-03	0.00E+00	2.29E-05	1.19E+03	1.57E-16	0.00E+00
LA-140	3.44E+02	1.74E+02	4.58E+01	0.00E+00	0.00E+00	1.36E+05	4.58E+05	0.00E+00
LA-141	4.27E+00	1.33E+00	2.17E-01	0.00E+00	0.00E+00	1.08E+04	5.85E+04	0.00E+00
LA-142	6.83E-01	3.10E-01	7.72E-02	0.00E+00	0.00E+00	6.33E+03	2.11E+03	0.00E+00
CE-141	1.99E+04	1.35E+04	1.53E+03	0.00E+00	6.26E+03	3.62E+05	1.20E+05	0.00E+00
CE-143	1.86E+02	1.38E+02	1.53E+01	0.00E+00	6.08E+01	7.98E+04	2.26E+05	0.00E+00
CE-144	3.43E+06	1.43E+06	1.84E+05	0.00E+00	8.48E+05	7.78E+06	8.16E+05	0.00E+00
PR-143	9.36E+03	3.75E+03	4.64E+02	0.00E+00	2.16E+03	2.81E+05	2.00E+05	0.00E+00
PR-144	3.01E-02	1.25E-02	1.53E-03	0.00E+00	7.05E-03	1.02E+03	2.15E-08	0.00E+00
ND-147	5.27E+03	6.10E+03	3.65E+02	0.00E+00	3.56E+03	2.21E+05	1.73E+05	0.00E+00
PM-147	6.70E+05	6.30E+04	2.55E+04	0.00E+00	1.19E+05	5.28E+05	4.43E+04	0.00E+00
PM-148M	7.86E+04	2.03E+04	1.55E+04	0.00E+00	3.08E+04	1.71E+06	3.34E+05	0.00E+00
PM-148	3.07E+03	5.10E+02	2.56E+02	0.00E+00	9.60E+02	3.13E+05	4.64E+05	0.00E+00
PM-149	2.75E+02	3.90E+01	1.59E+01	0.00E+00	7.35E+01	5.77E+04	2.00E+05	0.00E+00
PM-151	6.80E+01	1.14E+01	5.77E+00	0.00E+00	2.04E+01	3.15E+04	1.60E+05	0.00E+00
SM-151	6.87E+05	1.18E+05	2.84E+04	0.00E+00	1.33E+05	3.56E+05	2.60E+04	0.00E+00
SM-153	1.36E+02	1.14E+02	8.32E+00	0.00E+00	3.67E+01	3.31E+04	1.26E+05	0.00E+00
EU-152	1.90E+06	4.33E+05	3.81E+05	0.00E+00	2.68E+06	2.74E+06	1.27E+05	0.00E+00
EU-154	5.92E+06	7.28E+05	5.18E+05	0.00E+00	3.49E+06	4.67E+06	2.72E+05	0.00E+00
EU-155	8.08E+05	1.14E+05	7.37E+04	0.00E+00	5.27E+05	7.57E+05	4.76E+04	0.00E+00
EU-156	1.54E+04	1.18E+04	1.92E+03	0.00E+00	7.96E+03	6.85E+05	3.60E+05	0.00E+00
TB-160	1.77E+05	0.00E+00	2.20E+04	0.00E+00	7.28E+04	1.54E+06	2.14E+05	0.00E+00

TABLE II-2

R_i / P_i DOSE FACTORS AGE: ADULT PATHWAY: INHALATIONmrem/yr per $\mu\text{Ci}/\text{m}^3$

NUCLIDE	BONE	LIVER	T BODY	THYROID	KIDNEY	LUNG	GI-LLI	SKIN
HO-166M	2.70E+06	8.40E+05	6.40E+05	0.00E+00	1.26E+06	3.15E+06	1.27E+05	0.00E+00
W-181	4.98E+01	1.62E+01	1.74E+00	0.00E+00	0.00E+00	1.37E+04	2.02E+03	0.00E+00
W-185	1.56E+03	5.18E+02	5.45E+01	0.00E+00	0.00E+00	4.46E+05	8.56E+04	0.00E+00
W-187	8.48E+00	7.08E+00	2.48E+00	0.00E+00	0.00E+00	2.90E+04	1.55E+05	0.00E+00
U-232	4.11E+08	0.00E+00	2.93E+07	0.00E+00	4.45E+07	1.78E+09	3.37E+05	0.00E+00
U-233	8.72E+07	0.00E+00	5.28E+06	0.00E+00	2.03E+07	4.26E+08	3.11E+05	0.00E+00
U-234	8.32E+07	0.00E+00	5.17E+06	0.00E+00	1.99E+07	4.18E+08	3.05E+05	0.00E+00
U-235	8.00E+07	0.00E+00	4.86E+06	0.00E+00	1.87E+07	3.92E+08	3.87E+05	0.00E+00
U-236	8.00E+07	0.00E+00	4.96E+06	0.00E+00	1.91E+07	4.00E+08	2.86E+05	0.00E+00
U-237	2.94E+02	0.00E+00	7.82E+01	0.00E+00	1.21E+03	8.16E+04	9.60E+04	0.00E+00
U-238	7.66E+07	0.00E+00	4.54E+06	0.00E+00	1.74E+07	3.66E+08	2.73E+05	0.00E+00
NP-237	1.25E+10	8.00E+09	5.50E+08	0.00E+00	4.08E+09	4.18E+08	3.94E+05	0.00E+00
NP-238	2.37E+03	5.76E+02	3.69E+01	0.00E+00	2.18E+02	8.16E+04	1.70E+05	0.00E+00
NP-239	2.30E+02	2.03E+02	1.24E+01	0.00E+00	7.00E+01	3.76E+04	1.19E+05	0.00E+00
PU-238	1.14E+10	7.77E+09	5.52E+08	0.00E+00	2.37E+09	1.46E+09	3.62E+05	0.00E+00
PU-239	1.33E+10	8.56E+09	6.20E+08	0.00E+00	2.64E+09	1.38E+09	3.30E+05	0.00E+00
PU-240	1.32E+10	8.56E+09	6.18E+08	0.00E+00	2.63E+09	1.38E+09	3.37E+05	0.00E+00
PU-241	2.74E+08	6.95E+07	1.03E+07	0.00E+00	4.74E+07	1.22E+06	6.92E+03	0.00E+00
PU-242	1.22E+10	8.24E+09	5.97E+08	0.00E+00	2.54E+09	1.32E+09	3.24E+05	0.00E+00
PU-244	1.43E+10	9.44E+09	6.83E+08	0.00E+00	2.91E+09	1.51E+09	4.82E+05	0.00E+00
AM-241	1.34E+10	9.04E+09	5.37E+08	0.00E+00	4.03E+09	4.85E+08	3.68E+05	0.00E+00
AM-242M	1.36E+10	8.48E+09	5.38E+08	0.00E+00	4.01E+09	1.95E+08	4.63E+05	0.00E+00
AM-243	1.34E+10	8.80E+09	5.26E+08	0.00E+00	3.96E+09	4.60E+08	4.32E+05	0.00E+00
CM-242	1.78E+08	1.42E+08	7.87E+06	0.00E+00	3.58E+07	3.14E+08	3.93E+05	0.00E+00
CM-243	8.80E+09	6.09E+09	3.69E+08	0.00E+00	1.72E+09	5.05E+08	3.87E+05	0.00E+00
CM-244	6.70E+09	4.70E+09	2.81E+08	0.00E+00	1.31E+09	4.85E+08	3.74E+05	0.00E+00
CM-245	1.39E+10	9.12E+09	5.71E+08	0.00E+00	2.66E+09	4.68E+08	3.49E+05	0.00E+00
CM-246	1.38E+10	9.12E+09	5.70E+08	0.00E+00	2.66E+09	4.77E+08	3.43E+05	0.00E+00
CM-247	1.34E+10	8.96E+09	5.62E+08	0.00E+00	2.62E+09	4.68E+08	4.50E+05	0.00E+00
CM-248	1.12E+09	7.41E+10	4.63E+09	0.00E+00	2.16E+10	3.86E+09	7.27E+06	0.00E+00
CF-252	4.34E+09	0.00E+00	1.86E+08	0.00E+00	0.00E+00	1.59E+09	1.42E+06	0.00E+00

TABLE II-2-3

R_i / P_i DOSE FACTORS AGE: TEEN PATHWAY: INHALATIONmrem/yr per $\mu\text{Ci}/\text{m}^3$

NUCLIDE	BONE	LIVER	T BODY	THYROID	KIDNEY	LUNG	GI-LLI	SKIN
H-3	0.00E+00	7.25E+02	7.25E+02	7.25E+02	7.25E+02	7.25E+02	7.25E+02	0.00E+00
C-14	2.60E+04	4.87E+03	4.87E+03	4.87E+03	4.87E+03	4.87E+03	4.87E+03	0.00E+00
NA-22	1.41E+05	1.41E+05	1.41E+05	1.41E+05	1.41E+05	1.41E+05	1.41E+05	0.00E+00
NA-24	1.38E+04	1.38E+04	1.38E+04	1.38E+04	1.38E+04	1.38E+04	1.38E+04	0.00E+00
P-32	1.89E+06	1.10E+05	7.16E+04	0.00E+00	0.00E+00	0.00E+00	9.28E+04	0.00E+00
CA-41	3.24E+05	0.00E+00	3.50E+04	0.00E+00	0.00E+00	8.08E+08	2.42E+03	0.00E+00
SC-46	5.79E+05	1.13E+06	3.34E+05	0.00E+00	1.08E+06	0.00E+00	2.38E+05	0.00E+00
CR-51	0.00E+00	0.00E+00	1.35E+02	7.50E+01	3.07E+01	2.10E+04	3.00E+03	0.00E+00
MN-54	0.00E+00	5.11E+04	8.40E+03	0.00E+00	1.27E+04	1.98E+06	6.68E+04	0.00E+00
MN-56	0.00E+00	1.70E+00	2.52E-01	0.00E+00	1.79E+00	1.52E+04	5.74E+04	0.00E+00
FE-55	3.34E+04	2.38E+04	5.54E+03	0.00E+00	0.00E+00	1.24E+05	6.39E+03	0.00E+00
FE-59	1.59E+04	3.70E+04	1.43E+04	0.00E+00	0.00E+00	1.53E+06	1.78E+05	0.00E+00
CO-57	0.00E+00	9.44E+02	9.20E+02	0.00E+00	0.00E+00	5.86E+05	3.14E+04	0.00E+00
CO-58	0.00E+00	2.07E+03	2.78E+03	0.00E+00	0.00E+00	1.34E+06	9.52E+04	0.00E+00
CO-60	0.00E+00	1.51E+04	1.98E+04	0.00E+00	0.00E+00	8.72E+06	2.59E+05	0.00E+00
NI-59	4.35E+04	1.62E+04	7.39E+03	0.00E+00	0.00E+00	1.13E+05	5.18E+03	0.00E+00
NI-63	5.80E+05	4.34E+04	1.98E+04	0.00E+00	0.00E+00	3.07E+05	1.42E+04	0.00E+00
NI-65	2.18E+00	2.93E-01	1.27E-01	0.00E+00	0.00E+00	9.36E+03	3.67E+04	0.00E+00
CU-64	0.00E+00	2.03E+00	8.48E-01	0.00E+00	6.41E+00	1.11E+04	6.14E+04	0.00E+00
ZN-65	3.86E+04	1.34E+05	6.24E+04	0.00E+00	8.64E+04	1.24E+06	4.66E+04	0.00E+00
ZN-69M	1.15E+01	2.71E+01	2.49E+00	0.00E+00	1.65E+01	3.14E+04	1.71E+05	0.00E+00
ZN-69	4.83E-02	9.20E-02	6.46E-03	0.00E+00	6.02E-02	1.58E+03	2.85E+02	0.00E+00
SE-79	0.00E+00	4.34E+03	6.97E+02	0.00E+00	6.50E+03	6.17E+05	2.82E+04	0.00E+00
BR-82	0.00E+00	0.00E+00	1.82E+04	0.00E+00	0.00E+00	0.00E+00	0.00E+00	0.00E+00
BR-83	0.00E+00	0.00E+00	3.44E+02	0.00E+00	0.00E+00	0.00E+00	0.00E+00	0.00E+00
BR-84	0.00E+00	0.00E+00	4.33E+02	0.00E+00	0.00E+00	0.00E+00	0.00E+00	0.00E+00
BR-85	0.00E+00	0.00E+00	1.83E+01	0.00E+00	0.00E+00	0.00E+00	0.00E+00	0.00E+00
RB-86	0.00E+00	1.90E+05	8.40E+04	0.00E+00	0.00E+00	0.00E+00	1.77E+04	0.00E+00
RB-87	0.00E+00	1.12E+05	3.66E+04	0.00E+00	0.00E+00	0.00E+00	2.44E+03	0.00E+00
RB-88	0.00E+00	5.46E+02	2.72E+02	0.00E+00	0.00E+00	0.00E+00	2.92E-05	0.00E+00
RB-89	0.00E+00	3.52E+02	2.33E+02	0.00E+00	0.00E+00	0.00E+00	3.38E-07	0.00E+00
SR-89	4.34E+05	0.00E+00	1.25E+04	0.00E+00	0.00E+00	2.42E+06	3.71E+05	0.00E+00
SR-90	3.31E+07	0.00E+00	6.66E+05	0.00E+00	0.00E+00	1.65E+07	7.65E+05	0.00E+00
SR-91	8.80E+01	0.00E+00	3.51E+00	0.00E+00	0.00E+00	6.07E+04	2.59E+05	0.00E+00
SR-92	9.52E+00	0.00E+00	4.06E-01	0.00E+00	0.00E+00	2.74E+04	1.19E+05	0.00E+00
Y-90	2.98E+03	0.00E+00	8.00E+01	0.00E+00	0.00E+00	2.93E+05	5.59E+05	0.00E+00
Y-91M	3.70E-01	0.00E+00	1.42E-02	0.00E+00	0.00E+00	3.20E+03	3.02E+01	0.00E+00

TABLE II-3

R_i / P_i DOSE FACTORS AGE: TEEN PATHWAY: INHALATIONmrem/yr per $\mu\text{Ci}/\text{m}^3$

NUCLIDE	BONE	LIVER	T BODY	THYROID	KIDNEY	LUNG	GI-LLI	SKIN
Y-91	6.61E+05	0.00E+00	1.77E+04	0.00E+00	0.00E+00	2.94E+06	4.09E+05	0.00E+00
Y-92	1.47E+01	0.00E+00	4.29E-01	0.00E+00	0.00E+00	2.68E+04	1.65E+05	0.00E+00
Y-93	1.35E+02	0.00E+00	3.72E+00	0.00E+00	0.00E+00	8.32E+04	5.79E+05	0.00E+00
ZR-93	5.46E+05	2.70E+04	1.47E+04	0.00E+00	9.28E+04	2.94E+05	1.28E+04	0.00E+00
ZR-95	1.46E+05	4.58E+04	3.15E+04	0.00E+00	6.74E+04	2.69E+06	1.49E+05	0.00E+00
ZR-97	1.38E+02	2.72E+01	1.26E+01	0.00E+00	4.12E+01	1.30E+05	6.30E+05	0.00E+00
NB-93M	3.31E+05	1.09E+05	2.73E+04	0.00E+00	1.27E+05	4.29E+05	2.02E+04	0.00E+00
NB-95	1.86E+04	1.03E+04	5.66E+03	0.00E+00	1.00E+04	7.51E+05	9.68E+04	0.00E+00
NB-97	3.14E-01	7.78E-02	2.84E-02	0.00E+00	9.12E-02	3.93E+03	2.17E+03	0.00E+00
MO-93	0.00E+00	1.33E+04	3.62E+02	0.00E+00	4.05E+03	7.05E+05	3.19E+04	0.00E+00
MO-99	0.00E+00	1.69E+02	3.22E+01	0.00E+00	4.11E+02	1.54E+05	2.69E+05	0.00E+00
TC-99M	1.38E-03	3.86E-03	4.99E-02	0.00E+00	5.76E-02	1.15E+03	6.13E+03	0.00E+00
TC-99	3.58E+02	5.26E+02	1.43E+02	0.00E+00	6.68E+03	1.39E+06	6.39E+04	0.00E+00
TC-101	5.92E-05	8.40E-05	8.24E-04	0.00E+00	1.52E-03	6.67E+02	8.72E-07	0.00E+00
RU-103	2.10E+03	0.00E+00	8.96E+02	0.00E+00	7.43E+03	7.83E+05	1.09E+05	0.00E+00
RU-105	1.12E+00	0.00E+00	4.34E-01	0.00E+00	1.41E+00	1.82E+04	9.04E+04	0.00E+00
RU-106	9.84E+04	0.00E+00	1.24E+04	0.00E+00	1.90E+05	1.61E+07	9.60E+05	0.00E+00
RH-105	1.06E+01	7.58E+00	4.99E+00	0.00E+00	3.23E+01	3.27E+04	9.84E+04	0.00E+00
PD-107	0.00E+00	9.36E+02	6.71E+01	0.00E+00	7.51E+03	1.30E+05	5.99E+03	0.00E+00
PD-109	0.00E+00	5.25E+00	1.33E+00	0.00E+00	2.69E+01	2.55E+04	1.57E+05	0.00E+00
AG-110M	1.38E+04	1.31E+04	7.99E+03	0.00E+00	2.50E+04	6.75E+06	2.73E+05	0.00E+00
AG-111	4.86E+02	2.02E+02	1.01E+02	0.00E+00	6.54E+02	3.20E+05	2.40E+05	0.00E+00
CD-113M	0.00E+00	1.74E+06	5.68E+04	0.00E+00	1.94E+06	2.87E+06	1.34E+05	0.00E+00
CD-115M	0.00E+00	2.78E+05	9.12E+03	0.00E+00	2.26E+05	2.42E+06	4.08E+05	0.00E+00
SN-123	3.45E+05	7.55E+03	1.12E+04	6.04E+03	0.00E+00	3.97E+06	3.33E+05	0.00E+00
SN-125	1.33E+04	3.54E+02	7.99E+02	2.76E+02	0.00E+00	1.01E+06	5.83E+05	0.00E+00
SN-126	1.74E+06	4.31E+04	6.59E+04	1.14E+04	0.00E+00	1.38E+07	1.34E+05	0.00E+00
SB-124	4.30E+04	7.94E+02	1.68E+04	9.76E+01	0.00E+00	3.85E+06	3.98E+05	0.00E+00
SB-125	7.38E+04	8.08E+02	1.72E+04	7.04E+01	0.00E+00	2.74E+06	9.92E+04	0.00E+00
SB-126	4.95E+03	1.02E+02	1.78E+03	2.80E+01	0.00E+00	1.24E+06	4.81E+05	0.00E+00
SB-127	3.71E+02	7.94E+00	1.40E+02	4.17E+00	0.00E+00	2.65E+05	3.15E+05	0.00E+00
TE-125M	4.88E+03	2.24E+03	6.67E+02	1.40E+03	0.00E+00	5.36E+05	7.50E+04	0.00E+00
TE-127M	1.80E+04	8.16E+03	2.18E+03	4.38E+03	6.54E+04	1.66E+06	1.59E+05	0.00E+00
TE-127	2.01E+00	9.12E-01	4.42E-01	1.42E+00	7.28E+00	1.12E+04	8.08E+04	0.00E+00
TE-129M	1.39E+04	6.58E+03	2.25E+03	4.58E+03	5.19E+04	1.98E+06	4.05E+05	0.00E+00
TE-129	7.10E-02	3.38E-02	1.76E-02	5.18E-02	2.66E-01	3.30E+03	1.62E+03	0.00E+00
TE-131M	9.84E+01	6.01E+01	4.02E+01	7.25E+01	4.39E+02	2.38E+05	6.21E+05	0.00E+00

TABLE II-2-3

R_i / P_i DOSE FACTORS AGE: TEEN PATHWAY: INHALATIONmrem/yr per $\mu\text{Ci}/\text{m}^3$

NUCLIDE	BONE	LIVER	T BODY	THYROID	KIDNEY	LUNG	GI-LLI	SKIN
TE-131	1.58E-02	8.32E-03	5.04E-03	1.24E-02	6.18E-02	2.34E+03	1.51E+01	0.00E+00
TE-132	3.60E+02	2.90E+02	2.19E+02	2.46E+02	1.95E+03	4.49E+05	4.63E+05	0.00E+00
TE-133M	8.08E-02	5.86E-02	4.57E-02	6.54E-02	4.06E-01	6.97E+03	9.84E+02	0.00E+00
TE-134	4.25E-02	3.48E-02	2.91E-02	3.57E-02	2.33E-01	5.40E+03	1.10E+01	0.00E+00
I-129	2.82E+04	2.35E+04	3.92E+04	2.93E+07	4.21E+04	0.00E+00	1.83E+03	0.00E+00
I-130	6.24E+03	1.79E+04	7.17E+03	1.49E+06	2.75E+04	0.00E+00	9.12E+03	0.00E+00
I-131	3.54E+04	4.91E+04	2.64E+04	1.46E+07	8.40E+04	0.00E+00	6.49E+03	0.00E+00
I-132	1.59E+03	4.38E+03	1.58E+03	1.51E+05	6.92E+03	0.00E+00	1.27E+03	0.00E+00
I-133	1.22E+04	2.05E+04	6.22E+03	2.92E+06	3.59E+04	0.00E+00	1.03E+04	0.00E+00
I-134	8.88E+02	2.32E+03	8.40E+02	3.95E+04	3.66E+03	0.00E+00	2.04E+01	0.00E+00
I-135	3.70E+03	9.44E+03	3.49E+03	6.21E+05	1.49E+04	0.00E+00	6.95E+03	0.00E+00
CS-134M	1.76E+02	3.48E+02	1.88E+02	0.00E+00	2.03E+02	3.65E+01	1.62E+02	0.00E+00
CS-134	5.02E+05	1.13E+06	5.49E+05	0.00E+00	3.75E+05	1.46E+05	9.76E+03	0.00E+00
CS-135	1.66E+05	1.46E+05	3.58E+04	0.00E+00	5.84E+04	2.16E+04	1.78E+03	0.00E+00
CS-136	5.15E+04	1.94E+05	1.37E+05	0.00E+00	1.10E+05	1.78E+04	1.09E+04	0.00E+00
CS-137	6.70E+05	8.48E+05	3.11E+05	0.00E+00	3.04E+05	1.21E+05	8.48E+03	0.00E+00
CS-138	4.66E+02	8.56E+02	4.46E+02	0.00E+00	6.62E+02	7.87E+01	2.70E-01	0.00E+00
CS-139	2.92E+02	4.10E+02	1.58E+02	0.00E+00	3.47E+02	3.89E+01	1.33E-13	0.00E+00
BA-139	1.34E+00	9.44E-04	3.90E-02	0.00E+00	8.88E-04	6.46E+03	6.45E+03	0.00E+00
BA-140	5.47E+04	6.70E+01	3.52E+03	0.00E+00	2.28E+01	2.03E+06	2.29E+05	0.00E+00
BA-141	1.42E-01	1.06E-04	4.74E-03	0.00E+00	9.84E-05	3.29E+03	7.46E-04	0.00E+00
BA-142	3.70E-02	3.70E-05	2.27E-03	0.00E+00	3.14E-05	1.91E+03	4.79E-10	0.00E+00
LA-140	4.79E+02	2.36E+02	6.26E+01	0.00E+00	0.00E+00	2.14E+05	4.87E+05	0.00E+00
LA-141	6.10E+00	1.88E+00	3.10E-01	0.00E+00	0.00E+00	1.85E+04	1.23E+05	0.00E+00
LA-142	9.60E-01	4.25E-01	1.06E-01	0.00E+00	0.00E+00	1.02E+04	1.20E+04	0.00E+00
CE-141	2.84E+04	1.90E+04	2.17E+03	0.00E+00	8.88E+03	6.14E+05	1.26E+05	0.00E+00
CE-143	2.66E+02	1.94E+02	2.16E+01	0.00E+00	8.64E+01	1.30E+05	2.55E+05	0.00E+00
CE-144	4.89E+06	2.02E+06	2.62E+05	0.00E+00	1.21E+06	1.34E+07	8.64E+05	0.00E+00
PR-143	1.34E+04	5.31E+03	6.62E+02	0.00E+00	3.09E+03	4.83E+05	2.14E+05	0.00E+00
PR-144	4.30E-02	1.76E-02	2.18E-03	0.00E+00	1.01E-02	1.75E+03	2.35E-04	0.00E+00
ND-147	7.86E+03	8.56E+03	5.13E+02	0.00E+00	5.02E+03	3.72E+05	1.82E+05	0.00E+00
PM-147	9.20E+05	8.80E+04	3.60E+04	0.00E+00	1.68E+05	9.12E+05	4.70E+04	0.00E+00
PM-148M	1.06E+05	2.68E+04	2.10E+04	0.00E+00	4.06E+04	2.56E+06	3.28E+05	0.00E+00
PM-148	4.35E+03	7.10E+02	3.58E+02	0.00E+00	1.28E+03	5.22E+05	4.91E+05	0.00E+00
PM-149	3.93E+02	5.51E+01	2.27E+01	0.00E+00	1.05E+02	9.92E+04	2.23E+05	0.00E+00
PM-151	9.60E+01	1.59E+01	8.08E+00	0.00E+00	2.86E+01	5.25E+04	1.82E+05	0.00E+00
SM-151	8.56E+05	1.68E+05	3.89E+04	0.00E+00	1.82E+05	6.14E+05	2.82E+04	0.00E+00

TABLE II-2-3

R_i / P_i DOSE FACTORS AGE: TEEN PATHWAY: INHALATIONmrem/yr per $\mu\text{Ci}/\text{m}^3$

NUCLIDE	BONE	LIVER	T BODY	THYROID	KIDNEY	LUNG	GI-LLI	SKIN
SM-153	1.94E+02	1.61E+02	1.18E+01	0.00E+00	5.25E+01	5.69E+04	1.42E+05	0.00E+00
EU-152	2.37E+06	5.75E+05	5.04E+05	0.00E+00	2.67E+06	4.01E+06	1.08E+05	0.00E+00
EU-154	7.54E+06	9.84E+05	6.88E+05	0.00E+00	4.35E+06	7.30E+06	2.67E+05	0.00E+00
EU-155	1.60E+06	1.57E+05	9.68E+04	0.00E+00	6.12E+05	1.21E+07	4.78E+05	0.00E+00
EU-156	2.16E+04	1.62E+04	2.64E+03	0.00E+00	1.09E+04	1.10E+06	3.65E+05	0.00E+00
TB-160	2.43E+05	0.00E+00	3.03E+04	0.00E+00	9.60E+04	2.38E+06	2.08E+05	0.00E+00
HO-166M	3.52E+06	1.09E+06	7.90E+05	0.00E+00	1.60E+06	4.99E+06	1.34E+05	0.00E+00
W-181	7.12E+01	2.30E+01	2.41E+00	0.00E+00	0.00E+00	2.36E+04	2.15E+03	0.00E+00
W-185	2.22E+03	7.34E+02	7.78E+01	0.00E+00	0.00E+00	7.68E+05	9.12E+04	0.00E+00
W-187	1.20E+01	9.76E+00	3.43E+00	0.00E+00	0.00E+00	4.74E+04	1.77E+05	0.00E+00
U-232	5.85E+08	0.00E+00	4.18E+07	0.00E+00	6.35E+07	3.07E+09	3.57E+05	0.00E+00
U-233	1.24E+08	0.00E+00	7.54E+06	0.00E+00	2.90E+07	7.34E+08	3.30E+05	0.00E+00
U-234	1.18E+08	0.00E+00	7.38E+06	0.00E+00	2.84E+07	7.19E+08	3.23E+05	0.00E+00
U-235	1.14E+08	0.00E+00	6.94E+06	0.00E+00	2.67E+07	6.75E+08	4.10E+05	0.00E+00
U-236	1.14E+08	0.00E+00	7.09E+06	0.00E+00	2.73E+07	6.90E+08	3.03E+05	0.00E+00
U-237	4.20E+02	0.00E+00	1.12E+02	0.00E+00	1.73E+03	1.41E+05	1.03E+05	0.00E+00
U-238	1.09E+08	0.00E+00	6.48E+06	0.00E+00	2.50E+07	6.31E+08	2.90E+05	0.00E+00
NP-237	1.31E+10	8.48E+09	5.77E+08	0.00E+00	4.28E+09	7.19E+08	4.18E+05	0.00E+00
NP-238	3.38E+03	8.16E+02	5.27E+01	0.00E+00	3.10E+02	1.40E+05	1.90E+05	0.00E+00
NP-239	3.38E+02	2.88E+02	1.77E+01	0.00E+00	1.00E+02	6.49E+04	1.32E+05	0.00E+00
PU-238	1.20E+10	8.24E+09	5.78E+08	0.00E+00	2.48E+09	2.50E+09	3.83E+05	0.00E+00
PU-239	1.38E+10	8.96E+09	6.44E+08	0.00E+00	2.75E+09	2.34E+09	3.50E+05	0.00E+00
PU-240	1.38E+10	8.96E+09	6.43E+08	0.00E+00	2.74E+09	2.34E+09	3.57E+05	0.00E+00
PU-241	2.99E+08	7.65E+07	1.12E+07	0.00E+00	5.18E+07	2.08E+06	7.34E+03	0.00E+00
PU-242	1.28E+10	8.64E+09	6.20E+08	0.00E+00	2.65E+09	2.26E+09	3.43E+05	0.00E+00
PU-244	1.50E+10	9.92E+09	7.10E+08	0.00E+00	3.03E+09	2.58E+09	5.11E+05	0.00E+00
AM-241	1.42E+10	9.60E+09	5.68E+08	0.00E+00	4.26E+09	8.40E+08	3.90E+05	0.00E+00
AM-242M	1.43E+10	9.04E+09	5.72E+08	0.00E+00	4.24E+09	3.37E+08	4.91E+05	0.00E+00
AM-243	1.42E+10	9.36E+09	5.56E+08	0.00E+00	4.17E+09	7.93E+08	4.58E+05	0.00E+00
CM-242	2.54E+08	2.01E+08	1.13E+07	0.00E+00	5.12E+07	5.41E+08	4.17E+05	0.00E+00
CM-243	9.52E+09	6.64E+09	4.00E+08	0.00E+00	1.87E+09	8.72E+08	4.10E+05	0.00E+00
CM-244	7.35E+09	5.22E+09	3.10E+08	0.00E+00	1.45E+09	8.40E+08	3.97E+05	0.00E+00
CM-245	1.46E+10	9.76E+09	6.02E+08	0.00E+00	2.82E+09	8.08E+08	3.70E+05	0.00E+00
CM-246	1.45E+10	9.76E+09	6.02E+08	0.00E+00	2.81E+09	8.24E+08	3.63E+05	0.00E+00
CM-247	1.42E+10	9.52E+09	5.93E+08	0.00E+00	2.77E+09	8.08E+08	4.78E+05	0.00E+00
CM-248	1.18E+09	7.86E+10	4.89E+09	0.00E+00	2.28E+10	6.66E+09	7.70E+06	0.00E+00
CF-252	5.73E+09	0.00E+00	2.46E+08	0.00E+00	0.00E+00	2.74E+09	1.51E+06	0.00E+00

TABLE II-2-4

R_i / P_i DOSE FACTORS AGE: CHILD PATHWAY: INHALATIONmrem/yr per $\mu\text{Ci}/\text{m}^3$

NUCLIDE	BONE	LIVER	T BODY	THYROID	KIDNEY	LUNG	GI-LLI	SKIN
H-3	0.00E+00	6.40E+02	6.40E+02	6.40E+02	6.40E+02	6.40E+02	6.40E+02	0.00E+00
C-14	3.59E+04	6.73E+03	6.73E+03	6.73E+03	6.73E+03	6.73E+03	6.73E+03	0.00E+00
NA-22	1.63E+05	1.63E+05	1.63E+05	1.63E+05	1.63E+05	1.63E+05	1.63E+05	0.00E+00
NA-24	1.61E+04	1.61E+04	1.61E+04	1.61E+04	1.61E+04	1.61E+04	1.61E+04	0.00E+00
P-32	2.60E+06	1.14E+05	9.88E+04	0.00E+00	0.00E+00	0.00E+00	4.22E+04	0.00E+00
CA-41	2.61E+05	0.00E+00	2.85E+04	0.00E+00	0.00E+00	2.67E+08	1.09E+03	0.00E+00
SC-46	7.29E+05	9.99E+05	3.85E+05	0.00E+00	8.84E+05	0.00E+00	9.07E+04	0.00E+00
CR-51	0.00E+00	0.00E+00	1.54E+02	8.55E+01	2.43E+01	1.70E+04	1.08E+03	0.00E+00
MN-54	0.00E+00	4.29E+04	9.51E+03	0.00E+00	1.00E+04	1.58E+06	2.29E+04	0.00E+00
MN-56	0.00E+00	1.66E+00	3.12E-01	0.00E+00	1.67E+00	1.31E+04	1.23E+05	0.00E+00
FE-55	4.74E+04	2.52E+04	7.77E+03	0.00E+00	0.00E+00	1.11E+05	2.87E+03	0.00E+00
FE-59	2.07E+04	3.34E+04	1.67E+04	0.00E+00	0.00E+00	1.27E+06	7.07E+04	0.00E+00
CO-57	0.00E+00	9.03E+02	1.07E+03	0.00E+00	0.00E+00	5.07E+05	1.32E+04	0.00E+00
CO-58	0.00E+00	1.77E+03	3.16E+03	0.00E+00	0.00E+00	1.11E+06	3.44E+04	0.00E+00
CO-60	0.00E+00	1.31E+04	2.26E+04	0.00E+00	0.00E+00	7.07E+06	9.62E+04	0.00E+00
NI-59	6.14E+04	1.73E+04	1.05E+04	0.00E+00	0.00E+00	1.01E+05	2.33E+03	0.00E+00
NI-63	8.21E+05	4.63E+04	2.80E+04	0.00E+00	0.00E+00	2.75E+05	6.33E+03	0.00E+00
NI-65	2.99E+00	2.96E-01	1.64E-01	0.00E+00	0.00E+00	8.18E+03	8.40E+04	0.00E+00
CU-64	0.00E+00	1.99E+00	1.07E+00	0.00E+00	6.03E+00	9.58E+03	3.67E+04	0.00E+00
ZN-65	4.26E+04	1.13E+05	7.03E+04	0.00E+00	7.14E+04	9.95E+05	1.63E+04	0.00E+00
ZN-69M	1.58E+01	2.69E+01	3.18E+00	0.00E+00	1.56E+01	2.72E+04	1.00E+05	0.00E+00
ZN-69	6.70E-02	9.66E-02	8.92E-03	0.00E+00	5.85E-02	1.42E+03	1.02E+04	0.00E+00
SE-79	0.00E+00	4.55E+03	9.62E+02	0.00E+00	6.33E+03	5.51E+05	1.27E+04	0.00E+00
BR-82	0.00E+00	0.00E+00	2.09E+04	0.00E+00	0.00E+00	0.00E+00	0.00E+00	0.00E+00
BR-83	0.00E+00	0.00E+00	4.74E+02	0.00E+00	0.00E+00	0.00E+00	0.00E+00	0.00E+00
BR-84	0.00E+00	0.00E+00	5.48E+02	0.00E+00	0.00E+00	0.00E+00	0.00E+00	0.00E+00
BR-85	0.00E+00	0.00E+00	2.53E+01	0.00E+00	0.00E+00	0.00E+00	0.00E+00	0.00E+00
RB-86	0.00E+00	1.98E+05	1.14E+05	0.00E+00	0.00E+00	0.00E+00	7.99E+03	0.00E+00
RB-87	0.00E+00	1.17E+05	5.07E+04	0.00E+00	0.00E+00	0.00E+00	1.10E+03	0.00E+00
RB-88	0.00E+00	5.62E+02	3.66E+02	0.00E+00	0.00E+00	0.00E+00	1.72E+01	0.00E+00
RB-89	0.00E+00	3.45E+02	2.90E+02	0.00E+00	0.00E+00	0.00E+00	1.89E+00	0.00E+00
SR-89	5.99E+05	0.00E+00	1.72E+04	0.00E+00	0.00E+00	2.16E+06	1.67E+05	0.00E+00
SR-90	3.85E+07	0.00E+00	7.66E+05	0.00E+00	0.00E+00	1.48E+07	3.43E+05	0.00E+00
SR-91	1.21E+02	0.00E+00	4.59E+00	0.00E+00	0.00E+00	5.33E+04	1.74E+05	0.00E+00
SR-92	1.31E+01	0.00E+00	5.25E-01	0.00E+00	0.00E+00	2.40E+04	2.42E+05	0.00E+00
Y-90	4.11E+03	0.00E+00	1.11E+02	0.00E+00	0.00E+00	2.62E+05	2.68E+05	0.00E+00
Y-91M	5.07E-01	0.00E+00	1.84E-02	0.00E+00	0.00E+00	2.81E+03	1.72E+03	0.00E+00
Y-91	9.14E+05	0.00E+00	2.44E+04	0.00E+00	0.00E+00	2.63E+06	1.84E+05	0.00E+00
Y-92	2.04E+01	0.00E+00	5.81E-01	0.00E+00	0.00E+00	2.39E+04	2.39E+05	0.00E+00

TABLE II-2-4

R_i / P_i DOSE FACTORS AGE: CHILD PATHWAY: INHALATIONmrem/yr per $\mu\text{Ci}/\text{m}^3$

NUCLIDE	BONE	LIVER	T BODY	THYROID	KIDNEY	LUNG	GI-LLI	SKIN
Y-93	1.86E+02	0.00E+00	5.11E+00	0.00E+00	0.00E+00	7.44E+04	3.89E+05	0.00E+00
ZR-93	7.66E+05	2.89E+04	2.05E+04	0.00E+00	1.11E+05	2.63E+05	5.44E+03	0.00E+00
ZR-95	1.90E+05	4.18E+04	3.70E+04	0.00E+00	5.96E+04	2.23E+06	6.11E+04	0.00E+00
ZR-97	1.88E+02	2.72E+01	1.60E+01	0.00E+00	3.89E+01	1.13E+05	3.51E+05	0.00E+00
NB-93M	4.70E+05	1.17E+05	3.85E+04	0.00E+00	1.27E+05	3.85E+05	9.07E+03	0.00E+00
NB-95	2.35E+04	9.18E+03	6.55E+03	0.00E+00	8.62E+03	6.14E+05	3.70E+04	0.00E+00
NB-97	4.29E-01	7.70E-02	3.60E-02	0.00E+00	8.55E-02	3.42E+03	2.78E+04	0.00E+00
MO-93	0.00E+00	1.39E+04	5.00E+02	0.00E+00	3.92E+03	6.29E+05	1.40E+04	0.00E+00
MO-99	0.00E+00	1.72E+02	4.26E+01	0.00E+00	3.92E+02	1.35E+05	1.27E+05	0.00E+00
TC-99M	1.78E-03	3.48E-03	5.77E-02	0.00E+00	5.07E-02	9.51E+02	4.81E+03	0.00E+00
TC-99	4.96E+02	5.51E+02	1.98E+02	0.00E+00	6.48E+03	1.25E+06	2.87E+04	0.00E+00
TC-101	8.10E-05	8.51E-05	1.08E-03	0.00E+00	1.45E-03	5.85E+02	1.63E+01	0.00E+00
RU-103	2.79E+03	0.00E+00	1.07E+03	0.00E+00	7.03E+03	6.62E+05	4.48E+04	0.00E+00
RU-105	1.53E+00	0.00E+00	5.55E-01	0.00E+00	1.34E+00	1.59E+04	9.95E+04	0.00E+00
RU-106	1.36E+05	0.00E+00	1.69E+04	0.00E+00	1.84E+05	1.43E+07	4.29E+05	0.00E+00
RH-105	1.45E+01	7.77E+00	6.62E+00	0.00E+00	3.10E+01	2.89E+04	4.92E+04	0.00E+00
PD-107	0.00E+00	9.81E+02	9.29E+01	0.00E+00	7.29E+03	1.17E+05	2.69E+03	0.00E+00
PD-109	0.00E+00	5.48E+00	1.83E+00	0.00E+00	2.61E+01	2.28E+04	9.58E+04	0.00E+00
AG-110M	1.69E+04	1.14E+04	9.14E+03	0.00E+00	2.12E+04	5.48E+06	1.00E+05	0.00E+00
AG-111	6.70E+02	2.10E+02	1.39E+02	0.00E+00	6.33E+02	2.86E+05	1.10E+05	0.00E+00
CD-113M	0.00E+00	1.82E+06	7.84E+04	0.00E+00	1.90E+06	2.57E+06	6.03E+04	0.00E+00
CD-115M	0.00E+00	2.92E+05	1.25E+04	0.00E+00	2.19E+05	2.17E+06	1.84E+05	0.00E+00
SN-123	4.77E+05	7.92E+03	1.55E+04	8.40E+03	0.00E+00	3.55E+06	1.50E+05	0.00E+00
SN-125	1.83E+04	3.68E+02	1.09E+03	3.81E+02	0.00E+00	8.99E+05	2.65E+05	0.00E+00
SN-126	2.31E+06	3.85E+04	8.73E+04	1.05E+04	0.00E+00	1.12E+07	6.03E+04	0.00E+00
SB-124	5.74E+04	7.40E+02	2.00E+04	1.26E+02	0.00E+00	3.24E+06	1.64E+05	0.00E+00
SB-125	9.84E+04	7.59E+02	2.07E+04	9.10E+01	0.00E+00	2.32E+06	4.03E+04	0.00E+00
SB-126	6.36E+03	9.69E+01	2.28E+03	3.70E+01	0.00E+00	1.06E+06	2.10E+05	0.00E+00
SB-127	5.03E+02	7.73E+00	1.74E+02	5.59E+00	0.00E+00	2.28E+05	1.41E+05	0.00E+00
TE-125M	6.73E+03	2.33E+03	9.14E+02	1.92E+03	0.00E+00	4.77E+05	3.38E+04	0.00E+00
TE-127M	2.49E+04	8.55E+03	3.02E+03	6.07E+03	6.36E+04	1.48E+06	7.14E+04	0.00E+00
TE-127	2.77E+00	9.51E-01	6.11E-01	1.96E+00	7.07E+00	1.00E+04	5.62E+04	0.00E+00
TE-129M	1.92E+04	6.85E+03	3.04E+03	6.33E+03	5.03E+04	1.76E+06	1.82E+05	0.00E+00
TE-129	9.77E-02	3.50E-02	2.38E-02	7.14E-02	2.57E-01	2.93E+03	2.55E+04	0.00E+00
TE-131M	1.34E+02	5.92E+01	5.07E+01	9.77E+01	4.00E+02	2.06E+05	3.08E+05	0.00E+00
TE-131	2.17E-02	8.44E-03	6.59E-03	1.70E-02	5.88E-02	2.05E+03	1.33E+03	0.00E+00
TE-132	4.81E+02	2.72E+02	2.63E+02	3.17E+02	1.77E+03	3.77E+05	1.38E+05	0.00E+00
TE-133M	1.08E-01	5.59E-02	5.55E-02	8.58E-02	3.74E-01	5.92E+03	1.76E+04	0.00E+00
TE-134	5.66E-02	3.26E-02	3.48E-02	4.59E-02	2.11E-01	4.55E+03	1.80E+03	0.00E+00

TABLE II-2-4

R_i / P_i DOSE FACTORS AGE: CHILD PATHWAY: INHALATIONmrem/yr per $\mu\text{Ci}/\text{m}^3$

NUCLIDE	BONE	LIVER	T BODY	THYROID	KIDNEY	LUNG	GI-LLI	SKIN
I-129	3.89E+04	2.37E+04	2.11E+04	1.58E+07	4.00E+04	0.00E+00	7.96E+02	0.00E+00
I-130	8.18E+03	1.64E+04	8.44E+03	1.85E+06	2.45E+04	0.00E+00	5.11E+03	0.00E+00
I-131	4.81E+04	4.81E+04	2.73E+04	1.62E+07	7.88E+04	0.00E+00	2.84E+03	0.00E+00
I-132	2.12E+03	4.07E+03	1.88E+03	1.94E+05	6.25E+03	0.00E+00	3.20E+03	0.00E+00
I-133	1.66E+04	2.03E+04	7.70E+03	3.85E+06	3.38E+04	0.00E+00	5.48E+03	0.00E+00
I-134	1.17E+03	2.16E+03	9.95E+02	5.07E+04	3.30E+03	0.00E+00	9.55E+02	0.00E+00
I-135	4.92E+03	8.73E+03	4.14E+03	7.92E+05	1.34E+04	0.00E+00	4.44E+03	0.00E+00
CS-134M	2.34E+02	3.30E+02	2.26E+02	0.00E+00	1.83E+02	3.09E+01	2.93E+02	0.00E+00
CS-134	6.51E+05	1.01E+06	2.25E+05	0.00E+00	3.30E+05	1.21E+05	3.85E+03	0.00E+00
CS-135	2.31E+05	1.53E+05	1.65E+04	0.00E+00	5.66E+04	1.93E+04	8.03E+02	0.00E+00
CS-136	6.51E+04	1.71E+05	1.16E+05	0.00E+00	9.55E+04	1.45E+04	4.18E+03	0.00E+00
CS-137	9.07E+05	8.25E+05	1.28E+05	0.00E+00	2.82E+05	1.04E+05	3.62E+03	0.00E+00
CS-138	6.33E+02	8.40E+02	5.55E+02	0.00E+00	6.22E+02	6.81E+01	2.70E+02	0.00E+00
CS-139	4.03E+02	4.26E+02	2.15E+02	0.00E+00	3.36E+02	3.46E+01	2.68E-02	0.00E+00
BA-139	1.84E+00	9.84E-04	5.37E-02	0.00E+00	8.62E-04	5.77E+03	5.77E+04	0.00E+00
BA-140	7.40E+04	6.48E+01	4.33E+03	0.00E+00	2.11E+01	1.74E+06	1.02E+05	0.00E+00
BA-141	1.96E-01	1.09E-04	6.36E-03	0.00E+00	9.47E-05	2.92E+03	2.75E+02	0.00E+00
BA-142	5.00E-02	3.60E-05	2.79E-03	0.00E+00	2.91E-05	1.64E+03	2.74E+00	0.00E+00
LA-140	6.44E+02	2.25E+02	7.55E+01	0.00E+00	0.00E+00	1.83E+05	2.26E+05	0.00E+00
LA-141	8.44E+00	1.96E+00	4.26E-01	0.00E+00	0.00E+00	1.66E+04	1.62E+05	0.00E+00
LA-142	1.30E+00	4.11E-01	1.29E-01	0.00E+00	0.00E+00	8.70E+03	7.59E+04	0.00E+00
CE-141	3.92E+04	1.95E+04	2.90E+03	0.00E+00	8.55E+03	5.44E+05	5.66E+04	0.00E+00
CE-143	3.66E+02	1.99E+02	2.87E+01	0.00E+00	8.36E+01	1.15E+05	1.27E+05	0.00E+00
CE-144	6.77E+06	2.12E+06	3.61E+05	0.00E+00	1.17E+06	1.20E+07	3.89E+05	0.00E+00
PR-143	1.85E+04	5.55E+03	9.14E+02	0.00E+00	3.00E+03	4.33E+05	9.73E+04	0.00E+00
PR-144	5.96E-02	1.85E-02	3.00E-03	0.00E+00	9.77E-03	1.57E+03	1.97E+02	0.00E+00
ND-147	1.08E+04	8.73E+03	6.81E+02	0.00E+00	4.81E+03	3.28E+05	8.21E+04	0.00E+00
PM-147	1.30E+06	9.32E+04	5.03E+04	0.00E+00	1.65E+05	8.14E+05	2.11E+04	0.00E+00
PM-148M	1.22E+05	2.42E+04	2.42E+04	0.00E+00	3.60E+04	2.12E+06	1.32E+05	0.00E+00
PM-148	5.96E+03	7.18E+02	4.63E+02	0.00E+00	1.22E+03	4.59E+05	2.22E+05	0.00E+00
PM-149	5.44E+02	5.77E+01	3.13E+01	0.00E+00	1.02E+02	8.88E+04	1.08E+05	0.00E+00
PM-151	1.32E+02	1.60E+01	1.04E+01	0.00E+00	2.72E+01	4.59E+04	9.25E+04	0.00E+00
SM-151	1.16E+06	1.76E+05	5.51E+04	0.00E+00	1.81E+05	5.48E+05	1.27E+04	0.00E+00
SM-153	2.68E+02	1.67E+02	1.61E+01	0.00E+00	5.07E+01	5.07E+04	6.92E+04	0.00E+00
EU-152	2.75E+06	5.07E+05	5.96E+05	0.00E+00	2.12E+06	3.33E+06	4.22E+04	0.00E+00
EU-154	1.01E+07	9.21E+05	8.40E+05	0.00E+00	4.03E+06	6.14E+06	1.10E+05	0.00E+00
EU-155	2.07E+06	1.50E+05	1.18E+05	0.00E+00	5.59E+05	1.03E+06	1.99E+05	0.00E+00
EU-156	2.92E+04	1.57E+04	3.24E+03	0.00E+00	1.01E+04	9.40E+05	1.57E+05	0.00E+00
TB-160	2.88E+05	0.00E+00	3.58E+04	0.00E+00	8.58E+04	1.98E+06	8.44E+04	0.00E+00

TABLE II-4

R_i / P_i DOSE FACTORS AGE: CHILD PATHWAY: INHALATIONmrem/yr per $\mu\text{Ci}/\text{m}^3$

NUCLIDE	BONE	LIVER	T BODY	THYROID	KIDNEY	LUNG	GI-LLI	SKIN
HO-166M	4.96E+06	1.04E+06	8.77E+05	0.00E+00	1.48E+06	4.18E+06	6.03E+04	0.00E+00
W-181	9.84E+01	2.41E+01	3.33E+00	0.00E+00	0.00E+00	2.11E+04	9.66E+02	0.00E+00
W-185	3.07E+03	7.70E+02	1.08E+02	0.00E+00	0.00E+00	6.88E+05	4.11E+04	0.00E+00
W-187	1.63E+01	9.66E+00	4.33E+00	0.00E+00	0.00E+00	4.11E+04	9.10E+04	0.00E+00
U-232	8.10E+08	0.00E+00	5.77E+07	0.00E+00	6.18E+07	2.75E+09	1.60E+05	0.00E+00
U-233	1.72E+08	0.00E+00	1.04E+07	0.00E+00	2.82E+07	6.55E+08	1.48E+05	0.00E+00
U-234	1.65E+08	0.00E+00	1.02E+07	0.00E+00	2.76E+07	6.44E+08	1.45E+05	0.00E+00
U-235	1.58E+08	0.00E+00	9.58E+06	0.00E+00	2.59E+07	6.03E+08	1.84E+05	0.00E+00
U-236	1.58E+08	0.00E+00	9.81E+06	0.00E+00	2.65E+07	6.18E+08	1.36E+05	0.00E+00
U-237	5.81E+02	0.00E+00	1.54E+02	0.00E+00	1.68E+03	1.26E+05	4.77E+04	0.00E+00
U-238	1.51E+08	0.00E+00	8.95E+06	0.00E+00	2.42E+07	5.66E+08	1.30E+05	0.00E+00
NP-237	1.01E+10	5.99E+09	4.40E+08	0.00E+00	2.74E+09	6.44E+08	1.87E+05	0.00E+00
NP-238	4.66E+03	8.51E+02	7.29E+01	0.00E+00	3.02E+02	1.25E+05	9.25E+04	0.00E+00
NP-239	4.66E+02	3.01E+02	2.35E+01	0.00E+00	9.73E+01	5.81E+04	6.40E+04	0.00E+00
PU-238	9.44E+09	5.92E+09	4.48E+08	0.00E+00	1.65E+09	2.25E+09	1.72E+05	0.00E+00
PU-239	1.03E+10	6.22E+09	4.74E+08	0.00E+00	1.77E+09	2.12E+09	1.57E+05	0.00E+00
PU-240	1.03E+10	6.22E+09	4.70E+08	0.00E+00	1.76E+09	2.11E+09	1.60E+05	0.00E+00
PU-241	2.94E+08	6.48E+07	1.08E+07	0.00E+00	4.07E+07	1.87E+06	3.29E+03	0.00E+00
PU-242	9.58E+09	5.99E+09	4.55E+08	0.00E+00	1.70E+09	2.04E+09	1.54E+05	0.00E+00
PU-244	1.12E+10	6.85E+09	5.22E+08	0.00E+00	1.95E+09	2.33E+09	2.29E+05	0.00E+00
AM-241	1.10E+10	6.81E+09	4.59E+08	0.00E+00	2.82E+09	7.47E+08	1.75E+05	0.00E+00
AM-242M	1.14E+10	6.51E+09	4.70E+08	0.00E+00	2.85E+09	3.01E+08	2.21E+05	0.00E+00
AM-243	1.09E+10	6.59E+09	4.44E+08	0.00E+00	2.75E+09	7.10E+08	2.05E+05	0.00E+00
CM-242	3.51E+08	2.10E+08	1.55E+07	0.00E+00	4.96E+07	4.85E+08	1.87E+05	0.00E+00
CM-243	8.58E+09	5.25E+09	3.68E+08	0.00E+00	1.38E+09	7.77E+08	1.84E+05	0.00E+00
CM-244	7.18E+09	4.37E+09	3.07E+08	0.00E+00	1.13E+09	7.47E+08	1.78E+05	0.00E+00
CM-245	1.13E+10	6.81E+09	4.74E+08	0.00E+00	1.86E+09	7.22E+08	1.66E+05	0.00E+00
CM-246	1.12E+10	6.81E+09	4.74E+08	0.00E+00	1.86E+09	7.36E+08	1.63E+05	0.00E+00
CM-247	1.09E+10	6.73E+09	4.66E+08	0.00E+00	1.83E+09	7.22E+08	2.15E+05	0.00E+00
CM-248	9.07E+08	5.55E+08	3.85E+09	0.00E+00	1.51E+10	5.96E+09	3.46E+06	0.00E+00
CF-252	8.07E+09	0.00E+00	3.45E+08	0.00E+00	0.00E+00	2.45E+09	6.81E+05	0.00E+00

TABLE II2-5

R_i / P_i DOSE FACTORS AGE: INFANT PATHWAY: INHALATIONmrem/yr per $\mu\text{Ci}/\text{m}^3$

NUCLIDE	BONE	LIVER	T BODY	THYROID	KIDNEY	LUNG	GI-LLI	SKIN
H-3	0.00E+00	3.68E+02	3.68E+02	3.68E+02	3.68E+02	3.68E+02	3.68E+02	0.00E+00
C-14	2.65E+04	5.31E+03	5.31E+03	5.31E+03	5.31E+03	5.31E+03	5.31E+03	0.00E+00
NA-22	1.03E+05	1.03E+05	1.03E+05	1.03E+05	1.03E+05	1.03E+05	1.03E+05	0.00E+00
NA-24	1.06E+04	1.06E+04	1.06E+04	1.06E+04	1.06E+04	1.06E+04	1.06E+04	0.00E+00
P-32	2.03E+06	1.12E+05	7.74E+04	0.00E+00	0.00E+00	0.00E+00	1.61E+04	0.00E+00
CA-41	1.05E+05	0.00E+00	1.14E+04	0.00E+00	0.00E+00	9.72E+07	4.14E+02	0.00E+00
SC-46	5.25E+05	7.57E+05	2.37E+05	0.00E+00	4.98E+05	0.00E+00	3.07E+04	0.00E+00
CR-51	0.00E+00	0.00E+00	8.95E+01	5.75E+01	1.32E+01	1.28E+04	3.57E+02	0.00E+00
MN-54	0.00E+00	2.53E+04	4.98E+03	0.00E+00	4.98E+03	1.00E+06	7.06E+03	0.00E+00
MN-56	0.00E+00	1.54E+00	2.21E-01	0.00E+00	1.10E+00	1.25E+04	7.17E+04	0.00E+00
FE-55	1.97E+04	1.17E+04	3.33E+03	0.00E+00	0.00E+00	8.69E+04	1.09E+03	0.00E+00
FE-59	1.36E+04	2.35E+04	9.48E+03	0.00E+00	0.00E+00	1.02E+06	2.48E+04	0.00E+00
CO-57	0.00E+00	6.51E+02	6.41E+02	0.00E+00	0.00E+00	3.79E+05	4.86E+03	0.00E+00
CO-58	0.00E+00	1.22E+03	1.82E+03	0.00E+00	0.00E+00	7.77E+05	1.11E+04	0.00E+00
CO-60	0.00E+00	8.02E+03	1.18E+04	0.00E+00	0.00E+00	4.51E+06	3.19E+04	0.00E+00
NI-59	2.53E+04	7.62E+03	4.34E+03	0.00E+00	0.00E+00	7.67E+04	8.88E+02	0.00E+00
NI-63	3.39E+05	2.04E+04	1.16E+04	0.00E+00	0.00E+00	2.09E+05	2.42E+03	0.00E+00
NI-65	2.39E+00	2.84E-01	1.23E-01	0.00E+00	0.00E+00	8.12E+03	5.01E+04	0.00E+00
CU-64	0.00E+00	1.88E+00	7.74E-01	0.00E+00	3.98E+00	9.30E+03	1.50E+04	0.00E+00
ZN-65	1.93E+04	6.26E+04	3.11E+04	0.00E+00	3.25E+04	6.47E+05	5.14E+04	0.00E+00
ZN-69M	1.26E+01	2.58E+01	2.34E+00	0.00E+00	1.04E+01	2.67E+04	4.09E+04	0.00E+00
ZN-69	5.39E-02	9.67E-02	7.18E-03	0.00E+00	4.02E-02	1.47E+03	1.32E+04	0.00E+00
SE-79	0.00E+00	3.15E+03	5.88E+02	0.00E+00	3.46E+03	4.19E+05	4.84E+03	0.00E+00
BR-82	0.00E+00	0.00E+00	1.33E+04	0.00E+00	0.00E+00	0.00E+00	0.00E+00	0.00E+00
BR-83	0.00E+00	0.00E+00	3.81E+02	0.00E+00	0.00E+00	0.00E+00	0.00E+00	0.00E+00
BR-84	0.00E+00	0.00E+00	4.00E+02	0.00E+00	0.00E+00	0.00E+00	0.00E+00	0.00E+00
BR-85	0.00E+00	0.00E+00	2.04E+01	0.00E+00	0.00E+00	0.00E+00	0.00E+00	0.00E+00
RB-86	0.00E+00	1.90E+05	8.82E+04	0.00E+00	0.00E+00	0.00E+00	3.04E+03	0.00E+00
RB-87	0.00E+00	9.95E+04	3.70E+04	0.00E+00	0.00E+00	0.00E+00	4.19E+02	0.00E+00
RB-88	0.00E+00	5.57E+02	2.87E+02	0.00E+00	0.00E+00	0.00E+00	3.39E+02	0.00E+00
RB-89	0.00E+00	3.21E+02	2.06E+02	0.00E+00	0.00E+00	0.00E+00	6.82E+01	0.00E+00
SR-89	3.98E+05	0.00E+00	1.14E+04	0.00E+00	0.00E+00	2.03E+06	6.40E+04	0.00E+00
SR-90	1.55E+07	0.00E+00	3.12E+05	0.00E+00	0.00E+00	1.12E+07	1.31E+05	0.00E+00
SR-91	9.56E+01	0.00E+00	3.46E+00	0.00E+00	0.00E+00	5.26E+04	7.34E+04	0.00E+00
SR-92	1.05E+01	0.00E+00	3.91E-01	0.00E+00	0.00E+00	2.38E+04	1.40E+05	0.00E+00
Y-90	3.29E+03	0.00E+00	8.82E+01	0.00E+00	0.00E+00	2.69E+05	1.04E+05	0.00E+00
Y-91M	4.07E-01	0.00E+00	1.39E-02	0.00E+00	0.00E+00	2.79E+03	2.35E+03	0.00E+00
Y-91	5.88E+05	0.00E+00	1.57E+04	0.00E+00	0.00E+00	2.45E+06	7.03E+04	0.00E+00
Y-92	1.64E+01	0.00E+00	4.61E-01	0.00E+00	0.00E+00	2.45E+04	1.27E+05	0.00E+00
Y-93	1.50E+02	0.00E+00	4.07E+00	0.00E+00	0.00E+00	7.64E+04	1.67E+05	0.00E+00

TABLE II2-5

R_i / P_i DOSE FACTORS AGE: INFANT PATHWAY: INHALATIONmrem/yr per $\mu\text{Ci}/\text{m}^3$

NUCLIDE	BONE	LIVER	T BODY	THYROID	KIDNEY	LUNG	GI-LLI	SKIN
ZR-93	3.14E+05	1.33E+04	8.65E+03	0.00E+00	4.47E+04	1.92E+05	2.07E+03	0.00E+00
ZR-95	1.15E+05	2.79E+04	2.03E+04	0.00E+00	3.11E+04	1.75E+06	2.17E+04	0.00E+00
ZR-97	1.50E+02	2.56E+01	1.17E+01	0.00E+00	2.59E+01	1.10E+05	1.40E+05	0.00E+00
NB-93M	1.93E+05	5.03E+04	1.61E+04	0.00E+00	5.15E+04	2.93E+05	3.46E+03	0.00E+00
NB-95	1.57E+04	6.43E+03	3.78E+03	0.00E+00	4.72E+03	4.79E+05	1.27E+04	0.00E+00
NB-97	3.42E-01	7.29E-02	2.63E-02	0.00E+00	5.70E-02	3.32E+03	2.69E+04	0.00E+00
MO-93	0.00E+00	9.04E+03	3.11E+02	0.00E+00	2.16E+03	4.76E+05	5.26E+03	0.00E+00
MO-99	0.00E+00	1.65E+02	3.23E+01	0.00E+00	2.65E+02	1.35E+05	4.87E+04	0.00E+00
TC-99M	1.40E-03	2.88E-03	3.72E-02	0.00E+00	3.11E-02	8.11E+02	2.03E+03	0.00E+00
TC-99	2.93E+02	3.75E+02	1.24E+02	0.00E+00	3.49E+03	9.48E+05	1.09E+04	0.00E+00
TC-101	6.51E-05	8.23E-05	8.12E-04	0.00E+00	9.79E-04	5.84E+02	8.44E+02	0.00E+00
RU-103	2.02E+03	0.00E+00	6.79E+02	0.00E+00	4.24E+03	5.52E+05	1.61E+04	0.00E+00
RU-105	1.22E+00	0.00E+00	4.10E-01	0.00E+00	8.99E-01	1.57E+04	4.84E+04	0.00E+00
RU-106	8.68E+04	0.00E+00	1.09E+04	0.00E+00	1.07E+05	1.16E+07	1.64E+05	0.00E+00
RH-105	1.16E+01	7.57E+00	5.08E+00	0.00E+00	2.10E+01	2.91E+04	1.92E+04	0.00E+00
PD-107	0.00E+00	6.89E+02	5.75E+01	0.00E+00	3.85E+03	8.88E+04	1.03E+03	0.00E+00
PD-109	0.00E+00	5.49E+00	1.47E+00	0.00E+00	1.79E+01	2.35E+04	3.99E+04	0.00E+00
AG-110M	9.98E+03	7.22E+03	5.00E+03	0.00E+00	1.09E+04	3.67E+06	3.30E+04	0.00E+00
AG-111	5.25E+02	2.03E+02	1.09E+02	0.00E+00	4.27E+02	2.88E+05	4.23E+04	0.00E+00
CD-113M	0.00E+00	9.34E+05	3.70E+04	0.00E+00	8.12E+05	1.96E+06	2.31E+04	0.00E+00
CD-115M	0.00E+00	2.42E+05	8.67E+03	0.00E+00	1.32E+05	2.06E+06	7.03E+04	0.00E+00
SN-123	2.93E+05	5.89E+03	1.02E+04	5.98E+03	0.00E+00	3.11E+06	5.71E+04	0.00E+00
SN-125	1.41E+04	3.51E+02	8.40E+02	3.46E+02	0.00E+00	9.00E+05	1.02E+05	0.00E+00
SN-126	1.16E+06	2.02E+04	4.93E+04	5.38E+03	0.00E+00	6.90E+06	2.31E+04	0.00E+00
SB-124	3.79E+04	5.56E+02	1.20E+04	1.01E+02	0.00E+00	2.65E+06	5.91E+04	0.00E+00
SB-125	5.17E+04	4.77E+02	1.09E+04	6.23E+01	0.00E+00	1.64E+06	1.47E+04	0.00E+00
SB-126	4.31E+03	8.41E+01	1.55E+03	3.29E+01	0.00E+00	9.63E+05	7.46E+04	0.00E+00
SB-127	3.95E+02	7.06E+00	1.23E+02	5.04E+00	0.00E+00	2.16E+05	5.29E+04	0.00E+00
TE-125M	4.76E+03	1.99E+03	6.58E+02	1.62E+03	0.00E+00	4.47E+05	1.29E+04	0.00E+00
TE-127M	1.67E+04	6.90E+03	2.07E+03	4.87E+03	3.75E+04	1.31E+06	2.73E+04	0.00E+00
TE-127	2.23E+00	9.53E-01	4.89E-01	1.85E+00	4.86E+00	1.03E+04	2.44E+04	0.00E+00
TE-129M	1.41E+04	6.09E+03	2.23E+03	5.47E+03	3.18E+04	1.68E+06	6.90E+04	0.00E+00
TE-129	7.88E-02	3.47E-02	1.88E-02	6.75E-02	1.75E-01	3.00E+03	2.63E+04	0.00E+00
TE-131M	1.07E+02	5.50E+01	3.63E+01	8.93E+01	2.65E+02	1.99E+05	1.19E+05	0.00E+00
TE-131	1.74E-02	8.22E-03	5.00E-03	1.58E-02	3.99E-02	2.06E+03	8.22E+03	0.00E+00
TE-132	3.72E+02	2.37E+02	1.76E+02	2.79E+02	1.03E+03	3.40E+05	4.41E+04	0.00E+00
TE-133M	8.58E-02	5.03E-02	3.84E-02	7.73E-02	2.41E-01	5.49E+03	2.23E+04	0.00E+00
TE-134	4.45E-02	2.86E-02	2.35E-02	4.07E-02	1.34E-01	4.10E+03	3.54E+03	0.00E+00
I-129	3.02E+04	2.23E+04	1.62E+04	1.46E+07	2.63E+04	0.00E+00	2.97E+02	0.00E+00
I-130	6.36E+03	1.39E+04	5.57E+03	1.60E+06	1.53E+04	0.00E+00	1.99E+03	0.00E+00
I-131	3.79E+04	4.44E+04	1.96E+04	1.48E+07	5.18E+04	0.00E+00	1.06E+03	0.00E+00
I-132	1.69E+03	3.54E+03	1.26E+03	1.69E+05	3.95E+03	0.00E+00	1.90E+03	0.00E+00

Rev. 30

Page 211 of 335

05/2018

TABLE II2-5

R_i / P_i DOSE FACTORS AGE: INFANT PATHWAY: INHALATIONmrem/yr per $\mu\text{Ci}/\text{m}^3$

NUCLIDE	BONE	LIVER	T BODY	THYROID	KIDNEY	LUNG	GI-LLI	SKIN
I-133	1.32E+04	1.92E+04	5.60E+03	3.56E+06	2.24E+04	0.00E+00	2.16E+03	0.00E+00
I-134	9.21E+02	1.88E+03	6.65E+02	4.45E+04	2.09E+03	0.00E+00	1.29E+03	0.00E+00
I-135	3.86E+03	7.60E+03	2.77E+03	6.96E+05	8.47E+03	0.00E+00	1.83E+03	0.00E+00
CS-134M	1.85E+02	2.94E+02	1.55E+02	0.00E+00	1.19E+02	2.80E+01	1.62E+02	0.00E+00
CS-134	3.96E+05	7.03E+05	7.45E+04	0.00E+00	1.90E+05	7.97E+04	1.33E+03	0.00E+00
CS-135	1.40E+05	1.21E+05	6.62E+03	0.00E+00	3.61E+04	1.41E+04	3.05E+02	0.00E+00
CS-136	4.83E+04	1.35E+05	5.29E+04	0.00E+00	5.64E+04	1.18E+04	1.43E+03	0.00E+00
CS-137	5.49E+05	6.12E+05	4.55E+04	0.00E+00	1.72E+05	7.13E+04	1.33E+03	0.00E+00
CS-138	5.05E+02	7.81E+02	3.98E+02	0.00E+00	4.10E+02	6.54E+01	8.76E+02	0.00E+00
CS-139	3.25E+02	4.24E+02	1.71E+02	0.00E+00	2.31E+02	3.54E+01	1.86E+01	0.00E+00
BA-139	1.48E+00	9.84E-04	4.30E-02	0.00E+00	5.92E-04	5.95E+03	5.10E+04	0.00E+00
BA-140	5.60E+04	5.60E+01	2.90E+03	0.00E+00	1.34E+01	1.60E+06	3.84E+04	0.00E+00
BA-141	1.57E-01	1.08E-04	4.97E-03	0.00E+00	6.50E-05	2.97E+03	4.75E+03	0.00E+00
BA-142	3.98E-02	3.30E-05	1.96E-03	0.00E+00	1.90E-05	1.55E+03	6.93E+02	0.00E+00
LA-140	5.05E+02	2.00E+02	5.15E+01	0.00E+00	0.00E+00	1.68E+05	8.48E+04	0.00E+00
LA-141	6.79E+00	1.96E+00	3.43E-01	0.00E+00	0.00E+00	1.71E+04	8.34E+04	0.00E+00
LA-142	1.03E+00	3.77E-01	9.04E-02	0.00E+00	0.00E+00	8.22E+03	5.95E+04	0.00E+00
CE-141	2.77E+04	1.67E+04	1.99E+03	0.00E+00	5.25E+03	5.17E+05	2.16E+04	0.00E+00
CE-143	2.93E+02	1.93E+02	2.21E+01	0.00E+00	5.64E+01	1.16E+05	4.97E+04	0.00E+00
CE-144	3.19E+06	1.21E+06	1.76E+05	0.00E+00	5.38E+05	9.84E+06	1.48E+05	0.00E+00
PR-143	1.40E+04	5.24E+03	6.99E+02	0.00E+00	1.97E+03	4.33E+05	3.72E+04	0.00E+00
PR-144	4.79E-02	1.85E-02	2.41E-03	0.00E+00	6.72E-03	1.61E+03	4.28E+03	0.00E+00
ND-147	7.94E+03	8.13E+03	5.00E+02	0.00E+00	3.15E+03	3.22E+05	3.12E+04	0.00E+00
PM-147	5.47E+05	4.30E+04	2.18E+04	0.00E+00	6.90E+04	6.37E+05	8.05E+03	0.00E+00
PM-148M	7.00E+04	1.74E+04	1.39E+04	0.00E+00	2.03E+04	1.71E+06	4.72E+04	0.00E+00
PM-148	4.68E+03	6.75E+02	3.42E+02	0.00E+00	8.06E+02	4.48E+05	8.46E+04	0.00E+00
PM-149	4.34E+02	5.71E+01	2.49E+01	0.00E+00	6.94E+01	9.10E+04	4.21E+04	0.00E+00
PM-151	1.05E+02	1.54E+01	7.77E+00	0.00E+00	1.82E+01	4.55E+04	3.61E+04	0.00E+00
SM-151	4.73E+05	9.03E+04	2.28E+04	0.00E+00	7.34E+04	4.17E+05	4.84E+03	0.00E+00
SM-153	2.14E+02	1.65E+02	1.27E+01	0.00E+00	3.46E+01	5.18E+04	2.70E+04	0.00E+00
EU-152	1.10E+06	2.48E+05	2.41E+05	0.00E+00	8.32E+05	2.07E+06	1.38E+04	0.00E+00
EU-154	4.14E+06	4.84E+05	3.43E+05	0.00E+00	1.60E+06	4.27E+06	3.98E+04	0.00E+00
EU-155	8.36E+05	8.01E+04	4.84E+04	0.00E+00	2.21E+05	7.28E+05	7.27E+04	0.00E+00
EU-156	2.18E+04	1.34E+04	2.16E+03	0.00E+00	6.27E+03	8.57E+05	5.80E+04	0.00E+00
TB-160	1.57E+05	0.00E+00	1.96E+04	0.00E+00	4.48E+04	1.55E+06	3.00E+04	0.00E+00
HO-166M	2.03E+06	4.30E+05	3.51E+05	0.00E+00	5.91E+05	2.87E+06	2.31E+04	0.00E+00
W-181	6.80E+01	2.04E+01	2.34E+00	0.00E+00	0.00E+00	1.86E+04	3.68E+02	0.00E+00
W-185	2.20E+03	6.76E+02	7.81E+01	0.00E+00	0.00E+00	6.27E+05	1.57E+04	0.00E+00
W-187	1.30E+01	9.02E+00	3.12E+00	0.00E+00	0.00E+00	3.96E+04	3.56E+04	0.00E+00
U-232	3.60E+08	0.00E+00	2.98E+07	0.00E+00	3.36E+07	2.09E+09	6.10E+04	0.00E+00
U-233	7.62E+07	0.00E+00	5.36E+06	0.00E+00	1.53E+07	4.98E+08	5.64E+04	0.00E+00
U-234	7.31E+07	0.00E+00	5.25E+06	0.00E+00	1.50E+07	4.89E+08	5.53E+04	0.00E+00

Rev. 30

Page 212 of 335

05/2018

TABLE II-5

R_i / P_i DOSE FACTORS AGE: INFANT PATHWAY: INHALATIONmrem/yr per $\mu\text{Ci}/\text{m}^3$

NUCLIDE	BONE	LIVER	T BODY	THYROID	KIDNEY	LUNG	GI-LLI	SKIN
U-235	7.01E+07	0.00E+00	4.93E+06	0.00E+00	1.41E+07	4.59E+08	7.03E+04	0.00E+00
U-236	7.01E+07	0.00E+00	5.04E+06	0.00E+00	1.44E+07	4.69E+08	5.19E+04	0.00E+00
U-237	4.55E+02	0.00E+00	1.21E+02	0.00E+00	1.13E+03	1.28E+05	1.83E+04	0.00E+00
U-238	6.71E+07	0.00E+00	4.61E+06	0.00E+00	1.32E+07	4.28E+08	4.96E+04	0.00E+00
NP-237	4.03E+09	2.39E+09	1.76E+08	0.00E+00	1.08E+09	4.89E+08	7.14E+04	0.00E+00
NP-238	3.74E+03	8.47E+02	5.82E+01	0.00E+00	2.06E+02	1.29E+05	3.61E+04	0.00E+00
NP-239	3.71E+02	2.98E+02	1.88E+01	0.00E+00	6.62E+01	5.95E+04	2.49E+04	0.00E+00
PU-238	3.77E+09	2.35E+09	1.78E+08	0.00E+00	6.50E+08	1.26E+09	6.57E+04	0.00E+00
PU-239	4.10E+09	2.46E+09	1.88E+08	0.00E+00	6.93E+08	1.19E+09	5.99E+04	0.00E+00
PU-240	4.10E+09	2.45E+09	1.88E+08	0.00E+00	6.92E+08	1.19E+09	6.10E+04	0.00E+00
PU-241	1.18E+08	2.59E+07	4.35E+06	0.00E+00	1.61E+07	1.07E+06	1.26E+03	0.00E+00
PU-242	3.81E+09	2.37E+09	1.81E+08	0.00E+00	6.68E+08	1.14E+09	5.88E+04	0.00E+00
PU-244	4.44E+09	2.72E+09	2.07E+08	0.00E+00	7.64E+08	1.31E+09	8.76E+04	0.00E+00
AM-241	4.41E+09	2.73E+09	1.83E+08	0.00E+00	1.11E+09	5.68E+08	6.69E+04	0.00E+00
AM-242M	4.55E+09	2.60E+09	1.89E+08	0.00E+00	1.12E+09	2.30E+08	8.41E+04	0.00E+00
AM-243	4.34E+09	2.63E+09	1.78E+08	0.00E+00	1.08E+09	5.39E+08	7.84E+04	0.00E+00
CM-242	1.79E+08	1.21E+08	7.98E+06	0.00E+00	2.37E+07	4.16E+08	7.14E+04	0.00E+00
CM-243	3.46E+09	2.13E+09	1.48E+08	0.00E+00	5.47E+08	5.94E+08	7.03E+04	0.00E+00
CM-244	2.90E+09	1.78E+09	1.24E+08	0.00E+00	4.49E+08	5.71E+08	6.80E+04	0.00E+00
CM-245	4.51E+09	2.74E+09	1.90E+08	0.00E+00	7.32E+08	5.49E+08	6.34E+04	0.00E+00
CM-246	4.48E+09	2.74E+09	1.90E+08	0.00E+00	7.32E+08	5.59E+08	6.23E+04	0.00E+00
CM-247	4.35E+09	2.70E+09	1.86E+08	0.00E+00	7.21E+08	5.49E+08	8.19E+04	0.00E+00
CM-248	3.61E+08	2.23E+08	1.54E+09	0.00E+00	5.94E+09	4.52E+09	1.32E+06	0.00E+00
CF-252	3.32E+09	0.00E+00	1.41E+08	0.00E+00	0.00E+00	1.92E+09	2.59E+05	0.00E+00

TABLE II2-6

R_i DOSE FACTORS AGE: ADULT PATHWAY: GROUND PLANEm²-mrem/yr per μ Ci/sec

NUCLIDE	BONE	LIVER	T BODY	THYROID	KIDNEY	LUNG	GI-LLI	SKIN
H-3	0.00E+00	0.00E+00	0.00E+00	0.00E+00	0.00E+00	0.00E+00	0.00E+00	0.00E+00
C-14	0.00E+00	0.00E+00	0.00E+00	0.00E+00	0.00E+00	0.00E+00	0.00E+00	0.00E+00
NA-22	1.16E+10	1.16E+10	1.16E+10	1.16E+10	1.16E+10	1.16E+10	1.16E+10	1.30E+10
NA-24	1.19E+07	1.19E+07	1.19E+07	1.19E+07	1.19E+07	1.19E+07	1.19E+07	1.39E+07
P-32	0.00E+00	0.00E+00	0.00E+00	0.00E+00	0.00E+00	0.00E+00	0.00E+00	0.00E+00
CA-41	1.65E+10	1.65E+10	1.65E+10	1.65E+10	1.65E+10	1.65E+10	1.65E+10	1.94E+10
SC-46	8.33E+08	8.33E+08	8.33E+08	8.33E+08	8.33E+08	8.33E+08	8.33E+08	9.61E+08
CR-51	4.66E+06	4.66E+06	4.66E+06	4.66E+06	4.66E+06	4.66E+06	4.66E+06	5.51E+06
MN-54	1.39E+09	1.39E+09	1.39E+09	1.39E+09	1.39E+09	1.39E+09	1.39E+09	1.63E+09
MN-56	9.03E+05	9.03E+05	9.03E+05	9.03E+05	9.03E+05	9.03E+05	9.03E+05	1.07E+06
FE-55	0.00E+00	0.00E+00	0.00E+00	0.00E+00	0.00E+00	0.00E+00	0.00E+00	0.00E+00
FE-59	2.73E+08	2.73E+08	2.73E+08	2.73E+08	2.73E+08	2.73E+08	2.73E+08	3.21E+08
CO-57	1.88E+08	1.88E+08	1.88E+08	1.88E+08	1.88E+08	1.88E+08	1.88E+08	2.07E+08
CO-58	3.79E+08	3.79E+08	3.79E+08	3.79E+08	3.79E+08	3.79E+08	3.79E+08	4.44E+08
CO-60	2.41E+10	2.41E+10	2.41E+10	2.41E+10	2.41E+10	2.41E+10	2.41E+10	2.83E+10
NI-59	0.00E+00	0.00E+00	0.00E+00	0.00E+00	0.00E+00	0.00E+00	0.00E+00	0.00E+00
NI-63	0.00E+00	0.00E+00	0.00E+00	0.00E+00	0.00E+00	0.00E+00	0.00E+00	0.00E+00
NI-65	2.97E+05	2.97E+05	2.97E+05	2.97E+05	2.97E+05	2.97E+05	2.97E+05	3.45E+05
CU-64	6.07E+05	6.07E+05	6.07E+05	6.07E+05	6.07E+05	6.07E+05	6.07E+05	6.88E+05
ZN-65	7.47E+08	7.47E+08	7.47E+08	7.47E+08	7.47E+08	7.47E+08	7.47E+08	8.59E+08
ZN-69M	1.27E+06	1.27E+06	1.27E+06	1.27E+06	1.27E+06	1.27E+06	1.27E+06	1.49E+06
ZN-69	0.00E+00	0.00E+00	0.00E+00	0.00E+00	0.00E+00	0.00E+00	0.00E+00	0.00E+00
SE-79	0.00E+00	0.00E+00	0.00E+00	0.00E+00	0.00E+00	0.00E+00	0.00E+00	0.00E+00
BR-82	2.14E+07	2.14E+07	2.14E+07	2.14E+07	2.14E+07	2.14E+07	2.14E+07	2.47E+07
BR-83	4.87E+03	4.87E+03	4.87E+03	4.87E+03	4.87E+03	4.87E+03	4.87E+03	7.08E+03
BR-84	2.03E+05	2.03E+05	2.03E+05	2.03E+05	2.03E+05	2.03E+05	2.03E+05	2.36E+05
BR-85	0.00E+00	0.00E+00	0.00E+00	0.00E+00	0.00E+00	0.00E+00	0.00E+00	0.00E+00
RB-86	8.99E+06	8.99E+06	8.99E+06	8.99E+06	8.99E+06	8.99E+06	8.99E+06	1.03E+07
RB-87	0.00E+00	0.00E+00	0.00E+00	0.00E+00	0.00E+00	0.00E+00	0.00E+00	0.00E+00
RB-88	3.31E+04	3.31E+04	3.31E+04	3.31E+04	3.31E+04	3.31E+04	3.31E+04	3.78E+04
RB-89	1.23E+05	1.23E+05	1.23E+05	1.23E+05	1.23E+05	1.23E+05	1.23E+05	1.48E+05
SR-89	2.16E+04	2.16E+04	2.16E+04	2.16E+04	2.16E+04	2.16E+04	2.16E+04	2.51E+04
SR-90	0.00E+00	0.00E+00	0.00E+00	0.00E+00	0.00E+00	0.00E+00	0.00E+00	0.00E+00
SR-91	2.15E+06	2.15E+06	2.15E+06	2.15E+06	2.15E+06	2.15E+06	2.15E+06	2.51E+06
SR-92	7.77E+05	7.77E+05	7.77E+05	7.77E+05	7.77E+05	7.77E+05	7.77E+05	8.63E+05
Y-90	4.49E+03	4.49E+03	4.49E+03	4.49E+03	4.49E+03	4.49E+03	4.49E+03	5.31E+03
Y-91M	1.00E+05	1.00E+05	1.00E+05	1.00E+05	1.00E+05	1.00E+05	1.00E+05	1.16E+05
Y-91	1.07E+06	1.07E+06	1.07E+06	1.07E+06	1.07E+06	1.07E+06	1.07E+06	1.21E+06
Y-92	1.80E+05	1.80E+05	1.80E+05	1.80E+05	1.80E+05	1.80E+05	1.80E+05	2.14E+05

Rev. 30

Page 214 of 335

05/2018

TABLE II-6

R_i DOSE FACTORS AGE: ADULT PATHWAY: GROUND PLANEm²-mrem/yr per μCi/sec

NUCLIDE	BONE	LIVER	T BODY	THYROID	KIDNEY	LUNG	GI-LLI	SKIN
Y-93	1.83E+05	1.83E+05	1.83E+05	1.83E+05	1.83E+05	1.83E+05	1.83E+05	2.51E+05
ZR-93	0.00E+00	0.00E+00	0.00E+00	0.00E+00	0.00E+00	0.00E+00	0.00E+00	0.00E+00
ZR-95	2.45E+08	2.45E+08	2.45E+08	2.45E+08	2.45E+08	2.45E+08	2.45E+08	2.84E+08
ZR-97	2.96E+06	2.96E+06	2.96E+06	2.96E+06	2.96E+06	2.96E+06	2.96E+06	3.44E+06
NB-93M	2.32E+06	2.32E+06	2.32E+06	2.32E+06	2.32E+06	2.32E+06	2.32E+06	2.83E+08
NB-95	1.37E+08	1.37E+08	1.37E+08	1.37E+08	1.37E+08	1.37E+08	1.37E+08	1.61E+08
NB-97	1.76E+05	1.76E+05	1.76E+05	1.76E+05	1.76E+05	1.76E+05	1.76E+05	2.07E+05
MO-93	1.11E+08	1.11E+08	1.11E+08	1.11E+08	1.11E+08	1.11E+08	1.11E+08	4.50E+09
MO-99	3.99E+06	3.99E+06	3.99E+06	3.99E+06	3.99E+06	3.99E+06	3.99E+06	4.63E+06
TC-99M	1.84E+05	1.84E+05	1.84E+05	1.84E+05	1.84E+05	1.84E+05	1.84E+05	2.11E+05
TC-99	0.00E+00	0.00E+00	0.00E+00	0.00E+00	0.00E+00	0.00E+00	0.00E+00	0.00E+00
TC-101	2.04E+04	2.04E+04	2.04E+04	2.04E+04	2.04E+04	2.04E+04	2.04E+04	2.26E+04
RU-103	1.08E+08	1.08E+08	1.08E+08	1.08E+08	1.08E+08	1.08E+08	1.08E+08	1.26E+08
RU-105	6.36E+05	6.36E+05	6.36E+05	6.36E+05	6.36E+05	6.36E+05	6.36E+05	7.21E+05
RU-106	4.22E+08	4.22E+08	4.22E+08	4.22E+08	4.22E+08	4.22E+08	4.22E+08	5.07E+08
RH-105	7.43E+05	7.43E+05	7.43E+05	7.43E+05	7.43E+05	7.43E+05	7.43E+05	8.67E+05
PD-107	0.00E+00	0.00E+00	0.00E+00	0.00E+00	0.00E+00	0.00E+00	0.00E+00	0.00E+00
PD-109	1.50E+04	1.50E+04	1.50E+04	1.50E+04	1.50E+04	1.50E+04	1.50E+04	1.71E+04
AG-110M	3.44E+09	3.44E+09	3.44E+09	3.44E+09	3.44E+09	3.44E+09	3.44E+09	4.01E+09
AG-111	1.03E+06	1.03E+06	1.03E+06	1.03E+06	1.03E+06	1.03E+06	1.03E+06	1.20E+06
CD-113M	6.31E+06	6.31E+06	6.31E+06	6.31E+06	6.31E+06	6.31E+06	6.31E+06	7.14E+06
CD-115M	0.00E+00	0.00E+00	0.00E+00	0.00E+00	0.00E+00	0.00E+00	0.00E+00	0.00E+00
SN-123	0.00E+00	0.00E+00	0.00E+00	0.00E+00	0.00E+00	0.00E+00	0.00E+00	6.38E+09
SN-125	4.20E+06	4.20E+06	4.20E+06	4.20E+06	4.20E+06	4.20E+06	4.20E+06	4.86E+06
SN-126	4.35E+10	4.35E+10	4.35E+10	4.35E+10	4.35E+10	4.35E+10	4.35E+10	4.84E+10
SB-124	5.98E+08	5.98E+08	5.98E+08	5.98E+08	5.98E+08	5.98E+08	5.98E+08	6.90E+08
SB-125	2.39E+09	2.39E+09	2.39E+09	2.39E+09	2.39E+09	2.39E+09	2.39E+09	2.70E+09
SB-126	8.44E+07	8.44E+07	8.44E+07	8.44E+07	8.44E+07	8.44E+07	8.44E+07	9.48E+07
SB-127	1.68E+07	1.68E+07	1.68E+07	1.68E+07	1.68E+07	1.68E+07	1.68E+07	1.94E+07
TE-125M	1.55E+06	1.55E+06	1.55E+06	1.55E+06	1.55E+06	1.55E+06	1.55E+06	2.13E+06
TE-127M	9.16E+04	9.16E+04	9.16E+04	9.16E+04	9.16E+04	9.16E+04	9.16E+04	1.08E+05
TE-127	2.98E+03	2.98E+03	2.98E+03	2.98E+03	2.98E+03	2.98E+03	2.98E+03	3.28E+03
TE-129M	1.98E+07	1.98E+07	1.98E+07	1.98E+07	1.98E+07	1.98E+07	1.98E+07	2.31E+07
TE-129	2.62E+04	2.62E+04	2.62E+04	2.62E+04	2.62E+04	2.62E+04	2.62E+04	3.10E+04
TE-131M	8.03E+06	8.03E+06	8.03E+06	8.03E+06	8.03E+06	8.03E+06	8.03E+06	9.46E+06
TE-131	2.92E+04	2.92E+04	2.92E+04	2.92E+04	2.92E+04	2.92E+04	2.92E+04	3.45E+07
TE-132	4.23E+06	4.23E+06	4.23E+06	4.23E+06	4.23E+06	4.23E+06	4.23E+06	4.98E+06
TE-133M	4.41E+05	4.41E+05	4.41E+05	4.41E+05	4.41E+05	4.41E+05	4.41E+05	5.00E+05
TE-134	2.22E+04	2.22E+04	2.22E+04	2.22E+04	2.22E+04	2.22E+04	2.22E+04	2.66E+04
I-129	2.18E+09	2.18E+09	2.18E+09	2.18E+09	2.18E+09	2.18E+09	2.18E+09	3.63E+09

TABLE II2-6

R_i DOSE FACTORS AGE: ADULT PATHWAY: GROUND PLANEm²-mrem/yr per μCi/sec

NUCLIDE	BONE	LIVER	T BODY	THYROID	KIDNEY	LUNG	GI-LLI	SKIN
I-130	5.51E+06	5.51E+06	5.51E+06	5.51E+06	5.51E+06	5.51E+06	5.51E+06	6.69E+06
I-131	1.72E+07	1.72E+07	1.72E+07	1.72E+07	1.72E+07	1.72E+07	1.72E+07	2.09E+07
I-132	1.25E+06	1.25E+06	1.25E+06	1.25E+06	1.25E+06	1.25E+06	1.25E+06	1.46E+06
I-133	2.45E+06	2.45E+06	2.45E+06	2.45E+06	2.45E+06	2.45E+06	2.45E+06	2.98E+06
I-134	4.47E+05	4.47E+05	4.47E+05	4.47E+05	4.47E+05	4.47E+05	4.47E+05	5.30E+05
I-135	2.53E+06	2.53E+06	2.53E+06	2.53E+06	2.53E+06	2.53E+06	2.53E+06	2.95E+06
CS-134M	5.73E+04	5.73E+04	5.73E+04	5.73E+04	5.73E+04	5.73E+04	5.73E+04	6.74E+04
CS-134	6.91E+09	6.91E+09	6.91E+09	6.91E+09	6.91E+09	6.91E+09	6.91E+09	8.06E+09
CS-135	0.00E+00	0.00E+00	0.00E+00	0.00E+00	0.00E+00	0.00E+00	0.00E+00	0.00E+00
CS-136	1.51E+08	1.51E+08	1.51E+08	1.51E+08	1.51E+08	1.51E+08	1.51E+08	1.71E+08
CS-137	1.55E+10	1.55E+10	1.55E+10	1.55E+10	1.55E+10	1.55E+10	1.55E+10	1.80E+10
CS-138	3.59E+05	3.59E+05	3.59E+05	3.59E+05	3.59E+05	3.59E+05	3.59E+05	4.10E+05
CS-139	3.14E+04	3.14E+04	3.14E+04	3.14E+04	3.14E+04	3.14E+04	3.14E+04	3.59E+04
BA-139	1.06E+05	1.06E+05	1.06E+05	1.06E+05	1.06E+05	1.06E+05	1.06E+05	1.19E+05
BA-140	2.05E+07	2.05E+07	2.05E+07	2.05E+07	2.05E+07	2.05E+07	2.05E+07	2.35E+07
BA-141	4.17E+04	4.17E+04	4.17E+04	4.17E+04	4.17E+04	4.17E+04	4.17E+04	4.75E+04
BA-142	4.49E+04	4.49E+04	4.49E+04	4.49E+04	4.49E+04	4.49E+04	4.49E+04	5.11E+04
LA-140	1.92E+07	1.92E+07	1.92E+07	1.92E+07	1.92E+07	1.92E+07	1.92E+07	2.18E+07
LA-141	3.14E+04	3.14E+04	3.14E+04	3.14E+04	3.14E+04	3.14E+04	3.14E+04	3.51E+04
LA-142	7.60E+05	7.60E+05	7.60E+05	7.60E+05	7.60E+05	7.60E+05	7.60E+05	9.11E+05
CE-141	1.37E+07	1.37E+07	1.37E+07	1.37E+07	1.37E+07	1.37E+07	1.37E+07	1.54E+07
CE-143	2.31E+06	2.31E+06	2.31E+06	2.31E+06	2.31E+06	2.31E+06	2.31E+06	2.63E+06
CE-144	6.95E+07	6.95E+07	6.95E+07	6.95E+07	6.95E+07	6.95E+07	6.95E+07	8.04E+07
PR-143	0.00E+00	0.00E+00	0.00E+00	0.00E+00	0.00E+00	0.00E+00	0.00E+00	0.00E+00
PR-144	1.83E+03	1.83E+03	1.83E+03	1.83E+03	1.83E+03	1.83E+03	1.83E+03	2.11E+03
ND-147	8.39E+06	8.39E+06	8.39E+06	8.39E+06	8.39E+06	8.39E+06	8.39E+06	1.01E+07
PM-147	0.00E+00	0.00E+00	0.00E+00	0.00E+00	0.00E+00	0.00E+00	0.00E+00	0.00E+00
PM-148M	4.45E+08	4.45E+08	4.45E+08	4.45E+08	4.45E+08	4.45E+08	4.45E+08	2.58E+09
PM-148	1.89E+07	1.89E+07	1.89E+07	1.89E+07	1.89E+07	1.89E+07	1.89E+07	2.18E+07
PM-149	4.23E+04	4.23E+04	4.23E+04	4.23E+04	4.23E+04	4.23E+04	4.23E+04	4.90E+04
PM-151	1.99E+06	1.99E+06	1.99E+06	1.99E+06	1.99E+06	1.99E+06	1.99E+06	2.08E+06
SM-151	2.11E+08	2.11E+08	2.11E+08	2.11E+08	2.11E+08	2.11E+08	2.11E+08	9.24E+08
SM-153	4.02E+05	4.02E+05	4.02E+05	4.02E+05	4.02E+05	4.02E+05	4.02E+05	4.46E+05
EU-152	2.02E+10	2.02E+10	2.02E+10	2.02E+10	2.02E+10	2.02E+10	2.02E+10	2.33E+10
EU-154	1.65E+10	1.65E+10	1.65E+10	1.65E+10	1.65E+10	1.65E+10	1.65E+10	1.90E+10
EU-155	5.12E+08	5.12E+08	5.12E+08	5.12E+08	5.12E+08	5.12E+08	5.12E+08	5.81E+08
EU-156	8.82E+07	8.82E+07	8.82E+07	8.82E+07	8.82E+07	8.82E+07	8.82E+07	1.01E+08
TB-160	4.75E+08	4.75E+08	4.75E+08	4.75E+08	4.75E+08	4.75E+08	4.75E+08	5.53E+08
HO-166M	4.27E+10	4.27E+10	4.27E+10	4.27E+10	4.27E+10	4.27E+10	4.27E+10	4.80E+10
W-181	1.94E+05	1.94E+05	1.94E+05	1.94E+05	1.94E+05	1.94E+05	1.94E+05	2.59E+05

TABLE II-6

R_i DOSE FACTORS AGE: ADULT PATHWAY: GROUND PLANEm²-mrem/yr per μ Ci/sec

NUCLIDE	BONE	LIVER	T BODY	THYROID	KIDNEY	LUNG	GI-LLI	SKIN
W-185	0.00E+00	0.00E+00	0.00E+00	0.00E+00	0.00E+00	0.00E+00	0.00E+00	0.00E+00
W-187	2.35E+06	2.35E+06	2.35E+06	2.35E+06	2.35E+06	2.35E+06	2.35E+06	2.73E+06
U-232	1.11E+07	1.11E+07	1.11E+07	1.11E+07	1.11E+07	1.11E+07	1.11E+07	1.16E+08
U-233	1.11E+10	1.11E+10	1.11E+10	1.11E+10	1.11E+10	1.11E+10	1.11E+10	1.35E+10
U-234	3.06E+06	3.06E+06	3.06E+06	3.06E+06	3.06E+06	3.06E+06	3.06E+06	7.69E+08
U-235	1.55E+10	1.55E+10	1.55E+10	1.55E+10	1.55E+10	1.55E+10	1.55E+10	1.94E+10
U-236	1.02E+05	1.02E+05	1.02E+05	1.02E+05	1.02E+05	1.02E+05	1.02E+05	8.71E+07
U-237	5.16E+06	5.16E+06	5.16E+06	5.16E+06	5.16E+06	5.16E+06	5.16E+06	6.71E+06
U-238	5.32E+08	5.32E+08	5.32E+08	5.32E+08	5.32E+08	5.32E+08	5.32E+08	7.26E+08
NP-237	6.77E+09	6.77E+09	6.77E+09	6.77E+09	6.77E+09	6.77E+09	6.77E+09	7.74E+09
NP-238	4.53E+06	4.53E+06	4.53E+06	4.53E+06	4.53E+06	4.53E+06	4.53E+06	5.18E+06
NP-239	1.71E+06	1.71E+06	1.71E+06	1.71E+06	1.71E+06	1.71E+06	1.71E+06	1.98E+06
PU-238	5.71E+06	5.71E+06	5.71E+06	5.71E+06	5.71E+06	5.71E+06	5.71E+06	7.90E+07
PU-239	3.82E+06	3.82E+06	3.82E+06	3.82E+06	3.82E+06	3.82E+06	3.82E+06	3.72E+07
PU-240	6.28E+06	6.28E+06	6.28E+06	6.28E+06	6.28E+06	6.28E+06	6.28E+06	8.70E+07
PU-241	1.29E+07	1.29E+07	1.29E+07	1.29E+07	1.29E+07	1.29E+07	1.29E+07	1.91E+07
PU-242	5.32E+06	5.32E+06	5.32E+06	5.32E+06	5.32E+06	5.32E+06	5.32E+06	7.74E+07
PU-244	4.33E+09	4.33E+09	4.33E+09	4.33E+09	4.33E+09	4.33E+09	4.33E+09	4.65E+09
AM-241	8.54E+08	8.54E+08	8.54E+08	8.54E+08	8.54E+08	8.54E+08	8.54E+08	1.23E+09
AM-242M	1.19E+08	1.19E+08	1.19E+08	1.19E+08	1.19E+08	1.19E+08	1.19E+08	8.23E+08
AM-243	6.28E+09	6.28E+09	6.28E+09	6.28E+09	6.28E+09	6.28E+09	6.28E+09	7.25E+09
CM-242	6.86E+05	6.86E+05	6.86E+05	6.86E+05	6.86E+05	6.86E+05	6.86E+05	2.87E+06
CM-243	8.34E+09	8.34E+09	8.34E+09	8.34E+09	8.34E+09	8.34E+09	8.34E+09	1.05E+10
CM-244	9.03E+06	9.03E+06	9.03E+06	9.03E+06	9.03E+06	9.03E+06	9.03E+06	5.61E+07
CM-245	4.59E+09	4.59E+09	4.59E+09	4.59E+09	4.59E+09	4.59E+09	4.59E+09	5.80E+09
CM-246	4.83E+06	4.83E+06	4.83E+06	4.83E+06	4.83E+06	4.83E+06	4.83E+06	7.24E+07
CM-247	1.06E+10	1.06E+10	1.06E+10	1.06E+10	1.06E+10	1.06E+10	1.06E+10	1.26E+10
CM-248	2.53E+10	2.53E+10	2.53E+10	2.53E+10	2.53E+10	2.53E+10	2.53E+10	3.29E+10
CF-252	4.86E+10	4.86E+10	4.86E+10	4.86E+10	4.86E+10	4.86E+10	4.86E+10	5.30E+10
Gross Alpha	9.16E+04	9.16E+04	9.16E+04	9.16E+04	9.16E+04	9.16E+04	9.16E+04	0.00E+00

TABLE II2-7

R_i DOSE FACTORS AGE: TEEN PATHWAY: GROUND PLANEm²-mrem/yr per μ Ci/sec

NUCLIDE	BONE	LIVER	T BODY	THYROID	KIDNEY	LUNG	GI-LLI	SKIN
H-3	0.00E+00	0.00E+00	0.00E+00	0.00E+00	0.00E+00	0.00E+00	0.00E+00	0.00E+00
C-14	0.00E+00	0.00E+00	0.00E+00	0.00E+00	0.00E+00	0.00E+00	0.00E+00	0.00E+00
NA-22	1.16E+10	1.16E+10	1.16E+10	1.16E+10	1.16E+10	1.16E+10	1.16E+10	1.30E+10
NA-24	1.19E+07	1.19E+07	1.19E+07	1.19E+07	1.19E+07	1.19E+07	1.19E+07	1.39E+07
P-32	0.00E+00	0.00E+00	0.00E+00	0.00E+00	0.00E+00	0.00E+00	0.00E+00	0.00E+00
CA-41	1.65E+10	1.65E+10	1.65E+10	1.65E+10	1.65E+10	1.65E+10	1.65E+10	1.94E+10
SC-46	8.33E+08	8.33E+08	8.33E+08	8.33E+08	8.33E+08	8.33E+08	8.33E+08	9.61E+08
CR-51	4.66E+06	4.66E+06	4.66E+06	4.66E+06	4.66E+06	4.66E+06	4.66E+06	5.51E+06
MN-54	1.39E+09	1.39E+09	1.39E+09	1.39E+09	1.39E+09	1.39E+09	1.39E+09	1.63E+09
MN-56	9.03E+05	9.03E+05	9.03E+05	9.03E+05	9.03E+05	9.03E+05	9.03E+05	1.07E+06
FE-55	0.00E+00	0.00E+00	0.00E+00	0.00E+00	0.00E+00	0.00E+00	0.00E+00	0.00E+00
FE-59	2.73E+08	2.73E+08	2.73E+08	2.73E+08	2.73E+08	2.73E+08	2.73E+08	3.21E+08
CO-57	1.88E+08	1.88E+08	1.88E+08	1.88E+08	1.88E+08	1.88E+08	1.88E+08	2.07E+08
CO-58	3.79E+08	3.79E+08	3.79E+08	3.79E+08	3.79E+08	3.79E+08	3.79E+08	4.44E+08
CO-60	2.41E+10	2.41E+10	2.41E+10	2.41E+10	2.41E+10	2.41E+10	2.41E+10	2.83E+10
NI-59	0.00E+00	0.00E+00	0.00E+00	0.00E+00	0.00E+00	0.00E+00	0.00E+00	0.00E+00
NI-63	0.00E+00	0.00E+00	0.00E+00	0.00E+00	0.00E+00	0.00E+00	0.00E+00	0.00E+00
NI-65	2.97E+05	2.97E+05	2.97E+05	2.97E+05	2.97E+05	2.97E+05	2.97E+05	3.45E+05
CU-64	6.07E+05	6.07E+05	6.07E+05	6.07E+05	6.07E+05	6.07E+05	6.07E+05	6.88E+05
ZN-65	7.47E+08	7.47E+08	7.47E+08	7.47E+08	7.47E+08	7.47E+08	7.47E+08	8.59E+08
ZN-69M	1.27E+06	1.27E+06	1.27E+06	1.27E+06	1.27E+06	1.27E+06	1.27E+06	1.49E+06
ZN-69	0.00E+00	0.00E+00	0.00E+00	0.00E+00	0.00E+00	0.00E+00	0.00E+00	0.00E+00
SE-79	0.00E+00	0.00E+00	0.00E+00	0.00E+00	0.00E+00	0.00E+00	0.00E+00	0.00E+00
BR-82	2.14E+07	2.14E+07	2.14E+07	2.14E+07	2.14E+07	2.14E+07	2.14E+07	2.47E+07
BR-83	4.87E+03	4.87E+03	4.87E+03	4.87E+03	4.87E+03	4.87E+03	4.87E+03	7.08E+03
BR-84	2.03E+05	2.03E+05	2.03E+05	2.03E+05	2.03E+05	2.03E+05	2.03E+05	2.36E+05
BR-85	0.00E+00	0.00E+00	0.00E+00	0.00E+00	0.00E+00	0.00E+00	0.00E+00	0.00E+00
RB-86	8.99E+06	8.99E+06	8.99E+06	8.99E+06	8.99E+06	8.99E+06	8.99E+06	1.03E+07
RB-87	0.00E+00	0.00E+00	0.00E+00	0.00E+00	0.00E+00	0.00E+00	0.00E+00	0.00E+00
RB-88	3.31E+04	3.31E+04	3.31E+04	3.31E+04	3.31E+04	3.31E+04	3.31E+04	3.78E+04
RB-89	1.23E+05	1.23E+05	1.23E+05	1.23E+05	1.23E+05	1.23E+05	1.23E+05	1.48E+05
SR-89	2.16E+04	2.16E+04	2.16E+04	2.16E+04	2.16E+04	2.16E+04	2.16E+04	2.51E+04
SR-90	0.00E+00	0.00E+00	0.00E+00	0.00E+00	0.00E+00	0.00E+00	0.00E+00	0.00E+00
SR-91	2.15E+06	2.15E+06	2.15E+06	2.15E+06	2.15E+06	2.15E+06	2.15E+06	2.51E+06
SR-92	7.77E+05	7.77E+05	7.77E+05	7.77E+05	7.77E+05	7.77E+05	7.77E+05	8.63E+05
Y-90	4.49E+03	4.49E+03	4.49E+03	4.49E+03	4.49E+03	4.49E+03	4.49E+03	5.31E+03
Y-91M	1.00E+05	1.00E+05	1.00E+05	1.00E+05	1.00E+05	1.00E+05	1.00E+05	1.16E+05
Y-91	1.07E+06	1.07E+06	1.07E+06	1.07E+06	1.07E+06	1.07E+06	1.07E+06	1.21E+06
Y-92	1.80E+05	1.80E+05	1.80E+05	1.80E+05	1.80E+05	1.80E+05	1.80E+05	2.14E+05
Y-93	1.83E+05	1.83E+05	1.83E+05	1.83E+05	1.83E+05	1.83E+05	1.83E+05	2.51E+05
ZR-93	0.00E+00	0.00E+00	0.00E+00	0.00E+00	0.00E+00	0.00E+00	0.00E+00	0.00E+00

TABLE II-7

R_i DOSE FACTORS AGE: TEEN PATHWAY: GROUND PLANEm²-mrem/yr per μCi/sec

NUCLIDE	BONE	LIVER	T BODY	THYROID	KIDNEY	LUNG	GI-LLI	SKIN
ZR-95	2.45E+08	2.45E+08	2.45E+08	2.45E+08	2.45E+08	2.45E+08	2.45E+08	2.84E+08
ZR-97	2.96E+06	2.96E+06	2.96E+06	2.96E+06	2.96E+06	2.96E+06	2.96E+06	3.44E+06
NB-93M	2.32E+06	2.32E+06	2.32E+06	2.32E+06	2.32E+06	2.32E+06	2.32E+06	2.83E+08
NB-95	1.37E+08	1.37E+08	1.37E+08	1.37E+08	1.37E+08	1.37E+08	1.37E+08	1.61E+08
NB-97	1.76E+05	1.76E+05	1.76E+05	1.76E+05	1.76E+05	1.76E+05	1.76E+05	2.07E+05
MO-93	1.11E+08	1.11E+08	1.11E+08	1.11E+08	1.11E+08	1.11E+08	1.11E+08	4.50E+09
MO-99	3.99E+06	3.99E+06	3.99E+06	3.99E+06	3.99E+06	3.99E+06	3.99E+06	4.63E+06
TC-99M	1.84E+05	1.84E+05	1.84E+05	1.84E+05	1.84E+05	1.84E+05	1.84E+05	2.11E+05
TC-99	0.00E+00	0.00E+00	0.00E+00	0.00E+00	0.00E+00	0.00E+00	0.00E+00	0.00E+00
TC-101	2.04E+04	2.04E+04	2.04E+04	2.04E+04	2.04E+04	2.04E+04	2.04E+04	2.26E+04
RU-103	1.08E+08	1.08E+08	1.08E+08	1.08E+08	1.08E+08	1.08E+08	1.08E+08	1.26E+08
RU-105	6.36E+05	6.36E+05	6.36E+05	6.36E+05	6.36E+05	6.36E+05	6.36E+05	7.21E+05
RU-106	4.22E+08	4.22E+08	4.22E+08	4.22E+08	4.22E+08	4.22E+08	4.22E+08	5.07E+08
RH-105	7.43E+05	7.43E+05	7.43E+05	7.43E+05	7.43E+05	7.43E+05	7.43E+05	8.67E+05
PD-107	0.00E+00	0.00E+00	0.00E+00	0.00E+00	0.00E+00	0.00E+00	0.00E+00	0.00E+00
PD-109	1.50E+04	1.50E+04	1.50E+04	1.50E+04	1.50E+04	1.50E+04	1.50E+04	1.71E+04
AG-110M	3.44E+09	3.44E+09	3.44E+09	3.44E+09	3.44E+09	3.44E+09	3.44E+09	4.01E+09
AG-111	1.03E+06	1.03E+06	1.03E+06	1.03E+06	1.03E+06	1.03E+06	1.03E+06	1.20E+06
CD-113M	6.31E+06	6.31E+06	6.31E+06	6.31E+06	6.31E+06	6.31E+06	6.31E+06	7.14E+06
CD-115M	0.00E+00	0.00E+00	0.00E+00	0.00E+00	0.00E+00	0.00E+00	0.00E+00	0.00E+00
SN-123	0.00E+00	0.00E+00	0.00E+00	0.00E+00	0.00E+00	0.00E+00	0.00E+00	6.38E+09
SN-125	4.20E+06	4.20E+06	4.20E+06	4.20E+06	4.20E+06	4.20E+06	4.20E+06	4.86E+06
SN-126	4.35E+10	4.35E+10	4.35E+10	4.35E+10	4.35E+10	4.35E+10	4.35E+10	4.84E+10
SB-124	5.98E+08	5.98E+08	5.98E+08	5.98E+08	5.98E+08	5.98E+08	5.98E+08	6.90E+08
SB-125	2.39E+09	2.39E+09	2.39E+09	2.39E+09	2.39E+09	2.39E+09	2.39E+09	2.70E+09
SB-126	8.44E+07	8.44E+07	8.44E+07	8.44E+07	8.44E+07	8.44E+07	8.44E+07	9.48E+07
SB-127	1.68E+07	1.68E+07	1.68E+07	1.68E+07	1.68E+07	1.68E+07	1.68E+07	1.94E+07
TE-125M	1.55E+06	1.55E+06	1.55E+06	1.55E+06	1.55E+06	1.55E+06	1.55E+06	2.13E+06
TE-127M	9.16E+04	9.16E+04	9.16E+04	9.16E+04	9.16E+04	9.16E+04	9.16E+04	1.08E+05
TE-127	2.98E+03	2.98E+03	2.98E+03	2.98E+03	2.98E+03	2.98E+03	2.98E+03	3.28E+03
TE-129M	1.98E+07	1.98E+07	1.98E+07	1.98E+07	1.98E+07	1.98E+07	1.98E+07	2.31E+07
TE-129	2.62E+04	2.62E+04	2.62E+04	2.62E+04	2.62E+04	2.62E+04	2.62E+04	3.10E+04
TE-131M	8.03E+06	8.03E+06	8.03E+06	8.03E+06	8.03E+06	8.03E+06	8.03E+06	9.46E+06
TE-131	2.92E+04	2.92E+04	2.92E+04	2.92E+04	2.92E+04	2.92E+04	2.92E+04	3.45E+07
TE-132	4.23E+06	4.23E+06	4.23E+06	4.23E+06	4.23E+06	4.23E+06	4.23E+06	4.98E+06
TE-133M	4.41E+05	4.41E+05	4.41E+05	4.41E+05	4.41E+05	4.41E+05	4.41E+05	5.00E+05
TE-134	2.22E+04	2.22E+04	2.22E+04	2.22E+04	2.22E+04	2.22E+04	2.22E+04	2.66E+04
I-129	2.18E+09	2.18E+09	2.18E+09	2.18E+09	2.18E+09	2.18E+09	2.18E+09	3.63E+09
I-130	5.51E+06	5.51E+06	5.51E+06	5.51E+06	5.51E+06	5.51E+06	5.51E+06	6.69E+06
I-131	1.72E+07	1.72E+07	1.72E+07	1.72E+07	1.72E+07	1.72E+07	1.72E+07	2.09E+07
I-132	1.25E+06	1.25E+06	1.25E+06	1.25E+06	1.25E+06	1.25E+06	1.25E+06	1.46E+06
I-133	2.45E+06	2.45E+06	2.45E+06	2.45E+06	2.45E+06	2.45E+06	2.45E+06	2.98E+06

TABLE II2-7

R_i DOSE FACTORS AGE: TEEN PATHWAY: GROUND PLANEm²-mrem/yr per μ Ci/sec

NUCLIDE	BONE	LIVER	T BODY	THYROID	KIDNEY	LUNG	GI-LLI	SKIN
I-134	4.47E+05	4.47E+05	4.47E+05	4.47E+05	4.47E+05	4.47E+05	4.47E+05	5.30E+05
I-135	2.53E+06	2.53E+06	2.53E+06	2.53E+06	2.53E+06	2.53E+06	2.53E+06	2.95E+06
CS-134M	5.73E+04	5.73E+04	5.73E+04	5.73E+04	5.73E+04	5.73E+04	5.73E+04	6.74E+04
CS-134	6.91E+09	6.91E+09	6.91E+09	6.91E+09	6.91E+09	6.91E+09	6.91E+09	8.06E+09
CS-135	0.00E+00	0.00E+00	0.00E+00	0.00E+00	0.00E+00	0.00E+00	0.00E+00	0.00E+00
CS-136	1.51E+08	1.51E+08	1.51E+08	1.51E+08	1.51E+08	1.51E+08	1.51E+08	1.71E+08
CS-137	1.55E+10	1.55E+10	1.55E+10	1.55E+10	1.55E+10	1.55E+10	1.55E+10	1.80E+10
CS-138	3.59E+05	3.59E+05	3.59E+05	3.59E+05	3.59E+05	3.59E+05	3.59E+05	4.10E+05
CS-139	3.14E+04	3.14E+04	3.14E+04	3.14E+04	3.14E+04	3.14E+04	3.14E+04	3.59E+04
BA-139	1.06E+05	1.06E+05	1.06E+05	1.06E+05	1.06E+05	1.06E+05	1.06E+05	1.19E+05
BA-140	2.05E+07	2.05E+07	2.05E+07	2.05E+07	2.05E+07	2.05E+07	2.05E+07	2.35E+07
BA-141	4.17E+04	4.17E+04	4.17E+04	4.17E+04	4.17E+04	4.17E+04	4.17E+04	4.75E+04
BA-142	4.49E+04	4.49E+04	4.49E+04	4.49E+04	4.49E+04	4.49E+04	4.49E+04	5.11E+04
LA-140	1.92E+07	1.92E+07	1.92E+07	1.92E+07	1.92E+07	1.92E+07	1.92E+07	2.18E+07
LA-141	3.14E+04	3.14E+04	3.14E+04	3.14E+04	3.14E+04	3.14E+04	3.14E+04	3.51E+04
LA-142	7.60E+05	7.60E+05	7.60E+05	7.60E+05	7.60E+05	7.60E+05	7.60E+05	9.11E+05
CE-141	1.37E+07	1.37E+07	1.37E+07	1.37E+07	1.37E+07	1.37E+07	1.37E+07	1.54E+07
CE-143	2.31E+06	2.31E+06	2.31E+06	2.31E+06	2.31E+06	2.31E+06	2.31E+06	2.63E+06
CE-144	6.95E+07	6.95E+07	6.95E+07	6.95E+07	6.95E+07	6.95E+07	6.95E+07	8.04E+07
PR-143	0.00E+00	0.00E+00	0.00E+00	0.00E+00	0.00E+00	0.00E+00	0.00E+00	0.00E+00
PR-144	1.83E+03	1.83E+03	1.83E+03	1.83E+03	1.83E+03	1.83E+03	1.83E+03	2.11E+03
ND-147	8.39E+06	8.39E+06	8.39E+06	8.39E+06	8.39E+06	8.39E+06	8.39E+06	1.01E+07
PM-147	0.00E+00	0.00E+00	0.00E+00	0.00E+00	0.00E+00	0.00E+00	0.00E+00	0.00E+00
PM-148M	4.45E+08	4.45E+08	4.45E+08	4.45E+08	4.45E+08	4.45E+08	4.45E+08	2.58E+09
PM-148	1.89E+07	1.89E+07	1.89E+07	1.89E+07	1.89E+07	1.89E+07	1.89E+07	2.18E+07
PM-149	4.23E+04	4.23E+04	4.23E+04	4.23E+04	4.23E+04	4.23E+04	4.23E+04	4.90E+04
PM-151	1.99E+06	1.99E+06	1.99E+06	1.99E+06	1.99E+06	1.99E+06	1.99E+06	2.08E+06
SM-151	2.11E+08	2.11E+08	2.11E+08	2.11E+08	2.11E+08	2.11E+08	2.11E+08	9.24E+08
SM-153	4.02E+05	4.02E+05	4.02E+05	4.02E+05	4.02E+05	4.02E+05	4.02E+05	4.46E+05
EU-152	2.02E+10	2.02E+10	2.02E+10	2.02E+10	2.02E+10	2.02E+10	2.02E+10	2.33E+10
EU-154	1.65E+10	1.65E+10	1.65E+10	1.65E+10	1.65E+10	1.65E+10	1.65E+10	1.90E+10
EU-155	5.12E+08	5.12E+08	5.12E+08	5.12E+08	5.12E+08	5.12E+08	5.12E+08	5.81E+08
EU-156	8.82E+07	8.82E+07	8.82E+07	8.82E+07	8.82E+07	8.82E+07	8.82E+07	1.01E+08
TB-160	4.75E+08	4.75E+08	4.75E+08	4.75E+08	4.75E+08	4.75E+08	4.75E+08	5.53E+08
HO-166M	4.27E+10	4.27E+10	4.27E+10	4.27E+10	4.27E+10	4.27E+10	4.27E+10	4.80E+10
W-181	1.94E+05	1.94E+05	1.94E+05	1.94E+05	1.94E+05	1.94E+05	1.94E+05	2.59E+05
W-185	0.00E+00	0.00E+00	0.00E+00	0.00E+00	0.00E+00	0.00E+00	0.00E+00	0.00E+00
W-187	2.35E+06	2.35E+06	2.35E+06	2.35E+06	2.35E+06	2.35E+06	2.35E+06	2.73E+06
U-232	1.11E+07	1.11E+07	1.11E+07	1.11E+07	1.11E+07	1.11E+07	1.11E+07	1.16E+08
U-233	1.11E+10	1.11E+10	1.11E+10	1.11E+10	1.11E+10	1.11E+10	1.11E+10	1.35E+10
U-234	3.06E+06	3.06E+06	3.06E+06	3.06E+06	3.06E+06	3.06E+06	3.06E+06	7.69E+08
U-235	1.55E+10	1.55E+10	1.55E+10	1.55E+10	1.55E+10	1.55E+10	1.55E+10	1.94E+10

TABLE II-7

R_i DOSE FACTORS AGE: TEEN PATHWAY: GROUND PLANEm²-mrem/yr per μ Ci/sec

NUCLIDE	BONE	LIVER	T BODY	THYROID	KIDNEY	LUNG	GI-LLI	SKIN
U-236	1.02E+05	1.02E+05	1.02E+05	1.02E+05	1.02E+05	1.02E+05	1.02E+05	8.71E+07
U-237	5.16E+06	5.16E+06	5.16E+06	5.16E+06	5.16E+06	5.16E+06	5.16E+06	6.71E+06
U-238	5.32E+08	5.32E+08	5.32E+08	5.32E+08	5.32E+08	5.32E+08	5.32E+08	7.26E+08
NP-237	6.77E+09	6.77E+09	6.77E+09	6.77E+09	6.77E+09	6.77E+09	6.77E+09	7.74E+09
NP-238	4.53E+06	4.53E+06	4.53E+06	4.53E+06	4.53E+06	4.53E+06	4.53E+06	5.18E+06
NP-239	1.71E+06	1.71E+06	1.71E+06	1.71E+06	1.71E+06	1.71E+06	1.71E+06	1.98E+06
PU-238	5.71E+06	5.71E+06	5.71E+06	5.71E+06	5.71E+06	5.71E+06	5.71E+06	7.90E+07
PU-239	3.82E+06	3.82E+06	3.82E+06	3.82E+06	3.82E+06	3.82E+06	3.82E+06	3.72E+07
PU-240	6.28E+06	6.28E+06	6.28E+06	6.28E+06	6.28E+06	6.28E+06	6.28E+06	8.70E+07
PU-241	1.29E+07	1.29E+07	1.29E+07	1.29E+07	1.29E+07	1.29E+07	1.29E+07	1.91E+07
PU-242	5.32E+06	5.32E+06	5.32E+06	5.32E+06	5.32E+06	5.32E+06	5.32E+06	7.74E+07
PU-244	4.33E+09	4.33E+09	4.33E+09	4.33E+09	4.33E+09	4.33E+09	4.33E+09	4.65E+09
AM-241	8.54E+08	8.54E+08	8.54E+08	8.54E+08	8.54E+08	8.54E+08	8.54E+08	1.23E+09
AM-242M	1.19E+08	1.19E+08	1.19E+08	1.19E+08	1.19E+08	1.19E+08	1.19E+08	8.23E+08
AM-243	6.28E+09	6.28E+09	6.28E+09	6.28E+09	6.28E+09	6.28E+09	6.28E+09	7.25E+09
CM-242	6.86E+05	6.86E+05	6.86E+05	6.86E+05	6.86E+05	6.86E+05	6.86E+05	2.87E+06
CM-243	8.34E+09	8.34E+09	8.34E+09	8.34E+09	8.34E+09	8.34E+09	8.34E+09	1.05E+10
CM-244	9.03E+06	9.03E+06	9.03E+06	9.03E+06	9.03E+06	9.03E+06	9.03E+06	5.61E+07
CM-245	4.59E+09	4.59E+09	4.59E+09	4.59E+09	4.59E+09	4.59E+09	4.59E+09	5.80E+09
CM-246	4.83E+06	4.83E+06	4.83E+06	4.83E+06	4.83E+06	4.83E+06	4.83E+06	7.24E+07
CM-247	1.06E+10	1.06E+10	1.06E+10	1.06E+10	1.06E+10	1.06E+10	1.06E+10	1.26E+10
CM-248	2.53E+10	2.53E+10	2.53E+10	2.53E+10	2.53E+10	2.53E+10	2.53E+10	3.29E+10
CF-252	4.86E+10	4.86E+10	4.86E+10	4.86E+10	4.86E+10	4.86E+10	4.86E+10	5.30E+10
Gross Alpha	9.16E+04	9.16E+04	9.16E+04	9.16E+04	9.16E+04	9.16E+04	9.16E+04	0.00E+00

TABLE II2-8

R_i DOSE FACTORS AGE: CHILD PATHWAY: GROUND PLANEm²-mrem/yr per μCi/sec

NUCLIDE	BONE	LIVER	T BODY	THYROID	KIDNEY	LUNG	GI-LLI	SKIN
H-3	0.00E+00	0.00E+00	0.00E+00	0.00E+00	0.00E+00	0.00E+00	0.00E+00	0.00E+00
C-14	0.00E+00	0.00E+00	0.00E+00	0.00E+00	0.00E+00	0.00E+00	0.00E+00	0.00E+00
NA-22	1.16E+10	1.16E+10	1.16E+10	1.16E+10	1.16E+10	1.16E+10	1.16E+10	1.30E+10
NA-24	1.19E+07	1.19E+07	1.19E+07	1.19E+07	1.19E+07	1.19E+07	1.19E+07	1.39E+07
P-32	0.00E+00	0.00E+00	0.00E+00	0.00E+00	0.00E+00	0.00E+00	0.00E+00	0.00E+00
CA-41	1.65E+10	1.65E+10	1.65E+10	1.65E+10	1.65E+10	1.65E+10	1.65E+10	1.94E+10
SC-46	8.33E+08	8.33E+08	8.33E+08	8.33E+08	8.33E+08	8.33E+08	8.33E+08	9.61E+08
CR-51	4.66E+06	4.66E+06	4.66E+06	4.66E+06	4.66E+06	4.66E+06	4.66E+06	5.51E+06
MN-54	1.39E+09	1.39E+09	1.39E+09	1.39E+09	1.39E+09	1.39E+09	1.39E+09	1.63E+09
MN-56	9.03E+05	9.03E+05	9.03E+05	9.03E+05	9.03E+05	9.03E+05	9.03E+05	1.07E+06
FE-55	0.00E+00	0.00E+00	0.00E+00	0.00E+00	0.00E+00	0.00E+00	0.00E+00	0.00E+00
FE-59	2.73E+08	2.73E+08	2.73E+08	2.73E+08	2.73E+08	2.73E+08	2.73E+08	3.21E+08
CO-57	1.88E+08	1.88E+08	1.88E+08	1.88E+08	1.88E+08	1.88E+08	1.88E+08	2.07E+08
CO-58	3.79E+08	3.79E+08	3.79E+08	3.79E+08	3.79E+08	3.79E+08	3.79E+08	4.44E+08
CO-60	2.41E+10	2.41E+10	2.41E+10	2.41E+10	2.41E+10	2.41E+10	2.41E+10	2.83E+10
NI-59	0.00E+00	0.00E+00	0.00E+00	0.00E+00	0.00E+00	0.00E+00	0.00E+00	0.00E+00
NI-63	0.00E+00	0.00E+00	0.00E+00	0.00E+00	0.00E+00	0.00E+00	0.00E+00	0.00E+00
NI-65	2.97E+05	2.97E+05	2.97E+05	2.97E+05	2.97E+05	2.97E+05	2.97E+05	3.45E+05
CU-64	6.07E+05	6.07E+05	6.07E+05	6.07E+05	6.07E+05	6.07E+05	6.07E+05	6.88E+05
ZN-65	7.47E+08	7.47E+08	7.47E+08	7.47E+08	7.47E+08	7.47E+08	7.47E+08	8.59E+08
ZN-69M	1.27E+06	1.27E+06	1.27E+06	1.27E+06	1.27E+06	1.27E+06	1.27E+06	1.49E+06
ZN-69	0.00E+00	0.00E+00	0.00E+00	0.00E+00	0.00E+00	0.00E+00	0.00E+00	0.00E+00
SE-79	0.00E+00	0.00E+00	0.00E+00	0.00E+00	0.00E+00	0.00E+00	0.00E+00	0.00E+00
BR-82	2.14E+07	2.14E+07	2.14E+07	2.14E+07	2.14E+07	2.14E+07	2.14E+07	2.47E+07
BR-83	4.87E+03	4.87E+03	4.87E+03	4.87E+03	4.87E+03	4.87E+03	4.87E+03	7.08E+03
BR-84	2.03E+05	2.03E+05	2.03E+05	2.03E+05	2.03E+05	2.03E+05	2.03E+05	2.36E+05
BR-85	0.00E+00	0.00E+00	0.00E+00	0.00E+00	0.00E+00	0.00E+00	0.00E+00	0.00E+00
RB-86	8.99E+06	8.99E+06	8.99E+06	8.99E+06	8.99E+06	8.99E+06	8.99E+06	1.03E+07
RB-87	0.00E+00	0.00E+00	0.00E+00	0.00E+00	0.00E+00	0.00E+00	0.00E+00	0.00E+00
RB-88	3.31E+04	3.31E+04	3.31E+04	3.31E+04	3.31E+04	3.31E+04	3.31E+04	3.78E+04
RB-89	1.23E+05	1.23E+05	1.23E+05	1.23E+05	1.23E+05	1.23E+05	1.23E+05	1.48E+05
SR-89	2.16E+04	2.16E+04	2.16E+04	2.16E+04	2.16E+04	2.16E+04	2.16E+04	2.51E+04
SR-90	0.00E+00	0.00E+00	0.00E+00	0.00E+00	0.00E+00	0.00E+00	0.00E+00	0.00E+00
SR-91	2.15E+06	2.15E+06	2.15E+06	2.15E+06	2.15E+06	2.15E+06	2.15E+06	2.51E+06
SR-92	7.77E+05	7.77E+05	7.77E+05	7.77E+05	7.77E+05	7.77E+05	7.77E+05	8.63E+05
Y-90	4.49E+03	4.49E+03	4.49E+03	4.49E+03	4.49E+03	4.49E+03	4.49E+03	5.31E+03
Y-91M	1.00E+05	1.00E+05	1.00E+05	1.00E+05	1.00E+05	1.00E+05	1.00E+05	1.16E+05
Y-91	1.07E+06	1.07E+06	1.07E+06	1.07E+06	1.07E+06	1.07E+06	1.07E+06	1.21E+06
Y-92	1.80E+05	1.80E+05	1.80E+05	1.80E+05	1.80E+05	1.80E+05	1.80E+05	2.14E+05
Y-93	1.83E+05	1.83E+05	1.83E+05	1.83E+05	1.83E+05	1.83E+05	1.83E+05	2.51E+05
ZR-93	0.00E+00	0.00E+00	0.00E+00	0.00E+00	0.00E+00	0.00E+00	0.00E+00	0.00E+00
ZR-95	2.45E+08	2.45E+08	2.45E+08	2.45E+08	2.45E+08	2.45E+08	2.45E+08	2.84E+08
ZR-97	2.96E+06	2.96E+06	2.96E+06	2.96E+06	2.96E+06	2.96E+06	2.96E+06	3.44E+06
NB-93M	2.32E+06	2.32E+06	2.32E+06	2.32E+06	2.32E+06	2.32E+06	2.32E+06	2.83E+08

Rev. 30

Page 222 of 335

05/2018

TABLE II2-8

R_i DOSE FACTORS AGE: CHILD PATHWAY: GROUND PLANEm²-mrem/yr per μ Ci/sec

NUCLIDE	BONE	LIVER	T BODY	THYROID	KIDNEY	LUNG	GI-LLI	SKIN
NB-95	1.37E+08	1.37E+08	1.37E+08	1.37E+08	1.37E+08	1.37E+08	1.37E+08	1.61E+08
NB-97	1.76E+05	1.76E+05	1.76E+05	1.76E+05	1.76E+05	1.76E+05	1.76E+05	2.07E+05
MO-93	1.11E+08	1.11E+08	1.11E+08	1.11E+08	1.11E+08	1.11E+08	1.11E+08	4.50E+09
MO-99	3.99E+06	3.99E+06	3.99E+06	3.99E+06	3.99E+06	3.99E+06	3.99E+06	4.63E+06
TC-99M	1.84E+05	1.84E+05	1.84E+05	1.84E+05	1.84E+05	1.84E+05	1.84E+05	2.11E+05
TC-99	0.00E+00	0.00E+00	0.00E+00	0.00E+00	0.00E+00	0.00E+00	0.00E+00	0.00E+00
TC-101	2.04E+04	2.04E+04	2.04E+04	2.04E+04	2.04E+04	2.04E+04	2.04E+04	2.26E+04
RU-103	1.08E+08	1.08E+08	1.08E+08	1.08E+08	1.08E+08	1.08E+08	1.08E+08	1.26E+08
RU-105	6.36E+05	6.36E+05	6.36E+05	6.36E+05	6.36E+05	6.36E+05	6.36E+05	7.21E+05
RU-106	4.22E+08	4.22E+08	4.22E+08	4.22E+08	4.22E+08	4.22E+08	4.22E+08	5.07E+08
RH-105	7.43E+05	7.43E+05	7.43E+05	7.43E+05	7.43E+05	7.43E+05	7.43E+05	8.67E+05
PD-107	0.00E+00	0.00E+00	0.00E+00	0.00E+00	0.00E+00	0.00E+00	0.00E+00	0.00E+00
PD-109	1.50E+04	1.50E+04	1.50E+04	1.50E+04	1.50E+04	1.50E+04	1.50E+04	1.71E+04
AG-110M	3.44E+09	3.44E+09	3.44E+09	3.44E+09	3.44E+09	3.44E+09	3.44E+09	4.01E+09
AG-111	1.03E+06	1.03E+06	1.03E+06	1.03E+06	1.03E+06	1.03E+06	1.03E+06	1.20E+06
CD-113M	6.31E+06	6.31E+06	6.31E+06	6.31E+06	6.31E+06	6.31E+06	6.31E+06	7.14E+06
CD-115M	0.00E+00	0.00E+00	0.00E+00	0.00E+00	0.00E+00	0.00E+00	0.00E+00	0.00E+00
SN-123	0.00E+00	0.00E+00	0.00E+00	0.00E+00	0.00E+00	0.00E+00	0.00E+00	6.38E+09
SN-125	4.20E+06	4.20E+06	4.20E+06	4.20E+06	4.20E+06	4.20E+06	4.20E+06	4.86E+06
SN-126	4.35E+10	4.35E+10	4.35E+10	4.35E+10	4.35E+10	4.35E+10	4.35E+10	4.84E+10
SB-124	5.98E+08	5.98E+08	5.98E+08	5.98E+08	5.98E+08	5.98E+08	5.98E+08	6.90E+08
SB-125	2.39E+09	2.39E+09	2.39E+09	2.39E+09	2.39E+09	2.39E+09	2.39E+09	2.70E+09
SB-126	8.44E+07	8.44E+07	8.44E+07	8.44E+07	8.44E+07	8.44E+07	8.44E+07	9.48E+07
SB-127	1.68E+07	1.68E+07	1.68E+07	1.68E+07	1.68E+07	1.68E+07	1.68E+07	1.94E+07
TE-125M	1.55E+06	1.55E+06	1.55E+06	1.55E+06	1.55E+06	1.55E+06	1.55E+06	2.13E+06
TE-127M	9.16E+04	9.16E+04	9.16E+04	9.16E+04	9.16E+04	9.16E+04	9.16E+04	1.08E+05
TE-127	2.98E+03	2.98E+03	2.98E+03	2.98E+03	2.98E+03	2.98E+03	2.98E+03	3.28E+03
TE-129M	1.98E+07	1.98E+07	1.98E+07	1.98E+07	1.98E+07	1.98E+07	1.98E+07	2.31E+07
TE-129	2.62E+04	2.62E+04	2.62E+04	2.62E+04	2.62E+04	2.62E+04	2.62E+04	3.10E+04
TE-131M	8.03E+06	8.03E+06	8.03E+06	8.03E+06	8.03E+06	8.03E+06	8.03E+06	9.46E+06
TE-131	2.92E+04	2.92E+04	2.92E+04	2.92E+04	2.92E+04	2.92E+04	2.92E+04	3.45E+07
TE-132	4.23E+06	4.23E+06	4.23E+06	4.23E+06	4.23E+06	4.23E+06	4.23E+06	4.98E+06
TE-133M	4.41E+05	4.41E+05	4.41E+05	4.41E+05	4.41E+05	4.41E+05	4.41E+05	5.00E+05
TE-134	2.22E+04	2.22E+04	2.22E+04	2.22E+04	2.22E+04	2.22E+04	2.22E+04	2.66E+04
I-129	2.18E+09	2.18E+09	2.18E+09	2.18E+09	2.18E+09	2.18E+09	2.18E+09	3.63E+09
I-130	5.51E+06	5.51E+06	5.51E+06	5.51E+06	5.51E+06	5.51E+06	5.51E+06	6.69E+06
I-131	1.72E+07	1.72E+07	1.72E+07	1.72E+07	1.72E+07	1.72E+07	1.72E+07	2.09E+07
I-132	1.25E+06	1.25E+06	1.25E+06	1.25E+06	1.25E+06	1.25E+06	1.25E+06	1.46E+06
I-133	2.45E+06	2.45E+06	2.45E+06	2.45E+06	2.45E+06	2.45E+06	2.45E+06	2.98E+06
I-134	4.47E+05	4.47E+05	4.47E+05	4.47E+05	4.47E+05	4.47E+05	4.47E+05	5.30E+05
I-135	2.53E+06	2.53E+06	2.53E+06	2.53E+06	2.53E+06	2.53E+06	2.53E+06	2.95E+06
CS-134M	5.73E+04	5.73E+04	5.73E+04	5.73E+04	5.73E+04	5.73E+04	5.73E+04	6.74E+04
CS-134	6.91E+09	6.91E+09	6.91E+09	6.91E+09	6.91E+09	6.91E+09	6.91E+09	8.06E+09
CS-135	0.00E+00	0.00E+00	0.00E+00	0.00E+00	0.00E+00	0.00E+00	0.00E+00	0.00E+00
CS-136	1.51E+08	1.51E+08	1.51E+08	1.51E+08	1.51E+08	1.51E+08	1.51E+08	1.71E+08

TABLE II-8

R_i DOSE FACTORS AGE: CHILD PATHWAY: GROUND PLANEm²-mrem/yr per μ Ci/sec

NUCLIDE	BONE	LIVER	T BODY	THYROID	KIDNEY	LUNG	GI-LLI	SKIN
CS-137	1.55E+10	1.55E+10	1.55E+10	1.55E+10	1.55E+10	1.55E+10	1.55E+10	1.80E+10
CS-138	3.59E+05	3.59E+05	3.59E+05	3.59E+05	3.59E+05	3.59E+05	3.59E+05	4.10E+05
CS-139	3.14E+04	3.14E+04	3.14E+04	3.14E+04	3.14E+04	3.14E+04	3.14E+04	3.59E+04
BA-139	1.06E+05	1.06E+05	1.06E+05	1.06E+05	1.06E+05	1.06E+05	1.06E+05	1.19E+05
BA-140	2.05E+07	2.05E+07	2.05E+07	2.05E+07	2.05E+07	2.05E+07	2.05E+07	2.35E+07
BA-141	4.17E+04	4.17E+04	4.17E+04	4.17E+04	4.17E+04	4.17E+04	4.17E+04	4.75E+04
BA-142	4.49E+04	4.49E+04	4.49E+04	4.49E+04	4.49E+04	4.49E+04	4.49E+04	5.11E+04
LA-140	1.92E+07	1.92E+07	1.92E+07	1.92E+07	1.92E+07	1.92E+07	1.92E+07	2.18E+07
LA-141	3.14E+04	3.14E+04	3.14E+04	3.14E+04	3.14E+04	3.14E+04	3.14E+04	3.51E+04
LA-142	7.60E+05	7.60E+05	7.60E+05	7.60E+05	7.60E+05	7.60E+05	7.60E+05	9.11E+05
CE-141	1.37E+07	1.37E+07	1.37E+07	1.37E+07	1.37E+07	1.37E+07	1.37E+07	1.54E+07
CE-143	2.31E+06	2.31E+06	2.31E+06	2.31E+06	2.31E+06	2.31E+06	2.31E+06	2.63E+06
CE-144	6.95E+07	6.95E+07	6.95E+07	6.95E+07	6.95E+07	6.95E+07	6.95E+07	8.04E+07
PR-143	0.00E+00	0.00E+00	0.00E+00	0.00E+00	0.00E+00	0.00E+00	0.00E+00	0.00E+00
PR-144	1.83E+03	1.83E+03	1.83E+03	1.83E+03	1.83E+03	1.83E+03	1.83E+03	2.11E+03
ND-147	8.39E+06	8.39E+06	8.39E+06	8.39E+06	8.39E+06	8.39E+06	8.39E+06	1.01E+07
PM-147	0.00E+00	0.00E+00	0.00E+00	0.00E+00	0.00E+00	0.00E+00	0.00E+00	0.00E+00
PM-148M	4.45E+08	4.45E+08	4.45E+08	4.45E+08	4.45E+08	4.45E+08	4.45E+08	2.58E+09
PM-148	1.89E+07	1.89E+07	1.89E+07	1.89E+07	1.89E+07	1.89E+07	1.89E+07	2.18E+07
PM-149	4.23E+04	4.23E+04	4.23E+04	4.23E+04	4.23E+04	4.23E+04	4.23E+04	4.90E+04
PM-151	1.99E+06	1.99E+06	1.99E+06	1.99E+06	1.99E+06	1.99E+06	1.99E+06	2.08E+06
SM-151	2.11E+08	2.11E+08	2.11E+08	2.11E+08	2.11E+08	2.11E+08	2.11E+08	9.24E+08
SM-153	4.02E+05	4.02E+05	4.02E+05	4.02E+05	4.02E+05	4.02E+05	4.02E+05	4.46E+05
EU-152	2.02E+10	2.02E+10	2.02E+10	2.02E+10	2.02E+10	2.02E+10	2.02E+10	2.33E+10
EU-154	1.65E+10	1.65E+10	1.65E+10	1.65E+10	1.65E+10	1.65E+10	1.65E+10	1.90E+10
EU-155	5.12E+08	5.12E+08	5.12E+08	5.12E+08	5.12E+08	5.12E+08	5.12E+08	5.81E+08
EU-156	8.82E+07	8.82E+07	8.82E+07	8.82E+07	8.82E+07	8.82E+07	8.82E+07	1.01E+08
TB-160	4.75E+08	4.75E+08	4.75E+08	4.75E+08	4.75E+08	4.75E+08	4.75E+08	5.53E+08
HO-166M	4.27E+10	4.27E+10	4.27E+10	4.27E+10	4.27E+10	4.27E+10	4.27E+10	4.80E+10
W-181	1.94E+05	1.94E+05	1.94E+05	1.94E+05	1.94E+05	1.94E+05	1.94E+05	2.59E+05
W-185	0.00E+00	0.00E+00	0.00E+00	0.00E+00	0.00E+00	0.00E+00	0.00E+00	0.00E+00
W-187	2.35E+06	2.35E+06	2.35E+06	2.35E+06	2.35E+06	2.35E+06	2.35E+06	2.73E+06
U-232	1.11E+07	1.11E+07	1.11E+07	1.11E+07	1.11E+07	1.11E+07	1.11E+07	1.16E+08
U-233	1.11E+10	1.11E+10	1.11E+10	1.11E+10	1.11E+10	1.11E+10	1.11E+10	1.35E+10
U-234	3.06E+06	3.06E+06	3.06E+06	3.06E+06	3.06E+06	3.06E+06	3.06E+06	7.69E+08
U-235	1.55E+10	1.55E+10	1.55E+10	1.55E+10	1.55E+10	1.55E+10	1.55E+10	1.94E+10
U-236	1.02E+05	1.02E+05	1.02E+05	1.02E+05	1.02E+05	1.02E+05	1.02E+05	8.71E+07
U-237	5.16E+06	5.16E+06	5.16E+06	5.16E+06	5.16E+06	5.16E+06	5.16E+06	6.71E+06
U-238	5.32E+08	5.32E+08	5.32E+08	5.32E+08	5.32E+08	5.32E+08	5.32E+08	7.26E+08
NP-237	6.77E+09	6.77E+09	6.77E+09	6.77E+09	6.77E+09	6.77E+09	6.77E+09	7.74E+09
NP-238	4.53E+06	4.53E+06	4.53E+06	4.53E+06	4.53E+06	4.53E+06	4.53E+06	5.18E+06
NP-239	1.71E+06	1.71E+06	1.71E+06	1.71E+06	1.71E+06	1.71E+06	1.71E+06	1.98E+06
PU-238	5.71E+06	5.71E+06	5.71E+06	5.71E+06	5.71E+06	5.71E+06	5.71E+06	7.90E+07
PU-239	3.82E+06	3.82E+06	3.82E+06	3.82E+06	3.82E+06	3.82E+06	3.82E+06	3.72E+07
PU-240	6.28E+06	6.28E+06	6.28E+06	6.28E+06	6.28E+06	6.28E+06	6.28E+06	8.70E+07

Rev. 30

Page 224 of 335

05/2018

TABLE II-8

R_i DOSE FACTORS AGE: CHILD PATHWAY: GROUND PLANEm²-mrem/yr per μ Ci/sec

NUCLIDE	BONE	LIVER	T BODY	THYROID	KIDNEY	LUNG	GI-LLI	SKIN
PU-241	1.29E+07	1.29E+07	1.29E+07	1.29E+07	1.29E+07	1.29E+07	1.29E+07	1.91E+07
PU-242	5.32E+06	5.32E+06	5.32E+06	5.32E+06	5.32E+06	5.32E+06	5.32E+06	7.74E+07
PU-244	4.33E+09	4.33E+09	4.33E+09	4.33E+09	4.33E+09	4.33E+09	4.33E+09	4.65E+09
AM-241	8.54E+08	8.54E+08	8.54E+08	8.54E+08	8.54E+08	8.54E+08	8.54E+08	1.23E+09
AM-242M	1.19E+08	1.19E+08	1.19E+08	1.19E+08	1.19E+08	1.19E+08	1.19E+08	8.23E+08
AM-243	6.28E+09	6.28E+09	6.28E+09	6.28E+09	6.28E+09	6.28E+09	6.28E+09	7.25E+09
CM-242	5.71E+06	5.71E+06	5.71E+06	5.71E+06	5.71E+06	5.71E+06	5.71E+06	7.90E+07
CM-243	8.34E+09	8.34E+09	8.34E+09	8.34E+09	8.34E+09	8.34E+09	8.34E+09	1.05E+10
CM-244	9.03E+06	9.03E+06	9.03E+06	9.03E+06	9.03E+06	9.03E+06	9.03E+06	5.61E+07
CM-245	4.59E+09	4.59E+09	4.59E+09	4.59E+09	4.59E+09	4.59E+09	4.59E+09	5.80E+09
CM-246	4.83E+06	4.83E+06	4.83E+06	4.83E+06	4.83E+06	4.83E+06	4.83E+06	7.24E+07
CM-247	1.06E+10	1.06E+10	1.06E+10	1.06E+10	1.06E+10	1.06E+10	1.06E+10	1.26E+10
CM-248	2.53E+10	2.53E+10	2.53E+10	2.53E+10	2.53E+10	2.53E+10	2.53E+10	3.29E+10
CF-252	4.86E+10	4.86E+10	4.86E+10	4.86E+10	4.86E+10	4.86E+10	4.86E+10	5.30E+10
Gross Alpha	9.16E+04	9.16E+04	9.16E+04	9.16E+04	9.16E+04	9.16E+04	9.16E+04	0.00E+00

TABLE II-9

R_i DOSE FACTORS AGE: INFANT PATHWAY: GROUND PLANEm²-mrem/yr per μCi/sec

NUCLIDE	BONE	LIVER	T BODY	THYROID	KIDNEY	LUNG	GI-LLI	SKIN
H-3	0.00E+00	0.00E+00	0.00E+00	0.00E+00	0.00E+00	0.00E+00	0.00E+00	0.00E+00
C-14	0.00E+00	0.00E+00	0.00E+00	0.00E+00	0.00E+00	0.00E+00	0.00E+00	0.00E+00
NA-22	1.16E+10	1.16E+10	1.16E+10	1.16E+10	1.16E+10	1.16E+10	1.16E+10	1.30E+10
NA-24	1.19E+07	1.19E+07	1.19E+07	1.19E+07	1.19E+07	1.19E+07	1.19E+07	1.39E+07
P-32	0.00E+00	0.00E+00	0.00E+00	0.00E+00	0.00E+00	0.00E+00	0.00E+00	0.00E+00
CA-41	1.65E+10	1.65E+10	1.65E+10	1.65E+10	1.65E+10	1.65E+10	1.65E+10	1.94E+10
SC-46	8.33E+08	8.33E+08	8.33E+08	8.33E+08	8.33E+08	8.33E+08	8.33E+08	9.61E+08
CR-51	4.66E+06	4.66E+06	4.66E+06	4.66E+06	4.66E+06	4.66E+06	4.66E+06	5.51E+06
MN-54	1.39E+09	1.39E+09	1.39E+09	1.39E+09	1.39E+09	1.39E+09	1.39E+09	1.63E+09
MN-56	9.03E+05	9.03E+05	9.03E+05	9.03E+05	9.03E+05	9.03E+05	9.03E+05	1.07E+06
FE-55	0.00E+00	0.00E+00	0.00E+00	0.00E+00	0.00E+00	0.00E+00	0.00E+00	0.00E+00
FE-59	2.73E+08	2.73E+08	2.73E+08	2.73E+08	2.73E+08	2.73E+08	2.73E+08	3.21E+08
CO-57	1.88E+08	1.88E+08	1.88E+08	1.88E+08	1.88E+08	1.88E+08	1.88E+08	2.07E+08
CO-58	3.79E+08	3.79E+08	3.79E+08	3.79E+08	3.79E+08	3.79E+08	3.79E+08	4.44E+08
CO-60	2.41E+10	2.41E+10	2.41E+10	2.41E+10	2.41E+10	2.41E+10	2.41E+10	2.83E+10
NI-59	0.00E+00	0.00E+00	0.00E+00	0.00E+00	0.00E+00	0.00E+00	0.00E+00	0.00E+00
NI-63	0.00E+00	0.00E+00	0.00E+00	0.00E+00	0.00E+00	0.00E+00	0.00E+00	0.00E+00
NI-65	2.97E+05	2.97E+05	2.97E+05	2.97E+05	2.97E+05	2.97E+05	2.97E+05	3.45E+05
CU-64	6.07E+05	6.07E+05	6.07E+05	6.07E+05	6.07E+05	6.07E+05	6.07E+05	6.88E+05
ZN-65	7.47E+08	7.47E+08	7.47E+08	7.47E+08	7.47E+08	7.47E+08	7.47E+08	8.59E+08
ZN-69M	1.27E+06	1.27E+06	1.27E+06	1.27E+06	1.27E+06	1.27E+06	1.27E+06	1.49E+06
ZN-69	0.00E+00	0.00E+00	0.00E+00	0.00E+00	0.00E+00	0.00E+00	0.00E+00	0.00E+00
SE-79	0.00E+00	0.00E+00	0.00E+00	0.00E+00	0.00E+00	0.00E+00	0.00E+00	0.00E+00
BR-82	2.14E+07	2.14E+07	2.14E+07	2.14E+07	2.14E+07	2.14E+07	2.14E+07	2.47E+07
BR-83	4.87E+03	4.87E+03	4.87E+03	4.87E+03	4.87E+03	4.87E+03	4.87E+03	7.08E+03
BR-84	2.03E+05	2.03E+05	2.03E+05	2.03E+05	2.03E+05	2.03E+05	2.03E+05	2.36E+05
BR-85	0.00E+00	0.00E+00	0.00E+00	0.00E+00	0.00E+00	0.00E+00	0.00E+00	0.00E+00
RB-86	8.99E+06	8.99E+06	8.99E+06	8.99E+06	8.99E+06	8.99E+06	8.99E+06	1.03E+07
RB-87	0.00E+00	0.00E+00	0.00E+00	0.00E+00	0.00E+00	0.00E+00	0.00E+00	0.00E+00
RB-88	3.31E+04	3.31E+04	3.31E+04	3.31E+04	3.31E+04	3.31E+04	3.31E+04	3.78E+04
RB-89	1.23E+05	1.23E+05	1.23E+05	1.23E+05	1.23E+05	1.23E+05	1.23E+05	1.48E+05
SR-89	2.16E+04	2.16E+04	2.16E+04	2.16E+04	2.16E+04	2.16E+04	2.16E+04	2.51E+04
SR-90	0.00E+00	0.00E+00	0.00E+00	0.00E+00	0.00E+00	0.00E+00	0.00E+00	0.00E+00
SR-91	2.15E+06	2.15E+06	2.15E+06	2.15E+06	2.15E+06	2.15E+06	2.15E+06	2.51E+06
SR-92	7.77E+05	7.77E+05	7.77E+05	7.77E+05	7.77E+05	7.77E+05	7.77E+05	8.63E+05
Y-90	4.49E+03	4.49E+03	4.49E+03	4.49E+03	4.49E+03	4.49E+03	4.49E+03	5.31E+03
Y-91M	1.00E+05	1.00E+05	1.00E+05	1.00E+05	1.00E+05	1.00E+05	1.00E+05	1.16E+05
Y-91	1.07E+06	1.07E+06	1.07E+06	1.07E+06	1.07E+06	1.07E+06	1.07E+06	1.21E+06
Y-92	1.80E+05	1.80E+05	1.80E+05	1.80E+05	1.80E+05	1.80E+05	1.80E+05	2.14E+05
Y-93	1.83E+05	1.83E+05	1.83E+05	1.83E+05	1.83E+05	1.83E+05	1.83E+05	2.51E+05
ZR-93	0.00E+00	0.00E+00	0.00E+00	0.00E+00	0.00E+00	0.00E+00	0.00E+00	0.00E+00
ZR-95	2.45E+08	2.45E+08	2.45E+08	2.45E+08	2.45E+08	2.45E+08	2.45E+08	2.84E+08
ZR-97	2.96E+06	2.96E+06	2.96E+06	2.96E+06	2.96E+06	2.96E+06	2.96E+06	3.44E+06
NB-93M	2.32E+06	2.32E+06	2.32E+06	2.32E+06	2.32E+06	2.32E+06	2.32E+06	2.83E+08

Rev. 30

Page 226 of 335

05/2018

TABLE II-9

R_i DOSE FACTORS AGE: INFANT PATHWAY: GROUND PLANEm²-mrem/yr per μ Ci/sec

NUCLIDE	BONE	LIVER	T BODY	THYROID	KIDNEY	LUNG	GI-LLI	SKIN
NB-95	1.37E+08	1.37E+08	1.37E+08	1.37E+08	1.37E+08	1.37E+08	1.37E+08	1.61E+08
NB-97	1.76E+05	1.76E+05	1.76E+05	1.76E+05	1.76E+05	1.76E+05	1.76E+05	2.07E+05
MO-93	1.11E+08	1.11E+08	1.11E+08	1.11E+08	1.11E+08	1.11E+08	1.11E+08	4.50E+09
MO-99	3.99E+06	3.99E+06	3.99E+06	3.99E+06	3.99E+06	3.99E+06	3.99E+06	4.63E+06
TC-99M	1.84E+05	1.84E+05	1.84E+05	1.84E+05	1.84E+05	1.84E+05	1.84E+05	2.11E+05
TC-99	0.00E+00	0.00E+00	0.00E+00	0.00E+00	0.00E+00	0.00E+00	0.00E+00	0.00E+00
TC-101	2.04E+04	2.04E+04	2.04E+04	2.04E+04	2.04E+04	2.04E+04	2.04E+04	2.26E+04
RU-103	1.08E+08	1.08E+08	1.08E+08	1.08E+08	1.08E+08	1.08E+08	1.08E+08	1.26E+08
RU-105	6.36E+05	6.36E+05	6.36E+05	6.36E+05	6.36E+05	6.36E+05	6.36E+05	7.21E+05
RU-106	4.22E+08	4.22E+08	4.22E+08	4.22E+08	4.22E+08	4.22E+08	4.22E+08	5.07E+08
RH-105	7.43E+05	7.43E+05	7.43E+05	7.43E+05	7.43E+05	7.43E+05	7.43E+05	8.67E+05
PD-107	0.00E+00	0.00E+00	0.00E+00	0.00E+00	0.00E+00	0.00E+00	0.00E+00	0.00E+00
PD-109	1.50E+04	1.50E+04	1.50E+04	1.50E+04	1.50E+04	1.50E+04	1.50E+04	1.71E+04
AG-110M	3.44E+09	3.44E+09	3.44E+09	3.44E+09	3.44E+09	3.44E+09	3.44E+09	4.01E+09
AG-111	1.03E+06	1.03E+06	1.03E+06	1.03E+06	1.03E+06	1.03E+06	1.03E+06	1.20E+06
CD-113M	6.31E+06	6.31E+06	6.31E+06	6.31E+06	6.31E+06	6.31E+06	6.31E+06	7.14E+06
CD-115M	0.00E+00	0.00E+00	0.00E+00	0.00E+00	0.00E+00	0.00E+00	0.00E+00	0.00E+00
SN-123	0.00E+00	0.00E+00	0.00E+00	0.00E+00	0.00E+00	0.00E+00	0.00E+00	6.38E+09
SN-125	4.20E+06	4.20E+06	4.20E+06	4.20E+06	4.20E+06	4.20E+06	4.20E+06	4.86E+06
SN-126	4.35E+10	4.35E+10	4.35E+10	4.35E+10	4.35E+10	4.35E+10	4.35E+10	4.84E+10
SB-124	5.98E+08	5.98E+08	5.98E+08	5.98E+08	5.98E+08	5.98E+08	5.98E+08	6.90E+08
SB-125	2.39E+09	2.39E+09	2.39E+09	2.39E+09	2.39E+09	2.39E+09	2.39E+09	2.70E+09
SB-126	8.44E+07	8.44E+07	8.44E+07	8.44E+07	8.44E+07	8.44E+07	8.44E+07	9.48E+07
SB-127	1.68E+07	1.68E+07	1.68E+07	1.68E+07	1.68E+07	1.68E+07	1.68E+07	1.94E+07
TE-125M	1.55E+06	1.55E+06	1.55E+06	1.55E+06	1.55E+06	1.55E+06	1.55E+06	2.13E+06
TE-127M	9.16E+04	9.16E+04	9.16E+04	9.16E+04	9.16E+04	9.16E+04	9.16E+04	1.08E+05
TE-127	2.98E+03	2.98E+03	2.98E+03	2.98E+03	2.98E+03	2.98E+03	2.98E+03	3.28E+03
TE-129M	1.98E+07	1.98E+07	1.98E+07	1.98E+07	1.98E+07	1.98E+07	1.98E+07	2.31E+07
TE-129	2.62E+04	2.62E+04	2.62E+04	2.62E+04	2.62E+04	2.62E+04	2.62E+04	3.10E+04
TE-131M	8.03E+06	8.03E+06	8.03E+06	8.03E+06	8.03E+06	8.03E+06	8.03E+06	9.46E+06
TE-131	2.92E+04	2.92E+04	2.92E+04	2.92E+04	2.92E+04	2.92E+04	2.92E+04	3.45E+07
TE-132	4.23E+06	4.23E+06	4.23E+06	4.23E+06	4.23E+06	4.23E+06	4.23E+06	4.98E+06
TE-133M	4.41E+05	4.41E+05	4.41E+05	4.41E+05	4.41E+05	4.41E+05	4.41E+05	5.00E+05
TE-134	2.22E+04	2.22E+04	2.22E+04	2.22E+04	2.22E+04	2.22E+04	2.22E+04	2.66E+04
I-129	2.18E+09	2.18E+09	2.18E+09	2.18E+09	2.18E+09	2.18E+09	2.18E+09	3.63E+09
I-130	5.51E+06	5.51E+06	5.51E+06	5.51E+06	5.51E+06	5.51E+06	5.51E+06	6.69E+06
I-131	1.72E+07	1.72E+07	1.72E+07	1.72E+07	1.72E+07	1.72E+07	1.72E+07	2.09E+07
I-132	1.25E+06	1.25E+06	1.25E+06	1.25E+06	1.25E+06	1.25E+06	1.25E+06	1.46E+06
I-133	2.45E+06	2.45E+06	2.45E+06	2.45E+06	2.45E+06	2.45E+06	2.45E+06	2.98E+06
I-134	4.47E+05	4.47E+05	4.47E+05	4.47E+05	4.47E+05	4.47E+05	4.47E+05	5.30E+05
I-135	2.53E+06	2.53E+06	2.53E+06	2.53E+06	2.53E+06	2.53E+06	2.53E+06	2.95E+06
CS-134M	5.73E+04	5.73E+04	5.73E+04	5.73E+04	5.73E+04	5.73E+04	5.73E+04	6.74E+04
CS-134	6.91E+09	6.91E+09	6.91E+09	6.91E+09	6.91E+09	6.91E+09	6.91E+09	8.06E+09
CS-135	0.00E+00	0.00E+00	0.00E+00	0.00E+00	0.00E+00	0.00E+00	0.00E+00	0.00E+00
CS-136	1.51E+08	1.51E+08	1.51E+08	1.51E+08	1.51E+08	1.51E+08	1.51E+08	1.71E+08

Rev. 30

Page 227 of 335

05/2018

TABLE II2-9

R_i DOSE FACTORS AGE: INFANT PATHWAY: GROUND PLANEm²-mrem/yr per μCi/sec

NUCLIDE	BONE	LIVER	T BODY	THYROID	KIDNEY	LUNG	GI-LLI	SKIN
CS-137	1.55E+10	1.55E+10	1.55E+10	1.55E+10	1.55E+10	1.55E+10	1.55E+10	1.80E+10
CS-138	3.59E+05	3.59E+05	3.59E+05	3.59E+05	3.59E+05	3.59E+05	3.59E+05	4.10E+05
CS-139	3.14E+04	3.14E+04	3.14E+04	3.14E+04	3.14E+04	3.14E+04	3.14E+04	3.59E+04
BA-139	1.06E+05	1.06E+05	1.06E+05	1.06E+05	1.06E+05	1.06E+05	1.06E+05	1.19E+05
BA-140	2.05E+07	2.05E+07	2.05E+07	2.05E+07	2.05E+07	2.05E+07	2.05E+07	2.35E+07
BA-141	4.17E+04	4.17E+04	4.17E+04	4.17E+04	4.17E+04	4.17E+04	4.17E+04	4.75E+04
BA-142	4.49E+04	4.49E+04	4.49E+04	4.49E+04	4.49E+04	4.49E+04	4.49E+04	5.11E+04
LA-140	1.92E+07	1.92E+07	1.92E+07	1.92E+07	1.92E+07	1.92E+07	1.92E+07	2.18E+07
LA-141	3.14E+04	3.14E+04	3.14E+04	3.14E+04	3.14E+04	3.14E+04	3.14E+04	3.51E+04
LA-142	7.60E+05	7.60E+05	7.60E+05	7.60E+05	7.60E+05	7.60E+05	7.60E+05	9.11E+05
CE-141	1.37E+07	1.37E+07	1.37E+07	1.37E+07	1.37E+07	1.37E+07	1.37E+07	1.54E+07
CE-143	2.31E+06	2.31E+06	2.31E+06	2.31E+06	2.31E+06	2.31E+06	2.31E+06	2.63E+06
CE-144	6.95E+07	6.95E+07	6.95E+07	6.95E+07	6.95E+07	6.95E+07	6.95E+07	8.04E+07
PR-143	0.00E+00	0.00E+00	0.00E+00	0.00E+00	0.00E+00	0.00E+00	0.00E+00	0.00E+00
PR-144	1.83E+03	1.83E+03	1.83E+03	1.83E+03	1.83E+03	1.83E+03	1.83E+03	2.11E+03
ND-147	8.39E+06	8.39E+06	8.39E+06	8.39E+06	8.39E+06	8.39E+06	8.39E+06	1.01E+07
PM-147	0.00E+00	0.00E+00	0.00E+00	0.00E+00	0.00E+00	0.00E+00	0.00E+00	0.00E+00
PM-148M	4.45E+08	4.45E+08	4.45E+08	4.45E+08	4.45E+08	4.45E+08	4.45E+08	2.58E+09
PM-148	1.89E+07	1.89E+07	1.89E+07	1.89E+07	1.89E+07	1.89E+07	1.89E+07	2.18E+07
PM-149	4.23E+04	4.23E+04	4.23E+04	4.23E+04	4.23E+04	4.23E+04	4.23E+04	4.90E+04
PM-151	1.99E+06	1.99E+06	1.99E+06	1.99E+06	1.99E+06	1.99E+06	1.99E+06	2.08E+06
SM-151	2.11E+08	2.11E+08	2.11E+08	2.11E+08	2.11E+08	2.11E+08	2.11E+08	9.24E+08
SM-153	4.02E+05	4.02E+05	4.02E+05	4.02E+05	4.02E+05	4.02E+05	4.02E+05	4.46E+05
EU-152	2.02E+10	2.02E+10	2.02E+10	2.02E+10	2.02E+10	2.02E+10	2.02E+10	2.33E+10
EU-154	1.65E+10	1.65E+10	1.65E+10	1.65E+10	1.65E+10	1.65E+10	1.65E+10	1.90E+10
EU-155	5.12E+08	5.12E+08	5.12E+08	5.12E+08	5.12E+08	5.12E+08	5.12E+08	5.81E+08
EU-156	8.82E+07	8.82E+07	8.82E+07	8.82E+07	8.82E+07	8.82E+07	8.82E+07	1.01E+08
TB-160	4.75E+08	4.75E+08	4.75E+08	4.75E+08	4.75E+08	4.75E+08	4.75E+08	5.53E+08
HO-166M	4.27E+10	4.27E+10	4.27E+10	4.27E+10	4.27E+10	4.27E+10	4.27E+10	4.80E+10
W-181	1.94E+05	1.94E+05	1.94E+05	1.94E+05	1.94E+05	1.94E+05	1.94E+05	2.59E+05
W-185	0.00E+00	0.00E+00	0.00E+00	0.00E+00	0.00E+00	0.00E+00	0.00E+00	0.00E+00
W-187	2.35E+06	2.35E+06	2.35E+06	2.35E+06	2.35E+06	2.35E+06	2.35E+06	2.73E+06
U-232	1.11E+07	1.11E+07	1.11E+07	1.11E+07	1.11E+07	1.11E+07	1.11E+07	1.16E+08
U-233	1.11E+10	1.11E+10	1.11E+10	1.11E+10	1.11E+10	1.11E+10	1.11E+10	1.35E+10
U-234	3.06E+06	3.06E+06	3.06E+06	3.06E+06	3.06E+06	3.06E+06	3.06E+06	7.69E+08
U-235	1.55E+10	1.55E+10	1.55E+10	1.55E+10	1.55E+10	1.55E+10	1.55E+10	1.94E+10
U-236	1.02E+05	1.02E+05	1.02E+05	1.02E+05	1.02E+05	1.02E+05	1.02E+05	8.71E+07
U-237	5.16E+06	5.16E+06	5.16E+06	5.16E+06	5.16E+06	5.16E+06	5.16E+06	6.71E+06
U-238	5.32E+08	5.32E+08	5.32E+08	5.32E+08	5.32E+08	5.32E+08	5.32E+08	7.26E+08
NP-237	6.77E+09	6.77E+09	6.77E+09	6.77E+09	6.77E+09	6.77E+09	6.77E+09	7.74E+09
NP-238	4.53E+06	4.53E+06	4.53E+06	4.53E+06	4.53E+06	4.53E+06	4.53E+06	5.18E+06
NP-239	1.71E+06	1.71E+06	1.71E+06	1.71E+06	1.71E+06	1.71E+06	1.71E+06	1.98E+06
PU-238	5.71E+06	5.71E+06	5.71E+06	5.71E+06	5.71E+06	5.71E+06	5.71E+06	7.90E+07
PU-239	3.82E+06	3.82E+06	3.82E+06	3.82E+06	3.82E+06	3.82E+06	3.82E+06	3.72E+07
PU-240	6.28E+06	6.28E+06	6.28E+06	6.28E+06	6.28E+06	6.28E+06	6.28E+06	8.70E+07

Rev. 30

Page 228 of 335

05/2018

TABLE II-9

R_i DOSE FACTORS AGE: INFANT PATHWAY: GROUND PLANEm²-mrem/yr per μCi/sec

NUCLIDE	BONE	LIVER	T BODY	THYROID	KIDNEY	LUNG	GI-LLI	SKIN
PU-241	1.29E+07	1.29E+07	1.29E+07	1.29E+07	1.29E+07	1.29E+07	1.29E+07	1.91E+07
PU-242	5.32E+06	5.32E+06	5.32E+06	5.32E+06	5.32E+06	5.32E+06	5.32E+06	7.74E+07
PU-244	4.33E+09	4.33E+09	4.33E+09	4.33E+09	4.33E+09	4.33E+09	4.33E+09	4.65E+09
AM-241	8.54E+08	8.54E+08	8.54E+08	8.54E+08	8.54E+08	8.54E+08	8.54E+08	1.23E+09
AM-242M	1.19E+08	1.19E+08	1.19E+08	1.19E+08	1.19E+08	1.19E+08	1.19E+08	8.23E+08
AM-243	6.28E+09	6.28E+09	6.28E+09	6.28E+09	6.28E+09	6.28E+09	6.28E+09	7.25E+09
CM-242	6.86E+05	6.86E+05	6.86E+05	6.86E+05	6.86E+05	6.86E+05	6.86E+05	2.87E+06
CM-243	8.34E+09	8.34E+09	8.34E+09	8.34E+09	8.34E+09	8.34E+09	8.34E+09	1.05E+10
CM-244	9.03E+06	9.03E+06	9.03E+06	9.03E+06	9.03E+06	9.03E+06	9.03E+06	5.61E+07
CM-245	4.59E+09	4.59E+09	4.59E+09	4.59E+09	4.59E+09	4.59E+09	4.59E+09	5.80E+09
CM-246	4.83E+06	4.83E+06	4.83E+06	4.83E+06	4.83E+06	4.83E+06	4.83E+06	7.24E+07
CM-247	1.06E+10	1.06E+10	1.06E+10	1.06E+10	1.06E+10	1.06E+10	1.06E+10	1.26E+10
CM-248	2.53E+10	2.53E+10	2.53E+10	2.53E+10	2.53E+10	2.53E+10	2.53E+10	3.29E+10
CF-252	4.86E+10	4.86E+10	4.86E+10	4.86E+10	4.86E+10	4.86E+10	4.86E+10	5.30E+10
Gross Alpha	9.16E+04	9.16E+04	9.16E+04	9.16E+04	9.16E+04	9.16E+04	9.16E+04	0.00E+00

TABLE I12-10

R_i DOSE FACTORS AGE: ADULT PATHWAY: GREEN LEAFY VEGETATIONm²-mrem/yr per μ Ci/sec

NUCLIDE	BONE	LIVER	T BODY	THYROID	KIDNEY	LUNG	GI-LLI	SKIN
H-3	0.00E+00	1.19E+03	1.19E+03	1.19E+03	1.19E+03	1.19E+03	1.19E+03	0.00E+00
C-14	8.24E+05	1.65E+05	1.65E+05	1.65E+05	1.65E+05	1.65E+05	1.65E+05	0.00E+00
NA-22	1.21E+09	1.21E+09	1.21E+09	1.21E+09	1.21E+09	1.21E+09	1.21E+09	0.00E+00
NA-24	1.12E+05	1.12E+05	1.12E+05	1.12E+05	1.12E+05	1.12E+05	1.12E+05	0.00E+00
P-32	8.03E+08	4.99E+07	3.10E+07	0.00E+00	0.00E+00	0.00E+00	9.02E+07	0.00E+00
CA-41	1.36E+10	0.00E+00	1.47E+09	0.00E+00	0.00E+00	0.00E+00	1.36E+07	0.00E+00
SC-46	2.20E+05	4.28E+05	1.24E+05	0.00E+00	3.99E+05	0.00E+00	2.08E+09	0.00E+00
CR-51	0.00E+00	0.00E+00	3.53E+04	2.11E+04	7.77E+03	4.68E+04	8.87E+06	0.00E+00
MN-54	0.00E+00	2.85E+08	5.43E+07	0.00E+00	8.47E+07	0.00E+00	8.72E+08	0.00E+00
MN-56	0.00E+00	6.48E+00	1.15E+00	0.00E+00	8.23E+00	0.00E+00	2.07E+02	0.00E+00
FE-55	1.92E+08	1.33E+08	3.09E+07	0.00E+00	0.00E+00	7.40E+07	7.61E+07	0.00E+00
FE-59	1.05E+08	2.47E+08	9.46E+07	0.00E+00	0.00E+00	6.90E+07	8.23E+08	0.00E+00
CO-57	0.00E+00	1.06E+07	1.77E+07	0.00E+00	0.00E+00	0.00E+00	2.70E+08	0.00E+00
CO-58	0.00E+00	2.67E+07	5.99E+07	0.00E+00	0.00E+00	0.00E+00	5.42E+08	0.00E+00
CO-60	0.00E+00	1.53E+08	3.38E+08	0.00E+00	0.00E+00	0.00E+00	2.88E+09	0.00E+00
NI-59	7.19E+08	2.47E+08	1.20E+08	0.00E+00	0.00E+00	0.00E+00	5.08E+07	0.00E+00
NI-63	9.56E+09	6.63E+08	3.21E+08	0.00E+00	0.00E+00	0.00E+00	1.38E+08	0.00E+00
NI-65	2.50E+01	3.25E+00	1.48E+00	0.00E+00	0.00E+00	0.00E+00	8.25E+01	0.00E+00
CU-64	0.00E+00	3.84E+03	1.80E+03	0.00E+00	9.68E+03	0.00E+00	3.27E+05	0.00E+00
ZN-65	2.88E+08	9.16E+08	4.14E+08	0.00E+00	6.12E+08	0.00E+00	5.77E+08	0.00E+00
ZN-69M	9.36E+03	2.25E+04	2.05E+03	0.00E+00	1.36E+04	0.00E+00	1.37E+06	0.00E+00
ZN-69	2.12E-06	4.06E-06	2.82E-07	0.00E+00	2.64E-06	0.00E+00	6.10E-07	0.00E+00
SE-79	0.00E+00	1.94E+08	3.23E+07	0.00E+00	3.35E+08	0.00E+00	3.96E+07	0.00E+00
BR-82	0.00E+00	0.00E+00	6.29E+05	0.00E+00	0.00E+00	0.00E+00	7.21E+05	0.00E+00
BR-83	0.00E+00	0.00E+00	1.26E+00	0.00E+00	0.00E+00	0.00E+00	1.82E+00	0.00E+00
BR-84	0.00E+00	0.00E+00	8.99E-12	0.00E+00	0.00E+00	0.00E+00	7.06E-17	0.00E+00
BR-85	0.00E+00	0.00E+00	0.00E+00	0.00E+00	0.00E+00	0.00E+00	0.00E+00	0.00E+00
RB-86	0.00E+00	1.44E+08	6.72E+07	0.00E+00	0.00E+00	0.00E+00	2.84E+07	0.00E+00
RB-87	0.00E+00	9.06E+08	3.15E+08	0.00E+00	0.00E+00	0.00E+00	4.24E+07	0.00E+00
RB-88	0.00E+00	1.11E-22	5.89E-23	0.00E+00	0.00E+00	0.00E+00	1.53E-33	0.00E+00
RB-89	0.00E+00	1.21E-26	8.51E-27	0.00E+00	0.00E+00	0.00E+00	7.03E-40	0.00E+00
SR-89	8.43E+09	0.00E+00	2.42E+08	0.00E+00	0.00E+00	0.00E+00	1.35E+09	0.00E+00
SR-90	6.38E+11	0.00E+00	1.28E+10	0.00E+00	0.00E+00	0.00E+00	1.61E+10	0.00E+00
SR-91	1.27E+05	0.00E+00	5.13E+03	0.00E+00	0.00E+00	0.00E+00	6.04E+05	0.00E+00
SR-92	1.74E+02	0.00E+00	7.53E+00	0.00E+00	0.00E+00	0.00E+00	3.45E+03	0.00E+00
Y-90	5.58E+03	0.00E+00	1.50E+02	0.00E+00	0.00E+00	0.00E+00	5.91E+07	0.00E+00
Y-91M	2.00E-09	0.00E+00	7.73E-11	0.00E+00	0.00E+00	0.00E+00	5.87E-09	0.00E+00
Y-91	4.38E+06	0.00E+00	1.17E+05	0.00E+00	0.00E+00	0.00E+00	2.41E+09	0.00E+00
Y-92	3.76E-01	0.00E+00	1.10E-02	0.00E+00	0.00E+00	0.00E+00	6.59E+03	0.00E+00
Y-93	7.07E+01	0.00E+00	1.95E+00	0.00E+00	0.00E+00	0.00E+00	2.24E+06	0.00E+00
ZR-93	3.08E+06	1.72E+05	8.03E+04	0.00E+00	6.53E+05	0.00E+00	1.79E+08	0.00E+00
ZR-95	1.01E+06	3.25E+05	2.20E+05	0.00E+00	5.11E+05	0.00E+00	1.03E+09	0.00E+00

TABLE I12-10

R_i DOSE FACTORS AGE: ADULT PATHWAY: GREEN LEAFY VEGETATIONm²-mrem/yr per μCi/sec

NUCLIDE	BONE	LIVER	T BODY	THYROID	KIDNEY	LUNG	GI-LLI	SKIN
ZR-97	1.41E+02	2.85E+01	1.30E+01	0.00E+00	4.30E+01	0.00E+00	8.81E+06	0.00E+00
NB-93M	1.86E+06	6.07E+05	1.50E+05	0.00E+00	6.98E+05	0.00E+00	2.80E+08	0.00E+00
NB-95	1.14E+05	6.35E+04	3.41E+04	0.00E+00	6.28E+04	0.00E+00	3.85E+08	0.00E+00
NB-97	8.48E-07	2.15E-07	7.83E-08	0.00E+00	2.50E-07	0.00E+00	7.91E-04	0.00E+00
MO-93	0.00E+00	5.53E+08	1.50E+07	0.00E+00	1.57E+08	0.00E+00	8.99E+07	0.00E+00
MO-99	0.00E+00	2.58E+06	4.91E+05	0.00E+00	5.84E+06	0.00E+00	5.98E+06	0.00E+00
TC-99M	1.29E+00	3.64E+00	4.63E+01	0.00E+00	5.52E+01	1.78E+00	2.15E+03	0.00E+00
TC-99	9.21E+06	1.37E+07	3.70E+06	0.00E+00	1.72E+08	1.16E+06	4.48E+08	0.00E+00
TC-101	2.49E-31	3.59E-31	3.52E-30	0.00E+00	6.47E-30	1.83E-31	1.08E-42	0.00E+00
RU-103	3.90E+06	0.00E+00	1.68E+06	0.00E+00	1.49E+07	0.00E+00	4.56E+08	0.00E+00
RU-105	2.22E+01	0.00E+00	8.78E+00	0.00E+00	2.87E+02	0.00E+00	1.36E+04	0.00E+00
RU-106	1.76E+08	0.00E+00	2.22E+07	0.00E+00	3.39E+08	0.00E+00	1.14E+10	0.00E+00
RH-105	3.38E+04	2.47E+04	1.63E+04	0.00E+00	1.05E+05	0.00E+00	3.93E+06	0.00E+00
PD-107	0.00E+00	1.08E+07	6.92E+05	0.00E+00	9.72E+07	0.00E+00	6.71E+07	0.00E+00
PD-109	0.00E+00	9.28E+03	2.09E+03	0.00E+00	5.30E+04	0.00E+00	1.03E+06	0.00E+00
AG-110M	9.56E+06	8.84E+06	5.25E+06	0.00E+00	1.74E+07	0.00E+00	3.61E+09	0.00E+00
AG-111	9.16E+04	3.83E+04	1.91E+04	0.00E+00	1.24E+05	0.00E+00	7.03E+07	0.00E+00
CD-113M	0.00E+00	2.32E+08	7.43E+06	0.00E+00	2.55E+08	0.00E+00	1.87E+09	0.00E+00
CD-115M	0.00E+00	4.45E+07	1.42E+06	0.00E+00	3.53E+07	0.00E+00	1.87E+09	0.00E+00
SN-123	1.53E+09	2.54E+07	3.74E+07	2.16E+07	0.00E+00	0.00E+00	3.12E+09	0.00E+00
SN-125	1.80E+07	3.62E+05	8.16E+05	3.00E+05	0.00E+00	0.00E+00	2.24E+08	0.00E+00
SN-126	6.22E+09	1.23E+08	1.77E+08	3.62E+07	0.00E+00	0.00E+00	1.79E+09	0.00E+00
SB-124	8.91E+07	1.68E+06	3.53E+07	2.16E+05	0.00E+00	6.94E+07	2.53E+09	0.00E+00
SB-125	1.25E+08	1.40E+06	2.98E+07	1.27E+05	0.00E+00	9.65E+07	1.38E+09	0.00E+00
SB-126	3.70E+06	7.53E+04	1.34E+06	2.27E+04	0.00E+00	2.27E+06	3.03E+08	0.00E+00
SB-127	2.18E+05	4.78E+03	8.37E+04	2.62E+03	0.00E+00	1.29E+05	4.99E+07	0.00E+00
TE-125M	8.27E+07	3.00E+07	1.11E+07	2.49E+07	3.37E+08	0.00E+00	3.30E+08	0.00E+00
TE-127M	3.11E+08	1.11E+08	3.78E+07	7.94E+07	1.26E+09	0.00E+00	1.04E+09	0.00E+00
TE-127	2.36E+03	8.47E+02	5.10E+02	1.75E+03	9.60E+03	0.00E+00	1.86E+05	0.00E+00
TE-129M	2.00E+08	7.45E+07	3.16E+07	6.86E+07	8.34E+08	0.00E+00	1.01E+09	0.00E+00
TE-129	3.00E-04	1.13E-04	7.30E-05	2.30E-04	1.26E-03	0.00E+00	2.26E-04	0.00E+00
TE-131M	3.82E+05	1.87E+05	1.56E+05	2.96E+05	1.89E+06	0.00E+00	1.85E+07	0.00E+00
TE-131	5.24E-16	2.19E-16	1.65E-16	4.31E-16	2.30E-15	0.00E+00	7.42E-17	0.00E+00
TE-132	1.80E+06	1.17E+06	1.10E+06	1.29E+06	1.12E+07	0.00E+00	5.52E+07	0.00E+00
TE-133M	8.89E-06	5.20E-06	5.01E-06	7.53E-06	5.14E-05	0.00E+00	1.78E-06	0.00E+00
TE-134	1.34E-08	8.77E-09	5.38E-09	1.17E-08	8.48E-08	0.00E+00	1.48E-11	0.00E+00
I-129	1.20E+09	1.03E+09	3.39E+09	2.66E+12	2.22E+09	0.00E+00	1.64E+08	0.00E+00
I-130	1.64E+05	4.83E+05	1.91E+05	4.09E+07	7.54E+05	0.00E+00	4.16E+05	0.00E+00
I-131	3.56E+07	5.10E+07	2.92E+07	1.67E+10	8.74E+07	0.00E+00	1.34E+07	0.00E+00
I-132	2.34E+01	6.26E+01	2.19E+01	2.19E+03	9.96E+01	0.00E+00	1.18E+01	0.00E+00
I-133	8.73E+05	1.52E+06	4.63E+05	2.23E+08	2.65E+06	0.00E+00	1.36E+06	0.00E+00
I-134	3.71E-05	1.01E-04	3.61E-05	1.75E-03	1.60E-04	0.00E+00	8.79E-08	0.00E+00

TABLE I12-10

R_i DOSE FACTORS AGE: ADULT PATHWAY: GREEN LEAFY VEGETATIONm²-mrem/yr per μ Ci/sec

NUCLIDE	BONE	LIVER	T BODY	THYROID	KIDNEY	LUNG	GI-LLI	SKIN
I-135	1.62E+04	4.24E+04	1.56E+04	2.79E+06	6.79E+04	0.00E+00	4.79E+04	0.00E+00
CS-134M	2.76E+00	5.80E+00	2.97E+00	0.00E+00	3.15E+00	4.96E-01	2.05E+00	0.00E+00
CS-134	4.27E+09	1.02E+10	8.31E+09	0.00E+00	3.29E+09	1.09E+09	1.78E+08	0.00E+00
CS-135	1.44E+09	1.33E+09	5.89E+08	0.00E+00	5.02E+08	1.50E+08	3.10E+07	0.00E+00
CS-136	2.33E+07	9.19E+07	6.62E+07	0.00E+00	5.12E+07	7.01E+06	1.04E+07	0.00E+00
CS-137	5.84E+09	7.99E+09	5.23E+09	0.00E+00	2.71E+09	9.02E+08	1.55E+08	0.00E+00
CS-138	1.42E-11	2.81E-11	1.39E-11	0.00E+00	2.07E-11	2.04E-12	1.20E-16	0.00E+00
CS-139	5.72E-45	8.52E-45	3.10E-45	0.00E+00	6.82E-45	6.20E-46	1.84E-67	0.00E+00
BA-139	1.13E-02	8.08E-06	3.32E-04	0.00E+00	7.56E-06	4.59E-06	2.01E-02	0.00E+00
BA-140	6.90E+07	8.67E+04	4.52E+06	0.00E+00	2.95E+04	4.96E+04	1.42E+08	0.00E+00
BA-141	3.76E-22	2.84E-25	1.27E-23	0.00E+00	2.64E-25	1.61E-25	1.77E-31	0.00E+00
BA-142	1.63E-39	1.67E-42	1.02E-40	0.00E+00	1.41E-42	9.48E-43	2.29E-57	0.00E+00
LA-140	8.29E+02	4.18E+02	1.10E+02	0.00E+00	0.00E+00	0.00E+00	3.07E+07	0.00E+00
LA-141	2.54E-01	7.89E-02	1.29E-02	0.00E+00	0.00E+00	0.00E+00	9.41E+03	0.00E+00
LA-142	8.08E-05	3.68E-05	9.16E-06	0.00E+00	0.00E+00	0.00E+00	2.68E-01	0.00E+00
CE-141	1.56E+05	1.05E+05	1.19E+04	0.00E+00	4.89E+04	0.00E+00	4.02E+08	0.00E+00
CE-143	4.18E+02	3.09E+05	3.42E+01	0.00E+00	1.36E+02	0.00E+00	1.16E+07	0.00E+00
CE-144	2.99E+07	1.25E+07	1.60E+06	0.00E+00	7.41E+06	0.00E+00	1.01E+10	0.00E+00
PR-143	3.47E+04	1.39E+04	1.72E+03	0.00E+00	8.04E+03	0.00E+00	1.52E+08	0.00E+00
PR-144	9.92E-27	4.12E-27	5.04E-28	0.00E+00	2.32E-27	0.00E+00	1.43E-33	0.00E+00
ND-147	1.65E+04	1.91E+04	1.14E+03	0.00E+00	1.12E+04	0.00E+00	9.16E+07	0.00E+00
PM-147	5.26E+06	4.94E+05	2.00E+05	0.00E+00	9.34E+05	0.00E+00	6.23E+08	0.00E+00
PM-148M	6.84E+05	1.77E+05	1.35E+05	0.00E+00	2.67E+05	0.00E+00	1.50E+09	0.00E+00
PM-148	8.25E+03	1.37E+03	6.90E+02	0.00E+00	2.59E+03	0.00E+00	1.08E+08	0.00E+00
PM-149	7.11E+02	1.01E+02	4.11E+01	0.00E+00	1.90E+02	0.00E+00	1.89E+07	0.00E+00
PM-151	1.42E+02	2.38E+01	1.20E+01	0.00E+00	4.25E+01	0.00E+00	6.55E+06	0.00E+00
SM-151	5.07E+06	8.75E+05	2.10E+05	0.00E+00	9.78E+05	0.00E+00	3.86E+08	0.00E+00
SM-153	3.44E+02	2.87E+02	2.09E+01	0.00E+00	9.26E+01	0.00E+00	1.02E+07	0.00E+00
EU-152	1.42E+07	3.24E+06	2.84E+06	0.00E+00	2.00E+07	0.00E+00	1.87E+09	0.00E+00
EU-154	4.46E+07	5.48E+06	3.90E+06	0.00E+00	2.62E+07	0.00E+00	3.97E+09	0.00E+00
EU-155	6.15E+06	8.73E+05	5.63E+05	0.00E+00	4.03E+06	0.00E+00	6.87E+08	0.00E+00
EU-156	6.38E+04	4.94E+04	7.97E+03	0.00E+00	3.30E+04	0.00E+00	3.38E+08	0.00E+00
TB-160	1.71E+06	0.00E+00	2.13E+05	0.00E+00	7.06E+05	0.00E+00	1.58E+09	0.00E+00
HO-166M	1.99E+07	6.21E+06	4.71E+06	0.00E+00	9.28E+06	0.00E+00	1.89E+09	0.00E+00
W-181	4.76E+05	1.55E+05	1.66E+04	0.00E+00	0.00E+00	0.00E+00	1.77E+07	0.00E+00
W-185	1.51E+07	5.04E+06	5.30E+05	0.00E+00	0.00E+00	0.00E+00	5.83E+08	0.00E+00
W-187	1.59E+04	1.33E+04	4.65E+03	0.00E+00	0.00E+00	0.00E+00	4.36E+06	0.00E+00
U-232	3.04E+11	0.00E+00	2.17E+10	0.00E+00	3.29E+10	0.00E+00	4.98E+09	0.00E+00
U-233	6.42E+10	0.00E+00	3.89E+09	0.00E+00	1.50E+10	0.00E+00	4.62E+09	0.00E+00
U-234	6.16E+10	0.00E+00	3.81E+09	0.00E+00	1.47E+10	0.00E+00	4.52E+09	0.00E+00
U-235	5.90E+10	0.00E+00	3.58E+09	0.00E+00	1.38E+10	0.00E+00	5.75E+09	0.00E+00
U-236	5.90E+10	0.00E+00	3.65E+09	0.00E+00	1.41E+10	0.00E+00	4.24E+09	0.00E+00

TABLE I12-10

R_i DOSE FACTORS AGE: ADULT PATHWAY: GREEN LEAFY VEGETATIONm²-mrem/yr per μCi/sec

NUCLIDE	BONE	LIVER	T BODY	THYROID	KIDNEY	LUNG	GI-LLI	SKIN
U-237	7.86E+04	0.00E+00	2.09E+04	0.00E+00	3.23E+05	0.00E+00	2.76E+07	0.00E+00
U-238	5.65E+10	0.00E+00	3.34E+09	0.00E+00	1.29E+10	0.00E+00	4.05E+09	0.00E+00
NP-237	9.28E+10	6.60E+09	4.08E+09	0.00E+00	3.03E+10	0.00E+00	5.85E+09	0.00E+00
NP-238	6.08E+03	1.64E+02	9.46E+01	0.00E+00	5.55E+02	0.00E+00	1.52E+07	0.00E+00
NP-239	5.99E+02	5.89E+01	3.25E+01	0.00E+00	1.84E+02	0.00E+00	1.21E+07	0.00E+00
PU-238	4.63E+10	5.87E+09	1.26E+09	0.00E+00	5.38E+09	0.00E+00	5.37E+09	0.00E+00
PU-239	5.34E+10	6.42E+09	1.41E+09	0.00E+00	5.97E+09	0.00E+00	4.91E+09	0.00E+00
PU-240	5.33E+10	6.41E+09	1.41E+09	0.00E+00	5.97E+09	0.00E+00	4.99E+09	0.00E+00
PU-241	1.14E+09	5.43E+07	2.42E+07	0.00E+00	1.12E+08	0.00E+00	1.02E+08	0.00E+00
PU-242	4.95E+10	6.18E+09	1.36E+09	0.00E+00	5.75E+09	0.00E+00	4.81E+09	0.00E+00
PU-244	5.78E+10	7.08E+09	1.55E+09	0.00E+00	6.59E+09	0.00E+00	7.17E+09	0.00E+00
AM-241	5.56E+10	5.19E+10	3.98E+09	0.00E+00	3.00E+10	0.00E+00	5.46E+09	0.00E+00
AM-242M	5.60E+10	4.88E+10	4.00E+09	0.00E+00	2.98E+10	0.00E+00	6.87E+09	0.00E+00
AM-243	5.55E+10	5.08E+10	3.90E+09	0.00E+00	2.94E+10	0.00E+00	6.41E+09	0.00E+00
CM-242	1.10E+09	1.17E+09	7.34E+07	0.00E+00	3.33E+08	0.00E+00	4.24E+09	0.00E+00
CM-243	4.39E+10	4.02E+10	2.75E+09	0.00E+00	1.28E+10	0.00E+00	5.72E+09	0.00E+00
CM-244	3.33E+10	3.12E+10	2.10E+09	0.00E+00	9.79E+09	0.00E+00	5.52E+09	0.00E+00
CM-245	6.91E+10	6.02E+10	4.24E+09	0.00E+00	1.98E+10	0.00E+00	5.19E+09	0.00E+00
CM-246	6.85E+10	6.01E+10	4.24E+09	0.00E+00	1.97E+10	0.00E+00	5.09E+09	0.00E+00
CM-247	6.68E+10	5.92E+10	4.18E+09	0.00E+00	1.94E+10	0.00E+00	6.70E+09	0.00E+00
CM-248	5.55E+11	4.88E+11	3.44E+10	0.00E+00	1.61E+11	0.00E+00	1.08E+11	0.00E+00
CF-252	1.82E+10	0.00E+00	4.39E+08	0.00E+00	0.00E+00	0.00E+00	2.01E+10	0.00E+00

TABLE I12-11

R_i DOSE FACTORS AGE: TEEN PATHWAY: GREEN LEAFY VEGETATIONm²-mrem/yr per μCi/sec

NUCLIDE	BONE	LIVER	T BODY	THYROID	KIDNEY	LUNG	GI-LLI	SKIN
H-3	0.00E+00	1.41E+03	1.41E+03	1.41E+03	1.41E+03	1.41E+03	1.41E+03	0.00E+00
C-14	1.39E+06	2.77E+05	2.77E+05	2.77E+05	2.77E+05	2.77E+05	2.77E+05	0.00E+00
NA-22	1.92E+09	1.92E+09	1.92E+09	1.92E+09	1.92E+09	1.92E+09	1.92E+09	0.00E+00
NA-24	9.98E+04	9.98E+04	9.98E+04	9.98E+04	9.98E+04	9.98E+04	9.98E+04	0.00E+00
P-32	1.04E+09	6.47E+07	4.05E+07	0.00E+00	0.00E+00	0.00E+00	8.78E+07	0.00E+00
CA-41	1.71E+10	0.00E+00	1.85E+09	0.00E+00	0.00E+00	0.00E+00	1.69E+07	0.00E+00
SC-46	3.35E+05	6.52E+05	1.93E+05	0.00E+00	6.24E+05	0.00E+00	2.22E+09	0.00E+00
CR-51	0.00E+00	0.00E+00	5.18E+04	2.88E+04	1.13E+04	7.39E+04	8.70E+06	0.00E+00
MN-54	0.00E+00	4.31E+08	8.54E+07	0.00E+00	1.28E+08	0.00E+00	8.83E+08	0.00E+00
MN-56	0.00E+00	5.84E+00	1.04E+00	0.00E+00	7.40E+00	0.00E+00	3.85E+02	0.00E+00
FE-55	3.10E+08	2.20E+08	5.13E+07	0.00E+00	0.00E+00	1.39E+08	9.51E+07	0.00E+00
FE-59	1.61E+08	3.75E+08	1.45E+08	0.00E+00	0.00E+00	1.18E+08	8.87E+08	0.00E+00
CO-57	0.00E+00	1.69E+07	2.84E+07	0.00E+00	0.00E+00	0.00E+00	3.16E+08	0.00E+00
CO-58	0.00E+00	4.02E+07	9.26E+07	0.00E+00	0.00E+00	0.00E+00	5.54E+08	0.00E+00
CO-60	0.00E+00	2.37E+08	5.33E+08	0.00E+00	0.00E+00	0.00E+00	3.08E+09	0.00E+00
NI-59	1.14E+09	4.04E+08	1.94E+08	0.00E+00	0.00E+00	0.00E+00	6.33E+07	0.00E+00
NI-63	1.53E+10	1.08E+09	5.19E+08	0.00E+00	0.00E+00	0.00E+00	1.72E+08	0.00E+00
NI-65	2.33E+01	2.98E+00	1.36E+00	0.00E+00	0.00E+00	0.00E+00	1.62E+02	0.00E+00
CU-64	0.00E+00	3.48E+03	1.64E+03	0.00E+00	8.81E+03	0.00E+00	2.70E+05	0.00E+00
ZN-65	4.01E+08	1.39E+09	6.49E+08	0.00E+00	8.91E+08	0.00E+00	5.89E+08	0.00E+00
ZN-69M	8.67E+03	2.04E+04	1.88E+03	0.00E+00	1.24E+04	0.00E+00	1.12E+06	0.00E+00
ZN-69	1.99E-06	3.79E-06	2.65E-07	0.00E+00	2.48E-06	0.00E+00	6.98E-06	0.00E+00
SE-79	0.00E+00	3.23E+08	5.43E+07	0.00E+00	5.63E+08	0.00E+00	4.94E+07	0.00E+00
BR-82	0.00E+00	0.00E+00	5.55E+05	0.00E+00	0.00E+00	0.00E+00	0.00E+00	0.00E+00
BR-83	0.00E+00	0.00E+00	1.18E+00	0.00E+00	0.00E+00	0.00E+00	0.00E+00	0.00E+00
BR-84	0.00E+00	0.00E+00	8.18E-12	0.00E+00	0.00E+00	0.00E+00	0.00E+00	0.00E+00
BR-85	0.00E+00	0.00E+00	0.00E+00	0.00E+00	0.00E+00	0.00E+00	0.00E+00	0.00E+00
RB-86	0.00E+00	2.04E+08	9.58E+07	0.00E+00	0.00E+00	0.00E+00	3.02E+07	0.00E+00
RB-87	0.00E+00	1.52E+09	5.29E+08	0.00E+00	0.00E+00	0.00E+00	5.29E+07	0.00E+00
RB-88	0.00E+00	1.03E-22	5.47E-23	0.00E+00	0.00E+00	0.00E+00	8.79E-30	0.00E+00
RB-89	0.00E+00	1.09E-26	7.70E-27	0.00E+00	0.00E+00	0.00E+00	1.67E-35	0.00E+00
SR-89	1.37E+10	0.00E+00	3.92E+08	0.00E+00	0.00E+00	0.00E+00	1.63E+09	0.00E+00
SR-90	8.79E+11	0.00E+00	1.76E+10	0.00E+00	0.00E+00	0.00E+00	2.01E+10	0.00E+00
SR-91	1.19E+05	0.00E+00	4.72E+03	0.00E+00	0.00E+00	0.00E+00	5.38E+05	0.00E+00
SR-92	1.62E+02	0.00E+00	6.91E+00	0.00E+00	0.00E+00	0.00E+00	4.13E+03	0.00E+00
Y-90	5.21E+03	0.00E+00	1.40E+02	0.00E+00	0.00E+00	0.00E+00	4.30E+07	0.00E+00
Y-91M	1.86E-09	0.00E+00	7.11E-11	0.00E+00	0.00E+00	0.00E+00	8.78E-08	0.00E+00
Y-91	7.15E+06	0.00E+00	1.92E+05	0.00E+00	0.00E+00	0.00E+00	2.93E+09	0.00E+00
Y-92	3.53E-01	0.00E+00	1.02E-02	0.00E+00	0.00E+00	0.00E+00	9.70E+03	0.00E+00
Y-93	6.63E+01	0.00E+00	1.82E+00	0.00E+00	0.00E+00	0.00E+00	2.02E+06	0.00E+00
ZR-93	4.79E+06	2.37E+05	1.29E+05	0.00E+00	8.36E+05	0.00E+00	2.24E+08	0.00E+00
ZR-95	1.58E+06	4.98E+05	3.43E+05	0.00E+00	7.32E+05	0.00E+00	1.15E+09	0.00E+00

TABLE I12-11

R_i DOSE FACTORS AGE: TEEN PATHWAY: GREEN LEAFY VEGETATIONm²-mrem/yr per μCi/sec

NUCLIDE	BONE	LIVER	T BODY	THYROID	KIDNEY	LUNG	GI-LLI	SKIN
ZR-97	1.31E+02	2.58E+01	1.19E+01	0.00E+00	3.92E+01	0.00E+00	7.00E+06	0.00E+00
NB-93M	2.95E+06	9.69E+05	2.43E+05	0.00E+00	1.13E+06	0.00E+00	3.49E+08	0.00E+00
NB-95	1.68E+05	9.31E+04	5.12E+04	0.00E+00	9.02E+04	0.00E+00	3.98E+08	0.00E+00
NB-97	7.86E-07	1.95E-07	7.12E-08	0.00E+00	2.28E-07	0.00E+00	4.66E-03	0.00E+00
MO-93	0.00E+00	9.18E+08	2.51E+07	0.00E+00	2.63E+08	0.00E+00	1.12E+08	0.00E+00
MO-99	0.00E+00	2.37E+06	4.52E+05	0.00E+00	5.42E+06	0.00E+00	4.24E+06	0.00E+00
TC-99M	1.13E+00	3.16E+00	4.10E+01	0.00E+00	4.72E+01	1.76E+00	2.08E+03	0.00E+00
TC-99	1.55E+07	2.28E+07	6.21E+06	0.00E+00	2.89E+08	2.36E+06	5.58E+08	0.00E+00
TC-101	2.32E-31	3.30E-31	3.24E-30	0.00E+00	5.96E-30	2.01E-31	5.63E-38	0.00E+00
RU-103	6.04E+06	0.00E+00	2.58E+06	0.00E+00	2.13E+07	0.00E+00	5.04E+08	0.00E+00
RU-105	2.07E+01	0.00E+00	8.01E+00	0.00E+00	2.60E+02	0.00E+00	1.67E+04	0.00E+00
RU-106	2.93E+08	0.00E+00	3.70E+07	0.00E+00	5.66E+08	0.00E+00	1.41E+10	0.00E+00
RH-105	3.17E+04	2.29E+04	1.50E+04	0.00E+00	9.72E+04	0.00E+00	2.91E+06	0.00E+00
PD-107	0.00E+00	1.80E+07	1.16E+06	0.00E+00	1.63E+08	0.00E+00	8.37E+07	0.00E+00
PD-109	0.00E+00	8.64E+03	1.96E+03	0.00E+00	4.99E+04	0.00E+00	8.71E+05	0.00E+00
AG-110M	1.43E+07	1.36E+07	8.25E+06	0.00E+00	2.59E+07	0.00E+00	3.81E+09	0.00E+00
AG-111	9.00E+04	3.74E+04	1.88E+04	0.00E+00	1.22E+05	0.00E+00	5.21E+07	0.00E+00
CD-113M	0.00E+00	3.87E+08	1.24E+07	0.00E+00	4.28E+08	0.00E+00	2.32E+09	0.00E+00
CD-115M	0.00E+00	7.11E+07	2.30E+06	0.00E+00	5.69E+07	0.00E+00	2.25E+09	0.00E+00
SN-123	2.55E+09	4.19E+07	6.20E+07	3.35E+07	0.00E+00	0.00E+00	3.85E+09	0.00E+00
SN-125	1.93E+07	3.85E+05	8.73E+05	3.02E+05	0.00E+00	0.00E+00	1.82E+08	0.00E+00
SN-126	1.01E+10	1.87E+08	2.86E+08	4.93E+07	0.00E+00	0.00E+00	2.24E+09	0.00E+00
SB-124	1.41E+08	2.60E+06	5.51E+07	3.20E+05	0.00E+00	1.23E+08	2.84E+09	0.00E+00
SB-125	2.04E+08	2.23E+06	4.76E+07	1.95E+05	0.00E+00	1.79E+08	1.59E+09	0.00E+00
SB-126	4.36E+06	8.91E+04	1.57E+06	2.47E+04	0.00E+00	3.13E+06	2.58E+08	0.00E+00
SB-127	2.01E+05	4.31E+03	7.60E+04	2.26E+03	0.00E+00	1.37E+05	3.42E+07	0.00E+00
TE-125M	1.35E+08	4.88E+07	1.81E+07	3.78E+07	0.00E+00	0.00E+00	3.99E+08	0.00E+00
TE-127M	5.15E+08	1.83E+08	6.13E+07	1.23E+08	2.09E+09	0.00E+00	1.28E+09	0.00E+00
TE-127	2.22E+03	7.88E+02	4.78E+02	1.53E+03	9.00E+03	0.00E+00	1.72E+05	0.00E+00
TE-129M	3.14E+08	1.16E+08	4.97E+07	1.01E+08	1.31E+09	0.00E+00	1.18E+09	0.00E+00
TE-129	2.81E-04	1.05E-04	6.83E-05	2.00E-04	1.18E-03	0.00E+00	1.53E-03	0.00E+00
TE-131M	3.54E+05	1.70E+05	1.41E+05	2.55E+05	1.77E+06	0.00E+00	1.36E+07	0.00E+00
TE-131	4.87E-16	2.01E-16	1.52E-16	3.75E-16	2.13E-15	0.00E+00	4.00E-17	0.00E+00
TE-132	1.64E+06	1.04E+06	9.77E+05	1.09E+06	9.96E+06	0.00E+00	3.29E+07	0.00E+00
TE-133M	8.14E-06	4.62E-06	4.50E-06	6.46E-06	4.57E-05	0.00E+00	1.87E-05	0.00E+00
TE-134	1.21E-08	7.79E-09	8.14E-09	9.96E-09	7.44E-08	0.00E+00	4.51E-10	0.00E+00
I-129	2.02E+09	1.70E+09	2.83E+09	2.07E+12	3.04E+09	0.00E+00	1.98E+08	0.00E+00
I-130	1.46E+05	4.24E+05	1.69E+05	3.45E+07	6.52E+05	0.00E+00	3.26E+05	0.00E+00
I-131	3.52E+07	4.93E+07	2.65E+07	1.44E+10	8.49E+07	0.00E+00	9.75E+06	0.00E+00
I-132	2.11E+01	5.52E+01	1.98E+01	1.86E+03	8.69E+01	0.00E+00	2.40E+01	0.00E+00
I-133	8.11E+05	1.38E+06	4.19E+05	1.92E+08	2.41E+06	0.00E+00	1.04E+06	0.00E+00
I-134	3.36E-05	8.90E-05	3.20E-05	1.48E-03	1.40E-04	0.00E+00	1.17E-06	0.00E+00

TABLE I12-11

R_i DOSE FACTORS AGE: TEEN PATHWAY: GREEN LEAFY VEGETATIONm²-mrem/yr per μCi/sec

NUCLIDE	BONE	LIVER	T BODY	THYROID	KIDNEY	LUNG	GI-LLI	SKIN
I-135	1.46E+04	3.76E+04	1.40E+04	2.42E+06	5.94E+04	0.00E+00	4.17E+04	0.00E+00
CS-134M	2.50E+00	5.18E+00	2.66E+00	0.00E+00	2.88E+00	5.06E-01	3.44E+00	0.00E+00
CS-134	6.75E+09	1.59E+10	7.37E+09	0.00E+00	5.05E+09	1.93E+09	1.98E+08	0.00E+00
CS-135	2.41E+09	2.21E+09	5.16E+08	0.00E+00	8.43E+08	3.05E+08	3.86E+07	0.00E+00
CS-136	2.69E+07	1.06E+08	7.12E+07	0.00E+00	5.77E+07	9.10E+06	8.53E+06	0.00E+00
CS-137	9.66E+09	1.28E+10	4.47E+09	0.00E+00	4.37E+09	1.70E+09	1.83E+08	0.00E+00
CS-138	1.31E-11	2.52E-11	1.26E-11	0.00E+00	1.86E-11	2.17E-12	1.14E-14	0.00E+00
CS-139	5.36E-45	7.89E-45	2.89E-45	0.00E+00	6.37E-45	6.98E-46	3.66E-60	0.00E+00
BA-139	1.07E-02	7.51E-06	3.11E-04	0.00E+00	7.08E-06	5.17E-06	9.52E-02	0.00E+00
BA-140	8.35E+07	1.02E+05	5.38E+06	0.00E+00	3.47E+04	6.88E+04	1.29E+08	0.00E+00
BA-141	3.51E-22	2.62E-25	1.17E-23	0.00E+00	2.43E-25	1.79E-25	7.48E-28	0.00E+00
BA-142	1.50E-39	1.50E-42	9.23E-41	0.00E+00	1.27E-42	9.99E-43	4.61E-51	0.00E+00
LA-140	7.57E+02	3.72E+02	9.90E+01	0.00E+00	0.00E+00	0.00E+00	2.14E+07	0.00E+00
LA-141	2.38E-01	7.33E-02	1.21E-02	0.00E+00	0.00E+00	0.00E+00	1.30E+04	0.00E+00
LA-142	7.42E-05	3.29E-05	8.21E-06	0.00E+00	0.00E+00	0.00E+00	1.00E+00	0.00E+00
CE-141	2.44E+05	1.63E+05	1.87E+04	0.00E+00	7.68E+04	0.00E+00	4.66E+08	0.00E+00
CE-143	3.91E+02	2.84E+05	3.18E+01	0.00E+00	1.28E+02	0.00E+00	8.55E+06	0.00E+00
CE-144	4.99E+07	2.07E+07	2.68E+06	0.00E+00	1.23E+07	0.00E+00	1.26E+10	0.00E+00
PR-143	4.40E+04	1.76E+04	2.19E+03	0.00E+00	1.02E+04	0.00E+00	1.45E+08	0.00E+00
PR-144	9.30E-27	3.81E-27	4.72E-28	0.00E+00	2.19E-27	0.00E+00	1.03E-29	0.00E+00
ND-147	1.97E+04	2.15E+04	1.29E+03	0.00E+00	1.26E+04	0.00E+00	7.74E+07	0.00E+00
PM-147	8.60E+06	8.16E+05	3.32E+05	0.00E+00	1.56E+06	0.00E+00	7.76E+08	0.00E+00
PM-148M	1.04E+06	2.63E+05	2.06E+05	0.00E+00	3.99E+05	0.00E+00	1.66E+09	0.00E+00
PM-148	7.75E+03	1.26E+03	6.36E+02	0.00E+00	2.28E+03	0.00E+00	7.53E+07	0.00E+00
PM-149	6.66E+02	9.36E+01	3.84E+01	0.00E+00	1.78E+02	0.00E+00	1.38E+07	0.00E+00
PM-151	1.32E+02	2.18E+01	1.10E+01	0.00E+00	3.91E+01	0.00E+00	4.89E+06	0.00E+00
SM-151	7.55E+06	1.45E+06	3.41E+05	0.00E+00	1.59E+06	0.00E+00	4.93E+08	0.00E+00
SM-153	3.21E+02	2.66E+02	1.95E+01	0.00E+00	8.68E+01	0.00E+00	7.50E+06	0.00E+00
EU-152	2.10E+07	5.06E+06	4.46E+06	0.00E+00	2.35E+07	0.00E+00	1.86E+09	0.00E+00
EU-154	6.74E+07	8.69E+06	6.13E+06	0.00E+00	3.88E+07	0.00E+00	4.59E+09	0.00E+00
EU-155	1.46E+07	1.41E+06	8.75E+05	0.00E+00	5.52E+06	0.00E+00	8.10E+09	0.00E+00
EU-156	8.35E+04	6.26E+04	1.02E+04	0.00E+00	4.22E+04	0.00E+00	3.20E+08	0.00E+00
TB-160	2.71E+06	0.00E+00	3.39E+05	0.00E+00	1.07E+06	0.00E+00	1.76E+09	0.00E+00
HO-166M	3.09E+07	9.53E+06	6.90E+06	0.00E+00	1.39E+07	0.00E+00	2.35E+09	0.00E+00
W-181	7.93E+05	2.56E+05	2.68E+04	0.00E+00	0.00E+00	0.00E+00	2.18E+07	0.00E+00
W-185	2.49E+07	8.23E+06	8.70E+05	0.00E+00	0.00E+00	0.00E+00	7.11E+08	0.00E+00
W-187	1.48E+04	1.21E+04	4.23E+03	0.00E+00	0.00E+00	0.00E+00	3.27E+06	0.00E+00
U-232	5.09E+11	0.00E+00	3.64E+10	0.00E+00	5.52E+10	0.00E+00	6.22E+09	0.00E+00
U-233	1.07E+11	0.00E+00	6.53E+09	0.00E+00	2.51E+10	0.00E+00	5.76E+09	0.00E+00
U-234	1.03E+11	0.00E+00	6.40E+09	0.00E+00	2.47E+10	0.00E+00	5.64E+09	0.00E+00
U-235	9.88E+10	0.00E+00	6.01E+09	0.00E+00	2.31E+10	0.00E+00	7.17E+09	0.00E+00
U-236	9.88E+10	0.00E+00	6.14E+09	0.00E+00	2.37E+10	0.00E+00	5.29E+09	0.00E+00

TABLE II2-11

R_i DOSE FACTORS AGE: TEEN PATHWAY: GREEN LEAFY VEGETATIONm²-mrem/yr per μ Ci/sec

NUCLIDE	BONE	LIVER	T BODY	THYROID	KIDNEY	LUNG	GI-LLI	SKIN
U-237	7.58E+04	0.00E+00	2.02E+04	0.00E+00	3.11E+05	0.00E+00	2.01E+07	0.00E+00
U-238	9.44E+10	0.00E+00	5.62E+09	0.00E+00	2.17E+10	0.00E+00	5.05E+09	0.00E+00
NP-237	1.15E+11	8.27E+09	5.07E+09	0.00E+00	3.75E+10	0.00E+00	7.29E+09	0.00E+00
NP-238	5.68E+03	1.52E+02	8.86E+01	0.00E+00	5.22E+02	0.00E+00	1.12E+07	0.00E+00
NP-239	5.81E+02	5.48E+01	3.04E+01	0.00E+00	1.72E+02	0.00E+00	8.82E+06	0.00E+00
PU-238	5.80E+10	7.42E+09	1.57E+09	0.00E+00	6.75E+09	0.00E+00	6.69E+09	0.00E+00
PU-239	6.63E+10	8.05E+09	1.74E+09	0.00E+00	7.42E+09	0.00E+00	6.12E+09	0.00E+00
PU-240	6.62E+10	8.03E+09	1.74E+09	0.00E+00	7.42E+09	0.00E+00	6.23E+09	0.00E+00
PU-241	1.50E+09	7.20E+07	3.16E+07	0.00E+00	1.47E+08	0.00E+00	1.27E+08	0.00E+00
PU-242	6.14E+10	7.75E+09	1.68E+09	0.00E+00	7.15E+09	0.00E+00	6.00E+09	0.00E+00
PU-244	7.17E+10	8.84E+09	1.92E+09	0.00E+00	8.19E+09	0.00E+00	8.92E+09	0.00E+00
AM-241	6.91E+10	6.52E+10	4.98E+09	0.00E+00	3.73E+10	0.00E+00	6.82E+09	0.00E+00
AM-242M	6.98E+10	6.15E+10	5.02E+09	0.00E+00	3.72E+10	0.00E+00	8.57E+09	0.00E+00
AM-243	6.90E+10	6.37E+10	4.87E+09	0.00E+00	3.66E+10	0.00E+00	8.00E+09	0.00E+00
CM-242	1.84E+09	1.94E+09	1.22E+08	0.00E+00	5.55E+08	0.00E+00	5.25E+09	0.00E+00
CM-243	5.60E+10	5.20E+10	3.53E+09	0.00E+00	1.65E+10	0.00E+00	7.14E+09	0.00E+00
CM-244	4.33E+10	4.10E+10	2.74E+09	0.00E+00	1.28E+10	0.00E+00	6.87E+09	0.00E+00
CM-245	8.58E+10	7.55E+10	5.28E+09	0.00E+00	2.47E+10	0.00E+00	6.46E+09	0.00E+00
CM-246	8.51E+10	7.54E+10	5.28E+09	0.00E+00	2.46E+10	0.00E+00	6.35E+09	0.00E+00
CM-247	8.29E+10	7.42E+10	5.20E+09	0.00E+00	2.43E+10	0.00E+00	8.34E+09	0.00E+00
CM-248	6.89E+11	6.12E+11	4.29E+10	0.00E+00	2.00E+11	0.00E+00	1.34E+11	0.00E+00
CF-252	2.84E+10	0.00E+00	6.86E+08	0.00E+00	0.00E+00	0.00E+00	2.50E+10	0.00E+00

TABLE II2-12

R_i DOSE FACTORS AGE: CHILD PATHWAY: GREEN LEAFY VEGETATIONm²-mrem/yr per μCi/sec

NUCLIDE	BONE	LIVER	T BODY	THYROID	KIDNEY	LUNG	GI-LLI	SKIN
H-3	0.00E+00	2.21E+03	2.21E+03	2.21E+03	2.21E+03	2.21E+03	2.21E+03	0.00E+00
C-14	3.38E+06	6.76E+05	6.76E+05	6.76E+05	6.76E+05	6.76E+05	6.76E+05	0.00E+00
NA-22	3.94E+09	3.94E+09	3.94E+09	3.94E+09	3.94E+09	3.94E+09	3.94E+09	0.00E+00
NA-24	1.56E+05	1.56E+05	1.56E+05	1.56E+05	1.56E+05	1.56E+05	1.56E+05	0.00E+00
P-32	2.33E+09	1.09E+08	8.96E+07	0.00E+00	0.00E+00	0.00E+00	6.43E+07	0.00E+00
CA-41	2.46E+10	0.00E+00	2.69E+09	0.00E+00	0.00E+00	0.00E+00	1.35E+07	0.00E+00
SC-46	7.41E+05	1.02E+06	3.91E+05	0.00E+00	8.99E+05	0.00E+00	1.49E+09	0.00E+00
CR-51	0.00E+00	0.00E+00	1.02E+05	5.66E+04	1.55E+04	1.03E+05	5.41E+06	0.00E+00
MN-54	0.00E+00	6.38E+08	1.70E+08	0.00E+00	1.79E+08	0.00E+00	5.35E+08	0.00E+00
MN-56	0.00E+00	7.65E+00	1.73E+00	0.00E+00	9.25E+00	0.00E+00	1.11E+03	0.00E+00
FE-55	7.71E+08	4.09E+08	1.27E+08	0.00E+00	0.00E+00	2.31E+08	7.58E+07	0.00E+00
FE-59	3.65E+08	5.91E+08	2.94E+08	0.00E+00	0.00E+00	1.71E+08	6.15E+08	0.00E+00
CO-57	0.00E+00	2.86E+07	5.79E+07	0.00E+00	0.00E+00	0.00E+00	2.35E+08	0.00E+00
CO-58	0.00E+00	6.05E+07	1.85E+08	0.00E+00	0.00E+00	0.00E+00	3.53E+08	0.00E+00
CO-60	0.00E+00	3.64E+08	1.07E+09	0.00E+00	0.00E+00	0.00E+00	2.02E+09	0.00E+00
NI-59	2.85E+09	7.58E+08	4.83E+08	0.00E+00	0.00E+00	0.00E+00	5.03E+07	0.00E+00
NI-63	3.81E+10	2.04E+09	1.30E+09	0.00E+00	0.00E+00	0.00E+00	1.37E+08	0.00E+00
NI-65	4.28E+01	4.03E+00	2.35E+00	0.00E+00	0.00E+00	0.00E+00	4.93E+02	0.00E+00
CU-64	0.00E+00	4.59E+03	2.77E+03	0.00E+00	1.11E+04	0.00E+00	2.15E+05	0.00E+00
ZN-65	7.79E+08	2.07E+09	1.29E+09	0.00E+00	1.31E+09	0.00E+00	3.64E+08	0.00E+00
ZN-69M	1.59E+04	2.71E+04	3.20E+03	0.00E+00	1.57E+04	0.00E+00	8.81E+05	0.00E+00
ZN-69	3.67E-06	5.30E-06	4.90E-07	0.00E+00	3.22E-06	0.00E+00	3.34E-04	0.00E+00
SE-79	0.00E+00	5.97E+08	1.33E+08	0.00E+00	9.71E+08	0.00E+00	3.92E+07	0.00E+00
BR-82	0.00E+00	0.00E+00	8.54E+05	0.00E+00	0.00E+00	0.00E+00	0.00E+00	0.00E+00
BR-83	0.00E+00	0.00E+00	2.18E+00	0.00E+00	0.00E+00	0.00E+00	0.00E+00	0.00E+00
BR-84	0.00E+00	0.00E+00	1.39E-11	0.00E+00	0.00E+00	0.00E+00	0.00E+00	0.00E+00
BR-85	0.00E+00	0.00E+00	0.00E+00	0.00E+00	0.00E+00	0.00E+00	0.00E+00	0.00E+00
RB-86	0.00E+00	3.55E+08	2.18E+08	0.00E+00	0.00E+00	0.00E+00	2.28E+07	0.00E+00
RB-87	0.00E+00	2.80E+09	1.30E+09	0.00E+00	0.00E+00	0.00E+00	4.20E+07	0.00E+00
RB-88	0.00E+00	1.42E-22	9.84E-23	0.00E+00	0.00E+00	0.00E+00	6.95E-24	0.00E+00
RB-89	0.00E+00	1.43E-26	1.28E-26	0.00E+00	0.00E+00	0.00E+00	1.25E-28	0.00E+00
SR-89	3.33E+10	0.00E+00	9.50E+08	0.00E+00	0.00E+00	0.00E+00	1.29E+09	0.00E+00
SR-90	1.80E+12	0.00E+00	3.63E+10	0.00E+00	0.00E+00	0.00E+00	1.61E+10	0.00E+00
SR-91	2.18E+05	0.00E+00	8.24E+03	0.00E+00	0.00E+00	0.00E+00	4.82E+05	0.00E+00
SR-92	2.97E+02	0.00E+00	1.19E+01	0.00E+00	0.00E+00	0.00E+00	5.63E+03	0.00E+00
Y-90	9.68E+03	0.00E+00	2.59E+02	0.00E+00	0.00E+00	0.00E+00	2.76E+07	0.00E+00
Y-91M	3.41E-09	0.00E+00	1.24E-10	0.00E+00	0.00E+00	0.00E+00	6.68E-06	0.00E+00
Y-91	1.74E+07	0.00E+00	4.65E+05	0.00E+00	0.00E+00	0.00E+00	2.32E+09	0.00E+00
Y-92	6.51E-01	0.00E+00	1.86E-02	0.00E+00	0.00E+00	0.00E+00	1.88E+04	0.00E+00
ZR-93	1.18E+07	4.43E+05	3.15E+05	0.00E+00	1.72E+06	0.00E+00	1.68E+08	0.00E+00
ZR-95	3.61E+06	7.93E+05	7.06E+05	0.00E+00	1.14E+06	0.00E+00	8.28E+08	0.00E+00
ZR-97	2.38E+02	3.44E+01	2.03E+01	0.00E+00	4.94E+01	0.00E+00	5.22E+06	0.00E+00
Y-93	1.22E+02	0.00E+00	3.35E+00	0.00E+00	0.00E+00	0.00E+00	1.82E+06	0.00E+00
NB-93M	7.37E+06	1.84E+06	6.04E+05	0.00E+00	1.99E+06	0.00E+00	2.77E+08	0.00E+00
NB-95	3.69E+05	1.44E+05	1.03E+05	0.00E+00	1.35E+05	0.00E+00	2.66E+08	0.00E+00

TABLE II-12

R_i DOSE FACTORS AGE: CHILD PATHWAY: GREEN LEAFY VEGETATIONm²-mrem/yr per μ Ci/sec

NUCLIDE	BONE	LIVER	T BODY	THYROID	KIDNEY	LUNG	GI-LLI	SKIN
NB-97	1.43E-06	2.59E-07	1.21E-07	0.00E+00	2.87E-07	0.00E+00	7.99E-02	0.00E+00
MO-93	0.00E+00	1.71E+09	6.13E+07	0.00E+00	4.50E+08	0.00E+00	8.65E+07	0.00E+00
MO-99	0.00E+00	3.24E+06	8.00E+05	0.00E+00	6.91E+06	0.00E+00	2.68E+06	0.00E+00
TC-99	3.79E+07	4.22E+07	1.52E+07	0.00E+00	4.98E+08	3.74E+06	4.43E+08	0.00E+00
TC-99M	1.95E+00	3.83E+00	6.35E+01	0.00E+00	5.56E+01	1.94E+00	2.18E+03	0.00E+00
TC-101	4.27E-31	4.46E-31	5.66E-30	0.00E+00	7.61E-30	2.36E-31	1.42E-30	0.00E+00
RU-103	1.39E+07	0.00E+00	5.36E+06	0.00E+00	3.51E+07	0.00E+00	3.61E+08	0.00E+00
RU-105	3.78E+01	0.00E+00	1.37E+01	0.00E+00	3.32E+02	0.00E+00	2.47E+04	0.00E+00
RU-106	7.16E+08	0.00E+00	8.93E+07	0.00E+00	9.67E+08	0.00E+00	1.11E+10	0.00E+00
RH-105	5.83E+04	3.13E+04	2.68E+04	0.00E+00	1.25E+05	0.00E+00	1.94E+06	0.00E+00
PD-107	0.00E+00	3.35E+07	2.84E+06	0.00E+00	2.80E+08	0.00E+00	6.64E+07	0.00E+00
PD-109	0.00E+00	1.21E+04	3.62E+03	0.00E+00	6.48E+04	0.00E+00	7.14E+05	0.00E+00
AG-110M	3.08E+07	2.08E+07	1.66E+07	0.00E+00	3.87E+07	0.00E+00	2.47E+09	0.00E+00
AG-111	1.72E+05	5.39E+04	3.56E+04	0.00E+00	1.63E+05	0.00E+00	3.30E+07	0.00E+00
CD-113M	0.00E+00	7.15E+08	3.04E+07	0.00E+00	7.36E+08	0.00E+00	1.84E+09	0.00E+00
CD-115M	0.00E+00	1.30E+08	5.55E+06	0.00E+00	9.68E+07	0.00E+00	1.77E+09	0.00E+00
SN-123	6.23E+09	7.73E+07	1.52E+08	8.19E+07	0.00E+00	0.00E+00	3.05E+09	0.00E+00
SN-125	3.91E+07	5.89E+05	1.75E+06	6.11E+05	0.00E+00	0.00E+00	1.21E+08	0.00E+00
SN-126	2.36E+10	2.94E+08	6.70E+08	8.08E+07	0.00E+00	0.00E+00	1.77E+09	0.00E+00
SB-124	3.28E+08	4.26E+06	1.15E+08	7.25E+05	0.00E+00	1.82E+08	2.05E+09	0.00E+00
SB-125	4.81E+08	3.71E+06	1.01E+08	4.45E+05	0.00E+00	2.68E+08	1.15E+09	0.00E+00
SB-126	8.72E+06	1.33E+05	3.13E+06	5.11E+04	0.00E+00	4.16E+06	1.76E+08	0.00E+00
SB-127	3.64E+05	5.64E+03	1.26E+05	4.05E+03	0.00E+00	1.58E+05	2.05E+07	0.00E+00
TE-125M	3.27E+08	8.85E+07	4.36E+07	9.17E+07	0.00E+00	0.00E+00	3.15E+08	0.00E+00
TE-127M	1.25E+09	3.38E+08	1.49E+08	3.00E+08	3.58E+09	0.00E+00	1.02E+09	0.00E+00
TE-127	4.10E+03	1.11E+03	8.79E+02	2.84E+03	1.17E+04	0.00E+00	1.60E+05	0.00E+00
TE-129M	7.52E+08	2.10E+08	1.17E+08	2.43E+08	2.21E+09	0.00E+00	9.18E+08	0.00E+00
TE-129	5.19E-04	1.45E-04	1.23E-04	3.71E-04	1.52E-03	0.00E+00	3.23E-02	0.00E+00
TE-131M	6.46E+05	2.23E+05	2.38E+05	4.59E+05	2.16E+06	0.00E+00	9.06E+06	0.00E+00
TE-131	8.97E-16	2.73E-16	2.67E-16	6.86E-16	2.71E-15	0.00E+00	4.71E-15	0.00E+00
TE-132	2.94E+06	1.30E+06	1.57E+06	1.89E+06	1.21E+07	0.00E+00	1.31E+07	0.00E+00
TE-133M	1.46E-05	5.91E-06	7.33E-06	1.13E-05	5.62E-05	0.00E+00	4.51E-04	0.00E+00
TE-134	2.17E-08	9.75E-09	1.30E-08	1.71E-08	9.02E-08	0.00E+00	9.90E-08	0.00E+00
I-129	4.93E+09	3.02E+09	2.70E+09	1.98E+12	5.10E+09	0.00E+00	1.52E+08	0.00E+00
I-130	2.57E+05	5.19E+05	2.68E+05	5.72E+07	7.76E+05	0.00E+00	2.43E+05	0.00E+00
I-131	6.72E+07	6.76E+07	3.84E+07	2.23E+10	1.11E+08	0.00E+00	6.01E+06	0.00E+00
I-132	3.74E+01	6.88E+01	3.16E+01	3.19E+03	1.05E+02	0.00E+00	8.10E+01	0.00E+00
I-133	1.48E+06	1.83E+06	6.91E+05	3.40E+08	3.05E+06	0.00E+00	7.36E+05	0.00E+00
I-134	5.96E-05	1.11E-04	5.09E-05	2.55E-03	1.69E-04	0.00E+00	7.34E-05	0.00E+00
I-135	2.60E+04	4.67E+04	2.21E+04	4.14E+06	7.17E+04	0.00E+00	3.56E+04	0.00E+00
CS-134M	4.44E+00	6.58E+00	4.29E+00	0.00E+00	3.47E+00	5.73E-01	8.31E+00	0.00E+00
CS-134	1.54E+10	2.53E+10	5.34E+09	0.00E+00	7.85E+09	2.82E+09	1.37E+08	0.00E+00
CS-135	5.88E+09	4.10E+09	4.20E+08	0.00E+00	1.45E+09	4.83E+08	3.07E+07	0.00E+00
CS-136	5.40E+07	1.48E+08	9.60E+07	0.00E+00	7.90E+07	1.18E+07	5.21E+06	0.00E+00
CS-137	2.31E+10	2.21E+10	3.26E+09	0.00E+00	7.19E+09	2.59E+09	1.38E+08	0.00E+00

TABLE II-12

R_i DOSE FACTORS AGE: CHILD PATHWAY: GREEN LEAFY VEGETATIONm²-mrem/yr per μ Ci/sec

NUCLIDE	BONE	LIVER	T BODY	THYROID	KIDNEY	LUNG	GI-LLI	SKIN
CS-138	2.39E-11	3.32E-11	2.11E-11	0.00E+00	2.34E-11	2.52E-12	1.53E-11	0.00E+00
CS-139	9.88E-45	1.10E-44	5.27E-45	0.00E+00	8.24E-45	8.31E-46	9.88E-49	0.00E+00
BA-139	1.97E-02	1.05E-05	5.70E-04	0.00E+00	9.17E-06	6.18E-06	1.14E+00	0.00E+00
BA-140	1.78E+08	1.56E+05	1.04E+07	0.00E+00	5.07E+04	9.28E+04	9.01E+07	0.00E+00
BA-141	6.48E-22	3.63E-25	2.11E-23	0.00E+00	3.14E-25	2.13E-24	3.69E-22	0.00E+00
BA-142	2.71E-39	1.95E-42	1.52E-40	0.00E+00	1.58E-42	1.15E-42	3.54E-41	0.00E+00
LA-140	1.36E+03	4.76E+02	1.60E+02	0.00E+00	0.00E+00	0.00E+00	1.33E+07	0.00E+00
LA-141	4.41E-01	1.03E-01	2.23E-02	0.00E+00	0.00E+00	0.00E+00	2.28E+04	0.00E+00
LA-142	1.34E-04	4.28E-05	1.34E-05	0.00E+00	0.00E+00	0.00E+00	8.49E+00	0.00E+00
CE-141	5.85E+05	2.92E+05	4.33E+04	0.00E+00	1.28E+05	0.00E+00	3.64E+08	0.00E+00
CE-143	7.20E+02	3.90E+05	5.65E+01	0.00E+00	1.64E+02	0.00E+00	5.71E+06	0.00E+00
CE-144	1.22E+08	3.82E+07	6.51E+06	0.00E+00	2.12E+07	0.00E+00	9.96E+09	0.00E+00
PR-143	9.73E+04	2.92E+04	4.83E+03	0.00E+00	1.58E+04	0.00E+00	1.05E+08	0.00E+00
PR-144	1.73E-26	5.34E-27	8.69E-28	0.00E+00	2.83E-27	0.00E+00	1.15E-23	0.00E+00
ND-147	4.12E+04	3.33E+04	2.58E+03	0.00E+00	1.83E+04	0.00E+00	5.28E+07	0.00E+00
PM-147	2.13E+07	1.52E+06	8.17E+05	0.00E+00	2.69E+06	0.00E+00	6.15E+08	0.00E+00
PM-148M	2.08E+06	4.15E+05	4.15E+05	0.00E+00	6.15E+05	0.00E+00	1.17E+09	0.00E+00
PM-148	1.43E+04	1.72E+03	1.11E+03	0.00E+00	2.92E+03	0.00E+00	4.58E+07	0.00E+00
PM-149	1.23E+03	1.31E+02	7.11E+01	0.00E+00	2.32E+02	0.00E+00	8.95E+06	0.00E+00
PM-151	2.41E+02	2.94E+01	1.91E+01	0.00E+00	4.98E+01	0.00E+00	3.33E+06	0.00E+00
SM-151	1.81E+07	2.70E+06	8.49E+05	0.00E+00	2.79E+06	0.00E+00	3.91E+08	0.00E+00
SM-153	5.94E+02	3.70E+02	3.57E+01	0.00E+00	1.13E+02	0.00E+00	4.92E+06	0.00E+00
EU-152	4.31E+07	7.85E+06	9.32E+06	0.00E+00	3.32E+07	0.00E+00	1.29E+09	0.00E+00
EU-154	1.60E+08	1.44E+07	1.32E+07	0.00E+00	6.33E+07	0.00E+00	3.35E+09	0.00E+00
EU-155	3.32E+07	2.39E+06	1.87E+06	0.00E+00	8.94E+06	0.00E+00	5.98E+09	0.00E+00
EU-156	1.84E+05	9.86E+04	2.04E+04	0.00E+00	6.35E+04	0.00E+00	2.24E+08	0.00E+00
TB-160	5.66E+06	0.00E+00	7.03E+05	0.00E+00	1.68E+06	0.00E+00	1.25E+09	0.00E+00
HO-166M	7.65E+07	1.60E+07	1.35E+07	0.00E+00	2.28E+07	0.00E+00	1.86E+09	0.00E+00
W-181	1.93E+06	4.74E+05	6.51E+04	0.00E+00	0.00E+00	0.00E+00	1.73E+07	0.00E+00
W-185	6.06E+07	1.51E+07	2.12E+06	0.00E+00	0.00E+00	0.00E+00	5.64E+08	0.00E+00
W-187	2.69E+04	1.59E+04	7.16E+03	0.00E+00	0.00E+00	0.00E+00	2.24E+06	0.00E+00
U-232	1.24E+12	0.00E+00	8.91E+10	0.00E+00	9.48E+10	0.00E+00	4.94E+09	0.00E+00
U-233	2.64E+11	0.00E+00	1.59E+10	0.00E+00	4.32E+10	0.00E+00	4.57E+09	0.00E+00
U-234	2.53E+11	0.00E+00	1.57E+10	0.00E+00	4.24E+10	0.00E+00	4.48E+09	0.00E+00
U-235	2.42E+11	0.00E+00	1.47E+10	0.00E+00	3.98E+10	0.00E+00	5.69E+09	0.00E+00
U-236	2.42E+11	0.00E+00	1.50E+10	0.00E+00	4.06E+10	0.00E+00	4.20E+09	0.00E+00
U-237	1.43E+05	0.00E+00	3.81E+04	0.00E+00	4.13E+05	0.00E+00	1.26E+07	0.00E+00
U-238	2.32E+11	0.00E+00	1.37E+10	0.00E+00	3.71E+10	0.00E+00	4.01E+09	0.00E+00
NP-237	1.58E+11	1.04E+10	6.94E+09	0.00E+00	4.29E+10	0.00E+00	5.78E+09	0.00E+00
NP-238	1.05E+04	2.13E+02	1.64E+02	0.00E+00	6.78E+02	0.00E+00	7.29E+06	0.00E+00
NP-239	1.07E+03	7.71E+01	5.42E+01	0.00E+00	2.23E+02	0.00E+00	5.70E+06	0.00E+00
PU-238	8.42E+10	9.76E+09	2.24E+09	0.00E+00	8.14E+09	0.00E+00	5.31E+09	0.00E+00
PU-239	9.14E+10	9.78E+09	2.35E+09	0.00E+00	8.65E+09	0.00E+00	4.85E+09	0.00E+00
PU-240	9.07E+10	1.01E+10	2.35E+09	0.00E+00	8.65E+09	0.00E+00	4.95E+09	0.00E+00
PU-241	2.71E+09	1.11E+08	5.64E+07	0.00E+00	2.08E+08	0.00E+00	1.01E+08	0.00E+00

TABLE II-12

R_i DOSE FACTORS AGE: CHILD PATHWAY: GREEN LEAFY VEGETATIONm²-mrem/yr per μ Ci/sec

NUCLIDE	BONE	LIVER	T BODY	THYROID	KIDNEY	LUNG	GI-LLI	SKIN
PU-242	8.43E+10	9.78E+09	2.26E+09	0.00E+00	8.29E+09	0.00E+00	4.76E+09	0.00E+00
PU-244	9.85E+10	1.12E+11	2.59E+09	0.00E+00	9.57E+09	0.00E+00	7.09E+09	0.00E+00
AM-241	9.64E+10	8.29E+10	7.23E+09	0.00E+00	4.41E+10	0.00E+00	5.41E+09	0.00E+00
AM-242M	9.91E+10	7.93E+10	7.36E+09	0.00E+00	4.46E+10	0.00E+00	6.80E+09	0.00E+00
AM-243	9.50E+10	8.01E+10	6.97E+09	0.00E+00	4.30E+10	0.00E+00	6.34E+09	0.00E+00
CM-242	4.48E+09	3.57E+09	2.98E+08	0.00E+00	9.53E+08	0.00E+00	4.16E+09	0.00E+00
CM-243	9.02E+10	7.33E+10	5.81E+09	0.00E+00	2.17E+10	0.00E+00	5.66E+09	0.00E+00
CM-244	7.59E+10	6.14E+10	4.87E+09	0.00E+00	1.79E+10	0.00E+00	5.46E+09	0.00E+00
CM-245	1.18E+11	9.50E+10	7.44E+09	0.00E+00	2.91E+10	0.00E+00	5.13E+09	0.00E+00
CM-246	1.17E+11	9.50E+10	7.44E+09	0.00E+00	2.91E+10	0.00E+00	5.04E+09	0.00E+00
CM-247	1.14E+11	9.36E+10	7.30E+09	0.00E+00	2.86E+10	0.00E+00	6.63E+09	0.00E+00
CM-248	9.50E+11	7.73E+11	6.04E+10	0.00E+00	2.36E+11	0.00E+00	1.07E+11	0.00E+00
CF-252	7.03E+10	0.00E+00	1.70E+09	0.00E+00	0.00E+00	0.00E+00	1.98E+10	0.00E+00

TABLE II2-13

R_i DOSE FACTORS AGE: INFANT PATHWAY: GREEN LEAFY VEGETATIONm²-mrem/yr per μ Ci/sec

NUCLIDE	BONE	LIVER	T BODY	THYROID	KIDNEY	LUNG	GI-LLI	SKIN
H-3	0.00E+00	0.00E+00	0.00E+00	0.00E+00	0.00E+00	0.00E+00	0.00E+00	0.00E+00
C-14	0.00E+00	0.00E+00	0.00E+00	0.00E+00	0.00E+00	0.00E+00	0.00E+00	0.00E+00
NA-22	0.00E+00	0.00E+00	0.00E+00	0.00E+00	0.00E+00	0.00E+00	0.00E+00	0.00E+00
NA-24	0.00E+00	0.00E+00	0.00E+00	0.00E+00	0.00E+00	0.00E+00	0.00E+00	0.00E+00
P-32	0.00E+00	0.00E+00	0.00E+00	0.00E+00	0.00E+00	0.00E+00	0.00E+00	0.00E+00
CA-41	0.00E+00	0.00E+00	0.00E+00	0.00E+00	0.00E+00	0.00E+00	0.00E+00	0.00E+00
SC-46	0.00E+00	0.00E+00	0.00E+00	0.00E+00	0.00E+00	0.00E+00	0.00E+00	0.00E+00
CR-51	0.00E+00	0.00E+00	0.00E+00	0.00E+00	0.00E+00	0.00E+00	0.00E+00	0.00E+00
MN-54	0.00E+00	0.00E+00	0.00E+00	0.00E+00	0.00E+00	0.00E+00	0.00E+00	0.00E+00
MN-56	0.00E+00	0.00E+00	0.00E+00	0.00E+00	0.00E+00	0.00E+00	0.00E+00	0.00E+00
FE-55	0.00E+00	0.00E+00	0.00E+00	0.00E+00	0.00E+00	0.00E+00	0.00E+00	0.00E+00
FE-59	0.00E+00	0.00E+00	0.00E+00	0.00E+00	0.00E+00	0.00E+00	0.00E+00	0.00E+00
CO-57	0.00E+00	0.00E+00	0.00E+00	0.00E+00	0.00E+00	0.00E+00	0.00E+00	0.00E+00
CO-58	0.00E+00	0.00E+00	0.00E+00	0.00E+00	0.00E+00	0.00E+00	0.00E+00	0.00E+00
CO-60	0.00E+00	0.00E+00	0.00E+00	0.00E+00	0.00E+00	0.00E+00	0.00E+00	0.00E+00
NI-59	0.00E+00	0.00E+00	0.00E+00	0.00E+00	0.00E+00	0.00E+00	0.00E+00	0.00E+00
NI-63	0.00E+00	0.00E+00	0.00E+00	0.00E+00	0.00E+00	0.00E+00	0.00E+00	0.00E+00
NI-65	0.00E+00	0.00E+00	0.00E+00	0.00E+00	0.00E+00	0.00E+00	0.00E+00	0.00E+00
CU-64	0.00E+00	0.00E+00	0.00E+00	0.00E+00	0.00E+00	0.00E+00	0.00E+00	0.00E+00
ZN-65	0.00E+00	0.00E+00	0.00E+00	0.00E+00	0.00E+00	0.00E+00	0.00E+00	0.00E+00
ZN-69M	0.00E+00	0.00E+00	0.00E+00	0.00E+00	0.00E+00	0.00E+00	0.00E+00	0.00E+00
ZN-69	0.00E+00	0.00E+00	0.00E+00	0.00E+00	0.00E+00	0.00E+00	0.00E+00	0.00E+00
SE-79	0.00E+00	0.00E+00	0.00E+00	0.00E+00	0.00E+00	0.00E+00	0.00E+00	0.00E+00
BR-82	0.00E+00	0.00E+00	0.00E+00	0.00E+00	0.00E+00	0.00E+00	0.00E+00	0.00E+00
BR-83	0.00E+00	0.00E+00	0.00E+00	0.00E+00	0.00E+00	0.00E+00	0.00E+00	0.00E+00
BR-84	0.00E+00	0.00E+00	0.00E+00	0.00E+00	0.00E+00	0.00E+00	0.00E+00	0.00E+00
BR-85	0.00E+00	0.00E+00	0.00E+00	0.00E+00	0.00E+00	0.00E+00	0.00E+00	0.00E+00
RB-86	0.00E+00	0.00E+00	0.00E+00	0.00E+00	0.00E+00	0.00E+00	0.00E+00	0.00E+00
RB-87	0.00E+00	0.00E+00	0.00E+00	0.00E+00	0.00E+00	0.00E+00	0.00E+00	0.00E+00
RB-88	0.00E+00	0.00E+00	0.00E+00	0.00E+00	0.00E+00	0.00E+00	0.00E+00	0.00E+00
RB-89	0.00E+00	0.00E+00	0.00E+00	0.00E+00	0.00E+00	0.00E+00	0.00E+00	0.00E+00
SR-89	0.00E+00	0.00E+00	0.00E+00	0.00E+00	0.00E+00	0.00E+00	0.00E+00	0.00E+00
SR-90	0.00E+00	0.00E+00	0.00E+00	0.00E+00	0.00E+00	0.00E+00	0.00E+00	0.00E+00
SR-91	0.00E+00	0.00E+00	0.00E+00	0.00E+00	0.00E+00	0.00E+00	0.00E+00	0.00E+00
SR-92	0.00E+00	0.00E+00	0.00E+00	0.00E+00	0.00E+00	0.00E+00	0.00E+00	0.00E+00
Y-90	0.00E+00	0.00E+00	0.00E+00	0.00E+00	0.00E+00	0.00E+00	0.00E+00	0.00E+00
Y-91M	0.00E+00	0.00E+00	0.00E+00	0.00E+00	0.00E+00	0.00E+00	0.00E+00	0.00E+00
Y-91	0.00E+00	0.00E+00	0.00E+00	0.00E+00	0.00E+00	0.00E+00	0.00E+00	0.00E+00
Y-92	0.00E+00	0.00E+00	0.00E+00	0.00E+00	0.00E+00	0.00E+00	0.00E+00	0.00E+00
ZR-93	0.00E+00	0.00E+00	0.00E+00	0.00E+00	0.00E+00	0.00E+00	0.00E+00	0.00E+00
ZR-95	0.00E+00	0.00E+00	0.00E+00	0.00E+00	0.00E+00	0.00E+00	0.00E+00	0.00E+00
ZR-97	0.00E+00	0.00E+00	0.00E+00	0.00E+00	0.00E+00	0.00E+00	0.00E+00	0.00E+00
Y-93	0.00E+00	0.00E+00	0.00E+00	0.00E+00	0.00E+00	0.00E+00	0.00E+00	0.00E+00
NB-93M	0.00E+00	0.00E+00	0.00E+00	0.00E+00	0.00E+00	0.00E+00	0.00E+00	0.00E+00
NB-95	0.00E+00	0.00E+00	0.00E+00	0.00E+00	0.00E+00	0.00E+00	0.00E+00	0.00E+00

TABLE II2-13

R_i DOSE FACTORS AGE: INFANT PATHWAY: GREEN LEAFY VEGETATIONm²-mrem/yr per μCi/sec

NUCLIDE	BONE	LIVER	T BODY	THYROID	KIDNEY	LUNG	GI-LLI	SKIN
NB-97	0.00E+00	0.00E+00	0.00E+00	0.00E+00	0.00E+00	0.00E+00	0.00E+00	0.00E+00
MO-93	0.00E+00	0.00E+00	0.00E+00	0.00E+00	0.00E+00	0.00E+00	0.00E+00	0.00E+00
MO-99	0.00E+00	0.00E+00	0.00E+00	0.00E+00	0.00E+00	0.00E+00	0.00E+00	0.00E+00
TC-99	0.00E+00	0.00E+00	0.00E+00	0.00E+00	0.00E+00	0.00E+00	0.00E+00	0.00E+00
TC-99M	0.00E+00	0.00E+00	0.00E+00	0.00E+00	0.00E+00	0.00E+00	0.00E+00	0.00E+00
TC-101	0.00E+00	0.00E+00	0.00E+00	0.00E+00	0.00E+00	0.00E+00	0.00E+00	0.00E+00
RU-103	0.00E+00	0.00E+00	0.00E+00	0.00E+00	0.00E+00	0.00E+00	0.00E+00	0.00E+00
RU-105	0.00E+00	0.00E+00	0.00E+00	0.00E+00	0.00E+00	0.00E+00	0.00E+00	0.00E+00
RU-106	0.00E+00	0.00E+00	0.00E+00	0.00E+00	0.00E+00	0.00E+00	0.00E+00	0.00E+00
RH-105	0.00E+00	0.00E+00	0.00E+00	0.00E+00	0.00E+00	0.00E+00	0.00E+00	0.00E+00
PD-107	0.00E+00	0.00E+00	0.00E+00	0.00E+00	0.00E+00	0.00E+00	0.00E+00	0.00E+00
PD-109	0.00E+00	0.00E+00	0.00E+00	0.00E+00	0.00E+00	0.00E+00	0.00E+00	0.00E+00
AG-110M	0.00E+00	0.00E+00	0.00E+00	0.00E+00	0.00E+00	0.00E+00	0.00E+00	0.00E+00
AG-111	0.00E+00	0.00E+00	0.00E+00	0.00E+00	0.00E+00	0.00E+00	0.00E+00	0.00E+00
CD-113M	0.00E+00	0.00E+00	0.00E+00	0.00E+00	0.00E+00	0.00E+00	0.00E+00	0.00E+00
CD-115M	0.00E+00	0.00E+00	0.00E+00	0.00E+00	0.00E+00	0.00E+00	0.00E+00	0.00E+00
SN-123	0.00E+00	0.00E+00	0.00E+00	0.00E+00	0.00E+00	0.00E+00	0.00E+00	0.00E+00
SN-125	0.00E+00	0.00E+00	0.00E+00	0.00E+00	0.00E+00	0.00E+00	0.00E+00	0.00E+00
SN-126	0.00E+00	0.00E+00	0.00E+00	0.00E+00	0.00E+00	0.00E+00	0.00E+00	0.00E+00
SB-124	0.00E+00	0.00E+00	0.00E+00	0.00E+00	0.00E+00	0.00E+00	0.00E+00	0.00E+00
SB-125	0.00E+00	0.00E+00	0.00E+00	0.00E+00	0.00E+00	0.00E+00	0.00E+00	0.00E+00
SB-126	0.00E+00	0.00E+00	0.00E+00	0.00E+00	0.00E+00	0.00E+00	0.00E+00	0.00E+00
SB-127	0.00E+00	0.00E+00	0.00E+00	0.00E+00	0.00E+00	0.00E+00	0.00E+00	0.00E+00
TE-125M	0.00E+00	0.00E+00	0.00E+00	0.00E+00	0.00E+00	0.00E+00	0.00E+00	0.00E+00
TE-127M	0.00E+00	0.00E+00	0.00E+00	0.00E+00	0.00E+00	0.00E+00	0.00E+00	0.00E+00
TE-127	0.00E+00	0.00E+00	0.00E+00	0.00E+00	0.00E+00	0.00E+00	0.00E+00	0.00E+00
TE-129M	0.00E+00	0.00E+00	0.00E+00	0.00E+00	0.00E+00	0.00E+00	0.00E+00	0.00E+00
TE-129	0.00E+00	0.00E+00	0.00E+00	0.00E+00	0.00E+00	0.00E+00	0.00E+00	0.00E+00
TE-131M	0.00E+00	0.00E+00	0.00E+00	0.00E+00	0.00E+00	0.00E+00	0.00E+00	0.00E+00
TE-131	0.00E+00	0.00E+00	0.00E+00	0.00E+00	0.00E+00	0.00E+00	0.00E+00	0.00E+00
TE-132	0.00E+00	0.00E+00	0.00E+00	0.00E+00	0.00E+00	0.00E+00	0.00E+00	0.00E+00
TE-133M	0.00E+00	0.00E+00	0.00E+00	0.00E+00	0.00E+00	0.00E+00	0.00E+00	0.00E+00
TE-134	0.00E+00	0.00E+00	0.00E+00	0.00E+00	0.00E+00	0.00E+00	0.00E+00	0.00E+00
I-129	0.00E+00	0.00E+00	0.00E+00	0.00E+00	0.00E+00	0.00E+00	0.00E+00	0.00E+00
I-130	0.00E+00	0.00E+00	0.00E+00	0.00E+00	0.00E+00	0.00E+00	0.00E+00	0.00E+00
I-131	0.00E+00	0.00E+00	0.00E+00	0.00E+00	0.00E+00	0.00E+00	0.00E+00	0.00E+00
I-132	0.00E+00	0.00E+00	0.00E+00	0.00E+00	0.00E+00	0.00E+00	0.00E+00	0.00E+00
I-133	0.00E+00	0.00E+00	0.00E+00	0.00E+00	0.00E+00	0.00E+00	0.00E+00	0.00E+00
I-134	0.00E+00	0.00E+00	0.00E+00	0.00E+00	0.00E+00	0.00E+00	0.00E+00	0.00E+00
I-135	0.00E+00	0.00E+00	0.00E+00	0.00E+00	0.00E+00	0.00E+00	0.00E+00	0.00E+00
CS-134M	0.00E+00	0.00E+00	0.00E+00	0.00E+00	0.00E+00	0.00E+00	0.00E+00	0.00E+00
CS-134	0.00E+00	0.00E+00	0.00E+00	0.00E+00	0.00E+00	0.00E+00	0.00E+00	0.00E+00
CS-135	0.00E+00	0.00E+00	0.00E+00	0.00E+00	0.00E+00	0.00E+00	0.00E+00	0.00E+00
CS-136	0.00E+00	0.00E+00	0.00E+00	0.00E+00	0.00E+00	0.00E+00	0.00E+00	0.00E+00
CS-137	0.00E+00	0.00E+00	0.00E+00	0.00E+00	0.00E+00	0.00E+00	0.00E+00	0.00E+00

TABLE II2-13

RI DOSE FACTORS AGE: INFANT PATHWAY: GREEN LEAFY VEGETATION

m²-mrem/yr per μ Ci/sec

NUCLIDE	BONE	LIVER	T BODY	THYROID	KIDNEY	LUNG	GI-LLI	SKIN
CS-138	0.00E+00	0.00E+00	0.00E+00	0.00E+00	0.00E+00	0.00E+00	0.00E+00	0.00E+00
CS-139	0.00E+00	0.00E+00	0.00E+00	0.00E+00	0.00E+00	0.00E+00	0.00E+00	0.00E+00
BA-139	0.00E+00	0.00E+00	0.00E+00	0.00E+00	0.00E+00	0.00E+00	0.00E+00	0.00E+00
BA-140	0.00E+00	0.00E+00	0.00E+00	0.00E+00	0.00E+00	0.00E+00	0.00E+00	0.00E+00
BA-141	0.00E+00	0.00E+00	0.00E+00	0.00E+00	0.00E+00	0.00E+00	0.00E+00	0.00E+00
BA-142	0.00E+00	0.00E+00	0.00E+00	0.00E+00	0.00E+00	0.00E+00	0.00E+00	0.00E+00
LA-140	0.00E+00	0.00E+00	0.00E+00	0.00E+00	0.00E+00	0.00E+00	0.00E+00	0.00E+00
LA-141	0.00E+00	0.00E+00	0.00E+00	0.00E+00	0.00E+00	0.00E+00	0.00E+00	0.00E+00
LA-142	0.00E+00	0.00E+00	0.00E+00	0.00E+00	0.00E+00	0.00E+00	0.00E+00	0.00E+00
CE-141	0.00E+00	0.00E+00	0.00E+00	0.00E+00	0.00E+00	0.00E+00	0.00E+00	0.00E+00
CE-143	0.00E+00	0.00E+00	0.00E+00	0.00E+00	0.00E+00	0.00E+00	0.00E+00	0.00E+00
CE-144	0.00E+00	0.00E+00	0.00E+00	0.00E+00	0.00E+00	0.00E+00	0.00E+00	0.00E+00
PR-143	0.00E+00	0.00E+00	0.00E+00	0.00E+00	0.00E+00	0.00E+00	0.00E+00	0.00E+00
PR-144	0.00E+00	0.00E+00	0.00E+00	0.00E+00	0.00E+00	0.00E+00	0.00E+00	0.00E+00
ND-147	0.00E+00	0.00E+00	0.00E+00	0.00E+00	0.00E+00	0.00E+00	0.00E+00	0.00E+00
PM-147	0.00E+00	0.00E+00	0.00E+00	0.00E+00	0.00E+00	0.00E+00	0.00E+00	0.00E+00
PM-148M	0.00E+00	0.00E+00	0.00E+00	0.00E+00	0.00E+00	0.00E+00	0.00E+00	0.00E+00
PM-148	0.00E+00	0.00E+00	0.00E+00	0.00E+00	0.00E+00	0.00E+00	0.00E+00	0.00E+00
PM-149	0.00E+00	0.00E+00	0.00E+00	0.00E+00	0.00E+00	0.00E+00	0.00E+00	0.00E+00
PM-151	0.00E+00	0.00E+00	0.00E+00	0.00E+00	0.00E+00	0.00E+00	0.00E+00	0.00E+00
SM-151	0.00E+00	0.00E+00	0.00E+00	0.00E+00	0.00E+00	0.00E+00	0.00E+00	0.00E+00
SM-153	0.00E+00	0.00E+00	0.00E+00	0.00E+00	0.00E+00	0.00E+00	0.00E+00	0.00E+00
EU-152	0.00E+00	0.00E+00	0.00E+00	0.00E+00	0.00E+00	0.00E+00	0.00E+00	0.00E+00
EU-154	0.00E+00	0.00E+00	0.00E+00	0.00E+00	0.00E+00	0.00E+00	0.00E+00	0.00E+00
EU-155	0.00E+00	0.00E+00	0.00E+00	0.00E+00	0.00E+00	0.00E+00	0.00E+00	0.00E+00
EU-156	0.00E+00	0.00E+00	0.00E+00	0.00E+00	0.00E+00	0.00E+00	0.00E+00	0.00E+00
TB-160	0.00E+00	0.00E+00	0.00E+00	0.00E+00	0.00E+00	0.00E+00	0.00E+00	0.00E+00
HO-166M	0.00E+00	0.00E+00	0.00E+00	0.00E+00	0.00E+00	0.00E+00	0.00E+00	0.00E+00
W-181	0.00E+00	0.00E+00	0.00E+00	0.00E+00	0.00E+00	0.00E+00	0.00E+00	0.00E+00
W-185	0.00E+00	0.00E+00	0.00E+00	0.00E+00	0.00E+00	0.00E+00	0.00E+00	0.00E+00
W-187	0.00E+00	0.00E+00	0.00E+00	0.00E+00	0.00E+00	0.00E+00	0.00E+00	0.00E+00
U-232	0.00E+00	0.00E+00	0.00E+00	0.00E+00	0.00E+00	0.00E+00	0.00E+00	0.00E+00
U-233	0.00E+00	0.00E+00	0.00E+00	0.00E+00	0.00E+00	0.00E+00	0.00E+00	0.00E+00
U-234	0.00E+00	0.00E+00	0.00E+00	0.00E+00	0.00E+00	0.00E+00	0.00E+00	0.00E+00
U-235	0.00E+00	0.00E+00	0.00E+00	0.00E+00	0.00E+00	0.00E+00	0.00E+00	0.00E+00
U-236	0.00E+00	0.00E+00	0.00E+00	0.00E+00	0.00E+00	0.00E+00	0.00E+00	0.00E+00
U-237	0.00E+00	0.00E+00	0.00E+00	0.00E+00	0.00E+00	0.00E+00	0.00E+00	0.00E+00
U-238	0.00E+00	0.00E+00	0.00E+00	0.00E+00	0.00E+00	0.00E+00	0.00E+00	0.00E+00
NP-237	0.00E+00	0.00E+00	0.00E+00	0.00E+00	0.00E+00	0.00E+00	0.00E+00	0.00E+00
NP-238	0.00E+00	0.00E+00	0.00E+00	0.00E+00	0.00E+00	0.00E+00	0.00E+00	0.00E+00
NP-239	0.00E+00	0.00E+00	0.00E+00	0.00E+00	0.00E+00	0.00E+00	0.00E+00	0.00E+00
PU-238	0.00E+00	0.00E+00	0.00E+00	0.00E+00	0.00E+00	0.00E+00	0.00E+00	0.00E+00
PU-239	0.00E+00	0.00E+00	0.00E+00	0.00E+00	0.00E+00	0.00E+00	0.00E+00	0.00E+00
PU-240	0.00E+00	0.00E+00	0.00E+00	0.00E+00	0.00E+00	0.00E+00	0.00E+00	0.00E+00
PU-241	0.00E+00	0.00E+00	0.00E+00	0.00E+00	0.00E+00	0.00E+00	0.00E+00	0.00E+00

TABLE II2-13

R_i DOSE FACTORS AGE: INFANT PATHWAY: GREEN LEAFY VEGETATIONm²-mrem/yr per μ Ci/sec

NUCLIDE	BONE	LIVER	T BODY	THYROID	KIDNEY	LUNG	GI-LLI	SKIN
PU-242	0.00E+00	0.00E+00	0.00E+00	0.00E+00	0.00E+00	0.00E+00	0.00E+00	0.00E+00
PU-244	0.00E+00	0.00E+00	0.00E+00	0.00E+00	0.00E+00	0.00E+00	0.00E+00	0.00E+00
AM-241	0.00E+00	0.00E+00	0.00E+00	0.00E+00	0.00E+00	0.00E+00	0.00E+00	0.00E+00
AM-242M	0.00E+00	0.00E+00	0.00E+00	0.00E+00	0.00E+00	0.00E+00	0.00E+00	0.00E+00
AM-243	0.00E+00	0.00E+00	0.00E+00	0.00E+00	0.00E+00	0.00E+00	0.00E+00	0.00E+00
CM-242	0.00E+00	0.00E+00	0.00E+00	0.00E+00	0.00E+00	0.00E+00	0.00E+00	0.00E+00
CM-243	0.00E+00	0.00E+00	0.00E+00	0.00E+00	0.00E+00	0.00E+00	0.00E+00	0.00E+00
CM-244	0.00E+00	0.00E+00	0.00E+00	0.00E+00	0.00E+00	0.00E+00	0.00E+00	0.00E+00
CM-245	0.00E+00	0.00E+00	0.00E+00	0.00E+00	0.00E+00	0.00E+00	0.00E+00	0.00E+00
CM-246	0.00E+00	0.00E+00	0.00E+00	0.00E+00	0.00E+00	0.00E+00	0.00E+00	0.00E+00
CM-247	0.00E+00	0.00E+00	0.00E+00	0.00E+00	0.00E+00	0.00E+00	0.00E+00	0.00E+00
CM-248	0.00E+00	0.00E+00	0.00E+00	0.00E+00	0.00E+00	0.00E+00	0.00E+00	0.00E+00
CF-252	0.00E+00	0.00E+00	0.00E+00	0.00E+00	0.00E+00	0.00E+00	0.00E+00	0.00E+00

TABLE I12-14

R_i DOSE FACTORS AGE: ADULT PATHWAY: MEATm²-mrem/yr per μ Ci/sec

NUCLIDE	BONE	LIVER	T BODY	THYROID	KIDNEY	LUNG	GI-LLI	SKIN
H-3	0.00E+00	1.85E+02	1.85E+02	1.85E+02	1.85E+02	1.85E+02	1.85E+02	0.00E+00
C-14	3.33E+05	6.66E+04	6.66E+04	6.66E+04	6.66E+04	6.66E+04	6.66E+04	0.00E+00
NA-22	7.29E+08	7.29E+08	7.29E+08	7.29E+08	7.29E+08	7.29E+08	7.29E+08	0.00E+00
NA-24	3.97E-04	3.97E-04	3.97E-04	3.97E-04	3.97E-04	3.97E-04	3.97E-04	0.00E+00
P-32	1.38E+09	8.56E+07	5.32E+07	0.00E+00	0.00E+00	0.00E+00	1.55E+08	0.00E+00
CA-41	1.10E+09	0.00E+00	1.19E+08	0.00E+00	0.00E+00	0.00E+00	1.09E+06	0.00E+00
SC-46	7.20E+04	1.40E+05	4.06E+04	0.00E+00	1.31E+05	0.00E+00	6.81E+08	0.00E+00
CR-51	0.00E+00	0.00E+00	2.24E+03	1.34E+03	4.95E+02	2.98E+03	5.65E+05	0.00E+00
MN-54	0.00E+00	4.55E+06	8.68E+05	0.00E+00	1.35E+06	0.00E+00	1.39E+07	0.00E+00
MN-56	0.00E+00	4.43E-54	7.86E-55	0.00E+00	5.63E-54	0.00E+00	1.41E-52	0.00E+00
FE-55	1.54E+08	1.06E+08	2.48E+07	0.00E+00	0.00E+00	5.93E+07	6.10E+07	0.00E+00
FE-59	9.39E+07	2.21E+08	8.46E+07	0.00E+00	0.00E+00	6.17E+07	7.36E+08	0.00E+00
CO-57	0.00E+00	2.76E+06	4.58E+06	0.00E+00	0.00E+00	0.00E+00	7.00E+07	0.00E+00
CO-58	0.00E+00	7.20E+06	1.61E+07	0.00E+00	0.00E+00	0.00E+00	1.46E+08	0.00E+00
CO-60	0.00E+00	4.00E+07	8.83E+07	0.00E+00	0.00E+00	0.00E+00	7.52E+08	0.00E+00
NI-59	7.66E+07	2.63E+07	1.28E+07	0.00E+00	0.00E+00	0.00E+00	5.42E+06	0.00E+00
NI-63	1.02E+09	7.06E+07	3.42E+07	0.00E+00	0.00E+00	0.00E+00	1.47E+07	0.00E+00
NI-65	6.57E-54	8.54E-55	3.89E-55	0.00E+00	0.00E+00	0.00E+00	2.17E-53	0.00E+00
CU-64	0.00E+00	7.94E-08	3.72E-08	0.00E+00	2.00E-07	0.00E+00	6.76E-06	0.00E+00
ZN-65	1.72E+08	5.48E+08	2.48E+08	0.00E+00	3.67E+08	0.00E+00	3.45E+08	0.00E+00
ZN-69M	4.90E-06	1.18E-05	1.08E-06	0.00E+00	7.12E-06	0.00E+00	7.18E-04	0.00E+00
ZN-69	0.00E+00	0.00E+00	0.00E+00	0.00E+00	0.00E+00	0.00E+00	0.00E+00	0.00E+00
SE-79	0.00E+00	5.84E+07	9.75E+06	0.00E+00	1.01E+08	0.00E+00	1.20E+07	0.00E+00
BR-82	0.00E+00	0.00E+00	3.58E+02	0.00E+00	0.00E+00	0.00E+00	4.10E+02	0.00E+00
BR-83	0.00E+00	0.00E+00	1.76E-57	0.00E+00	0.00E+00	0.00E+00	2.53E-57	0.00E+00
BR-84	0.00E+00	0.00E+00	0.00E+00	0.00E+00	0.00E+00	0.00E+00	0.00E+00	0.00E+00
BR-85	0.00E+00	0.00E+00	0.00E+00	0.00E+00	0.00E+00	0.00E+00	0.00E+00	0.00E+00
RB-86	0.00E+00	1.47E+08	6.84E+07	0.00E+00	0.00E+00	0.00E+00	2.89E+07	0.00E+00
RB-87	0.00E+00	5.65E+08	1.97E+08	0.00E+00	0.00E+00	0.00E+00	2.64E+07	0.00E+00
RB-88	0.00E+00	0.00E+00	0.00E+00	0.00E+00	0.00E+00	0.00E+00	0.00E+00	0.00E+00
RB-89	0.00E+00	0.00E+00	0.00E+00	0.00E+00	0.00E+00	0.00E+00	0.00E+00	0.00E+00
SR-89	1.10E+08	0.00E+00	3.16E+06	0.00E+00	0.00E+00	0.00E+00	1.76E+07	0.00E+00
SR-90	7.70E+09	0.00E+00	1.55E+08	0.00E+00	0.00E+00	0.00E+00	1.94E+08	0.00E+00
SR-91	4.44E-11	0.00E+00	1.79E-12	0.00E+00	0.00E+00	0.00E+00	2.12E-10	0.00E+00
SR-92	3.45E-50	0.00E+00	1.49E-51	0.00E+00	0.00E+00	0.00E+00	6.83E-49	0.00E+00
Y-90	3.15E+01	0.00E+00	8.44E-01	0.00E+00	0.00E+00	0.00E+00	3.34E+05	0.00E+00
Y-91M	0.00E+00	0.00E+00	0.00E+00	0.00E+00	0.00E+00	0.00E+00	0.00E+00	0.00E+00
Y-91	4.28E+05	0.00E+00	1.14E+04	0.00E+00	0.00E+00	0.00E+00	2.35E+08	0.00E+00
Y-92	4.44E-40	0.00E+00	1.30E-41	0.00E+00	0.00E+00	0.00E+00	7.77E-36	0.00E+00
Y-93	1.37E-12	0.00E+00	3.79E-14	0.00E+00	0.00E+00	0.00E+00	4.35E-08	0.00E+00
ZR-93	2.11E+06	1.18E+05	5.49E+04	0.00E+00	4.47E+05	0.00E+00	1.22E+08	0.00E+00
ZR-95	7.23E+05	2.32E+05	1.57E+05	0.00E+00	3.64E+05	0.00E+00	7.35E+08	0.00E+00

TABLE I12-14

R_i DOSE FACTORS AGE: ADULT PATHWAY: MEATm²-mrem/yr per μ Ci/sec

NUCLIDE	BONE	LIVER	T BODY	THYROID	KIDNEY	LUNG	GI-LLI	SKIN
ZR-97	6.05E-06	1.22E-06	5.58E-07	0.00E+00	1.84E-06	0.00E+00	3.78E-01	0.00E+00
NB-93M	1.05E+07	3.41E+06	8.41E+05	0.00E+00	3.93E+06	0.00E+00	1.58E+09	0.00E+00
NB-95	7.68E+05	4.27E+05	2.30E+05	0.00E+00	4.22E+05	0.00E+00	2.59E+09	0.00E+00
NB-97	0.00E+00	0.00E+00	0.00E+00	0.00E+00	0.00E+00	0.00E+00	0.00E+00	0.00E+00
MO-93	0.00E+00	8.90E+07	2.41E+06	0.00E+00	2.52E+07	0.00E+00	1.45E+07	0.00E+00
MO-99	0.00E+00	2.92E+04	5.56E+03	0.00E+00	6.62E+04	0.00E+00	6.78E+04	0.00E+00
TC-99M	1.30E-21	3.68E-21	4.68E-20	0.00E+00	5.58E-20	1.80E-21	2.18E-18	0.00E+00
TC-99	7.41E+07	1.10E+08	2.97E+07	0.00E+00	1.39E+09	9.36E+06	3.60E+09	0.00E+00
TC-101	0.00E+00	0.00E+00	0.00E+00	0.00E+00	0.00E+00	0.00E+00	0.00E+00	0.00E+00
RU-103	3.61E+07	0.00E+00	1.56E+07	0.00E+00	1.38E+08	0.00E+00	4.22E+09	0.00E+00
RU-105	1.69E-28	0.00E+00	6.67E-29	0.00E+00	2.18E-27	0.00E+00	1.03E-25	0.00E+00
RU-106	1.40E+09	0.00E+00	1.78E+08	0.00E+00	2.71E+09	0.00E+00	9.08E+10	0.00E+00
RH-105	1.12E+00	8.22E-01	5.42E-01	0.00E+00	3.49E+00	0.00E+00	1.31E+02	0.00E+00
PD-107	0.00E+00	8.71E+05	5.57E+04	0.00E+00	7.82E+06	0.00E+00	5.40E+06	0.00E+00
PD-109	0.00E+00	3.86E-07	8.70E-08	0.00E+00	2.20E-06	0.00E+00	4.27E-05	0.00E+00
AG-110M	3.24E+06	3.00E+06	1.78E+06	0.00E+00	5.90E+06	0.00E+00	1.22E+09	0.00E+00
AG-111	4.29E+04	1.79E+04	8.93E+03	0.00E+00	5.78E+04	0.00E+00	3.29E+07	0.00E+00
CD-113M	0.00E+00	2.47E+06	7.92E+04	0.00E+00	2.72E+06	0.00E+00	1.99E+07	0.00E+00
CD-115M	0.00E+00	5.27E+05	1.68E+04	0.00E+00	4.18E+05	0.00E+00	2.22E+07	0.00E+00
SN-123	2.46E+09	4.08E+07	6.01E+07	3.47E+07	0.00E+00	0.00E+00	5.01E+09	0.00E+00
SN-125	5.17E+07	1.04E+06	2.35E+06	8.63E+05	0.00E+00	0.00E+00	6.46E+08	0.00E+00
SN-126	1.00E+10	1.98E+08	2.84E+08	5.83E+07	0.00E+00	0.00E+00	2.88E+09	0.00E+00
SB-124	7.53E+06	1.42E+05	2.98E+06	1.83E+04	0.00E+00	5.86E+06	2.14E+08	0.00E+00
SB-125	1.00E+07	1.12E+05	2.39E+06	1.02E+04	0.00E+00	7.74E+06	1.10E+08	0.00E+00
SB-126	5.69E+05	1.16E+04	2.05E+05	3.48E+03	0.00E+00	3.49E+05	4.65E+07	0.00E+00
SB-127	4.85E+03	1.06E+02	1.86E+03	5.83E+01	0.00E+00	2.88E+03	1.11E+06	0.00E+00
TE-125M	1.35E+08	4.90E+07	1.81E+07	4.07E+07	5.50E+08	0.00E+00	5.40E+08	0.00E+00
TE-127M	4.82E+08	1.72E+08	5.87E+07	1.23E+08	1.96E+09	0.00E+00	1.62E+09	0.00E+00
TE-127	6.21E-11	2.23E-11	1.34E-11	4.60E-11	2.53E-10	0.00E+00	4.90E-09	0.00E+00
TE-129M	3.76E+08	1.40E+08	5.94E+07	1.29E+08	1.57E+09	0.00E+00	1.89E+09	0.00E+00
TE-129	0.00E+00	0.00E+00	0.00E+00	0.00E+00	0.00E+00	0.00E+00	0.00E+00	0.00E+00
TE-131M	1.32E+02	6.45E+01	5.38E+01	1.02E+02	6.54E+02	0.00E+00	6.41E+03	0.00E+00
TE-131	0.00E+00	0.00E+00	0.00E+00	0.00E+00	0.00E+00	0.00E+00	0.00E+00	0.00E+00
TE-132	4.15E+05	2.69E+05	2.52E+05	2.97E+05	2.59E+06	0.00E+00	1.27E+07	0.00E+00
TE-133M	0.00E+00	0.00E+00	0.00E+00	0.00E+00	0.00E+00	0.00E+00	0.00E+00	0.00E+00
TE-134	0.00E+00	0.00E+00	0.00E+00	0.00E+00	0.00E+00	0.00E+00	0.00E+00	0.00E+00
I-129	7.02E+07	6.04E+07	1.98E+08	1.55E+11	1.30E+08	0.00E+00	9.54E+06	0.00E+00
I-130	6.17E-07	1.82E-06	7.18E-07	1.54E-04	2.84E-06	0.00E+00	1.57E-06	0.00E+00
I-131	3.14E+06	4.49E+06	2.58E+06	1.47E+09	7.70E+06	0.00E+00	1.19E+06	0.00E+00
I-132	2.04E-59	5.45E-59	1.91E-59	1.91E-57	8.68E-59	0.00E+00	1.02E-59	0.00E+00
I-133	1.07E-01	1.86E-01	5.66E-02	2.73E+01	3.24E-01	0.00E+00	1.67E-01	0.00E+00
I-134	0.00E+00	0.00E+00	0.00E+00	0.00E+00	0.00E+00	0.00E+00	0.00E+00	0.00E+00

TABLE I12-14

R_i DOSE FACTORS AGE: ADULT PATHWAY: MEATm²-mrem/yr per μ Ci/sec

NUCLIDE	BONE	LIVER	T BODY	THYROID	KIDNEY	LUNG	GI-LLI	SKIN
I-135	1.29E-17	3.39E-17	1.25E-17	2.24E-15	5.44E-17	0.00E+00	3.83E-17	0.00E+00
CS-134M	7.65E-48	1.61E-47	8.23E-48	0.00E+00	8.73E-48	1.38E-48	5.67E-48	0.00E+00
CS-134	3.42E+08	8.14E+08	6.66E+08	0.00E+00	2.64E+08	8.75E+07	1.43E+07	0.00E+00
CS-135	1.16E+08	1.07E+08	4.73E+07	0.00E+00	4.03E+07	1.21E+07	2.49E+06	0.00E+00
CS-136	3.55E+06	1.40E+07	1.01E+07	0.00E+00	7.80E+06	1.07E+06	1.59E+06	0.00E+00
CS-137	4.70E+08	6.43E+08	4.21E+08	0.00E+00	2.18E+08	7.25E+07	1.24E+07	0.00E+00
CS-138	0.00E+00	0.00E+00	0.00E+00	0.00E+00	0.00E+00	0.00E+00	0.00E+00	0.00E+00
CS-139	0.00E+00	0.00E+00	0.00E+00	0.00E+00	0.00E+00	0.00E+00	0.00E+00	0.00E+00
BA-139	3.64E-102	2.59E-105	1.06E-103	0.00E+00	2.42E-105	1.47E-105	6.45E-102	0.00E+00
BA-140	8.46E+06	1.06E+04	5.54E+05	0.00E+00	3.61E+03	6.08E+03	1.74E+07	0.00E+00
BA-141	0.00E+00	0.00E+00	0.00E+00	0.00E+00	0.00E+00	0.00E+00	0.00E+00	0.00E+00
BA-142	0.00E+00	0.00E+00	0.00E+00	0.00E+00	0.00E+00	0.00E+00	0.00E+00	0.00E+00
LA-140	1.09E-02	5.47E-03	1.45E-03	0.00E+00	0.00E+00	0.00E+00	4.01E+02	0.00E+00
LA-141	1.14E-37	3.54E-38	5.79E-39	0.00E+00	0.00E+00	0.00E+00	4.22E-33	0.00E+00
LA-142	1.01E-92	4.58E-93	1.14E-93	0.00E+00	0.00E+00	0.00E+00	3.35E-89	0.00E+00
CE-141	4.62E+03	3.12E+03	3.54E+02	0.00E+00	1.45E+03	0.00E+00	1.19E+07	0.00E+00
CE-143	5.87E-03	4.34E+00	4.80E-04	0.00E+00	1.91E-03	0.00E+00	1.62E+02	0.00E+00
CE-144	7.16E+05	2.99E+05	3.85E+04	0.00E+00	1.78E+05	0.00E+00	2.42E+08	0.00E+00
PR-143	6.18E+03	2.48E+03	3.07E+02	0.00E+00	1.43E+03	0.00E+00	2.71E+07	0.00E+00
PR-144	0.00E+00	0.00E+00	0.00E+00	0.00E+00	0.00E+00	0.00E+00	0.00E+00	0.00E+00
ND-147	2.07E+03	2.40E+03	1.43E+02	0.00E+00	1.40E+03	0.00E+00	1.15E+07	0.00E+00
PM-147	5.06E+05	4.76E+04	1.92E+04	0.00E+00	8.99E+04	0.00E+00	5.99E+07	0.00E+00
PM-148M	7.49E+04	1.94E+04	1.48E+04	0.00E+00	2.93E+04	0.00E+00	1.64E+08	0.00E+00
PM-148	5.77E+02	9.58E+01	4.82E+01	0.00E+00	1.81E+02	0.00E+00	7.53E+06	0.00E+00
PM-149	1.50E+00	2.13E-01	8.68E-02	0.00E+00	4.01E-01	0.00E+00	3.98E+04	0.00E+00
PM-151	1.69E-03	2.83E-04	1.43E-04	0.00E+00	5.05E-04	0.00E+00	7.79E+01	0.00E+00
SM-151	5.10E+05	8.80E+04	2.11E+04	0.00E+00	9.83E+04	0.00E+00	3.88E+07	0.00E+00
SM-153	3.35E-01	2.79E-01	2.04E-02	0.00E+00	9.03E-02	0.00E+00	9.97E+03	0.00E+00
EU-152	1.37E+06	3.12E+05	2.74E+05	0.00E+00	1.93E+06	0.00E+00	1.80E+08	0.00E+00
EU-154	4.30E+06	5.28E+05	3.76E+05	0.00E+00	2.53E+06	0.00E+00	3.83E+08	0.00E+00
EU-155	5.93E+05	8.41E+04	5.42E+04	0.00E+00	3.88E+05	0.00E+00	6.62E+07	0.00E+00
EU-156	1.12E+04	8.64E+03	1.39E+03	0.00E+00	5.77E+03	0.00E+00	5.91E+07	0.00E+00
TB-160	1.56E+05	0.00E+00	1.94E+04	0.00E+00	6.43E+04	0.00E+00	1.43E+08	0.00E+00
HO-166M	1.76E+06	5.49E+05	4.17E+05	0.00E+00	8.21E+05	0.00E+00	1.67E+08	0.00E+00
W-181	1.24E+04	4.05E+03	4.34E+02	0.00E+00	0.00E+00	0.00E+00	4.62E+05	0.00E+00
W-185	4.05E+05	1.35E+05	1.42E+04	0.00E+00	0.00E+00	0.00E+00	1.56E+07	0.00E+00
W-187	6.05E-03	5.05E-03	1.77E-03	0.00E+00	0.00E+00	0.00E+00	1.66E+00	0.00E+00
U-232	2.08E+09	0.00E+00	1.48E+08	0.00E+00	2.25E+08	0.00E+00	3.41E+07	0.00E+00
U-233	4.39E+08	0.00E+00	2.66E+07	0.00E+00	1.02E+08	0.00E+00	3.16E+07	0.00E+00
U-234	4.21E+08	0.00E+00	2.60E+07	0.00E+00	1.00E+08	0.00E+00	3.09E+07	0.00E+00
U-235	4.03E+08	0.00E+00	2.45E+07	0.00E+00	9.42E+07	0.00E+00	3.93E+07	0.00E+00
U-236	4.03E+08	0.00E+00	2.50E+07	0.00E+00	9.62E+07	0.00E+00	2.90E+07	0.00E+00

TABLE I12-14

R_i DOSE FACTORS AGE: ADULT PATHWAY: MEATm²-mrem/yr per μ Ci/sec

NUCLIDE	BONE	LIVER	T BODY	THYROID	KIDNEY	LUNG	GI-LLI	SKIN
U-237	6.27E+02	0.00E+00	1.67E+02	0.00E+00	2.58E+03	0.00E+00	2.20E+05	0.00E+00
U-238	3.86E+08	0.00E+00	2.29E+07	0.00E+00	8.81E+07	0.00E+00	2.77E+07	0.00E+00
NP-237	3.73E+08	2.65E+07	1.64E+07	0.00E+00	1.22E+08	0.00E+00	2.35E+07	0.00E+00
NP-238	4.10E-01	1.11E-02	6.38E-03	0.00E+00	3.74E-02	0.00E+00	1.03E+03	0.00E+00
NP-239	7.58E-02	7.45E-03	4.11E-03	0.00E+00	2.33E-02	0.00E+00	1.53E+03	0.00E+00
PU-238	1.30E+07	1.65E+06	3.54E+05	0.00E+00	1.52E+06	0.00E+00	1.51E+06	0.00E+00
PU-239	1.50E+07	1.81E+06	3.96E+05	0.00E+00	1.68E+06	0.00E+00	1.38E+06	0.00E+00
PU-240	1.50E+07	1.80E+06	3.96E+05	0.00E+00	1.68E+06	0.00E+00	1.41E+06	0.00E+00
PU-241	3.22E+05	1.53E+04	6.81E+03	0.00E+00	3.14E+04	0.00E+00	2.87E+04	0.00E+00
PU-242	1.39E+07	1.74E+06	3.82E+05	0.00E+00	1.62E+06	0.00E+00	1.35E+06	0.00E+00
PU-244	1.63E+07	1.99E+06	4.38E+05	0.00E+00	1.86E+06	0.00E+00	2.02E+06	0.00E+00
AM-241	2.24E+08	2.09E+08	1.60E+07	0.00E+00	1.21E+08	0.00E+00	2.20E+07	0.00E+00
AM-242M	2.25E+08	1.96E+08	1.61E+07	0.00E+00	1.20E+08	0.00E+00	2.76E+07	0.00E+00
AM-243	2.23E+08	2.04E+08	1.57E+07	0.00E+00	1.18E+08	0.00E+00	2.58E+07	0.00E+00
CM-242	4.41E+06	4.69E+06	2.93E+05	0.00E+00	1.33E+06	0.00E+00	1.70E+07	0.00E+00
CM-243	1.76E+08	1.62E+08	1.10E+07	0.00E+00	5.16E+07	0.00E+00	2.30E+07	0.00E+00
CM-244	1.34E+08	1.25E+08	8.43E+06	0.00E+00	3.94E+07	0.00E+00	2.22E+07	0.00E+00
CM-245	2.78E+08	2.42E+08	1.71E+07	0.00E+00	7.97E+07	0.00E+00	2.09E+07	0.00E+00
CM-246	2.76E+08	2.42E+08	1.70E+07	0.00E+00	7.94E+07	0.00E+00	2.05E+07	0.00E+00
CM-247	2.69E+08	2.38E+08	1.68E+07	0.00E+00	7.82E+07	0.00E+00	2.69E+07	0.00E+00
CM-248	2.23E+09	1.96E+09	1.38E+08	0.00E+00	6.46E+08	0.00E+00	4.35E+08	0.00E+00
CF-252	7.30E+07	0.00E+00	1.76E+06	0.00E+00	0.00E+00	0.00E+00	8.05E+07	0.00E+00

TABLE II-15

R_i DOSE FACTORS AGE: TEEN PATHWAY: MEATm²-mrem/yr per μCi/sec

NUCLIDE	BONE	LIVER	T BODY	THYROID	KIDNEY	LUNG	GI-LLI	SKIN
H-3	0.00E+00	1.10E+02	1.10E+02	1.10E+02	1.10E+02	1.10E+02	1.10E+02	0.00E+00
C-14	2.81E+05	5.62E+04	5.62E+04	5.62E+04	5.62E+04	5.62E+04	5.62E+04	0.00E+00
NA-22	5.79E+08	5.79E+08	5.79E+08	5.79E+08	5.79E+08	5.79E+08	5.79E+08	0.00E+00
NA-24	3.17E-04	3.17E-04	3.17E-04	3.17E-04	3.17E-04	3.17E-04	3.17E-04	0.00E+00
P-32	1.16E+09	7.21E+07	4.51E+07	0.00E+00	0.00E+00	0.00E+00	9.78E+07	0.00E+00
CA-41	6.90E+08	0.00E+00	7.46E+07	0.00E+00	0.00E+00	0.00E+00	6.83E+05	0.00E+00
SC-46	5.59E+04	1.09E+05	3.23E+04	0.00E+00	1.04E+05	0.00E+00	3.71E+08	0.00E+00
CR-51	0.00E+00	0.00E+00	1.80E+03	9.97E+02	3.93E+02	2.56E+03	3.02E+05	0.00E+00
MN-54	0.00E+00	3.47E+06	6.88E+05	0.00E+00	1.03E+06	0.00E+00	7.11E+06	0.00E+00
MN-56	0.00E+00	3.60E-54	6.40E-55	0.00E+00	4.56E-54	0.00E+00	2.37E-52	0.00E+00
FE-55	1.25E+08	8.87E+07	2.07E+07	0.00E+00	0.00E+00	5.62E+07	3.84E+07	0.00E+00
FE-59	7.51E+07	1.75E+08	6.76E+07	0.00E+00	0.00E+00	5.52E+07	4.14E+08	0.00E+00
CO-57	0.00E+00	2.22E+06	3.71E+06	0.00E+00	0.00E+00	0.00E+00	4.13E+07	0.00E+00
CO-58	0.00E+00	5.55E+06	1.28E+07	0.00E+00	0.00E+00	0.00E+00	7.65E+07	0.00E+00
CO-60	0.00E+00	3.11E+07	7.00E+07	0.00E+00	0.00E+00	0.00E+00	4.04E+08	0.00E+00
NI-59	6.12E+07	2.16E+07	1.04E+07	0.00E+00	0.00E+00	0.00E+00	3.39E+06	0.00E+00
NI-63	8.20E+08	5.79E+07	2.78E+07	0.00E+00	0.00E+00	0.00E+00	9.22E+06	0.00E+00
NI-65	5.51E-54	7.04E-55	3.21E-55	0.00E+00	0.00E+00	0.00E+00	3.82E-53	0.00E+00
CU-64	0.00E+00	6.47E-08	3.05E-08	0.00E+00	1.64E-07	0.00E+00	5.02E-06	0.00E+00
ZN-65	1.21E+08	4.21E+08	1.96E+08	0.00E+00	2.69E+08	0.00E+00	1.78E+08	0.00E+00
ZN-69M	4.09E-06	9.64E-06	8.84E-07	0.00E+00	5.86E-06	0.00E+00	5.30E-04	0.00E+00
ZN-69	0.00E+00	0.00E+00	0.00E+00	0.00E+00	0.00E+00	0.00E+00	0.00E+00	0.00E+00
SE-79	0.00E+00	4.90E+07	8.23E+06	0.00E+00	8.53E+07	0.00E+00	7.48E+06	0.00E+00
BR-82	0.00E+00	0.00E+00	2.84E+02	0.00E+00	0.00E+00	0.00E+00	0.00E+00	0.00E+00
BR-83	0.00E+00	0.00E+00	1.48E-57	0.00E+00	0.00E+00	0.00E+00	0.00E+00	0.00E+00
BR-84	0.00E+00	0.00E+00	0.00E+00	0.00E+00	0.00E+00	0.00E+00	0.00E+00	0.00E+00
BR-85	0.00E+00	0.00E+00	0.00E+00	0.00E+00	0.00E+00	0.00E+00	0.00E+00	0.00E+00
RB-86	0.00E+00	1.22E+08	5.75E+07	0.00E+00	0.00E+00	0.00E+00	1.81E+07	0.00E+00
RB-87	0.00E+00	4.75E+08	1.66E+08	0.00E+00	0.00E+00	0.00E+00	1.66E+07	0.00E+00
RB-88	0.00E+00	0.00E+00	0.00E+00	0.00E+00	0.00E+00	0.00E+00	0.00E+00	0.00E+00
RB-89	0.00E+00	0.00E+00	0.00E+00	0.00E+00	0.00E+00	0.00E+00	0.00E+00	0.00E+00
SR-89	9.28E+07	0.00E+00	2.66E+06	0.00E+00	0.00E+00	0.00E+00	1.11E+07	0.00E+00
SR-90	5.33E+09	0.00E+00	1.07E+08	0.00E+00	0.00E+00	0.00E+00	1.22E+08	0.00E+00
SR-91	3.74E-11	0.00E+00	1.49E-12	0.00E+00	0.00E+00	0.00E+00	1.69E-10	0.00E+00
SR-92	2.89E-50	0.00E+00	1.23E-51	0.00E+00	0.00E+00	0.00E+00	7.36E-49	0.00E+00
Y-90	2.65E+01	0.00E+00	7.14E-01	0.00E+00	0.00E+00	0.00E+00	2.19E+05	0.00E+00
Y-91M	0.00E+00	0.00E+00	0.00E+00	0.00E+00	0.00E+00	0.00E+00	0.00E+00	0.00E+00
Y-91	3.60E+05	0.00E+00	9.66E+03	0.00E+00	0.00E+00	0.00E+00	1.48E+08	0.00E+00
Y-92	3.75E-40	0.00E+00	1.09E-41	0.00E+00	0.00E+00	0.00E+00	1.03E-35	0.00E+00
Y-93	1.16E-12	0.00E+00	3.18E-14	0.00E+00	0.00E+00	0.00E+00	3.54E-08	0.00E+00
ZR-93	1.65E+06	8.12E+04	4.43E+04	0.00E+00	2.87E+05	0.00E+00	7.68E+07	0.00E+00
ZR-95	5.79E+05	1.83E+05	1.26E+05	0.00E+00	2.68E+05	0.00E+00	4.21E+08	0.00E+00
ZR-97	5.04E-06	9.97E-07	4.59E-07	0.00E+00	1.51E-06	0.00E+00	2.70E-01	0.00E+00
NB-93M	8.34E+06	2.74E+06	6.86E+05	0.00E+00	3.20E+06	0.00E+00	9.87E+08	0.00E+00
NB-95	6.00E+05	3.33E+05	1.83E+05	0.00E+00	3.22E+05	0.00E+00	1.42E+09	0.00E+00

TABLE II-15

R_i DOSE FACTORS AGE: TEEN PATHWAY: MEATm²-mrem/yr per μCi/sec

NUCLIDE	BONE	LIVER	T BODY	THYROID	KIDNEY	LUNG	GI-LLI	SKIN
NB-97	0.00E+00	0.00E+00	0.00E+00	0.00E+00	0.00E+00	0.00E+00	0.00E+00	0.00E+00
MO-93	0.00E+00	7.42E+07	2.03E+06	0.00E+00	2.13E+07	0.00E+00	9.03E+06	0.00E+00
MO-99	0.00E+00	2.42E+04	4.61E+03	0.00E+00	5.53E+04	0.00E+00	4.33E+04	0.00E+00
TC-99M	1.03E-21	2.88E-21	3.74E-20	0.00E+00	4.30E-20	1.60E-21	1.89E-18	0.00E+00
TC-99	6.27E+07	9.21E+07	2.51E+07	0.00E+00	1.17E+09	9.52E+06	2.25E+09	0.00E+00
TC-101	0.00E+00	0.00E+00	0.00E+00	0.00E+00	0.00E+00	0.00E+00	0.00E+00	0.00E+00
RU-103	2.94E+07	0.00E+00	1.26E+07	0.00E+00	1.04E+08	0.00E+00	2.46E+09	0.00E+00
RU-105	1.41E-28	0.00E+00	5.48E-29	0.00E+00	1.78E-27	0.00E+00	1.14E-25	0.00E+00
RU-106	1.18E+09	0.00E+00	1.49E+08	0.00E+00	2.28E+09	0.00E+00	5.67E+10	0.00E+00
RH-105	9.50E-01	6.86E-01	4.50E-01	0.00E+00	2.91E+00	0.00E+00	8.73E+01	0.00E+00
PD-107	0.00E+00	7.28E+05	4.69E+04	0.00E+00	6.58E+06	0.00E+00	3.38E+06	0.00E+00
PD-109	0.00E+00	3.23E-07	7.35E-08	0.00E+00	1.87E-06	0.00E+00	3.26E-05	0.00E+00
AG-110M	2.46E+06	2.32E+06	1.41E+06	0.00E+00	4.43E+06	0.00E+00	6.53E+08	0.00E+00
AG-111	3.61E+04	1.50E+04	7.54E+03	0.00E+00	4.88E+04	0.00E+00	2.09E+07	0.00E+00
CD-113M	0.00E+00	2.07E+06	6.65E+04	0.00E+00	2.29E+06	0.00E+00	1.24E+07	0.00E+00
CD-115M	0.00E+00	4.40E+05	1.42E+04	0.00E+00	3.52E+05	0.00E+00	1.39E+07	0.00E+00
SN-123	2.08E+09	3.41E+07	5.05E+07	2.73E+07	0.00E+00	0.00E+00	3.14E+09	0.00E+00
SN-125	4.37E+07	8.70E+05	1.97E+06	6.82E+05	0.00E+00	0.00E+00	4.11E+08	0.00E+00
SN-126	8.12E+09	1.51E+08	2.31E+08	3.98E+07	0.00E+00	0.00E+00	1.81E+09	0.00E+00
SB-124	6.15E+06	1.13E+05	2.40E+06	1.39E+04	0.00E+00	5.37E+06	1.24E+08	0.00E+00
SB-125	8.22E+06	8.98E+04	1.92E+06	7.85E+03	0.00E+00	7.22E+06	6.39E+07	0.00E+00
SB-126	4.65E+05	9.50E+03	1.67E+05	2.63E+03	0.00E+00	3.33E+05	2.75E+07	0.00E+00
SB-127	4.04E+03	8.63E+01	1.52E+03	4.54E+01	0.00E+00	2.75E+03	6.85E+05	0.00E+00
TE-125M	1.14E+08	4.12E+07	1.53E+07	3.19E+07	0.00E+00	0.00E+00	3.37E+08	0.00E+00
TE-127M	4.07E+08	1.44E+08	4.84E+07	9.68E+07	1.65E+09	0.00E+00	1.01E+09	0.00E+00
TE-127	5.27E-11	1.87E-11	1.13E-11	3.63E-11	2.13E-10	0.00E+00	4.07E-09	0.00E+00
TE-129M	3.15E+08	1.17E+08	4.98E+07	1.02E+08	1.32E+09	0.00E+00	1.18E+09	0.00E+00
TE-129	0.00E+00	0.00E+00	0.00E+00	0.00E+00	0.00E+00	0.00E+00	0.00E+00	0.00E+00
TE-131M	1.10E+02	5.27E+01	4.40E+01	7.93E+01	5.50E+02	0.00E+00	4.23E+03	0.00E+00
TE-131	0.00E+00	0.00E+00	0.00E+00	0.00E+00	0.00E+00	0.00E+00	0.00E+00	0.00E+00
TE-132	3.40E+05	2.15E+05	2.02E+05	2.27E+05	2.06E+06	0.00E+00	6.81E+06	0.00E+00
TE-133M	0.00E+00	0.00E+00	0.00E+00	0.00E+00	0.00E+00	0.00E+00	0.00E+00	0.00E+00
TE-134	0.00E+00	0.00E+00	0.00E+00	0.00E+00	0.00E+00	0.00E+00	0.00E+00	0.00E+00
I-129	5.91E+07	4.98E+07	8.30E+07	6.05E+10	8.90E+07	0.00E+00	5.80E+06	0.00E+00
I-130	4.97E-07	1.44E-06	5.74E-07	1.17E-04	2.21E-06	0.00E+00	1.10E-06	0.00E+00
I-131	2.61E+06	3.66E+06	1.96E+06	1.07E+09	6.29E+06	0.00E+00	7.23E+05	0.00E+00
I-132	1.65E-59	4.33E-59	1.55E-59	1.46E-57	6.82E-59	0.00E+00	1.89E-59	0.00E+00
I-133	8.93E-02	1.52E-01	4.62E-02	2.12E+01	2.66E-01	0.00E+00	1.15E-01	0.00E+00
I-134	0.00E+00	0.00E+00	0.00E+00	0.00E+00	0.00E+00	0.00E+00	0.00E+00	0.00E+00
I-135	1.05E-17	2.71E-17	1.01E-17	1.74E-15	4.28E-17	0.00E+00	3.00E-17	0.00E+00
CS-134M	6.24E-48	1.29E-47	6.64E-48	0.00E+00	7.19E-48	1.26E-48	8.60E-48	0.00E+00
CS-134	2.72E+08	6.41E+08	2.97E+08	0.00E+00	2.04E+08	7.77E+07	7.97E+06	0.00E+00
CS-135	9.73E+07	8.93E+07	2.09E+07	0.00E+00	3.41E+07	1.23E+07	1.56E+06	0.00E+00
CS-136	2.77E+06	1.09E+07	7.32E+06	0.00E+00	5.93E+06	9.35E+05	8.77E+05	0.00E+00
CS-137	3.90E+08	5.19E+08	1.81E+08	0.00E+00	1.77E+08	6.86E+07	7.38E+06	0.00E+00

TABLE II2-15

R_i DOSE FACTORS AGE: TEEN PATHWAY: MEATm²-mrem/yr per μ Ci/sec

NUCLIDE	BONE	LIVER	T BODY	THYROID	KIDNEY	LUNG	GI-LLI	SKIN
CS-138	0.00E+00	0.00E+00	0.00E+00	0.00E+00	0.00E+00	0.00E+00	0.00E+00	0.00E+00
CS-139	0.00E+00	0.00E+00	0.00E+00	0.00E+00	0.00E+00	0.00E+00	0.00E+00	0.00E+00
BA-139	3.08E-102	2.17E-105	8.97E-104	0.00E+00	2.04E-105	1.49E-105	2.75E-101	0.00E+00
BA-140	6.99E+06	8.57E+03	4.51E+05	0.00E+00	2.91E+03	5.76E+03	1.08E+07	0.00E+00
BA-141	0.00E+00	0.00E+00	0.00E+00	0.00E+00	0.00E+00	0.00E+00	0.00E+00	0.00E+00
BA-142	0.00E+00	0.00E+00	0.00E+00	0.00E+00	0.00E+00	0.00E+00	0.00E+00	0.00E+00
LA-140	8.93E-03	4.39E-03	1.17E-03	0.00E+00	0.00E+00	0.00E+00	2.52E+02	0.00E+00
LA-141	9.61E-38	2.96E-38	4.88E-39	0.00E+00	0.00E+00	0.00E+00	5.24E-33	0.00E+00
LA-142	8.33E-93	3.70E-93	9.21E-94	0.00E+00	0.00E+00	0.00E+00	1.13E-88	0.00E+00
CE-141	3.88E+03	2.59E+03	2.97E+02	0.00E+00	1.22E+03	0.00E+00	7.41E+06	0.00E+00
CE-143	4.94E-03	3.60E+00	4.02E-04	0.00E+00	1.61E-03	0.00E+00	1.08E+02	0.00E+00
CE-144	6.04E+05	2.50E+05	3.24E+04	0.00E+00	1.49E+05	0.00E+00	1.52E+08	0.00E+00
PR-143	5.20E+03	2.08E+03	2.59E+02	0.00E+00	1.21E+03	0.00E+00	1.71E+07	0.00E+00
PR-144	0.00E+00	0.00E+00	0.00E+00	0.00E+00	0.00E+00	0.00E+00	0.00E+00	0.00E+00
ND-147	1.83E+03	1.99E+03	1.19E+02	0.00E+00	1.17E+03	0.00E+00	7.17E+06	0.00E+00
PM-147	4.16E+05	3.95E+04	1.61E+04	0.00E+00	7.53E+04	0.00E+00	3.75E+07	0.00E+00
PM-148M	5.97E+04	1.51E+04	1.18E+04	0.00E+00	2.29E+04	0.00E+00	9.53E+07	0.00E+00
PM-148	4.85E+02	7.90E+01	3.98E+01	0.00E+00	1.43E+02	0.00E+00	4.71E+06	0.00E+00
PM-149	1.27E+00	1.78E-01	7.30E-02	0.00E+00	3.39E-01	0.00E+00	2.62E+04	0.00E+00
PM-151	1.41E-03	2.33E-04	1.18E-04	0.00E+00	4.19E-04	0.00E+00	5.23E+01	0.00E+00
SM-151	3.81E+05	7.34E+04	1.72E+04	0.00E+00	8.04E+04	0.00E+00	2.49E+07	0.00E+00
SM-153	2.82E-01	2.33E-01	1.72E-02	0.00E+00	7.62E-02	0.00E+00	6.58E+03	0.00E+00
EU-152	1.02E+06	2.45E+05	2.16E+05	0.00E+00	1.14E+06	0.00E+00	9.01E+07	0.00E+00
EU-154	3.27E+06	4.21E+05	2.97E+05	0.00E+00	1.88E+06	0.00E+00	2.23E+08	0.00E+00
EU-155	7.09E+05	6.84E+04	4.24E+04	0.00E+00	2.68E+05	0.00E+00	3.92E+08	0.00E+00
EU-156	9.24E+03	6.93E+03	1.13E+03	0.00E+00	4.66E+03	0.00E+00	3.54E+07	0.00E+00
TB-160	1.27E+05	0.00E+00	1.58E+04	0.00E+00	5.01E+04	0.00E+00	8.20E+07	0.00E+00
HO-166M	1.37E+06	4.24E+05	3.07E+05	0.00E+00	6.20E+05	0.00E+00	1.04E+08	0.00E+00
W-181	1.05E+04	3.39E+03	3.55E+02	0.00E+00	0.00E+00	0.00E+00	2.89E+05	0.00E+00
W-185	3.42E+05	1.13E+05	1.19E+04	0.00E+00	0.00E+00	0.00E+00	9.75E+06	0.00E+00
W-187	5.06E-03	4.13E-03	1.45E-03	0.00E+00	0.00E+00	0.00E+00	1.12E+00	0.00E+00
U-232	1.75E+09	0.00E+00	1.25E+08	0.00E+00	1.89E+08	0.00E+00	2.14E+07	0.00E+00
U-233	3.69E+08	0.00E+00	2.24E+07	0.00E+00	8.63E+07	0.00E+00	1.98E+07	0.00E+00
U-234	3.54E+08	0.00E+00	2.20E+07	0.00E+00	8.48E+07	0.00E+00	1.94E+07	0.00E+00
U-235	3.39E+08	0.00E+00	2.07E+07	0.00E+00	7.95E+07	0.00E+00	2.46E+07	0.00E+00
U-236	3.39E+08	0.00E+00	2.11E+07	0.00E+00	8.12E+07	0.00E+00	1.82E+07	0.00E+00
NP-239	6.62E-02	6.25E-03	3.47E-03	0.00E+00	1.96E-02	0.00E+00	1.01E+03	0.00E+00
U-237	5.29E+02	0.00E+00	1.41E+02	0.00E+00	2.17E+03	0.00E+00	1.40E+05	0.00E+00
U-238	3.24E+08	0.00E+00	1.93E+07	0.00E+00	7.44E+07	0.00E+00	1.74E+07	0.00E+00
NP-237	2.33E+08	1.67E+07	1.02E+07	0.00E+00	7.58E+07	0.00E+00	1.47E+07	0.00E+00
NP-238	3.45E-01	9.24E-03	5.38E-03	0.00E+00	3.17E-02	0.00E+00	6.78E+02	0.00E+00
PU-238	8.20E+06	1.05E+06	2.23E+05	0.00E+00	9.54E+05	0.00E+00	9.46E+05	0.00E+00
PU-239	9.37E+06	1.14E+06	2.46E+05	0.00E+00	1.05E+06	0.00E+00	8.65E+05	0.00E+00
PU-240	9.36E+06	1.14E+06	2.46E+05	0.00E+00	1.05E+06	0.00E+00	8.81E+05	0.00E+00
PU-241	2.12E+05	1.02E+04	4.47E+03	0.00E+00	2.07E+04	0.00E+00	1.79E+04	0.00E+00

TABLE II2-15

R_i DOSE FACTORS AGE: TEEN PATHWAY: MEATm²-mrem/yr per μ Ci/sec

NUCLIDE	BONE	LIVER	T BODY	THYROID	KIDNEY	LUNG	GI-LLI	SKIN
PU-242	8.69E+06	1.10E+06	2.38E+05	0.00E+00	1.01E+06	0.00E+00	8.48E+05	0.00E+00
PU-244	1.01E+07	1.25E+06	2.72E+05	0.00E+00	1.16E+06	0.00E+00	1.26E+06	0.00E+00
AM-241	1.40E+08	1.32E+08	1.01E+07	0.00E+00	7.54E+07	0.00E+00	1.38E+07	0.00E+00
AM-242M	1.41E+08	1.24E+08	1.01E+07	0.00E+00	7.52E+07	0.00E+00	1.73E+07	0.00E+00
AM-243	1.39E+08	1.29E+08	9.84E+06	0.00E+00	7.39E+07	0.00E+00	1.62E+07	0.00E+00
CM-242	3.72E+06	3.92E+06	2.47E+05	0.00E+00	1.12E+06	0.00E+00	1.06E+07	0.00E+00
CM-243	1.13E+08	1.05E+08	7.12E+06	0.00E+00	3.33E+07	0.00E+00	1.44E+07	0.00E+00
CM-244	8.75E+07	8.28E+07	5.54E+06	0.00E+00	2.59E+07	0.00E+00	1.39E+07	0.00E+00
CM-245	1.73E+08	1.52E+08	1.07E+07	0.00E+00	4.99E+07	0.00E+00	1.31E+07	0.00E+00
CM-246	1.72E+08	1.52E+08	1.07E+07	0.00E+00	4.97E+07	0.00E+00	1.28E+07	0.00E+00
CM-247	1.68E+08	1.50E+08	1.05E+07	0.00E+00	4.90E+07	0.00E+00	1.69E+07	0.00E+00
CM-248	1.39E+09	1.24E+09	8.67E+07	0.00E+00	4.04E+08	0.00E+00	2.71E+08	0.00E+00
CF-252	5.73E+07	0.00E+00	1.38E+06	0.00E+00	0.00E+00	0.00E+00	5.04E+07	0.00E+00

TABLE II-2-16

R_i DOSE FACTORS AGE: CHILD PATHWAY: MEATm²-mrem/yr per μ Ci/sec

NUCLIDE	BONE	LIVER	T BODY	THYROID	KIDNEY	LUNG	GI-LLI	SKIN
H-3	0.00E+00	1.34E+02	1.34E+02	1.34E+02	1.34E+02	1.34E+02	1.34E+02	0.00E+00
C-14	5.29E+05	1.06E+05	1.06E+05	1.06E+05	1.06E+05	1.06E+05	1.06E+05	0.00E+00
NA-22	9.18E+08	9.18E+08	9.18E+08	9.18E+08	9.18E+08	9.18E+08	9.18E+08	0.00E+00
NA-24	5.04E-04	5.04E-04	5.04E-04	5.04E-04	5.04E-04	5.04E-04	5.04E-04	0.00E+00
P-32	2.19E+09	1.03E+08	8.45E+07	0.00E+00	0.00E+00	0.00E+00	6.06E+07	0.00E+00
CA-41	7.66E+08	0.00E+00	8.37E+07	0.00E+00	0.00E+00	0.00E+00	4.20E+05	0.00E+00
SC-46	9.59E+04	1.32E+05	5.07E+04	0.00E+00	1.16E+05	0.00E+00	1.92E+08	0.00E+00
CR-51	0.00E+00	0.00E+00	2.80E+03	1.55E+03	4.25E+02	2.84E+03	1.48E+05	0.00E+00
MN-54	0.00E+00	3.97E+06	1.06E+06	0.00E+00	1.11E+06	0.00E+00	3.33E+06	0.00E+00
MN-56	0.00E+00	4.80E-54	1.08E-54	0.00E+00	5.80E-54	0.00E+00	6.95E-52	0.00E+00
FE-55	2.40E+08	1.27E+08	3.94E+07	0.00E+00	0.00E+00	7.20E+07	2.36E+07	0.00E+00
FE-59	1.33E+08	2.15E+08	1.07E+08	0.00E+00	0.00E+00	6.24E+07	2.24E+08	0.00E+00
CO-57	0.00E+00	2.89E+06	5.86E+06	0.00E+00	0.00E+00	0.00E+00	2.37E+07	0.00E+00
CO-58	0.00E+00	6.48E+06	1.99E+07	0.00E+00	0.00E+00	0.00E+00	3.78E+07	0.00E+00
CO-60	0.00E+00	3.69E+07	1.09E+08	0.00E+00	0.00E+00	0.00E+00	2.04E+08	0.00E+00
NI-59	1.18E+08	3.13E+07	2.00E+07	0.00E+00	0.00E+00	0.00E+00	2.08E+06	0.00E+00
NI-63	1.57E+09	8.41E+07	5.35E+07	0.00E+00	0.00E+00	0.00E+00	5.67E+06	0.00E+00
NI-65	1.03E-53	9.69E-55	5.66E-55	0.00E+00	0.00E+00	0.00E+00	1.19E-52	0.00E+00
CU-64	0.00E+00	8.70E-08	5.26E-08	0.00E+00	2.10E-07	0.00E+00	4.08E-06	0.00E+00
ZN-65	1.82E+08	4.84E+08	3.01E+08	0.00E+00	3.05E+08	0.00E+00	8.51E+07	0.00E+00
ZN-69M	7.63E-06	1.30E-05	1.54E-06	0.00E+00	7.55E-06	0.00E+00	4.23E-04	0.00E+00
ZN-69	0.00E+00	0.00E+00	0.00E+00	0.00E+00	0.00E+00	0.00E+00	0.00E+00	0.00E+00
SE-79	0.00E+00	6.98E+07	1.55E+07	0.00E+00	1.13E+08	0.00E+00	4.58E+06	0.00E+00
BR-82	0.00E+00	0.00E+00	4.45E+02	0.00E+00	0.00E+00	0.00E+00	0.00E+00	0.00E+00
BR-83	0.00E+00	0.00E+00	2.78E-57	0.00E+00	0.00E+00	0.00E+00	0.00E+00	0.00E+00
BR-84	0.00E+00	0.00E+00	0.00E+00	0.00E+00	0.00E+00	0.00E+00	0.00E+00	0.00E+00
BR-85	0.00E+00	0.00E+00	0.00E+00	0.00E+00	0.00E+00	0.00E+00	0.00E+00	0.00E+00
RB-86	0.00E+00	1.74E+08	1.07E+08	0.00E+00	0.00E+00	0.00E+00	1.12E+07	0.00E+00
RB-87	0.00E+00	6.76E+08	3.13E+08	0.00E+00	0.00E+00	0.00E+00	1.01E+07	0.00E+00
RB-88	0.00E+00	0.00E+00	0.00E+00	0.00E+00	0.00E+00	0.00E+00	0.00E+00	0.00E+00
RB-89	0.00E+00	0.00E+00	0.00E+00	0.00E+00	0.00E+00	0.00E+00	0.00E+00	0.00E+00
SR-89	1.76E+08	0.00E+00	5.02E+06	0.00E+00	0.00E+00	0.00E+00	6.80E+06	0.00E+00
SR-90	8.43E+09	0.00E+00	1.70E+08	0.00E+00	0.00E+00	0.00E+00	7.55E+07	0.00E+00
SR-91	7.01E-11	0.00E+00	2.65E-12	0.00E+00	0.00E+00	0.00E+00	1.55E-10	0.00E+00
SR-92	5.39E-50	0.00E+00	2.16E-51	0.00E+00	0.00E+00	0.00E+00	1.02E-48	0.00E+00
Y-90	5.01E+01	0.00E+00	1.34E+00	0.00E+00	0.00E+00	0.00E+00	1.43E+05	0.00E+00
Y-91M	0.00E+00	0.00E+00	0.00E+00	0.00E+00	0.00E+00	0.00E+00	0.00E+00	0.00E+00
Y-91	6.81E+05	0.00E+00	1.82E+04	0.00E+00	0.00E+00	0.00E+00	9.07E+07	0.00E+00
Y-92	7.05E-40	0.00E+00	2.02E-41	0.00E+00	0.00E+00	0.00E+00	2.04E-35	0.00E+00
Y-93	2.18E-12	0.00E+00	5.97E-14	0.00E+00	0.00E+00	0.00E+00	3.24E-08	0.00E+00
ZR-93	3.13E+06	1.17E+05	8.35E+04	0.00E+00	4.54E+05	0.00E+00	4.45E+07	0.00E+00
ZR-95	1.03E+06	2.26E+05	2.01E+05	0.00E+00	3.23E+05	0.00E+00	2.36E+08	0.00E+00

TABLE II-16

R_i DOSE FACTORS AGE: CHILD PATHWAY: MEATm²-mrem/yr per μCi/sec

NUCLIDE	BONE	LIVER	T BODY	THYROID	KIDNEY	LUNG	GI-LLI	SKIN
ZR-97	9.37E-06	1.35E-06	7.99E-07	0.00E+00	1.94E-06	0.00E+00	2.05E-01	0.00E+00
NB-93M	1.61E+07	4.01E+06	1.32E+06	0.00E+00	4.33E+06	0.00E+00	6.04E+08	0.00E+00
NB-95	1.04E+06	4.03E+05	2.88E+05	0.00E+00	3.79E+05	0.00E+00	7.45E+08	0.00E+00
NB-97	0.00E+00	0.00E+00	0.00E+00	0.00E+00	0.00E+00	0.00E+00	0.00E+00	0.00E+00
MO-93	0.00E+00	1.06E+08	3.82E+06	0.00E+00	2.80E+07	0.00E+00	5.39E+06	0.00E+00
MO-99	0.00E+00	3.36E+04	8.32E+03	0.00E+00	7.18E+04	0.00E+00	2.78E+04	0.00E+00
TC-99M	1.81E-21	3.55E-21	5.89E-20	0.00E+00	5.16E-20	1.80E-21	2.02E-18	0.00E+00
TC-99	1.18E+08	1.32E+08	4.73E+07	0.00E+00	1.55E+09	1.16E+07	1.38E+09	0.00E+00
TC-101	0.00E+00	0.00E+00	0.00E+00	0.00E+00	0.00E+00	0.00E+00	0.00E+00	0.00E+00
RU-103	5.32E+07	0.00E+00	2.04E+07	0.00E+00	1.34E+08	0.00E+00	1.37E+09	0.00E+00
RU-105	2.64E-28	0.00E+00	9.57E-29	0.00E+00	2.32E-27	0.00E+00	1.72E-25	0.00E+00
RU-106	2.23E+09	0.00E+00	2.78E+08	0.00E+00	3.01E+09	0.00E+00	3.46E+10	0.00E+00
RH-105	1.78E+00	9.56E-01	8.17E-01	0.00E+00	3.81E+00	0.00E+00	5.92E+01	0.00E+00
PD-107	0.00E+00	1.04E+06	8.86E+04	0.00E+00	8.72E+06	0.00E+00	2.07E+06	0.00E+00
PD-109	0.00E+00	4.61E-07	1.38E-07	0.00E+00	2.47E-06	0.00E+00	2.72E-05	0.00E+00
AG-110M	4.07E+06	2.75E+06	2.20E+06	0.00E+00	5.12E+06	0.00E+00	3.27E+08	0.00E+00
AG-111	6.82E+04	2.13E+04	1.41E+04	0.00E+00	6.43E+04	0.00E+00	1.31E+07	0.00E+00
CD-113M	0.00E+00	2.95E+06	1.26E+05	0.00E+00	3.04E+06	0.00E+00	7.61E+06	0.00E+00
CD-115M	0.00E+00	6.29E+05	2.68E+04	0.00E+00	4.68E+05	0.00E+00	8.56E+06	0.00E+00
SN-123	3.92E+09	4.87E+07	9.56E+07	5.16E+07	0.00E+00	0.00E+00	1.92E+09	0.00E+00
SN-125	8.22E+07	1.24E+06	3.68E+06	1.28E+06	0.00E+00	0.00E+00	2.55E+08	0.00E+00
SN-126	1.47E+10	1.83E+08	4.18E+08	5.04E+07	0.00E+00	0.00E+00	1.10E+09	0.00E+00
SB-124	1.11E+07	1.44E+05	3.90E+06	2.45E+04	0.00E+00	6.17E+06	6.95E+07	0.00E+00
SB-125	1.50E+07	1.15E+05	3.13E+06	1.39E+04	0.00E+00	8.34E+06	3.57E+07	0.00E+00
SB-126	8.11E+05	1.24E+04	2.91E+05	4.76E+03	0.00E+00	3.87E+05	1.64E+07	0.00E+00
SB-127	7.43E+03	1.15E+02	2.58E+03	8.28E+01	0.00E+00	3.23E+03	4.19E+05	0.00E+00
TE-125M	2.14E+08	5.81E+07	2.86E+07	6.02E+07	0.00E+00	0.00E+00	2.07E+08	0.00E+00
TE-127M	7.67E+08	2.06E+08	9.10E+07	1.83E+08	2.19E+09	0.00E+00	6.21E+08	0.00E+00
TE-127	9.91E-11	2.67E-11	2.12E-11	6.86E-11	2.82E-10	0.00E+00	3.87E-09	0.00E+00
TE-129M	5.93E+08	1.66E+08	9.20E+07	1.91E+08	1.74E+09	0.00E+00	7.23E+08	0.00E+00
TE-129	0.00E+00	0.00E+00	0.00E+00	0.00E+00	0.00E+00	0.00E+00	0.00E+00	0.00E+00
TE-131M	2.05E+02	7.08E+01	7.53E+01	1.46E+02	6.85E+02	0.00E+00	2.87E+03	0.00E+00
TE-131	0.00E+00	0.00E+00	0.00E+00	0.00E+00	0.00E+00	0.00E+00	0.00E+00	0.00E+00
TE-132	6.20E+05	2.74E+05	3.32E+05	4.00E+05	2.55E+06	0.00E+00	2.76E+06	0.00E+00
TE-133M	0.00E+00	0.00E+00	0.00E+00	0.00E+00	0.00E+00	0.00E+00	0.00E+00	0.00E+00
TE-134	0.00E+00	0.00E+00	0.00E+00	0.00E+00	0.00E+00	0.00E+00	0.00E+00	0.00E+00
I-129	1.11E+08	6.83E+07	6.10E+07	4.47E+10	1.15E+08	0.00E+00	3.43E+06	0.00E+00
I-130	8.88E-07	1.79E-06	9.24E-07	1.98E-04	2.68E-06	0.00E+00	8.39E-07	0.00E+00
I-131	4.84E+06	4.87E+06	2.77E+06	1.61E+09	8.00E+06	0.00E+00	4.34E+05	0.00E+00
I-132	2.99E-59	5.50E-59	2.53E-59	2.55E-57	8.42E-59	0.00E+00	6.47E-59	0.00E+00
I-133	1.66E-01	2.05E-01	7.77E-02	3.81E+01	3.42E-01	0.00E+00	8.27E-02	0.00E+00
I-134	0.00E+00	0.00E+00	0.00E+00	0.00E+00	0.00E+00	0.00E+00	0.00E+00	0.00E+00

TABLE II-2-16

R_i DOSE FACTORS AGE: CHILD PATHWAY: MEATm²-mrem/yr per μ Ci/sec

NUCLIDE	BONE	LIVER	T BODY	THYROID	KIDNEY	LUNG	GI-LLI	SKIN
I-135	1.91E-17	3.43E-17	1.62E-17	3.04E-15	5.26E-17	0.00E+00	2.61E-17	0.00E+00
CS-134M	1.13E-47	1.67E-47	1.09E-47	0.00E+00	8.82E-48	1.46E-48	2.12E-47	0.00E+00
CS-134	4.80E+08	7.88E+08	1.66E+08	0.00E+00	2.44E+08	8.76E+07	4.25E+06	0.00E+00
CS-135	1.83E+08	1.28E+08	1.31E+07	0.00E+00	4.51E+07	1.50E+07	9.56E+05	0.00E+00
CS-136	4.78E+06	1.31E+07	8.50E+06	0.00E+00	6.99E+06	1.04E+06	4.62E+05	0.00E+00
CS-137	7.18E+08	6.88E+08	1.02E+08	0.00E+00	2.24E+08	8.06E+07	4.31E+06	0.00E+00
CS-138	0.00E+00	0.00E+00	0.00E+00	0.00E+00	0.00E+00	0.00E+00	0.00E+00	0.00E+00
CS-139	0.00E+00	0.00E+00	0.00E+00	0.00E+00	0.00E+00	0.00E+00	0.00E+00	0.00E+00
BA-139	5.78E-102	3.09E-105	1.68E-103	0.00E+00	2.70E-105	1.82E-105	3.34E-100	0.00E+00
BA-140	1.29E+07	1.13E+04	7.53E+05	0.00E+00	3.68E+03	6.74E+03	6.54E+06	0.00E+00
BA-141	0.00E+00	0.00E+00	0.00E+00	0.00E+00	0.00E+00	0.00E+00	0.00E+00	0.00E+00
BA-142	0.00E+00	0.00E+00	0.00E+00	0.00E+00	0.00E+00	0.00E+00	0.00E+00	0.00E+00
LA-140	1.63E-02	5.71E-03	1.93E-03	0.00E+00	0.00E+00	0.00E+00	1.59E+02	0.00E+00
LA-141	1.81E-37	4.22E-38	9.17E-39	0.00E+00	0.00E+00	0.00E+00	9.39E-33	0.00E+00
LA-142	1.54E-92	4.90E-93	1.53E-93	0.00E+00	0.00E+00	0.00E+00	9.71E-88	0.00E+00
CE-141	7.30E+03	3.64E+03	5.41E+02	0.00E+00	1.60E+03	0.00E+00	4.54E+06	0.00E+00
CE-143	9.27E-03	5.03E+00	7.28E-04	0.00E+00	2.11E-03	0.00E+00	7.36E+01	0.00E+00
CE-144	1.14E+06	3.57E+05	6.07E+04	0.00E+00	1.97E+05	0.00E+00	9.30E+07	0.00E+00
PR-143	9.85E+03	2.96E+03	4.89E+02	0.00E+00	1.60E+03	0.00E+00	1.06E+07	0.00E+00
PR-144	0.00E+00	0.00E+00	0.00E+00	0.00E+00	0.00E+00	0.00E+00	0.00E+00	0.00E+00
ND-147	3.43E+03	2.78E+03	2.15E+02	0.00E+00	1.52E+03	0.00E+00	4.40E+06	0.00E+00
PM-147	7.95E+05	5.67E+04	3.05E+04	0.00E+00	1.00E+05	0.00E+00	2.30E+07	0.00E+00
PM-148M	9.36E+04	1.86E+04	1.86E+04	0.00E+00	2.76E+04	0.00E+00	5.25E+07	0.00E+00
PM-148	9.06E+02	1.09E+02	7.05E+01	0.00E+00	1.85E+02	0.00E+00	2.91E+06	0.00E+00
PM-149	2.39E+00	2.54E-01	1.38E-01	0.00E+00	4.50E-01	0.00E+00	1.74E+04	0.00E+00
PM-151	2.63E-03	3.20E-04	2.08E-04	0.00E+00	5.43E-04	0.00E+00	3.63E+01	0.00E+00
SM-151	7.05E+05	1.05E+05	3.31E+04	0.00E+00	1.09E+05	0.00E+00	1.52E+07	0.00E+00
SM-153	5.32E-01	3.31E-01	3.19E-02	0.00E+00	1.01E-01	0.00E+00	4.40E+03	0.00E+00
EU-152	1.61E+06	2.93E+05	3.48E+05	0.00E+00	1.24E+06	0.00E+00	4.82E+07	0.00E+00
EU-154	5.99E+06	5.39E+05	4.92E+05	0.00E+00	2.37E+06	0.00E+00	1.25E+08	0.00E+00
EU-155	1.24E+06	8.92E+04	6.99E+04	0.00E+00	3.34E+05	0.00E+00	2.23E+08	0.00E+00
EU-156	1.71E+04	9.14E+03	1.89E+03	0.00E+00	5.89E+03	0.00E+00	2.07E+07	0.00E+00
TB-160	2.05E+05	0.00E+00	2.54E+04	0.00E+00	6.10E+04	0.00E+00	4.54E+07	0.00E+00
HO-166M	2.62E+06	5.49E+05	4.64E+05	0.00E+00	7.82E+05	0.00E+00	6.39E+07	0.00E+00
W-181	1.98E+04	4.86E+03	6.69E+02	0.00E+00	0.00E+00	0.00E+00	1.77E+05	0.00E+00
W-185	6.45E+05	1.61E+05	2.26E+04	0.00E+00	0.00E+00	0.00E+00	6.00E+06	0.00E+00
W-187	9.39E-03	5.56E-03	2.49E-03	0.00E+00	0.00E+00	0.00E+00	7.81E-01	0.00E+00
U-232	3.30E+09	0.00E+00	2.36E+08	0.00E+00	2.51E+08	0.00E+00	1.31E+07	0.00E+00
U-233	6.98E+08	0.00E+00	4.22E+07	0.00E+00	1.15E+08	0.00E+00	1.21E+07	0.00E+00
U-234	6.70E+08	0.00E+00	4.15E+07	0.00E+00	1.12E+08	0.00E+00	1.19E+07	0.00E+00
U-235	6.42E+08	0.00E+00	3.89E+07	0.00E+00	1.05E+08	0.00E+00	1.51E+07	0.00E+00
U-236	6.42E+08	0.00E+00	3.98E+07	0.00E+00	1.08E+08	0.00E+00	1.11E+07	0.00E+00

TABLE II2-16

R_i DOSE FACTORS AGE: CHILD PATHWAY: MEATm²-mrem/yr per μ Ci/sec

NUCLIDE	BONE	LIVER	T BODY	THYROID	KIDNEY	LUNG	GI-LLI	SKIN
U-237	9.99E+02	0.00E+00	2.65E+02	0.00E+00	2.88E+03	0.00E+00	8.80E+04	0.00E+00
U-238	6.14E+08	0.00E+00	3.64E+07	0.00E+00	9.84E+07	0.00E+00	1.06E+07	0.00E+00
NP-237	2.46E+08	1.62E+07	1.08E+07	0.00E+00	6.68E+07	0.00E+00	9.01E+06	0.00E+00
NP-238	6.51E-01	1.32E-02	1.01E-02	0.00E+00	4.20E-02	0.00E+00	4.51E+02	0.00E+00
NP-239	1.25E-01	8.95E-03	6.29E-03	0.00E+00	2.59E-02	0.00E+00	6.62E+02	0.00E+00
PU-238	9.18E+06	1.06E+06	2.44E+05	0.00E+00	8.87E+05	0.00E+00	5.79E+05	0.00E+00
PU-239	9.97E+06	1.07E+06	2.56E+05	0.00E+00	9.43E+05	0.00E+00	5.29E+05	0.00E+00
PU-240	9.89E+06	1.11E+06	2.56E+05	0.00E+00	9.43E+05	0.00E+00	5.40E+05	0.00E+00
PU-241	2.96E+05	1.21E+04	6.15E+03	0.00E+00	2.26E+04	0.00E+00	1.10E+04	0.00E+00
PU-242	9.20E+06	1.07E+06	2.47E+05	0.00E+00	9.04E+05	0.00E+00	5.19E+05	0.00E+00
PU-244	1.07E+07	1.22E+07	2.82E+05	0.00E+00	1.04E+06	0.00E+00	7.73E+05	0.00E+00
AM-241	1.50E+08	1.29E+08	1.13E+07	0.00E+00	6.88E+07	0.00E+00	8.43E+06	0.00E+00
AM-242M	1.54E+08	1.24E+08	1.15E+07	0.00E+00	6.95E+07	0.00E+00	1.06E+07	0.00E+00
AM-243	1.48E+08	1.25E+08	1.09E+07	0.00E+00	6.69E+07	0.00E+00	9.88E+06	0.00E+00
CM-242	7.01E+06	5.59E+06	4.66E+05	0.00E+00	1.49E+06	0.00E+00	6.51E+06	0.00E+00
CM-243	1.41E+08	1.14E+08	9.05E+06	0.00E+00	3.38E+07	0.00E+00	8.82E+06	0.00E+00
CM-244	1.18E+08	9.57E+07	7.59E+06	0.00E+00	2.78E+07	0.00E+00	8.51E+06	0.00E+00
CM-245	1.84E+08	1.48E+08	1.16E+07	0.00E+00	4.54E+07	0.00E+00	7.99E+06	0.00E+00
CM-246	1.82E+08	1.48E+08	1.16E+07	0.00E+00	4.53E+07	0.00E+00	7.85E+06	0.00E+00
CM-247	1.78E+08	1.46E+08	1.14E+07	0.00E+00	4.46E+07	0.00E+00	1.03E+07	0.00E+00
CM-248	1.48E+09	1.20E+09	9.41E+07	0.00E+00	3.68E+08	0.00E+00	1.67E+08	0.00E+00
CF-252	1.09E+08	0.00E+00	2.65E+06	0.00E+00	0.00E+00	0.00E+00	3.08E+07	0.00E+00

TABLE II-17

R_i DOSE FACTORS AGE: INFANT PATHWAY: MEATm²-mrem/yr per μCi/sec

NUCLIDE	BONE	LIVER	T BODY	THYROID	KIDNEY	LUNG	GI-LLI	SKIN
H-3	0.00E+00	0.00E+00	0.00E+00	0.00E+00	0.00E+00	0.00E+00	0.00E+00	0.00E+00
C-14	0.00E+00	0.00E+00	0.00E+00	0.00E+00	0.00E+00	0.00E+00	0.00E+00	0.00E+00
NA-22	0.00E+00	0.00E+00	0.00E+00	0.00E+00	0.00E+00	0.00E+00	0.00E+00	0.00E+00
NA-24	0.00E+00	0.00E+00	0.00E+00	0.00E+00	0.00E+00	0.00E+00	0.00E+00	0.00E+00
P-32	0.00E+00	0.00E+00	0.00E+00	0.00E+00	0.00E+00	0.00E+00	0.00E+00	0.00E+00
CA-41	0.00E+00	0.00E+00	0.00E+00	0.00E+00	0.00E+00	0.00E+00	0.00E+00	0.00E+00
SC-46	0.00E+00	0.00E+00	0.00E+00	0.00E+00	0.00E+00	0.00E+00	0.00E+00	0.00E+00
CR-51	0.00E+00	0.00E+00	0.00E+00	0.00E+00	0.00E+00	0.00E+00	0.00E+00	0.00E+00
MN-54	0.00E+00	0.00E+00	0.00E+00	0.00E+00	0.00E+00	0.00E+00	0.00E+00	0.00E+00
MN-56	0.00E+00	0.00E+00	0.00E+00	0.00E+00	0.00E+00	0.00E+00	0.00E+00	0.00E+00
FE-55	0.00E+00	0.00E+00	0.00E+00	0.00E+00	0.00E+00	0.00E+00	0.00E+00	0.00E+00
FE-59	0.00E+00	0.00E+00	0.00E+00	0.00E+00	0.00E+00	0.00E+00	0.00E+00	0.00E+00
CO-57	0.00E+00	0.00E+00	0.00E+00	0.00E+00	0.00E+00	0.00E+00	0.00E+00	0.00E+00
CO-58	0.00E+00	0.00E+00	0.00E+00	0.00E+00	0.00E+00	0.00E+00	0.00E+00	0.00E+00
CO-60	0.00E+00	0.00E+00	0.00E+00	0.00E+00	0.00E+00	0.00E+00	0.00E+00	0.00E+00
NI-59	0.00E+00	0.00E+00	0.00E+00	0.00E+00	0.00E+00	0.00E+00	0.00E+00	0.00E+00
NI-63	0.00E+00	0.00E+00	0.00E+00	0.00E+00	0.00E+00	0.00E+00	0.00E+00	0.00E+00
NI-65	0.00E+00	0.00E+00	0.00E+00	0.00E+00	0.00E+00	0.00E+00	0.00E+00	0.00E+00
CU-64	0.00E+00	0.00E+00	0.00E+00	0.00E+00	0.00E+00	0.00E+00	0.00E+00	0.00E+00
ZN-65	0.00E+00	0.00E+00	0.00E+00	0.00E+00	0.00E+00	0.00E+00	0.00E+00	0.00E+00
ZN-69M	0.00E+00	0.00E+00	0.00E+00	0.00E+00	0.00E+00	0.00E+00	0.00E+00	0.00E+00
ZN-69	0.00E+00	0.00E+00	0.00E+00	0.00E+00	0.00E+00	0.00E+00	0.00E+00	0.00E+00
SE-79	0.00E+00	0.00E+00	0.00E+00	0.00E+00	0.00E+00	0.00E+00	0.00E+00	0.00E+00
BR-82	0.00E+00	0.00E+00	0.00E+00	0.00E+00	0.00E+00	0.00E+00	0.00E+00	0.00E+00
BR-83	0.00E+00	0.00E+00	0.00E+00	0.00E+00	0.00E+00	0.00E+00	0.00E+00	0.00E+00
BR-84	0.00E+00	0.00E+00	0.00E+00	0.00E+00	0.00E+00	0.00E+00	0.00E+00	0.00E+00
BR-85	0.00E+00	0.00E+00	0.00E+00	0.00E+00	0.00E+00	0.00E+00	0.00E+00	0.00E+00
RB-86	0.00E+00	0.00E+00	0.00E+00	0.00E+00	0.00E+00	0.00E+00	0.00E+00	0.00E+00
RB-87	0.00E+00	0.00E+00	0.00E+00	0.00E+00	0.00E+00	0.00E+00	0.00E+00	0.00E+00
RB-88	0.00E+00	0.00E+00	0.00E+00	0.00E+00	0.00E+00	0.00E+00	0.00E+00	0.00E+00
RB-89	0.00E+00	0.00E+00	0.00E+00	0.00E+00	0.00E+00	0.00E+00	0.00E+00	0.00E+00
SR-89	0.00E+00	0.00E+00	0.00E+00	0.00E+00	0.00E+00	0.00E+00	0.00E+00	0.00E+00
SR-90	0.00E+00	0.00E+00	0.00E+00	0.00E+00	0.00E+00	0.00E+00	0.00E+00	0.00E+00
SR-91	0.00E+00	0.00E+00	0.00E+00	0.00E+00	0.00E+00	0.00E+00	0.00E+00	0.00E+00
SR-92	0.00E+00	0.00E+00	0.00E+00	0.00E+00	0.00E+00	0.00E+00	0.00E+00	0.00E+00
Y-90	0.00E+00	0.00E+00	0.00E+00	0.00E+00	0.00E+00	0.00E+00	0.00E+00	0.00E+00
Y-91M	0.00E+00	0.00E+00	0.00E+00	0.00E+00	0.00E+00	0.00E+00	0.00E+00	0.00E+00
Y-91	0.00E+00	0.00E+00	0.00E+00	0.00E+00	0.00E+00	0.00E+00	0.00E+00	0.00E+00
Y-92	0.00E+00	0.00E+00	0.00E+00	0.00E+00	0.00E+00	0.00E+00	0.00E+00	0.00E+00
Y-93	0.00E+00	0.00E+00	0.00E+00	0.00E+00	0.00E+00	0.00E+00	0.00E+00	0.00E+00
ZR-93	0.00E+00	0.00E+00	0.00E+00	0.00E+00	0.00E+00	0.00E+00	0.00E+00	0.00E+00
ZR-95	0.00E+00	0.00E+00	0.00E+00	0.00E+00	0.00E+00	0.00E+00	0.00E+00	0.00E+00
ZR-97	0.00E+00	0.00E+00	0.00E+00	0.00E+00	0.00E+00	0.00E+00	0.00E+00	0.00E+00
NB-93M	0.00E+00	0.00E+00	0.00E+00	0.00E+00	0.00E+00	0.00E+00	0.00E+00	0.00E+00
NB-95	0.00E+00	0.00E+00	0.00E+00	0.00E+00	0.00E+00	0.00E+00	0.00E+00	0.00E+00

TABLE II-17

R_i DOSE FACTORS AGE: INFANT PATHWAY: MEATm²-mrem/yr per μ Ci/sec

NUCLIDE	BONE	LIVER	T BODY	THYROID	KIDNEY	LUNG	GI-LLI	SKIN
NB-97	0.00E+00	0.00E+00	0.00E+00	0.00E+00	0.00E+00	0.00E+00	0.00E+00	0.00E+00
MO-93	0.00E+00	0.00E+00	0.00E+00	0.00E+00	0.00E+00	0.00E+00	0.00E+00	0.00E+00
MO-99	0.00E+00	0.00E+00	0.00E+00	0.00E+00	0.00E+00	0.00E+00	0.00E+00	0.00E+00
TC-99M	0.00E+00	0.00E+00	0.00E+00	0.00E+00	0.00E+00	0.00E+00	0.00E+00	0.00E+00
TC-99	0.00E+00	0.00E+00	0.00E+00	0.00E+00	0.00E+00	0.00E+00	0.00E+00	0.00E+00
TC-101	0.00E+00	0.00E+00	0.00E+00	0.00E+00	0.00E+00	0.00E+00	0.00E+00	0.00E+00
RU-103	0.00E+00	0.00E+00	0.00E+00	0.00E+00	0.00E+00	0.00E+00	0.00E+00	0.00E+00
RU-105	0.00E+00	0.00E+00	0.00E+00	0.00E+00	0.00E+00	0.00E+00	0.00E+00	0.00E+00
RU-106	0.00E+00	0.00E+00	0.00E+00	0.00E+00	0.00E+00	0.00E+00	0.00E+00	0.00E+00
RH-105	0.00E+00	0.00E+00	0.00E+00	0.00E+00	0.00E+00	0.00E+00	0.00E+00	0.00E+00
PD-107	0.00E+00	0.00E+00	0.00E+00	0.00E+00	0.00E+00	0.00E+00	0.00E+00	0.00E+00
PD-109	0.00E+00	0.00E+00	0.00E+00	0.00E+00	0.00E+00	0.00E+00	0.00E+00	0.00E+00
AG-110M	0.00E+00	0.00E+00	0.00E+00	0.00E+00	0.00E+00	0.00E+00	0.00E+00	0.00E+00
AG-111	0.00E+00	0.00E+00	0.00E+00	0.00E+00	0.00E+00	0.00E+00	0.00E+00	0.00E+00
CD-113M	0.00E+00	0.00E+00	0.00E+00	0.00E+00	0.00E+00	0.00E+00	0.00E+00	0.00E+00
CD-115M	0.00E+00	0.00E+00	0.00E+00	0.00E+00	0.00E+00	0.00E+00	0.00E+00	0.00E+00
SN-123	0.00E+00	0.00E+00	0.00E+00	0.00E+00	0.00E+00	0.00E+00	0.00E+00	0.00E+00
SN-125	0.00E+00	0.00E+00	0.00E+00	0.00E+00	0.00E+00	0.00E+00	0.00E+00	0.00E+00
SN-126	0.00E+00	0.00E+00	0.00E+00	0.00E+00	0.00E+00	0.00E+00	0.00E+00	0.00E+00
SB-124	0.00E+00	0.00E+00	0.00E+00	0.00E+00	0.00E+00	0.00E+00	0.00E+00	0.00E+00
SB-125	0.00E+00	0.00E+00	0.00E+00	0.00E+00	0.00E+00	0.00E+00	0.00E+00	0.00E+00
SB-126	0.00E+00	0.00E+00	0.00E+00	0.00E+00	0.00E+00	0.00E+00	0.00E+00	0.00E+00
SB-127	0.00E+00	0.00E+00	0.00E+00	0.00E+00	0.00E+00	0.00E+00	0.00E+00	0.00E+00
TE-125M	0.00E+00	0.00E+00	0.00E+00	0.00E+00	0.00E+00	0.00E+00	0.00E+00	0.00E+00
TE-127M	0.00E+00	0.00E+00	0.00E+00	0.00E+00	0.00E+00	0.00E+00	0.00E+00	0.00E+00
TE-127	0.00E+00	0.00E+00	0.00E+00	0.00E+00	0.00E+00	0.00E+00	0.00E+00	0.00E+00
TE-129M	0.00E+00	0.00E+00	0.00E+00	0.00E+00	0.00E+00	0.00E+00	0.00E+00	0.00E+00
TE-129	0.00E+00	0.00E+00	0.00E+00	0.00E+00	0.00E+00	0.00E+00	0.00E+00	0.00E+00
TE-131M	0.00E+00	0.00E+00	0.00E+00	0.00E+00	0.00E+00	0.00E+00	0.00E+00	0.00E+00
TE-131	0.00E+00	0.00E+00	0.00E+00	0.00E+00	0.00E+00	0.00E+00	0.00E+00	0.00E+00
TE-132	0.00E+00	0.00E+00	0.00E+00	0.00E+00	0.00E+00	0.00E+00	0.00E+00	0.00E+00
TE-133M	0.00E+00	0.00E+00	0.00E+00	0.00E+00	0.00E+00	0.00E+00	0.00E+00	0.00E+00
TE-134	0.00E+00	0.00E+00	0.00E+00	0.00E+00	0.00E+00	0.00E+00	0.00E+00	0.00E+00
I-129	0.00E+00	0.00E+00	0.00E+00	0.00E+00	0.00E+00	0.00E+00	0.00E+00	0.00E+00
I-130	0.00E+00	0.00E+00	0.00E+00	0.00E+00	0.00E+00	0.00E+00	0.00E+00	0.00E+00
I-131	0.00E+00	0.00E+00	0.00E+00	0.00E+00	0.00E+00	0.00E+00	0.00E+00	0.00E+00
I-132	0.00E+00	0.00E+00	0.00E+00	0.00E+00	0.00E+00	0.00E+00	0.00E+00	0.00E+00
I-133	0.00E+00	0.00E+00	0.00E+00	0.00E+00	0.00E+00	0.00E+00	0.00E+00	0.00E+00
I-134	0.00E+00	0.00E+00	0.00E+00	0.00E+00	0.00E+00	0.00E+00	0.00E+00	0.00E+00
I-135	0.00E+00	0.00E+00	0.00E+00	0.00E+00	0.00E+00	0.00E+00	0.00E+00	0.00E+00
CS-134M	0.00E+00	0.00E+00	0.00E+00	0.00E+00	0.00E+00	0.00E+00	0.00E+00	0.00E+00
CS-134	0.00E+00	0.00E+00	0.00E+00	0.00E+00	0.00E+00	0.00E+00	0.00E+00	0.00E+00
CS-135	0.00E+00	0.00E+00	0.00E+00	0.00E+00	0.00E+00	0.00E+00	0.00E+00	0.00E+00
CS-136	0.00E+00	0.00E+00	0.00E+00	0.00E+00	0.00E+00	0.00E+00	0.00E+00	0.00E+00
CS-137	0.00E+00	0.00E+00	0.00E+00	0.00E+00	0.00E+00	0.00E+00	0.00E+00	0.00E+00

TABLE II-17

R_i DOSE FACTORS AGE: INFANT PATHWAY: MEATm²-mrem/yr per μCi/sec

NUCLIDE	BONE	LIVER	T BODY	THYROID	KIDNEY	LUNG	GI-LLI	SKIN
CS-138	0.00E+00	0.00E+00	0.00E+00	0.00E+00	0.00E+00	0.00E+00	0.00E+00	0.00E+00
CS-139	0.00E+00	0.00E+00	0.00E+00	0.00E+00	0.00E+00	0.00E+00	0.00E+00	0.00E+00
BA-139	0.00E+00	0.00E+00	0.00E+00	0.00E+00	0.00E+00	0.00E+00	0.00E+00	0.00E+00
BA-140	0.00E+00	0.00E+00	0.00E+00	0.00E+00	0.00E+00	0.00E+00	0.00E+00	0.00E+00
BA-141	0.00E+00	0.00E+00	0.00E+00	0.00E+00	0.00E+00	0.00E+00	0.00E+00	0.00E+00
BA-142	0.00E+00	0.00E+00	0.00E+00	0.00E+00	0.00E+00	0.00E+00	0.00E+00	0.00E+00
LA-140	0.00E+00	0.00E+00	0.00E+00	0.00E+00	0.00E+00	0.00E+00	0.00E+00	0.00E+00
LA-141	0.00E+00	0.00E+00	0.00E+00	0.00E+00	0.00E+00	0.00E+00	0.00E+00	0.00E+00
LA-142	0.00E+00	0.00E+00	0.00E+00	0.00E+00	0.00E+00	0.00E+00	0.00E+00	0.00E+00
CE-141	0.00E+00	0.00E+00	0.00E+00	0.00E+00	0.00E+00	0.00E+00	0.00E+00	0.00E+00
CE-143	0.00E+00	0.00E+00	0.00E+00	0.00E+00	0.00E+00	0.00E+00	0.00E+00	0.00E+00
PR-143	0.00E+00	0.00E+00	0.00E+00	0.00E+00	0.00E+00	0.00E+00	0.00E+00	0.00E+00
CE-144	0.00E+00	0.00E+00	0.00E+00	0.00E+00	0.00E+00	0.00E+00	0.00E+00	0.00E+00
PR-144	0.00E+00	0.00E+00	0.00E+00	0.00E+00	0.00E+00	0.00E+00	0.00E+00	0.00E+00
ND-147	0.00E+00	0.00E+00	0.00E+00	0.00E+00	0.00E+00	0.00E+00	0.00E+00	0.00E+00
PM-147	0.00E+00	0.00E+00	0.00E+00	0.00E+00	0.00E+00	0.00E+00	0.00E+00	0.00E+00
PM-148M	0.00E+00	0.00E+00	0.00E+00	0.00E+00	0.00E+00	0.00E+00	0.00E+00	0.00E+00
PM-148	0.00E+00	0.00E+00	0.00E+00	0.00E+00	0.00E+00	0.00E+00	0.00E+00	0.00E+00
PM-149	0.00E+00	0.00E+00	0.00E+00	0.00E+00	0.00E+00	0.00E+00	0.00E+00	0.00E+00
PM-151	0.00E+00	0.00E+00	0.00E+00	0.00E+00	0.00E+00	0.00E+00	0.00E+00	0.00E+00
SM-151	0.00E+00	0.00E+00	0.00E+00	0.00E+00	0.00E+00	0.00E+00	0.00E+00	0.00E+00
SM-153	0.00E+00	0.00E+00	0.00E+00	0.00E+00	0.00E+00	0.00E+00	0.00E+00	0.00E+00
EU-152	0.00E+00	0.00E+00	0.00E+00	0.00E+00	0.00E+00	0.00E+00	0.00E+00	0.00E+00
EU-154	0.00E+00	0.00E+00	0.00E+00	0.00E+00	0.00E+00	0.00E+00	0.00E+00	0.00E+00
EU-155	0.00E+00	0.00E+00	0.00E+00	0.00E+00	0.00E+00	0.00E+00	0.00E+00	0.00E+00
EU-156	0.00E+00	0.00E+00	0.00E+00	0.00E+00	0.00E+00	0.00E+00	0.00E+00	0.00E+00
TB-160	0.00E+00	0.00E+00	0.00E+00	0.00E+00	0.00E+00	0.00E+00	0.00E+00	0.00E+00
HO-166M	0.00E+00	0.00E+00	0.00E+00	0.00E+00	0.00E+00	0.00E+00	0.00E+00	0.00E+00
W-181	0.00E+00	0.00E+00	0.00E+00	0.00E+00	0.00E+00	0.00E+00	0.00E+00	0.00E+00
W-185	0.00E+00	0.00E+00	0.00E+00	0.00E+00	0.00E+00	0.00E+00	0.00E+00	0.00E+00
W-187	0.00E+00	0.00E+00	0.00E+00	0.00E+00	0.00E+00	0.00E+00	0.00E+00	0.00E+00
U-232	0.00E+00	0.00E+00	0.00E+00	0.00E+00	0.00E+00	0.00E+00	0.00E+00	0.00E+00
U-233	0.00E+00	0.00E+00	0.00E+00	0.00E+00	0.00E+00	0.00E+00	0.00E+00	0.00E+00
U-234	0.00E+00	0.00E+00	0.00E+00	0.00E+00	0.00E+00	0.00E+00	0.00E+00	0.00E+00
U-235	0.00E+00	0.00E+00	0.00E+00	0.00E+00	0.00E+00	0.00E+00	0.00E+00	0.00E+00
U-236	0.00E+00	0.00E+00	0.00E+00	0.00E+00	0.00E+00	0.00E+00	0.00E+00	0.00E+00
U-237	0.00E+00	0.00E+00	0.00E+00	0.00E+00	0.00E+00	0.00E+00	0.00E+00	0.00E+00
U-238	0.00E+00	0.00E+00	0.00E+00	0.00E+00	0.00E+00	0.00E+00	0.00E+00	0.00E+00
NP-237	0.00E+00	0.00E+00	0.00E+00	0.00E+00	0.00E+00	0.00E+00	0.00E+00	0.00E+00
NP-238	0.00E+00	0.00E+00	0.00E+00	0.00E+00	0.00E+00	0.00E+00	0.00E+00	0.00E+00
NP-239	0.00E+00	0.00E+00	0.00E+00	0.00E+00	0.00E+00	0.00E+00	0.00E+00	0.00E+00
PU-238	0.00E+00	0.00E+00	0.00E+00	0.00E+00	0.00E+00	0.00E+00	0.00E+00	0.00E+00
PU-239	0.00E+00	0.00E+00	0.00E+00	0.00E+00	0.00E+00	0.00E+00	0.00E+00	0.00E+00
PU-240	0.00E+00	0.00E+00	0.00E+00	0.00E+00	0.00E+00	0.00E+00	0.00E+00	0.00E+00
PU-241	0.00E+00	0.00E+00	0.00E+00	0.00E+00	0.00E+00	0.00E+00	0.00E+00	0.00E+00

TABLE II2-17

R_i DOSE FACTORS AGE: INFANT PATHWAY: MEATm²-mrem/yr per μ Ci/sec

NUCLIDE	BONE	LIVER	T BODY	THYROID	KIDNEY	LUNG	GI-LLI	SKIN
PU-242	0.00E+00	0.00E+00	0.00E+00	0.00E+00	0.00E+00	0.00E+00	0.00E+00	0.00E+00
PU-244	0.00E+00	0.00E+00	0.00E+00	0.00E+00	0.00E+00	0.00E+00	0.00E+00	0.00E+00
AM-241	0.00E+00	0.00E+00	0.00E+00	0.00E+00	0.00E+00	0.00E+00	0.00E+00	0.00E+00
AM-242M	0.00E+00	0.00E+00	0.00E+00	0.00E+00	0.00E+00	0.00E+00	0.00E+00	0.00E+00
AM-243	0.00E+00	0.00E+00	0.00E+00	0.00E+00	0.00E+00	0.00E+00	0.00E+00	0.00E+00
CM-242	0.00E+00	0.00E+00	0.00E+00	0.00E+00	0.00E+00	0.00E+00	0.00E+00	0.00E+00
CM-243	0.00E+00	0.00E+00	0.00E+00	0.00E+00	0.00E+00	0.00E+00	0.00E+00	0.00E+00
CM-244	0.00E+00	0.00E+00	0.00E+00	0.00E+00	0.00E+00	0.00E+00	0.00E+00	0.00E+00
CM-245	0.00E+00	0.00E+00	0.00E+00	0.00E+00	0.00E+00	0.00E+00	0.00E+00	0.00E+00
CM-246	0.00E+00	0.00E+00	0.00E+00	0.00E+00	0.00E+00	0.00E+00	0.00E+00	0.00E+00
CM-247	0.00E+00	0.00E+00	0.00E+00	0.00E+00	0.00E+00	0.00E+00	0.00E+00	0.00E+00
CM-248	0.00E+00	0.00E+00	0.00E+00	0.00E+00	0.00E+00	0.00E+00	0.00E+00	0.00E+00
CF-252	0.00E+00	0.00E+00	0.00E+00	0.00E+00	0.00E+00	0.00E+00	0.00E+00	0.00E+00

TABLE I12-18

R_i DOSE FACTORS AGE: ADULT PATHWAY: COW MILKm²-mrem/yr per μ Ci/sec

NUCLIDE	BONE	LIVER	T BODY	THYROID	KIDNEY	LUNG	GI-LLI	SKIN
H-3	0.00E+00	4.35E+02	4.35E+02	4.35E+02	4.35E+02	4.35E+02	4.35E+02	0.00E+00
C-14	3.63E+05	7.26E+04	7.26E+04	7.26E+04	7.26E+04	7.26E+04	7.26E+04	0.00E+00
NA-22	2.78E+09	2.78E+09	2.78E+09	2.78E+09	2.78E+09	2.78E+09	2.78E+09	0.00E+00
NA-24	7.13E+05	7.13E+05	7.13E+05	7.13E+05	7.13E+05	7.13E+05	7.13E+05	0.00E+00
P-32	5.05E+09	3.14E+08	1.95E+08	0.00E+00	0.00E+00	0.00E+00	5.68E+08	0.00E+00
CA-41	6.18E+09	0.00E+00	6.68E+08	0.00E+00	0.00E+00	0.00E+00	6.14E+06	0.00E+00
SC-46	7.36E+01	1.43E+02	4.15E+01	0.00E+00	1.33E+02	0.00E+00	6.96E+05	0.00E+00
CR-51	0.00E+00	0.00E+00	9.10E+03	5.44E+03	2.01E+03	1.21E+04	2.29E+06	0.00E+00
MN-54	0.00E+00	4.17E+06	7.95E+05	0.00E+00	1.24E+06	0.00E+00	1.28E+07	0.00E+00
MN-56	0.00E+00	1.21E-03	2.15E-04	0.00E+00	1.54E-03	0.00E+00	3.87E-02	0.00E+00
FE-55	1.32E+07	9.11E+06	2.12E+06	0.00E+00	0.00E+00	5.08E+06	5.23E+06	0.00E+00
FE-59	1.05E+07	2.47E+07	9.46E+06	0.00E+00	0.00E+00	6.90E+06	8.23E+07	0.00E+00
CO-57	0.00E+00	6.26E+05	1.04E+06	0.00E+00	0.00E+00	0.00E+00	1.59E+07	0.00E+00
CO-58	0.00E+00	1.86E+06	4.17E+06	0.00E+00	0.00E+00	0.00E+00	3.77E+07	0.00E+00
CO-60	0.00E+00	8.73E+06	1.93E+07	0.00E+00	0.00E+00	0.00E+00	1.64E+08	0.00E+00
NI-59	2.73E+08	9.37E+07	4.56E+07	0.00E+00	0.00E+00	0.00E+00	1.93E+07	0.00E+00
NI-63	3.63E+09	2.52E+08	1.22E+08	0.00E+00	0.00E+00	0.00E+00	5.25E+07	0.00E+00
NI-65	1.08E-01	1.41E-02	6.41E-03	0.00E+00	0.00E+00	0.00E+00	3.57E-01	0.00E+00
CU-64	0.00E+00	6.97E+03	3.27E+03	0.00E+00	1.76E+04	0.00E+00	5.94E+05	0.00E+00
ZN-65	6.64E+08	2.11E+09	9.56E+08	0.00E+00	1.41E+09	0.00E+00	1.33E+09	0.00E+00
ZN-69M	5.23E+04	1.26E+05	1.15E+04	0.00E+00	7.60E+04	0.00E+00	7.67E+06	0.00E+00
ZN-69	6.12E-13	1.17E-12	8.14E-14	0.00E+00	7.60E-13	0.00E+00	1.76E-13	0.00E+00
SE-79	0.00E+00	4.94E+08	8.25E+07	0.00E+00	8.55E+08	0.00E+00	1.01E+08	0.00E+00
BR-82	0.00E+00	0.00E+00	9.45E+06	0.00E+00	0.00E+00	0.00E+00	1.08E+07	0.00E+00
BR-83	0.00E+00	0.00E+00	2.84E-02	0.00E+00	0.00E+00	0.00E+00	4.09E-02	0.00E+00
BR-84	0.00E+00	0.00E+00	4.71E-24	0.00E+00	0.00E+00	0.00E+00	3.69E-29	0.00E+00
BR-85	0.00E+00	0.00E+00	0.00E+00	0.00E+00	0.00E+00	0.00E+00	0.00E+00	0.00E+00
RB-86	0.00E+00	7.82E+08	3.64E+08	0.00E+00	0.00E+00	0.00E+00	1.54E+08	0.00E+00
RB-87	0.00E+00	1.54E+09	5.36E+08	0.00E+00	0.00E+00	0.00E+00	7.21E+07	0.00E+00
RB-88	0.00E+00	6.26E-46	3.32E-46	0.00E+00	0.00E+00	0.00E+00	8.64E-57	0.00E+00
RB-89	0.00E+00	1.27E-53	8.91E-54	0.00E+00	0.00E+00	0.00E+00	7.36E-67	0.00E+00
SR-89	5.29E+08	0.00E+00	1.52E+07	0.00E+00	0.00E+00	0.00E+00	8.48E+07	0.00E+00
SR-90	2.90E+10	0.00E+00	5.82E+08	0.00E+00	0.00E+00	0.00E+00	7.28E+08	0.00E+00
SR-91	8.46E+03	0.00E+00	3.42E+02	0.00E+00	0.00E+00	0.00E+00	4.03E+04	0.00E+00
SR-92	1.43E-01	0.00E+00	6.18E-03	0.00E+00	0.00E+00	0.00E+00	2.83E+00	0.00E+00
Y-90	2.07E+01	0.00E+00	5.56E-01	0.00E+00	0.00E+00	0.00E+00	2.20E+05	0.00E+00
Y-91M	1.75E-20	0.00E+00	6.78E-22	0.00E+00	0.00E+00	0.00E+00	5.14E-20	0.00E+00
Y-91	3.24E+03	0.00E+00	8.67E+01	0.00E+00	0.00E+00	0.00E+00	1.79E+06	0.00E+00
Y-92	1.63E-05	0.00E+00	4.77E-07	0.00E+00	0.00E+00	0.00E+00	2.86E-01	0.00E+00
Y-93	6.53E-02	0.00E+00	1.80E-03	0.00E+00	0.00E+00	0.00E+00	2.07E+03	0.00E+00
ZR-93	8.72E+02	4.88E+01	2.28E+01	0.00E+00	1.85E+02	0.00E+00	5.07E+04	0.00E+00
ZR-95	3.64E+02	1.17E+02	7.90E+01	0.00E+00	1.83E+02	0.00E+00	3.70E+05	0.00E+00

TABLE I12-18

R_i DOSE FACTORS AGE: ADULT PATHWAY: COW MILKm²-mrem/yr per μCi/sec

NUCLIDE	BONE	LIVER	T BODY	THYROID	KIDNEY	LUNG	GI-LLI	SKIN
ZR-97	1.27E-01	2.56E-02	1.17E-02	0.00E+00	3.86E-02	0.00E+00	7.92E+03	0.00E+00
NB-93M	2.64E+05	8.61E+04	2.12E+04	0.00E+00	9.91E+04	0.00E+00	3.97E+07	0.00E+00
NB-95	2.76E+04	1.53E+04	8.25E+03	0.00E+00	1.52E+04	0.00E+00	9.32E+07	0.00E+00
NB-97	9.62E-13	2.43E-13	8.89E-14	0.00E+00	2.84E-13	0.00E+00	8.98E-10	0.00E+00
MO-93	0.00E+00	2.35E+08	6.36E+06	0.00E+00	6.67E+07	0.00E+00	3.82E+07	0.00E+00
MO-99	0.00E+00	7.25E+06	1.38E+06	0.00E+00	1.64E+07	0.00E+00	1.68E+07	0.00E+00
TC-99M	9.71E-01	2.74E+00	3.50E+01	0.00E+00	4.17E+01	1.34E+00	1.62E+03	0.00E+00
TC-99	1.30E+07	1.94E+07	5.24E+06	0.00E+00	2.44E+08	1.65E+06	6.35E+08	0.00E+00
TC-101	7.58E-61	1.09E-60	1.07E-59	0.00E+00	1.97E-59	5.58E-61	3.28E-72	0.00E+00
RU-103	3.49E+02	0.00E+00	1.51E+02	0.00E+00	1.33E+03	0.00E+00	4.08E+04	0.00E+00
RU-105	2.51E-04	0.00E+00	9.89E-05	0.00E+00	3.24E-03	0.00E+00	1.53E-01	0.00E+00
RU-106	1.02E+04	0.00E+00	1.29E+03	0.00E+00	1.98E+04	0.00E+00	6.62E+05	0.00E+00
RH-105	1.02E+05	7.43E+04	4.89E+04	0.00E+00	3.16E+05	0.00E+00	1.18E+07	0.00E+00
PD-107	0.00E+00	6.14E+06	3.92E+05	0.00E+00	5.51E+07	0.00E+00	3.80E+07	0.00E+00
PD-109	0.00E+00	1.30E+04	2.92E+03	0.00E+00	7.39E+04	0.00E+00	1.43E+06	0.00E+00
AG-110M	2.83E+07	2.61E+07	1.55E+07	0.00E+00	5.14E+07	0.00E+00	1.07E+10	0.00E+00
AG-111	1.90E+06	7.93E+05	3.95E+05	0.00E+00	2.56E+06	0.00E+00	1.46E+09	0.00E+00
CD-113M	0.00E+00	1.58E+06	5.06E+04	0.00E+00	1.74E+06	0.00E+00	1.27E+07	0.00E+00
CD-115M	0.00E+00	4.45E+05	1.42E+04	0.00E+00	3.53E+05	0.00E+00	1.87E+07	0.00E+00
SN-123	2.39E+08	3.95E+06	5.83E+06	3.36E+06	0.00E+00	0.00E+00	4.86E+08	0.00E+00
SN-125	1.66E+07	3.36E+05	7.55E+05	2.78E+05	0.00E+00	0.00E+00	2.08E+08	0.00E+00
SN-126	8.82E+08	1.74E+07	2.50E+07	5.13E+06	0.00E+00	0.00E+00	2.54E+08	0.00E+00
SB-124	9.79E+06	1.85E+05	3.88E+06	2.37E+04	0.00E+00	7.62E+06	2.78E+08	0.00E+00
SB-125	1.07E+07	1.20E+05	2.56E+06	1.09E+04	0.00E+00	8.28E+06	1.18E+08	0.00E+00
SB-126	1.65E+06	3.35E+04	5.94E+05	1.01E+04	0.00E+00	1.01E+06	1.35E+08	0.00E+00
SB-127	1.32E+05	2.88E+03	5.05E+04	1.58E+03	0.00E+00	7.80E+04	3.01E+07	0.00E+00
TE-125M	6.14E+06	2.22E+06	8.23E+05	1.85E+06	2.50E+07	0.00E+00	2.45E+07	0.00E+00
TE-127M	1.98E+07	7.07E+06	2.41E+06	5.06E+06	8.04E+07	0.00E+00	6.63E+07	0.00E+00
TE-127	1.91E+02	6.86E+01	4.13E+01	1.41E+02	7.78E+02	0.00E+00	1.51E+04	0.00E+00
TE-129M	1.99E+07	7.44E+06	3.15E+06	6.85E+06	8.32E+07	0.00E+00	1.00E+08	0.00E+00
TE-129	8.26E-11	3.10E-11	2.01E-11	6.34E-11	3.47E-10	0.00E+00	6.23E-11	0.00E+00
TE-131M	1.06E+05	5.16E+04	4.30E+04	8.18E+04	5.23E+05	0.00E+00	5.13E+06	0.00E+00
TE-131	1.05E-33	4.40E-34	3.33E-34	8.67E-34	4.62E-33	0.00E+00	1.49E-34	0.00E+00
TE-132	7.02E+05	4.54E+05	4.26E+05	5.02E+05	4.38E+06	0.00E+00	2.15E+07	0.00E+00
TE-133M	6.16E-14	3.60E-14	3.46E-14	5.21E-14	3.56E-13	0.00E+00	1.23E-14	0.00E+00
TE-134	2.60E-19	1.70E-19	1.04E-19	2.27E-19	1.65E-18	0.00E+00	2.89E-22	0.00E+00
I-129	4.10E+08	3.52E+08	1.15E+09	9.05E+11	7.56E+08	0.00E+00	5.56E+07	0.00E+00
I-130	1.23E+05	3.62E+05	1.43E+05	3.07E+07	5.66E+05	0.00E+00	3.12E+05	0.00E+00
I-131	8.66E+07	1.24E+08	7.10E+07	4.06E+10	2.12E+08	0.00E+00	3.27E+07	0.00E+00
I-132	4.80E-02	1.29E-01	4.50E-02	4.50E+00	2.05E-01	0.00E+00	2.41E-02	0.00E+00
I-133	1.13E+06	1.97E+06	6.00E+05	2.89E+08	3.44E+06	0.00E+00	1.77E+06	0.00E+00
I-134	5.90E-13	1.60E-12	5.73E-13	2.78E-11	2.55E-12	0.00E+00	1.40E-15	0.00E+00

TABLE I12-18

R_i DOSE FACTORS AGE: ADULT PATHWAY: COW MILKm²-mrem/yr per μ Ci/sec

NUCLIDE	BONE	LIVER	T BODY	THYROID	KIDNEY	LUNG	GI-LLI	SKIN
I-135	3.75E+03	9.83E+03	3.63E+03	6.48E+05	1.58E+04	0.00E+00	1.11E+04	0.00E+00
CS-134M	5.08E-02	1.07E-01	5.46E-02	0.00E+00	5.79E-02	9.13E-03	3.77E-02	0.00E+00
CS-134	2.94E+09	7.00E+09	5.72E+09	0.00E+00	2.27E+09	7.52E+08	1.23E+08	0.00E+00
CS-135	9.77E+08	9.02E+08	4.00E+08	0.00E+00	3.41E+08	1.02E+08	2.11E+07	0.00E+00
CS-136	7.76E+07	3.06E+08	2.20E+08	0.00E+00	1.70E+08	2.34E+07	3.48E+07	0.00E+00
CS-137	3.98E+09	5.44E+09	3.56E+09	0.00E+00	1.85E+09	6.14E+08	1.05E+08	0.00E+00
CS-138	2.64E-24	5.22E-24	2.59E-24	0.00E+00	3.84E-24	3.79E-25	2.23E-29	0.00E+00
CS-139	1.98E-90	2.95E-90	1.08E-90	0.00E+00	2.37E-90	2.15E-91	6.40E-113	0.00E+00
BA-139	1.29E-08	9.21E-12	3.78E-10	0.00E+00	8.61E-12	5.22E-12	2.29E-08	0.00E+00
BA-140	7.91E+06	9.94E+03	5.18E+05	0.00E+00	3.38E+03	5.69E+03	1.63E+07	0.00E+00
BA-141	1.20E-46	9.05E-50	4.04E-48	0.00E+00	8.41E-50	5.14E-50	5.64E-56	0.00E+00
BA-142	7.77E-81	7.99E-84	4.89E-82	0.00E+00	6.75E-84	4.53E-84	1.09E-98	0.00E+00
LA-140	1.32E+00	6.65E-01	1.76E-01	0.00E+00	0.00E+00	0.00E+00	4.88E+04	0.00E+00
LA-141	8.90E-06	2.76E-06	4.52E-07	0.00E+00	0.00E+00	0.00E+00	3.29E-01	0.00E+00
LA-142	5.43E-12	2.47E-12	6.16E-13	0.00E+00	0.00E+00	0.00E+00	1.80E-08	0.00E+00
CE-141	1.59E+03	1.08E+03	1.22E+02	0.00E+00	5.00E+02	0.00E+00	4.12E+06	0.00E+00
CE-143	1.22E+01	8.99E+03	9.95E-01	0.00E+00	3.96E+00	0.00E+00	3.36E+05	0.00E+00
CE-144	1.76E+05	7.35E+04	9.44E+03	0.00E+00	4.36E+04	0.00E+00	5.94E+07	0.00E+00
PR-143	4.66E+01	1.87E+01	2.31E+00	0.00E+00	1.08E+01	0.00E+00	2.04E+05	0.00E+00
PR-144	1.72E-54	7.13E-55	8.73E-56	0.00E+00	4.02E-55	0.00E+00	2.47E-61	0.00E+00
ND-147	2.76E+01	3.19E+01	1.91E+00	0.00E+00	1.87E+01	0.00E+00	1.53E+05	0.00E+00
PM-147	1.50E+03	1.41E+02	5.73E+01	0.00E+00	2.67E+02	0.00E+00	1.78E+05	0.00E+00
PM-148M	2.97E+02	7.70E+01	5.89E+01	0.00E+00	1.16E+02	0.00E+00	6.53E+05	0.00E+00
PM-148	1.74E+01	2.88E+00	1.45E+00	0.00E+00	5.44E+00	0.00E+00	2.26E+05	0.00E+00
PM-149	1.25E+00	1.77E-01	7.23E-02	0.00E+00	3.34E-01	0.00E+00	3.32E+04	0.00E+00
PM-151	1.90E-01	3.19E-02	1.61E-02	0.00E+00	5.70E-02	0.00E+00	8.78E+03	0.00E+00
SM-151	1.44E+03	2.48E+02	5.94E+01	0.00E+00	2.77E+02	0.00E+00	1.09E+05	0.00E+00
SM-153	5.79E-01	4.83E-01	3.53E-02	0.00E+00	1.56E-01	0.00E+00	1.72E+04	0.00E+00
EU-152	4.03E+03	9.19E+02	8.07E+02	0.00E+00	5.69E+03	0.00E+00	5.30E+05	0.00E+00
EU-154	1.27E+04	1.56E+03	1.11E+03	0.00E+00	7.45E+03	0.00E+00	1.13E+06	0.00E+00
EU-155	1.75E+03	2.49E+02	1.60E+02	0.00E+00	1.15E+03	0.00E+00	1.96E+05	0.00E+00
EU-156	7.46E+01	5.77E+01	9.31E+00	0.00E+00	3.85E+01	0.00E+00	3.95E+05	0.00E+00
TB-160	5.93E+02	0.00E+00	7.39E+01	0.00E+00	2.45E+02	0.00E+00	5.46E+05	0.00E+00
HO-166M	5.63E+03	1.76E+03	1.34E+03	0.00E+00	2.63E+03	0.00E+00	5.34E+05	0.00E+00
W-181	1.49E+04	4.87E+03	5.22E+02	0.00E+00	0.00E+00	0.00E+00	5.55E+05	0.00E+00
W-185	5.18E+05	1.73E+05	1.82E+04	0.00E+00	0.00E+00	0.00E+00	2.00E+07	0.00E+00
W-187	1.91E+03	1.59E+03	5.57E+02	0.00E+00	0.00E+00	0.00E+00	5.22E+05	0.00E+00
U-232	8.61E+09	0.00E+00	6.15E+08	0.00E+00	9.31E+08	0.00E+00	1.41E+08	0.00E+00
U-233	1.82E+09	0.00E+00	1.10E+08	0.00E+00	4.24E+08	0.00E+00	1.31E+08	0.00E+00
U-234	1.74E+09	0.00E+00	1.08E+08	0.00E+00	4.15E+08	0.00E+00	1.28E+08	0.00E+00
U-235	1.67E+09	0.00E+00	1.01E+08	0.00E+00	3.90E+08	0.00E+00	1.63E+08	0.00E+00
U-236	1.67E+09	0.00E+00	1.04E+08	0.00E+00	3.99E+08	0.00E+00	1.20E+08	0.00E+00

TABLE II2-18

R_i DOSE FACTORS AGE: ADULT PATHWAY: COW MILKm²-mrem/yr per μCi/sec

NUCLIDE	BONE	LIVER	T BODY	THYROID	KIDNEY	LUNG	GI-LLI	SKIN
U-237	1.65E+04	0.00E+00	4.40E+03	0.00E+00	6.80E+04	0.00E+00	5.81E+06	0.00E+00
U-238	1.60E+09	0.00E+00	9.48E+07	0.00E+00	3.65E+08	0.00E+00	1.15E+08	0.00E+00
NP-237	2.63E+07	1.87E+06	1.16E+06	0.00E+00	8.60E+06	0.00E+00	1.66E+06	0.00E+00
NP-238	1.06E+01	2.84E-01	1.64E-01	0.00E+00	9.63E-01	0.00E+00	2.64E+04	0.00E+00
NP-239	1.07E+00	1.06E-01	5.82E-02	0.00E+00	3.30E-01	0.00E+00	2.17E+04	0.00E+00
PU-238	5.25E+06	6.65E+05	1.43E+05	0.00E+00	6.10E+05	0.00E+00	6.09E+05	0.00E+00
PU-239	6.05E+06	7.27E+05	1.59E+05	0.00E+00	6.77E+05	0.00E+00	5.56E+05	0.00E+00
PU-240	6.04E+06	7.26E+05	1.59E+05	0.00E+00	6.76E+05	0.00E+00	5.66E+05	0.00E+00
PU-241	1.30E+05	6.17E+03	2.75E+03	0.00E+00	1.27E+04	0.00E+00	1.16E+04	0.00E+00
PU-242	5.61E+06	7.00E+05	1.54E+05	0.00E+00	6.52E+05	0.00E+00	5.45E+05	0.00E+00
PU-244	6.55E+06	8.02E+05	1.76E+05	0.00E+00	7.47E+05	0.00E+00	8.12E+05	0.00E+00
AM-241	1.58E+07	1.47E+07	1.13E+06	0.00E+00	8.49E+06	0.00E+00	1.55E+06	0.00E+00
AM-242M	1.59E+07	1.38E+07	1.13E+06	0.00E+00	8.45E+06	0.00E+00	1.95E+06	0.00E+00
AM-243	1.57E+07	1.44E+07	1.11E+06	0.00E+00	8.33E+06	0.00E+00	1.82E+06	0.00E+00
CM-242	3.35E+05	3.57E+05	2.23E+04	0.00E+00	1.01E+05	0.00E+00	1.29E+06	0.00E+00
CM-243	1.24E+07	1.14E+07	7.79E+05	0.00E+00	3.64E+06	0.00E+00	1.62E+06	0.00E+00
CM-244	9.45E+06	8.85E+06	5.95E+05	0.00E+00	2.78E+06	0.00E+00	1.57E+06	0.00E+00
CM-245	1.96E+07	1.71E+07	1.20E+06	0.00E+00	5.61E+06	0.00E+00	1.47E+06	0.00E+00
CM-246	1.94E+07	1.70E+07	1.20E+06	0.00E+00	5.59E+06	0.00E+00	1.44E+06	0.00E+00
CM-247	1.89E+07	1.68E+07	1.18E+06	0.00E+00	5.51E+06	0.00E+00	1.90E+06	0.00E+00
CM-248	1.57E+08	1.38E+08	9.75E+06	0.00E+00	4.55E+07	0.00E+00	3.07E+07	0.00E+00
CF-252	5.21E+06	0.00E+00	1.26E+05	0.00E+00	0.00E+00	0.00E+00	5.75E+06	0.00E+00

TABLE II-19

R_i DOSE FACTORS AGE: TEEN PATHWAY: COW MILKm²-mrem/yr per μCi/sec

NUCLIDE	BONE	LIVER	T BODY	THYROID	KIDNEY	LUNG	GI-LLI	SKIN
H-3	0.00E+00	5.66E+02	5.66E+02	5.66E+02	5.66E+02	5.66E+02	5.66E+02	0.00E+00
C-14	6.70E+05	1.34E+05	1.34E+05	1.34E+05	1.34E+05	1.34E+05	1.34E+05	0.00E+00
NA-22	4.82E+09	4.82E+09	4.82E+09	4.82E+09	4.82E+09	4.82E+09	4.82E+09	0.00E+00
NA-24	1.24E+06	1.24E+06	1.24E+06	1.24E+06	1.24E+06	1.24E+06	1.24E+06	0.00E+00
P-32	9.32E+09	5.78E+08	3.61E+08	0.00E+00	0.00E+00	0.00E+00	7.84E+08	0.00E+00
CA-41	8.49E+09	0.00E+00	9.18E+08	0.00E+00	0.00E+00	0.00E+00	8.40E+06	0.00E+00
SC-46	1.25E+02	2.43E+02	7.20E+01	0.00E+00	2.33E+02	0.00E+00	8.27E+05	0.00E+00
CR-51	0.00E+00	0.00E+00	1.59E+04	8.83E+03	3.48E+03	2.27E+04	2.67E+06	0.00E+00
MN-54	0.00E+00	6.94E+06	1.38E+06	0.00E+00	2.07E+06	0.00E+00	1.42E+07	0.00E+00
MN-56	0.00E+00	2.15E-03	3.83E-04	0.00E+00	2.72E-03	0.00E+00	1.42E-01	0.00E+00
FE-55	2.34E+07	1.66E+07	3.87E+06	0.00E+00	0.00E+00	1.05E+07	7.17E+06	0.00E+00
FE-59	1.83E+07	4.28E+07	1.65E+07	0.00E+00	0.00E+00	1.35E+07	1.01E+08	0.00E+00
CO-57	0.00E+00	1.10E+06	1.84E+06	0.00E+00	0.00E+00	0.00E+00	2.05E+07	0.00E+00
CO-58	0.00E+00	3.14E+06	7.22E+06	0.00E+00	0.00E+00	0.00E+00	4.32E+07	0.00E+00
CO-60	0.00E+00	1.48E+07	3.33E+07	0.00E+00	0.00E+00	0.00E+00	1.93E+08	0.00E+00
NI-59	4.76E+08	1.68E+08	8.08E+07	0.00E+00	0.00E+00	0.00E+00	2.64E+07	0.00E+00
NI-63	6.38E+09	4.51E+08	2.16E+08	0.00E+00	0.00E+00	0.00E+00	7.17E+07	0.00E+00
NI-65	1.98E-01	2.53E-02	1.15E-02	0.00E+00	0.00E+00	0.00E+00	1.37E+00	0.00E+00
CU-64	0.00E+00	1.24E+04	5.84E+03	0.00E+00	3.14E+04	0.00E+00	9.63E+05	0.00E+00
ZN-65	1.02E+09	3.54E+09	1.65E+09	0.00E+00	2.27E+09	0.00E+00	1.50E+09	0.00E+00
ZN-69M	9.53E+04	2.25E+05	2.06E+04	0.00E+00	1.37E+05	0.00E+00	1.24E+07	0.00E+00
ZN-69	1.13E-12	2.15E-12	1.50E-13	0.00E+00	1.40E-12	0.00E+00	3.95E-12	0.00E+00
SE-79	0.00E+00	9.04E+08	1.52E+08	0.00E+00	1.58E+09	0.00E+00	1.38E+08	0.00E+00
BR-82	0.00E+00	0.00E+00	1.64E+07	0.00E+00	0.00E+00	0.00E+00	0.00E+00	0.00E+00
BR-83	0.00E+00	0.00E+00	5.24E-02	0.00E+00	0.00E+00	0.00E+00	0.00E+00	0.00E+00
BR-84	0.00E+00	0.00E+00	8.41E-24	0.00E+00	0.00E+00	0.00E+00	0.00E+00	0.00E+00
BR-85	0.00E+00	0.00E+00	0.00E+00	0.00E+00	0.00E+00	0.00E+00	0.00E+00	0.00E+00
RB-86	0.00E+00	1.42E+09	6.69E+08	0.00E+00	0.00E+00	0.00E+00	2.11E+08	0.00E+00
RB-87	0.00E+00	2.83E+09	9.87E+08	0.00E+00	0.00E+00	0.00E+00	9.87E+07	0.00E+00
RB-88	0.00E+00	1.14E-45	6.06E-46	0.00E+00	0.00E+00	0.00E+00	9.74E-53	0.00E+00
RB-89	0.00E+00	2.24E-53	1.59E-53	0.00E+00	0.00E+00	0.00E+00	3.44E-62	0.00E+00
SR-89	9.75E+08	0.00E+00	2.79E+07	0.00E+00	0.00E+00	0.00E+00	1.16E+08	0.00E+00
SR-90	4.38E+10	0.00E+00	8.75E+08	0.00E+00	0.00E+00	0.00E+00	1.00E+09	0.00E+00
SR-91	1.55E+04	0.00E+00	6.18E+02	0.00E+00	0.00E+00	0.00E+00	7.05E+04	0.00E+00
SR-92	2.61E-01	0.00E+00	1.11E-02	0.00E+00	0.00E+00	0.00E+00	6.66E+00	0.00E+00
Y-90	3.81E+01	0.00E+00	1.03E+00	0.00E+00	0.00E+00	0.00E+00	3.14E+05	0.00E+00
Y-91M	3.20E-20	0.00E+00	1.22E-21	0.00E+00	0.00E+00	0.00E+00	1.51E-18	0.00E+00
Y-91	5.97E+03	0.00E+00	1.60E+02	0.00E+00	0.00E+00	0.00E+00	2.45E+06	0.00E+00
Y-92	3.02E-05	0.00E+00	8.72E-07	0.00E+00	0.00E+00	0.00E+00	8.27E-01	0.00E+00
Y-93	1.20E-01	0.00E+00	3.30E-03	0.00E+00	0.00E+00	0.00E+00	3.68E+03	0.00E+00
ZR-93	1.49E+03	7.35E+01	4.01E+01	0.00E+00	2.60E+02	0.00E+00	6.95E+04	0.00E+00
ZR-95	6.37E+02	2.01E+02	1.38E+02	0.00E+00	2.95E+02	0.00E+00	4.64E+05	0.00E+00
ZR-97	2.31E-01	4.56E-02	2.10E-02	0.00E+00	6.92E-02	0.00E+00	1.24E+04	0.00E+00
NB-93M	4.59E+05	1.51E+05	3.78E+04	0.00E+00	1.76E+05	0.00E+00	5.44E+07	0.00E+00
NB-95	4.71E+04	2.61E+04	1.44E+04	0.00E+00	2.53E+04	0.00E+00	1.12E+08	0.00E+00

Rev. 30

Page 266 of 335

05/2018

TABLE II-19

R_i DOSE FACTORS AGE: TEEN PATHWAY: COW MILKm²-mrem/yr per μ Ci/sec

NUCLIDE	BONE	LIVER	T BODY	THYROID	KIDNEY	LUNG	GI-LLI	SKIN
NB-97	1.75E-12	4.35E-13	1.59E-13	0.00E+00	5.09E-13	0.00E+00	1.04E-08	0.00E+00
MO-93	0.00E+00	4.28E+08	1.17E+07	0.00E+00	1.23E+08	0.00E+00	5.21E+07	0.00E+00
MO-99	0.00E+00	1.31E+07	2.49E+06	0.00E+00	2.99E+07	0.00E+00	2.34E+07	0.00E+00
TC-99M	1.68E+00	4.70E+00	6.09E+01	0.00E+00	7.00E+01	2.61E+00	3.09E+03	0.00E+00
TC-99	2.41E+07	3.54E+07	9.66E+06	0.00E+00	4.50E+08	3.66E+06	8.67E+08	0.00E+00
TC-101	1.39E-60	1.97E-60	1.94E-59	0.00E+00	3.57E-59	1.20E-60	3.37E-67	0.00E+00
RU-103	6.21E+02	0.00E+00	2.66E+02	0.00E+00	2.19E+03	0.00E+00	5.19E+04	0.00E+00
RU-105	4.58E-04	0.00E+00	1.78E-04	0.00E+00	5.77E-03	0.00E+00	3.70E-01	0.00E+00
RU-106	1.88E+04	0.00E+00	2.37E+03	0.00E+00	3.63E+04	0.00E+00	9.02E+05	0.00E+00
RH-105	1.87E+05	1.35E+05	8.88E+04	0.00E+00	5.75E+05	0.00E+00	1.72E+07	0.00E+00
PD-107	0.00E+00	1.12E+07	7.22E+05	0.00E+00	1.01E+08	0.00E+00	5.20E+07	0.00E+00
PD-109	0.00E+00	2.37E+04	5.38E+03	0.00E+00	1.37E+05	0.00E+00	2.39E+06	0.00E+00
AG-110M	4.67E+07	4.42E+07	2.69E+07	0.00E+00	8.43E+07	0.00E+00	1.24E+10	0.00E+00
AG-111	3.49E+06	1.45E+06	7.28E+05	0.00E+00	4.72E+06	0.00E+00	2.02E+09	0.00E+00
CD-113M	0.00E+00	2.89E+06	9.29E+04	0.00E+00	3.20E+06	0.00E+00	1.74E+07	0.00E+00
CD-115M	0.00E+00	8.12E+05	2.62E+04	0.00E+00	6.49E+05	0.00E+00	2.57E+07	0.00E+00
SN-123	4.40E+08	7.22E+06	1.07E+07	5.79E+06	0.00E+00	0.00E+00	6.65E+08	0.00E+00
SN-125	3.07E+07	6.11E+05	1.38E+06	4.80E+05	0.00E+00	0.00E+00	2.89E+08	0.00E+00
SN-126	1.56E+09	2.91E+07	4.44E+07	7.66E+06	0.00E+00	0.00E+00	3.47E+08	0.00E+00
SB-124	1.75E+07	3.22E+05	6.81E+06	3.96E+04	0.00E+00	1.52E+07	3.52E+08	0.00E+00
SB-125	1.92E+07	2.10E+05	4.49E+06	1.83E+04	0.00E+00	1.69E+07	1.49E+08	0.00E+00
SB-126	2.94E+06	6.00E+04	1.05E+06	1.66E+04	0.00E+00	2.11E+06	1.74E+08	0.00E+00
SB-127	2.39E+05	5.11E+03	9.02E+04	2.68E+03	0.00E+00	1.63E+05	4.05E+07	0.00E+00
TE-125M	1.13E+07	4.08E+06	1.51E+06	3.16E+06	0.00E+00	0.00E+00	3.34E+07	0.00E+00
TE-127M	3.65E+07	1.29E+07	4.34E+06	8.67E+06	1.48E+08	0.00E+00	9.09E+07	0.00E+00
TE-127	3.54E+02	1.25E+02	7.62E+01	2.44E+02	1.43E+03	0.00E+00	2.73E+04	0.00E+00
TE-129M	3.65E+07	1.35E+07	5.77E+06	1.18E+07	1.53E+08	0.00E+00	1.37E+08	0.00E+00
TE-129	1.52E-10	5.67E-11	3.70E-11	1.09E-10	6.38E-10	0.00E+00	8.31E-10	0.00E+00
TE-131M	1.92E+05	9.22E+04	7.69E+04	1.39E+05	9.61E+05	0.00E+00	7.40E+06	0.00E+00
TE-131	1.93E-33	7.94E-34	6.02E-34	1.48E-33	8.42E-33	0.00E+00	1.58E-34	0.00E+00
TE-132	1.26E+06	7.95E+05	7.48E+05	8.38E+05	7.63E+06	0.00E+00	2.52E+07	0.00E+00
TE-133M	1.11E-13	6.29E-14	6.12E-14	8.79E-14	6.22E-13	0.00E+00	2.54E-13	0.00E+00
TE-134	4.64E-19	2.98E-19	3.11E-19	3.81E-19	2.84E-18	0.00E+00	1.72E-20	0.00E+00
I-129	7.53E+08	6.33E+08	1.06E+09	7.71E+11	1.13E+09	0.00E+00	7.38E+07	0.00E+00
I-130	2.16E+05	6.25E+05	2.50E+05	5.10E+07	9.63E+05	0.00E+00	4.80E+05	0.00E+00
I-131	1.57E+08	2.20E+08	1.18E+08	6.42E+10	3.79E+08	0.00E+00	4.35E+07	0.00E+00
I-132	8.52E-02	2.23E-01	8.00E-02	7.51E+00	3.51E-01	0.00E+00	9.71E-02	0.00E+00
I-133	2.07E+06	3.51E+06	1.07E+06	4.90E+08	6.15E+06	0.00E+00	2.65E+06	0.00E+00
I-134	1.05E-12	2.78E-12	9.98E-13	4.63E-11	4.38E-12	0.00E+00	3.66E-14	0.00E+00
I-135	6.67E+03	1.72E+04	6.37E+03	1.10E+06	2.71E+04	0.00E+00	1.90E+04	0.00E+00
CS-134M	9.05E-02	1.87E-01	9.63E-02	0.00E+00	1.04E-01	1.83E-02	1.25E-01	0.00E+00
CS-134	5.11E+09	1.20E+10	5.58E+09	0.00E+00	3.82E+09	1.46E+09	1.50E+08	0.00E+00
CS-135	1.80E+09	1.65E+09	3.85E+08	0.00E+00	6.29E+08	2.28E+08	2.88E+07	0.00E+00
CS-136	1.32E+08	5.20E+08	3.49E+08	0.00E+00	2.83E+08	4.46E+07	4.18E+07	0.00E+00
CS-137	7.21E+09	9.59E+09	3.34E+09	0.00E+00	3.26E+09	1.27E+09	1.36E+08	0.00E+00

Rev. 30

Page 267 of 335

05/2018

TABLE II-19

R_i DOSE FACTORS AGE: TEEN PATHWAY: COW MILKm²-mrem/yr per μ Ci/sec

NUCLIDE	BONE	LIVER	T BODY	THYROID	KIDNEY	LUNG	GI-LLI	SKIN
CS-138	4.80E-24	9.21E-24	4.61E-24	0.00E+00	6.80E-24	7.91E-25	4.18E-27	0.00E+00
CS-139	3.65E-90	5.38E-90	1.97E-90	0.00E+00	4.34E-90	4.76E-91	2.50E-105	0.00E+00
BA-139	2.39E-08	1.68E-11	6.96E-10	0.00E+00	1.59E-11	1.16E-11	2.13E-07	0.00E+00
BA-140	1.43E+07	1.75E+04	9.20E+05	0.00E+00	5.93E+03	1.18E+04	2.20E+07	0.00E+00
BA-141	2.20E-46	1.64E-49	7.35E-48	0.00E+00	1.53E-49	1.13E-49	4.69E-52	0.00E+00
BA-142	1.41E-80	1.41E-83	8.67E-82	0.00E+00	1.19E-83	9.37E-84	4.32E-92	0.00E+00
LA-140	2.37E+00	1.16E+00	3.10E-01	0.00E+00	0.00E+00	0.00E+00	6.69E+04	0.00E+00
LA-141	1.64E-05	5.04E-06	8.32E-07	0.00E+00	0.00E+00	0.00E+00	8.93E-01	0.00E+00
LA-142	9.81E-12	4.36E-12	1.08E-12	0.00E+00	0.00E+00	0.00E+00	1.33E-07	0.00E+00
CE-141	2.92E+03	1.95E+03	2.24E+02	0.00E+00	9.18E+02	0.00E+00	5.58E+06	0.00E+00
CE-143	2.23E+01	1.63E+04	1.82E+00	0.00E+00	7.29E+00	0.00E+00	4.89E+05	0.00E+00
CE-144	3.23E+05	1.34E+05	1.74E+04	0.00E+00	7.99E+04	0.00E+00	8.13E+07	0.00E+00
PR-143	8.56E+01	3.42E+01	4.26E+00	0.00E+00	1.99E+01	0.00E+00	2.82E+05	0.00E+00
PR-144	3.16E-54	1.30E-54	1.60E-55	0.00E+00	7.43E-55	0.00E+00	3.49E-57	0.00E+00
ND-147	5.31E+01	5.78E+01	3.46E+00	0.00E+00	3.39E+01	0.00E+00	2.08E+05	0.00E+00
PM-147	2.70E+03	2.56E+02	1.05E+02	0.00E+00	4.89E+02	0.00E+00	2.44E+05	0.00E+00
PM-148M	5.17E+02	1.31E+02	1.03E+02	0.00E+00	1.99E+02	0.00E+00	8.26E+05	0.00E+00
PM-148	3.18E+01	5.18E+00	2.61E+00	0.00E+00	9.37E+00	0.00E+00	3.09E+05	0.00E+00
PM-149	2.31E+00	3.24E-01	1.33E-01	0.00E+00	6.17E-01	0.00E+00	4.77E+04	0.00E+00
PM-151	3.47E-01	5.73E-02	2.90E-02	0.00E+00	1.03E-01	0.00E+00	1.29E+04	0.00E+00
SM-151	2.35E+03	4.52E+02	1.06E+02	0.00E+00	4.95E+02	0.00E+00	1.53E+05	0.00E+00
SM-153	1.06E+00	8.81E-01	6.48E-02	0.00E+00	2.88E-01	0.00E+00	2.49E+04	0.00E+00
EU-152	6.54E+03	1.58E+03	1.39E+03	0.00E+00	7.31E+03	0.00E+00	5.79E+05	0.00E+00
EU-154	2.10E+04	2.71E+03	1.91E+03	0.00E+00	1.21E+04	0.00E+00	1.43E+06	0.00E+00
EU-155	4.57E+03	4.42E+02	2.73E+02	0.00E+00	1.73E+03	0.00E+00	2.53E+06	0.00E+00
EU-156	1.35E+02	1.01E+02	1.65E+01	0.00E+00	6.81E+01	0.00E+00	5.17E+05	0.00E+00
TB-160	1.05E+03	0.00E+00	1.31E+02	0.00E+00	4.16E+02	0.00E+00	6.82E+05	0.00E+00
HO-166M	9.61E+03	2.96E+03	2.14E+03	0.00E+00	4.34E+03	0.00E+00	7.30E+05	0.00E+00
W-181	2.76E+04	8.91E+03	9.32E+02	0.00E+00	0.00E+00	0.00E+00	7.59E+05	0.00E+00
W-185	9.56E+05	3.15E+05	3.34E+04	0.00E+00	0.00E+00	0.00E+00	2.73E+07	0.00E+00
W-187	3.48E+03	2.84E+03	9.95E+02	0.00E+00	0.00E+00	0.00E+00	7.69E+05	0.00E+00
U-232	1.58E+10	0.00E+00	1.13E+09	0.00E+00	1.72E+09	0.00E+00	1.93E+08	0.00E+00
U-233	3.34E+09	0.00E+00	2.03E+08	0.00E+00	7.81E+08	0.00E+00	1.79E+08	0.00E+00
U-234	3.20E+09	0.00E+00	1.99E+08	0.00E+00	7.68E+08	0.00E+00	1.75E+08	0.00E+00
U-235	3.07E+09	0.00E+00	1.87E+08	0.00E+00	7.19E+08	0.00E+00	2.23E+08	0.00E+00
U-236	3.07E+09	0.00E+00	1.91E+08	0.00E+00	7.35E+08	0.00E+00	1.65E+08	0.00E+00
U-237	3.05E+04	0.00E+00	8.11E+03	0.00E+00	1.25E+05	0.00E+00	8.07E+06	0.00E+00
U-238	2.94E+09	0.00E+00	1.75E+08	0.00E+00	6.73E+08	0.00E+00	1.57E+08	0.00E+00
NP-237	3.58E+07	2.57E+06	1.58E+06	0.00E+00	1.17E+07	0.00E+00	2.26E+06	0.00E+00
NP-238	1.94E+01	5.19E-01	3.02E-01	0.00E+00	1.78E+00	0.00E+00	3.81E+04	0.00E+00
NP-239	2.05E+00	1.93E-01	1.07E-01	0.00E+00	6.07E-01	0.00E+00	3.11E+04	0.00E+00
PU-238	7.21E+06	9.23E+05	1.96E+05	0.00E+00	8.39E+05	0.00E+00	8.32E+05	0.00E+00
PU-239	8.24E+06	1.00E+06	2.17E+05	0.00E+00	9.23E+05	0.00E+00	7.61E+05	0.00E+00
PU-240	8.23E+06	9.99E+05	2.17E+05	0.00E+00	9.22E+05	0.00E+00	7.75E+05	0.00E+00
PU-241	1.87E+05	8.97E+03	3.94E+03	0.00E+00	1.83E+04	0.00E+00	1.58E+04	0.00E+00

Rev. 30

Page 268 of 335

05/2018

TABLE II2-19

R_i DOSE FACTORS AGE: TEEN PATHWAY: COW MILKm²-mrem/yr per μ Ci/sec

NUCLIDE	BONE	LIVER	T BODY	THYROID	KIDNEY	LUNG	GI-LLI	SKIN
PU-242	7.64E+06	9.63E+05	2.09E+05	0.00E+00	8.89E+05	0.00E+00	7.45E+05	0.00E+00
PU-244	8.92E+06	1.10E+06	2.39E+05	0.00E+00	1.02E+06	0.00E+00	1.11E+06	0.00E+00
AM-241	2.15E+07	2.03E+07	1.55E+06	0.00E+00	1.16E+07	0.00E+00	2.12E+06	0.00E+00
AM-242M	2.17E+07	1.91E+07	1.56E+06	0.00E+00	1.16E+07	0.00E+00	2.66E+06	0.00E+00
AM-243	2.14E+07	1.98E+07	1.51E+06	0.00E+00	1.14E+07	0.00E+00	2.49E+06	0.00E+00
CM-242	6.18E+05	6.51E+05	4.10E+04	0.00E+00	1.87E+05	0.00E+00	1.76E+06	0.00E+00
CM-243	1.74E+07	1.62E+07	1.10E+06	0.00E+00	5.12E+06	0.00E+00	2.22E+06	0.00E+00
CM-244	1.35E+07	1.28E+07	8.53E+05	0.00E+00	3.99E+06	0.00E+00	2.14E+06	0.00E+00
CM-245	2.67E+07	2.35E+07	1.64E+06	0.00E+00	7.68E+06	0.00E+00	2.01E+06	0.00E+00
CM-246	2.64E+07	2.34E+07	1.64E+06	0.00E+00	7.65E+06	0.00E+00	1.97E+06	0.00E+00
CM-247	2.58E+07	2.31E+07	1.62E+06	0.00E+00	7.54E+06	0.00E+00	2.59E+06	0.00E+00
CM-248	2.14E+08	1.90E+08	1.33E+07	0.00E+00	6.22E+07	0.00E+00	4.17E+07	0.00E+00
CF-252	8.93E+06	0.00E+00	2.15E+05	0.00E+00	0.00E+00	0.00E+00	7.85E+06	0.00E+00

TABLE II2-20

R_i DOSE FACTORS AGE: CHILD PATHWAY: COW MILKm²-mrem/yr per μCi/sec

NUCLIDE	BONE	LIVER	T BODY	THYROID	KIDNEY	LUNG	GI-LLI	SKIN
H-3	0.00E+00	8.97E+02	8.97E+02	8.97E+02	8.97E+02	8.97E+02	8.97E+02	0.00E+00
C-14	1.65E+06	3.29E+05	3.29E+05	3.29E+05	3.29E+05	3.29E+05	3.29E+05	0.00E+00
NA-22	9.99E+09	9.99E+09	9.99E+09	9.99E+09	9.99E+09	9.99E+09	9.99E+09	0.00E+00
NA-24	2.59E+06	2.59E+06	2.59E+06	2.59E+06	2.59E+06	2.59E+06	2.59E+06	0.00E+00
P-32	2.30E+10	1.08E+09	8.86E+08	0.00E+00	0.00E+00	0.00E+00	6.35E+08	0.00E+00
CA-41	1.23E+10	0.00E+00	1.35E+09	0.00E+00	0.00E+00	0.00E+00	6.75E+06	0.00E+00
SC-46	2.80E+02	3.84E+02	1.48E+02	0.00E+00	3.40E+02	0.00E+00	5.62E+05	0.00E+00
CR-51	0.00E+00	0.00E+00	3.24E+04	1.80E+04	4.92E+03	3.29E+04	1.72E+06	0.00E+00
MN-54	0.00E+00	1.04E+07	2.77E+06	0.00E+00	2.91E+06	0.00E+00	8.72E+06	0.00E+00
MN-56	0.00E+00	3.75E-03	8.47E-04	0.00E+00	4.54E-03	0.00E+00	5.44E-01	0.00E+00
FE-55	5.87E+07	3.11E+07	9.64E+06	0.00E+00	0.00E+00	1.76E+07	5.77E+06	0.00E+00
FE-59	4.25E+07	6.88E+07	3.43E+07	0.00E+00	0.00E+00	1.99E+07	7.16E+07	0.00E+00
CO-57	0.00E+00	1.88E+06	3.80E+06	0.00E+00	0.00E+00	0.00E+00	1.54E+07	0.00E+00
CO-58	0.00E+00	4.79E+06	1.47E+07	0.00E+00	0.00E+00	0.00E+00	2.79E+07	0.00E+00
CO-60	0.00E+00	2.30E+07	6.78E+07	0.00E+00	0.00E+00	0.00E+00	1.27E+08	0.00E+00
NI-59	1.20E+09	3.19E+08	2.03E+08	0.00E+00	0.00E+00	0.00E+00	2.11E+07	0.00E+00
NI-63	1.60E+10	8.56E+08	5.44E+08	0.00E+00	0.00E+00	0.00E+00	5.77E+07	0.00E+00
NI-65	4.84E-01	4.56E-02	2.66E-02	0.00E+00	0.00E+00	0.00E+00	5.58E+00	0.00E+00
CU-64	0.00E+00	2.18E+04	1.32E+04	0.00E+00	5.27E+04	0.00E+00	1.02E+06	0.00E+00
ZN-65	2.00E+09	5.33E+09	3.32E+09	0.00E+00	3.36E+09	0.00E+00	9.37E+08	0.00E+00
ZN-69M	2.33E+05	3.97E+05	4.69E+04	0.00E+00	2.30E+05	0.00E+00	1.29E+07	0.00E+00
ZN-69	2.77E-12	4.00E-12	3.70E-13	0.00E+00	2.43E-12	0.00E+00	2.52E-10	0.00E+00
SE-79	0.00E+00	1.69E+09	3.74E+08	0.00E+00	2.74E+09	0.00E+00	1.11E+08	0.00E+00
BR-82	0.00E+00	0.00E+00	3.36E+07	0.00E+00	0.00E+00	0.00E+00	0.00E+00	0.00E+00
BR-83	0.00E+00	0.00E+00	1.29E-01	0.00E+00	0.00E+00	0.00E+00	0.00E+00	0.00E+00
BR-84	0.00E+00	0.00E+00	1.90E-23	0.00E+00	0.00E+00	0.00E+00	0.00E+00	0.00E+00
BR-85	0.00E+00	0.00E+00	0.00E+00	0.00E+00	0.00E+00	0.00E+00	0.00E+00	0.00E+00
RB-86	0.00E+00	2.64E+09	1.62E+09	0.00E+00	0.00E+00	0.00E+00	1.70E+08	0.00E+00
RB-87	0.00E+00	5.27E+09	2.44E+09	0.00E+00	0.00E+00	0.00E+00	7.89E+07	0.00E+00
RB-88	0.00E+00	2.09E-45	1.45E-45	0.00E+00	0.00E+00	0.00E+00	1.03E-46	0.00E+00
RB-89	0.00E+00	3.93E-53	3.50E-53	0.00E+00	0.00E+00	0.00E+00	3.43E-55	0.00E+00
SR-89	2.41E+09	0.00E+00	6.89E+07	0.00E+00	0.00E+00	0.00E+00	9.34E+07	0.00E+00
SR-90	9.06E+10	0.00E+00	1.82E+09	0.00E+00	0.00E+00	0.00E+00	8.11E+08	0.00E+00
SR-91	3.81E+04	0.00E+00	1.44E+03	0.00E+00	0.00E+00	0.00E+00	8.42E+04	0.00E+00
SR-92	6.39E-01	0.00E+00	2.56E-02	0.00E+00	0.00E+00	0.00E+00	1.21E+01	0.00E+00
Y-90	9.42E+01	0.00E+00	2.52E+00	0.00E+00	0.00E+00	0.00E+00	2.68E+05	0.00E+00
Y-91M	7.83E-20	0.00E+00	2.85E-21	0.00E+00	0.00E+00	0.00E+00	1.53E-16	0.00E+00
Y-91	1.47E+04	0.00E+00	3.94E+02	0.00E+00	0.00E+00	0.00E+00	1.96E+06	0.00E+00
Y-92	7.40E-05	0.00E+00	2.12E-06	0.00E+00	0.00E+00	0.00E+00	2.14E+00	0.00E+00
Y-93	2.96E-01	0.00E+00	8.12E-03	0.00E+00	0.00E+00	0.00E+00	4.41E+03	0.00E+00
ZR-93	3.71E+03	1.39E+02	9.89E+01	0.00E+00	5.38E+02	0.00E+00	5.27E+04	0.00E+00
ZR-95	1.48E+03	3.25E+02	2.89E+02	0.00E+00	4.65E+02	0.00E+00	3.39E+05	0.00E+00

TABLE II2-20

R_i DOSE FACTORS AGE: CHILD PATHWAY: COW MILKm²-mrem/yr per μ Ci/sec

NUCLIDE	BONE	LIVER	T BODY	THYROID	KIDNEY	LUNG	GI-LLI	SKIN
ZR-97	5.61E-01	8.11E-02	4.78E-02	0.00E+00	1.16E-01	0.00E+00	1.23E+04	0.00E+00
NB-93M	1.16E+06	2.89E+05	9.49E+04	0.00E+00	3.12E+05	0.00E+00	4.35E+07	0.00E+00
NB-95	1.06E+05	4.14E+04	2.96E+04	0.00E+00	3.89E+04	0.00E+00	7.65E+07	0.00E+00
NB-97	4.26E-12	7.69E-13	3.59E-13	0.00E+00	8.54E-13	0.00E+00	2.37E-07	0.00E+00
MO-93	0.00E+00	8.03E+08	2.88E+07	0.00E+00	2.12E+08	0.00E+00	4.07E+07	0.00E+00
MO-99	0.00E+00	2.38E+07	5.89E+06	0.00E+00	5.08E+07	0.00E+00	1.97E+07	0.00E+00
TC-99M	3.86E+00	7.58E+00	1.26E+02	0.00E+00	1.10E+02	3.85E+00	4.31E+03	0.00E+00
TC-99	5.94E+07	6.62E+07	2.38E+07	0.00E+00	7.80E+08	5.85E+06	6.94E+08	0.00E+00
TC-101	3.40E-60	3.56E-60	4.51E-59	0.00E+00	6.07E-59	1.88E-60	1.13E-59	0.00E+00
RU-103	1.47E+03	0.00E+00	5.65E+02	0.00E+00	3.70E+03	0.00E+00	3.80E+04	0.00E+00
RU-105	1.12E-03	0.00E+00	4.05E-04	0.00E+00	9.82E-03	0.00E+00	7.29E-01	0.00E+00
RU-106	4.63E+04	0.00E+00	5.78E+03	0.00E+00	6.26E+04	0.00E+00	7.21E+05	0.00E+00
RH-105	4.59E+05	2.47E+05	2.11E+05	0.00E+00	9.83E+05	0.00E+00	1.53E+07	0.00E+00
PD-107	0.00E+00	2.10E+07	1.78E+06	0.00E+00	1.76E+08	0.00E+00	4.16E+07	0.00E+00
PD-109	0.00E+00	4.42E+04	1.32E+04	0.00E+00	2.37E+05	0.00E+00	2.61E+06	0.00E+00
AG-110M	1.01E+08	6.84E+07	5.47E+07	0.00E+00	1.27E+08	0.00E+00	8.14E+09	0.00E+00
AG-111	8.61E+06	2.70E+06	1.78E+06	0.00E+00	8.13E+06	0.00E+00	1.65E+09	0.00E+00
CD-113M	0.00E+00	5.39E+06	2.29E+05	0.00E+00	5.55E+06	0.00E+00	1.39E+07	0.00E+00
CD-115M	0.00E+00	1.52E+06	6.46E+04	0.00E+00	1.13E+06	0.00E+00	2.06E+07	0.00E+00
SN-123	1.09E+09	1.35E+07	2.65E+07	1.43E+07	0.00E+00	0.00E+00	5.33E+08	0.00E+00
SN-125	7.55E+07	1.14E+06	3.38E+06	1.18E+06	0.00E+00	0.00E+00	2.34E+08	0.00E+00
SN-126	3.70E+09	4.61E+07	1.05E+08	1.27E+07	0.00E+00	0.00E+00	2.78E+08	0.00E+00
SB-124	4.13E+07	5.36E+05	1.45E+07	9.12E+04	0.00E+00	2.29E+07	2.58E+08	0.00E+00
SB-125	4.57E+07	3.52E+05	9.58E+06	4.23E+04	0.00E+00	2.55E+07	1.09E+08	0.00E+00
SB-126	6.71E+06	1.03E+05	2.41E+06	3.93E+04	0.00E+00	3.20E+06	1.35E+08	0.00E+00
SB-127	5.75E+05	8.90E+03	2.00E+05	6.41E+03	0.00E+00	2.50E+05	3.24E+07	0.00E+00
TE-125M	2.78E+07	7.54E+06	3.71E+06	7.80E+06	0.00E+00	0.00E+00	2.68E+07	0.00E+00
TE-127M	8.99E+07	2.42E+07	1.07E+07	2.15E+07	2.56E+08	0.00E+00	7.28E+07	0.00E+00
TE-127	8.70E+02	2.35E+02	1.87E+02	6.02E+02	2.48E+03	0.00E+00	3.40E+04	0.00E+00
TE-129M	8.99E+07	2.51E+07	1.40E+07	2.90E+07	2.64E+08	0.00E+00	1.10E+08	0.00E+00
TE-129	3.75E-10	1.05E-10	8.90E-11	2.68E-10	1.10E-09	0.00E+00	2.34E-08	0.00E+00
TE-131M	4.68E+05	1.62E+05	1.72E+05	3.33E+05	1.57E+06	0.00E+00	6.56E+06	0.00E+00
TE-131	4.73E-33	1.44E-33	1.41E-33	3.62E-33	1.43E-32	0.00E+00	2.48E-32	0.00E+00
TE-132	3.00E+06	1.33E+06	1.60E+06	1.93E+06	1.23E+07	0.00E+00	1.34E+07	0.00E+00
TE-133M	2.65E-13	1.07E-13	1.33E-13	2.06E-13	1.02E-12	0.00E+00	8.19E-12	0.00E+00
TE-134	1.10E-18	4.96E-19	6.62E-19	8.73E-19	4.60E-18	0.00E+00	5.04E-18	0.00E+00
I-129	1.85E+09	1.14E+09	1.02E+09	7.44E+11	1.92E+09	0.00E+00	5.72E+07	0.00E+00
I-130	5.05E+05	1.02E+06	5.26E+05	1.12E+08	1.53E+06	0.00E+00	4.78E+05	0.00E+00
I-131	3.81E+08	3.84E+08	2.18E+08	1.27E+11	6.30E+08	0.00E+00	3.41E+07	0.00E+00
I-132	2.02E-01	3.70E-01	1.70E-01	1.72E+01	5.67E-01	0.00E+00	4.36E-01	0.00E+00
I-133	5.02E+06	6.21E+06	2.35E+06	1.15E+09	1.04E+07	0.00E+00	2.50E+06	0.00E+00
I-134	2.48E-12	4.61E-12	2.12E-12	1.06E-10	7.05E-12	0.00E+00	3.06E-12	0.00E+00

TABLE I12-20

R_i DOSE FACTORS AGE: CHILD PATHWAY: COW MILKm²-mrem/yr per μ Ci/sec

NUCLIDE	BONE	LIVER	T BODY	THYROID	KIDNEY	LUNG	GI-LLI	SKIN
I-135	1.58E+04	2.84E+04	1.34E+04	2.52E+06	4.36E+04	0.00E+00	2.17E+04	0.00E+00
CS-134M	2.14E-01	3.17E-01	2.07E-01	0.00E+00	1.67E-01	2.77E-02	4.01E-01	0.00E+00
CS-134	1.18E+10	1.93E+10	4.08E+09	0.00E+00	5.99E+09	2.15E+09	1.04E+08	0.00E+00
CS-135	4.43E+09	3.08E+09	3.16E+08	0.00E+00	1.09E+09	3.63E+08	2.31E+07	0.00E+00
CS-136	2.98E+08	8.19E+08	5.30E+08	0.00E+00	4.36E+08	6.51E+07	2.88E+07	0.00E+00
CS-137	1.74E+10	1.66E+10	2.45E+09	0.00E+00	5.42E+09	1.95E+09	1.04E+08	0.00E+00
CS-138	1.16E-23	1.62E-23	1.03E-23	0.00E+00	1.14E-23	1.22E-24	7.45E-24	0.00E+00
CS-139	8.98E-90	9.97E-90	4.79E-90	0.00E+00	7.49E-90	7.55E-91	8.98E-94	0.00E+00
BA-139	5.87E-08	3.14E-11	1.70E-09	0.00E+00	2.74E-11	1.84E-11	3.39E-06	0.00E+00
BA-140	3.45E+07	3.02E+04	2.01E+06	0.00E+00	9.83E+03	1.80E+04	1.75E+07	0.00E+00
BA-141	5.41E-46	3.03E-49	1.76E-47	0.00E+00	2.62E-49	1.78E-48	3.08E-46	0.00E+00
BA-142	3.40E-80	2.44E-83	1.90E-81	0.00E+00	1.98E-83	1.44E-83	4.43E-82	0.00E+00
LA-140	5.68E+00	1.98E+00	6.69E-01	0.00E+00	0.00E+00	0.00E+00	5.53E+04	0.00E+00
LA-141	4.04E-05	9.42E-06	2.04E-06	0.00E+00	0.00E+00	0.00E+00	2.09E+00	0.00E+00
LA-142	2.37E-11	7.55E-12	2.36E-12	0.00E+00	0.00E+00	0.00E+00	1.50E-06	0.00E+00
CE-141	7.19E+03	3.59E+03	5.33E+02	0.00E+00	1.57E+03	0.00E+00	4.47E+06	0.00E+00
CE-143	5.48E+01	2.97E+04	4.31E+00	0.00E+00	1.25E+01	0.00E+00	4.35E+05	0.00E+00
CE-144	7.97E+05	2.50E+05	4.26E+04	0.00E+00	1.38E+05	0.00E+00	6.52E+07	0.00E+00
PR-143	2.12E+02	6.36E+01	1.05E+01	0.00E+00	3.44E+01	0.00E+00	2.29E+05	0.00E+00
PR-144	7.83E-54	2.42E-54	3.94E-55	0.00E+00	1.28E-54	0.00E+00	5.22E-51	0.00E+00
ND-147	1.30E+02	1.06E+02	8.18E+00	0.00E+00	5.80E+01	0.00E+00	1.67E+05	0.00E+00
PM-147	6.75E+03	4.82E+02	2.59E+02	0.00E+00	8.52E+02	0.00E+00	1.95E+05	0.00E+00
PM-148M	1.06E+03	2.11E+02	2.11E+02	0.00E+00	3.13E+02	0.00E+00	5.96E+05	0.00E+00
PM-148	7.78E+01	9.35E+00	6.05E+00	0.00E+00	1.59E+01	0.00E+00	2.50E+05	0.00E+00
PM-149	5.69E+00	6.05E-01	3.28E-01	0.00E+00	1.07E+00	0.00E+00	4.13E+04	0.00E+00
PM-151	8.47E-01	1.03E-01	6.70E-02	0.00E+00	1.75E-01	0.00E+00	1.17E+04	0.00E+00
SM-151	5.68E+03	8.45E+02	2.66E+02	0.00E+00	8.74E+02	0.00E+00	1.23E+05	0.00E+00
SM-153	2.63E+00	1.63E+00	1.58E-01	0.00E+00	4.97E-01	0.00E+00	2.17E+04	0.00E+00
EU-152	1.35E+04	2.47E+03	2.93E+03	0.00E+00	1.04E+04	0.00E+00	4.05E+05	0.00E+00
EU-154	5.04E+04	4.54E+03	4.14E+03	0.00E+00	1.99E+04	0.00E+00	1.05E+06	0.00E+00
EU-155	1.05E+04	7.53E+02	5.90E+02	0.00E+00	2.82E+03	0.00E+00	1.88E+06	0.00E+00
EU-156	3.26E+02	1.74E+02	3.61E+01	0.00E+00	1.12E+02	0.00E+00	3.96E+05	0.00E+00
TB-160	2.23E+03	0.00E+00	2.76E+02	0.00E+00	6.63E+02	0.00E+00	4.94E+05	0.00E+00
HO-166M	2.40E+04	5.02E+03	4.24E+03	0.00E+00	7.15E+03	0.00E+00	5.84E+05	0.00E+00
W-181	6.79E+04	1.67E+04	2.29E+03	0.00E+00	0.00E+00	0.00E+00	6.08E+05	0.00E+00
W-185	2.36E+06	5.89E+05	8.24E+04	0.00E+00	0.00E+00	0.00E+00	2.19E+07	0.00E+00
W-187	8.45E+03	5.00E+03	2.24E+03	0.00E+00	0.00E+00	0.00E+00	7.03E+05	0.00E+00
U-232	3.90E+10	0.00E+00	2.79E+09	0.00E+00	2.97E+09	0.00E+00	1.55E+08	0.00E+00
U-233	8.27E+09	0.00E+00	5.00E+08	0.00E+00	1.36E+09	0.00E+00	1.43E+08	0.00E+00
U-234	7.93E+09	0.00E+00	4.91E+08	0.00E+00	1.33E+09	0.00E+00	1.40E+08	0.00E+00
U-235	7.60E+09	0.00E+00	4.60E+08	0.00E+00	1.25E+09	0.00E+00	1.78E+08	0.00E+00
U-236	7.60E+09	0.00E+00	4.71E+08	0.00E+00	1.27E+09	0.00E+00	1.32E+08	0.00E+00

TABLE II2-20

R_i DOSE FACTORS AGE: CHILD PATHWAY: COW MILKm²-mrem/yr per μCi/sec

NUCLIDE	BONE	LIVER	T BODY	THYROID	KIDNEY	LUNG	GI-LLI	SKIN
U-237	7.52E+04	0.00E+00	2.00E+04	0.00E+00	2.17E+05	0.00E+00	6.63E+06	0.00E+00
U-238	7.27E+09	0.00E+00	4.31E+08	0.00E+00	1.16E+09	0.00E+00	1.26E+08	0.00E+00
NP-237	4.95E+07	3.27E+06	2.18E+06	0.00E+00	1.34E+07	0.00E+00	1.81E+06	0.00E+00
NP-238	4.78E+01	9.68E-01	7.45E-01	0.00E+00	3.08E+00	0.00E+00	3.31E+04	0.00E+00
NP-239	5.05E+00	3.62E-01	2.55E-01	0.00E+00	1.05E+00	0.00E+00	2.68E+04	0.00E+00
PU-238	1.06E+07	1.22E+06	2.80E+05	0.00E+00	1.02E+06	0.00E+00	6.66E+05	0.00E+00
PU-239	1.15E+07	1.23E+06	2.94E+05	0.00E+00	1.08E+06	0.00E+00	6.09E+05	0.00E+00
PU-240	1.14E+07	1.27E+06	2.94E+05	0.00E+00	1.08E+06	0.00E+00	6.20E+05	0.00E+00
PU-241	3.41E+05	1.39E+04	7.09E+03	0.00E+00	2.61E+04	0.00E+00	1.27E+04	0.00E+00
PU-242	1.06E+07	1.23E+06	2.84E+05	0.00E+00	1.04E+06	0.00E+00	5.96E+05	0.00E+00
PU-244	1.24E+07	1.40E+07	3.24E+05	0.00E+00	1.20E+06	0.00E+00	8.89E+05	0.00E+00
AM-241	3.02E+07	2.60E+07	2.27E+06	0.00E+00	1.38E+07	0.00E+00	1.70E+06	0.00E+00
AM-242M	3.11E+07	2.49E+07	2.31E+06	0.00E+00	1.40E+07	0.00E+00	2.13E+06	0.00E+00
AM-243	2.98E+07	2.51E+07	2.18E+06	0.00E+00	1.35E+07	0.00E+00	1.99E+06	0.00E+00
CM-242	1.52E+06	1.22E+06	1.01E+05	0.00E+00	3.24E+05	0.00E+00	1.41E+06	0.00E+00
CM-243	2.83E+07	2.30E+07	1.82E+06	0.00E+00	6.81E+06	0.00E+00	1.78E+06	0.00E+00
CM-244	2.38E+07	1.93E+07	1.53E+06	0.00E+00	5.61E+06	0.00E+00	1.71E+06	0.00E+00
CM-245	3.71E+07	2.98E+07	2.33E+06	0.00E+00	9.13E+06	0.00E+00	1.61E+06	0.00E+00
CM-246	3.67E+07	2.98E+07	2.33E+06	0.00E+00	9.11E+06	0.00E+00	1.58E+06	0.00E+00
CM-247	3.58E+07	2.93E+07	2.29E+06	0.00E+00	8.98E+06	0.00E+00	2.08E+06	0.00E+00
CM-248	2.98E+08	2.42E+08	1.89E+07	0.00E+00	7.40E+07	0.00E+00	3.36E+07	0.00E+00
CF-252	2.23E+07	0.00E+00	5.40E+05	0.00E+00	0.00E+00	0.00E+00	6.29E+06	0.00E+00

TABLE II2-21

R_i DOSE FACTORS AGE: INFANT PATHWAY: COW MILKm²-mrem/yr per μ Ci/sec

NUCLIDE	BONE	LIVER	T BODY	THYROID	KIDNEY	LUNG	GI-LLI	SKIN
H-3	0.00E+00	1.36E+03	1.36E+03	1.36E+03	1.36E+03	1.36E+03	1.36E+03	0.00E+00
C-14	3.23E+06	6.89E+05	6.89E+05	6.89E+05	6.89E+05	6.89E+05	6.89E+05	0.00E+00
NA-22	1.67E+10	1.67E+10	1.67E+10	1.67E+10	1.67E+10	1.67E+10	1.67E+10	0.00E+00
NA-24	4.51E+06	4.51E+06	4.51E+06	4.51E+06	4.51E+06	4.51E+06	4.51E+06	0.00E+00
P-32	4.74E+10	2.79E+09	1.84E+09	0.00E+00	0.00E+00	0.00E+00	6.41E+08	0.00E+00
CA-41	1.33E+10	0.00E+00	1.45E+09	0.00E+00	0.00E+00	0.00E+00	6.79E+06	0.00E+00
SC-46	5.33E+02	7.69E+02	2.40E+02	0.00E+00	5.06E+02	0.00E+00	5.02E+05	0.00E+00
CR-51	0.00E+00	0.00E+00	5.14E+04	3.35E+04	7.32E+03	6.52E+04	1.50E+06	0.00E+00
MN-54	0.00E+00	1.93E+07	4.38E+06	0.00E+00	4.28E+06	0.00E+00	7.10E+06	0.00E+00
MN-56	0.00E+00	9.19E-03	1.58E-03	0.00E+00	7.90E-03	0.00E+00	8.35E-01	0.00E+00
FE-55	7.09E+07	4.58E+07	1.22E+07	0.00E+00	0.00E+00	2.24E+07	5.82E+06	0.00E+00
FE-59	7.94E+07	1.39E+08	5.46E+07	0.00E+00	0.00E+00	4.10E+07	6.62E+07	0.00E+00
CO-57	0.00E+00	4.38E+06	7.12E+06	0.00E+00	0.00E+00	0.00E+00	1.49E+07	0.00E+00
CO-58	0.00E+00	9.58E+06	2.39E+07	0.00E+00	0.00E+00	0.00E+00	2.39E+07	0.00E+00
CO-60	0.00E+00	4.69E+07	1.11E+08	0.00E+00	0.00E+00	0.00E+00	1.12E+08	0.00E+00
NI-59	1.41E+09	4.32E+08	2.43E+08	0.00E+00	0.00E+00	0.00E+00	2.13E+07	0.00E+00
NI-63	1.89E+10	1.17E+09	6.54E+08	0.00E+00	0.00E+00	0.00E+00	5.80E+07	0.00E+00
NI-65	1.03E+00	1.16E-01	5.28E-02	0.00E+00	0.00E+00	0.00E+00	8.83E+00	0.00E+00
CU-64	0.00E+00	5.43E+04	2.51E+04	0.00E+00	9.18E+04	0.00E+00	1.11E+06	0.00E+00
ZN-65	2.69E+09	9.22E+09	4.25E+09	0.00E+00	4.47E+09	0.00E+00	7.79E+09	0.00E+00
ZN-69M	4.92E+05	1.00E+06	9.14E+04	0.00E+00	4.06E+05	0.00E+00	1.39E+07	0.00E+00
ZN-69	5.90E-12	1.06E-11	7.90E-13	0.00E+00	4.41E-12	0.00E+00	8.66E-10	0.00E+00
SE-79	0.00E+00	4.20E+09	7.80E+08	0.00E+00	4.86E+09	0.00E+00	1.12E+08	0.00E+00
BR-82	0.00E+00	0.00E+00	5.65E+07	0.00E+00	0.00E+00	0.00E+00	0.00E+00	0.00E+00
BR-83	0.00E+00	0.00E+00	2.73E-01	0.00E+00	0.00E+00	0.00E+00	0.00E+00	0.00E+00
BR-84	0.00E+00	0.00E+00	3.67E-23	0.00E+00	0.00E+00	0.00E+00	0.00E+00	0.00E+00
BR-85	0.00E+00	0.00E+00	0.00E+00	0.00E+00	0.00E+00	0.00E+00	0.00E+00	0.00E+00
RB-86	0.00E+00	6.70E+09	3.31E+09	0.00E+00	0.00E+00	0.00E+00	1.72E+08	0.00E+00
RB-87	0.00E+00	1.18E+10	4.69E+09	0.00E+00	0.00E+00	0.00E+00	7.97E+07	0.00E+00
RB-88	0.00E+00	5.48E-45	3.00E-45	0.00E+00	0.00E+00	0.00E+00	5.34E-45	0.00E+00
RB-89	0.00E+00	9.62E-53	6.62E-53	0.00E+00	0.00E+00	0.00E+00	3.27E-53	0.00E+00
SR-89	4.59E+09	0.00E+00	1.32E+08	0.00E+00	0.00E+00	0.00E+00	9.43E+07	0.00E+00
SR-90	1.00E+11	0.00E+00	2.03E+09	0.00E+00	0.00E+00	0.00E+00	8.18E+08	0.00E+00
SR-91	7.94E+04	0.00E+00	2.88E+03	0.00E+00	0.00E+00	0.00E+00	9.40E+04	0.00E+00
SR-92	1.36E+00	0.00E+00	5.04E-02	0.00E+00	0.00E+00	0.00E+00	1.46E+01	0.00E+00
Y-90	1.99E+02	0.00E+00	5.34E+00	0.00E+00	0.00E+00	0.00E+00	2.75E+05	0.00E+00
Y-91M	1.66E-19	0.00E+00	5.66E-21	0.00E+00	0.00E+00	0.00E+00	5.53E-16	0.00E+00
Y-91	2.77E+04	0.00E+00	7.37E+02	0.00E+00	0.00E+00	0.00E+00	1.98E+06	0.00E+00
Y-92	1.57E-04	0.00E+00	4.42E-06	0.00E+00	0.00E+00	0.00E+00	3.00E+00	0.00E+00
Y-93	6.31E-01	0.00E+00	1.72E-02	0.00E+00	0.00E+00	0.00E+00	4.98E+03	0.00E+00
ZR-93	4.29E+03	2.04E+02	1.23E+02	0.00E+00	6.02E+02	0.00E+00	5.31E+04	0.00E+00
ZR-95	2.63E+03	6.40E+02	4.54E+02	0.00E+00	6.90E+02	0.00E+00	3.19E+05	0.00E+00
ZR-97	1.19E+00	2.04E-01	9.31E-02	0.00E+00	2.06E-01	0.00E+00	1.30E+04	0.00E+00
NB-93M	1.36E+06	3.67E+05	1.15E+05	0.00E+00	3.58E+05	0.00E+00	4.39E+07	0.00E+00
NB-95	1.98E+05	8.17E+04	4.72E+04	0.00E+00	5.86E+04	0.00E+00	6.89E+07	0.00E+00

TABLE II2-21

R_i DOSE FACTORS AGE: INFANT PATHWAY: COW MILKm²-mrem/yr per μCi/sec

NUCLIDE	BONE	LIVER	T BODY	THYROID	KIDNEY	LUNG	GI-LLI	SKIN
NB-97	9.01E-12	1.92E-12	6.93E-13	0.00E+00	1.50E-12	0.00E+00	6.06E-07	0.00E+00
MO-93	0.00E+00	1.88E+09	6.07E+07	0.00E+00	3.77E+08	0.00E+00	4.03E+07	0.00E+00
MO-99	0.00E+00	6.08E+07	1.19E+07	0.00E+00	9.09E+07	0.00E+00	2.00E+07	0.00E+00
TC-99M	8.04E+00	1.66E+01	2.13E+02	0.00E+00	1.78E+02	8.67E+00	4.81E+03	0.00E+00
TC-99	1.20E+08	1.62E+08	5.05E+07	0.00E+00	1.37E+09	1.58E+07	7.01E+08	0.00E+00
TC-101	7.21E-60	9.09E-60	8.99E-59	0.00E+00	1.08E-58	4.96E-60	1.54E-57	0.00E+00
RU-103	2.98E+03	0.00E+00	9.95E+02	0.00E+00	6.19E+03	0.00E+00	3.62E+04	0.00E+00
RU-105	2.36E-03	0.00E+00	7.93E-04	0.00E+00	1.73E-02	0.00E+00	9.37E-01	0.00E+00
RU-106	9.54E+04	0.00E+00	1.19E+04	0.00E+00	1.13E+05	0.00E+00	7.25E+05	0.00E+00
RH-105	9.74E+05	6.37E+05	4.28E+05	0.00E+00	1.77E+06	0.00E+00	1.58E+07	0.00E+00
PD-107	0.00E+00	5.29E+07	3.76E+06	0.00E+00	3.02E+08	0.00E+00	4.20E+07	0.00E+00
PD-109	0.00E+00	1.17E+05	2.82E+04	0.00E+00	4.29E+05	0.00E+00	2.87E+06	0.00E+00
AG-110M	1.87E+08	1.37E+08	9.04E+07	0.00E+00	1.96E+08	0.00E+00	7.09E+09	0.00E+00
AG-111	1.81E+07	7.02E+06	3.72E+06	0.00E+00	1.47E+07	0.00E+00	1.67E+09	0.00E+00
CD-113M	0.00E+00	9.36E+06	3.45E+05	0.00E+00	7.08E+06	0.00E+00	1.41E+07	0.00E+00
CD-115M	0.00E+00	3.66E+06	1.27E+05	0.00E+00	1.91E+06	0.00E+00	2.08E+07	0.00E+00
SN-123	2.04E+09	3.18E+07	5.31E+07	3.20E+07	0.00E+00	0.00E+00	5.38E+08	0.00E+00
SN-125	1.58E+08	2.94E+06	7.00E+06	2.89E+06	0.00E+00	0.00E+00	2.36E+08	0.00E+00
SN-126	6.14E+09	8.07E+07	2.00E+08	2.12E+07	0.00E+00	0.00E+00	2.80E+08	0.00E+00
SB-124	7.96E+07	1.17E+06	2.47E+07	2.11E+05	0.00E+00	4.99E+07	2.46E+08	0.00E+00
SB-125	7.85E+07	7.60E+05	1.62E+07	9.83E+04	0.00E+00	4.55E+07	1.05E+08	0.00E+00
SB-126	1.23E+07	2.41E+05	4.44E+06	9.44E+04	0.00E+00	7.73E+06	1.27E+08	0.00E+00
SB-127	1.21E+06	2.16E+04	3.75E+05	1.54E+04	0.00E+00	6.24E+05	3.21E+07	0.00E+00
TE-125M	5.68E+07	1.90E+07	7.68E+06	1.91E+07	0.00E+00	0.00E+00	2.71E+07	0.00E+00
TE-127M	1.82E+08	6.04E+07	2.20E+07	5.26E+07	4.48E+08	0.00E+00	7.34E+07	0.00E+00
TE-127	1.85E+03	6.19E+02	3.97E+02	1.50E+03	4.51E+03	0.00E+00	3.88E+04	0.00E+00
TE-129M	1.85E+08	6.33E+07	2.84E+07	7.09E+07	4.61E+08	0.00E+00	1.10E+08	0.00E+00
TE-129	7.95E-10	2.74E-10	1.86E-10	6.66E-10	1.98E-09	0.00E+00	6.36E-08	0.00E+00
TE-131M	9.88E+05	3.98E+05	3.28E+05	8.06E+05	2.74E+06	0.00E+00	6.69E+06	0.00E+00
TE-131	1.00E-32	3.70E-33	2.81E-33	8.94E-33	2.56E-32	0.00E+00	4.05E-31	0.00E+00
TE-132	6.17E+06	3.06E+06	2.85E+06	4.51E+06	1.91E+07	0.00E+00	1.13E+07	0.00E+00
TE-133M	5.55E-13	2.54E-13	2.43E-13	4.89E-13	1.73E-12	0.00E+00	2.74E-11	0.00E+00
TE-134	2.28E-18	1.15E-18	1.18E-18	2.05E-18	7.73E-18	0.00E+00	2.62E-17	0.00E+00
I-129	3.81E+09	2.83E+09	2.07E+09	1.81E+12	3.35E+09	0.00E+00	5.65E+07	0.00E+00
I-130	1.04E+06	2.28E+06	9.17E+05	2.56E+08	2.51E+06	0.00E+00	4.90E+05	0.00E+00
I-131	7.96E+08	9.38E+08	4.12E+08	3.08E+11	1.10E+09	0.00E+00	3.35E+07	0.00E+00
I-132	4.18E-01	8.49E-01	3.02E-01	3.98E+01	9.47E-01	0.00E+00	6.88E-01	0.00E+00
I-133	1.06E+07	1.54E+07	4.52E+06	2.81E+09	1.82E+07	0.00E+00	2.61E+06	0.00E+00
I-134	5.15E-12	1.05E-11	3.75E-12	2.46E-10	1.18E-11	0.00E+00	1.09E-11	0.00E+00
I-135	3.28E+04	6.53E+04	2.38E+04	5.86E+06	7.28E+04	0.00E+00	2.36E+04	0.00E+00
CS-134M	4.47E-01	7.44E-01	3.76E-01	0.00E+00	2.87E-01	6.60E-02	5.89E-01	0.00E+00
CS-134	1.90E+10	3.54E+10	3.57E+09	0.00E+00	9.11E+09	3.74E+09	9.62E+07	0.00E+00
CS-135	7.09E+09	6.45E+09	3.36E+08	0.00E+00	1.83E+09	6.99E+08	2.33E+07	0.00E+00
CS-136	5.82E+08	1.71E+09	6.39E+08	0.00E+00	6.82E+08	1.40E+08	2.60E+07	0.00E+00
CS-137	2.77E+10	3.25E+10	2.30E+09	0.00E+00	8.71E+09	3.53E+09	1.01E+08	0.00E+00

TABLE II2-21

R_i DOSE FACTORS AGE: INFANT PATHWAY: COW MILKm²-mrem/yr per μCi/sec

NUCLIDE	BONE	LIVER	T BODY	THYROID	KIDNEY	LUNG	GI-LLI	SKIN
CS-138	2.45E-23	3.99E-23	1.93E-23	0.00E+00	1.99E-23	3.11E-24	6.38E-23	0.00E+00
CS-139	1.92E-89	2.62E-89	1.00E-89	0.00E+00	1.36E-89	2.04E-90	1.65E-90	0.00E+00
BA-139	1.25E-07	8.28E-11	3.62E-09	0.00E+00	4.98E-11	5.02E-11	7.92E-06	0.00E+00
BA-140	7.10E+07	7.10E+04	3.66E+06	0.00E+00	1.68E+04	4.36E+04	1.74E+07	0.00E+00
BA-141	1.15E-45	7.87E-49	3.63E-47	0.00E+00	4.74E-49	4.79E-49	1.40E-44	0.00E+00
BA-142	7.15E-80	5.94E-83	3.52E-81	0.00E+00	3.42E-83	3.60E-83	2.95E-79	0.00E+00
LA-140	1.19E+01	4.67E+00	1.20E+00	0.00E+00	0.00E+00	0.00E+00	5.49E+04	0.00E+00
LA-141	8.58E-05	2.49E-05	4.34E-06	0.00E+00	0.00E+00	0.00E+00	2.85E+00	0.00E+00
LA-142	4.97E-11	1.83E-11	4.37E-12	0.00E+00	0.00E+00	0.00E+00	3.10E-06	0.00E+00
CE-141	1.43E+04	8.70E+03	1.02E+03	0.00E+00	2.68E+03	0.00E+00	4.49E+06	0.00E+00
CE-143	1.16E+02	7.70E+04	8.78E+00	0.00E+00	2.24E+01	0.00E+00	4.49E+05	0.00E+00
CE-144	1.14E+06	4.68E+05	6.40E+04	0.00E+00	1.89E+05	0.00E+00	6.56E+07	0.00E+00
PR-143	4.38E+02	1.64E+02	2.17E+01	0.00E+00	6.09E+01	0.00E+00	2.31E+05	0.00E+00
PR-144	1.66E-53	6.44E-54	8.38E-55	0.00E+00	2.33E-54	0.00E+00	2.99E-49	0.00E+00
ND-147	2.58E+02	2.65E+02	1.63E+01	0.00E+00	1.02E+02	0.00E+00	1.68E+05	0.00E+00
PM-147	8.24E+03	6.94E+02	3.38E+02	0.00E+00	1.04E+03	0.00E+00	1.97E+05	0.00E+00
PM-148M	1.70E+03	4.31E+02	3.38E+02	0.00E+00	4.95E+02	0.00E+00	5.61E+05	0.00E+00
PM-148	1.63E+02	2.35E+01	1.18E+01	0.00E+00	2.81E+01	0.00E+00	2.51E+05	0.00E+00
PM-149	1.21E+01	1.59E+00	6.92E-01	0.00E+00	1.93E+00	0.00E+00	4.26E+04	0.00E+00
PM-151	1.79E+00	2.61E-01	1.32E-01	0.00E+00	3.11E-01	0.00E+00	1.21E+04	0.00E+00
SM-151	6.43E+03	1.48E+03	3.20E+02	0.00E+00	1.01E+03	0.00E+00	1.24E+05	0.00E+00
SM-153	5.55E+00	4.30E+00	3.30E-01	0.00E+00	8.99E-01	0.00E+00	2.24E+04	0.00E+00
EU-152	1.48E+04	3.94E+03	3.33E+03	0.00E+00	1.11E+04	0.00E+00	3.50E+05	0.00E+00
EU-154	5.79E+04	8.04E+03	4.82E+03	0.00E+00	2.18E+04	0.00E+00	1.00E+06	0.00E+00
EU-155	1.18E+04	1.36E+03	7.01E+02	0.00E+00	3.04E+03	0.00E+00	1.82E+06	0.00E+00
EU-156	6.61E+02	4.09E+02	6.49E+01	0.00E+00	1.89E+02	0.00E+00	3.86E+05	0.00E+00
TB-160	3.48E+03	0.00E+00	4.35E+02	0.00E+00	9.89E+02	0.00E+00	4.63E+05	0.00E+00
HO-166M	2.78E+04	5.98E+03	4.73E+03	0.00E+00	7.93E+03	0.00E+00	5.91E+05	0.00E+00
W-181	1.42E+05	4.37E+04	4.88E+03	0.00E+00	0.00E+00	0.00E+00	6.13E+05	0.00E+00
W-185	4.93E+06	1.54E+06	1.76E+05	0.00E+00	0.00E+00	0.00E+00	2.21E+07	0.00E+00
W-187	1.78E+04	1.24E+04	4.27E+03	0.00E+00	0.00E+00	0.00E+00	7.27E+05	0.00E+00
U-232	5.37E+10	0.00E+00	4.79E+09	0.00E+00	5.26E+09	0.00E+00	1.56E+08	0.00E+00
U-233	1.13E+10	0.00E+00	8.60E+08	0.00E+00	2.40E+09	0.00E+00	1.45E+08	0.00E+00
U-234	1.08E+10	0.00E+00	8.44E+08	0.00E+00	2.36E+09	0.00E+00	1.42E+08	0.00E+00
U-235	1.04E+10	0.00E+00	7.91E+08	0.00E+00	2.21E+09	0.00E+00	1.80E+08	0.00E+00
U-236	1.04E+10	0.00E+00	8.09E+08	0.00E+00	2.24E+09	0.00E+00	1.33E+08	0.00E+00
U-237	1.58E+05	0.00E+00	4.21E+04	0.00E+00	3.92E+05	0.00E+00	6.72E+06	0.00E+00
U-238	9.93E+09	0.00E+00	7.40E+08	0.00E+00	2.06E+09	0.00E+00	1.27E+08	0.00E+00
NP-237	5.33E+07	3.53E+06	2.33E+06	0.00E+00	1.41E+07	0.00E+00	1.83E+06	0.00E+00
NP-238	1.02E+02	2.56E+00	1.58E+00	0.00E+00	5.59E+00	0.00E+00	3.42E+04	0.00E+00
NP-239	1.07E+01	9.54E-01	5.39E-01	0.00E+00	1.90E+00	0.00E+00	2.76E+04	0.00E+00
PU-238	1.14E+07	1.33E+06	3.02E+05	0.00E+00	1.07E+06	0.00E+00	6.72E+05	0.00E+00
PU-239	1.23E+07	1.38E+06	3.15E+05	0.00E+00	1.14E+06	0.00E+00	6.14E+05	0.00E+00
PU-240	1.23E+07	1.38E+06	3.15E+05	0.00E+00	1.14E+06	0.00E+00	6.26E+05	0.00E+00
PU-241	3.75E+05	1.55E+04	7.77E+03	0.00E+00	2.79E+04	0.00E+00	1.28E+04	0.00E+00

TABLE II-21

R_i DOSE FACTORS AGE: INFANT PATHWAY: COW MILKm²-mrem/yr per μ Ci/sec

NUCLIDE	BONE	LIVER	T BODY	THYROID	KIDNEY	LUNG	GI-LLI	SKIN
PU-242	1.14E+07	1.32E+06	3.03E+05	0.00E+00	1.09E+06	0.00E+00	6.02E+05	0.00E+00
PU-244	1.32E+07	1.52E+06	3.48E+05	0.00E+00	1.25E+06	0.00E+00	8.98E+05	0.00E+00
AM-241	3.24E+07	2.82E+07	2.42E+06	0.00E+00	1.45E+07	0.00E+00	1.71E+06	0.00E+00
AM-242M	3.35E+07	2.71E+07	2.51E+06	0.00E+00	1.47E+07	0.00E+00	2.15E+06	0.00E+00
AM-243	3.20E+07	2.73E+07	2.36E+06	0.00E+00	1.41E+07	0.00E+00	2.01E+06	0.00E+00
CM-242	2.37E+06	2.20E+06	1.58E+05	0.00E+00	4.54E+05	0.00E+00	1.43E+06	0.00E+00
CM-243	3.10E+07	2.54E+07	1.99E+06	0.00E+00	7.24E+06	0.00E+00	1.79E+06	0.00E+00
CM-244	2.60E+07	2.14E+07	1.68E+06	0.00E+00	5.98E+06	0.00E+00	1.73E+06	0.00E+00
CM-245	3.98E+07	3.22E+07	2.51E+06	0.00E+00	9.60E+06	0.00E+00	1.62E+06	0.00E+00
CM-246	3.93E+07	3.22E+07	2.51E+06	0.00E+00	9.58E+06	0.00E+00	1.59E+06	0.00E+00
CM-247	3.84E+07	3.18E+07	2.47E+06	0.00E+00	9.42E+06	0.00E+00	2.10E+06	0.00E+00
CM-248	3.18E+08	2.62E+08	2.04E+07	0.00E+00	7.78E+07	0.00E+00	3.38E+07	0.00E+00
CF-252	2.59E+07	0.00E+00	6.27E+05	0.00E+00	0.00E+00	0.00E+00	6.35E+06	0.00E+00

TABLE I12-22

R_i DOSE FACTORS AGE: ADULT PATHWAY: GOAT MILKm²-mrem/yr per μ Ci/sec

NUCLIDE	BONE	LIVER	T BODY	THYROID	KIDNEY	LUNG	GI-LLI	SKIN
H-3	0.00E+00	8.88E+02	8.88E+02	8.88E+02	8.88E+02	8.88E+02	8.88E+02	0.00E+00
C-14	3.63E+05	7.26E+04	7.26E+04	7.26E+04	7.26E+04	7.26E+04	7.26E+04	0.00E+00
NA-22	3.33E+08	3.33E+08	3.33E+08	3.33E+08	3.33E+08	3.33E+08	3.33E+08	0.00E+00
NA-24	8.56E+04	8.56E+04	8.56E+04	8.56E+04	8.56E+04	8.56E+04	8.56E+04	0.00E+00
P-32	6.06E+09	3.77E+08	2.34E+08	0.00E+00	0.00E+00	0.00E+00	6.82E+08	0.00E+00
CA-41	4.356E+10	0.00E+00	4.71E+09	0.00E+00	0.00E+00	0.00E+00	4.33E+07	0.00E+00
SC-46	8.83E+00	1.72E+01	4.98E+00	0.00E+00	1.60E+01	0.00E+00	8.35E+04	0.00E+00
CR-51	0.00E+00	0.00E+00	1.09E+03	6.53E+02	2.41E+02	1.45E+03	2.75E+05	0.00E+00
MN-54	0.00E+00	5.00E+05	9.54E+04	0.00E+00	1.49E+05	0.00E+00	1.53E+06	0.00E+00
FE-55	1.714E+05	1.184E+05	2.761E+04	0.000E+00	0.000E+00	6.606E+04	6.793E+04	0.000E+00
MN-56	0.00E+00	1.46E-04	2.58E-05	0.00E+00	1.85E-04	0.00E+00	4.65E-03	0.00E+00
CO-57	0.00E+00	7.51E+04	1.25E+05	0.00E+00	0.00E+00	0.00E+00	1.91E+06	0.00E+00
CO-58	0.00E+00	2.23E+05	5.01E+05	0.00E+00	0.00E+00	0.00E+00	4.53E+06	0.00E+00
FE-59	1.366E+05	3.209E+05	1.230E+05	0.000E+00	0.000E+00	8.967E+04	1.070E+06	0.000E+00
CO-60	0.00E+00	1.05E+06	2.31E+06	0.00E+00	0.00E+00	0.00E+00	1.97E+07	0.00E+00
NI-59	3.28E+07	1.12E+07	5.47E+06	0.00E+00	0.00E+00	0.00E+00	2.32E+06	0.00E+00
NI-63	4.36E+08	3.02E+07	1.46E+07	0.00E+00	0.00E+00	0.00E+00	6.30E+06	0.00E+00
CU-64	0.00E+00	7.77E+02	3.65E+02	0.00E+00	1.96E+03	0.00E+00	6.62E+04	0.00E+00
NI-65	1.30E-02	1.69E-03	7.70E-04	0.00E+00	0.00E+00	0.00E+00	4.28E-02	0.00E+00
ZN-65	7.97E+07	2.54E+08	1.15E+08	0.00E+00	1.70E+08	0.00E+00	1.60E+08	0.00E+00
ZN-69m	6.28E+03	1.51E+04	1.38E+03	0.00E+00	9.13E+03	0.00E+00	9.20E+05	0.00E+00
ZN-69	7.34E-14	1.40E-13	9.76E-15	0.00E+00	9.12E-14	0.00E+00	2.11E-14	0.00E+00
SE-79	0.00E+00	5.93E+07	9.90E+06	0.00E+00	1.03E+08	0.00E+00	1.21E+07	0.00E+00
BR-82	0.00E+00	0.00E+00	1.13E+06	0.00E+00	0.00E+00	0.00E+00	1.30E+06	0.00E+00
BR-83	0.00E+00	0.00E+00	3.41E-03	0.00E+00	0.00E+00	0.00E+00	4.91E-03	0.00E+00
BR-84	0.00E+00	0.00E+00	5.65E-25	0.00E+00	0.00E+00	0.00E+00	4.43E-30	0.00E+00
BR-85	0.00E+00	0.00E+00	0.00E+00	0.00E+00	0.00E+00	0.00E+00	0.00E+00	0.00E+00
RB-86	0.00E+00	9.38E+07	4.37E+07	0.00E+00	0.00E+00	0.00E+00	1.85E+07	0.00E+00
RB-87	0.00E+00	1.85E+08	6.43E+07	0.00E+00	0.00E+00	0.00E+00	8.66E+06	0.00E+00
RB-88	0.00E+00	7.51E-47	3.98E-47	0.00E+00	0.00E+00	0.00E+00	1.04E-57	0.00E+00
RB-89	0.00E+00	1.52E-54	1.07E-54	0.00E+00	0.00E+00	0.00E+00	8.83E-68	0.00E+00
SR-89	1.11E+09	0.00E+00	3.19E+07	0.00E+00	0.00E+00	0.00E+00	1.78E+08	0.00E+00
SR-90	6.08E+10	0.00E+00	1.22E+09	0.00E+00	0.00E+00	0.00E+00	1.53E+09	0.00E+00
Y-90	2.49E+00	0.00E+00	6.67E-02	0.00E+00	0.00E+00	0.00E+00	2.64E+04	0.00E+00
SR-91	1.78E+04	0.00E+00	7.18E+02	0.00E+00	0.00E+00	0.00E+00	8.46E+04	0.00E+00
Y-91m	2.10E-21	0.00E+00	8.13E-23	0.00E+00	0.00E+00	0.00E+00	6.17E-21	0.00E+00
Y-91	3.89E+02	0.00E+00	1.04E+01	0.00E+00	0.00E+00	0.00E+00	2.14E+05	0.00E+00
SR-92	3.00E-01	0.00E+00	1.30E-02	0.00E+00	0.00E+00	0.00E+00	5.94E+00	0.00E+00
Y-92	1.96E-06	0.00E+00	5.72E-08	0.00E+00	0.00E+00	0.00E+00	3.43E-02	0.00E+00
Y-93	7.84E-03	0.00E+00	2.16E-04	0.00E+00	0.00E+00	0.00E+00	2.49E+02	0.00E+00
NB-93m	3.17E+04	1.03E+04	2.55E+03	0.00E+00	1.19E+04	0.00E+00	4.77E+06	0.00E+00
NB-95	3.31E+03	1.84E+03	9.90E+02	0.00E+00	1.82E+03	0.00E+00	1.12E+07	0.00E+00

TABLE I12-22

R_i DOSE FACTORS AGE: ADULT PATHWAY: GOAT MILKm²-mrem/yr per μ Ci/sec

NUCLIDE	BONE	LIVER	T BODY	THYROID	KIDNEY	LUNG	GI-LLI	SKIN
NB-97	1.15E-13	2.92E-14	1.07E-14	0.00E+00	3.41E-14	0.00E+00	1.08E-10	0.00E+00
ZR-93	1.05E+02	5.86E+00	2.73E+00	0.00E+00	2.22E+01	0.00E+00	6.09E+03	0.00E+00
ZR-95	4.37E+01	1.40E+01	9.48E+00	0.00E+00	2.20E+01	0.00E+00	4.44E+04	0.00E+00
ZR-97	1.52E-02	3.07E-03	1.40E-03	0.00E+00	4.63E-03	0.00E+00	9.50E+02	0.00E+00
MO-93	0.00E+00	2.82E+07	7.63E+05	0.00E+00	8.00E+06	0.00E+00	4.58E+06	0.00E+00
MO-99	0.00E+00	8.69E+05	1.65E+05	0.00E+00	1.97E+06	0.00E+00	2.02E+06	0.00E+00
TC-99	1.57E+06	2.33E+06	6.29E+05	0.00E+00	2.93E+07	1.98E+05	7.61E+07	0.00E+00
TC-99m	1.17E-01	3.29E-01	4.20E+00	0.00E+00	5.00E+00	1.61E-01	1.95E+02	0.00E+00
TC-101	9.10E-62	1.31E-61	1.29E-60	0.00E+00	2.36E-60	6.70E-62	3.94E-73	0.00E+00
RU-103	4.19E+01	0.00E+00	1.81E+01	0.00E+00	1.60E+02	0.00E+00	4.90E+03	0.00E+00
RU-105	3.01E-05	0.00E+00	1.19E-05	0.00E+00	3.89E-04	0.00E+00	1.84E-02	0.00E+00
RU-106	1.23E+03	0.00E+00	1.55E+02	0.00E+00	2.37E+03	0.00E+00	7.95E+04	0.00E+00
RH-105	1.22E+04	8.91E+03	5.87E+03	0.00E+00	3.79E+04	0.00E+00	1.42E+06	0.00E+00
PD-107	0.00E+00	7.36E+05	4.71E+04	0.00E+00	6.61E+06	0.00E+00	4.56E+06	0.00E+00
PD-109	0.00E+00	1.55E+03	3.50E+02	0.00E+00	8.87E+03	0.00E+00	1.72E+05	0.00E+00
AG-110m	3.39E+06	3.14E+06	1.86E+06	0.00E+00	6.17E+06	0.00E+00	1.28E+09	0.00E+00
AG-111	2.27E+05	9.51E+04	4.74E+04	0.00E+00	3.07E+05	0.00E+00	1.75E+08	0.00E+00
CD-113m	0.00E+00	1.89E+05	6.08E+03	0.00E+00	2.09E+05	0.00E+00	1.53E+06	0.00E+00
CD-115m	0.00E+00	5.34E+04	1.70E+03	0.00E+00	4.24E+04	0.00E+00	2.25E+06	0.00E+00
SN-123	2.87E+07	4.75E+05	6.99E+05	4.04E+05	0.00E+00	0.00E+00	5.83E+07	0.00E+00
SN-125	2.00E+06	4.03E+04	9.06E+04	3.33E+04	0.00E+00	0.00E+00	2.49E+07	0.00E+00
SN-126	1.06E+08	2.09E+06	3.01E+06	6.16E+05	0.00E+00	0.00E+00	3.04E+07	0.00E+00
SB-124	1.17E+06	2.22E+04	4.66E+05	2.85E+03	0.00E+00	9.14E+05	3.33E+07	0.00E+00
SB-125	1.29E+06	1.44E+04	3.07E+05	1.31E+03	0.00E+00	9.93E+05	1.42E+07	0.00E+00
SB-126	1.98E+05	4.02E+03	7.13E+04	1.21E+03	0.00E+00	1.21E+05	1.62E+07	0.00E+00
SB-127	1.58E+04	3.46E+02	6.06E+03	1.90E+02	0.00E+00	9.36E+03	3.61E+06	0.00E+00
TE-125m	7.37E+05	2.67E+05	9.87E+04	2.22E+05	3.00E+06	0.00E+00	2.94E+06	0.00E+00
TE-127m	2.37E+06	8.49E+05	2.89E+05	6.07E+05	9.64E+06	0.00E+00	7.96E+06	0.00E+00
TE-127	2.29E+01	8.23E+00	4.96E+00	1.70E+01	9.33E+01	0.00E+00	1.81E+03	0.00E+00
TE-129m	2.39E+06	8.92E+05	3.79E+05	8.22E+05	9.98E+06	0.00E+00	1.20E+07	0.00E+00
TE-129	9.91E-12	3.72E-12	2.41E-12	7.61E-12	4.17E-11	0.00E+00	7.48E-12	0.00E+00
TE-133m	7.39E-15	4.32E-15	4.16E-15	6.25E-15	4.27E-14	0.00E+00	1.48E-15	0.00E+00
TE-134	3.13E-20	2.04E-20	1.25E-20	2.73E-20	1.98E-19	0.00E+00	3.46E-23	0.00E+00
I-129	4.91E+08	4.22E+08	1.38E+09	1.09E+12	9.08E+08	0.00E+00	6.67E+07	0.00E+00
I-130	1.47E+05	4.35E+05	1.72E+05	3.69E+07	6.79E+05	0.00E+00	3.74E+05	0.00E+00
I-131	1.04E+08	1.49E+08	8.52E+07	4.87E+10	2.55E+08	0.00E+00	3.92E+07	0.00E+00
TE-131m	1.27E+04	6.20E+03	5.16E+03	9.82E+03	6.28E+04	0.00E+00	6.15E+05	0.00E+00
TE-131	1.26E-34	5.28E-35	3.99E-35	1.04E-34	5.54E-34	0.00E+00	1.79E-35	0.00E+00
I-132	5.76E-02	1.54E-01	5.40E-02	5.40E+00	2.46E-01	0.00E+00	2.90E-02	0.00E+00
TE-132	8.43E+04	5.45E+04	5.12E+04	6.02E+04	5.25E+05	0.00E+00	2.58E+06	0.00E+00
I-133	1.36E+06	2.36E+06	7.20E+05	3.47E+08	4.12E+06	0.00E+00	2.12E+06	0.00E+00
CS-134m	1.52E-01	3.20E-01	1.64E-01	0.00E+00	1.74E-01	2.74E-02	1.13E-01	0.00E+00

TABLE I12-22

R_i DOSE FACTORS AGE: ADULT PATHWAY: GOAT MILKm²-mrem/yr per μCi/sec

NUCLIDE	BONE	LIVER	T BODY	THYROID	KIDNEY	LUNG	GI-LLI	SKIN
CS-134	8.83E+09	2.10E+10	1.72E+10	0.00E+00	6.80E+09	2.26E+09	3.68E+08	0.00E+00
I-134	7.08E-13	1.92E-12	6.88E-13	3.33E-11	3.06E-12	0.00E+00	1.68E-15	0.00E+00
I-135	4.51E+03	1.18E+04	4.35E+03	7.78E+05	1.89E+04	0.00E+00	1.33E+04	0.00E+00
CS-135	2.93E+09	2.71E+09	1.20E+09	0.00E+00	1.02E+09	3.07E+08	6.33E+07	0.00E+00
CS-136	2.33E+08	9.19E+08	6.61E+08	0.00E+00	5.11E+08	7.01E+07	1.04E+08	0.00E+00
CS-137	1.19E+10	1.63E+10	1.07E+10	0.00E+00	5.54E+09	1.84E+09	3.16E+08	0.00E+00
CS-138	7.93E-24	1.57E-23	7.76E-24	0.00E+00	1.15E-23	1.14E-24	6.68E-29	0.00E+00
CS-139	5.95E-90	8.86E-90	3.23E-90	0.00E+00	7.10E-90	6.46E-91	1.92E-112	0.00E+00
BA-139	1.55E-09	1.11E-12	4.54E-11	0.00E+00	1.03E-12	6.27E-13	2.75E-09	0.00E+00
BA-140	9.49E+05	1.19E+03	6.22E+04	0.00E+00	4.06E+02	6.83E+02	1.96E+06	0.00E+00
LA-140	1.58E-01	7.98E-02	2.11E-02	0.00E+00	0.00E+00	0.00E+00	5.86E+03	0.00E+00
BA-141	1.44E-47	1.09E-50	4.85E-49	0.00E+00	1.01E-50	6.16E-51	6.77E-57	0.00E+00
LA-141	1.07E-06	3.31E-07	5.42E-08	0.00E+00	0.00E+00	0.00E+00	3.95E-02	0.00E+00
CE-141	1.91E+02	1.29E+02	1.47E+01	0.00E+00	6.00E+01	0.00E+00	4.94E+05	0.00E+00
BA-142	9.33E-82	9.59E-85	5.87E-83	0.00E+00	8.10E-85	5.43E-85	1.31E-99	0.00E+00
LA-142	6.52E-13	2.97E-13	7.39E-14	0.00E+00	0.00E+00	0.00E+00	2.17E-09	0.00E+00
CE-143	1.46E+00	1.08E+03	1.19E-01	0.00E+00	4.75E-01	0.00E+00	4.03E+04	0.00E+00
PR-143	5.59E+00	2.24E+00	2.77E-01	0.00E+00	1.29E+00	0.00E+00	2.45E+04	0.00E+00
CE-144	2.11E+04	8.82E+03	1.13E+03	0.00E+00	5.23E+03	0.00E+00	7.13E+06	0.00E+00
PR-144	2.06E-55	8.55E-56	1.05E-56	0.00E+00	4.82E-56	0.00E+00	2.96E-62	0.00E+00
ND-147	3.31E+00	3.83E+00	2.29E-01	0.00E+00	2.24E+00	0.00E+00	1.84E+04	0.00E+00
PM-147	1.80E+02	1.70E+01	6.87E+00	0.00E+00	3.21E+01	0.00E+00	2.14E+04	0.00E+00
PM-148m	3.57E+01	9.24E+00	7.07E+00	0.00E+00	1.39E+01	0.00E+00	7.84E+04	0.00E+00
PM-148	2.08E+00	3.46E-01	1.74E-01	0.00E+00	6.53E-01	0.00E+00	2.72E+04	0.00E+00
PM-149	1.50E-01	2.12E-02	8.67E-03	0.00E+00	4.01E-02	0.00E+00	3.98E+03	0.00E+00
PM-151	2.28E-02	3.83E-03	1.93E-03	0.00E+00	6.84E-03	0.00E+00	1.05E+03	0.00E+00
SM-151	1.73E+02	2.98E+01	7.13E+00	0.00E+00	3.33E+01	0.00E+00	1.31E+04	0.00E+00
SM-153	6.95E-02	5.80E-02	4.23E-03	0.00E+00	1.87E-02	0.00E+00	2.07E+03	0.00E+00
EU-152	4.84E+02	1.10E+02	9.68E+01	0.00E+00	6.83E+02	0.00E+00	6.36E+04	0.00E+00
EU-154	1.52E+03	1.87E+02	1.33E+02	0.00E+00	8.94E+02	0.00E+00	1.35E+05	0.00E+00
EU-155	2.10E+02	2.98E+01	1.92E+01	0.00E+00	1.38E+02	0.00E+00	2.35E+04	0.00E+00
EU-156	8.95E+00	6.92E+00	1.12E+00	0.00E+00	4.62E+00	0.00E+00	4.74E+04	0.00E+00
TB-160	7.11E+01	0.00E+00	8.86E+00	0.00E+00	2.93E+01	0.00E+00	6.55E+04	0.00E+00
HO-166m	6.76E+02	2.11E+02	1.60E+02	0.00E+00	3.16E+02	0.00E+00	6.41E+04	0.00E+00
W-181	1.79E+03	5.84E+02	6.26E+01	0.00E+00	0.00E+00	0.00E+00	6.66E+04	0.00E+00
W-185	6.22E+04	2.07E+04	2.18E+03	0.00E+00	0.00E+00	0.00E+00	2.40E+06	0.00E+00
W-187	2.29E+02	1.91E+02	6.68E+01	0.00E+00	0.00E+00	0.00E+00	6.26E+04	0.00E+00
NP-239	1.29E-01	1.27E-02	6.99E-03	0.00E+00	3.95E-02	0.00E+00	2.60E+03	0.00E+00
U-232	1.03E+09	0.00E+00	7.38E+07	0.00E+00	1.12E+08	0.00E+00	1.70E+07	0.00E+00
U-233	2.18E+08	0.00E+00	1.32E+07	0.00E+00	5.08E+07	0.00E+00	1.57E+07	0.00E+00
U-234	2.09E+08	0.00E+00	1.29E+07	0.00E+00	4.98E+07	0.00E+00	1.54E+07	0.00E+00
U-235	2.01E+08	0.00E+00	1.22E+07	0.00E+00	4.68E+07	0.00E+00	1.96E+07	0.00E+00

TABLE II2-22

R_i DOSE FACTORS AGE: ADULT PATHWAY: GOAT MILKm²-mrem/yr per μ Ci/sec

NUCLIDE	BONE	LIVER	T BODY	THYROID	KIDNEY	LUNG	GI-LLI	SKIN
U-236	2.01E+08	0.00E+00	1.24E+07	0.00E+00	4.78E+07	0.00E+00	1.44E+07	0.00E+00
U-237	1.98E+03	0.00E+00	5.28E+02	0.00E+00	8.15E+03	0.00E+00	6.97E+05	0.00E+00
U-238	1.92E+08	0.00E+00	1.14E+07	0.00E+00	4.38E+07	0.00E+00	1.38E+07	0.00E+00
NP-237	3.16E+06	2.24E+05	1.39E+05	0.00E+00	1.03E+06	0.00E+00	1.99E+05	0.00E+00
NP-238	1.27E+00	3.41E-02	1.97E-02	0.00E+00	1.16E-01	0.00E+00	3.17E+03	0.00E+00
PU-238	6.30E+05	7.98E+04	1.71E+04	0.00E+00	7.32E+04	0.00E+00	7.30E+04	0.00E+00
PU-239	7.26E+05	8.73E+04	1.91E+04	0.00E+00	8.13E+04	0.00E+00	6.67E+04	0.00E+00
PU-240	7.25E+05	8.72E+04	1.91E+04	0.00E+00	8.12E+04	0.00E+00	6.79E+04	0.00E+00
PU-241	1.56E+04	7.40E+02	3.30E+02	0.00E+00	1.52E+03	0.00E+00	1.39E+03	0.00E+00
PU-242	6.73E+05	8.41E+04	1.84E+04	0.00E+00	7.82E+04	0.00E+00	6.54E+04	0.00E+00
PU-244	7.85E+05	9.63E+04	2.11E+04	0.00E+00	8.97E+04	0.00E+00	9.75E+04	0.00E+00
AM-241	1.89E+06	1.77E+06	1.35E+05	0.00E+00	1.02E+06	0.00E+00	1.86E+05	0.00E+00
AM-242m	1.90E+06	1.66E+06	1.36E+05	0.00E+00	1.01E+06	0.00E+00	2.34E+05	0.00E+00
AM-243	1.89E+06	1.73E+06	1.33E+05	0.00E+00	9.99E+05	0.00E+00	2.18E+05	0.00E+00
CM-242	4.03E+04	4.28E+04	2.68E+03	0.00E+00	1.22E+04	0.00E+00	1.55E+05	0.00E+00
CM-243	1.49E+06	1.37E+06	9.35E+04	0.00E+00	4.36E+05	0.00E+00	1.95E+05	0.00E+00
CM-244	1.13E+06	1.06E+06	7.14E+04	0.00E+00	3.33E+05	0.00E+00	1.88E+05	0.00E+00
CM-245	2.35E+06	2.05E+06	1.44E+05	0.00E+00	6.74E+05	0.00E+00	1.76E+05	0.00E+00
CM-246	2.33E+06	2.04E+06	1.44E+05	0.00E+00	6.71E+05	0.00E+00	1.73E+05	0.00E+00
CM-247	2.27E+06	2.01E+06	1.42E+05	0.00E+00	6.61E+05	0.00E+00	2.28E+05	0.00E+00
CM-248	1.89E+07	1.66E+07	1.17E+06	0.00E+00	5.46E+06	0.00E+00	3.68E+06	0.00E+00
CF-252	6.25E+05	0.00E+00	1.51E+04	0.00E+00	0.00E+00	0.00E+00	6.90E+05	0.00E+00

TABLE II2-23

R_i DOSE FACTORS AGE: TEEN PATHWAY: GOAT MILKm²-mrem/yr per μ Ci/sec

NUCLIDE	BONE	LIVER	T BODY	THYROID	KIDNEY	LUNG	GI-LLI	SKIN
H-3	0.00E+00	1.16E+03	1.16E+03	1.16E+03	1.16E+03	1.16E+03	1.16E+03	0.00E+00
C-14	6.70E+05	1.34E+05	1.34E+05	1.34E+05	1.34E+05	1.34E+05	1.34E+05	0.00E+00
NA-22	5.78E+08	5.78E+08	5.78E+08	5.78E+08	5.78E+08	5.78E+08	5.78E+08	0.00E+00
NA-24	1.49E+05	1.49E+05	1.49E+05	1.49E+05	1.49E+05	1.49E+05	1.49E+05	0.00E+00
P-32	1.12E+10	6.93E+08	4.34E+08	0.00E+00	0.00E+00	0.00E+00	9.41E+08	0.00E+00
CA-41	5.98E+10	0.00E+00	6.47E+09	0.00E+00	0.00E+00	0.00E+00	5.92E+07	0.00E+00
SC-46	1.50E+01	2.92E+01	8.65E+00	0.00E+00	2.79E+01	0.00E+00	9.93E+04	0.00E+00
CR-51	0.00E+00	0.00E+00	1.91E+03	1.06E+03	4.18E+02	2.72E+03	3.21E+05	0.00E+00
MN-54	0.00E+00	8.33E+05	1.65E+05	0.00E+00	2.49E+05	0.00E+00	1.71E+06	0.00E+00
FE-55	3.039E+05	2.155E+05	5.026E+04	0.000E+00	0.000E+00	1.367E+05	9.327E+04	0.000E+00
MN-56	0.00E+00	2.58E-04	4.59E-05	0.00E+00	3.27E-04	0.00E+00	1.70E-02	0.00E+00
CO-57	0.00E+00	1.32E+05	2.21E+05	0.00E+00	0.00E+00	0.00E+00	2.46E+06	0.00E+00
CO-58	0.00E+00	3.76E+05	8.67E+05	0.00E+00	0.00E+00	0.00E+00	5.19E+06	0.00E+00
FE-59	2.383E+05	5.562E+05	2.148E+05	0.000E+00	0.000E+00	1.754E+05	1.315E+06	0.000E+00
CO-60	0.00E+00	1.78E+06	4.00E+06	0.00E+00	0.00E+00	0.00E+00	2.31E+07	0.00E+00
NI-59	5.72E+07	2.02E+07	9.70E+06	0.00E+00	0.00E+00	0.00E+00	3.17E+06	0.00E+00
NI-63	7.66E+08	5.41E+07	2.60E+07	0.00E+00	0.00E+00	0.00E+00	8.61E+06	0.00E+00
CU-64	0.00E+00	1.38E+03	6.51E+02	0.00E+00	3.50E+03	0.00E+00	1.07E+05	0.00E+00
NI-65	2.38E-02	3.04E-03	1.38E-03	0.00E+00	0.00E+00	0.00E+00	1.65E-01	0.00E+00
ZN-65	1.22E+08	4.25E+08	1.98E+08	0.00E+00	2.72E+08	0.00E+00	1.80E+08	0.00E+00
ZN-69m	1.14E+04	2.70E+04	2.47E+03	0.00E+00	1.64E+04	0.00E+00	1.48E+06	0.00E+00
ZN-69	1.35E-13	2.57E-13	1.80E-14	0.00E+00	1.68E-13	0.00E+00	4.74E-13	0.00E+00
SE-79	0.00E+00	1.08E+08	1.82E+07	0.00E+00	1.89E+08	0.00E+00	1.66E+07	0.00E+00
BR-82	0.00E+00	0.00E+00	1.97E+06	0.00E+00	0.00E+00	0.00E+00	0.00E+00	0.00E+00
BR-83	0.00E+00	0.00E+00	6.28E-03	0.00E+00	0.00E+00	0.00E+00	0.00E+00	0.00E+00
BR-84	0.00E+00	0.00E+00	1.01E-24	0.00E+00	0.00E+00	0.00E+00	0.00E+00	0.00E+00
BR-85	0.00E+00	0.00E+00	0.00E+00	0.00E+00	0.00E+00	0.00E+00	0.00E+00	0.00E+00
RB-86	0.00E+00	1.71E+08	8.03E+07	0.00E+00	0.00E+00	0.00E+00	2.53E+07	0.00E+00
RB-87	0.00E+00	3.39E+08	1.18E+08	0.00E+00	0.00E+00	0.00E+00	1.18E+07	0.00E+00
RB-88	0.00E+00	1.36E-46	7.27E-47	0.00E+00	0.00E+00	0.00E+00	1.17E-53	0.00E+00
RB-89	0.00E+00	2.69E-54	1.90E-54	0.00E+00	0.00E+00	0.00E+00	4.12E-63	0.00E+00
SR-89	2.05E+09	0.00E+00	5.86E+07	0.00E+00	0.00E+00	0.00E+00	2.44E+08	0.00E+00
SR-90	9.19E+10	0.00E+00	1.84E+09	0.00E+00	0.00E+00	0.00E+00	2.10E+09	0.00E+00
Y-90	4.57E+00	0.00E+00	1.23E-01	0.00E+00	0.00E+00	0.00E+00	3.77E+04	0.00E+00
SR-91	3.26E+04	0.00E+00	1.30E+03	0.00E+00	0.00E+00	0.00E+00	1.48E+05	0.00E+00
Y-91m	3.84E-21	0.00E+00	1.47E-22	0.00E+00	0.00E+00	0.00E+00	1.82E-19	0.00E+00
Y-91	7.16E+02	0.00E+00	1.92E+01	0.00E+00	0.00E+00	0.00E+00	2.93E+05	0.00E+00
SR-92	5.49E-01	0.00E+00	2.34E-02	0.00E+00	0.00E+00	0.00E+00	1.40E+01	0.00E+00
Y-92	3.62E-06	0.00E+00	1.05E-07	0.00E+00	0.00E+00	0.00E+00	9.93E-02	0.00E+00
Y-93	1.45E-02	0.00E+00	3.96E-04	0.00E+00	0.00E+00	0.00E+00	4.42E+02	0.00E+00
NB-93m	5.51E+04	1.81E+04	4.54E+03	0.00E+00	2.12E+04	0.00E+00	6.52E+06	0.00E+00
NB-95	5.65E+03	3.13E+03	1.72E+03	0.00E+00	3.04E+03	0.00E+00	1.34E+07	0.00E+00
NB-97	2.10E-13	5.22E-14	1.91E-14	0.00E+00	6.11E-14	0.00E+00	1.25E-09	0.00E+00
ZR-93	1.79E+02	8.82E+00	4.82E+00	0.00E+00	3.12E+01	0.00E+00	8.34E+03	0.00E+00
ZR-95	7.64E+01	2.41E+01	1.66E+01	0.00E+00	3.54E+01	0.00E+00	5.56E+04	0.00E+00

TABLE II-23

R_i DOSE FACTORS AGE: TEEN PATHWAY: GOAT MILKm²-mrem/yr per μCi/sec

NUCLIDE	BONE	LIVER	T BODY	THYROID	KIDNEY	LUNG	GI-LLI	SKIN
ZR-97	2.77E-02	5.48E-03	2.52E-03	0.00E+00	8.30E-03	0.00E+00	1.48E+03	0.00E+00
MO-93	0.00E+00	5.14E+07	1.41E+06	0.00E+00	1.47E+07	0.00E+00	6.25E+06	0.00E+00
MO-99	0.00E+00	1.57E+06	2.99E+05	0.00E+00	3.59E+06	0.00E+00	2.81E+06	0.00E+00
TC-99	2.89E+06	4.25E+06	1.16E+06	0.00E+00	5.40E+07	4.40E+05	1.04E+08	0.00E+00
TC-99m	2.02E-01	5.64E-01	7.31E+00	0.00E+00	8.40E+00	3.13E-01	3.70E+02	0.00E+00
TC-101	1.66E-61	2.37E-61	2.33E-60	0.00E+00	4.28E-60	1.44E-61	4.04E-68	0.00E+00
RU-103	7.46E+01	0.00E+00	3.19E+01	0.00E+00	2.63E+02	0.00E+00	6.23E+03	0.00E+00
RU-105	5.49E-05	0.00E+00	2.13E-05	0.00E+00	6.93E-04	0.00E+00	4.43E-02	0.00E+00
RU-106	2.26E+03	0.00E+00	2.85E+02	0.00E+00	4.35E+03	0.00E+00	1.08E+05	0.00E+00
RH-105	2.25E+04	1.62E+04	1.07E+04	0.00E+00	6.90E+04	0.00E+00	2.07E+06	0.00E+00
PD-107	0.00E+00	1.34E+06	8.66E+04	0.00E+00	1.22E+07	0.00E+00	6.24E+06	0.00E+00
PD-109	0.00E+00	2.84E+03	6.46E+02	0.00E+00	1.64E+04	0.00E+00	2.87E+05	0.00E+00
AG-110m	5.61E+06	5.31E+06	3.23E+06	0.00E+00	1.01E+07	0.00E+00	1.49E+09	0.00E+00
AG-111	4.19E+05	1.74E+05	8.74E+04	0.00E+00	5.66E+05	0.00E+00	2.42E+08	0.00E+00
CD-113m	0.00E+00	3.47E+05	1.11E+04	0.00E+00	3.84E+05	0.00E+00	2.08E+06	0.00E+00
CD-115m	0.00E+00	9.74E+04	3.14E+03	0.00E+00	7.79E+04	0.00E+00	3.08E+06	0.00E+00
SN-123	5.28E+07	8.67E+05	1.28E+06	6.94E+05	0.00E+00	0.00E+00	7.98E+07	0.00E+00
SN-125	3.68E+06	7.33E+04	1.66E+05	5.75E+04	0.00E+00	0.00E+00	3.47E+07	0.00E+00
SN-126	1.87E+08	3.49E+06	5.33E+06	9.19E+05	0.00E+00	0.00E+00	4.17E+07	0.00E+00
SB-124	2.09E+06	3.86E+04	8.17E+05	4.75E+03	0.00E+00	1.83E+06	4.22E+07	0.00E+00
SB-125	2.30E+06	2.52E+04	5.39E+05	2.20E+03	0.00E+00	2.02E+06	1.79E+07	0.00E+00
SB-126	3.53E+05	7.21E+03	1.27E+05	1.99E+03	0.00E+00	2.53E+05	2.09E+07	0.00E+00
SB-127	2.87E+04	6.13E+02	1.08E+04	3.22E+02	0.00E+00	1.95E+04	4.86E+06	0.00E+00
TE-125m	1.36E+06	4.90E+05	1.82E+05	3.80E+05	0.00E+00	0.00E+00	4.01E+06	0.00E+00
TE-127m	4.38E+06	1.55E+06	5.20E+05	1.04E+06	1.77E+07	0.00E+00	1.09E+07	0.00E+00
TE-127	4.25E+01	1.51E+01	9.14E+00	2.93E+01	1.72E+02	0.00E+00	3.28E+03	0.00E+00
TE-129m	4.37E+06	1.62E+06	6.92E+05	1.41E+06	1.83E+07	0.00E+00	1.64E+07	0.00E+00
TE-129	1.82E-11	6.80E-12	4.44E-12	1.30E-11	7.66E-11	0.00E+00	9.98E-11	0.00E+00
TE-133m	1.33E-14	7.55E-15	7.35E-15	1.05E-14	7.47E-14	0.00E+00	3.05E-14	0.00E+00
TE-134	5.56E-20	3.57E-20	3.73E-20	4.57E-20	3.41E-19	0.00E+00	2.07E-21	0.00E+00
I-129	9.04E+08	7.60E+08	1.27E+09	9.25E+11	1.36E+09	0.00E+00	8.86E+07	0.00E+00
I-130	2.59E+05	7.50E+05	2.99E+05	6.12E+07	1.16E+06	0.00E+00	5.76E+05	0.00E+00
I-131	1.89E+08	2.64E+08	1.42E+08	7.71E+10	4.55E+08	0.00E+00	5.22E+07	0.00E+00
TE-131m	2.31E+04	1.11E+04	9.23E+03	1.66E+04	1.15E+05	0.00E+00	8.88E+05	0.00E+00
TE-131	2.31E-34	9.53E-35	7.22E-35	1.78E-34	1.01E-33	0.00E+00	1.90E-35	0.00E+00
I-132	1.02E-01	2.67E-01	9.60E-02	9.01E+00	4.21E-01	0.00E+00	1.17E-01	0.00E+00
TE-132	1.51E+05	9.54E+04	8.98E+04	1.01E+05	9.15E+05	0.00E+00	3.02E+06	0.00E+00
I-133	2.48E+06	4.21E+06	1.28E+06	5.87E+08	7.38E+06	0.00E+00	3.18E+06	0.00E+00
CS-134m	2.71E-01	5.62E-01	2.89E-01	0.00E+00	3.13E-01	5.49E-02	3.74E-01	0.00E+00
CS-134	1.53E+10	3.61E+10	1.67E+10	0.00E+00	1.15E+10	4.38E+09	4.49E+08	0.00E+00
I-134	1.26E-12	3.33E-12	1.20E-12	5.56E-11	5.26E-12	0.00E+00	4.39E-14	0.00E+00
I-135	8.01E+03	2.06E+04	7.64E+03	1.33E+06	3.25E+04	0.00E+00	2.28E+04	0.00E+00
CS-135	5.39E+09	4.94E+09	1.16E+09	0.00E+00	1.89E+09	6.83E+08	8.65E+07	0.00E+00
CS-136	3.96E+08	1.56E+09	1.05E+09	0.00E+00	8.49E+08	1.34E+08	1.25E+08	0.00E+00
CS-137	2.16E+10	2.88E+10	1.00E+10	0.00E+00	9.79E+09	3.80E+09	4.09E+08	0.00E+00

TABLE II-23

R_i DOSE FACTORS AGE: TEEN PATHWAY: GOAT MILKm²-mrem/yr per μ Ci/sec

NUCLIDE	BONE	LIVER	T BODY	THYROID	KIDNEY	LUNG	GI-LLI	SKIN
CS-138	1.44E-23	2.76E-23	1.38E-23	0.00E+00	2.04E-23	2.37E-24	1.25E-26	0.00E+00
CS-139	1.10E-89	1.61E-89	5.92E-90	0.00E+00	1.30E-89	1.43E-90	7.50E-105	0.00E+00
BA-139	2.87E-09	2.02E-12	8.36E-11	0.00E+00	1.90E-12	1.39E-12	2.56E-08	0.00E+00
BA-140	1.71E+06	2.10E+03	1.10E+05	0.00E+00	7.12E+02	1.41E+03	2.64E+06	0.00E+00
LA-140	2.84E-01	1.40E-01	3.72E-02	0.00E+00	0.00E+00	0.00E+00	8.03E+03	0.00E+00
BA-141	2.64E-47	1.97E-50	8.82E-49	0.00E+00	1.83E-50	1.35E-50	5.63E-53	0.00E+00
LA-141	1.97E-06	6.05E-07	9.98E-08	0.00E+00	0.00E+00	0.00E+00	1.07E-01	0.00E+00
CE-141	3.50E+02	2.34E+02	2.69E+01	0.00E+00	1.10E+02	0.00E+00	6.69E+05	0.00E+00
BA-142	1.69E-81	1.69E-84	1.04E-82	0.00E+00	1.43E-84	1.12E-84	5.19E-93	0.00E+00
LA-142	1.18E-12	5.23E-13	1.30E-13	0.00E+00	0.00E+00	0.00E+00	1.59E-08	0.00E+00
CE-143	2.68E+00	1.95E+03	2.18E-01	0.00E+00	8.75E-01	0.00E+00	5.86E+04	0.00E+00
PR-143	1.03E+01	4.10E+00	5.11E-01	0.00E+00	2.38E+00	0.00E+00	3.38E+04	0.00E+00
CE-144	3.88E+04	1.61E+04	2.09E+03	0.00E+00	9.59E+03	0.00E+00	9.76E+06	0.00E+00
PR-144	3.80E-55	1.55E-55	1.93E-56	0.00E+00	8.92E-56	0.00E+00	4.19E-58	0.00E+00
ND-147	6.38E+00	6.93E+00	4.15E-01	0.00E+00	4.07E+00	0.00E+00	2.50E+04	0.00E+00
PM-147	3.24E+02	3.08E+01	1.25E+01	0.00E+00	5.87E+01	0.00E+00	2.93E+04	0.00E+00
PM-148m	6.21E+01	1.57E+01	1.23E+01	0.00E+00	2.38E+01	0.00E+00	9.91E+04	0.00E+00
PM-148	3.82E+00	6.22E-01	3.13E-01	0.00E+00	1.12E+00	0.00E+00	3.71E+04	0.00E+00
PM-149	2.77E-01	3.89E-02	1.59E-02	0.00E+00	7.41E-02	0.00E+00	5.72E+03	0.00E+00
PM-151	4.17E-02	6.88E-03	3.48E-03	0.00E+00	1.24E-02	0.00E+00	1.54E+03	0.00E+00
SM-151	2.82E+02	5.42E+01	1.27E+01	0.00E+00	5.94E+01	0.00E+00	1.84E+04	0.00E+00
SM-153	1.28E-01	1.06E-01	7.78E-03	0.00E+00	3.45E-02	0.00E+00	2.98E+03	0.00E+00
EU-152	7.85E+02	1.89E+02	1.67E+02	0.00E+00	8.78E+02	0.00E+00	6.95E+04	0.00E+00
EU-154	2.52E+03	3.25E+02	2.29E+02	0.00E+00	1.45E+03	0.00E+00	1.72E+05	0.00E+00
EU-155	5.49E+02	5.30E+01	3.28E+01	0.00E+00	2.07E+02	0.00E+00	3.04E+05	0.00E+00
EU-156	1.62E+01	1.21E+01	1.98E+00	0.00E+00	8.17E+00	0.00E+00	6.20E+04	0.00E+00
TB-160	1.26E+02	0.00E+00	1.58E+01	0.00E+00	5.00E+01	0.00E+00	8.18E+04	0.00E+00
HO-166m	1.15E+03	3.55E+02	2.57E+02	0.00E+00	5.20E+02	0.00E+00	8.76E+04	0.00E+00
W-181	3.31E+03	1.07E+03	1.12E+02	0.00E+00	0.00E+00	0.00E+00	9.10E+04	0.00E+00
W-185	1.15E+05	3.79E+04	4.00E+03	0.00E+00	0.00E+00	0.00E+00	3.27E+06	0.00E+00
W-187	4.18E+02	3.41E+02	1.19E+02	0.00E+00	0.00E+00	0.00E+00	9.22E+04	0.00E+00
NP-239	2.46E-01	2.32E-02	1.29E-02	0.00E+00	7.28E-02	0.00E+00	3.73E+03	0.00E+00
U-232	1.90E+09	0.00E+00	1.36E+08	0.00E+00	2.06E+08	0.00E+00	2.32E+07	0.00E+00
U-233	4.01E+08	0.00E+00	2.44E+07	0.00E+00	9.37E+07	0.00E+00	2.15E+07	0.00E+00
U-234	3.85E+08	0.00E+00	2.39E+07	0.00E+00	9.21E+07	0.00E+00	2.10E+07	0.00E+00
U-235	3.68E+08	0.00E+00	2.24E+07	0.00E+00	8.63E+07	0.00E+00	2.68E+07	0.00E+00
U-236	3.68E+08	0.00E+00	2.29E+07	0.00E+00	8.82E+07	0.00E+00	1.97E+07	0.00E+00
U-237	3.66E+03	0.00E+00	9.73E+02	0.00E+00	1.50E+04	0.00E+00	9.69E+05	0.00E+00
U-238	3.52E+08	0.00E+00	2.10E+07	0.00E+00	8.08E+07	0.00E+00	1.88E+07	0.00E+00
NP-237	4.30E+06	3.09E+05	1.89E+05	0.00E+00	1.40E+06	0.00E+00	2.72E+05	0.00E+00
NP-238	2.33E+00	6.23E-02	3.63E-02	0.00E+00	2.14E-01	0.00E+00	4.57E+03	0.00E+00
PU-238	8.65E+05	1.11E+05	2.35E+04	0.00E+00	1.01E+05	0.00E+00	9.98E+04	0.00E+00
PU-239	9.89E+05	1.20E+05	2.60E+04	0.00E+00	1.11E+05	0.00E+00	9.13E+04	0.00E+00
PU-240	9.88E+05	1.20E+05	2.60E+04	0.00E+00	1.11E+05	0.00E+00	9.29E+04	0.00E+00
PU-241	2.24E+04	1.08E+03	4.73E+02	0.00E+00	2.19E+03	0.00E+00	1.90E+03	0.00E+00

TABLE II2-23

R_i DOSE FACTORS AGE: TEEN PATHWAY: GOAT MILKm²-mrem/yr per μ Ci/sec

NUCLIDE	BONE	LIVER	T BODY	THYROID	KIDNEY	LUNG	GI-LLI	SKIN
PU-242	9.17E+05	1.16E+05	2.51E+04	0.00E+00	1.07E+05	0.00E+00	8.95E+04	0.00E+00
PU-244	1.07E+06	1.32E+05	2.87E+04	0.00E+00	1.22E+05	0.00E+00	1.33E+05	0.00E+00
AM-241	2.58E+06	2.43E+06	1.86E+05	0.00E+00	1.39E+06	0.00E+00	2.54E+05	0.00E+00
AM-242m	2.61E+06	2.30E+06	1.87E+05	0.00E+00	1.39E+06	0.00E+00	3.20E+05	0.00E+00
AM-243	2.57E+06	2.38E+06	1.82E+05	0.00E+00	1.36E+06	0.00E+00	2.98E+05	0.00E+00
CM-242	7.41E+04	7.82E+04	4.92E+03	0.00E+00	2.24E+04	0.00E+00	2.12E+05	0.00E+00
CM-243	2.09E+06	1.94E+06	1.32E+05	0.00E+00	6.15E+05	0.00E+00	2.66E+05	0.00E+00
CM-244	1.62E+06	1.53E+06	1.02E+05	0.00E+00	4.78E+05	0.00E+00	2.57E+05	0.00E+00
CM-245	3.20E+06	2.81E+06	1.97E+05	0.00E+00	9.21E+05	0.00E+00	2.41E+05	0.00E+00
CM-246	3.17E+06	2.81E+06	1.97E+05	0.00E+00	9.18E+05	0.00E+00	2.37E+05	0.00E+00
CM-247	3.09E+06	2.77E+06	1.94E+05	0.00E+00	9.05E+05	0.00E+00	3.11E+05	0.00E+00
CM-248	2.57E+07	2.28E+07	1.60E+06	0.00E+00	7.47E+06	0.00E+00	5.01E+06	0.00E+00
CF-252	1.07E+06	0.00E+00	2.59E+04	0.00E+00	0.00E+00	0.00E+00	9.42E+05	0.00E+00

TABLE I12-24

R_i DOSE FACTORS AGE: CHILD PATHWAY: GOAT MILKm²-mrem/yr per μ Ci/sec

NUCLIDE	BONE	LIVER	T BODY	THYROID	KIDNEY	LUNG	GI-LLI	SKIN
H-3	0.00E+00	1.83E+03	1.83E+03	1.83E+03	1.83E+03	1.83E+03	1.83E+03	0.00E+00
C-14	1.65E+06	3.29E+05	3.29E+05	3.29E+05	3.29E+05	3.29E+05	3.29E+05	0.00E+00
NA-22	1.20E+09	1.20E+09	1.20E+09	1.20E+09	1.20E+09	1.20E+09	1.20E+09	0.00E+00
NA-24	3.11E+05	3.11E+05	3.11E+05	3.11E+05	3.11E+05	3.11E+05	3.11E+05	0.00E+00
P-32	2.76E+10	1.29E+09	1.06E+09	0.00E+00	0.00E+00	0.00E+00	7.63E+08	0.00E+00
CA-41	8.70E+10	0.00E+00	9.50E+09	0.00E+00	0.00E+00	0.00E+00	4.76E+07	0.00E+00
SC-46	3.36E+01	4.61E+01	1.77E+01	0.00E+00	4.08E+01	0.00E+00	6.74E+04	0.00E+00
CR-51	0.00E+00	0.00E+00	3.89E+03	2.16E+03	5.90E+02	3.94E+03	2.06E+05	0.00E+00
MN-54	0.00E+00	1.25E+06	3.32E+05	0.00E+00	3.49E+05	0.00E+00	1.05E+06	0.00E+00
FE-55	7.629E+05	4.047E+05	1.254E+05	0.000E+00	0.000E+00	2.289E+05	7.496E+04	0.000E+00
MN-56	0.00E+00	4.50E-04	1.02E-04	0.00E+00	5.45E-04	0.00E+00	6.53E-02	0.00E+00
CO-57	0.00E+00	2.25E+05	4.56E+05	0.00E+00	0.00E+00	0.00E+00	1.85E+06	0.00E+00
CO-58	0.00E+00	5.75E+05	1.76E+06	0.00E+00	0.00E+00	0.00E+00	3.35E+06	0.00E+00
FE-59	5.526E+05	8.943E+05	4.455E+05	0.000E+00	0.000E+00	2.592E+05	9.311E+05	0.000E+00
CO-60	0.00E+00	2.76E+06	8.13E+06	0.00E+00	0.00E+00	0.00E+00	1.53E+07	0.00E+00
NI-59	1.44E+08	3.82E+07	2.44E+07	0.00E+00	0.00E+00	0.00E+00	2.54E+06	0.00E+00
NI-63	1.92E+09	1.03E+08	6.53E+07	0.00E+00	0.00E+00	0.00E+00	6.92E+06	0.00E+00
CU-64	0.00E+00	2.43E+03	1.47E+03	0.00E+00	5.88E+03	0.00E+00	1.14E+05	0.00E+00
NI-65	5.81E-02	5.47E-03	3.19E-03	0.00E+00	0.00E+00	0.00E+00	6.70E-01	0.00E+00
ZN-65	2.40E+08	6.40E+08	3.98E+08	0.00E+00	4.03E+08	0.00E+00	1.12E+08	0.00E+00
ZN-69m	2.79E+04	4.76E+04	5.62E+03	0.00E+00	2.76E+04	0.00E+00	1.55E+06	0.00E+00
ZN-69	3.32E-13	4.80E-13	4.44E-14	0.00E+00	2.91E-13	0.00E+00	3.03E-11	0.00E+00
SE-79	0.00E+00	2.02E+08	4.49E+07	0.00E+00	3.29E+08	0.00E+00	1.33E+07	0.00E+00
BR-82	0.00E+00	0.00E+00	4.03E+06	0.00E+00	0.00E+00	0.00E+00	0.00E+00	0.00E+00
BR-83	0.00E+00	0.00E+00	1.54E-02	0.00E+00	0.00E+00	0.00E+00	0.00E+00	0.00E+00
BR-84	0.00E+00	0.00E+00	2.28E-24	0.00E+00	0.00E+00	0.00E+00	0.00E+00	0.00E+00
BR-85	0.00E+00	0.00E+00	0.00E+00	0.00E+00	0.00E+00	0.00E+00	0.00E+00	0.00E+00
RB-86	0.00E+00	3.17E+08	1.95E+08	0.00E+00	0.00E+00	0.00E+00	2.04E+07	0.00E+00
RB-87	0.00E+00	6.32E+08	2.93E+08	0.00E+00	0.00E+00	0.00E+00	9.47E+06	0.00E+00
RB-88	0.00E+00	2.51E-46	1.74E-46	0.00E+00	0.00E+00	0.00E+00	1.23E-47	0.00E+00
RB-89	0.00E+00	4.72E-54	4.20E-54	0.00E+00	0.00E+00	0.00E+00	4.12E-56	0.00E+00
SR-89	5.07E+09	0.00E+00	1.45E+08	0.00E+00	0.00E+00	0.00E+00	1.96E+08	0.00E+00
SR-90	1.90E+11	0.00E+00	3.83E+09	0.00E+00	0.00E+00	0.00E+00	1.70E+09	0.00E+00
Y-90	1.13E+01	0.00E+00	3.03E-01	0.00E+00	0.00E+00	0.00E+00	3.22E+04	0.00E+00
SR-91	8.01E+04	0.00E+00	3.02E+03	0.00E+00	0.00E+00	0.00E+00	1.77E+05	0.00E+00
Y-91m	9.39E-21	0.00E+00	3.42E-22	0.00E+00	0.00E+00	0.00E+00	1.84E-17	0.00E+00
Y-91	1.77E+03	0.00E+00	4.73E+01	0.00E+00	0.00E+00	0.00E+00	2.36E+05	0.00E+00
SR-92	1.34E+00	0.00E+00	5.38E-02	0.00E+00	0.00E+00	0.00E+00	2.54E+01	0.00E+00
Y-92	8.88E-06	0.00E+00	2.54E-07	0.00E+00	0.00E+00	0.00E+00	2.57E-01	0.00E+00
Y-93	3.55E-02	0.00E+00	9.75E-04	0.00E+00	0.00E+00	0.00E+00	5.29E+02	0.00E+00
NB-93m	1.39E+05	3.46E+04	1.14E+04	0.00E+00	3.74E+04	0.00E+00	5.22E+06	0.00E+00
NB-95	1.28E+04	4.96E+03	3.55E+03	0.00E+00	4.66E+03	0.00E+00	9.18E+06	0.00E+00

TABLE II2-24

R_i DOSE FACTORS AGE: CHILD PATHWAY: GOAT MILKm²-mrem/yr per μ Ci/sec

NUCLIDE	BONE	LIVER	T BODY	THYROID	KIDNEY	LUNG	GI-LLI	SKIN
NB-97	5.11E-13	9.23E-14	4.31E-14	0.00E+00	1.02E-13	0.00E+00	2.85E-08	0.00E+00
ZR-93	4.45E+02	1.67E+01	1.19E+01	0.00E+00	6.45E+01	0.00E+00	6.32E+03	0.00E+00
ZR-95	1.77E+02	3.90E+01	3.47E+01	0.00E+00	5.58E+01	0.00E+00	4.07E+04	0.00E+00
ZR-97	6.73E-02	9.73E-03	5.74E-03	0.00E+00	1.40E-02	0.00E+00	1.47E+03	0.00E+00
MO-93	0.00E+00	9.64E+07	3.46E+06	0.00E+00	2.54E+07	0.00E+00	4.88E+06	0.00E+00
MO-99	0.00E+00	2.86E+06	7.06E+05	0.00E+00	6.10E+06	0.00E+00	2.36E+06	0.00E+00
TC-99	7.13E+06	7.95E+06	2.85E+06	0.00E+00	9.36E+07	7.03E+05	8.33E+07	0.00E+00
TC-99m	4.64E-01	9.09E-01	1.51E+01	0.00E+00	1.32E+01	4.62E-01	5.17E+02	0.00E+00
TC-101	4.08E-61	4.27E-61	5.42E-60	0.00E+00	7.28E-60	2.26E-61	1.36E-60	0.00E+00
RU-103	1.76E+02	0.00E+00	6.78E+01	0.00E+00	4.44E+02	0.00E+00	4.56E+03	0.00E+00
RU-105	1.34E-04	0.00E+00	4.86E-05	0.00E+00	1.18E-03	0.00E+00	8.75E-02	0.00E+00
RU-106	5.56E+03	0.00E+00	6.94E+02	0.00E+00	7.51E+03	0.00E+00	8.65E+04	0.00E+00
RH-105	5.51E+04	2.96E+04	2.53E+04	0.00E+00	1.18E+05	0.00E+00	1.83E+06	0.00E+00
PD-107	0.00E+00	2.52E+06	2.14E+05	0.00E+00	2.11E+07	0.00E+00	5.00E+06	0.00E+00
PD-109	0.00E+00	5.30E+03	1.59E+03	0.00E+00	2.84E+04	0.00E+00	3.13E+05	0.00E+00
AG-110m	1.22E+07	8.21E+06	6.57E+06	0.00E+00	1.53E+07	0.00E+00	9.77E+08	0.00E+00
AG-111	1.03E+06	3.23E+05	2.13E+05	0.00E+00	9.75E+05	0.00E+00	1.98E+08	0.00E+00
CD-113m	0.00E+00	6.47E+05	2.75E+04	0.00E+00	6.66E+05	0.00E+00	1.67E+06	0.00E+00
CD-115m	0.00E+00	1.82E+05	7.76E+03	0.00E+00	1.35E+05	0.00E+00	2.48E+06	0.00E+00
SN-123	1.30E+08	1.62E+06	3.18E+06	1.72E+06	0.00E+00	0.00E+00	6.40E+07	0.00E+00
SN-125	9.06E+06	1.37E+05	4.06E+05	1.42E+05	0.00E+00	0.00E+00	2.81E+07	0.00E+00
SN-126	4.44E+08	5.53E+06	1.26E+07	1.52E+06	0.00E+00	0.00E+00	3.33E+07	0.00E+00
SB-124	4.96E+06	6.43E+04	1.74E+06	1.09E+04	0.00E+00	2.75E+06	3.10E+07	0.00E+00
SB-125	5.49E+06	4.23E+04	1.15E+06	5.08E+03	0.00E+00	3.06E+06	1.31E+07	0.00E+00
SB-126	8.05E+05	1.23E+04	2.89E+05	4.72E+03	0.00E+00	3.84E+05	1.62E+07	0.00E+00
SB-127	6.91E+04	1.07E+03	2.40E+04	7.69E+02	0.00E+00	3.00E+04	3.89E+06	0.00E+00
TE-125m	3.34E+06	9.04E+05	4.45E+05	9.37E+05	0.00E+00	0.00E+00	3.22E+06	0.00E+00
TE-127m	1.08E+07	2.90E+06	1.28E+06	2.58E+06	3.08E+07	0.00E+00	8.74E+06	0.00E+00
TE-127	1.04E+02	2.82E+01	2.24E+01	7.23E+01	2.97E+02	0.00E+00	4.08E+03	0.00E+00
TE-129m	1.08E+07	3.01E+06	1.67E+06	3.48E+06	3.17E+07	0.00E+00	1.32E+07	0.00E+00
TE-129	4.50E-11	1.26E-11	1.07E-11	3.21E-11	1.32E-10	0.00E+00	2.80E-09	0.00E+00
TE-133m	3.18E-14	1.29E-14	1.60E-14	2.47E-14	1.22E-13	0.00E+00	9.82E-13	0.00E+00
TE-134	1.32E-19	5.96E-20	7.95E-20	1.05E-19	5.51E-19	0.00E+00	6.05E-19	0.00E+00
I-129	2.22E+09	1.36E+09	1.22E+09	8.93E+11	2.30E+09	0.00E+00	6.86E+07	0.00E+00
I-130	6.06E+05	1.22E+06	6.31E+05	1.35E+08	1.83E+06	0.00E+00	5.73E+05	0.00E+00
I-131	4.58E+08	4.60E+08	2.61E+08	1.52E+11	7.55E+08	0.00E+00	4.10E+07	0.00E+00
TE-131m	5.61E+04	1.94E+04	2.07E+04	3.99E+04	1.88E+05	0.00E+00	7.88E+05	0.00E+00
TE-131	5.67E-34	1.73E-34	1.69E-34	4.34E-34	1.72E-33	0.00E+00	2.98E-33	0.00E+00
I-132	2.42E-01	4.44E-01	2.04E-01	2.06E+01	6.80E-01	0.00E+00	5.23E-01	0.00E+00
TE-132	3.60E+05	1.59E+05	1.92E+05	2.32E+05	1.48E+06	0.00E+00	1.60E+06	0.00E+00
I-133	6.03E+06	7.45E+06	2.82E+06	1.38E+09	1.24E+07	0.00E+00	3.00E+06	0.00E+00
CS-134m	6.43E-01	9.52E-01	6.21E-01	0.00E+00	5.02E-01	8.30E-02	1.20E+00	0.00E+00

TABLE I12-24

R_i DOSE FACTORS AGE: CHILD PATHWAY: GOAT MILKm²-mrem/yr per μ Ci/sec

NUCLIDE	BONE	LIVER	T BODY	THYROID	KIDNEY	LUNG	GI-LLI	SKIN
CS-134	3.53E+10	5.80E+10	1.22E+10	0.00E+00	1.80E+10	6.45E+09	3.13E+08	0.00E+00
I-134	2.98E-12	5.53E-12	2.54E-12	1.27E-10	8.46E-12	0.00E+00	3.67E-12	0.00E+00
I-135	1.89E+04	3.41E+04	1.61E+04	3.02E+06	5.23E+04	0.00E+00	2.60E+04	0.00E+00
CS-135	1.33E+10	9.25E+09	9.49E+08	0.00E+00	3.26E+09	1.09E+09	6.93E+07	0.00E+00
CS-136	8.94E+08	2.46E+09	1.59E+09	0.00E+00	1.31E+09	1.95E+08	8.64E+07	0.00E+00
CS-137	5.21E+10	4.99E+10	7.36E+09	0.00E+00	1.63E+10	5.85E+09	3.12E+08	0.00E+00
CS-138	3.49E-23	4.85E-23	3.08E-23	0.00E+00	3.41E-23	3.67E-24	2.23E-23	0.00E+00
CS-139	2.69E-89	2.99E-89	1.44E-89	0.00E+00	2.25E-89	2.27E-90	2.69E-93	0.00E+00
BA-139	7.05E-09	3.76E-12	2.04E-10	0.00E+00	3.29E-12	2.21E-12	4.07E-07	0.00E+00
BA-140	4.14E+06	3.62E+03	2.41E+05	0.00E+00	1.18E+03	2.16E+03	2.10E+06	0.00E+00
LA-140	6.81E-01	2.38E-01	8.02E-02	0.00E+00	0.00E+00	0.00E+00	6.63E+03	0.00E+00
BA-141	6.49E-47	3.64E-50	2.11E-48	0.00E+00	3.15E-50	2.14E-49	3.70E-47	0.00E+00
LA-141	4.85E-06	1.13E-06	2.45E-07	0.00E+00	0.00E+00	0.00E+00	2.51E-01	0.00E+00
CE-141	8.63E+02	4.30E+02	6.39E+01	0.00E+00	1.89E+02	0.00E+00	5.37E+05	0.00E+00
BA-142	4.07E-81	2.93E-84	2.28E-82	0.00E+00	2.37E-84	1.72E-84	5.31E-83	0.00E+00
LA-142	2.84E-12	9.06E-13	2.84E-13	0.00E+00	0.00E+00	0.00E+00	1.80E-07	0.00E+00
CE-143	6.58E+00	3.57E+03	5.17E-01	0.00E+00	1.50E+00	0.00E+00	5.22E+04	0.00E+00
PR-143	2.54E+01	7.63E+00	1.26E+00	0.00E+00	4.13E+00	0.00E+00	2.74E+04	0.00E+00
CE-144	9.57E+04	3.00E+04	5.11E+03	0.00E+00	1.66E+04	0.00E+00	7.82E+06	0.00E+00
PR-144	9.40E-55	2.91E-55	4.73E-56	0.00E+00	1.54E-55	0.00E+00	6.26E-52	0.00E+00
ND-147	1.56E+01	1.27E+01	9.82E-01	0.00E+00	6.96E+00	0.00E+00	2.01E+04	0.00E+00
PM-147	8.10E+02	5.78E+01	3.11E+01	0.00E+00	1.02E+02	0.00E+00	2.34E+04	0.00E+00
PM-148m	1.27E+02	2.54E+01	2.54E+01	0.00E+00	3.76E+01	0.00E+00	7.15E+04	0.00E+00
PM-148	9.34E+00	1.12E+00	7.26E-01	0.00E+00	1.91E+00	0.00E+00	3.00E+04	0.00E+00
PM-149	6.83E-01	7.26E-02	3.93E-02	0.00E+00	1.28E-01	0.00E+00	4.95E+03	0.00E+00
PM-151	1.02E-01	1.24E-02	8.04E-03	0.00E+00	2.10E-02	0.00E+00	1.40E+03	0.00E+00
SM-151	6.82E+02	1.01E+02	3.20E+01	0.00E+00	1.05E+02	0.00E+00	1.47E+04	0.00E+00
SM-153	3.15E-01	1.96E-01	1.89E-02	0.00E+00	5.97E-02	0.00E+00	2.61E+03	0.00E+00
EU-152	1.63E+03	2.96E+02	3.51E+02	0.00E+00	1.25E+03	0.00E+00	4.86E+04	0.00E+00
EU-154	6.05E+03	5.44E+02	4.97E+02	0.00E+00	2.39E+03	0.00E+00	1.27E+05	0.00E+00
EU-155	1.25E+03	9.03E+01	7.08E+01	0.00E+00	3.38E+02	0.00E+00	2.26E+05	0.00E+00
EU-156	3.91E+01	2.09E+01	4.33E+00	0.00E+00	1.35E+01	0.00E+00	4.75E+04	0.00E+00
TB-160	2.67E+02	0.00E+00	3.32E+01	0.00E+00	7.96E+01	0.00E+00	5.93E+04	0.00E+00
HO-166m	2.88E+03	6.03E+02	5.09E+02	0.00E+00	8.58E+02	0.00E+00	7.01E+04	0.00E+00
W-181	8.15E+03	2.00E+03	2.75E+02	0.00E+00	0.00E+00	0.00E+00	7.30E+04	0.00E+00
W-185	2.83E+05	7.06E+04	9.89E+03	0.00E+00	0.00E+00	0.00E+00	2.63E+06	0.00E+00
W-187	1.01E+03	6.00E+02	2.69E+02	0.00E+00	0.00E+00	0.00E+00	8.44E+04	0.00E+00
NP-239	6.05E-01	4.35E-02	3.06E-02	0.00E+00	1.26E-01	0.00E+00	3.22E+03	0.00E+00
U-232	4.68E+09	0.00E+00	3.35E+08	0.00E+00	3.57E+08	0.00E+00	1.86E+07	0.00E+00
U-233	9.92E+08	0.00E+00	6.00E+07	0.00E+00	1.63E+08	0.00E+00	1.72E+07	0.00E+00
U-234	9.52E+08	0.00E+00	5.89E+07	0.00E+00	1.59E+08	0.00E+00	1.69E+07	0.00E+00
U-235	9.12E+08	0.00E+00	5.52E+07	0.00E+00	1.50E+08	0.00E+00	2.14E+07	0.00E+00

TABLE II2-24

R_i DOSE FACTORS AGE: CHILD PATHWAY: GOAT MILKm²-mrem/yr per μ Ci/sec

NUCLIDE	BONE	LIVER	T BODY	THYROID	KIDNEY	LUNG	GI-LLI	SKIN
U-236	9.12E+08	0.00E+00	5.65E+07	0.00E+00	1.53E+08	0.00E+00	1.58E+07	0.00E+00
U-237	9.03E+03	0.00E+00	2.40E+03	0.00E+00	2.60E+04	0.00E+00	7.95E+05	0.00E+00
U-238	8.72E+08	0.00E+00	5.17E+07	0.00E+00	1.40E+08	0.00E+00	1.51E+07	0.00E+00
NP-237	5.95E+06	3.92E+05	2.61E+05	0.00E+00	1.61E+06	0.00E+00	2.18E+05	0.00E+00
NP-238	5.74E+00	1.16E-01	8.94E-02	0.00E+00	3.70E-01	0.00E+00	3.98E+03	0.00E+00
PU-238	1.27E+06	1.47E+05	3.37E+04	0.00E+00	1.22E+05	0.00E+00	7.99E+04	0.00E+00
PU-239	1.38E+06	1.47E+05	3.53E+04	0.00E+00	1.30E+05	0.00E+00	7.31E+04	0.00E+00
PU-240	1.37E+06	1.53E+05	3.53E+04	0.00E+00	1.30E+05	0.00E+00	7.44E+04	0.00E+00
PU-241	4.09E+04	1.67E+03	8.50E+02	0.00E+00	3.13E+03	0.00E+00	1.52E+03	0.00E+00
PU-242	1.27E+06	1.47E+05	3.40E+04	0.00E+00	1.25E+05	0.00E+00	7.16E+04	0.00E+00
PU-244	1.48E+06	1.69E+06	3.89E+04	0.00E+00	1.44E+05	0.00E+00	1.07E+05	0.00E+00
AM-241	3.63E+06	3.12E+06	2.72E+05	0.00E+00	1.66E+06	0.00E+00	2.04E+05	0.00E+00
AM-242m	3.73E+06	2.98E+06	2.77E+05	0.00E+00	1.68E+06	0.00E+00	2.56E+05	0.00E+00
AM-243	3.57E+06	3.01E+06	2.62E+05	0.00E+00	1.62E+06	0.00E+00	2.39E+05	0.00E+00
CM-242	1.83E+05	1.46E+05	1.21E+04	0.00E+00	3.89E+04	0.00E+00	1.70E+05	0.00E+00
CM-243	3.40E+06	2.76E+06	2.19E+05	0.00E+00	8.18E+05	0.00E+00	2.13E+05	0.00E+00
CM-244	2.86E+06	2.31E+06	1.84E+05	0.00E+00	6.73E+05	0.00E+00	2.06E+05	0.00E+00
CM-245	4.45E+06	3.57E+06	2.80E+05	0.00E+00	1.10E+06	0.00E+00	1.93E+05	0.00E+00
CM-246	4.40E+06	3.57E+06	2.80E+05	0.00E+00	1.09E+06	0.00E+00	1.90E+05	0.00E+00
CM-247	4.29E+06	3.52E+06	2.75E+05	0.00E+00	1.08E+06	0.00E+00	2.49E+05	0.00E+00
CM-248	3.57E+07	2.91E+07	2.27E+06	0.00E+00	8.88E+06	0.00E+00	4.03E+06	0.00E+00
CF-252	2.68E+06	0.00E+00	6.47E+04	0.00E+00	0.00E+00	0.00E+00	7.54E+05	0.00E+00

TABLE II2-25

R_i DOSE FACTORS AGE: INFANT PATHWAY: GOAT MILKm²-mrem/yr per μCi/sec

NUCLIDE	BONE	LIVER	T BODY	THYROID	KIDNEY	LUNG	GI-LLI	SKIN
H-3	0.00E+00	2.78E+03	2.78E+03	2.78E+03	2.78E+03	2.78E+03	2.78E+03	0.00E+00
C-14	3.23E+06	6.89E+05	6.89E+05	6.89E+05	6.89E+05	6.89E+05	6.89E+05	0.00E+00
NA-22	2.00E+09	2.00E+09	2.00E+09	2.00E+09	2.00E+09	2.00E+09	2.00E+09	0.00E+00
NA-24	5.41E+05	5.41E+05	5.41E+05	5.41E+05	5.41E+05	5.41E+05	5.41E+05	0.00E+00
P-32	5.69E+10	3.34E+09	2.20E+09	0.00E+00	0.00E+00	0.00E+00	7.69E+08	0.00E+00
CA-41	9.37E+10	0.00E+00	1.02E+10	0.00E+00	0.00E+00	0.00E+00	4.79E+07	0.00E+00
SC-46	6.40E+01	9.23E+01	2.88E+01	0.00E+00	6.07E+01	0.00E+00	6.02E+04	0.00E+00
CR-51	0.00E+00	0.00E+00	6.16E+03	4.02E+03	8.79E+02	7.82E+03	1.80E+05	0.00E+00
MN-54	0.00E+00	2.32E+06	5.25E+05	0.00E+00	5.14E+05	0.00E+00	8.52E+05	0.00E+00
FE-55	9.221E+05	5.957E+05	1.592E+05	0.000E+00	0.000E+00	2.912E+05	7.563E+04	0.000E+00
MN-56	0.00E+00	1.10E-03	1.90E-04	0.00E+00	9.48E-04	0.00E+00	1.00E-01	0.00E+00
CO-57	0.00E+00	5.25E+05	8.54E+05	0.00E+00	0.00E+00	0.00E+00	1.79E+06	0.00E+00
CO-58	0.00E+00	1.15E+06	2.87E+06	0.00E+00	0.00E+00	0.00E+00	2.86E+06	0.00E+00
FE-59	1.032E+06	1.802E+06	7.101E+05	0.000E+00	0.000E+00	5.325E+05	8.608E+05	0.000E+00
CO-60	0.00E+00	5.63E+06	1.33E+07	0.00E+00	0.00E+00	0.00E+00	1.34E+07	0.00E+00
NI-59	1.69E+08	5.18E+07	2.92E+07	0.00E+00	0.00E+00	0.00E+00	2.56E+06	0.00E+00
NI-63	2.26E+09	1.40E+08	7.85E+07	0.00E+00	0.00E+00	0.00E+00	6.96E+06	0.00E+00
CU-64	0.00E+00	6.05E+03	2.80E+03	0.00E+00	1.02E+04	0.00E+00	1.24E+05	0.00E+00
NI-65	1.23E-01	1.39E-02	6.33E-03	0.00E+00	0.00E+00	0.00E+00	1.06E+00	0.00E+00
ZN-65	3.23E+08	1.11E+09	5.10E+08	0.00E+00	5.37E+08	0.00E+00	9.35E+08	0.00E+00
ZN-69m	5.90E+04	1.20E+05	1.10E+04	0.00E+00	4.88E+04	0.00E+00	1.67E+06	0.00E+00
ZN-69	7.08E-13	1.27E-12	9.48E-14	0.00E+00	5.30E-13	0.00E+00	1.04E-10	0.00E+00
SE-79	0.00E+00	5.04E+08	9.36E+07	0.00E+00	5.83E+08	0.00E+00	1.34E+07	0.00E+00
BR-82	0.00E+00	0.00E+00	6.79E+06	0.00E+00	0.00E+00	0.00E+00	0.00E+00	0.00E+00
BR-83	0.00E+00	0.00E+00	3.28E-02	0.00E+00	0.00E+00	0.00E+00	0.00E+00	0.00E+00
BR-84	0.00E+00	0.00E+00	4.41E-24	0.00E+00	0.00E+00	0.00E+00	0.00E+00	0.00E+00
BR-85	0.00E+00	0.00E+00	0.00E+00	0.00E+00	0.00E+00	0.00E+00	0.00E+00	0.00E+00
RB-86	0.00E+00	8.04E+08	3.97E+08	0.00E+00	0.00E+00	0.00E+00	2.06E+07	0.00E+00
RB-87	0.00E+00	1.42E+09	5.63E+08	0.00E+00	0.00E+00	0.00E+00	9.57E+06	0.00E+00
RB-88	0.00E+00	6.58E-46	3.61E-46	0.00E+00	0.00E+00	0.00E+00	6.41E-46	0.00E+00
RB-89	0.00E+00	1.15E-53	7.95E-54	0.00E+00	0.00E+00	0.00E+00	3.93E-54	0.00E+00
SR-89	9.64E+09	0.00E+00	2.76E+08	0.00E+00	0.00E+00	0.00E+00	1.98E+08	0.00E+00
SR-90	2.10E+11	0.00E+00	4.27E+09	0.00E+00	0.00E+00	0.00E+00	1.72E+09	0.00E+00
Y-90	2.39E+01	0.00E+00	6.41E-01	0.00E+00	0.00E+00	0.00E+00	3.30E+04	0.00E+00
SR-91	1.67E+05	0.00E+00	6.04E+03	0.00E+00	0.00E+00	0.00E+00	1.97E+05	0.00E+00
Y-91m	1.99E-20	0.00E+00	6.79E-22	0.00E+00	0.00E+00	0.00E+00	6.64E-17	0.00E+00
Y-91	3.32E+03	0.00E+00	8.84E+01	0.00E+00	0.00E+00	0.00E+00	2.38E+05	0.00E+00
SR-92	2.85E+00	0.00E+00	1.06E-01	0.00E+00	0.00E+00	0.00E+00	3.07E+01	0.00E+00
Y-92	1.89E-05	0.00E+00	5.30E-07	0.00E+00	0.00E+00	0.00E+00	3.60E-01	0.00E+00
Y-93	7.57E-02	0.00E+00	2.06E-03	0.00E+00	0.00E+00	0.00E+00	5.98E+02	0.00E+00
NB-93m	1.63E+05	4.40E+04	1.38E+04	0.00E+00	4.30E+04	0.00E+00	5.26E+06	0.00E+00
NB-95	2.38E+04	9.80E+03	5.67E+03	0.00E+00	7.03E+03	0.00E+00	8.27E+06	0.00E+00
NB-97	1.08E-12	2.31E-13	8.31E-14	0.00E+00	1.80E-13	0.00E+00	7.28E-08	0.00E+00
ZR-93	5.15E+02	2.45E+01	1.48E+01	0.00E+00	7.23E+01	0.00E+00	6.37E+03	0.00E+00
ZR-95	3.15E+02	7.68E+01	5.45E+01	0.00E+00	8.28E+01	0.00E+00	3.82E+04	0.00E+00

TABLE II2-25

R_i DOSE FACTORS AGE: INFANT PATHWAY: GOAT MILKm²-mrem/yr per μ Ci/sec

NUCLIDE	BONE	LIVER	T BODY	THYROID	KIDNEY	LUNG	GI-LLI	SKIN
ZR-97	1.43E-01	2.45E-02	1.12E-02	0.00E+00	2.47E-02	0.00E+00	1.56E+03	0.00E+00
MO-93	0.00E+00	2.26E+08	7.28E+06	0.00E+00	4.52E+07	0.00E+00	4.84E+06	0.00E+00
MO-99	0.00E+00	7.30E+06	1.42E+06	0.00E+00	1.09E+07	0.00E+00	2.41E+06	0.00E+00
TC-99	1.44E+07	1.95E+07	6.07E+06	0.00E+00	1.64E+08	1.89E+06	8.41E+07	0.00E+00
TC-99m	9.65E-01	1.99E+00	2.56E+01	0.00E+00	2.14E+01	1.04E+00	5.78E+02	0.00E+00
TC-101	8.66E-61	1.09E-60	1.08E-59	0.00E+00	1.30E-59	5.95E-61	1.85E-58	0.00E+00
RU-103	3.57E+02	0.00E+00	1.19E+02	0.00E+00	7.43E+02	0.00E+00	4.34E+03	0.00E+00
RU-105	2.83E-04	0.00E+00	9.52E-05	0.00E+00	2.08E-03	0.00E+00	1.12E-01	0.00E+00
RU-106	1.15E+04	0.00E+00	1.43E+03	0.00E+00	1.35E+04	0.00E+00	8.70E+04	0.00E+00
RH-105	1.17E+05	7.64E+04	5.13E+04	0.00E+00	2.12E+05	0.00E+00	1.90E+06	0.00E+00
PD-107	0.00E+00	6.35E+06	4.51E+05	0.00E+00	3.62E+07	0.00E+00	5.04E+06	0.00E+00
PD-109	0.00E+00	1.40E+04	3.38E+03	0.00E+00	5.15E+04	0.00E+00	3.44E+05	0.00E+00
AG-110m	2.25E+07	1.64E+07	1.09E+07	0.00E+00	2.35E+07	0.00E+00	8.51E+08	0.00E+00
AG-111	2.17E+06	8.42E+05	4.46E+05	0.00E+00	1.76E+06	0.00E+00	2.01E+08	0.00E+00
CD-113m	0.00E+00	1.12E+06	4.14E+04	0.00E+00	8.50E+05	0.00E+00	1.69E+06	0.00E+00
CD-115m	0.00E+00	4.39E+05	1.52E+04	0.00E+00	2.29E+05	0.00E+00	2.50E+06	0.00E+00
SN-123	2.44E+08	3.82E+06	6.38E+06	3.84E+06	0.00E+00	0.00E+00	6.45E+07	0.00E+00
SN-125	1.89E+07	3.52E+05	8.40E+05	3.47E+05	0.00E+00	0.00E+00	2.83E+07	0.00E+00
SN-126	7.37E+08	9.68E+06	2.40E+07	2.55E+06	0.00E+00	0.00E+00	3.36E+07	0.00E+00
SB-124	9.56E+06	1.41E+05	2.96E+06	2.54E+04	0.00E+00	5.98E+06	2.95E+07	0.00E+00
SB-125	9.43E+06	9.12E+04	1.94E+06	1.18E+04	0.00E+00	5.46E+06	1.26E+07	0.00E+00
SB-126	1.47E+06	2.89E+04	5.32E+05	1.13E+04	0.00E+00	9.27E+05	1.53E+07	0.00E+00
SB-127	1.45E+05	2.59E+03	4.50E+04	1.85E+03	0.00E+00	7.49E+04	3.85E+06	0.00E+00
TE-125m	6.82E+06	2.28E+06	9.22E+05	2.29E+06	0.00E+00	0.00E+00	3.25E+06	0.00E+00
TE-127m	2.18E+07	7.24E+06	2.64E+06	6.31E+06	5.38E+07	0.00E+00	8.81E+06	0.00E+00
TE-127	2.22E+02	7.43E+01	4.77E+01	1.81E+02	5.41E+02	0.00E+00	4.66E+03	0.00E+00
TE-129m	2.21E+07	7.60E+06	3.41E+06	8.50E+06	5.54E+07	0.00E+00	1.32E+07	0.00E+00
TE-129	9.54E-11	3.29E-11	2.23E-11	8.00E-11	2.38E-10	0.00E+00	7.63E-09	0.00E+00
TE-133m	6.66E-14	3.05E-14	2.91E-14	5.87E-14	2.08E-13	0.00E+00	3.29E-12	0.00E+00
TE-134	2.74E-19	1.38E-19	1.42E-19	2.45E-19	9.27E-19	0.00E+00	3.14E-18	0.00E+00
I-129	4.58E+09	3.39E+09	2.48E+09	2.18E+12	4.02E+09	0.00E+00	6.78E+07	0.00E+00
I-130	1.25E+06	2.74E+06	1.10E+06	3.07E+08	3.01E+06	0.00E+00	5.88E+05	0.00E+00
I-131	9.55E+08	1.13E+09	4.95E+08	3.70E+11	1.31E+09	0.00E+00	4.02E+07	0.00E+00
TE-131m	1.19E+05	4.77E+04	3.94E+04	9.67E+04	3.28E+05	0.00E+00	8.03E+05	0.00E+00
TE-131	1.20E-33	4.44E-34	3.38E-34	1.07E-33	3.08E-33	0.00E+00	4.86E-32	0.00E+00
I-132	5.02E-01	1.02E+00	3.63E-01	4.78E+01	1.14E+00	0.00E+00	8.25E-01	0.00E+00
TE-132	7.41E+05	3.67E+05	3.42E+05	5.41E+05	2.29E+06	0.00E+00	1.36E+06	0.00E+00
I-133	1.27E+07	1.85E+07	5.43E+06	3.37E+09	2.18E+07	0.00E+00	3.14E+06	0.00E+00
CS-134m	1.34E+00	2.23E+00	1.13E+00	0.00E+00	8.60E-01	1.98E-01	1.77E+00	0.00E+00
CS-134	5.69E+10	1.06E+11	1.07E+10	0.00E+00	2.73E+10	1.12E+10	2.89E+08	0.00E+00
I-134	6.18E-12	1.27E-11	4.50E-12	2.95E-10	1.41E-11	0.00E+00	1.31E-11	0.00E+00
I-135	3.94E+04	7.84E+04	2.86E+04	7.03E+06	8.74E+04	0.00E+00	2.84E+04	0.00E+00
CS-135	2.13E+10	1.94E+10	1.01E+09	0.00E+00	5.50E+09	2.10E+09	6.99E+07	0.00E+00
CS-136	1.75E+09	5.14E+09	1.92E+09	0.00E+00	2.05E+09	4.19E+08	7.80E+07	0.00E+00
CS-137	8.32E+10	9.74E+10	6.90E+09	0.00E+00	2.61E+10	1.06E+10	3.04E+08	0.00E+00

TABLE II2-25

R_i DOSE FACTORS AGE: INFANT PATHWAY: GOAT MILKm²-mrem/yr per μCi/sec

NUCLIDE	BONE	LIVER	T BODY	THYROID	KIDNEY	LUNG	GI-LLI	SKIN
CS-138	7.36E-23	1.20E-22	5.80E-23	0.00E+00	5.97E-23	9.32E-24	1.91E-22	0.00E+00
CS-139	5.76E-89	7.87E-89	3.01E-89	0.00E+00	4.07E-89	6.13E-90	4.94E-90	0.00E+00
BA-139	1.50E-08	9.94E-12	4.34E-10	0.00E+00	5.98E-12	6.03E-12	9.50E-07	0.00E+00
BA-140	8.51E+06	8.51E+03	4.39E+05	0.00E+00	2.02E+03	5.23E+03	2.09E+06	0.00E+00
LA-140	1.42E+00	5.61E-01	1.44E-01	0.00E+00	0.00E+00	0.00E+00	6.59E+03	0.00E+00
BA-141	1.38E-46	9.45E-50	4.35E-48	0.00E+00	5.68E-50	5.75E-50	1.69E-45	0.00E+00
LA-141	1.03E-05	2.99E-06	5.20E-07	0.00E+00	0.00E+00	0.00E+00	3.43E-01	0.00E+00
CE-141	1.71E+03	1.04E+03	1.23E+02	0.00E+00	3.22E+02	0.00E+00	5.39E+05	0.00E+00
BA-142	8.58E-81	7.13E-84	4.22E-82	0.00E+00	4.11E-84	4.32E-84	3.54E-80	0.00E+00
LA-142	5.97E-12	2.19E-12	5.24E-13	0.00E+00	0.00E+00	0.00E+00	3.72E-07	0.00E+00
CE-143	1.39E+01	9.24E+03	1.05E+00	0.00E+00	2.69E+00	0.00E+00	5.39E+04	0.00E+00
PR-143	5.26E+01	1.97E+01	2.61E+00	0.00E+00	7.31E+00	0.00E+00	2.77E+04	0.00E+00
CE-144	1.37E+05	5.61E+04	7.68E+03	0.00E+00	2.27E+04	0.00E+00	7.87E+06	0.00E+00
PR-144	2.00E-54	7.72E-55	1.01E-55	0.00E+00	2.80E-55	0.00E+00	3.59E-50	0.00E+00
ND-147	3.10E+01	3.19E+01	1.95E+00	0.00E+00	1.23E+01	0.00E+00	2.02E+04	0.00E+00
PM-147	9.89E+02	8.33E+01	4.05E+01	0.00E+00	1.24E+02	0.00E+00	2.36E+04	0.00E+00
PM-148m	2.04E+02	5.17E+01	4.06E+01	0.00E+00	5.94E+01	0.00E+00	6.73E+04	0.00E+00
PM-148	1.95E+01	2.82E+00	1.42E+00	0.00E+00	3.37E+00	0.00E+00	3.01E+04	0.00E+00
PM-149	1.45E+00	1.90E-01	8.31E-02	0.00E+00	2.31E-01	0.00E+00	5.11E+03	0.00E+00
PM-151	2.15E-01	3.14E-02	1.59E-02	0.00E+00	3.73E-02	0.00E+00	1.45E+03	0.00E+00
SM-151	7.72E+02	1.78E+02	3.83E+01	0.00E+00	1.21E+02	0.00E+00	1.49E+04	0.00E+00
SM-153	6.67E-01	5.15E-01	3.95E-02	0.00E+00	1.08E-01	0.00E+00	2.69E+03	0.00E+00
EU-152	1.78E+03	4.73E+02	3.99E+02	0.00E+00	1.33E+03	0.00E+00	4.20E+04	0.00E+00
EU-154	6.94E+03	9.65E+02	5.79E+02	0.00E+00	2.62E+03	0.00E+00	1.20E+05	0.00E+00
EU-155	1.41E+03	1.63E+02	8.41E+01	0.00E+00	3.64E+02	0.00E+00	2.18E+05	0.00E+00
EU-156	7.93E+01	4.91E+01	7.79E+00	0.00E+00	2.27E+01	0.00E+00	4.64E+04	0.00E+00
TB-160	4.17E+02	0.00E+00	5.22E+01	0.00E+00	1.19E+02	0.00E+00	5.56E+04	0.00E+00
HO-166m	3.33E+03	7.17E+02	5.68E+02	0.00E+00	9.52E+02	0.00E+00	7.09E+04	0.00E+00
W-181	1.70E+04	5.24E+03	5.85E+02	0.00E+00	0.00E+00	0.00E+00	7.36E+04	0.00E+00
W-185	5.92E+05	1.85E+05	2.11E+04	0.00E+00	0.00E+00	0.00E+00	2.65E+06	0.00E+00
W-187	2.13E+03	1.48E+03	5.13E+02	0.00E+00	0.00E+00	0.00E+00	8.72E+04	0.00E+00
NP-239	1.28E+00	1.15E-01	6.47E-02	0.00E+00	2.28E-01	0.00E+00	3.31E+03	0.00E+00
U-232	6.44E+09	0.00E+00	5.75E+08	0.00E+00	6.31E+08	0.00E+00	1.87E+07	0.00E+00
U-233	1.35E+09	0.00E+00	1.03E+08	0.00E+00	2.88E+08	0.00E+00	1.74E+07	0.00E+00
U-234	1.30E+09	0.00E+00	1.01E+08	0.00E+00	2.83E+08	0.00E+00	1.70E+07	0.00E+00
U-235	1.25E+09	0.00E+00	9.49E+07	0.00E+00	2.65E+08	0.00E+00	2.16E+07	0.00E+00
U-236	1.25E+09	0.00E+00	9.71E+07	0.00E+00	2.69E+08	0.00E+00	1.59E+07	0.00E+00
U-237	1.89E+04	0.00E+00	5.05E+03	0.00E+00	4.70E+04	0.00E+00	8.07E+05	0.00E+00
U-238	1.19E+09	0.00E+00	8.88E+07	0.00E+00	2.47E+08	0.00E+00	1.52E+07	0.00E+00
NP-237	6.40E+06	4.24E+05	2.80E+05	0.00E+00	1.69E+06	0.00E+00	2.19E+05	0.00E+00
NP-238	1.22E+01	3.07E-01	1.89E-01	0.00E+00	6.70E-01	0.00E+00	4.11E+03	0.00E+00
PU-238	1.36E+06	1.60E+05	3.62E+04	0.00E+00	1.29E+05	0.00E+00	8.06E+04	0.00E+00
PU-239	1.47E+06	1.65E+05	3.78E+04	0.00E+00	1.37E+05	0.00E+00	7.37E+04	0.00E+00
PU-240	1.47E+06	1.65E+05	3.78E+04	0.00E+00	1.37E+05	0.00E+00	7.51E+04	0.00E+00
PU-241	4.50E+04	1.86E+03	9.33E+02	0.00E+00	3.35E+03	0.00E+00	1.53E+03	0.00E+00

TABLE II-25

R_i DOSE FACTORS AGE: INFANT PATHWAY: GOAT MILKm²-mrem/yr per μ Ci/sec

NUCLIDE	BONE	LIVER	T BODY	THYROID	KIDNEY	LUNG	GI-LLI	SKIN
PU-242	1.37E+06	1.59E+05	3.64E+04	0.00E+00	1.31E+05	0.00E+00	7.22E+04	0.00E+00
PU-244	1.59E+06	1.82E+05	4.17E+04	0.00E+00	1.50E+05	0.00E+00	1.08E+05	0.00E+00
AM-241	3.89E+06	3.39E+06	2.91E+05	0.00E+00	1.75E+06	0.00E+00	2.05E+05	0.00E+00
AM-242m	4.02E+06	3.25E+06	3.01E+05	0.00E+00	1.77E+06	0.00E+00	2.58E+05	0.00E+00
AM-243	3.84E+06	3.28E+06	2.83E+05	0.00E+00	1.70E+06	0.00E+00	2.41E+05	0.00E+00
CM-242	2.85E+05	2.64E+05	1.89E+04	0.00E+00	5.45E+04	0.00E+00	1.71E+05	0.00E+00
CM-243	3.72E+06	3.05E+06	2.38E+05	0.00E+00	8.68E+05	0.00E+00	2.15E+05	0.00E+00
CM-244	3.13E+06	2.57E+06	2.01E+05	0.00E+00	7.18E+05	0.00E+00	2.08E+05	0.00E+00
CM-245	4.77E+06	3.87E+06	3.01E+05	0.00E+00	1.15E+06	0.00E+00	1.95E+05	0.00E+00
CM-246	4.72E+06	3.87E+06	3.01E+05	0.00E+00	1.15E+06	0.00E+00	1.91E+05	0.00E+00
CM-247	4.61E+06	3.81E+06	2.96E+05	0.00E+00	1.13E+06	0.00E+00	2.51E+05	0.00E+00
CM-248	3.81E+07	3.15E+07	2.44E+06	0.00E+00	9.33E+06	0.00E+00	4.05E+06	0.00E+00
CF-252	3.11E+06	0.00E+00	7.52E+04	0.00E+00	0.00E+00	0.00E+00	7.62E+05	0.00E+00

Table II2-26

STABLE ELEMENT TRANSFER DATA

NUCLIDE	VEG/SOIL	COW MILK (D/L)	MEAT (D/KG)	GOAT MILK (D/L)
H-3	4.8E+00	1.0E-02	1.2E-02	1.7E-01
C-14	5.5E+00	1.2E-02	3.1E-02	1.0E-01
NA-22	5.2E-02	4.0E-02	3.0E-02	4.0E-02
NA-24	5.2E-02	4.0E-02	3.0E-02	4.0E-02
P-32	1.1E+00	2.5E-02	4.6E-02	2.5E-01
CA-41	3.6E-02	8.0E-03	4.0E-03	8.0E-03
SC-46	1.1E-03	5.0E-06	1.6E-02	5.0E-06
CR-51	2.5E-04	2.2E-03	2.4E-03	2.2E-03
MN-54	2.9E-02	2.5E-04	8.0E-04	2.5E-04
MN-56	2.9E-02	2.5E-04	8.0E-04	2.5E-04
FE-55	6.6E-04	1.2E-03	4.0E-02	1.3E-04
FE-59	6.6E-04	1.2E-03	4.0E-02	1.3E-04
CO-57	9.4E-03	1.0E-03	1.3E-02	1.0E-03
CO-58	9.4E-03	1.0E-03	1.3E-02	1.0E-03
CO-60	9.4E-03	1.0E-03	1.3E-02	1.0E-03
NI-59	1.9E-02	6.7E-03	5.3E-03	6.7E-03
NI-63	1.9E-02	6.7E-03	5.3E-03	6.7E-03
NI-65	1.9E-02	6.7E-03	5.3E-03	6.7E-03
CU-64	1.2E-01	1.4E-02	8.0E-03	1.3E-02
ZN-65	4.0E-01	3.9E-02	3.0E-02	3.9E-02
ZN-69M	4.0E-01	3.9E-02	3.0E-02	3.9E-02
ZN-69	4.0E-01	3.9E-02	3.0E-02	3.9E-02
SE-79	1.3E+00	4.5E-02	1.5E-02	4.5E-02
BR-82	7.6E-01	5.0E-02	2.6E-02	5.0E-02
BR-83	7.6E-01	5.0E-02	2.6E-02	5.0E-02
BR-84	7.6E-01	5.0E-02	2.6E-02	5.0E-02
BR-85	7.6E-01	5.0E-02	2.6E-02	5.0E-02
RB-86	1.3E-01	3.0E-02	3.1E-02	3.0E-02
RB-87	1.3E-01	3.0E-02	3.1E-02	3.0E-02
RB-88	1.3E-01	3.0E-02	3.1E-02	3.0E-02
RB-89	1.3E-01	3.0E-02	3.1E-02	3.0E-02
SR-89	1.7E-02	8.0E-04	6.0E-04	1.4E-02
SR-90	1.7E-02	8.0E-04	6.0E-04	1.4E-02
SR-91	1.7E-02	8.0E-04	6.0E-04	1.4E-02
SR-92	1.7E-02	8.0E-04	6.0E-04	1.4E-02
Y-90	2.6E-03	1.0E-05	4.6E-03	1.0E-05
Y-91M	2.6E-03	1.0E-05	4.6E-03	1.0E-05
Y-91	2.6E-03	1.0E-05	4.6E-03	1.0E-05
Y-92	2.6E-03	1.0E-05	4.6E-03	1.0E-05
Y-93	2.6E-03	1.0E-05	4.6E-03	1.0E-05
ZR-93	1.7E-04	5.0E-06	3.4E-02	5.0E-06
ZR-95	1.7E-04	5.0E-06	3.4E-02	5.0E-06
ZR-97	1.7E-04	5.0E-06	3.4E-02	5.0E-06
NB-93M	9.4E-03	2.5E-03	2.8E-01	2.5E-03

Table II-26

STABLE ELEMENT TRANSFER DATA

NUCLIDE	VEG/SOIL	COW MILK (D/L)	MEAT (D/KG)	GOAT MILK (D/L)
NB-95	9.4E-03	2.5E-03	2.8E-01	2.5E-03
NB-97	9.4E-03	2.5E-03	2.8E-01	2.5E-03
MO-93	1.2E-01	7.5E-03	8.0E-03	7.5E-03
MO-99	1.2E-01	7.5E-03	8.0E-03	7.5E-03
TC-99M	2.5E-01	2.5E-02	4.0E-01	2.5E-02
TC-99	2.5E-01	2.5E-02	4.0E-01	2.5E-02
TC-101	2.5E-01	2.5E-02	4.0E-01	2.5E-02
RU-103	5.0E-02	1.0E-06	4.0E-01	1.0E-06
RU-105	5.0E-02	1.0E-06	4.0E-01	1.0E-06
RU-106	5.0E-02	1.0E-06	4.0E-01	1.0E-06
RH-105	1.3E+01	1.0E-02	1.5E-03	1.0E-02
PD-107	5.0E+00	1.0E-02	4.0E-03	1.0E-02
PD-109	5.0E+00	1.0E-02	4.0E-03	1.0E-02
AG-110M	1.5E-01	5.0E-02	1.7E-02	5.0E-02
AG-111	1.5E-01	5.0E-02	1.7E-02	5.0E-02
CD-113M	3.0E-01	1.2E-04	5.3E-04	1.2E-04
CD-115M	3.0E-01	1.2E-04	5.3E-04	1.2E-04
SN-123	2.5E-03	2.5E-03	8.0E-02	2.5E-03
SN-125	2.5E-03	2.5E-03	8.0E-02	2.5E-03
SN-126	2.5E-03	2.5E-03	8.0E-02	2.5E-03
SB-124	1.1E-02	1.5E-03	4.0E-03	1.5E-03
SB-125	1.1E-02	1.5E-03	4.0E-03	1.5E-03
SB-126	1.1E-02	1.5E-03	4.0E-03	1.5E-03
SB-127	1.1E-02	1.5E-03	4.0E-03	1.5E-03
TE-125M	1.3E+00	1.0E-03	7.7E-02	1.0E-03
TE-127M	1.3E+00	1.0E-03	7.7E-02	1.0E-03
TE-127	1.3E+00	1.0E-03	7.7E-02	1.0E-03
TE-129M	1.3E+00	1.0E-03	7.7E-02	1.0E-03
TE-129	1.3E+00	1.0E-03	7.7E-02	1.0E-03
TE-131M	1.3E+00	1.0E-03	7.7E-02	1.0E-03
TE-131	1.3E+00	1.0E-03	7.7E-02	1.0E-03
TE-132	1.3E+00	1.0E-03	7.7E-02	1.0E-03
TE-133M	1.3E+00	1.0E-03	7.7E-02	1.0E-03
TE-134	1.3E+00	1.0E-03	7.7E-02	1.0E-03
I-129	2.0E-02	6.0E-03	2.9E-03	6.0E-02
I-130	2.0E-02	6.0E-03	2.9E-03	6.0E-02
I-131	2.0E-02	6.0E-03	2.9E-03	6.0E-02
I-132	2.0E-02	6.0E-03	2.9E-03	6.0E-03
I-133	2.0E-02	6.0E-03	2.9E-03	6.0E-02
I-134	2.0E-02	6.0E-03	2.9E-03	6.0E-02
I-135	2.0E-02	6.0E-03	2.9E-03	6.0E-02
CS-134M	1.0E-02	1.2E-02	4.0E-03	3.0E-01
CS-134	1.0E-02	1.2E-02	4.0E-03	3.0E-01
CS-135	1.0E-02	1.2E-02	4.0E-03	3.0E-01

Table II2-26

STABLE ELEMENT TRANSFER DATA

NUCLIDE	VEG/SOIL	COW MILK (D/L)	MEAT (D/KG)	GOAT MILK (D/L)
CS-136	1.0E-02	1.2E-02	4.0E-03	3.0E-01
CS-137	1.0E-02	1.2E-02	4.0E-03	3.0E-01
CS-138	1.0E-02	1.2E-02	4.0E-03	3.0E-01
CS-139	1.0E-02	1.2E-02	4.0E-03	3.0E-01
BA-139	5.0E-03	4.0E-04	3.2E-03	4.0E-04
BA-140	5.0E-03	4.0E-04	3.2E-03	4.0E-04
BA-141	5.0E-03	4.0E-04	3.2E-03	4.0E-04
BA-142	5.0E-03	4.0E-04	3.2E-03	4.0E-04
LA-140	2.5E-03	5.0E-06	2.0E-04	5.0E-06
LA-141	2.5E-03	5.0E-06	2.0E-04	5.0E-06
LA-142	2.5E-03	5.0E-06	2.0E-04	5.0E-06
CE-141	2.5E-03	1.0E-04	1.2E-03	1.0E-04
CE-143	2.5E-03	1.0E-04	1.2E-03	1.0E-04
CE-144	2.5E-03	1.0E-04	1.2E-03	1.0E-04
PR-143	2.5E-03	5.0E-06	4.7E-03	5.0E-06
PR-144	2.5E-03	5.0E-06	4.7E-03	5.0E-06
ND-147	2.4E-03	5.0E-06	3.3E-03	5.0E-06
PM-147	2.5E-03	5.0E-06	4.8E-03	5.0E-06
PM-148M	2.5E-03	5.0E-06	4.8E-03	5.0E-06
PM-148	2.5E-03	5.0E-06	4.8E-03	5.0E-06
PM-149	2.5E-03	5.0E-06	4.8E-03	5.0E-06
PM-151	2.5E-03	5.0E-06	4.8E-03	5.0E-06
SM-151	2.5E-03	5.0E-06	5.0E-03	5.0E-06
SM-153	2.5E-03	5.0E-06	5.0E-03	5.0E-06
EU-152	2.5E-03	5.0E-06	4.8E-03	5.0E-06
EU-154	2.5E-03	5.0E-06	4.8E-03	5.0E-06
EU-155	2.5E-03	5.0E-06	4.8E-03	5.0E-06
EU-156	2.5E-03	5.0E-06	4.8E-03	5.0E-06
TB-160	2.6E-03	5.0E-06	4.4E-03	5.0E-06
HO-166M	2.6E-03	5.0E-06	4.4E-03	5.0E-06
W-181	1.8E-02	5.0E-04	1.3E-03	5.0E-04
W-185	1.8E-02	5.0E-04	1.3E-03	5.0E-04
W-187	1.8E-02	5.0E-04	1.3E-03	5.0E-04
U-232	2.5E-03	5.0E-04	3.4E-04	5.0E-04
U-233	2.5E-03	5.0E-04	3.4E-04	5.0E-04
U-234	2.5E-03	5.0E-04	3.4E-04	5.0E-04
U-235	2.5E-03	5.0E-04	3.4E-04	5.0E-04
U-236	2.5E-03	5.0E-04	3.4E-04	5.0E-04
U-237	2.5E-03	5.0E-04	3.4E-04	5.0E-04
U-238	2.5E-03	5.0E-04	3.4E-04	5.0E-04
NP-237	2.5E-03	5.0E-06	2.0E-04	5.0E-06
NP-238	2.5E-03	5.0E-06	2.0E-04	5.0E-06
NP-239	2.5E-03	5.0E-06	2.0E-04	5.0E-06
PU-238	2.5E-04	2.0E-06	1.4E-05	2.0E-06

Table II2-26

STABLE ELEMENT TRANSFER DATA

NUCLIDE	VEG/SOIL	COW MILK (D/L)	MEAT (D/KG)	GOAT MILK (D/L)
PU-239	2.5E-04	2.0E-06	1.4E-05	2.0E-06
PU-240	2.5E-04	2.0E-06	1.4E-05	2.0E-06
PU-241	2.5E-04	2.0E-06	1.4E-05	2.0E-06
PU-242	2.5E-04	2.0E-06	1.4E-05	2.0E-06
PU-244	2.5E-04	2.0E-06	1.4E-05	2.0E-06
AM-241	2.5E-04	5.0E-06	2.0E-04	5.0E-06
AM-242M	2.5E-04	5.0E-06	2.0E-04	5.0E-06
AM-243	2.5E-04	5.0E-06	2.0E-04	5.0E-06
CM-242	2.5E-03	5.0E-06	2.0E-04	5.0E-06
CM-243	2.5E-03	5.0E-06	2.0E-04	5.0E-06
CM-244	2.5E-03	5.0E-06	2.0E-04	5.0E-06
CM-245	2.5E-03	5.0E-06	2.0E-04	5.0E-06
CM-246	2.5E-03	5.0E-06	2.0E-04	5.0E-06
CM-247	2.5E-03	5.0E-06	2.0E-04	5.0E-06
CM-248	2.5E-03	5.0E-06	2.0E-04	5.0E-06
CF-252	2.5E-03	5.0E-06	2.0E-04	5.0E-06

NUREG/CR-4653 GASPAR II, Technical Reference and User Guide

TABLE II2-27

INHALATION DOSE FACTORS FOR ADULT (D_{aipj})

(mrem per pCi inhaled)

NUCLIDE	BONE	LIVER	T BODY	THYROID	KIDNEY	LUNG	GI-LLI
H-3	0.00E+00	8.98E-08	8.98E-08	8.98E-08	8.98E-08	8.98E-08	8.98E-08
C-14	2.27E-06	4.26E-07	4.26E-07	4.26E-07	4.26E-07	4.26E-07	4.26E-07
NA-22	1.30E-05	1.30E-05	1.30E-05	1.30E-05	1.30E-05	1.30E-05	1.30E-05
NA-24	1.28E-06	1.28E-06	1.28E-06	1.28E-06	1.28E-06	1.28E-06	1.28E-06
P-32	1.65E-04	9.64E-06	6.26E-06	0.00E+00	0.00E+00	0.00E+00	1.08E-05
CA-41	3.83E-05	0.00E+00	4.13E-06	0.00E+00	0.00E+00	3.83E-06	2.86E-07
SC-46	5.51E-05	1.07E-04	3.11E-05	0.00E+00	9.99E-05	0.00E+00	3.23E-05
CR-51	0.00E+00	0.00E+00	1.25E-08	7.44E-09	2.85E-09	1.80E-06	4.15E-07
MN-54	0.00E+00	4.95E-06	7.87E-07	0.00E+00	1.23E-06	1.75E-04	9.67E-06
MN-56	0.00E+00	1.55E-10	2.29E-11	0.00E+00	1.63E-10	1.18E-06	2.53E-06
FE-55	3.07E-06	2.12E-06	4.93E-07	0.00E+00	0.00E+00	9.01E-06	7.54E-07
FE-59	1.47E-06	3.47E-06	1.32E-06	0.00E+00	0.00E+00	1.27E-04	2.35E-05
CO-57	0.00E+00	8.65E-08	8.39E-08	0.00E+00	0.00E+00	4.62E-05	3.93E-06
CO-58	0.00E+00	1.98E-07	2.59E-07	0.00E+00	0.00E+00	1.16E-04	1.33E-05
CO-60	0.00E+00	1.44E-06	1.85E-06	0.00E+00	0.00E+00	7.46E-04	3.56E-05
NI-59	4.06E-06	1.46E-06	6.77E-07	0.00E+00	0.00E+00	8.20E-06	6.11E-07
NI-63	5.40E-05	3.93E-06	1.81E-06	0.00E+00	0.00E+00	2.23E-05	1.67E-06
NI-65	1.92E-10	2.62E-11	1.14E-11	0.00E+00	0.00E+00	7.00E-07	1.54E-06
CU-64	0.00E+00	1.83E-10	7.69E-11	0.00E+00	5.78E-10	8.48E-07	6.12E-06
ZN-65	4.05E-06	1.29E-05	5.82E-06	0.00E+00	8.62E-06	1.08E-04	6.68E-06
ZN-69M	1.02E-09	2.45E-09	2.24E-10	0.00E+00	1.48E-09	2.38E-06	1.71E-05
ZN-69	4.23E-12	8.14E-12	5.65E-13	0.00E+00	5.27E-12	1.15E-07	2.04E-09
SE-79	0.00E+00	3.83E-07	6.09E-08	0.00E+00	5.69E-07	4.47E-05	3.33E-06
BR-82	0.00E+00	0.00E+00	1.69E-06	0.00E+00	0.00E+00	0.00E+00	1.30E-06
BR-83	0.00E+00	0.00E+00	3.01E-08	0.00E+00	0.00E+00	0.00E+00	2.90E-08
BR-84	0.00E+00	0.00E+00	3.91E-08	0.00E+00	0.00E+00	0.00E+00	2.05E-13
BR-85	0.00E+00	0.00E+00	1.60E-09	0.00E+00	0.00E+00	0.00E+00	0.00E+00
RB-86	0.00E+00	1.69E-05	7.37E-06	0.00E+00	0.00E+00	0.00E+00	2.08E-06
RB-87	0.00E+00	9.86E-06	3.21E-06	0.00E+00	0.00E+00	0.00E+00	2.88E-07
RB-88	0.00E+00	4.84E-08	2.41E-08	0.00E+00	0.00E+00	0.00E+00	4.18E-19
RB-89	0.00E+00	3.20E-08	2.12E-08	0.00E+00	0.00E+00	0.00E+00	1.16E-21
SR-89	3.80E-05	0.00E+00	1.09E-06	0.00E+00	0.00E+00	1.75E-04	4.37E-05
SR-90	3.59E-03	0.00E+00	7.21E-05	0.00E+00	0.00E+00	1.20E-03	9.02E-05
SR-91	7.74E-09	0.00E+00	3.13E-10	0.00E+00	0.00E+00	4.56E-06	2.39E-05
SR-92	8.43E-10	0.00E+00	3.64E-11	0.00E+00	0.00E+00	2.06E-06	5.38E-06
Y-90	2.61E-07	0.00E+00	7.01E-09	0.00E+00	0.00E+00	2.12E-05	6.32E-05
Y-91M	3.26E-11	0.00E+00	1.27E-12	0.00E+00	0.00E+00	2.40E-07	1.66E-10
Y-91	5.78E-05	0.00E+00	1.55E-06	0.00E+00	0.00E+00	2.13E-04	4.81E-05
Y-92	1.29E-09	0.00E+00	3.77E-11	0.00E+00	0.00E+00	1.96E-06	9.19E-06
Y-93	1.18E-08	0.00E+00	3.26E-10	0.00E+00	0.00E+00	6.06E-06	5.27E-05
ZR-93	5.22E-05	2.92E-06	1.37E-06	0.00E+00	1.11E-05	2.13E-05	1.51E-06
ZR-95	1.34E-05	4.30E-06	2.91E-06	0.00E+00	6.77E-06	2.21E-04	1.88E-05
ZR-97	1.21E-08	2.45E-09	1.13E-09	0.00E+00	3.71E-09	9.84E-06	6.54E-05
NB-93M	3.10E-05	1.01E-05	2.49E-06	0.00E+00	1.16E-05	3.11E-05	2.38E-06
NB-95	1.76E-06	9.77E-07	5.26E-07	0.00E+00	9.67E-07	6.31E-05	1.30E-05

TABLE II2-27

INHALATION DOSE FACTORS FOR ADULT (D_{aipj})

(mrem per pCi inhaled)

NUCLIDE	BONE	LIVER	T BODY	THYROID	KIDNEY	LUNG	GI-LLI
NB-97	2.78E-11	7.03E-12	2.56E-12	0.00E+00	8.18E-12	3.00E-07	3.02E-08
MO-93	0.00E+00	1.17E-06	3.17E-08	0.00E+00	3.55E-07	5.11E-05	3.79E-06
MO-99	0.00E+00	1.51E-08	2.87E-09	0.00E+00	3.64E-08	1.14E-05	3.10E-05
TC-99M	1.29E-13	3.64E-13	4.63E-12	0.00E+00	5.52E-12	9.55E-08	5.20E-07
TC-99	3.13E-08	4.64E-08	1.25E-08	0.00E+00	5.85E-07	1.01E-04	7.54E-06
TC-101	5.22E-15	7.52E-15	7.38E-14	0.00E+00	1.35E-13	4.99E-08	1.36E-21
RU-103	1.91E-07	0.00E+00	8.23E-08	0.00E+00	7.29E-07	6.31E-05	1.38E-05
RU-105	9.88E-11	0.00E+00	3.89E-11	0.00E+00	1.27E-10	1.37E-06	6.02E-06
RU-106	8.64E-06	0.00E+00	1.09E-06	0.00E+00	1.67E-05	1.17E-03	1.14E-04
RH-105	9.24E-10	6.73E-10	4.43E-10	0.00E+00	2.86E-09	2.41E-06	1.09E-05
PD-107	0.00E+00	8.27E-08	5.87E-09	0.00E+00	6.57E-07	9.47E-06	7.06E-07
PD-109	0.00E+00	4.63E-10	1.16E-10	0.00E+00	2.35E-09	1.85E-06	1.52E-05
AG-110M	1.35E-06	1.25E-06	7.43E-07	0.00E+00	2.46E-06	5.79E-04	3.78E-05
AG-111	4.25E-08	1.78E-08	8.87E-09	0.00E+00	5.74E-08	2.33E-05	2.79E-05
CD-113M	0.00E+00	1.54E-04	4.97E-06	0.00E+00	1.71E-04	2.08E-04	1.59E-05
CD-115M	0.00E+00	2.46E-05	7.95E-07	0.00E+00	1.98E-05	1.76E-04	4.80E-05
SN-123	3.02E-05	6.67E-07	9.82E-07	5.67E-07	0.00E+00	2.88E-04	3.92E-05
SN-125	1.16E-06	3.12E-08	7.03E-08	2.59E-08	0.00E+00	7.37E-05	6.81E-05
SN-126	1.58E-04	4.18E-06	6.00E-06	1.23E-06	0.00E+00	1.17E-03	1.59E-05
SB-124	3.90E-06	7.36E-08	1.55E-06	9.44E-09	0.00E+00	3.10E-04	5.08E-05
SB-125	6.67E-06	7.44E-08	1.58E-06	6.75E-09	0.00E+00	2.18E-04	1.26E-05
SB-126	4.50E-07	9.13E-09	1.62E-07	2.75E-09	0.00E+00	9.57E-05	6.01E-05
SB-127	3.30E-08	7.22E-10	1.27E-08	3.97E-10	0.00E+00	2.05E-05	3.77E-05
TE-125M	4.27E-07	1.98E-07	5.84E-08	1.31E-07	1.55E-06	3.92E-05	8.83E-06
TE-127M	1.58E-06	7.21E-07	1.96E-07	4.11E-07	5.72E-06	1.20E-04	1.87E-05
TE-127	1.75E-10	8.03E-11	3.87E-11	1.32E-10	6.37E-10	8.14E-07	7.17E-06
TE-129M	1.22E-06	5.84E-07	1.98E-07	4.30E-07	4.57E-06	1.45E-04	4.79E-05
TE-129	6.22E-12	2.99E-12	1.55E-12	4.87E-12	2.34E-11	2.42E-07	1.96E-08
TE-131M	8.74E-09	5.45E-09	3.63E-09	6.88E-09	3.86E-08	1.82E-05	6.95E-05
TE-131	1.39E-12	7.44E-13	4.49E-13	1.17E-12	5.46E-12	1.74E-07	2.30E-09
TE-132	3.25E-08	2.69E-08	2.02E-08	2.37E-08	1.82E-07	3.60E-05	6.37E-05
TE-133M	7.24E-12	5.40E-12	4.17E-12	6.27E-12	3.74E-11	5.51E-07	7.65E-09
TE-134	3.84E-12	3.22E-12	1.57E-12	3.44E-12	2.18E-11	4.34E-07	2.97E-11
I-129	2.48E-06	2.11E-06	6.91E-06	5.54E-03	4.53E-06	0.00E+00	2.22E-07
I-130	5.72E-07	1.68E-06	6.60E-07	1.42E-04	2.61E-06	0.00E+00	9.61E-07
I-131	3.15E-06	4.47E-06	2.56E-06	1.49E-03	7.66E-06	0.00E+00	7.85E-07
I-132	1.45E-07	4.07E-07	1.45E-07	1.43E-05	6.48E-07	0.00E+00	5.08E-08
I-133	1.08E-06	1.85E-06	5.65E-07	2.69E-04	3.23E-06	0.00E+00	1.11E-06
I-134	8.05E-08	2.16E-07	7.69E-08	3.73E-06	3.44E-07	0.00E+00	1.26E-10
I-135	3.35E-07	8.73E-07	3.21E-07	5.60E-05	1.39E-06	0.00E+00	6.56E-07
CS-134M	1.59E-08	3.20E-08	1.72E-08	0.00E+00	1.83E-08	2.93E-09	7.92E-09
CS-134	4.66E-05	1.06E-04	9.10E-05	0.00E+00	3.59E-05	1.22E-05	1.30E-06
CS-135	1.46E-05	1.29E-05	5.99E-06	0.00E+00	5.11E-06	1.57E-06	2.11E-07
CS-136	4.88E-06	1.83E-05	1.38E-05	0.00E+00	1.07E-05	1.50E-06	1.46E-06
CS-137	5.98E-05	7.76E-05	5.35E-05	0.00E+00	2.78E-05	9.40E-06	1.05E-06

TABLE II2-27

INHALATION DOSE FACTORS FOR ADULT (D_{aipj})

(mrem per pCi inhaled)

NUCLIDE	BONE	LIVER	T BODY	THYROID	KIDNEY	LUNG	GI-LLI
CS-138	4.14E-08	7.76E-08	4.05E-08	0.00E+00	6.00E-08	6.07E-09	2.33E-13
CS-139	2.56E-08	3.63E-08	1.39E-08	0.00E+00	3.05E-08	2.84E-09	5.49E-31
BA-139	1.17E-10	8.32E-14	3.42E-12	0.00E+00	7.78E-14	4.70E-07	1.12E-07
BA-140	4.88E-06	6.13E-09	3.21E-07	0.00E+00	2.09E-09	1.59E-04	2.73E-05
BA-141	1.25E-11	9.41E-15	4.20E-13	0.00E+00	8.75E-15	2.42E-07	1.45E-17
BA-142	3.29E-12	3.38E-15	2.07E-13	0.00E+00	2.86E-15	1.49E-07	1.96E-26
LA-140	4.30E-08	2.17E-08	5.73E-09	0.00E+00	0.00E+00	1.70E-05	5.73E-05
LA-141	5.34E-10	1.66E-10	2.71E-11	0.00E+00	0.00E+00	1.35E-06	7.31E-06
LA-142	8.54E-11	3.88E-11	9.65E-12	0.00E+00	0.00E+00	7.91E-07	2.64E-07
CE-141	2.49E-06	1.69E-06	1.91E-07	0.00E+00	7.83E-07	4.52E-05	1.50E-05
CE-143	2.33E-08	1.72E-08	1.91E-09	0.00E+00	7.60E-09	9.97E-06	2.83E-05
CE-144	4.29E-04	1.79E-04	2.30E-05	0.00E+00	1.06E-04	9.72E-04	1.02E-04
PR-143	1.17E-06	4.69E-07	5.80E-08	0.00E+00	2.70E-07	3.51E-05	2.50E-05
PR-144	3.76E-12	1.56E-12	1.91E-13	0.00E+00	8.81E-13	1.27E-07	2.69E-18
ND-147	6.59E-07	7.62E-07	4.56E-08	0.00E+00	4.45E-07	2.76E-05	2.16E-05
PM-147	8.37E-05	7.87E-06	3.19E-06	0.00E+00	1.49E-05	6.60E-05	5.54E-06
PM-148M	9.82E-06	2.54E-06	1.94E-06	0.00E+00	3.85E-06	2.14E-04	4.18E-05
PM-148	3.84E-07	6.37E-08	3.20E-08	0.00E+00	1.20E-07	3.91E-05	5.80E-05
PM-149	3.44E-08	4.87E-09	1.99E-09	0.00E+00	9.19E-09	7.21E-06	2.50E-05
PM-151	8.50E-09	1.42E-09	7.21E-10	0.00E+00	2.55E-09	3.94E-06	2.00E-05
SM-151	8.59E-05	1.48E-05	3.55E-06	0.00E+00	1.66E-05	4.45E-05	3.25E-06
SM-153	1.70E-08	1.42E-08	1.04E-09	0.00E+00	4.59E-09	4.14E-06	1.58E-05
EU-152	2.38E-04	5.41E-05	4.76E-05	0.00E+00	3.35E-04	3.43E-04	1.59E-05
EU-154	7.40E-04	9.10E-05	6.48E-05	0.00E+00	4.36E-04	5.84E-04	3.40E-05
EU-155	1.01E-04	1.43E-05	9.21E-06	0.00E+00	6.59E-05	9.46E-05	5.95E-06
EU-156	1.93E-06	1.48E-06	2.40E-07	0.00E+00	9.95E-07	8.56E-05	4.50E-05
TB-160	2.21E-05	0.00E+00	2.75E-06	0.00E+00	9.10E-06	1.92E-04	2.68E-05
HO-166M	3.37E-04	1.05E-04	8.00E-05	0.00E+00	1.57E-04	3.94E-04	1.59E-05
W-181	6.23E-09	2.03E-09	2.17E-10	0.00E+00	0.00E+00	1.71E-06	2.53E-07
W-185	1.95E-07	6.47E-08	6.81E-09	0.00E+00	0.00E+00	5.57E-05	1.07E-05
W-187	1.06E-09	8.85E-10	3.10E-10	0.00E+00	0.00E+00	3.63E-06	1.94E-05
U-232	5.14E-02	0.00E+00	3.66E-03	0.00E+00	5.56E-03	2.22E-01	4.21E-05
U-233	1.09E-02	0.00E+00	6.60E-04	0.00E+00	2.54E-03	5.32E-02	3.89E-05
U-234	1.04E-02	0.00E+00	6.46E-04	0.00E+00	2.49E-03	5.22E-02	3.81E-05
U-235	1.00E-02	0.00E+00	6.07E-04	0.00E+00	2.34E-03	4.90E-02	4.84E-05
U-236	1.00E-02	0.00E+00	6.20E-04	0.00E+00	2.39E-03	5.00E-02	3.57E-05
U-237	3.67E-08	0.00E+00	9.77E-09	0.00E+00	1.51E-07	1.02E-05	1.20E-05
U-238	9.58E-03	0.00E+00	5.67E-04	0.00E+00	2.18E-03	4.58E-02	3.41E-05
NP-237	1.56E+00	1.00E+00	6.87E-02	0.00E+00	5.10E-01	5.22E-02	4.92E-05
NP-238	2.96E-07	7.20E-08	4.61E-09	0.00E+00	2.72E-08	1.02E-05	2.13E-05
NP-239	2.87E-08	2.54E-08	1.55E-09	0.00E+00	8.75E-09	4.70E-06	1.49E-05
PU-238	1.43E+00	9.71E-01	6.90E-02	0.00E+00	2.96E-01	1.82E-01	4.52E-05
PU-239	1.66E+00	1.07E+00	7.75E-02	0.00E+00	3.30E-01	1.72E-01	4.13E-05
PU-240	1.65E+00	1.07E+00	7.73E-02	0.00E+00	3.29E-01	1.72E-01	4.21E-05
PU-241	3.42E-02	8.69E-03	1.29E-03	0.00E+00	5.93E-03	1.52E-04	8.65E-07

TABLE II-27

INHALATION DOSE FACTORS FOR ADULT (D_{aipj})

(mrem per pCi inhaled)

NUCLIDE	BONE	LIVER	T BODY	THYROID	KIDNEY	LUNG	GI-LLI
PU-242	1.53E+00	1.03E+00	7.46E-02	0.00E+00	3.17E-01	1.65E-01	4.05E-05
PU-244	1.79E+00	1.18E+00	8.54E-02	0.00E+00	3.64E-01	1.89E-01	6.03E-05
AM-241	1.68E+00	1.13E+00	6.71E-02	0.00E+00	5.04E-01	6.06E-02	4.60E-05
AM-242M	1.70E+00	1.06E+00	6.73E-02	0.00E+00	5.01E-01	2.44E-02	5.79E-05
AM-243	1.68E+00	1.10E+00	6.57E-02	0.00E+00	4.95E-01	5.75E-02	5.40E-05
CM-242	2.22E-02	1.77E-02	9.84E-04	0.00E+00	4.48E-03	3.92E-02	4.91E-05
CM-243	1.10E+00	7.61E-01	4.61E-02	0.00E+00	2.15E-01	6.31E-02	4.84E-05
CM-244	8.37E-01	5.88E-01	3.51E-02	0.00E+00	1.64E-01	6.06E-02	4.68E-05
CM-245	1.74E+00	1.14E+00	7.14E-02	0.00E+00	3.33E-01	5.85E-02	4.36E-05
CM-246	1.73E+00	1.14E+00	7.13E-02	0.00E+00	3.33E-01	5.96E-02	4.29E-05
CM-247	1.68E+00	1.12E+00	7.03E-02	0.00E+00	3.28E-01	5.85E-02	5.63E-05
CM-248	1.40E-01	9.26E+00	5.79E-01	0.00E+00	2.70E+00	4.82E-01	9.09E-04
CF-252	5.43E-01	0.00E+00	2.33E-02	0.00E+00	0.00E+00	1.99E-01	1.78E-04

NUREG/CR-4653 GASPAR II, Technical Reference and User Guide

TABLE II2-28

INHALATION DOSE FACTORS FOR TEENAGER (D_{aipj})

(mrem per pCi inhaled)

NUCLIDE	BONE	LIVER	T BODY	THYROID	KIDNEY	LUNG	GI-LLI
H-3	0.00E+00	9.06E-08	9.06E-08	9.06E-08	9.06E-08	9.06E-08	9.06E-08
C-14	3.25E-06	6.09E-07	6.09E-07	6.09E-07	6.09E-07	6.09E-07	6.09E-07
NA-22	1.76E-05	1.76E-05	1.76E-05	1.76E-05	1.76E-05	1.76E-05	1.76E-05
NA-24	1.72E-06	1.72E-06	1.72E-06	1.72E-06	1.72E-06	1.72E-06	1.72E-06
P-32	2.36E-04	1.37E-05	8.95E-06	0.00E+00	0.00E+00	0.00E+00	1.16E-05
CA-41	4.05E-05	0.00E+00	4.38E-06	0.00E+00	0.00E+00	1.01E-01	3.03E-07
SC-46	7.24E-05	1.41E-04	4.18E-05	0.00E+00	1.35E-04	0.00E+00	2.98E-05
CR-51	0.00E+00	0.00E+00	1.69E-08	9.37E-09	3.84E-09	2.62E-06	3.75E-07
MN-54	0.00E+00	6.39E-06	1.05E-06	0.00E+00	1.59E-06	2.48E-04	8.35E-06
MN-56	0.00E+00	2.12E-10	3.15E-11	0.00E+00	2.24E-10	1.90E-06	7.18E-06
FE-55	4.18E-06	2.98E-06	6.93E-07	0.00E+00	0.00E+00	1.55E-05	7.99E-07
FE-59	1.99E-06	4.62E-06	1.79E-06	0.00E+00	0.00E+00	1.91E-04	2.23E-05
CO-57	0.00E+00	1.18E-07	1.15E-07	0.00E+00	0.00E+00	7.33E-05	3.93E-06
CO-58	0.00E+00	2.59E-07	3.47E-07	0.00E+00	0.00E+00	1.68E-04	1.19E-05
CO-60	0.00E+00	1.89E-06	2.48E-06	0.00E+00	0.00E+00	1.09E-03	3.24E-05
NI-59	5.44E-06	2.02E-06	9.24E-07	0.00E+00	0.00E+00	1.41E-05	6.48E-07
NI-63	7.25E-05	5.43E-06	2.47E-06	0.00E+00	0.00E+00	3.84E-05	1.77E-06
NI-65	2.73E-10	3.66E-11	1.59E-11	0.00E+00	0.00E+00	1.17E-06	4.59E-06
CU-64	0.00E+00	2.54E-10	1.06E-10	0.00E+00	8.01E-10	1.39E-06	7.68E-06
ZN-65	4.82E-06	1.67E-05	7.80E-06	0.00E+00	1.08E-05	1.55E-04	5.83E-06
ZN-69M	1.44E-09	3.39E-09	3.11E-10	0.00E+00	2.06E-09	3.92E-06	2.14E-05
ZN-69	6.04E-12	1.15E-11	8.07E-13	0.00E+00	7.53E-12	1.98E-07	3.56E-08
SE-79	0.00E+00	5.43E-07	8.71E-08	0.00E+00	8.13E-07	7.71E-05	3.53E-06
BR-82	0.00E+00	0.00E+00	2.28E-06	0.00E+00	0.00E+00	0.00E+00	0.00E+00
BR-83	0.00E+00	0.00E+00	4.30E-08	0.00E+00	0.00E+00	0.00E+00	0.00E+00
BR-84	0.00E+00	0.00E+00	5.41E-08	0.00E+00	0.00E+00	0.00E+00	0.00E+00
BR-85	0.00E+00	0.00E+00	2.29E-09	0.00E+00	0.00E+00	0.00E+00	0.00E+00
RB-86	0.00E+00	2.38E-05	1.05E-05	0.00E+00	0.00E+00	0.00E+00	2.21E-06
RB-87	0.00E+00	1.40E-05	4.58E-06	0.00E+00	0.00E+00	0.00E+00	3.05E-07
RB-88	0.00E+00	6.82E-08	3.40E-08	0.00E+00	0.00E+00	0.00E+00	3.65E-15
RB-89	0.00E+00	4.40E-08	2.91E-08	0.00E+00	0.00E+00	0.00E+00	4.22E-17
SR-89	5.43E-05	0.00E+00	1.56E-06	0.00E+00	0.00E+00	3.02E-04	4.64E-05
SR-90	4.14E-03	0.00E+00	8.33E-05	0.00E+00	0.00E+00	2.06E-03	9.56E-05
SR-91	1.10E-08	0.00E+00	4.39E-10	0.00E+00	0.00E+00	7.59E-06	3.24E-05
SR-92	1.19E-09	0.00E+00	5.08E-11	0.00E+00	0.00E+00	3.43E-06	1.49E-05
Y-90	3.73E-07	0.00E+00	1.00E-08	0.00E+00	0.00E+00	3.66E-05	6.99E-05
Y-91M	4.63E-11	0.00E+00	1.77E-12	0.00E+00	0.00E+00	4.00E-07	3.77E-09
Y-91	8.26E-05	0.00E+00	2.21E-06	0.00E+00	0.00E+00	3.67E-04	5.11E-05
Y-92	1.84E-09	0.00E+00	5.36E-11	0.00E+00	0.00E+00	3.35E-06	2.06E-05
Y-93	1.69E-08	0.00E+00	4.65E-10	0.00E+00	0.00E+00	1.04E-05	7.24E-05
ZR-93	6.83E-05	3.38E-06	1.84E-06	0.00E+00	1.16E-05	3.67E-05	1.60E-06
ZR-95	1.82E-05	5.73E-06	3.94E-06	0.00E+00	8.42E-06	3.36E-04	1.86E-05
ZR-97	1.72E-08	3.40E-09	1.57E-09	0.00E+00	5.15E-09	1.62E-05	7.88E-05
NB-93M	4.14E-05	1.36E-05	3.41E-06	0.00E+00	1.59E-05	5.36E-05	2.52E-06
NB-95	2.32E-06	1.29E-06	7.08E-07	0.00E+00	1.25E-06	9.39E-05	1.21E-05

TABLE II2-28

INHALATION DOSE FACTORS FOR TEENAGER (D_{aij})

(mrem per pCi inhaled)

NUCLIDE	BONE	LIVER	T BODY	THYROID	KIDNEY	LUNG	GI-LLI
NB-97	3.92E-11	9.72E-12	3.55E-12	0.00E+00	1.14E-11	4.91E-07	2.71E-07
MO-93	0.00E+00	1.66E-06	4.52E-08	0.00E+00	5.06E-07	8.81E-05	3.99E-06
MO-99	0.00E+00	2.11E-08	4.03E-09	0.00E+00	5.14E-08	1.92E-05	3.36E-05
TC-99M	1.73E-13	4.83E-13	6.24E-12	0.00E+00	7.20E-12	1.44E-07	7.66E-07
TC-99	4.48E-08	6.58E-08	1.79E-08	0.00E+00	8.35E-07	1.74E-04	7.99E-06
TC-101	7.40E-15	1.05E-14	1.03E-13	0.00E+00	1.90E-13	8.34E-08	1.09E-16
RU-103	2.63E-07	0.00E+00	1.12E-07	0.00E+00	9.29E-07	9.79E-05	1.36E-05
RU-105	1.40E-10	0.00E+00	5.42E-11	0.00E+00	1.76E-10	2.27E-06	1.13E-05
RU-106	1.23E-05	0.00E+00	1.55E-06	0.00E+00	2.38E-05	2.01E-03	1.20E-04
RH-105	1.32E-09	9.48E-10	6.24E-10	0.00E+00	4.04E-09	4.09E-06	1.23E-05
PD-107	0.00E+00	1.17E-07	8.39E-09	0.00E+00	9.39E-07	1.63E-05	7.49E-07
PD-109	0.00E+00	6.56E-10	1.66E-10	0.00E+00	3.36E-09	3.19E-06	1.96E-05
AG-110M	1.73E-06	1.64E-06	9.99E-07	0.00E+00	3.13E-06	8.44E-04	3.41E-05
AG-111	6.07E-08	2.52E-08	1.26E-08	0.00E+00	8.17E-08	4.00E-05	3.00E-05
CD-113M	0.00E+00	2.17E-04	7.10E-06	0.00E+00	2.43E-04	3.59E-04	1.68E-05
CD-115M	0.00E+00	3.48E-05	1.14E-06	0.00E+00	2.82E-05	3.03E-04	5.10E-05
SN-123	4.31E-05	9.44E-07	1.40E-06	7.55E-07	0.00E+00	4.96E-04	4.16E-05
SN-125	1.66E-06	4.42E-08	9.99E-08	3.45E-08	0.00E+00	1.26E-04	7.29E-05
SN-126	2.18E-04	5.39E-06	8.24E-06	1.42E-06	0.00E+00	1.72E-03	1.68E-05
SB-124	5.38E-06	9.92E-08	2.10E-06	1.22E-08	0.00E+00	4.81E-04	4.98E-05
SB-125	9.23E-06	1.01E-07	2.15E-06	8.80E-09	0.00E+00	3.42E-04	1.24E-05
SB-126	6.19E-07	1.27E-08	2.23E-07	3.50E-09	0.00E+00	1.55E-04	6.01E-05
SB-127	4.64E-08	9.92E-10	1.75E-08	5.21E-10	0.00E+00	3.31E-05	3.94E-05
TE-125M	6.10E-07	2.80E-07	8.34E-08	1.75E-07	0.00E+00	6.70E-05	9.38E-06
TE-127M	2.25E-06	1.02E-06	2.73E-07	5.48E-07	8.17E-06	2.07E-04	1.99E-05
TE-127	2.51E-10	1.14E-10	5.52E-11	1.77E-10	9.10E-10	1.40E-06	1.01E-05
TE-129M	1.74E-06	8.23E-07	2.81E-07	5.72E-07	6.49E-06	2.47E-04	5.06E-05
TE-129	8.87E-12	4.22E-12	2.20E-12	6.48E-12	3.32E-11	4.12E-07	2.02E-07
TE-131M	1.23E-08	7.51E-09	5.03E-09	9.06E-09	5.49E-08	2.97E-05	7.76E-05
TE-131	1.97E-12	1.04E-12	6.30E-13	1.55E-12	7.72E-12	2.92E-07	1.89E-09
TE-132	4.50E-08	3.63E-08	2.74E-08	3.07E-08	2.44E-07	5.61E-05	5.79E-05
TE-133M	1.01E-11	7.33E-12	5.71E-12	8.18E-12	5.07E-11	8.71E-07	1.23E-07
TE-134	5.31E-12	4.35E-12	3.64E-12	4.46E-12	2.91E-11	6.75E-07	1.37E-09
I-129	3.53E-06	2.94E-06	4.90E-06	3.66E-03	5.26E-06	0.00E+00	2.29E-07
I-130	7.80E-07	2.24E-06	8.96E-07	1.86E-04	3.44E-06	0.00E+00	1.14E-06
I-131	4.43E-06	6.14E-06	3.30E-06	1.83E-03	1.05E-05	0.00E+00	8.11E-07
I-132	1.99E-07	5.47E-07	1.97E-07	1.89E-05	8.65E-07	0.00E+00	1.59E-07
I-133	1.52E-06	2.56E-06	7.78E-07	3.65E-04	4.49E-06	0.00E+00	1.29E-06
I-134	1.11E-07	2.90E-07	1.05E-07	4.94E-06	4.58E-07	0.00E+00	2.55E-09
I-135	4.62E-07	1.18E-06	4.36E-07	7.76E-05	1.86E-06	0.00E+00	8.69E-07
CS-134M	2.20E-08	4.35E-08	2.35E-08	0.00E+00	2.54E-08	4.56E-09	2.02E-08
CS-134	6.28E-05	1.41E-04	6.86E-05	0.00E+00	4.69E-05	1.83E-05	1.22E-06
CS-135	2.08E-05	1.82E-05	4.47E-06	0.00E+00	7.30E-06	2.70E-06	2.23E-07
CS-136	6.44E-06	2.42E-05	1.71E-05	0.00E+00	1.38E-05	2.22E-06	1.36E-06
CS-137	8.38E-05	1.06E-04	3.89E-05	0.00E+00	3.80E-05	1.51E-05	1.06E-06

TABLE II2-28

INHALATION DOSE FACTORS FOR TEENAGER (D_{aipj})

(mrem per pCi inhaled)

NUCLIDE	BONE	LIVER	T BODY	THYROID	KIDNEY	LUNG	GI-LLI
CS-138	5.82E-08	1.07E-07	5.58E-08	0.00E+00	8.28E-08	9.84E-09	3.38E-11
CS-139	3.65E-08	5.12E-08	1.97E-08	0.00E+00	4.34E-08	4.86E-09	1.66E-23
BA-139	1.67E-10	1.18E-13	4.87E-12	0.00E+00	1.11E-13	8.08E-07	8.06E-07
BA-140	6.84E-06	8.38E-09	4.40E-07	0.00E+00	2.85E-09	2.54E-04	2.86E-05
BA-141	1.78E-11	1.32E-14	5.93E-13	0.00E+00	1.23E-14	4.11E-07	9.33E-14
BA-142	4.62E-12	4.63E-15	2.84E-13	0.00E+00	3.92E-15	2.39E-07	5.99E-20
LA-140	5.99E-08	2.95E-08	7.82E-09	0.00E+00	0.00E+00	2.68E-05	6.09E-05
LA-141	7.63E-10	2.35E-10	3.87E-11	0.00E+00	0.00E+00	2.31E-06	1.54E-05
LA-142	1.20E-10	5.31E-11	1.32E-11	0.00E+00	0.00E+00	1.27E-06	1.50E-06
CE-141	3.55E-06	2.37E-06	2.71E-07	0.00E+00	1.11E-06	7.67E-05	1.58E-05
CE-143	3.32E-08	2.42E-08	2.70E-09	0.00E+00	1.08E-08	1.63E-05	3.19E-05
CE-144	6.11E-04	2.53E-04	3.28E-05	0.00E+00	1.51E-04	1.67E-03	1.08E-04
PR-143	1.67E-06	6.64E-07	8.28E-08	0.00E+00	3.86E-07	6.04E-05	2.67E-05
PR-144	5.37E-12	2.20E-12	2.72E-13	0.00E+00	1.26E-12	2.19E-07	2.94E-14
ND-147	9.83E-07	1.07E-06	6.41E-08	0.00E+00	6.28E-07	4.65E-05	2.28E-05
PM-147	1.15E-04	1.10E-05	4.50E-06	0.00E+00	2.10E-05	1.14E-04	5.87E-06
PM-148M	1.32E-05	3.35E-06	2.62E-06	0.00E+00	5.07E-06	3.20E-04	4.10E-05
PM-148	5.44E-07	8.88E-08	4.48E-08	0.00E+00	1.60E-07	6.52E-05	6.14E-05
PM-149	4.91E-08	6.89E-09	2.84E-09	0.00E+00	1.31E-08	1.24E-05	2.79E-05
PM-151	1.20E-08	1.99E-09	1.01E-09	0.00E+00	3.57E-09	6.56E-06	2.27E-05
SM-151	1.07E-04	2.10E-05	4.86E-06	0.00E+00	2.27E-05	7.68E-05	3.53E-06
SM-153	2.43E-08	2.01E-08	1.47E-09	0.00E+00	6.56E-09	7.11E-06	1.77E-05
EU-152	2.96E-04	7.19E-05	6.30E-05	0.00E+00	3.34E-04	5.01E-04	1.35E-05
EU-154	9.43E-04	1.23E-04	8.60E-05	0.00E+00	5.44E-04	9.12E-04	3.34E-05
EU-155	2.00E-04	1.96E-05	1.21E-05	0.00E+00	7.65E-05	1.51E-03	5.97E-05
EU-156	2.70E-06	2.03E-06	3.30E-07	0.00E+00	1.36E-06	1.37E-04	4.56E-05
TB-160	3.04E-05	0.00E+00	3.79E-06	0.00E+00	1.20E-05	2.97E-04	2.60E-05
HO-166M	4.40E-04	1.36E-04	9.87E-05	0.00E+00	2.00E-04	6.24E-04	1.68E-05
W-181	8.90E-09	2.88E-09	3.01E-10	0.00E+00	0.00E+00	2.95E-06	2.69E-07
W-185	2.78E-07	9.17E-08	9.73E-09	0.00E+00	0.00E+00	9.60E-05	1.14E-05
W-187	1.50E-09	1.22E-09	4.29E-10	0.00E+00	0.00E+00	5.92E-06	2.21E-05
U-232	7.31E-02	0.00E+00	5.23E-03	0.00E+00	7.94E-03	3.84E-01	4.46E-05
U-233	1.55E-02	0.00E+00	9.42E-04	0.00E+00	3.63E-03	9.18E-02	4.12E-05
U-234	1.48E-02	0.00E+00	9.23E-04	0.00E+00	3.55E-03	8.99E-02	4.04E-05
U-235	1.42E-02	0.00E+00	8.67E-04	0.00E+00	3.34E-03	8.44E-02	5.13E-05
U-236	1.42E-02	0.00E+00	8.86E-04	0.00E+00	3.41E-03	8.62E-02	3.79E-05
U-237	5.25E-08	0.00E+00	1.40E-08	0.00E+00	2.16E-07	1.76E-05	1.29E-05
U-238	1.36E-02	0.00E+00	8.10E-04	0.00E+00	3.12E-03	7.89E-02	3.62E-05
NP-237	1.64E+00	1.06E+00	7.21E-02	0.00E+00	5.35E-01	8.99E-02	5.22E-05
NP-238	4.23E-07	1.02E-07	6.59E-09	0.00E+00	3.88E-08	1.75E-05	2.38E-05
NP-239	4.23E-08	3.60E-08	2.21E-09	0.00E+00	1.25E-08	8.11E-06	1.65E-05
PU-238	1.50E+00	1.03E+00	7.22E-02	0.00E+00	3.10E-01	3.12E-01	4.79E-05
PU-239	1.73E+00	1.12E+00	8.05E-02	0.00E+00	3.44E-01	2.93E-01	4.37E-05
PU-240	1.72E+00	1.12E+00	8.04E-02	0.00E+00	3.43E-01	2.93E-01	4.46E-05
PU-241	3.74E-02	9.56E-03	1.40E-03	0.00E+00	6.47E-03	2.60E-04	9.17E-07

TABLE II-28

INHALATION DOSE FACTORS FOR TEENAGER (D_{aipj})

(mrem per pCi inhaled)

NUCLIDE	BONE	LIVER	T BODY	THYROID	KIDNEY	LUNG	GI-LLI
PU-242	1.60E+00	1.08E+00	7.75E-02	0.00E+00	3.31E-01	2.82E-01	4.29E-05
PU-244	1.87E+00	1.24E+00	8.88E-02	0.00E+00	3.79E-01	3.23E-01	6.39E-05
AM-241	1.77E+00	1.20E+00	7.10E-02	0.00E+00	5.32E-01	1.05E-01	4.88E-05
AM-242M	1.79E+00	1.13E+00	7.15E-02	0.00E+00	5.30E-01	4.21E-02	6.14E-05
AM-243	1.77E+00	1.17E+00	6.95E-02	0.00E+00	5.21E-01	9.91E-02	5.72E-05
CM-242	3.17E-02	2.51E-02	1.41E-03	0.00E+00	6.40E-03	6.76E-02	5.21E-05
CM-243	1.19E+00	8.30E-01	5.00E-02	0.00E+00	2.34E-01	1.09E-01	5.13E-05
CM-244	9.19E-01	6.53E-01	3.88E-02	0.00E+00	1.81E-01	1.05E-01	4.96E-05
CM-245	1.83E+00	1.22E+00	7.53E-02	0.00E+00	3.52E-01	1.01E-01	4.63E-05
CM-246	1.81E+00	1.22E+00	7.52E-02	0.00E+00	3.51E-01	1.03E-01	4.54E-05
CM-247	1.77E+00	1.19E+00	7.41E-02	0.00E+00	3.46E-01	1.01E-01	5.97E-05
CM-248	1.47E-01	9.83E+00	6.11E-01	0.00E+00	2.85E+00	8.32E-01	9.63E-04
CF-252	7.16E-01	0.00E+00	3.07E-02	0.00E+00	0.00E+00	3.43E-01	1.89E-04

NUREG/CR-4653 GASPAR II, Technical Reference and User Guide

TABLE II2-29

INHALATION DOSE FACTORS FOR CHILD (D_{airp})

(mrem per pCi inhaled)

NUCLIDE	BONE	LIVER	T BODY	THYROID	KIDNEY	LUNG	GI-LLI
H-3	0.00E+00	1.73E-07	1.73E-07	1.73E-07	1.73E-07	1.73E-07	1.73E-07
C-14	9.70E-06	1.82E-06	1.82E-06	1.82E-06	1.82E-06	1.82E-06	1.82E-06
NA-22	4.41E-05	4.41E-05	4.41E-05	4.41E-05	4.41E-05	4.41E-05	4.41E-05
NA-24	4.35E-06	4.35E-06	4.35E-06	4.35E-06	4.35E-06	4.35E-06	4.35E-06
P-32	7.04E-04	3.09E-05	2.67E-05	0.00E+00	0.00E+00	0.00E+00	1.14E-05
CA-41	7.06E-05	0.00E+00	7.70E-06	0.00E+00	0.00E+00	7.21E-02	2.94E-07
SC-46	1.97E-04	2.70E-04	1.04E-04	0.00E+00	2.39E-04	0.00E+00	2.45E-05
CR-51	0.00E+00	0.00E+00	4.17E-08	2.31E-08	6.57E-09	4.59E-06	2.93E-07
MN-54	0.00E+00	1.16E-05	2.57E-06	0.00E+00	2.71E-06	4.26E-04	6.19E-06
MN-56	0.00E+00	4.48E-10	8.43E-11	0.00E+00	4.52E-10	3.55E-06	3.33E-05
FE-55	1.28E-05	6.80E-06	2.10E-06	0.00E+00	0.00E+00	3.00E-05	7.75E-07
FE-59	5.59E-06	9.04E-06	4.51E-06	0.00E+00	0.00E+00	3.43E-04	1.91E-05
CO-57	0.00E+00	2.44E-07	2.88E-07	0.00E+00	0.00E+00	1.37E-04	3.58E-06
CO-58	0.00E+00	4.79E-07	8.55E-07	0.00E+00	0.00E+00	2.99E-04	9.29E-06
CO-60	0.00E+00	3.55E-06	6.12E-06	0.00E+00	0.00E+00	1.91E-03	2.60E-05
NI-59	1.66E-05	4.67E-06	2.83E-06	0.00E+00	0.00E+00	2.73E-05	6.29E-07
NI-63	2.22E-04	1.25E-05	7.56E-06	0.00E+00	0.00E+00	7.43E-05	1.71E-06
NI-65	8.08E-10	7.99E-11	4.44E-11	0.00E+00	0.00E+00	2.21E-06	2.27E-05
CU-64	0.00E+00	5.39E-10	2.90E-10	0.00E+00	1.63E-09	2.59E-06	9.92E-06
ZN-65	1.15E-05	3.06E-05	1.90E-05	0.00E+00	1.93E-05	2.69E-04	4.41E-06
ZN-69M	4.26E-09	7.28E-09	8.59E-10	0.00E+00	4.22E-09	7.36E-06	2.71E-05
ZN-69	1.81E-11	2.61E-11	2.41E-12	0.00E+00	1.58E-11	3.84E-07	2.75E-06
SE-79	0.00E+00	1.23E-06	2.60E-07	0.00E+00	1.71E-06	1.49E-04	3.43E-06
BR-82	0.00E+00	0.00E+00	5.66E-06	0.00E+00	0.00E+00	0.00E+00	0.00E+00
BR-83	0.00E+00	0.00E+00	1.28E-07	0.00E+00	0.00E+00	0.00E+00	0.00E+00
BR-84	0.00E+00	0.00E+00	1.48E-07	0.00E+00	0.00E+00	0.00E+00	0.00E+00
BR-85	0.00E+00	0.00E+00	6.84E-09	0.00E+00	0.00E+00	0.00E+00	0.00E+00
RB-86	0.00E+00	5.36E-05	3.09E-05	0.00E+00	0.00E+00	0.00E+00	2.16E-06
RB-87	0.00E+00	3.16E-05	1.37E-05	0.00E+00	0.00E+00	0.00E+00	2.96E-07
RB-88	0.00E+00	1.52E-07	9.90E-08	0.00E+00	0.00E+00	0.00E+00	4.66E-09
RB-89	0.00E+00	9.33E-08	7.83E-08	0.00E+00	0.00E+00	0.00E+00	5.11E-10
SR-89	1.62E-04	0.00E+00	4.66E-06	0.00E+00	0.00E+00	5.83E-04	4.52E-05
SR-90	1.04E-02	0.00E+00	2.07E-04	0.00E+00	0.00E+00	3.99E-03	9.28E-05
SR-91	3.28E-08	0.00E+00	1.24E-09	0.00E+00	0.00E+00	1.44E-05	4.70E-05
SR-92	3.54E-09	0.00E+00	1.42E-10	0.00E+00	0.00E+00	6.49E-06	6.55E-05
Y-90	1.11E-06	0.00E+00	2.99E-08	0.00E+00	0.00E+00	7.07E-05	7.24E-05
Y-91M	1.37E-10	0.00E+00	4.98E-12	0.00E+00	0.00E+00	7.60E-07	4.64E-07
Y-91	2.47E-04	0.00E+00	6.59E-06	0.00E+00	0.00E+00	7.10E-04	4.97E-05
Y-92	5.50E-09	0.00E+00	1.57E-10	0.00E+00	0.00E+00	6.46E-06	6.46E-05
Y-93	5.04E-08	0.00E+00	1.38E-09	0.00E+00	0.00E+00	2.01E-05	1.05E-04
ZR-93	2.07E-04	7.80E-06	5.55E-06	0.00E+00	3.00E-05	7.10E-05	1.47E-06
ZR-95	5.13E-05	1.13E-05	1.00E-05	0.00E+00	1.61E-05	6.03E-04	1.65E-05
ZR-97	5.07E-08	7.34E-09	4.32E-09	0.00E+00	1.05E-08	3.06E-05	9.49E-05
NB-93M	1.27E-04	3.17E-05	1.04E-05	0.00E+00	3.44E-05	1.04E-04	2.45E-06
NB-95	6.35E-06	2.48E-06	1.77E-06	0.00E+00	2.33E-06	1.66E-04	1.00E-05

TABLE II2-29

INHALATION DOSE FACTORS FOR CHILD (D_{aipj})

(mrem per pCi inhaled)

NUCLIDE	BONE	LIVER	T BODY	THYROID	KIDNEY	LUNG	GI-LLI
NB-97	1.16E-10	2.08E-11	9.74E-12	0.00E+00	2.31E-11	9.23E-07	7.52E-06
MO-93	0.00E+00	3.76E-06	1.35E-07	0.00E+00	1.06E-06	1.70E-04	3.78E-06
MO-99	0.00E+00	4.66E-08	1.15E-08	0.00E+00	1.06E-07	3.66E-05	3.42E-05
TC-99M	4.81E-13	9.41E-13	1.56E-11	0.00E+00	1.37E-11	2.57E-07	1.30E-06
TC-99	1.34E-07	1.49E-07	5.35E-08	0.00E+00	1.75E-06	3.37E-04	7.75E-06
TC-101	2.19E-14	2.30E-14	2.91E-13	0.00E+00	3.92E-13	1.58E-07	4.41E-09
RU-103	7.55E-07	0.00E+00	2.90E-07	0.00E+00	1.90E-06	1.79E-04	1.21E-05
RU-105	4.13E-10	0.00E+00	1.50E-10	0.00E+00	3.63E-10	4.30E-06	2.69E-05
RU-106	3.68E-05	0.00E+00	4.57E-06	0.00E+00	4.97E-05	3.87E-03	1.16E-04
RH-105	3.91E-09	2.10E-09	1.79E-09	0.00E+00	8.39E-09	7.82E-06	1.33E-05
PD-107	0.00E+00	2.65E-07	2.51E-08	0.00E+00	1.97E-06	3.16E-05	7.26E-07
PD-109	0.00E+00	1.48E-09	4.95E-10	0.00E+00	7.06E-09	6.16E-06	2.59E-05
AG-110M	4.56E-06	3.08E-06	2.47E-06	0.00E+00	5.74E-06	1.48E-03	2.71E-05
AG-111	1.81E-07	5.68E-08	3.75E-08	0.00E+00	1.71E-07	7.73E-05	2.98E-05
CD-113M	0.00E+00	4.93E-04	2.12E-05	0.00E+00	5.13E-04	6.94E-04	1.63E-05
CD-115M	0.00E+00	7.88E-05	3.39E-06	0.00E+00	5.93E-05	5.86E-04	4.97E-05
SN-123	1.29E-04	2.14E-06	4.19E-06	2.27E-06	0.00E+00	9.59E-04	4.05E-05
SN-125	4.95E-06	9.94E-08	2.95E-07	1.03E-07	0.00E+00	2.43E-04	7.17E-05
SN-126	6.23E-04	1.04E-05	2.36E-05	2.84E-06	0.00E+00	3.02E-03	1.63E-05
SB-124	1.55E-05	2.00E-07	5.41E-06	3.41E-08	0.00E+00	8.76E-04	4.43E-05
SB-125	2.66E-05	2.05E-07	5.59E-06	2.46E-08	0.00E+00	6.27E-04	1.09E-05
SB-126	1.72E-06	2.62E-08	6.16E-07	1.00E-08	0.00E+00	2.86E-04	5.67E-05
SB-127	1.36E-07	2.09E-09	4.70E-08	1.51E-09	0.00E+00	6.17E-05	3.82E-05
TE-125M	1.82E-06	6.29E-07	2.47E-07	5.20E-07	0.00E+00	1.29E-04	9.13E-06
TE-127M	6.72E-06	2.31E-06	8.16E-07	1.64E-06	1.72E-05	4.00E-04	1.93E-05
TE-127	7.49E-10	2.57E-10	1.65E-10	5.30E-10	1.91E-09	2.71E-06	1.52E-05
TE-129M	5.19E-06	1.85E-06	8.22E-07	1.71E-06	1.36E-05	4.76E-04	4.91E-05
TE-129	2.64E-11	9.45E-12	6.44E-12	1.93E-11	6.94E-11	7.93E-07	6.89E-06
TE-131M	3.63E-08	1.60E-08	1.37E-08	2.64E-08	1.08E-07	5.56E-05	8.32E-05
TE-131	5.87E-12	2.28E-12	1.78E-12	4.59E-12	1.59E-11	5.55E-07	3.60E-07
TE-132	1.30E-07	7.36E-08	7.12E-08	8.58E-08	4.79E-07	1.02E-04	3.72E-05
TE-133M	2.93E-11	1.51E-11	1.50E-11	2.32E-11	1.01E-10	1.60E-06	4.77E-06
TE-134	1.53E-11	8.81E-12	9.40E-12	1.24E-11	5.71E-11	1.23E-06	4.87E-07
I-129	1.05E-05	6.40E-06	5.71E-06	4.28E-03	1.08E-05	0.00E+00	2.15E-07
I-130	2.21E-06	4.43E-06	2.28E-06	4.99E-04	6.61E-06	0.00E+00	1.38E-06
I-131	1.30E-05	1.30E-05	7.37E-06	4.39E-03	2.13E-05	0.00E+00	7.68E-07
I-132	5.72E-07	1.10E-06	5.07E-07	5.23E-05	1.69E-06	0.00E+00	8.65E-07
I-133	4.48E-06	5.49E-06	2.08E-06	1.04E-03	9.13E-06	0.00E+00	1.48E-06
I-134	3.17E-07	5.84E-07	2.69E-07	1.37E-05	8.92E-07	0.00E+00	2.58E-07
I-135	1.33E-06	2.36E-06	1.12E-06	2.14E-04	3.62E-06	0.00E+00	1.20E-06
CS-134M	6.33E-08	8.92E-08	6.12E-08	0.00E+00	4.94E-08	8.35E-09	7.92E-08
CS-134	1.76E-04	2.74E-04	6.07E-05	0.00E+00	8.93E-05	3.27E-05	1.04E-06
CS-135	6.23E-05	4.13E-05	4.45E-06	0.00E+00	1.53E-05	5.22E-06	2.17E-07
CS-136	1.76E-05	4.62E-05	3.14E-05	0.00E+00	2.58E-05	3.93E-06	1.13E-06
CS-137	2.45E-04	2.23E-04	3.47E-05	0.00E+00	7.63E-05	2.81E-05	9.78E-07

TABLE II2-29

INHALATION DOSE FACTORS FOR CHILD (D_{aipj})

(mrem per pCi inhaled)

NUCLIDE	BONE	LIVER	T BODY	THYROID	KIDNEY	LUNG	GI-LLI
CS-138	1.71E-07	2.27E-07	1.50E-07	0.00E+00	1.68E-07	1.84E-08	7.29E-08
CS-139	1.09E-07	1.15E-07	5.80E-08	0.00E+00	9.08E-08	9.36E-09	7.23E-12
BA-139	4.98E-10	2.66E-13	1.45E-11	0.00E+00	2.33E-13	1.56E-06	1.56E-05
BA-140	2.00E-05	1.75E-08	1.17E-06	0.00E+00	5.71E-09	4.71E-04	2.75E-05
BA-141	5.29E-11	2.95E-14	1.72E-12	0.00E+00	2.56E-14	7.89E-07	7.44E-08
BA-142	1.35E-11	9.73E-15	7.54E-13	0.00E+00	7.87E-15	4.44E-07	7.41E-10
LA-140	1.74E-07	6.08E-08	2.04E-08	0.00E+00	0.00E+00	4.94E-05	6.10E-05
LA-141	2.28E-09	5.31E-10	1.15E-10	0.00E+00	0.00E+00	4.48E-06	4.37E-05
LA-142	3.50E-10	1.11E-10	3.49E-11	0.00E+00	0.00E+00	2.35E-06	2.05E-05
CE-141	1.06E-05	5.28E-06	7.83E-07	0.00E+00	2.31E-06	1.47E-04	1.53E-05
CE-143	9.89E-08	5.37E-08	7.77E-09	0.00E+00	2.26E-08	3.12E-05	3.44E-05
CE-144	1.83E-03	5.72E-04	9.77E-05	0.00E+00	3.17E-04	3.23E-03	1.05E-04
PR-143	4.99E-06	1.50E-06	2.47E-07	0.00E+00	8.11E-07	1.17E-04	2.63E-05
PR-144	1.61E-11	4.99E-12	8.10E-13	0.00E+00	2.64E-12	4.23E-07	5.32E-08
ND-147	2.92E-06	2.36E-06	1.84E-07	0.00E+00	1.30E-06	8.87E-05	2.22E-05
PM-147	3.52E-04	2.52E-05	1.36E-05	0.00E+00	4.45E-05	2.20E-04	5.70E-06
PM-148M	3.31E-05	6.55E-06	6.55E-06	0.00E+00	9.74E-06	5.72E-04	3.58E-05
PM-148	1.61E-06	1.94E-07	1.25E-07	0.00E+00	3.30E-07	1.24E-04	6.01E-05
PM-149	1.47E-07	1.56E-08	8.45E-09	0.00E+00	2.75E-08	2.40E-05	2.92E-05
PM-151	3.57E-08	4.33E-09	2.82E-09	0.00E+00	7.35E-09	1.24E-05	2.50E-05
SM-151	3.14E-04	4.75E-05	1.49E-05	0.00E+00	4.89E-05	1.48E-04	3.43E-06
SM-153	7.24E-08	4.51E-08	4.35E-09	0.00E+00	1.37E-08	1.37E-05	1.87E-05
EU-152	7.42E-04	1.37E-04	1.61E-04	0.00E+00	5.73E-04	9.00E-04	1.14E-05
EU-154	2.74E-03	2.49E-04	2.27E-04	0.00E+00	1.09E-03	1.66E-03	2.98E-05
EU-155	5.60E-04	4.05E-05	3.18E-05	0.00E+00	1.51E-04	2.79E-04	5.39E-05
EU-156	7.89E-06	4.23E-06	8.75E-07	0.00E+00	2.72E-06	2.54E-04	4.24E-05
TB-160	7.79E-05	0.00E+00	9.67E-06	0.00E+00	2.32E-05	5.34E-04	2.28E-05
HO-166M	1.34E-03	2.81E-04	2.37E-04	0.00E+00	4.01E-04	1.13E-03	1.63E-05
W-181	2.66E-08	6.52E-09	8.99E-10	0.00E+00	0.00E+00	5.71E-06	2.61E-07
W-185	8.31E-07	2.08E-07	2.91E-08	0.00E+00	0.00E+00	1.86E-04	1.11E-05
W-187	4.41E-09	2.61E-09	1.17E-09	0.00E+00	0.00E+00	1.11E-05	2.46E-05
U-232	2.19E-01	0.00E+00	1.56E-02	0.00E+00	1.67E-02	7.42E-01	4.33E-05
U-233	4.64E-02	0.00E+00	2.82E-03	0.00E+00	7.62E-03	1.77E-01	4.00E-05
U-234	4.46E-02	0.00E+00	2.76E-03	0.00E+00	7.47E-03	1.74E-01	3.92E-05
U-235	4.27E-02	0.00E+00	2.59E-03	0.00E+00	7.01E-03	1.63E-01	4.98E-05
U-236	4.27E-02	0.00E+00	2.65E-03	0.00E+00	7.16E-03	1.67E-01	3.67E-05
U-237	1.57E-07	0.00E+00	4.17E-08	0.00E+00	4.53E-07	3.40E-05	1.29E-05
U-238	4.09E-02	0.00E+00	2.42E-03	0.00E+00	6.55E-03	1.53E-01	3.51E-05
NP-237	2.72E+00	1.62E+00	1.19E-01	0.00E+00	7.41E-01	1.74E-01	5.06E-05
NP-238	1.26E-06	2.30E-07	1.97E-08	0.00E+00	8.16E-08	3.39E-05	2.50E-05
NP-239	1.26E-07	8.14E-08	6.35E-09	0.00E+00	2.63E-08	1.57E-05	1.73E-05
PU-238	2.55E+00	1.60E+00	1.21E-01	0.00E+00	4.47E-01	6.08E-01	4.65E-05
PU-239	2.79E+00	1.68E+00	1.28E-01	0.00E+00	4.78E-01	5.72E-01	4.24E-05
PU-240	2.79E+00	1.68E+00	1.27E-01	0.00E+00	4.77E-01	5.71E-01	4.33E-05
PU-241	7.94E-02	1.75E-02	2.93E-03	0.00E+00	1.10E-02	5.06E-04	8.90E-07

TABLE II-29

INHALATION DOSE FACTORS FOR CHILD (D_{aipj})

(mrem per pCi inhaled)

NUCLIDE	BONE	LIVER	T BODY	THYROID	KIDNEY	LUNG	GI-LLI
PU-242	2.59E+00	1.62E+00	1.23E-01	0.00E+00	4.60E-01	5.50E-01	4.16E-05
PU-244	3.02E+00	1.85E+00	1.41E-01	0.00E+00	5.27E-01	6.30E-01	6.20E-05
AM-241	2.97E+00	1.84E+00	1.24E-01	0.00E+00	7.63E-01	2.02E-01	4.73E-05
AM-242M	3.07E+00	1.76E+00	1.27E-01	0.00E+00	7.71E-01	8.14E-02	5.96E-05
AM-243	2.94E+00	1.78E+00	1.20E-01	0.00E+00	7.42E-01	1.92E-01	5.55E-05
CM-242	9.48E-02	5.68E-02	4.20E-03	0.00E+00	1.34E-02	1.31E-01	5.06E-05
CM-243	2.32E+00	1.42E+00	9.95E-02	0.00E+00	3.74E-01	2.10E-01	4.98E-05
CM-244	1.94E+00	1.18E+00	8.31E-02	0.00E+00	3.06E-01	2.02E-01	4.82E-05
CM-245	3.05E+00	1.84E+00	1.28E-01	0.00E+00	5.03E-01	1.95E-01	4.49E-05
CM-246	3.02E+00	1.84E+00	1.28E-01	0.00E+00	5.03E-01	1.99E-01	4.41E-05
CM-247	2.94E+00	1.82E+00	1.26E-01	0.00E+00	4.95E-01	1.95E-01	5.80E-05
CM-248	2.45E-01	1.50E-01	1.04E+00	0.00E+00	4.08E+00	1.61E+00	9.35E-04
CF-252	2.18E+00	0.00E+00	9.33E-02	0.00E+00	0.00E+00	6.62E-01	1.84E-04

NUREG/CR-4653 GASPAR II, Technical Reference and User Guide

TABLE II2-30

INHALATION DOSE FACTORS FOR INFANT (D_{aipj})

(mrem per pCi inhaled)

NUCLIDE	BONE	LIVER	T BODY	THYROID	KIDNEY	LUNG	GI-LLI
H-3	0.00E+00	2.63E-07	2.63E-07	2.63E-07	2.63E-07	2.63E-07	2.63E-07
C-14	1.89E-05	3.79E-06	3.79E-06	3.79E-06	3.79E-06	3.79E-06	3.79E-06
NA-22	7.37E-05	7.37E-05	7.37E-05	7.37E-05	7.37E-05	7.37E-05	7.37E-05
NA-24	7.54E-06	7.54E-06	7.54E-06	7.54E-06	7.54E-06	7.54E-06	7.54E-06
P-32	1.45E-03	8.03E-05	5.53E-05	0.00E+00	0.00E+00	0.00E+00	1.15E-05
CA-41	7.48E-05	0.00E+00	8.16E-06	0.00E+00	0.00E+00	6.94E-02	2.96E-07
SC-46	3.75E-04	5.41E-04	1.69E-04	0.00E+00	3.56E-04	0.00E+00	2.19E-05
CR-51	0.00E+00	0.00E+00	6.39E-08	4.11E-08	9.45E-09	9.17E-06	2.55E-07
MN-54	0.00E+00	1.81E-05	3.56E-06	0.00E+00	3.56E-06	7.14E-04	5.04E-06
MN-56	0.00E+00	1.10E-09	1.58E-10	0.00E+00	7.86E-10	8.95E-06	5.12E-05
FE-55	1.41E-05	8.39E-06	2.38E-06	0.00E+00	0.00E+00	6.21E-05	7.82E-07
FE-59	9.69E-06	1.68E-05	6.77E-06	0.00E+00	0.00E+00	7.25E-04	1.77E-05
CO-57	0.00E+00	4.65E-07	4.58E-07	0.00E+00	0.00E+00	2.71E-04	3.47E-06
CO-58	0.00E+00	8.71E-07	1.30E-06	0.00E+00	0.00E+00	5.55E-04	7.95E-06
CO-60	0.00E+00	5.73E-06	8.41E-06	0.00E+00	0.00E+00	3.22E-03	2.28E-05
NI-59	1.81E-05	5.44E-06	3.10E-06	0.00E+00	0.00E+00	5.48E-05	6.34E-07
NI-63	2.42E-04	1.46E-05	8.29E-06	0.00E+00	0.00E+00	1.49E-04	1.73E-06
NI-65	1.71E-09	2.03E-10	8.79E-11	0.00E+00	0.00E+00	5.80E-06	3.58E-05
CU-64	0.00E+00	1.34E-09	5.53E-10	0.00E+00	2.84E-09	6.64E-06	1.07E-05
ZN-65	1.38E-05	4.47E-05	2.22E-05	0.00E+00	2.32E-05	4.62E-04	3.67E-05
ZN-69M	8.98E-09	1.84E-08	1.67E-09	0.00E+00	7.45E-09	1.91E-05	2.92E-05
ZN-69	3.85E-11	6.91E-11	5.13E-12	0.00E+00	2.87E-11	1.05E-06	9.44E-06
SE-79	0.00E+00	2.25E-06	4.20E-07	0.00E+00	2.47E-06	2.99E-04	3.46E-06
BR-82	0.00E+00	0.00E+00	9.49E-06	0.00E+00	0.00E+00	0.00E+00	0.00E+00
BR-83	0.00E+00	0.00E+00	2.72E-07	0.00E+00	0.00E+00	0.00E+00	0.00E+00
BR-84	0.00E+00	0.00E+00	2.86E-07	0.00E+00	0.00E+00	0.00E+00	0.00E+00
BR-85	0.00E+00	0.00E+00	1.46E-08	0.00E+00	0.00E+00	0.00E+00	0.00E+00
RB-86	0.00E+00	1.36E-04	6.30E-05	0.00E+00	0.00E+00	0.00E+00	2.17E-06
RB-87	0.00E+00	7.11E-05	2.64E-05	0.00E+00	0.00E+00	0.00E+00	2.99E-07
RB-88	0.00E+00	3.98E-07	2.05E-07	0.00E+00	0.00E+00	0.00E+00	2.42E-07
RB-89	0.00E+00	2.29E-07	1.47E-07	0.00E+00	0.00E+00	0.00E+00	4.87E-08
SR-89	2.84E-04	0.00E+00	8.15E-06	0.00E+00	0.00E+00	1.45E-03	4.57E-05
SR-90	1.11E-02	0.00E+00	2.23E-04	0.00E+00	0.00E+00	8.03E-03	9.36E-05
SR-91	6.83E-08	0.00E+00	2.47E-09	0.00E+00	0.00E+00	3.76E-05	5.24E-05
SR-92	7.50E-09	0.00E+00	2.79E-10	0.00E+00	0.00E+00	1.70E-05	1.00E-04
Y-90	2.35E-06	0.00E+00	6.30E-08	0.00E+00	0.00E+00	1.92E-04	7.43E-05
Y-91M	2.91E-10	0.00E+00	9.90E-12	0.00E+00	0.00E+00	1.99E-06	1.68E-06
Y-91	4.20E-04	0.00E+00	1.12E-05	0.00E+00	0.00E+00	1.75E-03	5.02E-05
Y-92	1.17E-08	0.00E+00	3.29E-10	0.00E+00	0.00E+00	1.75E-05	9.04E-05
Y-93	1.07E-07	0.00E+00	2.91E-09	0.00E+00	0.00E+00	5.46E-05	1.19E-04
ZR-93	2.24E-04	9.51E-06	6.18E-06	0.00E+00	3.19E-05	1.37E-04	1.48E-06
ZR-95	8.24E-05	1.99E-05	1.45E-05	0.00E+00	2.22E-05	1.25E-03	1.55E-05
ZR-97	1.07E-07	1.83E-08	8.36E-09	0.00E+00	1.85E-08	7.88E-05	1.00E-04
NB-93M	1.38E-04	3.59E-05	1.15E-05	0.00E+00	3.68E-05	2.09E-04	2.47E-06
NB-95	1.12E-05	4.59E-06	2.70E-06	0.00E+00	3.37E-06	3.42E-04	9.05E-06

TABLE II2-30

INHALATION DOSE FACTORS FOR INFANT (D_{aipj})

(mrem per pCi inhaled)

NUCLIDE	BONE	LIVER	T BODY	THYROID	KIDNEY	LUNG	GI-LLI
NB-97	2.44E-10	5.21E-11	1.88E-11	0.00E+00	4.07E-11	2.37E-06	1.92E-05
MO-93	0.00E+00	6.46E-06	2.22E-07	0.00E+00	1.54E-06	3.40E-04	3.76E-06
MO-99	0.00E+00	1.18E-07	2.31E-08	0.00E+00	1.89E-07	9.63E-05	3.48E-05
TC-99M	9.98E-13	2.06E-12	2.66E-11	0.00E+00	2.22E-11	5.79E-07	1.45E-06
TC-99	2.09E-07	2.68E-07	8.85E-08	0.00E+00	2.49E-06	6.77E-04	7.82E-06
TC-101	4.65E-14	5.88E-14	5.80E-13	0.00E+00	6.99E-13	4.17E-07	6.03E-07
RU-103	1.44E-06	0.00E+00	4.85E-07	0.00E+00	3.03E-06	3.94E-04	1.15E-05
RU-105	8.74E-10	0.00E+00	2.93E-10	0.00E+00	6.42E-10	1.12E-05	3.46E-05
RU-106	6.20E-05	0.00E+00	7.77E-06	0.00E+00	7.61E-05	8.26E-03	1.17E-04
RH-105	8.26E-09	5.41E-09	3.63E-09	0.00E+00	1.50E-08	2.08E-05	1.37E-05
PD-107	0.00E+00	4.92E-07	4.11E-08	0.00E+00	2.75E-06	6.34E-05	7.33E-07
PD-109	0.00E+00	3.92E-09	1.05E-09	0.00E+00	1.28E-08	1.68E-05	2.85E-05
AG-110M	7.13E-06	5.16E-06	3.57E-06	0.00E+00	7.80E-06	2.62E-03	2.36E-05
AG-111	3.75E-07	1.45E-07	7.75E-08	0.00E+00	3.05E-07	2.06E-04	3.02E-05
CD-113M	0.00E+00	6.67E-04	2.64E-05	0.00E+00	5.80E-04	1.40E-03	1.65E-05
CD-115M	0.00E+00	1.73E-04	6.19E-06	0.00E+00	9.41E-05	1.47E-03	5.02E-05
SN-123	2.09E-04	4.21E-06	7.28E-06	4.27E-06	0.00E+00	2.22E-03	4.08E-05
SN-125	1.01E-05	2.51E-07	6.00E-07	2.47E-07	0.00E+00	6.43E-04	7.26E-05
SN-126	8.30E-04	1.44E-05	3.52E-05	3.84E-06	0.00E+00	4.93E-03	1.65E-05
SB-124	2.71E-05	3.97E-07	8.56E-06	7.18E-08	0.00E+00	1.89E-03	4.22E-05
SB-125	3.69E-05	3.41E-07	7.78E-06	4.45E-08	0.00E+00	1.17E-03	1.05E-05
SB-126	3.08E-06	6.01E-08	1.11E-06	2.35E-08	0.00E+00	6.88E-04	5.33E-05
SB-127	2.82E-07	5.04E-09	8.76E-08	3.60E-09	0.00E+00	1.54E-04	3.78E-05
TE-125M	3.40E-06	1.42E-06	4.70E-07	1.16E-06	0.00E+00	3.19E-04	9.22E-06
TE-127M	1.19E-05	4.93E-06	1.48E-06	3.48E-06	2.68E-05	9.37E-04	1.95E-05
TE-127	1.59E-09	6.81E-10	3.49E-10	1.32E-09	3.47E-09	7.39E-06	1.74E-05
TE-129M	1.01E-05	4.35E-06	1.59E-06	3.91E-06	2.27E-05	1.20E-03	4.93E-05
TE-129	5.63E-11	2.48E-11	1.34E-11	4.82E-11	1.25E-10	2.14E-06	1.88E-05
TE-131M	7.62E-08	3.93E-08	2.59E-08	6.38E-08	1.89E-07	1.42E-04	8.51E-05
TE-131	1.24E-11	5.87E-12	3.57E-12	1.13E-11	2.85E-11	1.47E-06	5.87E-06
TE-132	2.66E-07	1.69E-07	1.26E-07	1.99E-07	7.39E-07	2.43E-04	3.15E-05
TE-133M	6.13E-11	3.59E-11	2.74E-11	5.52E-11	1.72E-10	3.92E-06	1.59E-05
TE-134	3.18E-11	2.04E-11	1.68E-11	2.91E-11	9.59E-11	2.93E-06	2.53E-06
I-129	2.16E-05	1.59E-05	1.16E-05	1.04E-02	1.88E-05	0.00E+00	2.12E-07
I-130	4.54E-06	9.91E-06	3.98E-06	1.14E-03	1.09E-05	0.00E+00	1.42E-06
I-131	2.71E-05	3.17E-05	1.40E-05	1.06E-02	3.70E-05	0.00E+00	7.56E-07
I-132	1.21E-06	2.53E-06	8.99E-07	1.21E-04	2.82E-06	0.00E+00	1.36E-06
I-133	9.46E-06	1.37E-05	4.00E-06	2.54E-03	1.60E-05	0.00E+00	1.54E-06
I-134	6.58E-07	1.34E-06	4.75E-07	3.18E-05	1.49E-06	0.00E+00	9.21E-07
I-135	2.76E-06	5.43E-06	1.98E-06	4.97E-04	6.05E-06	0.00E+00	1.31E-06
CS-134M	1.32E-07	2.10E-07	1.11E-07	0.00E+00	8.50E-08	2.00E-08	1.16E-07
CS-134	2.83E-04	5.02E-04	5.32E-05	0.00E+00	1.36E-04	5.69E-05	9.53E-07
CS-135	1.00E-04	8.66E-05	4.73E-06	0.00E+00	2.58E-05	1.01E-05	2.18E-07
CS-136	3.45E-05	9.61E-05	3.78E-05	0.00E+00	4.03E-05	8.40E-06	1.02E-06
CS-137	3.92E-04	4.37E-04	3.25E-05	0.00E+00	1.23E-04	5.09E-05	9.53E-07

TABLE II2-30

INHALATION DOSE FACTORS FOR INFANT (D_{aipj})

(mrem per pCi inhaled)

NUCLIDE	BONE	LIVER	T BODY	THYROID	KIDNEY	LUNG	GI-LLI
CS-138	3.61E-07	5.58E-07	2.84E-07	0.00E+00	2.93E-07	4.67E-08	6.26E-07
CS-139	2.32E-07	3.03E-07	1.22E-07	0.00E+00	1.65E-07	2.53E-08	1.33E-08
BA-139	1.06E-09	7.03E-13	3.07E-11	0.00E+00	4.23E-13	4.25E-06	3.64E-05
BA-140	4.00E-05	4.00E-08	2.07E-06	0.00E+00	9.59E-09	1.14E-03	2.74E-05
BA-141	1.12E-10	7.70E-14	3.55E-12	0.00E+00	4.64E-14	2.12E-06	3.39E-06
BA-142	2.84E-11	2.36E-14	1.40E-12	0.00E+00	1.36E-14	1.11E-06	4.95E-07
LA-140	3.61E-07	1.43E-07	3.68E-08	0.00E+00	0.00E+00	1.20E-04	6.06E-05
LA-141	4.85E-09	1.40E-09	2.45E-10	0.00E+00	0.00E+00	1.22E-05	5.96E-05
LA-142	7.36E-10	2.69E-10	6.46E-11	0.00E+00	0.00E+00	5.87E-06	4.25E-05
CE-141	1.98E-05	1.19E-05	1.42E-06	0.00E+00	3.75E-06	3.69E-04	1.54E-05
CE-143	2.09E-07	1.38E-07	1.58E-08	0.00E+00	4.03E-08	8.30E-05	3.55E-05
CE-144	2.28E-03	8.65E-04	1.26E-04	0.00E+00	3.84E-04	7.03E-03	1.06E-04
PR-143	1.00E-05	3.74E-06	4.99E-07	0.00E+00	1.41E-06	3.09E-04	2.66E-05
PR-144	3.42E-11	1.32E-11	1.72E-12	0.00E+00	4.80E-12	1.15E-06	3.06E-06
ND-147	5.67E-06	5.81E-06	3.57E-07	0.00E+00	2.25E-06	2.30E-04	2.23E-05
PM-147	3.91E-04	3.07E-05	1.56E-05	0.00E+00	4.93E-05	4.55E-04	5.75E-06
PM-148M	5.00E-05	1.24E-05	9.94E-06	0.00E+00	1.45E-05	1.22E-03	3.37E-05
PM-148	3.34E-06	4.82E-07	2.44E-07	0.00E+00	5.76E-07	3.20E-04	6.04E-05
PM-149	3.10E-07	4.08E-08	1.78E-08	0.00E+00	4.96E-08	6.50E-05	3.01E-05
PM-151	7.52E-08	1.10E-08	5.55E-09	0.00E+00	1.30E-08	3.25E-05	2.58E-05
SM-151	3.38E-04	6.45E-05	1.63E-05	0.00E+00	5.24E-05	2.98E-04	3.46E-06
SM-153	1.53E-07	1.18E-07	9.06E-09	0.00E+00	2.47E-08	3.70E-05	1.93E-05
EU-152	7.83E-04	1.77E-04	1.72E-04	0.00E+00	5.94E-04	1.48E-03	9.88E-06
EU-154	2.96E-03	3.46E-04	2.45E-04	0.00E+00	1.14E-03	3.05E-03	2.84E-05
EU-155	5.97E-04	5.72E-05	3.46E-05	0.00E+00	1.58E-04	5.20E-04	5.19E-05
EU-156	1.56E-05	9.59E-06	1.54E-06	0.00E+00	4.48E-06	6.12E-04	4.14E-05
TB-160	1.12E-04	0.00E+00	1.40E-05	0.00E+00	3.20E-05	1.11E-03	2.14E-05
HO-166M	1.45E-03	3.07E-04	2.51E-04	0.00E+00	4.22E-04	2.05E-03	1.65E-05
W-181	4.86E-08	1.46E-08	1.67E-09	0.00E+00	0.00E+00	1.33E-05	2.63E-07
W-185	1.57E-06	4.83E-07	5.58E-08	0.00E+00	0.00E+00	4.48E-04	1.12E-05
W-187	9.26E-09	6.44E-09	2.23E-09	0.00E+00	0.00E+00	2.83E-05	2.54E-05
U-232	2.57E-01	0.00E+00	2.13E-02	0.00E+00	2.40E-02	1.49E+00	4.36E-05
U-233	5.44E-02	0.00E+00	3.83E-03	0.00E+00	1.09E-02	3.56E-01	4.03E-05
U-234	5.22E-02	0.00E+00	3.75E-03	0.00E+00	1.07E-02	3.49E-01	3.95E-05
U-235	5.01E-02	0.00E+00	3.52E-03	0.00E+00	1.01E-02	3.28E-01	5.02E-05
U-236	5.01E-02	0.00E+00	3.60E-03	0.00E+00	1.03E-02	3.35E-01	3.71E-05
U-237	3.25E-07	0.00E+00	8.65E-08	0.00E+00	8.08E-07	9.13E-05	1.31E-05
U-238	4.79E-02	0.00E+00	3.29E-03	0.00E+00	9.40E-03	3.06E-01	3.54E-05
NP-237	2.88E+00	1.71E+00	1.26E-01	0.00E+00	7.69E-01	3.49E-01	5.10E-05
NP-238	2.67E-06	6.05E-07	4.16E-08	0.00E+00	1.47E-07	9.19E-05	2.58E-05
NP-239	2.65E-07	2.13E-07	1.34E-08	0.00E+00	4.73E-08	4.25E-05	1.78E-05
PU-238	2.69E+00	1.68E+00	1.27E-01	0.00E+00	4.64E-01	9.03E-01	4.69E-05
PU-239	2.93E+00	1.76E+00	1.34E-01	0.00E+00	4.95E-01	8.47E-01	4.28E-05
PU-240	2.93E+00	1.75E+00	1.34E-01	0.00E+00	4.94E-01	8.47E-01	4.36E-05
PU-241	8.43E-02	1.85E-02	3.11E-03	0.00E+00	1.15E-02	7.62E-04	8.97E-07

TABLE II-30

INHALATION DOSE FACTORS FOR INFANT (D_{aipj})

(mrem per pCi inhaled)

NUCLIDE	BONE	LIVER	T BODY	THYROID	KIDNEY	LUNG	GI-LLI
PU-242	2.72E+00	1.69E+00	1.29E-01	0.00E+00	4.77E-01	8.15E-01	4.20E-05
PU-244	3.17E+00	1.94E+00	1.48E-01	0.00E+00	5.46E-01	9.33E-01	6.26E-05
AM-241	3.15E+00	1.95E+00	1.31E-01	0.00E+00	7.94E-01	4.06E-01	4.78E-05
AM-242M	3.25E+00	1.86E+00	1.35E-01	0.00E+00	8.03E-01	1.64E-01	6.01E-05
AM-243	3.10E+00	1.88E+00	1.27E-01	0.00E+00	7.72E-01	3.85E-01	5.60E-05
CM-242	1.28E-01	8.65E-02	5.70E-03	0.00E+00	1.69E-02	2.97E-01	5.10E-05
CM-243	2.47E+00	1.52E+00	1.06E-01	0.00E+00	3.91E-01	4.24E-01	5.02E-05
CM-244	2.07E+00	1.27E+00	8.89E-02	0.00E+00	3.21E-01	4.08E-01	4.86E-05
CM-245	3.22E+00	1.96E+00	1.36E-01	0.00E+00	5.23E-01	3.92E-01	4.53E-05
CM-246	3.20E+00	1.96E+00	1.36E-01	0.00E+00	5.23E-01	3.99E-01	4.45E-05
CM-247	3.11E+00	1.93E+00	1.33E-01	0.00E+00	5.15E-01	3.92E-01	5.85E-05
CM-248	2.58E-01	1.59E-01	1.10E+00	0.00E+00	4.24E+00	3.23E+00	9.43E-04
CF-252	2.37E+00	0.00E+00	1.01E-01	0.00E+00	0.00E+00	1.37E+00	1.85E-04

NUREG/CR-4653 GASPAR II, Technical Reference and User Guide

TABLE I12-31
ASSUMPTIONS USED IN LIMERICK GASEOUS EFFLUENT R_i CALCULATIONS⁽¹⁾

Symbol	Description	Value	Reference ⁽²⁾
f _i	Fraction of annual intake of fresh, leafy vegetation grown locally	0.42	Site Spec.
f _g	Fraction of annual intake of stored vegetation grown locally	0.76	E-15
Y _v	Vegetation area density (kg/m ²)	2.0	E-15
r	Fraction of deposited particulates retained on vegetation	0.20	E-15
r	Fraction of deposited iodines retained on vegetation	1.0	E-15
SF	Shielding factor of residential structures	0.7	E-15
t	Period of buildup of activity in soil (sec)	7.89E08	Site Spec. Based on T _b
t _f	Transport time milkman (sec)	1.73E05	E-15
t _h	Delay time for ingestion of stored feed by animals (sec)	7.78E06	E-15
t _i	Delay time for ingestion of leafy vegetable by man (sec)	8.64E04	E-15
t _h	Delay time for ingestion of other vegetable by man (sec)	5.18E06	E-15
t _s	Time between slaughter and consumption of meat animal (sec)	1.73E06	E-15
T _b	Approximate midpoint of facility operating life (years)	25	Reg Guide 1.109, App C, Equation C-1 adjusted for license renewal
Y _p	Grass yield (kg/m ²)	0.7	E-15
Y _s	Stored feed yield (kg/m ²)	2.0	E-15
λ _w	Weathering rate constant for activity on veg (sec ⁻¹)	5.73E-07	E-15
Q _F	Milk cow feed consumption rate (kg/day wet)	50.0	E-3
Q _F	Beef cattle consumption rate (kg/day wet)	50.0	E-3
Q _F	Goat feed consumption rate (kg/day wet)	6.0	E-3
K ["]	Ground exposure (all age groups) (hr/yr)	8760.0	C-2 ⁽³⁾
BR	Breathing Rate adult (m ³ /yr)	8000.0	E-5
BR	Breathing Rate teen (m ³ /yr)	8000.0	E-5
BR	Breathing Rate child (m ³ /yr)	3700.0	E-5
BR	Breathing Rate infant (m ³ /yr)	1400.0	E-5
U _A ^L	Leafy veg consumption rate adult (kg/yr)	64.0	E-5
U _A ^L	Leafy veg consumption rate teen (kg/yr)	42.0	E-5
U _A ^L	Leafy veg consumption rate child (kg/yr)	26.0	E-5
U _A ^L	Leafy veg consumption rate infant (kg/yr)	0.0	E-5
U _A ^S	Stored veg consumption rate adult (kg/yr)	520.0	E-5
U _A ^S	Stored veg consumption rate teen (kg/yr)	630.0	E-5
U _A ^S	Stored veg consumption rate child (kg/yr)	520.0	E-5
U _A ^S	Stored veg consumption rate infant (kg/yr)	0.0	E-5
U _{ap}	Cow milk consumption rate adult (l/yr)	310.0	E-5
U _{ap}	Cow milk consumption rate teen (l/yr)	400.0	E-5
U _{ap}	Cow milk consumption rate child (l/yr)	330.0	E-5
U _{ap}	Cow milk consumption rate infant (l/yr)	330.0	E-5
U _{ap}	Goat milk consumption rate adult (l/yr)	310.0	E-5
U _{ap}	Goat milk consumption rate teen (l/yr)	400.0	E-5
U _{ap}	Goat milk consumption rate child (l/yr)	330.0	E-5
U _{ap}	Goat milk consumption rate infant (l/yr)	330.0	E-5
U _{ap}	Meat consumption rate adult (kg/yr)	110.0	E-5
U _{ap}	Meat consumption rate teen (kg/yr)	65.0	E-5
U _{ap}	Meat consumption rate child (kg/yr)	41.0	E-5

TABLE II2-31
ASSUMPTIONS USED IN LIMERICK GASEOUS EFFLUENT R_i CALCULATIONS⁽¹⁾

Symbol	Description	Value	Reference ⁽²⁾
U _{ap}	Meat consumption rate infant (kg/yr)	0.0	E-5
f _p	Fraction of year animals on pasture	0.75	Site Spec.
f _s	Fraction of feed from pasture when on pasture	0.39	Site Spec.
H	Atmosphere absolute humidity (gm/m ³)	8.0	(4)
χ/Q	Highest annual average relative concentration (NE Sector) (sec/m ³) used for setpoint determination.	1.10E-05	(5)
χ/Q	Highest annual average relative concentration (sec/m ³), Site Boundary Dose Rate (SE Sector)	9.97E-07	Site Spec. (6)
χ/Q	Highest annual average relative concentration (sec/m ³), Residence Pathway (SE Sector)	5.63E-07	Site Spec. (6)
χ/Q	Highest annual average relative concentration (sec/m ³), Garden Pathway (ESE Sector)	3.45E-07	Site Spec. (6)
χ/Q	Highest annual average relative concentration (sec/m ³), Meat Pathway (ESE Sector)	2.42E-07	Site Spec. (6)
χ/Q	Highest annual average relative concentration (sec/m ³), Milk Animal Pathway (SSW Sector)	8.80E-08	Site Spec. (6)
D/Q	Highest average annual deposition (1/m ²), Residence Pathway (SE Sector)	9.83E-09	Site Spec. (6)
D/Q	Highest average annual deposition (1/m ²), Garden Pathway (ESE Sector)	4.87E-09	Site Spec. (6)
D/Q	Highest average annual deposition (1/m ²), Meat Pathway (ESE Sector)	1.14E-09	Site Spec. (6)
D/Q	Highest average annual deposition (1/m ²), Milk Animal Pathway (SSW Sector)	3.14E-10	Site Spec. (6)

NOTES:

- 1) R_i values are calculated in accordance with the methodologies given in NUREG-0133.
- 2) The References refer to tables contained in Regulatory Guide 1.109 unless otherwise specified.
- 3) From Reg. Guide 1.109, Appendix C, Equation C-2
- 4) From NUREG-0133, Section 5.3.1.3
- 5) Site specific value from the Limerick Generating Station Final Environmental Statement (NUREG-0974)
- 6) 2010 – 2014 Five year average of site meteorology data

TABLE II-32

NEAREST GASEOUS EFFLUENT DOSE RECEPTOR DISTANCES

(Meters)

Direction	Plume Ground Inhalation Pathways (Nearest Residence) ⁽¹⁾	Vegetation Pathway ⁽¹⁾	Meat Pathway ⁽¹⁾	Cow Pathway ⁽¹⁾	Goat Pathway ⁽¹⁾
N	948	1016	7551	7551	0
NNE	825	2929	8015	0	0
NE	1057	4358	4287	0	0
ENE	985	4331	2271	0	0
E	873	3573	0	0	0
ESE	1047	1371 ⁽²⁾	3775	0	0
SE	1202	7113 ⁽²⁾	7695	0	0
SSE	1647	2107	0	0	0
S	1325	1860	3722	6740	0
SSW	1543	1622	2323	3167	0
SW	991	1389	7055	0	0
WSW	1158	1374	4321	4321	0
W	1105	1317	5223	0	0
WNW	1123	0	0	0	0
NW	1104	2499	0	0	0
NNW	1540	1703	6379	0	0

(1) Based upon Control 3.3.2, Land Use Census (2015)

(2) REMP garden located in the ESE sector at 555 meters and in the SE sector at 390 meters.

FIGURES

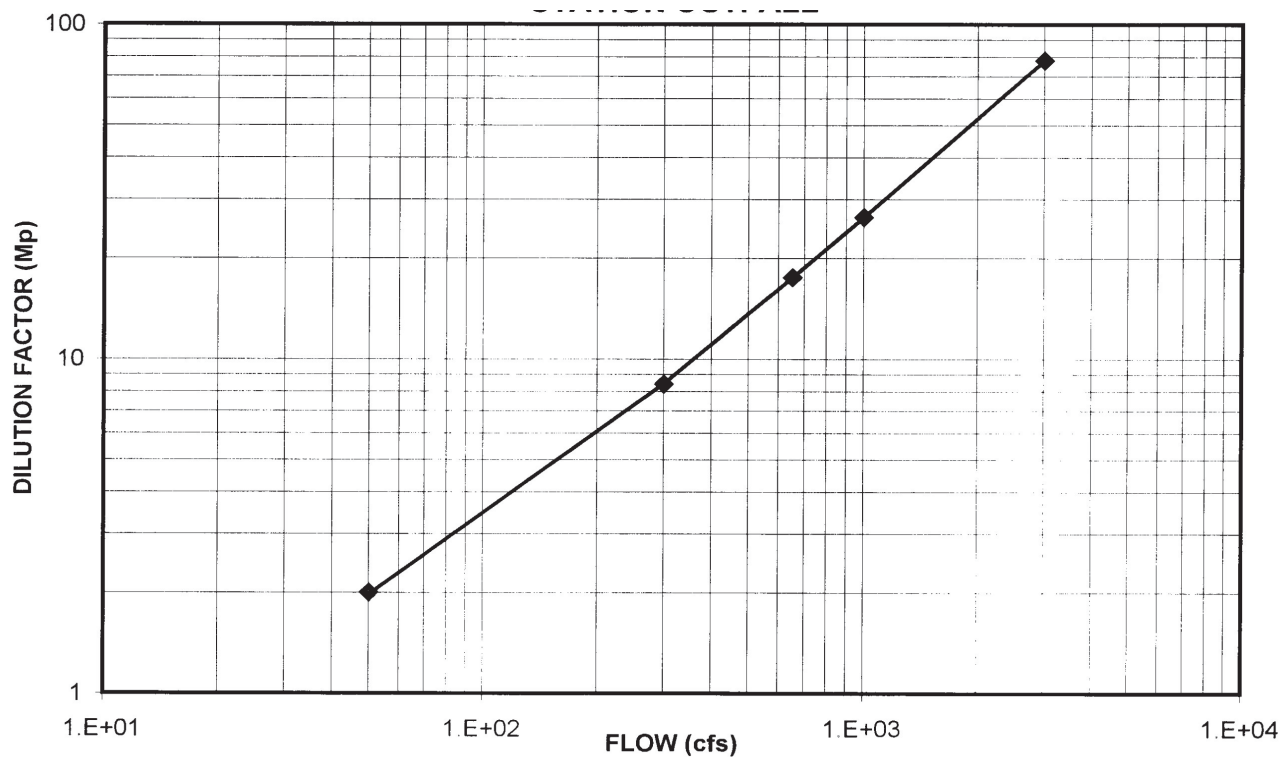

Figure II.3.1-1

LGS DILUTION FACTOR (Mp) vs. RIVER FLOW
STATION OUTFALL

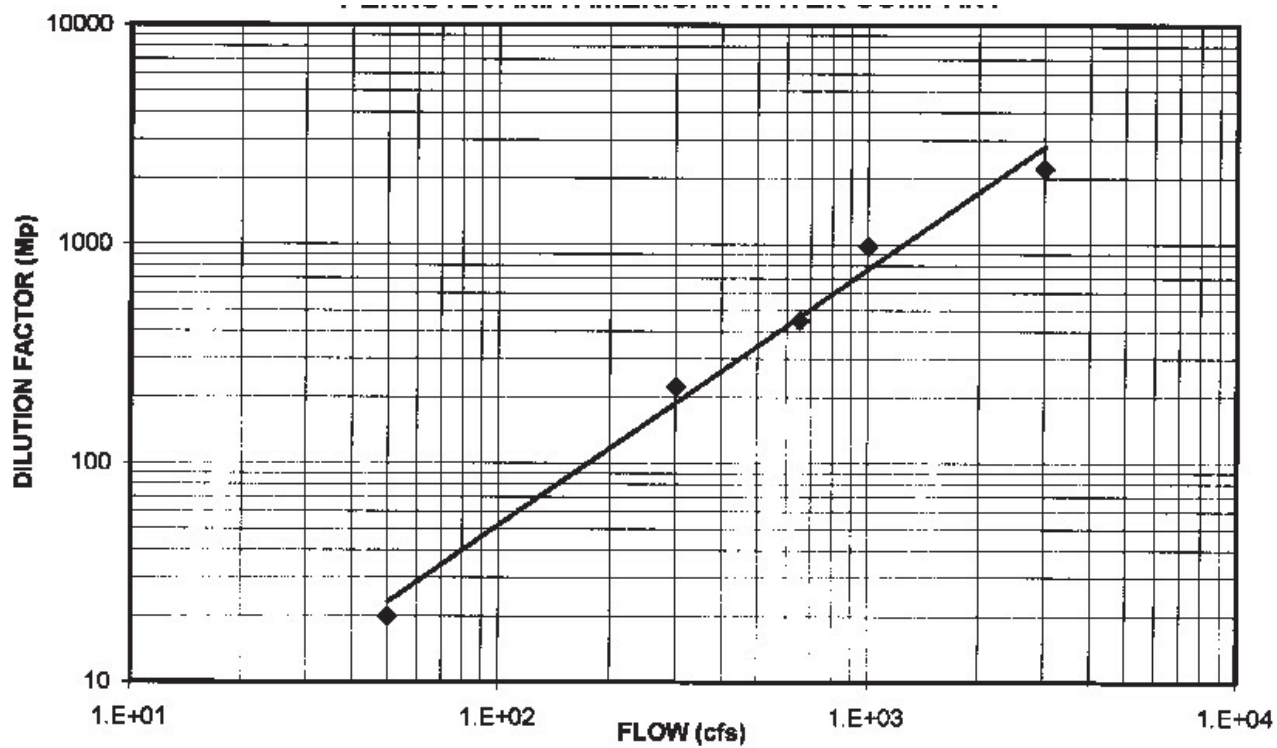

Figure II1.3.1-2

LGS DILUTION FACTOR (Mp) vs. RIVER FLOW
PENNSYLVANIA AMERICA WATER

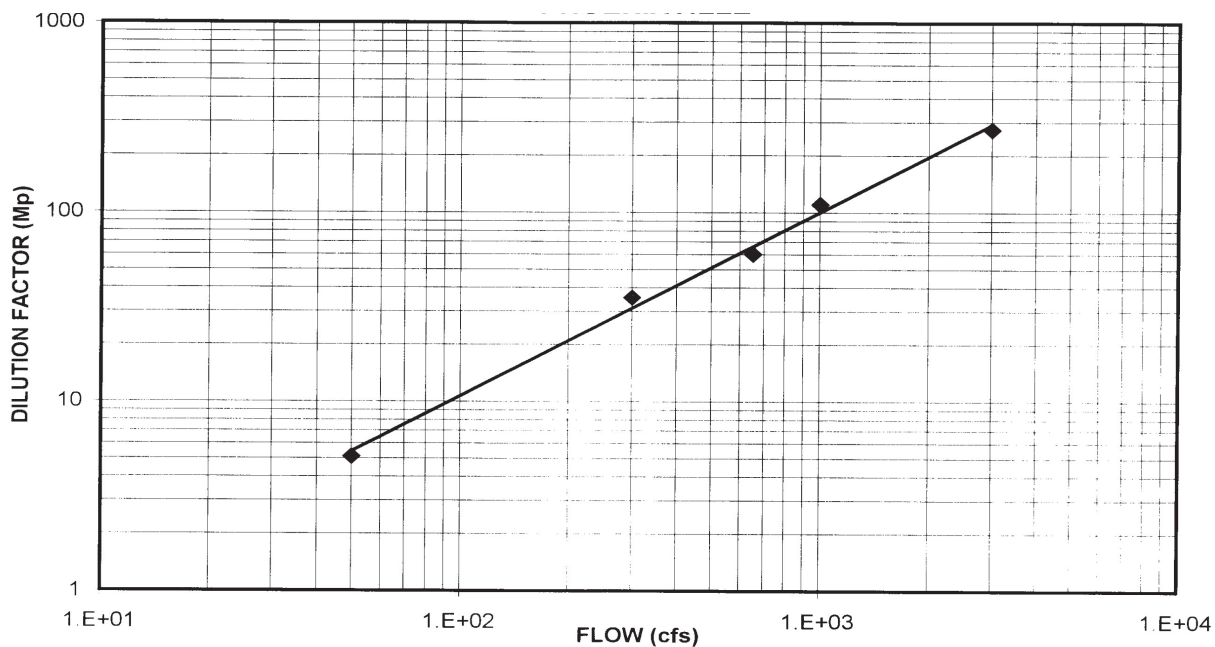

Figure II1.3.1-3

LGS DILUTION FACTOR (Mp) vs. RIVER FLOW
PHOENIXVILLE

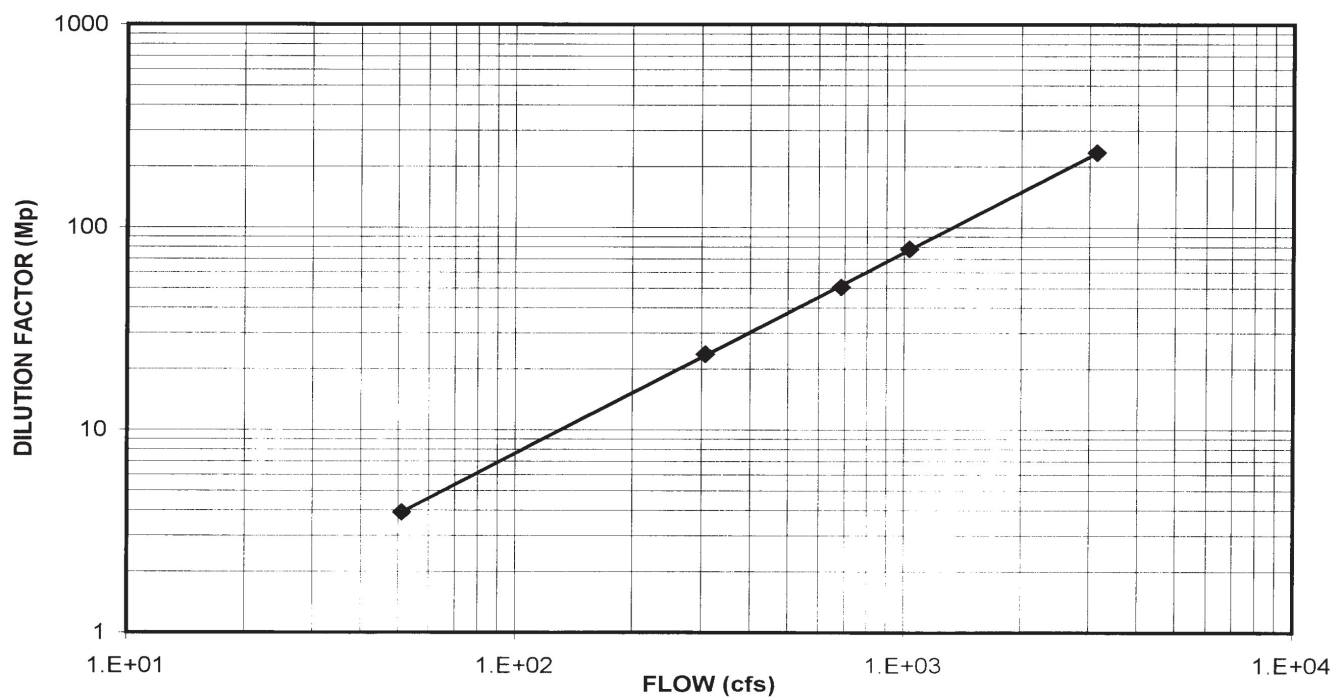

Figure II1.3.1-4

LGS DILUTION FACTOR (Mp) vs. RIVER FLOW
AQUA AMERICA

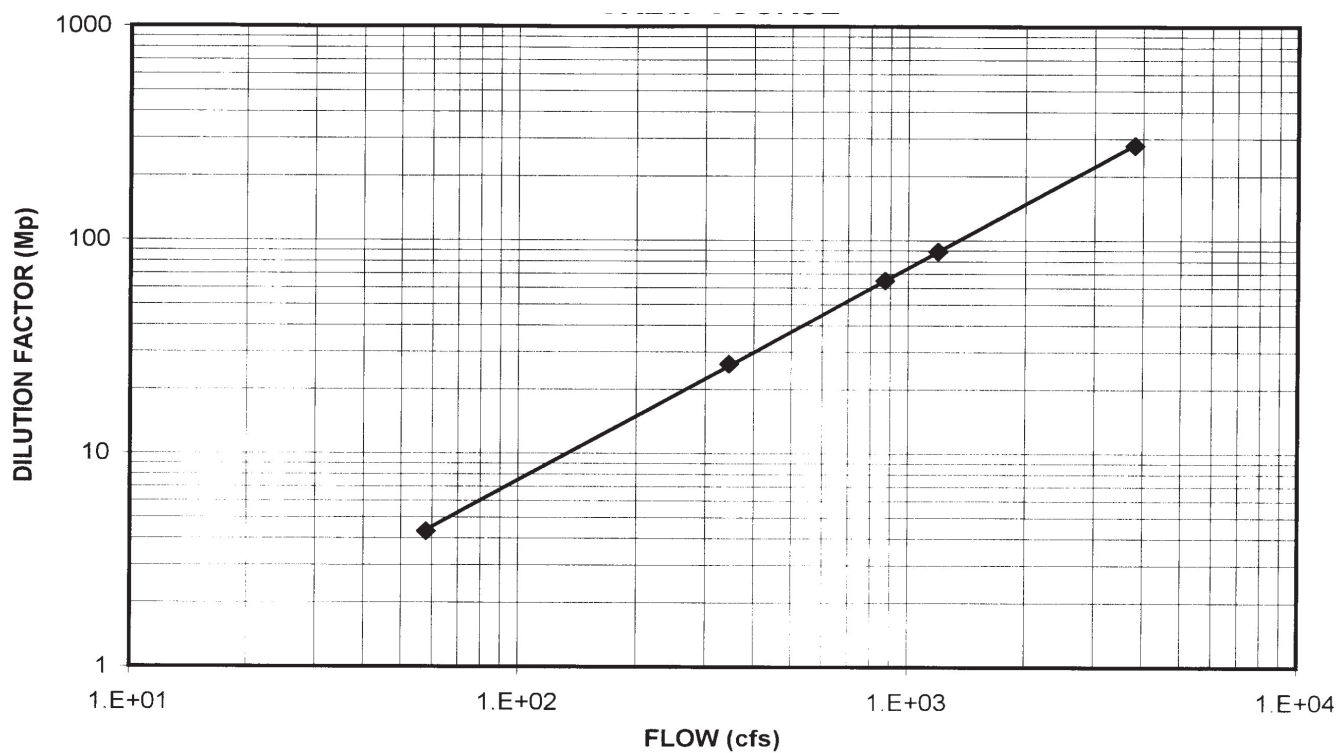

Figure II1.3.1-5

LGS DILUTION FACTOR (Mp) vs. RIVER FLOW
CREW COURSE

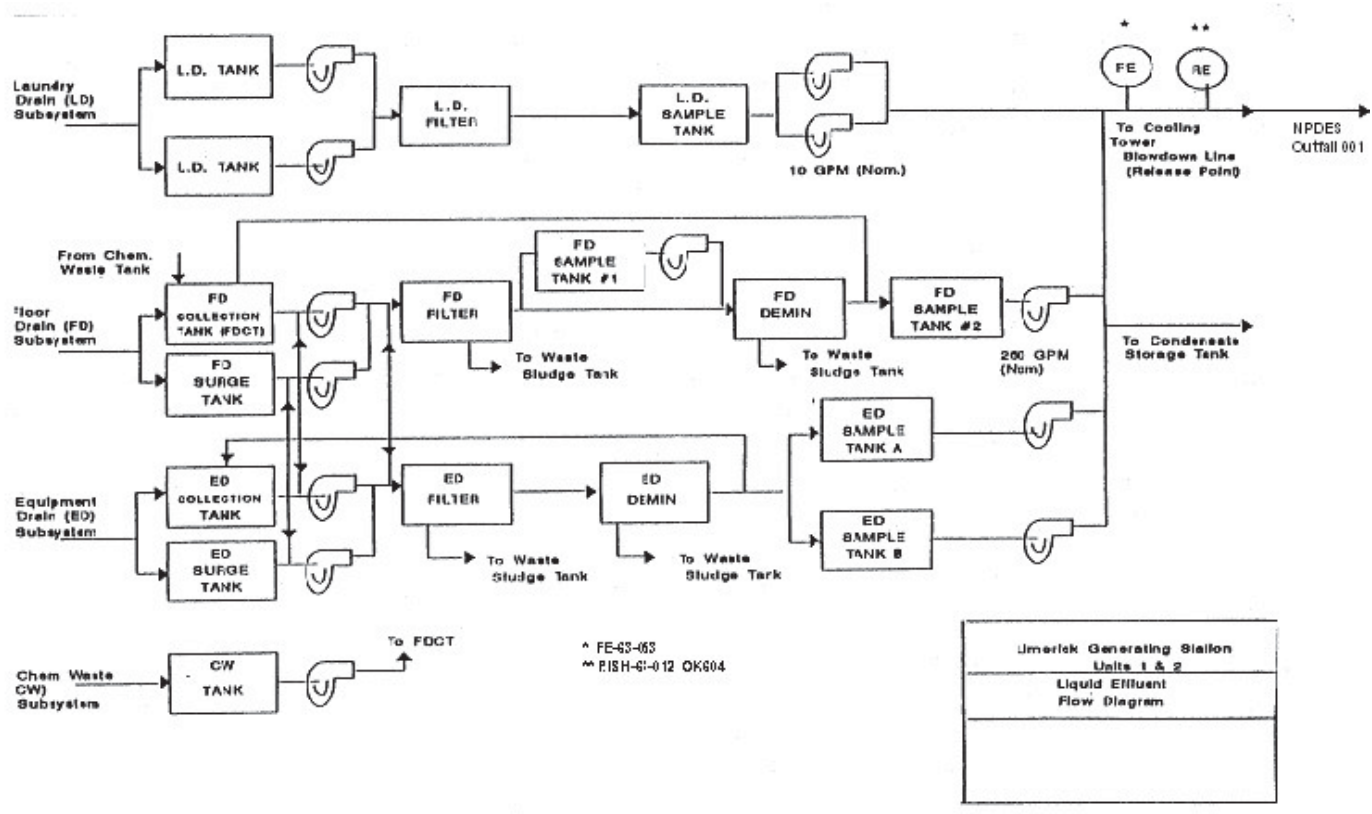

Figure II-1

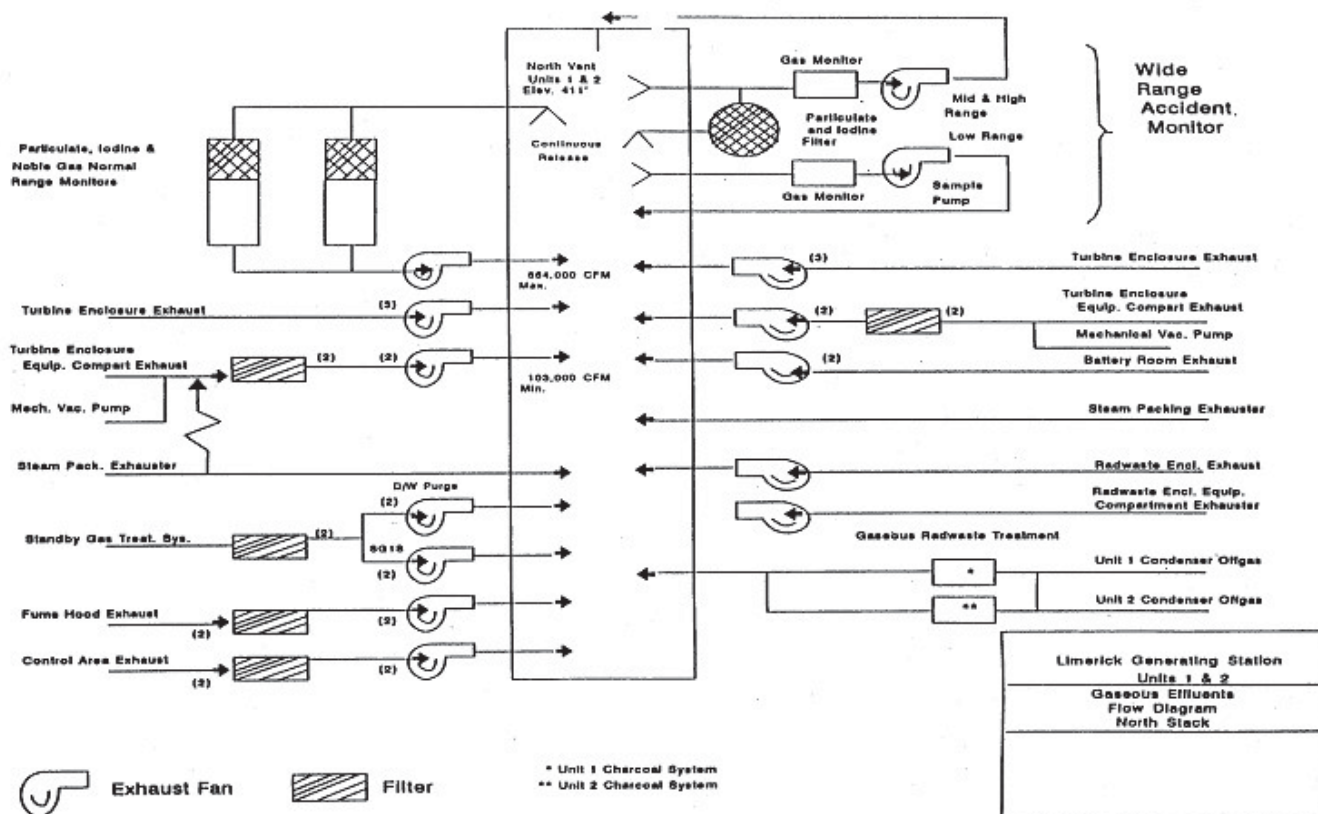

Figure II2-1

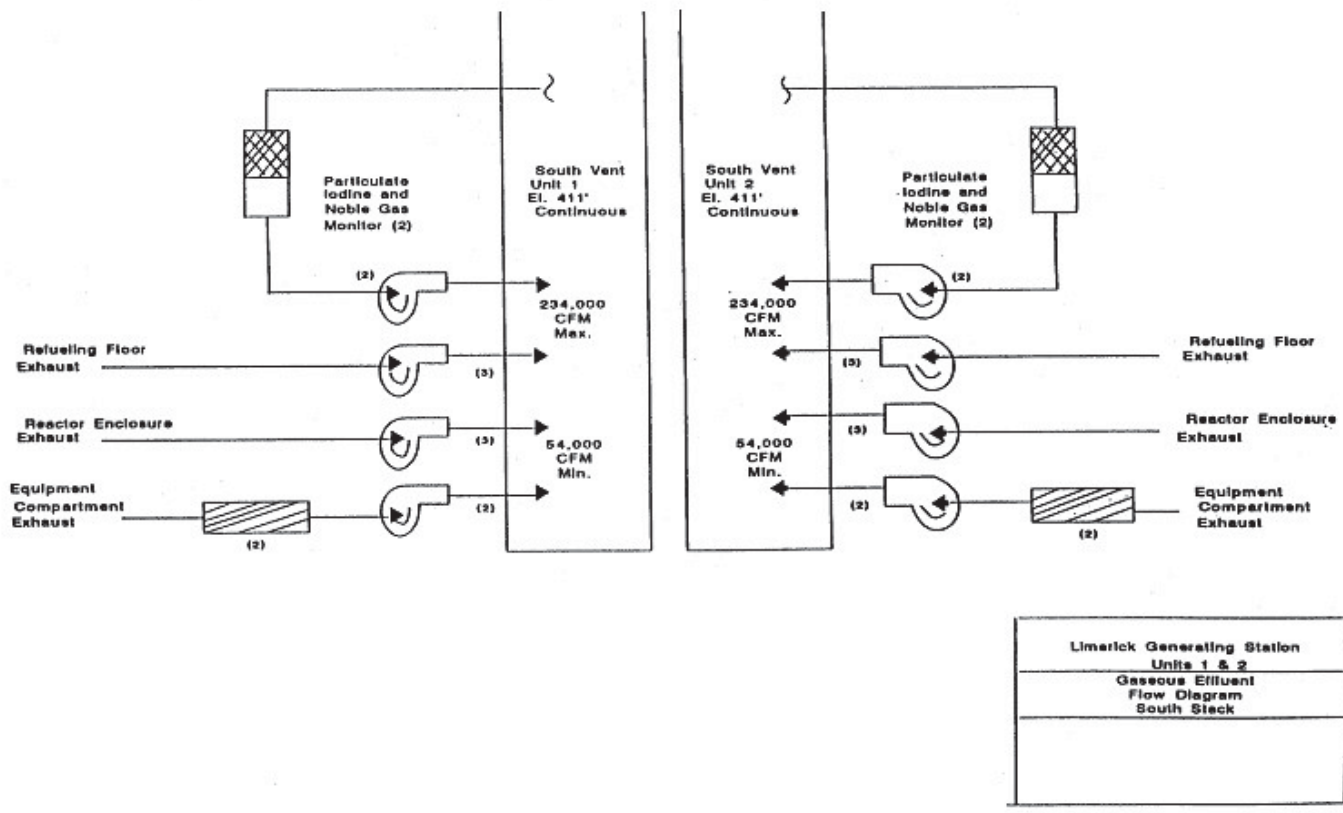

Figure II2-2

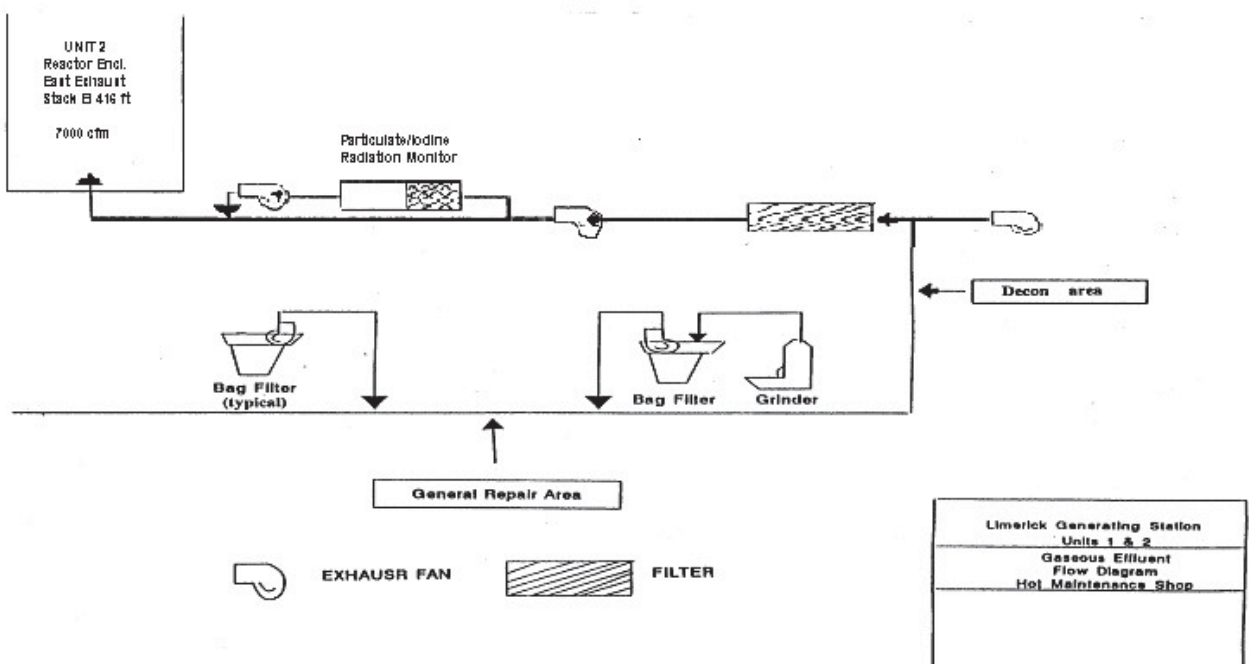

Figure II2-3

APPENDIX A

RADIOLOGICAL ENVIRONMENTAL MONITORING PROGRAM -
SAMPLE TYPE, LOCATION, AND ANALYSIS

TABLE A-1

ODCM - Limerick Generating Station
Radiological Environmental Monitoring Program

Pathway	Station Code	Location	Collection Method	Analyses	
I <u>Direct</u> (1) Inner Ring	36S2	3,183 feet N of site	1 set of four (4) dosimeters from each location at least quarterly	Gamma dose quarterly	
	3S1	2,301 feet NNE of site			
	5S1	2,350 feet NE of site			
	7S1	3,099 feet ENE of site			
	10S3	2,648 feet E of site			
	11S1	2,017 feet ESE of site			
	13S2	2,149 feet SE of site			
	14S1	3,319 feet SSE of site			
	18S2	1,390 feet S of site			
	21S2	977 feet SSW of site			
	23S2	2,793 feet SW of site			
	25S2	2,445 feet WSW of site			
	26S3	2,088 feet W of site			
	29S1	2,886 feet WNW of site			
	31S1	1,395 feet NW of site			
	34S2	3,071 feet NNW of site			
	(2) Outer Ring	36D1			18,527 feet N of site
		2E1			25,112 feet NNE of site
		4E1			25,221 feet NE of site
		7E1			22,489 feet ENE of site
		10E1			20,826 feet E of site
		10F3			29,442 feet ESE of site
		13E1			22,772 feet SE of site
		16F1			26,608 feet SSE of site
		19D1			18,439 feet S of site
		20F1			27,648 feet SSW of site
		24D1			20,972 feet SW of site
25D1		21,044 feet WSW of site			
28D2		20,231 feet W of site			
29E1		26,110 feet WNW of site			
31D2		20,446 feet NW of site			
34E1		24,243 feet NNW of site			

TABLE A-1 (Continued)

Page 2 of 3

Pathway	Station Code	Location	Collection Method	Analyses	
I. Direct (Continued) (3) Controls and Special Interest	5H1 C	130,742 feet NE of site			
	6C1	11,305 feet NE of site			
	9C1	11,377 feet E of site			
	13C1	14,980 feet SE of site			
	15D1	16,877 feet SE of site			
	17B1	8,462 feet S of site			
	20D1	16,157 feet SSW of site			
	31D1	15,853 feet WNW of site			
II. <u>Airborne</u> Particulates	10S3	2,648 feet E of site	Approximately 1 cfm continuous flow through glass fiber filter which is collected weekly.	Gross beta analysis on each weekly sample. Gamma spectrometry shall be done when gross beta exceeds ten times the yearly mean of control station value.	
	11S1	2,017 feet ESE of site			
	14S1	3,319 feet SSE of site			
	13S4	1,186 feet SE of site			
	15D1	16,877 feet SE of site			
	22G1 C	93,619 feet SW of site			
	Iodine	10S3	2,648 feet E of site	A TEDA impregnated flow-through cartridge is connected to air sampler and is collected weekly at site filter change.	Iodine 131 analysis on each weekly sample.
		11S1	2,017 feet ESE of site		
		14S1	3,319 feet SSE of site		
		13S4	1,186 feet SE of site		
22G1 C		93,619 feet SW of site			
III. <u>Water</u> a. Surface	24SI C	1,058 feet SW of site	Sample collected from a continuous water sampler, monthly. In event sampler is inoperable, weekly grab samples will be collected until sampler returned to service.	Gamma isotopic analysis monthly.	
	13BI	9,225 feet SE of site		H-3 on quarterly composite	
b. Ground	No Ground water is sampled and analyzed, because ground water flow is to the river per UFSAR Section 2.4.13				
c. Drinking	15F7	33,400 feet SSE of site	Sample collected from a continuous water sampler monthly. In event sampler is inoperable, weekly grab samples will be collected until sampler returned to service.	Iodine-131 LL, Gross beta and gamma isotopic monthly,	
	15F4	45,514 feet SE of site			
	16C2	14,034 feet SSE of site			
	28F3 C	30,811 feet WNW of site		H-3 on quarterly composite	
d. Sediment from shoreline	16C4	11,510 feet SSE of site	A sediment sample is taken down stream of discharge semi-annually	Gamma isotopic analysis each sample	

TABLE A-1 (Continued)

Page 3 of 3

Pathway	Station Code	Location	Collection Method	Analyses
IV. <u>Ingestion</u>	18E1	22,704 feet S of site		
a. Milk	19B1	10,317 feet SSW of site		
	25C1	14,224 feet WSW of site		
	23F1 C	26,505 feet SW of site	Sample of fresh milk is collected from each farm biweekly when cows are on pasture (April) through October), monthly at other times.	Gamma isotopic and I-131 analyses on each sample
b. Fish and Invertebrates	16C5	9,251 feet SE of site	Two species of recreationally important fish (Predator and bottom feeder) sampled in season or semiannually if not seasonal. Seasons are Spring and Fall	Gamma isotopic analyses on edible portions.
	29C1 C	13,725 feet WNW of site	There are no commercially or recreationally important species of invertebrates. Therefore no invertebrates are sampled.	
c. Food Products	There are no downstream food products that are irrigated by water in which liquid plant wastes have been discharged. No broad leaf vegetation sampling is performed, because milk sampling is performed.			

C = Control Location

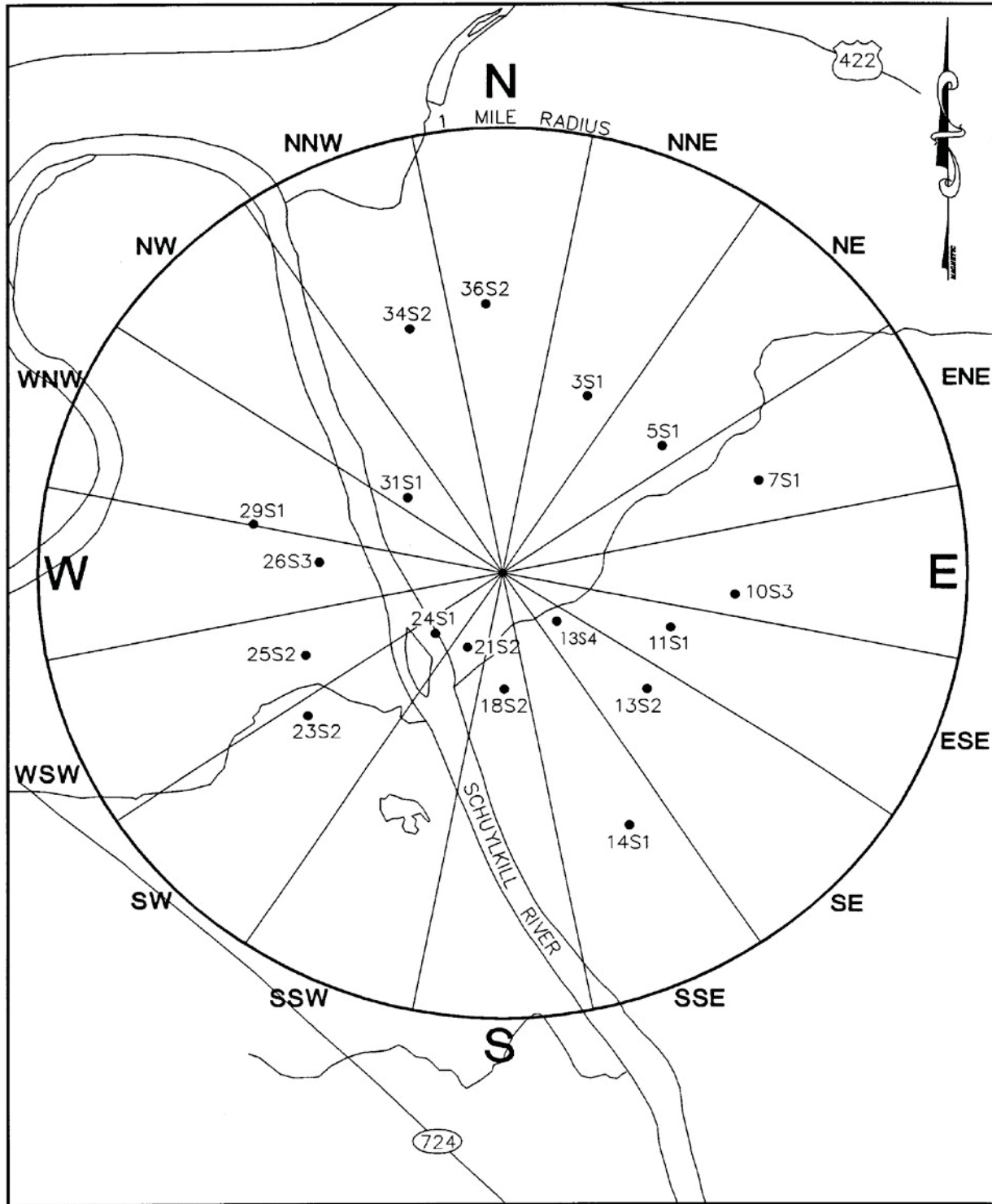

Figure A-1
Environmental Sampling Locations On Site or
Near the Limerick Generating Station

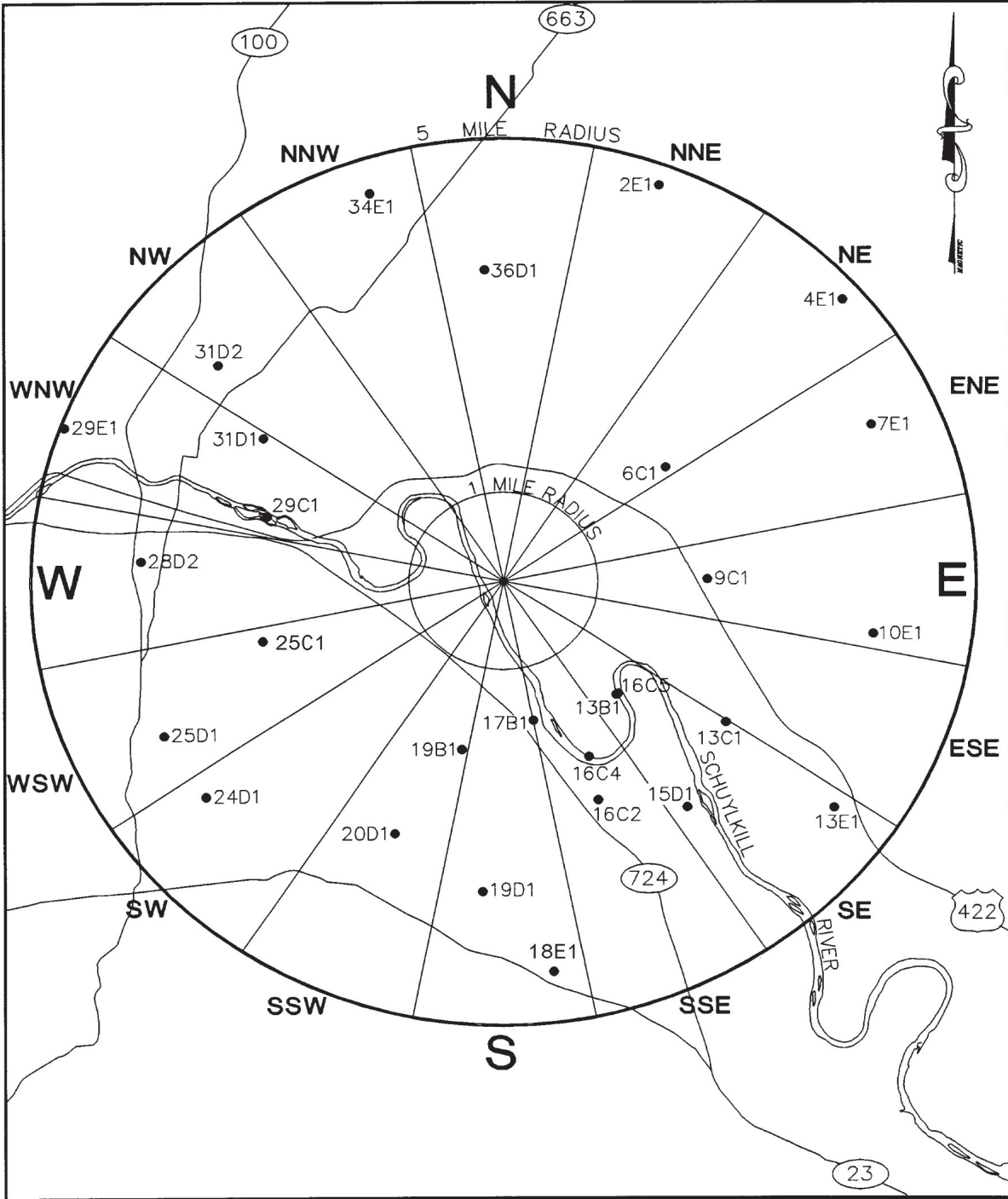

Figure A-2
Environmental Sampling Locations at Distances Less Than Five Miles from the Limerick
Generating Station.

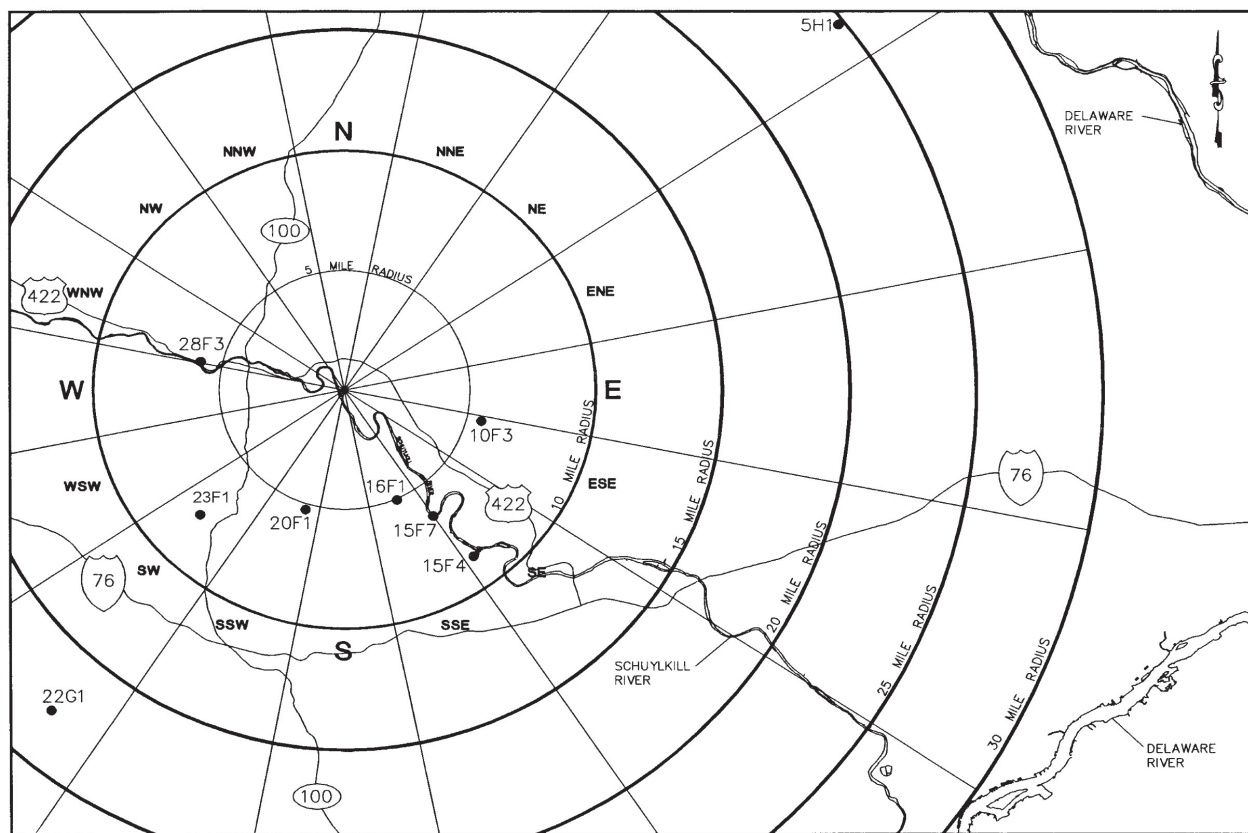

Figure A-3
Environmental Sampling Locations at Distances Greater Than Five Miles from the Limerick Generating Station.

REFERENCES

1. Regulatory Guide 1.109, "Calculation of Annual Doses to Man from Routine Releases of Reactor Effluents for the Purpose of Evaluating Compliance with 10 CFR Part 50, Appendix I," Revision 1, U.S. Nuclear Regulatory Commission, Washington, D.C. 20555, October 1977.
2. Regulatory Guide 1.111, "Methods for Estimating Atmospheric Transport and Dispersion of Gaseous Effluents in Routine Releases from Light-Water-Cooled Reactors," Revision 1, U.S. Nuclear Regulatory Commission, Washington, D.C. 20555, July 1977.
3. Regulatory Guide 1.112, "Calculation of Releases of Radioactive Materials in Gaseous and Liquid Effluents from Light-Water-Cooled Power Reactors," U.S. Nuclear Regulatory Commission, Washington, D.C. 20555, April 1976.
4. Regulatory Guide 1.113, "Estimating Aquatic Dispersion of Effluents from Accidental and Routine Reactor Releases for the Purpose of Implementing Appendix I," Revision 1, U.S. Nuclear Regulatory Commission, Washington, D.C. 20555, April 1977.
5. U.S. Nuclear Regulatory Commission, "Calculation of Releases of Radioactive Materials in Gaseous and Liquid Effluents from Boiling Water Reactors (BWR-GALE Code)," USNRC Report NUREG-0016, Washington, D.C. 20555, April 1976.
6. U.S. Nuclear Regulatory Commission, "X0QD0Q, Program for the Methodological Evaluation of Routine Effluent Releases at Nuclear Power Stations," USNRC Report NUREG-0324, Washington, D.C. 20555, September, 1977.
7. Title 10, "Energy," Chapter I, Code of Federal Regulations; Part 20, Appendix B, U.S. Government Printing Office, Washington, D.C. 20402, January 1, 1977.
8. Title 10, "Energy," Chapter I, Code of Federal Regulations; Part 100, U.S. Government Printing Office, Washington, D.C. 20404, January 1, 1977.
9. Title 40, "Protection of Environment," Chapter I, Code of Federal Regulations, Part 141, U.S. Government Printing Office, Washington, D.C. 20402, January 1, 1977.
10. Regulatory Guide 1.21, "Measuring, Evaluating, and Reporting Radioactivity in Solid Wastes and Releases of Radioactive Materials in Liquid and Gaseous Effluents from Light-Water-Cooled Nuclear Power Plants," Revision 1, U.S. Nuclear Regulatory Commission, Washington, D.C. 20555, June 1974.
11. Title 40, "Protection of Environment," Chapter I, Code of Federal Regulations, Part 190, Federal Register, Vol. 42, No. 9, Washington, D.C. 20402, January 13, 1977.
12. U.S. Nuclear Regulatory Commission, "Short Term Diffusion Estimates," Section 2.3.4, Standard Review Plan for the Review of Safety Analysis Reports for Nuclear Power Plants - LWR Edition, USNRC Report NUREG-75/087, Washington, D.C. 20555, November 1975.
13. U.S. Nuclear Regulatory Commission, "Preparation of Radiological Effluent Technical Specifications for Nuclear Power Plants," USNRC Report NUREG-0133, Washington, D.C. 20555, October 1978.

14. Letter From Thomas E. Marley, Director Office of Nuclear Reactor Regulations, To Thomas E. Tipton Vice President and Director Operations, Nuclear Management and Resources Council, 6/30/93.
15. ANSI N42.14-1991 (Revision of ANSI N42.14-1978) "Calibration and Use of Germanium Spectrometers For the Measurement of Gamma-Ray Emission Rates of Radionuclides", Sect. 6.2.2
16. EML Procedures Manual, H.L. Volchok and G. dePlangue, Editors, U.S. Dept. Of Energy (Revised Annually)
17. L.A. Currie, "Limits For Qualitative Detection and Quantitative Determination - Application to Radiochemistry", Analytical Chemistry, Vol. 40, pp. 586-593 (TABLE II), 1968
18. NUREG/CR-4007, "Lower Limit of Detection: Definition and Elaboration of a Proposed Position for Radiological Effluent and Environmental Measurements", prepared by NRC by L.A. Currie (Chapter II, Sect. D.2; Chapter III, Sect. C.1), September 1984
19. Tech. Spec. Section 1.24 (Definitions)
20. USNRC Generic Letter, 89-01
21. Tech. Spec. Section 6.14.
22. Tech. Spec. Section 6.5.1.6m.
23. Tech. Spec. Section 6.5.3.
24. Tech. Spec. Section 6.8.4d, e and f.
25. Tech. Spec. Section 6.9.1.8/ODCM Control I.3.6.
26. Tech. Spec. Section 6.10.3m and n.
27. UFSAR, Section 11.5.6.
28. Bechtel, Inc., "Dilution Studies for Routine and Accidental Releases from Limerick Nuclear Plant into the Schuylkill River", March, 1996.
29. ANSI/ANS-6.6.1-1979 "calculation and measurement of direct and scattered gamma radiation from LWR nuclear power plants, Section 7.
30. Hartwell, J.K., "Detection Limits for Radioanalytical Counting Techniques," Atlantic Richfield Hanford Company Report ARH-SA-215 (June, 1975).
31. NUREG/CR-4653 GASPARD II, Technical Reference and User Guide
32. NUREG/CR-4013, LADTAP II Technical Reference and User Guide.
33. Kocher, David C., "Radioactive Decay Data Tables," DOE/TIC-11026,138 (1981).
34. NUREG 1302, "Offsite Dose Calculation Manual Guidance: Standard Radiological Effluent Controls for Boiling Water Reactors."
35. NUREG-0974, Final Environmental Statement related to the operation of Limerick Generating Station, Units 1 and 2 (April 1984)

Attachment 3

Limerick Generating Station Units 1 and 2

Offsite Dose Calculation Manual

Revision 31

This page is intentionally left blank

Change Summary Matrix for ODCM Revision 31

Determination A – Administrative

Determination B – Main Condenser Offgas Radiation Monitor

Determination C – REMP

Item No.	Rev 30 page	Rev 31 Page	Determination Identifier	Description of Change
1.	7	7	A	<p>Updated Table of Contents.</p> <p>Reason: Addition of setpoint methodology required a Table of Contents update.</p>
2.	67-71	25-30	B	<p>Incorporated LCO 3.3.7.12, Table 3.3.7.12-1, Surveillance Requirements 4.3.7.12, and Table 4.3.7.12-1 into the 4/3.1.2 Radioactive Gaseous Effluent Monitoring Instrumentation Controls.</p> <p>Reason: The formatting of these controls is changing to follow the layout of NUREG-1302 (Offsite Dose Calculation Manual Guidance: Standard Radiological Effluent Controls for Boiling Water Reactors, Generic Letter 89091, Supplement No. 1).</p>
3.	72	25	B	<p>The Surveillance Requirement 4.11.2.6.1 is captured in the ODCM Surveillance Requirements 4.1.2.</p> <p style="padding-left: 40px;">4.11.2.6.1 The rate of the sum of the activities of noble gases at the recombiner after condenser discharge shall be continuously monitored in accordance with Specification 3.3.7.12.</p> <p style="padding-left: 40px;">ODCM 4.1.2 Each radioactive gaseous effluent monitoring instrumentation channel shall be demonstrated OPERABLE by performance of the CHANNEL CHECK, SOURCE CHECK, CHANNEL CALIBRATION, AND CHANNEL FUNCTIONAL TEST operations at the frequencies shown in Table 4.1-2.</p> <p>Reason: The formatting of these controls is changing to follow the layout of NUREG-1302 (Offsite Dose Calculation Manual Guidance: Standard Radiological Effluent Controls for Boiling Water Reactors, Generic Letter 89091, Supplement No. 1). There is no change to the surveillance frequency or monitoring requirements.</p>
4.	69	28	B	<p>Changed the Action response for when the minimum channels requirement in Table 3.3.7.12-1 for the Main condenser Offgas Pre-Treatment Radioactivity Monitory cannot be met, removing the 72 hour shutdown statement and adding additional sampling requirements. New action statement requires the following:</p> <ul style="list-style-type: none"> a. The North Stack Effluent Noble Gas Activity Monitor requirements of Table 3.1-2 are met and b. Grab samples are taken once per 24 hours and isotopic analysis is performed within 4 hours of sample time to verify that the noble gas gross activity rate is $\leq 330,000$ uCi/second. <p>Reason: Revision removes unnecessary shutdown</p>

Change Summary Matrix for ODCM Revision 31

Determination A – Administrative

Determination B – Main Condenser Offgas Radiation Monitor

Determination C – REMP

Item No.	Rev 30 page	Rev 31 Page	Determination Identifier	Description of Change
				<p>requirement associated with inoperable SJAE radiation monitors based on the implementation of compensatory sampling requirements that adequately determine offgas system release rates ensuring that the limits and requirements of T.S. 3.11.2.6 are not exceeded.</p> <p>Provides consistency with industry practice as determined through benchmarking of Exelon and industry BWRs.</p> <p>NUREG-1302 guidance regarding the not putting the system in bypass was not incorporated as this mode is not possible for either Limerick unit. This was confirmed by print reviews and discussion with multiple operators.</p>
5.	N/A	93-95, 102	B	<p>Added a statement on the methodology for Main Condenser Offgas Radiation Monitor High High Trip, High Trip, and Reset Setpoints.</p> <p>Reason: Since the rad monitor was added to the ODCM, it is appropriate to state or reference the basis for the setpoint methodology.</p>
6.	328-333	323-328	C	<p>Added all REMP sample location, including locations outside of the minimum requirements of REMP. Included table notations to designate the difference. Updated map to reflect all locations.</p> <p>Reason: Provide consistency between the ODCM and the Annual Radiological Environmental Operating Report.</p>
7.	335	330	A	<p>Update and additions to references.</p> <p>Reason: Reference enhancements.</p>

Determination A will not go through the rigor of the determination questions. Those specific questions are administrative in nature; containing an update to the Table of Contents and Reference section. They are not technical changes.

LIMERICK GENERATING STATION

UNITS 1 AND 2

OFFSITE DOSE CALCULATION MANUAL

Revision 31

EXELON NUCLEAR

DOCKET NOS. 50-352 AND 50-353

(This Manual cannot be changed without PORC and Plant Manager Approval)

Limerick Generating Station
Offsite Dose Calculation Manual

PURPOSE:

The OFFSITE DOSE CALCULATION MANUAL (ODCM) shall contain the methodology and parameters used in the calculation of offsite doses resulting from radioactive gaseous and liquid effluent, in the calculation of gaseous and liquid effluent monitoring alarm/trip setpoints, and in the conduct of the Radiological Environmental Monitoring Program.

SCOPE:

The ODCM shall also contain the Radioactive Effluent Controls Programs, the Meteorological Monitoring Program, the Radiological Environmental Monitoring Program required by Tech. Spec. Section 6.8.4 and the descriptions of the information that should be included in the Annual Radiological Environmental Operating and Annual Radioactive Effluent Release Reports required by Tech Spec. Sections 6.9.1.7 and 6.9.1.8, respectively.

Change Matrix

The following details the linkage between the Revision 21 of the ODCM and the current revision of the ODCM regarding the renumbering of the various sections. The purpose of this section is to permit a cross-reference from the old to new revision of the ODCM for procedures and surveillance tests. Changes to procedures to address the new numbering will occur as the procedures are revised on their normal revision process cycle.

Revision 21 – Old	Current Revision
Part I	
1.0 Definitions Table I1-1 Figure I2.2-1a Figure I2.2-1b	1.0 Definitions Table 1-1 Figure 1-1 Figure 1-2
2.0 Bases	Bases
	3.0 Applicability 3.0.1 3.0.2 3.0.3 3.0.4 4.0 Surveillance Requirement 4.0.1 4.0.2 4.0.3 4.0.4
3.1 Meteorology 3.1-1 Table I3.1-1 Table I3.1-2 Table I3.1-3 Figure I3.1-1	3.3.4 Meteorology 4.3.4 Table 3.3-3 Table 4.3-2 Figure 3.3-1
3.2.1 Radioactive Liquid Effluent Monitoring Instrumentation 3.2.1-1 Table I3.2-1 Table I3.2-2	3.1.1 Radioactive Liquid Effluent Monitoring Instrumentation 4.1.1 Table 3.1-1 Table 4.1-1
3.2.2 Concentration in Liquid Effluents 3.2.2-1 3.2.2-2 Table I3.2-3	3.2.1.1 Concentration Liquid Effluents 4.2.1.1.1 4.2.1.1.2 Table 4.2-1
3.2.3 Dose due to Liquid Effluents 3.2.3-1	3.2.1.2 Dose Liquid Effluents 4.2.1.2

Revision 21 – Old	Current Revision
Part I	
3.2.4 Liquid Radwaste Treatment System 3.2.4-1	3.2.1.3 Liquid Radwaste Treatment System 4.2.1.3.1 4.2.1.3.2
3.3.1 Radioactive Gaseous Effluent Monitoring Instrumentation 3.3.1-1 Table I3.3-1 Table I3.3-2	3.1.2 Radioactive Gaseous Effluent Monitoring Instrumentation 4.1.2 Table 3.1-2 Table 4.1-2
3.3.2 Site Boundary Dose Rate 3.3.2-1 3.3.2-2 Table I3.3-3	3.2.2.1 Dose Rate 4.2.2.1.1 4.2.2.1.2 Table 4.2-2
3.3.3 Dose – Noble Gas 3.3.3-1	3.2.2.2 Dose – Noble Gas 4.2.2.2
3.3.4 Dose – Iodine-133, tritium and radionuclides in particulate forms 3.3.4-1	3.2.2.3 Dose – Iodine-131, Iodine-133, tritium and radionuclides in particulate forms 4.2.2.3
None	3.2.2.4 Gaseous Radwaste Treatment System
3.3.5 Ventilation Exhaust Treatment System 3.3.5-1 —	3.2.2.5 Ventilation Exhaust Treatment System 4.2.2.5.1 4.2.2.5.2
3.3.6 Venting or Purging 3.3.6-1 3.3.6-2	3.2.2.7 Venting or Purging 4.2.2.7.1 4.2.2.7.2
3.3.7 Total Dose 3.3.7-1 3.3.7-2	3.2.3 Total Dose 4.2.3.1 4.2.3.2
3.3.8 Dose – Incineration of Radioactive Waste Oil 3.3.8-1 3.3.8-2	3.2.2.6 Incineration of Radioactive Waste Oil 4.2.2.6.1 4.2.2.6.2
3.4.1 Radiological Environmental Monitoring Program 3.4.1-1 Table I3.4-1 REMP Table I3.4-2 Reporting Levels Table I3.4-3 Lower Limit of Detection	3.3.1 Radiological Environmental Monitoring Program 4.3.1 Table 3.3-1 REMP Table 3.3-2 Reporting Levels Table 4.3-1 Lower Limit of Detection
3.4.2 Land Use Census 3.4.2-1	3.3.2 Land Use Census 4.3.2

Revision 21 – Old	Current Revision
Part I	
3.4.3 Interlaboratory Comparison Program 3.4.3-1	3.3.3 Interlaboratory Comparison Program 4.3.3
— 3.5 Annual Radiological Environmental Operating Report 3.6 Annual Radioactive Effluent Release Report 3.7 Major Changes to Radioactive Waste Treatment Systems	6.0 Administrative Controls 6.1 Annual Radiological Environmental Operating Report 6.2 Annual Radioactive Effluent Release Report 6.3 Major Changes to Radioactive Waste Treatment Systems
Part II	
1.4 Liquid Effluent Dose Projection	1.3.2 Liquid Effluent Dose Projection
Appendix A Technical Specification/ODCM Matrix	Deleted
Appendix B - Radiological Environmental Monitoring Program – Sample Type, Location and Analysis	Appendix A - Radiological Environmental Monitoring Program – Sample Type, Location and Analysis
Appendix C – ODCM Revision Process	Part I, Section 6.4 Changes to the ODCM

TABLE OF CONTENTS

PART I - RADIOLOGICAL EFFLUENT CONTROLS	11
1.0 DEFINITIONS	12
3.0 APPLICABILITY	18
3.1 INSTRUMENTATION	20
3.1.1 RADIOACTIVE LIQUID EFFLUENT MONITORING INSTRUMENTATION	20
3.1.2 RADIOACTIVE GASEOUS EFFLUENT MONITORING INSTRUMENTATION	25
3.2 RADIOACTIVE EFFLUENTS	31
3.2.1 LIQUID EFFLUENTS	31
3.2.1.1 CONCENTRATION	31
3.2.1.2 DOSE	35
3.2.1.3 LIQUID RADWASTE TREATMENT SYSTEM	36
3.2.2 GASEOUS EFFLUENTS	37
3.2.2.1 DOSE RATE	37
3.2.2.2 DOSE - NOBLE GASES	41
3.2.2.3 DOSE - IODINE-131, IODINE-133, TRITIUM, AND RADIONUCLIDES IN PARTICULATE FORM	42
3.2.2.4 GASEOUS RADWASTE (OFFGAS) TREATMENT SYSTEM	43
3.2.2.5 VENTILATION EXHAUST TREATMENT SYSTEM	44
3.2.2.7 MARK II CONTAINMENT	46
3.2.3 TOTAL DOSE	47
3.3 RADIOLOGICAL ENVIRONMENTAL MONITORING	48
3.3.1 MONITORING PROGRAM	48
3.3.2 LAND USE CENSUS	61
3.3.3 INTERLABORATORY COMPARISON PROGRAM	62
3.3.4 METEOROLOGICAL MONITORING INSTRUMENTATION	63
BASES	67
6.0 ADMINISTRATIVE CONTROLS	77
6.1 ANNUAL RADIOLOGICAL ENVIRONMENTAL OPERATING REPORT	77
6.2 ANNUAL RADIOACTIVE EFFLUENT RELEASE REPORT	78
6.3 MAJOR CHANGES TO RADIOACTIVE WASTE TREATMENT SYSTEMS	80
6.4 CHANGES TO THE ODCM	81

PART II - CALCULATION METHODOLOGIES	82
1.0 LIQUID EFFLUENTS	83
1.1 RADIATION MONITORING INSTRUMENTATION AND CONTROLS	83
1.2 LIQUID EFFLUENT MONITOR SETPOINT DETERMINATION	84
1.2.1 Radwaste Discharge Monitor and Discharge Flow Rate	84
1.2.2 Service Water and RHR Service Water Radiation Monitor	87
1.3 LIQUID EFFLUENT DOSE CALCULATIONS - 10 CFR 50	88
1.3.1 Dose to Members of the Public	88
1.3.2 Liquid Effluent Dose Projection	91
2.0 GASEOUS EFFLUENTS	93
2.1 RADIATION MONITORING INSTRUMENTATION AND CONTROLS	93
2.2 GASEOUS EFFLUENT MONITOR SETPOINT DETERMINATION	93
2.2.1 North Vent Noble Gas Effluent Monitors	95
2.2.2 South Vent Noble Gas Effluent Monitors	96
2.2.3 Noble Gas Effluent Fractional Contribution	98
2.2.4 Noble Gas Effluent Default Setpoints	98
2.2.5 WRAM Noble Gas Effluent Monitor	100
2.2.6 Main Condenser Offgas Pre-Treatment Radiation Monitor	102
2.3 GASEOUS EFFLUENT DOSE EVALUATIONS	103
2.3.1 Site Boundary Dose Rate - Noble Gases	103
2.3.2 Site Boundary Dose Rate - Radioiodine and Particulates	104
2.3.3 Noble Gas Air Dose	105
2.3.4 Radioiodine and Particulate Dose Calculations	106
2.3.6 Gaseous Effluent Dose Projection	112
3.0 ANNUAL DOSE EVALUATION	113
4.0 SPECIAL DOSE ANALYSIS	113
4.1 TOTAL DOSES TO MEMBERS OF THE PUBLIC	113
4.2 DOSES DUE TO ACTIVITIES INSIDE THE SITE BOUNDARY	114
5.0 RADIOLOGICAL ENVIRONMENTAL MONITORING PROGRAM	115
5.1 SAMPLING PROGRAM	115
5.2 INTERLABORATORY COMPARISON PROGRAM	115
REFERENCES	329

LIST OF TABLES

PART I

1-1	Surveillance Frequency Notation	15
3.1-1	Radioactive Liquid Effluent Monitoring Instrumentation	21
4.1-1	Radioactive Liquid Effluent Monitoring Instrumentation Surveillance Requirements	23
3.1-2	Radioactive Gaseous Effluent Monitoring Instrumentation	26
4.1-2	Radioactive Gaseous Effluent Monitoring Instrumentation Surveillance Requirements	29
4.2-1	Radioactive Liquid Waste Sampling and Analysis Program	32
4.2-2	Radioactive Gaseous Waste Sampling and Analysis Program	38
3.3-1	Radiological Environmental Monitoring Program	50
3.3-2	Reporting Levels for Radioactivity Concentrations In Environmental Samples	57
4.3-1	Detection Capabilities For Environmental Sample Analysis	58
3.3-3	Meteorological Monitoring Instrumentation	64
4.3-2	Meteorological Monitoring Instrumentation Surveillance Requirements	65

PART II

II1-1	Decay Constants For Nuclides Of Interest	117
II1-2	Bioaccumulation Factors For Freshwater Fish	121
II1-3	Ingestion Dose Factors for Adult (D_{aipj})	122
II1-4	Ingestion Dose Factors for Teen (D_{aipj})	126
II1-5	Ingestion Dose Factors for Child (D_{aipj})	130
II1-6	Ingestion Dose Factors for Infant (D_{aipj})	134
II1-7	Dose Factors for Standing on Contaminated Ground (D_{aipj})	138
II1-8	Aquatic Pathway Usage Factors (U_{ap})	142
II1-9	Adult Drinking Water A_{iT} Factors	143
II1-10	Adult Freshwater Fish A_{iT} Factors	147
II1-11	Adult Shoreline A_{iT} Factors	151
II1-12	Teen Drinking Water A_{iT} Factors	155
II1-13	Teen Freshwater Fish A_{iT} Factors	159
II1-14	Teen Shoreline A_{iT} Factors	163
II1-15	Child Drinking Water A_{iT} Factors	167
II1-16	Child Freshwater Fish A_{iT} Factors	171
II1-17	Child Shoreline A_{iT} Factors	175
II1-18	Infant Drinking Water A_{iT} Factors	179

II1-19	Infant Freshwater Fish A _{ir} Factors	183
II1-20	Infant Shoreline A _{ir} Factors	187
II1-21	Assumptions Used In Limerick Liquid Effluent Dose Evaluations	191
II2-1	Dose Factors for Noble Gases	192
II2-2	R _i Dose Factors Age: Adult Pathway: Inhalation	193
II2-3	R _i Dose Factors Age: Teen Pathway: Inhalation	197
II2-4	R _i Dose Factors Age: Child Pathway: Inhalation	201
II2-5	R _i Dose Factors Age: Infant Pathway: Inhalation	205
II2-6	R _i Dose Factors Age: Adult Pathway: Ground	209
II2-7	R _i Dose Factors Age: Teen Pathway: Ground	213
II2-8	R _i Dose Factors Age: Child Pathway: Ground	217
II2-9	R _i Dose Factors Age: Infant Pathway: Ground	221
II2-10	R _i Dose Factors Age: Adult Pathway: Vegetation	225
II2-11	R _i Dose Factors Age: Teen Pathway: Vegetation	229
II2-12	R _i Dose Factors Age: Child Pathway: Vegetation	233
II2-13	R _i Dose Factors Age: Infant Pathway: Vegetation	237
II2-14	R _i Dose Factors Age: Adult Pathway: Meat	241
II2-15	R _i Dose Factors Age: Teen Pathway: Meat	245
II2-16	R _i Dose Factors Age: Child Pathway: Meat	249
II2-17	R _i Dose Factors Age: Infant Pathway: Meat	253
II2-18	R _i Dose Factors Age: Adult Pathway: Cow Milk	257
II2-19	R _i Dose Factors Age: Teen Pathway: Cow Milk	261
II2-20	R _i Dose Factors Age: Child Pathway: Cow Milk	265
II2-21	R _i Dose Factors Age: Infant Pathway: Cow Milk	269
II2-22	R _i Dose Factors Age: Adult Pathway: Goat Milk	273
II2-23	R _i Dose Factors Age: Teen Pathway: Goat Milk	277
II2-24	R _i Dose Factors Age: Child Pathway: Goat Milk	281
II2-25	R _i Dose Factors Age: Infant Pathway: Goat Milk	285
II2-26	Stable Element Transfer Data	289
II2-27	Inhalation Dose Factors For Adult (D _{aijp})	293

II2-28	Inhalation Dose Factors For Teenager ($D_{ai pj}$)	297
II2-29	Inhalation Dose Factors For Child ($D_{ai pj}$)	301
II2-30	Inhalation Dose Factors For Infant ($D_{ai pj}$)	305
II2-31	Assumptions Used In Limerick Gaseous Effluent R_i Evaluation	309
II2-32	Nearest Gaseous Effluent Dose Receptor Distances	311
A-1	ODCM – Limerick Generating Station Radiological Environmental Monitoring Program	323

LIST OF FIGURES

PART I

1-1	Map Detailing the Restricted Area Boundary for Radioactive Gaseous And Liquid Effluents	16
1-2	Map Detailing Low Population Areas for Radioactive Gaseous and Liquid Effluents	17
3.3-1	Meteorological Tower Locations	66

PART II

II1.3.1-1	LGS Dilution Vs River Flow (Station Outfall)	313
II1.3.1-2	LGS Dilution Vs River Flow (Pennsylvania American Water Company)	314
II1.3.1-3	LGS Dilution Vs River Flow (Phoenixville)	315
II1.3.1-4	LGS Dilution Vs River Flow (Aqua America)	316
II1.3.1-5	LGS Dilution Vs River Flow (Crew Course)	317
II1-1	Liquid Effluent Flow Diagram	318
II2-1	Gaseous Effluent Flow Diagram - North Stack	319
II2-2	Gaseous Effluent Flow Diagram - South Stack	320
II2-3	Gaseous Effluent Flow Diagram - Hot Maintenance Shop	321
A-1	Environmental Sampling Location on Site or Near the Limerick Generating Station	326
A-2	Environmental Sampling Locations at Distances Less Than Five Miles from the Limerick Generating Station	327
A-3	Environmental Sampling Locations at Distances Greater Than Five Miles from the Limerick Generating Station	328

PART I
RADIOLOGICAL EFFLUENT CONTROLS

1.0 DEFINITIONS

The following terms are taken from LGS Unit 1/Unit 2 Tech Specs, unless otherwise noted:

1.1 ACTION

ACTION shall be that part of a specification, which prescribes remedial measures, required under designated conditions.

1.2 CHANNEL CALIBRATION

A CHANNEL CALIBRATION shall be the adjustment, as necessary, of the channel output such that it responds with the necessary range and accuracy to known values of the parameter which the channel monitors. The CHANNEL CALIBRATION shall encompass the entire channel including the sensor and alarm and/or trip functions, and shall include the CHANNEL FUNCTION TEST. The CHANNEL CALIBRATION may be performed by any series of sequential, overlapping or total channel steps such that the entire channel is calibrated.

1.3 CHANNEL CHECK

A CHANNEL CHECK shall be the qualitative assessment of channel behavior during operation by observation. This determination shall include, where possible, comparison of the channel indication and/or status with other indications and/or status derived from independent instrument channels measuring the same parameter.

1.4 CHANNEL FUNCTIONAL TEST

A CHANNEL FUNCTIONAL TEST shall be:

- a. Analog channels - the injection of a simulated signal into the channel as close to the sensor as practicable to verify OPERABILITY including alarm and/or trip functions and channel failure trips.
- b. Bistable channels - the injection of a simulated signal into the sensor to verify OPERABILITY including alarm and/or trip functions.

The CHANNEL FUNCTIONAL TEST may be performed by any series of sequential, overlapping or total channel steps such that the entire channel is tested.

1.0 DEFINITIONS

1.5 CONTROLLED AREA

CONTROLLED AREA means an area, outside of a restricted area but inside the site boundary, access to which can be limited by the licensee for any reason. The CONTROLLED AREA equals the RESTRICTED AREA. By definition Limerick does not have a CONTROLLED AREA.

1.6 DOSE EQUIVALENT I-131

DOSE EQUIVALENT I-131 shall be that concentration of I-131, microcuries per gram, which alone would produce the same inhalation committed effective dose equivalent (CEDE) as the quantity and isotopic mixture of I-131, I-132, I-133, I-134, and I-135 actually present. The inhalation committed effective dose equivalent (CEDE) conversion factors used for this calculation shall be those listed in Table 2.1 of Federal Guidance Report 11, Limiting Values of Radionuclide Intake and Air Concentration and Dose Conversion Factors for Inhalation, Submersion, and Ingestion," ORNL, 1989, as described in Regulatory Guide 1.183. The factors in the column headed "effective" yield doses corresponding to the CEDE.

1.7 FREQUENCY NOTATION

The FREQUENCY NOTATION specified for the performance of Surveillance Requirements shall correspond to the intervals defined in Table 1-1.

1.8 MEMBER(S) OF THE PUBLIC

MEMBER(S) OF THE PUBLIC means any individual except when that individual is receiving an occupational dose.

1.9 OPERABLE - OPERABILITY

A system, subsystem, train, component or device shall be OPERABLE or have OPERABILITY when it is capable of performing its specified functions(s) and when all necessary attendant instrumentation, controls, electrical power, cooling or seal water, lubrication or other auxiliary equipment that are required for the system, subsystem, train, component or device to perform its function(s) are also capable of performing their related support function(s).

1.10 OPERATIONAL CONDITION - CONDITION

An OPERATIONAL CONDITION, i.e., CONDITION, shall be any one inclusive combination of mode switch position and average reactor coolant temperature as defined in the Technical Specifications.

1.0 DEFINITIONS

1.11 PURGE - PURGING

PURGE or PURGING shall be the controlled process of discharging air or gas from a confinement to maintain temperature, pressure, humidity, concentration or other operating condition, in such a manner that replacement air or gas is required to purify the confinement.

1.12 RATED THERMAL POWER

See current LGS Tech Spec definition.

1.13 REPORTABLE EVENT

A REPORTABLE EVENT shall be any of those conditions specified in Section 50.73 of 10 CFR Part 50 or 10 CFR 72.75.

1.14 RESTRICTED AREA

The RESTRICTED AREA means an area, access to which is limited by the licensee for the purpose of protecting individuals against undue risks from exposure to radiation and radioactive materials (Figure 1-1). Per UFSAR 2.1.1.3 the RESTRICTED AREA extends to the SITE BOUNDARY.

1.15 SITE BOUNDARY

The SITE BOUNDARY shall be that line beyond which the land or property is not owned, leased, or otherwise controlled by the licensee (Figure 1-1).

1.16 SOURCE CHECK

A SOURCE CHECK shall be the qualitative assessment of channel response when the channel sensor is exposed to a radioactive source.

1.17 THERMAL POWER

THERMAL POWER shall be the total reactor core heat transfer rate to the reactor coolant.

1.18 UNRESTRICTED AREA

UNRESTRICTED AREA means an area, access to which is neither limited nor controlled by the licensee.

1.19 VENTILATION EXHAUST TREATMENT SYSTEM

A VENTILATION EXHAUST TREATMENT SYSTEM shall be any system designed and installed to reduce gaseous radioiodine or radioactive material in particulate form in effluents by passing ventilation or vent exhaust gases through charcoal absorbers and/or HEPA filters for the purpose of removing iodines or particulates from the gaseous exhaust stream prior to the release to the environment (such a system is not considered to have any effect on noble gas effluents). Engineered Safety Feature (ESF) atmospheric cleanup systems are

1.0 DEFINITIONS

not considered to be VENTILATION EXHAUST TREATMENT SYSTEM components.

1.20 VENTING

VENTING shall be the controlled process of discharging air or gas from a confinement to maintain temperature, pressure, humidity, concentration or other operating condition, in such a manner that replacement air or gas is not provided or required during VENTING. Vent, used in system names, does not imply a VENTING process.

TABLE 1-1

SURVEILLANCE FREQUENCY NOTATION

<u>NOTATION</u>	<u>FREQUENCY</u>
S (Shift)	At least once per 12 hours.
D (Daily)	At least once per 24 hours.
W (Weekly)	At least once per 7 days.
M (Monthly)	At least once per 31 days.
Q (Quarterly)	At least once per 92 days.
SA (Semi-annual)	At least once per 184 days.
A (Annual)	At least once per 366 days.
E	At least once per 18 months (550 days).
R	At least once per 24 months (731 days).
S/U	Prior to each reactor startup.
P	Prior to each radioactive release.
N.A.	Not applicable

1.0 DEFINITIONS

FIGURE 1-1

MAP DETAILING THE RESTRICTED AREA BOUNDARY FOR RADIOACTIVE GASEOUS AND LIQUID EFFLUENTS

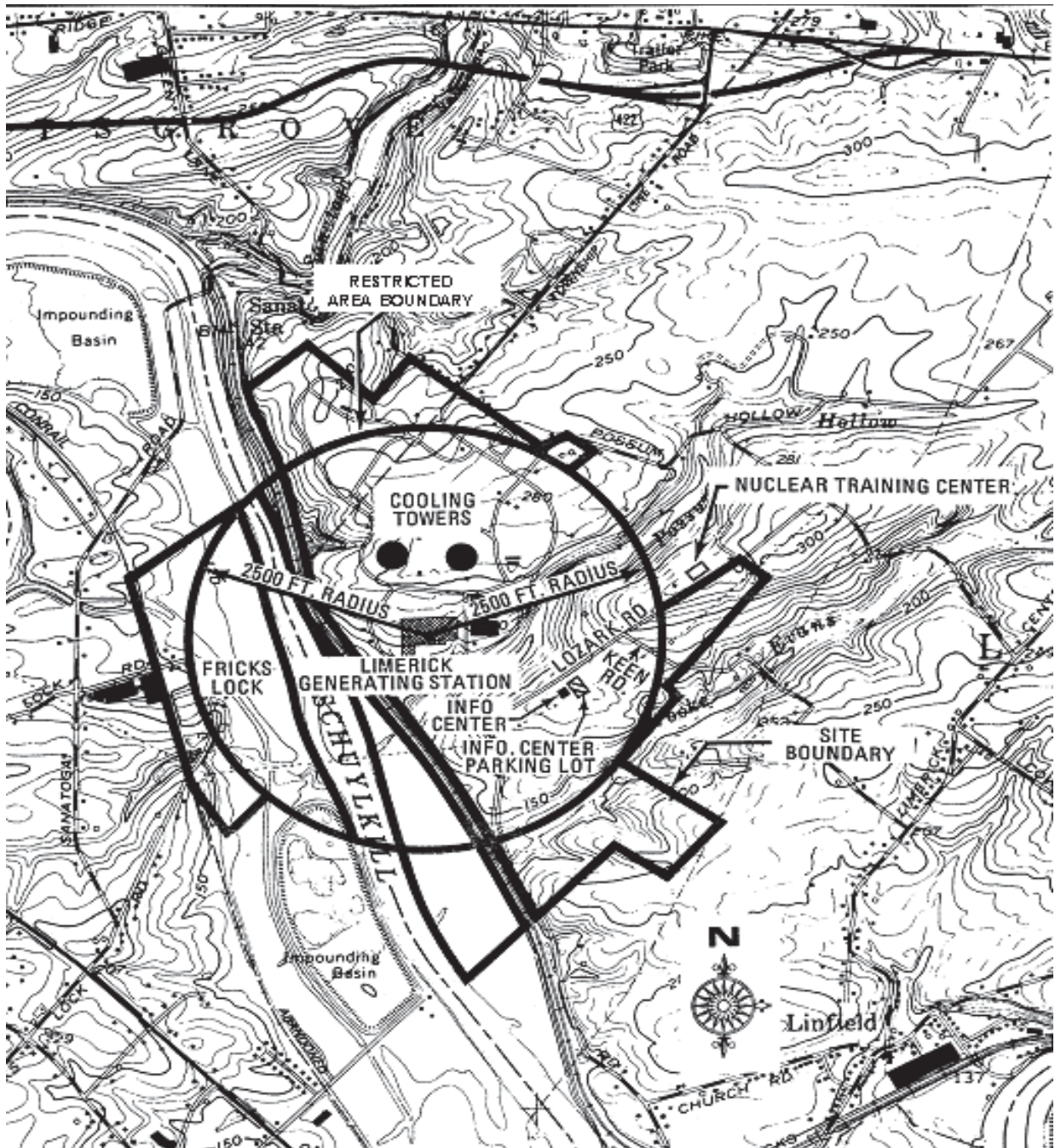

1.0 DEFINITIONS

FIGURE 1-2

MAP DETAILING LOW POPULATION AREAS FOR RADIOACTIVE GASEOUS AND LIQUID EFFLUENTS

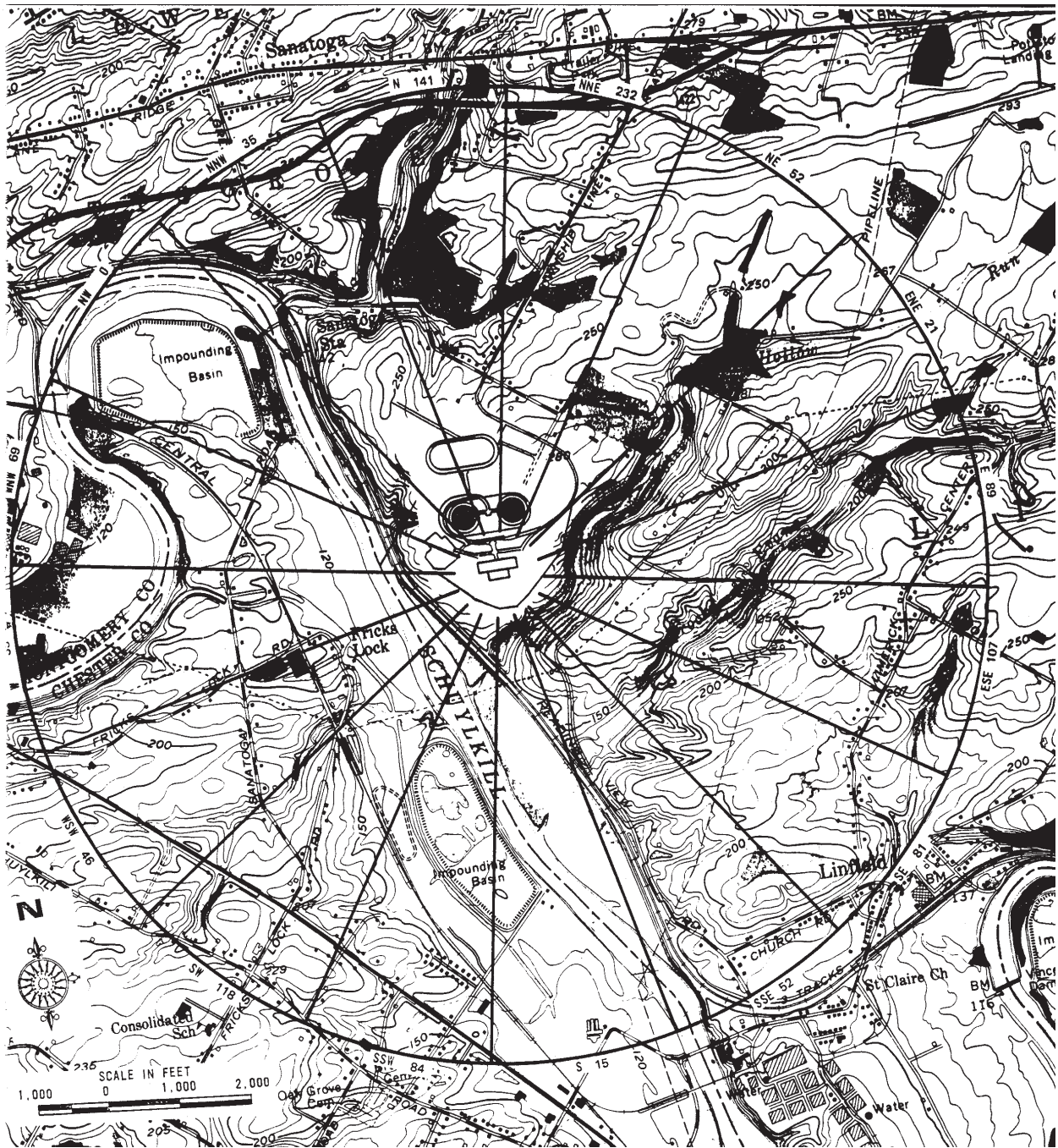

3/4 CONTROLS AND SURVEILLANCE REQUIREMENTS

3/4.0 APPLICABILITY

CONTROLS

- 3.0.1 Compliance with the Controls contained in the succeeding controls is required during the OPERATIONAL CONDITIONS or other conditions specified therein; except that upon failure to meet the Control, the associated ACTION requirements shall be met.
- 3.0.2 Noncompliance with a Control shall exist when the requirements of the Control and associated ACTION requirements are not met within the specified time intervals. If the Control is restored prior to expiration of the specified time intervals, completion of the ACTION requirements is not required.
- 3.0.3 When a Control is not met, except as provide in the associated ACTION requirements, within 1 hour action shall be initiated to place the unit in an
- At least STARTUP within the next 6 hours
 - At least HOT SHUTDOWN within the following 6 hours, and
 - At least COLD SHUTDOWN within the subsequent 24 hours.
- Where corrective measures are completed that permit operation under the ACTION requirements, the ACTION may be taken in accordance with the specified time limits as measured from the time of failure to meet the Control. Exceptions to these requirements are stated in the individual controls.
- This control is not applicable in OPERATIONAL CONDITIONS 4 or 5.
- 3.0.4 When a Limiting Condition for Operation is not met, entry into an OPERATIONAL CONDITION or other specified condition in the Applicability shall only be made:
- When the associated ACTION requirements to be entered permit continued operation in the OPERATIONAL CONDITION or other specified condition in the Applicability for an unlimited period of time; or
 - After performance of a risk assessment addressing inoperable systems and components, consideration of the results, determination of the acceptability of entering the OPERATIONAL CONDITION or other specified condition in the Applicability, and establishment of risk management actions, if appropriate; exceptions to this Control are stated in the individual Controls; or
 - When an allowance is stated in the individual value, parameter, or other Control.

3/4 CONTROLS AND SURVEILLANCE REQUIREMENTS

3/4.0 APPLICABILITY

SURVEILLANCE REQUIREMENTS

- 4.0.1 Surveillance Requirements shall be met during the OPERATIONAL CONDITIONS or other specified conditions in the Applicability for individual Controls, unless otherwise stated in the Surveillance Requirement. Failure to meet a Surveillance, whether such failure is experienced during the performance of the Surveillance or between performances of the Surveillance, shall be failure to meet the Control. Failure to perform a Surveillance within the specified Surveillance time interval and allowed extension per Surveillance Requirement 4.0.2, shall be failure to meet the Control except as provided in Surveillance Requirement 4.0.3. Surveillances do not have to be performed on inoperable equipment or variables outside specified limits.
- 4.0.2 Each Surveillance Requirement shall be performed within the specified surveillance time interval with a maximum allowable extension not to exceed 25% of the surveillance interval.
- 4.0.3 If it is discovered that a Surveillance was not performed within its specified Surveillance time interval and allowed extension per Surveillance Requirement 4.0.2, then compliance with the requirement to declare the Control not met may be delayed, from the time of discovery, up to 24 hours or up to the limit of the specified Surveillance time interval, whichever is greater. This delay period is permitted to allow performance of the Surveillance. A risk evaluation shall be performed for any Surveillance delayed greater than 24 hours and the risk impact shall be managed.
- If the Surveillance is not performed within the delay period, the Control must immediately be declared not met, and the applicable ACTION requirements must be entered.
- When the Surveillance is performed within the delay period and the Surveillance is not met, the Control must immediately be declared not met, and the applicable ACTION requirements must be entered.
- 4.0.4 Entry into an OPERATIONAL CONDITION or other specified condition in the Applicability of a Control shall only be made when the Control's Surveillance Requirements have been met within their Surveillance time interval, except as provided in Surveillance Requirement 4.0.3. When a Control is not met due to its Surveillance Requirements not having been met, entry into an OPERATIONAL CONDITION or other specified condition in the Applicability shall only be made in accordance with Control 3.0.4.

3/4.1 INSTRUMENTATION

3/4.1.1 RADIOACTIVE LIQUID EFFLUENT MONITORING INSTRUMENTATION CONTROLS

3.1.1 The radioactive liquid effluent monitoring instrumentation channels shown in Table 3.1-1 shall be OPERABLE with their Alarm/Trip Setpoints set to ensure that the limits of Control 3.2.1.1 are not exceeded. The Alarm/Trip Setpoints* of these channels shall be determined and adjusted in accordance with the methodology and parameters in ODCM Part II, Section 1.2.

APPLICABILITY: As shown in Table 3.1-1

ACTION:

- a. With a radioactive liquid effluent monitoring instrumentation channel Alarm/Trip Setpoint less conservative than required by the above control, immediately suspend the release of radioactive liquid effluents monitored by the affected channel, or declare the channel inoperable, or change the setpoint so it is acceptably conservative.
- b. With less than the minimum number of radioactive liquid effluent monitoring instrumentation channels OPERABLE, take the ACTION shown in Table 3.1-1. Restore the inoperable instrumentation to OPERABLE status within 30 days and, if unsuccessful explain in the next Annual Radioactive Effluent Release Report pursuant to CONTROL 6.2 why this inoperability was not corrected in a timely manner.
- c. The provisions of Controls 3.0.3 and 3.0.4 are not applicable. Report all deviations in the Annual Radioactive Effluent Release Report.

SURVEILLANCE REQUIREMENTS

4.1.1 Each radioactive liquid effluent monitoring instrumentation channel shall be demonstrated OPERABLE by performance of the CHANNEL CHECK, SOURCE CHECK, CHANNEL CALIBRATION and CHANNEL FUNCTIONAL TEST operations at the frequencies shown in Table 4.1-1.

* Excluding the flow rate measuring devices which are not determined and adjusted in accordance with the ODCM.

TABLE 3.1-1
RADIOACTIVE LIQUID EFFLUENT MONITORING INSTRUMENTATION

INSTRUMENT	MINIMUM CHANNELS OPERABLE	APPLICABILITY	ACTION
1. Gross Radioactivity Monitors Providing Automatic Termination of Release a. Liquid Radwaste Effluent Line b. A/B RHR Service Water Effluent Line *	1 1/loop	*** **	100 101
2. Gross Radioactivity Monitors Not Providing Automatic Termination of Release a. Service Water Effluent Line	1	**	101
3. Flow Rate Measurement Devices a. Liquid Radwaste Effluent Line b. Discharge Line	1 1	*** ***	102 102

* Termination of the release is accomplished by auto trip of the RHRSW pumps and remote manual closure of isolation valves.

** While system pumps are in operation.

*** During a liquid effluent release.

TABLE 3.1-1 (Continued)ACTION STATEMENTS

- Action 100 - With the number of channels OPERABLE less than required by the Minimum Channels requirement, effluent releases via this pathway may continue provided that prior to initiating a release:
- a. At least two independent samples are analyzed in accordance with SURVEILLANCE REQUIREMENT 4.2.1.1.1, and
 - b. At least two technically qualified members of the facility staff independently verify the release rate calculations and discharge line valving.
- Otherwise, suspend release of radioactive effluents via this pathway.
- Action 101 - With the number of channels OPERABLE less than required by the Minimum Channels OPERABLE requirement, effluent releases via this pathway may continue provided that, at least once per 12 hours, grab samples are collected and analyzed for radioactivity at a lower limit of detection (LLD) of no more than $1E-7$ uCi/ml.
- If the A or B RHRSW Process Rad Monitor should become inoperable, sampling is required at least once every twelve (12) hours at a sample point common with the inoperable A and/or B RHRSW Process Rad Monitor(s). If a monitor is inoperable but will still continuously sample and annunciate on high activity, i.e. rad monitor bypass switch placed in "Bypass", Chemistry sampling is not required as the continuous monitor sampling complies with the periodic sampling requirement.
- Action 102 - With the number of channels OPERABLE less than required by the Minimum Channels requirement, effluent releases via this pathway may continue provided the flow rate is estimated at least once per 4 hours during actual releases. Pump performance curves generated in place may be used to estimate flow.

TABLE 4.1-1

RADIOACTIVE LIQUID EFFLUENT MONITORING INSTRUMENTATION SURVEILLANCE REQUIREMENTS

INSTRUMENT	CHANNEL CHECK	SOURCE CHECK	CHANNEL CALIBRATION	CHANNEL FUNCTIONAL TEST
1. Gross Radioactivity Monitors Providing Automatic Termination of Release				
a. Liquid Radwaste Effluent Line	D*	D*	R(3)	Q(1)
b. RHR Service Water System Effluent Line	D	M	R(3)	Q(1)
2. Gross Radioactivity Monitored Not Providing Automatic Termination of Release				
a. Service Water System Effluent Line	D	M	R(3)	Q(2)
3. Flow Rate Measurement Devices				
a. Liquid Radwaste Effluent Line	D(4)	N.A.	R	Q
b. Discharge Line	D(4)	N.A.	R	Q

* Daily when in use

TABLE 4.1-1 (Continued)TABLE NOTATIONS

- (1) The CHANNEL FUNCTIONAL TEST shall also demonstrate that automatic isolation of this pathway and control room alarm annunciation will occur if any of the following conditions exists:
 1. Instrument indicates measured levels above the alarm/trip setpoint.
 2. Circuit failure.
 3. Instrument indicates a downscale failure.

- (2) The CHANNEL FUNCTIONAL TEST shall also demonstrate that control room alarm annunciation occurs if any of the following conditions exists:
 1. Instrument indicates measured levels above the alarm setpoint.
 2. Circuit failure.
 3. Instrument indicates a downscale failure.

- (3) The initial CHANNEL CALIBRATION shall be performed using reference standards certified by the National Institute of Standards and Technology (NIST) obtained from suppliers that participate in measurement assurance activities with NIST. These standards shall permit calibrating the system over its intended range of energy and measurements range. For subsequent CHANNEL CALIBRATION, sources that have been related to the initial calibration shall be used.

- (4) CHANNEL CHECK shall consist of verifying indication of flow during periods of release. CHANNEL CHECK shall be made at least once per 24 hours on days on which batch releases are made.

3/4.1 INSTRUMENTATION

3/4.1.2 RADIOACTIVE GASEOUS EFFLUENT MONITORING INSTRUMENTATION CONTROLS

- 3.1.2 The radioactive gaseous effluents monitoring instrumentation channels in Table 3.1-2 shall be OPERABLE with their Alarm/Trip Setpoints set to ensure that the limits of ODCM Control 3.2.2.1 or LGS Technical Specification Control 3.11.2.6 are not exceeded. The alarm/trip setpoints of the applicable channels shall be determined in accordance with the methodology and parameters in ODCM Part II, Section 2.2.

APPLICABILITY: As shown in Table 3.1-2.

ACTION:

- a. With a radioactive gaseous effluent monitoring instrumentation channel Alarm/Trip Setpoints less conservative than required by the above control, immediately suspend the release of radioactive gaseous effluents monitored by the affected channel, or declare the channel inoperable, or change the setpoint so it is acceptably conservative.
- b. With less than the minimum number of radioactive gaseous effluent monitoring instrumentation channels OPERABLE, take the ACTION shown in Table 3.1-2. Restore the inoperable instrumentation to OPERABLE status within 30 days and, if unsuccessful, explain in the next Annual Radioactive Effluent Release Report pursuant to Control 6.2 why this inoperability was not corrected in a timely manner.
- c. The provisions of Controls 3.0.3 and 3.0.4 are not applicable. Report all deviations in the Annual Radioactive Effluent Release Report.

SURVEILLANCE REQUIREMENTS

- 4.1.2 Each radioactive gaseous effluent monitoring instrumentation channel shall be demonstrated OPERABLE by performance of the CHANNEL CHECK, SOURCE CHECK, CHANNEL CALIBRATION AND CHANNEL FUNCTIONAL TEST operations at the frequencies shown in Table 4.1-2.

TABLE 3.1-2

RADIOACTIVE GASEOUS EFFLUENT MONITORING INSTRUMENTATION

INSTRUMENT	MINIMUM CHANNELS OPERABLE	APPLICABILITY	ACTION
1. SOUTH STACK EFFLUENT MONITORING SYSTEM			
a. Noble Gas Activity Monitor	1	*	111
b. Iodine Sampler	1	*	112
c. Particulate Sampler	1	*	112
d. Effluent System Flow Rate Monitor	1	*	113
e. Sampler Flow Rate Monitor	1	*	116
2. NORTH STACK EFFLUENT MONITORING SYSTEM +			
a. Noble Gas Activity Monitor	1	*	114
b. Iodine Sampler	1	*	112
c. Particulate Sampler	1	*	112
d. Effluent System Flow Rate Monitor	1	*	113
e. Sampler Flow Rate Monitor	1	*	116
3. HOT MAINTENANCE SHOP VENTILATION EXHAUST RADIATION MONITOR			
a. Iodine Sampler	1	**	115
b. Particulate Sampler	1	**	115
c. Effluent System Flow Rate Monitor	1	**	113
d. Sampler Flow Rate Monitor	1	**	116
4. MAIN CONDENSER OFFGAS PRE TREATMENT RADIOACTIVITY MONITOR			
a. Noble Gas Activity Monitor	1	***	117

TABLE 3.1-2 (Continued)
TABLE NOTATIONS
ACTION STATEMENTS

- + The (A or B) North Stack Normal Range Radiation Monitors OR the Wide Range Accident Monitor (Low Range) may be used to satisfy requirements for the North Stack Effluent Monitoring System.
- * At all times.
- ** During operation of the hot maintenance shop ventilation system.
- *** During operation of the main condenser steam jet air ejector and offgas treatment system.

ACTION 111 –
(SS Noble Gas)

With the number of channels OPERABLE less than required by the Minimum Channels OPERABLE requirement, effluent releases via this pathway may continue provided grab samples are taken at least once per 12 hours and these samples are analyzed for radioactivity within 24 hours.

IF monitor readings are available from local computer output, **THEN** GRAB SAMPLES ARE NOT REQUIRED. Obtain monitor readings at least once per 12 hours.

ACTION 112 –
(NS and SS Iodine & Part.)

With the number of channels OPERABLE less than required by the Minimum Channels OPERABLE requirement, effluent releases via the affected pathway may continue provided samples are continuously collected with auxiliary sampling equipment as required in Table 4.2-2.

IF replacing particulate and iodine filter media for weekly analysis as required by Table 4.2-2,

THEN auxiliary sampling equipment is **not** required if the interruption of sample collection will **not** exceed one (1) hour.

ACTION 113 –
(Effluent Flow Rate)

With the number of channels OPERABLE less than required by the Minimum Channels OPERABLE requirement, effluent releases via NS, SS or HMS may continue provided the Effluent System flow rate is estimated by adding the nominal flow rates indicated in P&ID M-26 for each in-service fan. This shall be documented in the MCR operations Shift Log at least once per 4 hours.

TABLE 3.1-2 (Continued)
TABLE NOTATIONS
ACTION STATEMENTS

ACTION 114 – (NS Noble Gas)	<p>With the number of channels OPERABLE less than required by the Minimum Channels OPERABLE requirement, effluent releases via this pathway may continue provided grab samples are taken at least once per 12 hours and these samples are analyzed for radioactivity within 24 hours. The Mechanical Vacuum Pumps may not be operated while in this action statement.</p> <p><u>IF</u> monitor readings are available from local computer output, <u>THEN</u> GRAB SAMPLES ARE NOT REQUIRED. Obtain monitor readings at least once per 12 hours.</p>
ACTION 115 – (HMS)	<p>With the number of channels OPERABLE less than required by the Minimum Channels OPERABLE requirement, then secure Hot Maintenance Shop Ventilation.</p> <p><u>IF</u> replacing particulate and iodine filter media for weekly analysis as required by Table 4.2-2, <u>THEN</u> Hot Maintenance Shop Ventilation may remain in service if the interruption of sample collection will not exceed one (1) hour.</p>
ACTION 116 – (Sample Flow Rate)	<p>With the number of channels OPERABLE less than required by the Minimum Channels OPERABLE requirement, the sample pump shall be documented in service by recording the air pump local flow indicator value in the MCR operations Shift Log at least once per 8 hours.</p>
ACTION 117 – (Offgas Noble Gas)	<p>With the number of channels OPERABLE less than required by the Minimum Channels OPERABLE requirement, effluent releases via this pathway may continue provided:</p> <ol style="list-style-type: none"> a. The North Stack Effluent Noble Gas Activity Monitor requirements (operable channels or compensatory sampling) of Table 3.1-2 are met and, b. Grab samples taken within the first four (4) hours and then once per 24 hours after initial sample and isotopic analysis is performed within 4 hours of sample time to verify that the rate of the sum of the activities of noble gases measured at the recombiner after-condenser discharge is $\leq 330,000$ uCi/second.

TABLE 4.1-2

RADIOACTIVE GASEOUS EFFLUENT MONITORING INSTRUMENTATION SURVEILLANCE REQUIREMENTS

INSTRUMENT	CHANNEL CHECK	SOURCE CHECK	CHANNEL CALIBR.	CHANNEL FUNCT. TEST	MODES IN WHICH SURVEILLANCE IS REQUIRED
1. SOUTH STACK EFFLUENT MONITORING SYSTEM					
a. Noble Gas Activity Monitor	D	M	R(2)	Q(1)	*
b. Iodine Sampler	W(3)	N.A.	N.A.	N.A.	*
c. Particulate Sampler	W(3)	N.A.	N.A.	N.A.	*
d. Effluent System Flow Rate Monitor	D	N.A.	R	Q	*
e. Sampler Flow Rate Monitor	D	N.A.	R	Q	*
2. NORTH STACK EFFLUENT MONITORING SYSTEM +					
a. Noble Gas Activity Monitor	D	M	R(2)	Q(1)	*
b. Iodine Sampler	W(3)	N.A.	N.A.	N.A.	*
c. Particulate Sampler	W(3)	N.A.	N.A.	N.A.	*
d. Effluent System Flow Rate Monitor	D	N.A.	R	Q	*
e. Sampler Flow Rate Monitor	D	N.A.	R	Q	*
3. HOT MAINTENANCE SHOP VENTILATION EXHAUST RADIATION MONITOR					
a. Iodine Sampler	W(3)	N.A.	N.A.	N.A.	**
b. Particulate Sampler	W(3)	N.A.	N.A.	N.A.	**
c. Effluent System Flow Rate Monitor	D	N.A.	R	Q	**
d. Sampler Flow Rate Monitor	D	N.A.	R	Q	**
4. MAIN CONDENSER OFFGAS PRE TREATMENT RADIOACTIVITY MONITOR (STEAM JET AIR EJECTOR)					
a. Noble Gas Activity Monitor	D	M	R(2)	A(1)	***

TABLE 4.1-2 (Continued)TABLE NOTATIONS

- + The (A or B) Wide Range Accident Monitor (WRAM) surveillance is specified in Technical Specification 3.3.7.5.
- * At all times.
- ** During operation of the hot maintenance shop ventilation exhaust system.
- *** During operation of the main condenser steam jet air ejector and offgas treatment system.
- (1) The CHANNEL FUNCTIONAL TEST shall also demonstrate that control room alarm annunciation occurs if any of the following conditions exists:
1. Instruments indicate measured levels above the alarm/trip setpoint.
 2. Circuit failure.
 3. Instrument indicates a downscale failure.
 4. Instrument controls not set in operate mode.
- (2) The initial CHANNEL CALIBRATION shall be performed using one or more of the reference standards certified by the National Institute of Standards and Testing (NIST) or using standards that have been obtained from suppliers that participate in measurement assurance activities with NIST. These standards shall permit calibrating the system over its intended range of energy and measurement range. For subsequent CHANNEL CALIBRATION, sources that are traceable to the initial calibration shall be used.
- (3) The iodine cartridges and particulate filters will be changed and analyzed at least once per 7 days.

3/4.2 RADIOACTIVE EFFLUENTS

3/4.2.1 LIQUID EFFLUENTS

3/4.2.1.1 CONCENTRATION

CONTROLS

- 3.2.1.1 The concentration of radioactive material released in liquid effluents to UNRESTRICTED AREAS (see Figures 1-1 and 1-2) shall be limited to 10 times the effluent concentration limits (ECL) specified in 10 CFR Part 20, Appendix B, Table 2, Column 2 for radionuclides other than dissolved or entrained noble gases. For dissolved or entrained noble gases, the concentration shall be limited to 2E-4 microcuries/ml total activity (NUREG 0133, Section 2).

APPLICABILITY: At all times.

ACTION:

- a. With the concentration of radioactive material released in liquid effluents to UNRESTRICTED AREAS exceeding the above limits, immediately restore the concentration to within the above limits or terminate the release.
- b. The provisions of Controls 3.0.3 and 3.0.4 are not applicable.

SURVEILLANCE REQUIREMENTS

- 4.2.1.1.1 Radioactive liquid wastes shall be sampled and analyzed according to the sampling and analysis program of Table 4.2-1.
- 4.2.1.1.2 The results of the radioactivity analyses shall be used in accordance with the methodology and parameters in ODCM Part II, Section 1.2 to assure that the concentrations at the point of release are maintained within the limits of Control 3.2.1.1.

TABLE 4.2-1

RADIOACTIVE LIQUID WASTE SAMPLING AND ANALYSIS PROGRAM

Liquid Release Type	Sampling Frequency	Minimum Analysis Frequency	Type of Activity Analysis	Lower Limit of Detection (LLD) ^a (uCi/ml)
A. Batch Waste Release Tanks ^b	P Each Batch	P Each Batch	Principal Gamma Emitters ^c	5E-7
1. Floor Drain Sample Tank			I-131	1E-6
2. Equip. Drain Sample Tanks			Dissolved and Entrained Gases (Gamma Emitters) ^c	1E-5
3. Laundry Drain Sample Tank		M Composite ^d	H-3 Gross Alpha	1E-5 1E-7
		Q Composite ^d	Sr-89, Sr-90 Fe-55	5E-8 1E-6
B. Continuous Release ^e	W Grab Sample	W	Principal Gamma Emitters ^c	5E-7
1. RHR Service Water System Effluent Line ^f			I-131	1E-6
			Dissolved and Entrained Gases (Gamma Emitters) ^c	1E-5
2. Service Water System Effluent Line ^f		M Composite ^d	H-3 Gross Alpha	1E-5 1E-7
		Q Composite ^d	Sr-89, Sr-90 Fe-55	5E-8 1E-6

TABLE 4.2-1 (Continued)TABLE NOTATIONS

- a. The LLD is defined as the smallest concentration of radioactive material in a sample that will yield a net count, above system background, that will be detected with 95% probability with only 5% probability of falsely concluding that a blank observation represents a "real" signal.

For a measurement system, which may include radiochemical separation:

$$\text{LLD (Composite)} = \frac{(2.71 + 4.66\sigma_B) (\lambda\Delta t_2)}{E \cdot V \cdot 2.22E6 \cdot Y \cdot [\exp(-\lambda\Delta t_1)] (1-\exp(-\lambda\Delta t_2))}$$

$$\text{LLD (Grab Samples)} = \frac{(2.71 + 4.66 \sigma_B)}{E \cdot V \cdot 2.22E6 \cdot Y (\exp - \lambda\Delta t_1)}$$

Where:

- 2.71 is a statistical term to properly calculate the LLD as the background approaches zero (see reference 17). When background is greater than 70 counts the factor is not necessary for the calculation.
- LLD is the a priori lower limit of detection as defined above (as microcuries per unit mass or volume). The LLD for composite samples contains a correction to account for the decay of radionuclides during the collection time $\{(\lambda\Delta t_2) / [\exp(-\lambda\Delta t_1)](1-\exp(-\lambda\Delta t_2))\}$.
- σ_B is the standard deviation of the background counting rate or of the counting rate of blank sample as appropriate (as counts per minute),
- E is the counting efficiency, as counts per disintegration,
- V is the sample size, in units of mass or volume,
- 2.22E6 is the number of disintegrations per minute per microcurie,
- Y is the fractional radiochemical yield, when applicable,
- λ is the radioactive decay constant for the particular radionuclide,
- Δt_1 for the plant effluents is the elapsed time between the end of the sample collection and the start of sample count.
- Δt_2 for the plant effluents is the elapsed time between the start and the end of sample collection.

TABLE 4.2-1 (Continued)TABLE NOTATIONS

It should be recognized that the LLD is defined as an a priori (before the fact) limit representing the capability of a measurement system and not as an after the fact limit for a particular measurement.

- b. A batch release is the discharge of liquid wastes of a discrete volume. Prior to sampling for analyses, each batch shall be isolated, and then thoroughly mixed to assure representative sampling.
- c. The principal gamma emitters for which the LLD specification applies include the following radionuclides: Mn-54, Fe-59, Co-58, Co-60, Zn-65, Mo-99, Cs-134, Cs-137, Ce-141 and Ce-144. The dissolved and entrained noble gases (gamma emitters) for which the LLD specification applies include the following radionuclides: Kr-87, Kr-88, Xe-133, Xe-133m, Xe-135, Xe-135m, Xe-138. This list does not mean that only these nuclides are to be considered. Other gamma peaks that are identifiable, together with those of the above nuclides, shall also be analyzed and reported in the Annual Radioactive Effluent Release Report pursuant to Administrative Control 6.2.
- d. The term "Composite Sample" means a combination of individual samples obtained at regular intervals over a time period. Either the volume of each individual sample is proportional to discharge flow rates, or the sampling interval (for constant volume samples) is proportional to flow rates over the time period used to produce the composite.
- e. A continuous release is the discharge of liquid wastes of non-discrete volume, e.g. from a volume of a system that has an input flow during the continuous release.
- f. Whenever effluent releases are in excess of the monitor's setpoint.

3/4.2 RADIOACTIVE EFFLUENTS

3/4.2.1 LIQUID EFFLUENTS

3/4.2.1.2 DOSE

CONTROLS

- 3.2.1.2 The dose or dose commitment to a MEMBER OF THE PUBLIC from radioactive materials in liquid effluents released from the site to UNRESTRICTED AREAS (See Figure 1-1) shall be limited:
- a. During any calendar quarter to less than or equal to 3 mrem to the total body and to less than or equal to 10 mrem to any organ, and
 - b. During any calendar year to less than or equal to 6 mrem to the total body and to less than or equal to 20 mrem to any organ.

APPLICABILITY: At all times.

ACTION:

- a. With the calculated dose from the release of radioactive materials in liquid effluents exceeding any of the above limits, Initiate a Special Report that identifies the cause(s) for exceeding the limit(s) and defines the corrective actions that have been taken to reduce the releases and the proposed corrective actions to be taken to assure that subsequent releases will be in compliance with the above limits. This Special Report shall also include: (1) the results of the radiological analyses of the drinking water source, and (2) the radiological impact on finished drinking water supplies with regard to the requirements of 40 CFR Part 141, Safe Drinking Water Act.*
- b. The provisions of Controls 3.0.3 and 3.0.4 are not applicable.

SURVEILLANCE REQUIREMENTS

- 4.2.1.2 Cumulative dose contributions from liquid effluents for the current calendar quarter and the current calendar year shall be determined at least once per 31 days.

* The requirements of Action A. (1) and (2) are applicable only if drinking water supply is taken from the receiving water body within 3 miles of the plant discharge. In the case of river-sited plants this is 3 miles downstream only.

3/4.2 RADIOACTIVE EFFLUENTS

3/4.2.1 LIQUID EFFLUENTS

3/4.2.1.3 LIQUID RADWASTE TREATMENT SYSTEM

CONTROLS

3.2.1.3 The liquid radwaste treatment system shall be IN SERVICE and appropriate portions of the system shall be used to reduce the radioactive materials in liquid waste prior to their discharge when the projected doses due to the liquid effluent, from the site, to UNRESTRICTED AREAS (See Figure 1-1) would exceed 0.12 mrem to the total body or 0.4 mrem to any organ in a 31-day period.

APPLICABILITY: At all times.

ACTION:

- a. With radioactive liquid waste being discharged without treatment and in excess of the above limits and any portion of the Liquid Radwaste Treatment System not in operation initiate a Special Report that includes the following information:
 1. Explanation of what liquid radwaste was being discharged without treatment, identification of any inoperable equipment or subsystems, and the reason for the inoperability.
 2. Action(s) taken to restore the inoperable equipment to OPERABLE status, and
 3. Summary description of action(s) taken to prevent a recurrence.
- b. The provisions of Controls 3.0.3 and 3.0.4 are not applicable.

SURVEILLANCE REQUIREMENTS

- 4.2.1.3.1 Dose due to liquid releases from the site to UNRESTRICTED AREAS shall be projected at least once per 31 days, in accordance with the methodology and parameters in the ODCM when Liquid Radwaste Treatment Systems are not being fully utilized.
- 4.2.1.3.2 The installed Liquid Radwaste Treatment System shall be considered OPERABLE by meeting Controls 3.2.1.1 and 3.2.1.2

3/4.2 RADIOACTIVE EFFLUENTS

3/4.2.2 GASEOUS EFFLUENTS

3/4.2.2.1 DOSE RATE

CONTROLS

- 3.2.2.1 The dose rate due to radioactive materials released in gaseous effluents from the site to areas at or beyond the SITE BOUNDARY (See Figure 1-1) shall be limited to:
- a. For noble gases: less than or equal to 500 mrem/yr to the total body and less than or equal to 3000 mrem/yr to the skin, and
 - b. For iodine-131, iodine-133, tritium, and for all radionuclides in particulate form with half-lives greater than 8 days: less than or equal to 1500 mrem/yr to any organ (Inhalation pathway only).

APPLICABILITY: At all times.

ACTION:

- a. With the dose rate(s) exceeding the above limits, immediately restore the release rate to within the above limits.
- b. The provisions of Controls 3.0.3 and 3.0.4 are not applicable.

SURVEILLANCE REQUIREMENTS

- 4.2.2.1.1 The dose rate due to noble gases in gaseous effluents shall be determined to be within the above limits in accordance with the methodology and parameters in the ODCM.
- 4.2.2.1.2 The dose rate due to iodine-131, iodine-133, tritium, and all radionuclides in particulate form with half-lives greater than 8 days in gaseous effluents shall be determined to be within the above limits in accordance with the methodology and parameters in the ODCM by obtaining representative samples and performing analyses in accordance with the sampling and analysis program specified in Table 4.2-2.

TABLE 4.2-2

RADIOACTIVE GASEOUS WASTE SAMPLING AND ANALYSIS PROGRAM

Gaseous Release Point	Sampling Frequency	Minimum Analysis Frequency	Type of Activity Analysis	Lower Limit of Detection (LLD) ^a	
A. North Stack/ South Stack	M ^b Grab Smpl.	M ^b	Noble Gas	1E-4 uCi/cc	
			H-3	1E-6 uCi/cc	
	Continuous ^d	W ^c Char. Smpl. Part. Smpl.	I-131		1E-12 uCi/cc
				Principal Gamma Emitters ^e	1E-11 uCi/cc
				Gross Alpha	1E-11 uCi/cc
				Sr-89, Sr-90	1E-11 uCi/cc
Continuous ^d	M Comp. Part. Sample Continuous Noble Gas Monitor	Noble Gas Beta or Gamma	1E-6 (Based on Xe-133)		
B. Hot Mainten. Shop Vent Exhaust ^f	Continuous ^d	W Char. Smpl.	I-131	1E-12 uCi/cc	
			Part. Smpl.	1E-11 uCi/cc	
		M Comp. Part. Sample	Gross Alpha	1E-11 uCi/cc	
			Sr-89, Sr-90	1E-11 uCi/cc	

TABLE 4.2-2 (Continued)TABLE NOTATIONS

- a. The LLD is defined, as the smallest concentration of radioactive material in a sample that will yield a net count, above system background, that will be detected with 95% probability with only 5% probability of falsely concluding that a blank observation represents a "real" signal. It should be recognized that the LLD is defined as an a priori (before the fact) limit representing the capability of a measurement system and not as an after the fact limit for a particular measurement.

For a particular measurement system, (which may include radiochemical separation):

$$\text{LLD (Composite)} = \frac{(2.71 + 4.66\sigma_B)(\lambda\Delta t_2)}{E \cdot V \cdot 2.22E6 \cdot Y \cdot [\exp(-\lambda\Delta t_1)](1-\exp(-\lambda\Delta t_2))}$$

$$\text{LLD (Grab Samples)} = \frac{(2.71 + 4.66\sigma_B)}{E \cdot V \cdot 2.22E6 \cdot Y \cdot (\exp -\lambda\Delta t_1)}$$

Where:

- 2.71 is a statistical term to properly calculate the LLD as the background approaches zero (see reference 17). When background is greater than 70 counts the factor is not necessary for the calculation.
- LLD is the a priori lower limit of detection as defined above (uCi/cc or uCi/ml). The LLD for composite samples contains a correction to account for the decay of radionuclides during the collection time $\{(\lambda\Delta t_2)/[\exp(-\lambda\Delta t_1)](1-\exp(-\lambda\Delta t_2))\}$,
- σ_B is the standard deviation of the background counting rate or of the counting rate of blank sample as appropriate (as cpm), shall be based on the actual observed variance of the background counting rate or of the counting rate of the blank samples (as appropriate) rather than on an unverified theoretically predicted variance.
- E is the counting efficiency, as counts per disintegration,
- V is the sample size, in units of cc or ml,
- 2.22E6 is the number of dpm/uCi
- Y is the fractional radiochemical yield, when applicable,
- λ is the radioactive decay constant for the particular radionuclide, and
- Δt_1 for the plant effluents is the elapsed time between the end of the sample collection and the start of sample count.
- Δt_2 for the plant effluents is the elapsed time between the start and the end of sample collection.

TABLE 4.2-2 (Continued)TABLE NOTATIONS

- b. Sampling and analyses shall also be performed following shutdown, startup, or a THERMAL POWER change exceeding 15% of the RATED THERMAL POWER within a 1-hour period. This requirement does not apply if (1) analysis show that the DOSE EQUIVALENT I-131 concentration in the primary coolant has not increased more than a factor of 3; and (2) the main condenser offgas pre-treatment radioactivity monitor shows that effluent activity has not increased more than a factor of 3.
- c. Samples shall be changed at least once per 7 days and analyses shall be completed within 48 hours after changing, or after removal from sampler. Sampling shall also be performed at least once per 24 hours for at least 7 days following each shutdown, startup or THERMAL POWER change exceeding 15% of RATED THERMAL POWER in 1 hour and analyses completed within 48 hours of changing. When samples collected for 24 hours are analyzed, the corresponding LLDs may be increased by a factor of 10. This requirement does not apply if (1) analysis shows that the DOSE EQUIVALENT I-131 concentration in the primary coolant has not increased more than a factor of 3; and (2) the noble gas monitor shows that effluent activity has not increased more than a factor of 3.
- d. The ratio of the sample flow rate to the sampled stream flow rate shall be known for the time period covered by each dose or dose rate calculation made in accordance with Controls 3.2.2.1, 3.2.2.2, and 3.2.2.3.
- e. The principal gamma emitters for which the LLD specification applies include the following radionuclides: Kr-87, Kr-88, Xe-133, Xe-133m, Xe-135, Xe-135m and Xe-138 for gaseous emissions and Mn-54, Fe-59, Co-58, Co-60, Zn-65, Mo-99, I-131, Cs-134, Cs-137, Ce-141 and Ce-144 for particulate emissions. This list does not mean that only these nuclides are to be considered. Other gamma peaks which are identifiable, together with the above nuclides, shall also be analyzed and reported in the Annual Radioactive Effluent Release Report, pursuant to Administrative Control 6.2.
- f. Required for the hot maintenance shop ventilation exhaust only during operation of the hot maintenance shop ventilation exhaust system.

3/4.2 RADIOACTIVE EFFLUENTS

3/4.2.2 GASEOUS EFFLUENTS

3/4.2.2.2 DOSE - NOBLE GASES

CONTROLS

- 3.2.2.2 The air dose due to noble gases released in gaseous effluents, from the site to areas at and beyond the SITE BOUNDARY (See Figure 1-1) shall be limited to the following:
- a. During any calendar quarter: less than or equal to 10 mrad for gamma radiation and less than or equal to 20 mrad for beta radiation, and
 - b. During any calendar year: less than or equal to 20 mrad for gamma radiation and less than or equal to 40 mrad for beta radiation.

APPLICABILITY: At all times.

ACTION:

- a. With the calculated air dose from radioactive noble gases in gaseous effluents exceeding any of the above limits, initiate a Special Report that identifies the cause(s) for exceeding the limit(s) and defines the corrective actions that have been taken to reduce the releases and the proposed corrective actions to be taken to assure that subsequent releases will be in compliance with the above limits.
- b. The provisions of Controls 3.0.3 and 3.0.4 are not applicable.

SURVEILLANCE REQUIREMENTS

- 4.2.2.2 Cumulative dose contributions for the current quarter and current calendar year for noble gases shall be determined in accordance with the methodology and parameters in the ODCM at least once per 31 days.

3/4.2 RADIOACTIVE EFFLUENTS

3/4.2.2 GASEOUS EFFLUENTS

3/4.2.2.3 DOSE – IODINE-131, IODINE-133, TRITIUM, AND RADIOACTIVE MATERIAL IN PARTICULATE FORM

CONTROLS

3.2.2.3 The dose to a MEMBER OF THE PUBLIC from iodine-131, iodine-133, tritium and all radionuclides in particulate form with half-lives greater than 8 days in gaseous effluents released from the site to areas at or beyond the SITE BOUNDARY (See Figure 1-1) shall be limited to the following:

- a. During any calendar quarter: less than or equal to 15 mrem to any organ and,
- b. During any calendar year: less than or equal to 30 mrem to any organ.

APPLICABILITY: At all times.

ACTION:

- a. With the calculated dose from the release of iodine-131, iodine-133, tritium and all radionuclides in particulate form with half-lives greater than 8 days in gaseous effluents exceeding any of the above limits, initiate a Special Report that identifies the cause(s) for exceeding the limit and defines the corrective actions that have been taken to reduce the releases and the proposed corrective actions to be taken to assure that subsequent releases will be in compliance with the above limits.
- b. The provisions of Controls 3.0.3 and 3.0.4 are not applicable.

SURVEILLANCE REQUIREMENTS

4.2.2.3 Cumulative dose contributions for the current calendar quarter and current calendar year for iodine-131, iodine-133, tritium and radionuclides in particulate form with half-lives greater than 8 days shall be determined in accordance with the methodology and parameters in the ODCM at least once per 31 days.

3/4.2 RADIOACTIVE EFFLUENTS

3/4.2.2 GASEOUS EFFLUENTS

3/4.2.2.4 GASEOUS RADWASTE (OFFGAS) TREATMENT SYSTEM
CONTROLS

3.2.2.4 Section is not applicable. See UFSAR Chapter 11.3.

3/4.2 RADIOACTIVE EFFLUENTS3/4.2.2 GASEOUS EFFLUENTS3/4.2.2.5 VENTILATION EXHAUST TREATMENT SYSTEMCONTROLS

3.2.2.5 The VENTILATION EXHAUST TREATMENT SYSTEM shall be OPERABLE and appropriate portions of the system shall be used to reduce releases of radioactivity when the projected doses in 31 days due to gaseous effluent releases, from the site to areas at and beyond the SITE BOUNDARY (See Figure 1-1) would exceed

- a. 0.4 mrad to air from gamma radiation, or
- b. 0.8 mrad to air from beta radiation, or
- c. 0.6 mrem to any organ of a MEMBER OF THE PUBLIC.

APPLICABILITY: At all times.

ACTION:

- a. With gaseous waste being discharged without treatment, and in excess of the above limits, initiate a Special Report that includes the following information:
 - 1. Identification of any inoperable equipment or subsystems, and the reason for the inoperability.
 - 2. Action(s) taken to restore the inoperable equipment to OPERABLE status, and
 - 3. Summary description of action(s) taken to prevent a recurrence.
- b. The provisions of Controls 3.0.3 and 3.0.4 are not applicable.

SURVEILLANCE REQUIREMENTS

- 4.2.2.5.1 Doses due to gaseous releases from the site to areas at and beyond the SITE BOUNDARY shall be projected at least once per 31 days in accordance with the methodology and parameters in the ODCM, when the Ventilation Exhaust Treatment System is not being fully utilized.
- 4.2.2.5.2 The installed VENTILATION EXHAUST TREATMENT SYSTEM shall be considered OPERABLE by meeting Controls 3.2.2.1, and either 3.2.2.2 or 3.2.2.3

3/4.2 RADIOACTIVE EFFLUENTS

3/4.2.2 GASEOUS EFFLUENTS

3/4.2.2.6 Not Used

CONTROLS

3.2.2.6 Section is not applicable.

3/4.2 RADIOACTIVE EFFLUENTS3/4.2.2 GASEOUS EFFLUENTS3/4.2.2.7 MARK II CONTAINMENTCONTROLS

3.2.2.7 The VENTING or PURGING of the Mark II containment drywell shall be through the Standby Gas Treatment System.

APPLICABILITY: Whenever the drywell is vented or purged. *

ACTION:

- a. With the requirements of the above control not satisfied, suspend all VENTING and PURGING of the drywell.
- b. The provisions of Controls 3.0.3 and 3.0.4 are not applicable.

SURVEILLANCE REQUIREMENTS

4.2.2.7.1 The containment drywell shall be determined to be aligned for VENTING or PURGING through the Standby Gas Treatment System within 4 hours prior to start of and at least once per 12 hours during VENTING or PURGING of the containment.

4.2.2.7.2 Prior to use of the purge system through the standby gas treatment system assure that:

- a. Both standby gas treatment system trains are OPERABLE whenever the purge system is in use, and
- b. Whenever the purge system is in use, only one of the standby gas treatment system trains shall be used to prevent damage to both trains should a LOCA occur (LCO 3.6.5.3 ACTION a applies during this configuration).

* Except after Containment is deinerted and purged **OR** for the one inch/two inch vent valves to the Reactor Enclosure Equipment Compartment Exhaust Filters when used for containment pressure control and nitrogen make-up operations.

3/4.2 RADIOACTIVE EFFLUENTS

3/4.2.3 TOTAL DOSE

CONTROLS

- 3.2.3 The annual (calendar year) dose or dose commitment to any MEMBER OF THE PUBLIC, due to releases of radioactivity and radiation, from uranium fuel cycle sources shall be limited to less than or equal to 25 mrem to the total body or any organ, except the thyroid, which shall be limited to less than or equal to 75 mrem.

APPLICABILITY: At all times.

ACTION:

- a. With the calculated doses from the release of radioactive materials in liquid or gaseous effluents exceeding the limits of Controls 3.2.1.2.a., 3.2.1.2.b., 3.2.2.2.a., 3.2.2.2.b., 3.2.2.3.a., or 3.2.2.3.b calculations shall be made including direct radiation contributions from the reactor units (including outside storage tanks, etc.) to determine whether the above limits of Control 3.2.3 have been exceeded. If such is the case, initiate a Special Report that defines the corrective action to be taken to reduce subsequent releases to prevent recurrence of exceeding the above limits and includes the schedule for achieving conformance with the above limits. This Report, as defined in 10 CFR 20.2203, shall include an analysis that estimates the radiation exposure (dose) to a MEMBER OF THE PUBLIC from the uranium fuel cycle sources, including all effluent pathways and direct radiation, for the calendar year that includes the release(s) covered by this report. It shall also describe levels of radiation and concentration of radioactive material involved, and the cause of the exposure levels or concentrations. If the estimated dose(s) exceeds the above limits, and if the release condition resulting in violation of 40 CFR Part 190 or 10 CFR 72.104 has not already been corrected, the Special Report shall include a request for a variance in accordance with the provisions of 40 CFR Part 190 or 10 CFR 72.104. Submittal of the report is considered a timely request, and a variance is granted until staff action on the request is complete.
- b. The provisions of Controls 3.0.3 and 3.0.4 are not applicable.

SURVEILLANCE REQUIREMENTS

- 4.2.3.1 Cumulative dose contributions from liquid and gaseous effluents shall be determined in accordance with Surveillance Requirements 4.2.1.2, 4.2.2.2, and 4.2.2.3, and in accordance with the methodology and parameters in the ODCM.
- 4.2.3.2 Cumulative dose contributions from direct radiation from the units (including outside storage tanks, ISFSI, etc.) shall be determined in accordance with the methodology and parameters in the ODCM. This requirement is applicable only under conditions set forth in Action a. of Control 3.2.3.

3/4.3 RADIOLOGICAL ENVIRONMENTAL MONITORING

3/4.3.1 MONITORING PROGRAM

CONTROLS

3.3.1 The Radiological Environmental Monitoring Program shall be conducted as specified in Table 3.3-1.

APPLICABILITY: At all times.

ACTION:

- a. With the Radiological Environmental Monitoring Program not being conducted as specified in Table 3.3-1, prepare and submit to the Commission, in the Annual Radiological Environmental Operating Report required by Administrative Control 6.1, a description of the reasons for not conducting the program as required and the plans for preventing a recurrence.
- b. With the level of radioactivity as the result of plant effluents in an environmental sampling medium at a specified location exceeding the reporting levels of Table 3.3-2 when averaged over any calendar quarter, initiate a Special Report that identifies the cause(s) for exceeding the limit(s) and defines the corrective actions to be taken to reduce radioactive effluents so that the potential annual dose to a MEMBER OF THE PUBLIC is less than the calendar year limits of Controls 3.2.1.2, 3.2.2.2, or 3.2.2.3. When more than one of the radionuclides in Table 3.3-2 are detected in the sampling medium, this report shall be submitted if:

$$\frac{\text{concentration (1)}}{\text{reporting level (1)}} + \frac{\text{concentration (2)}}{\text{reporting level (2)}} + \dots \geq 1.0$$

When radionuclides other than those in Table 3.3-2 are detected and are the result of plant effluents, a Special Report shall be initiated if the potential annual dose* to a MEMBER OF THE PUBLIC is equal to or greater than the calendar year limits of Controls 3.2.1.2, 3.2.2.2, or 3.2.2.3. A Special Report is not required if the measured level of radioactivity was not the result of plant effluents; however, in such an event, the condition shall be reported and described in the Annual Radiological Environmental Operating Report required by Administrative Control 6.1.

- * The methodology and parameters used to estimate the potential annual dose to a MEMBER OF THE PUBLIC shall be indicated in this report.

3/4.3 RADIOLOGICAL ENVIRONMENTAL MONITORING

3/4.3.1 MONITORING PROGRAM

CONTROLS

ACTION (Continued)

- c. With milk or fresh leafy vegetable samples unavailable from one or more of the sample locations required by Table 3.3-1, identify locations for obtaining replacement samples and add them to the radiological environmental monitoring program within 30 days. The specific locations from which samples were unavailable may then be deleted from the monitoring program. Pursuant to Technical Specification 6.14, submit as a part of or concurrent with the Annual Radioactive Effluent Release Report, a complete, legible copy of the entire ODCM, including a revised figure(s) and table for the ODCM reflecting the new location(s).
- d. The provisions of Controls 3.0.3 and 3.0.4 are not applicable.

SURVEILLANCE REQUIREMENTS

- 4.3.1 The radiological environmental monitoring samples shall be collected pursuant to Table 3.3-1 from the specific locations given in the table and figure(s) in the ODCM and shall be analyzed pursuant to the requirements of Table 3.3-1, with the detection capabilities required by the Table 4.3-1.

TABLE 3.3-1

RADIOLOGICAL ENVIRONMENTAL MONITORING PROGRAM*

EXPOSURE PATHWAY AND/OR SAMPLE	NUMBER OF REPRESENTATIVE SAMPLES AND SAMPLE LOCATION ^(a)	SAMPLING AND COLLECTION FREQ.	TYPE AND FREQUENCY OF ANALYSIS
1. DIRECT RADIATION ^b	40 routine monitoring stations either with two or more dosimeters or with one instrument for measuring and recording dose rate continuously placed as follows: (1) An inner ring of stations, one in each meteorological sector, in the general area of the SITE BOUNDARY: (2) An outer ring of stations, one in each meteorological sector, in the 3-9 mile range from the site; (3) The balance of the stations placed in special interest areas such as population centers, nearby residences, schools and in 1 or 2 areas to serve as control stations.	Quarterly	Gamma dose quarterly.

* The number, media, frequency, and location of samples may vary from site to site. This table presents an acceptable minimum program for a site at which each entry is applicable. Local site characteristics must be examined to determine if pathways not covered by this table may significantly contribute to an individual's dose and should be included in the sample program.

TABLE 3.3-1 (Continued)

RADIOLOGICAL ENVIRONMENTAL MONITORING PROGRAM

EXPOSURE PATHWAY AND/OR SAMPLE	NUMBER OF REPRESENTATIVE SAMPLES AND SAMPLE LOCATION ^(a)	SAMPLING AND COLLECTION FREQ.	TYPE AND FREQUENCY OF ANALYSIS
2. AIRBORNE Radioiodine and Particulates	<p>Samples from 5 locations: 3 samples from close to the 3 SITE BOUNDARY locations (in different sectors) of the highest calculated annual average ground-level D/Q. 1 sample from the vicinity community having one of the highest calculated annual ground level D/Q. 1 sample from a control location, as for example 15-30 km distant and in the least prevalent wind direction.</p>	<p>Continuous sampler operation with sample collection weekly, or more frequently if required by dust loading.</p>	<p><u>Radioiodine canisters:</u> I-131 analysis weekly</p> <p><u>Particulate Sampler:</u> Gross beta radio activity analysis following filter change:^c Gamma isotopic analysis^d of composite (by location) at least quarterly</p>

TABLE 3.3-1 (Continued)

RADIOLOGICAL ENVIRONMENTAL MONITORING PROGRAM

EXPOSURE PATHWAY AND/OR SAMPLE	NUMBER OF REPRESENTATIVE SAMPLES AND SAMPLE LOCATION ^(a)	SAMPLING AND COLLECTION FREQ.	TYPE AND FREQUENCY OF ANALYSIS
3. WATERBORNE			
a. Surface ^e	1 sample upstream 1 sample downstream	Composite sample over 1-month period ^f .	Gamma isotopic analysis ^d monthly. Composite for tritium analysis quarterly.
b. Ground	Samples from 1 or 2 sources only if likely to be affected ^g	Quarterly.	Gamma isotopic ^d and tritium analysis
c. Drinking	1 sample of each on 1 to 3 of the nearest water supplies that could be affected by its discharge.	Composite sample over 2-week period ^f when I-131 analysis is performed; monthly composite otherwise.	I-131 analysis on each composite when the dose calculated for the consumption of the water is greater than 1 mrem per year. ^h Composite for gross beta and gamma isotopic ^d analysis monthly. Composite for tritium analysis quarterly.
d. Sediment from shoreline	1 sample from downstream area with existing or potential recreational value.	Semiannually.	Gamma isotopic analysis ^d semiannually.

TABLE 3.3-1 (Continued)

RADIOLOGICAL ENVIRONMENTAL MONITORING PROGRAM

EXPOSURE PATHWAY AND/OR SAMPLE	NUMBER OF REPRESENTATIVE SAMPLES AND SAMPLE LOCATION ^(a)	SAMPLING AND COLLECTION FREQ.	TYPE AND FREQUENCY OF ANALYSIS
4. INGESTION	Samples from milking animals in 3 locations within 5 km distance having the highest dose potential.	Semimonthly when animals are on pasture, monthly at other times.	Gamma isotopic ^d and I-131 analysis semimonthly when animals are on pasture (April 1 - Oct. 1); monthly at other times.
a. Milk	If there are none, then 1 sample from milking animals in each of 3 areas between 5 to 8 km distance where dose are calculated to be greater than 1 mrem per year. ^h 1 sample from milking animals at a control location (15-30 km distance) and in the least prevalent wind direction.		
b. Fish and Invertebrates	1 sample of each commercially and recreationally important species in vicinity of plant discharge area.	Sample in season, or semiannually if they are not seasonal.	Gamma isotopic ^d analysis on edible portions.
	1 sample of same species in area not influenced by plant discharge.		

TABLE 3.3-1 (Continued)

RADIOLOGICAL ENVIRONMENTAL MONITORING PROGRAM

EXPOSURE PATHWAY AND/OR SAMPLE	NUMBER OF REPRESENTATIVE SAMPLES AND SAMPLE LOCATION ^(a)	SAMPLING AND COLLECTION FREQ.	TYPE AND FREQUENCY OF ANALYSIS
4. INGESTION (Continued) c. Food Products	1 sample of each principal class of food products from any area that is irrigated by water in which liquid plant wastes have been discharged	At time of harvest ⁱ	Gamma isotopic ^d and I-131 analysis.
	Samples of 3 different kinds of broad leaf vegetation grown nearest each of 2 different offsite locations of highest predicted annual average ground level D/Q if milk sampling is not performed.	Monthly during the growing season	Gamma isotopic ^d and I-131 analysis.
	1 sample of each of the similar broad leaf vegetation grown 15-30 km distance in the least prevalent wind direction if milk sampling is not performed.	Monthly during the growing season	Gamma isotopic ^d and I-131 analysis.

TABLE 3.3-1 (Continued)TABLE NOTATIONS

- a. Specific parameters of distance and direction sector from the centerline of the two reactors and additional description where pertinent, shall be provided for each and every sample location in Table 3.3-1 in a table and figure(s) in the ODCM. Deviations are permitted from the required sampling schedule if specimens are unobtainable due to hazardous conditions, seasonal unavailability, malfunction of automatic sampling equipment and other legitimate reasons. If specimens are unobtainable due to sampling equipment malfunction, every effort shall be made to complete corrective action prior to the end of the next sampling period. All deviations from the sampling schedule shall be documented in the Annual Radiological Environmental Operating Report pursuant to Administrative Control 6.1. It is recognized that, at times, it may not be possible or practicable to continue to obtain samples of the media of choice at the most desired location or time. In these instances suitable alternative media and locations may be chosen for the particular pathway in question and appropriate substitutions made within 30 days in the radiological environmental monitoring program. Pursuant to Technical Specification 6.14, submit as a part of or concurrent with the next Annual Radioactive Effluent Release Report a complete legible copy of the ODCM including a revised figure(s) and table for the ODCM reflecting the new location(s).
- b. One or more instruments, such as a pressurized ion chamber, for measuring and recording dose rate continuously may be used in place of, or in addition to, integrating dosimeters. For the purpose of this table, a dosimeter (OSL, TLD, or similar) is considered to be one element; two or more elements in a packet are considered as two or more dosimeters. Film badges shall not be used as dosimeters for measuring direct radiation.
- c. Airborne particulate sample filters shall be analyzed for gross beta radioactivity 24 hours or more after sampling to allow for radon and thoron daughter decay. If gross beta activity in air particulate samples is greater than 10 times the yearly mean of control samples, gamma isotopic analysis shall be performed on the individual samples.
- d. Gamma isotopic analysis means the identification and quantification of gamma-emitting radionuclides that may be attributable to the effluents from the facility.
- e. The "upstream sample" shall be taken at a distance beyond significant influence of the discharge. The "downstream sample" shall be taken in an area beyond but near the mixing zone.

TABLE 3.3-1 (Continued)TABLE NOTATIONS (Continued)

- f. A composite sample is one in which the quantity (aliquot) of liquid sampled is proportional to the quantity of flowing liquid and in which the method of sampling employed results in a specimen that is representative of the liquid flow. In this program composite sample aliquots shall be collected at time intervals that are very short (e.g., hourly) relative to the compositing period (e.g., monthly) in order to assure obtaining a representative sample.
- g. Groundwater samples shall be taken when this source is tapped for drinking or irrigation purposes in areas where the hydraulic gradient or recharge properties are suitable for contamination.
- h. The dose shall be calculated for the maximum organ and age group using the methodology and parameters in the ODCM.
- i. If harvest occurs more than once a year, sampling shall be performed during each discrete harvest. If harvest occurs continuously, sampling shall be monthly. Attention shall be paid to including samples of tuberous and root food products.

TABLE 3.3-2
 REPORTING LEVELS FOR RADIOACTIVITY CONCENTRATIONS IN ENVIRONMENTAL SAMPLES

Reporting Levels

ANALYSIS	WATER (pCi/l)	AIRBORNE PARTICULATE or GASES(pCi/m ³)	FISH (pCi/kg, wet)	MILK (pCi/l)	FOOD PRODUCTS (pCi/kg, wet)
H-3	20,000*				
Mn-54	1,000		30,000		
Fe-59	400		10,000		
Co-58	1,000		30,000		
Co-60	300		10,000		
Zn-65	300		20,000		
Zr-Nb-95	400***				
I-131	2**	0.9		3	100
Cs-134	30	10	1,000	60	1,000
Cs-137	50	20	2,000	70	2,000
Ba-La-140	200***			300	

* For drinking water samples. This is a 40 CFR Part 141 value. If no drinking pathway exists, a value of 30,000 pCi/l may be used.

** If no drinking water pathway exists, a value of 20 pCi/l may be used

*** Total for parent and daughter.

TABLE 4.3-1
DETECTION CAPABILITIES FOR ENVIRONMENTAL SAMPLE ANALYSIS^{(a) (b)}

Lower limit of Detection (LLD)^(c)

ANALYSIS	WATER (pCi/l)	AIRBORNE PARTICULATE or GASES (pCi/m ³)	FISH (pCi/kg, wet)	MILK (pCi/l)	FOOD PRODUCTS (pCi/kg, wet)	SEDIMENT (pCi/kg, dry)
Gross Beta	4	0.01				
H-3	2,000*					
Mn-54	15		130			
Fe-59	30		260			
Co-58	15		130			
Co-60	15		130			
Zn-65	30		260			
Zr-95	30					
Nb-95	15					
I-131	1**	0.07		1	60	
Cs-134	15	0.05	130	15	60	150
Cs-137	18	0.06	150	18	80	180
Ba-140	60			60		
La-140	15			15		

* If no drinking water pathway exists, a value of 3000 pCi/l may be used.

** If no drinking water pathway exists, a value of 15 pCi/l may be used.

TABLE 4.3-1 (Continued)TABLE NOTATIONS

- (a) This list does not mean that only these nuclides are to be considered. Other peaks that are identifiable at 95% confidence level, together with those of the above nuclides, shall also be analyzed and reported in the Annual Radiological Environmental Operating report pursuant to Administrative Control 6.1.
- (b) Required detection capabilities for thermoluminescent dosimeters used for environmental measurements are given in Regulatory Guide 4.13.
- (c) The LLD is defined, for purposes of these controls, as the smallest concentration of radioactive material in a sample that will yield a net count (above system background) that will be detected with 95% probability with only 5% probability of falsely concluding that a blank observation represents a "real" signal.

For a particular measurement system (which may include radiochemical separation):

$$LLD = \frac{4.66 s_b}{E \cdot V \cdot 2.22 \cdot Y \cdot \exp(-\lambda \Delta t)}$$

Where:

- LLD is the a priori lower limit of detection as defined above (as picocuries per unit mass or volume),
- s_b is the standard deviation of the background counting rate or of the counting rate of blank sample as appropriate (as counts per minute),
- E is the counting efficiency (as counts per disintegration),
- V is the sample size (in units of mass or volume),
- 2.22 is the number of disintegrations per minute per picocurie,
- Y is the fractional radiochemical yield (when applicable),
- λ is the radioactive decay constant for the particular radionuclide, and
- Δt for the environmental samples is the elapsed time between sample collection (or end of the sample collection period) and time of counting.

Typical values of E, V, Y and Δt should be used in the calculation

TABLE 4.3-1 (Continued)TABLE NOTATIONS (Continued)

It should be recognized that the LLD is defined as an a priori (before the fact) limit representing the capability of a measurement system and not as an after the fact limit for a particular measurement. Analyses shall be performed in such a manner that the stated LLDs will be achieved under routine conditions. Occasionally background fluctuations, unavoidably small sample sizes, the presence of interfering nuclides, or other uncontrollable circumstances may render these LLDs unachievable. In such cases, the contributing factors shall be identified and described in the Annual Radiological Environmental Operating Report pursuant to Administrative Control 6.1.

3/4.3 RADIOLOGICAL ENVIRONMENTAL MONITORING

3/4.3.2 LAND USE CENSUS

CONTROLS

- 3.3.2 A land use census shall be conducted and shall identify within a distance of 8 km (5 miles) the location (in each of the 16 meteorological sectors) of the nearest milk animal, the nearest residence and the nearest garden* of greater than 50 m² (500 ft²) producing broad leaf vegetation.

APPLICABILITY: At all times.

ACTION:

- a. With a land use census identifying a location(s) that yields a calculation dose or dose commitment greater than the values currently being calculated in Control 3.2.2.3, identify the new location(s) in the next Annual Radioactive Effluent Release Report, pursuant to Administrative Control 6.2.
- b. With a land use census identifying a location(s) that yields a calculated dose or dose commitment (via the same exposure pathway) 20% greater than at a location from which samples are currently being obtained in accordance with Control 3.2.2.3, add the new location(s) to the radiological environmental monitoring program within 30 days. The sampling location(s), excluding the control station location, having the lowest calculated dose or dose commitment(s) (via the same exposure pathway) may be deleted from this monitoring program after October 31 of the year in which this land use census was conducted. Pursuant to Technical Specification 6.14, submit as a part of or concurrent with in the next Annual Radioactive Effluent Release Report a complete, legible copy of the entire ODCM including a revised figure(s) and table(s) for the ODCM reflecting the new location(s).
- c. The provisions of Controls 3.0.3 and 3.0.4 are not applicable.

SURVEILLANCE REQUIREMENTS

- 4.3.2 The land use census shall be conducted during the growing season at least once per 12 months using that information that will provide the best results, such as by a door-to-door survey, aerial survey, or by consulting local agriculture authorities. The results of the land use census are included in the Annual Radiological Environmental Operating Report pursuant to Administrative Control 6.1.

* Broad leaf vegetation sampling of at least 3 different kinds of vegetation may be performed at the SITE BOUNDARY in each of 2 different direction sectors with the highest predicted D/Qs in lieu of the garden census. Controls for broad leaf vegetation sampling in Table 3.3-1 item 4.c. shall be followed, including analysis of control samples.

3/4.3 RADIOLOGICAL ENVIRONMENTAL MONITORING

3/4.3.3 INTERLABORATORY COMPARISON PROGRAM

CONTROLS

3.3.3 In accordance with LGS Technical Specification 6.8.4.f, analyses shall be performed on radioactive materials supplied as part of an Interlaboratory Comparison Program traceable to NIST, that correspond to samples required by Table 3.3-1.

APPLICABILITY: At all times.

ACTION:

- a. With analyses not being performed as required above, report the corrective actions taken to prevent a recurrence to the Commission in the Annual Radiological Environmental Operating Report pursuant to Administrative Control 6.1.
- b. The provisions of Controls 3.0.3 and 3.0.4 are not applicable.

SURVEILLANCE REQUIREMENTS

4.3.3 The Interlaboratory Comparison Program shall be described in the ODCM. A summary of the results shall be included in the Annual Radiological Environmental Operating Report pursuant to Administrative Control 6.1

3/4.3 RADIOLOGICAL ENVIRONMENTAL MONITORING

3/4.3.4 METEOROLOGICAL MONITORING INSTRUMENTATION CONTROLS

3.3.4 The meteorological monitoring instrumentation channels shown in Table 3.3-3 shall be OPERABLE.

APPLICABILITY: At all times.

ACTION:

- a. With less than the minimum required instrumentation channels OPERABLE for more than 7 days, initiate an Issue Report outlining the cause of the malfunction and the plans for restoring the instrumentation to OPERABLE status.
- b. The provisions of Controls 3.0.3 and 3.0.4 are not applicable.

SURVEILLANCE REQUIREMENTS

4.3.4 Each of the above required meteorological monitoring instrumentation channels shall be demonstrated OPERABLE by the performance of the CHANNEL CHECK and CHANNEL CALIBRATION operations at the frequencies shown in Table 4.3-2.

TABLE 3.3-3METEOROLOGICAL MONITORING INSTRUMENTATION

INSTRUMENT		TOWER 1 (PRIMARY)	TOWER 2 (BACKUP)	MINIMUM INSTRUMENT OPERABLE
1.	Wind Speed			
	a. Elevation 1	30 feet	159 feet	1
	b. Elevation 2	175 feet	304 feet	1
2.	Wind Direction			
	a. Elevation 1	30 feet	159 feet	1
	b. Elevation 2	175 feet	304 feet	1
3.	Air Temperature Difference (ΔT)			
	a. Elevations	266 feet 26 feet	300 feet 26 feet	1

TABLE 4.3-2

METEOROLOGICAL MONITORING INSTRUMENTATION SURVEILLANCE
REQUIREMENTS

INSTRUMENT	CHANNEL CHECK	CHANNEL CALIBRATION
1. Wind Speed		
a. Elevation 1 (Tower 1 and Tower 2)	D	SA
b. Elevation 2 (Tower 1 and Tower 2)	D	SA
2. Wind Direction		
a. Elevation 1 (Tower 1 and Tower 2)	D	SA
b. Elevation 2 (Tower 1 and Tower 2)	D	SA
3. Air Temperature Difference (ΔT)		
a. Elevations 266 - 26 ft (Tower 1)	D	SA
b. Elevations 300 - 26 ft (Tower 2)	D	SA

NOTE:

The meteorological towers shall be located as shown on Figure 3.3-1.

Figure 3.3-1

METEOROLOGICAL TOWER LOCATIONS

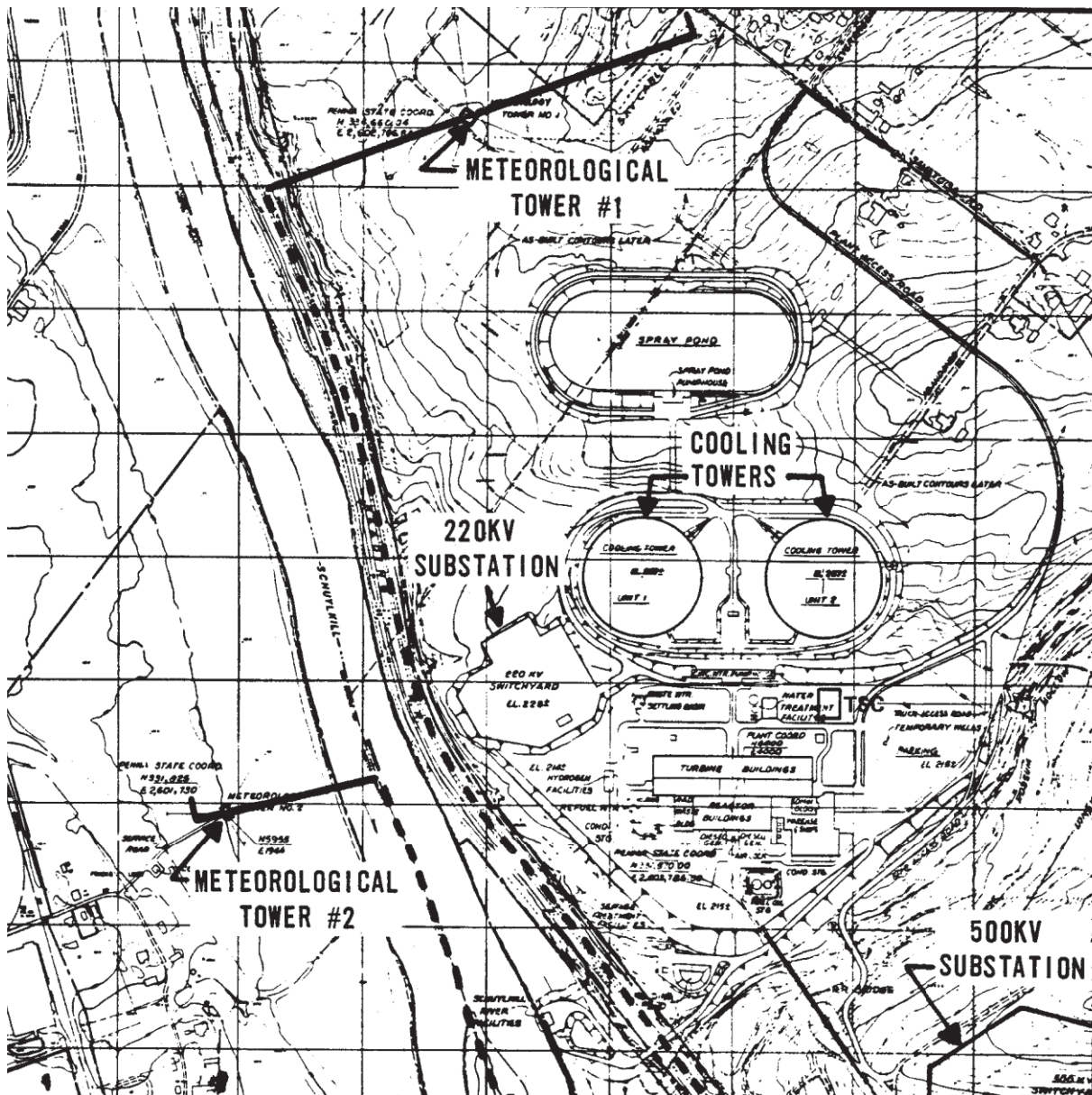

3/4.0 CONTROLS

BASES

GENERAL

It is expected that releases of radioactive material in effluents will be kept at small fractions of the limits specified in Section 20.1302 of 10 CFR, Part 20. At the same time, the licensee is permitted the flexibility of operation, compatible with consideration of health and safety, to assure that the public is provided a dependable source of power even under unusual operating conditions which may temporarily result in releases higher than such small fractions, but still within the limits specified in Section 20.1302 of 10 CFR, Part 20. It is expected that in using this operational flexibility under unusual operating conditions the licensee will exert his best efforts to keep levels of radioactive material in effluents as low as practicable.

MAPS DEFINING UNRESTRICTED AREAS AND SITE BOUNDARY FOR RADIOACTIVE GASEOUS AND LIQUID EFFLUENTS

Information regarding radioactive gaseous and liquid effluents, which will allow identification of structures and release points as well as definition of UNRESTRICTED AREAS within the SITE BOUNDARY that are accessible to MEMBER(S) OF THE PUBLIC, shall be as shown in Technical Specifications Figures 5.1.3-1a and 5.1.3-1b.

The exclusion area and low population zone shall be as shown in Figures 1-1 and 1-2.

10 CFR 20

Per Technical Specification Section 6.8.4.d, the Radioactive Effluent Controls Program must conform with limitations specified in 10 CFR 50.36a, 10 CFR Part 50, Appendix I, 10 times the ECL limits of 10 CFR Part 20, Appendix B, Table 2, Column 2 and 40 CFR 190. (See Reference 14)

3/4.0 CONTROLS

BASES

3/4.0 APPLICABILITY

Compliance with the controls is required during the OPERATIONAL CONDITIONS or other conditions specified therein; except that upon failure to meet the controls, the associated ACTION requirements shall be met.

Non compliance with a Control shall exist when the requirements of the control and associated ACTION requirements are not performed within the specified time intervals. If the control is restored prior to expiration of the specified time intervals, completion of the ACTION requirements is not required.

There are no actions in the ODCM which would require an operational condition change.

There are no restrictions on changing operating conditions in any of the controls on the ODCM.

Surveillance Requirements shall be met during the OPERATIONAL CONDITIONS or other conditions specified for individual controls unless otherwise stated in an individual Surveillance Requirement.

Each Surveillance Requirement shall be performed within the specified interval with a maximum allowable extension not to exceed 25% of the surveillance interval.

Failure to perform a Surveillance Requirement within the allowed surveillance interval defined by Surveillance Requirement 4.0.2.a, shall constitute noncompliance with the OPERABILITY requirements for a control. The time limits of the ACTION requirements are applicable at the time it is identified that a Surveillance Requirement has not been performed. The ACTION requirements may be delayed for up to 24 hours to permit the completion of the surveillance when the allowable outage time limits of the ACTION requirements are less than 24 hours. Surveillance requirements do not have to be performed on inoperable equipment.

The associated bases from the LGS Technical Specifications apply to this section.

3/4.1 INSTRUMENTATION

BASES

3/4.1.1 RADIOACTIVE LIQUID EFFLUENT MONITORING INSTRUMENTATION

The radioactive liquid effluent instrumentation is provided to monitor and control, as applicable, the releases of radioactive materials in liquid effluents during actual or potential releases of liquid effluents. The alarm/trip setpoints for these instruments shall be calculated in accordance with the procedures in the ODCM Part II to ensure that the alarm/trip will occur prior to exceeding the limits of 10 CFR Part 20. The OPERABILITY and use of this instrumentation is consistent with the requirements of General Design Criteria 60, 63, and 64 of Appendix A to 10 CFR Part 50.

3/4.1.2 RADIOACTIVE GASEOUS EFFLUENT MONITORING INSTRUMENTATION

The radioactive gaseous effluent instrumentation is provided to monitor and control, as applicable, the releases of radioactive materials in gaseous effluents during actual or potential releases of gaseous effluents. The alarm/trip setpoints for these instruments shall be calculated in accordance with the procedures in the ODCM Part II to ensure that the alarm/trip will occur prior to exceeding the limits of 10 CFR Part 20. The OPERABILITY and use of this instrumentation is consistent with the requirements of General Design Criteria 60, 63, and 64 of Appendix A to 10 CFR Part 50.

3/4.2 RADIOACTIVE EFFLUENTS

BASES

3/4.2.1 LIQUID EFFLUENTS

3/4.2.1.1 CONCENTRATION

This control is provided to ensure that the concentration of radioactive materials released in liquid waste effluents to areas at and beyond the UNRESTRICTED AREAS will be less than 10 times the effluent concentration limits (ECL) specified in 10 CFR Part 20, Appendix B, Table 2, Column 2. This instantaneous limitation provides additional assurance that the levels of radioactive materials in bodies of water in areas at and beyond the SITE BOUNDARY will result in exposures within (1) the Section II.A design objectives of Appendix I, 10 CFR Part 50, to a MEMBER OF THE PUBLIC, and (2) the limits of 10 CFR 20.1302 to the population. The concentration limits for dissolved or entrained noble gases are based upon the assumption that Xe-135 is the controlling radioisotope and its ECL in air (submersion) was converted to an equivalent concentration in water using the methods described in the International Commission on Radiological Protection (ICRP) Publication 2.

The required detection capabilities for radioactive materials in liquid waste samples are tabulated in terms of the lower limits of detection (LLDs). Detailed discussion of the LLD, and other detection limits can be found in HASL Procedures Manual, HASL-300 (revised annually); Currie, L.A., "Limits for Qualitative Detection and Quantitative Determination - Application to Radiochemistry"; Anal. Chem. 40, 586-93 (1968); and Hartwell, J.K., "Detection Limits for Radioanalytical Counting Techniques", Atlantic Richfield Hanford Company Report ARH-SA-215 (June, 1975).

3/4.2.1.2 DOSE

This Control is provided to implement the requirements of Sections II.A, III.A, and IV.A of Appendix I, 10 CFR Part 50. Control 3.2.1.2 implements the guidance set forth in Section II.A of Appendix I and provides the required operating flexibility and at the same time implement the guides set forth in Section IV.A of Appendix I to assure that the releases of radioactive material in liquid effluents will be kept "as low as reasonably achievable". Also, for fresh water sites with drinking water supplies which can be potentially affected by plant operations, there is reasonable assurance that the operation of the facility will not result in radionuclide concentrations in the finished drinking water that are in excess of the requirements of 40 CFR Part 141. The Surveillance Requirement 4.2.1.2 implement the requirements in Section III.A of Appendix I that conformance with the guidance of Appendix I be shown by calculational procedures based on models and data, such that the actual exposure of a MEMBER OF THE PUBLIC through appropriate pathways is unlikely to be substantially underestimated. The equations specified in the ODCM for calculating the doses due to the actual release rates of radioactive materials in liquid effluents are

3/4.2 RADIOACTIVE EFFLUENTS

BASES

consistent with the methodology provided in NUREG-0133, "Preparation of Radiological Effluent Technical Specifications for Nuclear Power Plants" and Regulatory Guide 1.113, "Estimating Aquatic Dispersion of Effluents from Accidental and Routine Reactor Releases for the Purpose of Implementing Appendix I," April, 1977.

This control applies to the release of radioactive materials in liquid effluents from the site.

3/4.2.1.3 LIQUID RADWASTE TREATMENT SYSTEM

The requirement that the appropriate portions of this system be used when specified provides assurance that the releases of radioactive materials in liquid effluents will be kept "as low as reasonably achievable". Control 3.2.1.3 implements the requirements of 10 CFR 50.35a, General Design Criterion 60 of Appendix A to 10 CFR Part 50 and the design objective given in Section II.D of Appendix I to 10 CFR Part 50. The specified limits governing the use of appropriate portions of the liquid radwaste treatment system were specified as a suitable fraction of the dose design objectives set forth in Section II.A of Appendix I, 10 CFR Part 50, for liquid effluents.

3/4.2.2 GASEOUS EFFLUENTS

3/4.2.2.1 DOSE RATE

This control is provided to ensure that the dose from radioactive materials in gaseous effluents at and beyond the SITE BOUNDARY will be within the annual dose limits of 10 CFR Part 20 to UNRESTRICTED AREAS. The annual dose limits are the doses associated with the concentrations of 10 CFR Part 20, Appendix B, Table 2, Column 1. These limits provide reasonable assurance that radioactive material discharged in gaseous effluents will not result in the exposure of a MEMBER OF THE PUBLIC, either within or outside the SITE BOUNDARY, to annual average concentrations exceeding the limits specified in Appendix B, Table 2 of 10 CFR Part 20. For MEMBERS OF THE PUBLIC who may at times be within the SITE BOUNDARY, the occupancy factor for that MEMBER OF THE PUBLIC will usually be sufficiently low to compensate for any increase in the atmospheric diffusion factor for above that for the SITE BOUNDARY. Examples of calculations for such MEMBERS OF THE PUBLIC, with the appropriate occupancy factors, are given in the ODCM. The specified release rate limits restrict, at all times, the corresponding gamma and beta dose rates above background to a MEMBER OF THE PUBLIC at or beyond the SITE BOUNDARY to less than or equal to 500 mrem/year to the total body or to less than or equal to 3000 mrem/year to the skin. These release rate limits also restrict, at all times, the corresponding thyroid dose rate above background to a child via the inhalation pathway to less than or equal to 1500 mrem/year.

3/4.2 RADIOACTIVE EFFLUENTS

BASES

This Control applies to the release of radioactive materials in gaseous effluents from all reactors at the site.

The required detection capability for radioactive materials in gaseous waste samples are tabulated in terms of the lower limits of detection (LLDs). Detailed discussion of the LLD, and other detection limits can be found in HASL Procedures Manual, HASL-300 (revised annually); Currie, L.A., "Limits for Qualitative Detection and Quantitative Determination - Application to Radiochemistry"; Anal. Chem. 40, 586-93 (1986); and Hartwell, J.K., "Detection Limits for Radioanalytical Counting Techniques." Atlantic Richfield Hanford Company Report ARH-SA-215 (June 1975).

3/4.2.2.2 DOSE - NOBLE GASES

This control is provided to implement the requirements of Sections II.B, III.A, and IV.A of Appendix I, 10 CFR Part 50. Control 3.2.2.2 implements the guidance set forth in Section II.B of Appendix I and provides the required operating flexibility to implement the guides set forth in Section IV.A of Appendix I to assure that the releases of radioactive material in gaseous effluents will be kept "as low as reasonably achievable". The Surveillance Requirement 4.2.2.2 implement the requirements in Section III.A of Appendix I that conformance with the guides of Appendix I be shown by calculational procedures based on appropriate pathways is unlikely to be substantially underestimated. The dose calculation established in the ODCM for calculating the doses due to the actual release rates of radioactive noble gases in gaseous effluents are consistent with the methodology provided in NUREG-0133, "Preparation of Radiological Effluent Technical Specifications for Nuclear Power Plants" and Regulatory Guide 1.111, "Methods for Estimating Atmospheric Transport and Dispersion of Gaseous Effluents in Routing Releases from Light-Water Cooled Reactors," Revision 1, July 1977 with site specific dispersion curves and deposition methodology.

The ODCM equations provided for determining the air doses at and beyond the SITE BOUNDARY are based upon the historical average atmospheric conditions.

3/4.2.2.3 DOSE - IODINE-131, IODINE-133, TRITIUM, AND RADIONUCLIDES IN PARTICULATE FORM

This control is provided to implement the requirements of Sections II.C, III.A, and IV.A of Appendix I, 10 CFR Part 50. Control 3.2.2.3 implements the guidance set forth in Section II.C of Appendix I and provides the required operating flexibility to implement the guides set forth in Section IV.A of Appendix I to assure that the releases of radioactive materials in gaseous effluents will be kept "as low as is reasonably achievable." The ODCM calculational methods specified in the Surveillance Requirements 4.2.2.3 implement the

3/4.2 RADIOACTIVE EFFLUENTS

BASES

requirements in Section III.A of Appendix I, that conformance with the guides of Appendix I be shown by calculational procedures based on models and data, such that the actual exposure of a MEMBER OF THE PUBLIC through appropriate pathways is unlikely to be substantially underestimated. The ODCM calculational methods for calculating the doses due to the actual release rates of the subject materials are consistent with the methodology provided in NUREG-0133, "Preparation of Radiological Effluent Technical Specifications for Nuclear Power Plants" and Regulatory Guide 1.111, "Methods for Estimating Atmospheric Transport and Dispersion of Gaseous Effluents in Routine Releases from Light-Water-Cooled Reactors," Revision 1, July 1977 with site specific dispersion curves and deposition methodology. These equations also provide for determining the actual doses based upon the historical average atmospheric conditions. The release rate specifications for iodine-131, iodine-133, tritium, and radionuclides in particulate form with half-lives greater than 8 days are dependent on the existing radionuclides pathways to man in areas at and beyond the SITE BOUNDARY. The pathways which were examined in the development of these calculations were: (1) individual inhalation of airborne radionuclides, (2) deposition of radionuclides onto green leafy vegetation with subsequent consumption by man, (3) deposition onto grassy areas where milk animals and meat-producing animals graze with consumption of the milk and meat by man, and (4) deposition on the ground with subsequent exposure of man.

3/4.2.2.4 AND 3/4.2.2.5 GASEOUS RADWASTE TREATMENT SYSTEM AND VENTILATION EXHAUST TREATMENT SYSTEM

The requirement that the appropriate portions of this system be used, when specified, provides reasonable assurance that the releases of radioactive materials in gaseous effluents will be kept "as low as is reasonably achievable." Controls 3.2.2.4 and 3.2.2.5 implements the requirements of 10 CFR 50.36a, General Design Criteria 60 of Appendix A to 10 CFR Part 50, and the design objectives given in Section II.D of Appendix I to 10 CFR Part 50. The specified limits governing the use of appropriate portions of the systems were specified as a suitable fraction of the dose design objectives set forth in Section II.B and II.C of Appendix I, 10 CFR Part 50, for gaseous effluents.

3/4.2.2.7 MARK II CONTAINMENT

This control provides reasonable assurance that releases from drywell venting or purging operations will not exceed the annual dose limits of 10 CFR Part 20 for areas at or beyond the UNRESTRICTED AREAS.

3/4.2 RADIOACTIVE EFFLUENTS

BASES

3/4.2.3 TOTAL DOSE

This control is provided to meet the dose limitations of 40 CFR Part 190 that have been incorporated into 10 CFR Part 20 by 46 CFR 18525, as well as the dose limitations specific to Independent Spent Fuel Storage Installation (ISFSI) operations in accordance with 10 CFR 72.104. Over the long term, as more storage modules containing dry shielded canisters of spent fuel are placed on the ISFSI pad, it is expected that ISFSI operations will become the prominent contributor to the dose limits in this section. ISFSI dose contribution is in the form of direct radiation as no liquid or gas releases are expected to occur from the ISFSI canisters. The LGS 10 CFR 72.212 Report prepared in accordance with 10 CFR 72 requirements assumes a certain array of storage modules exists on the pad. The dose contribution from this array of casks combination with historical uranium fuel cycle operations prior to ISFSI operations was analyzed to be within the 40 CFR 190 and 10 CFR 72.104 limits. Control 3.2.3 requires the preparation and submittal of a Special Report whenever the calculated doses due to releases of radioactivity and to radiation from uranium fuel cycle sources exceed 25 mrem to the whole body or any organ, except the thyroid, which shall be limited to less than or equal to 75 mrem. For sites containing up to four reactors, it is highly unlikely that the resultant dose to a MEMBER OF THE PUBLIC will exceed the dose limits of 40 CFR Part 190 if the individual reactors remain within twice the dose design objectives of Appendix I, and if direct radiation does from the units (including outside storage tanks, etc.) are kept small.

The Special Report will describe a course of action that should result in the limitation of the annual dose to a MEMBER OF THE PUBLIC to within the 40 CFR Part 190 limits. For the purposes of the Special Report, it may be assumed that the dose commitment to the MEMBER OF THE PUBLIC from other uranium fuel cycle sources is negligible, with the exception that dose contributions from other nuclear fuel cycle facilities at the same site or within a radius of 5 miles must be considered. If the dose to any MEMBER OF THE PUBLIC is estimated to exceed the requirements of 40 CFR Part 190 or 10 CFR 72.104, the Special Report with a request for a variance (provided the release condition resulting in violation of 40 CFR Part 190 or 10 CFR 72.104 have not already been corrected), in accordance with the provisions of 40 CFR 190.11, or 10 CFR 72.104 and 10 CFR 20.2203, is considered to be a timely request and fulfills the requirements of 40 CFR Part 190 or 10 CFR 72.104 until NRC staff action is completed. The variance only relates to the limits of 40 CFR Part 190 or 10 CFR 72.104, and does not apply in any way to the other requirements for dose limitation of 10 CFR Part 20, as addressed in Controls 3.2.1.1 and 3.2.2.1. An individual is not considered a MEMBER OF THE PUBLIC during any period in which he/she is engaged in carrying out any operation that is part of the nuclear fuel cycle.

3/4.3 RADIOLOGICAL ENVIRONMENTAL MONITORING BASES

3/4.3.1 MONITORING PROGRAM

The Radiological Environmental Monitoring Program (REMP) required by this control provides representative measurements of radiation and of radioactive materials in those exposure pathways and for those radionuclides that lead to the highest potential radiation exposures of MEMBER OF THE PUBLIC resulting from the station operation. This monitoring program implements Section IV.B.2 of Appendix I to 10 CFR Part 50 and thereby supplements the radiological effluent monitoring program by verifying that the measurable concentrations of radioactive materials and levels of radiation are not higher than expected on the basis of the effluent measurements and modeling of the environmental exposure pathways.

The required detection capabilities for environmental sample analyses are tabulated in terms of the lower limits of detection (LLDs). The LLDs required by Table 4.3-1 are considered optimum for routine environmental measurements in industrial laboratories. It should be recognized that the LLD is defined as an a priori (before the fact) limit representing the capability of a measurement system and not an after the fact limit for a particular measurement.

Detailed discussion of the LLD, and other detection limits, can be found in HASL Procedures Manual, HASL-300 (revised annually); Currie L.A., "Limits for Qualitative Detection and Quantitative Determination - Application to Radiochemistry," Anal. Chem. 40, 586-93 (1968), and Hartwell, J.K., "Detection Limits for Radioanalytical Counting Techniques", Atlantic Richfield Hanford Company Report ARH-SA-215 (June, 1975).

3/4.3.2 LAND USE CENSUS

This control is provided to ensure that changes in the use of areas at and beyond the SITE BOUNDARY are identified and that modifications to the monitoring program are made if required by the results of the census. The best information from the door-to-door survey, aerial survey or consulting with local agricultural authorities or any combination of these methods shall be used. This census satisfies the requirements of Section IV.B.3 of Appendix I to 10 CFR Part 50. Restricting the census to gardens of greater than 500 square feet provides assurance that significant exposure pathways via leafy vegetables will be identified and monitored since a garden of this size is the minimum required to produce the quantity (26 Kg/year) of leafy vegetables assumed in Regulatory Guide 1.109 for consumption by a child. To determine this minimum garden size, the following assumptions were used: (1) that 20% of the garden was used for growing broad leafy vegetation (i.e. similar to lettuce and cabbage), and (2) a vegetation yield of 2 kg/Square meter.

3/4.3 RADIOLOGICAL ENVIRONMENTAL MONITORING BASES

3/4.3.3 INTERLABORATORY COMPARISON PROGRAM

The requirement for participation in an Interlaboratory Comparison Program ensures that independent checks on the precision and accuracy of the measurements of radioactive material in environmental sample matrices are performed as part of the quality assurance program for environmental monitoring in order to demonstrate that the results are reasonably valid for the purpose of Section IV.B.2 of Appendix I to 10 CFR Part 50.

3/4.3.4 METEOROLOGICAL MONITORING INSTRUMENTATION

The OPERABILITY of the meteorological monitoring instrumentation ensures that sufficient meteorological data is available for estimating potential radiation doses to the public as a result of routine or accidental release of radioactive materials to the atmosphere. This capability is required to evaluate the need for initiating measures to protect the health and safety of the public. This instrumentation is consistent with the recommendations of Regulatory Guide 1.23 "Onsite Meteorological Programs," February, 1972.

Site data compiled since January 1972 provide correlation between Elevation 1 (Tower 1) and Elevation 1 (Tower 2), and between Elevation 2 (Tower 1) and Elevation 2 (Tower 2). This correlation serves as justification for the use of the appropriate Tower 2 instrument as a back-up to the Tower 1 instrument as shown in Table 3.3-3.

6.0 ADMINISTRATIVE CONTROLS

6.1 ANNUAL RADIOLOGICAL ENVIRONMENTAL OPERATING REPORT

- 6.1 Routine Annual Radiological Environmental Operating Report covering the operation of Unit 1 and Unit 2 during the previous calendar year shall be submitted prior to May 1 for each year. The initial report was submitted prior to May 1 of the year following initial criticality (1984). A single report is submitted for a multiple unit station. The Annual Radiological Environmental Operating Report shall include summaries, interpretations, and an analysis of trends of the results report period, including a comparison (as appropriate), with preoperational studies, operational controls and previous environmental surveillance reports and an assessment of the observed impacts of the plant operation on the environment. The reports shall also include the results of land use census required by Control 3.3.2. The Annual Radiological Environmental Operating Report shall include the results of all radiological environmental samples and of all environmental radiation measurements taken during the report period pursuant to the locations specified in the tables and figures in the OFFSITE DOSE CALCULATION MANUAL, as well as summarized and tabulated results of these analyses and measurements in the format of the table in NUREG 1302. In the event that some individual results are not available for inclusion with the report, the report shall be submitted noting and explaining the reasons for the missing results. The missing data shall be submitted as soon as possible in a supplementary report. The report shall also include the following: a summary description of the radiological environmental monitoring program and at least two legible maps. One map shall cover stations near the SITE BOUNDARY; a second shall include the more detailed distant stations. Covering all sampling locations keyed to a table giving distances and directions from the centerline of the reactor plant; the results of licensee participation in the Interlaboratory Comparison Program, required by Control 3.3.3 discussion of all deviations from the Sampling Schedule of Table 3.3-1; and discussion of all analyses in which the LLD required by Table 4.3-1 was not achievable.

The Annual Radiological Environmental Monitoring Report shall include a summary of Special Reports detailing level of radioactivity as the result of plant effluents in an environmental sampling medium exceed the reporting levels of Table 3.3-2.

6.0 ADMINISTRATIVE CONTROLS6.2 ANNUAL RADIOACTIVE EFFLUENT RELEASE REPORT

6.2 A Routine Annual Radioactive Effluent Release Report covering the operation of Unit 1 and Unit 2 during the previous year shall be submitted in accordance with Tech Spec section 6.9.1.8. The period of the first report shall begin with the date of initial criticality. A single unit submittal is made for the 2-unit station. The submittal combines those sections that are common to all units at the station. The Annual Radioactive Effluent Release Report shall include a summary of the quantities of radioactive liquid and gaseous effluents and solid waste released from the facility as outlined in Regulatory Guide 1.21, "Measuring, Evaluation, and Reporting Radioactivity in Solid Wastes and Releases of Radioactive Materials in Liquid and Gaseous Effluents from Light-Water-Cooled Nuclear Power Plants," Revision 1, June 1974, with data summarized on a quarterly basis following the format of Appendix B with the following exception: (1) Gaseous dose rates rather than effluent concentrations are used to calculate permissible release rates for gaseous releases. (2) ODCM Control 3.2.2.1 limits the dose equivalent rates due to the release of noble gases to less than or equal to 500 mrem per year to the total body and less than or equal to 3000 mrem per year to the skin. Therefore, the average beta and gamma energies (\bar{E}) of the radionuclide mixture in releases of fission and activation gases are not applicable. (3) Achieving doses of less than the limits of 10 CFR Part 50, Appendix I demonstrate that Limerick's gaseous effluents are ALARA. Therefore, calculations of total body doses to the population out to 50 miles from gaseous effluents are not performed.

The Annual Radioactive Effluent Release Report shall include an annual summary of hourly meteorological data collected over the previous year. This annual summary may be either in the form of an hour-by-hour listing on magnetic tape of wind speed, wind direction and atmospheric stability, and precipitation (if measured), or in the form of joint frequency distributions of wind speed, wind direction, atmospheric stability. The licensee has the option of retaining this summary of required meteorological data on site in a file that shall be provided to the NRC upon request. This same report shall include an assessment of the radiation doses due to the radioactive liquid and gaseous effluents released from both units during the previous calendar year. This same report shall also include an assessment of the radiation doses from radioactive liquid and gaseous effluents to MEMBER OF THE PUBLIC due to their activities inside the SITE BOUNDARY (Figures 1-1 and 1-2) during the report period. All assumptions used in making these assessments shall be included in these reports. The assessment of radiation doses shall be performed in accordance with the methodology and parameters of the OFFSITE DOSE CALCULATION MANUAL (ODCM).

The Annual Radioactive Effluent Release Report shall also include an assessment of radiation doses to the hypothetically highest exposed MEMBER OF THE PUBLIC from reactor releases, ISFSI and other nearby uranium fuel cycle sources (including doses from primary effluent pathways and direct radiation) for the previous calendar

6.0 ADMINISTRATIVE CONTROLS6.2 ANNUAL RADIOACTIVE EFFLUENT RELEASE REPORT

year to show conformance with 40 CFR Part 190, Environmental Radiation Protection Standards for Nuclear Power Operation. Dose contribution from liquid and gaseous effluents is calculated based on NUREG-0133 methodology.

The Annual Radioactive Effluent Release Reports includes the following information for each type of solid waste (as defined in 10 CFR Part 61) shipped offsite during the report period:

1. Total volume, activity and estimated total % error for each waste type:
 - a. Spent resins filter sludges, evaporator bottoms, etc.
 - b. Dry compressible waste, contaminated equipment, etc.
 - c. Irradiated components, control rods, etc.
 - d. Others (describe).
2. Activity and percentage of each principle radionuclide (>1%), for each individual waste type as defined in 1. (a-d) above.
3. The disposition of solid waste shipments (identify the number of shipments, the mode of transport, and the destination).
4. The disposition of irradiated fuel shipments (identify the number of shipments, the mode of transport, and the destination).

The Annual Radioactive Effluent Release Report includes a list and description of unplanned releases from the site to UNRESTRICTED AREAS of radioactive material in gaseous and liquid effluents made during the reporting period.

Changes made during the reporting period to procedure RW-AA-100 (formerly the PROCESS CONTROL PROGRAM) and to the ODCM, as well as a listing of new locations for dose calculations and/or environmental monitoring identified by the land use census pursuant to Control 3.3.2. shall be submitted in the form of a complete, legible copy of the entire ODCM as part of or concurrent with the Annual Radiological Effluent Release Report for the period of the report in which any change to the ODCM was made.

The Annual Radioactive Effluent Release Report shall include an explanation as to why the inoperability of liquid or gaseous effluent monitoring instrumentation was not corrected within the time specified in Controls 3.1.1 or 3.1.2, respectively;

The Annual Radioactive Effluent Release Report shall include a summary of Special Reports detailing why discharge of liquid radwaste or gaseous radwaste without treatment exceeded the time specified in Controls 3.2.1.3 or 3.2.2.4, respectively.

The Annual Radioactive Effluent Release Report shall include a summary of Special Reports for exceeding the calculated doses from the release of radioactive materials in liquid or gaseous effluents exceeding the limits of Controls 3.2.1.2.a., 3.2.1.2.b., 3.2.2.2.a., 3.2.2.2.b., 3.2.2.3.a., 3.2.2.3.b., 3.2.2.5.a., 3.2.2.5.b., 3.2.2.5.c., and 3.2.3.

6.0 ADMINISTRATIVE CONTROLS

6.3 MAJOR CHANGES TO RADIOACTIVE WASTE TREATMENT SYSTEMS

- 6.3 Licensee-initiated major changes to the radioactive waste systems (liquid, gaseous, and solid):
- a. Shall be reported to the Commission in the Annual Radioactive Effluent Release Report for the period in which the change was made effective. The discussion of each change shall contain:
1. A summary of the evaluation that led to the determination that the change could be made in accordance with 10 CFR 50.59;
 2. Sufficient detailed information to totally support the reason for the change without benefit of additional or supplemental information;
 3. A detailed description of the equipment, components, and processes involved and the interface with other plant systems;
 4. An evaluation of the change which shows the predicted releases of radioactive materials in liquid and gaseous effluents and/or quantity of solid waste that differ from those previously predicted in the license application and amendments thereto;
 5. An evaluation of the change which shows the expected maximum exposures to individual in the UNRESTRICTED AREA and to the general population that differ from those previously estimated in the license application and amendments thereto;
 6. A comparison of the predicted releases of radioactive materials, in liquid and gaseous effluents and in solid waste, to the actual releases for the period prior to when the changes are to be made; and
 7. An estimate of the exposure to plant operating personnel as a result of the change.

6.0 ADMINISTRATIVE CONTROLS

6.4 CHANGES TO THE ODCM

6.4 Licensee-initiated changes to the Offsite Dose Calculational Manual:

- a. Shall contain the program elements described in Technical Specifications 6.8.4.d, e and f.
- b. Shall be revised in accordance with the requirements described in Technical Specification 6.14.
- c. Shall be revised per applicable procedures detailing other requirements for making changes to the ODCM.
- d. Shall be reviewed and accepted by PORC and signed by the Plant Manager prior to implementation.

PART II

CALCULATION METHODOLOGIES

CALCULATION METHODOLOGIES

1.0 LIQUID EFFLUENTS

1.1 RADIATION MONITORING INSTRUMENTATION AND CONTROLS

The liquid effluent monitoring instrumentation and controls at Limerick for controlling and monitoring normal radioactive material releases in accordance with the Limerick ODCM Controls are summarized as follows:

- 1) Liquid Radwaste System: The liquid radwaste discharge monitor (RISH-63-0K604) provides an alarm and automatic termination of radioactive material releases from the liquid radwaste system as required by ODCM Control 3.1.1. Additional design features of the liquid radwaste system which prevent inadvertent releases to the environment include 1) redundant discharge valves, 2) single discharge line with loop seal and siphon breaker to eliminate probability of inadvertent discharges, 3) Low Cooling Tower Blowdown flow interlock which isolates the radwaste discharge line.
- 2) Service Water System: The Service Water discharge monitor (RISH-10-1K605 AND RISH-10-2K605) provides an alarm upon indication of activity in the service water system as required by ODCM Control 3.1.1. While the service water system is not a normal release pathway, the monitor provides an indication of potential problems due to excessive leakage of the heat exchangers. In addition, the service water side of the fuel pool heat exchangers is kept at a higher pressure than the shell side to prevent potential radioactive contamination of the service water.
- 3) RHR Service Water System: The RHR Service Water Radiation (RHRSW) Monitors (RISH-12-0K619A, RISH-12-0K619B) provide alarm and automatic termination* of radioactive material release from the RHRSW system, as required by ODCM Control 3.1.1. The Residual Heat Removal (RHR) Service Water System provides water from the Emergency Service Water (ESW) spray pond to the RHR heat exchangers. In post accident conditions, RHR Service Water can supply water for vessel and containment flooding. While the RHRSW system is not a normal release pathway, the monitors provide indication of potential problems due to excessive leakage of the heat exchangers.

*Termination of the release is accomplished by auto trip of the RHRSW pumps and remote manual closure of isolation valves.

CALCULATION METHODOLOGIES

1.2 LIQUID EFFLUENT MONITOR SETPOINT DETERMINATION

Per the requirements of ODCM Control 3.1.1, alarm setpoints shall be established for the liquid effluent monitoring instrumentation to ensure that the release concentration limits of ODCM Control 3.2.1.1 are met. The concentration of radioactive material released in liquid effluents to UNRESTRICTED AREAS shall be limited to 10 times the effluent concentration limits specified in 10 CFR 20, Appendix B, Table 2, Column 2, for radionuclides other than noble gases and $2.0E-04$ $\mu\text{Ci/ml}$ for dissolved or entrained noble gases (NUREG 0133).

1.2.1 Radwaste Discharge Monitor and Discharge Flow Rate – RISH-63-0K604

The setpoint for the liquid radwaste discharge monitor is determined by equation 1-1. The radwaste discharge monitor high-high alarm/isolation setpoint is calculated with each tank release based on isotopes detected in the liquid radwaste sample tank to be released ($\sum C_{iY}$), the default minimum cooling tower blowdown of 5,000 gallons per minute (CTBD), the radwaste discharge flow rate of 255 gpm and the maximum tank volume in gallons.

The flow rate determination is calculated for each release and determined by equation 1-2.

The ECL fraction calculated includes, in the concentration mix (dissolved and entrained noble gases), the most recent results the quarterly composite for SR-89, SR-90 and Fe-55, and the monthly composite for H-3 and gross alpha.

If the calculated setpoint is less than the existing setpoint, the setpoint will be reduced to the new value or the tank will be returned for more processing. If the calculated setpoint is greater than the existing setpoint, the setpoint may remain at the lower value or be increased to the higher calculated value.

The actual setpoint may be reduced to a value less than the calculated setpoint at the discretion of supervision.

CALCULATION METHODOLOGIES

1.2.1.1 Setpoint Determination – RISH-63-0K604

The setpoints for the liquid radwaste discharge monitor is determined by the following equations:

$$\text{Hi-Hi Setpoint} = CPM_{(LRD)} \leq \left[1 - \frac{(S)(RR)[\sum(C_{i\beta})/ECL_{i\beta}]}{(RR+CTBD)} \right] \left[\frac{(\sum C_{i\gamma})(RR+CTBD)}{(S)(E)(RR)(\sum C_{i\gamma}/ECL_{i\gamma})} \right] + BKG_{(LRD)} \quad (1-1)$$

$$\text{Hi Setpoint} = (F)(\text{Hi-Hi Setpoint}) + BKG_{(LRD)} \quad (1-1a)$$

where:

- $CPM_{(LRD)}$ = calculated liquid radwaste discharge monitor (RISH-63-0K604) count rate attributable to the gamma emitting radionuclide, cpm
- $\sum C_{i\gamma}$ = the sum of the concentration of the identified gamma emitting nuclides ($\mu\text{Ci/ml}$),
- CTBD = the required minimum cooling tower blowdown rate during discharge (gpm),
- RR = average liquid radwaste discharge flow (gpm),
- $BKG_{(LRD)}$ = background count rate of liquid radwaste discharge monitor (CPM),
- E = the gross detection efficiency of the liquid radwaste discharge monitor ($\mu\text{Ci/ml/cpm}$), and
- S = 2; margin of safety factor to assure that the release is terminated prior to 10 CFR 20 limits being exceeded. Included in this factor are errors associated with monitor uncertainty, sampling uncertainty, flow rate uncertainty, and the contribution of other release paths (Service Water and RHRSW) which are not normally contaminated.
- F = 0.75 (a factor less than 1 that is used to calculate the Hi-Setpoint)
- $\sum C_{i\gamma}/ECL_{i\gamma}$ = the effective gamma ECL ratio for the mixture of radionuclides in the liquid radwaste discharge line (unitless).

where:

- $C_{i\gamma}$ = the concentration of each identified gamma emitting radionuclide 'i' in the liquid effluent (undiluted) ($\mu\text{Ci/ml}$)
- $ECL_{i\gamma}$ = the ECL value for radionuclide 'i' corresponding to 10 times the ECL limit from 10 CFR 20 Appendix B, Table 2, Column 2 (dissolved and entrained noble gases ECL = $2.0\text{E-4 } \mu\text{Ci/ml}$)

CALCULATION METHODOLOGIES

$\sum C_{i\beta} / ECL_{i\beta}$ = the effective nongamma ECL ratio for the mixture of radionuclides in the liquid radwaste discharge line (unitless)

where:

$C_{i\beta}$ = the concentration of each identified nongamma radionuclide ' i ' in the liquid effluent (undiluted) ($\mu\text{Ci/ml}$)
* (See note below)

$ECL_{i\beta}$ = the ECL value for radionuclide ' i ' corresponding to 10 times the ECL limit from 10 CFR 20, Appendix B, Table 2, Column 2

* **NOTE:** The concentration mix must include the most recent sample data for H-3, Sr-89, Sr-90, Fe-55 and gross alpha.

EXAMPLE:

Given the following information:

Tank Discharge Rate: 255 gpm

Cooling Tower Blowdown: 5000 gpm

Monitor Efficiency: 3.66E-09

Radwaste sample activity:

Nuclide	Activity $\mu\text{Ci/ml}$	10 x ECL	Pre Dilution ECL Fraction
H-3	3.19E-03	1.00E-02	3.19E-01
Mn-54	9.00E-08	3.00E-04	3.00E-04
Co-60	7.00E-08	3.00E-05	2.33E-03
Cs-137	1.10E-07	1.00E-05	1.10E-02
Total Beta	3.19E-03		3.19E-01
Total Gamma	2.70E-07		1.36E-02

$$5.402E + 04 \leq \left[1 - \frac{(2)(255)[(3.19E-01)]}{(255+5000)} \right] \left[\frac{(2.70E-07)(255+5000)}{(2)(3.66E-09)(255)(1.36E-02)} \right] + 0.00$$

1.2.1.2 Flow Rate Determination

The maximum liquid radwaste tank flow rate discharge to the river is determined by the following equation:

CALCULATION METHODOLOGIES

$$FLOW_{(LRD)} \leq \frac{CTBD}{S \left| \sum (C_i / ECL_i) - 1 \right|} \quad (1-2)$$

where:

$FLOW_{(LRD)}$ = flow limit for radwaste discharge line (gpm).

CTBD = required minimum cooling tower blowdown flow during discharge (gpm).

S = 2; margin of safety factor to assure that the release does not exceed 10 CFR 20 limits.

$\sum(C_i/ECL_i)$ = the effective ECL ratio for the mixture of radionuclides in the liquid radwaste discharge line (unitless) for $\sum(C_i/ECL_i) > 1$. If $\sum(C_i/ECL_i) < 1$, then no flow rate determination is necessary.

where:

C_i = the concentration of each identified radionuclide ' i ' in the liquid effluent (undiluted) ($\mu\text{Ci/ml}$)* (See note below)

ECL_i = the ECL value for radionuclide ' i ' corresponding to 10 times the ECL limit from 10 CFR 20 Appendix B, Table 2, Column 2, (dissolved and entrained noble gases $ECL = 2E-4 \mu\text{Ci/ml}$).

* **NOTE:** The concentration mix must include the most recent sample data for H-3, Sr-89, Sr-90, Fe-55, gross alpha and dissolved and entrained noble gases.

1.2.2 Service Water Radiation Monitor – RISH-010-1K605, -2K605 RHR Service Water Monitor – RISH-012-0K619A, -0K619B

The High-High radiation setpoints for the Service Water and the RHR Service Water monitors are set at 10 times the Cs 137 Effluent Concentration Limits (ECL) of $1.0E-06 \mu\text{Ci/mL}$. Considering the radionuclides predominant in the Limerick reactors (e.g., Co-58, Co-60, Fe-59, Mn-54, Zn-65 and Cr-51), the use of a setpoint based on the Cs-137 Effluent Concentration Limit (ECL) is reasonable due to the following parameters:

- 1) High photon abundance (85%),
- 2) Spectrum midrange photon energy (0.662 MeV)
- 3) Conservative magnitude of the applicable ECL limit ($1.0E-05 \mu\text{Ci/ml}$)

CALCULATION METHODOLOGIES

The Service Water and the RHR Service Water maximum Radiation Monitor (High-High) setpoint is determined by the following equation to meet the requirements of ODCM Control 3.2.1.1.

The High Setpoint shall be administratively controlled to a value that is less than the High-High setpoint.

1.2.2.1 Setpoint Determination

The setpoints for the Service Water and RHR Service Water Radiation Monitors are determined by the following equations:

$$\text{Hi-Hi Setpoint} = \text{CPM} = (10 * ECL_{Cs-137})(CF) + (0.5)B \quad (1-3)$$

$$\text{Hi Setpoint} = (F)(\text{Hi-Hi Setpoint}) \quad (1-4)$$

where:

CPM = calculated maximum radiation monitor (RISH-010-1K605, -2K605, RISH-012-0K619A, -0K619B) count rate, cpm

10 = 10 times the ECL limit from 10 CFR 20 Appendix B, Table 2, Column 2 to maintain the 500 mrem/yr instantaneous release limits

ECL_{Cs-137} = ECL limit for Cs-137 (1.0E-06 $\mu\text{Ci/ml}$)

CF = monitor calibration factor - in cpm/ $\mu\text{Ci/ml}$

B = Background count rate (cpm)

F = a factor less than 1 that is used to calculate the Hi-Setpoint.

$$F_{\text{Service Water}} = 0.75$$

$$F_{\text{RHR Service Water}} = 0.50$$

1.3 LIQUID EFFLUENT DOSE CALCULATION - 10 CFR 50

1.3.1 Dose to Members of the Public

Control 3.2.1.2 limits the dose or dose commitment to MEMBERS OF THE PUBLIC from radioactive materials in liquid effluents from Limerick Generating Station to:

During any Calendar Quarter	During any Calendar Year
≤ 3 mrem to total body	≤ 6 mrem to total body
≤ 10 mrem to any organ.	≤ 20 mrem to any organ

CALCULATION METHODOLOGIES

Per Surveillance Requirement 4.2.1.2 the cumulative dose contribution from liquid effluents for the current calendar quarter and calendar year shall be determined at least once per 31 days in accordance with the following calculation methods. The results are accumulated to give the quarterly doses and the quarterly results are accumulated to give the annual doses.

Receptor Location	Dist. (mi)	Pathways		
		Potable Water	Fish	Shoreline
LGS Outfall	0		X	X
PA. American Water	2.5	X	X	X
Phoenixville Water	9.0	X	X	X
Aqua America	13.6	X		X
Crew Course	37.8			X

Software currently used at the Limerick Generating Station calculates doses from liquid releases based upon the methodology presented in NUREG-0133.

The NUREG-0133 methodology is based upon that presented in Reg. Guide 1.109, but has been simplified. Comparisons between the two methodologies indicate the doses calculated by NUREG-0133 are approximately 3 to 5% higher than those calculated using Reg. Guide 1.109 methodology.

1.3.1.1 Aquatic Pathway - NUREG-0133

$$D_{\tau} = \frac{\sum_i \left[A_{i\tau} \sum_{\ell=1}^m \Delta t_{\ell} C_{i\ell} F_{\ell} \right]}{D_w} \quad (1-5)$$

where:

- D_{τ} = The cumulative dose commitment to the total body or any organ, τ , from liquid effluents for the total time period $\sum_{\ell=1}^m \Delta t_{\ell}$, in mrem.
- Δt_{ℓ} = The length of the ℓ th time period over which $C_{i\ell}$ and F_{ℓ} are averaged for the liquid release, in hours.
- $C_{i\ell}$ = The average concentration of radionuclide, i , in undiluted liquid effluent during time period Δt_{ℓ} , from any liquid release,

CALCULATION METHODOLOGIES

(determined by the effluent sampling analysis program, ODCM Part I, Table 4.2-1, in uCi/ml).

F_ℓ = The near field average dilution factor for C_{i_ℓ} during any liquid effluent release. Defined as the ratio of the maximum undiluted liquid waste flow during the release to the average flow through the discharge pathway (minimum factor is 0.04853) defined by the following:

$$F_\ell = \frac{(\text{tank volume}_{\text{gallons}})}{(\text{tank volume}_{\text{gallons}}) + (\text{Cooling Tower Dilution}_{\text{gallons}})} \quad (1-6)$$

D_w = The dilution factor at point of exposure or at point of withdrawal of drinking water (dimensionless). Values are based on average daily river flow. D_w factors are calculated in equations 1-7 through 1-11.

$$\text{LGS Outfall} \quad 0.685 + 0.026 * \text{rflow} \quad (1-7)$$

$$\text{American Water} \quad 0.237 * \text{rflow}^{1.17} \quad (1-8)$$

$$\text{Phoenixville Water} \quad 0.121 * \text{rflow}^{0.973} \quad (1-9)$$

$$\text{Aqua America} \quad 0.089 * \text{rflow}^{0.993} \quad (1-10)$$

$$\text{Phil. Crew Course} \quad 0.076 * \text{rflow}^{0.996} \quad (1-11)$$

where:

rflow is river flow in ft³/sec.

$A_{i\tau}$ = The site specific ingestion dose commitment factor to the total body or organ, τ , for each radionuclide and pathway listed in Table II1-10 through Table II1-17 in mrem-mL per uCi-hr. $A_{i\tau}$ for each pathway and age group are calculated using the following equations:

Drinking Water

$$A_{i\tau} = k_0 * U_w * D_{aipj} * RC * e^{(-\lambda_i t_p^D)} \quad (1-12)$$

Freshwater Fish

$$A_{i\tau} = k_0 * U_F * BF_i * D_{aipj} * RC * e^{(-\lambda_i t_p^F)} \quad (1-13)$$

Shoreline

$$A_{i\tau} = k_{0S} * U_s * W * T_i * D_{aipj} * RC \left(e^{-\lambda_i t_p^S} \right) \left(1 - e^{-\lambda_i T_b} \right) \quad (1-14)$$

where:

k_0 = 114155, units conversion factor (1.0 E6 pCi/uCi * 1000 ml/L/ 8760 hr/yr). Note for fish units are g/kg.

CALCULATION METHODOLOGIES

k_{0S}	=	11416000, units conversion factor to account for the proportionality constant used in the sediment radioactivity model. (100 L/kg-hr kg/m ² hr/day * 1000 ml/L * 1.0E6 pCi/uCi/8760 hr/yr).
U	=	usage factor per pathway – Table II1-8.
D_{aipj}	=	dose conversion factor for nuclide, i , for total body or any organ, τ , in mrem/pCi, from Tables II1-3 through II1-7.
BF_i	=	bioaccumulation factor for nuclide, i , in fresh water fish, pCi/kg per pCi/L, from Table II1-2.
RC	=	reconcentration factor as indicated in Table II1-21.
W	=	shoreline width factor (dimensionless) as indicated in Table II1-21.
T_i	=	radioactive half-life of nuclide ' i ' (days) from Table II1-1.
λ_i	=	radioactive decay constant of nuclide ' i ' (hr ⁻¹) from Table II1-1.
t_p^D	=	delay time for water pathway in hours to allow for nuclide decay during transport through the water purification plant and the water distribution system as indicated in Table II1-21.
t_p^F	=	delay time for fish pathway to allow for nuclide decay during transport through the food chain, as well as during food preparation as indicated in Table II1-21.
t_p^S	=	delay time in hours for shoreline pathway as indicated in Table II1-21. Zero hours are assumed as shoreline activities can occur at the outfall.
T_b	=	time period during which sediment is exposed to contaminated water as indicated in Table II1-21.

1.3.2 Liquid Effluent Dose Projections

Control 3.2.1.3 requires that the liquid radwaste treatment system shall be operable and appropriate portions of the systems used to reduce the radioactive materials in liquid waste prior to their discharge when the projected doses due to the liquid effluent to UNRESTRICTED AREAS would exceed:

0.12 mrem to the total body

or

0.4 mrem to any organ.

Dose projections are made at least once per 31-days when liquid radwaste treatment systems are not being fully utilized using the following equations:

$$D_{tbp} = (D_{tb}/d) * 31 \text{ days} \quad (1-15)$$

$$D_{maxp} = (D_{max}/d) * 31 \text{ days} \quad (1-16)$$

CALCULATION METHODOLOGIES

where:

- D_{tbp} = the total body dose projection for the current 31-day period (mrem).
- D_{tb} = the total body dose to date for the current calendar quarter as determined by equation 1-5 (mrem).
- D_{maxp} = the maximum organ dose projection for the current 31-day period (mrem).
- D_{max} = the maximum organ dose to date for the current calendar quarter as determined by equations 1-5 (mrem).
- d = the actual number of days in the current calendar quarter at the end of the release (days).
- 31 days = the number of days of concern

CALCULATION METHODOLOGIES

2.0 GASEOUS EFFLUENTS

2.1 RADIATION MONITORING INSTRUMENTATION AND CONTROLS

The gaseous effluent monitoring instrumentation and controls at Limerick for controlling and monitoring radioactive material releases in accordance with the ODCM Part I are summarized as follows:

- 1) North Vent (Common): The plant gaseous discharges via this vent are monitored by two Particulate, Iodine and Gas (PIG) monitors (RY26-075A and RY26-075B) in parallel and by the Wide Range Accident Monitor (WRAM) (RY26-076). The PIGS have separate Particulate, Iodine, and Gas sampling and monitoring channels but the Controls require only particulate and iodine sampling and noble gas monitoring. The WRAM has extended range (via three channels) noble gas monitoring and particulate and iodine sampling capability. In addition, the WRAM provides an isolation (Group 6A) of the large Drywell Purge and Vent valves.
- 2) South Vent (one per unit): The plant gaseous discharges via each South Vent are monitored by two redundant PIG monitors (RY26-285A,B). As is the case of the North Vent, each PIG has separate particulate, iodine, and gas sampling and monitoring channels but the Controls require only particulate and iodine sampling with gas monitoring.
- 3) Hot Maintenance Shop (Common): Due to the composition of the radioactive materials in the effluent steam (i.e., very low potential for noble gas), this release point is sampled by a particulate and iodine (P&I) monitor (RY26-025). The P&I monitor has a separate particulate and iodine sampling and monitoring channels but Controls require only particulate and iodine sampling.
- 4) Main Condenser Offgas Pre Treatment (one per unit): The function of the offgas system is to collect and delay release of noncondensable radioactive gases removed from the main condenser by the air ejectors during normal plant operation. The gaseous discharge is monitored by 2 redundant gamma-ion chambers (RISH-026-*K601A,B).

2.2 GASEOUS EFFLUENT MONITOR SETPOINT DETERMINATION

Control 3.1.2 requires that an alarm setpoint be established for the noble gas effluent monitoring channels (RY26-075A(B), RY26-185A(B), RY26-285A(B), RY26-076, RISH-026-1K601A(B), and RISH-026-2K601A(B)) to ensure that the release rate of radioactive materials does not exceed the limits of Control

CALCULATION METHODOLOGIES

3.2.2.1.a, which corresponds to a dose rate at the SITE BOUNDARY of 500 mrem/yr to the total body or 3000 mrem/yr to the skin.

Control limits are expressed in terms of dose rate, while the instruments that monitor effluents produce data in units of concentration or release rate. It is therefore necessary to identify the isotopes and calculate the corresponding release rate that will result in the dose rate limit being reached at the site boundary. This calculation is made more complex by the use of multiple release points at LGS.

Additionally, Control 3.1.2 requires that the alarm setpoint be established for the noble gas monitoring channels RISH-026-*K601A(B) so that the rate of the sum of the activities of the noble gases Kr-85m, Kr-87, Kr-88, Xe-133, Xe-135, and Xe-138 measured at the recombiner after-condenser discharge shall be limited to less than or equal to 330 millicuries/second, as stated in LGS Technical Specification 3.11.2.6.

Calculation Bases

RY26-075A(B), RY26-185A(B), RY26-285A(B), RY26-076

The alarm setpoint calculation is performed whenever the default Hi-Hi setpoint alarms based on analytical results of grab samples from the appropriate release point. The concentration of each identified radionuclide in the grab samples is determined, and the data is used to perform a setpoint calculation for that nuclide mix and release point.

The highest calculated annual average concentration (χ/Q) for an area at or beyond the site boundary (Table II2-31) is used in the setpoint calculation. Maximum flow rates through the North and South vents are used in alarm setpoint calculations. This is necessary since flow can vary. By using maximum values, any flow less than the maximum will assure that the monitor will alarm before release rate limits are exceeded.

The fractional contribution of noble gas is calculated for each release point. The fractional contribution to the whole body and skin dose rates due to noble gases for the north stack and south stack vents are calculated by taking the product of this fraction and the limiting release rate. A comparison of the release rate for whole body and skin dose rates due to noble gas release is made to determine if the whole body or skin dose limit will be most restrictive. It is expected that the whole body limit will always be most restrictive, but the comparison is necessary to assure compliance with Control 3.2.2.1. The sum of the contributions from each release point, independently calculated for noble gases, will equal the maximum instantaneous release rate allowed from the site.

CALCULATION METHODOLOGIES

RISH-026-1K601A(B), RISH-026-2K601A(B)

The alarm setpoint calculation is performed monthly. The current radiation monitor reading and most recent offgas sample data (sum of six and radiation monitor reading) is used for each setpoint calculation performed.

2.2.1 North Vent Noble Gas Effluent Monitors (RY26-075A-3, RY26-075B-3, and RY26-076-2)

The North Vent Noble Gas Effluent monitor high-high setpoint is calculated whenever the default Hi-Hi setpoint alarms based on the grab sample results performed in accordance with Table 4.2-2. If any calculated alarm setpoint is less than the existing monitor setpoint, the setpoint will be reduced to the new value. If the calculated setpoint value is greater than the existing value, the setpoint may remain at the lower value or be increased to the new value.

2.2.1.1 Setpoint Determination

The High-High setpoint is calculated per equation 2-1 or 2-2. The High-High setpoint for the North Vent Noble Gas Effluent Monitor is set at or below the lesser of the NVSP(Hi-Hi)_{NGWB} OR NVSP(Hi-Hi)_{NGSK} value (equations 2-1 or 2-2).

$$NSVP(HI-HI)_{NGWB} \leq \frac{[VF_{NVNG}][500][\Sigma C_{iNV}]}{[3.471E + 9] \Sigma[(C_{iNV})(K_i)]} \quad (2-1)$$

$$NVSP(Hi - Hi)_{NGSK} \leq \frac{[VF_{NVNG}][3000][\Sigma C_{iNV}]}{[3.471E + 9] \Sigma[(C_{iNV})(L_i + 1.11M_i)]} \quad (2-2)$$

The High Setpoint shall be administratively controlled to a value that is less than the High-High Setpoint.

$$Hi \text{ Setpoint} = (F)(Hi-Hi \text{ Setpoint}) \quad (2-2a)$$

where:

NVSP (Hi-Hi)_{NGSK} = north vent high-high setpoint - noble gas skin ($\mu\text{Ci/cc}$).

NVSP (Hi-Hi)_{NGWB} = north vent high-high setpoint - noble gas whole body ($\mu\text{Ci/cc}$).

VF_{NVNG} = fractional contribution to site boundary noble gas dose rate from the North Vent. (unitless).

500 = total body dose rate limit (mrem/yr)

CALCULATION METHODOLOGIES

$$\begin{aligned}
 3000 &= \text{skin dose rate limit (mrem/yr)} \\
 \sum C_{iNV} &= \text{total noble gas activity from North Vent grab sample} \\
 &\quad (\mu\text{Ci/cc}) \\
 F &= 0.289855 \text{ (a factor less than 1 that is used to calculate the} \\
 &\quad \text{Hi-Setpoint)} \\
 3.471E+9 &= \text{conversion factor, units are } \frac{(p\text{Ci})(\text{cc})}{(\mu\text{Ci})(\text{m}^3)} \\
 &\quad \left(\frac{1.1E-5 \text{ sec}}{\text{m}^3} \right) \left(\frac{1.0E+6 \text{ pCi}}{\mu\text{Ci}} \right) \left(\frac{668,450 \text{ ft}^3}{\text{min}} \right) \left(\frac{1 \text{ min}}{60 \text{ sec}} \right) \left(\frac{2.832E+4 \text{ cc}}{\text{ft}^3} \right) \quad (2-3)
 \end{aligned}$$

where:

$$\begin{aligned}
 1.1E-5 \text{ sec/m}^3 &= \text{highest annual average } \chi/Q \text{ (NE Sector)} \\
 1E+6 \text{ pCi}/\mu\text{Ci} &= \text{units conversion} \\
 668,450 \text{ cfm} &= \text{maximum North Vent flow rate for two unit operation} \\
 1 \text{ min}/60 \text{ sec} &= \text{units conversion} \\
 2.832E+4 \text{ cc/ft}^3 &= \text{units conversion} \\
 C_{iNV} &= \text{concentration of noble gas nuclide ' i ' as determined by radioanalysis of North Vent grab sample } (\mu\text{Ci/cc}). \\
 K_i &= \text{total body dose conversion factor for noble gas nuclide ' i ' (mrem/yr per pCi/m}^3, \text{ from ODCM Table II2-1).} \\
 L_i &= \text{beta skin dose conversion factor noble gas nuclide ' i ' (mrem/yr per pCi/m}^3, \text{ from ODCM Table II2-1).} \\
 M_i &= \text{gamma air dose conversion factor for noble gas nuclide ' i ' (mrad/yr per pCi/m}^3, \text{ From ODCM Table II2-1).} \\
 1.11 &= \text{the average ratio of tissue to air energy absorption coefficients (mrem/mrad) (Ref: Regulatory Guide 1.109, Section 2.0).}
 \end{aligned}$$

2.2.2 South Vent Noble Gas Effluent Monitors (RY26-185A-3, RY26-185B-3, RY26-285A-3, and RY26-285B-3)

Each unit's South Vent Noble Gas Effluent monitor High-High setpoint is calculated whenever the default Hi-Hi setpoint alarms based on the grab sample results performed in accordance with ODCM Part I, Table 4.2-2. If any calculated alarm setpoint is less than the existing monitor setpoint, the setpoint will be reduced to the new value. If the calculated setpoint value is greater than the existing value, the setpoint may remain at the lower value, or be increased to the new value.

CALCULATION METHODOLOGIES

2.2.2.1 Setpoint determination

The High-High setpoint for the South Vent Noble Gas Effluent Monitor is set at the lesser of the $SVSP(Hi-Hi)_{NGWB}$ and $SVSP(Hi-Hi)_{NGSK}$ value. $SVSP(Hi-Hi)_{NGWB}$ and $SVSP(Hi-Hi)_{NGSK}$ are calculated for each unit's South Vent.

The High-High setpoint is calculated per equation 2-4 or 2-5.

$$SVSP(HI-HI)_{NGWB} \leq \frac{[VF_{SVNG}][500][\sum C_{isv}]}{[1.2149E + 9]\sum[(C_{isv})(K_i)]} \quad (2-4)$$

$$SVSP(HI-HI)_{NGSK} \leq \frac{[VF_{SVNG}][3000][\sum C_{isv}]}{[1.2149E + 9]\sum[(C_{isv})(L_i + 1.11M_i)]} \quad (2-5)$$

The High Setpoint shall be administratively controlled to a value that is less than the High-High Setpoint.

$$Hi \text{ Setpoint} = (F)(Hi-Hi \text{ Setpoint}) \quad (2-5a)$$

where:

$SVSP(Hi-Hi)_{NGWB}$	= south vent high-high setpoint - noble gas whole body ($\mu\text{Ci/cc}$)
$SVSP(Hi-Hi)_{NGSK}$	= south vent high-high setpoint - noble gas skin ($\mu\text{Ci/cc}$)
VF_{SVNG}	= fractional contribution to site boundary noble gas dose rate from the Unit's South Vent. (unitless)
500	= total body dose rate limit (mrem/yr)
3000	= skin dose rate limit (mrem/yr)
F	= 0.5 (a factor less than 1 that is used to calculate the Hi-Setpoint)
$\sum C_{isv}$	= total noble gas activity from each unit South Vent grab sample ($\mu\text{Ci/cc}$).
C_{isv}	= concentration of noble gas nuclide ' i ' determined by radioanalysis of South Vent grab sample ($\mu\text{Ci/cc}$)
K_i	= total body dose conversion factor for noble gas nuclide ' i ' (mrem/yr per pCi/m ³ , from ODCM Table II2-1).
L_i	= beta skin dose conversion factor noble gas nuclide ' i ' (mrem/yr per pCi/m ³ , From ODCM Table II2-1).
M_i	= gamma air dose conversion factor for noble gas nuclide ' i ' (mrad/yr per pCi/m ³ , From ODCM Table II2-1).

CALCULATION METHODOLOGIES

1.11 = the average ratio of tissue to air energy absorption coefficients (mrem/mrad) (Ref: Regulatory Guide 1.109, Section 2.0)

1.2149E+9 = conversion factor units are in $\frac{(pCi)(cc)}{(\mu Ci)(m^3)}$

$$\left(\frac{1.1E-5 \text{ sec}}{m^3}\right) \left(\frac{1.0E+6 \text{ pCi}}{\mu Ci}\right) \left(\frac{2.34E+5 \text{ ft}^3}{\text{min}}\right) \left(\frac{1 \text{ min}}{60 \text{ sec}}\right) \left(\frac{2.832E+4 \text{ cc}}{\text{ft}^3}\right) \quad (2-6)$$

where:

1.1E-5 sec/m³ = highest annual average χ/Q (NE Sector)

1E+6 pCi/ μ Ci = units conversion

2.34E+5 ft³/m = maximum South Vent flow rate

1/60 min/sec = units conversion

2.832E+4 cc/ft³ = units conversion

2.2.3 Noble Gas Effluent Fractional Contribution

The three release points will be partitioned such that the sum does not exceed 100 percent of the limit (500 mrem/yr whole body noble gas, 3000 mrem/yr skin noble gas.) The default fraction will be set at 80 percent for the North Vent, 10 percent for the Unit-1 South Vent and 10 percent for the Unit-2 South Vent.

These percentages can vary should operational concentrations warrant such change. However, the sum of the percentages shall be equal to or less than 100%.

The following relationship shall be met:

$$VF_{NVNG} + VF_{1SVNG} + VF_{2SVNG} \leq 1 \quad (2-7)$$

where:

VF_{NVNG} = fractional contribution to site boundary noble gas total body dose rate from the North Vent (unitless).

VF_{1SVNG} = fractional contribution to site boundary noble gas total body dose rate from the Unit 1 South Vent (unitless).

VF_{2SVNG} = fractional contribution to site boundary noble gas total body dose rate from the Unit 2 South Vent (unitless).

2.2.4 Noble Gas Effluent Default Setpoint

This methodology may be used when grab sample results from either the North Vent or the South Vent do not identify any radionuclides. This methodology is based on expected release concentration ratios as outlined in Section 11.3 of the Limerick UFSAR.

CALCULATION METHODOLOGIES

2.2.4.1 North Vent Noble Gas Monitors (RY26-075A-3 and RY26-075B-3). The default High-High setpoint for the North Vent Noble Gas Effluent Monitor is set at or below the NVSP(Hi-Hi)_{NGD} value.

$$\text{NVSP}(\text{Hi} - \text{Hi})_{\text{NGD}} \leq \frac{[8.00\text{E} - 1][500][1.31\text{E} - 6]}{[3.471\text{E} + 9][4.37\text{E} - 9]} \quad (2-8)$$

$$\text{NVSP}(\text{Hi-Hi})_{\text{NGD}} \leq 3.45\text{E-5 } \mu\text{Ci/cc}$$

where:

NVSP(Hi-Hi)_{NGD} = default north vent high-high setpoint - noble gas whole body ($\mu\text{Ci/cc}$)

8.00E-1 = default fractional contribution to site boundary noble gas total body dose rate from the North Vent (unitless) .

500 = total body dose rate limit (mrem/yr).

1.31E-6 = total noble gas concentration from North Vent ($\mu\text{Ci/cc}$).

Ref: a) based on UFSAR Table 11.3-1.

b) based on maximum North Vent flow of 668,450 cfm.

3.471E+9 = conversion factor, units are in $\frac{(p\text{Ci})(\text{cc})}{(\mu\text{Ci})(\text{m}^3)}$. See Equation

2-3.

4.37E-9 = summation of the north vent concentration of noble gas nuclide ' i ' multiplied by the corresponding whole body dose factor. Units are in $\frac{(\mu\text{Ci})(\text{mrem})(\text{m}^3)}{(\text{cc})(\text{yr})(p\text{Ci})}$

Ref: a) based on UFSAR Table 11.3-1.

b) based on maximum North Vent flow of 668,450 cfm.

c) ODCM Table II2-1.

2.2.4.2 South Vent Noble Gas Monitors (RY26-185A-3, RY26-285A-3, RY26-185B-3, and RY26-285B-3). The default High-High setpoint for each Unit's South Vent Noble Gas Effluent Monitor is set at or below the SVSP(Hi-Hi)_{NGD} value.

$$\text{SVSP}(\text{Hi} - \text{Hi})_{\text{NGD}} \leq \frac{[1.00\text{E} - 1][500][1.02\text{E} - 7]}{[1.2149\text{E} + 9][2.71\text{E} - 10]} \quad (2-9)$$

$$\text{SVSP}(\text{Hi-Hi})_{\text{NGD}} \leq 1.54\text{E-5 } \mu\text{Ci/cc}$$

where:

SVSP(Hi-Hi)_{NGD} = default south vent setpoint - noble gas ($\mu\text{Ci/cc}$).

CALCULATION METHODOLOGIES

1.00E-1	= default fractional contribution to site boundary noble gas total body dose rate from the South Vent (unitless).
500	= total body dose rate limit (mrem/yr).
1.02E-7	= total noble gas concentration from South Vent ($\mu\text{Ci/cc}$). Ref: a) Based on UFSAR Table 11.3-1. b) Based on maximum South Vent flow of 234,000 cfm.
1.2149E+9	= conversion factor, units are in $\frac{(p\text{Ci})(cc)}{(\mu\text{Ci})(m^3)}$. See Equation 2-6.
2.71E-10	= summation of the south vent concentration of noble gas nuclide ' i ' multiplied by the corresponding whole body dose factor. Units are in $\frac{(\mu\text{Ci})(mrem)(m^3)}{(cc)(yr)(p\text{Ci})}$ Ref: a) Based on UFSAR Table 11.3-1. b) Based on maximum South Vent flow of 234,000 cfm. c) ODCM Table II2-1.

2.2.5 Wide Range Accident Monitor Noble Gas Effluent Monitor (RIX-26-076-4)
The Wide Range Accident Monitor (WRAM) noble gas total effluent channel displays the North Vent noble gas release rate. This monitor has Main Control Room Annunciation as well as a group 6A isolation function on the primary containment purge and vent valves. The isolation setpoint value of $\leq 2.1 \mu\text{Ci/cc}$ specified in Technical Specification Table 3.3.2-2 is based on the accident dose limits for containment purge during an accident (Ref: UFSAR Section 1.13). For routine operations the total effluent high and high-high setpoints are based upon the methodology of Sections II 2.2.5.1 and II 2.2.5.2. The setpoint units are in microcuries per second using the two-unit maximum North Vent flow rate of 668,450 scfm. The total effluent channel High-High setpoint is set at a value less than or equal to ten times the High setpoint (not to exceed the $2.1 \mu\text{Ci/cc}$ equivalent using the two-unit maximum North Vent flow rate). These values are always more conservative than the Technical Specification Table 3.3.2-2 required value of $\leq 2.1 \mu\text{Ci/cc}$.

CALCULATION METHODOLOGIES

If the calculated setpoint value is less than the existing monitor setpoint, the setpoint will be reduced to the new value. If the calculated setpoint is greater than the existing value, the setpoint may remain at the lower value, or be increased to the new value.

2.2.5.1 Routine Operations High Setpoint Determination

For routine operations, the High setpoint for the WRAM Noble Gas Total Effluent Channel is set at or below the lesser of the $NVSP(Hi-Hi)_{NGWB}$ or $NVSP(Hi-Hi)_{NGSK}$ value when activity is detected. When no activity is detected, the High setpoint is set at or below the $NVSP(Hi-Hi)_{NGD}$. This setpoint is calculated to ensure compliance with Control 3.2.2.1.a.

The setpoint values are converted from $\mu Ci/cc$ to $\mu Ci/sec$ using the maximum two-unit North Vent flow rate:

$$WRAM(Hi)_{WB} = [NVSP(Hi-Hi)_{NGWB \text{ OR } NGD}] [3.155E+8] \quad (2-10)$$

$$WRAM(Hi)_{SK} = [NVSP(Hi-Hi)_{NGSK}] [3.155E+8] \quad (2-11)$$

where:

$WRAM(Hi)_{WB}$ = WRAM total effluent channel north vent high setpoint - noble gas whole body ($\mu Ci/sec$).

$WRAM(Hi)_{SK}$ = WRAM total effluent channel north vent high setpoint - noble gas skin ($\mu Ci/sec$).

$NVSP(Hi-Hi)_{NGWB}$
OR NGD = North Vent high-high setpoint - noble gas whole body ($\mu Ci/cc$) from equation 2-1 or 2-8.

$NVSP(Hi-Hi)_{NGSK}$ = North Vent high-high setpoint - noble gas skin ($\mu Ci/cc$) from equation 2-2.

$$3.155E+8 = \text{conversion factor (cc/sec)} \\ = \left(\frac{668,450 \text{ sft}^3}{\text{min}} \right) \left(\frac{1 \text{ min}}{60 \text{ sec}} \right) \left(\frac{2.832E+4 \text{ cc}}{\text{ft}^3} \right) \quad (2-12)$$

2.2.5.2 Routine Operations High-High Setpoint Determination

For routine operations, the High-High setpoint for the WRAM Noble Gas total effluent channel is set at or below ten times the lesser of the routine operations $WRAM(Hi)_{WB}$ or $WRAM(Hi)_{SK}$ value.

$$WRAM(Hi-Hi)_{WB} = [WRAM(Hi)_{WB}] [10] \quad (2-13)$$

$$WRAM(Hi-Hi)_{SK} = [WRAM(Hi)_{SK}] [10] \quad (2-14)$$

where:

CALCULATION METHODOLOGIES

$WRAM(Hi-Hi)_{WB}$	= WRAM total effluent channel north vent high-high setpoint noble gas whole body ($\mu Ci/sec$).
$WRAM(Hi-Hi)_{SK}$	= WRAM total effluent channel north vent high-high setpoint noble gas skin ($\mu Ci/sec$).
$WRAM(Hi)_{WB}$	= WRAM total effluent channel north vent high setpoint - noble gas whole body ($\mu Ci/sec$) from equation 2-10.
$WRAM(Hi)_{SK}$	= WRAM total effluent channel north vent setpoint - noble gas skin ($\mu Ci/sec$) from equation 2-11.
10	= multiplication factor to calculate high-high value (unitless)

2.2.6 MAIN CONDENSER OFFGAS PRE-TREATMENT RADIATION MONITOR

Restricting the gross radioactivity rate of noble gases from the main condenser provides reasonable assurance that the total body exposure to an individual at the exclusion area boundary will not exceed a small fraction of the limits of 10 CFR Part 100 in the event this effluent is inadvertently discharged directly to the environment without treatment. This specification implements the requirements of General Design Criteria 60 and 64 of Appendix A to 10 CFR Part 50.

The setpoint methodology can be found in the appropriate surveillance tests for RISH-026-1K601A(B), and RISH-026-2K601A(B).

CALCULATION METHODOLOGIES

2.3 GASEOUS EFFLUENT DOSE EVALUATION

Dose calculations are performed based on limiting sector average annual meteorological dispersion parameters. For the noble gas dose calculation, effluent release data are based on grab sample analysis for radionuclide composition and weekly stack effluent radiation monitor readings. For the iodine and particulate dose calculations, the effluent release radionuclide composition and release activity are based on weekly continuous samples.

The quarterly and annual dose calculations are a summation of the applicable dose results for the period of interest.

2.3.1 Site Boundary Dose Rate - Noble Gases (10CFR20 Limits)

Control 3.2.2.1.a limits the dose rate in gaseous effluents from the site to areas at or beyond the SITE BOUNDARY due to noble gas releases to ≤ 500 mrem/yr total body and ≤ 3000 mrem/yr skin. Radiation monitor alarm setpoints are established to ensure that these release limits are not exceeded.

Simultaneous releases from the North and South Vents are considered in evaluating compliance with the release rate limits of Control 3.2.2.1.a. following any releases exceeding the alarm setpoints. Monitor indications (readings) are averaged over time periods not to exceed 60 minutes.

NOTE: For administrative purposes, more conservative alarm setpoints than those required to meet 10 CFR 20 Dose Rate limits are imposed. However, conditions exceeding these more limiting alarm setpoints do not necessarily indicate radioactive material release rates exceeding the dose limits of Control 3.2.2.1.a. Provided actual releases do not result in radiation monitor indications exceeding values based on the dose rate limits of Control 3.2.2.1.a., no further analyses are required for demonstrating compliance with the limits of Control 3.2.2.1.a. In the event of a noble gas effluent release exceeding the setpoint value specified in ODCM Part II, Sections 2.2.1 or 2.2.2, the site boundary dose rate from the release is calculated using the methodology stated below. This methodology is based on worst sector annual average meteorological dispersion but, if further refinement is required to meet the requirements of Control 3.2.2.1.a, actual meteorological data from the time period of concern may be used to calculate actual meteorological dispersion.

CALCULATION METHODOLOGIES

$$D_{TB} = \chi/Q (1E + 6) \left[\sum_{i=1}^n (\dot{Q}_i K_i) \right] \quad (2-15)$$

$$D_{\gamma} = \chi/Q (1E + 6) \left[\sum_{i=1}^n (L_i + 1.1M_i) \dot{Q}_i \right] \quad (2-16)$$

where:

D_{TB}	= total body plume dose rate (mrem/yr).
D_{γ}	= skin plume dose rate (mrem/yr).
χ/Q	= highest annual average relative concentration (sec/m ³) at site boundary (see Table II2-31).
\dot{Q}_i	= The release rate of noble gas nuclide ' i ' from all vent releases averaged over one hour (uCi/sec).
K_i	= total body dose factor for noble gas nuclide ' i ' in units of mrem/yr per pCi/m ³ . Values are listed in ODCM Table II2-1.
L_i	= skin dose factor for the beta contribution for noble gas nuclide ' i ' in units of mrem/yr per pCi/m ³ . Values are listed in ODCM Table II2-1.
1.1	= the ratio of tissue to air absorption coefficients over the range of photons of interest. This ratio converts dose (mrad) to dose equivalent (mrem).
M_i	= gamma air dose factor for noble gas nuclide ' i ' in units of mrad/yr per pCi/m ³ . Values are listed in ODCM Table II2-1.
1E+6	= units conversion pCi/μCi.

2.3.2 Site Boundary Dose Rate - Radioiodine and Particulates (10CFR20 Limits)

Control 3.2.2.1.b limits the dose rate to ≤1500 mrem/yr to any organ (inhalation pathways only) for I-131, I-133, Tritium, and all radionuclides in particulate form with half-lives greater than 8 days in gaseous effluents.

Simultaneous releases from the North and South Vents are considered in evaluating compliance with the release rate limits of Control 3.2.2.1.b. Release activity is based upon the results of the weekly continuous sample analysis performed in accordance with ODCM Part I, Table 4.2-2.

CALCULATION METHODOLOGIES

$$D_{IH} = \chi/Q \sum_{i=1}^n P_i \dot{Q}_i \quad (2-17)$$

where:

D_{IH} = inhalation dose rate (mrem/yr).
 χ/Q = highest average annual χ/Q (sec/m³) (see Table II2-31).

P_i = dose factor for radionuclides other than noble gases for the inhalation pathway only (mrem/yr per $\mu\text{Ci}/\text{m}^3$). Values are listed in ODCM Table II2-2 through Table II2-5.

$$P_i = k' (BR) (D_{aipj}) \quad (2-17a)$$

where:

k' = 1.0E+6 unit conversion pCi/uCi.
 BR = breathing rate from Table II2-31.
 D_{aipj} = Inhalation Dose Factor Table II2-27 through Table II2-30.

\dot{Q}_i = The release rate of radionuclide ' i ' other than noble gases from all vent releases ($\mu\text{Ci}/\text{s}$).

2.3.3 Noble Gas Air Doses (10CFR50, Appendix I Limits)

Control 3.2.2.2 limits the air dose due to noble gases released in gaseous effluents (from both reactor units) to areas at or beyond the SITE BOUNDARY to:

- ≤ 10 mrad gamma for any quarter
- ≤ 20 mrad beta for any quarter
- ≤ 20 mrad gamma during any calendar year
- ≤ 40 mrad beta during any calendar year

As required by Surveillance Requirement 4.2.2.2, these doses are calculated at least once per 31 days using the results of the most recent grab samples for isotopic composition performed in accordance with ODCM Part I, Table 4.2-2. The dose calculation is performed using the most limiting average annual meteorological dispersion values. The quarterly and annual doses are based on the summation of the applicable dose results for the period of interest. The dose calculations are performed in accordance with the methodology below.

CALCULATION METHODOLOGIES

$$D_{\gamma AIR} = (3.17E - 8)(1.00E + 6) \chi / Q \sum_{i=1}^n M_i Q_i \quad (2-18)$$

$$D_{\beta AIR} = (3.17E - 8)(1.00E + 6) \chi / Q \sum_{i=1}^n N_i Q_i \quad (2-19)$$

where:

$D_{\gamma AIR}$	= gamma air dose from noble gas releases in mrad.
$D_{\beta AIR}$	= beta air dose from noble gas release in mrad.
3.17E-8	= units conversion [year/sec].
1.00E+6	= units conversion $\rho Ci/uCi$.
χ/Q	= highest average annual relative concentration in sec/m^3 (see Table II2-31).
Q_i	= release of noble gas radionuclides ' i ' from all vents in uCi . Releases shall be cumulative over the period of interest.
M_i	= gamma air dose factor for noble gas nuclide ' i ' in units of mrad/yr per pCi/m^3 . Values are listed in ODCM Table II2-1.
N_i	= beta air dose factor for noble gas nuclide ' i ' in units of mrad/yr per pCi/m^3 . Values are listed in ODCM Table II2-1.

2.3.4 Radioiodine and Particulate Dose Calculations (10CFR50, Appendix I Limits)

Control 3.2.2.3 limits the dose (from both reactor units) to a MEMBER OF THE PUBLIC from I-131, I-133, Tritium, and all radionuclides in particulate form with half-lives greater than 8 days in gaseous effluents released to areas at or beyond the SITE BOUNDARY to:

≤ 15 mrem to any organ during any calendar quarter

≤ 30 mrem to any organ during any calendar year

As required by Surveillance Requirement 4.2.2.3, these doses are calculated at least once per 31 days using the results of the weekly continuous sample analysis performed in accordance with ODCM Part I, Table 4.2-2. The dose calculation is performed using the most limiting average annual meteorological dispersion values for the appropriate dose receptor pathway (e.g. milk pathway SSE sector 2.5 miles, etc.). The quarterly and annual doses are based on the summation of

CALCULATION METHODOLOGIES

the applicable dose results determined during the period of interest. The dose calculations are performed in accordance with the methodology below. Total organ dose is the maximum organ dose obtained by the summation of the organ dose from each pathway.

2.3.4.1 Ground Pathway

$$D_{GPAR} = 3.17E-8 \left[D/Q \sum_{i=1}^n R_i Q_i \right] \quad (2-20)$$

where:

D_{GPAR} = dose from ground pathway due to release of particulates and iodines (mrem).

3.17E-8 = units conversion (year/sec).

D/Q = highest average annual deposition ($1/m^2$) (see Table II2-31).

Q_i = release of nuclide 'i' from all vents in uCi. Releases shall be cumulative over the time period of interest.

R_i = dose factor for organ type, age group, and pathway (for radionuclides other than noble gas); dose factors are calculated based on the methodology given in NUREG-0133. - Values of R_i are provided in ODCM Table II2-6 through Table II2-9 and calculated per the following equation:

$$R_i = (k')(k'')(SF) * D_{aipj} \left[(1 - e^{-\lambda_i t}) / \lambda_i \right] \quad (2-20a)$$

where:

$R_i^G [D/Q]$ = m^2 -mrem/yr per uCi/sec.

k' = $1E+06$ pCi/uCi.

k'' = 8760 hr/yr.

SF = shielding factor (see Table II2-31).

D_{aipj} = dose factor for standing on contaminated ground (see Table II1-7).

λ_i = decay constant for nuclide i in seconds (see Table II1-1).

t = period of buildup in soil in seconds (see Table II2-31).

CALCULATION METHODOLOGIES

2.3.4.2 Vegetation, Meat and Cow Milk or Goat Milk Pathway

$$D_{V\text{PAR}} = 3.17E-8 \left[\chi/Q \sum_{i=1}^2 R_i Q_i + D/Q \sum_{i=3}^n R_i Q_i \right] \quad (2-21)$$

where:

$D_{V\text{PAR}}$	=	dose from vegetation, meat, cow milk, and goat milk, pathways due to releases of particulates, iodines, and tritium (mrem).
3.17E-8	=	units conversion (year/sec).
$i = 1, 2$	=	^3H , ^{14}C .
$i = 3 \text{ thru } n$	=	all other isotopes (particulate and iodine).
Q_i	=	the release of nuclide ' i ' from all vents in uCi. Releases shall be cumulative over the time period of interest.
χ/Q	=	highest average annual χ/Q (sec/m ³) (see Table II2-31).
D/Q	=	highest average annual deposition rate (1/m ²) (see Table II2-31).
R_i	=	dose factor for organ type, age group, and pathway (for radionuclides other than noble gas); dose factors are calculated based on the methodology given in NUREG-0133. - Values of R_i are provided in ODCM Table II2-10 through Table II2-25 and calculated per the following equations.

Vegetation Pathway R_i

$$R_i^V = (k') \frac{(r)}{Y_v (\lambda_i + \lambda_w)} * D_{a\text{ipj}} * \left[U_a^L * (f_L) e^{-\lambda_i t_L} + U_a^S * (f_g) e^{-\lambda_i t_h} \right] \quad (2-21a)$$

where:

R_i^V	=	m ² -mrem/yr per uCi/sec
k'	=	1.0 E+6 pCi/uCi
r	=	fraction of deposited particulates retained on vegetation (Table II2-31).
Y_v	=	vegetation area density kg/m ² (Table II2-31).
λ_i	=	decay constant for the ith radionuclide, in sec ⁻¹ (Table II1-1).
λ_w	=	decay constant for removal of activity on leaf and plant surfaces by weathering, in sec ⁻¹ (Table II2-31).
$D_{a\text{ipj}}$	=	ingestion dose factor, in mrem/pCi (Table II1-3 through Table II1-6).

CALCULATION METHODOLOGIES

U_a^L	=	consumption rate of fresh leafy vegetation by the receptor in age group (a), in kg/yr (Table II2-31).
f_L	=	fraction of the annual intake of fresh leafy vegetation grown locally (dimensionless) (Table II2-31).
t_L	=	average time between harvest of leafy vegetation and its consumption, in seconds (Table II2-31).
U_a^S	=	consumption rate of stored vegetation by the receptor in age group (a), in kg/yr (Table II2-31).
f_g	=	fraction of the annual intake of stored vegetation grown locally (dimensionless) (Table II2-31).
t_h	=	average time between harvest of stored vegetation and its consumption, in seconds (Table II2-31).

The concentrations of tritium and carbon-14 in vegetation are based on their airborne concentrations rather than their deposition. Therefore, the R_i is based on $[x/Q]$ as follows:

$$R_{H-3}^V = (k') * (k'') * \left[U_a^L * (f_L) + U_a^S * (f_g) \right] * D_{aij} * \left[0.75 * (0.5/H) \right] \quad (2-21b)$$

$$R_{C-14}^V = (k') * (k'') * \left[U_a^L * (f_L) + U_a^S * (f_g) \right] * D_{aij} * p \left[0.11 * 0.16 \right] \quad (2-21c)$$

where:

R_{H-3}^V	=	mrem/yr per uCi/m ³ .
R_{C-14}^V	=	mrem/yr per uCi/m ³ .
k''	=	1E+3, constant of unit conversion (gm/kg).
H	=	absolute humidity of the atmosphere, in gm/m ³ (Table II2-31).
0.75	=	fraction of total feed that is water.
0.5	=	ratio of the specific activity of the feed grass water to the atmospheric water.
P	=	fractional equilibrium ratio (4400 hrs/8760 hrs). The ratio of the total annual release time (for C-14) atmospheric releases) to the total annual time during photosynthesis occurs (taken to be 4400 hrs), under the condition that the value of p should never exceed unity. For continuous C-14 releases, p is taken to be unity.
0.11	=	the fraction of total plant mass that is natural carbon, dimensionless.
0.16	=	the concentration of natural carbon in the atmosphere, in g/m ³

CALCULATION METHODOLOGIES

All other values as previously defined above.

Cow Milk / Goat Milk / Meat Pathway

$$R_i^M = (k') \frac{(Q_F * U_{AP})}{(\lambda_i + \lambda_w)} * (F_m) * (r) * D_{aipj} * \left[\frac{f_p f_s}{Y_p} + \frac{(1 - f_p f_s) e^{-\lambda_i t_h}}{Y_s} \right] e^{-\lambda_i t_f} \quad (2-21d)$$

where:

R_i^M	=	m ² -mrem/yr per uCi/sec.
k'	=	1.0E+6 pCi/uCi.
Q_F	=	cow/goat consumption rate kg/day (wet weight) (Table II2-31).
U_{AP}	=	receptor's milk consumption rate or meat consumption rate for age (a), in liters/yr or kg/yr (Table II2-31).
λ_i	=	decay constant for the ith radionuclide, in sec ⁻¹ (Table II1-1).
λ_w	=	decay constant for removal of activity on leaf and plant surfaces by weathering, in sec ⁻¹ (Table II2-31).
F_m	=	stable element transfer coefficients in days/liter or days/kg (Table II2-26).
r	=	fraction of deposited particulates retained on vegetation (Table II2-31).
D_{aipj}	=	ingestion dose factor, in mrem/pCi (Table II1-3 through Table II1-6).
f_p	=	fraction of the year that the cow/goat is on pasture (dimensionless) (Table II2-31).
f_s	=	fraction of the cow/goat feed that is pasture grass while the animal is on pasture (dimensionless) (Table II2-31).
Y_p	=	agricultural productivity by unit area of pasture feed grass, in kg/m ² (Table II2-31).
Y_s	=	agricultural productivity by unit area of stored feed, in kg/m ² (Table II2-31).
$T_{h(milk)}$	=	transport time from pasture to harvest, to milk animal, to milk, to receptor, in sec (Table II2-31).
$T_{f(milk)}$	=	transport time from pasture to milk animal, to milk, to receptor, in sec (Table II2-31).
$T_{h(meat)}$	=	transport time from crop field to ingestion receptor, in sec (Table II2-31).
$T_{f(meat)}$	=	transport time from pasture to ingestion receptor, in sec (Table II2-31).

The concentrations of tritium and carbon-14 in milk and meat are based on their airborne concentration rather than their deposition. Therefore, the R_i is based on $[x/Q]$ as follows:

$$R_{H-3}^M = (k') * (k''') * F_m * Q_F * U_{ap} * D_{aipj} * [0.75 * (0.5 / H)] \quad (2-21e)$$

$$R_{C-14}^M = (k') * (k''') * F_m * Q_F * U_{ap} * D_{aipj} * p * [0.11 / 0.16] \quad (2-21f)$$

where:

$$R_{H-3}^M = \text{mrem/yr per uCi/m}^3$$

$$R_{C-14}^M = \text{mrem/yr per uCi/m}^3$$

CALCULATION METHODOLOGIES

All other values as previously defined above.

2.3.4.3 Inhalation Pathway

$$D_{IPAR} = 3.17E-8 \left[\chi/Q \sum R_i Q_i \right] \quad (2-22)$$

where:

- D_{IPAR} = dose from inhalation pathway due to release of particulates, iodines, and tritium (mrem).
 $3.17E-8$ = units conversion (year/sec).
 Q_i = the release of nuclide ' i ' from all vents in uCi. Releases shall be cumulative over the time period of interest.
 χ/Q = highest average annual χ/Q (sec/m³) (see Table II2-31).
 R_i = dose factor for organ type, age group, and pathway (for radionuclides other than noble gas); dose factors are calculated based on the methodology given in NUREG-0133. - values of R_i are provided in ODCM Table II2-2 through Table II2-5 and calculated from the following equation.

$$R_i^I = k' (BR) (D_{aipj}) \quad (2-22a)$$

where:

- R_i^I = mrem/yr per uCi/m³.
 k' = 1.0E+6 unit conversion pCi/uCi.
 BR = breathing rate from Table II2-31.
 D_{aipj} = Inhalation Dose Factor Table II2-27 through Table II2-30.

2.3.5 Intentionally left blank.

CALCULATION METHODOLOGIES

2.3.6 Gaseous Effluent Dose Projection

Control 3.2.2.5 requires the VENTILATION EXHAUST TREATMENT SYSTEM be used to reduce radioactive material levels prior to discharge when projected doses from both units to areas at and beyond the SITE BOUNDARY would exceed in a 31 day period:

- a. 0.4 mrad to air from gamma radiation, or
- b. 0.8 mrad to air from beta radiation, or
- c. 0.6 mrem to any organ of a MEMBER OF THE PUBLIC

A dose projection is performed at least once per 31-days by the following equations:

$$D_{\max_{\text{gamma}}} = (D_{\max g} / d) * 31 \quad (2-23)$$

$$D_{\max_{\text{beta}}} = (D_{\max b} / d) * 31 \quad (2-24)$$

$$D_{\max_{\text{organ}}} = (D_{\max o} / d) * 31 \quad (2-25)$$

where:

$D_{\max_{\text{gamma}}}$	=	maximum gamma air dose projection for current 31-day period (mrad)
$D_{\max_{\text{beta}}}$	=	maximum beta air dose projection for current 31-day period (mrad)
$D_{\max_{\text{organ}}}$	=	maximum organ dose projection for current 31-day period (mrem)
$D_{\max g}$	=	maximum gamma air dose to date for current calendar quarter as obtained by equation (2-18).
$D_{\max b}$	=	maximum beta air dose to date for current calendar quarter as obtained by equation (2-19).
$D_{\max o}$	=	maximum organ dose to date for current calendar quarter as determined by summing the organ dose obtained from equations (2-20), (2-21) and (2-22) (mrem).
d	=	number of days in current calendar quarter at the end of the release.
31	=	the number of days of concern.

CALCULATION METHODOLOGIES

3.0 ANNUAL DOSE EVALUATION

The assessment of radiation doses for the Annual Radioactive Effluent Release Report (ARERR) shall be performed utilizing the methodology provided in NUREG-0133, Preparation of Radiological Effluent Technical Specifications for Nuclear Power Plants, October 1978. Any deviations from the methodology provided NUREG-0133 shall be documented in the Annual Radioactive Effluent Release Report.

The meteorological conditions concurrent with the time of release of radioactive materials (as determined by sampling frequency of measurement) or approximate methods shall be used as input to the dose model.

4.0 SPECIAL DOSE ANALYSIS

4.1 TOTAL DOSE TO MEMBERS OF THE PUBLIC

Control 3.2.3 requires that the annual dose or dose commitment to any MEMBER OF THE PUBLIC, due to releases of radioactivity and radiation, from the uranium fuel cycle shall be limited to:

- ≤ 25 mrem whole body or any organ except thyroid
- ≤ 75 mrem thyroid

Surveillance Requirement 4.2.3.2 requires that cumulative dose contributions from direct radiation from operations be evaluated when the calculated dose from the release of radioactive materials in liquid or gaseous effluents exceed the limits of Controls 3.2.1.2.a, 3.2.1.2.b, 3.2.2.2.a, 3.2.2.2.b, 3.2.2.3.a, or 3.2.2.3.b. The direct radiation contribution shall be determined by the methodology described below. This methodology calculates the direct radiation contribution, which then must be added to the dose or dose commitment determined in accordance with ODCM Part II, Sections 1.3.1, 2.3.3, and 2.3.4 to determine total dose from all pathways. This evaluation of direct radiation contribution is in accordance with ANSI/ANS 6.6.1-1979 Section 7. The error using this method is estimated to be approximately 8%. The following evaluation is performed for each receptor of concern.

$$D_{WB} = D_{1EFFL-WB} + (D_{TD} - D_{XBKG}) \quad (4-1)$$

$$D_O = D_{1EFFL-O} + (D_{TD} - D_{XBKG}) \quad (4-2)$$

$$D_T = D_{1EFFL-T} + (D_{TD} - D_{XBKG}) \quad (4-3)$$

CALCULATION METHODOLOGIES

where:

D_{WB}	=	cumulative total body dose contribution from direct radiation, liquid and gaseous effluents at the appropriate receptors (mrem).
D_O	=	cumulative organ dose contribution from direct radiation, liquid and gaseous effluents at the appropriate receptors (mrem).
D_T	=	cumulative thyroid dose contribution from direct radiation, liquid and gaseous effluents at the appropriate receptors (mrem).
D_{TD}	=	total dose at receptor of interest as evaluated by dosimetry measurement (mrem).

NOTE: If there is not a dosimetry location at the actual receptor location, a more conservative location will be used to evaluate Total Dose.

NOTE: Due to the statistics of radiation measurements and to the conservative nature of effluent calculations it is plausible the $D_{TD} - D_{XBKG}$ may yield a negative value. In this situation the value for $D_{TD} - D_{XBKG}$ shall be reported as zero (0).

D_{XBKG}	=	Background dose as evaluated by dosimetry at background sites (mrem).
$D_{1EFFL-TB}$	=	effluent contribution to total body dose (as evaluated in ODCM Part II, Sections 1.3.1, 2.3.3, and 2.3.4).
$D_{1EFFL-O}$	=	effluent contribution to organ dose (as evaluated in ODCM Part II, Sections 1.3.1, 2.3.3, and 2.3.4).
$D_{1EFFL-T}$	=	effluent contribution to thyroid dose (as evaluated in ODCM Part II, Sections 1.3.1, 2.3.3, and 2.3.4).

4.2 DOSES DUE TO ACTIVITIES INSIDE THE SITE BOUNDARY

In accordance with Administrative Control 6.2, the Annual Radioactive Effluent Release Report shall include an assessment of radiation dose from radioactive liquid and gaseous effluents to MEMBERS OF THE PUBLIC due to their activities inside the SITE BOUNDARY.

There are three locations within the SITE BOUNDARY that are accessible to MEMBERS OF THE PUBLIC for activities unrelated to the operation of Limerick Station. These locations are: 1) the railroad tracks which run along the river within the SITE BOUNDARY; 2) the Limerick Information Center, on Longview Road next to the 500kv substation; and 3) Fricks Lock. Of these three locations, the railroad tracks are the closest to the plant confines. Sectors and distances of these locations are provided below:

CALCULATION METHODOLOGIES

<u>Sector</u>	<u>Distance to Location (m)</u>
<u>Railroad Tracks:</u>	
S	300
SSW	225
SW	225
WSW	225
W	225
WNW	345
NW	450
<u>Information Center:</u>	
ESE	884
<u>Fricks Lock:</u>	
WSW	450

Annual doses will be calculated in accordance with NUREG-0133 methodology, as appropriate and assume an occupancy factor of 0.25. The maximum dose calculated will be reported in the Annual Radioactive Effluent Release Report.

5.0 RADIOLOGICAL ENVIRONMENTAL MONITORING PROGRAM

5.1 SAMPLING PROGRAM

The operational phase of the Radiological Environmental Monitoring Program (REMP) is conducted in accordance with the requirements of Control 3.3.1. The objectives of the program are:

- To provide data on measurable levels of radiation and radioactive materials in the site environs.
- To evaluate the relationship between quantities of radioactive materials released from LGS and resultant radiation doses to individuals from principal pathways of exposure.

The sampling requirements (type of samples, collection frequency, and analysis) and sample locations are presented in Appendix A.

5.2 INTERLABORATORY COMPARISON PROGRAM

Control 3.3.3 requires analyses be performed on radioactive material supplied as part of an Interlaboratory Comparison.

Participation in an NIST traceable Interlaboratory Comparison Program provides a check on the preciseness of measurements of radioactive material in environmental samples. A summary of the Interlaboratory Comparison Program results is provided in the Annual Radiological Environmental Operating Report pursuant to Administrative Control 6.1.

TABLES

TABLE II-1

DECAY CONSTANTS FOR NUCLIDES OF INTEREST¹

NUCLIDE	KOCHER		DECAY CONSTANT		DECAY CONSTANT		DECAY CONSTANT	
	T _{1/2}		T _{1/2} HOURS	HR ⁻¹	T _{1/2} SECONDS	SEC ⁻¹	T _{1/2} DAYS	DAYS ⁻¹
H-3	1.228E+01	Y	1.076E+05	6.439E-06	3.875E+08	1.789E-09	4.485E+03	1.545E-04
C-14	5.730E+03	Y	5.023E+07	1.380E-08	1.808E+11	3.833E-12	2.093E+06	3.312E-07
NA-22	2.602E+00	Y	2.281E+04	3.039E-05	8.211E+07	8.441E-09	9.504E+02	7.293E-04
NA-24	1.500E+01	H	1.500E+01	4.621E-02	5.400E+04	1.284E-05	6.250E-01	1.109E+00
P-32	1.429E+01	D	3.430E+02	2.021E-03	1.235E+06	5.614E-07	1.429E+01	4.851E-02
CA-41	1.030E+05	Y	9.029E+08	7.677E-10	3.250E+12	2.132E-13	3.762E+07	1.842E-08
SC-46	8.383E+01	D	2.012E+03	3.445E-04	7.243E+06	9.570E-08	8.383E+01	8.268E-03
CR-51	2.770E+01	D	6.649E+02	1.042E-03	2.394E+06	2.896E-07	2.770E+01	2.502E-02
MN-54	3.127E+02	D	7.505E+03	9.236E-05	2.702E+07	2.566E-08	3.127E+02	2.217E-03
FE-55	2.700E+00	Y	2.367E+04	2.929E-05	8.521E+07	8.135E-09	9.862E+02	7.029E-04
MN-56	2.579E+00	H	2.579E+00	2.688E-01	9.283E+03	7.467E-05	1.074E-01	6.452E+00
CO-57	2.709E+02	D	6.502E+03	1.066E-04	2.341E+07	2.961E-08	2.709E+02	2.559E-03
CO-58	7.080E+01	D	1.699E+03	4.079E-04	6.117E+06	1.133E-07	7.080E+01	9.790E-03
FE-59	4.463E+01	D	1.071E+03	6.471E-04	3.856E+06	1.798E-07	4.463E+01	1.553E-02
CO-60	5.271E+00	Y	4.621E+04	1.500E-05	1.663E+08	4.167E-09	1.925E+03	3.600E-04
NI-59	7.500E+04	Y	6.575E+08	1.054E-09	2.367E+12	2.929E-13	2.739E+07	2.530E-08
NI-63	1.001E+02	Y	8.775E+05	7.899E-07	3.159E+09	2.194E-10	3.656E+04	1.896E-05
CU-64	1.270E+01	H	1.270E+01	5.457E-02	4.572E+04	1.516E-05	5.292E-01	1.310E+00
NI-65	2.520E+00	H	2.520E+00	2.751E-01	9.072E+03	7.641E-05	1.050E-01	6.601E+00
ZN-65	2.444E+02	D	5.866E+03	1.182E-04	2.112E+07	3.283E-08	2.444E+02	2.836E-03
ZN-69M	1.376E+01	H	1.376E+01	5.039E-02	4.952E+04	1.400E-05	5.732E-01	1.209E+00
ZN-69	9.267E-01	H	9.267E-01	7.480E-01	3.336E+03	2.078E-04	3.861E-02	1.795E+01
SE-79	6.500E+04	Y	5.698E+08	1.216E-09	2.051E+12	3.379E-13	2.374E+07	2.920E-08
BR-82	3.530E+01	H	3.530E+01	1.964E-02	1.271E+05	5.454E-06	1.471E+00	4.713E-01
BR-83	2.390E+00	H	2.390E+00	2.900E-01	8.604E+03	8.056E-05	9.958E-02	6.960E+00
BR-84	5.300E-01	H	5.300E-01	1.308E+00	1.908E+03	3.633E-04	2.208E-02	3.139E+01
BR-85	4.778E-02	H	4.778E-02	1.451E+01	1.720E+02	4.030E-03	1.991E-03	3.482E+02
RB-86	1.866E+01	D	4.478E+02	1.548E-03	1.612E+06	4.299E-07	1.866E+01	3.715E-02
RB-87	4.730E+10	Y	4.146E+14	1.672E-15	1.493E+18	4.644E-19	1.728E+13	4.012E-14
RB-88	2.967E-01	H	2.967E-01	2.336E+00	1.068E+03	6.490E-04	1.236E-02	5.607E+01
RB-89	2.573E-01	H	2.573E-01	2.694E+00	9.264E+02	7.482E-04	1.072E-02	6.465E+01
SR-89	5.055E+01	D	1.213E+03	5.713E-04	4.368E+06	1.587E-07	5.055E+01	1.371E-02
SR-90	2.860E+01	Y	2.507E+05	2.765E-06	9.025E+08	7.680E-10	1.045E+04	6.635E-05
Y-90	6.410E+01	H	6.410E+01	1.081E-02	2.308E+05	3.004E-06	2.671E+00	2.595E-01
SR-91	9.500E+00	H	9.500E+00	7.296E-02	3.420E+04	2.027E-05	3.958E-01	1.751E+00
Y-91M	8.285E-01	H	8.285E-01	8.366E-01	2.983E+03	2.324E-04	3.452E-02	2.008E+01
Y-91	5.851E+01	D	1.404E+03	4.936E-04	5.055E+06	1.371E-07	5.851E+01	1.185E-02
SR-92	2.710E+00	H	2.710E+00	2.558E-01	9.756E+03	7.105E-05	1.129E-01	6.139E+00
Y-92	3.540E+00	H	3.540E+00	1.958E-01	1.274E+04	5.439E-05	1.475E-01	4.699E+00
Y-93	1.010E+01	H	1.010E+01	6.863E-02	3.636E+04	1.906E-05	4.208E-01	1.647E+00
NB-93M	1.460E+01	Y	1.280E+05	5.416E-06	4.607E+08	1.504E-09	5.333E+03	1.300E-04
NB-95	3.506E+01	D	8.414E+02	8.238E-04	3.029E+06	2.288E-07	3.506E+01	1.977E-02

TABLE II-1

DECAY CONSTANTS FOR NUCLIDES OF INTEREST¹

NUCLIDE	KOCHER		DECAY CONSTANT		DECAY CONSTANT		DECAY CONSTANT	
	T _{1/2}		T _{1/2}	HR ⁻¹	T _{1/2}	SEC ⁻¹	T _{1/2}	DAYS ⁻¹
	T _{1/2}	HOURS			SECONDS		DAYS	
NB-97	1.202E+00	H	1.202E+00	5.768E-01	4.326E+03	1.602E-04	5.007E-02	1.384E+01
ZR-93	1.530E+06	Y	1.341E+10	5.168E-11	4.828E+13	1.436E-14	5.588E+08	1.240E-09
ZR-95	6.402E+01	D	1.536E+03	4.511E-04	5.531E+06	1.253E-07	6.402E+01	1.083E-02
ZR-97	1.690E+01	H	1.690E+01	4.101E-02	6.084E+04	1.139E-05	7.042E-01	9.844E-01
MO-93	3.500E+03	Y	3.068E+07	2.259E-08	1.105E+11	6.276E-12	1.278E+06	5.422E-07
MO-99	6.602E+01	H	6.602E+01	1.050E-02	2.377E+05	2.916E-06	2.751E+00	2.520E-01
TC-99	2.130E+05	Y	1.867E+09	3.712E-10	6.722E+12	1.031E-13	7.780E+07	8.910E-09
TC-99M	6.020E+00	H	6.020E+00	1.151E-01	2.167E+04	3.198E-05	2.508E-01	2.763E+00
TC-101	2.367E-01	H	2.367E-01	2.929E+00	8.520E+02	8.136E-04	9.861E-03	7.029E+01
RU-103	3.935E+01	D	9.444E+02	7.340E-04	3.400E+06	2.039E-07	3.935E+01	1.761E-02
RU-105	4.440E+00	H	4.440E+00	1.561E-01	1.598E+04	4.337E-05	1.850E-01	3.747E+00
RU-106	3.682E+02	D	8.837E+03	7.844E-05	3.181E+07	2.179E-08	3.682E+02	1.883E-03
RH-105	3.536E+01	H	3.536E+01	1.960E-02	1.273E+05	5.445E-06	1.473E+00	4.705E-01
PD-107	6.500E+06	Y	5.698E+10	1.216E-11	2.051E+14	3.379E-15	2.374E+09	2.920E-10
PD-109	1.345E+01	H	1.345E+01	5.152E-02	4.843E+04	1.431E-05	5.605E-01	1.237E+00
AG-110M	2.499E+02	D	5.996E+03	1.156E-04	2.159E+07	3.211E-08	2.499E+02	2.774E-03
AG-111	7.460E+00	D	1.790E+02	3.871E-03	6.445E+05	1.075E-06	7.460E+00	9.292E-02
CD-113M	1.370E+01	Y	1.201E+05	5.772E-06	4.323E+08	1.603E-09	5.004E+03	1.385E-04
CD-115M	4.460E+01	D	1.070E+03	6.476E-04	3.853E+06	1.799E-07	4.460E+01	1.554E-02
SN-123	1.292E+02	D	3.101E+03	2.235E-04	1.116E+07	6.209E-08	1.292E+02	5.365E-03
SN-125	9.640E+00	D	2.314E+02	2.996E-03	8.329E+05	8.322E-07	9.640E+00	7.190E-02
SN-126	1.000E+05	Y	8.766E+08	7.907E-10	3.156E+12	2.196E-13	3.653E+07	1.898E-08
SB-124	6.020E+01	D	1.445E+03	4.798E-04	5.201E+06	1.333E-07	6.020E+01	1.151E-02
SB-125	2.770E+00	Y	2.428E+04	2.855E-05	8.741E+07	7.929E-09	1.012E+03	6.851E-04
SB-126	1.240E+01	D	2.976E+02	2.329E-03	1.071E+06	6.470E-07	1.240E+01	5.590E-02
SB-127	3.850E+00	D	9.240E+01	7.502E-03	3.326E+05	2.084E-06	3.850E+00	1.800E-01
TE-125M	5.800E+01	D	1.392E+03	4.980E-04	5.011E+06	1.383E-07	5.800E+01	1.195E-02
TE-127M	1.090E+02	D	2.616E+03	2.650E-04	9.418E+06	7.360E-08	1.090E+02	6.359E-03
TE-127	9.350E+00	H	9.350E+00	7.413E-02	3.366E+04	2.059E-05	3.896E-01	1.779E+00
TE-129M	3.360E+01	D	8.064E+02	8.596E-04	2.903E+06	2.388E-07	3.360E+01	2.063E-02
TE-129	1.160E+00	H	1.160E+00	5.975E-01	4.176E+03	1.660E-04	4.833E-02	1.434E+01
TE-133M	9.233E-01	H	9.233E-01	7.507E-01	3.324E+03	2.085E-04	3.847E-02	1.802E+01
TE-134	6.967E-01	H	6.967E-01	9.949E-01	2.508E+03	2.764E-04	2.903E-02	2.388E+01
I-129	1.570E+07	Y	1.376E+11	5.036E-12	4.955E+14	1.399E-15	5.734E+09	1.209E-10
I-130	1.236E+01	H	1.236E+01	5.608E-02	4.450E+04	1.558E-05	5.150E-01	1.346E+00
I-131	8.040E+00	D	1.930E+02	3.592E-03	6.947E+05	9.978E-07	8.040E+00	8.621E-02
TE-131M	3.000E+01	H	3.000E+01	2.310E-02	1.080E+05	6.418E-06	1.250E+00	5.545E-01
TE-131	4.167E-01	H	4.167E-01	1.664E+00	1.500E+03	4.621E-04	1.736E-02	3.993E+01
I-132	2.300E+00	H	2.300E+00	3.014E-01	8.280E+03	8.371E-05	9.583E-02	7.233E+00
TE-132	7.820E+01	H	7.820E+01	8.864E-03	2.815E+05	2.462E-06	3.258E+00	2.127E-01
I-133	2.080E+01	H	2.080E+01	3.332E-02	7.488E+04	9.257E-06	8.667E-01	7.998E-01
CS-134M	2.900E+00	H	2.900E+00	2.390E-01	1.044E+04	6.639E-05	1.208E-01	5.736E+00
CS-134	2.062E+00	Y	1.808E+04	3.835E-05	6.507E+07	1.065E-08	7.531E+02	9.203E-04

TABLE II-1

DECAY CONSTANTS FOR NUCLIDES OF INTEREST¹

NUCLIDE	KOCHER		DECAY CONSTANT		DECAY CONSTANT		DECAY CONSTANT	
	T _{1/2}		T _{1/2}	HR ⁻¹	T _{1/2}	SEC ⁻¹	T _{1/2}	DAYS ⁻¹
	T _{1/2}	HOURS			SECONDS		DAYS	
I-134	8.767E-01	H	8.767E-01	7.907E-01	3.156E+03	2.196E-04	3.653E-02	1.898E+01
I-135	6.610E+00	H	6.610E+00	1.049E-01	2.380E+04	2.913E-05	2.754E-01	2.517E+00
CS-135	2.300E+06	Y	2.016E+10	3.438E-11	7.258E+13	9.550E-15	8.401E+08	8.251E-10
CS-136	1.316E+01	D	3.158E+02	2.195E-03	1.137E+06	6.096E-07	1.316E+01	5.267E-02
CS-137	3.017E+01	Y	2.645E+05	2.621E-06	9.521E+08	7.280E-10	1.102E+04	6.290E-05
CS-138	5.367E-01	H	5.367E-01	1.292E+00	1.932E+03	3.588E-04	2.236E-02	3.100E+01
CS-139	1.567E-01	H	1.567E-01	4.424E+00	5.640E+02	1.229E-03	6.528E-03	1.062E+02
BA-139	1.385E+00	H	1.385E+00	5.005E-01	4.986E+03	1.390E-04	5.771E-02	1.201E+01
BA-140	1.279E+01	D	3.069E+02	2.258E-03	1.105E+06	6.273E-07	1.279E+01	5.420E-02
LA-140	4.022E+01	H	4.022E+01	1.723E-02	1.448E+05	4.787E-06	1.676E+00	4.136E-01
BA-141	3.045E-01	H	3.045E-01	2.276E+00	1.096E+03	6.323E-04	1.269E-02	5.463E+01
LA-141	3.940E+00	H	3.940E+00	1.759E-01	1.418E+04	4.887E-05	1.642E-01	4.222E+00
CE-141	3.250E+01	D	7.800E+02	8.887E-04	2.808E+06	2.468E-07	3.250E+01	2.133E-02
BA-142	1.783E-01	H	1.783E-01	3.887E+00	6.420E+02	1.080E-03	7.431E-03	9.328E+01
LA-142	1.590E+00	H	1.590E+00	4.359E-01	5.724E+03	1.211E-04	6.625E-02	1.046E+01
CE-143	3.300E+01	H	3.300E+01	2.100E-02	1.188E+05	5.835E-06	1.375E+00	5.041E-01
PR-143	1.356E+01	D	3.254E+02	2.130E-03	1.172E+06	5.916E-07	1.356E+01	5.112E-02
CE-144	2.843E+02	D	6.823E+03	1.016E-04	2.456E+07	2.822E-08	2.843E+02	2.438E-03
PR-144	2.880E-01	H	2.880E-01	2.407E+00	1.037E+03	6.685E-04	1.200E-02	5.776E+01
ND-147	1.098E+01	D	2.635E+02	2.630E-03	9.487E+05	7.306E-07	1.098E+01	6.313E-02
PM-147	2.623E+00	Y	2.300E+04	3.014E-05	8.279E+07	8.373E-09	9.582E+02	7.234E-04
PM-148M	4.130E+01	D	9.912E+02	6.993E-04	3.568E+06	1.943E-07	4.130E+01	1.678E-02
PM-148	5.370E+00	D	1.289E+02	5.378E-03	4.640E+05	1.494E-06	5.370E+00	1.291E-01
PM-149	5.308E+01	H	5.308E+01	1.306E-02	1.911E+05	3.627E-06	2.212E+00	3.134E-01
PM-151	2.840E+01	H	2.840E+01	2.441E-02	1.022E+05	6.780E-06	1.183E+00	5.858E-01
SM-151	9.000E+01	Y	7.889E+05	8.786E-07	2.840E+09	2.441E-10	3.287E+04	2.109E-05
SM-153	4.670E+01	H	4.670E+01	1.484E-02	1.681E+05	4.123E-06	1.946E+00	3.562E-01
EU-152	1.360E+01	Y	1.192E+05	5.814E-06	4.292E+08	1.615E-09	4.967E+03	1.395E-04
EU-154	8.800E+00	Y	7.714E+04	8.985E-06	2.777E+08	2.496E-09	3.214E+03	2.157E-04
EU-155	4.960E+00	Y	4.348E+04	1.594E-05	1.565E+08	4.428E-09	1.812E+03	3.826E-04
EU-156	1.519E+01	D	3.646E+02	1.901E-03	1.312E+06	5.281E-07	1.519E+01	4.563E-02
TB-160	7.230E+01	D	1.735E+03	3.995E-04	6.247E+06	1.110E-07	7.230E+01	9.587E-03
HO-166M	1.200E+03	Y	1.052E+07	6.589E-08	3.787E+10	1.830E-11	4.383E+05	1.581E-06
W-181	1.210E+02	D	2.903E+03	2.388E-04	1.045E+07	6.633E-08	1.210E+02	5.731E-03
W-185	7.510E+01	D	1.802E+03	3.846E-04	6.489E+06	1.068E-07	7.510E+01	9.230E-03
W-187	2.383E+01	H	2.383E+01	2.909E-02	8.579E+04	8.080E-06	9.929E-01	6.981E-01
NP-239	2.355E+00	D	5.652E+01	1.226E-02	2.035E+05	3.407E-06	2.355E+00	2.943E-01
U-232	7.200E+01	Y	6.312E+05	1.098E-06	2.272E+09	3.051E-10	2.630E+04	2.636E-05
U-233	1.592E+05	Y	1.396E+09	4.967E-10	5.024E+12	1.380E-13	5.815E+07	1.192E-08
U-234	2.445E+05	Y	2.143E+09	3.234E-10	7.716E+12	8.983E-14	8.930E+07	7.762E-09
U-235	7.038E+08	Y	6.170E+12	1.124E-13	2.221E+16	3.121E-17	2.571E+11	2.696E-12
U-236	2.342E+07	Y	2.053E+11	3.377E-12	7.389E+14	9.381E-16	8.552E+09	8.105E-11
U-237	6.750E+00	D	1.620E+02	4.279E-03	5.832E+05	1.189E-06	6.750E+00	1.027E-01

TABLE II-1

DECAY CONSTANTS FOR NUCLIDES OF INTEREST¹

NUCLIDE	KOCHER		DECAY CONSTANT		DECAY CONSTANT		DECAY CONSTANT	
	T _{1/2}		T _{1/2}	HR ⁻¹	T _{1/2}	SEC ⁻¹	T _{1/2}	DAYS ⁻¹
	T _{1/2}	HOURS			SECONDS		DAYS	
U-238	4.468E+09	Y	3.917E+13	1.770E-14	1.410E+17	4.916E-18	1.632E+12	4.247E-13
NP-237	2.140E+06	Y	1.876E+10	3.695E-11	6.753E+13	1.026E-14	7.816E+08	8.868E-10
NP-238	2.117E+00	D	5.081E+01	1.364E-02	1.829E+05	3.790E-06	2.117E+00	3.274E-01
PU-238	8.775E+01	Y	7.692E+05	9.011E-07	2.769E+09	2.503E-10	3.205E+04	2.163E-05
PU-239	2.413E+04	Y	2.115E+08	3.277E-09	7.615E+11	9.102E-13	8.814E+06	7.864E-08
PU-240	6.569E+03	Y	5.758E+07	1.204E-08	2.073E+11	3.344E-12	2.399E+06	2.889E-07
PU-241	1.440E+01	Y	1.262E+05	5.491E-06	4.544E+08	1.525E-09	5.260E+03	1.318E-04
PU-242	3.758E+05	Y	3.294E+09	2.104E-10	1.186E+13	5.845E-14	1.373E+08	5.050E-09
PU-244	8.260E+07	Y	7.241E+11	9.573E-13	2.607E+15	2.659E-16	3.017E+10	2.297E-11
AM-241	4.322E+02	Y	3.789E+06	1.830E-07	1.364E+10	5.082E-11	1.579E+05	4.391E-06
AM-242M	1.520E+02	Y	1.332E+06	5.202E-07	4.797E+09	1.445E-10	5.552E+04	1.249E-05
AM-243	7.380E+03	Y	6.469E+07	1.071E-08	2.329E+11	2.976E-12	2.696E+06	2.571E-07
CM-242	1.632E+02	D	3.917E+03	1.770E-04	1.410E+07	4.916E-08	1.632E+02	4.247E-03
CM-243	2.850E+01	Y	2.498E+05	2.774E-06	8.994E+08	7.707E-10	1.041E+04	6.659E-05
CM-244	1.811E+01	Y	1.588E+05	4.366E-06	5.715E+08	1.213E-09	6.615E+03	1.048E-04
CM-245	8.500E+03	Y	7.451E+07	9.303E-09	2.682E+11	2.584E-12	3.105E+06	2.233E-07
CM-246	4.750E+03	Y	4.164E+07	1.665E-08	1.499E+11	4.624E-12	1.735E+06	3.995E-07
CM-247	1.560E+07	Y	1.367E+11	5.069E-12	4.923E+14	1.408E-15	5.698E+09	1.216E-10
CM-248	3.390E+05	Y	2.972E+09	2.333E-10	1.070E+13	6.479E-14	1.238E+08	5.598E-09
CF-252	2.639E+00	Y	2.313E+04	2.996E-05	8.328E+07	8.323E-09	9.639E+02	7.191E-04

1. Kocher, David C., "Radioactive Decay Data Tables," DOE/TIC-11026,138 (1981).

TABLE II-2

BIOACCUMULATION FACTORS FOR FRESHWATER FISH (pCi/kg per pCi/liter)¹

NUCLIDE	FISH	NUCLIDE	FISH	NUCLIDE	FISH	NUCLIDE	FISH
H-3	9.0E-01	ZR-93	3.3E+00	I-131	1.5E+01	W-187	1.2E+03
C-14	4.6E+03	ZR-95	3.3E+00	I-132	1.5E+01	U-232	2.0E+00
NA-22	1.0E+02	ZR-97	3.3E+00	I-133	1.5E+01	U-233	2.0E+00
NA-24	1.0E+02	NB-93M	3.0E+04	I-134	1.5E+01	U-234	2.0E+00
P-32 ²	3.0E+03 ²	NB-95	3.0E+04	I-135	1.5E+01	U-235	2.0E+00
CA-41	4.0E+01	NB-97	3.0E+04	CS-134M	2.0E+03	U-236	2.0E+00
SC-46	2.0E+00	MO-93	1.0E+01	CS-134	2.0E+03	U-237	2.0E+00
CR-51	2.0E+02	MO-99	1.0E+01	CS-135	2.0E+03	U-238	2.0E+00
MN-54	4.0E+02	TC-99M	1.5E+01	CS-136	2.0E+03	NP-237	1.0E+01
MN-56	4.0E+02	TC-99	1.5E+01	CS-137	2.0E+03	NP-238	1.0E+01
FE-55	1.0E+02	TC-101	1.5E+01	CS-138	2.0E+03	NP-239	1.0E+01
FE-59	1.0E+02	RU-103	1.0E+01	CS-139	2.0E+03	PU-238	3.5E+00
CO-57	5.0E+01	RU-105	1.0E+01	BA-139	4.0E+00	PU-239	3.5E+00
CO-58	5.0E+01	RU-106	1.0E+01	BA-140	4.0E+00	PU-240	3.5E+00
CO-60	5.0E+01	RH-105	1.0E+01	BA-141	4.0E+00	PU-241	3.5E+00
NI-59	1.0E+02	PD-107	1.0E+01	BA-142	4.0E+00	PU-242	3.5E+00
NI-63	1.0E+02	PD-109	1.0E+01	LA-140	2.5E+01	PU-244	3.5E+00
NI-65	1.0E+02	AG-110M	2.5E+00	LA-141	2.5E+01	AM-241	2.5E+01
CU-64	5.0E+01	AG-111	2.5E+00	LA-142	2.5E+01	AM-242M	2.5E+01
ZN-65	2.0E+03	CD-113M	2.0E+02	CE-141	1.0E+00	AM-243	2.5E+01
ZN-69M	2.0E+03	CD-115M	2.0E+02	CE-143	1.0E+00	CM-242	2.5E+01
ZN-69	2.0E+03	SN-123	3.0E+03	CE-144	1.0E+00	CM-243	2.5E+01
SE-79	1.7E+02	SN-125	3.0E+03	PR-143	2.5E+01	CM-244	2.5E+01
BR-82	4.2E+02	SN-126	3.0E+03	PR-144	2.5E+01	CM-245	2.5E+01
BR-83	4.2E+02	SB-124	1.0E+00	ND-147	2.5E+01	CM-246	2.5E+01
BR-84	4.2E+02	SB-125	1.0E+00	PM-147	2.5E+01	CM-247	2.5E+01
BR-85	4.2E+02	SB-126	1.0E+00	PM-148M	2.5E+01	CM-248	2.5E+01
RB-86	2.0E+03	SB-127	1.0E+00	PM-148	2.5E+01	CF-252	2.5E+01
RB-87	2.0E+03	TE-125M	4.0E+02	PM-149	2.5E+01		
RB-88	2.0E+03	TE-127M	4.0E+02	PM-151	2.5E+01		
RB-89	2.0E+03	TE-127	4.0E+02	SM-151	2.5E+01		
SR-89	3.0E+01	TE-129M	4.0E+02	SM-153	2.5E+01		
SR-90	3.0E+01	TE-129	4.0E+02	EU-152	2.5E+01		
SR-91	3.0E+01	TE-131M	4.0E+02	EU-154	2.5E+01		
SR-92	3.0E+01	TE-131	4.0E+02	EU-155	2.5E+01		
Y-90	2.5E+01	TE-132	4.0E+02	EU-156	2.5E+01		
Y-91M	2.5E+01	TE-133M	4.0E+02	TB-160	2.5E+01		
Y-91	2.5E+01	TE-134	4.0E+02	HO-166M	2.5E+01		
Y-92	2.5E+01	I-129	1.5E+01	W-181	1.2E+03		
Y-93	2.5E+01	I-130	1.5E+01	W-185	1.2E+03		

1 NUREG/CR-4013, LADTAP II, Technical Reference and User Guide, Table 3.1

2 Letter LTR 881209L001, from R.J. Clark, U.S.N.R.C., to G.A. Hunger, Philadelphia Electric Co., December 9, 1988, transmitting evaluation of Limerick ODCM.

TABLE II-3

 INGESTION DOSE FACTORS FOR ADULT (D_{aipj})
 mrem/pCi

NUCLIDE	BONE	LIVER	T BODY	THYROID	KIDNEY	LUNG	GI-LLI	SKIN
H-3	0.00E+00	5.99E-08	5.99E-08	5.99E-08	5.99E-08	5.99E-08	5.99E-08	0.00E+00
C-14	2.84E-06	5.68E-07	5.68E-07	5.68E-07	5.68E-07	5.68E-07	5.68E-07	0.00E+00
NA-22	1.74E-05	1.74E-05	1.74E-05	1.74E-05	1.74E-05	1.74E-05	1.74E-05	0.00E+00
NA-24	1.70E-06	1.70E-06	1.70E-06	1.70E-06	1.70E-06	1.70E-06	1.70E-06	0.00E+00
P-32	1.93E-04	1.20E-05	7.46E-06	0.00E+00	0.00E+00	0.00E+00	2.17E-05	0.00E+00
CA-41	1.85E-04	0.00E+00	2.00E-05	0.00E+00	0.00E+00	0.00E+00	1.84E-07	0.00E+00
SC-46	5.51E-09	1.07E-08	3.11E-09	0.00E+00	9.99E-09	0.00E+00	5.21E-05	0.00E+00
CR-51	0.00E+00	0.00E+00	2.66E-09	1.59E-09	5.86E-10	3.53E-09	6.69E-07	0.00E+00
MN-54	0.00E+00	4.57E-06	8.72E-07	0.00E+00	1.36E-06	0.00E+00	1.40E-05	0.00E+00
MN-56	0.00E+00	1.15E-07	2.04E-08	0.00E+00	1.46E-07	0.00E+00	3.67E-06	0.00E+00
FE-55	2.75E-06	1.90E-06	4.43E-07	0.00E+00	0.00E+00	1.06E-06	1.09E-06	0.00E+00
FE-59	4.34E-06	1.02E-05	3.91E-06	0.00E+00	0.00E+00	2.85E-06	3.40E-05	0.00E+00
CO-57	0.00E+00	1.75E-07	2.91E-07	0.00E+00	0.00E+00	0.00E+00	4.44E-06	0.00E+00
CO-58	0.00E+00	7.45E-07	1.67E-06	0.00E+00	0.00E+00	0.00E+00	1.51E-05	0.00E+00
CO-60	0.00E+00	2.14E-06	4.72E-06	0.00E+00	0.00E+00	0.00E+00	4.02E-05	0.00E+00
NI-59	9.76E-06	3.35E-06	1.63E-06	0.00E+00	0.00E+00	0.00E+00	6.90E-07	0.00E+00
NI-63	1.30E-04	9.01E-06	4.36E-06	0.00E+00	0.00E+00	0.00E+00	1.88E-06	0.00E+00
NI-65	5.28E-07	6.86E-08	3.13E-08	0.00E+00	0.00E+00	0.00E+00	1.74E-06	0.00E+00
CU-64	0.00E+00	8.33E-08	3.91E-08	0.00E+00	2.10E-07	0.00E+00	7.10E-06	0.00E+00
ZN-65	4.84E-06	1.54E-05	6.96E-06	0.00E+00	1.03E-05	0.00E+00	9.70E-06	0.00E+00
ZN-69M	1.70E-07	4.08E-07	3.73E-08	0.00E+00	2.47E-07	0.00E+00	2.49E-05	0.00E+00
ZN-69	1.03E-08	1.97E-08	1.37E-09	0.00E+00	1.28E-08	0.00E+00	2.96E-09	0.00E+00
SE-79	0.00E+00	2.63E-06	4.39E-07	0.00E+00	4.55E-06	0.00E+00	5.38E-07	0.00E+00
BR-82	0.00E+00	0.00E+00	2.26E-06	0.00E+00	0.00E+00	0.00E+00	2.59E-06	0.00E+00
BR-83	0.00E+00	0.00E+00	4.02E-08	0.00E+00	0.00E+00	0.00E+00	5.79E-08	0.00E+00
BR-84	0.00E+00	0.00E+00	5.21E-08	0.00E+00	0.00E+00	0.00E+00	4.09E-13	0.00E+00
BR-85	0.00E+00	0.00E+00	2.14E-09	0.00E+00	0.00E+00	0.00E+00	0.00E+00	0.00E+00
RB-86	0.00E+00	2.11E-05	9.83E-06	0.00E+00	0.00E+00	0.00E+00	4.16E-06	0.00E+00
RB-87	0.00E+00	1.23E-05	4.28E-06	0.00E+00	0.00E+00	0.00E+00	5.76E-07	0.00E+00
RB-88	0.00E+00	6.05E-08	3.21E-08	0.00E+00	0.00E+00	0.00E+00	8.36E-19	0.00E+00
RB-89	0.00E+00	4.01E-08	2.82E-08	0.00E+00	0.00E+00	0.00E+00	2.33E-21	0.00E+00
SR-89	3.08E-04	0.00E+00	8.84E-06	0.00E+00	0.00E+00	0.00E+00	4.94E-05	0.00E+00
SR-90	8.71E-03	0.00E+00	1.75E-04	0.00E+00	0.00E+00	0.00E+00	2.19E-04	0.00E+00
SR-91	5.67E-06	0.00E+00	2.29E-07	0.00E+00	0.00E+00	0.00E+00	2.70E-05	0.00E+00
SR-92	2.15E-06	0.00E+00	9.30E-08	0.00E+00	0.00E+00	0.00E+00	4.26E-05	0.00E+00
Y-90	9.62E-09	0.00E+00	2.58E-10	0.00E+00	0.00E+00	0.00E+00	1.02E-04	0.00E+00
Y-91M	9.09E-11	0.00E+00	3.52E-12	0.00E+00	0.00E+00	0.00E+00	2.67E-10	0.00E+00
Y-91	1.41E-07	0.00E+00	3.77E-09	0.00E+00	0.00E+00	0.00E+00	7.76E-05	0.00E+00
Y-92	8.45E-10	0.00E+00	2.47E-11	0.00E+00	0.00E+00	0.00E+00	1.48E-05	0.00E+00
Y-93	2.68E-09	0.00E+00	7.40E-11	0.00E+00	0.00E+00	0.00E+00	8.50E-05	0.00E+00
ZR-93	4.18E-08	2.34E-09	1.09E-09	0.00E+00	8.87E-09	0.00E+00	2.43E-06	0.00E+00
ZR-95	3.04E-08	9.75E-09	6.60E-09	0.00E+00	1.53E-08	0.00E+00	3.09E-05	0.00E+00
ZR-97	1.68E-09	3.39E-10	1.55E-10	0.00E+00	5.12E-10	0.00E+00	1.05E-04	0.00E+00
NB-93M	2.55E-08	8.32E-09	2.05E-09	0.00E+00	9.57E-09	0.00E+00	3.84E-06	0.00E+00
NB-95	6.22E-09	3.46E-09	1.86E-09	0.00E+00	3.42E-09	0.00E+00	2.10E-05	0.00E+00
NB-97	5.22E-11	1.32E-11	4.82E-12	0.00E+00	1.54E-11	0.00E+00	4.87E-08	0.00E+00

TABLE II-3

 INGESTION DOSE FACTORS FOR ADULT (D_{aipj})
 mrem/pCi

NUCLIDE	BONE	LIVER	T BODY	THYROID	KIDNEY	LUNG	GI-LLI	SKIN
MO-93	0.00E+00	7.51E-06	2.03E-07	0.00E+00	2.13E-06	0.00E+00	1.22E-06	0.00E+00
MO-99	0.00E+00	4.31E-06	8.20E-07	0.00E+00	9.76E-06	0.00E+00	9.99E-06	0.00E+00
TC-99M	2.47E-10	6.98E-10	8.89E-09	0.00E+00	1.06E-08	3.42E-10	4.13E-07	0.00E+00
TC-99	1.25E-07	1.86E-07	5.02E-08	0.00E+00	2.34E-06	1.58E-08	6.08E-06	0.00E+00
TC-101	2.54E-10	3.66E-10	3.59E-09	0.00E+00	6.59E-09	1.87E-10	1.10E-21	0.00E+00
RU-103	1.85E-07	0.00E+00	7.97E-08	0.00E+00	7.06E-07	0.00E+00	2.16E-05	0.00E+00
RU-105	1.54E-08	0.00E+00	6.08E-09	0.00E+00	1.99E-07	0.00E+00	9.42E-06	0.00E+00
RU-106	2.75E-06	0.00E+00	3.48E-07	0.00E+00	5.31E-06	0.00E+00	1.78E-04	0.00E+00
RH-105	1.21E-07	8.85E-08	5.83E-08	0.00E+00	3.76E-07	0.00E+00	1.41E-05	0.00E+00
PD-107	0.00E+00	1.47E-07	9.40E-09	0.00E+00	1.32E-06	0.00E+00	9.11E-07	0.00E+00
PD-109	0.00E+00	1.77E-07	3.99E-08	0.00E+00	1.01E-06	0.00E+00	1.96E-05	0.00E+00
AG-110M	1.60E-07	1.48E-07	8.79E-08	0.00E+00	2.91E-07	0.00E+00	6.04E-05	0.00E+00
AG-111	5.81E-08	2.43E-08	1.21E-08	0.00E+00	7.84E-08	0.00E+00	4.46E-05	0.00E+00
CD-113M	0.00E+00	3.18E-06	1.02E-07	0.00E+00	3.50E-06	0.00E+00	2.56E-05	0.00E+00
CD-115M	0.00E+00	1.84E-06	5.87E-08	0.00E+00	1.46E-06	0.00E+00	7.74E-05	0.00E+00
SN-123	3.11E-05	5.15E-07	7.59E-07	4.38E-07	0.00E+00	0.00E+00	6.33E-05	0.00E+00
SN-125	8.33E-06	1.68E-07	3.78E-07	1.39E-07	0.00E+00	0.00E+00	1.04E-04	0.00E+00
SN-126	8.45E-05	1.67E-06	2.40E-06	4.92E-07	0.00E+00	0.00E+00	2.43E-05	0.00E+00
SB-124	2.80E-06	5.29E-08	1.11E-06	6.79E-09	0.00E+00	2.18E-06	7.95E-05	0.00E+00
SB-125	1.79E-06	2.00E-08	4.26E-07	1.82E-09	0.00E+00	1.38E-06	1.97E-05	0.00E+00
SB-126	1.15E-06	2.34E-08	4.15E-07	7.04E-09	0.00E+00	7.05E-07	9.40E-05	0.00E+00
SB-127	2.58E-07	5.65E-09	9.90E-08	3.10E-09	0.00E+00	1.53E-07	5.90E-05	0.00E+00
TE-125M	2.68E-06	9.71E-07	3.59E-07	8.06E-07	1.09E-05	0.00E+00	1.07E-05	0.00E+00
TE-127M	6.77E-06	2.42E-06	8.25E-07	1.73E-06	2.75E-05	0.00E+00	2.27E-05	0.00E+00
TE-127	1.10E-07	3.95E-08	2.38E-08	8.15E-08	4.48E-07	0.00E+00	8.68E-06	0.00E+00
TE-129M	1.15E-05	4.29E-06	1.82E-06	3.95E-06	4.80E-05	0.00E+00	5.79E-05	0.00E+00
TE-129	3.14E-08	1.18E-08	7.65E-09	2.41E-08	1.32E-07	0.00E+00	2.37E-08	0.00E+00
TE-131M	1.73E-06	8.46E-07	7.05E-07	1.34E-06	8.57E-06	0.00E+00	8.40E-05	0.00E+00
TE-131	1.97E-08	8.23E-09	6.22E-09	1.62E-08	8.63E-08	0.00E+00	2.79E-09	0.00E+00
TE-133M	4.62E-08	2.70E-08	2.60E-08	3.91E-08	2.67E-07	0.00E+00	9.26E-09	0.00E+00
TE-134	3.24E-08	2.12E-08	1.30E-08	2.83E-08	2.05E-07	0.00E+00	3.59E-11	0.00E+00
TE-132	2.52E-06	1.63E-06	1.53E-06	1.80E-06	1.57E-05	0.00E+00	7.71E-05	0.00E+00
I-129	3.27E-06	2.81E-06	9.21E-06	7.23E-03	6.04E-06	0.00E+00	4.44E-07	0.00E+00
I-130	7.56E-07	2.23E-06	8.80E-07	1.89E-04	3.48E-06	0.00E+00	1.92E-06	0.00E+00
I-131	4.16E-06	5.95E-06	3.41E-06	1.95E-03	1.02E-05	0.00E+00	1.57E-06	0.00E+00
I-132	2.03E-07	5.43E-07	1.90E-07	1.90E-05	8.65E-07	0.00E+00	1.02E-07	0.00E+00
I-133	1.42E-06	2.47E-06	7.53E-07	3.63E-04	4.31E-06	0.00E+00	2.22E-06	0.00E+00
I-134	1.06E-07	2.88E-07	1.03E-07	4.99E-06	4.58E-07	0.00E+00	2.51E-10	0.00E+00
I-135	4.43E-07	1.16E-06	4.28E-07	7.65E-05	1.86E-06	0.00E+00	1.31E-06	0.00E+00
CS-134M	2.13E-08	4.48E-08	2.29E-08	0.00E+00	2.43E-08	3.83E-09	1.58E-08	0.00E+00
CS-134	6.22E-05	1.48E-04	1.21E-04	0.00E+00	4.79E-05	1.59E-05	2.59E-06	0.00E+00
CS-135	1.95E-05	1.80E-05	7.99E-06	0.00E+00	6.81E-06	2.04E-06	4.21E-07	0.00E+00
CS-136	6.51E-06	2.57E-05	1.85E-05	0.00E+00	1.43E-05	1.96E-06	2.92E-06	0.00E+00
CS-137	7.97E-05	1.09E-04	7.14E-05	0.00E+00	3.70E-05	1.23E-05	2.11E-06	0.00E+00
CS-138	5.52E-08	1.09E-07	5.40E-08	0.00E+00	8.01E-08	7.91E-09	4.65E-13	0.00E+00
CS-139	3.41E-08	5.08E-08	1.85E-08	0.00E+00	4.07E-08	3.70E-09	1.10E-30	0.00E+00
BA-139	9.70E-08	6.91E-11	2.84E-09	0.00E+00	6.46E-11	3.92E-11	1.72E-07	0.00E+00

TABLE II1-3

INGESTION DOSE FACTORS FOR ADULT (D_{aipj})
mrem/pCi

NUCLIDE	BONE	LIVER	T BODY	THYROID	KIDNEY	LUNG	GI-LLI	SKIN
BA-140	2.03E-05	2.55E-08	1.33E-06	0.00E+00	8.67E-09	1.46E-08	4.18E-05	0.00E+00
BA-141	4.71E-08	3.56E-11	1.59E-09	0.00E+00	3.31E-11	2.02E-11	2.22E-17	0.00E+00
BA-142	2.13E-08	2.19E-11	1.34E-09	0.00E+00	1.85E-11	1.24E-11	3.00E-26	0.00E+00
LA-140	2.50E-09	1.26E-09	3.33E-10	0.00E+00	0.00E+00	0.00E+00	9.25E-05	0.00E+00
LA-141	3.19E-10	9.90E-11	1.62E-11	0.00E+00	0.00E+00	0.00E+00	1.18E-05	0.00E+00
LA-142	1.28E-10	5.82E-11	1.45E-11	0.00E+00	0.00E+00	0.00E+00	4.25E-07	0.00E+00
CE-141	9.36E-09	6.33E-09	7.18E-10	0.00E+00	2.94E-09	0.00E+00	2.42E-05	0.00E+00
CE-143	1.65E-09	1.22E-06	1.35E-10	0.00E+00	5.37E-10	0.00E+00	4.56E-05	0.00E+00
CE-144	4.88E-07	2.04E-07	2.62E-08	0.00E+00	1.21E-07	0.00E+00	1.65E-04	0.00E+00
PR-143	9.20E-09	3.69E-09	4.56E-10	0.00E+00	2.13E-09	0.00E+00	4.03E-05	0.00E+00
PR-144	3.01E-11	1.25E-11	1.53E-12	0.00E+00	7.05E-12	0.00E+00	4.33E-18	0.00E+00
ND-147	6.29E-09	7.27E-09	4.35E-10	0.00E+00	4.25E-09	0.00E+00	3.49E-05	0.00E+00
PM-147	7.54E-08	7.09E-09	2.8E-09	0.00E+00	1.34E-08	0.00E+00	8.93E-06	0.00E+00
PM-148M	3.07E-08	7.95E-09	6.08E-09	0.00E+00	1.20E-08	0.00E+00	6.74E-05	0.00E+00
PM-148	7.17E-09	1.19E-09	5.99E-10	0.00E+00	2.25E-09	0.00E+00	9.35E-05	0.00E+00
PM-149	1.52E-09	2.15E-10	8.78E-11	0.00E+00	4.06E-10	0.00E+00	4.03E-05	0.00E+00
PM-151	6.97E-10	1.17E-10	5.91E-11	0.00E+00	2.09E-10	0.00E+00	3.22E-05	0.00E+00
SM-151	6.90E-08	1.19E-08	2.85E-09	0.00E+00	1.33E-08	0.00E+00	5.25E-06	0.00E+00
SM-153	8.57E-10	7.15E-10	5.22E-11	0.00E+00	2.31E-10	0.00E+00	2.55E-05	0.00E+00
EU-152	1.95E-07	4.44E-08	3.90E-08	0.00E+00	2.75E-07	0.00E+00	2.56E-05	0.00E+00
EU-154	6.15E-07	7.56E-08	5.38E-08	0.00E+00	3.62E-07	0.00E+00	5.48E-05	0.00E+00
EU-155	8.60E-08	1.22E-08	7.87E-09	0.00E+00	5.63E-08	0.00E+00	9.60E-06	0.00E+00
EU-156	1.37E-08	1.06E-08	1.71E-09	0.00E+00	7.08E-09	0.00E+00	7.26E-05	0.00E+00
TB-160	4.70E-08	0.00E+00	5.86E-09	0.00E+00	1.94E-08	0.00E+00	4.33E-05	0.00E+00
HO-166M	2.70E-07	8.43E-08	6.40E-08	0.00E+00	1.26E-07	0.00E+00	2.56E-05	0.00E+00
W-181	9.91E-09	3.23E-09	3.46E-10	0.00E+00	0.00E+00	0.00E+00	3.68E-07	0.00E+00
W-185	4.05E-07	1.35E-07	1.42E-08	0.00E+00	0.00E+00	0.00E+00	1.56E-05	0.00E+00
W-187	1.03E-07	8.61E-08	3.01E-08	0.00E+00	0.00E+00	0.00E+00	2.82E-05	0.00E+00
U-232	4.13E-03	0.00E+00	2.95E-04	0.00E+00	4.47E-04	0.00E+00	6.78E-05	0.00E+00
U-233	8.71E-04	0.00E+00	5.28E-05	0.00E+00	2.03E-04	0.00E+00	6.27E-05	0.00E+00
U-234	8.36E-04	0.00E+00	5.17E-05	0.00E+00	1.99E-04	0.00E+00	6.14E-05	0.00E+00
U-235	8.01E-04	0.00E+00	4.86E-05	0.00E+00	1.87E-04	0.00E+00	7.81E-05	0.00E+00
U-236	8.01E-04	0.00E+00	4.96E-05	0.00E+00	1.91E-04	0.00E+00	5.76E-05	0.00E+00
U-237	5.52E-08	0.00E+00	1.47E-08	0.00E+00	2.27E-07	0.00E+00	1.94E-05	0.00E+00
U-238	7.67E-04	0.00E+00	4.54E-05	0.00E+00	1.75E-04	0.00E+00	5.50E-05	0.00E+00
NP-237	1.26E-03	8.96E-05	5.54E-05	0.00E+00	4.12E-04	0.00E+00	7.94E-05	0.00E+00
NP-238	1.37E-08	3.69E-10	2.13E-10	0.00E+00	1.25E-09	0.00E+00	3.43E-05	0.00E+00
NP-239	1.19E-09	1.17E-10	6.45E-11	0.00E+00	3.65E-10	0.00E+00	2.40E-05	0.00E+00
PU-238	6.30E-04	7.98E-05	1.71E-05	0.00E+00	7.32E-05	0.00E+00	7.30E-05	0.00E+00
PU-239	7.25E-04	8.71E-05	1.91E-05	0.00E+00	8.11E-05	0.00E+00	6.66E-05	0.00E+00
PU-240	7.24E-04	8.70E-05	1.91E-05	0.00E+00	8.10E-05	0.00E+00	6.78E-05	0.00E+00
PU-241	1.57E-05	7.45E-07	3.32E-07	0.00E+00	1.53E-06	0.00E+00	1.40E-06	0.00E+00
PU-242	6.72E-04	8.39E-05	1.84E-05	0.00E+00	7.81E-05	0.00E+00	6.53E-05	0.00E+00
PU-244	7.84E-04	9.61E-05	2.11E-05	0.00E+00	8.95E-05	0.00E+00	9.73E-05	0.00E+00
AM-241	7.55E-04	7.05E-04	5.41E-05	0.00E+00	4.07E-04	0.00E+00	7.42E-05	0.00E+00
AM-242M	7.61E-04	6.63E-04	5.43E-05	0.00E+00	4.05E-04	0.00E+00	9.34E-05	0.00E+00
AM-243	7.54E-04	6.90E-04	5.30E-05	0.00E+00	3.99E-04	0.00E+00	8.70E-05	0.00E+00

TABLE II-3

INGESTION DOSE FACTORS FOR ADULT (D_{aipj})
mrem/pCi

NUCLIDE	BONE	LIVER	T BODY	THYROID	KIDNEY	LUNG	GI-LLI	SKIN
CM-242	2.06E-05	2.19E-05	1.37E-06	0.00E+00	6.22E-06	0.00E+00	7.92E-05	0.00E+00
CM-243	5.99E-04	5.49E-04	3.75E-05	0.00E+00	1.75E-04	0.00E+00	7.81E-05	0.00E+00
CM-244	4.56E-04	4.27E-04	2.87E-05	0.00E+00	1.34E-04	0.00E+00	7.55E-05	0.00E+00
CM-245	9.38E-04	8.17E-04	5.76E-05	0.00E+00	2.69E-04	0.00E+00	7.04E-05	0.00E+00
CM-246	9.30E-04	8.16E-04	5.75E-05	0.00E+00	2.68E-04	0.00E+00	6.91E-05	0.00E+00
CM-247	9.07E-04	8.04E-04	5.67E-05	0.00E+00	2.64E-04	0.00E+00	9.09E-05	0.00E+00
CM-248	7.54E-03	6.63E-03	4.67E-04	0.00E+00	2.18E-03	0.00E+00	1.47E-03	0.00E+00
CF-252	2.61E-04	0.00E+00	6.29E-06	0.00E+00	0.00E+00	0.00E+00	2.88E-04	0.00E+00

NUREG/CR-4653, GASPAR II, Technical Reference and User Guide

TABLE II-4

INGESTION DOSE FACTORS FOR TEEN (D_{aipj})
mrem/pCi

NUCLIDE	BONE	LIVER	T BODY	THYROID	KIDNEY	LUNG	GI-LLI	SKIN
H-3	0.00E+00	6.04E-08	6.04E-08	6.04E-08	6.04E-08	6.04E-08	6.04E-08	0.00E+00
C-14	4.06E-06	8.12E-07	8.12E-07	8.12E-07	8.12E-07	8.12E-07	8.12E-07	0.00E+00
NA-22	2.34E-05	2.34E-05	2.34E-05	2.34E-05	2.34E-05	2.34E-05	2.34E-05	0.00E+00
NA-24	2.30E-06	2.30E-06	2.30E-06	2.30E-06	2.30E-06	2.30E-06	2.30E-06	0.00E+00
P-32	2.76E-04	1.71E-05	1.07E-05	0.00E+00	0.00E+00	0.00E+00	2.32E-05	0.00E+00
CA-41	1.97E-04	0.00E+00	2.13E-05	0.00E+00	0.00E+00	0.00E+00	1.95E-07	0.00E+00
SC-46	7.24E-09	1.41E-08	4.18E-09	0.00E+00	1.35E-08	0.00E+00	4.80E-05	0.00E+00
CR-51	0.00E+00	0.00E+00	3.60E-09	2.00E-09	7.89E-10	5.14E-09	6.05E-07	0.00E+00
MN-54	0.00E+00	5.90E-06	1.17E-06	0.00E+00	1.76E-06	0.00E+00	1.21E-05	0.00E+00
MN-56	0.00E+00	1.58E-07	2.81E-08	0.00E+00	2.00E-07	0.00E+00	1.04E-05	0.00E+00
FE-55	3.78E-06	2.68E-06	6.25E-07	0.00E+00	0.00E+00	1.70E-06	1.16E-06	0.00E+00
FE-59	5.87E-06	1.37E-05	5.29E-06	0.00E+00	0.00E+00	4.32E-06	3.24E-05	0.00E+00
CO-57	0.00E+00	2.38E-07	3.99E-07	0.00E+00	0.00E+00	0.00E+00	4.44E-06	0.00E+00
CO-58	0.00E+00	9.72E-07	2.24E-06	0.00E+00	0.00E+00	0.00E+00	1.34E-05	0.00E+00
CO-60	0.00E+00	2.81E-06	6.33E-06	0.00E+00	0.00E+00	0.00E+00	3.66E-05	0.00E+00
NI-59	1.32E-05	4.66E-06	2.24E-06	0.00E+00	0.00E+00	0.00E+00	7.31E-07	0.00E+00
NI-63	1.77E-04	1.25E-05	6.00E-06	0.00E+00	0.00E+00	0.00E+00	1.99E-06	0.00E+00
NI-65	7.49E-07	9.57E-08	4.36E-08	0.00E+00	0.00E+00	0.00E+00	5.19E-06	0.00E+00
CU-64	0.00E+00	1.15E-07	5.41E-08	0.00E+00	2.91E-07	0.00E+00	8.92E-06	0.00E+00
ZN-65	5.76E-06	2.00E-05	9.33E-06	0.00E+00	1.28E-05	0.00E+00	8.47E-06	0.00E+00
ZN-69M	2.40E-07	5.66E-07	5.19E-08	0.00E+00	3.44E-07	0.00E+00	3.11E-05	0.00E+00
ZN-69	1.47E-08	2.80E-08	1.96E-09	0.00E+00	1.83E-08	0.00E+00	5.16E-08	0.00E+00
SE-79	0.00E+00	3.73E-06	6.27E-07	0.00E+00	6.50E-06	0.00E+00	5.70E-07	0.00E+00
BR-82	0.00E+00	0.00E+00	3.04E-06	0.00E+00	0.00E+00	0.00E+00	0.00E+00	0.00E+00
BR-83	0.00E+00	0.00E+00	5.74E-08	0.00E+00	0.00E+00	0.00E+00	0.00E+00	0.00E+00
BR-84	0.00E+00	0.00E+00	7.22E-08	0.00E+00	0.00E+00	0.00E+00	0.00E+00	0.00E+00
BR-85	0.00E+00	0.00E+00	3.05E-09	0.00E+00	0.00E+00	0.00E+00	0.00E+00	0.00E+00
RB-86	0.00E+00	2.98E-05	1.40E-05	0.00E+00	0.00E+00	0.00E+00	4.41E-06	0.00E+00
RB-87	0.00E+00	1.75E-05	6.11E-06	0.00E+00	0.00E+00	0.00E+00	6.11E-07	0.00E+00
RB-88	0.00E+00	8.52E-08	4.54E-08	0.00E+00	0.00E+00	0.00E+00	7.30E-15	0.00E+00
RB-89	0.00E+00	5.50E-08	3.89E-08	0.00E+00	0.00E+00	0.00E+00	8.43E-17	0.00E+00
SR-89	4.40E-04	0.00E+00	1.26E-05	0.00E+00	0.00E+00	0.00E+00	5.24E-05	0.00E+00
SR-90	1.02E-02	0.00E+00	2.04E-04	0.00E+00	0.00E+00	0.00E+00	2.33E-04	0.00E+00
SR-91	8.07E-06	0.00E+00	3.21E-07	0.00E+00	0.00E+00	0.00E+00	3.66E-05	0.00E+00
SR-92	3.05E-06	0.00E+00	1.30E-07	0.00E+00	0.00E+00	0.00E+00	7.77E-05	0.00E+00
Y-90	1.37E-08	0.00E+00	3.69E-10	0.00E+00	0.00E+00	0.00E+00	1.13E-04	0.00E+00
Y-91M	1.29E-10	0.00E+00	4.93E-12	0.00E+00	0.00E+00	0.00E+00	6.09E-09	0.00E+00
Y-91	2.01E-07	0.00E+00	5.39E-09	0.00E+00	0.00E+00	0.00E+00	8.24E-05	0.00E+00
Y-92	1.21E-09	0.00E+00	3.50E-11	0.00E+00	0.00E+00	0.00E+00	3.32E-05	0.00E+00
Y-93	3.83E-09	0.00E+00	1.05E-10	0.00E+00	0.00E+00	0.00E+00	1.17E-04	0.00E+00
ZR-93	5.53E-08	2.73E-09	1.49E-09	0.00E+00	9.65E-09	0.00E+00	2.58E-09	0.00E+00
ZR-95	4.12E-08	1.30E-08	8.94E-09	0.00E+00	1.91E-08	0.00E+00	3.00E-05	0.00E+00
ZR-97	2.37E-09	4.69E-10	2.16E-10	0.00E+00	7.11E-10	0.00E+00	1.27E-04	0.00E+00
NB-93M	3.44E-08	1.13E-08	2.83E-09	0.00E+00	1.32E-08	0.00E+00	4.07E-06	0.00E+00
NB-95	8.22E-09	4.56E-09	2.51E-09	0.00E+00	4.42E-09	0.00E+00	1.95E-05	0.00E+00

TABLE II-4

INGESTION DOSE FACTORS FOR TEEN (D_{aipj})
mrem/pCi

NUCLIDE	BONE	LIVER	T BODY	THYROID	KIDNEY	LUNG	GI-LLI	SKIN
NB-97	7.37E-11	1.83E-11	6.68E-12	0.00E+00	2.14E-11	0.00E+00	4.37E-07	0.00E+00
MO-93	0.00E+00	1.06E-05	2.90E-07	0.00E+00	3.04E-06	0.00E+00	1.29E-06	0.00E+00
MO-99	0.00E+00	6.03E-06	1.15E-06	0.00E+00	1.38E-05	0.00E+00	1.08E-05	0.00E+00
TC-99M	3.32E-10	9.26E-10	1.20E-08	0.00E+00	1.38E-08	5.14E-10	6.08E-07	0.00E+00
TC-99	1.79E-07	2.63E-07	7.17E-08	0.00E+00	3.34E-06	2.72E-08	6.44E-06	0.00E+00
TC-101	3.60E-10	5.12E-10	5.03E-09	0.00E+00	9.26E-09	3.12E-10	8.75E-17	0.00E+00
RU-103	2.55E-07	0.00E+00	1.09E-07	0.00E+00	8.99E-07	0.00E+00	2.13E-05	0.00E+00
RU-105	2.18E-08	0.00E+00	8.46E-09	0.00E+00	2.75E-07	0.00E+00	1.76E-05	0.00E+00
RU-106	3.92E-06	0.00E+00	4.94E-07	0.00E+00	7.56E-06	0.00E+00	1.88E-04	0.00E+00
RH-105	1.73E-07	1.25E-07	8.20E-08	0.00E+00	5.31E-07	0.00E+00	1.59E-05	0.00E+00
PD-107	0.00E+00	2.08E-07	1.34E-08	0.00E+00	1.88E-06	0.00E+00	9.66E-07	0.00E+00
PD-109	0.00E+00	2.51E-07	5.70E-08	0.00E+00	1.45E-06	0.00E+00	2.53E-05	0.00E+00
AG-110M	2.05E-07	1.94E-07	1.18E-07	0.00E+00	3.70E-07	0.00E+00	5.45E-05	0.00E+00
AG-111	8.29E-08	3.44E-08	1.73E-08	0.00E+00	1.12E-07	0.00E+00	4.80E-05	0.00E+00
CD-113M	0.00E+00	4.51E-06	1.45E-07	0.00E+00	4.99E-06	0.00E+00	2.71E-05	0.00E+00
CD-115M	0.00E+00	2.60E-06	8.39E-08	0.00E+00	2.08E-06	0.00E+00	8.23E-05	0.00E+00
SN-123	4.44E-05	7.29E-07	1.08E-06	5.84E-07	0.00E+00	0.00E+00	6.71E-05	0.00E+00
SN-125	1.19E-05	2.37E-07	5.37E-07	1.86E-07	0.00E+00	0.00E+00	1.12E-04	0.00E+00
SN-126	1.16E-04	2.16E-06	3.30E-06	5.69E-07	0.00E+00	0.00E+00	2.58E-05	0.00E+00
SB-124	3.87E-06	7.13E-08	1.51E-06	8.78E-09	0.00E+00	3.38E-06	7.80E-05	0.00E+00
SB-125	2.48E-06	2.71E-08	5.80E-07	2.37E-09	0.00E+00	2.18E-06	1.93E-05	0.00E+00
SB-126	1.59E-06	3.25E-08	5.71E-07	8.99E-09	0.00E+00	1.14E-06	9.41E-05	0.00E+00
SB-127	3.63E-07	7.76E-09	1.37E-07	4.08E-09	0.00E+00	2.47E-07	6.16E-05	0.00E+00
TE-125M	3.83E-06	1.38E-06	5.12E-07	1.07E-06	0.00E+00	0.00E+00	1.13E-05	0.00E+00
TE-127M	9.67E-06	3.43E-06	1.15E-06	2.30E-06	3.92E-05	0.00E+00	2.41E-05	0.00E+00
TE-127	1.58E-07	5.60E-08	3.40E-08	1.09E-07	6.40E-07	0.00E+00	1.22E-05	0.00E+00
TE-129M	1.63E-05	6.05E-06	2.58E-06	5.26E-06	6.82E-05	0.00E+00	6.12E-05	0.00E+00
TE-129	4.48E-08	1.67E-08	1.09E-08	3.20E-08	1.88E-07	0.00E+00	2.45E-07	0.00E+00
TE-131M	2.44E-06	1.17E-06	9.76E-07	1.76E-06	1.22E-05	0.00E+00	9.39E-05	0.00E+00
TE-131	2.79E-08	1.15E-08	8.72E-09	2.15E-08	1.22E-07	0.00E+00	2.29E-09	0.00E+00
TE-132	3.49E-06	2.21E-06	2.08E-06	2.33E-06	2.12E-05	0.00E+00	7.00E-05	0.00E+00
TE-133M	6.44E-08	3.66E-08	3.56E-08	5.11E-08	3.62E-07	0.00E+00	1.48E-07	0.00E+00
TE-134	4.47E-08	2.87E-08	3.00E-08	3.67E-08	2.74E-07	0.00E+00	1.66E-09	0.00E+00
I-129	4.66E-06	3.92E-06	6.54E-06	4.77E-03	7.01E-06	0.00E+00	4.57E-07	0.00E+00
I-130	1.03E-06	2.98E-06	1.19E-06	2.43E-04	4.59E-06	0.00E+00	2.29E-06	0.00E+00
I-131	5.85E-06	8.19E-06	4.40E-06	2.39E-03	1.41E-05	0.00E+00	1.62E-06	0.00E+00
I-132	2.79E-07	7.30E-07	2.62E-07	2.46E-05	1.15E-06	0.00E+00	3.18E-07	0.00E+00
I-133	2.01E-06	3.41E-06	1.04E-06	4.76E-04	5.98E-06	0.00E+00	2.58E-06	0.00E+00
I-134	1.46E-07	3.87E-07	1.39E-07	6.45E-06	6.10E-07	0.00E+00	5.10E-09	0.00E+00
I-135	6.10E-07	1.57E-06	5.82E-07	1.01E-04	2.48E-06	0.00E+00	1.74E-06	0.00E+00
CS-134M	2.94E-08	6.09E-08	3.13E-08	0.00E+00	3.39E-08	5.95E-09	4.05E-08	0.00E+00
CS-134	8.37E-05	1.97E-04	9.14E-05	0.00E+00	6.26E-05	2.39E-05	2.45E-06	0.00E+00
CS-135	2.78E-05	2.55E-05	5.96E-06	0.00E+00	9.73E-06	3.52E-06	4.46E-07	0.00E+00
CS-136	8.59E-06	3.38E-05	2.27E-05	0.00E+00	1.84E-05	2.90E-06	2.72E-06	0.00E+00
CS-137	1.12E-04	1.49E-04	5.19E-05	0.00E+00	5.07E-05	1.97E-05	2.12E-06	0.00E+00
CS-138	7.76E-08	1.49E-07	7.45E-08	0.00E+00	1.10E-07	1.28E-08	6.76E-11	0.00E+00
CS-139	4.87E-08	7.17E-08	2.63E-08	0.00E+00	5.79E-08	6.34E-09	3.33E-23	0.00E+00

TABLE II-4

 INGESTION DOSE FACTORS FOR TEEN (D_{aipj})
 mrem/pCi

NUCLIDE	BONE	LIVER	T BODY	THYROID	KIDNEY	LUNG	GI-LLI	SKIN
BA-139	1.39E-07	9.78E-11	4.05E-09	0.00E+00	9.22E-11	6.74E-11	1.24E-06	0.00E+00
BA-140	2.84E-05	3.48E-08	1.83E-06	0.00E+00	1.18E-08	2.34E-08	4.38E-05	0.00E+00
BA-141	6.71E-08	5.01E-11	2.24E-09	0.00E+00	4.65E-11	3.43E-11	1.43E-13	0.00E+00
BA-142	2.99E-08	2.99E-11	1.84E-09	0.00E+00	2.53E-11	1.99E-11	9.18E-20	0.00E+00
LA-140	3.48E-09	1.71E-09	4.55E-10	0.00E+00	0.00E+00	0.00E+00	9.82E-05	0.00E+00
LA-141	4.55E-10	1.40E-10	2.31E-11	0.00E+00	0.00E+00	0.00E+00	2.48E-05	0.00E+00
LA-142	1.79E-10	7.95E-11	1.98E-11	0.00E+00	0.00E+00	0.00E+00	2.42E-06	0.00E+00
CE-141	1.33E-08	8.88E-09	1.02E-09	0.00E+00	4.18E-09	0.00E+00	2.54E-05	0.00E+00
CE-143	2.35E-09	1.71E-06	1.91E-10	0.00E+00	7.67E-10	0.00E+00	5.14E-05	0.00E+00
CE-144	6.96E-07	2.88E-07	3.74E-08	0.00E+00	1.72E-07	0.00E+00	1.75E-04	0.00E+00
PR-143	1.31E-08	5.23E-09	6.52E-10	0.00E+00	3.04E-09	0.00E+00	4.31E-05	0.00E+00
PR-144	4.30E-11	1.76E-11	2.18E-12	0.00E+00	1.01E-11	0.00E+00	4.74E-14	0.00E+00
ND-147	9.38E-09	1.02E-08	6.11E-10	0.00E+00	5.99E-09	0.00E+00	3.68E-05	0.00E+00
PM-147	1.05E-07	9.96E-09	4.06E-09	0.00E+00	1.90E-08	0.00E+00	9.47E-06	0.00E+00
PM-148M	4.14E-08	1.05E-08	8.21E-09	0.00E+00	1.59E-08	0.00E+00	6.61E-05	0.00E+00
PM-148	1.02E-08	1.66E-09	8.36E-10	0.00E+00	3.00E-09	0.00E+00	9.90E-05	0.00E+00
PM-149	2.17E-09	3.05E-10	1.25E-10	0.00E+00	5.81E-10	0.00E+00	4.49E-05	0.00E+00
PM-151	9.87E-10	1.63E-10	8.25E-11	0.00E+00	2.93E-10	0.00E+00	3.66E-05	0.00E+00
SM-151	8.73E-08	1.68E-08	3.94E-09	0.00E+00	1.84E-08	0.00E+00	5.70E-06	0.00E+00
SM-153	1.22E-09	1.01E-09	7.43E-11	0.00E+00	3.30E-10	0.00E+00	2.85E-05	0.00E+00
EU-152	2.45E-07	5.90E-08	5.20E-08	0.00E+00	2.74E-07	0.00E+00	2.17E-05	0.00E+00
EU-154	7.91E-07	1.02E-07	7.19E-08	0.00E+00	4.56E-07	0.00E+00	5.39E-05	0.00E+00
EU-155	1.74E-07	1.68E-08	1.04E-08	0.00E+00	6.57E-08	0.00E+00	9.63E-05	0.00E+00
EU-156	1.92E-08	1.44E-08	2.35E-09	0.00E+00	9.69E-09	0.00E+00	7.36E-05	0.00E+00
TB-160	6.47E-08	0.00E+00	8.07E-09	0.00E+00	2.56E-08	0.00E+00	4.19E-05	0.00E+00
HO-166M	3.57E-07	1.10E-07	7.96E-08	0.00E+00	1.61E-07	0.00E+00	2.71E-05	0.00E+00
W-181	1.42E-08	4.58E-09	4.79E-10	0.00E+00	0.00E+00	0.00E+00	3.90E-07	0.00E+00
W-185	5.79E-07	1.91E-07	2.02E-08	0.00E+00	0.00E+00	0.00E+00	1.65E-05	0.00E+00
W-187	1.46E-07	1.19E-07	4.17E-08	0.00E+00	0.00E+00	0.00E+00	3.22E-05	0.00E+00
U-232	5.89E-03	0.00E+00	4.21E-04	0.00E+00	6.38E-04	0.00E+00	7.19E-05	0.00E+00
U-233	1.24E-03	0.00E+00	7.54E-05	0.00E+00	2.90E-04	0.00E+00	6.65E-05	0.00E+00
U-234	1.19E-03	0.00E+00	7.39E-05	0.00E+00	2.85E-04	0.00E+00	6.51E-05	0.00E+00
U-235	1.14E-03	0.00E+00	6.94E-05	0.00E+00	2.67E-04	0.00E+00	8.28E-05	0.00E+00
U-236	1.14E-03	0.00E+00	7.09E-05	0.00E+00	2.73E-04	0.00E+00	6.11E-05	0.00E+00
U-237	7.89E-08	0.00E+00	2.10E-08	0.00E+00	3.24E-07	0.00E+00	2.09E-05	0.00E+00
U-238	1.09E-03	0.00E+00	6.49E-05	0.00E+00	2.50E-04	0.00E+00	5.83E-05	0.00E+00
NP-237	1.33E-03	9.55E-05	5.85E-05	0.00E+00	4.33E-04	0.00E+00	8.41E-05	0.00E+00
NP-238	1.95E-08	5.22E-10	3.04E-10	0.00E+00	1.79E-09	0.00E+00	3.83E-05	0.00E+00
NP-239	1.76E-09	1.66E-10	9.22E-11	0.00E+00	5.21E-10	0.00E+00	2.67E-05	0.00E+00
PU-238	6.70E-04	8.58E-05	1.82E-05	0.00E+00	7.80E-05	0.00E+00	7.73E-05	0.00E+00
PU-239	7.65E-04	9.29E-05	2.01E-05	0.00E+00	8.57E-05	0.00E+00	7.06E-05	0.00E+00
PU-240	7.64E-04	9.27E-05	2.01E-05	0.00E+00	8.56E-05	0.00E+00	7.19E-05	0.00E+00
PU-241	1.75E-05	8.40E-07	3.69E-07	0.00E+00	1.71E-06	0.00E+00	1.48E-06	0.00E+00
PU-242	7.09E-04	8.94E-05	1.94E-05	0.00E+00	8.25E-05	0.00E+00	6.92E-05	0.00E+00
PU-244	8.28E-04	1.02E-04	2.22E-05	0.00E+00	9.45E-05	0.00E+00	1.03E-04	0.00E+00
AM-241	7.98E-04	7.53E-04	5.75E-05	0.00E+00	4.31E-04	0.00E+00	7.87E-05	0.00E+00
AM-242M	8.07E-04	7.11E-04	5.80E-05	0.00E+00	4.30E-04	0.00E+00	9.90E-05	0.00E+00

TABLE II-4

INGESTION DOSE FACTORS FOR TEEN (D_{aipj})
mrem/pCi

NUCLIDE	BONE	LIVER	T BODY	THYROID	KIDNEY	LUNG	GI-LLI	SKIN
AM-243	7.96E-04	7.35E-04	5.62E-05	0.00E+00	4.22E-04	0.00E+00	9.23E-05	0.00E+00
CM-242	2.94E-05	3.10E-05	1.95E-06	0.00E+00	8.89E-06	0.00E+00	8.40E-05	0.00E+00
CM-243	6.50E-04	6.03E-04	4.09E-05	0.00E+00	1.91E-04	0.00E+00	8.28E-05	0.00E+00
CM-244	5.04E-04	4.77E-04	3.19E-05	0.00E+00	1.49E-04	0.00E+00	8.00E-05	0.00E+00
CM-245	9.90E-04	8.71E-04	6.10E-05	0.00E+00	2.85E-04	0.00E+00	7.46E-05	0.00E+00
CM-246	9.82E-04	8.70E-04	6.09E-05	0.00E+00	2.84E-04	0.00E+00	7.33E-05	0.00E+00
CM-247	9.57E-04	8.57E-04	6.00E-05	0.00E+00	2.80E-04	0.00E+00	9.63E-05	0.00E+00
CM-248	7.95E-03	7.06E-03	4.95E-04	0.00E+00	2.31E-03	0.00E+00	1.55E-03	0.00E+00
CF-252	3.47E-04	0.00E+00	8.37E-06	0.00E+00	0.00E+00	0.00E+00	3.05E-04	0.00E+00

NUREG/CR-4653, GASPAR II, Technical Reference and User Guide

TABLE II-5

 INGESTION DOSE FACTORS FOR CHILD (D_{aipj})
 mrem/pCi

NUCLIDE	BONE	LIVER	T BODY	THYROID	KIDNEY	LUNG	GI-LLI	SKIN
H-3	0.00E+00	1.16E-07	1.16E-07	1.16E-07	1.16E-07	1.16E-07	1.16E-07	0.00E+00
C-14	1.21E-05	2.42E-06	2.42E-06	2.42E-06	2.42E-06	2.42E-06	2.42E-06	0.00E+00
NA-22	5.88E-05	5.88E-05	5.88E-05	5.88E-05	5.88E-05	5.88E-05	5.88E-05	0.00E+00
NA-24	5.80E-06	5.80E-06	5.80E-06	5.80E-06	5.80E-06	5.80E-06	5.80E-06	0.00E+00
P-32	8.25E-04	3.86E-05	3.18E-05	0.00E+00	0.00E+00	0.00E+00	2.28E-05	0.00E+00
CA-41	3.47E-04	0.00E+00	3.79E-05	0.00E+00	0.00E+00	0.00E+00	1.90E-07	0.00E+00
SC-46	1.97E-08	2.70E-08	1.04E-08	0.00E+00	2.39E-08	0.00E+00	3.95E-05	0.00E+00
CR-51	0.00E+00	0.00E+00	8.90E-09	4.94E-09	1.35E-09	9.02E-09	4.72E-07	0.00E+00
MN-54	0.00E+00	1.07E-05	2.85E-06	0.00E+00	3.00E-06	0.00E+00	8.98E-06	0.00E+00
MN-56	0.00E+00	3.34E-07	7.54E-08	0.00E+00	4.04E-07	0.00E+00	4.84E-05	0.00E+00
FE-55	1.15E-05	6.10E-06	1.89E-06	0.00E+00	0.00E+00	3.45E-06	1.13E-06	0.00E+00
FE-59	1.65E-05	2.67E-05	1.33E-05	0.00E+00	0.00E+00	7.74E-06	2.78E-05	0.00E+00
CO-57	0.00E+00	4.93E-07	9.98E-07	0.00E+00	0.00E+00	0.00E+00	4.04E-06	0.00E+00
CO-58	0.00E+00	1.80E-06	5.51E-06	0.00E+00	0.00E+00	0.00E+00	1.05E-05	0.00E+00
CO-60	0.00E+00	5.29E-06	1.56E-05	0.00E+00	0.00E+00	0.00E+00	2.93E-05	0.00E+00
NI-59	4.02E-05	1.07E-05	6.82E-06	0.00E+00	0.00E+00	0.00E+00	7.10E-07	0.00E+00
NI-63	5.38E-04	2.88E-05	1.83E-05	0.00E+00	0.00E+00	0.00E+00	1.94E-06	0.00E+00
NI-65	2.22E-06	2.09E-07	1.22E-07	0.00E+00	0.00E+00	0.00E+00	2.56E-05	0.00E+00
CU-64	0.00E+00	2.45E-07	1.48E-07	0.00E+00	5.92E-07	0.00E+00	1.15E-05	0.00E+00
ZN-65	1.37E-05	3.65E-05	2.27E-05	0.00E+00	2.30E-05	0.00E+00	6.41E-06	0.00E+00
ZN-69M	7.10E-07	1.21E-06	1.43E-07	0.00E+00	7.03E-07	0.00E+00	3.94E-05	0.00E+00
ZN-69	4.38E-08	6.33E-08	5.85E-09	0.00E+00	3.84E-08	0.00E+00	3.99E-06	0.00E+00
SE-79	0.00E+00	8.43E-06	1.87E-06	0.00E+00	1.37E-05	0.00E+00	5.53E-07	0.00E+00
BR-82	0.00E+00	0.00E+00	7.55E-06	0.00E+00	0.00E+00	0.00E+00	0.00E+00	0.00E+00
BR-83	0.00E+00	0.00E+00	1.71E-07	0.00E+00	0.00E+00	0.00E+00	0.00E+00	0.00E+00
BR-84	0.00E+00	0.00E+00	1.98E-07	0.00E+00	0.00E+00	0.00E+00	0.00E+00	0.00E+00
BR-85	0.00E+00	0.00E+00	9.12E-09	0.00E+00	0.00E+00	0.00E+00	0.00E+00	0.00E+00
RB-86	0.00E+00	6.70E-05	4.12E-05	0.00E+00	0.00E+00	0.00E+00	4.31E-06	0.00E+00
RB-87	0.00E+00	3.95E-05	1.83E-05	0.00E+00	0.00E+00	0.00E+00	5.92E-07	0.00E+00
RB-88	0.00E+00	1.90E-07	1.32E-07	0.00E+00	0.00E+00	0.00E+00	9.32E-09	0.00E+00
RB-89	0.00E+00	1.17E-07	1.04E-07	0.00E+00	0.00E+00	0.00E+00	1.02E-09	0.00E+00
SR-89	1.32E-03	0.00E+00	3.77E-05	0.00E+00	0.00E+00	0.00E+00	5.11E-05	0.00E+00
SR-90	2.56E-02	0.00E+00	5.15E-04	0.00E+00	0.00E+00	0.00E+00	2.29E-04	0.00E+00
SR-91	2.40E-05	0.00E+00	9.06E-07	0.00E+00	0.00E+00	0.00E+00	5.30E-05	0.00E+00
SR-92	9.03E-06	0.00E+00	3.62E-07	0.00E+00	0.00E+00	0.00E+00	1.71E-04	0.00E+00
Y-90	4.11E-08	0.00E+00	1.10E-09	0.00E+00	0.00E+00	0.00E+00	1.17E-04	0.00E+00
Y-91M	3.82E-10	0.00E+00	1.39E-11	0.00E+00	0.00E+00	0.00E+00	7.48E-07	0.00E+00
Y-91	6.02E-07	0.00E+00	1.61E-08	0.00E+00	0.00E+00	0.00E+00	8.02E-05	0.00E+00
Y-92	3.60E-09	0.00E+00	1.03E-10	0.00E+00	0.00E+00	0.00E+00	1.04E-04	0.00E+00
Y-93	1.14E-08	0.00E+00	3.13E-10	0.00E+00	0.00E+00	0.00E+00	1.70E-04	0.00E+00
ZR-93	1.67E-07	6.25E-09	4.45E-09	0.00E+00	2.42E-08	0.00E+00	2.37E-06	0.00E+00
ZR-95	1.16E-07	2.55E-08	2.27E-08	0.00E+00	3.65E-08	0.00E+00	2.66E-05	0.00E+00
ZR-97	6.99E-09	1.01E-09	5.96E-10	0.00E+00	1.45E-09	0.00E+00	1.53E-04	0.00E+00
NB-93M	1.05E-07	2.62E-08	8.61E-09	0.00E+00	2.83E-08	0.00E+00	3.95E-06	0.00E+00
NB-95	2.25E-08	8.76E-09	6.26E-09	0.00E+00	8.23E-09	0.00E+00	1.62E-05	0.00E+00

TABLE II-5

INGESTION DOSE FACTORS FOR CHILD (D_{aipj})
mrem/pCi

NUCLIDE	BONE	LIVER	T BODY	THYROID	KIDNEY	LUNG	GI-LLI	SKIN
NB-97	2.17E-10	3.92E-11	1.83E-11	0.00E+00	4.35E-11	0.00E+00	1.21E-05	0.00E+00
MO-93	0.00E+00	2.41E-05	8.65E-07	0.00E+00	6.35E-06	0.00E+00	1.22E-06	0.00E+00
MO-99	0.00E+00	1.33E-05	3.29E-06	0.00E+00	2.84E-05	0.00E+00	1.10E-05	0.00E+00
TC-99M	9.23E-10	1.81E-09	3.00E-08	0.00E+00	2.63E-08	9.19E-10	1.03E-06	0.00E+00
TC-99	5.35E-07	5.96E-07	2.14E-07	0.00E+00	7.02E-06	5.27E-08	6.25E-06	0.00E+00
TC-101	1.07E-09	1.12E-09	1.42E-08	0.00E+00	1.91E-08	5.92E-10	3.56E-09	0.00E+00
RU-103	7.31E-07	0.00E+00	2.81E-07	0.00E+00	1.84E-06	0.00E+00	1.89E-05	0.00E+00
RU-105	6.45E-08	0.00E+00	2.34E-08	0.00E+00	5.67E-07	0.00E+00	4.21E-05	0.00E+00
RU-106	1.17E-05	0.00E+00	1.46E-06	0.00E+00	1.58E-05	0.00E+00	1.82E-04	0.00E+00
RH-105	5.14E-07	2.76E-07	2.36E-07	0.00E+00	1.10E-06	0.00E+00	1.71E-05	0.00E+00
PD-107	0.00E+00	4.72E-07	4.01E-08	0.00E+00	3.95E-06	0.00E+00	9.37E-07	0.00E+00
PD-109	0.00E+00	5.67E-07	1.70E-07	0.00E+00	3.04E-06	0.00E+00	3.35E-05	0.00E+00
AG-110M	5.39E-07	3.64E-07	2.91E-07	0.00E+00	6.78E-07	0.00E+00	4.33E-05	0.00E+00
AG-111	2.48E-07	7.76E-08	5.12E-08	0.00E+00	2.34E-07	0.00E+00	4.75E-05	0.00E+00
CD-113M	0.00E+00	1.02E-05	4.34E-07	0.00E+00	1.05E-05	0.00E+00	2.63E-05	0.00E+00
CD-115M	0.00E+00	5.89E-06	2.51E-07	0.00E+00	4.38E-06	0.00E+00	8.01E-05	0.00E+00
SN-123	1.33E-04	1.65E-06	3.24E-06	1.75E-06	0.00E+00	0.00E+00	6.52E-05	0.00E+00
SN-125	3.55E-05	5.35E-07	1.59E-06	5.55E-07	0.00E+00	0.00E+00	1.10E-04	0.00E+00
SN-126	3.33E-04	4.15E-06	9.46E-06	1.14E-06	0.00E+00	0.00E+00	2.50E-05	0.00E+00
SB-124	1.11E-05	1.44E-07	3.89E-06	2.45E-08	0.00E+00	6.16E-06	6.94E-05	0.00E+00
SB-125	7.16E-06	5.52E-08	1.50E-06	6.63E-09	0.00E+00	3.99E-06	1.71E-05	0.00E+00
SB-126	4.40E-06	6.73E-08	1.58E-06	2.58E-08	0.00E+00	2.10E-06	8.87E-05	0.00E+00
SB-127	1.06E-06	1.64E-08	3.68E-07	1.18E-08	0.00E+00	4.60E-07	5.97E-05	0.00E+00
TE-125M	1.14E-05	3.09E-06	1.52E-06	3.20E-06	0.00E+00	0.00E+00	1.10E-05	0.00E+00
TE-127M	2.89E-05	7.78E-06	3.43E-06	6.91E-06	8.24E-05	0.00E+00	2.34E-05	0.00E+00
TE-127	4.71E-07	1.27E-07	1.01E-07	3.26E-07	1.34E-06	0.00E+00	1.84E-05	0.00E+00
TE-129M	4.87E-05	1.36E-05	7.56E-06	1.57E-05	1.43E-04	0.00E+00	5.94E-05	0.00E+00
TE-129	1.34E-07	3.74E-08	3.18E-08	9.56E-08	3.92E-07	0.00E+00	8.34E-06	0.00E+00
TE-131M	7.20E-06	2.49E-06	2.65E-06	5.12E-06	2.41E-05	0.00E+00	1.01E-04	0.00E+00
TE-131	8.30E-08	2.53E-08	2.47E-08	6.35E-08	2.51E-07	0.00E+00	4.36E-07	0.00E+00
TE-132	1.01E-05	4.47E-06	5.40E-06	6.51E-06	4.15E-05	0.00E+00	4.50E-05	0.00E+00
TE-133M	1.87E-07	7.56E-08	9.37E-08	1.45E-07	7.18E-07	0.00E+00	5.77E-06	0.00E+00
TE-134	1.29E-07	5.80E-08	7.74E-08	1.02E-07	5.37E-07	0.00E+00	5.89E-07	0.00E+00
I-129	1.39E-05	8.53E-06	7.62E-06	5.58E-03	1.44E-05	0.00E+00	4.29E-07	0.00E+00
I-130	2.92E-06	5.90E-06	3.04E-06	6.50E-04	8.82E-06	0.00E+00	2.76E-06	0.00E+00
I-131	1.72E-05	1.73E-05	9.83E-06	5.72E-03	2.84E-05	0.00E+00	1.54E-06	0.00E+00
I-132	8.00E-07	1.47E-06	6.76E-07	6.82E-05	2.25E-06	0.00E+00	1.73E-06	0.00E+00
I-133	5.92E-06	7.32E-06	2.77E-06	1.36E-03	1.22E-05	0.00E+00	2.95E-06	0.00E+00
I-134	4.19E-07	7.78E-07	3.58E-07	1.79E-05	1.19E-06	0.00E+00	5.16E-07	0.00E+00
I-135	1.75E-06	3.15E-06	1.49E-06	2.79E-04	4.83E-06	0.00E+00	2.40E-06	0.00E+00
CS-134M	8.44E-08	1.25E-07	8.16E-08	0.00E+00	6.59E-08	1.09E-08	1.58E-07	0.00E+00
CS-134	2.34E-04	3.84E-04	8.10E-05	0.00E+00	1.19E-04	4.27E-05	2.07E-06	0.00E+00
CS-135	8.30E-05	5.78E-05	5.93E-06	0.00E+00	2.04E-05	6.81E-06	4.33E-07	0.00E+00
CS-136	2.35E-05	6.46E-05	4.18E-05	0.00E+00	3.44E-05	5.13E-06	2.27E-06	0.00E+00
CS-137	3.27E-04	3.13E-04	4.62E-05	0.00E+00	1.02E-04	3.67E-05	1.96E-06	0.00E+00
CS-138	2.28E-07	3.17E-07	2.01E-07	0.00E+00	2.23E-07	2.40E-08	1.46E-07	0.00E+00
CS-139	1.45E-07	1.61E-07	7.74E-08	0.00E+00	1.21E-07	1.22E-08	1.45E-11	0.00E+00

TABLE II-5

INGESTION DOSE FACTORS FOR CHILD (D_{aipj})
mrem/pCi

NUCLIDE	BONE	LIVER	T BODY	THYROID	KIDNEY	LUNG	GI-LLI	SKIN
BA-139	4.14E-07	2.21E-10	1.20E-08	0.00E+00	1.93E-10	1.30E-10	2.39E-05	0.00E+00
BA-140	8.31E-05	7.28E-08	4.85E-06	0.00E+00	2.37E-08	4.34E-08	4.21E-05	0.00E+00
BA-141	2.00E-07	1.12E-10	6.51E-09	0.00E+00	9.69E-11	6.58E-10	1.14E-07	0.00E+00
BA-142	8.74E-08	6.29E-11	4.88E-09	0.00E+00	5.09E-11	3.70E-11	1.14E-09	0.00E+00
LA-140	1.01E-08	3.53E-09	1.19E-09	0.00E+00	0.00E+00	0.00E+00	9.84E-05	0.00E+00
LA-141	1.36E-09	3.17E-10	6.88E-11	0.00E+00	0.00E+00	0.00E+00	7.05E-05	0.00E+00
LA-142	5.24E-10	1.67E-10	5.23E-11	0.00E+00	0.00E+00	0.00E+00	3.31E-05	0.00E+00
CE-141	3.97E-08	1.98E-08	2.94E-09	0.00E+00	8.68E-09	0.00E+00	2.47E-05	0.00E+00
CE-143	6.99E-09	3.79E-06	5.49E-10	0.00E+00	1.59E-09	0.00E+00	5.55E-05	0.00E+00
CE-144	2.08E-06	6.52E-07	1.11E-07	0.00E+00	3.61E-07	0.00E+00	1.70E-04	0.00E+00
PR-143	3.93E-08	1.18E-08	1.95E-09	0.00E+00	6.39E-09	0.00E+00	4.24E-05	0.00E+00
PR-144	1.29E-10	3.99E-11	6.49E-12	0.00E+00	2.11E-11	0.00E+00	8.59E-08	0.00E+00
ND-147	2.79E-08	2.26E-08	1.75E-09	0.00E+00	1.24E-08	0.00E+00	3.58E-05	0.00E+00
PM-147	3.18E-07	2.27E-08	1.22E-08	0.00E+00	4.01E-08	0.00E+00	9.19E-06	0.00E+00
PM-148M	1.03E-07	2.05E-08	2.05E-08	0.00E+00	3.04E-08	0.00E+00	5.78E-05	0.00E+00
PM-148	3.02E-08	3.63E-09	2.35E-09	0.00E+00	6.17E-09	0.00E+00	9.70E-05	0.00E+00
PM-149	6.49E-09	6.90E-10	3.74E-10	0.00E+00	1.22E-09	0.00E+00	4.71E-05	0.00E+00
PM-151	2.92E-09	3.55E-10	2.31E-10	0.00E+00	6.02E-10	0.00E+00	4.03E-05	0.00E+00
SM-151	2.56E-07	3.81E-08	1.20E-08	0.00E+00	3.94E-08	0.00E+00	5.53E-06	0.00E+00
SM-153	3.65E-09	2.27E-09	2.19E-10	0.00E+00	6.91E-10	0.00E+00	3.02E-05	0.00E+00
EU-152	6.15E-07	1.12E-07	1.33E-07	0.00E+00	4.73E-07	0.00E+00	1.84E-05	0.00E+00
EU-154	2.30E-06	2.07E-07	1.89E-07	0.00E+00	9.09E-07	0.00E+00	4.81E-05	0.00E+00
EU-155	4.82E-07	3.47E-08	2.72E-08	0.00E+00	1.30E-07	0.00E+00	8.69E-05	0.00E+00
EU-156	5.62E-08	3.01E-08	6.23E-09	0.00E+00	1.94E-08	0.00E+00	6.83E-05	0.00E+00
TB-160	1.66E-07	0.00E+00	2.06E-08	0.00E+00	4.94E-08	0.00E+00	3.68E-05	0.00E+00
HO-166M	1.08E-06	2.26E-07	1.91E-07	0.00E+00	3.22E-07	0.00E+00	2.63E-05	0.00E+00
W-181	4.23E-08	1.04E-08	1.43E-09	0.00E+00	0.00E+00	0.00E+00	3.79E-07	0.00E+00
W-185	1.73E-06	4.32E-07	6.05E-08	0.00E+00	0.00E+00	0.00E+00	1.61E-05	0.00E+00
W-187	4.29E-07	2.54E-07	1.14E-07	0.00E+00	0.00E+00	0.00E+00	3.57E-05	0.00E+00
U-232	1.76E-02	0.00E+00	1.26E-03	0.00E+00	1.34E-03	0.00E+00	6.98E-05	0.00E+00
U-233	3.72E-03	0.00E+00	2.25E-04	0.00E+00	6.10E-04	0.00E+00	6.45E-05	0.00E+00
U-234	3.57E-03	0.00E+00	2.21E-04	0.00E+00	5.98E-04	0.00E+00	6.32E-05	0.00E+00
U-235	3.42E-03	0.00E+00	2.07E-04	0.00E+00	5.61E-04	0.00E+00	8.03E-05	0.00E+00
U-236	3.42E-03	0.00E+00	2.12E-04	0.00E+00	5.73E-04	0.00E+00	5.92E-05	0.00E+00
U-237	2.36E-07	0.00E+00	6.27E-08	0.00E+00	6.81E-07	0.00E+00	2.08E-05	0.00E+00
U-238	3.27E-03	0.00E+00	1.94E-04	0.00E+00	5.24E-04	0.00E+00	5.66E-05	0.00E+00
NP-237	2.23E-03	1.47E-04	9.79E-05	0.00E+00	6.05E-04	0.00E+00	8.16E-05	0.00E+00
NP-238	5.83E-08	1.18E-09	9.08E-10	0.00E+00	3.76E-09	0.00E+00	4.04E-05	0.00E+00
NP-239	5.25E-09	3.77E-10	2.65E-10	0.00E+00	1.09E-09	0.00E+00	2.79E-05	0.00E+00
PU-238	1.19E-03	1.38E-04	3.16E-05	0.00E+00	1.15E-04	0.00E+00	7.50E-05	0.00E+00
PU-239	1.29E-03	1.38E-04	3.31E-05	0.00E+00	1.22E-04	0.00E+00	6.85E-05	0.00E+00
PU-240	1.28E-03	1.43E-04	3.31E-05	0.00E+00	1.22E-04	0.00E+00	6.98E-05	0.00E+00
PU-241	3.87E-05	1.58E-06	8.04E-07	0.00E+00	2.96E-06	0.00E+00	1.44E-06	0.00E+00
PU-242	1.19E-03	1.38E-04	3.19E-05	0.00E+00	1.17E-04	0.00E+00	6.71E-05	0.00E+00
PU-244	1.39E-03	1.58E-03	3.65E-05	0.00E+00	1.35E-04	0.00E+00	1.00E-04	0.00E+00
AM-241	1.36E-03	1.17E-03	1.02E-04	0.00E+00	6.23E-04	0.00E+00	7.64E-05	0.00E+00
AM-242M	1.40E-03	1.12E-03	1.04E-04	0.00E+00	6.30E-04	0.00E+00	9.61E-05	0.00E+00

TABLE II-5

INGESTION DOSE FACTORS FOR CHILD (D_{aipj})
mrem/pCi

NUCLIDE	BONE	LIVER	T BODY	THYROID	KIDNEY	LUNG	GI-LLI	SKIN
AM-243	1.34E-03	1.13E-03	9.83E-05	0.00E+00	6.06E-04	0.00E+00	8.95E-05	0.00E+00
CM-242	8.78E-05	7.01E-05	5.84E-06	0.00E+00	1.87E-05	0.00E+00	8.16E-05	0.00E+00
CM-243	1.28E-03	1.04E-03	8.24E-05	0.00E+00	3.08E-04	0.00E+00	8.03E-05	0.00E+00
CM-244	1.08E-03	8.74E-04	6.93E-05	0.00E+00	2.54E-04	0.00E+00	7.77E-05	0.00E+00
CM-245	1.67E-03	1.34E-03	1.05E-04	0.00E+00	4.11E-04	0.00E+00	7.24E-05	0.00E+00
CM-246	1.65E-03	1.34E-03	1.05E-04	0.00E+00	4.10E-04	0.00E+00	7.11E-05	0.00E+00
CM-247	1.61E-03	1.32E-03	1.03E-04	0.00E+00	4.04E-04	0.00E+00	9.35E-05	0.00E+00
CM-248	1.34E-02	1.09E-02	8.52E-04	0.00E+00	3.33E-03	0.00E+00	1.51E-03	0.00E+00
CF-252	1.05E-03	0.00E+00	2.54E-05	0.00E+00	0.00E+00	0.00E+00	2.96E-04	0.00E+00

NUREG/CR-4653, GASPAR II, Technical Reference and User Guide

TABLE II1-6

INGESTION DOSE FACTORS FOR INFANT (D_{aipj})
mrem/pCi

NUCLIDE	BONE	LIVER	T BODY	THYROID	KIDNEY	LUNG	GI-LLI	SKIN
H-3	0.00E+00	1.76E-07	1.76E-07	1.76E-07	1.76E-07	1.76E-07	1.76E-07	0.00E+00
C-14	2.37E-05	5.06E-06	5.06E-06	5.06E-06	5.06E-06	5.06E-06	5.06E-06	0.00E+00
NA-22	9.83E-05	9.83E-05	9.83E-05	9.83E-05	9.83E-05	9.83E-05	9.83E-05	0.00E+00
NA-24	1.01E-05	1.01E-05	1.01E-05	1.01E-05	1.01E-05	1.01E-05	1.01E-05	0.00E+00
P-32	1.70E-03	1.00E-04	6.59E-05	0.00E+00	0.00E+00	0.00E+00	2.30E-05	0.00E+00
CA-41	3.74E-04	0.00E+00	4.08E-05	0.00E+00	0.00E+00	0.00E+00	1.91E-07	0.00E+00
SC-46	3.75E-08	5.41E-08	1.69E-08	0.00E+00	3.56E-08	0.00E+00	3.53E-05	0.00E+00
CR-51	0.00E+00	0.00E+00	1.41E-08	9.20E-09	2.01E-09	1.79E-08	4.11E-07	0.00E+00
MN-54	0.00E+00	1.99E-05	4.51E-06	0.00E+00	4.41E-06	0.00E+00	7.31E-06	0.00E+00
MN-56	0.00E+00	8.18E-07	1.41E-07	0.00E+00	7.03E-07	0.00E+00	7.43E-05	0.00E+00
FE-55	1.39E-05	8.98E-06	2.40E-06	0.00E+00	0.00E+00	4.39E-06	1.14E-06	0.00E+00
FE-59	3.08E-05	5.38E-05	2.12E-05	0.00E+00	0.00E+00	1.59E-05	2.57E-05	0.00E+00
CO-57	0.00E+00	1.15E-06	1.87E-06	0.00E+00	0.00E+00	0.00E+00	3.92E-06	0.00E+00
CO-58	0.00E+00	3.60E-06	8.98E-06	0.00E+00	0.00E+00	0.00E+00	8.97E-06	0.00E+00
CO-60	0.00E+00	1.08E-05	2.55E-05	0.00E+00	0.00E+00	0.00E+00	2.57E-05	0.00E+00
NI-59	4.73E-05	1.45E-05	8.17E-06	0.00E+00	0.00E+00	0.00E+00	7.16E-07	0.00E+00
NI-63	6.34E-04	3.92E-05	2.20E-05	0.00E+00	0.00E+00	0.00E+00	1.95E-06	0.00E+00
NI-65	4.70E-06	5.32E-07	2.42E-07	0.00E+00	0.00E+00	0.00E+00	4.05E-05	0.00E+00
CU-64	0.00E+00	6.09E-07	2.82E-07	0.00E+00	1.03E-06	0.00E+00	1.25E-05	0.00E+00
ZN-65	1.84E-05	6.31E-05	2.91E-05	0.00E+00	3.06E-05	0.00E+00	5.33E-05	0.00E+00
ZN-69M	1.50E-06	3.06E-06	2.79E-07	0.00E+00	1.24E-06	0.00E+00	4.24E-05	0.00E+00
ZN-69	9.33E-08	1.68E-07	1.25E-08	0.00E+00	6.98E-08	0.00E+00	1.37E-05	0.00E+00
SE-79	0.00E+00	2.10E-05	3.90E-06	0.00E+00	2.43E-05	0.00E+00	5.58E-07	0.00E+00
BR-82	0.00E+00	0.00E+00	1.27E-05	0.00E+00	0.00E+00	0.00E+00	0.00E+00	0.00E+00
BR-83	0.00E+00	0.00E+00	3.63E-07	0.00E+00	0.00E+00	0.00E+00	0.00E+00	0.00E+00
BR-84	0.00E+00	0.00E+00	3.82E-07	0.00E+00	0.00E+00	0.00E+00	0.00E+00	0.00E+00
BR-85	0.00E+00	0.00E+00	1.94E-08	0.00E+00	0.00E+00	0.00E+00	0.00E+00	0.00E+00
RB-86	0.00E+00	1.70E-04	8.40E-05	0.00E+00	0.00E+00	0.00E+00	4.35E-06	0.00E+00
RB-87	0.00E+00	8.88E-05	3.52E-05	0.00E+00	0.00E+00	0.00E+00	5.98E-07	0.00E+00
RB-88	0.00E+00	4.98E-07	2.73E-07	0.00E+00	0.00E+00	0.00E+00	4.85E-07	0.00E+00
RB-89	0.00E+00	2.86E-07	1.97E-07	0.00E+00	0.00E+00	0.00E+00	9.74E-08	0.00E+00
SR-89	2.51E-03	0.00E+00	7.20E-05	0.00E+00	0.00E+00	0.00E+00	5.16E-05	0.00E+00
SR-90	2.83E-02	0.00E+00	5.74E-04	0.00E+00	0.00E+00	0.00E+00	2.31E-04	0.00E+00
SR-91	5.00E-05	0.00E+00	1.81E-06	0.00E+00	0.00E+00	0.00E+00	5.92E-05	0.00E+00
SR-92	1.92E-05	0.00E+00	7.13E-07	0.00E+00	0.00E+00	0.00E+00	2.07E-04	0.00E+00
Y-90	8.69E-08	0.00E+00	2.33E-09	0.00E+00	0.00E+00	0.00E+00	1.20E-04	0.00E+00
Y-91M	8.10E-10	0.00E+00	2.76E-11	0.00E+00	0.00E+00	0.00E+00	2.70E-06	0.00E+00
Y-91	1.13E-06	0.00E+00	3.01E-08	0.00E+00	0.00E+00	0.00E+00	8.10E-05	0.00E+00
Y-92	7.65E-09	0.00E+00	2.15E-10	0.00E+00	0.00E+00	0.00E+00	1.46E-04	0.00E+00
Y-93	2.43E-08	0.00E+00	6.62E-10	0.00E+00	0.00E+00	0.00E+00	1.92E-04	0.00E+00
ZR-93	1.93E-07	9.19E-09	5.54E-09	0.00E+00	2.71E-08	0.00E+00	2.39E-06	0.00E+00
ZR-95	2.06E-07	5.02E-08	3.56E-08	0.00E+00	5.41E-08	0.00E+00	2.50E-05	0.00E+00
ZR-97	1.48E-08	2.54E-09	1.16E-09	0.00E+00	2.56E-09	0.00E+00	1.62E-04	0.00E+00
NB-93M	1.23E-07	3.33E-08	1.04E-08	0.00E+00	3.25E-08	0.00E+00	3.98E-06	0.00E+00
NB-95	4.20E-08	1.73E-08	1.00E-08	0.00E+00	1.24E-08	0.00E+00	1.46E-05	0.00E+00

TABLE II-6

 INGESTION DOSE FACTORS FOR INFANT (D_{aipj})
 mrem/pCi

NUCLIDE	BONE	LIVER	T BODY	THYROID	KIDNEY	LUNG	GI-LLI	SKIN
NB-97	4.59E-10	9.79E-11	3.53E-11	0.00E+00	7.65E-11	0.00E+00	3.09E-05	0.00E+00
MO-93	0.00E+00	5.65E-05	1.82E-06	0.00E+00	1.13E-05	0.00E+00	1.21E-06	0.00E+00
MO-99	0.00E+00	3.40E-05	6.63E-06	0.00E+00	5.08E-05	0.00E+00	1.12E-05	0.00E+00
TC-99M	1.92E-09	3.96E-09	5.10E-08	0.00E+00	4.26E-08	2.07E-09	1.15E-06	0.00E+00
TC-99	1.08E-06	1.46E-06	4.55E-07	0.00E+00	1.23E-05	1.42E-07	6.31E-06	0.00E+00
TC-101	2.27E-09	2.86E-09	2.83E-08	0.00E+00	3.40E-08	1.56E-09	4.86E-07	0.00E+00
RU-103	1.48E-06	0.00E+00	4.95E-07	0.00E+00	3.08E-06	0.00E+00	1.80E-05	0.00E+00
RU-105	1.36E-07	0.00E+00	4.58E-08	0.00E+00	1.00E-06	0.00E+00	5.41E-05	0.00E+00
RU-106	2.41E-05	0.00E+00	3.01E-06	0.00E+00	2.85E-05	0.00E+00	1.83E-04	0.00E+00
RH-105	1.09E-06	7.13E-07	4.79E-07	0.00E+00	1.98E-06	0.00E+00	1.77E-05	0.00E+00
PD-107	0.00E+00	1.19E-06	8.45E-08	0.00E+00	6.79E-06	0.00E+00	9.46E-07	0.00E+00
PD-109	0.00E+00	1.50E-06	3.62E-07	0.00E+00	5.51E-06	0.00E+00	3.68E-05	0.00E+00
AG-110M	9.96E-07	7.27E-07	4.81E-07	0.00E+00	1.04E-06	0.00E+00	3.77E-05	0.00E+00
AG-111	5.20E-07	2.02E-07	1.07E-07	0.00E+00	4.22E-07	0.00E+00	4.82E-05	0.00E+00
CD-113M	0.00E+00	1.77E-05	6.52E-07	0.00E+00	1.34E-05	0.00E+00	2.66E-05	0.00E+00
CD-115M	0.00E+00	1.42E-05	4.93E-07	0.00E+00	7.41E-06	0.00E+00	8.09E-05	0.00E+00
SN-123	2.49E-04	3.89E-06	6.50E-06	3.91E-06	0.00E+00	0.00E+00	6.58E-05	0.00E+00
SN-125	7.41E-05	1.38E-06	3.29E-06	1.36E-06	0.00E+00	0.00E+00	1.11E-04	0.00E+00
SN-126	5.53E-04	7.26E-06	1.80E-05	1.91E-06	0.00E+00	0.00E+00	2.52E-05	0.00E+00
SB-124	2.14E-05	3.15E-07	6.63E-06	5.68E-08	0.00E+00	1.34E-05	6.60E-05	0.00E+00
SB-125	1.23E-05	1.19E-07	2.53E-06	1.54E-08	0.00E+00	7.12E-06	1.64E-05	0.00E+00
SB-126	8.06E-06	1.58E-07	2.91E-06	6.19E-08	0.00E+00	5.07E-06	8.35E-05	0.00E+00
SB-127	2.23E-06	3.98E-08	6.90E-07	2.84E-08	0.00E+00	1.15E-06	5.91E-05	0.00E+00
TE-125M	2.33E-05	7.79E-06	3.15E-06	7.84E-06	0.00E+00	0.00E+00	1.11E-05	0.00E+00
TE-127M	5.85E-05	1.94E-05	7.08E-06	1.69E-05	1.44E-04	0.00E+00	2.36E-05	0.00E+00
TE-127	1.00E-06	3.35E-07	2.15E-07	8.14E-07	2.44E-06	0.00E+00	2.10E-05	0.00E+00
TE-129M	1.00E-04	3.43E-05	1.54E-05	3.84E-05	2.50E-04	0.00E+00	5.97E-05	0.00E+00
TE-129	2.84E-07	9.79E-08	6.63E-08	2.38E-07	7.07E-07	0.00E+00	2.27E-05	0.00E+00
TE-131M	1.52E-05	6.12E-06	5.05E-06	1.24E-05	4.21E-05	0.00E+00	1.03E-04	0.00E+00
TE-131	1.76E-07	6.50E-08	4.94E-08	1.57E-07	4.50E-07	0.00E+00	7.11E-06	0.00E+00
TE-132	2.08E-05	1.03E-05	9.61E-06	1.52E-05	6.44E-05	0.00E+00	3.81E-05	0.00E+00
TE-133M	3.91E-07	1.79E-07	1.71E-07	3.45E-07	1.22E-06	0.00E+00	1.93E-05	0.00E+00
TE-134	2.67E-07	1.34E-07	1.38E-07	2.39E-07	9.03E-07	0.00E+00	3.06E-06	0.00E+00
I-129	2.86E-05	2.12E-05	1.55E-05	1.36E-02	2.51E-05	0.00E+00	4.24E-07	0.00E+00
I-130	6.00E-06	1.32E-05	5.30E-06	1.48E-03	1.45E-05	0.00E+00	2.83E-06	0.00E+00
I-131	3.59E-05	4.23E-05	1.86E-05	1.39E-02	4.94E-05	0.00E+00	1.51E-06	0.00E+00
I-132	1.66E-06	3.37E-06	1.20E-06	1.58E-04	3.76E-06	0.00E+00	2.73E-06	0.00E+00
I-133	1.25E-05	1.82E-05	5.33E-06	3.31E-03	2.14E-05	0.00E+00	3.08E-06	0.00E+00
I-134	8.69E-07	1.78E-06	6.33E-07	4.15E-05	1.99E-06	0.00E+00	1.84E-06	0.00E+00
I-135	3.64E-06	7.24E-06	2.64E-06	6.49E-04	8.07E-06	0.00E+00	2.62E-06	0.00E+00
CS-134M	1.76E-07	2.93E-07	1.48E-07	0.00E+00	1.13E-07	2.60E-08	2.32E-07	0.00E+00
CS-134	3.77E-04	7.03E-04	7.10E-05	0.00E+00	1.81E-04	7.42E-05	1.91E-06	0.00E+00
CS-135	1.33E-04	1.21E-04	6.30E-06	0.00E+00	3.44E-05	1.31E-05	4.37E-07	0.00E+00
CS-136	4.59E-05	1.35E-04	5.04E-05	0.00E+00	5.38E-05	1.10E-05	2.05E-06	0.00E+00
CS-137	5.22E-04	6.11E-04	4.33E-05	0.00E+00	1.64E-04	6.64E-05	1.91E-06	0.00E+00
CS-138	4.81E-07	7.82E-07	3.79E-07	0.00E+00	3.90E-07	6.09E-08	1.25E-06	0.00E+00

TABLE II-6

INGESTION DOSE FACTORS FOR INFANT (D_{aipj})
mrem/pCi

NUCLIDE	BONE	LIVER	T BODY	THYROID	KIDNEY	LUNG	GI-LLI	SKIN
CS-139	3.10E-07	4.24E-07	1.62E-07	0.00E+00	2.19E-07	3.30E-08	2.66E-08	0.00E+00
BA-139	8.81E-07	5.84E-10	2.55E-08	0.00E+00	3.51E-10	3.54E-10	5.58E-05	0.00E+00
BA-140	1.71E-04	1.71E-07	8.81E-06	0.00E+00	4.06E-08	1.05E-07	4.20E-05	0.00E+00
BA-141	4.25E-07	2.91E-10	1.34E-08	0.00E+00	1.75E-10	1.77E-10	5.19E-06	0.00E+00
BA-142	1.84E-07	1.53E-10	9.06E-09	0.00E+00	8.81E-11	9.26E-11	7.59E-07	0.00E+00
LA-140	2.11E-08	8.32E-09	2.14E-09	0.00E+00	0.00E+00	0.00E+00	9.77E-05	0.00E+00
LA-141	2.89E-09	8.38E-10	1.46E-10	0.00E+00	0.00E+00	0.00E+00	9.61E-05	0.00E+00
LA-142	1.10E-09	4.04E-10	9.67E-11	0.00E+00	0.00E+00	0.00E+00	6.86E-05	0.00E+00
CE-141	7.87E-08	4.80E-08	5.65E-09	0.00E+00	1.48E-08	0.00E+00	2.48E-05	0.00E+00
CE-143	1.48E-08	9.82E-06	1.12E-09	0.00E+00	2.86E-09	0.00E+00	5.73E-05	0.00E+00
CE-144	2.98E-06	1.22E-06	1.67E-07	0.00E+00	4.93E-07	0.00E+00	1.71E-04	0.00E+00
PR-143	8.13E-08	3.04E-08	4.03E-09	0.00E+00	1.13E-08	0.00E+00	4.29E-05	0.00E+00
PR-144	2.74E-10	1.06E-10	1.38E-11	0.00E+00	3.84E-11	0.00E+00	4.93E-06	0.00E+00
ND-147	5.53E-08	5.68E-08	3.48E-09	0.00E+00	2.19E-08	0.00E+00	3.60E-05	0.00E+00
PM-147	3.88E-07	3.27E-08	1.59E-08	0.00E+00	4.88E-08	0.00E+00	9.27E-06	0.00E+00
PM-148M	1.65E-07	4.18E-08	3.28E-08	0.00E+00	4.80E-08	0.00E+00	5.44E-05	0.00E+00
PM-148	6.32E-08	9.13E-09	4.60E-09	0.00E+00	1.09E-08	0.00E+00	9.74E-05	0.00E+00
PM-149	1.38E-08	1.81E-09	7.90E-10	0.00E+00	2.20E-09	0.00E+00	4.86E-05	0.00E+00
PM-151	6.18E-09	9.01E-10	4.56E-10	0.00E+00	1.07E-09	0.00E+00	4.17E-05	0.00E+00
SM-151	2.90E-07	6.67E-08	1.44E-08	0.00E+00	4.53E-08	0.00E+00	5.58E-06	0.00E+00
SM-153	7.72E-09	5.97E-09	4.58E-10	0.00E+00	1.25E-09	0.00E+00	3.12E-05	0.00E+00
EU-152	6.74E-07	1.79E-07	1.51E-07	0.00E+00	5.02E-07	0.00E+00	1.59E-05	0.00E+00
EU-154	2.64E-06	3.67E-07	2.20E-07	0.00E+00	9.95E-07	0.00E+00	4.58E-05	0.00E+00
EU-155	5.42E-07	6.25E-08	3.23E-08	0.00E+00	1.40E-07	0.00E+00	8.37E-05	0.00E+00
EU-156	1.14E-07	7.06E-08	1.12E-08	0.00E+00	3.26E-08	0.00E+00	6.67E-05	0.00E+00
TB-160	2.59E-07	0.00E+00	3.24E-08	0.00E+00	7.37E-08	0.00E+00	3.45E-05	0.00E+00
HO-166M	1.25E-06	2.69E-07	2.13E-07	0.00E+00	3.57E-07	0.00E+00	2.66E-05	0.00E+00
W-181	8.85E-08	2.72E-08	3.04E-09	0.00E+00	0.00E+00	0.00E+00	3.82E-07	0.00E+00
W-185	3.62E-06	1.13E-06	1.29E-07	0.00E+00	0.00E+00	0.00E+00	1.62E-05	0.00E+00
W-187	9.03E-07	6.28E-07	2.17E-07	0.00E+00	0.00E+00	0.00E+00	3.69E-05	0.00E+00
U-232	2.42E-02	0.00E+00	2.16E-03	0.00E+00	2.37E-03	0.00E+00	7.04E-05	0.00E+00
U-233	5.08E-03	0.00E+00	3.87E-04	0.00E+00	1.08E-03	0.00E+00	6.51E-05	0.00E+00
U-234	4.88E-03	0.00E+00	3.80E-04	0.00E+00	1.06E-03	0.00E+00	6.37E-05	0.00E+00
U-235	4.67E-03	0.00E+00	3.56E-04	0.00E+00	9.93E-04	0.00E+00	8.10E-05	0.00E+00
U-236	4.67E-03	0.00E+00	3.64E-04	0.00E+00	1.01E-03	0.00E+00	5.98E-05	0.00E+00
U-237	4.95E-07	0.00E+00	1.32E-07	0.00E+00	1.23E-06	0.00E+00	2.11E-05	0.00E+00
U-238	4.47E-03	0.00E+00	3.33E-04	0.00E+00	9.28E-04	0.00E+00	5.71E-05	0.00E+00
NP-237	2.40E-03	1.59E-04	1.05E-04	0.00E+00	6.34E-04	0.00E+00	8.23E-05	0.00E+00
NP-238	1.24E-07	3.12E-09	1.92E-09	0.00E+00	6.81E-09	0.00E+00	4.17E-05	0.00E+00
NP-239	1.11E-08	9.93E-10	5.61E-10	0.00E+00	1.98E-09	0.00E+00	2.87E-05	0.00E+00
PU-238	1.28E-03	1.50E-04	3.40E-05	0.00E+00	1.21E-04	0.00E+00	7.57E-05	0.00E+00
PU-239	1.38E-03	1.55E-04	3.54E-05	0.00E+00	1.28E-04	0.00E+00	6.91E-05	0.00E+00
PU-240	1.38E-03	1.55E-04	3.54E-05	0.00E+00	1.28E-04	0.00E+00	7.04E-05	0.00E+00
PU-241	4.25E-05	1.76E-06	8.82E-07	0.00E+00	3.17E-06	0.00E+00	1.45E-06	0.00E+00
PU-242	1.28E-03	1.49E-04	3.41E-05	0.00E+00	1.23E-04	0.00E+00	6.77E-05	0.00E+00
PU-244	1.49E-03	1.71E-04	3.91E-05	0.00E+00	1.41E-04	0.00E+00	1.01E-04	0.00E+00

TABLE II1-6

INGESTION DOSE FACTORS FOR INFANT (D_{aipj})
mrem/pCi

NUCLIDE	BONE	LIVER	T BODY	THYROID	KIDNEY	LUNG	GI-LLI	SKIN
AM-241	1.46E-03	1.27E-03	1.09E-04	0.00E+00	6.55E-04	0.00E+00	7.70E-05	0.00E+00
AM-242M	1.51E-03	1.22E-03	1.13E-04	0.00E+00	6.64E-04	0.00E+00	9.69E-05	0.00E+00
AM-243	1.44E-03	1.23E-03	1.06E-04	0.00E+00	6.36E-04	0.00E+00	9.03E-05	0.00E+00
CM-242	1.37E-04	1.27E-04	9.10E-06	0.00E+00	2.62E-05	0.00E+00	8.23E-05	0.00E+00
CM-243	1.40E-03	1.15E-03	8.98E-05	0.00E+00	3.27E-04	0.00E+00	8.10E-05	0.00E+00
CM-244	1.18E-03	9.70E-04	7.59E-05	0.00E+00	2.71E-04	0.00E+00	7.84E-05	0.00E+00
CM-245	1.79E-03	1.45E-03	1.13E-04	0.00E+00	4.32E-04	0.00E+00	7.30E-05	0.00E+00
CM-246	1.77E-03	1.45E-03	1.13E-04	0.00E+00	4.31E-04	0.00E+00	7.17E-05	0.00E+00
CM-247	1.73E-03	1.43E-03	1.11E-04	0.00E+00	4.24E-04	0.00E+00	9.43E-05	0.00E+00
CM-248	1.43E-02	1.18E-02	9.16E-04	0.00E+00	3.50E-03	0.00E+00	1.52E-03	0.00E+00
CF-252	1.22E-03	0.00E+00	2.95E-05	0.00E+00	0.00E+00	0.00E+00	2.99E-04	0.00E+00

NUREG/CR-4653, GASPAR II, Technical Reference and User Guide

TABLE II-7

DOSE FACTORS FOR STANDING ON CONTAMINATED GROUND (D_{aipj})(mrem/hr per pCi/m²)

NUCLIDE	BONE	LIVER	T BODY	THYROID	KIDNEY	LUNG	GI-LLI	SKIN
H-3	0.00E+00	0.00E+00	0.00E+00	0.00E+00	0.00E+00	0.00E+00	0.00E+00	0.00E+00
C-14	0.00E+00	0.00E+00	0.00E+00	0.00E+00	0.00E+00	0.00E+00	0.00E+00	0.00E+00
NA-22	1.60E-08	1.60E-08	1.60E-08	1.60E-08	1.60E-08	1.60E-08	1.60E-08	1.80E-08
NA-24	2.50E-08	2.50E-08	2.50E-08	2.50E-08	2.50E-08	2.50E-08	2.50E-08	2.90E-08
P-32	0.00E+00	0.00E+00	0.00E+00	0.00E+00	0.00E+00	0.00E+00	0.00E+00	0.00E+00
CA-41	3.41E-09	3.41E-09	3.41E-09	3.41E-09	3.41E-09	3.41E-09	3.41E-09	4.01E-09
SC-46	1.30E-08	1.30E-08	1.30E-08	1.30E-08	1.30E-08	1.30E-08	1.30E-08	1.50E-08
CR-51	2.20E-10	2.20E-10	2.20E-10	2.20E-10	2.20E-10	2.20E-10	2.20E-10	2.60E-10
MN-54	5.80E-09	5.80E-09	5.80E-09	5.80E-09	5.80E-09	5.80E-09	5.80E-09	6.80E-09
MN-56	1.10E-08	1.10E-08	1.10E-08	1.10E-08	1.10E-08	1.10E-08	1.10E-08	1.30E-08
FE-55	0.00E+00	0.00E+00	0.00E+00	0.00E+00	0.00E+00	0.00E+00	0.00E+00	0.00E+00
FE-59	8.00E-09	8.00E-09	8.00E-09	8.00E-09	8.00E-09	8.00E-09	8.00E-09	9.40E-09
CO-57	9.10E-10	9.10E-10	9.10E-10	9.10E-10	9.10E-10	9.10E-10	9.10E-10	1.00E-09
CO-58	7.00E-09	7.00E-09	7.00E-09	7.00E-09	7.00E-09	7.00E-09	7.00E-09	8.20E-09
CO-60	1.70E-08	1.70E-08	1.70E-08	1.70E-08	1.70E-08	1.70E-08	1.70E-08	2.00E-08
NI-59	0.00E+00	0.00E+00	0.00E+00	0.00E+00	0.00E+00	0.00E+00	0.00E+00	0.00E+00
NI-63	0.00E+00	0.00E+00	0.00E+00	0.00E+00	0.00E+00	0.00E+00	0.00E+00	0.00E+00
NI-65	3.70E-09	3.70E-09	3.70E-09	3.70E-09	3.70E-09	3.70E-09	3.70E-09	4.30E-09
CU-64	1.50E-09	1.50E-09	1.50E-09	1.50E-09	1.50E-09	1.50E-09	1.50E-09	1.70E-09
ZN-65	4.00E-09	4.00E-09	4.00E-09	4.00E-09	4.00E-09	4.00E-09	4.00E-09	4.60E-09
ZN-69M	2.90E-09	2.90E-09	2.90E-09	2.90E-09	2.90E-09	2.90E-09	2.90E-09	3.40E-09
ZN-69	0.00E+00	0.00E+00	0.00E+00	0.00E+00	0.00E+00	0.00E+00	0.00E+00	0.00E+00
SE-79	0.00E+00	0.00E+00	0.00E+00	0.00E+00	0.00E+00	0.00E+00	0.00E+00	0.00E+00
BR-82	1.90E-08	1.90E-08	1.90E-08	1.90E-08	1.90E-08	1.90E-08	1.90E-08	2.20E-08
BR-83	6.40E-11	6.40E-11	6.40E-11	6.40E-11	6.40E-11	6.40E-11	6.40E-11	9.30E-11
BR-84	1.20E-08	1.20E-08	1.20E-08	1.20E-08	1.20E-08	1.20E-08	1.20E-08	1.40E-08
BR-85	0.00E+00	0.00E+00	0.00E+00	0.00E+00	0.00E+00	0.00E+00	0.00E+00	0.00E+00
RB-86	6.30E-10	6.30E-10	6.30E-10	6.30E-10	6.30E-10	6.30E-10	6.30E-10	7.20E-10
RB-87	0.00E+00	0.00E+00	0.00E+00	0.00E+00	0.00E+00	0.00E+00	0.00E+00	0.00E+00
RB-88	3.50E-09	3.50E-09	3.50E-09	3.50E-09	3.50E-09	3.50E-09	3.50E-09	4.00E-09
RB-89	1.50E-08	1.50E-08	1.50E-08	1.50E-08	1.50E-08	1.50E-08	1.50E-08	1.80E-08
SR-89	5.60E-13	5.60E-13	5.60E-13	5.60E-13	5.60E-13	5.60E-13	5.60E-13	6.50E-13
SR-90	0.00E+00	0.00E+00	0.00E+00	0.00E+00	0.00E+00	0.00E+00	0.00E+00	0.00E+00
SR-91	7.10E-09	7.10E-09	7.10E-09	7.10E-09	7.10E-09	7.10E-09	7.10E-09	8.30E-09
SR-92	9.00E-09	9.00E-09	9.00E-09	9.00E-09	9.00E-09	9.00E-09	9.00E-09	1.00E-08
Y-90	2.20E-12	2.20E-12	2.20E-12	2.20E-12	2.20E-12	2.20E-12	2.20E-12	2.60E-12
Y-91M	3.80E-09	3.80E-09	3.80E-09	3.80E-09	3.80E-09	3.80E-09	3.80E-09	4.40E-09
Y-91	2.40E-11	2.40E-11	2.40E-11	2.40E-11	2.40E-11	2.40E-11	2.40E-11	2.70E-11
Y-92	1.60E-09	1.60E-09	1.60E-09	1.60E-09	1.60E-09	1.60E-09	1.60E-09	1.90E-09
Y-93	5.70E-10	5.70E-10	5.70E-10	5.70E-10	5.70E-10	5.70E-10	5.70E-10	7.80E-10
ZR-93	0.00E+00	0.00E+00	0.00E+00	0.00E+00	0.00E+00	0.00E+00	0.00E+00	0.00E+00
ZR-95	5.00E-09	5.00E-09	5.00E-09	5.00E-09	5.00E-09	5.00E-09	5.00E-09	5.80E-09
ZR-97	5.50E-09	5.50E-09	5.50E-09	5.50E-09	5.50E-09	5.50E-09	5.50E-09	6.40E-09
NB-93M	8.20E-13	8.20E-13	8.20E-13	8.20E-13	8.20E-13	8.20E-13	8.20E-13	1.00E-10

TABLE II-7

DOSE FACTORS FOR STANDING ON CONTAMINATED GROUND (D_{aipj})(mrem/hr per pCi/m²)

NUCLIDE	BONE	LIVER	T BODY	THYROID	KIDNEY	LUNG	GI-LLI	SKIN
NB-95	5.10E-09	5.10E-09	5.10E-09	5.10E-09	5.10E-09	5.10E-09	5.10E-09	6.00E-09
NB-97	4.60E-09	4.60E-09	4.60E-09	4.60E-09	4.60E-09	4.60E-09	4.60E-09	5.40E-09
MO-93	2.29E-11	2.29E-11	2.29E-11	2.29E-11	2.29E-11	2.29E-11	2.29E-11	9.32E-10
MO-99	1.90E-09	1.90E-09	1.90E-09	1.90E-09	1.90E-09	1.90E-09	1.90E-09	2.20E-09
TC-99M	9.60E-10	9.60E-10	9.60E-10	9.60E-10	9.60E-10	9.60E-10	9.60E-10	1.10E-09
TC-99	0.00E+00	0.00E+00	0.00E+00	0.00E+00	0.00E+00	0.00E+00	0.00E+00	0.00E+00
TC-101	2.70E-09	2.70E-09	2.70E-09	2.70E-09	2.70E-09	2.70E-09	2.70E-09	3.00E-09
RU-103	3.60E-09	3.60E-09	3.60E-09	3.60E-09	3.60E-09	3.60E-09	3.60E-09	4.20E-09
RU-105	4.50E-09	4.50E-09	4.50E-09	4.50E-09	4.50E-09	4.50E-09	4.50E-09	5.10E-09
RU-106	1.50E-09	1.50E-09	1.50E-09	1.50E-09	1.50E-09	1.50E-09	1.50E-09	1.80E-09
RH-105	6.60E-10	6.60E-10	6.60E-10	6.60E-10	6.60E-10	6.60E-10	6.60E-10	7.70E-10
PD-107	0.00E+00	0.00E+00	0.00E+00	0.00E+00	0.00E+00	0.00E+00	0.00E+00	0.00E+00
PD-109	3.50E-11	3.50E-11	3.50E-11	3.50E-11	3.50E-11	3.50E-11	3.50E-11	4.00E-11
AG-110M	1.80E-08	1.80E-08	1.80E-08	1.80E-08	1.80E-08	1.80E-08	1.80E-08	2.10E-08
AG-111	1.80E-10	1.80E-10	1.80E-10	1.80E-10	1.80E-10	1.80E-10	1.80E-10	2.10E-10
CD-113M	2.30E-12	2.30E-12	2.30E-12	2.30E-12	2.30E-12	2.30E-12	2.30E-12	2.60E-12
CD-115M	0.00E+00	0.00E+00	0.00E+00	0.00E+00	0.00E+00	0.00E+00	0.00E+00	0.00E+00
SN-123	0.00E+00	0.00E+00	0.00E+00	0.00E+00	0.00E+00	0.00E+00	0.00E+00	6.46E-08
SN-125	5.70E-10	5.70E-10	5.70E-10	5.70E-10	5.70E-10	5.70E-10	5.70E-10	6.60E-10
SN-126	9.00E-09	9.00E-09	9.00E-09	9.00E-09	9.00E-09	9.00E-09	9.00E-09	1.00E-08
SB-124	1.30E-08	1.30E-08	1.30E-08	1.30E-08	1.30E-08	1.30E-08	1.30E-08	1.50E-08
SB-125	3.10E-09	3.10E-09	3.10E-09	3.10E-09	3.10E-09	3.10E-09	3.10E-09	3.50E-09
SB-126	8.90E-09	8.90E-09	8.90E-09	8.90E-09	8.90E-09	8.90E-09	8.90E-09	1.00E-08
SB-127	5.70E-09	5.70E-09	5.70E-09	5.70E-09	5.70E-09	5.70E-09	5.70E-09	6.60E-09
TE-125M	3.50E-11	3.50E-11	3.50E-11	3.50E-11	3.50E-11	3.50E-11	3.50E-11	4.80E-11
TE-127M	1.10E-12	1.10E-12	1.10E-12	1.10E-12	1.10E-12	1.10E-12	1.10E-12	1.30E-12
TE-127	1.00E-11	1.00E-11	1.00E-11	1.00E-11	1.00E-11	1.00E-11	1.00E-11	1.10E-11
TE-129M	7.70E-10	7.70E-10	7.70E-10	7.70E-10	7.70E-10	7.70E-10	7.70E-10	9.00E-10
TE-129	7.10E-10	7.10E-10	7.10E-10	7.10E-10	7.10E-10	7.10E-10	7.10E-10	8.40E-10
TE-131M	8.40E-09	8.40E-09	8.40E-09	8.40E-09	8.40E-09	8.40E-09	8.40E-09	9.90E-09
TE-131	2.20E-09	2.20E-09	2.20E-09	2.20E-09	2.20E-09	2.20E-09	2.20E-09	2.60E-06
TE-132	1.70E-09	1.70E-09	1.70E-09	1.70E-09	1.70E-09	1.70E-09	1.70E-09	2.00E-09
TE-133M	1.50E-08	1.50E-08	1.50E-08	1.50E-08	1.50E-08	1.50E-08	1.50E-08	1.70E-08
TE-134	1.00E-09	1.00E-09	1.00E-09	1.00E-09	1.00E-09	1.00E-09	1.00E-09	1.20E-09
I-129	4.50E-10	4.50E-10	4.50E-10	4.50E-10	4.50E-10	4.50E-10	4.50E-10	7.50E-10
I-130	1.40E-08	1.40E-08	1.40E-08	1.40E-08	1.40E-08	1.40E-08	1.40E-08	1.70E-08
I-131	2.80E-09	2.80E-09	2.80E-09	2.80E-09	2.80E-09	2.80E-09	2.80E-09	3.40E-09
I-132	1.70E-08	1.70E-08	1.70E-08	1.70E-08	1.70E-08	1.70E-08	1.70E-08	2.00E-08
I-133	3.70E-09	3.70E-09	3.70E-09	3.70E-09	3.70E-09	3.70E-09	3.70E-09	4.50E-09
I-134	1.60E-08	1.60E-08	1.60E-08	1.60E-08	1.60E-08	1.60E-08	1.60E-08	1.90E-08
I-135	1.20E-08	1.20E-08	1.20E-08	1.20E-08	1.20E-08	1.20E-08	1.20E-08	1.40E-08
CS-134M	6.20E-10	6.20E-10	6.20E-10	6.20E-10	6.20E-10	6.20E-10	6.20E-10	7.30E-10
CS-134	1.20E-08	1.20E-08	1.20E-08	1.20E-08	1.20E-08	1.20E-08	1.20E-08	1.40E-08
CS-135	0.00E+00	0.00E+00	0.00E+00	0.00E+00	0.00E+00	0.00E+00	0.00E+00	0.00E+00

TABLE II-7

DOSE FACTORS FOR STANDING ON CONTAMINATED GROUND (D_{aipj})(mrem/hr per pCi/m²)

NUCLIDE	BONE	LIVER	T BODY	THYROID	KIDNEY	LUNG	GI-LLI	SKIN
CS-136	1.50E-08	1.50E-08	1.50E-08	1.50E-08	1.50E-08	1.50E-08	1.50E-08	1.70E-08
CS-137	4.20E-09	4.20E-09	4.20E-09	4.20E-09	4.20E-09	4.20E-09	4.20E-09	4.90E-09
CS-138	2.10E-08	2.10E-08	2.10E-08	2.10E-08	2.10E-08	2.10E-08	2.10E-08	2.40E-08
CS-139	6.30E-09	6.30E-09	6.30E-09	6.30E-09	6.30E-09	6.30E-09	6.30E-09	7.20E-09
BA-139	2.40E-09	2.40E-09	2.40E-09	2.40E-09	2.40E-09	2.40E-09	2.40E-09	2.70E-09
BA-140	2.10E-09	2.10E-09	2.10E-09	2.10E-09	2.10E-09	2.10E-09	2.10E-09	2.40E-09
BA-141	4.30E-09	4.30E-09	4.30E-09	4.30E-09	4.30E-09	4.30E-09	4.30E-09	4.90E-09
BA-142	7.90E-09	7.90E-09	7.90E-09	7.90E-09	7.90E-09	7.90E-09	7.90E-09	9.00E-09
LA-140	1.50E-08	1.50E-08	1.50E-08	1.50E-08	1.50E-08	1.50E-08	1.50E-08	1.70E-08
LA-141	2.50E-10	2.50E-10	2.50E-10	2.50E-10	2.50E-10	2.50E-10	2.50E-10	2.80E-10
LA-142	1.50E-08	1.50E-08	1.50E-08	1.50E-08	1.50E-08	1.50E-08	1.50E-08	1.80E-08
CE-141	5.50E-10	5.50E-10	5.50E-10	5.50E-10	5.50E-10	5.50E-10	5.50E-10	6.20E-10
CE-143	2.20E-09	2.20E-09	2.20E-09	2.20E-09	2.20E-09	2.20E-09	2.20E-09	2.50E-09
CE-144	3.20E-10	3.20E-10	3.20E-10	3.20E-10	3.20E-10	3.20E-10	3.20E-10	3.70E-10
PR-143	0.00E+00	0.00E+00	0.00E+00	0.00E+00	0.00E+00	0.00E+00	0.00E+00	0.00E+00
PR-144	2.00E-10	2.00E-10	2.00E-10	2.00E-10	2.00E-10	2.00E-10	2.00E-10	2.30E-10
ND-147	1.00E-09	1.00E-09	1.00E-09	1.00E-09	1.00E-09	1.00E-09	1.00E-09	1.20E-09
PM-147	0.00E+00	0.00E+00	0.00E+00	0.00E+00	0.00E+00	0.00E+00	0.00E+00	0.00E+00
PM-148M	1.41E-08	1.41E-08	1.41E-08	1.41E-08	1.41E-08	1.41E-08	1.41E-08	8.16E-08
PM-148	4.60E-09	4.60E-09	4.60E-09	4.60E-09	4.60E-09	4.60E-09	4.60E-09	5.30E-09
PM-149	2.50E-11	2.50E-11	2.50E-11	2.50E-11	2.50E-11	2.50E-11	2.50E-11	2.90E-11
PM-151	2.20E-09	2.20E-09	2.20E-09	2.20E-09	2.20E-09	2.20E-09	2.20E-09	2.30E-09
SM-151	4.80E-11	4.80E-11	4.80E-11	4.80E-11	4.80E-11	4.80E-11	4.80E-11	2.10E-10
SM-153	2.70E-10	2.70E-10	2.70E-10	2.70E-10	2.70E-10	2.70E-10	2.70E-10	3.00E-10
EU-152	7.37E-09	7.37E-09	7.37E-09	7.37E-09	7.37E-09	7.37E-09	7.37E-09	8.53E-09
EU-154	7.80E-09	7.80E-09	7.80E-09	7.80E-09	7.80E-09	7.80E-09	7.80E-09	9.00E-09
EU-155	3.81E-10	3.81E-10	3.81E-10	3.81E-10	3.81E-10	3.81E-10	3.81E-10	4.33E-10
EU-156	7.60E-09	7.60E-09	7.60E-09	7.60E-09	7.60E-09	7.60E-09	7.60E-09	8.70E-09
TB-160	8.60E-09	8.60E-09	8.60E-09	8.60E-09	8.60E-09	8.60E-09	8.60E-09	1.00E-08
HO-166M	8.90E-09	8.90E-09	8.90E-09	8.90E-09	8.90E-09	8.90E-09	8.90E-09	1.00E-08
W-181	2.10E-12	2.10E-12	2.10E-12	2.10E-12	2.10E-12	2.10E-12	2.10E-12	2.80E-12
W-185	0.00E+00	0.00E+00	0.00E+00	0.00E+00	0.00E+00	0.00E+00	0.00E+00	0.00E+00
W-187	3.10E-09	3.10E-09	3.10E-09	3.10E-09	3.10E-09	3.10E-09	3.10E-09	3.60E-09
U-232	2.59E-12	2.59E-12	2.59E-12	2.59E-12	2.59E-12	2.59E-12	2.59E-12	2.69E-11
U-233	2.30E-09	2.30E-09	2.30E-09	2.30E-09	2.30E-09	2.30E-09	2.30E-09	2.80E-09
U-234	6.32E-13	6.32E-13	6.32E-13	6.32E-13	6.32E-13	6.32E-13	6.32E-13	1.59E-10
U-235	3.20E-09	3.20E-09	3.20E-09	3.20E-09	3.20E-09	3.20E-09	3.20E-09	4.00E-09
U-236	2.10E-14	2.10E-14	2.10E-14	2.10E-14	2.10E-14	2.10E-14	2.10E-14	1.80E-11
U-237	1.00E-09	1.00E-09	1.00E-09	1.00E-09	1.00E-09	1.00E-09	1.00E-09	1.30E-09
U-238	1.10E-10	1.10E-10	1.10E-10	1.10E-10	1.10E-10	1.10E-10	1.10E-10	1.50E-10
NP-237	1.40E-09	1.40E-09	1.40E-09	1.40E-09	1.40E-09	1.40E-09	1.40E-09	1.60E-09
NP-238	2.80E-09	2.80E-09	2.80E-09	2.80E-09	2.80E-09	2.80E-09	2.80E-09	3.20E-09
NP-239	9.50E-10	9.50E-10	9.50E-10	9.50E-10	9.50E-10	9.50E-10	9.50E-10	1.10E-09
PU-238	1.30E-12	1.30E-12	1.30E-12	1.30E-12	1.30E-12	1.30E-12	1.30E-12	1.80E-11

TABLE II-7

DOSE FACTORS FOR STANDING ON CONTAMINATED GROUND (D_{aipj})(mrem/hr per pCi/m²)

NUCLIDE	BONE	LIVER	T BODY	THYROID	KIDNEY	LUNG	GI-LLI	SKIN
PU-239	7.90E-13	7.90E-13	7.90E-13	7.90E-13	7.90E-13	7.90E-13	7.90E-13	7.70E-12
PU-240	1.30E-12	1.30E-12	1.30E-12	1.30E-12	1.30E-12	1.30E-12	1.30E-12	1.80E-11
PU-241	4.60E-12	4.60E-12	4.60E-12	4.60E-12	4.60E-12	4.60E-12	4.60E-12	6.80E-12
PU-242	1.10E-12	1.10E-12	1.10E-12	1.10E-12	1.10E-12	1.10E-12	1.10E-12	1.60E-11
PU-244	8.95E-10	8.95E-10	8.95E-10	8.95E-10	8.95E-10	8.95E-10	8.95E-10	9.62E-10
AM-241	1.80E-10	1.80E-10	1.80E-10	1.80E-10	1.80E-10	1.80E-10	1.80E-10	2.60E-10
AM-242M	2.60E-11	2.60E-11	2.60E-11	2.60E-11	2.60E-11	2.60E-11	2.60E-11	1.80E-10
AM-243	1.30E-09	1.30E-09	1.30E-09	1.30E-09	1.30E-09	1.30E-09	1.30E-09	1.50E-09
CM-242	5.50E-12	5.50E-12	5.50E-12	5.50E-12	5.50E-12	5.50E-12	5.50E-12	2.30E-11
CM-243	2.30E-09	2.30E-09	2.30E-09	2.30E-09	2.30E-09	2.30E-09	2.30E-09	2.90E-09
CM-244	2.90E-12	2.90E-12	2.90E-12	2.90E-12	2.90E-12	2.90E-12	2.90E-12	1.80E-11
CM-245	9.50E-10	9.50E-10	9.50E-10	9.50E-10	9.50E-10	9.50E-10	9.50E-10	1.20E-09
CM-246	1.00E-12	1.00E-12	1.00E-12	1.00E-12	1.00E-12	1.00E-12	1.00E-12	1.50E-11
CM-247	2.20E-09	2.20E-09	2.20E-09	2.20E-09	2.20E-09	2.20E-09	2.20E-09	2.60E-09
CM-248	5.23E-09	5.23E-09	5.23E-09	5.23E-09	5.23E-09	5.23E-09	5.23E-09	6.81E-09
CF-252	6.60E-08	6.60E-08	6.60E-08	6.60E-08	6.60E-08	6.60E-08	6.60E-08	7.20E-08

NUREG/CR-4653, GASPAR II, Technical Reference and User Guide

TABLE II-8

AQUATIC PATHWAY USAGE FACTORS (U_{ap})

Pathway	Infant	Child	Teen	Adult
Fish (kg/yr)	-	6.9 ^a	16 ^a	21 ^a
Potable Water (l/yr)	330 ^a	510 ^a	510 ^a	730 ^a
Shoreline Recreation (hr/yr)	-	90 ^b	600 ^b	600 ^b

Ref: ^a Regulatory Guide 1.109, Rev 1, Table E-5

^b EROL Table 5.2.A-3

TABLE II-9
ADULT DRINKING WATER A₁₇ FACTORS

mrem-ml per uCi-hr

NUCLIDE	BONE	LIVER	T BODY	THYROID	KIDNEY	LUNG	GI-LLI	SKIN
H-3	0.00E+00	4.99E+00	4.99E+00	4.99E+00	4.99E+00	4.99E+00	4.99E+00	0.00E+00
C-14	2.37E+02	4.73E+01	4.73E+01	4.73E+01	4.73E+01	4.73E+01	4.73E+01	0.00E+00
NA-22	1.45E+03	1.45E+03	1.45E+03	1.45E+03	1.45E+03	1.45E+03	1.45E+03	0.00E+00
NA-24	8.14E+01	8.14E+01	8.14E+01	8.14E+01	8.14E+01	8.14E+01	8.14E+01	0.00E+00
P-32	1.57E+04	9.76E+02	6.07E+02	0.00E+00	0.00E+00	0.00E+00	1.77E+03	0.00E+00
CA-41	1.54E+04	0.00E+00	1.67E+03	0.00E+00	0.00E+00	0.00E+00	1.53E+01	0.00E+00
SC-46	4.57E-01	8.88E-01	2.58E-01	0.00E+00	8.29E-01	0.00E+00	4.32E+03	0.00E+00
CR-51	0.00E+00	0.00E+00	2.19E-01	1.31E-01	4.82E-02	2.91E-01	5.51E+01	0.00E+00
MN-54	0.00E+00	3.80E+02	7.26E+01	0.00E+00	1.13E+02	0.00E+00	1.17E+03	0.00E+00
MN-56	0.00E+00	3.81E-01	6.75E-02	0.00E+00	4.83E-01	0.00E+00	1.21E+01	0.00E+00
FE-55	2.29E+02	1.58E+02	3.69E+01	0.00E+00	0.00E+00	8.83E+01	9.08E+01	0.00E+00
FE-59	3.59E+02	8.43E+02	3.23E+02	0.00E+00	0.00E+00	2.36E+02	2.81E+03	0.00E+00
CO-57	0.00E+00	1.46E+01	2.42E+01	0.00E+00	0.00E+00	0.00E+00	3.70E+02	0.00E+00
CO-58	0.00E+00	6.18E+01	1.38E+02	0.00E+00	0.00E+00	0.00E+00	1.25E+03	0.00E+00
CO-60	0.00E+00	1.78E+02	3.93E+02	0.00E+00	0.00E+00	0.00E+00	3.35E+03	0.00E+00
NI-59	8.13E+02	2.79E+02	1.36E+02	0.00E+00	0.00E+00	0.00E+00	5.75E+01	0.00E+00
NI-63	1.08E+04	7.51E+02	3.63E+02	0.00E+00	0.00E+00	0.00E+00	1.57E+02	0.00E+00
NI-65	1.62E+00	2.11E-01	9.61E-02	0.00E+00	0.00E+00	0.00E+00	5.34E+00	0.00E+00
CU-64	0.00E+00	3.61E+00	1.69E+00	0.00E+00	9.09E+00	0.00E+00	3.07E+02	0.00E+00
ZN-65	4.03E+02	1.28E+03	5.79E+02	0.00E+00	8.57E+02	0.00E+00	8.07E+02	0.00E+00
ZN-69M	7.74E+00	1.86E+01	1.70E+00	0.00E+00	1.12E+01	0.00E+00	1.13E+03	0.00E+00
ZN-69	1.08E-04	2.08E-04	1.44E-05	0.00E+00	1.35E-04	0.00E+00	3.12E-05	0.00E+00
SE-79	0.00E+00	2.19E+02	3.66E+01	0.00E+00	3.79E+02	0.00E+00	4.48E+01	0.00E+00
BR-82	0.00E+00	0.00E+00	1.49E+02	0.00E+00	0.00E+00	0.00E+00	1.71E+02	0.00E+00
BR-83	0.00E+00	0.00E+00	1.03E-01	0.00E+00	0.00E+00	0.00E+00	1.49E-01	0.00E+00
BR-84	0.00E+00	0.00E+00	6.64E-07	0.00E+00	0.00E+00	0.00E+00	5.21E-12	0.00E+00
BR-85	0.00E+00	0.00E+00	4.40E-77	0.00E+00	0.00E+00	0.00E+00	0.00E+00	0.00E+00
RB-86	0.00E+00	1.73E+03	8.04E+02	0.00E+00	0.00E+00	0.00E+00	3.40E+02	0.00E+00
RB-87	0.00E+00	1.03E+03	3.57E+02	0.00E+00	0.00E+00	0.00E+00	4.80E+01	0.00E+00
RB-88	0.00E+00	3.36E-12	1.78E-12	0.00E+00	0.00E+00	0.00E+00	4.64E-23	0.00E+00
RB-89	0.00E+00	3.06E-14	2.15E-14	0.00E+00	0.00E+00	0.00E+00	1.78E-27	0.00E+00
SR-89	2.55E+04	0.00E+00	7.32E+02	0.00E+00	0.00E+00	0.00E+00	4.09E+03	0.00E+00
SR-90	7.26E+05	0.00E+00	1.46E+04	0.00E+00	0.00E+00	0.00E+00	1.82E+04	0.00E+00
SR-91	1.97E+02	0.00E+00	7.95E+00	0.00E+00	0.00E+00	0.00E+00	9.37E+02	0.00E+00
SR-92	8.32E+00	0.00E+00	3.60E-01	0.00E+00	0.00E+00	0.00E+00	1.65E+02	0.00E+00
Y-90	7.04E-01	0.00E+00	1.89E-02	0.00E+00	0.00E+00	0.00E+00	7.47E+03	0.00E+00
Y-91M	3.31E-07	0.00E+00	1.28E-08	0.00E+00	0.00E+00	0.00E+00	9.71E-07	0.00E+00

TABLE II-9
ADULT DRINKING WATER A₁₇ FACTORS

mrem-ml per uCi-hr

NUCLIDE	BONE	LIVER	T BODY	THYROID	KIDNEY	LUNG	GI-LLI	SKIN
Y-91	1.17E+01	0.00E+00	3.12E-01	0.00E+00	0.00E+00	0.00E+00	6.43E+03	0.00E+00
Y-92	6.72E-03	0.00E+00	1.96E-04	0.00E+00	0.00E+00	0.00E+00	1.18E+02	0.00E+00
Y-93	9.80E-02	0.00E+00	2.71E-03	0.00E+00	0.00E+00	0.00E+00	3.11E+03	0.00E+00
ZR-93	3.48E+00	1.95E-01	9.08E-02	0.00E+00	7.39E-01	0.00E+00	2.03E+02	0.00E+00
ZR-95	2.52E+00	8.08E-01	5.47E-01	0.00E+00	1.27E+00	0.00E+00	2.56E+03	0.00E+00
ZR-97	8.56E-02	1.73E-02	7.90E-03	0.00E+00	2.61E-02	0.00E+00	5.35E+03	0.00E+00
NB-93M	2.12E+00	6.93E-01	1.71E-01	0.00E+00	7.97E-01	0.00E+00	3.20E+02	0.00E+00
NB-95	5.13E-01	2.85E-01	1.53E-01	0.00E+00	2.82E-01	0.00E+00	1.73E+03	0.00E+00
NB-97	4.29E-06	1.08E-06	3.96E-07	0.00E+00	1.27E-06	0.00E+00	4.00E-03	0.00E+00
MO-93	0.00E+00	6.26E+02	1.69E+01	0.00E+00	1.78E+02	0.00E+00	1.02E+02	0.00E+00
MO-99	0.00E+00	3.17E+02	6.02E+01	0.00E+00	7.17E+02	0.00E+00	7.34E+02	0.00E+00
TC-99M	5.17E-03	1.46E-02	1.86E-01	0.00E+00	2.22E-01	7.16E-03	8.64E+00	0.00E+00
TC-99	1.04E+01	1.55E+01	4.18E+00	0.00E+00	1.95E+02	1.32E+00	5.07E+02	0.00E+00
TC-101	1.15E-17	1.66E-17	1.63E-16	0.00E+00	2.99E-16	8.50E-18	5.00E-29	0.00E+00
RU-103	1.53E+01	0.00E+00	6.58E+00	0.00E+00	5.83E+01	0.00E+00	1.78E+03	0.00E+00
RU-105	1.97E-01	0.00E+00	7.78E-02	0.00E+00	2.55E+00	0.00E+00	1.21E+02	0.00E+00
RU-106	2.29E+02	0.00E+00	2.90E+01	0.00E+00	4.42E+02	0.00E+00	1.48E+04	0.00E+00
RH-105	7.97E+00	5.83E+00	3.84E+00	0.00E+00	2.48E+01	0.00E+00	9.29E+02	0.00E+00
PD-107	0.00E+00	1.23E+01	7.83E-01	0.00E+00	1.10E+02	0.00E+00	7.59E+01	0.00E+00
PD-109	0.00E+00	7.95E+00	1.79E+00	0.00E+00	4.54E+01	0.00E+00	8.80E+02	0.00E+00
AG-110M	1.33E+01	1.23E+01	7.31E+00	0.00E+00	2.42E+01	0.00E+00	5.03E+03	0.00E+00
AG-111	4.62E+00	1.93E+00	9.63E-01	0.00E+00	6.24E+00	0.00E+00	3.55E+03	0.00E+00
CD-113M	0.00E+00	2.65E+02	8.50E+00	0.00E+00	2.92E+02	0.00E+00	2.13E+03	0.00E+00
CD-115M	0.00E+00	1.52E+02	4.85E+00	0.00E+00	1.21E+02	0.00E+00	6.40E+03	0.00E+00
SN-123	2.58E+03	4.28E+01	6.31E+01	3.64E+01	0.00E+00	0.00E+00	5.26E+03	0.00E+00
SN-125	6.70E+02	1.35E+01	3.04E+01	1.12E+01	0.00E+00	0.00E+00	8.36E+03	0.00E+00
SN-126	7.04E+03	1.39E+02	2.00E+02	4.10E+01	0.00E+00	0.00E+00	2.03E+03	0.00E+00
SB-124	2.32E+02	4.38E+00	9.20E+01	5.63E-01	0.00E+00	1.81E+02	6.59E+03	0.00E+00
SB-125	1.49E+02	1.67E+00	3.55E+01	1.52E-01	0.00E+00	1.15E+02	1.64E+03	0.00E+00
SB-126	9.32E+01	1.90E+00	3.36E+01	5.70E-01	0.00E+00	5.71E+01	7.62E+03	0.00E+00
SB-127	1.96E+01	4.30E-01	7.54E+00	2.36E-01	0.00E+00	1.17E+01	4.49E+03	0.00E+00
TE-125M	2.22E+02	8.04E+01	2.97E+01	6.68E+01	9.03E+02	0.00E+00	8.86E+02	0.00E+00
TE-127M	5.62E+02	2.01E+02	6.85E+01	1.44E+02	2.28E+03	0.00E+00	1.89E+03	0.00E+00
TE-127	3.77E+00	1.35E+00	8.15E-01	2.79E+00	1.53E+01	0.00E+00	2.97E+02	0.00E+00
TE-129M	9.48E+02	3.54E+02	1.50E+02	3.26E+02	3.96E+03	0.00E+00	4.78E+03	0.00E+00
TE-129	2.01E-03	7.56E-04	4.90E-04	1.54E-03	8.46E-03	0.00E+00	1.52E-03	0.00E+00
TE-131M	1.09E+02	5.34E+01	4.45E+01	8.46E+01	5.41E+02	0.00E+00	5.31E+03	0.00E+00
TE-131	3.51E-09	1.47E-09	1.11E-09	2.89E-09	1.54E-08	0.00E+00	4.97E-10	0.00E+00

TABLE II-9
ADULT DRINKING WATER A₁₇ FACTORS

mrem-ml per uCi-hr

NUCLIDE	BONE	LIVER	T BODY	THYROID	KIDNEY	LUNG	GI-LLI	SKIN
TE-132	1.89E+02	1.22E+02	1.15E+02	1.35E+02	1.18E+03	0.00E+00	5.78E+03	0.00E+00
TE-133M	4.71E-04	2.75E-04	2.65E-04	3.99E-04	2.72E-03	0.00E+00	9.44E-05	0.00E+00
TE-134	1.76E-05	1.15E-05	7.07E-06	1.54E-05	1.12E-04	0.00E+00	1.95E-08	0.00E+00
I-129	2.73E+02	2.34E+02	7.68E+02	6.03E+05	5.03E+02	0.00E+00	3.70E+01	0.00E+00
I-130	3.21E+01	9.48E+01	3.74E+01	8.04E+03	1.48E+02	0.00E+00	8.16E+01	0.00E+00
I-131	3.32E+02	4.75E+02	2.72E+02	1.56E+05	8.14E+02	0.00E+00	1.25E+02	0.00E+00
I-132	4.55E-01	1.22E+00	4.26E-01	4.26E+01	1.94E+00	0.00E+00	2.28E-01	0.00E+00
I-133	7.93E+01	1.38E+02	4.21E+01	2.03E+04	2.41E+02	0.00E+00	1.24E+02	0.00E+00
I-134	6.69E-04	1.82E-03	6.50E-04	3.15E-02	2.89E-03	0.00E+00	1.58E-06	0.00E+00
I-135	1.05E+01	2.75E+01	1.01E+01	1.81E+03	4.40E+01	0.00E+00	3.10E+01	0.00E+00
CS-134M	1.01E-01	2.12E-01	1.08E-01	0.00E+00	1.15E-01	1.81E-02	7.48E-02	0.00E+00
CS-134	5.18E+03	1.23E+04	1.01E+04	0.00E+00	3.99E+03	1.32E+03	2.16E+02	0.00E+00
CS-135	1.63E+03	1.50E+03	6.66E+02	0.00E+00	5.68E+02	1.70E+02	3.51E+01	0.00E+00
CS-136	5.28E+02	2.09E+03	1.50E+03	0.00E+00	1.16E+03	1.59E+02	2.37E+02	0.00E+00
CS-137	6.64E+03	9.08E+03	5.95E+03	0.00E+00	3.08E+03	1.02E+03	1.76E+02	0.00E+00
CS-138	8.54E-07	1.69E-06	8.36E-07	0.00E+00	1.24E-06	1.22E-07	7.20E-12	0.00E+00
CS-139	2.49E-23	3.71E-23	1.35E-23	0.00E+00	2.97E-23	2.70E-24	8.03E-46	0.00E+00
BA-139	1.99E-02	1.42E-05	5.83E-04	0.00E+00	1.33E-05	8.05E-06	3.53E-02	0.00E+00
BA-140	1.65E+03	2.07E+00	1.08E+02	0.00E+00	7.03E-01	1.18E+00	3.39E+03	0.00E+00
BA-141	5.38E-12	4.06E-15	1.82E-13	0.00E+00	3.78E-15	2.31E-15	2.53E-21	0.00E+00
BA-142	9.84E-21	1.01E-23	6.19E-22	0.00E+00	8.55E-24	5.73E-24	1.39E-38	0.00E+00
LA-140	1.69E-01	8.54E-02	2.26E-02	0.00E+00	0.00E+00	0.00E+00	6.27E+03	0.00E+00
LA-141	3.22E-03	9.99E-04	1.63E-04	0.00E+00	0.00E+00	0.00E+00	1.19E+02	0.00E+00
LA-142	5.70E-05	2.59E-05	6.46E-06	0.00E+00	0.00E+00	0.00E+00	1.89E-01	0.00E+00
CE-141	7.72E-01	5.22E-01	5.92E-02	0.00E+00	2.42E-01	0.00E+00	2.00E+03	0.00E+00
CE-143	1.07E-01	7.90E+01	8.74E-03	0.00E+00	3.48E-02	0.00E+00	2.95E+03	0.00E+00
CE-144	4.06E+01	1.70E+01	2.18E+00	0.00E+00	1.01E+01	0.00E+00	1.37E+04	0.00E+00
PR-143	7.47E-01	3.00E-01	3.70E-02	0.00E+00	1.73E-01	0.00E+00	3.27E+03	0.00E+00
PR-144	7.19E-16	2.98E-16	3.65E-17	0.00E+00	1.68E-16	0.00E+00	1.03E-22	0.00E+00
ND-147	5.08E-01	5.87E-01	3.51E-02	0.00E+00	3.43E-01	0.00E+00	2.82E+03	0.00E+00
PM-147	6.28E+00	5.91E-01	2.39E-01	0.00E+00	1.12E+00	0.00E+00	7.44E+02	0.00E+00
PM-148M	2.54E+00	6.57E-01	5.02E-01	0.00E+00	9.92E-01	0.00E+00	5.57E+03	0.00E+00
PM-148	5.60E-01	9.30E-02	4.68E-02	0.00E+00	1.76E-01	0.00E+00	7.30E+03	0.00E+00
PM-149	1.08E-01	1.53E-02	6.26E-03	0.00E+00	2.89E-02	0.00E+00	2.87E+03	0.00E+00
PM-151	4.33E-02	7.27E-03	3.67E-03	0.00E+00	1.30E-02	0.00E+00	2.00E+03	0.00E+00
SM-151	5.75E+00	9.92E-01	2.37E-01	0.00E+00	1.11E+00	0.00E+00	4.37E+02	0.00E+00
SM-153	5.98E-02	4.99E-02	3.64E-03	0.00E+00	1.61E-02	0.00E+00	1.78E+03	0.00E+00
EU-152	1.62E+01	3.70E+00	3.25E+00	0.00E+00	2.29E+01	0.00E+00	2.13E+03	0.00E+00

TABLE II-9
ADULT DRINKING WATER A_{IT} FACTORS

mrem-ml per uCi-hr

NUCLIDE	BONE	LIVER	T BODY	THYROID	KIDNEY	LUNG	GI-LLI	SKIN
EU-154	5.12E+01	6.30E+00	4.48E+00	0.00E+00	3.02E+01	0.00E+00	4.57E+03	0.00E+00
EU-155	7.17E+00	1.02E+00	6.56E-01	0.00E+00	4.69E+00	0.00E+00	8.00E+02	0.00E+00
EU-156	1.12E+00	8.63E-01	1.39E-01	0.00E+00	5.77E-01	0.00E+00	5.91E+03	0.00E+00
TB-160	3.90E+00	0.00E+00	4.86E-01	0.00E+00	1.61E+00	0.00E+00	3.59E+03	0.00E+00
HO-166M	2.25E+01	7.02E+00	5.33E+00	0.00E+00	1.05E+01	0.00E+00	2.13E+03	0.00E+00
W-181	8.23E-01	2.68E-01	2.88E-02	0.00E+00	0.00E+00	0.00E+00	3.06E+01	0.00E+00
W-185	3.36E+01	1.12E+01	1.18E+00	0.00E+00	0.00E+00	0.00E+00	1.29E+03	0.00E+00
W-187	6.05E+00	5.06E+00	1.77E+00	0.00E+00	0.00E+00	0.00E+00	1.66E+03	0.00E+00
U-232	3.44E+05	0.00E+00	2.46E+04	0.00E+00	3.72E+04	0.00E+00	5.65E+03	0.00E+00
U-233	7.26E+04	0.00E+00	4.40E+03	0.00E+00	1.69E+04	0.00E+00	5.23E+03	0.00E+00
U-234	6.97E+04	0.00E+00	4.31E+03	0.00E+00	1.66E+04	0.00E+00	5.12E+03	0.00E+00
U-235	6.68E+04	0.00E+00	4.05E+03	0.00E+00	1.56E+04	0.00E+00	6.51E+03	0.00E+00
U-236	6.68E+04	0.00E+00	4.13E+03	0.00E+00	1.59E+04	0.00E+00	4.80E+03	0.00E+00
U-237	4.37E+00	0.00E+00	1.16E+00	0.00E+00	1.80E+01	0.00E+00	1.54E+03	0.00E+00
U-238	6.39E+04	0.00E+00	3.78E+03	0.00E+00	1.46E+04	0.00E+00	4.58E+03	0.00E+00
NP-237	1.05E+05	7.47E+03	4.62E+03	0.00E+00	3.43E+04	0.00E+00	6.62E+03	0.00E+00
NP-238	9.69E-01	2.61E-02	1.51E-02	0.00E+00	8.84E-02	0.00E+00	2.43E+03	0.00E+00
NP-239	8.56E-02	8.42E-03	4.64E-03	0.00E+00	2.63E-02	0.00E+00	1.73E+03	0.00E+00
PU-238	5.25E+04	6.65E+03	1.42E+03	0.00E+00	6.10E+03	0.00E+00	6.08E+03	0.00E+00
PU-239	6.04E+04	7.26E+03	1.59E+03	0.00E+00	6.76E+03	0.00E+00	5.55E+03	0.00E+00
PU-240	6.03E+04	7.25E+03	1.59E+03	0.00E+00	6.75E+03	0.00E+00	5.65E+03	0.00E+00
PU-241	1.31E+03	6.21E+01	2.77E+01	0.00E+00	1.27E+02	0.00E+00	1.17E+02	0.00E+00
PU-242	5.60E+04	6.99E+03	1.53E+03	0.00E+00	6.51E+03	0.00E+00	5.44E+03	0.00E+00
PU-244	6.53E+04	8.01E+03	1.76E+03	0.00E+00	7.46E+03	0.00E+00	8.11E+03	0.00E+00
AM-241	6.29E+04	5.87E+04	4.51E+03	0.00E+00	3.39E+04	0.00E+00	6.18E+03	0.00E+00
AM-242M	6.34E+04	5.52E+04	4.52E+03	0.00E+00	3.37E+04	0.00E+00	7.78E+03	0.00E+00
AM-243	6.28E+04	5.75E+04	4.42E+03	0.00E+00	3.33E+04	0.00E+00	7.25E+03	0.00E+00
CM-242	1.71E+03	1.82E+03	1.14E+02	0.00E+00	5.17E+02	0.00E+00	6.59E+03	0.00E+00
CM-243	4.99E+04	4.57E+04	3.12E+03	0.00E+00	1.46E+04	0.00E+00	6.51E+03	0.00E+00
CM-244	3.80E+04	3.56E+04	2.39E+03	0.00E+00	1.12E+04	0.00E+00	6.29E+03	0.00E+00
CM-245	7.82E+04	6.81E+04	4.80E+03	0.00E+00	2.24E+04	0.00E+00	5.87E+03	0.00E+00
CM-246	7.75E+04	6.80E+04	4.79E+03	0.00E+00	2.23E+04	0.00E+00	5.76E+03	0.00E+00
CM-247	7.56E+04	6.70E+04	4.73E+03	0.00E+00	2.20E+04	0.00E+00	7.58E+03	0.00E+00
CM-248	6.28E+05	5.53E+05	3.89E+04	0.00E+00	1.82E+05	0.00E+00	1.23E+05	0.00E+00
CF-252	2.17E+04	0.00E+00	5.24E+02	0.00E+00	0.00E+00	0.00E+00	2.40E+04	0.00E+00

TABLE II1-10

ADULT FRESHWATER FISH A_{IT} FACTORS

mrem-ml peruCi-hr

NUCLIDE	BONE	LIVER	T BODY	THYROID	KIDNEY	LUNG	GI-LLI	SKIN
H-3	0.00E+00	1.29E-01	1.29E-01	1.29E-01	1.29E-01	1.29E-01	1.29E-01	0.00E+00
C-14	3.13E+04	6.26E+03	6.26E+03	6.26E+03	6.26E+03	6.26E+03	6.26E+03	0.00E+00
NA-22	4.17E+03	4.17E+03	4.17E+03	4.17E+03	4.17E+03	4.17E+03	4.17E+03	0.00E+00
NA-24	1.34E+02	1.34E+02	1.34E+02	1.34E+02	1.34E+02	1.34E+02	1.34E+02	0.00E+00
P-32	1.32E+06	8.22E+04	5.11E+04	0.00E+00	0.00E+00	0.00E+00	1.49E+05	0.00E+00
CA-41	1.77E+04	0.00E+00	1.92E+03	0.00E+00	0.00E+00	0.00E+00	1.76E+01	0.00E+00
SC-46	2.62E-02	5.09E-02	1.48E-02	0.00E+00	4.75E-02	0.00E+00	2.48E+02	0.00E+00
CR-51	0.00E+00	0.00E+00	1.24E+00	7.43E-01	2.74E-01	1.65E+00	3.13E+02	0.00E+00
MN-54	0.00E+00	4.37E+03	8.34E+02	0.00E+00	1.30E+03	0.00E+00	1.34E+04	0.00E+00
MN-56	0.00E+00	1.74E-01	3.09E-02	0.00E+00	2.21E-01	0.00E+00	5.55E+00	0.00E+00
FE-55	6.59E+02	4.55E+02	1.06E+02	0.00E+00	0.00E+00	2.54E+02	2.61E+02	0.00E+00
FE-59	1.02E+03	2.41E+03	9.23E+02	0.00E+00	0.00E+00	6.73E+02	8.03E+03	0.00E+00
CO-57	0.00E+00	2.09E+01	3.48E+01	0.00E+00	0.00E+00	0.00E+00	5.31E+02	0.00E+00
CO-58	0.00E+00	8.84E+01	1.98E+02	0.00E+00	0.00E+00	0.00E+00	1.79E+03	0.00E+00
CO-60	0.00E+00	2.56E+02	5.66E+02	0.00E+00	0.00E+00	0.00E+00	4.82E+03	0.00E+00
NI-59	2.34E+03	8.03E+02	3.91E+02	0.00E+00	0.00E+00	0.00E+00	1.65E+02	0.00E+00
NI-63	3.12E+04	2.16E+03	1.05E+03	0.00E+00	0.00E+00	0.00E+00	4.51E+02	0.00E+00
NI-65	1.72E-01	2.23E-02	1.02E-02	0.00E+00	0.00E+00	0.00E+00	5.67E-01	0.00E+00
CU-64	0.00E+00	2.69E+00	1.26E+00	0.00E+00	6.79E+00	0.00E+00	2.30E+02	0.00E+00
ZN-65	2.31E+04	7.36E+04	3.33E+04	0.00E+00	4.92E+04	0.00E+00	4.64E+04	0.00E+00
ZN-69M	2.43E+02	5.84E+02	5.34E+01	0.00E+00	3.53E+02	0.00E+00	3.56E+04	0.00E+00
ZN-69	7.89E-07	1.51E-06	1.05E-07	0.00E+00	9.81E-07	0.00E+00	2.27E-07	0.00E+00
SE-79	0.00E+00	1.07E+03	1.79E+02	0.00E+00	1.85E+03	0.00E+00	2.19E+02	0.00E+00
BR-82	0.00E+00	0.00E+00	1.42E+03	0.00E+00	0.00E+00	0.00E+00	1.63E+03	0.00E+00
BR-83	0.00E+00	0.00E+00	3.84E-02	0.00E+00	0.00E+00	0.00E+00	5.53E-02	0.00E+00
BR-84	0.00E+00	0.00E+00	1.23E-12	0.00E+00	0.00E+00	0.00E+00	9.62E-18	0.00E+00
BR-85	0.00E+00	0.00E+00	1.31E-151	0.00E+00	0.00E+00	0.00E+00	0.00E+00	0.00E+00
RB-86	0.00E+00	9.75E+04	4.54E+04	0.00E+00	0.00E+00	0.00E+00	1.92E+04	0.00E+00
RB-87	0.00E+00	5.90E+04	2.05E+04	0.00E+00	0.00E+00	0.00E+00	2.76E+03	0.00E+00
RB-88	0.00E+00	1.29E-22	6.83E-23	0.00E+00	0.00E+00	0.00E+00	1.78E-33	0.00E+00
RB-89	0.00E+00	1.62E-26	1.14E-26	0.00E+00	0.00E+00	0.00E+00	9.39E-40	0.00E+00
SR-89	2.18E+04	0.00E+00	6.27E+02	0.00E+00	0.00E+00	0.00E+00	3.50E+03	0.00E+00
SR-90	6.26E+05	0.00E+00	1.26E+04	0.00E+00	0.00E+00	0.00E+00	1.57E+04	0.00E+00
SR-91	7.08E+01	0.00E+00	2.86E+00	0.00E+00	0.00E+00	0.00E+00	3.37E+02	0.00E+00
SR-92	3.34E-01	0.00E+00	1.44E-02	0.00E+00	0.00E+00	0.00E+00	6.61E+00	0.00E+00
Y-90	4.45E-01	0.00E+00	1.19E-02	0.00E+00	0.00E+00	0.00E+00	4.72E+03	0.00E+00
Y-91M	1.04E-11	0.00E+00	4.02E-13	0.00E+00	0.00E+00	0.00E+00	3.05E-11	0.00E+00

TABLE II1-10

ADULT FRESHWATER FISH A₁₇ FACTORS

mrem-ml peruCi-hr

NUCLIDE	BONE	LIVER	T BODY	THYROID	KIDNEY	LUNG	GI-LLI	SKIN
Y-91	8.35E+00	0.00E+00	2.23E-01	0.00E+00	0.00E+00	0.00E+00	4.60E+03	0.00E+00
Y-92	4.61E-04	0.00E+00	1.35E-05	0.00E+00	0.00E+00	0.00E+00	8.07E+00	0.00E+00
Y-93	3.09E-02	0.00E+00	8.54E-04	0.00E+00	0.00E+00	0.00E+00	9.81E+02	0.00E+00
ZR-93	3.31E-01	1.85E-02	8.62E-03	0.00E+00	7.02E-02	0.00E+00	1.92E+01	0.00E+00
ZR-95	2.38E-01	7.63E-02	5.17E-02	0.00E+00	1.20E-01	0.00E+00	2.42E+02	0.00E+00
ZR-97	4.97E-03	1.00E-03	4.58E-04	0.00E+00	1.51E-03	0.00E+00	3.10E+02	0.00E+00
NB-93M	1.83E+03	5.98E+02	1.47E+02	0.00E+00	6.88E+02	0.00E+00	2.76E+05	0.00E+00
NB-95	4.39E+02	2.44E+02	1.31E+02	0.00E+00	2.41E+02	0.00E+00	1.48E+06	0.00E+00
NB-97	3.65E-06	9.23E-07	3.37E-07	0.00E+00	1.08E-06	0.00E+00	3.40E-03	0.00E+00
MO-93	0.00E+00	1.80E+02	4.87E+00	0.00E+00	5.11E+01	0.00E+00	2.92E+01	0.00E+00
MO-99	0.00E+00	8.03E+01	1.53E+01	0.00E+00	1.82E+02	0.00E+00	1.86E+02	0.00E+00
TC-99M	5.60E-04	1.58E-03	2.02E-02	0.00E+00	2.40E-02	7.76E-04	9.37E-01	0.00E+00
TC-99	4.49E+00	6.69E+00	1.81E+00	0.00E+00	8.41E+01	5.68E-01	2.19E+02	0.00E+00
TC-101	2.71E-33	3.91E-33	3.84E-32	0.00E+00	7.04E-32	2.00E-33	1.18E-44	0.00E+00
RU-103	4.36E+00	0.00E+00	1.88E+00	0.00E+00	1.66E+01	0.00E+00	5.09E+02	0.00E+00
RU-105	8.71E-03	0.00E+00	3.44E-03	0.00E+00	1.13E-01	0.00E+00	5.33E+00	0.00E+00
RU-106	6.58E+01	0.00E+00	8.33E+00	0.00E+00	1.27E+02	0.00E+00	4.26E+03	0.00E+00
RH-105	1.81E+00	1.33E+00	8.73E-01	0.00E+00	5.63E+00	0.00E+00	2.11E+02	0.00E+00
PD-107	0.00E+00	3.52E+00	2.25E-01	0.00E+00	3.16E+01	0.00E+00	2.18E+01	0.00E+00
PD-109	0.00E+00	1.23E+00	2.78E-01	0.00E+00	7.03E+00	0.00E+00	1.36E+02	0.00E+00
AG-110M	8.80E-01	8.14E-01	4.83E-01	0.00E+00	1.60E+00	0.00E+00	3.32E+02	0.00E+00
AG-111	2.92E-01	1.22E-01	6.08E-02	0.00E+00	3.94E-01	0.00E+00	2.24E+02	0.00E+00
CD-113M	0.00E+00	1.52E+03	4.89E+01	0.00E+00	1.68E+03	0.00E+00	1.23E+04	0.00E+00
CD-115M	0.00E+00	8.69E+02	2.77E+01	0.00E+00	6.89E+02	0.00E+00	3.65E+04	0.00E+00
SN-123	2.22E+05	3.68E+03	5.43E+03	3.13E+03	0.00E+00	0.00E+00	4.53E+05	0.00E+00
SN-125	5.58E+04	1.12E+03	2.53E+03	9.30E+02	0.00E+00	0.00E+00	6.96E+05	0.00E+00
SN-126	6.08E+05	1.20E+04	1.73E+04	3.54E+03	0.00E+00	0.00E+00	1.75E+05	0.00E+00
SB-124	6.64E+00	1.25E-01	2.63E+00	1.61E-02	0.00E+00	5.17E+00	1.88E+02	0.00E+00
SB-125	4.29E+00	4.79E-02	1.02E+00	4.36E-03	0.00E+00	3.31E+00	4.72E+01	0.00E+00
SB-126	2.61E+00	5.30E-02	9.41E-01	1.60E-02	0.00E+00	1.60E+00	2.13E+02	0.00E+00
SB-127	5.17E-01	1.13E-02	1.98E-01	6.21E-03	0.00E+00	3.06E-01	1.18E+02	0.00E+00
TE-125M	2.54E+03	9.20E+02	3.40E+02	7.64E+02	1.03E+04	0.00E+00	1.01E+04	0.00E+00
TE-127M	6.45E+03	2.31E+03	7.86E+02	1.65E+03	2.62E+04	0.00E+00	2.16E+04	0.00E+00
TE-127	1.78E+01	6.39E+00	3.85E+00	1.32E+01	7.25E+01	0.00E+00	1.40E+03	0.00E+00
TE-129M	1.08E+04	4.03E+03	1.71E+03	3.71E+03	4.51E+04	0.00E+00	5.44E+04	0.00E+00
TE-129	1.78E-05	6.69E-06	4.34E-06	1.37E-05	7.48E-05	0.00E+00	1.34E-05	0.00E+00
TE-131M	9.53E+02	4.66E+02	3.88E+02	7.38E+02	4.72E+03	0.00E+00	4.63E+04	0.00E+00
TE-131	8.65E-17	3.61E-17	2.73E-17	7.11E-17	3.79E-16	0.00E+00	1.22E-17	0.00E+00

TABLE II1-10

ADULT FRESHWATER FISH A₁₇ FACTORS

mrem-ml peruCi-hr

NUCLIDE	BONE	LIVER	T BODY	THYROID	KIDNEY	LUNG	GI-LLI	SKIN
TE-132	1.95E+03	1.26E+03	1.19E+03	1.40E+03	1.22E+04	0.00E+00	5.98E+04	0.00E+00
TE-133M	6.63E-07	3.88E-07	3.73E-07	5.61E-07	3.83E-06	0.00E+00	1.33E-07	0.00E+00
TE-134	1.32E-09	8.66E-10	5.31E-10	1.16E-09	8.38E-09	0.00E+00	1.47E-12	0.00E+00
I-129	1.18E+02	1.01E+02	3.31E+02	2.60E+05	2.17E+02	0.00E+00	1.60E+01	0.00E+00
I-130	7.08E+00	2.09E+01	8.24E+00	1.77E+03	3.26E+01	0.00E+00	1.80E+01	0.00E+00
I-131	1.37E+02	1.96E+02	1.12E+02	6.43E+04	3.36E+02	0.00E+00	5.18E+01	0.00E+00
I-132	5.27E-03	1.41E-02	4.94E-03	4.94E-01	2.25E-02	0.00E+00	2.65E-03	0.00E+00
I-133	2.29E+01	3.99E+01	1.22E+01	5.87E+03	6.97E+01	0.00E+00	3.59E+01	0.00E+00
I-134	2.19E-08	5.94E-08	2.13E-08	1.03E-06	9.45E-08	0.00E+00	5.18E-11	0.00E+00
I-135	1.29E+00	3.37E+00	1.24E+00	2.22E+02	5.40E+00	0.00E+00	3.80E+00	0.00E+00
CS-134M	3.29E-01	6.93E-01	3.54E-01	0.00E+00	3.76E-01	5.92E-02	2.44E-01	0.00E+00
CS-134	2.98E+05	7.09E+05	5.80E+05	0.00E+00	2.29E+05	7.62E+04	1.24E+04	0.00E+00
CS-135	9.35E+04	8.63E+04	3.83E+04	0.00E+00	3.27E+04	9.78E+03	2.02E+03	0.00E+00
CS-136	2.96E+04	1.17E+05	8.41E+04	0.00E+00	6.50E+04	8.92E+03	1.33E+04	0.00E+00
CS-137	3.82E+05	5.23E+05	3.42E+05	0.00E+00	1.77E+05	5.90E+04	1.01E+04	0.00E+00
CS-138	9.13E-12	1.80E-11	8.93E-12	0.00E+00	1.32E-11	1.31E-12	7.69E-17	0.00E+00
CS-139	1.25E-44	1.87E-44	6.80E-45	0.00E+00	1.50E-44	1.36E-45	4.04E-67	0.00E+00
BA-139	5.65E-06	4.03E-09	1.65E-07	0.00E+00	3.76E-09	2.28E-09	1.00E-05	0.00E+00
BA-140	1.84E+02	2.32E-01	1.21E+01	0.00E+00	7.88E-02	1.33E-01	3.80E+02	0.00E+00
BA-141	8.48E-25	6.41E-28	2.86E-26	0.00E+00	5.96E-28	3.64E-28	4.00E-34	0.00E+00
BA-142	6.28E-42	6.45E-45	3.95E-43	0.00E+00	5.45E-45	3.65E-45	8.84E-60	0.00E+00
LA-140	9.91E-02	4.99E-02	1.32E-02	0.00E+00	0.00E+00	0.00E+00	3.67E+03	0.00E+00
LA-141	2.80E-04	8.70E-05	1.42E-05	0.00E+00	0.00E+00	0.00E+00	1.04E+01	0.00E+00
LA-142	2.19E-07	9.97E-08	2.48E-08	0.00E+00	0.00E+00	0.00E+00	7.28E-04	0.00E+00
CE-141	2.20E-02	1.49E-02	1.68E-03	0.00E+00	6.90E-03	0.00E+00	5.68E+01	0.00E+00
CE-143	2.39E-03	1.77E+00	1.95E-04	0.00E+00	7.78E-04	0.00E+00	6.60E+01	0.00E+00
CE-144	1.17E+00	4.88E-01	6.27E-02	0.00E+00	2.89E-01	0.00E+00	3.95E+02	0.00E+00
PR-143	5.24E-01	2.10E-01	2.60E-02	0.00E+00	1.21E-01	0.00E+00	2.29E+03	0.00E+00
PR-144	1.48E-28	6.15E-29	7.53E-30	0.00E+00	3.47E-29	0.00E+00	2.13E-35	0.00E+00
ND-147	3.54E-01	4.09E-01	2.45E-02	0.00E+00	2.39E-01	0.00E+00	1.96E+03	0.00E+00
PM-147	4.52E+00	4.25E-01	1.72E-01	0.00E+00	8.03E-01	0.00E+00	5.35E+02	0.00E+00
PM-148M	1.81E+00	4.69E-01	3.58E-01	0.00E+00	7.07E-01	0.00E+00	3.97E+03	0.00E+00
PM-148	3.78E-01	6.27E-02	3.16E-02	0.00E+00	1.19E-01	0.00E+00	4.93E+03	0.00E+00
PM-149	6.66E-02	9.42E-03	3.85E-03	0.00E+00	1.78E-02	0.00E+00	1.77E+03	0.00E+00
PM-151	2.33E-02	3.90E-03	1.97E-03	0.00E+00	6.97E-03	0.00E+00	1.07E+03	0.00E+00
SM-151	4.14E+00	7.13E-01	1.71E-01	0.00E+00	7.97E-01	0.00E+00	3.15E+02	0.00E+00
SM-153	3.60E-02	3.00E-02	2.19E-03	0.00E+00	9.70E-03	0.00E+00	1.07E+03	0.00E+00
EU-152	1.17E+01	2.66E+00	2.34E+00	0.00E+00	1.65E+01	0.00E+00	1.53E+03	0.00E+00

TABLE II1-10

ADULT FRESHWATER FISH A₁₇ FACTORS

mrem-ml peruCi-hr

NUCLIDE	BONE	LIVER	T BODY	THYROID	KIDNEY	LUNG	GI-LLI	SKIN
EU-154	3.68E+01	4.53E+00	3.22E+00	0.00E+00	2.17E+01	0.00E+00	3.28E+03	0.00E+00
EU-155	5.15E+00	7.31E-01	4.71E-01	0.00E+00	3.37E+00	0.00E+00	5.75E+02	0.00E+00
EU-156	7.84E-01	6.07E-01	9.79E-02	0.00E+00	4.05E-01	0.00E+00	4.16E+03	0.00E+00
TB-160	2.79E+00	0.00E+00	3.48E-01	0.00E+00	1.15E+00	0.00E+00	2.57E+03	0.00E+00
HO-166M	1.62E+01	5.05E+00	3.84E+00	0.00E+00	7.55E+00	0.00E+00	1.53E+03	0.00E+00
W-181	2.83E+01	9.24E+00	9.90E-01	0.00E+00	0.00E+00	0.00E+00	1.05E+03	0.00E+00
W-185	1.15E+03	3.85E+02	4.05E+01	0.00E+00	0.00E+00	0.00E+00	4.45E+04	0.00E+00
W-187	1.47E+02	1.23E+02	4.31E+01	0.00E+00	0.00E+00	0.00E+00	4.04E+04	0.00E+00
U-232	1.98E+04	0.00E+00	1.41E+03	0.00E+00	2.14E+03	0.00E+00	3.25E+02	0.00E+00
U-233	4.18E+03	0.00E+00	2.53E+02	0.00E+00	9.73E+02	0.00E+00	3.01E+02	0.00E+00
U-234	4.01E+03	0.00E+00	2.48E+02	0.00E+00	9.54E+02	0.00E+00	2.94E+02	0.00E+00
U-235	3.84E+03	0.00E+00	2.33E+02	0.00E+00	8.97E+02	0.00E+00	3.74E+02	0.00E+00
U-236	3.84E+03	0.00E+00	2.38E+02	0.00E+00	9.16E+02	0.00E+00	2.76E+02	0.00E+00
U-237	2.39E-01	0.00E+00	6.36E-02	0.00E+00	9.82E-01	0.00E+00	8.39E+01	0.00E+00
U-238	3.68E+03	0.00E+00	2.18E+02	0.00E+00	8.39E+02	0.00E+00	2.64E+02	0.00E+00
NP-237	3.02E+04	2.15E+03	1.33E+03	0.00E+00	9.88E+03	0.00E+00	1.90E+03	0.00E+00
NP-238	2.37E-01	6.38E-03	3.68E-03	0.00E+00	2.16E-02	0.00E+00	5.93E+02	0.00E+00
NP-239	2.13E-02	2.09E-03	1.15E-03	0.00E+00	6.52E-03	0.00E+00	4.29E+02	0.00E+00
PU-238	5.29E+03	6.70E+02	1.43E+02	0.00E+00	6.14E+02	0.00E+00	6.12E+02	0.00E+00
PU-239	6.08E+03	7.31E+02	1.60E+02	0.00E+00	6.80E+02	0.00E+00	5.59E+02	0.00E+00
PU-240	6.07E+03	7.30E+02	1.60E+02	0.00E+00	6.80E+02	0.00E+00	5.69E+02	0.00E+00
PU-241	1.32E+02	6.25E+00	2.79E+00	0.00E+00	1.28E+01	0.00E+00	1.17E+01	0.00E+00
PU-242	5.64E+03	7.04E+02	1.54E+02	0.00E+00	6.55E+02	0.00E+00	5.48E+02	0.00E+00
PU-244	6.58E+03	8.06E+02	1.77E+02	0.00E+00	7.51E+02	0.00E+00	8.16E+02	0.00E+00
AM-241	4.52E+04	4.23E+04	3.24E+03	0.00E+00	2.44E+04	0.00E+00	4.45E+03	0.00E+00
AM-242M	4.56E+04	3.97E+04	3.25E+03	0.00E+00	2.43E+04	0.00E+00	5.60E+03	0.00E+00
AM-243	4.52E+04	4.14E+04	3.18E+03	0.00E+00	2.39E+04	0.00E+00	5.21E+03	0.00E+00
CM-242	1.23E+03	1.31E+03	8.18E+01	0.00E+00	3.71E+02	0.00E+00	4.73E+03	0.00E+00
CM-243	3.59E+04	3.29E+04	2.25E+03	0.00E+00	1.05E+04	0.00E+00	4.68E+03	0.00E+00
CM-244	2.73E+04	2.56E+04	1.72E+03	0.00E+00	8.03E+03	0.00E+00	4.52E+03	0.00E+00
CM-245	5.62E+04	4.90E+04	3.45E+03	0.00E+00	1.61E+04	0.00E+00	4.22E+03	0.00E+00
CM-246	5.57E+04	4.89E+04	3.45E+03	0.00E+00	1.61E+04	0.00E+00	4.14E+03	0.00E+00
CM-247	5.44E+04	4.82E+04	3.40E+03	0.00E+00	1.58E+04	0.00E+00	5.45E+03	0.00E+00
CM-248	4.52E+05	3.97E+05	2.80E+04	0.00E+00	1.31E+05	0.00E+00	8.81E+04	0.00E+00
CF-252	1.56E+04	0.00E+00	3.77E+02	0.00E+00	0.00E+00	0.00E+00	1.72E+04	0.00E+00

TABLE II1-11

ADULT SHORELINE A₁₇ FACTORS

mrem-ml per uCi-hr

NUCLIDE	BONE	LIVER	T BODY	THYROID	KIDNEY	LUNG	GI-LLI	SKIN
H-3	0.00E+00	0.00E+00	0.00E+00	0.00E+00	0.00E+00	0.00E+00	0.00E+00	0.00E+00
C-14	0.00E+00	0.00E+00	0.00E+00	0.00E+00	0.00E+00	0.00E+00	0.00E+00	0.00E+00
NA-22	2.08E+04	2.08E+04	2.08E+04	2.08E+04	2.08E+04	2.08E+04	2.08E+04	2.34E+04
NA-24	2.14E+01	2.14E+01	2.14E+01	2.14E+01	2.14E+01	2.14E+01	2.14E+01	2.48E+01
P-32	0.00E+00	0.00E+00	0.00E+00	0.00E+00	0.00E+00	0.00E+00	0.00E+00	0.00E+00
CA-41	2.96E+04	2.96E+04	2.96E+04	2.96E+04	2.96E+04	2.96E+04	2.96E+04	3.48E+04
SC-46	1.49E+03	1.49E+03	1.49E+03	1.49E+03	1.49E+03	1.49E+03	1.49E+03	1.72E+03
CR-51	8.35E+00	8.35E+00	8.35E+00	8.35E+00	8.35E+00	8.35E+00	8.35E+00	9.87E+00
MN-54	2.48E+03	2.48E+03	2.48E+03	2.48E+03	2.48E+03	2.48E+03	2.48E+03	2.91E+03
MN-56	1.62E+00	1.62E+00	1.62E+00	1.62E+00	1.62E+00	1.62E+00	1.62E+00	1.91E+00
FE-55	0.00E+00	0.00E+00	0.00E+00	0.00E+00	0.00E+00	0.00E+00	0.00E+00	0.00E+00
FE-59	4.89E+02	4.89E+02	4.89E+02	4.89E+02	4.89E+02	4.89E+02	4.89E+02	5.75E+02
CO-57	3.38E+02	3.38E+02	3.38E+02	3.38E+02	3.38E+02	3.38E+02	3.38E+02	3.71E+02
CO-58	6.79E+02	6.79E+02	6.79E+02	6.79E+02	6.79E+02	6.79E+02	6.79E+02	7.95E+02
CO-60	4.32E+04	4.32E+04	4.32E+04	4.32E+04	4.32E+04	4.32E+04	4.32E+04	5.08E+04
NI-59	0.00E+00	0.00E+00	0.00E+00	0.00E+00	0.00E+00	0.00E+00	0.00E+00	0.00E+00
NI-63	0.00E+00	0.00E+00	0.00E+00	0.00E+00	0.00E+00	0.00E+00	0.00E+00	0.00E+00
NI-65	5.32E-01	5.32E-01	5.32E-01	5.32E-01	5.32E-01	5.32E-01	5.32E-01	6.19E-01
CU-64	1.09E+00	1.09E+00	1.09E+00	1.09E+00	1.09E+00	1.09E+00	1.09E+00	1.23E+00
ZN-65	1.34E+03	1.34E+03	1.34E+03	1.34E+03	1.34E+03	1.34E+03	1.34E+03	1.54E+03
ZN-69M	2.28E+00	2.28E+00	2.28E+00	2.28E+00	2.28E+00	2.28E+00	2.28E+00	2.67E+00
ZN-69	0.00E+00	0.00E+00	0.00E+00	0.00E+00	0.00E+00	0.00E+00	0.00E+00	0.00E+00
SE-79	0.00E+00	0.00E+00	0.00E+00	0.00E+00	0.00E+00	0.00E+00	0.00E+00	0.00E+00
BR-82	3.83E+01	3.83E+01	3.83E+01	3.83E+01	3.83E+01	3.83E+01	3.83E+01	4.43E+01
BR-83	8.73E-03	8.73E-03	8.73E-03	8.73E-03	8.73E-03	8.73E-03	8.73E-03	1.27E-02
BR-84	3.63E-01	3.63E-01	3.63E-01	3.63E-01	3.63E-01	3.63E-01	3.63E-01	4.24E-01
BR-85	0.00E+00	0.00E+00	0.00E+00	0.00E+00	0.00E+00	0.00E+00	0.00E+00	0.00E+00
RB-86	1.61E+01	1.61E+01	1.61E+01	1.61E+01	1.61E+01	1.61E+01	1.61E+01	1.84E+01
RB-87	0.00E+00	0.00E+00	0.00E+00	0.00E+00	0.00E+00	0.00E+00	0.00E+00	0.00E+00
RB-88	5.93E-02	5.93E-02	5.93E-02	5.93E-02	5.93E-02	5.93E-02	5.93E-02	6.77E-02
RB-89	2.20E-01	2.20E-01	2.20E-01	2.20E-01	2.20E-01	2.20E-01	2.20E-01	2.64E-01
SR-89	3.88E-02	3.88E-02	3.88E-02	3.88E-02	3.88E-02	3.88E-02	3.88E-02	4.50E-02
SR-90	0.00E+00	0.00E+00	0.00E+00	0.00E+00	0.00E+00	0.00E+00	0.00E+00	0.00E+00
SR-91	3.85E+00	3.85E+00	3.85E+00	3.85E+00	3.85E+00	3.85E+00	3.85E+00	4.50E+00
SR-92	1.39E+00	1.39E+00	1.39E+00	1.39E+00	1.39E+00	1.39E+00	1.39E+00	1.55E+00
Y-90	8.05E-03	8.05E-03	8.05E-03	8.05E-03	8.05E-03	8.05E-03	8.05E-03	9.51E-03
Y-91M	1.80E-01	1.80E-01	1.80E-01	1.80E-01	1.80E-01	1.80E-01	1.80E-01	2.08E-01

TABLE II1-11

ADULT SHORELINE A₁₇ FACTORS

mrem-ml per uCi-hr

NUCLIDE	BONE	LIVER	T BODY	THYROID	KIDNEY	LUNG	GI-LLI	SKIN
Y-91	1.92E+00	1.92E+00	1.92E+00	1.92E+00	1.92E+00	1.92E+00	1.92E+00	2.16E+00
Y-92	3.23E-01	3.23E-01	3.23E-01	3.23E-01	3.23E-01	3.23E-01	3.23E-01	3.84E-01
Y-93	3.29E-01	3.29E-01	3.29E-01	3.29E-01	3.29E-01	3.29E-01	3.29E-01	4.50E-01
ZR-93	0.00E+00	0.00E+00	0.00E+00	0.00E+00	0.00E+00	0.00E+00	0.00E+00	0.00E+00
ZR-95	4.39E+02	4.39E+02	4.39E+02	4.39E+02	4.39E+02	4.39E+02	4.39E+02	5.09E+02
ZR-97	5.31E+00	5.31E+00	5.31E+00	5.31E+00	5.31E+00	5.31E+00	5.31E+00	6.17E+00
NB-93M	4.16E+00	4.16E+00	4.16E+00	4.16E+00	4.16E+00	4.16E+00	4.16E+00	5.08E+02
NB-95	2.45E+02	2.45E+02	2.45E+02	2.45E+02	2.45E+02	2.45E+02	2.45E+02	2.88E+02
NB-97	3.16E-01	3.16E-01	3.16E-01	3.16E-01	3.16E-01	3.16E-01	3.16E-01	3.70E-01
MO-93	1.98E+02	1.98E+02	1.98E+02	1.98E+02	1.98E+02	1.98E+02	1.98E+02	8.06E+03
MO-99	7.16E+00	7.16E+00	7.16E+00	7.16E+00	7.16E+00	7.16E+00	7.16E+00	8.29E+00
TC-99M	3.30E-01	3.30E-01	3.30E-01	3.30E-01	3.30E-01	3.30E-01	3.30E-01	3.78E-01
TC-99	0.00E+00	0.00E+00	0.00E+00	0.00E+00	0.00E+00	0.00E+00	0.00E+00	0.00E+00
TC-101	3.65E-02	3.65E-02	3.65E-02	3.65E-02	3.65E-02	3.65E-02	3.65E-02	4.05E-02
RU-103	1.94E+02	1.94E+02	1.94E+02	1.94E+02	1.94E+02	1.94E+02	1.94E+02	2.26E+02
RU-105	1.14E+00	1.14E+00	1.14E+00	1.14E+00	1.14E+00	1.14E+00	1.14E+00	1.29E+00
RU-106	7.57E+02	7.57E+02	7.57E+02	7.57E+02	7.57E+02	7.57E+02	7.57E+02	9.08E+02
RH-105	1.33E+00	1.33E+00	1.33E+00	1.33E+00	1.33E+00	1.33E+00	1.33E+00	1.55E+00
PD-107	0.00E+00	0.00E+00	0.00E+00	0.00E+00	0.00E+00	0.00E+00	0.00E+00	0.00E+00
PD-109	2.69E-02	2.69E-02	2.69E-02	2.69E-02	2.69E-02	2.69E-02	2.69E-02	3.07E-02
AG-110M	6.16E+03	6.16E+03	6.16E+03	6.16E+03	6.16E+03	6.16E+03	6.16E+03	7.19E+03
AG-111	1.84E+00	1.84E+00	1.84E+00	1.84E+00	1.84E+00	1.84E+00	1.84E+00	2.15E+00
CD-113M	1.13E+01	1.13E+01	1.13E+01	1.13E+01	1.13E+01	1.13E+01	1.13E+01	1.28E+01
CD-115M	0.00E+00	0.00E+00	0.00E+00	0.00E+00	0.00E+00	0.00E+00	0.00E+00	0.00E+00
SN-123	0.00E+00	0.00E+00	0.00E+00	0.00E+00	0.00E+00	0.00E+00	0.00E+00	1.14E+04
SN-125	7.53E+00	7.53E+00	7.53E+00	7.53E+00	7.53E+00	7.53E+00	7.53E+00	8.72E+00
SN-126	7.80E+04	7.80E+04	7.80E+04	7.80E+04	7.80E+04	7.80E+04	7.80E+04	8.67E+04
SB-124	1.07E+03	1.07E+03	1.07E+03	1.07E+03	1.07E+03	1.07E+03	1.07E+03	1.24E+03
SB-125	4.29E+03	4.29E+03	4.29E+03	4.29E+03	4.29E+03	4.29E+03	4.29E+03	4.84E+03
SB-126	1.51E+02	1.51E+02	1.51E+02	1.51E+02	1.51E+02	1.51E+02	1.51E+02	1.70E+02
SB-127	3.01E+01	3.01E+01	3.01E+01	3.01E+01	3.01E+01	3.01E+01	3.01E+01	3.48E+01
TE-125M	2.78E+00	2.78E+00	2.78E+00	2.78E+00	2.78E+00	2.78E+00	2.78E+00	3.81E+00
TE-127M	1.64E-01	1.64E-01	1.64E-01	1.64E-01	1.64E-01	1.64E-01	1.64E-01	1.94E-01
TE-127	5.34E-03	5.34E-03	5.34E-03	5.34E-03	5.34E-03	5.34E-03	5.34E-03	5.87E-03
TE-129M	3.54E+01	3.54E+01	3.54E+01	3.54E+01	3.54E+01	3.54E+01	3.54E+01	4.14E+01
TE-129	4.70E-02	4.70E-02	4.70E-02	4.70E-02	4.70E-02	4.70E-02	4.70E-02	5.56E-02
TE-131M	1.44E+01	1.44E+01	1.44E+01	1.44E+01	1.44E+01	1.44E+01	1.44E+01	1.70E+01
TE-131	5.23E-02	5.23E-02	5.23E-02	5.23E-02	5.23E-02	5.23E-02	5.23E-02	6.18E+01

TABLE II1-11

ADULT SHORELINE A₁₇ FACTORS

mrem-ml per uCi-hr

NUCLIDE	BONE	LIVER	T BODY	THYROID	KIDNEY	LUNG	GI-LLI	SKIN
TE-132	7.59E+00	7.59E+00	7.59E+00	7.59E+00	7.59E+00	7.59E+00	7.59E+00	8.93E+00
TE-133M	7.91E-01	7.91E-01	7.91E-01	7.91E-01	7.91E-01	7.91E-01	7.91E-01	8.96E-01
TE-134	3.98E-02	3.98E-02	3.98E-02	3.98E-02	3.98E-02	3.98E-02	3.98E-02	4.77E-02
I-129	3.90E+03	3.90E+03	3.90E+03	3.90E+03	3.90E+03	3.90E+03	3.90E+03	6.50E+03
I-130	9.88E+00	9.88E+00	9.88E+00	9.88E+00	9.88E+00	9.88E+00	9.88E+00	1.20E+01
I-131	3.08E+01	3.08E+01	3.08E+01	3.08E+01	3.08E+01	3.08E+01	3.08E+01	3.74E+01
I-132	2.23E+00	2.23E+00	2.23E+00	2.23E+00	2.23E+00	2.23E+00	2.23E+00	2.63E+00
I-133	4.39E+00	4.39E+00	4.39E+00	4.39E+00	4.39E+00	4.39E+00	4.39E+00	5.34E+00
I-134	8.01E-01	8.01E-01	8.01E-01	8.01E-01	8.01E-01	8.01E-01	8.01E-01	9.51E-01
I-135	4.53E+00	4.53E+00	4.53E+00	4.53E+00	4.53E+00	4.53E+00	4.53E+00	5.28E+00
CS-134M	1.03E-01	1.03E-01	1.03E-01	1.03E-01	1.03E-01	1.03E-01	1.03E-01	1.21E-01
CS-134	1.24E+04	1.24E+04	1.24E+04	1.24E+04	1.24E+04	1.24E+04	1.24E+04	1.44E+04
CS-135	0.00E+00	0.00E+00	0.00E+00	0.00E+00	0.00E+00	0.00E+00	0.00E+00	0.00E+00
CS-136	2.70E+02	2.70E+02	2.70E+02	2.70E+02	2.70E+02	2.70E+02	2.70E+02	3.06E+02
CS-137	2.77E+04	2.77E+04	2.77E+04	2.77E+04	2.77E+04	2.77E+04	2.77E+04	3.23E+04
CS-138	6.43E-01	6.43E-01	6.43E-01	6.43E-01	6.43E-01	6.43E-01	6.43E-01	7.35E-01
CS-139	5.63E-02	5.63E-02	5.63E-02	5.63E-02	5.63E-02	5.63E-02	5.63E-02	6.44E-02
BA-139	1.90E-01	1.90E-01	1.90E-01	1.90E-01	1.90E-01	1.90E-01	1.90E-01	2.13E-01
BA-140	3.68E+01	3.68E+01	3.68E+01	3.68E+01	3.68E+01	3.68E+01	3.68E+01	4.20E+01
BA-141	7.47E-02	7.47E-02	7.47E-02	7.47E-02	7.47E-02	7.47E-02	7.47E-02	8.52E-02
BA-142	8.04E-02	8.04E-02	8.04E-02	8.04E-02	8.04E-02	8.04E-02	8.04E-02	9.16E-02
LA-140	3.44E+01	3.44E+01	3.44E+01	3.44E+01	3.44E+01	3.44E+01	3.44E+01	3.90E+01
LA-141	5.62E-02	5.62E-02	5.62E-02	5.62E-02	5.62E-02	5.62E-02	5.62E-02	6.30E-02
LA-142	1.36E+00	1.36E+00	1.36E+00	1.36E+00	1.36E+00	1.36E+00	1.36E+00	1.63E+00
CE-141	2.45E+01	2.45E+01	2.45E+01	2.45E+01	2.45E+01	2.45E+01	2.45E+01	2.76E+01
CE-143	4.14E+00	4.14E+00	4.14E+00	4.14E+00	4.14E+00	4.14E+00	4.14E+00	4.71E+00
CE-144	1.25E+02	1.25E+02	1.25E+02	1.25E+02	1.25E+02	1.25E+02	1.25E+02	1.44E+02
PR-143	0.00E+00	0.00E+00	0.00E+00	0.00E+00	0.00E+00	0.00E+00	0.00E+00	0.00E+00
PR-144	3.29E-03	3.29E-03	3.29E-03	3.29E-03	3.29E-03	3.29E-03	3.29E-03	3.78E-03
ND-147	1.50E+01	1.50E+01	1.50E+01	1.50E+01	1.50E+01	1.50E+01	1.50E+01	1.81E+01
PM-147	0.00E+00	0.00E+00	0.00E+00	0.00E+00	0.00E+00	0.00E+00	0.00E+00	0.00E+00
PM-148M	7.98E+02	7.98E+02	7.98E+02	7.98E+02	7.98E+02	7.98E+02	7.98E+02	4.62E+03
PM-148	3.38E+01	3.38E+01	3.38E+01	3.38E+01	3.38E+01	3.38E+01	3.38E+01	3.90E+01
PM-149	7.57E-02	7.57E-02	7.57E-02	7.57E-02	7.57E-02	7.57E-02	7.57E-02	8.79E-02
PM-151	3.57E+00	3.57E+00	3.57E+00	3.57E+00	3.57E+00	3.57E+00	3.57E+00	3.73E+00
SM-151	3.79E+02	3.79E+02	3.79E+02	3.79E+02	3.79E+02	3.79E+02	3.79E+02	1.66E+03
SM-153	7.20E-01	7.20E-01	7.20E-01	7.20E-01	7.20E-01	7.20E-01	7.20E-01	8.00E-01
EU-152	3.61E+04	3.61E+04	3.61E+04	3.61E+04	3.61E+04	3.61E+04	3.61E+04	4.18E+04

TABLE II1-11

ADULT SHORELINE A₁₇ FACTORS

mrem-ml per uCi-hr

NUCLIDE	BONE	LIVER	T BODY	THYROID	KIDNEY	LUNG	GI-LLI	SKIN
EU-154	2.96E+04	2.96E+04	2.96E+04	2.96E+04	2.96E+04	2.96E+04	2.96E+04	3.41E+04
EU-155	9.17E+02	9.17E+02	9.17E+02	9.17E+02	9.17E+02	9.17E+02	9.17E+02	1.04E+03
EU-156	1.58E+02	1.58E+02	1.58E+02	1.58E+02	1.58E+02	1.58E+02	1.58E+02	1.81E+02
TB-160	8.52E+02	8.52E+02	8.52E+02	8.52E+02	8.52E+02	8.52E+02	8.52E+02	9.90E+02
HO-166M	7.66E+04	7.66E+04	7.66E+04	7.66E+04	7.66E+04	7.66E+04	7.66E+04	8.61E+04
W-181	3.48E-01	3.48E-01	3.48E-01	3.48E-01	3.48E-01	3.48E-01	3.48E-01	4.64E-01
W-185	0.00E+00	0.00E+00	0.00E+00	0.00E+00	0.00E+00	0.00E+00	0.00E+00	0.00E+00
W-187	4.22E+00	4.22E+00	4.22E+00	4.22E+00	4.22E+00	4.22E+00	4.22E+00	4.90E+00
U-232	2.00E+01	2.00E+01	2.00E+01	2.00E+01	2.00E+01	2.00E+01	2.00E+01	2.07E+02
U-233	1.99E+04	1.99E+04	1.99E+04	1.99E+04	1.99E+04	1.99E+04	1.99E+04	2.43E+04
U-234	5.48E+00	5.48E+00	5.48E+00	5.48E+00	5.48E+00	5.48E+00	5.48E+00	1.38E+03
U-235	2.77E+04	2.77E+04	2.77E+04	2.77E+04	2.77E+04	2.77E+04	2.77E+04	3.47E+04
U-236	1.82E-01	1.82E-01	1.82E-01	1.82E-01	1.82E-01	1.82E-01	1.82E-01	1.56E+02
U-237	9.25E+00	9.25E+00	9.25E+00	9.25E+00	9.25E+00	9.25E+00	9.25E+00	1.20E+01
U-238	9.54E+02	9.54E+02	9.54E+02	9.54E+02	9.54E+02	9.54E+02	9.54E+02	1.30E+03
NP-237	1.21E+04	1.21E+04	1.21E+04	1.21E+04	1.21E+04	1.21E+04	1.21E+04	1.39E+04
NP-238	8.12E+00	8.12E+00	8.12E+00	8.12E+00	8.12E+00	8.12E+00	8.12E+00	9.28E+00
NP-239	3.06E+00	3.06E+00	3.06E+00	3.06E+00	3.06E+00	3.06E+00	3.06E+00	3.55E+00
PU-238	1.02E+01	1.02E+01	1.02E+01	1.02E+01	1.02E+01	1.02E+01	1.02E+01	1.42E+02
PU-239	6.85E+00	6.85E+00	6.85E+00	6.85E+00	6.85E+00	6.85E+00	6.85E+00	6.67E+01
PU-240	1.13E+01	1.13E+01	1.13E+01	1.13E+01	1.13E+01	1.13E+01	1.13E+01	1.56E+02
PU-241	2.32E+01	2.32E+01	2.32E+01	2.32E+01	2.32E+01	2.32E+01	2.32E+01	3.43E+01
PU-242	9.54E+00	9.54E+00	9.54E+00	9.54E+00	9.54E+00	9.54E+00	9.54E+00	1.39E+02
PU-244	7.76E+03	7.76E+03	7.76E+03	7.76E+03	7.76E+03	7.76E+03	7.76E+03	8.34E+03
AM-241	1.53E+03	1.53E+03	1.53E+03	1.53E+03	1.53E+03	1.53E+03	1.53E+03	2.21E+03
AM-242M	2.13E+02	2.13E+02	2.13E+02	2.13E+02	2.13E+02	2.13E+02	2.13E+02	1.48E+03
AM-243	1.13E+04	1.13E+04	1.13E+04	1.13E+04	1.13E+04	1.13E+04	1.13E+04	1.30E+04
CM-242	1.23E+00	1.23E+00	1.23E+00	1.23E+00	1.23E+00	1.23E+00	1.23E+00	5.14E+00
CM-243	1.49E+04	1.49E+04	1.49E+04	1.49E+04	1.49E+04	1.49E+04	1.49E+04	1.88E+04
CM-244	1.62E+01	1.62E+01	1.62E+01	1.62E+01	1.62E+01	1.62E+01	1.62E+01	1.00E+02
CM-245	8.23E+03	8.23E+03	8.23E+03	8.23E+03	8.23E+03	8.23E+03	8.23E+03	1.04E+04
CM-246	8.65E+00	8.65E+00	8.65E+00	8.65E+00	8.65E+00	8.65E+00	8.65E+00	1.30E+02
CM-247	1.91E+04	1.91E+04	1.91E+04	1.91E+04	1.91E+04	1.91E+04	1.91E+04	2.25E+04
CM-248	4.53E+04	4.53E+04	4.53E+04	4.53E+04	4.53E+04	4.53E+04	4.53E+04	5.90E+04
CF-252	8.70E+04	8.70E+04	8.70E+04	8.70E+04	8.70E+04	8.70E+04	8.70E+04	9.49E+04

TABLE II1-12

TEEN DRINKING WATER A₁₇ FACTORS

mrem-ml per uCi-hr

NUCLIDE	BONE	LIVER	T BODY	THYROID	KIDNEY	LUNG	GI-LLI	SKIN
H-3	0.00E+00	3.52E+00	3.52E+00	3.52E+00	3.52E+00	3.52E+00	3.52E+00	0.00E+00
C-14	2.36E+02	4.73E+01	4.73E+01	4.73E+01	4.73E+01	4.73E+01	4.73E+01	0.00E+00
NA-22	1.36E+03	1.36E+03	1.36E+03	1.36E+03	1.36E+03	1.36E+03	1.36E+03	0.00E+00
NA-24	7.69E+01	7.69E+01	7.69E+01	7.69E+01	7.69E+01	7.69E+01	7.69E+01	0.00E+00
P-32	1.57E+04	9.72E+02	6.08E+02	0.00E+00	0.00E+00	0.00E+00	1.32E+03	0.00E+00
CA-41	1.15E+04	0.00E+00	1.24E+03	0.00E+00	0.00E+00	0.00E+00	1.14E+01	0.00E+00
SC-46	4.20E-01	8.18E-01	2.42E-01	0.00E+00	7.83E-01	0.00E+00	2.78E+03	0.00E+00
CR-51	0.00E+00	0.00E+00	2.07E-01	1.15E-01	4.54E-02	2.96E-01	3.48E+01	0.00E+00
MN-54	0.00E+00	3.43E+02	6.80E+01	0.00E+00	1.02E+02	0.00E+00	7.04E+02	0.00E+00
MN-56	0.00E+00	3.65E-01	6.50E-02	0.00E+00	4.63E-01	0.00E+00	2.41E+01	0.00E+00
FE-55	2.20E+02	1.56E+02	3.64E+01	0.00E+00	0.00E+00	9.89E+01	6.75E+01	0.00E+00
FE-59	3.39E+02	7.91E+02	3.06E+02	0.00E+00	0.00E+00	2.50E+02	1.87E+03	0.00E+00
CO-57	0.00E+00	1.38E+01	2.32E+01	0.00E+00	0.00E+00	0.00E+00	2.58E+02	0.00E+00
CO-58	0.00E+00	5.63E+01	1.30E+02	0.00E+00	0.00E+00	0.00E+00	7.76E+02	0.00E+00
CO-60	0.00E+00	1.64E+02	3.68E+02	0.00E+00	0.00E+00	0.00E+00	2.13E+03	0.00E+00
NI-59	7.68E+02	2.71E+02	1.30E+02	0.00E+00	0.00E+00	0.00E+00	4.26E+01	0.00E+00
NI-63	1.03E+04	7.28E+02	3.49E+02	0.00E+00	0.00E+00	0.00E+00	1.16E+02	0.00E+00
NI-65	1.61E+00	2.05E-01	9.36E-02	0.00E+00	0.00E+00	0.00E+00	1.11E+01	0.00E+00
CU-64	0.00E+00	3.48E+00	1.64E+00	0.00E+00	8.80E+00	0.00E+00	2.70E+02	0.00E+00
ZN-65	3.35E+02	1.16E+03	5.42E+02	0.00E+00	7.44E+02	0.00E+00	4.92E+02	0.00E+00
ZN-69M	7.63E+00	1.80E+01	1.65E+00	0.00E+00	1.09E+01	0.00E+00	9.89E+02	0.00E+00
ZN-69	1.08E-04	2.06E-04	1.44E-05	0.00E+00	1.35E-04	0.00E+00	3.80E-04	0.00E+00
SE-79	0.00E+00	2.17E+02	3.65E+01	0.00E+00	3.78E+02	0.00E+00	3.32E+01	0.00E+00
BR-82	0.00E+00	0.00E+00	1.40E+02	0.00E+00	0.00E+00	0.00E+00	0.00E+00	0.00E+00
BR-83	0.00E+00	0.00E+00	1.03E-01	0.00E+00	0.00E+00	0.00E+00	0.00E+00	0.00E+00
BR-84	0.00E+00	0.00E+00	6.42E-07	0.00E+00	0.00E+00	0.00E+00	0.00E+00	0.00E+00
BR-85	0.00E+00	0.00E+00	4.38E-77	0.00E+00	0.00E+00	0.00E+00	0.00E+00	0.00E+00
RB-86	0.00E+00	1.70E+03	8.00E+02	0.00E+00	0.00E+00	0.00E+00	2.52E+02	0.00E+00
RB-87	0.00E+00	1.02E+03	3.56E+02	0.00E+00	0.00E+00	0.00E+00	3.56E+01	0.00E+00
RB-88	0.00E+00	3.30E-12	1.76E-12	0.00E+00	0.00E+00	0.00E+00	2.83E-19	0.00E+00
RB-89	0.00E+00	2.94E-14	2.08E-14	0.00E+00	0.00E+00	0.00E+00	4.50E-23	0.00E+00
SR-89	2.54E+04	0.00E+00	7.29E+02	0.00E+00	0.00E+00	0.00E+00	3.03E+03	0.00E+00
SR-90	5.94E+05	0.00E+00	1.19E+04	0.00E+00	0.00E+00	0.00E+00	1.36E+04	0.00E+00
SR-91	1.96E+02	0.00E+00	7.79E+00	0.00E+00	0.00E+00	0.00E+00	8.88E+02	0.00E+00
SR-92	8.25E+00	0.00E+00	3.52E-01	0.00E+00	0.00E+00	0.00E+00	2.10E+02	0.00E+00
Y-90	7.01E-01	0.00E+00	1.89E-02	0.00E+00	0.00E+00	0.00E+00	5.78E+03	0.00E+00
Y-91M	3.28E-07	0.00E+00	1.25E-08	0.00E+00	0.00E+00	0.00E+00	1.55E-05	0.00E+00

TABLE II1-12

TEEN DRINKING WATER A₁₇ FACTORS

mrem-ml per uCi-hr

NUCLIDE	BONE	LIVER	T BODY	THYROID	KIDNEY	LUNG	GI-LLI	SKIN
Y-91	1.16E+01	0.00E+00	3.12E-01	0.00E+00	0.00E+00	0.00E+00	4.77E+03	0.00E+00
Y-92	6.72E-03	0.00E+00	1.94E-04	0.00E+00	0.00E+00	0.00E+00	1.84E+02	0.00E+00
Y-93	9.79E-02	0.00E+00	2.68E-03	0.00E+00	0.00E+00	0.00E+00	2.99E+03	0.00E+00
ZR-93	3.22E+00	1.59E-01	8.67E-02	0.00E+00	5.62E-01	0.00E+00	1.50E+02	0.00E+00
ZR-95	2.39E+00	7.53E-01	5.18E-01	0.00E+00	1.11E+00	0.00E+00	1.74E+03	0.00E+00
ZR-97	8.43E-02	1.67E-02	7.69E-03	0.00E+00	2.53E-02	0.00E+00	4.52E+03	0.00E+00
NB-93M	2.00E+00	6.58E-01	1.65E-01	0.00E+00	7.68E-01	0.00E+00	2.37E+02	0.00E+00
NB-95	4.74E-01	2.63E-01	1.45E-01	0.00E+00	2.55E-01	0.00E+00	1.12E+03	0.00E+00
NB-97	4.23E-06	1.05E-06	3.83E-07	0.00E+00	1.23E-06	0.00E+00	2.51E-02	0.00E+00
MO-93	0.00E+00	6.17E+02	1.69E+01	0.00E+00	1.77E+02	0.00E+00	7.51E+01	0.00E+00
MO-99	0.00E+00	3.10E+02	5.90E+01	0.00E+00	7.08E+02	0.00E+00	5.54E+02	0.00E+00
TC-99M	4.85E-03	1.35E-02	1.75E-01	0.00E+00	2.02E-01	7.52E-03	8.89E+00	0.00E+00
TC-99	1.04E+01	1.53E+01	4.17E+00	0.00E+00	1.94E+02	1.58E+00	3.75E+02	0.00E+00
TC-101	1.14E-17	1.62E-17	1.60E-16	0.00E+00	2.94E-16	9.90E-18	2.78E-24	0.00E+00
RU-103	1.47E+01	0.00E+00	6.29E+00	0.00E+00	5.19E+01	0.00E+00	1.23E+03	0.00E+00
RU-105	1.95E-01	0.00E+00	7.57E-02	0.00E+00	2.46E+00	0.00E+00	1.57E+02	0.00E+00
RU-106	2.28E+02	0.00E+00	2.87E+01	0.00E+00	4.40E+02	0.00E+00	1.09E+04	0.00E+00
RH-105	7.96E+00	5.75E+00	3.77E+00	0.00E+00	2.44E+01	0.00E+00	7.32E+02	0.00E+00
PD-107	0.00E+00	1.21E+01	7.80E-01	0.00E+00	1.09E+02	0.00E+00	5.62E+01	0.00E+00
PD-109	0.00E+00	7.87E+00	1.79E+00	0.00E+00	4.55E+01	0.00E+00	7.94E+02	0.00E+00
AG-110M	1.19E+01	1.13E+01	6.86E+00	0.00E+00	2.15E+01	0.00E+00	3.17E+03	0.00E+00
AG-111	4.61E+00	1.91E+00	9.61E-01	0.00E+00	6.22E+00	0.00E+00	2.67E+03	0.00E+00
CD-113M	0.00E+00	2.63E+02	8.44E+00	0.00E+00	2.90E+02	0.00E+00	1.58E+03	0.00E+00
CD-115M	0.00E+00	1.50E+02	4.85E+00	0.00E+00	1.20E+02	0.00E+00	4.75E+03	0.00E+00
SN-123	2.58E+03	4.23E+01	6.27E+01	3.39E+01	0.00E+00	0.00E+00	3.90E+03	0.00E+00
SN-125	6.68E+02	1.33E+01	3.02E+01	1.04E+01	0.00E+00	0.00E+00	6.29E+03	0.00E+00
SN-126	6.75E+03	1.26E+02	1.92E+02	3.31E+01	0.00E+00	0.00E+00	1.50E+03	0.00E+00
SB-124	2.24E+02	4.13E+00	8.74E+01	5.08E-01	0.00E+00	1.96E+02	4.52E+03	0.00E+00
SB-125	1.44E+02	1.58E+00	3.38E+01	1.38E-01	0.00E+00	1.27E+02	1.12E+03	0.00E+00
SB-126	9.00E+01	1.84E+00	3.23E+01	5.09E-01	0.00E+00	6.45E+01	5.33E+03	0.00E+00
SB-127	1.93E+01	4.13E-01	7.29E+00	2.17E-01	0.00E+00	1.31E+01	3.28E+03	0.00E+00
TE-125M	2.22E+02	7.99E+01	2.96E+01	6.19E+01	0.00E+00	0.00E+00	6.54E+02	0.00E+00
TE-127M	5.61E+02	1.99E+02	6.67E+01	1.33E+02	2.27E+03	0.00E+00	1.40E+03	0.00E+00
TE-127	3.78E+00	1.34E+00	8.13E-01	2.61E+00	1.53E+01	0.00E+00	2.92E+02	0.00E+00
TE-129M	9.39E+02	3.49E+02	1.49E+02	3.03E+02	3.93E+03	0.00E+00	3.53E+03	0.00E+00
TE-129	2.01E-03	7.48E-04	4.88E-04	1.43E-03	8.42E-03	0.00E+00	1.10E-02	0.00E+00
TE-131M	1.08E+02	5.16E+01	4.31E+01	7.77E+01	5.38E+02	0.00E+00	4.14E+03	0.00E+00
TE-131	3.48E-09	1.43E-09	1.09E-09	2.68E-09	1.52E-08	0.00E+00	2.85E-10	0.00E+00

TABLE II1-12

TEEN DRINKING WATER A₁₇ FACTORS

mrem-ml per uCi-hr

NUCLIDE	BONE	LIVER	T BODY	THYROID	KIDNEY	LUNG	GI-LLI	SKIN
TE-132	1.83E+02	1.16E+02	1.09E+02	1.22E+02	1.11E+03	0.00E+00	3.66E+03	0.00E+00
TE-133M	4.59E-04	2.61E-04	2.54E-04	3.64E-04	2.58E-03	0.00E+00	1.05E-03	0.00E+00
TE-134	1.70E-05	1.09E-05	1.14E-05	1.39E-05	1.04E-04	0.00E+00	6.31E-07	0.00E+00
I-129	2.71E+02	2.28E+02	3.81E+02	2.78E+05	4.08E+02	0.00E+00	2.66E+01	0.00E+00
I-130	3.06E+01	8.85E+01	3.53E+01	7.22E+03	1.36E+02	0.00E+00	6.80E+01	0.00E+00
I-131	3.26E+02	4.57E+02	2.45E+02	1.33E+05	7.86E+02	0.00E+00	9.03E+01	0.00E+00
I-132	4.37E-01	1.14E+00	4.10E-01	3.85E+01	1.80E+00	0.00E+00	4.98E-01	0.00E+00
I-133	7.84E+01	1.33E+02	4.06E+01	1.86E+04	2.33E+02	0.00E+00	1.01E+02	0.00E+00
I-134	6.44E-04	1.71E-03	6.13E-04	2.84E-02	2.69E-03	0.00E+00	2.25E-05	0.00E+00
I-135	1.01E+01	2.60E+01	9.63E+00	1.67E+03	4.10E+01	0.00E+00	2.88E+01	0.00E+00
CS-134M	9.72E-02	2.01E-01	1.04E-01	0.00E+00	1.12E-01	1.97E-02	1.34E-01	0.00E+00
CS-134	4.87E+03	1.15E+04	5.32E+03	0.00E+00	3.64E+03	1.39E+03	1.43E+02	0.00E+00
CS-135	1.62E+03	1.48E+03	3.47E+02	0.00E+00	5.66E+02	2.05E+02	2.60E+01	0.00E+00
CS-136	4.87E+02	1.92E+03	1.29E+03	0.00E+00	1.04E+03	1.64E+02	1.54E+02	0.00E+00
CS-137	6.52E+03	8.67E+03	3.02E+03	0.00E+00	2.95E+03	1.15E+03	1.23E+02	0.00E+00
CS-138	8.39E-07	1.61E-06	8.06E-07	0.00E+00	1.19E-06	1.38E-07	7.31E-10	0.00E+00
CS-139	2.48E-23	3.66E-23	1.34E-23	0.00E+00	2.95E-23	3.23E-24	1.70E-38	0.00E+00
BA-139	1.99E-02	1.40E-05	5.81E-04	0.00E+00	1.32E-05	9.67E-06	1.78E-01	0.00E+00
BA-140	1.61E+03	1.97E+00	1.04E+02	0.00E+00	6.69E-01	1.33E+00	2.48E+03	0.00E+00
BA-141	5.35E-12	4.00E-15	1.79E-13	0.00E+00	3.71E-15	2.74E-15	1.14E-17	0.00E+00
BA-142	9.65E-21	9.65E-24	5.94E-22	0.00E+00	8.17E-24	6.42E-24	2.96E-32	0.00E+00
LA-140	1.65E-01	8.10E-02	2.15E-02	0.00E+00	0.00E+00	0.00E+00	4.65E+03	0.00E+00
LA-141	3.21E-03	9.87E-04	1.63E-04	0.00E+00	0.00E+00	0.00E+00	1.75E+02	0.00E+00
LA-142	5.57E-05	2.47E-05	6.16E-06	0.00E+00	0.00E+00	0.00E+00	7.53E-01	0.00E+00
CE-141	7.66E-01	5.12E-01	5.88E-02	0.00E+00	2.41E-01	0.00E+00	1.46E+03	0.00E+00
CE-143	1.06E-01	7.74E+01	8.64E-03	0.00E+00	3.47E-02	0.00E+00	2.33E+03	0.00E+00
CE-144	4.05E+01	1.67E+01	2.17E+00	0.00E+00	1.00E+01	0.00E+00	1.02E+04	0.00E+00
PR-143	7.43E-01	2.97E-01	3.70E-02	0.00E+00	1.73E-01	0.00E+00	2.45E+03	0.00E+00
PR-144	7.17E-16	2.94E-16	3.64E-17	0.00E+00	1.68E-16	0.00E+00	7.91E-19	0.00E+00
ND-147	5.29E-01	5.75E-01	3.45E-02	0.00E+00	3.38E-01	0.00E+00	2.08E+03	0.00E+00
PM-147	6.11E+00	5.80E-01	2.36E-01	0.00E+00	1.11E+00	0.00E+00	5.51E+02	0.00E+00
PM-148M	2.39E+00	6.06E-01	4.74E-01	0.00E+00	9.18E-01	0.00E+00	3.82E+03	0.00E+00
PM-148	5.57E-01	9.06E-02	4.56E-02	0.00E+00	1.64E-01	0.00E+00	5.40E+03	0.00E+00
PM-149	1.08E-01	1.52E-02	6.22E-03	0.00E+00	2.89E-02	0.00E+00	2.23E+03	0.00E+00
PM-151	4.29E-02	7.08E-03	3.58E-03	0.00E+00	1.27E-02	0.00E+00	1.59E+03	0.00E+00
SM-151	5.08E+00	9.78E-01	2.29E-01	0.00E+00	1.07E+00	0.00E+00	3.32E+02	0.00E+00
SM-153	5.94E-02	4.92E-02	3.62E-03	0.00E+00	1.61E-02	0.00E+00	1.39E+03	0.00E+00
EU-152	1.43E+01	3.43E+00	3.03E+00	0.00E+00	1.60E+01	0.00E+00	1.26E+03	0.00E+00

TABLE II1-12

TEEN DRINKING WATER A₁₇ FACTORS

mrem-ml per uCi-hr

NUCLIDE	BONE	LIVER	T BODY	THYROID	KIDNEY	LUNG	GI-LLI	SKIN
EU-154	4.60E+01	5.94E+00	4.19E+00	0.00E+00	2.65E+01	0.00E+00	3.14E+03	0.00E+00
EU-155	1.01E+01	9.78E-01	6.05E-01	0.00E+00	3.82E+00	0.00E+00	5.61E+03	0.00E+00
EU-156	1.09E+00	8.19E-01	1.34E-01	0.00E+00	5.51E-01	0.00E+00	4.19E+03	0.00E+00
TB-160	3.75E+00	0.00E+00	4.68E-01	0.00E+00	1.48E+00	0.00E+00	2.43E+03	0.00E+00
HO-166M	2.08E+01	6.40E+00	4.63E+00	0.00E+00	9.37E+00	0.00E+00	1.58E+03	0.00E+00
W-181	8.24E-01	2.66E-01	2.78E-02	0.00E+00	0.00E+00	0.00E+00	2.26E+01	0.00E+00
W-185	3.36E+01	1.11E+01	1.17E+00	0.00E+00	0.00E+00	0.00E+00	9.56E+02	0.00E+00
W-187	6.00E+00	4.89E+00	1.71E+00	0.00E+00	0.00E+00	0.00E+00	1.32E+03	0.00E+00
U-232	3.43E+05	0.00E+00	2.45E+04	0.00E+00	3.71E+04	0.00E+00	4.19E+03	0.00E+00
U-233	7.22E+04	0.00E+00	4.39E+03	0.00E+00	1.69E+04	0.00E+00	3.87E+03	0.00E+00
U-234	6.93E+04	0.00E+00	4.30E+03	0.00E+00	1.66E+04	0.00E+00	3.79E+03	0.00E+00
U-235	6.64E+04	0.00E+00	4.04E+03	0.00E+00	1.55E+04	0.00E+00	4.82E+03	0.00E+00
U-236	6.64E+04	0.00E+00	4.13E+03	0.00E+00	1.59E+04	0.00E+00	3.56E+03	0.00E+00
U-237	4.36E+00	0.00E+00	1.16E+00	0.00E+00	1.79E+01	0.00E+00	1.16E+03	0.00E+00
U-238	6.35E+04	0.00E+00	3.78E+03	0.00E+00	1.46E+04	0.00E+00	3.39E+03	0.00E+00
NP-237	7.74E+04	5.56E+03	3.41E+03	0.00E+00	2.52E+04	0.00E+00	4.90E+03	0.00E+00
NP-238	9.64E-01	2.58E-02	1.50E-02	0.00E+00	8.85E-02	0.00E+00	1.89E+03	0.00E+00
NP-239	8.84E-02	8.34E-03	4.63E-03	0.00E+00	2.62E-02	0.00E+00	1.34E+03	0.00E+00
PU-238	3.90E+04	5.00E+03	1.06E+03	0.00E+00	4.54E+03	0.00E+00	4.50E+03	0.00E+00
PU-239	4.45E+04	5.41E+03	1.17E+03	0.00E+00	4.99E+03	0.00E+00	4.11E+03	0.00E+00
PU-240	4.45E+04	5.40E+03	1.17E+03	0.00E+00	4.98E+03	0.00E+00	4.19E+03	0.00E+00
PU-241	1.02E+03	4.89E+01	2.15E+01	0.00E+00	9.95E+01	0.00E+00	8.62E+01	0.00E+00
PU-242	4.13E+04	5.20E+03	1.13E+03	0.00E+00	4.80E+03	0.00E+00	4.03E+03	0.00E+00
PU-244	4.82E+04	5.94E+03	1.29E+03	0.00E+00	5.50E+03	0.00E+00	6.00E+03	0.00E+00
AM-241	4.65E+04	4.38E+04	3.35E+03	0.00E+00	2.51E+04	0.00E+00	4.58E+03	0.00E+00
AM-242M	4.70E+04	4.14E+04	3.38E+03	0.00E+00	2.50E+04	0.00E+00	5.76E+03	0.00E+00
AM-243	4.63E+04	4.28E+04	3.27E+03	0.00E+00	2.46E+04	0.00E+00	5.37E+03	0.00E+00
CM-242	1.71E+03	1.80E+03	1.13E+02	0.00E+00	5.16E+02	0.00E+00	4.88E+03	0.00E+00
CM-243	3.78E+04	3.51E+04	2.38E+03	0.00E+00	1.11E+04	0.00E+00	4.82E+03	0.00E+00
CM-244	2.93E+04	2.78E+04	1.86E+03	0.00E+00	8.67E+03	0.00E+00	4.66E+03	0.00E+00
CM-245	5.76E+04	5.07E+04	3.55E+03	0.00E+00	1.66E+04	0.00E+00	4.34E+03	0.00E+00
CM-246	5.72E+04	5.07E+04	3.55E+03	0.00E+00	1.65E+04	0.00E+00	4.27E+03	0.00E+00
CM-247	5.57E+04	4.99E+04	3.49E+03	0.00E+00	1.63E+04	0.00E+00	5.61E+03	0.00E+00
CM-248	4.63E+05	4.11E+05	2.88E+04	0.00E+00	1.34E+05	0.00E+00	9.02E+04	0.00E+00
CF-252	2.02E+04	0.00E+00	4.87E+02	0.00E+00	0.00E+00	0.00E+00	1.78E+04	0.00E+00

TABLE II1-13

TEEN FRESHWATER FISH A_{IT} FACTORS

mrem-ml per uCi-hr

NUCLIDE	BONE	LIVER	T BODY	THYROID	KIDNEY	LUNG	GI-LLI	SKIN
H-3	0.00E+00	9.93E-02	9.93E-02	9.93E-02	9.93E-02	9.93E-02	9.93E-02	0.00E+00
C-14	3.41E+04	6.82E+03	6.82E+03	6.82E+03	6.82E+03	6.82E+03	6.82E+03	0.00E+00
NA-22	4.27E+03	4.27E+03	4.27E+03	4.27E+03	4.27E+03	4.27E+03	4.27E+03	0.00E+00
NA-24	1.39E+02	1.39E+02	1.39E+02	1.39E+02	1.39E+02	1.39E+02	1.39E+02	0.00E+00
P-32	1.44E+06	8.93E+04	5.59E+04	0.00E+00	0.00E+00	0.00E+00	1.21E+05	0.00E+00
CA-41	1.44E+04	0.00E+00	1.56E+03	0.00E+00	0.00E+00	0.00E+00	1.42E+01	0.00E+00
SC-46	2.62E-02	5.11E-02	1.51E-02	0.00E+00	4.89E-02	0.00E+00	1.74E+02	0.00E+00
CR-51	0.00E+00	0.00E+00	1.28E+00	7.13E-01	2.81E-01	1.83E+00	2.16E+02	0.00E+00
MN-54	0.00E+00	4.30E+03	8.53E+02	0.00E+00	1.28E+03	0.00E+00	8.82E+03	0.00E+00
MN-56	0.00E+00	1.82E-01	3.24E-02	0.00E+00	2.31E-01	0.00E+00	1.20E+01	0.00E+00
FE-55	6.90E+02	4.89E+02	1.14E+02	0.00E+00	0.00E+00	3.10E+02	2.12E+02	0.00E+00
FE-59	1.06E+03	2.46E+03	9.51E+02	0.00E+00	0.00E+00	7.77E+02	5.83E+03	0.00E+00
CO-57	0.00E+00	2.17E+01	3.63E+01	0.00E+00	0.00E+00	0.00E+00	4.04E+02	0.00E+00
CO-58	0.00E+00	8.79E+01	2.03E+02	0.00E+00	0.00E+00	0.00E+00	1.21E+03	0.00E+00
CO-60	0.00E+00	2.57E+02	5.78E+02	0.00E+00	0.00E+00	0.00E+00	3.34E+03	0.00E+00
NI-59	2.41E+03	8.51E+02	4.09E+02	0.00E+00	0.00E+00	0.00E+00	1.34E+02	0.00E+00
NI-63	3.23E+04	2.28E+03	1.10E+03	0.00E+00	0.00E+00	0.00E+00	3.63E+02	0.00E+00
NI-65	1.86E-01	2.37E-02	1.08E-02	0.00E+00	0.00E+00	0.00E+00	1.29E+00	0.00E+00
CU-64	0.00E+00	2.83E+00	1.33E+00	0.00E+00	7.17E+00	0.00E+00	2.20E+02	0.00E+00
ZN-65	2.10E+04	7.29E+04	3.40E+04	0.00E+00	4.66E+04	0.00E+00	3.09E+04	0.00E+00
ZN-69M	2.62E+02	6.17E+02	5.66E+01	0.00E+00	3.75E+02	0.00E+00	3.39E+04	0.00E+00
ZN-69	8.58E-07	1.63E-06	1.14E-07	0.00E+00	1.07E-06	0.00E+00	3.01E-06	0.00E+00
SE-79	0.00E+00	1.16E+03	1.95E+02	0.00E+00	2.02E+03	0.00E+00	1.77E+02	0.00E+00
BR-82	0.00E+00	0.00E+00	1.46E+03	0.00E+00	0.00E+00	0.00E+00	0.00E+00	0.00E+00
BR-83	0.00E+00	0.00E+00	4.18E-02	0.00E+00	0.00E+00	0.00E+00	0.00E+00	0.00E+00
BR-84	0.00E+00	0.00E+00	1.29E-12	0.00E+00	0.00E+00	0.00E+00	0.00E+00	0.00E+00
BR-85	0.00E+00	0.00E+00	1.43E-151	0.00E+00	0.00E+00	0.00E+00	0.00E+00	0.00E+00
RB-86	0.00E+00	1.05E+05	4.93E+04	0.00E+00	0.00E+00	0.00E+00	1.55E+04	0.00E+00
RB-87	0.00E+00	6.39E+04	2.23E+04	0.00E+00	0.00E+00	0.00E+00	2.23E+03	0.00E+00
RB-88	0.00E+00	1.38E-22	7.36E-23	0.00E+00	0.00E+00	0.00E+00	1.18E-29	0.00E+00
RB-89	0.00E+00	1.69E-26	1.19E-26	0.00E+00	0.00E+00	0.00E+00	2.59E-35	0.00E+00
SR-89	2.38E+04	0.00E+00	6.81E+02	0.00E+00	0.00E+00	0.00E+00	2.83E+03	0.00E+00
SR-90	5.59E+05	0.00E+00	1.12E+04	0.00E+00	0.00E+00	0.00E+00	1.28E+04	0.00E+00
SR-91	7.68E+01	0.00E+00	3.05E+00	0.00E+00	0.00E+00	0.00E+00	3.48E+02	0.00E+00
SR-92	3.61E-01	0.00E+00	1.54E-02	0.00E+00	0.00E+00	0.00E+00	9.19E+00	0.00E+00
Y-90	4.83E-01	0.00E+00	1.30E-02	0.00E+00	0.00E+00	0.00E+00	3.98E+03	0.00E+00
Y-91M	1.12E-11	0.00E+00	4.29E-13	0.00E+00	0.00E+00	0.00E+00	5.30E-10	0.00E+00

TABLE II1-13

TEEN FRESHWATER FISH A₁₇ FACTORS

mrem-ml per uCi-hr

NUCLIDE	BONE	LIVER	T BODY	THYROID	KIDNEY	LUNG	GI-LLI	SKIN
Y-91	9.07E+00	0.00E+00	2.43E-01	0.00E+00	0.00E+00	0.00E+00	3.72E+03	0.00E+00
Y-92	5.03E-04	0.00E+00	1.45E-05	0.00E+00	0.00E+00	0.00E+00	1.38E+01	0.00E+00
Y-93	3.37E-02	0.00E+00	9.23E-04	0.00E+00	0.00E+00	0.00E+00	1.03E+03	0.00E+00
ZR-93	3.33E-01	1.65E-02	8.98E-03	0.00E+00	5.82E-02	0.00E+00	1.56E+01	0.00E+00
ZR-95	2.46E-01	7.75E-02	5.33E-02	0.00E+00	1.14E-01	0.00E+00	1.79E+02	0.00E+00
ZR-97	5.34E-03	1.06E-03	4.87E-04	0.00E+00	1.60E-03	0.00E+00	2.86E+02	0.00E+00
NB-93M	1.88E+03	6.19E+02	1.55E+02	0.00E+00	7.23E+02	0.00E+00	2.23E+05	0.00E+00
NB-95	4.42E+02	2.45E+02	1.35E+02	0.00E+00	2.37E+02	0.00E+00	1.05E+06	0.00E+00
NB-97	3.93E-06	9.75E-07	3.56E-07	0.00E+00	1.14E-06	0.00E+00	2.33E-02	0.00E+00
MO-93	0.00E+00	1.94E+02	5.30E+00	0.00E+00	5.55E+01	0.00E+00	2.36E+01	0.00E+00
MO-99	0.00E+00	8.56E+01	1.63E+01	0.00E+00	1.96E+02	0.00E+00	1.53E+02	0.00E+00
TC-99M	5.74E-04	1.60E-03	2.07E-02	0.00E+00	2.38E-02	8.88E-04	1.05E+00	0.00E+00
TC-99	4.90E+00	7.21E+00	1.96E+00	0.00E+00	9.15E+01	7.45E-01	1.76E+02	0.00E+00
TC-101	2.93E-33	4.17E-33	4.10E-32	0.00E+00	7.54E-32	2.54E-33	7.12E-40	0.00E+00
RU-103	4.58E+00	0.00E+00	1.96E+00	0.00E+00	1.61E+01	0.00E+00	3.82E+02	0.00E+00
RU-105	9.39E-03	0.00E+00	3.65E-03	0.00E+00	1.19E-01	0.00E+00	7.58E+00	0.00E+00
RU-106	7.15E+01	0.00E+00	9.01E+00	0.00E+00	1.38E+02	0.00E+00	3.43E+03	0.00E+00
RH-105	1.97E+00	1.43E+00	9.36E-01	0.00E+00	6.06E+00	0.00E+00	1.81E+02	0.00E+00
PD-107	0.00E+00	3.80E+00	2.45E-01	0.00E+00	3.43E+01	0.00E+00	1.76E+01	0.00E+00
PD-109	0.00E+00	1.33E+00	3.02E-01	0.00E+00	7.69E+00	0.00E+00	1.34E+02	0.00E+00
AG-110M	8.59E-01	8.13E-01	4.94E-01	0.00E+00	1.55E+00	0.00E+00	2.28E+02	0.00E+00
AG-111	3.17E-01	1.32E-01	6.62E-02	0.00E+00	4.29E-01	0.00E+00	1.84E+02	0.00E+00
CD-113M	0.00E+00	1.65E+03	5.30E+01	0.00E+00	1.82E+03	0.00E+00	9.90E+03	0.00E+00
CD-115M	0.00E+00	9.35E+02	3.02E+01	0.00E+00	7.48E+02	0.00E+00	2.96E+04	0.00E+00
SN-123	2.42E+05	3.97E+03	5.89E+03	3.18E+03	0.00E+00	0.00E+00	3.66E+05	0.00E+00
SN-125	6.07E+04	1.21E+03	2.74E+03	9.48E+02	0.00E+00	0.00E+00	5.71E+05	0.00E+00
SN-126	6.36E+05	1.18E+04	1.81E+04	3.12E+03	0.00E+00	0.00E+00	1.41E+05	0.00E+00
SB-124	6.99E+00	1.29E-01	2.73E+00	1.59E-02	0.00E+00	6.10E+00	1.41E+02	0.00E+00
SB-125	4.53E+00	4.95E-02	1.06E+00	4.33E-03	0.00E+00	3.98E+00	3.52E+01	0.00E+00
SB-126	2.75E+00	5.61E-02	9.86E-01	1.55E-02	0.00E+00	1.97E+00	1.63E+02	0.00E+00
SB-127	5.54E-01	1.18E-02	2.09E-01	6.22E-03	0.00E+00	3.77E-01	9.40E+01	0.00E+00
TE-125M	2.76E+03	9.96E+02	3.70E+02	7.72E+02	0.00E+00	0.00E+00	8.16E+03	0.00E+00
TE-127M	7.02E+03	2.49E+03	8.35E+02	1.67E+03	2.85E+04	0.00E+00	1.75E+04	0.00E+00
TE-127	1.95E+01	6.91E+00	4.19E+00	1.34E+01	7.89E+01	0.00E+00	1.50E+03	0.00E+00
TE-129M	1.17E+04	4.33E+03	1.85E+03	3.76E+03	4.88E+04	0.00E+00	4.38E+04	0.00E+00
TE-129	1.94E-05	7.21E-06	4.71E-06	1.38E-05	8.12E-05	0.00E+00	1.06E-04	0.00E+00
TE-131M	1.02E+03	4.91E+02	4.10E+02	7.39E+02	5.12E+03	0.00E+00	3.94E+04	0.00E+00
TE-131	9.33E-17	3.85E-17	2.92E-17	7.19E-17	4.08E-16	0.00E+00	7.66E-18	0.00E+00

TABLE II1-13

TEEN FRESHWATER FISH A₁₇ FACTORS

mrem-ml per uCi-hr

NUCLIDE	BONE	LIVER	T BODY	THYROID	KIDNEY	LUNG	GI-LLI	SKIN
TE-132	2.06E+03	1.31E+03	1.23E+03	1.38E+03	1.25E+04	0.00E+00	4.13E+04	0.00E+00
TE-133M	7.05E-07	4.00E-07	3.90E-07	5.59E-07	3.96E-06	0.00E+00	1.62E-06	0.00E+00
TE-134	1.39E-09	8.94E-10	9.34E-10	1.14E-09	8.53E-09	0.00E+00	5.17E-11	0.00E+00
I-129	1.28E+02	1.07E+02	1.79E+02	1.31E+05	1.92E+02	0.00E+00	1.25E+01	0.00E+00
I-130	7.35E+00	2.13E+01	8.49E+00	1.73E+03	3.27E+01	0.00E+00	1.63E+01	0.00E+00
I-131	1.47E+02	2.06E+02	1.11E+02	6.01E+04	3.54E+02	0.00E+00	4.07E+01	0.00E+00
I-132	5.52E-03	1.44E-02	5.19E-03	4.87E-01	2.28E-02	0.00E+00	6.29E-03	0.00E+00
I-133	2.47E+01	4.20E+01	1.28E+01	5.86E+03	7.36E+01	0.00E+00	3.18E+01	0.00E+00
I-134	2.30E-08	6.09E-08	2.19E-08	1.01E-06	9.59E-08	0.00E+00	8.02E-10	0.00E+00
I-135	1.35E+00	3.47E+00	1.29E+00	2.23E+02	5.48E+00	0.00E+00	3.85E+00	0.00E+00
CS-134M	3.47E-01	7.18E-01	3.69E-01	0.00E+00	4.00E-01	7.01E-02	4.77E-01	0.00E+00
CS-134	3.05E+05	7.19E+05	3.34E+05	0.00E+00	2.28E+05	8.72E+04	8.94E+03	0.00E+00
CS-135	1.02E+05	9.32E+04	2.18E+04	0.00E+00	3.55E+04	1.29E+04	1.63E+03	0.00E+00
CS-136	2.98E+04	1.17E+05	7.87E+04	0.00E+00	6.38E+04	1.01E+04	9.43E+03	0.00E+00
CS-137	4.09E+05	5.44E+05	1.90E+05	0.00E+00	1.85E+05	7.20E+04	7.74E+03	0.00E+00
CS-138	9.78E-12	1.88E-11	9.39E-12	0.00E+00	1.39E-11	1.61E-12	8.52E-15	0.00E+00
CS-139	1.36E-44	2.01E-44	7.37E-45	0.00E+00	1.62E-44	1.78E-45	9.33E-60	0.00E+00
BA-139	6.17E-06	4.34E-09	1.80E-07	0.00E+00	4.09E-09	2.99E-09	5.50E-05	0.00E+00
BA-140	1.97E+02	2.41E-01	1.27E+01	0.00E+00	8.17E-02	1.62E-01	3.03E+02	0.00E+00
BA-141	9.20E-25	6.87E-28	3.07E-26	0.00E+00	6.38E-28	4.70E-28	1.96E-30	0.00E+00
BA-142	6.71E-42	6.71E-45	4.13E-43	0.00E+00	5.68E-45	4.47E-45	2.06E-53	0.00E+00
LA-140	1.05E-01	5.16E-02	1.37E-02	0.00E+00	0.00E+00	0.00E+00	2.97E+03	0.00E+00
LA-141	3.05E-04	9.38E-05	1.55E-05	0.00E+00	0.00E+00	0.00E+00	1.66E+01	0.00E+00
LA-142	2.34E-07	1.04E-07	2.58E-08	0.00E+00	0.00E+00	0.00E+00	3.16E-03	0.00E+00
CE-141	2.38E-02	1.59E-02	1.82E-03	0.00E+00	7.47E-03	0.00E+00	4.54E+01	0.00E+00
CE-143	2.59E-03	1.89E+00	2.11E-04	0.00E+00	8.46E-04	0.00E+00	5.67E+01	0.00E+00
CE-144	1.27E+00	5.25E-01	6.81E-02	0.00E+00	3.13E-01	0.00E+00	3.19E+02	0.00E+00
PR-143	5.68E-01	2.27E-01	2.83E-02	0.00E+00	1.32E-01	0.00E+00	1.87E+03	0.00E+00
PR-144	1.61E-28	6.60E-29	8.17E-30	0.00E+00	3.78E-29	0.00E+00	1.78E-31	0.00E+00
ND-147	4.02E-01	4.37E-01	2.62E-02	0.00E+00	2.57E-01	0.00E+00	1.58E+03	0.00E+00
PM-147	4.79E+00	4.54E-01	1.85E-01	0.00E+00	8.67E-01	0.00E+00	4.32E+02	0.00E+00
PM-148M	1.86E+00	4.71E-01	3.69E-01	0.00E+00	7.14E-01	0.00E+00	2.97E+03	0.00E+00
PM-148	4.09E-01	6.66E-02	3.36E-02	0.00E+00	1.20E-01	0.00E+00	3.97E+03	0.00E+00
PM-149	7.24E-02	1.02E-02	4.17E-03	0.00E+00	1.94E-02	0.00E+00	1.50E+03	0.00E+00
PM-151	2.51E-02	4.14E-03	2.10E-03	0.00E+00	7.45E-03	0.00E+00	9.30E+02	0.00E+00
SM-151	3.99E+00	7.67E-01	1.80E-01	0.00E+00	8.40E-01	0.00E+00	2.60E+02	0.00E+00
SM-153	3.90E-02	3.23E-02	2.38E-03	0.00E+00	1.06E-02	0.00E+00	9.11E+02	0.00E+00
EU-152	1.12E+01	2.69E+00	2.37E+00	0.00E+00	1.25E+01	0.00E+00	9.91E+02	0.00E+00

TABLE II1-13

TEEN FRESHWATER FISH A₁₇ FACTORS

mrem-ml per uCi-hr

NUCLIDE	BONE	LIVER	T BODY	THYROID	KIDNEY	LUNG	GI-LLI	SKIN
EU-154	3.61E+01	4.66E+00	3.28E+00	0.00E+00	2.08E+01	0.00E+00	2.46E+03	0.00E+00
EU-155	7.94E+00	7.67E-01	4.75E-01	0.00E+00	3.00E+00	0.00E+00	4.40E+03	0.00E+00
EU-156	8.38E-01	6.28E-01	1.03E-01	0.00E+00	4.23E-01	0.00E+00	3.21E+03	0.00E+00
TB-160	2.93E+00	0.00E+00	3.65E-01	0.00E+00	1.16E+00	0.00E+00	1.89E+03	0.00E+00
HO-166M	1.63E+01	5.02E+00	3.63E+00	0.00E+00	7.35E+00	0.00E+00	1.24E+03	0.00E+00
W-181	3.09E+01	9.98E+00	1.04E+00	0.00E+00	0.00E+00	0.00E+00	8.50E+02	0.00E+00
W-185	1.26E+03	4.15E+02	4.39E+01	0.00E+00	0.00E+00	0.00E+00	3.58E+04	0.00E+00
W-187	1.59E+02	1.30E+02	4.55E+01	0.00E+00	0.00E+00	0.00E+00	3.51E+04	0.00E+00
U-232	2.15E+04	0.00E+00	1.54E+03	0.00E+00	2.33E+03	0.00E+00	2.63E+02	0.00E+00
U-233	4.53E+03	0.00E+00	2.75E+02	0.00E+00	1.06E+03	0.00E+00	2.43E+02	0.00E+00
U-234	4.35E+03	0.00E+00	2.70E+02	0.00E+00	1.04E+03	0.00E+00	2.38E+02	0.00E+00
U-235	4.16E+03	0.00E+00	2.54E+02	0.00E+00	9.75E+02	0.00E+00	3.02E+02	0.00E+00
U-236	4.16E+03	0.00E+00	2.59E+02	0.00E+00	9.97E+02	0.00E+00	2.23E+02	0.00E+00
U-237	2.60E-01	0.00E+00	6.92E-02	0.00E+00	1.07E+00	0.00E+00	6.89E+01	0.00E+00
U-238	3.98E+03	0.00E+00	2.37E+02	0.00E+00	9.13E+02	0.00E+00	2.13E+02	0.00E+00
NP-237	2.43E+04	1.74E+03	1.07E+03	0.00E+00	7.91E+03	0.00E+00	1.54E+03	0.00E+00
NP-238	2.57E-01	6.87E-03	4.00E-03	0.00E+00	2.36E-02	0.00E+00	5.04E+02	0.00E+00
NP-239	2.39E-02	2.26E-03	1.25E-03	0.00E+00	7.09E-03	0.00E+00	3.63E+02	0.00E+00
PU-238	4.28E+03	5.48E+02	1.16E+02	0.00E+00	4.99E+02	0.00E+00	4.94E+02	0.00E+00
PU-239	4.89E+03	5.94E+02	1.28E+02	0.00E+00	5.48E+02	0.00E+00	4.51E+02	0.00E+00
PU-240	4.88E+03	5.93E+02	1.28E+02	0.00E+00	5.47E+02	0.00E+00	4.60E+02	0.00E+00
PU-241	1.12E+02	5.37E+00	2.36E+00	0.00E+00	1.09E+01	0.00E+00	9.46E+00	0.00E+00
PU-242	4.53E+03	5.72E+02	1.24E+02	0.00E+00	5.27E+02	0.00E+00	4.42E+02	0.00E+00
PU-244	5.29E+03	6.52E+02	1.42E+02	0.00E+00	6.04E+02	0.00E+00	6.58E+02	0.00E+00
AM-241	3.64E+04	3.44E+04	2.63E+03	0.00E+00	1.97E+04	0.00E+00	3.59E+03	0.00E+00
AM-242M	3.68E+04	3.25E+04	2.65E+03	0.00E+00	1.96E+04	0.00E+00	4.52E+03	0.00E+00
AM-243	3.63E+04	3.36E+04	2.57E+03	0.00E+00	1.93E+04	0.00E+00	4.21E+03	0.00E+00
CM-242	1.34E+03	1.41E+03	8.87E+01	0.00E+00	4.04E+02	0.00E+00	3.82E+03	0.00E+00
CM-243	2.97E+04	2.75E+04	1.87E+03	0.00E+00	8.72E+03	0.00E+00	3.78E+03	0.00E+00
CM-244	2.30E+04	2.18E+04	1.46E+03	0.00E+00	6.80E+03	0.00E+00	3.65E+03	0.00E+00
CM-245	4.52E+04	3.98E+04	2.79E+03	0.00E+00	1.30E+04	0.00E+00	3.41E+03	0.00E+00
CM-246	4.48E+04	3.97E+04	2.78E+03	0.00E+00	1.30E+04	0.00E+00	3.35E+03	0.00E+00
CM-247	4.37E+04	3.91E+04	2.74E+03	0.00E+00	1.28E+04	0.00E+00	4.40E+03	0.00E+00
CM-248	3.63E+05	3.22E+05	2.26E+04	0.00E+00	1.05E+05	0.00E+00	7.08E+04	0.00E+00
CF-252	1.58E+04	0.00E+00	3.82E+02	0.00E+00	0.00E+00	0.00E+00	1.39E+04	0.00E+00

TABLE II1-14

TEEN SHORELINE A₁₇ FACTORS

mrem-ml per uCi-hr

NUCLIDE	BONE	LIVER	T BODY	THYROID	KIDNEY	LUNG	GI-LLI	SKIN
H-3	0.00E+00	0.00E+00	0.00E+00	0.00E+00	0.00E+00	0.00E+00	0.00E+00	0.00E+00
C-14	0.00E+00	0.00E+00	0.00E+00	0.00E+00	0.00E+00	0.00E+00	0.00E+00	0.00E+00
NA-22	2.08E+04	2.08E+04	2.08E+04	2.08E+04	2.08E+04	2.08E+04	2.08E+04	2.34E+04
NA-24	2.14E+01	2.14E+01	2.14E+01	2.14E+01	2.14E+01	2.14E+01	2.14E+01	2.48E+01
P-32	0.00E+00	0.00E+00	0.00E+00	0.00E+00	0.00E+00	0.00E+00	0.00E+00	0.00E+00
CA-41	2.96E+04	2.96E+04	2.96E+04	2.96E+04	2.96E+04	2.96E+04	2.96E+04	3.48E+04
SC-46	1.49E+03	1.49E+03	1.49E+03	1.49E+03	1.49E+03	1.49E+03	1.49E+03	1.72E+03
CR-51	8.35E+00	8.35E+00	8.35E+00	8.35E+00	8.35E+00	8.35E+00	8.35E+00	9.87E+00
MN-54	2.48E+03	2.48E+03	2.48E+03	2.48E+03	2.48E+03	2.48E+03	2.48E+03	2.91E+03
MN-56	1.62E+00	1.62E+00	1.62E+00	1.62E+00	1.62E+00	1.62E+00	1.62E+00	1.91E+00
FE-55	0.00E+00	0.00E+00	0.00E+00	0.00E+00	0.00E+00	0.00E+00	0.00E+00	0.00E+00
FE-59	4.89E+02	4.89E+02	4.89E+02	4.89E+02	4.89E+02	4.89E+02	4.89E+02	5.75E+02
CO-57	3.38E+02	3.38E+02	3.38E+02	3.38E+02	3.38E+02	3.38E+02	3.38E+02	3.71E+02
CO-58	6.79E+02	6.79E+02	6.79E+02	6.79E+02	6.79E+02	6.79E+02	6.79E+02	7.95E+02
CO-60	4.32E+04	4.32E+04	4.32E+04	4.32E+04	4.32E+04	4.32E+04	4.32E+04	5.08E+04
NI-59	0.00E+00	0.00E+00	0.00E+00	0.00E+00	0.00E+00	0.00E+00	0.00E+00	0.00E+00
NI-63	0.00E+00	0.00E+00	0.00E+00	0.00E+00	0.00E+00	0.00E+00	0.00E+00	0.00E+00
NI-65	5.32E-01	5.32E-01	5.32E-01	5.32E-01	5.32E-01	5.32E-01	5.32E-01	6.19E-01
CU-64	1.09E+00	1.09E+00	1.09E+00	1.09E+00	1.09E+00	1.09E+00	1.09E+00	1.23E+00
ZN-65	1.34E+03	1.34E+03	1.34E+03	1.34E+03	1.34E+03	1.34E+03	1.34E+03	1.54E+03
ZN-69M	2.28E+00	2.28E+00	2.28E+00	2.28E+00	2.28E+00	2.28E+00	2.28E+00	2.67E+00
ZN-69	0.00E+00	0.00E+00	0.00E+00	0.00E+00	0.00E+00	0.00E+00	0.00E+00	0.00E+00
SE-79	0.00E+00	0.00E+00	0.00E+00	0.00E+00	0.00E+00	0.00E+00	0.00E+00	0.00E+00
BR-82	3.83E+01	3.83E+01	3.83E+01	3.83E+01	3.83E+01	3.83E+01	3.83E+01	4.43E+01
BR-83	8.73E-03	8.73E-03	8.73E-03	8.73E-03	8.73E-03	8.73E-03	8.73E-03	1.27E-02
BR-84	3.63E-01	3.63E-01	3.63E-01	3.63E-01	3.63E-01	3.63E-01	3.63E-01	4.24E-01
BR-85	0.00E+00	0.00E+00	0.00E+00	0.00E+00	0.00E+00	0.00E+00	0.00E+00	0.00E+00
RB-86	1.61E+01	1.61E+01	1.61E+01	1.61E+01	1.61E+01	1.61E+01	1.61E+01	1.84E+01
RB-87	0.00E+00	0.00E+00	0.00E+00	0.00E+00	0.00E+00	0.00E+00	0.00E+00	0.00E+00
RB-88	5.93E-02	5.93E-02	5.93E-02	5.93E-02	5.93E-02	5.93E-02	5.93E-02	6.77E-02
RB-89	2.20E-01	2.20E-01	2.20E-01	2.20E-01	2.20E-01	2.20E-01	2.20E-01	2.64E-01
SR-89	3.88E-02	3.88E-02	3.88E-02	3.88E-02	3.88E-02	3.88E-02	3.88E-02	4.50E-02
SR-90	0.00E+00	0.00E+00	0.00E+00	0.00E+00	0.00E+00	0.00E+00	0.00E+00	0.00E+00
SR-91	3.85E+00	3.85E+00	3.85E+00	3.85E+00	3.85E+00	3.85E+00	3.85E+00	4.50E+00
SR-92	1.39E+00	1.39E+00	1.39E+00	1.39E+00	1.39E+00	1.39E+00	1.39E+00	1.55E+00
Y-90	8.05E-03	8.05E-03	8.05E-03	8.05E-03	8.05E-03	8.05E-03	8.05E-03	9.51E-03
Y-91M	1.80E-01	1.80E-01	1.80E-01	1.80E-01	1.80E-01	1.80E-01	1.80E-01	2.08E-01

TABLE II1-14

TEEN SHORELINE A₁₇ FACTORS

mrem-ml per uCi-hr

NUCLIDE	BONE	LIVER	T BODY	THYROID	KIDNEY	LUNG	GI-LLI	SKIN
Y-91	1.92E+00	1.92E+00	1.92E+00	1.92E+00	1.92E+00	1.92E+00	1.92E+00	2.16E+00
Y-92	3.23E-01	3.23E-01	3.23E-01	3.23E-01	3.23E-01	3.23E-01	3.23E-01	3.84E-01
Y-93	3.29E-01	3.29E-01	3.29E-01	3.29E-01	3.29E-01	3.29E-01	3.29E-01	4.50E-01
ZR-93	0.00E+00	0.00E+00	0.00E+00	0.00E+00	0.00E+00	0.00E+00	0.00E+00	0.00E+00
ZR-95	4.39E+02	4.39E+02	4.39E+02	4.39E+02	4.39E+02	4.39E+02	4.39E+02	5.09E+02
ZR-97	5.31E+00	5.31E+00	5.31E+00	5.31E+00	5.31E+00	5.31E+00	5.31E+00	6.17E+00
NB-93M	4.16E+00	4.16E+00	4.16E+00	4.16E+00	4.16E+00	4.16E+00	4.16E+00	5.08E+02
NB-95	2.45E+02	2.45E+02	2.45E+02	2.45E+02	2.45E+02	2.45E+02	2.45E+02	2.88E+02
NB-97	3.16E-01	3.16E-01	3.16E-01	3.16E-01	3.16E-01	3.16E-01	3.16E-01	3.70E-01
MO-93	1.98E+02	1.98E+02	1.98E+02	1.98E+02	1.98E+02	1.98E+02	1.98E+02	8.06E+03
MO-99	7.16E+00	7.16E+00	7.16E+00	7.16E+00	7.16E+00	7.16E+00	7.16E+00	8.29E+00
TC-99M	3.30E-01	3.30E-01	3.30E-01	3.30E-01	3.30E-01	3.30E-01	3.30E-01	3.78E-01
TC-99	0.00E+00	0.00E+00	0.00E+00	0.00E+00	0.00E+00	0.00E+00	0.00E+00	0.00E+00
TC-101	3.65E-02	3.65E-02	3.65E-02	3.65E-02	3.65E-02	3.65E-02	3.65E-02	4.05E-02
RU-103	1.94E+02	1.94E+02	1.94E+02	1.94E+02	1.94E+02	1.94E+02	1.94E+02	2.26E+02
RU-105	1.14E+00	1.14E+00	1.14E+00	1.14E+00	1.14E+00	1.14E+00	1.14E+00	1.29E+00
RU-106	7.57E+02	7.57E+02	7.57E+02	7.57E+02	7.57E+02	7.57E+02	7.57E+02	9.08E+02
RH-105	1.33E+00	1.33E+00	1.33E+00	1.33E+00	1.33E+00	1.33E+00	1.33E+00	1.55E+00
PD-107	0.00E+00	0.00E+00	0.00E+00	0.00E+00	0.00E+00	0.00E+00	0.00E+00	0.00E+00
PD-109	2.69E-02	2.69E-02	2.69E-02	2.69E-02	2.69E-02	2.69E-02	2.69E-02	3.07E-02
AG-110M	6.16E+03	6.16E+03	6.16E+03	6.16E+03	6.16E+03	6.16E+03	6.16E+03	7.19E+03
AG-111	1.84E+00	1.84E+00	1.84E+00	1.84E+00	1.84E+00	1.84E+00	1.84E+00	2.15E+00
CD-113M	1.13E+01	1.13E+01	1.13E+01	1.13E+01	1.13E+01	1.13E+01	1.13E+01	1.28E+01
CD-115M	0.00E+00	0.00E+00	0.00E+00	0.00E+00	0.00E+00	0.00E+00	0.00E+00	0.00E+00
SN-123	0.00E+00	0.00E+00	0.00E+00	0.00E+00	0.00E+00	0.00E+00	0.00E+00	1.14E+04
SN-125	7.53E+00	7.53E+00	7.53E+00	7.53E+00	7.53E+00	7.53E+00	7.53E+00	8.72E+00
SN-126	7.80E+04	7.80E+04	7.80E+04	7.80E+04	7.80E+04	7.80E+04	7.80E+04	8.67E+04
SB-124	1.07E+03	1.07E+03	1.07E+03	1.07E+03	1.07E+03	1.07E+03	1.07E+03	1.24E+03
SB-125	4.29E+03	4.29E+03	4.29E+03	4.29E+03	4.29E+03	4.29E+03	4.29E+03	4.84E+03
SB-126	1.51E+02	1.51E+02	1.51E+02	1.51E+02	1.51E+02	1.51E+02	1.51E+02	1.70E+02
SB-127	3.01E+01	3.01E+01	3.01E+01	3.01E+01	3.01E+01	3.01E+01	3.01E+01	3.48E+01
TE-125M	2.78E+00	2.78E+00	2.78E+00	2.78E+00	2.78E+00	2.78E+00	2.78E+00	3.81E+00
TE-127M	1.64E-01	1.64E-01	1.64E-01	1.64E-01	1.64E-01	1.64E-01	1.64E-01	1.94E-01
TE-127	5.34E-03	5.34E-03	5.34E-03	5.34E-03	5.34E-03	5.34E-03	5.34E-03	5.87E-03
TE-129M	3.54E+01	3.54E+01	3.54E+01	3.54E+01	3.54E+01	3.54E+01	3.54E+01	4.14E+01
TE-129	4.70E+02	4.70E+02	4.70E+02	4.70E+02	4.70E+02	4.70E+02	4.70E+02	5.56E+02
TE-131M	1.44E+01	1.44E+01	1.44E+01	1.44E+01	1.44E+01	1.44E+01	1.44E+01	1.70E+01
TE-131	5.23E-02	5.23E-02	5.23E-02	5.23E-02	5.23E-02	5.23E-02	5.23E-02	6.18E+01

TABLE II1-14

TEEN SHORELINE A₁₇ FACTORS

mrem-ml per uCi-hr

NUCLIDE	BONE	LIVER	T BODY	THYROID	KIDNEY	LUNG	GI-LLI	SKIN
TE-132	7.59E+00	7.59E+00	7.59E+00	7.59E+00	7.59E+00	7.59E+00	7.59E+00	8.93E+00
TE-133M	7.91E-01	7.91E-01	7.91E-01	7.91E-01	7.91E-01	7.91E-01	7.91E-01	8.96E-01
TE-134	3.98E-02	3.98E-02	3.98E-02	3.98E-02	3.98E-02	3.98E-02	3.98E-02	4.77E-02
I-129	3.90E+03	3.90E+03	3.90E+03	3.90E+03	3.90E+03	3.90E+03	3.90E+03	6.50E+03
I-130	9.88E+00	9.88E+00	9.88E+00	9.88E+00	9.88E+00	9.88E+00	9.88E+00	1.20E+01
I-131	3.08E+01	3.08E+01	3.08E+01	3.08E+01	3.08E+01	3.08E+01	3.08E+01	3.74E+01
I-132	2.23E+00	2.23E+00	2.23E+00	2.23E+00	2.23E+00	2.23E+00	2.23E+00	2.63E+00
I-133	4.39E+00	4.39E+00	4.39E+00	4.39E+00	4.39E+00	4.39E+00	4.39E+00	5.34E+00
I-134	8.01E-01	8.01E-01	8.01E-01	8.01E-01	8.01E-01	8.01E-01	8.01E-01	9.51E-01
I-135	4.53E+00	4.53E+00	4.53E+00	4.53E+00	4.53E+00	4.53E+00	4.53E+00	5.28E+00
CS-134M	1.03E-01	1.03E-01	1.03E-01	1.03E-01	1.03E-01	1.03E-01	1.03E-01	1.21E-01
CS-134	1.24E+04	1.24E+04	1.24E+04	1.24E+04	1.24E+04	1.24E+04	1.24E+04	1.44E+04
CS-135	0.00E+00	0.00E+00	0.00E+00	0.00E+00	0.00E+00	0.00E+00	0.00E+00	0.00E+00
CS-136	2.70E+02	2.70E+02	2.70E+02	2.70E+02	2.70E+02	2.70E+02	2.70E+02	3.06E+02
CS-137	2.77E+04	2.77E+04	2.77E+04	2.77E+04	2.77E+04	2.77E+04	2.77E+04	3.23E+04
CS-138	6.43E-01	6.43E-01	6.43E-01	6.43E-01	6.43E-01	6.43E-01	6.43E-01	7.35E-01
CS-139	5.63E-02	5.63E-02	5.63E-02	5.63E-02	5.63E-02	5.63E-02	5.63E-02	6.44E-02
BA-139	1.90E-01	1.90E-01	1.90E-01	1.90E-01	1.90E-01	1.90E-01	1.90E-01	2.13E-01
BA-140	3.68E+01	3.68E+01	3.68E+01	3.68E+01	3.68E+01	3.68E+01	3.68E+01	4.20E+01
BA-141	7.47E-02	7.47E-02	7.47E-02	7.47E-02	7.47E-02	7.47E-02	7.47E-02	8.52E-02
BA-142	8.04E-02	8.04E-02	8.04E-02	8.04E-02	8.04E-02	8.04E-02	8.04E-02	9.16E-02
LA-140	3.44E+01	3.44E+01	3.44E+01	3.44E+01	3.44E+01	3.44E+01	3.44E+01	3.90E+01
LA-141	5.62E-02	5.62E-02	5.62E-02	5.62E-02	5.62E-02	5.62E-02	5.62E-02	6.30E-02
LA-142	1.36E+00	1.36E+00	1.36E+00	1.36E+00	1.36E+00	1.36E+00	1.36E+00	1.63E+00
CE-141	2.45E+01	2.45E+01	2.45E+01	2.45E+01	2.45E+01	2.45E+01	2.45E+01	2.76E+01
CE-143	4.14E+00	4.14E+00	4.14E+00	4.14E+00	4.14E+00	4.14E+00	4.14E+00	4.71E+00
CE-144	1.25E+02	1.25E+02	1.25E+02	1.25E+02	1.25E+02	1.25E+02	1.25E+02	1.44E+02
PR-143	0.00E+00	0.00E+00	0.00E+00	0.00E+00	0.00E+00	0.00E+00	0.00E+00	0.00E+00
PR-144	3.29E-03	3.29E-03	3.29E-03	3.29E-03	3.29E-03	3.29E-03	3.29E-03	3.78E-03
ND-147	1.50E+01	1.50E+01	1.50E+01	1.50E+01	1.50E+01	1.50E+01	1.50E+01	1.81E+01
PM-147	0.00E+00	0.00E+00	0.00E+00	0.00E+00	0.00E+00	0.00E+00	0.00E+00	0.00E+00
PM-148M	7.98E+02	7.98E+02	7.98E+02	7.98E+02	7.98E+02	7.98E+02	7.98E+02	4.62E+03
PM-148	3.38E+01	3.38E+01	3.38E+01	3.38E+01	3.38E+01	3.38E+01	3.38E+01	3.90E+01
PM-149	7.57E-02	7.57E-02	7.57E-02	7.57E-02	7.57E-02	7.57E-02	7.57E-02	8.79E-02
PM-151	3.57E+00	3.57E+00	3.57E+00	3.57E+00	3.57E+00	3.57E+00	3.57E+00	3.73E+00
SM-151	3.79E+02	3.79E+02	3.79E+02	3.79E+02	3.79E+02	3.79E+02	3.79E+02	1.66E+03
SM-153	7.20E-01	7.20E-01	7.20E-01	7.20E-01	7.20E-01	7.20E-01	7.20E-01	8.00E-01
EU-152	3.61E+04	3.61E+04	3.61E+04	3.61E+04	3.61E+04	3.61E+04	3.61E+04	4.18E+04

TABLE II1-14

TEEN SHORELINE A₁₇ FACTORS

mrem-ml per uCi-hr

NUCLIDE	BONE	LIVER	T BODY	THYROID	KIDNEY	LUNG	GI-LLI	SKIN
EU-154	2.96E+04	2.96E+04	2.96E+04	2.96E+04	2.96E+04	2.96E+04	2.96E+04	3.41E+04
EU-155	9.17E+02	9.17E+02	9.17E+02	9.17E+02	9.17E+02	9.17E+02	9.17E+02	1.04E+03
EU-156	1.58E+02	1.58E+02	1.58E+02	1.58E+02	1.58E+02	1.58E+02	1.58E+02	1.81E+02
TB-160	8.52E+02	8.52E+02	8.52E+02	8.52E+02	8.52E+02	8.52E+02	8.52E+02	9.90E+02
HO-166M	7.66E+04	7.66E+04	7.66E+04	7.66E+04	7.66E+04	7.66E+04	7.66E+04	8.61E+04
W-181	3.48E-01	3.48E-01	3.48E-01	3.48E-01	3.48E-01	3.48E-01	3.48E-01	4.64E-01
W-185	0.00E+00	0.00E+00	0.00E+00	0.00E+00	0.00E+00	0.00E+00	0.00E+00	0.00E+00
W-187	4.22E+00	4.22E+00	4.22E+00	4.22E+00	4.22E+00	4.22E+00	4.22E+00	4.90E+00
U-232	2.00E+01	2.00E+01	2.00E+01	2.00E+01	2.00E+01	2.00E+01	2.00E+01	2.07E+02
U-233	1.99E+04	1.99E+04	1.99E+04	1.99E+04	1.99E+04	1.99E+04	1.99E+04	2.43E+04
U-234	5.48E+00	5.48E+00	5.48E+00	5.48E+00	5.48E+00	5.48E+00	5.48E+00	1.38E+03
U-235	2.77E+04	2.77E+04	2.77E+04	2.77E+04	2.77E+04	2.77E+04	2.77E+04	3.47E+04
U-236	1.82E-01	1.82E-01	1.82E-01	1.82E-01	1.82E-01	1.82E-01	1.82E-01	1.56E+02
U-237	9.25E+00	9.25E+00	9.25E+00	9.25E+00	9.25E+00	9.25E+00	9.25E+00	1.20E+01
U-238	9.54E+02	9.54E+02	9.54E+02	9.54E+02	9.54E+02	9.54E+02	9.54E+02	1.30E+03
NP-237	1.21E+04	1.21E+04	1.21E+04	1.21E+04	1.21E+04	1.21E+04	1.21E+04	1.39E+04
NP-238	8.12E+00	8.12E+00	8.12E+00	8.12E+00	8.12E+00	8.12E+00	8.12E+00	9.28E+00
NP-239	3.06E+00	3.06E+00	3.06E+00	3.06E+00	3.06E+00	3.06E+00	3.06E+00	3.55E+00
PU-238	1.02E+01	1.02E+01	1.02E+01	1.02E+01	1.02E+01	1.02E+01	1.02E+01	1.42E+02
PU-239	6.85E+00	6.85E+00	6.85E+00	6.85E+00	6.85E+00	6.85E+00	6.85E+00	6.67E+01
PU-240	1.13E+01	1.13E+01	1.13E+01	1.13E+01	1.13E+01	1.13E+01	1.13E+01	1.56E+02
PU-241	2.32E+01	2.32E+01	2.32E+01	2.32E+01	2.32E+01	2.32E+01	2.32E+01	3.43E+01
PU-242	9.54E+00	9.54E+00	9.54E+00	9.54E+00	9.54E+00	9.54E+00	9.54E+00	1.39E+02
PU-244	7.76E+03	7.76E+03	7.76E+03	7.76E+03	7.76E+03	7.76E+03	7.76E+03	8.34E+03
AM-241	1.53E+03	1.53E+03	1.53E+03	1.53E+03	1.53E+03	1.53E+03	1.53E+03	2.21E+03
AM-242M	2.13E+02	2.13E+02	2.13E+02	2.13E+02	2.13E+02	2.13E+02	2.13E+02	1.48E+03
AM-243	1.13E+04	1.13E+04	1.13E+04	1.13E+04	1.13E+04	1.13E+04	1.13E+04	1.30E+04
CM-242	1.23E+00	1.23E+00	1.23E+00	1.23E+00	1.23E+00	1.23E+00	1.23E+00	5.14E+00
CM-243	1.49E+04	1.49E+04	1.49E+04	1.49E+04	1.49E+04	1.49E+04	1.49E+04	1.88E+04
CM-244	1.62E+01	1.62E+01	1.62E+01	1.62E+01	1.62E+01	1.62E+01	1.62E+01	1.00E+02
CM-245	8.23E+03	8.23E+03	8.23E+03	8.23E+03	8.23E+03	8.23E+03	8.23E+03	1.04E+04
CM-246	8.65E+00	8.65E+00	8.65E+00	8.65E+00	8.65E+00	8.65E+00	8.65E+00	1.30E+02
CM-247	1.91E+04	1.91E+04	1.91E+04	1.91E+04	1.91E+04	1.91E+04	1.91E+04	2.25E+04
CM-248	4.53E+04	4.53E+04	4.53E+04	4.53E+04	4.53E+04	4.53E+04	4.53E+04	5.90E+04
CF-252	8.70E+04	8.70E+04	8.70E+04	8.70E+04	8.70E+04	8.70E+04	8.70E+04	9.49E+04

TABLE II1-15

CHILD DRINKING WATER A_{IT} FACTORS

mrem-ml per uCi-hr

NUCLIDE	BONE	LIVER	T BODY	THYROID	KIDNEY	LUNG	GI-LLI	SKIN
H-3	0.00E+00	6.75E+00	6.75E+00	6.75E+00	6.75E+00	6.75E+00	6.75E+00	0.00E+00
C-14	7.04E+02	1.41E+02	1.41E+02	1.41E+02	1.41E+02	1.41E+02	1.41E+02	0.00E+00
NA-22	3.42E+03	3.42E+03	3.42E+03	3.42E+03	3.42E+03	3.42E+03	3.42E+03	0.00E+00
NA-24	1.94E+02	1.94E+02	1.94E+02	1.94E+02	1.94E+02	1.94E+02	1.94E+02	0.00E+00
P-32	4.69E+04	2.19E+03	1.81E+03	0.00E+00	0.00E+00	0.00E+00	1.30E+03	0.00E+00
CA-41	2.02E+04	0.00E+00	2.21E+03	0.00E+00	0.00E+00	0.00E+00	1.11E+01	0.00E+00
SC-46	1.14E+00	1.57E+00	6.03E-01	0.00E+00	1.39E+00	0.00E+00	2.29E+03	0.00E+00
CR-51	0.00E+00	0.00E+00	5.12E-01	2.84E-01	7.76E-02	5.19E-01	2.71E+01	0.00E+00
MN-54	0.00E+00	6.22E+02	1.66E+02	0.00E+00	1.74E+02	0.00E+00	5.22E+02	0.00E+00
MN-56	0.00E+00	7.72E-01	1.74E-01	0.00E+00	9.34E-01	0.00E+00	1.12E+02	0.00E+00
FE-55	6.69E+02	3.55E+02	1.10E+02	0.00E+00	0.00E+00	2.01E+02	6.58E+01	0.00E+00
FE-59	9.53E+02	1.54E+03	7.68E+02	0.00E+00	0.00E+00	4.47E+02	1.61E+03	0.00E+00
CO-57	0.00E+00	2.87E+01	5.80E+01	0.00E+00	0.00E+00	0.00E+00	2.35E+02	0.00E+00
CO-58	0.00E+00	1.04E+02	3.19E+02	0.00E+00	0.00E+00	0.00E+00	6.08E+02	0.00E+00
CO-60	0.00E+00	3.08E+02	9.08E+02	0.00E+00	0.00E+00	0.00E+00	1.71E+03	0.00E+00
NI-59	2.34E+03	6.23E+02	3.97E+02	0.00E+00	0.00E+00	0.00E+00	4.13E+01	0.00E+00
NI-63	3.13E+04	1.68E+03	1.07E+03	0.00E+00	0.00E+00	0.00E+00	1.13E+02	0.00E+00
NI-65	4.76E+00	4.48E-01	2.62E-01	0.00E+00	0.00E+00	0.00E+00	5.49E+01	0.00E+00
CU-64	0.00E+00	7.41E+00	4.48E+00	0.00E+00	1.79E+01	0.00E+00	3.48E+02	0.00E+00
ZN-65	7.96E+02	2.12E+03	1.32E+03	0.00E+00	1.34E+03	0.00E+00	3.73E+02	0.00E+00
ZN-69M	2.26E+01	3.85E+01	4.55E+00	0.00E+00	2.24E+01	0.00E+00	1.25E+03	0.00E+00
ZN-69	3.22E-04	4.66E-04	4.31E-05	0.00E+00	2.83E-04	0.00E+00	2.94E-02	0.00E+00
SE-79	0.00E+00	4.91E+02	1.09E+02	0.00E+00	7.98E+02	0.00E+00	3.22E+01	0.00E+00
BR-82	0.00E+00	0.00E+00	3.47E+02	0.00E+00	0.00E+00	0.00E+00	0.00E+00	0.00E+00
BR-83	0.00E+00	0.00E+00	3.07E-01	0.00E+00	0.00E+00	0.00E+00	0.00E+00	0.00E+00
BR-84	0.00E+00	0.00E+00	1.76E-06	0.00E+00	0.00E+00	0.00E+00	0.00E+00	0.00E+00
BR-85	0.00E+00	0.00E+00	1.31E-76	0.00E+00	0.00E+00	0.00E+00	0.00E+00	0.00E+00
RB-86	0.00E+00	3.83E+03	2.35E+03	0.00E+00	0.00E+00	0.00E+00	2.46E+02	0.00E+00
RB-87	0.00E+00	2.30E+03	1.07E+03	0.00E+00	0.00E+00	0.00E+00	3.45E+01	0.00E+00
RB-88	0.00E+00	7.37E-12	5.12E-12	0.00E+00	0.00E+00	0.00E+00	3.61E-13	0.00E+00
RB-89	0.00E+00	6.25E-14	5.55E-14	0.00E+00	0.00E+00	0.00E+00	5.45E-16	0.00E+00
SR-89	7.63E+04	0.00E+00	2.18E+03	0.00E+00	0.00E+00	0.00E+00	2.95E+03	0.00E+00
SR-90	1.49E+06	0.00E+00	3.00E+04	0.00E+00	0.00E+00	0.00E+00	1.33E+04	0.00E+00
SR-91	5.82E+02	0.00E+00	2.20E+01	0.00E+00	0.00E+00	0.00E+00	1.29E+03	0.00E+00
SR-92	2.44E+01	0.00E+00	9.79E-01	0.00E+00	0.00E+00	0.00E+00	4.62E+02	0.00E+00
Y-90	2.10E+00	0.00E+00	5.62E-02	0.00E+00	0.00E+00	0.00E+00	5.98E+03	0.00E+00
Y-91M	9.71E-07	0.00E+00	3.53E-08	0.00E+00	0.00E+00	0.00E+00	1.90E-03	0.00E+00

TABLE II1-15

CHILD DRINKING WATER A₁₇ FACTORS

mrem-ml per uCi-hr

NUCLIDE	BONE	LIVER	T BODY	THYROID	KIDNEY	LUNG	GI-LLI	SKIN
Y-91	3.48E+01	0.00E+00	9.32E-01	0.00E+00	0.00E+00	0.00E+00	4.64E+03	0.00E+00
Y-92	2.00E-02	0.00E+00	5.72E-04	0.00E+00	0.00E+00	0.00E+00	5.78E+02	0.00E+00
Y-93	2.91E-01	0.00E+00	8.00E-03	0.00E+00	0.00E+00	0.00E+00	4.34E+03	0.00E+00
ZR-93	9.72E+00	3.64E-01	2.59E-01	0.00E+00	1.41E+00	0.00E+00	1.38E+02	0.00E+00
ZR-95	6.72E+00	1.48E+00	1.31E+00	0.00E+00	2.11E+00	0.00E+00	1.54E+03	0.00E+00
ZR-97	2.49E-01	3.59E-02	2.12E-02	0.00E+00	5.16E-02	0.00E+00	5.45E+03	0.00E+00
NB-93M	6.11E+00	1.53E+00	5.01E-01	0.00E+00	1.65E+00	0.00E+00	2.30E+02	0.00E+00
NB-95	1.30E+00	5.05E-01	3.61E-01	0.00E+00	4.74E-01	0.00E+00	9.34E+02	0.00E+00
NB-97	1.25E-05	2.25E-06	1.05E-06	0.00E+00	2.50E-06	0.00E+00	6.95E-01	0.00E+00
MO-93	0.00E+00	1.40E+03	5.04E+01	0.00E+00	3.70E+02	0.00E+00	7.10E+01	0.00E+00
MO-99	0.00E+00	6.83E+02	1.69E+02	0.00E+00	1.46E+03	0.00E+00	5.65E+02	0.00E+00
TC-99M	1.35E-02	2.65E-02	4.39E-01	0.00E+00	3.85E-01	1.34E-02	1.51E+01	0.00E+00
TC-99	3.11E+01	3.47E+01	1.25E+01	0.00E+00	4.09E+02	3.07E+00	3.64E+02	0.00E+00
TC-101	3.40E-17	3.55E-17	4.51E-16	0.00E+00	6.06E-16	1.88E-17	1.13E-16	0.00E+00
RU-103	4.22E+01	0.00E+00	1.62E+01	0.00E+00	1.06E+02	0.00E+00	1.09E+03	0.00E+00
RU-105	5.77E-01	0.00E+00	2.09E-01	0.00E+00	5.07E+00	0.00E+00	3.76E+02	0.00E+00
RU-106	6.81E+02	0.00E+00	8.49E+01	0.00E+00	9.19E+02	0.00E+00	1.06E+04	0.00E+00
RH-105	2.37E+01	1.27E+01	1.09E+01	0.00E+00	5.06E+01	0.00E+00	7.87E+02	0.00E+00
PD-107	0.00E+00	2.75E+01	2.33E+00	0.00E+00	2.30E+02	0.00E+00	5.46E+01	0.00E+00
PD-109	0.00E+00	1.78E+01	5.33E+00	0.00E+00	9.54E+01	0.00E+00	1.05E+03	0.00E+00
AG-110M	3.13E+01	2.12E+01	1.69E+01	0.00E+00	3.94E+01	0.00E+00	2.52E+03	0.00E+00
AG-111	1.38E+01	4.31E+00	2.85E+00	0.00E+00	1.30E+01	0.00E+00	2.64E+03	0.00E+00
CD-113M	0.00E+00	5.94E+02	2.53E+01	0.00E+00	6.11E+02	0.00E+00	1.53E+03	0.00E+00
CD-115M	0.00E+00	3.40E+02	1.45E+01	0.00E+00	2.53E+02	0.00E+00	4.63E+03	0.00E+00
SN-123	7.72E+03	9.58E+01	1.88E+02	1.02E+02	0.00E+00	0.00E+00	3.79E+03	0.00E+00
SN-125	1.99E+03	3.00E+01	8.93E+01	3.12E+01	0.00E+00	0.00E+00	6.18E+03	0.00E+00
SN-126	1.94E+04	2.42E+02	5.51E+02	6.64E+01	0.00E+00	0.00E+00	1.46E+03	0.00E+00
SB-124	6.43E+02	8.34E+00	2.25E+02	1.42E+00	0.00E+00	3.57E+02	4.02E+03	0.00E+00
SB-125	4.17E+02	3.21E+00	8.73E+01	3.86E-01	0.00E+00	2.32E+02	9.95E+02	0.00E+00
SB-126	2.49E+02	3.81E+00	8.95E+01	1.46E+00	0.00E+00	1.19E+02	5.02E+03	0.00E+00
SB-127	5.64E+01	8.73E-01	1.96E+01	6.28E-01	0.00E+00	2.45E+01	3.18E+03	0.00E+00
TE-125M	6.60E+02	1.79E+02	8.80E+01	1.85E+02	0.00E+00	0.00E+00	6.37E+02	0.00E+00
TE-127M	1.68E+03	4.52E+02	1.99E+02	4.01E+02	4.78E+03	0.00E+00	1.36E+03	0.00E+00
TE-127	1.13E+01	3.04E+00	2.42E+00	7.80E+00	3.20E+01	0.00E+00	4.40E+02	0.00E+00
TE-129M	2.81E+03	7.84E+02	4.36E+02	9.05E+02	8.24E+03	0.00E+00	3.42E+03	0.00E+00
TE-129	6.00E-03	1.67E-03	1.42E-03	4.28E-03	1.75E-02	0.00E+00	3.73E-01	0.00E+00
TE-131M	3.18E+02	1.10E+02	1.17E+02	2.26E+02	1.06E+03	0.00E+00	4.46E+03	0.00E+00
TE-131	1.03E-08	3.15E-09	3.08E-09	7.91E-09	3.13E-08	0.00E+00	5.43E-08	0.00E+00

TABLE II1-15

CHILD DRINKING WATER A_{IT} FACTORS

mrem-ml per uCi-hr

NUCLIDE	BONE	LIVER	T BODY	THYROID	KIDNEY	LUNG	GI-LLI	SKIN
TE-132	5.29E+02	2.34E+02	2.83E+02	3.41E+02	2.17E+03	0.00E+00	2.36E+03	0.00E+00
TE-133M	1.33E-03	5.39E-04	6.68E-04	1.03E-03	5.12E-03	0.00E+00	4.11E-02	0.00E+00
TE-134	4.90E-05	2.20E-05	2.94E-05	3.88E-05	2.04E-04	0.00E+00	2.24E-04	0.00E+00
I-129	8.09E+02	4.97E+02	4.44E+02	3.25E+05	8.38E+02	0.00E+00	2.50E+01	0.00E+00
I-130	8.67E+01	1.75E+02	9.03E+01	1.93E+04	2.62E+02	0.00E+00	8.20E+01	0.00E+00
I-131	9.59E+02	9.65E+02	5.48E+02	3.19E+05	1.58E+03	0.00E+00	8.59E+01	0.00E+00
I-132	1.25E+00	2.30E+00	1.06E+00	1.07E+02	3.52E+00	0.00E+00	2.71E+00	0.00E+00
I-133	2.31E+02	2.86E+02	1.08E+02	5.31E+04	4.76E+02	0.00E+00	1.15E+02	0.00E+00
I-134	1.85E-03	3.43E-03	1.58E-03	7.90E-02	5.25E-03	0.00E+00	2.28E-03	0.00E+00
I-135	2.89E+01	5.21E+01	2.46E+01	4.61E+03	7.99E+01	0.00E+00	3.97E+01	0.00E+00
CS-134M	2.79E-01	4.13E-01	2.70E-01	0.00E+00	2.18E-01	3.60E-02	5.22E-01	0.00E+00
CS-134	1.36E+04	2.23E+04	4.71E+03	0.00E+00	6.92E+03	2.48E+03	1.20E+02	0.00E+00
CS-135	4.83E+03	3.37E+03	3.45E+02	0.00E+00	1.19E+03	3.96E+02	2.52E+01	0.00E+00
CS-136	1.33E+03	3.66E+03	2.37E+03	0.00E+00	1.95E+03	2.91E+02	1.29E+02	0.00E+00
CS-137	1.90E+04	1.82E+04	2.69E+03	0.00E+00	5.94E+03	2.14E+03	1.14E+02	0.00E+00
CS-138	2.47E-06	3.43E-06	2.17E-06	0.00E+00	2.41E-06	2.60E-07	1.58E-06	0.00E+00
CS-139	7.39E-23	8.21E-23	3.95E-23	0.00E+00	6.17E-23	6.22E-24	7.39E-27	0.00E+00
BA-139	5.94E-02	3.17E-05	1.72E-03	0.00E+00	2.77E-05	1.87E-05	3.43E+00	0.00E+00
BA-140	4.71E+03	4.13E+00	2.75E+02	0.00E+00	1.34E+00	2.46E+00	2.39E+03	0.00E+00
BA-141	1.60E-11	8.93E-15	5.19E-13	0.00E+00	7.73E-15	5.25E-14	9.09E-12	0.00E+00
BA-142	2.82E-20	2.03E-23	1.57E-21	0.00E+00	1.64E-23	1.19E-23	3.68E-22	0.00E+00
LA-140	4.78E-01	1.67E-01	5.63E-02	0.00E+00	0.00E+00	0.00E+00	4.66E+03	0.00E+00
LA-141	9.59E-03	2.24E-03	4.85E-04	0.00E+00	0.00E+00	0.00E+00	4.97E+02	0.00E+00
LA-142	1.63E-04	5.20E-05	1.63E-05	0.00E+00	0.00E+00	0.00E+00	1.03E+01	0.00E+00
CE-141	2.29E+00	1.14E+00	1.69E-01	0.00E+00	5.00E-01	0.00E+00	1.42E+03	0.00E+00
CE-143	3.16E-01	1.71E+02	2.48E-02	0.00E+00	7.19E-02	0.00E+00	2.51E+03	0.00E+00
CE-144	1.21E+02	3.79E+01	6.45E+00	0.00E+00	2.10E+01	0.00E+00	9.89E+03	0.00E+00
PR-143	2.23E+00	6.70E-01	1.11E-01	0.00E+00	3.63E-01	0.00E+00	2.41E+03	0.00E+00
PR-144	2.15E-15	6.65E-16	1.08E-16	0.00E+00	3.52E-16	0.00E+00	1.43E-12	0.00E+00
ND-147	1.57E+00	1.27E+00	9.87E-02	0.00E+00	6.99E-01	0.00E+00	2.02E+03	0.00E+00
PM-147	1.85E+01	1.32E+00	7.10E-01	0.00E+00	2.33E+00	0.00E+00	5.35E+02	0.00E+00
PM-148M	5.95E+00	1.18E+00	1.18E+00	0.00E+00	1.76E+00	0.00E+00	3.34E+03	0.00E+00
PM-148	1.65E+00	1.98E-01	1.28E-01	0.00E+00	3.37E-01	0.00E+00	5.29E+03	0.00E+00
PM-149	3.23E-01	3.43E-02	1.86E-02	0.00E+00	6.07E-02	0.00E+00	2.34E+03	0.00E+00
PM-151	1.27E-01	1.54E-02	1.00E-02	0.00E+00	2.61E-02	0.00E+00	1.75E+03	0.00E+00
SM-151	1.49E+01	2.22E+00	6.99E-01	0.00E+00	2.29E+00	0.00E+00	3.22E+02	0.00E+00
SM-153	1.78E-01	1.11E-01	1.07E-02	0.00E+00	3.37E-02	0.00E+00	1.47E+03	0.00E+00
EU-152	3.58E+01	6.52E+00	7.74E+00	0.00E+00	2.75E+01	0.00E+00	1.07E+03	0.00E+00

TABLE II1-15

CHILD DRINKING WATER A_{IT} FACTORS

mrem-ml per uCi-hr

NUCLIDE	BONE	LIVER	T BODY	THYROID	KIDNEY	LUNG	GI-LLI	SKIN
EU-154	1.34E+02	1.21E+01	1.10E+01	0.00E+00	5.29E+01	0.00E+00	2.80E+03	0.00E+00
EU-155	2.81E+01	2.02E+00	1.58E+00	0.00E+00	7.57E+00	0.00E+00	5.06E+03	0.00E+00
EU-156	3.20E+00	1.71E+00	3.55E-01	0.00E+00	1.10E+00	0.00E+00	3.89E+03	0.00E+00
TB-160	9.62E+00	0.00E+00	1.19E+00	0.00E+00	2.86E+00	0.00E+00	2.13E+03	0.00E+00
HO-166M	6.29E+01	1.32E+01	1.11E+01	0.00E+00	1.87E+01	0.00E+00	1.53E+03	0.00E+00
W-181	2.46E+00	6.04E-01	8.30E-02	0.00E+00	0.00E+00	0.00E+00	2.20E+01	0.00E+00
W-185	1.00E+02	2.50E+01	3.51E+00	0.00E+00	0.00E+00	0.00E+00	9.33E+02	0.00E+00
W-187	1.76E+01	1.04E+01	4.68E+00	0.00E+00	0.00E+00	0.00E+00	1.47E+03	0.00E+00
U-232	1.02E+06	0.00E+00	7.34E+04	0.00E+00	7.80E+04	0.00E+00	4.06E+03	0.00E+00
U-233	2.17E+05	0.00E+00	1.31E+04	0.00E+00	3.55E+04	0.00E+00	3.76E+03	0.00E+00
U-234	2.08E+05	0.00E+00	1.29E+04	0.00E+00	3.48E+04	0.00E+00	3.68E+03	0.00E+00
U-235	1.99E+05	0.00E+00	1.21E+04	0.00E+00	3.27E+04	0.00E+00	4.68E+03	0.00E+00
U-236	1.99E+05	0.00E+00	1.23E+04	0.00E+00	3.34E+04	0.00E+00	3.45E+03	0.00E+00
U-237	1.31E+01	0.00E+00	3.47E+00	0.00E+00	3.77E+01	0.00E+00	1.15E+03	0.00E+00
U-238	1.90E+05	0.00E+00	1.13E+04	0.00E+00	3.05E+04	0.00E+00	3.30E+03	0.00E+00
NP-237	1.30E+05	8.56E+03	5.70E+03	0.00E+00	3.52E+04	0.00E+00	4.75E+03	0.00E+00
NP-238	2.88E+00	5.83E-02	4.49E-02	0.00E+00	1.86E-01	0.00E+00	2.00E+03	0.00E+00
NP-239	2.64E-01	1.89E-02	1.33E-02	0.00E+00	5.48E-02	0.00E+00	1.40E+03	0.00E+00
PU-238	6.93E+04	8.03E+03	1.84E+03	0.00E+00	6.70E+03	0.00E+00	4.37E+03	0.00E+00
PU-239	7.51E+04	8.03E+03	1.93E+03	0.00E+00	7.10E+03	0.00E+00	3.99E+03	0.00E+00
PU-240	7.45E+04	8.33E+03	1.93E+03	0.00E+00	7.10E+03	0.00E+00	4.06E+03	0.00E+00
PU-241	2.25E+03	9.20E+01	4.68E+01	0.00E+00	1.72E+02	0.00E+00	8.38E+01	0.00E+00
PU-242	6.93E+04	8.03E+03	1.86E+03	0.00E+00	6.81E+03	0.00E+00	3.91E+03	0.00E+00
PU-244	8.09E+04	9.20E+04	2.13E+03	0.00E+00	7.86E+03	0.00E+00	5.82E+03	0.00E+00
AM-241	7.92E+04	6.81E+04	5.94E+03	0.00E+00	3.63E+04	0.00E+00	4.45E+03	0.00E+00
AM-242M	8.15E+04	6.52E+04	6.05E+03	0.00E+00	3.67E+04	0.00E+00	5.59E+03	0.00E+00
AM-243	7.80E+04	6.58E+04	5.72E+03	0.00E+00	3.53E+04	0.00E+00	5.21E+03	0.00E+00
CM-242	5.10E+03	4.07E+03	3.39E+02	0.00E+00	1.09E+03	0.00E+00	4.74E+03	0.00E+00
CM-243	7.45E+04	6.05E+04	4.80E+03	0.00E+00	1.79E+04	0.00E+00	4.67E+03	0.00E+00
CM-244	6.29E+04	5.09E+04	4.03E+03	0.00E+00	1.48E+04	0.00E+00	4.52E+03	0.00E+00
CM-245	9.72E+04	7.80E+04	6.11E+03	0.00E+00	2.39E+04	0.00E+00	4.22E+03	0.00E+00
CM-246	9.61E+04	7.80E+04	6.11E+03	0.00E+00	2.39E+04	0.00E+00	4.14E+03	0.00E+00
CM-247	9.37E+04	7.68E+04	6.00E+03	0.00E+00	2.35E+04	0.00E+00	5.44E+03	0.00E+00
CM-248	7.80E+05	6.35E+05	4.96E+04	0.00E+00	1.94E+05	0.00E+00	8.79E+04	0.00E+00
CF-252	6.11E+04	0.00E+00	1.48E+03	0.00E+00	0.00E+00	0.00E+00	1.72E+04	0.00E+00

TABLE II1-16

CHILD FRESHWATER FISH A₁₇ FACTORS

mrem-ml per uCi-hr

NUCLIDE	BONE	LIVER	T BODY	THYROID	KIDNEY	LUNG	GI-LLI	SKIN
H-3	0.00E+00	8.22E-02	8.22E-02	8.22E-02	8.22E-02	8.22E-02	8.22E-02	0.00E+00
C-14	4.38E+04	8.77E+03	8.77E+03	8.77E+03	8.77E+03	8.77E+03	8.77E+03	0.00E+00
NA-22	4.63E+03	4.63E+03	4.63E+03	4.63E+03	4.63E+03	4.63E+03	4.63E+03	0.00E+00
NA-24	1.51E+02	1.51E+02	1.51E+02	1.51E+02	1.51E+02	1.51E+02	1.51E+02	0.00E+00
P-32	1.86E+06	8.69E+04	7.16E+04	0.00E+00	0.00E+00	0.00E+00	5.13E+04	0.00E+00
CA-41	1.09E+04	0.00E+00	1.19E+03	0.00E+00	0.00E+00	0.00E+00	5.99E+00	0.00E+00
SC-46	3.08E-02	4.22E-02	1.62E-02	0.00E+00	3.73E-02	0.00E+00	6.17E+01	0.00E+00
CR-51	0.00E+00	0.00E+00	1.37E+00	7.59E-01	2.07E-01	1.39E+00	7.25E+01	0.00E+00
MN-54	0.00E+00	3.36E+03	8.96E+02	0.00E+00	9.43E+02	0.00E+00	2.82E+03	0.00E+00
MN-56	0.00E+00	1.66E-01	3.75E-02	0.00E+00	2.01E-01	0.00E+00	2.41E+01	0.00E+00
FE-55	9.05E+02	4.80E+02	1.49E+02	0.00E+00	0.00E+00	2.72E+02	8.89E+01	0.00E+00
FE-59	1.28E+03	2.07E+03	1.03E+03	0.00E+00	0.00E+00	6.00E+02	2.16E+03	0.00E+00
CO-57	0.00E+00	1.94E+01	3.92E+01	0.00E+00	0.00E+00	0.00E+00	1.59E+02	0.00E+00
CO-58	0.00E+00	7.02E+01	2.15E+02	0.00E+00	0.00E+00	0.00E+00	4.09E+02	0.00E+00
CO-60	0.00E+00	2.08E+02	6.14E+02	0.00E+00	0.00E+00	0.00E+00	1.15E+03	0.00E+00
NI-59	3.17E+03	8.43E+02	5.37E+02	0.00E+00	0.00E+00	0.00E+00	5.59E+01	0.00E+00
NI-63	4.24E+04	2.27E+03	1.44E+03	0.00E+00	0.00E+00	0.00E+00	1.53E+02	0.00E+00
NI-65	2.38E-01	2.24E-02	1.31E-02	0.00E+00	0.00E+00	0.00E+00	2.74E+00	0.00E+00
CU-64	0.00E+00	2.60E+00	1.57E+00	0.00E+00	6.29E+00	0.00E+00	1.22E+02	0.00E+00
ZN-65	2.15E+04	5.73E+04	3.57E+04	0.00E+00	3.61E+04	0.00E+00	1.01E+04	0.00E+00
ZN-69M	3.34E+02	5.69E+02	6.72E+01	0.00E+00	3.30E+02	0.00E+00	1.85E+04	0.00E+00
ZN-69	1.10E-06	1.59E-06	1.47E-07	0.00E+00	9.67E-07	0.00E+00	1.00E-04	0.00E+00
SE-79	0.00E+00	1.13E+03	2.50E+02	0.00E+00	1.83E+03	0.00E+00	7.40E+01	0.00E+00
BR-82	0.00E+00	0.00E+00	1.56E+03	0.00E+00	0.00E+00	0.00E+00	0.00E+00	0.00E+00
BR-83	0.00E+00	0.00E+00	5.37E-02	0.00E+00	0.00E+00	0.00E+00	0.00E+00	0.00E+00
BR-84	0.00E+00	0.00E+00	1.53E-12	0.00E+00	0.00E+00	0.00E+00	0.00E+00	0.00E+00
BR-85	0.00E+00	0.00E+00	1.84E-151	0.00E+00	0.00E+00	0.00E+00	0.00E+00	0.00E+00
RB-86	0.00E+00	1.02E+05	6.25E+04	0.00E+00	0.00E+00	0.00E+00	6.54E+03	0.00E+00
RB-87	0.00E+00	6.22E+04	2.88E+04	0.00E+00	0.00E+00	0.00E+00	9.33E+02	0.00E+00
RB-88	0.00E+00	1.33E-22	9.22E-23	0.00E+00	0.00E+00	0.00E+00	6.51E-24	0.00E+00
RB-89	0.00E+00	1.55E-26	1.38E-26	0.00E+00	0.00E+00	0.00E+00	1.35E-28	0.00E+00
SR-89	3.08E+04	0.00E+00	8.79E+02	0.00E+00	0.00E+00	0.00E+00	1.19E+03	0.00E+00
SR-90	6.05E+05	0.00E+00	1.22E+04	0.00E+00	0.00E+00	0.00E+00	5.41E+03	0.00E+00
SR-91	9.84E+01	0.00E+00	3.72E+00	0.00E+00	0.00E+00	0.00E+00	2.17E+02	0.00E+00
SR-92	4.60E-01	0.00E+00	1.85E-02	0.00E+00	0.00E+00	0.00E+00	8.72E+00	0.00E+00
Y-90	6.24E-01	0.00E+00	1.67E-02	0.00E+00	0.00E+00	0.00E+00	1.78E+03	0.00E+00
Y-91M	1.43E-11	0.00E+00	5.21E-13	0.00E+00	0.00E+00	0.00E+00	2.81E-08	0.00E+00

TABLE II1-16

CHILD FRESHWATER FISH A_{IT} FACTORS

mrem-ml per uCi-hr

NUCLIDE	BONE	LIVER	T BODY	THYROID	KIDNEY	LUNG	GI-LLI	SKIN
Y-91	1.17E+01	0.00E+00	3.13E-01	0.00E+00	0.00E+00	0.00E+00	1.56E+03	0.00E+00
Y-92	6.45E-04	0.00E+00	1.85E-05	0.00E+00	0.00E+00	0.00E+00	1.86E+01	0.00E+00
Y-93	4.32E-02	0.00E+00	1.19E-03	0.00E+00	0.00E+00	0.00E+00	6.45E+02	0.00E+00
ZR-93	4.34E-01	1.62E-02	1.16E-02	0.00E+00	6.29E-02	0.00E+00	6.16E+00	0.00E+00
ZR-95	2.98E-01	6.56E-02	5.84E-02	0.00E+00	9.39E-02	0.00E+00	6.84E+01	0.00E+00
ZR-97	6.79E-03	9.81E-04	5.79E-04	0.00E+00	1.41E-03	0.00E+00	1.49E+02	0.00E+00
NB-93M	2.48E+03	6.19E+02	2.03E+02	0.00E+00	6.69E+02	0.00E+00	9.33E+04	0.00E+00
NB-95	5.21E+02	2.03E+02	1.45E+02	0.00E+00	1.91E+02	0.00E+00	3.75E+05	0.00E+00
NB-97	4.99E-06	9.01E-07	4.20E-07	0.00E+00	9.99E-07	0.00E+00	2.78E-01	0.00E+00
MO-93	0.00E+00	1.90E+02	6.81E+00	0.00E+00	5.00E+01	0.00E+00	9.61E+00	0.00E+00
MO-99	0.00E+00	8.14E+01	2.01E+01	0.00E+00	1.74E+02	0.00E+00	6.73E+01	0.00E+00
TC-99M	6.88E-04	1.35E-03	2.24E-02	0.00E+00	1.96E-02	6.85E-04	7.68E-01	0.00E+00
TC-99	6.32E+00	7.04E+00	2.53E+00	0.00E+00	8.29E+01	6.23E-01	7.38E+01	0.00E+00
TC-101	3.76E-33	3.93E-33	4.99E-32	0.00E+00	6.71E-32	2.08E-33	1.25E-32	0.00E+00
RU-103	5.66E+00	0.00E+00	2.17E+00	0.00E+00	1.42E+01	0.00E+00	1.46E+02	0.00E+00
RU-105	1.20E-02	0.00E+00	4.35E-03	0.00E+00	1.05E-01	0.00E+00	7.82E+00	0.00E+00
RU-106	9.20E+01	0.00E+00	1.15E+01	0.00E+00	1.24E+02	0.00E+00	1.43E+03	0.00E+00
RH-105	2.53E+00	1.36E+00	1.16E+00	0.00E+00	5.41E+00	0.00E+00	8.41E+01	0.00E+00
PD-107	0.00E+00	3.72E+00	3.16E-01	0.00E+00	3.11E+01	0.00E+00	7.38E+00	0.00E+00
PD-109	0.00E+00	1.30E+00	3.89E-01	0.00E+00	6.95E+00	0.00E+00	7.66E+01	0.00E+00
AG-110M	9.74E-01	6.58E-01	5.26E-01	0.00E+00	1.22E+00	0.00E+00	7.82E+01	0.00E+00
AG-111	4.09E-01	1.28E-01	8.45E-02	0.00E+00	3.86E-01	0.00E+00	7.84E+01	0.00E+00
CD-113M	0.00E+00	1.61E+03	6.84E+01	0.00E+00	1.65E+03	0.00E+00	4.14E+03	0.00E+00
CD-115M	0.00E+00	9.14E+02	3.89E+01	0.00E+00	6.79E+02	0.00E+00	1.24E+04	0.00E+00
SN-123	3.13E+05	3.88E+03	7.62E+03	4.11E+03	0.00E+00	0.00E+00	1.53E+05	0.00E+00
SN-125	7.81E+04	1.18E+03	3.50E+03	1.22E+03	0.00E+00	0.00E+00	2.42E+05	0.00E+00
SN-126	7.87E+05	9.81E+03	2.24E+04	2.69E+03	0.00E+00	0.00E+00	5.91E+04	0.00E+00
SB-124	8.64E+00	1.12E-01	3.03E+00	1.91E-02	0.00E+00	4.80E+00	5.40E+01	0.00E+00
SB-125	5.64E+00	4.34E-02	1.18E+00	5.22E-03	0.00E+00	3.14E+00	1.35E+01	0.00E+00
SB-126	3.28E+00	5.01E-02	1.18E+00	1.92E-02	0.00E+00	1.56E+00	6.61E+01	0.00E+00
SB-127	6.97E-01	1.08E-02	2.42E-01	7.76E-03	0.00E+00	3.03E-01	3.93E+01	0.00E+00
TE-125M	3.55E+03	9.62E+02	4.73E+02	9.96E+02	0.00E+00	0.00E+00	3.42E+03	0.00E+00
TE-127M	9.05E+03	2.44E+03	1.07E+03	2.16E+03	2.58E+04	0.00E+00	7.33E+03	0.00E+00
TE-127	2.50E+01	6.75E+00	5.37E+00	1.73E+01	7.13E+01	0.00E+00	9.78E+02	0.00E+00
TE-129M	1.50E+04	4.20E+03	2.33E+03	4.85E+03	4.41E+04	0.00E+00	1.83E+04	0.00E+00
TE-129	2.50E-05	6.97E-06	5.92E-06	1.78E-05	7.30E-05	0.00E+00	1.55E-03	0.00E+00
TE-131M	1.30E+03	4.51E+02	4.80E+02	9.27E+02	4.36E+03	0.00E+00	1.83E+04	0.00E+00
TE-131	1.20E-16	3.65E-17	3.56E-17	9.16E-17	3.62E-16	0.00E+00	6.29E-16	0.00E+00

TABLE II1-16

CHILD FRESHWATER FISH A₁₇ FACTORS

mrem-ml per uCi-hr

NUCLIDE	BONE	LIVER	T BODY	THYROID	KIDNEY	LUNG	GI-LLI	SKIN
TE-132	2.57E+03	1.14E+03	1.38E+03	1.66E+03	1.06E+04	0.00E+00	1.15E+04	0.00E+00
TE-133M	8.82E-07	3.57E-07	4.42E-07	6.84E-07	3.39E-06	0.00E+00	2.72E-05	0.00E+00
TE-134	1.73E-09	7.79E-10	1.04E-09	1.37E-09	7.21E-09	0.00E+00	7.91E-09	0.00E+00
I-129	1.64E+02	1.01E+02	9.00E+01	6.59E+04	1.70E+02	0.00E+00	5.07E+00	0.00E+00
I-130	8.98E+00	1.81E+01	9.35E+00	2.00E+03	2.71E+01	0.00E+00	8.49E+00	0.00E+00
I-131	1.86E+02	1.88E+02	1.07E+02	6.20E+04	3.08E+02	0.00E+00	1.67E+01	0.00E+00
I-132	6.83E-03	1.25E-02	5.77E-03	5.82E-01	1.92E-02	0.00E+00	1.48E-02	0.00E+00
I-133	3.14E+01	3.89E+01	1.47E+01	7.22E+03	6.48E+01	0.00E+00	1.57E+01	0.00E+00
I-134	2.84E-08	5.28E-08	2.43E-08	1.21E-06	8.07E-08	0.00E+00	3.50E-08	0.00E+00
I-135	1.67E+00	3.00E+00	1.42E+00	2.66E+02	4.61E+00	0.00E+00	2.29E+00	0.00E+00
CS-134M	4.29E-01	6.35E-01	4.15E-01	0.00E+00	3.35E-01	5.54E-02	8.03E-01	0.00E+00
CS-134	3.68E+05	6.04E+05	1.27E+05	0.00E+00	1.87E+05	6.72E+04	3.26E+03	0.00E+00
CS-135	1.31E+05	9.11E+04	9.34E+03	0.00E+00	3.21E+04	1.07E+04	6.82E+02	0.00E+00
CS-136	3.51E+04	9.65E+04	6.25E+04	0.00E+00	5.14E+04	7.67E+03	3.39E+03	0.00E+00
CS-137	5.15E+05	4.93E+05	7.28E+04	0.00E+00	1.61E+05	5.78E+04	3.09E+03	0.00E+00
CS-138	1.24E-11	1.72E-11	1.09E-11	0.00E+00	1.21E-11	1.30E-12	7.93E-12	0.00E+00
CS-139	1.75E-44	1.95E-44	9.35E-45	0.00E+00	1.46E-44	1.47E-45	1.75E-48	0.00E+00
BA-139	7.93E-06	4.23E-09	2.30E-07	0.00E+00	3.69E-09	2.49E-09	4.58E-04	0.00E+00
BA-140	2.48E+02	2.17E-01	1.45E+01	0.00E+00	7.07E-02	1.30E-01	1.26E+02	0.00E+00
BA-141	1.18E-24	6.62E-28	3.85E-26	0.00E+00	5.73E-28	3.89E-27	6.74E-25	0.00E+00
BA-142	8.46E-42	6.09E-45	4.72E-43	0.00E+00	4.93E-45	3.58E-45	1.10E-43	0.00E+00
LA-140	1.32E-01	4.60E-02	1.55E-02	0.00E+00	0.00E+00	0.00E+00	1.28E+03	0.00E+00
LA-141	3.93E-04	9.16E-05	1.99E-05	0.00E+00	0.00E+00	0.00E+00	2.04E+01	0.00E+00
LA-142	2.95E-07	9.40E-08	2.94E-08	0.00E+00	0.00E+00	0.00E+00	1.86E-02	0.00E+00
CE-141	3.06E-02	1.53E-02	2.27E-03	0.00E+00	6.69E-03	0.00E+00	1.90E+01	0.00E+00
CE-143	3.33E-03	1.80E+00	2.61E-04	0.00E+00	7.57E-04	0.00E+00	2.64E+01	0.00E+00
CE-144	1.63E+00	5.12E-01	8.72E-02	0.00E+00	2.84E-01	0.00E+00	1.34E+02	0.00E+00
PR-143	7.35E-01	2.21E-01	3.65E-02	0.00E+00	1.20E-01	0.00E+00	7.93E+02	0.00E+00
PR-144	2.08E-28	6.45E-29	1.05E-29	0.00E+00	3.41E-29	0.00E+00	1.39E-25	0.00E+00
ND-147	5.16E-01	4.18E-01	3.24E-02	0.00E+00	2.29E-01	0.00E+00	6.62E+02	0.00E+00
PM-147	6.26E+00	4.47E-01	2.40E-01	0.00E+00	7.89E-01	0.00E+00	1.81E+02	0.00E+00
PM-148M	1.99E+00	3.97E-01	3.97E-01	0.00E+00	5.89E-01	0.00E+00	1.12E+03	0.00E+00
PM-148	5.23E-01	6.28E-02	4.07E-02	0.00E+00	1.07E-01	0.00E+00	1.68E+03	0.00E+00
PM-149	9.34E-02	9.93E-03	5.38E-03	0.00E+00	1.76E-02	0.00E+00	6.78E+02	0.00E+00
PM-151	3.20E-02	3.89E-03	2.53E-03	0.00E+00	6.60E-03	0.00E+00	4.42E+02	0.00E+00
SM-151	5.04E+00	7.50E-01	2.36E-01	0.00E+00	7.76E-01	0.00E+00	1.09E+02	0.00E+00
SM-153	5.03E-02	3.13E-02	3.02E-03	0.00E+00	9.53E-03	0.00E+00	4.16E+02	0.00E+00
EU-152	1.21E+01	2.21E+00	2.62E+00	0.00E+00	9.31E+00	0.00E+00	3.62E+02	0.00E+00

TABLE II1-16

CHILD FRESHWATER FISH A_{IT} FACTORS

mrem-ml per uCi-hr

NUCLIDE	BONE	LIVER	T BODY	THYROID	KIDNEY	LUNG	GI-LLI	SKIN
EU-154	4.53E+01	4.08E+00	3.72E+00	0.00E+00	1.79E+01	0.00E+00	9.47E+02	0.00E+00
EU-155	9.49E+00	6.83E-01	5.35E-01	0.00E+00	2.56E+00	0.00E+00	1.71E+03	0.00E+00
EU-156	1.06E+00	5.66E-01	1.17E-01	0.00E+00	3.65E-01	0.00E+00	1.28E+03	0.00E+00
TB-160	3.24E+00	0.00E+00	4.02E-01	0.00E+00	9.63E-01	0.00E+00	7.18E+02	0.00E+00
HO-166M	2.13E+01	4.45E+00	3.76E+00	0.00E+00	6.34E+00	0.00E+00	5.18E+02	0.00E+00
W-181	3.98E+01	9.77E+00	1.34E+00	0.00E+00	0.00E+00	0.00E+00	3.56E+02	0.00E+00
W-185	1.62E+03	4.05E+02	5.67E+01	0.00E+00	0.00E+00	0.00E+00	1.51E+04	0.00E+00
W-187	2.02E+02	1.19E+02	5.36E+01	0.00E+00	0.00E+00	0.00E+00	1.68E+04	0.00E+00
U-232	2.77E+04	0.00E+00	1.98E+03	0.00E+00	2.11E+03	0.00E+00	1.10E+02	0.00E+00
U-233	5.86E+03	0.00E+00	3.54E+02	0.00E+00	9.61E+02	0.00E+00	1.02E+02	0.00E+00
U-234	5.62E+03	0.00E+00	3.48E+02	0.00E+00	9.42E+02	0.00E+00	9.96E+01	0.00E+00
U-235	5.39E+03	0.00E+00	3.26E+02	0.00E+00	8.84E+02	0.00E+00	1.27E+02	0.00E+00
U-236	5.39E+03	0.00E+00	3.34E+02	0.00E+00	9.03E+02	0.00E+00	9.33E+01	0.00E+00
U-237	3.35E-01	0.00E+00	8.91E-02	0.00E+00	9.68E-01	0.00E+00	2.96E+01	0.00E+00
U-238	5.15E+03	0.00E+00	3.06E+02	0.00E+00	8.25E+02	0.00E+00	8.92E+01	0.00E+00
NP-237	1.76E+04	1.16E+03	7.71E+02	0.00E+00	4.77E+03	0.00E+00	6.43E+02	0.00E+00
NP-238	3.31E-01	6.70E-03	5.16E-03	0.00E+00	2.13E-02	0.00E+00	2.29E+02	0.00E+00
NP-239	3.08E-02	2.21E-03	1.56E-03	0.00E+00	6.40E-03	0.00E+00	1.64E+02	0.00E+00
PU-238	3.28E+03	3.80E+02	8.71E+01	0.00E+00	3.17E+02	0.00E+00	2.07E+02	0.00E+00
PU-239	3.56E+03	3.80E+02	9.13E+01	0.00E+00	3.36E+02	0.00E+00	1.89E+02	0.00E+00
PU-240	3.53E+03	3.94E+02	9.13E+01	0.00E+00	3.36E+02	0.00E+00	1.92E+02	0.00E+00
PU-241	1.07E+02	4.36E+00	2.22E+00	0.00E+00	8.16E+00	0.00E+00	3.97E+00	0.00E+00
PU-242	3.28E+03	3.80E+02	8.79E+01	0.00E+00	3.23E+02	0.00E+00	1.85E+02	0.00E+00
PU-244	3.83E+03	4.36E+03	1.01E+02	0.00E+00	3.72E+02	0.00E+00	2.76E+02	0.00E+00
AM-241	2.68E+04	2.30E+04	2.01E+03	0.00E+00	1.23E+04	0.00E+00	1.50E+03	0.00E+00
AM-242M	2.76E+04	2.21E+04	2.05E+03	0.00E+00	1.24E+04	0.00E+00	1.89E+03	0.00E+00
AM-243	2.64E+04	2.23E+04	1.94E+03	0.00E+00	1.19E+04	0.00E+00	1.76E+03	0.00E+00
CM-242	1.72E+03	1.37E+03	1.15E+02	0.00E+00	3.67E+02	0.00E+00	1.60E+03	0.00E+00
CM-243	2.52E+04	2.05E+04	1.62E+03	0.00E+00	6.06E+03	0.00E+00	1.58E+03	0.00E+00
CM-244	2.13E+04	1.72E+04	1.36E+03	0.00E+00	5.00E+03	0.00E+00	1.53E+03	0.00E+00
CM-245	3.29E+04	2.64E+04	2.07E+03	0.00E+00	8.09E+03	0.00E+00	1.43E+03	0.00E+00
CM-246	3.25E+04	2.64E+04	2.07E+03	0.00E+00	8.07E+03	0.00E+00	1.40E+03	0.00E+00
CM-247	3.17E+04	2.60E+04	2.03E+03	0.00E+00	7.96E+03	0.00E+00	1.84E+03	0.00E+00
CM-248	2.64E+05	2.15E+05	1.68E+04	0.00E+00	6.56E+04	0.00E+00	2.97E+04	0.00E+00
CF-252	2.07E+04	0.00E+00	5.00E+02	0.00E+00	0.00E+00	0.00E+00	5.82E+03	0.00E+00

TABLE II1-17

CHILD SHORELINE A_{IT} FACTORS

mrem-ml per uCi-hr

NUCLIDE	BONE	LIVER	T BODY	THYROID	KIDNEY	LUNG	GI-LLI	SKIN
H-3	0.00E+00	0.00E+00	0.00E+00	0.00E+00	0.00E+00	0.00E+00	0.00E+00	0.00E+00
C-14	0.00E+00	0.00E+00	0.00E+00	0.00E+00	0.00E+00	0.00E+00	0.00E+00	0.00E+00
NA-22	3.12E+03	3.12E+03	3.12E+03	3.12E+03	3.12E+03	3.12E+03	3.12E+03	3.51E+03
NA-24	3.21E+00	3.21E+00	3.21E+00	3.21E+00	3.21E+00	3.21E+00	3.21E+00	3.72E+00
P-32	0.00E+00	0.00E+00	0.00E+00	0.00E+00	0.00E+00	0.00E+00	0.00E+00	0.00E+00
CA-41	4.43E+03	4.43E+03	4.43E+03	4.43E+03	4.43E+03	4.43E+03	4.43E+03	5.21E+03
SC-46	2.24E+02	2.24E+02	2.24E+02	2.24E+02	2.24E+02	2.24E+02	2.24E+02	2.58E+02
CR-51	1.25E+00	1.25E+00	1.25E+00	1.25E+00	1.25E+00	1.25E+00	1.25E+00	1.48E+00
MN-54	3.73E+02	3.73E+02	3.73E+02	3.73E+02	3.73E+02	3.73E+02	3.73E+02	4.37E+02
MN-56	2.43E-01	2.43E-01	2.43E-01	2.43E-01	2.43E-01	2.43E-01	2.43E-01	2.87E-01
FE-55	0.00E+00	0.00E+00	0.00E+00	0.00E+00	0.00E+00	0.00E+00	0.00E+00	0.00E+00
FE-59	7.34E+01	7.34E+01	7.34E+01	7.34E+01	7.34E+01	7.34E+01	7.34E+01	8.62E+01
CO-57	5.07E+01	5.07E+01	5.07E+01	5.07E+01	5.07E+01	5.07E+01	5.07E+01	5.57E+01
CO-58	1.02E+02	1.02E+02	1.02E+02	1.02E+02	1.02E+02	1.02E+02	1.02E+02	1.19E+02
CO-60	6.47E+03	6.47E+03	6.47E+03	6.47E+03	6.47E+03	6.47E+03	6.47E+03	7.62E+03
NI-59	0.00E+00	0.00E+00	0.00E+00	0.00E+00	0.00E+00	0.00E+00	0.00E+00	0.00E+00
NI-63	0.00E+00	0.00E+00	0.00E+00	0.00E+00	0.00E+00	0.00E+00	0.00E+00	0.00E+00
NI-65	7.98E-02	7.98E-02	7.98E-02	7.98E-02	7.98E-02	7.98E-02	7.98E-02	9.28E-02
CU-64	1.63E-01	1.63E-01	1.63E-01	1.63E-01	1.63E-01	1.63E-01	1.63E-01	1.85E-01
ZN-65	2.01E+02	2.01E+02	2.01E+02	2.01E+02	2.01E+02	2.01E+02	2.01E+02	2.31E+02
ZN-69M	3.42E-01	3.42E-01	3.42E-01	3.42E-01	3.42E-01	3.42E-01	3.42E-01	4.00E-01
ZN-69	0.00E+00	0.00E+00	0.00E+00	0.00E+00	0.00E+00	0.00E+00	0.00E+00	0.00E+00
SE-79	0.00E+00	0.00E+00	0.00E+00	0.00E+00	0.00E+00	0.00E+00	0.00E+00	0.00E+00
BR-82	5.74E+00	5.74E+00	5.74E+00	5.74E+00	5.74E+00	5.74E+00	5.74E+00	6.65E+00
BR-83	1.31E-03	1.31E-03	1.31E-03	1.31E-03	1.31E-03	1.31E-03	1.31E-03	1.90E-03
BR-84	5.45E-02	5.45E-02	5.45E-02	5.45E-02	5.45E-02	5.45E-02	5.45E-02	6.35E-02
BR-85	0.00E+00	0.00E+00	0.00E+00	0.00E+00	0.00E+00	0.00E+00	0.00E+00	0.00E+00
RB-86	2.42E+00	2.42E+00	2.42E+00	2.42E+00	2.42E+00	2.42E+00	2.42E+00	2.76E+00
RB-87	0.00E+00	0.00E+00	0.00E+00	0.00E+00	0.00E+00	0.00E+00	0.00E+00	0.00E+00
RB-88	8.89E-03	8.89E-03	8.89E-03	8.89E-03	8.89E-03	8.89E-03	8.89E-03	1.02E-02
RB-89	3.30E-02	3.30E-02	3.30E-02	3.30E-02	3.30E-02	3.30E-02	3.30E-02	3.97E-02
SR-89	5.82E-03	5.82E-03	5.82E-03	5.82E-03	5.82E-03	5.82E-03	5.82E-03	6.75E-03
SR-90	0.00E+00	0.00E+00	0.00E+00	0.00E+00	0.00E+00	0.00E+00	0.00E+00	0.00E+00
SR-91	5.78E-01	5.78E-01	5.78E-01	5.78E-01	5.78E-01	5.78E-01	5.78E-01	6.75E-01
SR-92	2.09E-01	2.09E-01	2.09E-01	2.09E-01	2.09E-01	2.09E-01	2.09E-01	2.32E-01
Y-90	1.21E-03	1.21E-03	1.21E-03	1.21E-03	1.21E-03	1.21E-03	1.21E-03	1.43E-03
Y-91M	2.70E-02	2.70E-02	2.70E-02	2.70E-02	2.70E-02	2.70E-02	2.70E-02	3.12E-02

TABLE II1-17

CHILD SHORELINE A_{IT} FACTORS

mrem-ml per uCi-hr

NUCLIDE	BONE	LIVER	T BODY	THYROID	KIDNEY	LUNG	GI-LLI	SKIN
Y-91	2.89E-01	2.89E-01	2.89E-01	2.89E-01	2.89E-01	2.89E-01	2.89E-01	3.25E-01
Y-92	4.85E-02	4.85E-02	4.85E-02	4.85E-02	4.85E-02	4.85E-02	4.85E-02	5.76E-02
Y-93	4.93E-02	4.93E-02	4.93E-02	4.93E-02	4.93E-02	4.93E-02	4.93E-02	6.75E-02
ZR-93	0.00E+00	0.00E+00	0.00E+00	0.00E+00	0.00E+00	0.00E+00	0.00E+00	0.00E+00
ZR-95	6.58E+01	6.58E+01	6.58E+01	6.58E+01	6.58E+01	6.58E+01	6.58E+01	7.63E+01
ZR-97	7.96E-01	7.96E-01	7.96E-01	7.96E-01	7.96E-01	7.96E-01	7.96E-01	9.26E-01
NB-93M	6.24E-01	6.24E-01	6.24E-01	6.24E-01	6.24E-01	6.24E-01	6.24E-01	7.61E+01
NB-95	3.67E+01	3.67E+01	3.67E+01	3.67E+01	3.67E+01	3.67E+01	3.67E+01	4.32E+01
NB-97	4.73E-02	4.73E-02	4.73E-02	4.73E-02	4.73E-02	4.73E-02	4.73E-02	5.56E-02
MO-93	2.97E+01	2.97E+01	2.97E+01	2.97E+01	2.97E+01	2.97E+01	2.97E+01	1.21E+03
MO-99	1.07E+00	1.07E+00	1.07E+00	1.07E+00	1.07E+00	1.07E+00	1.07E+00	1.24E+00
TC-99M	4.95E-02	4.95E-02	4.95E-02	4.95E-02	4.95E-02	4.95E-02	4.95E-02	5.67E-02
TC-99	0.00E+00	0.00E+00	0.00E+00	0.00E+00	0.00E+00	0.00E+00	0.00E+00	0.00E+00
TC-101	5.47E-03	5.47E-03	5.47E-03	5.47E-03	5.47E-03	5.47E-03	5.47E-03	6.08E-03
RU-103	2.91E+01	2.91E+01	2.91E+01	2.91E+01	2.91E+01	2.91E+01	2.91E+01	3.40E+01
RU-105	1.71E-01	1.71E-01	1.71E-01	1.71E-01	1.71E-01	1.71E-01	1.71E-01	1.94E-01
RU-106	1.13E+02	1.13E+02	1.13E+02	1.13E+02	1.13E+02	1.13E+02	1.13E+02	1.36E+02
RH-105	2.00E-01	2.00E-01	2.00E-01	2.00E-01	2.00E-01	2.00E-01	2.00E-01	2.33E-01
PD-107	0.00E+00	0.00E+00	0.00E+00	0.00E+00	0.00E+00	0.00E+00	0.00E+00	0.00E+00
PD-109	4.03E-03	4.03E-03	4.03E-03	4.03E-03	4.03E-03	4.03E-03	4.03E-03	4.61E-03
AG-110M	9.24E+02	9.24E+02	9.24E+02	9.24E+02	9.24E+02	9.24E+02	9.24E+02	1.08E+03
AG-111	2.76E-01	2.76E-01	2.76E-01	2.76E-01	2.76E-01	2.76E-01	2.76E-01	3.22E-01
CD-113M	1.70E+00	1.70E+00	1.70E+00	1.70E+00	1.70E+00	1.70E+00	1.70E+00	1.92E+00
CD-115M	0.00E+00	0.00E+00	0.00E+00	0.00E+00	0.00E+00	0.00E+00	0.00E+00	0.00E+00
SN-123	0.00E+00	0.00E+00	0.00E+00	0.00E+00	0.00E+00	0.00E+00	0.00E+00	1.72E+03
SN-125	1.13E+00	1.13E+00	1.13E+00	1.13E+00	1.13E+00	1.13E+00	1.13E+00	1.31E+00
SN-126	1.17E+04	1.17E+04	1.17E+04	1.17E+04	1.17E+04	1.17E+04	1.17E+04	1.30E+04
SB-124	1.61E+02	1.61E+02	1.61E+02	1.61E+02	1.61E+02	1.61E+02	1.61E+02	1.86E+02
SB-125	6.43E+02	6.43E+02	6.43E+02	6.43E+02	6.43E+02	6.43E+02	6.43E+02	7.26E+02
SB-126	2.27E+01	2.27E+01	2.27E+01	2.27E+01	2.27E+01	2.27E+01	2.27E+01	2.55E+01
SB-127	4.51E+00	4.51E+00	4.51E+00	4.51E+00	4.51E+00	4.51E+00	4.51E+00	5.22E+00
TE-125M	4.17E-01	4.17E-01	4.17E-01	4.17E-01	4.17E-01	4.17E-01	4.17E-01	5.72E-01
TE-127M	2.46E-02	2.46E-02	2.46E-02	2.46E-02	2.46E-02	2.46E-02	2.46E-02	2.91E-02
TE-127	8.01E-04	8.01E-04	8.01E-04	8.01E-04	8.01E-04	8.01E-04	8.01E-04	8.81E-04
TE-129M	5.32E+00	5.32E+00	5.32E+00	5.32E+00	5.32E+00	5.32E+00	5.32E+00	6.21E+00
TE-129	7.05E-03	7.05E-03	7.05E-03	7.05E-03	7.05E-03	7.05E-03	7.05E-03	8.34E-03
TE-131M	2.16E+00	2.16E+00	2.16E+00	2.16E+00	2.16E+00	2.16E+00	2.16E+00	2.54E+00
TE-131	7.85E-03	7.85E-03	7.85E-03	7.85E-03	7.85E-03	7.85E-03	7.85E-03	9.28E+00

TABLE II1-17

CHILD SHORELINE A_{IT} FACTORS

mrem-ml per uCi-hr

NUCLIDE	BONE	LIVER	T BODY	THYROID	KIDNEY	LUNG	GI-LLI	SKIN
TE-132	1.14E+00	1.14E+00	1.14E+00	1.14E+00	1.14E+00	1.14E+00	1.14E+00	1.34E+00
TE-133M	1.19E-01	1.19E-01	1.19E-01	1.19E-01	1.19E-01	1.19E-01	1.19E-01	1.34E-01
TE-134	5.96E-03	5.96E-03	5.96E-03	5.96E-03	5.96E-03	5.96E-03	5.96E-03	7.16E-03
I-129	5.85E+02	5.85E+02	5.85E+02	5.85E+02	5.85E+02	5.85E+02	5.85E+02	9.75E+02
I-130	1.48E+00	1.48E+00	1.48E+00	1.48E+00	1.48E+00	1.48E+00	1.48E+00	1.80E+00
I-131	4.63E+00	4.63E+00	4.63E+00	4.63E+00	4.63E+00	4.63E+00	4.63E+00	5.62E+00
I-132	3.35E-01	3.35E-01	3.35E-01	3.35E-01	3.35E-01	3.35E-01	3.35E-01	3.94E-01
I-133	6.59E-01	6.59E-01	6.59E-01	6.59E-01	6.59E-01	6.59E-01	6.59E-01	8.01E-01
I-134	1.20E-01	1.20E-01	1.20E-01	1.20E-01	1.20E-01	1.20E-01	1.20E-01	1.43E-01
I-135	6.79E-01	6.79E-01	6.79E-01	6.79E-01	6.79E-01	6.79E-01	6.79E-01	7.92E-01
CS-134M	1.54E-02	1.54E-02	1.54E-02	1.54E-02	1.54E-02	1.54E-02	1.54E-02	1.81E-02
CS-134	1.86E+03	1.86E+03	1.86E+03	1.86E+03	1.86E+03	1.86E+03	1.86E+03	2.17E+03
CS-135	0.00E+00	0.00E+00	0.00E+00	0.00E+00	0.00E+00	0.00E+00	0.00E+00	0.00E+00
CS-136	4.06E+01	4.06E+01	4.06E+01	4.06E+01	4.06E+01	4.06E+01	4.06E+01	4.60E+01
CS-137	4.16E+03	4.16E+03	4.16E+03	4.16E+03	4.16E+03	4.16E+03	4.16E+03	4.85E+03
CS-138	9.65E-02	9.65E-02	9.65E-02	9.65E-02	9.65E-02	9.65E-02	9.65E-02	1.10E-01
CS-139	8.45E-03	8.45E-03	8.45E-03	8.45E-03	8.45E-03	8.45E-03	8.45E-03	9.66E-03
BA-139	2.85E-02	2.85E-02	2.85E-02	2.85E-02	2.85E-02	2.85E-02	2.85E-02	3.20E-02
BA-140	5.52E+00	5.52E+00	5.52E+00	5.52E+00	5.52E+00	5.52E+00	5.52E+00	6.31E+00
BA-141	1.12E-02	1.12E-02	1.12E-02	1.12E-02	1.12E-02	1.12E-02	1.12E-02	1.28E-02
BA-142	1.21E-02	1.21E-02	1.21E-02	1.21E-02	1.21E-02	1.21E-02	1.21E-02	1.37E-02
LA-140	5.17E+00	5.17E+00	5.17E+00	5.17E+00	5.17E+00	5.17E+00	5.17E+00	5.85E+00
LA-141	8.43E-03	8.43E-03	8.43E-03	8.43E-03	8.43E-03	8.43E-03	8.43E-03	9.45E-03
LA-142	2.04E-01	2.04E-01	2.04E-01	2.04E-01	2.04E-01	2.04E-01	2.04E-01	2.45E-01
CE-141	3.67E+00	3.67E+00	3.67E+00	3.67E+00	3.67E+00	3.67E+00	3.67E+00	4.14E+00
CE-143	6.22E-01	6.22E-01	6.22E-01	6.22E-01	6.22E-01	6.22E-01	6.22E-01	7.06E-01
CE-144	1.87E+01	1.87E+01	1.87E+01	1.87E+01	1.87E+01	1.87E+01	1.87E+01	2.16E+01
PR-143	0.00E+00	0.00E+00	0.00E+00	0.00E+00	0.00E+00	0.00E+00	0.00E+00	0.00E+00
PR-144	4.93E-04	4.93E-04	4.93E-04	4.93E-04	4.93E-04	4.93E-04	4.93E-04	5.67E-04
ND-147	2.26E+00	2.26E+00	2.26E+00	2.26E+00	2.26E+00	2.26E+00	2.26E+00	2.71E+00
PM-147	0.00E+00	0.00E+00	0.00E+00	0.00E+00	0.00E+00	0.00E+00	0.00E+00	0.00E+00
PM-148M	1.20E+02	1.20E+02	1.20E+02	1.20E+02	1.20E+02	1.20E+02	1.20E+02	6.93E+02
PM-148	5.08E+00	5.08E+00	5.08E+00	5.08E+00	5.08E+00	5.08E+00	5.08E+00	5.85E+00
PM-149	1.14E-02	1.14E-02	1.14E-02	1.14E-02	1.14E-02	1.14E-02	1.14E-02	1.32E-02
PM-151	5.35E-01	5.35E-01	5.35E-01	5.35E-01	5.35E-01	5.35E-01	5.35E-01	5.59E-01
SM-151	5.68E+01	5.68E+01	5.68E+01	5.68E+01	5.68E+01	5.68E+01	5.68E+01	2.48E+02
SM-153	1.08E-01	1.08E-01	1.08E-01	1.08E-01	1.08E-01	1.08E-01	1.08E-01	1.20E-01
EU-152	5.42E+03	5.42E+03	5.42E+03	5.42E+03	5.42E+03	5.42E+03	5.42E+03	6.27E+03

TABLE II1-17

CHILD SHORELINE A_{IT} FACTORS

mrem-ml per uCi-hr

NUCLIDE	BONE	LIVER	T BODY	THYROID	KIDNEY	LUNG	GI-LLI	SKIN
EU-154	4.43E+03	4.43E+03	4.43E+03	4.43E+03	4.43E+03	4.43E+03	4.43E+03	5.11E+03
EU-155	1.38E+02	1.38E+02	1.38E+02	1.38E+02	1.38E+02	1.38E+02	1.38E+02	1.56E+02
EU-156	2.37E+01	2.37E+01	2.37E+01	2.37E+01	2.37E+01	2.37E+01	2.37E+01	2.72E+01
TB-160	1.28E+02	1.28E+02	1.28E+02	1.28E+02	1.28E+02	1.28E+02	1.28E+02	1.49E+02
HO-166M	1.15E+04	1.15E+04	1.15E+04	1.15E+04	1.15E+04	1.15E+04	1.15E+04	1.29E+04
W-181	5.22E-02	5.22E-02	5.22E-02	5.22E-02	5.22E-02	5.22E-02	5.22E-02	6.96E-02
W-185	0.00E+00	0.00E+00	0.00E+00	0.00E+00	0.00E+00	0.00E+00	0.00E+00	0.00E+00
W-187	6.33E-01	6.33E-01	6.33E-01	6.33E-01	6.33E-01	6.33E-01	6.33E-01	7.35E-01
U-232	2.99E+00	2.99E+00	2.99E+00	2.99E+00	2.99E+00	2.99E+00	2.99E+00	3.11E+01
U-233	2.99E+03	2.99E+03	2.99E+03	2.99E+03	2.99E+03	2.99E+03	2.99E+03	3.64E+03
U-234	8.22E-01	8.22E-01	8.22E-01	8.22E-01	8.22E-01	8.22E-01	8.22E-01	2.07E+02
U-235	4.16E+03	4.16E+03	4.16E+03	4.16E+03	4.16E+03	4.16E+03	4.16E+03	5.20E+03
U-236	2.73E-02	2.73E-02	2.73E-02	2.73E-02	2.73E-02	2.73E-02	2.73E-02	2.34E+01
U-237	1.39E+00	1.39E+00	1.39E+00	1.39E+00	1.39E+00	1.39E+00	1.39E+00	1.80E+00
U-238	1.43E+02	1.43E+02	1.43E+02	1.43E+02	1.43E+02	1.43E+02	1.43E+02	1.95E+02
NP-237	1.82E+03	1.82E+03	1.82E+03	1.82E+03	1.82E+03	1.82E+03	1.82E+03	2.08E+03
NP-238	1.22E+00	1.22E+00	1.22E+00	1.22E+00	1.22E+00	1.22E+00	1.22E+00	1.39E+00
NP-239	4.60E-01	4.60E-01	4.60E-01	4.60E-01	4.60E-01	4.60E-01	4.60E-01	5.32E-01
PU-238	1.53E+00	1.53E+00	1.53E+00	1.53E+00	1.53E+00	1.53E+00	1.53E+00	2.12E+01
PU-239	1.03E+00	1.03E+00	1.03E+00	1.03E+00	1.03E+00	1.03E+00	1.03E+00	1.00E+01
PU-240	1.69E+00	1.69E+00	1.69E+00	1.69E+00	1.69E+00	1.69E+00	1.69E+00	2.34E+01
PU-241	3.48E+00	3.48E+00	3.48E+00	3.48E+00	3.48E+00	3.48E+00	3.48E+00	5.14E+00
PU-242	1.43E+00	1.43E+00	1.43E+00	1.43E+00	1.43E+00	1.43E+00	1.43E+00	2.08E+01
PU-244	1.16E+03	1.16E+03	1.16E+03	1.16E+03	1.16E+03	1.16E+03	1.16E+03	1.25E+03
AM-241	2.29E+02	2.29E+02	2.29E+02	2.29E+02	2.29E+02	2.29E+02	2.29E+02	3.31E+02
AM-242M	3.20E+01	3.20E+01	3.20E+01	3.20E+01	3.20E+01	3.20E+01	3.20E+01	2.21E+02
AM-243	1.69E+03	1.69E+03	1.69E+03	1.69E+03	1.69E+03	1.69E+03	1.69E+03	1.95E+03
CM-242	1.84E-01	1.84E-01	1.84E-01	1.84E-01	1.84E-01	1.84E-01	1.84E-01	7.71E-01
CM-243	2.24E+03	2.24E+03	2.24E+03	2.24E+03	2.24E+03	2.24E+03	2.24E+03	2.83E+03
CM-244	2.43E+00	2.43E+00	2.43E+00	2.43E+00	2.43E+00	2.43E+00	2.43E+00	1.51E+01
CM-245	1.23E+03	1.23E+03	1.23E+03	1.23E+03	1.23E+03	1.23E+03	1.23E+03	1.56E+03
CM-246	1.30E+00	1.30E+00	1.30E+00	1.30E+00	1.30E+00	1.30E+00	1.30E+00	1.95E+01
CM-247	2.86E+03	2.86E+03	2.86E+03	2.86E+03	2.86E+03	2.86E+03	2.86E+03	3.38E+03
CM-248	6.80E+03	6.80E+03	6.80E+03	6.80E+03	6.80E+03	6.80E+03	6.80E+03	8.86E+03
CF-252	1.31E+04	1.31E+04	1.31E+04	1.31E+04	1.31E+04	1.31E+04	1.31E+04	1.42E+04

TABLE II1-18

INFANT DRINKING WATER A₁₇ FACTORS

mrem-ml per uCi-hr

NUCLIDE	BONE	LIVER	T BODY	THYROID	KIDNEY	LUNG	GI-LLI	SKIN
H-3	0.00E+00	6.63E+00	6.63E+00	6.63E+00	6.63E+00	6.63E+00	6.63E+00	0.00E+00
C-14	8.93E+02	1.91E+02	1.91E+02	1.91E+02	1.91E+02	1.91E+02	1.91E+02	0.00E+00
NA-22	3.70E+03	3.70E+03	3.70E+03	3.70E+03	3.70E+03	3.70E+03	3.70E+03	0.00E+00
NA-24	2.19E+02	2.19E+02	2.19E+02	2.19E+02	2.19E+02	2.19E+02	2.19E+02	0.00E+00
P-32	6.25E+04	3.68E+03	2.42E+03	0.00E+00	0.00E+00	0.00E+00	8.46E+02	0.00E+00
CA-41	1.41E+04	0.00E+00	1.54E+03	0.00E+00	0.00E+00	0.00E+00	7.20E+00	0.00E+00
SC-46	1.41E+00	2.03E+00	6.34E-01	0.00E+00	1.34E+00	0.00E+00	1.32E+03	0.00E+00
CR-51	0.00E+00	0.00E+00	5.25E-01	3.42E-01	7.48E-02	6.66E-01	1.53E+01	0.00E+00
MN-54	0.00E+00	7.49E+02	1.70E+02	0.00E+00	1.66E+02	0.00E+00	2.75E+02	0.00E+00
MN-56	0.00E+00	1.22E+00	2.11E-01	0.00E+00	1.05E+00	0.00E+00	1.11E+02	0.00E+00
FE-55	5.23E+02	3.38E+02	9.04E+01	0.00E+00	0.00E+00	1.65E+02	4.29E+01	0.00E+00
FE-59	1.15E+03	2.01E+03	7.92E+02	0.00E+00	0.00E+00	5.94E+02	9.61E+02	0.00E+00
CO-57	0.00E+00	4.33E+01	7.04E+01	0.00E+00	0.00E+00	0.00E+00	1.47E+02	0.00E+00
CO-58	0.00E+00	1.35E+02	3.37E+02	0.00E+00	0.00E+00	0.00E+00	3.36E+02	0.00E+00
CO-60	0.00E+00	4.07E+02	9.60E+02	0.00E+00	0.00E+00	0.00E+00	9.68E+02	0.00E+00
NI-59	1.78E+03	5.46E+02	3.08E+02	0.00E+00	0.00E+00	0.00E+00	2.70E+01	0.00E+00
NI-63	2.39E+04	1.48E+03	8.29E+02	0.00E+00	0.00E+00	0.00E+00	7.35E+01	0.00E+00
NI-65	6.53E+00	7.39E-01	3.36E-01	0.00E+00	0.00E+00	0.00E+00	5.62E+01	0.00E+00
CU-64	0.00E+00	1.19E+01	5.52E+00	0.00E+00	2.02E+01	0.00E+00	2.45E+02	0.00E+00
ZN-65	6.92E+02	2.37E+03	1.09E+03	0.00E+00	1.15E+03	0.00E+00	2.01E+03	0.00E+00
ZN-69M	3.09E+01	6.30E+01	5.74E+00	0.00E+00	2.55E+01	0.00E+00	8.73E+02	0.00E+00
ZN-69	4.44E-04	8.00E-04	5.95E-05	0.00E+00	3.32E-04	0.00E+00	6.52E-02	0.00E+00
SE-79	0.00E+00	7.91E+02	1.47E+02	0.00E+00	9.15E+02	0.00E+00	2.10E+01	0.00E+00
BR-82	0.00E+00	0.00E+00	3.78E+02	0.00E+00	0.00E+00	0.00E+00	0.00E+00	0.00E+00
BR-83	0.00E+00	0.00E+00	4.21E-01	0.00E+00	0.00E+00	0.00E+00	0.00E+00	0.00E+00
BR-84	0.00E+00	0.00E+00	2.20E-06	0.00E+00	0.00E+00	0.00E+00	0.00E+00	0.00E+00
BR-85	0.00E+00	0.00E+00	1.80E-76	0.00E+00	0.00E+00	0.00E+00	0.00E+00	0.00E+00
RB-86	0.00E+00	6.29E+03	3.11E+03	0.00E+00	0.00E+00	0.00E+00	1.61E+02	0.00E+00
RB-87	0.00E+00	3.35E+03	1.33E+03	0.00E+00	0.00E+00	0.00E+00	2.25E+01	0.00E+00
RB-88	0.00E+00	1.25E-11	6.85E-12	0.00E+00	0.00E+00	0.00E+00	1.22E-11	0.00E+00
RB-89	0.00E+00	9.88E-14	6.80E-14	0.00E+00	0.00E+00	0.00E+00	3.36E-14	0.00E+00
SR-89	9.39E+04	0.00E+00	2.69E+03	0.00E+00	0.00E+00	0.00E+00	1.93E+03	0.00E+00
SR-90	1.07E+06	0.00E+00	2.16E+04	0.00E+00	0.00E+00	0.00E+00	8.70E+03	0.00E+00
SR-91	7.85E+02	0.00E+00	2.84E+01	0.00E+00	0.00E+00	0.00E+00	9.29E+02	0.00E+00
SR-92	3.36E+01	0.00E+00	1.25E+00	0.00E+00	0.00E+00	0.00E+00	3.62E+02	0.00E+00
Y-90	2.88E+00	0.00E+00	7.71E-02	0.00E+00	0.00E+00	0.00E+00	3.97E+03	0.00E+00
Y-91M	1.33E-06	0.00E+00	4.54E-08	0.00E+00	0.00E+00	0.00E+00	4.44E-03	0.00E+00

TABLE II1-18

INFANT DRINKING WATER A₁₇ FACTORS

mrem-ml per uCi-hr

NUCLIDE	BONE	LIVER	T BODY	THYROID	KIDNEY	LUNG	GI-LLI	SKIN
Y-91	4.23E+01	0.00E+00	1.13E+00	0.00E+00	0.00E+00	0.00E+00	3.03E+03	0.00E+00
Y-92	2.75E-02	0.00E+00	7.73E-04	0.00E+00	0.00E+00	0.00E+00	5.25E+02	0.00E+00
Y-93	4.02E-01	0.00E+00	1.09E-02	0.00E+00	0.00E+00	0.00E+00	3.17E+03	0.00E+00
ZR-93	7.27E+00	3.46E-01	2.09E-01	0.00E+00	1.02E+00	0.00E+00	9.00E+01	0.00E+00
ZR-95	7.72E+00	1.88E+00	1.33E+00	0.00E+00	2.03E+00	0.00E+00	9.37E+02	0.00E+00
ZR-97	3.41E-01	5.85E-02	2.67E-02	0.00E+00	5.90E-02	0.00E+00	3.73E+03	0.00E+00
NB-93M	4.63E+00	1.25E+00	3.92E-01	0.00E+00	1.22E+00	0.00E+00	1.50E+02	0.00E+00
NB-95	1.57E+00	6.45E-01	3.73E-01	0.00E+00	4.63E-01	0.00E+00	5.45E+02	0.00E+00
NB-97	1.70E-05	3.64E-06	1.31E-06	0.00E+00	2.84E-06	0.00E+00	1.15E+00	0.00E+00
MO-93	0.00E+00	2.13E+03	6.86E+01	0.00E+00	4.26E+02	0.00E+00	4.56E+01	0.00E+00
MO-99	0.00E+00	1.13E+03	2.20E+02	0.00E+00	1.69E+03	0.00E+00	3.72E+02	0.00E+00
TC-99M	1.82E-02	3.75E-02	4.83E-01	0.00E+00	4.03E-01	1.96E-02	1.09E+01	0.00E+00
TC-99	4.07E+01	5.50E+01	1.71E+01	0.00E+00	4.63E+02	5.35E+00	2.38E+02	0.00E+00
TC-101	4.66E-17	5.87E-17	5.81E-16	0.00E+00	6.98E-16	3.20E-17	9.98E-15	0.00E+00
RU-103	5.53E+01	0.00E+00	1.85E+01	0.00E+00	1.15E+02	0.00E+00	6.72E+02	0.00E+00
RU-105	7.87E-01	0.00E+00	2.65E-01	0.00E+00	5.79E+00	0.00E+00	3.13E+02	0.00E+00
RU-106	9.07E+02	0.00E+00	1.13E+02	0.00E+00	1.07E+03	0.00E+00	6.89E+03	0.00E+00
RH-105	3.25E+01	2.12E+01	1.43E+01	0.00E+00	5.90E+01	0.00E+00	5.27E+02	0.00E+00
PD-107	0.00E+00	4.48E+01	3.18E+00	0.00E+00	2.56E+02	0.00E+00	3.56E+01	0.00E+00
PD-109	0.00E+00	3.04E+01	7.35E+00	0.00E+00	1.12E+02	0.00E+00	7.47E+02	0.00E+00
AG-110M	3.75E+01	2.73E+01	1.81E+01	0.00E+00	3.91E+01	0.00E+00	1.42E+03	0.00E+00
AG-111	1.87E+01	7.26E+00	3.85E+00	0.00E+00	1.52E+01	0.00E+00	1.73E+03	0.00E+00
CD-113M	0.00E+00	6.67E+02	2.46E+01	0.00E+00	5.05E+02	0.00E+00	1.00E+03	0.00E+00
CD-115M	0.00E+00	5.31E+02	1.84E+01	0.00E+00	2.77E+02	0.00E+00	3.02E+03	0.00E+00
SN-123	9.36E+03	1.46E+02	2.44E+02	1.47E+02	0.00E+00	0.00E+00	2.47E+03	0.00E+00
SN-125	2.69E+03	5.02E+01	1.20E+02	4.94E+01	0.00E+00	0.00E+00	4.03E+03	0.00E+00
SN-126	2.08E+04	2.73E+02	6.78E+02	7.20E+01	0.00E+00	0.00E+00	9.49E+02	0.00E+00
SB-124	8.02E+02	1.18E+01	2.48E+02	2.13E+00	0.00E+00	5.02E+02	2.47E+03	0.00E+00
SB-125	4.63E+02	4.48E+00	9.53E+01	5.80E-01	0.00E+00	2.68E+02	6.18E+02	0.00E+00
SB-126	2.95E+02	5.79E+00	1.07E+02	2.27E+00	0.00E+00	1.86E+02	3.06E+03	0.00E+00
SB-127	7.68E+01	1.37E+00	2.38E+01	9.78E-01	0.00E+00	3.96E+01	2.03E+03	0.00E+00
TE-125M	8.73E+02	2.92E+02	1.18E+02	2.94E+02	0.00E+00	0.00E+00	4.16E+02	0.00E+00
TE-127M	2.20E+03	7.29E+02	2.66E+02	6.35E+02	5.41E+03	0.00E+00	8.86E+02	0.00E+00
TE-127	1.55E+01	5.18E+00	3.33E+00	1.26E+01	3.78E+01	0.00E+00	3.25E+02	0.00E+00
TE-129M	3.73E+03	1.28E+03	5.74E+02	1.43E+03	9.32E+03	0.00E+00	2.23E+03	0.00E+00
TE-129	8.23E-03	2.84E-03	1.92E-03	6.89E-03	2.05E-02	0.00E+00	6.58E-01	0.00E+00
TE-131M	4.34E+02	1.75E+02	1.44E+02	3.54E+02	1.20E+03	0.00E+00	2.94E+03	0.00E+00
TE-131	1.42E-08	5.24E-09	3.98E-09	1.27E-08	3.63E-08	0.00E+00	5.73E-07	0.00E+00

Rev. 31

Page 180 of 330

05/2018

TABLE II1-18

INFANT DRINKING WATER A₁₇ FACTORS

mrem-ml per uCi-hr

NUCLIDE	BONE	LIVER	T BODY	THYROID	KIDNEY	LUNG	GI-LLI	SKIN
TE-132	7.04E+02	3.49E+02	3.25E+02	5.15E+02	2.18E+03	0.00E+00	1.29E+03	0.00E+00
TE-133M	1.80E-03	8.25E-04	7.88E-04	1.59E-03	5.62E-03	0.00E+00	8.90E-02	0.00E+00
TE-134	6.57E-05	3.30E-05	3.39E-05	5.88E-05	2.22E-04	0.00E+00	7.53E-04	0.00E+00
I-129	1.08E+03	7.99E+02	5.84E+02	5.12E+05	9.46E+02	0.00E+00	1.60E+01	0.00E+00
I-130	1.15E+02	2.54E+02	1.02E+02	2.84E+04	2.79E+02	0.00E+00	5.44E+01	0.00E+00
I-131	1.30E+03	1.53E+03	6.71E+02	5.02E+05	1.78E+03	0.00E+00	5.45E+01	0.00E+00
I-132	1.68E+00	3.41E+00	1.22E+00	1.60E+02	3.81E+00	0.00E+00	2.76E+00	0.00E+00
I-133	3.16E+02	4.60E+02	1.35E+02	8.36E+04	5.40E+02	0.00E+00	7.78E+01	0.00E+00
I-134	2.48E-03	5.08E-03	1.81E-03	1.18E-01	5.68E-03	0.00E+00	5.25E-03	0.00E+00
I-135	3.90E+01	7.75E+01	2.83E+01	6.95E+03	8.64E+01	0.00E+00	2.80E+01	0.00E+00
CS-134M	3.77E-01	6.27E-01	3.17E-01	0.00E+00	2.42E-01	5.56E-02	4.96E-01	0.00E+00
CS-134	1.42E+04	2.65E+04	2.67E+03	0.00E+00	6.82E+03	2.79E+03	7.19E+01	0.00E+00
CS-135	5.01E+03	4.56E+03	2.37E+02	0.00E+00	1.30E+03	4.93E+02	1.65E+01	0.00E+00
CS-136	1.68E+03	4.95E+03	1.85E+03	0.00E+00	1.97E+03	4.04E+02	7.52E+01	0.00E+00
CS-137	1.97E+04	2.30E+04	1.63E+03	0.00E+00	6.18E+03	2.50E+03	7.19E+01	0.00E+00
CS-138	3.37E-06	5.47E-06	2.65E-06	0.00E+00	2.73E-06	4.26E-07	8.75E-06	0.00E+00
CS-139	1.02E-22	1.40E-22	5.34E-23	0.00E+00	7.22E-23	1.09E-23	8.78E-24	0.00E+00
BA-139	8.18E-02	5.42E-05	2.37E-03	0.00E+00	3.26E-05	3.29E-05	5.18E+00	0.00E+00
BA-140	6.27E+03	6.27E+00	3.23E+02	0.00E+00	1.49E+00	3.85E+00	1.54E+03	0.00E+00
BA-141	2.19E-11	1.50E-14	6.92E-13	0.00E+00	9.03E-15	9.14E-15	2.68E-10	0.00E+00
BA-142	3.84E-20	3.20E-23	1.89E-21	0.00E+00	1.84E-23	1.93E-23	1.58E-19	0.00E+00
LA-140	6.46E-01	2.55E-01	6.56E-02	0.00E+00	0.00E+00	0.00E+00	2.99E+03	0.00E+00
LA-141	1.32E-02	3.82E-03	6.66E-04	0.00E+00	0.00E+00	0.00E+00	4.38E+02	0.00E+00
LA-142	2.22E-04	8.14E-05	1.95E-05	0.00E+00	0.00E+00	0.00E+00	1.38E+01	0.00E+00
CE-141	2.93E+00	1.79E+00	2.11E-01	0.00E+00	5.52E-01	0.00E+00	9.24E+02	0.00E+00
CE-143	4.33E-01	2.88E+02	3.28E-02	0.00E+00	8.37E-02	0.00E+00	1.68E+03	0.00E+00
CE-144	1.12E+02	4.59E+01	6.28E+00	0.00E+00	1.85E+01	0.00E+00	6.43E+03	0.00E+00
PR-143	2.99E+00	1.12E+00	1.48E-01	0.00E+00	4.15E-01	0.00E+00	1.58E+03	0.00E+00
PR-144	2.96E-15	1.14E-15	1.49E-16	0.00E+00	4.14E-16	0.00E+00	5.32E-11	0.00E+00
ND-147	2.02E+00	2.07E+00	1.27E-01	0.00E+00	7.99E-01	0.00E+00	1.31E+03	0.00E+00
PM-147	1.46E+01	1.23E+00	5.99E-01	0.00E+00	1.84E+00	0.00E+00	3.49E+02	0.00E+00
PM-148M	6.16E+00	1.56E+00	1.23E+00	0.00E+00	1.79E+00	0.00E+00	2.03E+03	0.00E+00
PM-148	2.23E+00	3.22E-01	1.62E-01	0.00E+00	3.85E-01	0.00E+00	3.44E+03	0.00E+00
PM-149	4.44E-01	5.83E-02	2.54E-02	0.00E+00	7.09E-02	0.00E+00	1.57E+03	0.00E+00
PM-151	1.74E-01	2.53E-02	1.28E-02	0.00E+00	3.01E-02	0.00E+00	1.17E+03	0.00E+00
SM-151	1.09E+01	2.51E+00	5.42E-01	0.00E+00	1.71E+00	0.00E+00	2.10E+02	0.00E+00
SM-153	2.43E-01	1.88E-01	1.44E-02	0.00E+00	3.94E-02	0.00E+00	9.84E+02	0.00E+00
EU-152	2.54E+01	6.74E+00	5.69E+00	0.00E+00	1.89E+01	0.00E+00	5.99E+02	0.00E+00

TABLE II1-18

INFANT DRINKING WATER A₁₇ FACTORS

mrem-ml per uCi-hr

NUCLIDE	BONE	LIVER	T BODY	THYROID	KIDNEY	LUNG	GI-LLI	SKIN
EU-154	9.94E+01	1.38E+01	8.29E+00	0.00E+00	3.75E+01	0.00E+00	1.73E+03	0.00E+00
EU-155	2.04E+01	2.35E+00	1.22E+00	0.00E+00	5.27E+00	0.00E+00	3.15E+03	0.00E+00
EU-156	4.20E+00	2.60E+00	4.12E-01	0.00E+00	1.20E+00	0.00E+00	2.46E+03	0.00E+00
TB-160	9.71E+00	0.00E+00	1.21E+00	0.00E+00	2.76E+00	0.00E+00	1.29E+03	0.00E+00
HO-166M	4.71E+01	1.01E+01	8.02E+00	0.00E+00	1.34E+01	0.00E+00	1.00E+03	0.00E+00
W-181	3.32E+00	1.02E+00	1.14E-01	0.00E+00	0.00E+00	0.00E+00	1.43E+01	0.00E+00
W-185	1.36E+02	4.24E+01	4.84E+00	0.00E+00	0.00E+00	0.00E+00	6.07E+02	0.00E+00
W-187	2.40E+01	1.67E+01	5.77E+00	0.00E+00	0.00E+00	0.00E+00	9.81E+02	0.00E+00
U-232	9.12E+05	0.00E+00	8.14E+04	0.00E+00	8.93E+04	0.00E+00	2.65E+03	0.00E+00
U-233	1.91E+05	0.00E+00	1.46E+04	0.00E+00	4.07E+04	0.00E+00	2.45E+03	0.00E+00
U-234	1.84E+05	0.00E+00	1.43E+04	0.00E+00	3.99E+04	0.00E+00	2.40E+03	0.00E+00
U-235	1.76E+05	0.00E+00	1.34E+04	0.00E+00	3.74E+04	0.00E+00	3.05E+03	0.00E+00
U-236	1.76E+05	0.00E+00	1.37E+04	0.00E+00	3.80E+04	0.00E+00	2.25E+03	0.00E+00
U-237	1.77E+01	0.00E+00	4.72E+00	0.00E+00	4.40E+01	0.00E+00	7.55E+02	0.00E+00
U-238	1.68E+05	0.00E+00	1.25E+04	0.00E+00	3.50E+04	0.00E+00	2.15E+03	0.00E+00
NP-237	9.04E+04	5.99E+03	3.96E+03	0.00E+00	2.39E+04	0.00E+00	3.10E+03	0.00E+00
NP-238	3.97E+00	9.98E-02	6.14E-02	0.00E+00	2.18E-01	0.00E+00	1.33E+03	0.00E+00
NP-239	3.61E-01	3.23E-02	1.82E-02	0.00E+00	6.44E-02	0.00E+00	9.33E+02	0.00E+00
PU-238	4.82E+04	5.65E+03	1.28E+03	0.00E+00	4.56E+03	0.00E+00	2.85E+03	0.00E+00
PU-239	5.20E+04	5.84E+03	1.33E+03	0.00E+00	4.82E+03	0.00E+00	2.60E+03	0.00E+00
PU-240	5.20E+04	5.84E+03	1.33E+03	0.00E+00	4.82E+03	0.00E+00	2.65E+03	0.00E+00
PU-241	1.60E+03	6.63E+01	3.32E+01	0.00E+00	1.19E+02	0.00E+00	5.46E+01	0.00E+00
PU-242	4.82E+04	5.61E+03	1.28E+03	0.00E+00	4.63E+03	0.00E+00	2.55E+03	0.00E+00
PU-244	5.61E+04	6.44E+03	1.47E+03	0.00E+00	5.31E+03	0.00E+00	3.80E+03	0.00E+00
AM-241	5.50E+04	4.78E+04	4.11E+03	0.00E+00	2.47E+04	0.00E+00	2.90E+03	0.00E+00
AM-242M	5.69E+04	4.60E+04	4.26E+03	0.00E+00	2.50E+04	0.00E+00	3.65E+03	0.00E+00
AM-243	5.42E+04	4.63E+04	3.99E+03	0.00E+00	2.40E+04	0.00E+00	3.40E+03	0.00E+00
CM-242	5.15E+03	4.77E+03	3.42E+02	0.00E+00	9.85E+02	0.00E+00	3.09E+03	0.00E+00
CM-243	5.27E+04	4.33E+04	3.38E+03	0.00E+00	1.23E+04	0.00E+00	3.05E+03	0.00E+00
CM-244	4.44E+04	3.65E+04	2.86E+03	0.00E+00	1.02E+04	0.00E+00	2.95E+03	0.00E+00
CM-245	6.74E+04	5.46E+04	4.26E+03	0.00E+00	1.63E+04	0.00E+00	2.75E+03	0.00E+00
CM-246	6.67E+04	5.46E+04	4.26E+03	0.00E+00	1.62E+04	0.00E+00	2.70E+03	0.00E+00
CM-247	6.52E+04	5.39E+04	4.18E+03	0.00E+00	1.60E+04	0.00E+00	3.55E+03	0.00E+00
CM-248	5.39E+05	4.45E+05	3.45E+04	0.00E+00	1.32E+05	0.00E+00	5.73E+04	0.00E+00
CF-252	4.59E+04	0.00E+00	1.11E+03	0.00E+00	0.00E+00	0.00E+00	1.13E+04	0.00E+00

TABLE II-19

INFANT FRESHWATER FISH A_{IT} FACTORS

mrem-ml per uCi-hr

NUCLIDE	BONE	LIVER	T BODY	THYROID	KIDNEY	LUNG	GI-LLI	SKIN
H-3	0.00E+00	0.00E+00	0.00E+00	0.00E+00	0.00E+00	0.00E+00	0.00E+00	0.00E+00
C-14	0.00E+00	0.00E+00	0.00E+00	0.00E+00	0.00E+00	0.00E+00	0.00E+00	0.00E+00
NA-22	0.00E+00	0.00E+00	0.00E+00	0.00E+00	0.00E+00	0.00E+00	0.00E+00	0.00E+00
NA-24	0.00E+00	0.00E+00	0.00E+00	0.00E+00	0.00E+00	0.00E+00	0.00E+00	0.00E+00
P-32	0.00E+00	0.00E+00	0.00E+00	0.00E+00	0.00E+00	0.00E+00	0.00E+00	0.00E+00
CA-41	0.00E+00	0.00E+00	0.00E+00	0.00E+00	0.00E+00	0.00E+00	0.00E+00	0.00E+00
SC-46	0.00E+00	0.00E+00	0.00E+00	0.00E+00	0.00E+00	0.00E+00	0.00E+00	0.00E+00
CR-51	0.00E+00	0.00E+00	0.00E+00	0.00E+00	0.00E+00	0.00E+00	0.00E+00	0.00E+00
MN-54	0.00E+00	0.00E+00	0.00E+00	0.00E+00	0.00E+00	0.00E+00	0.00E+00	0.00E+00
MN-56	0.00E+00	0.00E+00	0.00E+00	0.00E+00	0.00E+00	0.00E+00	0.00E+00	0.00E+00
FE-55	0.00E+00	0.00E+00	0.00E+00	0.00E+00	0.00E+00	0.00E+00	0.00E+00	0.00E+00
FE-59	0.00E+00	0.00E+00	0.00E+00	0.00E+00	0.00E+00	0.00E+00	0.00E+00	0.00E+00
CO-57	0.00E+00	0.00E+00	0.00E+00	0.00E+00	0.00E+00	0.00E+00	0.00E+00	0.00E+00
CO-58	0.00E+00	0.00E+00	0.00E+00	0.00E+00	0.00E+00	0.00E+00	0.00E+00	0.00E+00
CO-60	0.00E+00	0.00E+00	0.00E+00	0.00E+00	0.00E+00	0.00E+00	0.00E+00	0.00E+00
NI-59	0.00E+00	0.00E+00	0.00E+00	0.00E+00	0.00E+00	0.00E+00	0.00E+00	0.00E+00
NI-63	0.00E+00	0.00E+00	0.00E+00	0.00E+00	0.00E+00	0.00E+00	0.00E+00	0.00E+00
NI-65	0.00E+00	0.00E+00	0.00E+00	0.00E+00	0.00E+00	0.00E+00	0.00E+00	0.00E+00
CU-64	0.00E+00	0.00E+00	0.00E+00	0.00E+00	0.00E+00	0.00E+00	0.00E+00	0.00E+00
ZN-65	0.00E+00	0.00E+00	0.00E+00	0.00E+00	0.00E+00	0.00E+00	0.00E+00	0.00E+00
ZN-69M	0.00E+00	0.00E+00	0.00E+00	0.00E+00	0.00E+00	0.00E+00	0.00E+00	0.00E+00
ZN-69	0.00E+00	0.00E+00	0.00E+00	0.00E+00	0.00E+00	0.00E+00	0.00E+00	0.00E+00
SE-79	0.00E+00	0.00E+00	0.00E+00	0.00E+00	0.00E+00	0.00E+00	0.00E+00	0.00E+00
BR-82	0.00E+00	0.00E+00	0.00E+00	0.00E+00	0.00E+00	0.00E+00	0.00E+00	0.00E+00
BR-83	0.00E+00	0.00E+00	0.00E+00	0.00E+00	0.00E+00	0.00E+00	0.00E+00	0.00E+00
BR-84	0.00E+00	0.00E+00	0.00E+00	0.00E+00	0.00E+00	0.00E+00	0.00E+00	0.00E+00
BR-85	0.00E+00	0.00E+00	0.00E+00	0.00E+00	0.00E+00	0.00E+00	0.00E+00	0.00E+00
RB-86	0.00E+00	0.00E+00	0.00E+00	0.00E+00	0.00E+00	0.00E+00	0.00E+00	0.00E+00
RB-87	0.00E+00	0.00E+00	0.00E+00	0.00E+00	0.00E+00	0.00E+00	0.00E+00	0.00E+00
RB-88	0.00E+00	0.00E+00	0.00E+00	0.00E+00	0.00E+00	0.00E+00	0.00E+00	0.00E+00
RB-89	0.00E+00	0.00E+00	0.00E+00	0.00E+00	0.00E+00	0.00E+00	0.00E+00	0.00E+00
SR-89	0.00E+00	0.00E+00	0.00E+00	0.00E+00	0.00E+00	0.00E+00	0.00E+00	0.00E+00
SR-90	0.00E+00	0.00E+00	0.00E+00	0.00E+00	0.00E+00	0.00E+00	0.00E+00	0.00E+00
SR-91	0.00E+00	0.00E+00	0.00E+00	0.00E+00	0.00E+00	0.00E+00	0.00E+00	0.00E+00
SR-92	0.00E+00	0.00E+00	0.00E+00	0.00E+00	0.00E+00	0.00E+00	0.00E+00	0.00E+00
Y-90	0.00E+00	0.00E+00	0.00E+00	0.00E+00	0.00E+00	0.00E+00	0.00E+00	0.00E+00
Y-91M	0.00E+00	0.00E+00	0.00E+00	0.00E+00	0.00E+00	0.00E+00	0.00E+00	0.00E+00

TABLE II-19

INFANT FRESHWATER FISH A_{17} FACTORS

mrem-ml per uCi-hr

NUCLIDE	BONE	LIVER	T BODY	THYROID	KIDNEY	LUNG	GI-LLI	SKIN
Y-91	0.00E+00	0.00E+00	0.00E+00	0.00E+00	0.00E+00	0.00E+00	0.00E+00	0.00E+00
Y-92	0.00E+00	0.00E+00	0.00E+00	0.00E+00	0.00E+00	0.00E+00	0.00E+00	0.00E+00
Y-93	0.00E+00	0.00E+00	0.00E+00	0.00E+00	0.00E+00	0.00E+00	0.00E+00	0.00E+00
ZR-93	0.00E+00	0.00E+00	0.00E+00	0.00E+00	0.00E+00	0.00E+00	0.00E+00	0.00E+00
ZR-95	0.00E+00	0.00E+00	0.00E+00	0.00E+00	0.00E+00	0.00E+00	0.00E+00	0.00E+00
ZR-97	0.00E+00	0.00E+00	0.00E+00	0.00E+00	0.00E+00	0.00E+00	0.00E+00	0.00E+00
NB-93M	0.00E+00	0.00E+00	0.00E+00	0.00E+00	0.00E+00	0.00E+00	0.00E+00	0.00E+00
NB-95	0.00E+00	0.00E+00	0.00E+00	0.00E+00	0.00E+00	0.00E+00	0.00E+00	0.00E+00
NB-97	0.00E+00	0.00E+00	0.00E+00	0.00E+00	0.00E+00	0.00E+00	0.00E+00	0.00E+00
MO-93	0.00E+00	0.00E+00	0.00E+00	0.00E+00	0.00E+00	0.00E+00	0.00E+00	0.00E+00
MO-99	0.00E+00	0.00E+00	0.00E+00	0.00E+00	0.00E+00	0.00E+00	0.00E+00	0.00E+00
TC-99M	0.00E+00	0.00E+00	0.00E+00	0.00E+00	0.00E+00	0.00E+00	0.00E+00	0.00E+00
TC-99	0.00E+00	0.00E+00	0.00E+00	0.00E+00	0.00E+00	0.00E+00	0.00E+00	0.00E+00
TC-101	0.00E+00	0.00E+00	0.00E+00	0.00E+00	0.00E+00	0.00E+00	0.00E+00	0.00E+00
RU-103	0.00E+00	0.00E+00	0.00E+00	0.00E+00	0.00E+00	0.00E+00	0.00E+00	0.00E+00
RU-105	0.00E+00	0.00E+00	0.00E+00	0.00E+00	0.00E+00	0.00E+00	0.00E+00	0.00E+00
RU-106	0.00E+00	0.00E+00	0.00E+00	0.00E+00	0.00E+00	0.00E+00	0.00E+00	0.00E+00
RH-105	0.00E+00	0.00E+00	0.00E+00	0.00E+00	0.00E+00	0.00E+00	0.00E+00	0.00E+00
PD-107	0.00E+00	0.00E+00	0.00E+00	0.00E+00	0.00E+00	0.00E+00	0.00E+00	0.00E+00
PD-109	0.00E+00	0.00E+00	0.00E+00	0.00E+00	0.00E+00	0.00E+00	0.00E+00	0.00E+00
AG-110M	0.00E+00	0.00E+00	0.00E+00	0.00E+00	0.00E+00	0.00E+00	0.00E+00	0.00E+00
AG-111	0.00E+00	0.00E+00	0.00E+00	0.00E+00	0.00E+00	0.00E+00	0.00E+00	0.00E+00
CD-113M	0.00E+00	0.00E+00	0.00E+00	0.00E+00	0.00E+00	0.00E+00	0.00E+00	0.00E+00
CD-115M	0.00E+00	0.00E+00	0.00E+00	0.00E+00	0.00E+00	0.00E+00	0.00E+00	0.00E+00
SN-123	0.00E+00	0.00E+00	0.00E+00	0.00E+00	0.00E+00	0.00E+00	0.00E+00	0.00E+00
SN-125	0.00E+00	0.00E+00	0.00E+00	0.00E+00	0.00E+00	0.00E+00	0.00E+00	0.00E+00
SN-126	0.00E+00	0.00E+00	0.00E+00	0.00E+00	0.00E+00	0.00E+00	0.00E+00	0.00E+00
SB-124	0.00E+00	0.00E+00	0.00E+00	0.00E+00	0.00E+00	0.00E+00	0.00E+00	0.00E+00
SB-125	0.00E+00	0.00E+00	0.00E+00	0.00E+00	0.00E+00	0.00E+00	0.00E+00	0.00E+00
SB-126	0.00E+00	0.00E+00	0.00E+00	0.00E+00	0.00E+00	0.00E+00	0.00E+00	0.00E+00
SB-127	0.00E+00	0.00E+00	0.00E+00	0.00E+00	0.00E+00	0.00E+00	0.00E+00	0.00E+00
TE-125M	0.00E+00	0.00E+00	0.00E+00	0.00E+00	0.00E+00	0.00E+00	0.00E+00	0.00E+00
TE-127M	0.00E+00	0.00E+00	0.00E+00	0.00E+00	0.00E+00	0.00E+00	0.00E+00	0.00E+00
TE-127	0.00E+00	0.00E+00	0.00E+00	0.00E+00	0.00E+00	0.00E+00	0.00E+00	0.00E+00
TE-129M	0.00E+00	0.00E+00	0.00E+00	0.00E+00	0.00E+00	0.00E+00	0.00E+00	0.00E+00
TE-129	0.00E+00	0.00E+00	0.00E+00	0.00E+00	0.00E+00	0.00E+00	0.00E+00	0.00E+00
TE-131M	0.00E+00	0.00E+00	0.00E+00	0.00E+00	0.00E+00	0.00E+00	0.00E+00	0.00E+00
TE-131	0.00E+00	0.00E+00	0.00E+00	0.00E+00	0.00E+00	0.00E+00	0.00E+00	0.00E+00

TABLE II1-19

INFANT FRESHWATER FISH A_{17} FACTORS

mrem-ml per uCi-hr

NUCLIDE	BONE	LIVER	T BODY	THYROID	KIDNEY	LUNG	GI-LLI	SKIN
TE-132	0.00E+00	0.00E+00	0.00E+00	0.00E+00	0.00E+00	0.00E+00	0.00E+00	0.00E+00
TE-133M	0.00E+00	0.00E+00	0.00E+00	0.00E+00	0.00E+00	0.00E+00	0.00E+00	0.00E+00
TE-134	0.00E+00	0.00E+00	0.00E+00	0.00E+00	0.00E+00	0.00E+00	0.00E+00	0.00E+00
I-129	0.00E+00	0.00E+00	0.00E+00	0.00E+00	0.00E+00	0.00E+00	0.00E+00	0.00E+00
I-130	0.00E+00	0.00E+00	0.00E+00	0.00E+00	0.00E+00	0.00E+00	0.00E+00	0.00E+00
I-131	0.00E+00	0.00E+00	0.00E+00	0.00E+00	0.00E+00	0.00E+00	0.00E+00	0.00E+00
I-132	0.00E+00	0.00E+00	0.00E+00	0.00E+00	0.00E+00	0.00E+00	0.00E+00	0.00E+00
I-133	0.00E+00	0.00E+00	0.00E+00	0.00E+00	0.00E+00	0.00E+00	0.00E+00	0.00E+00
I-134	0.00E+00	0.00E+00	0.00E+00	0.00E+00	0.00E+00	0.00E+00	0.00E+00	0.00E+00
I-135	0.00E+00	0.00E+00	0.00E+00	0.00E+00	0.00E+00	0.00E+00	0.00E+00	0.00E+00
CS-134M	0.00E+00	0.00E+00	0.00E+00	0.00E+00	0.00E+00	0.00E+00	0.00E+00	0.00E+00
CS-134	0.00E+00	0.00E+00	0.00E+00	0.00E+00	0.00E+00	0.00E+00	0.00E+00	0.00E+00
CS-135	0.00E+00	0.00E+00	0.00E+00	0.00E+00	0.00E+00	0.00E+00	0.00E+00	0.00E+00
CS-136	0.00E+00	0.00E+00	0.00E+00	0.00E+00	0.00E+00	0.00E+00	0.00E+00	0.00E+00
CS-137	0.00E+00	0.00E+00	0.00E+00	0.00E+00	0.00E+00	0.00E+00	0.00E+00	0.00E+00
CS-138	0.00E+00	0.00E+00	0.00E+00	0.00E+00	0.00E+00	0.00E+00	0.00E+00	0.00E+00
CS-139	0.00E+00	0.00E+00	0.00E+00	0.00E+00	0.00E+00	0.00E+00	0.00E+00	0.00E+00
BA-139	0.00E+00	0.00E+00	0.00E+00	0.00E+00	0.00E+00	0.00E+00	0.00E+00	0.00E+00
BA-140	0.00E+00	0.00E+00	0.00E+00	0.00E+00	0.00E+00	0.00E+00	0.00E+00	0.00E+00
BA-141	0.00E+00	0.00E+00	0.00E+00	0.00E+00	0.00E+00	0.00E+00	0.00E+00	0.00E+00
BA-142	0.00E+00	0.00E+00	0.00E+00	0.00E+00	0.00E+00	0.00E+00	0.00E+00	0.00E+00
LA-140	0.00E+00	0.00E+00	0.00E+00	0.00E+00	0.00E+00	0.00E+00	0.00E+00	0.00E+00
LA-141	0.00E+00	0.00E+00	0.00E+00	0.00E+00	0.00E+00	0.00E+00	0.00E+00	0.00E+00
LA-142	0.00E+00	0.00E+00	0.00E+00	0.00E+00	0.00E+00	0.00E+00	0.00E+00	0.00E+00
CE-141	0.00E+00	0.00E+00	0.00E+00	0.00E+00	0.00E+00	0.00E+00	0.00E+00	0.00E+00
CE-143	0.00E+00	0.00E+00	0.00E+00	0.00E+00	0.00E+00	0.00E+00	0.00E+00	0.00E+00
CE-144	0.00E+00	0.00E+00	0.00E+00	0.00E+00	0.00E+00	0.00E+00	0.00E+00	0.00E+00
PR-143	0.00E+00	0.00E+00	0.00E+00	0.00E+00	0.00E+00	0.00E+00	0.00E+00	0.00E+00
PR-144	0.00E+00	0.00E+00	0.00E+00	0.00E+00	0.00E+00	0.00E+00	0.00E+00	0.00E+00
ND-147	0.00E+00	0.00E+00	0.00E+00	0.00E+00	0.00E+00	0.00E+00	0.00E+00	0.00E+00
PM-147	0.00E+00	0.00E+00	0.00E+00	0.00E+00	0.00E+00	0.00E+00	0.00E+00	0.00E+00
PM-148M	0.00E+00	0.00E+00	0.00E+00	0.00E+00	0.00E+00	0.00E+00	0.00E+00	0.00E+00
PM-148	0.00E+00	0.00E+00	0.00E+00	0.00E+00	0.00E+00	0.00E+00	0.00E+00	0.00E+00
PM-149	0.00E+00	0.00E+00	0.00E+00	0.00E+00	0.00E+00	0.00E+00	0.00E+00	0.00E+00
PM-151	0.00E+00	0.00E+00	0.00E+00	0.00E+00	0.00E+00	0.00E+00	0.00E+00	0.00E+00
SM-151	0.00E+00	0.00E+00	0.00E+00	0.00E+00	0.00E+00	0.00E+00	0.00E+00	0.00E+00
SM-153	0.00E+00	0.00E+00	0.00E+00	0.00E+00	0.00E+00	0.00E+00	0.00E+00	0.00E+00
EU-152	0.00E+00	0.00E+00	0.00E+00	0.00E+00	0.00E+00	0.00E+00	0.00E+00	0.00E+00

TABLE II1-19

INFANT FRESHWATER FISH A_{17} FACTORS

mrem-ml per uCi-hr

NUCLIDE	BONE	LIVER	T BODY	THYROID	KIDNEY	LUNG	GI-LLI	SKIN
EU-154	0.00E+00	0.00E+00	0.00E+00	0.00E+00	0.00E+00	0.00E+00	0.00E+00	0.00E+00
EU-155	0.00E+00	0.00E+00	0.00E+00	0.00E+00	0.00E+00	0.00E+00	0.00E+00	0.00E+00
EU-156	0.00E+00	0.00E+00	0.00E+00	0.00E+00	0.00E+00	0.00E+00	0.00E+00	0.00E+00
TB-160	0.00E+00	0.00E+00	0.00E+00	0.00E+00	0.00E+00	0.00E+00	0.00E+00	0.00E+00
HO-166M	0.00E+00	0.00E+00	0.00E+00	0.00E+00	0.00E+00	0.00E+00	0.00E+00	0.00E+00
W-181	0.00E+00	0.00E+00	0.00E+00	0.00E+00	0.00E+00	0.00E+00	0.00E+00	0.00E+00
W-185	0.00E+00	0.00E+00	0.00E+00	0.00E+00	0.00E+00	0.00E+00	0.00E+00	0.00E+00
W-187	0.00E+00	0.00E+00	0.00E+00	0.00E+00	0.00E+00	0.00E+00	0.00E+00	0.00E+00
U-232	0.00E+00	0.00E+00	0.00E+00	0.00E+00	0.00E+00	0.00E+00	0.00E+00	0.00E+00
U-233	0.00E+00	0.00E+00	0.00E+00	0.00E+00	0.00E+00	0.00E+00	0.00E+00	0.00E+00
U-234	0.00E+00	0.00E+00	0.00E+00	0.00E+00	0.00E+00	0.00E+00	0.00E+00	0.00E+00
U-235	0.00E+00	0.00E+00	0.00E+00	0.00E+00	0.00E+00	0.00E+00	0.00E+00	0.00E+00
U-236	0.00E+00	0.00E+00	0.00E+00	0.00E+00	0.00E+00	0.00E+00	0.00E+00	0.00E+00
U-237	0.00E+00	0.00E+00	0.00E+00	0.00E+00	0.00E+00	0.00E+00	0.00E+00	0.00E+00
U-238	0.00E+00	0.00E+00	0.00E+00	0.00E+00	0.00E+00	0.00E+00	0.00E+00	0.00E+00
NP-237	0.00E+00	0.00E+00	0.00E+00	0.00E+00	0.00E+00	0.00E+00	0.00E+00	0.00E+00
NP-238	0.00E+00	0.00E+00	0.00E+00	0.00E+00	0.00E+00	0.00E+00	0.00E+00	0.00E+00
NP-239	0.00E+00	0.00E+00	0.00E+00	0.00E+00	0.00E+00	0.00E+00	0.00E+00	0.00E+00
PU-238	0.00E+00	0.00E+00	0.00E+00	0.00E+00	0.00E+00	0.00E+00	0.00E+00	0.00E+00
PU-239	0.00E+00	0.00E+00	0.00E+00	0.00E+00	0.00E+00	0.00E+00	0.00E+00	0.00E+00
PU-240	0.00E+00	0.00E+00	0.00E+00	0.00E+00	0.00E+00	0.00E+00	0.00E+00	0.00E+00
PU-241	0.00E+00	0.00E+00	0.00E+00	0.00E+00	0.00E+00	0.00E+00	0.00E+00	0.00E+00
PU-242	0.00E+00	0.00E+00	0.00E+00	0.00E+00	0.00E+00	0.00E+00	0.00E+00	0.00E+00
PU-244	0.00E+00	0.00E+00	0.00E+00	0.00E+00	0.00E+00	0.00E+00	0.00E+00	0.00E+00
AM-241	0.00E+00	0.00E+00	0.00E+00	0.00E+00	0.00E+00	0.00E+00	0.00E+00	0.00E+00
AM-242M	0.00E+00	0.00E+00	0.00E+00	0.00E+00	0.00E+00	0.00E+00	0.00E+00	0.00E+00
AM-243	0.00E+00	0.00E+00	0.00E+00	0.00E+00	0.00E+00	0.00E+00	0.00E+00	0.00E+00
CM-242	0.00E+00	0.00E+00	0.00E+00	0.00E+00	0.00E+00	0.00E+00	0.00E+00	0.00E+00
CM-243	0.00E+00	0.00E+00	0.00E+00	0.00E+00	0.00E+00	0.00E+00	0.00E+00	0.00E+00
CM-244	0.00E+00	0.00E+00	0.00E+00	0.00E+00	0.00E+00	0.00E+00	0.00E+00	0.00E+00
CM-245	0.00E+00	0.00E+00	0.00E+00	0.00E+00	0.00E+00	0.00E+00	0.00E+00	0.00E+00
CM-246	0.00E+00	0.00E+00	0.00E+00	0.00E+00	0.00E+00	0.00E+00	0.00E+00	0.00E+00
CM-247	0.00E+00	0.00E+00	0.00E+00	0.00E+00	0.00E+00	0.00E+00	0.00E+00	0.00E+00
CM-248	0.00E+00	0.00E+00	0.00E+00	0.00E+00	0.00E+00	0.00E+00	0.00E+00	0.00E+00
CF-252	0.00E+00	0.00E+00	0.00E+00	0.00E+00	0.00E+00	0.00E+00	0.00E+00	0.00E+00

TABLE II1-20

INFANT SHORELINE A₁₇ FACTORS

mrem-ml per uCi-hr

NUCLIDE	BONE	LIVER	T BODY	THYROID	KIDNEY	LUNG	GI-LLI	SKIN
H-3	0.00E+00	0.00E+00	0.00E+00	0.00E+00	0.00E+00	0.00E+00	0.00E+00	0.00E+00
C-14	0.00E+00	0.00E+00	0.00E+00	0.00E+00	0.00E+00	0.00E+00	0.00E+00	0.00E+00
NA-22	0.00E+00	0.00E+00	0.00E+00	0.00E+00	0.00E+00	0.00E+00	0.00E+00	0.00E+00
NA-24	0.00E+00	0.00E+00	0.00E+00	0.00E+00	0.00E+00	0.00E+00	0.00E+00	0.00E+00
P-32	0.00E+00	0.00E+00	0.00E+00	0.00E+00	0.00E+00	0.00E+00	0.00E+00	0.00E+00
CA-41	0.00E+00	0.00E+00	0.00E+00	0.00E+00	0.00E+00	0.00E+00	0.00E+00	0.00E+00
SC-46	0.00E+00	0.00E+00	0.00E+00	0.00E+00	0.00E+00	0.00E+00	0.00E+00	0.00E+00
CR-51	0.00E+00	0.00E+00	0.00E+00	0.00E+00	0.00E+00	0.00E+00	0.00E+00	0.00E+00
MN-54	0.00E+00	0.00E+00	0.00E+00	0.00E+00	0.00E+00	0.00E+00	0.00E+00	0.00E+00
MN-56	0.00E+00	0.00E+00	0.00E+00	0.00E+00	0.00E+00	0.00E+00	0.00E+00	0.00E+00
FE-55	0.00E+00	0.00E+00	0.00E+00	0.00E+00	0.00E+00	0.00E+00	0.00E+00	0.00E+00
FE-59	0.00E+00	0.00E+00	0.00E+00	0.00E+00	0.00E+00	0.00E+00	0.00E+00	0.00E+00
CO-57	0.00E+00	0.00E+00	0.00E+00	0.00E+00	0.00E+00	0.00E+00	0.00E+00	0.00E+00
CO-58	0.00E+00	0.00E+00	0.00E+00	0.00E+00	0.00E+00	0.00E+00	0.00E+00	0.00E+00
CO-60	0.00E+00	0.00E+00	0.00E+00	0.00E+00	0.00E+00	0.00E+00	0.00E+00	0.00E+00
NI-59	0.00E+00	0.00E+00	0.00E+00	0.00E+00	0.00E+00	0.00E+00	0.00E+00	0.00E+00
NI-63	0.00E+00	0.00E+00	0.00E+00	0.00E+00	0.00E+00	0.00E+00	0.00E+00	0.00E+00
NI-65	0.00E+00	0.00E+00	0.00E+00	0.00E+00	0.00E+00	0.00E+00	0.00E+00	0.00E+00
CU-64	0.00E+00	0.00E+00	0.00E+00	0.00E+00	0.00E+00	0.00E+00	0.00E+00	0.00E+00
ZN-65	0.00E+00	0.00E+00	0.00E+00	0.00E+00	0.00E+00	0.00E+00	0.00E+00	0.00E+00
ZN-69M	0.00E+00	0.00E+00	0.00E+00	0.00E+00	0.00E+00	0.00E+00	0.00E+00	0.00E+00
ZN-69	0.00E+00	0.00E+00	0.00E+00	0.00E+00	0.00E+00	0.00E+00	0.00E+00	0.00E+00
SE-79	0.00E+00	0.00E+00	0.00E+00	0.00E+00	0.00E+00	0.00E+00	0.00E+00	0.00E+00
BR-82	0.00E+00	0.00E+00	0.00E+00	0.00E+00	0.00E+00	0.00E+00	0.00E+00	0.00E+00
BR-83	0.00E+00	0.00E+00	0.00E+00	0.00E+00	0.00E+00	0.00E+00	0.00E+00	0.00E+00
BR-84	0.00E+00	0.00E+00	0.00E+00	0.00E+00	0.00E+00	0.00E+00	0.00E+00	0.00E+00
BR-85	0.00E+00	0.00E+00	0.00E+00	0.00E+00	0.00E+00	0.00E+00	0.00E+00	0.00E+00
RB-86	0.00E+00	0.00E+00	0.00E+00	0.00E+00	0.00E+00	0.00E+00	0.00E+00	0.00E+00
RB-87	0.00E+00	0.00E+00	0.00E+00	0.00E+00	0.00E+00	0.00E+00	0.00E+00	0.00E+00
RB-88	0.00E+00	0.00E+00	0.00E+00	0.00E+00	0.00E+00	0.00E+00	0.00E+00	0.00E+00
RB-89	0.00E+00	0.00E+00	0.00E+00	0.00E+00	0.00E+00	0.00E+00	0.00E+00	0.00E+00
SR-89	0.00E+00	0.00E+00	0.00E+00	0.00E+00	0.00E+00	0.00E+00	0.00E+00	0.00E+00
SR-90	0.00E+00	0.00E+00	0.00E+00	0.00E+00	0.00E+00	0.00E+00	0.00E+00	0.00E+00
SR-91	0.00E+00	0.00E+00	0.00E+00	0.00E+00	0.00E+00	0.00E+00	0.00E+00	0.00E+00
SR-92	0.00E+00	0.00E+00	0.00E+00	0.00E+00	0.00E+00	0.00E+00	0.00E+00	0.00E+00
Y-90	0.00E+00	0.00E+00	0.00E+00	0.00E+00	0.00E+00	0.00E+00	0.00E+00	0.00E+00
Y-91M	0.00E+00	0.00E+00	0.00E+00	0.00E+00	0.00E+00	0.00E+00	0.00E+00	0.00E+00
Y-91	0.00E+00	0.00E+00	0.00E+00	0.00E+00	0.00E+00	0.00E+00	0.00E+00	0.00E+00

TABLE II1-20

INFANT SHORELINE A₁₇ FACTORS

mrem-ml per uCi-hr

NUCLIDE	BONE	LIVER	T BODY	THYROID	KIDNEY	LUNG	GI-LLI	SKIN
Y-92	0.00E+00	0.00E+00	0.00E+00	0.00E+00	0.00E+00	0.00E+00	0.00E+00	0.00E+00
Y-93	0.00E+00	0.00E+00	0.00E+00	0.00E+00	0.00E+00	0.00E+00	0.00E+00	0.00E+00
ZR-93	0.00E+00	0.00E+00	0.00E+00	0.00E+00	0.00E+00	0.00E+00	0.00E+00	0.00E+00
ZR-95	0.00E+00	0.00E+00	0.00E+00	0.00E+00	0.00E+00	0.00E+00	0.00E+00	0.00E+00
ZR-97	0.00E+00	0.00E+00	0.00E+00	0.00E+00	0.00E+00	0.00E+00	0.00E+00	0.00E+00
NB-93M	0.00E+00	0.00E+00	0.00E+00	0.00E+00	0.00E+00	0.00E+00	0.00E+00	0.00E+00
NB-95	0.00E+00	0.00E+00	0.00E+00	0.00E+00	0.00E+00	0.00E+00	0.00E+00	0.00E+00
NB-97	0.00E+00	0.00E+00	0.00E+00	0.00E+00	0.00E+00	0.00E+00	0.00E+00	0.00E+00
MO-93	0.00E+00	0.00E+00	0.00E+00	0.00E+00	0.00E+00	0.00E+00	0.00E+00	0.00E+00
MO-99	0.00E+00	0.00E+00	0.00E+00	0.00E+00	0.00E+00	0.00E+00	0.00E+00	0.00E+00
TC-99M	0.00E+00	0.00E+00	0.00E+00	0.00E+00	0.00E+00	0.00E+00	0.00E+00	0.00E+00
TC-99	0.00E+00	0.00E+00	0.00E+00	0.00E+00	0.00E+00	0.00E+00	0.00E+00	0.00E+00
TC-101	0.00E+00	0.00E+00	0.00E+00	0.00E+00	0.00E+00	0.00E+00	0.00E+00	0.00E+00
RU-103	0.00E+00	0.00E+00	0.00E+00	0.00E+00	0.00E+00	0.00E+00	0.00E+00	0.00E+00
RU-105	0.00E+00	0.00E+00	0.00E+00	0.00E+00	0.00E+00	0.00E+00	0.00E+00	0.00E+00
RU-106	0.00E+00	0.00E+00	0.00E+00	0.00E+00	0.00E+00	0.00E+00	0.00E+00	0.00E+00
RH-105	0.00E+00	0.00E+00	0.00E+00	0.00E+00	0.00E+00	0.00E+00	0.00E+00	0.00E+00
PD-107	0.00E+00	0.00E+00	0.00E+00	0.00E+00	0.00E+00	0.00E+00	0.00E+00	0.00E+00
PD-109	0.00E+00	0.00E+00	0.00E+00	0.00E+00	0.00E+00	0.00E+00	0.00E+00	0.00E+00
AG-110M	0.00E+00	0.00E+00	0.00E+00	0.00E+00	0.00E+00	0.00E+00	0.00E+00	0.00E+00
AG-111	0.00E+00	0.00E+00	0.00E+00	0.00E+00	0.00E+00	0.00E+00	0.00E+00	0.00E+00
CD-113M	0.00E+00	0.00E+00	0.00E+00	0.00E+00	0.00E+00	0.00E+00	0.00E+00	0.00E+00
CD-115M	0.00E+00	0.00E+00	0.00E+00	0.00E+00	0.00E+00	0.00E+00	0.00E+00	0.00E+00
SN-123	0.00E+00	0.00E+00	0.00E+00	0.00E+00	0.00E+00	0.00E+00	0.00E+00	0.00E+00
SN-125	0.00E+00	0.00E+00	0.00E+00	0.00E+00	0.00E+00	0.00E+00	0.00E+00	0.00E+00
SN-126	0.00E+00	0.00E+00	0.00E+00	0.00E+00	0.00E+00	0.00E+00	0.00E+00	0.00E+00
SB-124	0.00E+00	0.00E+00	0.00E+00	0.00E+00	0.00E+00	0.00E+00	0.00E+00	0.00E+00
SB-125	0.00E+00	0.00E+00	0.00E+00	0.00E+00	0.00E+00	0.00E+00	0.00E+00	0.00E+00
SB-126	0.00E+00	0.00E+00	0.00E+00	0.00E+00	0.00E+00	0.00E+00	0.00E+00	0.00E+00
SB-127	0.00E+00	0.00E+00	0.00E+00	0.00E+00	0.00E+00	0.00E+00	0.00E+00	0.00E+00
TE-125M	0.00E+00	0.00E+00	0.00E+00	0.00E+00	0.00E+00	0.00E+00	0.00E+00	0.00E+00
TE-127M	0.00E+00	0.00E+00	0.00E+00	0.00E+00	0.00E+00	0.00E+00	0.00E+00	0.00E+00
TE-127	0.00E+00	0.00E+00	0.00E+00	0.00E+00	0.00E+00	0.00E+00	0.00E+00	0.00E+00
TE-129M	0.00E+00	0.00E+00	0.00E+00	0.00E+00	0.00E+00	0.00E+00	0.00E+00	0.00E+00
TE-129	0.00E+00	0.00E+00	0.00E+00	0.00E+00	0.00E+00	0.00E+00	0.00E+00	0.00E+00
TE-131M	0.00E+00	0.00E+00	0.00E+00	0.00E+00	0.00E+00	0.00E+00	0.00E+00	0.00E+00
TE-131	0.00E+00	0.00E+00	0.00E+00	0.00E+00	0.00E+00	0.00E+00	0.00E+00	0.00E+00
TE-132	0.00E+00	0.00E+00	0.00E+00	0.00E+00	0.00E+00	0.00E+00	0.00E+00	0.00E+00

TABLE II1-20

INFANT SHORELINE A₁₇ FACTORS

mrem-ml per uCi-hr

NUCLIDE	BONE	LIVER	T BODY	THYROID	KIDNEY	LUNG	GI-LLI	SKIN
TE-133M	0.00E+00	0.00E+00	0.00E+00	0.00E+00	0.00E+00	0.00E+00	0.00E+00	0.00E+00
TE-134	0.00E+00	0.00E+00	0.00E+00	0.00E+00	0.00E+00	0.00E+00	0.00E+00	0.00E+00
I-129	0.00E+00	0.00E+00	0.00E+00	0.00E+00	0.00E+00	0.00E+00	0.00E+00	0.00E+00
I-130	0.00E+00	0.00E+00	0.00E+00	0.00E+00	0.00E+00	0.00E+00	0.00E+00	0.00E+00
I-131	0.00E+00	0.00E+00	0.00E+00	0.00E+00	0.00E+00	0.00E+00	0.00E+00	0.00E+00
I-132	0.00E+00	0.00E+00	0.00E+00	0.00E+00	0.00E+00	0.00E+00	0.00E+00	0.00E+00
I-133	0.00E+00	0.00E+00	0.00E+00	0.00E+00	0.00E+00	0.00E+00	0.00E+00	0.00E+00
I-134	0.00E+00	0.00E+00	0.00E+00	0.00E+00	0.00E+00	0.00E+00	0.00E+00	0.00E+00
I-135	0.00E+00	0.00E+00	0.00E+00	0.00E+00	0.00E+00	0.00E+00	0.00E+00	0.00E+00
CS-134M	0.00E+00	0.00E+00	0.00E+00	0.00E+00	0.00E+00	0.00E+00	0.00E+00	0.00E+00
CS-134	0.00E+00	0.00E+00	0.00E+00	0.00E+00	0.00E+00	0.00E+00	0.00E+00	0.00E+00
CS-135	0.00E+00	0.00E+00	0.00E+00	0.00E+00	0.00E+00	0.00E+00	0.00E+00	0.00E+00
CS-136	0.00E+00	0.00E+00	0.00E+00	0.00E+00	0.00E+00	0.00E+00	0.00E+00	0.00E+00
CS-137	0.00E+00	0.00E+00	0.00E+00	0.00E+00	0.00E+00	0.00E+00	0.00E+00	0.00E+00
CS-138	0.00E+00	0.00E+00	0.00E+00	0.00E+00	0.00E+00	0.00E+00	0.00E+00	0.00E+00
CS-139	0.00E+00	0.00E+00	0.00E+00	0.00E+00	0.00E+00	0.00E+00	0.00E+00	0.00E+00
BA-139	0.00E+00	0.00E+00	0.00E+00	0.00E+00	0.00E+00	0.00E+00	0.00E+00	0.00E+00
BA-140	0.00E+00	0.00E+00	0.00E+00	0.00E+00	0.00E+00	0.00E+00	0.00E+00	0.00E+00
BA-141	0.00E+00	0.00E+00	0.00E+00	0.00E+00	0.00E+00	0.00E+00	0.00E+00	0.00E+00
BA-142	0.00E+00	0.00E+00	0.00E+00	0.00E+00	0.00E+00	0.00E+00	0.00E+00	0.00E+00
LA-140	0.00E+00	0.00E+00	0.00E+00	0.00E+00	0.00E+00	0.00E+00	0.00E+00	0.00E+00
LA-141	0.00E+00	0.00E+00	0.00E+00	0.00E+00	0.00E+00	0.00E+00	0.00E+00	0.00E+00
LA-142	0.00E+00	0.00E+00	0.00E+00	0.00E+00	0.00E+00	0.00E+00	0.00E+00	0.00E+00
CE-141	0.00E+00	0.00E+00	0.00E+00	0.00E+00	0.00E+00	0.00E+00	0.00E+00	0.00E+00
CE-143	0.00E+00	0.00E+00	0.00E+00	0.00E+00	0.00E+00	0.00E+00	0.00E+00	0.00E+00
CE-144	0.00E+00	0.00E+00	0.00E+00	0.00E+00	0.00E+00	0.00E+00	0.00E+00	0.00E+00
PR-143	0.00E+00	0.00E+00	0.00E+00	0.00E+00	0.00E+00	0.00E+00	0.00E+00	0.00E+00
PR-144	0.00E+00	0.00E+00	0.00E+00	0.00E+00	0.00E+00	0.00E+00	0.00E+00	0.00E+00
ND-147	0.00E+00	0.00E+00	0.00E+00	0.00E+00	0.00E+00	0.00E+00	0.00E+00	0.00E+00
PM-147	0.00E+00	0.00E+00	0.00E+00	0.00E+00	0.00E+00	0.00E+00	0.00E+00	0.00E+00
PM-148M	0.00E+00	0.00E+00	0.00E+00	0.00E+00	0.00E+00	0.00E+00	0.00E+00	0.00E+00
PM-148	0.00E+00	0.00E+00	0.00E+00	0.00E+00	0.00E+00	0.00E+00	0.00E+00	0.00E+00
PM-149	0.00E+00	0.00E+00	0.00E+00	0.00E+00	0.00E+00	0.00E+00	0.00E+00	0.00E+00
PM-151	0.00E+00	0.00E+00	0.00E+00	0.00E+00	0.00E+00	0.00E+00	0.00E+00	0.00E+00
SM-151	0.00E+00	0.00E+00	0.00E+00	0.00E+00	0.00E+00	0.00E+00	0.00E+00	0.00E+00
SM-153	0.00E+00	0.00E+00	0.00E+00	0.00E+00	0.00E+00	0.00E+00	0.00E+00	0.00E+00
EU-152	0.00E+00	0.00E+00	0.00E+00	0.00E+00	0.00E+00	0.00E+00	0.00E+00	0.00E+00
EU-154	0.00E+00	0.00E+00	0.00E+00	0.00E+00	0.00E+00	0.00E+00	0.00E+00	0.00E+00

TABLE II1-20

INFANT SHORELINE A₁₇ FACTORS

mrem-ml per uCi-hr

NUCLIDE	BONE	LIVER	T BODY	THYROID	KIDNEY	LUNG	GI-LLI	SKIN
EU-155	0.00E+00	0.00E+00	0.00E+00	0.00E+00	0.00E+00	0.00E+00	0.00E+00	0.00E+00
EU-156	0.00E+00	0.00E+00	0.00E+00	0.00E+00	0.00E+00	0.00E+00	0.00E+00	0.00E+00
TB-160	0.00E+00	0.00E+00	0.00E+00	0.00E+00	0.00E+00	0.00E+00	0.00E+00	0.00E+00
HO-166M	0.00E+00	0.00E+00	0.00E+00	0.00E+00	0.00E+00	0.00E+00	0.00E+00	0.00E+00
W-181	0.00E+00	0.00E+00	0.00E+00	0.00E+00	0.00E+00	0.00E+00	0.00E+00	0.00E+00
W-185	0.00E+00	0.00E+00	0.00E+00	0.00E+00	0.00E+00	0.00E+00	0.00E+00	0.00E+00
W-187	0.00E+00	0.00E+00	0.00E+00	0.00E+00	0.00E+00	0.00E+00	0.00E+00	0.00E+00
U-232	0.00E+00	0.00E+00	0.00E+00	0.00E+00	0.00E+00	0.00E+00	0.00E+00	0.00E+00
U-233	0.00E+00	0.00E+00	0.00E+00	0.00E+00	0.00E+00	0.00E+00	0.00E+00	0.00E+00
U-234	0.00E+00	0.00E+00	0.00E+00	0.00E+00	0.00E+00	0.00E+00	0.00E+00	0.00E+00
U-235	0.00E+00	0.00E+00	0.00E+00	0.00E+00	0.00E+00	0.00E+00	0.00E+00	0.00E+00
U-236	0.00E+00	0.00E+00	0.00E+00	0.00E+00	0.00E+00	0.00E+00	0.00E+00	0.00E+00
U-237	0.00E+00	0.00E+00	0.00E+00	0.00E+00	0.00E+00	0.00E+00	0.00E+00	0.00E+00
U-238	0.00E+00	0.00E+00	0.00E+00	0.00E+00	0.00E+00	0.00E+00	0.00E+00	0.00E+00
NP-237	0.00E+00	0.00E+00	0.00E+00	0.00E+00	0.00E+00	0.00E+00	0.00E+00	0.00E+00
NP-238	0.00E+00	0.00E+00	0.00E+00	0.00E+00	0.00E+00	0.00E+00	0.00E+00	0.00E+00
NP-239	0.00E+00	0.00E+00	0.00E+00	0.00E+00	0.00E+00	0.00E+00	0.00E+00	0.00E+00
PU-238	0.00E+00	0.00E+00	0.00E+00	0.00E+00	0.00E+00	0.00E+00	0.00E+00	0.00E+00
PU-239	0.00E+00	0.00E+00	0.00E+00	0.00E+00	0.00E+00	0.00E+00	0.00E+00	0.00E+00
PU-240	0.00E+00	0.00E+00	0.00E+00	0.00E+00	0.00E+00	0.00E+00	0.00E+00	0.00E+00
PU-241	0.00E+00	0.00E+00	0.00E+00	0.00E+00	0.00E+00	0.00E+00	0.00E+00	0.00E+00
PU-242	0.00E+00	0.00E+00	0.00E+00	0.00E+00	0.00E+00	0.00E+00	0.00E+00	0.00E+00
PU-244	0.00E+00	0.00E+00	0.00E+00	0.00E+00	0.00E+00	0.00E+00	0.00E+00	0.00E+00
AM-241	0.00E+00	0.00E+00	0.00E+00	0.00E+00	0.00E+00	0.00E+00	0.00E+00	0.00E+00
AM-242M	0.00E+00	0.00E+00	0.00E+00	0.00E+00	0.00E+00	0.00E+00	0.00E+00	0.00E+00
AM-243	0.00E+00	0.00E+00	0.00E+00	0.00E+00	0.00E+00	0.00E+00	0.00E+00	0.00E+00
CM-242	0.00E+00	0.00E+00	0.00E+00	0.00E+00	0.00E+00	0.00E+00	0.00E+00	0.00E+00
CM-243	0.00E+00	0.00E+00	0.00E+00	0.00E+00	0.00E+00	0.00E+00	0.00E+00	0.00E+00
CM-244	0.00E+00	0.00E+00	0.00E+00	0.00E+00	0.00E+00	0.00E+00	0.00E+00	0.00E+00
CM-245	0.00E+00	0.00E+00	0.00E+00	0.00E+00	0.00E+00	0.00E+00	0.00E+00	0.00E+00
CM-246	0.00E+00	0.00E+00	0.00E+00	0.00E+00	0.00E+00	0.00E+00	0.00E+00	0.00E+00
CM-247	0.00E+00	0.00E+00	0.00E+00	0.00E+00	0.00E+00	0.00E+00	0.00E+00	0.00E+00
CM-248	0.00E+00	0.00E+00	0.00E+00	0.00E+00	0.00E+00	0.00E+00	0.00E+00	0.00E+00
CF-252	0.00E+00	0.00E+00	0.00E+00	0.00E+00	0.00E+00	0.00E+00	0.00E+00	0.00E+00

TABLE II1-21

ASSUMPTIONS USED IN LIMERICK LIQUID EFFLUENT DOSE EVALUATION

Symbol	Description	Value	Reference(1)
T _b	Period of buildup of activity in sediment(hr)	2.192E+05	RG 1.109 Appendix A Equation A-4 adjusted for license renewal (25 years)
t _p ^D	Envtl transit time for water ingestion (hr)	1.200E+01	A-2 ⁽²⁾
t _p ^F	Envtl transit time for fish ingestion (hr)	2.400E+01	A-3 ⁽²⁾
t _p ^S	Envtl transit time for shore exposure (hr)	0.000E+00	Site Specific
U _{ap}	Water ingestion (1/yr) adult	7.300E+02	E-5
U _{ap}	Water ingestion (1/yr) teen	5.100E+02	E-5
U _{ap}	Water ingestion (1/yr) child	5.100E+02	E-5
U _{ap}	Water ingestion (1/yr) infant	3.300E+02	E-5
U _{ap}	Shore exposure (hr/yr) adult	6.000E+02	Site Specific
U _{ap}	Shore exposure (hr/yr) teen	6.000E+02	Site Specific
U _{ap}	Shore exposure (hr/yr) child	9.000E+01	Site Specific
U _{ap}	Shore exposure (hr/yr) infant	0.000E+00	Site Specific
U _{ap}	Fresh water fish ingestion (kg/yr) adult	2.100E+01	E-5
U _{ap}	Fresh water fish ingestion (kg/yr) teen	1.600E+01	E-5
U _{ap}	Fresh water fish ingestion (kg/yr) child	6.900E+00	E-5
U _{ap}	Fresh water fish ingestion (kg/yr) infant	0.000E+00	E-5
RC	Reconcentration Factor	1.000E+00	Site Specific
W	Shoreline Width Factor (dimensionless)	2.000E-01	A-2 ⁽³⁾

- 1) The References refer to tables contained in Regulatory Guide 1.109 unless otherwise specified.
- 2) Equation A-2 and A-3 from Reg. Guide 1.109, Appendix A.
- 3) Table A-2 from Reg. Guide 1.109, Appendix A.

TABLE II2-1

DOSE FACTORS FOR NOBLE GAS

From Table B-1 of Reg. Guide 1.109

RADIONUCLIDE	TOTAL BODY DOSE FACTOR KI (MREM/YR PER PCI/M ³)	BETA SKIN DOSE FACTOR LI (MREM/YR PER PCI/M ³)	GAMMA AIR DOSE FACTOR MI (MRAD/YR PER PCI/M ³)	BETA AIR DOSE FACTOR NI (MRAD/YR PER PCI/M ³)
AR-41	8.84E-03	2.69E-03	9.30E-03	3.28E-03
KR-83M	7.56E-08	-----	1.93E-05	2.88E-04
KR-85M	1.17E-03	1.46E-03	1.23E-03	1.97E-03
KR-85	1.61E-05	1.34E-03	1.72E-05	1.95E-03
KR-87	5.92E-03	9.73E-03	6.17E-03	1.03E-02
KR-88	1.47E-02	2.37E-03	1.52E-02	2.93E-03
KR-89	1.66E-02	1.01E-02	1.73E-02	1.06E-02
KR-90	1.56E-02	7.29E-03	1.63E-02	7.83E-03
XE-131M	9.15E-05	4.76E-04	1.56E-04	1.11E-03
XE-133M	2.51E-04	9.94E-04	3.27E-04	1.48E-03
XE-133	2.94E-04	3.06E-04	3.53E-04	1.05E-03
XE-135M	3.12E-03	7.11E-04	3.36E-03	7.39E-04
XE-135	1.81E-03	1.86E-03	1.92E-03	2.46E-03
XE-137	1.42E-03	1.22E-02	1.51E-03	1.27E-02
XE-138	8.83E-03	4.13E-03	9.21E-03	4.75E-03

TABLE II-2

R_i / P_i DOSE FACTORS AGE: ADULT PATHWAY: INHALATIONmrem/yr per $\mu\text{Ci}/\text{m}^3$

NUCLIDE	BONE	LIVER	T BODY	THYROID	KIDNEY	LUNG	GI-LLI	SKIN
H-3	0.00E+00	7.18E+02	7.18E+02	7.18E+02	7.18E+02	7.18E+02	7.18E+02	0.00E+00
C-14	1.82E+04	3.41E+03	3.41E+03	3.41E+03	3.41E+03	3.41E+03	3.41E+03	0.00E+00
NA-22	1.04E+05	1.04E+05	1.04E+05	1.04E+05	1.04E+05	1.04E+05	1.04E+05	0.00E+00
NA-24	1.02E+04	1.02E+04	1.02E+04	1.02E+04	1.02E+04	1.02E+04	1.02E+04	0.00E+00
P-32	1.32E+06	7.71E+04	5.01E+04	0.00E+00	0.00E+00	0.00E+00	8.64E+04	0.00E+00
CA-41	3.06E+05	0.00E+00	3.30E+04	0.00E+00	0.00E+00	3.06E+04	2.29E+03	0.00E+00
SC-46	4.41E+05	8.56E+05	2.49E+05	0.00E+00	7.99E+05	0.00E+00	2.58E+05	0.00E+00
CR-51	0.00E+00	0.00E+00	1.00E+02	5.95E+01	2.28E+01	1.44E+04	3.32E+03	0.00E+00
MN-54	0.00E+00	3.96E+04	6.30E+03	0.00E+00	9.84E+03	1.40E+06	7.74E+04	0.00E+00
MN-56	0.00E+00	1.24E+00	1.83E-01	0.00E+00	1.30E+00	9.44E+03	2.02E+04	0.00E+00
FE-55	2.46E+04	1.70E+04	3.94E+03	0.00E+00	0.00E+00	7.21E+04	6.03E+03	0.00E+00
FE-59	1.18E+04	2.78E+04	1.06E+04	0.00E+00	0.00E+00	1.02E+06	1.88E+05	0.00E+00
CO-57	0.00E+00	6.92E+02	6.71E+02	0.00E+00	0.00E+00	3.70E+05	3.14E+04	0.00E+00
CO-58	0.00E+00	1.58E+03	2.07E+03	0.00E+00	0.00E+00	9.28E+05	1.06E+05	0.00E+00
CO-60	0.00E+00	1.15E+04	1.48E+04	0.00E+00	0.00E+00	5.97E+06	2.85E+05	0.00E+00
NI-59	3.25E+04	1.17E+04	5.42E+03	0.00E+00	0.00E+00	6.56E+04	4.89E+03	0.00E+00
NI-63	4.32E+05	3.14E+04	1.45E+04	0.00E+00	0.00E+00	1.78E+05	1.34E+04	0.00E+00
NI-65	1.54E+00	2.10E-01	9.12E-02	0.00E+00	0.00E+00	5.60E+03	1.23E+04	0.00E+00
CU-64	0.00E+00	1.46E+00	6.15E-01	0.00E+00	4.62E+00	6.78E+03	4.90E+04	0.00E+00
ZN-65	3.24E+04	1.03E+05	4.66E+04	0.00E+00	6.90E+04	8.64E+05	5.34E+04	0.00E+00
ZN-69M	8.16E+00	1.96E+01	1.79E+00	0.00E+00	1.18E+01	1.90E+04	1.37E+05	0.00E+00
ZN-69	3.38E-02	6.51E-02	4.52E-03	0.00E+00	4.22E-02	9.20E+02	1.63E+01	0.00E+00
SE-79	0.00E+00	3.06E+03	4.87E+02	0.00E+00	4.55E+03	3.58E+05	2.66E+04	0.00E+00
BR-82	0.00E+00	0.00E+00	1.35E+04	0.00E+00	0.00E+00	0.00E+00	1.04E+04	0.00E+00
BR-83	0.00E+00	0.00E+00	2.41E+02	0.00E+00	0.00E+00	0.00E+00	2.32E+02	0.00E+00
BR-84	0.00E+00	0.00E+00	3.13E+02	0.00E+00	0.00E+00	0.00E+00	1.64E-03	0.00E+00
BR-85	0.00E+00	0.00E+00	1.28E+01	0.00E+00	0.00E+00	0.00E+00	0.00E+00	0.00E+00
RB-86	0.00E+00	1.35E+05	5.90E+04	0.00E+00	0.00E+00	0.00E+00	1.66E+04	0.00E+00
RB-87	0.00E+00	7.89E+04	2.57E+04	0.00E+00	0.00E+00	0.00E+00	2.30E+03	0.00E+00
RB-88	0.00E+00	3.87E+02	1.93E+02	0.00E+00	0.00E+00	0.00E+00	3.34E-09	0.00E+00
RB-89	0.00E+00	2.56E+02	1.70E+02	0.00E+00	0.00E+00	0.00E+00	9.28E-12	0.00E+00
SR-89	3.04E+05	0.00E+00	8.72E+03	0.00E+00	0.00E+00	1.40E+06	3.50E+05	0.00E+00
SR-90	2.87E+07	0.00E+00	5.77E+05	0.00E+00	0.00E+00	9.60E+06	7.22E+05	0.00E+00
SR-91	6.19E+01	0.00E+00	2.50E+00	0.00E+00	0.00E+00	3.65E+04	1.91E+05	0.00E+00
SR-92	6.74E+00	0.00E+00	2.91E-01	0.00E+00	0.00E+00	1.65E+04	4.30E+04	0.00E+00
Y-90	2.09E+03	0.00E+00	5.61E+01	0.00E+00	0.00E+00	1.70E+05	5.06E+05	0.00E+00
Y-91M	2.61E-01	0.00E+00	1.02E-02	0.00E+00	0.00E+00	1.92E+03	1.33E+00	0.00E+00
Y-91	4.62E+05	0.00E+00	1.24E+04	0.00E+00	0.00E+00	1.70E+06	3.85E+05	0.00E+00
Y-92	1.03E+01	0.00E+00	3.02E-01	0.00E+00	0.00E+00	1.57E+04	7.35E+04	0.00E+00

TABLE II-2

R_i / P_i DOSE FACTORS AGE: ADULT PATHWAY: INHALATIONmrem/yr per $\mu\text{Ci}/\text{m}^3$

NUCLIDE	BONE	LIVER	T BODY	THYROID	KIDNEY	LUNG	GI-LLI	SKIN
Y-93	9.44E+01	0.00E+00	2.61E+00	0.00E+00	0.00E+00	4.85E+04	4.22E+05	0.00E+00
ZR-93	4.18E+05	2.34E+04	1.10E+04	0.00E+00	8.88E+04	1.70E+05	1.21E+04	0.00E+00
ZR-95	1.07E+05	3.44E+04	2.33E+04	0.00E+00	5.42E+04	1.77E+06	1.50E+05	0.00E+00
ZR-97	9.68E+01	1.96E+01	9.04E+00	0.00E+00	2.97E+01	7.87E+04	5.23E+05	0.00E+00
NB-93M	2.48E+05	8.08E+04	1.99E+04	0.00E+00	9.28E+04	2.49E+05	1.90E+04	0.00E+00
NB-95	1.41E+04	7.82E+03	4.21E+03	0.00E+00	7.74E+03	5.05E+05	1.04E+05	0.00E+00
NB-97	2.22E-01	5.62E-02	2.05E-02	0.00E+00	6.54E-02	2.40E+03	2.42E+02	0.00E+00
MO-93	0.00E+00	9.36E+03	2.54E+02	0.00E+00	2.84E+03	4.09E+05	3.03E+04	0.00E+00
MO-99	0.00E+00	1.21E+02	2.30E+01	0.00E+00	2.91E+02	9.12E+04	2.48E+05	0.00E+00
TC-99M	1.03E-03	2.91E-03	3.70E-02	0.00E+00	4.42E-02	7.64E+02	4.16E+03	0.00E+00
TC-99	2.50E+02	3.71E+02	1.00E+02	0.00E+00	4.68E+03	8.08E+05	6.03E+04	0.00E+00
TC-101	4.18E-05	6.02E-05	5.90E-04	0.00E+00	1.08E-03	3.99E+02	1.09E-11	0.00E+00
RU-103	1.53E+03	0.00E+00	6.58E+02	0.00E+00	5.83E+03	5.05E+05	1.10E+05	0.00E+00
RU-105	7.90E-01	0.00E+00	3.11E-01	0.00E+00	1.02E+00	1.10E+04	4.82E+04	0.00E+00
RU-106	6.91E+04	0.00E+00	8.72E+03	0.00E+00	1.34E+05	9.36E+06	9.12E+05	0.00E+00
RH-105	7.39E+00	5.38E+00	3.54E+00	0.00E+00	2.29E+01	1.93E+04	8.72E+04	0.00E+00
PD-107	0.00E+00	6.62E+02	4.70E+01	0.00E+00	5.26E+03	7.58E+04	5.65E+03	0.00E+00
PD-109	0.00E+00	3.70E+00	9.28E-01	0.00E+00	1.88E+01	1.48E+04	1.22E+05	0.00E+00
AG-110M	1.08E+04	1.00E+04	5.94E+03	0.00E+00	1.97E+04	4.63E+06	3.02E+05	0.00E+00
AG-111	3.40E+02	1.42E+02	7.10E+01	0.00E+00	4.59E+02	1.86E+05	2.23E+05	0.00E+00
CD-113M	0.00E+00	1.23E+06	3.98E+04	0.00E+00	1.37E+06	1.66E+06	1.27E+05	0.00E+00
CD-115M	0.00E+00	1.97E+05	6.36E+03	0.00E+00	1.58E+05	1.41E+06	3.84E+05	0.00E+00
SN-123	2.42E+05	5.34E+03	7.86E+03	4.54E+03	0.00E+00	2.30E+06	3.14E+05	0.00E+00
SN-125	9.28E+03	2.50E+02	5.62E+02	2.07E+02	0.00E+00	5.90E+05	5.45E+05	0.00E+00
SN-126	1.26E+06	3.34E+04	4.80E+04	9.84E+03	0.00E+00	9.36E+06	1.27E+05	0.00E+00
SB-124	3.12E+04	5.89E+02	1.24E+04	7.55E+01	0.00E+00	2.48E+06	4.06E+05	0.00E+00
SB-125	5.34E+04	5.95E+02	1.26E+04	5.40E+01	0.00E+00	1.74E+06	1.01E+05	0.00E+00
SB-126	3.60E+03	7.30E+01	1.30E+03	2.20E+01	0.00E+00	7.66E+05	4.81E+05	0.00E+00
SB-127	2.64E+02	5.78E+00	1.02E+02	3.18E+00	0.00E+00	1.64E+05	3.02E+05	0.00E+00
TE-125M	3.42E+03	1.58E+03	4.67E+02	1.05E+03	1.24E+04	3.14E+05	7.06E+04	0.00E+00
TE-127M	1.26E+04	5.77E+03	1.57E+03	3.29E+03	4.58E+04	9.60E+05	1.50E+05	0.00E+00
TE-127	1.40E+00	6.42E-01	3.10E-01	1.06E+00	5.10E+00	6.51E+03	5.74E+04	0.00E+00
TE-129M	9.76E+03	4.67E+03	1.58E+03	3.44E+03	3.66E+04	1.16E+06	3.83E+05	0.00E+00
TE-129	4.98E-02	2.39E-02	1.24E-02	3.90E-02	1.87E-01	1.94E+03	1.57E+02	0.00E+00
TE-131M	6.99E+01	4.36E+01	2.90E+01	5.50E+01	3.09E+02	1.46E+05	5.56E+05	0.00E+00
TE-131	1.11E-02	5.95E-03	3.59E-03	9.36E-03	4.37E-02	1.39E+03	1.84E+01	0.00E+00
TE-132	2.60E+02	2.15E+02	1.62E+02	1.90E+02	1.46E+03	2.88E+05	5.10E+05	0.00E+00
TE-133M	5.79E-02	4.32E-02	3.34E-02	5.02E-02	2.99E-01	4.41E+03	6.12E+01	0.00E+00
TE-134	3.07E-02	2.58E-02	1.26E-02	2.75E-02	1.74E-01	3.47E+03	2.38E-01	0.00E+00

TABLE II-2

R_i / P_i DOSE FACTORS AGE: ADULT PATHWAY: INHALATIONmrem/yr per $\mu\text{Ci}/\text{m}^3$

NUCLIDE	BONE	LIVER	T BODY	THYROID	KIDNEY	LUNG	GI-LLI	SKIN
I-129	1.98E+04	1.69E+04	5.53E+04	4.43E+07	3.62E+04	0.00E+00	1.78E+03	0.00E+00
I-130	4.58E+03	1.34E+04	5.28E+03	1.14E+06	2.09E+04	0.00E+00	7.69E+03	0.00E+00
I-131	2.52E+04	3.58E+04	2.05E+04	1.19E+07	6.13E+04	0.00E+00	6.28E+03	0.00E+00
I-132	1.16E+03	3.26E+03	1.16E+03	1.14E+05	5.18E+03	0.00E+00	4.06E+02	0.00E+00
I-133	8.64E+03	1.48E+04	4.52E+03	2.15E+06	2.58E+04	0.00E+00	8.88E+03	0.00E+00
I-134	6.44E+02	1.73E+03	6.15E+02	2.98E+04	2.75E+03	0.00E+00	1.01E+00	0.00E+00
I-135	2.68E+03	6.98E+03	2.57E+03	4.48E+05	1.11E+04	0.00E+00	5.25E+03	0.00E+00
CS-134M	1.27E+02	2.56E+02	1.38E+02	0.00E+00	1.46E+02	2.34E+01	6.34E+01	0.00E+00
CS-134	3.73E+05	8.48E+05	7.28E+05	0.00E+00	2.87E+05	9.76E+04	1.04E+04	0.00E+00
CS-135	1.17E+05	1.03E+05	4.79E+04	0.00E+00	4.09E+04	1.26E+04	1.69E+03	0.00E+00
CS-136	3.90E+04	1.46E+05	1.10E+05	0.00E+00	8.56E+04	1.20E+04	1.17E+04	0.00E+00
CS-137	4.78E+05	6.21E+05	4.28E+05	0.00E+00	2.22E+05	7.52E+04	8.40E+03	0.00E+00
CS-138	3.31E+02	6.21E+02	3.24E+02	0.00E+00	4.80E+02	4.86E+01	1.86E-03	0.00E+00
CS-139	2.05E+02	2.90E+02	1.11E+02	0.00E+00	2.44E+02	2.27E+01	4.39E-21	0.00E+00
BA-139	9.36E-01	6.66E-04	2.74E-02	0.00E+00	6.22E-04	3.76E+03	8.96E+02	0.00E+00
BA-140	3.90E+04	4.90E+01	2.57E+03	0.00E+00	1.67E+01	1.27E+06	2.18E+05	0.00E+00
BA-141	1.00E-01	7.53E-05	3.36E-03	0.00E+00	7.00E-05	1.94E+03	1.16E-07	0.00E+00
BA-142	2.63E-02	2.70E-05	1.66E-03	0.00E+00	2.29E-05	1.19E+03	1.57E-16	0.00E+00
LA-140	3.44E+02	1.74E+02	4.58E+01	0.00E+00	0.00E+00	1.36E+05	4.58E+05	0.00E+00
LA-141	4.27E+00	1.33E+00	2.17E-01	0.00E+00	0.00E+00	1.08E+04	5.85E+04	0.00E+00
LA-142	6.83E-01	3.10E-01	7.72E-02	0.00E+00	0.00E+00	6.33E+03	2.11E+03	0.00E+00
CE-141	1.99E+04	1.35E+04	1.53E+03	0.00E+00	6.26E+03	3.62E+05	1.20E+05	0.00E+00
CE-143	1.86E+02	1.38E+02	1.53E+01	0.00E+00	6.08E+01	7.98E+04	2.26E+05	0.00E+00
CE-144	3.43E+06	1.43E+06	1.84E+05	0.00E+00	8.48E+05	7.78E+06	8.16E+05	0.00E+00
PR-143	9.36E+03	3.75E+03	4.64E+02	0.00E+00	2.16E+03	2.81E+05	2.00E+05	0.00E+00
PR-144	3.01E-02	1.25E-02	1.53E-03	0.00E+00	7.05E-03	1.02E+03	2.15E-08	0.00E+00
ND-147	5.27E+03	6.10E+03	3.65E+02	0.00E+00	3.56E+03	2.21E+05	1.73E+05	0.00E+00
PM-147	6.70E+05	6.30E+04	2.55E+04	0.00E+00	1.19E+05	5.28E+05	4.43E+04	0.00E+00
PM-148M	7.86E+04	2.03E+04	1.55E+04	0.00E+00	3.08E+04	1.71E+06	3.34E+05	0.00E+00
PM-148	3.07E+03	5.10E+02	2.56E+02	0.00E+00	9.60E+02	3.13E+05	4.64E+05	0.00E+00
PM-149	2.75E+02	3.90E+01	1.59E+01	0.00E+00	7.35E+01	5.77E+04	2.00E+05	0.00E+00
PM-151	6.80E+01	1.14E+01	5.77E+00	0.00E+00	2.04E+01	3.15E+04	1.60E+05	0.00E+00
SM-151	6.87E+05	1.18E+05	2.84E+04	0.00E+00	1.33E+05	3.56E+05	2.60E+04	0.00E+00
SM-153	1.36E+02	1.14E+02	8.32E+00	0.00E+00	3.67E+01	3.31E+04	1.26E+05	0.00E+00
EU-152	1.90E+06	4.33E+05	3.81E+05	0.00E+00	2.68E+06	2.74E+06	1.27E+05	0.00E+00
EU-154	5.92E+06	7.28E+05	5.18E+05	0.00E+00	3.49E+06	4.67E+06	2.72E+05	0.00E+00
EU-155	8.08E+05	1.14E+05	7.37E+04	0.00E+00	5.27E+05	7.57E+05	4.76E+04	0.00E+00
EU-156	1.54E+04	1.18E+04	1.92E+03	0.00E+00	7.96E+03	6.85E+05	3.60E+05	0.00E+00
TB-160	1.77E+05	0.00E+00	2.20E+04	0.00E+00	7.28E+04	1.54E+06	2.14E+05	0.00E+00

TABLE II-2

R_i / P_i DOSE FACTORS AGE: ADULT PATHWAY: INHALATIONmrem/yr per $\mu\text{Ci}/\text{m}^3$

NUCLIDE	BONE	LIVER	T BODY	THYROID	KIDNEY	LUNG	GI-LLI	SKIN
HO-166M	2.70E+06	8.40E+05	6.40E+05	0.00E+00	1.26E+06	3.15E+06	1.27E+05	0.00E+00
W-181	4.98E+01	1.62E+01	1.74E+00	0.00E+00	0.00E+00	1.37E+04	2.02E+03	0.00E+00
W-185	1.56E+03	5.18E+02	5.45E+01	0.00E+00	0.00E+00	4.46E+05	8.56E+04	0.00E+00
W-187	8.48E+00	7.08E+00	2.48E+00	0.00E+00	0.00E+00	2.90E+04	1.55E+05	0.00E+00
U-232	4.11E+08	0.00E+00	2.93E+07	0.00E+00	4.45E+07	1.78E+09	3.37E+05	0.00E+00
U-233	8.72E+07	0.00E+00	5.28E+06	0.00E+00	2.03E+07	4.26E+08	3.11E+05	0.00E+00
U-234	8.32E+07	0.00E+00	5.17E+06	0.00E+00	1.99E+07	4.18E+08	3.05E+05	0.00E+00
U-235	8.00E+07	0.00E+00	4.86E+06	0.00E+00	1.87E+07	3.92E+08	3.87E+05	0.00E+00
U-236	8.00E+07	0.00E+00	4.96E+06	0.00E+00	1.91E+07	4.00E+08	2.86E+05	0.00E+00
U-237	2.94E+02	0.00E+00	7.82E+01	0.00E+00	1.21E+03	8.16E+04	9.60E+04	0.00E+00
U-238	7.66E+07	0.00E+00	4.54E+06	0.00E+00	1.74E+07	3.66E+08	2.73E+05	0.00E+00
NP-237	1.25E+10	8.00E+09	5.50E+08	0.00E+00	4.08E+09	4.18E+08	3.94E+05	0.00E+00
NP-238	2.37E+03	5.76E+02	3.69E+01	0.00E+00	2.18E+02	8.16E+04	1.70E+05	0.00E+00
NP-239	2.30E+02	2.03E+02	1.24E+01	0.00E+00	7.00E+01	3.76E+04	1.19E+05	0.00E+00
PU-238	1.14E+10	7.77E+09	5.52E+08	0.00E+00	2.37E+09	1.46E+09	3.62E+05	0.00E+00
PU-239	1.33E+10	8.56E+09	6.20E+08	0.00E+00	2.64E+09	1.38E+09	3.30E+05	0.00E+00
PU-240	1.32E+10	8.56E+09	6.18E+08	0.00E+00	2.63E+09	1.38E+09	3.37E+05	0.00E+00
PU-241	2.74E+08	6.95E+07	1.03E+07	0.00E+00	4.74E+07	1.22E+06	6.92E+03	0.00E+00
PU-242	1.22E+10	8.24E+09	5.97E+08	0.00E+00	2.54E+09	1.32E+09	3.24E+05	0.00E+00
PU-244	1.43E+10	9.44E+09	6.83E+08	0.00E+00	2.91E+09	1.51E+09	4.82E+05	0.00E+00
AM-241	1.34E+10	9.04E+09	5.37E+08	0.00E+00	4.03E+09	4.85E+08	3.68E+05	0.00E+00
AM-242M	1.36E+10	8.48E+09	5.38E+08	0.00E+00	4.01E+09	1.95E+08	4.63E+05	0.00E+00
AM-243	1.34E+10	8.80E+09	5.26E+08	0.00E+00	3.96E+09	4.60E+08	4.32E+05	0.00E+00
CM-242	1.78E+08	1.42E+08	7.87E+06	0.00E+00	3.58E+07	3.14E+08	3.93E+05	0.00E+00
CM-243	8.80E+09	6.09E+09	3.69E+08	0.00E+00	1.72E+09	5.05E+08	3.87E+05	0.00E+00
CM-244	6.70E+09	4.70E+09	2.81E+08	0.00E+00	1.31E+09	4.85E+08	3.74E+05	0.00E+00
CM-245	1.39E+10	9.12E+09	5.71E+08	0.00E+00	2.66E+09	4.68E+08	3.49E+05	0.00E+00
CM-246	1.38E+10	9.12E+09	5.70E+08	0.00E+00	2.66E+09	4.77E+08	3.43E+05	0.00E+00
CM-247	1.34E+10	8.96E+09	5.62E+08	0.00E+00	2.62E+09	4.68E+08	4.50E+05	0.00E+00
CM-248	1.12E+09	7.41E+10	4.63E+09	0.00E+00	2.16E+10	3.86E+09	7.27E+06	0.00E+00
CF-252	4.34E+09	0.00E+00	1.86E+08	0.00E+00	0.00E+00	1.59E+09	1.42E+06	0.00E+00

TABLE II-2-3

R_i / P_i DOSE FACTORS AGE: TEEN PATHWAY: INHALATIONmrem/yr per $\mu\text{Ci}/\text{m}^3$

NUCLIDE	BONE	LIVER	T BODY	THYROID	KIDNEY	LUNG	GI-LLI	SKIN
H-3	0.00E+00	7.25E+02	7.25E+02	7.25E+02	7.25E+02	7.25E+02	7.25E+02	0.00E+00
C-14	2.60E+04	4.87E+03	4.87E+03	4.87E+03	4.87E+03	4.87E+03	4.87E+03	0.00E+00
NA-22	1.41E+05	1.41E+05	1.41E+05	1.41E+05	1.41E+05	1.41E+05	1.41E+05	0.00E+00
NA-24	1.38E+04	1.38E+04	1.38E+04	1.38E+04	1.38E+04	1.38E+04	1.38E+04	0.00E+00
P-32	1.89E+06	1.10E+05	7.16E+04	0.00E+00	0.00E+00	0.00E+00	9.28E+04	0.00E+00
CA-41	3.24E+05	0.00E+00	3.50E+04	0.00E+00	0.00E+00	8.08E+08	2.42E+03	0.00E+00
SC-46	5.79E+05	1.13E+06	3.34E+05	0.00E+00	1.08E+06	0.00E+00	2.38E+05	0.00E+00
CR-51	0.00E+00	0.00E+00	1.35E+02	7.50E+01	3.07E+01	2.10E+04	3.00E+03	0.00E+00
MN-54	0.00E+00	5.11E+04	8.40E+03	0.00E+00	1.27E+04	1.98E+06	6.68E+04	0.00E+00
MN-56	0.00E+00	1.70E+00	2.52E-01	0.00E+00	1.79E+00	1.52E+04	5.74E+04	0.00E+00
FE-55	3.34E+04	2.38E+04	5.54E+03	0.00E+00	0.00E+00	1.24E+05	6.39E+03	0.00E+00
FE-59	1.59E+04	3.70E+04	1.43E+04	0.00E+00	0.00E+00	1.53E+06	1.78E+05	0.00E+00
CO-57	0.00E+00	9.44E+02	9.20E+02	0.00E+00	0.00E+00	5.86E+05	3.14E+04	0.00E+00
CO-58	0.00E+00	2.07E+03	2.78E+03	0.00E+00	0.00E+00	1.34E+06	9.52E+04	0.00E+00
CO-60	0.00E+00	1.51E+04	1.98E+04	0.00E+00	0.00E+00	8.72E+06	2.59E+05	0.00E+00
NI-59	4.35E+04	1.62E+04	7.39E+03	0.00E+00	0.00E+00	1.13E+05	5.18E+03	0.00E+00
NI-63	5.80E+05	4.34E+04	1.98E+04	0.00E+00	0.00E+00	3.07E+05	1.42E+04	0.00E+00
NI-65	2.18E+00	2.93E-01	1.27E-01	0.00E+00	0.00E+00	9.36E+03	3.67E+04	0.00E+00
CU-64	0.00E+00	2.03E+00	8.48E-01	0.00E+00	6.41E+00	1.11E+04	6.14E+04	0.00E+00
ZN-65	3.86E+04	1.34E+05	6.24E+04	0.00E+00	8.64E+04	1.24E+06	4.66E+04	0.00E+00
ZN-69M	1.15E+01	2.71E+01	2.49E+00	0.00E+00	1.65E+01	3.14E+04	1.71E+05	0.00E+00
ZN-69	4.83E-02	9.20E-02	6.46E-03	0.00E+00	6.02E-02	1.58E+03	2.85E+02	0.00E+00
SE-79	0.00E+00	4.34E+03	6.97E+02	0.00E+00	6.50E+03	6.17E+05	2.82E+04	0.00E+00
BR-82	0.00E+00	0.00E+00	1.82E+04	0.00E+00	0.00E+00	0.00E+00	0.00E+00	0.00E+00
BR-83	0.00E+00	0.00E+00	3.44E+02	0.00E+00	0.00E+00	0.00E+00	0.00E+00	0.00E+00
BR-84	0.00E+00	0.00E+00	4.33E+02	0.00E+00	0.00E+00	0.00E+00	0.00E+00	0.00E+00
BR-85	0.00E+00	0.00E+00	1.83E+01	0.00E+00	0.00E+00	0.00E+00	0.00E+00	0.00E+00
RB-86	0.00E+00	1.90E+05	8.40E+04	0.00E+00	0.00E+00	0.00E+00	1.77E+04	0.00E+00
RB-87	0.00E+00	1.12E+05	3.66E+04	0.00E+00	0.00E+00	0.00E+00	2.44E+03	0.00E+00
RB-88	0.00E+00	5.46E+02	2.72E+02	0.00E+00	0.00E+00	0.00E+00	2.92E-05	0.00E+00
RB-89	0.00E+00	3.52E+02	2.33E+02	0.00E+00	0.00E+00	0.00E+00	3.38E-07	0.00E+00
SR-89	4.34E+05	0.00E+00	1.25E+04	0.00E+00	0.00E+00	2.42E+06	3.71E+05	0.00E+00
SR-90	3.31E+07	0.00E+00	6.66E+05	0.00E+00	0.00E+00	1.65E+07	7.65E+05	0.00E+00
SR-91	8.80E+01	0.00E+00	3.51E+00	0.00E+00	0.00E+00	6.07E+04	2.59E+05	0.00E+00
SR-92	9.52E+00	0.00E+00	4.06E-01	0.00E+00	0.00E+00	2.74E+04	1.19E+05	0.00E+00
Y-90	2.98E+03	0.00E+00	8.00E+01	0.00E+00	0.00E+00	2.93E+05	5.59E+05	0.00E+00
Y-91M	3.70E-01	0.00E+00	1.42E-02	0.00E+00	0.00E+00	3.20E+03	3.02E+01	0.00E+00

TABLE II-2-3

R_i / P_i DOSE FACTORS AGE: TEEN PATHWAY: INHALATIONmrem/yr per $\mu\text{Ci}/\text{m}^3$

NUCLIDE	BONE	LIVER	T BODY	THYROID	KIDNEY	LUNG	GI-LLI	SKIN
Y-91	6.61E+05	0.00E+00	1.77E+04	0.00E+00	0.00E+00	2.94E+06	4.09E+05	0.00E+00
Y-92	1.47E+01	0.00E+00	4.29E-01	0.00E+00	0.00E+00	2.68E+04	1.65E+05	0.00E+00
Y-93	1.35E+02	0.00E+00	3.72E+00	0.00E+00	0.00E+00	8.32E+04	5.79E+05	0.00E+00
ZR-93	5.46E+05	2.70E+04	1.47E+04	0.00E+00	9.28E+04	2.94E+05	1.28E+04	0.00E+00
ZR-95	1.46E+05	4.58E+04	3.15E+04	0.00E+00	6.74E+04	2.69E+06	1.49E+05	0.00E+00
ZR-97	1.38E+02	2.72E+01	1.26E+01	0.00E+00	4.12E+01	1.30E+05	6.30E+05	0.00E+00
NB-93M	3.31E+05	1.09E+05	2.73E+04	0.00E+00	1.27E+05	4.29E+05	2.02E+04	0.00E+00
NB-95	1.86E+04	1.03E+04	5.66E+03	0.00E+00	1.00E+04	7.51E+05	9.68E+04	0.00E+00
NB-97	3.14E-01	7.78E-02	2.84E-02	0.00E+00	9.12E-02	3.93E+03	2.17E+03	0.00E+00
MO-93	0.00E+00	1.33E+04	3.62E+02	0.00E+00	4.05E+03	7.05E+05	3.19E+04	0.00E+00
MO-99	0.00E+00	1.69E+02	3.22E+01	0.00E+00	4.11E+02	1.54E+05	2.69E+05	0.00E+00
TC-99M	1.38E-03	3.86E-03	4.99E-02	0.00E+00	5.76E-02	1.15E+03	6.13E+03	0.00E+00
TC-99	3.58E+02	5.26E+02	1.43E+02	0.00E+00	6.68E+03	1.39E+06	6.39E+04	0.00E+00
TC-101	5.92E-05	8.40E-05	8.24E-04	0.00E+00	1.52E-03	6.67E+02	8.72E-07	0.00E+00
RU-103	2.10E+03	0.00E+00	8.96E+02	0.00E+00	7.43E+03	7.83E+05	1.09E+05	0.00E+00
RU-105	1.12E+00	0.00E+00	4.34E-01	0.00E+00	1.41E+00	1.82E+04	9.04E+04	0.00E+00
RU-106	9.84E+04	0.00E+00	1.24E+04	0.00E+00	1.90E+05	1.61E+07	9.60E+05	0.00E+00
RH-105	1.06E+01	7.58E+00	4.99E+00	0.00E+00	3.23E+01	3.27E+04	9.84E+04	0.00E+00
PD-107	0.00E+00	9.36E+02	6.71E+01	0.00E+00	7.51E+03	1.30E+05	5.99E+03	0.00E+00
PD-109	0.00E+00	5.25E+00	1.33E+00	0.00E+00	2.69E+01	2.55E+04	1.57E+05	0.00E+00
AG-110M	1.38E+04	1.31E+04	7.99E+03	0.00E+00	2.50E+04	6.75E+06	2.73E+05	0.00E+00
AG-111	4.86E+02	2.02E+02	1.01E+02	0.00E+00	6.54E+02	3.20E+05	2.40E+05	0.00E+00
CD-113M	0.00E+00	1.74E+06	5.68E+04	0.00E+00	1.94E+06	2.87E+06	1.34E+05	0.00E+00
CD-115M	0.00E+00	2.78E+05	9.12E+03	0.00E+00	2.26E+05	2.42E+06	4.08E+05	0.00E+00
SN-123	3.45E+05	7.55E+03	1.12E+04	6.04E+03	0.00E+00	3.97E+06	3.33E+05	0.00E+00
SN-125	1.33E+04	3.54E+02	7.99E+02	2.76E+02	0.00E+00	1.01E+06	5.83E+05	0.00E+00
SN-126	1.74E+06	4.31E+04	6.59E+04	1.14E+04	0.00E+00	1.38E+07	1.34E+05	0.00E+00
SB-124	4.30E+04	7.94E+02	1.68E+04	9.76E+01	0.00E+00	3.85E+06	3.98E+05	0.00E+00
SB-125	7.38E+04	8.08E+02	1.72E+04	7.04E+01	0.00E+00	2.74E+06	9.92E+04	0.00E+00
SB-126	4.95E+03	1.02E+02	1.78E+03	2.80E+01	0.00E+00	1.24E+06	4.81E+05	0.00E+00
SB-127	3.71E+02	7.94E+00	1.40E+02	4.17E+00	0.00E+00	2.65E+05	3.15E+05	0.00E+00
TE-125M	4.88E+03	2.24E+03	6.67E+02	1.40E+03	0.00E+00	5.36E+05	7.50E+04	0.00E+00
TE-127M	1.80E+04	8.16E+03	2.18E+03	4.38E+03	6.54E+04	1.66E+06	1.59E+05	0.00E+00
TE-127	2.01E+00	9.12E-01	4.42E-01	1.42E+00	7.28E+00	1.12E+04	8.08E+04	0.00E+00
TE-129M	1.39E+04	6.58E+03	2.25E+03	4.58E+03	5.19E+04	1.98E+06	4.05E+05	0.00E+00
TE-129	7.10E-02	3.38E-02	1.76E-02	5.18E-02	2.66E-01	3.30E+03	1.62E+03	0.00E+00
TE-131M	9.84E+01	6.01E+01	4.02E+01	7.25E+01	4.39E+02	2.38E+05	6.21E+05	0.00E+00

TABLE II-2-3

R_i / P_i DOSE FACTORS AGE: TEEN PATHWAY: INHALATIONmrem/yr per $\mu\text{Ci}/\text{m}^3$

NUCLIDE	BONE	LIVER	T BODY	THYROID	KIDNEY	LUNG	GI-LLI	SKIN
TE-131	1.58E-02	8.32E-03	5.04E-03	1.24E-02	6.18E-02	2.34E+03	1.51E+01	0.00E+00
TE-132	3.60E+02	2.90E+02	2.19E+02	2.46E+02	1.95E+03	4.49E+05	4.63E+05	0.00E+00
TE-133M	8.08E-02	5.86E-02	4.57E-02	6.54E-02	4.06E-01	6.97E+03	9.84E+02	0.00E+00
TE-134	4.25E-02	3.48E-02	2.91E-02	3.57E-02	2.33E-01	5.40E+03	1.10E+01	0.00E+00
I-129	2.82E+04	2.35E+04	3.92E+04	2.93E+07	4.21E+04	0.00E+00	1.83E+03	0.00E+00
I-130	6.24E+03	1.79E+04	7.17E+03	1.49E+06	2.75E+04	0.00E+00	9.12E+03	0.00E+00
I-131	3.54E+04	4.91E+04	2.64E+04	1.46E+07	8.40E+04	0.00E+00	6.49E+03	0.00E+00
I-132	1.59E+03	4.38E+03	1.58E+03	1.51E+05	6.92E+03	0.00E+00	1.27E+03	0.00E+00
I-133	1.22E+04	2.05E+04	6.22E+03	2.92E+06	3.59E+04	0.00E+00	1.03E+04	0.00E+00
I-134	8.88E+02	2.32E+03	8.40E+02	3.95E+04	3.66E+03	0.00E+00	2.04E+01	0.00E+00
I-135	3.70E+03	9.44E+03	3.49E+03	6.21E+05	1.49E+04	0.00E+00	6.95E+03	0.00E+00
CS-134M	1.76E+02	3.48E+02	1.88E+02	0.00E+00	2.03E+02	3.65E+01	1.62E+02	0.00E+00
CS-134	5.02E+05	1.13E+06	5.49E+05	0.00E+00	3.75E+05	1.46E+05	9.76E+03	0.00E+00
CS-135	1.66E+05	1.46E+05	3.58E+04	0.00E+00	5.84E+04	2.16E+04	1.78E+03	0.00E+00
CS-136	5.15E+04	1.94E+05	1.37E+05	0.00E+00	1.10E+05	1.78E+04	1.09E+04	0.00E+00
CS-137	6.70E+05	8.48E+05	3.11E+05	0.00E+00	3.04E+05	1.21E+05	8.48E+03	0.00E+00
CS-138	4.66E+02	8.56E+02	4.46E+02	0.00E+00	6.62E+02	7.87E+01	2.70E-01	0.00E+00
CS-139	2.92E+02	4.10E+02	1.58E+02	0.00E+00	3.47E+02	3.89E+01	1.33E-13	0.00E+00
BA-139	1.34E+00	9.44E-04	3.90E-02	0.00E+00	8.88E-04	6.46E+03	6.45E+03	0.00E+00
BA-140	5.47E+04	6.70E+01	3.52E+03	0.00E+00	2.28E+01	2.03E+06	2.29E+05	0.00E+00
BA-141	1.42E-01	1.06E-04	4.74E-03	0.00E+00	9.84E-05	3.29E+03	7.46E-04	0.00E+00
BA-142	3.70E-02	3.70E-05	2.27E-03	0.00E+00	3.14E-05	1.91E+03	4.79E-10	0.00E+00
LA-140	4.79E+02	2.36E+02	6.26E+01	0.00E+00	0.00E+00	2.14E+05	4.87E+05	0.00E+00
LA-141	6.10E+00	1.88E+00	3.10E-01	0.00E+00	0.00E+00	1.85E+04	1.23E+05	0.00E+00
LA-142	9.60E-01	4.25E-01	1.06E-01	0.00E+00	0.00E+00	1.02E+04	1.20E+04	0.00E+00
CE-141	2.84E+04	1.90E+04	2.17E+03	0.00E+00	8.88E+03	6.14E+05	1.26E+05	0.00E+00
CE-143	2.66E+02	1.94E+02	2.16E+01	0.00E+00	8.64E+01	1.30E+05	2.55E+05	0.00E+00
CE-144	4.89E+06	2.02E+06	2.62E+05	0.00E+00	1.21E+06	1.34E+07	8.64E+05	0.00E+00
PR-143	1.34E+04	5.31E+03	6.62E+02	0.00E+00	3.09E+03	4.83E+05	2.14E+05	0.00E+00
PR-144	4.30E-02	1.76E-02	2.18E-03	0.00E+00	1.01E-02	1.75E+03	2.35E-04	0.00E+00
ND-147	7.86E+03	8.56E+03	5.13E+02	0.00E+00	5.02E+03	3.72E+05	1.82E+05	0.00E+00
PM-147	9.20E+05	8.80E+04	3.60E+04	0.00E+00	1.68E+05	9.12E+05	4.70E+04	0.00E+00
PM-148M	1.06E+05	2.68E+04	2.10E+04	0.00E+00	4.06E+04	2.56E+06	3.28E+05	0.00E+00
PM-148	4.35E+03	7.10E+02	3.58E+02	0.00E+00	1.28E+03	5.22E+05	4.91E+05	0.00E+00
PM-149	3.93E+02	5.51E+01	2.27E+01	0.00E+00	1.05E+02	9.92E+04	2.23E+05	0.00E+00
PM-151	9.60E+01	1.59E+01	8.08E+00	0.00E+00	2.86E+01	5.25E+04	1.82E+05	0.00E+00
SM-151	8.56E+05	1.68E+05	3.89E+04	0.00E+00	1.82E+05	6.14E+05	2.82E+04	0.00E+00

TABLE II-2-3

R_i / P_i DOSE FACTORS AGE: TEEN PATHWAY: INHALATIONmrem/yr per $\mu\text{Ci}/\text{m}^3$

NUCLIDE	BONE	LIVER	T BODY	THYROID	KIDNEY	LUNG	GI-LLI	SKIN
SM-153	1.94E+02	1.61E+02	1.18E+01	0.00E+00	5.25E+01	5.69E+04	1.42E+05	0.00E+00
EU-152	2.37E+06	5.75E+05	5.04E+05	0.00E+00	2.67E+06	4.01E+06	1.08E+05	0.00E+00
EU-154	7.54E+06	9.84E+05	6.88E+05	0.00E+00	4.35E+06	7.30E+06	2.67E+05	0.00E+00
EU-155	1.60E+06	1.57E+05	9.68E+04	0.00E+00	6.12E+05	1.21E+07	4.78E+05	0.00E+00
EU-156	2.16E+04	1.62E+04	2.64E+03	0.00E+00	1.09E+04	1.10E+06	3.65E+05	0.00E+00
TB-160	2.43E+05	0.00E+00	3.03E+04	0.00E+00	9.60E+04	2.38E+06	2.08E+05	0.00E+00
HO-166M	3.52E+06	1.09E+06	7.90E+05	0.00E+00	1.60E+06	4.99E+06	1.34E+05	0.00E+00
W-181	7.12E+01	2.30E+01	2.41E+00	0.00E+00	0.00E+00	2.36E+04	2.15E+03	0.00E+00
W-185	2.22E+03	7.34E+02	7.78E+01	0.00E+00	0.00E+00	7.68E+05	9.12E+04	0.00E+00
W-187	1.20E+01	9.76E+00	3.43E+00	0.00E+00	0.00E+00	4.74E+04	1.77E+05	0.00E+00
U-232	5.85E+08	0.00E+00	4.18E+07	0.00E+00	6.35E+07	3.07E+09	3.57E+05	0.00E+00
U-233	1.24E+08	0.00E+00	7.54E+06	0.00E+00	2.90E+07	7.34E+08	3.30E+05	0.00E+00
U-234	1.18E+08	0.00E+00	7.38E+06	0.00E+00	2.84E+07	7.19E+08	3.23E+05	0.00E+00
U-235	1.14E+08	0.00E+00	6.94E+06	0.00E+00	2.67E+07	6.75E+08	4.10E+05	0.00E+00
U-236	1.14E+08	0.00E+00	7.09E+06	0.00E+00	2.73E+07	6.90E+08	3.03E+05	0.00E+00
U-237	4.20E+02	0.00E+00	1.12E+02	0.00E+00	1.73E+03	1.41E+05	1.03E+05	0.00E+00
U-238	1.09E+08	0.00E+00	6.48E+06	0.00E+00	2.50E+07	6.31E+08	2.90E+05	0.00E+00
NP-237	1.31E+10	8.48E+09	5.77E+08	0.00E+00	4.28E+09	7.19E+08	4.18E+05	0.00E+00
NP-238	3.38E+03	8.16E+02	5.27E+01	0.00E+00	3.10E+02	1.40E+05	1.90E+05	0.00E+00
NP-239	3.38E+02	2.88E+02	1.77E+01	0.00E+00	1.00E+02	6.49E+04	1.32E+05	0.00E+00
PU-238	1.20E+10	8.24E+09	5.78E+08	0.00E+00	2.48E+09	2.50E+09	3.83E+05	0.00E+00
PU-239	1.38E+10	8.96E+09	6.44E+08	0.00E+00	2.75E+09	2.34E+09	3.50E+05	0.00E+00
PU-240	1.38E+10	8.96E+09	6.43E+08	0.00E+00	2.74E+09	2.34E+09	3.57E+05	0.00E+00
PU-241	2.99E+08	7.65E+07	1.12E+07	0.00E+00	5.18E+07	2.08E+06	7.34E+03	0.00E+00
PU-242	1.28E+10	8.64E+09	6.20E+08	0.00E+00	2.65E+09	2.26E+09	3.43E+05	0.00E+00
PU-244	1.50E+10	9.92E+09	7.10E+08	0.00E+00	3.03E+09	2.58E+09	5.11E+05	0.00E+00
AM-241	1.42E+10	9.60E+09	5.68E+08	0.00E+00	4.26E+09	8.40E+08	3.90E+05	0.00E+00
AM-242M	1.43E+10	9.04E+09	5.72E+08	0.00E+00	4.24E+09	3.37E+08	4.91E+05	0.00E+00
AM-243	1.42E+10	9.36E+09	5.56E+08	0.00E+00	4.17E+09	7.93E+08	4.58E+05	0.00E+00
CM-242	2.54E+08	2.01E+08	1.13E+07	0.00E+00	5.12E+07	5.41E+08	4.17E+05	0.00E+00
CM-243	9.52E+09	6.64E+09	4.00E+08	0.00E+00	1.87E+09	8.72E+08	4.10E+05	0.00E+00
CM-244	7.35E+09	5.22E+09	3.10E+08	0.00E+00	1.45E+09	8.40E+08	3.97E+05	0.00E+00
CM-245	1.46E+10	9.76E+09	6.02E+08	0.00E+00	2.82E+09	8.08E+08	3.70E+05	0.00E+00
CM-246	1.45E+10	9.76E+09	6.02E+08	0.00E+00	2.81E+09	8.24E+08	3.63E+05	0.00E+00
CM-247	1.42E+10	9.52E+09	5.93E+08	0.00E+00	2.77E+09	8.08E+08	4.78E+05	0.00E+00
CM-248	1.18E+09	7.86E+10	4.89E+09	0.00E+00	2.28E+10	6.66E+09	7.70E+06	0.00E+00
CF-252	5.73E+09	0.00E+00	2.46E+08	0.00E+00	0.00E+00	2.74E+09	1.51E+06	0.00E+00

TABLE II-4

R_i / P_i DOSE FACTORS AGE: CHILD PATHWAY: INHALATIONmrem/yr per $\mu\text{Ci}/\text{m}^3$

NUCLIDE	BONE	LIVER	T BODY	THYROID	KIDNEY	LUNG	GI-LLI	SKIN
H-3	0.00E+00	6.40E+02	6.40E+02	6.40E+02	6.40E+02	6.40E+02	6.40E+02	0.00E+00
C-14	3.59E+04	6.73E+03	6.73E+03	6.73E+03	6.73E+03	6.73E+03	6.73E+03	0.00E+00
NA-22	1.63E+05	1.63E+05	1.63E+05	1.63E+05	1.63E+05	1.63E+05	1.63E+05	0.00E+00
NA-24	1.61E+04	1.61E+04	1.61E+04	1.61E+04	1.61E+04	1.61E+04	1.61E+04	0.00E+00
P-32	2.60E+06	1.14E+05	9.88E+04	0.00E+00	0.00E+00	0.00E+00	4.22E+04	0.00E+00
CA-41	2.61E+05	0.00E+00	2.85E+04	0.00E+00	0.00E+00	2.67E+08	1.09E+03	0.00E+00
SC-46	7.29E+05	9.99E+05	3.85E+05	0.00E+00	8.84E+05	0.00E+00	9.07E+04	0.00E+00
CR-51	0.00E+00	0.00E+00	1.54E+02	8.55E+01	2.43E+01	1.70E+04	1.08E+03	0.00E+00
MN-54	0.00E+00	4.29E+04	9.51E+03	0.00E+00	1.00E+04	1.58E+06	2.29E+04	0.00E+00
MN-56	0.00E+00	1.66E+00	3.12E-01	0.00E+00	1.67E+00	1.31E+04	1.23E+05	0.00E+00
FE-55	4.74E+04	2.52E+04	7.77E+03	0.00E+00	0.00E+00	1.11E+05	2.87E+03	0.00E+00
FE-59	2.07E+04	3.34E+04	1.67E+04	0.00E+00	0.00E+00	1.27E+06	7.07E+04	0.00E+00
CO-57	0.00E+00	9.03E+02	1.07E+03	0.00E+00	0.00E+00	5.07E+05	1.32E+04	0.00E+00
CO-58	0.00E+00	1.77E+03	3.16E+03	0.00E+00	0.00E+00	1.11E+06	3.44E+04	0.00E+00
CO-60	0.00E+00	1.31E+04	2.26E+04	0.00E+00	0.00E+00	7.07E+06	9.62E+04	0.00E+00
NI-59	6.14E+04	1.73E+04	1.05E+04	0.00E+00	0.00E+00	1.01E+05	2.33E+03	0.00E+00
NI-63	8.21E+05	4.63E+04	2.80E+04	0.00E+00	0.00E+00	2.75E+05	6.33E+03	0.00E+00
NI-65	2.99E+00	2.96E-01	1.64E-01	0.00E+00	0.00E+00	8.18E+03	8.40E+04	0.00E+00
CU-64	0.00E+00	1.99E+00	1.07E+00	0.00E+00	6.03E+00	9.58E+03	3.67E+04	0.00E+00
ZN-65	4.26E+04	1.13E+05	7.03E+04	0.00E+00	7.14E+04	9.95E+05	1.63E+04	0.00E+00
ZN-69M	1.58E+01	2.69E+01	3.18E+00	0.00E+00	1.56E+01	2.72E+04	1.00E+05	0.00E+00
ZN-69	6.70E-02	9.66E-02	8.92E-03	0.00E+00	5.85E-02	1.42E+03	1.02E+04	0.00E+00
SE-79	0.00E+00	4.55E+03	9.62E+02	0.00E+00	6.33E+03	5.51E+05	1.27E+04	0.00E+00
BR-82	0.00E+00	0.00E+00	2.09E+04	0.00E+00	0.00E+00	0.00E+00	0.00E+00	0.00E+00
BR-83	0.00E+00	0.00E+00	4.74E+02	0.00E+00	0.00E+00	0.00E+00	0.00E+00	0.00E+00
BR-84	0.00E+00	0.00E+00	5.48E+02	0.00E+00	0.00E+00	0.00E+00	0.00E+00	0.00E+00
BR-85	0.00E+00	0.00E+00	2.53E+01	0.00E+00	0.00E+00	0.00E+00	0.00E+00	0.00E+00
RB-86	0.00E+00	1.98E+05	1.14E+05	0.00E+00	0.00E+00	0.00E+00	7.99E+03	0.00E+00
RB-87	0.00E+00	1.17E+05	5.07E+04	0.00E+00	0.00E+00	0.00E+00	1.10E+03	0.00E+00
RB-88	0.00E+00	5.62E+02	3.66E+02	0.00E+00	0.00E+00	0.00E+00	1.72E+01	0.00E+00
RB-89	0.00E+00	3.45E+02	2.90E+02	0.00E+00	0.00E+00	0.00E+00	1.89E+00	0.00E+00
SR-89	5.99E+05	0.00E+00	1.72E+04	0.00E+00	0.00E+00	2.16E+06	1.67E+05	0.00E+00
SR-90	3.85E+07	0.00E+00	7.66E+05	0.00E+00	0.00E+00	1.48E+07	3.43E+05	0.00E+00
SR-91	1.21E+02	0.00E+00	4.59E+00	0.00E+00	0.00E+00	5.33E+04	1.74E+05	0.00E+00
SR-92	1.31E+01	0.00E+00	5.25E-01	0.00E+00	0.00E+00	2.40E+04	2.42E+05	0.00E+00
Y-90	4.11E+03	0.00E+00	1.11E+02	0.00E+00	0.00E+00	2.62E+05	2.68E+05	0.00E+00
Y-91M	5.07E-01	0.00E+00	1.84E-02	0.00E+00	0.00E+00	2.81E+03	1.72E+03	0.00E+00
Y-91	9.14E+05	0.00E+00	2.44E+04	0.00E+00	0.00E+00	2.63E+06	1.84E+05	0.00E+00
Y-92	2.04E+01	0.00E+00	5.81E-01	0.00E+00	0.00E+00	2.39E+04	2.39E+05	0.00E+00

TABLE II-2-4

R_i / P_i DOSE FACTORS AGE: CHILD PATHWAY: INHALATIONmrem/yr per $\mu\text{Ci}/\text{m}^3$

NUCLIDE	BONE	LIVER	T BODY	THYROID	KIDNEY	LUNG	GI-LLI	SKIN
Y-93	1.86E+02	0.00E+00	5.11E+00	0.00E+00	0.00E+00	7.44E+04	3.89E+05	0.00E+00
ZR-93	7.66E+05	2.89E+04	2.05E+04	0.00E+00	1.11E+05	2.63E+05	5.44E+03	0.00E+00
ZR-95	1.90E+05	4.18E+04	3.70E+04	0.00E+00	5.96E+04	2.23E+06	6.11E+04	0.00E+00
ZR-97	1.88E+02	2.72E+01	1.60E+01	0.00E+00	3.89E+01	1.13E+05	3.51E+05	0.00E+00
NB-93M	4.70E+05	1.17E+05	3.85E+04	0.00E+00	1.27E+05	3.85E+05	9.07E+03	0.00E+00
NB-95	2.35E+04	9.18E+03	6.55E+03	0.00E+00	8.62E+03	6.14E+05	3.70E+04	0.00E+00
NB-97	4.29E-01	7.70E-02	3.60E-02	0.00E+00	8.55E-02	3.42E+03	2.78E+04	0.00E+00
MO-93	0.00E+00	1.39E+04	5.00E+02	0.00E+00	3.92E+03	6.29E+05	1.40E+04	0.00E+00
MO-99	0.00E+00	1.72E+02	4.26E+01	0.00E+00	3.92E+02	1.35E+05	1.27E+05	0.00E+00
TC-99M	1.78E-03	3.48E-03	5.77E-02	0.00E+00	5.07E-02	9.51E+02	4.81E+03	0.00E+00
TC-99	4.96E+02	5.51E+02	1.98E+02	0.00E+00	6.48E+03	1.25E+06	2.87E+04	0.00E+00
TC-101	8.10E-05	8.51E-05	1.08E-03	0.00E+00	1.45E-03	5.85E+02	1.63E+01	0.00E+00
RU-103	2.79E+03	0.00E+00	1.07E+03	0.00E+00	7.03E+03	6.62E+05	4.48E+04	0.00E+00
RU-105	1.53E+00	0.00E+00	5.55E-01	0.00E+00	1.34E+00	1.59E+04	9.95E+04	0.00E+00
RU-106	1.36E+05	0.00E+00	1.69E+04	0.00E+00	1.84E+05	1.43E+07	4.29E+05	0.00E+00
RH-105	1.45E+01	7.77E+00	6.62E+00	0.00E+00	3.10E+01	2.89E+04	4.92E+04	0.00E+00
PD-107	0.00E+00	9.81E+02	9.29E+01	0.00E+00	7.29E+03	1.17E+05	2.69E+03	0.00E+00
PD-109	0.00E+00	5.48E+00	1.83E+00	0.00E+00	2.61E+01	2.28E+04	9.58E+04	0.00E+00
AG-110M	1.69E+04	1.14E+04	9.14E+03	0.00E+00	2.12E+04	5.48E+06	1.00E+05	0.00E+00
AG-111	6.70E+02	2.10E+02	1.39E+02	0.00E+00	6.33E+02	2.86E+05	1.10E+05	0.00E+00
CD-113M	0.00E+00	1.82E+06	7.84E+04	0.00E+00	1.90E+06	2.57E+06	6.03E+04	0.00E+00
CD-115M	0.00E+00	2.92E+05	1.25E+04	0.00E+00	2.19E+05	2.17E+06	1.84E+05	0.00E+00
SN-123	4.77E+05	7.92E+03	1.55E+04	8.40E+03	0.00E+00	3.55E+06	1.50E+05	0.00E+00
SN-125	1.83E+04	3.68E+02	1.09E+03	3.81E+02	0.00E+00	8.99E+05	2.65E+05	0.00E+00
SN-126	2.31E+06	3.85E+04	8.73E+04	1.05E+04	0.00E+00	1.12E+07	6.03E+04	0.00E+00
SB-124	5.74E+04	7.40E+02	2.00E+04	1.26E+02	0.00E+00	3.24E+06	1.64E+05	0.00E+00
SB-125	9.84E+04	7.59E+02	2.07E+04	9.10E+01	0.00E+00	2.32E+06	4.03E+04	0.00E+00
SB-126	6.36E+03	9.69E+01	2.28E+03	3.70E+01	0.00E+00	1.06E+06	2.10E+05	0.00E+00
SB-127	5.03E+02	7.73E+00	1.74E+02	5.59E+00	0.00E+00	2.28E+05	1.41E+05	0.00E+00
TE-125M	6.73E+03	2.33E+03	9.14E+02	1.92E+03	0.00E+00	4.77E+05	3.38E+04	0.00E+00
TE-127M	2.49E+04	8.55E+03	3.02E+03	6.07E+03	6.36E+04	1.48E+06	7.14E+04	0.00E+00
TE-127	2.77E+00	9.51E-01	6.11E-01	1.96E+00	7.07E+00	1.00E+04	5.62E+04	0.00E+00
TE-129M	1.92E+04	6.85E+03	3.04E+03	6.33E+03	5.03E+04	1.76E+06	1.82E+05	0.00E+00
TE-129	9.77E-02	3.50E-02	2.38E-02	7.14E-02	2.57E-01	2.93E+03	2.55E+04	0.00E+00
TE-131M	1.34E+02	5.92E+01	5.07E+01	9.77E+01	4.00E+02	2.06E+05	3.08E+05	0.00E+00
TE-131	2.17E-02	8.44E-03	6.59E-03	1.70E-02	5.88E-02	2.05E+03	1.33E+03	0.00E+00
TE-132	4.81E+02	2.72E+02	2.63E+02	3.17E+02	1.77E+03	3.77E+05	1.38E+05	0.00E+00
TE-133M	1.08E-01	5.59E-02	5.55E-02	8.58E-02	3.74E-01	5.92E+03	1.76E+04	0.00E+00
TE-134	5.66E-02	3.26E-02	3.48E-02	4.59E-02	2.11E-01	4.55E+03	1.80E+03	0.00E+00

TABLE II-2-4

R_i / P_i DOSE FACTORS AGE: CHILD PATHWAY: INHALATIONmrem/yr per $\mu\text{Ci}/\text{m}^3$

NUCLIDE	BONE	LIVER	T BODY	THYROID	KIDNEY	LUNG	GI-LLI	SKIN
I-129	3.89E+04	2.37E+04	2.11E+04	1.58E+07	4.00E+04	0.00E+00	7.96E+02	0.00E+00
I-130	8.18E+03	1.64E+04	8.44E+03	1.85E+06	2.45E+04	0.00E+00	5.11E+03	0.00E+00
I-131	4.81E+04	4.81E+04	2.73E+04	1.62E+07	7.88E+04	0.00E+00	2.84E+03	0.00E+00
I-132	2.12E+03	4.07E+03	1.88E+03	1.94E+05	6.25E+03	0.00E+00	3.20E+03	0.00E+00
I-133	1.66E+04	2.03E+04	7.70E+03	3.85E+06	3.38E+04	0.00E+00	5.48E+03	0.00E+00
I-134	1.17E+03	2.16E+03	9.95E+02	5.07E+04	3.30E+03	0.00E+00	9.55E+02	0.00E+00
I-135	4.92E+03	8.73E+03	4.14E+03	7.92E+05	1.34E+04	0.00E+00	4.44E+03	0.00E+00
CS-134M	2.34E+02	3.30E+02	2.26E+02	0.00E+00	1.83E+02	3.09E+01	2.93E+02	0.00E+00
CS-134	6.51E+05	1.01E+06	2.25E+05	0.00E+00	3.30E+05	1.21E+05	3.85E+03	0.00E+00
CS-135	2.31E+05	1.53E+05	1.65E+04	0.00E+00	5.66E+04	1.93E+04	8.03E+02	0.00E+00
CS-136	6.51E+04	1.71E+05	1.16E+05	0.00E+00	9.55E+04	1.45E+04	4.18E+03	0.00E+00
CS-137	9.07E+05	8.25E+05	1.28E+05	0.00E+00	2.82E+05	1.04E+05	3.62E+03	0.00E+00
CS-138	6.33E+02	8.40E+02	5.55E+02	0.00E+00	6.22E+02	6.81E+01	2.70E+02	0.00E+00
CS-139	4.03E+02	4.26E+02	2.15E+02	0.00E+00	3.36E+02	3.46E+01	2.68E-02	0.00E+00
BA-139	1.84E+00	9.84E-04	5.37E-02	0.00E+00	8.62E-04	5.77E+03	5.77E+04	0.00E+00
BA-140	7.40E+04	6.48E+01	4.33E+03	0.00E+00	2.11E+01	1.74E+06	1.02E+05	0.00E+00
BA-141	1.96E-01	1.09E-04	6.36E-03	0.00E+00	9.47E-05	2.92E+03	2.75E+02	0.00E+00
BA-142	5.00E-02	3.60E-05	2.79E-03	0.00E+00	2.91E-05	1.64E+03	2.74E+00	0.00E+00
LA-140	6.44E+02	2.25E+02	7.55E+01	0.00E+00	0.00E+00	1.83E+05	2.26E+05	0.00E+00
LA-141	8.44E+00	1.96E+00	4.26E-01	0.00E+00	0.00E+00	1.66E+04	1.62E+05	0.00E+00
LA-142	1.30E+00	4.11E-01	1.29E-01	0.00E+00	0.00E+00	8.70E+03	7.59E+04	0.00E+00
CE-141	3.92E+04	1.95E+04	2.90E+03	0.00E+00	8.55E+03	5.44E+05	5.66E+04	0.00E+00
CE-143	3.66E+02	1.99E+02	2.87E+01	0.00E+00	8.36E+01	1.15E+05	1.27E+05	0.00E+00
CE-144	6.77E+06	2.12E+06	3.61E+05	0.00E+00	1.17E+06	1.20E+07	3.89E+05	0.00E+00
PR-143	1.85E+04	5.55E+03	9.14E+02	0.00E+00	3.00E+03	4.33E+05	9.73E+04	0.00E+00
PR-144	5.96E-02	1.85E-02	3.00E-03	0.00E+00	9.77E-03	1.57E+03	1.97E+02	0.00E+00
ND-147	1.08E+04	8.73E+03	6.81E+02	0.00E+00	4.81E+03	3.28E+05	8.21E+04	0.00E+00
PM-147	1.30E+06	9.32E+04	5.03E+04	0.00E+00	1.65E+05	8.14E+05	2.11E+04	0.00E+00
PM-148M	1.22E+05	2.42E+04	2.42E+04	0.00E+00	3.60E+04	2.12E+06	1.32E+05	0.00E+00
PM-148	5.96E+03	7.18E+02	4.63E+02	0.00E+00	1.22E+03	4.59E+05	2.22E+05	0.00E+00
PM-149	5.44E+02	5.77E+01	3.13E+01	0.00E+00	1.02E+02	8.88E+04	1.08E+05	0.00E+00
PM-151	1.32E+02	1.60E+01	1.04E+01	0.00E+00	2.72E+01	4.59E+04	9.25E+04	0.00E+00
SM-151	1.16E+06	1.76E+05	5.51E+04	0.00E+00	1.81E+05	5.48E+05	1.27E+04	0.00E+00
SM-153	2.68E+02	1.67E+02	1.61E+01	0.00E+00	5.07E+01	5.07E+04	6.92E+04	0.00E+00
EU-152	2.75E+06	5.07E+05	5.96E+05	0.00E+00	2.12E+06	3.33E+06	4.22E+04	0.00E+00
EU-154	1.01E+07	9.21E+05	8.40E+05	0.00E+00	4.03E+06	6.14E+06	1.10E+05	0.00E+00
EU-155	2.07E+06	1.50E+05	1.18E+05	0.00E+00	5.59E+05	1.03E+06	1.99E+05	0.00E+00
EU-156	2.92E+04	1.57E+04	3.24E+03	0.00E+00	1.01E+04	9.40E+05	1.57E+05	0.00E+00
TB-160	2.88E+05	0.00E+00	3.58E+04	0.00E+00	8.58E+04	1.98E+06	8.44E+04	0.00E+00

TABLE II-4

R_i / P_i DOSE FACTORS AGE: CHILD PATHWAY: INHALATIONmrem/yr per $\mu\text{Ci}/\text{m}^3$

NUCLIDE	BONE	LIVER	T BODY	THYROID	KIDNEY	LUNG	GI-LLI	SKIN
HO-166M	4.96E+06	1.04E+06	8.77E+05	0.00E+00	1.48E+06	4.18E+06	6.03E+04	0.00E+00
W-181	9.84E+01	2.41E+01	3.33E+00	0.00E+00	0.00E+00	2.11E+04	9.66E+02	0.00E+00
W-185	3.07E+03	7.70E+02	1.08E+02	0.00E+00	0.00E+00	6.88E+05	4.11E+04	0.00E+00
W-187	1.63E+01	9.66E+00	4.33E+00	0.00E+00	0.00E+00	4.11E+04	9.10E+04	0.00E+00
U-232	8.10E+08	0.00E+00	5.77E+07	0.00E+00	6.18E+07	2.75E+09	1.60E+05	0.00E+00
U-233	1.72E+08	0.00E+00	1.04E+07	0.00E+00	2.82E+07	6.55E+08	1.48E+05	0.00E+00
U-234	1.65E+08	0.00E+00	1.02E+07	0.00E+00	2.76E+07	6.44E+08	1.45E+05	0.00E+00
U-235	1.58E+08	0.00E+00	9.58E+06	0.00E+00	2.59E+07	6.03E+08	1.84E+05	0.00E+00
U-236	1.58E+08	0.00E+00	9.81E+06	0.00E+00	2.65E+07	6.18E+08	1.36E+05	0.00E+00
U-237	5.81E+02	0.00E+00	1.54E+02	0.00E+00	1.68E+03	1.26E+05	4.77E+04	0.00E+00
U-238	1.51E+08	0.00E+00	8.95E+06	0.00E+00	2.42E+07	5.66E+08	1.30E+05	0.00E+00
NP-237	1.01E+10	5.99E+09	4.40E+08	0.00E+00	2.74E+09	6.44E+08	1.87E+05	0.00E+00
NP-238	4.66E+03	8.51E+02	7.29E+01	0.00E+00	3.02E+02	1.25E+05	9.25E+04	0.00E+00
NP-239	4.66E+02	3.01E+02	2.35E+01	0.00E+00	9.73E+01	5.81E+04	6.40E+04	0.00E+00
PU-238	9.44E+09	5.92E+09	4.48E+08	0.00E+00	1.65E+09	2.25E+09	1.72E+05	0.00E+00
PU-239	1.03E+10	6.22E+09	4.74E+08	0.00E+00	1.77E+09	2.12E+09	1.57E+05	0.00E+00
PU-240	1.03E+10	6.22E+09	4.70E+08	0.00E+00	1.76E+09	2.11E+09	1.60E+05	0.00E+00
PU-241	2.94E+08	6.48E+07	1.08E+07	0.00E+00	4.07E+07	1.87E+06	3.29E+03	0.00E+00
PU-242	9.58E+09	5.99E+09	4.55E+08	0.00E+00	1.70E+09	2.04E+09	1.54E+05	0.00E+00
PU-244	1.12E+10	6.85E+09	5.22E+08	0.00E+00	1.95E+09	2.33E+09	2.29E+05	0.00E+00
AM-241	1.10E+10	6.81E+09	4.59E+08	0.00E+00	2.82E+09	7.47E+08	1.75E+05	0.00E+00
AM-242M	1.14E+10	6.51E+09	4.70E+08	0.00E+00	2.85E+09	3.01E+08	2.21E+05	0.00E+00
AM-243	1.09E+10	6.59E+09	4.44E+08	0.00E+00	2.75E+09	7.10E+08	2.05E+05	0.00E+00
CM-242	3.51E+08	2.10E+08	1.55E+07	0.00E+00	4.96E+07	4.85E+08	1.87E+05	0.00E+00
CM-243	8.58E+09	5.25E+09	3.68E+08	0.00E+00	1.38E+09	7.77E+08	1.84E+05	0.00E+00
CM-244	7.18E+09	4.37E+09	3.07E+08	0.00E+00	1.13E+09	7.47E+08	1.78E+05	0.00E+00
CM-245	1.13E+10	6.81E+09	4.74E+08	0.00E+00	1.86E+09	7.22E+08	1.66E+05	0.00E+00
CM-246	1.12E+10	6.81E+09	4.74E+08	0.00E+00	1.86E+09	7.36E+08	1.63E+05	0.00E+00
CM-247	1.09E+10	6.73E+09	4.66E+08	0.00E+00	1.83E+09	7.22E+08	2.15E+05	0.00E+00
CM-248	9.07E+08	5.55E+08	3.85E+09	0.00E+00	1.51E+10	5.96E+09	3.46E+06	0.00E+00
CF-252	8.07E+09	0.00E+00	3.45E+08	0.00E+00	0.00E+00	2.45E+09	6.81E+05	0.00E+00

TABLE II-5

R_i / P_i DOSE FACTORS AGE: INFANT PATHWAY: INHALATIONmrem/yr per $\mu\text{Ci}/\text{m}^3$

NUCLIDE	BONE	LIVER	T BODY	THYROID	KIDNEY	LUNG	GI-LLI	SKIN
H-3	0.00E+00	3.68E+02	3.68E+02	3.68E+02	3.68E+02	3.68E+02	3.68E+02	0.00E+00
C-14	2.65E+04	5.31E+03	5.31E+03	5.31E+03	5.31E+03	5.31E+03	5.31E+03	0.00E+00
NA-22	1.03E+05	1.03E+05	1.03E+05	1.03E+05	1.03E+05	1.03E+05	1.03E+05	0.00E+00
NA-24	1.06E+04	1.06E+04	1.06E+04	1.06E+04	1.06E+04	1.06E+04	1.06E+04	0.00E+00
P-32	2.03E+06	1.12E+05	7.74E+04	0.00E+00	0.00E+00	0.00E+00	1.61E+04	0.00E+00
CA-41	1.05E+05	0.00E+00	1.14E+04	0.00E+00	0.00E+00	9.72E+07	4.14E+02	0.00E+00
SC-46	5.25E+05	7.57E+05	2.37E+05	0.00E+00	4.98E+05	0.00E+00	3.07E+04	0.00E+00
CR-51	0.00E+00	0.00E+00	8.95E+01	5.75E+01	1.32E+01	1.28E+04	3.57E+02	0.00E+00
MN-54	0.00E+00	2.53E+04	4.98E+03	0.00E+00	4.98E+03	1.00E+06	7.06E+03	0.00E+00
MN-56	0.00E+00	1.54E+00	2.21E-01	0.00E+00	1.10E+00	1.25E+04	7.17E+04	0.00E+00
FE-55	1.97E+04	1.17E+04	3.33E+03	0.00E+00	0.00E+00	8.69E+04	1.09E+03	0.00E+00
FE-59	1.36E+04	2.35E+04	9.48E+03	0.00E+00	0.00E+00	1.02E+06	2.48E+04	0.00E+00
CO-57	0.00E+00	6.51E+02	6.41E+02	0.00E+00	0.00E+00	3.79E+05	4.86E+03	0.00E+00
CO-58	0.00E+00	1.22E+03	1.82E+03	0.00E+00	0.00E+00	7.77E+05	1.11E+04	0.00E+00
CO-60	0.00E+00	8.02E+03	1.18E+04	0.00E+00	0.00E+00	4.51E+06	3.19E+04	0.00E+00
NI-59	2.53E+04	7.62E+03	4.34E+03	0.00E+00	0.00E+00	7.67E+04	8.88E+02	0.00E+00
NI-63	3.39E+05	2.04E+04	1.16E+04	0.00E+00	0.00E+00	2.09E+05	2.42E+03	0.00E+00
NI-65	2.39E+00	2.84E-01	1.23E-01	0.00E+00	0.00E+00	8.12E+03	5.01E+04	0.00E+00
CU-64	0.00E+00	1.88E+00	7.74E-01	0.00E+00	3.98E+00	9.30E+03	1.50E+04	0.00E+00
ZN-65	1.93E+04	6.26E+04	3.11E+04	0.00E+00	3.25E+04	6.47E+05	5.14E+04	0.00E+00
ZN-69M	1.26E+01	2.58E+01	2.34E+00	0.00E+00	1.04E+01	2.67E+04	4.09E+04	0.00E+00
ZN-69	5.39E-02	9.67E-02	7.18E-03	0.00E+00	4.02E-02	1.47E+03	1.32E+04	0.00E+00
SE-79	0.00E+00	3.15E+03	5.88E+02	0.00E+00	3.46E+03	4.19E+05	4.84E+03	0.00E+00
BR-82	0.00E+00	0.00E+00	1.33E+04	0.00E+00	0.00E+00	0.00E+00	0.00E+00	0.00E+00
BR-83	0.00E+00	0.00E+00	3.81E+02	0.00E+00	0.00E+00	0.00E+00	0.00E+00	0.00E+00
BR-84	0.00E+00	0.00E+00	4.00E+02	0.00E+00	0.00E+00	0.00E+00	0.00E+00	0.00E+00
BR-85	0.00E+00	0.00E+00	2.04E+01	0.00E+00	0.00E+00	0.00E+00	0.00E+00	0.00E+00
RB-86	0.00E+00	1.90E+05	8.82E+04	0.00E+00	0.00E+00	0.00E+00	3.04E+03	0.00E+00
RB-87	0.00E+00	9.95E+04	3.70E+04	0.00E+00	0.00E+00	0.00E+00	4.19E+02	0.00E+00
RB-88	0.00E+00	5.57E+02	2.87E+02	0.00E+00	0.00E+00	0.00E+00	3.39E+02	0.00E+00
RB-89	0.00E+00	3.21E+02	2.06E+02	0.00E+00	0.00E+00	0.00E+00	6.82E+01	0.00E+00
SR-89	3.98E+05	0.00E+00	1.14E+04	0.00E+00	0.00E+00	2.03E+06	6.40E+04	0.00E+00
SR-90	1.55E+07	0.00E+00	3.12E+05	0.00E+00	0.00E+00	1.12E+07	1.31E+05	0.00E+00
SR-91	9.56E+01	0.00E+00	3.46E+00	0.00E+00	0.00E+00	5.26E+04	7.34E+04	0.00E+00
SR-92	1.05E+01	0.00E+00	3.91E-01	0.00E+00	0.00E+00	2.38E+04	1.40E+05	0.00E+00
Y-90	3.29E+03	0.00E+00	8.82E+01	0.00E+00	0.00E+00	2.69E+05	1.04E+05	0.00E+00
Y-91M	4.07E-01	0.00E+00	1.39E-02	0.00E+00	0.00E+00	2.79E+03	2.35E+03	0.00E+00
Y-91	5.88E+05	0.00E+00	1.57E+04	0.00E+00	0.00E+00	2.45E+06	7.03E+04	0.00E+00
Y-92	1.64E+01	0.00E+00	4.61E-01	0.00E+00	0.00E+00	2.45E+04	1.27E+05	0.00E+00
Y-93	1.50E+02	0.00E+00	4.07E+00	0.00E+00	0.00E+00	7.64E+04	1.67E+05	0.00E+00

TABLE II2-5

R_i / P_i DOSE FACTORS AGE: INFANT PATHWAY: INHALATIONmrem/yr per $\mu\text{Ci}/\text{m}^3$

NUCLIDE	BONE	LIVER	T BODY	THYROID	KIDNEY	LUNG	GI-LLI	SKIN
ZR-93	3.14E+05	1.33E+04	8.65E+03	0.00E+00	4.47E+04	1.92E+05	2.07E+03	0.00E+00
ZR-95	1.15E+05	2.79E+04	2.03E+04	0.00E+00	3.11E+04	1.75E+06	2.17E+04	0.00E+00
ZR-97	1.50E+02	2.56E+01	1.17E+01	0.00E+00	2.59E+01	1.10E+05	1.40E+05	0.00E+00
NB-93M	1.93E+05	5.03E+04	1.61E+04	0.00E+00	5.15E+04	2.93E+05	3.46E+03	0.00E+00
NB-95	1.57E+04	6.43E+03	3.78E+03	0.00E+00	4.72E+03	4.79E+05	1.27E+04	0.00E+00
NB-97	3.42E-01	7.29E-02	2.63E-02	0.00E+00	5.70E-02	3.32E+03	2.69E+04	0.00E+00
MO-93	0.00E+00	9.04E+03	3.11E+02	0.00E+00	2.16E+03	4.76E+05	5.26E+03	0.00E+00
MO-99	0.00E+00	1.65E+02	3.23E+01	0.00E+00	2.65E+02	1.35E+05	4.87E+04	0.00E+00
TC-99M	1.40E-03	2.88E-03	3.72E-02	0.00E+00	3.11E-02	8.11E+02	2.03E+03	0.00E+00
TC-99	2.93E+02	3.75E+02	1.24E+02	0.00E+00	3.49E+03	9.48E+05	1.09E+04	0.00E+00
TC-101	6.51E-05	8.23E-05	8.12E-04	0.00E+00	9.79E-04	5.84E+02	8.44E+02	0.00E+00
RU-103	2.02E+03	0.00E+00	6.79E+02	0.00E+00	4.24E+03	5.52E+05	1.61E+04	0.00E+00
RU-105	1.22E+00	0.00E+00	4.10E-01	0.00E+00	8.99E-01	1.57E+04	4.84E+04	0.00E+00
RU-106	8.68E+04	0.00E+00	1.09E+04	0.00E+00	1.07E+05	1.16E+07	1.64E+05	0.00E+00
RH-105	1.16E+01	7.57E+00	5.08E+00	0.00E+00	2.10E+01	2.91E+04	1.92E+04	0.00E+00
PD-107	0.00E+00	6.89E+02	5.75E+01	0.00E+00	3.85E+03	8.88E+04	1.03E+03	0.00E+00
PD-109	0.00E+00	5.49E+00	1.47E+00	0.00E+00	1.79E+01	2.35E+04	3.99E+04	0.00E+00
AG-110M	9.98E+03	7.22E+03	5.00E+03	0.00E+00	1.09E+04	3.67E+06	3.30E+04	0.00E+00
AG-111	5.25E+02	2.03E+02	1.09E+02	0.00E+00	4.27E+02	2.88E+05	4.23E+04	0.00E+00
CD-113M	0.00E+00	9.34E+05	3.70E+04	0.00E+00	8.12E+05	1.96E+06	2.31E+04	0.00E+00
CD-115M	0.00E+00	2.42E+05	8.67E+03	0.00E+00	1.32E+05	2.06E+06	7.03E+04	0.00E+00
SN-123	2.93E+05	5.89E+03	1.02E+04	5.98E+03	0.00E+00	3.11E+06	5.71E+04	0.00E+00
SN-125	1.41E+04	3.51E+02	8.40E+02	3.46E+02	0.00E+00	9.00E+05	1.02E+05	0.00E+00
SN-126	1.16E+06	2.02E+04	4.93E+04	5.38E+03	0.00E+00	6.90E+06	2.31E+04	0.00E+00
SB-124	3.79E+04	5.56E+02	1.20E+04	1.01E+02	0.00E+00	2.65E+06	5.91E+04	0.00E+00
SB-125	5.17E+04	4.77E+02	1.09E+04	6.23E+01	0.00E+00	1.64E+06	1.47E+04	0.00E+00
SB-126	4.31E+03	8.41E+01	1.55E+03	3.29E+01	0.00E+00	9.63E+05	7.46E+04	0.00E+00
SB-127	3.95E+02	7.06E+00	1.23E+02	5.04E+00	0.00E+00	2.16E+05	5.29E+04	0.00E+00
TE-125M	4.76E+03	1.99E+03	6.58E+02	1.62E+03	0.00E+00	4.47E+05	1.29E+04	0.00E+00
TE-127M	1.67E+04	6.90E+03	2.07E+03	4.87E+03	3.75E+04	1.31E+06	2.73E+04	0.00E+00
TE-127	2.23E+00	9.53E-01	4.89E-01	1.85E+00	4.86E+00	1.03E+04	2.44E+04	0.00E+00
TE-129M	1.41E+04	6.09E+03	2.23E+03	5.47E+03	3.18E+04	1.68E+06	6.90E+04	0.00E+00
TE-129	7.88E-02	3.47E-02	1.88E-02	6.75E-02	1.75E-01	3.00E+03	2.63E+04	0.00E+00
TE-131M	1.07E+02	5.50E+01	3.63E+01	8.93E+01	2.65E+02	1.99E+05	1.19E+05	0.00E+00
TE-131	1.74E-02	8.22E-03	5.00E-03	1.58E-02	3.99E-02	2.06E+03	8.22E+03	0.00E+00
TE-132	3.72E+02	2.37E+02	1.76E+02	2.79E+02	1.03E+03	3.40E+05	4.41E+04	0.00E+00
TE-133M	8.58E-02	5.03E-02	3.84E-02	7.73E-02	2.41E-01	5.49E+03	2.23E+04	0.00E+00
TE-134	4.45E-02	2.86E-02	2.35E-02	4.07E-02	1.34E-01	4.10E+03	3.54E+03	0.00E+00
I-129	3.02E+04	2.23E+04	1.62E+04	1.46E+07	2.63E+04	0.00E+00	2.97E+02	0.00E+00
I-130	6.36E+03	1.39E+04	5.57E+03	1.60E+06	1.53E+04	0.00E+00	1.99E+03	0.00E+00
I-131	3.79E+04	4.44E+04	1.96E+04	1.48E+07	5.18E+04	0.00E+00	1.06E+03	0.00E+00
I-132	1.69E+03	3.54E+03	1.26E+03	1.69E+05	3.95E+03	0.00E+00	1.90E+03	0.00E+00

Rev. 31

Page 206 of 330

05/2018

TABLE II2-5

R_i / P_i DOSE FACTORS AGE: INFANT PATHWAY: INHALATIONmrem/yr per $\mu\text{Ci}/\text{m}^3$

NUCLIDE	BONE	LIVER	T BODY	THYROID	KIDNEY	LUNG	GI-LLI	SKIN
I-133	1.32E+04	1.92E+04	5.60E+03	3.56E+06	2.24E+04	0.00E+00	2.16E+03	0.00E+00
I-134	9.21E+02	1.88E+03	6.65E+02	4.45E+04	2.09E+03	0.00E+00	1.29E+03	0.00E+00
I-135	3.86E+03	7.60E+03	2.77E+03	6.96E+05	8.47E+03	0.00E+00	1.83E+03	0.00E+00
CS-134M	1.85E+02	2.94E+02	1.55E+02	0.00E+00	1.19E+02	2.80E+01	1.62E+02	0.00E+00
CS-134	3.96E+05	7.03E+05	7.45E+04	0.00E+00	1.90E+05	7.97E+04	1.33E+03	0.00E+00
CS-135	1.40E+05	1.21E+05	6.62E+03	0.00E+00	3.61E+04	1.41E+04	3.05E+02	0.00E+00
CS-136	4.83E+04	1.35E+05	5.29E+04	0.00E+00	5.64E+04	1.18E+04	1.43E+03	0.00E+00
CS-137	5.49E+05	6.12E+05	4.55E+04	0.00E+00	1.72E+05	7.13E+04	1.33E+03	0.00E+00
CS-138	5.05E+02	7.81E+02	3.98E+02	0.00E+00	4.10E+02	6.54E+01	8.76E+02	0.00E+00
CS-139	3.25E+02	4.24E+02	1.71E+02	0.00E+00	2.31E+02	3.54E+01	1.86E+01	0.00E+00
BA-139	1.48E+00	9.84E-04	4.30E-02	0.00E+00	5.92E-04	5.95E+03	5.10E+04	0.00E+00
BA-140	5.60E+04	5.60E+01	2.90E+03	0.00E+00	1.34E+01	1.60E+06	3.84E+04	0.00E+00
BA-141	1.57E-01	1.08E-04	4.97E-03	0.00E+00	6.50E-05	2.97E+03	4.75E+03	0.00E+00
BA-142	3.98E-02	3.30E-05	1.96E-03	0.00E+00	1.90E-05	1.55E+03	6.93E+02	0.00E+00
LA-140	5.05E+02	2.00E+02	5.15E+01	0.00E+00	0.00E+00	1.68E+05	8.48E+04	0.00E+00
LA-141	6.79E+00	1.96E+00	3.43E-01	0.00E+00	0.00E+00	1.71E+04	8.34E+04	0.00E+00
LA-142	1.03E+00	3.77E-01	9.04E-02	0.00E+00	0.00E+00	8.22E+03	5.95E+04	0.00E+00
CE-141	2.77E+04	1.67E+04	1.99E+03	0.00E+00	5.25E+03	5.17E+05	2.16E+04	0.00E+00
CE-143	2.93E+02	1.93E+02	2.21E+01	0.00E+00	5.64E+01	1.16E+05	4.97E+04	0.00E+00
CE-144	3.19E+06	1.21E+06	1.76E+05	0.00E+00	5.38E+05	9.84E+06	1.48E+05	0.00E+00
PR-143	1.40E+04	5.24E+03	6.99E+02	0.00E+00	1.97E+03	4.33E+05	3.72E+04	0.00E+00
PR-144	4.79E-02	1.85E-02	2.41E-03	0.00E+00	6.72E-03	1.61E+03	4.28E+03	0.00E+00
ND-147	7.94E+03	8.13E+03	5.00E+02	0.00E+00	3.15E+03	3.22E+05	3.12E+04	0.00E+00
PM-147	5.47E+05	4.30E+04	2.18E+04	0.00E+00	6.90E+04	6.37E+05	8.05E+03	0.00E+00
PM-148M	7.00E+04	1.74E+04	1.39E+04	0.00E+00	2.03E+04	1.71E+06	4.72E+04	0.00E+00
PM-148	4.68E+03	6.75E+02	3.42E+02	0.00E+00	8.06E+02	4.48E+05	8.46E+04	0.00E+00
PM-149	4.34E+02	5.71E+01	2.49E+01	0.00E+00	6.94E+01	9.10E+04	4.21E+04	0.00E+00
PM-151	1.05E+02	1.54E+01	7.77E+00	0.00E+00	1.82E+01	4.55E+04	3.61E+04	0.00E+00
SM-151	4.73E+05	9.03E+04	2.28E+04	0.00E+00	7.34E+04	4.17E+05	4.84E+03	0.00E+00
SM-153	2.14E+02	1.65E+02	1.27E+01	0.00E+00	3.46E+01	5.18E+04	2.70E+04	0.00E+00
EU-152	1.10E+06	2.48E+05	2.41E+05	0.00E+00	8.32E+05	2.07E+06	1.38E+04	0.00E+00
EU-154	4.14E+06	4.84E+05	3.43E+05	0.00E+00	1.60E+06	4.27E+06	3.98E+04	0.00E+00
EU-155	8.36E+05	8.01E+04	4.84E+04	0.00E+00	2.21E+05	7.28E+05	7.27E+04	0.00E+00
EU-156	2.18E+04	1.34E+04	2.16E+03	0.00E+00	6.27E+03	8.57E+05	5.80E+04	0.00E+00
TB-160	1.57E+05	0.00E+00	1.96E+04	0.00E+00	4.48E+04	1.55E+06	3.00E+04	0.00E+00
HO-166M	2.03E+06	4.30E+05	3.51E+05	0.00E+00	5.91E+05	2.87E+06	2.31E+04	0.00E+00
W-181	6.80E+01	2.04E+01	2.34E+00	0.00E+00	0.00E+00	1.86E+04	3.68E+02	0.00E+00
W-185	2.20E+03	6.76E+02	7.81E+01	0.00E+00	0.00E+00	6.27E+05	1.57E+04	0.00E+00
W-187	1.30E+01	9.02E+00	3.12E+00	0.00E+00	0.00E+00	3.96E+04	3.56E+04	0.00E+00
U-232	3.60E+08	0.00E+00	2.98E+07	0.00E+00	3.36E+07	2.09E+09	6.10E+04	0.00E+00
U-233	7.62E+07	0.00E+00	5.36E+06	0.00E+00	1.53E+07	4.98E+08	5.64E+04	0.00E+00
U-234	7.31E+07	0.00E+00	5.25E+06	0.00E+00	1.50E+07	4.89E+08	5.53E+04	0.00E+00

Rev. 31

Page 207 of 330

05/2018

TABLE II2-5

R_i / P_i DOSE FACTORS AGE: INFANT PATHWAY: INHALATIONmrem/yr per $\mu\text{Ci}/\text{m}^3$

NUCLIDE	BONE	LIVER	T BODY	THYROID	KIDNEY	LUNG	GI-LLI	SKIN
U-235	7.01E+07	0.00E+00	4.93E+06	0.00E+00	1.41E+07	4.59E+08	7.03E+04	0.00E+00
U-236	7.01E+07	0.00E+00	5.04E+06	0.00E+00	1.44E+07	4.69E+08	5.19E+04	0.00E+00
U-237	4.55E+02	0.00E+00	1.21E+02	0.00E+00	1.13E+03	1.28E+05	1.83E+04	0.00E+00
U-238	6.71E+07	0.00E+00	4.61E+06	0.00E+00	1.32E+07	4.28E+08	4.96E+04	0.00E+00
NP-237	4.03E+09	2.39E+09	1.76E+08	0.00E+00	1.08E+09	4.89E+08	7.14E+04	0.00E+00
NP-238	3.74E+03	8.47E+02	5.82E+01	0.00E+00	2.06E+02	1.29E+05	3.61E+04	0.00E+00
NP-239	3.71E+02	2.98E+02	1.88E+01	0.00E+00	6.62E+01	5.95E+04	2.49E+04	0.00E+00
PU-238	3.77E+09	2.35E+09	1.78E+08	0.00E+00	6.50E+08	1.26E+09	6.57E+04	0.00E+00
PU-239	4.10E+09	2.46E+09	1.88E+08	0.00E+00	6.93E+08	1.19E+09	5.99E+04	0.00E+00
PU-240	4.10E+09	2.45E+09	1.88E+08	0.00E+00	6.92E+08	1.19E+09	6.10E+04	0.00E+00
PU-241	1.18E+08	2.59E+07	4.35E+06	0.00E+00	1.61E+07	1.07E+06	1.26E+03	0.00E+00
PU-242	3.81E+09	2.37E+09	1.81E+08	0.00E+00	6.68E+08	1.14E+09	5.88E+04	0.00E+00
PU-244	4.44E+09	2.72E+09	2.07E+08	0.00E+00	7.64E+08	1.31E+09	8.76E+04	0.00E+00
AM-241	4.41E+09	2.73E+09	1.83E+08	0.00E+00	1.11E+09	5.68E+08	6.69E+04	0.00E+00
AM-242M	4.55E+09	2.60E+09	1.89E+08	0.00E+00	1.12E+09	2.30E+08	8.41E+04	0.00E+00
AM-243	4.34E+09	2.63E+09	1.78E+08	0.00E+00	1.08E+09	5.39E+08	7.84E+04	0.00E+00
CM-242	1.79E+08	1.21E+08	7.98E+06	0.00E+00	2.37E+07	4.16E+08	7.14E+04	0.00E+00
CM-243	3.46E+09	2.13E+09	1.48E+08	0.00E+00	5.47E+08	5.94E+08	7.03E+04	0.00E+00
CM-244	2.90E+09	1.78E+09	1.24E+08	0.00E+00	4.49E+08	5.71E+08	6.80E+04	0.00E+00
CM-245	4.51E+09	2.74E+09	1.90E+08	0.00E+00	7.32E+08	5.49E+08	6.34E+04	0.00E+00
CM-246	4.48E+09	2.74E+09	1.90E+08	0.00E+00	7.32E+08	5.59E+08	6.23E+04	0.00E+00
CM-247	4.35E+09	2.70E+09	1.86E+08	0.00E+00	7.21E+08	5.49E+08	8.19E+04	0.00E+00
CM-248	3.61E+08	2.23E+08	1.54E+09	0.00E+00	5.94E+09	4.52E+09	1.32E+06	0.00E+00
CF-252	3.32E+09	0.00E+00	1.41E+08	0.00E+00	0.00E+00	1.92E+09	2.59E+05	0.00E+00

TABLE II2-6

R_i DOSE FACTORS AGE: ADULT PATHWAY: GROUND PLANEm²-mrem/yr per μ Ci/sec

NUCLIDE	BONE	LIVER	T BODY	THYROID	KIDNEY	LUNG	GI-LLI	SKIN
H-3	0.00E+00	0.00E+00	0.00E+00	0.00E+00	0.00E+00	0.00E+00	0.00E+00	0.00E+00
C-14	0.00E+00	0.00E+00	0.00E+00	0.00E+00	0.00E+00	0.00E+00	0.00E+00	0.00E+00
NA-22	1.16E+10	1.16E+10	1.16E+10	1.16E+10	1.16E+10	1.16E+10	1.16E+10	1.30E+10
NA-24	1.19E+07	1.19E+07	1.19E+07	1.19E+07	1.19E+07	1.19E+07	1.19E+07	1.39E+07
P-32	0.00E+00	0.00E+00	0.00E+00	0.00E+00	0.00E+00	0.00E+00	0.00E+00	0.00E+00
CA-41	1.65E+10	1.65E+10	1.65E+10	1.65E+10	1.65E+10	1.65E+10	1.65E+10	1.94E+10
SC-46	8.33E+08	8.33E+08	8.33E+08	8.33E+08	8.33E+08	8.33E+08	8.33E+08	9.61E+08
CR-51	4.66E+06	4.66E+06	4.66E+06	4.66E+06	4.66E+06	4.66E+06	4.66E+06	5.51E+06
MN-54	1.39E+09	1.39E+09	1.39E+09	1.39E+09	1.39E+09	1.39E+09	1.39E+09	1.63E+09
MN-56	9.03E+05	9.03E+05	9.03E+05	9.03E+05	9.03E+05	9.03E+05	9.03E+05	1.07E+06
FE-55	0.00E+00	0.00E+00	0.00E+00	0.00E+00	0.00E+00	0.00E+00	0.00E+00	0.00E+00
FE-59	2.73E+08	2.73E+08	2.73E+08	2.73E+08	2.73E+08	2.73E+08	2.73E+08	3.21E+08
CO-57	1.88E+08	1.88E+08	1.88E+08	1.88E+08	1.88E+08	1.88E+08	1.88E+08	2.07E+08
CO-58	3.79E+08	3.79E+08	3.79E+08	3.79E+08	3.79E+08	3.79E+08	3.79E+08	4.44E+08
CO-60	2.41E+10	2.41E+10	2.41E+10	2.41E+10	2.41E+10	2.41E+10	2.41E+10	2.83E+10
NI-59	0.00E+00	0.00E+00	0.00E+00	0.00E+00	0.00E+00	0.00E+00	0.00E+00	0.00E+00
NI-63	0.00E+00	0.00E+00	0.00E+00	0.00E+00	0.00E+00	0.00E+00	0.00E+00	0.00E+00
NI-65	2.97E+05	2.97E+05	2.97E+05	2.97E+05	2.97E+05	2.97E+05	2.97E+05	3.45E+05
CU-64	6.07E+05	6.07E+05	6.07E+05	6.07E+05	6.07E+05	6.07E+05	6.07E+05	6.88E+05
ZN-65	7.47E+08	7.47E+08	7.47E+08	7.47E+08	7.47E+08	7.47E+08	7.47E+08	8.59E+08
ZN-69M	1.27E+06	1.27E+06	1.27E+06	1.27E+06	1.27E+06	1.27E+06	1.27E+06	1.49E+06
ZN-69	0.00E+00	0.00E+00	0.00E+00	0.00E+00	0.00E+00	0.00E+00	0.00E+00	0.00E+00
SE-79	0.00E+00	0.00E+00	0.00E+00	0.00E+00	0.00E+00	0.00E+00	0.00E+00	0.00E+00
BR-82	2.14E+07	2.14E+07	2.14E+07	2.14E+07	2.14E+07	2.14E+07	2.14E+07	2.47E+07
BR-83	4.87E+03	4.87E+03	4.87E+03	4.87E+03	4.87E+03	4.87E+03	4.87E+03	7.08E+03
BR-84	2.03E+05	2.03E+05	2.03E+05	2.03E+05	2.03E+05	2.03E+05	2.03E+05	2.36E+05
BR-85	0.00E+00	0.00E+00	0.00E+00	0.00E+00	0.00E+00	0.00E+00	0.00E+00	0.00E+00
RB-86	8.99E+06	8.99E+06	8.99E+06	8.99E+06	8.99E+06	8.99E+06	8.99E+06	1.03E+07
RB-87	0.00E+00	0.00E+00	0.00E+00	0.00E+00	0.00E+00	0.00E+00	0.00E+00	0.00E+00
RB-88	3.31E+04	3.31E+04	3.31E+04	3.31E+04	3.31E+04	3.31E+04	3.31E+04	3.78E+04
RB-89	1.23E+05	1.23E+05	1.23E+05	1.23E+05	1.23E+05	1.23E+05	1.23E+05	1.48E+05
SR-89	2.16E+04	2.16E+04	2.16E+04	2.16E+04	2.16E+04	2.16E+04	2.16E+04	2.51E+04
SR-90	0.00E+00	0.00E+00	0.00E+00	0.00E+00	0.00E+00	0.00E+00	0.00E+00	0.00E+00
SR-91	2.15E+06	2.15E+06	2.15E+06	2.15E+06	2.15E+06	2.15E+06	2.15E+06	2.51E+06
SR-92	7.77E+05	7.77E+05	7.77E+05	7.77E+05	7.77E+05	7.77E+05	7.77E+05	8.63E+05
Y-90	4.49E+03	4.49E+03	4.49E+03	4.49E+03	4.49E+03	4.49E+03	4.49E+03	5.31E+03
Y-91M	1.00E+05	1.00E+05	1.00E+05	1.00E+05	1.00E+05	1.00E+05	1.00E+05	1.16E+05
Y-91	1.07E+06	1.07E+06	1.07E+06	1.07E+06	1.07E+06	1.07E+06	1.07E+06	1.21E+06
Y-92	1.80E+05	1.80E+05	1.80E+05	1.80E+05	1.80E+05	1.80E+05	1.80E+05	2.14E+05

Rev. 31

Page 209 of 330

05/2018

TABLE II-6

R_i DOSE FACTORS AGE: ADULT PATHWAY: GROUND PLANEm²-mrem/yr per μ Ci/sec

NUCLIDE	BONE	LIVER	T BODY	THYROID	KIDNEY	LUNG	GI-LLI	SKIN
Y-93	1.83E+05	1.83E+05	1.83E+05	1.83E+05	1.83E+05	1.83E+05	1.83E+05	2.51E+05
ZR-93	0.00E+00	0.00E+00	0.00E+00	0.00E+00	0.00E+00	0.00E+00	0.00E+00	0.00E+00
ZR-95	2.45E+08	2.45E+08	2.45E+08	2.45E+08	2.45E+08	2.45E+08	2.45E+08	2.84E+08
ZR-97	2.96E+06	2.96E+06	2.96E+06	2.96E+06	2.96E+06	2.96E+06	2.96E+06	3.44E+06
NB-93M	2.32E+06	2.32E+06	2.32E+06	2.32E+06	2.32E+06	2.32E+06	2.32E+06	2.83E+08
NB-95	1.37E+08	1.37E+08	1.37E+08	1.37E+08	1.37E+08	1.37E+08	1.37E+08	1.61E+08
NB-97	1.76E+05	1.76E+05	1.76E+05	1.76E+05	1.76E+05	1.76E+05	1.76E+05	2.07E+05
MO-93	1.11E+08	1.11E+08	1.11E+08	1.11E+08	1.11E+08	1.11E+08	1.11E+08	4.50E+09
MO-99	3.99E+06	3.99E+06	3.99E+06	3.99E+06	3.99E+06	3.99E+06	3.99E+06	4.63E+06
TC-99M	1.84E+05	1.84E+05	1.84E+05	1.84E+05	1.84E+05	1.84E+05	1.84E+05	2.11E+05
TC-99	0.00E+00	0.00E+00	0.00E+00	0.00E+00	0.00E+00	0.00E+00	0.00E+00	0.00E+00
TC-101	2.04E+04	2.04E+04	2.04E+04	2.04E+04	2.04E+04	2.04E+04	2.04E+04	2.26E+04
RU-103	1.08E+08	1.08E+08	1.08E+08	1.08E+08	1.08E+08	1.08E+08	1.08E+08	1.26E+08
RU-105	6.36E+05	6.36E+05	6.36E+05	6.36E+05	6.36E+05	6.36E+05	6.36E+05	7.21E+05
RU-106	4.22E+08	4.22E+08	4.22E+08	4.22E+08	4.22E+08	4.22E+08	4.22E+08	5.07E+08
RH-105	7.43E+05	7.43E+05	7.43E+05	7.43E+05	7.43E+05	7.43E+05	7.43E+05	8.67E+05
PD-107	0.00E+00	0.00E+00	0.00E+00	0.00E+00	0.00E+00	0.00E+00	0.00E+00	0.00E+00
PD-109	1.50E+04	1.50E+04	1.50E+04	1.50E+04	1.50E+04	1.50E+04	1.50E+04	1.71E+04
AG-110M	3.44E+09	3.44E+09	3.44E+09	3.44E+09	3.44E+09	3.44E+09	3.44E+09	4.01E+09
AG-111	1.03E+06	1.03E+06	1.03E+06	1.03E+06	1.03E+06	1.03E+06	1.03E+06	1.20E+06
CD-113M	6.31E+06	6.31E+06	6.31E+06	6.31E+06	6.31E+06	6.31E+06	6.31E+06	7.14E+06
CD-115M	0.00E+00	0.00E+00	0.00E+00	0.00E+00	0.00E+00	0.00E+00	0.00E+00	0.00E+00
SN-123	0.00E+00	0.00E+00	0.00E+00	0.00E+00	0.00E+00	0.00E+00	0.00E+00	6.38E+09
SN-125	4.20E+06	4.20E+06	4.20E+06	4.20E+06	4.20E+06	4.20E+06	4.20E+06	4.86E+06
SN-126	4.35E+10	4.35E+10	4.35E+10	4.35E+10	4.35E+10	4.35E+10	4.35E+10	4.84E+10
SB-124	5.98E+08	5.98E+08	5.98E+08	5.98E+08	5.98E+08	5.98E+08	5.98E+08	6.90E+08
SB-125	2.39E+09	2.39E+09	2.39E+09	2.39E+09	2.39E+09	2.39E+09	2.39E+09	2.70E+09
SB-126	8.44E+07	8.44E+07	8.44E+07	8.44E+07	8.44E+07	8.44E+07	8.44E+07	9.48E+07
SB-127	1.68E+07	1.68E+07	1.68E+07	1.68E+07	1.68E+07	1.68E+07	1.68E+07	1.94E+07
TE-125M	1.55E+06	1.55E+06	1.55E+06	1.55E+06	1.55E+06	1.55E+06	1.55E+06	2.13E+06
TE-127M	9.16E+04	9.16E+04	9.16E+04	9.16E+04	9.16E+04	9.16E+04	9.16E+04	1.08E+05
TE-127	2.98E+03	2.98E+03	2.98E+03	2.98E+03	2.98E+03	2.98E+03	2.98E+03	3.28E+03
TE-129M	1.98E+07	1.98E+07	1.98E+07	1.98E+07	1.98E+07	1.98E+07	1.98E+07	2.31E+07
TE-129	2.62E+04	2.62E+04	2.62E+04	2.62E+04	2.62E+04	2.62E+04	2.62E+04	3.10E+04
TE-131M	8.03E+06	8.03E+06	8.03E+06	8.03E+06	8.03E+06	8.03E+06	8.03E+06	9.46E+06
TE-131	2.92E+04	2.92E+04	2.92E+04	2.92E+04	2.92E+04	2.92E+04	2.92E+04	3.45E+07
TE-132	4.23E+06	4.23E+06	4.23E+06	4.23E+06	4.23E+06	4.23E+06	4.23E+06	4.98E+06
TE-133M	4.41E+05	4.41E+05	4.41E+05	4.41E+05	4.41E+05	4.41E+05	4.41E+05	5.00E+05
TE-134	2.22E+04	2.22E+04	2.22E+04	2.22E+04	2.22E+04	2.22E+04	2.22E+04	2.66E+04
I-129	2.18E+09	2.18E+09	2.18E+09	2.18E+09	2.18E+09	2.18E+09	2.18E+09	3.63E+09

TABLE II2-6

R_i DOSE FACTORS AGE: ADULT PATHWAY: GROUND PLANEm²-mrem/yr per μ Ci/sec

NUCLIDE	BONE	LIVER	T BODY	THYROID	KIDNEY	LUNG	GI-LLI	SKIN
I-130	5.51E+06	5.51E+06	5.51E+06	5.51E+06	5.51E+06	5.51E+06	5.51E+06	6.69E+06
I-131	1.72E+07	1.72E+07	1.72E+07	1.72E+07	1.72E+07	1.72E+07	1.72E+07	2.09E+07
I-132	1.25E+06	1.25E+06	1.25E+06	1.25E+06	1.25E+06	1.25E+06	1.25E+06	1.46E+06
I-133	2.45E+06	2.45E+06	2.45E+06	2.45E+06	2.45E+06	2.45E+06	2.45E+06	2.98E+06
I-134	4.47E+05	4.47E+05	4.47E+05	4.47E+05	4.47E+05	4.47E+05	4.47E+05	5.30E+05
I-135	2.53E+06	2.53E+06	2.53E+06	2.53E+06	2.53E+06	2.53E+06	2.53E+06	2.95E+06
CS-134M	5.73E+04	5.73E+04	5.73E+04	5.73E+04	5.73E+04	5.73E+04	5.73E+04	6.74E+04
CS-134	6.91E+09	6.91E+09	6.91E+09	6.91E+09	6.91E+09	6.91E+09	6.91E+09	8.06E+09
CS-135	0.00E+00	0.00E+00	0.00E+00	0.00E+00	0.00E+00	0.00E+00	0.00E+00	0.00E+00
CS-136	1.51E+08	1.51E+08	1.51E+08	1.51E+08	1.51E+08	1.51E+08	1.51E+08	1.71E+08
CS-137	1.55E+10	1.55E+10	1.55E+10	1.55E+10	1.55E+10	1.55E+10	1.55E+10	1.80E+10
CS-138	3.59E+05	3.59E+05	3.59E+05	3.59E+05	3.59E+05	3.59E+05	3.59E+05	4.10E+05
CS-139	3.14E+04	3.14E+04	3.14E+04	3.14E+04	3.14E+04	3.14E+04	3.14E+04	3.59E+04
BA-139	1.06E+05	1.06E+05	1.06E+05	1.06E+05	1.06E+05	1.06E+05	1.06E+05	1.19E+05
BA-140	2.05E+07	2.05E+07	2.05E+07	2.05E+07	2.05E+07	2.05E+07	2.05E+07	2.35E+07
BA-141	4.17E+04	4.17E+04	4.17E+04	4.17E+04	4.17E+04	4.17E+04	4.17E+04	4.75E+04
BA-142	4.49E+04	4.49E+04	4.49E+04	4.49E+04	4.49E+04	4.49E+04	4.49E+04	5.11E+04
LA-140	1.92E+07	1.92E+07	1.92E+07	1.92E+07	1.92E+07	1.92E+07	1.92E+07	2.18E+07
LA-141	3.14E+04	3.14E+04	3.14E+04	3.14E+04	3.14E+04	3.14E+04	3.14E+04	3.51E+04
LA-142	7.60E+05	7.60E+05	7.60E+05	7.60E+05	7.60E+05	7.60E+05	7.60E+05	9.11E+05
CE-141	1.37E+07	1.37E+07	1.37E+07	1.37E+07	1.37E+07	1.37E+07	1.37E+07	1.54E+07
CE-143	2.31E+06	2.31E+06	2.31E+06	2.31E+06	2.31E+06	2.31E+06	2.31E+06	2.63E+06
CE-144	6.95E+07	6.95E+07	6.95E+07	6.95E+07	6.95E+07	6.95E+07	6.95E+07	8.04E+07
PR-143	0.00E+00	0.00E+00	0.00E+00	0.00E+00	0.00E+00	0.00E+00	0.00E+00	0.00E+00
PR-144	1.83E+03	1.83E+03	1.83E+03	1.83E+03	1.83E+03	1.83E+03	1.83E+03	2.11E+03
ND-147	8.39E+06	8.39E+06	8.39E+06	8.39E+06	8.39E+06	8.39E+06	8.39E+06	1.01E+07
PM-147	0.00E+00	0.00E+00	0.00E+00	0.00E+00	0.00E+00	0.00E+00	0.00E+00	0.00E+00
PM-148M	4.45E+08	4.45E+08	4.45E+08	4.45E+08	4.45E+08	4.45E+08	4.45E+08	2.58E+09
PM-148	1.89E+07	1.89E+07	1.89E+07	1.89E+07	1.89E+07	1.89E+07	1.89E+07	2.18E+07
PM-149	4.23E+04	4.23E+04	4.23E+04	4.23E+04	4.23E+04	4.23E+04	4.23E+04	4.90E+04
PM-151	1.99E+06	1.99E+06	1.99E+06	1.99E+06	1.99E+06	1.99E+06	1.99E+06	2.08E+06
SM-151	2.11E+08	2.11E+08	2.11E+08	2.11E+08	2.11E+08	2.11E+08	2.11E+08	9.24E+08
SM-153	4.02E+05	4.02E+05	4.02E+05	4.02E+05	4.02E+05	4.02E+05	4.02E+05	4.46E+05
EU-152	2.02E+10	2.02E+10	2.02E+10	2.02E+10	2.02E+10	2.02E+10	2.02E+10	2.33E+10
EU-154	1.65E+10	1.65E+10	1.65E+10	1.65E+10	1.65E+10	1.65E+10	1.65E+10	1.90E+10
EU-155	5.12E+08	5.12E+08	5.12E+08	5.12E+08	5.12E+08	5.12E+08	5.12E+08	5.81E+08
EU-156	8.82E+07	8.82E+07	8.82E+07	8.82E+07	8.82E+07	8.82E+07	8.82E+07	1.01E+08
TB-160	4.75E+08	4.75E+08	4.75E+08	4.75E+08	4.75E+08	4.75E+08	4.75E+08	5.53E+08
HO-166M	4.27E+10	4.27E+10	4.27E+10	4.27E+10	4.27E+10	4.27E+10	4.27E+10	4.80E+10
W-181	1.94E+05	1.94E+05	1.94E+05	1.94E+05	1.94E+05	1.94E+05	1.94E+05	2.59E+05

TABLE II-6

R_i DOSE FACTORS AGE: ADULT PATHWAY: GROUND PLANEm²-mrem/yr per μ Ci/sec

NUCLIDE	BONE	LIVER	T BODY	THYROID	KIDNEY	LUNG	GI-LLI	SKIN
W-185	0.00E+00	0.00E+00	0.00E+00	0.00E+00	0.00E+00	0.00E+00	0.00E+00	0.00E+00
W-187	2.35E+06	2.35E+06	2.35E+06	2.35E+06	2.35E+06	2.35E+06	2.35E+06	2.73E+06
U-232	1.11E+07	1.11E+07	1.11E+07	1.11E+07	1.11E+07	1.11E+07	1.11E+07	1.16E+08
U-233	1.11E+10	1.11E+10	1.11E+10	1.11E+10	1.11E+10	1.11E+10	1.11E+10	1.35E+10
U-234	3.06E+06	3.06E+06	3.06E+06	3.06E+06	3.06E+06	3.06E+06	3.06E+06	7.69E+08
U-235	1.55E+10	1.55E+10	1.55E+10	1.55E+10	1.55E+10	1.55E+10	1.55E+10	1.94E+10
U-236	1.02E+05	1.02E+05	1.02E+05	1.02E+05	1.02E+05	1.02E+05	1.02E+05	8.71E+07
U-237	5.16E+06	5.16E+06	5.16E+06	5.16E+06	5.16E+06	5.16E+06	5.16E+06	6.71E+06
U-238	5.32E+08	5.32E+08	5.32E+08	5.32E+08	5.32E+08	5.32E+08	5.32E+08	7.26E+08
NP-237	6.77E+09	6.77E+09	6.77E+09	6.77E+09	6.77E+09	6.77E+09	6.77E+09	7.74E+09
NP-238	4.53E+06	4.53E+06	4.53E+06	4.53E+06	4.53E+06	4.53E+06	4.53E+06	5.18E+06
NP-239	1.71E+06	1.71E+06	1.71E+06	1.71E+06	1.71E+06	1.71E+06	1.71E+06	1.98E+06
PU-238	5.71E+06	5.71E+06	5.71E+06	5.71E+06	5.71E+06	5.71E+06	5.71E+06	7.90E+07
PU-239	3.82E+06	3.82E+06	3.82E+06	3.82E+06	3.82E+06	3.82E+06	3.82E+06	3.72E+07
PU-240	6.28E+06	6.28E+06	6.28E+06	6.28E+06	6.28E+06	6.28E+06	6.28E+06	8.70E+07
PU-241	1.29E+07	1.29E+07	1.29E+07	1.29E+07	1.29E+07	1.29E+07	1.29E+07	1.91E+07
PU-242	5.32E+06	5.32E+06	5.32E+06	5.32E+06	5.32E+06	5.32E+06	5.32E+06	7.74E+07
PU-244	4.33E+09	4.33E+09	4.33E+09	4.33E+09	4.33E+09	4.33E+09	4.33E+09	4.65E+09
AM-241	8.54E+08	8.54E+08	8.54E+08	8.54E+08	8.54E+08	8.54E+08	8.54E+08	1.23E+09
AM-242M	1.19E+08	1.19E+08	1.19E+08	1.19E+08	1.19E+08	1.19E+08	1.19E+08	8.23E+08
AM-243	6.28E+09	6.28E+09	6.28E+09	6.28E+09	6.28E+09	6.28E+09	6.28E+09	7.25E+09
CM-242	6.86E+05	6.86E+05	6.86E+05	6.86E+05	6.86E+05	6.86E+05	6.86E+05	2.87E+06
CM-243	8.34E+09	8.34E+09	8.34E+09	8.34E+09	8.34E+09	8.34E+09	8.34E+09	1.05E+10
CM-244	9.03E+06	9.03E+06	9.03E+06	9.03E+06	9.03E+06	9.03E+06	9.03E+06	5.61E+07
CM-245	4.59E+09	4.59E+09	4.59E+09	4.59E+09	4.59E+09	4.59E+09	4.59E+09	5.80E+09
CM-246	4.83E+06	4.83E+06	4.83E+06	4.83E+06	4.83E+06	4.83E+06	4.83E+06	7.24E+07
CM-247	1.06E+10	1.06E+10	1.06E+10	1.06E+10	1.06E+10	1.06E+10	1.06E+10	1.26E+10
CM-248	2.53E+10	2.53E+10	2.53E+10	2.53E+10	2.53E+10	2.53E+10	2.53E+10	3.29E+10
CF-252	4.86E+10	4.86E+10	4.86E+10	4.86E+10	4.86E+10	4.86E+10	4.86E+10	5.30E+10
Gross Alpha	9.16E+04	9.16E+04	9.16E+04	9.16E+04	9.16E+04	9.16E+04	9.16E+04	0.00E+00

TABLE II-7

R_i DOSE FACTORS AGE: TEEN PATHWAY: GROUND PLANEm²-mrem/yr per μ Ci/sec

NUCLIDE	BONE	LIVER	T BODY	THYROID	KIDNEY	LUNG	GI-LLI	SKIN
H-3	0.00E+00	0.00E+00	0.00E+00	0.00E+00	0.00E+00	0.00E+00	0.00E+00	0.00E+00
C-14	0.00E+00	0.00E+00	0.00E+00	0.00E+00	0.00E+00	0.00E+00	0.00E+00	0.00E+00
NA-22	1.16E+10	1.16E+10	1.16E+10	1.16E+10	1.16E+10	1.16E+10	1.16E+10	1.30E+10
NA-24	1.19E+07	1.19E+07	1.19E+07	1.19E+07	1.19E+07	1.19E+07	1.19E+07	1.39E+07
P-32	0.00E+00	0.00E+00	0.00E+00	0.00E+00	0.00E+00	0.00E+00	0.00E+00	0.00E+00
CA-41	1.65E+10	1.65E+10	1.65E+10	1.65E+10	1.65E+10	1.65E+10	1.65E+10	1.94E+10
SC-46	8.33E+08	8.33E+08	8.33E+08	8.33E+08	8.33E+08	8.33E+08	8.33E+08	9.61E+08
CR-51	4.66E+06	4.66E+06	4.66E+06	4.66E+06	4.66E+06	4.66E+06	4.66E+06	5.51E+06
MN-54	1.39E+09	1.39E+09	1.39E+09	1.39E+09	1.39E+09	1.39E+09	1.39E+09	1.63E+09
MN-56	9.03E+05	9.03E+05	9.03E+05	9.03E+05	9.03E+05	9.03E+05	9.03E+05	1.07E+06
FE-55	0.00E+00	0.00E+00	0.00E+00	0.00E+00	0.00E+00	0.00E+00	0.00E+00	0.00E+00
FE-59	2.73E+08	2.73E+08	2.73E+08	2.73E+08	2.73E+08	2.73E+08	2.73E+08	3.21E+08
CO-57	1.88E+08	1.88E+08	1.88E+08	1.88E+08	1.88E+08	1.88E+08	1.88E+08	2.07E+08
CO-58	3.79E+08	3.79E+08	3.79E+08	3.79E+08	3.79E+08	3.79E+08	3.79E+08	4.44E+08
CO-60	2.41E+10	2.41E+10	2.41E+10	2.41E+10	2.41E+10	2.41E+10	2.41E+10	2.83E+10
NI-59	0.00E+00	0.00E+00	0.00E+00	0.00E+00	0.00E+00	0.00E+00	0.00E+00	0.00E+00
NI-63	0.00E+00	0.00E+00	0.00E+00	0.00E+00	0.00E+00	0.00E+00	0.00E+00	0.00E+00
NI-65	2.97E+05	2.97E+05	2.97E+05	2.97E+05	2.97E+05	2.97E+05	2.97E+05	3.45E+05
CU-64	6.07E+05	6.07E+05	6.07E+05	6.07E+05	6.07E+05	6.07E+05	6.07E+05	6.88E+05
ZN-65	7.47E+08	7.47E+08	7.47E+08	7.47E+08	7.47E+08	7.47E+08	7.47E+08	8.59E+08
ZN-69M	1.27E+06	1.27E+06	1.27E+06	1.27E+06	1.27E+06	1.27E+06	1.27E+06	1.49E+06
ZN-69	0.00E+00	0.00E+00	0.00E+00	0.00E+00	0.00E+00	0.00E+00	0.00E+00	0.00E+00
SE-79	0.00E+00	0.00E+00	0.00E+00	0.00E+00	0.00E+00	0.00E+00	0.00E+00	0.00E+00
BR-82	2.14E+07	2.14E+07	2.14E+07	2.14E+07	2.14E+07	2.14E+07	2.14E+07	2.47E+07
BR-83	4.87E+03	4.87E+03	4.87E+03	4.87E+03	4.87E+03	4.87E+03	4.87E+03	7.08E+03
BR-84	2.03E+05	2.03E+05	2.03E+05	2.03E+05	2.03E+05	2.03E+05	2.03E+05	2.36E+05
BR-85	0.00E+00	0.00E+00	0.00E+00	0.00E+00	0.00E+00	0.00E+00	0.00E+00	0.00E+00
RB-86	8.99E+06	8.99E+06	8.99E+06	8.99E+06	8.99E+06	8.99E+06	8.99E+06	1.03E+07
RB-87	0.00E+00	0.00E+00	0.00E+00	0.00E+00	0.00E+00	0.00E+00	0.00E+00	0.00E+00
RB-88	3.31E+04	3.31E+04	3.31E+04	3.31E+04	3.31E+04	3.31E+04	3.31E+04	3.78E+04
RB-89	1.23E+05	1.23E+05	1.23E+05	1.23E+05	1.23E+05	1.23E+05	1.23E+05	1.48E+05
SR-89	2.16E+04	2.16E+04	2.16E+04	2.16E+04	2.16E+04	2.16E+04	2.16E+04	2.51E+04
SR-90	0.00E+00	0.00E+00	0.00E+00	0.00E+00	0.00E+00	0.00E+00	0.00E+00	0.00E+00
SR-91	2.15E+06	2.15E+06	2.15E+06	2.15E+06	2.15E+06	2.15E+06	2.15E+06	2.51E+06
SR-92	7.77E+05	7.77E+05	7.77E+05	7.77E+05	7.77E+05	7.77E+05	7.77E+05	8.63E+05
Y-90	4.49E+03	4.49E+03	4.49E+03	4.49E+03	4.49E+03	4.49E+03	4.49E+03	5.31E+03
Y-91M	1.00E+05	1.00E+05	1.00E+05	1.00E+05	1.00E+05	1.00E+05	1.00E+05	1.16E+05
Y-91	1.07E+06	1.07E+06	1.07E+06	1.07E+06	1.07E+06	1.07E+06	1.07E+06	1.21E+06
Y-92	1.80E+05	1.80E+05	1.80E+05	1.80E+05	1.80E+05	1.80E+05	1.80E+05	2.14E+05
Y-93	1.83E+05	1.83E+05	1.83E+05	1.83E+05	1.83E+05	1.83E+05	1.83E+05	2.51E+05
ZR-93	0.00E+00	0.00E+00	0.00E+00	0.00E+00	0.00E+00	0.00E+00	0.00E+00	0.00E+00

TABLE II-7

R_i DOSE FACTORS AGE: TEEN PATHWAY: GROUND PLANEm²-mrem/yr per μ Ci/sec

NUCLIDE	BONE	LIVER	T BODY	THYROID	KIDNEY	LUNG	GI-LLI	SKIN
ZR-95	2.45E+08	2.45E+08	2.45E+08	2.45E+08	2.45E+08	2.45E+08	2.45E+08	2.84E+08
ZR-97	2.96E+06	2.96E+06	2.96E+06	2.96E+06	2.96E+06	2.96E+06	2.96E+06	3.44E+06
NB-93M	2.32E+06	2.32E+06	2.32E+06	2.32E+06	2.32E+06	2.32E+06	2.32E+06	2.83E+08
NB-95	1.37E+08	1.37E+08	1.37E+08	1.37E+08	1.37E+08	1.37E+08	1.37E+08	1.61E+08
NB-97	1.76E+05	1.76E+05	1.76E+05	1.76E+05	1.76E+05	1.76E+05	1.76E+05	2.07E+05
MO-93	1.11E+08	1.11E+08	1.11E+08	1.11E+08	1.11E+08	1.11E+08	1.11E+08	4.50E+09
MO-99	3.99E+06	3.99E+06	3.99E+06	3.99E+06	3.99E+06	3.99E+06	3.99E+06	4.63E+06
TC-99M	1.84E+05	1.84E+05	1.84E+05	1.84E+05	1.84E+05	1.84E+05	1.84E+05	2.11E+05
TC-99	0.00E+00	0.00E+00	0.00E+00	0.00E+00	0.00E+00	0.00E+00	0.00E+00	0.00E+00
TC-101	2.04E+04	2.04E+04	2.04E+04	2.04E+04	2.04E+04	2.04E+04	2.04E+04	2.26E+04
RU-103	1.08E+08	1.08E+08	1.08E+08	1.08E+08	1.08E+08	1.08E+08	1.08E+08	1.26E+08
RU-105	6.36E+05	6.36E+05	6.36E+05	6.36E+05	6.36E+05	6.36E+05	6.36E+05	7.21E+05
RU-106	4.22E+08	4.22E+08	4.22E+08	4.22E+08	4.22E+08	4.22E+08	4.22E+08	5.07E+08
RH-105	7.43E+05	7.43E+05	7.43E+05	7.43E+05	7.43E+05	7.43E+05	7.43E+05	8.67E+05
PD-107	0.00E+00	0.00E+00	0.00E+00	0.00E+00	0.00E+00	0.00E+00	0.00E+00	0.00E+00
PD-109	1.50E+04	1.50E+04	1.50E+04	1.50E+04	1.50E+04	1.50E+04	1.50E+04	1.71E+04
AG-110M	3.44E+09	3.44E+09	3.44E+09	3.44E+09	3.44E+09	3.44E+09	3.44E+09	4.01E+09
AG-111	1.03E+06	1.03E+06	1.03E+06	1.03E+06	1.03E+06	1.03E+06	1.03E+06	1.20E+06
CD-113M	6.31E+06	6.31E+06	6.31E+06	6.31E+06	6.31E+06	6.31E+06	6.31E+06	7.14E+06
CD-115M	0.00E+00	0.00E+00	0.00E+00	0.00E+00	0.00E+00	0.00E+00	0.00E+00	0.00E+00
SN-123	0.00E+00	0.00E+00	0.00E+00	0.00E+00	0.00E+00	0.00E+00	0.00E+00	6.38E+09
SN-125	4.20E+06	4.20E+06	4.20E+06	4.20E+06	4.20E+06	4.20E+06	4.20E+06	4.86E+06
SN-126	4.35E+10	4.35E+10	4.35E+10	4.35E+10	4.35E+10	4.35E+10	4.35E+10	4.84E+10
SB-124	5.98E+08	5.98E+08	5.98E+08	5.98E+08	5.98E+08	5.98E+08	5.98E+08	6.90E+08
SB-125	2.39E+09	2.39E+09	2.39E+09	2.39E+09	2.39E+09	2.39E+09	2.39E+09	2.70E+09
SB-126	8.44E+07	8.44E+07	8.44E+07	8.44E+07	8.44E+07	8.44E+07	8.44E+07	9.48E+07
SB-127	1.68E+07	1.68E+07	1.68E+07	1.68E+07	1.68E+07	1.68E+07	1.68E+07	1.94E+07
TE-125M	1.55E+06	1.55E+06	1.55E+06	1.55E+06	1.55E+06	1.55E+06	1.55E+06	2.13E+06
TE-127M	9.16E+04	9.16E+04	9.16E+04	9.16E+04	9.16E+04	9.16E+04	9.16E+04	1.08E+05
TE-127	2.98E+03	2.98E+03	2.98E+03	2.98E+03	2.98E+03	2.98E+03	2.98E+03	3.28E+03
TE-129M	1.98E+07	1.98E+07	1.98E+07	1.98E+07	1.98E+07	1.98E+07	1.98E+07	2.31E+07
TE-129	2.62E+04	2.62E+04	2.62E+04	2.62E+04	2.62E+04	2.62E+04	2.62E+04	3.10E+04
TE-131M	8.03E+06	8.03E+06	8.03E+06	8.03E+06	8.03E+06	8.03E+06	8.03E+06	9.46E+06
TE-131	2.92E+04	2.92E+04	2.92E+04	2.92E+04	2.92E+04	2.92E+04	2.92E+04	3.45E+07
TE-132	4.23E+06	4.23E+06	4.23E+06	4.23E+06	4.23E+06	4.23E+06	4.23E+06	4.98E+06
TE-133M	4.41E+05	4.41E+05	4.41E+05	4.41E+05	4.41E+05	4.41E+05	4.41E+05	5.00E+05
TE-134	2.22E+04	2.22E+04	2.22E+04	2.22E+04	2.22E+04	2.22E+04	2.22E+04	2.66E+04
I-129	2.18E+09	2.18E+09	2.18E+09	2.18E+09	2.18E+09	2.18E+09	2.18E+09	3.63E+09
I-130	5.51E+06	5.51E+06	5.51E+06	5.51E+06	5.51E+06	5.51E+06	5.51E+06	6.69E+06
I-131	1.72E+07	1.72E+07	1.72E+07	1.72E+07	1.72E+07	1.72E+07	1.72E+07	2.09E+07
I-132	1.25E+06	1.25E+06	1.25E+06	1.25E+06	1.25E+06	1.25E+06	1.25E+06	1.46E+06
I-133	2.45E+06	2.45E+06	2.45E+06	2.45E+06	2.45E+06	2.45E+06	2.45E+06	2.98E+06

TABLE II2-7

R_i DOSE FACTORS AGE: TEEN PATHWAY: GROUND PLANEm²-mrem/yr per μ Ci/sec

NUCLIDE	BONE	LIVER	T BODY	THYROID	KIDNEY	LUNG	GI-LLI	SKIN
I-134	4.47E+05	4.47E+05	4.47E+05	4.47E+05	4.47E+05	4.47E+05	4.47E+05	5.30E+05
I-135	2.53E+06	2.53E+06	2.53E+06	2.53E+06	2.53E+06	2.53E+06	2.53E+06	2.95E+06
CS-134M	5.73E+04	5.73E+04	5.73E+04	5.73E+04	5.73E+04	5.73E+04	5.73E+04	6.74E+04
CS-134	6.91E+09	6.91E+09	6.91E+09	6.91E+09	6.91E+09	6.91E+09	6.91E+09	8.06E+09
CS-135	0.00E+00	0.00E+00	0.00E+00	0.00E+00	0.00E+00	0.00E+00	0.00E+00	0.00E+00
CS-136	1.51E+08	1.51E+08	1.51E+08	1.51E+08	1.51E+08	1.51E+08	1.51E+08	1.71E+08
CS-137	1.55E+10	1.55E+10	1.55E+10	1.55E+10	1.55E+10	1.55E+10	1.55E+10	1.80E+10
CS-138	3.59E+05	3.59E+05	3.59E+05	3.59E+05	3.59E+05	3.59E+05	3.59E+05	4.10E+05
CS-139	3.14E+04	3.14E+04	3.14E+04	3.14E+04	3.14E+04	3.14E+04	3.14E+04	3.59E+04
BA-139	1.06E+05	1.06E+05	1.06E+05	1.06E+05	1.06E+05	1.06E+05	1.06E+05	1.19E+05
BA-140	2.05E+07	2.05E+07	2.05E+07	2.05E+07	2.05E+07	2.05E+07	2.05E+07	2.35E+07
BA-141	4.17E+04	4.17E+04	4.17E+04	4.17E+04	4.17E+04	4.17E+04	4.17E+04	4.75E+04
BA-142	4.49E+04	4.49E+04	4.49E+04	4.49E+04	4.49E+04	4.49E+04	4.49E+04	5.11E+04
LA-140	1.92E+07	1.92E+07	1.92E+07	1.92E+07	1.92E+07	1.92E+07	1.92E+07	2.18E+07
LA-141	3.14E+04	3.14E+04	3.14E+04	3.14E+04	3.14E+04	3.14E+04	3.14E+04	3.51E+04
LA-142	7.60E+05	7.60E+05	7.60E+05	7.60E+05	7.60E+05	7.60E+05	7.60E+05	9.11E+05
CE-141	1.37E+07	1.37E+07	1.37E+07	1.37E+07	1.37E+07	1.37E+07	1.37E+07	1.54E+07
CE-143	2.31E+06	2.31E+06	2.31E+06	2.31E+06	2.31E+06	2.31E+06	2.31E+06	2.63E+06
CE-144	6.95E+07	6.95E+07	6.95E+07	6.95E+07	6.95E+07	6.95E+07	6.95E+07	8.04E+07
PR-143	0.00E+00	0.00E+00	0.00E+00	0.00E+00	0.00E+00	0.00E+00	0.00E+00	0.00E+00
PR-144	1.83E+03	1.83E+03	1.83E+03	1.83E+03	1.83E+03	1.83E+03	1.83E+03	2.11E+03
ND-147	8.39E+06	8.39E+06	8.39E+06	8.39E+06	8.39E+06	8.39E+06	8.39E+06	1.01E+07
PM-147	0.00E+00	0.00E+00	0.00E+00	0.00E+00	0.00E+00	0.00E+00	0.00E+00	0.00E+00
PM-148M	4.45E+08	4.45E+08	4.45E+08	4.45E+08	4.45E+08	4.45E+08	4.45E+08	2.58E+09
PM-148	1.89E+07	1.89E+07	1.89E+07	1.89E+07	1.89E+07	1.89E+07	1.89E+07	2.18E+07
PM-149	4.23E+04	4.23E+04	4.23E+04	4.23E+04	4.23E+04	4.23E+04	4.23E+04	4.90E+04
PM-151	1.99E+06	1.99E+06	1.99E+06	1.99E+06	1.99E+06	1.99E+06	1.99E+06	2.08E+06
SM-151	2.11E+08	2.11E+08	2.11E+08	2.11E+08	2.11E+08	2.11E+08	2.11E+08	9.24E+08
SM-153	4.02E+05	4.02E+05	4.02E+05	4.02E+05	4.02E+05	4.02E+05	4.02E+05	4.46E+05
EU-152	2.02E+10	2.02E+10	2.02E+10	2.02E+10	2.02E+10	2.02E+10	2.02E+10	2.33E+10
EU-154	1.65E+10	1.65E+10	1.65E+10	1.65E+10	1.65E+10	1.65E+10	1.65E+10	1.90E+10
EU-155	5.12E+08	5.12E+08	5.12E+08	5.12E+08	5.12E+08	5.12E+08	5.12E+08	5.81E+08
EU-156	8.82E+07	8.82E+07	8.82E+07	8.82E+07	8.82E+07	8.82E+07	8.82E+07	1.01E+08
TB-160	4.75E+08	4.75E+08	4.75E+08	4.75E+08	4.75E+08	4.75E+08	4.75E+08	5.53E+08
HO-166M	4.27E+10	4.27E+10	4.27E+10	4.27E+10	4.27E+10	4.27E+10	4.27E+10	4.80E+10
W-181	1.94E+05	1.94E+05	1.94E+05	1.94E+05	1.94E+05	1.94E+05	1.94E+05	2.59E+05
W-185	0.00E+00	0.00E+00	0.00E+00	0.00E+00	0.00E+00	0.00E+00	0.00E+00	0.00E+00
W-187	2.35E+06	2.35E+06	2.35E+06	2.35E+06	2.35E+06	2.35E+06	2.35E+06	2.73E+06
U-232	1.11E+07	1.11E+07	1.11E+07	1.11E+07	1.11E+07	1.11E+07	1.11E+07	1.16E+08
U-233	1.11E+10	1.11E+10	1.11E+10	1.11E+10	1.11E+10	1.11E+10	1.11E+10	1.35E+10
U-234	3.06E+06	3.06E+06	3.06E+06	3.06E+06	3.06E+06	3.06E+06	3.06E+06	7.69E+08
U-235	1.55E+10	1.55E+10	1.55E+10	1.55E+10	1.55E+10	1.55E+10	1.55E+10	1.94E+10

TABLE II-7

R_i DOSE FACTORS AGE: TEEN PATHWAY: GROUND PLANEm²-mrem/yr per μ Ci/sec

NUCLIDE	BONE	LIVER	T BODY	THYROID	KIDNEY	LUNG	GI-LLI	SKIN
U-236	1.02E+05	1.02E+05	1.02E+05	1.02E+05	1.02E+05	1.02E+05	1.02E+05	8.71E+07
U-237	5.16E+06	5.16E+06	5.16E+06	5.16E+06	5.16E+06	5.16E+06	5.16E+06	6.71E+06
U-238	5.32E+08	5.32E+08	5.32E+08	5.32E+08	5.32E+08	5.32E+08	5.32E+08	7.26E+08
NP-237	6.77E+09	6.77E+09	6.77E+09	6.77E+09	6.77E+09	6.77E+09	6.77E+09	7.74E+09
NP-238	4.53E+06	4.53E+06	4.53E+06	4.53E+06	4.53E+06	4.53E+06	4.53E+06	5.18E+06
NP-239	1.71E+06	1.71E+06	1.71E+06	1.71E+06	1.71E+06	1.71E+06	1.71E+06	1.98E+06
PU-238	5.71E+06	5.71E+06	5.71E+06	5.71E+06	5.71E+06	5.71E+06	5.71E+06	7.90E+07
PU-239	3.82E+06	3.82E+06	3.82E+06	3.82E+06	3.82E+06	3.82E+06	3.82E+06	3.72E+07
PU-240	6.28E+06	6.28E+06	6.28E+06	6.28E+06	6.28E+06	6.28E+06	6.28E+06	8.70E+07
PU-241	1.29E+07	1.29E+07	1.29E+07	1.29E+07	1.29E+07	1.29E+07	1.29E+07	1.91E+07
PU-242	5.32E+06	5.32E+06	5.32E+06	5.32E+06	5.32E+06	5.32E+06	5.32E+06	7.74E+07
PU-244	4.33E+09	4.33E+09	4.33E+09	4.33E+09	4.33E+09	4.33E+09	4.33E+09	4.65E+09
AM-241	8.54E+08	8.54E+08	8.54E+08	8.54E+08	8.54E+08	8.54E+08	8.54E+08	1.23E+09
AM-242M	1.19E+08	1.19E+08	1.19E+08	1.19E+08	1.19E+08	1.19E+08	1.19E+08	8.23E+08
AM-243	6.28E+09	6.28E+09	6.28E+09	6.28E+09	6.28E+09	6.28E+09	6.28E+09	7.25E+09
CM-242	6.86E+05	6.86E+05	6.86E+05	6.86E+05	6.86E+05	6.86E+05	6.86E+05	2.87E+06
CM-243	8.34E+09	8.34E+09	8.34E+09	8.34E+09	8.34E+09	8.34E+09	8.34E+09	1.05E+10
CM-244	9.03E+06	9.03E+06	9.03E+06	9.03E+06	9.03E+06	9.03E+06	9.03E+06	5.61E+07
CM-245	4.59E+09	4.59E+09	4.59E+09	4.59E+09	4.59E+09	4.59E+09	4.59E+09	5.80E+09
CM-246	4.83E+06	4.83E+06	4.83E+06	4.83E+06	4.83E+06	4.83E+06	4.83E+06	7.24E+07
CM-247	1.06E+10	1.06E+10	1.06E+10	1.06E+10	1.06E+10	1.06E+10	1.06E+10	1.26E+10
CM-248	2.53E+10	2.53E+10	2.53E+10	2.53E+10	2.53E+10	2.53E+10	2.53E+10	3.29E+10
CF-252	4.86E+10	4.86E+10	4.86E+10	4.86E+10	4.86E+10	4.86E+10	4.86E+10	5.30E+10
Gross Alpha	9.16E+04	9.16E+04	9.16E+04	9.16E+04	9.16E+04	9.16E+04	9.16E+04	0.00E+00

TABLE II2-8

R_i DOSE FACTORS AGE: CHILD PATHWAY: GROUND PLANEm²-mrem/yr per μ Ci/sec

NUCLIDE	BONE	LIVER	T BODY	THYROID	KIDNEY	LUNG	GI-LLI	SKIN
H-3	0.00E+00	0.00E+00	0.00E+00	0.00E+00	0.00E+00	0.00E+00	0.00E+00	0.00E+00
C-14	0.00E+00	0.00E+00	0.00E+00	0.00E+00	0.00E+00	0.00E+00	0.00E+00	0.00E+00
NA-22	1.16E+10	1.16E+10	1.16E+10	1.16E+10	1.16E+10	1.16E+10	1.16E+10	1.30E+10
NA-24	1.19E+07	1.19E+07	1.19E+07	1.19E+07	1.19E+07	1.19E+07	1.19E+07	1.39E+07
P-32	0.00E+00	0.00E+00	0.00E+00	0.00E+00	0.00E+00	0.00E+00	0.00E+00	0.00E+00
CA-41	1.65E+10	1.65E+10	1.65E+10	1.65E+10	1.65E+10	1.65E+10	1.65E+10	1.94E+10
SC-46	8.33E+08	8.33E+08	8.33E+08	8.33E+08	8.33E+08	8.33E+08	8.33E+08	9.61E+08
CR-51	4.66E+06	4.66E+06	4.66E+06	4.66E+06	4.66E+06	4.66E+06	4.66E+06	5.51E+06
MN-54	1.39E+09	1.39E+09	1.39E+09	1.39E+09	1.39E+09	1.39E+09	1.39E+09	1.63E+09
MN-56	9.03E+05	9.03E+05	9.03E+05	9.03E+05	9.03E+05	9.03E+05	9.03E+05	1.07E+06
FE-55	0.00E+00	0.00E+00	0.00E+00	0.00E+00	0.00E+00	0.00E+00	0.00E+00	0.00E+00
FE-59	2.73E+08	2.73E+08	2.73E+08	2.73E+08	2.73E+08	2.73E+08	2.73E+08	3.21E+08
CO-57	1.88E+08	1.88E+08	1.88E+08	1.88E+08	1.88E+08	1.88E+08	1.88E+08	2.07E+08
CO-58	3.79E+08	3.79E+08	3.79E+08	3.79E+08	3.79E+08	3.79E+08	3.79E+08	4.44E+08
CO-60	2.41E+10	2.41E+10	2.41E+10	2.41E+10	2.41E+10	2.41E+10	2.41E+10	2.83E+10
NI-59	0.00E+00	0.00E+00	0.00E+00	0.00E+00	0.00E+00	0.00E+00	0.00E+00	0.00E+00
NI-63	0.00E+00	0.00E+00	0.00E+00	0.00E+00	0.00E+00	0.00E+00	0.00E+00	0.00E+00
NI-65	2.97E+05	2.97E+05	2.97E+05	2.97E+05	2.97E+05	2.97E+05	2.97E+05	3.45E+05
CU-64	6.07E+05	6.07E+05	6.07E+05	6.07E+05	6.07E+05	6.07E+05	6.07E+05	6.88E+05
ZN-65	7.47E+08	7.47E+08	7.47E+08	7.47E+08	7.47E+08	7.47E+08	7.47E+08	8.59E+08
ZN-69M	1.27E+06	1.27E+06	1.27E+06	1.27E+06	1.27E+06	1.27E+06	1.27E+06	1.49E+06
ZN-69	0.00E+00	0.00E+00	0.00E+00	0.00E+00	0.00E+00	0.00E+00	0.00E+00	0.00E+00
SE-79	0.00E+00	0.00E+00	0.00E+00	0.00E+00	0.00E+00	0.00E+00	0.00E+00	0.00E+00
BR-82	2.14E+07	2.14E+07	2.14E+07	2.14E+07	2.14E+07	2.14E+07	2.14E+07	2.47E+07
BR-83	4.87E+03	4.87E+03	4.87E+03	4.87E+03	4.87E+03	4.87E+03	4.87E+03	7.08E+03
BR-84	2.03E+05	2.03E+05	2.03E+05	2.03E+05	2.03E+05	2.03E+05	2.03E+05	2.36E+05
BR-85	0.00E+00	0.00E+00	0.00E+00	0.00E+00	0.00E+00	0.00E+00	0.00E+00	0.00E+00
RB-86	8.99E+06	8.99E+06	8.99E+06	8.99E+06	8.99E+06	8.99E+06	8.99E+06	1.03E+07
RB-87	0.00E+00	0.00E+00	0.00E+00	0.00E+00	0.00E+00	0.00E+00	0.00E+00	0.00E+00
RB-88	3.31E+04	3.31E+04	3.31E+04	3.31E+04	3.31E+04	3.31E+04	3.31E+04	3.78E+04
RB-89	1.23E+05	1.23E+05	1.23E+05	1.23E+05	1.23E+05	1.23E+05	1.23E+05	1.48E+05
SR-89	2.16E+04	2.16E+04	2.16E+04	2.16E+04	2.16E+04	2.16E+04	2.16E+04	2.51E+04
SR-90	0.00E+00	0.00E+00	0.00E+00	0.00E+00	0.00E+00	0.00E+00	0.00E+00	0.00E+00
SR-91	2.15E+06	2.15E+06	2.15E+06	2.15E+06	2.15E+06	2.15E+06	2.15E+06	2.51E+06
SR-92	7.77E+05	7.77E+05	7.77E+05	7.77E+05	7.77E+05	7.77E+05	7.77E+05	8.63E+05
Y-90	4.49E+03	4.49E+03	4.49E+03	4.49E+03	4.49E+03	4.49E+03	4.49E+03	5.31E+03
Y-91M	1.00E+05	1.00E+05	1.00E+05	1.00E+05	1.00E+05	1.00E+05	1.00E+05	1.16E+05
Y-91	1.07E+06	1.07E+06	1.07E+06	1.07E+06	1.07E+06	1.07E+06	1.07E+06	1.21E+06
Y-92	1.80E+05	1.80E+05	1.80E+05	1.80E+05	1.80E+05	1.80E+05	1.80E+05	2.14E+05
Y-93	1.83E+05	1.83E+05	1.83E+05	1.83E+05	1.83E+05	1.83E+05	1.83E+05	2.51E+05
ZR-93	0.00E+00	0.00E+00	0.00E+00	0.00E+00	0.00E+00	0.00E+00	0.00E+00	0.00E+00
ZR-95	2.45E+08	2.45E+08	2.45E+08	2.45E+08	2.45E+08	2.45E+08	2.45E+08	2.84E+08
ZR-97	2.96E+06	2.96E+06	2.96E+06	2.96E+06	2.96E+06	2.96E+06	2.96E+06	3.44E+06
NB-93M	2.32E+06	2.32E+06	2.32E+06	2.32E+06	2.32E+06	2.32E+06	2.32E+06	2.83E+08

Rev. 31

Page 217 of 330

05/2018

TABLE II-8

R_i DOSE FACTORS AGE: CHILD PATHWAY: GROUND PLANEm²-mrem/yr per μ Ci/sec

NUCLIDE	BONE	LIVER	T BODY	THYROID	KIDNEY	LUNG	GI-LLI	SKIN
NB-95	1.37E+08	1.37E+08	1.37E+08	1.37E+08	1.37E+08	1.37E+08	1.37E+08	1.61E+08
NB-97	1.76E+05	1.76E+05	1.76E+05	1.76E+05	1.76E+05	1.76E+05	1.76E+05	2.07E+05
MO-93	1.11E+08	1.11E+08	1.11E+08	1.11E+08	1.11E+08	1.11E+08	1.11E+08	4.50E+09
MO-99	3.99E+06	3.99E+06	3.99E+06	3.99E+06	3.99E+06	3.99E+06	3.99E+06	4.63E+06
TC-99M	1.84E+05	1.84E+05	1.84E+05	1.84E+05	1.84E+05	1.84E+05	1.84E+05	2.11E+05
TC-99	0.00E+00	0.00E+00	0.00E+00	0.00E+00	0.00E+00	0.00E+00	0.00E+00	0.00E+00
TC-101	2.04E+04	2.04E+04	2.04E+04	2.04E+04	2.04E+04	2.04E+04	2.04E+04	2.26E+04
RU-103	1.08E+08	1.08E+08	1.08E+08	1.08E+08	1.08E+08	1.08E+08	1.08E+08	1.26E+08
RU-105	6.36E+05	6.36E+05	6.36E+05	6.36E+05	6.36E+05	6.36E+05	6.36E+05	7.21E+05
RU-106	4.22E+08	4.22E+08	4.22E+08	4.22E+08	4.22E+08	4.22E+08	4.22E+08	5.07E+08
RH-105	7.43E+05	7.43E+05	7.43E+05	7.43E+05	7.43E+05	7.43E+05	7.43E+05	8.67E+05
PD-107	0.00E+00	0.00E+00	0.00E+00	0.00E+00	0.00E+00	0.00E+00	0.00E+00	0.00E+00
PD-109	1.50E+04	1.50E+04	1.50E+04	1.50E+04	1.50E+04	1.50E+04	1.50E+04	1.71E+04
AG-110M	3.44E+09	3.44E+09	3.44E+09	3.44E+09	3.44E+09	3.44E+09	3.44E+09	4.01E+09
AG-111	1.03E+06	1.03E+06	1.03E+06	1.03E+06	1.03E+06	1.03E+06	1.03E+06	1.20E+06
CD-113M	6.31E+06	6.31E+06	6.31E+06	6.31E+06	6.31E+06	6.31E+06	6.31E+06	7.14E+06
CD-115M	0.00E+00	0.00E+00	0.00E+00	0.00E+00	0.00E+00	0.00E+00	0.00E+00	0.00E+00
SN-123	0.00E+00	0.00E+00	0.00E+00	0.00E+00	0.00E+00	0.00E+00	0.00E+00	6.38E+09
SN-125	4.20E+06	4.20E+06	4.20E+06	4.20E+06	4.20E+06	4.20E+06	4.20E+06	4.86E+06
SN-126	4.35E+10	4.35E+10	4.35E+10	4.35E+10	4.35E+10	4.35E+10	4.35E+10	4.84E+10
SB-124	5.98E+08	5.98E+08	5.98E+08	5.98E+08	5.98E+08	5.98E+08	5.98E+08	6.90E+08
SB-125	2.39E+09	2.39E+09	2.39E+09	2.39E+09	2.39E+09	2.39E+09	2.39E+09	2.70E+09
SB-126	8.44E+07	8.44E+07	8.44E+07	8.44E+07	8.44E+07	8.44E+07	8.44E+07	9.48E+07
SB-127	1.68E+07	1.68E+07	1.68E+07	1.68E+07	1.68E+07	1.68E+07	1.68E+07	1.94E+07
TE-125M	1.55E+06	1.55E+06	1.55E+06	1.55E+06	1.55E+06	1.55E+06	1.55E+06	2.13E+06
TE-127M	9.16E+04	9.16E+04	9.16E+04	9.16E+04	9.16E+04	9.16E+04	9.16E+04	1.08E+05
TE-127	2.98E+03	2.98E+03	2.98E+03	2.98E+03	2.98E+03	2.98E+03	2.98E+03	3.28E+03
TE-129M	1.98E+07	1.98E+07	1.98E+07	1.98E+07	1.98E+07	1.98E+07	1.98E+07	2.31E+07
TE-129	2.62E+04	2.62E+04	2.62E+04	2.62E+04	2.62E+04	2.62E+04	2.62E+04	3.10E+04
TE-131M	8.03E+06	8.03E+06	8.03E+06	8.03E+06	8.03E+06	8.03E+06	8.03E+06	9.46E+06
TE-131	2.92E+04	2.92E+04	2.92E+04	2.92E+04	2.92E+04	2.92E+04	2.92E+04	3.45E+07
TE-132	4.23E+06	4.23E+06	4.23E+06	4.23E+06	4.23E+06	4.23E+06	4.23E+06	4.98E+06
TE-133M	4.41E+05	4.41E+05	4.41E+05	4.41E+05	4.41E+05	4.41E+05	4.41E+05	5.00E+05
TE-134	2.22E+04	2.22E+04	2.22E+04	2.22E+04	2.22E+04	2.22E+04	2.22E+04	2.66E+04
I-129	2.18E+09	2.18E+09	2.18E+09	2.18E+09	2.18E+09	2.18E+09	2.18E+09	3.63E+09
I-130	5.51E+06	5.51E+06	5.51E+06	5.51E+06	5.51E+06	5.51E+06	5.51E+06	6.69E+06
I-131	1.72E+07	1.72E+07	1.72E+07	1.72E+07	1.72E+07	1.72E+07	1.72E+07	2.09E+07
I-132	1.25E+06	1.25E+06	1.25E+06	1.25E+06	1.25E+06	1.25E+06	1.25E+06	1.46E+06
I-133	2.45E+06	2.45E+06	2.45E+06	2.45E+06	2.45E+06	2.45E+06	2.45E+06	2.98E+06
I-134	4.47E+05	4.47E+05	4.47E+05	4.47E+05	4.47E+05	4.47E+05	4.47E+05	5.30E+05
I-135	2.53E+06	2.53E+06	2.53E+06	2.53E+06	2.53E+06	2.53E+06	2.53E+06	2.95E+06
CS-134M	5.73E+04	5.73E+04	5.73E+04	5.73E+04	5.73E+04	5.73E+04	5.73E+04	6.74E+04
CS-134	6.91E+09	6.91E+09	6.91E+09	6.91E+09	6.91E+09	6.91E+09	6.91E+09	8.06E+09
CS-135	0.00E+00	0.00E+00	0.00E+00	0.00E+00	0.00E+00	0.00E+00	0.00E+00	0.00E+00
CS-136	1.51E+08	1.51E+08	1.51E+08	1.51E+08	1.51E+08	1.51E+08	1.51E+08	1.71E+08

TABLE II-8

R_i DOSE FACTORS AGE: CHILD PATHWAY: GROUND PLANEm²-mrem/yr per μ Ci/sec

NUCLIDE	BONE	LIVER	T BODY	THYROID	KIDNEY	LUNG	GI-LLI	SKIN
CS-137	1.55E+10	1.55E+10	1.55E+10	1.55E+10	1.55E+10	1.55E+10	1.55E+10	1.80E+10
CS-138	3.59E+05	3.59E+05	3.59E+05	3.59E+05	3.59E+05	3.59E+05	3.59E+05	4.10E+05
CS-139	3.14E+04	3.14E+04	3.14E+04	3.14E+04	3.14E+04	3.14E+04	3.14E+04	3.59E+04
BA-139	1.06E+05	1.06E+05	1.06E+05	1.06E+05	1.06E+05	1.06E+05	1.06E+05	1.19E+05
BA-140	2.05E+07	2.05E+07	2.05E+07	2.05E+07	2.05E+07	2.05E+07	2.05E+07	2.35E+07
BA-141	4.17E+04	4.17E+04	4.17E+04	4.17E+04	4.17E+04	4.17E+04	4.17E+04	4.75E+04
BA-142	4.49E+04	4.49E+04	4.49E+04	4.49E+04	4.49E+04	4.49E+04	4.49E+04	5.11E+04
LA-140	1.92E+07	1.92E+07	1.92E+07	1.92E+07	1.92E+07	1.92E+07	1.92E+07	2.18E+07
LA-141	3.14E+04	3.14E+04	3.14E+04	3.14E+04	3.14E+04	3.14E+04	3.14E+04	3.51E+04
LA-142	7.60E+05	7.60E+05	7.60E+05	7.60E+05	7.60E+05	7.60E+05	7.60E+05	9.11E+05
CE-141	1.37E+07	1.37E+07	1.37E+07	1.37E+07	1.37E+07	1.37E+07	1.37E+07	1.54E+07
CE-143	2.31E+06	2.31E+06	2.31E+06	2.31E+06	2.31E+06	2.31E+06	2.31E+06	2.63E+06
CE-144	6.95E+07	6.95E+07	6.95E+07	6.95E+07	6.95E+07	6.95E+07	6.95E+07	8.04E+07
PR-143	0.00E+00	0.00E+00	0.00E+00	0.00E+00	0.00E+00	0.00E+00	0.00E+00	0.00E+00
PR-144	1.83E+03	1.83E+03	1.83E+03	1.83E+03	1.83E+03	1.83E+03	1.83E+03	2.11E+03
ND-147	8.39E+06	8.39E+06	8.39E+06	8.39E+06	8.39E+06	8.39E+06	8.39E+06	1.01E+07
PM-147	0.00E+00	0.00E+00	0.00E+00	0.00E+00	0.00E+00	0.00E+00	0.00E+00	0.00E+00
PM-148M	4.45E+08	4.45E+08	4.45E+08	4.45E+08	4.45E+08	4.45E+08	4.45E+08	2.58E+09
PM-148	1.89E+07	1.89E+07	1.89E+07	1.89E+07	1.89E+07	1.89E+07	1.89E+07	2.18E+07
PM-149	4.23E+04	4.23E+04	4.23E+04	4.23E+04	4.23E+04	4.23E+04	4.23E+04	4.90E+04
PM-151	1.99E+06	1.99E+06	1.99E+06	1.99E+06	1.99E+06	1.99E+06	1.99E+06	2.08E+06
SM-151	2.11E+08	2.11E+08	2.11E+08	2.11E+08	2.11E+08	2.11E+08	2.11E+08	9.24E+08
SM-153	4.02E+05	4.02E+05	4.02E+05	4.02E+05	4.02E+05	4.02E+05	4.02E+05	4.46E+05
EU-152	2.02E+10	2.02E+10	2.02E+10	2.02E+10	2.02E+10	2.02E+10	2.02E+10	2.33E+10
EU-154	1.65E+10	1.65E+10	1.65E+10	1.65E+10	1.65E+10	1.65E+10	1.65E+10	1.90E+10
EU-155	5.12E+08	5.12E+08	5.12E+08	5.12E+08	5.12E+08	5.12E+08	5.12E+08	5.81E+08
EU-156	8.82E+07	8.82E+07	8.82E+07	8.82E+07	8.82E+07	8.82E+07	8.82E+07	1.01E+08
TB-160	4.75E+08	4.75E+08	4.75E+08	4.75E+08	4.75E+08	4.75E+08	4.75E+08	5.53E+08
HO-166M	4.27E+10	4.27E+10	4.27E+10	4.27E+10	4.27E+10	4.27E+10	4.27E+10	4.80E+10
W-181	1.94E+05	1.94E+05	1.94E+05	1.94E+05	1.94E+05	1.94E+05	1.94E+05	2.59E+05
W-185	0.00E+00	0.00E+00	0.00E+00	0.00E+00	0.00E+00	0.00E+00	0.00E+00	0.00E+00
W-187	2.35E+06	2.35E+06	2.35E+06	2.35E+06	2.35E+06	2.35E+06	2.35E+06	2.73E+06
U-232	1.11E+07	1.11E+07	1.11E+07	1.11E+07	1.11E+07	1.11E+07	1.11E+07	1.16E+08
U-233	1.11E+10	1.11E+10	1.11E+10	1.11E+10	1.11E+10	1.11E+10	1.11E+10	1.35E+10
U-234	3.06E+06	3.06E+06	3.06E+06	3.06E+06	3.06E+06	3.06E+06	3.06E+06	7.69E+08
U-235	1.55E+10	1.55E+10	1.55E+10	1.55E+10	1.55E+10	1.55E+10	1.55E+10	1.94E+10
U-236	1.02E+05	1.02E+05	1.02E+05	1.02E+05	1.02E+05	1.02E+05	1.02E+05	8.71E+07
U-237	5.16E+06	5.16E+06	5.16E+06	5.16E+06	5.16E+06	5.16E+06	5.16E+06	6.71E+06
U-238	5.32E+08	5.32E+08	5.32E+08	5.32E+08	5.32E+08	5.32E+08	5.32E+08	7.26E+08
NP-237	6.77E+09	6.77E+09	6.77E+09	6.77E+09	6.77E+09	6.77E+09	6.77E+09	7.74E+09
NP-238	4.53E+06	4.53E+06	4.53E+06	4.53E+06	4.53E+06	4.53E+06	4.53E+06	5.18E+06
NP-239	1.71E+06	1.71E+06	1.71E+06	1.71E+06	1.71E+06	1.71E+06	1.71E+06	1.98E+06
PU-238	5.71E+06	5.71E+06	5.71E+06	5.71E+06	5.71E+06	5.71E+06	5.71E+06	7.90E+07
PU-239	3.82E+06	3.82E+06	3.82E+06	3.82E+06	3.82E+06	3.82E+06	3.82E+06	3.72E+07
PU-240	6.28E+06	6.28E+06	6.28E+06	6.28E+06	6.28E+06	6.28E+06	6.28E+06	8.70E+07

TABLE II-8

R_i DOSE FACTORS AGE: CHILD PATHWAY: GROUND PLANEm²-mrem/yr per μ Ci/sec

NUCLIDE	BONE	LIVER	T BODY	THYROID	KIDNEY	LUNG	GI-LLI	SKIN
PU-241	1.29E+07	1.29E+07	1.29E+07	1.29E+07	1.29E+07	1.29E+07	1.29E+07	1.91E+07
PU-242	5.32E+06	5.32E+06	5.32E+06	5.32E+06	5.32E+06	5.32E+06	5.32E+06	7.74E+07
PU-244	4.33E+09	4.33E+09	4.33E+09	4.33E+09	4.33E+09	4.33E+09	4.33E+09	4.65E+09
AM-241	8.54E+08	8.54E+08	8.54E+08	8.54E+08	8.54E+08	8.54E+08	8.54E+08	1.23E+09
AM-242M	1.19E+08	1.19E+08	1.19E+08	1.19E+08	1.19E+08	1.19E+08	1.19E+08	8.23E+08
AM-243	6.28E+09	6.28E+09	6.28E+09	6.28E+09	6.28E+09	6.28E+09	6.28E+09	7.25E+09
CM-242	5.71E+06	5.71E+06	5.71E+06	5.71E+06	5.71E+06	5.71E+06	5.71E+06	7.90E+07
CM-243	8.34E+09	8.34E+09	8.34E+09	8.34E+09	8.34E+09	8.34E+09	8.34E+09	1.05E+10
CM-244	9.03E+06	9.03E+06	9.03E+06	9.03E+06	9.03E+06	9.03E+06	9.03E+06	5.61E+07
CM-245	4.59E+09	4.59E+09	4.59E+09	4.59E+09	4.59E+09	4.59E+09	4.59E+09	5.80E+09
CM-246	4.83E+06	4.83E+06	4.83E+06	4.83E+06	4.83E+06	4.83E+06	4.83E+06	7.24E+07
CM-247	1.06E+10	1.06E+10	1.06E+10	1.06E+10	1.06E+10	1.06E+10	1.06E+10	1.26E+10
CM-248	2.53E+10	2.53E+10	2.53E+10	2.53E+10	2.53E+10	2.53E+10	2.53E+10	3.29E+10
CF-252	4.86E+10	4.86E+10	4.86E+10	4.86E+10	4.86E+10	4.86E+10	4.86E+10	5.30E+10
Gross Alpha	9.16E+04	9.16E+04	9.16E+04	9.16E+04	9.16E+04	9.16E+04	9.16E+04	0.00E+00

TABLE II2-9

R_i DOSE FACTORS AGE: INFANT PATHWAY: GROUND PLANEm²-mrem/yr per μCi/sec

NUCLIDE	BONE	LIVER	T BODY	THYROID	KIDNEY	LUNG	GI-LLI	SKIN
H-3	0.00E+00	0.00E+00	0.00E+00	0.00E+00	0.00E+00	0.00E+00	0.00E+00	0.00E+00
C-14	0.00E+00	0.00E+00	0.00E+00	0.00E+00	0.00E+00	0.00E+00	0.00E+00	0.00E+00
NA-22	1.16E+10	1.16E+10	1.16E+10	1.16E+10	1.16E+10	1.16E+10	1.16E+10	1.30E+10
NA-24	1.19E+07	1.19E+07	1.19E+07	1.19E+07	1.19E+07	1.19E+07	1.19E+07	1.39E+07
P-32	0.00E+00	0.00E+00	0.00E+00	0.00E+00	0.00E+00	0.00E+00	0.00E+00	0.00E+00
CA-41	1.65E+10	1.65E+10	1.65E+10	1.65E+10	1.65E+10	1.65E+10	1.65E+10	1.94E+10
SC-46	8.33E+08	8.33E+08	8.33E+08	8.33E+08	8.33E+08	8.33E+08	8.33E+08	9.61E+08
CR-51	4.66E+06	4.66E+06	4.66E+06	4.66E+06	4.66E+06	4.66E+06	4.66E+06	5.51E+06
MN-54	1.39E+09	1.39E+09	1.39E+09	1.39E+09	1.39E+09	1.39E+09	1.39E+09	1.63E+09
MN-56	9.03E+05	9.03E+05	9.03E+05	9.03E+05	9.03E+05	9.03E+05	9.03E+05	1.07E+06
FE-55	0.00E+00	0.00E+00	0.00E+00	0.00E+00	0.00E+00	0.00E+00	0.00E+00	0.00E+00
FE-59	2.73E+08	2.73E+08	2.73E+08	2.73E+08	2.73E+08	2.73E+08	2.73E+08	3.21E+08
CO-57	1.88E+08	1.88E+08	1.88E+08	1.88E+08	1.88E+08	1.88E+08	1.88E+08	2.07E+08
CO-58	3.79E+08	3.79E+08	3.79E+08	3.79E+08	3.79E+08	3.79E+08	3.79E+08	4.44E+08
CO-60	2.41E+10	2.41E+10	2.41E+10	2.41E+10	2.41E+10	2.41E+10	2.41E+10	2.83E+10
NI-59	0.00E+00	0.00E+00	0.00E+00	0.00E+00	0.00E+00	0.00E+00	0.00E+00	0.00E+00
NI-63	0.00E+00	0.00E+00	0.00E+00	0.00E+00	0.00E+00	0.00E+00	0.00E+00	0.00E+00
NI-65	2.97E+05	2.97E+05	2.97E+05	2.97E+05	2.97E+05	2.97E+05	2.97E+05	3.45E+05
CU-64	6.07E+05	6.07E+05	6.07E+05	6.07E+05	6.07E+05	6.07E+05	6.07E+05	6.88E+05
ZN-65	7.47E+08	7.47E+08	7.47E+08	7.47E+08	7.47E+08	7.47E+08	7.47E+08	8.59E+08
ZN-69M	1.27E+06	1.27E+06	1.27E+06	1.27E+06	1.27E+06	1.27E+06	1.27E+06	1.49E+06
ZN-69	0.00E+00	0.00E+00	0.00E+00	0.00E+00	0.00E+00	0.00E+00	0.00E+00	0.00E+00
SE-79	0.00E+00	0.00E+00	0.00E+00	0.00E+00	0.00E+00	0.00E+00	0.00E+00	0.00E+00
BR-82	2.14E+07	2.14E+07	2.14E+07	2.14E+07	2.14E+07	2.14E+07	2.14E+07	2.47E+07
BR-83	4.87E+03	4.87E+03	4.87E+03	4.87E+03	4.87E+03	4.87E+03	4.87E+03	7.08E+03
BR-84	2.03E+05	2.03E+05	2.03E+05	2.03E+05	2.03E+05	2.03E+05	2.03E+05	2.36E+05
BR-85	0.00E+00	0.00E+00	0.00E+00	0.00E+00	0.00E+00	0.00E+00	0.00E+00	0.00E+00
RB-86	8.99E+06	8.99E+06	8.99E+06	8.99E+06	8.99E+06	8.99E+06	8.99E+06	1.03E+07
RB-87	0.00E+00	0.00E+00	0.00E+00	0.00E+00	0.00E+00	0.00E+00	0.00E+00	0.00E+00
RB-88	3.31E+04	3.31E+04	3.31E+04	3.31E+04	3.31E+04	3.31E+04	3.31E+04	3.78E+04
RB-89	1.23E+05	1.23E+05	1.23E+05	1.23E+05	1.23E+05	1.23E+05	1.23E+05	1.48E+05
SR-89	2.16E+04	2.16E+04	2.16E+04	2.16E+04	2.16E+04	2.16E+04	2.16E+04	2.51E+04
SR-90	0.00E+00	0.00E+00	0.00E+00	0.00E+00	0.00E+00	0.00E+00	0.00E+00	0.00E+00
SR-91	2.15E+06	2.15E+06	2.15E+06	2.15E+06	2.15E+06	2.15E+06	2.15E+06	2.51E+06
SR-92	7.77E+05	7.77E+05	7.77E+05	7.77E+05	7.77E+05	7.77E+05	7.77E+05	8.63E+05
Y-90	4.49E+03	4.49E+03	4.49E+03	4.49E+03	4.49E+03	4.49E+03	4.49E+03	5.31E+03
Y-91M	1.00E+05	1.00E+05	1.00E+05	1.00E+05	1.00E+05	1.00E+05	1.00E+05	1.16E+05
Y-91	1.07E+06	1.07E+06	1.07E+06	1.07E+06	1.07E+06	1.07E+06	1.07E+06	1.21E+06
Y-92	1.80E+05	1.80E+05	1.80E+05	1.80E+05	1.80E+05	1.80E+05	1.80E+05	2.14E+05
Y-93	1.83E+05	1.83E+05	1.83E+05	1.83E+05	1.83E+05	1.83E+05	1.83E+05	2.51E+05
ZR-93	0.00E+00	0.00E+00	0.00E+00	0.00E+00	0.00E+00	0.00E+00	0.00E+00	0.00E+00
ZR-95	2.45E+08	2.45E+08	2.45E+08	2.45E+08	2.45E+08	2.45E+08	2.45E+08	2.84E+08
ZR-97	2.96E+06	2.96E+06	2.96E+06	2.96E+06	2.96E+06	2.96E+06	2.96E+06	3.44E+06
NB-93M	2.32E+06	2.32E+06	2.32E+06	2.32E+06	2.32E+06	2.32E+06	2.32E+06	2.83E+08

Rev. 31

Page 221 of 330

05/2018

TABLE II2-9

R_i DOSE FACTORS AGE: INFANT PATHWAY: GROUND PLANEm²-mrem/yr per μ Ci/sec

NUCLIDE	BONE	LIVER	T BODY	THYROID	KIDNEY	LUNG	GI-LLI	SKIN
NB-95	1.37E+08	1.37E+08	1.37E+08	1.37E+08	1.37E+08	1.37E+08	1.37E+08	1.61E+08
NB-97	1.76E+05	1.76E+05	1.76E+05	1.76E+05	1.76E+05	1.76E+05	1.76E+05	2.07E+05
MO-93	1.11E+08	1.11E+08	1.11E+08	1.11E+08	1.11E+08	1.11E+08	1.11E+08	4.50E+09
MO-99	3.99E+06	3.99E+06	3.99E+06	3.99E+06	3.99E+06	3.99E+06	3.99E+06	4.63E+06
TC-99M	1.84E+05	1.84E+05	1.84E+05	1.84E+05	1.84E+05	1.84E+05	1.84E+05	2.11E+05
TC-99	0.00E+00	0.00E+00	0.00E+00	0.00E+00	0.00E+00	0.00E+00	0.00E+00	0.00E+00
TC-101	2.04E+04	2.04E+04	2.04E+04	2.04E+04	2.04E+04	2.04E+04	2.04E+04	2.26E+04
RU-103	1.08E+08	1.08E+08	1.08E+08	1.08E+08	1.08E+08	1.08E+08	1.08E+08	1.26E+08
RU-105	6.36E+05	6.36E+05	6.36E+05	6.36E+05	6.36E+05	6.36E+05	6.36E+05	7.21E+05
RU-106	4.22E+08	4.22E+08	4.22E+08	4.22E+08	4.22E+08	4.22E+08	4.22E+08	5.07E+08
RH-105	7.43E+05	7.43E+05	7.43E+05	7.43E+05	7.43E+05	7.43E+05	7.43E+05	8.67E+05
PD-107	0.00E+00	0.00E+00	0.00E+00	0.00E+00	0.00E+00	0.00E+00	0.00E+00	0.00E+00
PD-109	1.50E+04	1.50E+04	1.50E+04	1.50E+04	1.50E+04	1.50E+04	1.50E+04	1.71E+04
AG-110M	3.44E+09	3.44E+09	3.44E+09	3.44E+09	3.44E+09	3.44E+09	3.44E+09	4.01E+09
AG-111	1.03E+06	1.03E+06	1.03E+06	1.03E+06	1.03E+06	1.03E+06	1.03E+06	1.20E+06
CD-113M	6.31E+06	6.31E+06	6.31E+06	6.31E+06	6.31E+06	6.31E+06	6.31E+06	7.14E+06
CD-115M	0.00E+00	0.00E+00	0.00E+00	0.00E+00	0.00E+00	0.00E+00	0.00E+00	0.00E+00
SN-123	0.00E+00	0.00E+00	0.00E+00	0.00E+00	0.00E+00	0.00E+00	0.00E+00	6.38E+09
SN-125	4.20E+06	4.20E+06	4.20E+06	4.20E+06	4.20E+06	4.20E+06	4.20E+06	4.86E+06
SN-126	4.35E+10	4.35E+10	4.35E+10	4.35E+10	4.35E+10	4.35E+10	4.35E+10	4.84E+10
SB-124	5.98E+08	5.98E+08	5.98E+08	5.98E+08	5.98E+08	5.98E+08	5.98E+08	6.90E+08
SB-125	2.39E+09	2.39E+09	2.39E+09	2.39E+09	2.39E+09	2.39E+09	2.39E+09	2.70E+09
SB-126	8.44E+07	8.44E+07	8.44E+07	8.44E+07	8.44E+07	8.44E+07	8.44E+07	9.48E+07
SB-127	1.68E+07	1.68E+07	1.68E+07	1.68E+07	1.68E+07	1.68E+07	1.68E+07	1.94E+07
TE-125M	1.55E+06	1.55E+06	1.55E+06	1.55E+06	1.55E+06	1.55E+06	1.55E+06	2.13E+06
TE-127M	9.16E+04	9.16E+04	9.16E+04	9.16E+04	9.16E+04	9.16E+04	9.16E+04	1.08E+05
TE-127	2.98E+03	2.98E+03	2.98E+03	2.98E+03	2.98E+03	2.98E+03	2.98E+03	3.28E+03
TE-129M	1.98E+07	1.98E+07	1.98E+07	1.98E+07	1.98E+07	1.98E+07	1.98E+07	2.31E+07
TE-129	2.62E+04	2.62E+04	2.62E+04	2.62E+04	2.62E+04	2.62E+04	2.62E+04	3.10E+04
TE-131M	8.03E+06	8.03E+06	8.03E+06	8.03E+06	8.03E+06	8.03E+06	8.03E+06	9.46E+06
TE-131	2.92E+04	2.92E+04	2.92E+04	2.92E+04	2.92E+04	2.92E+04	2.92E+04	3.45E+07
TE-132	4.23E+06	4.23E+06	4.23E+06	4.23E+06	4.23E+06	4.23E+06	4.23E+06	4.98E+06
TE-133M	4.41E+05	4.41E+05	4.41E+05	4.41E+05	4.41E+05	4.41E+05	4.41E+05	5.00E+05
TE-134	2.22E+04	2.22E+04	2.22E+04	2.22E+04	2.22E+04	2.22E+04	2.22E+04	2.66E+04
I-129	2.18E+09	2.18E+09	2.18E+09	2.18E+09	2.18E+09	2.18E+09	2.18E+09	3.63E+09
I-130	5.51E+06	5.51E+06	5.51E+06	5.51E+06	5.51E+06	5.51E+06	5.51E+06	6.69E+06
I-131	1.72E+07	1.72E+07	1.72E+07	1.72E+07	1.72E+07	1.72E+07	1.72E+07	2.09E+07
I-132	1.25E+06	1.25E+06	1.25E+06	1.25E+06	1.25E+06	1.25E+06	1.25E+06	1.46E+06
I-133	2.45E+06	2.45E+06	2.45E+06	2.45E+06	2.45E+06	2.45E+06	2.45E+06	2.98E+06
I-134	4.47E+05	4.47E+05	4.47E+05	4.47E+05	4.47E+05	4.47E+05	4.47E+05	5.30E+05
I-135	2.53E+06	2.53E+06	2.53E+06	2.53E+06	2.53E+06	2.53E+06	2.53E+06	2.95E+06
CS-134M	5.73E+04	5.73E+04	5.73E+04	5.73E+04	5.73E+04	5.73E+04	5.73E+04	6.74E+04
CS-134	6.91E+09	6.91E+09	6.91E+09	6.91E+09	6.91E+09	6.91E+09	6.91E+09	8.06E+09
CS-135	0.00E+00	0.00E+00	0.00E+00	0.00E+00	0.00E+00	0.00E+00	0.00E+00	0.00E+00
CS-136	1.51E+08	1.51E+08	1.51E+08	1.51E+08	1.51E+08	1.51E+08	1.51E+08	1.71E+08

TABLE II2-9

R_i DOSE FACTORS AGE: INFANT PATHWAY: GROUND PLANEm²-mrem/yr per μ Ci/sec

NUCLIDE	BONE	LIVER	T BODY	THYROID	KIDNEY	LUNG	GI-LLI	SKIN
CS-137	1.55E+10	1.55E+10	1.55E+10	1.55E+10	1.55E+10	1.55E+10	1.55E+10	1.80E+10
CS-138	3.59E+05	3.59E+05	3.59E+05	3.59E+05	3.59E+05	3.59E+05	3.59E+05	4.10E+05
CS-139	3.14E+04	3.14E+04	3.14E+04	3.14E+04	3.14E+04	3.14E+04	3.14E+04	3.59E+04
BA-139	1.06E+05	1.06E+05	1.06E+05	1.06E+05	1.06E+05	1.06E+05	1.06E+05	1.19E+05
BA-140	2.05E+07	2.05E+07	2.05E+07	2.05E+07	2.05E+07	2.05E+07	2.05E+07	2.35E+07
BA-141	4.17E+04	4.17E+04	4.17E+04	4.17E+04	4.17E+04	4.17E+04	4.17E+04	4.75E+04
BA-142	4.49E+04	4.49E+04	4.49E+04	4.49E+04	4.49E+04	4.49E+04	4.49E+04	5.11E+04
LA-140	1.92E+07	1.92E+07	1.92E+07	1.92E+07	1.92E+07	1.92E+07	1.92E+07	2.18E+07
LA-141	3.14E+04	3.14E+04	3.14E+04	3.14E+04	3.14E+04	3.14E+04	3.14E+04	3.51E+04
LA-142	7.60E+05	7.60E+05	7.60E+05	7.60E+05	7.60E+05	7.60E+05	7.60E+05	9.11E+05
CE-141	1.37E+07	1.37E+07	1.37E+07	1.37E+07	1.37E+07	1.37E+07	1.37E+07	1.54E+07
CE-143	2.31E+06	2.31E+06	2.31E+06	2.31E+06	2.31E+06	2.31E+06	2.31E+06	2.63E+06
CE-144	6.95E+07	6.95E+07	6.95E+07	6.95E+07	6.95E+07	6.95E+07	6.95E+07	8.04E+07
PR-143	0.00E+00	0.00E+00	0.00E+00	0.00E+00	0.00E+00	0.00E+00	0.00E+00	0.00E+00
PR-144	1.83E+03	1.83E+03	1.83E+03	1.83E+03	1.83E+03	1.83E+03	1.83E+03	2.11E+03
ND-147	8.39E+06	8.39E+06	8.39E+06	8.39E+06	8.39E+06	8.39E+06	8.39E+06	1.01E+07
PM-147	0.00E+00	0.00E+00	0.00E+00	0.00E+00	0.00E+00	0.00E+00	0.00E+00	0.00E+00
PM-148M	4.45E+08	4.45E+08	4.45E+08	4.45E+08	4.45E+08	4.45E+08	4.45E+08	2.58E+09
PM-148	1.89E+07	1.89E+07	1.89E+07	1.89E+07	1.89E+07	1.89E+07	1.89E+07	2.18E+07
PM-149	4.23E+04	4.23E+04	4.23E+04	4.23E+04	4.23E+04	4.23E+04	4.23E+04	4.90E+04
PM-151	1.99E+06	1.99E+06	1.99E+06	1.99E+06	1.99E+06	1.99E+06	1.99E+06	2.08E+06
SM-151	2.11E+08	2.11E+08	2.11E+08	2.11E+08	2.11E+08	2.11E+08	2.11E+08	9.24E+08
SM-153	4.02E+05	4.02E+05	4.02E+05	4.02E+05	4.02E+05	4.02E+05	4.02E+05	4.46E+05
EU-152	2.02E+10	2.02E+10	2.02E+10	2.02E+10	2.02E+10	2.02E+10	2.02E+10	2.33E+10
EU-154	1.65E+10	1.65E+10	1.65E+10	1.65E+10	1.65E+10	1.65E+10	1.65E+10	1.90E+10
EU-155	5.12E+08	5.12E+08	5.12E+08	5.12E+08	5.12E+08	5.12E+08	5.12E+08	5.81E+08
EU-156	8.82E+07	8.82E+07	8.82E+07	8.82E+07	8.82E+07	8.82E+07	8.82E+07	1.01E+08
TB-160	4.75E+08	4.75E+08	4.75E+08	4.75E+08	4.75E+08	4.75E+08	4.75E+08	5.53E+08
HO-166M	4.27E+10	4.27E+10	4.27E+10	4.27E+10	4.27E+10	4.27E+10	4.27E+10	4.80E+10
W-181	1.94E+05	1.94E+05	1.94E+05	1.94E+05	1.94E+05	1.94E+05	1.94E+05	2.59E+05
W-185	0.00E+00	0.00E+00	0.00E+00	0.00E+00	0.00E+00	0.00E+00	0.00E+00	0.00E+00
W-187	2.35E+06	2.35E+06	2.35E+06	2.35E+06	2.35E+06	2.35E+06	2.35E+06	2.73E+06
U-232	1.11E+07	1.11E+07	1.11E+07	1.11E+07	1.11E+07	1.11E+07	1.11E+07	1.16E+08
U-233	1.11E+10	1.11E+10	1.11E+10	1.11E+10	1.11E+10	1.11E+10	1.11E+10	1.35E+10
U-234	3.06E+06	3.06E+06	3.06E+06	3.06E+06	3.06E+06	3.06E+06	3.06E+06	7.69E+08
U-235	1.55E+10	1.55E+10	1.55E+10	1.55E+10	1.55E+10	1.55E+10	1.55E+10	1.94E+10
U-236	1.02E+05	1.02E+05	1.02E+05	1.02E+05	1.02E+05	1.02E+05	1.02E+05	8.71E+07
U-237	5.16E+06	5.16E+06	5.16E+06	5.16E+06	5.16E+06	5.16E+06	5.16E+06	6.71E+06
U-238	5.32E+08	5.32E+08	5.32E+08	5.32E+08	5.32E+08	5.32E+08	5.32E+08	7.26E+08
NP-237	6.77E+09	6.77E+09	6.77E+09	6.77E+09	6.77E+09	6.77E+09	6.77E+09	7.74E+09
NP-238	4.53E+06	4.53E+06	4.53E+06	4.53E+06	4.53E+06	4.53E+06	4.53E+06	5.18E+06
NP-239	1.71E+06	1.71E+06	1.71E+06	1.71E+06	1.71E+06	1.71E+06	1.71E+06	1.98E+06
PU-238	5.71E+06	5.71E+06	5.71E+06	5.71E+06	5.71E+06	5.71E+06	5.71E+06	7.90E+07
PU-239	3.82E+06	3.82E+06	3.82E+06	3.82E+06	3.82E+06	3.82E+06	3.82E+06	3.72E+07
PU-240	6.28E+06	6.28E+06	6.28E+06	6.28E+06	6.28E+06	6.28E+06	6.28E+06	8.70E+07

TABLE II-9

R_i DOSE FACTORS AGE: INFANT PATHWAY: GROUND PLANEm²-mrem/yr per μ Ci/sec

NUCLIDE	BONE	LIVER	T BODY	THYROID	KIDNEY	LUNG	GI-LLI	SKIN
PU-241	1.29E+07	1.29E+07	1.29E+07	1.29E+07	1.29E+07	1.29E+07	1.29E+07	1.91E+07
PU-242	5.32E+06	5.32E+06	5.32E+06	5.32E+06	5.32E+06	5.32E+06	5.32E+06	7.74E+07
PU-244	4.33E+09	4.33E+09	4.33E+09	4.33E+09	4.33E+09	4.33E+09	4.33E+09	4.65E+09
AM-241	8.54E+08	8.54E+08	8.54E+08	8.54E+08	8.54E+08	8.54E+08	8.54E+08	1.23E+09
AM-242M	1.19E+08	1.19E+08	1.19E+08	1.19E+08	1.19E+08	1.19E+08	1.19E+08	8.23E+08
AM-243	6.28E+09	6.28E+09	6.28E+09	6.28E+09	6.28E+09	6.28E+09	6.28E+09	7.25E+09
CM-242	6.86E+05	6.86E+05	6.86E+05	6.86E+05	6.86E+05	6.86E+05	6.86E+05	2.87E+06
CM-243	8.34E+09	8.34E+09	8.34E+09	8.34E+09	8.34E+09	8.34E+09	8.34E+09	1.05E+10
CM-244	9.03E+06	9.03E+06	9.03E+06	9.03E+06	9.03E+06	9.03E+06	9.03E+06	5.61E+07
CM-245	4.59E+09	4.59E+09	4.59E+09	4.59E+09	4.59E+09	4.59E+09	4.59E+09	5.80E+09
CM-246	4.83E+06	4.83E+06	4.83E+06	4.83E+06	4.83E+06	4.83E+06	4.83E+06	7.24E+07
CM-247	1.06E+10	1.06E+10	1.06E+10	1.06E+10	1.06E+10	1.06E+10	1.06E+10	1.26E+10
CM-248	2.53E+10	2.53E+10	2.53E+10	2.53E+10	2.53E+10	2.53E+10	2.53E+10	3.29E+10
CF-252	4.86E+10	4.86E+10	4.86E+10	4.86E+10	4.86E+10	4.86E+10	4.86E+10	5.30E+10
Gross Alpha	9.16E+04	9.16E+04	9.16E+04	9.16E+04	9.16E+04	9.16E+04	9.16E+04	0.00E+00

TABLE I12-10

R_i DOSE FACTORS AGE: ADULT PATHWAY: GREEN LEAFY VEGETATIONm²-mrem/yr per μ Ci/sec

NUCLIDE	BONE	LIVER	T BODY	THYROID	KIDNEY	LUNG	GI-LLI	SKIN
H-3	0.00E+00	1.19E+03	1.19E+03	1.19E+03	1.19E+03	1.19E+03	1.19E+03	0.00E+00
C-14	8.24E+05	1.65E+05	1.65E+05	1.65E+05	1.65E+05	1.65E+05	1.65E+05	0.00E+00
NA-22	1.21E+09	1.21E+09	1.21E+09	1.21E+09	1.21E+09	1.21E+09	1.21E+09	0.00E+00
NA-24	1.12E+05	1.12E+05	1.12E+05	1.12E+05	1.12E+05	1.12E+05	1.12E+05	0.00E+00
P-32	8.03E+08	4.99E+07	3.10E+07	0.00E+00	0.00E+00	0.00E+00	9.02E+07	0.00E+00
CA-41	1.36E+10	0.00E+00	1.47E+09	0.00E+00	0.00E+00	0.00E+00	1.36E+07	0.00E+00
SC-46	2.20E+05	4.28E+05	1.24E+05	0.00E+00	3.99E+05	0.00E+00	2.08E+09	0.00E+00
CR-51	0.00E+00	0.00E+00	3.53E+04	2.11E+04	7.77E+03	4.68E+04	8.87E+06	0.00E+00
MN-54	0.00E+00	2.85E+08	5.43E+07	0.00E+00	8.47E+07	0.00E+00	8.72E+08	0.00E+00
MN-56	0.00E+00	6.48E+00	1.15E+00	0.00E+00	8.23E+00	0.00E+00	2.07E+02	0.00E+00
FE-55	1.92E+08	1.33E+08	3.09E+07	0.00E+00	0.00E+00	7.40E+07	7.61E+07	0.00E+00
FE-59	1.05E+08	2.47E+08	9.46E+07	0.00E+00	0.00E+00	6.90E+07	8.23E+08	0.00E+00
CO-57	0.00E+00	1.06E+07	1.77E+07	0.00E+00	0.00E+00	0.00E+00	2.70E+08	0.00E+00
CO-58	0.00E+00	2.67E+07	5.99E+07	0.00E+00	0.00E+00	0.00E+00	5.42E+08	0.00E+00
CO-60	0.00E+00	1.53E+08	3.38E+08	0.00E+00	0.00E+00	0.00E+00	2.88E+09	0.00E+00
NI-59	7.19E+08	2.47E+08	1.20E+08	0.00E+00	0.00E+00	0.00E+00	5.08E+07	0.00E+00
NI-63	9.56E+09	6.63E+08	3.21E+08	0.00E+00	0.00E+00	0.00E+00	1.38E+08	0.00E+00
NI-65	2.50E+01	3.25E+00	1.48E+00	0.00E+00	0.00E+00	0.00E+00	8.25E+01	0.00E+00
CU-64	0.00E+00	3.84E+03	1.80E+03	0.00E+00	9.68E+03	0.00E+00	3.27E+05	0.00E+00
ZN-65	2.88E+08	9.16E+08	4.14E+08	0.00E+00	6.12E+08	0.00E+00	5.77E+08	0.00E+00
ZN-69M	9.36E+03	2.25E+04	2.05E+03	0.00E+00	1.36E+04	0.00E+00	1.37E+06	0.00E+00
ZN-69	2.12E-06	4.06E-06	2.82E-07	0.00E+00	2.64E-06	0.00E+00	6.10E-07	0.00E+00
SE-79	0.00E+00	1.94E+08	3.23E+07	0.00E+00	3.35E+08	0.00E+00	3.96E+07	0.00E+00
BR-82	0.00E+00	0.00E+00	6.29E+05	0.00E+00	0.00E+00	0.00E+00	7.21E+05	0.00E+00
BR-83	0.00E+00	0.00E+00	1.26E+00	0.00E+00	0.00E+00	0.00E+00	1.82E+00	0.00E+00
BR-84	0.00E+00	0.00E+00	8.99E-12	0.00E+00	0.00E+00	0.00E+00	7.06E-17	0.00E+00
BR-85	0.00E+00	0.00E+00	0.00E+00	0.00E+00	0.00E+00	0.00E+00	0.00E+00	0.00E+00
RB-86	0.00E+00	1.44E+08	6.72E+07	0.00E+00	0.00E+00	0.00E+00	2.84E+07	0.00E+00
RB-87	0.00E+00	9.06E+08	3.15E+08	0.00E+00	0.00E+00	0.00E+00	4.24E+07	0.00E+00
RB-88	0.00E+00	1.11E-22	5.89E-23	0.00E+00	0.00E+00	0.00E+00	1.53E-33	0.00E+00
RB-89	0.00E+00	1.21E-26	8.51E-27	0.00E+00	0.00E+00	0.00E+00	7.03E-40	0.00E+00
SR-89	8.43E+09	0.00E+00	2.42E+08	0.00E+00	0.00E+00	0.00E+00	1.35E+09	0.00E+00
SR-90	6.38E+11	0.00E+00	1.28E+10	0.00E+00	0.00E+00	0.00E+00	1.61E+10	0.00E+00
SR-91	1.27E+05	0.00E+00	5.13E+03	0.00E+00	0.00E+00	0.00E+00	6.04E+05	0.00E+00
SR-92	1.74E+02	0.00E+00	7.53E+00	0.00E+00	0.00E+00	0.00E+00	3.45E+03	0.00E+00
Y-90	5.58E+03	0.00E+00	1.50E+02	0.00E+00	0.00E+00	0.00E+00	5.91E+07	0.00E+00
Y-91M	2.00E-09	0.00E+00	7.73E-11	0.00E+00	0.00E+00	0.00E+00	5.87E-09	0.00E+00
Y-91	4.38E+06	0.00E+00	1.17E+05	0.00E+00	0.00E+00	0.00E+00	2.41E+09	0.00E+00
Y-92	3.76E-01	0.00E+00	1.10E-02	0.00E+00	0.00E+00	0.00E+00	6.59E+03	0.00E+00
Y-93	7.07E+01	0.00E+00	1.95E+00	0.00E+00	0.00E+00	0.00E+00	2.24E+06	0.00E+00
ZR-93	3.08E+06	1.72E+05	8.03E+04	0.00E+00	6.53E+05	0.00E+00	1.79E+08	0.00E+00
ZR-95	1.01E+06	3.25E+05	2.20E+05	0.00E+00	5.11E+05	0.00E+00	1.03E+09	0.00E+00

TABLE I12-10

R_i DOSE FACTORS AGE: ADULT PATHWAY: GREEN LEAFY VEGETATIONm²-mrem/yr per μCi/sec

NUCLIDE	BONE	LIVER	T BODY	THYROID	KIDNEY	LUNG	GI-LLI	SKIN
ZR-97	1.41E+02	2.85E+01	1.30E+01	0.00E+00	4.30E+01	0.00E+00	8.81E+06	0.00E+00
NB-93M	1.86E+06	6.07E+05	1.50E+05	0.00E+00	6.98E+05	0.00E+00	2.80E+08	0.00E+00
NB-95	1.14E+05	6.35E+04	3.41E+04	0.00E+00	6.28E+04	0.00E+00	3.85E+08	0.00E+00
NB-97	8.48E-07	2.15E-07	7.83E-08	0.00E+00	2.50E-07	0.00E+00	7.91E-04	0.00E+00
MO-93	0.00E+00	5.53E+08	1.50E+07	0.00E+00	1.57E+08	0.00E+00	8.99E+07	0.00E+00
MO-99	0.00E+00	2.58E+06	4.91E+05	0.00E+00	5.84E+06	0.00E+00	5.98E+06	0.00E+00
TC-99M	1.29E+00	3.64E+00	4.63E+01	0.00E+00	5.52E+01	1.78E+00	2.15E+03	0.00E+00
TC-99	9.21E+06	1.37E+07	3.70E+06	0.00E+00	1.72E+08	1.16E+06	4.48E+08	0.00E+00
TC-101	2.49E-31	3.59E-31	3.52E-30	0.00E+00	6.47E-30	1.83E-31	1.08E-42	0.00E+00
RU-103	3.90E+06	0.00E+00	1.68E+06	0.00E+00	1.49E+07	0.00E+00	4.56E+08	0.00E+00
RU-105	2.22E+01	0.00E+00	8.78E+00	0.00E+00	2.87E+02	0.00E+00	1.36E+04	0.00E+00
RU-106	1.76E+08	0.00E+00	2.22E+07	0.00E+00	3.39E+08	0.00E+00	1.14E+10	0.00E+00
RH-105	3.38E+04	2.47E+04	1.63E+04	0.00E+00	1.05E+05	0.00E+00	3.93E+06	0.00E+00
PD-107	0.00E+00	1.08E+07	6.92E+05	0.00E+00	9.72E+07	0.00E+00	6.71E+07	0.00E+00
PD-109	0.00E+00	9.28E+03	2.09E+03	0.00E+00	5.30E+04	0.00E+00	1.03E+06	0.00E+00
AG-110M	9.56E+06	8.84E+06	5.25E+06	0.00E+00	1.74E+07	0.00E+00	3.61E+09	0.00E+00
AG-111	9.16E+04	3.83E+04	1.91E+04	0.00E+00	1.24E+05	0.00E+00	7.03E+07	0.00E+00
CD-113M	0.00E+00	2.32E+08	7.43E+06	0.00E+00	2.55E+08	0.00E+00	1.87E+09	0.00E+00
CD-115M	0.00E+00	4.45E+07	1.42E+06	0.00E+00	3.53E+07	0.00E+00	1.87E+09	0.00E+00
SN-123	1.53E+09	2.54E+07	3.74E+07	2.16E+07	0.00E+00	0.00E+00	3.12E+09	0.00E+00
SN-125	1.80E+07	3.62E+05	8.16E+05	3.00E+05	0.00E+00	0.00E+00	2.24E+08	0.00E+00
SN-126	6.22E+09	1.23E+08	1.77E+08	3.62E+07	0.00E+00	0.00E+00	1.79E+09	0.00E+00
SB-124	8.91E+07	1.68E+06	3.53E+07	2.16E+05	0.00E+00	6.94E+07	2.53E+09	0.00E+00
SB-125	1.25E+08	1.40E+06	2.98E+07	1.27E+05	0.00E+00	9.65E+07	1.38E+09	0.00E+00
SB-126	3.70E+06	7.53E+04	1.34E+06	2.27E+04	0.00E+00	2.27E+06	3.03E+08	0.00E+00
SB-127	2.18E+05	4.78E+03	8.37E+04	2.62E+03	0.00E+00	1.29E+05	4.99E+07	0.00E+00
TE-125M	8.27E+07	3.00E+07	1.11E+07	2.49E+07	3.37E+08	0.00E+00	3.30E+08	0.00E+00
TE-127M	3.11E+08	1.11E+08	3.78E+07	7.94E+07	1.26E+09	0.00E+00	1.04E+09	0.00E+00
TE-127	2.36E+03	8.47E+02	5.10E+02	1.75E+03	9.60E+03	0.00E+00	1.86E+05	0.00E+00
TE-129M	2.00E+08	7.45E+07	3.16E+07	6.86E+07	8.34E+08	0.00E+00	1.01E+09	0.00E+00
TE-129	3.00E-04	1.13E-04	7.30E-05	2.30E-04	1.26E-03	0.00E+00	2.26E-04	0.00E+00
TE-131M	3.82E+05	1.87E+05	1.56E+05	2.96E+05	1.89E+06	0.00E+00	1.85E+07	0.00E+00
TE-131	5.24E-16	2.19E-16	1.65E-16	4.31E-16	2.30E-15	0.00E+00	7.42E-17	0.00E+00
TE-132	1.80E+06	1.17E+06	1.10E+06	1.29E+06	1.12E+07	0.00E+00	5.52E+07	0.00E+00
TE-133M	8.89E-06	5.20E-06	5.01E-06	7.53E-06	5.14E-05	0.00E+00	1.78E-06	0.00E+00
TE-134	1.34E-08	8.77E-09	5.38E-09	1.17E-08	8.48E-08	0.00E+00	1.48E-11	0.00E+00
I-129	1.20E+09	1.03E+09	3.39E+09	2.66E+12	2.22E+09	0.00E+00	1.64E+08	0.00E+00
I-130	1.64E+05	4.83E+05	1.91E+05	4.09E+07	7.54E+05	0.00E+00	4.16E+05	0.00E+00
I-131	3.56E+07	5.10E+07	2.92E+07	1.67E+10	8.74E+07	0.00E+00	1.34E+07	0.00E+00
I-132	2.34E+01	6.26E+01	2.19E+01	2.19E+03	9.96E+01	0.00E+00	1.18E+01	0.00E+00
I-133	8.73E+05	1.52E+06	4.63E+05	2.23E+08	2.65E+06	0.00E+00	1.36E+06	0.00E+00
I-134	3.71E-05	1.01E-04	3.61E-05	1.75E-03	1.60E-04	0.00E+00	8.79E-08	0.00E+00

TABLE I12-10

R_i DOSE FACTORS AGE: ADULT PATHWAY: GREEN LEAFY VEGETATIONm²-mrem/yr per μ Ci/sec

NUCLIDE	BONE	LIVER	T BODY	THYROID	KIDNEY	LUNG	GI-LLI	SKIN
I-135	1.62E+04	4.24E+04	1.56E+04	2.79E+06	6.79E+04	0.00E+00	4.79E+04	0.00E+00
CS-134M	2.76E+00	5.80E+00	2.97E+00	0.00E+00	3.15E+00	4.96E-01	2.05E+00	0.00E+00
CS-134	4.27E+09	1.02E+10	8.31E+09	0.00E+00	3.29E+09	1.09E+09	1.78E+08	0.00E+00
CS-135	1.44E+09	1.33E+09	5.89E+08	0.00E+00	5.02E+08	1.50E+08	3.10E+07	0.00E+00
CS-136	2.33E+07	9.19E+07	6.62E+07	0.00E+00	5.12E+07	7.01E+06	1.04E+07	0.00E+00
CS-137	5.84E+09	7.99E+09	5.23E+09	0.00E+00	2.71E+09	9.02E+08	1.55E+08	0.00E+00
CS-138	1.42E-11	2.81E-11	1.39E-11	0.00E+00	2.07E-11	2.04E-12	1.20E-16	0.00E+00
CS-139	5.72E-45	8.52E-45	3.10E-45	0.00E+00	6.82E-45	6.20E-46	1.84E-67	0.00E+00
BA-139	1.13E-02	8.08E-06	3.32E-04	0.00E+00	7.56E-06	4.59E-06	2.01E-02	0.00E+00
BA-140	6.90E+07	8.67E+04	4.52E+06	0.00E+00	2.95E+04	4.96E+04	1.42E+08	0.00E+00
BA-141	3.76E-22	2.84E-25	1.27E-23	0.00E+00	2.64E-25	1.61E-25	1.77E-31	0.00E+00
BA-142	1.63E-39	1.67E-42	1.02E-40	0.00E+00	1.41E-42	9.48E-43	2.29E-57	0.00E+00
LA-140	8.29E+02	4.18E+02	1.10E+02	0.00E+00	0.00E+00	0.00E+00	3.07E+07	0.00E+00
LA-141	2.54E-01	7.89E-02	1.29E-02	0.00E+00	0.00E+00	0.00E+00	9.41E+03	0.00E+00
LA-142	8.08E-05	3.68E-05	9.16E-06	0.00E+00	0.00E+00	0.00E+00	2.68E-01	0.00E+00
CE-141	1.56E+05	1.05E+05	1.19E+04	0.00E+00	4.89E+04	0.00E+00	4.02E+08	0.00E+00
CE-143	4.18E+02	3.09E+05	3.42E+01	0.00E+00	1.36E+02	0.00E+00	1.16E+07	0.00E+00
CE-144	2.99E+07	1.25E+07	1.60E+06	0.00E+00	7.41E+06	0.00E+00	1.01E+10	0.00E+00
PR-143	3.47E+04	1.39E+04	1.72E+03	0.00E+00	8.04E+03	0.00E+00	1.52E+08	0.00E+00
PR-144	9.92E-27	4.12E-27	5.04E-28	0.00E+00	2.32E-27	0.00E+00	1.43E-33	0.00E+00
ND-147	1.65E+04	1.91E+04	1.14E+03	0.00E+00	1.12E+04	0.00E+00	9.16E+07	0.00E+00
PM-147	5.26E+06	4.94E+05	2.00E+05	0.00E+00	9.34E+05	0.00E+00	6.23E+08	0.00E+00
PM-148M	6.84E+05	1.77E+05	1.35E+05	0.00E+00	2.67E+05	0.00E+00	1.50E+09	0.00E+00
PM-148	8.25E+03	1.37E+03	6.90E+02	0.00E+00	2.59E+03	0.00E+00	1.08E+08	0.00E+00
PM-149	7.11E+02	1.01E+02	4.11E+01	0.00E+00	1.90E+02	0.00E+00	1.89E+07	0.00E+00
PM-151	1.42E+02	2.38E+01	1.20E+01	0.00E+00	4.25E+01	0.00E+00	6.55E+06	0.00E+00
SM-151	5.07E+06	8.75E+05	2.10E+05	0.00E+00	9.78E+05	0.00E+00	3.86E+08	0.00E+00
SM-153	3.44E+02	2.87E+02	2.09E+01	0.00E+00	9.26E+01	0.00E+00	1.02E+07	0.00E+00
EU-152	1.42E+07	3.24E+06	2.84E+06	0.00E+00	2.00E+07	0.00E+00	1.87E+09	0.00E+00
EU-154	4.46E+07	5.48E+06	3.90E+06	0.00E+00	2.62E+07	0.00E+00	3.97E+09	0.00E+00
EU-155	6.15E+06	8.73E+05	5.63E+05	0.00E+00	4.03E+06	0.00E+00	6.87E+08	0.00E+00
EU-156	6.38E+04	4.94E+04	7.97E+03	0.00E+00	3.30E+04	0.00E+00	3.38E+08	0.00E+00
TB-160	1.71E+06	0.00E+00	2.13E+05	0.00E+00	7.06E+05	0.00E+00	1.58E+09	0.00E+00
HO-166M	1.99E+07	6.21E+06	4.71E+06	0.00E+00	9.28E+06	0.00E+00	1.89E+09	0.00E+00
W-181	4.76E+05	1.55E+05	1.66E+04	0.00E+00	0.00E+00	0.00E+00	1.77E+07	0.00E+00
W-185	1.51E+07	5.04E+06	5.30E+05	0.00E+00	0.00E+00	0.00E+00	5.83E+08	0.00E+00
W-187	1.59E+04	1.33E+04	4.65E+03	0.00E+00	0.00E+00	0.00E+00	4.36E+06	0.00E+00
U-232	3.04E+11	0.00E+00	2.17E+10	0.00E+00	3.29E+10	0.00E+00	4.98E+09	0.00E+00
U-233	6.42E+10	0.00E+00	3.89E+09	0.00E+00	1.50E+10	0.00E+00	4.62E+09	0.00E+00
U-234	6.16E+10	0.00E+00	3.81E+09	0.00E+00	1.47E+10	0.00E+00	4.52E+09	0.00E+00
U-235	5.90E+10	0.00E+00	3.58E+09	0.00E+00	1.38E+10	0.00E+00	5.75E+09	0.00E+00
U-236	5.90E+10	0.00E+00	3.65E+09	0.00E+00	1.41E+10	0.00E+00	4.24E+09	0.00E+00

TABLE I12-10

R_i DOSE FACTORS AGE: ADULT PATHWAY: GREEN LEAFY VEGETATIONm²-mrem/yr per μ Ci/sec

NUCLIDE	BONE	LIVER	T BODY	THYROID	KIDNEY	LUNG	GI-LLI	SKIN
U-237	7.86E+04	0.00E+00	2.09E+04	0.00E+00	3.23E+05	0.00E+00	2.76E+07	0.00E+00
U-238	5.65E+10	0.00E+00	3.34E+09	0.00E+00	1.29E+10	0.00E+00	4.05E+09	0.00E+00
NP-237	9.28E+10	6.60E+09	4.08E+09	0.00E+00	3.03E+10	0.00E+00	5.85E+09	0.00E+00
NP-238	6.08E+03	1.64E+02	9.46E+01	0.00E+00	5.55E+02	0.00E+00	1.52E+07	0.00E+00
NP-239	5.99E+02	5.89E+01	3.25E+01	0.00E+00	1.84E+02	0.00E+00	1.21E+07	0.00E+00
PU-238	4.63E+10	5.87E+09	1.26E+09	0.00E+00	5.38E+09	0.00E+00	5.37E+09	0.00E+00
PU-239	5.34E+10	6.42E+09	1.41E+09	0.00E+00	5.97E+09	0.00E+00	4.91E+09	0.00E+00
PU-240	5.33E+10	6.41E+09	1.41E+09	0.00E+00	5.97E+09	0.00E+00	4.99E+09	0.00E+00
PU-241	1.14E+09	5.43E+07	2.42E+07	0.00E+00	1.12E+08	0.00E+00	1.02E+08	0.00E+00
PU-242	4.95E+10	6.18E+09	1.36E+09	0.00E+00	5.75E+09	0.00E+00	4.81E+09	0.00E+00
PU-244	5.78E+10	7.08E+09	1.55E+09	0.00E+00	6.59E+09	0.00E+00	7.17E+09	0.00E+00
AM-241	5.56E+10	5.19E+10	3.98E+09	0.00E+00	3.00E+10	0.00E+00	5.46E+09	0.00E+00
AM-242M	5.60E+10	4.88E+10	4.00E+09	0.00E+00	2.98E+10	0.00E+00	6.87E+09	0.00E+00
AM-243	5.55E+10	5.08E+10	3.90E+09	0.00E+00	2.94E+10	0.00E+00	6.41E+09	0.00E+00
CM-242	1.10E+09	1.17E+09	7.34E+07	0.00E+00	3.33E+08	0.00E+00	4.24E+09	0.00E+00
CM-243	4.39E+10	4.02E+10	2.75E+09	0.00E+00	1.28E+10	0.00E+00	5.72E+09	0.00E+00
CM-244	3.33E+10	3.12E+10	2.10E+09	0.00E+00	9.79E+09	0.00E+00	5.52E+09	0.00E+00
CM-245	6.91E+10	6.02E+10	4.24E+09	0.00E+00	1.98E+10	0.00E+00	5.19E+09	0.00E+00
CM-246	6.85E+10	6.01E+10	4.24E+09	0.00E+00	1.97E+10	0.00E+00	5.09E+09	0.00E+00
CM-247	6.68E+10	5.92E+10	4.18E+09	0.00E+00	1.94E+10	0.00E+00	6.70E+09	0.00E+00
CM-248	5.55E+11	4.88E+11	3.44E+10	0.00E+00	1.61E+11	0.00E+00	1.08E+11	0.00E+00
CF-252	1.82E+10	0.00E+00	4.39E+08	0.00E+00	0.00E+00	0.00E+00	2.01E+10	0.00E+00

TABLE I12-11

R_i DOSE FACTORS AGE: TEEN PATHWAY: GREEN LEAFY VEGETATIONm²-mrem/yr per μ Ci/sec

NUCLIDE	BONE	LIVER	T BODY	THYROID	KIDNEY	LUNG	GI-LLI	SKIN
H-3	0.00E+00	1.41E+03	1.41E+03	1.41E+03	1.41E+03	1.41E+03	1.41E+03	0.00E+00
C-14	1.39E+06	2.77E+05	2.77E+05	2.77E+05	2.77E+05	2.77E+05	2.77E+05	0.00E+00
NA-22	1.92E+09	1.92E+09	1.92E+09	1.92E+09	1.92E+09	1.92E+09	1.92E+09	0.00E+00
NA-24	9.98E+04	9.98E+04	9.98E+04	9.98E+04	9.98E+04	9.98E+04	9.98E+04	0.00E+00
P-32	1.04E+09	6.47E+07	4.05E+07	0.00E+00	0.00E+00	0.00E+00	8.78E+07	0.00E+00
CA-41	1.71E+10	0.00E+00	1.85E+09	0.00E+00	0.00E+00	0.00E+00	1.69E+07	0.00E+00
SC-46	3.35E+05	6.52E+05	1.93E+05	0.00E+00	6.24E+05	0.00E+00	2.22E+09	0.00E+00
CR-51	0.00E+00	0.00E+00	5.18E+04	2.88E+04	1.13E+04	7.39E+04	8.70E+06	0.00E+00
MN-54	0.00E+00	4.31E+08	8.54E+07	0.00E+00	1.28E+08	0.00E+00	8.83E+08	0.00E+00
MN-56	0.00E+00	5.84E+00	1.04E+00	0.00E+00	7.40E+00	0.00E+00	3.85E+02	0.00E+00
FE-55	3.10E+08	2.20E+08	5.13E+07	0.00E+00	0.00E+00	1.39E+08	9.51E+07	0.00E+00
FE-59	1.61E+08	3.75E+08	1.45E+08	0.00E+00	0.00E+00	1.18E+08	8.87E+08	0.00E+00
CO-57	0.00E+00	1.69E+07	2.84E+07	0.00E+00	0.00E+00	0.00E+00	3.16E+08	0.00E+00
CO-58	0.00E+00	4.02E+07	9.26E+07	0.00E+00	0.00E+00	0.00E+00	5.54E+08	0.00E+00
CO-60	0.00E+00	2.37E+08	5.33E+08	0.00E+00	0.00E+00	0.00E+00	3.08E+09	0.00E+00
NI-59	1.14E+09	4.04E+08	1.94E+08	0.00E+00	0.00E+00	0.00E+00	6.33E+07	0.00E+00
NI-63	1.53E+10	1.08E+09	5.19E+08	0.00E+00	0.00E+00	0.00E+00	1.72E+08	0.00E+00
NI-65	2.33E+01	2.98E+00	1.36E+00	0.00E+00	0.00E+00	0.00E+00	1.62E+02	0.00E+00
CU-64	0.00E+00	3.48E+03	1.64E+03	0.00E+00	8.81E+03	0.00E+00	2.70E+05	0.00E+00
ZN-65	4.01E+08	1.39E+09	6.49E+08	0.00E+00	8.91E+08	0.00E+00	5.89E+08	0.00E+00
ZN-69M	8.67E+03	2.04E+04	1.88E+03	0.00E+00	1.24E+04	0.00E+00	1.12E+06	0.00E+00
ZN-69	1.99E-06	3.79E-06	2.65E-07	0.00E+00	2.48E-06	0.00E+00	6.98E-06	0.00E+00
SE-79	0.00E+00	3.23E+08	5.43E+07	0.00E+00	5.63E+08	0.00E+00	4.94E+07	0.00E+00
BR-82	0.00E+00	0.00E+00	5.55E+05	0.00E+00	0.00E+00	0.00E+00	0.00E+00	0.00E+00
BR-83	0.00E+00	0.00E+00	1.18E+00	0.00E+00	0.00E+00	0.00E+00	0.00E+00	0.00E+00
BR-84	0.00E+00	0.00E+00	8.18E-12	0.00E+00	0.00E+00	0.00E+00	0.00E+00	0.00E+00
BR-85	0.00E+00	0.00E+00	0.00E+00	0.00E+00	0.00E+00	0.00E+00	0.00E+00	0.00E+00
RB-86	0.00E+00	2.04E+08	9.58E+07	0.00E+00	0.00E+00	0.00E+00	3.02E+07	0.00E+00
RB-87	0.00E+00	1.52E+09	5.29E+08	0.00E+00	0.00E+00	0.00E+00	5.29E+07	0.00E+00
RB-88	0.00E+00	1.03E-22	5.47E-23	0.00E+00	0.00E+00	0.00E+00	8.79E-30	0.00E+00
RB-89	0.00E+00	1.09E-26	7.70E-27	0.00E+00	0.00E+00	0.00E+00	1.67E-35	0.00E+00
SR-89	1.37E+10	0.00E+00	3.92E+08	0.00E+00	0.00E+00	0.00E+00	1.63E+09	0.00E+00
SR-90	8.79E+11	0.00E+00	1.76E+10	0.00E+00	0.00E+00	0.00E+00	2.01E+10	0.00E+00
SR-91	1.19E+05	0.00E+00	4.72E+03	0.00E+00	0.00E+00	0.00E+00	5.38E+05	0.00E+00
SR-92	1.62E+02	0.00E+00	6.91E+00	0.00E+00	0.00E+00	0.00E+00	4.13E+03	0.00E+00
Y-90	5.21E+03	0.00E+00	1.40E+02	0.00E+00	0.00E+00	0.00E+00	4.30E+07	0.00E+00
Y-91M	1.86E-09	0.00E+00	7.11E-11	0.00E+00	0.00E+00	0.00E+00	8.78E-08	0.00E+00
Y-91	7.15E+06	0.00E+00	1.92E+05	0.00E+00	0.00E+00	0.00E+00	2.93E+09	0.00E+00
Y-92	3.53E-01	0.00E+00	1.02E-02	0.00E+00	0.00E+00	0.00E+00	9.70E+03	0.00E+00
Y-93	6.63E+01	0.00E+00	1.82E+00	0.00E+00	0.00E+00	0.00E+00	2.02E+06	0.00E+00
ZR-93	4.79E+06	2.37E+05	1.29E+05	0.00E+00	8.36E+05	0.00E+00	2.24E+08	0.00E+00
ZR-95	1.58E+06	4.98E+05	3.43E+05	0.00E+00	7.32E+05	0.00E+00	1.15E+09	0.00E+00

TABLE I12-11

R_i DOSE FACTORS AGE: TEEN PATHWAY: GREEN LEAFY VEGETATIONm²-mrem/yr per μ Ci/sec

NUCLIDE	BONE	LIVER	T BODY	THYROID	KIDNEY	LUNG	GI-LLI	SKIN
ZR-97	1.31E+02	2.58E+01	1.19E+01	0.00E+00	3.92E+01	0.00E+00	7.00E+06	0.00E+00
NB-93M	2.95E+06	9.69E+05	2.43E+05	0.00E+00	1.13E+06	0.00E+00	3.49E+08	0.00E+00
NB-95	1.68E+05	9.31E+04	5.12E+04	0.00E+00	9.02E+04	0.00E+00	3.98E+08	0.00E+00
NB-97	7.86E-07	1.95E-07	7.12E-08	0.00E+00	2.28E-07	0.00E+00	4.66E-03	0.00E+00
MO-93	0.00E+00	9.18E+08	2.51E+07	0.00E+00	2.63E+08	0.00E+00	1.12E+08	0.00E+00
MO-99	0.00E+00	2.37E+06	4.52E+05	0.00E+00	5.42E+06	0.00E+00	4.24E+06	0.00E+00
TC-99M	1.13E+00	3.16E+00	4.10E+01	0.00E+00	4.72E+01	1.76E+00	2.08E+03	0.00E+00
TC-99	1.55E+07	2.28E+07	6.21E+06	0.00E+00	2.89E+08	2.36E+06	5.58E+08	0.00E+00
TC-101	2.32E-31	3.30E-31	3.24E-30	0.00E+00	5.96E-30	2.01E-31	5.63E-38	0.00E+00
RU-103	6.04E+06	0.00E+00	2.58E+06	0.00E+00	2.13E+07	0.00E+00	5.04E+08	0.00E+00
RU-105	2.07E+01	0.00E+00	8.01E+00	0.00E+00	2.60E+02	0.00E+00	1.67E+04	0.00E+00
RU-106	2.93E+08	0.00E+00	3.70E+07	0.00E+00	5.66E+08	0.00E+00	1.41E+10	0.00E+00
RH-105	3.17E+04	2.29E+04	1.50E+04	0.00E+00	9.72E+04	0.00E+00	2.91E+06	0.00E+00
PD-107	0.00E+00	1.80E+07	1.16E+06	0.00E+00	1.63E+08	0.00E+00	8.37E+07	0.00E+00
PD-109	0.00E+00	8.64E+03	1.96E+03	0.00E+00	4.99E+04	0.00E+00	8.71E+05	0.00E+00
AG-110M	1.43E+07	1.36E+07	8.25E+06	0.00E+00	2.59E+07	0.00E+00	3.81E+09	0.00E+00
AG-111	9.00E+04	3.74E+04	1.88E+04	0.00E+00	1.22E+05	0.00E+00	5.21E+07	0.00E+00
CD-113M	0.00E+00	3.87E+08	1.24E+07	0.00E+00	4.28E+08	0.00E+00	2.32E+09	0.00E+00
CD-115M	0.00E+00	7.11E+07	2.30E+06	0.00E+00	5.69E+07	0.00E+00	2.25E+09	0.00E+00
SN-123	2.55E+09	4.19E+07	6.20E+07	3.35E+07	0.00E+00	0.00E+00	3.85E+09	0.00E+00
SN-125	1.93E+07	3.85E+05	8.73E+05	3.02E+05	0.00E+00	0.00E+00	1.82E+08	0.00E+00
SN-126	1.01E+10	1.87E+08	2.86E+08	4.93E+07	0.00E+00	0.00E+00	2.24E+09	0.00E+00
SB-124	1.41E+08	2.60E+06	5.51E+07	3.20E+05	0.00E+00	1.23E+08	2.84E+09	0.00E+00
SB-125	2.04E+08	2.23E+06	4.76E+07	1.95E+05	0.00E+00	1.79E+08	1.59E+09	0.00E+00
SB-126	4.36E+06	8.91E+04	1.57E+06	2.47E+04	0.00E+00	3.13E+06	2.58E+08	0.00E+00
SB-127	2.01E+05	4.31E+03	7.60E+04	2.26E+03	0.00E+00	1.37E+05	3.42E+07	0.00E+00
TE-125M	1.35E+08	4.88E+07	1.81E+07	3.78E+07	0.00E+00	0.00E+00	3.99E+08	0.00E+00
TE-127M	5.15E+08	1.83E+08	6.13E+07	1.23E+08	2.09E+09	0.00E+00	1.28E+09	0.00E+00
TE-127	2.22E+03	7.88E+02	4.78E+02	1.53E+03	9.00E+03	0.00E+00	1.72E+05	0.00E+00
TE-129M	3.14E+08	1.16E+08	4.97E+07	1.01E+08	1.31E+09	0.00E+00	1.18E+09	0.00E+00
TE-129	2.81E-04	1.05E-04	6.83E-05	2.00E-04	1.18E-03	0.00E+00	1.53E-03	0.00E+00
TE-131M	3.54E+05	1.70E+05	1.41E+05	2.55E+05	1.77E+06	0.00E+00	1.36E+07	0.00E+00
TE-131	4.87E-16	2.01E-16	1.52E-16	3.75E-16	2.13E-15	0.00E+00	4.00E-17	0.00E+00
TE-132	1.64E+06	1.04E+06	9.77E+05	1.09E+06	9.96E+06	0.00E+00	3.29E+07	0.00E+00
TE-133M	8.14E-06	4.62E-06	4.50E-06	6.46E-06	4.57E-05	0.00E+00	1.87E-05	0.00E+00
TE-134	1.21E-08	7.79E-09	8.14E-09	9.96E-09	7.44E-08	0.00E+00	4.51E-10	0.00E+00
I-129	2.02E+09	1.70E+09	2.83E+09	2.07E+12	3.04E+09	0.00E+00	1.98E+08	0.00E+00
I-130	1.46E+05	4.24E+05	1.69E+05	3.45E+07	6.52E+05	0.00E+00	3.26E+05	0.00E+00
I-131	3.52E+07	4.93E+07	2.65E+07	1.44E+10	8.49E+07	0.00E+00	9.75E+06	0.00E+00
I-132	2.11E+01	5.52E+01	1.98E+01	1.86E+03	8.69E+01	0.00E+00	2.40E+01	0.00E+00
I-133	8.11E+05	1.38E+06	4.19E+05	1.92E+08	2.41E+06	0.00E+00	1.04E+06	0.00E+00
I-134	3.36E-05	8.90E-05	3.20E-05	1.48E-03	1.40E-04	0.00E+00	1.17E-06	0.00E+00

TABLE I12-11

R_i DOSE FACTORS AGE: TEEN PATHWAY: GREEN LEAFY VEGETATIONm²-mrem/yr per μ Ci/sec

NUCLIDE	BONE	LIVER	T BODY	THYROID	KIDNEY	LUNG	GI-LLI	SKIN
I-135	1.46E+04	3.76E+04	1.40E+04	2.42E+06	5.94E+04	0.00E+00	4.17E+04	0.00E+00
CS-134M	2.50E+00	5.18E+00	2.66E+00	0.00E+00	2.88E+00	5.06E-01	3.44E+00	0.00E+00
CS-134	6.75E+09	1.59E+10	7.37E+09	0.00E+00	5.05E+09	1.93E+09	1.98E+08	0.00E+00
CS-135	2.41E+09	2.21E+09	5.16E+08	0.00E+00	8.43E+08	3.05E+08	3.86E+07	0.00E+00
CS-136	2.69E+07	1.06E+08	7.12E+07	0.00E+00	5.77E+07	9.10E+06	8.53E+06	0.00E+00
CS-137	9.66E+09	1.28E+10	4.47E+09	0.00E+00	4.37E+09	1.70E+09	1.83E+08	0.00E+00
CS-138	1.31E-11	2.52E-11	1.26E-11	0.00E+00	1.86E-11	2.17E-12	1.14E-14	0.00E+00
CS-139	5.36E-45	7.89E-45	2.89E-45	0.00E+00	6.37E-45	6.98E-46	3.66E-60	0.00E+00
BA-139	1.07E-02	7.51E-06	3.11E-04	0.00E+00	7.08E-06	5.17E-06	9.52E-02	0.00E+00
BA-140	8.35E+07	1.02E+05	5.38E+06	0.00E+00	3.47E+04	6.88E+04	1.29E+08	0.00E+00
BA-141	3.51E-22	2.62E-25	1.17E-23	0.00E+00	2.43E-25	1.79E-25	7.48E-28	0.00E+00
BA-142	1.50E-39	1.50E-42	9.23E-41	0.00E+00	1.27E-42	9.99E-43	4.61E-51	0.00E+00
LA-140	7.57E+02	3.72E+02	9.90E+01	0.00E+00	0.00E+00	0.00E+00	2.14E+07	0.00E+00
LA-141	2.38E-01	7.33E-02	1.21E-02	0.00E+00	0.00E+00	0.00E+00	1.30E+04	0.00E+00
LA-142	7.42E-05	3.29E-05	8.21E-06	0.00E+00	0.00E+00	0.00E+00	1.00E+00	0.00E+00
CE-141	2.44E+05	1.63E+05	1.87E+04	0.00E+00	7.68E+04	0.00E+00	4.66E+08	0.00E+00
CE-143	3.91E+02	2.84E+05	3.18E+01	0.00E+00	1.28E+02	0.00E+00	8.55E+06	0.00E+00
CE-144	4.99E+07	2.07E+07	2.68E+06	0.00E+00	1.23E+07	0.00E+00	1.26E+10	0.00E+00
PR-143	4.40E+04	1.76E+04	2.19E+03	0.00E+00	1.02E+04	0.00E+00	1.45E+08	0.00E+00
PR-144	9.30E-27	3.81E-27	4.72E-28	0.00E+00	2.19E-27	0.00E+00	1.03E-29	0.00E+00
ND-147	1.97E+04	2.15E+04	1.29E+03	0.00E+00	1.26E+04	0.00E+00	7.74E+07	0.00E+00
PM-147	8.60E+06	8.16E+05	3.32E+05	0.00E+00	1.56E+06	0.00E+00	7.76E+08	0.00E+00
PM-148M	1.04E+06	2.63E+05	2.06E+05	0.00E+00	3.99E+05	0.00E+00	1.66E+09	0.00E+00
PM-148	7.75E+03	1.26E+03	6.36E+02	0.00E+00	2.28E+03	0.00E+00	7.53E+07	0.00E+00
PM-149	6.66E+02	9.36E+01	3.84E+01	0.00E+00	1.78E+02	0.00E+00	1.38E+07	0.00E+00
PM-151	1.32E+02	2.18E+01	1.10E+01	0.00E+00	3.91E+01	0.00E+00	4.89E+06	0.00E+00
SM-151	7.55E+06	1.45E+06	3.41E+05	0.00E+00	1.59E+06	0.00E+00	4.93E+08	0.00E+00
SM-153	3.21E+02	2.66E+02	1.95E+01	0.00E+00	8.68E+01	0.00E+00	7.50E+06	0.00E+00
EU-152	2.10E+07	5.06E+06	4.46E+06	0.00E+00	2.35E+07	0.00E+00	1.86E+09	0.00E+00
EU-154	6.74E+07	8.69E+06	6.13E+06	0.00E+00	3.88E+07	0.00E+00	4.59E+09	0.00E+00
EU-155	1.46E+07	1.41E+06	8.75E+05	0.00E+00	5.52E+06	0.00E+00	8.10E+09	0.00E+00
EU-156	8.35E+04	6.26E+04	1.02E+04	0.00E+00	4.22E+04	0.00E+00	3.20E+08	0.00E+00
TB-160	2.71E+06	0.00E+00	3.39E+05	0.00E+00	1.07E+06	0.00E+00	1.76E+09	0.00E+00
HO-166M	3.09E+07	9.53E+06	6.90E+06	0.00E+00	1.39E+07	0.00E+00	2.35E+09	0.00E+00
W-181	7.93E+05	2.56E+05	2.68E+04	0.00E+00	0.00E+00	0.00E+00	2.18E+07	0.00E+00
W-185	2.49E+07	8.23E+06	8.70E+05	0.00E+00	0.00E+00	0.00E+00	7.11E+08	0.00E+00
W-187	1.48E+04	1.21E+04	4.23E+03	0.00E+00	0.00E+00	0.00E+00	3.27E+06	0.00E+00
U-232	5.09E+11	0.00E+00	3.64E+10	0.00E+00	5.52E+10	0.00E+00	6.22E+09	0.00E+00
U-233	1.07E+11	0.00E+00	6.53E+09	0.00E+00	2.51E+10	0.00E+00	5.76E+09	0.00E+00
U-234	1.03E+11	0.00E+00	6.40E+09	0.00E+00	2.47E+10	0.00E+00	5.64E+09	0.00E+00
U-235	9.88E+10	0.00E+00	6.01E+09	0.00E+00	2.31E+10	0.00E+00	7.17E+09	0.00E+00
U-236	9.88E+10	0.00E+00	6.14E+09	0.00E+00	2.37E+10	0.00E+00	5.29E+09	0.00E+00

TABLE II2-11

R_i DOSE FACTORS AGE: TEEN PATHWAY: GREEN LEAFY VEGETATIONm²-mrem/yr per μ Ci/sec

NUCLIDE	BONE	LIVER	T BODY	THYROID	KIDNEY	LUNG	GI-LLI	SKIN
U-237	7.58E+04	0.00E+00	2.02E+04	0.00E+00	3.11E+05	0.00E+00	2.01E+07	0.00E+00
U-238	9.44E+10	0.00E+00	5.62E+09	0.00E+00	2.17E+10	0.00E+00	5.05E+09	0.00E+00
NP-237	1.15E+11	8.27E+09	5.07E+09	0.00E+00	3.75E+10	0.00E+00	7.29E+09	0.00E+00
NP-238	5.68E+03	1.52E+02	8.86E+01	0.00E+00	5.22E+02	0.00E+00	1.12E+07	0.00E+00
NP-239	5.81E+02	5.48E+01	3.04E+01	0.00E+00	1.72E+02	0.00E+00	8.82E+06	0.00E+00
PU-238	5.80E+10	7.42E+09	1.57E+09	0.00E+00	6.75E+09	0.00E+00	6.69E+09	0.00E+00
PU-239	6.63E+10	8.05E+09	1.74E+09	0.00E+00	7.42E+09	0.00E+00	6.12E+09	0.00E+00
PU-240	6.62E+10	8.03E+09	1.74E+09	0.00E+00	7.42E+09	0.00E+00	6.23E+09	0.00E+00
PU-241	1.50E+09	7.20E+07	3.16E+07	0.00E+00	1.47E+08	0.00E+00	1.27E+08	0.00E+00
PU-242	6.14E+10	7.75E+09	1.68E+09	0.00E+00	7.15E+09	0.00E+00	6.00E+09	0.00E+00
PU-244	7.17E+10	8.84E+09	1.92E+09	0.00E+00	8.19E+09	0.00E+00	8.92E+09	0.00E+00
AM-241	6.91E+10	6.52E+10	4.98E+09	0.00E+00	3.73E+10	0.00E+00	6.82E+09	0.00E+00
AM-242M	6.98E+10	6.15E+10	5.02E+09	0.00E+00	3.72E+10	0.00E+00	8.57E+09	0.00E+00
AM-243	6.90E+10	6.37E+10	4.87E+09	0.00E+00	3.66E+10	0.00E+00	8.00E+09	0.00E+00
CM-242	1.84E+09	1.94E+09	1.22E+08	0.00E+00	5.55E+08	0.00E+00	5.25E+09	0.00E+00
CM-243	5.60E+10	5.20E+10	3.53E+09	0.00E+00	1.65E+10	0.00E+00	7.14E+09	0.00E+00
CM-244	4.33E+10	4.10E+10	2.74E+09	0.00E+00	1.28E+10	0.00E+00	6.87E+09	0.00E+00
CM-245	8.58E+10	7.55E+10	5.28E+09	0.00E+00	2.47E+10	0.00E+00	6.46E+09	0.00E+00
CM-246	8.51E+10	7.54E+10	5.28E+09	0.00E+00	2.46E+10	0.00E+00	6.35E+09	0.00E+00
CM-247	8.29E+10	7.42E+10	5.20E+09	0.00E+00	2.43E+10	0.00E+00	8.34E+09	0.00E+00
CM-248	6.89E+11	6.12E+11	4.29E+10	0.00E+00	2.00E+11	0.00E+00	1.34E+11	0.00E+00
CF-252	2.84E+10	0.00E+00	6.86E+08	0.00E+00	0.00E+00	0.00E+00	2.50E+10	0.00E+00

TABLE II-12

R_i DOSE FACTORS AGE: CHILD PATHWAY: GREEN LEAFY VEGETATIONm²-mrem/yr per μCi/sec

NUCLIDE	BONE	LIVER	T BODY	THYROID	KIDNEY	LUNG	GI-LLI	SKIN
H-3	0.00E+00	2.21E+03	2.21E+03	2.21E+03	2.21E+03	2.21E+03	2.21E+03	0.00E+00
C-14	3.38E+06	6.76E+05	6.76E+05	6.76E+05	6.76E+05	6.76E+05	6.76E+05	0.00E+00
NA-22	3.94E+09	3.94E+09	3.94E+09	3.94E+09	3.94E+09	3.94E+09	3.94E+09	0.00E+00
NA-24	1.56E+05	1.56E+05	1.56E+05	1.56E+05	1.56E+05	1.56E+05	1.56E+05	0.00E+00
P-32	2.33E+09	1.09E+08	8.96E+07	0.00E+00	0.00E+00	0.00E+00	6.43E+07	0.00E+00
CA-41	2.46E+10	0.00E+00	2.69E+09	0.00E+00	0.00E+00	0.00E+00	1.35E+07	0.00E+00
SC-46	7.41E+05	1.02E+06	3.91E+05	0.00E+00	8.99E+05	0.00E+00	1.49E+09	0.00E+00
CR-51	0.00E+00	0.00E+00	1.02E+05	5.66E+04	1.55E+04	1.03E+05	5.41E+06	0.00E+00
MN-54	0.00E+00	6.38E+08	1.70E+08	0.00E+00	1.79E+08	0.00E+00	5.35E+08	0.00E+00
MN-56	0.00E+00	7.65E+00	1.73E+00	0.00E+00	9.25E+00	0.00E+00	1.11E+03	0.00E+00
FE-55	7.71E+08	4.09E+08	1.27E+08	0.00E+00	0.00E+00	2.31E+08	7.58E+07	0.00E+00
FE-59	3.65E+08	5.91E+08	2.94E+08	0.00E+00	0.00E+00	1.71E+08	6.15E+08	0.00E+00
CO-57	0.00E+00	2.86E+07	5.79E+07	0.00E+00	0.00E+00	0.00E+00	2.35E+08	0.00E+00
CO-58	0.00E+00	6.05E+07	1.85E+08	0.00E+00	0.00E+00	0.00E+00	3.53E+08	0.00E+00
CO-60	0.00E+00	3.64E+08	1.07E+09	0.00E+00	0.00E+00	0.00E+00	2.02E+09	0.00E+00
NI-59	2.85E+09	7.58E+08	4.83E+08	0.00E+00	0.00E+00	0.00E+00	5.03E+07	0.00E+00
NI-63	3.81E+10	2.04E+09	1.30E+09	0.00E+00	0.00E+00	0.00E+00	1.37E+08	0.00E+00
NI-65	4.28E+01	4.03E+00	2.35E+00	0.00E+00	0.00E+00	0.00E+00	4.93E+02	0.00E+00
CU-64	0.00E+00	4.59E+03	2.77E+03	0.00E+00	1.11E+04	0.00E+00	2.15E+05	0.00E+00
ZN-65	7.79E+08	2.07E+09	1.29E+09	0.00E+00	1.31E+09	0.00E+00	3.64E+08	0.00E+00
ZN-69M	1.59E+04	2.71E+04	3.20E+03	0.00E+00	1.57E+04	0.00E+00	8.81E+05	0.00E+00
ZN-69	3.67E-06	5.30E-06	4.90E-07	0.00E+00	3.22E-06	0.00E+00	3.34E-04	0.00E+00
SE-79	0.00E+00	5.97E+08	1.33E+08	0.00E+00	9.71E+08	0.00E+00	3.92E+07	0.00E+00
BR-82	0.00E+00	0.00E+00	8.54E+05	0.00E+00	0.00E+00	0.00E+00	0.00E+00	0.00E+00
BR-83	0.00E+00	0.00E+00	2.18E+00	0.00E+00	0.00E+00	0.00E+00	0.00E+00	0.00E+00
BR-84	0.00E+00	0.00E+00	1.39E-11	0.00E+00	0.00E+00	0.00E+00	0.00E+00	0.00E+00
BR-85	0.00E+00	0.00E+00	0.00E+00	0.00E+00	0.00E+00	0.00E+00	0.00E+00	0.00E+00
RB-86	0.00E+00	3.55E+08	2.18E+08	0.00E+00	0.00E+00	0.00E+00	2.28E+07	0.00E+00
RB-87	0.00E+00	2.80E+09	1.30E+09	0.00E+00	0.00E+00	0.00E+00	4.20E+07	0.00E+00
RB-88	0.00E+00	1.42E-22	9.84E-23	0.00E+00	0.00E+00	0.00E+00	6.95E-24	0.00E+00
RB-89	0.00E+00	1.43E-26	1.28E-26	0.00E+00	0.00E+00	0.00E+00	1.25E-28	0.00E+00
SR-89	3.33E+10	0.00E+00	9.50E+08	0.00E+00	0.00E+00	0.00E+00	1.29E+09	0.00E+00
SR-90	1.80E+12	0.00E+00	3.63E+10	0.00E+00	0.00E+00	0.00E+00	1.61E+10	0.00E+00
SR-91	2.18E+05	0.00E+00	8.24E+03	0.00E+00	0.00E+00	0.00E+00	4.82E+05	0.00E+00
SR-92	2.97E+02	0.00E+00	1.19E+01	0.00E+00	0.00E+00	0.00E+00	5.63E+03	0.00E+00
Y-90	9.68E+03	0.00E+00	2.59E+02	0.00E+00	0.00E+00	0.00E+00	2.76E+07	0.00E+00
Y-91M	3.41E-09	0.00E+00	1.24E-10	0.00E+00	0.00E+00	0.00E+00	6.68E-06	0.00E+00
Y-91	1.74E+07	0.00E+00	4.65E+05	0.00E+00	0.00E+00	0.00E+00	2.32E+09	0.00E+00
Y-92	6.51E-01	0.00E+00	1.86E-02	0.00E+00	0.00E+00	0.00E+00	1.88E+04	0.00E+00
ZR-93	1.18E+07	4.43E+05	3.15E+05	0.00E+00	1.72E+06	0.00E+00	1.68E+08	0.00E+00
ZR-95	3.61E+06	7.93E+05	7.06E+05	0.00E+00	1.14E+06	0.00E+00	8.28E+08	0.00E+00
ZR-97	2.38E+02	3.44E+01	2.03E+01	0.00E+00	4.94E+01	0.00E+00	5.22E+06	0.00E+00
Y-93	1.22E+02	0.00E+00	3.35E+00	0.00E+00	0.00E+00	0.00E+00	1.82E+06	0.00E+00
NB-93M	7.37E+06	1.84E+06	6.04E+05	0.00E+00	1.99E+06	0.00E+00	2.77E+08	0.00E+00
NB-95	3.69E+05	1.44E+05	1.03E+05	0.00E+00	1.35E+05	0.00E+00	2.66E+08	0.00E+00

TABLE II-12

R_i DOSE FACTORS AGE: CHILD PATHWAY: GREEN LEAFY VEGETATIONm²-mrem/yr per μ Ci/sec

NUCLIDE	BONE	LIVER	T BODY	THYROID	KIDNEY	LUNG	GI-LLI	SKIN
NB-97	1.43E-06	2.59E-07	1.21E-07	0.00E+00	2.87E-07	0.00E+00	7.99E-02	0.00E+00
MO-93	0.00E+00	1.71E+09	6.13E+07	0.00E+00	4.50E+08	0.00E+00	8.65E+07	0.00E+00
MO-99	0.00E+00	3.24E+06	8.00E+05	0.00E+00	6.91E+06	0.00E+00	2.68E+06	0.00E+00
TC-99	3.79E+07	4.22E+07	1.52E+07	0.00E+00	4.98E+08	3.74E+06	4.43E+08	0.00E+00
TC-99M	1.95E+00	3.83E+00	6.35E+01	0.00E+00	5.56E+01	1.94E+00	2.18E+03	0.00E+00
TC-101	4.27E-31	4.46E-31	5.66E-30	0.00E+00	7.61E-30	2.36E-31	1.42E-30	0.00E+00
RU-103	1.39E+07	0.00E+00	5.36E+06	0.00E+00	3.51E+07	0.00E+00	3.61E+08	0.00E+00
RU-105	3.78E+01	0.00E+00	1.37E+01	0.00E+00	3.32E+02	0.00E+00	2.47E+04	0.00E+00
RU-106	7.16E+08	0.00E+00	8.93E+07	0.00E+00	9.67E+08	0.00E+00	1.11E+10	0.00E+00
RH-105	5.83E+04	3.13E+04	2.68E+04	0.00E+00	1.25E+05	0.00E+00	1.94E+06	0.00E+00
PD-107	0.00E+00	3.35E+07	2.84E+06	0.00E+00	2.80E+08	0.00E+00	6.64E+07	0.00E+00
PD-109	0.00E+00	1.21E+04	3.62E+03	0.00E+00	6.48E+04	0.00E+00	7.14E+05	0.00E+00
AG-110M	3.08E+07	2.08E+07	1.66E+07	0.00E+00	3.87E+07	0.00E+00	2.47E+09	0.00E+00
AG-111	1.72E+05	5.39E+04	3.56E+04	0.00E+00	1.63E+05	0.00E+00	3.30E+07	0.00E+00
CD-113M	0.00E+00	7.15E+08	3.04E+07	0.00E+00	7.36E+08	0.00E+00	1.84E+09	0.00E+00
CD-115M	0.00E+00	1.30E+08	5.55E+06	0.00E+00	9.68E+07	0.00E+00	1.77E+09	0.00E+00
SN-123	6.23E+09	7.73E+07	1.52E+08	8.19E+07	0.00E+00	0.00E+00	3.05E+09	0.00E+00
SN-125	3.91E+07	5.89E+05	1.75E+06	6.11E+05	0.00E+00	0.00E+00	1.21E+08	0.00E+00
SN-126	2.36E+10	2.94E+08	6.70E+08	8.08E+07	0.00E+00	0.00E+00	1.77E+09	0.00E+00
SB-124	3.28E+08	4.26E+06	1.15E+08	7.25E+05	0.00E+00	1.82E+08	2.05E+09	0.00E+00
SB-125	4.81E+08	3.71E+06	1.01E+08	4.45E+05	0.00E+00	2.68E+08	1.15E+09	0.00E+00
SB-126	8.72E+06	1.33E+05	3.13E+06	5.11E+04	0.00E+00	4.16E+06	1.76E+08	0.00E+00
SB-127	3.64E+05	5.64E+03	1.26E+05	4.05E+03	0.00E+00	1.58E+05	2.05E+07	0.00E+00
TE-125M	3.27E+08	8.85E+07	4.36E+07	9.17E+07	0.00E+00	0.00E+00	3.15E+08	0.00E+00
TE-127M	1.25E+09	3.38E+08	1.49E+08	3.00E+08	3.58E+09	0.00E+00	1.02E+09	0.00E+00
TE-127	4.10E+03	1.11E+03	8.79E+02	2.84E+03	1.17E+04	0.00E+00	1.60E+05	0.00E+00
TE-129M	7.52E+08	2.10E+08	1.17E+08	2.43E+08	2.21E+09	0.00E+00	9.18E+08	0.00E+00
TE-129	5.19E-04	1.45E-04	1.23E-04	3.71E-04	1.52E-03	0.00E+00	3.23E-02	0.00E+00
TE-131M	6.46E+05	2.23E+05	2.38E+05	4.59E+05	2.16E+06	0.00E+00	9.06E+06	0.00E+00
TE-131	8.97E-16	2.73E-16	2.67E-16	6.86E-16	2.71E-15	0.00E+00	4.71E-15	0.00E+00
TE-132	2.94E+06	1.30E+06	1.57E+06	1.89E+06	1.21E+07	0.00E+00	1.31E+07	0.00E+00
TE-133M	1.46E-05	5.91E-06	7.33E-06	1.13E-05	5.62E-05	0.00E+00	4.51E-04	0.00E+00
TE-134	2.17E-08	9.75E-09	1.30E-08	1.71E-08	9.02E-08	0.00E+00	9.90E-08	0.00E+00
I-129	4.93E+09	3.02E+09	2.70E+09	1.98E+12	5.10E+09	0.00E+00	1.52E+08	0.00E+00
I-130	2.57E+05	5.19E+05	2.68E+05	5.72E+07	7.76E+05	0.00E+00	2.43E+05	0.00E+00
I-131	6.72E+07	6.76E+07	3.84E+07	2.23E+10	1.11E+08	0.00E+00	6.01E+06	0.00E+00
I-132	3.74E+01	6.88E+01	3.16E+01	3.19E+03	1.05E+02	0.00E+00	8.10E+01	0.00E+00
I-133	1.48E+06	1.83E+06	6.91E+05	3.40E+08	3.05E+06	0.00E+00	7.36E+05	0.00E+00
I-134	5.96E-05	1.11E-04	5.09E-05	2.55E-03	1.69E-04	0.00E+00	7.34E-05	0.00E+00
I-135	2.60E+04	4.67E+04	2.21E+04	4.14E+06	7.17E+04	0.00E+00	3.56E+04	0.00E+00
CS-134M	4.44E+00	6.58E+00	4.29E+00	0.00E+00	3.47E+00	5.73E-01	8.31E+00	0.00E+00
CS-134	1.54E+10	2.53E+10	5.34E+09	0.00E+00	7.85E+09	2.82E+09	1.37E+08	0.00E+00
CS-135	5.88E+09	4.10E+09	4.20E+08	0.00E+00	1.45E+09	4.83E+08	3.07E+07	0.00E+00
CS-136	5.40E+07	1.48E+08	9.60E+07	0.00E+00	7.90E+07	1.18E+07	5.21E+06	0.00E+00
CS-137	2.31E+10	2.21E+10	3.26E+09	0.00E+00	7.19E+09	2.59E+09	1.38E+08	0.00E+00

TABLE II-12

R_i DOSE FACTORS AGE: CHILD PATHWAY: GREEN LEAFY VEGETATIONm²-mrem/yr per μ Ci/sec

NUCLIDE	BONE	LIVER	T BODY	THYROID	KIDNEY	LUNG	GI-LLI	SKIN
CS-138	2.39E-11	3.32E-11	2.11E-11	0.00E+00	2.34E-11	2.52E-12	1.53E-11	0.00E+00
CS-139	9.88E-45	1.10E-44	5.27E-45	0.00E+00	8.24E-45	8.31E-46	9.88E-49	0.00E+00
BA-139	1.97E-02	1.05E-05	5.70E-04	0.00E+00	9.17E-06	6.18E-06	1.14E+00	0.00E+00
BA-140	1.78E+08	1.56E+05	1.04E+07	0.00E+00	5.07E+04	9.28E+04	9.01E+07	0.00E+00
BA-141	6.48E-22	3.63E-25	2.11E-23	0.00E+00	3.14E-25	2.13E-24	3.69E-22	0.00E+00
BA-142	2.71E-39	1.95E-42	1.52E-40	0.00E+00	1.58E-42	1.15E-42	3.54E-41	0.00E+00
LA-140	1.36E+03	4.76E+02	1.60E+02	0.00E+00	0.00E+00	0.00E+00	1.33E+07	0.00E+00
LA-141	4.41E-01	1.03E-01	2.23E-02	0.00E+00	0.00E+00	0.00E+00	2.28E+04	0.00E+00
LA-142	1.34E-04	4.28E-05	1.34E-05	0.00E+00	0.00E+00	0.00E+00	8.49E+00	0.00E+00
CE-141	5.85E+05	2.92E+05	4.33E+04	0.00E+00	1.28E+05	0.00E+00	3.64E+08	0.00E+00
CE-143	7.20E+02	3.90E+05	5.65E+01	0.00E+00	1.64E+02	0.00E+00	5.71E+06	0.00E+00
CE-144	1.22E+08	3.82E+07	6.51E+06	0.00E+00	2.12E+07	0.00E+00	9.96E+09	0.00E+00
PR-143	9.73E+04	2.92E+04	4.83E+03	0.00E+00	1.58E+04	0.00E+00	1.05E+08	0.00E+00
PR-144	1.73E-26	5.34E-27	8.69E-28	0.00E+00	2.83E-27	0.00E+00	1.15E-23	0.00E+00
ND-147	4.12E+04	3.33E+04	2.58E+03	0.00E+00	1.83E+04	0.00E+00	5.28E+07	0.00E+00
PM-147	2.13E+07	1.52E+06	8.17E+05	0.00E+00	2.69E+06	0.00E+00	6.15E+08	0.00E+00
PM-148M	2.08E+06	4.15E+05	4.15E+05	0.00E+00	6.15E+05	0.00E+00	1.17E+09	0.00E+00
PM-148	1.43E+04	1.72E+03	1.11E+03	0.00E+00	2.92E+03	0.00E+00	4.58E+07	0.00E+00
PM-149	1.23E+03	1.31E+02	7.11E+01	0.00E+00	2.32E+02	0.00E+00	8.95E+06	0.00E+00
PM-151	2.41E+02	2.94E+01	1.91E+01	0.00E+00	4.98E+01	0.00E+00	3.33E+06	0.00E+00
SM-151	1.81E+07	2.70E+06	8.49E+05	0.00E+00	2.79E+06	0.00E+00	3.91E+08	0.00E+00
SM-153	5.94E+02	3.70E+02	3.57E+01	0.00E+00	1.13E+02	0.00E+00	4.92E+06	0.00E+00
EU-152	4.31E+07	7.85E+06	9.32E+06	0.00E+00	3.32E+07	0.00E+00	1.29E+09	0.00E+00
EU-154	1.60E+08	1.44E+07	1.32E+07	0.00E+00	6.33E+07	0.00E+00	3.35E+09	0.00E+00
EU-155	3.32E+07	2.39E+06	1.87E+06	0.00E+00	8.94E+06	0.00E+00	5.98E+09	0.00E+00
EU-156	1.84E+05	9.86E+04	2.04E+04	0.00E+00	6.35E+04	0.00E+00	2.24E+08	0.00E+00
TB-160	5.66E+06	0.00E+00	7.03E+05	0.00E+00	1.68E+06	0.00E+00	1.25E+09	0.00E+00
HO-166M	7.65E+07	1.60E+07	1.35E+07	0.00E+00	2.28E+07	0.00E+00	1.86E+09	0.00E+00
W-181	1.93E+06	4.74E+05	6.51E+04	0.00E+00	0.00E+00	0.00E+00	1.73E+07	0.00E+00
W-185	6.06E+07	1.51E+07	2.12E+06	0.00E+00	0.00E+00	0.00E+00	5.64E+08	0.00E+00
W-187	2.69E+04	1.59E+04	7.16E+03	0.00E+00	0.00E+00	0.00E+00	2.24E+06	0.00E+00
U-232	1.24E+12	0.00E+00	8.91E+10	0.00E+00	9.48E+10	0.00E+00	4.94E+09	0.00E+00
U-233	2.64E+11	0.00E+00	1.59E+10	0.00E+00	4.32E+10	0.00E+00	4.57E+09	0.00E+00
U-234	2.53E+11	0.00E+00	1.57E+10	0.00E+00	4.24E+10	0.00E+00	4.48E+09	0.00E+00
U-235	2.42E+11	0.00E+00	1.47E+10	0.00E+00	3.98E+10	0.00E+00	5.69E+09	0.00E+00
U-236	2.42E+11	0.00E+00	1.50E+10	0.00E+00	4.06E+10	0.00E+00	4.20E+09	0.00E+00
U-237	1.43E+05	0.00E+00	3.81E+04	0.00E+00	4.13E+05	0.00E+00	1.26E+07	0.00E+00
U-238	2.32E+11	0.00E+00	1.37E+10	0.00E+00	3.71E+10	0.00E+00	4.01E+09	0.00E+00
NP-237	1.58E+11	1.04E+10	6.94E+09	0.00E+00	4.29E+10	0.00E+00	5.78E+09	0.00E+00
NP-238	1.05E+04	2.13E+02	1.64E+02	0.00E+00	6.78E+02	0.00E+00	7.29E+06	0.00E+00
NP-239	1.07E+03	7.71E+01	5.42E+01	0.00E+00	2.23E+02	0.00E+00	5.70E+06	0.00E+00
PU-238	8.42E+10	9.76E+09	2.24E+09	0.00E+00	8.14E+09	0.00E+00	5.31E+09	0.00E+00
PU-239	9.14E+10	9.78E+09	2.35E+09	0.00E+00	8.65E+09	0.00E+00	4.85E+09	0.00E+00
PU-240	9.07E+10	1.01E+10	2.35E+09	0.00E+00	8.65E+09	0.00E+00	4.95E+09	0.00E+00
PU-241	2.71E+09	1.11E+08	5.64E+07	0.00E+00	2.08E+08	0.00E+00	1.01E+08	0.00E+00

TABLE II2-12

R_i DOSE FACTORS AGE: CHILD PATHWAY: GREEN LEAFY VEGETATIONm²-mrem/yr per μCi/sec

NUCLIDE	BONE	LIVER	T BODY	THYROID	KIDNEY	LUNG	GI-LLI	SKIN
PU-242	8.43E+10	9.78E+09	2.26E+09	0.00E+00	8.29E+09	0.00E+00	4.76E+09	0.00E+00
PU-244	9.85E+10	1.12E+11	2.59E+09	0.00E+00	9.57E+09	0.00E+00	7.09E+09	0.00E+00
AM-241	9.64E+10	8.29E+10	7.23E+09	0.00E+00	4.41E+10	0.00E+00	5.41E+09	0.00E+00
AM-242M	9.91E+10	7.93E+10	7.36E+09	0.00E+00	4.46E+10	0.00E+00	6.80E+09	0.00E+00
AM-243	9.50E+10	8.01E+10	6.97E+09	0.00E+00	4.30E+10	0.00E+00	6.34E+09	0.00E+00
CM-242	4.48E+09	3.57E+09	2.98E+08	0.00E+00	9.53E+08	0.00E+00	4.16E+09	0.00E+00
CM-243	9.02E+10	7.33E+10	5.81E+09	0.00E+00	2.17E+10	0.00E+00	5.66E+09	0.00E+00
CM-244	7.59E+10	6.14E+10	4.87E+09	0.00E+00	1.79E+10	0.00E+00	5.46E+09	0.00E+00
CM-245	1.18E+11	9.50E+10	7.44E+09	0.00E+00	2.91E+10	0.00E+00	5.13E+09	0.00E+00
CM-246	1.17E+11	9.50E+10	7.44E+09	0.00E+00	2.91E+10	0.00E+00	5.04E+09	0.00E+00
CM-247	1.14E+11	9.36E+10	7.30E+09	0.00E+00	2.86E+10	0.00E+00	6.63E+09	0.00E+00
CM-248	9.50E+11	7.73E+11	6.04E+10	0.00E+00	2.36E+11	0.00E+00	1.07E+11	0.00E+00
CF-252	7.03E+10	0.00E+00	1.70E+09	0.00E+00	0.00E+00	0.00E+00	1.98E+10	0.00E+00

TABLE II2-13

R_i DOSE FACTORS AGE: INFANT PATHWAY: GREEN LEAFY VEGETATIONm²-mrem/yr per μ Ci/sec

NUCLIDE	BONE	LIVER	T BODY	THYROID	KIDNEY	LUNG	GI-LLI	SKIN
H-3	0.00E+00	0.00E+00	0.00E+00	0.00E+00	0.00E+00	0.00E+00	0.00E+00	0.00E+00
C-14	0.00E+00	0.00E+00	0.00E+00	0.00E+00	0.00E+00	0.00E+00	0.00E+00	0.00E+00
NA-22	0.00E+00	0.00E+00	0.00E+00	0.00E+00	0.00E+00	0.00E+00	0.00E+00	0.00E+00
NA-24	0.00E+00	0.00E+00	0.00E+00	0.00E+00	0.00E+00	0.00E+00	0.00E+00	0.00E+00
P-32	0.00E+00	0.00E+00	0.00E+00	0.00E+00	0.00E+00	0.00E+00	0.00E+00	0.00E+00
CA-41	0.00E+00	0.00E+00	0.00E+00	0.00E+00	0.00E+00	0.00E+00	0.00E+00	0.00E+00
SC-46	0.00E+00	0.00E+00	0.00E+00	0.00E+00	0.00E+00	0.00E+00	0.00E+00	0.00E+00
CR-51	0.00E+00	0.00E+00	0.00E+00	0.00E+00	0.00E+00	0.00E+00	0.00E+00	0.00E+00
MN-54	0.00E+00	0.00E+00	0.00E+00	0.00E+00	0.00E+00	0.00E+00	0.00E+00	0.00E+00
MN-56	0.00E+00	0.00E+00	0.00E+00	0.00E+00	0.00E+00	0.00E+00	0.00E+00	0.00E+00
FE-55	0.00E+00	0.00E+00	0.00E+00	0.00E+00	0.00E+00	0.00E+00	0.00E+00	0.00E+00
FE-59	0.00E+00	0.00E+00	0.00E+00	0.00E+00	0.00E+00	0.00E+00	0.00E+00	0.00E+00
CO-57	0.00E+00	0.00E+00	0.00E+00	0.00E+00	0.00E+00	0.00E+00	0.00E+00	0.00E+00
CO-58	0.00E+00	0.00E+00	0.00E+00	0.00E+00	0.00E+00	0.00E+00	0.00E+00	0.00E+00
CO-60	0.00E+00	0.00E+00	0.00E+00	0.00E+00	0.00E+00	0.00E+00	0.00E+00	0.00E+00
NI-59	0.00E+00	0.00E+00	0.00E+00	0.00E+00	0.00E+00	0.00E+00	0.00E+00	0.00E+00
NI-63	0.00E+00	0.00E+00	0.00E+00	0.00E+00	0.00E+00	0.00E+00	0.00E+00	0.00E+00
NI-65	0.00E+00	0.00E+00	0.00E+00	0.00E+00	0.00E+00	0.00E+00	0.00E+00	0.00E+00
CU-64	0.00E+00	0.00E+00	0.00E+00	0.00E+00	0.00E+00	0.00E+00	0.00E+00	0.00E+00
ZN-65	0.00E+00	0.00E+00	0.00E+00	0.00E+00	0.00E+00	0.00E+00	0.00E+00	0.00E+00
ZN-69M	0.00E+00	0.00E+00	0.00E+00	0.00E+00	0.00E+00	0.00E+00	0.00E+00	0.00E+00
ZN-69	0.00E+00	0.00E+00	0.00E+00	0.00E+00	0.00E+00	0.00E+00	0.00E+00	0.00E+00
SE-79	0.00E+00	0.00E+00	0.00E+00	0.00E+00	0.00E+00	0.00E+00	0.00E+00	0.00E+00
BR-82	0.00E+00	0.00E+00	0.00E+00	0.00E+00	0.00E+00	0.00E+00	0.00E+00	0.00E+00
BR-83	0.00E+00	0.00E+00	0.00E+00	0.00E+00	0.00E+00	0.00E+00	0.00E+00	0.00E+00
BR-84	0.00E+00	0.00E+00	0.00E+00	0.00E+00	0.00E+00	0.00E+00	0.00E+00	0.00E+00
BR-85	0.00E+00	0.00E+00	0.00E+00	0.00E+00	0.00E+00	0.00E+00	0.00E+00	0.00E+00
RB-86	0.00E+00	0.00E+00	0.00E+00	0.00E+00	0.00E+00	0.00E+00	0.00E+00	0.00E+00
RB-87	0.00E+00	0.00E+00	0.00E+00	0.00E+00	0.00E+00	0.00E+00	0.00E+00	0.00E+00
RB-88	0.00E+00	0.00E+00	0.00E+00	0.00E+00	0.00E+00	0.00E+00	0.00E+00	0.00E+00
RB-89	0.00E+00	0.00E+00	0.00E+00	0.00E+00	0.00E+00	0.00E+00	0.00E+00	0.00E+00
SR-89	0.00E+00	0.00E+00	0.00E+00	0.00E+00	0.00E+00	0.00E+00	0.00E+00	0.00E+00
SR-90	0.00E+00	0.00E+00	0.00E+00	0.00E+00	0.00E+00	0.00E+00	0.00E+00	0.00E+00
SR-91	0.00E+00	0.00E+00	0.00E+00	0.00E+00	0.00E+00	0.00E+00	0.00E+00	0.00E+00
SR-92	0.00E+00	0.00E+00	0.00E+00	0.00E+00	0.00E+00	0.00E+00	0.00E+00	0.00E+00
Y-90	0.00E+00	0.00E+00	0.00E+00	0.00E+00	0.00E+00	0.00E+00	0.00E+00	0.00E+00
Y-91M	0.00E+00	0.00E+00	0.00E+00	0.00E+00	0.00E+00	0.00E+00	0.00E+00	0.00E+00
Y-91	0.00E+00	0.00E+00	0.00E+00	0.00E+00	0.00E+00	0.00E+00	0.00E+00	0.00E+00
Y-92	0.00E+00	0.00E+00	0.00E+00	0.00E+00	0.00E+00	0.00E+00	0.00E+00	0.00E+00
ZR-93	0.00E+00	0.00E+00	0.00E+00	0.00E+00	0.00E+00	0.00E+00	0.00E+00	0.00E+00
ZR-95	0.00E+00	0.00E+00	0.00E+00	0.00E+00	0.00E+00	0.00E+00	0.00E+00	0.00E+00
ZR-97	0.00E+00	0.00E+00	0.00E+00	0.00E+00	0.00E+00	0.00E+00	0.00E+00	0.00E+00
Y-93	0.00E+00	0.00E+00	0.00E+00	0.00E+00	0.00E+00	0.00E+00	0.00E+00	0.00E+00
NB-93M	0.00E+00	0.00E+00	0.00E+00	0.00E+00	0.00E+00	0.00E+00	0.00E+00	0.00E+00
NB-95	0.00E+00	0.00E+00	0.00E+00	0.00E+00	0.00E+00	0.00E+00	0.00E+00	0.00E+00

TABLE II2-13

R_i DOSE FACTORS AGE: INFANT PATHWAY: GREEN LEAFY VEGETATIONm²-mrem/yr per μ Ci/sec

NUCLIDE	BONE	LIVER	T BODY	THYROID	KIDNEY	LUNG	GI-LLI	SKIN
NB-97	0.00E+00	0.00E+00	0.00E+00	0.00E+00	0.00E+00	0.00E+00	0.00E+00	0.00E+00
MO-93	0.00E+00	0.00E+00	0.00E+00	0.00E+00	0.00E+00	0.00E+00	0.00E+00	0.00E+00
MO-99	0.00E+00	0.00E+00	0.00E+00	0.00E+00	0.00E+00	0.00E+00	0.00E+00	0.00E+00
TC-99	0.00E+00	0.00E+00	0.00E+00	0.00E+00	0.00E+00	0.00E+00	0.00E+00	0.00E+00
TC-99M	0.00E+00	0.00E+00	0.00E+00	0.00E+00	0.00E+00	0.00E+00	0.00E+00	0.00E+00
TC-101	0.00E+00	0.00E+00	0.00E+00	0.00E+00	0.00E+00	0.00E+00	0.00E+00	0.00E+00
RU-103	0.00E+00	0.00E+00	0.00E+00	0.00E+00	0.00E+00	0.00E+00	0.00E+00	0.00E+00
RU-105	0.00E+00	0.00E+00	0.00E+00	0.00E+00	0.00E+00	0.00E+00	0.00E+00	0.00E+00
RU-106	0.00E+00	0.00E+00	0.00E+00	0.00E+00	0.00E+00	0.00E+00	0.00E+00	0.00E+00
RH-105	0.00E+00	0.00E+00	0.00E+00	0.00E+00	0.00E+00	0.00E+00	0.00E+00	0.00E+00
PD-107	0.00E+00	0.00E+00	0.00E+00	0.00E+00	0.00E+00	0.00E+00	0.00E+00	0.00E+00
PD-109	0.00E+00	0.00E+00	0.00E+00	0.00E+00	0.00E+00	0.00E+00	0.00E+00	0.00E+00
AG-110M	0.00E+00	0.00E+00	0.00E+00	0.00E+00	0.00E+00	0.00E+00	0.00E+00	0.00E+00
AG-111	0.00E+00	0.00E+00	0.00E+00	0.00E+00	0.00E+00	0.00E+00	0.00E+00	0.00E+00
CD-113M	0.00E+00	0.00E+00	0.00E+00	0.00E+00	0.00E+00	0.00E+00	0.00E+00	0.00E+00
CD-115M	0.00E+00	0.00E+00	0.00E+00	0.00E+00	0.00E+00	0.00E+00	0.00E+00	0.00E+00
SN-123	0.00E+00	0.00E+00	0.00E+00	0.00E+00	0.00E+00	0.00E+00	0.00E+00	0.00E+00
SN-125	0.00E+00	0.00E+00	0.00E+00	0.00E+00	0.00E+00	0.00E+00	0.00E+00	0.00E+00
SN-126	0.00E+00	0.00E+00	0.00E+00	0.00E+00	0.00E+00	0.00E+00	0.00E+00	0.00E+00
SB-124	0.00E+00	0.00E+00	0.00E+00	0.00E+00	0.00E+00	0.00E+00	0.00E+00	0.00E+00
SB-125	0.00E+00	0.00E+00	0.00E+00	0.00E+00	0.00E+00	0.00E+00	0.00E+00	0.00E+00
SB-126	0.00E+00	0.00E+00	0.00E+00	0.00E+00	0.00E+00	0.00E+00	0.00E+00	0.00E+00
SB-127	0.00E+00	0.00E+00	0.00E+00	0.00E+00	0.00E+00	0.00E+00	0.00E+00	0.00E+00
TE-125M	0.00E+00	0.00E+00	0.00E+00	0.00E+00	0.00E+00	0.00E+00	0.00E+00	0.00E+00
TE-127M	0.00E+00	0.00E+00	0.00E+00	0.00E+00	0.00E+00	0.00E+00	0.00E+00	0.00E+00
TE-127	0.00E+00	0.00E+00	0.00E+00	0.00E+00	0.00E+00	0.00E+00	0.00E+00	0.00E+00
TE-129M	0.00E+00	0.00E+00	0.00E+00	0.00E+00	0.00E+00	0.00E+00	0.00E+00	0.00E+00
TE-129	0.00E+00	0.00E+00	0.00E+00	0.00E+00	0.00E+00	0.00E+00	0.00E+00	0.00E+00
TE-131M	0.00E+00	0.00E+00	0.00E+00	0.00E+00	0.00E+00	0.00E+00	0.00E+00	0.00E+00
TE-131	0.00E+00	0.00E+00	0.00E+00	0.00E+00	0.00E+00	0.00E+00	0.00E+00	0.00E+00
TE-132	0.00E+00	0.00E+00	0.00E+00	0.00E+00	0.00E+00	0.00E+00	0.00E+00	0.00E+00
TE-133M	0.00E+00	0.00E+00	0.00E+00	0.00E+00	0.00E+00	0.00E+00	0.00E+00	0.00E+00
TE-134	0.00E+00	0.00E+00	0.00E+00	0.00E+00	0.00E+00	0.00E+00	0.00E+00	0.00E+00
I-129	0.00E+00	0.00E+00	0.00E+00	0.00E+00	0.00E+00	0.00E+00	0.00E+00	0.00E+00
I-130	0.00E+00	0.00E+00	0.00E+00	0.00E+00	0.00E+00	0.00E+00	0.00E+00	0.00E+00
I-131	0.00E+00	0.00E+00	0.00E+00	0.00E+00	0.00E+00	0.00E+00	0.00E+00	0.00E+00
I-132	0.00E+00	0.00E+00	0.00E+00	0.00E+00	0.00E+00	0.00E+00	0.00E+00	0.00E+00
I-133	0.00E+00	0.00E+00	0.00E+00	0.00E+00	0.00E+00	0.00E+00	0.00E+00	0.00E+00
I-134	0.00E+00	0.00E+00	0.00E+00	0.00E+00	0.00E+00	0.00E+00	0.00E+00	0.00E+00
I-135	0.00E+00	0.00E+00	0.00E+00	0.00E+00	0.00E+00	0.00E+00	0.00E+00	0.00E+00
CS-134M	0.00E+00	0.00E+00	0.00E+00	0.00E+00	0.00E+00	0.00E+00	0.00E+00	0.00E+00
CS-134	0.00E+00	0.00E+00	0.00E+00	0.00E+00	0.00E+00	0.00E+00	0.00E+00	0.00E+00
CS-135	0.00E+00	0.00E+00	0.00E+00	0.00E+00	0.00E+00	0.00E+00	0.00E+00	0.00E+00
CS-136	0.00E+00	0.00E+00	0.00E+00	0.00E+00	0.00E+00	0.00E+00	0.00E+00	0.00E+00
CS-137	0.00E+00	0.00E+00	0.00E+00	0.00E+00	0.00E+00	0.00E+00	0.00E+00	0.00E+00

TABLE II2-13

R_i DOSE FACTORS AGE: INFANT PATHWAY: GREEN LEAFY VEGETATIONm²-mrem/yr per μ Ci/sec

NUCLIDE	BONE	LIVER	T BODY	THYROID	KIDNEY	LUNG	GI-LLI	SKIN
CS-138	0.00E+00	0.00E+00	0.00E+00	0.00E+00	0.00E+00	0.00E+00	0.00E+00	0.00E+00
CS-139	0.00E+00	0.00E+00	0.00E+00	0.00E+00	0.00E+00	0.00E+00	0.00E+00	0.00E+00
BA-139	0.00E+00	0.00E+00	0.00E+00	0.00E+00	0.00E+00	0.00E+00	0.00E+00	0.00E+00
BA-140	0.00E+00	0.00E+00	0.00E+00	0.00E+00	0.00E+00	0.00E+00	0.00E+00	0.00E+00
BA-141	0.00E+00	0.00E+00	0.00E+00	0.00E+00	0.00E+00	0.00E+00	0.00E+00	0.00E+00
BA-142	0.00E+00	0.00E+00	0.00E+00	0.00E+00	0.00E+00	0.00E+00	0.00E+00	0.00E+00
LA-140	0.00E+00	0.00E+00	0.00E+00	0.00E+00	0.00E+00	0.00E+00	0.00E+00	0.00E+00
LA-141	0.00E+00	0.00E+00	0.00E+00	0.00E+00	0.00E+00	0.00E+00	0.00E+00	0.00E+00
LA-142	0.00E+00	0.00E+00	0.00E+00	0.00E+00	0.00E+00	0.00E+00	0.00E+00	0.00E+00
CE-141	0.00E+00	0.00E+00	0.00E+00	0.00E+00	0.00E+00	0.00E+00	0.00E+00	0.00E+00
CE-143	0.00E+00	0.00E+00	0.00E+00	0.00E+00	0.00E+00	0.00E+00	0.00E+00	0.00E+00
CE-144	0.00E+00	0.00E+00	0.00E+00	0.00E+00	0.00E+00	0.00E+00	0.00E+00	0.00E+00
PR-143	0.00E+00	0.00E+00	0.00E+00	0.00E+00	0.00E+00	0.00E+00	0.00E+00	0.00E+00
PR-144	0.00E+00	0.00E+00	0.00E+00	0.00E+00	0.00E+00	0.00E+00	0.00E+00	0.00E+00
ND-147	0.00E+00	0.00E+00	0.00E+00	0.00E+00	0.00E+00	0.00E+00	0.00E+00	0.00E+00
PM-147	0.00E+00	0.00E+00	0.00E+00	0.00E+00	0.00E+00	0.00E+00	0.00E+00	0.00E+00
PM-148M	0.00E+00	0.00E+00	0.00E+00	0.00E+00	0.00E+00	0.00E+00	0.00E+00	0.00E+00
PM-148	0.00E+00	0.00E+00	0.00E+00	0.00E+00	0.00E+00	0.00E+00	0.00E+00	0.00E+00
PM-149	0.00E+00	0.00E+00	0.00E+00	0.00E+00	0.00E+00	0.00E+00	0.00E+00	0.00E+00
PM-151	0.00E+00	0.00E+00	0.00E+00	0.00E+00	0.00E+00	0.00E+00	0.00E+00	0.00E+00
SM-151	0.00E+00	0.00E+00	0.00E+00	0.00E+00	0.00E+00	0.00E+00	0.00E+00	0.00E+00
SM-153	0.00E+00	0.00E+00	0.00E+00	0.00E+00	0.00E+00	0.00E+00	0.00E+00	0.00E+00
EU-152	0.00E+00	0.00E+00	0.00E+00	0.00E+00	0.00E+00	0.00E+00	0.00E+00	0.00E+00
EU-154	0.00E+00	0.00E+00	0.00E+00	0.00E+00	0.00E+00	0.00E+00	0.00E+00	0.00E+00
EU-155	0.00E+00	0.00E+00	0.00E+00	0.00E+00	0.00E+00	0.00E+00	0.00E+00	0.00E+00
EU-156	0.00E+00	0.00E+00	0.00E+00	0.00E+00	0.00E+00	0.00E+00	0.00E+00	0.00E+00
TB-160	0.00E+00	0.00E+00	0.00E+00	0.00E+00	0.00E+00	0.00E+00	0.00E+00	0.00E+00
HO-166M	0.00E+00	0.00E+00	0.00E+00	0.00E+00	0.00E+00	0.00E+00	0.00E+00	0.00E+00
W-181	0.00E+00	0.00E+00	0.00E+00	0.00E+00	0.00E+00	0.00E+00	0.00E+00	0.00E+00
W-185	0.00E+00	0.00E+00	0.00E+00	0.00E+00	0.00E+00	0.00E+00	0.00E+00	0.00E+00
W-187	0.00E+00	0.00E+00	0.00E+00	0.00E+00	0.00E+00	0.00E+00	0.00E+00	0.00E+00
U-232	0.00E+00	0.00E+00	0.00E+00	0.00E+00	0.00E+00	0.00E+00	0.00E+00	0.00E+00
U-233	0.00E+00	0.00E+00	0.00E+00	0.00E+00	0.00E+00	0.00E+00	0.00E+00	0.00E+00
U-234	0.00E+00	0.00E+00	0.00E+00	0.00E+00	0.00E+00	0.00E+00	0.00E+00	0.00E+00
U-235	0.00E+00	0.00E+00	0.00E+00	0.00E+00	0.00E+00	0.00E+00	0.00E+00	0.00E+00
U-236	0.00E+00	0.00E+00	0.00E+00	0.00E+00	0.00E+00	0.00E+00	0.00E+00	0.00E+00
U-237	0.00E+00	0.00E+00	0.00E+00	0.00E+00	0.00E+00	0.00E+00	0.00E+00	0.00E+00
U-238	0.00E+00	0.00E+00	0.00E+00	0.00E+00	0.00E+00	0.00E+00	0.00E+00	0.00E+00
NP-237	0.00E+00	0.00E+00	0.00E+00	0.00E+00	0.00E+00	0.00E+00	0.00E+00	0.00E+00
NP-238	0.00E+00	0.00E+00	0.00E+00	0.00E+00	0.00E+00	0.00E+00	0.00E+00	0.00E+00
NP-239	0.00E+00	0.00E+00	0.00E+00	0.00E+00	0.00E+00	0.00E+00	0.00E+00	0.00E+00
PU-238	0.00E+00	0.00E+00	0.00E+00	0.00E+00	0.00E+00	0.00E+00	0.00E+00	0.00E+00
PU-239	0.00E+00	0.00E+00	0.00E+00	0.00E+00	0.00E+00	0.00E+00	0.00E+00	0.00E+00
PU-240	0.00E+00	0.00E+00	0.00E+00	0.00E+00	0.00E+00	0.00E+00	0.00E+00	0.00E+00
PU-241	0.00E+00	0.00E+00	0.00E+00	0.00E+00	0.00E+00	0.00E+00	0.00E+00	0.00E+00

TABLE II2-13

R_i DOSE FACTORS AGE: INFANT PATHWAY: GREEN LEAFY VEGETATIONm²-mrem/yr per μ Ci/sec

NUCLIDE	BONE	LIVER	T BODY	THYROID	KIDNEY	LUNG	GI-LLI	SKIN
PU-242	0.00E+00	0.00E+00	0.00E+00	0.00E+00	0.00E+00	0.00E+00	0.00E+00	0.00E+00
PU-244	0.00E+00	0.00E+00	0.00E+00	0.00E+00	0.00E+00	0.00E+00	0.00E+00	0.00E+00
AM-241	0.00E+00	0.00E+00	0.00E+00	0.00E+00	0.00E+00	0.00E+00	0.00E+00	0.00E+00
AM-242M	0.00E+00	0.00E+00	0.00E+00	0.00E+00	0.00E+00	0.00E+00	0.00E+00	0.00E+00
AM-243	0.00E+00	0.00E+00	0.00E+00	0.00E+00	0.00E+00	0.00E+00	0.00E+00	0.00E+00
CM-242	0.00E+00	0.00E+00	0.00E+00	0.00E+00	0.00E+00	0.00E+00	0.00E+00	0.00E+00
CM-243	0.00E+00	0.00E+00	0.00E+00	0.00E+00	0.00E+00	0.00E+00	0.00E+00	0.00E+00
CM-244	0.00E+00	0.00E+00	0.00E+00	0.00E+00	0.00E+00	0.00E+00	0.00E+00	0.00E+00
CM-245	0.00E+00	0.00E+00	0.00E+00	0.00E+00	0.00E+00	0.00E+00	0.00E+00	0.00E+00
CM-246	0.00E+00	0.00E+00	0.00E+00	0.00E+00	0.00E+00	0.00E+00	0.00E+00	0.00E+00
CM-247	0.00E+00	0.00E+00	0.00E+00	0.00E+00	0.00E+00	0.00E+00	0.00E+00	0.00E+00
CM-248	0.00E+00	0.00E+00	0.00E+00	0.00E+00	0.00E+00	0.00E+00	0.00E+00	0.00E+00
CF-252	0.00E+00	0.00E+00	0.00E+00	0.00E+00	0.00E+00	0.00E+00	0.00E+00	0.00E+00

TABLE I12-14

R_i DOSE FACTORS AGE: ADULT PATHWAY: MEATm²-mrem/yr per μ Ci/sec

NUCLIDE	BONE	LIVER	T BODY	THYROID	KIDNEY	LUNG	GI-LLI	SKIN
H-3	0.00E+00	1.85E+02	1.85E+02	1.85E+02	1.85E+02	1.85E+02	1.85E+02	0.00E+00
C-14	3.33E+05	6.66E+04	6.66E+04	6.66E+04	6.66E+04	6.66E+04	6.66E+04	0.00E+00
NA-22	7.29E+08	7.29E+08	7.29E+08	7.29E+08	7.29E+08	7.29E+08	7.29E+08	0.00E+00
NA-24	3.97E-04	3.97E-04	3.97E-04	3.97E-04	3.97E-04	3.97E-04	3.97E-04	0.00E+00
P-32	1.38E+09	8.56E+07	5.32E+07	0.00E+00	0.00E+00	0.00E+00	1.55E+08	0.00E+00
CA-41	1.10E+09	0.00E+00	1.19E+08	0.00E+00	0.00E+00	0.00E+00	1.09E+06	0.00E+00
SC-46	7.20E+04	1.40E+05	4.06E+04	0.00E+00	1.31E+05	0.00E+00	6.81E+08	0.00E+00
CR-51	0.00E+00	0.00E+00	2.24E+03	1.34E+03	4.95E+02	2.98E+03	5.65E+05	0.00E+00
MN-54	0.00E+00	4.55E+06	8.68E+05	0.00E+00	1.35E+06	0.00E+00	1.39E+07	0.00E+00
MN-56	0.00E+00	4.43E-54	7.86E-55	0.00E+00	5.63E-54	0.00E+00	1.41E-52	0.00E+00
FE-55	1.54E+08	1.06E+08	2.48E+07	0.00E+00	0.00E+00	5.93E+07	6.10E+07	0.00E+00
FE-59	9.39E+07	2.21E+08	8.46E+07	0.00E+00	0.00E+00	6.17E+07	7.36E+08	0.00E+00
CO-57	0.00E+00	2.76E+06	4.58E+06	0.00E+00	0.00E+00	0.00E+00	7.00E+07	0.00E+00
CO-58	0.00E+00	7.20E+06	1.61E+07	0.00E+00	0.00E+00	0.00E+00	1.46E+08	0.00E+00
CO-60	0.00E+00	4.00E+07	8.83E+07	0.00E+00	0.00E+00	0.00E+00	7.52E+08	0.00E+00
NI-59	7.66E+07	2.63E+07	1.28E+07	0.00E+00	0.00E+00	0.00E+00	5.42E+06	0.00E+00
NI-63	1.02E+09	7.06E+07	3.42E+07	0.00E+00	0.00E+00	0.00E+00	1.47E+07	0.00E+00
NI-65	6.57E-54	8.54E-55	3.89E-55	0.00E+00	0.00E+00	0.00E+00	2.17E-53	0.00E+00
CU-64	0.00E+00	7.94E-08	3.72E-08	0.00E+00	2.00E-07	0.00E+00	6.76E-06	0.00E+00
ZN-65	1.72E+08	5.48E+08	2.48E+08	0.00E+00	3.67E+08	0.00E+00	3.45E+08	0.00E+00
ZN-69M	4.90E-06	1.18E-05	1.08E-06	0.00E+00	7.12E-06	0.00E+00	7.18E-04	0.00E+00
ZN-69	0.00E+00	0.00E+00	0.00E+00	0.00E+00	0.00E+00	0.00E+00	0.00E+00	0.00E+00
SE-79	0.00E+00	5.84E+07	9.75E+06	0.00E+00	1.01E+08	0.00E+00	1.20E+07	0.00E+00
BR-82	0.00E+00	0.00E+00	3.58E+02	0.00E+00	0.00E+00	0.00E+00	4.10E+02	0.00E+00
BR-83	0.00E+00	0.00E+00	1.76E-57	0.00E+00	0.00E+00	0.00E+00	2.53E-57	0.00E+00
BR-84	0.00E+00	0.00E+00	0.00E+00	0.00E+00	0.00E+00	0.00E+00	0.00E+00	0.00E+00
BR-85	0.00E+00	0.00E+00	0.00E+00	0.00E+00	0.00E+00	0.00E+00	0.00E+00	0.00E+00
RB-86	0.00E+00	1.47E+08	6.84E+07	0.00E+00	0.00E+00	0.00E+00	2.89E+07	0.00E+00
RB-87	0.00E+00	5.65E+08	1.97E+08	0.00E+00	0.00E+00	0.00E+00	2.64E+07	0.00E+00
RB-88	0.00E+00	0.00E+00	0.00E+00	0.00E+00	0.00E+00	0.00E+00	0.00E+00	0.00E+00
RB-89	0.00E+00	0.00E+00	0.00E+00	0.00E+00	0.00E+00	0.00E+00	0.00E+00	0.00E+00
SR-89	1.10E+08	0.00E+00	3.16E+06	0.00E+00	0.00E+00	0.00E+00	1.76E+07	0.00E+00
SR-90	7.70E+09	0.00E+00	1.55E+08	0.00E+00	0.00E+00	0.00E+00	1.94E+08	0.00E+00
SR-91	4.44E-11	0.00E+00	1.79E-12	0.00E+00	0.00E+00	0.00E+00	2.12E-10	0.00E+00
SR-92	3.45E-50	0.00E+00	1.49E-51	0.00E+00	0.00E+00	0.00E+00	6.83E-49	0.00E+00
Y-90	3.15E+01	0.00E+00	8.44E-01	0.00E+00	0.00E+00	0.00E+00	3.34E+05	0.00E+00
Y-91M	0.00E+00	0.00E+00	0.00E+00	0.00E+00	0.00E+00	0.00E+00	0.00E+00	0.00E+00
Y-91	4.28E+05	0.00E+00	1.14E+04	0.00E+00	0.00E+00	0.00E+00	2.35E+08	0.00E+00
Y-92	4.44E-40	0.00E+00	1.30E-41	0.00E+00	0.00E+00	0.00E+00	7.77E-36	0.00E+00
Y-93	1.37E-12	0.00E+00	3.79E-14	0.00E+00	0.00E+00	0.00E+00	4.35E-08	0.00E+00
ZR-93	2.11E+06	1.18E+05	5.49E+04	0.00E+00	4.47E+05	0.00E+00	1.22E+08	0.00E+00
ZR-95	7.23E+05	2.32E+05	1.57E+05	0.00E+00	3.64E+05	0.00E+00	7.35E+08	0.00E+00

TABLE I12-14

R_i DOSE FACTORS AGE: ADULT PATHWAY: MEATm²-mrem/yr per μ Ci/sec

NUCLIDE	BONE	LIVER	T BODY	THYROID	KIDNEY	LUNG	GI-LLI	SKIN
ZR-97	6.05E-06	1.22E-06	5.58E-07	0.00E+00	1.84E-06	0.00E+00	3.78E-01	0.00E+00
NB-93M	1.05E+07	3.41E+06	8.41E+05	0.00E+00	3.93E+06	0.00E+00	1.58E+09	0.00E+00
NB-95	7.68E+05	4.27E+05	2.30E+05	0.00E+00	4.22E+05	0.00E+00	2.59E+09	0.00E+00
NB-97	0.00E+00	0.00E+00	0.00E+00	0.00E+00	0.00E+00	0.00E+00	0.00E+00	0.00E+00
MO-93	0.00E+00	8.90E+07	2.41E+06	0.00E+00	2.52E+07	0.00E+00	1.45E+07	0.00E+00
MO-99	0.00E+00	2.92E+04	5.56E+03	0.00E+00	6.62E+04	0.00E+00	6.78E+04	0.00E+00
TC-99M	1.30E-21	3.68E-21	4.68E-20	0.00E+00	5.58E-20	1.80E-21	2.18E-18	0.00E+00
TC-99	7.41E+07	1.10E+08	2.97E+07	0.00E+00	1.39E+09	9.36E+06	3.60E+09	0.00E+00
TC-101	0.00E+00	0.00E+00	0.00E+00	0.00E+00	0.00E+00	0.00E+00	0.00E+00	0.00E+00
RU-103	3.61E+07	0.00E+00	1.56E+07	0.00E+00	1.38E+08	0.00E+00	4.22E+09	0.00E+00
RU-105	1.69E-28	0.00E+00	6.67E-29	0.00E+00	2.18E-27	0.00E+00	1.03E-25	0.00E+00
RU-106	1.40E+09	0.00E+00	1.78E+08	0.00E+00	2.71E+09	0.00E+00	9.08E+10	0.00E+00
RH-105	1.12E+00	8.22E-01	5.42E-01	0.00E+00	3.49E+00	0.00E+00	1.31E+02	0.00E+00
PD-107	0.00E+00	8.71E+05	5.57E+04	0.00E+00	7.82E+06	0.00E+00	5.40E+06	0.00E+00
PD-109	0.00E+00	3.86E-07	8.70E-08	0.00E+00	2.20E-06	0.00E+00	4.27E-05	0.00E+00
AG-110M	3.24E+06	3.00E+06	1.78E+06	0.00E+00	5.90E+06	0.00E+00	1.22E+09	0.00E+00
AG-111	4.29E+04	1.79E+04	8.93E+03	0.00E+00	5.78E+04	0.00E+00	3.29E+07	0.00E+00
CD-113M	0.00E+00	2.47E+06	7.92E+04	0.00E+00	2.72E+06	0.00E+00	1.99E+07	0.00E+00
CD-115M	0.00E+00	5.27E+05	1.68E+04	0.00E+00	4.18E+05	0.00E+00	2.22E+07	0.00E+00
SN-123	2.46E+09	4.08E+07	6.01E+07	3.47E+07	0.00E+00	0.00E+00	5.01E+09	0.00E+00
SN-125	5.17E+07	1.04E+06	2.35E+06	8.63E+05	0.00E+00	0.00E+00	6.46E+08	0.00E+00
SN-126	1.00E+10	1.98E+08	2.84E+08	5.83E+07	0.00E+00	0.00E+00	2.88E+09	0.00E+00
SB-124	7.53E+06	1.42E+05	2.98E+06	1.83E+04	0.00E+00	5.86E+06	2.14E+08	0.00E+00
SB-125	1.00E+07	1.12E+05	2.39E+06	1.02E+04	0.00E+00	7.74E+06	1.10E+08	0.00E+00
SB-126	5.69E+05	1.16E+04	2.05E+05	3.48E+03	0.00E+00	3.49E+05	4.65E+07	0.00E+00
SB-127	4.85E+03	1.06E+02	1.86E+03	5.83E+01	0.00E+00	2.88E+03	1.11E+06	0.00E+00
TE-125M	1.35E+08	4.90E+07	1.81E+07	4.07E+07	5.50E+08	0.00E+00	5.40E+08	0.00E+00
TE-127M	4.82E+08	1.72E+08	5.87E+07	1.23E+08	1.96E+09	0.00E+00	1.62E+09	0.00E+00
TE-127	6.21E-11	2.23E-11	1.34E-11	4.60E-11	2.53E-10	0.00E+00	4.90E-09	0.00E+00
TE-129M	3.76E+08	1.40E+08	5.94E+07	1.29E+08	1.57E+09	0.00E+00	1.89E+09	0.00E+00
TE-129	0.00E+00	0.00E+00	0.00E+00	0.00E+00	0.00E+00	0.00E+00	0.00E+00	0.00E+00
TE-131M	1.32E+02	6.45E+01	5.38E+01	1.02E+02	6.54E+02	0.00E+00	6.41E+03	0.00E+00
TE-131	0.00E+00	0.00E+00	0.00E+00	0.00E+00	0.00E+00	0.00E+00	0.00E+00	0.00E+00
TE-132	4.15E+05	2.69E+05	2.52E+05	2.97E+05	2.59E+06	0.00E+00	1.27E+07	0.00E+00
TE-133M	0.00E+00	0.00E+00	0.00E+00	0.00E+00	0.00E+00	0.00E+00	0.00E+00	0.00E+00
TE-134	0.00E+00	0.00E+00	0.00E+00	0.00E+00	0.00E+00	0.00E+00	0.00E+00	0.00E+00
I-129	7.02E+07	6.04E+07	1.98E+08	1.55E+11	1.30E+08	0.00E+00	9.54E+06	0.00E+00
I-130	6.17E-07	1.82E-06	7.18E-07	1.54E-04	2.84E-06	0.00E+00	1.57E-06	0.00E+00
I-131	3.14E+06	4.49E+06	2.58E+06	1.47E+09	7.70E+06	0.00E+00	1.19E+06	0.00E+00
I-132	2.04E-59	5.45E-59	1.91E-59	1.91E-57	8.68E-59	0.00E+00	1.02E-59	0.00E+00
I-133	1.07E-01	1.86E-01	5.66E-02	2.73E+01	3.24E-01	0.00E+00	1.67E-01	0.00E+00
I-134	0.00E+00	0.00E+00	0.00E+00	0.00E+00	0.00E+00	0.00E+00	0.00E+00	0.00E+00

TABLE I12-14

R_i DOSE FACTORS AGE: ADULT PATHWAY: MEATm²-mrem/yr per μ Ci/sec

NUCLIDE	BONE	LIVER	T BODY	THYROID	KIDNEY	LUNG	GI-LLI	SKIN
I-135	1.29E-17	3.39E-17	1.25E-17	2.24E-15	5.44E-17	0.00E+00	3.83E-17	0.00E+00
CS-134M	7.65E-48	1.61E-47	8.23E-48	0.00E+00	8.73E-48	1.38E-48	5.67E-48	0.00E+00
CS-134	3.42E+08	8.14E+08	6.66E+08	0.00E+00	2.64E+08	8.75E+07	1.43E+07	0.00E+00
CS-135	1.16E+08	1.07E+08	4.73E+07	0.00E+00	4.03E+07	1.21E+07	2.49E+06	0.00E+00
CS-136	3.55E+06	1.40E+07	1.01E+07	0.00E+00	7.80E+06	1.07E+06	1.59E+06	0.00E+00
CS-137	4.70E+08	6.43E+08	4.21E+08	0.00E+00	2.18E+08	7.25E+07	1.24E+07	0.00E+00
CS-138	0.00E+00	0.00E+00	0.00E+00	0.00E+00	0.00E+00	0.00E+00	0.00E+00	0.00E+00
CS-139	0.00E+00	0.00E+00	0.00E+00	0.00E+00	0.00E+00	0.00E+00	0.00E+00	0.00E+00
BA-139	3.64E-102	2.59E-105	1.06E-103	0.00E+00	2.42E-105	1.47E-105	6.45E-102	0.00E+00
BA-140	8.46E+06	1.06E+04	5.54E+05	0.00E+00	3.61E+03	6.08E+03	1.74E+07	0.00E+00
BA-141	0.00E+00	0.00E+00	0.00E+00	0.00E+00	0.00E+00	0.00E+00	0.00E+00	0.00E+00
BA-142	0.00E+00	0.00E+00	0.00E+00	0.00E+00	0.00E+00	0.00E+00	0.00E+00	0.00E+00
LA-140	1.09E-02	5.47E-03	1.45E-03	0.00E+00	0.00E+00	0.00E+00	4.01E+02	0.00E+00
LA-141	1.14E-37	3.54E-38	5.79E-39	0.00E+00	0.00E+00	0.00E+00	4.22E-33	0.00E+00
LA-142	1.01E-92	4.58E-93	1.14E-93	0.00E+00	0.00E+00	0.00E+00	3.35E-89	0.00E+00
CE-141	4.62E+03	3.12E+03	3.54E+02	0.00E+00	1.45E+03	0.00E+00	1.19E+07	0.00E+00
CE-143	5.87E-03	4.34E+00	4.80E-04	0.00E+00	1.91E-03	0.00E+00	1.62E+02	0.00E+00
CE-144	7.16E+05	2.99E+05	3.85E+04	0.00E+00	1.78E+05	0.00E+00	2.42E+08	0.00E+00
PR-143	6.18E+03	2.48E+03	3.07E+02	0.00E+00	1.43E+03	0.00E+00	2.71E+07	0.00E+00
PR-144	0.00E+00	0.00E+00	0.00E+00	0.00E+00	0.00E+00	0.00E+00	0.00E+00	0.00E+00
ND-147	2.07E+03	2.40E+03	1.43E+02	0.00E+00	1.40E+03	0.00E+00	1.15E+07	0.00E+00
PM-147	5.06E+05	4.76E+04	1.92E+04	0.00E+00	8.99E+04	0.00E+00	5.99E+07	0.00E+00
PM-148M	7.49E+04	1.94E+04	1.48E+04	0.00E+00	2.93E+04	0.00E+00	1.64E+08	0.00E+00
PM-148	5.77E+02	9.58E+01	4.82E+01	0.00E+00	1.81E+02	0.00E+00	7.53E+06	0.00E+00
PM-149	1.50E+00	2.13E-01	8.68E-02	0.00E+00	4.01E-01	0.00E+00	3.98E+04	0.00E+00
PM-151	1.69E-03	2.83E-04	1.43E-04	0.00E+00	5.05E-04	0.00E+00	7.79E+01	0.00E+00
SM-151	5.10E+05	8.80E+04	2.11E+04	0.00E+00	9.83E+04	0.00E+00	3.88E+07	0.00E+00
SM-153	3.35E-01	2.79E-01	2.04E-02	0.00E+00	9.03E-02	0.00E+00	9.97E+03	0.00E+00
EU-152	1.37E+06	3.12E+05	2.74E+05	0.00E+00	1.93E+06	0.00E+00	1.80E+08	0.00E+00
EU-154	4.30E+06	5.28E+05	3.76E+05	0.00E+00	2.53E+06	0.00E+00	3.83E+08	0.00E+00
EU-155	5.93E+05	8.41E+04	5.42E+04	0.00E+00	3.88E+05	0.00E+00	6.62E+07	0.00E+00
EU-156	1.12E+04	8.64E+03	1.39E+03	0.00E+00	5.77E+03	0.00E+00	5.91E+07	0.00E+00
TB-160	1.56E+05	0.00E+00	1.94E+04	0.00E+00	6.43E+04	0.00E+00	1.43E+08	0.00E+00
HO-166M	1.76E+06	5.49E+05	4.17E+05	0.00E+00	8.21E+05	0.00E+00	1.67E+08	0.00E+00
W-181	1.24E+04	4.05E+03	4.34E+02	0.00E+00	0.00E+00	0.00E+00	4.62E+05	0.00E+00
W-185	4.05E+05	1.35E+05	1.42E+04	0.00E+00	0.00E+00	0.00E+00	1.56E+07	0.00E+00
W-187	6.05E-03	5.05E-03	1.77E-03	0.00E+00	0.00E+00	0.00E+00	1.66E+00	0.00E+00
U-232	2.08E+09	0.00E+00	1.48E+08	0.00E+00	2.25E+08	0.00E+00	3.41E+07	0.00E+00
U-233	4.39E+08	0.00E+00	2.66E+07	0.00E+00	1.02E+08	0.00E+00	3.16E+07	0.00E+00
U-234	4.21E+08	0.00E+00	2.60E+07	0.00E+00	1.00E+08	0.00E+00	3.09E+07	0.00E+00
U-235	4.03E+08	0.00E+00	2.45E+07	0.00E+00	9.42E+07	0.00E+00	3.93E+07	0.00E+00
U-236	4.03E+08	0.00E+00	2.50E+07	0.00E+00	9.62E+07	0.00E+00	2.90E+07	0.00E+00

TABLE I12-14

R_i DOSE FACTORS AGE: ADULT PATHWAY: MEATm²-mrem/yr per μ Ci/sec

NUCLIDE	BONE	LIVER	T BODY	THYROID	KIDNEY	LUNG	GI-LLI	SKIN
U-237	6.27E+02	0.00E+00	1.67E+02	0.00E+00	2.58E+03	0.00E+00	2.20E+05	0.00E+00
U-238	3.86E+08	0.00E+00	2.29E+07	0.00E+00	8.81E+07	0.00E+00	2.77E+07	0.00E+00
NP-237	3.73E+08	2.65E+07	1.64E+07	0.00E+00	1.22E+08	0.00E+00	2.35E+07	0.00E+00
NP-238	4.10E-01	1.11E-02	6.38E-03	0.00E+00	3.74E-02	0.00E+00	1.03E+03	0.00E+00
NP-239	7.58E-02	7.45E-03	4.11E-03	0.00E+00	2.33E-02	0.00E+00	1.53E+03	0.00E+00
PU-238	1.30E+07	1.65E+06	3.54E+05	0.00E+00	1.52E+06	0.00E+00	1.51E+06	0.00E+00
PU-239	1.50E+07	1.81E+06	3.96E+05	0.00E+00	1.68E+06	0.00E+00	1.38E+06	0.00E+00
PU-240	1.50E+07	1.80E+06	3.96E+05	0.00E+00	1.68E+06	0.00E+00	1.41E+06	0.00E+00
PU-241	3.22E+05	1.53E+04	6.81E+03	0.00E+00	3.14E+04	0.00E+00	2.87E+04	0.00E+00
PU-242	1.39E+07	1.74E+06	3.82E+05	0.00E+00	1.62E+06	0.00E+00	1.35E+06	0.00E+00
PU-244	1.63E+07	1.99E+06	4.38E+05	0.00E+00	1.86E+06	0.00E+00	2.02E+06	0.00E+00
AM-241	2.24E+08	2.09E+08	1.60E+07	0.00E+00	1.21E+08	0.00E+00	2.20E+07	0.00E+00
AM-242M	2.25E+08	1.96E+08	1.61E+07	0.00E+00	1.20E+08	0.00E+00	2.76E+07	0.00E+00
AM-243	2.23E+08	2.04E+08	1.57E+07	0.00E+00	1.18E+08	0.00E+00	2.58E+07	0.00E+00
CM-242	4.41E+06	4.69E+06	2.93E+05	0.00E+00	1.33E+06	0.00E+00	1.70E+07	0.00E+00
CM-243	1.76E+08	1.62E+08	1.10E+07	0.00E+00	5.16E+07	0.00E+00	2.30E+07	0.00E+00
CM-244	1.34E+08	1.25E+08	8.43E+06	0.00E+00	3.94E+07	0.00E+00	2.22E+07	0.00E+00
CM-245	2.78E+08	2.42E+08	1.71E+07	0.00E+00	7.97E+07	0.00E+00	2.09E+07	0.00E+00
CM-246	2.76E+08	2.42E+08	1.70E+07	0.00E+00	7.94E+07	0.00E+00	2.05E+07	0.00E+00
CM-247	2.69E+08	2.38E+08	1.68E+07	0.00E+00	7.82E+07	0.00E+00	2.69E+07	0.00E+00
CM-248	2.23E+09	1.96E+09	1.38E+08	0.00E+00	6.46E+08	0.00E+00	4.35E+08	0.00E+00
CF-252	7.30E+07	0.00E+00	1.76E+06	0.00E+00	0.00E+00	0.00E+00	8.05E+07	0.00E+00

TABLE II2-15

R_i DOSE FACTORS AGE: TEEN PATHWAY: MEATm²-mrem/yr per μCi/sec

NUCLIDE	BONE	LIVER	T BODY	THYROID	KIDNEY	LUNG	GI-LLI	SKIN
H-3	0.00E+00	1.10E+02	1.10E+02	1.10E+02	1.10E+02	1.10E+02	1.10E+02	0.00E+00
C-14	2.81E+05	5.62E+04	5.62E+04	5.62E+04	5.62E+04	5.62E+04	5.62E+04	0.00E+00
NA-22	5.79E+08	5.79E+08	5.79E+08	5.79E+08	5.79E+08	5.79E+08	5.79E+08	0.00E+00
NA-24	3.17E-04	3.17E-04	3.17E-04	3.17E-04	3.17E-04	3.17E-04	3.17E-04	0.00E+00
P-32	1.16E+09	7.21E+07	4.51E+07	0.00E+00	0.00E+00	0.00E+00	9.78E+07	0.00E+00
CA-41	6.90E+08	0.00E+00	7.46E+07	0.00E+00	0.00E+00	0.00E+00	6.83E+05	0.00E+00
SC-46	5.59E+04	1.09E+05	3.23E+04	0.00E+00	1.04E+05	0.00E+00	3.71E+08	0.00E+00
CR-51	0.00E+00	0.00E+00	1.80E+03	9.97E+02	3.93E+02	2.56E+03	3.02E+05	0.00E+00
MN-54	0.00E+00	3.47E+06	6.88E+05	0.00E+00	1.03E+06	0.00E+00	7.11E+06	0.00E+00
MN-56	0.00E+00	3.60E-54	6.40E-55	0.00E+00	4.56E-54	0.00E+00	2.37E-52	0.00E+00
FE-55	1.25E+08	8.87E+07	2.07E+07	0.00E+00	0.00E+00	5.62E+07	3.84E+07	0.00E+00
FE-59	7.51E+07	1.75E+08	6.76E+07	0.00E+00	0.00E+00	5.52E+07	4.14E+08	0.00E+00
CO-57	0.00E+00	2.22E+06	3.71E+06	0.00E+00	0.00E+00	0.00E+00	4.13E+07	0.00E+00
CO-58	0.00E+00	5.55E+06	1.28E+07	0.00E+00	0.00E+00	0.00E+00	7.65E+07	0.00E+00
CO-60	0.00E+00	3.11E+07	7.00E+07	0.00E+00	0.00E+00	0.00E+00	4.04E+08	0.00E+00
NI-59	6.12E+07	2.16E+07	1.04E+07	0.00E+00	0.00E+00	0.00E+00	3.39E+06	0.00E+00
NI-63	8.20E+08	5.79E+07	2.78E+07	0.00E+00	0.00E+00	0.00E+00	9.22E+06	0.00E+00
NI-65	5.51E-54	7.04E-55	3.21E-55	0.00E+00	0.00E+00	0.00E+00	3.82E-53	0.00E+00
CU-64	0.00E+00	6.47E-08	3.05E-08	0.00E+00	1.64E-07	0.00E+00	5.02E-06	0.00E+00
ZN-65	1.21E+08	4.21E+08	1.96E+08	0.00E+00	2.69E+08	0.00E+00	1.78E+08	0.00E+00
ZN-69M	4.09E-06	9.64E-06	8.84E-07	0.00E+00	5.86E-06	0.00E+00	5.30E-04	0.00E+00
ZN-69	0.00E+00	0.00E+00	0.00E+00	0.00E+00	0.00E+00	0.00E+00	0.00E+00	0.00E+00
SE-79	0.00E+00	4.90E+07	8.23E+06	0.00E+00	8.53E+07	0.00E+00	7.48E+06	0.00E+00
BR-82	0.00E+00	0.00E+00	2.84E+02	0.00E+00	0.00E+00	0.00E+00	0.00E+00	0.00E+00
BR-83	0.00E+00	0.00E+00	1.48E-57	0.00E+00	0.00E+00	0.00E+00	0.00E+00	0.00E+00
BR-84	0.00E+00	0.00E+00	0.00E+00	0.00E+00	0.00E+00	0.00E+00	0.00E+00	0.00E+00
BR-85	0.00E+00	0.00E+00	0.00E+00	0.00E+00	0.00E+00	0.00E+00	0.00E+00	0.00E+00
RB-86	0.00E+00	1.22E+08	5.75E+07	0.00E+00	0.00E+00	0.00E+00	1.81E+07	0.00E+00
RB-87	0.00E+00	4.75E+08	1.66E+08	0.00E+00	0.00E+00	0.00E+00	1.66E+07	0.00E+00
RB-88	0.00E+00	0.00E+00	0.00E+00	0.00E+00	0.00E+00	0.00E+00	0.00E+00	0.00E+00
RB-89	0.00E+00	0.00E+00	0.00E+00	0.00E+00	0.00E+00	0.00E+00	0.00E+00	0.00E+00
SR-89	9.28E+07	0.00E+00	2.66E+06	0.00E+00	0.00E+00	0.00E+00	1.11E+07	0.00E+00
SR-90	5.33E+09	0.00E+00	1.07E+08	0.00E+00	0.00E+00	0.00E+00	1.22E+08	0.00E+00
SR-91	3.74E-11	0.00E+00	1.49E-12	0.00E+00	0.00E+00	0.00E+00	1.69E-10	0.00E+00
SR-92	2.89E-50	0.00E+00	1.23E-51	0.00E+00	0.00E+00	0.00E+00	7.36E-49	0.00E+00
Y-90	2.65E+01	0.00E+00	7.14E-01	0.00E+00	0.00E+00	0.00E+00	2.19E+05	0.00E+00
Y-91M	0.00E+00	0.00E+00	0.00E+00	0.00E+00	0.00E+00	0.00E+00	0.00E+00	0.00E+00
Y-91	3.60E+05	0.00E+00	9.66E+03	0.00E+00	0.00E+00	0.00E+00	1.48E+08	0.00E+00
Y-92	3.75E-40	0.00E+00	1.09E-41	0.00E+00	0.00E+00	0.00E+00	1.03E-35	0.00E+00
Y-93	1.16E-12	0.00E+00	3.18E-14	0.00E+00	0.00E+00	0.00E+00	3.54E-08	0.00E+00
ZR-93	1.65E+06	8.12E+04	4.43E+04	0.00E+00	2.87E+05	0.00E+00	7.68E+07	0.00E+00
ZR-95	5.79E+05	1.83E+05	1.26E+05	0.00E+00	2.68E+05	0.00E+00	4.21E+08	0.00E+00
ZR-97	5.04E-06	9.97E-07	4.59E-07	0.00E+00	1.51E-06	0.00E+00	2.70E-01	0.00E+00
NB-93M	8.34E+06	2.74E+06	6.86E+05	0.00E+00	3.20E+06	0.00E+00	9.87E+08	0.00E+00
NB-95	6.00E+05	3.33E+05	1.83E+05	0.00E+00	3.22E+05	0.00E+00	1.42E+09	0.00E+00

Rev. 31

Page 245 of 330

05/2018

TABLE II-15

R_i DOSE FACTORS AGE: TEEN PATHWAY: MEATm²-mrem/yr per μCi/sec

NUCLIDE	BONE	LIVER	T BODY	THYROID	KIDNEY	LUNG	GI-LLI	SKIN
NB-97	0.00E+00	0.00E+00	0.00E+00	0.00E+00	0.00E+00	0.00E+00	0.00E+00	0.00E+00
MO-93	0.00E+00	7.42E+07	2.03E+06	0.00E+00	2.13E+07	0.00E+00	9.03E+06	0.00E+00
MO-99	0.00E+00	2.42E+04	4.61E+03	0.00E+00	5.53E+04	0.00E+00	4.33E+04	0.00E+00
TC-99M	1.03E-21	2.88E-21	3.74E-20	0.00E+00	4.30E-20	1.60E-21	1.89E-18	0.00E+00
TC-99	6.27E+07	9.21E+07	2.51E+07	0.00E+00	1.17E+09	9.52E+06	2.25E+09	0.00E+00
TC-101	0.00E+00	0.00E+00	0.00E+00	0.00E+00	0.00E+00	0.00E+00	0.00E+00	0.00E+00
RU-103	2.94E+07	0.00E+00	1.26E+07	0.00E+00	1.04E+08	0.00E+00	2.46E+09	0.00E+00
RU-105	1.41E-28	0.00E+00	5.48E-29	0.00E+00	1.78E-27	0.00E+00	1.14E-25	0.00E+00
RU-106	1.18E+09	0.00E+00	1.49E+08	0.00E+00	2.28E+09	0.00E+00	5.67E+10	0.00E+00
RH-105	9.50E-01	6.86E-01	4.50E-01	0.00E+00	2.91E+00	0.00E+00	8.73E+01	0.00E+00
PD-107	0.00E+00	7.28E+05	4.69E+04	0.00E+00	6.58E+06	0.00E+00	3.38E+06	0.00E+00
PD-109	0.00E+00	3.23E-07	7.35E-08	0.00E+00	1.87E-06	0.00E+00	3.26E-05	0.00E+00
AG-110M	2.46E+06	2.32E+06	1.41E+06	0.00E+00	4.43E+06	0.00E+00	6.53E+08	0.00E+00
AG-111	3.61E+04	1.50E+04	7.54E+03	0.00E+00	4.88E+04	0.00E+00	2.09E+07	0.00E+00
CD-113M	0.00E+00	2.07E+06	6.65E+04	0.00E+00	2.29E+06	0.00E+00	1.24E+07	0.00E+00
CD-115M	0.00E+00	4.40E+05	1.42E+04	0.00E+00	3.52E+05	0.00E+00	1.39E+07	0.00E+00
SN-123	2.08E+09	3.41E+07	5.05E+07	2.73E+07	0.00E+00	0.00E+00	3.14E+09	0.00E+00
SN-125	4.37E+07	8.70E+05	1.97E+06	6.82E+05	0.00E+00	0.00E+00	4.11E+08	0.00E+00
SN-126	8.12E+09	1.51E+08	2.31E+08	3.98E+07	0.00E+00	0.00E+00	1.81E+09	0.00E+00
SB-124	6.15E+06	1.13E+05	2.40E+06	1.39E+04	0.00E+00	5.37E+06	1.24E+08	0.00E+00
SB-125	8.22E+06	8.98E+04	1.92E+06	7.85E+03	0.00E+00	7.22E+06	6.39E+07	0.00E+00
SB-126	4.65E+05	9.50E+03	1.67E+05	2.63E+03	0.00E+00	3.33E+05	2.75E+07	0.00E+00
SB-127	4.04E+03	8.63E+01	1.52E+03	4.54E+01	0.00E+00	2.75E+03	6.85E+05	0.00E+00
TE-125M	1.14E+08	4.12E+07	1.53E+07	3.19E+07	0.00E+00	0.00E+00	3.37E+08	0.00E+00
TE-127M	4.07E+08	1.44E+08	4.84E+07	9.68E+07	1.65E+09	0.00E+00	1.01E+09	0.00E+00
TE-127	5.27E-11	1.87E-11	1.13E-11	3.63E-11	2.13E-10	0.00E+00	4.07E-09	0.00E+00
TE-129M	3.15E+08	1.17E+08	4.98E+07	1.02E+08	1.32E+09	0.00E+00	1.18E+09	0.00E+00
TE-129	0.00E+00	0.00E+00	0.00E+00	0.00E+00	0.00E+00	0.00E+00	0.00E+00	0.00E+00
TE-131M	1.10E+02	5.27E+01	4.40E+01	7.93E+01	5.50E+02	0.00E+00	4.23E+03	0.00E+00
TE-131	0.00E+00	0.00E+00	0.00E+00	0.00E+00	0.00E+00	0.00E+00	0.00E+00	0.00E+00
TE-132	3.40E+05	2.15E+05	2.02E+05	2.27E+05	2.06E+06	0.00E+00	6.81E+06	0.00E+00
TE-133M	0.00E+00	0.00E+00	0.00E+00	0.00E+00	0.00E+00	0.00E+00	0.00E+00	0.00E+00
TE-134	0.00E+00	0.00E+00	0.00E+00	0.00E+00	0.00E+00	0.00E+00	0.00E+00	0.00E+00
I-129	5.91E+07	4.98E+07	8.30E+07	6.05E+10	8.90E+07	0.00E+00	5.80E+06	0.00E+00
I-130	4.97E-07	1.44E-06	5.74E-07	1.17E-04	2.21E-06	0.00E+00	1.10E-06	0.00E+00
I-131	2.61E+06	3.66E+06	1.96E+06	1.07E+09	6.29E+06	0.00E+00	7.23E+05	0.00E+00
I-132	1.65E-59	4.33E-59	1.55E-59	1.46E-57	6.82E-59	0.00E+00	1.89E-59	0.00E+00
I-133	8.93E-02	1.52E-01	4.62E-02	2.12E+01	2.66E-01	0.00E+00	1.15E-01	0.00E+00
I-134	0.00E+00	0.00E+00	0.00E+00	0.00E+00	0.00E+00	0.00E+00	0.00E+00	0.00E+00
I-135	1.05E-17	2.71E-17	1.01E-17	1.74E-15	4.28E-17	0.00E+00	3.00E-17	0.00E+00
CS-134M	6.24E-48	1.29E-47	6.64E-48	0.00E+00	7.19E-48	1.26E-48	8.60E-48	0.00E+00
CS-134	2.72E+08	6.41E+08	2.97E+08	0.00E+00	2.04E+08	7.77E+07	7.97E+06	0.00E+00
CS-135	9.73E+07	8.93E+07	2.09E+07	0.00E+00	3.41E+07	1.23E+07	1.56E+06	0.00E+00
CS-136	2.77E+06	1.09E+07	7.32E+06	0.00E+00	5.93E+06	9.35E+05	8.77E+05	0.00E+00
CS-137	3.90E+08	5.19E+08	1.81E+08	0.00E+00	1.77E+08	6.86E+07	7.38E+06	0.00E+00

Rev. 31

Page 246 of 330

05/2018

TABLE II2-15

R_i DOSE FACTORS AGE: TEEN PATHWAY: MEATm²-mrem/yr per μ Ci/sec

NUCLIDE	BONE	LIVER	T BODY	THYROID	KIDNEY	LUNG	GI-LLI	SKIN
CS-138	0.00E+00	0.00E+00	0.00E+00	0.00E+00	0.00E+00	0.00E+00	0.00E+00	0.00E+00
CS-139	0.00E+00	0.00E+00	0.00E+00	0.00E+00	0.00E+00	0.00E+00	0.00E+00	0.00E+00
BA-139	3.08E-102	2.17E-105	8.97E-104	0.00E+00	2.04E-105	1.49E-105	2.75E-101	0.00E+00
BA-140	6.99E+06	8.57E+03	4.51E+05	0.00E+00	2.91E+03	5.76E+03	1.08E+07	0.00E+00
BA-141	0.00E+00	0.00E+00	0.00E+00	0.00E+00	0.00E+00	0.00E+00	0.00E+00	0.00E+00
BA-142	0.00E+00	0.00E+00	0.00E+00	0.00E+00	0.00E+00	0.00E+00	0.00E+00	0.00E+00
LA-140	8.93E-03	4.39E-03	1.17E-03	0.00E+00	0.00E+00	0.00E+00	2.52E+02	0.00E+00
LA-141	9.61E-38	2.96E-38	4.88E-39	0.00E+00	0.00E+00	0.00E+00	5.24E-33	0.00E+00
LA-142	8.33E-93	3.70E-93	9.21E-94	0.00E+00	0.00E+00	0.00E+00	1.13E-88	0.00E+00
CE-141	3.88E+03	2.59E+03	2.97E+02	0.00E+00	1.22E+03	0.00E+00	7.41E+06	0.00E+00
CE-143	4.94E-03	3.60E+00	4.02E-04	0.00E+00	1.61E-03	0.00E+00	1.08E+02	0.00E+00
CE-144	6.04E+05	2.50E+05	3.24E+04	0.00E+00	1.49E+05	0.00E+00	1.52E+08	0.00E+00
PR-143	5.20E+03	2.08E+03	2.59E+02	0.00E+00	1.21E+03	0.00E+00	1.71E+07	0.00E+00
PR-144	0.00E+00	0.00E+00	0.00E+00	0.00E+00	0.00E+00	0.00E+00	0.00E+00	0.00E+00
ND-147	1.83E+03	1.99E+03	1.19E+02	0.00E+00	1.17E+03	0.00E+00	7.17E+06	0.00E+00
PM-147	4.16E+05	3.95E+04	1.61E+04	0.00E+00	7.53E+04	0.00E+00	3.75E+07	0.00E+00
PM-148M	5.97E+04	1.51E+04	1.18E+04	0.00E+00	2.29E+04	0.00E+00	9.53E+07	0.00E+00
PM-148	4.85E+02	7.90E+01	3.98E+01	0.00E+00	1.43E+02	0.00E+00	4.71E+06	0.00E+00
PM-149	1.27E+00	1.78E-01	7.30E-02	0.00E+00	3.39E-01	0.00E+00	2.62E+04	0.00E+00
PM-151	1.41E-03	2.33E-04	1.18E-04	0.00E+00	4.19E-04	0.00E+00	5.23E+01	0.00E+00
SM-151	3.81E+05	7.34E+04	1.72E+04	0.00E+00	8.04E+04	0.00E+00	2.49E+07	0.00E+00
SM-153	2.82E-01	2.33E-01	1.72E-02	0.00E+00	7.62E-02	0.00E+00	6.58E+03	0.00E+00
EU-152	1.02E+06	2.45E+05	2.16E+05	0.00E+00	1.14E+06	0.00E+00	9.01E+07	0.00E+00
EU-154	3.27E+06	4.21E+05	2.97E+05	0.00E+00	1.88E+06	0.00E+00	2.23E+08	0.00E+00
EU-155	7.09E+05	6.84E+04	4.24E+04	0.00E+00	2.68E+05	0.00E+00	3.92E+08	0.00E+00
EU-156	9.24E+03	6.93E+03	1.13E+03	0.00E+00	4.66E+03	0.00E+00	3.54E+07	0.00E+00
TB-160	1.27E+05	0.00E+00	1.58E+04	0.00E+00	5.01E+04	0.00E+00	8.20E+07	0.00E+00
HO-166M	1.37E+06	4.24E+05	3.07E+05	0.00E+00	6.20E+05	0.00E+00	1.04E+08	0.00E+00
W-181	1.05E+04	3.39E+03	3.55E+02	0.00E+00	0.00E+00	0.00E+00	2.89E+05	0.00E+00
W-185	3.42E+05	1.13E+05	1.19E+04	0.00E+00	0.00E+00	0.00E+00	9.75E+06	0.00E+00
W-187	5.06E-03	4.13E-03	1.45E-03	0.00E+00	0.00E+00	0.00E+00	1.12E+00	0.00E+00
U-232	1.75E+09	0.00E+00	1.25E+08	0.00E+00	1.89E+08	0.00E+00	2.14E+07	0.00E+00
U-233	3.69E+08	0.00E+00	2.24E+07	0.00E+00	8.63E+07	0.00E+00	1.98E+07	0.00E+00
U-234	3.54E+08	0.00E+00	2.20E+07	0.00E+00	8.48E+07	0.00E+00	1.94E+07	0.00E+00
U-235	3.39E+08	0.00E+00	2.07E+07	0.00E+00	7.95E+07	0.00E+00	2.46E+07	0.00E+00
U-236	3.39E+08	0.00E+00	2.11E+07	0.00E+00	8.12E+07	0.00E+00	1.82E+07	0.00E+00
NP-239	6.62E-02	6.25E-03	3.47E-03	0.00E+00	1.96E-02	0.00E+00	1.01E+03	0.00E+00
U-237	5.29E+02	0.00E+00	1.41E+02	0.00E+00	2.17E+03	0.00E+00	1.40E+05	0.00E+00
U-238	3.24E+08	0.00E+00	1.93E+07	0.00E+00	7.44E+07	0.00E+00	1.74E+07	0.00E+00
NP-237	2.33E+08	1.67E+07	1.02E+07	0.00E+00	7.58E+07	0.00E+00	1.47E+07	0.00E+00
NP-238	3.45E-01	9.24E-03	5.38E-03	0.00E+00	3.17E-02	0.00E+00	6.78E+02	0.00E+00
PU-238	8.20E+06	1.05E+06	2.23E+05	0.00E+00	9.54E+05	0.00E+00	9.46E+05	0.00E+00
PU-239	9.37E+06	1.14E+06	2.46E+05	0.00E+00	1.05E+06	0.00E+00	8.65E+05	0.00E+00
PU-240	9.36E+06	1.14E+06	2.46E+05	0.00E+00	1.05E+06	0.00E+00	8.81E+05	0.00E+00
PU-241	2.12E+05	1.02E+04	4.47E+03	0.00E+00	2.07E+04	0.00E+00	1.79E+04	0.00E+00

Rev. 31

Page 247 of 330

05/2018

TABLE II2-15

R_i DOSE FACTORS AGE: TEEN PATHWAY: MEATm²-mrem/yr per μ Ci/sec

NUCLIDE	BONE	LIVER	T BODY	THYROID	KIDNEY	LUNG	GI-LLI	SKIN
PU-242	8.69E+06	1.10E+06	2.38E+05	0.00E+00	1.01E+06	0.00E+00	8.48E+05	0.00E+00
PU-244	1.01E+07	1.25E+06	2.72E+05	0.00E+00	1.16E+06	0.00E+00	1.26E+06	0.00E+00
AM-241	1.40E+08	1.32E+08	1.01E+07	0.00E+00	7.54E+07	0.00E+00	1.38E+07	0.00E+00
AM-242M	1.41E+08	1.24E+08	1.01E+07	0.00E+00	7.52E+07	0.00E+00	1.73E+07	0.00E+00
AM-243	1.39E+08	1.29E+08	9.84E+06	0.00E+00	7.39E+07	0.00E+00	1.62E+07	0.00E+00
CM-242	3.72E+06	3.92E+06	2.47E+05	0.00E+00	1.12E+06	0.00E+00	1.06E+07	0.00E+00
CM-243	1.13E+08	1.05E+08	7.12E+06	0.00E+00	3.33E+07	0.00E+00	1.44E+07	0.00E+00
CM-244	8.75E+07	8.28E+07	5.54E+06	0.00E+00	2.59E+07	0.00E+00	1.39E+07	0.00E+00
CM-245	1.73E+08	1.52E+08	1.07E+07	0.00E+00	4.99E+07	0.00E+00	1.31E+07	0.00E+00
CM-246	1.72E+08	1.52E+08	1.07E+07	0.00E+00	4.97E+07	0.00E+00	1.28E+07	0.00E+00
CM-247	1.68E+08	1.50E+08	1.05E+07	0.00E+00	4.90E+07	0.00E+00	1.69E+07	0.00E+00
CM-248	1.39E+09	1.24E+09	8.67E+07	0.00E+00	4.04E+08	0.00E+00	2.71E+08	0.00E+00
CF-252	5.73E+07	0.00E+00	1.38E+06	0.00E+00	0.00E+00	0.00E+00	5.04E+07	0.00E+00

TABLE II-2-16

R_i DOSE FACTORS AGE: CHILD PATHWAY: MEAT

NUCLIDE	m ² -mrem/yr per μCi/sec							
	BONE	LIVER	T BODY	THYROID	KIDNEY	LUNG	GI-LLI	SKIN
H-3	0.00E+00	1.34E+02	1.34E+02	1.34E+02	1.34E+02	1.34E+02	1.34E+02	0.00E+00
C-14	5.29E+05	1.06E+05	1.06E+05	1.06E+05	1.06E+05	1.06E+05	1.06E+05	0.00E+00
NA-22	9.18E+08	9.18E+08	9.18E+08	9.18E+08	9.18E+08	9.18E+08	9.18E+08	0.00E+00
NA-24	5.04E-04	5.04E-04	5.04E-04	5.04E-04	5.04E-04	5.04E-04	5.04E-04	0.00E+00
P-32	2.19E+09	1.03E+08	8.45E+07	0.00E+00	0.00E+00	0.00E+00	6.06E+07	0.00E+00
CA-41	7.66E+08	0.00E+00	8.37E+07	0.00E+00	0.00E+00	0.00E+00	4.20E+05	0.00E+00
SC-46	9.59E+04	1.32E+05	5.07E+04	0.00E+00	1.16E+05	0.00E+00	1.92E+08	0.00E+00
CR-51	0.00E+00	0.00E+00	2.80E+03	1.55E+03	4.25E+02	2.84E+03	1.48E+05	0.00E+00
MN-54	0.00E+00	3.97E+06	1.06E+06	0.00E+00	1.11E+06	0.00E+00	3.33E+06	0.00E+00
MN-56	0.00E+00	4.80E-54	1.08E-54	0.00E+00	5.80E-54	0.00E+00	6.95E-52	0.00E+00
FE-55	2.40E+08	1.27E+08	3.94E+07	0.00E+00	0.00E+00	7.20E+07	2.36E+07	0.00E+00
FE-59	1.33E+08	2.15E+08	1.07E+08	0.00E+00	0.00E+00	6.24E+07	2.24E+08	0.00E+00
CO-57	0.00E+00	2.89E+06	5.86E+06	0.00E+00	0.00E+00	0.00E+00	2.37E+07	0.00E+00
CO-58	0.00E+00	6.48E+06	1.99E+07	0.00E+00	0.00E+00	0.00E+00	3.78E+07	0.00E+00
CO-60	0.00E+00	3.69E+07	1.09E+08	0.00E+00	0.00E+00	0.00E+00	2.04E+08	0.00E+00
NI-59	1.18E+08	3.13E+07	2.00E+07	0.00E+00	0.00E+00	0.00E+00	2.08E+06	0.00E+00
NI-63	1.57E+09	8.41E+07	5.35E+07	0.00E+00	0.00E+00	0.00E+00	5.67E+06	0.00E+00
NI-65	1.03E-53	9.69E-55	5.66E-55	0.00E+00	0.00E+00	0.00E+00	1.19E-52	0.00E+00
CU-64	0.00E+00	8.70E-08	5.26E-08	0.00E+00	2.10E-07	0.00E+00	4.08E-06	0.00E+00
ZN-65	1.82E+08	4.84E+08	3.01E+08	0.00E+00	3.05E+08	0.00E+00	8.51E+07	0.00E+00
ZN-69M	7.63E-06	1.30E-05	1.54E-06	0.00E+00	7.55E-06	0.00E+00	4.23E-04	0.00E+00
ZN-69	0.00E+00	0.00E+00	0.00E+00	0.00E+00	0.00E+00	0.00E+00	0.00E+00	0.00E+00
SE-79	0.00E+00	6.98E+07	1.55E+07	0.00E+00	1.13E+08	0.00E+00	4.58E+06	0.00E+00
BR-82	0.00E+00	0.00E+00	4.45E+02	0.00E+00	0.00E+00	0.00E+00	0.00E+00	0.00E+00
BR-83	0.00E+00	0.00E+00	2.78E-57	0.00E+00	0.00E+00	0.00E+00	0.00E+00	0.00E+00
BR-84	0.00E+00	0.00E+00	0.00E+00	0.00E+00	0.00E+00	0.00E+00	0.00E+00	0.00E+00
BR-85	0.00E+00	0.00E+00	0.00E+00	0.00E+00	0.00E+00	0.00E+00	0.00E+00	0.00E+00
RB-86	0.00E+00	1.74E+08	1.07E+08	0.00E+00	0.00E+00	0.00E+00	1.12E+07	0.00E+00
RB-87	0.00E+00	6.76E+08	3.13E+08	0.00E+00	0.00E+00	0.00E+00	1.01E+07	0.00E+00
RB-88	0.00E+00	0.00E+00	0.00E+00	0.00E+00	0.00E+00	0.00E+00	0.00E+00	0.00E+00
RB-89	0.00E+00	0.00E+00	0.00E+00	0.00E+00	0.00E+00	0.00E+00	0.00E+00	0.00E+00
SR-89	1.76E+08	0.00E+00	5.02E+06	0.00E+00	0.00E+00	0.00E+00	6.80E+06	0.00E+00
SR-90	8.43E+09	0.00E+00	1.70E+08	0.00E+00	0.00E+00	0.00E+00	7.55E+07	0.00E+00
SR-91	7.01E-11	0.00E+00	2.65E-12	0.00E+00	0.00E+00	0.00E+00	1.55E-10	0.00E+00
SR-92	5.39E-50	0.00E+00	2.16E-51	0.00E+00	0.00E+00	0.00E+00	1.02E-48	0.00E+00
Y-90	5.01E+01	0.00E+00	1.34E+00	0.00E+00	0.00E+00	0.00E+00	1.43E+05	0.00E+00
Y-91M	0.00E+00	0.00E+00	0.00E+00	0.00E+00	0.00E+00	0.00E+00	0.00E+00	0.00E+00
Y-91	6.81E+05	0.00E+00	1.82E+04	0.00E+00	0.00E+00	0.00E+00	9.07E+07	0.00E+00
Y-92	7.05E-40	0.00E+00	2.02E-41	0.00E+00	0.00E+00	0.00E+00	2.04E-35	0.00E+00
Y-93	2.18E-12	0.00E+00	5.97E-14	0.00E+00	0.00E+00	0.00E+00	3.24E-08	0.00E+00
ZR-93	3.13E+06	1.17E+05	8.35E+04	0.00E+00	4.54E+05	0.00E+00	4.45E+07	0.00E+00
ZR-95	1.03E+06	2.26E+05	2.01E+05	0.00E+00	3.23E+05	0.00E+00	2.36E+08	0.00E+00

TABLE II-16

R_i DOSE FACTORS AGE: CHILD PATHWAY: MEAT

NUCLIDE	m ² -mrem/yr per μCi/sec							
	BONE	LIVER	T BODY	THYROID	KIDNEY	LUNG	GI-LLI	SKIN
ZR-97	9.37E-06	1.35E-06	7.99E-07	0.00E+00	1.94E-06	0.00E+00	2.05E-01	0.00E+00
NB-93M	1.61E+07	4.01E+06	1.32E+06	0.00E+00	4.33E+06	0.00E+00	6.04E+08	0.00E+00
NB-95	1.04E+06	4.03E+05	2.88E+05	0.00E+00	3.79E+05	0.00E+00	7.45E+08	0.00E+00
NB-97	0.00E+00	0.00E+00	0.00E+00	0.00E+00	0.00E+00	0.00E+00	0.00E+00	0.00E+00
MO-93	0.00E+00	1.06E+08	3.82E+06	0.00E+00	2.80E+07	0.00E+00	5.39E+06	0.00E+00
MO-99	0.00E+00	3.36E+04	8.32E+03	0.00E+00	7.18E+04	0.00E+00	2.78E+04	0.00E+00
TC-99M	1.81E-21	3.55E-21	5.89E-20	0.00E+00	5.16E-20	1.80E-21	2.02E-18	0.00E+00
TC-99	1.18E+08	1.32E+08	4.73E+07	0.00E+00	1.55E+09	1.16E+07	1.38E+09	0.00E+00
TC-101	0.00E+00	0.00E+00	0.00E+00	0.00E+00	0.00E+00	0.00E+00	0.00E+00	0.00E+00
RU-103	5.32E+07	0.00E+00	2.04E+07	0.00E+00	1.34E+08	0.00E+00	1.37E+09	0.00E+00
RU-105	2.64E-28	0.00E+00	9.57E-29	0.00E+00	2.32E-27	0.00E+00	1.72E-25	0.00E+00
RU-106	2.23E+09	0.00E+00	2.78E+08	0.00E+00	3.01E+09	0.00E+00	3.46E+10	0.00E+00
RH-105	1.78E+00	9.56E-01	8.17E-01	0.00E+00	3.81E+00	0.00E+00	5.92E+01	0.00E+00
PD-107	0.00E+00	1.04E+06	8.86E+04	0.00E+00	8.72E+06	0.00E+00	2.07E+06	0.00E+00
PD-109	0.00E+00	4.61E-07	1.38E-07	0.00E+00	2.47E-06	0.00E+00	2.72E-05	0.00E+00
AG-110M	4.07E+06	2.75E+06	2.20E+06	0.00E+00	5.12E+06	0.00E+00	3.27E+08	0.00E+00
AG-111	6.82E+04	2.13E+04	1.41E+04	0.00E+00	6.43E+04	0.00E+00	1.31E+07	0.00E+00
CD-113M	0.00E+00	2.95E+06	1.26E+05	0.00E+00	3.04E+06	0.00E+00	7.61E+06	0.00E+00
CD-115M	0.00E+00	6.29E+05	2.68E+04	0.00E+00	4.68E+05	0.00E+00	8.56E+06	0.00E+00
SN-123	3.92E+09	4.87E+07	9.56E+07	5.16E+07	0.00E+00	0.00E+00	1.92E+09	0.00E+00
SN-125	8.22E+07	1.24E+06	3.68E+06	1.28E+06	0.00E+00	0.00E+00	2.55E+08	0.00E+00
SN-126	1.47E+10	1.83E+08	4.18E+08	5.04E+07	0.00E+00	0.00E+00	1.10E+09	0.00E+00
SB-124	1.11E+07	1.44E+05	3.90E+06	2.45E+04	0.00E+00	6.17E+06	6.95E+07	0.00E+00
SB-125	1.50E+07	1.15E+05	3.13E+06	1.39E+04	0.00E+00	8.34E+06	3.57E+07	0.00E+00
SB-126	8.11E+05	1.24E+04	2.91E+05	4.76E+03	0.00E+00	3.87E+05	1.64E+07	0.00E+00
SB-127	7.43E+03	1.15E+02	2.58E+03	8.28E+01	0.00E+00	3.23E+03	4.19E+05	0.00E+00
TE-125M	2.14E+08	5.81E+07	2.86E+07	6.02E+07	0.00E+00	0.00E+00	2.07E+08	0.00E+00
TE-127M	7.67E+08	2.06E+08	9.10E+07	1.83E+08	2.19E+09	0.00E+00	6.21E+08	0.00E+00
TE-127	9.91E-11	2.67E-11	2.12E-11	6.86E-11	2.82E-10	0.00E+00	3.87E-09	0.00E+00
TE-129M	5.93E+08	1.66E+08	9.20E+07	1.91E+08	1.74E+09	0.00E+00	7.23E+08	0.00E+00
TE-129	0.00E+00	0.00E+00	0.00E+00	0.00E+00	0.00E+00	0.00E+00	0.00E+00	0.00E+00
TE-131M	2.05E+02	7.08E+01	7.53E+01	1.46E+02	6.85E+02	0.00E+00	2.87E+03	0.00E+00
TE-131	0.00E+00	0.00E+00	0.00E+00	0.00E+00	0.00E+00	0.00E+00	0.00E+00	0.00E+00
TE-132	6.20E+05	2.74E+05	3.32E+05	4.00E+05	2.55E+06	0.00E+00	2.76E+06	0.00E+00
TE-133M	0.00E+00	0.00E+00	0.00E+00	0.00E+00	0.00E+00	0.00E+00	0.00E+00	0.00E+00
TE-134	0.00E+00	0.00E+00	0.00E+00	0.00E+00	0.00E+00	0.00E+00	0.00E+00	0.00E+00
I-129	1.11E+08	6.83E+07	6.10E+07	4.47E+10	1.15E+08	0.00E+00	3.43E+06	0.00E+00
I-130	8.88E-07	1.79E-06	9.24E-07	1.98E-04	2.68E-06	0.00E+00	8.39E-07	0.00E+00
I-131	4.84E+06	4.87E+06	2.77E+06	1.61E+09	8.00E+06	0.00E+00	4.34E+05	0.00E+00
I-132	2.99E-59	5.50E-59	2.53E-59	2.55E-57	8.42E-59	0.00E+00	6.47E-59	0.00E+00
I-133	1.66E-01	2.05E-01	7.77E-02	3.81E+01	3.42E-01	0.00E+00	8.27E-02	0.00E+00
I-134	0.00E+00	0.00E+00	0.00E+00	0.00E+00	0.00E+00	0.00E+00	0.00E+00	0.00E+00

TABLE II-2-16

R_i DOSE FACTORS AGE: CHILD PATHWAY: MEAT

m²-mrem/yr per μCi/sec

NUCLIDE	BONE	LIVER	T BODY	THYROID	KIDNEY	LUNG	GI-LLI	SKIN
I-135	1.91E-17	3.43E-17	1.62E-17	3.04E-15	5.26E-17	0.00E+00	2.61E-17	0.00E+00
CS-134M	1.13E-47	1.67E-47	1.09E-47	0.00E+00	8.82E-48	1.46E-48	2.12E-47	0.00E+00
CS-134	4.80E+08	7.88E+08	1.66E+08	0.00E+00	2.44E+08	8.76E+07	4.25E+06	0.00E+00
CS-135	1.83E+08	1.28E+08	1.31E+07	0.00E+00	4.51E+07	1.50E+07	9.56E+05	0.00E+00
CS-136	4.78E+06	1.31E+07	8.50E+06	0.00E+00	6.99E+06	1.04E+06	4.62E+05	0.00E+00
CS-137	7.18E+08	6.88E+08	1.02E+08	0.00E+00	2.24E+08	8.06E+07	4.31E+06	0.00E+00
CS-138	0.00E+00	0.00E+00	0.00E+00	0.00E+00	0.00E+00	0.00E+00	0.00E+00	0.00E+00
CS-139	0.00E+00	0.00E+00	0.00E+00	0.00E+00	0.00E+00	0.00E+00	0.00E+00	0.00E+00
BA-139	5.78E-102	3.09E-105	1.68E-103	0.00E+00	2.70E-105	1.82E-105	3.34E-100	0.00E+00
BA-140	1.29E+07	1.13E+04	7.53E+05	0.00E+00	3.68E+03	6.74E+03	6.54E+06	0.00E+00
BA-141	0.00E+00	0.00E+00	0.00E+00	0.00E+00	0.00E+00	0.00E+00	0.00E+00	0.00E+00
BA-142	0.00E+00	0.00E+00	0.00E+00	0.00E+00	0.00E+00	0.00E+00	0.00E+00	0.00E+00
LA-140	1.63E-02	5.71E-03	1.93E-03	0.00E+00	0.00E+00	0.00E+00	1.59E+02	0.00E+00
LA-141	1.81E-37	4.22E-38	9.17E-39	0.00E+00	0.00E+00	0.00E+00	9.39E-33	0.00E+00
LA-142	1.54E-92	4.90E-93	1.53E-93	0.00E+00	0.00E+00	0.00E+00	9.71E-88	0.00E+00
CE-141	7.30E+03	3.64E+03	5.41E+02	0.00E+00	1.60E+03	0.00E+00	4.54E+06	0.00E+00
CE-143	9.27E-03	5.03E+00	7.28E-04	0.00E+00	2.11E-03	0.00E+00	7.36E+01	0.00E+00
CE-144	1.14E+06	3.57E+05	6.07E+04	0.00E+00	1.97E+05	0.00E+00	9.30E+07	0.00E+00
PR-143	9.85E+03	2.96E+03	4.89E+02	0.00E+00	1.60E+03	0.00E+00	1.06E+07	0.00E+00
PR-144	0.00E+00	0.00E+00	0.00E+00	0.00E+00	0.00E+00	0.00E+00	0.00E+00	0.00E+00
ND-147	3.43E+03	2.78E+03	2.15E+02	0.00E+00	1.52E+03	0.00E+00	4.40E+06	0.00E+00
PM-147	7.95E+05	5.67E+04	3.05E+04	0.00E+00	1.00E+05	0.00E+00	2.30E+07	0.00E+00
PM-148M	9.36E+04	1.86E+04	1.86E+04	0.00E+00	2.76E+04	0.00E+00	5.25E+07	0.00E+00
PM-148	9.06E+02	1.09E+02	7.05E+01	0.00E+00	1.85E+02	0.00E+00	2.91E+06	0.00E+00
PM-149	2.39E+00	2.54E-01	1.38E-01	0.00E+00	4.50E-01	0.00E+00	1.74E+04	0.00E+00
PM-151	2.63E-03	3.20E-04	2.08E-04	0.00E+00	5.43E-04	0.00E+00	3.63E+01	0.00E+00
SM-151	7.05E+05	1.05E+05	3.31E+04	0.00E+00	1.09E+05	0.00E+00	1.52E+07	0.00E+00
SM-153	5.32E-01	3.31E-01	3.19E-02	0.00E+00	1.01E-01	0.00E+00	4.40E+03	0.00E+00
EU-152	1.61E+06	2.93E+05	3.48E+05	0.00E+00	1.24E+06	0.00E+00	4.82E+07	0.00E+00
EU-154	5.99E+06	5.39E+05	4.92E+05	0.00E+00	2.37E+06	0.00E+00	1.25E+08	0.00E+00
EU-155	1.24E+06	8.92E+04	6.99E+04	0.00E+00	3.34E+05	0.00E+00	2.23E+08	0.00E+00
EU-156	1.71E+04	9.14E+03	1.89E+03	0.00E+00	5.89E+03	0.00E+00	2.07E+07	0.00E+00
TB-160	2.05E+05	0.00E+00	2.54E+04	0.00E+00	6.10E+04	0.00E+00	4.54E+07	0.00E+00
HO-166M	2.62E+06	5.49E+05	4.64E+05	0.00E+00	7.82E+05	0.00E+00	6.39E+07	0.00E+00
W-181	1.98E+04	4.86E+03	6.69E+02	0.00E+00	0.00E+00	0.00E+00	1.77E+05	0.00E+00
W-185	6.45E+05	1.61E+05	2.26E+04	0.00E+00	0.00E+00	0.00E+00	6.00E+06	0.00E+00
W-187	9.39E-03	5.56E-03	2.49E-03	0.00E+00	0.00E+00	0.00E+00	7.81E-01	0.00E+00
U-232	3.30E+09	0.00E+00	2.36E+08	0.00E+00	2.51E+08	0.00E+00	1.31E+07	0.00E+00
U-233	6.98E+08	0.00E+00	4.22E+07	0.00E+00	1.15E+08	0.00E+00	1.21E+07	0.00E+00
U-234	6.70E+08	0.00E+00	4.15E+07	0.00E+00	1.12E+08	0.00E+00	1.19E+07	0.00E+00
U-235	6.42E+08	0.00E+00	3.89E+07	0.00E+00	1.05E+08	0.00E+00	1.51E+07	0.00E+00
U-236	6.42E+08	0.00E+00	3.98E+07	0.00E+00	1.08E+08	0.00E+00	1.11E+07	0.00E+00

TABLE II2-16

R_i DOSE FACTORS AGE: CHILD PATHWAY: MEATm²-mrem/yr per μ Ci/sec

NUCLIDE	BONE	LIVER	T BODY	THYROID	KIDNEY	LUNG	GI-LLI	SKIN
U-237	9.99E+02	0.00E+00	2.65E+02	0.00E+00	2.88E+03	0.00E+00	8.80E+04	0.00E+00
U-238	6.14E+08	0.00E+00	3.64E+07	0.00E+00	9.84E+07	0.00E+00	1.06E+07	0.00E+00
NP-237	2.46E+08	1.62E+07	1.08E+07	0.00E+00	6.68E+07	0.00E+00	9.01E+06	0.00E+00
NP-238	6.51E-01	1.32E-02	1.01E-02	0.00E+00	4.20E-02	0.00E+00	4.51E+02	0.00E+00
NP-239	1.25E-01	8.95E-03	6.29E-03	0.00E+00	2.59E-02	0.00E+00	6.62E+02	0.00E+00
PU-238	9.18E+06	1.06E+06	2.44E+05	0.00E+00	8.87E+05	0.00E+00	5.79E+05	0.00E+00
PU-239	9.97E+06	1.07E+06	2.56E+05	0.00E+00	9.43E+05	0.00E+00	5.29E+05	0.00E+00
PU-240	9.89E+06	1.11E+06	2.56E+05	0.00E+00	9.43E+05	0.00E+00	5.40E+05	0.00E+00
PU-241	2.96E+05	1.21E+04	6.15E+03	0.00E+00	2.26E+04	0.00E+00	1.10E+04	0.00E+00
PU-242	9.20E+06	1.07E+06	2.47E+05	0.00E+00	9.04E+05	0.00E+00	5.19E+05	0.00E+00
PU-244	1.07E+07	1.22E+07	2.82E+05	0.00E+00	1.04E+06	0.00E+00	7.73E+05	0.00E+00
AM-241	1.50E+08	1.29E+08	1.13E+07	0.00E+00	6.88E+07	0.00E+00	8.43E+06	0.00E+00
AM-242M	1.54E+08	1.24E+08	1.15E+07	0.00E+00	6.95E+07	0.00E+00	1.06E+07	0.00E+00
AM-243	1.48E+08	1.25E+08	1.09E+07	0.00E+00	6.69E+07	0.00E+00	9.88E+06	0.00E+00
CM-242	7.01E+06	5.59E+06	4.66E+05	0.00E+00	1.49E+06	0.00E+00	6.51E+06	0.00E+00
CM-243	1.41E+08	1.14E+08	9.05E+06	0.00E+00	3.38E+07	0.00E+00	8.82E+06	0.00E+00
CM-244	1.18E+08	9.57E+07	7.59E+06	0.00E+00	2.78E+07	0.00E+00	8.51E+06	0.00E+00
CM-245	1.84E+08	1.48E+08	1.16E+07	0.00E+00	4.54E+07	0.00E+00	7.99E+06	0.00E+00
CM-246	1.82E+08	1.48E+08	1.16E+07	0.00E+00	4.53E+07	0.00E+00	7.85E+06	0.00E+00
CM-247	1.78E+08	1.46E+08	1.14E+07	0.00E+00	4.46E+07	0.00E+00	1.03E+07	0.00E+00
CM-248	1.48E+09	1.20E+09	9.41E+07	0.00E+00	3.68E+08	0.00E+00	1.67E+08	0.00E+00
CF-252	1.09E+08	0.00E+00	2.65E+06	0.00E+00	0.00E+00	0.00E+00	3.08E+07	0.00E+00

TABLE II2-17

R_i DOSE FACTORS AGE: INFANT PATHWAY: MEATm²-mrem/yr per μ Ci/sec

NUCLIDE	BONE	LIVER	T BODY	THYROID	KIDNEY	LUNG	GI-LLI	SKIN
H-3	0.00E+00	0.00E+00	0.00E+00	0.00E+00	0.00E+00	0.00E+00	0.00E+00	0.00E+00
C-14	0.00E+00	0.00E+00	0.00E+00	0.00E+00	0.00E+00	0.00E+00	0.00E+00	0.00E+00
NA-22	0.00E+00	0.00E+00	0.00E+00	0.00E+00	0.00E+00	0.00E+00	0.00E+00	0.00E+00
NA-24	0.00E+00	0.00E+00	0.00E+00	0.00E+00	0.00E+00	0.00E+00	0.00E+00	0.00E+00
P-32	0.00E+00	0.00E+00	0.00E+00	0.00E+00	0.00E+00	0.00E+00	0.00E+00	0.00E+00
CA-41	0.00E+00	0.00E+00	0.00E+00	0.00E+00	0.00E+00	0.00E+00	0.00E+00	0.00E+00
SC-46	0.00E+00	0.00E+00	0.00E+00	0.00E+00	0.00E+00	0.00E+00	0.00E+00	0.00E+00
CR-51	0.00E+00	0.00E+00	0.00E+00	0.00E+00	0.00E+00	0.00E+00	0.00E+00	0.00E+00
MN-54	0.00E+00	0.00E+00	0.00E+00	0.00E+00	0.00E+00	0.00E+00	0.00E+00	0.00E+00
MN-56	0.00E+00	0.00E+00	0.00E+00	0.00E+00	0.00E+00	0.00E+00	0.00E+00	0.00E+00
FE-55	0.00E+00	0.00E+00	0.00E+00	0.00E+00	0.00E+00	0.00E+00	0.00E+00	0.00E+00
FE-59	0.00E+00	0.00E+00	0.00E+00	0.00E+00	0.00E+00	0.00E+00	0.00E+00	0.00E+00
CO-57	0.00E+00	0.00E+00	0.00E+00	0.00E+00	0.00E+00	0.00E+00	0.00E+00	0.00E+00
CO-58	0.00E+00	0.00E+00	0.00E+00	0.00E+00	0.00E+00	0.00E+00	0.00E+00	0.00E+00
CO-60	0.00E+00	0.00E+00	0.00E+00	0.00E+00	0.00E+00	0.00E+00	0.00E+00	0.00E+00
NI-59	0.00E+00	0.00E+00	0.00E+00	0.00E+00	0.00E+00	0.00E+00	0.00E+00	0.00E+00
NI-63	0.00E+00	0.00E+00	0.00E+00	0.00E+00	0.00E+00	0.00E+00	0.00E+00	0.00E+00
NI-65	0.00E+00	0.00E+00	0.00E+00	0.00E+00	0.00E+00	0.00E+00	0.00E+00	0.00E+00
CU-64	0.00E+00	0.00E+00	0.00E+00	0.00E+00	0.00E+00	0.00E+00	0.00E+00	0.00E+00
ZN-65	0.00E+00	0.00E+00	0.00E+00	0.00E+00	0.00E+00	0.00E+00	0.00E+00	0.00E+00
ZN-69M	0.00E+00	0.00E+00	0.00E+00	0.00E+00	0.00E+00	0.00E+00	0.00E+00	0.00E+00
ZN-69	0.00E+00	0.00E+00	0.00E+00	0.00E+00	0.00E+00	0.00E+00	0.00E+00	0.00E+00
SE-79	0.00E+00	0.00E+00	0.00E+00	0.00E+00	0.00E+00	0.00E+00	0.00E+00	0.00E+00
BR-82	0.00E+00	0.00E+00	0.00E+00	0.00E+00	0.00E+00	0.00E+00	0.00E+00	0.00E+00
BR-83	0.00E+00	0.00E+00	0.00E+00	0.00E+00	0.00E+00	0.00E+00	0.00E+00	0.00E+00
BR-84	0.00E+00	0.00E+00	0.00E+00	0.00E+00	0.00E+00	0.00E+00	0.00E+00	0.00E+00
BR-85	0.00E+00	0.00E+00	0.00E+00	0.00E+00	0.00E+00	0.00E+00	0.00E+00	0.00E+00
RB-86	0.00E+00	0.00E+00	0.00E+00	0.00E+00	0.00E+00	0.00E+00	0.00E+00	0.00E+00
RB-87	0.00E+00	0.00E+00	0.00E+00	0.00E+00	0.00E+00	0.00E+00	0.00E+00	0.00E+00
RB-88	0.00E+00	0.00E+00	0.00E+00	0.00E+00	0.00E+00	0.00E+00	0.00E+00	0.00E+00
RB-89	0.00E+00	0.00E+00	0.00E+00	0.00E+00	0.00E+00	0.00E+00	0.00E+00	0.00E+00
SR-89	0.00E+00	0.00E+00	0.00E+00	0.00E+00	0.00E+00	0.00E+00	0.00E+00	0.00E+00
SR-90	0.00E+00	0.00E+00	0.00E+00	0.00E+00	0.00E+00	0.00E+00	0.00E+00	0.00E+00
SR-91	0.00E+00	0.00E+00	0.00E+00	0.00E+00	0.00E+00	0.00E+00	0.00E+00	0.00E+00
SR-92	0.00E+00	0.00E+00	0.00E+00	0.00E+00	0.00E+00	0.00E+00	0.00E+00	0.00E+00
Y-90	0.00E+00	0.00E+00	0.00E+00	0.00E+00	0.00E+00	0.00E+00	0.00E+00	0.00E+00
Y-91M	0.00E+00	0.00E+00	0.00E+00	0.00E+00	0.00E+00	0.00E+00	0.00E+00	0.00E+00
Y-91	0.00E+00	0.00E+00	0.00E+00	0.00E+00	0.00E+00	0.00E+00	0.00E+00	0.00E+00
Y-92	0.00E+00	0.00E+00	0.00E+00	0.00E+00	0.00E+00	0.00E+00	0.00E+00	0.00E+00
Y-93	0.00E+00	0.00E+00	0.00E+00	0.00E+00	0.00E+00	0.00E+00	0.00E+00	0.00E+00
ZR-93	0.00E+00	0.00E+00	0.00E+00	0.00E+00	0.00E+00	0.00E+00	0.00E+00	0.00E+00
ZR-95	0.00E+00	0.00E+00	0.00E+00	0.00E+00	0.00E+00	0.00E+00	0.00E+00	0.00E+00
ZR-97	0.00E+00	0.00E+00	0.00E+00	0.00E+00	0.00E+00	0.00E+00	0.00E+00	0.00E+00
NB-93M	0.00E+00	0.00E+00	0.00E+00	0.00E+00	0.00E+00	0.00E+00	0.00E+00	0.00E+00
NB-95	0.00E+00	0.00E+00	0.00E+00	0.00E+00	0.00E+00	0.00E+00	0.00E+00	0.00E+00

TABLE II-17

R_i DOSE FACTORS AGE: INFANT PATHWAY: MEATm²-mrem/yr per μ Ci/sec

NUCLIDE	BONE	LIVER	T BODY	THYROID	KIDNEY	LUNG	GI-LLI	SKIN
NB-97	0.00E+00	0.00E+00	0.00E+00	0.00E+00	0.00E+00	0.00E+00	0.00E+00	0.00E+00
MO-93	0.00E+00	0.00E+00	0.00E+00	0.00E+00	0.00E+00	0.00E+00	0.00E+00	0.00E+00
MO-99	0.00E+00	0.00E+00	0.00E+00	0.00E+00	0.00E+00	0.00E+00	0.00E+00	0.00E+00
TC-99M	0.00E+00	0.00E+00	0.00E+00	0.00E+00	0.00E+00	0.00E+00	0.00E+00	0.00E+00
TC-99	0.00E+00	0.00E+00	0.00E+00	0.00E+00	0.00E+00	0.00E+00	0.00E+00	0.00E+00
TC-101	0.00E+00	0.00E+00	0.00E+00	0.00E+00	0.00E+00	0.00E+00	0.00E+00	0.00E+00
RU-103	0.00E+00	0.00E+00	0.00E+00	0.00E+00	0.00E+00	0.00E+00	0.00E+00	0.00E+00
RU-105	0.00E+00	0.00E+00	0.00E+00	0.00E+00	0.00E+00	0.00E+00	0.00E+00	0.00E+00
RU-106	0.00E+00	0.00E+00	0.00E+00	0.00E+00	0.00E+00	0.00E+00	0.00E+00	0.00E+00
RH-105	0.00E+00	0.00E+00	0.00E+00	0.00E+00	0.00E+00	0.00E+00	0.00E+00	0.00E+00
PD-107	0.00E+00	0.00E+00	0.00E+00	0.00E+00	0.00E+00	0.00E+00	0.00E+00	0.00E+00
PD-109	0.00E+00	0.00E+00	0.00E+00	0.00E+00	0.00E+00	0.00E+00	0.00E+00	0.00E+00
AG-110M	0.00E+00	0.00E+00	0.00E+00	0.00E+00	0.00E+00	0.00E+00	0.00E+00	0.00E+00
AG-111	0.00E+00	0.00E+00	0.00E+00	0.00E+00	0.00E+00	0.00E+00	0.00E+00	0.00E+00
CD-113M	0.00E+00	0.00E+00	0.00E+00	0.00E+00	0.00E+00	0.00E+00	0.00E+00	0.00E+00
CD-115M	0.00E+00	0.00E+00	0.00E+00	0.00E+00	0.00E+00	0.00E+00	0.00E+00	0.00E+00
SN-123	0.00E+00	0.00E+00	0.00E+00	0.00E+00	0.00E+00	0.00E+00	0.00E+00	0.00E+00
SN-125	0.00E+00	0.00E+00	0.00E+00	0.00E+00	0.00E+00	0.00E+00	0.00E+00	0.00E+00
SN-126	0.00E+00	0.00E+00	0.00E+00	0.00E+00	0.00E+00	0.00E+00	0.00E+00	0.00E+00
SB-124	0.00E+00	0.00E+00	0.00E+00	0.00E+00	0.00E+00	0.00E+00	0.00E+00	0.00E+00
SB-125	0.00E+00	0.00E+00	0.00E+00	0.00E+00	0.00E+00	0.00E+00	0.00E+00	0.00E+00
SB-126	0.00E+00	0.00E+00	0.00E+00	0.00E+00	0.00E+00	0.00E+00	0.00E+00	0.00E+00
SB-127	0.00E+00	0.00E+00	0.00E+00	0.00E+00	0.00E+00	0.00E+00	0.00E+00	0.00E+00
TE-125M	0.00E+00	0.00E+00	0.00E+00	0.00E+00	0.00E+00	0.00E+00	0.00E+00	0.00E+00
TE-127M	0.00E+00	0.00E+00	0.00E+00	0.00E+00	0.00E+00	0.00E+00	0.00E+00	0.00E+00
TE-127	0.00E+00	0.00E+00	0.00E+00	0.00E+00	0.00E+00	0.00E+00	0.00E+00	0.00E+00
TE-129M	0.00E+00	0.00E+00	0.00E+00	0.00E+00	0.00E+00	0.00E+00	0.00E+00	0.00E+00
TE-129	0.00E+00	0.00E+00	0.00E+00	0.00E+00	0.00E+00	0.00E+00	0.00E+00	0.00E+00
TE-131M	0.00E+00	0.00E+00	0.00E+00	0.00E+00	0.00E+00	0.00E+00	0.00E+00	0.00E+00
TE-131	0.00E+00	0.00E+00	0.00E+00	0.00E+00	0.00E+00	0.00E+00	0.00E+00	0.00E+00
TE-132	0.00E+00	0.00E+00	0.00E+00	0.00E+00	0.00E+00	0.00E+00	0.00E+00	0.00E+00
TE-133M	0.00E+00	0.00E+00	0.00E+00	0.00E+00	0.00E+00	0.00E+00	0.00E+00	0.00E+00
TE-134	0.00E+00	0.00E+00	0.00E+00	0.00E+00	0.00E+00	0.00E+00	0.00E+00	0.00E+00
I-129	0.00E+00	0.00E+00	0.00E+00	0.00E+00	0.00E+00	0.00E+00	0.00E+00	0.00E+00
I-130	0.00E+00	0.00E+00	0.00E+00	0.00E+00	0.00E+00	0.00E+00	0.00E+00	0.00E+00
I-131	0.00E+00	0.00E+00	0.00E+00	0.00E+00	0.00E+00	0.00E+00	0.00E+00	0.00E+00
I-132	0.00E+00	0.00E+00	0.00E+00	0.00E+00	0.00E+00	0.00E+00	0.00E+00	0.00E+00
I-133	0.00E+00	0.00E+00	0.00E+00	0.00E+00	0.00E+00	0.00E+00	0.00E+00	0.00E+00
I-134	0.00E+00	0.00E+00	0.00E+00	0.00E+00	0.00E+00	0.00E+00	0.00E+00	0.00E+00
I-135	0.00E+00	0.00E+00	0.00E+00	0.00E+00	0.00E+00	0.00E+00	0.00E+00	0.00E+00
CS-134M	0.00E+00	0.00E+00	0.00E+00	0.00E+00	0.00E+00	0.00E+00	0.00E+00	0.00E+00
CS-134	0.00E+00	0.00E+00	0.00E+00	0.00E+00	0.00E+00	0.00E+00	0.00E+00	0.00E+00
CS-135	0.00E+00	0.00E+00	0.00E+00	0.00E+00	0.00E+00	0.00E+00	0.00E+00	0.00E+00
CS-136	0.00E+00	0.00E+00	0.00E+00	0.00E+00	0.00E+00	0.00E+00	0.00E+00	0.00E+00
CS-137	0.00E+00	0.00E+00	0.00E+00	0.00E+00	0.00E+00	0.00E+00	0.00E+00	0.00E+00

TABLE II-17

R_i DOSE FACTORS AGE: INFANT PATHWAY: MEATm²-mrem/yr per μ Ci/sec

NUCLIDE	BONE	LIVER	T BODY	THYROID	KIDNEY	LUNG	GI-LLI	SKIN
CS-138	0.00E+00	0.00E+00	0.00E+00	0.00E+00	0.00E+00	0.00E+00	0.00E+00	0.00E+00
CS-139	0.00E+00	0.00E+00	0.00E+00	0.00E+00	0.00E+00	0.00E+00	0.00E+00	0.00E+00
BA-139	0.00E+00	0.00E+00	0.00E+00	0.00E+00	0.00E+00	0.00E+00	0.00E+00	0.00E+00
BA-140	0.00E+00	0.00E+00	0.00E+00	0.00E+00	0.00E+00	0.00E+00	0.00E+00	0.00E+00
BA-141	0.00E+00	0.00E+00	0.00E+00	0.00E+00	0.00E+00	0.00E+00	0.00E+00	0.00E+00
BA-142	0.00E+00	0.00E+00	0.00E+00	0.00E+00	0.00E+00	0.00E+00	0.00E+00	0.00E+00
LA-140	0.00E+00	0.00E+00	0.00E+00	0.00E+00	0.00E+00	0.00E+00	0.00E+00	0.00E+00
LA-141	0.00E+00	0.00E+00	0.00E+00	0.00E+00	0.00E+00	0.00E+00	0.00E+00	0.00E+00
LA-142	0.00E+00	0.00E+00	0.00E+00	0.00E+00	0.00E+00	0.00E+00	0.00E+00	0.00E+00
CE-141	0.00E+00	0.00E+00	0.00E+00	0.00E+00	0.00E+00	0.00E+00	0.00E+00	0.00E+00
CE-143	0.00E+00	0.00E+00	0.00E+00	0.00E+00	0.00E+00	0.00E+00	0.00E+00	0.00E+00
PR-143	0.00E+00	0.00E+00	0.00E+00	0.00E+00	0.00E+00	0.00E+00	0.00E+00	0.00E+00
CE-144	0.00E+00	0.00E+00	0.00E+00	0.00E+00	0.00E+00	0.00E+00	0.00E+00	0.00E+00
PR-144	0.00E+00	0.00E+00	0.00E+00	0.00E+00	0.00E+00	0.00E+00	0.00E+00	0.00E+00
ND-147	0.00E+00	0.00E+00	0.00E+00	0.00E+00	0.00E+00	0.00E+00	0.00E+00	0.00E+00
PM-147	0.00E+00	0.00E+00	0.00E+00	0.00E+00	0.00E+00	0.00E+00	0.00E+00	0.00E+00
PM-148M	0.00E+00	0.00E+00	0.00E+00	0.00E+00	0.00E+00	0.00E+00	0.00E+00	0.00E+00
PM-148	0.00E+00	0.00E+00	0.00E+00	0.00E+00	0.00E+00	0.00E+00	0.00E+00	0.00E+00
PM-149	0.00E+00	0.00E+00	0.00E+00	0.00E+00	0.00E+00	0.00E+00	0.00E+00	0.00E+00
PM-151	0.00E+00	0.00E+00	0.00E+00	0.00E+00	0.00E+00	0.00E+00	0.00E+00	0.00E+00
SM-151	0.00E+00	0.00E+00	0.00E+00	0.00E+00	0.00E+00	0.00E+00	0.00E+00	0.00E+00
SM-153	0.00E+00	0.00E+00	0.00E+00	0.00E+00	0.00E+00	0.00E+00	0.00E+00	0.00E+00
EU-152	0.00E+00	0.00E+00	0.00E+00	0.00E+00	0.00E+00	0.00E+00	0.00E+00	0.00E+00
EU-154	0.00E+00	0.00E+00	0.00E+00	0.00E+00	0.00E+00	0.00E+00	0.00E+00	0.00E+00
EU-155	0.00E+00	0.00E+00	0.00E+00	0.00E+00	0.00E+00	0.00E+00	0.00E+00	0.00E+00
EU-156	0.00E+00	0.00E+00	0.00E+00	0.00E+00	0.00E+00	0.00E+00	0.00E+00	0.00E+00
TB-160	0.00E+00	0.00E+00	0.00E+00	0.00E+00	0.00E+00	0.00E+00	0.00E+00	0.00E+00
HO-166M	0.00E+00	0.00E+00	0.00E+00	0.00E+00	0.00E+00	0.00E+00	0.00E+00	0.00E+00
W-181	0.00E+00	0.00E+00	0.00E+00	0.00E+00	0.00E+00	0.00E+00	0.00E+00	0.00E+00
W-185	0.00E+00	0.00E+00	0.00E+00	0.00E+00	0.00E+00	0.00E+00	0.00E+00	0.00E+00
W-187	0.00E+00	0.00E+00	0.00E+00	0.00E+00	0.00E+00	0.00E+00	0.00E+00	0.00E+00
U-232	0.00E+00	0.00E+00	0.00E+00	0.00E+00	0.00E+00	0.00E+00	0.00E+00	0.00E+00
U-233	0.00E+00	0.00E+00	0.00E+00	0.00E+00	0.00E+00	0.00E+00	0.00E+00	0.00E+00
U-234	0.00E+00	0.00E+00	0.00E+00	0.00E+00	0.00E+00	0.00E+00	0.00E+00	0.00E+00
U-235	0.00E+00	0.00E+00	0.00E+00	0.00E+00	0.00E+00	0.00E+00	0.00E+00	0.00E+00
U-236	0.00E+00	0.00E+00	0.00E+00	0.00E+00	0.00E+00	0.00E+00	0.00E+00	0.00E+00
U-237	0.00E+00	0.00E+00	0.00E+00	0.00E+00	0.00E+00	0.00E+00	0.00E+00	0.00E+00
U-238	0.00E+00	0.00E+00	0.00E+00	0.00E+00	0.00E+00	0.00E+00	0.00E+00	0.00E+00
NP-237	0.00E+00	0.00E+00	0.00E+00	0.00E+00	0.00E+00	0.00E+00	0.00E+00	0.00E+00
NP-238	0.00E+00	0.00E+00	0.00E+00	0.00E+00	0.00E+00	0.00E+00	0.00E+00	0.00E+00
NP-239	0.00E+00	0.00E+00	0.00E+00	0.00E+00	0.00E+00	0.00E+00	0.00E+00	0.00E+00
PU-238	0.00E+00	0.00E+00	0.00E+00	0.00E+00	0.00E+00	0.00E+00	0.00E+00	0.00E+00
PU-239	0.00E+00	0.00E+00	0.00E+00	0.00E+00	0.00E+00	0.00E+00	0.00E+00	0.00E+00
PU-240	0.00E+00	0.00E+00	0.00E+00	0.00E+00	0.00E+00	0.00E+00	0.00E+00	0.00E+00
PU-241	0.00E+00	0.00E+00	0.00E+00	0.00E+00	0.00E+00	0.00E+00	0.00E+00	0.00E+00

TABLE II2-17

R_i DOSE FACTORS AGE: INFANT PATHWAY: MEATm²-mrem/yr per μ Ci/sec

NUCLIDE	BONE	LIVER	T BODY	THYROID	KIDNEY	LUNG	GI-LLI	SKIN
PU-242	0.00E+00	0.00E+00	0.00E+00	0.00E+00	0.00E+00	0.00E+00	0.00E+00	0.00E+00
PU-244	0.00E+00	0.00E+00	0.00E+00	0.00E+00	0.00E+00	0.00E+00	0.00E+00	0.00E+00
AM-241	0.00E+00	0.00E+00	0.00E+00	0.00E+00	0.00E+00	0.00E+00	0.00E+00	0.00E+00
AM-242M	0.00E+00	0.00E+00	0.00E+00	0.00E+00	0.00E+00	0.00E+00	0.00E+00	0.00E+00
AM-243	0.00E+00	0.00E+00	0.00E+00	0.00E+00	0.00E+00	0.00E+00	0.00E+00	0.00E+00
CM-242	0.00E+00	0.00E+00	0.00E+00	0.00E+00	0.00E+00	0.00E+00	0.00E+00	0.00E+00
CM-243	0.00E+00	0.00E+00	0.00E+00	0.00E+00	0.00E+00	0.00E+00	0.00E+00	0.00E+00
CM-244	0.00E+00	0.00E+00	0.00E+00	0.00E+00	0.00E+00	0.00E+00	0.00E+00	0.00E+00
CM-245	0.00E+00	0.00E+00	0.00E+00	0.00E+00	0.00E+00	0.00E+00	0.00E+00	0.00E+00
CM-246	0.00E+00	0.00E+00	0.00E+00	0.00E+00	0.00E+00	0.00E+00	0.00E+00	0.00E+00
CM-247	0.00E+00	0.00E+00	0.00E+00	0.00E+00	0.00E+00	0.00E+00	0.00E+00	0.00E+00
CM-248	0.00E+00	0.00E+00	0.00E+00	0.00E+00	0.00E+00	0.00E+00	0.00E+00	0.00E+00
CF-252	0.00E+00	0.00E+00	0.00E+00	0.00E+00	0.00E+00	0.00E+00	0.00E+00	0.00E+00

TABLE I12-18

R_i DOSE FACTORS AGE: ADULT PATHWAY: COW MILKm²-mrem/yr per μCi/sec

NUCLIDE	BONE	LIVER	T BODY	THYROID	KIDNEY	LUNG	GI-LLI	SKIN
H-3	0.00E+00	4.35E+02	4.35E+02	4.35E+02	4.35E+02	4.35E+02	4.35E+02	0.00E+00
C-14	3.63E+05	7.26E+04	7.26E+04	7.26E+04	7.26E+04	7.26E+04	7.26E+04	0.00E+00
NA-22	2.78E+09	2.78E+09	2.78E+09	2.78E+09	2.78E+09	2.78E+09	2.78E+09	0.00E+00
NA-24	7.13E+05	7.13E+05	7.13E+05	7.13E+05	7.13E+05	7.13E+05	7.13E+05	0.00E+00
P-32	5.05E+09	3.14E+08	1.95E+08	0.00E+00	0.00E+00	0.00E+00	5.68E+08	0.00E+00
CA-41	6.18E+09	0.00E+00	6.68E+08	0.00E+00	0.00E+00	0.00E+00	6.14E+06	0.00E+00
SC-46	7.36E+01	1.43E+02	4.15E+01	0.00E+00	1.33E+02	0.00E+00	6.96E+05	0.00E+00
CR-51	0.00E+00	0.00E+00	9.10E+03	5.44E+03	2.01E+03	1.21E+04	2.29E+06	0.00E+00
MN-54	0.00E+00	4.17E+06	7.95E+05	0.00E+00	1.24E+06	0.00E+00	1.28E+07	0.00E+00
MN-56	0.00E+00	1.21E-03	2.15E-04	0.00E+00	1.54E-03	0.00E+00	3.87E-02	0.00E+00
FE-55	1.32E+07	9.11E+06	2.12E+06	0.00E+00	0.00E+00	5.08E+06	5.23E+06	0.00E+00
FE-59	1.05E+07	2.47E+07	9.46E+06	0.00E+00	0.00E+00	6.90E+06	8.23E+07	0.00E+00
CO-57	0.00E+00	6.26E+05	1.04E+06	0.00E+00	0.00E+00	0.00E+00	1.59E+07	0.00E+00
CO-58	0.00E+00	1.86E+06	4.17E+06	0.00E+00	0.00E+00	0.00E+00	3.77E+07	0.00E+00
CO-60	0.00E+00	8.73E+06	1.93E+07	0.00E+00	0.00E+00	0.00E+00	1.64E+08	0.00E+00
NI-59	2.73E+08	9.37E+07	4.56E+07	0.00E+00	0.00E+00	0.00E+00	1.93E+07	0.00E+00
NI-63	3.63E+09	2.52E+08	1.22E+08	0.00E+00	0.00E+00	0.00E+00	5.25E+07	0.00E+00
NI-65	1.08E-01	1.41E-02	6.41E-03	0.00E+00	0.00E+00	0.00E+00	3.57E-01	0.00E+00
CU-64	0.00E+00	6.97E+03	3.27E+03	0.00E+00	1.76E+04	0.00E+00	5.94E+05	0.00E+00
ZN-65	6.64E+08	2.11E+09	9.56E+08	0.00E+00	1.41E+09	0.00E+00	1.33E+09	0.00E+00
ZN-69M	5.23E+04	1.26E+05	1.15E+04	0.00E+00	7.60E+04	0.00E+00	7.67E+06	0.00E+00
ZN-69	6.12E-13	1.17E-12	8.14E-14	0.00E+00	7.60E-13	0.00E+00	1.76E-13	0.00E+00
SE-79	0.00E+00	4.94E+08	8.25E+07	0.00E+00	8.55E+08	0.00E+00	1.01E+08	0.00E+00
BR-82	0.00E+00	0.00E+00	9.45E+06	0.00E+00	0.00E+00	0.00E+00	1.08E+07	0.00E+00
BR-83	0.00E+00	0.00E+00	2.84E-02	0.00E+00	0.00E+00	0.00E+00	4.09E-02	0.00E+00
BR-84	0.00E+00	0.00E+00	4.71E-24	0.00E+00	0.00E+00	0.00E+00	3.69E-29	0.00E+00
BR-85	0.00E+00	0.00E+00	0.00E+00	0.00E+00	0.00E+00	0.00E+00	0.00E+00	0.00E+00
RB-86	0.00E+00	7.82E+08	3.64E+08	0.00E+00	0.00E+00	0.00E+00	1.54E+08	0.00E+00
RB-87	0.00E+00	1.54E+09	5.36E+08	0.00E+00	0.00E+00	0.00E+00	7.21E+07	0.00E+00
RB-88	0.00E+00	6.26E-46	3.32E-46	0.00E+00	0.00E+00	0.00E+00	8.64E-57	0.00E+00
RB-89	0.00E+00	1.27E-53	8.91E-54	0.00E+00	0.00E+00	0.00E+00	7.36E-67	0.00E+00
SR-89	5.29E+08	0.00E+00	1.52E+07	0.00E+00	0.00E+00	0.00E+00	8.48E+07	0.00E+00
SR-90	2.90E+10	0.00E+00	5.82E+08	0.00E+00	0.00E+00	0.00E+00	7.28E+08	0.00E+00
SR-91	8.46E+03	0.00E+00	3.42E+02	0.00E+00	0.00E+00	0.00E+00	4.03E+04	0.00E+00
SR-92	1.43E-01	0.00E+00	6.18E-03	0.00E+00	0.00E+00	0.00E+00	2.83E+00	0.00E+00
Y-90	2.07E+01	0.00E+00	5.56E-01	0.00E+00	0.00E+00	0.00E+00	2.20E+05	0.00E+00
Y-91M	1.75E-20	0.00E+00	6.78E-22	0.00E+00	0.00E+00	0.00E+00	5.14E-20	0.00E+00
Y-91	3.24E+03	0.00E+00	8.67E+01	0.00E+00	0.00E+00	0.00E+00	1.79E+06	0.00E+00
Y-92	1.63E-05	0.00E+00	4.77E-07	0.00E+00	0.00E+00	0.00E+00	2.86E-01	0.00E+00
Y-93	6.53E-02	0.00E+00	1.80E-03	0.00E+00	0.00E+00	0.00E+00	2.07E+03	0.00E+00
ZR-93	8.72E+02	4.88E+01	2.28E+01	0.00E+00	1.85E+02	0.00E+00	5.07E+04	0.00E+00
ZR-95	3.64E+02	1.17E+02	7.90E+01	0.00E+00	1.83E+02	0.00E+00	3.70E+05	0.00E+00

TABLE I12-18

R_i DOSE FACTORS AGE: ADULT PATHWAY: COW MILKm²-mrem/yr per μ Ci/sec

NUCLIDE	BONE	LIVER	T BODY	THYROID	KIDNEY	LUNG	GI-LLI	SKIN
ZR-97	1.27E-01	2.56E-02	1.17E-02	0.00E+00	3.86E-02	0.00E+00	7.92E+03	0.00E+00
NB-93M	2.64E+05	8.61E+04	2.12E+04	0.00E+00	9.91E+04	0.00E+00	3.97E+07	0.00E+00
NB-95	2.76E+04	1.53E+04	8.25E+03	0.00E+00	1.52E+04	0.00E+00	9.32E+07	0.00E+00
NB-97	9.62E-13	2.43E-13	8.89E-14	0.00E+00	2.84E-13	0.00E+00	8.98E-10	0.00E+00
MO-93	0.00E+00	2.35E+08	6.36E+06	0.00E+00	6.67E+07	0.00E+00	3.82E+07	0.00E+00
MO-99	0.00E+00	7.25E+06	1.38E+06	0.00E+00	1.64E+07	0.00E+00	1.68E+07	0.00E+00
TC-99M	9.71E-01	2.74E+00	3.50E+01	0.00E+00	4.17E+01	1.34E+00	1.62E+03	0.00E+00
TC-99	1.30E+07	1.94E+07	5.24E+06	0.00E+00	2.44E+08	1.65E+06	6.35E+08	0.00E+00
TC-101	7.58E-61	1.09E-60	1.07E-59	0.00E+00	1.97E-59	5.58E-61	3.28E-72	0.00E+00
RU-103	3.49E+02	0.00E+00	1.51E+02	0.00E+00	1.33E+03	0.00E+00	4.08E+04	0.00E+00
RU-105	2.51E-04	0.00E+00	9.89E-05	0.00E+00	3.24E-03	0.00E+00	1.53E-01	0.00E+00
RU-106	1.02E+04	0.00E+00	1.29E+03	0.00E+00	1.98E+04	0.00E+00	6.62E+05	0.00E+00
RH-105	1.02E+05	7.43E+04	4.89E+04	0.00E+00	3.16E+05	0.00E+00	1.18E+07	0.00E+00
PD-107	0.00E+00	6.14E+06	3.92E+05	0.00E+00	5.51E+07	0.00E+00	3.80E+07	0.00E+00
PD-109	0.00E+00	1.30E+04	2.92E+03	0.00E+00	7.39E+04	0.00E+00	1.43E+06	0.00E+00
AG-110M	2.83E+07	2.61E+07	1.55E+07	0.00E+00	5.14E+07	0.00E+00	1.07E+10	0.00E+00
AG-111	1.90E+06	7.93E+05	3.95E+05	0.00E+00	2.56E+06	0.00E+00	1.46E+09	0.00E+00
CD-113M	0.00E+00	1.58E+06	5.06E+04	0.00E+00	1.74E+06	0.00E+00	1.27E+07	0.00E+00
CD-115M	0.00E+00	4.45E+05	1.42E+04	0.00E+00	3.53E+05	0.00E+00	1.87E+07	0.00E+00
SN-123	2.39E+08	3.95E+06	5.83E+06	3.36E+06	0.00E+00	0.00E+00	4.86E+08	0.00E+00
SN-125	1.66E+07	3.36E+05	7.55E+05	2.78E+05	0.00E+00	0.00E+00	2.08E+08	0.00E+00
SN-126	8.82E+08	1.74E+07	2.50E+07	5.13E+06	0.00E+00	0.00E+00	2.54E+08	0.00E+00
SB-124	9.79E+06	1.85E+05	3.88E+06	2.37E+04	0.00E+00	7.62E+06	2.78E+08	0.00E+00
SB-125	1.07E+07	1.20E+05	2.56E+06	1.09E+04	0.00E+00	8.28E+06	1.18E+08	0.00E+00
SB-126	1.65E+06	3.35E+04	5.94E+05	1.01E+04	0.00E+00	1.01E+06	1.35E+08	0.00E+00
SB-127	1.32E+05	2.88E+03	5.05E+04	1.58E+03	0.00E+00	7.80E+04	3.01E+07	0.00E+00
TE-125M	6.14E+06	2.22E+06	8.23E+05	1.85E+06	2.50E+07	0.00E+00	2.45E+07	0.00E+00
TE-127M	1.98E+07	7.07E+06	2.41E+06	5.06E+06	8.04E+07	0.00E+00	6.63E+07	0.00E+00
TE-127	1.91E+02	6.86E+01	4.13E+01	1.41E+02	7.78E+02	0.00E+00	1.51E+04	0.00E+00
TE-129M	1.99E+07	7.44E+06	3.15E+06	6.85E+06	8.32E+07	0.00E+00	1.00E+08	0.00E+00
TE-129	8.26E-11	3.10E-11	2.01E-11	6.34E-11	3.47E-10	0.00E+00	6.23E-11	0.00E+00
TE-131M	1.06E+05	5.16E+04	4.30E+04	8.18E+04	5.23E+05	0.00E+00	5.13E+06	0.00E+00
TE-131	1.05E-33	4.40E-34	3.33E-34	8.67E-34	4.62E-33	0.00E+00	1.49E-34	0.00E+00
TE-132	7.02E+05	4.54E+05	4.26E+05	5.02E+05	4.38E+06	0.00E+00	2.15E+07	0.00E+00
TE-133M	6.16E-14	3.60E-14	3.46E-14	5.21E-14	3.56E-13	0.00E+00	1.23E-14	0.00E+00
TE-134	2.60E-19	1.70E-19	1.04E-19	2.27E-19	1.65E-18	0.00E+00	2.89E-22	0.00E+00
I-129	4.10E+08	3.52E+08	1.15E+09	9.05E+11	7.56E+08	0.00E+00	5.56E+07	0.00E+00
I-130	1.23E+05	3.62E+05	1.43E+05	3.07E+07	5.66E+05	0.00E+00	3.12E+05	0.00E+00
I-131	8.66E+07	1.24E+08	7.10E+07	4.06E+10	2.12E+08	0.00E+00	3.27E+07	0.00E+00
I-132	4.80E-02	1.29E-01	4.50E-02	4.50E+00	2.05E-01	0.00E+00	2.41E-02	0.00E+00
I-133	1.13E+06	1.97E+06	6.00E+05	2.89E+08	3.44E+06	0.00E+00	1.77E+06	0.00E+00
I-134	5.90E-13	1.60E-12	5.73E-13	2.78E-11	2.55E-12	0.00E+00	1.40E-15	0.00E+00

TABLE I12-18

R_i DOSE FACTORS AGE: ADULT PATHWAY: COW MILKm²-mrem/yr per μ Ci/sec

NUCLIDE	BONE	LIVER	T BODY	THYROID	KIDNEY	LUNG	GI-LLI	SKIN
I-135	3.75E+03	9.83E+03	3.63E+03	6.48E+05	1.58E+04	0.00E+00	1.11E+04	0.00E+00
CS-134M	5.08E-02	1.07E-01	5.46E-02	0.00E+00	5.79E-02	9.13E-03	3.77E-02	0.00E+00
CS-134	2.94E+09	7.00E+09	5.72E+09	0.00E+00	2.27E+09	7.52E+08	1.23E+08	0.00E+00
CS-135	9.77E+08	9.02E+08	4.00E+08	0.00E+00	3.41E+08	1.02E+08	2.11E+07	0.00E+00
CS-136	7.76E+07	3.06E+08	2.20E+08	0.00E+00	1.70E+08	2.34E+07	3.48E+07	0.00E+00
CS-137	3.98E+09	5.44E+09	3.56E+09	0.00E+00	1.85E+09	6.14E+08	1.05E+08	0.00E+00
CS-138	2.64E-24	5.22E-24	2.59E-24	0.00E+00	3.84E-24	3.79E-25	2.23E-29	0.00E+00
CS-139	1.98E-90	2.95E-90	1.08E-90	0.00E+00	2.37E-90	2.15E-91	6.40E-113	0.00E+00
BA-139	1.29E-08	9.21E-12	3.78E-10	0.00E+00	8.61E-12	5.22E-12	2.29E-08	0.00E+00
BA-140	7.91E+06	9.94E+03	5.18E+05	0.00E+00	3.38E+03	5.69E+03	1.63E+07	0.00E+00
BA-141	1.20E-46	9.05E-50	4.04E-48	0.00E+00	8.41E-50	5.14E-50	5.64E-56	0.00E+00
BA-142	7.77E-81	7.99E-84	4.89E-82	0.00E+00	6.75E-84	4.53E-84	1.09E-98	0.00E+00
LA-140	1.32E+00	6.65E-01	1.76E-01	0.00E+00	0.00E+00	0.00E+00	4.88E+04	0.00E+00
LA-141	8.90E-06	2.76E-06	4.52E-07	0.00E+00	0.00E+00	0.00E+00	3.29E-01	0.00E+00
LA-142	5.43E-12	2.47E-12	6.16E-13	0.00E+00	0.00E+00	0.00E+00	1.80E-08	0.00E+00
CE-141	1.59E+03	1.08E+03	1.22E+02	0.00E+00	5.00E+02	0.00E+00	4.12E+06	0.00E+00
CE-143	1.22E+01	8.99E+03	9.95E-01	0.00E+00	3.96E+00	0.00E+00	3.36E+05	0.00E+00
CE-144	1.76E+05	7.35E+04	9.44E+03	0.00E+00	4.36E+04	0.00E+00	5.94E+07	0.00E+00
PR-143	4.66E+01	1.87E+01	2.31E+00	0.00E+00	1.08E+01	0.00E+00	2.04E+05	0.00E+00
PR-144	1.72E-54	7.13E-55	8.73E-56	0.00E+00	4.02E-55	0.00E+00	2.47E-61	0.00E+00
ND-147	2.76E+01	3.19E+01	1.91E+00	0.00E+00	1.87E+01	0.00E+00	1.53E+05	0.00E+00
PM-147	1.50E+03	1.41E+02	5.73E+01	0.00E+00	2.67E+02	0.00E+00	1.78E+05	0.00E+00
PM-148M	2.97E+02	7.70E+01	5.89E+01	0.00E+00	1.16E+02	0.00E+00	6.53E+05	0.00E+00
PM-148	1.74E+01	2.88E+00	1.45E+00	0.00E+00	5.44E+00	0.00E+00	2.26E+05	0.00E+00
PM-149	1.25E+00	1.77E-01	7.23E-02	0.00E+00	3.34E-01	0.00E+00	3.32E+04	0.00E+00
PM-151	1.90E-01	3.19E-02	1.61E-02	0.00E+00	5.70E-02	0.00E+00	8.78E+03	0.00E+00
SM-151	1.44E+03	2.48E+02	5.94E+01	0.00E+00	2.77E+02	0.00E+00	1.09E+05	0.00E+00
SM-153	5.79E-01	4.83E-01	3.53E-02	0.00E+00	1.56E-01	0.00E+00	1.72E+04	0.00E+00
EU-152	4.03E+03	9.19E+02	8.07E+02	0.00E+00	5.69E+03	0.00E+00	5.30E+05	0.00E+00
EU-154	1.27E+04	1.56E+03	1.11E+03	0.00E+00	7.45E+03	0.00E+00	1.13E+06	0.00E+00
EU-155	1.75E+03	2.49E+02	1.60E+02	0.00E+00	1.15E+03	0.00E+00	1.96E+05	0.00E+00
EU-156	7.46E+01	5.77E+01	9.31E+00	0.00E+00	3.85E+01	0.00E+00	3.95E+05	0.00E+00
TB-160	5.93E+02	0.00E+00	7.39E+01	0.00E+00	2.45E+02	0.00E+00	5.46E+05	0.00E+00
HO-166M	5.63E+03	1.76E+03	1.34E+03	0.00E+00	2.63E+03	0.00E+00	5.34E+05	0.00E+00
W-181	1.49E+04	4.87E+03	5.22E+02	0.00E+00	0.00E+00	0.00E+00	5.55E+05	0.00E+00
W-185	5.18E+05	1.73E+05	1.82E+04	0.00E+00	0.00E+00	0.00E+00	2.00E+07	0.00E+00
W-187	1.91E+03	1.59E+03	5.57E+02	0.00E+00	0.00E+00	0.00E+00	5.22E+05	0.00E+00
U-232	8.61E+09	0.00E+00	6.15E+08	0.00E+00	9.31E+08	0.00E+00	1.41E+08	0.00E+00
U-233	1.82E+09	0.00E+00	1.10E+08	0.00E+00	4.24E+08	0.00E+00	1.31E+08	0.00E+00
U-234	1.74E+09	0.00E+00	1.08E+08	0.00E+00	4.15E+08	0.00E+00	1.28E+08	0.00E+00
U-235	1.67E+09	0.00E+00	1.01E+08	0.00E+00	3.90E+08	0.00E+00	1.63E+08	0.00E+00
U-236	1.67E+09	0.00E+00	1.04E+08	0.00E+00	3.99E+08	0.00E+00	1.20E+08	0.00E+00

TABLE II2-18

R_i DOSE FACTORS AGE: ADULT PATHWAY: COW MILKm²-mrem/yr per μ Ci/sec

NUCLIDE	BONE	LIVER	T BODY	THYROID	KIDNEY	LUNG	GI-LLI	SKIN
U-237	1.65E+04	0.00E+00	4.40E+03	0.00E+00	6.80E+04	0.00E+00	5.81E+06	0.00E+00
U-238	1.60E+09	0.00E+00	9.48E+07	0.00E+00	3.65E+08	0.00E+00	1.15E+08	0.00E+00
NP-237	2.63E+07	1.87E+06	1.16E+06	0.00E+00	8.60E+06	0.00E+00	1.66E+06	0.00E+00
NP-238	1.06E+01	2.84E-01	1.64E-01	0.00E+00	9.63E-01	0.00E+00	2.64E+04	0.00E+00
NP-239	1.07E+00	1.06E-01	5.82E-02	0.00E+00	3.30E-01	0.00E+00	2.17E+04	0.00E+00
PU-238	5.25E+06	6.65E+05	1.43E+05	0.00E+00	6.10E+05	0.00E+00	6.09E+05	0.00E+00
PU-239	6.05E+06	7.27E+05	1.59E+05	0.00E+00	6.77E+05	0.00E+00	5.56E+05	0.00E+00
PU-240	6.04E+06	7.26E+05	1.59E+05	0.00E+00	6.76E+05	0.00E+00	5.66E+05	0.00E+00
PU-241	1.30E+05	6.17E+03	2.75E+03	0.00E+00	1.27E+04	0.00E+00	1.16E+04	0.00E+00
PU-242	5.61E+06	7.00E+05	1.54E+05	0.00E+00	6.52E+05	0.00E+00	5.45E+05	0.00E+00
PU-244	6.55E+06	8.02E+05	1.76E+05	0.00E+00	7.47E+05	0.00E+00	8.12E+05	0.00E+00
AM-241	1.58E+07	1.47E+07	1.13E+06	0.00E+00	8.49E+06	0.00E+00	1.55E+06	0.00E+00
AM-242M	1.59E+07	1.38E+07	1.13E+06	0.00E+00	8.45E+06	0.00E+00	1.95E+06	0.00E+00
AM-243	1.57E+07	1.44E+07	1.11E+06	0.00E+00	8.33E+06	0.00E+00	1.82E+06	0.00E+00
CM-242	3.35E+05	3.57E+05	2.23E+04	0.00E+00	1.01E+05	0.00E+00	1.29E+06	0.00E+00
CM-243	1.24E+07	1.14E+07	7.79E+05	0.00E+00	3.64E+06	0.00E+00	1.62E+06	0.00E+00
CM-244	9.45E+06	8.85E+06	5.95E+05	0.00E+00	2.78E+06	0.00E+00	1.57E+06	0.00E+00
CM-245	1.96E+07	1.71E+07	1.20E+06	0.00E+00	5.61E+06	0.00E+00	1.47E+06	0.00E+00
CM-246	1.94E+07	1.70E+07	1.20E+06	0.00E+00	5.59E+06	0.00E+00	1.44E+06	0.00E+00
CM-247	1.89E+07	1.68E+07	1.18E+06	0.00E+00	5.51E+06	0.00E+00	1.90E+06	0.00E+00
CM-248	1.57E+08	1.38E+08	9.75E+06	0.00E+00	4.55E+07	0.00E+00	3.07E+07	0.00E+00
CF-252	5.21E+06	0.00E+00	1.26E+05	0.00E+00	0.00E+00	0.00E+00	5.75E+06	0.00E+00

TABLE II-19

R_i DOSE FACTORS AGE: TEEN PATHWAY: COW MILKm²-mrem/yr per μ Ci/sec

NUCLIDE	BONE	LIVER	T BODY	THYROID	KIDNEY	LUNG	GI-LLI	SKIN
H-3	0.00E+00	5.66E+02	5.66E+02	5.66E+02	5.66E+02	5.66E+02	5.66E+02	0.00E+00
C-14	6.70E+05	1.34E+05	1.34E+05	1.34E+05	1.34E+05	1.34E+05	1.34E+05	0.00E+00
NA-22	4.82E+09	4.82E+09	4.82E+09	4.82E+09	4.82E+09	4.82E+09	4.82E+09	0.00E+00
NA-24	1.24E+06	1.24E+06	1.24E+06	1.24E+06	1.24E+06	1.24E+06	1.24E+06	0.00E+00
P-32	9.32E+09	5.78E+08	3.61E+08	0.00E+00	0.00E+00	0.00E+00	7.84E+08	0.00E+00
CA-41	8.49E+09	0.00E+00	9.18E+08	0.00E+00	0.00E+00	0.00E+00	8.40E+06	0.00E+00
SC-46	1.25E+02	2.43E+02	7.20E+01	0.00E+00	2.33E+02	0.00E+00	8.27E+05	0.00E+00
CR-51	0.00E+00	0.00E+00	1.59E+04	8.83E+03	3.48E+03	2.27E+04	2.67E+06	0.00E+00
MN-54	0.00E+00	6.94E+06	1.38E+06	0.00E+00	2.07E+06	0.00E+00	1.42E+07	0.00E+00
MN-56	0.00E+00	2.15E-03	3.83E-04	0.00E+00	2.72E-03	0.00E+00	1.42E-01	0.00E+00
FE-55	2.34E+07	1.66E+07	3.87E+06	0.00E+00	0.00E+00	1.05E+07	7.17E+06	0.00E+00
FE-59	1.83E+07	4.28E+07	1.65E+07	0.00E+00	0.00E+00	1.35E+07	1.01E+08	0.00E+00
CO-57	0.00E+00	1.10E+06	1.84E+06	0.00E+00	0.00E+00	0.00E+00	2.05E+07	0.00E+00
CO-58	0.00E+00	3.14E+06	7.22E+06	0.00E+00	0.00E+00	0.00E+00	4.32E+07	0.00E+00
CO-60	0.00E+00	1.48E+07	3.33E+07	0.00E+00	0.00E+00	0.00E+00	1.93E+08	0.00E+00
NI-59	4.76E+08	1.68E+08	8.08E+07	0.00E+00	0.00E+00	0.00E+00	2.64E+07	0.00E+00
NI-63	6.38E+09	4.51E+08	2.16E+08	0.00E+00	0.00E+00	0.00E+00	7.17E+07	0.00E+00
NI-65	1.98E-01	2.53E-02	1.15E-02	0.00E+00	0.00E+00	0.00E+00	1.37E+00	0.00E+00
CU-64	0.00E+00	1.24E+04	5.84E+03	0.00E+00	3.14E+04	0.00E+00	9.63E+05	0.00E+00
ZN-65	1.02E+09	3.54E+09	1.65E+09	0.00E+00	2.27E+09	0.00E+00	1.50E+09	0.00E+00
ZN-69M	9.53E+04	2.25E+05	2.06E+04	0.00E+00	1.37E+05	0.00E+00	1.24E+07	0.00E+00
ZN-69	1.13E-12	2.15E-12	1.50E-13	0.00E+00	1.40E-12	0.00E+00	3.95E-12	0.00E+00
SE-79	0.00E+00	9.04E+08	1.52E+08	0.00E+00	1.58E+09	0.00E+00	1.38E+08	0.00E+00
BR-82	0.00E+00	0.00E+00	1.64E+07	0.00E+00	0.00E+00	0.00E+00	0.00E+00	0.00E+00
BR-83	0.00E+00	0.00E+00	5.24E-02	0.00E+00	0.00E+00	0.00E+00	0.00E+00	0.00E+00
BR-84	0.00E+00	0.00E+00	8.41E-24	0.00E+00	0.00E+00	0.00E+00	0.00E+00	0.00E+00
BR-85	0.00E+00	0.00E+00	0.00E+00	0.00E+00	0.00E+00	0.00E+00	0.00E+00	0.00E+00
RB-86	0.00E+00	1.42E+09	6.69E+08	0.00E+00	0.00E+00	0.00E+00	2.11E+08	0.00E+00
RB-87	0.00E+00	2.83E+09	9.87E+08	0.00E+00	0.00E+00	0.00E+00	9.87E+07	0.00E+00
RB-88	0.00E+00	1.14E-45	6.06E-46	0.00E+00	0.00E+00	0.00E+00	9.74E-53	0.00E+00
RB-89	0.00E+00	2.24E-53	1.59E-53	0.00E+00	0.00E+00	0.00E+00	3.44E-62	0.00E+00
SR-89	9.75E+08	0.00E+00	2.79E+07	0.00E+00	0.00E+00	0.00E+00	1.16E+08	0.00E+00
SR-90	4.38E+10	0.00E+00	8.75E+08	0.00E+00	0.00E+00	0.00E+00	1.00E+09	0.00E+00
SR-91	1.55E+04	0.00E+00	6.18E+02	0.00E+00	0.00E+00	0.00E+00	7.05E+04	0.00E+00
SR-92	2.61E-01	0.00E+00	1.11E-02	0.00E+00	0.00E+00	0.00E+00	6.66E+00	0.00E+00
Y-90	3.81E+01	0.00E+00	1.03E+00	0.00E+00	0.00E+00	0.00E+00	3.14E+05	0.00E+00
Y-91M	3.20E-20	0.00E+00	1.22E-21	0.00E+00	0.00E+00	0.00E+00	1.51E-18	0.00E+00
Y-91	5.97E+03	0.00E+00	1.60E+02	0.00E+00	0.00E+00	0.00E+00	2.45E+06	0.00E+00
Y-92	3.02E-05	0.00E+00	8.72E-07	0.00E+00	0.00E+00	0.00E+00	8.27E-01	0.00E+00
Y-93	1.20E-01	0.00E+00	3.30E-03	0.00E+00	0.00E+00	0.00E+00	3.68E+03	0.00E+00
ZR-93	1.49E+03	7.35E+01	4.01E+01	0.00E+00	2.60E+02	0.00E+00	6.95E+04	0.00E+00
ZR-95	6.37E+02	2.01E+02	1.38E+02	0.00E+00	2.95E+02	0.00E+00	4.64E+05	0.00E+00
ZR-97	2.31E-01	4.56E-02	2.10E-02	0.00E+00	6.92E-02	0.00E+00	1.24E+04	0.00E+00
NB-93M	4.59E+05	1.51E+05	3.78E+04	0.00E+00	1.76E+05	0.00E+00	5.44E+07	0.00E+00
NB-95	4.71E+04	2.61E+04	1.44E+04	0.00E+00	2.53E+04	0.00E+00	1.12E+08	0.00E+00

Rev. 31

Page 261 of 330

05/2018

TABLE II-19

R_i DOSE FACTORS AGE: TEEN PATHWAY: COW MILKm²-mrem/yr per μ Ci/sec

NUCLIDE	BONE	LIVER	T BODY	THYROID	KIDNEY	LUNG	GI-LLI	SKIN
NB-97	1.75E-12	4.35E-13	1.59E-13	0.00E+00	5.09E-13	0.00E+00	1.04E-08	0.00E+00
MO-93	0.00E+00	4.28E+08	1.17E+07	0.00E+00	1.23E+08	0.00E+00	5.21E+07	0.00E+00
MO-99	0.00E+00	1.31E+07	2.49E+06	0.00E+00	2.99E+07	0.00E+00	2.34E+07	0.00E+00
TC-99M	1.68E+00	4.70E+00	6.09E+01	0.00E+00	7.00E+01	2.61E+00	3.09E+03	0.00E+00
TC-99	2.41E+07	3.54E+07	9.66E+06	0.00E+00	4.50E+08	3.66E+06	8.67E+08	0.00E+00
TC-101	1.39E-60	1.97E-60	1.94E-59	0.00E+00	3.57E-59	1.20E-60	3.37E-67	0.00E+00
RU-103	6.21E+02	0.00E+00	2.66E+02	0.00E+00	2.19E+03	0.00E+00	5.19E+04	0.00E+00
RU-105	4.58E-04	0.00E+00	1.78E-04	0.00E+00	5.77E-03	0.00E+00	3.70E-01	0.00E+00
RU-106	1.88E+04	0.00E+00	2.37E+03	0.00E+00	3.63E+04	0.00E+00	9.02E+05	0.00E+00
RH-105	1.87E+05	1.35E+05	8.88E+04	0.00E+00	5.75E+05	0.00E+00	1.72E+07	0.00E+00
PD-107	0.00E+00	1.12E+07	7.22E+05	0.00E+00	1.01E+08	0.00E+00	5.20E+07	0.00E+00
PD-109	0.00E+00	2.37E+04	5.38E+03	0.00E+00	1.37E+05	0.00E+00	2.39E+06	0.00E+00
AG-110M	4.67E+07	4.42E+07	2.69E+07	0.00E+00	8.43E+07	0.00E+00	1.24E+10	0.00E+00
AG-111	3.49E+06	1.45E+06	7.28E+05	0.00E+00	4.72E+06	0.00E+00	2.02E+09	0.00E+00
CD-113M	0.00E+00	2.89E+06	9.29E+04	0.00E+00	3.20E+06	0.00E+00	1.74E+07	0.00E+00
CD-115M	0.00E+00	8.12E+05	2.62E+04	0.00E+00	6.49E+05	0.00E+00	2.57E+07	0.00E+00
SN-123	4.40E+08	7.22E+06	1.07E+07	5.79E+06	0.00E+00	0.00E+00	6.65E+08	0.00E+00
SN-125	3.07E+07	6.11E+05	1.38E+06	4.80E+05	0.00E+00	0.00E+00	2.89E+08	0.00E+00
SN-126	1.56E+09	2.91E+07	4.44E+07	7.66E+06	0.00E+00	0.00E+00	3.47E+08	0.00E+00
SB-124	1.75E+07	3.22E+05	6.81E+06	3.96E+04	0.00E+00	1.52E+07	3.52E+08	0.00E+00
SB-125	1.92E+07	2.10E+05	4.49E+06	1.83E+04	0.00E+00	1.69E+07	1.49E+08	0.00E+00
SB-126	2.94E+06	6.00E+04	1.05E+06	1.66E+04	0.00E+00	2.11E+06	1.74E+08	0.00E+00
SB-127	2.39E+05	5.11E+03	9.02E+04	2.68E+03	0.00E+00	1.63E+05	4.05E+07	0.00E+00
TE-125M	1.13E+07	4.08E+06	1.51E+06	3.16E+06	0.00E+00	0.00E+00	3.34E+07	0.00E+00
TE-127M	3.65E+07	1.29E+07	4.34E+06	8.67E+06	1.48E+08	0.00E+00	9.09E+07	0.00E+00
TE-127	3.54E+02	1.25E+02	7.62E+01	2.44E+02	1.43E+03	0.00E+00	2.73E+04	0.00E+00
TE-129M	3.65E+07	1.35E+07	5.77E+06	1.18E+07	1.53E+08	0.00E+00	1.37E+08	0.00E+00
TE-129	1.52E-10	5.67E-11	3.70E-11	1.09E-10	6.38E-10	0.00E+00	8.31E-10	0.00E+00
TE-131M	1.92E+05	9.22E+04	7.69E+04	1.39E+05	9.61E+05	0.00E+00	7.40E+06	0.00E+00
TE-131	1.93E-33	7.94E-34	6.02E-34	1.48E-33	8.42E-33	0.00E+00	1.58E-34	0.00E+00
TE-132	1.26E+06	7.95E+05	7.48E+05	8.38E+05	7.63E+06	0.00E+00	2.52E+07	0.00E+00
TE-133M	1.11E-13	6.29E-14	6.12E-14	8.79E-14	6.22E-13	0.00E+00	2.54E-13	0.00E+00
TE-134	4.64E-19	2.98E-19	3.11E-19	3.81E-19	2.84E-18	0.00E+00	1.72E-20	0.00E+00
I-129	7.53E+08	6.33E+08	1.06E+09	7.71E+11	1.13E+09	0.00E+00	7.38E+07	0.00E+00
I-130	2.16E+05	6.25E+05	2.50E+05	5.10E+07	9.63E+05	0.00E+00	4.80E+05	0.00E+00
I-131	1.57E+08	2.20E+08	1.18E+08	6.42E+10	3.79E+08	0.00E+00	4.35E+07	0.00E+00
I-132	8.52E-02	2.23E-01	8.00E-02	7.51E+00	3.51E-01	0.00E+00	9.71E-02	0.00E+00
I-133	2.07E+06	3.51E+06	1.07E+06	4.90E+08	6.15E+06	0.00E+00	2.65E+06	0.00E+00
I-134	1.05E-12	2.78E-12	9.98E-13	4.63E-11	4.38E-12	0.00E+00	3.66E-14	0.00E+00
I-135	6.67E+03	1.72E+04	6.37E+03	1.10E+06	2.71E+04	0.00E+00	1.90E+04	0.00E+00
CS-134M	9.05E-02	1.87E-01	9.63E-02	0.00E+00	1.04E-01	1.83E-02	1.25E-01	0.00E+00
CS-134	5.11E+09	1.20E+10	5.58E+09	0.00E+00	3.82E+09	1.46E+09	1.50E+08	0.00E+00
CS-135	1.80E+09	1.65E+09	3.85E+08	0.00E+00	6.29E+08	2.28E+08	2.88E+07	0.00E+00
CS-136	1.32E+08	5.20E+08	3.49E+08	0.00E+00	2.83E+08	4.46E+07	4.18E+07	0.00E+00
CS-137	7.21E+09	9.59E+09	3.34E+09	0.00E+00	3.26E+09	1.27E+09	1.36E+08	0.00E+00

Rev. 31

Page 262 of 330

05/2018

TABLE II-19

R_i DOSE FACTORS AGE: TEEN PATHWAY: COW MILKm²-mrem/yr per μ Ci/sec

NUCLIDE	BONE	LIVER	T BODY	THYROID	KIDNEY	LUNG	GI-LLI	SKIN
CS-138	4.80E-24	9.21E-24	4.61E-24	0.00E+00	6.80E-24	7.91E-25	4.18E-27	0.00E+00
CS-139	3.65E-90	5.38E-90	1.97E-90	0.00E+00	4.34E-90	4.76E-91	2.50E-105	0.00E+00
BA-139	2.39E-08	1.68E-11	6.96E-10	0.00E+00	1.59E-11	1.16E-11	2.13E-07	0.00E+00
BA-140	1.43E+07	1.75E+04	9.20E+05	0.00E+00	5.93E+03	1.18E+04	2.20E+07	0.00E+00
BA-141	2.20E-46	1.64E-49	7.35E-48	0.00E+00	1.53E-49	1.13E-49	4.69E-52	0.00E+00
BA-142	1.41E-80	1.41E-83	8.67E-82	0.00E+00	1.19E-83	9.37E-84	4.32E-92	0.00E+00
LA-140	2.37E+00	1.16E+00	3.10E-01	0.00E+00	0.00E+00	0.00E+00	6.69E+04	0.00E+00
LA-141	1.64E-05	5.04E-06	8.32E-07	0.00E+00	0.00E+00	0.00E+00	8.93E-01	0.00E+00
LA-142	9.81E-12	4.36E-12	1.08E-12	0.00E+00	0.00E+00	0.00E+00	1.33E-07	0.00E+00
CE-141	2.92E+03	1.95E+03	2.24E+02	0.00E+00	9.18E+02	0.00E+00	5.58E+06	0.00E+00
CE-143	2.23E+01	1.63E+04	1.82E+00	0.00E+00	7.29E+00	0.00E+00	4.89E+05	0.00E+00
CE-144	3.23E+05	1.34E+05	1.74E+04	0.00E+00	7.99E+04	0.00E+00	8.13E+07	0.00E+00
PR-143	8.56E+01	3.42E+01	4.26E+00	0.00E+00	1.99E+01	0.00E+00	2.82E+05	0.00E+00
PR-144	3.16E-54	1.30E-54	1.60E-55	0.00E+00	7.43E-55	0.00E+00	3.49E-57	0.00E+00
ND-147	5.31E+01	5.78E+01	3.46E+00	0.00E+00	3.39E+01	0.00E+00	2.08E+05	0.00E+00
PM-147	2.70E+03	2.56E+02	1.05E+02	0.00E+00	4.89E+02	0.00E+00	2.44E+05	0.00E+00
PM-148M	5.17E+02	1.31E+02	1.03E+02	0.00E+00	1.99E+02	0.00E+00	8.26E+05	0.00E+00
PM-148	3.18E+01	5.18E+00	2.61E+00	0.00E+00	9.37E+00	0.00E+00	3.09E+05	0.00E+00
PM-149	2.31E+00	3.24E-01	1.33E-01	0.00E+00	6.17E-01	0.00E+00	4.77E+04	0.00E+00
PM-151	3.47E-01	5.73E-02	2.90E-02	0.00E+00	1.03E-01	0.00E+00	1.29E+04	0.00E+00
SM-151	2.35E+03	4.52E+02	1.06E+02	0.00E+00	4.95E+02	0.00E+00	1.53E+05	0.00E+00
SM-153	1.06E+00	8.81E-01	6.48E-02	0.00E+00	2.88E-01	0.00E+00	2.49E+04	0.00E+00
EU-152	6.54E+03	1.58E+03	1.39E+03	0.00E+00	7.31E+03	0.00E+00	5.79E+05	0.00E+00
EU-154	2.10E+04	2.71E+03	1.91E+03	0.00E+00	1.21E+04	0.00E+00	1.43E+06	0.00E+00
EU-155	4.57E+03	4.42E+02	2.73E+02	0.00E+00	1.73E+03	0.00E+00	2.53E+06	0.00E+00
EU-156	1.35E+02	1.01E+02	1.65E+01	0.00E+00	6.81E+01	0.00E+00	5.17E+05	0.00E+00
TB-160	1.05E+03	0.00E+00	1.31E+02	0.00E+00	4.16E+02	0.00E+00	6.82E+05	0.00E+00
HO-166M	9.61E+03	2.96E+03	2.14E+03	0.00E+00	4.34E+03	0.00E+00	7.30E+05	0.00E+00
W-181	2.76E+04	8.91E+03	9.32E+02	0.00E+00	0.00E+00	0.00E+00	7.59E+05	0.00E+00
W-185	9.56E+05	3.15E+05	3.34E+04	0.00E+00	0.00E+00	0.00E+00	2.73E+07	0.00E+00
W-187	3.48E+03	2.84E+03	9.95E+02	0.00E+00	0.00E+00	0.00E+00	7.69E+05	0.00E+00
U-232	1.58E+10	0.00E+00	1.13E+09	0.00E+00	1.72E+09	0.00E+00	1.93E+08	0.00E+00
U-233	3.34E+09	0.00E+00	2.03E+08	0.00E+00	7.81E+08	0.00E+00	1.79E+08	0.00E+00
U-234	3.20E+09	0.00E+00	1.99E+08	0.00E+00	7.68E+08	0.00E+00	1.75E+08	0.00E+00
U-235	3.07E+09	0.00E+00	1.87E+08	0.00E+00	7.19E+08	0.00E+00	2.23E+08	0.00E+00
U-236	3.07E+09	0.00E+00	1.91E+08	0.00E+00	7.35E+08	0.00E+00	1.65E+08	0.00E+00
U-237	3.05E+04	0.00E+00	8.11E+03	0.00E+00	1.25E+05	0.00E+00	8.07E+06	0.00E+00
U-238	2.94E+09	0.00E+00	1.75E+08	0.00E+00	6.73E+08	0.00E+00	1.57E+08	0.00E+00
NP-237	3.58E+07	2.57E+06	1.58E+06	0.00E+00	1.17E+07	0.00E+00	2.26E+06	0.00E+00
NP-238	1.94E+01	5.19E-01	3.02E-01	0.00E+00	1.78E+00	0.00E+00	3.81E+04	0.00E+00
NP-239	2.05E+00	1.93E-01	1.07E-01	0.00E+00	6.07E-01	0.00E+00	3.11E+04	0.00E+00
PU-238	7.21E+06	9.23E+05	1.96E+05	0.00E+00	8.39E+05	0.00E+00	8.32E+05	0.00E+00
PU-239	8.24E+06	1.00E+06	2.17E+05	0.00E+00	9.23E+05	0.00E+00	7.61E+05	0.00E+00
PU-240	8.23E+06	9.99E+05	2.17E+05	0.00E+00	9.22E+05	0.00E+00	7.75E+05	0.00E+00
PU-241	1.87E+05	8.97E+03	3.94E+03	0.00E+00	1.83E+04	0.00E+00	1.58E+04	0.00E+00

Rev. 31

Page 263 of 330

05/2018

TABLE II2-19

R_i DOSE FACTORS AGE: TEEN PATHWAY: COW MILKm²-mrem/yr per μ Ci/sec

NUCLIDE	BONE	LIVER	T BODY	THYROID	KIDNEY	LUNG	GI-LLI	SKIN
PU-242	7.64E+06	9.63E+05	2.09E+05	0.00E+00	8.89E+05	0.00E+00	7.45E+05	0.00E+00
PU-244	8.92E+06	1.10E+06	2.39E+05	0.00E+00	1.02E+06	0.00E+00	1.11E+06	0.00E+00
AM-241	2.15E+07	2.03E+07	1.55E+06	0.00E+00	1.16E+07	0.00E+00	2.12E+06	0.00E+00
AM-242M	2.17E+07	1.91E+07	1.56E+06	0.00E+00	1.16E+07	0.00E+00	2.66E+06	0.00E+00
AM-243	2.14E+07	1.98E+07	1.51E+06	0.00E+00	1.14E+07	0.00E+00	2.49E+06	0.00E+00
CM-242	6.18E+05	6.51E+05	4.10E+04	0.00E+00	1.87E+05	0.00E+00	1.76E+06	0.00E+00
CM-243	1.74E+07	1.62E+07	1.10E+06	0.00E+00	5.12E+06	0.00E+00	2.22E+06	0.00E+00
CM-244	1.35E+07	1.28E+07	8.53E+05	0.00E+00	3.99E+06	0.00E+00	2.14E+06	0.00E+00
CM-245	2.67E+07	2.35E+07	1.64E+06	0.00E+00	7.68E+06	0.00E+00	2.01E+06	0.00E+00
CM-246	2.64E+07	2.34E+07	1.64E+06	0.00E+00	7.65E+06	0.00E+00	1.97E+06	0.00E+00
CM-247	2.58E+07	2.31E+07	1.62E+06	0.00E+00	7.54E+06	0.00E+00	2.59E+06	0.00E+00
CM-248	2.14E+08	1.90E+08	1.33E+07	0.00E+00	6.22E+07	0.00E+00	4.17E+07	0.00E+00
CF-252	8.93E+06	0.00E+00	2.15E+05	0.00E+00	0.00E+00	0.00E+00	7.85E+06	0.00E+00

TABLE II2-20

R_i DOSE FACTORS AGE: CHILD PATHWAY: COW MILKm²-mrem/yr per μCi/sec

NUCLIDE	BONE	LIVER	T BODY	THYROID	KIDNEY	LUNG	GI-LLI	SKIN
H-3	0.00E+00	8.97E+02	8.97E+02	8.97E+02	8.97E+02	8.97E+02	8.97E+02	0.00E+00
C-14	1.65E+06	3.29E+05	3.29E+05	3.29E+05	3.29E+05	3.29E+05	3.29E+05	0.00E+00
NA-22	9.99E+09	9.99E+09	9.99E+09	9.99E+09	9.99E+09	9.99E+09	9.99E+09	0.00E+00
NA-24	2.59E+06	2.59E+06	2.59E+06	2.59E+06	2.59E+06	2.59E+06	2.59E+06	0.00E+00
P-32	2.30E+10	1.08E+09	8.86E+08	0.00E+00	0.00E+00	0.00E+00	6.35E+08	0.00E+00
CA-41	1.23E+10	0.00E+00	1.35E+09	0.00E+00	0.00E+00	0.00E+00	6.75E+06	0.00E+00
SC-46	2.80E+02	3.84E+02	1.48E+02	0.00E+00	3.40E+02	0.00E+00	5.62E+05	0.00E+00
CR-51	0.00E+00	0.00E+00	3.24E+04	1.80E+04	4.92E+03	3.29E+04	1.72E+06	0.00E+00
MN-54	0.00E+00	1.04E+07	2.77E+06	0.00E+00	2.91E+06	0.00E+00	8.72E+06	0.00E+00
MN-56	0.00E+00	3.75E-03	8.47E-04	0.00E+00	4.54E-03	0.00E+00	5.44E-01	0.00E+00
FE-55	5.87E+07	3.11E+07	9.64E+06	0.00E+00	0.00E+00	1.76E+07	5.77E+06	0.00E+00
FE-59	4.25E+07	6.88E+07	3.43E+07	0.00E+00	0.00E+00	1.99E+07	7.16E+07	0.00E+00
CO-57	0.00E+00	1.88E+06	3.80E+06	0.00E+00	0.00E+00	0.00E+00	1.54E+07	0.00E+00
CO-58	0.00E+00	4.79E+06	1.47E+07	0.00E+00	0.00E+00	0.00E+00	2.79E+07	0.00E+00
CO-60	0.00E+00	2.30E+07	6.78E+07	0.00E+00	0.00E+00	0.00E+00	1.27E+08	0.00E+00
NI-59	1.20E+09	3.19E+08	2.03E+08	0.00E+00	0.00E+00	0.00E+00	2.11E+07	0.00E+00
NI-63	1.60E+10	8.56E+08	5.44E+08	0.00E+00	0.00E+00	0.00E+00	5.77E+07	0.00E+00
NI-65	4.84E-01	4.56E-02	2.66E-02	0.00E+00	0.00E+00	0.00E+00	5.58E+00	0.00E+00
CU-64	0.00E+00	2.18E+04	1.32E+04	0.00E+00	5.27E+04	0.00E+00	1.02E+06	0.00E+00
ZN-65	2.00E+09	5.33E+09	3.32E+09	0.00E+00	3.36E+09	0.00E+00	9.37E+08	0.00E+00
ZN-69M	2.33E+05	3.97E+05	4.69E+04	0.00E+00	2.30E+05	0.00E+00	1.29E+07	0.00E+00
ZN-69	2.77E-12	4.00E-12	3.70E-13	0.00E+00	2.43E-12	0.00E+00	2.52E-10	0.00E+00
SE-79	0.00E+00	1.69E+09	3.74E+08	0.00E+00	2.74E+09	0.00E+00	1.11E+08	0.00E+00
BR-82	0.00E+00	0.00E+00	3.36E+07	0.00E+00	0.00E+00	0.00E+00	0.00E+00	0.00E+00
BR-83	0.00E+00	0.00E+00	1.29E-01	0.00E+00	0.00E+00	0.00E+00	0.00E+00	0.00E+00
BR-84	0.00E+00	0.00E+00	1.90E-23	0.00E+00	0.00E+00	0.00E+00	0.00E+00	0.00E+00
BR-85	0.00E+00	0.00E+00	0.00E+00	0.00E+00	0.00E+00	0.00E+00	0.00E+00	0.00E+00
RB-86	0.00E+00	2.64E+09	1.62E+09	0.00E+00	0.00E+00	0.00E+00	1.70E+08	0.00E+00
RB-87	0.00E+00	5.27E+09	2.44E+09	0.00E+00	0.00E+00	0.00E+00	7.89E+07	0.00E+00
RB-88	0.00E+00	2.09E-45	1.45E-45	0.00E+00	0.00E+00	0.00E+00	1.03E-46	0.00E+00
RB-89	0.00E+00	3.93E-53	3.50E-53	0.00E+00	0.00E+00	0.00E+00	3.43E-55	0.00E+00
SR-89	2.41E+09	0.00E+00	6.89E+07	0.00E+00	0.00E+00	0.00E+00	9.34E+07	0.00E+00
SR-90	9.06E+10	0.00E+00	1.82E+09	0.00E+00	0.00E+00	0.00E+00	8.11E+08	0.00E+00
SR-91	3.81E+04	0.00E+00	1.44E+03	0.00E+00	0.00E+00	0.00E+00	8.42E+04	0.00E+00
SR-92	6.39E-01	0.00E+00	2.56E-02	0.00E+00	0.00E+00	0.00E+00	1.21E+01	0.00E+00
Y-90	9.42E+01	0.00E+00	2.52E+00	0.00E+00	0.00E+00	0.00E+00	2.68E+05	0.00E+00
Y-91M	7.83E-20	0.00E+00	2.85E-21	0.00E+00	0.00E+00	0.00E+00	1.53E-16	0.00E+00
Y-91	1.47E+04	0.00E+00	3.94E+02	0.00E+00	0.00E+00	0.00E+00	1.96E+06	0.00E+00
Y-92	7.40E-05	0.00E+00	2.12E-06	0.00E+00	0.00E+00	0.00E+00	2.14E+00	0.00E+00
Y-93	2.96E-01	0.00E+00	8.12E-03	0.00E+00	0.00E+00	0.00E+00	4.41E+03	0.00E+00
ZR-93	3.71E+03	1.39E+02	9.89E+01	0.00E+00	5.38E+02	0.00E+00	5.27E+04	0.00E+00
ZR-95	1.48E+03	3.25E+02	2.89E+02	0.00E+00	4.65E+02	0.00E+00	3.39E+05	0.00E+00

TABLE I12-20

R_i DOSE FACTORS AGE: CHILD PATHWAY: COW MILKm²-mrem/yr per μ Ci/sec

NUCLIDE	BONE	LIVER	T BODY	THYROID	KIDNEY	LUNG	GI-LLI	SKIN
ZR-97	5.61E-01	8.11E-02	4.78E-02	0.00E+00	1.16E-01	0.00E+00	1.23E+04	0.00E+00
NB-93M	1.16E+06	2.89E+05	9.49E+04	0.00E+00	3.12E+05	0.00E+00	4.35E+07	0.00E+00
NB-95	1.06E+05	4.14E+04	2.96E+04	0.00E+00	3.89E+04	0.00E+00	7.65E+07	0.00E+00
NB-97	4.26E-12	7.69E-13	3.59E-13	0.00E+00	8.54E-13	0.00E+00	2.37E-07	0.00E+00
MO-93	0.00E+00	8.03E+08	2.88E+07	0.00E+00	2.12E+08	0.00E+00	4.07E+07	0.00E+00
MO-99	0.00E+00	2.38E+07	5.89E+06	0.00E+00	5.08E+07	0.00E+00	1.97E+07	0.00E+00
TC-99M	3.86E+00	7.58E+00	1.26E+02	0.00E+00	1.10E+02	3.85E+00	4.31E+03	0.00E+00
TC-99	5.94E+07	6.62E+07	2.38E+07	0.00E+00	7.80E+08	5.85E+06	6.94E+08	0.00E+00
TC-101	3.40E-60	3.56E-60	4.51E-59	0.00E+00	6.07E-59	1.88E-60	1.13E-59	0.00E+00
RU-103	1.47E+03	0.00E+00	5.65E+02	0.00E+00	3.70E+03	0.00E+00	3.80E+04	0.00E+00
RU-105	1.12E-03	0.00E+00	4.05E-04	0.00E+00	9.82E-03	0.00E+00	7.29E-01	0.00E+00
RU-106	4.63E+04	0.00E+00	5.78E+03	0.00E+00	6.26E+04	0.00E+00	7.21E+05	0.00E+00
RH-105	4.59E+05	2.47E+05	2.11E+05	0.00E+00	9.83E+05	0.00E+00	1.53E+07	0.00E+00
PD-107	0.00E+00	2.10E+07	1.78E+06	0.00E+00	1.76E+08	0.00E+00	4.16E+07	0.00E+00
PD-109	0.00E+00	4.42E+04	1.32E+04	0.00E+00	2.37E+05	0.00E+00	2.61E+06	0.00E+00
AG-110M	1.01E+08	6.84E+07	5.47E+07	0.00E+00	1.27E+08	0.00E+00	8.14E+09	0.00E+00
AG-111	8.61E+06	2.70E+06	1.78E+06	0.00E+00	8.13E+06	0.00E+00	1.65E+09	0.00E+00
CD-113M	0.00E+00	5.39E+06	2.29E+05	0.00E+00	5.55E+06	0.00E+00	1.39E+07	0.00E+00
CD-115M	0.00E+00	1.52E+06	6.46E+04	0.00E+00	1.13E+06	0.00E+00	2.06E+07	0.00E+00
SN-123	1.09E+09	1.35E+07	2.65E+07	1.43E+07	0.00E+00	0.00E+00	5.33E+08	0.00E+00
SN-125	7.55E+07	1.14E+06	3.38E+06	1.18E+06	0.00E+00	0.00E+00	2.34E+08	0.00E+00
SN-126	3.70E+09	4.61E+07	1.05E+08	1.27E+07	0.00E+00	0.00E+00	2.78E+08	0.00E+00
SB-124	4.13E+07	5.36E+05	1.45E+07	9.12E+04	0.00E+00	2.29E+07	2.58E+08	0.00E+00
SB-125	4.57E+07	3.52E+05	9.58E+06	4.23E+04	0.00E+00	2.55E+07	1.09E+08	0.00E+00
SB-126	6.71E+06	1.03E+05	2.41E+06	3.93E+04	0.00E+00	3.20E+06	1.35E+08	0.00E+00
SB-127	5.75E+05	8.90E+03	2.00E+05	6.41E+03	0.00E+00	2.50E+05	3.24E+07	0.00E+00
TE-125M	2.78E+07	7.54E+06	3.71E+06	7.80E+06	0.00E+00	0.00E+00	2.68E+07	0.00E+00
TE-127M	8.99E+07	2.42E+07	1.07E+07	2.15E+07	2.56E+08	0.00E+00	7.28E+07	0.00E+00
TE-127	8.70E+02	2.35E+02	1.87E+02	6.02E+02	2.48E+03	0.00E+00	3.40E+04	0.00E+00
TE-129M	8.99E+07	2.51E+07	1.40E+07	2.90E+07	2.64E+08	0.00E+00	1.10E+08	0.00E+00
TE-129	3.75E-10	1.05E-10	8.90E-11	2.68E-10	1.10E-09	0.00E+00	2.34E-08	0.00E+00
TE-131M	4.68E+05	1.62E+05	1.72E+05	3.33E+05	1.57E+06	0.00E+00	6.56E+06	0.00E+00
TE-131	4.73E-33	1.44E-33	1.41E-33	3.62E-33	1.43E-32	0.00E+00	2.48E-32	0.00E+00
TE-132	3.00E+06	1.33E+06	1.60E+06	1.93E+06	1.23E+07	0.00E+00	1.34E+07	0.00E+00
TE-133M	2.65E-13	1.07E-13	1.33E-13	2.06E-13	1.02E-12	0.00E+00	8.19E-12	0.00E+00
TE-134	1.10E-18	4.96E-19	6.62E-19	8.73E-19	4.60E-18	0.00E+00	5.04E-18	0.00E+00
I-129	1.85E+09	1.14E+09	1.02E+09	7.44E+11	1.92E+09	0.00E+00	5.72E+07	0.00E+00
I-130	5.05E+05	1.02E+06	5.26E+05	1.12E+08	1.53E+06	0.00E+00	4.78E+05	0.00E+00
I-131	3.81E+08	3.84E+08	2.18E+08	1.27E+11	6.30E+08	0.00E+00	3.41E+07	0.00E+00
I-132	2.02E-01	3.70E-01	1.70E-01	1.72E+01	5.67E-01	0.00E+00	4.36E-01	0.00E+00
I-133	5.02E+06	6.21E+06	2.35E+06	1.15E+09	1.04E+07	0.00E+00	2.50E+06	0.00E+00
I-134	2.48E-12	4.61E-12	2.12E-12	1.06E-10	7.05E-12	0.00E+00	3.06E-12	0.00E+00

TABLE II2-20

R_i DOSE FACTORS AGE: CHILD PATHWAY: COW MILKm²-mrem/yr per μCi/sec

NUCLIDE	BONE	LIVER	T BODY	THYROID	KIDNEY	LUNG	GI-LLI	SKIN
I-135	1.58E+04	2.84E+04	1.34E+04	2.52E+06	4.36E+04	0.00E+00	2.17E+04	0.00E+00
CS-134M	2.14E-01	3.17E-01	2.07E-01	0.00E+00	1.67E-01	2.77E-02	4.01E-01	0.00E+00
CS-134	1.18E+10	1.93E+10	4.08E+09	0.00E+00	5.99E+09	2.15E+09	1.04E+08	0.00E+00
CS-135	4.43E+09	3.08E+09	3.16E+08	0.00E+00	1.09E+09	3.63E+08	2.31E+07	0.00E+00
CS-136	2.98E+08	8.19E+08	5.30E+08	0.00E+00	4.36E+08	6.51E+07	2.88E+07	0.00E+00
CS-137	1.74E+10	1.66E+10	2.45E+09	0.00E+00	5.42E+09	1.95E+09	1.04E+08	0.00E+00
CS-138	1.16E-23	1.62E-23	1.03E-23	0.00E+00	1.14E-23	1.22E-24	7.45E-24	0.00E+00
CS-139	8.98E-90	9.97E-90	4.79E-90	0.00E+00	7.49E-90	7.55E-91	8.98E-94	0.00E+00
BA-139	5.87E-08	3.14E-11	1.70E-09	0.00E+00	2.74E-11	1.84E-11	3.39E-06	0.00E+00
BA-140	3.45E+07	3.02E+04	2.01E+06	0.00E+00	9.83E+03	1.80E+04	1.75E+07	0.00E+00
BA-141	5.41E-46	3.03E-49	1.76E-47	0.00E+00	2.62E-49	1.78E-48	3.08E-46	0.00E+00
BA-142	3.40E-80	2.44E-83	1.90E-81	0.00E+00	1.98E-83	1.44E-83	4.43E-82	0.00E+00
LA-140	5.68E+00	1.98E+00	6.69E-01	0.00E+00	0.00E+00	0.00E+00	5.53E+04	0.00E+00
LA-141	4.04E-05	9.42E-06	2.04E-06	0.00E+00	0.00E+00	0.00E+00	2.09E+00	0.00E+00
LA-142	2.37E-11	7.55E-12	2.36E-12	0.00E+00	0.00E+00	0.00E+00	1.50E-06	0.00E+00
CE-141	7.19E+03	3.59E+03	5.33E+02	0.00E+00	1.57E+03	0.00E+00	4.47E+06	0.00E+00
CE-143	5.48E+01	2.97E+04	4.31E+00	0.00E+00	1.25E+01	0.00E+00	4.35E+05	0.00E+00
CE-144	7.97E+05	2.50E+05	4.26E+04	0.00E+00	1.38E+05	0.00E+00	6.52E+07	0.00E+00
PR-143	2.12E+02	6.36E+01	1.05E+01	0.00E+00	3.44E+01	0.00E+00	2.29E+05	0.00E+00
PR-144	7.83E-54	2.42E-54	3.94E-55	0.00E+00	1.28E-54	0.00E+00	5.22E-51	0.00E+00
ND-147	1.30E+02	1.06E+02	8.18E+00	0.00E+00	5.80E+01	0.00E+00	1.67E+05	0.00E+00
PM-147	6.75E+03	4.82E+02	2.59E+02	0.00E+00	8.52E+02	0.00E+00	1.95E+05	0.00E+00
PM-148M	1.06E+03	2.11E+02	2.11E+02	0.00E+00	3.13E+02	0.00E+00	5.96E+05	0.00E+00
PM-148	7.78E+01	9.35E+00	6.05E+00	0.00E+00	1.59E+01	0.00E+00	2.50E+05	0.00E+00
PM-149	5.69E+00	6.05E-01	3.28E-01	0.00E+00	1.07E+00	0.00E+00	4.13E+04	0.00E+00
PM-151	8.47E-01	1.03E-01	6.70E-02	0.00E+00	1.75E-01	0.00E+00	1.17E+04	0.00E+00
SM-151	5.68E+03	8.45E+02	2.66E+02	0.00E+00	8.74E+02	0.00E+00	1.23E+05	0.00E+00
SM-153	2.63E+00	1.63E+00	1.58E-01	0.00E+00	4.97E-01	0.00E+00	2.17E+04	0.00E+00
EU-152	1.35E+04	2.47E+03	2.93E+03	0.00E+00	1.04E+04	0.00E+00	4.05E+05	0.00E+00
EU-154	5.04E+04	4.54E+03	4.14E+03	0.00E+00	1.99E+04	0.00E+00	1.05E+06	0.00E+00
EU-155	1.05E+04	7.53E+02	5.90E+02	0.00E+00	2.82E+03	0.00E+00	1.88E+06	0.00E+00
EU-156	3.26E+02	1.74E+02	3.61E+01	0.00E+00	1.12E+02	0.00E+00	3.96E+05	0.00E+00
TB-160	2.23E+03	0.00E+00	2.76E+02	0.00E+00	6.63E+02	0.00E+00	4.94E+05	0.00E+00
HO-166M	2.40E+04	5.02E+03	4.24E+03	0.00E+00	7.15E+03	0.00E+00	5.84E+05	0.00E+00
W-181	6.79E+04	1.67E+04	2.29E+03	0.00E+00	0.00E+00	0.00E+00	6.08E+05	0.00E+00
W-185	2.36E+06	5.89E+05	8.24E+04	0.00E+00	0.00E+00	0.00E+00	2.19E+07	0.00E+00
W-187	8.45E+03	5.00E+03	2.24E+03	0.00E+00	0.00E+00	0.00E+00	7.03E+05	0.00E+00
U-232	3.90E+10	0.00E+00	2.79E+09	0.00E+00	2.97E+09	0.00E+00	1.55E+08	0.00E+00
U-233	8.27E+09	0.00E+00	5.00E+08	0.00E+00	1.36E+09	0.00E+00	1.43E+08	0.00E+00
U-234	7.93E+09	0.00E+00	4.91E+08	0.00E+00	1.33E+09	0.00E+00	1.40E+08	0.00E+00
U-235	7.60E+09	0.00E+00	4.60E+08	0.00E+00	1.25E+09	0.00E+00	1.78E+08	0.00E+00
U-236	7.60E+09	0.00E+00	4.71E+08	0.00E+00	1.27E+09	0.00E+00	1.32E+08	0.00E+00

TABLE II2-20

R_i DOSE FACTORS AGE: CHILD PATHWAY: COW MILKm²-mrem/yr per μCi/sec

NUCLIDE	BONE	LIVER	T BODY	THYROID	KIDNEY	LUNG	GI-LLI	SKIN
U-237	7.52E+04	0.00E+00	2.00E+04	0.00E+00	2.17E+05	0.00E+00	6.63E+06	0.00E+00
U-238	7.27E+09	0.00E+00	4.31E+08	0.00E+00	1.16E+09	0.00E+00	1.26E+08	0.00E+00
NP-237	4.95E+07	3.27E+06	2.18E+06	0.00E+00	1.34E+07	0.00E+00	1.81E+06	0.00E+00
NP-238	4.78E+01	9.68E-01	7.45E-01	0.00E+00	3.08E+00	0.00E+00	3.31E+04	0.00E+00
NP-239	5.05E+00	3.62E-01	2.55E-01	0.00E+00	1.05E+00	0.00E+00	2.68E+04	0.00E+00
PU-238	1.06E+07	1.22E+06	2.80E+05	0.00E+00	1.02E+06	0.00E+00	6.66E+05	0.00E+00
PU-239	1.15E+07	1.23E+06	2.94E+05	0.00E+00	1.08E+06	0.00E+00	6.09E+05	0.00E+00
PU-240	1.14E+07	1.27E+06	2.94E+05	0.00E+00	1.08E+06	0.00E+00	6.20E+05	0.00E+00
PU-241	3.41E+05	1.39E+04	7.09E+03	0.00E+00	2.61E+04	0.00E+00	1.27E+04	0.00E+00
PU-242	1.06E+07	1.23E+06	2.84E+05	0.00E+00	1.04E+06	0.00E+00	5.96E+05	0.00E+00
PU-244	1.24E+07	1.40E+07	3.24E+05	0.00E+00	1.20E+06	0.00E+00	8.89E+05	0.00E+00
AM-241	3.02E+07	2.60E+07	2.27E+06	0.00E+00	1.38E+07	0.00E+00	1.70E+06	0.00E+00
AM-242M	3.11E+07	2.49E+07	2.31E+06	0.00E+00	1.40E+07	0.00E+00	2.13E+06	0.00E+00
AM-243	2.98E+07	2.51E+07	2.18E+06	0.00E+00	1.35E+07	0.00E+00	1.99E+06	0.00E+00
CM-242	1.52E+06	1.22E+06	1.01E+05	0.00E+00	3.24E+05	0.00E+00	1.41E+06	0.00E+00
CM-243	2.83E+07	2.30E+07	1.82E+06	0.00E+00	6.81E+06	0.00E+00	1.78E+06	0.00E+00
CM-244	2.38E+07	1.93E+07	1.53E+06	0.00E+00	5.61E+06	0.00E+00	1.71E+06	0.00E+00
CM-245	3.71E+07	2.98E+07	2.33E+06	0.00E+00	9.13E+06	0.00E+00	1.61E+06	0.00E+00
CM-246	3.67E+07	2.98E+07	2.33E+06	0.00E+00	9.11E+06	0.00E+00	1.58E+06	0.00E+00
CM-247	3.58E+07	2.93E+07	2.29E+06	0.00E+00	8.98E+06	0.00E+00	2.08E+06	0.00E+00
CM-248	2.98E+08	2.42E+08	1.89E+07	0.00E+00	7.40E+07	0.00E+00	3.36E+07	0.00E+00
CF-252	2.23E+07	0.00E+00	5.40E+05	0.00E+00	0.00E+00	0.00E+00	6.29E+06	0.00E+00

TABLE II2-21

R_i DOSE FACTORS AGE: INFANT PATHWAY: COW MILKm²-mrem/yr per μCi/sec

NUCLIDE	BONE	LIVER	T BODY	THYROID	KIDNEY	LUNG	GI-LLI	SKIN
H-3	0.00E+00	1.36E+03	1.36E+03	1.36E+03	1.36E+03	1.36E+03	1.36E+03	0.00E+00
C-14	3.23E+06	6.89E+05	6.89E+05	6.89E+05	6.89E+05	6.89E+05	6.89E+05	0.00E+00
NA-22	1.67E+10	1.67E+10	1.67E+10	1.67E+10	1.67E+10	1.67E+10	1.67E+10	0.00E+00
NA-24	4.51E+06	4.51E+06	4.51E+06	4.51E+06	4.51E+06	4.51E+06	4.51E+06	0.00E+00
P-32	4.74E+10	2.79E+09	1.84E+09	0.00E+00	0.00E+00	0.00E+00	6.41E+08	0.00E+00
CA-41	1.33E+10	0.00E+00	1.45E+09	0.00E+00	0.00E+00	0.00E+00	6.79E+06	0.00E+00
SC-46	5.33E+02	7.69E+02	2.40E+02	0.00E+00	5.06E+02	0.00E+00	5.02E+05	0.00E+00
CR-51	0.00E+00	0.00E+00	5.14E+04	3.35E+04	7.32E+03	6.52E+04	1.50E+06	0.00E+00
MN-54	0.00E+00	1.93E+07	4.38E+06	0.00E+00	4.28E+06	0.00E+00	7.10E+06	0.00E+00
MN-56	0.00E+00	9.19E-03	1.58E-03	0.00E+00	7.90E-03	0.00E+00	8.35E-01	0.00E+00
FE-55	7.09E+07	4.58E+07	1.22E+07	0.00E+00	0.00E+00	2.24E+07	5.82E+06	0.00E+00
FE-59	7.94E+07	1.39E+08	5.46E+07	0.00E+00	0.00E+00	4.10E+07	6.62E+07	0.00E+00
CO-57	0.00E+00	4.38E+06	7.12E+06	0.00E+00	0.00E+00	0.00E+00	1.49E+07	0.00E+00
CO-58	0.00E+00	9.58E+06	2.39E+07	0.00E+00	0.00E+00	0.00E+00	2.39E+07	0.00E+00
CO-60	0.00E+00	4.69E+07	1.11E+08	0.00E+00	0.00E+00	0.00E+00	1.12E+08	0.00E+00
NI-59	1.41E+09	4.32E+08	2.43E+08	0.00E+00	0.00E+00	0.00E+00	2.13E+07	0.00E+00
NI-63	1.89E+10	1.17E+09	6.54E+08	0.00E+00	0.00E+00	0.00E+00	5.80E+07	0.00E+00
NI-65	1.03E+00	1.16E-01	5.28E-02	0.00E+00	0.00E+00	0.00E+00	8.83E+00	0.00E+00
CU-64	0.00E+00	5.43E+04	2.51E+04	0.00E+00	9.18E+04	0.00E+00	1.11E+06	0.00E+00
ZN-65	2.69E+09	9.22E+09	4.25E+09	0.00E+00	4.47E+09	0.00E+00	7.79E+09	0.00E+00
ZN-69M	4.92E+05	1.00E+06	9.14E+04	0.00E+00	4.06E+05	0.00E+00	1.39E+07	0.00E+00
ZN-69	5.90E-12	1.06E-11	7.90E-13	0.00E+00	4.41E-12	0.00E+00	8.66E-10	0.00E+00
SE-79	0.00E+00	4.20E+09	7.80E+08	0.00E+00	4.86E+09	0.00E+00	1.12E+08	0.00E+00
BR-82	0.00E+00	0.00E+00	5.65E+07	0.00E+00	0.00E+00	0.00E+00	0.00E+00	0.00E+00
BR-83	0.00E+00	0.00E+00	2.73E-01	0.00E+00	0.00E+00	0.00E+00	0.00E+00	0.00E+00
BR-84	0.00E+00	0.00E+00	3.67E-23	0.00E+00	0.00E+00	0.00E+00	0.00E+00	0.00E+00
BR-85	0.00E+00	0.00E+00	0.00E+00	0.00E+00	0.00E+00	0.00E+00	0.00E+00	0.00E+00
RB-86	0.00E+00	6.70E+09	3.31E+09	0.00E+00	0.00E+00	0.00E+00	1.72E+08	0.00E+00
RB-87	0.00E+00	1.18E+10	4.69E+09	0.00E+00	0.00E+00	0.00E+00	7.97E+07	0.00E+00
RB-88	0.00E+00	5.48E-45	3.00E-45	0.00E+00	0.00E+00	0.00E+00	5.34E-45	0.00E+00
RB-89	0.00E+00	9.62E-53	6.62E-53	0.00E+00	0.00E+00	0.00E+00	3.27E-53	0.00E+00
SR-89	4.59E+09	0.00E+00	1.32E+08	0.00E+00	0.00E+00	0.00E+00	9.43E+07	0.00E+00
SR-90	1.00E+11	0.00E+00	2.03E+09	0.00E+00	0.00E+00	0.00E+00	8.18E+08	0.00E+00
SR-91	7.94E+04	0.00E+00	2.88E+03	0.00E+00	0.00E+00	0.00E+00	9.40E+04	0.00E+00
SR-92	1.36E+00	0.00E+00	5.04E-02	0.00E+00	0.00E+00	0.00E+00	1.46E+01	0.00E+00
Y-90	1.99E+02	0.00E+00	5.34E+00	0.00E+00	0.00E+00	0.00E+00	2.75E+05	0.00E+00
Y-91M	1.66E-19	0.00E+00	5.66E-21	0.00E+00	0.00E+00	0.00E+00	5.53E-16	0.00E+00
Y-91	2.77E+04	0.00E+00	7.37E+02	0.00E+00	0.00E+00	0.00E+00	1.98E+06	0.00E+00
Y-92	1.57E-04	0.00E+00	4.42E-06	0.00E+00	0.00E+00	0.00E+00	3.00E+00	0.00E+00
Y-93	6.31E-01	0.00E+00	1.72E-02	0.00E+00	0.00E+00	0.00E+00	4.98E+03	0.00E+00
ZR-93	4.29E+03	2.04E+02	1.23E+02	0.00E+00	6.02E+02	0.00E+00	5.31E+04	0.00E+00
ZR-95	2.63E+03	6.40E+02	4.54E+02	0.00E+00	6.90E+02	0.00E+00	3.19E+05	0.00E+00
ZR-97	1.19E+00	2.04E-01	9.31E-02	0.00E+00	2.06E-01	0.00E+00	1.30E+04	0.00E+00
NB-93M	1.36E+06	3.67E+05	1.15E+05	0.00E+00	3.58E+05	0.00E+00	4.39E+07	0.00E+00
NB-95	1.98E+05	8.17E+04	4.72E+04	0.00E+00	5.86E+04	0.00E+00	6.89E+07	0.00E+00

TABLE II2-21

R_i DOSE FACTORS AGE: INFANT PATHWAY: COW MILKm²-mrem/yr per μCi/sec

NUCLIDE	BONE	LIVER	T BODY	THYROID	KIDNEY	LUNG	GI-LLI	SKIN
NB-97	9.01E-12	1.92E-12	6.93E-13	0.00E+00	1.50E-12	0.00E+00	6.06E-07	0.00E+00
MO-93	0.00E+00	1.88E+09	6.07E+07	0.00E+00	3.77E+08	0.00E+00	4.03E+07	0.00E+00
MO-99	0.00E+00	6.08E+07	1.19E+07	0.00E+00	9.09E+07	0.00E+00	2.00E+07	0.00E+00
TC-99M	8.04E+00	1.66E+01	2.13E+02	0.00E+00	1.78E+02	8.67E+00	4.81E+03	0.00E+00
TC-99	1.20E+08	1.62E+08	5.05E+07	0.00E+00	1.37E+09	1.58E+07	7.01E+08	0.00E+00
TC-101	7.21E-60	9.09E-60	8.99E-59	0.00E+00	1.08E-58	4.96E-60	1.54E-57	0.00E+00
RU-103	2.98E+03	0.00E+00	9.95E+02	0.00E+00	6.19E+03	0.00E+00	3.62E+04	0.00E+00
RU-105	2.36E-03	0.00E+00	7.93E-04	0.00E+00	1.73E-02	0.00E+00	9.37E-01	0.00E+00
RU-106	9.54E+04	0.00E+00	1.19E+04	0.00E+00	1.13E+05	0.00E+00	7.25E+05	0.00E+00
RH-105	9.74E+05	6.37E+05	4.28E+05	0.00E+00	1.77E+06	0.00E+00	1.58E+07	0.00E+00
PD-107	0.00E+00	5.29E+07	3.76E+06	0.00E+00	3.02E+08	0.00E+00	4.20E+07	0.00E+00
PD-109	0.00E+00	1.17E+05	2.82E+04	0.00E+00	4.29E+05	0.00E+00	2.87E+06	0.00E+00
AG-110M	1.87E+08	1.37E+08	9.04E+07	0.00E+00	1.96E+08	0.00E+00	7.09E+09	0.00E+00
AG-111	1.81E+07	7.02E+06	3.72E+06	0.00E+00	1.47E+07	0.00E+00	1.67E+09	0.00E+00
CD-113M	0.00E+00	9.36E+06	3.45E+05	0.00E+00	7.08E+06	0.00E+00	1.41E+07	0.00E+00
CD-115M	0.00E+00	3.66E+06	1.27E+05	0.00E+00	1.91E+06	0.00E+00	2.08E+07	0.00E+00
SN-123	2.04E+09	3.18E+07	5.31E+07	3.20E+07	0.00E+00	0.00E+00	5.38E+08	0.00E+00
SN-125	1.58E+08	2.94E+06	7.00E+06	2.89E+06	0.00E+00	0.00E+00	2.36E+08	0.00E+00
SN-126	6.14E+09	8.07E+07	2.00E+08	2.12E+07	0.00E+00	0.00E+00	2.80E+08	0.00E+00
SB-124	7.96E+07	1.17E+06	2.47E+07	2.11E+05	0.00E+00	4.99E+07	2.46E+08	0.00E+00
SB-125	7.85E+07	7.60E+05	1.62E+07	9.83E+04	0.00E+00	4.55E+07	1.05E+08	0.00E+00
SB-126	1.23E+07	2.41E+05	4.44E+06	9.44E+04	0.00E+00	7.73E+06	1.27E+08	0.00E+00
SB-127	1.21E+06	2.16E+04	3.75E+05	1.54E+04	0.00E+00	6.24E+05	3.21E+07	0.00E+00
TE-125M	5.68E+07	1.90E+07	7.68E+06	1.91E+07	0.00E+00	0.00E+00	2.71E+07	0.00E+00
TE-127M	1.82E+08	6.04E+07	2.20E+07	5.26E+07	4.48E+08	0.00E+00	7.34E+07	0.00E+00
TE-127	1.85E+03	6.19E+02	3.97E+02	1.50E+03	4.51E+03	0.00E+00	3.88E+04	0.00E+00
TE-129M	1.85E+08	6.33E+07	2.84E+07	7.09E+07	4.61E+08	0.00E+00	1.10E+08	0.00E+00
TE-129	7.95E-10	2.74E-10	1.86E-10	6.66E-10	1.98E-09	0.00E+00	6.36E-08	0.00E+00
TE-131M	9.88E+05	3.98E+05	3.28E+05	8.06E+05	2.74E+06	0.00E+00	6.69E+06	0.00E+00
TE-131	1.00E-32	3.70E-33	2.81E-33	8.94E-33	2.56E-32	0.00E+00	4.05E-31	0.00E+00
TE-132	6.17E+06	3.06E+06	2.85E+06	4.51E+06	1.91E+07	0.00E+00	1.13E+07	0.00E+00
TE-133M	5.55E-13	2.54E-13	2.43E-13	4.89E-13	1.73E-12	0.00E+00	2.74E-11	0.00E+00
TE-134	2.28E-18	1.15E-18	1.18E-18	2.05E-18	7.73E-18	0.00E+00	2.62E-17	0.00E+00
I-129	3.81E+09	2.83E+09	2.07E+09	1.81E+12	3.35E+09	0.00E+00	5.65E+07	0.00E+00
I-130	1.04E+06	2.28E+06	9.17E+05	2.56E+08	2.51E+06	0.00E+00	4.90E+05	0.00E+00
I-131	7.96E+08	9.38E+08	4.12E+08	3.08E+11	1.10E+09	0.00E+00	3.35E+07	0.00E+00
I-132	4.18E-01	8.49E-01	3.02E-01	3.98E+01	9.47E-01	0.00E+00	6.88E-01	0.00E+00
I-133	1.06E+07	1.54E+07	4.52E+06	2.81E+09	1.82E+07	0.00E+00	2.61E+06	0.00E+00
I-134	5.15E-12	1.05E-11	3.75E-12	2.46E-10	1.18E-11	0.00E+00	1.09E-11	0.00E+00
I-135	3.28E+04	6.53E+04	2.38E+04	5.86E+06	7.28E+04	0.00E+00	2.36E+04	0.00E+00
CS-134M	4.47E-01	7.44E-01	3.76E-01	0.00E+00	2.87E-01	6.60E-02	5.89E-01	0.00E+00
CS-134	1.90E+10	3.54E+10	3.57E+09	0.00E+00	9.11E+09	3.74E+09	9.62E+07	0.00E+00
CS-135	7.09E+09	6.45E+09	3.36E+08	0.00E+00	1.83E+09	6.99E+08	2.33E+07	0.00E+00
CS-136	5.82E+08	1.71E+09	6.39E+08	0.00E+00	6.82E+08	1.40E+08	2.60E+07	0.00E+00
CS-137	2.77E+10	3.25E+10	2.30E+09	0.00E+00	8.71E+09	3.53E+09	1.01E+08	0.00E+00

TABLE II2-21

R_i DOSE FACTORS AGE: INFANT PATHWAY: COW MILKm²-mrem/yr per μCi/sec

NUCLIDE	BONE	LIVER	T BODY	THYROID	KIDNEY	LUNG	GI-LLI	SKIN
CS-138	2.45E-23	3.99E-23	1.93E-23	0.00E+00	1.99E-23	3.11E-24	6.38E-23	0.00E+00
CS-139	1.92E-89	2.62E-89	1.00E-89	0.00E+00	1.36E-89	2.04E-90	1.65E-90	0.00E+00
BA-139	1.25E-07	8.28E-11	3.62E-09	0.00E+00	4.98E-11	5.02E-11	7.92E-06	0.00E+00
BA-140	7.10E+07	7.10E+04	3.66E+06	0.00E+00	1.68E+04	4.36E+04	1.74E+07	0.00E+00
BA-141	1.15E-45	7.87E-49	3.63E-47	0.00E+00	4.74E-49	4.79E-49	1.40E-44	0.00E+00
BA-142	7.15E-80	5.94E-83	3.52E-81	0.00E+00	3.42E-83	3.60E-83	2.95E-79	0.00E+00
LA-140	1.19E+01	4.67E+00	1.20E+00	0.00E+00	0.00E+00	0.00E+00	5.49E+04	0.00E+00
LA-141	8.58E-05	2.49E-05	4.34E-06	0.00E+00	0.00E+00	0.00E+00	2.85E+00	0.00E+00
LA-142	4.97E-11	1.83E-11	4.37E-12	0.00E+00	0.00E+00	0.00E+00	3.10E-06	0.00E+00
CE-141	1.43E+04	8.70E+03	1.02E+03	0.00E+00	2.68E+03	0.00E+00	4.49E+06	0.00E+00
CE-143	1.16E+02	7.70E+04	8.78E+00	0.00E+00	2.24E+01	0.00E+00	4.49E+05	0.00E+00
CE-144	1.14E+06	4.68E+05	6.40E+04	0.00E+00	1.89E+05	0.00E+00	6.56E+07	0.00E+00
PR-143	4.38E+02	1.64E+02	2.17E+01	0.00E+00	6.09E+01	0.00E+00	2.31E+05	0.00E+00
PR-144	1.66E-53	6.44E-54	8.38E-55	0.00E+00	2.33E-54	0.00E+00	2.99E-49	0.00E+00
ND-147	2.58E+02	2.65E+02	1.63E+01	0.00E+00	1.02E+02	0.00E+00	1.68E+05	0.00E+00
PM-147	8.24E+03	6.94E+02	3.38E+02	0.00E+00	1.04E+03	0.00E+00	1.97E+05	0.00E+00
PM-148M	1.70E+03	4.31E+02	3.38E+02	0.00E+00	4.95E+02	0.00E+00	5.61E+05	0.00E+00
PM-148	1.63E+02	2.35E+01	1.18E+01	0.00E+00	2.81E+01	0.00E+00	2.51E+05	0.00E+00
PM-149	1.21E+01	1.59E+00	6.92E-01	0.00E+00	1.93E+00	0.00E+00	4.26E+04	0.00E+00
PM-151	1.79E+00	2.61E-01	1.32E-01	0.00E+00	3.11E-01	0.00E+00	1.21E+04	0.00E+00
SM-151	6.43E+03	1.48E+03	3.20E+02	0.00E+00	1.01E+03	0.00E+00	1.24E+05	0.00E+00
SM-153	5.55E+00	4.30E+00	3.30E-01	0.00E+00	8.99E-01	0.00E+00	2.24E+04	0.00E+00
EU-152	1.48E+04	3.94E+03	3.33E+03	0.00E+00	1.11E+04	0.00E+00	3.50E+05	0.00E+00
EU-154	5.79E+04	8.04E+03	4.82E+03	0.00E+00	2.18E+04	0.00E+00	1.00E+06	0.00E+00
EU-155	1.18E+04	1.36E+03	7.01E+02	0.00E+00	3.04E+03	0.00E+00	1.82E+06	0.00E+00
EU-156	6.61E+02	4.09E+02	6.49E+01	0.00E+00	1.89E+02	0.00E+00	3.86E+05	0.00E+00
TB-160	3.48E+03	0.00E+00	4.35E+02	0.00E+00	9.89E+02	0.00E+00	4.63E+05	0.00E+00
HO-166M	2.78E+04	5.98E+03	4.73E+03	0.00E+00	7.93E+03	0.00E+00	5.91E+05	0.00E+00
W-181	1.42E+05	4.37E+04	4.88E+03	0.00E+00	0.00E+00	0.00E+00	6.13E+05	0.00E+00
W-185	4.93E+06	1.54E+06	1.76E+05	0.00E+00	0.00E+00	0.00E+00	2.21E+07	0.00E+00
W-187	1.78E+04	1.24E+04	4.27E+03	0.00E+00	0.00E+00	0.00E+00	7.27E+05	0.00E+00
U-232	5.37E+10	0.00E+00	4.79E+09	0.00E+00	5.26E+09	0.00E+00	1.56E+08	0.00E+00
U-233	1.13E+10	0.00E+00	8.60E+08	0.00E+00	2.40E+09	0.00E+00	1.45E+08	0.00E+00
U-234	1.08E+10	0.00E+00	8.44E+08	0.00E+00	2.36E+09	0.00E+00	1.42E+08	0.00E+00
U-235	1.04E+10	0.00E+00	7.91E+08	0.00E+00	2.21E+09	0.00E+00	1.80E+08	0.00E+00
U-236	1.04E+10	0.00E+00	8.09E+08	0.00E+00	2.24E+09	0.00E+00	1.33E+08	0.00E+00
U-237	1.58E+05	0.00E+00	4.21E+04	0.00E+00	3.92E+05	0.00E+00	6.72E+06	0.00E+00
U-238	9.93E+09	0.00E+00	7.40E+08	0.00E+00	2.06E+09	0.00E+00	1.27E+08	0.00E+00
NP-237	5.33E+07	3.53E+06	2.33E+06	0.00E+00	1.41E+07	0.00E+00	1.83E+06	0.00E+00
NP-238	1.02E+02	2.56E+00	1.58E+00	0.00E+00	5.59E+00	0.00E+00	3.42E+04	0.00E+00
NP-239	1.07E+01	9.54E-01	5.39E-01	0.00E+00	1.90E+00	0.00E+00	2.76E+04	0.00E+00
PU-238	1.14E+07	1.33E+06	3.02E+05	0.00E+00	1.07E+06	0.00E+00	6.72E+05	0.00E+00
PU-239	1.23E+07	1.38E+06	3.15E+05	0.00E+00	1.14E+06	0.00E+00	6.14E+05	0.00E+00
PU-240	1.23E+07	1.38E+06	3.15E+05	0.00E+00	1.14E+06	0.00E+00	6.26E+05	0.00E+00
PU-241	3.75E+05	1.55E+04	7.77E+03	0.00E+00	2.79E+04	0.00E+00	1.28E+04	0.00E+00

TABLE II-21

R_i DOSE FACTORS AGE: INFANT PATHWAY: COW MILKm²-mrem/yr per μ Ci/sec

NUCLIDE	BONE	LIVER	T BODY	THYROID	KIDNEY	LUNG	GI-LLI	SKIN
PU-242	1.14E+07	1.32E+06	3.03E+05	0.00E+00	1.09E+06	0.00E+00	6.02E+05	0.00E+00
PU-244	1.32E+07	1.52E+06	3.48E+05	0.00E+00	1.25E+06	0.00E+00	8.98E+05	0.00E+00
AM-241	3.24E+07	2.82E+07	2.42E+06	0.00E+00	1.45E+07	0.00E+00	1.71E+06	0.00E+00
AM-242M	3.35E+07	2.71E+07	2.51E+06	0.00E+00	1.47E+07	0.00E+00	2.15E+06	0.00E+00
AM-243	3.20E+07	2.73E+07	2.36E+06	0.00E+00	1.41E+07	0.00E+00	2.01E+06	0.00E+00
CM-242	2.37E+06	2.20E+06	1.58E+05	0.00E+00	4.54E+05	0.00E+00	1.43E+06	0.00E+00
CM-243	3.10E+07	2.54E+07	1.99E+06	0.00E+00	7.24E+06	0.00E+00	1.79E+06	0.00E+00
CM-244	2.60E+07	2.14E+07	1.68E+06	0.00E+00	5.98E+06	0.00E+00	1.73E+06	0.00E+00
CM-245	3.98E+07	3.22E+07	2.51E+06	0.00E+00	9.60E+06	0.00E+00	1.62E+06	0.00E+00
CM-246	3.93E+07	3.22E+07	2.51E+06	0.00E+00	9.58E+06	0.00E+00	1.59E+06	0.00E+00
CM-247	3.84E+07	3.18E+07	2.47E+06	0.00E+00	9.42E+06	0.00E+00	2.10E+06	0.00E+00
CM-248	3.18E+08	2.62E+08	2.04E+07	0.00E+00	7.78E+07	0.00E+00	3.38E+07	0.00E+00
CF-252	2.59E+07	0.00E+00	6.27E+05	0.00E+00	0.00E+00	0.00E+00	6.35E+06	0.00E+00

TABLE I12-22

R_i DOSE FACTORS AGE: ADULT PATHWAY: GOAT MILKm²-mrem/yr per μ Ci/sec

NUCLIDE	BONE	LIVER	T BODY	THYROID	KIDNEY	LUNG	GI-LLI	SKIN
H-3	0.00E+00	8.88E+02	8.88E+02	8.88E+02	8.88E+02	8.88E+02	8.88E+02	0.00E+00
C-14	3.63E+05	7.26E+04	7.26E+04	7.26E+04	7.26E+04	7.26E+04	7.26E+04	0.00E+00
NA-22	3.33E+08	3.33E+08	3.33E+08	3.33E+08	3.33E+08	3.33E+08	3.33E+08	0.00E+00
NA-24	8.56E+04	8.56E+04	8.56E+04	8.56E+04	8.56E+04	8.56E+04	8.56E+04	0.00E+00
P-32	6.06E+09	3.77E+08	2.34E+08	0.00E+00	0.00E+00	0.00E+00	6.82E+08	0.00E+00
CA-41	4.356E+10	0.00E+00	4.71E+09	0.00E+00	0.00E+00	0.00E+00	4.33E+07	0.00E+00
SC-46	8.83E+00	1.72E+01	4.98E+00	0.00E+00	1.60E+01	0.00E+00	8.35E+04	0.00E+00
CR-51	0.00E+00	0.00E+00	1.09E+03	6.53E+02	2.41E+02	1.45E+03	2.75E+05	0.00E+00
MN-54	0.00E+00	5.00E+05	9.54E+04	0.00E+00	1.49E+05	0.00E+00	1.53E+06	0.00E+00
FE-55	1.714E+05	1.184E+05	2.761E+04	0.000E+00	0.000E+00	6.606E+04	6.793E+04	0.000E+00
MN-56	0.00E+00	1.46E-04	2.58E-05	0.00E+00	1.85E-04	0.00E+00	4.65E-03	0.00E+00
CO-57	0.00E+00	7.51E+04	1.25E+05	0.00E+00	0.00E+00	0.00E+00	1.91E+06	0.00E+00
CO-58	0.00E+00	2.23E+05	5.01E+05	0.00E+00	0.00E+00	0.00E+00	4.53E+06	0.00E+00
FE-59	1.366E+05	3.209E+05	1.230E+05	0.000E+00	0.000E+00	8.967E+04	1.070E+06	0.000E+00
CO-60	0.00E+00	1.05E+06	2.31E+06	0.00E+00	0.00E+00	0.00E+00	1.97E+07	0.00E+00
NI-59	3.28E+07	1.12E+07	5.47E+06	0.00E+00	0.00E+00	0.00E+00	2.32E+06	0.00E+00
NI-63	4.36E+08	3.02E+07	1.46E+07	0.00E+00	0.00E+00	0.00E+00	6.30E+06	0.00E+00
CU-64	0.00E+00	7.77E+02	3.65E+02	0.00E+00	1.96E+03	0.00E+00	6.62E+04	0.00E+00
NI-65	1.30E-02	1.69E-03	7.70E-04	0.00E+00	0.00E+00	0.00E+00	4.28E-02	0.00E+00
ZN-65	7.97E+07	2.54E+08	1.15E+08	0.00E+00	1.70E+08	0.00E+00	1.60E+08	0.00E+00
ZN-69m	6.28E+03	1.51E+04	1.38E+03	0.00E+00	9.13E+03	0.00E+00	9.20E+05	0.00E+00
ZN-69	7.34E-14	1.40E-13	9.76E-15	0.00E+00	9.12E-14	0.00E+00	2.11E-14	0.00E+00
SE-79	0.00E+00	5.93E+07	9.90E+06	0.00E+00	1.03E+08	0.00E+00	1.21E+07	0.00E+00
BR-82	0.00E+00	0.00E+00	1.13E+06	0.00E+00	0.00E+00	0.00E+00	1.30E+06	0.00E+00
BR-83	0.00E+00	0.00E+00	3.41E-03	0.00E+00	0.00E+00	0.00E+00	4.91E-03	0.00E+00
BR-84	0.00E+00	0.00E+00	5.65E-25	0.00E+00	0.00E+00	0.00E+00	4.43E-30	0.00E+00
BR-85	0.00E+00	0.00E+00	0.00E+00	0.00E+00	0.00E+00	0.00E+00	0.00E+00	0.00E+00
RB-86	0.00E+00	9.38E+07	4.37E+07	0.00E+00	0.00E+00	0.00E+00	1.85E+07	0.00E+00
RB-87	0.00E+00	1.85E+08	6.43E+07	0.00E+00	0.00E+00	0.00E+00	8.66E+06	0.00E+00
RB-88	0.00E+00	7.51E-47	3.98E-47	0.00E+00	0.00E+00	0.00E+00	1.04E-57	0.00E+00
RB-89	0.00E+00	1.52E-54	1.07E-54	0.00E+00	0.00E+00	0.00E+00	8.83E-68	0.00E+00
SR-89	1.11E+09	0.00E+00	3.19E+07	0.00E+00	0.00E+00	0.00E+00	1.78E+08	0.00E+00
SR-90	6.08E+10	0.00E+00	1.22E+09	0.00E+00	0.00E+00	0.00E+00	1.53E+09	0.00E+00
Y-90	2.49E+00	0.00E+00	6.67E-02	0.00E+00	0.00E+00	0.00E+00	2.64E+04	0.00E+00
SR-91	1.78E+04	0.00E+00	7.18E+02	0.00E+00	0.00E+00	0.00E+00	8.46E+04	0.00E+00
Y-91m	2.10E-21	0.00E+00	8.13E-23	0.00E+00	0.00E+00	0.00E+00	6.17E-21	0.00E+00
Y-91	3.89E+02	0.00E+00	1.04E+01	0.00E+00	0.00E+00	0.00E+00	2.14E+05	0.00E+00
SR-92	3.00E-01	0.00E+00	1.30E-02	0.00E+00	0.00E+00	0.00E+00	5.94E+00	0.00E+00
Y-92	1.96E-06	0.00E+00	5.72E-08	0.00E+00	0.00E+00	0.00E+00	3.43E-02	0.00E+00
Y-93	7.84E-03	0.00E+00	2.16E-04	0.00E+00	0.00E+00	0.00E+00	2.49E+02	0.00E+00
NB-93m	3.17E+04	1.03E+04	2.55E+03	0.00E+00	1.19E+04	0.00E+00	4.77E+06	0.00E+00
NB-95	3.31E+03	1.84E+03	9.90E+02	0.00E+00	1.82E+03	0.00E+00	1.12E+07	0.00E+00

TABLE I12-22

R_i DOSE FACTORS AGE: ADULT PATHWAY: GOAT MILKm²-mrem/yr per μCi/sec

NUCLIDE	BONE	LIVER	T BODY	THYROID	KIDNEY	LUNG	GI-LLI	SKIN
NB-97	1.15E-13	2.92E-14	1.07E-14	0.00E+00	3.41E-14	0.00E+00	1.08E-10	0.00E+00
ZR-93	1.05E+02	5.86E+00	2.73E+00	0.00E+00	2.22E+01	0.00E+00	6.09E+03	0.00E+00
ZR-95	4.37E+01	1.40E+01	9.48E+00	0.00E+00	2.20E+01	0.00E+00	4.44E+04	0.00E+00
ZR-97	1.52E-02	3.07E-03	1.40E-03	0.00E+00	4.63E-03	0.00E+00	9.50E+02	0.00E+00
MO-93	0.00E+00	2.82E+07	7.63E+05	0.00E+00	8.00E+06	0.00E+00	4.58E+06	0.00E+00
MO-99	0.00E+00	8.69E+05	1.65E+05	0.00E+00	1.97E+06	0.00E+00	2.02E+06	0.00E+00
TC-99	1.57E+06	2.33E+06	6.29E+05	0.00E+00	2.93E+07	1.98E+05	7.61E+07	0.00E+00
TC-99m	1.17E-01	3.29E-01	4.20E+00	0.00E+00	5.00E+00	1.61E-01	1.95E+02	0.00E+00
TC-101	9.10E-62	1.31E-61	1.29E-60	0.00E+00	2.36E-60	6.70E-62	3.94E-73	0.00E+00
RU-103	4.19E+01	0.00E+00	1.81E+01	0.00E+00	1.60E+02	0.00E+00	4.90E+03	0.00E+00
RU-105	3.01E-05	0.00E+00	1.19E-05	0.00E+00	3.89E-04	0.00E+00	1.84E-02	0.00E+00
RU-106	1.23E+03	0.00E+00	1.55E+02	0.00E+00	2.37E+03	0.00E+00	7.95E+04	0.00E+00
RH-105	1.22E+04	8.91E+03	5.87E+03	0.00E+00	3.79E+04	0.00E+00	1.42E+06	0.00E+00
PD-107	0.00E+00	7.36E+05	4.71E+04	0.00E+00	6.61E+06	0.00E+00	4.56E+06	0.00E+00
PD-109	0.00E+00	1.55E+03	3.50E+02	0.00E+00	8.87E+03	0.00E+00	1.72E+05	0.00E+00
AG-110m	3.39E+06	3.14E+06	1.86E+06	0.00E+00	6.17E+06	0.00E+00	1.28E+09	0.00E+00
AG-111	2.27E+05	9.51E+04	4.74E+04	0.00E+00	3.07E+05	0.00E+00	1.75E+08	0.00E+00
CD-113m	0.00E+00	1.89E+05	6.08E+03	0.00E+00	2.09E+05	0.00E+00	1.53E+06	0.00E+00
CD-115m	0.00E+00	5.34E+04	1.70E+03	0.00E+00	4.24E+04	0.00E+00	2.25E+06	0.00E+00
SN-123	2.87E+07	4.75E+05	6.99E+05	4.04E+05	0.00E+00	0.00E+00	5.83E+07	0.00E+00
SN-125	2.00E+06	4.03E+04	9.06E+04	3.33E+04	0.00E+00	0.00E+00	2.49E+07	0.00E+00
SN-126	1.06E+08	2.09E+06	3.01E+06	6.16E+05	0.00E+00	0.00E+00	3.04E+07	0.00E+00
SB-124	1.17E+06	2.22E+04	4.66E+05	2.85E+03	0.00E+00	9.14E+05	3.33E+07	0.00E+00
SB-125	1.29E+06	1.44E+04	3.07E+05	1.31E+03	0.00E+00	9.93E+05	1.42E+07	0.00E+00
SB-126	1.98E+05	4.02E+03	7.13E+04	1.21E+03	0.00E+00	1.21E+05	1.62E+07	0.00E+00
SB-127	1.58E+04	3.46E+02	6.06E+03	1.90E+02	0.00E+00	9.36E+03	3.61E+06	0.00E+00
TE-125m	7.37E+05	2.67E+05	9.87E+04	2.22E+05	3.00E+06	0.00E+00	2.94E+06	0.00E+00
TE-127m	2.37E+06	8.49E+05	2.89E+05	6.07E+05	9.64E+06	0.00E+00	7.96E+06	0.00E+00
TE-127	2.29E+01	8.23E+00	4.96E+00	1.70E+01	9.33E+01	0.00E+00	1.81E+03	0.00E+00
TE-129m	2.39E+06	8.92E+05	3.79E+05	8.22E+05	9.98E+06	0.00E+00	1.20E+07	0.00E+00
TE-129	9.91E-12	3.72E-12	2.41E-12	7.61E-12	4.17E-11	0.00E+00	7.48E-12	0.00E+00
TE-133m	7.39E-15	4.32E-15	4.16E-15	6.25E-15	4.27E-14	0.00E+00	1.48E-15	0.00E+00
TE-134	3.13E-20	2.04E-20	1.25E-20	2.73E-20	1.98E-19	0.00E+00	3.46E-23	0.00E+00
I-129	4.91E+08	4.22E+08	1.38E+09	1.09E+12	9.08E+08	0.00E+00	6.67E+07	0.00E+00
I-130	1.47E+05	4.35E+05	1.72E+05	3.69E+07	6.79E+05	0.00E+00	3.74E+05	0.00E+00
I-131	1.04E+08	1.49E+08	8.52E+07	4.87E+10	2.55E+08	0.00E+00	3.92E+07	0.00E+00
TE-131m	1.27E+04	6.20E+03	5.16E+03	9.82E+03	6.28E+04	0.00E+00	6.15E+05	0.00E+00
TE-131	1.26E-34	5.28E-35	3.99E-35	1.04E-34	5.54E-34	0.00E+00	1.79E-35	0.00E+00
I-132	5.76E-02	1.54E-01	5.40E-02	5.40E+00	2.46E-01	0.00E+00	2.90E-02	0.00E+00
TE-132	8.43E+04	5.45E+04	5.12E+04	6.02E+04	5.25E+05	0.00E+00	2.58E+06	0.00E+00
I-133	1.36E+06	2.36E+06	7.20E+05	3.47E+08	4.12E+06	0.00E+00	2.12E+06	0.00E+00
CS-134m	1.52E-01	3.20E-01	1.64E-01	0.00E+00	1.74E-01	2.74E-02	1.13E-01	0.00E+00

TABLE I12-22

R_i DOSE FACTORS AGE: ADULT PATHWAY: GOAT MILKm²-mrem/yr per μ Ci/sec

NUCLIDE	BONE	LIVER	T BODY	THYROID	KIDNEY	LUNG	GI-LLI	SKIN
CS-134	8.83E+09	2.10E+10	1.72E+10	0.00E+00	6.80E+09	2.26E+09	3.68E+08	0.00E+00
I-134	7.08E-13	1.92E-12	6.88E-13	3.33E-11	3.06E-12	0.00E+00	1.68E-15	0.00E+00
I-135	4.51E+03	1.18E+04	4.35E+03	7.78E+05	1.89E+04	0.00E+00	1.33E+04	0.00E+00
CS-135	2.93E+09	2.71E+09	1.20E+09	0.00E+00	1.02E+09	3.07E+08	6.33E+07	0.00E+00
CS-136	2.33E+08	9.19E+08	6.61E+08	0.00E+00	5.11E+08	7.01E+07	1.04E+08	0.00E+00
CS-137	1.19E+10	1.63E+10	1.07E+10	0.00E+00	5.54E+09	1.84E+09	3.16E+08	0.00E+00
CS-138	7.93E-24	1.57E-23	7.76E-24	0.00E+00	1.15E-23	1.14E-24	6.68E-29	0.00E+00
CS-139	5.95E-90	8.86E-90	3.23E-90	0.00E+00	7.10E-90	6.46E-91	1.92E-112	0.00E+00
BA-139	1.55E-09	1.11E-12	4.54E-11	0.00E+00	1.03E-12	6.27E-13	2.75E-09	0.00E+00
BA-140	9.49E+05	1.19E+03	6.22E+04	0.00E+00	4.06E+02	6.83E+02	1.96E+06	0.00E+00
LA-140	1.58E-01	7.98E-02	2.11E-02	0.00E+00	0.00E+00	0.00E+00	5.86E+03	0.00E+00
BA-141	1.44E-47	1.09E-50	4.85E-49	0.00E+00	1.01E-50	6.16E-51	6.77E-57	0.00E+00
LA-141	1.07E-06	3.31E-07	5.42E-08	0.00E+00	0.00E+00	0.00E+00	3.95E-02	0.00E+00
CE-141	1.91E+02	1.29E+02	1.47E+01	0.00E+00	6.00E+01	0.00E+00	4.94E+05	0.00E+00
BA-142	9.33E-82	9.59E-85	5.87E-83	0.00E+00	8.10E-85	5.43E-85	1.31E-99	0.00E+00
LA-142	6.52E-13	2.97E-13	7.39E-14	0.00E+00	0.00E+00	0.00E+00	2.17E-09	0.00E+00
CE-143	1.46E+00	1.08E+03	1.19E-01	0.00E+00	4.75E-01	0.00E+00	4.03E+04	0.00E+00
PR-143	5.59E+00	2.24E+00	2.77E-01	0.00E+00	1.29E+00	0.00E+00	2.45E+04	0.00E+00
CE-144	2.11E+04	8.82E+03	1.13E+03	0.00E+00	5.23E+03	0.00E+00	7.13E+06	0.00E+00
PR-144	2.06E-55	8.55E-56	1.05E-56	0.00E+00	4.82E-56	0.00E+00	2.96E-62	0.00E+00
ND-147	3.31E+00	3.83E+00	2.29E-01	0.00E+00	2.24E+00	0.00E+00	1.84E+04	0.00E+00
PM-147	1.80E+02	1.70E+01	6.87E+00	0.00E+00	3.21E+01	0.00E+00	2.14E+04	0.00E+00
PM-148m	3.57E+01	9.24E+00	7.07E+00	0.00E+00	1.39E+01	0.00E+00	7.84E+04	0.00E+00
PM-148	2.08E+00	3.46E-01	1.74E-01	0.00E+00	6.53E-01	0.00E+00	2.72E+04	0.00E+00
PM-149	1.50E-01	2.12E-02	8.67E-03	0.00E+00	4.01E-02	0.00E+00	3.98E+03	0.00E+00
PM-151	2.28E-02	3.83E-03	1.93E-03	0.00E+00	6.84E-03	0.00E+00	1.05E+03	0.00E+00
SM-151	1.73E+02	2.98E+01	7.13E+00	0.00E+00	3.33E+01	0.00E+00	1.31E+04	0.00E+00
SM-153	6.95E-02	5.80E-02	4.23E-03	0.00E+00	1.87E-02	0.00E+00	2.07E+03	0.00E+00
EU-152	4.84E+02	1.10E+02	9.68E+01	0.00E+00	6.83E+02	0.00E+00	6.36E+04	0.00E+00
EU-154	1.52E+03	1.87E+02	1.33E+02	0.00E+00	8.94E+02	0.00E+00	1.35E+05	0.00E+00
EU-155	2.10E+02	2.98E+01	1.92E+01	0.00E+00	1.38E+02	0.00E+00	2.35E+04	0.00E+00
EU-156	8.95E+00	6.92E+00	1.12E+00	0.00E+00	4.62E+00	0.00E+00	4.74E+04	0.00E+00
TB-160	7.11E+01	0.00E+00	8.86E+00	0.00E+00	2.93E+01	0.00E+00	6.55E+04	0.00E+00
HO-166m	6.76E+02	2.11E+02	1.60E+02	0.00E+00	3.16E+02	0.00E+00	6.41E+04	0.00E+00
W-181	1.79E+03	5.84E+02	6.26E+01	0.00E+00	0.00E+00	0.00E+00	6.66E+04	0.00E+00
W-185	6.22E+04	2.07E+04	2.18E+03	0.00E+00	0.00E+00	0.00E+00	2.40E+06	0.00E+00
W-187	2.29E+02	1.91E+02	6.68E+01	0.00E+00	0.00E+00	0.00E+00	6.26E+04	0.00E+00
NP-239	1.29E-01	1.27E-02	6.99E-03	0.00E+00	3.95E-02	0.00E+00	2.60E+03	0.00E+00
U-232	1.03E+09	0.00E+00	7.38E+07	0.00E+00	1.12E+08	0.00E+00	1.70E+07	0.00E+00
U-233	2.18E+08	0.00E+00	1.32E+07	0.00E+00	5.08E+07	0.00E+00	1.57E+07	0.00E+00
U-234	2.09E+08	0.00E+00	1.29E+07	0.00E+00	4.98E+07	0.00E+00	1.54E+07	0.00E+00
U-235	2.01E+08	0.00E+00	1.22E+07	0.00E+00	4.68E+07	0.00E+00	1.96E+07	0.00E+00

TABLE II2-22

R_i DOSE FACTORS AGE: ADULT PATHWAY: GOAT MILKm²-mrem/yr per μCi/sec

NUCLIDE	BONE	LIVER	T BODY	THYROID	KIDNEY	LUNG	GI-LLI	SKIN
U-236	2.01E+08	0.00E+00	1.24E+07	0.00E+00	4.78E+07	0.00E+00	1.44E+07	0.00E+00
U-237	1.98E+03	0.00E+00	5.28E+02	0.00E+00	8.15E+03	0.00E+00	6.97E+05	0.00E+00
U-238	1.92E+08	0.00E+00	1.14E+07	0.00E+00	4.38E+07	0.00E+00	1.38E+07	0.00E+00
NP-237	3.16E+06	2.24E+05	1.39E+05	0.00E+00	1.03E+06	0.00E+00	1.99E+05	0.00E+00
NP-238	1.27E+00	3.41E-02	1.97E-02	0.00E+00	1.16E-01	0.00E+00	3.17E+03	0.00E+00
PU-238	6.30E+05	7.98E+04	1.71E+04	0.00E+00	7.32E+04	0.00E+00	7.30E+04	0.00E+00
PU-239	7.26E+05	8.73E+04	1.91E+04	0.00E+00	8.13E+04	0.00E+00	6.67E+04	0.00E+00
PU-240	7.25E+05	8.72E+04	1.91E+04	0.00E+00	8.12E+04	0.00E+00	6.79E+04	0.00E+00
PU-241	1.56E+04	7.40E+02	3.30E+02	0.00E+00	1.52E+03	0.00E+00	1.39E+03	0.00E+00
PU-242	6.73E+05	8.41E+04	1.84E+04	0.00E+00	7.82E+04	0.00E+00	6.54E+04	0.00E+00
PU-244	7.85E+05	9.63E+04	2.11E+04	0.00E+00	8.97E+04	0.00E+00	9.75E+04	0.00E+00
AM-241	1.89E+06	1.77E+06	1.35E+05	0.00E+00	1.02E+06	0.00E+00	1.86E+05	0.00E+00
AM-242m	1.90E+06	1.66E+06	1.36E+05	0.00E+00	1.01E+06	0.00E+00	2.34E+05	0.00E+00
AM-243	1.89E+06	1.73E+06	1.33E+05	0.00E+00	9.99E+05	0.00E+00	2.18E+05	0.00E+00
CM-242	4.03E+04	4.28E+04	2.68E+03	0.00E+00	1.22E+04	0.00E+00	1.55E+05	0.00E+00
CM-243	1.49E+06	1.37E+06	9.35E+04	0.00E+00	4.36E+05	0.00E+00	1.95E+05	0.00E+00
CM-244	1.13E+06	1.06E+06	7.14E+04	0.00E+00	3.33E+05	0.00E+00	1.88E+05	0.00E+00
CM-245	2.35E+06	2.05E+06	1.44E+05	0.00E+00	6.74E+05	0.00E+00	1.76E+05	0.00E+00
CM-246	2.33E+06	2.04E+06	1.44E+05	0.00E+00	6.71E+05	0.00E+00	1.73E+05	0.00E+00
CM-247	2.27E+06	2.01E+06	1.42E+05	0.00E+00	6.61E+05	0.00E+00	2.28E+05	0.00E+00
CM-248	1.89E+07	1.66E+07	1.17E+06	0.00E+00	5.46E+06	0.00E+00	3.68E+06	0.00E+00
CF-252	6.25E+05	0.00E+00	1.51E+04	0.00E+00	0.00E+00	0.00E+00	6.90E+05	0.00E+00

TABLE II2-23

R_i DOSE FACTORS AGE: TEEN PATHWAY: GOAT MILKm²-mrem/yr per μ Ci/sec

NUCLIDE	BONE	LIVER	T BODY	THYROID	KIDNEY	LUNG	GI-LLI	SKIN
H-3	0.00E+00	1.16E+03	1.16E+03	1.16E+03	1.16E+03	1.16E+03	1.16E+03	0.00E+00
C-14	6.70E+05	1.34E+05	1.34E+05	1.34E+05	1.34E+05	1.34E+05	1.34E+05	0.00E+00
NA-22	5.78E+08	5.78E+08	5.78E+08	5.78E+08	5.78E+08	5.78E+08	5.78E+08	0.00E+00
NA-24	1.49E+05	1.49E+05	1.49E+05	1.49E+05	1.49E+05	1.49E+05	1.49E+05	0.00E+00
P-32	1.12E+10	6.93E+08	4.34E+08	0.00E+00	0.00E+00	0.00E+00	9.41E+08	0.00E+00
CA-41	5.98E+10	0.00E+00	6.47E+09	0.00E+00	0.00E+00	0.00E+00	5.92E+07	0.00E+00
SC-46	1.50E+01	2.92E+01	8.65E+00	0.00E+00	2.79E+01	0.00E+00	9.93E+04	0.00E+00
CR-51	0.00E+00	0.00E+00	1.91E+03	1.06E+03	4.18E+02	2.72E+03	3.21E+05	0.00E+00
MN-54	0.00E+00	8.33E+05	1.65E+05	0.00E+00	2.49E+05	0.00E+00	1.71E+06	0.00E+00
FE-55	3.039E+05	2.155E+05	5.026E+04	0.000E+00	0.000E+00	1.367E+05	9.327E+04	0.000E+00
MN-56	0.00E+00	2.58E-04	4.59E-05	0.00E+00	3.27E-04	0.00E+00	1.70E-02	0.00E+00
CO-57	0.00E+00	1.32E+05	2.21E+05	0.00E+00	0.00E+00	0.00E+00	2.46E+06	0.00E+00
CO-58	0.00E+00	3.76E+05	8.67E+05	0.00E+00	0.00E+00	0.00E+00	5.19E+06	0.00E+00
FE-59	2.383E+05	5.562E+05	2.148E+05	0.000E+00	0.000E+00	1.754E+05	1.315E+06	0.000E+00
CO-60	0.00E+00	1.78E+06	4.00E+06	0.00E+00	0.00E+00	0.00E+00	2.31E+07	0.00E+00
NI-59	5.72E+07	2.02E+07	9.70E+06	0.00E+00	0.00E+00	0.00E+00	3.17E+06	0.00E+00
NI-63	7.66E+08	5.41E+07	2.60E+07	0.00E+00	0.00E+00	0.00E+00	8.61E+06	0.00E+00
CU-64	0.00E+00	1.38E+03	6.51E+02	0.00E+00	3.50E+03	0.00E+00	1.07E+05	0.00E+00
NI-65	2.38E-02	3.04E-03	1.38E-03	0.00E+00	0.00E+00	0.00E+00	1.65E-01	0.00E+00
ZN-65	1.22E+08	4.25E+08	1.98E+08	0.00E+00	2.72E+08	0.00E+00	1.80E+08	0.00E+00
ZN-69m	1.14E+04	2.70E+04	2.47E+03	0.00E+00	1.64E+04	0.00E+00	1.48E+06	0.00E+00
ZN-69	1.35E-13	2.57E-13	1.80E-14	0.00E+00	1.68E-13	0.00E+00	4.74E-13	0.00E+00
SE-79	0.00E+00	1.08E+08	1.82E+07	0.00E+00	1.89E+08	0.00E+00	1.66E+07	0.00E+00
BR-82	0.00E+00	0.00E+00	1.97E+06	0.00E+00	0.00E+00	0.00E+00	0.00E+00	0.00E+00
BR-83	0.00E+00	0.00E+00	6.28E-03	0.00E+00	0.00E+00	0.00E+00	0.00E+00	0.00E+00
BR-84	0.00E+00	0.00E+00	1.01E-24	0.00E+00	0.00E+00	0.00E+00	0.00E+00	0.00E+00
BR-85	0.00E+00	0.00E+00	0.00E+00	0.00E+00	0.00E+00	0.00E+00	0.00E+00	0.00E+00
RB-86	0.00E+00	1.71E+08	8.03E+07	0.00E+00	0.00E+00	0.00E+00	2.53E+07	0.00E+00
RB-87	0.00E+00	3.39E+08	1.18E+08	0.00E+00	0.00E+00	0.00E+00	1.18E+07	0.00E+00
RB-88	0.00E+00	1.36E-46	7.27E-47	0.00E+00	0.00E+00	0.00E+00	1.17E-53	0.00E+00
RB-89	0.00E+00	2.69E-54	1.90E-54	0.00E+00	0.00E+00	0.00E+00	4.12E-63	0.00E+00
SR-89	2.05E+09	0.00E+00	5.86E+07	0.00E+00	0.00E+00	0.00E+00	2.44E+08	0.00E+00
SR-90	9.19E+10	0.00E+00	1.84E+09	0.00E+00	0.00E+00	0.00E+00	2.10E+09	0.00E+00
Y-90	4.57E+00	0.00E+00	1.23E-01	0.00E+00	0.00E+00	0.00E+00	3.77E+04	0.00E+00
SR-91	3.26E+04	0.00E+00	1.30E+03	0.00E+00	0.00E+00	0.00E+00	1.48E+05	0.00E+00
Y-91m	3.84E-21	0.00E+00	1.47E-22	0.00E+00	0.00E+00	0.00E+00	1.82E-19	0.00E+00
Y-91	7.16E+02	0.00E+00	1.92E+01	0.00E+00	0.00E+00	0.00E+00	2.93E+05	0.00E+00
SR-92	5.49E-01	0.00E+00	2.34E-02	0.00E+00	0.00E+00	0.00E+00	1.40E+01	0.00E+00
Y-92	3.62E-06	0.00E+00	1.05E-07	0.00E+00	0.00E+00	0.00E+00	9.93E-02	0.00E+00
Y-93	1.45E-02	0.00E+00	3.96E-04	0.00E+00	0.00E+00	0.00E+00	4.42E+02	0.00E+00
NB-93m	5.51E+04	1.81E+04	4.54E+03	0.00E+00	2.12E+04	0.00E+00	6.52E+06	0.00E+00
NB-95	5.65E+03	3.13E+03	1.72E+03	0.00E+00	3.04E+03	0.00E+00	1.34E+07	0.00E+00
NB-97	2.10E-13	5.22E-14	1.91E-14	0.00E+00	6.11E-14	0.00E+00	1.25E-09	0.00E+00
ZR-93	1.79E+02	8.82E+00	4.82E+00	0.00E+00	3.12E+01	0.00E+00	8.34E+03	0.00E+00
ZR-95	7.64E+01	2.41E+01	1.66E+01	0.00E+00	3.54E+01	0.00E+00	5.56E+04	0.00E+00

TABLE II-23

R_i DOSE FACTORS AGE: TEEN PATHWAY: GOAT MILKm²-mrem/yr per μCi/sec

NUCLIDE	BONE	LIVER	T BODY	THYROID	KIDNEY	LUNG	GI-LLI	SKIN
ZR-97	2.77E-02	5.48E-03	2.52E-03	0.00E+00	8.30E-03	0.00E+00	1.48E+03	0.00E+00
MO-93	0.00E+00	5.14E+07	1.41E+06	0.00E+00	1.47E+07	0.00E+00	6.25E+06	0.00E+00
MO-99	0.00E+00	1.57E+06	2.99E+05	0.00E+00	3.59E+06	0.00E+00	2.81E+06	0.00E+00
TC-99	2.89E+06	4.25E+06	1.16E+06	0.00E+00	5.40E+07	4.40E+05	1.04E+08	0.00E+00
TC-99m	2.02E-01	5.64E-01	7.31E+00	0.00E+00	8.40E+00	3.13E-01	3.70E+02	0.00E+00
TC-101	1.66E-61	2.37E-61	2.33E-60	0.00E+00	4.28E-60	1.44E-61	4.04E-68	0.00E+00
RU-103	7.46E+01	0.00E+00	3.19E+01	0.00E+00	2.63E+02	0.00E+00	6.23E+03	0.00E+00
RU-105	5.49E-05	0.00E+00	2.13E-05	0.00E+00	6.93E-04	0.00E+00	4.43E-02	0.00E+00
RU-106	2.26E+03	0.00E+00	2.85E+02	0.00E+00	4.35E+03	0.00E+00	1.08E+05	0.00E+00
RH-105	2.25E+04	1.62E+04	1.07E+04	0.00E+00	6.90E+04	0.00E+00	2.07E+06	0.00E+00
PD-107	0.00E+00	1.34E+06	8.66E+04	0.00E+00	1.22E+07	0.00E+00	6.24E+06	0.00E+00
PD-109	0.00E+00	2.84E+03	6.46E+02	0.00E+00	1.64E+04	0.00E+00	2.87E+05	0.00E+00
AG-110m	5.61E+06	5.31E+06	3.23E+06	0.00E+00	1.01E+07	0.00E+00	1.49E+09	0.00E+00
AG-111	4.19E+05	1.74E+05	8.74E+04	0.00E+00	5.66E+05	0.00E+00	2.42E+08	0.00E+00
CD-113m	0.00E+00	3.47E+05	1.11E+04	0.00E+00	3.84E+05	0.00E+00	2.08E+06	0.00E+00
CD-115m	0.00E+00	9.74E+04	3.14E+03	0.00E+00	7.79E+04	0.00E+00	3.08E+06	0.00E+00
SN-123	5.28E+07	8.67E+05	1.28E+06	6.94E+05	0.00E+00	0.00E+00	7.98E+07	0.00E+00
SN-125	3.68E+06	7.33E+04	1.66E+05	5.75E+04	0.00E+00	0.00E+00	3.47E+07	0.00E+00
SN-126	1.87E+08	3.49E+06	5.33E+06	9.19E+05	0.00E+00	0.00E+00	4.17E+07	0.00E+00
SB-124	2.09E+06	3.86E+04	8.17E+05	4.75E+03	0.00E+00	1.83E+06	4.22E+07	0.00E+00
SB-125	2.30E+06	2.52E+04	5.39E+05	2.20E+03	0.00E+00	2.02E+06	1.79E+07	0.00E+00
SB-126	3.53E+05	7.21E+03	1.27E+05	1.99E+03	0.00E+00	2.53E+05	2.09E+07	0.00E+00
SB-127	2.87E+04	6.13E+02	1.08E+04	3.22E+02	0.00E+00	1.95E+04	4.86E+06	0.00E+00
TE-125m	1.36E+06	4.90E+05	1.82E+05	3.80E+05	0.00E+00	0.00E+00	4.01E+06	0.00E+00
TE-127m	4.38E+06	1.55E+06	5.20E+05	1.04E+06	1.77E+07	0.00E+00	1.09E+07	0.00E+00
TE-127	4.25E+01	1.51E+01	9.14E+00	2.93E+01	1.72E+02	0.00E+00	3.28E+03	0.00E+00
TE-129m	4.37E+06	1.62E+06	6.92E+05	1.41E+06	1.83E+07	0.00E+00	1.64E+07	0.00E+00
TE-129	1.82E-11	6.80E-12	4.44E-12	1.30E-11	7.66E-11	0.00E+00	9.98E-11	0.00E+00
TE-133m	1.33E-14	7.55E-15	7.35E-15	1.05E-14	7.47E-14	0.00E+00	3.05E-14	0.00E+00
TE-134	5.56E-20	3.57E-20	3.73E-20	4.57E-20	3.41E-19	0.00E+00	2.07E-21	0.00E+00
I-129	9.04E+08	7.60E+08	1.27E+09	9.25E+11	1.36E+09	0.00E+00	8.86E+07	0.00E+00
I-130	2.59E+05	7.50E+05	2.99E+05	6.12E+07	1.16E+06	0.00E+00	5.76E+05	0.00E+00
I-131	1.89E+08	2.64E+08	1.42E+08	7.71E+10	4.55E+08	0.00E+00	5.22E+07	0.00E+00
TE-131m	2.31E+04	1.11E+04	9.23E+03	1.66E+04	1.15E+05	0.00E+00	8.88E+05	0.00E+00
TE-131	2.31E-34	9.53E-35	7.22E-35	1.78E-34	1.01E-33	0.00E+00	1.90E-35	0.00E+00
I-132	1.02E-01	2.67E-01	9.60E-02	9.01E+00	4.21E-01	0.00E+00	1.17E-01	0.00E+00
TE-132	1.51E+05	9.54E+04	8.98E+04	1.01E+05	9.15E+05	0.00E+00	3.02E+06	0.00E+00
I-133	2.48E+06	4.21E+06	1.28E+06	5.87E+08	7.38E+06	0.00E+00	3.18E+06	0.00E+00
CS-134m	2.71E-01	5.62E-01	2.89E-01	0.00E+00	3.13E-01	5.49E-02	3.74E-01	0.00E+00
CS-134	1.53E+10	3.61E+10	1.67E+10	0.00E+00	1.15E+10	4.38E+09	4.49E+08	0.00E+00
I-134	1.26E-12	3.33E-12	1.20E-12	5.56E-11	5.26E-12	0.00E+00	4.39E-14	0.00E+00
I-135	8.01E+03	2.06E+04	7.64E+03	1.33E+06	3.25E+04	0.00E+00	2.28E+04	0.00E+00
CS-135	5.39E+09	4.94E+09	1.16E+09	0.00E+00	1.89E+09	6.83E+08	8.65E+07	0.00E+00
CS-136	3.96E+08	1.56E+09	1.05E+09	0.00E+00	8.49E+08	1.34E+08	1.25E+08	0.00E+00
CS-137	2.16E+10	2.88E+10	1.00E+10	0.00E+00	9.79E+09	3.80E+09	4.09E+08	0.00E+00

TABLE II-23

R_i DOSE FACTORS AGE: TEEN PATHWAY: GOAT MILKm²-mrem/yr per μ Ci/sec

NUCLIDE	BONE	LIVER	T BODY	THYROID	KIDNEY	LUNG	GI-LLI	SKIN
CS-138	1.44E-23	2.76E-23	1.38E-23	0.00E+00	2.04E-23	2.37E-24	1.25E-26	0.00E+00
CS-139	1.10E-89	1.61E-89	5.92E-90	0.00E+00	1.30E-89	1.43E-90	7.50E-105	0.00E+00
BA-139	2.87E-09	2.02E-12	8.36E-11	0.00E+00	1.90E-12	1.39E-12	2.56E-08	0.00E+00
BA-140	1.71E+06	2.10E+03	1.10E+05	0.00E+00	7.12E+02	1.41E+03	2.64E+06	0.00E+00
LA-140	2.84E-01	1.40E-01	3.72E-02	0.00E+00	0.00E+00	0.00E+00	8.03E+03	0.00E+00
BA-141	2.64E-47	1.97E-50	8.82E-49	0.00E+00	1.83E-50	1.35E-50	5.63E-53	0.00E+00
LA-141	1.97E-06	6.05E-07	9.98E-08	0.00E+00	0.00E+00	0.00E+00	1.07E-01	0.00E+00
CE-141	3.50E+02	2.34E+02	2.69E+01	0.00E+00	1.10E+02	0.00E+00	6.69E+05	0.00E+00
BA-142	1.69E-81	1.69E-84	1.04E-82	0.00E+00	1.43E-84	1.12E-84	5.19E-93	0.00E+00
LA-142	1.18E-12	5.23E-13	1.30E-13	0.00E+00	0.00E+00	0.00E+00	1.59E-08	0.00E+00
CE-143	2.68E+00	1.95E+03	2.18E-01	0.00E+00	8.75E-01	0.00E+00	5.86E+04	0.00E+00
PR-143	1.03E+01	4.10E+00	5.11E-01	0.00E+00	2.38E+00	0.00E+00	3.38E+04	0.00E+00
CE-144	3.88E+04	1.61E+04	2.09E+03	0.00E+00	9.59E+03	0.00E+00	9.76E+06	0.00E+00
PR-144	3.80E-55	1.55E-55	1.93E-56	0.00E+00	8.92E-56	0.00E+00	4.19E-58	0.00E+00
ND-147	6.38E+00	6.93E+00	4.15E-01	0.00E+00	4.07E+00	0.00E+00	2.50E+04	0.00E+00
PM-147	3.24E+02	3.08E+01	1.25E+01	0.00E+00	5.87E+01	0.00E+00	2.93E+04	0.00E+00
PM-148m	6.21E+01	1.57E+01	1.23E+01	0.00E+00	2.38E+01	0.00E+00	9.91E+04	0.00E+00
PM-148	3.82E+00	6.22E-01	3.13E-01	0.00E+00	1.12E+00	0.00E+00	3.71E+04	0.00E+00
PM-149	2.77E-01	3.89E-02	1.59E-02	0.00E+00	7.41E-02	0.00E+00	5.72E+03	0.00E+00
PM-151	4.17E-02	6.88E-03	3.48E-03	0.00E+00	1.24E-02	0.00E+00	1.54E+03	0.00E+00
SM-151	2.82E+02	5.42E+01	1.27E+01	0.00E+00	5.94E+01	0.00E+00	1.84E+04	0.00E+00
SM-153	1.28E-01	1.06E-01	7.78E-03	0.00E+00	3.45E-02	0.00E+00	2.98E+03	0.00E+00
EU-152	7.85E+02	1.89E+02	1.67E+02	0.00E+00	8.78E+02	0.00E+00	6.95E+04	0.00E+00
EU-154	2.52E+03	3.25E+02	2.29E+02	0.00E+00	1.45E+03	0.00E+00	1.72E+05	0.00E+00
EU-155	5.49E+02	5.30E+01	3.28E+01	0.00E+00	2.07E+02	0.00E+00	3.04E+05	0.00E+00
EU-156	1.62E+01	1.21E+01	1.98E+00	0.00E+00	8.17E+00	0.00E+00	6.20E+04	0.00E+00
TB-160	1.26E+02	0.00E+00	1.58E+01	0.00E+00	5.00E+01	0.00E+00	8.18E+04	0.00E+00
HO-166m	1.15E+03	3.55E+02	2.57E+02	0.00E+00	5.20E+02	0.00E+00	8.76E+04	0.00E+00
W-181	3.31E+03	1.07E+03	1.12E+02	0.00E+00	0.00E+00	0.00E+00	9.10E+04	0.00E+00
W-185	1.15E+05	3.79E+04	4.00E+03	0.00E+00	0.00E+00	0.00E+00	3.27E+06	0.00E+00
W-187	4.18E+02	3.41E+02	1.19E+02	0.00E+00	0.00E+00	0.00E+00	9.22E+04	0.00E+00
NP-239	2.46E-01	2.32E-02	1.29E-02	0.00E+00	7.28E-02	0.00E+00	3.73E+03	0.00E+00
U-232	1.90E+09	0.00E+00	1.36E+08	0.00E+00	2.06E+08	0.00E+00	2.32E+07	0.00E+00
U-233	4.01E+08	0.00E+00	2.44E+07	0.00E+00	9.37E+07	0.00E+00	2.15E+07	0.00E+00
U-234	3.85E+08	0.00E+00	2.39E+07	0.00E+00	9.21E+07	0.00E+00	2.10E+07	0.00E+00
U-235	3.68E+08	0.00E+00	2.24E+07	0.00E+00	8.63E+07	0.00E+00	2.68E+07	0.00E+00
U-236	3.68E+08	0.00E+00	2.29E+07	0.00E+00	8.82E+07	0.00E+00	1.97E+07	0.00E+00
U-237	3.66E+03	0.00E+00	9.73E+02	0.00E+00	1.50E+04	0.00E+00	9.69E+05	0.00E+00
U-238	3.52E+08	0.00E+00	2.10E+07	0.00E+00	8.08E+07	0.00E+00	1.88E+07	0.00E+00
NP-237	4.30E+06	3.09E+05	1.89E+05	0.00E+00	1.40E+06	0.00E+00	2.72E+05	0.00E+00
NP-238	2.33E+00	6.23E-02	3.63E-02	0.00E+00	2.14E-01	0.00E+00	4.57E+03	0.00E+00
PU-238	8.65E+05	1.11E+05	2.35E+04	0.00E+00	1.01E+05	0.00E+00	9.98E+04	0.00E+00
PU-239	9.89E+05	1.20E+05	2.60E+04	0.00E+00	1.11E+05	0.00E+00	9.13E+04	0.00E+00
PU-240	9.88E+05	1.20E+05	2.60E+04	0.00E+00	1.11E+05	0.00E+00	9.29E+04	0.00E+00
PU-241	2.24E+04	1.08E+03	4.73E+02	0.00E+00	2.19E+03	0.00E+00	1.90E+03	0.00E+00

TABLE II2-23

R_i DOSE FACTORS AGE: TEEN PATHWAY: GOAT MILKm²-mrem/yr per μ Ci/sec

NUCLIDE	BONE	LIVER	T BODY	THYROID	KIDNEY	LUNG	GI-LLI	SKIN
PU-242	9.17E+05	1.16E+05	2.51E+04	0.00E+00	1.07E+05	0.00E+00	8.95E+04	0.00E+00
PU-244	1.07E+06	1.32E+05	2.87E+04	0.00E+00	1.22E+05	0.00E+00	1.33E+05	0.00E+00
AM-241	2.58E+06	2.43E+06	1.86E+05	0.00E+00	1.39E+06	0.00E+00	2.54E+05	0.00E+00
AM-242m	2.61E+06	2.30E+06	1.87E+05	0.00E+00	1.39E+06	0.00E+00	3.20E+05	0.00E+00
AM-243	2.57E+06	2.38E+06	1.82E+05	0.00E+00	1.36E+06	0.00E+00	2.98E+05	0.00E+00
CM-242	7.41E+04	7.82E+04	4.92E+03	0.00E+00	2.24E+04	0.00E+00	2.12E+05	0.00E+00
CM-243	2.09E+06	1.94E+06	1.32E+05	0.00E+00	6.15E+05	0.00E+00	2.66E+05	0.00E+00
CM-244	1.62E+06	1.53E+06	1.02E+05	0.00E+00	4.78E+05	0.00E+00	2.57E+05	0.00E+00
CM-245	3.20E+06	2.81E+06	1.97E+05	0.00E+00	9.21E+05	0.00E+00	2.41E+05	0.00E+00
CM-246	3.17E+06	2.81E+06	1.97E+05	0.00E+00	9.18E+05	0.00E+00	2.37E+05	0.00E+00
CM-247	3.09E+06	2.77E+06	1.94E+05	0.00E+00	9.05E+05	0.00E+00	3.11E+05	0.00E+00
CM-248	2.57E+07	2.28E+07	1.60E+06	0.00E+00	7.47E+06	0.00E+00	5.01E+06	0.00E+00
CF-252	1.07E+06	0.00E+00	2.59E+04	0.00E+00	0.00E+00	0.00E+00	9.42E+05	0.00E+00

TABLE I12-24

R_i DOSE FACTORS AGE: CHILD PATHWAY: GOAT MILKm²-mrem/yr per μ Ci/sec

NUCLIDE	BONE	LIVER	T BODY	THYROID	KIDNEY	LUNG	GI-LLI	SKIN
H-3	0.00E+00	1.83E+03	1.83E+03	1.83E+03	1.83E+03	1.83E+03	1.83E+03	0.00E+00
C-14	1.65E+06	3.29E+05	3.29E+05	3.29E+05	3.29E+05	3.29E+05	3.29E+05	0.00E+00
NA-22	1.20E+09	1.20E+09	1.20E+09	1.20E+09	1.20E+09	1.20E+09	1.20E+09	0.00E+00
NA-24	3.11E+05	3.11E+05	3.11E+05	3.11E+05	3.11E+05	3.11E+05	3.11E+05	0.00E+00
P-32	2.76E+10	1.29E+09	1.06E+09	0.00E+00	0.00E+00	0.00E+00	7.63E+08	0.00E+00
CA-41	8.70E+10	0.00E+00	9.50E+09	0.00E+00	0.00E+00	0.00E+00	4.76E+07	0.00E+00
SC-46	3.36E+01	4.61E+01	1.77E+01	0.00E+00	4.08E+01	0.00E+00	6.74E+04	0.00E+00
CR-51	0.00E+00	0.00E+00	3.89E+03	2.16E+03	5.90E+02	3.94E+03	2.06E+05	0.00E+00
MN-54	0.00E+00	1.25E+06	3.32E+05	0.00E+00	3.49E+05	0.00E+00	1.05E+06	0.00E+00
FE-55	7.629E+05	4.047E+05	1.254E+05	0.000E+00	0.000E+00	2.289E+05	7.496E+04	0.000E+00
MN-56	0.00E+00	4.50E-04	1.02E-04	0.00E+00	5.45E-04	0.00E+00	6.53E-02	0.00E+00
CO-57	0.00E+00	2.25E+05	4.56E+05	0.00E+00	0.00E+00	0.00E+00	1.85E+06	0.00E+00
CO-58	0.00E+00	5.75E+05	1.76E+06	0.00E+00	0.00E+00	0.00E+00	3.35E+06	0.00E+00
FE-59	5.526E+05	8.943E+05	4.455E+05	0.000E+00	0.000E+00	2.592E+05	9.311E+05	0.000E+00
CO-60	0.00E+00	2.76E+06	8.13E+06	0.00E+00	0.00E+00	0.00E+00	1.53E+07	0.00E+00
NI-59	1.44E+08	3.82E+07	2.44E+07	0.00E+00	0.00E+00	0.00E+00	2.54E+06	0.00E+00
NI-63	1.92E+09	1.03E+08	6.53E+07	0.00E+00	0.00E+00	0.00E+00	6.92E+06	0.00E+00
CU-64	0.00E+00	2.43E+03	1.47E+03	0.00E+00	5.88E+03	0.00E+00	1.14E+05	0.00E+00
NI-65	5.81E-02	5.47E-03	3.19E-03	0.00E+00	0.00E+00	0.00E+00	6.70E-01	0.00E+00
ZN-65	2.40E+08	6.40E+08	3.98E+08	0.00E+00	4.03E+08	0.00E+00	1.12E+08	0.00E+00
ZN-69m	2.79E+04	4.76E+04	5.62E+03	0.00E+00	2.76E+04	0.00E+00	1.55E+06	0.00E+00
ZN-69	3.32E-13	4.80E-13	4.44E-14	0.00E+00	2.91E-13	0.00E+00	3.03E-11	0.00E+00
SE-79	0.00E+00	2.02E+08	4.49E+07	0.00E+00	3.29E+08	0.00E+00	1.33E+07	0.00E+00
BR-82	0.00E+00	0.00E+00	4.03E+06	0.00E+00	0.00E+00	0.00E+00	0.00E+00	0.00E+00
BR-83	0.00E+00	0.00E+00	1.54E-02	0.00E+00	0.00E+00	0.00E+00	0.00E+00	0.00E+00
BR-84	0.00E+00	0.00E+00	2.28E-24	0.00E+00	0.00E+00	0.00E+00	0.00E+00	0.00E+00
BR-85	0.00E+00	0.00E+00	0.00E+00	0.00E+00	0.00E+00	0.00E+00	0.00E+00	0.00E+00
RB-86	0.00E+00	3.17E+08	1.95E+08	0.00E+00	0.00E+00	0.00E+00	2.04E+07	0.00E+00
RB-87	0.00E+00	6.32E+08	2.93E+08	0.00E+00	0.00E+00	0.00E+00	9.47E+06	0.00E+00
RB-88	0.00E+00	2.51E-46	1.74E-46	0.00E+00	0.00E+00	0.00E+00	1.23E-47	0.00E+00
RB-89	0.00E+00	4.72E-54	4.20E-54	0.00E+00	0.00E+00	0.00E+00	4.12E-56	0.00E+00
SR-89	5.07E+09	0.00E+00	1.45E+08	0.00E+00	0.00E+00	0.00E+00	1.96E+08	0.00E+00
SR-90	1.90E+11	0.00E+00	3.83E+09	0.00E+00	0.00E+00	0.00E+00	1.70E+09	0.00E+00
Y-90	1.13E+01	0.00E+00	3.03E-01	0.00E+00	0.00E+00	0.00E+00	3.22E+04	0.00E+00
SR-91	8.01E+04	0.00E+00	3.02E+03	0.00E+00	0.00E+00	0.00E+00	1.77E+05	0.00E+00
Y-91m	9.39E-21	0.00E+00	3.42E-22	0.00E+00	0.00E+00	0.00E+00	1.84E-17	0.00E+00
Y-91	1.77E+03	0.00E+00	4.73E+01	0.00E+00	0.00E+00	0.00E+00	2.36E+05	0.00E+00
SR-92	1.34E+00	0.00E+00	5.38E-02	0.00E+00	0.00E+00	0.00E+00	2.54E+01	0.00E+00
Y-92	8.88E-06	0.00E+00	2.54E-07	0.00E+00	0.00E+00	0.00E+00	2.57E-01	0.00E+00
Y-93	3.55E-02	0.00E+00	9.75E-04	0.00E+00	0.00E+00	0.00E+00	5.29E+02	0.00E+00
NB-93m	1.39E+05	3.46E+04	1.14E+04	0.00E+00	3.74E+04	0.00E+00	5.22E+06	0.00E+00
NB-95	1.28E+04	4.96E+03	3.55E+03	0.00E+00	4.66E+03	0.00E+00	9.18E+06	0.00E+00

TABLE II2-24

R_i DOSE FACTORS AGE: CHILD PATHWAY: GOAT MILKm²-mrem/yr per μ Ci/sec

NUCLIDE	BONE	LIVER	T BODY	THYROID	KIDNEY	LUNG	GI-LLI	SKIN
NB-97	5.11E-13	9.23E-14	4.31E-14	0.00E+00	1.02E-13	0.00E+00	2.85E-08	0.00E+00
ZR-93	4.45E+02	1.67E+01	1.19E+01	0.00E+00	6.45E+01	0.00E+00	6.32E+03	0.00E+00
ZR-95	1.77E+02	3.90E+01	3.47E+01	0.00E+00	5.58E+01	0.00E+00	4.07E+04	0.00E+00
ZR-97	6.73E-02	9.73E-03	5.74E-03	0.00E+00	1.40E-02	0.00E+00	1.47E+03	0.00E+00
MO-93	0.00E+00	9.64E+07	3.46E+06	0.00E+00	2.54E+07	0.00E+00	4.88E+06	0.00E+00
MO-99	0.00E+00	2.86E+06	7.06E+05	0.00E+00	6.10E+06	0.00E+00	2.36E+06	0.00E+00
TC-99	7.13E+06	7.95E+06	2.85E+06	0.00E+00	9.36E+07	7.03E+05	8.33E+07	0.00E+00
TC-99m	4.64E-01	9.09E-01	1.51E+01	0.00E+00	1.32E+01	4.62E-01	5.17E+02	0.00E+00
TC-101	4.08E-61	4.27E-61	5.42E-60	0.00E+00	7.28E-60	2.26E-61	1.36E-60	0.00E+00
RU-103	1.76E+02	0.00E+00	6.78E+01	0.00E+00	4.44E+02	0.00E+00	4.56E+03	0.00E+00
RU-105	1.34E-04	0.00E+00	4.86E-05	0.00E+00	1.18E-03	0.00E+00	8.75E-02	0.00E+00
RU-106	5.56E+03	0.00E+00	6.94E+02	0.00E+00	7.51E+03	0.00E+00	8.65E+04	0.00E+00
RH-105	5.51E+04	2.96E+04	2.53E+04	0.00E+00	1.18E+05	0.00E+00	1.83E+06	0.00E+00
PD-107	0.00E+00	2.52E+06	2.14E+05	0.00E+00	2.11E+07	0.00E+00	5.00E+06	0.00E+00
PD-109	0.00E+00	5.30E+03	1.59E+03	0.00E+00	2.84E+04	0.00E+00	3.13E+05	0.00E+00
AG-110m	1.22E+07	8.21E+06	6.57E+06	0.00E+00	1.53E+07	0.00E+00	9.77E+08	0.00E+00
AG-111	1.03E+06	3.23E+05	2.13E+05	0.00E+00	9.75E+05	0.00E+00	1.98E+08	0.00E+00
CD-113m	0.00E+00	6.47E+05	2.75E+04	0.00E+00	6.66E+05	0.00E+00	1.67E+06	0.00E+00
CD-115m	0.00E+00	1.82E+05	7.76E+03	0.00E+00	1.35E+05	0.00E+00	2.48E+06	0.00E+00
SN-123	1.30E+08	1.62E+06	3.18E+06	1.72E+06	0.00E+00	0.00E+00	6.40E+07	0.00E+00
SN-125	9.06E+06	1.37E+05	4.06E+05	1.42E+05	0.00E+00	0.00E+00	2.81E+07	0.00E+00
SN-126	4.44E+08	5.53E+06	1.26E+07	1.52E+06	0.00E+00	0.00E+00	3.33E+07	0.00E+00
SB-124	4.96E+06	6.43E+04	1.74E+06	1.09E+04	0.00E+00	2.75E+06	3.10E+07	0.00E+00
SB-125	5.49E+06	4.23E+04	1.15E+06	5.08E+03	0.00E+00	3.06E+06	1.31E+07	0.00E+00
SB-126	8.05E+05	1.23E+04	2.89E+05	4.72E+03	0.00E+00	3.84E+05	1.62E+07	0.00E+00
SB-127	6.91E+04	1.07E+03	2.40E+04	7.69E+02	0.00E+00	3.00E+04	3.89E+06	0.00E+00
TE-125m	3.34E+06	9.04E+05	4.45E+05	9.37E+05	0.00E+00	0.00E+00	3.22E+06	0.00E+00
TE-127m	1.08E+07	2.90E+06	1.28E+06	2.58E+06	3.08E+07	0.00E+00	8.74E+06	0.00E+00
TE-127	1.04E+02	2.82E+01	2.24E+01	7.23E+01	2.97E+02	0.00E+00	4.08E+03	0.00E+00
TE-129m	1.08E+07	3.01E+06	1.67E+06	3.48E+06	3.17E+07	0.00E+00	1.32E+07	0.00E+00
TE-129	4.50E-11	1.26E-11	1.07E-11	3.21E-11	1.32E-10	0.00E+00	2.80E-09	0.00E+00
TE-133m	3.18E-14	1.29E-14	1.60E-14	2.47E-14	1.22E-13	0.00E+00	9.82E-13	0.00E+00
TE-134	1.32E-19	5.96E-20	7.95E-20	1.05E-19	5.51E-19	0.00E+00	6.05E-19	0.00E+00
I-129	2.22E+09	1.36E+09	1.22E+09	8.93E+11	2.30E+09	0.00E+00	6.86E+07	0.00E+00
I-130	6.06E+05	1.22E+06	6.31E+05	1.35E+08	1.83E+06	0.00E+00	5.73E+05	0.00E+00
I-131	4.58E+08	4.60E+08	2.61E+08	1.52E+11	7.55E+08	0.00E+00	4.10E+07	0.00E+00
TE-131m	5.61E+04	1.94E+04	2.07E+04	3.99E+04	1.88E+05	0.00E+00	7.88E+05	0.00E+00
TE-131	5.67E-34	1.73E-34	1.69E-34	4.34E-34	1.72E-33	0.00E+00	2.98E-33	0.00E+00
I-132	2.42E-01	4.44E-01	2.04E-01	2.06E+01	6.80E-01	0.00E+00	5.23E-01	0.00E+00
TE-132	3.60E+05	1.59E+05	1.92E+05	2.32E+05	1.48E+06	0.00E+00	1.60E+06	0.00E+00
I-133	6.03E+06	7.45E+06	2.82E+06	1.38E+09	1.24E+07	0.00E+00	3.00E+06	0.00E+00
CS-134m	6.43E-01	9.52E-01	6.21E-01	0.00E+00	5.02E-01	8.30E-02	1.20E+00	0.00E+00

TABLE I12-24

R_i DOSE FACTORS AGE: CHILD PATHWAY: GOAT MILKm²-mrem/yr per μ Ci/sec

NUCLIDE	BONE	LIVER	T BODY	THYROID	KIDNEY	LUNG	GI-LLI	SKIN
CS-134	3.53E+10	5.80E+10	1.22E+10	0.00E+00	1.80E+10	6.45E+09	3.13E+08	0.00E+00
I-134	2.98E-12	5.53E-12	2.54E-12	1.27E-10	8.46E-12	0.00E+00	3.67E-12	0.00E+00
I-135	1.89E+04	3.41E+04	1.61E+04	3.02E+06	5.23E+04	0.00E+00	2.60E+04	0.00E+00
CS-135	1.33E+10	9.25E+09	9.49E+08	0.00E+00	3.26E+09	1.09E+09	6.93E+07	0.00E+00
CS-136	8.94E+08	2.46E+09	1.59E+09	0.00E+00	1.31E+09	1.95E+08	8.64E+07	0.00E+00
CS-137	5.21E+10	4.99E+10	7.36E+09	0.00E+00	1.63E+10	5.85E+09	3.12E+08	0.00E+00
CS-138	3.49E-23	4.85E-23	3.08E-23	0.00E+00	3.41E-23	3.67E-24	2.23E-23	0.00E+00
CS-139	2.69E-89	2.99E-89	1.44E-89	0.00E+00	2.25E-89	2.27E-90	2.69E-93	0.00E+00
BA-139	7.05E-09	3.76E-12	2.04E-10	0.00E+00	3.29E-12	2.21E-12	4.07E-07	0.00E+00
BA-140	4.14E+06	3.62E+03	2.41E+05	0.00E+00	1.18E+03	2.16E+03	2.10E+06	0.00E+00
LA-140	6.81E-01	2.38E-01	8.02E-02	0.00E+00	0.00E+00	0.00E+00	6.63E+03	0.00E+00
BA-141	6.49E-47	3.64E-50	2.11E-48	0.00E+00	3.15E-50	2.14E-49	3.70E-47	0.00E+00
LA-141	4.85E-06	1.13E-06	2.45E-07	0.00E+00	0.00E+00	0.00E+00	2.51E-01	0.00E+00
CE-141	8.63E+02	4.30E+02	6.39E+01	0.00E+00	1.89E+02	0.00E+00	5.37E+05	0.00E+00
BA-142	4.07E-81	2.93E-84	2.28E-82	0.00E+00	2.37E-84	1.72E-84	5.31E-83	0.00E+00
LA-142	2.84E-12	9.06E-13	2.84E-13	0.00E+00	0.00E+00	0.00E+00	1.80E-07	0.00E+00
CE-143	6.58E+00	3.57E+03	5.17E-01	0.00E+00	1.50E+00	0.00E+00	5.22E+04	0.00E+00
PR-143	2.54E+01	7.63E+00	1.26E+00	0.00E+00	4.13E+00	0.00E+00	2.74E+04	0.00E+00
CE-144	9.57E+04	3.00E+04	5.11E+03	0.00E+00	1.66E+04	0.00E+00	7.82E+06	0.00E+00
PR-144	9.40E-55	2.91E-55	4.73E-56	0.00E+00	1.54E-55	0.00E+00	6.26E-52	0.00E+00
ND-147	1.56E+01	1.27E+01	9.82E-01	0.00E+00	6.96E+00	0.00E+00	2.01E+04	0.00E+00
PM-147	8.10E+02	5.78E+01	3.11E+01	0.00E+00	1.02E+02	0.00E+00	2.34E+04	0.00E+00
PM-148m	1.27E+02	2.54E+01	2.54E+01	0.00E+00	3.76E+01	0.00E+00	7.15E+04	0.00E+00
PM-148	9.34E+00	1.12E+00	7.26E-01	0.00E+00	1.91E+00	0.00E+00	3.00E+04	0.00E+00
PM-149	6.83E-01	7.26E-02	3.93E-02	0.00E+00	1.28E-01	0.00E+00	4.95E+03	0.00E+00
PM-151	1.02E-01	1.24E-02	8.04E-03	0.00E+00	2.10E-02	0.00E+00	1.40E+03	0.00E+00
SM-151	6.82E+02	1.01E+02	3.20E+01	0.00E+00	1.05E+02	0.00E+00	1.47E+04	0.00E+00
SM-153	3.15E-01	1.96E-01	1.89E-02	0.00E+00	5.97E-02	0.00E+00	2.61E+03	0.00E+00
EU-152	1.63E+03	2.96E+02	3.51E+02	0.00E+00	1.25E+03	0.00E+00	4.86E+04	0.00E+00
EU-154	6.05E+03	5.44E+02	4.97E+02	0.00E+00	2.39E+03	0.00E+00	1.27E+05	0.00E+00
EU-155	1.25E+03	9.03E+01	7.08E+01	0.00E+00	3.38E+02	0.00E+00	2.26E+05	0.00E+00
EU-156	3.91E+01	2.09E+01	4.33E+00	0.00E+00	1.35E+01	0.00E+00	4.75E+04	0.00E+00
TB-160	2.67E+02	0.00E+00	3.32E+01	0.00E+00	7.96E+01	0.00E+00	5.93E+04	0.00E+00
HO-166m	2.88E+03	6.03E+02	5.09E+02	0.00E+00	8.58E+02	0.00E+00	7.01E+04	0.00E+00
W-181	8.15E+03	2.00E+03	2.75E+02	0.00E+00	0.00E+00	0.00E+00	7.30E+04	0.00E+00
W-185	2.83E+05	7.06E+04	9.89E+03	0.00E+00	0.00E+00	0.00E+00	2.63E+06	0.00E+00
W-187	1.01E+03	6.00E+02	2.69E+02	0.00E+00	0.00E+00	0.00E+00	8.44E+04	0.00E+00
NP-239	6.05E-01	4.35E-02	3.06E-02	0.00E+00	1.26E-01	0.00E+00	3.22E+03	0.00E+00
U-232	4.68E+09	0.00E+00	3.35E+08	0.00E+00	3.57E+08	0.00E+00	1.86E+07	0.00E+00
U-233	9.92E+08	0.00E+00	6.00E+07	0.00E+00	1.63E+08	0.00E+00	1.72E+07	0.00E+00
U-234	9.52E+08	0.00E+00	5.89E+07	0.00E+00	1.59E+08	0.00E+00	1.69E+07	0.00E+00
U-235	9.12E+08	0.00E+00	5.52E+07	0.00E+00	1.50E+08	0.00E+00	2.14E+07	0.00E+00

TABLE II2-24

R_i DOSE FACTORS AGE: CHILD PATHWAY: GOAT MILKm²-mrem/yr per μ Ci/sec

NUCLIDE	BONE	LIVER	T BODY	THYROID	KIDNEY	LUNG	GI-LLI	SKIN
U-236	9.12E+08	0.00E+00	5.65E+07	0.00E+00	1.53E+08	0.00E+00	1.58E+07	0.00E+00
U-237	9.03E+03	0.00E+00	2.40E+03	0.00E+00	2.60E+04	0.00E+00	7.95E+05	0.00E+00
U-238	8.72E+08	0.00E+00	5.17E+07	0.00E+00	1.40E+08	0.00E+00	1.51E+07	0.00E+00
NP-237	5.95E+06	3.92E+05	2.61E+05	0.00E+00	1.61E+06	0.00E+00	2.18E+05	0.00E+00
NP-238	5.74E+00	1.16E-01	8.94E-02	0.00E+00	3.70E-01	0.00E+00	3.98E+03	0.00E+00
PU-238	1.27E+06	1.47E+05	3.37E+04	0.00E+00	1.22E+05	0.00E+00	7.99E+04	0.00E+00
PU-239	1.38E+06	1.47E+05	3.53E+04	0.00E+00	1.30E+05	0.00E+00	7.31E+04	0.00E+00
PU-240	1.37E+06	1.53E+05	3.53E+04	0.00E+00	1.30E+05	0.00E+00	7.44E+04	0.00E+00
PU-241	4.09E+04	1.67E+03	8.50E+02	0.00E+00	3.13E+03	0.00E+00	1.52E+03	0.00E+00
PU-242	1.27E+06	1.47E+05	3.40E+04	0.00E+00	1.25E+05	0.00E+00	7.16E+04	0.00E+00
PU-244	1.48E+06	1.69E+06	3.89E+04	0.00E+00	1.44E+05	0.00E+00	1.07E+05	0.00E+00
AM-241	3.63E+06	3.12E+06	2.72E+05	0.00E+00	1.66E+06	0.00E+00	2.04E+05	0.00E+00
AM-242m	3.73E+06	2.98E+06	2.77E+05	0.00E+00	1.68E+06	0.00E+00	2.56E+05	0.00E+00
AM-243	3.57E+06	3.01E+06	2.62E+05	0.00E+00	1.62E+06	0.00E+00	2.39E+05	0.00E+00
CM-242	1.83E+05	1.46E+05	1.21E+04	0.00E+00	3.89E+04	0.00E+00	1.70E+05	0.00E+00
CM-243	3.40E+06	2.76E+06	2.19E+05	0.00E+00	8.18E+05	0.00E+00	2.13E+05	0.00E+00
CM-244	2.86E+06	2.31E+06	1.84E+05	0.00E+00	6.73E+05	0.00E+00	2.06E+05	0.00E+00
CM-245	4.45E+06	3.57E+06	2.80E+05	0.00E+00	1.10E+06	0.00E+00	1.93E+05	0.00E+00
CM-246	4.40E+06	3.57E+06	2.80E+05	0.00E+00	1.09E+06	0.00E+00	1.90E+05	0.00E+00
CM-247	4.29E+06	3.52E+06	2.75E+05	0.00E+00	1.08E+06	0.00E+00	2.49E+05	0.00E+00
CM-248	3.57E+07	2.91E+07	2.27E+06	0.00E+00	8.88E+06	0.00E+00	4.03E+06	0.00E+00
CF-252	2.68E+06	0.00E+00	6.47E+04	0.00E+00	0.00E+00	0.00E+00	7.54E+05	0.00E+00

TABLE II2-25

R_i DOSE FACTORS AGE: INFANT PATHWAY: GOAT MILKm²-mrem/yr per μCi/sec

NUCLIDE	BONE	LIVER	T BODY	THYROID	KIDNEY	LUNG	GI-LLI	SKIN
H-3	0.00E+00	2.78E+03	2.78E+03	2.78E+03	2.78E+03	2.78E+03	2.78E+03	0.00E+00
C-14	3.23E+06	6.89E+05	6.89E+05	6.89E+05	6.89E+05	6.89E+05	6.89E+05	0.00E+00
NA-22	2.00E+09	2.00E+09	2.00E+09	2.00E+09	2.00E+09	2.00E+09	2.00E+09	0.00E+00
NA-24	5.41E+05	5.41E+05	5.41E+05	5.41E+05	5.41E+05	5.41E+05	5.41E+05	0.00E+00
P-32	5.69E+10	3.34E+09	2.20E+09	0.00E+00	0.00E+00	0.00E+00	7.69E+08	0.00E+00
CA-41	9.37E+10	0.00E+00	1.02E+10	0.00E+00	0.00E+00	0.00E+00	4.79E+07	0.00E+00
SC-46	6.40E+01	9.23E+01	2.88E+01	0.00E+00	6.07E+01	0.00E+00	6.02E+04	0.00E+00
CR-51	0.00E+00	0.00E+00	6.16E+03	4.02E+03	8.79E+02	7.82E+03	1.80E+05	0.00E+00
MN-54	0.00E+00	2.32E+06	5.25E+05	0.00E+00	5.14E+05	0.00E+00	8.52E+05	0.00E+00
FE-55	9.221E+05	5.957E+05	1.592E+05	0.000E+00	0.000E+00	2.912E+05	7.563E+04	0.000E+00
MN-56	0.00E+00	1.10E-03	1.90E-04	0.00E+00	9.48E-04	0.00E+00	1.00E-01	0.00E+00
CO-57	0.00E+00	5.25E+05	8.54E+05	0.00E+00	0.00E+00	0.00E+00	1.79E+06	0.00E+00
CO-58	0.00E+00	1.15E+06	2.87E+06	0.00E+00	0.00E+00	0.00E+00	2.86E+06	0.00E+00
FE-59	1.032E+06	1.802E+06	7.101E+05	0.000E+00	0.000E+00	5.325E+05	8.608E+05	0.000E+00
CO-60	0.00E+00	5.63E+06	1.33E+07	0.00E+00	0.00E+00	0.00E+00	1.34E+07	0.00E+00
NI-59	1.69E+08	5.18E+07	2.92E+07	0.00E+00	0.00E+00	0.00E+00	2.56E+06	0.00E+00
NI-63	2.26E+09	1.40E+08	7.85E+07	0.00E+00	0.00E+00	0.00E+00	6.96E+06	0.00E+00
CU-64	0.00E+00	6.05E+03	2.80E+03	0.00E+00	1.02E+04	0.00E+00	1.24E+05	0.00E+00
NI-65	1.23E-01	1.39E-02	6.33E-03	0.00E+00	0.00E+00	0.00E+00	1.06E+00	0.00E+00
ZN-65	3.23E+08	1.11E+09	5.10E+08	0.00E+00	5.37E+08	0.00E+00	9.35E+08	0.00E+00
ZN-69m	5.90E+04	1.20E+05	1.10E+04	0.00E+00	4.88E+04	0.00E+00	1.67E+06	0.00E+00
ZN-69	7.08E-13	1.27E-12	9.48E-14	0.00E+00	5.30E-13	0.00E+00	1.04E-10	0.00E+00
SE-79	0.00E+00	5.04E+08	9.36E+07	0.00E+00	5.83E+08	0.00E+00	1.34E+07	0.00E+00
BR-82	0.00E+00	0.00E+00	6.79E+06	0.00E+00	0.00E+00	0.00E+00	0.00E+00	0.00E+00
BR-83	0.00E+00	0.00E+00	3.28E-02	0.00E+00	0.00E+00	0.00E+00	0.00E+00	0.00E+00
BR-84	0.00E+00	0.00E+00	4.41E-24	0.00E+00	0.00E+00	0.00E+00	0.00E+00	0.00E+00
BR-85	0.00E+00	0.00E+00	0.00E+00	0.00E+00	0.00E+00	0.00E+00	0.00E+00	0.00E+00
RB-86	0.00E+00	8.04E+08	3.97E+08	0.00E+00	0.00E+00	0.00E+00	2.06E+07	0.00E+00
RB-87	0.00E+00	1.42E+09	5.63E+08	0.00E+00	0.00E+00	0.00E+00	9.57E+06	0.00E+00
RB-88	0.00E+00	6.58E-46	3.61E-46	0.00E+00	0.00E+00	0.00E+00	6.41E-46	0.00E+00
RB-89	0.00E+00	1.15E-53	7.95E-54	0.00E+00	0.00E+00	0.00E+00	3.93E-54	0.00E+00
SR-89	9.64E+09	0.00E+00	2.76E+08	0.00E+00	0.00E+00	0.00E+00	1.98E+08	0.00E+00
SR-90	2.10E+11	0.00E+00	4.27E+09	0.00E+00	0.00E+00	0.00E+00	1.72E+09	0.00E+00
Y-90	2.39E+01	0.00E+00	6.41E-01	0.00E+00	0.00E+00	0.00E+00	3.30E+04	0.00E+00
SR-91	1.67E+05	0.00E+00	6.04E+03	0.00E+00	0.00E+00	0.00E+00	1.97E+05	0.00E+00
Y-91m	1.99E-20	0.00E+00	6.79E-22	0.00E+00	0.00E+00	0.00E+00	6.64E-17	0.00E+00
Y-91	3.32E+03	0.00E+00	8.84E+01	0.00E+00	0.00E+00	0.00E+00	2.38E+05	0.00E+00
SR-92	2.85E+00	0.00E+00	1.06E-01	0.00E+00	0.00E+00	0.00E+00	3.07E+01	0.00E+00
Y-92	1.89E-05	0.00E+00	5.30E-07	0.00E+00	0.00E+00	0.00E+00	3.60E-01	0.00E+00
Y-93	7.57E-02	0.00E+00	2.06E-03	0.00E+00	0.00E+00	0.00E+00	5.98E+02	0.00E+00
NB-93m	1.63E+05	4.40E+04	1.38E+04	0.00E+00	4.30E+04	0.00E+00	5.26E+06	0.00E+00
NB-95	2.38E+04	9.80E+03	5.67E+03	0.00E+00	7.03E+03	0.00E+00	8.27E+06	0.00E+00
NB-97	1.08E-12	2.31E-13	8.31E-14	0.00E+00	1.80E-13	0.00E+00	7.28E-08	0.00E+00
ZR-93	5.15E+02	2.45E+01	1.48E+01	0.00E+00	7.23E+01	0.00E+00	6.37E+03	0.00E+00
ZR-95	3.15E+02	7.68E+01	5.45E+01	0.00E+00	8.28E+01	0.00E+00	3.82E+04	0.00E+00

TABLE II2-25

R_i DOSE FACTORS AGE: INFANT PATHWAY: GOAT MILKm²-mrem/yr per μ Ci/sec

NUCLIDE	BONE	LIVER	T BODY	THYROID	KIDNEY	LUNG	GI-LLI	SKIN
ZR-97	1.43E-01	2.45E-02	1.12E-02	0.00E+00	2.47E-02	0.00E+00	1.56E+03	0.00E+00
MO-93	0.00E+00	2.26E+08	7.28E+06	0.00E+00	4.52E+07	0.00E+00	4.84E+06	0.00E+00
MO-99	0.00E+00	7.30E+06	1.42E+06	0.00E+00	1.09E+07	0.00E+00	2.41E+06	0.00E+00
TC-99	1.44E+07	1.95E+07	6.07E+06	0.00E+00	1.64E+08	1.89E+06	8.41E+07	0.00E+00
TC-99m	9.65E-01	1.99E+00	2.56E+01	0.00E+00	2.14E+01	1.04E+00	5.78E+02	0.00E+00
TC-101	8.66E-61	1.09E-60	1.08E-59	0.00E+00	1.30E-59	5.95E-61	1.85E-58	0.00E+00
RU-103	3.57E+02	0.00E+00	1.19E+02	0.00E+00	7.43E+02	0.00E+00	4.34E+03	0.00E+00
RU-105	2.83E-04	0.00E+00	9.52E-05	0.00E+00	2.08E-03	0.00E+00	1.12E-01	0.00E+00
RU-106	1.15E+04	0.00E+00	1.43E+03	0.00E+00	1.35E+04	0.00E+00	8.70E+04	0.00E+00
RH-105	1.17E+05	7.64E+04	5.13E+04	0.00E+00	2.12E+05	0.00E+00	1.90E+06	0.00E+00
PD-107	0.00E+00	6.35E+06	4.51E+05	0.00E+00	3.62E+07	0.00E+00	5.04E+06	0.00E+00
PD-109	0.00E+00	1.40E+04	3.38E+03	0.00E+00	5.15E+04	0.00E+00	3.44E+05	0.00E+00
AG-110m	2.25E+07	1.64E+07	1.09E+07	0.00E+00	2.35E+07	0.00E+00	8.51E+08	0.00E+00
AG-111	2.17E+06	8.42E+05	4.46E+05	0.00E+00	1.76E+06	0.00E+00	2.01E+08	0.00E+00
CD-113m	0.00E+00	1.12E+06	4.14E+04	0.00E+00	8.50E+05	0.00E+00	1.69E+06	0.00E+00
CD-115m	0.00E+00	4.39E+05	1.52E+04	0.00E+00	2.29E+05	0.00E+00	2.50E+06	0.00E+00
SN-123	2.44E+08	3.82E+06	6.38E+06	3.84E+06	0.00E+00	0.00E+00	6.45E+07	0.00E+00
SN-125	1.89E+07	3.52E+05	8.40E+05	3.47E+05	0.00E+00	0.00E+00	2.83E+07	0.00E+00
SN-126	7.37E+08	9.68E+06	2.40E+07	2.55E+06	0.00E+00	0.00E+00	3.36E+07	0.00E+00
SB-124	9.56E+06	1.41E+05	2.96E+06	2.54E+04	0.00E+00	5.98E+06	2.95E+07	0.00E+00
SB-125	9.43E+06	9.12E+04	1.94E+06	1.18E+04	0.00E+00	5.46E+06	1.26E+07	0.00E+00
SB-126	1.47E+06	2.89E+04	5.32E+05	1.13E+04	0.00E+00	9.27E+05	1.53E+07	0.00E+00
SB-127	1.45E+05	2.59E+03	4.50E+04	1.85E+03	0.00E+00	7.49E+04	3.85E+06	0.00E+00
TE-125m	6.82E+06	2.28E+06	9.22E+05	2.29E+06	0.00E+00	0.00E+00	3.25E+06	0.00E+00
TE-127m	2.18E+07	7.24E+06	2.64E+06	6.31E+06	5.38E+07	0.00E+00	8.81E+06	0.00E+00
TE-127	2.22E+02	7.43E+01	4.77E+01	1.81E+02	5.41E+02	0.00E+00	4.66E+03	0.00E+00
TE-129m	2.21E+07	7.60E+06	3.41E+06	8.50E+06	5.54E+07	0.00E+00	1.32E+07	0.00E+00
TE-129	9.54E-11	3.29E-11	2.23E-11	8.00E-11	2.38E-10	0.00E+00	7.63E-09	0.00E+00
TE-133m	6.66E-14	3.05E-14	2.91E-14	5.87E-14	2.08E-13	0.00E+00	3.29E-12	0.00E+00
TE-134	2.74E-19	1.38E-19	1.42E-19	2.45E-19	9.27E-19	0.00E+00	3.14E-18	0.00E+00
I-129	4.58E+09	3.39E+09	2.48E+09	2.18E+12	4.02E+09	0.00E+00	6.78E+07	0.00E+00
I-130	1.25E+06	2.74E+06	1.10E+06	3.07E+08	3.01E+06	0.00E+00	5.88E+05	0.00E+00
I-131	9.55E+08	1.13E+09	4.95E+08	3.70E+11	1.31E+09	0.00E+00	4.02E+07	0.00E+00
TE-131m	1.19E+05	4.77E+04	3.94E+04	9.67E+04	3.28E+05	0.00E+00	8.03E+05	0.00E+00
TE-131	1.20E-33	4.44E-34	3.38E-34	1.07E-33	3.08E-33	0.00E+00	4.86E-32	0.00E+00
I-132	5.02E-01	1.02E+00	3.63E-01	4.78E+01	1.14E+00	0.00E+00	8.25E-01	0.00E+00
TE-132	7.41E+05	3.67E+05	3.42E+05	5.41E+05	2.29E+06	0.00E+00	1.36E+06	0.00E+00
I-133	1.27E+07	1.85E+07	5.43E+06	3.37E+09	2.18E+07	0.00E+00	3.14E+06	0.00E+00
CS-134m	1.34E+00	2.23E+00	1.13E+00	0.00E+00	8.60E-01	1.98E-01	1.77E+00	0.00E+00
CS-134	5.69E+10	1.06E+11	1.07E+10	0.00E+00	2.73E+10	1.12E+10	2.89E+08	0.00E+00
I-134	6.18E-12	1.27E-11	4.50E-12	2.95E-10	1.41E-11	0.00E+00	1.31E-11	0.00E+00
I-135	3.94E+04	7.84E+04	2.86E+04	7.03E+06	8.74E+04	0.00E+00	2.84E+04	0.00E+00
CS-135	2.13E+10	1.94E+10	1.01E+09	0.00E+00	5.50E+09	2.10E+09	6.99E+07	0.00E+00
CS-136	1.75E+09	5.14E+09	1.92E+09	0.00E+00	2.05E+09	4.19E+08	7.80E+07	0.00E+00
CS-137	8.32E+10	9.74E+10	6.90E+09	0.00E+00	2.61E+10	1.06E+10	3.04E+08	0.00E+00

TABLE II2-25

R_i DOSE FACTORS AGE: INFANT PATHWAY: GOAT MILKm²-mrem/yr per μCi/sec

NUCLIDE	BONE	LIVER	T BODY	THYROID	KIDNEY	LUNG	GI-LLI	SKIN
CS-138	7.36E-23	1.20E-22	5.80E-23	0.00E+00	5.97E-23	9.32E-24	1.91E-22	0.00E+00
CS-139	5.76E-89	7.87E-89	3.01E-89	0.00E+00	4.07E-89	6.13E-90	4.94E-90	0.00E+00
BA-139	1.50E-08	9.94E-12	4.34E-10	0.00E+00	5.98E-12	6.03E-12	9.50E-07	0.00E+00
BA-140	8.51E+06	8.51E+03	4.39E+05	0.00E+00	2.02E+03	5.23E+03	2.09E+06	0.00E+00
LA-140	1.42E+00	5.61E-01	1.44E-01	0.00E+00	0.00E+00	0.00E+00	6.59E+03	0.00E+00
BA-141	1.38E-46	9.45E-50	4.35E-48	0.00E+00	5.68E-50	5.75E-50	1.69E-45	0.00E+00
LA-141	1.03E-05	2.99E-06	5.20E-07	0.00E+00	0.00E+00	0.00E+00	3.43E-01	0.00E+00
CE-141	1.71E+03	1.04E+03	1.23E+02	0.00E+00	3.22E+02	0.00E+00	5.39E+05	0.00E+00
BA-142	8.58E-81	7.13E-84	4.22E-82	0.00E+00	4.11E-84	4.32E-84	3.54E-80	0.00E+00
LA-142	5.97E-12	2.19E-12	5.24E-13	0.00E+00	0.00E+00	0.00E+00	3.72E-07	0.00E+00
CE-143	1.39E+01	9.24E+03	1.05E+00	0.00E+00	2.69E+00	0.00E+00	5.39E+04	0.00E+00
PR-143	5.26E+01	1.97E+01	2.61E+00	0.00E+00	7.31E+00	0.00E+00	2.77E+04	0.00E+00
CE-144	1.37E+05	5.61E+04	7.68E+03	0.00E+00	2.27E+04	0.00E+00	7.87E+06	0.00E+00
PR-144	2.00E-54	7.72E-55	1.01E-55	0.00E+00	2.80E-55	0.00E+00	3.59E-50	0.00E+00
ND-147	3.10E+01	3.19E+01	1.95E+00	0.00E+00	1.23E+01	0.00E+00	2.02E+04	0.00E+00
PM-147	9.89E+02	8.33E+01	4.05E+01	0.00E+00	1.24E+02	0.00E+00	2.36E+04	0.00E+00
PM-148m	2.04E+02	5.17E+01	4.06E+01	0.00E+00	5.94E+01	0.00E+00	6.73E+04	0.00E+00
PM-148	1.95E+01	2.82E+00	1.42E+00	0.00E+00	3.37E+00	0.00E+00	3.01E+04	0.00E+00
PM-149	1.45E+00	1.90E-01	8.31E-02	0.00E+00	2.31E-01	0.00E+00	5.11E+03	0.00E+00
PM-151	2.15E-01	3.14E-02	1.59E-02	0.00E+00	3.73E-02	0.00E+00	1.45E+03	0.00E+00
SM-151	7.72E+02	1.78E+02	3.83E+01	0.00E+00	1.21E+02	0.00E+00	1.49E+04	0.00E+00
SM-153	6.67E-01	5.15E-01	3.95E-02	0.00E+00	1.08E-01	0.00E+00	2.69E+03	0.00E+00
EU-152	1.78E+03	4.73E+02	3.99E+02	0.00E+00	1.33E+03	0.00E+00	4.20E+04	0.00E+00
EU-154	6.94E+03	9.65E+02	5.79E+02	0.00E+00	2.62E+03	0.00E+00	1.20E+05	0.00E+00
EU-155	1.41E+03	1.63E+02	8.41E+01	0.00E+00	3.64E+02	0.00E+00	2.18E+05	0.00E+00
EU-156	7.93E+01	4.91E+01	7.79E+00	0.00E+00	2.27E+01	0.00E+00	4.64E+04	0.00E+00
TB-160	4.17E+02	0.00E+00	5.22E+01	0.00E+00	1.19E+02	0.00E+00	5.56E+04	0.00E+00
HO-166m	3.33E+03	7.17E+02	5.68E+02	0.00E+00	9.52E+02	0.00E+00	7.09E+04	0.00E+00
W-181	1.70E+04	5.24E+03	5.85E+02	0.00E+00	0.00E+00	0.00E+00	7.36E+04	0.00E+00
W-185	5.92E+05	1.85E+05	2.11E+04	0.00E+00	0.00E+00	0.00E+00	2.65E+06	0.00E+00
W-187	2.13E+03	1.48E+03	5.13E+02	0.00E+00	0.00E+00	0.00E+00	8.72E+04	0.00E+00
NP-239	1.28E+00	1.15E-01	6.47E-02	0.00E+00	2.28E-01	0.00E+00	3.31E+03	0.00E+00
U-232	6.44E+09	0.00E+00	5.75E+08	0.00E+00	6.31E+08	0.00E+00	1.87E+07	0.00E+00
U-233	1.35E+09	0.00E+00	1.03E+08	0.00E+00	2.88E+08	0.00E+00	1.74E+07	0.00E+00
U-234	1.30E+09	0.00E+00	1.01E+08	0.00E+00	2.83E+08	0.00E+00	1.70E+07	0.00E+00
U-235	1.25E+09	0.00E+00	9.49E+07	0.00E+00	2.65E+08	0.00E+00	2.16E+07	0.00E+00
U-236	1.25E+09	0.00E+00	9.71E+07	0.00E+00	2.69E+08	0.00E+00	1.59E+07	0.00E+00
U-237	1.89E+04	0.00E+00	5.05E+03	0.00E+00	4.70E+04	0.00E+00	8.07E+05	0.00E+00
U-238	1.19E+09	0.00E+00	8.88E+07	0.00E+00	2.47E+08	0.00E+00	1.52E+07	0.00E+00
NP-237	6.40E+06	4.24E+05	2.80E+05	0.00E+00	1.69E+06	0.00E+00	2.19E+05	0.00E+00
NP-238	1.22E+01	3.07E-01	1.89E-01	0.00E+00	6.70E-01	0.00E+00	4.11E+03	0.00E+00
PU-238	1.36E+06	1.60E+05	3.62E+04	0.00E+00	1.29E+05	0.00E+00	8.06E+04	0.00E+00
PU-239	1.47E+06	1.65E+05	3.78E+04	0.00E+00	1.37E+05	0.00E+00	7.37E+04	0.00E+00
PU-240	1.47E+06	1.65E+05	3.78E+04	0.00E+00	1.37E+05	0.00E+00	7.51E+04	0.00E+00
PU-241	4.50E+04	1.86E+03	9.33E+02	0.00E+00	3.35E+03	0.00E+00	1.53E+03	0.00E+00

TABLE II-25

R_i DOSE FACTORS AGE: INFANT PATHWAY: GOAT MILKm²-mrem/yr per μ Ci/sec

NUCLIDE	BONE	LIVER	T BODY	THYROID	KIDNEY	LUNG	GI-LLI	SKIN
PU-242	1.37E+06	1.59E+05	3.64E+04	0.00E+00	1.31E+05	0.00E+00	7.22E+04	0.00E+00
PU-244	1.59E+06	1.82E+05	4.17E+04	0.00E+00	1.50E+05	0.00E+00	1.08E+05	0.00E+00
AM-241	3.89E+06	3.39E+06	2.91E+05	0.00E+00	1.75E+06	0.00E+00	2.05E+05	0.00E+00
AM-242m	4.02E+06	3.25E+06	3.01E+05	0.00E+00	1.77E+06	0.00E+00	2.58E+05	0.00E+00
AM-243	3.84E+06	3.28E+06	2.83E+05	0.00E+00	1.70E+06	0.00E+00	2.41E+05	0.00E+00
CM-242	2.85E+05	2.64E+05	1.89E+04	0.00E+00	5.45E+04	0.00E+00	1.71E+05	0.00E+00
CM-243	3.72E+06	3.05E+06	2.38E+05	0.00E+00	8.68E+05	0.00E+00	2.15E+05	0.00E+00
CM-244	3.13E+06	2.57E+06	2.01E+05	0.00E+00	7.18E+05	0.00E+00	2.08E+05	0.00E+00
CM-245	4.77E+06	3.87E+06	3.01E+05	0.00E+00	1.15E+06	0.00E+00	1.95E+05	0.00E+00
CM-246	4.72E+06	3.87E+06	3.01E+05	0.00E+00	1.15E+06	0.00E+00	1.91E+05	0.00E+00
CM-247	4.61E+06	3.81E+06	2.96E+05	0.00E+00	1.13E+06	0.00E+00	2.51E+05	0.00E+00
CM-248	3.81E+07	3.15E+07	2.44E+06	0.00E+00	9.33E+06	0.00E+00	4.05E+06	0.00E+00
CF-252	3.11E+06	0.00E+00	7.52E+04	0.00E+00	0.00E+00	0.00E+00	7.62E+05	0.00E+00

Table II2-26

STABLE ELEMENT TRANSFER DATA

NUCLIDE	VEG/SOIL	COW MILK (D/L)	MEAT (D/KG)	GOAT MILK (D/L)
H-3	4.8E+00	1.0E-02	1.2E-02	1.7E-01
C-14	5.5E+00	1.2E-02	3.1E-02	1.0E-01
NA-22	5.2E-02	4.0E-02	3.0E-02	4.0E-02
NA-24	5.2E-02	4.0E-02	3.0E-02	4.0E-02
P-32	1.1E+00	2.5E-02	4.6E-02	2.5E-01
CA-41	3.6E-02	8.0E-03	4.0E-03	8.0E-03
SC-46	1.1E-03	5.0E-06	1.6E-02	5.0E-06
CR-51	2.5E-04	2.2E-03	2.4E-03	2.2E-03
MN-54	2.9E-02	2.5E-04	8.0E-04	2.5E-04
MN-56	2.9E-02	2.5E-04	8.0E-04	2.5E-04
FE-55	6.6E-04	1.2E-03	4.0E-02	1.3E-04
FE-59	6.6E-04	1.2E-03	4.0E-02	1.3E-04
CO-57	9.4E-03	1.0E-03	1.3E-02	1.0E-03
CO-58	9.4E-03	1.0E-03	1.3E-02	1.0E-03
CO-60	9.4E-03	1.0E-03	1.3E-02	1.0E-03
NI-59	1.9E-02	6.7E-03	5.3E-03	6.7E-03
NI-63	1.9E-02	6.7E-03	5.3E-03	6.7E-03
NI-65	1.9E-02	6.7E-03	5.3E-03	6.7E-03
CU-64	1.2E-01	1.4E-02	8.0E-03	1.3E-02
ZN-65	4.0E-01	3.9E-02	3.0E-02	3.9E-02
ZN-69M	4.0E-01	3.9E-02	3.0E-02	3.9E-02
ZN-69	4.0E-01	3.9E-02	3.0E-02	3.9E-02
SE-79	1.3E+00	4.5E-02	1.5E-02	4.5E-02
BR-82	7.6E-01	5.0E-02	2.6E-02	5.0E-02
BR-83	7.6E-01	5.0E-02	2.6E-02	5.0E-02
BR-84	7.6E-01	5.0E-02	2.6E-02	5.0E-02
BR-85	7.6E-01	5.0E-02	2.6E-02	5.0E-02
RB-86	1.3E-01	3.0E-02	3.1E-02	3.0E-02
RB-87	1.3E-01	3.0E-02	3.1E-02	3.0E-02
RB-88	1.3E-01	3.0E-02	3.1E-02	3.0E-02
RB-89	1.3E-01	3.0E-02	3.1E-02	3.0E-02
SR-89	1.7E-02	8.0E-04	6.0E-04	1.4E-02
SR-90	1.7E-02	8.0E-04	6.0E-04	1.4E-02
SR-91	1.7E-02	8.0E-04	6.0E-04	1.4E-02
SR-92	1.7E-02	8.0E-04	6.0E-04	1.4E-02
Y-90	2.6E-03	1.0E-05	4.6E-03	1.0E-05
Y-91M	2.6E-03	1.0E-05	4.6E-03	1.0E-05
Y-91	2.6E-03	1.0E-05	4.6E-03	1.0E-05
Y-92	2.6E-03	1.0E-05	4.6E-03	1.0E-05
Y-93	2.6E-03	1.0E-05	4.6E-03	1.0E-05
ZR-93	1.7E-04	5.0E-06	3.4E-02	5.0E-06
ZR-95	1.7E-04	5.0E-06	3.4E-02	5.0E-06
ZR-97	1.7E-04	5.0E-06	3.4E-02	5.0E-06
NB-93M	9.4E-03	2.5E-03	2.8E-01	2.5E-03

Table II-26

STABLE ELEMENT TRANSFER DATA

NUCLIDE	VEG/SOIL	COW MILK (D/L)	MEAT (D/KG)	GOAT MILK (D/L)
NB-95	9.4E-03	2.5E-03	2.8E-01	2.5E-03
NB-97	9.4E-03	2.5E-03	2.8E-01	2.5E-03
MO-93	1.2E-01	7.5E-03	8.0E-03	7.5E-03
MO-99	1.2E-01	7.5E-03	8.0E-03	7.5E-03
TC-99M	2.5E-01	2.5E-02	4.0E-01	2.5E-02
TC-99	2.5E-01	2.5E-02	4.0E-01	2.5E-02
TC-101	2.5E-01	2.5E-02	4.0E-01	2.5E-02
RU-103	5.0E-02	1.0E-06	4.0E-01	1.0E-06
RU-105	5.0E-02	1.0E-06	4.0E-01	1.0E-06
RU-106	5.0E-02	1.0E-06	4.0E-01	1.0E-06
RH-105	1.3E+01	1.0E-02	1.5E-03	1.0E-02
PD-107	5.0E+00	1.0E-02	4.0E-03	1.0E-02
PD-109	5.0E+00	1.0E-02	4.0E-03	1.0E-02
AG-110M	1.5E-01	5.0E-02	1.7E-02	5.0E-02
AG-111	1.5E-01	5.0E-02	1.7E-02	5.0E-02
CD-113M	3.0E-01	1.2E-04	5.3E-04	1.2E-04
CD-115M	3.0E-01	1.2E-04	5.3E-04	1.2E-04
SN-123	2.5E-03	2.5E-03	8.0E-02	2.5E-03
SN-125	2.5E-03	2.5E-03	8.0E-02	2.5E-03
SN-126	2.5E-03	2.5E-03	8.0E-02	2.5E-03
SB-124	1.1E-02	1.5E-03	4.0E-03	1.5E-03
SB-125	1.1E-02	1.5E-03	4.0E-03	1.5E-03
SB-126	1.1E-02	1.5E-03	4.0E-03	1.5E-03
SB-127	1.1E-02	1.5E-03	4.0E-03	1.5E-03
TE-125M	1.3E+00	1.0E-03	7.7E-02	1.0E-03
TE-127M	1.3E+00	1.0E-03	7.7E-02	1.0E-03
TE-127	1.3E+00	1.0E-03	7.7E-02	1.0E-03
TE-129M	1.3E+00	1.0E-03	7.7E-02	1.0E-03
TE-129	1.3E+00	1.0E-03	7.7E-02	1.0E-03
TE-131M	1.3E+00	1.0E-03	7.7E-02	1.0E-03
TE-131	1.3E+00	1.0E-03	7.7E-02	1.0E-03
TE-132	1.3E+00	1.0E-03	7.7E-02	1.0E-03
TE-133M	1.3E+00	1.0E-03	7.7E-02	1.0E-03
TE-134	1.3E+00	1.0E-03	7.7E-02	1.0E-03
I-129	2.0E-02	6.0E-03	2.9E-03	6.0E-02
I-130	2.0E-02	6.0E-03	2.9E-03	6.0E-02
I-131	2.0E-02	6.0E-03	2.9E-03	6.0E-02
I-132	2.0E-02	6.0E-03	2.9E-03	6.0E-03
I-133	2.0E-02	6.0E-03	2.9E-03	6.0E-02
I-134	2.0E-02	6.0E-03	2.9E-03	6.0E-02
I-135	2.0E-02	6.0E-03	2.9E-03	6.0E-02
CS-134M	1.0E-02	1.2E-02	4.0E-03	3.0E-01
CS-134	1.0E-02	1.2E-02	4.0E-03	3.0E-01
CS-135	1.0E-02	1.2E-02	4.0E-03	3.0E-01

Table II2-26

STABLE ELEMENT TRANSFER DATA

NUCLIDE	VEG/SOIL	COW MILK (D/L)	MEAT (D/KG)	GOAT MILK (D/L)
CS-136	1.0E-02	1.2E-02	4.0E-03	3.0E-01
CS-137	1.0E-02	1.2E-02	4.0E-03	3.0E-01
CS-138	1.0E-02	1.2E-02	4.0E-03	3.0E-01
CS-139	1.0E-02	1.2E-02	4.0E-03	3.0E-01
BA-139	5.0E-03	4.0E-04	3.2E-03	4.0E-04
BA-140	5.0E-03	4.0E-04	3.2E-03	4.0E-04
BA-141	5.0E-03	4.0E-04	3.2E-03	4.0E-04
BA-142	5.0E-03	4.0E-04	3.2E-03	4.0E-04
LA-140	2.5E-03	5.0E-06	2.0E-04	5.0E-06
LA-141	2.5E-03	5.0E-06	2.0E-04	5.0E-06
LA-142	2.5E-03	5.0E-06	2.0E-04	5.0E-06
CE-141	2.5E-03	1.0E-04	1.2E-03	1.0E-04
CE-143	2.5E-03	1.0E-04	1.2E-03	1.0E-04
CE-144	2.5E-03	1.0E-04	1.2E-03	1.0E-04
PR-143	2.5E-03	5.0E-06	4.7E-03	5.0E-06
PR-144	2.5E-03	5.0E-06	4.7E-03	5.0E-06
ND-147	2.4E-03	5.0E-06	3.3E-03	5.0E-06
PM-147	2.5E-03	5.0E-06	4.8E-03	5.0E-06
PM-148M	2.5E-03	5.0E-06	4.8E-03	5.0E-06
PM-148	2.5E-03	5.0E-06	4.8E-03	5.0E-06
PM-149	2.5E-03	5.0E-06	4.8E-03	5.0E-06
PM-151	2.5E-03	5.0E-06	4.8E-03	5.0E-06
SM-151	2.5E-03	5.0E-06	5.0E-03	5.0E-06
SM-153	2.5E-03	5.0E-06	5.0E-03	5.0E-06
EU-152	2.5E-03	5.0E-06	4.8E-03	5.0E-06
EU-154	2.5E-03	5.0E-06	4.8E-03	5.0E-06
EU-155	2.5E-03	5.0E-06	4.8E-03	5.0E-06
EU-156	2.5E-03	5.0E-06	4.8E-03	5.0E-06
TB-160	2.6E-03	5.0E-06	4.4E-03	5.0E-06
HO-166M	2.6E-03	5.0E-06	4.4E-03	5.0E-06
W-181	1.8E-02	5.0E-04	1.3E-03	5.0E-04
W-185	1.8E-02	5.0E-04	1.3E-03	5.0E-04
W-187	1.8E-02	5.0E-04	1.3E-03	5.0E-04
U-232	2.5E-03	5.0E-04	3.4E-04	5.0E-04
U-233	2.5E-03	5.0E-04	3.4E-04	5.0E-04
U-234	2.5E-03	5.0E-04	3.4E-04	5.0E-04
U-235	2.5E-03	5.0E-04	3.4E-04	5.0E-04
U-236	2.5E-03	5.0E-04	3.4E-04	5.0E-04
U-237	2.5E-03	5.0E-04	3.4E-04	5.0E-04
U-238	2.5E-03	5.0E-04	3.4E-04	5.0E-04
NP-237	2.5E-03	5.0E-06	2.0E-04	5.0E-06
NP-238	2.5E-03	5.0E-06	2.0E-04	5.0E-06
NP-239	2.5E-03	5.0E-06	2.0E-04	5.0E-06
PU-238	2.5E-04	2.0E-06	1.4E-05	2.0E-06

Table II2-26

STABLE ELEMENT TRANSFER DATA

NUCLIDE	VEG/SOIL	COW MILK (D/L)	MEAT (D/KG)	GOAT MILK (D/L)
PU-239	2.5E-04	2.0E-06	1.4E-05	2.0E-06
PU-240	2.5E-04	2.0E-06	1.4E-05	2.0E-06
PU-241	2.5E-04	2.0E-06	1.4E-05	2.0E-06
PU-242	2.5E-04	2.0E-06	1.4E-05	2.0E-06
PU-244	2.5E-04	2.0E-06	1.4E-05	2.0E-06
AM-241	2.5E-04	5.0E-06	2.0E-04	5.0E-06
AM-242M	2.5E-04	5.0E-06	2.0E-04	5.0E-06
AM-243	2.5E-04	5.0E-06	2.0E-04	5.0E-06
CM-242	2.5E-03	5.0E-06	2.0E-04	5.0E-06
CM-243	2.5E-03	5.0E-06	2.0E-04	5.0E-06
CM-244	2.5E-03	5.0E-06	2.0E-04	5.0E-06
CM-245	2.5E-03	5.0E-06	2.0E-04	5.0E-06
CM-246	2.5E-03	5.0E-06	2.0E-04	5.0E-06
CM-247	2.5E-03	5.0E-06	2.0E-04	5.0E-06
CM-248	2.5E-03	5.0E-06	2.0E-04	5.0E-06
CF-252	2.5E-03	5.0E-06	2.0E-04	5.0E-06

NUREG/CR-4653 GASPAR II, Technical Reference and User Guide

TABLE II2-27

INHALATION DOSE FACTORS FOR ADULT (D_{aipj})

(mrem per pCi inhaled)

NUCLIDE	BONE	LIVER	T BODY	THYROID	KIDNEY	LUNG	GI-LLI
H-3	0.00E+00	8.98E-08	8.98E-08	8.98E-08	8.98E-08	8.98E-08	8.98E-08
C-14	2.27E-06	4.26E-07	4.26E-07	4.26E-07	4.26E-07	4.26E-07	4.26E-07
NA-22	1.30E-05	1.30E-05	1.30E-05	1.30E-05	1.30E-05	1.30E-05	1.30E-05
NA-24	1.28E-06	1.28E-06	1.28E-06	1.28E-06	1.28E-06	1.28E-06	1.28E-06
P-32	1.65E-04	9.64E-06	6.26E-06	0.00E+00	0.00E+00	0.00E+00	1.08E-05
CA-41	3.83E-05	0.00E+00	4.13E-06	0.00E+00	0.00E+00	3.83E-06	2.86E-07
SC-46	5.51E-05	1.07E-04	3.11E-05	0.00E+00	9.99E-05	0.00E+00	3.23E-05
CR-51	0.00E+00	0.00E+00	1.25E-08	7.44E-09	2.85E-09	1.80E-06	4.15E-07
MN-54	0.00E+00	4.95E-06	7.87E-07	0.00E+00	1.23E-06	1.75E-04	9.67E-06
MN-56	0.00E+00	1.55E-10	2.29E-11	0.00E+00	1.63E-10	1.18E-06	2.53E-06
FE-55	3.07E-06	2.12E-06	4.93E-07	0.00E+00	0.00E+00	9.01E-06	7.54E-07
FE-59	1.47E-06	3.47E-06	1.32E-06	0.00E+00	0.00E+00	1.27E-04	2.35E-05
CO-57	0.00E+00	8.65E-08	8.39E-08	0.00E+00	0.00E+00	4.62E-05	3.93E-06
CO-58	0.00E+00	1.98E-07	2.59E-07	0.00E+00	0.00E+00	1.16E-04	1.33E-05
CO-60	0.00E+00	1.44E-06	1.85E-06	0.00E+00	0.00E+00	7.46E-04	3.56E-05
NI-59	4.06E-06	1.46E-06	6.77E-07	0.00E+00	0.00E+00	8.20E-06	6.11E-07
NI-63	5.40E-05	3.93E-06	1.81E-06	0.00E+00	0.00E+00	2.23E-05	1.67E-06
NI-65	1.92E-10	2.62E-11	1.14E-11	0.00E+00	0.00E+00	7.00E-07	1.54E-06
CU-64	0.00E+00	1.83E-10	7.69E-11	0.00E+00	5.78E-10	8.48E-07	6.12E-06
ZN-65	4.05E-06	1.29E-05	5.82E-06	0.00E+00	8.62E-06	1.08E-04	6.68E-06
ZN-69M	1.02E-09	2.45E-09	2.24E-10	0.00E+00	1.48E-09	2.38E-06	1.71E-05
ZN-69	4.23E-12	8.14E-12	5.65E-13	0.00E+00	5.27E-12	1.15E-07	2.04E-09
SE-79	0.00E+00	3.83E-07	6.09E-08	0.00E+00	5.69E-07	4.47E-05	3.33E-06
BR-82	0.00E+00	0.00E+00	1.69E-06	0.00E+00	0.00E+00	0.00E+00	1.30E-06
BR-83	0.00E+00	0.00E+00	3.01E-08	0.00E+00	0.00E+00	0.00E+00	2.90E-08
BR-84	0.00E+00	0.00E+00	3.91E-08	0.00E+00	0.00E+00	0.00E+00	2.05E-13
BR-85	0.00E+00	0.00E+00	1.60E-09	0.00E+00	0.00E+00	0.00E+00	0.00E+00
RB-86	0.00E+00	1.69E-05	7.37E-06	0.00E+00	0.00E+00	0.00E+00	2.08E-06
RB-87	0.00E+00	9.86E-06	3.21E-06	0.00E+00	0.00E+00	0.00E+00	2.88E-07
RB-88	0.00E+00	4.84E-08	2.41E-08	0.00E+00	0.00E+00	0.00E+00	4.18E-19
RB-89	0.00E+00	3.20E-08	2.12E-08	0.00E+00	0.00E+00	0.00E+00	1.16E-21
SR-89	3.80E-05	0.00E+00	1.09E-06	0.00E+00	0.00E+00	1.75E-04	4.37E-05
SR-90	3.59E-03	0.00E+00	7.21E-05	0.00E+00	0.00E+00	1.20E-03	9.02E-05
SR-91	7.74E-09	0.00E+00	3.13E-10	0.00E+00	0.00E+00	4.56E-06	2.39E-05
SR-92	8.43E-10	0.00E+00	3.64E-11	0.00E+00	0.00E+00	2.06E-06	5.38E-06
Y-90	2.61E-07	0.00E+00	7.01E-09	0.00E+00	0.00E+00	2.12E-05	6.32E-05
Y-91M	3.26E-11	0.00E+00	1.27E-12	0.00E+00	0.00E+00	2.40E-07	1.66E-10
Y-91	5.78E-05	0.00E+00	1.55E-06	0.00E+00	0.00E+00	2.13E-04	4.81E-05
Y-92	1.29E-09	0.00E+00	3.77E-11	0.00E+00	0.00E+00	1.96E-06	9.19E-06
Y-93	1.18E-08	0.00E+00	3.26E-10	0.00E+00	0.00E+00	6.06E-06	5.27E-05
ZR-93	5.22E-05	2.92E-06	1.37E-06	0.00E+00	1.11E-05	2.13E-05	1.51E-06
ZR-95	1.34E-05	4.30E-06	2.91E-06	0.00E+00	6.77E-06	2.21E-04	1.88E-05
ZR-97	1.21E-08	2.45E-09	1.13E-09	0.00E+00	3.71E-09	9.84E-06	6.54E-05
NB-93M	3.10E-05	1.01E-05	2.49E-06	0.00E+00	1.16E-05	3.11E-05	2.38E-06
NB-95	1.76E-06	9.77E-07	5.26E-07	0.00E+00	9.67E-07	6.31E-05	1.30E-05

TABLE II2-27

INHALATION DOSE FACTORS FOR ADULT (D_{aipj})

(mrem per pCi inhaled)

NUCLIDE	BONE	LIVER	T BODY	THYROID	KIDNEY	LUNG	GI-LLI
NB-97	2.78E-11	7.03E-12	2.56E-12	0.00E+00	8.18E-12	3.00E-07	3.02E-08
MO-93	0.00E+00	1.17E-06	3.17E-08	0.00E+00	3.55E-07	5.11E-05	3.79E-06
MO-99	0.00E+00	1.51E-08	2.87E-09	0.00E+00	3.64E-08	1.14E-05	3.10E-05
TC-99M	1.29E-13	3.64E-13	4.63E-12	0.00E+00	5.52E-12	9.55E-08	5.20E-07
TC-99	3.13E-08	4.64E-08	1.25E-08	0.00E+00	5.85E-07	1.01E-04	7.54E-06
TC-101	5.22E-15	7.52E-15	7.38E-14	0.00E+00	1.35E-13	4.99E-08	1.36E-21
RU-103	1.91E-07	0.00E+00	8.23E-08	0.00E+00	7.29E-07	6.31E-05	1.38E-05
RU-105	9.88E-11	0.00E+00	3.89E-11	0.00E+00	1.27E-10	1.37E-06	6.02E-06
RU-106	8.64E-06	0.00E+00	1.09E-06	0.00E+00	1.67E-05	1.17E-03	1.14E-04
RH-105	9.24E-10	6.73E-10	4.43E-10	0.00E+00	2.86E-09	2.41E-06	1.09E-05
PD-107	0.00E+00	8.27E-08	5.87E-09	0.00E+00	6.57E-07	9.47E-06	7.06E-07
PD-109	0.00E+00	4.63E-10	1.16E-10	0.00E+00	2.35E-09	1.85E-06	1.52E-05
AG-110M	1.35E-06	1.25E-06	7.43E-07	0.00E+00	2.46E-06	5.79E-04	3.78E-05
AG-111	4.25E-08	1.78E-08	8.87E-09	0.00E+00	5.74E-08	2.33E-05	2.79E-05
CD-113M	0.00E+00	1.54E-04	4.97E-06	0.00E+00	1.71E-04	2.08E-04	1.59E-05
CD-115M	0.00E+00	2.46E-05	7.95E-07	0.00E+00	1.98E-05	1.76E-04	4.80E-05
SN-123	3.02E-05	6.67E-07	9.82E-07	5.67E-07	0.00E+00	2.88E-04	3.92E-05
SN-125	1.16E-06	3.12E-08	7.03E-08	2.59E-08	0.00E+00	7.37E-05	6.81E-05
SN-126	1.58E-04	4.18E-06	6.00E-06	1.23E-06	0.00E+00	1.17E-03	1.59E-05
SB-124	3.90E-06	7.36E-08	1.55E-06	9.44E-09	0.00E+00	3.10E-04	5.08E-05
SB-125	6.67E-06	7.44E-08	1.58E-06	6.75E-09	0.00E+00	2.18E-04	1.26E-05
SB-126	4.50E-07	9.13E-09	1.62E-07	2.75E-09	0.00E+00	9.57E-05	6.01E-05
SB-127	3.30E-08	7.22E-10	1.27E-08	3.97E-10	0.00E+00	2.05E-05	3.77E-05
TE-125M	4.27E-07	1.98E-07	5.84E-08	1.31E-07	1.55E-06	3.92E-05	8.83E-06
TE-127M	1.58E-06	7.21E-07	1.96E-07	4.11E-07	5.72E-06	1.20E-04	1.87E-05
TE-127	1.75E-10	8.03E-11	3.87E-11	1.32E-10	6.37E-10	8.14E-07	7.17E-06
TE-129M	1.22E-06	5.84E-07	1.98E-07	4.30E-07	4.57E-06	1.45E-04	4.79E-05
TE-129	6.22E-12	2.99E-12	1.55E-12	4.87E-12	2.34E-11	2.42E-07	1.96E-08
TE-131M	8.74E-09	5.45E-09	3.63E-09	6.88E-09	3.86E-08	1.82E-05	6.95E-05
TE-131	1.39E-12	7.44E-13	4.49E-13	1.17E-12	5.46E-12	1.74E-07	2.30E-09
TE-132	3.25E-08	2.69E-08	2.02E-08	2.37E-08	1.82E-07	3.60E-05	6.37E-05
TE-133M	7.24E-12	5.40E-12	4.17E-12	6.27E-12	3.74E-11	5.51E-07	7.65E-09
TE-134	3.84E-12	3.22E-12	1.57E-12	3.44E-12	2.18E-11	4.34E-07	2.97E-11
I-129	2.48E-06	2.11E-06	6.91E-06	5.54E-03	4.53E-06	0.00E+00	2.22E-07
I-130	5.72E-07	1.68E-06	6.60E-07	1.42E-04	2.61E-06	0.00E+00	9.61E-07
I-131	3.15E-06	4.47E-06	2.56E-06	1.49E-03	7.66E-06	0.00E+00	7.85E-07
I-132	1.45E-07	4.07E-07	1.45E-07	1.43E-05	6.48E-07	0.00E+00	5.08E-08
I-133	1.08E-06	1.85E-06	5.65E-07	2.69E-04	3.23E-06	0.00E+00	1.11E-06
I-134	8.05E-08	2.16E-07	7.69E-08	3.73E-06	3.44E-07	0.00E+00	1.26E-10
I-135	3.35E-07	8.73E-07	3.21E-07	5.60E-05	1.39E-06	0.00E+00	6.56E-07
CS-134M	1.59E-08	3.20E-08	1.72E-08	0.00E+00	1.83E-08	2.93E-09	7.92E-09
CS-134	4.66E-05	1.06E-04	9.10E-05	0.00E+00	3.59E-05	1.22E-05	1.30E-06
CS-135	1.46E-05	1.29E-05	5.99E-06	0.00E+00	5.11E-06	1.57E-06	2.11E-07
CS-136	4.88E-06	1.83E-05	1.38E-05	0.00E+00	1.07E-05	1.50E-06	1.46E-06
CS-137	5.98E-05	7.76E-05	5.35E-05	0.00E+00	2.78E-05	9.40E-06	1.05E-06

TABLE II2-27

INHALATION DOSE FACTORS FOR ADULT (D_{aipj})

(mrem per pCi inhaled)

NUCLIDE	BONE	LIVER	T BODY	THYROID	KIDNEY	LUNG	GI-LLI
CS-138	4.14E-08	7.76E-08	4.05E-08	0.00E+00	6.00E-08	6.07E-09	2.33E-13
CS-139	2.56E-08	3.63E-08	1.39E-08	0.00E+00	3.05E-08	2.84E-09	5.49E-31
BA-139	1.17E-10	8.32E-14	3.42E-12	0.00E+00	7.78E-14	4.70E-07	1.12E-07
BA-140	4.88E-06	6.13E-09	3.21E-07	0.00E+00	2.09E-09	1.59E-04	2.73E-05
BA-141	1.25E-11	9.41E-15	4.20E-13	0.00E+00	8.75E-15	2.42E-07	1.45E-17
BA-142	3.29E-12	3.38E-15	2.07E-13	0.00E+00	2.86E-15	1.49E-07	1.96E-26
LA-140	4.30E-08	2.17E-08	5.73E-09	0.00E+00	0.00E+00	1.70E-05	5.73E-05
LA-141	5.34E-10	1.66E-10	2.71E-11	0.00E+00	0.00E+00	1.35E-06	7.31E-06
LA-142	8.54E-11	3.88E-11	9.65E-12	0.00E+00	0.00E+00	7.91E-07	2.64E-07
CE-141	2.49E-06	1.69E-06	1.91E-07	0.00E+00	7.83E-07	4.52E-05	1.50E-05
CE-143	2.33E-08	1.72E-08	1.91E-09	0.00E+00	7.60E-09	9.97E-06	2.83E-05
CE-144	4.29E-04	1.79E-04	2.30E-05	0.00E+00	1.06E-04	9.72E-04	1.02E-04
PR-143	1.17E-06	4.69E-07	5.80E-08	0.00E+00	2.70E-07	3.51E-05	2.50E-05
PR-144	3.76E-12	1.56E-12	1.91E-13	0.00E+00	8.81E-13	1.27E-07	2.69E-18
ND-147	6.59E-07	7.62E-07	4.56E-08	0.00E+00	4.45E-07	2.76E-05	2.16E-05
PM-147	8.37E-05	7.87E-06	3.19E-06	0.00E+00	1.49E-05	6.60E-05	5.54E-06
PM-148M	9.82E-06	2.54E-06	1.94E-06	0.00E+00	3.85E-06	2.14E-04	4.18E-05
PM-148	3.84E-07	6.37E-08	3.20E-08	0.00E+00	1.20E-07	3.91E-05	5.80E-05
PM-149	3.44E-08	4.87E-09	1.99E-09	0.00E+00	9.19E-09	7.21E-06	2.50E-05
PM-151	8.50E-09	1.42E-09	7.21E-10	0.00E+00	2.55E-09	3.94E-06	2.00E-05
SM-151	8.59E-05	1.48E-05	3.55E-06	0.00E+00	1.66E-05	4.45E-05	3.25E-06
SM-153	1.70E-08	1.42E-08	1.04E-09	0.00E+00	4.59E-09	4.14E-06	1.58E-05
EU-152	2.38E-04	5.41E-05	4.76E-05	0.00E+00	3.35E-04	3.43E-04	1.59E-05
EU-154	7.40E-04	9.10E-05	6.48E-05	0.00E+00	4.36E-04	5.84E-04	3.40E-05
EU-155	1.01E-04	1.43E-05	9.21E-06	0.00E+00	6.59E-05	9.46E-05	5.95E-06
EU-156	1.93E-06	1.48E-06	2.40E-07	0.00E+00	9.95E-07	8.56E-05	4.50E-05
TB-160	2.21E-05	0.00E+00	2.75E-06	0.00E+00	9.10E-06	1.92E-04	2.68E-05
HO-166M	3.37E-04	1.05E-04	8.00E-05	0.00E+00	1.57E-04	3.94E-04	1.59E-05
W-181	6.23E-09	2.03E-09	2.17E-10	0.00E+00	0.00E+00	1.71E-06	2.53E-07
W-185	1.95E-07	6.47E-08	6.81E-09	0.00E+00	0.00E+00	5.57E-05	1.07E-05
W-187	1.06E-09	8.85E-10	3.10E-10	0.00E+00	0.00E+00	3.63E-06	1.94E-05
U-232	5.14E-02	0.00E+00	3.66E-03	0.00E+00	5.56E-03	2.22E-01	4.21E-05
U-233	1.09E-02	0.00E+00	6.60E-04	0.00E+00	2.54E-03	5.32E-02	3.89E-05
U-234	1.04E-02	0.00E+00	6.46E-04	0.00E+00	2.49E-03	5.22E-02	3.81E-05
U-235	1.00E-02	0.00E+00	6.07E-04	0.00E+00	2.34E-03	4.90E-02	4.84E-05
U-236	1.00E-02	0.00E+00	6.20E-04	0.00E+00	2.39E-03	5.00E-02	3.57E-05
U-237	3.67E-08	0.00E+00	9.77E-09	0.00E+00	1.51E-07	1.02E-05	1.20E-05
U-238	9.58E-03	0.00E+00	5.67E-04	0.00E+00	2.18E-03	4.58E-02	3.41E-05
NP-237	1.56E+00	1.00E+00	6.87E-02	0.00E+00	5.10E-01	5.22E-02	4.92E-05
NP-238	2.96E-07	7.20E-08	4.61E-09	0.00E+00	2.72E-08	1.02E-05	2.13E-05
NP-239	2.87E-08	2.54E-08	1.55E-09	0.00E+00	8.75E-09	4.70E-06	1.49E-05
PU-238	1.43E+00	9.71E-01	6.90E-02	0.00E+00	2.96E-01	1.82E-01	4.52E-05
PU-239	1.66E+00	1.07E+00	7.75E-02	0.00E+00	3.30E-01	1.72E-01	4.13E-05
PU-240	1.65E+00	1.07E+00	7.73E-02	0.00E+00	3.29E-01	1.72E-01	4.21E-05
PU-241	3.42E-02	8.69E-03	1.29E-03	0.00E+00	5.93E-03	1.52E-04	8.65E-07

TABLE II-27

INHALATION DOSE FACTORS FOR ADULT (D_{aipj})

(mrem per pCi inhaled)

NUCLIDE	BONE	LIVER	T BODY	THYROID	KIDNEY	LUNG	GI-LLI
PU-242	1.53E+00	1.03E+00	7.46E-02	0.00E+00	3.17E-01	1.65E-01	4.05E-05
PU-244	1.79E+00	1.18E+00	8.54E-02	0.00E+00	3.64E-01	1.89E-01	6.03E-05
AM-241	1.68E+00	1.13E+00	6.71E-02	0.00E+00	5.04E-01	6.06E-02	4.60E-05
AM-242M	1.70E+00	1.06E+00	6.73E-02	0.00E+00	5.01E-01	2.44E-02	5.79E-05
AM-243	1.68E+00	1.10E+00	6.57E-02	0.00E+00	4.95E-01	5.75E-02	5.40E-05
CM-242	2.22E-02	1.77E-02	9.84E-04	0.00E+00	4.48E-03	3.92E-02	4.91E-05
CM-243	1.10E+00	7.61E-01	4.61E-02	0.00E+00	2.15E-01	6.31E-02	4.84E-05
CM-244	8.37E-01	5.88E-01	3.51E-02	0.00E+00	1.64E-01	6.06E-02	4.68E-05
CM-245	1.74E+00	1.14E+00	7.14E-02	0.00E+00	3.33E-01	5.85E-02	4.36E-05
CM-246	1.73E+00	1.14E+00	7.13E-02	0.00E+00	3.33E-01	5.96E-02	4.29E-05
CM-247	1.68E+00	1.12E+00	7.03E-02	0.00E+00	3.28E-01	5.85E-02	5.63E-05
CM-248	1.40E-01	9.26E+00	5.79E-01	0.00E+00	2.70E+00	4.82E-01	9.09E-04
CF-252	5.43E-01	0.00E+00	2.33E-02	0.00E+00	0.00E+00	1.99E-01	1.78E-04

NUREG/CR-4653 GASPAR II, Technical Reference and User Guide

TABLE II2-28

INHALATION DOSE FACTORS FOR TEENAGER (D_{aipj})

(mrem per pCi inhaled)

NUCLIDE	BONE	LIVER	T BODY	THYROID	KIDNEY	LUNG	GI-LLI
H-3	0.00E+00	9.06E-08	9.06E-08	9.06E-08	9.06E-08	9.06E-08	9.06E-08
C-14	3.25E-06	6.09E-07	6.09E-07	6.09E-07	6.09E-07	6.09E-07	6.09E-07
NA-22	1.76E-05	1.76E-05	1.76E-05	1.76E-05	1.76E-05	1.76E-05	1.76E-05
NA-24	1.72E-06	1.72E-06	1.72E-06	1.72E-06	1.72E-06	1.72E-06	1.72E-06
P-32	2.36E-04	1.37E-05	8.95E-06	0.00E+00	0.00E+00	0.00E+00	1.16E-05
CA-41	4.05E-05	0.00E+00	4.38E-06	0.00E+00	0.00E+00	1.01E-01	3.03E-07
SC-46	7.24E-05	1.41E-04	4.18E-05	0.00E+00	1.35E-04	0.00E+00	2.98E-05
CR-51	0.00E+00	0.00E+00	1.69E-08	9.37E-09	3.84E-09	2.62E-06	3.75E-07
MN-54	0.00E+00	6.39E-06	1.05E-06	0.00E+00	1.59E-06	2.48E-04	8.35E-06
MN-56	0.00E+00	2.12E-10	3.15E-11	0.00E+00	2.24E-10	1.90E-06	7.18E-06
FE-55	4.18E-06	2.98E-06	6.93E-07	0.00E+00	0.00E+00	1.55E-05	7.99E-07
FE-59	1.99E-06	4.62E-06	1.79E-06	0.00E+00	0.00E+00	1.91E-04	2.23E-05
CO-57	0.00E+00	1.18E-07	1.15E-07	0.00E+00	0.00E+00	7.33E-05	3.93E-06
CO-58	0.00E+00	2.59E-07	3.47E-07	0.00E+00	0.00E+00	1.68E-04	1.19E-05
CO-60	0.00E+00	1.89E-06	2.48E-06	0.00E+00	0.00E+00	1.09E-03	3.24E-05
NI-59	5.44E-06	2.02E-06	9.24E-07	0.00E+00	0.00E+00	1.41E-05	6.48E-07
NI-63	7.25E-05	5.43E-06	2.47E-06	0.00E+00	0.00E+00	3.84E-05	1.77E-06
NI-65	2.73E-10	3.66E-11	1.59E-11	0.00E+00	0.00E+00	1.17E-06	4.59E-06
CU-64	0.00E+00	2.54E-10	1.06E-10	0.00E+00	8.01E-10	1.39E-06	7.68E-06
ZN-65	4.82E-06	1.67E-05	7.80E-06	0.00E+00	1.08E-05	1.55E-04	5.83E-06
ZN-69M	1.44E-09	3.39E-09	3.11E-10	0.00E+00	2.06E-09	3.92E-06	2.14E-05
ZN-69	6.04E-12	1.15E-11	8.07E-13	0.00E+00	7.53E-12	1.98E-07	3.56E-08
SE-79	0.00E+00	5.43E-07	8.71E-08	0.00E+00	8.13E-07	7.71E-05	3.53E-06
BR-82	0.00E+00	0.00E+00	2.28E-06	0.00E+00	0.00E+00	0.00E+00	0.00E+00
BR-83	0.00E+00	0.00E+00	4.30E-08	0.00E+00	0.00E+00	0.00E+00	0.00E+00
BR-84	0.00E+00	0.00E+00	5.41E-08	0.00E+00	0.00E+00	0.00E+00	0.00E+00
BR-85	0.00E+00	0.00E+00	2.29E-09	0.00E+00	0.00E+00	0.00E+00	0.00E+00
RB-86	0.00E+00	2.38E-05	1.05E-05	0.00E+00	0.00E+00	0.00E+00	2.21E-06
RB-87	0.00E+00	1.40E-05	4.58E-06	0.00E+00	0.00E+00	0.00E+00	3.05E-07
RB-88	0.00E+00	6.82E-08	3.40E-08	0.00E+00	0.00E+00	0.00E+00	3.65E-15
RB-89	0.00E+00	4.40E-08	2.91E-08	0.00E+00	0.00E+00	0.00E+00	4.22E-17
SR-89	5.43E-05	0.00E+00	1.56E-06	0.00E+00	0.00E+00	3.02E-04	4.64E-05
SR-90	4.14E-03	0.00E+00	8.33E-05	0.00E+00	0.00E+00	2.06E-03	9.56E-05
SR-91	1.10E-08	0.00E+00	4.39E-10	0.00E+00	0.00E+00	7.59E-06	3.24E-05
SR-92	1.19E-09	0.00E+00	5.08E-11	0.00E+00	0.00E+00	3.43E-06	1.49E-05
Y-90	3.73E-07	0.00E+00	1.00E-08	0.00E+00	0.00E+00	3.66E-05	6.99E-05
Y-91M	4.63E-11	0.00E+00	1.77E-12	0.00E+00	0.00E+00	4.00E-07	3.77E-09
Y-91	8.26E-05	0.00E+00	2.21E-06	0.00E+00	0.00E+00	3.67E-04	5.11E-05
Y-92	1.84E-09	0.00E+00	5.36E-11	0.00E+00	0.00E+00	3.35E-06	2.06E-05
Y-93	1.69E-08	0.00E+00	4.65E-10	0.00E+00	0.00E+00	1.04E-05	7.24E-05
ZR-93	6.83E-05	3.38E-06	1.84E-06	0.00E+00	1.16E-05	3.67E-05	1.60E-06
ZR-95	1.82E-05	5.73E-06	3.94E-06	0.00E+00	8.42E-06	3.36E-04	1.86E-05
ZR-97	1.72E-08	3.40E-09	1.57E-09	0.00E+00	5.15E-09	1.62E-05	7.88E-05
NB-93M	4.14E-05	1.36E-05	3.41E-06	0.00E+00	1.59E-05	5.36E-05	2.52E-06
NB-95	2.32E-06	1.29E-06	7.08E-07	0.00E+00	1.25E-06	9.39E-05	1.21E-05

TABLE II2-28

INHALATION DOSE FACTORS FOR TEENAGER ($D_{ai,pj}$)

(mrem per pCi inhaled)

NUCLIDE	BONE	LIVER	T BODY	THYROID	KIDNEY	LUNG	GI-LLI
NB-97	3.92E-11	9.72E-12	3.55E-12	0.00E+00	1.14E-11	4.91E-07	2.71E-07
MO-93	0.00E+00	1.66E-06	4.52E-08	0.00E+00	5.06E-07	8.81E-05	3.99E-06
MO-99	0.00E+00	2.11E-08	4.03E-09	0.00E+00	5.14E-08	1.92E-05	3.36E-05
TC-99M	1.73E-13	4.83E-13	6.24E-12	0.00E+00	7.20E-12	1.44E-07	7.66E-07
TC-99	4.48E-08	6.58E-08	1.79E-08	0.00E+00	8.35E-07	1.74E-04	7.99E-06
TC-101	7.40E-15	1.05E-14	1.03E-13	0.00E+00	1.90E-13	8.34E-08	1.09E-16
RU-103	2.63E-07	0.00E+00	1.12E-07	0.00E+00	9.29E-07	9.79E-05	1.36E-05
RU-105	1.40E-10	0.00E+00	5.42E-11	0.00E+00	1.76E-10	2.27E-06	1.13E-05
RU-106	1.23E-05	0.00E+00	1.55E-06	0.00E+00	2.38E-05	2.01E-03	1.20E-04
RH-105	1.32E-09	9.48E-10	6.24E-10	0.00E+00	4.04E-09	4.09E-06	1.23E-05
PD-107	0.00E+00	1.17E-07	8.39E-09	0.00E+00	9.39E-07	1.63E-05	7.49E-07
PD-109	0.00E+00	6.56E-10	1.66E-10	0.00E+00	3.36E-09	3.19E-06	1.96E-05
AG-110M	1.73E-06	1.64E-06	9.99E-07	0.00E+00	3.13E-06	8.44E-04	3.41E-05
AG-111	6.07E-08	2.52E-08	1.26E-08	0.00E+00	8.17E-08	4.00E-05	3.00E-05
CD-113M	0.00E+00	2.17E-04	7.10E-06	0.00E+00	2.43E-04	3.59E-04	1.68E-05
CD-115M	0.00E+00	3.48E-05	1.14E-06	0.00E+00	2.82E-05	3.03E-04	5.10E-05
SN-123	4.31E-05	9.44E-07	1.40E-06	7.55E-07	0.00E+00	4.96E-04	4.16E-05
SN-125	1.66E-06	4.42E-08	9.99E-08	3.45E-08	0.00E+00	1.26E-04	7.29E-05
SN-126	2.18E-04	5.39E-06	8.24E-06	1.42E-06	0.00E+00	1.72E-03	1.68E-05
SB-124	5.38E-06	9.92E-08	2.10E-06	1.22E-08	0.00E+00	4.81E-04	4.98E-05
SB-125	9.23E-06	1.01E-07	2.15E-06	8.80E-09	0.00E+00	3.42E-04	1.24E-05
SB-126	6.19E-07	1.27E-08	2.23E-07	3.50E-09	0.00E+00	1.55E-04	6.01E-05
SB-127	4.64E-08	9.92E-10	1.75E-08	5.21E-10	0.00E+00	3.31E-05	3.94E-05
TE-125M	6.10E-07	2.80E-07	8.34E-08	1.75E-07	0.00E+00	6.70E-05	9.38E-06
TE-127M	2.25E-06	1.02E-06	2.73E-07	5.48E-07	8.17E-06	2.07E-04	1.99E-05
TE-127	2.51E-10	1.14E-10	5.52E-11	1.77E-10	9.10E-10	1.40E-06	1.01E-05
TE-129M	1.74E-06	8.23E-07	2.81E-07	5.72E-07	6.49E-06	2.47E-04	5.06E-05
TE-129	8.87E-12	4.22E-12	2.20E-12	6.48E-12	3.32E-11	4.12E-07	2.02E-07
TE-131M	1.23E-08	7.51E-09	5.03E-09	9.06E-09	5.49E-08	2.97E-05	7.76E-05
TE-131	1.97E-12	1.04E-12	6.30E-13	1.55E-12	7.72E-12	2.92E-07	1.89E-09
TE-132	4.50E-08	3.63E-08	2.74E-08	3.07E-08	2.44E-07	5.61E-05	5.79E-05
TE-133M	1.01E-11	7.33E-12	5.71E-12	8.18E-12	5.07E-11	8.71E-07	1.23E-07
TE-134	5.31E-12	4.35E-12	3.64E-12	4.46E-12	2.91E-11	6.75E-07	1.37E-09
I-129	3.53E-06	2.94E-06	4.90E-06	3.66E-03	5.26E-06	0.00E+00	2.29E-07
I-130	7.80E-07	2.24E-06	8.96E-07	1.86E-04	3.44E-06	0.00E+00	1.14E-06
I-131	4.43E-06	6.14E-06	3.30E-06	1.83E-03	1.05E-05	0.00E+00	8.11E-07
I-132	1.99E-07	5.47E-07	1.97E-07	1.89E-05	8.65E-07	0.00E+00	1.59E-07
I-133	1.52E-06	2.56E-06	7.78E-07	3.65E-04	4.49E-06	0.00E+00	1.29E-06
I-134	1.11E-07	2.90E-07	1.05E-07	4.94E-06	4.58E-07	0.00E+00	2.55E-09
I-135	4.62E-07	1.18E-06	4.36E-07	7.76E-05	1.86E-06	0.00E+00	8.69E-07
CS-134M	2.20E-08	4.35E-08	2.35E-08	0.00E+00	2.54E-08	4.56E-09	2.02E-08
CS-134	6.28E-05	1.41E-04	6.86E-05	0.00E+00	4.69E-05	1.83E-05	1.22E-06
CS-135	2.08E-05	1.82E-05	4.47E-06	0.00E+00	7.30E-06	2.70E-06	2.23E-07
CS-136	6.44E-06	2.42E-05	1.71E-05	0.00E+00	1.38E-05	2.22E-06	1.36E-06
CS-137	8.38E-05	1.06E-04	3.89E-05	0.00E+00	3.80E-05	1.51E-05	1.06E-06

TABLE II2-28

INHALATION DOSE FACTORS FOR TEENAGER (D_{aipj})

(mrem per pCi inhaled)

NUCLIDE	BONE	LIVER	T BODY	THYROID	KIDNEY	LUNG	GI-LLI
CS-138	5.82E-08	1.07E-07	5.58E-08	0.00E+00	8.28E-08	9.84E-09	3.38E-11
CS-139	3.65E-08	5.12E-08	1.97E-08	0.00E+00	4.34E-08	4.86E-09	1.66E-23
BA-139	1.67E-10	1.18E-13	4.87E-12	0.00E+00	1.11E-13	8.08E-07	8.06E-07
BA-140	6.84E-06	8.38E-09	4.40E-07	0.00E+00	2.85E-09	2.54E-04	2.86E-05
BA-141	1.78E-11	1.32E-14	5.93E-13	0.00E+00	1.23E-14	4.11E-07	9.33E-14
BA-142	4.62E-12	4.63E-15	2.84E-13	0.00E+00	3.92E-15	2.39E-07	5.99E-20
LA-140	5.99E-08	2.95E-08	7.82E-09	0.00E+00	0.00E+00	2.68E-05	6.09E-05
LA-141	7.63E-10	2.35E-10	3.87E-11	0.00E+00	0.00E+00	2.31E-06	1.54E-05
LA-142	1.20E-10	5.31E-11	1.32E-11	0.00E+00	0.00E+00	1.27E-06	1.50E-06
CE-141	3.55E-06	2.37E-06	2.71E-07	0.00E+00	1.11E-06	7.67E-05	1.58E-05
CE-143	3.32E-08	2.42E-08	2.70E-09	0.00E+00	1.08E-08	1.63E-05	3.19E-05
CE-144	6.11E-04	2.53E-04	3.28E-05	0.00E+00	1.51E-04	1.67E-03	1.08E-04
PR-143	1.67E-06	6.64E-07	8.28E-08	0.00E+00	3.86E-07	6.04E-05	2.67E-05
PR-144	5.37E-12	2.20E-12	2.72E-13	0.00E+00	1.26E-12	2.19E-07	2.94E-14
ND-147	9.83E-07	1.07E-06	6.41E-08	0.00E+00	6.28E-07	4.65E-05	2.28E-05
PM-147	1.15E-04	1.10E-05	4.50E-06	0.00E+00	2.10E-05	1.14E-04	5.87E-06
PM-148M	1.32E-05	3.35E-06	2.62E-06	0.00E+00	5.07E-06	3.20E-04	4.10E-05
PM-148	5.44E-07	8.88E-08	4.48E-08	0.00E+00	1.60E-07	6.52E-05	6.14E-05
PM-149	4.91E-08	6.89E-09	2.84E-09	0.00E+00	1.31E-08	1.24E-05	2.79E-05
PM-151	1.20E-08	1.99E-09	1.01E-09	0.00E+00	3.57E-09	6.56E-06	2.27E-05
SM-151	1.07E-04	2.10E-05	4.86E-06	0.00E+00	2.27E-05	7.68E-05	3.53E-06
SM-153	2.43E-08	2.01E-08	1.47E-09	0.00E+00	6.56E-09	7.11E-06	1.77E-05
EU-152	2.96E-04	7.19E-05	6.30E-05	0.00E+00	3.34E-04	5.01E-04	1.35E-05
EU-154	9.43E-04	1.23E-04	8.60E-05	0.00E+00	5.44E-04	9.12E-04	3.34E-05
EU-155	2.00E-04	1.96E-05	1.21E-05	0.00E+00	7.65E-05	1.51E-03	5.97E-05
EU-156	2.70E-06	2.03E-06	3.30E-07	0.00E+00	1.36E-06	1.37E-04	4.56E-05
TB-160	3.04E-05	0.00E+00	3.79E-06	0.00E+00	1.20E-05	2.97E-04	2.60E-05
HO-166M	4.40E-04	1.36E-04	9.87E-05	0.00E+00	2.00E-04	6.24E-04	1.68E-05
W-181	8.90E-09	2.88E-09	3.01E-10	0.00E+00	0.00E+00	2.95E-06	2.69E-07
W-185	2.78E-07	9.17E-08	9.73E-09	0.00E+00	0.00E+00	9.60E-05	1.14E-05
W-187	1.50E-09	1.22E-09	4.29E-10	0.00E+00	0.00E+00	5.92E-06	2.21E-05
U-232	7.31E-02	0.00E+00	5.23E-03	0.00E+00	7.94E-03	3.84E-01	4.46E-05
U-233	1.55E-02	0.00E+00	9.42E-04	0.00E+00	3.63E-03	9.18E-02	4.12E-05
U-234	1.48E-02	0.00E+00	9.23E-04	0.00E+00	3.55E-03	8.99E-02	4.04E-05
U-235	1.42E-02	0.00E+00	8.67E-04	0.00E+00	3.34E-03	8.44E-02	5.13E-05
U-236	1.42E-02	0.00E+00	8.86E-04	0.00E+00	3.41E-03	8.62E-02	3.79E-05
U-237	5.25E-08	0.00E+00	1.40E-08	0.00E+00	2.16E-07	1.76E-05	1.29E-05
U-238	1.36E-02	0.00E+00	8.10E-04	0.00E+00	3.12E-03	7.89E-02	3.62E-05
NP-237	1.64E+00	1.06E+00	7.21E-02	0.00E+00	5.35E-01	8.99E-02	5.22E-05
NP-238	4.23E-07	1.02E-07	6.59E-09	0.00E+00	3.88E-08	1.75E-05	2.38E-05
NP-239	4.23E-08	3.60E-08	2.21E-09	0.00E+00	1.25E-08	8.11E-06	1.65E-05
PU-238	1.50E+00	1.03E+00	7.22E-02	0.00E+00	3.10E-01	3.12E-01	4.79E-05
PU-239	1.73E+00	1.12E+00	8.05E-02	0.00E+00	3.44E-01	2.93E-01	4.37E-05
PU-240	1.72E+00	1.12E+00	8.04E-02	0.00E+00	3.43E-01	2.93E-01	4.46E-05
PU-241	3.74E-02	9.56E-03	1.40E-03	0.00E+00	6.47E-03	2.60E-04	9.17E-07

TABLE II-28

INHALATION DOSE FACTORS FOR TEENAGER (D_{aipj})

(mrem per pCi inhaled)

NUCLIDE	BONE	LIVER	T BODY	THYROID	KIDNEY	LUNG	GI-LLI
PU-242	1.60E+00	1.08E+00	7.75E-02	0.00E+00	3.31E-01	2.82E-01	4.29E-05
PU-244	1.87E+00	1.24E+00	8.88E-02	0.00E+00	3.79E-01	3.23E-01	6.39E-05
AM-241	1.77E+00	1.20E+00	7.10E-02	0.00E+00	5.32E-01	1.05E-01	4.88E-05
AM-242M	1.79E+00	1.13E+00	7.15E-02	0.00E+00	5.30E-01	4.21E-02	6.14E-05
AM-243	1.77E+00	1.17E+00	6.95E-02	0.00E+00	5.21E-01	9.91E-02	5.72E-05
CM-242	3.17E-02	2.51E-02	1.41E-03	0.00E+00	6.40E-03	6.76E-02	5.21E-05
CM-243	1.19E+00	8.30E-01	5.00E-02	0.00E+00	2.34E-01	1.09E-01	5.13E-05
CM-244	9.19E-01	6.53E-01	3.88E-02	0.00E+00	1.81E-01	1.05E-01	4.96E-05
CM-245	1.83E+00	1.22E+00	7.53E-02	0.00E+00	3.52E-01	1.01E-01	4.63E-05
CM-246	1.81E+00	1.22E+00	7.52E-02	0.00E+00	3.51E-01	1.03E-01	4.54E-05
CM-247	1.77E+00	1.19E+00	7.41E-02	0.00E+00	3.46E-01	1.01E-01	5.97E-05
CM-248	1.47E-01	9.83E+00	6.11E-01	0.00E+00	2.85E+00	8.32E-01	9.63E-04
CF-252	7.16E-01	0.00E+00	3.07E-02	0.00E+00	0.00E+00	3.43E-01	1.89E-04

NUREG/CR-4653 GASPAR II, Technical Reference and User Guide

TABLE II2-29

INHALATION DOSE FACTORS FOR CHILD (D_{airp})

(mrem per pCi inhaled)

NUCLIDE	BONE	LIVER	T BODY	THYROID	KIDNEY	LUNG	GI-LLI
H-3	0.00E+00	1.73E-07	1.73E-07	1.73E-07	1.73E-07	1.73E-07	1.73E-07
C-14	9.70E-06	1.82E-06	1.82E-06	1.82E-06	1.82E-06	1.82E-06	1.82E-06
NA-22	4.41E-05	4.41E-05	4.41E-05	4.41E-05	4.41E-05	4.41E-05	4.41E-05
NA-24	4.35E-06	4.35E-06	4.35E-06	4.35E-06	4.35E-06	4.35E-06	4.35E-06
P-32	7.04E-04	3.09E-05	2.67E-05	0.00E+00	0.00E+00	0.00E+00	1.14E-05
CA-41	7.06E-05	0.00E+00	7.70E-06	0.00E+00	0.00E+00	7.21E-02	2.94E-07
SC-46	1.97E-04	2.70E-04	1.04E-04	0.00E+00	2.39E-04	0.00E+00	2.45E-05
CR-51	0.00E+00	0.00E+00	4.17E-08	2.31E-08	6.57E-09	4.59E-06	2.93E-07
MN-54	0.00E+00	1.16E-05	2.57E-06	0.00E+00	2.71E-06	4.26E-04	6.19E-06
MN-56	0.00E+00	4.48E-10	8.43E-11	0.00E+00	4.52E-10	3.55E-06	3.33E-05
FE-55	1.28E-05	6.80E-06	2.10E-06	0.00E+00	0.00E+00	3.00E-05	7.75E-07
FE-59	5.59E-06	9.04E-06	4.51E-06	0.00E+00	0.00E+00	3.43E-04	1.91E-05
CO-57	0.00E+00	2.44E-07	2.88E-07	0.00E+00	0.00E+00	1.37E-04	3.58E-06
CO-58	0.00E+00	4.79E-07	8.55E-07	0.00E+00	0.00E+00	2.99E-04	9.29E-06
CO-60	0.00E+00	3.55E-06	6.12E-06	0.00E+00	0.00E+00	1.91E-03	2.60E-05
NI-59	1.66E-05	4.67E-06	2.83E-06	0.00E+00	0.00E+00	2.73E-05	6.29E-07
NI-63	2.22E-04	1.25E-05	7.56E-06	0.00E+00	0.00E+00	7.43E-05	1.71E-06
NI-65	8.08E-10	7.99E-11	4.44E-11	0.00E+00	0.00E+00	2.21E-06	2.27E-05
CU-64	0.00E+00	5.39E-10	2.90E-10	0.00E+00	1.63E-09	2.59E-06	9.92E-06
ZN-65	1.15E-05	3.06E-05	1.90E-05	0.00E+00	1.93E-05	2.69E-04	4.41E-06
ZN-69M	4.26E-09	7.28E-09	8.59E-10	0.00E+00	4.22E-09	7.36E-06	2.71E-05
ZN-69	1.81E-11	2.61E-11	2.41E-12	0.00E+00	1.58E-11	3.84E-07	2.75E-06
SE-79	0.00E+00	1.23E-06	2.60E-07	0.00E+00	1.71E-06	1.49E-04	3.43E-06
BR-82	0.00E+00	0.00E+00	5.66E-06	0.00E+00	0.00E+00	0.00E+00	0.00E+00
BR-83	0.00E+00	0.00E+00	1.28E-07	0.00E+00	0.00E+00	0.00E+00	0.00E+00
BR-84	0.00E+00	0.00E+00	1.48E-07	0.00E+00	0.00E+00	0.00E+00	0.00E+00
BR-85	0.00E+00	0.00E+00	6.84E-09	0.00E+00	0.00E+00	0.00E+00	0.00E+00
RB-86	0.00E+00	5.36E-05	3.09E-05	0.00E+00	0.00E+00	0.00E+00	2.16E-06
RB-87	0.00E+00	3.16E-05	1.37E-05	0.00E+00	0.00E+00	0.00E+00	2.96E-07
RB-88	0.00E+00	1.52E-07	9.90E-08	0.00E+00	0.00E+00	0.00E+00	4.66E-09
RB-89	0.00E+00	9.33E-08	7.83E-08	0.00E+00	0.00E+00	0.00E+00	5.11E-10
SR-89	1.62E-04	0.00E+00	4.66E-06	0.00E+00	0.00E+00	5.83E-04	4.52E-05
SR-90	1.04E-02	0.00E+00	2.07E-04	0.00E+00	0.00E+00	3.99E-03	9.28E-05
SR-91	3.28E-08	0.00E+00	1.24E-09	0.00E+00	0.00E+00	1.44E-05	4.70E-05
SR-92	3.54E-09	0.00E+00	1.42E-10	0.00E+00	0.00E+00	6.49E-06	6.55E-05
Y-90	1.11E-06	0.00E+00	2.99E-08	0.00E+00	0.00E+00	7.07E-05	7.24E-05
Y-91M	1.37E-10	0.00E+00	4.98E-12	0.00E+00	0.00E+00	7.60E-07	4.64E-07
Y-91	2.47E-04	0.00E+00	6.59E-06	0.00E+00	0.00E+00	7.10E-04	4.97E-05
Y-92	5.50E-09	0.00E+00	1.57E-10	0.00E+00	0.00E+00	6.46E-06	6.46E-05
Y-93	5.04E-08	0.00E+00	1.38E-09	0.00E+00	0.00E+00	2.01E-05	1.05E-04
ZR-93	2.07E-04	7.80E-06	5.55E-06	0.00E+00	3.00E-05	7.10E-05	1.47E-06
ZR-95	5.13E-05	1.13E-05	1.00E-05	0.00E+00	1.61E-05	6.03E-04	1.65E-05
ZR-97	5.07E-08	7.34E-09	4.32E-09	0.00E+00	1.05E-08	3.06E-05	9.49E-05
NB-93M	1.27E-04	3.17E-05	1.04E-05	0.00E+00	3.44E-05	1.04E-04	2.45E-06
NB-95	6.35E-06	2.48E-06	1.77E-06	0.00E+00	2.33E-06	1.66E-04	1.00E-05

TABLE II2-29

INHALATION DOSE FACTORS FOR CHILD (D_{aipj})

(mrem per pCi inhaled)

NUCLIDE	BONE	LIVER	T BODY	THYROID	KIDNEY	LUNG	GI-LLI
NB-97	1.16E-10	2.08E-11	9.74E-12	0.00E+00	2.31E-11	9.23E-07	7.52E-06
MO-93	0.00E+00	3.76E-06	1.35E-07	0.00E+00	1.06E-06	1.70E-04	3.78E-06
MO-99	0.00E+00	4.66E-08	1.15E-08	0.00E+00	1.06E-07	3.66E-05	3.42E-05
TC-99M	4.81E-13	9.41E-13	1.56E-11	0.00E+00	1.37E-11	2.57E-07	1.30E-06
TC-99	1.34E-07	1.49E-07	5.35E-08	0.00E+00	1.75E-06	3.37E-04	7.75E-06
TC-101	2.19E-14	2.30E-14	2.91E-13	0.00E+00	3.92E-13	1.58E-07	4.41E-09
RU-103	7.55E-07	0.00E+00	2.90E-07	0.00E+00	1.90E-06	1.79E-04	1.21E-05
RU-105	4.13E-10	0.00E+00	1.50E-10	0.00E+00	3.63E-10	4.30E-06	2.69E-05
RU-106	3.68E-05	0.00E+00	4.57E-06	0.00E+00	4.97E-05	3.87E-03	1.16E-04
RH-105	3.91E-09	2.10E-09	1.79E-09	0.00E+00	8.39E-09	7.82E-06	1.33E-05
PD-107	0.00E+00	2.65E-07	2.51E-08	0.00E+00	1.97E-06	3.16E-05	7.26E-07
PD-109	0.00E+00	1.48E-09	4.95E-10	0.00E+00	7.06E-09	6.16E-06	2.59E-05
AG-110M	4.56E-06	3.08E-06	2.47E-06	0.00E+00	5.74E-06	1.48E-03	2.71E-05
AG-111	1.81E-07	5.68E-08	3.75E-08	0.00E+00	1.71E-07	7.73E-05	2.98E-05
CD-113M	0.00E+00	4.93E-04	2.12E-05	0.00E+00	5.13E-04	6.94E-04	1.63E-05
CD-115M	0.00E+00	7.88E-05	3.39E-06	0.00E+00	5.93E-05	5.86E-04	4.97E-05
SN-123	1.29E-04	2.14E-06	4.19E-06	2.27E-06	0.00E+00	9.59E-04	4.05E-05
SN-125	4.95E-06	9.94E-08	2.95E-07	1.03E-07	0.00E+00	2.43E-04	7.17E-05
SN-126	6.23E-04	1.04E-05	2.36E-05	2.84E-06	0.00E+00	3.02E-03	1.63E-05
SB-124	1.55E-05	2.00E-07	5.41E-06	3.41E-08	0.00E+00	8.76E-04	4.43E-05
SB-125	2.66E-05	2.05E-07	5.59E-06	2.46E-08	0.00E+00	6.27E-04	1.09E-05
SB-126	1.72E-06	2.62E-08	6.16E-07	1.00E-08	0.00E+00	2.86E-04	5.67E-05
SB-127	1.36E-07	2.09E-09	4.70E-08	1.51E-09	0.00E+00	6.17E-05	3.82E-05
TE-125M	1.82E-06	6.29E-07	2.47E-07	5.20E-07	0.00E+00	1.29E-04	9.13E-06
TE-127M	6.72E-06	2.31E-06	8.16E-07	1.64E-06	1.72E-05	4.00E-04	1.93E-05
TE-127	7.49E-10	2.57E-10	1.65E-10	5.30E-10	1.91E-09	2.71E-06	1.52E-05
TE-129M	5.19E-06	1.85E-06	8.22E-07	1.71E-06	1.36E-05	4.76E-04	4.91E-05
TE-129	2.64E-11	9.45E-12	6.44E-12	1.93E-11	6.94E-11	7.93E-07	6.89E-06
TE-131M	3.63E-08	1.60E-08	1.37E-08	2.64E-08	1.08E-07	5.56E-05	8.32E-05
TE-131	5.87E-12	2.28E-12	1.78E-12	4.59E-12	1.59E-11	5.55E-07	3.60E-07
TE-132	1.30E-07	7.36E-08	7.12E-08	8.58E-08	4.79E-07	1.02E-04	3.72E-05
TE-133M	2.93E-11	1.51E-11	1.50E-11	2.32E-11	1.01E-10	1.60E-06	4.77E-06
TE-134	1.53E-11	8.81E-12	9.40E-12	1.24E-11	5.71E-11	1.23E-06	4.87E-07
I-129	1.05E-05	6.40E-06	5.71E-06	4.28E-03	1.08E-05	0.00E+00	2.15E-07
I-130	2.21E-06	4.43E-06	2.28E-06	4.99E-04	6.61E-06	0.00E+00	1.38E-06
I-131	1.30E-05	1.30E-05	7.37E-06	4.39E-03	2.13E-05	0.00E+00	7.68E-07
I-132	5.72E-07	1.10E-06	5.07E-07	5.23E-05	1.69E-06	0.00E+00	8.65E-07
I-133	4.48E-06	5.49E-06	2.08E-06	1.04E-03	9.13E-06	0.00E+00	1.48E-06
I-134	3.17E-07	5.84E-07	2.69E-07	1.37E-05	8.92E-07	0.00E+00	2.58E-07
I-135	1.33E-06	2.36E-06	1.12E-06	2.14E-04	3.62E-06	0.00E+00	1.20E-06
CS-134M	6.33E-08	8.92E-08	6.12E-08	0.00E+00	4.94E-08	8.35E-09	7.92E-08
CS-134	1.76E-04	2.74E-04	6.07E-05	0.00E+00	8.93E-05	3.27E-05	1.04E-06
CS-135	6.23E-05	4.13E-05	4.45E-06	0.00E+00	1.53E-05	5.22E-06	2.17E-07
CS-136	1.76E-05	4.62E-05	3.14E-05	0.00E+00	2.58E-05	3.93E-06	1.13E-06
CS-137	2.45E-04	2.23E-04	3.47E-05	0.00E+00	7.63E-05	2.81E-05	9.78E-07

TABLE II2-29

INHALATION DOSE FACTORS FOR CHILD (D_{airp})

(mrem per pCi inhaled)

NUCLIDE	BONE	LIVER	T BODY	THYROID	KIDNEY	LUNG	GI-LLI
CS-138	1.71E-07	2.27E-07	1.50E-07	0.00E+00	1.68E-07	1.84E-08	7.29E-08
CS-139	1.09E-07	1.15E-07	5.80E-08	0.00E+00	9.08E-08	9.36E-09	7.23E-12
BA-139	4.98E-10	2.66E-13	1.45E-11	0.00E+00	2.33E-13	1.56E-06	1.56E-05
BA-140	2.00E-05	1.75E-08	1.17E-06	0.00E+00	5.71E-09	4.71E-04	2.75E-05
BA-141	5.29E-11	2.95E-14	1.72E-12	0.00E+00	2.56E-14	7.89E-07	7.44E-08
BA-142	1.35E-11	9.73E-15	7.54E-13	0.00E+00	7.87E-15	4.44E-07	7.41E-10
LA-140	1.74E-07	6.08E-08	2.04E-08	0.00E+00	0.00E+00	4.94E-05	6.10E-05
LA-141	2.28E-09	5.31E-10	1.15E-10	0.00E+00	0.00E+00	4.48E-06	4.37E-05
LA-142	3.50E-10	1.11E-10	3.49E-11	0.00E+00	0.00E+00	2.35E-06	2.05E-05
CE-141	1.06E-05	5.28E-06	7.83E-07	0.00E+00	2.31E-06	1.47E-04	1.53E-05
CE-143	9.89E-08	5.37E-08	7.77E-09	0.00E+00	2.26E-08	3.12E-05	3.44E-05
CE-144	1.83E-03	5.72E-04	9.77E-05	0.00E+00	3.17E-04	3.23E-03	1.05E-04
PR-143	4.99E-06	1.50E-06	2.47E-07	0.00E+00	8.11E-07	1.17E-04	2.63E-05
PR-144	1.61E-11	4.99E-12	8.10E-13	0.00E+00	2.64E-12	4.23E-07	5.32E-08
ND-147	2.92E-06	2.36E-06	1.84E-07	0.00E+00	1.30E-06	8.87E-05	2.22E-05
PM-147	3.52E-04	2.52E-05	1.36E-05	0.00E+00	4.45E-05	2.20E-04	5.70E-06
PM-148M	3.31E-05	6.55E-06	6.55E-06	0.00E+00	9.74E-06	5.72E-04	3.58E-05
PM-148	1.61E-06	1.94E-07	1.25E-07	0.00E+00	3.30E-07	1.24E-04	6.01E-05
PM-149	1.47E-07	1.56E-08	8.45E-09	0.00E+00	2.75E-08	2.40E-05	2.92E-05
PM-151	3.57E-08	4.33E-09	2.82E-09	0.00E+00	7.35E-09	1.24E-05	2.50E-05
SM-151	3.14E-04	4.75E-05	1.49E-05	0.00E+00	4.89E-05	1.48E-04	3.43E-06
SM-153	7.24E-08	4.51E-08	4.35E-09	0.00E+00	1.37E-08	1.37E-05	1.87E-05
EU-152	7.42E-04	1.37E-04	1.61E-04	0.00E+00	5.73E-04	9.00E-04	1.14E-05
EU-154	2.74E-03	2.49E-04	2.27E-04	0.00E+00	1.09E-03	1.66E-03	2.98E-05
EU-155	5.60E-04	4.05E-05	3.18E-05	0.00E+00	1.51E-04	2.79E-04	5.39E-05
EU-156	7.89E-06	4.23E-06	8.75E-07	0.00E+00	2.72E-06	2.54E-04	4.24E-05
TB-160	7.79E-05	0.00E+00	9.67E-06	0.00E+00	2.32E-05	5.34E-04	2.28E-05
HO-166M	1.34E-03	2.81E-04	2.37E-04	0.00E+00	4.01E-04	1.13E-03	1.63E-05
W-181	2.66E-08	6.52E-09	8.99E-10	0.00E+00	0.00E+00	5.71E-06	2.61E-07
W-185	8.31E-07	2.08E-07	2.91E-08	0.00E+00	0.00E+00	1.86E-04	1.11E-05
W-187	4.41E-09	2.61E-09	1.17E-09	0.00E+00	0.00E+00	1.11E-05	2.46E-05
U-232	2.19E-01	0.00E+00	1.56E-02	0.00E+00	1.67E-02	7.42E-01	4.33E-05
U-233	4.64E-02	0.00E+00	2.82E-03	0.00E+00	7.62E-03	1.77E-01	4.00E-05
U-234	4.46E-02	0.00E+00	2.76E-03	0.00E+00	7.47E-03	1.74E-01	3.92E-05
U-235	4.27E-02	0.00E+00	2.59E-03	0.00E+00	7.01E-03	1.63E-01	4.98E-05
U-236	4.27E-02	0.00E+00	2.65E-03	0.00E+00	7.16E-03	1.67E-01	3.67E-05
U-237	1.57E-07	0.00E+00	4.17E-08	0.00E+00	4.53E-07	3.40E-05	1.29E-05
U-238	4.09E-02	0.00E+00	2.42E-03	0.00E+00	6.55E-03	1.53E-01	3.51E-05
NP-237	2.72E+00	1.62E+00	1.19E-01	0.00E+00	7.41E-01	1.74E-01	5.06E-05
NP-238	1.26E-06	2.30E-07	1.97E-08	0.00E+00	8.16E-08	3.39E-05	2.50E-05
NP-239	1.26E-07	8.14E-08	6.35E-09	0.00E+00	2.63E-08	1.57E-05	1.73E-05
PU-238	2.55E+00	1.60E+00	1.21E-01	0.00E+00	4.47E-01	6.08E-01	4.65E-05
PU-239	2.79E+00	1.68E+00	1.28E-01	0.00E+00	4.78E-01	5.72E-01	4.24E-05
PU-240	2.79E+00	1.68E+00	1.27E-01	0.00E+00	4.77E-01	5.71E-01	4.33E-05
PU-241	7.94E-02	1.75E-02	2.93E-03	0.00E+00	1.10E-02	5.06E-04	8.90E-07

TABLE II-29

INHALATION DOSE FACTORS FOR CHILD (D_{aipj})

(mrem per pCi inhaled)

NUCLIDE	BONE	LIVER	T BODY	THYROID	KIDNEY	LUNG	GI-LLI
PU-242	2.59E+00	1.62E+00	1.23E-01	0.00E+00	4.60E-01	5.50E-01	4.16E-05
PU-244	3.02E+00	1.85E+00	1.41E-01	0.00E+00	5.27E-01	6.30E-01	6.20E-05
AM-241	2.97E+00	1.84E+00	1.24E-01	0.00E+00	7.63E-01	2.02E-01	4.73E-05
AM-242M	3.07E+00	1.76E+00	1.27E-01	0.00E+00	7.71E-01	8.14E-02	5.96E-05
AM-243	2.94E+00	1.78E+00	1.20E-01	0.00E+00	7.42E-01	1.92E-01	5.55E-05
CM-242	9.48E-02	5.68E-02	4.20E-03	0.00E+00	1.34E-02	1.31E-01	5.06E-05
CM-243	2.32E+00	1.42E+00	9.95E-02	0.00E+00	3.74E-01	2.10E-01	4.98E-05
CM-244	1.94E+00	1.18E+00	8.31E-02	0.00E+00	3.06E-01	2.02E-01	4.82E-05
CM-245	3.05E+00	1.84E+00	1.28E-01	0.00E+00	5.03E-01	1.95E-01	4.49E-05
CM-246	3.02E+00	1.84E+00	1.28E-01	0.00E+00	5.03E-01	1.99E-01	4.41E-05
CM-247	2.94E+00	1.82E+00	1.26E-01	0.00E+00	4.95E-01	1.95E-01	5.80E-05
CM-248	2.45E-01	1.50E-01	1.04E+00	0.00E+00	4.08E+00	1.61E+00	9.35E-04
CF-252	2.18E+00	0.00E+00	9.33E-02	0.00E+00	0.00E+00	6.62E-01	1.84E-04

NUREG/CR-4653 GASPAR II, Technical Reference and User Guide

TABLE II2-30

INHALATION DOSE FACTORS FOR INFANT (D_{aipj})

(mrem per pCi inhaled)

NUCLIDE	BONE	LIVER	T BODY	THYROID	KIDNEY	LUNG	GI-LLI
H-3	0.00E+00	2.63E-07	2.63E-07	2.63E-07	2.63E-07	2.63E-07	2.63E-07
C-14	1.89E-05	3.79E-06	3.79E-06	3.79E-06	3.79E-06	3.79E-06	3.79E-06
NA-22	7.37E-05	7.37E-05	7.37E-05	7.37E-05	7.37E-05	7.37E-05	7.37E-05
NA-24	7.54E-06	7.54E-06	7.54E-06	7.54E-06	7.54E-06	7.54E-06	7.54E-06
P-32	1.45E-03	8.03E-05	5.53E-05	0.00E+00	0.00E+00	0.00E+00	1.15E-05
CA-41	7.48E-05	0.00E+00	8.16E-06	0.00E+00	0.00E+00	6.94E-02	2.96E-07
SC-46	3.75E-04	5.41E-04	1.69E-04	0.00E+00	3.56E-04	0.00E+00	2.19E-05
CR-51	0.00E+00	0.00E+00	6.39E-08	4.11E-08	9.45E-09	9.17E-06	2.55E-07
MN-54	0.00E+00	1.81E-05	3.56E-06	0.00E+00	3.56E-06	7.14E-04	5.04E-06
MN-56	0.00E+00	1.10E-09	1.58E-10	0.00E+00	7.86E-10	8.95E-06	5.12E-05
FE-55	1.41E-05	8.39E-06	2.38E-06	0.00E+00	0.00E+00	6.21E-05	7.82E-07
FE-59	9.69E-06	1.68E-05	6.77E-06	0.00E+00	0.00E+00	7.25E-04	1.77E-05
CO-57	0.00E+00	4.65E-07	4.58E-07	0.00E+00	0.00E+00	2.71E-04	3.47E-06
CO-58	0.00E+00	8.71E-07	1.30E-06	0.00E+00	0.00E+00	5.55E-04	7.95E-06
CO-60	0.00E+00	5.73E-06	8.41E-06	0.00E+00	0.00E+00	3.22E-03	2.28E-05
NI-59	1.81E-05	5.44E-06	3.10E-06	0.00E+00	0.00E+00	5.48E-05	6.34E-07
NI-63	2.42E-04	1.46E-05	8.29E-06	0.00E+00	0.00E+00	1.49E-04	1.73E-06
NI-65	1.71E-09	2.03E-10	8.79E-11	0.00E+00	0.00E+00	5.80E-06	3.58E-05
CU-64	0.00E+00	1.34E-09	5.53E-10	0.00E+00	2.84E-09	6.64E-06	1.07E-05
ZN-65	1.38E-05	4.47E-05	2.22E-05	0.00E+00	2.32E-05	4.62E-04	3.67E-05
ZN-69M	8.98E-09	1.84E-08	1.67E-09	0.00E+00	7.45E-09	1.91E-05	2.92E-05
ZN-69	3.85E-11	6.91E-11	5.13E-12	0.00E+00	2.87E-11	1.05E-06	9.44E-06
SE-79	0.00E+00	2.25E-06	4.20E-07	0.00E+00	2.47E-06	2.99E-04	3.46E-06
BR-82	0.00E+00	0.00E+00	9.49E-06	0.00E+00	0.00E+00	0.00E+00	0.00E+00
BR-83	0.00E+00	0.00E+00	2.72E-07	0.00E+00	0.00E+00	0.00E+00	0.00E+00
BR-84	0.00E+00	0.00E+00	2.86E-07	0.00E+00	0.00E+00	0.00E+00	0.00E+00
BR-85	0.00E+00	0.00E+00	1.46E-08	0.00E+00	0.00E+00	0.00E+00	0.00E+00
RB-86	0.00E+00	1.36E-04	6.30E-05	0.00E+00	0.00E+00	0.00E+00	2.17E-06
RB-87	0.00E+00	7.11E-05	2.64E-05	0.00E+00	0.00E+00	0.00E+00	2.99E-07
RB-88	0.00E+00	3.98E-07	2.05E-07	0.00E+00	0.00E+00	0.00E+00	2.42E-07
RB-89	0.00E+00	2.29E-07	1.47E-07	0.00E+00	0.00E+00	0.00E+00	4.87E-08
SR-89	2.84E-04	0.00E+00	8.15E-06	0.00E+00	0.00E+00	1.45E-03	4.57E-05
SR-90	1.11E-02	0.00E+00	2.23E-04	0.00E+00	0.00E+00	8.03E-03	9.36E-05
SR-91	6.83E-08	0.00E+00	2.47E-09	0.00E+00	0.00E+00	3.76E-05	5.24E-05
SR-92	7.50E-09	0.00E+00	2.79E-10	0.00E+00	0.00E+00	1.70E-05	1.00E-04
Y-90	2.35E-06	0.00E+00	6.30E-08	0.00E+00	0.00E+00	1.92E-04	7.43E-05
Y-91M	2.91E-10	0.00E+00	9.90E-12	0.00E+00	0.00E+00	1.99E-06	1.68E-06
Y-91	4.20E-04	0.00E+00	1.12E-05	0.00E+00	0.00E+00	1.75E-03	5.02E-05
Y-92	1.17E-08	0.00E+00	3.29E-10	0.00E+00	0.00E+00	1.75E-05	9.04E-05
Y-93	1.07E-07	0.00E+00	2.91E-09	0.00E+00	0.00E+00	5.46E-05	1.19E-04
ZR-93	2.24E-04	9.51E-06	6.18E-06	0.00E+00	3.19E-05	1.37E-04	1.48E-06
ZR-95	8.24E-05	1.99E-05	1.45E-05	0.00E+00	2.22E-05	1.25E-03	1.55E-05
ZR-97	1.07E-07	1.83E-08	8.36E-09	0.00E+00	1.85E-08	7.88E-05	1.00E-04
NB-93M	1.38E-04	3.59E-05	1.15E-05	0.00E+00	3.68E-05	2.09E-04	2.47E-06
NB-95	1.12E-05	4.59E-06	2.70E-06	0.00E+00	3.37E-06	3.42E-04	9.05E-06

TABLE II2-30

INHALATION DOSE FACTORS FOR INFANT (D_{aipj})

(mrem per pCi inhaled)

NUCLIDE	BONE	LIVER	T BODY	THYROID	KIDNEY	LUNG	GI-LLI
NB-97	2.44E-10	5.21E-11	1.88E-11	0.00E+00	4.07E-11	2.37E-06	1.92E-05
MO-93	0.00E+00	6.46E-06	2.22E-07	0.00E+00	1.54E-06	3.40E-04	3.76E-06
MO-99	0.00E+00	1.18E-07	2.31E-08	0.00E+00	1.89E-07	9.63E-05	3.48E-05
TC-99M	9.98E-13	2.06E-12	2.66E-11	0.00E+00	2.22E-11	5.79E-07	1.45E-06
TC-99	2.09E-07	2.68E-07	8.85E-08	0.00E+00	2.49E-06	6.77E-04	7.82E-06
TC-101	4.65E-14	5.88E-14	5.80E-13	0.00E+00	6.99E-13	4.17E-07	6.03E-07
RU-103	1.44E-06	0.00E+00	4.85E-07	0.00E+00	3.03E-06	3.94E-04	1.15E-05
RU-105	8.74E-10	0.00E+00	2.93E-10	0.00E+00	6.42E-10	1.12E-05	3.46E-05
RU-106	6.20E-05	0.00E+00	7.77E-06	0.00E+00	7.61E-05	8.26E-03	1.17E-04
RH-105	8.26E-09	5.41E-09	3.63E-09	0.00E+00	1.50E-08	2.08E-05	1.37E-05
PD-107	0.00E+00	4.92E-07	4.11E-08	0.00E+00	2.75E-06	6.34E-05	7.33E-07
PD-109	0.00E+00	3.92E-09	1.05E-09	0.00E+00	1.28E-08	1.68E-05	2.85E-05
AG-110M	7.13E-06	5.16E-06	3.57E-06	0.00E+00	7.80E-06	2.62E-03	2.36E-05
AG-111	3.75E-07	1.45E-07	7.75E-08	0.00E+00	3.05E-07	2.06E-04	3.02E-05
CD-113M	0.00E+00	6.67E-04	2.64E-05	0.00E+00	5.80E-04	1.40E-03	1.65E-05
CD-115M	0.00E+00	1.73E-04	6.19E-06	0.00E+00	9.41E-05	1.47E-03	5.02E-05
SN-123	2.09E-04	4.21E-06	7.28E-06	4.27E-06	0.00E+00	2.22E-03	4.08E-05
SN-125	1.01E-05	2.51E-07	6.00E-07	2.47E-07	0.00E+00	6.43E-04	7.26E-05
SN-126	8.30E-04	1.44E-05	3.52E-05	3.84E-06	0.00E+00	4.93E-03	1.65E-05
SB-124	2.71E-05	3.97E-07	8.56E-06	7.18E-08	0.00E+00	1.89E-03	4.22E-05
SB-125	3.69E-05	3.41E-07	7.78E-06	4.45E-08	0.00E+00	1.17E-03	1.05E-05
SB-126	3.08E-06	6.01E-08	1.11E-06	2.35E-08	0.00E+00	6.88E-04	5.33E-05
SB-127	2.82E-07	5.04E-09	8.76E-08	3.60E-09	0.00E+00	1.54E-04	3.78E-05
TE-125M	3.40E-06	1.42E-06	4.70E-07	1.16E-06	0.00E+00	3.19E-04	9.22E-06
TE-127M	1.19E-05	4.93E-06	1.48E-06	3.48E-06	2.68E-05	9.37E-04	1.95E-05
TE-127	1.59E-09	6.81E-10	3.49E-10	1.32E-09	3.47E-09	7.39E-06	1.74E-05
TE-129M	1.01E-05	4.35E-06	1.59E-06	3.91E-06	2.27E-05	1.20E-03	4.93E-05
TE-129	5.63E-11	2.48E-11	1.34E-11	4.82E-11	1.25E-10	2.14E-06	1.88E-05
TE-131M	7.62E-08	3.93E-08	2.59E-08	6.38E-08	1.89E-07	1.42E-04	8.51E-05
TE-131	1.24E-11	5.87E-12	3.57E-12	1.13E-11	2.85E-11	1.47E-06	5.87E-06
TE-132	2.66E-07	1.69E-07	1.26E-07	1.99E-07	7.39E-07	2.43E-04	3.15E-05
TE-133M	6.13E-11	3.59E-11	2.74E-11	5.52E-11	1.72E-10	3.92E-06	1.59E-05
TE-134	3.18E-11	2.04E-11	1.68E-11	2.91E-11	9.59E-11	2.93E-06	2.53E-06
I-129	2.16E-05	1.59E-05	1.16E-05	1.04E-02	1.88E-05	0.00E+00	2.12E-07
I-130	4.54E-06	9.91E-06	3.98E-06	1.14E-03	1.09E-05	0.00E+00	1.42E-06
I-131	2.71E-05	3.17E-05	1.40E-05	1.06E-02	3.70E-05	0.00E+00	7.56E-07
I-132	1.21E-06	2.53E-06	8.99E-07	1.21E-04	2.82E-06	0.00E+00	1.36E-06
I-133	9.46E-06	1.37E-05	4.00E-06	2.54E-03	1.60E-05	0.00E+00	1.54E-06
I-134	6.58E-07	1.34E-06	4.75E-07	3.18E-05	1.49E-06	0.00E+00	9.21E-07
I-135	2.76E-06	5.43E-06	1.98E-06	4.97E-04	6.05E-06	0.00E+00	1.31E-06
CS-134M	1.32E-07	2.10E-07	1.11E-07	0.00E+00	8.50E-08	2.00E-08	1.16E-07
CS-134	2.83E-04	5.02E-04	5.32E-05	0.00E+00	1.36E-04	5.69E-05	9.53E-07
CS-135	1.00E-04	8.66E-05	4.73E-06	0.00E+00	2.58E-05	1.01E-05	2.18E-07
CS-136	3.45E-05	9.61E-05	3.78E-05	0.00E+00	4.03E-05	8.40E-06	1.02E-06
CS-137	3.92E-04	4.37E-04	3.25E-05	0.00E+00	1.23E-04	5.09E-05	9.53E-07

TABLE II2-30

INHALATION DOSE FACTORS FOR INFANT (D_{aipj})

(mrem per pCi inhaled)

NUCLIDE	BONE	LIVER	T BODY	THYROID	KIDNEY	LUNG	GI-LLI
CS-138	3.61E-07	5.58E-07	2.84E-07	0.00E+00	2.93E-07	4.67E-08	6.26E-07
CS-139	2.32E-07	3.03E-07	1.22E-07	0.00E+00	1.65E-07	2.53E-08	1.33E-08
BA-139	1.06E-09	7.03E-13	3.07E-11	0.00E+00	4.23E-13	4.25E-06	3.64E-05
BA-140	4.00E-05	4.00E-08	2.07E-06	0.00E+00	9.59E-09	1.14E-03	2.74E-05
BA-141	1.12E-10	7.70E-14	3.55E-12	0.00E+00	4.64E-14	2.12E-06	3.39E-06
BA-142	2.84E-11	2.36E-14	1.40E-12	0.00E+00	1.36E-14	1.11E-06	4.95E-07
LA-140	3.61E-07	1.43E-07	3.68E-08	0.00E+00	0.00E+00	1.20E-04	6.06E-05
LA-141	4.85E-09	1.40E-09	2.45E-10	0.00E+00	0.00E+00	1.22E-05	5.96E-05
LA-142	7.36E-10	2.69E-10	6.46E-11	0.00E+00	0.00E+00	5.87E-06	4.25E-05
CE-141	1.98E-05	1.19E-05	1.42E-06	0.00E+00	3.75E-06	3.69E-04	1.54E-05
CE-143	2.09E-07	1.38E-07	1.58E-08	0.00E+00	4.03E-08	8.30E-05	3.55E-05
CE-144	2.28E-03	8.65E-04	1.26E-04	0.00E+00	3.84E-04	7.03E-03	1.06E-04
PR-143	1.00E-05	3.74E-06	4.99E-07	0.00E+00	1.41E-06	3.09E-04	2.66E-05
PR-144	3.42E-11	1.32E-11	1.72E-12	0.00E+00	4.80E-12	1.15E-06	3.06E-06
ND-147	5.67E-06	5.81E-06	3.57E-07	0.00E+00	2.25E-06	2.30E-04	2.23E-05
PM-147	3.91E-04	3.07E-05	1.56E-05	0.00E+00	4.93E-05	4.55E-04	5.75E-06
PM-148M	5.00E-05	1.24E-05	9.94E-06	0.00E+00	1.45E-05	1.22E-03	3.37E-05
PM-148	3.34E-06	4.82E-07	2.44E-07	0.00E+00	5.76E-07	3.20E-04	6.04E-05
PM-149	3.10E-07	4.08E-08	1.78E-08	0.00E+00	4.96E-08	6.50E-05	3.01E-05
PM-151	7.52E-08	1.10E-08	5.55E-09	0.00E+00	1.30E-08	3.25E-05	2.58E-05
SM-151	3.38E-04	6.45E-05	1.63E-05	0.00E+00	5.24E-05	2.98E-04	3.46E-06
SM-153	1.53E-07	1.18E-07	9.06E-09	0.00E+00	2.47E-08	3.70E-05	1.93E-05
EU-152	7.83E-04	1.77E-04	1.72E-04	0.00E+00	5.94E-04	1.48E-03	9.88E-06
EU-154	2.96E-03	3.46E-04	2.45E-04	0.00E+00	1.14E-03	3.05E-03	2.84E-05
EU-155	5.97E-04	5.72E-05	3.46E-05	0.00E+00	1.58E-04	5.20E-04	5.19E-05
EU-156	1.56E-05	9.59E-06	1.54E-06	0.00E+00	4.48E-06	6.12E-04	4.14E-05
TB-160	1.12E-04	0.00E+00	1.40E-05	0.00E+00	3.20E-05	1.11E-03	2.14E-05
HO-166M	1.45E-03	3.07E-04	2.51E-04	0.00E+00	4.22E-04	2.05E-03	1.65E-05
W-181	4.86E-08	1.46E-08	1.67E-09	0.00E+00	0.00E+00	1.33E-05	2.63E-07
W-185	1.57E-06	4.83E-07	5.58E-08	0.00E+00	0.00E+00	4.48E-04	1.12E-05
W-187	9.26E-09	6.44E-09	2.23E-09	0.00E+00	0.00E+00	2.83E-05	2.54E-05
U-232	2.57E-01	0.00E+00	2.13E-02	0.00E+00	2.40E-02	1.49E+00	4.36E-05
U-233	5.44E-02	0.00E+00	3.83E-03	0.00E+00	1.09E-02	3.56E-01	4.03E-05
U-234	5.22E-02	0.00E+00	3.75E-03	0.00E+00	1.07E-02	3.49E-01	3.95E-05
U-235	5.01E-02	0.00E+00	3.52E-03	0.00E+00	1.01E-02	3.28E-01	5.02E-05
U-236	5.01E-02	0.00E+00	3.60E-03	0.00E+00	1.03E-02	3.35E-01	3.71E-05
U-237	3.25E-07	0.00E+00	8.65E-08	0.00E+00	8.08E-07	9.13E-05	1.31E-05
U-238	4.79E-02	0.00E+00	3.29E-03	0.00E+00	9.40E-03	3.06E-01	3.54E-05
NP-237	2.88E+00	1.71E+00	1.26E-01	0.00E+00	7.69E-01	3.49E-01	5.10E-05
NP-238	2.67E-06	6.05E-07	4.16E-08	0.00E+00	1.47E-07	9.19E-05	2.58E-05
NP-239	2.65E-07	2.13E-07	1.34E-08	0.00E+00	4.73E-08	4.25E-05	1.78E-05
PU-238	2.69E+00	1.68E+00	1.27E-01	0.00E+00	4.64E-01	9.03E-01	4.69E-05
PU-239	2.93E+00	1.76E+00	1.34E-01	0.00E+00	4.95E-01	8.47E-01	4.28E-05
PU-240	2.93E+00	1.75E+00	1.34E-01	0.00E+00	4.94E-01	8.47E-01	4.36E-05
PU-241	8.43E-02	1.85E-02	3.11E-03	0.00E+00	1.15E-02	7.62E-04	8.97E-07

TABLE II-30

INHALATION DOSE FACTORS FOR INFANT (D_{aipj})

(mrem per pCi inhaled)

NUCLIDE	BONE	LIVER	T BODY	THYROID	KIDNEY	LUNG	GI-LLI
PU-242	2.72E+00	1.69E+00	1.29E-01	0.00E+00	4.77E-01	8.15E-01	4.20E-05
PU-244	3.17E+00	1.94E+00	1.48E-01	0.00E+00	5.46E-01	9.33E-01	6.26E-05
AM-241	3.15E+00	1.95E+00	1.31E-01	0.00E+00	7.94E-01	4.06E-01	4.78E-05
AM-242M	3.25E+00	1.86E+00	1.35E-01	0.00E+00	8.03E-01	1.64E-01	6.01E-05
AM-243	3.10E+00	1.88E+00	1.27E-01	0.00E+00	7.72E-01	3.85E-01	5.60E-05
CM-242	1.28E-01	8.65E-02	5.70E-03	0.00E+00	1.69E-02	2.97E-01	5.10E-05
CM-243	2.47E+00	1.52E+00	1.06E-01	0.00E+00	3.91E-01	4.24E-01	5.02E-05
CM-244	2.07E+00	1.27E+00	8.89E-02	0.00E+00	3.21E-01	4.08E-01	4.86E-05
CM-245	3.22E+00	1.96E+00	1.36E-01	0.00E+00	5.23E-01	3.92E-01	4.53E-05
CM-246	3.20E+00	1.96E+00	1.36E-01	0.00E+00	5.23E-01	3.99E-01	4.45E-05
CM-247	3.11E+00	1.93E+00	1.33E-01	0.00E+00	5.15E-01	3.92E-01	5.85E-05
CM-248	2.58E-01	1.59E-01	1.10E+00	0.00E+00	4.24E+00	3.23E+00	9.43E-04
CF-252	2.37E+00	0.00E+00	1.01E-01	0.00E+00	0.00E+00	1.37E+00	1.85E-04

NUREG/CR-4653 GASPAR II, Technical Reference and User Guide

TABLE I12-31
ASSUMPTIONS USED IN LIMERICK GASEOUS EFFLUENT R_i CALCULATIONS⁽¹⁾

Symbol	Description	Value	Reference ⁽²⁾
f _l	Fraction of annual intake of fresh, leafy vegetation grown locally	0.42	Site Spec.
f _g	Fraction of annual intake of stored vegetation grown locally	0.76	E-15
Y _v	Vegetation area density (kg/m ²)	2.0	E-15
r	Fraction of deposited particulates retained on vegetation	0.20	E-15
r	Fraction of deposited iodines retained on vegetation	1.0	E-15
SF	Shielding factor of residential structures	0.7	E-15
t	Period of buildup of activity in soil (sec)	7.89E08	Site Spec. Based on T _b
t _f	Transport time milkman (sec)	1.73E05	E-15
t _h	Delay time for ingestion of stored feed by animals (sec)	7.78E06	E-15
t _l	Delay time for ingestion of leafy vegetable by man (sec)	8.64E04	E-15
t _h	Delay time for ingestion of other vegetable by man (sec)	5.18E06	E-15
t _s	Time between slaughter and consumption of meat animal (sec)	1.73E06	E-15
T _b	Approximate midpoint of facility operating life (years)	25	Reg Guide 1.109, App C, Equation C-1 adjusted for license renewal
Y _p	Grass yield (kg/m ²)	0.7	E-15
Y _s	Stored feed yield (kg/m ²)	2.0	E-15
λ _w	Weathering rate constant for activity on veg (sec ⁻¹)	5.73E-07	E-15
Q _F	Milk cow feed consumption rate (kg/day wet)	50.0	E-3
Q _F	Beef cattle consumption rate (kg/day wet)	50.0	E-3
Q _F	Goat feed consumption rate (kg/day wet)	6.0	E-3
K ["]	Ground exposure (all age groups) (hr/yr)	8760.0	C-2 ⁽³⁾
BR	Breathing Rate adult (m ³ /yr)	8000.0	E-5
BR	Breathing Rate teen (m ³ /yr)	8000.0	E-5
BR	Breathing Rate child (m ³ /yr)	3700.0	E-5
BR	Breathing Rate infant (m ³ /yr)	1400.0	E-5
U _A ^L	Leafy veg consumption rate adult (kg/yr)	64.0	E-5
U _A ^L	Leafy veg consumption rate teen (kg/yr)	42.0	E-5
U _A ^L	Leafy veg consumption rate child (kg/yr)	26.0	E-5
U _A ^L	Leafy veg consumption rate infant (kg/yr)	0.0	E-5
U _A ^S	Stored veg consumption rate adult (kg/yr)	520.0	E-5
U _A ^S	Stored veg consumption rate teen (kg/yr)	630.0	E-5
U _A ^S	Stored veg consumption rate child (kg/yr)	520.0	E-5
U _A ^S	Stored veg consumption rate infant (kg/yr)	0.0	E-5
U _{ap}	Cow milk consumption rate adult (l/yr)	310.0	E-5
U _{ap}	Cow milk consumption rate teen (l/yr)	400.0	E-5
U _{ap}	Cow milk consumption rate child (l/yr)	330.0	E-5
U _{ap}	Cow milk consumption rate infant (l/yr)	330.0	E-5
U _{ap}	Goat milk consumption rate adult (l/yr)	310.0	E-5
U _{ap}	Goat milk consumption rate teen (l/yr)	400.0	E-5
U _{ap}	Goat milk consumption rate child (l/yr)	330.0	E-5
U _{ap}	Goat milk consumption rate infant (l/yr)	330.0	E-5
U _{ap}	Meat consumption rate adult (kg/yr)	110.0	E-5
U _{ap}	Meat consumption rate teen (kg/yr)	65.0	E-5
U _{ap}	Meat consumption rate child (kg/yr)	41.0	E-5

TABLE II2-31
ASSUMPTIONS USED IN LIMERICK GASEOUS EFFLUENT R_i CALCULATIONS⁽¹⁾

Symbol	Description	Value	Reference ⁽²⁾
U _{ap}	Meat consumption rate infant (kg/yr)	0.0	E-5
f _p	Fraction of year animals on pasture	0.75	Site Spec.
f _s	Fraction of feed from pasture when on pasture	0.39	Site Spec.
H	Atmosphere absolute humidity (gm/m ³)	8.0	(4)
χ/Q	Highest annual average relative concentration (NE Sector) (sec/m ³) used for setpoint determination.	1.10E-05	(5)
χ/Q	Highest annual average relative concentration (sec/m ³), Site Boundary Dose Rate (SE Sector)	9.97E-07	Site Spec. (6)
χ/Q	Highest annual average relative concentration (sec/m ³), Residence Pathway (SE Sector)	5.63E-07	Site Spec. (6)
χ/Q	Highest annual average relative concentration (sec/m ³), Garden Pathway (ESE Sector)	3.45E-07	Site Spec. (6)
χ/Q	Highest annual average relative concentration (sec/m ³), Meat Pathway (ESE Sector)	2.42E-07	Site Spec. (6)
χ/Q	Highest annual average relative concentration (sec/m ³), Milk Animal Pathway (SSW Sector)	8.80E-08	Site Spec. (6)
D/Q	Highest average annual deposition (1/m ²), Residence Pathway (SE Sector)	9.83E-09	Site Spec. (6)
D/Q	Highest average annual deposition (1/m ²), Garden Pathway (ESE Sector)	4.87E-09	Site Spec. (6)
D/Q	Highest average annual deposition (1/m ²), Meat Pathway (ESE Sector)	1.14E-09	Site Spec. (6)
D/Q	Highest average annual deposition (1/m ²), Milk Animal Pathway (SSW Sector)	3.14E-10	Site Spec. (6)

NOTES:

- 1) R_i values are calculated in accordance with the methodologies given in NUREG-0133.
- 2) The References refer to tables contained in Regulatory Guide 1.109 unless otherwise specified.
- 3) From Reg. Guide 1.109, Appendix C, Equation C-2
- 4) From NUREG-0133, Section 5.3.1.3
- 5) Site specific value from the Limerick Generating Station Final Environmental Statement (NUREG-0974)
- 6) 2010 – 2014 Five year average of site meteorology data

TABLE II-32

NEAREST GASEOUS EFFLUENT DOSE RECEPTOR DISTANCES

(Meters)

Direction	Plume Ground Inhalation Pathways (Nearest Residence) ⁽¹⁾	Vegetation Pathway ⁽¹⁾	Meat Pathway ⁽¹⁾	Cow Pathway ⁽¹⁾	Goat Pathway ⁽¹⁾
N	948	1016	7551	7551	0
NNE	825	2929	8015	0	0
NE	1057	4358	4287	0	0
ENE	985	4331	2271	0	0
E	873	3573	0	0	0
ESE	1047	1371 ⁽²⁾	3775	0	0
SE	1202	7113 ⁽²⁾	7695	0	0
SSE	1647	2107	0	0	0
S	1325	1860	3722	6740	0
SSW	1543	1622	2323	3167	0
SW	991	1389	7055	0	0
WSW	1158	1374	4321	4321	0
W	1105	1317	5223	0	0
WNW	1123	0	0	0	0
NW	1104	2499	0	0	0
NNW	1540	1703	6379	0	0

(1) Based upon Control 3.3.2, Land Use Census (2015)

(2) REMP garden located in the ESE sector at 555 meters and in the SE sector at 390 meters.

FIGURES

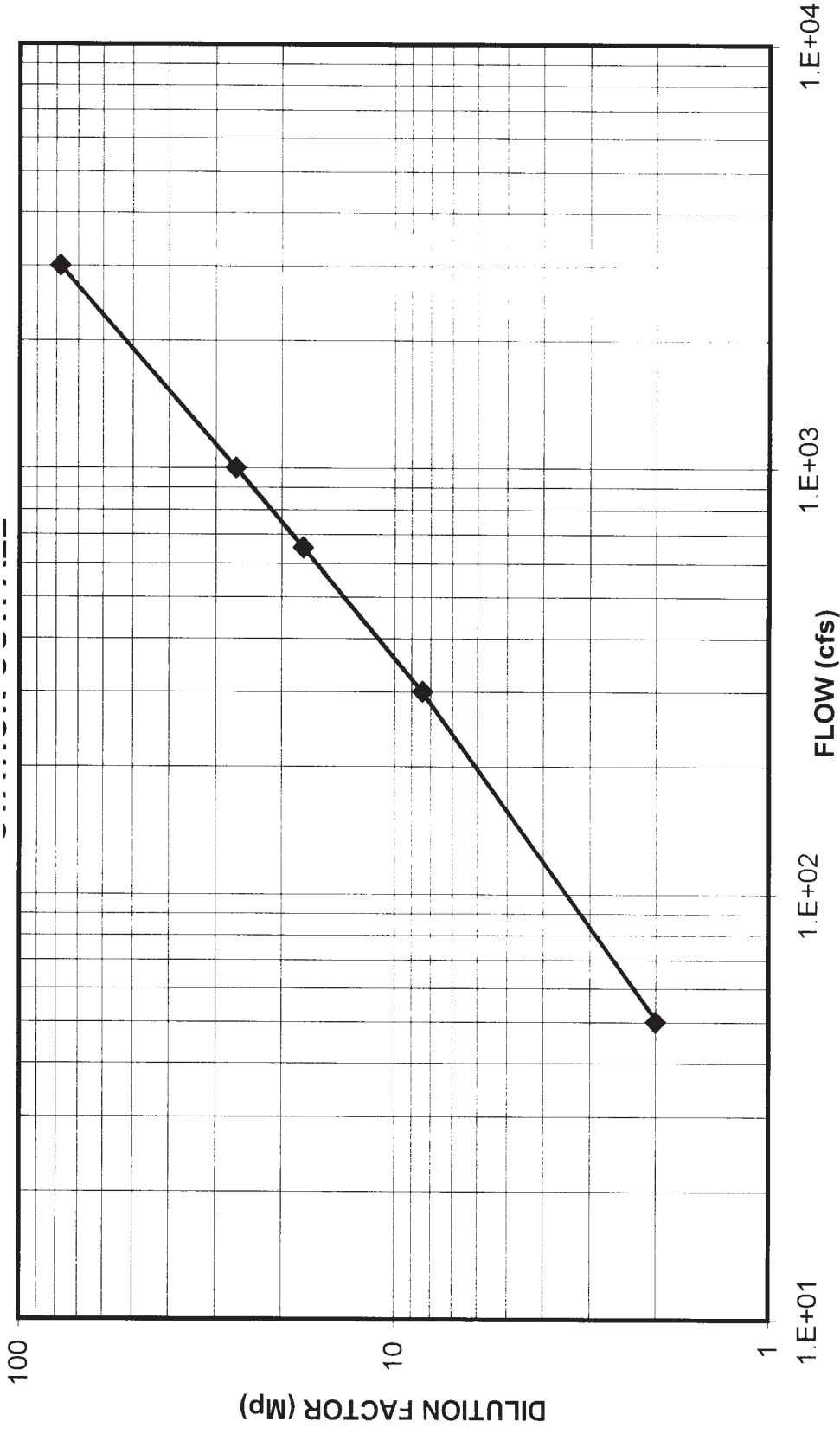

Figure II1.3.1-1

LGS DILUTION FACTOR (Mp) vs. RIVER FLOW
STATION OUTFALL

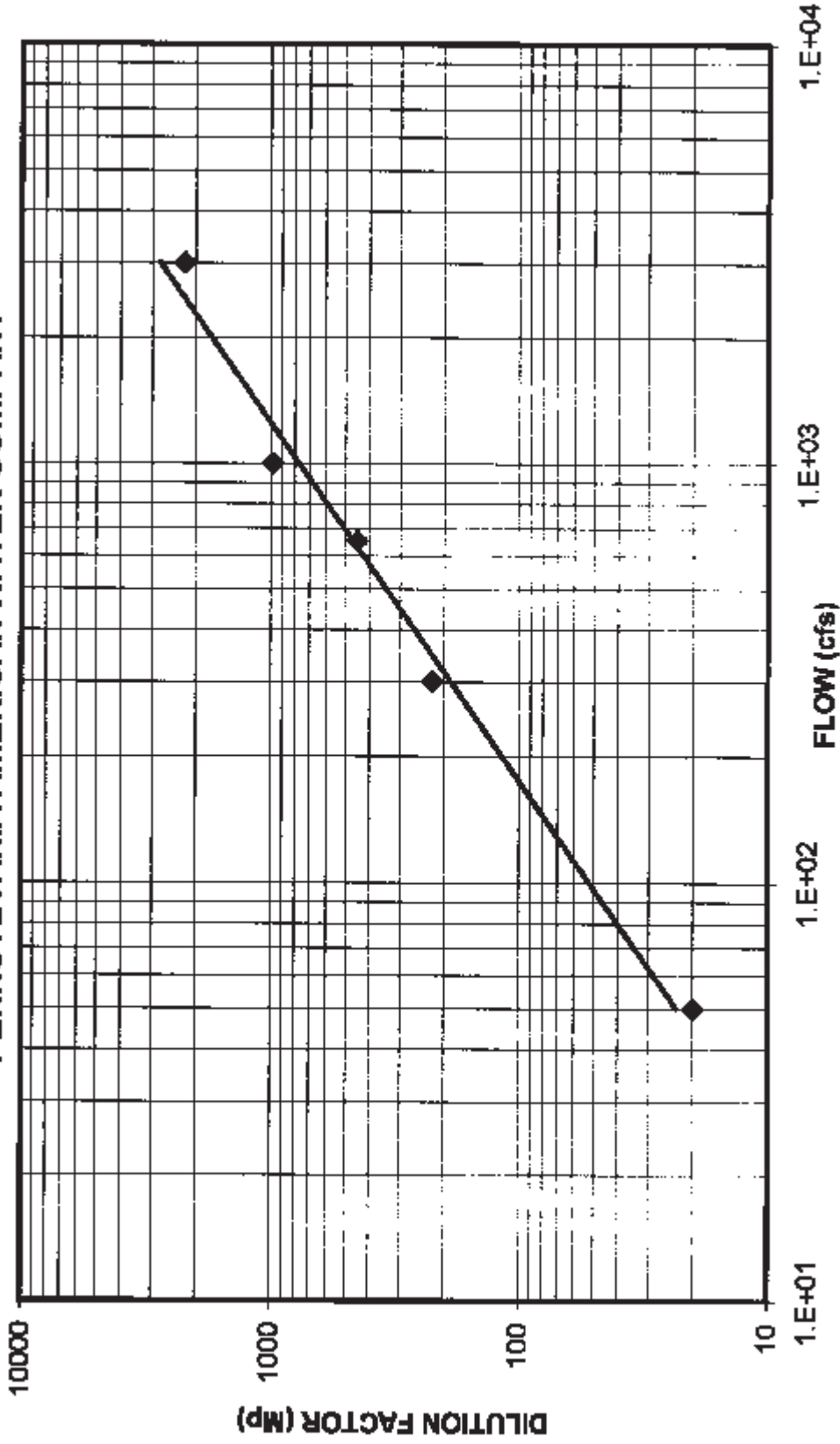

Figure II.3.1-2

LGS DILUTION FACTOR (Mp) vs. RIVER FLOW
PENNSYLVANIA AMERICA WATER

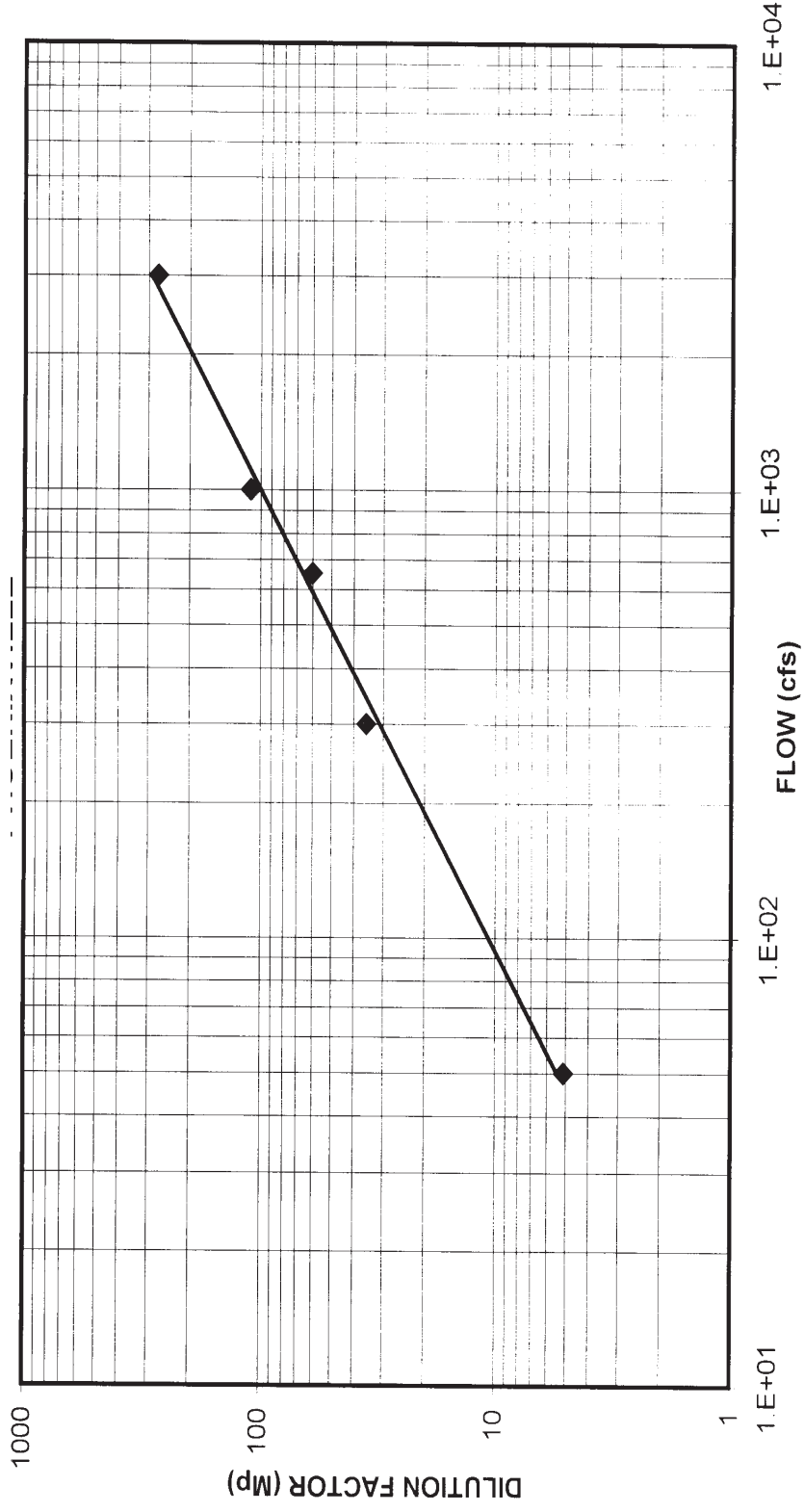

Figure II1.3.1-3

LGS DILUTION FACTOR (Mp) vs. RIVER FLOW
PHOENIXVILLE

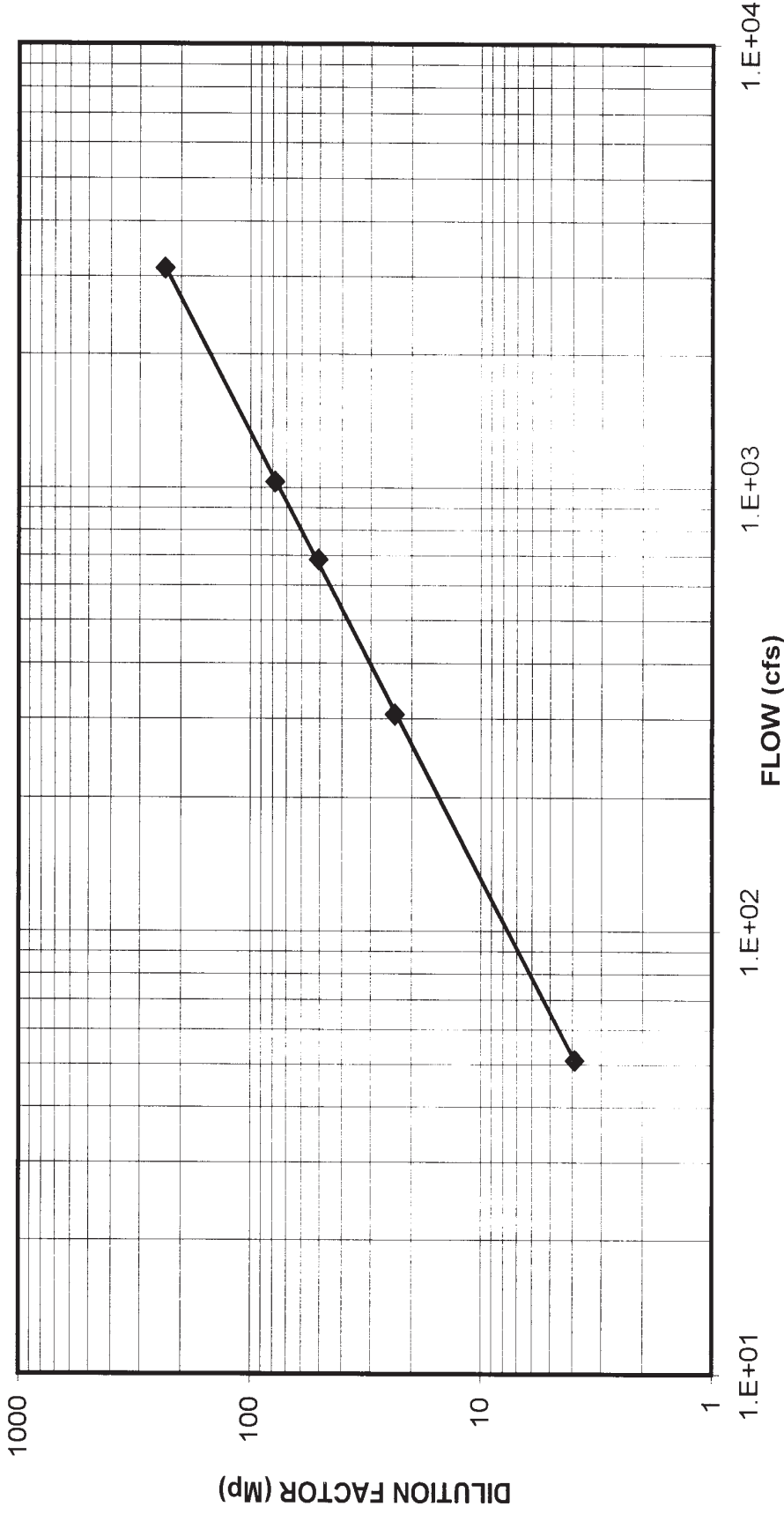

Figure II1.3.1-4

LGS DILUTION FACTOR (Mp) vs. RIVER FLOW
AQUA AMERICA

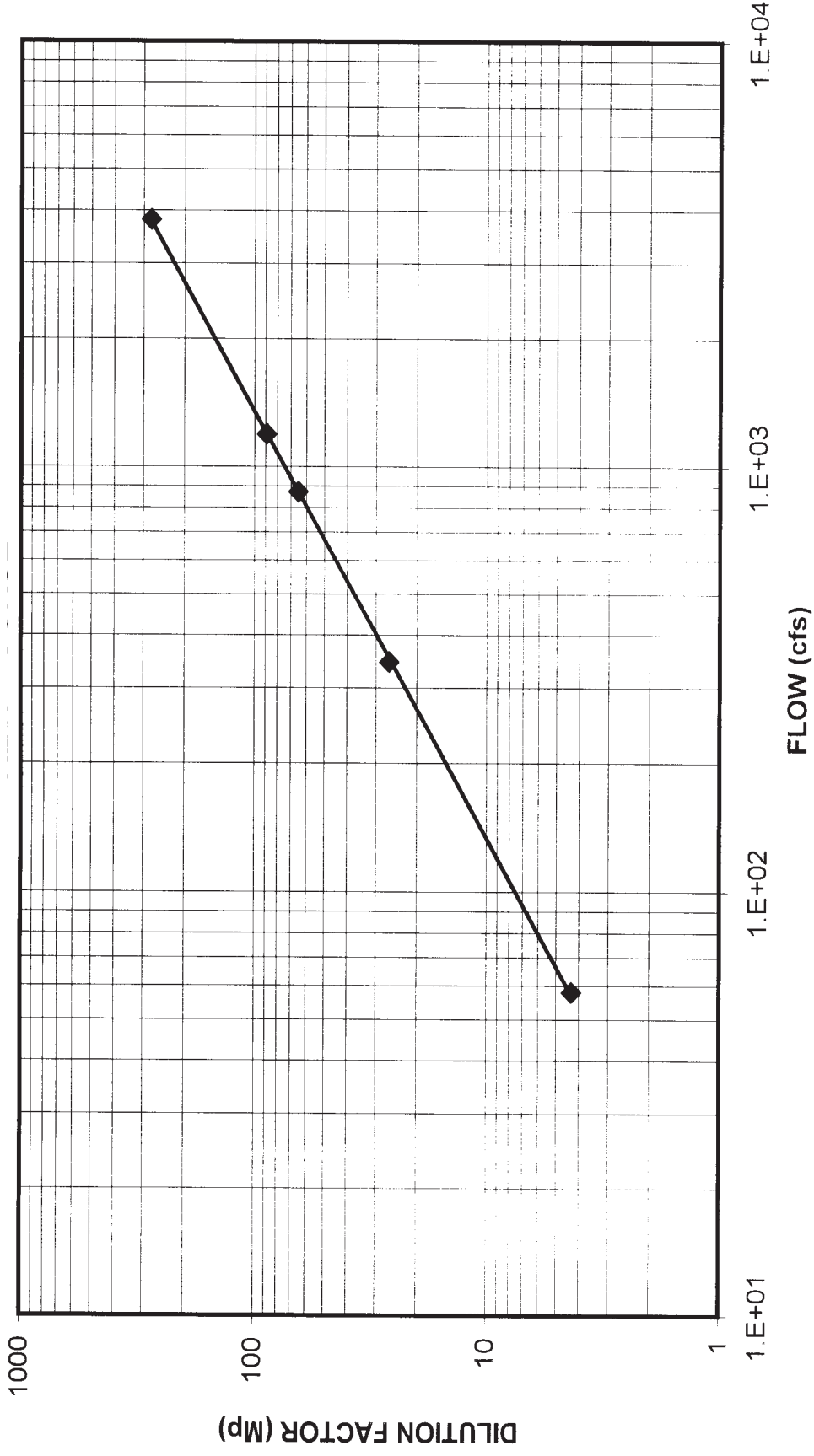

Figure II1.3.1-5

LGS DILUTION FACTOR (Mp) vs. RIVER FLOW
CREW COURSE

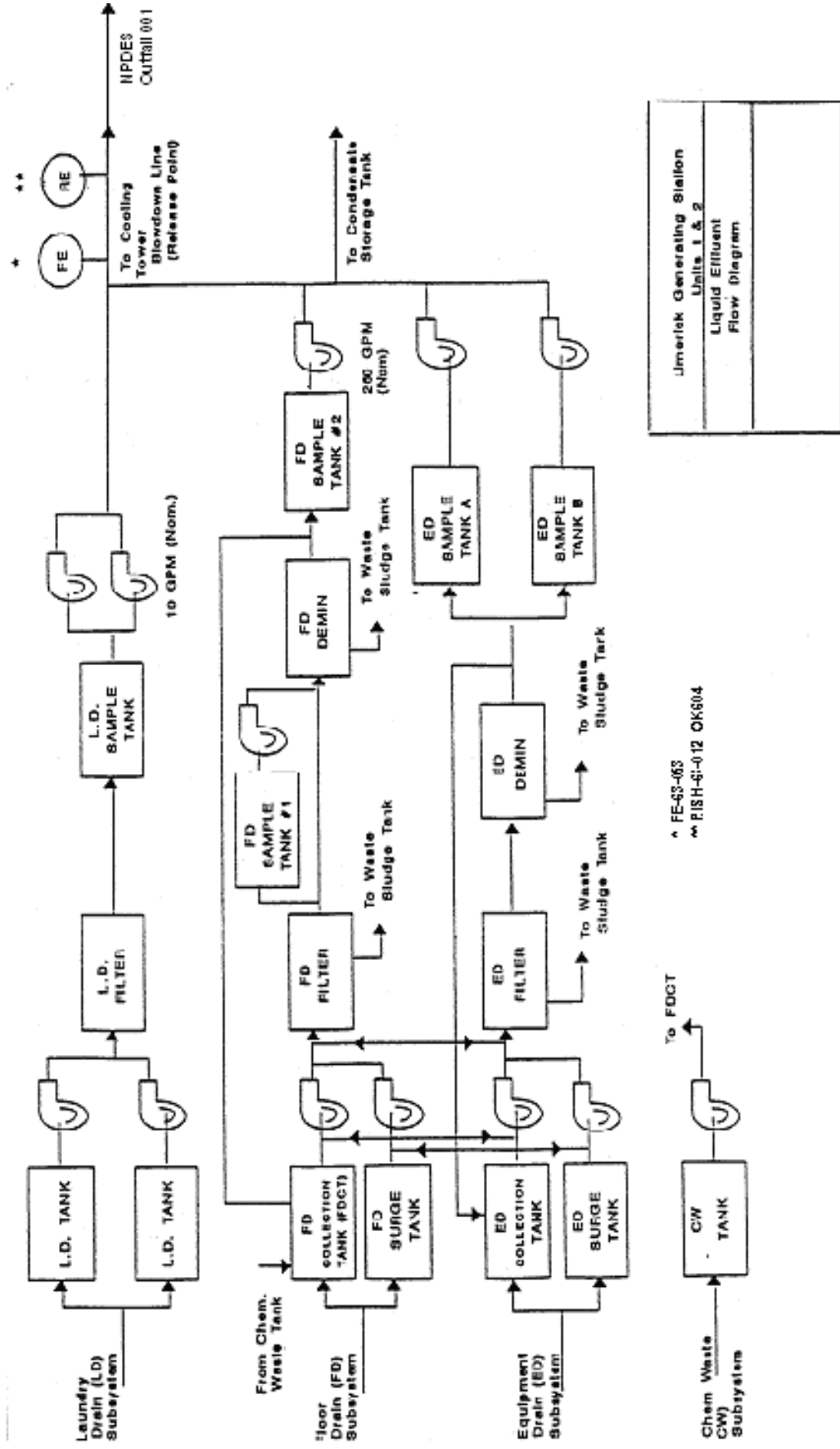

Figure II1-1

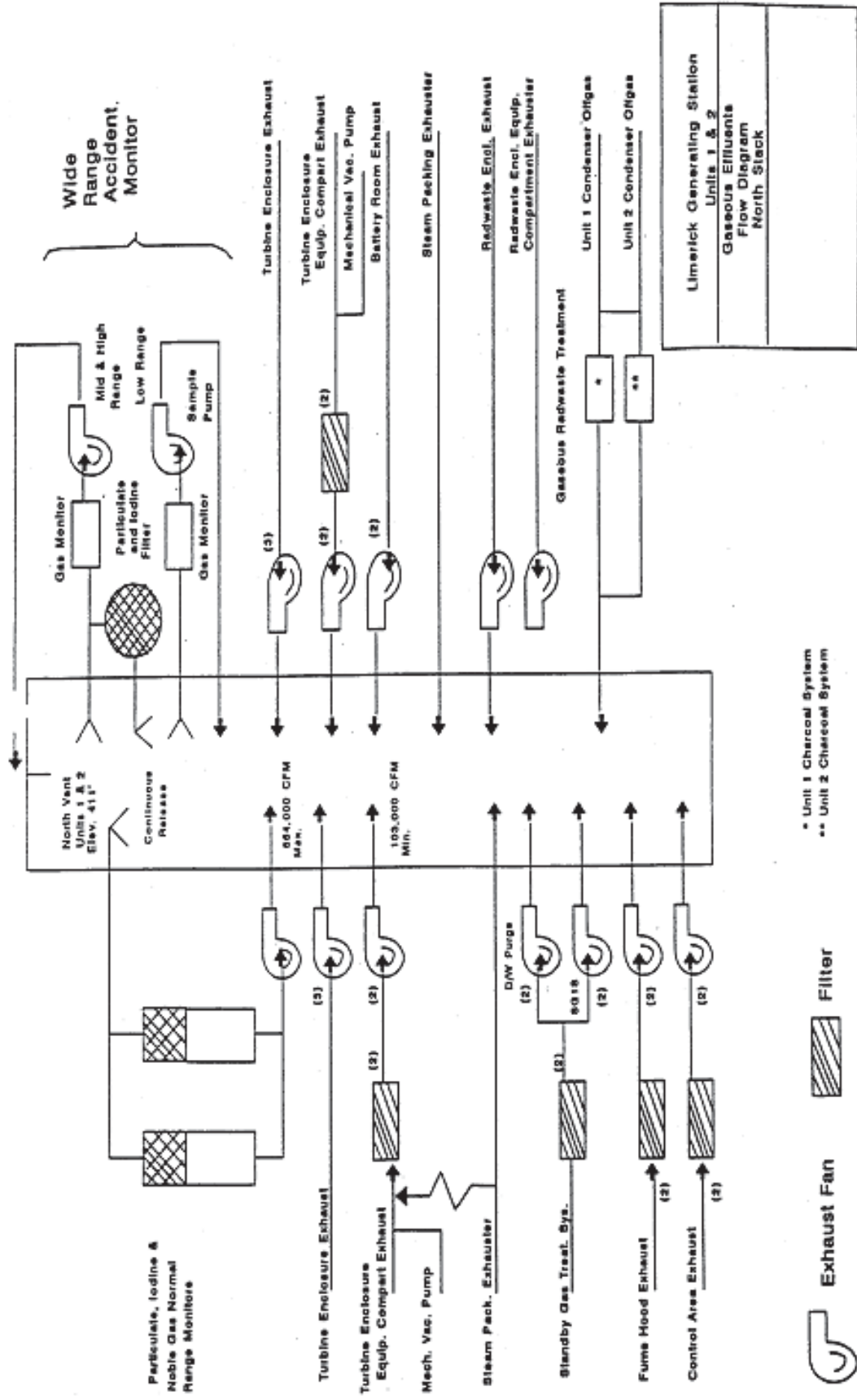

Figure II2-1

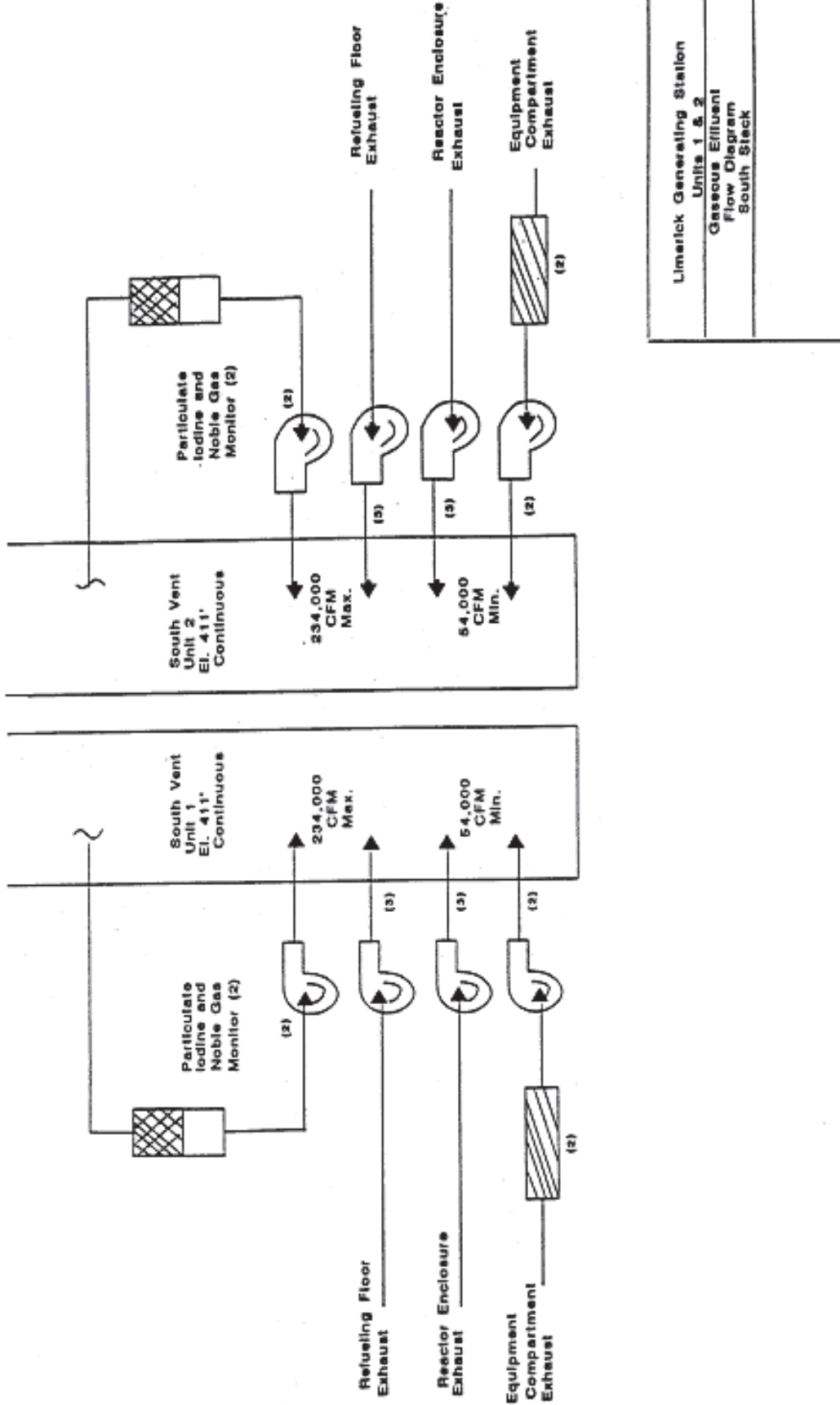

Figure II2-2

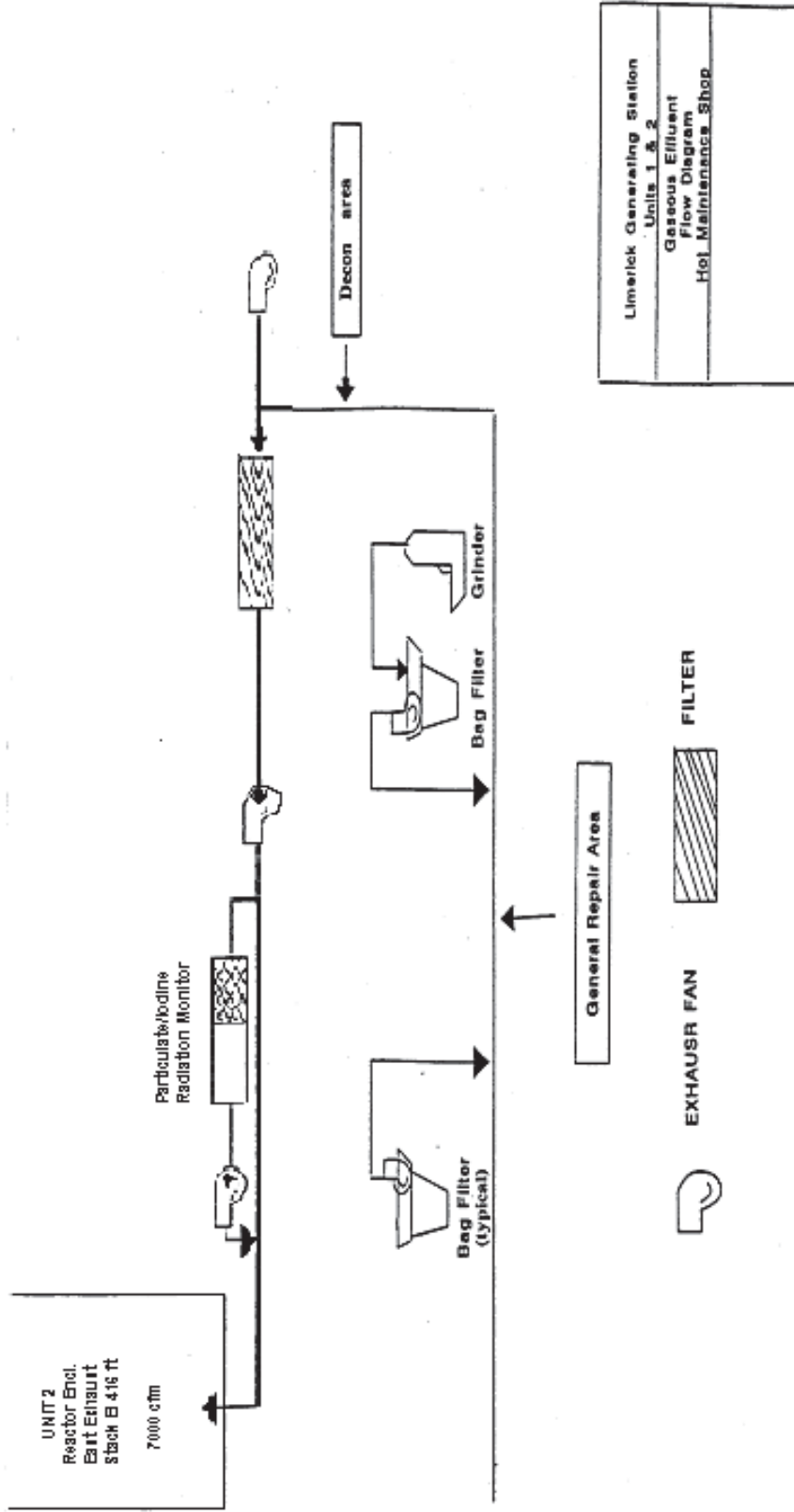

Figure II2-3

APPENDIX A

RADIOLOGICAL ENVIRONMENTAL MONITORING PROGRAM -
SAMPLE TYPE, LOCATION, AND ANALYSIS

TABLE A-1
 ODCM - Limerick Generating Station
 Radiological Environmental Monitoring Program

Pathway	Station Code	Location	Collection Method	Analyses			
(1) Inner Ring	*36S2	3,183 feet N of site	1 set of four (4) dosimeters from each location at least quarterly	Gamma dose quarterly			
	*3S1	2,301 feet NNE of site					
	*5S1	2,350 feet NE of site					
	*7S1	3,099 feet ENE of site					
	*10S3	2,648 feet E of site					
	*11S1	2,017 feet ESE of site					
	*13S2	2,149 feet SE of site					
	*14S1	3,319 feet SSE of site					
	*18S2	1,390 feet S of site					
	*21S2	977 feet SSW of site					
	*23S2	2,793 feet SW of site					
	*25S2	2,445 feet WSW of site					
	*26S3	2,088 feet W of site					
	*29S1	2,886 feet WNW of site					
	*31S1	1,395 feet NW of site					
	*34S2	3,071 feet NNW of site					
	(2) Outer Ring	*36D1			18,527 feet N of site		
		*2E1			25,112 feet NNE of site		
		*4E1			25,221 feet NE of site		
		*7E1			22,489 feet ENE of site		
*10E1		20,826 feet E of site					
*10F3		29,442 feet ESE of site					
*13E1		22,772 feet SE of site					
*16F1		26,608 feet SSE of site					
*19D1		18,439 feet S of site					
*20F1		27,648 feet SSW of site					
*24D1		20,972 feet SW of site					
*25D1		21,044 feet WSW of site					
*28D2		20,231 feet W of site					
*29E1		26,110 feet WNW of site					
*31D2		20,446 feet NW of site					
*34E1		24,243 feet NNW of site					

TABLE A-1 (Continued)

Pathway	Station Code	Location	Collection Method	Analyses	
I Direct (Continued) (3) Controls and Special Interest	*5H1 C	130,742 feet NE of site			
	*6C1	11,305 feet NE of site			
	*9C1	11,377 feet E of site			
	*13C1	14,980 feet SE of site			
	*15D1	16,877 feet SE of site			
	*17B1	8,462 feet S of site			
	*20D1	16,157 feet SSW of site			
	*31D1	15,853 feet WNW of site			
	II. <u>Airborne</u> Particulates	6C1	11,305 feet N of site	Approximately 1 cfm continuous flow through glass fiber filter which is collected weekly.	Gross beta analysis on each weekly sample. Gamma spectrometry shall be done when gross beta exceeds ten times the yearly mean of control station value.
		*10S3	2,648 feet E of site		
*11S1		2,017 feet ESE of site			
11S2 (QC)		2,017 feet ESE of site			
*14S1		3,319 feet SSE of site			
*13S4		1,186 feet SE of site		Gross beta analysis done 24 hrs after sampling to allow for Radon and Thoron daughter decay.	
*15D1		16,877 feet SE of site			
*22G1 C		93,619 feet SW of site		Gamma Spec on quarterly composite.	
III. <u>Water</u> a. Surface		6C1	11,305 feet N of site	A TEDA impregnated flow-through cartridge is connected to air sampler and is collected weekly at site filter change.	Iodine 131 analysis on each weekly sample.
		*10S3	2,648 feet E of site		
	*11S1	2,017 feet ESE of site			
	11S2 (QC)	2,017 feet ESE of site			
	*14S1	3,319 feet SSE of site			
	*13S4	1,186 feet SE of site			
	*15D1	16,877 feet SE of site			
	*22G1 C	93,619 feet SW of site			
	*24S1 C	1,058 feet SW of site	Sample collected from a continuous water sampler, monthly. In event sampler is inoperable, weekly grab samples will be collected until sampler returned to service.	Gamma isotopic analysis monthly.	
	*13B1	9,225 feet SE of site		H-3 on quarterly composite	
b. Ground	No Ground water is sampled and analyzed, because ground water flow is to the river per UFSAR Section 2.4.13				
c. Drinking	*15F7	33,400 feet SSE of site	Sample collected from a continuous water sampler monthly. In event sampler is inoperable, weekly grab samples will be collected until sampler returned to service.	Iodine-131 LL, Gross beta and gamma isotopic monthly,	
	*15F4	45,514 feet SE of site			
	*16C2	14,034 feet SSE of site			
	*28F3 C	30,811 feet WNW of site		H-3 on quarterly composite	

TABLE A-1 (Continued)

Pathway	Station Code	Location	Collection Method	Analyses
d. Sediment from shoreline	16B2 *16C4 33A2 C	7,128 feet SSE of site 11,510 feet SSE of site 4,435 feet NNW of site	A sediment sample is taken down stream of discharge semi-annually	Gamma isotopic analysis each sample
IV. <u>Ingestion</u> a. Milk	10F4 *18E1 *19B1 *25C1 *23F1 C 36E1 C	34,848 feet ESE of site 22,704 feet S of site 10,317 feet SSW of site 14,224 feet WSW of site 26,505 feet SW of site 24,816 feet N of site	Sample of fresh milk is collected from each farm biweekly when cows are on pasture (April) through October), monthly at other times.	Gamma isotopic and I-131 analyses on each sample
b. Fish and Invertebrates	*16C5 *29C1 C	9,251 feet SE of site 13,725 feet WNW of site	Two species of recreationally important fish (Predator and bottom feeder) sampled in season or semiannually if not seasonal. Seasons are Spring and Fall There are no commercially or recreationally important species of invertebrates. Therefore, no invertebrates are sampled.	Gamma isotopic analyses on edible portions.
c. Food Products			There are no downstream food products that are irrigated by water in which liquid plant wastes have been discharged. No broad leaf vegetation sampling is credited toward REMP, because milk sampling is performed.	
	11S3 13S3 31G1 C	1,848 feet ESE of site 1,267 feet SE of site 71,808 feet NW of site	Samples of 3 different kinds of broad leaf vegetation grown is collected on a monthly basis during the growing season	Gamma isotopic and I-131 analyses on each sample

* Sampled as part of the REMP as designated in Table 3.3-1

C Indicates a Control location

QC Indicates a Quality Control duplicate sample location

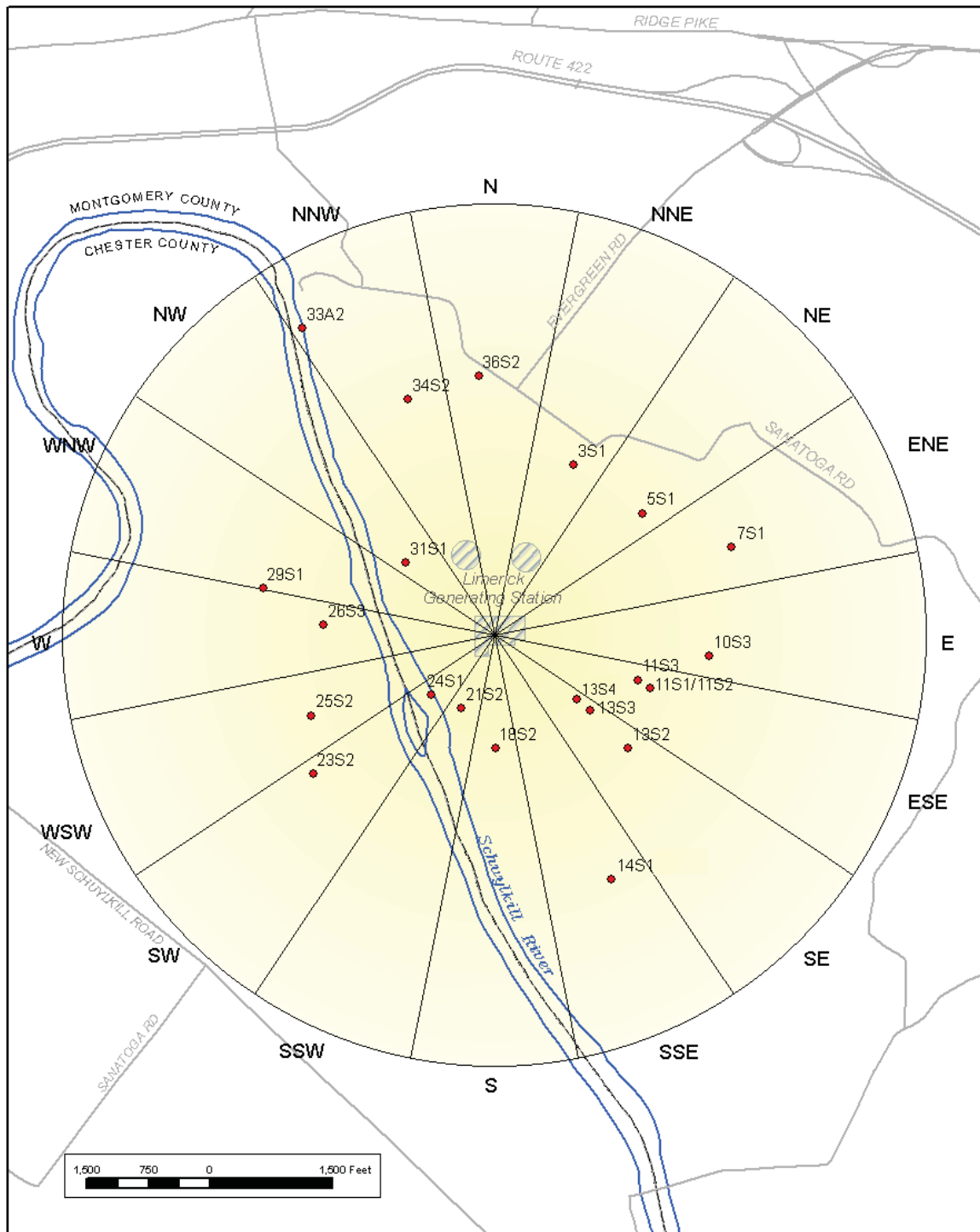

Figure A-1
 Environmental Sampling Locations On Site or
 Near the Limerick Generating Station

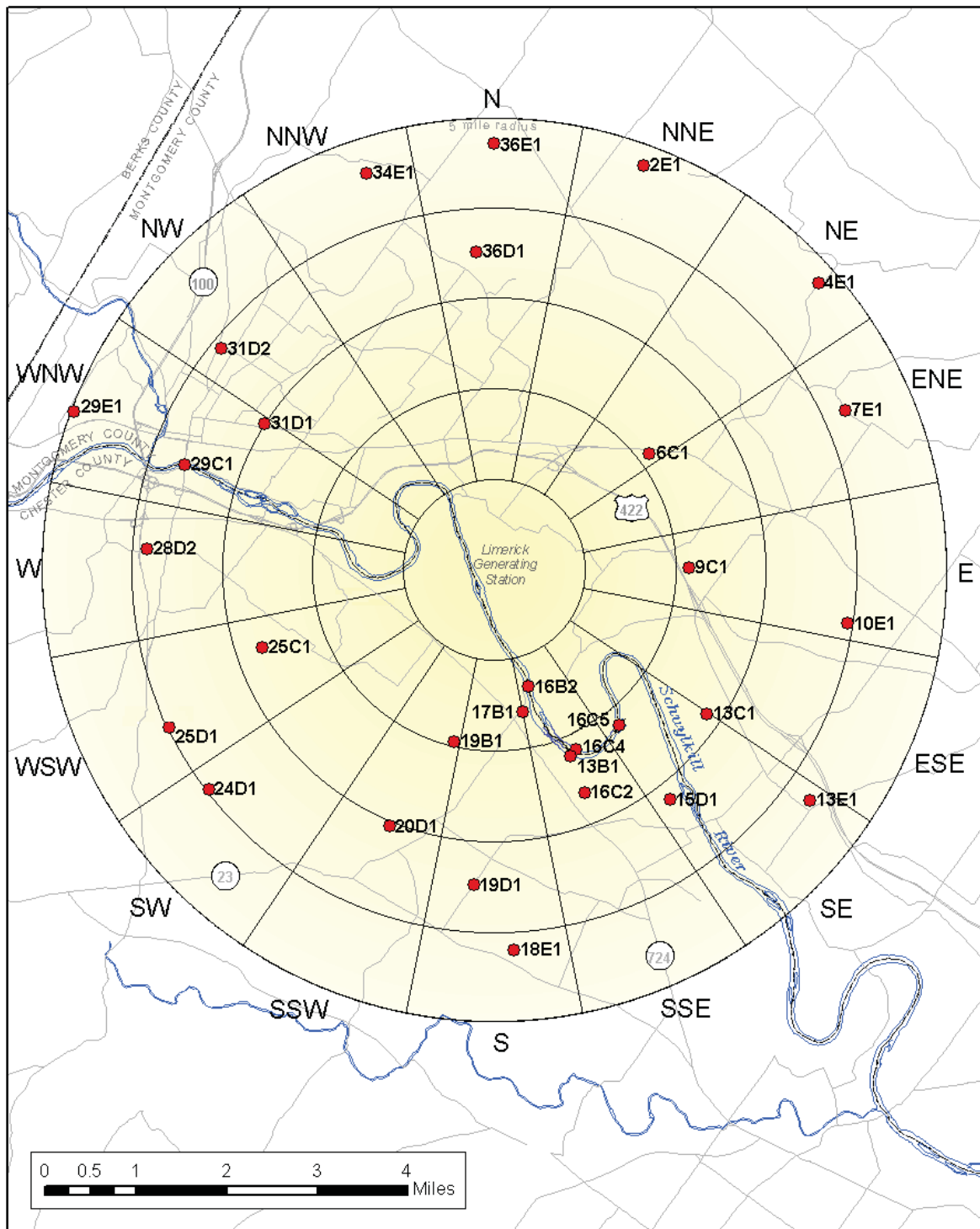

Figure A-2
 Environmental Sampling Locations at Distances Less Than Five Miles (26,400 feet)
 from the Limerick Generating Station.

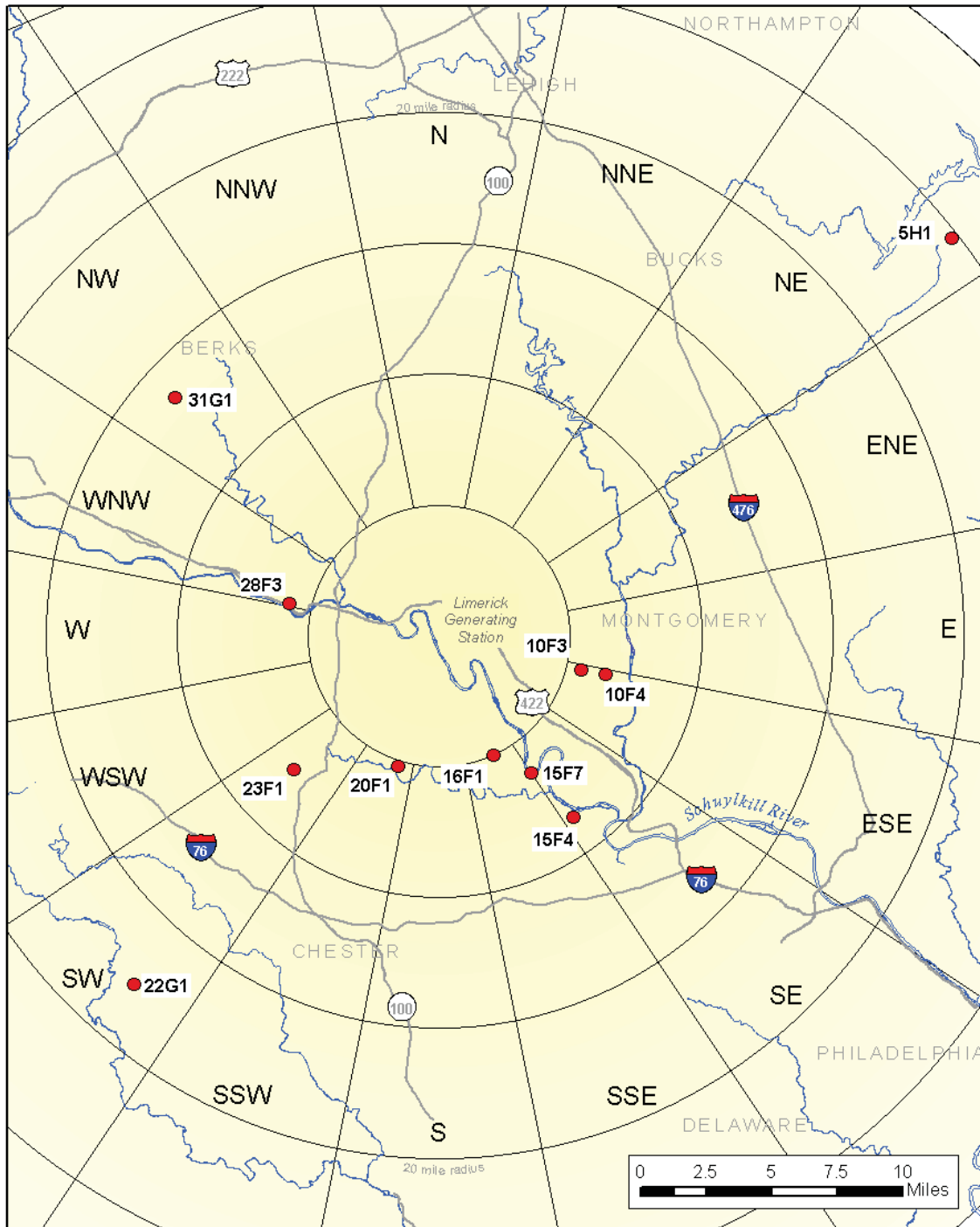

Figure A-3
 Environmental Sampling Locations at Distances Greater Than Five Miles (26,400 feet)
 from the Limerick Generating Station.

REFERENCES

1. Regulatory Guide 1.109, "Calculation of Annual Doses to Man from Routine Releases of Reactor Effluents for the Purpose of Evaluating Compliance with 10 CFR Part 50, Appendix I," Revision 1, U.S. Nuclear Regulatory Commission, Washington, D.C. 20555, October 1977.
2. Regulatory Guide 1.111, "Methods for Estimating Atmospheric Transport and Dispersion of Gaseous Effluents in Routine Releases from Light-Water-Cooled Reactors," Revision 1, U.S. Nuclear Regulatory Commission, Washington, D.C. 20555, July 1977.
3. Regulatory Guide 1.112, "Calculation of Releases of Radioactive Materials in Gaseous and Liquid Effluents from Light-Water-Cooled Power Reactors," U.S. Nuclear Regulatory Commission, Washington, D.C. 20555, April 1976.
4. Regulatory Guide 1.113, "Estimating Aquatic Dispersion of Effluents from Accidental and Routine Reactor Releases for the Purpose of Implementing Appendix I," Revision 1, U.S. Nuclear Regulatory Commission, Washington, D.C. 20555, April 1977.
5. U.S. Nuclear Regulatory Commission, "Calculation of Releases of Radioactive Materials in Gaseous and Liquid Effluents from Boiling Water Reactors (BWR-GALE Code)," USNRC Report NUREG-0016, Washington, D.C. 20555, April 1976.
6. U.S. Nuclear Regulatory Commission, "X0QD0Q, Program for the Methodological Evaluation of Routine Effluent Releases at Nuclear Power Stations," USNRC Report NUREG-0324, Washington, D.C. 20555, September, 1977.
7. Title 10, "Energy," Chapter I, Code of Federal Regulations; Part 20, Appendix B, U.S. Government Printing Office, Washington, D.C. 20402, January 1, 1977.
8. Title 10, "Energy," Chapter I, Code of Federal Regulations; Part 100, U.S. Government Printing Office, Washington, D.C. 20404, January 1, 1977.
9. Title 40, "Protection of Environment," Chapter I, Code of Federal Regulations, Part 141, U.S. Government Printing Office, Washington, D.C. 20402, January 1, 1977.
10. Regulatory Guide 1.21, "Measuring, Evaluating, and Reporting Radioactivity in Solid Wastes and Releases of Radioactive Materials in Liquid and Gaseous Effluents from Light-Water-Cooled Nuclear Power Plants," Revision 1, U.S. Nuclear Regulatory Commission, Washington, D.C. 20555, June 1974.
11. Title 40, "Protection of Environment," Chapter I, Code of Federal Regulations, Part 190, Federal Register, Vol. 42, No. 9, Washington, D.C. 20402, January 13, 1977.
12. U.S. Nuclear Regulatory Commission, "Short Term Diffusion Estimates," Section 2.3.4, Standard Review Plan for the Review of Safety Analysis Reports for Nuclear Power Plants - LWR Edition, USNRC Report NUREG-75/087, Washington, D.C. 20555, November 1975.
13. U.S. Nuclear Regulatory Commission, "Preparation of Radiological Effluent Technical Specifications for Nuclear Power Plants," USNRC Report NUREG-0133, Washington, D.C. 20555, October 1978.

14. Letter From Thomas E. Marley, Director Office of Nuclear Reactor Regulations, To Thomas E. Tipton Vice President and Director Operations, Nuclear Management and Resources Council, 6/30/93.
15. ANSI N42.14-1991 (Revision of ANSI N42.14-1978) "Calibration and Use of Germanium Spectrometers For the Measurement of Gamma-Ray Emission Rates of Radionuclides", Sect. 6.2.2
16. EML Procedures Manual, H.L. Volchok and G. dePlangue, Editors, U.S. Dept. Of Energy (Revised Annually)
17. L.A. Currie, "Limits For Qualitative Detection and Quantitative Determination - Application to Radiochemistry", Analytical Chemistry, Vol. 40, pp. 586-593 (TABLE II), 1968
18. NUREG/CR-4007, "Lower Limit of Detection: Definition and Elaboration of a Proposed Position for Radiological Effluent and Environmental Measurements", prepared by NRC by L.A. Currie (Chapter II, Sect. D.2; Chapter III, Sect. C.1), September 1984
19. Tech. Spec. Section 1.24 (Definitions)
20. USNRC Generic Letter, 89-01
21. Tech. Spec. Section 6.14.
22. Tech. Spec. Section 6.8.4d, e and f.
23. Tech. Spec. Section 6.9.1.7/ODCM Administrative Control 6.1
24. Tech. Spec. Section 6.9.1.8/ODCM Administrative Control 6.2
25. UFSAR, Section 11.5.6.
26. NO-AA-10, Quality Assurance Topical Report (QATR)
27. Bechtel, Inc., "Dilution Studies for Routine and Accidental Releases from Limerick Nuclear Plant into the Schuylkill River", March, 1996.
28. ANSI/ANS-6.6.1-1979 "calculation and measurement of direct and scattered gamma radiation from LWR nuclear power plants, Section 7.
29. Hartwell, J.K., "Detection Limits for Radioanalytical Counting Techniques," Atlantic Richfield Hanford Company Report ARH-SA-215 (June, 1975).
30. NUREG/CR-4653 GASPARD II, Technical Reference and User Guide
31. NUREG/CR-4013, LADTAP II Technical Reference and User Guide.
32. Kocher, David C., "Radioactive Decay Data Tables," DOE/TIC-11026,138 (1981).
33. NUREG 1302, "Offsite Dose Calculation Manual Guidance: Standard Radiological Effluent Controls for Boiling Water Reactors."
34. NUREG-0974, Final Environmental Statement related to the operation of Limerick Generating Station, Units 1 and 2 (April 1984)