

2807 West County Road 75  
Monticello, MN 55362

800.895.4999  
xcelenergy.com



May 10, 2018

L-MT-18-027  
10 CFR 50.36a

ATTN: Document Control Desk  
U.S. Nuclear Regulatory Commission  
Washington, DC 20555-0001

Monticello Nuclear Generating Plant  
Docket 50-263  
Renewed Facility Operating License No. DPR-22

2017 Annual Radioactive Effluent Release Report

Pursuant to 10 CFR 50.36a "Technical specifications on effluents from nuclear power reactors," paragraph (a)(2), and in accordance with Monticello Nuclear Generating Plant (MNGP) Technical Specification (TS) Section 5.5.1, "Offsite Dose Calculation Manual (ODCM)," and 5.6.2 "Radioactive Effluent Release Report," the Northern States Power Company (NSPM), a Minnesota corporation, d/b/a Xcel Energy, is submitting the following enclosures:

- Radioactive Effluent Release Report for January 1 - December 31, 2017 (Enclosure 1)
- Offsite Dose Calculation Manual (Enclosure 2)

Summary of Commitments

This letter makes no new commitments and no revisions to existing commitments.

A handwritten signature in black ink, appearing to read 'Chris Church', written over a white background.

Christopher R. Church  
Site Vice President  
Monticello Nuclear Generating Plant  
Northern States Power Company – Minnesota

Enclosures (2)

cc: Administrator, Region III, USNRC  
Project Manager, Monticello, USNRC  
Resident Inspector, Monticello, USNRC  
Minnesota Department of Commerce

**ENCLOSURE 1**

**RADIOACTIVE EFFLUENT RELEASE REPORT FOR**

**JANUARY 1 – DECEMBER 31, 2017**



# 2017 Annual Radioactive Effluent Release Report

---

For Monticello Nuclear Generating Plant

For the period covering January 1, 2017 through December 31, 2017



## CONTENTS

---

List of Figures .....	iii
List of Tables .....	iv
Executive Summary:.....	1
Introduction: .....	3
About Nuclear Power .....	3
About Radiation Dose .....	4
About Dose Calculation.....	5
Dose Assessment for Operation of MNGP during the 2017 Calendar Year.....	7
Critical Receptor.....	7
Offsite Dose due to Gaseous Releases.....	8
Offsite Dose Due to Liquid Releases .....	9
Dose to Individuals Due to Their Activities Inside the Site Boundary.....	10
Dose to the Likely Most-Exposed Member of the Public (40 CFR 190) .....	11
Supplemental Information:.....	12
Abnormal Releases/Discharges.....	12
Environmental Monitoring.....	14
Radioactive Solid Waste Disposal .....	18
Effluent Radiation Monitors Out of Service for Greater than 30 Days.....	18
Changes to the ODCM.....	18
Changes to the Process Control Program (PCP).....	18
Corrections to Previous ARERRs .....	18
References .....	19
Attachment A: 2017 ARERR Release Summary Tables .....	20
Attachment B: 2017 REMP TLD Dose Information .....	28
Attachment C: Ground Water Monitoring Well Locations .....	29
Attachment D: 2017 Groundwater Protection Program Well Data.....	31

## LIST OF FIGURES

---

Figure 1: Typical Boiling Water Reactor (BWR) design. (US NRC, Ref. (10)) .....	3
Figure 2: Example of a fission reaction. (Wikimedia Commons, Ref. (11)).....	3
Figure 3: Gaseous Radwaste Treatment System at MNGP.....	4
Figure 4: US Population dose distribution for major sources of exposure. (NCRP Report 160, Ref. (1)).....	4
Figure 5: Potential exposure pathways to Members of the Public due to operation of MNGP.....	5
Figure 6: MNGP Groundwater Monitoring Well Locations (Ref. (8)).....	29

## LIST OF TABLES

---

Table 1: Critical Receptor 2017.....	7
Table 2: Critical Receptor Organ Dose.....	8
Table 3: Air Dose due to Noble Gases at the Maximum Site Boundary Location.....	8
Table 4: Liquid Effluent Dose.....	9
Table 5: Maximum Effluent Dose to Individuals due to Their Activities Inside the Site Boundary.....	10
Table 6: Total Dose Due To All Uranium Fuel Cycle Sources (40 CFR 190).....	11
Table 7: Bounding concentrations of radioactive isotopes from 4/27/2017 Abnormal Discharge.....	13
Table 8: Groundwater Monitoring Well Sampling Frequencies.....	16
Table 9: Gaseous Effluents – Summation of All Releases (RG-1.21 Table 1A).....	22
Table 10: Gaseous Effluents - Elevated Releases (RG-1.21 Table 1B).....	23
Table 11: Gaseous Effluents – Reactor Building Vent Releases (RG-1.21 Table 1C).....	24
Table 12: Liquid Effluents - Summation of All Releases (RG-1.21 Table 2A).....	25
Table 13: Liquid Effluents (RG-1.21 Table 2B).....	26
Table 14: Solid Waste and Irradiated Fuel Shipments (RG-1.21 Table 3).....	27
Table 15: 2017 REMP TLD Dose Results.....	28
Table 16: MNGP Monitoring Well Locations from FP-CY-GWPP-01. (Ref. (7)).....	30
Table 17: 2017 Groundwater Monitoring Well Data for MNGP.....	31

## EXECUTIVE SUMMARY:

---

Monticello Nuclear Generating Plant (MNGP) is a Boiling Water Reactor (BWR) located in central Minnesota. The plant releases small quantities of radioactive materials in gaseous form and does not make routine releases of radioactive liquids. Radioactive material in the environment due to plant operations remains below detectible levels, as discussed in the Annual Radiological Environmental Operating Report (AREOR) for MNGP. Technical Specifications limit the quantities of radioactive material that may be released, based on calculated radiation doses or dose rates. Dose to Members of the Public due to radioactive materials released from the plant is limited by Appendix I of 10 CFR 50 and by 40 CFR 190. During 2017, operational doses to the public were calculated to be very small compared to the limits required by regulation and compared to other sources of radiation dose and pose no health hazard. Below is a brief summary of the significant sections of the report.

### DOSE ASSESSMENT FOR OPERATION OF MNGP IN 2017

The Critical Receptor for MNGP remained the same in 2017 as it was in 2016, 2015, and 2014, located at 1.18 miles SSE. The Critical Receptor was a Child with dose due to Ground, Inhalation and Vegetable pathways. Total Annual Maximum Organ Dose calculated for this receptor was 0.115 mrem Thyroid. This annual dose is a small fraction of the 10 CFR 50, Appendix I guideline of 15 mrem to the Maximum Organ.

Maximum Gaseous Site Boundary Air Doses were calculated to be 0.0116 mrad gamma and 0.00792 mrad beta. These doses are also small compared to the 10 CFR 50, Appendix I guidelines for air dose of 10 mrad gamma and 20 mrad beta.

Effluent-related dose to individuals due to their activities inside the site boundary was found to be highest for a hypothetical worker in the subyard working 40 hours/week. The maximum organ dose due to gaseous effluents was found to be 0.0554 mrem Thyroid, after taking into account occupancy time.

The Likely Most-Exposed Individual due to all Uranium Fuel Cycle Operations for demonstration of compliance with 40 CFR 190 was determined to be the same as the Critical Receptor identified above. The doses received were calculated to be 0.0172 mrem Whole Body, 0.122 mrem Thyroid, and 0.0389 mrem Bone (Max Organ other than Thyroid) using Ground Plane, Plume (noble gas), Inhalation and Vegetable Ingestion pathways. The assessment looked at Radiological Environmental Monitoring Program (REMP) Thermoluminescent Dosimeters (TLDs) and found that no Facility Related Dose was detected at any REMT TLD locations for MNGP in 2017.

One Abnormal Release of liquid radioactivity occurred in 2017 due to contamination of the clean Demineralized water system. A bounding assessment of the quantities of radioactive material released and associated doses are provided in the Supplemental Information section.

### ENVIRONMENTAL MONITORING

REMP results for 2017 did not detect radioactive material due to plant operation in offsite samples. This confirms that impact on the environment and the public due to plant effluents remains very low, consistent with the small dose values reported in the Dose Assessment section.

Two areas of particular interest with regard to environmental monitoring for the present report are TLD and groundwater monitoring. TLD results were analyzed using methodology based on ANSI/HPS N13.37-2014 and found to indicate no Facility Related Dose at, or beyond, the site boundary. This result indicates that direct radiation due to operating the plant or the Independent Spent Fuel Storage Installation (ISFSI) is not contributing measurable dose to people living around the plant.

Groundwater monitoring of onsite wells found that one monitoring well location (MW-9A) indicated tritium concentrations above those observed in rainwater captured onsite. Evidence suggests that the tritium detected originated from process water containing tritium that leached through the turbine building concrete base mat. The highest groundwater tritium activity for 2017 (5,306 pCi/l) was found in MW-9A; this activity is below the REMP reporting threshold of 20,000 pCi/l from the MNGP ODCM and is consistent with maximum tritium concentrations observed since 2014. Tritium activities identified in all other wells were less than 300 pCi/l and no discharge of tritium to groundwater is reported. All gamma isotopic results for groundwater samples were less than the minimum detectable concentration (MDC) for each nuclide.



## INTRODUCTION:

While many of readers of this report will be very familiar with the scientific, design, and operational principles of nuclear power generation, the sections below provides a brief introduction for the reader that may not have a background in the nuclear industry.

## ABOUT NUCLEAR POWER

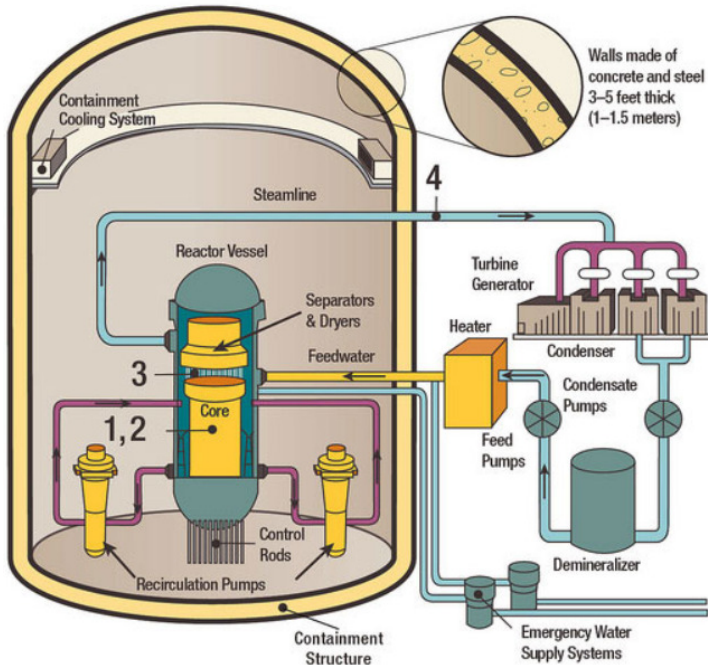

FIGURE 1: TYPICAL BOILING WATER REACTOR (BWR) DESIGN.  
(US NRC, REF. (10))

Commercial nuclear power plants are generally classified as either Boiling Water Reactors (BWRs) or Pressurized Water Reactors (PWRs), based on their design. Monticello Nuclear Generating Plant is classified as a BWR and the discussion below will focus on that technology.

Electricity is generated by a BWR similarly to the way that electricity is generated at other conventional types of power plants, such as those driven by coal or natural gas. Water is boiled to generate steam, the steam turns a turbine that is attached to a generator and the steam is condensed back into water to be returned to the boiler. Figure 1 shows a schematic representation for a typical BWR. What makes nuclear power different from these other types of power plants is that the heat is generated by fission and decay reactions occurring within and around the core containing fissionable uranium (U-235).

Nuclear fission occurs when certain nuclides (primarily U-233, U-235, or Pu-239) absorb a neutron and break into several smaller nuclides (called fission products) as well as some additional neutrons. Among the fission products are noble gases, krypton (Kr) and xenon (Xe), which must be removed along with other non-condensable gases (due to air leaks) from the condenser in order to maintain a working vacuum to pull steam across the turbine. Figure 2 shows an example of a fission reaction of U-235; of note in the diagram are two fission products (Ba-139 and Kr-95), two additional neutrons produced, and 200 MeV of energy released.

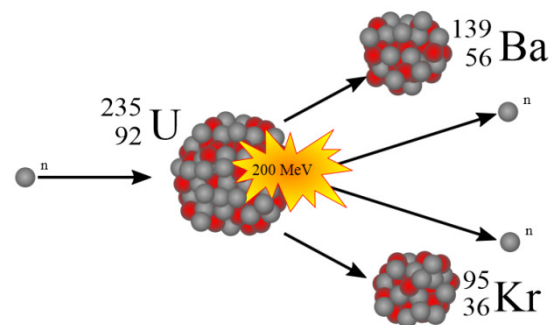

FIGURE 2: EXAMPLE OF A FISSION REACTION.  
(WIKIMEDIA COMMONS, REF. (11))

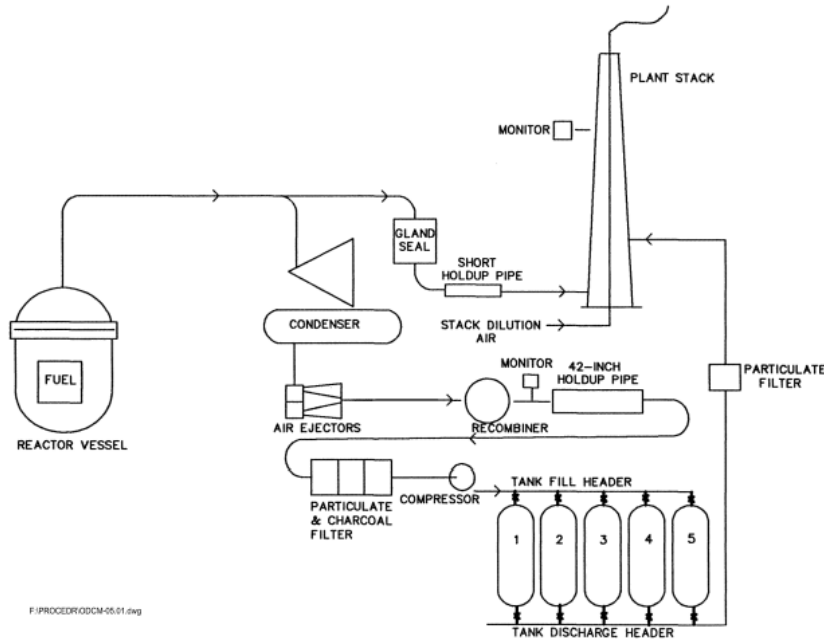

FIGURE 3: GASEOUS RADWASTE TREATMENT SYSTEM AT MNGP.

At MNGP, the non-condensable gases are treated with the Gaseous Radwaste Treatment System; this system reduces the amount of radioactive material released to the environment by holding gases in compressed gas tanks for a minimum of 50 hours to allow for decay of shorter lived isotopes. The treated gases are released through the 100-meter Plant Stack. The Plant Stack provides additional dilution time for activity in the plume to dissipate prior to reaching the ground level where people could be exposed to the radioactive material that it contains. The Gaseous Radwaste Treatment System includes filtration to reduce particulate

and iodine activity that is released; however, because filters are not perfectly efficient, small quantities of particulate, iodine and tritium activity are also released through the Plant Stack. Figure 3 provides a schematic representation of the Gaseous Radwaste Treatment System at MNGP.

## ABOUT RADIATION DOSE

Ionizing radiation, including alpha, beta, and gamma radiation from radioactive decay, has sufficient energy to break chemical bonds in tissues and result in damage to tissue or genetic material. The amount of ionization that will be generated by a given exposure to ionizing radiation is quantified as dose. The units for dose are generally given in millirem (mrem) in the US.

The National Council on Radiation Protection (NCRP) has evaluated the population dose for the US and determined that the average individual is exposed to approximately 620 mrem per year (Ref. (1)). There are many sources

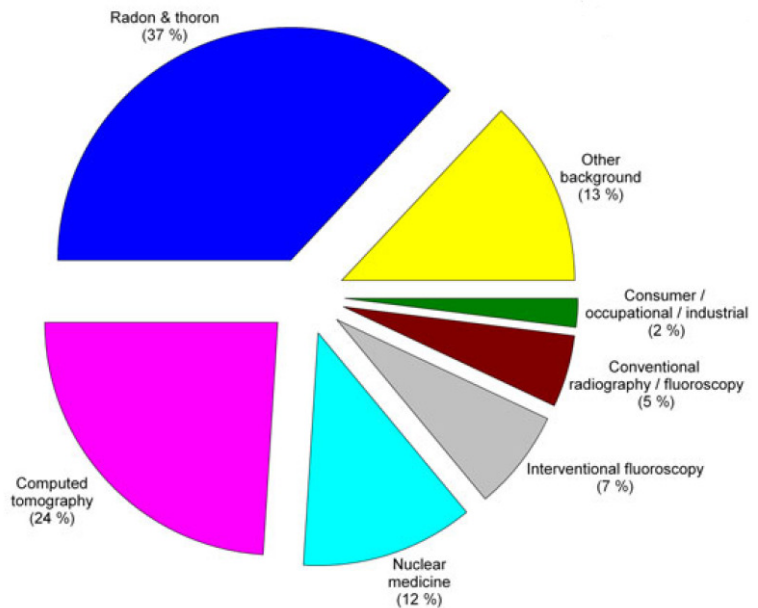

FIGURE 4: US POPULATION DOSE DISTRIBUTION FOR MAJOR SOURCES OF EXPOSURE. (NCRP REPORT 160, REF. (1))

for radiation dose, ranging from natural background sources to medical procedures, air travel, and industrial processes. Approximately half (310 mrem) of the average exposure is due to natural sources of radiation including exposure to Radon, cosmic radiation, and internal radiation and terrestrial due to naturally occurring radionuclides. The remaining 310 mrem of exposure is due to man-made sources of exposure, with the most significant contributors being medical (48%) due to radiation used in various types of medical scans and treatments. Of the remaining 2% of dose, most is due to consumer activities such as air travel, smoking cigarettes, and building materials. A small fraction of this 2% is due to industrial activities including generation of nuclear power.

Readers that are curious about common sources and effects of radiation dose that they may encounter can find excellent sources of information from the Health Physics Society, including the Radiation Fact Sheets (<http://hps.org/hpspublications/radiationfactsheets.html>), and from the US Nuclear Regulatory Commission website (<http://www.nrc.gov/about-nrc/radiation.html>). The Personal Annual Radiation Dose Calculator on the NRC website can be particularly interesting to look at (<http://www.nrc.gov/about-nrc/radiation/around-us/calculator.html>). When the facts are examined, it becomes apparent that the dose to the public due to routine nuclear plant operations is very small when compared to common background and medical sources of radiation exposure.

## ABOUT DOSE CALCULATION

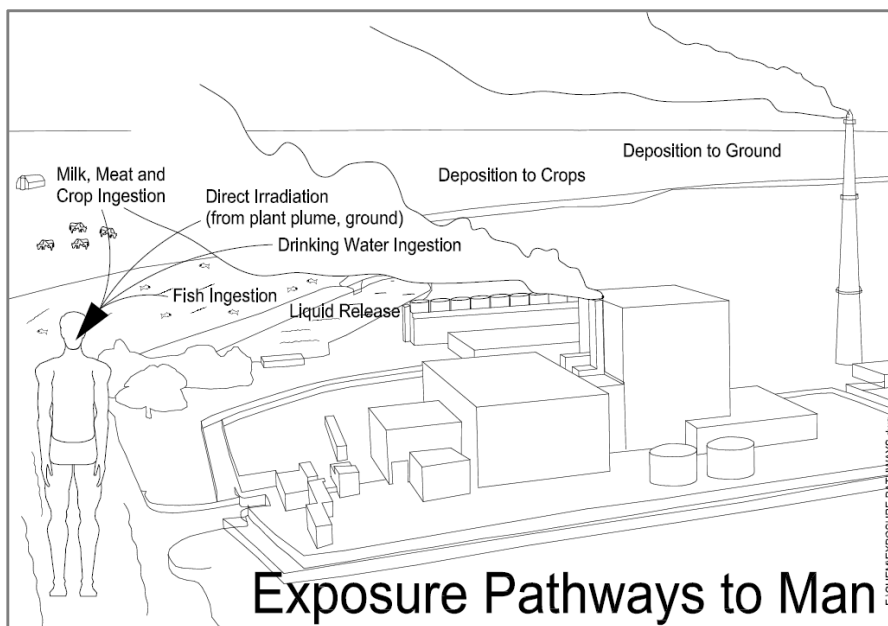

FIGURE 5: POTENTIAL EXPOSURE PATHWAYS TO MEMBERS OF THE PUBLIC DUE TO OPERATION OF MNGP.

Concentrations of radioactive material in the environment resulting from the operation of MNGP are very small and it is not possible to determine doses directly using measured activities of environmental samples. To overcome this, Dose Calculations based on measured activities of effluent streams are used to model the dose impact for Members of the Public due to plant operation and effluents. There are several mechanisms that can result in dose to Members of the

Public, including: Ingestion of radionuclides in food or water; Inhalation of radionuclides in air; Immersion in a plume of noble gases; and Direct Radiation from the ground, the plant or from an elevated plume (See Figure 5).

The MNGP Offsite Dose Calculation Manual (ODCM) specifies the methodology used to obtain the doses in the Dose Assessment section of this report. The methodology in the ODCM is based on NRC

Regulatory Guide 1.109 (Ref. (2)) and NUREG-0133 (Ref. (3)). Doses are calculated by determining what the nuclide concentration will be in air, on the ground or in food products based on plant effluent releases. Release points are continuously monitored to quantify what concentrations of nuclides are being released, then meteorological data is used to determine how much of the released activity will be present at a given location outside of the plant either deposited onto the ground or in gaseous form. Intake patterns and nuclide bio-concentration factors are used to determine how much activity will be transferred into animal milk or meat. Finally human ingestion factors and dose factors are used to determine how much activity will be consumed and how much dose the consumer will receive. Inhalation dose is calculated by determining the concentration of nuclides and how much air is breathed by the individual.

Each year MNGP performs a Land Use Census to determine what potential dose pathways currently exist within a five-mile radius around the plant, the area most affected by plant operations. The Annual Land Use Census identifies the locations of vegetable gardens, nearest residences, milk animals and meat animals. The data from the census is used to determine who is likely to receive the highest radiation dose as a result of plant operation.

There is uncertainty in dose calculation results due to modeling atmospheric dispersion of material released and bioaccumulation factors, as well as assumptions associated with consumption and land-use patterns. Even with these sources of uncertainty, the calculations do provide a reasonable estimate of the order of magnitude of the exposure. Conservative assumptions are made in the calculation inputs, including the amounts of various foods and water consumed and the amount of air inhaled, such that the actual dose received is likely lower than the calculated dose. Even with the built in conservatism, doses calculated for the highest hypothetical exposed individual due to plant operation (on the order of less than 1 mrem) are a very small fraction of the annual dose that is received due to other sources that are not related to plant operation (about 620 mrem). The calculated doses due to plant effluents, along with REMP results indicating no identified radioactive material due to plant operations, serve to provide assurance that MNGP is not having a negative impact on the environment or people living near the plant.

## DOSE ASSESSMENT FOR OPERATION OF MNGP DURING THE 2017 CALENDAR YEAR

---

Below is an assessment of radiation dose due to operation of MNGP during the period of January 1, 2017 through December 31, 2017. The doses calculated represent a small fraction of the dose limits contained in 40 CFR 190 and Appendix I of 10 CFR 50.

### CRITICAL RECEPTOR

---

The Land Use Census for MNGP identifies real exposure pathways for radioactive effluents based on Ingestion (Gardens, Milk Animals, and Meat Animals), Inhalation and Direct Radiation Exposure (Residence Locations). Inhalation and Direct Radiation Exposure are assumed to exist at all locations, while Ingestion Pathways are assumed only where vegetable gardens, milk animals, or meat animals are actively used for consumption. For any given location and pathway, all age groups are assumed to be present and consume conservative quantities of food products, water, and inhaled air (based on Table E-5 of Regulatory Guide 1.109, Ref. (2)). The person that is identified as having the largest potential exposure is called the Critical Receptor.

For 2017, the Critical Receptor identified by the MNGP Land Use Census remained the same location identified previously. This Critical Receptor is used for determination of compliance with the dose limits of 10 CFR 50, Appendix I.

TABLE 1: CRITICAL RECEPTOR 2017.

<b>SECTOR</b>	<b>SSE</b>
<b>DISTANCE</b>	<b>1.18 miles</b>
<b>PATHWAYS</b>	<b>Ground, Inhalation, and Vegetable</b>
<b>Age Group</b>	<b>Child</b>
<b>Organ</b>	<b>Thyroid</b>

## OFFSITE DOSE DUE TO GASEOUS RELEASES

Critical Receptor dose results below were calculated using the 2017 effluent source term from Table 10 and Table 11. The Critical Receptor doses include dose from C-14 released between May 1 and September 30, in accordance with the methodology in the MNGP ODCM; this is because only C-14 released during the growing season will be incorporated into food products that contribute to the calculated dose for the Ingestion pathways. Dose due to noble gases released from the Plant Stack and Reactor Building Vent (RBV) release points have been determined for the SSE site boundary location.

The calculated quarterly and annual doses remain a small percentage of the Guidelines provided in Appendix I to 10 CFR 50.

TABLE 2: CRITICAL RECEPTOR ORGAN DOSE

Max Organ	Period	Dose*	10 CFR 50, Appendix I Design Objective	% of Guideline
Thyroid	Q1	0.0500 mrem	7.5 mrem/quarter	0.67%
Thyroid	Q2	0.0355 mrem		0.47%
Bone	Q3	0.0192 mrem		0.26%
Thyroid	Q4	0.0126 mrem		0.17%
<b>Thyroid</b>	<b>Annual</b>	<b>0.115 mrem</b>	<b>15 mrem/year</b>	<b>0.77%</b>

\*Includes dose from Iodines, Particulates, Tritium, and Carbon-14.

TABLE 3: AIR DOSE DUE TO NOBLE GASES AT THE MAXIMUM SITE BOUNDARY LOCATION

Exposure Type	Period	Exposure*	10 CFR 50, Appendix I Design Objective	% of Guideline
Gamma Air Dose	Q1	0.00517 mrad	5 mrad/quarter	0.10%
	Q2	0.00249 mrad		0.05%
	Q3	0.00216 mrad		0.04%
	Q4	0.00176 mrad		0.04%
	<b>Annual</b>	<b>0.0116 mrad</b>	<b>10 mrad/year</b>	<b>0.12%</b>
Beta Air Dose	Q1	0.00448 mrad	10 mrad/quarter	0.04%
	Q2	0.00083 mrad		0.01%
	Q3	0.00130 mrad		0.01%
	Q4	0.00130 mrad		0.01%
	<b>Annual</b>	<b>0.00792 mrad</b>	<b>20 mrad/year</b>	<b>0.04%</b>

\*Includes dose due to Noble Gases only.

## OFFSITE DOSE DUE TO LIQUID RELEASES

---

An Abnormal Discharge of radioactive liquid occurred on 4/27/17, following contamination of a small section of piping containing demineralized water. A conservative bounding assessment was completed to validate compliance with dose limits from Appendix I of 10CFR50 and concentration limits from Technical Specifications. The noteworthy exposure pathways evaluated included consumption of Freshwater Fish and St. Paul Drinking Water. The resulting doses are presented below and show a small fraction of the limits.

Additional discussion regarding the Abnormal Release and corrective actions can be found in the Supplemental Information section (pg. 12).

TABLE 4: LIQUID EFFLUENT DOSE

<b>Organ</b>	<b>Dose</b>	<b>10 CFR 50, Appendix I Design Objective</b>	<b>% of Guideline</b>
Whole Body	0.00049 mrem	3 mrem	0.02%
Max Organ (Liver)	0.00103 mrem	10 mrem	0.01%

**DOSE TO INDIVIDUALS DUE TO THEIR ACTIVITIES INSIDE THE SITE BOUNDARY**

This section evaluates dose to non-occupationally exposed workers that may be onsite for various reasons. Groups of concern include cleaning contractors at the Receiving Warehouse and Site Administrative Building, and Xcel Energy Company Transmission and Distribution (T&D) crews working in the subyard, and nearby logging operations within the Gaseous Site Boundary to the North of the plant. These workers are considered not to be occupationally exposed because the work activities are only remotely related to plant-operational activities. Use of a very conservative assumption of 40 hours/week spent inside the site boundary by these groups conservatively represents the most-exposed individual.

The annual whole body, skin and organ dose was computed using the 2017 source term using the noble gas dose calculation methodology provided in the ODCM. Elevated finite plume dose factors for the site boundary were used for Plant Stack noble gas total body doses; these dose factors provide a good approximation of the elevated finite plume dose factors that would be determined at the location of interest. The highest calculated organ dose to non-radiation workers within the site boundary due to plant effluent releases was determined to be 0.0554 mrem Thyroid for workers in the subyard. This computed dose includes a reduction by the factor of 40/168 to account for limited occupancy factor for these individuals. The calculated doses due to gaseous effluents for Whole Body, Thyroid and Skin for non-rad workers onsite are presented in Table 5.

TABLE 5: MAXIMUM EFFLUENT DOSE TO INDIVIDUALS DUE TO THEIR ACTIVITIES INSIDE THE SITE BOUNDARY

Organ	Dose*
Whole Body	0.0252 mrem
Thyroid	0.0554 mrem
Max Other Organ (Skin)	0.0299 mrem

*\*Includes doses due to Gaseous Effluent Releases of Noble Gases, Iodines, Particulates, and Tritium. Pathways calculated were Inhalation and Direct Radiation due to Semi-Infinite Plume and Ground-Plane Deposition.*



**DOSE TO THE LIKELY MOST-EXPOSED MEMBER OF THE PUBLIC (40 CFR 190)**

Compliance with 40 CFR 190, Environmental Radiation Protection Standards for Nuclear Power Operations, requires controlling dose to any member of the public due to all radiation sources from the uranium fuel cycle below 25 mrem to the whole body, 75 mrem to the thyroid and 25 mrem to any other organ. These limits apply to dose in the general environment outside of the site boundary due to effluents in addition to other sources of dose from the uranium fuel cycle that impact members of the public. In the case of Monticello Nuclear Generating Plant, no other nearby uranium fuel cycle sources are present and only doses due to effluents, direct radiation from the reactor and steam turbines and direct radiation due to the ISFSI are included in the assessment.

In order to determine the maximum exposed individual, it is necessary to determine whether direct radiation dose due to plant operations has been detected outside of the site boundary. MNGP has analyzed the 2017 REMP TLD data using methodology based on ANSI/HPS N13.37-2014 (Ref. (4)) and has found that direct radiation dose was not detected for any REMP TLD during 2017. Attachment B summarizes the REMP TLD data for 2017. See Direct Radiation Dose below on pg. 15 for more information on REMP TLDs.

Therefore, the Likely Most-Exposed Member of the Public would be the Critical Receptor identified in the 2017 Land Use Census. Doses due to Iodines, Tritium, Carbon-14, Particulates with > 8-day half-life, and Noble Gases were summed to determine total dose due to gaseous effluents, and the results are reported in Table 6.

TABLE 6: TOTAL DOSE DUE TO ALL URANIUM FUEL CYCLE SOURCES (40 CFR 190)

Dose Type	Organ	Dose	40 CFR 190 Limits	% of Limit
Direct Radiation Dose*	All	Not detected	-	0.00%
Noble Gases	Whole Body	0.0070 mrem	-	0.03%
	Skin	0.0213 mrem	-	0.09%
Particulates, Iodines, Tritium and Carbon-14	Whole Body	0.0102 mrem	-	0.04%
	Thyroid	0.115 mrem	-	0.15%
	Max Other Organ (Bone)	0.0319 mrem	-	0.13%
<b>Total Dose **</b>	<b>Whole Body</b>	<b>0.0172 mrem</b>	<b>25 mrem</b>	<b>0.07%</b>
	<b>Thyroid</b>	<b>0.122 mrem</b>	<b>75 mrem</b>	<b>0.16%</b>
	<b>Max Other Organ (Bone)</b>	<b>0.0389 mrem</b>	<b>25 mrem</b>	<b>0.16%</b>

\* Based on REMP TLD Results, as discussed in the Environmental Monitoring Section below.

\*\* For the Critical Receptor identified in Table 1, above. Because Direct (TLD) dose is 0.0, then this represents the likely most-exposed individual. Doses in **bold** include contributions due to Iodines, Particulates, Tritium, Carbon-14, and Noble Gases.

## SUPPLEMENTAL INFORMATION:

---

### ABNORMAL RELEASES/DISCHARGES

---

One abnormal release of radioactive liquid occurred on April 27, 2017. The Abnormal Discharge was due to contamination in a valve and piping that supply demineralized water that is used for flushing the Service Water Radiation Monitor. The contamination was most likely caused by having a hose connected between a contaminated system and the demineralized water system when power was lost to the demineralized water transfer pumps during performance of Alternate Shutdown System (ASDS) testing during a Refueling Outage, allowing backflow of contaminated water into a portion of the demineralized water piping. When the Service Water Radiation Monitor was back flushed, slightly contaminated water was discharged through the monitor plumbing. The water in this system is eventually released to the Mississippi River via the Discharge Canal.

The amount of activity released due to this contamination event could not be accurately quantified due to its unanticipated and transient nature; a bounding assessment was used to determine the maximum amount of activity that could have been released during the event. The water supply upstream of the contaminated valve was sampled and found to be uncontaminated; this indicated that the maximum volume of piping contaminated would have been approximately 15 gallons. Because it is not known how much the contamination had been diluted in the demineralized water that was contained in the piping, it was assumed that the concentration was that of reactor water. The actual volume and activity released was far lower than the bounding assumption, based on the relatively brief response on the radiation monitor (~1-2 minutes total) and the relatively small magnitude of the spike to ~12 counts per second (cps); with full concentration reactor coolant the expected response would have been approximately 2,000-3,000 cps. The spike did not result in an alarm on the radiation monitor because the setpoint for the Service Water Radiation Monitor is maintained at 20 cps. The spike occurred at approximately 13:00 on 4/27/17, but was not discovered until approximately 18:30 during a review of the previous shift's data. Effluent grab samples at the Service Water Radiation Monitor and at the Discharge Canal were taken when the release was discovered, approximately 8 hours after the spike, and indicated no detectible activity at that time. No increase in measured activity was visible on the Discharge Canal Radiation Monitor due to the release.

Bounding concentrations of gamma-emitting nuclides released were determined based on Fuel Pool/Reactor Coolant isotopic analysis from 4/28/2017. Hard-to-detect nuclides Fe-55, Sr-89, and Sr-90 were estimated using scaling factors for Co-60 and Cs-137 based on solid radioactive waste characterization analyses for Reactor Water Cleanup resin (10 CFR 61 analysis). It was assumed the 56.8 liters of reactor coolant were released over 2 minutes, based on piping volume and radiation monitor response. Dilution of activity by Service Water flow (1.35E+4 gpm) was used in determining concentration entering the Discharge Canal. Additional dilution by the volume of water contained in the discharge canal would further drop concentrations prior to entering the Mississippi River; however, this additional dilution was not included in determination of compliance with effluent concentration limits. The dose calculations are based on the effluent concentration, and therefore, are very conservative in this case. As reported above, the dose impact for this bounding assessment was 4.87E-4 mrem to the Whole Body and 1.03E-3 mrem to the Max Organ (Liver) due to consumption of freshwater fish. Actual doses received would have been very small due to additional dilution and the short period of release in

this case. Drinking water exposure was also considered, but indicated smaller calculated doses than the Freshwater Fish pathway. Other pathways (such as irrigation) were not applicable during this release.

Corrective actions taken following this event included replacement of piping and valves that were contaminated and procedure changes to ensure that demineralized water hoses are disconnected from contaminated systems prior to tests that remove power to the demineralized water transfer pumps (potentially allowing backflow into the demineralized water system). The Minnesota Pollution Control Agency was notified of the release due to non-compliance with requirements in MNGP's National Pollutant Discharge Elimination System (NPDES) permit on 4/28/2017 and the NRC was notified by R3DO of 'an event where notification to other government agencies has been made' at 21:21 on 4/28/2017.

TABLE 7: BOUNDING CONCENTRATIONS OF RADIOACTIVE ISOTOPES FROM 4/27/2017 ABNORMAL DISCHARGE.

Isotope	Initial Concentration (μCi/mL)	Total Activity (μCi)	Tech Spec limit (μCi/mL)	Concentration Entering Canal (μCi/mL)	% of Tech Spec 5.5.3.b. limit at canal
H-3	5.00E-03	2.84E+02	1.00E-02	2.78E-06	0.03%
I-132	2.23E-06	1.27E-01	1.00E-03	1.24E-09	0.00%
Cr-51	1.47E-04	8.35E+00	5.00E-03	8.18E-08	0.00%
Mn-54	1.11E-04	6.30E+00	3.00E-04	6.17E-08	0.02%
Fe-55	1.64E-04	9.32E+00	1.00E-03	9.12E-08	0.01%
Fe-59	1.02E-05	5.79E-01	1.00E-04	5.67E-09	0.01%
Co-58	6.28E-05	3.57E+00	2.00E-04	3.49E-08	0.02%
Co-60	2.59E-04	1.47E+01	3.00E-05	1.44E-07	0.48%
Zn-65	5.22E-04	2.96E+01	5.00E-05	2.90E-07	0.58%
Sr-89	7.51E-06	4.27E-01	8.00E-05	4.18E-09	0.01%
Sr-90	3.37E-07	1.91E-02	5.00E-06	1.87E-10	0.00%
Tc-99m	4.74E-06	2.69E-01	1.00E-02	2.64E-09	0.00%
Sb-122	1.71E-06	9.71E-02	1.00E-04	9.51E-10	0.00%
Sb-124	1.75E-05	9.94E-01	7.00E-05	9.73E-09	0.01%
Sb-125	3.16E-06	1.79E-01	3.00E-04	1.76E-09	0.00%
Cs-137	1.59E-05	9.03E-01	1.00E-05	8.84E-09	0.09%
Ta-182	6.71E-06	3.81E-01	1.00E-04	3.73E-09	0.00%
Re-188	2.98E-06	1.69E-01	2.00E-04	1.66E-09	0.00%
				Total TS Limit Ratio	1.23%

## ENVIRONMENTAL MONITORING

---

The REMP at MNGP provides additional assurance that there are no significant dose or environmental impacts due to operation of the plant. The MNGP ODCM specifies REMP requirements, including TLD samples for direct radiation exposure, Water Samples (Surface, Ground, and Drinking Water sources), Air sampling for Particulate and Iodine radionuclides, Vegetation and Milk sampling, and sampling of Shoreline Sediments, Fish and Invertebrates. REMP sampling continues to indicate that radionuclides in the environment due to operation of MNGP remain below detectable levels. Complete results and analyses for MNGP REMP Sampling in 2017 are available in the 2017 AREOR for MNGP (Ref. (5)).

### CHANGES IN LAND USE AND NON-OBTAINABLE MILK OR VEGETABLE SAMPLES

---

There were no changes in land use resulting in changes to the REMP sampling program.

Milk samples were not available during 2017 because no milk animals have been located within 5 miles of MNGP during the 2014 through 2017 Land Use Censuses. All required compensatory vegetation sampling in lieu of milk sampling was performed and samples were analyzed according to ODCM-07.01, Table 1.

Corn and Potato sampling was not required because no liquid discharges were made during the growing season. Additionally, the Land Use Census found that there are no water use permits for irrigation using water from the Mississippi River within 5 miles downstream of the plant.

## DIRECT RADIATION DOSE MONITORING

---

TLDs are stationed around MNGP to measure the ambient gamma radiation field. Monitoring stations are placed near the site boundary and approximately five (5) miles from the reactor, in locations representing sixteen (16) compass sectors. Other locations are chosen to measure the radiation field at places of special interest such as nearby residences, meeting places and population centers. Control sites are located farther than ten (10) miles from the site, in areas that will not be affected by plant operations.

In order to reliably determine whether direct radiation dose due to plant operation has been detected at or beyond the site boundary, Monticello has begun to analyze REMP TLD's using methodology based on ANSI/HPS N13.37-2014 (Reference (4)), starting with the 2015 ARERR. This methodology uses the historical average background TLD dose for each location and the Minimum Differential Dose (MDD) based on the performance of the TLD system to determine if a statistically significant dose due to plant operation has been detected. A table summarizing the 2017 TLD analysis is presented in Attachment B (pg. 28). Complete results for the REMP TLDs are also reported in the AREOR.

Historically, the site has used guidance from NUREG-0543, METHODS FOR DEMONSTRATING LWR COMPLIANCE WITH THE EPA URANIUM FUEL CYCLE STANDARD (40 CFR PART 190), which states in Section IV, "As long as a nuclear plant site operates at a level below the Appendix I reporting requirements, no extra analysis is required to demonstrate compliance with 40 CFR Part 190". This statement remains true, assuming that there are no potentially significant sources of direct radiation dose. With the inclusion of spent fuel storage onsite (ISFSI), it is necessary to verify that direct radiation does not reach a level that would cause the total dose to exceed the 40 CFR 190 limits. Hence, the more reliable ANSI/HPS methodology was implemented in order to determine direct radiation dose moving forward.

The ISFSI at Monticello Nuclear Generating Plant was constructed west of the plant in 2007. The initial loading campaign was completed in 2008 with 10 Horizontal Storage Modules (HSM's) loaded with spent fuel. In 2013 an additional five HSM's were loaded with spent fuel. In 2016 one additional HSM was moved out to the ISFSI, bringing the total number of stored modules to 16.

## GROUNDWATER PROTECTION PROGRAM (GWPP)

Onsite groundwater is monitored at MNGP in accordance with the guidance presented in NEI 07-07 (Reference (6)). This initiative was developed by NEI and nuclear industry stakeholders to address a gap in industry guidance and practices for monitoring groundwater and responding to inadvertent releases of radioactive material with the potential to contaminate groundwater. The initiative sets forth voluntary requirements for evaluating and monitoring Systems, Structures and Components (SSCs) with a high risk of contaminating groundwater. Additionally, the guidance specifies reporting requirements for onsite groundwater sample results that exceed REMP reporting thresholds and that all onsite groundwater results are reported in either the ARERR (Effluent) or AREOR (REMP) reports.

Prior to 2015, all groundwater sample results were reported in the REMP report. It was determined that onsite groundwater monitoring results are more appropriately reported in the Effluent report, while the REMP well water sample results belong in the REMP report. For 2015, the results for onsite groundwater monitoring wells were reported in both reports. The onsite groundwater monitoring well results will be exclusively reported in the ARERR for reports covering 2016 and beyond.

The current groundwater monitoring program includes 19 wells at 15 different locations. Four of the locations include a “nested” configuration, where one sample is taken at the level of the water table (GWPP locations ending with an A) while a second sample can be taken from deeper water (GWPP locations ending with a B). A Map of groundwater sample locations is provided in Attachment C (pg. 29).

The wells are sampled at different frequencies depending on how likely they are to include non-natural activity; Table 8 summarizes the current sampling frequencies for groundwater monitoring wells at MNGP. Wells that have historically read only at background levels and are unlikely to become contaminated are monitored once annually for tritium and gamma-emitting nuclides. Wells that have historically indicated tritium near background levels but are more likely to include activity from leaks or spills are monitored quarterly for tritium and gamma-emitting nuclides. The remaining wells are monitored more frequently to ensure that high-risk SSCs are adequately monitored and that existing activity is characterized with sufficient resolution; these wells are monitored monthly for tritium and quarterly for gamma-emitting nuclides. Several wells are considered sentinel wells that would indicate if radioactive material were migrating offsite into the Mississippi River; these wells are indicated in **bold** in Table 8, below.

TABLE 8: GROUNDWATER MONITORING WELL SAMPLING FREQUENCIES.

Tritium Sampling Frequency	Number of Monitoring Wells	Groundwater Monitoring Well Identities Locations in <b>bold</b> typeface are considered sentinel wells.
Quarterly	8	MW-1, <b>MW-2, MW-3, MW-4</b> , MW-9B, MW-11, MW-12A, MW-12B
Monthly	7	MW-9A, MW-10, MW-13A, MW-13B, <b>MW-14, MW-15A, MW-15B</b>
Annual	4	MW-5, MW-6, MW-7, MW-8

Water depths are determined at all 19 wells on a monthly basis and the data is used to determine static water levels. It has been noted that groundwater generally flows toward the river, but there are fluctuations in the gradient and periods of flow reversal have been observed when river level is particularly high.

Additional sampling performed under the guidance of the GWPP includes sampling water from storm drains. These samples periodically indicate elevated tritium activities due to recapture of tritium from gaseous effluents. Rain and snow samples taken onsite indicate that tritium is commonly detected in rain water at concentrations ranging from approximately 200 pCi/l to nearly 1,000 pCi/l. The highest detected concentrations of tritium in rain and snow samples around MNGP have approached 2,000 pCi/l.

Historically, monitoring Well MW-9A has indicated elevated tritium levels that vary seasonally since 2009. It is understood that there is likely a plume of water containing tritium under the Turbine Building that moves tritium activity into, and out from, the monitoring well depending upon the hydraulic gradient at the time of sampling; the plume is considered to be stagnant under the turbine building, based on results from surrounding wells. Evidence indicates that the activity in the plume originated from process water containing tritium that migrated through the turbine building concrete base mat. Potential sources of tritium were thoroughly evaluated in the Corrective Action Program and all identified sources that were potentially contributing tritium to the turbine building base mat were corrected during the 2011 refueling outage. Corrective actions taken included lining sumps and discontinuing use of embedded piping that were identified as potential sources of the tritium found in the plume.

Tritium is also regularly identified in samples from MW-10. Levels of tritium activity in this well are more consistent throughout the year and at a significantly lower level than the levels of activity observed in MW-9A. All samples from MW-10 for 2017 contained tritium concentrations of less than 300 pCi/l.

Results for 2017 indicate that monitoring well MW-9A contained tritium activities ranging from  $5,306 \pm 225$  pCi/l to  $<153$  pCi/l; this peak concentration is comparable to, but slightly lower than, the peak concentrations in 2014, 2015, and 2016 ( $5,911 \pm 279$  pCi/l,  $6,493 \pm 237$  pCi/l, and  $6,559 \pm 242$  pCi/l, respectively). Monitoring well MW-10 indicates results ranging from  $293 \pm 90$  pCi/l to  $<151$  pCi/l and is also consistent with 2014, 2015, and 2016 results for this well. All other monitoring wells indicated activities that were less than 300 pCi/l. No gamma emitting isotopes were identified in groundwater samples during 2017. The full results for 2017 onsite groundwater well monitoring are presented in Attachment D (pg. 31).

The Lower Limit of Detection (LLD) for groundwater monitoring of tritium at MNGP during 2017 was less than 300 pCi/l, in accordance with station processes and procedures; this LLD is far below the required REMP LLD (2,000 pCi/l) and very far below the REMP reporting threshold for water samples (20,000 pCi/l). The site has chosen to use this low LLD in order to quickly identify and characterize any potential contamination sources. The LLD as reported represents the activity at which there is a 95% chance that a sample containing that level of activity would be characterized as detected with only a 5% chance that the sample would be characterized as a blank.

The Xcel Energy Groundwater Monitoring Program (Ref. (7)) has established a Baseline Threshold Level for tritium, defined as the 95% Confidence Level determined using Student's t and a statistical mean of ten or more sample results; at this level a sample would be considered to be statistically different from background, based on analytical results. For wells that consistently indicate near or below LLD, the Baseline Threshold Level is 400 pCi/l. The program also provides an Action Level of 3-times the Baseline Threshold Level, or 1200 pCi/l for these wells; at this level, additional action is taken to evaluate the cause of the change in activity and work through the Corrective Action process to address the concern.

No statistically significant concentrations of tritium were identified in sentinel wells in 2017; therefore no tritium discharge to ground water is reported.

### RADIOACTIVE SOLID WASTE DISPOSAL

During 2017, a total of 57.1 Ci of Solid, Class-A, Low-Level Radioactive waste was shipped offsite for disposal. A total of 13 shipments were made to three locations. Tables summarizing types and quantities of waste shipped are included in Attachment A, Table 14.

### EFFLUENT RADIATION MONITORS OUT OF SERVICE FOR GREATER THAN 30 DAYS

There were no effluent radiation monitors with fewer than the required number of channels Functional for greater than 30 days during 2017.

### CHANGES TO THE ODCM

There were two changes to sections of the ODCM during 2017. The ODCM including all changes through 2017 is included as Enclosure 2 with this report. Below is a summary of the significant changes.

ODCM Section (Rev)	Effective Date	Significant Changes
ODCM-04.01 (Rev. 4) Liquid Effluent Calculations	6/13/17	- Added radiation monitor efficiency values to the setpoint calculation sections and made minor editorial changes to efficiency definitions. - Added default setpoint calculation examples as Tables 3-6 and additional columns in Table 1.
ODCM-05.01 (Rev. 11) Gaseous Effluent Calculations	6/13/2017	- Added default setpoint calculation examples as Tables 26-27

### CHANGES TO THE PROCESS CONTROL PROGRAM (PCP)

There were no changes to the PCP in 2017.

### CORRECTIONS TO PREVIOUS ARERRS

There were no corrections to previous ARERRs in 2017.



## REFERENCES

---

1. *NCRP Report No. 160: Ionizing Radiation Exposure of the Population of the United States*. Bethesda, MD : National Council on Radiation Protection and Measurements, 2009.
2. *Regulatory Guide 1.109, Rev. 1: Calculation of Annual Doses to Man from Routine Releases of Reactor Effluents for the Purpose of Evaluating Compliance with 10 CFR 50, Appendix I*. Washington, D.C. : U.S. Nuclear Regulatory Commission, 1977.
3. **Burke, W. C. and Congel, F. J.** *NUREG-0133: Preparation of Radiological Effluent Technical Specifications for Nuclear Power Plants*. Washington D.C. : US Nuclear Regulatory Commission, 1978.
4. *ANSI/HPS N13.37-2014: Environmental Dosimetry - Criteria for System Design and Implementation*. McLean, VA : Health Physics Society, 2014.
5. **Environmental, Inc. Midwest Laboratory.** *2017 Annual Radiological Environmental Operating Report for Monticello Nuclear Generating Plant*. Monticello, MN : Xcel Energy, 2018.
6. *NEI 07-07: Industry Ground Water Protection Initiative - Final Guidance Document*. Washington, DC : Nuclear Energy Institute, 2007.
7. *FP-CY-GWPP-01, "Fleet Groundwater Protection Program"*. Minneapolis, MN : Xcel Energy (internal procedure), 2016.
8. **Braegelmann, Jon and Carlson, Wade A.** *2017 Annual Groundwater Monitoring Report - Monticello Nuclear Generating Plant*. Lino Lakes, MN : Carlson McCain, Inc., 2018.
9. *Offsite Dose Calculation Manual for Monticello Nuclear Generating Plant*. Monticello, MN : Xcel Energy.
10. Boiling Water Reactors (BWRs). *U.S. NRC Homepage, Nuclear Reactors*. [Online] January 15, 2015. [Cited: April 11, 2016.] <http://www.nrc.gov/reactors/bwrs.html>.
11. **Stefan-XP.** Wikimedia Commons. *Kernspaltung.svg (Nuclear fission of Uranium 235)*. [Online] November 23, 2009. [Cited: April 16, 2016.] <https://commons.wikimedia.org/w/index.php?curid=8540436>.

---

## ATTACHMENT A: 2017 ARERR RELEASE SUMMARY TABLES

---

### Covering the Operating Period of Jan – Dec 2017

**Facility:** Monticello Nuclear Generating Plant

**Licensee:** Xcel Energy

**License Number:** DPR-22

#### 1. Regulatory Limits

- a. Fission and activation gases:
  - 1. **Quarterly** dose at or beyond the site boundary
    - 5 mrad gamma radiation
    - 10 mrad beta radiation
  - 2. **Annual** dose at or beyond the site boundary
    - 10 mrad gamma radiation
    - 20 mrad beta radiation
- b. Iodine-131, Iodine-133, Tritium and Particulates, half-lives >8 days:
  - 1. **Quarterly**
    - 7.5 mrem to any organ
  - 2. **Annual**
    - 15 mrem to any organ
- c. Liquid Effluents:
  - 1. **Quarterly:**
    - 1.5 mrem total body
    - 5 mrem to any organ
  - 2. **Annual:**
    - 3 mrem total body
    - 10 mrem to any organ

#### 2. Maximum Permissible Concentrations

- a. Fission and Activation Gases:
  - 10 CFR 20, Appendix B, Table 2, Column 1
- b. Iodine-131, Iodine-133, Tritium and Particulates, half-lives >8 days:
  - 10 CFR 20, Appendix B, Table 2, Column 1
- c. Liquid effluents:
  - 10 times 10 CFR 20, Appendix B, Table 2, Column 2
  - 2.0E-4 µCi/ml for dissolved and entrained gases

#### 3. Average Energy

(Not Applicable)

**4. Measurements and Approximations of Total Radioactivity**

a. **Noble Gases :**

Continuous gross activity monitors in Reactor Building Vent and Plant Stack exhaust streams. Weekly isotopic analysis of exhaust streams.

b. **Iodines in Gaseous Effluent :**

Continuous monitoring with charcoal cartridges in Reactor Building Vent and Plant Stack exhaust streams with weekly analysis.

c. **Particulates in Gaseous Effluent :**

Continuous monitoring with particulate filters in Reactor Building Vent and Plant Stack exhaust streams with weekly analysis.

d. **Tritium in Gaseous Effluent:**

Monthly grab samples from Reactor Building Vent and Plant Stack exhaust streams.

e. **Liquid Effluents**

Tank sample analyzed prior to each planned release and continuous monitoring of gross activity during planned release.

**5. Batch Releases**

a. **Liquid**

1. Number of batch Releases	1	
2. Total time period for batch releases	1.5	min
3. Maximum time period for a batch release	1.5	min
4. Average time period for a batch release	1.5	min
5. Minimum time period for a batch release	1.5	min
6. Average river flow during release	8.67E+5	cfm

b. **Gaseous**

1. Number of batch Releases	3	
2. Total time period for batch releases	2422	min
3. Maximum time period for a batch release	1651	min
4. Average time period for a batch release	807	min
5. Minimum time period for a batch release	280	min

**6. Abnormal Releases**

a. **Liquid**

1. Number of releases:	1	
2. Total activity released:	3.60E-4	Ci

b. **Gaseous**

1. Number of releases:	0	
2. Total activity released:	0	Ci

Table 9: Gaseous Effluents – Summation of All Releases (RG-1.21 Table 1A)

Type of Effluent	Units	Qtr 1	Qtr 2	Qtr 3	Qtr 4	Est. Total Error, %
<b>A. Fission &amp; Activation Gases</b>						
1. Total Release	Curies	2.41E+02	1.40E+02	1.36E+02	1.00E+02	3.50E+01
2. Average Release Rate for Period	µCi/sec	3.10E+01	1.78E+01	1.71E+01	1.26E+01	
3. Percent of Applicable Limit	%	N/A	N/A	N/A	N/A	
<b>B. Iodines</b>						
1. Total Iodine-131	Curies	3.54E-03	2.53E-03	1.71E-03	1.37E-03	3.20E+01
2. Total Iodines (131, 133 & 135)	Curies	1.10E-01	2.88E-02	2.87E-02	2.13E-02	
3. Average Release Rate for Period	µCi/sec	1.41E-02	3.66E-03	3.61E-03	2.68E-03	
4. Percent of Applicable Limit	%	N/A	N/A	N/A	N/A	
<b>C. Particulates</b>						
1. Total Particulates (Half-lives > 8 days)	Curies	3.86E-04	7.92E-04	1.74E-04	1.28E-04	3.90E+01
2. Average Release Rate for Period	µCi/sec	4.97E-05	1.01E-04	2.18E-05	1.61E-05	
3. Percent of Applicable Limit	%	N/A	N/A	N/A	N/A	
4. Gross Alpha Activity	Curies	4.47E-07	3.99E-07	6.16E-07	3.90E-07	2.90E+01
<b>D. Tritium</b>						
1. Total Release	Curies	3.57E+00	3.60E+00	3.46E+00	4.27E+00	3.30E+01
2. Average Release Rate for Period	µCi/sec	4.59E-01	4.58E-01	4.36E-01	5.37E-01	
3. Percent of Applicable Limit	%	N/A	N/A	N/A	N/A	
<b>E. Carbon-14</b>						
1. Total Release	Curies	2.02E+00	1.15E+00	1.80E+00	1.79E+00	N/A

Table 10: Gaseous Effluents - Elevated Releases (RG-1.21 Table 1B)

		Continuous Mode				Batch Mode			
Nuclides Released	Units	Qtr 1	Qtr 2	Qtr 3	Qtr 4	Qtr 1	Qtr 2	Qtr 3	Qtr 4
<b>1. Fission and Activation Gases</b>									
Ar-41	Curies	1.45E-01	3.71E-01	1.57E-01	0.00E+00	0.00E+00	4.39E-03	0.00E+00	0.00E+00
Kr-85M	Curies	1.86E+00	4.43E+00	1.60E+00	1.60E-01	0.00E+00	0.00E+00	0.00E+00	0.00E+00
Kr-87	Curies	4.79E+00	9.33E+00	2.47E+00	1.27E+00	0.00E+00	0.00E+00	0.00E+00	0.00E+00
Kr-88	Curies	4.57E+00	1.24E+01	3.36E+00	2.64E-01	0.00E+00	0.00E+00	0.00E+00	0.00E+00
Xe-133	Curies	3.79E+01	3.36E+01	1.80E+01	1.55E+01	0.00E+00	3.13E-03	0.00E+00	0.00E+00
Xe-133m	Curies	6.13E-01	1.07E+00	1.36E-01	2.94E-01	0.00E+00	0.00E+00	0.00E+00	0.00E+00
Xe-135	Curies	2.03E+01	3.72E+01	1.82E+01	2.72E+00	0.00E+00	2.16E-03	0.00E+00	0.00E+00
Xe-135m	Curies	1.75E+01	4.22E+00	1.04E+01	8.64E+00	0.00E+00	0.00E+00	0.00E+00	0.00E+00
Xe-137	Curies	1.02E+02	2.60E+01	5.87E+01	4.89E+01	0.00E+00	0.00E+00	0.00E+00	0.00E+00
Xe-138	Curies	4.16E+01	1.15E+01	2.27E+01	2.15E+01	0.00E+00	0.00E+00	0.00E+00	0.00E+00
<b>Total for Period</b>	<b>Curies</b>	<b>2.32E+02</b>	<b>1.40E+02</b>	<b>1.36E+02</b>	<b>9.92E+01</b>	<b>0.00E+00</b>	<b>9.67E-03</b>	<b>0.00E+00</b>	<b>0.00E+00</b>
<b>2. Iodines</b>									
I-131	Curies	1.65E-03	9.57E-04	1.51E-03	1.10E-03	0.00E+00	0.00E+00	0.00E+00	0.00E+00
I-133	Curies	1.20E-02	6.04E-03	1.03E-02	7.18E-03	0.00E+00	0.00E+00	0.00E+00	0.00E+00
I-135	Curies	1.94E-02	8.96E-03	1.51E-02	1.05E-02	0.00E+00	0.00E+00	0.00E+00	0.00E+00
<b>Total for Period</b>	<b>Curies</b>	<b>3.30E-02</b>	<b>1.60E-02</b>	<b>2.69E-02</b>	<b>1.87E-02</b>	<b>0.00E+00</b>	<b>0.00E+00</b>	<b>0.00E+00</b>	<b>0.00E+00</b>
<b>3. Particulates</b>									
Ba-140	Curies	1.16E-04	9.28E-05	9.08E-05	6.33E-05	0.00E+00	0.00E+00	0.00E+00	0.00E+00
Co-58	Curies	0.00E+00	2.09E-07	0.00E+00	0.00E+00	0.00E+00	0.00E+00	0.00E+00	0.00E+00
Co-60	Curies	0.00E+00	1.51E-06	0.00E+00	0.00E+00	0.00E+00	9.12E-09	0.00E+00	0.00E+00
Cr-51	Curies	0.00E+00	2.22E-06	0.00E+00	0.00E+00	0.00E+00	0.00E+00	0.00E+00	0.00E+00
Cs-137	Curies	3.27E-06	7.67E-06	2.72E-07	0.00E+00	0.00E+00	0.00E+00	0.00E+00	0.00E+00
Mn-54	Curies	0.00E+00	3.92E-07	0.00E+00	0.00E+00	0.00E+00	0.00E+00	0.00E+00	0.00E+00
Sr-89	Curies	5.76E-05	2.74E-04	2.97E-05	1.33E-05	0.00E+00	0.00E+00	0.00E+00	0.00E+00
Sr-90	Curies	1.33E-07	2.16E-07	1.71E-07	1.40E-07	0.00E+00	0.00E+00	0.00E+00	0.00E+00
Zn-65	Curies	0.00E+00	2.58E-07	0.00E+00	0.00E+00	0.00E+00	0.00E+00	0.00E+00	0.00E+00
<b>Total for Period</b>	<b>Curies</b>	<b>1.77E-04</b>	<b>3.79E-04</b>	<b>1.21E-04</b>	<b>7.67E-05</b>	<b>0.00E+00</b>	<b>9.12E-09</b>	<b>0.00E+00</b>	<b>0.00E+00</b>
<b>4. Tritium</b>									
H-3	Curies	8.12E-01	5.55E-01	1.02E+00	7.10E-01	0.00E+00	1.30E-02	0.00E+00	0.00E+00
<b>5. Carbon-14</b>									
C-14	Curies	2.02E+00	1.15E+00	1.80E+00	1.79E+00	0.00E+00	0.00E+00	0.00E+00	0.00E+00



Table 12: Liquid Effluents - Summation of All Releases (RG-1.21 Table 2A)

Type of Effluent	Units	Qtr 1	Qtr 2	Qtr 3	Qtr 4	Est. Total Error, %
<b>A. Fission &amp; Activation Products</b>						
1. Total Release (not including Tritium, Gases, and Alpha)	Curies	0.00E+00	7.60E-05	0.00E+00	0.00E+00	N/A*
2. Average Diluted Concentration During Period	µCi/ml	0.00E+00	9.91E-07	0.00E+00	0.00E+00	
3. Percent of Applicable Limit	%	0.00E+00	1.52E-03	0.00E+00	0.00E+00	
<b>B. Tritium</b>						
1. Total Release	Curies	0.00E+00	2.84E-04	0.00E+00	0.00E+00	N/A*
2. Average Diluted Concentration During Period	µCi/ml	0.00E+00	3.70E-06	0.00E+00	0.00E+00	
3. Percent of Applicable Limit	%	0.00E+00	3.70E-01	0.00E+00	0.00E+00	
<b>C. Dissolved and Entrained Gases</b>						
1. Total Release	Curies	0.00E+00	0.00E+00	0.00E+00	0.00E+00	N/A*
2. Average Diluted Concentration During Period	µCi/ml	0.00E+00	0.00E+00	0.00E+00	0.00E+00	
3. Percent of Applicable Limit	%	0.00E+00	0.00E+00	0.00E+00	0.00E+00	
<b>D. Gross Alpha Radioactivity</b>						
1. Total Release	Curies	0.00E+00	0.00E+00	0.00E+00	0.00E+00	N/A*
<b>E. Waste Volume Released (Pre-Dilution)</b>						
E. Waste Volume Released (Pre-Dilution)	Liters	0.00E+00	5.68E+01	0.00E+00	0.00E+00	N/A*
<b>F. Volume of Dilution Water Used</b>						
F. Volume of Dilution Water Used	Liters	0.00E+00	7.66E+04	0.00E+00	0.00E+00	N/A*

\* Quantities released are based on a bounding assessment in order to demonstrate compliance. Actual quantities of liquid radioactivity released are likely significantly smaller than the quantities reported in this section.

Table 13: Liquid Effluents (RG-1.21 Table 2B)

Nuclides Released	Units	Continuous Mode				Batch Mode			
		Qtr 1	Qtr 2	Qtr 3	Qtr 4	Qtr 1	Qtr 2*	Qtr 3	Qtr 4
Co-58	Curies	0.00E+00	0.00E+00	0.00E+00	0.00E+00	0.00E+00	3.57E-06	0.00E+00	0.00E+00
Co-60	Curies	0.00E+00	0.00E+00	0.00E+00	0.00E+00	0.00E+00	1.47E-05	0.00E+00	0.00E+00
Cr-51	Curies	0.00E+00	0.00E+00	0.00E+00	0.00E+00	0.00E+00	8.35E-06	0.00E+00	0.00E+00
Cs-137	Curies	0.00E+00	0.00E+00	0.00E+00	0.00E+00	0.00E+00	9.03E-07	0.00E+00	0.00E+00
Fe-55	Curies	0.00E+00	0.00E+00	0.00E+00	0.00E+00	0.00E+00	9.31E-06	0.00E+00	0.00E+00
Fe-59	Curies	0.00E+00	0.00E+00	0.00E+00	0.00E+00	0.00E+00	5.79E-07	0.00E+00	0.00E+00
H-3	Curies	0.00E+00	0.00E+00	0.00E+00	0.00E+00	0.00E+00	2.84E-04	0.00E+00	0.00E+00
I-132	Curies	0.00E+00	0.00E+00	0.00E+00	0.00E+00	0.00E+00	1.27E-07	0.00E+00	0.00E+00
Mn-54	Curies	0.00E+00	0.00E+00	0.00E+00	0.00E+00	0.00E+00	6.30E-06	0.00E+00	0.00E+00
Re-188	Curies	0.00E+00	0.00E+00	0.00E+00	0.00E+00	0.00E+00	1.69E-07	0.00E+00	0.00E+00
Sb-122	Curies	0.00E+00	0.00E+00	0.00E+00	0.00E+00	0.00E+00	9.71E-08	0.00E+00	0.00E+00
Sb-124	Curies	0.00E+00	0.00E+00	0.00E+00	0.00E+00	0.00E+00	9.94E-07	0.00E+00	0.00E+00
Sb-125	Curies	0.00E+00	0.00E+00	0.00E+00	0.00E+00	0.00E+00	1.79E-07	0.00E+00	0.00E+00
Sr-89	Curies	0.00E+00	0.00E+00	0.00E+00	0.00E+00	0.00E+00	4.26E-07	0.00E+00	0.00E+00
Sr-90	Curies	0.00E+00	0.00E+00	0.00E+00	0.00E+00	0.00E+00	1.91E-08	0.00E+00	0.00E+00
Ta-182	Curies	0.00E+00	0.00E+00	0.00E+00	0.00E+00	0.00E+00	3.81E-07	0.00E+00	0.00E+00
Tc-99m	Curies	0.00E+00	0.00E+00	0.00E+00	0.00E+00	0.00E+00	2.69E-07	0.00E+00	0.00E+00
Zn-65	Curies	0.00E+00	0.00E+00	0.00E+00	0.00E+00	0.00E+00	2.96E-05	0.00E+00	0.00E+00
Total for Period	Curies	0.00E+00	0.00E+00	0.00E+00	0.00E+00	0.00E+00	3.60E-04	0.00E+00	0.00E+00

\* Quantities released are based on a bounding assessment in order to demonstrate compliance. Actual quantities of liquid radioactivity released are likely significantly smaller than the quantities reported in this section.



Table 14: Solid Waste and Irradiated Fuel Shipments (RG-1.21 Table 3)

**A. Solid Waste Shipped Offsite for Burial or Disposal**

1. Type of waste	Waste Class	Unit	1/1/2017 – 12/31/2017	Est. Total Error, %	Major Nuclides for this waste type:
a. Spent Resins, Filters, and Evaporator Bottoms	A	ft <sup>3</sup> m <sup>3</sup> Ci	6.80E+02 1.93E+01 5.68E+01	2.50E+01	H-3, C-14, Cr-51, Mn-54, Fe-55, Co-58, Co-60, Ni-59, Ni-63, Zn-65, Sr-90, Tc-99, I-129, I-131, Cs-137, Pu-238, Pu-239, Pu-241, Am-241, Cm-242, Cm-243
b. Dry Active Waste (DAW)	A	ft <sup>3</sup> m <sup>3</sup> Ci	1.30E+04 3.67E+02 2.95E-01	2.50E+01	H-3, C-14, Cr-51, Mn-54, Fe-55, Co-58, Co-60, Ni-63, Zn-65, Sr-90, Tc-99, I-129, Cs-137, Ce-144, Pu-238, Pu-239, Pu-241, Am-241, Cm-242
c. Irradiated Components	NA	ft <sup>3</sup> m <sup>3</sup> Ci	0.00E+00	NA	NA
d. Other Wastes	A	ft <sup>3</sup> m <sup>3</sup> Ci	3.50E+01 9.91 E-01 1.64E-03	2.50E+01	H-3, C-14, Cr-51, Mn-54, Fe-55, Co-58, Co-60, Ni-63, Zn-65, Sr-90, Tc-99, I-129, Cs-137, Ce-144, Am-241, Cm-242
<b>Sum of All Low-Level Waste Shipped from the Site</b>	<b>A</b>	<b>ft<sup>3</sup> m<sup>3</sup> Ci</b>	<b>1.37E+04 3.88E+02 5.71E+01</b>	<b>2.50E+01</b>	<b>H-3, C-14, Cr-51, Mn-54, Fe-55, Co-58, Co-60, Ni-59, Ni-63, Zn-65, Sr-90, Tc-99, I-129, I-131, Cs-137, Ce-144, Pu-238, Pu-239, Pu-241, Am-241, Cm-242, Cm-243</b>

**2. Estimate of major nuclide composition (by type of waste)**

Type of waste	Nuclide Name	Abundance, % (1.0% cutoff)	Activity, Ci
a. Spent Resins, Filters, and Evaporator Bottoms	Cr-51	2.78%	1.58E+00
	Mn-54	6.93%	3.94E+00
	Fe-55	19.02%	1.08E+01
	Co-58	2.43%	1.38E+00
	Co-60	41.03%	2.33E+01
	Ni-63	1.48%	8.43E-01
	Zn-65	13.39%	7.61E+00
b. Dry Active Waste (DAW)	Cs-137	11.41	6.48E+00
	Cr-51	6.36%	1.88E-02
	Mn-54	5.26%	1.55E-02
	Fe-55	16.45%	4.85E-02
	Co-58	1.98%	5.85E-03
	Co-60	46.83%	1.38E-01
	Ni-63	3.36%	9.89E-03
c. Irradiated Components	Zn-65	4.71%	1.39E-02
	Cs-137	12.73%	3.75E-02
	-	-	-
	-	-	-
	-	-	-
d. Other Wastes	Cr-51	5.98%	9.83E-05
	Mn-54	5.49%	9.02E-05
	Fe-55	17.28%	2.84E-04
	Co-58	2%	3.29E-05
	Co-60	48.09%	7.90E-04
	Zn-65	4.90%	8.05E-05
	Cs-137	13.27%	2.18E-04

**3. Solid Waste Disposition**

Number of Shipments	Mode of Transportation	Destination
4	Hittman Transport Services	Energy Solutions LLC CWF Clive Disposal Site Clive, UT
2	Xcel Energy Trucking	Energy Solutions Bear Creek 1560 Bear Creek Road Oak Ridge, TN
7	Xcel Energy Trucking	UniTech Services Group Oak Ridge Service Center Oak Ridge, TN

**B. Irradiated Fuel Shipments (Disposition)**

There were no shipments of irradiated fuel from MNGP in 2017.

## ATTACHMENT B: 2017 REMP TLD DOSE INFORMATION

TABLE 15: 2017 REMP TLD DOSE RESULTS.

	Quarterly Baseline, $B_Q$ (mrem)		Normalized Quarterly Monitoring Data, $M_Q$ (mrem per standard quarter)				Quarterly Facility Dose, $F_Q = M_Q - B_Q$ (mrem)				Annual Baseline, $B_A$ (mrem)	Annual Monitoring Data, $M_A$ (mrem)	Annual Facility Dose, $F_A = M_A - B_A$ (mrem)	
	Q1	Q2-Q4	Q1	Q2	Q3	Q4	Q1	Q2	Q3	Q4				
Inner Ring	M01A	13.2	15.1	17.5	16.0	16.9	16.0	ND	ND	ND	ND	58.5	66.4	ND
	M02A	14.2	16.1	16.3	15.8	16.5	16.4	ND	ND	ND	ND	62.6	65.0	ND
	M03A	13.9	15.7	15.9	15.8	15.1	16.1	ND	ND	ND	ND	61.0	62.9	ND
	M04A	13.1	15.6	14.1	15.7	14.0	16.4	ND	ND	ND	ND	59.8	60.2	ND
	M05A	13.2	15.9	17.1	14.3	16.2	14.7	ND	ND	ND	ND	60.8	62.3	ND
	M06A	14.1	16.1	17.5	17.1	16.4	14.5	ND	ND	ND	ND	62.4	65.5	ND
	M07A	13.9	15.9	15.3	16.2	14.5	16.9	ND	ND	ND	ND	61.4	62.9	ND
	M08A	13.9	15.8	16.3	16.1	16.2	16.1	ND	ND	ND	ND	61.5	64.7	ND
	M09A	14.3	15.8	16.1	14.9	15.4	15.7	ND	ND	ND	ND	61.5	62.1	ND
	M10A	14.3	16.4	15.8	15.4	15.0	16.3	ND	ND	ND	ND	63.4	62.5	ND
	M11A	15.4	16.9	17.5	17.1	17.6	17.2	ND	ND	ND	ND	66.0	69.4	ND
	M12A	15.5	17.1	17.6	16.7	17.1	17.0	ND	ND	ND	ND	66.5	68.4	ND
	M13A	13.6	14.6	16.5	15.4	15.5	15.4	ND	ND	ND	ND	57.3	62.8	ND
	M14A	14.3	16.3	16.0	16.1	15.8	16.2	ND	ND	ND	ND	63.4	64.1	ND
Outer Ring	M01B	14.3	15.4	14.9	15.6	14.9	15.1	ND	ND	ND	ND	60.7	60.5	ND
	M02B	14.6	15.4	15.4	15.1	15.4	14.4	ND	ND	ND	ND	60.8	60.3	ND
	M03B	12.2	12.9	11.7	12.0	12.4	13.1	ND	ND	ND	ND	50.9	49.2	ND
	M04B	12.9	14.4	14.5	13.9	14.9	14.5	ND	ND	ND	ND	56.1	57.8	ND
	M05B	14.6	16.0	14.7	15.2	14.7	15.7	ND	ND	ND	ND	62.5	60.3	ND
	M06B	12.8	15.4	12.7	15.8	14.3	16.0	ND	ND	ND	ND	58.8	58.8	ND
	M07B	15.3	16.1	16.2	15.1	16.3	15.9	ND	ND	ND	ND	63.5	63.5	ND
	M08B	13.6	14.8	14.6	14.1	15.2	14.7	ND	ND	ND	ND	58.0	58.6	ND
	M09B	14.2	16.7	14.8	16.6	15.8	15.7	ND	ND	ND	ND	64.3	62.9	ND
	M10B	14.5	16.0	15.4	15.2	16.3	15.8	ND	ND	ND	ND	62.5	62.7	ND
	M11B	13.9	16.0	15.4	16.2	17.0	17.1	ND	ND	ND	ND	61.8	65.7	ND
	M12B	13.5	15.6	13.5	16.0	14.8	16.6	ND	ND	ND	ND	60.3	60.9	ND
	M13B	13.5	14.4	15.5	14.5	15.8	15.1	ND	ND	ND	ND	56.6	60.9	ND
	M14B	13.4	15.5	15.8	17.2	17.3	17.6	ND	ND	ND	ND	59.9	67.9	ND
M15B	13.5	15.0	14.5	15.4	*	15.2	ND	ND	*	ND	58.4	60.1	ND	
M16B	13.0	13.5	13.6	14.3	16.1	15.0	ND	ND	ND	ND	53.4	59.0	ND	
Spec. Interest	M01S	12.1	13.3	13.3	12.0	12.3	12.6	ND	ND	ND	ND	51.7	50.2	ND
	M02S	11.5	12.7	14.7	13.9	14.4	14.5	ND	ND	ND	ND	49.7	57.5	ND
	M03S	13.6	15.3	13.6	14.9	15.4	15.5	ND	ND	ND	ND	59.4	59.4	ND
	M04S	14.3	15.8	16.3	15.6	17.0	16.5	ND	ND	ND	ND	61.7	65.4	ND
	M05S	14.1	15.3	14.1	14.5	15.1	16.1	ND	ND	ND	ND	60.1	59.8	ND
	M06S	15.9	16.9	15.2	15.2	16.1	16.2	ND	ND	ND	ND	66.6	62.7	ND
Control	M01C	14.0	14.8	13.0	14.0	14.1	14.0	ND	ND	ND	ND	58.4	55.1	ND
	M02C	14.0	15.6	*	15.9	13.5	13.7	*	ND	ND	ND	60.9	57.5	ND
	M03C	15.3	16.3	14.8	15.4	15.5	15.9	ND	ND	ND	ND	64.3	61.6	ND
	M04C	14.1	14.8	14.8	14.0	16.7	14.8	ND	ND	ND	ND	58.7	60.3	ND

MDD <sub>Q</sub>	4.7
MDD <sub>A</sub>	11.2

ND = Not Detected, where  $M_Q \leq (B_Q + MDD_Q)$  or  $M_A \leq (B_A + MDD_A)$  for quarterly and annual data, respectively.

\* The Q1 sample for M02C and Q3 sample for M15B were missing in the field.

MDD<sub>Q</sub> and MDD<sub>A</sub> were determined using ten years of REMP TLD Data from 2001 through 2010. (See ANSI/HPS N13.37-2014 (Ref. (4)) for details on the methodology for determining facility related dose using REMP TLDs.)

## ATTACHMENT C: GROUND WATER MONITORING WELL LOCATIONS

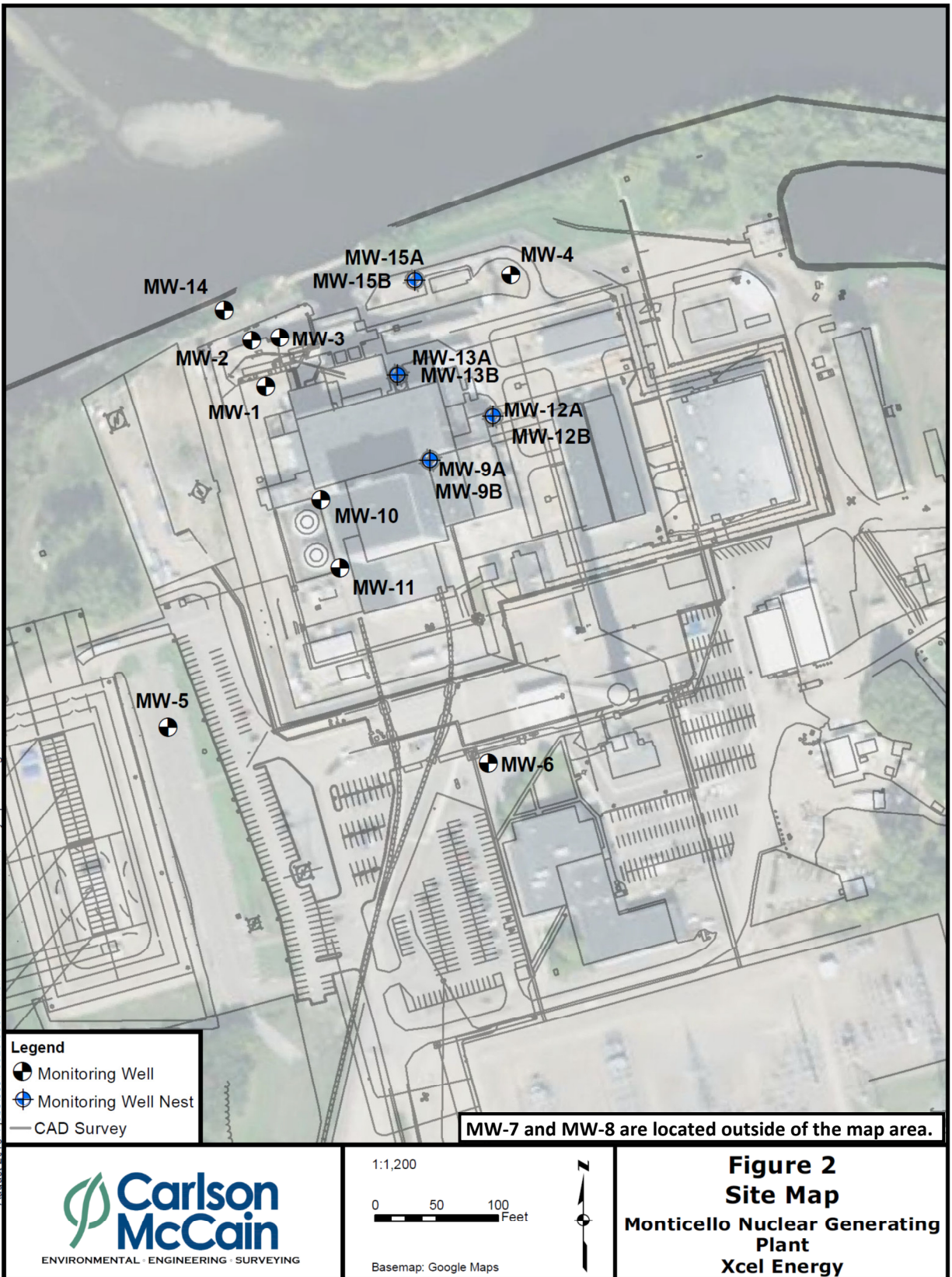

FIGURE 6: MNGP GROUNDWATER MONITORING WELL LOCATIONS (REF. (8)).

TABLE 16: MNGP MONITORING WELL LOCATIONS FROM FP-CY-GWPP-01. (REF. (7))

Well ID	Location		Unique Number	Date Installed	Screen Interval (ft)	Elevation (ft)		
	East	North				Surface	Top of Riser	Bottom of well
MW-1	4847.19	10248.69	547747	8/10/94	902.37 – 912.37	930.39	930.19	902.37
MW-2	4843.43	10326.78	547748	8/10/94	897.46 – 907.46	921.82	923.82	897.46
MW-3	4889.37	10319.18	547749	8/10/94	901.19 – 911.19	919.91	921.91	901.19
MW-4	5281.42	10320.84	747055	10/08/07	899.1 – 909.1	925.40	927.86	898.70
MW-5	4549.88	9757.05	747056	9/06/07	902.1 – 912.1	943.00	942.75	901.70
MW-6	5035.29	9563.03	747057	9/07/07	900.3 – 910.3	930.70	933.24	899.90
MW-7	6205.26	9609.17	747058	9/05/07	898.5 – 908.5	920.00	922.49	898.10
MW-8	5393.93	8251.55	747059	9/05/07	900.5 – 910.5	931.50	934.00	900.10
MW-9	5074.19	10064.31	725274	9/04/09	901.2 – 911.2	927.87	927.58	901.20
MW-9B	5075.65	10054.35	772236	11/17/09	883.6 – 888.5	927.90	927.75	883.50
MW-10	4885.05	10045.62	725272	9/02/09	899.8 – 909.8	935.03	934.69	899.80
MW-11	4886.97	9931.96	725273	9/02/09	899.7 – 909.7	934.86	934.51	899.70
MW-12A	5191.46	10105.31	772328	10/29/09	898.7 – 908.7	931.80	932.14	898.70
MW-12B	5195.51	10106.27	772329	11/02/09	886.6 – 891.6	932.00	932.13	886.60
MW-13A	5059.49	10210.48	772330	10/29/09	897.9 – 907.9	931.20	933.82	897.90
MW-13B	5062.00	10212.53	772331	11/01/09	873.4 – 878.4	930.90	933.81	873.40
MW-14	4829.09	10402.98	778176	9/13/10	902.11 – 905.11	909.92	911.36	902.11
MW-15A	5126.35	10392.88	789990	6/25/2012	903.0-913.0	919	918.67	903
MW-15B	5131.93	10352.93	789991	6/25/2012	869.5-874.5	919.1	918.79	865.5

## ATTACHMENT D: 2017 GROUNDWATER PROTECTION PROGRAM WELL DATA

TABLE 17: 2017 GROUNDWATER MONITORING WELL DATA FOR MNGP.

Lab Code	Collection Date	Concentration (pCi/L)										
		<sup>3</sup> H	<sup>54</sup> Mn	<sup>59</sup> Fe	<sup>58</sup> Co	<sup>60</sup> Co	<sup>65</sup> Zn	<sup>95</sup> ZrNb	<sup>134</sup> Cs	<sup>137</sup> Cs	<sup>140</sup> BaLa	<sup>144</sup> Ce
<u>Monitoring Well #1 (M-33)</u>												
MWW- 764	02/21/17	< 155	< 10	< 30	< 10	< 10	< 30	< 15	< 10	< 10	< 15	< 19
MWW- 2673	05/25/17	< 150	< 10	< 30	< 10	< 10	< 30	< 15	< 10	< 10	< 15	< 27
MWW- 4609	08/31/17	< 187	< 10	< 30	< 10	< 10	< 30	< 15	< 10	< 10	< 15	< 36
MWW- 6227	11/20/17	< 148	< 10	< 58	< 12	< 10	< 30	< 38	< 10	< 10	< 5986	< 24 <sup>a</sup>
<u>Monitoring Well #2 (M-34)</u>												
MWW- 765	02/21/17	182 ± 86	< 10	< 30	< 10	< 10	< 30	< 15	< 10	< 10	< 15	< 19
MWW- 2674	05/25/17	< 150	< 10	< 30	< 10	< 10	< 30	< 15	< 10	< 10	< 15	< 33
MWW- 4610	08/31/17	< 187	< 10	< 30	< 10	< 10	< 30	< 15	< 10	< 10	< 15	< 25
MWW- 6228	11/20/17	195 ± 82	< 10	< 51	< 13	< 10	< 30	< 54	< 10	< 10	< 5529	< 42 <sup>a</sup>
<u>Monitoring Well #3 (M-35)</u>												
MWW- 766	02/21/17	< 155	< 10	< 30	< 10	< 10	< 30	< 15	< 10	< 10	< 15	< 32
MWW- 2675	05/25/17	< 150	< 10	< 30	< 10	< 10	< 30	< 15	< 10	< 10	< 15	< 19
MWW- 4611	08/31/17	< 187	< 10	< 30	< 10	< 10	< 30	< 15	< 10	< 10	< 15	< 15
MWW- 6229	11/20/17	157 ± 80	< 10	< 52	< 10	< 10	< 30	< 35	< 10	< 10	< 5258	< 26 <sup>a</sup>
<u>Monitoring Well #4 (M-36)</u>												
MWW- 767	02/21/17	< 155	< 10	< 30	< 10	< 10	< 30	< 15	< 10	< 10	< 15	< 24
MWW- 2676	05/25/17	193 ± 85	< 10	< 30	< 10	< 10	< 30	< 15	< 10	< 10	< 15	< 26
MWW- 4612	08/31/17	< 187	< 10	< 30	< 10	< 10	< 30	< 15	< 10	< 10	< 15	< 25
MWW- 6230	11/21/17	170 ± 81	< 10	< 67	< 13	< 10	< 30	< 66	< 10	< 10	< 6274	< 51 <sup>a</sup>
<u>Monitoring Well #5 (M-37)</u>												
MWW- 4613	09/01/17	< 187	< 10	< 30	< 10	< 10	< 30	< 15	< 10	< 10	< 15	< 19
<u>Monitoring Well #6 (M-38)</u>												
MWW- 4614	09/01/17	< 187	< 10	< 30	< 10	< 10	< 30	< 15	< 10	< 10	< 15	< 25
<u>Monitoring Well #7 (M-39)</u>												
MWW- 4615	09/01/17	< 187	< 10	< 30	< 10	< 10	< 30	< 15	< 10	< 10	< 15	< 25
<u>Monitoring Well #8 (M-40)</u>												
MWW- 4616	09/01/17	< 187	< 10	< 30	< 10	< 10	< 30	< 15	< 10	< 10	< 15	< 26

<sup>a</sup> Required LLDs for gamma isotopic were not achieved for 4Q18 samples due to insufficient sample volume and delay in counting samples.

TABLE 17: 2017 GROUNDWATER MONITORING WELL DATA (CONTINUED).

Lab Code	Collection Date	Concentration (pCi/L)										
		<sup>3</sup> H	<sup>54</sup> Mn	<sup>59</sup> Fe	<sup>58</sup> Co	<sup>60</sup> Co	<sup>65</sup> Zn	<sup>95</sup> ZrNb	<sup>134</sup> Cs	<sup>137</sup> Cs	<sup>140</sup> BaLa	<sup>144</sup> Ce
<u>Monitoring Well #9A (M-44)</u>												
MWW- 265	01/17/17	1375 ± 134										<sup>a</sup>
MWW- 768	02/20/17	657 ± 108	< 10	< 30	< 10	< 10	< 30	< 15	< 10	< 10	< 15	< 25
MWW- 1282	03/23/17	958 ± 115										
MWW- 1788	04/20/17	< 153										
MWW- 2839	05/25/17	5306 ± 225	< 10	< 30	< 10	< 10	< 30	< 15	< 10	< 10	< 15	< 35
MWW- 3118	06/21/17	1941 ± 147										
MWW- 3776	07/19/17	2515 ± 166										
MWW- 4617	09/01/17	< 187	< 10	< 30	< 10	< 10	< 30	< 15	< 10	< 10	< 15	< 15 <sup>c</sup>
MWW- 4987	09/21/17	1384 ± 135										
MWW- 5461	10/12/17	< 157										
MWW- 6543	11/21/17	3060 ± 181	< 4	< 5	< 4	< 5	< 13	< 9	< 6	< 6	< 15	< 28
MWW- 6618	12/20/17	943 ± 122										
<u>Monitoring Well #9B (M-51)</u>												
MWW- 769	02/20/17	< 155	< 10	< 30	< 10	< 10	< 30	< 15	< 10	< 10	< 15	< 24
MWW- 2677	05/25/17	< 150	< 10	< 30	< 10	< 10	< 30	< 15	< 10	< 10	< 15	< 31
MWW- 4618	09/01/17	< 187	< 10	< 30	< 10	< 10	< 30	< 15	< 10	< 10	< 15	< 21
MWW- 6274	11/21/17	< 148	< 3	< 6	< 4	< 4	< 10	< 6	< 4	< 4	< 10	< 33
<u>Monitoring Well #10 (M-45)</u>												
MWW- 276	01/17/17	210 ± 88										
MWW- 770	02/21/17	167 ± 86	< 10	< 30	< 10	< 10	< 30	< 15	< 10	< 10	< 15	< 21
MWW- 1211	03/27/17	209 ± 86										
MWW- 1789	04/21/17	175 ± 83										
MWW- 2678	05/25/17	293 ± 90	< 10	< 30	< 10	< 10	< 30	< 15	< 10	< 10	< 15	< 24
MWW- 3093	06/21/17	199 ± 84										
MWW- 3748	07/20/17	< 151										
MWW- 4619	08/31/17	198 ± 95	< 10	< 30	< 10	< 10	< 30	< 15	< 10	< 10	< 15	< 20
MWW- 4939	09/21/17	185 ± 98										
MWW- 5462	10/12/17	174 ± 83										
MWW- 6231	11/20/17	237 ± 84	< 10	< 30	< 10	< 10	< 30	< 48	< 10	< 10	< 4822	< 21 <sup>b</sup>
MWW- 6619	12/19/17	< 158										
<u>Monitoring Well #11 (M-46)</u>												
MWW- 771	02/21/17	< 155	< 10	< 30	< 10	< 10	< 30	< 15	< 10	< 10	< 15	< 40
MWW- 2679	05/25/17	< 150	< 10	< 30	< 10	< 10	< 30	< 15	< 10	< 10	< 15	< 23
MWW- 4620	08/31/17	< 187	< 10	< 30	< 10	< 10	< 30	< 15	< 10	< 10	< 15	< 22
MWW- 6232	11/20/17	< 148	< 10	< 44	< 12	< 10	< 30	< 48	< 10	< 10	< 6527	< 25 <sup>b</sup>
<u>Monitoring Well #12A (M-47)</u>												
MWW- 772	02/21/17	< 155	< 10	< 30	< 10	< 10	< 30	< 15	< 10	< 10	< 15	< 17
MWW- 2680	05/25/17	< 150	< 10	< 30	< 10	< 10	< 30	< 15	< 10	< 10	< 15	< 28
MWW- 4621	08/31/17	< 187	< 10	< 30	< 10	< 10	< 30	< 15	< 10	< 10	< 15	< 25
MWW- 6233	11/21/17	< 148	< 10	< 69	< 10	< 10	< 30	< 64	< 10	< 10	< 9600	< 52 <sup>b</sup>

<sup>a</sup> Station duplicate sent. MWW-275 result = 1384±134 pCi/L.

<sup>b</sup> Required LLDs for gamma isotopic were not achieved for 4Q18 samples due to insufficient sample volume and delay in counting samples.

<sup>c</sup> 3Q14 samples were taken on 8/31/17-9/1/17 due to equipment and resource availability.

TABLE 17: 2017 GROUNDWATER MONITORING WELL DATA (CONTINUED).

Lab Code	Collection Date	Concentration (pCi/L)										
		<sup>3</sup> H	<sup>54</sup> Mn	<sup>59</sup> Fe	<sup>58</sup> Co	<sup>60</sup> Co	<sup>65</sup> Zn	<sup>95</sup> ZrNb	<sup>134</sup> Cs	<sup>137</sup> Cs	<sup>140</sup> BaLa	<sup>144</sup> Ce
<u>Monitoring Well #12B (M-48)</u>												
MWW- 773	02/21/17	< 155	< 10	< 30	< 10	< 10	< 30	< 15	< 10	< 10	< 15	< 22
MWW- 2681	05/25/17	< 150	< 10	< 30	< 10	< 10	< 30	< 15	< 10	< 10	< 15	< 14
MWW- 4622	08/31/17	< 187	< 10	< 30	< 10	< 10	< 30	< 15	< 10	< 10	< 15	< 22
MWW- 6234	11/21/17	< 148	< 10	< 44	< 13	< 10	< 30	< 56	< 10	< 10	< 6511	< 30 <sup>a</sup>
<u>Monitoring Well #13A (M-49)</u>												
MWW- 277	01/17/17	< 160										
MWW- 774	02/21/17	< 155	< 10	< 30	< 10	< 10	< 30	< 15	< 10	< 10	< 15	< 16
MWW- 1212	03/27/17	< 151										
	04/19/17											<sup>b</sup>
MWW- 2682	05/25/17	< 150	< 10	< 30	< 10	< 10	< 30	< 15	< 10	< 10	< 15	< 34
MWW- 3094	06/21/17	< 148										
MWW- 3749	07/19/17	< 151										
MWW- 4623	08/31/17	< 187	< 10	< 30	< 10	< 10	< 30	< 15	< 10	< 10	< 15	< 28
MWW- 4940	09/21/17	< 183										
MWW- 5463	10/11/17	< 157										
MWW- 6235	11/20/17	< 148	< 10	< 76	< 15	< 10	< 30	< 61	< 10	< 10	< 9206	< 43 <sup>a</sup>
MWW- 6620	12/19/17	< 158										
<u>Monitoring Well #13B (M-50)</u>												
MWW- 279	01/17/17	< 160										
MWW- 775	02/21/17	< 155	< 10	< 30	< 10	< 10	< 30	< 15	< 10	< 10	< 15	< 40
MWW- 1213	03/27/17	< 151										
	04/19/17											<sup>b</sup>
MWW- 2683	05/25/17	173 ± 84	< 10	< 30	< 10	< 10	< 30	< 15	< 10	< 10	< 15	< 24
MWW- 3095	06/21/17	< 148										
MWW- 3750	07/19/17	157 ± 87										
MWW- 4624	08/31/17	< 187	< 10	< 30	< 10	< 10	< 30	< 15	< 10	< 10	< 15	< 31
MWW- 4941	09/21/17	< 183										
MWW- 5464	10/11/17	< 157										
MWW- 6236	11/20/17	252 ± 85	< 10	< 35	< 12	< 10	< 30	< 54	< 10	< 10	< 7761	< 29 <sup>a</sup>
MWW- 6621	12/19/17	< 158										
<u>Monitoring Well #14 (M-52)</u>												
MWW- 280	01/16/17	< 160										
MWW- 776	02/17/17	< 155	-	-	-	-	-	-	-	-	-	- <sup>c</sup>
	03/27/17											<sup>d</sup>
MWW- 1790	04/19/17	< 153										
MWW- 2684	05/24/17	< 150	< 10	< 30	< 10	< 10	< 30	< 15	< 10	< 10	< 15	< 28
MWW- 3096	06/19/17	< 148										
MWW- 3751	07/17/17	< 151										
MWW- 4625	08/28/17	< 187	< 10	< 30	< 10	< 10	< 30	< 15	< 10	< 10	< 15	< 24
MWW- 4942	09/18/17	< 183										
MWW- 5465	10/10/17	< 157										
MWW- 6237	11/20/17	< 148	< 10	< 39	< 13	< 10	< 30	< 44	< 10	< 10	< 5364	< 26 <sup>a</sup>
MWW- 6622	12/18/17	< 158										

<sup>a</sup> Required LLDs for gamma isotopic were not achieved for 4Q18 samples due to insufficient sample volume and delay in counting samples.

<sup>b</sup> Missed MW-13 sample due to in-use temporary diesel generator blocking access during RFO 28.

<sup>c</sup> No gamma isotopic result for Feb 2017 MW-14 sample due to small sample size.

<sup>d</sup> Missed MW-14 sample for March 2017 due to frozen water blocking well access

TABLE 17: 2017 GROUNDWATER MONITORING WELL DATA (CONTINUED).

Lab Code	Collection Date	Concentration (pCi/L)										
		<sup>3</sup> H	<sup>54</sup> Mn	<sup>59</sup> Fe	<sup>58</sup> Co	<sup>60</sup> Co	<sup>65</sup> Zn	<sup>95</sup> ZrNb	<sup>134</sup> Cs	<sup>137</sup> Cs	<sup>140</sup> BaLa	<sup>144</sup> Ce
<u>Monitoring Well #15A (M-53)</u>												
MWW- 281	01/17/17	< 160										
MWW- 778	02/17/17	< 155	< 10	< 30	< 10	< 10	< 30	< 15	< 10	< 10	< 15	< 30
MWW- 1214	03/27/17	< 151										
MWW- 1791	04/21/17	< 153										
MWW- 2685	05/25/17	< 150	< 10	< 30	< 10	< 10	< 30	< 15	< 10	< 10	< 15	< 31
MWW- 3097	06/19/17	< 148										
MWW- 3752	07/19/17	< 151										
MWW- 4626	08/31/17	< 187	< 10	< 30	< 10	< 10	< 30	< 15	< 10	< 10	< 15	< 26
MWW- 4943	09/21/17	< 183										
MWW- 5466	10/11/17	< 157										
MWW- 6238	11/21/17	197 ± 82	< 10	< 61	< 14	< 10	< 30	< 73	< 10	< 10	< 5226	< 30 <sup>a</sup>
MWW- 6623	12/19/17	< 158										
<u>Monitoring Well #15B (M-54)</u>												
MWW- 282	01/17/17	< 160										
MWW- 779	02/17/17	173 ± 86	< 10	< 30	< 10	< 10	< 30	< 15	< 10	< 10	< 15	< 26
MWW- 1215	03/27/17	< 151										
MWW- 1792	04/21/17	< 153										
MWW- 2686	05/25/17	< 150	< 10	< 30	< 10	< 10	< 30	< 15	< 10	< 10	< 15	< 30
MWW- 3098	06/19/17	< 148										
MWW- 3753	07/19/17	< 151										
MWW- 4628	08/31/17	< 187	< 10	< 30	< 10	< 10	< 30	< 15	< 10	< 10	< 15	< 24
MWW- 4944	09/21/17	< 183										
MWW- 5467	10/11/17	< 157										
MWW- 6239	11/21/17	< 148	< 10	< 36	< 13	< 10	< 30	< 41	< 10	< 10	< 5382	< 25 <sup>a</sup>
MWW- 6624	12/19/17	< 158										
<u>Storm Water Run-off (SD-006)</u>												
MXW- 321	01/19/17	675 ± 133	< 10	< 30	< 10	< 10	< 30	< 15	< 10	< 10	< 15	< 23
MXW- 322	01/19/17	506 ± 128	< 10	< 30	< 10	< 10	< 30	< 15	< 10	< 10	< 15	< 21 <sup>b</sup>
MXW- 1901	04/26/17	1320 ± 127	< 10	< 30	< 10	< 10	< 30	< 15	< 10	< 10	< 15	< 33
MXW- 3743	07/18/17	< 183	< 10	< 30	< 10	< 10	< 30	< 15	< 10	< 10	< 15	< 9
MXW- 5233	10/03/17	< 179	< 10	< 30	< 10	< 10	< 30	< 15	< 10	< 10	< 15	< 37
<u>Storm Water Run-off (Sewer Lift Station)</u>												
MXW- 2594	05/30/17	< 153										
MXW- 6275	11/27/17	< 148	< 10	< 30	< 10	< 10	< 30	< 15	< 10	< 10	< 15	< 15

Gap Drain

<sup>a</sup> Required LLDs for gamma isotopic were not achieved for 4Q18 samples due to insufficient sample volume and delay in counting samples.

<sup>b</sup> Station duplicate.



## ENCLOSURE 2

### OFFSITE DOSE CALCULATION MANUAL

The Offsite Dose Calculation Manual for the Monticello Nuclear Generating Plant is comprised of the following documents:

<u>Document Number</u>	<u>Title</u>	<u>Revision</u>
ODCM-Index	Index	4
ODCM-01.01	Introduction	8
ODCM-02.01	Liquid Effluents	12
ODCM-03.01	Gaseous Effluents	14
ODCM-04.01	Liquid Effluent Calculations	4*
ODCM-05.01	Gaseous Effluent Calculations	11*
ODCM-06.01	Dose From All Uranium Fuel Cycle Sources	4
ODCM-07.01	Radiological Environmental Monitoring Program	25
ODCM-08.01	Reporting Requirements	9
ODCM-APP-A	Appendix A	3
ODCM-APP-B	Appendix B	2
ODCM-APP-C	Appendix C	0
ODCM-HISTORY	ODCM History	0

---

\*Section was revised in 2017

<b>MONTICELLO NUCLEAR GENERATING PLANT</b>		ODCM-INDEX
<b>TITLE:</b>	<b>OFFSITE DOSE CALCULATION MANUAL INDEX</b>	Revision 4
		Page 1 of 1

Approval: ODC 01473827

<b><u>NO.</u></b>	<b><u>TITLE</u></b>
ODCM-01.01	INTRODUCTION
ODCM-02.01	LIQUID EFFLUENTS
ODCM-03.01	GASEOUS EFFLUENTS
ODCM-04.01	LIQUID EFFLUENT CALCULATIONS
ODCM-05.01	GASEOUS EFFLUENT CALCULATIONS
ODCM-06.01	DOSE FROM ALL URANIUM FUEL CYCLE SOURCES
ODCM-07.01	RADIOLOGICAL ENVIRONMENTAL MONITORING PROGRAM
ODCM-08.01	REPORTING REQUIREMENTS
ODCM-APP-A	APPENDIX A
ODCM-APP-B	APPENDIX B
ODCM-APP-C	APPENDIX C
ODCM-HISTORY	ODCM-HISTORY

<b>MONTICELLO NUCLEAR GENERATING PLANT</b>		ODCM-INDEX
<b>TITLE:</b>	<b>OFFSITE DOSE CALCULATION MANUAL INDEX</b>	Revision 4
		Page 1 of 1

Approval: ODC 01473827

<b><u>NO.</u></b>	<b><u>TITLE</u></b>
ODCM-01.01	INTRODUCTION
ODCM-02.01	LIQUID EFFLUENTS
ODCM-03.01	GASEOUS EFFLUENTS
ODCM-04.01	LIQUID EFFLUENT CALCULATIONS
ODCM-05.01	GASEOUS EFFLUENT CALCULATIONS
ODCM-06.01	DOSE FROM ALL URANIUM FUEL CYCLE SOURCES
ODCM-07.01	RADIOLOGICAL ENVIRONMENTAL MONITORING PROGRAM
ODCM-08.01	REPORTING REQUIREMENTS
ODCM-APP-A	APPENDIX A
ODCM-APP-B	APPENDIX B
ODCM-APP-C	APPENDIX C
ODCM-HISTORY	ODCM-HISTORY

<b>MONTICELLO NUCLEAR GENERATING PLANT</b>		ODCM-01.01
<b>TITLE:</b>	<b>INTRODUCTION</b>	Revision 8
		Page 1 of 9

Approval: PCR 01474725

**OFFSITE DOSE CALCULATION MANUAL - TABLE OF CONTENTS**

<b><u>SECTION</u></b>	<b><u>PAGE</u></b>
1.0 RECORD OF REVISION .....	2
2.0 OFF-SITE DOSE CALCULATION MANUAL (ODCM) INTRODUCTION .....	3
2.1 ODCM Description and Control .....	3
2.2 Licensee Initiated Changes to the ODCM .....	3
2.3 Definitions .....	4
2.4 Radiological Effluent Controls And Surveillance Requirement .....	8

<b>MONTICELLO NUCLEAR GENERATING PLANT</b>		ODCM-01.01
<b>TITLE:</b>	<b>INTRODUCTION</b>	Revision 8
		Page 2 of 9

## 1.0 RECORD OF REVISION

<u>Revision No.</u>	<u>Date</u>	<u>Reason for Revision</u>
1	December - 1998	Corrected typo in reference to 10CFR50.36a on page 2, paragraph 1.
2	October - 2000	Incorporated Tech Spec 6.8.A.1, 6.8.A.2, and 6.8.A.3 relating to ODCM control and the relocated definitions into document.
3	January - 2004	Changed definition of "Member of the Public" to the new 10CFR20 definition.
4	June - 2005	Incorporated changes made during the conversion of the Current Technical Specifications to the Improved Technical Specifications. This includes dual step annotation.
5	March - 2008	Added reference to ISFSI and 10CFR72.104. Removed references to CTS. Revised 2.4.1 to include the 30 day reporting requirement if any of the controls are exceeded.
6	December – 2013	Corrected out of date terminology throughout document. Corrective change to align definition of Dose Equivalent I-131 in 2.3.5 with that given in Technical Specifications, Section 1.1.
7	May - 2015	Corrected definition for Functional/ Functionality to definition from NRC Inspection Manual Chapter 0326. Added definition for Plant Startup to align with Tech Specs, per AR01467719.
8		Changed definition of 'Abnormal Release' to directly agree with Reg. Guide 1.21 Rev. 1 (AR01440121). Added Definition of Reportable Event based on NUREG-1302. Alphabetized Section 2.3, Definitions.

<b>MONTICELLO NUCLEAR GENERATING PLANT</b>		ODCM-01.01
<b>TITLE:</b>	<b>INTRODUCTION</b>	Revision 8
		Page 3 of 9

## **2.0 OFF-SITE DOSE CALCULATION MANUAL (ODCM) INTRODUCTION**

### **2.1 ODCM Description and Control**

- 2.1.1 In accordance with Tech Spec 5.5.1.a., the ODCM contains the methodology and parameters used in the calculation of off-site doses resulting from radioactive gaseous and liquid effluents, in the calculation of gaseous and liquid effluent monitoring alarm and trip setpoints, and in the conduct of the Radiological Environmental Monitoring Program.
- 2.1.2 In accordance with Tech Spec 5.5.1.b., the ODCM also contains the radioactive effluent controls and radiological environmental monitoring activities and descriptions of the information that should be included in the Radiological Environmental Operating Program report and Radioactive Effluent Release reports required by 10CFR50, Appendix I, and 10CFR50.36a.
- 2.1.3 The ODCM also contains the controls for direct radiation for the plant ISFSI IAW 10CFR72.104.

### **2.2 Licensee Initiated Changes to the ODCM**

- 2.2.1 In accordance with Tech Spec 5.5.1.c., licensee initiated changes to the ODCM **SHALL** be documented and records of review performed **SHALL** be retained. This documentation **SHALL** contain:
  - A. Sufficient information to support the change(s) together with the appropriate analyses or evaluations justifying the change(s), and
  - B. A determination that the change(s) maintain the levels of radioactive effluent control required by 10CFR20.1302, 40CFR190, 10CFR50.36a, 10CFR72.104, and 10CFR50, Appendix I, and not adversely impact the accuracy or reliability of effluent, dose, or setpoint calculations.
- 2.2.2 Changes **SHALL** become effective after review and approval by the Plant Manager.
- 2.2.3 Changes **SHALL** be submitted to the NRC in the form of a complete, legible copy of the entire ODCM as a part of or concurrent with the Radioactive Effluent Release Report for the period of the report in which any change in the ODCM was made. Each change **SHALL** be identified by markings in the margin of the affected pages, clearly indicating the area of the page that was changed, and **SHALL** indicate the date (i.e., month and year) the change was implemented.

<b>MONTICELLO NUCLEAR GENERATING PLANT</b>		ODCM-01.01
<b>TITLE:</b>	<b>INTRODUCTION</b>	Revision 8
		Page 4 of 9

## 2.3 Definitions

### 2.3.1 Abnormal Release

An unplanned or uncontrolled release of radioactive material from the site boundary.

### 2.3.2 Action

ACTION **SHALL** be that part of a control which prescribes required actions to be taken under designated conditions within specified completion times.

### 2.3.3 Batch Release

A BATCH RELEASE is a discharge of liquid or gaseous radioactive effluent of a discrete volume. Prior to sampling for analysis, each batch **SHALL** be isolated and thoroughly mixed to assure representative sampling.

### 2.3.4 Composite Sample

A COMPOSITE SAMPLE is one in which the quantity of liquid sampled is proportional to the quantity of liquid waste discharged and in which the method of sampling employed results in a specimen which is representative of the liquids released.

### 2.3.5 Dose Equivalent I-131

See Section 1.1 of the Technical Specifications for the Monticello Nuclear Generating Plant.

### 2.3.6 Exclusion Area Boundary

The EXCLUSION AREA BOUNDARY is the same as the Site Boundary described in ODCM-03.01 Figure 1. The EXCLUSION AREA is the area encompassed by the EXCLUSION AREA BOUNDARY.

### 2.3.7 Functional - Functionality

Functionality is an attribute of an SSC(s) that is not controlled by TSs. An SSC not controlled by TSs is functional or has functionality when it is capable of performing its function(s) as set forth in the Current Licensing Basis (CLB). These CLB function(s) may include the capability to perform a necessary and related support function for an SSC(s) controlled by TSs.

<b>MONTICELLO NUCLEAR GENERATING PLANT</b>		ODCM-01.01
<b>TITLE:</b>	<b>INTRODUCTION</b>	Revision 8
		Page 5 of 9

2.3.8 Instrument Calibration

An instrument calibration means the adjustment of an instrument signal output so that it corresponds, within acceptable range, accuracy, and response time to a known value(s) of the parameter which the instrument monitors. Calibration **SHALL** encompass the entire instrument including actuation, alarm or trip.

2.3.9 Instrument Functional Test

An instrument functional test means the injection of a simulated signal into the primary sensor to verify proper instrument channel response, alarm, and/or initiating action.

2.3.10 Liquid Radwaste Treatment System

The LIQUID RADWASTE TREATMENT SYSTEM **SHALL** be any system designed and installed to reduce radioactive effluents by holdup or collecting radioactive materials by means of filtering, evaporation, ion exchange or chemical reaction for the purpose of reducing the total radioactivity prior to release to the environment.

2.3.11 Long Term Release

“Long-term” refers to releases that are generally continuous and stable in release rate with some anticipated variation (i.e., < 50%, based on a running monthly average) in release rate, such as is experienced in normal ventilation system effluents at nuclear power plants. Determination of doses due to long-term releases should use the historical annual average relative concentration ( $\chi/Q$ ) based on meteorological data summarized, as recommended in Regulatory Guide 1.111.

2.3.12 Member Of The Public

MEMBER OF THE PUBLIC is any individual except when that individual is receiving an occupational dose.

2.3.13 Offgas Treatment System

The OFFGAS TREATMENT SYSTEM **SHALL** be any system designed and installed to reduce radioactive effluents by collecting primary coolant system offgas from the primary system and providing for delay or holdup for the purpose of reducing the total radioactivity prior to release to the environment.



<b>MONTICELLO NUCLEAR GENERATING PLANT</b>		ODCM-01.01
<b>TITLE:</b>	<b>INTRODUCTION</b>	Revision 8
		Page 6 of 9

2.3.14 Plant Startup

When the plant is in the Startup Mode.

See Table 1.1-1 (MODES) in the Technical Specifications for the Monticello Nuclear Generating Plant.

2.3.15 Purge - Purging

PURGE - PURGING **SHALL** be any controlled process of discharging air or gas from a confinement to maintain temperature, pressure, humidity, concentration or other operating condition, in such a manner that replacement air or gas is required to purify the confinement.

2.3.16 Radiological Environmental Monitoring Program (REMP)

The RADIOLOGICAL ENVIRONMENTAL MONITORING PROGRAM is established for monitoring the radiation and radionuclides in the environs of the plant. The program **SHALL** provide representative measurements of radioactivity in the highest potential exposure pathways and verification of the accuracy of potential exposure pathways and verification of the accuracy of the effluent monitoring program and modeling of the environmental exposure pathways.

2.3.17 Reportable Event

A Reportable Event **SHALL** be any of those conditions specified in Section 50.73 of 10CFR50.

2.3.18 Sensor Check

A qualitative determination of functionality by observation of sensor behavior during operation. This determination **SHALL** include, where possible, comparison with other independent sensor measuring the same variable.

2.3.19 Short Term Release

“Short-term” refers to releases that are intermittent in radionuclide concentrations or flow, such as releases from drywell purges and systems or components with infrequent use. Short-term releases may be due to operational variations which result in radioactive releases greater than 50% of the releases normally considered as long-term. Short-term releases from these sources during normal operation, including anticipated operational occurrences, are defined as those which occur for a total of 500 hours or less in a calendar year but not more than 150 hours in any quarter.

<b>MONTICELLO NUCLEAR GENERATING PLANT</b>		ODCM-01.01
<b>TITLE:</b>	<b>INTRODUCTION</b>	Revision 8
		Page 7 of 9

2.3.20 Site Boundary

Means a line within which the land is owned, leased, or otherwise controlled by the licensee. The site boundary for liquid releases of radioactive material is defined in ODCM-02.01 (LIQUID EFFLUENT), Figure 1. The site boundary for gaseous releases of radioactive material is defined in ODCM-03.01 (GASEOUS EFFLUENTS), Figure 1.

2.3.21 Source Check

A SOURCE CHECK **SHALL** be the qualitative assessment of channel response when the channel sensor is exposed to a radioactive source.

2.3.22 Unrestricted Area

An UNRESTRICTED AREA means any area at or beyond the site boundary to which access is not controlled by the licensee for purposes of protection of individuals from exposure to radiation and radioactive materials or any area within the site boundary used for residential quarters or industrial, commercial, institutional and/or recreational purposes.

2.3.23 Uranium Fuel Cycle

The URANIUM FUEL CYCLE is defined in 40CFR Part 190.02(b) as: "The operation of milling of uranium ore, chemical conversion of uranium, isotopic enrichment of uranium, fabrication of uranium fuel, generation of electricity by a light-water-cooled nuclear power plant using uranium fuel, and reprocessing of spent uranium fuel, to the extent that these directly support the production of electrical power for public use utilizing nuclear energy, but excludes mining operations, operations at waste disposal sites, transportation of any radioactive material in support of these operations, and the use of recovered non-uranium special nuclear and by-product materials from the cycle."

2.3.24 Venting

VENTING **SHALL** be the controlled process of discharging air or gas from a confinement to maintain temperature, pressure, humidity, concentration or other operating condition, in such a manner that replacement air or gas is NOT provided or required.

<b>MONTICELLO NUCLEAR GENERATING PLANT</b>		ODCM-01.01
<b>TITLE:</b>	<b>INTRODUCTION</b>	Revision 8
		Page 8 of 9

## 2.4 Radiological Effluent Controls And Surveillance Requirement

### 2.4.1 Controls

- A. Compliance with the controls contained within ODCM-02.01, ODCM-03.01 and ODCM-06.01 is required during the conditions specified. Upon failure to meet the control, the associated ACTION requirements **SHALL** be met.
- B. Noncompliance with a control **SHALL** exist when the requirements of the Control and associated ACTION requirements are not met within the specified time interval. If the Control is restored prior to expiration of the specified time interval, completion of the ACTION requirements is not required.
- C. With the calculated dose from the release of radioactive materials in liquid or gaseous effluents exceeding any of the limits of Controls ODCM-02.01 Section 2.2.1, ODCM-03.01 Section 2.2.1, or ODCM 03.01 Section 2.3.1, prepare and submit within 30 days a special report to the Commission which includes the following:
  - 1. Identifies the cause(s) for exceeding the limit(s) and defines the corrective action(s) that has been taken to reduce the release(s).
  - 2. Lists the proposed corrective action(s) to be taken to assure that subsequent releases will be in compliance with the limits.
- D. Noncompliance with a CONTROL and associated ACTION, or a Surveillance Requirement **SHALL** be documented in the annual "Radioactive Effluent Release Report" covering the period of the noncompliance. Documentation of a noncompliance **SHALL** identify the cause of the noncompliance, define the corrective actions taken to correct the noncompliance, and a description of actions taken to prevent recurrence.

<b>MONTICELLO NUCLEAR GENERATING PLANT</b>		ODCM-01.01
<b>TITLE:</b>	<b>INTRODUCTION</b>	Revision 8
		Page 9 of 9

2.4.2 Surveillance Requirements

- A. Surveillance Requirements **SHALL** be met during the conditions specified for individual controls unless otherwise stated in an individual Surveillance Requirement.
- B. Each Surveillance Requirement **SHALL** be performed within the specified time interval with the following exceptions:
  - 1. Specified time intervals between tests may be adjusted plus 25% to accommodate normal test schedules.
- C. Failure to perform a Surveillance Requirement within the allowed surveillance interval, defined by Control B, **SHALL** constitute noncompliance with the FUNCTIONALITY requirements for a Control for operation. The time limits of the ACTION requirements are applicable at the time it is identified that a Surveillance Requirement has not been performed. The ACTION requirements may be delayed for up to 24 hours to permit the completion of the surveillance when the allowable outage time limits of the ACTION requirements are less than 24 hours. Surveillance Requirements do not have to be performed on non-functional equipment.

<b>MONTICELLO NUCLEAR GENERATING PLANT</b>		ODCM-02.01
<b>TITLE:</b>	<b>LIQUID EFFLUENTS</b>	Revision 12
		Page 1 of 14

Approval: ODC 01525637

**OFFSITE DOSE CALCULATION MANUAL - TABLE OF CONTENTS**

<b><u>SECTION</u></b>		<b><u>PAGE</u></b>
1.0	RECORD OF REVISION .....	2
2.0	LIQUID EFFLUENTS .....	4
2.1	Concentration.....	4
2.2	Dose.....	5
2.3	Liquid Radwaste Treatment Systems.....	5
2.4	Liquid Holdup Tanks .....	6
2.5	Bases .....	7
Figure 1	Monticello Nuclear Generating Plant Site Boundary for Liquid Effluents .....	10
Table 1	Radioactive Liquid Effluent Monitoring Instrumentation Surveillance Requirements .....	11
Table 2	Radioactive Liquid Waste Sampling and Analysis Program .....	12
Table 3	Radioactive Liquid Effluent Monitoring Instrumentation.....	14

<b>MONTICELLO NUCLEAR GENERATING PLANT</b>		ODCM-02.01
<b>TITLE:</b>	<b>LIQUID EFFLUENTS</b>	Revision 12
		Page 2 of 14

## 1.0 RECORD OF REVISION

<u>Revision No.</u>	<u>Reason for Revision</u>
1	Corrected reference to Table 2.1-1 from 2.1.2.
2	Incorporated Radiological Effluents Tech Specs section 3.8.A and 4.8.A. into document.
3	Revised Actions 2.2.3 and 2.3.3 to standardize documentation and reporting.
4	Table numbering was restarted to reflect 1, 2 and 3 verses 3, 4 and 5 throughout the document.
5	Incorporated changes made during the conversion of the Current Technical Specifications to the Improved Technical Specifications. This includes dual step annotation.
6	This change is being submitted per GAR 01012990. There are no additional changes to the procedures. This revision is being issued to allow PORC review of changes made in revision 5. Revision bars for revision 5 are maintained for review purposes.
7	Removed references to CTS. Added 30 day reporting requirement to 2.2.3.A  Removed duplicate paragraph from Bases section 2.5.1.D. Moved paragraph from 2.5.1.D. to 2.5.1.A.
8	Included frequencies for Flow Instrument Channel Checks in Table 1 IAW NUREG 1302 (Offsite Dose Calculation Manual Guidance) Table 4.3-8.  Revised the frequency of Service Water and Discharge Canal grab samples in Table 3 from every 8 hours to 12 hours IAW NUREG 1302 (Offsite Dose Calculation Manual Guidance). Table 3.3-12 Action 37.  Created a separate reference to the Service Water Flow Monitor in Table 3 to clarify that only when the Radioactivity Monitor is non-functional that grab samples are required.
9	In Table 3, removed asterisk after "Service Water Discharge Pipe Sample Pump Flow Monitor". The asterisk indicates monitor provided with automatic alarm; this alarm was removed by EC-13285.

<b>MONTICELLO NUCLEAR GENERATING PLANT</b>		ODCM-02.01
<b>TITLE:</b>	<b>LIQUID EFFLUENTS</b>	Revision 12
		Page 3 of 14

<u>Revision No.</u>	<u>Reason for Revision</u>
10	In Table 3, removed the column for “Service Water Discharge Pipe Sample Pump Flow Monitor.” The requirement for a daily Channel Check is listed in Table 1, which is in accordance with NUREG 1302 (Offsite Dose Calculation Manual Guidance) Table 4.3-8. The Channel Check requirement is satisfied by the completion of 0000-J OPERATIONS DAILY LOG-PART J OUTPLANT.
11	Correct out of date terminology throughout document.
12	<p>Added LLD Bases from NUREG-1302.</p> <p>Updated Liquid Effluent Site Boundary Map in Figure 1 making it more legible and consistent with current locations.</p> <p>Clarified and updated the Sample Flow Verification for Service Water Radiation Monitor in Table 1. Clarified Sensor Check applicability for Flow instruments, based on NUREG-1302. Removed daily sample flow verification for Discharge Canal Radiation Monitor.</p> <p>Updated LLD equation to use <math>\mu\text{Ci/ml}</math>, rather than <math>\text{pCi/l}</math>, consistent with the required LLD in Table 2.</p> <p>Deleted Date column from Record of Revision Section.</p>

<b>MONTICELLO NUCLEAR GENERATING PLANT</b>		ODCM-02.01
<b>TITLE:</b>	<b>LIQUID EFFLUENTS</b>	Revision 12
		Page 4 of 14

## 2.0 LIQUID EFFLUENTS

### 2.1 Concentration

#### 2.1.1 Controls

- A. In accordance with Tech Spec 5.5.3.a, 5.5.3.b, and 5.5.3.c, the concentration of liquid radioactive material released from the site (Figure 1) **SHALL** be limited to ten times the concentration values specified in Appendix B, Table 2, Column 2 of 10CFR20.1001-20.2402 for radionuclides other than dissolved or entrained noble gases. For dissolved or entrained noble gases, the concentration **SHALL** be limited to  $2 \times 10^{-4}$   $\mu\text{Ci/ml}$  total activity.

#### 2.1.2 Applicability

At all times.

#### 2.1.3 Action

- A. When the concentration of radioactive material in liquid released from the site exceeds the above limits, immediately restore the concentration within acceptable limits.
- B. Radioactive material in liquid effluent released from the site **SHALL** be continuously monitored in accordance with Table 3.
- C. The liquid effluent monitors having provisions for automatic alarms as listed in Table 3 **SHALL** be used to limit the concentration of radioactive material released at any time from the site to the values given in 2.1.1.A. Setpoints **SHALL** be determined in accordance with the methods in ODCM-04.01 (Liquid Effluent Calculations).
- D. Report all deviations in the Annual Radioactive Effluent Release Report.

#### 2.1.4 Surveillance Requirements

- A. Radioactive liquid wastes **SHALL** be sampled and analyzed according to the sampling and analysis program of Table 2.
- B. The results of radioactive analysis **SHALL** be used in accordance with the methods of the ODCM to assure that the concentrations at the point of release are maintained within the limits of Control 2.1.1.A.
- C. Liquid effluent monitoring instrumentation surveillance **SHALL** be performed as required by Table 1.



<b>MONTICELLO NUCLEAR GENERATING PLANT</b>		ODCM-02.01
<b>TITLE:</b>	<b>LIQUID EFFLUENTS</b>	Revision 12
		Page 5 of 14

## 2.2 Dose

### 2.2.1 Controls

- A. In accordance with Tech Spec 5.5.3.a, 5.5.3.c, 5.5.3.d, and 5.5.3.e, the dose or dose commitment to a MEMBER OF THE PUBLIC from radioactive material in liquid effluents released from the site **SHALL** be limited to the following values:
1. During any calendar quarter to  $\leq 1.5$  mrem to the total body and to  $\leq 5$  mrem to any organ, and
  2. During any calendar year to  $\leq 3$  mrem to the total body and to  $\leq 10$  mrem to any organ.

### 2.2.2 Applicability

At all times.

### 2.2.3 Action

- A. With the calculated dose from the release of radioactive materials in liquid effluents exceeding any of the above limits, document and report IAW ODCM-01.01, Section 2.4.1.C.

### 2.2.4 Surveillance Requirements

- A. Cumulative dose contributions for the current calendar quarter and current calendar year **SHALL** be determined monthly in accordance with the ODCM.

## 2.3 Liquid Radwaste Treatment Systems

### 2.3.1 Controls

- A. In accordance with Tech Spec 5.5.3.a, 5.5.3.c, and 5.5.3.f, the LIQUID RADWASTE TREATMENT SYSTEM **SHALL** be used to reduce the radioactive materials in liquid wastes prior to their discharge when the projected doses, due to the liquid effluent from the site would exceed 0.06 mrem to the whole body or 0.2 mrem to any organ when averaged over one month.

### 2.3.2 Applicability

At all times.

<b>MONTICELLO NUCLEAR GENERATING PLANT</b>		ODCM-02.01
<b>TITLE:</b>	<b>LIQUID EFFLUENTS</b>	Revision 12
		Page 6 of 14

### 2.3.3 Action

- A. With radioactive liquid waste being discharged without treatment and in excess of the above limits, prepare and submit within 30 days a special report to the commission which includes the following:
  1. Explanation of why liquid radwaste was being discharged without treatment, identification of any non-functional equipment or subsystems, and the reason for the non-functionality.
  2. Action(s) taken to restore the non-functional equipment to FUNCTIONAL status.
  3. Summary description of actions taken to prevent a recurrence.

### 2.3.4 Surveillance Requirements

- A. Doses due to liquid releases **SHALL** be projected at least once each month in accordance with the ODCM.

## 2.4 Liquid Holdup Tanks

### 2.4.1 Controls

- A. In accordance with Tech Spec 5.5.7.c, the quantity of radioactive material contained in each outside temporary tank **SHALL** be limited to  $\leq 10$  curies, excluding tritium and dissolved or entrained gases.

### 2.4.2 Applicability

At all times.

### 2.4.3 Action

- A. With the quantity of radioactive material contained in any outside temporary tank exceeding the limit in 2.4.1.A. above, immediately suspend all additions of radioactive material to the tank and within 48 hours reduce the tank contents to within the limit.

### 2.4.4 Surveillance Requirements

- A. The quantity of radioactive material contained in each outside temporary tank **SHALL** be determined to be within the limit in 2.4.1.A. by analyzing a representative sample of the tank's contents at least weekly when radioactive materials are being added to the tank.

<b>MONTICELLO NUCLEAR GENERATING PLANT</b>		ODCM-02.01
<b>TITLE:</b>	<b>LIQUID EFFLUENTS</b>	Revision 12
		Page 7 of 14

## 2.5 Bases

### 2.5.1 Liquid Effluents

#### A. Concentration

Control 2.1.1.A. is provided to ensure that the concentration of radioactive materials released in liquid waste effluents to Unrestricted Areas will be less than 10 times the concentration values specified in Appendix B, Table 2, Column 2 to 10CFR20.1001-20.2402. The control provides operational flexibility for releasing liquid effluents in concentrations to follow the Section II.A and II.C design objectives of Appendix I to 10CFR Part 50. This limitation provides reasonable assurance that the levels of radioactive materials in bodies of water in Unrestricted Areas will result in exposures within (1) the Section II.A design objectives of Appendix I, 10CFR Part 50, to a Member of the Public and (2) restrictions authorized by 10CFR20.1301(e). The concentration limit for the dissolved or entrained noble gases is based upon the assumption that Xe-135 is the controlling radionuclide and its effluent concentration in air (submersion) was converted to an equivalent concentration in water. This control does not affect the requirement to comply with the annual limitations of 10CFR20.1301(a).

Surveillance requirements for continuous liquid release points are not provided since all Monticello releases are "batch" type releases.

The required detection capabilities for radioactive materials in liquid waste samples are tabulated in terms of the lower limits of detection (LLDs). Detailed discussion of the LLD, and other detection limits, can be found in Currie, L. A., "Lower Limit of Detection: Definition and Elaboration of a Proposed Position for Radiological Effluent and Environmental Measurements," NUREG/CR-4007 (September 1984), and in the HASL Procedures Manual, HASL-300.

#### B. Dose

Control 2.2.1.A. is provided to implement the requirements of Sections II.A, III.A and IV.A of Appendix I, 10CFR Part 50. Action required by Control 2.2.1 provides the required operating flexibility and at the same time implements the guides set forth in Section IV.A of Appendix I to assure that the releases of radioactive material in liquid effluents will be kept "as low as is reasonably achievable". Considering that the nearest drinking water supply using the receiving water is 33 river miles downstream, there is reasonable assurance that the operation of the facility will not result in radionuclide concentrations in the finished drinking water that are in excess of the requirements of 40CFR141.

<b>MONTICELLO NUCLEAR GENERATING PLANT</b>		ODCM-02.01
<b>TITLE:</b>	<b>LIQUID EFFLUENTS</b>	Revision 12
		Page 8 of 14

The dose calculations in the ODCM implement the requirements in Section III.A of Appendix I that conformance with the guides of Appendix I be shown by calculational procedures based on models and data such that the actual exposure of an individual through appropriate pathways is unlikely to be substantially underestimated. The equations specified in the ODCM for calculating the doses due to the actual release rates of radioactive materials in liquid effluents will be consistent with the methodology provided in Regulatory Guide 1.109, "Calculation of Annual Doses to Man from Routine Releases of Reactor Effluents for the Purpose of Evaluating Compliance with 10CFR50, Appendix I," Revision 1, October 1977 and Regulatory Guide 1.113, "Estimating Aquatic Dispersion of Effluents from Accidental and Routine Reactor Releases for the Purpose of Implementing Appendix I, Revision 1," April 1977. NUREG-0133, October 1978 provides methods for dose calculations consistent with Regulatory Guides 1.109 and 1.113.

C. Liquid Radwaste Treatment Systems

Control 2.3.1.A. provides assurance that the liquid radwaste treatment system will be available for use whenever liquid effluents require treatment prior to release to the environment. The requirements that the appropriate portions of this system be used when specified provides assurance that the releases of radioactive materials in liquid effluents will be kept "as low as is reasonably achievable". This control implements the requirements of 10CFR Part 50.36a, General Design Criterion 60 of Appendix A to 10CFR Part 50 and design objective Section II.D of Appendix I to 10CFR Part 50. The specified limits governing the use of appropriate portions of the liquid radwaste treatment system were specified as a suitable fraction of the guide set forth in Section II.A of Appendix I, 10CFR Part 50, for liquid effluents.

The radioactive liquid effluent monitoring instrumentation is provided to monitor and control, as applicable, the releases of radioactive materials in liquid effluents during actual or potential releases of liquid effluents. The Alarm/Trip Setpoint for these instruments **SHALL** be calculated and adjusted in accordance with the methodologies and parameters in the ODCM to ensure that the alarm/trip will occur prior to exceeding the limits of 10CFR Part 20. The FUNCTIONALITY and use of this instrumentation is consistent with the requirements of General Design Criteria 60, 63, and 64 of Appendix A to 10CFR Part 50.

<b>MONTICELLO NUCLEAR GENERATING PLANT</b>		ODCM-02.01
<b>TITLE:</b>	<b>LIQUID EFFLUENTS</b>	Revision 12
		Page 9 of 14

D. Liquid Holdup Tanks

Restrictions on the quantity of radioactive liquid material contained in tanks are required only for temporary tanks. All exterior permanent tanks are diked to prevent release of their contents in the event of leakage. Restricting the quantity of radioactive material contained in the specified tanks provides assurance that in the event of an uncontrolled release of the tanks contents, the resulting concentrations would be less than the values given in Appendix B, Table 2, Column 2, to 10CFR20.1001-20.2402 at the nearest potable water supply and the nearest surface water supply in an unrestricted area.

<b>MONTICELLO NUCLEAR GENERATING PLANT</b>		ODCM-02.01
<b>TITLE:</b>	<b>LIQUID EFFLUENTS</b>	Revision 12
		Page 10 of 14

Figure 1 Monticello Nuclear Generating Plant Site Boundary for Liquid Effluents

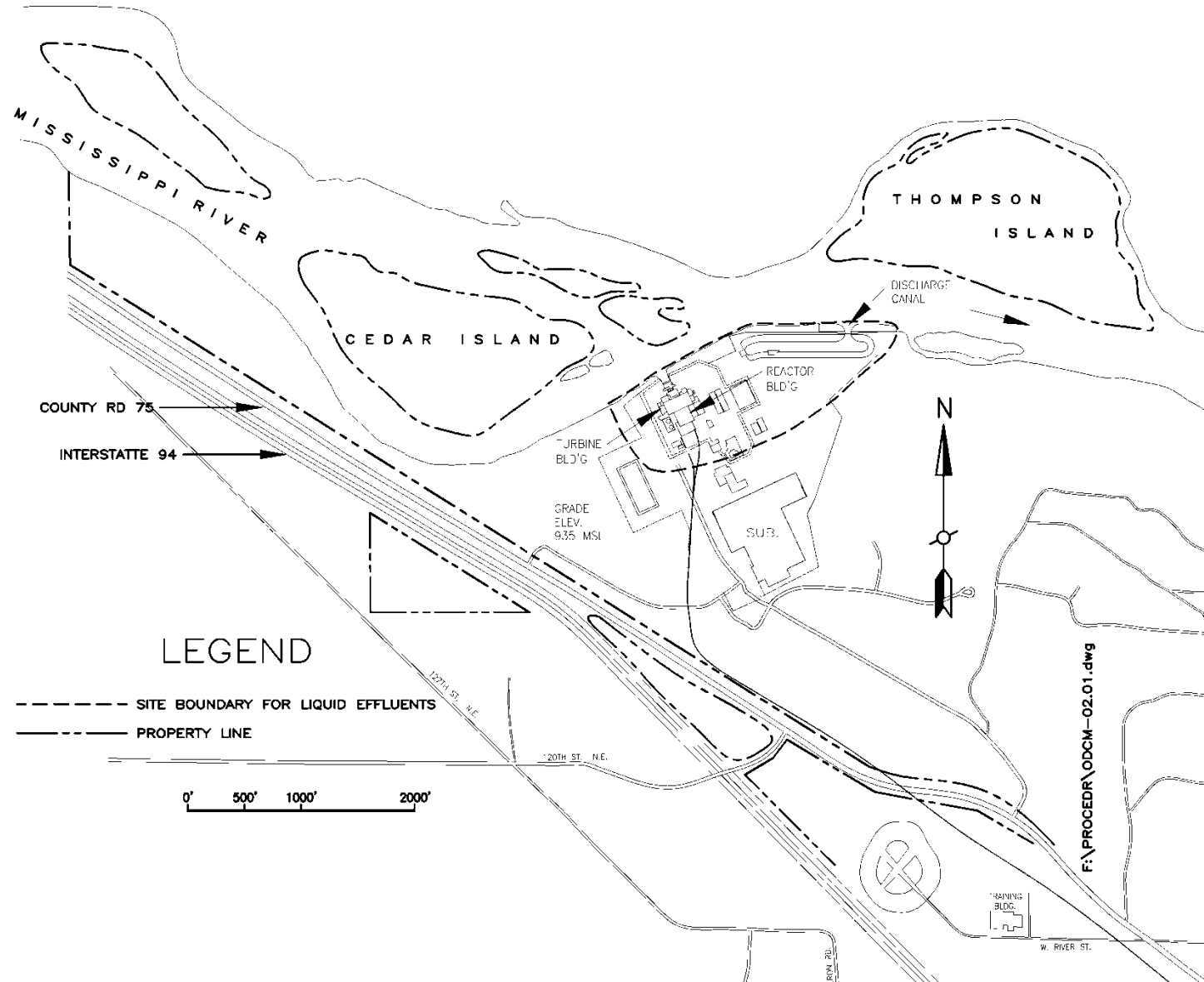

Table 1 Radioactive Liquid Effluent Monitoring Instrumentation Surveillance Requirements

Instrument	Sample Flow Verification <sup>#</sup> Frequency	Sensor Check Frequency	Source Check Frequency	Functional Test Frequency	Calibration Frequency
Liquid Radwaste Effluent Line Gross Radioactivity Monitor	-	Daily during release	Immediately Prior to Each Release	Within 3 months prior to making a release	Within 12 months prior to making a release.**
Liquid Radwaste Effluent Line Flow Instrument	-	Daily during release*	-	Within 3 months prior to making a release	Within 12 months prior to making a release.
Instruments used in Determination of Discharge Canal Flow	-	Daily during release*	-	Within 3 months prior to making a release	Within 18 months prior to making a release.
Service Water Discharge Pipe Gross Radioactivity Monitor	Daily	Daily	Monthly	Quarterly	Each Operating Cycle**
Discharge Canal Gross Radioactivity Monitor	-	Daily	Monthly	Quarterly	Each Operating Cycle***
Turbine Building Normal Waste Sump Monitor	-	Daily	Monthly	Quarterly	Each Operating Cycle
Level Monitors for Temporary Outdoor Tanks Holding Radioactive Liquid	-	Daily when in use	-	Quarterly when in use	Each Operating Cycle when in use

- # - Verification of sample flow is used to ensure functionality for Service Water Effluent Radiation Monitor. This monitor does not alarm on low sample flow (EC13285).
- \* - Sensor Check **SHALL** consist of verifying indication of flow during periods of release. Sensor Check **SHALL** be made at least once per 24 hours on days on which continuous, periodic, or batch releases are made.
- \*\* - The initial Instrument Calibration **SHALL** be performed using one or more of the reference standards certified by the National Bureau of Standards (NBS) or using sources traceable to NBS standards. These standards **SHALL** permit calibrating the system over its intended range of energy and measurement range. For subsequent calibration sources that have been related to the initial calibration **SHALL** be used.
- \*\*\* - An initial Instrument Calibration was performed using a liquid reference standard over the systems intended range of energy and measurement range. Solid calibration sources traceable to NBS Standards currently being applied for instrument calibrations were related to the initial calibration. If, in the future, the canal radioactivity monitor is replaced, the following conditions **SHALL** apply:
- Detector response and system efficiency **SHALL** be equal to or better than the present system.
  - Footnote (\*\*) **SHALL** apply

<b>MONTICELLO NUCLEAR GENERATING PLANT</b>		ODCM-02.01
<b>TITLE:</b>	<b>LIQUID EFFLUENTS</b>	Revision 12
		Page 12 of 14

Table 2 Radioactive Liquid Waste Sampling and Analysis Program

Liquid Release Type	Sampling Frequency	Minimum Analysis Frequency	Type of Activity Analysis	Lower Limit of Detection (LLD) (uci/ml) <sup>a, e</sup>
Batch Waste Release Tanks <sup>b</sup>	Each Batch	Each Batch	Principal Gamma Emitters <sup>d</sup>	$5 \times 10^{-7}$
			I-131	$1 \times 10^{-6}$
	One Batch Each Month	One Batch Each Month	Dissolved and Entrained Gases	$1 \times 10^{-5}$
	Each Batch	Monthly Composite <sup>c</sup>	H-3	$1 \times 10^{-5}$
			Gross alpha	$1 \times 10^{-7}$
	Each Batch	Quarterly Composite <sup>c</sup>	Sr-89, Sr-90	$5 \times 10^{-8}$
			Fe-55	$1 \times 10^{-6}$



<b>MONTICELLO NUCLEAR GENERATING PLANT</b>		ODCM-02.01
<b>TITLE:</b>	<b>LIQUID EFFLUENTS</b>	Revision 12
		Page 13 of 14

Table 2 Radioactive Liquid Waste Sampling and Analysis Program (cont'd)

**Notes**

- a. The LLD is the smallest concentration of radioactive material in a sample that will be detected with 95% probability with 5% probability of falsely concluding that a blank observation represents a “real” signal.

For a particular measurement system (which may include radiochemical separation):

$$LLD = \frac{4.66 s_b}{E \cdot V \cdot 2.22 \times 10^6 \cdot Y \cdot \exp(-\lambda \Delta t)}$$

where:

LLD is the a priori lower limit of detection as defined above (as microcurie per unit mass or volume),

$s_b$  is the standard deviation of the background counting rate or of the counting rate of a blank sample as appropriate (as counts per minute). Typical values of E, V, Y and  $\Delta t$  **SHALL** be used in the calculations.

E is the counting efficiency (as counts per transformation),

V is the sample size (in units of mass or volume),

$2.22 \times 10^6$  is the number of transformations per minute per microcurie,

Y is the fractional radiochemical yield (when applicable),

$\lambda$  is the radioactive decay constant for the particular radionuclide, and

$\Delta t$  is the elapsed time between midpoint of sample collection and time of counting.

- b. A batch release is the discharge of liquid wastes of a discrete volume. Prior to sampling for analyses, each batch **SHALL** be isolated and then thoroughly mixed to assure representative sampling.
- c. A composite sample is one in which the quantity of liquid sampled is proportional to the quantity of liquid waste discharged and in which the method of sampling employed results in a specimen which is representative of the liquids released.
- d. The principal gamma emitters for which the LLD specification will apply are exclusively the following radionuclides: Mn-54, Fe-59, Co-58, Co-60, Zn-65, Mo-99, Cs-134, Cs-137, Ce-141, and Ce-144. This list does not mean that only these nuclides are to be detected and reported. Other peaks which are measurable and identifiable, together with the above nuclides, **SHALL** also be identified and reported.
- e. Nuclides which are below the LLD for the analyses **SHALL** be reported as “less than” the LLD of the nuclide and should not be reported as being present at the LLD level for that nuclide. The “less than” values **SHALL** not be used in the required dose calculations. When unusual circumstances result in LLDs higher than required, the reasons **SHALL** be documented in the Radioactive Effluent Release Report.

<b>MONTICELLO NUCLEAR GENERATING PLANT</b>		ODCM-02.01
<b>TITLE:</b>	<b>LIQUID EFFLUENTS</b>	Revision 12
		Page 14 of 14

Table 3 Radioactive Liquid Effluent Monitoring Instrumentation

Instrument	Minimum Channels Functional	Applicability	Action if Minimum Channels not functional
Liquid Radwaste Effluent Line Gross Radioactivity Monitor	1	During Release of Liquid Radwaste	Liquid radwaste releases may continue for up to 14 days provided that prior to initiating a release: a. At least two independent samples are analyzed in accordance with Table 2. b. At least two technically qualified members of the Facility Staff independently verify the release rate calculations and discharge line valving; Otherwise, suspend release of radioactive effluents via this pathway.
Liquid Radwaste Effluent Flow Instrument	1	During Release of Liquid Radwaste	Liquid radwaste releases via this pathway may continue for up to 30 days provided the flow rate is estimated at least every four hours during actual releases. Pump curves may be used to estimate flow.
Discharge Canal Flow Measurement: - Open Cycle Mode - Closed/Helper Cycle Mode	1 1	During Release of Liquid Radwaste	Effluent releases via this pathway may continue for up to 30 days provided the flow rate is estimated at least once every four hours during actual releases. Pump curves may be used to estimate flow.
Discharge Canal Gross Radioactivity Monitor*	1	At all times	Effluent releases may continue for up to 30 days provided that at least once every 12 hours a grab sample <b>SHALL</b> be collected and analyzed for gross beta at an LLD of $10^{-7}$ $\mu$ Ci/ml or gamma isotopic for principal gamma emitters at an LLD of $5.0 \times 10^{-7}$ $\mu$ Ci/ml.
Service Water Discharge Pipe Gross Radioactivity Monitor*	1	At all times	Service water discharge may continue for up to 30 days provided that at least once every 12 hours a grab sample <b>SHALL</b> be collected and analyzed for gross beta at an LLD of $10^{-7}$ $\mu$ Ci/ml or gamma isotopic for principal gamma emitters at an LLD of $5.0 \times 10^{-7}$ $\mu$ Ci/ml.
Turbine Building Normal Waste Sump Monitor*	1	At all times	Liquid sump releases may continue for up to 30 days provided that at least once every 12 hours a grab sample <b>SHALL</b> be collected and analyzed for gross beta at an LLD of $10^{-7}$ $\mu$ Ci/ml or gamma isotopic for principal gamma emitters at an LLD of $5.0 \times 10^{-7}$ $\mu$ Ci/ml.
Level Monitors for Temporary Outdoor Tanks Holding Radioactive Liquid	1	When tanks are in use	Liquid additions to a tank may continue for up to 30 days provided the tank level is estimated during all liquid additions.

\* - Indicates monitor provided with automatic alarm.

<b>MONTICELLO NUCLEAR GENERATING PLANT</b>		ODCM-03.01
<b>TITLE:</b>	<b>GASEOUS EFFLUENTS</b>	Revision 14
		Page 1 of 21

Approval: ODC 01525641

**OFFSITE DOSE CALCULATION MANUAL - TABLE OF CONTENTS**

<b><u>SECTION</u></b>	<b><u>PAGE</u></b>
1.0 RECORD OF REVISION .....	2
2.0 GASEOUS EFFLUENTS .....	5
2.1 Dose Rate .....	5
2.2 Dose - Noble Gases .....	6
2.3 Dose - Iodine-131, Iodine-133, Tritium and Particulates .....	7
2.4 Off-gas Treatment System .....	7
2.5 Main Condenser Off-Gas Pretreatment Radiation Monitor .....	9
2.6 Containment Venting and Purging .....	10
2.7 Bases .....	11
Figure 1 Monticello Nuclear Generating Plant Site Boundary for Gaseous Effluents .....	15
Table 1 Radioactive Gaseous Effluent Monitoring Instrumentation Surveillance Requirements .....	16
Table 2 Radioactive Gaseous Waste Sampling and Analysis Program.....	17
Table 3 Radioactive Gaseous Effluent Monitoring Instrumentation .....	20

<b>MONTICELLO NUCLEAR GENERATING PLANT</b>		ODCM-03.01
<b>TITLE:</b>	<b>GASEOUS EFFLUENTS</b>	Revision 14
		Page 2 of 21

## 1.0 RECORD OF REVISION

<u>Revision No.</u>	<u>Reason for Revision</u>
1	<p>Page 3 of 23, 2nd paragraph - Changed "In addition, prior to containment purge and venting," to "In addition, prior to containment purging". This change was made because setpoint recalculation is required only for containment purging and to be consistent with the rest of the ODCM.</p> <p>Page 3 of 23, first paragraph - Changed "Reactor Building Vent Plenum Monitor which initiates isolation of Reactor Building releases" to "Reactor Building Vent Noble Gas Monitor". This change was made to differentiate the noble gas monitor from the plenum radiation monitor and because the isolation function has been removed from the noble gas monitor system.</p> <p>Page 3 of 23, section 1.1.1 - Changed "Reactor Building Vent Isolation Setpoint" to "Reactor Building Vent Alarm Setpoint". This change was made because the setpoint exceedance no longer causes the Reactor Building Vent to isolate.</p> <p>Page 4 of 23, Section 1.1.1.B - Changed "For purge releases, substitute (x/q)v, the highest short term dispersion factor from Table A-12" to "For purge releases, substitute the value obtained from Chemistry Manual Procedure I.06.07 (ATMOSPHERIC DISPERSION DETERMINATION)". This change was made to more accurately predict off-site dose from containment purging by using near real time actual dispersion values.</p>
2	Incorporated Radiological Effluents Tech Specs section 3.8.B and 4.8.B into document.
3	Added clarification to section 2.4.1.A. and 2.4.3.A. to more accurately describe Off-gas Treatment System operation requirements. Corrected reference in Note h. of Table 2.
4	Revised Actions 2.2.3 and 2.3.3 to standardize documentation and reporting. Revised action in Table 3 to make non-functional air ejector off-gas radiation monitors consistent with high monitor readings action in T.S.3.8.A. Revised action in Table 3 to add compensatory sampling for non-functional hydrogen monitors similar to other non-functional monitors in Table 3.
5	Revised Control 2.4.1.A to make it consistent with Tech Spec 6.8.D.6. Revised Action 2.4.3.A to accommodate the revised Control (2.4.1.A).

<b>MONTICELLO NUCLEAR GENERATING PLANT</b>		ODCM-03.01
<b>TITLE:</b>	<b>GASEOUS EFFLUENTS</b>	Revision 14
		Page 3 of 21

<u>Revision No.</u>	<u>Reason for Revision</u>
6	Revised Control 2.6.1.A to make it consistent with Tech Spec 3.7.D.3.a. Deleted surveillance requirement 2.6.4.A to conform to T.S.3.7.D.3.a.
7	Incorporated changes made during the conversion of the Current Technical Specifications to the Improved Technical Specifications. This includes dual step annotation.
8	This change is being submitted per GAR 01012990. There are no additional changes to the procedures. This revision is being issued to allow PORC review of changes made in revision 7. Revision bars from revision 7 are maintained for review purposes.
9	Revised Control 2.6.1 and it's bases to allow the use of Standby Gas Treatment System during inerting and deinerting activities.
10	Removed references to CTS. Added 30 day reporting requirements to 2.4.3.A.
11	Revised to correct out of date terminology throughout document.
12	Corrected Table 2; Tech Spec requirement for sampling radioactive iodines every four hours if greater than 0.2 uCi/gm.
13	Removed exceptions for operation of Off-gas Treatment System in section 2.4.1 and 2.4.3 to ensure that the Off-gas Holdup System is operated whenever possible and to require the Special report whenever bypassing >7 days.  Made all Controls in 2.4.1 Applicable whenever SJAE's are in operation. Moved Action statement from Control 2.4.1.C. down to Action 2.4.3.B. Removed references to TS 5.5.3.a and 5.5.3.b from Control 2.4.1.A. These TS's do not relate to this Control.

<b>MONTICELLO NUCLEAR GENERATING PLANT</b>		ODCM-03.01
<b>TITLE:</b>	<b>GASEOUS EFFLUENTS</b>	Revision 14
		Page 4 of 21

Revision No.

Reason for Revision

14

Moved Dose Rate Actions 2.1.3.B. and 2.1.3.C. up to the Controls section. Added Actions supporting the moved Controls. Added Surveillance Requirement 2.4.4.B. requiring Dose Projection and 2.4.4.C. requiring Hydrogen Monitor Surveillance according to Table 1.

Renamed Off-gas Treatment System Section (2.5) to Off-Gas Pretreatment Radiation Monitor. Removed Controls, Actions, and Surveillance Requirements duplicating TS 3.7.6. Added Actions 2.5.3.A and 2.5.3.B. and Surveillance requirement 2.5.4.A. related to Off-gas Rad Monitor Functionality. Corrected FUNCTIONALITY to OPERABILITY in Control 2.6.1.A., consistent with TS 3.6.1.1.

Added notes to Bases Section for On-site Dose and LLD, based on NUREG-1302.

Updated Bases for Off-gas Rad Monitor section to reference TS 3.7.6 and added bases for Controls in 2.5.1.

Updated Gaseous Effluent Site Boundary Map in Figure 1 to improve readability and update road locations.

Changed Table 2, Note c. to require daily sampling when DEI exceeds 10% of the TS limit.

Deleted Date Column from Record of Revision.

<b>MONTICELLO NUCLEAR GENERATING PLANT</b>		ODCM-03.01
<b>TITLE:</b>	<b>GASEOUS EFFLUENTS</b>	Revision 14
		Page 5 of 21

## 2.0 GASEOUS EFFLUENTS

### 2.1 Dose Rate

#### 2.1.1 Controls

- A. In accordance with Tech Spec 5.5.3.a, 5.5.3.c, and 5.5.3.g, the dose rate due to radioactive materials released in gaseous effluents from the site (Figure 1) **SHALL** be limited to the following values:
1. For Noble Gases: Less than or equal to a dose rate of 500 mrem/yr to the total body and less than or equal to a dose rate of 3000 mrem/yr to the skin, and
  2. For Iodine-131, Iodine-133, Tritium, and for all radionuclides in particulate form with half-lives greater than 8 days: Less than or equal to a dose rate of 1500 mrem/yr to any organ.
- B. Radioactive material in gaseous effluents released from the site **SHALL** be continuously monitored in accordance with Table 3.
- C. The Noble Gas Effluent monitors having provisions for the automatic termination of gaseous releases, as listed in Table 3 **SHALL** be used to limit off-site dose rates to the values established in 2.1.1.A.1. Setpoints **SHALL** be determined in accordance with the ODCM.

#### 2.1.2 Applicability

At all times.

#### 2.1.3 Action

- A. With the dose rate(s) exceeding the above limits, immediately decrease the release rate to within acceptable limits(s).
- B. With radioactive gaseous effluent monitoring instrumentation channel Alarm/Trip Setpoint less conservative than required by Control 2.1.1.C., immediately suspend the release of radioactive gaseous effluents monitored by the affected channel, or declare the channel nonfunctional, or change the setpoint so it is acceptably conservative.
- C. With less than the minimum number of radioactive gaseous effluent monitoring instrumentation channels Functional, take Action shown in Table 3. Restore the nonfunctional instrumentation to FUNCTIONAL status within 30 days and, if unsuccessful, explain in the next Annual Radioactive Effluent Release Report why this nonfunctionality was not corrected in a timely manner.

<b>MONTICELLO NUCLEAR GENERATING PLANT</b>		ODCM-03.01
<b>TITLE:</b>	<b>GASEOUS EFFLUENTS</b>	Revision 14
		Page 6 of 21

#### 2.1.4 Surveillance Requirements

- A. Gaseous effluent monitoring instrument surveillance **SHALL** be performed as required by Table 1.
- B. The release rate due to Iodine-131, Iodine-133, Tritium, and Radioactive Particulates with half-lives greater than 8 days **SHALL** be determined by obtaining representative samples and performing analysis in accordance with the sampling and analysis program specified in Table 2. Following each analysis, the dose rate due to I-131, I-133, Tritium and Radioactive Particulates with half-lives greater than 8 days, **SHALL** be determined to be less than the limit in 2.1.1.A.2. in accordance with the ODCM.

### 2.2 Dose - Noble Gases

#### 2.2.1 Controls

- A. In accordance with Tech Spec 5.5.3.a, 5.5.3.c, 5.5.3.e and 5.5.3.h, the air dose due to noble gases released in gaseous effluents from the site (Figure 1) **SHALL** be limited to the following values:
  - 1. During any calendar quarter:  $\leq 5$  mrad for gamma radiation and  $\leq 10$  mrad for beta radiation, and
  - 2. During any calendar year:  $\leq 10$  mrad for gamma radiation and  $\leq 20$  mrad for beta radiation.

#### 2.2.2 Applicability

At all times.

#### 2.2.3 Action

- A. With the calculated air dose from radioactive noble gases in gaseous effluent exceeding any of the above limits, document and report IAW ODCM-01.01, Section 2.4.1.C.

#### 2.2.4 Surveillance Requirements

- A. Cumulative dose contributions for the current calendar quarter and current calendar year from noble gases in gaseous effluents **SHALL** be determined monthly in accordance with the ODCM.



<b>MONTICELLO NUCLEAR GENERATING PLANT</b>		ODCM-03.01
<b>TITLE:</b>	<b>GASEOUS EFFLUENTS</b>	Revision 14
		Page 7 of 21

## 2.3 Dose - Iodine-131, Iodine-133, Tritium and Particulates

### 2.3.1 Controls

- A. In accordance with Tech Spec 5.5.3.a, 5.5.3.c, and 5.5.3.i, the dose to any organ of an individual due to Iodine-131, Iodine-133, Tritium, and radioactive particulates with a half-life greater than 8 days released from the site (FIGURE 1) in gaseous effluent **SHALL** be limited to the following values:
1. During any calendar quarter:  $\leq 7.5$  mrem, and
  2. During any calendar year:  $\leq 15$  mrem.

### 2.3.2 Applicability

At all times.

### 2.3.3 Action

- A. With the calculated dose from the release of Iodine-131, Iodine-133, Tritium, and Radioactive Particulates with half-lives greater than 8 days, exceeding any of the above limits, document and report IAW ODCM-01.01, Section 2.4.1.C.

### 2.3.4 Surveillance Requirements

- A. Cumulative dose contributions for the current calendar quarter and current calendar year for Iodine-131, Iodine-133, Tritium, and Radioactive Particulates with half-lives greater than 8 days in gaseous effluents **SHALL** be determined in accordance with the ODCM monthly.

## 2.4 Off-gas Treatment System

### 2.4.1 Controls

- A. In accordance with Tech Spec 5.5.3.f, the OFF-GAS TREATMENT SYSTEM **SHALL** be in operation.
- B. In accordance with Tech Spec 5.5.7.b, the quantity of radioactivity after 12 hours holdup contained in each gas storage tank **SHALL** be limited to  $\leq 22,000$  curies of noble gases (considered as dose equivalent Xe-133).
- C. In accordance with Tech Spec 5.5.7.a, the concentration of hydrogen in the compressed storage subsystem **SHALL** be limited to  $\leq 2\%$  by volume.
- D. The hydrogen monitors **SHALL** be functional as specified in Table 3 and set to automatically trip the off-gas compressors at  $\leq 4\%$  hydrogen by volume.

<b>MONTICELLO NUCLEAR GENERATING PLANT</b>		ODCM-03.01
<b>TITLE:</b>	<b>GASEOUS EFFLUENTS</b>	Revision 14
		Page 8 of 21

2.4.2 Applicability

Whenever the Main Condenser Air Ejector system is in operation.

2.4.3 Action

- A. With gaseous waste being discharged for more than seven (7) days with an average holdup time of less than 50 hours, prepare and submit within 30 days a special report to the Commission which includes the following:
  - 1. Identification of the non-functional equipment or subsystems and the reason for non-functionality.
  - 2. Action(s) taken to restore the non-functional equipment to FUNCTIONAL status.
  - 3. Summary description of action(s) taken to prevent recurrence.
- B. With the concentration of hydrogen > 2% by volume, but ≤ 4% by volume, restore the concentration of hydrogen to < 2% by volume within 48 hours or suspend operation of the compressed storage subsystem.

2.4.4 Surveillance Requirements

- A. Following each isotopic analysis of a sample of gases from the Main Condenser Off-gas System Pretreatment monitor station required by Tech Spec 3.7.6, verify that the maximum storage tank activity limit specified in 2.4.1.B cannot be exceeded using the method in the ODCM.
- B. Doses due to gaseous releases to areas at and beyond the SITE BOUNDARY **SHALL** be projected at least once per 31 days in accordance with the methodology and parameters in the ODCM as required by Tech Spec 5.5.3.e.
- C. The Main Condenser Off-gas Treatment System Hydrogen Monitors **SHALL** be demonstrated FUNCTIONAL by performance of the Sensor Check, Functional Test and Calibration at the frequencies shown in Table 1.

<b>MONTICELLO NUCLEAR GENERATING PLANT</b>		ODCM-03.01
<b>TITLE:</b>	<b>GASEOUS EFFLUENTS</b>	Revision 14
		Page 9 of 21

## 2.5 Main Condenser Off-Gas Pretreatment Radiation Monitor

### 2.5.1 Controls

- A. The activity of radioactive material in gaseous form removed from the main condenser **SHALL** be continuously monitored by the Main Condenser Off-Gas Pretreatment monitors in accordance with Table 3.
- B. The Main Condenser Off-Gas Pretreatment monitors **SHALL** be set to automatically terminate off-gas flow within 30 minutes at the limit established in Technical Specification 3.7.6.

### 2.5.2 Applicability

At all times

### 2.5.3 Action

- A. With the Off-gas Pretreatment Radiation Monitor Alarm/Trip Setpoint less conservative than required by Control 2.5.1.B., immediately suspend the release of radioactive gaseous effluents monitored by the affected channel, or declare the channel nonfunctional, or change the setpoint so it is acceptably conservative.
- B. With less than the minimum number of channels Functional, Take the Action shown in Table 3. Restore the nonfunctional instrumentation to Functional status within 30 days and, if unsuccessful, explain in the next Annual Radioactive Effluent Release Report why this nonfunctionality was not corrected in a timely manner.

### 2.5.4 Surveillance Requirements

- A. Each Off-gas Pretreatment Radiation Monitor channel **SHALL** be demonstrated Functional by performance of the Sensor Check, Source Check, Functional Test, and Calibration at the frequencies shown in Table 1.

<b>MONTICELLO NUCLEAR GENERATING PLANT</b>		ODCM-03.01
<b>TITLE:</b>	<b>GASEOUS EFFLUENTS</b>	Revision 14
		Page 10 of 21

## 2.6 Containment Venting and Purging

### 2.6.1 Controls

- A. In accordance with Tech Spec 5.5.3.a, 5.5.3.c, 5.5.3.k, and 3.6.1.3, the inerting and deinerting operations permitted by Tech Spec 3.6.3.1 **SHALL** be via the 18-inch purge and vent valves (equipped with 40-degree limit stops). All other purging and venting, when primary containment OPERABILITY is required, **SHALL** be via the 2-inch purge and vent valve bypass line and the Standby Gas Treatment System.
- B. In accordance with Tech Spec 5.5.3.a, 5.5.3.c, and 5.5.3.k, Containment inerting following startup and deinerting prior to shutdown should be via the Standby Gas Treatment System.

### 2.6.2 Applicability

At all times.

### 2.6.3 Action

None

### 2.6.4 Surveillance Requirements

- A. Prior to containment purging, the sampling and analysis requirements of Table 2 **SHALL** be met.

<b>MONTICELLO NUCLEAR GENERATING PLANT</b>		ODCM-03.01
<b>TITLE:</b>	<b>GASEOUS EFFLUENTS</b>	Revision 14
		Page 11 of 21

## 2.7 Bases

### 2.7.1 Gaseous Effluents

#### A. Dose Rate

Control 2.1.1.A. provides reasonable assurance that radioactive material discharged in gaseous effluents will not result in the exposure of a Member of the Public in an Unrestricted Area, either at or beyond the Site Boundary in excess of the design objectives of Appendix I to 10CFR Part 50. This specification is provided to ensure that gaseous effluents from all units on the site will be appropriately controlled. It provides operational flexibility for releasing gaseous effluents to satisfy the Section II.A and II.C design objectives of Appendix I to 10CFR Part 50. For Members of the Public who may at times be within the Site Boundary, the occupancy of that Member of the Public will usually be sufficiently low to compensate for the reduced atmospheric dispersion of gaseous effluents relative to that for the Site Boundary. Examples of calculations for such Members of the Public, with the appropriate occupancy factors, **SHALL** be given in the ODCM. The specified release rate limits restrict, at all times, the corresponding dose rates above background to a Member of the Public at or beyond the Site Boundary to less than or equal to 500 mrem/year to the total body or to less than or equal to 3000 mrem/year to the skin. These release rate limits also restrict, at all times, the corresponding thyroid dose rate above background to a child via the inhalation pathway to less than or equal to 1500 mrem/year. This specification does not affect the requirement to comply with the annual limitations of 10CFR20.1301(a).

The required detection capabilities for radioactive material in gaseous waste samples are tabulated in terms of the lower limits of detection (LLDs). Detailed discussion of the LLD, and the other detection limits can be found in Currie, L. A., "Lower Limit of Detection: Definition and Elaboration of a Proposed Position for Radilological Effluent and Environmental Measurements," NUREG/CR-4007 (September 1984), and in the HASL Procedures Manual, HASL-300.

#### B. Dose From Noble Gas

Control 2.2.1.A. is provided to implement the requirements of Sections II.B, III.A and IV.A of Appendix I, 10CFR Part 50. Action required by Control 2.2.1 provides the required operating flexibility and at the same time implements the guides set forth in Section IV.A of Appendix I to assure that the releases of radioactive material in gaseous effluents will be kept "as low as reasonably achievable".

<b>MONTICELLO NUCLEAR GENERATING PLANT</b>		ODCM-03.01
<b>TITLE:</b>	<b>GASEOUS EFFLUENTS</b>	Revision 14
		Page 12 of 21

The Surveillance Requirements implement the requirements in Section III.A of Appendix I that conformance with the guides of Appendix I is to be shown by calculational procedures based on models and data such that the actual exposure of an individual through the appropriate pathways is unlikely to be substantially underestimated. The dose calculations established in the ODCM for calculating the doses due to the actual release rates of radioactive noble gases in gaseous effluents will be consistent with the methodology provided in Regulatory Guide 1.109, "Calculation of Annual Doses to Man from Routine Releases of Reactor Effluents for the Purpose of Evaluating Compliance with

10CFR Part 50, Appendix I," Revision 1, October 1977 and Regulatory Guide 1.111, "Methods for Estimating Atmospheric Transport and Dispersion of Gaseous Effluents in Routine Releases from Light-Water-Cooled Reactors," Revision 1, July 1977. The ODCM equations provided for determining the air doses at the restricted area boundary may be based upon the historical average atmospheric conditions. NUREG-0133, October, 1978 provides methods for dose calculations with Regulatory Guides 1.109 and 1.111.

C. Dose From Iodine 131, Iodine 133, Tritium & Particulates

Control 2.3.1.A. is provided to implement the requirements of Section II.C, III.A and IV.A of Appendix I, 10CFR Part 50. The release rate specifications for I-131, I-133, tritium and radioactive particulates with half-lives greater than eight days are dependent on the existing radionuclide pathways to man in the Unrestricted Area. The pathways which are examined in the development of these calculations are: 1) individual inhalation of airborne radionuclides, 2) deposition of radionuclides onto green leafy vegetation with subsequent consumption by man, 3) deposition onto grassy areas where milk animals and meat producing animals graze with consumption of the milk and meat by man, and 4) deposition on the ground with subsequent exposure of man.

D. Off-gas Treatment Systems

Control 2.4.1.A. provides assurance that appropriate portions of the Off-gas Treatment System be used when specified, and provides reasonable assurance that the releases of radioactive materials in gaseous effluents will be kept "as low as is reasonably achievable". This specification implements the requirements of 10CFR50.36a, General Design Criterion 60 of Appendix A to 10CFR Part 50, and design objective Section II.D of Appendix I to 10CFR Part 50. The specified limits governing the use of appropriate portions of the systems were specified as a suitable fraction of the guide set forth in Sections II.B and II.C of Appendix I, 10CFR Part 50, for gaseous effluents.

<b>MONTICELLO NUCLEAR GENERATING PLANT</b>		ODCM-03.01
<b>TITLE:</b>	<b>GASEOUS EFFLUENTS</b>	Revision 14
		Page 13 of 21

Control 2.4.1.B. is provided to limit the radioactivity which can be stored in one decay tank. Restricting the quantity of radioactivity contained in each gas storage tank provides assurance that in the event of an uncontrolled release of the tank's contents, the resulting total body exposure to an individual at the Site Boundary will not exceed 20 mrem. A flow restrictor in the discharge line of the decay tanks prevents a tank from being discharged at an uncontrolled rate. In addition, interlocks prevent the contents of a tank from being released with less than 12 hours of holdup.

The radioactive gaseous effluent monitoring instrumentation is provided to monitor and control, as applicable, the releases of radioactive materials in gaseous effluents during actual or potential releases of gaseous effluents. The Alarm/Trip Setpoint for these instruments will be calculated in accordance with NRC approved methods in the ODCM to ensure that the alarm/trip will occur prior to exceeding the limits of 10CFR Part 20. The FUNCTIONALITY requirements for this instrumentation are consistent with the requirements of General Design Criteria 60, 63, and 64 of Appendix A to 10CFR Part 50.

E. Main Condenser Off-Gas Pretreatment Radiation Monitor

Technical Specification 3.7.6 establishes a maximum activity at the steam jet air ejector. Restricting the gross radioactivity rate of noble gases from the main condenser provides reasonable assurance that the total body exposure to an individual at the restricted area boundary will not exceed the limits of 10CFR Part 20 in the event this effluent is inadvertently discharged directly to the environment with minimal treatment. This specification implements the requirements of General Design Criteria 60 and 64 of Appendix A to 10CFR Part 50.

Control 2.5.1.A establishes the requirement to calibrate and verify functionality of the Off-gas Pretreatment Monitor. Control 2.5.1.B ensures that a setpoint is used to terminate flow of the monitor if the detected activity is in excess of the TS 3.7.6 limit.

<b>MONTICELLO NUCLEAR GENERATING PLANT</b>		ODCM-03.01
<b>TITLE:</b>	<b>GASEOUS EFFLUENTS</b>	Revision 14
		Page 14 of 21

F. Containment Venting and Purging

Control 2.6.1 requires the containment to be purged and vented through the Standby Gas Treatment System. This provides for iodine and particulate removal from the containment atmosphere. During outages when the containment is opened for maintenance, the containment ventilation exhaust is directed to the monitored Reactor Building vent. Use of the 2 inch flow path prevents damage to the Standby Gas Treatment System in the event of a loss of coolant accident during purging or venting.

Use of the Standby Gas Treatment System or Reactor Building Plenum and vent flow path for inerting and deinerting operations permits the Control Room Operators to monitor the activity level of the resulting effluent by use of the Offgas Stack or Reactor Building Vent Wide Range Gas Monitors. In the event that the Reactor Building release rate exceeds the Offgas Stack or Reactor Building Vent Wide Range Gas Monitor alarm settings, the monitors will alarm in the Control Room alerting the operators to take actions to limit the release of gaseous radioactive effluents. The alarm settings for the Offgas Stack or Reactor Building Vent Wide Range Gas Monitors are calculated in accordance with the NRC approved methods in the ODCM to ensure that alarms will alert Control Room Operators prior to the limits of 10CFR Part 20 being exceeded.



<b>MONTICELLO NUCLEAR GENERATING PLANT</b>		ODCM-03.01
<b>TITLE:</b>	<b>GASEOUS EFFLUENTS</b>	Revision 14
		Page 15 of 21

Figure 1 Monticello Nuclear Generating Plant Site Boundary for Gaseous Effluents

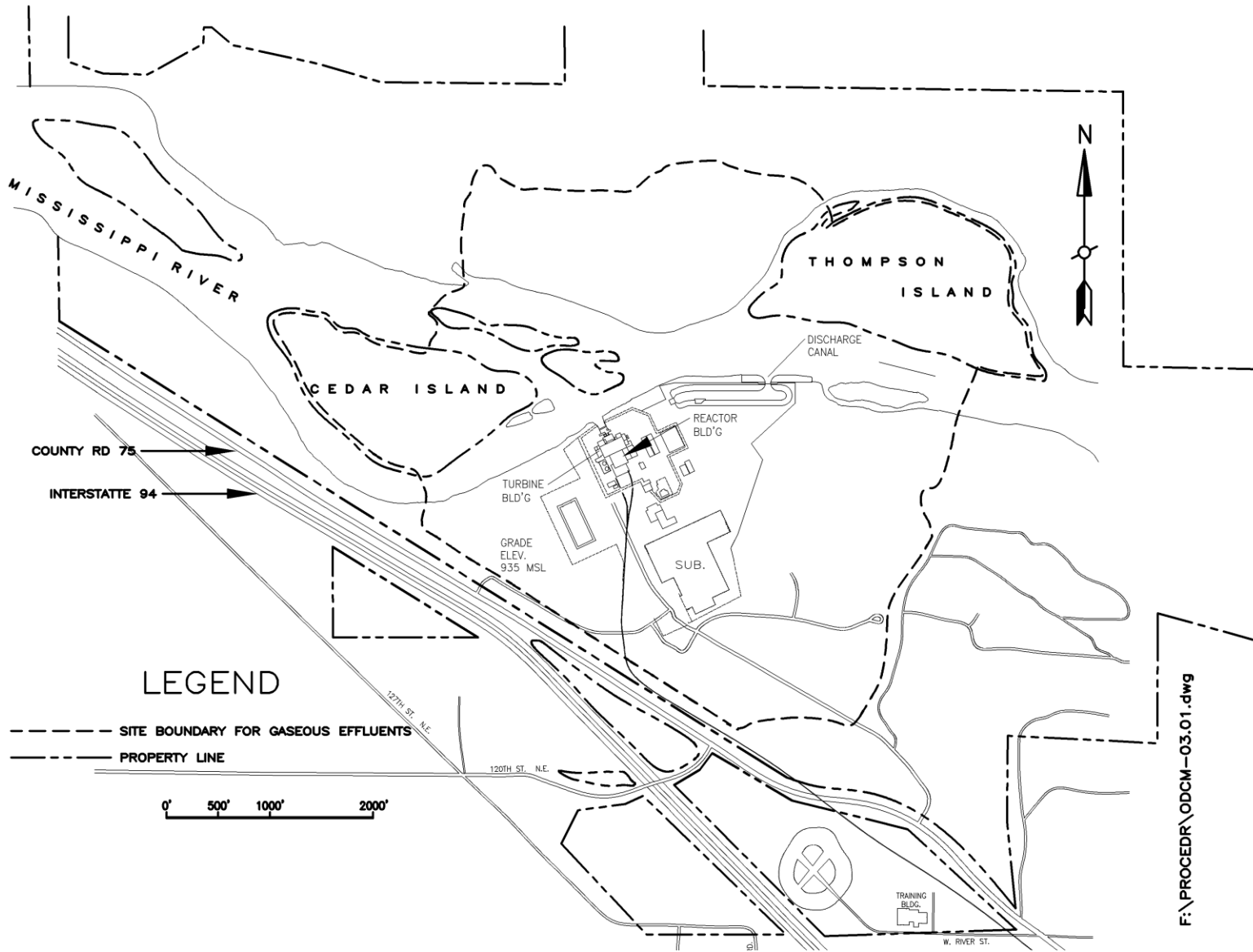

<b>MONTICELLO NUCLEAR GENERATING PLANT</b>		ODCM-03.01
<b>TITLE:</b>	<b>GASEOUS EFFLUENTS</b>	Revision 14
		Page 16 of 21

Table 1 Radioactive Gaseous Effluent Monitoring Instrumentation Surveillance Requirements

Instrument	Sensor Check Frequency	Source Check Frequency	Functional Test Frequency	Calibration Frequency
Main Condenser Air Ejector Noble Gas Activity Monitors	Daily during air ejector operation		Quarterly	Once each Operating Cycle
Main Condenser Off-gas Treatment System Hydrogen Monitors	Daily during air ejector operation		Monthly	Quarterly #
Plant Stack Wide Range Noble Gas Activity Monitors	Daily	Monthly	Quarterly	Once each Operating Cycle*
Plant Stack Iodine and Particulate Samplers	Weekly			
Plant Stack Flow Monitor	Daily			Once each Operating Cycle
Plant Stack Sample Flow Instruments	Daily			Once each Operating Cycle
Reactor Building Vent Wide Range Noble Gas Activity Monitors	Daily	Monthly	Quarterly	Once each Operating Cycle*
Reactor Building Vent Iodine and Particulate Samplers	Weekly			
Reactor Building Vent Duct Flow Monitors	Daily			Once each Operating Cycle
Reactor Building Vent Sample Flow Instruments	Daily			Once each Operating Cycle

\* - The initial Instrument Calibration **SHALL** be performed using one or more of the reference standards certified by the National Bureau of Standards (NBS) or using sources traceable to NBS standards. These standards **SHALL** permit calibrating the system over its intended range of energy and measurement range. For subsequent calibration sources that have been related to the initial calibration **SHALL** be used.

# - The Calibration **SHALL** include the use of standard gas samples containing a nominal four volume percent hydrogen.

<b>MONTICELLO NUCLEAR GENERATING PLANT</b>		ODCM-03.01
<b>TITLE:</b>	<b>GASEOUS EFFLUENTS</b>	Revision 14
		Page 17 of 21

Table 2 Radioactive Gaseous Waste Sampling and Analysis Program

Gaseous Release Type	Sampling Frequency	Minimum Analysis Frequency	Type of Activity Analysis	Lower Limit of Detection (LLD) (uci/ml) <sup>a,e,f</sup>
Containment Purge	Each Purge Grab Sample	Each Purge	Principal Gamma Emitters <sup>e</sup>	1 x 10 <sup>-4</sup>
			H-3 <sup>h</sup>	1 x 10 <sup>-6</sup>
Plant Stack and Reactor Building Vent	Monthly <sup>b</sup> Grab Sample	Monthly	Principal Gamma Emitters <sup>e</sup>	1 x 10 <sup>-4</sup>
			H-3 <sup>i</sup>	1 x 10 <sup>-6</sup>
	Continuous <sup>g</sup>	Weekly <sup>c</sup> Charcoal Sample	I-131 I-133	1 x 10 <sup>-12</sup> 1 x 10 <sup>-10</sup>
	Continuous <sup>g</sup>	Weekly <sup>c</sup> Particulate Sample	Principal Gamma Emitters <sup>e</sup>	1 x 10 <sup>-11</sup>
	Continuous <sup>g</sup>	Monthly <sup>d</sup> Composite Particulate Sample	Gross Alpha	1 x 10 <sup>-11</sup>
	Continuous <sup>g</sup>	Quarterly <sup>d</sup> Composite Particulate Sample	Sr-89, Sr-90	1 x 10 <sup>-11</sup>
	Continuous <sup>g</sup>	Noble Gas monitor	Gross gamma or gross beta noble gas activity	1 x 10 <sup>-6</sup>

<b>MONTICELLO NUCLEAR GENERATING PLANT</b>		ODCM-03.01
<b>TITLE:</b>	<b>GASEOUS EFFLUENTS</b>	Revision 14
		Page 18 of 21

Table 2 Radioactive Gaseous Waste Sampling and Analysis Program (cont'd)

**Notes**

- a. The LLD is the smallest concentration of radioactive material in a sample that will be detected with 95% probability with 5% probability of falsely concluding that a blank observation represents a “real” signal.

For a particular measurement system, which may include radiochemical separation:

$$LLD = \frac{4.66 s_b}{E \cdot V \cdot 2.22 \times 10^6 \cdot Y \cdot \exp(-\lambda \Delta t)}$$

Where:

LLD = the “a priori” lower limit of detection (microCurie per unit mass or volume),

$s_b$  = the standard deviation of the background counting rate or of the counting rate of a blank sample as appropriate (counts per minute),

E = the counting efficiency (counts per disintegration),

V = the sample size (units of mass or volume),

$2.22 \times 10^6$  = the number of disintegrations per minute per microCurie,

Y = the fractional radiochemical yield, when applicable,

$\lambda$  = the radioactive decay constant for the particular radionuclide ( $\text{sec}^{-1}$ ), and

$\Delta t$  = the elapsed time between the midpoint of sample collection and the time of counting (sec).

It should be recognized that the LLD is defined as an a priori (before the fact) limit representing the capability of the measurement system and not as an a posteriori (after the fact) limit for a particular measurement.

- b. Grab samples taken at the discharge of the plant stack and Reactor Building vent are generally below minimum detectable levels for most nuclides with existing analytical equipment. For this reason, isotopic analysis data, corrected for holdup time, for samples taken at the steam jet air ejector may be used to calculate noble gas ratios.
- c. Whenever the steady state radioiodine concentration is greater than 10 percent of the limit of Tech Spec 3.4.6, daily sampling of reactor coolant for radioactive iodines of I-131 through I-135 is required. Whenever a change of 25% or more in calculated Dose Equivalent I-131 is detected under these conditions, the iodine and particulate collection devices for all release points **SHALL** be removed and analyzed daily until it is shown that a pattern exists which can be used to predict the release rate. Sampling may then revert to weekly. When samples collected for one day are analyzed, the corresponding LLDs may be increased by a factor of 10. Samples **SHALL** be analyzed within 48 hours after removal.

<b>MONTICELLO NUCLEAR GENERATING PLANT</b>		ODCM-03.01
<b>TITLE:</b>	<b>GASEOUS EFFLUENTS</b>	Revision 14
		Page 19 of 21

Table 2 Radioactive Gaseous Waste Sampling and Analysis Program (cont'd)

- d. To be representative of the average quantities and concentrations of radioactive materials in particulate form in gaseous effluents, samples should be collected in proportion to the rate of flow of the effluent streams.
- e. The principal gamma emitters for which the LLD specification will apply are exclusively the following radionuclides: Kr-87, Kr-88, Xe-133, Xe-133m, Xe-135, and Xe-138 for gaseous emissions and Mn-54, Fe-59, Co-58, Co-60, Zn-65, Mo-99, I-131, Cs-134, Cs-137, Ce-141, and Ce-144 for particulate emissions. This list does not mean that only these nuclides are to be detected and reported. Other peaks which are measurable and identifiable, together with the above nuclides, **SHALL** also be identified and reported.
- f. Nuclides which are below the LLD for the analyses **SHALL** be reported as "less than" the LLD of the nuclide and should not be reported as being present at the LLD level for that nuclide. The "less than" values **SHALL NOT** be used in the required dose calculations. When unusual circumstances result in LLDs higher than reported, the reasons **SHALL** be documented in the semiannual effluent report.
- g. The ratio of the sample flow rate to the sampled stream flow rate **SHALL** be known for the time period sampled.
- h. H<sup>3</sup> analysis **SHALL NOT** be required prior to purging if the limits of control 2.1.1 are satisfied for other nuclides. However, the H<sup>3</sup> analysis **SHALL** be completed within 24 hours after sampling.
- i. In lieu of grab samples, continuous monitoring with bi-weekly analysis using silica-gel samplers may be provided.

Table 3 Radioactive Gaseous Effluent Monitoring Instrumentation

Instrument	Minimum Channels Functional	Applicability	Action if Minimum Channels Not Functional
Main Condenser Air Ejector Noble Gas Activity Monitor	2	During air ejector operation	From and after the date that one of the two steam jet air ejector off-gas radiation monitors is made or found to be non-functional, continued reactor power operation is permissible provided the non-functional radiation monitor instrument channel is tripped. Upon loss of both steam jet air ejector off-gas radiation monitors, power operation is permissible up to 72 hours provided the off-gas treatment system and post-treatment monitors are functional. If an air ejector off-gas radiation monitor is not restored to service within 72 hours, either: Isolate all main steam lines within 12 hours; or Isolate the Steam Jet Air Ejectors within 12 hours; or Be in hot shutdown within 12 hours and cold shutdown within the following 24 hours.
Main Condenser Off-gas Treatment System Hydrogen Monitors	2#	During air ejector operation	Operation may continue for up to 14 days with one Functional channel per operating recombiner train. With all channels non-functional, operation may continue provided the compressed gas storage system is bypassed.
Plant Stack Wide Range Noble Gas Activity Monitors*	1	At all times	Releases via this pathway may continue for up to 30 days provided grab samples are taken and analyzed at least once every 8 hours.
Iodine Sampler Cartridge	1	At all times	Releases via this pathway may continue for up to 30 days provided within 8 hours samples are continuously collected with auxiliary sampling equipment as required by Table 2.
Particulate Sampler Filter	1	At all times	Releases via this pathway may continue for up to 30 days provided within 8 hours samples are continuously collected with auxiliary sampling equipment as required by Table 2.
Stack Flow Monitor	1	At all times	Releases via the pathway may continue for up to 30 days provided the flow rate is estimated at least once every 4 hours.
Sample Flow Instrument	1	At all times	Releases via the pathway may continue for up to 30 days provided the flow rate is estimated at least once every 4 hours.

<b>MONTICELLO NUCLEAR GENERATING PLANT</b>		ODCM-03.01
<b>TITLE:</b>	<b>GASEOUS EFFLUENTS</b>	Revision 14
		Page 21 of 21

Table 3 Radioactive Gaseous Effluent Monitoring Instrumentation (cont'd)

Instrument	Minimum Channels Functional	Applicability	Action if Minimum Channels Not Functional
Reactor Building Vent (includes Turbine Building & Radwaste Building releases) Wide Range Noble Gas Activity Monitors**	1	At all times	Releases via this pathway may continue for to 30 days provided grab samples are taken and analyzed at least every 8 hours.
Iodine Sampler Cartridge	1	At all times	Releases via this pathway may continue for up to 30 days provided within 8 hours samples are continuously collected with auxiliary sampling equipment as required by Table 2.
Particulate Sampler Cartridge	1	At all times	Releases via this pathway may continue for up to 30 days provided within 8 hours samples are continuously collected with auxiliary sampling equipment as required by Table 2.
Duct Flow Monitors	1	At all times	Releases via the pathway may continue for up to 30 days provided the flow rate is estimated at least once every 4 hours.
Sample Flow Instruments	1	At all times	Releases via the pathway may continue for up to 30 days provided the flow rate is estimated at least once every 4 hours.

**Notes:**

- # - Indicates number of channels required per operating recombiner train.
- \* - Provides automatic termination of off-gas treatment system releases.
- \*\* - Provides Control Room indication prior to exceeding 10CFR Part 20 release limits.

<b>MONTICELLO NUCLEAR GENERATING PLANT</b>		ODCM-04.01
<b>TITLE:</b>	<b>LIQUID EFFLUENT CALCULATIONS</b>	Revision 4
		Page 1 of 26

Approval: ODC 01559664

**OFFSITE DOSE CALCULATION MANUAL - TABLE OF CONTENTS**

<b><u>SECTION</u></b>	<b><u>PAGE</u></b>
1.0 RECORD OF REVISION .....	2
2.0 LIQUID EFFLUENT CALCULATIONS .....	3
2.1 Monitor Alarm Setpoint Determination .....	3
2.2 Liquid Effluent Concentration - Compliance With 10CFR20.....	12
2.3 Liquid Effluent Doses - Compliance With 10CFR50.....	13
2.4 References.....	17
Figure 1 Radwaste Clean, Dirty, Solid Waste.....	18
Table 1 Liquid Source Terms .....	19
Table 2 A <sub>ij</sub> Values for the Monticello Nuclear Generating Plant (mrem/hr per μCi/ml)....	20
Table 3 Liquid Radwaste Monitor Default Setpoint Calculation .....	23
Table 4 Service Water Radiation Monitor Default Setpoint Calculation .....	25
Table 5 Discharge Canal Radiation Monitor Default Setpoint Calculation .....	24
Table 6 Turbine Building Normal Waste Sump Default Setpoint Calculation.....	26



<b>MONTICELLO NUCLEAR GENERATING PLANT</b>		ODCM-04.01
<b>TITLE:</b>	<b>LIQUID EFFLUENT CALCULATIONS</b>	Revision 4
		Page 2 of 26

## 1.0 RECORD OF REVISION

<u>Revision No.</u>	<u>Reason for Revision</u>
1	<p>Moved previous ODCM-02.01 (LIQUID EFFLUENTS) into this section and renamed this section "LIQUID EFFLUENTS CALCULATIONS" to facilitate moving the Radiological Effluents Tech Specs to the ODCM.</p> <p>Removed dilution flow from setpoint calculations for the Service Water and Turbine Normal Drain Monitors to ensure the setpoints are valid for all plant modes. Revised the Table 1 MPC<sub>i</sub> values to 10 times the concentration values of 10CFR20.1001-20.2402, Table 2, Column 2.</p>
2	<p>Added clarification of use of computer program LIQDOS to section 2.0. Changed Turbine Building Normal Drain Sump to Turbine Building Normal Waste Sump.</p>
3	<p>Removed references to specific computer programs.  Added setpoint safety factors.  Removed reference to calculating monitor setpoints monthly. Monthly frequency is not required by regulation and liquid setpoints are based on GALE Code, which does not change.  Added Release Rate (R<sub>k</sub>) to denominator of dilution equation (2.3.1.A) to match methodology in RADEAS.  Elective formatting changes.</p>
4	<p>Added radiation monitor efficiency values to the setpoint calculation sections and made minor editorial changes to efficiency definitions. Added default setpoint calculation examples as Tables 3-6 and additional columns in Table 1, in support of AR01537833.</p>

<b>MONTICELLO NUCLEAR GENERATING PLANT</b>		ODCM-04.01
<b>TITLE:</b>	<b>LIQUID EFFLUENT CALCULATIONS</b>	Revision 4
		Page 3 of 26

## 2.0 LIQUID EFFLUENT CALCULATIONS

It is MNGP's policy to make no routine liquid releases, this section is used to:

- A. Determine alarm setpoints for liquid monitors;
- B. Determine that liquid concentrations in effluents are below 10 times the allowable concentrations given in 10CFR20;
- C. Calculate dose commitments to individuals; and
- D. Project doses for the next month due to liquid radioactive effluents.
- E. Compute liquid effluent doses if liquid effluent releases are made.

### 2.1 Monitor Alarm Setpoint Determination

Monitor alarm setpoints are determined to assure compliance with Tech Specs. The setpoints indicate if the concentration of radionuclides in the liquid effluent at the site boundary exceeds 10 times the concentrations specified in Appendix B, Table 2, Column 2 of 10CFR20.1001-20.2402 for radionuclides other than dissolved or entrained noble gases. The setpoints will also assure that a concentration of  $2 \times 10^{-4}$   $\mu\text{Ci/ml}$  for dissolved or entrained noble gases is not exceeded.

The setpoint calculation is performed in the following manner:

- A. If no liquid release is planned, the BWR GALE Code source terms (Table 1)<sup>(2)</sup> are used as the basis for the release rate and monitor setpoints.
- B. Prior to a planned release, the setpoints for the affected monitors are calculated based on the waste activity and dilution flow.
- C. If the calculated setpoint is less than the existing monitor setpoint, the setpoint will be reduced to the new lower value.
- D. If the calculated setpoint is greater than the existing monitor setpoint, the setpoint may remain at the lower value or be increased to the new value.

<b>MONTICELLO NUCLEAR GENERATING PLANT</b>		ODCM-04.01
<b>TITLE:</b>	<b>LIQUID EFFLUENT CALCULATIONS</b>	Revision 4
		Page 4 of 26

### 2.1.1 Radwaste Discharge Line Monitor

The following method applies to liquid releases from the plant via the discharge canal when determining the high-high alarm setpoint for the Liquid Radwaste Effluent Monitor during all operational conditions. The radwaste discharge flowrate is assumed to be maintained relatively constant at or near the maximum Liquid Radwaste Pump design flowrate. Circulating water is used for dilution because the setpoint is applied at the liquid effluent site boundary (ODCM-02.01, Figure 1).

A. Determine the “mix” (radionuclides and composition) of the liquid effluent.

1. Determine the liquid source terms that are representative of the “mix” of the liquid effluent. Liquid source terms are the total curies of each isotope released during the previous month. Table 1 source terms may be used if there have been no liquid releases.
2. Determine  $S_i$  (the fraction of the total radioactivity in the liquid effluent comprised by radionuclide  $i$ ) for each individual radionuclide in the liquid effluent.

a. 
$$S_i = \frac{A_i}{\sum A_i}$$

where

$A_i$  = The radioactivity of radionuclide  $i$  in the liquid effluent from Table 1.

<b>MONTICELLO NUCLEAR GENERATING PLANT</b>		ODCM-04.01
<b>TITLE:</b>	<b>LIQUID EFFLUENT CALCULATIONS</b>	Revision 4
		Page 5 of 26

- B. Determine  $C_t$ , the maximum acceptable total radioactivity concentration of all radionuclides in the liquid effluent prior to dilution ( $\mu\text{Ci/ml}$ ).

$$1. \quad C_t = \frac{F}{f * \sum \frac{S_i}{\text{MPC}_i}}$$

where

$F$  = Dilution water flowrate (gpm):  
= Current circulating water flowrate or 240,000 gpm from two circulating water pumps, whichever is less.

$f$  = The maximum acceptable discharge flowrate prior to dilution (gpm);  
= 50 gpm from the Liquid Radwaste Pump <sup>(3)</sup>;

and

$\text{MPC}_i$  = The liquid effluent radioactivity concentration limit for radionuclide  $i$  ( $\mu\text{Ci/ml}$ ) from Table 1.

- C. Determine  $C_m$ , the maximum acceptable total radioactivity concentration of the radionuclides (minus tritium) in the liquid discharge prior to dilution ( $\mu\text{Ci/ml}$ ).

$$1. \quad C_m = C_t - (C_t S_H)$$

where

$S_H$  = The fraction of the total radioactivity in the liquid effluent comprised of tritium and other radionuclides that do not emit gamma or x ray radiation.

<b>MONTICELLO NUCLEAR GENERATING PLANT</b>		ODCM-04.01
<b>TITLE:</b>	<b>LIQUID EFFLUENT CALCULATIONS</b>	Revision 4
		Page 6 of 26

D. Determine C.R., the calculated monitor count rate above background attributed to the radionuclides (ncps).

$$1. \quad C.R. = \frac{C_m}{E} * SF$$

where

E = 2.50E-06  $\mu$ Ci/ml per cps  
The detection efficiency of the Liquid Radwaste Effluent radiation monitor, based on the primary calibration.

SF = Setpoint safety factor (0.8)

E. The monitor high-high alarm setpoint above background (ncps) should be set at or less than the C.R. value. Since only one tank can be released at a time, adjustment of this value is not necessary to compensate for releases from more than one source.

### 2.1.2 Discharge Canal Monitor

The following method determines the high-high alarm setpoint for the Discharge Canal Monitor during all operational conditions.

A. Determine the "mix" (radionuclides and composition) of all liquids released into the discharge canal.

1. Determine the liquid source terms that are representative of the "mix" of all liquid released into discharge canal. Liquid source terms are the total curies of each isotope released during the previous month. Table 1 source terms may be used if there have been no liquid releases.

2. Determine  $S_i$ , the fraction of the total radioactivity of all liquids released into the discharge canal comprised by radionuclide  $i$  for each individual radionuclide released into the discharge canal.

$$a. \quad S_i = \frac{A_i}{\sum A_i}$$

where

$A_i$  = The radioactivity of radionuclide  $i$  released into the discharge canal.

<b>MONTICELLO NUCLEAR GENERATING PLANT</b>		ODCM-04.01
<b>TITLE:</b>	<b>LIQUID EFFLUENT CALCULATIONS</b>	Revision 4
		Page 7 of 26

- B. Determine  $C_d$ , the maximum acceptable total radioactivity concentration of all radionuclides released into the discharge canal ( $\mu\text{Ci/ml}$ ).

$$1. \quad C_d = \frac{1}{\sum \frac{S_i}{MPC_i}}$$

where

$MPC_i$  = The liquid effluent radioactivity concentration limit for radionuclide  $i$  ( $\mu\text{Ci/ml}$ ) from Table 1.

- C. Determine  $C_m$ , the maximum acceptable total radioactivity concentration of the radionuclides (minus tritium) released into the discharge canal ( $\mu\text{Ci/ml}$ ).

$$1. \quad C_m = C_d - (C_d S_H)$$

where

$S_H$  = The fraction of the total radioactivity released into the discharge canal comprised of tritium and other radionuclides that do not emit gamma or x-ray radiation.

- D. Determine C.R., the calculated monitor count rate above background attributed to the radionuclides (ncps).

$$1. \quad \text{C.R.} = \frac{C_m}{E} * \text{SF}$$

where

$E$  =  $1.30\text{E-}07 \mu\text{Ci/ml}$  per cps  
The detection efficiency of the Discharge Canal radiation monitor, based on the primary calibration.

$\text{SF}$  = Setpoint safety factor (0.8)

- E. The monitor high-high alarm setpoint above background (ncps) should be set at or less than the C.R. value.

<b>MONTICELLO NUCLEAR GENERATING PLANT</b>		ODCM-04.01
<b>TITLE:</b>	<b>LIQUID EFFLUENT CALCULATIONS</b>	Revision 4
		Page 8 of 26

### 2.1.3 Service Water Discharge Pipe Monitor

Dilution flow is not used for the service water discharge pipe monitor setpoint determination to ensure the setpoint is valid for all modes of plant operation. The following method determines the high-high alarm setpoint for the Service Water Discharge Pipe Monitor during all operational conditions.

- A. Determine the “mix” (radionuclides and composition) of the service water effluent.
1. Determine the liquid source terms that are representative of the “mix” of the service water effluent. Liquid source terms are the total curies of each isotope released during the previous month. Table 1 source terms may be used if there have been no liquid releases.
  2. Determine  $S_i$  the fraction of the total radioactivity in the service water effluent comprised by radionuclide  $i$ , for each individual radionuclide in the liquid effluent.

a. 
$$S_i = \frac{A_i}{\sum A_i}$$

where

$A_i$  = The radioactivity of radionuclide  $i$  in the service water effluent.

- B. Determine  $C_t$ , the maximum acceptable total radioactivity concentration of all radionuclides in the service water effluent prior to dilution ( $\mu\text{Ci/ml}$ ).

1. 
$$C_t = \frac{1}{\sum \frac{S_i}{\text{MPC}_i}}$$

where

$\text{MPC}_i$  = The liquid effluent radioactivity concentration limit for radionuclide  $i$  ( $\mu\text{Ci/ml}$ ) from Table 1.

<b>MONTICELLO NUCLEAR GENERATING PLANT</b>		ODCM-04.01
<b>TITLE:</b>	<b>LIQUID EFFLUENT CALCULATIONS</b>	Revision 4
		Page 9 of 26

C. Determine  $C_m$ , the maximum acceptable total radioactivity concentration of the radionuclides (minus tritium) in the service water prior to dilution ( $\mu\text{Ci/ml}$ ).

1.  $C_m = C_t - (C_t S_H)$

where

$S_H$  = The fraction of the total radioactivity in the service water effluent comprised of tritium and other radionuclides that do not emit gamma or x-ray radiation.

D. Determine C.R., (the calculated monitor count rate above background attributed to the radionuclides (ncps)).

1.  $C.R. = \frac{C_m}{E} * SF$

where

$E$  = 4.30E-07  $\mu\text{Ci/ml}$  per cps  
The detection efficiency of the Service Water radiation monitor, based on the primary calibration.

$SF$  = Setpoint safety factor (0.8)

E. The monitor high-high alarm setpoint above background (ncps) should be set at or less than the C.R. value.



<b>MONTICELLO NUCLEAR GENERATING PLANT</b>		ODCM-04.01
<b>TITLE:</b>	<b>LIQUID EFFLUENT CALCULATIONS</b>	Revision 4
		Page 10 of 26

#### 2.1.4 Turbine Building Normal Waste Sump Monitor

Dilution flow is not used for the Turbine Building Normal Waste Sump Monitor setpoint determination to ensure the setpoint is valid for all modes of plant operation. The following method determines the high-high alarm setpoint for the Turbine Building Normal Waste Sump Monitor during all operational conditions.

- A. Determine the “mix” (radionuclides and composition) of the TBNWS effluent.
1. Determine the liquid source terms that are representative of the “mix” of the TBNWS effluent. Liquid source terms are the total curies of each isotope released during the previous month. Table 1 source terms may be used if there have been no liquid releases.
  2. Determine  $S_i$ , the fraction of the total radioactivity in the TBNWS effluent comprised by radionuclide  $i$ , for each individual radionuclide in the liquid effluent.

a. 
$$S_i = \frac{A_i}{\sum A_i}$$

where

$A_i$  = The radioactivity of radionuclide  $i$  in the TBNWS effluent.

- B. Determine  $C_t$ , the maximum acceptable total radioactivity concentration of all radionuclides in the TBNWS effluent prior to dilution ( $\mu\text{Ci/ml}$ ).

1. 
$$C_t = \frac{1}{\sum \frac{S_i}{\text{MPC}_i}}$$

where

$\text{MPC}_i$  = The liquid effluent radioactivity concentration limit for radionuclide  $i$  ( $\mu\text{Ci/ml}$ ) from Table 1.

<b>MONTICELLO NUCLEAR GENERATING PLANT</b>		ODCM-04.01
<b>TITLE:</b>	<b>LIQUID EFFLUENT CALCULATIONS</b>	Revision 4
		Page 11 of 26

C. Determine  $C_m$ , the maximum acceptable total radioactivity concentration of the radionuclides (minus tritium) in the TBNWS prior to dilution ( $\mu\text{Ci/ml}$ ).

$$1. \quad C_m = C_t - (C_t S_H)$$

where

$S_H$  = The fraction of the total radioactivity in the TBNWS effluent comprised of tritium and other radionuclides that do not emit gamma or x-ray radiation.

D. Determine C.R., the calculated monitor count rate above background attributed to the radionuclides (ncpm).

$$1. \quad \text{C.R.} = \frac{C_m}{E} * \text{SF}$$

where

$E$  = 3.42E-09  $\mu\text{Ci/ml}$  per cpm  
The detection efficiency of the Turbine Building Normal Waste Sump radiation monitor, based on the primary calibration.

$\text{SF}$  = Setpoint safety factor (0.8)

E. The monitor high-high alarm setpoint above background (ncpm) should be set at or less than the C.R. value.

### 2.1.5 Multiple Release Points

The discharge canal monitor, service water discharge and TBNWS line monitor are provided to detect unplanned or accidental releases. All normal releases are monitored by the radwaste discharge line monitor. There are, therefore, no multiple release points and monitor settings do not have to be reduced to account for multiple releases.

<b>MONTICELLO NUCLEAR GENERATING PLANT</b>		ODCM-04.01
<b>TITLE:</b>	<b>LIQUID EFFLUENT CALCULATIONS</b>	Revision 4
		Page 12 of 26

## 2.2 Liquid Effluent Concentration - Compliance With 10CFR20

In order to demonstrate compliance with 10CFR20, the concentrations of radionuclides in liquid effluents are determined and compared to 10 times the concentrations specified in Appendix B, Table 2, Column 2 to 10CFR20.1001-20.2402. The concentration of radioactivity in effluents prior to dilution is determined.

### 2.2.1 Batch Releases

#### A. Prerelease

The radioactivity content of each batch release is determined prior to release. MNGP will show compliance with Tech Specs (TS) in the following manner:

The concentration of the various radionuclides in the batch release prior to dilution flow to obtain the concentration at the unrestricted area. This calculation is shown in the following equation:

$$1. \quad \text{Conc}_i = \frac{C_i R}{\text{MDF}}$$

where

$\text{Conc}_i$  = concentration of radionuclide i at the unrestricted area, ( $\mu\text{Ci/ml}$ );

$C_i$  = concentration of radionuclide i in the potential batch release, ( $\mu\text{Ci/ml}$ );

$R$  = release rate of the batch, (gpm);

$\text{MDF}$  = minimum dilution flow, (gpm).

The projected concentration in the unrestricted area is compared to 10 times the concentrations specified in Appendix B, Table 2, Column 2 to 10CFR20.1001-20.2402. These concentrations are given in Table 1. Before a release may occur, Equation 2.2.1.A.2 must be met for all nuclides. For the MNGP the MDF is 240,000 gpm. The maximum release rate is 50 gpm.

$$2. \quad \sum \frac{\text{Conc}_i}{\text{MPC}_i} \leq 1$$

where

$\text{MPC}_i$  = maximum concentration of radionuclide i from Table 1, ( $\mu\text{Ci/ml}$ ).

<b>MONTICELLO NUCLEAR GENERATING PLANT</b>		ODCM-04.01
<b>TITLE:</b>	<b>LIQUID EFFLUENT CALCULATIONS</b>	Revision 4
		Page 13 of 26

### 2.3 Liquid Effluent Doses - Compliance With 10CFR50

Doses resulting from liquid effluents are calculated monthly to show compliance with 10CFR 50. A cumulative summation of total body and organ doses for each calendar quarter and calendar year is maintained as well as projected doses for the next month.

#### 2.3.1 Determination of Liquid Effluent Dilution

To determine doses from liquid effluents the near field average dilution factor for the period of release must be calculated. This dilution factor must be calculated for each batch release. The dilution factor is determined by:

$$A. \quad F_k = \frac{R_k}{X(ADF_k + R_k)}$$

where

$F_k$  = near field average dilution factor;

$R_k$  = release rate of the batch during time period k, (gpm);

and

$ADF_k$  = actual dilution flow during the time period of release k, (gpm).

The value of X is the site specific value for the mixing effect of the MNGP discharge structure. This value is 1.0 for MNGP while operating in the once-through cooling mode. Although not expected to occur, if radioactive material is discharged while operating in the recycle mode, this value may be 1.86.<sup>(4)</sup>

<b>MONTICELLO NUCLEAR GENERATING PLANT</b>		ODCM-04.01
<b>TITLE:</b>	<b>LIQUID EFFLUENT CALCULATIONS</b>	Revision 4
		Page 14 of 26

### 2.3.2 Dose Calculations

The dose contribution from the release of liquid effluents is calculated monthly. The dose contribution is calculated using the following equation:

$$A. \quad D_j = \sum_k \sum_i A_{ij} t_k C_{ik} F_k$$

where

$D_j$  = the dose commitment to the total body or any organ, from the liquid effluents for the 31 day period, (mrem);

$C_{ik}$  = the average concentration of radionuclide,  $i$ , in undiluted liquid effluent for release  $k$ , ( $\mu\text{Ci/ml}$ );

$A_{ij}$  = the site related ingestion dose commitment factor to the total body or any organ  $j$  for each identified principal gamma and beta emitter, (mrem/hr per  $\mu\text{Ci/ml}$ );

$F_k$  = the near field average dilution factor for  $C_{ik}$  during liquid effluent release  $k$ , as defined in Equation 2.3.1.A, and

$t_k$  = the length of time for release  $k$ , (hours).

<b>MONTICELLO NUCLEAR GENERATING PLANT</b>		ODCM-04.01
<b>TITLE:</b>	<b>LIQUID EFFLUENT CALCULATIONS</b>	Revision 4
		Page 15 of 26

The dose factor  $A_{ij}$  was calculated for an adult for each isotope using the following equation:

$$B. \quad A_{ij} = 1.14 \times 10^5 \left( \frac{730}{D_w} + 21 * BF_i \right) DF_{ij}$$

where

$$1.14 \times 10^5 = \frac{10^6 \text{ pCi}}{\mu\text{Ci}} * \frac{10^3 \text{ ml}}{\text{liter}} * \frac{1 \text{ yr}}{8760 \text{ hr}}$$

730 = adult water consumption rate, (liters/yr);

$D_w$  = dilution factor from the near field area to the potable water intake for adult water consumption;

21 = adult fish consumption, (kg/yr);

$BF_i$  = bioaccumulation factor for radionuclide  $i$  in fish from Table A-1 of Regulatory Guide 1.109 Rev. 1, <sup>(5)</sup> (pCi/kg per pCi/liter);

$DF_{ij}$  = dose conversion factor for radionuclide  $i$  for adults for particular organ  $j$  from Table E-11 of Regulatory Guide 1.109 Rev. 1, (mrem/pCi).

The  $A_{ij}$  values for an adult at the MNGP are given in Table 2. The far field dilution factor,  $D_w$  for the MNGP is 7:1 for the nearest downstream water supply in St. Paul. This value was determined by assuming that effluents are completely mixed in 50% of the Mississippi River flow (7431 cfs at Anoka, MN). <sup>(6)</sup>

<b>MONTICELLO NUCLEAR GENERATING PLANT</b>		ODCM-04.01
<b>TITLE:</b>	<b>LIQUID EFFLUENT CALCULATIONS</b>	Revision 4
		Page 16 of 26

### 2.3.3 Cumulation of Doses

Doses calculated monthly are summed for comparison with quarterly and annual limits. The monthly results should be added to the doses cumulated from the other months in the quarter of interest and in the year of interest.

- A. For the quarter:
  - 1.  $D \leq 1.5$  mrem total body
  - 2.  $D \leq 5$  mrem any organ
- B. For the Calendar Year,
  - 1.  $D \leq 3$  mrem total body
  - 2.  $D \leq 10$  mrem any organ

The quarterly limits given above represent one half of the annual design objective.<sup>(7)</sup> If these quarterly or annual limits are exceeded, a special report should be submitted stating the reason and corrective action to be taken. This report will include results of analysis of Mississippi River water and an analysis of possible impacts through the drinking water pathway. If twice these limits are exceeded, a special report will be submitted showing compliance with 40CFR190.<sup>(8)</sup>

### 2.3.4 Projection of Doses

Anticipated doses resulting from the release of liquid effluents are projected monthly. If the projected doses for the month exceed 2% of Equation 2.3.3.B.1 or 2.3.3.B.2, additional components of the liquid radwaste treatment system will be used to process waste. The projected doses are calculated using Equation 2.3.2.A. The dilution factor,  $F_k$ , is calculated by replacing the term  $ADF_k$  in Equation 2.3.1.A with the term MDF from Equation 2.2.1.A.1.

The total source term utilized for the most recent dose calculation should be used for the projections unless information exists indicating that actual releases could differ significantly in the next month. In this case, the source term would be adjusted to reflect this information and the justification for the adjustment noted. This adjustment should account for any radwaste equipment which was operated during the previous month that could be out of service in the coming month.

<b>MONTICELLO NUCLEAR GENERATING PLANT</b>		ODCM-04.01
<b>TITLE:</b>	<b>LIQUID EFFLUENT CALCULATIONS</b>	Revision 4
		Page 17 of 26

## 2.4 References

1. USNRC, Title 10, Code of Federal Regulation, Part 20.1001-20.2402, "Standards for Protection Against Radiation", Appendix B, Table II, Column 2.
2. NSP - Monticello Nuclear Generating Plant, Appendix I Analysis - Supplement No. 1 - Docket No. 50-263, Table 2.1-2.
3. NSP - Monticello Nuclear Generating Plant, Appendix I Analysis - Supplement No. 1 - docket No. 50-263, Table 2.1-1.
4. Boegli, J.S., et. al. Eds, Section 4.3 in "Preparation of Radiological Effluent Technical Specifications for Nuclear Power Plants, NUREG-0133, 1978, NTIS, Springfield, VA.
5. USNRC, Regulatory Guide 1.109. "Calculation of Annual Doses to Man from Routine Releases of Reactor Effluents for the Purpose of Evaluating Compliance with 10CFR50, Appendix I", Rev. 1, Oct. 1977, USNRC, Washington, DC.
6. NSP - Monticello Nuclear Generating Plant, Final Draft Safety Analysis Report - Amendment 4, Question 3.3, and Amendment 8 in entirety.
7. USNRC, Title 10, Code of Federal Regulation, Part 50, "Domestic Licensing of Production and Utilization Facilities", Appendix I, "Numerical Guides for Design Objectives and Limiting Conditions for Operation to Meet the Criterion As Low as is Reasonably Achievable for Radioactive Material in Light-Water-Cooled Nuclear Power Reactor Effluents".
8. EPA, Title 40, Code of Federal Regulations, Part 190 "Environmental Radiation Protection Standards for Nuclear Power Operations".



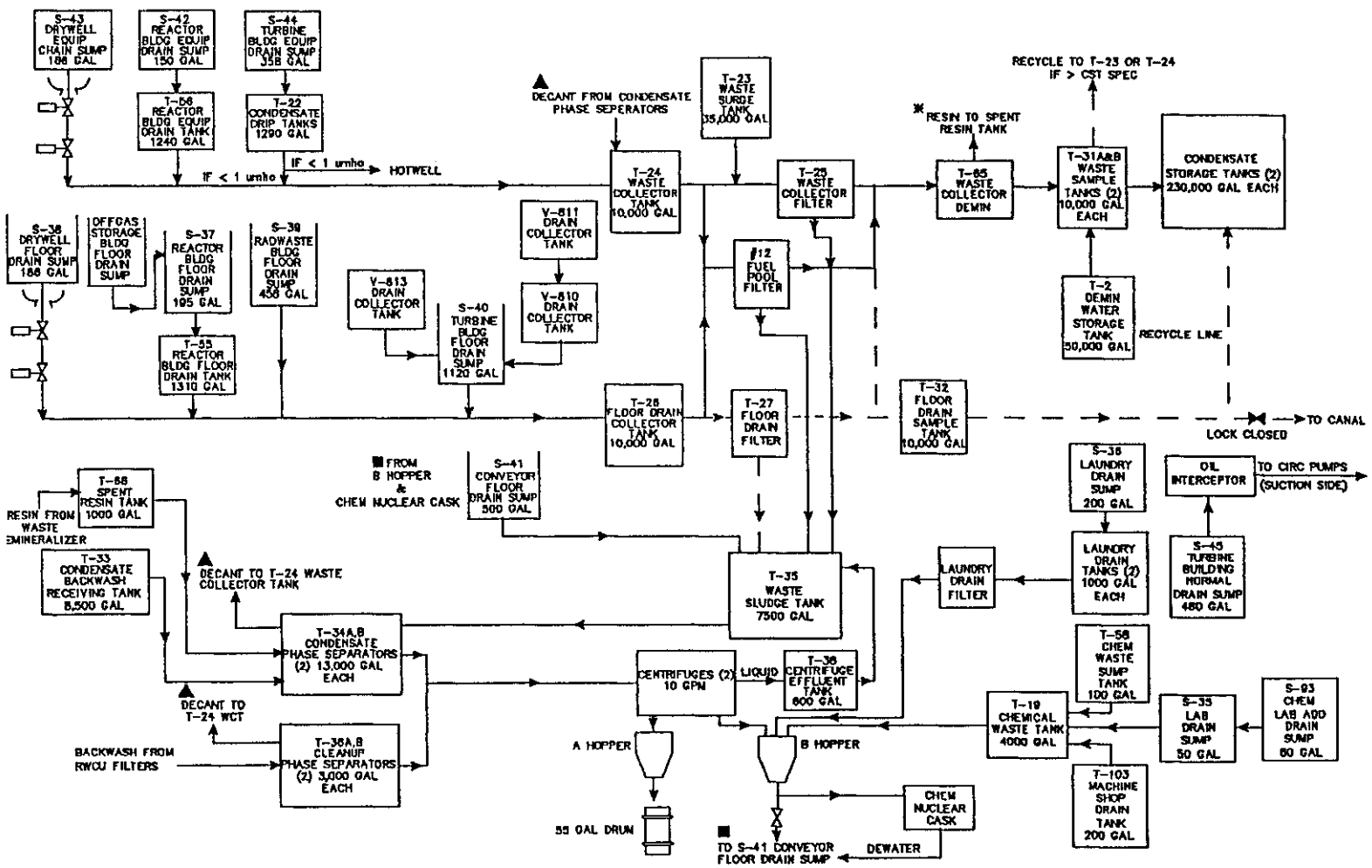

Figure 1 Radwaste Clean, Dirty, Solid Waste

Table 1 Liquid Source Terms

Radionuclide	Radioactivity A <sub>i</sub> Ci/yr*	MPC <sub>i</sub> μCi/ml**	S <sub>i</sub>	S <sub>i</sub> /MPC <sub>i</sub>
H-3	2.1E 1	1E-2	8.77E-01	8.8E+01
Na-24	1.7E-1	5E-4	7.1E-03	1.4E+01
Mn-54	2.6E-3	3E-4	1.1E-04	3.6E-01
Mn-56	2.7E-1	7E-4	1.1E-02	1.6E+01
Fe-59	8.1E-4	1E-4	3.4E-05	3.4E-01
Co-58	9.3E-3	2E-4	3.9E-04	1.9E+00
Co-60	2.0E-2	3E-5	8.3E-04	2.8E+01
Cu-64	5.4E-1	2E-3	2.3E-02	1.1E+01
Zn-65	5.3E-3	5E-5	2.2E-04	4.4E+00
Zn-69m	3.7E-2	6E-4	1.5E-03	2.6E+00
Br-83	1.4E-2	9E-3	5.8E-04	6.5E-02
Sr-89	2.8E-3	8E-5	1.2E-04	1.5E+00
Sr-90	1.7E-4	5E-6	7.1E-06	1.4E+00
Sr-91	6.4E-2	2E-4	2.7E-03	1.3E+01
Sr-92	5.8E-2	4E-4	2.4E-03	6.1E+00
Y-92	1.0E-1	4E-4	4.2E-03	1.0E+01
Y-93	6.6E-2	2E-4	2.8E-03	1.4E+01
Mo-99	5.0E-2	2E-4	2.1E-03	1.0E+01
I-131	1.3E-1	1E-5	5.4E-03	5.4E+02
I-132	1.3E-1	1E-3	5.4E-03	5.4E+00
I-133	4.0E-1	7E-5	1.7E-02	2.4E+02
I-134	6.4E-2	4E-3	2.7E-03	6.7E-01
I-135	2.5E-1	3E-4	1.0E-02	3.5E+01
Cs-134	8.3E-2	9E-6	3.5E-03	3.8E+02
Cs-136	2.6E-2	6E-5	1.1E-03	1.8E+01
Cs-137	1.2E-1	1E-5	5.0E-03	5.0E+02
Cs-138	1.5E-1	4E-3	6.3E-03	1.6E+00
Ba-140	1.1E-2	8E-5	4.6E-04	5.7E+00
La-141	5.7E-3	5E-4	2.4E-04	4.8E-01
Ce-141	8.5E-4	3E-4	3.5E-05	1.2E-01
Ce-144	5.3E-3	3E-5	2.2E-04	7.4E+00
Np-239	1.7E-1	2E-4	7.1E-03	3.5E+01
Noble Gases	-	-	-	-
Total	2.40E1		100.00%	2.00E+03

\* These source terms were calculated in accordance with NUREG-0016 by using the USNRC "GALE" Code.

\*\* MPC<sub>i</sub> Values are 10 times the concentration values of 10CFR20.1001 - 20.2402 Table 2 Column 2.

<b>MONTICELLO NUCLEAR GENERATING PLANT</b>		ODCM-04.01
<b>TITLE:</b>	<b>LIQUID EFFLUENT CALCULATIONS</b>	Revision 4
		Page 20 of 26

Table 2 A<sub>ij</sub> Values for the Monticello Nuclear Generating Plant (mrem/hr per  $\mu$ Ci/ml)

Nuclide	Bone	Liver	T. Body	Thyroid	Kidney	Lung	GI-LLI
1 H-3	0.00E 00	1.47E 00	1.47E 00	1.47E 00	1.47E 00	1.47E 00	1.47E 00
6 C 14	3.13E 04	6.26E 03	6.26E 03	6.26E 03	6.26E 03	6.26E 03	6.26E 03
11 Na-24	4.27E 02	4.27E 02	4.27E 02	4.27E 02	4.27E 02	4.27E 02	4.27E 02
24 Cr-51	0.00E 00	0.00E 00	1.31E 00	7.80E 01	2.38E 01	1.73E 00	3.28E 02
25 Mn-54	0.00E 00	4.43E 02	8.45E 02	0.00E 00	1.32E 03	0.00E 00	1.36E 04
25 Mn-56	0.00E 00	1.11E 02	1.98E 01	0.00E 00	1.42E 02	0.00E 00	3.56E 03
26 Fe-55	6.91E 02	4.77E 02	1.11E 02	0.00E 00	0.00E 00	2.66E 02	2.74E 02
26 Fe-59	1.09E 03	2.56E 03	9.83E 02	0.00E 00	0.00E 00	7.16E 02	8.54E 03
27 Co-58	0.00E 00	9.80E 01	2.20E 02	0.00E 00	0.00E 00	0.00E 00	1.99E 03
27 Co-60	0.00E 00	2.82E 02	6.21E 02	0.00E 00	0.00E 00	0.00E 00	5.29E 03
28 Ni-63	3.27E 04	2.26E 03	1.10E 03	0.00E 00	0.00E 00	0.00E 00	4.72E 02
28 Ni-65	1.33E 02	1.72E 01	7.87E 00	0.00E 00	0.00E 00	0.00E 00	4.37E 02
29 Cu-64	0.00E 00	1.10E 01	5.15E 00	0.00E 00	2.76E 01	0.00E 00	9.34E 02
30 Zn-65	2.32E 04	7.39E 04	3.34E 04	0.00E 00	4.94E 04	0.00E 00	4.66E 04
30 Zn-69	4.94E 01	9.46E 01	6.58E 00	0.00E 00	6.14E 01	0.00E 00	1.42E 01
35 Br-83	0.00E 00	0.00E 00	4.09E 01	0.00E 00	0.00E 00	0.00E 00	5.89E 01
35 Br-84	0.00E 00	0.00E 00	5.30E 01	0.00E 00	0.00E 00	0.00E 00	4.16E-04
35 Br-85	0.00E 00	0.00E 00	2.18E 00	0.00E 00	0.00E 00	0.00E 00	1.02E-15
37 Rb-86	0.00E 00	1.01E 05	4.72E 04	0.00E 00	0.00E 00	0.00E 00	2.00E 04
37 Rb-88	0.00E 00	2.90E 02	1.54E 02	0.00E 00	0.00E 00	0.00E 00	4.01E-09
37 Rb-89	0.00E 00	1.92E 02	1.35E 02	0.00E 00	0.00E 00	0.00E 00	1.12E-11
38 Sr-89	2.58E 04	0.00E 00	7.40E 02	0.00E 00	0.00E 00	0.00E 00	4.14E 03
38 Sr-90	6.35E 05	0.00E 00	1.56E 05	0.00E 00	0.00E 00	0.00E 00	1.83E 04
38 Sr-91	4.75E 02	0.00E 00	1.92E 01	0.00E 00	0.00E 00	0.00E 00	2.26E 03
38 Sr-92	1.80E 02	0.00E 00	7.78E 00	0.00E 00	0.00E 00	0.00E 00	3.57E 03

<b>MONTICELLO NUCLEAR GENERATING PLANT</b>		ODCM-04.01
<b>TITLE:</b>	<b>LIQUID EFFLUENT CALCULATIONS</b>	Revision 4
		Page 21 of 26

Table 2 A<sub>ij</sub> Values for the Monticello Nuclear Generating Plant (mrem/hr per  $\mu\text{Ci/ml}$ ) (cont'd)

Nuclide	Bone	Liver	T. Body	Thyroid	Kidney	Lung	GI-LLI
39 Y-90	6.90E-01	0.00E 00	1.35E-02	0.00E 00	0.00E 00	0.00E 00	7.32E 03
39 Y-91m	6.52E-03	0.00E 00	2.53E-04	0.00E 00	0.00E 00	0.00E 00	1.92E-02
39 Y-91	1.01E 01	0.00E 00	2.70E-01	0.00E 00	0.00E 00	0.00E 00	5.57E 03
39 Y-92	6.06E-02	0.00E 00	1.77E-03	0.00E 00	0.00E 00	0.00E 00	1.06E 03
39 Y-93	1.92E-01	0.00E 00	5.31E-03	0.00E 00	0.00E 00	0.00E 00	6.10E 03
40 Zr-95	6.02E-01	1.93E-01	1.31E-01	0.00E 00	3.03E-01	0.00E 00	6.11E 02
40 Zr-97	3.32E-02	6.71E-03	3.07E-03	0.00E 00	1.01E-02	0.00E 00	2.08E 03
41 Nb-95	4.47E 02	2.49E 02	1.34E 02	0.00E 00	2.46E 02	0.00E 00	1.51E 06
42 Mo-99	0.00E 00	1.54E 02	2.94E 01	0.00E 00	3.50E 02	0.00E 00	3.58E 02
43 Tc-99m	1.13E-02	3.34E-02	4.25E-01	0.00E 00	5.07E-01	1.63E-02	1.97E 01
43 Tc-101	1.21E-02	1.75E-02	1.72E-01	0.00E 00	3.15E-01	8.94E-03	5.26E-14
44 Ru-103	6.63E 00	0.00E 00	2.86E 00	0.00E 00	2.53E 01	0.00E 00	7.74E 02
44 Ru-105	5.52E 01	0.00E 00	2.18E-01	0.00E 00	7.13E 00	0.00E 00	3.38E 02
44 Ru-106	9.85E 01	0.00E 00	1.25E 01	0.00E 00	1.90E 02	0.00E 00	6.38E 03
47 Ag-110m	2.78E 00	2.57E 00	1.53E 00	0.00E 00	5.06E 00	0.00E 00	1.05E 03
52 Te-125m	2.60E 03	9.41E 02	3.48E 02	7.81E 02	1.06E 04	0.00E 00	1.04E 04
52 Te-127m	6.56E 03	2.35E 03	8.00E 02	1.68E 03	2.67E 04	0.00E 00	2.20E 04
52 Te-127	1.07E 02	3.83E 01	2.31E 01	7.90E 01	4.34E 02	0.00E 00	3.42E 03
52 Te-129m	1.11E 04	4.16E 03	1.76E 03	3.83E 03	4.65E 04	0.00E 00	5.61E 04
52 Te-129	3.04E 01	1.14E 01	7.42E 00	2.34E 01	1.23E 02	0.00E 00	2.30E 01
52 Te-131m	1.68E 03	8.20E 02	6.83E 02	1.30E 03	9.31E 03	0.00E 00	8.14E 04
52 Te-131	1.81E 01	7.98E 00	6.03E 00	1.57E 01	8.37E 01	0.00E 00	2.70E 00
52 Te-132	2.44E 03	1.58E 03	1.48E 03	1.75E 03	1.52E 04	0.00E 00	7.47E 04
53 I-130	3.61E 01	1.07E 02	4.21E 01	9.03E 03	1.66E 02	0.00E 00	9.18E 01
53 I-131	1.99E 02	2.84E 02	1.63E 02	9.32E 04	4.88E 02	0.00E 00	7.50E 01
53 I-132	9.70E 00	2.60E 01	9.08E 00	9.08E 02	4.13E 01	0.00E 00	4.88E 00
53 I-133	6.79E 01	1.18E 02	3.60E 01	1.74E 04	2.06E 02	0.00E 00	1.06E 02
53 I-134	5.07E 00	1.38E 01	4.92E 00	2.39E 02	2.19E 01	0.00E 00	1.20E-02
53 I-135	2.12E 01	5.54E 01	2.05E 01	3.66E 03	8.89E 01	0.00E 00	6.26E 01

<b>MONTICELLO NUCLEAR GENERATING PLANT</b>		ODCM-04.01
<b>TITLE:</b>	<b>LIQUID EFFLUENT CALCULATIONS</b>	Revision 4
		Page 22 of 26

Table 2 A<sub>ij</sub> Values for the Monticello Nuclear Generating Plant (mrem/hr per  $\mu$ Ci/ml) (cont'd)

Nuclide	Bone	Liver	T. Body	Thyroid	Kidney	Lung	GI-LLI
55 Cs-134	2.99E 05	7.10E 05	5.81E 05	0.00E 00	2.30E 05	7.63E 04	1.24E 04
55 Cs-136	3.12E 04	2.23E 05	8.88E 04	0.00E 00	6.86E 04	9.41E 03	1.40E 04
55 Cs-137	3.83E 05	5.23E 05	3.43E 05	0.00E 00	1.78E 05	5.90E 04	1.01E 04
55 Cs-138	2.65E 02	5.23E 02	2.59E 02	0.00E 00	3.84E 02	3.80E 01	2.23E-03
56 Ba-139	2.08E 00	1.48E-03	6.10E-02	0.00E 00	1.39E-03	8.41E 04	3.69E 00
56 Ba-140	4.36E 02	5.47E-01	2.85E 01	0.00E 00	1.86E-01	3.13E 01	8.97E 02
56 Ba-141	1.01E 00	7.64E-04	3.41E-02	0.00E 00	7.10E-04	4.34E 04	4.77E-10
56 Ba-142	4.57E-01	4.70E-04	2.88E-02	0.00E 00	3.97E-04	2.66E 04	6.44E-19
57 La-140	1.79E-01	9.04E-02	2.39E-02	0.00E 00	0.00E 00	0.00E 00	6.64E 03
57 La-142	9.18E-03	4.18E-03	1.04E-03	0.00E 00	0.00E 00	0.00E 00	3.05E 01
58 Ce-141	1.34E-01	9.04E-02	1.03E-02	0.00E 00	4.20E-02	0.00E 00	3.46E 02
58 Ce-143	2.36E-02	1.74E 01	1.93E-03	0.00E 00	7.67E-03	0.00E 00	6.51E 02
58 Ce-144	6.97E 00	2.91E 00	3.74E-01	0.00E 00	1.73E 00	0.00E 00	2.36E 03
59 Pr-143	6.60E-01	2.65E-01	3.27E-02	0.00E 00	1.53E-01	0.00E 00	2.89E 03
59 Pr-144	2.16E-03	8.97E-04	1.10E-04	0.00E 00	5.06E-04	0.00E 00	3.11E-14
60 Nd-147	4.51E-01	5.22E-01	3.12E-02	0.00E 00	3.05E-01	0.00E 00	2.50E 04
74 W-187	2.97E 02	2.48E 02	8.68E 01	0.00E 00	0.00E 00	0.00E 00	8.13E 04
93 Np-239	4.26E-02	4.19E-03	2.31E-03	0.00E 00	1.31E-02	0.00E 00	8.60E 02

<b>MONTICELLO NUCLEAR GENERATING PLANT</b>		ODCM-04.01
<b>TITLE:</b>	<b>LIQUID EFFLUENT CALCULATIONS</b>	Revision 4
		Page 23 of 26

Table 3 Liquid Radwaste Monitor Default Setpoint Calculation

Inputs	$\Sigma(S_i/MPC_i)$	2.00E+03	From Table 1
	F (gpm)	240000	Dilution Flowrate
	f (gpm)	50	Maximum Discharge Flowrate
	$S_h$	0.877	Fraction of total activity due to Hard to Detect Nuclides
	E	2.50E-06	Detector Efficiency ( $\mu\text{Ci/ml}$ per cps)
	SF	0.80	Setpoint Safety Factor
	Background	-	Background C.R.
Intermediate Results	$C_t$ ( $\mu\text{Ci/ml}$ )	2.40E+00	Maximum Concentration
	$C_m$ ( $\mu\text{Ci/ml}$ )	2.96E-01	Max Concentration of gamma emitters
Calculated Setpoint	C.R. (cps)	1.18E+05	net cps (No Safety Factor)
		9.46E+04	net cps (Includes 0.8 Safety Factor)

<b>MONTICELLO NUCLEAR GENERATING PLANT</b>		ODCM-04.01
<b>TITLE:</b>	<b>LIQUID EFFLUENT CALCULATIONS</b>	Revision 4
		Page 24 of 26

Table 4 Discharge Canal Radiation Monitor Default Setpoint Calculation

Inputs	$\Sigma(S_i/MPC_i)$	2.00E+03	From Table 1
	$S_h$	0.877	Fraction of total activity due to Hard to Detect Nuclides
	E	1.30E-07	Detector Efficiency ( $\mu\text{Ci/ml}$ per cps)
	SF	0.80	Setpoint Safety Factor
	Background	-	Background C.R.
Intermediate Results	$C_d$ ( $\mu\text{Ci/ml}$ )	5.00E-04	Maximum Concentration
	$C_m$ ( $\mu\text{Ci/ml}$ )	6.16E-05	Max Concentration of gamma emitters
Calculated Setpoint	C.R. (cps)	4.74E+02	net cps (No Safety Factor)
		3.79E+02	net cps (Includes 0.8 Safety Factor)

<b>MONTICELLO NUCLEAR GENERATING PLANT</b>		ODCM-04.01
<b>TITLE:</b>	<b>LIQUID EFFLUENT CALCULATIONS</b>	Revision 4
		Page 25 of 26

Table 5 Service Water Radiation Monitor Default Setpoint Calculation

Inputs	$\Sigma(S_i/MPC_i)$	2.00E+03	From Table 1
	$S_h$	0.877	Fraction of total activity due to Hard to Detect Nuclides
	E	4.30E-07	Detector Efficiency ( $\mu\text{Ci/ml}$ per cps)
	SF	0.80	Setpoint Safety Factor
	Background	-	Background C.R.
Intermediate Results	$C_t$ ( $\mu\text{Ci/ml}$ )	5.00E-04	Maximum Concentration
	$C_m$ ( $\mu\text{Ci/ml}$ )	6.16E-05	Max Concentration of gamma emitters
Calculated Setpoint	C.R. (cps)	1.43E+02	net cps (No Safety Factor)
		1.15E+02	net cps (Includes 0.8 Safety Factor)



<b>MONTICELLO NUCLEAR GENERATING PLANT</b>		ODCM-04.01
<b>TITLE:</b>	<b>LIQUID EFFLUENT CALCULATIONS</b>	Revision 4
		Page 26 of 26

Table 6 Turbine Building Normal Waste Sump Default Setpoint Calculation

Inputs	$\Sigma(S_i/MPC_i)$	2.00E+03	From Table 1
	$S_h$	0.877	Fraction of total activity due to Hard to Detect Nuclides
	E	3.42E-09	Detector Efficiency ( $\mu\text{Ci/ml}$ per cpm)
	SF	0.80	Setpoint Safety Factor
	Background	-	Background C.R.
Intermediate Results	$C_t$ ( $\mu\text{Ci/ml}$ )	5.00E-04	Maximum Concentration
	$C_m$ ( $\mu\text{Ci/ml}$ )	6.16E-05	Max Concentration of gamma emitters
Calculated Setpoint	C.R. (cpm)	1.80E+04	net cpm (No Safety Factor)
		1.44E+04	net cpm (Includes 0.8 Safety Factor)

<b>MONTICELLO NUCLEAR GENERATING PLANT</b>		ODCM-05.01
<b>TITLE:</b>	<b>GASEOUS EFFLUENT CALCULATIONS</b>	Revision 11
		Page 1 of 70

Approval: ODC 01559809

**OFFSITE DOSE CALCULATION MANUAL - TABLE OF CONTENTS**

<b><u>SECTION</u></b>	<b><u>PAGE</u></b>
1.0 RECORD OF REVISION .....	3
2.0 GASEOUS EFFLUENT CALCULATIONS.....	5
2.1 Monitor Alarm Setpoint Determination .....	5
2.2 Gaseous Effluent Dose Rate - Compliance With Technical Specifications ..	13
2.3 Gaseous Effluents - Compliance With 10CFR50 .....	15
2.4 Gaseous Effluents – Compliance with 40CFR190 .....	22
2.5 Determination of Onsite Dose .....	23
2.6 Offgas Release Rate and Gas Holdup Tank Activity .....	23
2.7 Dose Parameters for Radioiodines, Particulates and Tritium .....	29
2.8 References.....	38
Figure 1 Gaseous Radwaste .....	40
Figure 2 Ventilation System.....	41
Table 1 Gaseous Source Terms <sup>(1)</sup> A <sub>i</sub> , Ci/yr* .....	42
Table 2 Air Ejector Monitor Trip Setting and Storage Tank Contents Storage Tank Activity in Dose Equivalent Curies Xe-133 12 Hours After Completion of Tank Fill Release Rate Set to 1.00 of Maximum Trip Setting .....	43
Table 3 Child Critical Organ Dose Parameters for Radionuclide i for the Inhalation Pathway.....	46
Table 4 Dose Factors for Noble Gases and Daughters That May Be Detected in Gaseous Effluents .....	47
Table 5 Dose Parameters for Elevated Finite Plumes for the Critical Boundary Location 0.51 mi from the Stack in the SSE Sector .....	48
Table 6 R <sub>i</sub> Values for the Monticello Nuclear Generating Plant Ground Pathway .....	49
Table 7 R <sub>i</sub> Values for the Monticello Nuclear Generating Plant Vegetable Pathway Adult Age Group.....	50
Table 8 R <sub>i</sub> Values for the Monticello Nuclear Generating Plant Vegetable Pathway Teen Age Group.....	51
Table 9 R <sub>i</sub> Values for the Monticello Nuclear Generating Plant Vegetable Pathway Child Age Group.....	52
Table 10 R <sub>i</sub> Values for the Monticello Nuclear Generating Plant Meat Pathway Adult Age Group.....	53
Table 11 R <sub>i</sub> Values for the Monticello Nuclear Generating Plant Meat Pathway Teen Age Group.....	54

<b>MONTICELLO NUCLEAR GENERATING PLANT</b>		ODCM-05.01
<b>TITLE:</b>	<b>GASEOUS EFFLUENT CALCULATIONS</b>	Revision 11
		Page 2 of 70

**OFFSITE DOSE CALCULATION MANUAL - TABLE OF CONTENTS (Cont'd)**

<b><u>SECTION</u></b>	<b><u>PAGE</u></b>
Table 12 R <sub>i</sub> Values for the Monticello Nuclear Generating Plant Meat Pathway Child Age Group.....	55
Table 13 R <sub>i</sub> Values for the Monticello Nuclear Generating Plant Cow Milk Pathway Adult Age Group.....	56
Table 14 R <sub>i</sub> Values for the Monticello Nuclear Generating Plant Cow Milk Pathway Teen Age Group.....	57
Table 15 R <sub>i</sub> Values for the Monticello Nuclear Generating Plant Cow Milk Pathway Child Age Group.....	58
Table 16 R <sub>i</sub> Values for the Monticello Nuclear Generating Plant Cow Milk Pathway Infant Age Group.....	59
Table 17 R <sub>i</sub> Values for the Monticello Nuclear Generating Plant Goat Milk Pathway Adult Age Group.....	60
Table 18 R <sub>i</sub> Values for the Monticello Nuclear Generating Plant Goat Milk Pathway Teen Age Group.....	61
Table 19 R <sub>i</sub> Values for the Monticello Nuclear Generating Plant Goat Milk Pathway Child Age Group.....	62
Table 20 R <sub>i</sub> Values for the Monticello Nuclear Generating Plant Goat Milk Pathway Infant Age Group.....	63
Table 21 R <sub>i</sub> Values for the Monticello Nuclear Generating Plant Inhalation Pathway Adult Age Group.....	64
Table 22 R <sub>i</sub> Values for the Monticello Nuclear Generating Plant Inhalation Pathway Teen Age Group.....	65
Table 23 R <sub>i</sub> Values for the Monticello Nuclear Generating Plant Inhalation Pathway Child Age Group.....	66
Table 24 R <sub>i</sub> Values for the Monticello Nuclear Generating Plant Inhalation Pathway Infant Age Group.....	67
Table 25 Table of Radioisotope Constants Used for Offgas Calculations*.....	68
Table 26 Default Reactor Building Vent WRGM Setpoint (Section 2.1.1.A.).....	69
Table 27 Default Plant Stack WRGM Setpoint (Section 2.1.1.B.).....	70

<b>MONTICELLO NUCLEAR GENERATING PLANT</b>		ODCM-05.01
<b>TITLE:</b>	<b>GASEOUS EFFLUENT CALCULATIONS</b>	Revision 11
		Page 3 of 70

## 1.0 RECORD OF REVISION

<u>Revision No.</u>	<u>Reason for Revision</u>
1	Changed word "waste" to "effluent" in section 1.0, changed 1st sentence in section 2.0 to exact wording in T.S., added section 3.0 to reference section 1.0 word change to LAR 39.
2	Moved previous ODCM-03.01 (GASEOUS EFFLUENTS) into this section and renamed this section "GASEOUS EFFLUENTS CALCULATIONS" to facilitate moving the Radiological Effluents Tech Specs to the ODCM.  Moved associated figures and tables into this section to make the section easier to use. Removed references to the unused MIDAS System. Revised references to the X/Q and D/Q values now located in Appendix A.
3	Replaced maximum acceptable flow rate in equation 2.1-9 (85.5 cfm) to the effluent flowrate at the Offgas Pretreatment Monitor.
4	Fixed typographical errors on equations 2.1-4, 2.5-4 and 2.5-5. Removed plant activity uptake through soil factors from equations 2.5-5, 2.5-7 and 2.5-9. This term models plant activity uptake through the soil. Experience has shown this to be an insignificant pathway and the NRC drops it from consideration in NUREG 0133. Removed reference to 10CFR20 in sections 2.0.B., 2.2.1, 2.2, 2.2.1 and 2.2.2. With the revision to 10CFR20, the connection between the 400 and 3000 mRem/yr dose rate limits for gaseous effluent monitor alarm setpoints was broken. These limits still exist, but they are Technical Specification only requirements. Moved sentence about real time x/Q and MIDAS XP computer program in section 2.2.3 to section 2.2.2 where it belongs. Added sentence about historical atmospheric dispersion factors (D/Q) being used to determine critical receptor to section 2.2.3.
5	Changed references for "10CFR100" to "10CFR50.67" as required by License Amendment 148 (Alternate Source Term).
6	Added note to Table 1 stating that the Source terms were calculated in accordance with NUREG-0016 by using USNRC "GALE" Code. Made various format and typographical error corrections.
7	Editorial corrections to several equations as a result of SAR Action (01301985). Added Section 2.5.3 and updated Tables 7 through 21 for Carbon-14 dose factors.
8	Editorial correction to $U_{ap}$ for Cow/Goat-Meat pathway units incorrect. Changed from liters/yr to kg/yr.

<b>MONTICELLO NUCLEAR GENERATING PLANT</b>		ODCM-05.01
<b>TITLE:</b>	<b>GASEOUS EFFLUENT CALCULATIONS</b>	Revision 11
		Page 4 of 70

**1.0 RECORD OF REVISION (Cont)**

<u>Revision No.</u>	<u>Reason for Revision</u>
9	<p>Removed references to the use of specific computer programs.  Added methodology for projecting doses in Section 2.3.4.  Removed reference to calculating real time <math>\chi/Q</math> using procedure I.06.07 (ATMOSPHERIC DISPERSION DETERMINATION).  Removed weathering factor of plant uptake from direct foliar deposits from equations 2.5.2.C.1, 2.5.2.D.1, and 2.5.2.E.1.  Updated Tables 6 - 24 for removed factors in equations 2.5.2.C.1, 2.5.2.D.1, and 2.5.2.E.1.  Fixed typographical error in equation 2.5.2.E.2.  Updated Carbon-14 calculations and discussion and added equation numbers.  Deleted Table 2 as raw data available in Table 5.  Corrected reference for Dose Rate Limits from 10CFR20 to Technical Specifications.  Changed subscripts on <math>R_i</math> and <math>P_i</math> to improve clarity.  Added note that Kr-83m is not included in actual setpoint calculations (AR 01452892).  Removed <math>I_i</math> factor from Equations 2.5.2.B.1, 2.5.2.C.1, 2.5.2.D.1, &amp; 2.5.2.E.1. The term accounted for elemental iodine fraction and was not used at Monticello.  Elective formatting changes.</p>
10	<p>Added methodology for calculating Noble Gas Total Body and Skin Dose. (AR01520418)  Removed references to EBARR computer program and updated discussion regarding release rates and tank activities.  Updated fission yields and half lives for noble gases in Table 25 based on EPRI Fuel Reliability Monitoring and Failure Evaluation Handbook (2010).  Editorial corrections.</p>
11	<p>Added default setpoint calculation examples as Tables 26-27, in support of AR01537833.</p>

<b>MONTICELLO NUCLEAR GENERATING PLANT</b>		ODCM-05.01
<b>TITLE:</b>	<b>GASEOUS EFFLUENT CALCULATIONS</b>	Revision 11
		Page 5 of 70

## **2.0 GASEOUS EFFLUENT CALCULATIONS**

This section describes the procedures used by MNGP to:

- A. Determine alarm point settings for gaseous effluent monitors;
- B. Determine that dose rates at the site boundary from noble gases, particulates, and iodines remain below the limits of Technical Specifications, and
- C. Determine that the total dose from airborne effluents for the year is within the limits of Appendix I of 10CFR50.

The computations of this section may be done manually, by use of computer programs which implement these algorithms.

### **2.1 Monitor Alarm Setpoint Determination**

This procedure determines the effluent monitor alarm setpoint that indicates if the dose rate at or beyond the site boundary due to noble gas radionuclides in the gaseous effluent released from the site exceeds 500 mrem/year to the whole body or exceeds 3000 mrem/year to the skin. Accident monitors are set to limit effluent releases to a small fraction of the limits specified in 10CFR50.67. In addition this section calculates the maximum activity permitted in each off-gas storage tank.

Monitor high alarm or isolation setpoints are established in one of the following ways:

1. At least monthly, perform calculation of setpoints using the methodology of Section 2.1.1 for noble gas nuclides in releases during the previous release period.
2. Prior to each containment purge, recalculation of the setpoint using the methodology of Section 2.1.1 based on the sample taken prior to purging.

<b>MONTICELLO NUCLEAR GENERATING PLANT</b>		ODCM-05.01
<b>TITLE:</b>	<b>GASEOUS EFFLUENT CALCULATIONS</b>	Revision 11
		Page 6 of 70

### 2.1.1 Effluent Monitors

Monitor alarm setpoints are determined to assure compliance with Technical Specifications. The setpoints indicate that the dose rate at or beyond the site boundary due to noble gas radionuclides in the gaseous effluent released from the site exceeds 500 mrem/year to the whole body or exceeds 3000 mrem/year to the skin.

Monitor alarm setpoints are calculated for the Reactor Building Ventilation Plenum Noble Gas monitors and the Stack Noble Gas monitors at least once per month. These calculations are based on the noble gas isotopes in releases made during the previous release period.

In addition, prior to containment purging, the monitor setpoint for the monitor release point is recalculated. The monitor setpoint is determined as follows:

1. If no detectable noble gas activity is found in the purge sample, the values used as the basis for the alarm point setting are from the column, "Drywell purging" in Table 1, Gaseous Source Terms.
2. If any calculated setpoint is less than the existing monitor setpoint, the setpoint is reduced to the new value.
3. If the calculated setpoint is greater than the existing monitor setpoint, the setpoint may remain at the lower value or be increased to the new value.
4. The setpoint during purging may not be increased above the setpoint determined for continuous releases, however.

The small amount of containment atmosphere released by the containment sampling system on a continuous basis is not considered a venting operation.

#### A. Reactor Building Vent Alarm Setpoint

The following method applies to gaseous releases via the Reactor Building vent (RBV) when determining the high-high alarm setpoint for the Reactor Building Vent Noble Gas Monitor. This method is applied to both continuous releases and batch releases (containment inerting and deinerting).

1. Determine the "mix" (noble gas radionuclides and composition) of the gaseous effluent.
  - a. Determine the gaseous source terms that are representative of the "mix" of the gaseous effluent. Gaseous source terms are the total curies of each noble gas released during the previous month or a representative analysis of the gaseous effluent.

<b>MONTICELLO NUCLEAR GENERATING PLANT</b>		ODCM-05.01
<b>TITLE:</b>	<b>GASEOUS EFFLUENT CALCULATIONS</b>	Revision 11
		Page 7 of 70

Table 1 source terms may be used if the Reactor Building releases for the previous month were below the lower limits of detection (LLD), or, in the case of inerting and deinerting releases, no detectable activity was found in the grab sample taken prior to purging.

- b. Determine  $S_i$ , the fraction of the total radioactivity in the gaseous effluent comprised by noble gas radionuclide "i", for each individual noble gas radionuclide in the gaseous effluent.

$$1) \quad S_i = \frac{A_i}{\sum_i A_i}$$

where

$A_i$  = The radioactivity of noble gas radionuclide "i" in the gaseous effluent.

2. Determine  $Q_t$ , the maximum acceptable total release rate of all noble gas radionuclides in the gaseous effluent ( $\mu\text{Ci}/\text{sec}$ ), based upon the whole body exposure limit (500 mrem/yr).

$$a. \quad Q_t = \frac{500}{(\chi/Q)_v \sum_i K_i S_i}$$

where

$(\chi/Q)_v$  = The highest calculated average relative concentration of effluents released via the Reactor Building vent for any area at or beyond the site boundary for all sectors ( $\text{sec}/\text{m}^3$ ) from Appendix A, Table 3. For purge releases, substitute the value obtained from Appendix A, Table 12.

$K_i$  = The total whole body dose factor due to gamma emissions from noble gas radionuclide "i" (mrem/year per  $\mu\text{Ci}/\text{m}^3$ ) from Table 4.

$S_i$  = The fraction of the total radioactivity in the RBV gaseous effluent comprised by noble gas "i" from 2.1.1.A.1.b.1) above (unitless).



<b>MONTICELLO NUCLEAR GENERATING PLANT</b>		ODCM-05.01
<b>TITLE:</b>	<b>GASEOUS EFFLUENT CALCULATIONS</b>	Revision 11
		Page 8 of 70

3. Determine  $Q_t$  based upon the skin exposure limit (3000 mrem/yr).

- a. 
$$Q_t = \frac{3000}{(\chi/Q) \sum_i (L_i + 1.1 M_i)} S_i$$

where

$L_i$  = Skin Dose Factor (mrem/yr per  $\mu\text{Ci}/\text{m}^3$ )

1.1 = conversion from mrad to mrem.

$M_i$  = Gamma Air Dose Factor (mrad/yr per  $\mu\text{Ci}/\text{m}^3$ )

4. Determine HHSP (the monitor high-high alarm setpoint above background (net  $\mu\text{Ci}/\text{sec}$ )).

**NOTE:** Use the lowest of the  $Q_t$  values obtained in Sections 2.1.1.A.2. and 2.1.1.A.3 as calculated using the previous release period or the GALE Code values.

- a. 
$$\text{HHSP} = 0.50 Q_t$$

0.50 = Fraction of the total radioactivity from the site via the monitored release point to ensure that the site boundary limit is not exceeded due to simultaneous releases from several release points.

## B. Stack Isolation Setpoint

The following method applies to gaseous releases via the Stack when determining the high-high alarm setpoint for the Stack Gas Monitor which initiates isolation of Stack releases. The method is applied to both continuous releases and batch releases (containment inerting and deinerting). Mechanical vacuum pump releases (relatively insignificant) will be controlled using the continuous setpoint.

1. Determine the "mix" (noble gases and composition) of the gaseous effluent.
  - a. Determine the gaseous source terms that are representative of the "mix" of the gaseous effluent. Gaseous source terms are the total curies of each noble gas released during the previous month or a representative analysis of the gaseous effluent. Table 1 source terms may be used if the Stack releases for the previous month were below the lower limits of detection (LLD).

<b>MONTICELLO NUCLEAR GENERATING PLANT</b>		ODCM-05.01
<b>TITLE:</b>	<b>GASEOUS EFFLUENT CALCULATIONS</b>	Revision 11
		Page 9 of 70

- b. Determine  $S_i$ , the fraction of the total radioactivity in the gaseous effluent comprised by noble gas radionuclide "i", for each individual noble gas radionuclide in the gaseous effluent.

$$1) \quad S_i = \frac{A_i}{\sum_i A_i}$$

where

$A_i$  = The radioactivity of noble gas radionuclide "i" in the gaseous effluent.

2. Determine  $Q_t$ , the maximum acceptable total release rate of all noble gas radionuclides in the gaseous effluent ( $\mu\text{Ci/sec}$ ), based upon the whole body exposure limit (500 mrem/yr).

$$a. \quad Q_t = \frac{500}{\sum_i V_i S_i}$$

**NOTE:** For short-term batch releases (equal to or less than 500 hrs/yr) via drywell purging, substitute  $v_i$  for  $V_i$  in Equation 2.1.1.B.2.a.

where

$V_i$  = The constant for long-term releases (greater than 500 hr/yr) for noble gas radionuclide "i" accounting for the gamma radiation from the elevated finite plume (mrem/year per  $\mu\text{Ci/sec}$ ) from Table 5.

$v_i$  = The constant for short-term releases (equal to or less than 500hr/yr) for noble gas radionuclide "i" accounting for the gamma radiation from the elevated finite plume (mrem/yr per  $\mu\text{Ci/sec}$ ) from Table 5.

$S_i$  = The fraction of the total radioactivity in the Stack gaseous effluent comprised by noble gas "i" from 2.1.1.B.1.b.1) above (unitless).

<b>MONTICELLO NUCLEAR GENERATING PLANT</b>		ODCM-05.01
<b>TITLE:</b>	<b>GASEOUS EFFLUENT CALCULATIONS</b>	Revision 11
		Page 10 of 70

3. Determine  $Q_t$  based upon the skin exposure limit (3000 mrem/yr).

- a. 
$$Q_t = \frac{3000}{\sum_i (L_i (\gamma/Q)_s + 1.1B_i)} S_i$$

**NOTE:** For short-term batch releases (equal to or less than 500 hours per year) via drywell purging, use the short-term  $(\gamma/q)_s$  value and substitute  $b_i$  for  $B_i$  in Equation 2.1.1.B.3.a.

where

$L_i$  = Skin Dose Factor (mrem/yr per  $\mu\text{Ci}/\text{m}^3$ ) from Table 4.

1.1 = conversion from mrad to mrem.

$B_i$  = The constant for long-term releases (greater than 500 hr/yr) for noble gas radionuclide "i" accounting for the gamma radiation from the elevated finite plume (mrem/year per mCi/sec) from Table 5.

$b_i$  = The constant for short-term releases (greater than 500 hr/yr) for noble gas radionuclide "i" accounting for the gamma radiation from the elevated finite plume (mrem/year per mCi/sec) from Table 5.

4. Determine HHSP (the monitor high-high alarm setpoint above background ( $\mu\text{Ci}/\text{sec}$ )).

**NOTE:** Use the lowest of the  $Q_t$  values obtained in sections 2.1.1.B.2 and 2.1.1.B.3 as calculated using the previous release period or the GALE Code values.

- a.  $\text{HHSP} = 0.50 Q_t$

where

0.50 = Fraction of the total radioactivity from the site via the monitored release point to ensure that the site boundary limit is not exceeded due to simultaneous releases from several release points.

<b>MONTICELLO NUCLEAR GENERATING PLANT</b>		ODCM-05.01
<b>TITLE:</b>	<b>GASEOUS EFFLUENT CALCULATIONS</b>	Revision 11
		Page 11 of 70

### 2.1.2 Accident Monitors

The gross radioactivity in noble gases removed from the main condenser by means of steam jet air ejectors as measured prior to entering the treatment, adsorption, and delay systems **SHALL** be limited by an alarm setpoint for the Offgas Monitor.

This procedure determines the monitor alarm setpoint that indicates if the potential body accident dose to an individual at or beyond the site boundary due to noble gas radionuclides in the gaseous effluent released from the site exceeds a small fraction of the limits specified in 10CFR50.67 in the event this effluent, including the radioactivity accumulated in the treatment system, is inadvertently discharged directly to the environment without treatment. Offgas flow is automatically terminated when this setpoint is reached.

#### A. Maximum Release Rate

Determine  $Q_{tot}$ , the maximum acceptable total release rate in  $\mu\text{Ci}/\text{sec}$  of all noble gas radionuclides in the gaseous effluent at the Offgas Monitor after a 5-minute decay, based on the maximum acceptable total release rate of  $2.60\text{E}5 \mu\text{Ci}/\text{sec}$  after a 30-minute decay.

1. Determine the offgas mixture of the gaseous effluent. The offgas mixture is the fraction of the offgas noble gas radioactivity caused by each recoil diffusion, and equilibrium component. The offgas mixture is determined at least once per month.
2. Determine  $Q_{tot}$  based on the offgas mixture using Table 2. This table was prepared using a variation of the methodology described in Section 2.6.

#### B. Maximum Concentration

Determine  $C_t$ , the maximum acceptable total radioactivity concentration of all noble gas radionuclides in the gaseous effluent ( $\mu\text{Ci}/\text{cc}$ ).

$$1. \quad C_t = 2.12 \text{ E-}03 \frac{Q_{tot}}{f}$$

where

$f$  = The effluent flowrate at the Offgas Pretreatment Monitor (cfm);

$2.12\text{E-}03$  = Inverse conversion factor from cfm to cc/sec ( $\text{ft}^3/\text{min}$  per  $\text{cm}^3/\text{sec}$ ).

$Q_{tot}$  = The maximum acceptable total release rate at 5 minutes for a given offgas mixture from Table 2 ( $\mu\text{Ci}/\text{sec}$ ).

<b>MONTICELLO NUCLEAR GENERATING PLANT</b>		ODCM-05.01
<b>TITLE:</b>	<b>GASEOUS EFFLUENT CALCULATIONS</b>	Revision 11
		Page 12 of 70

C. Monitor Reading

Determine C.R., the calculated monitor reading above background attributed to the noble gas radionuclides (mR/hr).

$$1. \quad C.R. = \frac{C_t}{E}$$

where

E = The detection efficiency of the monitor for noble gas radionuclides represented in main condenser offgas ( $\mu\text{Ci}/\text{cc}$  per mR/hr) from Plant Chemistry Surveillance procedures.

D. Monitor High High Setpoint

The monitor high-high alarm setpoint above background (mR/hr) should be set at or below the C.R. value.

2.1.3 Offgas Storage Tank Maximum Activity

The maximum activity in each storage tank is limited to less than 22,000 curies of noble gas (considered as dose equivalent Xe-133) after 12 hours of holdup. To verify that this limit is not exceeded, Table 2 is used.

The gross radioactivity of noble gases from the main condenser air ejector is determined by isotopic analysis monthly and whenever a significant increase in offgas activity is noted. Analysis of this data is used to determine the primary mode of fission product release from the fuel (recoil, equilibrium, or diffusion) and the gross release rate. This information combined with the condenser air leakage rate (cfm) and the air ejector monitor release rate is used to confirm that the maximum tank contents limit is not exceeded.

Table 2 is entered with the offgas mixture (fraction recoil, diffusion, and equilibrium rounded to one decimal place) and the air leakage rate (in cfm). The resulting tank activity is multiplied by the current total release rate after a 30 minute decay ( $\mu\text{Ci}/\text{sec}$ ) and divided by the maximum permitted air ejector release rate of 260,000  $\mu\text{Ci}/\text{sec}$ . Linear interpolation of air leakage is used.

As noted earlier, Table 2 is derived from the methodology described in Section 2.6. It is extremely unlikely that the maximum tank activity limit will be exceeded.

<b>MONTICELLO NUCLEAR GENERATING PLANT</b>		ODCM-05.01
<b>TITLE:</b>	<b>GASEOUS EFFLUENT CALCULATIONS</b>	Revision 11
		Page 13 of 70

## 2.2 Gaseous Effluent Dose Rate - Compliance With Technical Specifications

Dose rates resulting from the release of noble gases, and from radioiodines and particulates must be calculated to show compliance with Technical Specification 5.5.3. The dose rate limits of Technical Specifications are conservatively applied on an instantaneous basis at the hypothetical worst case location.

### 2.2.1 Noble Gases

The dose rate in unrestricted areas resulting from noble gas effluents is limited to 500 mrem/yr to the total body and 3000 mrem/yr to the skin. The setpoint determinations discussed in the previous section are based on the dose rate calculation method presented in NUREG-0133<sup>(4)</sup>. This represents a backward solution to the limiting dose rate equations in NUREG-0133. Setting alarm trip setpoints in this manner will ensure that the limits of Technical Specifications are met for noble gas releases. Therefore, no routine dose rate calculations for noble gases will be needed to show compliance with this part.

### 2.2.2 Radioiodine and Radioactive Particulates and Other Radionuclides

The dose rate in unrestricted areas resulting from the release of radioiodines and particulates with half lives greater than 8 days is limited by Technical Specifications to 1500 mrem/yr to any organ. The calculation of dose rate from radioiodines and particulates is performed for drywell purges prior to the release and weekly for all releases. The calculations are based on the results of analyses obtained pursuant to Surveillance Requirement 3.1.4.B. To show compliance with Technical Specifications, Equation 2.2.2.A will be evaluated for I-131, I-133, tritium, and radioactive particulates with half lives greater than eight days.

$$A. \quad \sum P_{i \text{ (inhalation)}} [(\chi/Q)_v Q_{iv} + (\chi/Q)_s Q_{is}] < 1500 \text{ mrem/yr}$$

where

$P_{i \text{ (inhalation)}}$  = child critical organ dose parameter for radionuclide  $i$  for the inhalation pathway, mrem/yr per  $\mu\text{Ci}/\text{m}^3$ , (Table 3)

$(\chi/Q)_v$  = annual average relative concentration for long term release from the Reactor Building vent at the critical location,  $\text{sec}/\text{m}^3$  (Appendix A, Table 3);

$(\chi/Q)_s$  = annual average relative concentration for long term releases from the offgas stack at the critical location,  $\text{sec}/\text{m}^3$  (Appendix A, Table 6);

<b>MONTICELLO NUCLEAR GENERATING PLANT</b>		ODCM-05.01
<b>TITLE:</b>	<b>GASEOUS EFFLUENT CALCULATIONS</b>	Revision 11
		Page 14 of 70

- $Q_{iv}$  = the release rate of radionuclide  $i$  from the Reactor Building vent for the week of interest,  $\mu\text{Ci}/\text{sec}$ ;
- $Q_{is}$  = the release rate of radionuclide  $i$  from the offgas stack for the week of interest,  $\mu\text{Ci}/\text{sec}$ .

The  $\chi/Q$  values presented in Appendix A, Tables 3 and 6 have been calculated using the USNRC computer code "XOQDOQ"<sup>(5)</sup>. Dose rate calculations using Equation 2.2.2.A are made once per week. The source terms  $Q_{iv}$  and  $Q_{is}$  are determined from the results of analysis of weekly stack and Reactor Building particulate filters and charcoal cartridges. These source terms include all gaseous releases from MNGP. They are recorded and reported as the total dose for compliance with Technical Specifications.

Radioiodines and particulates may be released from both the offgas stack and the Reactor Building vent. As specified in NUREG-0133, the critical receptor location is identified based on the Reactor Building vent  $\chi/Q$ .

A component of the total stack or vent source term may be due to short term releases occurring as a result of containment drywell purging. Dose rate calculations are made on this component separately to further assure compliance with Technical Specifications prior to release. The calculated dose rate is used only to determine whether or not the drywell can be purged. All dose rates from drywell purges will be accounted for and reported through the weekly calculations discussed above. Release rates are determined from the results of analyses of samples from the drywell.

The term  $Q_{is}$  for the calculation of drywell purge dose rate is determined by multiplying the concentration of each nuclide in the drywell by the rate of release. Credit will be taken for the expected reduction in radionuclide concentration due to use of the standby gas treatment system. Equation 2.2.2.B is used to calculate purge dose rates. Only one source term is used depending on the release point (stack or Reactor Building vent). Short term values of  $\chi/q$  from Appendix A, Table 9 or Table 12 are used in the purge dose rate calculation. The limiting dose rate limit for each purge is determined using:

$$B. \quad BL = 1500 - (D_{cv} + D_{cs} - D_{dw})$$

where

$BL$  = limiting dose rate for the batch,  $\text{mrem}/\text{yr}$ ;

1500 = the instantaneous dose rate limit for Iodines, Tritium and Particulates w/  $t_{1/2} > 8$  days from ODCM-03.01, Control 2.1.1.A.2. ( $\text{mrem}/\text{year}$ )

<b>MONTICELLO NUCLEAR GENERATING PLANT</b>		ODCM-05.01
<b>TITLE:</b>	<b>GASEOUS EFFLUENT CALCULATIONS</b>	Revision 11
		Page 15 of 70

- $D_{cv}$  = previous week's dose rate from Reactor Building continuous and batch releases, mrem/yr;
- $D_{cs}$  = previous week's dose rate from offgas stack continuous and batch releases, mrem/yr;
- $D_{dw}$  = previous week's total dose rate from drywell purge releases, mrem/yr, for the purge release point.

Although mechanical vacuum pump releases are batch mode, they cannot be sampled prior to release. For this reason, no prerelease dose rate calculations can be made from this source. Experience has shown mechanical vacuum pump release to be well within Technical Specifications limits.

### 2.2.3 Critical Receptor Identification

As stated in 5.2.1 of NUREG-0133, when the critical receptor is different for stack and vent releases, the controlling location for vent releases should be used. For this reason, the Reactor Building vent dispersion parameters are used to identify the critical receptor. (Historical Atmospheric Dispersion factors (D/Q) are used for determining the critical receptor (App A, Table 5).) As discussed previously, weekly and batch dose rate calculations are performed for the critical boundary location. The critical boundary location is based on reactor vent long term  $\chi/Q$  (Appendix A, Table 3) is 0.43 miles in the SSE sector.

## 2.3 Gaseous Effluents - Compliance With 10CFR50

Doses resulting from the release of noble gases, and radioiodines and particulates must be calculated to show compliance with Appendix I of 10CFR50. The calculations are performed at least monthly for all gaseous effluents.

This section describes the methods and equations used at MNGP to perform the dose evaluation using manual methods based on historical meteorological dispersion parameters.

### 2.3.1 Noble Gases

The air dose in unrestricted areas at MNGP is limited to:

- A. for any calendar quarter:

$$D_{\gamma} \leq 5 \text{ mrad due to gamma radiation; and}$$

$$D_{\beta} \leq 10 \text{ mrad due to beta radiation; and}$$

- B. for any calendar year:

$$D_{\gamma} \leq 10 \text{ mrad due to gamma radiation; and}$$

$$D_{\beta} \leq 20 \text{ mrad due to beta radiation.}$$



<b>MONTICELLO NUCLEAR GENERATING PLANT</b>		ODCM-05.01
<b>TITLE:</b>	<b>GASEOUS EFFLUENT CALCULATIONS</b>	Revision 11
		Page 16 of 70

Air doses may be calculated using historical meteorological data using the highest normalized concentration statistics as the best estimator of the atmospheric dispersion.

C. Air Dose Based on Historical Meteorology

The limiting air dose, D, based on historical meteorology is based on the critical receptor in the unrestricted area. For air doses the critical receptor is described by the off-site location with the highest long term annual average relative concentration ( $\chi/Q$ ) at or beyond the restricted area boundary. For short-term vent releases (less than 500 hours per year), the location with the highest short-term average relative concentration ( $\chi/q$ ) is chosen. The critical receptor is described in section 2.3.5.

For gamma radiation, the air dose is given by:

$$1. \quad D_{\gamma} = 3.17 \times 10^{-8} \sum_i (M_i [(\chi/Q)_v Q_{iv} + (\chi/q)_v q_{iv}] + B_i Q_{is} + b_i q_{is})$$

The historical meteorological data base is the basis for the method described in the original MNGP ODCM.

For beta radiation, the air dose is:

$$2. \quad D_{\beta} = 3.17 \times 10^{-8} \sum_i N_i [(\chi/Q)_v Q_{iv} + (\chi/q)_v q_{iv} + (\chi/Q)_s Q_{is} + (\chi/q)_s q_{is}]$$

where

$M_i$  = The air dose factor due to gamma emission for each identified noble gas radionuclide i, mrad/yr per  $\mu\text{Ci}/\text{m}^3$ ; (Table 4)

$N_i$  = the air dose factor due to beta emissions for each identified noble gas radionuclide i, mrad/yr per  $\mu\text{Ci}/\text{m}^3$ ; (Table 4)

$(\chi/Q)_v$  = the annual average relative concentration for areas at or beyond the site boundary for long-term Reactor Building vent releases (greater than 500 hr/yr),  $\text{sec}/\text{m}^3$ , (Appendix A, Table 3);

$(\chi/q)_v$  = the relative concentration for areas at or beyond the site boundary for short-term Reactor Building vent releases (equal to or less than 500 hr/yr),  $\text{sec}/\text{m}^3$ , (Appendix A, Table 12);

<b>MONTICELLO NUCLEAR GENERATING PLANT</b>		ODCM-05.01
<b>TITLE:</b>	<b>GASEOUS EFFLUENT CALCULATIONS</b>	Revision 11
		Page 17 of 70

- $(\chi/Q)_s$  = the annual average relative concentration for areas at or beyond the site boundary for long-term offgas stack releases (greater than 500 hr/yr), sec/m<sup>3</sup> (Appendix A, Table 6);
- $(\chi/q)_s$  = the relative concentration for areas at or beyond the site boundary for short-term offgas stack releases (equal to or less than 500 hr/yr), sec/m<sup>3</sup> (Appendix A, Table 9);
- $q_{is}$  = the average release of the noble gas radionuclide i in gaseous effluents for short-term offgas stack releases (equal to or less than 500 hr/yr),  $\mu\text{Ci}$ ;
- $q_{iv}$  = the average total release of the noble gas radionuclide i in gaseous effluents for short-term Reactor Building vent releases (equal to or less than 500 hr/yr),  $\mu\text{Ci}$ ;
- $Q_{is}$  = the total release of noble gas radionuclide i in gaseous releases for long-term offgas stack releases (greater than 500 hr/yr),  $\mu\text{Ci}$ ;
- $Q_{iv}$  = the total release of noble gas radionuclide i in gaseous effluents for long-term Reactor Building vent releases (greater than 500 hr/yr),  $\mu\text{Ci}$ ;
- $B_i$  = the constant for long-term releases (greater than 500 hr/yr) for each identified noble gas radionuclide i accounting for the gamma radiation from the elevated finite plume, mrad/yr per  $\mu\text{Ci}/\text{sec}$  (Table 5);
- $b_i$  = the constant for short-term releases (less than or equal to 500hr/yr) for each identified noble gas radionuclide i accounting for the gamma radiation from the elevated finite plume, mrad/yr per  $\mu\text{Ci}/\text{sec}$  (Table 5);
- $3.17 \times 10^{-8}$  = the inverse of the number of seconds in a year. (years/sec)

Noble gases are continuously released from the Reactor Building vent and the plant stack. These long-term releases rates are determined from the continuous noble gas monitor readings and periodic radionuclide analyses. There are infrequent containment purges from either release point. To separate the short-term

<b>MONTICELLO NUCLEAR GENERATING PLANT</b>		ODCM-05.01
<b>TITLE:</b>	<b>GASEOUS EFFLUENT CALCULATIONS</b>	Revision 11
		Page 18 of 70

release from the long term release (the continuous monitor records both), the drywell source term should be subtracted from the total source term whenever a purge release occurs. Periodic radionuclide analysis of main condenser offgas and radionuclide analysis of each purge prior to release are used in conjunction with the total activity measured by the monitor to quantify individual noble gas nuclides released.

Long-term and short-term  $\chi/Q$ 's are given in Appendix A for both the Reactor Building vent and the plant stack. Short-term  $\chi/q$ 's were calculated using the USNRC computer code "XOQDOQ" assuming 144 hours per year drywell purge. Values of M and N were calculated using the methodology presented in NUREG-0133 and are given in Table 4. Table 5 presents values of  $B_i$  and  $b_i$  calculated using the USNRC computer code "RABFIN." This code was also used to calculate values of  $V_i$  presented in section 1.0. Values of  $v_i$ , were calculated by multiplying  $V_i$  by the ratio of  $b_i$  to  $B_i$ . The  $v_i$ ,  $B_i$ , and  $b_i$  values of Table 5 are the maximum values for the site boundaries location. This location, 0.51 mi SSE, is different than the critical site boundary location based upon the Reactor Building vent  $\chi/Q$ .

### 2.3.2 Radioiodine, Particulates, and Other Radionuclides

The dose,  $D_{aj}$ , to an individual from radioiodines, radioactive materials in particulate form and radionuclides other than noble gases with half lives greater than eight days in gaseous effluents released to unrestricted areas **SHALL** be limited to:

$$D_{aj} \leq 7.5 \text{ mrem for any calendar quarter}$$

$$D_{aj} \leq 15 \text{ mrem for any calendar year}$$

These limits apply to the receptor location where the combination of existing pathways and age groups indicates the maximum exposure.

#### A. Dose from Radioiodines and Particulates Based on Historical Meteorology

The worst case dose to an individual from I-131, tritium and radioactive particulates with half-lives greater than eight days in gaseous effluents released to unrestricted areas is determined by the following expressions:

$$1. \quad D_{aj} = 3.17 \times 10^{-8} \sum_p \sum_i R_{iapj} [W_v Q_{iv} + w_v q_{iv} + W_s Q_{is} + w_s q_{is}]$$

where

$Q_{is}$  = release of radionuclide i for long-term offgas stack releases (greater than 500 hr/yr),  $\mu\text{Ci}$ ;

<b>MONTICELLO NUCLEAR GENERATING PLANT</b>		ODCM-05.01
<b>TITLE:</b>	<b>GASEOUS EFFLUENT CALCULATIONS</b>	Revision 11
		Page 19 of 70

- $Q_{iv}$  = release of radionuclide i for long-term Reactor Building vent releases (greater than 500 hr/yr),  $\mu\text{Ci}$ ;
- $q_{is}$  = release of radionuclide i for short-term offgas stack purge releases (equal to or less than 500 hr/yr);  $\mu\text{Ci}$ ;
- $q_{iv}$  = release of radionuclide i for short-term Reactor Building vent purge releases (equal to or less than 500 hr/yr);  $\mu\text{Ci}$ ;
- $W_s$  = the dispersion parameter for estimating the dose to an individual at the controlling location for long-term offgas stack releases (greater than 500 hr/yr),  $\text{sec}/\text{m}^3$  or  $\text{m}^{-2}$ ;
- $W_v$  = the dispersion parameter for estimating the dose to an individual at the controlling location for long-term Reactor Building vent releases (greater than 500 hr/yr),  $\text{sec}/\text{m}^3$  or  $\text{m}^{-2}$ ;
- $w_s$  = the dispersion parameter for estimating the dose to an individual at the controlling location for short-term offgas stack releases (equal to or less than 500 hr/yr),  $\text{sec}/\text{m}^3$  or  $\text{m}^{-2}$ ;
- $w_v$  = the dispersion parameter for estimating the dose to an individual at the controlling location for short-term Reactor Building vent releases (equal to or less than 500 hr/yr),  $\text{sec}/\text{m}^3$  or  $\text{m}^{-2}$ ;
- $3.17 \times 10^{-8}$  = the inverse of the number of seconds in a year.
- $R_{iapj}$  = the dose factor for each identified radionuclide i, pathway p, age group a, and organ j,  $\text{m}^2 \text{mrem}/\text{yr}$  per  $\mu\text{Ci}/\text{sec}$  or  $\text{mrem}/\text{yr}$  per  $\mu\text{Ci}/\text{m}^3$ .

<b>MONTICELLO NUCLEAR GENERATING PLANT</b>		ODCM-05.01
<b>TITLE:</b>	<b>GASEOUS EFFLUENT CALCULATIONS</b>	Revision 11
		Page 20 of 70

The above equation is applied to each combination of age group and organ. Values of  $R_{iapj}$  have been calculated using the methodology given in NUREG-0133 and are given in Tables 6 through 24. The equation is applied to a controlling location which will be one of the following:

- A. residence,
- B. vegetable garden,
- C. milk animal.

The selection of the actual receptor is discussed in section 2.3.5. The W values are in terms of  $\chi/Q$  (sec/m<sup>3</sup>) for the inhalation pathways and in terms of D/Q (m<sup>-2</sup>) for all other pathways.

Section 2.7.2 contains the methodology for calculating  $R_{iapj}$  values. This method will be used to compute dose factors for nuclides not tabulated in Tables 6 through 24 if they are encountered.

### 2.3.3 Cumulation of Doses

Doses calculated monthly are summed for comparison with quarterly and annual limits. The monthly results are added to the doses cumulated from the other months in the quarter of interest and in the year of interest and compared to the limits given in section 2.3.1 and 2.3.2. If these limits are exceeded, a Special Report will be submitted to the USNRC. If twice the limits are exceeded, a Special Report showing compliance with 40CFR190<sup>(8)</sup> will be submitted.

<b>MONTICELLO NUCLEAR GENERATING PLANT</b>		ODCM-05.01
<b>TITLE:</b>	<b>GASEOUS EFFLUENT CALCULATIONS</b>	Revision 11
		Page 21 of 70

#### 2.3.4 Projection of Doses

Doses due to gaseous effluents are projected at least every 31 days IAW Tech Spec 5.5.3.e.

Cumulative dose is determined with each weekly release permit generation. Dose projections based on the most recent weekly data are used to determine whether doses would exceed 0.2% of the annual 10CFR50 Appendix I limits if releases continued at the same rate. The use of weekly data is conservative in that it will provide an early warning that doses could approach the 0.2% limit and to enact corrective actions to reduce effluent dose.

$$A. \quad D_{\text{projected}} = \frac{D_{\text{previous}}}{\text{days}_{\text{previous}}} * 31 \text{ days}$$

where

$D_{\text{projected}}$  = Projected dose for the next 31 days.

$D_{\text{previous}}$  = Calculated dose for previous release period.

$\text{days}_{\text{previous}}$  = Days in the previous release period (typically the previous 7 days).

31 days = Length of dose projection.

#### 2.3.5 Critical Receptor Identification

The critical receptors for compliance with 10CFR50, Appendix I will be identified. For the noble gas specification the critical location is based on the external dose pathway only. This location is the off-site location with the highest long-term Reactor Building vent  $\chi/Q$  and is selected using the  $\chi/Q$  values given in Appendix A, Table 4. The critical receptor location is used for showing compliance with 10CFR20 and remains the same unless meteorological data is re-evaluated or the site boundary changes.

The critical location for the radioiodine and particulate pathway is selected once per year. This selection follows the annual land use census performed within 5 miles of the MNGP. Each of the following locations is evaluated as a potential critical receptor before implementing the effluent technical specifications:

- A. Residences in each sector.
- B. Vegetable garden producing leafy green vegetables.
- C. All identified milk animal locations.

The critical receptor is selected based on this evaluation.

<b>MONTICELLO NUCLEAR GENERATING PLANT</b>		ODCM-05.01
<b>TITLE:</b>	<b>GASEOUS EFFLUENT CALCULATIONS</b>	Revision 11
		Page 22 of 70

Following the annual survey, doses are calculated using Equation 2.3.2.A.1 for all newly identified receptors and those receptors whose characteristics have changed significantly. The calculation includes appropriate information shown to exist at each location. The dispersion parameters given in this manual should be employed. The total releases reported for the previous calendar year should be used as the source term.

## 2.4 Gaseous Effluents – Compliance with 40CFR190

In order to demonstrate compliance with 40CFR190, total dose to the likely most exposed member of the public from all Uranium Fuel Cycle radiation sources are summed (including both effluents and direct radiation) as discussed in ODCM-06.01. The dose limits for 40CFR190 are 25 mrem total body, 75 mrem thyroid, and 25 mrem to any other organ.

$$2.4.1 \quad \text{Total Dose} = D_{\text{TLD}} + D_{\text{aj}} + D_{\text{NG}}$$

Where:

$D_{\text{TLD}}$  = Facility Related Dose as determined from environmental TLD measurements ( $\Sigma F_Q$  or  $F_A$  from ODCM-06.01)

$D_{\text{aj}}$  = Dose due to Radioiodines, particulates, tritium and  $^{14}\text{C}$  for age group a, and organ j, from section 2.3.2

$D_{\text{NG}}$  = Dose due to noble gases, either total body or skin and due to elevated or mixed-mode release. Total Body doses also apply to all non-skin organs.

For Elevated releases, at locations where  $(\chi/Q)_s$  has not reached peak concentration, doses due to elevated, finite-plume exposure from the Plant Stack and doses due to the semi-infinite cloud from the Reactor Building Vent are considered. Short-term variations of these releases are also included, as appropriate.

$$2.4.2 \quad D_{\text{t. body, elevated plume}} = 3.17 \cdot 10^{-8} \sum_i \left[ V_i Q_{\text{is}} + K_i \left( \frac{\chi}{Q} \right)_v Q_{\text{iv}} \right]$$

$$2.4.3 \quad D_{\text{skin, elevated plume}} = 3.17 \cdot 10^{-8} \sum_i \left\{ \left[ L_i \left( \frac{\chi}{Q} \right)_s + 1.1 B_i \right] Q_{\text{is}} + \left[ L_i + 1.1 M_i \right] \left( \frac{\chi}{Q} \right)_v Q_{\text{iv}} \right\}$$

<b>MONTICELLO NUCLEAR GENERATING PLANT</b>		ODCM-05.01
<b>TITLE:</b>	<b>GASEOUS EFFLUENT CALCULATIONS</b>	Revision 11
		Page 23 of 70

For releases where the elevated plume has reached maximum  $(\chi/Q)_s$ , semi-infinite cloud models are used for both Plant Stack and Reactor Building Vent releases. Short term variations of these releases are also included, as appropriate.

$$2.4.4 \quad D_{t, \text{ body, immersion}} = 3.17 \cdot 10^{-8} \sum_i K_i \left[ \left( \frac{\chi}{Q} \right)_s Q_{is} + \left( \frac{\chi}{Q} \right)_v Q_{iv} \right]$$

$$2.4.5 \quad D_{\text{skin, immersion}} = 3.17 \cdot 10^{-8} \sum_i \left\{ [L_i + 1.1M_i] * \left[ \left( \frac{\chi}{Q} \right)_s Q_{is} + \left( \frac{\chi}{Q} \right)_v Q_{iv} \right] \right\}$$

All variables in these equations have been previously defined.

## 2.5 Determination of Onsite Dose

Onsite dose to Members of the Public due to effluents is required to be reported in the ARERR per ODCM-08.01 STEP 2.1.2.; these non-occupationally exposed workers may be onsite for various reasons. Groups of concern include cleaning contractors at the Receiving Warehouse and Site Administrative Building, and Xcel Energy Company Transmission and Distribution (T&D) crews working in the subyard. These workers are considered not to be occupationally exposed because the work activities are only remotely related to plant-operational activities.

Onsite dose calculations are performed by determining the effluent dose due to noble gases, radioiodines, particulates, and tritium and scaling the annual dose based on occupancy factors. Exposure pathways considered are immersion/elevated plume for noble gases, and inhalation and ground plane pathways for iodines, particulates and tritium. Use of a very conservative assumption of 40 hours/week spent inside the site boundary by these groups conservatively represents the most exposed individual. Other occupancy factors may be used with a documented basis.

## 2.6 Offgas Release Rate and Gas Holdup Tank Activity

The following calculations are used to predict the offgas composition and activity at various stages of waste gas treatment and at the time of release. The data inputs consist of the release rate (in  $\mu\text{Ci}/\text{sec}$  measured at the SJAE) of six readily measurable fission product noble gases: Xe-133, Xe-135, Kr-85M, Kr-88, Kr-87, and Xe-138. There are nine other noble gases of interest from a radioactive effluent point of view. They are: Kr-90, Xe-139, Kr-89, Xe-137, Xe-135m, Kr-83m, Xe-133m, Xe-131m, and Kr-85. Many of these nine gases are not directly measurable in the presence of the others. By establishing the offgas release mode from the six measured release rates, the release rates of the other nine gases known to be present can be calculated.



<b>MONTICELLO NUCLEAR GENERATING PLANT</b>		ODCM-05.01
<b>TITLE:</b>	<b>GASEOUS EFFLUENT CALCULATIONS</b>	Revision 11
		Page 24 of 70

The first step performed is to correct the release rates of the six measured noble gases for decay during their transit from the reactor vessel to the SJAE:

$$2.6.1 \quad A_i(0) = A_i(t_{dly}) e^{\lambda_i t_{dly}}$$

where

$A_i(t)$  = release rate of noble gas  $i$  at the time  $t$  after leaving reactor,  $\mu\text{Ci}/\text{sec}$ ;

$t_{dly}$  = transit time from reactor to SJAE, sec;

$\lambda_i$  = decay constant of noble gas  $i$ ,  $\text{sec}^{-1}$ .

A least square fitting routine is used to determine the values of  $B_1$ ,  $B_2$ , and  $B_3$  giving the best fit to  $A_1(0)$  through  $A_6(0)$  in the equation:

$$2.6.2 \quad \log \left[ \frac{A_i}{y_i \lambda_i} \right] = \log \left[ B_1 + \frac{B_2}{\sqrt{\lambda_i}} + \frac{B_3}{\lambda_i} \right]$$

where

$y_i$  = fraction of all fissions yielding noble gas  $i$ .

This equation consists of three terms; a recoil release mode term, a diffusion release mode term, and an equilibrium release mode term. This is the standard General Electric offgas distribution model.

The values of  $B_1$ ,  $B_2$ , and  $B_3$ , are used to characterize the offgas release mechanism in terms of percent recoil, percent diffusion, and percent equilibrium type release. This characterization is useful in fuel performance evaluation. The equation for these three fractions are:

$$2.6.3 \quad \% \text{ Recoil} = 100 \times \frac{\sum_{i=1,6} B_1 y_i \lambda_i}{\sum_{i=1,6} (B_1 y_i \lambda_i + B_2 y_i \sqrt{\lambda_i} + B_3 y_i)}$$

$$2.6.4 \quad \% \text{ Diffusion} = 100 \times \frac{\sum_{i=1,6} B_2 y_i \sqrt{\lambda_i}}{\sum_{i=1,6} (B_1 y_i \lambda_i + B_2 y_i \sqrt{\lambda_i} + B_3 y_i)}$$

$$2.6.5 \quad \% \text{ Equilibrium} = 100 \times \frac{\sum_{i=1,6} B_3 y_i}{\sum_{i=1,6} (B_1 y_i \lambda_i + B_2 y_i \sqrt{\lambda_i} + B_3 y_i)}$$

<b>MONTICELLO NUCLEAR GENERATING PLANT</b>		ODCM-05.01
<b>TITLE:</b>	<b>GASEOUS EFFLUENT CALCULATIONS</b>	Revision 11
		Page 25 of 70

The release rate from the reactor vessel for the nine noble gases not measured is then:

$$2.6.6 \quad A_i(0) = B_1 y_i \lambda_i + B_2 y_i \sqrt{\lambda_i} + B_3 y_i$$

where

$y_i$  = Fraction of all fissions yielding noble gas  $i$  (i.e. the cumulative fission yield for nuclide  $i$ , converted to unitless ratio; see Table 25).

At any time,  $t$ , after leaving the reactor vessel the release rate is:

$$2.6.7 \quad A_i(t) = A_i(0) e^{-\lambda_i t}, \text{ for } i = 3 \text{ through } 14$$

and

$$2.6.8 \quad A_i(t) = A_i(0) e^{-\lambda_i t} + \frac{\alpha_i \lambda_i A_j(0)}{\lambda_i - \lambda_j} (e^{-\lambda_j t} - e^{-\lambda_i t}), \text{ for } i = 1, 2, \text{ and } 15$$

where

$\alpha_i$  = fraction of disintegrations of isotope  $j$  producing isotope  $i$ .

Equation (2.6.8) contains an additional factor to account for the decay of Xe-131m to Xe-133, Xe-135m to Xe-135, and Kr-85m to Kr-85. This factor is normally small.

As shown in Table 25, the plant stack noble gas release consists of three components:

- A. main condenser non-condensibles;
- B. gland exhaust; and
- C. stack dilution air drawn from Reactor and Turbine Buildings.

<b>MONTICELLO NUCLEAR GENERATING PLANT</b>		ODCM-05.01
<b>TITLE:</b>	<b>GASEOUS EFFLUENT CALCULATIONS</b>	Revision 11
		Page 26 of 70

Source C is considered to be negligible compared to sources A and B. The composition of the gland exhaust release is assumed to be identical to the offgas mixture at the SJAE. Therefore, the stack release rate of isotope i is:

$$2.6.9 \quad R_i(t) = A_i(t) + F_{loc}A_i(t_{dly})$$

where

$F_{loc}$  = fraction of main steam flow diverted to gland seal steam supply and the total noble gas release rate at any time is:

$$2.6.10 \quad R_{tot}(t) = \sum_{i=1,15} [A_i(t) + F_{loc}A_i(t_{dly})]$$

The operations below are used to calculate compressed offgas storage tank contents in terms of dose equivalent Xe-133. Control 2.4.1.B in ODCM-03.01 limits this quantity to 22,000 Curies 12 hours after placing a tank in storage (when the discharge valve interlock permits the tank to be released).

Prior to reaching the storage tanks (Figure 1), the offgas stream is delayed several hours flowing from the recombiners to the compressors via the 42-inch holdup pipe. Offgas reaching the tanks is therefore delayed by:

$$2.6.11 \quad t_{ddly} = t_{dly} + \frac{P_{42}V_{42}}{P_a L}$$

where

$V_{42}$  = 42-inch pipe volume;

$P_{42}$  = 42-inch pipe pressure;

$L$  = total air inleakage, SCFM, (Bleed air and condenser inleakage);

$P_a$  = atmospheric pressure.

<b>MONTICELLO NUCLEAR GENERATING PLANT</b>		ODCM-05.01
<b>TITLE:</b>	<b>GASEOUS EFFLUENT CALCULATIONS</b>	Revision 11
		Page 27 of 70

While a tank is being filled, offgas enters the tank at rate L. The activity of each isotope in the tank,  $C_i$ , is a function of time from the start of filling,  $t_f$ , is computed as follows:

$$2.6.12 \quad C_i(t_f) = \frac{A_i(t_{ddly})}{\lambda_i} (1 - e^{-\lambda_i t_f}) \quad \text{for } i = 3 \text{ to } 14$$

and

$$2.6.13 \quad C_i(t_f) = \frac{A_i(t_{ddly})}{\lambda_i} (1 - e^{-\lambda_i t_f}) + \frac{\alpha_i \lambda_i A_j(t_{ddly})}{\lambda_j} \left[ \frac{e^{-\lambda_i t_f} - e^{-\lambda_j t_f}}{\lambda_i - \lambda_j} + \frac{1 - e^{-\lambda_i t_f}}{\lambda_i} \right]$$

for  $i=1, 2, \text{ and } 15$

Equation 2.6.13 contains an additional factor to account for the decay of Xe-133m to Xe-133, Xe-135m to Xe-135, and Kr-85m to Kr-85. This factor is normally small.

Pressure builds up in the tank at the rate:

$$2.6.14 \quad p(t_f) = \frac{t_f L P_a}{V_{tk}}$$

where

$V_{tk}$  = volume of storage tank.

<b>MONTICELLO NUCLEAR GENERATING PLANT</b>		ODCM-05.01
<b>TITLE:</b>	<b>GASEOUS EFFLUENT CALCULATIONS</b>	Revision 11
		Page 28 of 70

When the pressure in the tank reaches the design value,  $P_{max}$ , at  $t_{fill}$ , it is assumed that the tank is full. Total tank activity,  $C$ , and total tank Xe-133 dose equivalent activity,  $D$ , is computed at  $t_{rel}$  when the interlock on the tank discharge valve permits the tank to be released after an additional delay of  $t_{intk}$ :

$$2.6.15 \quad t_{fill} = \frac{P_{max} V_{tk}}{P_a L}$$

$$2.6.16 \quad t_{rel} = t_{fill} + t_{intk}$$

$$2.6.17 \quad C_i(t_{rel}) = C_i(t_{fill}) e^{-\lambda_i t_{intk}}, \text{ for } i = 3 \text{ through } 14$$

and

$$2.6.18 \quad C_i(t_{rel}) = C_i(t_{fill}) e^{-\lambda_i t_{intk}} + \frac{\alpha_i \lambda_j C_j(t_{fill})}{\lambda_i - \lambda_j} (e^{-\lambda_j t_{intk}} - e^{-\lambda_i t_{intk}}) \text{ for } i=1,2, \text{ and } 15$$

$$2.6.19 \quad C(t_{rel}) = \sum_{i=1,15} C_i(t_{rel})$$

$$2.6.20 \quad D(t_{rel}) = \frac{\sum_{i=1,15} C_i(t_{rel}) K_i}{K_{Xe-133}}$$

where

$K_{Xe-133}$  = value of  $K_i$  for Xe-133 ( $i = 1$ ) from Table 4.

The minimum offgas holdup time is:

$$2.6.21 \quad t_{holdup} = t_{ddly} + t_{rel}$$

When the system is operating normally; however, with all five holdup tanks in service, the holdup time is given by:

$$2.6.22 \quad t_{holdup} = t_{ddly} + 4 t_{fill}$$

<b>MONTICELLO NUCLEAR GENERATING PLANT</b>		ODCM-05.01
<b>TITLE:</b>	<b>GASEOUS EFFLUENT CALCULATIONS</b>	Revision 11
		Page 29 of 70

## 2.7 Dose Parameters for Radioiodines, Particulates and Tritium

This section contains the methodology which was used to calculate the dose parameters for radioiodines, particulates, and tritium to show compliance with 10CFR20 and Appendix I of 10CFR50 for gaseous effluents. These dose parameters,  $P_i$  and  $R_i$  were calculated using the methodology outlines in NUREG-0133 along with Regulatory Guide 1.109 Revision 1. The following sections provide the specific methodology which was utilized in calculating the  $P_i$  and  $R_i$  values for the various exposure pathways.

### 2.7.1 Calculation of $P_i$

The parameter,  $P_i$ , contained in the radioiodine and particulates portion of Section 2.2, includes pathway transport parameters of the  $i^{\text{th}}$  radionuclide, the receptor's usage of the pathway media and the dosimetry of the exposure. Pathway usage rates and the internal dosimetry are functions of the receptor's age; however, the child age group will always receive the maximum dose under the exposure conditions assumed.

#### A. Inhalation Pathway

$$1. \quad P_{i \text{ (inhalation)}} = K' (BR) DFA_i$$

where

$P_{i \text{ (inhalation)}}$  = dose parameter for radionuclide  $i$  for the inhalation pathway, mrem/yr per  $\mu\text{Ci}/\text{m}^3$ ;

$K'$  = a constant of unit conversion,  
=  $10^6 \text{ pCi}/\mu\text{Ci}$ ;

$BR$  = the breathing rate of the child age group,  
 $\text{m}^3/\text{yr}$

$DFA_i$  = the maximum organ inhalation dose factor for the child age group for radionuclide  $i$ ,  
mrem/pCi.

The age group considered is the child group. The child's breathing rate is taken as  $3700 \text{ m}^3/\text{yr}$  from Table E-5 of Regulatory Guide 1.109 Revision 1. The inhalation dose factors for the child,  $DFA_i$ , are presented in Table E-9 of Regulatory Guide 1.109 in units of mrem/pCi. The total body is considered as an organ in the selection of  $DFA_i$ .

The incorporation of breathing rate of the child and the unit conversion factor results in the following:

$$2. \quad P_{i \text{ (inhalation)}} = 3.7E9 \times DFA_i$$

<b>MONTICELLO NUCLEAR GENERATING PLANT</b>		ODCM-05.01
<b>TITLE:</b>	<b>GASEOUS EFFLUENT CALCULATIONS</b>	Revision 11
		Page 30 of 70

### 2.7.2 Calculation of R<sub>i</sub>

The radioiodine and particulate Control 2.3.1.A. is applicable to the location in the unrestricted area where the combination of existing pathways and receptor age groups indicates the maximum potential exposure occurs. The inhalation and ground plane exposure pathways **SHALL** be considered to exist at all locations. The grass-goat-milk, the grass-cow-milk, grass-cow-meat, and vegetation pathways are considered based on their existence at the various locations. R<sub>i</sub> values have been calculated for the adult, teen, child, and infant age groups for the ground plane, cow milk, goat milk, vegetable and beef ingestion pathways. The methodology which was utilized to calculate these values is presented below.

#### A. Inhalation Pathway

$$1. \quad R_{i \text{ (inhalation)}} = K'(BR)_a (DFA_i)_a$$

where

$R_{i \text{ (inhalation)}}$  = dose factor for each identified radionuclide i of the organ of interest, mrem/yr per  $\mu\text{Ci}/\text{m}^3$ ;

$K'$  = a constant of unit conversion,

$$= 10^6 \text{ pCi}/\mu\text{Ci};$$

$(BR)_a$  = breathing rate of the receptor of age group a,  $\text{m}^3/\text{yr}$ ;

$(DFA_i)_a$  = organ inhalation dose factor for radionuclide i for the receptor of age group a, mrem/pCi.

The breathing rates  $(BR)_a$  for the various age groups are tabulated below, as given in Table E-5 of the Regulatory Guide 1.109 Revision 1.

<u>Age Group (a)</u>	<u>Breathing Rate (<math>\text{m}^3/\text{yr}</math>)</u>
Infant	1400
Child	3700
Teen	8000
Adult	8000

Inhalation dose factors  $(DFA_i)_a$  for the various age groups are given in Tables E-7 through E-10 of Regulatory Guide 1.109 Revision 1.

<b>MONTICELLO NUCLEAR GENERATING PLANT</b>		ODCM-05.01
<b>TITLE:</b>	<b>GASEOUS EFFLUENT CALCULATIONS</b>	Revision 11
		Page 31 of 70

B. Ground Plane Pathway

$$1. \quad R_{i(\text{ground plane})} = \frac{K'K''(\text{SF})\text{DFG}_i(1-e^{-\lambda_i t_b})}{\lambda_i}$$

where

$R_{i(\text{ground plane})}$  = dose factor for the ground plane pathway for each identified radionuclide  $i$  for the organ of interest; mrem/yr per  $\mu\text{Ci}/\text{sec}$  per  $\text{m}^2$ ;

$K'$  = a constant of unit conversion,  
=  $10^6$  pCi/ $\mu\text{Ci}$ ;

$K''$  = a constant of unit conversion,  
= 8760 hr/yr;

$\lambda_i$  = the radiological decay constant for radionuclide  $i$ ,  $\text{sec}^{-1}$ ;

$t_b$  = the exposure time, sec,  
=  $4.73 \times 10^8$  sec (15 years);

$\text{DFG}_i$  = the ground plane dose conversion factor for radionuclide  $i$ , mrem/hr per  $\text{pCi}/\text{m}^2$

SF = the shielding factor (dimensionless);

A shielding factor of 0.7 is suggested in Table E-15 of Regulatory Guide 1.109 Revision 1. A tabulation of  $\text{DFG}_i$  values is presented in Table E-6 of Regulatory Guide 1.109 Revision 1.



<b>MONTICELLO NUCLEAR GENERATING PLANT</b>		ODCM-05.01
<b>TITLE:</b>	<b>GASEOUS EFFLUENT CALCULATIONS</b>	Revision 11
		Page 32 of 70

C. Grass-Cow or Goat-Milk Pathway

$$1. \quad R_{i(\text{milk})} = K' Q_F U_{ap} F_m (DFL_i)_a \frac{r}{(\lambda_i + \lambda_w)} \left[ \frac{f_p f_s}{Y_p} + \frac{(1 - f_p f_s) e^{-\lambda_i t_f}}{Y_s} \right] e^{-\lambda_i t_f}$$

where

- $R_{i(\text{milk})}$  = dose factor for the cow milk or goat milk pathway, for each identified radionuclide  $i$  for the organ of interest, mrem/yr per  $\mu\text{Ci}/\text{sec}$  per  $\text{m}^2$ ;
- $K'$  = a constant of unit conversion,  
=  $10^6$  pCi/ $\mu\text{Ci}$ ;
- $Q_F$  = the cow or goat feed consumption rate, kg/day (wet weight);
- $U_{ap}$  = the receptor's milk consumption rate for age group  $a$ , liters/yr;
- $Y_p$  = the agricultural productivity by unit area of pasture feed grass,  $\text{kg}/\text{m}^2$
- $Y_s$  = the agricultural productivity by unit area of stored feed,  $\text{kg}/\text{m}^2$
- $F_m$  = the stable element transfer coefficients, pCi/liter per pCi/day;
- $r$  = fraction of deposited activity retained on cow feed grass;
- $(DFL_i)_a$  = the organ ingestion dose factor for radionuclide  $i$  for the receptor in age group  $a$ , mrem/pCi;
- $\lambda_i$  = the radiological decay constant for radionuclide  $i$ ,  $\text{sec}^{-1}$ ;
- $\lambda_w$  = the decay constant for removal of activity on leaf and plant surfaces by weathering,  $\text{sec}^{-1}$ ,  
=  $5.73 \times 10^{-7} \text{ sec}^{-1}$  (corresponding to a 14 day half-life);
- $t_f$  = the transport time from feed to cow or goat, to milk, to receptor, sec;

<b>MONTICELLO NUCLEAR GENERATING PLANT</b>		ODCM-05.01
<b>TITLE:</b>	<b>GASEOUS EFFLUENT CALCULATIONS</b>	Revision 11
		Page 33 of 70

- $t_h$  = the transport time from harvest to ingestion of forage by milk animal, sec;
- $f_p$  = fraction of the year that the cow or goat is on pasture;
- $f_s$  = fraction of the cow feed that is pasture grass while the cow is on pasture;

Milk cattle and goats are considered to be fed from two potential sources, pasture grass and stored feeds. Following the development in Regulatory Guide 1.109 Revision 1, the value of  $f_s$  is considered unity in lieu of site-specific information. The value of  $f_p$  is 0.500 based upon an 6 month grazing period.

Appendix C, Table 1 contains the appropriate parameter values and their source in Regulatory Guide 1.109 Revision 1.

The concentration of tritium in milk is based on the airborne concentration rather than the deposition. Therefore, the  $R_i$  is based on  $\chi/Q$ :

$$2. \quad R_{H-3 \text{ (milk)}} = K'K''F_m Q_F U_{ap} (DFL_i)_a 0.75(0.5/H)$$

where

- $R_{H-3 \text{ (milk)}}$  = dose factor for the cow or goat milk pathway for tritium for the organ of interest, mrem/yr per  $\mu\text{Ci}/\text{m}^3$ ;
- $K''$  = a constant of conversion,  
=  $10^3 \text{ gm}/\text{kg}$ ;
- $H$  = absolute humidity of the atmosphere,  $\text{gm}/\text{m}^3$ ;
- 0.75 = the fraction of total feed that is water;
- 0.5 = the ratio of the specific activity of the feed grass water to the atmospheric water;

and the other parameters and values are as given above. A value for  $H$  of  $8 \text{ grams}/\text{m}^3$ , was used in lieu of site-specific information.

<b>MONTICELLO NUCLEAR GENERATING PLANT</b>		ODCM-05.01
<b>TITLE:</b>	<b>GASEOUS EFFLUENT CALCULATIONS</b>	Revision 11
		Page 34 of 70

#### D. Grass-Cow-Meat Pathway

The integrated concentration in meat follows in a similar manner to the development for the milk pathway, therefore:

$$1. \quad R_{i(\text{meat})} = K'Q_F U_{ap} F_f (DFL_i)_a \frac{r}{(\lambda_i + \lambda_w)} \left[ \frac{f_p f_s}{Y_p} + \frac{(1 - f_p f_s) e^{-\lambda_i t_h}}{Y_s} \right] e^{-\lambda_i t_s}$$

where

$R_{i(\text{meat})}$  = dose factor for the meat ingestion pathway for radionuclide  $i$  for any organ of interest, mRem/yr per  $\mu\text{Ci}/\text{sec}$  per  $\text{m}^2$ ;

$F_f$  = the stable element transfer coefficient, pCi/kg per pCi/day;

$U_{ap}$  = the receptor's meat consumption rate for age group  $a$ , kg/yr;

$t_s$  = the transport time from slaughter to meat consumption, sec;

$t_h$  = the transport time from harvest to ingestion of forage by meat animal, sec.

All other terms remain the same as defined in Equation 2.7.2.C.1. Appendix C, Table 2 contains the values which were used in calculating  $R_i$  for the meat pathway.

The concentration of tritium in meat is based on its airborne concentration rather than the deposition. Therefore, the  $R_i$  is based on  $\chi/Q$ .

$$2. \quad R_{\text{H-3}(\text{meat})} = K'K'' F_f Q_F U_{ap} (DFL_i)_a 0.75(0.5/H)$$

where

$R_{\text{H-3}(\text{meat})}$  = dose factor for the meat ingestion pathway for tritium for any organ of interest, mrem/yr per  $\mu\text{Ci}/\text{m}^3$ ,

All other terms are defined in Equation 2.7.2.C.2 and 2.7.2.D.1, above.

<b>MONTICELLO NUCLEAR GENERATING PLANT</b>		ODCM-05.01
<b>TITLE:</b>	<b>GASEOUS EFFLUENT CALCULATIONS</b>	Revision 11
		Page 35 of 70

### E. Vegetation Pathway

The integrated concentration in vegetation consumed by man follows the expression developed in the derivation of the milk factor. Man is considered to consume two types of vegetation (fresh and stored) that differ only in the time period between harvest and consumption, therefore:

$$1. \quad R_{i(\text{vegetation})} = K'(DFL_i)_a \frac{r}{Y_v(\lambda_i + \lambda_w)} [U_a^L f_L e^{-\lambda_i t_L} + U_a^S f_g e^{-\lambda_i t_h}]$$

where

$R_{i(\text{vegetation})}$  = dose factor for vegetable pathway for radionuclide  $i$  for the organ of interest, mrem/yr per  $\mu\text{Ci}/\text{sec}$  per  $\text{m}^{-2}$ ;

$U_a^L$  = the consumption rate of fresh leafy vegetation by the receptor in age group  $a$ , kg/yr;

$U_a^S$  = the consumption rate of stored vegetation by the receptor in age group  $a$ , kg/yr;

$f_L$  = the fraction of the annual intake of fresh leafy vegetation grown locally;

$f_g$  = the fraction of the annual intake of stored vegetation grown locally;

$t_L$  = the average time between harvest of leafy vegetation and its consumption, sec;

$t_h$  = the average time between harvest of stored vegetation and its consumption, sec;

$Y_v$  = the vegetation areal density,  $\text{kg}/\text{m}^2$ ;

Appendix C, Table 3 presents the appropriate parameter values and their source in Regulatory Guide 1.109 Revision 1.

In lieu of site-specific data, default values for  $f_L$  and  $f_g$ , 1.0 and 0.76, respectively, were used in the calculation of  $R_i$ . These values were obtained from Table E-15 of Regulatory Guide 1.109 Revision 1.

<b>MONTICELLO NUCLEAR GENERATING PLANT</b>		ODCM-05.01
<b>TITLE:</b>	<b>GASEOUS EFFLUENT CALCULATIONS</b>	Revision 11
		Page 36 of 70

The concentration of tritium in vegetation is based on the airborne concentration rather than the deposition. Therefore, the  $R_i$  is based on  $\chi/Q$ :

$$2. \quad R_{H-3 \text{ (vegetation)}} = K'K''[U_a^L f_L + U_a^S f_g](DFL_i)_a \cdot 0.75(0.5/H)$$

where

$$R_{H-3 \text{ (vegetation)}} = \text{dose factor for the vegetable pathway for tritium for any organ of interest, mrem/yr per } \mu\text{Ci/m}^3,$$

All other terms remain the same as those in Equations 2.7.2.C.2 and 2.7.2.E.1.

### 2.7.3 Calculation of $R_i$ for $^{14}\text{C}$ Using NUREG 0133 Methodology

Carbon-14 ( $^{14}\text{C}$ ) is a pure beta emitter with no ground plane dose contribution. Inhalation dose for  $^{14}\text{C}$  is insignificant due to the chemical form ( $\text{CO}_2$ ) not being incorporated into the body through inhalation. Thus, only the ingestion pathways are a significant source of dose from  $^{14}\text{C}$ .

$^{14}\text{C}$  concentration in food products is based on specific activity and assumes that the ratio of  $^{14}\text{C}$  to stable carbon reaches equilibrium in all food products. The incorporation of  $\text{CO}_2$  into the human food chain occurs only through direct or indirect (milk or meat) vegetation ingestion. This process is complex and very dynamic therefore it is unlikely that true equilibrium is ever reached. The specific activity approach assumes constant environmental concentrations and is therefore admittedly very conservative. Nevertheless, it is the standard approach that is used for  $^{14}\text{C}$ , as similar to the model for  $^3\text{H}$ .

Plants uptake  $^{14}\text{C}$  only during photosynthesis. Only  $^{14}\text{C}$  released during the growing season contributes to ingestion dose. For MNGP, the growing season is defined as May 1 through September 30 based on historical trends in last freeze of Spring and first freeze of Fall (Skaggs and Baker, 1985).

NUREG 0133 makes use of site specific dose factors referred to as  $R_i$ . These  $R_i$  values are typically calculated and tabulated in the ODCM for each nuclide, age group, pathway and organ of interest. Use of the  $R_i$  values was intended to simplify the more complicated calculations of Reg Guide 1.109. NUREG 0133 implements the calculational methodology of Reg Guide 1.109 but in a more convenient mathematical format.

<b>MONTICELLO NUCLEAR GENERATING PLANT</b>		ODCM-05.01
<b>TITLE:</b>	<b>GASEOUS EFFLUENT CALCULATIONS</b>	Revision 11
		Page 37 of 70

NUREG 0133 does not contain guidance on how to calculate  $R_i$  values for  $^{14}\text{C}$ . The following equations provide the appropriate means for calculating  $^{14}\text{C}$   $R_i$  values that can be used in the NUREG 0133 methodology.

A. Vegetation Dose Factor

$$1. \quad R_{\text{C-14 (vegetation)}} = K'K''(U_{\text{a}f_{\text{L}}}^{\text{L}} + U_{\text{a}f_{\text{g}}}^{\text{S}})(\text{DFL}_{\text{a}})_i \frac{\text{CF}_{\text{g}}}{0.19}$$

Where:

$R_{\text{C-14 (vegetation)}}$  = dose factor for vegetable pathway, for  $^{14}\text{C}$  for the organ of interest, mrem/yr per uCi/sec per  $\text{m}^{-2}$

0.19 = Atmospheric concentration of natural carbon in  $\text{gm}/\text{m}^3$  based on EPA published value of 383 ppm.

$\text{CF}_{\text{g}}$  = Natural carbon fraction for vegetation group **G** in Kg-Carbon per Kg-Vegetation. Reg Guide 1.109 uses a default value of 0.11 (see Reg Guide 1.109, App C, Section 3.a, page 26).

B. Milk Dose Factor

$$1. \quad R_{\text{C-14 (milk)}} = K'K''U_{\text{ap}}(\text{DFL}_{\text{a}})_i \frac{\text{CF}_{\text{g}}}{0.19}$$

Where:

$R_{\text{C-14 (milk)}}$  = dose factor for cow milk or goat milk pathway, for  $^{14}\text{C}$  for the organ of interest, mrem/yr per uCi/sec per  $\text{m}^{-2}$

$U_{\text{ap}}$  = The receptor's milk consumption rate for age group a, kg/yr from Table 1 of Appendix C.

0.19 = Atmospheric concentration of natural carbon in  $\text{gm}/\text{m}^3$  based on EPA published value of 383 ppm.

<b>MONTICELLO NUCLEAR GENERATING PLANT</b>		ODCM-05.01
<b>TITLE:</b>	<b>GASEOUS EFFLUENT CALCULATIONS</b>	Revision 11
		Page 38 of 70

C. Meat Dose Factor

$$1. \quad R_{C-14 \text{ (meat)}} = K'K''U_{ap}(DFL_a)_i \frac{CF_g}{0.19}$$

Where:

$R_{C-14 \text{ (meat)}}$  = dose factor for meat ingestion pathway, for  $^{14}\text{C}$  for the organ of interest, mrem/yr per uCi/sec per  $\text{m}^2$

$U_{ap}$  = The receptor's meat consumption rate for age group a, kg/yr from Table 2 of Appendix C.

**2.8 References**

1. Monticello Nuclear Generating Plant Technical Specifications, TS-B.2.4-Radioactive Effluents, Specification 2.4.3F Rev. 25.
2. USNRC, Title 10, Code of Federal Regulation, Part 50, "Domestic Licensing of Production and Utilization Facilities", Appendix I, "Numerical Guides for Design Objectives and Limiting Conditions for Operation to Meet the Criterion 'As Low as is Reasonably Achievable' for Radioactive Material in Light-Water-Cooled Nuclear Power Reactor Effluents".
3. NSP - Monticello Nuclear Generating Plant, Appendix I Analysis - Supplement No. 1 - Docket No. 50-263, Table 2.1-3.
4. Boegli, J.S., et. al. Eds, "Preparation of Radiological Effluent Technical Specifications for Nuclear Power Plants, NUREG-0133, 1978, NTIS, Springfield Va.
5. Sangendorf, J.F. and J. T. Goll, "XOQDOQ - Program for the Meteorological Evaluation of Routine Effluent Releases at Nuclear Power Stations", NUREG-0324, 1977, USNRC, Washington, D.C.
6. USNRC, Regulatory Guide 1.109, "Calculation of Annual Doses to Man from Routine Releases of Reactor Effluents for the Purpose of Evaluating Compliance with 10 CFR 50, Appendix I", Rev. 1, Oct. 1977, USNRC, Washington.
7. USNRC, Regulatory Guide 1.111, "Methods for Estimating Atmospheric Transport and Dispersion of Gaseous Effluents in Routine Releases from Light-Water-Cooled Reactors", July 1977. USNRC, Washington, D.C.
8. EPA, Title 40, Code of Federal Regulations, Part 190 "Environmental Radiation Protection Standards for Nuclear Power Operations".

<b>MONTICELLO NUCLEAR GENERATING PLANT</b>		ODCM-05.01
<b>TITLE:</b>	<b>GASEOUS EFFLUENT CALCULATIONS</b>	Revision 11
		Page 39 of 70

9. Skaggs, R.H. and Baker D.G., "Fluctuation in the Length of the Growing Season in Minnesota", from Climatic Change, 1985, 7, 403-414.
10. Fuel Reliability Monitoring and Failure Evaluation Handbook (2010): Revision 2. EPRI, Palo Alto, CA: 2010. 1019107
11. England, T.R. and Rider, B.F., "Evaluation and Compilation of Fission Product Yields", LA-UR-94-3106, ENDF-349, Los Alamos National Laboratory, 1993.



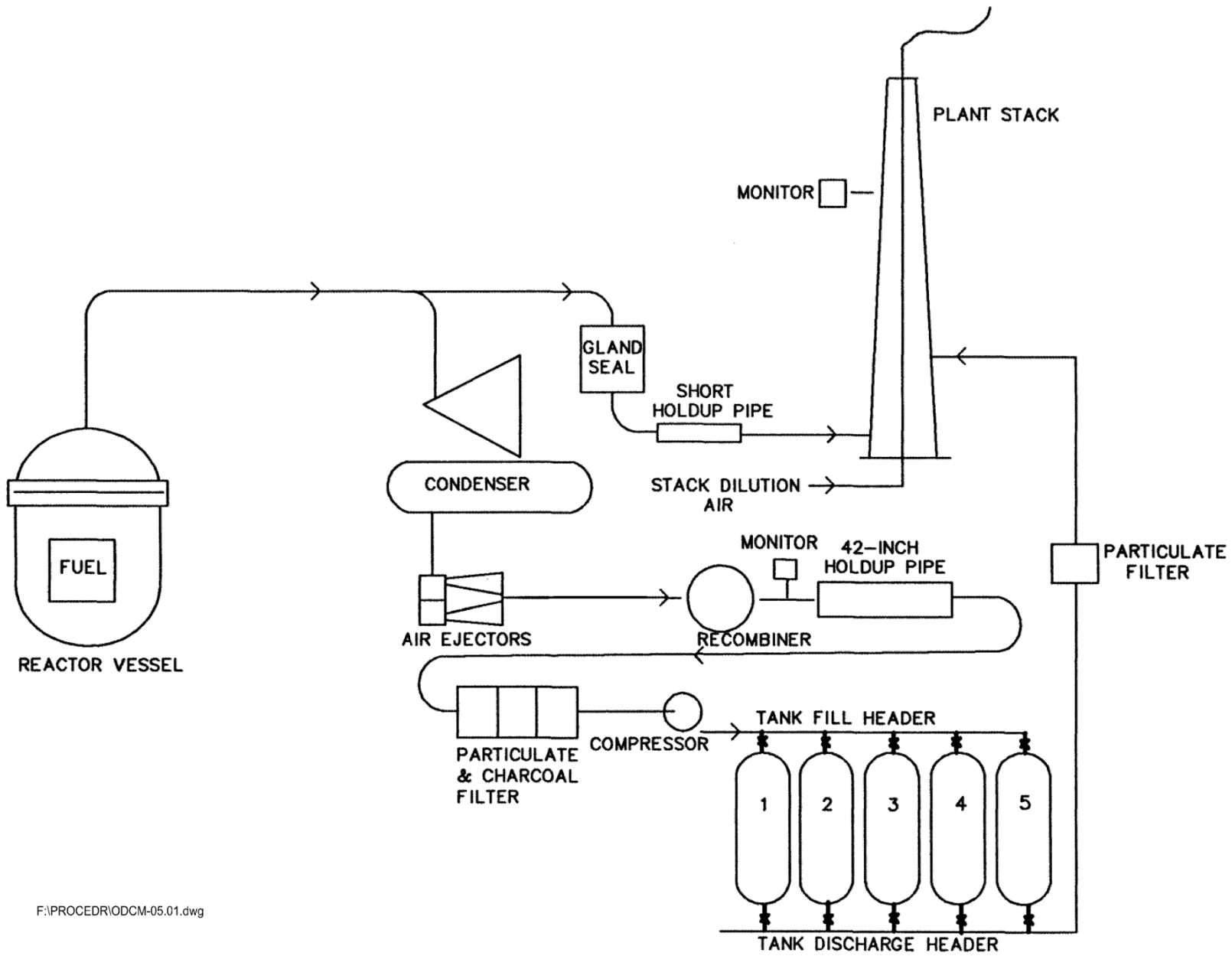
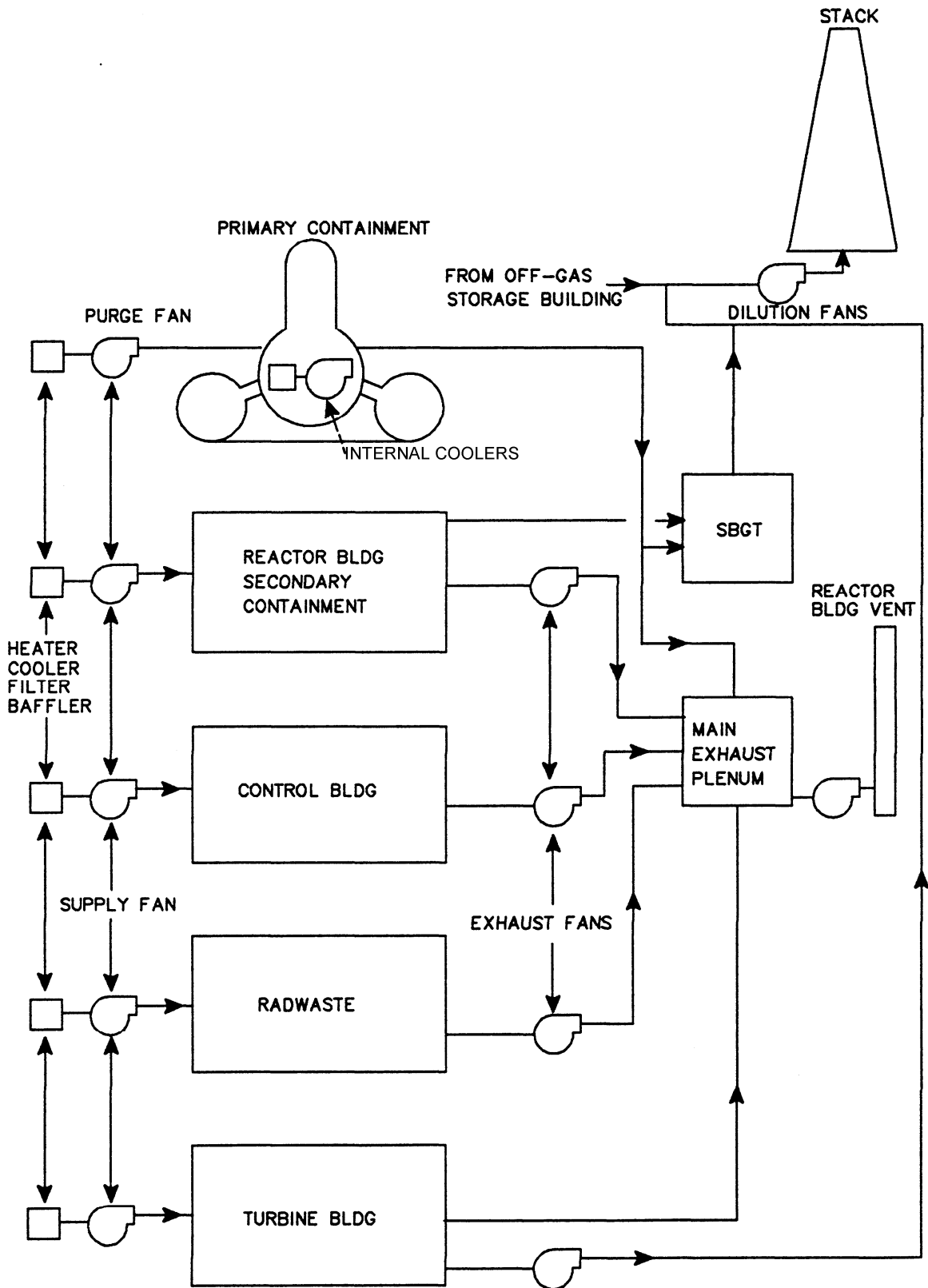

Figure 1 Gaseous Radwaste

<b>MONTICELLO NUCLEAR GENERATING PLANT</b>	<b>ODCM-05.01</b>
<b>TITLE: GASEOUS EFFLUENT CALCULATIONS</b>	<b>Revision 11</b>
	<b>Page 40 of 70</b>

<b>MONTICELLO NUCLEAR GENERATING PLANT</b>		ODCM-05.01
<b>TITLE:</b>	<b>GASEOUS EFFLUENT CALCULATIONS</b>	Revision 11
		Page 41 of 70

Figure 2 Ventilation System



<b>MONTICELLO NUCLEAR GENERATING PLANT</b>		ODCM-05.01
<b>TITLE:</b>	<b>GASEOUS EFFLUENT CALCULATIONS</b>	Revision 11
		Page 42 of 70

Table 1 Gaseous Source Terms<sup>(1)</sup> A<sub>i</sub>, Ci/yr\*

Radionuclide	Reactor Building Vent	Gland Seal	Mechanical Vacuum Pump	Gaseous Radwaste	Drywell Purging
Kr-83m**	--	2.3E 01	--	--	--
Kr-85m	7.1E 01	4.1E 01	--	--	3.0E 00
Kr-85	--	--	--	1.3E 02	--
Kr-87	1.33E 02	1.4E 02	--	--	3.0E 00
Kr-88	2.33E 02	1.4E 02	--	--	3.0E 00
Kr-89	--	6.0E 02	--	--	--
Kr-90	--	--	--	--	--
Xe-131m	--	--	--	4.5E 01	--
Xe-133m	--	2.0E 00	--	2.7E 01	--
Xe-133	3.26E 02	5.6E 01	2.3E 03	8.9E 03	6.6E 01
Xe-135m	6.96E 02	1.7E 01	--	--	4.6E 01
Xe-135	7.09E 02	1.5E 02	3.5E 02	--	3.4E 01
Xe-137	--	7.3E 02	--	--	--
Xe-138	1.41E 03	5.6E 02	--	--	7.0E 00
Xe-139	--	--	--	--	--
Ar-41	--	--	--	--	--
Total	3.58E 03	2.46E 03	2.65E 03	9.10E 03	1.62E 02

\* These source terms were calculated in accordance with NUREG-0016 by using the USNRC "GALE" Code and approved for use at the Monticello Nuclear Plant.

\*\* Kr-83m is not detectable by High Purity Ge detectors because it only emits low energy gamma rays (<40 keV). While Kr-83m is included in the GALE Code Source Term, it is not used in the setpoint calculation source term (Equations 2.1.1.A.1.b.1) and 2.1.1.B.1.b.1)). This results in a slightly lower (~1%) calculated setpoint. (AR01452892)

Table 2 Air Ejector Monitor Trip Setting and Storage Tank Contents Storage Tank Activity in Dose Equivalent Curies Xe-133 12 Hours After Completion of Tank Fill Release Rate Set to 1.00 of Maximum Trip Setting

		Condenser Air Inleakage, CFM												
Recoil/Diff/Eq	Qtot(5 Min)	Qtot(30 Min)	3	6	9	12	15	18	21	24	27	30		
1.0	0.0	0.0	2.149E 06	2.600E 05	956.	1492.	1806.	1970	2045.	2068.	2062.	2039.	2005.	1965.
0.9	0.1	0.0	1.876E 06	2.600E 05	2008.	2459.	2743.	2880.	2923.	2912.	2872.	2815.	2750.	2680.
0.9	0.0	0.1	2.042E 06	2.600E 05	2480.	2585.	2702.	2747.	2738.	2697.	2639.	2572.	2502.	2431.
0.8	0.2	0.0	1.664E 06	2.600E 05	2823.	3206.	3469.	3584.	3602.	3565.	3499.	3416.	3326.	3234.
0.8	0.1	0.1	1.772E 06	2.600E 05	3371.	3444.	3556.	3589.	3558.	3490.	3403.	3308.	3209.	3111.
0.8	0.2	0.2	1.925E 06	2.600E 05	4145.	3779.	3680.	3595.	3495.	3384.	3269.	3155.	3045.	2939.
0.7	0.3	0.0	1.495E 06	2.600E 05	3471.	3802.	4046.	4144.	4143.	4086.	3998.	3895.	3785.	3674.
0.7	0.2	0.1	1.565E 06	2.600E 05	4053.	4102.	4211.	4233.	4186.	4098.	3989.	3871.	3751.	3633.
0.7	0.1	0.2	1.661E 06	2.600E 05	4842.	4507.	4434.	4554.	4243.	4114.	3977.	3840.	3705.	3576.
0.7	0.0	0.3	1.797E 06	2.600E 05	5971.	5088.	4752.	4526.	4325.	4137.	3960.	3794.	3640.	3496.
0.6	0.4	0.0	1.385E 06	2.600E 05	4000.	4288.	4517.	4602.	4585.	4510.	4405.	4285.	4160.	4034.
0.6	0.3	0.1	1.402E 06	2.600E 05	4593.	4621.	4728.	4743.	4682.	4578.	4452.	4317.	4180.	4045.
0.6	0.2	0.2	1.460E 06	2.600E 05	5370.	5059.	5005.	4928.	4810.	4667.	4514.	4358.	4206.	4060.
0.6	0.1	0.3	1.540E 06	2.600E 05	6435.	5659.	5383.	5182.	4985.	4789.	4598.	4415.	4242.	4080.
0.6	0.0	0.4	1.655E 06	2.600E 05	7982.	6530.	5934.	5551.	5240.	4967.	4721.	4498.	4295.	4109.
0.5	0.5	0.0	1.243E 06	2.600E 05	4440.	4691.	4909.	4982.	4951.	4862.	4743.	4609.	4471.	4332.
0.5	0.4	0.1	1.270E 06	2.600E 05	5030.	5043.	5148.	5156.	5084.	4967.	4827.	4678.	4527.	4379.
0.5	0.3	0.2	1.303E 06	2.600E 05	5784.	5492.	5453.	5379.	5254.	5101.	4934.	4765.	4599.	4439.
0.5	0.2	0.3	1.347E 06	2.600E 05	6782.	6086.	5856.	5673.	5479.	5278.	5076.	4881.	4694.	4518.
0.5	0.1	0.4	1.408E 06	2.600E 05	8165.	6909.	6415.	6082.	5791.	5523.	5273.	5041.	4826.	4627.
0.5	0.0	0.5	1.498E 06	2.600E 05	10208.	8126.	7241.	6685.	6552.	5885.	5663.	5277.	5021.	4788.
0.4	0.6	0.0	1.147E 06	2.600E 05	4811.	5032.	5240.	5302.	5261.	5160.	5028.	4883.	4733.	4584.
0.4	0.5	0.1	1.160E 06	2.600E 05	5391.	5391.	5494.	5497.	5417.	5289.	5137.	4976.	4814.	4655.
0.4	0.4	0.2	1.176E 06	2.600E 05	6118.	5840.	5813.	5741.	5612.	5450.	5273.	5092.	4915.	4744.
0.4	0.3	0.3	1.197E 06	2.600E 05	7052.	6418.	6223.	6055.	5864.	5657.	5448.	5242.	5045.	4858.
0.4	0.2	0.4	1.225E 06	2.600E 05	8300.	7190.	6771.	6475.	6199.	5934.	5681.	5442.	5218.	5010.
0.4	0.1	0.5	1.265E 06	2.600E 05	10051.	8273.	7540.	7063.	6670.	6322.	6008.	5723.	5462.	5223.
0.4	0.0	0.6	1.324E 06	2.600E 05	12686.	9902.	8697.	7948.	7378.	6907.	6501.	6145.	5828.	5544.

Table 2 Air Ejector Monitor Trip Setting and Storage Tank Contents Storage Tank Activity in Dose Equivalent Curies Xe-133 12 Hours After Completion of Tank Fill Release Rate Set to 1.00 of Maximum Trip Setting (cont'd)

Recoil/Diff/Eq	Qtot(5 Min)	Qtot(30 Min)	Condenser Air Inleakage, CFM											
			3	6	9	12	15	18	21	24	27	30		
0.3 0.7 0.0	1.064E 06	2.600E 05	5148.	5324.	5522.	5577.	5526.	5415.	5273.	5117.	4948.	4800.		
0.3 0.6 0.1	1.068E 06	2.600E 05	5695.	5684.	5786.	5784.	5697.	5559.	5398.	5227.	5055.	4887.		
0.3 0.5 0.2	1.072E 06	2.600E 05	6392.	6127.	6110.	6040.	5907.	5737.	5551.	5362.	5175.	4995.		
0.3 0.4 0.3	1.078E 06	2.600E 05	7268.	6684.	6517.	6361.	6171.	5961.	5744.	5531.	5325.	5129.		
0.3 0.3 0.4	1.085E 06	2.600E 05	8404.	7406.	7046.	6777.	6513.	6251.	5995.	5751.	5521.	5304.		
0.3 0.2 0.5	1.092E 06	2.600E 05	9937.	8380.	7758.	7338.	6975.	6642.	6333.	6047.	5784.	5540.		
0.3 0.1 0.6	1.108E 06	2.600E 05	12115.	9765.	8771.	8136.	7632.	7197.	6813.	6469.	6158.	5876.		
0.3 0.0 0.7	1.129E 06	2.600E 05	15459.	11891.	10326.	9361.	8639.	8051.	7550.	7115.	6732.	6391.		
0.2 0.8 0.0	9.929E 05	2.600E 05	5403.	5576.	5767.	5814.	5755.	5635.	5484.	5320.	5153.	4987.		
0.2 0.7 0.1	9.894E 05	2.600E 05	5954.	5934.	6034.	6029.	5935.	5790.	5620.	5441.	5261.	5085.		
0.2 0.6 0.2	9.052E 05	2.600E 05	6621.	6366.	6358.	6289.	6153.	5977.	5784.	5587.	5393.	5204.		
0.2 0.5 0.3	9.799E 05	2.600E 05	7444.	6901.	6757.	6610.	6422.	6209.	5987.	5768.	5555.	5352.		
0.2 0.4 0.4	9.733E 05	2.600E 05	8487.	7577.	7263.	7017.	6762.	6502.	6244.	5996.	5760.	5538.		
0.2 0.3 0.5	9.646E 05	2.600E 05	9849.	8462.	7924.	7548.	7207.	6885.	6508.	6295.	6029.	5782.		
0.2 0.2 0.6	9.528E 05	2.600E 05	11706.	9667.	8825.	8272.	7814.	7406.	7038.	6702.	6395.	6114.		
0.2 0.1 0.7	9.357E 05	2.600E 05	14384.	11405.	10124.	9316.	8689.	8159.	7698.	7289.	6923.	6593.		
0.2 0.0 0.8	9.090E 05	2.600E 05	18586.	14132.	12163.	10954.	10061.	9340.	8734.	8210.	7751.	7345.		
0.1 0.9 0.0	9.305E 05	2.600E 05	5643.	5796.	5981.	6022.	5955.	5827.	5669.	5497.	5322.	5150.		
0.1 0.8 0.1	9.217E 05	2.600E 05	6178.	6149.	6249.	6240.	6141.	5989.	5812.	5625.	5439.	5256.		
0.1 0.7 0.2	9.112E 05	2.600E 05	6816.	6570.	6568.	6501.	6362.	6181.	5982.	5778.	5577.	5383.		
0.1 0.6 0.3	8.985E 05	2.600E 05	7591.	7082.	6957.	6818.	6631.	6415.	6190.	5964.	5764.	5537.		
0.1 0.5 0.4	8.826E 05	2.600E 05	8554.	7717.	7440.	7212.	6995.	6706.	6447.	6195.	5955.	5728.		
0.1 0.4 0.5	8.624E 05	2.600E 05	9781.	8526.	8055.	7713.	7309.	7076.	6775.	6490.	6222.	5972.		
0.1 0.3 0.6	8.358E 05	2.600E 05	11397.	9593.	8865.	8374.	7951.	7564.	7207.	6877.	6573.	6293.		
0.1 0.2 0.7	7.992E 05	2.600E 05	13625.	11062.	9982.	9284.	8723.	8236.	7802.	7411.	7058.	6736.		
0.1 0.1 0.8	7.454E 05	2.600E 05	16890.	13216.	11619.	10619.	9856.	9222.	8675.	8194.	7768.	7385.		
0.1 0.0 0.9	6.591E 05	2.600E 05	22138.	16679.	14250.	12764.	11676.	10805.	10077.	9453.	8909.	8428.		
0.0 1.0 0.0	8.755E 05	2.600E 05	5855.	5990.	6169.	6205.	6132.	5997.	5832.	5653.	5472.	5293.		
0.0 0.9 0.1	8.628E 05	2.600E 05	6372.	6336.	6435.	6424.	6320.	6162.	5979.	5786.	5593.	5405.		
0.0 0.8 0.2	8.477E 05	2.600E 05	6983.	6745.	6750.	6683.	6542.	6357.	6152.	5943.	5732.	5536.		
0.0 0.7 0.3	8.296E 05	2.600E 05	7716.	7235.	7126.	6994.	6808.	6590.	6361.	6131.	5908.	5694.		
0.0 0.6 0.4	8.075E 05	2.600E 05	8610.	7832.	7586.	7373.	7133.	6875.	6615.	6360.	6117.	5886.		

<b>MONTICELLO NUCLEAR GENERATING PLANT</b>		ODCM-05.01
<b>TITLE:</b>	<b>GASEOUS EFFLUENT CALCULATIONS</b>	Revision 11
		Page 45 of 70

Table 2 Air Ejector Monitor Trip Setting and Storage Tank Contents Storage Tank Activity in Dose Equivalent Curies Xe-133 12 Hours After Completion of Tank Fill Release Rate Set to 1.00 of Maximum Trip Setting (cont'd)

Recoil/Diff/Eq	Qtot(5 Min)	Qtot(30 Min)	Condenser Air Inleakage, CFM										
			3	6	9	12	15	18	21	24	27	30	
0.0	0.5	7.799E 05	2.600E 05	9725	8578.	8160.	7846.	7538.	7231.	6932.	6647.	6378.	6126.
0.0	0.4	7.446E 05	2.600E 05	11156.	9533.	8897.	8454.	8058.	7687.	7339.	7014.	6713.	6433.
0.0	0.3	6.976E 05	2.600E 05	13059.	10807.	9876.	9261.	8749.	8293.	7880.	7508.	7158.	6843.
0.0	0.2	6.320E 05	2.600E 05	15713.	12581.	11241.	10386.	9713.	9139.	8634.	8184.	7779.	7413.
0.0	0.1	5.342E 05	2.600E 05	19670.	15227.	13277.	12065.	11151.	10401.	9759.	9200.	8705.	8264.
0.0	0.0	3.727E 05	2.600E 05	26207.	19597.	16640.	14838.	13527.	12484.	11617.	10878.	10235.	9670.

<b>MONTICELLO NUCLEAR GENERATING PLANT</b>		ODCM-05.01
<b>TITLE:</b>	<b>GASEOUS EFFLUENT CALCULATIONS</b>	Revision 11
		Page 46 of 70

Table 3 Child Critical Organ Dose Parameters for Radionuclide i for the Inhalation Pathway

Nuclide	$P_i$ (inhalation) mrem/yr per $\mu\text{Ci}/\text{m}^3$
H-3	1.12E 03
Cr-51	1.70E 04
Mn-54	1.58E 06
Fe-59	1.27E 06
Co-58	1.11E 06
Co-60	7.07E 06
Zn-65	9.95E 05
Rb-86	1.98E 05
Sr-89	2.16E 06
Sr-90	1.01E 08
Y-91	2.63E 06
Zr-95	2.23E 06
Nb-95	6.14E 05
Ru-103	6.62E 05
Ru-106	1.43E 07
Ag-110m	5.48E 06
Te-127m	1.48E 06
Te-129m	1.76E 06
Cs-134	1.01E 06
Cs-136	1.71E 05
Cs-137	9.07E 05
Ba-140	1.74E 06
Ce-141	5.44E 05
Ce-144	1.20E 07
I-131	1.62E 07
I-133	3.85E 06
I-135	7.92E 05

<b>MONTICELLO NUCLEAR GENERATING PLANT</b>		ODCM-05.01
<b>TITLE:</b>	<b>GASEOUS EFFLUENT CALCULATIONS</b>	Revision 11
		Page 47 of 70

Table 4 Dose Factors for Noble Gases and Daughters That May Be Detected in Gaseous Effluents

Radionuclide	Total Body Dose Factor $K_i$ mrem/yr $\mu\text{Ci}/\text{m}^3$	Skin Dose Factor $L_i$ mrem/yr $\mu\text{Ci}/\text{m}^3$	Gamma Air Dose Factor $M_i$ mrad/yr $\mu\text{Ci}/\text{m}^3$	Beta Air Dose Factor $N_i$ mrad/yr $\mu\text{Ci}/\text{m}^3$
Kr-83m	7.56E-02	--	1.93E+01	2.88E+02
Kr-85m	1.17E+03	1.46E+03	1.23E+03	1.97E+03
Kr-85	1.61E+01	1.34E+03	1.72E+01	1.95E+03
Kr-87	5.92E+03	9.73E+03	6.17E+03	1.03E+04
Kr-88	1.47E+04	2.37E+03	1.52E+04	2.93E+03
Kr-89	1.66E+04	1.01E+04	1.73E+04	1.06E+04
Kr-90	1.56E+04	7.29E+03	1.63E+04	7.83E+03
Xe-131m	9.15E+01	4.76E+02	1.56E+02	1.11E+03
Xe-133m	2.51E+02	9.94E+02	3.27E+02	1.48E+03
Xe-133	2.94E+02	3.06E+02	3.53E+02	1.05E+03
Xe-135m	3.12E+03	7.11E+02	3.36E+03	7.39E+02
Xe-135	1.81E+03	1.86E+03	1.92E+03	2.46E+03
Xe-137	1.42E+03	1.22E+04	1.51E+03	1.27E+04
Xe-138	8.83E+03	4.13E+03	9.21E+03	4.75E+03
Xe-139	5.02E+03	6.52E+04	5.28E+03	6.52E+04
Ar-41	8.84E+03	2.69E+03	9.30E+03	3.28E+03



<b>MONTICELLO NUCLEAR GENERATING PLANT</b>		ODCM-05.01
<b>TITLE:</b>	<b>GASEOUS EFFLUENT CALCULATIONS</b>	Revision 11
		Page 48 of 70

Table 5 Dose Parameters for Elevated Finite Plumes for the Critical Boundary Location 0.51 mi from the Stack in the SSE Sector

Noble Gas Radionuclide	Long Term Release*		Short Term Release**	
	Total Body $V_i$ <u>mrem/yr</u> $\mu\text{Ci/sec}$	Gamma Air $B_i$ <u>mrad/yr</u> $\mu\text{Ci/sec}$	Total Body $v_i$ <u>mrem/yr</u> $\mu\text{Ci/sec}$	Gamma Air $b_i$ <u>mrad/yr</u> $\mu\text{Ci/sec}$
Kr-83m	2.61E-09	3.77E-07	2.99E-09	4.32E-07
Kr-85m	1.39E-04	2.07E-04	1.59E-04	2.37E-04
Kr-85	2.10E-06	3.18E-06	2.40E-06	3.64E-06
Kr-87	6.33E-04	9.52E-04	7.25E-02	1.09E-03
Kr-88	1.66E-03	2.49E-03	1.90E-03	2.85E-03
Kr-89	1.12E-03	1.68E-03	1.28E-03	1.92E-03
Kr-90	1.61E-04	2.42E-04	1.85E-04	2.78E-04
Xe-131m	3.31E-05	5.21E-05	3.79E-05	5.97E-05
Xe-133m	2.51E-05	4.09E-05	2.87E-05	4.68E-05
Xe-133	2.61E-05	4.08E-05	2.99E-05	4.67E-05
Xe-135m	3.34E-04	5.06E-04	3.82E-04	5.79E-04
Xe-135	2.24E-04	3.37E-04	2.57E-04	3.89E-04
Xe-137	9.99E-05	1.51E-04	1.14E-04	1.73E-04
Xe-138	9.90E-04	1.49E-03	1.13E-03	1.70E-03
Xe-139	5.79E-05	8.69E-05	6.63E-05	9.95E-05
Ar-41	1.20E-03	1.80E-03	1.38E-03	2.07E-03

\* Values are annual average

\*\* Values are for 144 hours per year purge.

<b>MONTICELLO NUCLEAR GENERATING PLANT</b>		ODCM-05.01
<b>TITLE:</b>	<b>GASEOUS EFFLUENT CALCULATIONS</b>	Revision 11
		Page 49 of 70

Table 6 R<sub>i</sub> Values for the Monticello Nuclear Generating Plant Ground Pathway

Nuclide	T. Body	GI Tract	Bone	Liver	Kidney	Thyroid	Lung	Skin
Cr-51	4.66E+06	4.66E+06	4.66E+06	4.66E+06	4.66E+06	4.66E+06	4.66E+06	5.51E+06
Mn-54	1.39E+09	1.39E+09	1.39E+09	1.39E+09	1.39E+09	1.39E+09	1.39E+09	1.63E+09
Fe-59	2.73E+08	2.73E+08	2.73E+08	2.73E+08	2.73E+08	2.73E+08	2.73E+08	3.21E+08
Co-58	3.79E+08	3.79E+08	3.79E+08	3.79E+08	3.79E+08	3.79E+08	3.79E+08	4.44E+08
Co-60	2.15E+10	2.15E+10	2.15E+10	2.15E+10	2.15E+10	2.15E+10	2.15E+10	2.53E+10
Zn-65	7.47E+08	7.47E+08	7.47E+08	7.47E+08	7.47E+08	7.47E+08	7.47E+08	8.59E+08
Sr-89	2.16E+04	2.16E+04	2.16E+04	2.16E+04	2.16E+04	2.16E+04	2.16E+04	2.51E+04
Zr-95	2.45E+08	2.45E+08	2.45E+08	2.45E+08	2.45E+08	2.45E+08	2.45E+08	2.84E+08
I-131	1.72E+07	1.72E+07	1.72E+07	1.72E+07	1.72E+07	1.72E+07	1.72E+07	2.09E+07
I-133	2.45E+06	2.45E+06	2.45E+06	2.45E+06	2.45E+06	2.45E+06	2.45E+06	2.98E+06
I-135	2.53E+06	2.53E+06	2.53E+06	2.53E+06	2.53E+06	2.53E+06	2.53E+06	2.95E+06
Cs-134	6.86E+09	6.86E+09	6.86E+09	6.86E+09	6.86E+09	6.86E+09	6.86E+09	8.00E+09
Cs-136	1.51E+08	1.51E+08	1.51E+08	1.51E+08	1.51E+08	1.51E+08	1.51E+08	1.71E+08
Cs-137	1.03E+10	1.03E+10	1.03E+10	1.03E+10	1.03E+10	1.03E+10	1.03E+10	1.20E+10
Ba-140	2.05E+07	2.05E+07	2.05E+07	2.05E+07	2.05E+07	2.05E+07	2.05E+07	2.35E+07
Ce-141	1.37E+07	1.37E+07	1.37E+07	1.37E+07	1.37E+07	1.37E+07	1.37E+07	1.54E+07
Ce-144	6.95E+07	6.95E+07	6.95E+07	6.95E+07	6.95E+07	6.95E+07	6.95E+07	8.04E+07
Nb-95	1.37E+08	1.37E+08	1.37E+08	1.37E+08	1.37E+08	1.37E+08	1.37E+08	1.61E+08
Ru-103	1.08E+08	1.08E+08	1.08E+08	1.08E+08	1.08E+08	1.08E+08	1.08E+08	1.26E+08

\*R<sub>i</sub> values are in units of units of m<sup>2</sup> mRem/yr per μCi/Sec for Ground Plane Pathway.

<b>MONTICELLO NUCLEAR GENERATING PLANT</b>		ODCM-05.01
<b>TITLE:</b>	<b>GASEOUS EFFLUENT CALCULATIONS</b>	Revision 11
		Page 50 of 70

Table 7 R<sub>i</sub> Values for the Monticello Nuclear Generating Plant Vegetable Pathway Adult Age Group

Nuclide	T. Body	GI Tract	Bone	Liver	Kidney	Thyroid	Lung	Skin
H-3	2.26E+03	2.26E+03		2.26E+03	2.26E+03	2.26E+03	2.26E+03	
C-14	1.51E+05	1.51E+05	7.55E+05	1.51E+05	1.51E+05	1.51E+05	1.51E+05	
Cr-51	4.64E+04	1.17E+07			1.02E+04	2.77E+04	6.16E+04	
Mn-54	5.97E+07	9.58E+08		3.13E+08	9.31E+07			
Fe-59	1.14E+08	9.88E+08	1.26E+08	2.96E+08			8.28E+07	
Co-58	6.89E+07	6.23E+08		3.07E+07				
Co-60	3.69E+08	3.14E+09		1.67E+08				
Zn-65	4.56E+08	6.36E+08	3.17E+08	1.01E+09	6.75E+08			
Sr-89	2.86E+08	1.60E+09	9.96E+09					
Sr-90	1.48E+11	1.75E+10	6.05E+11					
Zr-95	2.55E+05	1.19E+09	1.17E+06	3.77E+05	5.91E+05			
I-131	6.62E+07	3.05E+07	8.07E+07	1.15E+08	1.98E+08	3.78E+10		
I-133	1.10E+06	3.25E+06	2.08E+06	3.61E+06	6.31E+06	5.31E+08		
I-135	3.72E+04	1.14E+05	3.85E+04	1.01E+05	1.62E+05	6.65E+06		
Cs-134	9.08E+09	1.94E+08	4.67E+09	1.11E+10	3.59E+09		1.19E+09	
Cs-136	1.21E+08	1.91E+07	4.26E+07	1.68E+08	9.37E+07		1.28E+07	
Cs-137	5.70E+09	1.68E+08	6.36E+09	8.70E+09	2.95E+09		9.81E+08	
Ba-140	8.41E+06	2.64E+08	1.28E+08	1.61E+05	5.48E+04		9.23E+04	
Ce-141	1.51E+04	5.09E+08	1.97E+05	1.33E+05	6.19E+04			
Ce-144	1.77E+06	1.11E+10	3.29E+07	1.38E+07	8.16E+06			
Nb-95	4.26E+04	4.80E+08	1.42E+05	7.92E+04	7.82E+04			
Ru-103	2.05E+06	5.57E+08	4.77E+06		1.82E+07			

\*R<sub>i</sub> values are in units of mRem/yr per  $\mu\text{Ci}/\text{m}^3$  for H-3 and C-14, and units of  $\text{m}^2$  mRem/yr per uCi/Sec for all others.

<b>MONTICELLO NUCLEAR GENERATING PLANT</b>		ODCM-05.01
<b>TITLE:</b>	<b>GASEOUS EFFLUENT CALCULATIONS</b>	Revision 11
		Page 51 of 70

Table 8 R<sub>i</sub> Values for the Monticello Nuclear Generating Plant Vegetable Pathway Teen Age Group

Nuclide	T. Body	GI Tract	Bone	Liver	Kidney	Thyroid	Lung	Skin
H-3	2.59E+03	2.59E+03		2.59E+03	2.59E+03	2.59E+03	2.59E+03	
C-14	2.45E+05	2.45E+05	1.22E+06	2.45E+05	2.45E+05	2.45E+05	2.45E+05	
Cr-51	6.16E+04	1.04E+07			1.35E+04	3.42E+04	8.80E+04	
Mn-54	9.01E+07	9.32E+08		4.54E+08	1.36E+08			
Fe-59	1.62E+08	9.90E+08	1.79E+08	4.18E+08			1.32E+08	
Co-58	1.00E+08	6.01E+08		4.36E+07				
Co-60	5.60E+08	3.24E+09		2.49E+08				
Zn-65	6.86E+08	6.23E+08	4.24E+08	1.47E+09	9.42E+08			
Sr-89	4.33E+08	1.80E+09	1.51E+10					
Sr-90	1.85E+11	2.11E+10	7.51E+11					
Zr-95	3.73E+05	1.25E+09	1.72E+06	5.43E+05	7.98E+05			
I-131	5.78E+07	2.13E+07	7.68E+07	1.08E+08	1.85E+08	3.14E+10		
I-133	9.99E+05	2.48E+06	1.93E+06	3.27E+06	5.74E+06	4.57E+08		
I-135	3.32E+04	9.93E+04	3.48E+04	8.96E+04	1.42E+05	5.76E+06		
Cs-134	7.75E+09	2.08E+08	7.10E+09	1.67E+10	5.31E+09		2.03E+09	
Cs-136	1.15E+08	1.38E+07	4.37E+07	1.72E+08	9.36E+07		1.48E+07	
Cs-137	4.69E+09	1.92E+08	1.01E+10	1.35E+10	4.59E+09		1.78E+09	
Ba-140	8.89E+06	2.13E+08	1.38E+08	1.69E+05	5.73E+04		1.14E+05	
Ce-141	2.17E+04	5.40E+08	2.83E+05	1.89E+05	8.89E+04			
Ce-144	2.83E+06	1.33E+10	5.27E+07	2.18E+07	1.30E+07			
Nb-95	5.87E+04	4.56E+08	1.92E+05	1.07E+05	1.03E+05			
Ru-103	2.91E+06	5.69E+08	6.82E+06		2.40E+07			

\*R<sub>i</sub> values are in units of mRem/yr per  $\mu\text{Ci}/\text{m}^3$  for H-3 and C-14, and units of  $\text{m}^2$  mRem/yr per uCi/Sec for all others.

<b>MONTICELLO NUCLEAR GENERATING PLANT</b>		ODCM-05.01
<b>TITLE:</b>	<b>GASEOUS EFFLUENT CALCULATIONS</b>	Revision 11
		Page 52 of 70

Table 9 R<sub>i</sub> Values for the Monticello Nuclear Generating Plant Vegetable Pathway Child Age Group

Nuclide	T. Body	GI Tract	Bone	Liver	Kidney	Thyroid	Lung	Skin
H-3	4.01E+03	4.01E+03		4.01E+03	4.01E+03	4.01E+03	4.01E+03	
C-14	5.90E+05	5.90E+05	2.95E+06	5.90E+05	5.90E+05	5.90E+05	5.90E+05	
Cr-51	1.17E+05	6.21E+06			1.78E+04	6.50E+04	1.19E+05	
Mn-54	1.77E+08	5.58E+08		6.65E+08	1.86E+08			
Fe-59	3.20E+08	6.69E+08	3.97E+08	6.43E+08			1.86E+08	
Co-58	1.97E+08	3.75E+08		6.44E+07				
Co-60	1.12E+09	2.10E+09		3.78E+08				
Zn-65	1.35E+09	3.80E+08	8.12E+08	2.16E+09	1.36E+09			
Sr-89	1.03E+09	1.39E+09	3.59E+10					
Sr-90	3.15E+11	1.67E+10	1.24E+12					
Zr-95	7.55E+05	8.84E+08	3.86E+06	8.48E+05	1.21E+06			
I-131	8.16E+07	1.28E+07	1.43E+08	1.44E+08	2.36E+08	4.75E+10		
I-133	1.65E+06	1.75E+06	3.52E+06	4.35E+06	7.25E+06	8.08E+08		
I-135	5.26E+04	8.48E+04	6.18E+04	1.11E+05	1.71E+05	9.86E+06		
Cs-134	5.55E+09	1.42E+08	1.60E+10	2.63E+10	8.15E+09		2.93E+09	
Cs-136	1.46E+08	7.95E+06	8.23E+07	2.26E+08	1.21E+08		1.80E+07	
Cs-137	3.38E+09	1.43E+08	2.39E+10	2.29E+10	7.46E+09		2.68E+09	
Ba-140	1.61E+07	1.40E+08	2.76E+08	2.42E+05	7.88E+04		1.44E+05	
Ce-141	4.85E+04	4.08E+08	6.55E+05	3.27E+05	1.43E+05			
Ce-144	6.78E+06	1.04E+10	1.27E+08	3.98E+07	2.21E+07			
Nb-95	1.14E+05	2.95E+08	4.10E+05	1.60E+05	1.50E+05			
Ru-103	5.89E+06	3.96E+08	1.53E+07		3.86E+07			

\*R<sub>i</sub> values are in units of mRem/yr per  $\mu\text{Ci}/\text{m}^3$  for H-3 and C-14, and units of  $\text{m}^2$  mRem/yr per uCi/Sec for all others.

<b>MONTICELLO NUCLEAR GENERATING PLANT</b>		ODCM-05.01
<b>TITLE:</b>	<b>GASEOUS EFFLUENT CALCULATIONS</b>	Revision 11
		Page 53 of 70

Table 10 R<sub>i</sub> Values for the Monticello Nuclear Generating Plant Meat Pathway Adult Age Group

Nuclide	T. Body	GI Tract	Bone	Liver	Kidney	Thyroid	Lung	Skin
H-3	3.25E+02	3.25E+02		3.25E+02	3.25E+02	3.25E+02	3.25E+02	
C-14	3.62E+04	3.62E+04	1.81E+05	3.62E+04	3.62E+04	3.62E+04	3.62E+04	
Cr-51	3.66E+03	9.19E+05			8.05E+02	2.18E+03	4.85E+03	
Mn-54	1.13E+06	1.81E+07		5.91E+06	1.76E+06			
Fe-59	1.30E+08	1.13E+09	1.44E+08	3.39E+08			9.48E+07	
Co-58	2.34E+07	2.12E+08		1.04E+07				
Co-60	1.11E+08	9.46E+08		5.03E+07				
Zn-65	3.25E+08	4.53E+08	2.26E+08	7.20E+08	4.81E+08			
Sr-89	4.77E+06	2.67E+07	1.66E+08					
Sr-90	2.06E+09	2.42E+08	8.38E+09					
Zr-95	2.30E+05	1.08E+09	1.06E+06	3.40E+05	5.34E+05			
I-131	4.41E+06	2.03E+06	5.38E+06	7.70E+06	1.32E+07	2.52E+09		
I-133	9.86E-02	2.91E-01	1.86E-01	3.24E-01	5.65E-01	4.75E+01		
I-135	2.27E-17	6.94E-17	2.35E-17	6.14E-17	9.85E-17	4.05E-15		
Cs-134	8.46E+08	1.81E+07	4.35E+08	1.03E+09	3.35E+08		1.11E+08	
Cs-136	1.72E+07	2.71E+06	6.05E+06	2.39E+07	1.33E+07		1.82E+06	
Cs-137	5.27E+08	1.56E+07	5.88E+08	8.04E+08	2.73E+08		9.07E+07	
Ba-140	9.45E+05	2.97E+07	1.44E+07	1.81E+04	6.16E+03		1.04E+04	
Ce-141	5.67E+02	1.91E+07	7.39E+03	5.00E+03	2.32E+03			
Ce-144	5.01E+04	3.16E+08	9.34E+05	3.90E+05	2.32E+05			
Nb-95	3.64E+05	4.11E+09	1.22E+06	6.77E+05	6.69E+05			
Ru-103	2.43E+07	6.58E+09	5.64E+07		2.15E+08			

\*R<sub>i</sub> values are in units of mRem/yr per μCi/m<sup>3</sup> for H-3 and C-14, and units of m<sup>2</sup> mRem/yr per uCi/Sec for all others.

<b>MONTICELLO NUCLEAR GENERATING PLANT</b>		ODCM-05.01
<b>TITLE:</b>	<b>GASEOUS EFFLUENT CALCULATIONS</b>	Revision 11
		Page 54 of 70

Table 11 R<sub>i</sub> Values for the Monticello Nuclear Generating Plant Meat Pathway Teen Age Group

Nuclide	T. Body	GI Tract	Bone	Liver	Kidney	Thyroid	Lung	Skin
H-3	1.94E+02	1.94E+02		1.94E+02	1.94E+02	1.94E+02	1.94E+02	
C-14	3.06E+04	3.06E+04	1.53E+05	3.06E+04	3.06E+04	3.06E+04	3.06E+04	
Cr-51	2.92E+03	4.91E+05			6.41E+02	1.62E+03	4.17E+03	
Mn-54	8.94E+05	9.24E+06		4.51E+06	1.34E+06			
Fe-59	1.04E+08	6.37E+08	1.15E+08	2.69E+08			8.49E+07	
Co-58	1.85E+07	1.11E+08		8.05E+06				
Co-60	8.80E+07	5.09E+08		3.91E+07				
Zn-65	2.58E+08	2.34E+08	1.59E+08	5.52E+08	3.53E+08			
Sr-89	4.02E+06	1.67E+07	1.40E+08					
Sr-90	1.34E+09	1.52E+08	5.42E+09					
Zr-95	1.84E+05	6.18E+08	8.49E+05	2.68E+05	3.94E+05			
I-131	3.36E+06	1.24E+06	4.47E+06	6.26E+06	1.08E+07	1.83E+09		
I-133	8.05E-02	2.00E-01	1.56E-01	2.64E-01	4.63E-01	3.68E+01		
I-135	1.82E-17	5.44E-17	1.91E-17	4.91E-17	7.76E-17	3.16E-15		
Cs-134	3.77E+08	1.01E+07	3.46E+08	8.14E+08	2.59E+08		9.87E+07	
Cs-136	1.25E+07	1.49E+06	4.72E+06	1.86E+07	1.01E+07		1.59E+06	
Cs-137	2.26E+08	9.24E+06	4.88E+08	6.49E+08	2.21E+08		8.59E+07	
Ba-140	7.68E+05	1.84E+07	1.19E+07	1.46E+04	4.95E+03		9.82E+03	
Ce-141	4.76E+02	1.18E+07	6.20E+03	4.14E+03	1.95E+03			
Ce-144	4.23E+04	1.98E+08	7.87E+05	3.26E+05	1.94E+05			
Nb-95	2.90E+05	2.25E+09	9.50E+05	5.27E+05	5.11E+05			
Ru-103	1.96E+07	3.84E+09	4.59E+07		1.62E+08			

\*R<sub>i</sub> values are in units of mRem/yr per  $\mu\text{Ci}/\text{m}^3$  for H-3 and C-14, and units of  $\text{m}^2$  mRem/yr per uCi/Sec for all others.

<b>MONTICELLO NUCLEAR GENERATING PLANT</b>		ODCM-05.01
<b>TITLE:</b>	<b>GASEOUS EFFLUENT CALCULATIONS</b>	Revision 11
		Page 55 of 70

Table 12 R<sub>i</sub> Values for the Monticello Nuclear Generating Plant Meat Pathway Child Age Group

Nuclide	T. Body	GI Tract	Bone	Liver	Kidney	Thyroid	Lung	Skin
H-3	2.34E+02	2.34E+02		2.34E+02	2.34E+02	2.34E+02	2.34E+02	
C-14	5.74E+04	5.74E+04	2.87E+05	5.74E+04	5.74E+04	5.74E+04	5.74E+04	
Cr-51	4.56E+03	2.42E+05			6.91E+02	2.53E+03	4.62E+03	
Mn-54	1.37E+06	4.33E+06		5.15E+06	1.45E+06			
Fe-59	1.65E+08	3.45E+08	2.04E+08	3.31E+08			9.59E+07	
Co-58	2.88E+07	5.48E+07		9.40E+06				
Co-60	1.37E+08	2.57E+08		4.64E+07				
Zn-65	3.95E+08	1.12E+08	2.39E+08	6.36E+08	4.01E+08			
Sr-89	7.58E+06	1.03E+07	2.65E+08					
Sr-90	1.78E+09	9.44E+07	7.01E+09					
Zr-95	2.95E+05	3.46E+08	1.51E+06	3.31E+05	4.74E+05			
I-131	4.74E+06	7.42E+05	8.29E+06	8.34E+06	1.37E+07	2.76E+09		
I-133	1.35E-01	1.44E-01	2.89E-01	3.57E-01	5.96E-01	6.64E+01		
I-135	2.94E-17	4.74E-17	3.45E-17	6.22E-17	9.53E-17	5.51E-15		
Cs-134	2.11E+08	5.39E+06	6.10E+08	1.00E+09	3.10E+08		1.11E+08	
Cs-136	1.45E+07	7.87E+05	8.14E+06	2.24E+07	1.19E+07		1.78E+06	
Cs-137	1.27E+08	5.39E+06	8.99E+08	8.60E+08	2.80E+08		1.01E+08	
Ba-140	1.28E+06	1.11E+07	2.20E+07	1.93E+04	6.28E+03		1.15E+04	
Ce-141	8.65E+02	7.27E+06	1.17E+04	5.82E+03	2.55E+03			
Ce-144	7.92E+04	1.21E+08	1.48E+06	4.65E+05	2.57E+05			
Nb-95	4.57E+05	1.18E+09	1.64E+06	6.39E+05	6.00E+05			
Ru-103	3.19E+07	2.15E+09	8.30E+07		2.09E+08			

\*R<sub>i</sub> values are in units of mRem/yr per  $\mu\text{Ci}/\text{m}^3$  for H-3 and C-14, and units of  $\text{m}^2$  mRem/yr per uCi/Sec for all others.



<b>MONTICELLO NUCLEAR GENERATING PLANT</b>		ODCM-05.01
<b>TITLE:</b>	<b>GASEOUS EFFLUENT CALCULATIONS</b>	Revision 11
		Page 56 of 70

Table 13 R<sub>i</sub> Values for the Monticello Nuclear Generating Plant Cow Milk Pathway Adult Age Group

Nuclide	T. Body	GI Tract	Bone	Liver	Kidney	Thyroid	Lung	Skin
H-3	7.63E+02	7.63E+02		7.63E+02	7.63E+02	7.63E+02	7.63E+02	
C-14	1.02E+05	1.02E+05	5.10E+05	1.02E+05	1.02E+05	1.02E+05	1.02E+05	
Cr-51	1.48E+04	3.73E+06			3.26E+03	8.86E+03	1.97E+04	
Mn-54	1.03E+06	1.66E+07		5.41E+06	1.61E+06			
Fe-59	1.45E+07	1.26E+08	1.61E+07	3.79E+07			1.06E+07	
Co-58	6.05E+06	5.47E+07		2.70E+06				
Co-60	2.42E+07	2.06E+08		1.10E+07				
Zn-65	1.25E+09	1.75E+09	8.72E+08	2.77E+09	1.86E+09			
Sr-89	2.29E+07	1.28E+08	7.99E+08					
Sr-90	7.74E+09	9.11E+08	3.15E+10					
Zr-95	1.16E+02	5.43E+05	5.34E+02	1.71E+02	2.69E+02			
I-131	1.21E+08	5.59E+07	1.48E+08	2.12E+08	3.63E+08	6.94E+10		
I-133	1.03E+06	3.03E+06	1.94E+06	3.37E+06	5.88E+06	4.95E+08		
I-135	6.24E+03	1.91E+04	6.46E+03	1.69E+04	2.71E+04	1.11E+06		
Cs-134	7.27E+09	1.56E+08	3.74E+09	8.89E+09	2.88E+09		9.55E+08	
Cs-136	3.75E+08	5.92E+07	1.32E+08	5.21E+08	2.90E+08		3.98E+07	
Cs-137	4.46E+09	1.32E+08	4.98E+09	6.80E+09	2.31E+09		7.68E+08	
Ba-140	8.83E+05	2.77E+07	1.35E+07	1.69E+04	5.76E+03		9.69E+03	
Ce-141	1.95E+02	6.58E+06	2.55E+03	1.72E+03	8.00E+02			
Ce-144	1.23E+04	7.75E+07	2.29E+05	9.58E+04	5.68E+04			
Nb-95	1.31E+04	1.48E+08	4.37E+04	2.43E+04	2.40E+04			
Ru-103	2.35E+02	6.37E+04	5.46E+02		2.08E+03			

\*R<sub>i</sub> values are in units of mRem/yr per μCi/m<sup>3</sup> for H-3 and C-14, and units of m<sup>2</sup> mRem/yr per uCi/Sec for all others.

<b>MONTICELLO NUCLEAR GENERATING PLANT</b>		ODCM-05.01
<b>TITLE:</b>	<b>GASEOUS EFFLUENT CALCULATIONS</b>	Revision 11
		Page 57 of 70

Table 14 R<sub>i</sub> Values for the Monticello Nuclear Generating Plant Cow Milk Pathway Teen Age Group

Nuclide	T. Body	GI Tract	Bone	Liver	Kidney	Thyroid	Lung	Skin
H-3	9.94E+02	9.94E+02		9.94E+02	9.94E+02	9.94E+02	9.94E+02	
C-14	1.88E+05	1.88E+05	9.40E+05	1.88E+05	1.88E+05	1.88E+05	1.88E+05	
Cr-51	2.59E+04	4.35E+06			5.67E+03	1.44E+04	3.69E+04	
Mn-54	1.79E+06	1.85E+07		9.02E+06	2.69E+06			
Fe-59	2.54E+07	1.55E+08	2.82E+07	6.57E+07			2.07E+07	
Co-58	1.05E+07	6.26E+07		4.54E+06				
Co-60	4.19E+07	2.42E+08		1.86E+07				
Zn-65	2.17E+09	1.97E+09	1.34E+09	4.65E+09	2.98E+09			
Sr-89	4.22E+07	1.75E+08	1.47E+09					
Sr-90	1.10E+10	1.25E+09	4.46E+10					
Zr-95	2.03E+02	6.80E+05	9.34E+02	2.95E+02	4.33E+02			
I-131	2.02E+08	7.44E+07	2.69E+08	3.76E+08	6.48E+08	1.10E+11		
I-133	1.83E+06	4.54E+06	3.54E+06	6.01E+06	1.05E+07	8.38E+08		
I-135	1.09E+04	3.27E+04	1.15E+04	2.95E+04	4.66E+04	1.90E+06		
Cs-134	7.09E+09	1.90E+08	6.49E+09	1.53E+10	4.85E+09		1.85E+09	
Cs-136	5.94E+08	7.12E+07	2.25E+08	8.85E+08	4.82E+08		7.59E+07	
Cs-137	4.18E+09	1.71E+08	9.02E+09	1.20E+10	4.08E+09		1.59E+09	
Ba-140	1.57E+06	3.75E+07	2.43E+07	2.98E+04	1.01E+04		2.00E+04	
Ce-141	3.58E+02	8.92E+06	4.67E+03	3.12E+03	1.47E+03			
Ce-144	2.27E+04	1.06E+08	4.22E+05	1.74E+05	1.04E+05			
Nb-95	2.28E+04	1.77E+08	7.45E+04	4.14E+04	4.01E+04			
Ru-103	4.15E+02	8.10E+04	9.70E+02		3.42E+03			

\*R<sub>i</sub> values are in units of mRem/yr per  $\mu\text{Ci}/\text{m}^3$  for H-3 and C-14, and units of  $\text{m}^2$  mRem/yr per uCi/Sec for all others.

<b>MONTICELLO NUCLEAR GENERATING PLANT</b>		ODCM-05.01
<b>TITLE:</b>	<b>GASEOUS EFFLUENT CALCULATIONS</b>	Revision 11
		Page 58 of 70

Table 15 R<sub>i</sub> Values for the Monticello Nuclear Generating Plant Cow Milk Pathway Child Age Group

Nuclide	T. Body	GI Tract	Bone	Liver	Kidney	Thyroid	Lung	Skin
H-3	1.57E+03	1.57E+03		1.57E+03	1.57E+03	1.57E+03	1.57E+03	
C-14	4.62E+05	4.62E+05	2.31E+06	4.62E+05	4.62E+05	4.62E+05	4.62E+05	
Cr-51	5.28E+04	2.80E+06			8.00E+03	2.93E+04	5.35E+04	
Mn-54	3.59E+06	1.13E+07		1.35E+07	3.78E+06			
Fe-59	5.26E+07	1.10E+08	6.53E+07	1.06E+08			3.06E+07	
Co-58	2.12E+07	4.05E+07		6.94E+06				
Co-60	8.52E+07	1.60E+08		2.89E+07				
Zn-65	4.35E+09	1.23E+09	2.63E+09	7.00E+09	4.41E+09			
Sr-89	1.04E+08	1.41E+08	3.65E+09					
Sr-90	1.91E+10	1.01E+09	7.53E+10					
Zr-95	4.24E+02	4.97E+05	2.17E+03	4.77E+02	6.82E+02			
I-131	3.72E+08	5.84E+07	6.52E+08	6.56E+08	1.08E+09	2.17E+11		
I-133	4.02E+06	4.29E+06	8.60E+06	1.06E+07	1.77E+07	1.98E+09		
I-135	2.31E+04	3.72E+04	2.71E+04	4.89E+04	7.49E+04	4.33E+06		
Cs-134	5.18E+09	1.32E+08	1.50E+10	2.46E+10	7.61E+09		2.73E+09	
Cs-136	9.03E+08	4.90E+07	5.07E+08	1.39E+09	7.43E+08		1.11E+08	
Cs-137	3.07E+09	1.30E+08	2.17E+10	2.08E+10	6.78E+09		2.44E+09	
Ba-140	3.43E+06	2.98E+07	5.87E+07	5.14E+04	1.67E+04		3.07E+04	
Ce-141	8.52E+02	7.15E+06	1.15E+04	5.73E+03	2.51E+03			
Ce-144	5.55E+04	8.50E+07	1.04E+06	3.26E+05	1.80E+05			
Nb-95	4.68E+04	1.21E+08	1.68E+05	6.55E+04	6.16E+04			
Ru-103	8.82E+02	5.93E+04	2.29E+03		5.78E+03			

\*R<sub>i</sub> values are in units of mRem/yr per  $\mu\text{Ci}/\text{m}^3$  for H-3 and C-14, and units of  $\text{m}^2$  mRem/yr per uCi/Sec for all others.

<b>MONTICELLO NUCLEAR GENERATING PLANT</b>		ODCM-05.01
<b>TITLE:</b>	<b>GASEOUS EFFLUENT CALCULATIONS</b>	Revision 11
		Page 59 of 70

Table 16 R<sub>i</sub> Values for the Monticello Nuclear Generating Plant Cow Milk Pathway Infant Age Group

Nuclide	T. Body	GI Tract	Bone	Liver	Kidney	Thyroid	Lung	Skin
H-3	2.38E+03	2.38E+03		2.38E+03	2.38E+03	2.38E+03	2.38E+03	
C-14	9.67E+05	9.67E+05	4.53E+06	9.67E+05	9.67E+05	9.67E+05	9.67E+05	
Cr-51	8.36E+04	2.44E+06			1.19E+04	5.45E+04	1.06E+05	
Mn-54	5.69E+06	9.22E+06		2.51E+07	5.56E+06			
Fe-59	8.39E+07	1.02E+08	1.22E+08	2.13E+08			6.29E+07	
Co-58	3.44E+07	3.46E+07		1.39E+07				
Co-60	1.39E+08	1.40E+08		5.90E+07				
Zn-65	5.58E+09	1.02E+10	3.53E+09	1.21E+10	5.87E+09			
Sr-89	1.99E+08	1.43E+08	6.93E+09					
Sr-90	2.09E+10	1.02E+09	8.19E+10					
Zr-95	6.66E+02	4.67E+05	3.85E+03	9.39E+02	1.01E+03			
I-131	7.05E+08	5.72E+07	1.36E+09	1.60E+09	1.87E+09	5.27E+11		
I-133	7.74E+06	4.48E+06	1.82E+07	2.64E+07	3.11E+07	4.81E+09		
I-135	4.10E+04	4.06E+04	5.65E+04	1.12E+05	1.25E+05	1.01E+07		
Cs-134	4.54E+09	1.22E+08	2.41E+10	4.50E+10	1.16E+10		4.75E+09	
Cs-136	1.09E+09	4.43E+07	9.91E+08	2.91E+09	1.16E+09		2.38E+08	
Cs-137	2.88E+09	1.27E+08	3.47E+10	4.06E+10	1.09E+10		4.41E+09	
Ba-140	6.23E+06	2.97E+07	1.21E+08	1.21E+05	2.87E+04		7.42E+04	
Ce-141	1.64E+03	7.18E+06	2.28E+04	1.39E+04	4.29E+03			
Ce-144	8.35E+04	8.55E+07	1.49E+06	6.10E+05	2.46E+05			
Nb-95	7.48E+04	1.09E+08	3.14E+05	1.29E+05	9.28E+04			
Ru-103	1.55E+03	5.65E+04	4.65E+03		9.67E+03			

\*R<sub>i</sub> values are in units of mRem/yr per  $\mu\text{Ci}/\text{m}^3$  for H-3 and C-14, and units of  $\text{m}^2$  mRem/yr per uCi/Sec for all others.

<b>MONTICELLO NUCLEAR GENERATING PLANT</b>		ODCM-05.01
<b>TITLE:</b>	<b>GASEOUS EFFLUENT CALCULATIONS</b>	Revision 11
		Page 60 of 70

Table 17 R<sub>i</sub> Values for the Monticello Nuclear Generating Plant Goat Milk Pathway Adult Age Group

Nuclide	T. Body	GI Tract	Bone	Liver	Kidney	Thyroid	Lung	Skin
H-3	1.56E+03	1.56E+03		1.56E+03	1.56E+03	1.56E+03	1.56E+03	
C-14	1.02E+05	1.02E+05	5.10E+05	1.02E+05	1.02E+05	1.02E+05	1.02E+05	
Cr-51	1.78E+03	4.47E+05			3.92E+02	1.06E+03	2.36E+03	
Mn-54	1.24E+05	1.99E+06		6.50E+05	1.93E+05			
Fe-59	1.89E+05	1.64E+06	2.10E+05	4.93E+05			1.38E+05	
Co-58	7.26E+05	6.56E+06		3.24E+05				
Co-60	2.91E+06	2.48E+07		1.32E+06				
Zn-65	1.50E+08	2.10E+08	1.05E+08	3.33E+08	2.23E+08			
Sr-89	4.82E+07	2.69E+08	1.68E+09					
Sr-90	1.63E+10	1.91E+09	6.62E+10					
Zr-95	1.39E+01	6.51E+04	6.41E+01	2.05E+01	3.22E+01			
I-131	1.46E+08	6.71E+07	1.78E+08	2.54E+08	4.36E+08	8.33E+10		
I-133	1.23E+06	3.64E+06	2.33E+06	4.05E+06	7.06E+06	5.95E+08		
I-135	7.49E+03	2.29E+04	7.75E+03	2.03E+04	3.25E+04	1.34E+06		
Cs-134	2.18E+10	4.67E+08	1.12E+10	2.67E+10	8.63E+09		2.87E+09	
Cs-136	1.13E+09	1.78E+08	3.96E+08	1.56E+09	8.70E+08		1.19E+08	
Cs-137	1.34E+10	3.95E+08	1.49E+10	2.04E+10	6.93E+09		2.30E+09	
Ba-140	1.06E+05	3.33E+06	1.62E+06	2.03E+03	6.91E+02		1.16E+03	
Ce-141	2.34E+01	7.90E+05	3.06E+02	2.07E+02	9.60E+01			
Ce-144	1.48E+03	9.30E+06	2.75E+04	1.15E+04	6.82E+03			
Nb-95	1.57E+03	1.77E+07	5.25E+03	2.92E+03	2.88E+03			
Ru-103	2.82E+01	7.64E+03	6.55E+01		2.50E+02			

\*R<sub>i</sub> values are in units of mRem/yr per μCi/m<sup>3</sup> for H-3 and C-14, and units of m<sup>2</sup> mRem/yr per uCi/Sec for all others.

<b>MONTICELLO NUCLEAR GENERATING PLANT</b>		ODCM-05.01
<b>TITLE:</b>	<b>GASEOUS EFFLUENT CALCULATIONS</b>	Revision 11
		Page 61 of 70

Table 18 R<sub>i</sub> Values for the Monticello Nuclear Generating Plant Goat Milk Pathway Teen Age Group

Nuclide	T. Body	GI Tract	Bone	Liver	Kidney	Thyroid	Lung	Skin
H-3	2.03E+03	2.03E+03		2.03E+03	2.03E+03	2.03E+03	2.03E+03	
C-14	1.88E+05	1.88E+05	9.40E+05	1.88E+05	1.88E+05	1.88E+05	1.88E+05	
Cr-51	3.10E+03	5.22E+05			6.80E+02	1.72E+03	4.43E+03	
Mn-54	2.15E+05	2.22E+06		1.08E+06	3.23E+05			
Fe-59	3.30E+05	2.02E+06	3.66E+05	8.54E+05			2.69E+05	
Co-58	1.26E+06	7.52E+06		5.45E+05				
Co-60	5.03E+06	2.91E+07		2.23E+06				
Zn-65	2.60E+08	2.36E+08	1.61E+08	5.58E+08	3.57E+08			
Sr-89	8.86E+07	3.69E+08	3.09E+09					
Sr-90	2.31E+10	2.63E+09	9.36E+10					
Zr-95	2.43E+01	8.16E+04	1.12E+02	3.54E+01	5.19E+01			
I-131	2.43E+08	8.93E+07	3.22E+08	4.51E+08	7.77E+08	1.32E+11		
I-133	2.20E+06	5.45E+06	4.25E+06	7.21E+06	1.26E+07	1.01E+09		
I-135	1.31E+04	3.93E+04	1.38E+04	3.54E+04	5.60E+04	2.28E+06		
Cs-134	2.13E+10	5.70E+08	1.95E+10	4.58E+10	1.46E+10		5.56E+09	
Cs-136	1.78E+09	2.14E+08	6.74E+08	2.65E+09	1.44E+09		2.28E+08	
Cs-137	1.25E+10	5.12E+08	2.71E+10	3.60E+10	1.23E+10		4.76E+09	
Ba-140	1.88E+05	4.50E+06	2.92E+06	3.58E+03	1.21E+03		2.41E+03	
Ce-141	4.30E+01	1.07E+06	5.60E+02	3.74E+02	1.76E+02			
Ce-144	2.72E+03	1.27E+07	5.06E+04	2.09E+04	1.25E+04			
Nb-95	2.73E+03	2.12E+07	8.94E+03	4.96E+03	4.81E+03			
Ru-103	4.98E+01	9.73E+03	1.16E+02		4.10E+02			

\*R<sub>i</sub> values are in units of mRem/yr per  $\mu\text{Ci}/\text{m}^3$  for H-3 and C-14, and units of  $\text{m}^2$  mRem/yr per uCi/Sec for all others.

<b>MONTICELLO NUCLEAR GENERATING PLANT</b>		ODCM-05.01
<b>TITLE:</b>	<b>GASEOUS EFFLUENT CALCULATIONS</b>	Revision 11
		Page 62 of 70

Table 19 R<sub>i</sub> Values for the Monticello Nuclear Generating Plant Goat Milk Pathway Child Age Group

Nuclide	T. Body	GI Tract	Bone	Liver	Kidney	Thyroid	Lung	Skin
H-3	3.20E+03	3.20E+03		3.20E+03	3.20E+03	3.20E+03	3.20E+03	
C-14	4.62E+05	4.62E+05	2.31E+06	4.62E+05	4.62E+05	4.62E+05	4.62E+05	
Cr-51	6.33E+03	3.36E+05			9.60E+02	3.51E+03	6.42E+03	
Mn-54	4.31E+05	1.36E+06		1.62E+06	4.54E+05			
Fe-59	6.84E+05	1.43E+06	8.49E+05	1.37E+06			3.98E+05	
Co-58	2.55E+06	4.86E+06		8.33E+05				
Co-60	1.02E+07	1.92E+07		3.47E+06				
Zn-65	5.22E+08	1.48E+08	3.15E+08	8.40E+08	5.29E+08			
Sr-89	2.19E+08	2.96E+08	7.66E+09					
Sr-90	4.01E+10	2.13E+09	1.58E+11					
Zr-95	5.09E+01	5.97E+04	2.60E+02	5.72E+01	8.19E+01			
I-131	4.47E+08	7.00E+07	7.82E+08	7.87E+08	1.29E+09	2.60E+11		
I-133	4.83E+06	5.14E+06	1.03E+07	1.28E+07	2.13E+07	2.37E+09		
I-135	2.77E+04	4.47E+04	3.26E+04	5.86E+04	8.99E+04	5.19E+06		
Cs-134	1.55E+10	3.97E+08	4.49E+10	7.37E+10	2.28E+10		8.19E+09	
Cs-136	2.71E+09	1.47E+08	1.52E+09	4.18E+09	2.23E+09		3.32E+08	
Cs-137	9.21E+09	3.91E+08	6.52E+10	6.24E+10	2.03E+10		7.32E+09	
Ba-140	4.11E+05	3.57E+06	7.05E+06	6.17E+03	2.01E+03		3.68E+03	
Ce-141	1.02E+02	8.58E+05	1.38E+03	6.88E+02	3.02E+02			
Ce-144	6.66E+03	1.02E+07	1.25E+05	3.91E+04	2.17E+04			
Nb-95	5.62E+03	1.45E+07	2.02E+04	7.86E+03	7.39E+03			
Ru-103	1.06E+02	7.12E+03	2.75E+02		6.93E+02			

\*R<sub>i</sub> values are in units of mRem/yr per  $\mu\text{Ci}/\text{m}^3$  for H-3 and C-14, and units of  $\text{m}^2$  mRem/yr per uCi/Sec for all others.

<b>MONTICELLO NUCLEAR GENERATING PLANT</b>		ODCM-05.01
<b>TITLE:</b>	<b>GASEOUS EFFLUENT CALCULATIONS</b>	Revision 11
		Page 63 of 70

Table 20 R<sub>i</sub> Values for the Monticello Nuclear Generating Plant Goat Milk Pathway Infant Age Group

Nuclide	T. Body	GI Tract	Bone	Liver	Kidney	Thyroid	Lung	Skin
H-3	4.86E+03	4.86E+03		4.86E+03	4.86E+03	4.86E+03	4.86E+03	
C-14	9.67E+05	9.67E+05	4.53E+06	9.67E+05	9.67E+05	9.67E+05	9.67E+05	
Cr-51	1.00E+04	2.92E+05			1.43E+03	6.55E+03	1.27E+04	
Mn-54	6.82E+05	1.11E+06		3.01E+06	6.67E+05			
Fe-59	1.09E+06	1.32E+06	1.58E+06	2.77E+06			8.18E+05	
Co-58	4.13E+06	4.15E+06		1.67E+06				
Co-60	1.67E+07	1.69E+07		7.08E+06				
Zn-65	6.70E+08	1.23E+09	4.23E+08	1.45E+09	7.04E+08			
Sr-89	4.18E+08	2.99E+08	1.46E+10					
Sr-90	4.38E+10	2.15E+09	1.72E+11					
Zr-95	7.99E+01	5.61E+04	4.62E+02	1.13E+02	1.21E+02			
I-131	8.46E+08	6.87E+07	1.63E+09	1.92E+09	2.25E+09	6.32E+11		
I-133	9.29E+06	5.37E+06	2.18E+07	3.17E+07	3.73E+07	5.77E+09		
I-135	4.91E+04	4.88E+04	6.78E+04	1.35E+05	1.50E+05	1.21E+07		
Cs-134	1.36E+10	3.66E+08	7.23E+10	1.35E+11	3.47E+10		1.42E+10	
Cs-136	3.26E+09	1.33E+08	2.97E+09	8.74E+09	3.48E+09		7.13E+08	
Cs-137	8.63E+09	3.81E+08	1.04E+11	1.22E+11	3.27E+10		1.32E+10	
Ba-140	7.47E+05	3.56E+06	1.45E+07	1.45E+04	3.44E+03		8.90E+03	
Ce-141	1.96E+02	8.62E+05	2.74E+03	1.67E+03	5.14E+02			
Ce-144	1.00E+04	1.03E+07	1.79E+05	7.32E+04	2.96E+04			
Nb-95	8.98E+03	1.31E+07	3.77E+04	1.55E+04	1.11E+04			
Ru-103	1.86E+02	6.78E+03	5.57E+02		1.16E+03			

\*R<sub>i</sub> values are in units of mRem/yr per μCi/m<sup>3</sup> for H-3 and C-14, and units of m<sup>2</sup> mRem/yr per uCi/Sec for all others.



<b>MONTICELLO NUCLEAR GENERATING PLANT</b>		ODCM-05.01
<b>TITLE:</b>	<b>GASEOUS EFFLUENT CALCULATIONS</b>	Revision 11
		Page 64 of 70

Table 21 R<sub>i</sub> Values for the Monticello Nuclear Generating Plant Inhalation Pathway Adult Age Group

Nuclide	T. Body	GI Tract	Bone	Liver	Kidney	Thyroid	Lung	Skin
H-3	1.26E+03	1.26E+03		1.26E+03	1.26E+03	1.26E+03	1.26E+03	
Cr-51	1.00E+02	3.32E+03			2.28E+01	5.95E+01	1.44E+04	
Mn-54	6.30E+03	7.74E+04		3.96E+04	9.84E+03		1.40E+06	
Fe-59	1.06E+04	1.88E+05	1.18E+04	2.78E+04			1.02E+06	
Co-58	2.07E+03	1.06E+05		1.58E+03			9.28E+05	
Co-60	1.48E+04	2.85E+05		1.15E+04			5.97E+06	
Zn-65	4.66E+04	5.34E+04	3.24E+04	1.03E+05	6.90E+04		8.64E+05	
Sr-89	8.72E+03	3.50E+05	3.04E+05				1.40E+06	
Sr-90	6.10E+06	7.22E+05	9.92E+07				9.60E+06	
Zr-95	2.33E+04	1.50E+05	1.07E+05	3.44E+04	5.42E+04		1.77E+06	
I-131	2.05E+04	6.28E+03	2.52E+04	3.58E+04	6.13E+04	1.19E+07		
I-133	4.52E+03	8.88E+03	8.64E+03	1.48E+04	2.58E+04	2.15E+06		
I-135	2.57E+03	5.25E+03	2.68E+03	6.98E+03	1.11E+04	4.48E+05		
Cs-134	7.28E+05	1.04E+04	3.73E+05	8.48E+05	2.87E+05		9.76E+04	
Cs-136	1.10E+05	1.17E+04	3.90E+04	1.46E+05	8.56E+04		1.20E+04	
Cs-137	4.28E+05	8.40E+03	4.78E+05	6.21E+05	2.22E+05		7.52E+04	
Ba-140	2.57E+03	2.18E+05	3.90E+04	4.90E+01	1.67E+01		1.27E+06	
Ce-141	1.53E+03	1.20E+05	1.99E+04	1.35E+04	6.26E+03		3.62E+05	
Ce-144	1.84E+05	8.16E+05	3.43E+06	1.43E+06	8.48E+05		7.78E+06	
Nb-95	4.21E+03	1.04E+05	1.41E+04	7.82E+03	7.74E+03		5.05E+05	
Ru-103	6.58E+02	1.10E+05	1.53E+03		5.83E+03		5.05E+05	

\*R<sub>i</sub> values are in units of mRem/yr per uCi/m<sup>3</sup> for the Inhalation Pathway.

<b>MONTICELLO NUCLEAR GENERATING PLANT</b>		ODCM-05.01
<b>TITLE:</b>	<b>GASEOUS EFFLUENT CALCULATIONS</b>	Revision 11
		Page 65 of 70

Table 22 R<sub>i</sub> Values for the Monticello Nuclear Generating Plant Inhalation Pathway Teen Age Group

Nuclide	T. Body	GI Tract	Bone	Liver	Kidney	Thyroid	Lung	Skin
H-3	1.27E+03	1.27E+03		1.27E+03	1.27E+03	1.27E+03	1.27E+03	
Cr-51	1.35E+02	3.00E+03			3.07E+01	7.50E+01	2.10E+04	
Mn-54	8.40E+03	6.68E+04		5.11E+04	1.27E+04		1.98E+06	
Fe-59	1.43E+04	1.78E+05	1.59E+04	3.70E+04			1.53E+06	
Co-58	2.78E+03	9.52E+04		2.07E+03			1.34E+06	
Co-60	1.98E+04	2.59E+05		1.51E+04			8.72E+06	
Zn-65	6.24E+04	4.66E+04	3.86E+04	1.34E+05	8.64E+04		1.24E+06	
Sr-89	1.25E+04	3.71E+05	4.34E+05				2.42E+06	
Sr-90	6.68E+06	7.65E+05	1.08E+08				1.65E+07	
Zr-95	3.15E+04	1.49E+05	1.46E+05	4.58E+04	6.74E+04		2.69E+06	
I-131	2.64E+04	6.49E+03	3.54E+04	4.91E+04	8.40E+04	1.46E+07		
I-133	6.22E+03	1.03E+04	1.22E+04	1.89E+04	3.59E+04	2.92E+06		
I-135	3.49E+03	6.95E+03	3.70E+03	9.44E+03	1.49E+04	6.21E+05		
Cs-134	5.49E+05	9.76E+03	5.02E+05	1.13E+06	3.75E+05		1.46E+05	
Cs-136	1.37E+05	1.09E+04	5.15E+04	1.94E+05	1.10E+05		1.78E+04	
Cs-137	3.11E+05	8.48E+03	6.70E+05	8.48E+05	3.04E+05		1.21E+05	
Ba-140	3.52E+03	2.29E+05	5.47E+04	6.70E+01	2.28E+01		2.03E+06	
Ce-141	2.17E+03	1.26E+05	2.84E+04	1.90E+04	8.88E+03		6.14E+05	
Ce-144	2.62E+05	8.64E+05	4.89E+06	2.02E+06	1.21E+06		1.34E+07	
Nb-95	5.66E+03	9.68E+04	1.86E+04	1.03E+04	1.00E+04		7.51E+05	
Ru-103	8.96E+02	1.09E+05	2.10E+03		7.43E+03		7.83E+05	

\*R<sub>i</sub> values are in units of mRem/yr per uCi/m<sup>3</sup> for the Inhalation Pathway.

<b>MONTICELLO NUCLEAR GENERATING PLANT</b>		ODCM-05.01
<b>TITLE:</b>	<b>GASEOUS EFFLUENT CALCULATIONS</b>	Revision 11
		Page 66 of 70

Table 23 R<sub>i</sub> Values for the Monticello Nuclear Generating Plant Inhalation Pathway Child Age Group

Nuclide	T. Body	GI Tract	Bone	Liver	Kidney	Thyroid	Lung	Skin
H-3	1.12E+03	1.12E+03		1.12E+03	1.12E+03	1.12E+03	1.12E+03	
Cr-51	1.54E+02	1.08E+03			2.43E+01	8.55E+01	1.70E+04	
Mn-54	9.51E+03	2.29E+04		4.29E+04	1.00E+04		1.58E+06	
Fe-59	1.67E+04	7.07E+04	2.07E+04	3.34E+04			1.27E+06	
Co-58	3.16E+03	3.44E+04		1.77E+03			1.11E+06	
Co-60	2.26E+04	9.62E+04		1.31E+04			7.07E+06	
Zn-65	7.03E+04	1.63E+04	4.26E+04	1.13E+05	7.14E+04		9.95E+05	
Sr-89	1.72E+04	1.67E+05	5.99E+05				2.16E+06	
Sr-90	6.44E+06	3.43E+05	1.01E+08				1.48E+07	
Zr-95	3.70E+04	6.11E+04	1.90E+05	4.18E+04	5.96E+04		2.23E+06	
I-131	2.73E+04	2.84E+03	4.81E+04	4.81E+04	7.88E+04	1.62E+07		
I-133	7.70E+03	5.48E+03	1.66E+04	2.03E+04	3.38E+04	3.85E+06		
I-135	4.14E+03	4.44E+03	4.92E+03	8.73E+03	1.34E+04	7.92E+05		
Cs-134	2.25E+05	3.85E+03	6.51E+05	1.01E+06	3.30E+05		1.21E+05	
Cs-136	1.16E+05	4.18E+03	6.51E+04	1.71E+05	9.55E+04		1.45E+04	
Cs-137	1.28E+05	3.62E+03	9.07E+05	8.25E+05	2.82E+05		1.04E+05	
Ba-140	4.33E+03	1.02E+05	7.40E+04	6.48E+01	2.11E+01		1.74E+06	
Ce-141	2.90E+03	5.66E+04	3.92E+04	1.95E+04	8.55E+03		5.44E+05	
Ce-144	3.61E+05	3.89E+05	6.77E+06	2.12E+06	1.17E+06		1.20E+07	
Nb-95	6.55E+03	3.70E+04	2.35E+04	9.18E+03	8.62E+03		6.14E+05	
Ru-103	1.07E+03	4.48E+04	2.79E+03		7.03E+03		6.62E+05	

\*R<sub>i</sub> values are in units of mRem/yr per uCi/m<sup>3</sup> for the Inhalation Pathway.

<b>MONTICELLO NUCLEAR GENERATING PLANT</b>		ODCM-05.01
<b>TITLE:</b>	<b>GASEOUS EFFLUENT CALCULATIONS</b>	Revision 11
		Page 67 of 70

Table 24 R<sub>i</sub> Values for the Monticello Nuclear Generating Plant Inhalation Pathway Infant Age Group

Nuclide	T. Body	GI Tract	Bone	Liver	Kidney	Thyroid	Lung	Skin
H-3	6.47E+02	6.47E+02		6.47E+02	6.47E+02	6.47E+02	6.47E+02	
Cr-51	8.95E+01	3.57E+02			1.32E+01	5.75E+01	1.28E+04	
Mn-54	4.98E+03	7.06E+03		2.53E+04	4.98E+03		1.00E+06	
Fe-59	9.48E+03	2.48E+04	1.36E+04	2.35E+04			1.02E+06	
Co-58	1.82E+03	1.11E+04		1.22E+03			7.77E+05	
Co-60	1.18E+04	3.19E+04		8.02E+03			4.51E+06	
Zn-65	3.11E+04	5.14E+04	1.93E+04	6.26E+04	3.25E+04		6.47E+05	
Sr-89	1.14E+04	6.40E+04	3.98E+05				2.03E+06	
Sr-90	2.59E+06	1.31E+05	4.09E+07				1.12E+07	
Zr-95	2.03E+04	2.17E+04	1.15E+05	2.79E+04	3.11E+04		1.75E+06	
I-131	1.96E+04	1.06E+03	3.79E+04	4.44E+04	5.18E+04	1.48E+07		
I-133	5.60E+03	2.16E+03	1.32E+04	1.92E+04	2.24E+04	3.56E+06		
I-135	2.77E+03	1.83E+03	3.86E+03	7.60E+03	8.47E+03	6.96E+05		
Cs-134	7.45E+04	1.33E+03	3.96E+05	7.03E+05	1.90E+05		7.97E+04	
Cs-136	5.29E+04	1.43E+03	4.83E+04	1.35E+05	5.64E+04		1.18E+04	
Cs-137	4.55E+04	1.33E+03	5.49E+05	6.12E+05	1.72E+05		7.13E+04	
Ba-140	2.90E+03	3.84E+04	5.60E+04	5.60E+01	1.34E+01		1.60E+06	
Ce-141	1.99E+03	2.16E+04	2.77E+04	1.67E+04	5.25E+03		5.17E+05	
Ce-144	1.76E+05	1.48E+05	3.19E+06	1.21E+06	5.38E+05		9.84E+06	
Nb-95	3.78E+03	1.27E+04	1.57E+04	6.43E+03	4.72E+03		4.79E+05	
Ru-103	6.79E+02	1.61E+04	2.02E+03		4.24E+03		5.52E+05	

\*R<sub>i</sub> values are in units of mRem/yr per uCi/m<sup>3</sup> for the Inhalation Pathway.

<b>MONTICELLO NUCLEAR GENERATING PLANT</b>		ODCM-05.01
<b>TITLE:</b>	<b>GASEOUS EFFLUENT CALCULATIONS</b>	Revision 11
		Page 68 of 70

Table 25 Table of Radioisotope Constants Used for Offgas Calculations\*

i	Nuclide	Cumulative Fission Yield** (%)	Decay Constant (s <sup>-1</sup> )	Half-Life
1	Xe-133	6.921	1.53E-06	5.243 d
2	Xe-135	7.287	2.12E-05	9.1 h
3	Kr-85m	0.782	4.30E-05	4.48 h
4	Kr-88	1.956	6.78E-05	2.84 h
5	Kr-87	1.460	1.52E-04	1.27 h
6	Xe-138	5.509	8.19E-04	14.1 m
7	Kr-90	2.345	2.15E-02	32.3 s
8	Xe-139	3.672	1.75E-02	39.7 s
9	Kr-89	2.370	3.67E-03	3.15 m
10	Xe-137	6.014	3.02E-03	3.82 m
11	Xe-135m	1.530	7.55E-04	15.3 m
12	Kr-83m	0.369	1.05E-04	1.83 h
13	Xe-133m	0.217	3.66E-06	2.19 d
14	Xe-131m	0.050	6.74E-07	11.9 d
15	Kr-85	0.171	2.05E-09	10.73 y

\* Data taken from EPRI Fuel Reliability Monitoring and Failure Evaluation Handbook (2010), Revision 2 1019107 (Reference 10), and ENDF-349, Appendix A (Reference 11).

\*\* Cumulative Fission Yields were calculated assuming 30% U-235 and 70% Pu-239. Other ratios may be used as appropriate if the basis for the new ratio is provided.

<b>MONTICELLO NUCLEAR GENERATING PLANT</b>		ODCM-05.01
<b>TITLE:</b>	<b>GASEOUS EFFLUENT CALCULATIONS</b>	Revision 11
		Page 69 of 70

Table 26 Default Reactor Building Vent WRGM Setpoint (Section 2.1.1.A.)

$(\gamma/Q)_v$	4.08E-06	Highest Site Boundary $(\gamma/Q)$ for RBV releases from ODCM-APP-A Table 3. SSE boundary.
----------------	----------	--

Radionuclide	Reactor Building Vent (Table 1) <sup>1</sup>	S <sub>i</sub> (RVB, Unitless)	Total Body Dose Factor K <sub>i</sub> (mrem/yr per $\mu\text{Ci}/\text{m}^3$ , Table 4)	S <sub>i</sub> *K <sub>i</sub>	Skin Dose Factor L <sub>i</sub> (mrem/yr per $\mu\text{Ci}/\text{m}^3$ , Table 4)	Gamma Air Dose Factor M <sub>i</sub> (mrad/yr per $\mu\text{Ci}/\text{m}^3$ , Table 4)	L <sub>i</sub> +1.1M <sub>i</sub>	S <sub>i</sub> *(L <sub>i</sub> +1.1M <sub>i</sub> )
Kr-83m	-	-	7.56E-02	-	-	1.93E+01	2.12E+01	-
Kr-85m	7.10E+01	1.98E-02	1.17E+03	2.32E+01	1.46E+03	1.23E+03	2.81E+03	5.58E+01
Kr-85	-	-	1.61E+01	-	1.34E+03	1.72E+01	1.36E+03	-
Kr-87	1.33E+02	3.72E-02	5.92E+03	2.20E+02	9.73E+03	6.17E+03	1.65E+04	6.14E+02
Kr-88	2.33E+02	6.51E-02	1.47E+04	9.57E+02	2.37E+03	1.52E+04	1.91E+04	1.24E+03
Kr-89	-	-	1.66E+04	-	1.01E+04	1.73E+04	2.91E+04	-
Kr-90	-	-	1.56E+04	-	7.29E+03	1.63E+04	2.52E+04	-
Xe-131m	-	-	9.15E+01	-	4.76E+02	1.56E+02	6.48E+02	-
Xe-133m	-	-	2.51E+02	-	9.94E+02	3.27E+02	1.35E+03	-
Xe-133	3.26E+02	9.11E-02	2.94E+02	2.68E+01	3.06E+02	3.53E+02	6.94E+02	6.33E+01
Xe-135m	6.96E+02	1.95E-01	3.12E+03	6.07E+02	7.11E+02	3.36E+03	4.41E+03	8.57E+02
Xe-135	7.09E+02	1.98E-01	1.81E+03	3.59E+02	1.86E+03	1.92E+03	3.97E+03	7.87E+02
Xe-137	-	-	1.42E+03	-	1.22E+04	1.51E+03	1.39E+04	-
Xe-138	1.41E+03	3.94E-01	8.83E+03	3.48E+03	4.13E+03	9.21E+03	1.43E+04	5.62E+03
Xe-139	-	-	5.02E+03	-	6.52E+04	5.28E+03	7.10E+04	-
Ar-41	-	-	8.84E+03	-	2.69E+03	9.30E+03	1.29E+04	-
Total	3.58E+03			5.67E+03				9.24E+03

Qtb	2.16E+04
Qts	7.96E+04
HHSP	1.08E+04

<sup>1</sup> For the Reactor Building Vent default setpoint calculation, the GALE Code source term for Reactor Building Vent is used, exclusively.

<b>MONTICELLO NUCLEAR GENERATING PLANT</b>		ODCM-05.01
<b>TITLE:</b>	<b>GASEOUS EFFLUENT CALCULATIONS</b>	Revision 11
		Page 70 of 70

Table 27 Default Plant Stack WRGM Setpoint (Section 2.1.1.B.)

$(\chi/Q)_s$	1.08E-07	Highest Site Boundary $(\chi/Q)$ from ODCM-APP-A Table 6. NNW boundary.
--------------	----------	---

Radionuclide	Gland Seal <sup>1</sup>	S <sub>i</sub> (Gland Seal, No Kr-83)	Total Body Dose Factor for Elevated Plume, V <sub>i</sub> (Table 5)	S <sub>i</sub> *V <sub>i</sub>	Gamma Air Dose Factor for Elevated Plume B <sub>i</sub> (Table 5)	L <sub>i</sub>	L <sub>i</sub> *(X/Q) <sub>s</sub> +1.1B <sub>i</sub>	S <sub>i</sub> *(L <sub>i</sub> *(X/Q) <sub>s</sub> +1.1B <sub>i</sub> )
Kr-83m	- <sup>2</sup>	-	2.61E-09	-	3.77E-07	-	4.15E-07	-
Kr-85m	4.10E+01	1.68E-02	1.39E-04	2.34E-06	2.07E-04	1.46E+03	3.85E-04	6.49E-06
Kr-85	-	-	2.10E-06	-	3.18E-06	1.34E+03	1.48E-04	-
Kr-87	1.40E+02	5.75E-02	6.33E-04	3.64E-05	9.52E-04	9.73E+03	2.10E-03	1.21E-04
Kr-88	1.40E+02	5.75E-02	1.66E-03	9.54E-05	2.49E-03	2.37E+03	2.99E-03	1.72E-04
Kr-89	6.00E+02	2.46E-01	1.12E-03	2.76E-04	1.68E-03	1.01E+04	2.94E-03	7.24E-04
Kr-90	-	-	1.61E-04	-	2.42E-04	7.29E+03	1.05E-03	-
Xe-131m	-	-	3.31E-05	-	5.21E-05	4.76E+02	1.09E-04	-
Xe-133m	2.00E+00	8.21E-04	2.51E-05	2.06E-08	4.09E-05	9.94E+02	1.52E-04	1.25E-07
Xe-133	5.60E+01	2.30E-02	2.61E-05	6.00E-07	4.08E-05	3.06E+02	7.79E-05	1.79E-06
Xe-135m	1.70E+01	6.98E-03	3.34E-04	2.33E-06	5.06E-04	7.11E+02	6.33E-04	4.42E-06
Xe-135	1.50E+02	6.16E-02	2.24E-04	1.38E-05	3.37E-04	1.86E+03	5.72E-04	3.52E-05
Xe-137	7.30E+02	3.00E-01	9.99E-05	2.99E-05	1.51E-04	1.22E+04	1.48E-03	4.45E-04
Xe-138	5.60E+02	2.30E-01	9.90E-04	2.28E-04	1.49E-03	4.13E+03	2.09E-03	4.79E-04
Xe-139	-	-	5.79E-05	-	8.69E-05	6.52E+04	7.14E-03	-
Ar-41	-	-	1.20E-03	-	1.80E-03	2.69E+03	2.27E-03	-
Total	2.44E+03	1.00E+00		6.84E-04				1.99E-03

Qtb	7.31E+05
Qts	1.51E+06
Hi-Hi Setpoint	3.65E+05

<sup>1</sup> For the Plant Stack default setpoint calculation, the GALE Code source term for Gland Seal is used to determine the default maximum High setpoint.

<sup>2</sup> Kr-83m is dropped from the setpoint because it cannot be detected by either the HPGe or WRGM. This produces a conservatively low default max setpoint.

<b>MONTICELLO NUCLEAR GENERATING PLANT</b>		ODCM-06.01
<b>TITLE:</b>	<b>DOSE FROM ALL URANIUM FUEL CYCLE SOURCES</b>	Revision 4
		Page 1 of 7

Approval: ODC 01480982

**OFFSITE DOSE CALCULATION MANUAL - TABLE OF CONTENTS**

<b><u>SECTION</u></b>	<b><u>PAGE</u></b>
1.0 RECORD OF REVISION .....	2
2.0 DOSE FROM ALL URANIUM FUEL CYCLE SOURCES .....	3
2.1 Dose Commitment .....	3
2.2 Direct Dose Determination .....	4
2.3 Bases .....	6
2.4 References.....	7



<b>MONTICELLO NUCLEAR GENERATING PLANT</b>		ODCM-06.01
<b>TITLE:</b>	<b>DOSE FROM ALL URANIUM FUEL CYCLE SOURCES</b>	Revision 4
		Page 2 of 7

**1.0 RECORD OF REVISION**

<u>Revision No.</u>	<u>Reason for Revision</u>
1	Moved previous ODCM-04.01 (INFORMATION RELATED TO 40CFR190 and 40CFR141) into this document, changed the title to "DOSE FROM ALL URANIUM FUEL CYCLE SOURCES" and incorporated Tech Specs section 3.8.D and 4.8.D into document.
2	Incorporated changes made during the conversion of the Current Technical Specifications to the Improved Technical Specifications. This includes dual step annotation.
3	Added requirements of 10CFR72.104 for doses from the plant ISFSI. Removed references to CTS.
4	Clarified reporting requirements to specify Calendar Year and include radiation levels/concentrations. Added Surveillance Requirement to determine direct radiation dose. Added Methodology to calculate direct radiation dose from TLD's. Added Reference to ANSI/HPS N13.37-2014.

<b>MONTICELLO NUCLEAR GENERATING PLANT</b>		ODCM-06.01
<b>TITLE:</b>	<b>DOSE FROM ALL URANIUM FUEL CYCLE SOURCES</b>	Revision 4
		Page 3 of 7

## **2.0 DOSE FROM ALL URANIUM FUEL CYCLE SOURCES**

### **2.1 Dose Commitment**

#### **2.1.1 Controls**

- A. In accordance with Tech Spec 5.5.3.j. and 10CFR72.104, the dose or dose commitment to any member of the public from all uranium fuel cycle sources **SHALL** be limited to less than or equal to 25 mrem to the total body or any organ, except for the thyroid, which **SHALL** be limited to less than or equal to 75 mrem over a period of 12 consecutive months.

#### **2.1.2 Applicability**

At all times

#### **2.1.3 Action**

- A. With the calculated dose from the release of radioactive materials in liquid or gaseous effluents exceeding twice any of the limits of Controls ODCM-02.01 Section 2.2.1, ODCM-03.01 Section 2.2.1 or ODCM-03.01 Section 2.3.1, prepare and submit within 30 days a special report to the Commission which:
1. Defines corrective actions and calculates the highest radiation exposure to any member of the general public from all uranium fuel cycle sources (including all effluent pathways and direct radiation) for the calendar year covered by the report.
  2. Describes the levels of radiation and concentrations of radioactive material involved, and the cause of the exposure levels or concentrations.
- B. Unless the above report shows that exposures are less than the 40CFR Part 190 standard, either apply to the Commission for a variance to continue releases which exceed the 40CFR Part 190 standard or reduce subsequent releases to permit the standard to be met.

#### **2.1.4 Surveillance Requirements**

- A. Cumulative dose contributions from all liquid and gaseous effluents **SHALL** be determined in accordance with surveillance requirements ODCM-02.01 Section 2.2.4, ODCM-03.01 Section 2.2.4, and ODCM-03.01 Section 2.3.4 and in accordance with the ODCM.

<b>MONTICELLO NUCLEAR GENERATING PLANT</b>		ODCM-06.01
<b>TITLE:</b>	<b>DOSE FROM ALL URANIUM FUEL CYCLE SOURCES</b>	Revision 4
		Page 4 of 7

- B. Cumulative dose contributions from direct radiation from the unit (including ISFSI, outside storage tanks, etc.) **SHALL** be determined in accordance with the methodology and parameters in the ODCM. This requirement is applicable only under conditions set forth in Action 2.1.3 of ODCM-06.01.

## 2.2 Direct Dose Determination

2.2.1 Direct radiation doses due to ISFSI, the reactor or steam turbine is determined using environmental TLD data. TLD data is received from the vendor as Normalized Quarterly Dose ( $M_Q$ ) with Extraneous Dose (due to transport and storage) and normalization to 91-day Standard Quarters already addressed. Dose in the context of Section 2.2.1 refers to dose in milliroentgen (mR), properly referred to as exposure; these "dose" values in mR are converted to dose in mrem in Step 2.2.1.D. TLD data **SHALL** be analyzed to determine the Facility Related Dose using the following method (based on ANSI/HPS N13.37-2014).

- A. Baseline Background Dose and Minimum Detectible Dose are determined using a representative 5 to 10-year data set. This is not performed each year, but should be updated if the existing baseline values are no longer representative.
1. Select a 5 to 10-year span of TLD data. Ensure that the data has been normalized to 91-day quarters.
  2. Perform a QA review of the data looking for anomalous points that may be affected by:
    - a. Dosimeter failure
    - b. Deep snowpack
    - c. Construction activities
    - d. Exposure to other radiation sources
    - e. Plant effects
  3. Determine Baseline Quarterly Dose ( $B_Q$ ) for each location as the average of quarterly data. Determine the Standard Deviation for Quarterly Data ( $S_Q$ ) for each location.
  4. Determine Baseline Annual Dose ( $B_A$ ) for each location as the average of annual data where Annual Normalized Dose ( $M_A$ ) is the sum of the quarterly doses ( $M_Q$ ) for a given year.
  5. Determine the Standard Deviation for Annual Data ( $S_A$ ) for each location.

<b>MONTICELLO NUCLEAR GENERATING PLANT</b>		ODCM-06.01
<b>TITLE:</b>	<b>DOSE FROM ALL URANIUM FUEL CYCLE SOURCES</b>	Revision 4
		Page 5 of 7

6. Determine the 90th percentile value for  $S_Q$  and  $S_A$ ; these represent  $\sigma_Q$  and  $\sigma_A$  respectively.
7. Determine Minimum Detectable Dose for Quarterly ( $MDD_Q$ ) and Annual ( $MDD_A$ ) data:

$$MDD_Q = 3 * \sigma_Q$$

and

$$MDD_A = 3 * \sigma_A$$

Where:

$\sigma_Q$  = 90th Percentile of Quarterly Standard Deviations  
 $\sigma_A$  = 90th Percentile of Annual Standard Deviations  
 $MDD_Q$  = Minimum Detectable Dose for Quarterly Measurements  
 $MDD_A$  = Minimum Detectable Dose for Annual Results

- B. Determine Facility Related Dose for Quarterly ( $F_Q$ ) and Annual ( $F_A$ ):

$$\text{If } M_Q > (B_Q + MDD_Q) \text{ then } F_Q = M_Q - B_Q$$

$$\text{If } M_Q \leq (B_Q + MDD_Q) \text{ then } F_Q = \text{Not Detected}$$

and

$$\text{If } M_A > (B_A + MDD_A) \text{ then } F_A = M_A - B_A$$

$$\text{If } M_A \leq (B_A + MDD_A) \text{ then } F_A = \text{Not Detected}$$

Where:

$B_Q$  = Baseline Quarterly Dose  
 $B_A$  = Baseline Annual Dose  
 $M_Q$  = Normalized Quarterly Field Dose  
 $M_A$  = is the sum of the four Normalized Quarterly Field Doses  
 $F_Q$  = Quarterly Facility Related Dose  
 $F_A$  = Annual Facility Related Dose  
 $MDD_Q$  = Minimum Detectable Dose for Quarterly Measurements  
 $MDD_A$  = Minimum Detectable Dose for Annual Results

- C. A QA review should be performed on the results prior to reporting. Positive  $F_Q$  or  $F_A$  results should be investigated to ensure that the dose is due to facility operation prior to reporting. If non-facility related factors are determined to be the cause of the positive result, then appropriate corrections should be made prior to reporting the results.

<b>MONTICELLO NUCLEAR GENERATING PLANT</b>		ODCM-06.01
<b>TITLE:</b>	<b>DOSE FROM ALL URANIUM FUEL CYCLE SOURCES</b>	Revision 4
		Page 6 of 7

- D. Dose to a Member of the Public due to external radiation from operation of the facility may be calculated using the Facility Related dose values above by multiplying the dose value in milliroentgen (mR) by 0.95 mrem/mR. Dose may be extrapolated to the point of interest. Doses below 1 mrem should be reported as Not Detected because they imply a sensitivity that is inconsistent with the system's minimum differential dose.

## 2.3 Bases

### 2.3.1 Dose From All Uranium Fuel Cycle Sources

#### A. Dose Commitment

Control 2.1.1.A. is provided to meet the dose limitations of 40CFR190. The specification requires the preparation and submittal of a special report whenever the calculated doses from plant radioactive effluents exceed twice the design objective doses of Appendix I. Submittal of the report is considered a timely request and a variance is granted until Staff action on the request is complete. For sites containing up to 4 reactors, it is highly unlikely that the resultant dose to a real individual will exceed 40CFR190 if the individual reactors remain within the reporting requirement level. For the purpose of the special report it may be assumed that the dose commitment to the real individual from other uranium fuel cycle sources is negligible, with the exception that dose contributions from other nuclear fuel cycle facilities at the same site or within a radius of 5 miles must be considered.

Control 2.1.1.A. also contains the dose limitations of 10CFR72.104, Criteria for Radioactive Materials in Effluents and Direct Radiation From an ISFSI or MRS. The dose limitations for 10CFR72.104 are the same as those in 40CFR190. MNGP installed an ISFSI in 2008.

#### B. Direct Dose Determination

Step 2.2.1.D uses 0.95 mrem/mR to convert exposure (milliroentgen) to dose (millirem). This value is based on discussion in Introduction to Health Physics (Cember, 1983) that indicates "an exposure of 1R, which corresponds to 87.8 ergs per gram air, leads to an absorption of 95 ergs per gram muscle tissue." (pg. 142) 1 rad=100 ergs/g=1 rem, based on a quality factor of 1 for gamma radiation as defined in 10 CFR 20.1004.

<b>MONTICELLO NUCLEAR GENERATING PLANT</b>		ODCM-06.01
<b>TITLE:</b>	<b>DOSE FROM ALL URANIUM FUEL CYCLE SOURCES</b>	Revision 4
		Page 7 of 7

#### **2.4 References**

1. ANSI/HPS N13.37-2014, Environmental Dosimetry - Criteria for System Design and Implementation. Apr. 2014, Health Physics Society, McLean, VA.
2. Cember, H., Introduction to Health Physics, 2nd Ed. Pergamon Press, New York, NY, 1983.

<b>MONTICELLO NUCLEAR GENERATING PLANT</b>		ODCM-07.01
<b>TITLE:</b>	<b>RADIOLOGICAL ENVIRONMENTAL MONITORING PROGRAM</b>	Revision 25
		Page 1 of 28

Approval: ODC 01525648

**OFFSITE DOSE CALCULATION MANUAL - TABLE OF CONTENTS**

<b><u>SECTION</u></b>		<b><u>PAGE</u></b>
1.0	RECORD OF REVISION .....	2
2.0	RADIOLOGICAL ENVIRONMENTAL MONITORING PROGRAM.....	5
2.1	Monitoring Program.....	5
2.2	Land Use Census.....	7
2.3	Sampling .....	8
2.4	Interlaboratory Comparison Program .....	9
2.5	Bases .....	10
Figure 1	Radiation Environmental Monitoring Program Sampling Locations.....	11
Figure 2	4 - 5 Mile Ring and Special Interest TLD Locations .....	12
Figure 3	Site Boundary TLD Locations.....	13
Figure 4	Control Locations .....	14
Figure 5	ISFSI TLD Locations .....	15
Table 1	Monticello Nuclear Generating Plant Radiological Environmental Monitoring Program Sample Collection and Analysis.....	16
Table 2	Reporting Levels for Radioactivity Concentrations in Environmental Samples (Reporting Levels).....	20
Table 3	Maximum Values for the Lower Limits of Detection (LLD) <sup>e</sup> .....	21
Table 4	Monticello Nuclear Generating Plant Radiological Environmental Monitoring Program Sampling Locations .....	23
Table 5	Non-REMP ISFSI Monitoring Locations <sup>a</sup> .....	28

<b>MONTICELLO NUCLEAR GENERATING PLANT</b>		ODCM-07.01
<b>TITLE:</b>	<b>RADIOLOGICAL ENVIRONMENTAL MONITORING PROGRAM</b>	Revision 25
		Page 2 of 28

## 1.0 RECORD OF REVISION

<u>Revision No.</u>	<u>Reason for Revision</u>
1	Moved previous ODCM-05.01 (RADIATION ENVIRONMENTAL MONITORING PROGRAM) into this document, changed the title to "RADIOLOGICAL ENVIRONMENTAL MONITORING PROGRAM" and incorporated Tech Spec section 4.16 "Radiation Environmental Monitoring Program" into this document.
2	Deleted incorrect reference in section 2.1.3.C.
3	Table 4, page 22, TLD M02S from Edgar Klucas Res., 1.1, 148, SE to Krone Residence, 0.5, 223, SW.
4	Table 4, page 20, TLD M-10 <sub>c</sub> from Goenner Farm, 12.4, 322, NW to Campbell Farm, 10.6, 357, N.
5	Change in the Critical Garden location.
6	Updated sampling locations on Figures 1, 2 and 3.
7	Change in the Critical Garden location.  Change 2.4.1.A. to require cross check program to be NIST traceable. NRC no longer approves cross check programs.
8	Incorporated changes made during the conversion of the Current Technical Specifications to the Improved Technical Specifications. This includes dual step annotation.
9	Updated all sample locations with GPS. Corrected inconsistencies between location on map and actual location with GPS.
10	Incorporated changes suggested by NRC IP 71122.01 sections 02.01.d and 02.02.e as requested in GAR 01055347. Removed references to Current Technical Specifications.
11	Corrected location of air sampler M-4 to correct sector.
12	Removed Wienand farm (M-24) from milk locations. The farm went out of business. Added new groundwater wells for groundwater characterization study. Updated Figure 3 for site boundary TLD locations. Added neutron and gamma TLDs for ISFSI monitoring.
13	Added sampling requirements and locations for vegetation sampling.



<b>MONTICELLO NUCLEAR GENERATING PLANT</b>		ODCM-07.01
<b>TITLE:</b>	<b>RADIOLOGICAL ENVIRONMENTAL MONITORING PROGRAM</b>	Revision 25
		Page 3 of 28

<u>Revision No.</u>	<u>Reason for Revision</u>
14	Removed Milk Sampling locations M-28 and M-10. Hoglund farm went out of business and the control milk location is no longer needed. Updated Figure 1, Radiological Environmental Monitoring Program Sampling Locations, to remove M-28. Added ground water monitoring wells MW-9, MW-10, and MW-11
15	Updated Table 4, Radiological Environmental Monitoring Program Sample Locations, added ground water monitoring wells MW 9B, MW12A,12B,13A,13B
16	Replaced M-10c (Campbell Farm) Drinking Water control sample location with M-43c (Imholte Farm). Changing the control drinking water location is due to the Campbell Farm no longer having an accessible sample location.
17	Updated Section 2.3.2, Site Groundwater Characterization Study, and Table 4, Radiological Environmental Monitoring Program Sample Locations, to add groundwater monitoring well MW-14. Deleted reference to M-10 on Figure 1 to reflect replacement of M-10c (Campbell Farm) Drinking Water control sample location with M-43c (Imholte Farm). Added Kitzman Farm (M-16) and Greniger Farm (M-17c). The Kitzman Farm was identified as milking goats for commercial use. The Greniger Farm was chosen as the control goat milk location.
18	Changed Critical Garden Location.
19	Changed location of TLD's M07A, M08A and M01B. M07A and M08A were moved due to rerouting County Road 75 and bridge removal. The TLD's were moved closer to the plant. M01B was moved due to the removal of the Sherco air monitoring station near Becker. A new GPS software has been obtained and sample location bearings and distances updated IAW new software.
20	Updated Table 4, Radiological Environmental Monitoring Program Sample Locations, added ground water monitoring wells, MW-15A and MW-15B.
21	Updated Table 4 and Figure 1 for new highest D/Q garden location as determined by the Annual Land Use Census.
22	Updated Table 4 and Figure 1 for new highest D/Q garden location as determined by the Annual Land Use Census. Removed goat milk locations from Table 4. Added superscript to Table 3 that had been previously removed.

<b>MONTICELLO NUCLEAR GENERATING PLANT</b>		ODCM-07.01
<b>TITLE:</b>	<b>RADIOLOGICAL ENVIRONMENTAL MONITORING PROGRAM</b>	Revision 25
		Page 4 of 28

<u>Revision No.</u>	<u>Reason for Revision</u>
23	Changed location of REMP drinking water sample from Wise residence to Hasbrouck residence to the Wise location no longer inhabited. Removed requirement to sample vegetation from the highest D/Q garden. The D/Q garden vegetation sample is not required by regulation. PCR 01427501.
24	Updated Table 4 and Figure 1 for new highest D/Q garden location as determined by the Annual Land Use Census. PCR 01452154.
25	Updated Site Groundwater Characterization Study Section. Updated all REMP Sample Location Maps to improve readability and update for construction changes. Added ISFSI TLD map and separated Outer Ring and Control maps. Updated ISFSI TLD requirements in Tables 1 & 4. Separated true REMP locations from those around the ISFSI. Added Table 5 for ISFSI Fence TLDs. Removed Groundwater Protection Program Well samples from Tables 1 & 4. These samples are not considered to be REMP samples and are controlled by FP-CY-GWPP-01. Re-characterized REMP well water samples as Ground Water in Tables 1 & 4. This essentially reverses a change from Rev. 10. Replaced footnote from Table 3 stating "Total for parent and daughter" for Ba-La-140 and Zr-Nb-95, with "Applies to parent and daughter individually." Updated Table 3 LLDs to match those given in NUREG-1302. Reorganized portions of Table 4 to incorporate neutron TLDs and improve readability. Deleted REMP Location M-27, associated control broad-leaf location, and associated note 'a' in Table 4. Various Editorial Corrections. Deleted Date column from the Record of Revision Section.

<b>MONTICELLO NUCLEAR GENERATING PLANT</b>		ODCM-07.01
<b>TITLE:</b>	<b>RADIOLOGICAL ENVIRONMENTAL MONITORING PROGRAM</b>	Revision 25
		Page 5 of 28

**2.0 RADIOLOGICAL ENVIRONMENTAL MONITORING PROGRAM**

**2.1 Monitoring Program**

2.1.1 Controls

- A. In accordance with Tech Spec 5.5.1, the Radiological Environmental Monitoring Program (REMP) **SHALL** be conducted as specified in Table 1.
- B. Radioanalysis **SHALL** be conducted meeting the requirements of Table 3.

2.1.2 Applicability

At all times.

2.1.3 Action

- A. Whenever the Radiological Environmental Monitoring Program is not being conducted as specified in Table 1 the Annual Radiological Environmental Operating Report **SHALL** include a description of the reasons for not conducting the program as required and plans for preventing a recurrence.
- B. Deviations are permitted from the required sampling schedule if samples are unobtainable due to hazardous conditions, seasonable unavailability, or to malfunctions of automatic sampling equipment. If the latter occurs, every effort **SHALL** be made to complete corrective action prior to the end of the next sampling period.
- C. With the level of radioactivity in an environmental sampling medium exceeding the reporting levels of Table 2 when averaged over any calendar quarter, submit a special report to the Commission within 30 days from the end of the affected calendar quarter. When more than one of the radionuclides in Table 2 are detected in the sampling medium, this report **SHALL** be submitted if:

$$\frac{\text{concentration (1)}}{\text{limit level (1)}} + \frac{\text{concentration (2)}}{\text{limit level (2)}} + \dots > 1.0$$

<b>MONTICELLO NUCLEAR GENERATING PLANT</b>		ODCM-07.01
<b>TITLE:</b>	<b>RADIOLOGICAL ENVIRONMENTAL MONITORING PROGRAM</b>	Revision 25
		Page 6 of 28

When radionuclides other than those in Table 2 are detected and are the result of plant effluents, this report **SHALL** be submitted if the potential annual dose to an individual is equal to or greater than the calendar year limits of ODCM-02.01 (LIQUID EFFLUENTS) Control 1.2.1.A, ODC-M-03.01 (GASEOUS EFFLUENTS) Control 1.2.1.A, or ODCM-03.01 Control 1.3.1.A. This report is not required if the measured level of radioactivity was not the result of plant effluents; however, in such an event, the condition **SHALL** be reported and described in the Annual Radiological Environmental Operating Report.

- D. Although deviations from the sampling schedule are permitted under Paragraph B. above, whenever milk or broad leaf vegetation samples can no longer be obtained from the designated sample locations required by Table 1, the Annual Radiological Environmental Operating Report **SHALL** explain why the samples can no longer be obtained and identify the new locations which have been or will be added to and deleted from the monitoring program.

#### 2.1.4 Surveillance Requirements

The radiological environmental monitoring samples **SHALL** be collected pursuant to Table 1 from the specific locations in Table 4 and **SHALL** be analyzed pursuant to the requirements of Table 1 and the detection capabilities required by Table 3.

<b>MONTICELLO NUCLEAR GENERATING PLANT</b>		ODCM-07.01
<b>TITLE:</b>	<b>RADIOLOGICAL ENVIRONMENTAL MONITORING PROGRAM</b>	Revision 25
		Page 7 of 28

## 2.2 Land Use Census

### 2.2.1 Controls

A Land Use Census **SHALL** be conducted and **SHALL** identify:

- A. The location of the nearest milk animal, the nearest residence, and the nearest garden of greater than 500 ft<sup>2</sup> producing broad leaf vegetables in each of the 16 meteorological sectors within a distance of 5 miles.
- B. The location of ALL milk animals and ALL 500 ft<sup>2</sup> or greater gardens producing broad leaf vegetables in each of the meteorological sectors within a distance of 3 miles.

### 2.2.2 Applicability

At all times.

### 2.2.3 Action

- A. With a Land Use Census identifying a location which yields a calculated dose or dose commitment (via the same exposure pathway) 20 percent greater than at a location from which samples are currently being obtained in accordance with Controls 2.1.1.A, the Annual Radioactive Effluent Release Report for this period **SHALL** identify the new location. The new location **SHALL** be added to the Radiological Environmental Monitoring Program within 30 days. The sampling location, excluding the control station location, having the lowest calculated dose or dose commitment (via the same exposure pathway) may be deleted from this monitoring program after October 31 of the year in which this Land Use Census was conducted.

### 2.2.4 Surveillance Requirements

- A. The Land Use Census **SHALL** be conducted at least once per year between the dates of May 1 and October 31 by door to door survey, aerial survey, or by consulting local agricultural associations.

<b>MONTICELLO NUCLEAR GENERATING PLANT</b>		ODCM-07.01
<b>TITLE:</b>	<b>RADIOLOGICAL ENVIRONMENTAL MONITORING PROGRAM</b>	Revision 25
		Page 8 of 28

## 2.3 Sampling

Table 1 and Figure 1 specify the current sampling locations for the radiological environmental monitoring program. These sampling locations are based on the latest land use census and the Site Groundwater Characterization Study.

### 2.3.1 Land Use Census

- A. If it is learned from an annual census that milk animals or gardens are present at the location which yields a calculated thyroid dose greater than those locations previously sampled, the new milk animal or garden locations resulting in the higher calculated doses **SHALL** be added to the surveillance program as soon as practicable. Sample locations (except the control) having lower calculated doses may be dropped from the program at the end of the grazing or growing season (October 31) to keep the total number of sample locations constant.
- B. If the plant begins routine discharges of liquid radioactive effluent into the Mississippi River, a land use survey **SHALL** be conducted to determine whether any crops are irrigated with water taken from the Mississippi River between the plant discharge canal and a point 5 miles downstream. If edible crops are being irrigated from Mississippi River water, appropriate samples **SHALL** be collected and analyzed per Table 1.

### 2.3.2 Site Groundwater Characterization Study

Review of the available groundwater piezometric data shows that shallow groundwater generally flows toward the Mississippi River, and possible upward flow gradients are present from the deep groundwater aquifer toward the shallow groundwater at the MNGP site. Therefore, any tritium releases into the subsoil environment should move towards the Mississippi River in the shallow groundwater without potentially impacting the deeper groundwater in rock. The average velocity of shallow groundwater flow is estimated at approximately 3 feet per day.

A system of sixteen additional shallow groundwater monitoring wells was installed, and monitoring is controlled by the Fleet Groundwater Protection Program Procedure (FP-CY-GWPP-01), based on guidance from NEI 07-07. This monitoring system will effectively confirm the shallow groundwater flow directions during the year and will help to demonstrate that the potential impact of any releases within the plant area on groundwater inland of the plant is negligible.

<b>MONTICELLO NUCLEAR GENERATING PLANT</b>		ODCM-07.01
<b>TITLE:</b>	<b>RADIOLOGICAL ENVIRONMENTAL MONITORING PROGRAM</b>	Revision 25
		Page 9 of 28

## 2.4 Interlaboratory Comparison Program

### 2.4.1 Controls

- A. Analyses **SHALL** be performed on radioactive materials supplied as part of a NIST traceable cross-check program. This program involves the analyses of samples provided by a control laboratory and comparison of results with those of the control laboratory as well as with other laboratories which receive portions of the same samples. Media used in this program (air, milk, water, etc.) **SHALL** be limited to those found in the Radiological Environmental Monitoring Program.

### 2.4.2 Applicability

At all times.

### 2.4.3 Action

- A. When required analyses are not performed, corrective action **SHALL** be reported in the Annual Radiological Environmental Operating Report.

### 2.4.4 Surveillance Requirements

- A. The summary results of analyses performed as part of the above required program **SHALL** be included in the Annual Radiological Environmental Operating Report.

<b>MONTICELLO NUCLEAR GENERATING PLANT</b>		ODCM-07.01
<b>TITLE:</b>	<b>RADIOLOGICAL ENVIRONMENTAL MONITORING PROGRAM</b>	Revision 25
		Page 10 of 28

## 2.5 Bases

### 2.5.1 Monitoring Program

Control 2.1.1 provides measurements of radiation and radioactive materials in those exposure pathways and for those radionuclides which lead to the highest potential radiation exposures of individuals resulting from the plant operation. This program thereby supplements the radiological effluent monitoring by verifying that the measurable concentrations of radioactive materials and levels of radiation are not higher than expected on the basis of the effluent measurements and modeling of the environmental exposure pathways. After a specific program has been in effect for at least 3 years of operation, program changes may be initiated based on this experience.

The detection capabilities required by Table 3 are state-of-the art for routine environmental measurements in industrial laboratories. The LLDs for drinking water meet the requirement of 40CFR Part 141.

### 2.5.2 Land Use Census

Control 2.2.1 is provided to ensure that changes in the use of off-site areas are identified and that modifications to the monitoring program are made if required by the results of this census. The best survey information from door-to-door, aerial or consulting with local agricultural associations **SHALL** be used. This census satisfies the requirements of Section IV.B.3 of Appendix I to 10CFR Part 50. Restricting the census to gardens of greater than 500 square feet provides assurance that significant exposure pathways via broad leaf vegetables will be identified and monitored since a garden of this size is the minimum required to produce the quantity (26 kg/year) of broad leaf vegetables assumed in Regulatory Guide 1.109 for consumption by a child. To determine this minimum garden size, the following assumptions were used: 1) that 20% of the garden was used for growing broad leaf vegetables (i.e., similar to lettuce and cabbage), and 2) a vegetation yield of 2 kg/square meter.

### 2.5.3 Sampling

Section 2.3.1.B. is worded to conform to LAR-39 and its associated NRC Safety Evaluation (SER).

### 2.5.4 Interlaboratory Comparison Program

The requirement for participation in an interlaboratory comparison program is provided to ensure that independent checks on the precision and accuracy of the measurements of radioactive material in environmental sample matrices are performed as part of a quality assurance program for environmental monitoring in order to demonstrate that the results are reasonably valid.



<b>MONTICELLO NUCLEAR GENERATING PLANT</b>		ODCM-07.01
<b>TITLE:</b>	<b>RADIOLOGICAL ENVIRONMENTAL MONITORING PROGRAM</b>	Revision 25
		Page 11 of 28

Figure 1 Radiation Environmental Monitoring Program Sampling Locations

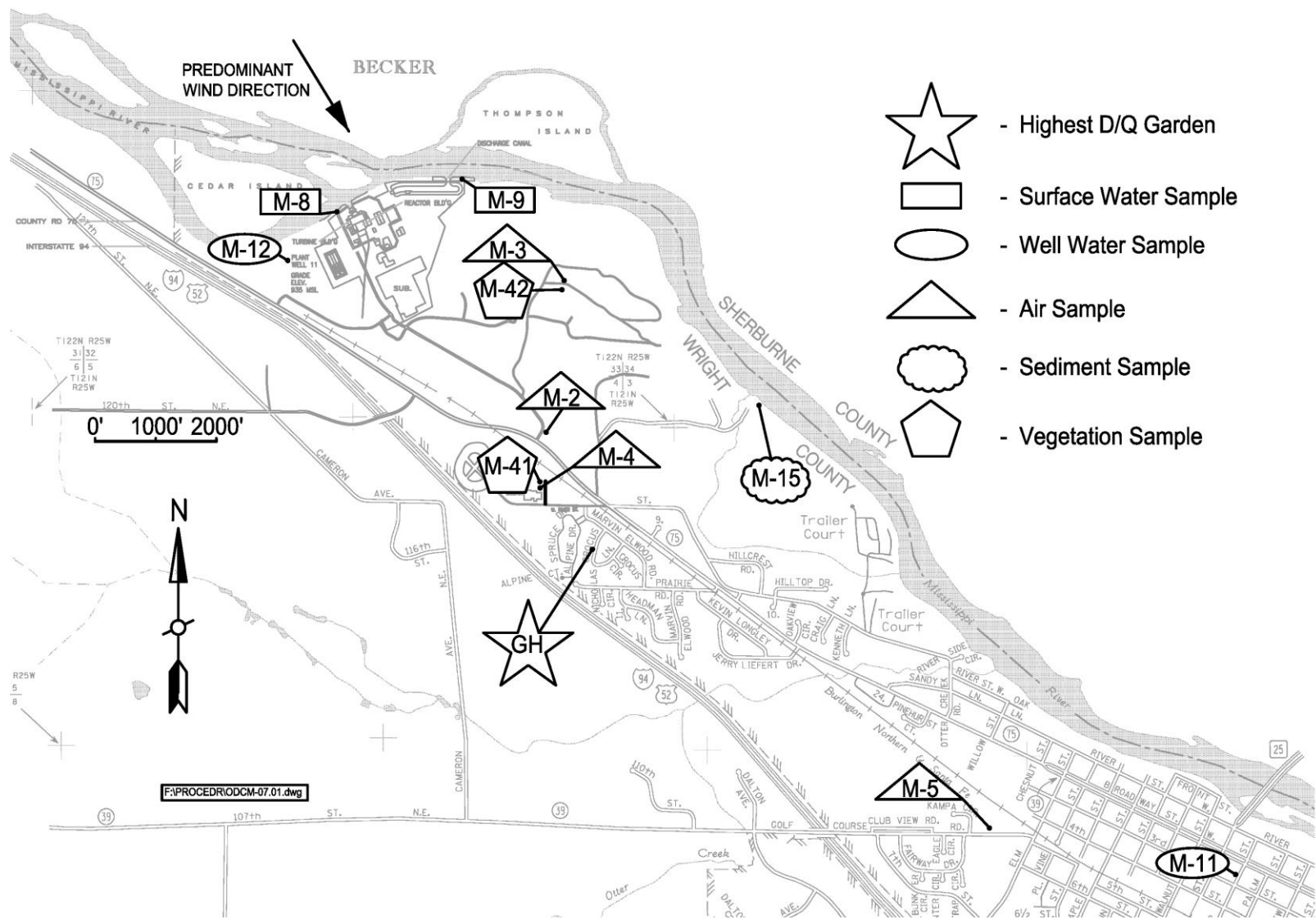

<b>MONTICELLO NUCLEAR GENERATING PLANT</b>		ODCM-07.01
<b>TITLE:</b>	<b>RADIOLOGICAL ENVIRONMENTAL MONITORING PROGRAM</b>	Revision 25
		Page 12 of 28

Figure 2 4 - 5 Mile Ring and Special Interest TLD Locations

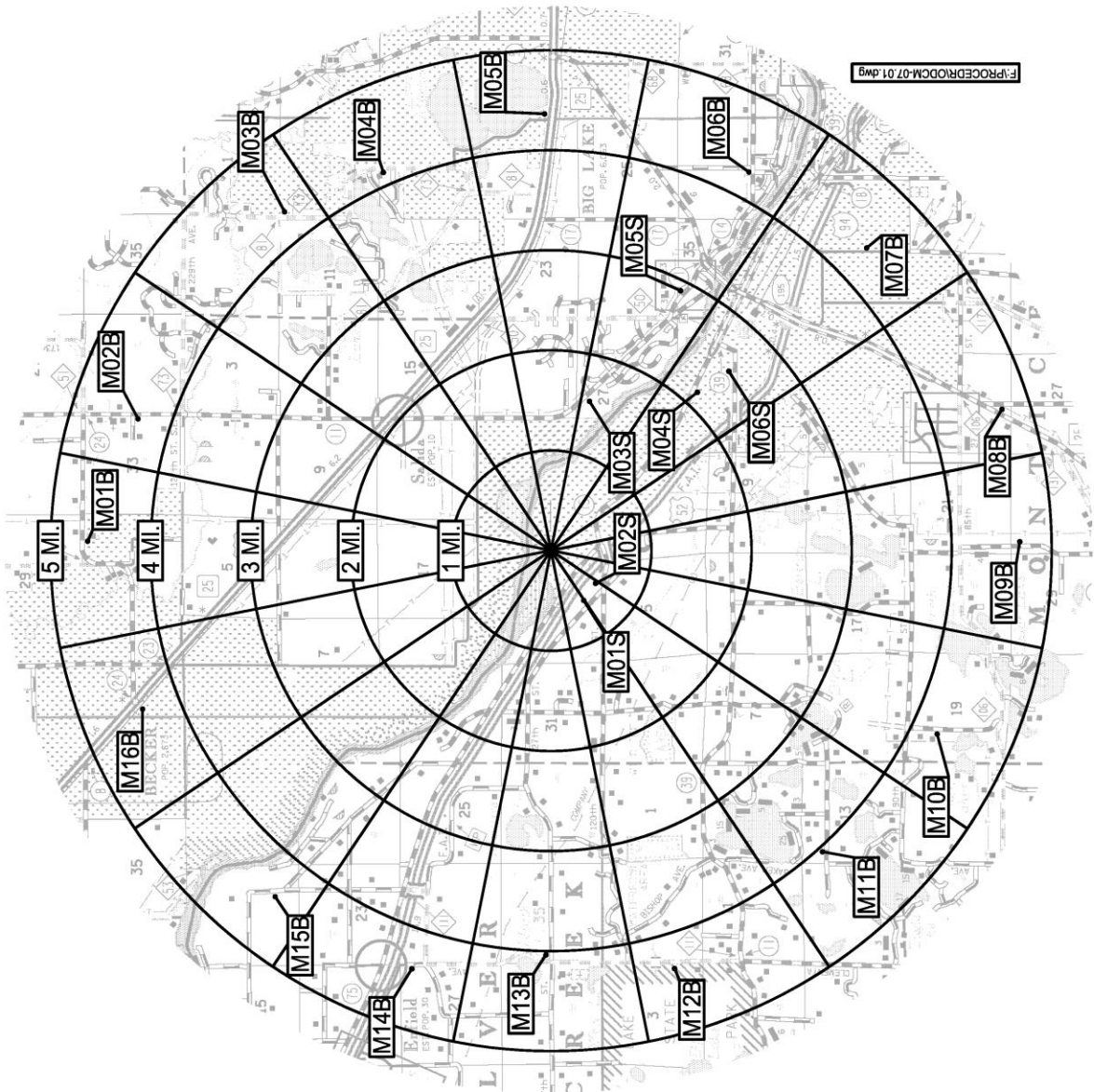

<b>MONTICELLO NUCLEAR GENERATING PLANT</b>	<b>ODCM-07.01</b>
<b>TITLE: RADIOLOGICAL ENVIRONMENTAL MONITORING PROGRAM</b>	<b>Revision 25</b>
	<b>Page 13 of 28</b>

Figure 3 Site Boundary TLD Locations

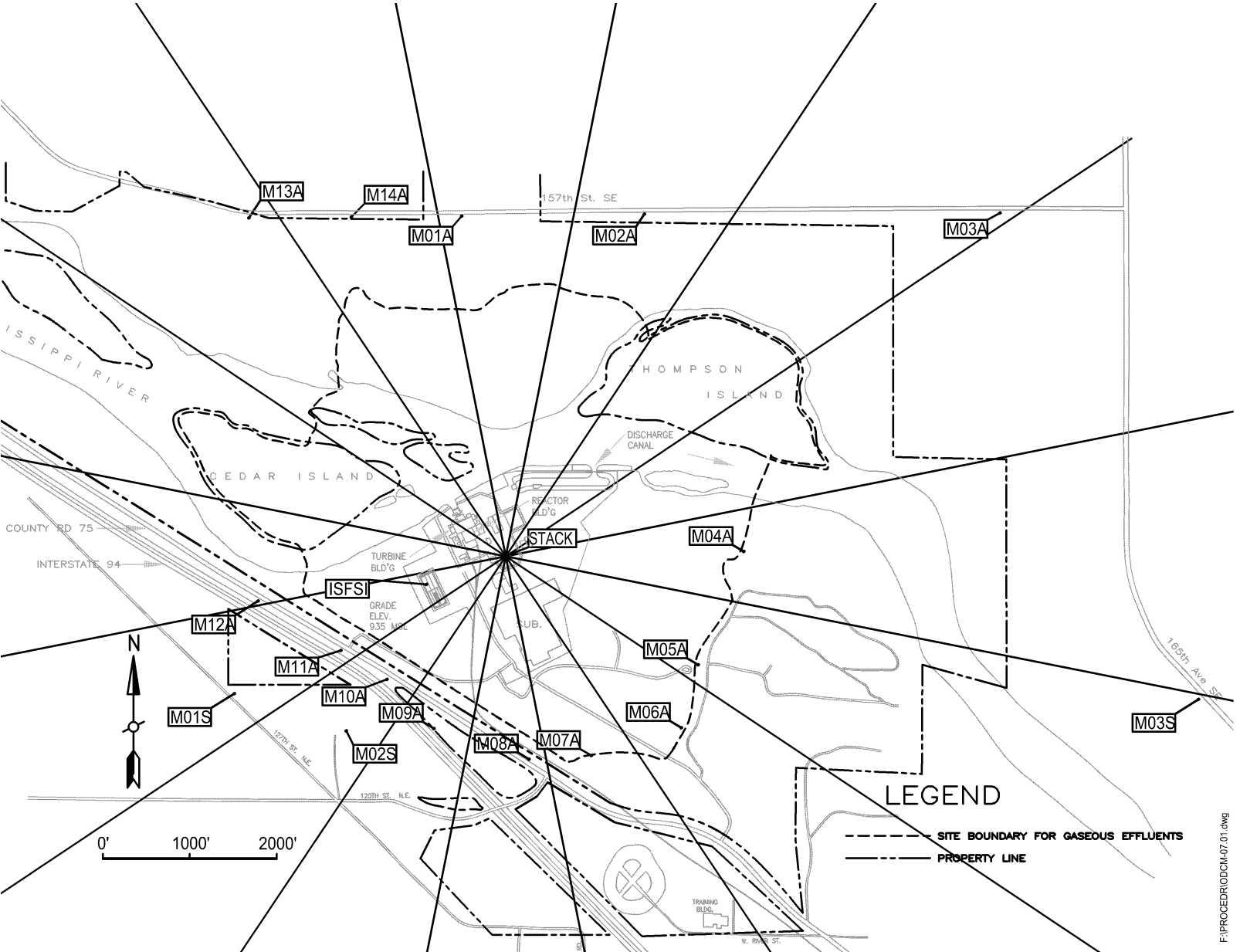

F:\PROCEDR\ODCM\07.01.dwg

<b>MONTICELLO NUCLEAR GENERATING PLANT</b>		ODCM-07.01
<b>TITLE:</b>	<b>RADIOLOGICAL ENVIRONMENTAL MONITORING PROGRAM</b>	Revision 25
		Page 14 of 28

Figure 4 Control Locations

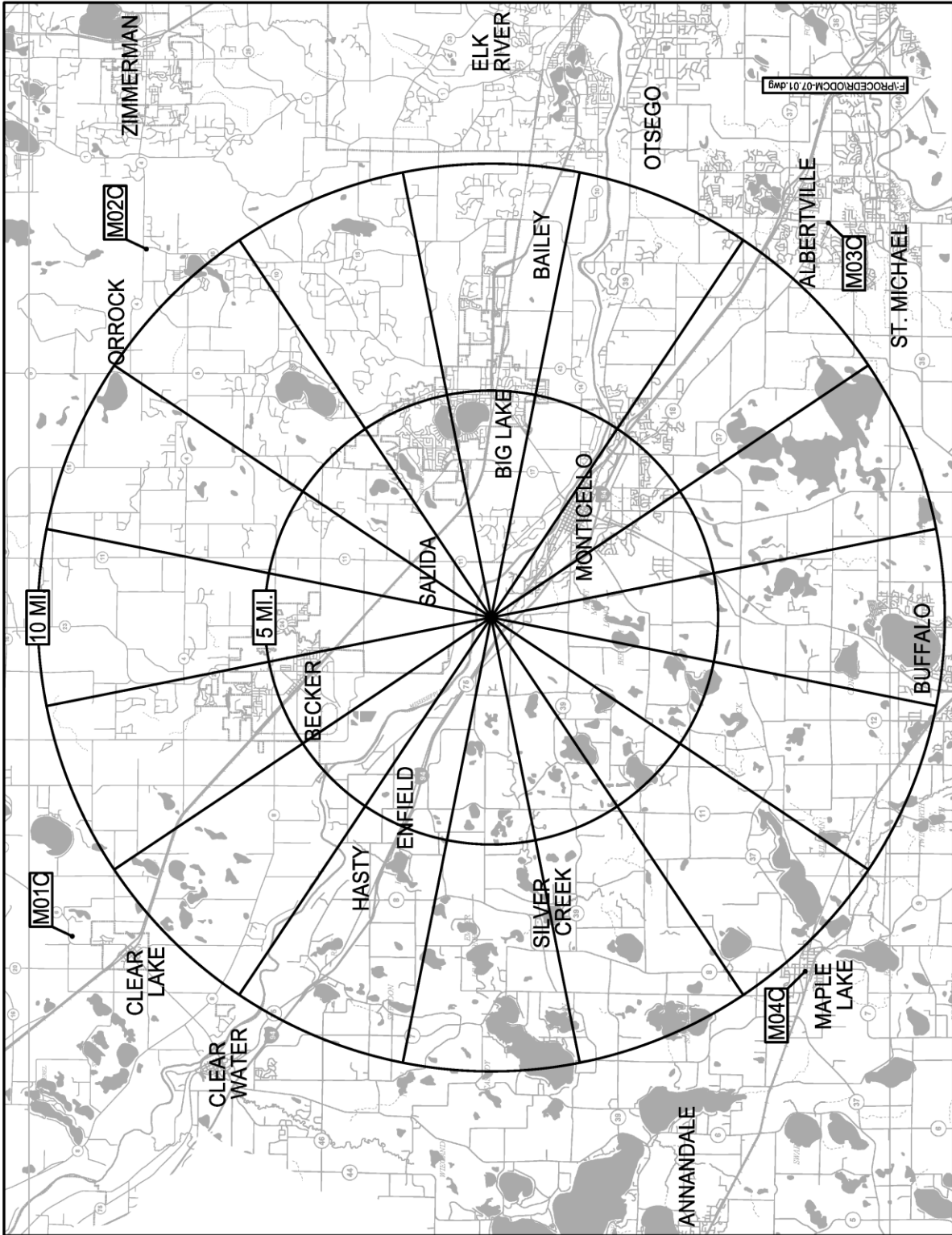

<b>MONTICELLO NUCLEAR GENERATING PLANT</b>		ODCM-07.01
<b>TITLE:</b>	<b>RADIOLOGICAL ENVIRONMENTAL MONITORING PROGRAM</b>	Revision 25
		Page 15 of 28

Figure 5 ISFSI TLD Locations

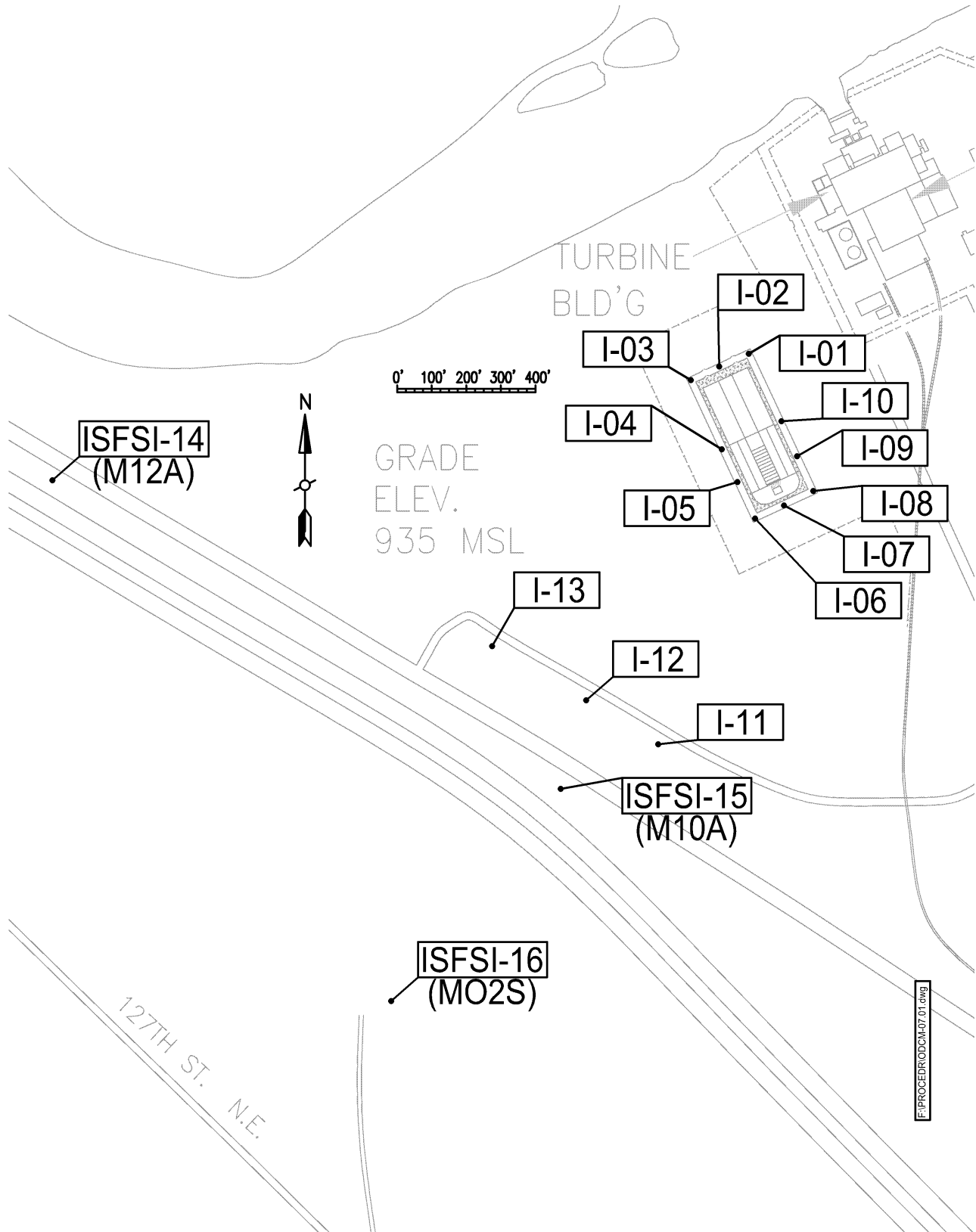

<b>MONTICELLO NUCLEAR GENERATING PLANT</b>		ODCM-07.01
<b>TITLE:</b>	<b>RADIOLOGICAL ENVIRONMENTAL MONITORING PROGRAM</b>	Revision 25
		Page 16 of 28

Table 1 Monticello Nuclear Generating Plant Radiological Environmental Monitoring Program Sample Collection and Analysis

Exposure Pathway and/or Sample	Number of Samples and Sample Locations**	Sampling and Collection Frequency	Type and Frequency of Analysis
1. <u>Airborne</u> Radioiodine & Particulates	Samples from 5 locations: 3 samples from offsite locations (in different sectors) of the highest calculated annual average ground level D/Q, 1 sample from the vicinity of a community having the highest calculated annual average ground-level D/Q, and 1 sample from a control location specified in Table 4.	Continuous Sampler operation with sample collection weekly.	Radioiodine analysis Weekly for I-131  Particulate: Gross beta activity on each filter weekly*. Analysis <b>SHALL</b> be performed more than 24 hours following filter change. Perform gamma isotopic analysis on composite (by location) sample quarterly.

\* If gross beta activity in any indication sample exceeds 10 times the yearly average of the control sample, a gamma isotopic analysis is required.

\*\* Sample locations are further described in Table 4.

<b>MONTICELLO NUCLEAR GENERATING PLANT</b>		ODCM-07.01
<b>TITLE:</b>	<b>RADIOLOGICAL ENVIRONMENTAL MONITORING PROGRAM</b>	Revision 25
		Page 17 of 28

Table 1 Monticello Nuclear Generating Plant Radiological Environmental Monitoring Program Sample Collection and Analysis (Cont'd)

Exposure Pathway and/or Sample	Number of Samples and Sample Locations**	Sampling and Collection Frequency	Type and Frequency of Analysis
2. <u>Direct Radiation</u>	<p>40 TLD stations established with duplicate dosimeters placed at the following locations:****</p> <ol style="list-style-type: none"> <li>1. Using the 16 meteorological sectors as guidelines, an inner ring of stations in the general area of the site boundary is established and an outer ring of stations at 4 to 5 mile distance from the plant site is established. Because of inaccessibility, two sectors in the inner ring are not covered.</li> <li>2. Ten dosimeters are established at special interest areas and four control stations.</li> <li>3. Three neutron and gamma dosimeter sets are located along the OCA fence. Additionally, three neutron dosimeters are stationed with Special Interest and Inner Ring TLDs and four neutron control dosimeters are stationed with the REMP control TLDs.</li> </ol>	Quarterly	Gamma/Neutron Dose quarterly

\*\* Sample locations are further described in Table 4.

\*\*\*\* Three control TLD locations have only one dosimeter.

<b>MONTICELLO NUCLEAR GENERATING PLANT</b>		ODCM-07.01
<b>TITLE:</b>	<b>RADIOLOGICAL ENVIRONMENTAL MONITORING PROGRAM</b>	Revision 25
		Page 18 of 28

Table 1 Monticello Nuclear Generating Plant Radiological Environmental Monitoring Program Sample Collection and Analysis (Cont'd)

Exposure Pathway and/or Sample	Number of Samples and Sample Locations**	Sampling and Collection Frequency	Type and Frequency of Analysis
3. <u>Waterborne</u>			
a. Surface	Upstream & downstream locations.	Monthly composite of weekly samples (water & ice conditions permitting)	Gamma Isotopic analysis of each monthly composite  Tritium analysis of quarterly composites of monthly composites
b. Ground	Three samples from wells within 5 miles of the plant site and one sample from a well greater than 10 miles from the plant site.	Quarterly	Gamma Isotopic and tritium analyses of each sample
c. Drinking	One sample from the City of Minneapolis water supply.	Monthly composite of weekly samples	I-131 Analysis and Gross beta and Gamma isotopic analysis of each monthly composite Tritium analysis of quarterly composites of monthly composites
d. Sediment from Shoreline	One sample upstream of plant, one sample downstream of plant, and one sample from shoreline of recreational area.	Semiannually	Gamma isotopic analysis of each sample

\*\* Sample locations are further described in Table 4.



<b>MONTICELLO NUCLEAR GENERATING PLANT</b>		ODCM-07.01
<b>TITLE:</b>	<b>RADIOLOGICAL ENVIRONMENTAL MONITORING PROGRAM</b>	Revision 25
		Page 19 of 28

Table 1 Monticello Nuclear Generating Plant Radiological Environmental Monitoring Program Sample Collection and Analysis (Cont'd)

Exposure Pathway and/or Sample	Number of Samples and Sample Locations**	Sampling and Collection Frequency	Type and Frequency of Analysis
4. <u>Ingestion</u>			
a. Milk	One sample from dairy farm having highest D/Q, one sample from each of three dairy farms (if available) calculated to have doses from I-131 > 1 mrem/yr, and one sample from 10-20 miles	Monthly or biweekly if animals are on pasture	Gamma Isotopic and I-131 analysis of each sample.
b. Vegetation	Samples of vegetation grown nearest each of two different offsite locations of highest predicted annual average D/Q if milk sampling is not performed, and one sample from 10-20 miles in the least prevalent wind direction.	Monthly during growing season	Gamma Isotopic and I-131 analysis of each sample.
c. Fish and Invertebrates	One sample of one game specie of fish located upstream and downstream of the plant site. One sample of Invertebrates upstream and downstream of the plant site.	Samples collected semi-annually	Gamma isotopic analysis on each sample (edible portion only on fish).
d. Food Products	One sample of corn and potatoes from any area that is irrigated by water in which liquid radioactive effluent has been discharged.***	At time of harvest	Gamma isotopic analysis of edible portion of each sample

\*\* Sample locations are further described in Table 4.

\*\*\* As determined by methods outlines in section 2.3.

<b>MONTICELLO NUCLEAR GENERATING PLANT</b>		ODCM-07.01
<b>TITLE:</b>	<b>RADIOLOGICAL ENVIRONMENTAL MONITORING PROGRAM</b>	Revision 25
		Page 20 of 28

Table 2 Reporting Levels for Radioactivity Concentrations in Environmental Samples (Reporting Levels)

Analysis	Water (pCi/l)	Airborne Particulate or Gas (pCi/m <sup>3</sup> )	Fish (pCi/kg, wet)	Milk (pCi/l)	Vegetables (pCi/kg, wet)
H-3	20,000 <sup>a</sup>				
Mn-54	1,000		30,000		
Fe-59	400		10,000		
Co-58	1,000		30,000		
Co-60	300		10,000		
Zn-65	300		20,000		
Zr-Nb-95	400 <sup>b</sup>				
I-131	2 <sup>c</sup>	0.9		3	100
Cs-134	30	10	1,000	60	1,000
Cs-137	50	20	2,000	70	2,000
Ba-La-140	200 <sup>b</sup>			300 <sup>b</sup>	

a - For drinking water samples. This is a 40 CFR Part 141 value. If no drinking water pathway exists, a value of 30,000 pCi/l may be used.

b - Total for parent and daughter

c - If no drinking water pathways exist, a value of 20 pCi/l may be used.

<b>MONTICELLO NUCLEAR GENERATING PLANT</b>		ODCM-07.01
<b>TITLE:</b>	<b>RADIOLOGICAL ENVIRONMENTAL MONITORING PROGRAM</b>	Revision 25
		Page 21 of 28

Table 3 Maximum Values for the Lower Limits of Detection (LLD)<sup>d</sup>

Analysis	Water (pCi/l)	Airborne Particulate or Gas (pCi/m <sup>3</sup> )	Fish (pCi/kg, wet)	Milk (pCi/l)	Food Products (pCi/kg, wet)	Sediment (pCi/kg, dry)
Gross beta	4	0.01				
<sup>3</sup> H	2000*					
<sup>54</sup> Mn	15		130			
<sup>59</sup> Fe	30		260			
<sup>58, 60</sup> Co	15		130			
<sup>65</sup> Zn	30		260			
<sup>95</sup> Zr-Nb	15 <sup>b</sup>					
<sup>131</sup> I <sup>c</sup>	1**	0.07		1	60	
<sup>134</sup> Cs	15	0.05	130	15	60	150
<sup>137</sup> Cs	18	0.06	150	18	80	180
<sup>140</sup> Ba-La	15 <sup>b</sup>			15 <sup>b</sup>		

\* If no drinking water pathway exists, a value of 3000 pCi/l may be used.

\*\* If no drinking water pathway exists, a value of 15 pCi/l may be used.

<b>MONTICELLO NUCLEAR GENERATING PLANT</b>		ODCM-07.01
<b>TITLE:</b>	<b>RADIOLOGICAL ENVIRONMENTAL MONITORING PROGRAM</b>	Revision 25
		Page 22 of 28

Table 3 Maximum Values for the Lower Limits of Detection (LLD) (Cont'd)

TABLE NOTATION

a - The LLD is the smallest concentration of radioactive material in a sample that will be detected with 95% probability with 5% probability of falsely concluding that a blank observation represents a “real” signal.

For a particular measurement system (which may include radiochemical separation):

$$LLD = \frac{4.66 s_b}{E \cdot V \cdot 2.22 \cdot Y \cdot \exp(-\lambda \Delta t)}$$

Where:

- LLD is the apriori lower limit of detection as defined above (as picocurie per unit mass or volume),
- sb is the standard deviation of the background counting rate or of the counting rate of a blank sample as appropriate (as counts per minute). Typical values of E, V, Y and Δt shall be used in the calculations.
- E is the counting efficiency (as counts per transformation)
- V is the sample size (in units of mass or volume)
- 2.22 is the number of transformations per minute per picocurie
- Y is the fraction radiochemical yield (when applicable)
- λ is the radioactive decay constant for the particular radionuclide
- Δ t is the elapsed time between sample collection (or end the sample collection period) and time of counting

b - Applies to parent and daughter individually.

c - These LLDs apply only where “I-131 analysis” is specified.

d - Where “Gamma Isotopic Analysis” is specified, the LLD specifications applies to the following radionuclides: Mn-54, Fe-59, Co-58, Co-60, Zn-65, Zr-Nb-95, Cs-134, Cs-137 and Ba-La-140. Other peaks which are measurable and identifiable, together with the above nuclides shall be identified and reported.

<b>MONTICELLO NUCLEAR GENERATING PLANT</b>		ODCM-07.01
<b>TITLE:</b>	<b>RADIOLOGICAL ENVIRONMENTAL MONITORING PROGRAM</b>	Revision 25
		Page 23 of 28

Table 4 Monticello Nuclear Generating Plant Radiological Environmental Monitoring Program Sampling Locations

Type of Sample	Code	Collection Site	Location		
			Distance Miles	Compass Heading	Sector
River water	M-8c	Upstream of plant	w/in 1000 ft upstream of plant intake		
River water	M-9	Downstream of plant	w/in 1000 ft downstream of plant discharge		
Drinking water	M-14	City of Minneapolis	37.0	132	SE
Ground water	M-43c	Imholte Farm	12.3	313	NW
Ground water	M-11	City of Monticello	3.3	127	SE
Ground water	M-12	Plant Well No. 11	0.26	252	WSW
Ground water	M-55	Hasbrouck Residence	1.60	255	WSW
Sediment-River	M-8c	Upstream of plant	w/in 1000 ft upstream of plant intake		
Sediment-River	M-9	Downstream of plant	w/in 1000 ft downstream of plant discharge		
Sediment-Shoreline	M-15	Montissippi Park	1.27	114	ESE
Periphyton or Macroinvertebrates	M-8c	Upstream of plant	w/in 1000 ft upstream of plant intake		
	M-9	Downstream of plant	w/in 1000 ft downstream of plant discharge		
Fish	M-8c	Upstream of plant	w/in 1000 ft upstream of plant intake		
Fish	M-9	Downstream of plant	w/in 1000 ft downstream of plant discharge		
Vegetation	M-41	Training Center	0.8	151	SSE
Vegetation	M-42	Biology Station Road	0.6	134	SE
Vegetation	M-43c	Imholte Farm	12.3	313	NW
Cultivated crops (corn)*  (potatoes)*					
* Collected only if plant discharges radioactive effluent into the river, then only from river irrigated fields. (See Section 2.1)					

<b>MONTICELLO NUCLEAR GENERATING PLANT</b>		ODCM-07.01
<b>TITLE:</b>	<b>RADIOLOGICAL ENVIRONMENTAL MONITORING PROGRAM</b>	Revision 25
		Page 24 of 28

Table 4 Monticello Nuclear Generating Plant Radiological Environmental Monitoring Program Sampling Locations (Cont'd)

Type of Sample	Code	Collection Site	Location		
			Distance Miles	Compass Heading	Sector
Particulates and Radio-iodine					
(air)	M-1c	Air Station M-1	11.0	307	NW
(air)	M-2	Air Station M-2	0.8	140	SE
(air)	M-3	Air Station M-3	0.6	104	ESE
(air)	M-4	Air Station M-4	0.8	147	SSE
(air)	M-5	Air Station M-5	2.6	134	SE
Direct Radiation Inner Ring - (general area of the site boundary)					
(TLD)	M01A	Sherburne Ave. So.	0.75	353	N
(TLD)	M02A	Sherburne Ave. So.	0.79	23	NNE
(TLD)	M03A	Sherburne Ave. So.	1.29	56	NE
(TLD)	M04A	Biology Station Rd.	0.5	92	E
(TLD)	M05A	Biology Station Rd.	0.48	122	ESE
(TLD)	M06A	Biology Station Rd.	0.54	138	SE
(TLD)	M07A	Parking Lot H	0.47	158	SSE
(TLD)	M08A	Parking Lot F	0.45	175	S
(TLD)	M09A	County Road 75	0.38	206	SSW
(TLD)	M10A & ISFSI-15 (neutron)	County Road 75	0.38	224	SW
(TLD)	M11A	County Road 75	0.4	237	WSW
(TLD)	M12A & ISFSI-14 (neutron)	County Road 75	0.5	262	W
(TLD)	M13A	North Boundary Rd.	0.89	322	NW
(TLD)	M14A	North Boundary Rd.	0.78	335	NNW

<b>MONTICELLO NUCLEAR GENERATING PLANT</b>		ODCM-07.01
<b>TITLE:</b>	<b>RADIOLOGICAL ENVIRONMENTAL MONITORING PROGRAM</b>	Revision 25
		Page 25 of 28

Table 4 Monticello Nuclear Generating Plant Radiological Environmental Monitoring Program Sampling Locations (Cont'd)

Type of Sample	Code	Collection Site	Location		
			Distance Miles	Compass Heading	Sector
Direct Radiation Outer Ring - (about 4 to 5 miles distant from the plant)					
(TLD)	M01B	117th Street	4.65	1	N
(TLD)	M02B	County Road 11	4.4	18	NNE
(TLD)	M03B	County Rd. 73 & 81	4.3	51	NE
(TLD)	M04B	County Rd. 73 (196th Street)	4.2	67	ENE
(TLD)	M05B	City of Big Lake	4.3	89	E
(TLD)	M06B	County Rd 14 & 196th Street	4.3	117	ESE
(TLD)	M07B	Monticello Industrial Dr.	4.3	136	SE
(TLD)	M08B	Residence Hwy 25 & Davidson Ave	4.6	162	SSE
(TLD)	M09B	Weinand Farm	4.7	178	S
(TLD)	M10B	Reisewitz Farm - Acacia Ave	4.2	204	SSW
(TLD)	M11B	Vanlith Farm - 97th Ave	4.0	228	SW
(TLD)	M12B	Lake Maria St. Park	4.2	254	WSW
(TLD)	M13B	Bridgewater Sta.	4.1	270	W
(TLD)	M14B	Anderson Res. - Cty Rd 111	4.3	289	WNW
(TLD)	M15B	Red Oak Wild Bird Farm	4.3	309	NW
(TLD)	M16B	Sand Plain Research Farm	4.4	341	NNW

<b>MONTICELLO NUCLEAR GENERATING PLANT</b>		ODCM-07.01
<b>TITLE:</b>	<b>RADIOLOGICAL ENVIRONMENTAL MONITORING PROGRAM</b>	Revision 25
		Page 26 of 28

Table 4 Monticello Nuclear Generating Plant Radiological Environmental Monitoring Program Sampling Locations (Cont'd)

Type of Sample	Code	Collection Site	Location		
			Distance Miles	Compass Heading	Sector
Direct Radiation - (special interest locations)					
(TLD)	M01S	Osowski Fun Market	0.66	241	WSW
(TLD)	M02S & ISFSI-16 (neutron)	Krone Residence	0.5	220	SW
(TLD)	M03S	Big Oaks Park	1.53	103	ESE
(TLD)	M04S	Pinewood School	2.3	131	SE
(TLD)	M05S	Rivercrest Christian Academy	3.0	118	ESE
(TLD)	M06S	Monticello Public Works	2.6	134	SE
(TLD)	I-11 & ISFSI-11 (neutron)	OCA Fence South, on exit road	0.31	222	SW
(TLD)	I-12 & ISFSI-12 (neutron)	OCA Fence Middle, on exit road	0.32	230	SW
(TLD)	I-13 & ISFSI-13 (neutron)	OCA Fence North, on exit road	0.34	240	WSW
Direct Radiation - (10 to 12 miles distant from plant)					
(TLD)	M01C & Neutron Control D	Kirchenbauer Farm	11.5	323	NW
(TLD)	M02C & Neutron Control C	Cty Rd 4 & 15	11.2	47	NE
(TLD)	M03C & Neutron Control A	Cty Rd 19 & Jason Ave	11.6	130	SE
(TLD)	M04C & Neutron Control B	Maple Lake Water Tower	10.3	226	SW



<b>MONTICELLO NUCLEAR GENERATING PLANT</b>		ODCM-07.01
<b>TITLE:</b>	<b>RADIOLOGICAL ENVIRONMENTAL MONITORING PROGRAM</b>	Revision 25
		Page 27 of 28

Table 4 Monticello Nuclear Generating Plant Radiological Environmental Monitoring Program  
Sampling Locations (Cont'd)

Notes on Table 4:

"c" denotes control locations. All other locations are indicator locations.

The letters after TLD code numbers have the following meanings:

- A Locations in the general area of the site boundary;
- B Locations about 4 to 5 miles distant from the plant
- C Locations of control TLDs greater than 10 miles from the plant;
- S Special interest locations.

<b>MONTICELLO NUCLEAR GENERATING PLANT</b>		ODCM-07.01
<b>TITLE:</b>	<b>RADIOLOGICAL ENVIRONMENTAL MONITORING PROGRAM</b>	Revision 25
		Page 28 of 28

Table 5 Non-REMP ISFSI Monitoring Locations<sup>a</sup>

Type of Sample	Code	Location
(TLD)	ISFSI-1 (neutron) and I-01 (gamma)	NE corner of ISFSI
(TLD)	ISFSI-2 (neutron) and I-02 (gamma)	North side of ISFSI, center
(TLD)	ISFSI-3 (neutron) and I-03 (gamma)	NW corner of ISFSI
(TLD)	ISFSI-4 (neutron) and I-04 (gamma)	West side of ISFSI, middle
(TLD)	ISFSI-5 (neutron) and I-05 (gamma)	West side of ISFSI, at center of array
(TLD)	ISFSI-6 (neutron) and I-06 (gamma)	SW corner of ISFSI
(TLD)	ISFSI-7 (neutron) and I-07 (gamma)	South side of ISFSI, center
(TLD)	ISFSI-8 (neutron) and I-08 (gamma)	SE corner of ISFSI
(TLD)	ISFSI-9 (neutron) and I-09 (gamma)	East side of ISFSI, at center of array
(TLD)	ISFSI-10 (neutron) and I-10 (gamma)	East side of ISFSI, middle

Notes for Table 5:

- a Neutron and Gamma TLDs located around the ISFSI pad are not considered REMP samples. These TLDs are provided to ensure that radiation due to spent fuel storage is adequately monitored and consistent with expected dose rates.

<b>MONTICELLO NUCLEAR GENERATING PLANT</b>		ODCM-08.01
<b>TITLE:</b>	<b>REPORTING REQUIREMENTS</b>	Revision 9
		Page 1 of 8

Approval: PCR 01480983

**OFFSITE DOSE CALCULATION MANUAL - TABLE OF CONTENTS**

<u><b>SECTION</b></u>		<u><b>PAGE</b></u>
1.0	RECORD OF REVISION .....	2
2.0	REPORTING REQUIREMENTS.....	3
2.1	Radioactive Effluent Release Report .....	3
2.2	Radiological Environmental Operating Report .....	5
2.3	Annual Summary of Meteorological Data .....	6
2.4	Industry Initiative on Groundwater Protection.....	6
2.5	Record Retention .....	8

<b>MONTICELLO NUCLEAR GENERATING PLANT</b>		ODCM-08.01
<b>TITLE:</b>	<b>REPORTING REQUIREMENTS</b>	Revision 9
		Page 2 of 8

## 1.0 RECORD OF REVISION

<u>Revision No.</u>	<u>Reason for Revision</u>
1	Moved previous ODCM-08.01 contents to ODCM-APP-B, Rev 0. Changed this section name to "REPORTING REQUIREMENTS" and incorporated applicable sections of T.S. sections 6.6.A, 6.6.B, 6.7.A.4, 6.7.A.5, and 6.7.C into this document.
2	Corrected above revision number to Revision 1. Changed 2.5.1. from T.S.6.6.A to OQAP, section 19.12.1. Changed 2.5.2. from T.S.6.6.B to OQAP, section 19.12.2.
3	Incorporated changes made during the conversion of the Current Technical Specifications to the Improved Technical Specifications. This includes dual step annotation.
4	Incorporated NEI Enhanced Groundwater Protection initiative reporting requirements. Changed 2.5.1 to remove reference to OQAP and refer to Fleet Procedure FP-G-RM-01 (RECORDS MANAGEMENT). Incorporated 2.5.2 into 2.5.1.
5	Added NEI to agencies to be notified as part of voluntary communication. Revised voluntary communication criteria per NEI 07-07[Final], August, 2007.
6.	Added reporting requirements, per NEI-07-07 (August 2007), in sections 2.1.10 and 2.2.9.
7.	Revised information to be included for solid waste shipped off-site on the Radioactive Effluent Release Report; sections 2.1.5.E and F.
8.	Enhanced reporting requirements in section 2.2.2 to clarify the data that is required to be in the annual report. This enhancement is a result of CAP 01343310.
9.	Revised REMP Reporting requirements to match TS5.6.1. (AR01480497) Moved TS verbiage under primary section headings in 2.1 and 2.2. and changed wording to match TSs 5.6.1 and 5.6.2. Moved groundwater reporting to ARERR (AR01489004). Changed leafy green vegetable to vegetation. Leafy Green Vegetables are no longer obtained. Various editorial corrections.

<b>MONTICELLO NUCLEAR GENERATING PLANT</b>		ODCM-08.01
<b>TITLE:</b>	<b>REPORTING REQUIREMENTS</b>	Revision 9
		Page 3 of 8

## 2.0 REPORTING REQUIREMENTS

### 2.1 Annual Radioactive Effluent Release Report (ARERR)

In accordance with Tech Spec 5.6.2, the ARERR covering the operation of the unit during the previous year **SHALL** be submitted prior to May 15 of each year in accordance with 10 CFR 50.36a. The report **SHALL** include a summary of the quantities of radioactive liquid and gaseous effluents and solid waste released from the unit. The material provided **SHALL** be consistent with the objectives outlined in the ODCM and Process Control Program and in conformance with 10 CFR 50.36a and 10 CFR Part 50, Appendix I, Section IV.B.1.

- 2.1.1 The ARERR **SHALL** include a summary of the quantities of radioactive liquid and gaseous effluents and solid waste released as outlined in Appendix B of Regulatory Guide 1.21, Revision 1, June, 1974, with the data summarized on a quarterly basis. In the event that some results are not available for inclusion with the report, the report **SHALL** be submitted noting and explaining the reasons for the missing results. The missing data **SHALL** be submitted as soon as possible in a supplementary report.
- 2.1.2 The ARERR **SHALL** include an assessment of the radiation doses from radioactive effluents released from the unit during the previous calendar year. This report **SHALL** also include an assessment of the radiation doses from radioactive liquid and gaseous effluents to the individuals due to their activities inside the site boundary (ODCM-02.01 Figure 1 and ODCM-03.01 Figure 1) during the report period. All assumptions used in making these assessments (i.e., specific activity, exposure time and location) **SHALL** be included in the reports. The assessment of radiation doses **SHALL** be performed in accordance with the ODCM or standard NRC computer codes.
- 2.1.3 The ARERR **SHALL** also include an assessment of radiation doses to the most likely exposed member of the public from reactor releases and other nearby uranium fuel cycle sources (including doses from primary effluent pathways and direct radiation) for the previous calendar year to show compliance with 40 CFR 190, Environmental Radiation Protection Standards for Nuclear Power Operation.
- 2.1.4 The ARERR **SHALL** include the following information for solid waste shipped off-site during the report period.
- A. Container volume
  - B. Total curie quantity (specify whether determined by measurements or estimate),
  - C. Principal radionuclides (specify whether determined by measurement or estimate),

<b>MONTICELLO NUCLEAR GENERATING PLANT</b>		ODCM-08.01
<b>TITLE:</b>	<b>REPORTING REQUIREMENTS</b>	Revision 9
		Page 4 of 8

- D. Type of waste (e.g., spent resin, compacted dry waste),
  - E. Mode of Transportation.
  - F. Transportation Destination.
- 2.1.5 The ARERR **SHALL** include unplanned releases from the site of radioactive materials in gaseous and liquid effluents on a quarterly basis.
- 2.1.6 The ARERR **SHALL** include a description of changes to the Process Control Program (PCP).
- 2.1.7 The ARERR **SHALL** contain a report of when milk or vegetation samples specified in ODCM-07.01 Table 1 cannot be obtained from the designated sample locations, and identify the new locations added to and deleted from the monitoring program.
- 2.1.8 The ARERR **SHALL** identify Land Use Census identified locations which yield a calculated dose or dose commitment (via the same exposure pathway) 20 percent greater than at a location from which samples are currently being obtained in accordance with ODCM-07.01 Control 2.1.1.
- 2.1.9 The ARERR **SHALL** include on-site ground water sample results for:
- A. Samples that are taken in support of the Industry Groundwater Protection Initiative (NEI 07-07) but are not part of the REMP program; and
  - B. Samples from long-term monitoring sample points that are not included in the REMP.
- 2.1.10 The ARERR **SHALL** include a description of all leaks or spills that are communicated per section 2.4.2.
- 2.1.11 The ARERR **SHALL** include a description of all on-site or off-site groundwater sample results that exceeded REMP reporting thresholds that were communicated per section 2.4.2.B.

<b>MONTICELLO NUCLEAR GENERATING PLANT</b>		ODCM-08.01
<b>TITLE:</b>	<b>REPORTING REQUIREMENTS</b>	Revision 9
		Page 5 of 8

## 2.2 Annual Radiological Environmental Operating Report (AREOR)

In accordance with Tech Spec 5.6.1, the AREOR covering the operation of the unit during the previous calendar year **SHALL** be submitted by May 15 of each year. The report **SHALL** include summaries, interpretations, and analyses of trends of the results of the Radiological Environmental Monitoring Program for the reporting period. The material provided **SHALL** be consistent with the objectives outlined in the Offsite Dose Calculation Manual (ODCM), and in 10 CFR 50, Appendix I, Sections IV.B.2, IV.B.3, and IV.C.

The AREOR **SHALL** include the results of analyses of all radiological environmental samples and of all environmental radiation measurements taken during the period pursuant to the locations specified in the table and figures in the ODCM, as well as summarized and tabulated results of these analyses and measurements in the format of the table in the Radiological Assessment Branch Technical Position, Revision 1, November 1979. In the event that some individual results are not available for inclusion with the report, the report **SHALL** be submitted noting and explaining the reasons for the missing results. The missing data **SHALL** be submitted in a supplementary report as soon as possible.

- 2.2.1 The AREOR **SHALL** also include the results of the land use census required by ODCM-07.01 Control 2.2.1. If harmful effects or evidence of irreversible damage are detected by the monitoring, the report **SHALL** provide an analysis of the problem and a planned course of action to alleviate the problem.
- 2.2.2 The AREOR **SHALL** include the following: a summary description of the Radiological Environmental Monitoring Program; a map of sampling locations keyed to a table giving distances and directions from the reactor; and the results of licensee participation in the Interlaboratory Comparison Program, required by ODCM-07.01 Control 2.4.1.A.
- 2.2.3 The AREOR **SHALL** include reasons for all deviations from the REMP sampling program as specified in ODCM-07.01 Table 1 and plans for the prevention of a recurrence, if applicable.
- 2.2.4 If the level of radioactivity in an environmental sampling medium at a specified location exceeds the reporting levels of ODCM-07.01 Table 2 for the sample type specified in ODCM-07.01 Table 1 and is NOT the result of plant effluents, the condition **SHALL** be reported in the AREOR.
- 2.2.5 A summary of the Interlaboratory Comparison Program **SHALL** be included in the AREOR. If the required Interlaboratory Comparison Program analyses are NOT performed, corrective action **SHALL** be reported in the AREOR.

<b>MONTICELLO NUCLEAR GENERATING PLANT</b>		ODCM-08.01
<b>TITLE:</b>	<b>REPORTING REQUIREMENTS</b>	Revision 9
		Page 6 of 8

### 2.3 Annual Summary of Meteorological Data

The annual summary of meteorological data **SHALL** be submitted for the previous calendar year in the form of joint frequency tables of wind speed, wind direction, and atmospheric stability at the request of the Nuclear Regulatory Commission.

### 2.4 Industry Initiative on Groundwater Protection (NEI 07-07)

**NOTE:** For purposes of this section, groundwater is defined as any subsurface moisture or water, regardless of where it is located beneath the earth's surface; any water located in wells, regardless of depth, type, or whether it is potable; water in storm drains, unless it has been demonstrated that the storm drains do not leak to ground; and water in sumps that communicate with subsurface water.

#### 2.4.1 30-day report to NRC

- A. Submit the NRC within 30 days, a special report for any on-site or off-site groundwater sample that:
  - 1. Exceeds the ODCM criteria for 30-day reporting for off-site samples; and
  - 2. Could potentially reach groundwater that is or could be used in the future as a source of drinking water. Any groundwater that is potable should be considered as a potential source of drinking water.
- B. Include the following items in the report:
  - 1. A statement that the report is being submitted as part of NEI Enhanced Groundwater Protection Initiative;
  - 2. Level and nature of the contaminant;
  - 3. Actions taken and related sample results to date;
  - 4. Determination of potential or bounding annual dose to a member of the public; and
  - 5. Any necessary corrective actions to be taken to reduce the potential annual dose to a member of the public to less than the calendar year limits of the ODCM.
- C. Concurrently, provide copies of the 30-day written report to the designated State and Local Officials.



<b>MONTICELLO NUCLEAR GENERATING PLANT</b>		ODCM-08.01
<b>TITLE:</b>	<b>REPORTING REQUIREMENTS</b>	Revision 9
		Page 7 of 8

#### 2.4.2 Voluntary Communications to State/Local Officials

- A. Make informal communications by the end of next business day to the designated State/Local officials if an inadvertent leak or spill to the environment has or can potentially get into the ground water and exceeds any of the following criteria:
1. Leak or spill exceeds 100 gallons from a source containing licensed material;
  2. Volume of spill or leak cannot be quantified but is likely to exceed 100 gallons from a source containing licensed material; or
  3. Any leak or spill, regardless of volume or activity, deemed by the licensee to warrant voluntary communication.
- B. Communication with the designated State/Local officials **SHALL** be made before the end of the next business day for a water sample result that meets either of the following criteria:
1. A sample of off-site ground water or surface water exceeds any of the REMP reporting criteria for water; or
  2. A sample of on-site surface water, that is hydrologically connected to ground water, or ground water that is or could be used as a source of drinking water, exceeds any REMP reporting criteria for water.
- The basis for concluding that the on-site ground water is not or would not be considered a source of drinking water **SHALL** be documented.
- C. When communicating with State/Local officials, be clear and precise in quantifying the actual release information as it applies to the appropriate regulatory criteria. The following information should be provided as part of the communication:
1. That the communication is being made as part of the NEI Enhanced Ground Water Protection Initiative;
  2. Date and time of spill, leak, or sample result(s);
  3. Whether or not the spill has been contained or the leak has been stopped;
  4. If known, the location of the leak or spill or water sample(s);
  5. Source of the leak or spill, if known;

<b>MONTICELLO NUCLEAR GENERATING PLANT</b>		ODCM-08.01
<b>TITLE:</b>	<b>REPORTING REQUIREMENTS</b>	Revision 9
		Page 8 of 8

6. List of the contaminant(s) and verified concentration(s);
  7. Description of action(s) already taken and a general description of future actions;
  8. An estimate of the potential or bounding annual dose to a member of the public, if available; and
  9. An estimated time/date to provide additional information or follow-up.
- D. Contact NEI by e-mail to GW\_Notice@nei.org as part of voluntary communication event.
  - E. Following communication with State/Local officials and NEI, complete a 4-hour 10 CFR 50.72 NRC notification.

## **2.5 Record Retention**

2.5.1 The following records **SHALL** be maintained in accordance with FP-G-RM-01 (QUALITY ASSURANCE RECORDS CONTROL) for the life of the corporation plus 10 years:

- A. Periodic checks, inspections, tests and calibrations of components and systems as related to the specifications and treatment systems defined in the ODCM.
- B. Records of wind speed and direction.
- C. Records of reviews performed for changes made to the Offsite Dose Calculation Manual.
- D. Liquid and gaseous radioactive releases to the environs.
- E. Off-site environmental surveys
- F. Radioactive shipments

<b>MONTICELLO NUCLEAR GENERATING PLANT</b>		ODCM-APP-A
<b>TITLE:</b>	<b>APPENDIX A</b>	Revision 3
		Page 1 of 71

Approval: ODC 01473823

**OFFSITE DOSE CALCULATION MANUAL - TABLE OF CONTENTS**

<b><u>SECTION</u></b>	<b><u>PAGE</u></b>
1.0 RECORD OF REVISION .....	2
2.0 SUMMARY OF DISPERSION CALCULATION PROCEDURES .....	3
2.1 References.....	4
Table 1 Monticello Release Conditions .....	5
Table 2 Distances to Controlling Unrestricted Area Boundary Locations .....	6
Table 3 Monticello Reactor Vent Dispersion Parameters for Long Term Mixed Mode Releases > 500 Hrs /Yr or >150 Hrs / Qtr .....	7
Table 4 Monticello Reactor Vent Dispersion Parameters for Long Term Mixed Mode Releases > 500 Hrs/Yr or >150 Hrs/Qtr .....	8
Table 5 Monticello Reactor Vent Dispersion Parameters for Long Term Mixed Mode Releases > 500 Hrs/Yr or >150 Hrs/Qtr .....	13
Table 6 Monticello Offgas Stack Dispersion Parameters for Long Term Elevated Releases > 500 Hrs/Yr or >150 Hrs/Qtr .....	21
Table 7 Monticello Offgas Stack Dispersion Parameters for Long Term Elevated Releases > 500 Hrs/Yr or >150 Hrs/Qtr .....	22
Table 8 Monticello Offgas Stack Dispersion Parameters for Long Term Elevated Releases > 500 Hrs/Yr or >150 Hrs/Qtr .....	30
Table 9 Monticello Offgas Stack Dispersion Parameters for Short Term Elevated Releases ≤ 500 Hrs/Yr or ≤150 Hrs/Qtr.....	38
Table 10 Monticello Offgas Stack Dispersion Parameters for Short Term Elevated Releases ≤ 500 Hrs/Yr or ≤150 Hrs/Qtr.....	39
Table 11 Monticello Offgas Stack Dispersion Parameters for Short Term Elevated Releases ≤ 500 HrsYr or ≤150 Hrs/Qtr.....	47
Table 12 Monticello Reactor Building Vent Dispersion Parameters for Short Term Elevated Releases ≤ 500 Hrs/Yr or ≤150 Hrs/Qtr .....	55
Table 13 Reactor Building Vent Dispersion Parameters for Short Term Elevated Releases ≤ 500 Hrs/Yr or ≤150 Hrs/Qtr.....	56
Table 14 Reactor Building Vent Dispersion Parameters for Short Term Elevated Releases ≤ 500 Hrs/Yr or ≤150 Hrs/Qtr.....	64

<b>MONTICELLO NUCLEAR GENERATING PLANT</b>		ODCM-APP-A
<b>TITLE:</b>	<b>APPENDIX A</b>	Revision 3
		Page 2 of 71

**1.0 RECORD OF REVISION**

<u>Revision No.</u>	<u>Date</u>	<u>Reason for Revision</u>
0	October - 2000	Moved previous ODCM-06.01 tables into this Appendix to make the ODCM easier to use.
1	June - 2010	Various items cleaned up from document conversion to Word.
2	December - 2013	Added statement to address changing $\chi/Q$ and D/Q values and the practice for updating values. CAP 01397500
3	May - 2014	Updated Table 4 with new $\chi/Q$ data following new calculations using MET data from 2006 to 2010 IAW Section 2.0, paragraph 6 of this procedure. PCR 01424740. CAP 01397500.

<b>MONTICELLO NUCLEAR GENERATING PLANT</b>		ODCM-APP-A
<b>TITLE:</b>	<b>APPENDIX A</b>	Revision 3
		Page 3 of 71

## 2.0 SUMMARY OF DISPERSION CALCULATION PROCEDURES

Updepleted, undecayed dispersion parameters were computed using the computer program XOQDOQ (Sagendorf and Goll, 1977). Specifically, sector average  $\chi/Q$  and D/Q values were obtained for a sector width of 22.5 degrees. Credit was taken for momentum plume rise and effective plume height was adjusted for local terrain height for elevated releases. Building wake corrections were used to adjust calculations for ground-level releases. Standard open terrain recirculation correction factors were also applied as available as default values in XOQDOQ.

Dispersion calculations were based on mixed mode releases for the reactor vent and on elevated releases for the offgas stack. A summary of release conditions used as input to XOQDOQ is presented in Table 1 and controlling site boundary distances are defined in Table 2. Computed  $\chi/Q$  and D/Q values for unrestricted area boundary locations (relative to release points) and for standard distances (to five miles from the source in 0.1 mile increments) are presented in Tables 3 through 11.

For certain meteorological and release conditions, the enveloping interpolation routines in XOQDOQ used to compute short-term  $\chi/Q$  and D/Q values do not provide reasonable results. Because of this, results were reviewed for consistency and where possible, the distributions of calculated  $\chi/Q$  values were enveloped and interpolated by hand.

In some cases, use of the NRC methodology is implemented in XOQDOQ for estimating short term dispersion values results in values which are lower than the annual values. For these cases, the annual average  $\chi/Q$  and D/Q values are used to conservatively represent short-term values.  $\chi/Q$  and D/Q values for on-site EPA locations were adjusted (multiplied by a factor of 0.238) to account for limited daily exposure of workers in accordance with NUREG-0473<sup>(2)</sup>.

On-site meteorological data for the period September 1, 1976 through August 31, 1978 (as presented in Appendix B) were used as input to XOQDOQ. Data were collected and  $\Delta T$  stability classes were defined in conformance with NRC Regulatory Guide 1.23<sup>(3)</sup>. Dispersion calculations for the reactor vent were based on  $\Delta T_{42.7-10m}$  and 10 meter wind data (joint data recovery of 94 percent). Dispersion calculations for the offgas stack were based on  $\Delta T_{100-10m}$  and 100 meter wind data (joint data recovery of 95 percent).

Review of  $\chi/Q$  and D/Q values are performed every 5 years using the previous 5 years data. If the  $\chi/Q$  or D/Q values increase by greater than 20% from the original analysis, then the values in APP-A should be updated. There is no specific guidance for reviewing and revising the  $\chi/Q$  and D/Q values in the ODCM. MNGP has selected 5 years as a frequency and 20% increase for revision based on industry practice and recommendations. The 5 year data set review insures that there is enough data to prevent one year of abnormal meteorological data adversely affecting the average data. An increase in  $\chi/Q$  or D/Q of greater than 20% prevents statistically insignificant changes in weather patterns having a large effect on environmental monitoring and dose calculations.

<b>MONTICELLO NUCLEAR GENERATING PLANT</b>		ODCM-APP-A
<b>TITLE:</b>	<b>APPENDIX A</b>	Revision 3
		Page 4 of 71

## 2.1 References

1. Sagendorf, J. F. and Goll, J. T., XOQDOQ Program for the Evaluation of Routine Effluent Releases at Nuclear Power Stations. NUREG 0324, U.S. Nuclear Regulatory Commission, September 1977.
2. NUREG-0473
3. USNRC Regulatory Guide 1.23

<b>MONTICELLO NUCLEAR GENERATING PLANT</b>		ODCM-APP-A
<b>TITLE:</b>	<b>APPENDIX A</b>	Revision 3
		Page 5 of 71

Table 1 Monticello Release Conditions

	Reactor Vent	Off-Gas Stack
Release Type	Mixed mode (Long and short-term)	Elevated (Long and short-term)
Release point height, m	42	100
Adjacent building height, m	42	42
Relative location to adjacent structures	Adjacent to Turbine Building	400' SE of Reactor Building
Exit velocity, m/Sec	6.1	19.0
Internal stack diameter, m	2.41	0.36
Building cross-sectional area*, m <sup>2</sup>	1480	N/A
Purge frequency**, times per year	6	6
Purge duration**, hours/release	24	24

\* Applied to ground level releases.

\*\* Applied to short-term calculations only.

<b>MONTICELLO NUCLEAR GENERATING PLANT</b>		ODCM-APP-A
<b>TITLE:</b>	<b>APPENDIX A</b>	Revision 3
		Page 6 of 71

Table 2 Distances to Controlling Unrestricted Area Boundary Locations

Miles

Column 1 As measured from Reactor Vent		Column 2* As Measured from Offgas Stack	
Sector	Distance	Sector	Distance
N	0.51	N	0.59
NNE	0.58	N	0.63
NE	0.65	NNE	0.65
ENE	0.83	ENE	0.78
E	0.59	E	0.50
ESE	0.59	E	0.50
SE	0.61	SSE	0.51
SSE	0.43	S	0.36
S	0.34	SSW	0.31
SSW	0.32	SW	0.33
SW	0.32	SW	0.33
WSW	0.35	WSW	0.38
W	0.48	W	0.56
WNW	0.68	NW	0.78
NW	0.43	NW	0.53
NNW	0.53	NNW	0.61

\* Locations specified in Column 2 are the same geographic points as specified in Column 1 although the reference points are different.



<b>MONTICELLO NUCLEAR GENERATING PLANT</b>		ODCM-APP-A
<b>TITLE:</b>	<b>APPENDIX A</b>	Revision 3
		Page 7 of 71

Table 3 Monticello Reactor Vent Dispersion Parameters for Long Term Mixed Mode Releases  
> 500 Hrs /Yr or >150 Hrs / Qtr

Site Boundary Sector*	$\chi/Q$ (sec/m <sup>3</sup> )	D/Q (m <sup>-2</sup> )
N	2.09E-06	2.89E-08
NNE	1.29E-06	1.82E-08
NE	7.76E-07	9.42E-09
ENE	6.11E-07	5.62E-09
E	1.38E-06	1.45E-08
ESE	2.42E-06	3.15E-08
SE	2.53E-06	3.30E-08
SSE	4.08E-06	5.95E-08
S	2.30E-06	3.08E-08
SSW	1.80E-06	2.13E-08
SW	1.96E-06	2.54E-08
WSW	1.54E-06	1.72E-08
W	1.10E-06	1.23E-08
WNW	1.22E-06	1.19E-08
NW	2.11E-06	2.61E-08
NNW	1.87E-06	2.55E-08

Period of record: 9-1-76 to 8-31-78

\* Measured relevant to the Reactor Vent.

<b>MONTICELLO NUCLEAR GENERATING PLANT</b>		ODCM-APP-A
<b>TITLE:</b>	<b>APPENDIX A</b>	Revision 3
		Page 8 of 71

Table 4 Monticello Reactor Vent Dispersion Parameters for Long Term Mixed Mode Releases  
> 500 Hrs/Yr or >150 Hrs/Qtr

For Standard Distances (As Measured from the Reactor Vent) ( $\chi/Q$ ), sec/m<sup>3</sup>  
Miles

Sector*	Distance in Miles from Vent									
	0.1	0.2	0.3	0.4	0.5	0.6	0.7	0.8	0.9	1.0
N	3.40E-05	1.00E-05	5.30E-06	3.50E-06	2.68E-06	2.20E-06	1.90E-06	1.60E-06	1.40E-06	1.15E-06
NNE	1.60E-05	5.10E-06	2.70E-06	1.90E-06	1.45E-06	1.20E-06	1.10E-06	9.70E-07	8.30E-07	7.15E-07
NE	5.30E-06	1.80E-06	1.00E-06	6.90E-07	5.71E-07	5.20E-07	5.20E-07	5.10E-07	4.70E-07	4.32E-07
ENE	5.70E-06	2.10E-06	1.10E-06	7.80E-07	6.36E-07	5.70E-07	5.60E-07	5.50E-07	5.10E-07	4.73E-07
E	1.30E-05	4.30E-06	2.30E-06	1.60E-06	1.25E-06	1.10E-06	9.90E-07	9.00E-07	7.90E-07	7.04E-07
ESE	1.70E-05	5.50E-06	3.00E-06	2.10E-06	1.69E-06	1.50E-06	1.30E-06	1.20E-06	1.00E-06	8.84E-07
SE	2.30E-05	6.90E-06	3.90E-06	2.70E-06	2.16E-06	1.90E-06	1.70E-06	1.50E-06	1.20E-06	1.08E-06
SSE	3.00E-05	9.30E-06	5.10E-06	3.60E-06	2.93E-06	2.60E-06	2.30E-06	2.10E-06	1.80E-06	1.53E-06
S	1.20E-05	3.80E-06	2.10E-06	1.50E-06	1.26E-06	1.10E-06	1.10E-06	9.80E-07	8.60E-07	7.53E-07
SSW	8.20E-06	2.70E-06	1.60E-06	1.10E-06	9.44E-07	8.50E-07	8.10E-07	7.50E-07	6.70E-07	5.94E-07
SW	7.90E-06	2.50E-06	1.40E-06	1.00E-06	8.71E-07	8.00E-07	7.70E-07	7.20E-07	6.40E-07	5.80E-07
WSW	7.20E-06	2.30E-06	1.40E-06	1.00E-06	8.84E-07	8.30E-07	8.10E-07	7.70E-07	6.90E-07	6.21E-07
W	5.10E-06	1.80E-06	1.10E-06	8.00E-07	7.24E-07	7.20E-07	7.60E-07	7.70E-07	7.30E-07	6.82E-07
WNW	1.10E-05	3.50E-06	2.00E-06	1.40E-06	1.14E-06	1.00E-06	9.40E-07	8.70E-07	7.70E-07	6.94E-07
NW	1.20E-05	3.90E-06	2.10E-06	1.50E-06	1.16E-06	1.00E-06	9.30E-07	8.40E-07	7.30E-07	6.49E-07
NNW	2.20E-05	6.70E-06	3.60E-06	2.40E-06	1.87E-06	1.60E-06	1.40E-06	1.20E-06	1.10E-06	9.16E-07

Period of Record: 2006 to 2010

\* Measured relevant to the Reactor Vent.

M/eak

<b>MONTICELLO NUCLEAR GENERATING PLANT</b>		ODCM-APP-A
<b>TITLE:</b>	<b>APPENDIX A</b>	Revision 3
		Page 9 of 71

Table 4 Monticello Reactor Vent Dispersion Parameters for Long Term Mixed Mode Releases > 500 Hrs/Yr or >150 Hrs/Qtr  
(cont'd)  
For Standard Distances (As Measured from the Reactor Vent) ( $\chi/Q$ ), sec/m<sup>3</sup>  
Miles

Sector*	Distance in Miles from Vent									
	1.1	1.2	1.3	1.4	1.5	1.6	1.7	1.8	1.9	2.0
N	1.00E-06	8.80E-07	7.80E-07	7.00E-07	6.32E-07	5.80E-07	5.30E-07	4.90E-07	4.60E-07	4.26E-07
NNE	6.20E-07	5.50E-07	4.90E-07	4.50E-07	4.05E-07	3.70E-07	3.40E-07	3.10E-07	2.90E-07	2.71E-07
NE	4.00E-07	3.60E-07	3.30E-07	3.10E-07	2.86E-07	2.70E-07	2.50E-07	2.30E-07	2.20E-07	2.03E-07
ENE	4.30E-07	4.00E-07	3.70E-07	3.40E-07	3.16E-07	2.90E-07	2.70E-07	2.60E-07	2.40E-07	2.27E-07
E	6.30E-07	5.80E-07	5.30E-07	4.80E-07	4.44E-07	4.10E-07	3.80E-07	3.50E-07	3.30E-07	3.08E-07
ESE	7.70E-07	6.80E-07	6.00E-07	5.40E-07	4.88E-07	4.40E-07	4.00E-07	3.70E-07	3.40E-07	3.14E-07
SE	9.50E-07	8.50E-07	7.60E-07	6.90E-07	6.24E-07	5.70E-07	5.20E-07	4.80E-07	4.50E-07	4.18E-07
SSE	1.30E-06	1.20E-06	1.00E-06	9.10E-07	8.19E-07	7.40E-07	6.70E-07	6.10E-07	5.60E-07	5.21E-07
S	6.60E-07	5.90E-07	5.30E-07	4.80E-07	4.37E-07	4.00E-07	3.70E-07	3.40E-07	3.10E-07	2.90E-07
SSW	5.30E-07	4.80E-07	4.40E-07	4.00E-07	3.65E-07	3.40E-07	3.10E-07	2.90E-07	2.70E-07	2.52E-07
SW	5.30E-07	4.80E-07	4.40E-07	4.00E-07	3.72E-07	3.40E-07	3.20E-07	3.00E-07	2.80E-07	2.61E-07
WSW	5.60E-07	5.10E-07	4.60E-07	4.30E-07	3.91E-07	3.60E-07	3.30E-07	3.10E-07	2.90E-07	2.71E-07
W	6.30E-07	5.90E-07	5.50E-07	5.10E-07	4.76E-07	4.40E-07	4.10E-07	3.90E-07	3.60E-07	3.43E-07
WNW	6.40E-07	5.90E-07	5.40E-07	5.00E-07	4.66E-07	4.30E-07	4.10E-07	3.80E-07	3.60E-07	3.36E-07
NW	5.80E-07	5.30E-07	4.80E-07	4.40E-07	4.01E-07	3.70E-07	3.40E-07	3.20E-07	3.00E-07	2.77E-07
NNW	8.00E-07	7.10E-07	6.40E-07	5.80E-07	5.27E-07	4.80E-07	4.40E-07	4.10E-07	3.80E-07	3.56E-07

Period of Record: 2006 to 2010

\* Measured relevant to the Reactor Vent.

Table 4 Monticello Reactor Vent Dispersion Parameters for Long Term Mixed Mode Releases > 500 Hrs/Yr or >150 Hrs/Qtr  
(cont'd)  
For Standard Distances (As Measured from the Reactor Vent) ( $\chi/Q$ ), sec/m<sup>3</sup>  
Miles

Sector*	Distance in Miles from Vent									
	2.1	2.2	2.3	2.4	2.5	2.6	2.7	2.8	2.9	3.0
N	4.00E-07	3.80E-07	3.60E-07	3.40E-07	3.21E-07	3.10E-07	2.90E-07	2.80E-07	2.70E-07	2.59E-07
NNE	2.50E-07	2.40E-07	2.20E-07	2.10E-07	1.99E-07	1.90E-07	1.80E-07	1.70E-07	1.60E-07	1.56E-07
NE	1.90E-07	1.80E-07	1.70E-07	1.60E-07	1.53E-07	1.50E-07	1.40E-07	1.30E-07	1.30E-07	1.21E-07
ENE	2.10E-07	2.00E-07	1.90E-07	1.80E-07	1.72E-07	1.60E-07	1.60E-07	1.50E-07	1.40E-07	1.37E-07
E	2.90E-07	2.70E-07	2.60E-07	2.40E-07	2.29E-07	2.20E-07	2.10E-07	2.00E-07	1.90E-07	1.78E-07
ESE	2.90E-07	2.70E-07	2.50E-07	2.40E-07	2.22E-07	2.10E-07	2.00E-07	1.90E-07	1.80E-07	1.67E-07
SE	3.90E-07	3.70E-07	3.40E-07	3.30E-07	3.08E-07	2.90E-07	2.80E-07	2.60E-07	2.50E-07	2.41E-07
SSE	4.80E-07	4.50E-07	4.20E-07	3.90E-07	3.67E-07	3.50E-07	3.30E-07	3.10E-07	2.90E-07	2.77E-07
S	2.70E-07	2.50E-07	2.40E-07	2.20E-07	2.10E-07	2.00E-07	1.90E-07	1.80E-07	1.70E-07	1.61E-07
SSW	2.40E-07	2.20E-07	2.10E-07	2.00E-07	1.88E-07	1.80E-07	1.70E-07	1.60E-07	1.50E-07	1.48E-07
SW	2.50E-07	2.30E-07	2.20E-07	2.10E-07	1.98E-07	1.90E-07	1.80E-07	1.70E-07	1.60E-07	1.58E-07
WSW	2.50E-07	2.40E-07	2.30E-07	2.10E-07	2.02E-07	1.90E-07	1.80E-07	1.70E-07	1.70E-07	1.60E-07
W	3.20E-07	3.10E-07	2.90E-07	2.80E-07	2.62E-07	2.50E-07	2.40E-07	2.30E-07	2.20E-07	2.09E-07
WNW	3.20E-07	3.00E-07	2.80E-07	2.70E-07	2.58E-07	2.50E-07	2.40E-07	2.30E-07	2.20E-07	2.08E-07
NW	2.60E-07	2.40E-07	2.30E-07	2.20E-07	2.06E-07	2.00E-07	1.90E-07	1.80E-07	1.70E-07	1.62E-07
NNW	3.30E-07	3.10E-07	2.90E-07	2.80E-07	2.64E-07	2.50E-07	2.40E-07	2.30E-07	2.20E-07	2.08E-07

Period of Record: 2006 to 2010

\* Measured relevant to the Reactor Vent.

Table 4 Monticello Reactor Vent Dispersion Parameters for Long Term Mixed Mode Releases > 500 Hrs/Yr or >150 Hrs/Qtr  
(cont'd)  
For Standard Distances (As Measured from the Reactor Vent) ( $\chi/Q$ ), sec/m<sup>3</sup>  
Miles

Sector*	Distance in Miles from Vent									
	3.1	3.2	3.3	3.4	3.5	3.6	3.7	3.8	3.9	4.0
N	2.50E-07	2.40E-07	2.30E-07	2.30E-07	2.18E-07	2.10E-07	2.10E-07	2.00E-07	1.90E-07	1.90E-07
NNE	1.50E-07	1.40E-07	1.40E-07	1.30E-07	1.28E-07	1.20E-07	1.20E-07	1.10E-07	1.10E-07	1.08E-07
NE	1.20E-07	1.10E-07	1.10E-07	1.00E-07	9.94E-08	9.60E-08	9.30E-08	8.90E-08	8.60E-08	8.37E-08
ENE	1.30E-07	1.30E-07	1.20E-07	1.20E-07	1.13E-07	1.10E-07	1.00E-07	1.00E-07	9.80E-08	9.50E-08
E	1.70E-07	1.60E-07	1.60E-07	1.50E-07	1.44E-07	1.40E-07	1.30E-07	1.30E-07	1.20E-07	1.20E-07
ESE	1.60E-07	1.50E-07	1.40E-07	1.40E-07	1.31E-07	1.30E-07	1.20E-07	1.20E-07	1.10E-07	1.07E-07
SE	2.30E-07	2.20E-07	2.10E-07	2.00E-07	1.97E-07	1.90E-07	1.80E-07	1.80E-07	1.70E-07	1.67E-07
SSE	2.60E-07	2.50E-07	2.40E-07	2.30E-07	2.19E-07	2.10E-07	2.00E-07	1.90E-07	1.90E-07	1.80E-07
S	1.50E-07	1.50E-07	1.40E-07	1.30E-07	1.30E-07	1.20E-07	1.20E-07	1.20E-07	1.10E-07	1.08E-07
SSW	1.40E-07	1.40E-07	1.30E-07	1.30E-07	1.21E-07	1.20E-07	1.10E-07	1.10E-07	1.10E-07	1.02E-07
SW	1.50E-07	1.50E-07	1.40E-07	1.40E-07	1.31E-07	1.30E-07	1.20E-07	1.20E-07	1.20E-07	1.12E-07
WSW	1.50E-07	1.50E-07	1.40E-07	1.40E-07	1.31E-07	1.30E-07	1.20E-07	1.20E-07	1.10E-07	1.11E-07
W	2.00E-07	1.90E-07	1.90E-07	1.80E-07	1.73E-07	1.70E-07	1.60E-07	1.60E-07	1.50E-07	1.47E-07
WNW	2.00E-07	1.90E-07	1.90E-07	1.80E-07	1.74E-07	1.70E-07	1.60E-07	1.60E-07	1.50E-07	1.50E-07
NW	1.50E-07	1.50E-07	1.40E-07	1.40E-07	1.32E-07	1.30E-07	1.20E-07	1.20E-07	1.10E-07	1.11E-07
NNW	2.00E-07	1.90E-07	1.80E-07	1.80E-07	1.70E-07	1.60E-07	1.60E-07	1.50E-07	1.50E-07	1.44E-07

Period of Record: 2006 to 2010

\* Measured relevant to the Reactor Vent.

Table 4 Monticello Reactor Vent Dispersion Parameters for Long Term Mixed Mode Releases > 500 Hrs/Yr or >150 Hrs/Qtr  
(cont'd)  
For Standard Distances (As Measured from the Reactor Vent) ( $\chi/Q$ ), sec/m<sup>3</sup>  
Miles

Sector*	Distance in Miles from Vent									
	4.1	4.2	4.3	4.4	4.5	4.6	4.7	4.8	4.9	5.0
N	1.90E-07	1.80E-07	1.80E-07	1.70E-07	1.69E-07	1.60E-07	1.60E-07	1.60E-07	1.60E-07	1.52E-07
NNE	1.00E-07	1.00E-07	9.90E-08	9.60E-08	9.33E-08	9.10E-08	8.90E-08	8.60E-08	8.40E-08	8.22E-08
NE	8.10E-08	7.90E-08	7.60E-08	7.40E-08	7.20E-08	7.00E-08	6.80E-08	6.60E-08	6.50E-08	6.30E-08
ENE	9.20E-08	8.90E-08	8.70E-08	8.40E-08	8.19E-08	8.00E-08	7.70E-08	7.50E-08	7.40E-08	7.17E-08
E	1.20E-07	1.10E-07	1.10E-07	1.10E-07	1.03E-07	1.00E-07	9.70E-08	9.40E-08	9.10E-08	8.90E-08
ESE	1.00E-07	9.90E-08	9.60E-08	9.30E-08	8.96E-08	8.70E-08	8.40E-08	8.10E-08	7.90E-08	7.66E-08
SE	1.60E-07	1.60E-07	1.50E-07	1.50E-07	1.44E-07	1.40E-07	1.40E-07	1.30E-07	1.30E-07	1.27E-07
SSE	1.70E-07	1.70E-07	1.60E-07	1.60E-07	1.51E-07	1.50E-07	1.40E-07	1.40E-07	1.30E-07	1.30E-07
S	1.00E-07	1.00E-07	9.70E-08	9.40E-08	9.15E-08	8.90E-08	8.60E-08	8.40E-08	8.20E-08	7.94E-08
SSW	9.90E-08	9.60E-08	9.40E-08	9.10E-08	8.85E-08	8.60E-08	8.40E-08	8.20E-08	8.00E-08	7.77E-08
SW	1.10E-07	1.10E-07	1.00E-07	1.00E-07	9.70E-08	9.50E-08	9.20E-08	9.00E-08	8.80E-08	8.55E-08
WSW	1.10E-07	1.00E-07	1.00E-07	9.90E-08	9.58E-08	9.30E-08	9.10E-08	8.90E-08	8.60E-08	8.43E-08
W	1.40E-07	1.40E-07	1.30E-07	1.30E-07	1.27E-07	1.20E-07	1.20E-07	1.20E-07	1.20E-07	1.12E-07
WNW	1.50E-07	1.40E-07	1.40E-07	1.40E-07	1.32E-07	1.30E-07	1.30E-07	1.20E-07	1.20E-07	1.18E-07
NW	1.10E-07	1.00E-07	1.00E-07	9.90E-08	9.59E-08	9.30E-08	9.10E-08	8.90E-08	8.60E-08	8.42E-08
NNW	1.40E-07	1.40E-07	1.30E-07	1.30E-07	1.25E-07	1.20E-07	1.20E-07	1.20E-07	1.10E-07	1.10E-07

Period of Record: 2006 to 2010

\* Measured relevant to the Reactor Vent.

<b>MONTICELLO NUCLEAR GENERATING PLANT</b>		ODCM-APP-A
<b>TITLE:</b>	<b>APPENDIX A</b>	Revision 3
		Page 13 of 71

Table 5 Monticello Reactor Vent Dispersion Parameters for Long Term Mixed Mode Releases  
> 500 Hrs/Yr or >150 Hrs/Qtr

For Standard Distances (As Measured from the Reactor Vent) (D/Q), /m<sup>2</sup>  
Miles

Sector*	0.1	0.2	0.3	0.4	0.5	0.6	0.7
N	2.75E-07	1.10E-07	6.31E-08	4.18E-08	3.01E-08	2.28E-08	1.80E-08
NNE	1.89E-07	7.89E-08	4.70E-08	3.17E-08	2.30E-08	1.74E-08	1.37E-08
NE	1.11E-07	4.68E-08	2.81E-08	1.91E-08	1.39E-08	1.06E-08	8.41E-09
ENE	1.03E-07	4.32E-08	2.61E-08	1.78E-08	1.31E-08	1.00E-08	7.94E-09
E	1.58E-07	6.46E-08	3.08E-08	2.56E-08	1.87E-08	1.42E-08	1.13E-08
ESE	3.79E-07	1.49E-07	8.53E-08	5.66E-08	4.09E-08	3.11E-08	2.46E-08
SE	4.31E-07	1.67E-07	9.41E-08	6.19E-08	4.43E-08	3.36E-08	2.65E-08
SSE	4.49E-07	1.77E-07	1.01E-07	6.65E-08	4.78E-08	3.62E-08	2.86E-08
S	1.47E-07	6.03E-08	3.58E-08	2.43E-08	1.79E-08	1.38E-08	1.10E-08
SSW	9.22E-08	3.85E-08	2.33E-08	1.62E-08	1.21E-08	9.50E-09	7.72E-09
SW	1.21E-07	4.80E-08	2.79E-08	1.90E-08	1.41E-08	1.10E-08	8.89E-09
WSW	8.33E-08	3.44E-08	2.07E-08	1.44E-08	1.09E-08	8.57E-09	7.01E-09
W	9.09E-08	3.80E-08	2.29E-08	1.58E-08	1.18E-08	9.18E-09	7.41E-09
WNW	1.51E-07	6.14E-08	3.65E-08	2.49E-08	1.83E-08	1.41E-08	1.13E-08
NW	1.86E-07	7.43E-08	4.30E-08	2.89E-08	2.11E-08	1.62E-08	1.29E-08
NNW	2.45E-07	9.85E-08	5.73E-08	3.82E-08	2.76E-08	2.10E-08	1.66E-08

Period of Record: 9-1-76 to 8-31-78

\* Measured relevant to the Reactor Vent.

<b>MONTICELLO NUCLEAR GENERATING PLANT</b>		ODCM-APP-A
<b>TITLE:</b>	<b>APPENDIX A</b>	Revision 3
		Page 14 of 71

Table 5 Monticello Reactor Vent Dispersion Parameters for Long Term Mixed Mode Releases  
> 500 Hrs/Yr or >150 Hrs/Qtr (cont'd)

For Standard Distances (As Measured from the Reactor Vent) (D/Q), /m<sup>2</sup>

Miles

Sector*	0.8	0.9	1.0	1.1	1.2	1.3	1.4
N	1.38E-08	1.02E-08	7.88E-09	6.23E-09	5.03E-09	4.14E-09	3.55E-09
NNE	1.05E-08	7.83E-09	6.02E-09	4.76E-09	3.85E-09	3.17E-09	2.72E-09
NE	6.48E-09	4.84E-09	3.74E-09	2.96E-09	2.40E-09	1.98E-09	1.66E-09
ENE	6.14E-09	4.60E-09	3.56E-09	2.83E-09	2.30E-09	1.90E-09	1.60E-09
E	8.71E-09	6.51E-09	5.04E-09	4.00E-09	3.24E-09	2.68E-09	2.24E-09
ESE	1.89E-08	1.41E-09	1.09E-08	8.64E-09	7.00E-09	5.77E-09	4.83E-09
SE	2.03E-08	1.51E-08	1.17E-08	9.22E-09	7.45E-09	6.14E-09	5.13E-09
SSE	2.19E-08	1.63E-08	1.26E-08	9.93E-09	8.03E-09	6.61E-09	5.75E-09
S	8.57E-09	6.44E-09	5.01E-09	3.99E-09	3.46E-09	2.85E-09	2.38E-09
SSW	6.08E-09	4.63E-09	3.63E-09	2.92E-09	2.39E-09	2.09E-09	1.76E-09
SW	6.99E-09	5.31E-09	4.16E-09	3.34E-09	2.73E-09	2.41E-09	2.02E-09
WSW	5.56E-09	4.86E-09	3.36E-09	2.71E-09	2.23E-09	1.86E-09	1.63E-09
W	5.81E-09	4.41E-09	3.45E-09	2.77E-09	2.27E-09	1.89E-09	1.65E-09
WNW	8.82E-09	7.50E-09	5.17E-09	4.13E-09	3.76E-09	2.79E-09	2.48E-09
NW	9.99E-09	7.50E-09	5.82E-09	4.63E-09	3.76E-09	3.11E-09	2.61E-09
NNW	1.27E-08	9.47E-09	7.30E-09	5.78E-09	4.67E-09	3.85E-09	3.32E-09

Period of Record: 9-1-76 to 8-31-78

\* Measured relevant to the Reactor Vent.



<b>MONTICELLO NUCLEAR GENERATING PLANT</b>		ODCM-APP-A
<b>TITLE:</b>	<b>APPENDIX A</b>	Revision 3
		Page 15 of 71

Table 5 Monticello Reactor Vent Dispersion Parameters for Long Term Mixed Mode Releases  
> 500 Hrs/Yr or >150 Hrs/Qtr (cont'd)

For Standard Distances (As Measured from the Reactor Vent) (D/Q), /m<sup>2</sup>

Sector*	Miles						
	1.5	1.6	1.7	1.8	1.9	2.0	2.1
N	3.00E-09	2.57E-09	2.22E-09	1.93E-09	1.70E-09	1.51E-09	1.34E-09
NNE	2.30E-09	1.97E-09	1.71E-09	1.49E-09	1.31E-09	1.16E-09	1.04E-09
NE	1.41E-09	1.21E-09	1.05E-09	9.18E-10	8.12E-10	7.20E-10	6.44E-10
ENE	1.36E-09	1.17E-09	1.01E-09	8.84E-10	7.81E-10	6.94E-10	6.20E-10
E	1.91E-09	1.64E-09	1.42E-09	1.24E-09	1.09E-09	9.71E-10	8.67E-10
ESE	4.09E-09	3.51E-09	3.04E-09	2.65E-09	2.34E-09	2.07E-09	1.85E-09
SE	4.34E-09	3.72E-09	3.22E-09	2.81E-09	2.48E-09	2.19E-09	1.96E-09
SSE	4.86E-09	4.16E-09	3.59E-09	3.13E-09	2.75E-09	2.43E-09	2.17E-09
S	2.03E-09	1.74E-09	1.50E-09	1.31E-09	1.16E-09	1.02E-09	9.13E-10
SSW	1.50E-09	1.33E-09	1.15E-09	1.01E-09	9.52E-10	8.43E-10	7.52E-10
SW	1.72E-09	1.52E-09	1.32E-09	1.15E-09	1.08E-09	9.53E-10	8.49E-10
WSW	1.39E-09	1.25E-09	1.09E-09	9.54E-10	9.16E-10	8.11E-10	7.23E-10
W	1.40E-09	1.24E-09	1.08E-09	9.44E-10	8.93E-10	7.91E-10	7.05E-10
WNW	2.10E-09	1.84E-09	1.59E-09	1.39E-09	1.28E-09	1.13E-09	1.01E-09
NW	2.22E-09	1.91E-09	1.65E-09	1.45E-09	1.28E-09	1.13E-09	1.01E-09
NNW	2.81E-09	2.40E-09	2.08E-09	1.81E-09	1.59E-09	1.42E-09	1.27E-09

Period of Record: 9-1-76 to 8-31-78

\* Measured relevant to the Reactor Vent.

<b>MONTICELLO NUCLEAR GENERATING PLANT</b>		ODCM-APP-A
<b>TITLE:</b>	<b>APPENDIX A</b>	Revision 3
		Page 16 of 71

Table 5 Monticello Reactor Vent Dispersion Parameters for Long Term Mixed Mode Releases  
> 500 Hrs/Yr or >150 Hrs/Qtr (cont'd)

For Standard Distances (As Measured from the Reactor Vent) (D/Q), /m<sup>2</sup>

Sector*	Miles						
	2.2	2.3	2.4	2.5	2.6	2.7	2.8
N	1.21E-09	1.09E-09	9.85E-10	8.97E-10	8.29E-10	7.64E-10	7.05E-10
NNE	9.29E-10	8.38E-10	7.60E-10	6.92E-10	6.33E-10	5.81E-10	5.35E-10
NE	5.78E-10	5.23E-10	4.83E-10	4.40E-10	4.03E-10	3.70E-10	3.41E-10
ENE	5.70E-10	5.14E-10	4.67E-10	4.25E-10	3.89E-10	3.57E-10	3.29E-10
E	7.79E-10	7.03E-10	6.38E-10	5.82E-10	5.32E-10	4.89E-10	4.51E-10
ESE	1.66E-09	1.50E-09	1.36E-09	1.24E-09	1.13E-09	1.04E-09	9.56E-10
SE	1.81E-09	1.63E-09	1.47E-09	1.35E-09	1.23E-09	1.13E-09	1.04E-09
SSE	1.94E-09	1.75E-09	1.59E-09	1.44E-09	1.32E-09	1.21E-09	1.11E-09
S	8.91E-10	7.38E-10	6.69E-10	6.09E-10	5.59E-10	5.16E-10	4.76E-10
SSW	6.74E-10	6.08E-10	5.51E-10	5.02E-10	4.60E-10	4.22E-10	3.90E-10
SW	7.61E-10	6.86E-10	6.22E-10	5.66E-10	5.18E-10	4.75E-10	4.38E-10
WSW	6.49E-10	5.85E-10	5.30E-10	4.83E-10	4.42E-10	4.07E-10	3.75E-10
W	6.33E-10	5.71E-10	5.18E-10	4.72E-10	4.32E-10	3.98E-10	3.67E-10
WNW	9.02E-10	8.14E-10	7.38E-10	6.72E-10	6.15E-10	5.66E-10	5.22E-10
NW	9.09E-10	8.48E-10	7.69E-10	7.00E-10	6.48E-10	5.95E-10	5.52E-10
NNW	1.14E-09	1.03E-09	9.29E-10	8.46E-10	7.77E-10	7.14E-10	6.59E-10

Period of Record: 9-1-76 to 8-31-78

\* Measured relevant to the Reactor Vent.

<b>MONTICELLO NUCLEAR GENERATING PLANT</b>		ODCM-APP-A
<b>TITLE:</b>	<b>APPENDIX A</b>	Revision 3
		Page 17 of 71

Table 5 Monticello Reactor Vent Dispersion Parameters for Long Term Mixed Mode Releases  
> 500 Hrs/Yr or >150 Hrs/Qtr (cont'd)

For Standard Distances (As Measured from the Reactor Vent) (D/Q), /m<sup>2</sup>

Sector*	Miles						
	2.9	3.0	3.1	3.2	3.3	3.4	3.5
N	6.52E-10	6.09E-10	5.67E-10	5.30E-10	5.00E-10	4.71E-10	4.46E-10
NNE	4.95E-10	4.59E-10	4.26E-10	3.97E-10	3.71E-10	3.48E-10	3.27E-10
NE	3.15E-10	2.92E-10	2.72E-10	2.53E-10	2.37E-10	2.22E-10	2.08E-10
ENE	3.04E-10	2.82E-10	2.62E-10	2.44E-10	2.28E-10	2.14E-10	2.01E-10
E	4.16E-10	3.86E-10	3.59E-10	3.34E-10	3.12E-10	2.93E-10	2.75E-10
ESE	8.83E-10	8.18E-10	7.60E-10	7.08E-10	6.61E-10	6.19E-10	5.80E-10
SE	9.59E-10	8.88E-10	8.25E-10	7.68E-10	7.17E-10	6.71E-10	6.30E-10
SSE	1.03E-09	9.56E-10	8.89E-10	8.28E-10	7.73E-10	7.24E-10	6.79E-10
S	4.42E-10	4.12E-10	3.93E-10	3.68E-10	3.44E-10	3.24E-10	3.05E-10
SSW	3.61E-10	3.35E-10	3.13E-10	2.92E-10	2.74E-10	2.58E-10	2.43E-10
SW	4.05E-10	3.76E-10	3.50E-10	3.27E-10	3.06E-10	2.87E-10	2.71E-10
WSW	3.47E-10	3.23E-10	3.01E-10	2.81E-10	2.64E-10	2.48E-10	2.34E-10
W	3.40E-10	3.16E-10	2.95E-10	2.76E-10	2.60E-10	2.44E-10	2.31E-10
WNW	4.83E-10	4.49E-10	4.19E-10	3.91E-10	3.68E-10	3.90E-10	3.98E-10
NW	5.13E-10	4.78E-10	4.54E-10	4.25E-10	3.99E-10	3.75E-10	3.53E-10
NNW	6.10E-10	5.66E-10	5.27E-10	4.92E-10	4.61E-10	4.33E-10	4.08E-10

Period of Record: 9-1-76 to 8-31-78

\* Measured relevant to the Reactor Vent.

<b>MONTICELLO NUCLEAR GENERATING PLANT</b>		ODCM-APP-A
<b>TITLE:</b>	<b>APPENDIX A</b>	Revision 3
		Page 18 of 71

Table 5 Monticello Reactor Vent Dispersion Parameters for Long Term Mixed Mode Releases  
> 500 Hrs/Yr or >150 Hrs/Qtr (cont'd)

For Standard Distances (As Measured from the Reactor Vent) (D/Q), /m<sup>2</sup>

Miles

Sector*	3.6	3.7	3.8	3.9	4.0	4.1	4.2
N	4.22E-10	4.00E-10	3.80E-10	3.62E-10	3.45E-10	3.30E-10	3.16E-10
NNE	3.08E-10	2.90E-10	2.74E-10	2.59E-10	2.46E-10	2.34E-10	2.22E-10
NE	1.96E-10	1.87E-10	1.75E-10	1.65E-10	1.57E-10	1.49E-10	1.41E-10
ENE	1.89E-10	1.78E-10	1.68E-10	1.59E-10	1.51E-10	1.43E-10	1.36E-10
E	2.58E-10	2.43E-10	2.29E-10	2.17E-10	2.05E-10	1.95E-10	1.85E-10
ESE	5.45E-10	5.13E-10	4.84E-10	4.57E-10	4.33E-10	4.10E-10	3.89E-10
SE	5.93E-10	5.58E-10	5.27E-10	4.98E-10	4.72E-10	4.48E-10	4.26E-10
SSE	6.46E-10	6.09E-10	5.76E-10	5.55E-10	5.27E-10	5.02E-10	4.79E-10
S	2.88E-10	2.73E-10	2.59E-10	2.46E-10	2.35E-10	2.24E-10	2.14E-10
SSW	2.30E-10	2.18E-10	2.07E-10	1.97E-10	1.88E-10	1.80E-10	1.72E-10
SW	2.55E-10	2.42E-10	2.29E-10	2.18E-10	2.28E-10	2.33E-10	2.22E-10
WSW	2.21E-10	2.10E-10	1.99E-10	1.90E-10	1.81E-10	1.73E-10	1.66E-10
W	2.19E-10	2.08E-10	1.98E-10	1.88E-10	1.80E-10	1.72E-10	1.65E-10
WNW	3.75E-10	3.55E-10	3.36E-10	3.19E-10	3.04E-10	2.89E-10	2.76E-10
NW	3.34E-10	3.17E-10	3.01E-10	2.86E-10	2.73E-10	2.61E-10	2.50E-10
NNW	3.85E-10	3.64E-10	3.45E-10	3.28E-10	3.12E-10	3.04E-10	2.90E-10

Period of Record: 9-1-76 to 8-31-78

\* Measured relevant to the Reactor Vent.

<b>MONTICELLO NUCLEAR GENERATING PLANT</b>		ODCM-APP-A
<b>TITLE:</b>	<b>APPENDIX A</b>	Revision 3
		Page 19 of 71

Table 5 Monticello Reactor Vent Dispersion Parameters for Long Term Mixed Mode Releases  
> 500 Hrs/Yr or >150 Hrs/Qtr (cont'd)

For Standard Distances (As Measured from the Reactor Vent) (D/Q), /m<sup>2</sup>

Miles

Sector*	4.3	4.4	4.5	4.6	4.7	4.8	4.9
N	3.03E-10	2.91E-10	2.80E-10	2.70E-10	2.61E-10	2.52E-10	2.44E-10
NNE	2.12E-10	2.02E-10	1.93E-10	1.84E-10	1.76E-10	1.69E-10	1.62E-10
NE	1.35E-10	1.28E-10	1.23E-10	1.17E-10	1.12E-10	1.07E-10	1.03E-10
ENE	1.29E-10	1.23E-10	1.18E-10	1.12E-10	1.08E-10	1.03E-10	9.88E-11
E	1.76E-10	1.67E-10	1.59E-10	1.52E-10	1.45E-10	1.39E-10	1.33E-10
ESE	3.70E-10	3.52E-10	3.35E-10	3.20E-10	3.05E-10	2.92E-10	2.79E-10
SE	4.05E-10	3.87E-10	3.69E-10	3.53E-10	3.38E-10	3.24E-10	3.11E-10
SSE	4.61E-10	4.41E-10	4.26E-10	4.09E-10	3.94E-10	3.80E-10	3.66E-10
S	2.05E-10	1.97E-10	1.90E-10	1.83E-10	1.76E-10	1.70E-10	1.65E-10
SSW	1.65E-10	1.59E-10	1.53E-10	1.48E-10	1.43E-10	1.38E-10	1.34E-10
SW	2.42E-10	2.42E-10	2.41E-10	2.30E-10	2.20E-10	2.10E-10	2.01E-10
WSW	1.59E-10	1.53E-10	1.58E-10	1.52E-10	1.47E-10	1.42E-10	1.37E-10
W	1.59E-10	1.53E-10	1.48E-10	1.43E-10	1.38E-10	1.34E-10	1.30E-10
WNW	2.64E-10	2.53E-10	2.42E-10	2.33E-10	2.24E-10	2.16E-10	2.08E-10
NW	2.39E-10	2.30E-10	2.22E-10	2.14E-10	2.07E-10	2.00E-10	1.93E-10
NNW	2.78E-10	2.67E-10	2.57E-10	2.47E-10	2.38E-10	2.30E-10	2.22E-10

Period of Record: 9-1-76 to 8-31-78

\* Measured relevant to the Reactor Vent.

<b>MONTICELLO NUCLEAR GENERATING PLANT</b>		ODCM-APP-A
<b>TITLE:</b>	<b>APPENDIX A</b>	Revision 3
		Page 20 of 71

Table 5 Monticello Reactor Vent Dispersion Parameters for Long Term Mixed Mode Releases  
> 500 Hrs/Yr or >150 Hrs/Qtr (cont'd)

For Standard Distances (As Measured from the Reactor Vent) (D/Q), /m<sup>2</sup>  
Miles

Sector*	5.0
N	2.36E-10
NNE	1.56E-10
NE	9.90E-11
ENE	9.49E-11
E	1.27E-10
ESE	2.68E-10
SE	2.99E-10
SSE	3.54E-10
S	1.60E-10
SSW	1.30E-10
SW	1.93E-10
WSW	1.33E-10
W	1.27E-10
WNW	2.01E-10
NW	1.87E-10
NNW	2.15E-10

Period of Record: 9-1-76 to 8-31-78

\* Measured relevant to the Reactor Vent.

<b>MONTICELLO NUCLEAR GENERATING PLANT</b>		ODCM-APP-A
<b>TITLE:</b>	<b>APPENDIX A</b>	Revision 3
		Page 21 of 71

Table 6 Monticello Offgas Stack Dispersion Parameters for Long Term Elevated Releases  
> 500 Hrs/Yr or >150 Hrs/Qtr

Site Boundary Sector*	$\chi/Q$ (Sec/m <sup>3</sup> )	D/Q (m <sup>-2</sup> )
N	7.04E-08	4.51E-09
NNE	7.06E-08	4.30E-09
NE	1.00E-07	6.18E-09
ENE	6.20E-08	2.34E-09
E	4.46E-08	2.77E-09
ESE	5.28E-08	3.93E-09
SE	5.50E-08	4.98E-09
SSE	3.99E-08	4.20E-09
S	1.83E-08	2.63E-09
SSW	1.17E-08	1.46E-09
SW	1.17E-08	1.46E-09
WSW	1.34E-08	1.34E-09
W	3.42E-08	1.67E-09
WNW	7.22E-08	2.43E-09
NW	5.67E-08	2.82E-09
NNW	1.08E-07	5.80E-09

Period of record: 9-1-76 to 8-31-78.

\* Measured relevant to the Reactor Vent.

<b>MONTICELLO NUCLEAR GENERATING PLANT</b>		ODCM-APP-A
<b>TITLE:</b>	<b>APPENDIX A</b>	Revision 3
		Page 22 of 71

Table 7 Monticello Offgas Stack Dispersion Parameters for Long Term Elevated Releases  
> 500 Hrs/Yr or >150 Hrs/Qtr

For Standard Distances (As Measured from the Offgas Stack) ( $\chi/Q$ ),  $\text{sec/m}^3$

Sector*	Miles						
	0.1	0.2	0.3	0.4	0.5	0.6	0.7
N	2.39E-11	4.33E-08	6.96E-08	7.18E-08	7.08E-08	7.05E-08	7.15E-08
NNE	3.93E-11	6.93E-08	1.04E-07	1.03E-07	1.02E-07	1.01E-07	9.96E-08
NE	1.15E-11	2.27E-08	4.42E-08	5.50E-08	6.09E-08	6.34E-08	6.46E-08
ENE	1.00E-11	1.96E-08	3.74E-08	4.75E-08	5.48E-08	5.94E-08	6.22E-08
E	3.09E-12	7.35E-09	2.33E-08	3.64E-08	4.44E-08	4.93E-08	5.30E-08
ESE	2.80E-12	7.63E-09	2.67E-08	4.30E-08	5.31E-08	5.99E-08	6.61E-08
SE	5.57E-12	1.31E-08	3.90E-08	5.97E-08	7.41E-08	8.66E-08	9.91E-08
SSE	6.56E-12	1.40E-08	3.27E-08	4.50E-08	5.37E-08	6.41E-08	7.81E-08
S	4.93E-12	1.23E-08	3.06E-08	4.42E-08	5.35E-08	6.15E-08	6.95E-08
SSW	1.62E-12	4.83E-09	1.73E-08	2.93E-08	3.77E-08	4.45E-08	5.11E-08
SW	5.96E-13	2.06E-09	9.62E-09	1.69E-08	2.21E-08	2.73E-08	3.37E-08
WSW	3.07E-13	1.30E-09	7.80E-09	1.43E-08	1.87E-08	2.33E-08	2.94E-08
W	1.87E-12	6.43E-09	1.74E-08	2.59E-08	3.15E-08	3.63E-08	4.14E-08
WNW	1.56E-12	5.49E-09	2.06E-08	3.41E-08	4.21E-08	4.76E-08	5.27E-08
NW	5.29E-12	1.20E-08	3.15E-08	4.53E-08	5.46E-08	6.24E-08	6.92E-08
NNW	3.03E-11	5.55E-08	9.01E-08	9.73E-08	1.02E-07	1.07E-07	1.11E-07

Period of Record: 9-1-76 to 8-31-78

\* Measured relevant to the Offgas Stack.



<b>MONTICELLO NUCLEAR GENERATING PLANT</b>		ODCM-APP-A
<b>TITLE:</b>	<b>APPENDIX A</b>	Revision 3
		Page 23 of 71

Table 7 Monticello Offgas Stack Dispersion Parameters for Long Term Elevated Releases  
> 500 Hrs/Yr or >150 Hrs/Qtr (cont'd)

For Standard Distances (As Measured from the Offgas Stack) ( $\chi/Q$ ), sec/m<sup>3</sup>  
Miles

Sector*	0.8	0.9	1.0	1.1	1.2	1.3	1.4
N	7.07E-08	6.72E-08	6.55E-08	6.42E-08	6.30E-08	6.18E-08	6.05E-08
NNE	9.48E-08	8.63E-08	8.08E-08	7.65E-08	7.29E-08	6.97E-08	6.67E-08
NE	6.26E-08	5.76E-08	5.41E-08	5.13E-08	4.89E-08	4.69E-08	4.50E-08
ENE	6.13E-08	5.70E-08	5.38E-08	5.12E-08	4.89E-08	4.67E-08	4.47E-08
E	5.36E-08	5.10E-08	4.91E-08	4.74E-08	4.58E-08	4.43E-08	4.27E-08
ESE	6.89E-08	6.75E-08	6.63E-08	6.51E-08	6.36E-08	6.19E-08	6.00E-08
SE	1.06E-07	1.05E-07	1.04E-07	1.02E-07	9.96E-08	9.66E-08	9.32E-08
SSE	9.01E-08	9.61E-08	1.01E-07	1.04E-07	1.06E-07	1.06E-07	1.05E-07
S	7.41E-08	7.41E-08	7.42E-08	7.39E-08	7.31E-08	7.19E-08	7.04E-08
SSW	5.49E-08	5.49E-08	5.49E-08	5.44E-08	5.37E-08	5.26E-08	5.13E-08
SW	3.88E-08	4.13E-08	4.31E-08	4.43E-08	4.49E-08	4.49E-08	4.45E-08
WSW	3.49E-08	3.82E-08	4.10E-08	4.32E-08	4.46E-08	4.55E-08	4.58E-08
W	4.50E-08	4.59E-08	4.69E-08	4.77E-08	4.80E-08	4.80E-08	4.77E-08
WNW	5.52E-08	5.45E-08	5.42E-08	5.39E-08	5.33E-08	5.26E-08	5.16E-08
NW	7.18E-08	6.96E-08	6.77E-08	6.59E-08	6.40E-08	6.21E-08	6.01E-08
NNW	1.08E-07	9.96E-08	9.36E-08	8.85E-08	8.40E-08	8.00E-08	7.63E-08

Period of Record: 9-1-76 to 8-31-78

\* Measured relevant to the Offgas Stack.

<b>MONTICELLO NUCLEAR GENERATING PLANT</b>		ODCM-APP-A
<b>TITLE:</b>	<b>APPENDIX A</b>	Revision 3
		Page 24 of 71

Table 7 Monticello Offgas Stack Dispersion Parameters for Long Term Elevated Releases  
> 500 Hrs/Yr or >150 Hrs/Qtr (cont'd)

For Standard Distances (As Measured from the Offgas Stack) ( $\chi/Q$ ), sec/m<sup>3</sup>  
Miles

Sector*	1.5	1.6	1.7	1.8	1.9	2.0	2.1
N	5.91E-08	5.66E-08	5.43E-08	5.20E-08	4.99E-08	4.78E-08	4.59E-08
NNE	6.40E-08	6.06E-08	5.74E-08	5.45E-08	5.17E-08	4.92E-08	4.69E-08
NE	4.33E-08	4.23E-08	4.14E-08	4.06E-08	3.96E-08	3.88E-08	3.79E-08
ENE	4.28E-08	4.10E-08	3.93E-08	3.77E-08	3.62E-08	3.47E-08	3.34E-08
E	4.12E-08	3.94E-08	3.76E-08	3.60E-08	3.44E-08	3.29E-08	3.15E-08
ESE	5.80E-08	5.59E-08	5.39E-08	5.18E-08	4.98E-08	4.78E-08	4.60E-08
SE	8.97E-08	8.77E-08	8.55E-08	8.32E-08	8.07E-08	7.83E-08	7.59E-08
SSE	1.04E-08	9.98E-08	9.58E-08	9.19E-08	8.80E-08	8.42E-08	8.06E-08
S	6.85E-08	6.54E-08	6.23E-08	5.93E-08	5.65E-08	5.39E-08	5.14E-08
SSW	4.99E-08	5.03E-08	5.04E-08	5.04E-08	5.02E-08	4.99E-08	4.95E-08
SW	4.37E-08	4.46E-08	4.51E-08	4.54E-08	4.55E-08	4.54E-08	4.52E-08
WSW	4.57E-08	4.71E-08	4.81E-08	4.88E-08	4.92E-08	4.94E-08	4.95E-08
W	4.71E-08	4.79E-08	4.85E-08	4.89E-08	4.90E-08	4.90E-08	4.89E-08
WNW	5.05E-08	5.10E-08	5.12E-08	5.13E-08	5.12E-08	5.11E-08	5.08E-08
NW	5.81E-08	5.64E-08	5.47E-08	5.30E-08	5.13E-08	4.97E-08	4.82E-08
NNW	7.29E-08	6.89E-08	6.52E-08	6.18E-08	5.87E-08	5.58E-08	5.31E-08

Period of Record: 9-1-76 to 8-31-78

\* Measured relevant to the Offgas Stack.

<b>MONTICELLO NUCLEAR GENERATING PLANT</b>		ODCM-APP-A
<b>TITLE:</b>	<b>APPENDIX A</b>	Revision 3
		Page 25 of 71

Table 7 Monticello Offgas Stack Dispersion Parameters for Long Term Elevated Releases  
> 500 Hrs/Yr or >150 Hrs/Qtr (cont'd)

For Standard Distances (As Measured from the Offgas Stack) ( $\chi/Q$ ), sec/m<sup>3</sup>  
Miles

Sector*	2.2	2.3	2.4	2.5	2.6	2.7	2.8
N	4.41E-08	4.23E-08	4.07E-08	3.92E-08	3.82E-08	3.73E-08	3.64E-08
NNE	4.48E-08	4.28E-08	4.09E-08	3.92E-08	3.76E-08	3.61E-08	3.47E-08
NE	3.71E-08	3.63E-08	3.53E-08	3.47E-08	3.35E-08	3.24E-08	3.13E-08
ENE	3.21E-08	3.09E-08	2.98E-08	2.87E-08	2.76E-08	2.65E-08	2.55E-08
E	3.02E-08	2.90E-08	2.78E-08	2.67E-08	2.57E-08	2.47E-08	2.38E-08
ESE	4.42E-08	4.25E-08	4.09E-08	3.94E-08	3.79E-08	3.66E-08	3.53E-08
SE	7.35E-08	7.12E-08	6.89E-08	6.68E-08	6.38E-08	6.11E-08	5.85E-08
SSE	7.72E-08	7.39E-08	7.08E-08	6.79E-08	6.53E-08	6.28E-08	6.05E-08
S	4.91E-08	4.69E-08	4.48E-08	4.29E-08	4.20E-08	4.11E-08	4.03E-08
SSW	4.90E-08	4.85E-08	4.79E-08	4.73E-08	4.51E-08	4.30E-08	4.11E-08
SW	4.49E-08	4.46E-08	4.42E-08	4.38E-08	4.23E-08	4.09E-08	3.96E-08
WSW	4.93E-08	4.91E-08	4.88E-08	4.84E-08	4.63E-08	4.42E-08	4.24E-08
W	4.86E-08	4.83E-08	4.79E-08	4.75E-08	4.59E-08	4.44E-08	4.30E-08
WNW	5.05E-08	5.01E-08	4.97E-08	4.93E-08	4.84E-08	4.75E-08	4.66E-08
NW	4.67E-08	4.52E-08	4.38E-08	4.25E-08	4.19E-08	4.14E-08	4.08E-08
NNW	5.06E-08	4.83E-08	4.62E-08	4.42E-08	4.24E-08	4.07E-08	3.91E-08

Period of Record: 9-1-76 to 8-31-78

\* Measured relevant to the Offgas Stack.

<b>MONTICELLO NUCLEAR GENERATING PLANT</b>		ODCM-APP-A
<b>TITLE:</b>	<b>APPENDIX A</b>	Revision 3
		Page 26 of 71

Table 7 Monticello Offgas Stack Dispersion Parameters for Long Term Elevated Releases  
> 500 Hrs/Yr or >150 Hrs/Qtr (cont'd)

For Standard Distances (As Measured from the Offgas Stack) ( $\chi/Q$ ), sec/m<sup>3</sup>  
Miles

Sector*	2.9	3.0	3.1	3.2	3.3	3.4	3.5
N	3.55E-08	3.47E-08	3.39E-08	3.31E-08	3.24E-08	3.17E-08	3.10E-08
NNE	3.34E-08	3.22E-08	3.11E-08	3.00E-08	2.90E-08	2.80E-08	2.71E-08
NE	3.03E-08	2.93E-08	2.84E-08	2.76E-08	2.67E-08	2.60E-08	2.52E-08
ENE	2.46E-08	2.37E-08	2.29E-08	2.21E-08	2.14E-08	2.07E-08	2.00E-08
E	2.30E-08	2.22E-08	2.14E-08	2.07E-08	2.00E-08	1.94E-08	1.88E-08
ESE	3.41E-08	3.29E-08	3.18E-08	3.08E-08	2.98E-08	2.89E-08	2.80E-08
SE	5.62E-08	5.39E-08	5.18E-08	4.98E-08	4.80E-08	4.62E-08	4.46E-08
SSE	5.83E-08	5.62E-08	5.42E-08	5.23E-08	5.05E-08	4.89E-08	4.73E-08
S	3.94E-08	3.86E-08	3.78E-08	3.70E-08	3.63E-08	3.55E-08	3.49E-08
SSW	3.93E-08	3.77E-08	3.61E-08	3.47E-08	3.34E-08	3.21E-08	3.09E-08
SW	3.84E-08	3.72E-08	3.61E-08	3.51E-08	3.41E-08	3.32E-08	3.23E-08
WSW	4.06E-08	3.90E-08	3.74E-08	3.60E-08	3.47E-08	3.34E-08	3.22E-08
W	4.17E-08	4.04E-08	3.93E-08	3.81E-08	3.70E-08	3.60E-08	3.50E-08
WNW	4.58E-08	4.50E-08	4.42E-08	4.34E-08	4.27E-08	4.20E-08	4.14E-08
NW	4.02E-08	3.96E-08	3.90E-08	3.85E-08	3.79E-08	3.74E-08	3.68E-08
NNW	3.76E-08	3.62E-08	3.49E-08	3.36E-08	3.25E-08	3.14E-08	3.03E-08

Period of Record: 9-1-76 to 8-31-78

\* Measured relevant to the Offgas Stack.

<b>MONTICELLO NUCLEAR GENERATING PLANT</b>		ODCM-APP-A
<b>TITLE:</b>	<b>APPENDIX A</b>	Revision 3
		Page 27 of 71

Table 7 Monticello Offgas Stack Dispersion Parameters for Long Term Elevated Releases  
> 500 Hrs/Yr or >150 Hrs/Qtr (cont'd)

For Standard Distances (As Measured from the Offgas Stack) ( $\chi/Q$ ), sec/m<sup>3</sup>  
Miles

Sector*	3.6	3.7	3.8	3.9	4.0	4.1	4.2
N	3.00E-08	2.91E-08	2.82E-08	2.74E-08	2.66E-08	2.59E-08	2.51E-08
NNE	2.63E-08	2.54E-08	2.47E-08	2.40E-08	2.33E-08	2.26E-08	2.20E-08
NE	2.45E-08	2.39E-08	2.32E-08	2.26E-08	2.20E-08	2.15E-08	2.09E-08
ENE	1.94E-08	1.88E-08	1.83E-08	1.77E-08	1.73E-08	1.68E-08	1.63E-08
E	1.82E-08	1.77E-08	1.71E-08	1.66E-08	1.62E-08	1.57E-08	1.53E-08
ESE	2.72E-08	2.64E-08	2.56E-08	2.49E-08	2.42E-08	2.35E-08	2.29E-08
SE	4.30E-08	4.16E-08	4.02E-08	3.89E-08	3.77E-08	3.65E-08	3.54E-08
SSE	4.60E-08	4.49E-08	4.37E-08	4.27E-08	4.16E-08	4.06E-08	3.97E-08
S	3.39E-08	3.30E-08	3.22E-08	3.14E-08	3.06E-08	2.99E-08	2.92E-08
SSW	3.01E-08	2.93E-08	2.86E-08	2.79E-08	2.72E-08	2.65E-08	2.59E-08
SW	3.17E-08	3.12E-08	3.07E-08	3.02E-08	2.98E-08	2.93E-08	2.89E-08
WSW	3.17E-08	3.12E-08	3.07E-08	3.03E-08	2.98E-08	2.94E-08	2.89E-08
W	3.38E-08	3.26E-08	3.15E-08	3.05E-08	2.95E-08	2.86E-08	2.77E-08
WNW	3.99E-08	3.84E-08	3.71E-08	3.58E-08	3.46E-08	3.35E-08	3.24E-08
NW	3.60E-08	3.51E-08	3.43E-08	3.35E-08	3.28E-08	3.20E-08	3.13E-08
NNW	2.94E-08	2.84E-08	2.76E-08	2.67E-08	2.60E-08	2.52E-08	2.45E-08

Period of Record: 9-1-76 to 8-31-78

\* Measured relevant to the Offgas Stack.

<b>MONTICELLO NUCLEAR GENERATING PLANT</b>		ODCM-APP-A
<b>TITLE:</b>	<b>APPENDIX A</b>	Revision 3
		Page 28 of 71

Table 7 Monticello Offgas Stack Dispersion Parameters for Long Term Elevated Releases  
> 500 Hrs/Yr or >150 Hrs/Qtr (cont'd)

For Standard Distances (As Measured from the Offgas Stack) ( $\chi/Q$ ), sec/m<sup>3</sup>  
Miles

Sector*	4.3	4.4	4.5	4.6	4.7	4.8	4.9
N	2.45E-08	2.38E-08	2.32E-08	2.26E-08	2.20E-08	2.15E-08	2.10E-08
NNE	2.14E-08	2.08E-08	2.03E-08	1.98E-08	1.93E-08	1.88E-08	1.84E-08
NE	2.04E-08	1.99E-08	1.95E-08	1.90E-08	1.86E-08	1.82E-08	1.78E-08
ENE	1.59E-08	1.55E-08	1.51E-08	1.47E-08	1.44E-08	1.40E-08	1.37E-08
E	1.49E-08	1.45E-08	1.42E-08	1.38E-08	1.35E-08	1.31E-08	1.28E-08
ESE	2.23E-08	2.18E-08	2.12E-08	2.07E-08	2.02E-08	1.97E-08	1.93E-08
SE	3.43E-08	3.33E-08	3.24E-08	3.15E-08	3.06E-08	2.98E-08	2.90E-08
SSE	3.88E-08	3.79E-08	3.71E-08	3.60E-08	3.50E-08	3.41E-08	3.32E-08
S	2.85E-08	2.79E-08	2.73E-08	2.65E-08	2.57E-08	2.50E-08	2.43E-08
SSW	2.53E-08	2.48E-08	2.42E-08	2.35E-08	2.28E-08	2.22E-08	2.16E-08
SW	2.85E-08	2.81E-08	2.77E-08	2.69E-08	2.61E-08	2.53E-08	2.46E-08
WSW	2.85E-08	2.81E-08	2.77E-08	2.69E-08	2.61E-08	2.53E-08	2.46E-08
W	2.68E-08	2.60E-08	2.53E-08	2.46E-08	2.39E-08	2.33E-08	2.26E-08
WNW	3.14E-08	3.05E-08	2.95E-08	2.87E-08	2.79E-08	2.71E-08	2.64E-08
NW	3.07E-08	3.00E-08	2.94E-08	2.86E-08	2.78E-08	2.70E-08	2.63E-08
NNW	2.38E-08	2.32E-08	2.26E-08	2.20E-08	2.14E-08	2.08E-08	2.03E-08

Period of Record: 9-1-76 to 8-31-78

\* Measured relevant to the Offgas Stack.

<b>MONTICELLO NUCLEAR GENERATING PLANT</b>		ODCM-APP-A
<b>TITLE:</b>	<b>APPENDIX A</b>	Revision 3
		Page 29 of 71

Table 7 Monticello Offgas Stack Dispersion Parameters for Long Term Elevated Releases  
> 500 Hrs/Yr or >150 Hrs/Qtr (cont'd)

For Standard Distances (As Measured from the Offgas Stack) ( $\chi/Q$ ), sec/m<sup>3</sup>  
Miles

Sector*	5.0
N	2.05E-08
NNE	1.79E-08
NE	1.74E-08
ENE	1.34E-08
E	1.25E-08
ESE	1.88E-08
SE	2.82E-08
SSE	3.23E-08
S	2.36E-08
SSW	2.10E-08
SW	2.39E-08
WSW	2.39E-08
W	2.21E-08
WNW	2.57E-08
NW	2.57E-08
NNW	1.98E-08

Period of Record: 9-1-76 to 8-31-78

\* Measured relevant to the Offgas Stack.

<b>MONTICELLO NUCLEAR GENERATING PLANT</b>		ODCM-APP-A
<b>TITLE:</b>	<b>APPENDIX A</b>	Revision 3
		Page 30 of 71

Table 8 Monticello Offgas Stack Dispersion Parameters for Long Term Elevated Releases  
> 500 Hrs/Yr or >150 Hrs/Qtr

For Standard Distances (As Measured from the Offgas Stack) (D/Q), m<sup>-2</sup>

Sector*	Miles						
	0.1	0.2	0.3	0.4	0.5	0.6	0.7
N	1.44E-09	4.89E-09	6.31E-09	5.66E-09	5.00E-09	4.44E-09	4.00E-09
NNE	2.25E-09	7.63E-09	9.79E-09	8.72E-09	7.59E-09	6.61E-09	5.82E-09
NE	1.06E-09	3.60E-09	4.65E-09	4.17E-09	3.68E-09	3.27E-09	2.94E-09
ENE	9.73E-10	3.30E-09	4.25E-09	3.81E-09	3.34E-09	2.95E-09	2.64E-09
E	7.84E-10	2.67E-09	3.45E-09	3.11E-09	2.77E-09	2.49E-09	2.27E-09
ESE	1.06E-09	3.61E-09	4.70E-09	4.31E-09	3.92E-09	3.63E-09	3.42E-09
SE	1.42E-09	4.87E-09	6.41E-09	6.00E-09	5.64E-09	5.40E-09	5.30E-09
SSE	1.19E-09	4.11E-09	5.46E-09	5.20E-09	5.00E-09	4.92E-09	4.96E-09
S	9.90E-10	3.38E-09	4.42E-09	4.08E-09	3.75E-09	3.50E-09	3.34E-09
SSW	5.92E-10	2.02E-09	2.65E-09	2.45E-09	2.25E-09	2.11E-09	2.03E-09
SW	3.23E-10	1.11E-09	1.48E-09	1.41E-09	1.35E-09	1.33E-09	1.34E-09
WSW	2.97E-10	1.03E-09	1.38E-09	1.33E-09	1.31E-09	1.32E-09	1.36E-09
W	4.41E-10	1.51E-09	1.98E-09	1.85E-09	1.72E-09	1.64E-09	1.59E-09
WNW	6.23E-10	2.13E-09	1.78E-09	2.56E-09	2.35E-09	2.20E-09	2.10E-09
NW	7.59E-10	2.59E-09	3.39E-09	3.13E-09	2.87E-09	2.69E-09	2.57E-09
NNW	1.94E-09	6.59E-09	8.48E-09	7.59E-09	6.66E-09	5.88E-09	5.25E-09

Period of Record: 9-1-76 to 8-31-78

\* Measured relevant to the Offgas Stack.



<b>MONTICELLO NUCLEAR GENERATING PLANT</b>		ODCM-APP-A
<b>TITLE:</b>	<b>APPENDIX A</b>	Revision 3
		Page 31 of 71

Table 8 Monticello Offgas Stack Dispersion Parameters for Long Term Elevated Releases  
> 500 Hrs/Yr or >150 Hrs/Qtr (cont'd)

For Standard Distances (As Measured from the Offgas Stack) (D/Q), m<sup>-2</sup>

Sector*	Miles						
	0.8	0.9	1.0	1.1	1.2	1.3	1.4
N	3.47E-09	2.90E-09	2.39E-09	1.98E-09	1.67E-09	1.42E-09	1.23E-09
NNE	4.93E-09	4.00E-09	3.24E-09	2.65E-09	2.20E-09	1.85E-09	1.58E-09
NE	2.56E-09	2.13E-09	1.76E-09	1.46E-09	1.23E-09	1.05E-09	9.02E-10
ENE	2.27E-09	1.88E-09	1.54E-09	1.27E-09	1.06E-09	9.03E-10	7.75E-10
E	2.01E-09	1.70E-09	1.41E-09	1.18E-09	1.00E-09	8.59E-10	7.45E-10
ESE	3.12E-09	2.74E-09	2.32E-09	1.97E-09	1.69E-09	1.47E-09	1.29E-09
SE	5.02E-09	4.56E-09	3.94E-09	3.38E-09	2.94E-09	2.58E-09	2.29E-09
SSE	4.81E-09	4.46E-09	3.89E-09	3.37E-09	2.95E-09	2.61E-09	2.32E-09
S	3.09E-09	2.74E-09	2.34E-09	1.99E-09	1.72E-09	1.50E-09	1.32E-09
SSW	1.88E-09	1.67E-09	1.43E-09	1.22E-09	1.05E-09	9.18E-10	8.09E-10
SW	1.30E-09	1.21E-09	1.05E-09	9.14E-10	8.00E-10	7.06E-10	6.29E-10
WSW	1.35E-09	1.27E-09	1.12E-09	9.76E-10	8.59E-10	7.62E-10	6.81E-10
W	1.49E-09	1.35E-09	1.16E-09	9.93E-10	8.61E-10	7.54E-10	6.66E-10
WNW	1.93E-09	1.71E-09	1.46E-09	1.24E-09	1.07E-09	9.35E-10	8.22E-10
NW	2.37E-09	2.10E-09	1.80E-09	1.53E-09	1.32E-09	1.15E-09	1.01E-09
NNW	4.52E-09	3.73E-09	3.06E-09	2.53E-09	2.12E-09	1.80E-09	1.54E-09

Period of Record: 9-1-76 to 8-31-78

\* Measured relevant to the Offgas Stack.

<b>MONTICELLO NUCLEAR GENERATING PLANT</b>		ODCM-APP-A
<b>TITLE:</b>	<b>APPENDIX A</b>	Revision 3
		Page 32 of 71

Table 8 Monticello Offgas Stack Dispersion Parameters for Long Term Elevated Releases  
> 500 Hrs/Yr or >150 Hrs/Qtr (cont'd)

For Standard Distances (As Measured from the Offgas Stack) (D/Q), m<sup>-2</sup>

Sector*	Miles						
	1.5	1.6	1.7	1.8	1.9	2.0	2.1
N	1.07E-09	9.36E-10	8.27E-10	7.36E-10	6.92E-10	6.30E-10	5.75E-10
NNE	1.36E-09	1.18E-09	1.03E-09	9.08E-10	8.58E-10	7.77E-10	7.07E-10
NE	7.84E-10	6.88E-10	6.08E-10	5.41E-10	5.09E-10	4.63E-10	4.23E-10
ENE	6.72E-10	5.88E-10	5.18E-10	4.59E-10	4.32E-10	3.93E-10	3.58E-10
E	6.51E-10	5.75E-10	5.10E-10	4.56E-10	4.28E-10	3.90E-10	3.57E-10
ESE	1.14E-09	1.01E-09	9.06E-10	8.16E-10	7.64E-10	6.99E-10	6.43E-10
SE	2.04E-09	1.83E-09	1.65E-09	1.50E-09	1.40E-09	1.28E-09	1.18E-09
SSE	2.08E-09	1.87E-09	1.70E-09	1.54E-09	1.44E-09	1.32E-09	1.22E-09
S	1.17E-09	1.04E-09	9.35E-10	8.44E-10	7.89E-10	7.23E-10	6.66E-10
SSW	7.17E-10	6.41E-10	5.76E-10	5.20E-10	4.86E-10	4.46E-10	4.10E-10
SW	5.63E-10	5.08E-10	4.60E-10	4.18E-10	3.90E-10	3.59E-10	3.31E-10
WSW	6.12E-10	5.53E-10	5.02E-10	4.58E-10	4.26E-10	3.93E-10	3.63E-10
W	5.93E-10	5.32E-10	4.79E-10	4.34E-10	4.05E-10	3.72E-10	3.42E-10
WNW	7.28E-10	6.50E-10	5.84E-10	5.27E-10	4.92E-10	4.51E-10	4.15E-10
NW	8.97E-10	8.01E-10	7.20E-10	6.50E-10	6.07E-10	5.57E-10	5.12E-10
NNW	1.34E-09	1.17E-09	1.03E-09	9.12E-10	8.59E-10	7.81E-10	7.12E-10

Period of Record: 9-1-76 to 8-31-78

\* Measured relevant to the Offgas Stack.

<b>MONTICELLO NUCLEAR GENERATING PLANT</b>		ODCM-APP-A
<b>TITLE:</b>	<b>APPENDIX A</b>	Revision 3
		Page 33 of 71

Table 8 Monticello Offgas Stack Dispersion Parameters for Long Term Elevated Releases  
> 500 Hrs/Yr or >150 Hrs/Qtr (cont'd)

For Standard Distances (As Measured from the Offgas Stack) (D/Q), m<sup>-2</sup>

Sector*	Miles						
	2.2	2.3	2.4	2.5	2.6	2.7	2.8
N	5.28E-10	4.86E-10	4.49E-10	4.17E-10	3.87E-10	3.61E-10	3.37E-10
NNE	6.46E-10	5.93E-10	5.46E-10	5.05E-10	4.68E-10	4.35E-10	4.06E-10
NE	3.88E-10	3.58E-10	3.30E-10	3.06E-10	2.85E-10	2.65E-10	2.48E-10
ENE	3.28E-10	3.02E-10	2.79E-10	2.58E-10	2.40E-10	2.24E-10	2.09E-10
E	3.28E-10	3.03E-10	2.80E-10	2.60E-10	2.42E-10	2.26E-10	2.11E-10
ESE	5.93E-10	5.48E-10	5.09E-10	4.73E-10	4.41E-10	4.12E-10	3.86E-10
SE	1.09E-09	1.01E-09	9.43E-10	8.78E-10	8.21E-10	7.68E-10	7.20E-10
SSE	1.13E-09	1.05E-09	9.78E-10	9.12E-10	8.52E-10	7.98E-10	7.48E-10
S	6.14E-10	5.69E-10	5.28E-10	4.92E-10	4.59E-10	4.29E-10	4.02E-10
SSW	3.79E-10	3.76E-10	3.90E-10	3.92E-10	3.62E-10	3.34E-10	3.10E-10
SW	3.07E-10	2.98E-10	3.09E-10	3.18E-10	2.93E-10	2.71E-10	2.51E-10
WSW	3.36E-10	3.41E-10	3.44E-10	3.58E-10	3.30E-10	3.05E-10	2.83E-10
W	3.17E-10	3.11E-10	3.09E-10	3.19E-10	2.94E-10	2.72E-10	2.53E-10
WNW	3.83E-10	3.86E-10	3.86E-10	3.89E-10	3.59E-10	3.45E-10	3.20E-10
NW	4.73E-10	4.38E-10	4.07E-10	3.78E-10	3.53E-10	3.30E-10	3.09E-10
NNW	6.53E-10	6.01E-10	5.55E-10	5.14E-10	4.77E-10	4.44E-10	4.15E-10

Period of Record: 9-1-76 to 8-31-78

\* Measured relevant to the Offgas Stack.

<b>MONTICELLO NUCLEAR GENERATING PLANT</b>		ODCM-APP-A
<b>TITLE:</b>	<b>APPENDIX A</b>	Revision 3
		Page 34 of 71

Table 8 Monticello Offgas Stack Dispersion Parameters for Long Term Elevated Releases  
> 500 Hrs/Yr or >150 Hrs/Qtr (cont'd)

For Standard Distances (As Measured from the Offgas Stack) (D/Q), m<sup>-2</sup>

Sector*	Miles						
	2.9	3.0	3.1	3.2	3.3	3.4	3.5
N	3.16E-10	2.96E-10	2.78E-10	2.62E-10	2.47E-10	2.33E-10	2.20E-10
NNE	3.79E-10	3.55E-10	3.33E-10	3.13E-10	2.95E-10	2.78E-10	2.63E-10
NE	2.32E-10	2.18E-10	2.04E-10	1.92E-10	1.81E-10	1.71E-10	1.62E-10
ENE	1.95E-10	1.83E-10	1.72E-10	1.62E-10	1.52E-10	1.44E-10	1.36E-10
E	1.98E-10	1.86E-10	1.75E-10	1.64E-10	1.55E-10	1.46E-10	1.39E-10
ESE	3.62E-10	3.40E-10	3.20E-10	3.02E-10	2.85E-10	2.69E-10	2.55E-10
SE	6.76E-10	6.35E-10	5.98E-10	5.64E-10	5.33E-10	5.04E-10	4.77E-10
SSE	7.03E-10	6.62E-10	6.23E-10	5.88E-10	5.56E-10	5.26E-10	4.98E-10
S	3.77E-10	3.54E-10	3.33E-10	3.14E-10	2.97E-10	2.81E-10	2.66E-10
SSW	2.88E-10	2.68E-10	2.50E-10	2.34E-10	2.20E-10	2.06E-10	1.94E-10
SW	2.44E-10	2.27E-10	2.12E-10	1.98E-10	1.86E-10	1.75E-10	1.64E-10
WSW	2.63E-10	2.45E-10	2.29E-10	2.14E-10	2.01E-10	1.89E-10	1.78E-10
W	2.47E-10	2.30E-10	2.15E-10	2.01E-10	1.88E-10	1.77E-10	1.66E-10
WNW	2.97E-10	2.76E-10	2.58E-10	2.41E-10	2.26E-10	2.12E-10	2.00E-10
NW	2.90E-10	2.73E-10	2.57E-10	2.42E-10	2.26E-10	2.16E-10	2.04E-10
NNW	3.88E-10	3.64E-10	3.41E-10	3.21E-10	3.03E-10	2.86E-10	2.70E-10

Period of Record: 9-1-76 to 8-31-78

\* Measured relevant to the Offgas Stack.

<b>MONTICELLO NUCLEAR GENERATING PLANT</b>		ODCM-APP-A
<b>TITLE:</b>	<b>APPENDIX A</b>	Revision 3
		Page 35 of 71

Table 8 Monticello Offgas Stack Dispersion Parameters for Long Term Elevated Releases  
> 500 Hrs/Yr or >150 Hrs/Qtr (cont'd)

For Standard Distances (As Measured from the Offgas Stack) (D/Q), m<sup>-2</sup>

Sector*	Miles						
	3.6	3.7	3.8	3.9	4.0	4.1	4.2
N	2.09E-10	1.98E-10	1.88E-10	1.78E-10	1.70E-10	1.62E-10	1.54E-10
NNE	2.49E-10	2.36E-10	2.24E-10	2.13E-10	2.02E-10	1.93E-10	1.84E-10
NE	1.53E-10	1.45E-10	1.38E-10	1.31E-10	1.25E-10	1.19E-10	1.13E-10
ENE	1.29E-10	1.22E-10	1.16E-10	1.10E-10	1.05E-10	9.98E-11	9.51E-11
E	1.31E-10	1.24E-10	1.18E-10	1.12E-10	1.07E-10	1.02E-10	9.71E-11
ESE	2.42E-10	2.29E-10	2.18E-10	2.07E-10	1.97E-10	1.88E-10	1.79E-10
SE	4.53E-10	4.30E-10	4.08E-10	3.88E-10	3.69E-10	3.52E-10	3.36E-10
SSE	4.72E-10	4.48E-10	4.26E-10	4.05E-10	3.85E-10	3.67E-10	3.50E-10
S	2.52E-10	2.46E-10	2.34E-10	2.32E-10	2.34E-10	2.23E-10	2.12E-10
SSW	1.83E-10	1.73E-10	1.64E-10	1.59E-10	1.51E-10	1.43E-10	1.36E-10
SW	1.55E-10	1.46E-10	1.38E-10	1.31E-10	1.24E-10	1.18E-10	1.12E-10
WSW	1.68E-10	1.62E-10	1.54E-10	1.46E-10	1.38E-10	1.31E-10	1.25E-10
W	1.57E-10	1.48E-10	1.40E-10	1.33E-10	1.26E-10	1.20E-10	1.14E-10
WNW	1.88E-10	1.78E-10	1.68E-10	1.59E-10	1.51E-10	1.44E-10	1.37E-10
NW	1.94E-10	1.86E-10	1.77E-10	1.73E-10	1.76E-10	1.67E-10	1.59E-10
NNW	2.56E-10	2.43E-10	2.30E-10	2.19E-10	2.08E-10	1.98E-10	1.89E-10

Period of Record: 9-1-76 to 8-31-78

\* Measured relevant to the Offgas Stack.

<b>MONTICELLO NUCLEAR GENERATING PLANT</b>		ODCM-APP-A
<b>TITLE:</b>	<b>APPENDIX A</b>	Revision 3
		Page 36 of 71

Table 8 Monticello Offgas Stack Dispersion Parameters for Long Term Elevated Releases  
> 500 Hrs/Yr or >150 Hrs/Qtr (cont'd)

For Standard Distances (As Measured from the Offgas Stack) (D/Q), m<sup>-2</sup>

Sector*	Miles						
	4.3	4.4	4.5	4.6	4.7	4.8	4.9
N	1.47E-10	1.41E-10	1.34E-10	1.29E-10	1.23E-10	1.18E-10	1.13E-10
NNE	1.75E-10	1.67E-10	1.60E-10	1.53E-10	1.47E-10	1.41E-10	1.35E-10
NE	1.08E-10	1.03E-10	9.88E-11	9.45E-11	9.05E-11	8.68E-11	8.32E-11
ENE	9.08E-11	8.67E-11	8.29E-11	7.94E-11	7.60E-11	7.28E-11	6.99E-11
E	9.26E-11	8.85E-11	8.46E-11	8.10E-11	7.75E-11	7.43E-11	7.13E-11
ESE	1.71E-10	1.63E-10	1.56E-10	1.49E-10	1.43E-10	1.37E-10	1.31E-10
SE	3.20E-10	3.06E-10	2.92E-10	2.80E-10	2.68E-10	2.57E-10	2.46E-10
SSE	3.34E-10	3.19E-10	3.05E-10	2.92E-10	2.80E-10	2.68E-10	2.57E-10
S	2.08E-10	1.98E-10	1.89E-10	1.81E-10	1.73E-10	1.66E-10	1.59E-10
SSW	1.30E-10	1.24E-10	1.18E-10	1.13E-10	1.08E-10	1.03E-10	9.90E-11
SW	1.08E-10	1.03E-10	9.82E-11	9.39E-11	8.98E-11	8.59E-11	8.24E-11
WSW	1.19E-10	1.13E-10	1.08E-10	1.03E-10	9.88E-11	9.46E-11	9.06E-11
W	1.08E-10	1.03E-10	9.87E-11	9.43E-11	9.02E-11	8.64E-11	8.28E-11
WNW	1.30E-10	1.24E-10	1.18E-10	1.13E-10	1.08E-10	1.04E-10	9.94E-11
NW	1.58E-10	1.51E-10	1.44E-10	1.38E-10	1.32E-10	1.26E-10	1.21E-10
NNW	1.80E-10	1.72E-10	1.65E-10	1.58E-10	1.51E-10	1.45E-10	1.39E-10

Period of Record: 9-1-76 to 8-31-78

\* Measured relevant to the Offgas Stack.

<b>MONTICELLO NUCLEAR GENERATING PLANT</b>		ODCM-APP-A
<b>TITLE:</b>	<b>APPENDIX A</b>	Revision 3
		Page 37 of 71

Table 8 Monticello Offgas Stack Dispersion Parameters for Long Term Elevated Releases  
> 500 Hrs/Yr or >150 Hrs/Qtr (cont'd)

For Standard Distances (As Measured from the Offgas Stack) (D/Q), m<sup>-2</sup>

Miles

Sector*	5.0
N	1.09E-10
NNE	1.30E-10
NE	7.99E-11
ENE	6.71E-11
E	6.84E-11
ESE	1.26E-10
SE	2.36E-10
SSE	2.46E-10
S	1.52E-10
SSW	9.49E-11
SW	7.90E-11
WSW	8.69E-11
W	7.94E-11
WNW	9.53E-11
NW	1.16E-10
NNW	1.33E-10

Period of Record: 9-1-76 to 8-31-78

\* Measured relevant to the Offgas Stack.

<b>MONTICELLO NUCLEAR GENERATING PLANT</b>		ODCM-APP-A
<b>TITLE:</b>	<b>APPENDIX A</b>	Revision 3
		Page 38 of 71

Table 9 Monticello Offgas Stack Dispersion Parameters for Short Term Elevated Releases  
 $\leq 500$  Hrs/Yr or  $\leq 150$  Hrs/Qtr

Site Boundary Sector*	$\chi/Q$ (sec/m <sup>3</sup> )	D/q (m <sup>-2</sup> )
N	1.55E-07	9.93E-09
NNE	1.41E-07	8.59E-09
NE	1.88E-07	1.16E-08
ENE	1.60E-07	6.04E-09
E	1.47E-07	9.15E-09
ESE	***	***
SE	***	***
SSE	***	***
S	***	***
SSW	***	***
SW	***	***
WSW	***	***
W	5.95E-08	2.91E-09
WNW	1.39E-07	4.68E-09
NW	***	***
NNW	2.33E-07	1.25E-08

Period of record: 9-1-76 to 8-31-78

\* Measured relevant to the Offgas Stack.

\*\*\* See appropriate offgas stack long term elevated release values.



<b>MONTICELLO NUCLEAR GENERATING PLANT</b>		ODCM-APP-A
<b>TITLE:</b>	<b>APPENDIX A</b>	Revision 3
		Page 39 of 71

Table 10 Monticello Offgas Stack Dispersion Parameters for Short Term Elevated Releases  
 $\leq 500$  Hrs/Yr or  $\leq 150$  Hrs/Qtr

For Standard Distances (As Measured from the Offgas Stack) ( $\chi/q$ ),  $\text{sec/m}^3$

Sector*	Miles						
	0.1	0.2	0.3	0.4	0.5	0.6	0.7
N	**	**	**	1.67E-07	1.85E-07	1.50E-07	1.18E-07
NNE	**	**	**	2.82E-07	2.50E-07	2.12E-07	1.69E-07
NE	**	**	**	7.93E-08	1.29E-07	1.21E-07	1.08E-07
ENE	**	**	**	1.63E-07	1.87E-07	1.77E-07	1.46E-07
E	**	**	**	8.63E-08	1.47E-07	1.29E-07	1.07E-07
ESE	**	**	**	***	***	6.17E-08	1.02E-07
SE	**	**	**	***	***	***	1.17E-07
SSE	**	**	**	***	***	***	1.04E-07
S	**	**	**	***	***	7.75E-08	1.13E-07
SSW	**	**	**	***	***	7.15E-08	1.03E-07
SW	**	**	**	***	***	4.73E-08	8.22E-08
WSW	**	**	**	***	***	3.82E-08	6.85E-08
W	**	**	**	***	4.06E-08	7.49E-08	8.73E-08
WNW	**	**	**	***	4.56E-08	8.41E-08	9.88E-08
NW	**	**	**	***	***	7.36E-08	1.08E-07
NNW	**	**	**	2.73E-07	2.57E-07	2.37E-07	1.94E-07

Period of Record: 9-1-76 to 8-31-78

\* Measured relevant to the Offgas Stack.

\*\* Values less than the value for 0.4 miles.

\*\*\* See appropriate offgas stack long term elevated release values.

<b>MONTICELLO NUCLEAR GENERATING PLANT</b>		ODCM-APP-A
<b>TITLE:</b>	<b>APPENDIX A</b>	Revision 3
		Page 40 of 71

Table 10 Monticello Offgas Stack Dispersion Parameters for Short Term Elevated Releases  $\leq 500$  Hrs/Yr or  $\leq 150$  Hrs/Qtr (cont'd)

For Standard Distances (As Measured from the Offgas Stack) ( $\chi/q$ ),  $\text{sec}/\text{m}^3$

Sector*	Miles						
	0.8	0.9	1.0	1.1	1.2	1.3	1.4
N	1.52E-07	1.77E-07	1.94E-07	1.82E-07	1.96E-07	1.87E-07	2.07E-07
NNE	1.83E-07	2.05E-07	2.18E-07	2.30E-07	2.15E-07	1.99E-07	2.13E-07
NE	1.30E-07	1.60E-07	1.67E-07	1.75E-07	1.76E-07	1.61E-07	1.55E-07
ENE	1.62E-07	1.80E-07	1.75E-07	1.84E-07	1.96E-07	1.94E-07	1.91E-07
E	1.38E-07	1.62E-07	1.65E-07	1.75E-07	1.72E-07	1.59E-07	1.77E-07
ESE	1.36E-07	1.62E-07	1.71E-07	1.57E-07	1.62E-07	1.64E-07	1.70E-07
SE	1.56E-07	1.84E-07	1.98E-07	1.93E-07	2.02E-07	2.06E-07	2.46E-07
SSE	1.42E-07	1.78E-07	1.97E-07	2.50E-07	2.26E-07	2.35E-07	2.77E-07
S	1.55E-07	1.86E-07	2.07E-07	1.92E-07	2.08E-07	2.01E-07	2.71E-07
SSW	1.43E-07	1.64E-07	1.81E-07	1.86E-07	1.83E-07	1.79E-07	2.01E-07
SW	1.17E-07	1.45E-07	1.63E-07	1.77E-07	1.70E-07	1.74E-07	2.58E-07
WSW	9.91E-07	1.25E-07	1.31E-07	1.43E-07	1.62E-07	1.59E-07	2.45E-07
W	1.25E-07	1.56E-07	1.76E-07	1.86E-07	2.00E-07	2.04E-07	2.77E-07
WNW	1.39E-07	1.71E-07	1.89E-07	1.96E-07	2.04E-07	2.12E-07	2.79E-07
NW	1.44E-07	1.71E-07	1.89E-07	1.83E-07	1.72E-07	1.85E-07	2.15E-07
NNW	2.00E-07	2.24E-07	2.43E-07	2.48E-07	2.36E-07	2.14E-07	3.06E-07

Period of Record: 9-1-76 to 8-31-78

\* Measured relevant to the Offgas Stack.

\*\* Values less than the value for 0.4 miles.

\*\*\* See appropriate offgas stack long term elevated release values.

<b>MONTICELLO NUCLEAR GENERATING PLANT</b>		ODCM-APP-A
<b>TITLE:</b>	<b>APPENDIX A</b>	Revision 3
		Page 41 of 71

Table 10 Monticello Offgas Stack Dispersion Parameters for Short Term Elevated Releases  $\leq 500$  Hrs/Yr or  $\leq 150$  Hrs/Qtr (cont'd)

For Standard Distances (As Measured from the Offgas Stack) ( $\chi/q$ ),  $\text{sec}/\text{m}^3$

Sector*	Miles						
	1.5	1.6	1.7	1.8	1.9	2.0	2.1
N	2.56E-07	1.89E-07	2.10E-07	2.05E-07	1.94E-07	1.88E-07	1.79E-07
NNE	2.59E-07	1.97E-07	2.23E-07	2.13E-07	1.97E-07	1.87E-07	1.77E-07
NE	1.71E-07	1.63E-07	1.55E-07	1.86E-07	1.77E-07	1.74E-07	1.66E-07
ENE	1.82E-07	1.67E-07	2.13E-07	1.89E-07	1.74E-07	1.69E-07	1.64E-07
E	1.73E-07	1.61E-07	1.51E-07	1.88E-07	1.75E-07	1.66E-07	1.59E-07
ESE	1.84E-07	1.77E-07	1.70E-07	***	1.55E-07	1.52E-07	1.50E-07
SE	2.06E-07	2.05E-07	1.90E-07	2.00E-07	2.01E-07	1.89E-07	1.77E-07
SSE	2.25E-07	2.10E-07	2.01E-07	2.21E-07	1.77E-07	1.78E-07	1.78E-07
S	2.10E-07	***	2.38E-07	2.35E-07	2.18E-07	2.04E-07	2.97E-07
SSW	1.90E-07	1.84E-07	2.46E-07	2.34E-07	2.24E-07	2.20E-07	2.17E-07
SW	1.80E-07	1.74E-07	1.69E-07	1.87E-07	2.01E-07	1.99E-07	1.91E-07
WSW	1.78E-07	1.76E-07	1.72E-07	1.89E-07	2.00E-07	1.99E-07	1.94E-07
W	2.14E-07	2.22E-07	2.50E-07	2.50E-07	2.32E-07	2.31E-07	2.23E-07
WNW	1.96E-07	1.87E-07	1.81E-07	1.97E-07	2.11E-07	2.09E-07	2.01E-07
NW	2.00E-07	1.90E-07	2.59E-07	2.40E-07	2.28E-07	2.10E-07	2.01E-07
NNW	2.28E-07	2.01E-07	1.96E-07	1.92E-07	1.87E-07	1.81E-07	1.74E-07

Period of Record: 9-1-76 to 8-31-78

\* Measured relevant to the Offgas Stack.

\*\* Values less than the value for 0.4 miles.

\*\*\* See appropriate offgas stack long term elevated release values.

<b>MONTICELLO NUCLEAR GENERATING PLANT</b>		ODCM-APP-A
<b>TITLE:</b>	<b>APPENDIX A</b>	Revision 3
		Page 42 of 71

Table 10 Monticello Offgas Stack Dispersion Parameters for Short Term Elevated Releases  $\leq 500$  Hrs/Yr or  $\leq 150$  Hrs/Qtr (cont'd)

For Standard Distances (As Measured from the Offgas Stack) ( $\chi/q$ ),  $\text{sec/m}^3$

Sector*	Miles						
	2.2	2.3	2.4	2.5	2.6	2.7	2.8
N	1.70E-07	1.66E-07	1.58E-07	1.54E-07	1.51E-07	1.47E-07	1.37E-07
NNE	1.70E-07	1.62E-07	1.57E-07	1.51E-07	1.46E-07	1.44E-07	1.38E-07
NE	1.60E-07	1.53E-07	1.53E-07	1.47E-07	1.40E-07	1.36E-07	1.30E-07
ENE	1.57E-07	1.50E-07	1.47E-07	1.44E-07	1.36E-07	1.33E-07	1.28E-07
E	1.49E-07	1.44E-07	1.36E-07	1.33E-07	1.27E-07	1.23E-07	1.17E-07
ESE	1.48E-07	1.46E-07	1.43E-07	1.38E-07	1.33E-07	1.28E-07	1.23E-07
SE	1.95E-07	1.68E-07	1.64E-07	1.61E-07	1.55E-07	1.66E-07	1.60E-07
SSE	1.69E-07	1.58E-07	1.58E-07	1.50E-07	1.42E-07	1.35E-07	1.60E-07
S	1.65E-07	1.58E-07	1.51E-07	1.46E-07	1.41E-07	1.40E-07	1.65E-07
SSW	2.10E-07	2.11E-07	2.12E-07	1.89E-07	1.82E-07	1.76E-07	1.71E-07
SW	1.81E-07	1.90E-07	1.93E-07	1.93E-07	2.32E-07	2.23E-07	2.11E-07
WSW	1.82E-07	1.86E-07	1.79E-07	1.72E-07	1.90E-07	1.84E-07	2.12E-07
W	2.15E-07	2.18E-07	2.20E-07	2.19E-07	2.10E-07	2.08E-07	2.05E-07
WNW	1.89E-07	1.89E-07	1.90E-07	1.93E-07	2.26E-07	2.18E-07	2.11E-07
NW	1.91E-07	1.86E-07	1.80E-07	1.76E-07	1.72E-07	1.69E-07	1.64E-07
NNW	1.72E-07	1.68E-07	1.68E-07	1.59E-07	1.54E-07	1.45E-07	1.36E-07

Period of Record: 9-1-76 to 8-31-78

\* Measured relevant to the Offgas Stack.

\*\* Values less than the value for 0.4 miles.

\*\*\* See appropriate offgas stack long term elevated release values.

<b>MONTICELLO NUCLEAR GENERATING PLANT</b>		ODCM-APP-A
<b>TITLE:</b>	<b>APPENDIX A</b>	Revision 3
		Page 43 of 71

Table 10 Monticello Offgas Stack Dispersion Parameters for Short Term Elevated Releases  $\leq 500$  Hrs/Yr or  $\leq 150$  Hrs/Qtr (cont'd)

For Standard Distances (As Measured from the Offgas Stack) ( $\chi/q$ ),  $\text{sec/m}^3$

Sector*	Miles						
	2.9	3.0	3.1	3.2	3.3	3.4	3.5
N	1.35E-07	1.34E-07	1.32E-07	1.30E-07	1.28E-07	1.25E-07	1.23E-07
NNE	1.30E-07	1.26E-07	1.22E-07	1.19E-07	1.15E-07	1.12E-07	1.09E-07
NE	1.22E-07	1.20E-07	1.16E-07	1.14E-07	1.11E-07	1.09E-07	1.06E-07
ENE	1.21E-07	1.81E-07	1.15E-07	1.13E-07	1.10E-07	1.07E-07	1.04E-07
E	1.13E-07	1.10E-07	1.05E-07	1.03E-07	1.01E-07	1.01E-07	9.17E-08
ESE	1.19E-07	1.14E-07	1.08E-07	1.06E-07	1.03E-07	9.93E-08	9.89E-08
SE	1.31E-07	1.33E-07	1.35E-07	1.32E-07	1.26E-07	1.20E-07	1.15E-07
SSE	1.30E-07	1.32E-07	1.34E-07	1.35E-07	1.31E-07	1.26E-07	1.22E-07
S	1.63E-07	1.54E-07	1.46E-07	1.42E-07	1.34E-07	1.33E-07	1.32E-07
SSW	1.66E-07	1.57E-07	1.51E-07	1.46E-07	1.39E-07	1.34E-07	1.31E-07
SW	1.97E-07	1.82E-07	1.79E-07	1.71E-07	1.64E-07	1.59E-07	1.54E-07
WSW	2.02E-07	1.95E-07	1.85E-07	1.77E-07	1.69E-07	1.62E-07	1.54E-07
W	2.01E-07	1.92E-07	1.90E-07	1.84E-07	1.82E-07	1.78E-07	1.71E-07
WNW	2.02E-07	1.96E-07	1.92E-07	1.90E-07	1.85E-07	1.78E-07	1.75E-07
NW	1.70E-07	1.50E-07	1.48E-07	1.47E-07	1.39E-07	1.37E-07	1.38E-07
NNW	1.31E-07	1.30E-07	1.27E-07	1.22E-07	1.19E-07	1.16E-07	1.13E-07

Period of Record: 9-1-76 to 8-31-78

\* Measured relevant to the Offgas Stack.

\*\* Values less than the value for 0.4 miles.

\*\*\* See appropriate offgas stack long term elevated release values.

<b>MONTICELLO NUCLEAR GENERATING PLANT</b>		ODCM-APP-A
<b>TITLE:</b>	<b>APPENDIX A</b>	Revision 3
		Page 44 of 71

Table 10 Monticello Offgas Stack Dispersion Parameters for Short Term Elevated Releases  $\leq 500$  Hrs/Yr or  $\leq 150$  Hrs/Qtr (cont'd)

For Standard Distances (As Measured from the Offgas Stack) ( $\chi/q$ ),  $\text{sec}/\text{m}^3$   
Miles

Sector*	3.6	3.7	3.8	3.9	4.0	4.1	4.2
N	1.18E-07	1.15E-07	1.14E-07	1.11E-07	1.08E-07	1.06E-07	1.05E-07
NNE	1.07E-07	1.05E-07	1.01E-07	9.83E-08	9.61E-08	9.38E-08	9.04E-08
NE	1.03E-07	1.01E-07	9.84E-08	9.65E-08	9.20E-08	9.00E-08	8.81E-08
ENE	1.03E-07	1.01E-07	9.56E-08	9.34E-08	9.07E-08	8.79E-08	8.58E-08
E	9.00E-08	8.74E-08	8.37E-08	8.17E-08	7.94E-08	7.80E-08	7.64E-08
ESE	9.67E-08	9.46E-08	8.97E-08	8.91E-08	8.79E-08	8.64E-08	8.45E-08
SE	1.10E-07	1.06E-07	1.06E-07	1.02E-07	9.89E-08	1.03E-07	9.99E-08
SSE	1.18E-07	1.15E-07	1.11E-07	1.08E-07	1.12E-07	1.10E-07	1.08E-07
S	1.27E-07	1.23E-07	1.21E-07	1.17E-07	1.13E-07	1.10E-07	1.10E-07
SSW	1.27E-07	1.24E-07	1.21E-07	1.17E-07	1.15E-07	1.13E-07	1.08E-07
SW	1.52E-07	1.46E-07	1.43E-07	1.43E-07	1.41E-07	1.40E-07	1.38E-07
WSW	1.49E-07	1.43E-07	1.44E-07	1.43E-07	1.34E-07	1.33E-07	1.34E-07
W	1.66E-07	1.61E-07	1.56E-07	1.49E-07	1.42E-07	1.39E-07	1.35E-07
WNW	1.73E-07	1.67E-07	1.63E-07	1.58E-07	1.54E-07	1.49E-07	1.45E-07
NW	1.34E-07	1.27E-07	1.25E-07	1.24E-07	1.21E-07	1.19E-07	1.17E-07
NNW	1.10E-07	1.07E-07	1.02E-07	1.00E-07	9.75E-08	9.52E-08	9.37E-08

Period of Record: 9-1-76 to 8-31-78

\* Measured relevant to the Offgas Stack.

\*\* Values less than the value for 0.4 miles.

\*\*\* See appropriate offgas stack long term elevated release values.

<b>MONTICELLO NUCLEAR GENERATING PLANT</b>		ODCM-APP-A
<b>TITLE:</b>	<b>APPENDIX A</b>	Revision 3
		Page 45 of 71

Table 10 Monticello Offgas Stack Dispersion Parameters for Short Term Elevated Releases  $\leq 500$  Hrs/Yr or  $\leq 150$  Hrs/Qtr (cont'd)

For Standard Distances (As Measured from the Offgas Stack) ( $\chi/q$ ),  $\text{sec}/\text{m}^3$

Sector*	Miles						
	4.3	4.4	4.5	4.6	4.7	4.8	4.9
N	1.01E-07	9.83E-08	9.37E-08	9.14E-08	8.97E-08	8.80E-08	8.61E-08
NNE	8.88E-08	8.71E-08	8.63E-08	8.42E-08	8.14E-08	8.00E-08	7.84E-08
NE	8.69E-08	8.53E-08	8.40E-08	8.25E-08	8.19E-08	8.02E-08	7.81E-08
ENE	8.42E-08	8.26E-08	8.09E-08	7.87E-08	7.69E-08	7.55E-08	7.38E-08
E	7.33E-08	7.27E-08	7.02E-08	6.85E-08	6.71E-08	6.56E-08	6.40E-08
ESE	8.27E-08	8.10E-08	7.40E-08	7.77E-08	7.61E-08	7.46E-08	7.32E-08
SE	9.71E-08	9.47E-08	9.24E-08	9.01E-08	8.78E-08	8.56E-08	8.18E-08
SSE	1.07E-07	1.02E-07	1.02E-07	9.90E-08	9.66E-08	9.41E-08	1.19E-07
S	1.06E-07	1.04E-07	1.02E-07	9.72E-08	9.63E-08	9.35E-08	9.03E-08
SSW	1.05E-07	1.03E-07	1.01E-07	9.78E-08	9.46E-08	9.20E-08	9.00E-08
SW	1.38E-07	1.37E-07	1.34E-07	1.30E-07	1.26E-07	1.24E-07	1.22E-07
WSW	1.31E-07	1.28E-07	1.28E-07	1.22E-07	1.20E-07	1.19E-07	1.18E-07
W	1.33E-07	1.28E-07	1.25E-07	1.24E-07	1.20E-07	1.17E-07	1.15E-07
WNW	1.43E-07	1.38E-07	1.35E-07	1.33E-07	1.33E-07	1.27E-07	1.25E-07
NW	1.14E-07	1.12E-07	1.11E-07	1.07E-07	1.04E-07	1.01E-07	9.74E-08
NNW	9.12E-08	8.89E-08	8.64E-08	8.31E-08	8.26E-08	8.08E-08	7.72E-08

Period of Record: 9-1-76 to 8-31-78

\* Measured relevant to the Offgas Stack.

\*\* Values less than the value for 0.4 miles.

\*\*\* See appropriate offgas stack long term elevated release values.

<b>MONTICELLO NUCLEAR GENERATING PLANT</b>		ODCM-APP-A
<b>TITLE:</b>	<b>APPENDIX A</b>	Revision 3
		Page 46 of 71

Table 10 Monticello Offgas Stack Dispersion Parameters for Short Term Elevated Releases  
 $\leq 500$  Hrs/Yr or  $\leq 150$  Hrs/Qtr (cont'd)

For Standard Distances (As Measured from the Offgas Stack) ( $\chi/q$ ),  $\text{sec}/\text{m}^3$   
Miles

Sector*	5.0
N	8.28E-08
NNE	7.56E-08
NE	7.58E-08
ENE	7.11E-08
E	6.33E-08
ESE	7.16E-08
SE	8.10E-08
SSE	1.11E-07
S	8.84E-08
SSW	8.80E-08
SW	1.19E-07
WSW	1.13E-07
W	1.13E-07
WNW	1.21E-07
NW	9.51E-08
NNW	7.53E-08

Period of Record: 9-1-76 to 8-31-78

\* Measured relevant to the Offgas Stack.

\*\* Values less than the value for 0.4 miles.

\*\*\* See appropriate offgas stack long term elevated release values.



<b>MONTICELLO NUCLEAR GENERATING PLANT</b>		ODCM-APP-A
<b>TITLE:</b>	<b>APPENDIX A</b>	Revision 3
		Page 47 of 71

Table 11 Monticello Offgas Stack Dispersion Parameters for Short Term Elevated Releases  
 $\leq 500$  HrsYr or  $\leq 150$  Hrs/Qtr

For Standard Distances (As Measured from the Offgas Stack) (D/q), m<sup>-2</sup>

Sector*	Miles						
	0.1	0.2	0.3	0.4	0.5	0.6	0.7
N	**	**	**	1.32E-08	1.31E-08	9.45E-09	6.60E-09
NNE	**	**	**	2.39E-08	1.86E-08	1.39E-09	9.88E-09
NE	**	**	**	6.01E-09	7.80E-09	6.24E-09	4.92E-09
ENE	**	**	**	1.31E-08	1.14E-08	8.79E-09	6.20E-09
E	**	**	**	7.37E-09	9.17E-09	6.52E-09	4.58E-09
ESE	**	**	**	***	***	3.74E-09	5.28E-09
SE	**	**	**	***	***	***	6.26E-09
SSE	**	**	**	***	***	***	6.60E-09
S	**	**	**	***	***	4.41E-09	5.43E-09
SSW	**	**	**	***	***	3.39E-09	4.09E-09
SW	**	**	**	***	***	2.30E-09	3.34E-09
WSW	**	**	**	***	***	2.16E-09	3.17E-09
W	**	**	**	***	2.22E-09	3.38E-09	3.35E-09
WNW	**	**	**	***	2.55E-09	3.89E-09	3.94E-09
NW	**	**	**	***	***	3.17E-09	4.01E-09
NNW	**	**	**	2.13E-08	1.68E-08	1.30E-08	9.18E-09

Period of Record: 9-1-76 to 8-31-78

\* Measured relevant to the Offgas Stack.

\*\* Values less than the value for 0.4 miles.

\*\*\* See appropriate offgas stack long term elevated release values.

<b>MONTICELLO NUCLEAR GENERATING PLANT</b>		ODCM-APP-A
<b>TITLE:</b>	<b>APPENDIX A</b>	Revision 3
		Page 48 of 71

Table 11 Monticello Offgas Stack Dispersion Parameters for Short Term Elevated Releases  
 $\leq 500$  HrsYr or  $\leq 150$  Hrs/Qtr (cont'd)

For Standard Distances (As Measured from the Offgas Stack) (D/q), m<sup>-2</sup>

Sector*	Miles						
	0.8	0.9	1.0	1.1	1.2	1.3	1.4
N	7.46E-09	7.64E-09	7.08E-09	5.61E-09	5.20E-09	4.30E-09	4.21E-09
NNE	9.52E-09	9.50E-09	8.74E-09	7.97E-09	6.49E-09	5.28E-09	5.05E-09
NE	5.32E-09	5.92E-09	5.43E-09	4.98E-09	4.43E-09	3.60E-09	3.11E-09
ENE	6.00E-09	5.94E-09	5.01E-09	4.56E-09	4.25E-09	3.75E-09	3.31E-09
E	5.18E-09	5.40E-09	4.74E-09	4.36E-09	3.76E-09	3.08E-09	3.09E-09
ESE	6.16E-09	6.58E-09	5.98E-09	4.72E-09	4.30E-09	3.89E-09	3.66E-09
SE	7.39E-09	7.99E-09	7.50E-09	6.40E-09	5.96E-09	5.50E-09	6.04E-09
SSE	7.58E-09	8.26E-09	7.59E-09	6.02E-09	6.29E-09	5.79E-09	6.12E-09
S	6.46E-09	6.88E-09	6.53E-09	5.17E-09	4.89E-09	4.19E-09	5.08E-09
SSW	4.90E-09	4.99E-09	4.71E-09	4.17E-09	3.58E-09	3.12E-09	3.17E-09
SW	5.67E-09	4.25E-09	3.97E-09	3.65E-09	3.03E-09	2.74E-09	3.65E-09
WSW	3.83E-09	4.16E-09	3.58E-09	3.23E-09	3.12E-09	2.66E-09	3.64E-09
W	4.14E-09	4.59E-09	4.35E-09	3.87E-09	3.59E-09	3.20E-09	3.87E-09
WNW	4.86E-09	5.37E-09	5.09E-09	4.51E-09	4.10E-09	3.77E-09	4.44E-09
NW	4.75E-09	5.16E-09	5.03E-09	4.25E-09	3.55E-09	3.43E-09	3.86E-09
NNW	8.37E-09	8.39E-09	7.94E-09	7.09E-09	5.96E-09	4.82E-09	6.18E-09

Period of Record: 9-1-76 to 8-31-78

\* Measured relevant to the Offgas Stack.

<b>MONTICELLO NUCLEAR GENERATING PLANT</b>		ODCM-APP-A
<b>TITLE:</b>	<b>APPENDIX A</b>	Revision 3
		Page 49 of 71

Table 11 Monticello Offgas Stack Dispersion Parameters for Short Term Elevated Releases  
 $\leq 500$  HrsYr or  $\leq 150$  Hrs/Qtr (cont'd)

For Standard Distances (As Measured from the Offgas Stack) (D/q), m<sup>-2</sup>

Sector*	Miles						
	1.5	1.6	1.7	1.8	1.9	2.0	2.1
N	4.63E-09	3.13E-09	3.20E-09	2.90E-09	2.69E-09	2.48E-09	2.24E-09
NNE	5.50E-09	3.78E-09	4.02E-09	3.56E-09	3.27E-09	2.95E-09	2.66E-09
NE	3.10E-09	2.65E-09	2.28E-09	2.48E-09	2.27E-09	2.08E-09	1.85E-09
ENE	2.86E-09	2.40E-09	2.81E-09	2.31E-09	2.08E-09	1.91E-09	1.76E-09
E	2.73E-09	2.35E-09	2.05E-09	2.39E-09	2.18E-09	1.96E-09	1.81E-09
ESE	3.62E-09	3.20E-09	2.86E-09	***	2.38E-09	2.22E-09	2.10E-09
SE	4.68E-09	4.28E-09	3.67E-09	3.61E-09	3.49E-09	3.09E-09	2.75E-09
SSE	4.50E-09	3.93E-09	3.57E-09	3.70E-09	2.90E-09	2.79E-09	2.69E-09
S	3.59E-09	***	3.58E-09	3.34E-09	3.04E-09	2.74E-09	2.55E-09
SSW	2.73E-09	2.34E-09	2.81E-09	2.42E-09	2.17E-09	1.97E-09	1.80E-09
SW	2.32E-09	1.98E-09	1.72E-09	1.72E-09	1.72E-09	1.57E-09	1.40E-09
WSW	2.38E-09	2.07E-09	1.80E-09	1.77E-09	1.73E-09	1.58E-09	1.42E-09
W	2.70E-09	2.47E-09	2.47E-09	2.22E-09	1.92E-09	1.75E-09	1.57E-09
WNW	2.83E-09	2.38E-09	2.06E-09	2.02E-09	2.03E-09	1.84E-09	1.64E-09
NW	3.09E-09	2.70E-09	3.41E-09	2.94E-09	2.70E-09	2.35E-09	2.13E-09
NNW	4.19E-09	3.41E-09	3.09E-09	2.84E-09	2.74E-09	2.54E-09	2.33E-09

Period of Record: 9-1-76 to 8-31-78

\* Measured relevant to the Offgas Stack.

\*\*\* See appropriate long term values.

<b>MONTICELLO NUCLEAR GENERATING PLANT</b>		ODCM-APP-A
<b>TITLE:</b>	<b>APPENDIX A</b>	Revision 3
		Page 50 of 71

Table 11 Monticello Offgas Stack Dispersion Parameters for Short Term Elevated Releases  $\leq 500$  HrsYr or  $\leq 150$  Hrs/Qtr (cont'd)

For Standard Distances (As Measured from the Offgas Stack) (D/q),  $m^{-2}$

Sector*	Miles						
	2.2	2.3	2.4	2.5	2.6	2.7	2.8
N	2.04E-09	1.90E-09	1.75E-09	1.64E-09	1.53E-09	1.42E-09	1.27E-09
NNE	2.45E-09	2.25E-09	2.10E-09	1.95E-09	1.82E-09	1.73E-09	1.61E-09
NE	1.67E-09	1.51E-09	1.42E-09	1.30E-09	1.19E-09	1.11E-09	1.03E-09
ENE	1.61E-09	1.47E-09	1.38E-09	1.29E-09	1.18E-09	1.12E-09	1.04E-09
E	1.62E-09	1.51E-09	1.37E-09	1.30E-09	1.20E-09	1.12E-09	1.04E-09
ESE	1.99E-09	1.88E-09	1.78E-09	1.66E-09	1.55E-09	1.44E-09	1.34E-09
SE	2.89E-09	2.38E-09	2.24E-09	2.12E-09	1.97E-09	2.09E-09	1.97E-09
SSE	2.47E-09	2.24E-09	2.18E-09	2.01E-09	1.85E-09	1.72E-09	1.98E-09
S	2.06E-09	1.92E-09	1.80E-09	1.67E-09	1.54E-09	1.46E-09	1.64E-09
SSW	1.62E-09	1.64E-09	1.73E-09	1.57E-09	1.46E-09	1.37E-09	1.29E-09
SW	1.24E-09	1.27E-09	1.35E-09	1.40E-09	1.60E-09	1.48E-09	1.34E-09
WSW	1.24E-09	1.29E-09	1.26E-09	1.27E-09	1.35E-09	1.27E-09	1.42E-09
W	1.40E-09	1.40E-09	1.42E-09	1.47E-09	1.35E-09	1.27E-09	1.20E-09
WNW	1.43E-09	1.46E-09	1.48E-09	1.52E-09	1.68E-09	1.58E-09	1.44E-09
NW	1.93E-09	1.80E-09	1.67E-09	1.57E-09	1.45E-09	1.35E-09	1.25E-09
NNW	2.22E-09	2.09E-09	2.02E-09	1.85E-09	1.74E-09	1.58E-09	1.44E-09

Period of Record: 9-1-76 to 8-31-78

\* Measured relevant to the Offgas Stack.

<b>MONTICELLO NUCLEAR GENERATING PLANT</b>		ODCM-APP-A
<b>TITLE:</b>	<b>APPENDIX A</b>	Revision 3
		Page 51 of 71

Table 11 Monticello Offgas Stack Dispersion Parameters for Short Term Elevated Releases  $\leq 500$  HrsYr or  $\leq 150$  Hrs/Qtr (cont'd)

For Standard Distances (As Measured from the Offgas Stack) (D/q),  $m^{-2}$

Sector*	Miles						
	2.9	3.0	3.1	3.2	3.3	3.4	3.5
N	1.20E-09	1.15E-09	1.08E-09	1.03E-09	9.77E-10	9.22E-10	8.74E-10
NNE	1.47E-09	1.39E-09	1.31E-09	1.25E-09	1.17E-09	1.11E-09	1.06E-09
NE	9.37E-10	8.90E-10	8.37E-10	7.98E-10	7.54E-10	7.19E-10	6.82E10
ENE	9.64E-10	9.11E-10	8.65E-10	8.28E-10	7.85E-10	7.41E-10	7.09E-10
E	9.72E-10	9.18E-10	8.55E-10	8.15E-10	7.80E-10	7.63E-10	6.77E-10
ESE	1.26E-09	1.18E-09	1.09E-09	1.04E-09	9.85E-10	9.24E-10	9.01E-10
SE	1.58E-09	1.57E-09	1.56E-09	1.49E-09	1.40E-09	1.31E-09	1.23E-09
SSE	1.57E-09	1.55E-09	1.54E-09	1.52E-09	1.44E-09	1.36E-09	1.28E-09
S	1.56E-09	1.41E-09	1.29E-09	1.21E-09	1.10E-09	1.05E-09	1.01E-09
SSW	1.22E-09	1.12E-09	1.04E-09	9.83E-10	9.12E-10	8.63E-10	8.24E-10
SW	1.25E-09	1.11E-09	1.05E-09	9.69E-10	8.96E-10	8.36E-10	7.83E-10
WSW	1.31E-09	1.22E-09	1.13E-09	1.05E-09	9.80E-10	9.14E-10	8.49E-10
W	1.19E-09	1.09E-09	1.04E-09	9.69E-10	9.26E-10	8.75E-10	8.11E-10
WNW	1.31E-09	1.21E-09	1.12E-09	1.06E-09	9.78E-10	9.00E-10	8.43E-10
NW	1.23E-09	1.03E09	9.72E-10	9.26E-10	8.37E-10	7.94E-10	7.63E-10
NNW	1.35E-09	1.30E-09	1.25E-09	1.17E-09	1.11E-09	1.06E-09	1.44E-09

Period of Record: 9-1-76 to 8-31-78

\* Measured relevant to the Offgas Stack.

<b>MONTICELLO NUCLEAR GENERATING PLANT</b>		ODCM-APP-A
<b>TITLE:</b>	<b>APPENDIX A</b>	Revision 3
		Page 52 of 71

Table 11 Monticello Offgas Stack Dispersion Parameters for Short Term Elevated Releases  $\leq 500$  HrsYr or  $\leq 150$  Hrs/Qtr (cont'd)

For Standard Distances (As Measured from the Offgas Stack) (D/q),  $m^{-2}$

Sector*	Miles						
	3.6	3.7	3.8	3.9	4.0	4.1	4.2
N	8.20E-10	7.85E-10	7.57E-10	7.26E-10	6.90E-10	6.64E-10	6.42E-10
NNE	1.01E-09	9.76E-10	9.14E-10	8.72E-10	8.35E-10	7.98E-10	7.55E-10
NE	6.45E-10	6.15E-10	5.85E-10	5.60E-10	5.22E-10	4.99E-10	4.77E-10
ENE	6.83E-10	6.52E-10	6.06E-10	5.79E-10	5.51E-10	5.22E-10	5.00E-10
E	6.49E-10	6.16E-10	5.77E-10	5.51E-10	5.25E-10	5.05E-10	4.85E-10
ESE	8.60E-10	8.21E-10	7.64E-10	7.41E-10	7.16E-10	6.91E-10	6.61E-10
SE	1.16E-09	1.10E-09	1.08E-09	1.02E-09	9.68E-10	9.93E-10	9.48E-10
SSE	1.21E-09	1.15E-09	1.08E-09	1.02E-09	1.04E-09	9.94E-10	9.52E-10
S	9.44E-10	9.15E-10	8.76E-10	8.65E-10	8.63E-10	8.23E-10	7.95E-10
SSW	7.76E-10	7.35E-10	6.96E-10	6.69E-10	6.35E-10	6.08E-10	5.70E-10
SW	7.42E-10	6.82E-10	6.45E-10	6.21E-10	5.90E-10	5.64E-10	5.37E-10
WSW	7.90E-10	7.45E-10	7.21E-10	6.88E-10	6.21E-10	5.94E-10	5.78E-10
W	7.69E-10	7.29E-10	6.93E-10	6.50E-10	6.08E-10	5.83E-10	5.56E-10
WNW	8.16E-10	7.73E-10	7.41E-10	7.05E-10	6.72E-10	6.38E-10	6.11E-10
NW	7.24E-10	6.75E-10	6.45E-10	6.43E-10	6.48E-10	6.19E-10	5.95E-10
NNW	9.60E-10	9.10E-10	8.53E-10	8.18E-10	7.82E-10	7.49E-10	7.22E-10

Period of Record: 9-1-76 to 8-31-78

\* Measured relevant to the Offgas Stack.

<b>MONTICELLO NUCLEAR GENERATING PLANT</b>		ODCM-APP-A
<b>TITLE:</b>	<b>APPENDIX A</b>	Revision 3
		Page 53 of 71

Table 11 Monticello Offgas Stack Dispersion Parameters for Short Term Elevated Releases  
 $\leq 500$  HrsYr or  $\leq 150$  Hrs/Qtr (cont'd)

For Standard Distances (As Measured from the Offgas Stack) (D/q), m<sup>-2</sup>

Sector*	Miles						
	4.3	4.4	4.5	4.6	4.7	4.8	4.9
N	6.07E-10	5.80E-10	5.43E-10	5.20E-10	5.01E-10	4.83E-10	4.65E-10
NNE	7.27E-10	7.00E-10	6.81E-10	6.52E-10	6.20E-10	5.98E-10	5.76E-10
NE	4.61E-10	4.42E-10	4.27E-10	4.10E-10	3.99E-10	3.83E-10	3.66E-10
ENE	4.81E-10	4.63E-10	4.45E-10	4.24E-10	4.07E-10	3.92E-10	3.76E-10
E	4.55E-10	4.43E-10	4.19E-10	4.02E-10	3.86E-10	3.71E-10	3.55E-10
ESE	6.34E-10	6.06E-10	5.45E-10	5.59E-10	5.39E-10	5.19E-10	4.97E-10
SE	9.05E-10	8.70E-10	8.33E-10	8.01E-10	7.69E-10	7.38E-10	6.94E-10
SSE	9.43E-10	8.59E-10	8.39E-10	8.03E-10	7.73E-10	7.40E-10	9.18E-10
S	7.75E-10	7.42E-10	7.10E-10	6.65E-10	6.49E-10	6.21E-10	5.91E-10
SSW	5.39E-10	5.15E-10	4.91E-10	4.69E-10	4.47E-10	4.28E-10	4.13E-10
SW	5.23E-10	5.02E-10	4.74E-10	4.53E-10	4.35E-10	4.22E-10	4.08E-10
WSW	5.46E-10	5.16E-10	4.98E-10	4.69E-10	4.55E-10	4.45E-10	4.34E-10
W	5.35E-10	5.09E-10	4.89E-10	4.77E-10	4.53E-10	4.36E-10	4.20E-10
WNW	5.91E-10	5.61E-10	5.41E-10	5.24E-10	5.16E-10	4.87E-10	4.69E-10
NW	5.88E-10	5.66E-10	5.44E-10	5.17E-10	4.96E-10	4.72E-10	4.48E-10
NNW	6.90E-10	6.60E-10	6.30E-10	5.96E-10	5.83E-10	5.61E-10	5.28E-10

Period of Record: 9-1-76 to 8-31-78

\* Measured relevant to the Offgas Stack.

<b>MONTICELLO NUCLEAR GENERATING PLANT</b>		ODCM-APP-A
<b>TITLE:</b>	<b>APPENDIX A</b>	Revision 3
		Page 54 of 71

Table 11 Monticello Offgas Stack Dispersion Parameters for Short Term Elevated Releases  
 $\leq 500$  HrsYr or  $\leq 150$  Hrs/Qtr (cont'd)

For Standard Distances (As Measured from the Offgas Stack) (D/q), m<sup>-2</sup>

Miles

Sector*	5.0
N	4.39E-10
NNE	5.46E-10
NE	3.48E-10
ENE	3.56E-10
E	3.45E-10
ESE	4.80E-10
SE	6.78E-10
SSE	8.45E-10
S	5.70E-10
SSW	3.98E-10
SW	3.92E-10
WSW	4.12E-10
W	4.05E-10
WNW	4.48E-10
NW	4.31E-10
NNW	5.06E-10

Period of Record: 9-1-76 to 8-31-78

\* Measured relevant to the Offgas Stack.



<b>MONTICELLO NUCLEAR GENERATING PLANT</b>		ODCM-APP-A
<b>TITLE:</b>	<b>APPENDIX A</b>	Revision 3
		Page 55 of 71

Table 12 Monticello Reactor Building Vent Dispersion Parameters for Short Term Elevated Releases  $\leq 500$  Hrs/Yr or  $\leq 150$  Hrs/Qtr

Sector*	Distance		$\chi/q$ (sec/m) <sup>3</sup> No Decay Undepleted	D/q (m <sup>-2</sup> )
	Miles	Meters		
N	0.51	821.	5.18E-06	7.19E-08
NNE	0.58	933.	3.51E-06	5.02E-08
NE	0.65	1046.	2.33E-06	2.93E-08
ENE	0.83	1336.	1.82E-06	1.69E-08
E	0.59	950.	3.67E-06	3.90E-08
ESE	0.59	950.	4.95E-06	6.51E-08
SE	0.61	982.	4.96E-06	6.49E-08
SSE	0.43	692.	8.06E-06	1.18E-07
S	0.34	547.	6.92E-06	9.30E-08
SSW	0.32	515.	5.92E-06	7.04E-08
SW	0.32	515.	6.31E-06	8.24E-08
WSW	0.35	563.	4.91E-06	5.50E-08
W	0.48	772.	3.38E-06	3.82E-08
WNW	0.68	1094.	2.94E-06	2.88E-08
NW	0.43	692.	5.70E-06	7.09E-08
NNW	0.53	853.	4.44E-06	6.09E-08

Period of Record: 9-1-76 to 8-31-78

\* Measured relevant to the Reactor Vent.

<b>MONTICELLO NUCLEAR GENERATING PLANT</b>		ODCM-APP-A
<b>TITLE:</b>	<b>APPENDIX A</b>	Revision 3
		Page 56 of 71

Table 13 Reactor Building Vent Dispersion Parameters for Short Term Elevated Releases  
 $\leq 500$  Hrs/Yr or  $\leq 150$  Hrs/Qtr

For Standard Distances (As Measured from the Offgas Stack) ( $\chi/q$ ),  $\text{sec/m}^3$

Sector*	Miles						
	0.1	0.2	0.3	0.4	0.5	0.6	0.7
N	7.30E-05	2.19E-05	1.10E-05	7.14E-06	5.28E-06	4.19E-06	3.46E-06
NNE	5.81E-05	1.77E-05	8.96E-06	5.84E-06	4.23E-06	3.34E-06	2.79E-06
NE	4.26E-05	1.29E-05	6.69E-06	4.33E-06	3.19E-06	2.54E-06	2.16E-06
ENE	4.27E-05	1.29E-05	6.65E-06	4.32E-06	3.15E-06	2.53E-06	2.16E-06
E	5.76E-05	1.73E-05	9.22E-06	6.20E-06	4.51E-06	3.63E-06	3.04E-06
ESE	7.80E-05	2.30E-05	1.24E-05	8.28E-06	6.16E-06	4.84E-06	4.01E-06
SE	8.52E-05	2.48E-05	1.31E-05	8.85E-06	6.46E-06	5.08E-06	4.18E-06
SSE	8.87E-05	2.60E-05	1.36E-05	8.91E-06	6.53E-06	5.15E-06	4.22E-06
S	4.89E-05	1.47E-05	7.95E-06	5.35E-06	3.95E-06	3.17E-06	2.63E-06
SSW	4.04E-05	1.19E-05	6.58E-06	4.38E-06	3.34E-06	2.80E-06	2.46E-06
SW	4.37E-05	1.34E-05	7.26E-06	4.76E-06	3.62E-06	2.97E-06	2.62E-06
WSW	3.65E-05	1.09E-05	6.13E-06	4.11E-06	3.17E-06	2.70E-06	2.43E-06
W	4.07E-05	1.23E-05	6.47E-06	4.32E-06	3.19E-06	2.67E-06	2.35E-06
WNW	5.53E-05	1.65E-05	8.74E-06	5.74E-06	4.22E-06	3.37E-06	2.85E-06
NW	6.25E-05	1.85E-05	9.62E-06	6.32E-06	4.65E-06	3.76E-06	3.15E-06
NNW	7.11E-05	2.11E-05	1.04E-05	6.70E-06	4.78E-06	3.76E-06	3.15E-06

Period of Record: 9-1-76 to 8-31-78

\* Measured relevant to the Reactor Vent.

<b>MONTICELLO NUCLEAR GENERATING PLANT</b>		ODCM-APP-A
<b>TITLE:</b>	<b>APPENDIX A</b>	Revision 3
		Page 57 of 71

Table 13 Reactor Building Vent Dispersion Parameters for Short Term Elevated Releases  $\leq 500$  Hrs/Yr or  $\leq 150$  Hrs/Qtr (cont'd)

For Standard Distances (As Measured from the Offgas Stack) ( $\chi/q$ ),  $\text{sec}/\text{m}^3$

Sector*	Miles						
	0.8	0.9	1.0	1.1	1.2	1.3	1.4
N	2.84E-06	2.43E-06	2.05E-06	1.79E-06	1.61E-06	1.46E-06	1.31E-06
NNE	2.33E-06	2.02E-06	1.71E-06	1.51E-06	1.37E-06	1.24E-06	1.12E-06
NE	1.83E-06	1.58E-06	1.37E-06	1.21E-06	1.11E-06	9.99E-06	9.23E-06
ENE	1.87E-06	1.64E-06	1.46E-06	1.31E-06	1.20E-06	1.11E-06	1.04E-06
E	2.51E-06	2.18E-06	1.87E-06	1.64E-06	1.50E-06	1.38E-06	1.26E-06
ESE	3.34E-06	2.77E-06	2.38E-06	2.07E-06	1.80E-06	1.59E-06	1.44E-06
SE	3.42E-06	2.82E-06	2.39E-06	2.07E-06	1.78E-06	1.57E-06	1.40E-06
SSE	3.47E-06	2.89E-06	2.43E-06	2.12E-06	1.86E-06	1.64E-06	1.47E-06
S	2.27E-06	1.96E-06	1.70E-06	1.51E-06	1.38E-06	1.27E-06	1.15E-06
SSW	2.18E-06	1.93E-06	1.74E-06	1.52E-06	1.48E-06	1.33E-06	1.21E-06
SW	2.26E-06	1.99E-06	1.81E-06	1.58E-06	1.44E-06	1.32E-06	1.21E-06
WSW	2.18E-06	1.94E-06	1.82E-06	1.63E-06	1.48E-06	1.39E-06	1.29E-06
W	2.07E-06	1.87E-06	1.67E-06	1.52E-06	1.41E-06	1.29E-06	1.19E-06
WNW	2.47E-06	2.15E-06	1.86E-06	1.68E-06	1.52E-06	1.37E-06	1.26E-06
NW	2.60E-06	2.22E-06	1.89E-06	1.64E-06	1.49E-06	1.34E-06	1.22E-06
NNW	2.64E-06	2.25E-06	1.90E-06	1.68E-06	1.50E-06	1.37E-06	1.25E-06

Period of Record: 9-1-76 to 8-31-78

\* Measured relevant to the Reactor Vent.

<b>MONTICELLO NUCLEAR GENERATING PLANT</b>		ODCM-APP-A
<b>TITLE:</b>	<b>APPENDIX A</b>	Revision 3
		Page 58 of 71

Table 13 Reactor Building Vent Dispersion Parameters for Short Term Elevated Releases  
 $\leq 500$  Hrs/Yr or  $\leq 150$  Hrs/Qtr (cont'd)

For Standard Distances (As Measured from the Offgas Stack) ( $\chi/q$ ), sec/m<sup>3</sup>

Sector*	Miles						
	1.5	1.6	1.7	1.8	1.9	2.0	2.1
N	1.28E-06	1.15E-06	1.05E-06	9.60E-07	9.00E-07	8.28E-07	7.67E-07
NNE	1.11E-06	9.94E-07	9.14E-07	8.44E-07	7.91E-07	7.31E-07	6.94E-07
NE	8.63E-07	7.69E-07	7.26E-07	7.09E-07	6.71E-07	6.31E-07	6.08E-07
ENE	9.50E-07	9.08E-07	8.65E-07	8.22E-07	7.80E-07	7.31E-07	7.00E-07
E	1.15E-06	1.06E-06	1.02E-06	9.40E-07	8.72E-07	8.20E-07	7.72E-07
ESE	1.31E-06	1.16E-06	1.07E-06	1.03E-06	9.41E-07	8.73E-07	8.08E-07
SE	1.26E-06	1.15E-06	1.06E-06	1.01E-06	9.48E-07	8.74E-07	8.19E-07
SSE	1.33E-06	1.17E-06	1.09E-06	1.05E-06	9.69E-07	9.01E-07	8.34E-07
S	1.13E-06	1.00E-06	9.21E-07	8.55E-07	7.94E-07	7.33E-07	6.96E-07
SSW	1.19E-06	1.12E-06	1.08E-06	1.04E-06	1.02E-06	1.02E-06	9.95E-07
SW	1.18E-06	1.09E-06	1.06E-06	1.01E-06	9.62E-07	9.53E-07	9.34E-07
WSW	1.27E-06	1.21E-06	1.16E-06	1.09E-06	1.05E-06	1.04E-06	1.02E-06
W	1.19E-06	1.12E-06	1.06E-06	1.02E-06	1.01E-06	9.95E-07	9.91E-07
WNW	1.25E-06	1.16E-06	1.11E-06	1.06E-06	1.02E-06	1.01E-06	9.90E-07
NW	1.09E-06	9.91E-07	9.57E-07	8.87E-07	8.18E-07	7.65E-07	7.25E-07
NNW	1.24E-06	1.12E-06	1.03E-06	9.46E-07	8.85E-07	8.17E-07	7.74E-07

Period of Record: 9-1-76 to 8-31-78

\* Measured relevant to the Reactor Vent.

<b>MONTICELLO NUCLEAR GENERATING PLANT</b>		ODCM-APP-A
<b>TITLE:</b>	<b>APPENDIX A</b>	Revision 3
		Page 59 of 71

Table 13 Reactor Building Vent Dispersion Parameters for Short Term Elevated Releases  $\leq 500$  Hrs/Yr or  $\leq 150$  Hrs/Qtr (cont'd)

For Standard Distances (As Measured from the Offgas Stack) ( $\chi/q$ ),  $\text{sec/m}^3$

Sector*	Miles						
	2.2	2.3	2.4	2.5	2.6	2.7	2.8
N	7.21E-07	6.79E-07	6.38E-07	6.10E-07	5.92E-07	5.77E-07	5.62E-07
NNE	6.47E-07	6.14E-07	5.79E-07	5.45E-07	5.26E-07	4.99E-07	4.80E-07
NE	5.81E-07	5.55E-07	5.23E-07	5.11E-07	4.86E-07	4.63E-07	4.47E-07
ENE	6.68E-07	6.41E-07	6.10E-07	5.90E-07	5.62E-07	5.41E-07	5.22E-07
E	7.25E-07	6.92E-07	6.51E-07	6.19E-07	5.74E-07	5.53E-07	5.35E-07
ESE	7.53E-07	7.07E-07	6.62E-07	6.25E-07	5.91E-07	5.56E-07	5.28E-07
SE	7.76E-07	7.36E-07	7.02E-07	6.75E-07	6.37E-07	6.04E-07	5.74E-07
SSE	7.74E-07	7.28E-07	6.87E-07	6.46E-07	6.10E-07	5.77E-07	5.51E-07
S	6.44E-07	6.08E-07	5.80E-07	5.54E-07	5.40E-07	5.25E-07	5.14E-07
SSW	9.71E-07	9.89E-07	9.88E-07	9.58E-07	9.03E-07	8.47E-07	8.10E-07
SW	9.09E-07	9.03E-07	8.97E-07	8.65E-07	8.24E-07	7.90E-07	7.65E-07
WSW	9.86E-07	9.81E-07	9.76E-07	9.48E-07	8.87E-07	8.35E-07	7.92E-07
W	9.66E-07	9.80E-07	9.78E-07	9.56E-07	9.12E-07	8.87E-07	8.66E-07
WNW	9.90E-07	9.88E-07	9.97E-07	9.75E-07	9.54E-07	9.43E-07	9.29E-07
NW	6.91E-07	6.47E-07	6.07E-07	5.89E-07	5.72E-07	5.60E-07	5.51E-07
NNW	7.27E-07	6.76E-07	6.47E-07	6.28E-07	5.95E-07	5.74E-07	5.52E-07

Period of Record: 9-1-76 to 8-31-78

\* Measured relevant to the Reactor Vent.

<b>MONTICELLO NUCLEAR GENERATING PLANT</b>		ODCM-APP-A
<b>TITLE:</b>	<b>APPENDIX A</b>	Revision 3
		Page 60 of 71

Table 13 Reactor Building Vent Dispersion Parameters for Short Term Elevated Releases  
 $\leq 500$  Hrs/Yr or  $\leq 150$  Hrs/Qtr (cont'd)

For Standard Distances (As Measured from the Offgas Stack) ( $\chi/q$ ), sec/m<sup>3</sup>

Sector*	Miles						
	2.9	3.0	3.1	3.2	3.3	3.4	3.5
N	5.48E-07	5.29E-07	5.16E-07	5.02E-07	4.91E-07	4.99E-07	4.82E-07
NNE	4.65E-07	4.49E-07	4.30E-07	4.15E-07	3.98E-07	3.83E-07	3.71E-07
NE	4.31E-07	4.13E-07	3.96E-07	3.82E-07	3.66E-07	3.51E-07	3.39E-07
ENE	5.06E-07	4.87E-07	4.64E-07	4.52E-07	4.36E-07	4.25E-07	4.14E-07
E	5.13E-07	5.00E-07	4.80E-07	4.62E-07	4.45E-07	4.27E-07	4.09E-07
ESE	5.01E-07	4.74E-07	4.57E-07	4.36E-07	4.15E-07	3.99E-07	3.83E-07
SE	5.51E-07	5.28E-07	5.05E-07	4.78E-07	4.55E-07	4.35E-07	4.16E-07
SSE	5.27E-07	5.06E-07	4.85E-07	4.59E-07	4.44E-07	4.26E-07	4.10E-07
S	5.03E-07	4.91E-07	5.05E-07	4.93E-07	4.96E-07	4.76E-07	4.67E-07
SSW	7.70E-07	7.34E-07	7.03E-07	6.76E-07	6.48E-07	6.25E-07	5.97E-07
SW	7.38E-07	7.09E-07	6.87E-07	6.61E-07	6.43E-07	6.16E-07	5.94E-07
WSW	7.52E-07	7.13E-07	6.84E-07	6.52E-07	6.24E-07	6.02E-07	5.73E-07
W	8.43E-07	8.16E-07	7.91E-07	7.64E-07	7.44E-07	7.09E-07	6.90E-07
WNW	9.07E-07	8.94E-07	8.62E-07	8.44E-07	8.18E-07	8.00E-07	7.84E-07
NW	5.34E-07	5.22E-07	5.28E-07	5.15E-07	5.16E-07	5.04E-07	4.97E-07
NNW	5.28E-07	5.08E-07	4.93E-07	4.74E-07	4.55E-07	4.35E-07	4.20E-07

Period of Record: 9-1-76 to 8-31-78

\* Measured relevant to the Reactor Vent.

<b>MONTICELLO NUCLEAR GENERATING PLANT</b>		ODCM-APP-A
<b>TITLE:</b>	<b>APPENDIX A</b>	Revision 3
		Page 61 of 71

Table 13 Reactor Building Vent Dispersion Parameters for Short Term Elevated Releases  
 $\leq 500$  Hrs/Yr or  $\leq 150$  Hrs/Qtr (cont'd)

For Standard Distances (As Measured from the Offgas Stack) ( $\chi/q$ ), sec/m<sup>3</sup>

Sector*	Miles						
	3.6	3.7	3.8	3.9	4.0	4.1	4.2
N	4.65E-07	4.49E-07	4.32E-07	4.19E-07	4.06E-07	3.95E-07	3.83E-07
NNE	3.58E-07	3.47E-07	3.37E-07	3.25E-07	3.16E-07	3.18E-07	3.08E-07
NE	3.29E-07	3.18E-07	3.10E-07	3.01E-07	2.93E-07	2.90E-07	2.77E-07
ENE	4.02E-07	3.90E-07	3.80E-07	3.72E-07	3.60E-07	3.55E-07	3.46E-07
E	3.97E-07	3.83E-07	3.72E-07	3.74E-07	3.66E-07	3.55E-07	3.44E-07
ESE	3.71E-07	3.57E-07	3.42E-07	3.37E-07	3.28E-07	3.17E-07	3.06E-07
SE	4.01E-07	3.86E-07	3.70E-07	3.61E-07	3.48E-07	3.44E-07	3.42E-07
SSE	3.92E-07	3.78E-07	3.68E-07	3.66E-07	3.52E-07	3.41E-07	3.29E-07
S	4.49E-07	4.43E-07	4.36E-07	4.29E-07	4.22E-07	4.16E-07	4.12E-07
SSW	5.79E-07	5.58E-07	5.49E-07	5.38E-07	5.25E-07	5.14E-07	5.02E-07
SW	5.80E-07	5.64E-07	5.48E-07	5.28E-07	5.15E-07	5.04E-07	4.94E-07
WSW	5.61E-07	5.59E-07	5.50E-07	5.35E-07	5.23E-07	5.13E-07	4.90E-07
W	6.66E-07	6.40E-07	6.16E-07	5.94E-07	5.73E-07	5.54E-07	5.36E-07
WNW	7.52E-07	7.22E-07	6.90E-07	6.65E-07	6.37E-07	6.19E-07	5.97E-07
NW	4.79E-07	4.71E-07	4.66E-07	4.57E-07	4.49E-07	4.41E-07	4.38E-07
NNW	4.07E-07	3.95E-07	3.86E-07	3.72E-07	3.68E-07	3.57E-07	3.51E-07

Period of Record: 9-1-76 to 8-31-78

\* Measured relevant to the Reactor Vent.

<b>MONTICELLO NUCLEAR GENERATING PLANT</b>		ODCM-APP-A
<b>TITLE:</b>	<b>APPENDIX A</b>	Revision 3
		Page 62 of 71

Table 13 Reactor Building Vent Dispersion Parameters for Short Term Elevated Releases  
 $\leq 500$  Hrs/Yr or  $\leq 150$  Hrs/Qtr (cont'd)

For Standard Distances (As Measured from the Offgas Stack) ( $\chi/q$ ),  $\text{sec}/\text{m}^3$

Sector*	Miles						
	4.3	4.4	4.5	4.6	4.7	4.8	4.9
N	3.65E-07	3.55E-07	3.41E-07	3.33E-07	3.25E-07	3.20E-07	3.12E-07
NNE	3.08E-07	3.00E-07	2.85E-07	2.79E-07	2.72E-07	2.66E-07	2.59E-07
NE	2.79E-07	2.69E-07	2.53E-07	2.53E-07	2.48E-07	2.41E-07	2.36E-07
ENE	3.36E-07	3.29E-07	3.12E-07	3.07E-07	3.00E-07	2.98E-07	2.91E-07
E	3.37E-07	3.28E-07	3.19E-07	3.11E-07	3.02E-07	2.95E-07	2.85E-07
ESE	2.98E-07	2.89E-07	2.80E-07	2.71E-07	2.63E-07	2.56E-07	2.48E-07
SE	3.32E-07	3.20E-07	3.10E-07	3.01E-07	2.92E-07	2.83E-07	2.75E-07
SSE	3.21E-07	3.11E-07	3.02E-07	2.92E-07	2.84E-07	2.75E-07	2.68E-07
S	4.03E-07	3.94E-07	3.87E-07	3.76E-07	3.65E-07	3.53E-07	3.43E-07
SSW	4.92E-07	4.81E-07	4.71E-07	4.57E-07	4.39E-07	4.26E-07	4.11E-07
SW	4.84E-07	4.79E-07	4.69E-07	4.54E-07	4.39E-07	4.25E-07	4.12E-07
WSW	4.89E-07	4.77E-07	4.66E-07	4.50E-07	4.35E-07	4.24E-07	4.11E-07
W	5.19E-07	5.03E-07	4.87E-07	4.73E-07	4.56E-07	4.43E-07	4.25E-07
WNW	5.78E-07	5.59E-07	5.41E-07	5.25E-07	5.09E-07	4.92E-07	4.78E-07
NW	4.29E-07	4.20E-07	4.11E-07	4.00E-07	3.88E-07	3.77E-07	3.66E-07
NNW	3.45E-07	3.32E-07	3.22E-07	3.15E-07	3.07E-07	2.98E-07	2.91E-07

Period of Record: 9-1-76 to 8-31-78

\* Measured relevant to the Reactor Vent.



<b>MONTICELLO NUCLEAR GENERATING PLANT</b>		ODCM-APP-A
<b>TITLE:</b>	<b>APPENDIX A</b>	Revision 3
		Page 63 of 71

Table 13 Reactor Building Vent Dispersion Parameters for Short Term Elevated Releases  
 $\leq 500$  Hrs/Yr or  $\leq 150$  Hrs/Qtr (cont'd)

For Standard Distances (As Measured from the Offgas Stack) ( $\chi/q$ ),  $\text{sec/m}^3$   
Miles

Sector*	5.0
N	3.03E-07
NNE	2.52E-07
NE	2.30E-07
ENE	2.84E-07
E	2.82E-07
ESE	2.41E-07
SE	2.67E-07
SSE	2.62E-07
S	4.67E-07
SSW	4.00E-07
SW	3.99E-07
WSW	3.99E-07
W	4.12E-07
WNW	4.66E-07
NW	3.52E-07
NNW	2.78E-07

Period of Record: 9-1-76 to 8-31-78

\* Measured relevant to the Reactor Vent.

<b>MONTICELLO NUCLEAR GENERATING PLANT</b>		ODCM-APP-A
<b>TITLE:</b>	<b>APPENDIX A</b>	Revision 3
		Page 64 of 71

Table 14 Reactor Building Vent Dispersion Parameters for Short Term Elevated Releases  
 $\leq 500$  Hrs/Yr or  $\leq 150$  Hrs/Qtr

For Standard Distances (As Measured from the Offgas Stack) (D/q), m<sup>-2</sup>

Sector*	Miles						
	0.1	0.2	0.3	0.4	0.5	0.6	0.7
N	6.91E-07	2.69E-07	1.52E-07	1.01E-07	7.36E-08	5.53E-08	4.28E-08
NNE	5.55E-07	2.24E-07	1.30E-07	8.81E-08	6.33E-08	4.71E-08	3.65E-08
NE	3.90E-07	1.58E-07	9.37E-08	6.24E-08	4.48E-08	3.32E-08	2.59E-08
ENE	3.50E-07	1.43E-07	8.49E-08	5.71E-08	4.08E-08	3.02E-08	2.33E-08
E	4.63E-07	1.86E-07	1.10E-07	7.39E-08	5.16E-08	3.82E-08	2.91E-08
ESE	8.49E-07	3.27E-07	1.86E-07	1.21E-07	8.62E-08	6.33E-08	4.88E-08
SE	9.41E-07	3.56E-07	1.96E-07	1.29E-07	9.01E-08	6.69E-08	5.19E-08
SSE	9.60E-07	3.67E-07	2.02E-07	1.32E-07	9.36E-08	6.99E-08	5.40E-08
S	4.50E-07	1.79E-07	1.06E-07	7.18E-08	5.11E-08	3.80E-08	2.88E-08
SSW	3.27E-07	1.30E-07	7.81E-08	5.13E-08	3.67E-08	2.75E-08	2.15E-08
SW	4.13E-07	1.67E-07	9.51E-08	6.02E-08	4.24E-08	3.12E-08	2.46E-08
WSW	2.82E-07	1.14E-07	6.90E-08	4.53E-08	3.27E-08	2.46E-08	1.94E-08
W	3.06E-07	1.25E-07	7.41E-08	5.02E-08	3.55E-08	2.68E-08	2.10E-08
WNW	4.25E-07	1.69E-07	9.89E-08	6.61E-08	4.73E-08	3.52E-08	2.73E-08
NW	5.40E-07	2.12E-07	1.21E-07	7.91E-08	5.61E-08	4.23E-08	3.28E-08
NNW	6.42E-07	2.53E-07	1.42E-07	9.39E-08	6.65E-08	4.95E-08	3.87E-08

Period of Record: 9-1-76 to 8-31-78

\* Measured relevant to the Offgas Stack.

<b>MONTICELLO NUCLEAR GENERATING PLANT</b>		ODCM-APP-A
<b>TITLE:</b>	<b>APPENDIX A</b>	Revision 3
		Page 65 of 71

Table 14 Reactor Building Vent Dispersion Parameters for Short Term Elevated Releases  
 $\leq 500$  Hrs/Yr or  $\leq 150$  Hrs/Qtr (cont'd)

For Standard Distances (As Measured from the Offgas Stack) (D/q), m<sup>2</sup>

Sector*	Miles						
	0.8	0.9	1.0	1.1	1.2	1.3	1.4
N	3.25E-08	2.57E-08	1.99E-08	1.61E-08	1.34E-08	1.13E-08	9.77E-09
NNE	2.79E-08	2.22E-08	1.71E-08	1.39E-08	1.16E-08	9.77E-09	8.45E-09
NE	1.99E-08	1.56E-08	1.23E-08	1.00E-08	8.52E-09	7.15E-09	6.20E-09
ENE	1.80E-08	1.41E-08	1.12E-08	9.11E-09	7.57E-09	6.45E-09	5.55E09
E	2.17E-08	1.70E-08	1.33E-08	1.07E-08	9.01E-09	7.69E-09	6.56E-09
ESE	3.78E-08	2.92E-08	2.35E-08	1.93E-08	1.59E-08	1.34E-08	1.16E-08
SE	3.99E-08	3.10E-08	2.48E-08	2.04E-08	1.67E-08	1.40E-08	1.20E-08
SSE	4.16E-08	3.26E-08	2.57E-08	2.12E-08	1.76E-08	1.48E-08	1.27E-08
S	2.26E-08	1.78E-08	1.41E-08	1.16E-08	9.75E-09	8.85E-09	7.48E-09
SSW	1.69E-08	1.34E-08	1.10E-08	9.02E-09	7.60E-09	6.52E-09	5.84E-09
SW	1.89E-08	1.51E-08	1.25E-08	1.01E-08	8.52E-09	7.27E-09	6.61E-09
WSW	1.52E-08	1.20E-08	1.01E-08	8.20E-09	6.85E-09	5.94E-09	5.35E-09
W	1.62E-08	1.31E-08	1.04E-08	8.64E-09	7.29E-09	6.19E-09	5.49E-09
WNW	2.16E-08	1.72E-08	1.36E-08	1.12E-08	9.47E-09	7.95E-09	7.18E-09
NW	2.49E-08	1.97E-08	1.55E-08	1.26E-08	1.07E-08	9.05E-09	7.82E-09
NNW	3.00E-08	2.36E-08	1.82E-08	1.49E-08	1.22E-08	1.05E-08	9.21E-09

Period of Record: 9-1-76 to 8-31-78

\* Measured relevant to the Offgas Stack.

<b>MONTICELLO NUCLEAR GENERATING PLANT</b>		ODCM-APP-A
<b>TITLE:</b>	<b>APPENDIX A</b>	Revision 3
		Page 66 of 71

Table 14 Reactor Building Vent Dispersion Parameters for Short Term Elevated Releases  
 $\leq 500$  Hrs/Yr or  $\leq 150$  Hrs/Qtr (cont'd)

For Standard Distances (As Measured from the Offgas Stack) (D/q), m<sup>2</sup>

Sector*	Miles						
	1.5	1.6	1.7	1.8	1.9	2.0	2.1
N	8.90E-09	7.61E-09	6.62E-09	5.81E-09	5.23E-09	4.63E-09	4.13E-09
NNE	7.75E-09	6.61E-09	5.79E-09	5.10E-09	4.56E-09	4.07E-09	3.71E-09
NE	5.46E-09	4.54E-09	4.02E-09	3.69E-09	3.30E-09	2.93E-09	2.48E-09
ENE	4.71E-09	4.19E-09	3.73E-09	3.33E-09	2.98E-09	2.64E-09	2.40E-09
E	5.63E-09	4.93E-09	4.49E-09	3.96E-09	3.53E-09	3.18E-09	2.88E-09
ESE	1.01E-08	8.60E-09	7.60E-09	7.07E-09	6.28E-09	5.64E-09	5.07E-09
SE	1.03E-08	9.00E-09	7.94E-09	7.17E-09	6.48E-09	5.74E-09	5.17E-09
SSE	1.10E-08	9.30E-09	8.32E-09	7.72E-09	6.89E-09	6.20E-09	5.56E-09
S	6.89E-09	5.81E-09	5.11E-09	4.54E-09	4.06E-09	3.61E-09	3.30E-09
SSW	5.34E-09	4.70E-09	4.14E-09	3.63E-09	3.26E-09	3.21E-09	2.88E-09
SW	6.60E-09	5.31E-09	4.72E-09	4.14E-09	3.66E-09	3.56E-09	3.24E-09
WSW	4.91E-09	4.44E-09	3.92E-09	3.40E-09	3.03E-09	3.03E-09	2.76E-09
W	5.07E-09	4.44E-09	3.82E-09	3.36E-09	3.07E-09	2.96E-09	2.71E-09
WNW	6.67E-09	5.78E-09	5.06E-09	4.43E-09	3.92E-09	3.71E-09	3.34E-09
NW	6.67E-09	5.73E-09	5.26E-09	4.65E-09	4.11E-09	3.68E-09	3.35E-09
NNW	8.53E-09	7.30E-09	6.36E-09	5.58E-09	5.00E-09	4.42E-09	4.03E-09

Period of Record: 9-1-76 to 8-31-78

\* Measured relevant to the Offgas Stack.

<b>MONTICELLO NUCLEAR GENERATING PLANT</b>		ODCM-APP-A
<b>TITLE:</b>	<b>APPENDIX A</b>	Revision 3
		Page 67 of 71

Table 14 Reactor Building Vent Dispersion Parameters for Short Term Elevated Releases  
 $\leq 500$  Hrs/Yr or  $\leq 150$  Hrs/Qtr (cont'd)

For Standard Distances (As Measured from the Offgas Stack) (D/q),  $m^{-2}$

Sector*	Miles						
	2.2	2.3	2.4	2.5	2.6	2.7	2.8
N	3.75E-09	3.42E-09	3.11E-09	2.88E-09	2.68E-09	2.53E-09	2.38E-09
NNE	3.34E-09	3.06E-09	2.79E-09	2.55E-09	2.38E-09	2.20E-09	2.06E-09
NE	2.43E-09	2.21E-09	2.02E-09	1.89E-09	1.74E-09	1.61E-09	1.51E-09
ENE	2.18E-09	2.03E-09	1.85E-09	1.70E-09	1.57E-09	1.46E-09	1.36E-09
E	2.61E-09	2.41E-09	2.20E-09	2.02E-09	1.82E-09	1.71E-09	1.61E-09
ESE	4.60E-09	4.21E-09	3.84E-09	3.54E-09	3.28E-09	3.01E-09	2.80E-09
SE	4.71E-09	4.43E-09	4.07E-09	3.79E-09	3.49E-09	3.24E-09	3.02E-09
SSE	5.01E-09	4.58E-09	4.21E-09	3.86E-09	3.55E-09	3.28E-09	3.06E-09
S	2.95E-09	2.70E-09	2.50E-09	2.32E-09	2.15E-09	2.00E-09	1.86E-09
SSW	2.60E-09	2.45E-09	2.28E-09	2.06E-09	1.90E-09	1.75E-09	1.64E-09
SW	2.93E-09	2.72E-09	2.53E-09	2.29E-09	2.11E-09	1.96E-09	1.84E-09
WSW	2.48E-09	2.31E-09	2.16E-09	1.98E-09	1.81E-09	1.68E-09	1.56E-09
W	2.44E-09	2.29E-09	2.12E-09	1.93E-09	1.77E-09	1.66E-09	1.57E-09
WNW	3.09E-09	2.85E-09	2.67E-09	2.43E-09	2.25E-09	2.11E-09	1.98E-09
NW	3.06E-09	2.76E-09	2.58E-09	2.41E-09	2.25E-09	2.10E-09	1.98E-09
NNW	3.64E-09	3.26E-09	3.04E-09	2.85E-09	2.62E-09	2.45E-09	2.29E-09

Period of Record: 9-1-76 to 8-31-78

\* Measured relevant to the Offgas Stack.

<b>MONTICELLO NUCLEAR GENERATING PLANT</b>		ODCM-APP-A
<b>TITLE:</b>	<b>APPENDIX A</b>	Revision 3
		Page 68 of 71

Table 14 Reactor Building Vent Dispersion Parameters for Short Term Elevated Releases  
 $\leq 500$  Hrs/Yr or  $\leq 150$  Hrs/Qtr (cont'd)

For Standard Distances (As Measured from the Offgas Stack) (D/q),  $m^{-2}$

Sector*	Miles						
	2.9	3.0	3.1	3.2	3.3	3.4	3.5
N	2.23E-09	2.09E-09	1.96E-09	1.84E-09	1.74E-09	1.73E-09	1.63E-09
NNE	1.94E-09	1.82E-09	1.71E-09	1.61E-09	1.51E-09	1.42E-09	1.35E-09
NE	1.42E-09	1.33E-09	1.25E-09	1.17E-09	1.10E-09	1.03E-09	9.77E-10
ENE	1.28E-09	1.20E-09	1.11E-09	1.05E-09	9.92E-10	9.42E-10	8.97E-10
E	1.50E-09	1.43E-09	1.34E-09	1.26E-09	1.19E-09	1.11E-09	1.04E-10
ESE	2.60E-09	2.42E-09	2.29E-09	2.15E-09	2.00E-09	1.90E-09	1.79E-09
SE	2.84E-09	2.67E-09	2.50E-09	2.32E-09	2.18E-09	2.05E-09	1.93E-09
SSE	2.86E-09	2.69E-09	2.53E-09	2.34E-09	2.23E-09	2.10E-09	1.98E-09
S	1.74E-09	1.63E-09	1.64E-09	1.54E-09	1.48E-09	1.36E-09	1.29E-09
SSW	1.53E-09	1.44E-09	1.36E-09	1.29E-09	1.22E-09	1.16E-09	1.10E-09
SW	1.73E-09	1.61E-09	1.52E-09	1.43E-09	1.36E-09	1.27E-09	1.21E-09
WSW	1.46E-09	1.37E-09	1.29E-09	1.22E-09	1.15E-09	1.10E-09	1.04E-09
W	1.48E-09	1.40E-09	1.32E-09	1.24E-09	1.18E-09	1.10E-09	1.05E-09
WNW	1.84E-09	1.74E-09	1.61E-09	1.52E-09	1.42E-09	1.52E-09	1.56E-09
NW	1.83E-09	1.72E-09	1.67E-09	1.59E-09	1.53E-09	1.42E-09	1.36E-09
NNW	2.13E-09	2.01E-09	1.90E-09	1.79E-09	1.67E-09	1.57E-09	1.49E-09

Period of Record: 9-1-76 to 8-31-78

\* Measured relevant to the Offgas Stack.

<b>MONTICELLO NUCLEAR GENERATING PLANT</b>		ODCM-APP-A
<b>TITLE:</b>	<b>APPENDIX A</b>	Revision 3
		Page 69 of 71

Table 14 Reactor Building Vent Dispersion Parameters for Short Term Elevated Releases  
 $\leq 500$  Hrs/Yr or  $\leq 150$  Hrs/Qtr (cont'd)

For Standard Distances (As Measured from the Offgas Stack) (D/q), m<sup>2</sup>

Sector*	Miles						
	3.6	3.7	3.8	3.9	4.0	4.1	4.2
N	1.55E-09	1.47E-09	1.40E-09	1.34E-09	1.29E-09	1.24E-09	1.20E-09
NNE	1.27E-09	1.21E-09	1.16E-09	1.09E-09	1.04E-09	1.03E-09	9.85E-10
NE	9.27E-10	8.82E-10	8.44E-10	8.04E-10	7.68E-10	7.48E-10	7.05E-10
ENE	8.50E-10	8.08E-10	7.71E-10	7.38E-10	7.01E-10	6.78E-10	6.48E-10
E	9.92E-10	9.39E-10	8.94E-10	8.83E-10	8.48E-10	8.09E-10	7.71E-10
ESE	1.71E-09	1.61E-09	1.53E-09	1.48E-09	1.42E-09	1.35E-09	1.29E-09
SE	1.83E-09	1.73E-09	1.64E-09	1.57E-09	1.50E-09	1.46E-09	1.44E-09
SSE	1.86E-09	1.76E-09	1.69E-09	1.65E-09	1.56E-09	1.49E-09	1.42E-09
S	1.20E-09	1.16E-09	1.11E-09	1.07E-09	1.03E-09	9.96E-10	9.67E-10
SSW	1.04E-09	9.85E-10	9.51E-10	9.16E-10	8.78E-10	8.46E-10	8.15E-10
SW	1.14E-09	1.08E-09	1.02E-09	9.62E-10	1.01E-09	9.88E-10	9.93E-10
WSW	9.89E-10	9.58E-10	9.19E-10	8.74E-10	8.35E-10	8.03E-10	7.53E-10
W	1.01E-09	9.61E-10	9.21E-10	8.85E-10	8.52E-10	8.21E-10	7.93E-10
WNW	1.49E-09	1.42E-09	1.34E-09	1.29E-09	1.23E-09	1.18E-09	1.14E-09
NW	1.28E-09	1.23E-09	1.19E-09	1.14E-09	1.10E-09	1.06E-09	1.03E-09
NNW	1.41E-09	1.34E-09	1.29E-09	1.22E-09	1.19E-09	1.14E-09	1.10E-09

Period of Record: 9-1-76 to 8-31-78

\* Measured relevant to the Offgas Stack.

<b>MONTICELLO NUCLEAR GENERATING PLANT</b>		ODCM-APP-A
<b>TITLE:</b>	<b>APPENDIX A</b>	Revision 3
		Page 70 of 71

Table 14 Reactor Building Vent Dispersion Parameters for Short Term Elevated Releases  
 $\leq 500$  Hrs/Yr or  $\leq 150$  Hrs/Qtr (cont'd)

For Standard Distances (As Measured from the Offgas Stack) (D/q), m<sup>2</sup>

Sector*	Miles						
	4.3	4.4	4.5	4.6	4.7	4.8	4.9
N	1.13E-09	1.09E-09	1.05E-09	1.02E-09	9.85E-10	9.67E-10	9.40E-10
NNE	9.68E-10	9.29E-10	8.71E-10	8.40E-10	8.07E-10	7.79E-10	7.49E-10
NE	6.98E-10	6.63E-10	6.16E-10	6.06E-10	5.87E-10	5.62E-10	5.45E-10
ENE	6.19E-10	5.96E-10	5.55E-10	5.37E-10	5.17E-10	5.06E-10	4.86E-10
E	7.43E-10	7.10E-10	6.81E-10	6.53E-10	6.25E-10	6.01E-10	5.72E-10
ESE	1.24E-09	1.18E-09	1.13E-09	1.08E-09	1.04E-09	9.99E-10	9.57E-10
SE	1.38E-09	1.31E-09	1.26E-09	1.21E-09	1.16E-09	1.12E-09	1.07E-09
SSE	1.36E-09	1.30E-09	1.25E-09	1.18E-09	1.14E-09	1.09E-09	1.05E-09
S	9.28E-10	8.94E-10	8.64E-10	8.38E-10	8.12E-10	7.83E-10	7.60E-10
SSW	7.88E-10	7.61E-10	7.38E-10	7.17E-10	6.89E-10	6.70E-10	6.49E-10
SW	1.09E-09	1.06E-09	1.11E-09	1.07E-09	1.02E-09	9.83E-10	9.46E-10
WSW	7.39E-10	7.09E-10	7.33E-10	7.08E-10	6.86E-10	6.70E-10	6.50E-10
W	7.67E-10	7.44E-10	7.22E-10	7.02E-10	6.79E-10	6.61E-10	6.36E-10
WNW	1.10E-09	1.06E-09	1.02E-09	9.86E-10	9.55E-10	9.22E-10	8.94E-10
NW	9.96E-10	9.60E-10	9.27E-10	9.00E-10	8.73E-10	8.48E-10	8.24E-10
NNW	1.07E-09	1.02E-09	1.01E-09	9.77E-10	9.43E-10	9.13E-10	8.84E-10

Period of Record: 9-1-76 to 8-31-78

\* Measured relevant to the Offgas Stack.



<b>MONTICELLO NUCLEAR GENERATING PLANT</b>		ODCM-APP-A
<b>TITLE:</b>	<b>APPENDIX A</b>	Revision 3
		Page 71 of 71

Table 14 Reactor Building Vent Dispersion Parameters for Short Term Elevated Releases  
 $\leq 500$  Hrs/Yr or  $\leq 150$  Hrs/Qtr (cont'd)

For Standard Distances (As Measured from the Offgas Stack) (D/q), m<sup>-2</sup>

Miles

Sector*	5.0
N	9.09E-10
NNE	7.21E-10
NE	5.24E-10
ENE	4.68E-10
E	5.58E-10
ESE	9.19E-10
SE	1.04E-09
SSE	1.01E-09
S	1.29E-09
SSW	6.32E-10
SW	9.10E-10
WSW	6.32E-10
W	6.21E-10
WNW	8.70E-10
NW	7.93E-10
NNW	8.42E-10

Period of Record: 9-1-76 to 8-31-78

\* Measured relevant to the Offgas Stack.

<b>MONTICELLO NUCLEAR GENERATING PLANT</b>		ODCM-APP-B
<b>TITLE:</b>	<b>APPENDIX B</b>	Revision 2
		Page 1 of 20

Approval: ODC 01473824

**OFFSITE DOSE CALCULATION MANUAL - TABLE OF CONTENTS**

<b><u>SECTION</u></b>	<b><u>PAGE</u></b>
1.0 RECORD OF REVISION .....	2
Table 1 Monticello Nuclear Generating Plant Site Meteorology - Stability Class A, Elevation 10 Meters .....	3
Table 2 Monticello Nuclear Generating Plant Site Meteorology - Stability Class B, Elevation 10 Meters .....	4
Table 3 Monticello Nuclear Generating Plant Site Meteorology - Stability Class C, Elevation 10 Meters .....	5
Table 4 Monticello Nuclear Generating Plant Site Meteorology - Stability Class D, Elevation 10 Meters .....	6
Table 5 Monticello Nuclear Generating Plant Site Meteorology - Stability Class E, Elevation 10 Meters .....	7
Table 6 Monticello Nuclear Generating Plant Site Meteorology - Stability Class F, Elevation 10 Meters .....	8
Table 7 Monticello Nuclear Generating Plant Site Meteorology - Stability Class G, Elevation 10 Meters .....	9
Table 8 Monticello Nuclear Generating Plant Site Meteorology - All Classes Combined Elevation 10 Meters .....	10
Table 9 Monticello Nuclear Generating Plant Site Meteorology - Stability Class A, Elevation 100 Meters .....	12
Table 10 Monticello Nuclear Generating Plant Site Meteorology - Stability Class B, Elevation 100 Meters .....	13
Table 11 Monticello Nuclear Generating Plant Site Meteorology - Stability Class C, Elevation 100 Meters .....	14
Table 12 Monticello Nuclear Generating Plant Site Meteorology - Stability Class D, Elevation 100 Meters .....	15
Table 13 Monticello Nuclear Generating Plant Site Meteorology - Stability Class E, Elevation 100 Meters .....	16
Table 14 Monticello Nuclear Generating Plant Site Meteorology - Stability Class F, Elevation 100 Meters .....	17
Table 15 Monticello Nuclear Generating Plant Site Meteorology - Stability Class G, Elevation 100 Meters .....	18
Table 16 Monticello Nuclear Generating Plant Site Meteorology - All Classes Combined Elevation 100 Meters .....	19

<b>MONTICELLO NUCLEAR GENERATING PLANT</b>		ODCM-APP-B
<b>TITLE:</b>	<b>APPENDIX B</b>	Revision 2
		Page 2 of 20

**1.0 RECORD OF REVISION**

<u>Revision No.</u>	<u>Date</u>	<u>Reason for Revision</u>
0	October - 2000	Moved previous ODCM-07.01 and ODCM-08.01 tables of meteorological data to this document.
1	November - 2001	Typo, replaced missing M in Monticello on Page 1 of Table of Content.
2	October - 2010	Corrected Table of Contents page references, corrected wind direction error in Table 1 and added/corrected Wind Speed values to Table 12.

<b>MONTICELLO NUCLEAR GENERATING PLANT</b>		ODCM-APP-B
<b>TITLE:</b>	<b>APPENDIX B</b>	Revision 2
		Page 3 of 20

Table 1 Monticello Nuclear Generating Plant Site Meteorology - Stability Class A,  
Elevation 10 Meters

Frequency Distribution Tables, Hours at each Wind Speed and Direction

Period of record: 9-1-76 through 8-31-78

---

Wind Speed (mph) at 10 Meter Level

---

Direction	1 to 3	4 to 7	8 to 12	13 to 18	19 to 24	Above 24	Total
N	4	18	63	30	7	0	122
NNE	2	20	30	14	2	0	68
NE	1	13	21	26	2	2	65
ENE	1	14	16	4	0	0	35
E	0	28	40	12	0	0	80
ESE	3	33	50	5	6	0	97
SE	2	26	50	35	12	3	128
SSE	8	46	96	122	11	0	283
S	9	36	68	117	42	3	275
SSW	5	63	94	58	20	4	244
SW	4	35	64	32	5	3	143
WSW	3	25	74	26	0	0	128
W	0	29	47	18	1	0	95
WNW	4	34	73	79	14	0	204
NW	3	29	58	61	3	0	154
NNW	6	29	109	67	13	0	224
VAR	0	0	0	0	0	0	0

---

Total Hours This Class: 2350  
Hours of Calm This Class: 5  
Percent of All Data This Class: 14.27

---

<b>MONTICELLO NUCLEAR GENERATING PLANT</b>		ODCM-APP-B
<b>TITLE:</b>	<b>APPENDIX B</b>	Revision 2
		Page 4 of 20

Table 2 Monticello Nuclear Generating Plant Site Meteorology - Stability Class B,  
Elevation 10 Meters

Frequency Distribution Tables, Hours at each Wind Speed and Direction

Period of record: 9-1-76 through 8-31-78

---

Wind Speed (mph) at 10 Meter Level

---

Direction	1 to 3	4 to 7	8 to 12	13 to 18	19 to 24	Above 24	Total
N	2	14	19	4	0	1	40
NNE	4	10	8	5	0	0	27
NE	0	6	3	2	0	0	11
ENE	1	11	7	2	0	0	21
E	0	13	4	0	0	0	17
ESE	1	15	10	3	3	0	32
SE	0	9	9	9	0	0	27
SSE	2	12	9	9	0	0	32
S	2	13	21	7	1	0	44
SSW	1	22	19	4	0	0	46
SW	0	11	10	3	0	0	24
WSW	1	12	11	3	0	0	27
W	0	12	19	8	2	1	42
WNW	0	11	20	21	5	1	58
NW	1	8	22	13	3	0	47
NNW	1	8	40	26	4	1	80
VAR	0	0	0	0	0	0	0

---

Total Hours This Class: 575  
Hours of Calm This Class: 0  
Percent of All Data This Class: 3.49

---

<b>MONTICELLO NUCLEAR GENERATING PLANT</b>		ODCM-APP-B
<b>TITLE:</b>	<b>APPENDIX B</b>	Revision 2
		Page 5 of 20

Table 3 Monticello Nuclear Generating Plant Site Meteorology - Stability Class C,  
Elevation 10 Meters

Frequency Distribution Tables, Hours at each Wind Speed and Direction

Period of record: 9-1-76 through 8-31-78

---

Wind Speed (mph) at 10 Meter Level

---

Direction	1 to 3	4 to 7	8 to 12	13 to 18	19 to 24	Above 24	Total
N	0	12	16	8	0	0	36
NNE	3	13	13	4	1	0	34
NE	2	10	11	5	2	0	30
ENE	1	19	4	2	0	0	26
E	0	8	10	2	0	0	20
ESE	2	14	12	5	2	0	35
SE	0	12	16	9	0	0	37
SSE	0	10	21	8	0	0	39
S	6	12	28	18	3	0	67
SSW	3	16	12	3	2	1	37
SW	3	11	14	3	1	0	32
WSW	2	5	11	2	0	0	20
W	4	22	19	5	1	0	51
WNW	4	23	38	19	3	0	87
NW	3	17	18	30	4	0	72
NNW	2	22	40	27	5	1	97
VAR	0	0	0	0	0	0	0

---

Total Hours This Class: 720  
Hours of Calm This Class: 0  
Percent of All Data This Class: 4.37

---

<b>MONTICELLO NUCLEAR GENERATING PLANT</b>		ODCM-APP-B
<b>TITLE:</b>	<b>APPENDIX B</b>	Revision 2
		Page 6 of 20

Table 4 Monticello Nuclear Generating Plant Site Meteorology - Stability Class D,  
Elevation 10 Meters

Frequency Distribution Tables, Hours at each Wind Speed and Direction

Period of record: 9-1-76 through 8-31-78

---

Wind Speed (mph) at 10 Meter Level

---

Direction	1 to 3	4 to 7	8 to 12	13 to 18	19 to 24	Above 24	Total
N	9	107	135	39	1	0	291
NNE	32	132	87	18	1	0	270
NE	37	129	116	50	3	0	335
ENE	43	153	66	30	1	0	293
E	29	125	64	27	0	0	245
ESE	28	107	148	60	4	0	347
SE	16	103	153	36	2	0	310
SSE	13	97	103	35	2	0	250
S	19	84	96	33	1	0	233
SSW	16	73	70	19	6	1	185
SW	19	58	52	10	4	0	143
WSW	14	69	63	14	2	1	163
W	16	79	98	33	3	5	234
WNW	13	112	262	159	25	2	573
NW	17	82	255	232	61	3	650
NNW	19	104	247	246	49	1	666
VAR	0	0	0	0	0	0	0

---

Total Hours This Class: 5198  
Hours of Calm This Class: 10  
Percent of All Data This Class: 31.56

---

<b>MONTICELLO NUCLEAR GENERATING PLANT</b>		ODCM-APP-B
<b>TITLE:</b>	<b>APPENDIX B</b>	Revision 2
		Page 7 of 20

Table 5 Monticello Nuclear Generating Plant Site Meteorology - Stability Class E,  
Elevation 10 Meters

Frequency Distribution Tables, Hours at each Wind Speed and Direction

Period of record: 9-1-76 through 8-31-78

---

Wind Speed (mph) at 10 Meter Level

---

Direction	1 to 3	4 to 7	8 to 12	13 to 18	19 to 24	Above 24	Total
N	20	98	57	6	0	0	181
NNE	43	81	35	2	0	0	161
NE	35	94	41	6	2	0	178
ENE	50	122	29	10	0	0	211
E	36	109	40	2	0	0	187
ESE	26	117	46	6	0	0	195
SE	19	111	136	18	2	0	286
SSE	20	95	116	33	1	0	265
S	22	84	144	43	1	0	294
SSW	22	72	99	25	9	0	227
SW	23	84	57	10	2	0	176
WSW	37	86	44	4	0	0	171
W	30	156	123	12	4	0	325
WNW	24	195	233	41	2	0	495
NW	20	133	247	84	0	0	484
NNW	25	145	217	38	1	0	426
VAR	0	0	0	0	0	0	0

---

Total Hours This Class: 4269  
Hours of Calm This Class: 7  
Percent of All Data This Class: 25.92

---



<b>MONTICELLO NUCLEAR GENERATING PLANT</b>		ODCM-APP-B
<b>TITLE:</b>	<b>APPENDIX B</b>	Revision 2
		Page 8 of 20

Table 6 Monticello Nuclear Generating Plant Site Meteorology - Stability Class F,  
Elevation 10 Meters

Frequency Distribution Tables, Hours at each Wind Speed and Direction

Period of record: 9-1-76 through 8-31-78

---

Wind Speed (mph) at 10 Meter Level

---

Direction	1 to 3	4 to 7	8 to 12	13 to 18	19 to 24	Above 24	Total
N	30	62	3	0	0	0	95
NNE	37	54	0	0	0	0	91
NE	29	29	0	0	0	0	58
ENE	32	28	0	0	0	0	60
E	32	59	5	0	0	0	96
ESE	25	97	11	0	0	0	133
SE	22	83	19	0	0	0	124
SSE	16	122	12	0	0	0	150
S	24	93	31	3	0	0	151
SSW	27	67	14	0	0	0	108
SW	27	52	7	0	0	0	86
WSW	52	68	8	0	0	0	128
W	51	91	14	0	0	0	156
WNW	28	68	9	0	0	0	105
NW	36	67	12	0	0	0	115
NNW	30	119	29	0	0	0	178
VAR	0	0	0	0	0	0	0

---

Total Hours This Class: 1847  
Hours of Calm This Class: 13  
Percent of All Data This Class: 11.21

---

<b>MONTICELLO NUCLEAR GENERATING PLANT</b>		ODCM-APP-B
<b>TITLE:</b>	<b>APPENDIX B</b>	Revision 2
		Page 9 of 20

Table 7 Monticello Nuclear Generating Plant Site Meteorology - Stability Class G,  
Elevation 10 Meters

Frequency Distribution Tables, Hours at each Wind Speed and Direction

Period of record: 9-1-76 through 8-31-78

---

Wind Speed (mph) at 10 Meter Level

---

Direction	1 to 3	4 to 7	8 to 12	13 to 18	19 to 24	Above 24	Total
N	45	31	0	0	0	0	76
NNE	40	16	0	0	0	0	56
NE	33	12	0	0	0	0	45
ENE	31	5	0	0	0	0	36
E	46	18	0	0	0	0	64
ESE	47	54	2	0	0	0	103
SE	52	34	1	1	0	0	88
SSE	67	111	3	6	0	0	187
S	64	109	23	2	0	0	198
SSW	61	65	10	2	0	0	138
SW	43	32	1	0	0	0	76
WSW	77	37	0	0	0	0	114
W	53	31	0	0	0	0	84
WNW	37	13	2	0	0	0	52
NW	49	15	3	4	0	0	71
NNW	47	48	2	0	0	0	97
VAR	0	0	0	0	0	0	0

---

Total Hours This Class: 1512  
Hours of Calm This Class: 27  
Percent of All Data This Class: 9.18

---

<b>MONTICELLO NUCLEAR GENERATING PLANT</b>		ODCM-APP-B
<b>TITLE:</b>	<b>APPENDIX B</b>	Revision 2
		Page 10 of 20

Table 8 Monticello Nuclear Generating Plant Site Meteorology - All Classes Combined  
Elevation 10 Meters

Frequency Distribution Tables, Hours at each Wind Speed and Direction

Period of record: 9-1-76 through 8-31-78

---

Wind Speed (mph) at 10 Meter Level

---

Direction	1 to 3	4 to 7	8 to 12	13 to 18	19 to 24	Above 24	Total
N	110	342	293	87	8	1	841
NNE	161	326	173	43	4	0	707
NE	137	293	192	89	9	2	722
ENE	159	352	122	48	1	0	682
E	143	360	163	43	0	0	709
ESE	132	437	279	79	15	0	942
SE	111	378	384	108	16	3	1000
SSE	126	493	360	213	14	0	1206
S	146	431	411	223	48	3	1262
SSW	135	378	318	111	37	6	985
SW	119	283	205	58	12	3	680
WSW	186	302	211	49	2	1	751
W	154	420	320	76	11	6	987
WNW	110	456	637	319	49	3	1574
NW	129	351	615	424	71	3	1593
NNW	130	475	684	404	72	3	1768
VAR	0	0	0	0	0	0	0

---

<b>MONTICELLO NUCLEAR GENERATING PLANT</b>		ODCM-APP-B
<b>TITLE:</b>	<b>APPENDIX B</b>	Revision 2
		Page 11 of 20

Table 8 Monticello Nuclear Generating Plant Site Meteorology - All Classes Combined  
Elevation 10 Meters (cont'd)

Frequency Distribution Tables, Hours at each Wind Speed and Direction

Period of record: 9-1-76 through 8-31-78

---

Data Recovery for the Period

---

Total Hours:	17520
Hours of Calm:	62
Hours of Bad Data:	1049
Percent Data Recovery:	94.01

Percent Acceptable Observations in each Stability Class

Class A	14.27
Class B	3.49
Class C	4.37
Class D	31.56
Class E	25.92
Class F	11.21
Class G	9.18

Average Wind Speed for each Wind Category

1 to 3 MPH	2.5
4 to 7 MPH	5.5
8 to 12 MPH	9.7
13 to 18 MPH	14.7
19 to 24 MPH	20.6
Above 24 MPH	27.2

---

<b>MONTICELLO NUCLEAR GENERATING PLANT</b>		ODCM-APP-B
<b>TITLE:</b>	<b>APPENDIX B</b>	Revision 2
		Page 12 of 20

Table 9 Monticello Nuclear Generating Plant Site Meteorology - Stability Class A,  
Elevation 100 Meters

Frequency Distribution Tables, Hours at each Wind Speed and Direction

Period of record: 9-1-76 through 8-31-78

---

Wind Speed (mph) at 100 Meter Level

---

Direction	1 to 3	4 to 7	8 to 12	13 to 18	19 to 24	Above 24	Total
N	0	1	2	10	1	0	14
NNE	0	1	1	1	0	0	3
NE	0	0	1	0	0	0	1
ENE	0	0	0	0	1	0	1
E	0	1	4	0	0	0	5
ESE	0	0	4	0	0	0	4
SE	0	0	4	8	0	6	18
SSE	0	1	5	42	36	15	99
S	0	1	3	28	35	12	79
SSW	0	1	10	37	53	39	140
SW	0	0	4	19	6	5	36
WSW	0	0	3	16	10	1	30
W	0	0	0	7	2	0	9
WNW	0	0	2	4	1	2	9
NW	0	0	3	6	6	3	18
NNW	0	0	1	14	4	0	19
VAR	0	0	0	0	0	0	0

---

Total Hours This Class: 489  
Hours of Calm This Class: 4  
Percent of All Data This Class: 2.95

---

<b>MONTICELLO NUCLEAR GENERATING PLANT</b>		ODCM-APP-B
<b>TITLE:</b>	<b>APPENDIX B</b>	Revision 2
		Page 13 of 20

Table 10 Monticello Nuclear Generating Plant Site Meteorology - Stability Class B,  
Elevation 100 Meters

Frequency Distribution Tables, Hours at each Wind Speed and Direction

Period of record: 9-1-76 through 8-31-78

---

Wind Speed (mph) at 100 Meter Level

---

Direction	1 to 3	4 to 7	8 to 12	13 to 18	19 to 24	Above 24	Total
N	0	3	13	18	3	0	37
NNE	0	6	3	9	2	2	22
NE	0	1	7	6	0	0	14
ENE	0	2	3	7	2	0	14
E	0	2	15	1	0	0	18
ESE	0	5	17	3	0	2	27
SE	1	7	15	9	2	2	36
SSE	1	9	28	12	8	2	60
S	0	5	23	18	3	0	49
SSW	0	8	23	17	5	2	60
SW	0	7	18	8	5	1	39
WSW	0	7	8	14	2	1	32
W	0	4	8	18	5	0	35
WNW	0	4	12	17	7	6	46
NW	1	5	14	23	12	5	60
NNW	0	1	8	25	11	2	47
VAR	0	0	0	0	0	0	0

---

Total Hours This Class: 602  
Hours of Calm This Class: 6  
Percent of All Data This Class: 3.64

---

<b>MONTICELLO NUCLEAR GENERATING PLANT</b>		ODCM-APP-B
<b>TITLE:</b>	<b>APPENDIX B</b>	Revision 2
		Page 14 of 20

Table 11 Monticello Nuclear Generating Plant Site Meteorology - Stability Class C,  
Elevation 100 Meters

Frequency Distribution Tables, Hours at each Wind Speed and Direction

Period of record: 9-1-76 through 8-31-78

---

Wind Speed (mph) at 100 Meter Level

---

Direction	1 to 3	4 to 7	8 to 12	13 to 18	19 to 24	Above 24	Total
N	3	9	26	25	13	2	78
NNE	2	12	14	14	8	2	52
NE	1	7	9	8	2	0	27
ENE	0	5	12	6	1	0	24
E	0	13	19	1	2	0	35
ESE	0	13	25	11	1	1	51
SE	2	17	12	8	4	0	43
SSE	0	26	38	19	10	2	95
S	0	15	23	13	7	4	62
SSW	0	28	33	23	11	2	97
SW	0	20	24	17	4	0	65
WSW	3	17	27	14	3	1	65
W	3	10	20	14	8	3	58
WNW	3	10	16	27	18	9	83
NW	2	8	22	38	26	10	106
NNW	2	3	16	42	19	8	90
VAR	0	0	0	0	0	0	0

---

Total Hours This Class: 1041  
Hours of Calm This Class: 10  
Percent of All Data This Class: 4.29

---

<b>MONTICELLO NUCLEAR GENERATING PLANT</b>		ODCM-APP-B
<b>TITLE:</b>	<b>APPENDIX B</b>	Revision 2
		Page 15 of 20

Table 12 Monticello Nuclear Generating Plant Site Meteorology - Stability Class D,  
Elevation 100 Meters

Frequency Distribution Tables, Hours at each Wind Speed and Direction

Period of record: 9-1-76 through 8-31-78

---

Wind Speed (mph) at 100 Meter Level

---

Direction	1 to 3	4 to 7	8 to 12	13 to 18	19 to 24	Above 24	Total
N	11	51	82	95	181	130	550
NNE	11	41	106	120	50	12	340
NE	15	53	105	93	25	8	299
ENE	14	41	131	83	59	12	340
E	18	61	103	62	38	6	288
ESE	17	55	101	85	47	31	336
SE	13	57	108	152	68	23	421
SSE	9	63	119	148	71	17	427
S	16	61	95	122	61	8	363
SSW	14	61	85	120	46	34	360
SW	14	54	80	74	32	11	265
WSW	13	52	69	44	21	11	210
W	8	45	89	59	29	17	247
WNW	14	51	141	165	77	62	510
NW	7	50	170	366	312	143	1048
NNW	12	52	176	312	350	229	1131
VAR	0	0	0	0	0	0	0

---

Total Hours This Class: 7264  
Hours of Calm This Class: 129  
Percent of All Data This Class: 43.87

---



<b>MONTICELLO NUCLEAR GENERATING PLANT</b>		ODCM-APP-B
<b>TITLE:</b>	<b>APPENDIX B</b>	Revision 2
		Page 16 of 20

Table 13 Monticello Nuclear Generating Plant Site Meteorology - Stability Class E,  
Elevation 100 Meters

Frequency Distribution Tables, Hours at each Wind Speed and Direction

Period of record: 9-1-76 through 8-31-78

---

Wind Speed (mph) at 100 Meter Level

---

Direction	1 to 3	4 to 7	8 to 12	13 to 18	19 to 24	Above 24	Total
N	4	17	59	99	82	11	272
NNE	7	18	37	68	32	3	165
NE	4	16	47	58	20	2	147
ENE	4	33	68	93	27	9	234
E	4	27	64	75	15	2	187
ESE	5	20	46	74	37	11	193
SE	10	23	63	97	58	3	254
SSE	5	22	58	94	105	16	300
S	5	13	57	140	97	20	332
SSW	2	25	49	115	125	22	338
SW	7	24	67	102	84	18	302
WSW	3	19	42	73	37	8	182
W	5	20	47	55	35	2	164
WNW	4	18	63	136	93	13	327
NW	6	15	71	172	141	12	417
NNW	3	27	86	244	198	17	575
VAR	0	0	0	0	0	0	0

---

Total Hours This Class:	4433
Hours of Calm This Class:	44
Percent of All Data This Class:	26.77

---

<b>MONTICELLO NUCLEAR GENERATING PLANT</b>		ODCM-APP-B
<b>TITLE:</b>	<b>APPENDIX B</b>	Revision 2
		Page 17 of 20

Table 14 Monticello Nuclear Generating Plant Site Meteorology - Stability Class F,  
Elevation 100 Meters

Frequency Distribution Tables, Hours at each Wind Speed and Direction

Period of record: 9-1-76 through 8-31-78

---

Wind Speed (mph) at 100 Meter Level

---

Direction	1 to 3	4 to 7	8 to 12	13 to 18	19 to 24	Above 24	Total
N	3	12	28	45	28	0	116
NNE	2	4	15	39	16	1	77
NE	4	7	23	49	17	1	101
ENE	1	7	19	40	6	3	76
E	4	10	26	15	3	0	58
ESE	8	16	28	31	14	2	99
SE	2	7	28	46	19	5	107
SSE	2	8	25	62	40	1	138
S	1	12	30	60	36	1	140
SSW	1	11	28	58	57	4	159
SW	3	14	19	75	33	2	146
WSW	5	6	22	28	29	0	90
W	1	14	22	27	16	0	80
WNW	4	10	44	49	27	1	135
NW	4	12	37	87	29	0	169
NNW	4	14	38	51	21	1	129
VAR	0	0	0	0	0	0	0

---

Total Hours This Class: 1826  
Hours of Calm This Class: 6  
Percent of All Data This Class: 11.03

---

<b>MONTICELLO NUCLEAR GENERATING PLANT</b>		ODCM-APP-B
<b>TITLE:</b>	<b>APPENDIX B</b>	Revision 2
		Page 18 of 20

Table 15 Monticello Nuclear Generating Plant Site Meteorology - Stability Class G,  
Elevation 100 Meters

Frequency Distribution Tables, Hours at each Wind Speed and Direction

Period of record: 9-1-76 through 8-31-78

---

Wind Speed (mph) at 100 Meter Level

---

Direction	1 to 3	4 to 7	8 to 12	13 to 18	19 to 24	Above 24	Total
N	6	8	16	9	0	0	39
NNE	3	12	15	8	1	0	39
NE	4	6	11	16	4	0	41
ENE	6	11	15	11	3	1	47
E	8	7	11	11	1	0	38
ESE	1	12	9	16	2	0	40
SE	5	9	10	5	9	1	39
SSE	6	6	12	8	11	1	44
S	2	6	13	30	12	1	64
SSW	1	14	26	55	21	0	117
SW	1	9	21	26	25	3	85
WSW	5	16	29	16	14	0	80
W	3	14	8	16	18	2	61
WNW	5	15	23	21	9	0	73
NW	2	7	14	17	1	0	41
NNW	8	13	21	7	5	0	54
VAR	0	0	0	0	0	0	0

---

Total Hours This Class: 904  
Hours of Calm This Class: 2  
Percent of All Data This Class: 5.46

---

<b>MONTICELLO NUCLEAR GENERATING PLANT</b>		ODCM-APP-B
<b>TITLE:</b>	<b>APPENDIX B</b>	Revision 2
		Page 19 of 20

Table 16 Monticello Nuclear Generating Plant Site Meteorology - All Classes Combined  
Elevation 100 Meters

Frequency Distribution Tables, Hours at each Wind Speed and Direction

Period of record: 9-1-76 through 8-31-78

Wind Speed (mph) at 100 Meter Level							
Direction	1 to 3	4 to 7	8 to 12	13 to 18	19 to 24	Above 24	Total
N	27	101	239	387	257	95	1106
NNE	25	94	191	259	109	20	698
NE	28	90	203	230	68	11	630
ENE	25	99	248	240	99	25	736
E	34	121	242	165	59	8	629
ESE	31	121	230	220	101	47	750
SE	33	120	240	325	160	40	918
SSE	23	135	285	385	281	54	1163
S	24	113	244	411	251	46	1089
SSW	18	148	259	425	318	103	1271
SW	25	128	233	321	191	40	938
WSW	29	117	200	205	116	22	689
W	20	107	194	196	113	24	654
WNW	30	108	301	419	232	93	1183
NW	22	97	331	709	527	173	1859
NNW	29	110	346	695	608	257	2045
VAR	0	0	0	0	0	0	0

<b>MONTICELLO NUCLEAR GENERATING PLANT</b>		ODCM-APP-B
<b>TITLE:</b>	<b>APPENDIX B</b>	Revision 2
		Page 20 of 20

Table 16 Monticello Nuclear Generating Plant Site Meteorology - All Classes Combined  
Elevation 100 Meters (cont'd)

Frequency Distribution Tables, Hours at each Wind Speed and Direction

Period of record: 9-1-76 through 8-31-78

---

Data Recovery for the Period

---

Total Hours:	17520
Hours of Calm:	201
Hours of Bad Data:	961
Percent Data Recovery:	94.51

Percent Acceptable Observations in each Stability Class

Class A	2.95
Class B	3.64
Class C	6.29
Class D	43.87
Class E	26.77
Class F	11.03
Class G	5.46

Average Wind Speed for each Wind Category

1 to 3 MPH	2.5
4 to 7 MPH	5.8
8 to 12 MPH	10.1
13 to 18 MPH	15.4
19 to 24 MPH	20.9
Above 24 MPH	28.1

---

<b>MONTICELLO NUCLEAR GENERATING PLANT</b>		ODCM-APP-C
<b>TITLE:</b>	<b>APPENDIX C</b>	Revision 0
		Page 1 of 5

Approval: ODC 01473825

**OFFSITE DOSE CALCULATION MANUAL - TABLE OF CONTENTS**

<b><u>SECTION</u></b>	<b><u>PAGE</u></b>
1.0 RECORD OF REVISION .....	2
Table 1 Parameters for Cow and Goat Milk Pathways .....	3
Table 2 Parameters for the Cow Meat Pathway .....	4
Table 3 Parameters for the Vegetable Pathway .....	5

<b>MONTICELLO NUCLEAR GENERATING PLANT</b>		ODCM-APP-C
<b>TITLE:</b>	<b>APPENDIX C</b>	Revision 0
		Page 2 of 5

**1.0 RECORD OF REVISION**

<u>Revision No.</u>	<u>Date</u>	<u>Reason for Revision</u>
0	October - 2000	Moved previous ODCM-10.01 tables of parameters to this document.

<b>MONTICELLO NUCLEAR GENERATING PLANT</b>		ODCM-APP-C
<b>TITLE:</b>	<b>APPENDIX C</b>	Revision 0
		Page 3 of 5

Table 1 Parameters for Cow and Goat Milk Pathways

Parameter	Value	Reference in Reg. Guide 1.109 Rev. 1
$Q_F$ (kg/day)	50 (cow) 6 (goat)	Table E-3 Table E-3
$t_f$ (seconds)	$1.73 \times 10^5$ (2 days)	Table E-15
$r$	1.0 (radioiodines) 0.2 (particulates)	Table E-15 Table E-15
$(DFL_i)_a$ (mrem/pCi)	Each radionuclide	Table E-11 to E-14
$F_m$ (pCi/day per pCi/liter)	Each stable element	Table E-1 (cow) Table E-2 (goat)
$t_b$ (seconds)	$4.73 \times 10^8$ (15 yr)	Table E-15
$Y_s$ (kg/m <sup>2</sup> )	2.0	Table E-15
$Y_p$ (kg/m <sup>2</sup> )	.75	Table E-15
$t_h$ (seconds)	$7.78 \times 10^6$ (90 days)	Table E-15
$U_{ap}$ (liters/yr)	330 infant 330 child 400 teen 310 adult	Table E-5 Table E-5 Table E-5 Table E-5
$t_{ep}$ (seconds)	$2.59 \times 10^6$ (pasture)	Table E-15
$t_{es}$ (seconds)	$5.18 \times 10^6$ (stored feed)	Table E-15
$B_{iv}$ (pCi/kg (wet weight) per pCi/kg (dry soil))	Each stable element	Table E-1
$P$ (kg dry soil/m <sup>2</sup> )	240	Table E-15



<b>MONTICELLO NUCLEAR GENERATING PLANT</b>		ODCM-APP-C
<b>TITLE:</b>	<b>APPENDIX C</b>	Revision 0
		Page 4 of 5

Table 2 Parameters for the Cow Meat Pathway

Parameter	Value	Reference in Reg. Guide 1.109 Rev. 1
r	1.0 (radioiodines) 0.2 (particulates)	Table E-15 Table E-15
$F_f$ (pCi/kg per pCi/day)	Each stable element	Table E-1
$U_{ap}$ (kg/yr)	0 infant 41 child 65 teen 110 adult	Table E-5 Table E-5 Table E-5 Table E-5
$(DFL_i)_a$ (mrem/pCi)	Each radionuclide	Table E-11 to E-14
$Y_p$ (kg/m <sup>2</sup> )	0.7	Table E-15
$Y_s$ (kg/m <sup>2</sup> )	2.0	Table E-15
$t_b$ (seconds)	$4.73 \times 10^8$ (15 yr)	Table E-15
$t_s$ (seconds)	$1.73 \times 10^6$ (20 days)	Table E-15
$t_h$ (seconds)	$7.78 \times 10^6$ (90 days)	Table E-15
$t_{ep}$ (seconds)	$2.59 \times 10^6$ (pasture)	Table E-15
$t_{es}$ (seconds)	$5.18 \times 10^6$ (stored feed)	Table E-15
$Q_F$ (kg/day)	50	Table E-3
$B_{iv}$ (pCi/kg (wet weight) per pCi/kg (dry soil))	Each stable element	Table E-1
P (kg dry soil/m <sup>2</sup> )	240	Table E-15

Table 3 Parameters for the Vegetable Pathway

Parameter	Value	Reference in Reg. Guide 1.109 Rev. 1
r (dimensionless)	1.0 (radioiodines) 0.2 (particulates)	Table E-1 Table E-1
(DFL <sub>i</sub> ) <sub>a</sub> (mrem/Ci)	Each radionuclide	Tables E-11 to E-14
U <sup>L</sup> <sub>a</sub> (kg/yr)	0 Infant 26 Child 42 Teen 64 Adult	Table E-5 Table E-5 Table E-5 Table E-5
U <sup>S</sup> <sub>a</sub> (kg/yr)	0 Infant 520 Child 630 Teen 520 Adult	Table E-5 Table E-5 Table E-5 Table E-5
t <sub>L</sub> (seconds)	8.6 X 10 <sup>4</sup> (1 day)	Table E-15
t <sub>h</sub> (seconds)	5.18 X 10 <sup>6</sup> (60 days)	Table E-15
Y <sub>v</sub> (kg/m <sup>2</sup> )	2.0	Table E-15
t <sub>e</sub> (seconds)	5.18 X 10 <sup>6</sup> (60 days)	Table E-15
t <sub>b</sub> (seconds)	4.73 X 10 <sup>8</sup> (15 yr)	Table E-15
P (kg/(dry soil)/m <sup>2</sup> )	240	Table E-15
B <sub>iv</sub> (pCi/kg(wet weight) per pCi/kg (dry soil))	Each stable element	Table E-1

<b>MONTICELLO NUCLEAR GENERATING PLANT</b>		ODCM-HISTORY
<b>TITLE:</b>	<b>ODCM - HISTORY</b>	Revision 0
		Page 1 of 1

Approval: ODC 01473826

RECORD OF REVISION

<u>Revision No.</u>	<u>Date</u>	<u>Reason for Revision</u>
0	May 2, 1979	Original.
1	February 29, 1980	Incorporation of NRC Staff comments and correction of miscellaneous errors.
2	July 23, 1982	Incorporation of NRC Staff comments, addition of short term vent dispersion parameters, and addition of Appendices D and E.
3	March 24, 1983	Change in milk sampling location.
4	December 12, 1983	Change in milk sampling locations and remove formula for converting $\mu\text{Ci}/\text{sec}$ to $\text{mrad}/\text{hr}$ for stack and vent wide range gas monitors.
5	March 27, 1984	Change Table 3.2-1
6	January - 1988	Incorporation of MIDAS and complete retyping.
7	January - 1990	Incorporation of NRC staff comments, correction of miscellaneous errors, clarification of term abnormal release and addition of references to MNGP ODCM computer program.
0	November - 1993	Complete rewrite of ODCM creating modular format allowing changes of a section rather than the whole document.

“Record of Revision” is now incorporated into each individual procedure.