Tactical Training Reference Manual

Prepared by W.D. Telfair, D.A. Moul, J.W. Klingelhofer,
K.M. Jurjevich, W.R. Leonard

Battelle Columbus Division

**Prepared for
U.S. Nuclear Regulatory
Commission**

AVAILABILITY NOTICE

Availability of Reference Materials Cited in NRC Publications

Most documents cited in NRC publications will be available from one of the following sources:

1. The NRC Public Document Room, 2120 L Street, NW, Lower Level, Washington, DC 20555
2. The Superintendent of Documents, U.S. Government Printing Office, P.O. Box 37082, Washington, DC 20013-7082
3. The National Technical Information Service, Springfield, VA 22161

Although the listing that follows represents the majority of documents cited in NRC publications, it is not intended to be exhaustive.

Referenced documents available for inspection and copying for a fee from the NRC Public Document Room include NRC correspondence and internal NRC memoranda; NRC Office of Inspection and Enforcement bulletins, circulars, information notices, inspection and investigation notices; Licensee Event Reports; vendor reports and correspondence; Commission papers; and applicant and licensee documents and correspondence.

The following documents in the NUREG series are available for purchase from the GPO Sales Program: formal NRC staff and contractor reports, NRC-sponsored conference proceedings, and NRC booklets and brochures. Also available are Regulatory Guides, NRC regulations in the *Code of Federal Regulations*, and *Nuclear Regulatory Commission Issuances*.

Documents available from the National Technical Information Service include NUREG series reports and technical reports prepared by other federal agencies and reports prepared by the Atomic Energy Commission, forerunner agency to the Nuclear Regulatory Commission.

Documents available from public and special technical libraries include all open literature items, such as books, journal and periodical articles, and transactions. *Federal Register* notices, federal and state legislation, and congressional reports can usually be obtained from these libraries.

Documents such as theses, dissertations, foreign reports and translations, and non-NRC conference proceedings are available for purchase from the organization sponsoring the publication cited.

Single copies of NRC draft reports are available free, to the extent of supply, upon written request to the Office of Information Resources Management, Distribution Section, U.S. Nuclear Regulatory Commission, Washington, DC 20555.

Copies of industry codes and standards used in a substantive manner in the NRC regulatory process are maintained at the NRC Library, 7920 Norfolk Avenue, Bethesda, Maryland, and are available there for reference use by the public. Codes and standards are usually copyrighted and may be purchased from the originating organization or, if they are American National Standards, from the American National Standards Institute, 1430 Broadway, New York, NY 10018.

DISCLAIMER NOTICE

This report was prepared as an account of work sponsored by an agency of the United States Government. Neither the United States Government nor any agency thereof, or any of their employees, makes any warranty, expressed or implied, or assumes any legal liability of responsibility for any third party's use, or the results of such use, of any information, apparatus, product or process disclosed in this report, or represents that its use by such third party would not infringe privately owned rights.

Tactical Training Reference Manual

Manuscript Completed: November 1988
Date Published: April 1989

Prepared by
W.D. Telfair, D.A. Mc , J.W. Klingelhofer,
K.M. Jurjevich, W.R. Leonard

Battelle Columbus Division
505 King Avenue
Columbus, OH 43201-2693

Prepared for
Division of Safeguards and Transportation
Office of Nuclear Material Safety and Safeguards
U.S. Nuclear Regulatory Commission
Washington, DC 20555
NRC FIN D2055

This report imposes no requirements



ABSTRACT

This Manual provides training information for U.S. Nuclear Regulatory Commission licensees to assist in implementation of the Tactical Response Team (TRT) training and exercise requirements of the revised portions of 10 CFR Part 73, which requires that licensees possessing formula quantities of strategic special nuclear material establish TRTs and conduct tactical response exercises to enhance the capabilities of security forces in protecting NRC licensed fuel facilities from potential adversaries postulated in the design basis threat. Step-by-step illustrated instructional material is provided concerning both individual and team tactics and skills appropriate to meeting these requirements. The Manual consists of two parts. Part One addresses adversary attributes and essential tactical skills that each TRT member should master to assure personal safety and effective response to adversary actions. Part Two discusses more advanced tactics, command, control, and orders.

Tactical Training Reference Manual

TABLE OF CONTENTS

	PAGE
ABSTRACT	iii
ACKNOWLEDGMENTS	ix
PART ONE	
CHAPTER 1. INTRODUCTION	1-1
Purpose of This Manual	1-1
Manual Contents	1-2
CHAPTER 2. ADVERSARY CHARACTERISTICS	2-1
Introduction	2-1
Potential Adversaries	2-1
Adversary Aims	2-3
Adversary Weapons and Equipment	2-3
Adversary Tactics	2-4
Adversary Threats to Security Force Communications	2-5
The Insider Problem	2-6
Use of Land Vehicles by Adversaries	2-6
Chapter Summary	2-7
CHAPTER 3. COVER, CONCEALMENT AND TERRAIN ANALYSIS	3-1
Introduction	3-1
Cover	3-1
Concealment	3-3
Camouflage	3-6
Terrain Analysis	3-9
Chapter Summary	3-10
CHAPTER 4. TECHNIQUES OF OBSERVATION	4-1
Introduction	4-1
Observation Positions	4-1
Position Occupation and Use	4-4
Visual Terrain Search Methods	4-5
Target Indicators	4-7
Location Referencing	4-7
Optical Aids	4-9
Night Observation	4-12
Night Vision Devices	4-14
Information Collection and Reporting	4-16
Chapter Summary	4-18
CHAPTER 5. FIELD FIRING TECHNIQUES	5-1
Introduction	5-1
Firing Positions	5-1
Battlesights	5-2
Pointing	5-4
Special Techniques of Target Engagement	5-5
Night Firing	5-9

	Coordinated Delivery of Fire	5-10
	Fire Control and Fire Discipline	5-12
	Chapter Summary	5-13
CHAPTER 6.	DEFENSIVE POSITIONS	6-1
	Introduction	6-1
	General Considerations	6-1
	Specific Considerations	6-3
	Chapter Summary	6-6
CHAPTER 7.	INDIVIDUAL TACTICAL MOVEMENT	7-1
	Introduction	7-1
	Factors Affecting Individual Tactical Movement	7-1
	Individual Tactical Movement Techniques	7-1
	Special Techniques for Unique Circumstances	7-5
	Chapter Summary	7-10
CHAPTER 8.	TEAM TACTICAL MOVEMENT	8-1
	Introduction	8-1
	Considerations of Team Tactical Movement	8-1
	Principles of Team Tactical Movement	8-2
	Tactical Formations	8-2
	Team Movement Prior to Contact With the Adversary	8-6
	Team Movement Under Fire	8-9
	Tactical Withdrawal Under Fire	8-13
	Immediate-Action Drill	8-13
	Chapter Summary	8-18
CHAPTER 9.	TACTICAL DRIVING	9-1
	Introduction	9-1
	Escaping a Kill Zone	9-1
	Stopping and Exiting Under Fire	9-6
	Use of the Vehicle as Cover	9-8
	Night-Driving Techniques	9-9
	Route Selection	9-10
	Chapter Summary	9-10
CHAPTER 10.	COUNTERAMBUSH TECHNIQUES	10-1
	Introduction	10-1
	Ambush Characteristics	10-1
	Anticipating and Avoiding Ambushes	10-3
	Counterambush Tactics	10-4
	Chapter Summary	10-7
CHAPTER 11.	TACTICAL COMMUNICATIONS	11-1
	Introduction	11-1
	Tactical Use of Radios	11-1
	Tactical Use of Telephones	11-7
	Arm and Hand Signals	11-9
	Other Communication Methods	11-12
	Duress Signals	11-14
	Chapter Summary	11-15
CHAPTER 12.	CHEMICAL AGENTS	12-1
	Introduction	12-1
	Chemical Weapons	12-1
	Detection and Symptoms	12-6

Protective Masks	12-7
Measures to Take If No Mask Is Available	12-10
First Aid	12-11
Chapter Summary	12-11
CHAPTER 13. ADVERSARY APPREHENSION TECHNIQUES	13-1
Introduction	13-1
Giving Commands to the Adversary	13-1
Visual Search and Disarming Techniques	13-2
Incapacitation	13-9
Techniques for Adversary Approach	13-13
Handcuffing	13-16
Body-Search Techniques	13-25
Multiple Prisoners	13-28
Vehicle Approaches	13-30
Evacuating Prisoners	13-40
Chapter Summary	13-43
CHAPTER 14. RAPPELLING	14-1
Introduction	14-1
Equipment Selection and Care	14-1
Rappelling Safety	14-13
Knots	14-14
Anchor Placement	14-20
Rappel Hookup Procedures	14-23
Descent Procedures	14-29
Special Situations and Considerations	14-38
Rappelling from Helicopters	14-39
Chapter Summary	14-43
CHAPTER 15. SEARCH AND CLEAR OPERATIONS	15-1
Introduction	15-1
Team Organization and Equipment	15-1
Preparation	15-2
Approach	15-2
Entry	15-3
Room Searches	15-10
Adversary Contact	15-12
Chapter Summary	15-13
CHAPTER 16. SNIPER OPERATIONS	16-1
Introduction	16-1
Sniper Employment	16-2
Advantages of Sniper-Team Employment	16-3
Sniper Positions	16-3
Countersniper Operations	16-5
Chapter Summary	16-6
PART TWO	
CHAPTER 17. COMMAND, CONTROL, AND ON-SCENE COMMAND CONSIDERATIONS	17-1
Introduction	17-1
Transition of Command and Control	17-2
Types of On-Scene Command Posts	17-2
On-Scene Command Post Functions	17-3
Location of the On-Scene Command Post	17-4

Staffing Requirements	17-4
Rehearsals	17-5
Chapter Summary	17-6
CHAPTER 18. TACTICAL ORDERS	18-1
Introduction	18-1
The Operation Order	18-2
The Warning Order	18-8
The Frag Order	18-10
Chapter Summary	18-12
CHAPTER 19. CORDON OPERATIONS	19-1
Introduction	19-1
Establishing the Inner Perimeter	19-1
Establishing the Outer Perimeter	19-3
Blocking Techniques	19-3
Chapter Summary	19-6
CHAPTER 20. ASSAULT OPERATIONS	20-1
Introduction	20-1
Principles of Assault Operations	20-1
Elements Involved in Assault Operations	20-2
Special Considerations of Assault Operations	20-3
Example Assault Operation Order	20-7
Chapter Summary	20-14
REFERENCES	A-1
INDEX	B-1

ACKNOWLEDGMENTS

Battelle Columbus Division wishes to acknowledge the contribution of its subcontractor, Criterion Referenced Consultants, Inc. (CRC), and its primary contributor Kenneth M. Jurjevich, as well as Battelle consultant, William R. Leonard, who made major contributions to this manual.



PART ONE

Chapter 1

INTRODUCTION

Section 1. PURPOSE OF THIS MANUAL

Revised portions of 10 CFR Part 73 require, among other things, that U.S. Nuclear Regulatory Commission (NRC) licensees possessing formula quantities of strategic special nuclear material (SSNM) establish security force Tactical Response Teams (TRTs) and conduct tactical response exercises to assure the adequacy of security force capabilities. This Tactical Training Reference Manual (TTRM), which incorporates guidance from a similar U.S. Department of Energy (DOE) program, was developed to provide licensees a training resource document to assist in implementation of the TRT training and exercise requirements of the revised portions of 10 CFR Part 73.

This manual is derived from tactical training manuals developed for use by DOE in 1985 (Tactical Training Manuals TTM1-I, TTM1-II, and TTM1-III) and adapted to meet the needs of NRC licensee fuel facilities. Accordingly, this Manual is for reference purposes only and its contents should not be construed as acceptance criteria or regulatory requirements. It is to be viewed by licensees as a training resource for developing security force TRTs that are well-trained in tactics and capable of defending NRC licensed fuel facilities from the potential adversaries postulated in the design basis threat [10 CFR 73.1(a)].

The information in this Manual is not all-encompassing, nor does it reiterate or replace basic security training material. The focus is, rather, on effective tactical response to armed adversary action. The Manual is intentionally general rather than site specific, so that it can be adapted and applied successfully under a variety of site condi-

tions and tactical circumstances. The presentation of the material is designed to be easily understood and applied. Key points are highlighted in bold typeface throughout the text to permit rapid scanning and review.

The Manual consists of two parts. **Part One** addresses adversary attributes and essential tactical skills that each TRT member should master to assure personal safety and effective response to adversary actions. **Part Two** discusses more advanced tactics, tactical planning, and orders.

The TTRM is oriented primarily toward defensive tactics and response rather than offensive tactics. Although restrictions concerning deadly force are taken into account, the possibility that it may be required under certain circumstances is implied. Where the Manual implies the use of deadly force, the assumption is made that conditions are met under 10 CFR 73.50 (g) (3) and under appropriate law permitting the use of such force. The TTRM also stresses throughout the need for security personnel to assure their own safety at all times.

Section 2. MANUAL CONTENTS

Topics, by Chapter, covered in the TTRM are:

Part One

Chapter 2, "Adversary Characteristics," describes the types of adversaries that may be encountered in a tactical confrontation and discusses the adversaries' probable aims, weapons, equipment and tactics.

Chapter 3, "Cover, Concealment and Terrain Analysis," introduces the theory, procedures and specific techniques related to the three named subjects.

Chapter 4, "Techniques of Observation," describes the techniques and skills necessary for conducting observation missions in a tactical environment.

Chapter 5, "Field Firing Techniques," deals with the techniques for employing individual security force weapons such as rifles, shotguns and handguns in a tactical situation.

Chapter 6, "Defensive Positions," covers the purpose, selection and use of defensive positions in the NRC security environment.

Chapter 7, "Individual Tactical Movement," covers the reasons for using techniques of individual tactical movement and the factors affecting such movement. Basic and special techniques of individual tactical movement are described and illustrated.

Chapter 8, "Team Tactical Movement," covers the reasons for using team tactical movement and the factors affecting such movement. The principles of tactical movement are discussed, and basic and general techniques of team tactical movement are described, illustrated and consolidated in an example immediate-action drill.

Chapter 9, "Tactical Driving" describes the various tactical techniques that a vehicle operator can use to escape from a kill zone, to stop and exit under fire, to gain cover behind the vehicle, to drive at night and to safely approach the scene of a crisis.

Chapter 10, "Counterambush Techniques," addresses the likelihood that an adversary will employ ambush techniques and describes the various types of ambushes, the ways to anticipate and avoid ambushes and techniques for dealing with ambushes if they occur.

Chapter 11, "Tactical Communications," covers

the tactical capabilities, limitations and methods of employing radios, telephones, arm and hand signals, pyrotechnics, light and other visual signals, loudspeakers, messengers and sounds. The use of duress signals and site-specific communications systems also is discussed.

Chapter 12, "Chemical Agents," describes proper methods for employing riot control agents and covers the detection of such agents, the symptoms they cause and the measures that can be taken to protect against them.

Chapter 13, "Adversary-Apprehension Techniques," describes tactical methods of giving commands to the adversary and of disarming, incapacitating, handcuffing and searching an adversary. Techniques also are discussed for apprehending more than one adversary, for making a vehicle stop and for evacuating prisoners from a high-risk area.

Chapter 14, "Rappelling," deals with rappelling equipment and techniques and emphasizes safety precautions to be taken during rappelling.

Chapter 15, "Search and Clear Operations," addresses the principles and techniques related to conducting deliberate search and clear operations in potentially hostile areas.

Chapter 16, "Sniper Operations," describes the employment of snipers in an offensive role against an adversary and addresses countersniper operations.

Part Two

Chapter 17, "Command, Control, and On-Scene Command Considerations," covers planning for command and control of tactical operations, on-scene command and control, and rehearsals.

Chapter 18, "Tactical Orders," deals with the three types of military orders that can be adapted for NRC security force use and provides annotated examples of each type of order.

Chapter 19, "Cordon Operations," describes the planning that should take place prior to a cordon operation, the requirements for establishing inner and outer containment perimeters and techniques that can be used to block potential avenues of escape.

Chapter 20, "Assault Operations," presents the principles of offensive operations and describes the organization and execution of a small-unit offensive operation.

Chapter 2

ADVERSARY CHARACTERISTICS

Section 1. INTRODUCTION

Soldiers throughout history have heard the advice "know your enemy." This advice is just as important to security personnel as it is to soldiers. You should learn as much as possible about your potential adversaries. The better you understand your adversary, the greater the advantage you will have in a tactical encounter.

This chapter describes the adversary types most likely to engage in tactical confrontations with nuclear security forces. Probable adversary aims will be discussed. The arms, equipment, tactics and techniques that an adversary force may employ also will be covered.

Section 2. POTENTIAL ADVERSARIES

The security forces of nuclear facilities in the U.S. are faced with many types of potential adversaries: terrorists, organized/sophisticated criminals (task force criminals), extremist protestors, psychotic persons, disgruntled employees, and miscellaneous criminals (motivated by personal gain, revenge, greed). All of these potential adversaries represent a threat to nuclear facilities. However, only **criminals** (task force) and **terrorists** are likely to engage security forces in tactical confrontations. Generally, criminals take action for financial gain, while terrorists are likely to take hostile action for political gain or on the basis of ideological beliefs.

There is increasing potential for land vehicle use by potential adversaries as an aid in breaching of perimeter barriers and transporting adversary personnel and their equipment. While some facilities are more susceptible to vehicular threats than others, it is imperative that all facilities be capable of meeting this threat. This involves integration of barriers used for vehicle denial purposes with tactical response plans and tactics. Particular attention should be paid to the types, weights, and velocities of the vehicles that are postulated for use by adversaries, in order that effective safeguards measures can be implemented.

CRIMINALS

The group that is most likely to confront security forces at nuclear facilities in tactical situations is the organized, sophisticated, or task force criminals.

Because there have been very few nuclear-related terrorist incidents, literature on the subject refers to analogous criminal activities to determine the capabilities well-organized and directed criminal groups would be likely to assemble if they chose to attack a nuclear facility. Groups likely to have these capabilities are referred to as **task force criminals** who organize into groups where specific responsibilities are delegated to each person involved, as part of an overall scheme to assault a well-protected target. Task force type crimes are appropriate analogs to attacks directed at nuclear facilities since the activities involved require careful planning, execution, and specialized skills.

Task force criminals have some common characteristics that set them apart from other potential adversaries. They are usually motivated by personal financial gain and power. In other words, they normally only commit acts that benefit them personally. In tactical situations, task force criminals probably will not be willing to die, but may kill if necessary to accomplish their goals or to escape. They are more likely to use the threat of force rather than to use force itself. In general, economically motivated criminals commit the types of illegal acts that will result in the absolute minimum risk to themselves. They are likely to avoid the threat of bodily harm, capture, or even recognition.

Studies of this type of criminal revealed that:

- Most of the crimes committed were successful.
- They engage in long periods of surveillance, planning, and reconnaissance.
- Insider help is often essential.
- Violence is usually kept to a minimum, but where weapons are necessary, they are used in large numbers to demonstrate overwhelming firepower to discourage resistance.
- They rely heavily upon surreptitious methods, are opposed to taking unnecessary risks, and rarely would plan an overt attack. The ideal crime, from their standpoint, would be one in which they were finished and gone before the security forces even knew they had been

there. The criminal will not deliberately get involved in a tactical confrontation with security forces. Therefore, if there is a tactical confrontation with criminal adversaries, the reason probably will be that something has gone wrong with their plans.

- Few of the crimes involved more than seven individuals, but the higher the potential for economic gain, the more persons that are likely to be involved and the more likely it is that insiders will be used.
- The largest number of incidents occur when the targeted material is in transit.
- Deception increases the chances of success.

Criminal adversaries tend to be highly competent in technical areas. They are much more likely to try to bypass complicated alarm systems by some technically advanced procedure than they are to resort to the early use of force. They also may be expected to use forged badges or other fake credentials to gain nonforcible access to a target area.

These are the basic factors to remember about task force adversaries:

- They probably will not take any unnecessary risks.
- They conduct surveillance of their targets for extended periods, and their operations will probably involve accurate intelligence, careful planning, deception, and surprise.
- The preferred targets are assets in transit.
- They attempt to minimize violence and probably will avoid contact with security forces, if possible.
- Group success is usually dependent on insider help.
- They prefer "low profile" operations.
- They may be technically very sophisticated.

TERRORISTS

As with criminals, terrorists have certain common characteristics that set them apart from other potential adversaries. These common characteristics are based primarily on the political motivations of terrorists. Since terrorists' highest loyalty normally is to the group, they may be the most dangerous adversary. It is likely that a terrorist will be willing to die, or to accept great personal risk,

for the benefit of his group or cause. An adversary who is willing to kill and to die is more dangerous than one who only is willing to kill.

Willingness to accept personal risk also makes terrorists more likely than criminals to be opponents in a deliberate tactical confrontation. Whereas criminals probably will avoid security forces if possible, terrorists might deliberately provoke a confrontation if this serves their purposes. Even so, terrorists are likely to deliberately become tactically engaged with security forces only at a point when they are relatively sure of tactical success.

Terrorists now possess as many technical skills as criminal adversaries do. They also have strong tactical ability. On an international level, some terrorists spend years in training camps perfecting their tactical skills. In addition, the recent trend of state sponsorship of terrorist groups has placed greater resources for planning and conducting operations into the hands of fanatical terrorists.

The basic factors to remember about terrorist adversaries are

- Their operations will probably involve accurate intelligence, careful planning, deception, and surprise.
- They will take great personal risks.
- Bombing is a preferred method of attack.
- They may deliberately engage security forces if it suits their purposes.
- They may take part in "high profile" violent operations.
- They will have strong tactical leadership and skills, and will be well armed and equipped.

Section 3. ADVERSARY WEAPONS AND EQUIPMENT

The range of weapons available to criminals and terrorists today is staggering. Handguns, shotguns, rifles and submachine guns have been part of the criminal arsenal in the United States since the days of prohibition. Today, crew-served weapons including rocket-propelled grenades, machine guns, mortars and antitank guns as well as various chemical weapons have been added to the list. Modern explosives such as "Claymore" type mines and shaped charges are easily obtained or manufactured. Remotely controlled weapons and remotely detonated

explosives are within the reach of even the least informed adversary.

As with weapons, there appears to be no limit to the equipment that is available to potential adversaries. Almost any piece of equipment imaginable is available, at the right price, on the commercial market. If it suited their needs, adversaries could employ a full range of surface vehicles, heavy machinery, power tools and complex electronic equipment. When using certain types of equipment, such as vehicles and heavy machinery, adversaries probably would employ deception techniques to hide their true intent. For example, if a vehicle were used by an adversary, you could expect it to have police, news station or other deceptive markings.

Section 4. ADVERSARY TACTICS

Any theft or diversion attempt against a nuclear facility requires that the adversary get out. To prevent theft, the adversary must be prevented from escaping.

Depending on the final aim of the adversary force, adversary tactics will be aimed at accomplishing the three following actions

- **GAINING ENTRY**
- **PREVENTING INTERRUPTION**
- **ESCAPING**

The likelihood that these actions will occur makes it necessary that they be considered in security force response plans.

GAINING ENTRY

Regardless of any adversary's eventual aims, the early stages of entry are likely to be covert. An exception could occur in a facility where redundant alarm systems and barriers were coupled with a highly effective gate access system. A fence crash or gate crash might be attempted in this case.

If not discovered, adversaries are not likely to provoke early confrontation with security forces by an overt act. Instead, they will covertly breach barriers. If badge checks and portal searches are not thorough, an adversary is likely to attempt an unopposed entry with forged credentials or by some other deception. In short, unless an extremely effective, layered, security perimeter is in place, adversary entry into a target area is likely to go unopposed.

PREVENTING INTERRUPTION

Whether their plans involve theft or sabotage, adversaries must gain sufficient time after they are detected to accomplish their aims. The two probable methods of hindering responding security forces are

- The use of diversionary actions
- The use of adversary security forces

Diversionary Actions

Immediately prior to making their first overt move, adversaries may create a situation to divert responding security forces away from the primary adversary target. They might set off a criticality alarm, start a fire, detonate an explosive, or stage a mock attack on an apparently more vulnerable or more tactically important target. This last approach would be especially effective at a facility having multiple targets of varying degrees of tactical importance. For example, an adversary might stage a mock attack against an SSNM storage area while actually attacking another storage area where the quantities of SSNM held were much smaller but still adequate to meet adversary needs.

Adversary Security Elements

Always assume that adversaries will employ security elements. As a minimum, expect that look-outs or small ambush teams will be covering the most obvious response routes to the target area.

The mission of these adversary security elements could be to destroy responding security forces. However, adversary mission success probably will not depend on the destruction of responding forces. Simply by engaging responding security forces, thus causing them to deploy prior to reaching the target area, the adversary security elements would have done their job. Their aim would be to buy time during which the main adversary force could accomplish its mission and/or escape.

ESCAPING

In general, every adversary theft plan will include some means of escape. Even those plans, to be carried out by a terrorist adversary who may be willing to die if necessary, probably will include a means of escape to be used if possible.

The three general types of escape that an adversary could attempt are

- Covert escape

- Escape under pressure
- Escape with hostage

Covert Escape

Just as adversaries prefer covert entry to overt entry, so they prefer covert escape to escape under pressure. Particularly in a theft attempt, the ideal plan from the adversary's point of view would be one in which the theft was not even discovered until after escape had been accomplished. If alarm systems can be defeated and if barriers can be overcome without attention being attracted, you can expect the adversary to try to get out undetected.

Adversaries might plan to use surface vehicles or fixed or rotary wing aircraft for their final escape from the facility. However, surface vehicles and aircraft are easy to spot and are vulnerable to weapons fire. To keep the escape undetected, the plan probably would call for pickup points to be located out of sight of security forces and out of range of their weapons. Keep this likelihood in mind as you analyze adversary escape routes.

Escape Under Pressure

If detection systems cannot be defeated, adversaries must plan to escape under pressure from responding security forces. The same techniques that adversaries employ to prevent interruption could be employed to assist escape. That is, adversaries may employ diversionary actions and security elements to delay responding security forces. Since adversaries will know their exact escape route in advance, the probability that you will encounter an ambush while pursuing an escaping adversary is extremely high.

Escape with Hostages

You should always be prepared for a situation in which adversaries use hostages as human shields or for bargaining their way to freedom. Hostages may be taken as part of a deliberate plan or as a last effort to salvage a failing operation. The presence of hostages in an adversary escape attempt places immediate limitations on your use of deadly force. Your choice of a course of action may well be one of the hardest decisions you will ever have to make.

Section 5. ADVERSARY THREATS TO SECURITY FORCE COMMUNICATIONS

The single weakest link in the security chain at most nuclear facilities is tactical communications.

You can count on an adversary to take advantage of that weakness. The three most common methods that an adversary might employ to disrupt your communications are

- **MONITORING**
- **JAMMING**
- **DECEPTION**

MONITORING

By monitoring security force tactical communications, an adversary can learn the exact positions, movements and intentions of all responding security forces. Various commercial radio frequency scanners are available today that are simple to operate. If the tactical frequency is not secure, it can be expected that an adversary will listen in on your operations during an incident and probably for several days before. Even if you do operate with a secure communications system, you will still be subject to monitoring if the adversary can obtain one of your radios from, for example, a fallen security force member.

JAMMING

Jamming a frequency simply means blocking messages by transmitting on the same frequency with a transmitter having power equal to or greater than that of the transmitter being jammed. During a tactical situation, many important messages would come from lower powered, hand-held radios that would be easy to jam. Using a secure radio system does not prevent jamming since it is not necessary for an adversary to understand what is being said on a frequency in order to jam the frequency.

DECEPTION

If an adversary has the capability to monitor or jam your tactical communications, he probably will be able to make deceptive transmissions as well. False reports about activity in other areas and misleading instructions to responding security forces are just two means of communications deception that an adversary could use to delay a response.

Section 6. THE INSIDER PROBLEM

In the United States, the major threat against nuclear facilities comes from individuals who are moti-

vated by personal reasons such as financial gain, revenge, etc., or who have or desire access to inside information. Insider assistance is often essential for success and used in task-force crimes. Although terrorists do not use insider assistance to the extent of task-force criminals, terrorists are likely to use crimes of coercion involving an insider having appropriate knowledge and access.

10 CFR 73.1(a)(2) indicates the design basis threat that should be considered by NRC licensees in preventing theft or diversion of formula quantities of SSNM by insiders. It indicates that an external assault, attack by stealth, or deceptive actions can be presumed to have inside assistance which may include "a knowledgeable individual who attempts to participate in a passive role (e.g., provide information), an active role (e.g., facilitate entrance and exit, disable alarms and communications, participate in a violent attack), or both." The insider assistance may be "an individual, including an employee (in any position), and a conspiracy between individuals in any position who have: (A) access to and detailed knowledge of nuclear power plants or the facilities referred to in 10 CFR 73.20(a), or (B) items that could facilitate theft of special nuclear material (e.g., small tools, substitute materials, false documents, etc.), or both."

Task-force criminals frequently try to recruit insiders working at targeted facilities to provide assistance in criminal activities, but these criminals may also use corruption, extortion, blackmail, and physical intimidation to gain inside cooperation.

An adversary's strongest and most dangerous ally can be the insider. An insider, who is familiar with the security system, plant layout, and operating information, can be as valuable to an adversary as a greater number of armed personnel. The possibility that at least one insider can be coerced or recruited into aiding adversaries is great enough that it must be taken seriously. Your security systems should be designed so that they cannot be defeated by a lone adversary, and your facility response plans should be designed to protect the facility against the possibility of insider assistance to adversary threats.

Section 7. USE OF LAND VEHICLES BY ADVERSARIES

A change to the design basis threat in 10 CFR 73.1(a)(2) includes the use of land vehicles by potential adversaries attempting to commit theft of SSNM. This change recognizes that land vehicles can be used for breaching of perimeter barriers and

transportation of adversary personnel and their equipment.

Vehicle barriers that use natural terrain features to prevent or impede approach to or penetration of the protected area perimeter is one approach. In other instances, manufactured barriers or manufactured barriers in conjunction with natural terrain may provide the required level of protection. The vehicle denial system must allow for an authorized vehicle to enter into and exit from the protected area, while protecting against the land vehicle threat. The system may use, therefore, site-unique topographic features or modifications, static barriers, active barriers, or a combination of all three.

At points where vehicles are authorized to enter the protected area, the barrier system to prevent unauthorized vehicle entry must operate to prevent forcible vehicle entry at these points. The function of controlling authorized entry is provided by guard personnel utilizing vehicle control equipment and following prescribed procedures. Access to enter should be granted only after the authorization for a vehicle has been confirmed and entry of an unauthorized vehicle should not allow entry by an unauthorized vehicle tailgating behind an authorized vehicle. Final control of access should be accomplished by an individual located away from the barrier or within a bullet-resistant enclosure. Electronic security detection equipment should provide indications of intrusion at unmanned positions around the protected area's perimeter. If assessment reveals that a vehicle breach has occurred at a location along the perimeter barrier, security personnel must be prepared to respond as if the breach was made by personnel on foot.

Section 8. CHAPTER SUMMARY

This chapter has described the two major types of adversaries that responding security personnel

would most likely encounter in a tactical situation. These types were

- **Task force criminals**
- **Terrorists**

The chapter discussed the adversary aim that is of greatest concern to a responding security force member.

- **The theft or diversion of formula quantities of SSNM**

The probability of an actual adversary act against a nuclear facility also was discussed.

Adversary weapons and equipment were examined. It was concluded that sophisticated and lethal weapons and equipment are available to an adversary for use against nuclear security forces.

Adversary tactics likely to affect security force planning were discussed. These tactics include those designed to

- **Gain entry**
- **Prevent interruption**
- **Aid in escape**

Adversary threats to security communications were discussed. These threats include

- **Monitoring**
- **Jamming**
- **Deception**

The chapter concluded with a discussion of the insider as an aid to adversaries and as a serious nuclear security problem, as well as the land vehicle threat.

Chapter 3

COVER, CONCEALMENT AND TERRAIN ANALYSIS

Section 1. INTRODUCTION

Your survival in a tactical situation is largely dependent upon your ability to analyze terrain, to use cover and concealment as effective protection and to practice camouflage measures. This chapter will provide you with the basic principles and techniques of using these kinds of protection and of carrying out terrain analysis and camouflage measures. Through repeated practice of the techniques, you can develop the ability and the con-

fidence to operate individually and as a team member, day or night, in a hostile environment.

Cover, concealment, camouflage and terrain analysis will each be discussed separately in this chapter. It is important to remember, however, that these factors are interrelated and therefore must be considered together during a tactical crisis. You should analyze the terrain in order to choose your cover and concealment, and then you should supplement your cover and concealment by practicing camouflage.

Section 2. COVER

Cover is defined as anything that will protect you from the fire of the adversary's weapons. Cover may be natural or manmade (see Illus. 3-1). **Natural cover** includes trees, fallen logs, depressions in the ground, large rocks and boulders, reverse slopes and hollows and river banks. **Man-made cover** includes vehicles, drainage ditches, loading docks, guard posts, observation towers and solid structures such as buildings, retaining walls and curbs.

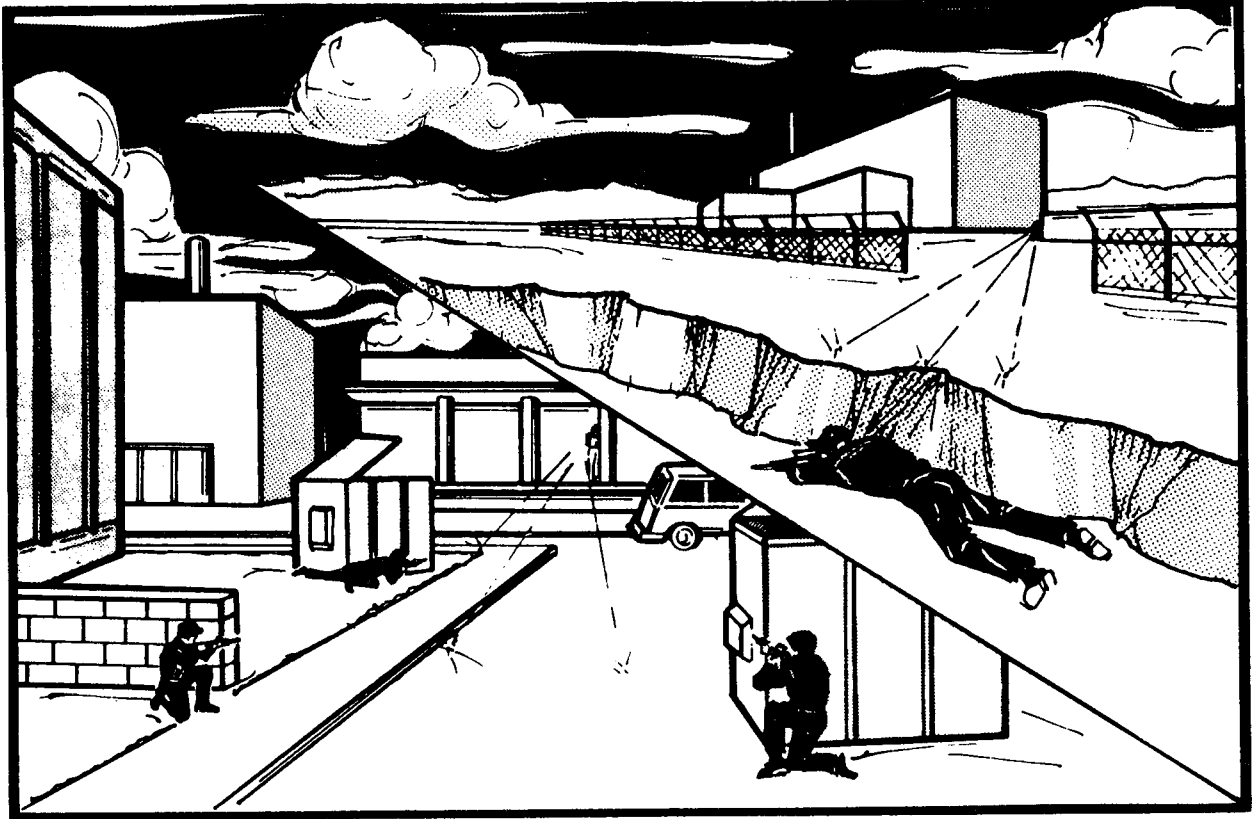

Illustration 3-1. Cover can be natural or manmade.

During tactical situations, you must develop the habit of locating and taking advantage of the cover that the terrain offers. You will find that the physical setting of the plant or facility, unlike typical battlefield terrain, provides an abundance of man-made objects and materials that can be used for cover without being modified or altered. You should select a position that will provide the maximum protection from adversary weapons fire.

Any time that you occupy a guard station or guard tower you should survey the cover in and around your location and think ahead about how you would use that cover during a tactical crisis. Consider how the station or tower is hardened or armored and be aware of the type of weapons fire that it will withstand. Take note of available firing ports, if any, through which you could attempt to return fire. Think of desks and other furniture as potentially providing extra cover. Determine what cover, such as metal or concrete barriers, may be available outside of the station or tower and think about how and under what circumstances you might move tactically to use that cover. Remember that

your possible reactions will be limited if you are taken under fire when in a guard station or tower and that your first priority should be to make effective use of cover so that you can stay alive to communicate and eventually to respond.

When you are moving, select a route that puts cover between you and the adversary. Avoid open fields and areas such as rooftops and ridges, where you may be silhouetted against the sky. By making it a habit to take advantage of available cover and by using proper tactical movement techniques, you can achieve the maximum protection against adversary weapons fire (see Illus. 3-2).

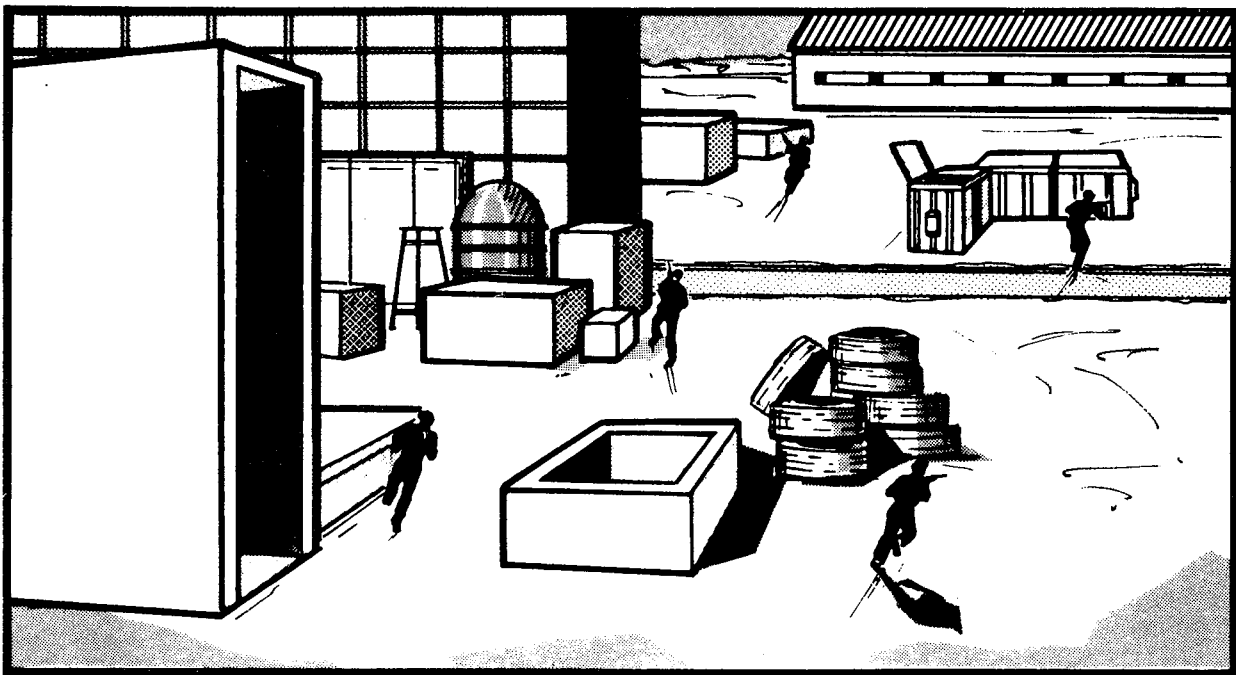

Illustration 3-2. Take advantage of available cover and use tactical movement techniques for maximum protection.

Section 3. CONCEALMENT

Concealment is defined as anything that will hide or obscure your presence or position from adversary observation. Concealment, like cover, may be natural or manmade. Natural concealment frequently is provided by your surroundings and needs no alteration to be used. Examples are trees, bushes, tall grass, shadows and darkness. Opaque glass, one-way windows and smoke are examples of manmade concealment. Within the industrial complex, you will find many objects and structures,

both natural and manmade, that provide concealment (see Illus. 3-3). During tactical situations, you must take advantage of the concealment that the terrain offers.

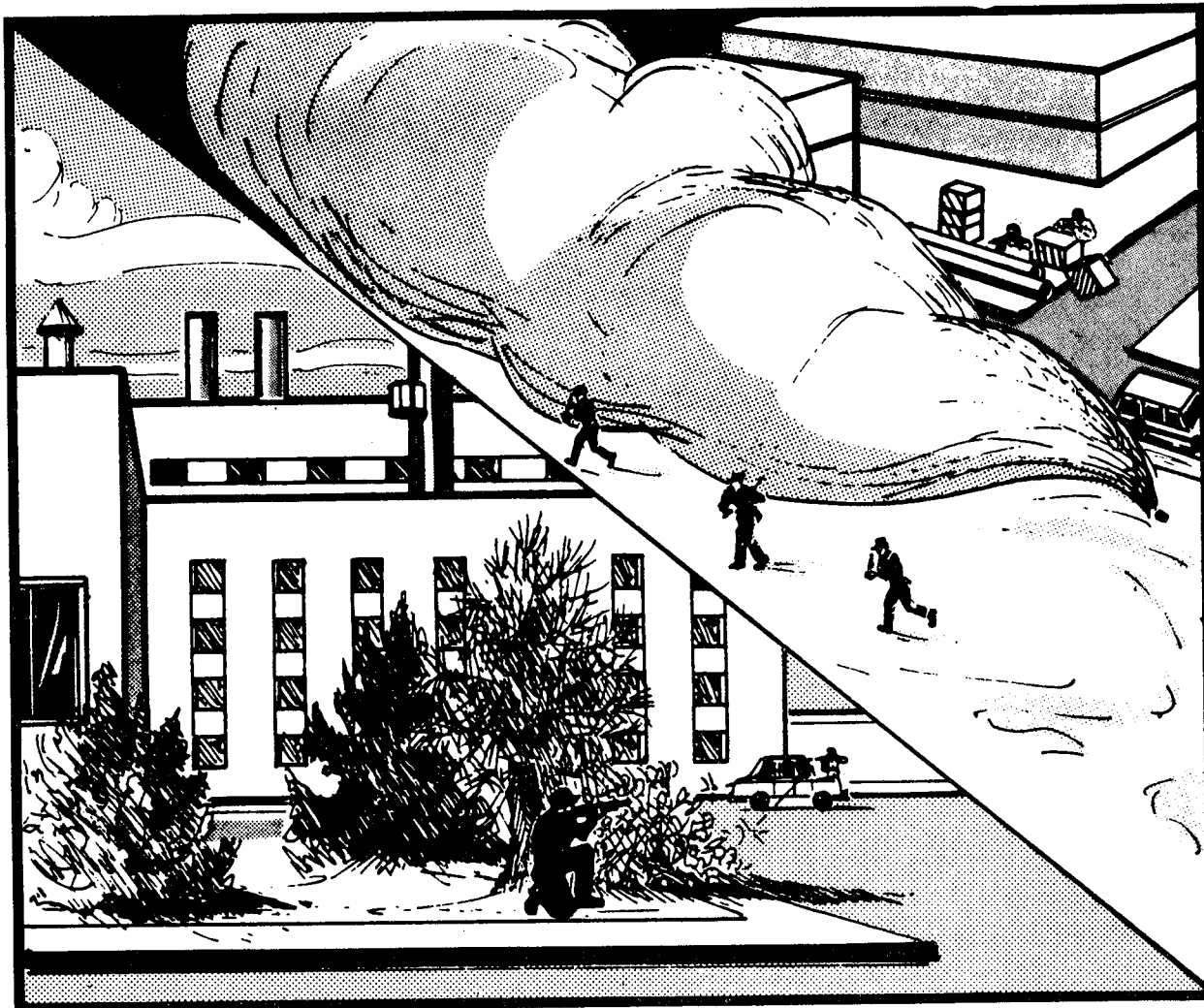

Illustration 3-3. Concealment can be natural or manmade.

Blending with your background is an important part of concealment. Background colors and patterns should not contrast sharply with those of your uniform (see Illus. 3-4).

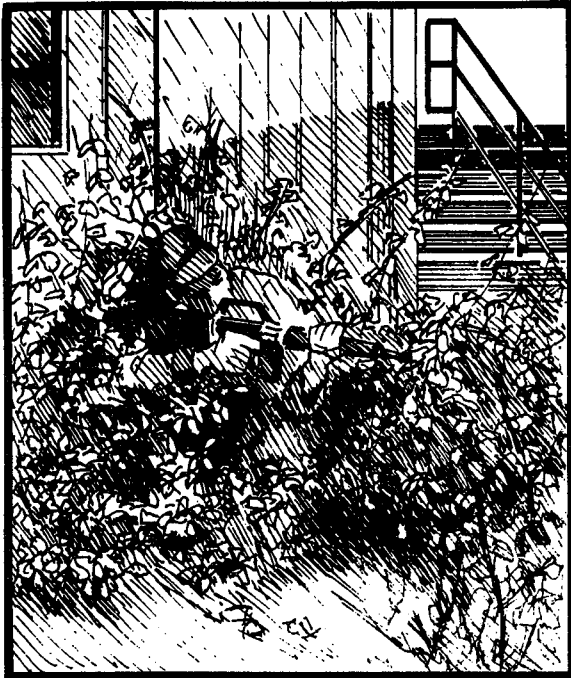

Illustration 3-4. Blending with your background is essential to concealment.

Do not move from your position or move around within your position unless you have to. By moving, you may attract the attention of the adversary. If you must change your position, select a route that provides both cover and concealment.

Practice noise and light discipline any time you are in a tactical situation. You must make as little noise as possible and you must restrict your use of artificial light to avoid being detected by an adversary.

When firing and observing from behind a position of cover or concealment, present the smallest profile possible.

Since shadows aid in concealment, select shaded positions when possible (see Illus. 3-5).

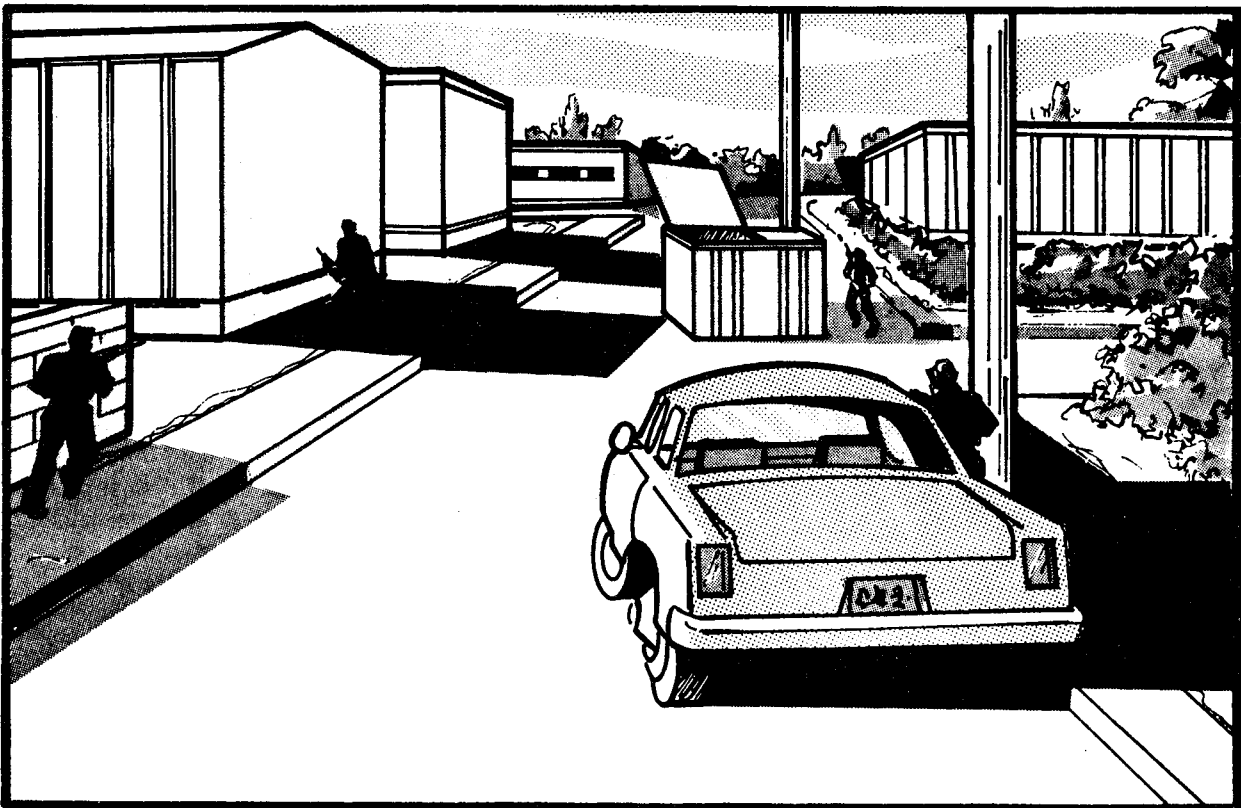

Illustration 3-5. Shadows aid in concealment.

Do not make the mistake of believing that you are protected from adversary weapons fire merely because you are hidden from observation. **Concealment** may not provide cover from fire.

Remember that darkness alone may not conceal your presence, because the adversary may be equipped with night-vision devices (NVDs) (see Illus. 3-6).

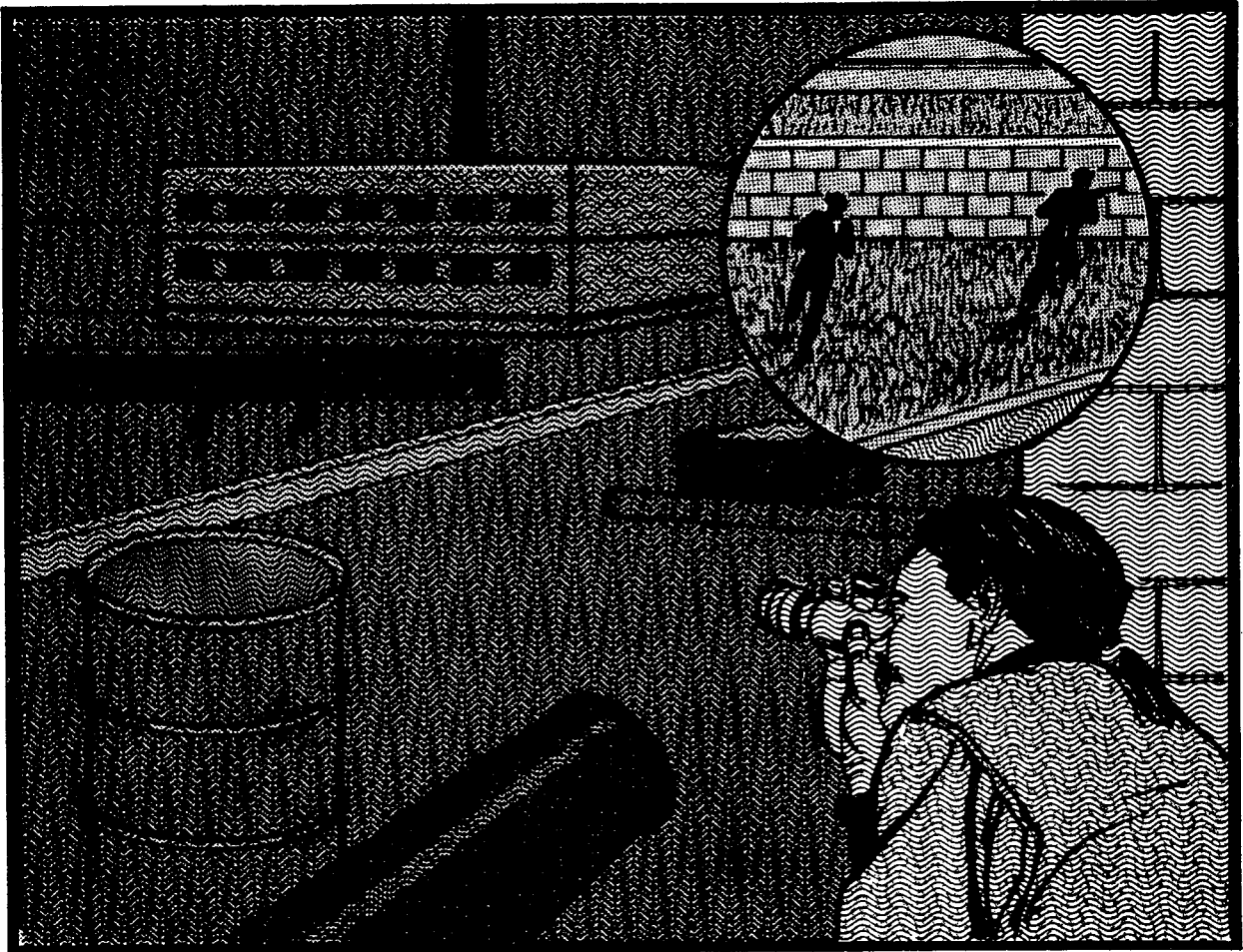

Illustration 3-6. The adversary may have night-vision devices.

Section 4. CAMOUFLAGE

Camouflage is concealment by means of disguise. Individuals, equipment and positions can be camouflaged by making them seem to be part of the existing environment. Camouflage may be accomplished through the use of manmade and natural materials. By taking advantage of all natural and manmade concealment and cover that is available, you also will be achieving a degree of camouflage.

In order to blend into natural surroundings, you must alter or disguise familiar outlines. Change the shape of easily identified items such as caps,

rifles and body outline. For example, caps and the body silhouette can be disguised through the use of foliage (see Illus. 3-7). Foliage should be used sparingly, however, and the pieces used should be naturally occurring in the area. The familiar shape of the rifle also can be disguised, through the use of camouflage tape or a material such as burlap.



Illustration 3-7. Familiar outlines can be disguised with foliage.

A flash of light, or shine, attracts attention instantly and may be seen from a great distance. Shine may originate from a light source such as a flashlight or cigarette or may be reflected from the smooth surfaces of cap bills, belt buckles, badges, pens and pencils, boots and shoes, wrist watches, radios, eyeglasses and frames and weapons and from exposed skin (see Illus. 3-8). In a tactical situation, you must either camouflage or remove any item that may emit or reflect light. Light-reflecting items such as badges, pens and watches

are removed easily. Larger items such as leather gear, weapons and radios should be camouflaged either with natural material such as mud or dirt or with a dull tape or paint to reduce the possibility of shine.

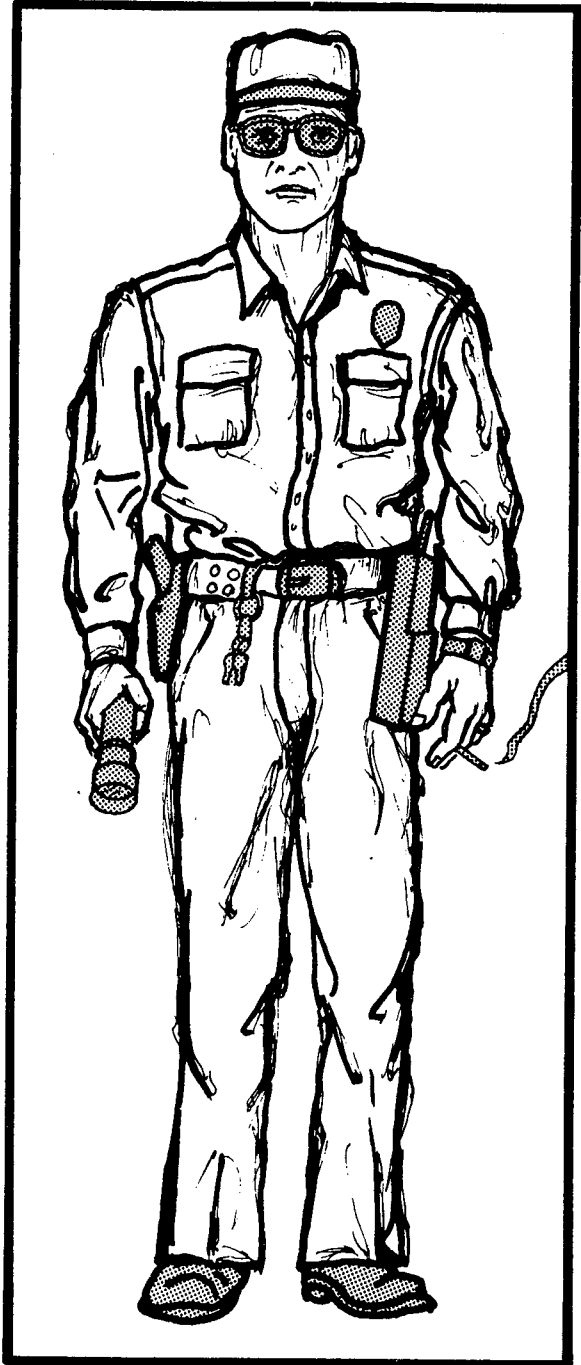

Illustration 3-8. Remove or camouflage items that produce or reflect light.

In all tactical situations, you must practice camouflage discipline. Always consider the following basic rules:

- **Ensure that all equipment, including your uniform, web and leather gear, weapon and survival vest, blends with the natural background.**
- **Use only as much camouflage material as you need. Excessive use of material (natural or manmade) can reveal your position.**
- **Alter or disguise distinctive silhouettes.**
- **Change camouflage colors when moving to an area with a different background color.**
- **Remember that mud and foliage have a tendency to change color as they dry.**
- **Cover all areas of skin with either clothing or camouflage material. Even very dark skin will reflect light because of the presence of natural body oils.**

When time permits, camouflage your face with either camouflage sticks or liquid face paint. Loam and light green paint should be used by light-skinned personnel in all terrain unless it is snow covered. Sand and light green paint should be used by dark-skinned personnel in all terrain unless it is snow covered. Loam and white paint should be used by all personnel when they are in snow-covered terrain. All shine areas of the face, including the forehead, cheekbones, nose and chin, should be darkened. The shadow areas around the eyes and under the nose and chin should be painted a dark color but not as dark as that used on the shine areas. The ears and the exposed skin on the neck also should be darkened (see Illus. 3-9). When applying camouflage paint, use the buddy system to apply the paint and to check each other if possible.

Security vehicles, like personnel, can be camouflaged with either natural or manmade materials. In the NRC licensee security environment, however, it is neither possible nor practical



Illustration 3-9. Darken all shine areas of the face when applying camouflage.

to camouflage vehicles prior to each tactical response. You will depend more on the techniques of tactical driving, as described in Chapter 9, than on camouflage techniques to give you protection when you are using a vehicle in an industrial setting.

Section 5. TERRAIN ANALYSIS

In any tactical situation, you must analyze the terrain to determine what effect the features of the area will have on the actions of both the responding forces and the adversary. Consider the following aspects when you analyze terrain:

- EFFECT ON OBSERVATION
- FIELDS OF FIRE
- COVER AND CONCEALMENT
- OBSTACLES
- KEY TERRAIN
- AVENUES OF APPROACH

EFFECT ON OBSERVATION

You must determine what **effect on observation** the terrain features of the area will have. You must consider not only how the terrain will affect your ability to observe adversary activity but also how terrain features will affect adversary observation of security force activity.

Identify the terrain features within and adjacent to the area of operations that will provide either friendly or adversary observers with a good field of observation as well as cover and concealment. Refer to Chapter 4, "Techniques of Observation," for a detailed explanation of these primary characteristics of a good observation position.

FIELDS OF FIRE

The **field of fire** for a given weapon is the area that the weapon can effectively cover from a given position. The fields of fire of direct-fire weapons such as automatic rifles and handguns are restricted by terrain features present between the weapons and the targets.

When doing a terrain analysis, you must consider the effects of the terrain on observation and on fields of fire together. Positions that offer excellent observation may have restricted fields of fire, and positions that offer clear fields of fire may

provide poor observation. Select positions that are favorable to both aspects when possible.

COVER AND CONCEALMENT

The modern industrial facility offers excellent **cover and concealment** for both the response force and the adversary. You have an advantage over the adversary in that you are more familiar with the setting. Based on your intimate knowledge of the facility, you should analyze the terrain and select the best cover and concealment that it has to offer.

OBSTACLES

An **obstacle** is any manmade or natural feature of the terrain that stops, impedes or diverts movement. The industrial setting itself creates obstacles to both the response force and the adversary. The streets, alleys and geometric patterns present obstacles to both men and vehicles.

An obstacle may be an advantage or a disadvantage, depending on the circumstances. For example, an area with a wide street or parking lot is an advantage to the defending element. However, an attacking element that must cross this area would consider it an obstacle and a disadvantage. Since narrow streets are easy to barricade and cover with fire, they may become obstacles to the attacking force and advantages to the defending force. You must analyze the terrain and consider the advantages and disadvantages that the obstacles within the area may present to you.

KEY TERRAIN

Key terrain is a feature that if occupied gives a **marked advantage** for control of the area. Depending on the nature of that advantage, the response force will want to occupy the key terrain, prevent the adversary from occupying it, or both. The critical element in determining whether or not a given terrain feature is key terrain rests in the judgment of the analyst.

Key terrain usually is located in the area of tactical engagement. However, any feature in or adjacent to the area that would give either the response force or the adversary effective observation or fields of fire must be considered key terrain. For example, a feature located outside the battle area that gives the adversary the capability of observing the approach route of the response force would be considered key terrain. You must analyze the terrain and identify those features that, when

occupied by either force will give that force a marked advantage toward control of a specific area.

AVENUE OF APPROACH

An **avenue of approach** is the route chosen by the response force to reach an objective. In the industrial setting, the best avenue of approach in terms of concealment and cover may be through adjacent buildings. Other avenues to consider are streets, alleys and drainage systems. Many buildings are connected by underground tunnels containing electrical wiring and pipes. These tunnels also can be used by the moving response force.

Section 6. CHAPTER SUMMARY

This chapter has presented the considerations, principles and techniques of using **cover, concealment and camouflage** and of carrying out **terrain analysis**.

The principles and techniques described for each of these factors must be considered each time response force personnel enter a hostile environment. Although each factor was discussed separately, all are interrelated and, as a result, must be considered together.

Chapter 4

TECHNIQUES OF OBSERVATION

Section 1. INTRODUCTION

Effective tactical response depends upon accurate, timely information collection and reporting. Because visual observation is the primary source of information about the adversary, every member of the security force must be a trained observer. This chapter will cover the observation skills that you should develop as well as the equipment and techniques that you can employ in day and night tactical observation.

Section 2. OBSERVATION POSITIONS

Although the natural and manmade features at your facility may provide many positions that you can occupy during a tactical situation, the features vary greatly in their suitability as observation positions. During a tactical situation, before selecting a place from which to observe, you should consider the **characteristics of a good observation position**. Such a position

- Provides the maximum field of observation
- Occupies high ground
- Provides cover and concealment

- Is approached by at least one covered or concealed route
- Allows communication
- Is not too obvious

The first of these characteristics is of primary concern. A position with the **maximum field of observation** will allow you to view all portions of your area of interest. Even if all of the other characteristics of a good position exist, a position will be of little use unless this first condition is met. From the position you choose, there should be only a minimal number of spots in the area of interest where an adversary can remain undetected.

The second characteristic of a good observation position is closely related to the first. In general, a position that occupies high ground in the surrounding terrain will provide the best field of

observation. For example, you generally can observe a larger area from the roof or upper stories of a building than you can from ground level (see Illus. 4-1).

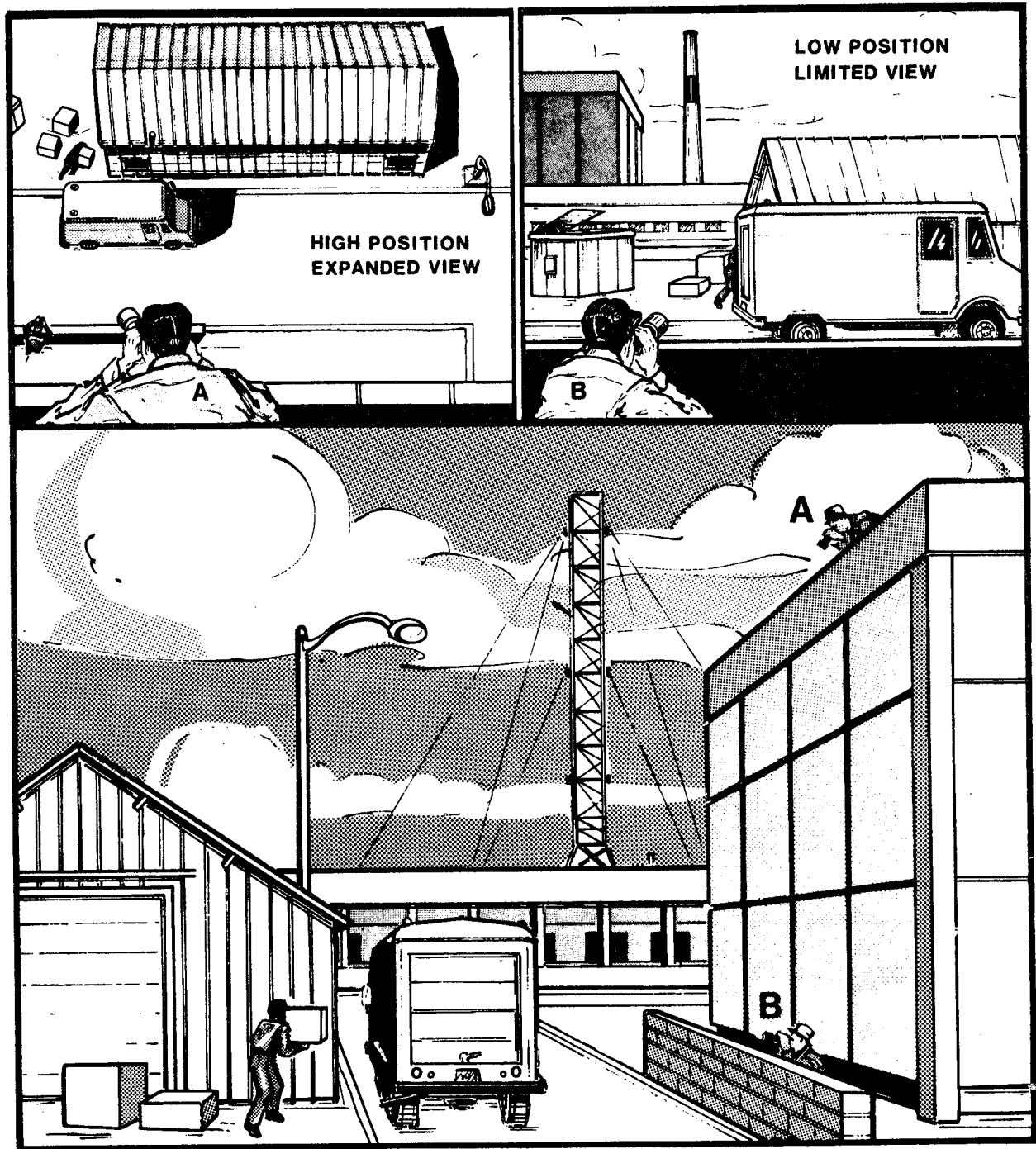

Illustration 4-1. The field of observation generally is better from a high position than from a low position.

The next characteristic of a good position is essential for your own safety and continued mission accomplishment. Your position should provide **cover and concealment** from adversary fire and observation. As a minimum, it should provide excellent concealment.

A good observation position also should have a **covered or concealed route of approach** so that you can enter it without being detected (see Illus. 4-2). Ideally, more than one such route should be available so that you can leave the position, undetected, by an alternate route.

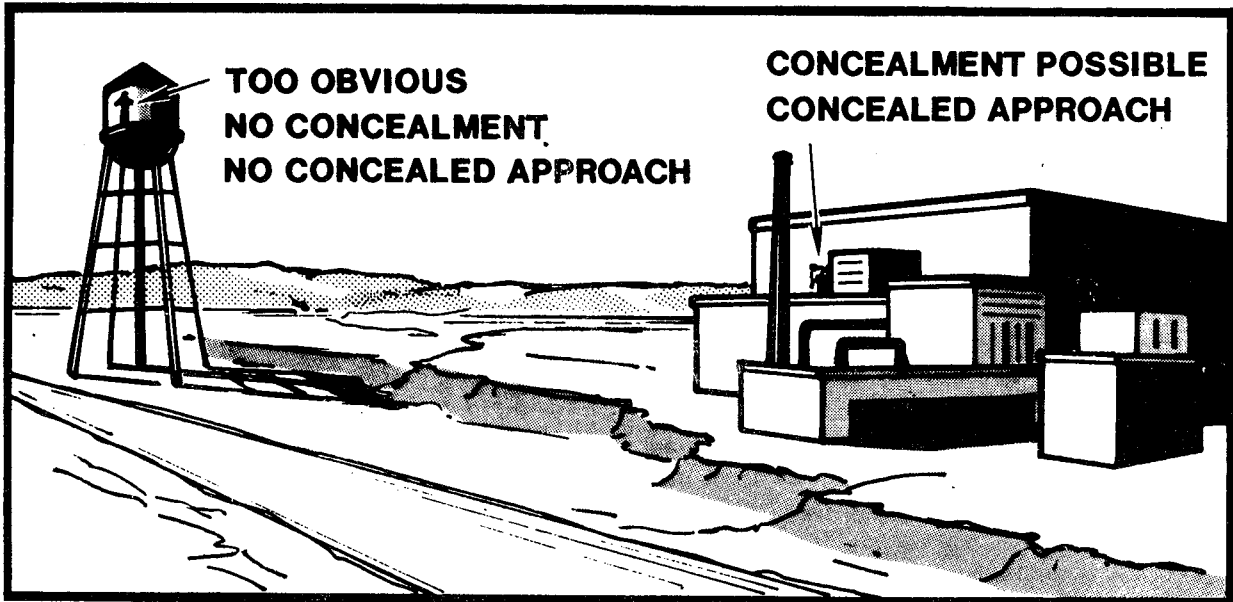

Illustration 4-2. Choose observation positions carefully.

The position you choose must **allow communication** since, to be useful as an observer, you must be able to send and receive timely information. If you rely on radio, select a position with minimal radio interference.

If you find a position with all of the characteristics discussed so far, you may think that it obviously is a good observation position. The adversary may think the same thing, however, and to protect his operation, he may neutralize the position or stay out of the area to avoid detection. You probably will observe more adversary activity if you choose a place that is **not too prominent a terrain feature** and that is **not too obvious a position**, yet that nevertheless has other characteristics of a good position (see Illus. 4-2).

Few observation positions have all of the desired characteristics. In a tactical situation, your safety and success as an observer may depend on a quick choice of position. In such a situation, when you do not have the time to search for a position that has all of the desired characteristics, your two pri-

mary criteria should be

- **Maximum Field of Observation**
- **Maximum Cover or Concealment**

Your **field of observation** directly affects your ability to perform observation tasks. If you cannot observe your entire area of interest, you may jeopardize the security mission.

Having **maximum cover or concealment** enhances your chance of continued mission performance. If the adversary can see you, he can take evasive action or steps to neutralize you.

You must be able to see, and you must be able to survive. You may have to accept a more restricted field of observation to gain some safety. You may have to give up some degree of safety to gain a better view. Your task in selecting an observation position in any given situation is to try to strike the optimum balance between field of observation and cover or concealment.

Section 3. POSITION OCCUPATION AND USE

Once you have selected a suitable observation position, you must occupy the position properly. Proper occupation means not only that you must approach and enter the position correctly but also that you must then make optimum use of that position.

ENTERING A POSITION

Approach and enter your position as secretly as possible. If your adversary sees you approaching or entering your new position, he will know where you are and will either avoid your observation effort or take direct action against you. The proper techniques for moving to your position are covered in Chapter 7, "Individual Tactical Movement."

USING A POSITION

After entering your observation position, you must place yourself within the position so that you can make the best use of it (see Illus. 4-3). You can obtain a good view while exposing yourself as little as possible by adopting the following techniques:

- **Use all available cover and concealment.** Expose as little of your body as possible.
- **Observe from the prone position.** Whenever possible, remain prone. This position creates the lowest, smallest profile, allows you to remain motionless and is comfortable for long periods of time.
- **Remain motionless.** Move as little as possible. Usually, some portion of your body remains exposed, and movement will attract attention quickly to your presence.
- **Keep quiet.** Noise, too, will betray your position. Do not cough, talk, bang or rattle equipment, rustle leaves or make any other noise. If you have a radio, use an earphone, or keep the volume turned down.
- **Look around or through an object.** This technique will allow you to keep as close to the ground as possible. Avoid looking over the top of an object.
- **Blend with your background.** Avoid backgrounds that contrast sharply with your clothing. This technique is especially important if you are forced to observe over the top

of an object or structure, such as over a long wall. Always try to position yourself so that you and your background blend.

- **Keep back from windows.** When observing from inside a building, do not stand up against the window. Move back into the room away from the window and into the shadows.
- **Keep off the skyline.** Any portion of your body that is higher than the skyline will be silhouetted against the sky. Move to lower ground, or get in front of a structure or object that is taller than you are.
- **Stay in the shade.** Always seek shadows rather than direct sunlight. Under any lighting conditions, shadows will provide some degree of concealment.
- **Avoid causing reflections.** Remove shiny objects, such as badges. If you are using binoculars or a scope, keep the lenses in the shade. If necessary, shade the lenses with a piece of clothing, wood, foliage or anything suitable that is at hand.

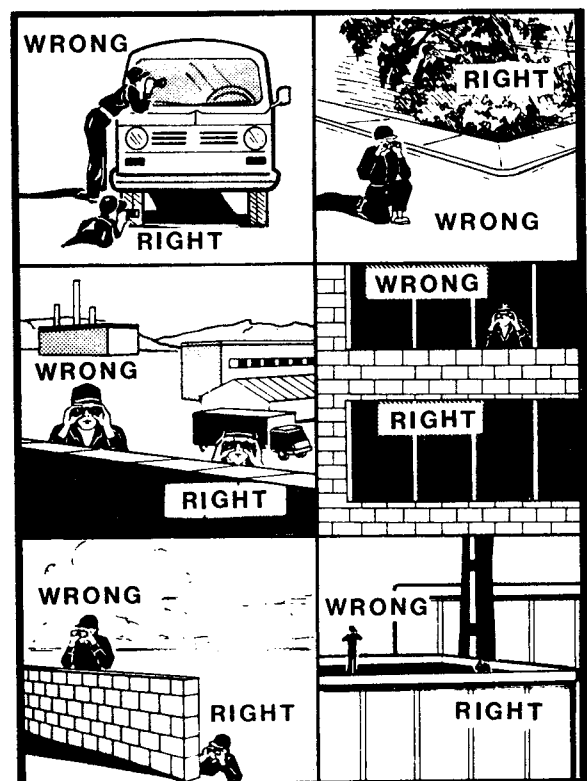

Illustration 4-3. Correct and incorrect use of observation positions.

Section 4. VISUAL TERRAIN SEARCH METHODS

Having selected and occupied an observation position, you now can employ specific techniques to properly search the terrain. Your search procedures must be methodical and thorough to minimize the chance that you will miss something significant. You begin with a **hasty search** to detect anything of immediate danger to you. Then, you conduct a **detailed search** to detect any sign of your adversary. Finally, you **maintain surveillance** of the area for as long as necessary. The proper techniques for accomplishing these three tasks will be covered in this section. The proper procedure for carrying out a fourth task, that of observing limited objectives, also will be described.

HASTY SEARCH

The **hasty search** takes 30 seconds or less and allows you to detect adversaries who are of immediate danger to you. Conduct the search by taking quick, focused glances at specific objects

such as trees, buildings, vehicles and doors in your field of view. Begin with those objects closest to you (see Illus. 4-4). This technique takes advantage of peripheral, or side, vision, which allows the eyes to detect even slight movements in the field of vision surrounding the point of focus. Peripheral vision works only when the eye is focused on a specific object. For this reason, you must focus briefly on objects throughout the area of observation. Illus. 4-4 shows an example sequence of focal points for a hasty search. If you detect any movement during the hasty search, examine the area more closely for signs of adversary activity.

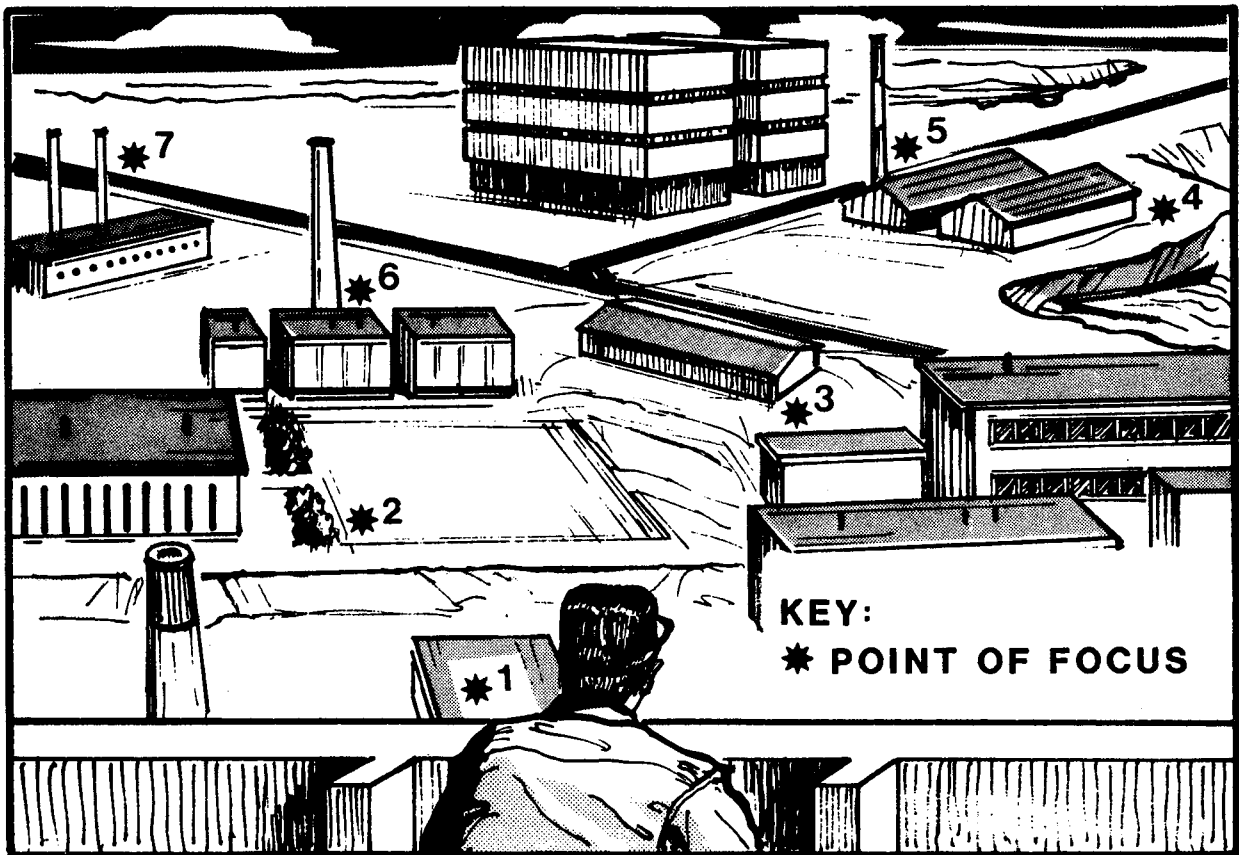

Illustration 4-4. The hasty search.

DETAILED SEARCH

If you do not find anything suspicious during the hasty search, conduct a **detailed search** of the area using the 50-meter overlapping-strip method. Starting at either side of your area of observation, search a strip 50 meters out from your position in a 180-degree arc until you reach the opposite side (see Illus. 4-5). When you have completed searching that strip, focus your eyes farther out from your position, and search the next 50-meter strip, going back in the opposite direction. Continue searching from side to side in 50-meter strips until you have searched as far out as you desire. Each 50-meter strip should include about 10 meters of the previous strip to ensure that no terrain is skipped between strips. As you search each strip from side to side, focus briefly on specific objects within the strip. This technique allows you to use your peripheral vision. If you notice anything suspicious, stop and examine that area more closely.

MAINTAINING OBSERVATION

If your mission requires that you **maintain observation** over an area for a long period of time, resume using the **hasty search** method. Glance at specific objects throughout the area, focusing briefly on each object. Establish a pattern for searching the area, and stick to that pattern to ensure that the entire area is covered. Periodically, or whenever your attention has been diverted, conduct another **detailed search** of the area.

OBSERVATION OF LIMITED OBJECTIVES

If only a limited area, such as a road, building or intersection, needs to be observed, you can focus your full attention on that area. If, for example, your task is to keep a building under surveillance, you can concentrate your observation on certain significant points, such as doors, windows and perhaps the roof.

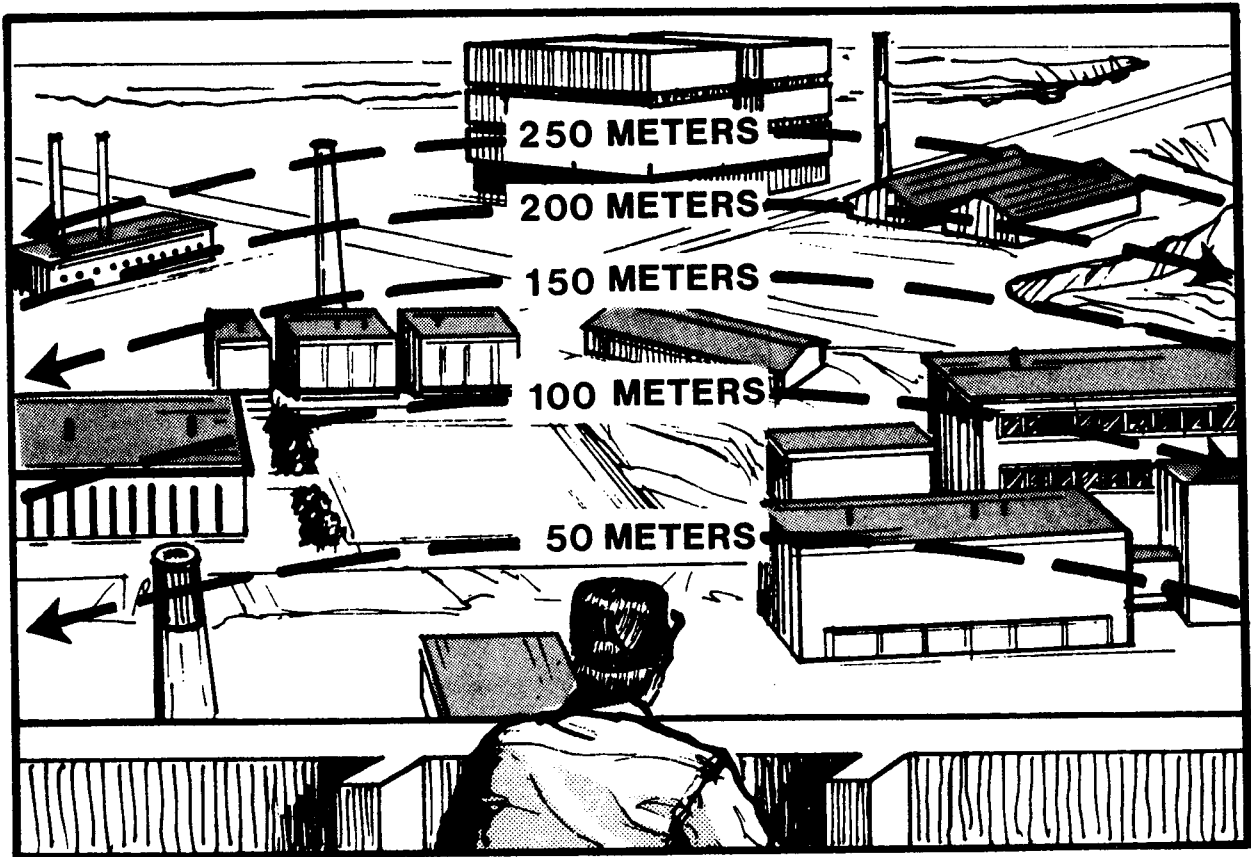

Illustration 4-5. Conducting a detailed search using the 50-meter overlapping-strip method.

Section 5. TARGET INDICATORS

The purpose of observing an area is to detect the presence and location of your adversary. If the adversary is trying to avoid detection, he will be difficult to find. However, there are various **target indicators** that will help you recognize the presence of an adversary. When conducting a terrain search, you should be alert to the following types of indicators:

- **Sound**
- **Movement**
- **Shine**
- **Regularity of outline**
- **Contrast**
- **Incorrect detail**

Sound is an important indicator, since it is difficult for an adversary to remain totally silent while moving or engaging in any activity. Be alert for vehicular sounds, footsteps, doors closing, glass breaking, equipment noises, coughing and gunfire, for example. You probably will not be able to pinpoint the adversary's location from sound, but you will be able to concentrate your search on a more specific area.

While focused on a specific point, your eye is very sensitive to **movement**. Rapid, jerky movements are easier for your eye to detect than are slow, smooth movements. Be alert for any kind of movement, including such signs as rising dust and the movement of branches and leaves.

Many manmade objects give off bright reflections of light. In other words, these objects give off **shine**. Radios, weapons, vehicles, eyeglasses, binocular lenses and clothing produce reflections of varying degrees of intensity. These objects also reflect light at night. Even skin reflects light, both during the day and at night. Look for shine, and identify the object that is causing it.

Certain objects have distinct outlines that are instantly recognizable. For example, because of their **regularity of outline**, such well-known objects as the human body, vehicles and rifles can be detected if all or part of their outlines are visible, even if the details of the object are not recognizable.

It is easy to see objects that **contrast** sharply against their backgrounds. An adversary in dark

clothing is easily detected while standing in front of a white building, but not so easily detected when standing in front of dark foliage. As an adversary moves, there will be exposure to different-colored backgrounds. No matter what color clothing is worn, the clothing will cause contrast with background part of the time.

You can become aware of the presence of an adversary by recognizing that things are not as they should be. Some examples of **incorrect details** include open doors and gates that should be closed, tire tracks where there should be none, vehicles parked in an unusual place, open and broken windows, equipment that is out of place and anything else that does not seem to be normal.

Section 6. LOCATION REFERENCING

When you have detected an adversary, you must be able to describe his location to other members of the security force in fairly accurate terms so that a response can be coordinated. The methods you can use to accurately describe the adversary's location are the **landmark method** and the **distance-from-landmark method**.

LANDMARK METHOD

The easiest way to describe a location is to do so in relation to easily identified landmarks. If the adversary is at or close to one or more landmarks that are easily found by all members of the security force, describe the location in terms of those landmarks. Some examples are as follows: "Adversary is on the roof of Building 819-C," or "Adversary is behind a green pickup truck parked at Gate 7a," or "Adversary is behind a fire hydrant at the corner of H Street and Teller Drive." Such descriptions leave no doubt as to the exact location of the adversary.

DISTANCE-FROM-LANDMARK METHOD

If the adversary is not close to a landmark, you may have to describe the adversary's position in terms of the direction and distance from your own position or from the closest landmark. For example, you would report, "Adversary is in the grass 350 meters west of my position," or "Adversary is in the tree line 200 meters upstream from Pump-house 3." To use this method, you must be able to estimate distance accurately.

A fairly accurate and simple method of distance estimation is the **100-meter unit-of-measure**

method. In order to use this method, you must be able to visualize the length of 100 meters (approximately the length of a football field) on the ground. To learn to use this method requires frequent practice over courses that have been accurately measured. Once you are able to accurately visualize a length of 100 meters, you can estimate greater distances as follows:

- For a distance up to 500 meters, estimate the number of 100-meter units between you and the adversary or between the points that you want to measure (see Illus. 4-6).
- For a distance of more than 500 meters, identify a point halfway to the adversary. Estimate the number of 100-meter units to the halfway point and double that number (see Illus. 4-7).



Illustration 4-6. Estimating distances using the 100-meter unit-of-measure method.

In order to achieve accuracy with this method, you must practice in an area that has the same types of terrain as the area has on which you will use the method. In addition, you must be able to

see all of the ground between the points being measured. If the type of terrain is unfamiliar to you or if there are portions of the terrain that you cannot see, distances will seem different to you.

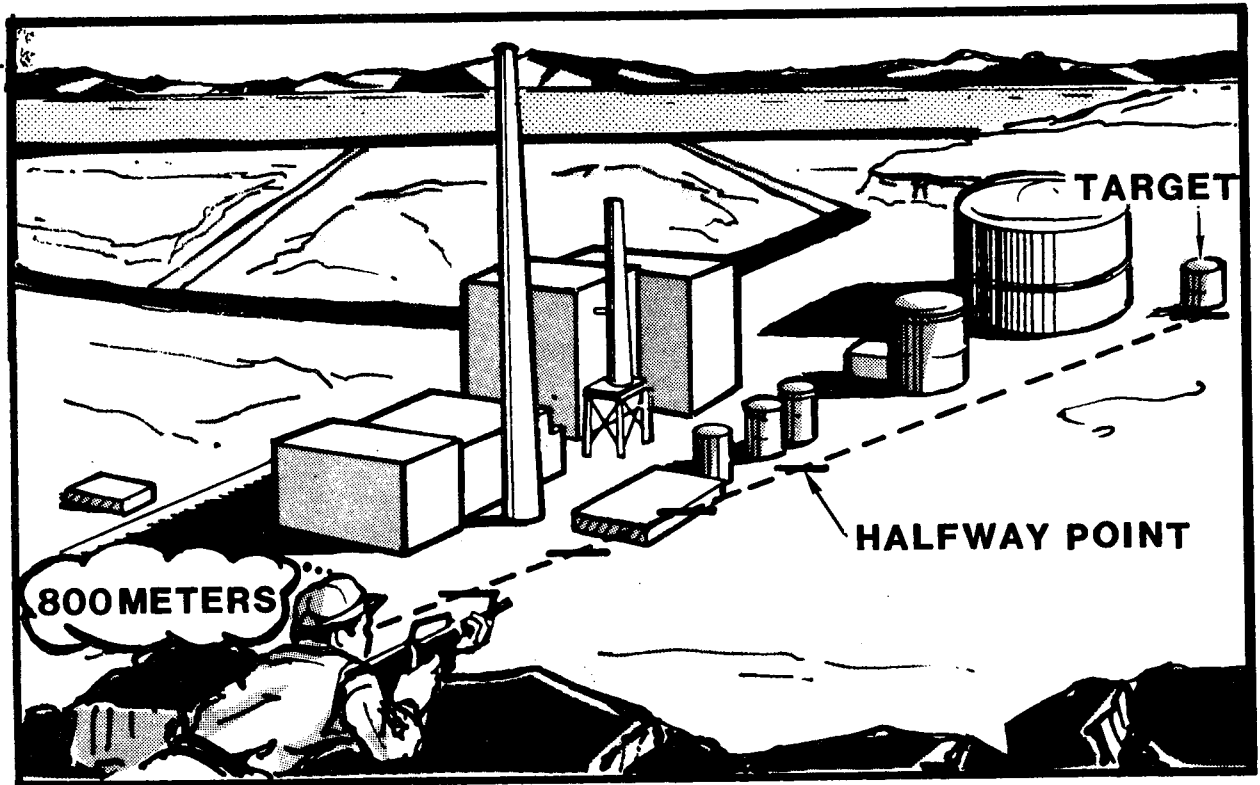

Illustration 4-7. Estimating distances greater than 500 meters.

Section 7. OPTICAL AIDS

Although most observation is conducted with the unaided eye, various optical devices can enhance observation under certain circumstances. Binoculars are the most widely used optical device. If weapon scopes are available, they, too, may be used in the secondary role of observation aid. Although there are limitations as well as advantages to using these optical aids in observation, they can be an overall asset if properly employed.

ADVANTAGES AND LIMITATIONS OF OPTICAL AIDS

The following advantages can be achieved by using optical aids such as binoculars and scopes to assist in observation:

- Objects too distant to be visible to the naked eye can be detected.
- Objects that are visible but not clear to the naked eye can be seen clearly and examined in detail (see Illus. 4-8).

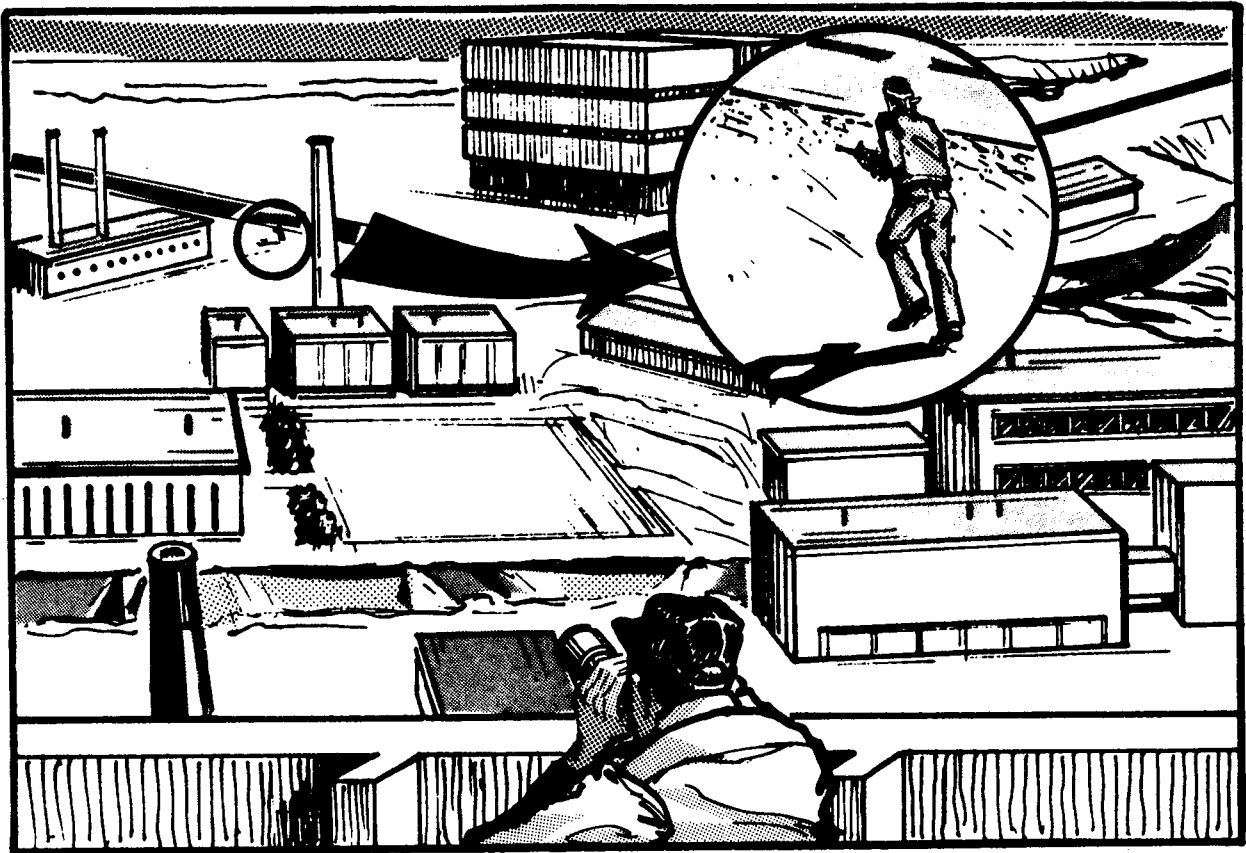

Illustration 4-8. Distant objects can be seen clearly when you use optical aids. Optical aids eliminate peripheral vision, however.

The optical aids that currently are available to security personnel to assist them in observation have the following limitations:

- They provide a very restricted field of vision, eliminating peripheral vision (see Illus. 4-8).
- They cause eye fatigue during prolonged use.
- They may be awkward and uncomfortable to use. This last set of limitations is particularly true of weapon scopes, which must be used with one eye closed and with the weapon in the firing position.

Because of the unique advantages and limitations associated with employing optical aids, you should use these devices to supplement rather than to replace observation with the naked eye. Conduct your hasty search and the bulk of your detailed search with your eyes unaided. Use your binocu-

lars or scope to study suspicious areas more closely, to observe detected targets in greater detail, to conduct distant terrain searches and to keep a limited area of interest under observation. Be aware that while looking through binoculars you may be unable to detect approaching danger at close range.

USE OF BINOCULARS

Binoculars will be of assistance to you only if they provide a clear, well-defined, well-focused image. In order to receive such an image, you must hold the binoculars properly and set the interpupillary and focal adjustments correctly.

Hold your binoculars as shown in Illus. 4-9. Grasp them lightly, letting the halves rest on the heels of your hands. Hold the eyepieces lightly to your eyes. Prevent any light from entering your eyes around the eyepieces by blocking it out with your thumbs. Support your elbows on a solid, stationary object if possible.

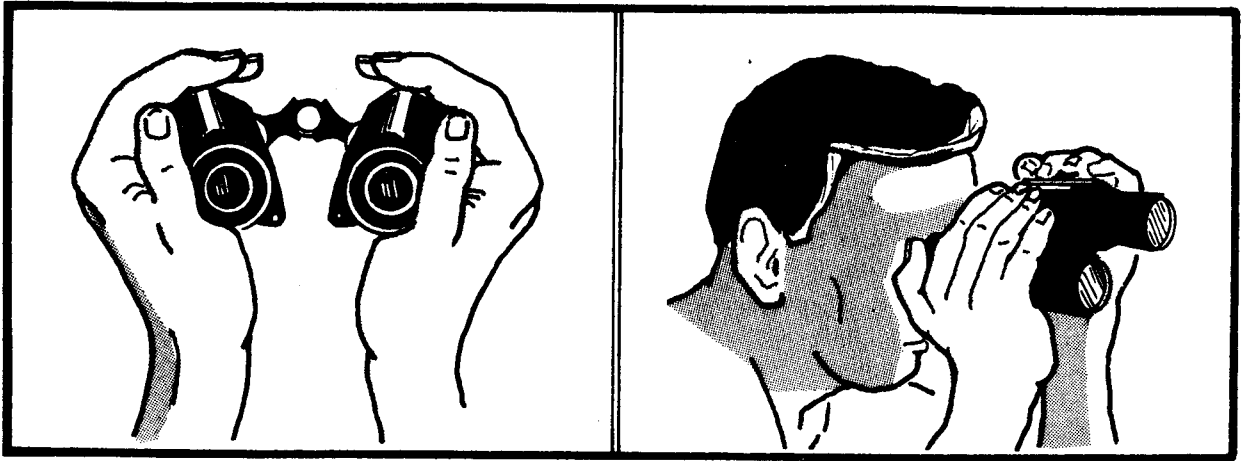

Illustration 4-9. The proper way to hold binoculars.

Before you will be able to see clearly through your binoculars, you must set the distance between the eyepieces to match your own **interpupillary distance** (the distance between the pupils of your eyes). Make this adjustment by looking through the eyepieces and moving the two halves of the binoculars on the hinge that connects them until you see the overlapping circles blend into a single circle (see Illus. 4-10).

Next, adjust the **focus**. Your binoculars will be center focusing, with a focus control in the center and a diopter adjustment ring on one eyepiece, or individual focusing, with focus rings on each eyepiece. On center focus binoculars, adjust the focus as follows:

1. Look at a distant object through the binoculars with both eyes open.
2. Put a hand over the lens with the diopter adjustment, and adjust the focus knob in the center of the binoculars until the scene is in focus.
3. Uncover the lens with the diopter adjustment, and cover the other lens.
4. Adjust the diopter focus until the scene is in focus.
5. Uncover the lens. The view should be clear to both eyes.

With individual focus binoculars, follow the same general procedure, but adjust each lens by turning the focus ring on its eyepiece.

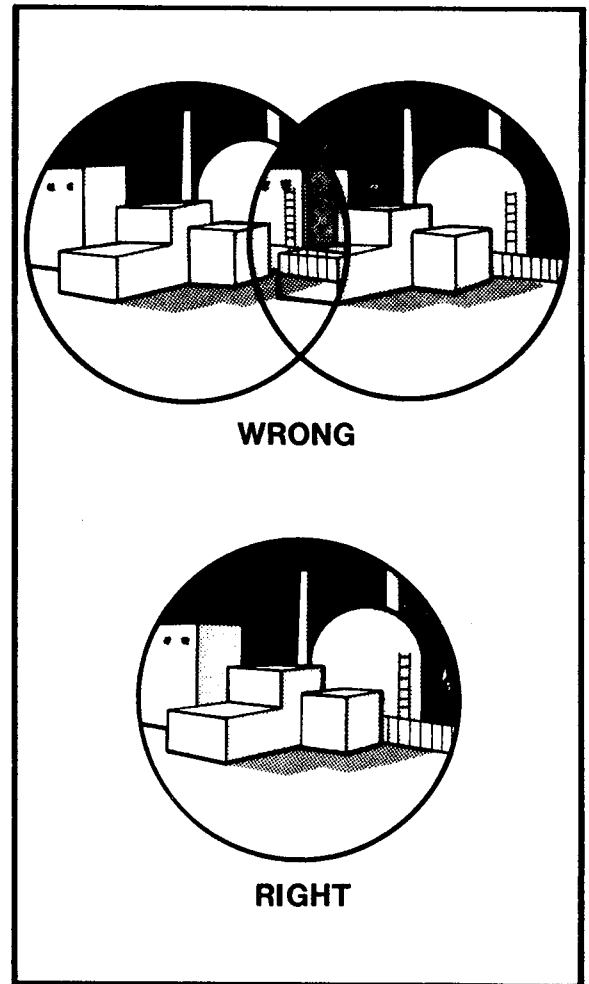

Illustration 4-10. Setting the distance between the eyepieces of binoculars.

Section 8. NIGHT OBSERVATION

Special techniques are required for **night observation** because the eyes function differently in the dark than they do in the light and because they are less efficient in the dark. In order to understand why these differences exist and how to compensate for inadequate light, you need to understand a little about the way the eye functions. The retina is the inside lining at the back of the eye that picks up images. There are two portions

of the retina. (See Illus. 4-11.) One portion is sensitive only in the light and can distinguish more color, shape and sharp contrast when the eyes are focused directly on an object. The other portion is sensitive only in the absence of bright light and can distinguish only black, white, shades of gray and general outlines. The latter portion does not clearly distinguish objects that the eye focuses on directly but, rather, detects objects surrounding the point of focus. Whenever you move from light to dark, or dark to light, the eye adjusts, allowing the proper portion of the retina to function.

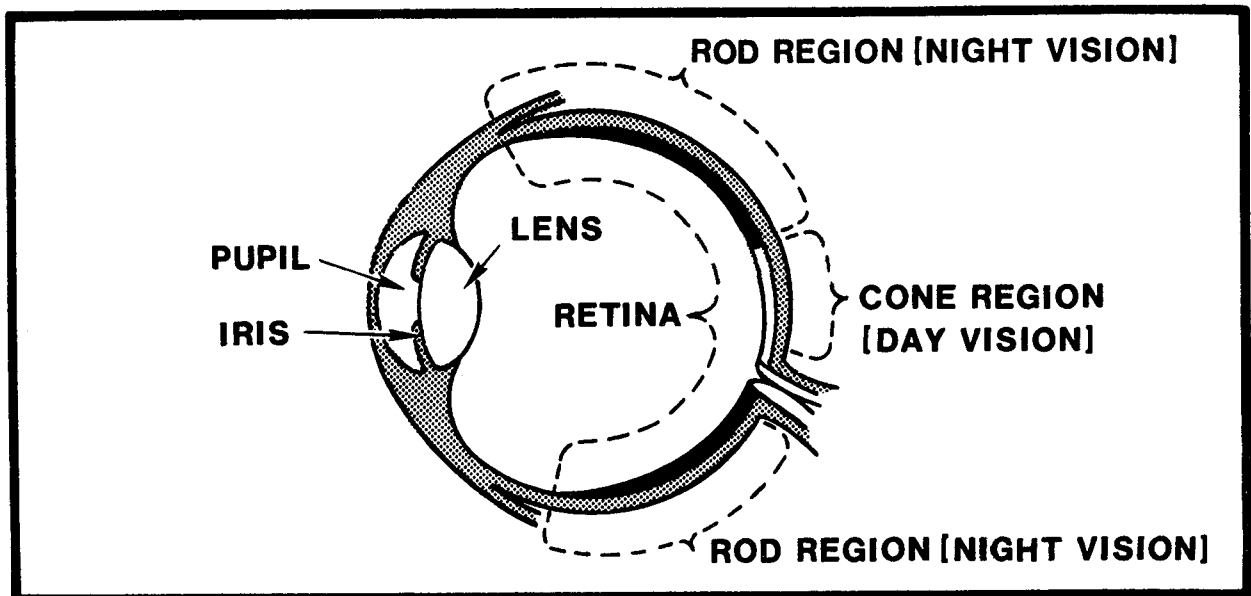

Illustration 4-11. The makeup of the human eye.

The techniques of **dark adaptation**, **scanning** and using **off-center vision** are all means by which you can adapt to the unique way that the eye functions in the dark. In this section, each of these techniques will be explained in detail as it applies to night observation. Then, special factors that must be taken into consideration when an **observation position is selected at night** will be covered. Finally, the **use of binoculars and scopes at night** will be discussed.

DARK ADAPTATION

When you move from a bright area to a dark area, the eyes become **dark adapted**. During this process, a chemical is produced that activates the dark-sensitive portion of the retinas, and the pupils dilate and let in as much light as possible. Dark

adaptation occurs gradually over a period of about 30 minutes.

You will be able to perform night observation tasks much more effectively after your eyes have become dark adapted. Therefore, you should allow the process to take place **before** you need to perform observation. One way to allow your eyes to adapt to the dark is simply to stay in the dark for 30 minutes. Another method is to stay in a red-lighted area or to wear red goggles for 20 minutes and then to spend 10 minutes in the dark to allow the process to be completed.

Once exposed to bright light, your eyes quickly lose their dark adaptation. If they do so, you will need to go through the entire dark-adaptation process again in order to resume night observation.

To preserve the dark adaptation of your eyes, therefore, you should

- Keep out of lighted areas.
- Avoid staring directly at lights.

- Close your eyes, or at least close or cover one eye, if you are exposed to bright light.
- Wear red goggles if you must enter a lighted area.

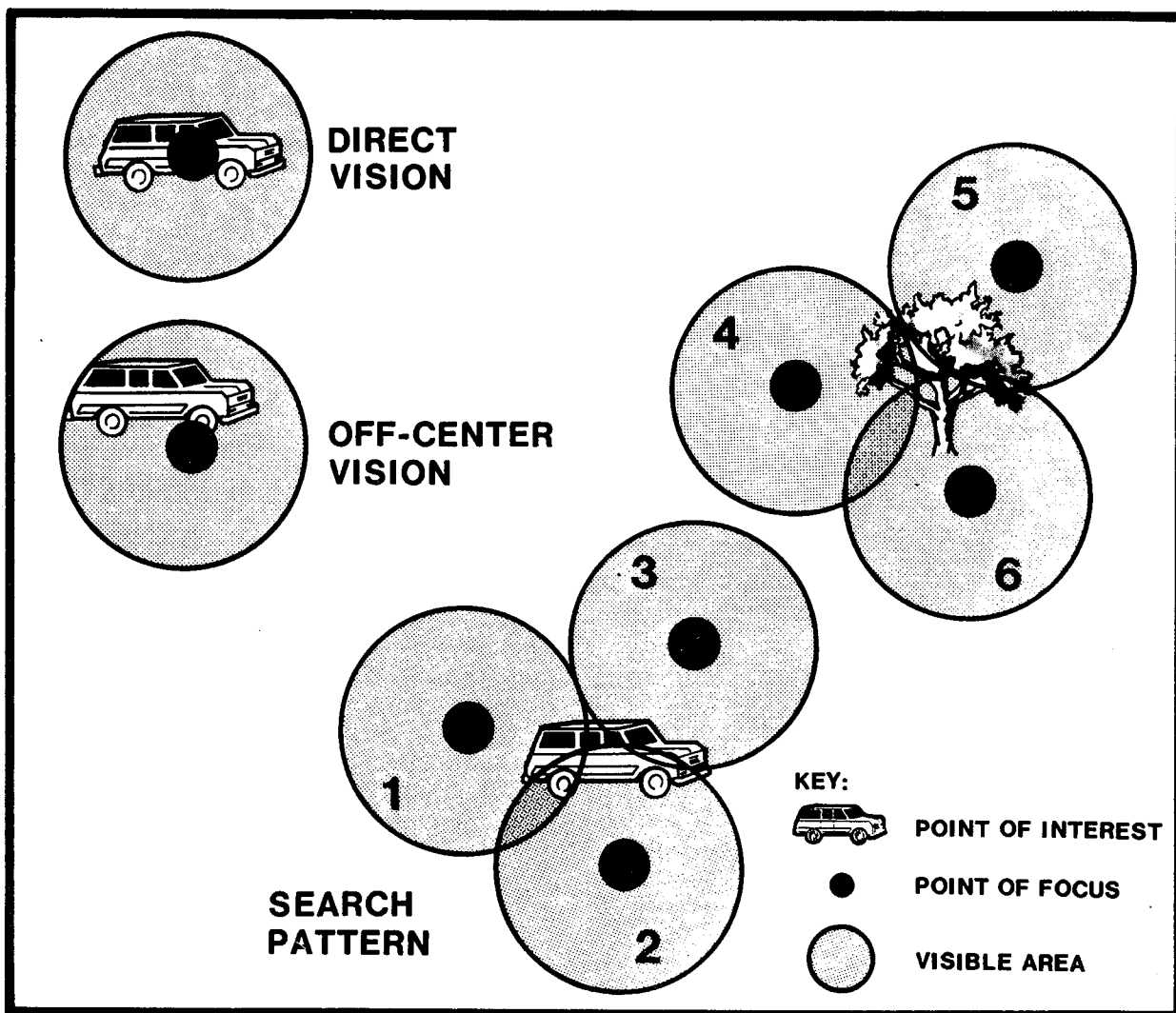

Illustration 4-12. The scanning procedure.

SCANNING

To conduct a terrain search at night, use the scanning procedure. To scan, move your eyes in short, quick, jerky movements throughout the area of interest (see Illus. 4-12). You must pause momentarily at each point since your eyes cannot focus while moving, but do not stare at one spot for more than a few seconds or your vision will blur.

OFF-CENTER VISION

If you stare directly at an object at night, it will appear to fade, blur and change shape. To observe a specific object at night, use the **off-center vision** technique. Focus your eyes at various points **around** (right, left, above, below) the object, about 6 to 10 degrees away from it (see Illus. 4-13). By using your peripheral night vision, you will be able to see a good overall image of the object.

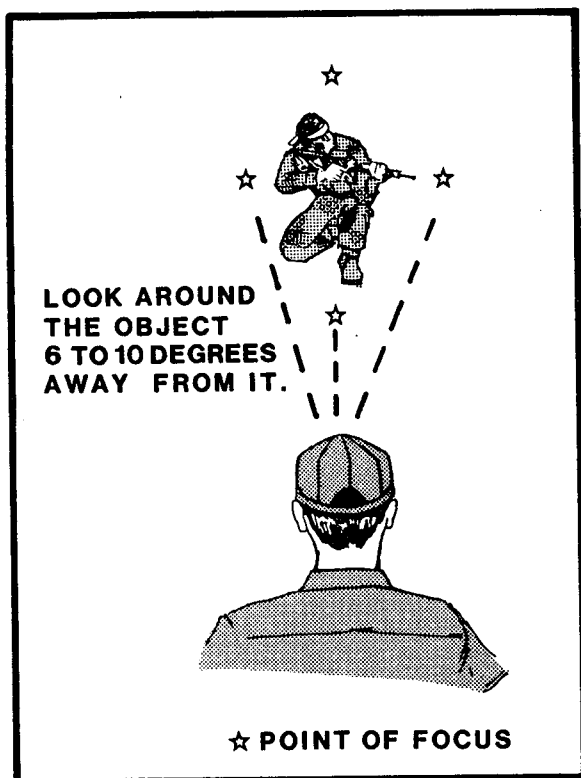

Illustration 4-13. The off-center-vision technique.

POSITION SELECTION AT NIGHT

When choosing an observation position at night, you should look for the characteristics of a good observation position as explained in Section 2, with one exception. It often is more advantageous to choose a **low** position rather than a high-ground position at night. Objects are easier to see at night if they are silhouetted against the skyline. The lower you get, the more the objects around you will be silhouetted on the skyline.

One additional characteristic of a good observation position should be considered at night. Since your vision is restricted at night, you must rely more on your sense of hearing than you do in the

daytime. Try to choose a quiet position at night, away from background noise that will interfere with your hearing. For example, do not locate yourself next to operating machinery. Also, remember that it is easier to hear footsteps and vehicle sounds if your ear is close to the ground. Therefore, a position which allows you to lie prone or to crouch close to the ground can be a good choice at night.

NIGHT USE OF BINOCULARS AND SCOPES

Binoculars and scopes can be used to assist you in night observation if there is enough light to enable you to see with the naked eye. It is better to use lower power optical devices at night because of a rule of optics: the higher the magnification of a lens, the lower is its light-gathering capacity. Generally, 7X50 or lower power binoculars are acceptable for night use, as are 7X or lower magnification scopes.

Section 9. NIGHT-VISION DEVICES (NVDs)

NVDs are valuable observation aids. By intensifying the little light available at night, these devices allow you to see well enough to locate targets, to drive and to identify adversaries. NVDs come in the forms of observation scopes, weapon scopes and goggles. Although many models are available and although the sizes and shapes vary widely, the **components, function, controls and employment** are similar for all NVDs.

COMPONENTS OF NVDs

The following major components are common to all NVDs (see Illus. 4-14):

- Objective lens
- Eyepiece
- Image intensifier tube
- Battery
- Phosphor screen
- Lens cap/daylight filter

FUNCTION OF NVDs

NVDs function by intensifying the light present in the area being viewed. These devices can intensify any visible light, such as moonlight, starlight

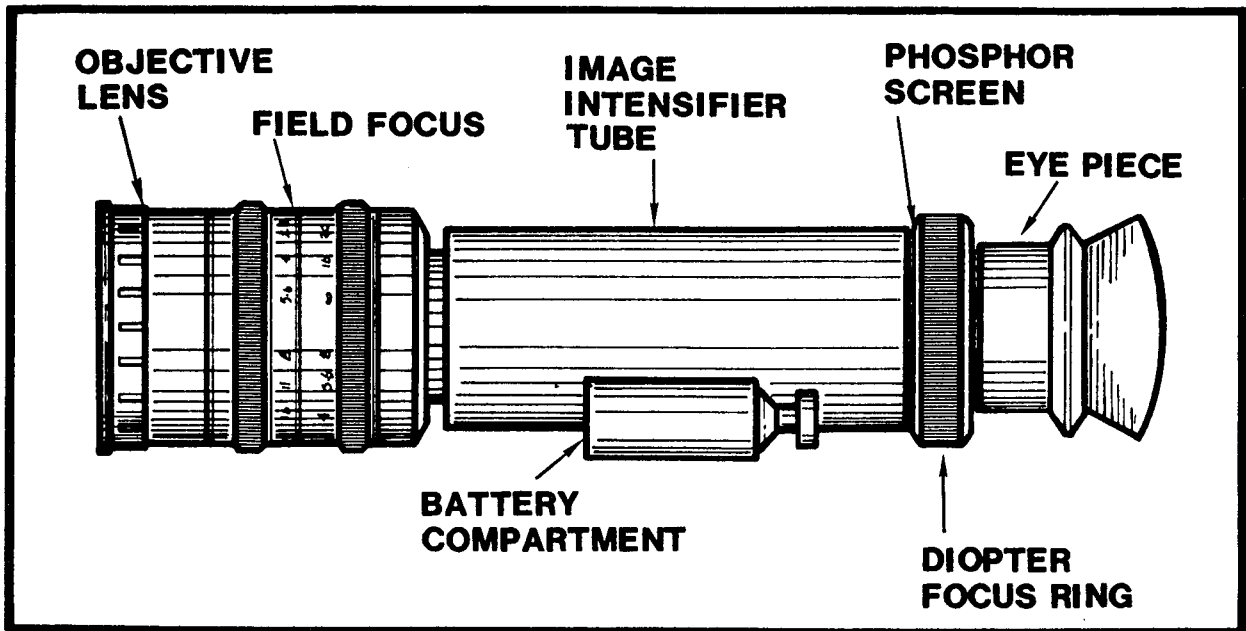

Illustration 4-14. The major components of a night-vision device.

or artificial light. They also can intensify infrared light, which is invisible to the naked eye. NVDs function in the following manner (see Illus. 4-14):

1. The **objective lens** collects and focuses the light reflected from the viewed scene.
2. The **image intensifier tube** electronically amplifies the light that was collected and focused by the objective lens.
3. The intensified scene is projected onto the **phosphor screen**.
4. The image on the phosphor screen is viewed through the **eyepiece**.

The following chart lists **typical NVD controls**:

NVD CONTROLS

Common To Most	Found On Some
Field focus	Elevation/windage adjustment
On/off switch	Gain control
Diopter focus	Reticle light control
	Infrared light-source switch

OPERATION OF NVDs

Operating procedures for NVDs are fairly

simple. Although the manufacturer's instructions for specific models should be followed, most NVDs are operated in a similar manner. General operating procedures are as follows:

1. **Turn the unit on.**
2. **Adjust the diopter focus.** Look through the eyepiece, and adjust the diopter focus ring until the **phosphor screen** is sharp and clear. Focus the surface of the phosphor screen, **not** the scene being projected onto the screen. Once adjusted, the diopter setting will not have to be changed.
3. **Adjust the field focus.** Turn the field focus ring until the scene you are viewing is sharp and clear. As in a camera, this focus must be readjusted each time you view a different scene or the same scene at a different distance.
4. **Adjust gain control, reticle intensity** and other features in accordance with instructions for specific models.

EMPLOYMENT OF NVDs

In any conditions other than absolute darkness, NVDs can be valuable night observation aids. As with any tool, they will be useful to you only if you understand how **external conditions** affect their use, what **precautions** need to be taken during their use and how to **care** for them.

External Conditions Affecting NVD Use

Since NVDs work by intensifying available light, their effectiveness depends upon the **amount of light present**. Cloudless, moonlit nights are ideal for the use of NVDs. NVDs also can be used effectively in areas lighted by streetlights or other sources of artificial light. On cloudy nights in areas that are not already artificially lighted, you may need to supplement the available light with light sources such as flares and vehicle lights.

NVDs also can be used **indoors**, if a light source exists. Enough light may enter through windows to allow you to move and observe. If the existing light must be supplemented, the employment of infrared light sources is ideal since infrared light can be used by an NVD but is invisible to the naked eye.

Too much light can restrict the effectiveness of NVDs. If you look directly at bright light sources such as headlights and lighted windows, you will lose any useful picture. With some NVD models, the automatic gain control will adjust to let in less light, and therefore, parts of the picture will become too dark to be useful. The brighter and closer the light source, the worse this problem becomes.

The **surrounding terrain** is another factor that can influence NVD use. NVD viewing is excellent in open terrain. Conditions are good when you are viewing from a dark area **into** an open area where existing light freely illuminates the scene. NVDs are much less useful, however, when you are looking into shaded areas such as heavily wooded and built-up terrain. Also, objects against dark backgrounds are very difficult to detect, even with the aid of NVDs.

Adverse weather conditions such as cloud cover, sleet and fog also will reduce the effectiveness of NVDs. However, even under these conditions, NVDs normally will provide better night vision than will the naked eye.

NVD Employment Precautions

NVDs have certain drawbacks that can be minimized or overcome if you take the proper precautions.

One drawback of NVD use is that you will experience some **loss of the dark adaptation of your eyes** each time you look into the light of the phosphor screen. To overcome this problem, you must

allow up to 30 minutes after the use of the NVD so that you can regain your dark adaptation before performing other night observation tasks.

Another problem to consider when you use an NVD is that your face may be illuminated by the **glow from the phosphor screen** as you remove your eye from the eyepiece. Some NVD models have self-closing petals over the eyepiece that eliminate this problem. If your NVD does not have this feature, you can overcome the problem easily by covering the eyepiece with your hand or by turning off the NVD before removing your eye from it.

A further drawback of NVD use is that you can expect to experience **eye fatigue** after about 10 minutes of continuous use. You can reduce the problem somewhat by alternating between both eyes.

Care of NVDs

The proper care of NVDs is an important aspect of effective employment. NVDs are sensitive electro-optical devices that will not stand up to rough treatment as well as your weapons and other equipment will. Always protect your NVD from severe shocks. Keep your rifle scope NVDs mounted on the appropriate weapon and stored in a rack or padded gun case for protection. Take special precautions with your NVDs during tactical movement.

Cleanliness is another essential part of NVD care. Protect your NVD from excessive dust and dirt. Keep the lenses clean so that light will enter the intensifier tube freely, giving you a clear picture.

Section 10. INFORMATION COLLECTION AND REPORTING

The preceding sections of this chapter have emphasized the physical techniques of observation. Effective observation is much more than a physical act, however. As an observer, you must have the proper mental attitude, be able to recognize important information and be able to give that information in the right way to the right people. In this section, the traits that you must develop in order to be an effective observer will be discussed. Guidance also will be given on how to collect and convey useful information.

TRAITS OF A GOOD OBSERVER

Because it can be very demanding, effective observation requires a positive mental attitude. In order to be a good observer, you should develop the following traits:

- **Patience**
- **Alertness**
- **Attention to detail**

Patience is essential in the observer because observation tasks can be boring. If there is no activity in your assigned section, you may be tempted to seek action somewhere else. You must resist this temptation, since there eventually may be activity in your sector, and you may be the only one in a position to see and report it.

Mental alertness is absolutely essential to detailed observation. Observation tasks can be mentally exhausting, and as time passes, it becomes ever more difficult to remain alert. You must make a constant effort to do so, however, since alertness is just as important in the third hour of a crisis as in the first five minutes.

Attention to detail also is extremely important. Your only clue to adversary presence in a large observation sector may be a door left ajar or the reflection of sunlight off a weapon. You must be able to detect such details and to recognize their significance.

IMPORTANT ELEMENTS OF INFORMATION

As an observer, you must be able to submit complete yet concise reports of adversary activity. Military observers use the SALUTE method of reporting. This method can be adapted easily to your use.

Each letter of the word **SALUTE** will remind you of an **important element of information** that should be reported:

- Size
- Activity
- Location
- Unit
- Time
- Equipment

When reporting the **size** of the adversary force, you can refer to the number of people or the num-

ber of vehicles sighted or to both quantities.

Activity refers to anything the adversary may be doing. If there is movement, report the direction and speed of movement.

Report the **location** of the observed activity as accurately as possible.

The term **unit** may not apply to adversaries in the NRC Licensee environment, but you may see some indication of adversary affiliation. If so, explain exactly what you observe.

Give the exact **time** of your observation.

Describe weapons, clothing, tools, packs, vehicles and other **equipment**. Be as precise as possible. If you are unable to positively identify equipment, describe exactly what you can see. Do not guess.

INFORMATION QUALITY

The **quality** of the information that you report is much more important than the **quantity**. You must not tie up radio frequencies or distract the attention of other personnel with a large volume of useless information. Essential information may be misunderstood or may go unnoticed if it is reported along with trivia. Your reports must be

- **Accurate**
- **Clear**
- **Complete**
- **Concise**
- **Timely**

An **accurate** report includes fact, not opinion. Tell exactly what you observe. If you see three people with rifles and packs enter a building, report, "Three people with rifles and packs just entered the 121 Building." Do not say, "Three terrorists with automatic weapons just went into the 121 Building to blow it up."

A **clear** report contains simple language phrased in a way that cannot be misunderstood. Sometimes a sketch can be included for added clarity.

A **complete** report includes all details that may be significant. If you are in doubt about the importance of an item, report it.

A **concise** report contains important information and leaves out unessential details. Include only the information that has a bearing on the situation.

Timely information is crucial to effective tactical response. For example, if you see a group of adversaries heading toward a sensitive area and you report their location and activity immediately, responding forces will be able to intercept them. If you are slow to report the information, however, the adversaries may do extensive harm to the facility before security forces are able to respond.

Section 11. CHAPTER SUMMARY

This chapter has covered the techniques and principles of tactical observation. Effective observation is a skill that involves much more than just "keeping your eyes open."

In the introduction, a brief explanation was given of the importance of observation during a tactical crisis.

In Section 2, "Observation Positions," the characteristics of a good position were discussed. Such a position

- **Provides the maximum field of observation**
- **Occupies high ground**
- **Provides cover and concealment**
- **Is approached by at least one covered or concealed route**
- **Allows communication**
- **Is not too obvious**

The two primary selection criteria, which were discussed further, were

- **Maximum field of observation**
- **Maximum cover or concealment**

Section 3, "Position Occupation and Use," covered techniques for entering a position. The following guidance was given for the optimum use of the position:

- **Use all available cover and concealment**
- **Observe from the prone position**
- **Remain motionless**
- **Keep quiet**
- **Look around or through an object**
- **Blend with your background**
- **Keep back from windows**
- **Keep off the skyline**
- **Stay in the shade**
- **Avoid causing reflections**

Section 4, "Visual Terrain Search Methods," presented techniques for **conducting hasty and detailed searches**. Techniques for **maintaining observation** and for **observing limited objectives** also were covered.

Section 5, "Target Indicators," described the following indicators that can help you recognize the presence of an adversary:

- **Sound**
- **Movement**
- **Shine**
- **Regularity of outline**
- **Contrast**
- **Incorrect detail**

In Section 6, "Location Referencing," two methods were given for describing the adversary's location. These methods were the **landmark method** and the **distance-from-landmark method**. A technique for estimating distance, called the **100-meter unit-of-measure method**, also was described.

In Section 7, "Optical Aids," the advantages and limitations of using binoculars and scopes for observation were introduced. The proper techniques for adjusting and using binoculars were described in detail.

Section 8, "Night Observation," described the way the eye functions at night and explained the techniques of **dark adaptation**, **scanning** and using

off-center vision. **Night position selection** and **night use of binoculars and scopes** also were covered.

The major components common to all NVDs were listed in Section 9, and the function of each component was described. General instructions then were given for **operating an NVD**. The following **external conditions** that affect the use of NVDs were discussed:

- **Amount of light present**
- **Surrounding terrain**
- **Weather conditions**

Covered next were **NVD employment precautions** that can be used to overcome the following drawbacks of NVD use:

- **Loss of dark adaptation**
- **Illumination from the glow of the phosphor screen**
- **Eye fatigue**

General guidance was given concerning the **care of NVDs**.

In Section 10, "Information Collection and Reporting," the traits of **patience**, **alertness** and **attention to detail**, which are essential in a good observer, were discussed. The **SALUTE** method of information reporting then was covered. Finally, the importance of quality rather than quantity of information was covered, and it was emphasized that an observer's reports must be **accurate**, **clear**, **complete**, **concise** and **timely**.

Chapter 5

FIELD FIRING TECHNIQUES

Section 1. INTRODUCTION

Firing your weapon in an actual armed engagement is far different from firing a standard qualification course on a firing range. You can master the basic skills of marksmanship on the firing range, but to survive and succeed in a firefight, you must master other skills as well. You must be able to employ field firing techniques that adapt fundamental marksmanship skills to the terrain and to the situation. This chapter will address the following aspects of field firing:

- **FIRING POSITIONS**
- **BATTLESIGHTS**
- **POINTING**
- **SPECIAL-TARGET ENGAGEMENT**
- **NIGHT FIRING**
- **COORDINATED DELIVERY OF FIRE**

Field firing techniques have been developed over time as a result of military and police experience and have proven to be useful and effective. Experience has shown that if you use these techniques during firefights, your effectiveness and level of personal safety will be greater than if you rely on instinct when firing.

Section 2. FIRING POSITIONS

During a firefight with an adversary, the positions you choose are extremely important.

Even during a fast-moving, dynamic situation, you will have to stop temporarily in order to deliver accurate fire against your adversary, because it is difficult to fire accurately while moving. Your personal safety and the effectiveness of your fire will depend in part upon the positions you occupy and how you use them. As the fight evolves, you must be able to choose quickly among the many positions that you could occupy in the vicinity. A good field firing position does the following:

- **Provides stable support**
- **Permits observation of the target area**
- **Provides cover and concealment**

In order to fire accurately, you must have **stable support** for your body so that you can hold your weapon steady. Most shooters fire the least accurately from the standing position with an unsupported weapon and the most accurately from a supported prone position. Remember that as the distance to the target increases, accuracy will be more difficult to achieve, and a stable support will become even more important.

Choose a position from which you have the maximum possible **clear observation of your target area**, since you cannot hit a target that you cannot see.

You also must choose a position that provides you as much **cover**, or protection, as possible from your adversary's weapons. Partial protection is better than no protection. If cover is not available, then try to find a position that provides **conceal-**

ment. The more of your body that you can conceal, the smaller the target your adversary has. (This subject is addressed in detail in Chapter 3, "Cover, Concealment and Terrain Analysis.")

You may never find a position that provides maximum support to steady your weapon, permits total observation of the target area and provides cover for your entire body. You usually will have to balance these factors and choose positions that provide some support, permit fairly good observation and provide at least a minimal level of cover or concealment. If you consciously consider these three factors, you usually will end up in a better firing position than you will if you stop and fire without thinking.

After you have selected and occupied a firing position, there are several steps you can take to make the best use of the position to deliver accurate fire.

- **Use any support available.** Use dirt, trees, walls, curbs or anything that can support those portions of your body that you use to steady your weapon. Objects low to the surface such as curbs, logs, planter boxes, dirt mounds and roof parapets can support your left forearm when you are in the prone position. Tree trunks and walls can support your left shoulder, leg and arm when you are in a kneeling position. Do not fire from an unsupported position if there is something available that could be used as support.
- **Use a hasty sling when possible.** When you are using a rifle, you can increase the stability of your weapon by using a hasty sling on your left arm. It will take you only a few seconds to rig a sling.
- **Do not touch the support with your weapon.** If you rest any portion of your weapon (except the bipod, if the weapon is so equipped) on or against the support, the weapon will be more difficult to control, the strike point of the bullet will differ from the established zero, and the time required for you to recover between shots will increase. Support the **weapon** with your **body**, and brace your body with the best available object.
- **Adjust your body position to fit the available support.** The available support may not be ideal for use with the basic firing positions, sitting, kneeling and prone, that you learned on the firing range. Yet, using body support

is so important to accuracy that you must modify your body position to be able to make the best use of the available support. Assume a comfortable, supported position that allows you to train your weapon on the target area without straining or contorting your body.

- **Operate in a tactically sound manner.** Make the best use of cover and concealment. Shoot around, under or through, rather than over, an object. If you fire around the left side of an object, shoot left-handed to expose less of your body. Keep as low as possible. Illus. 5-1 shows examples of correct and incorrect methods of using firing positions.

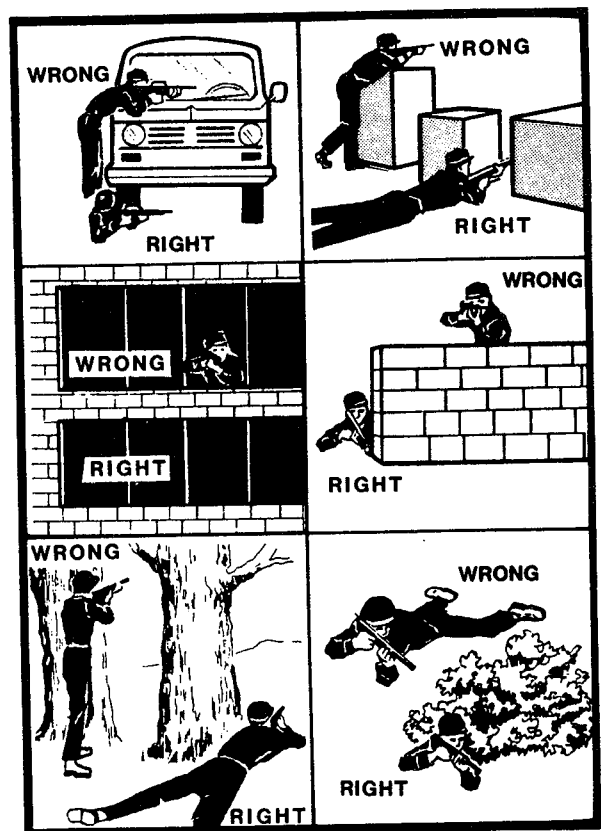

Illustration 5-1. Correct and incorrect use of firing positions.

Section 3. BATTLESIGHTS

When firing on a rifle range at targets located at a known distance, you can carefully adjust your rifle sights to bring the strike of the bullet to the desired location on the target. However, during a firefight, you may not know the distances to targets,

you may have targets at different ranges, and you probably will not have time to adjust your sights for each target. "Battlesights" is a predetermined sight setting that will allow you to engage man-sized targets at the most common combat ranges without having to manipulate your weapon's sights.

THE BATTLESIGHTS PRINCIPLE

The battlesights setting is established by zeroing your rifle at 275 meters. With a zero of 275

meters, the bullet will impact at your exact point of aim at targets at 275 meters and will cross your line of sight at one additional point closer to the muzzle (see Illus. 5-2). At all other distances between 0 and 300 meters, the points of impact of the bullets and the points of aim do not coincide exactly, as illustrated in Illus. 5-2. However, at these latter ranges, the difference is so slight that by using the battlesights setting you will be able to hit a man-sized target if you aim at a point in the center of the target.

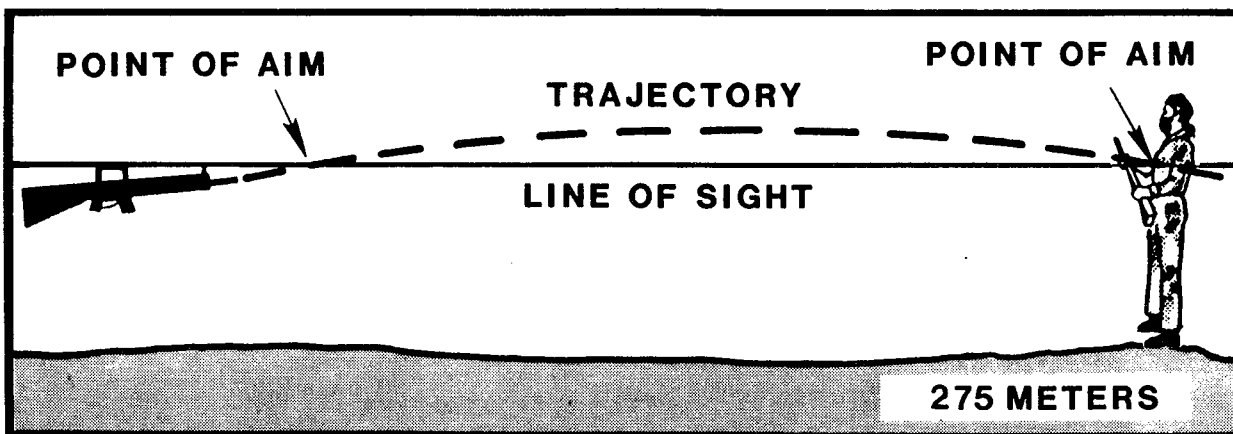

Illustration 5-2. The battlesights principle.

BATTLESIGHTS APPLICATION

Most targets engaged by security personnel who are not trained and equipped to be snipers will be at a distance of between 0 and 300 meters, and therefore, the battlesights principle can be applied to these targets. Although trajectories vary among rifles of different calibers and models, the battlesights principle will work with any high-powered rifle that you normally will use. The procedures for engaging targets by using the principle are as follows:

- **Targets at a distance out to 300 meters.** Simply aim at center mass of the target.
- **Targets at a distance greater than 300 meters.** If you are using an M-16 rifle, raise

the long-range ("L") rear-sight aperture before firing. If the target is much beyond 300 meters, aim a little high, at the adversary's neck or head. If your rifle does not have a long-range aperture, aim at the neck or head.

- **Compensation for crosswind.** The battlesights setting affects point of aim for range only. If there is a crosswind strong enough to significantly affect the bullet at battlesights ranges, you will have to make the appropriate windage adjustments to the sights or use "Kentucky Windage," that is, aim off target on the upwind side sufficiently to bring the bullet strike on target. You will learn through trial and error how much of an adjustment is sufficient.

Section 4. POINTING

You can achieve the greatest accuracy with your weapon by carefully aiming before you fire. However, aiming carefully takes time, and under certain circumstances, you may not have time to aim. For example, when an unexpected adversary suddenly appears dangerously close to you and there is no cover immediately available, you must get off a quick, accurate shot to survive. The "pointing," or "instinctive shooting," technique enables you to deliver **unaimed fire quickly and accurately** at targets out to 50 meters with a rifle and out to about 12 meters with a handgun. Pointing is very much like shooting a shotgun; the **principle** behind pointing is easy to understand, and the **technique** itself is easy to learn.

THE POINTING PRINCIPLE

When you look at an object and at the same time point at that object with your index finger, you will automatically align your finger on the object without making a conscious effort to do so. Similarly, when you bring your rifle to your shoulder, you make the weapon an extension of your pointed finger, and you unconsciously align the rifle on the object you are focusing upon. The same thing happens when you raise a handgun out in front of you. You automatically point it at the object your eyes are focused upon. This principle is the basis of the field firing technique of pointing.

POINTING TECHNIQUE AND EXECUTION

You should practice the basic pointing technique from a stable standing position until you have developed the eye-body coordination that is necessary to hit targets consistently. To master the technique, you must be able to

- **Concentrate your visual focus**
- **Take up a proper position**

In order to successfully engage a target with the pointing technique, you must be able to concentrate your **visual focus** on a specific point of the target, such as a belt buckle, for one-tenth of a second to one second. It is not enough for you to be aware of the target or to try to see the whole target. You must **concentrate intensely on a specific spot within the target area** until you have finished firing at the target.

You assume the basic pointing position for use with a shoulder-fired weapon, such as a rifle or

shotgun, as follows (see Illus. 5-3):

1. Lean slightly forward at the waist.
2. Place your weapon firmly in the pocket of your shoulder, with the stock pressed to your jaw.
3. Hold your head high, with both eyes open, and look 2 to 3 inches above the sights.
4. Spread your feet comfortably, with your weight on the balls of your feet and your knees slightly bent.

In this position, you can rotate your body to engage targets in a 120-degree arc in front of you without moving your feet.



Illustration 5-3. The pointing position to use with a shoulder-fired weapon.

You can assume the basic pointing position for use with a handgun as follows (see Illus. 5-4):

1. Lean slightly forward at the waist.
2. Spread your feet comfortably (slightly more than shoulder width), with your knees bent a little.
3. Hold your arms straight out from your chest, with your wrists, elbows and shoulders locked, and hold the gun in your normal two-handed grip at or just below eye level.

4. Hold your head high, with both eyes open, and look ahead above your weapon.

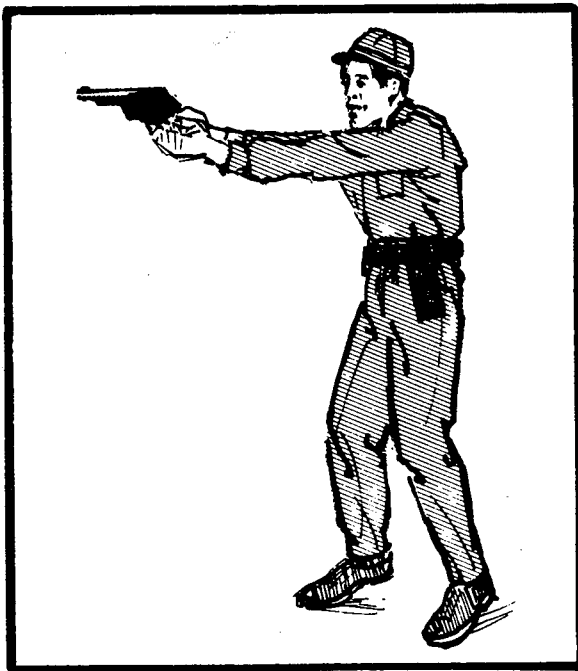

Illustration 5-4. The pointing position to use with a handgun.

From this position, you can engage targets in a 180-degree arc in front of you without moving your feet.

To execute the pointing technique, you must apply the pointing fundamentals—visual focus and positioning—in a smooth, coordinated manner, as follows:

1. Focus both eyes on a specific point in the target.
2. At the same time, spread your feet comfortably, with your weight on the balls of your feet and your knees slightly bent, and lean forward a little.
3. With both eyes still concentrating on the focal point within the target and with your head held high, bring your rifle to the hollow of your shoulder, and press the stock to your jaw. If you are using a handgun, bring it into position in front of your chest, and lock your wrists, elbows and shoulders.
4. Stare intently at the target, looking ahead 2 or 3 inches above the sights of your weapon. Do not look at the muzzle, although you may be aware of it in your peripheral vision.

5. Make **no** attempt to align your weapon with the target. **As soon** as the rifle is at your shoulder or your handgun is properly extended in front of you, fire the weapon.

The pointing technique can be valuable in a tight situation. Although it is a simple technique to master, like any skill it requires practice. Once you have become proficient in the basic technique, you will find that it is quite versatile. You can use the concept to fire when you are kneeling and to fire from behind cover; to shoot, move and shoot again; and even to fire a handgun while you are on the move. Pointing is often the best technique to use in sudden, close-in encounters, but remember that firing well-aimed rounds and using good marksmanship techniques are essential in other situations.

Section 5. SPECIAL TECHNIQUES OF TARGET ENGAGEMENT

The adversary as a target usually is more difficult to hit than are targets on a practice range. You cannot expect to find an adversary alone in the open, standing still, waiting to be shot. The adversary probably will be moving, or will be at least partially hidden. If you have a chance for a clear shot, it may last only for a moment. You may face several adversaries at once, and they may be shooting at **you**. Special field firing techniques are used to deal with these situations. Techniques for engaging moving targets, multiple targets and partially concealed targets will be presented in this section, and the use of ricochet shooting will be covered.

MOVING TARGETS

Moving targets are more difficult to hit than stationary targets are, and the difficulty increases the farther away the target is and the faster it is moving. To hit a moving target, you must track the target and fire in front of it. This technique is called giving the target a **lead**. The three factors that determine how much of a lead you must give the target are the target's

- Range
- Speed
- Angle of Movement

Illus. 5-5 shows the leads you should use for a **walking** target that is crossing in front of you at a right angle (90 degrees) to you at various ranges. Aim at the forward edge of the body of such a target if the target is at a range of 200 meters or less. If the target is at a range of 200 to 400 meters, use a lead of one body width. If the range is more than 400 meters, increase the lead to two body widths.

Illus. 5-6 gives you the leads for a **running** target that is crossing in front of you at various ranges. Notice that you must double or more than double your lead when the target is running.

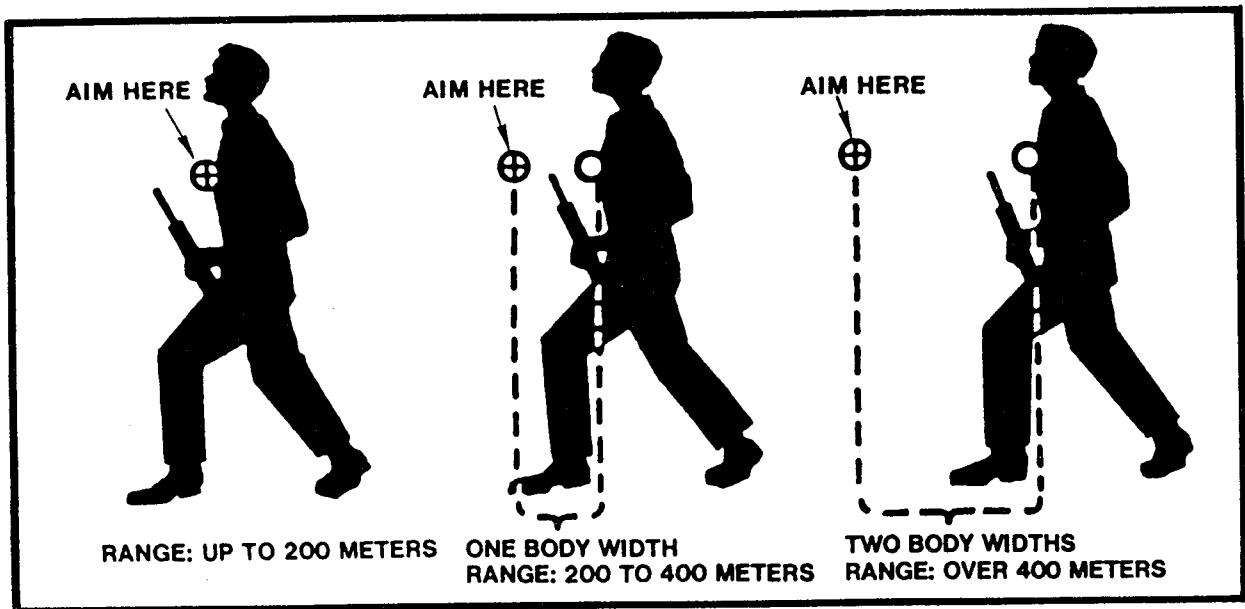

Illustration 5-5. Leads for engaging a walking target.

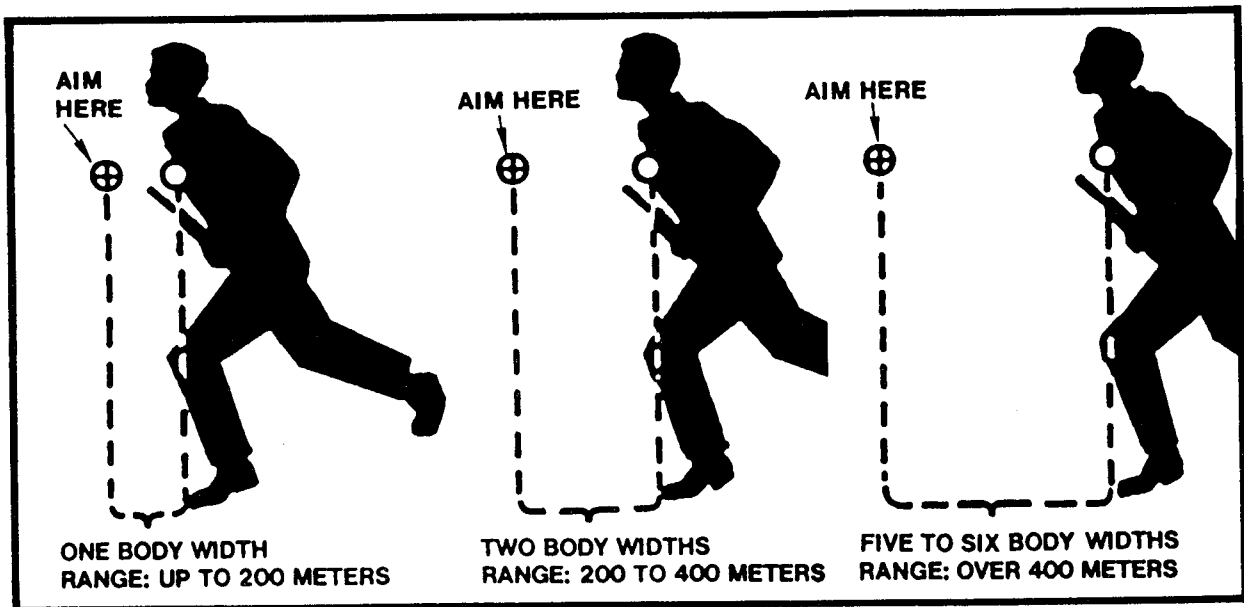

Illustration 5-6. Leads for engaging a running target.

Illus. 5-7 shows you how to adjust your lead for the target's angle of movement. If the target is crossing in front of you at an angle of 90 degrees, you will see one arm and one side (see Illus. 5-7a). Give that target a full lead as indicated in Illus. 5-5 or 5-6. If the target is moving obliquely, at a 45-degree angle, toward or away from you, you will see one arm and two-thirds of the front or back (see Illus. 5-7b and c). For that target, cut the lead given in Illus. 5-5 or 5-6 in half. If the target is moving directly toward or away from you, you will see both arms and the entire front or back (see Illus. 5-7d). Do not give that target a lead. Instead, engage as you would a stationary target.

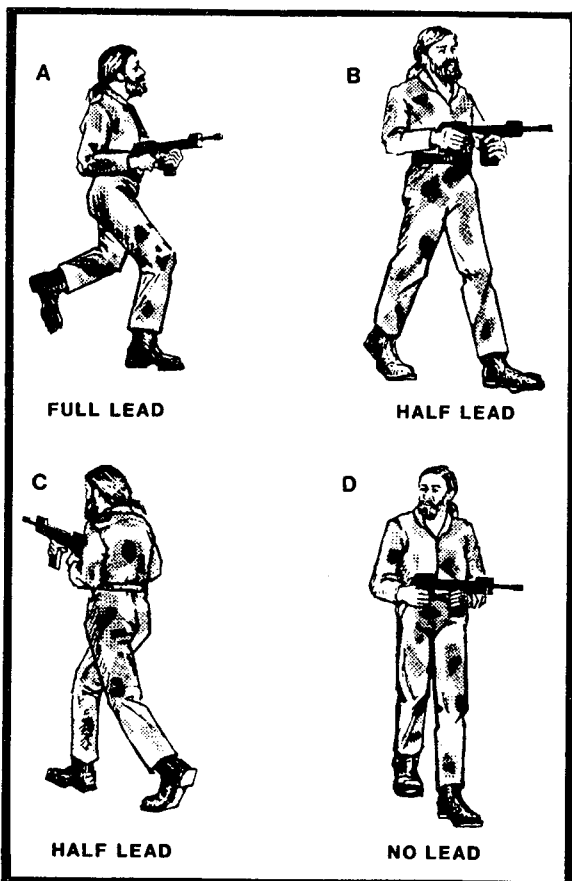

Illustration 5-7. Adjustment of the lead according to the target's angle of movement.

Keep in mind that the leads suggested for use in engaging moving targets are guidelines at best. These guidelines cannot be precise because they depend upon the speed of the target and upon the exact distance from you. As you practice firing at moving targets, you must test these leads, and with experience, you can refine them for your own use.

MULTIPLE TARGETS

One of the most difficult and demanding situations you may encounter is a sudden confrontation with two or more armed adversaries. The situation can be complicated further if the adversaries are spread out laterally, are at different ranges or even are at different heights. One adversary may be on a rooftop and another at street level. In such situations, you must make quick decisions and take immediate action in order to survive. The following principles apply to the engagement of multiple targets:

- Use cover if it is available.
- Engage targets one at a time.
- Engage the most dangerous target first.
- Use the pointing technique if appropriate.

The only safe way to engage multiple adversaries is from behind cover. If possible, take cover immediately. Sometimes, because of the immediate danger, you may have to engage one or two adversaries instantly and then move to cover to engage the rest. You will have to make a split-second decision as to whether to shoot or head for cover first. The worst possible situation exists when there is no cover available or absolutely no time to move to cover and you must engage all targets from an exposed position.

Whether you are facing five adversaries or two, you can shoot at only **one** of them at a time. Concentrate fully on one target, and then quickly move to the next. The amount of time and the number of rounds you can spend on each target depend upon the level of danger presented by the remaining targets. You may have to fire one or two rounds at each target in quick succession and then move back to the first target if the target was not neutralized by your first shots.

Since you can shoot effectively at only one target at a time, you must engage the adversaries in an order reflecting the threat they pose to you. Engage the most dangerous target first. The relative level of immediate danger that each target presents will depend upon the type of **weapon** the adversary has and the **distance** of the adversary from you. If you encounter three adversaries at 25 meters, two with pistols and one with a shotgun, you should try to eliminate the one with the shotgun first. However, if you encounter one adversary with a pistol at five meters and another adversary with a shotgun or submachine gun at 25

meters, you probably should engage the target having the pistol first. No matter which target you engage, you must make your decision and act immediately. You cannot afford to hesitate, trying to make up your mind, especially if you are in the open.

If the adversaries are close enough to be of immediate danger to you, they probably will be close enough for you to employ the pointing technique. As discussed in the section on pointing, you can deliver accurate fire much faster by using this technique than by aiming with the sights. From the pointing position, you also can shift fire quickly from target to target over a wide arc without moving your feet. If you are caught in the open by mul-

multiple adversaries, pointing is probably your best choice for initial target engagement.

PARTIALLY HIDDEN TARGETS

Even if you can see only a small portion of an adversary's body, the adversary may be vulnerable, if concealed by shrubbery, fencing, a wood-frame building or some other object that can be penetrated by your weapon fire, particularly if your weapon is a rifle. If the adversary is so concealed, guess where the rest of the body is, and aim at the concealed portion rather than at the small, exposed portion of the body. Illus. 5-8 illustrates some partially hidden yet vulnerable targets.

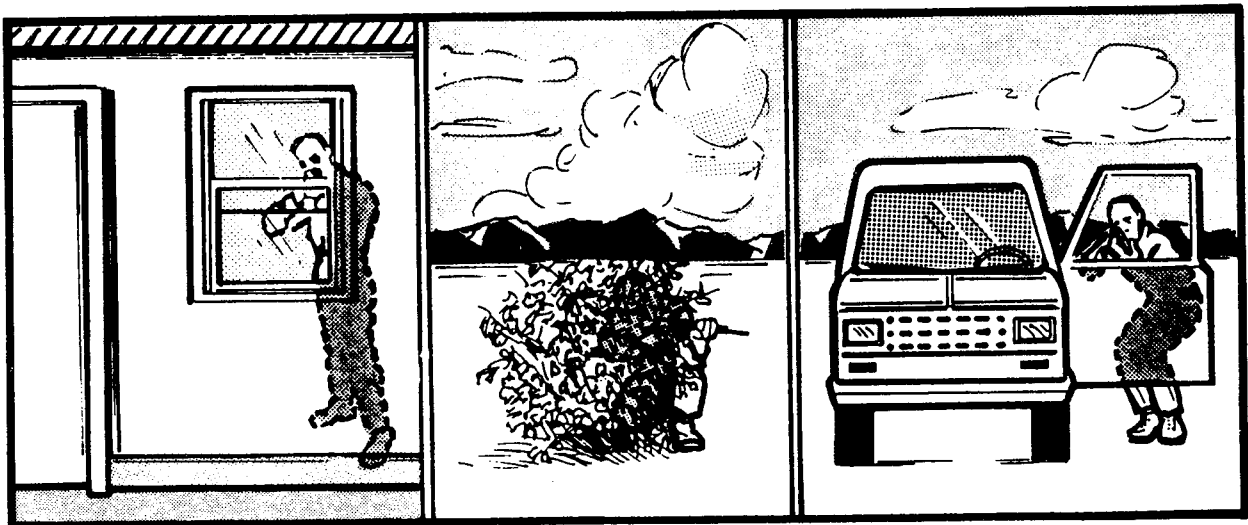

Illustration 5-8. Partially hidden yet vulnerable targets.

RICOCHET SHOOTING

You may encounter an adversary who is positioned to present a small target and therefore will be difficult to hit by direct fire. For example, the adversary may be hiding behind a vehicle, lying prone on the ground or peering around the corner of a building. It may be much easier to hit such a target by using a ricochet fire technique than by using direct fire.

A ricochet will occur when a bullet (or shot) hits a hard surface such as a street, sidewalk or ma-

sonry wall at an angle of less than 45 degrees. The bullet will flatten somewhat, bounce off the surface and continue traveling almost parallel to and a few inches off the surface.

You can take advantage of this ricochet phenomenon by shooting so that your bullet will hit the hard surface at an angle of less than 45 degrees in front of and in a direct line with the adversary. The bullet will glance off the surface and travel a few inches from the surface until it hits the adversary. Illus. 5-9 shows several examples that illustrate this technique.

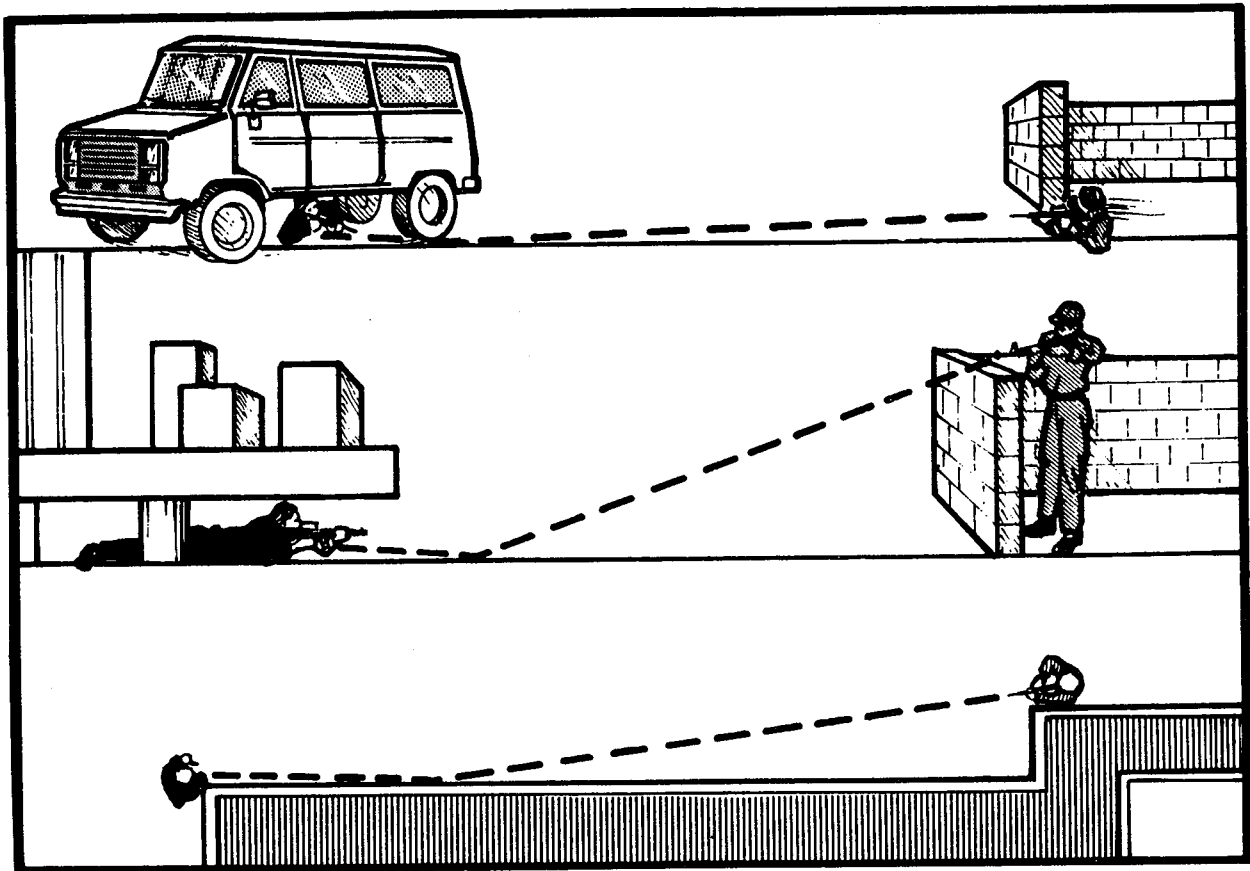

Illustration 5-9. The ricochet shooting technique.

Section 6. NIGHT FIRING

Because of reduced visibility at night, it will be more difficult for you to accurately locate and fire on targets at night than it will be in daylight. If artificial illumination is available or if your weapon is equipped with an NVD, you can use normal, daylight aiming and firing techniques at night. However, if it is so dark that you have difficulty seeing your adversary and your weapon's sights, you will have to employ night firing techniques.

TARGET ACQUISITION

In order to locate a target in the dark, you will have to apply the principles of night vision, which were explained in Chapter 4. You will have to use the night-vision techniques of dark adaptation, off-center vision and scanning to find your adversary so that you can fire effectively.

FIRING TECHNIQUE

You cannot use your weapon's sights in the dark.

Often, you will not be able to see the sights at all. Even if there is some surrounding light, you will be unable to aim with your sights because you cannot use off-center vision to view a rear sight, front sight and target simultaneously.

The proper method of firing at night is much the same as the pointing technique discussed earlier in this chapter. Align your weapon as follows:

1. Keep your head above the weapon, and look above the weapon. If you are using a rifle, rest your chin on the stock.
2. Keep both eyes open.
3. Make a conscious effort to lower the muzzle. If you are firing a rifle, slide your nontrigger hand forward beneath the forestock. This will lower the muzzle a little. Most shooters have a tendency to elevate the muzzle at night, which results in high shots.

You can use this alignment technique in any firing position.

ADDITIONAL FACTORS TO CONSIDER AT NIGHT

Position selection, muzzle flash and the availability of tracers are three additional factors that you should consider when you fire your weapon at night.

Position selection is just as important at night as it is in daylight. At night, your position still has to give you clear fields of fire, although these fields probably need not be as deep as they must be in the day, since you will not be able to see as far. Your position still needs to provide cover and concealment for your protection. Darkness alone usually does not provide complete concealment, and furthermore, it is possible that the adversary will be using NVDs that will reveal your presence if you are in the open.

Muzzle flash is a factor that can work for you or against you at night. When a weapon is fired

at night, a bright flash, which can be seen for quite a distance, is visible in front of the muzzle. This can be advantageous to you because you can locate an adversary by looking for muzzle flashes. When you see a muzzle flash, first make sure that it did not come from a friendly weapon. If the flash is from an adversary weapon, fire slightly to the right of it and then slightly to the left. Remember that muzzle flash also can be a danger to you, because the adversary can use the same technique to locate your position. If you are not behind good cover when you are firing at night, move after each time that you fire.

You may have **tracer** ammunition available for your rifle. Tracers are another factor to consider in a nighttime engagement because you can use them to direct rifle fire right where you want it. Since tracers allow you to see exactly where those rounds go, you can adjust subsequent rounds until you are on target.

Section 7. COORDINATED DELIVERY OF FIRE

You may be called upon to participate in operations that require the delivery of fire in a certain manner with the purpose of accomplishing a specific goal. The movement of friendly elements within the adversary's field of fire and the assault on an adversary position are situations that may require the delivery of suppressive fire, and assault fire respectively.

SUPPRESSIVE FIRE

When one portion of the security force advances or withdraws, other security force personnel can provide cover in the form of **suppressive fire**. This means that these covering personnel will place such a large volume of fire on the adversary's position that well-aimed or effective fire cannot be returned. Suppressive fire can be provided by one guard or by several teams if necessary. Whoever is supplying the suppressive fire is the covering element at that time.

The leader of the covering element must position personnel so that their fire can be controlled and, preferably, so that they can fire on the adver-

sary from the adversary's flank. Coordinated suppressive fire usually is achieved as follows:

- **On the leader's order, a heavy volume of fire is placed on the adversary's position. This position can include all known and suspected adversary locations. The purpose of the procedure is to pin down the adversary through surprise, high-volume, well-aimed fire.**
- **Once the adversary is pinned down (in other words, once fire superiority has been achieved) by the covering element, the volume of fire can be reduced to save ammunition but must remain sufficiently intense to maintain fire superiority.**
- **If the purpose of delivering suppressive fire is to support an assault on the adversary position, the volume and rate of suppressive fire must be increased again when the assaulting element is in place and ready to attack.**
- **As the assault element nears the adversary's position, the suppressive fire is stopped or shifted to other targets so as not to endanger the assault personnel. Illus. 5-10 depicts an example of the delivery of suppressive fire.**

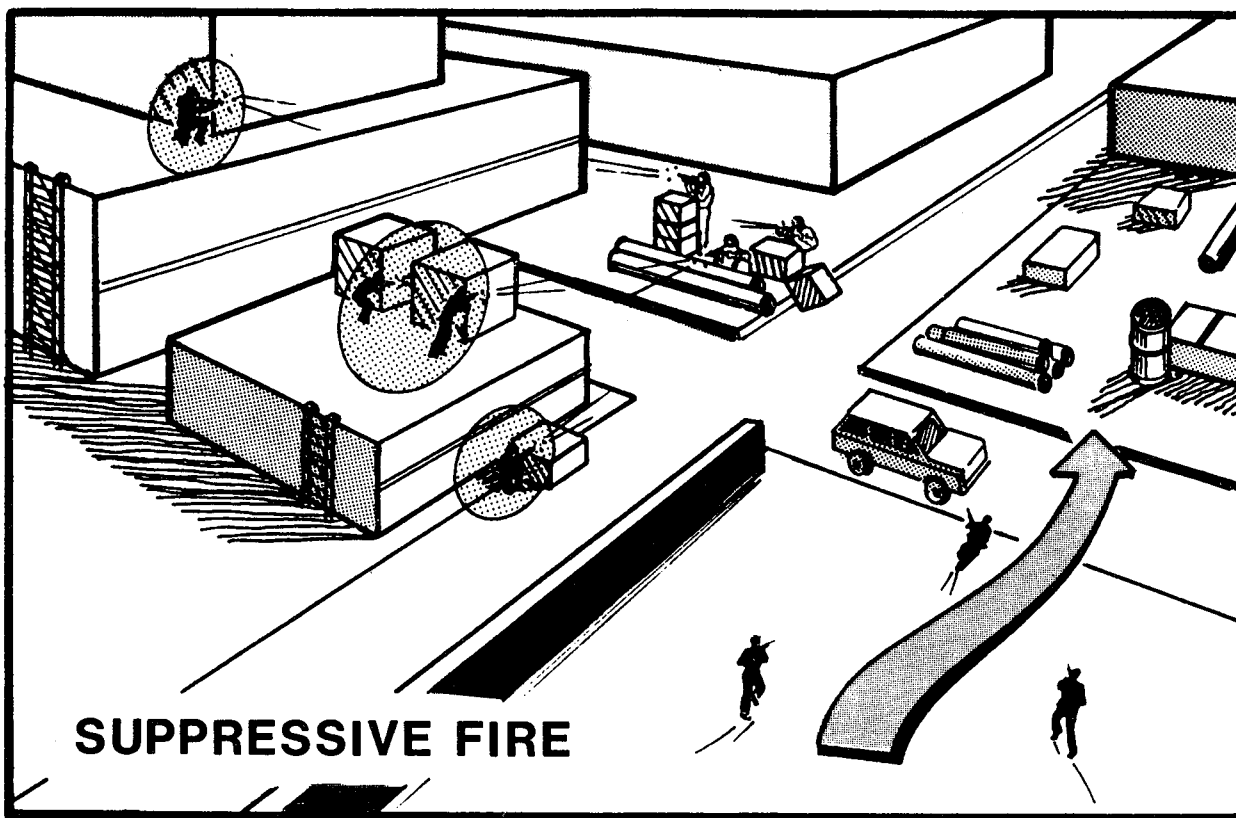

Illustration 5-10. While one portion of the security force advances, other security force personnel provide suppressive fire.

ASSAULT FIRE

As the assault element of the security force nears the adversary's position and the fire provided by the covering elements of the security force is stopped or shifted, the members of the assault element themselves have to provide sufficient fire to keep the adversaries pinned down until they can be neutralized. The fire delivered by the assault element during the final assault is called assault fire and is delivered as follows:

- Assault personnel deliver a high rate of accurate fire using the pointing technique. They do not fire from the hip, as such fire is largely ineffective.
- Fire is directed at all adversary locations and is continued until adversary resistance ends. Illus. 5-11 depicts an example of the delivery of assault fire.

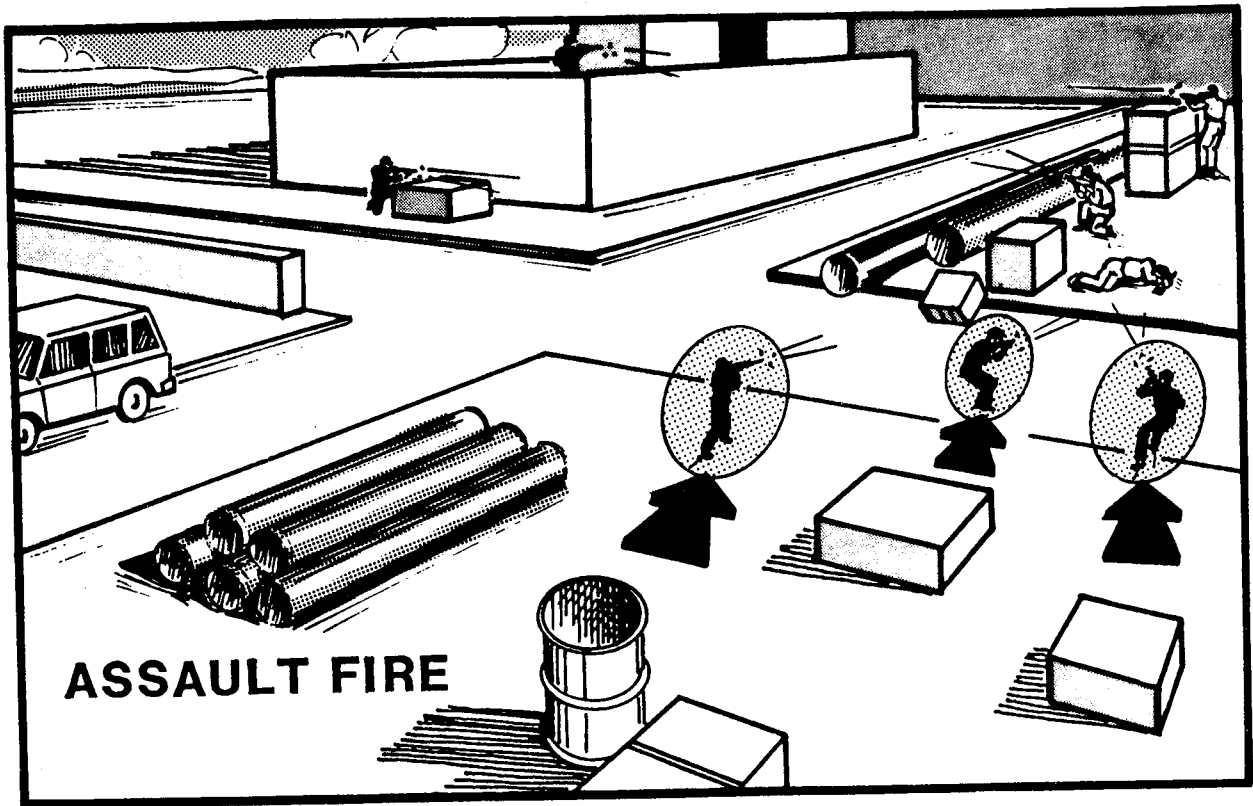

Illustration 5-11. As the assault element nears the adversary's position, the members of that element provide their own assault fire.

Section 8. FIRE CONTROL AND FIRE DISCIPLINE

Due to the locations of and population densities near most NRC licensee facilities, there is a high potential for damage to facilities and injury to innocent bystanders whenever an armed encounter occurs. Indiscriminate, uncontrolled and unnecessary weapons fire from the security force can only increase the probability of such needless damage and injury. For this reason, **fire control** and **fire discipline** are as important to the security force as is the ability to deliver accurate fire.

FIRE CONTROL

Whenever an element, either an organized team or a chance grouping, of the security force is engaged in a firefight with an adversary, someone in the element must be the leader, who controls the element's fire. The fire control responsibilities of a leader include

- **Positioning personnel so that they can deliver the desired fire and so that they can be controlled.**

- **Choosing which targets are to be attacked and by whom.**
- **Determining the rate and volume of fire to be delivered on each target.**
- **Determining when to commence firing, to shift fire and to cease firing.**

The leader must be able to make decisions concerning control of fire and then must be able to communicate these decisions to subordinates. Once instructed, the subordinates must be able to carry out the leader's commands. The importance of maintaining fire control can be illustrated in relation to the delivery of suppressive fire and assault fire as described in the previous section. Suppressive fire must be controlled carefully because its effectiveness depends on the correct volume of fire being delivered at the correct time. Also, without fire control, it would be difficult, if not impossible, for one security force element to cease all suppressive fire and another to begin assault fire, each at the right moment. A lack of fire control in either case could result in increased casualties suffered by the assault element of the security force.

FIRE DISCIPLINE

Whereas fire control refers to a leader's control over subordinates, fire discipline refers to security force personnel control over their own actions during a firefight. Fire discipline is achieved when each individual, whether alone or as part of an element, acts coolly, rationally and without panic during a conflict. You can achieve fire discipline by

- Following all fire orders from the leader.
- Positively identifying all targets before firing.
- Deciding when firing is necessary and when it is not.
- Delivering the number of rounds and the rate of fire required, and no more.
- Holding fire when your weapon is not appropriate to the situation.

Section 9. CHAPTER SUMMARY

This chapter has addressed field firing techniques that will help you to survive and succeed during an armed engagement with an adversary force.

The chapter began with a discussion of the general importance of field firing techniques and named the techniques.

The importance of selecting a good **firing position** was discussed, and the basic firing-position requirements were explained. A good firing position

- Provides stable support
- Permits observation of the target area
- Provides cover and concealment

Techniques for making the best use of firing positions were covered.

The principle behind **battlesights** was explained, and procedures for engaging targets with battlesights were described.

The principles and applications of the **pointing technique** were introduced, and directions were given for practicing the technique.

Special techniques to use in engaging **moving targets, multiple targets and partially hidden targets** were given. The special technique of **ricochet shooting** also was described.

Techniques for **acquiring and firing on targets at night** were covered, including factors that must be considered at night—position selection, muzzle flash and the availability of tracers.

The purpose of and the techniques for employing **suppressive fire** and **assault fire** were covered.

The importance of maintaining **fire control and fire discipline** was stressed, and methods were given for achieving each.

Chapter 6

DEFENSIVE POSITIONS

Section 1. INTRODUCTION

During a security emergency, your tactical responsibilities as a guard are likely to be primarily defensive in nature. For example, you may have to prevent the adversary from gaining access to a particular area, or from escaping from a penetrated area. To accomplish these and other defensive missions, you probably will have to occupy a defensive position or perhaps even a series of positions. By choosing tactically sound positions from which to fight, you will improve your chances of mission accomplishment and survival.

In a given area of any NRC licensee facility, there will be some, perhaps many, locations where you can establish defensive positions. You almost always will have a choice of positions from which to fight, and your ability to choose advantageous positions will affect your ability to accomplish your mission. Chapter 5, "Field Firing Techniques," provides detailed information concerning the selection, occupation and use of firing positions. That information remains valid under any tactical condition and will not be repeated in detail here. This chapter will focus specifically on the selection of positions for use in a defensive situation.

Section 2. GENERAL CONSIDERATIONS

The three categories of defensive positions

that you may use during an armed confrontation are

- **Permanent positions**
- **Crisis positions**
- **Expedient positions (positions of opportunity)**

Each of these categories is depicted in Illus. 6-1.

Permanent positions normally are established in structures such as guard towers and guard stations that are located at entry-control points occupied routinely by members of the security force. These structures sometimes are constructed to include firing ports and ballistic protection, and they may be equipped in other ways as firing positions.

Crisis positions are locations that are identified before a crisis occurs as having the potential for tactical use. They normally are not occupied until a tactical situation requires their use. They may be constructed specifically to be used as fighting positions, or they may be existing locations that have been identified as tactically sound positions that can be used under certain tactical circumstances. The important characteristics of crisis positions are that they have been **selected** as the result of a tactical analysis, **evaluated** as to their suitability for support of a specific or a general tactical mission and **designated** for use under certain tactical conditions.

Expedient positions, or positions of opportunity, are selected at the time of a tactical crisis for use

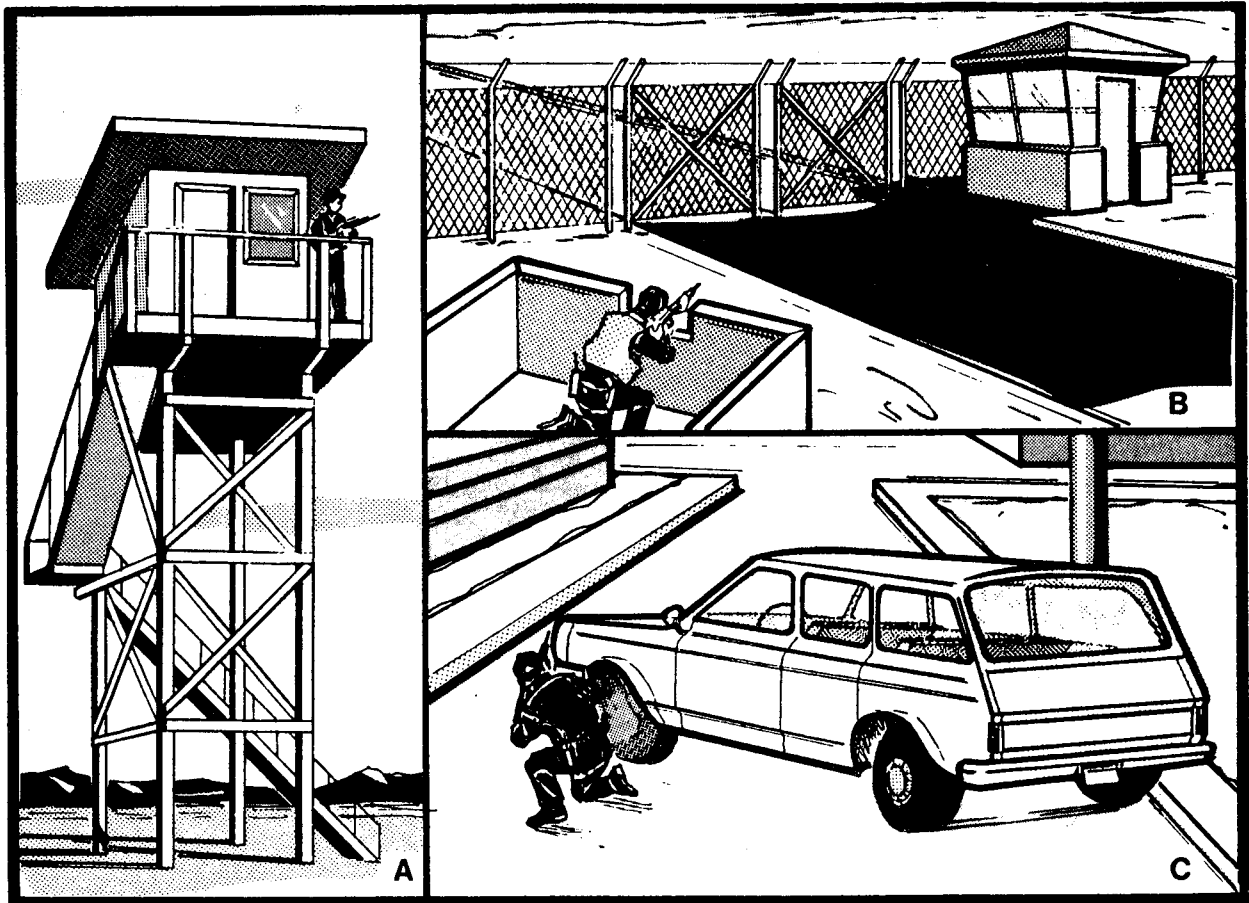

Illustration 6-1. During an armed confrontation, you may use (A) permanent, (B) crisis and (C) expedient defensive positions.

in accomplishing the current security mission. Based upon a quick analysis of the situation and mission, choose the best spot available from which to fight. The expedient position probably is the most commonly used type of defensive position.

The general factors influencing position selection are

- The mission
- Your opportunity for survival
- The terrain

You will choose a defensive position in accordance with your assigned **mission**. For example,

if you are assigned a sniping mission, you may select a high-ground position that provides long-range fields of observation and fire; if your mission is to establish a roadblock, you must choose a position on or near the road that is to be blocked.

Your opportunity for personal **survival** will be a consideration when you choose a defensive position. You will need some physical protection while you occupy the position. You should not choose open areas; and you will need an avenue of escape in case you are forced out of the position, so do not select locations such as blind alleys.

Your choice of a defensive position is dependent to some extent on the **terrain** in which you are operating. In some types of terrain the position possibilities are almost unlimited, while in other types of terrain the choices of position are severely restricted.

Section 3. SPECIFIC CONSIDERATIONS

After having considered your mission, your survival needs, and the terrain, you will have a general picture of the defensive position you are looking for, and you can focus on finding the most advantageous location available. The specific characteristics to look for are

- Fields of observation and fire
- Cover and concealment
- Presence of barriers
- Favorable situation for mutual support

- Ease of communicating
- Potential for improvement

Good fields of observation and fire are essential characteristics of a defensive position, because you must be able to see the adversary long before he or she reaches your position and you must be able to stop the adversary with weapons fire. Fields of observation and fields of fire are closely interrelated in that if you can see a target within the range of your weapon, you usually can shoot the target. If you choose a location that has minimal interference out to the target area, that location automatically will have both of these essential characteristics (see Illus. 6-2).

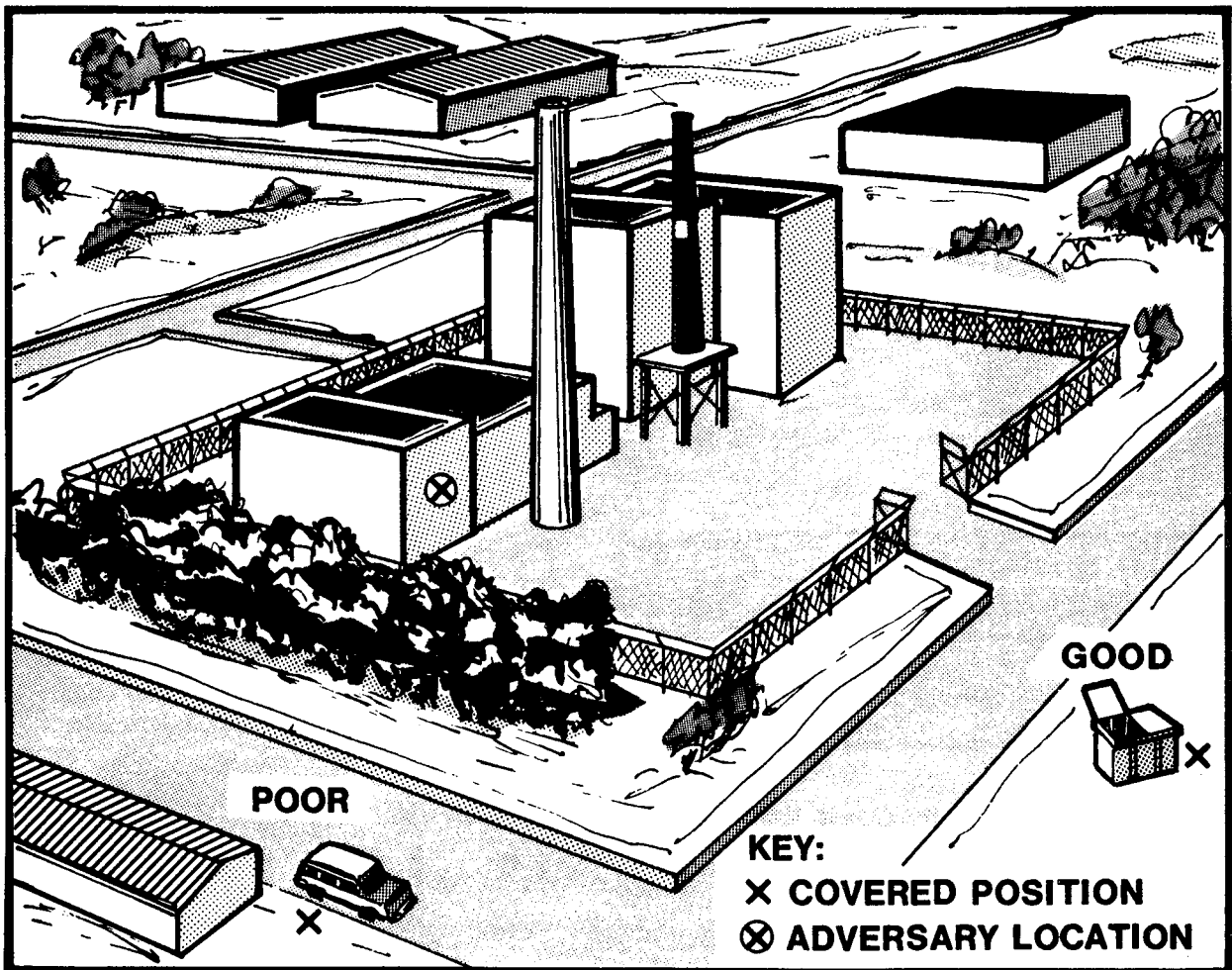

Illustration 6-2. In this illustration, the defensive position behind the dumpster provides better fields of fire and observation than does the position behind the vehicle.

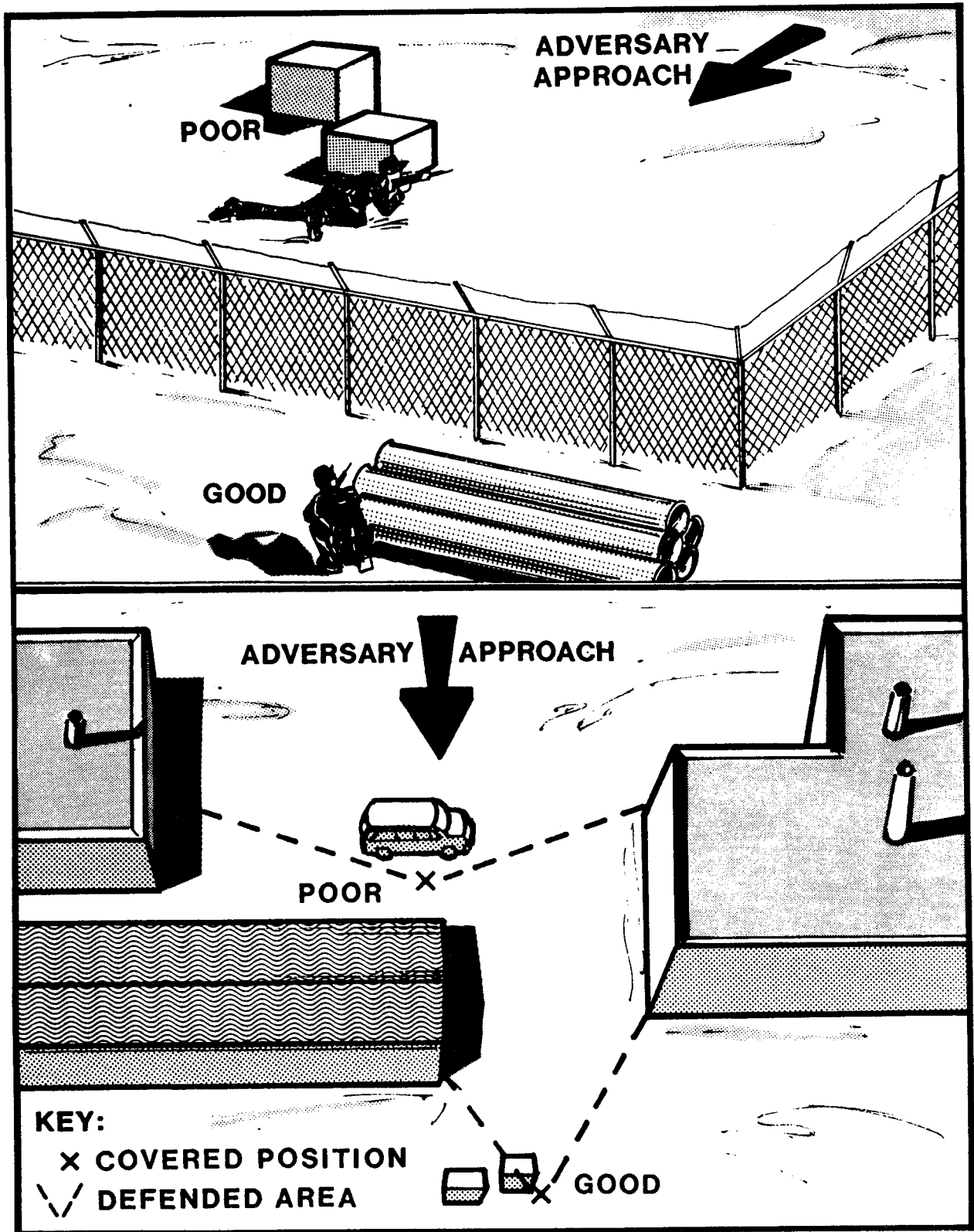

Illustration 6-3. Try to locate your defensive position behind a barrier so that the barrier will stop or slow the adversary before your position is reached.

Cover and concealment also are essential characteristics to look for when you are choosing a defensive position. Good cover is especially desirable since it will protect you from adversary fire. As a minimum, choose a position that provides excellent concealment. You also should choose a location with a covered or concealed approach that will permit you to enter and leave the position safely. Chapter 3, "Cover, Concealment and Terrain Analysis," provides a more detailed discussion of this subject.

Another characteristic of a good defensive position is the presence of **barriers** that you can use in carrying out your mission. A barrier is any natural or manmade obstacle that will stop, delay or channelize anyone who is trying to move past it. Numerous barriers including fences, walls, buildings, ravines and bodies of water are present at NRC licensee facilities. When possible, locate

your defensive position **behind** a barrier, so that the barrier will stop or slow the adversary **in front** of your position, thus making it easier for you to neutralize the target with weapons fire. (See Illus. 6-3.)

Still another characteristic of a **good** defensive position is that it provides the opportunity for **mutual support** with respect to at least one other defensive position that is established in the same area. The occupant of one defensive position in an area should be able to see and provide fire support to the occupant of at least one other such position and be seen and supported in turn by at least one other position. Additional support can be provided by snipers in high positions. It is much more difficult for an adversary to penetrate a defense carried out from mutually supporting positions than it is for the adversary to pass by a number of security personnel defending from isolated positions (see Illus. 6-4).

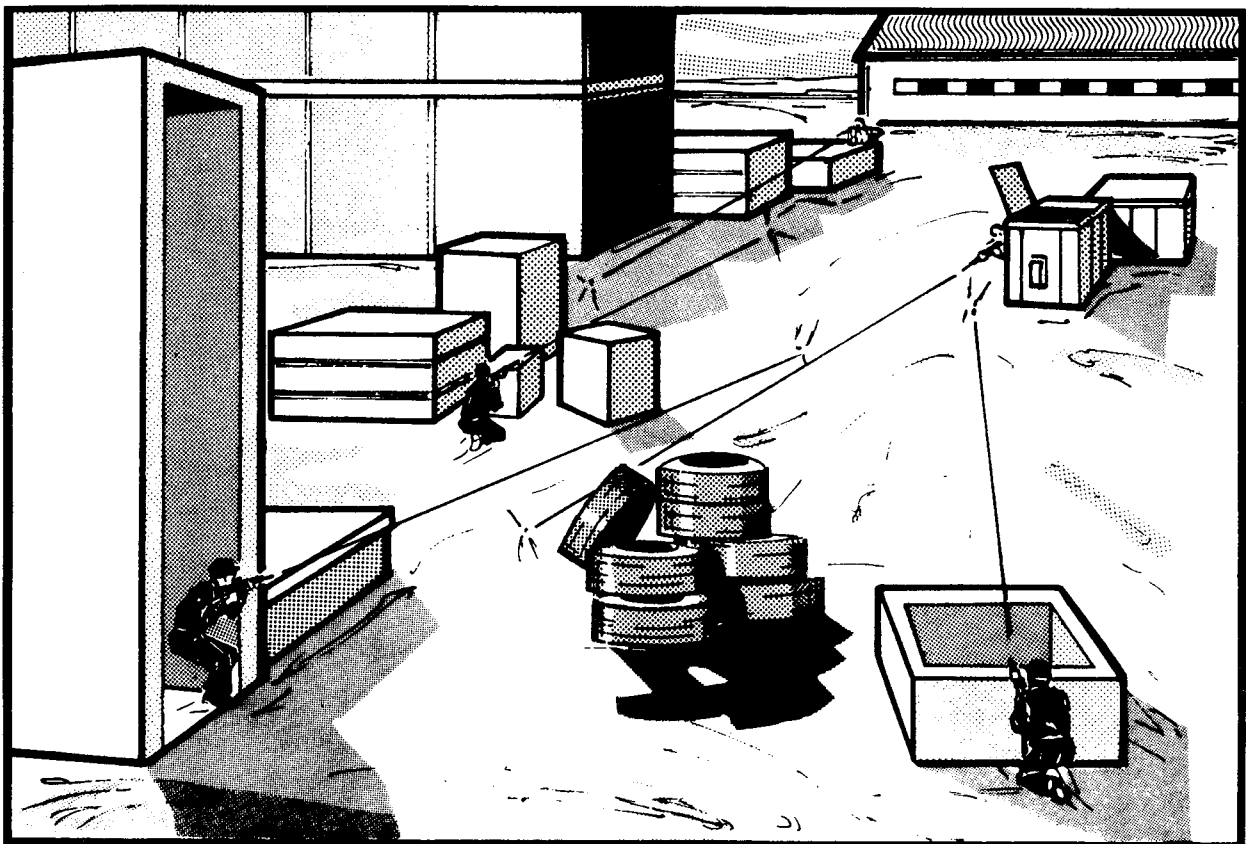

Illustration 6-4. A good defensive position provides the opportunity for mutual support.

A final characteristic of a good defensive position is that it is situated so that you can **communicate**, either by voice or by visual signals, with other members of the security force. You must be able to report your actions and observations, stay informed about the tactical situation and receive orders.

If you cannot find a location that has all of the characteristics of a good defensive position discussed thus far, choose a position that can be rapidly **improved**. You may be able to improve cover and concealment and fields of observation and fire by such means as repositioning vehicles, closing gates and stacking barrels or crates. Often you can create a good defensive position quickly and easily if you choose a location that has adequate potential for improvement.

The **permanent** and **crisis** positions at your facility probably will have all the characteristics of a good defensive position, since you will have time to select these positions carefully and to make necessary improvements. However, since **expedient** positions are selected quickly at the time of crisis, you may have to decide on trade-offs among the various position characteristics. Your overall concerns, when you must make trade-offs, should be mission accomplishment and personal survival.

Section 4. CHAPTER SUMMARY

This chapter has explained the general and the specific considerations that you should weigh when you are selecting a defensive position. Three categories of defensive positions were identified:

- **Permanent positions**
- **Crisis positions**
- **Expedient positions**

The following general factors that influence position selection were explained:

- **The mission**
- **Your opportunity for survival**
- **The terrain**

The following specific considerations concerning position selection were discussed:

- **Fields of observation and fire**
- **Cover and concealment**
- **Presence of barriers**
- **Favorable situation for mutual support**
- **Ease of communicating**
- **Potential for improvement**

Chapter 7

INDIVIDUAL TACTICAL MOVEMENT

Section 1. INTRODUCTION

Your ability to move effectively against an adversary can be as important to your mission and to your survival as your ability to fire your weapon effectively against an adversary. In general, it is more hazardous to move than it is to remain stationary in a good fighting position. However, there are times when you must move in order to accomplish your mission. During movement, you must make every effort to reduce your exposure to adversary fire.

In this chapter, the basic factors affecting individual tactical movement will be covered. General techniques of individual tactical movement that are appropriate for various tactical situations will be discussed. Special techniques that are required in unique circumstances also will be covered.

Section 2. FACTORS AFFECTING INDIVIDUAL TACTICAL MOVEMENT

Increased personal security is the single most important outcome of practicing sound individual tactical movement techniques. All of the factors affecting individual tactical movement must be weighed to determine the most **secure** technique for a particular situation. These factors include

- **Speed**
- **Cover**
- **Concealment**
- **Noise Discipline**

Speed is an essential part of secure individual tactical movement when no cover or concealment is available. In other words, when you must cross an open area in a tactical situation, it is essential for your security that you cross as quickly as possible.

Cover and **concealment** reduce the need for **speed**. **Cover** protects you from adversary fire. **Concealment** protects you from adversary observation. If, as you move, you cannot be seen by an adversary or struck by hostile fire, speed is a less important part of security.

Noise discipline can be an important aspect of **concealment**. Even if an adversary cannot see you, he may be able to fire effectively on your position if the noise you make reveals your location.

Section 3. INDIVIDUAL TACTICAL MOVEMENT TECHNIQUES

Four individual tactical movement techniques have been developed for use in different tactical situations. These techniques are

- **THE SILENT WALK**
- **THE LOW CRAWL**
- **THE HIGH CRAWL**
- **THE RUSH**

In order to choose the most secure technique of movement for a given situation, you must consider the interrelation of the factors of speed, cover, concealment and noise discipline in that situation.

The **silent walk** permits the best noise discipline of all individual tactical movement techniques. However, it is very slow, and it requires excellent cover or concealment if it is to be secure.

The **low crawl** also is very slow, but it requires less cover or concealment to be secure. It does not permit good noise discipline.

The **high crawl** is faster than the silent walk and the low crawl. It requires less cover and concealment than the silent walk but more than the

low crawl. Like the low crawl, it does not permit good noise discipline.

The **rush** is the fastest of all individual tactical movement techniques. When the rush is used properly, it requires no cover or concealment. The rush also permits almost no noise discipline.

The following chart summarizes this interrelation of the factors of individual tactical movement as they apply to each movement technique.

Technique	Cover and Concealment	Speed	Noise Discipline
Silent Walk	Most Important	Very Slow	Very Good
Low Crawl	Less Important	Slow	Poor
High Crawl	More Important	Moderate	Marginal
Rush	Not Important (during rush)	Very Fast	Very Poor

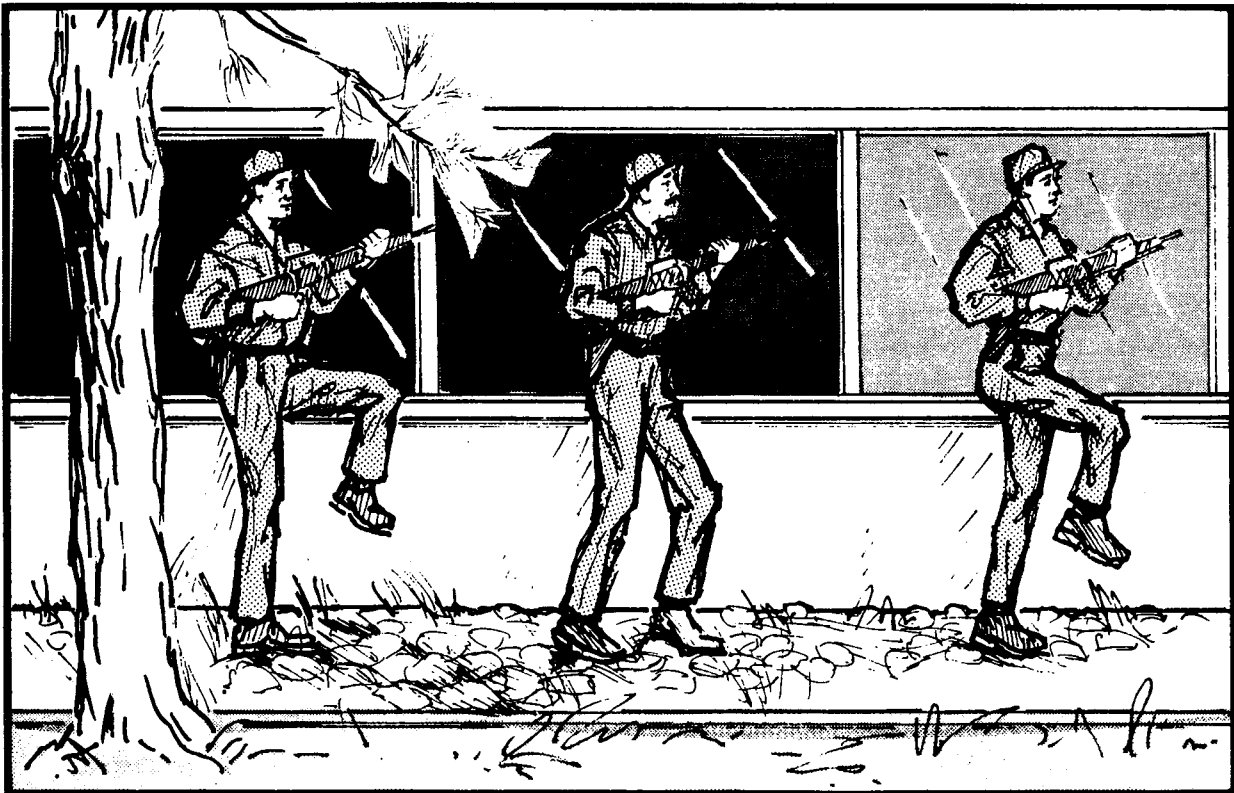

Illustration 7-1. The silent walk.

SILENT WALK

When performing the **silent walk** (see Illus. 7-1), you normally will carry your weapon in the port arms position. Maintain your weight on your trailing foot, and step forward with your lead foot. Step high enough so that you do not brush your foot against obstacles on the ground. Let your lead foot down slowly, toe first, and feel for a good solid footing. Then, shift your weight slowly to your lead foot, and repeat the process. Maintain your balance by taking short steps. Do not keep your eyes on the ground. You must observe the area around you carefully for evidence of the adversary. Take quick glances at the ground when necessary, but immediately return to searching the area around you.

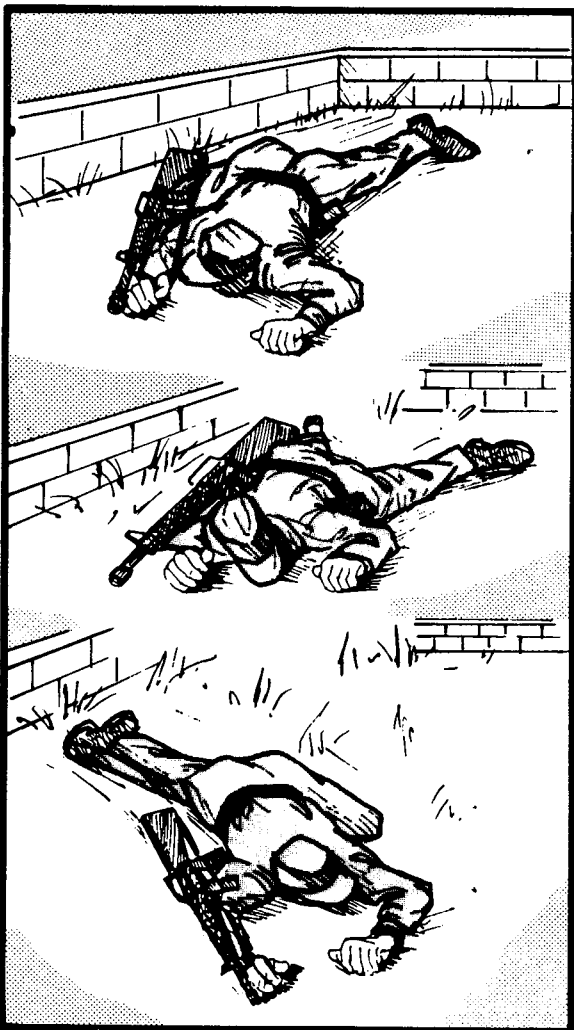

Illustration 7-2. The low crawl.

LOW CRAWL

When you perform the **low crawl** (see Illus. 7-2), keep your entire body as flat as possible on the ground. Grasp your rifle at the upper sling swivel. Let the balance of the rifle rest on your forearm, and let the butt of the rifle drag on the ground.

To move forward, pull with both arms at once and push with your right or left leg. To reduce fatigue, alternate your pushing leg from time to time.

HIGH CRAWL

When you perform the **high crawl** (see Illus. 7-3), keep your body off the ground, and rest your weight on your forearms and knees. Cradle your rifle in your arms, and be sure to keep the muzzle clear of the ground. Move forward by alternately advancing your right elbow and left knee and then your left elbow and right knee. Be sure to keep your buttocks as low as possible.

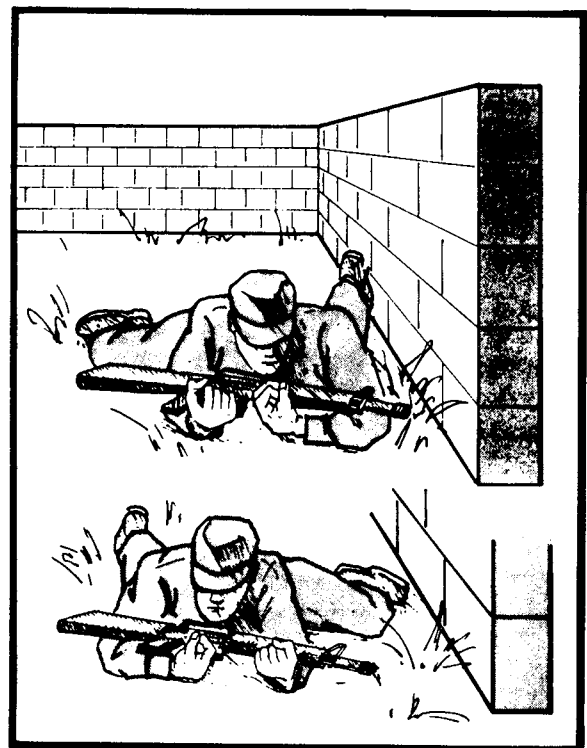

Illustration 7-3. The high crawl.

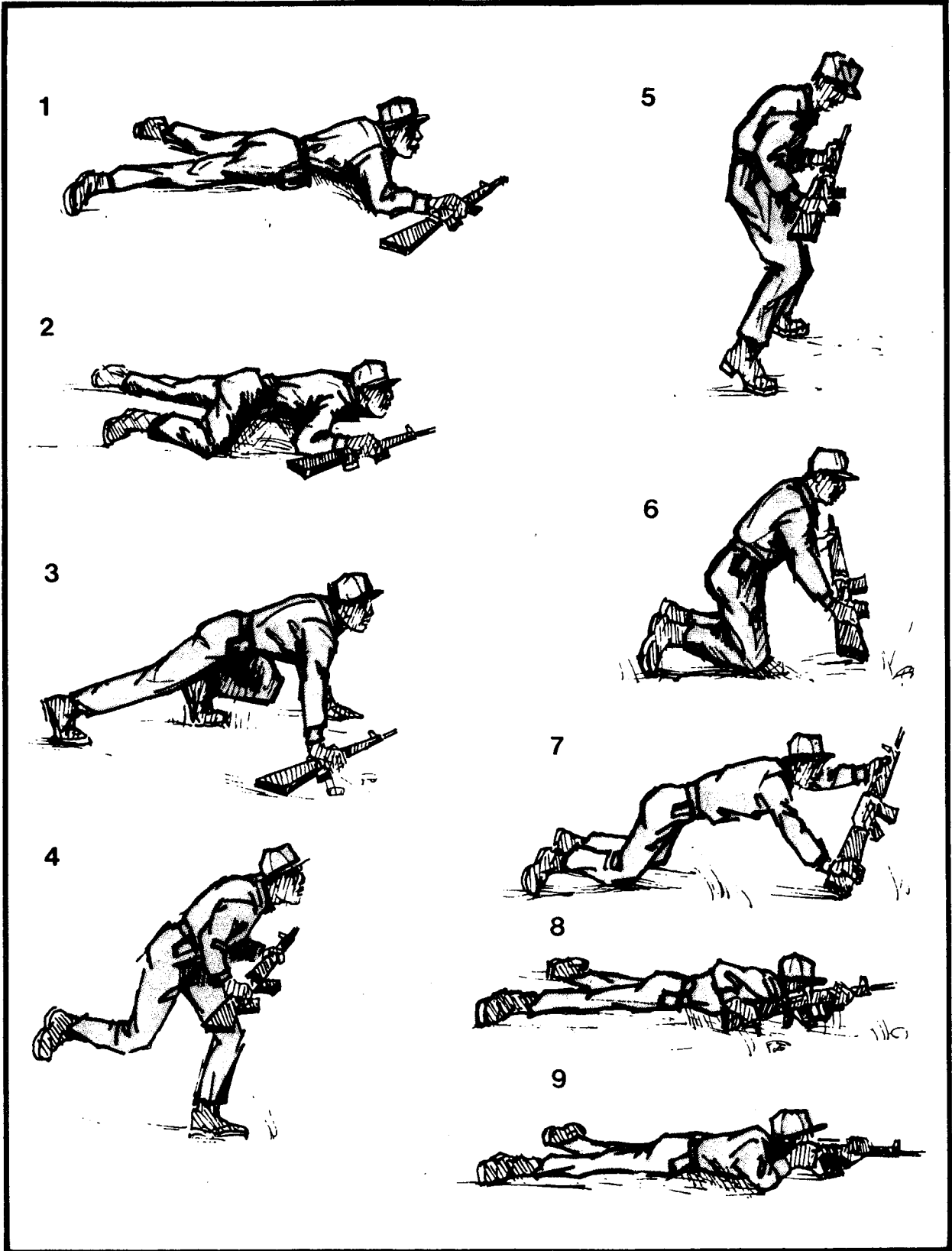

Illustration 7-4. The rush.

RUSH

When you have to move across short stretches where no **cover** or **concealment** is available, you should use the **rush**. The basic idea behind the rush is to move so fast, over such a short distance, that the adversary does not have time to aim at you and fire effectively during the brief period that you are exposed.

When you perform the rush (see Illus. 7-4), the first step is to look ahead of you and select your next covered position. If possible, it should be no more than a 3-to-5-second dash from your current position. When you are ready to move, draw your arms into your body, keep your elbows and buttocks down, and pull one leg forward. In one sudden movement, spring to your feet, and dash forward as fast as you can. Do not attempt to fire. Do not zig-zag. Run at top speed in a straight line to your next covered position. As you reach your next covered position, come to a stop by firmly planting both feet and falling forward. Break your fall by planting the butt of your rifle on the ground in front of you. Roll away from your firing shoulder, place the butt of the rifle into the hollow of your firing shoulder, and roll back into a firing position.

POINTS TO KEEP IN MIND WHEN PERFORMING THE RUSH

- Try to limit your exposure to 3 to 5 seconds maximum. However, do not hit the ground in the open at the end of a 3-to-5-second rush simply because the time is up. A successful rush must be from cover to cover or, as a minimum, from concealment to concealment.
- If you have been firing, do not rush from your exact firing position. Roll to your right or left before springing to your feet so that the adversary will not know where to expect to see you.
- When you have to end a rush at a position providing concealment but no cover, roll or crawl to a covered position before firing again.
- When you and another guard move together by the rush technique
 - Never rush at the same time.
 - Never get in the way of your partner's fire. In other words, never cross the straight

line between your partner's position and the adversary's.

Section 4. SPECIAL TECHNIQUES FOR UNIQUE CIRCUMSTANCES

Special individual tactical movement techniques apply to the following unique circumstances:

- SCALING BARRIERS
- DESCENDING FROM ELEVATED POSITIONS
- CROSSING DANGER AREAS
- PASSING WINDOWS AND OPEN DOORS
- REACTING TO SUDDEN ILLUMINATION
- REACTING TO FIRE

SCALING BARRIERS

The essential thing to remember when you have to scale a barrier, such as a wall or window ledge, is to keep your profile as low as possible. Hug the barrier as you roll across. Do not vault over the barrier. The difference in your exposure could mean the difference between life and death (see Illus. 7-5).

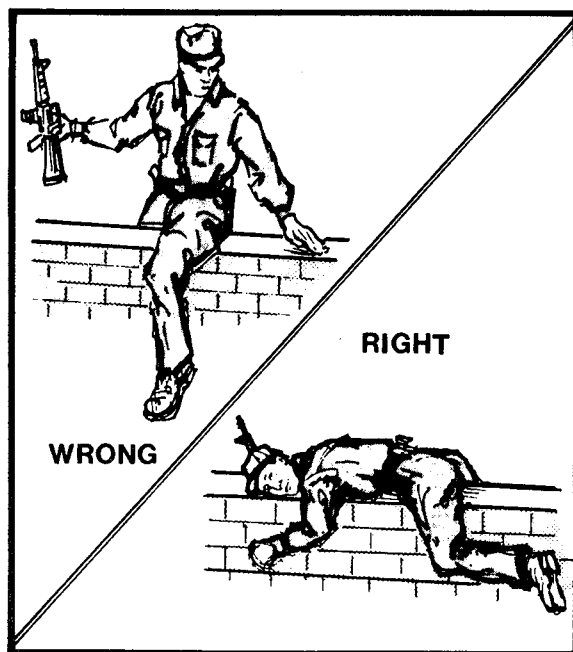

Illustration 7-5. Scaling a barrier.

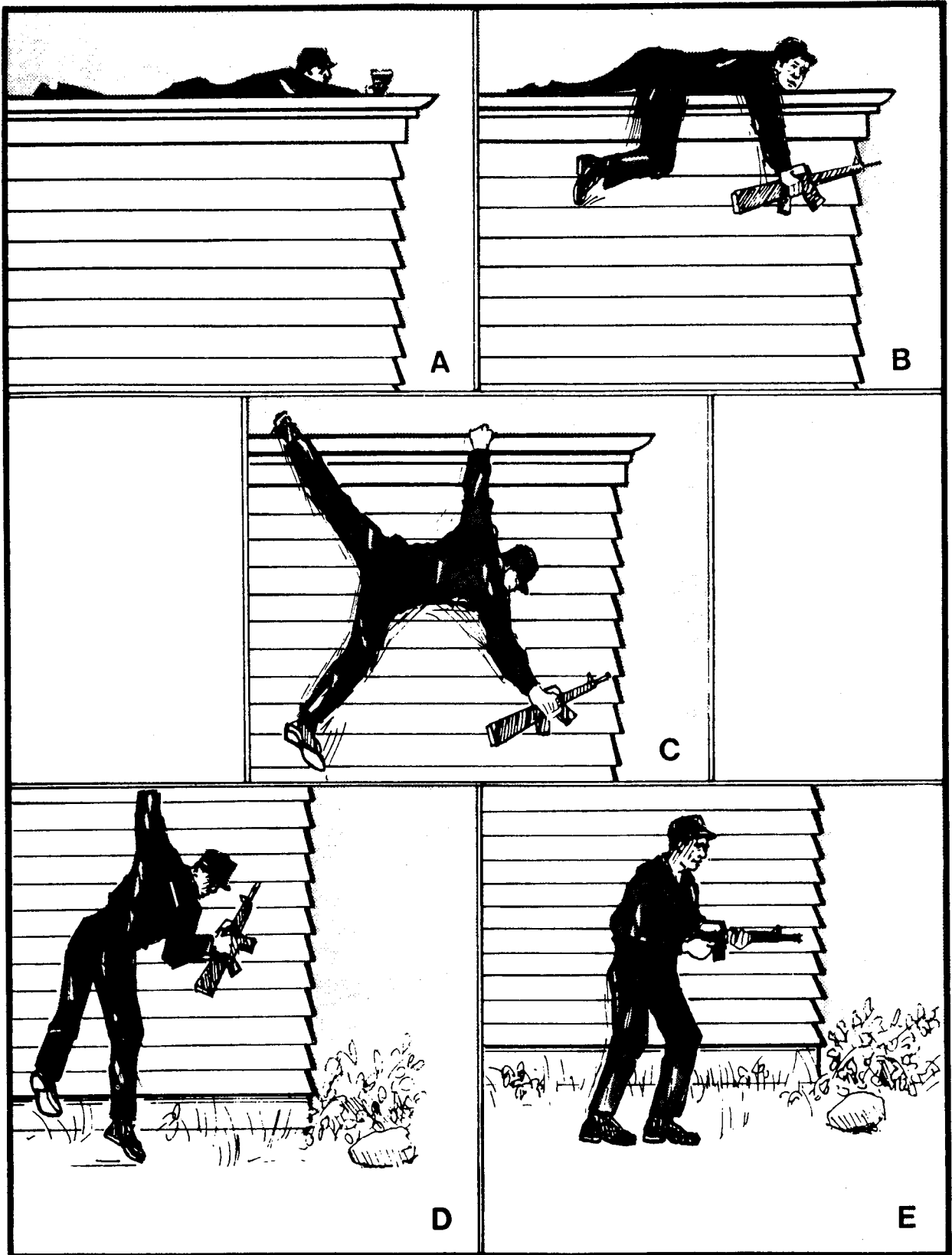

Illustration 7-6. Descending from elevated positions by means of the spider crawl.

DESCENDING FROM ELEVATED POSITIONS

During tactical movement, it may be necessary for you to descend from an elevated position such as the rooftop of a single-story building. To descend tactically, you should use the **spider crawl**. The spider crawl is performed as follows:

1. Approach the edge of the elevated position in a modified low crawl. Hold your rifle in your lead hand (see Illus. 7-6a).
2. Lower your lead arm, with your rifle, and your lead leg over the edge of the elevated position while keeping your trail arm and leg pressed against the top of the position (see Illus. 7-6b).
3. Slowly lower your body down the vertical face of the elevated position until only your trail hand and foot remain on top (see Illus. 7-6c).
4. Release your trail foot and swing down by your trail hand. As soon as you are hanging vertically, release your trail hand (see Illus. 7-6d).
5. Land on the balls of your feet with your rifle at the ready position and your legs spread enough to provide good balance (see Illus. 7-6e).

CROSSING DANGER AREAS

A **danger area** is any area where cover or concealment is minimal and where an adversary would be expected to set up an ambush. Examples of danger areas are

- Wide roads, streets and boulevards
- Vacant lots
- Natural and manmade clearings

To cross a danger area (see Illus. 7-7), you should first find a crossing point where the distance that requires exposed movement is minimal. Make sure you can cross from a **covered** position to a **covered** position. Never cross a danger area without being protected by covering fire. Use the buddy system. Have one guard cross the danger area while the other provides cover fire from a secure position.

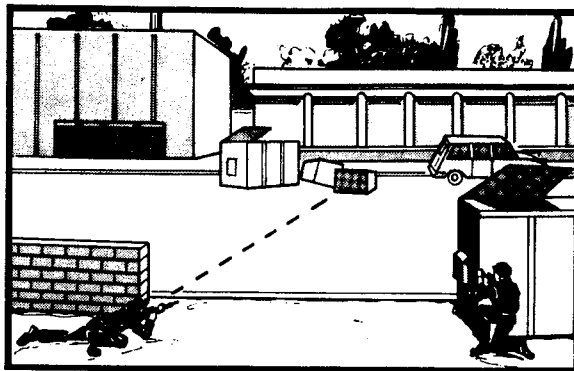

Illustration 7-7. Crossing danger areas.

PASSING WINDOWS AND DOORS

Usually, the safest way to pass a window is by using the **low crawl** or **high crawl** technique. The basic idea is to make sure that you are never exposed through the window (see Illus. 7-8).



Illustration 7-8. Passing a window safely.

If the window extends from floor to ceiling, then it must be passed in the same way that an open door would be passed. Since it is nearly impossible to maintain cover and concealment when passing an open door or a floor-to-ceiling window, **speed** is essential. Wait at the near edge of your covered position until there is no adversary fire, and then **rush** past the open door or window to the next **covered** position. Even the most alert adversary will find it impossible to see you and respond with effective fire in the brief period (less than a second)

that you would be exposed through a doorway or a window if you use the rush technique.

REACTING TO SUDDEN ILLUMINATION

Darkness can be one of the most effective aids to concealment. However, when you are depending on darkness for concealment and your position suddenly is illuminated by headlights, a searchlight beam, a flare or some other unexpected light, you must take immediate action. Remember, your adversary will be blinded by the sudden light just as you are. You should take advantage of his temporary blindness by immediately taking cover. You must not remain standing and exposed once you are illuminated. Immediately dive to a prone position behind the nearest cover or concealment. Even if you are trapped in the open and the nearest cover or concealment is too far away for a rush, you can reduce your vulnerability by immediately taking a prone position (see Illus. 7-9).

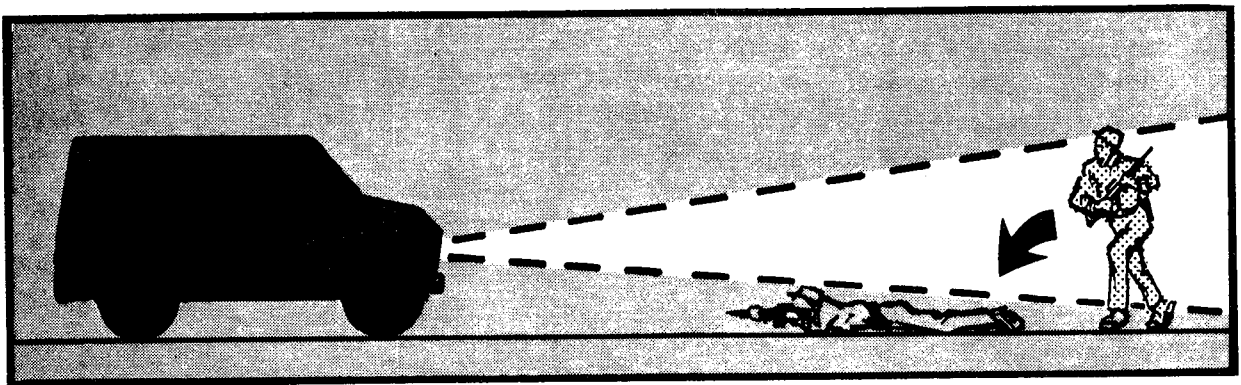

Illustration 7-9. Reacting to sudden illumination.

REACTING TO FIRE

The most dangerous situation you will ever encounter occurs when, during exposed movement, you are suddenly taken under fire. Your actions in the first fraction of a second can make the difference between life and death. Unless you are caught **completely in the open**, the best immediate action is to **dive to a prone position**. Do not attempt to return fire.

In such a situation, your chances of locating, firing on and neutralizing an adversary before being hit are extremely small. At the first indication that you are being fired upon, dive for cover. Then worry about locating your adversary and returning his fire.

If you try to outshoot adversaries when you first receive fire, you place yourself in more danger because

- They are under cover while you are exposed.
- They know where you are and you do not know where they are.
- They have already sighted you, missed once and are ready to correct for the second shot.

On the other hand, if you immediately dive for cover and then try to locate your adversary and return fire, you are closer to being on equal terms because

- You both are under cover.
- Neither of you knows exactly where the other is.
- Neither has a weapon sighted on the other.

Reacting to fire by diving for cover does not guarantee that you will be in a better position than your adversary. At best, it will even the odds. However, attempting to locate and outshoot your adversary when you are exposed and the adversary is concealed, when the adversary knows your location and you do not know his/hers and when he/she has you in his/her sights is almost certainly doomed to failure.

Even in relatively open areas, diving immediately into a prone position will make you a much harder target to hit. The only exception occurs when you are in an open area and you receive fire from above. This is the worst of all situations possible. If you are in the open and receive fire from above, your only hope is to **rush** as fast as possible to the nearest **covered** position, however far away that might be (see Illus. 7-10).

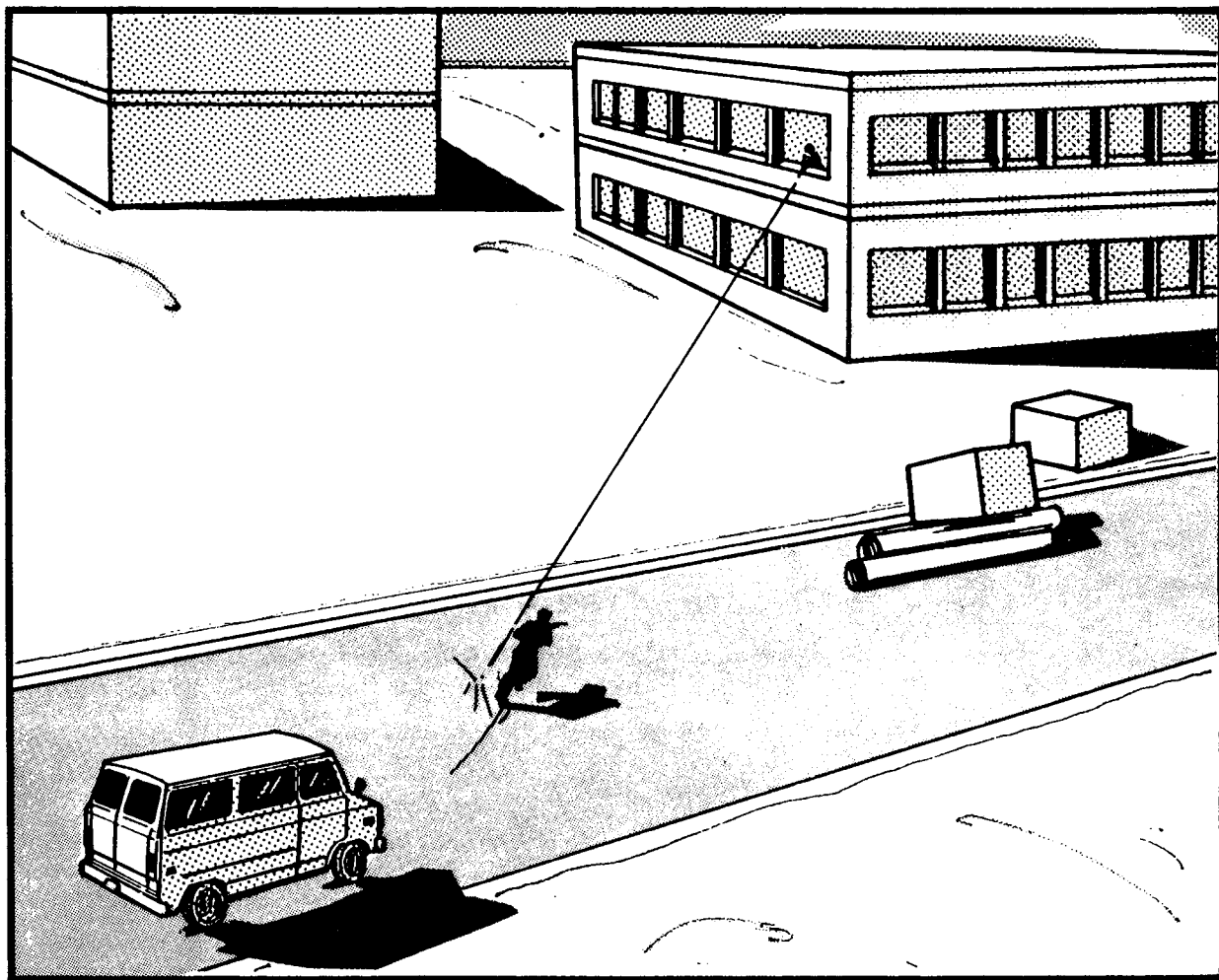

Illustration 7-10. If you are in the open and receive fire from above, rush as fast as possible to the nearest covered position.

Section 5. CHAPTER SUMMARY

This chapter has covered the basic factors affecting **individual tactical movement** including

- **Speed**
- **Cover**
- **Concealment**
- **Noise Discipline**

The chapter emphasized the paramount importance of **security** and explained how **speed, cover, concealment** and **noise discipline** interact to provide security.

The following **individual tactical movement techniques** were introduced:

- **The Silent Walk**

- **The Low Crawl**
- **The High Crawl**
- **The Rush**

The tactical characteristics of these techniques were described, and the details of executing each then were given.

The instruction concluded with a presentation of **special individual tactical movement techniques** that apply to the following unique circumstances:

- **Scaling barriers**
 - **Descending from elevated positions**
 - **Crossing danger areas**
 - **Passing windows and open doors**
 - **Reacting to sudden illumination**
 - **Reacting to fire**
-

Chapter 8

TEAM TACTICAL MOVEMENT

Section 1. INTRODUCTION

The ability of the responding force to move as a team, both when fire is expected and when the team is actually under fire, is essential. Several independently moving guards are vulnerable to an adversary, offer no mutual protection and may even present additional hazards to one another. However, when several guards move together as a team, with mutual support and coordinated action, the whole becomes much greater than the sum of the parts. A basketball team is much more than five individual players independently attempting to score points. In the same way, a response team must be more than several individuals independently attempting to move against an adversary.

In this chapter, basic considerations and principles of team tactical movement will be covered. These considerations and principles will be followed by a discussion of the specific formations and techniques of team tactical movement that you can use when you expect fire or when you are actually under fire.

Section 2. CONSIDERATIONS OF TEAM TACTICAL MOVEMENT

There are many factors involved in team

tactical movement. These factors may be grouped into three major considerations:

- **Control**
- **Security**
- **Speed**

The consideration that is given the greatest weight is generally dictated by the situation. For example, control is a major concern for a relatively complex response, such as one involving several units approaching from several different directions. Control is a lesser concern for a less complex response, such as one in which the members of a two-man team approach from the same general location.

Security and speed generally are a trade-off. Although an ideal response would be both fast and secure, it frequently is impossible to have both to the degree desired. For example, detection and delay systems at many sites are such that the response must be very rapid in order to be effective. A completely secure approach, providing maximum protection for the responding elements, may bring responding forces to the scene of a crisis too late to effectively contain an adversary. On the other hand, the most rapid response possible will be ineffective if it exposes the responding guards to lethal fire.

In the remainder of this chapter, the major considerations of team tactical movement—control, security and speed—will be linked to the specific formations and techniques that are presented.

Section 3. PRINCIPLES OF TEAM TACTICAL MOVEMENT

Principles of team tactical movement against an adversary have been developed over many years, on actual battlefields, by small units attempting to survive in combat and to inflict the maximum possible damage on their enemies. These principles, with only slight modifications, can be applied by NRC licensee security forces.

PRINCIPLES OF TEAM TACTICAL MOVEMENT

- **NEVER MOVE ALONE.** Always move as at least two separate elements whether it is two individuals, two responding security teams or two tactical vehicles.
- **USE COVERED AND CONCEALED ROUTES.** Do not move in the open more than is absolutely necessary. Do not take the most obvious route to your response position. Ensure that you use every natural and manmade object between you and your adversary to hide your movement and to protect you from adversary fire.
- **MAINTAIN SEPARATION.** Avoid having two elements so close together that they can be brought under fire from the same adversary location.
- **PROVIDE MUTUALLY SUPPORTING FIRE.** Always be prepared to support the other element or elements with fire.

To increase your chances of surviving initial contact with your adversary, you should follow these principles when you

- **Respond to an alarm**
- **Move to a containment position**
- **Approach or withdraw from a known or suspected adversary location**

In other words, you should follow the basic **Principles of Team Tactical Movement** at any time there is a possibility that you might be fired upon.

Since many security procedures require that individual guards patrol alone, following the **Principles of Team Tactical Movement** sometimes

may be difficult. However, the higher the possibility that an adversary may be encountered, the more important it will be to follow these principles. How you follow them will depend on the particular site and procedures involved. For example, two guards patrolling separately, who are directed to respond to an alarm, could link up and become a team well before they reach the alarm location. The significant thing to remember is that the greater the risk to you, the more important it is that you follow the **Principles of Team Tactical Movement**.

Section 4. TACTICAL FORMATIONS

The basic tactical formation is the wedge. It is well suited for providing dispersion and flank security. It also is relatively easy to control. The number of guards in a particular formation and the distances between personnel will vary. The basic principles of using the wedge, however, remain the same:

- **Ensure that no two guards can be struck by the same burst of adversary fire.**
- **Ensure that no more than two guards are ever in the same line of adversary fire.**

For these principles to be followed, wedges must be configured so that team members are **separated** enough to prevent any two from being struck by the same burst of adversary fire and **staggered** enough to ensure that no more than two are in the same line of adversary fire. Illus. 8-1 through 8-6 portray examples of the two-, three- and four-person wedges. Note that both **separation** and **stagger** are maintained.

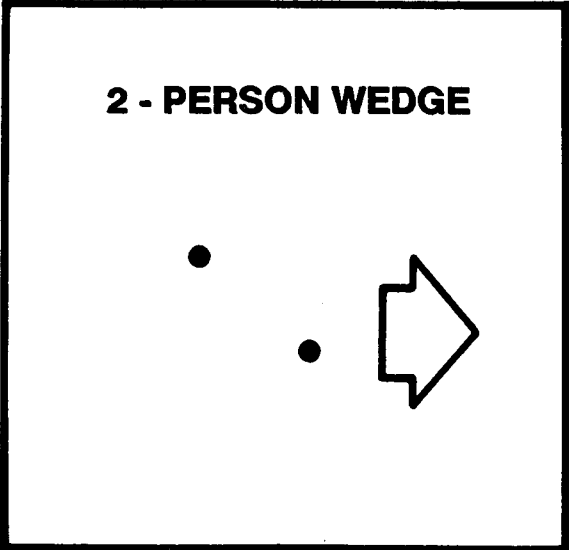

Illustration 8-1.

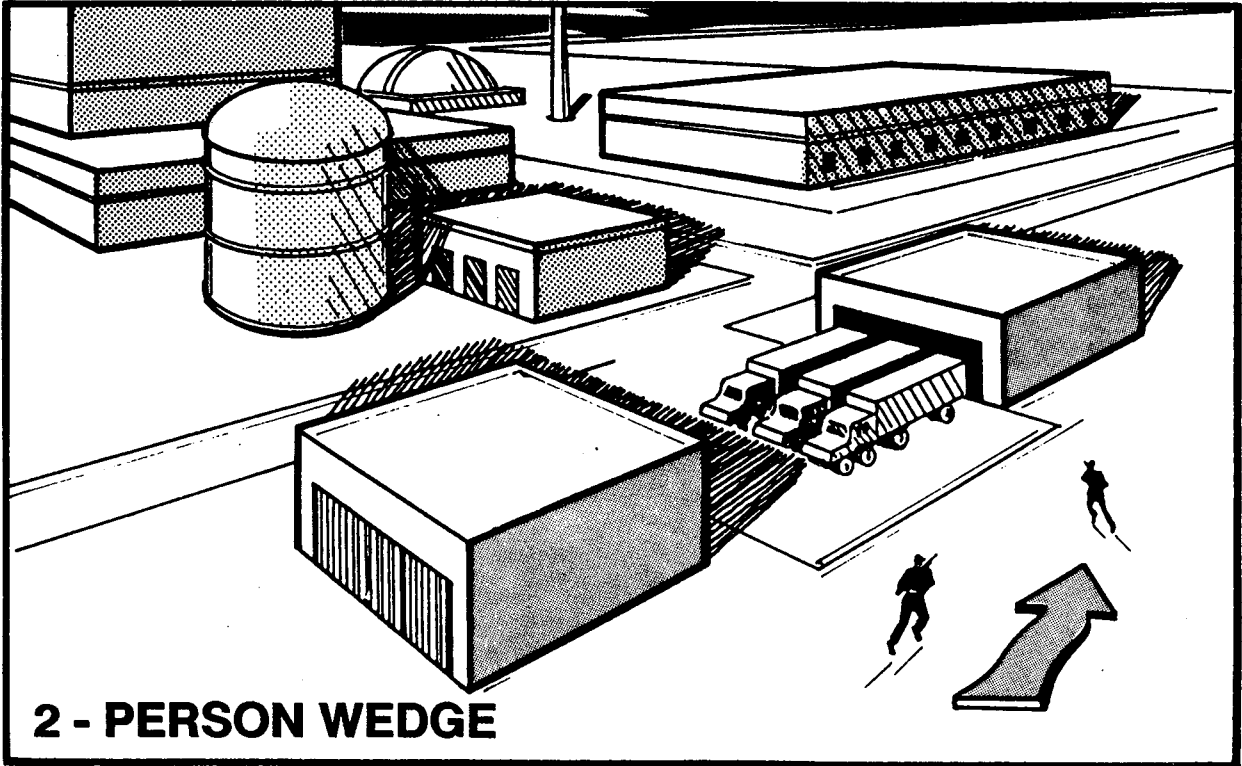

Illustration 8-2.

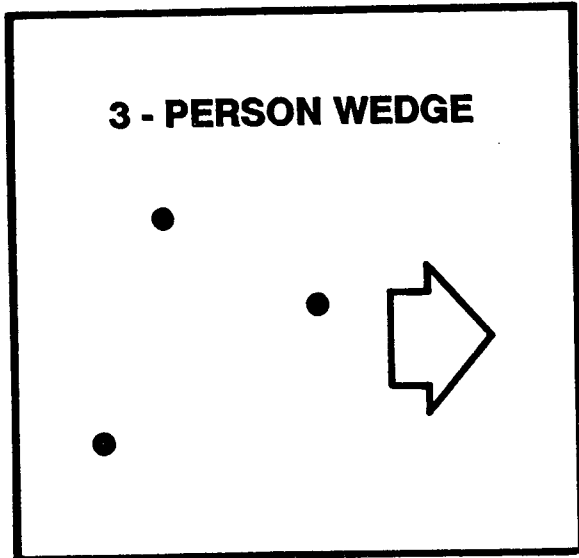

Illustration 8-3.

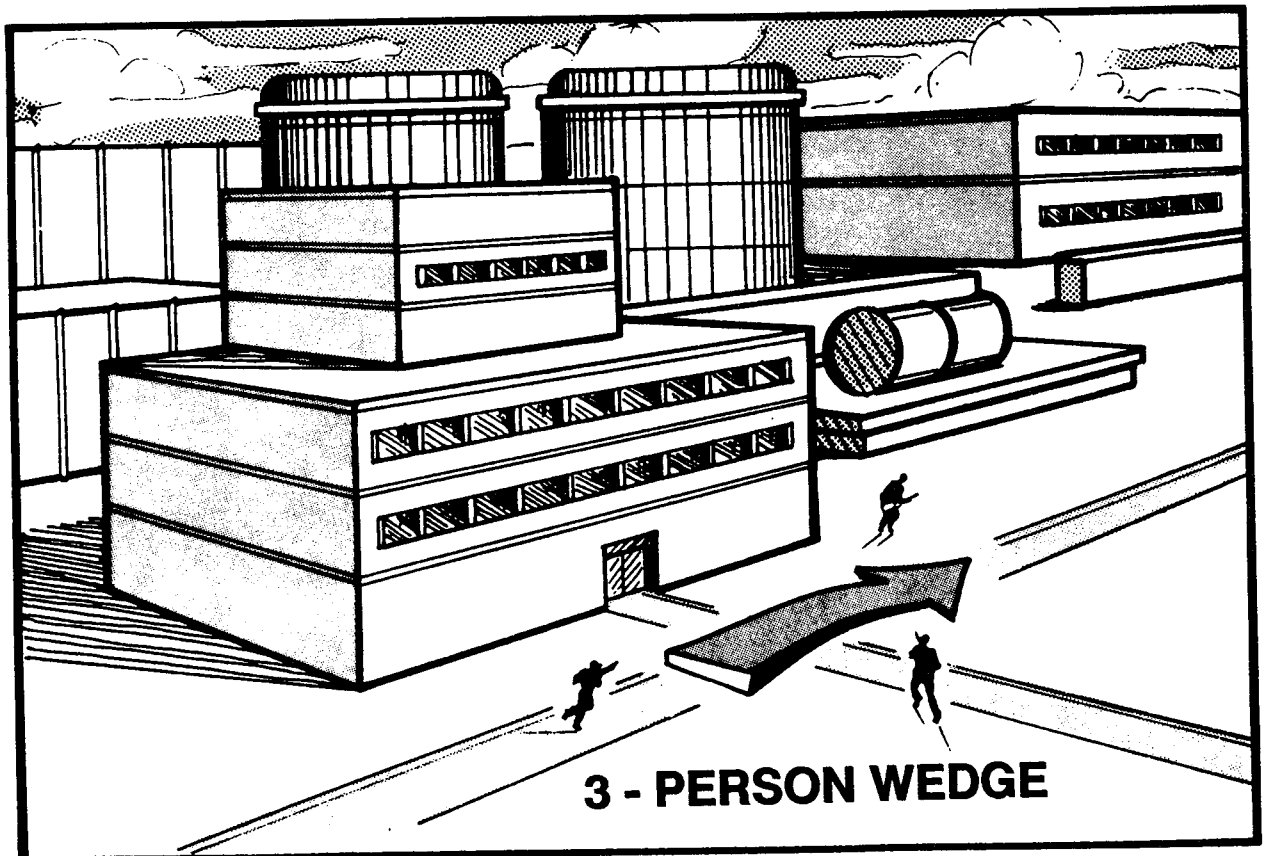

Illustration 8-4.

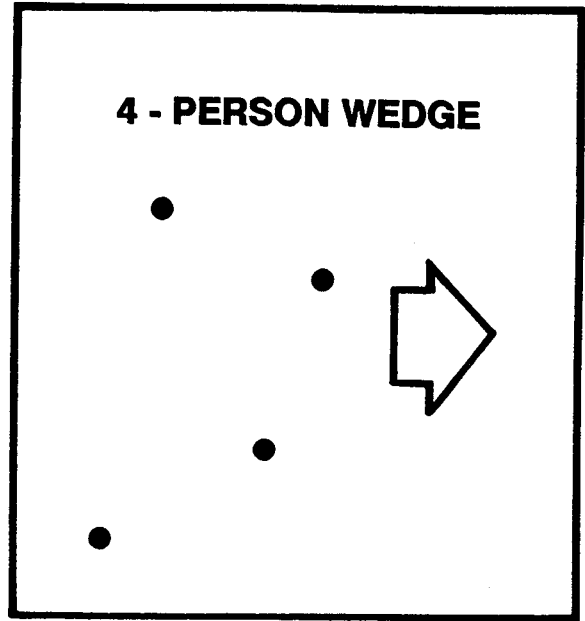

Illustration 8-5.

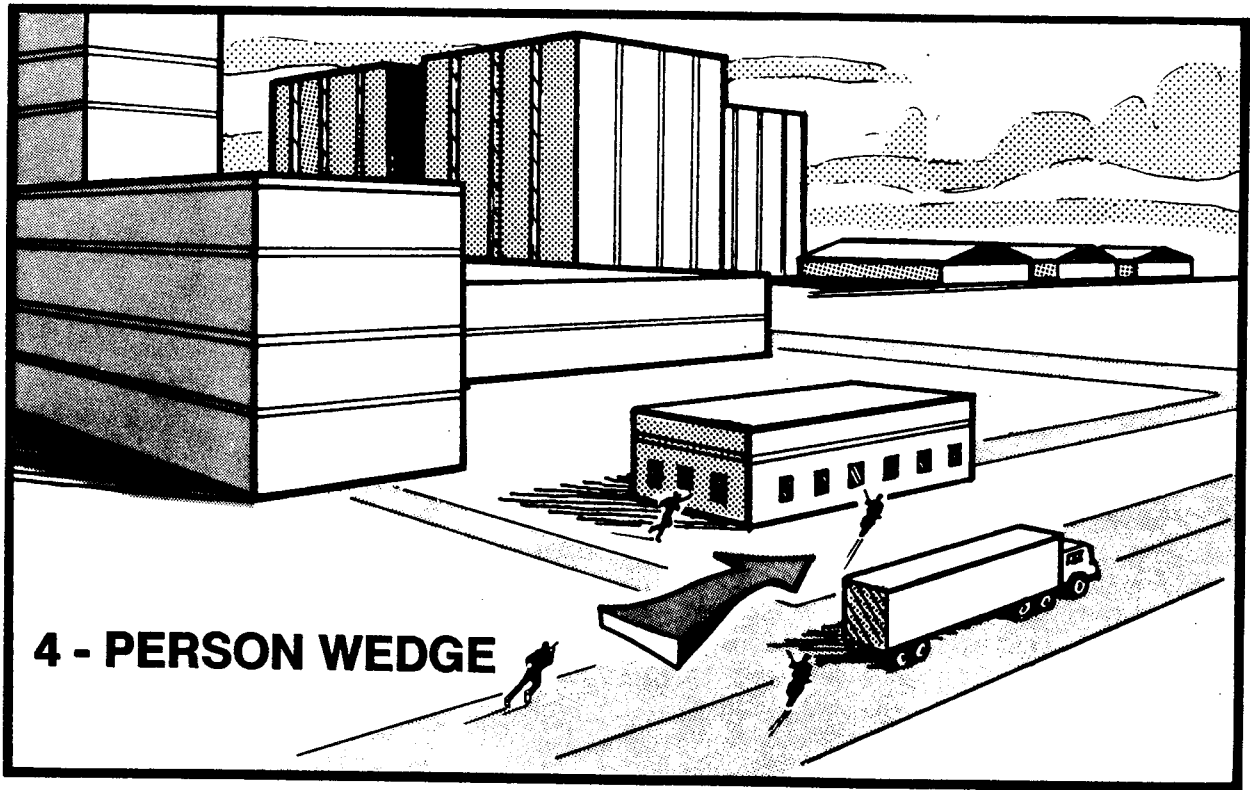

Illustration 8-6.

Section 5. TEAM MOVEMENT PRIOR TO CONTACT WITH THE ADVERSARY

Two techniques of team tactical movement that are used prior to adversary contact are particularly suitable for responding security forces. The techniques are

- **Traveling Overwatch**
- **Bounding Overwatch**

Both techniques make use of the **Principles of Team Tactical Movement**. The technique most appropriate for a particular situation is chosen based on the **Considerations of Team Tactical Movement**.

Traveling overwatch is used when contact is not likely or when speed is essential. This technique is less secure but is rapid and easy to control. **Bounding overwatch** is used when contact is likely or when speed is not essential. This technique is more secure but is slower and more difficult to control.

TECHNIQUES OF TEAM MOVEMENT (FIRE IS POSSIBLE)	
<p>TRAVELING OVERWATCH</p> <ul style="list-style-type: none"> • Contact not likely • Faster movement • Less secure • Easier to control 	<p>BOUNDING OVERWATCH</p> <ul style="list-style-type: none"> • Contact likely • Slower movement • More secure • More difficult to control

In **traveling overwatch**, the two teamed elements move at the same time along the same general route. They are separated enough from each other so that they cannot both be brought under fire from the same adversary location, but they are close enough to support each other by fire. Normally, the lead-team leader is also the overall responding response team leader. The **traveling overwatch** technique is rapid and easy to control, but because both elements are moving at once, the technique is more vulnerable.

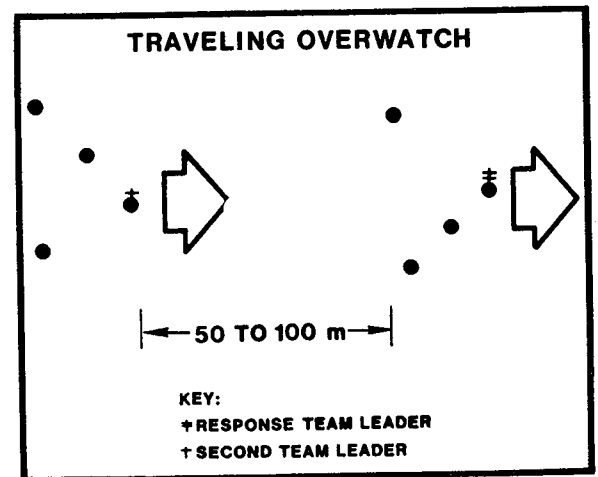

Illustration 8-7.

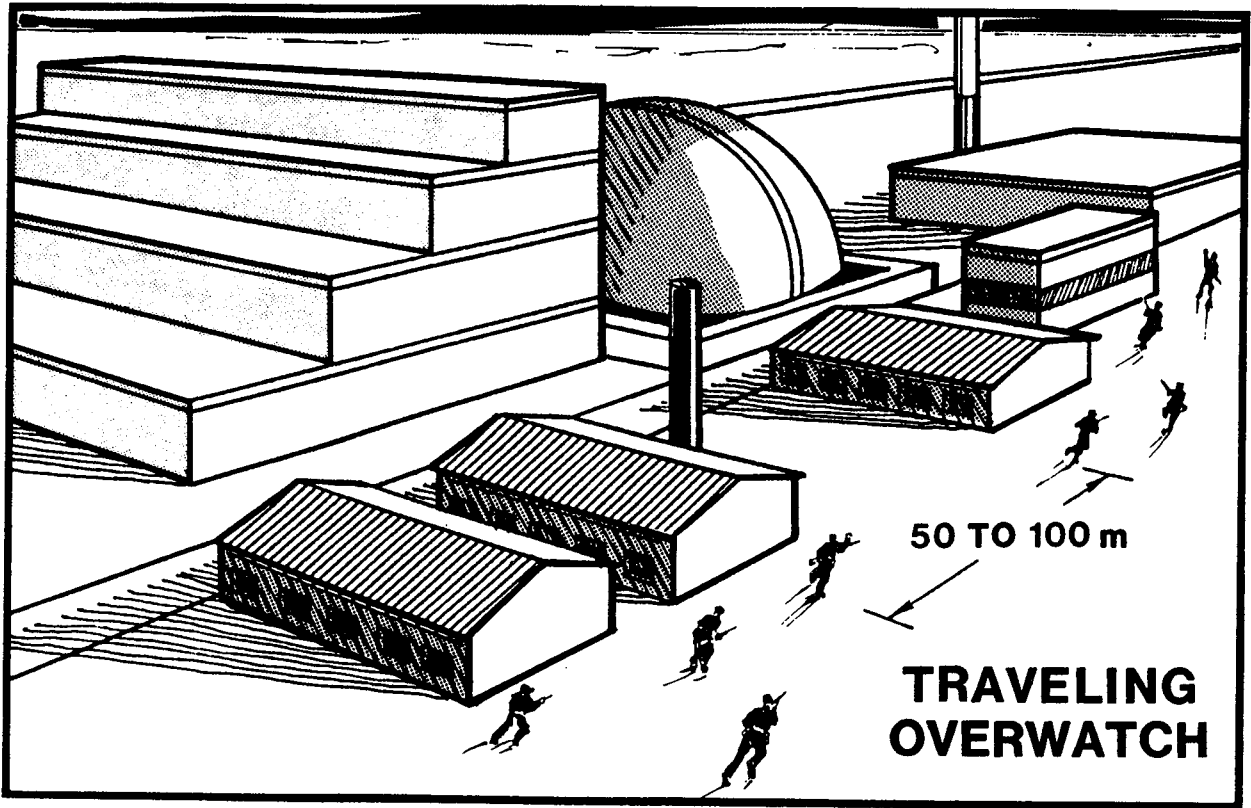

Illustration 8-8.

In **bounding overwatch**, only one element moves at a time, and usually each element moves over a slightly different route. While one element takes up a good, covered position and prepares to provide supporting fire, the other element bounds forward to the next covered position. Once the bounding element has reached the next covered position, it takes up overwatch while the other team bounds forward. The distance traveled on each bound will depend on the available cover and on the ability of the overwatch element to provide supporting fire.

Bounding overwatch is used when contact is likely and some speed must be given up for additional security. The technique provides for maximum protection because one element is always under cover and ready to fire on any adversary that engages the other element. Because only one element moves at a time, though, **bounding overwatch** is slower and more difficult to control.

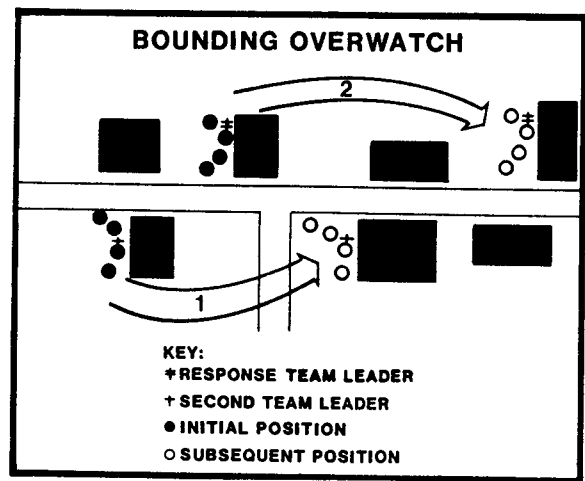

Illustration 8-9.

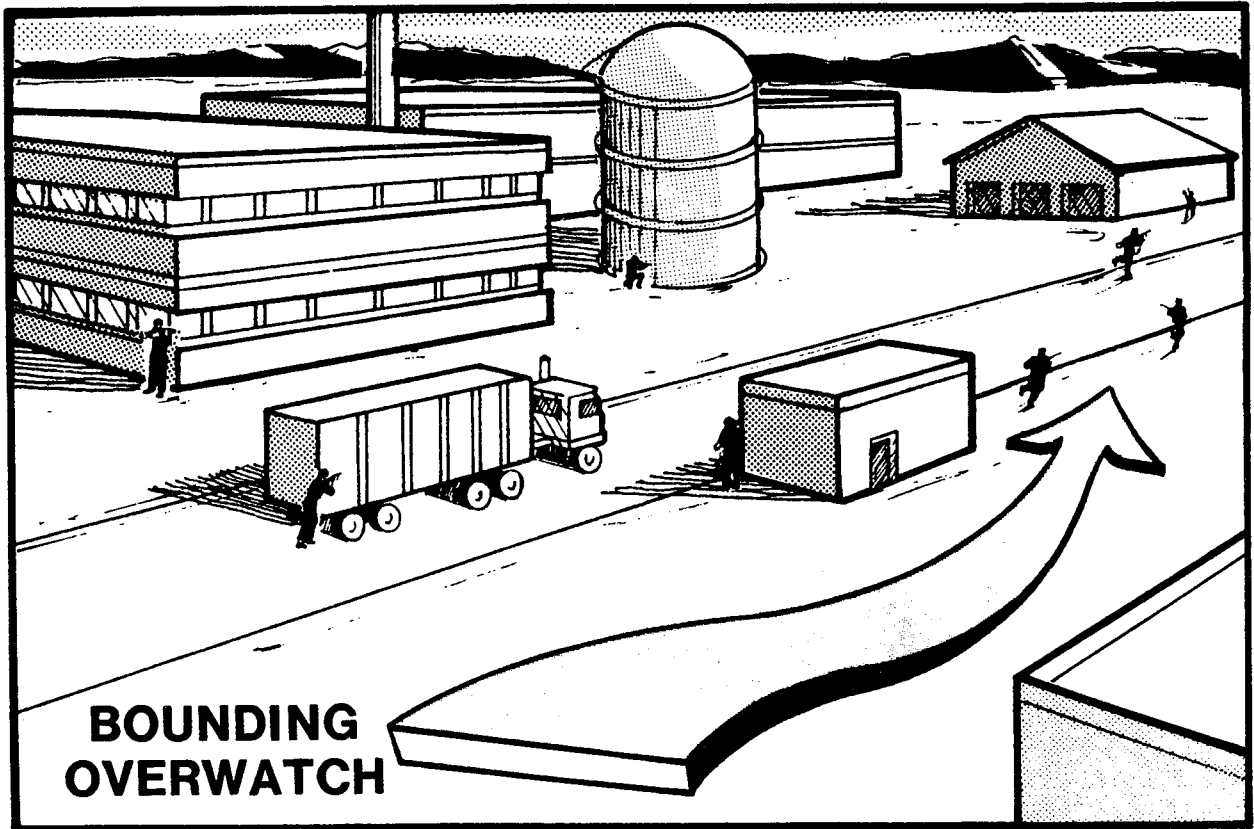

Illustration 8-10.

Bounding overwatch can be accomplished by either of two methods—"leapfrog" or "inchworm." In the "leapfrog" method, the bounding element passes the overwatch element. Then, the bounding element takes up a new overwatch position to the front and flank of the initial overwatch position. The second element then bounds past the first, and the process is repeated.

In the "inchworm" method, the lead element moves forward under the cover of the trail element, takes up new overwatch positions and provides cover as the trail element catches up.

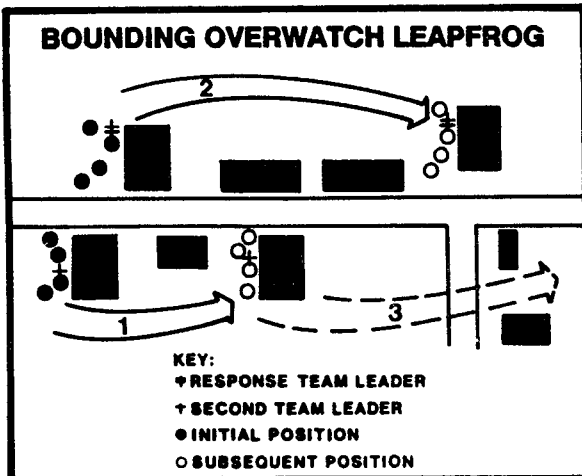

Illustration 8-11.

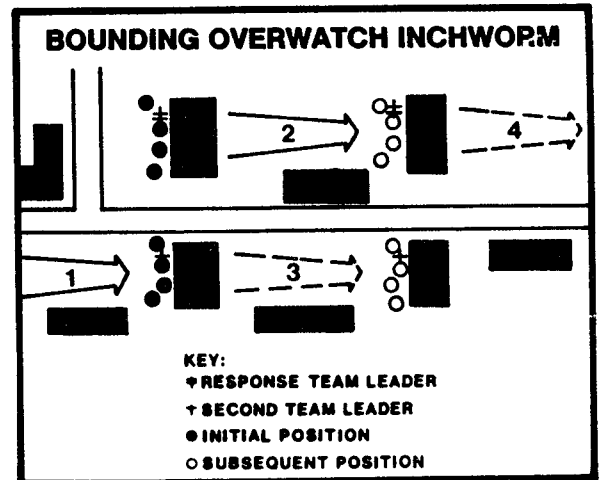

Illustration 8-12.

In summary, **traveling overwatch** and **bounding overwatch** were developed to provide protection for moving elements when contact with an adversary is possible. Both techniques employ **Principles of Team Tactical Movement** that apply to security forces. Either **traveling overwatch** or **bounding overwatch** should be used in all situations where a member of the responding security force might make contact with an adversary. The technique you use will depend upon the situation's

- Requirement for Control
- Requirement for Security
- Requirement for Speed

Section 6. TEAM MOVEMENT UNDER FIRE

After contact has been made with an adversary force and the responding security forces have been brought under fire, continued movement may be required to contain, dislodge or neutralize the hostile force. Three techniques of team tactical movement that are used when team elements are under fire are particularly suitable for responding security forces. The techniques are

- FIRE AND MANEUVER
- FIRE AND MOVEMENT
- ASSAULT FIRE

All three techniques make use of the **Principles of Team Tactical Movement**. The technique most appropriate for a particular situation is determined by the cover available to the responding security force and the distance to the adversary force.

Fire and maneuver is used upon initial contact, when the location from which fire is being received is relatively distant and there is adequate cover and concealment to provide security for a maneuvering element of the responding security force. **Fire and movement** is used when the responding security force is relatively close to the adversary and there no longer is adequate cover and concealment to provide security for the maneuvering element. **Assault fire** is used as a last resort, when the responding security force is extremely close to the adversary and there no longer is sufficient cover and concealment to allow the responding individuals to move.

TECHNIQUES OF TEAM MOVEMENT (UNDER FIRE)

Fire and Maneuver

- Distant from adversary (300 to 600 meters)
- Adequate cover and concealment

Fire and Movement

- Close to adversary (50 to 300 meters)
- Marginal cover and concealment

Assault Fire

- Extremely close to adversary (less than 50 meters)
- Little or no cover and concealment

FIRE AND MANEUVER

In **fire and maneuver**, the responding security force element that is in the most direct contact with the adversary force provides a base of covering fire while the other element breaks contact and attempts to maneuver into a better position, normally to the flank of or above the adversary position. The key to success in **fire and maneuver** is for the covering element to keep the adversary pinned down while the maneuvering element moves into a better position. **Fire and maneuver** can be used only if the adversary's fire can be neutralized by cover, concealment and supporting fire.

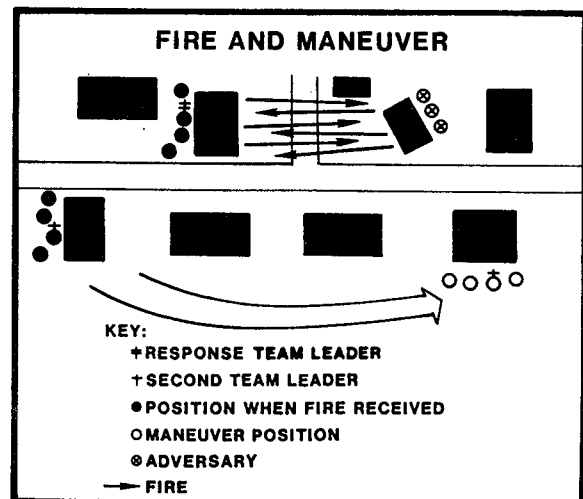

Illustration 8-13.

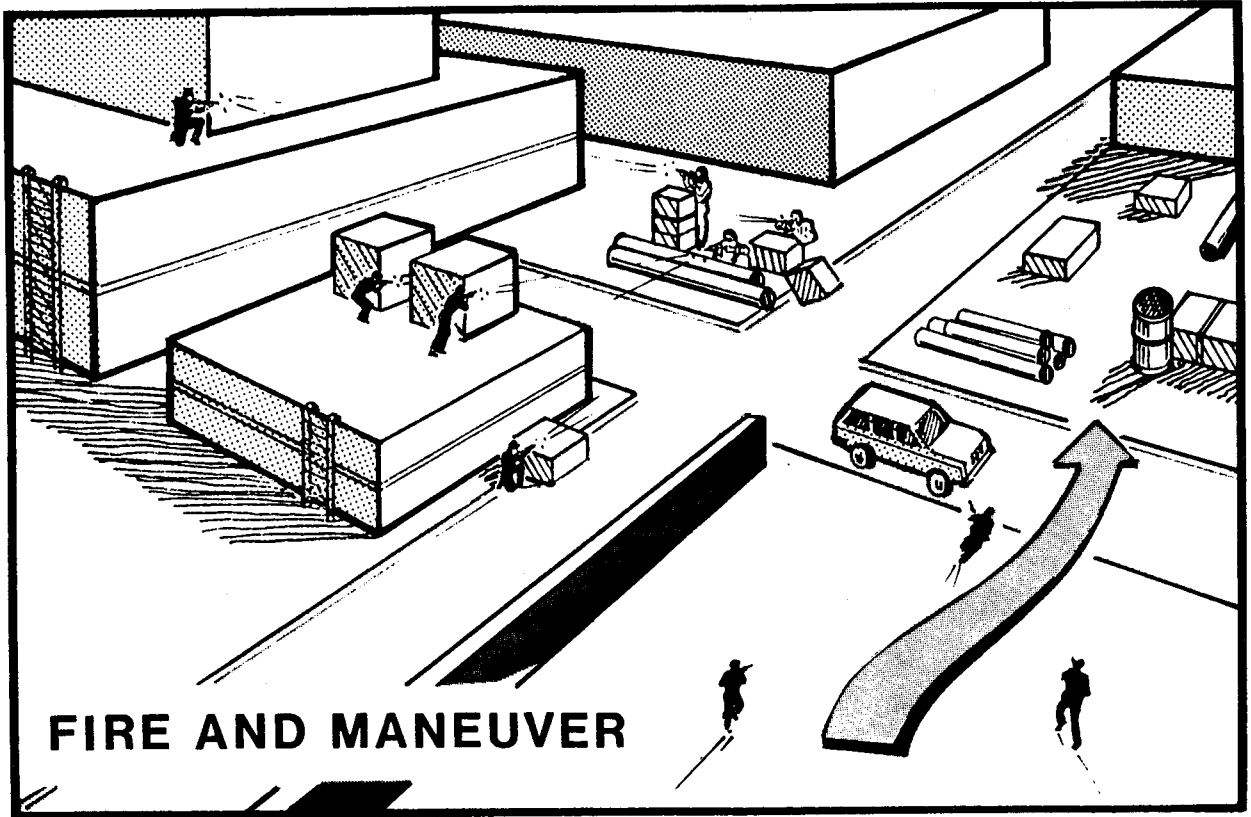

Illustration 8-14.

FIRE AND MOVEMENT

Once the adversary can fire effectively on the maneuvering element of the responding security force **fire and maneuver** no longer is possible. At that point, **fire and movement** must be used.

In **fire and movement**, only one member of the moving team moves, while the other members of the moving team add their fire to that of the supporting team. The individual's movement technique will vary depending on the available cover. The key to success in **fire and movement** is to maintain the heaviest volume of fire possible on the adversary to keep him from firing effectively on the one exposed and moving individual. Effective control of fire from both teams is essential in **fire and movement**.

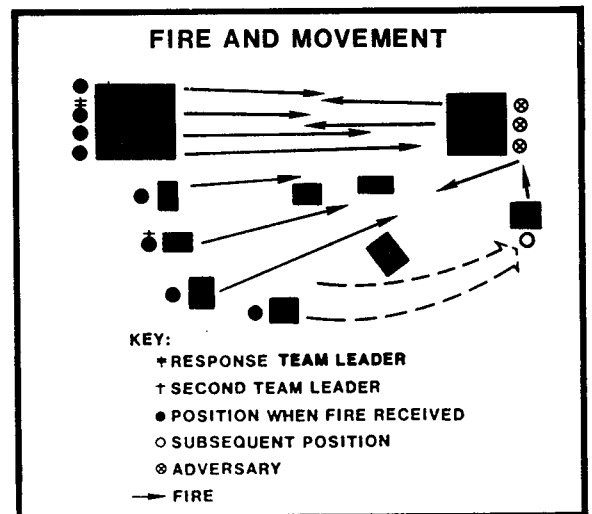

Illustration 8-15.

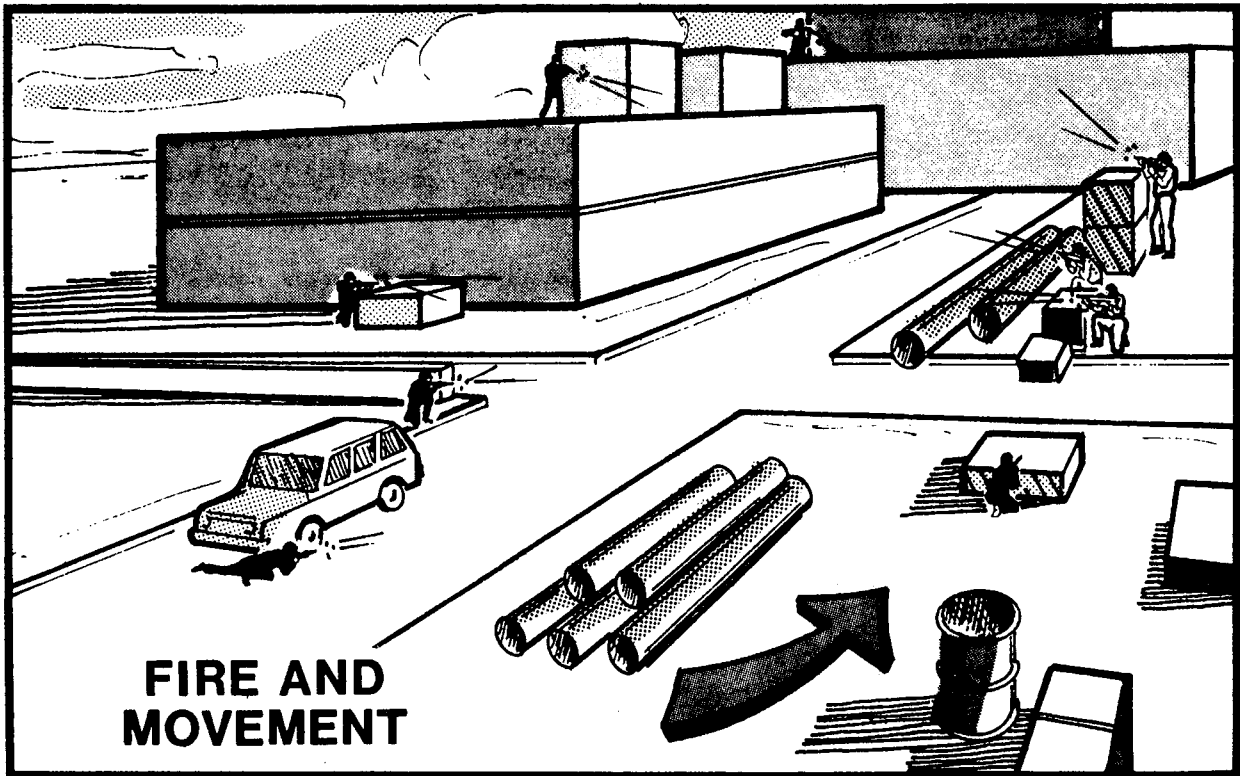

Illustration 8-16.

When the moving element of the responding security force has gotten so close to the adversary that it no longer is possible for an individual to move without encountering lethal fire, the hostile force should be neutralized by fire from the moving element's last covered position. If that is not possible and if the rapid neutralization of the adversary is absolutely essential, the moving element must resort to **assault fire**.

ASSAULT FIRE

Prior to the assault, the covering element maintains fire on the adversary position. As the assault begins, the volume of fire from the covering element increases and continues. On a signal from the leader of the assault element, members of the assault team spring to their feet and rapidly advance, firing as they move toward the adversary position. The fire from the covering team continues until the assault team is so close to the adversary that the assault element would be in danger from the fire that is covering it. Then, only the

advancing assault element continues firing. Because of the volume of fire from the covering element and from the assault team as it advances, the adversary can be prevented from returning fire until the assault team overruns the adversary position.

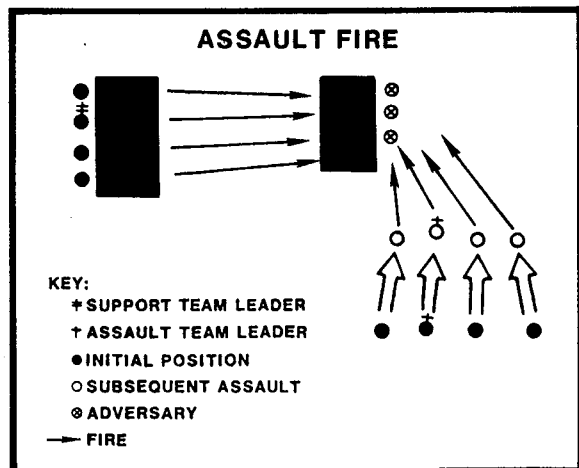

Illustration 8-17.

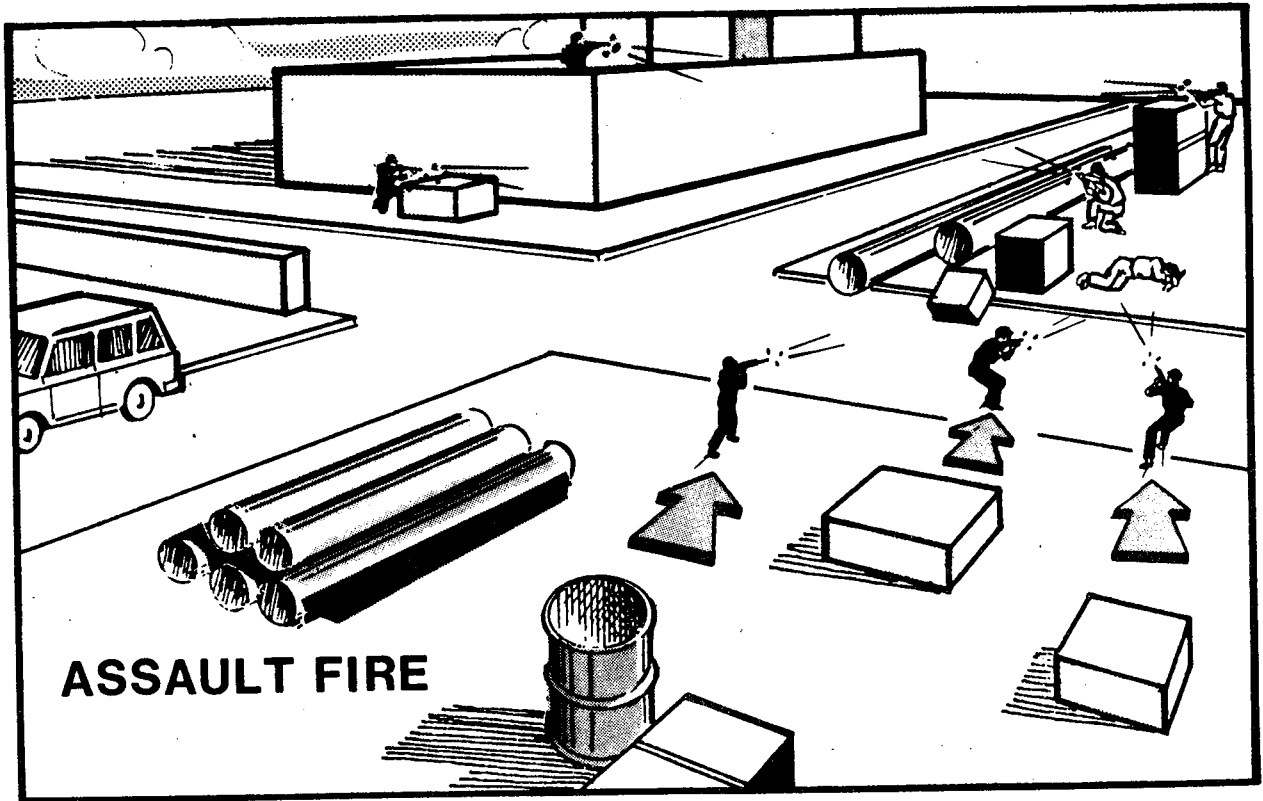

Illustration 8-18.

Assault fire is the last resort in moving on and neutralizing an adversary. Coordination among members of the assault team and between the leaders of the assault and cover teams is critical.

SECTION SUMMARY

Fire and maneuver, fire and movement and assault fire techniques were developed to provide protection for an assaulting force while inflicting maximum damage to an adversary. All three techniques employ **Principles of Team Tactical Movement** that apply to licensee security forces. The technique that will be employed will be determined by the

- Closeness to the adversary force
- Available cover and concealment

Section 7. TACTICAL WITHDRAWAL UNDER FIRE

Under some circumstances, a tactical response team may be forced to withdraw under fire. Such a withdrawal is not likely, but it could be necessary in order to strengthen outer containment, to achieve better defensive positions or to temporarily break contact with a superior adversary force.

The **Principles of Team Tactical Movement** that were covered in Section 3 and that apply to movement toward an adversary force apply equally to movement away from an adversary force. Again, the principles are

- **Never move alone**
- **Use covered and concealed routes**
- **Maintain separation**
- **Provide mutually supporting fire**

In a tactical withdrawal under fire, the procedures employed in **fire and maneuver** are reversed. The responding security force element in the most direct contact with the adversary force provides

a base of covering fire while the other element breaks contact and, using covered and concealed routes, attempts to withdraw from the scene of contact. Once contact has been broken, the withdrawing element selects an overwatch position from which it can provide covering fire on the adversary force. At that point, the initial covering team attempts to break contact and withdraw. If the closeness to the adversary force is such that effective fire is being received after the initial covering team withdraws, the process is repeated.

Section 8. IMMEDIATE-ACTION DRILL

Immediate-action drill is a term applied to the automatic and immediate flow from one form of tactical movement to another as a hostile-fire situation develops. In some circumstances, all of the previously discussed techniques might be employed. The following narrative provides such an example.

A two-element responding tactical response

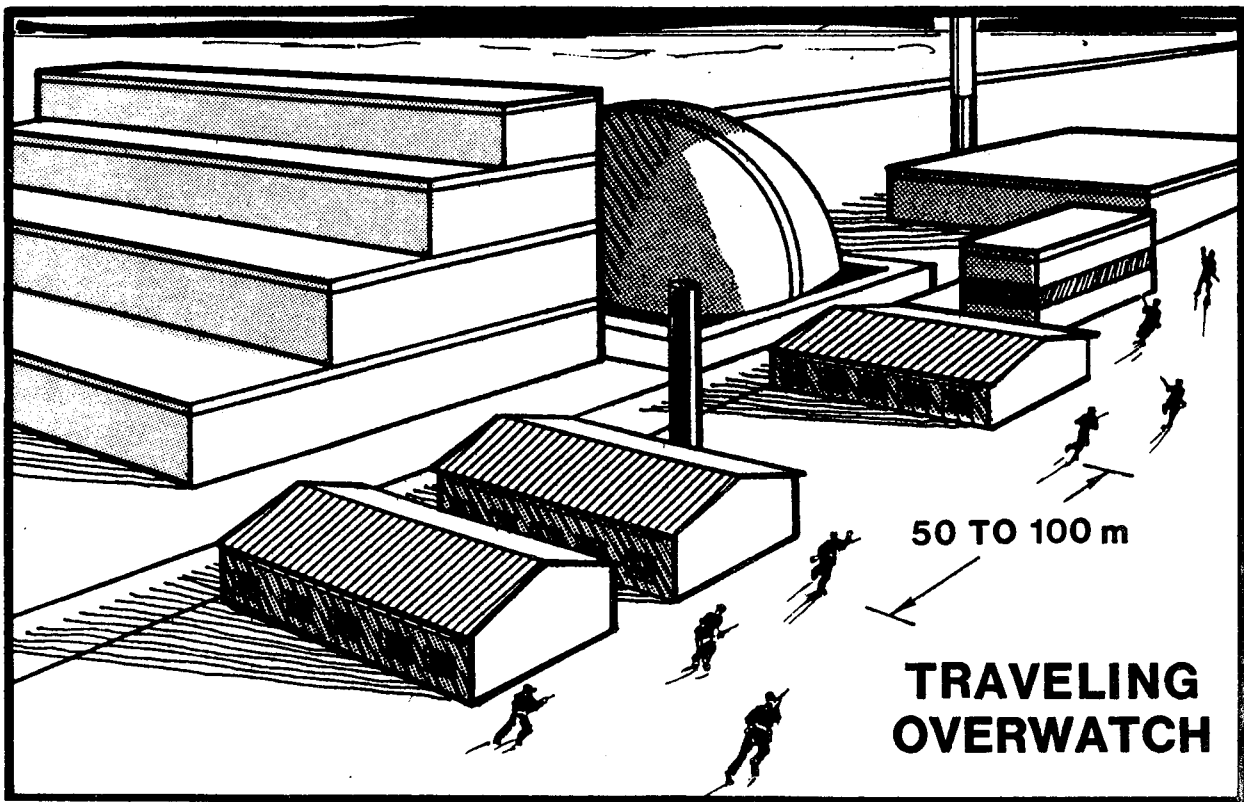

Illustration 8-19.

team moves toward a suspected adversary location. Because speed is essential and the suspected adversary location is still relatively distant, **traveling overwatch** is used.

As the responding tactical response team approaches the suspected adversary location, the team leader directs movement to proceed by **bounding overwatch**.

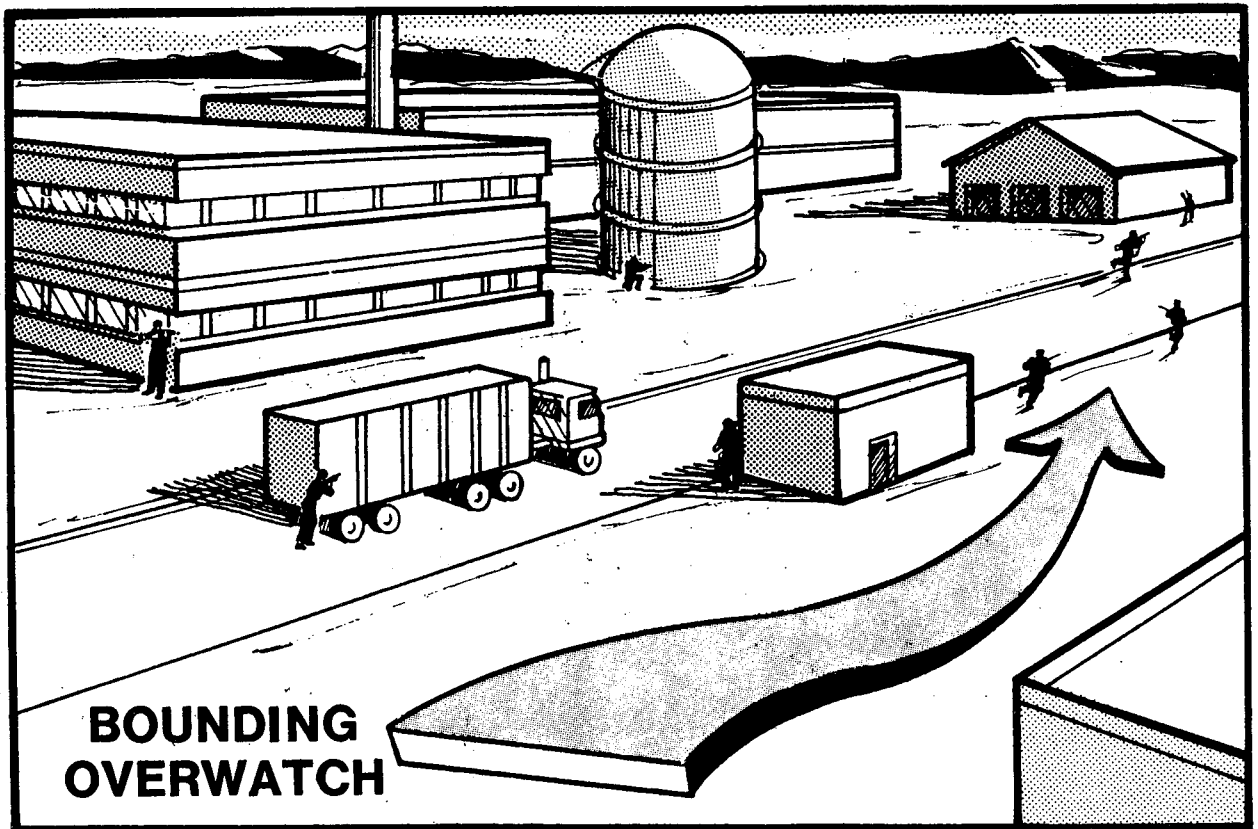

Illustration 8-20.

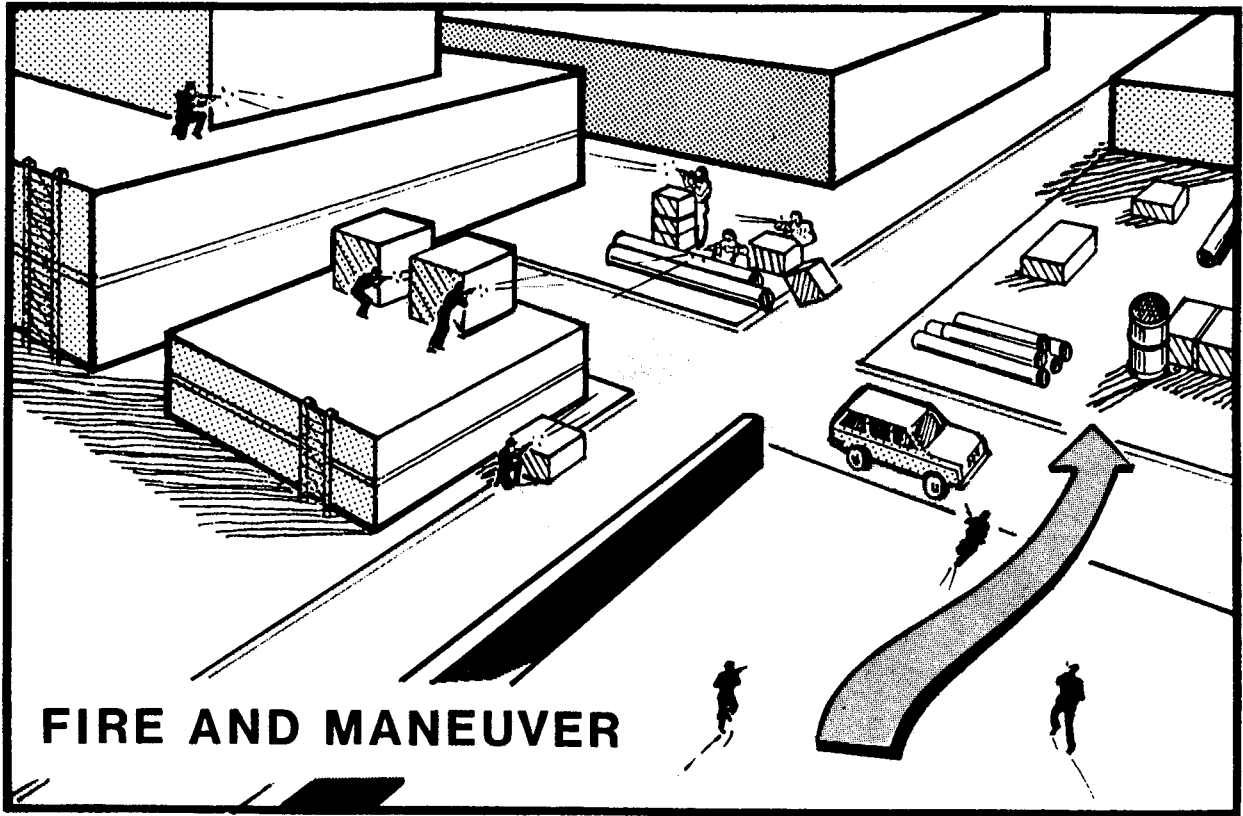

Illustration 8-21.

Suddenly, the lead element is taken under fire. Without waiting for a command, the tactical response team elements begin **fire and maneuver**.

As it approaches the adversary force, the maneuvering element is taken under fire. Automatically, it begins fire and movement.

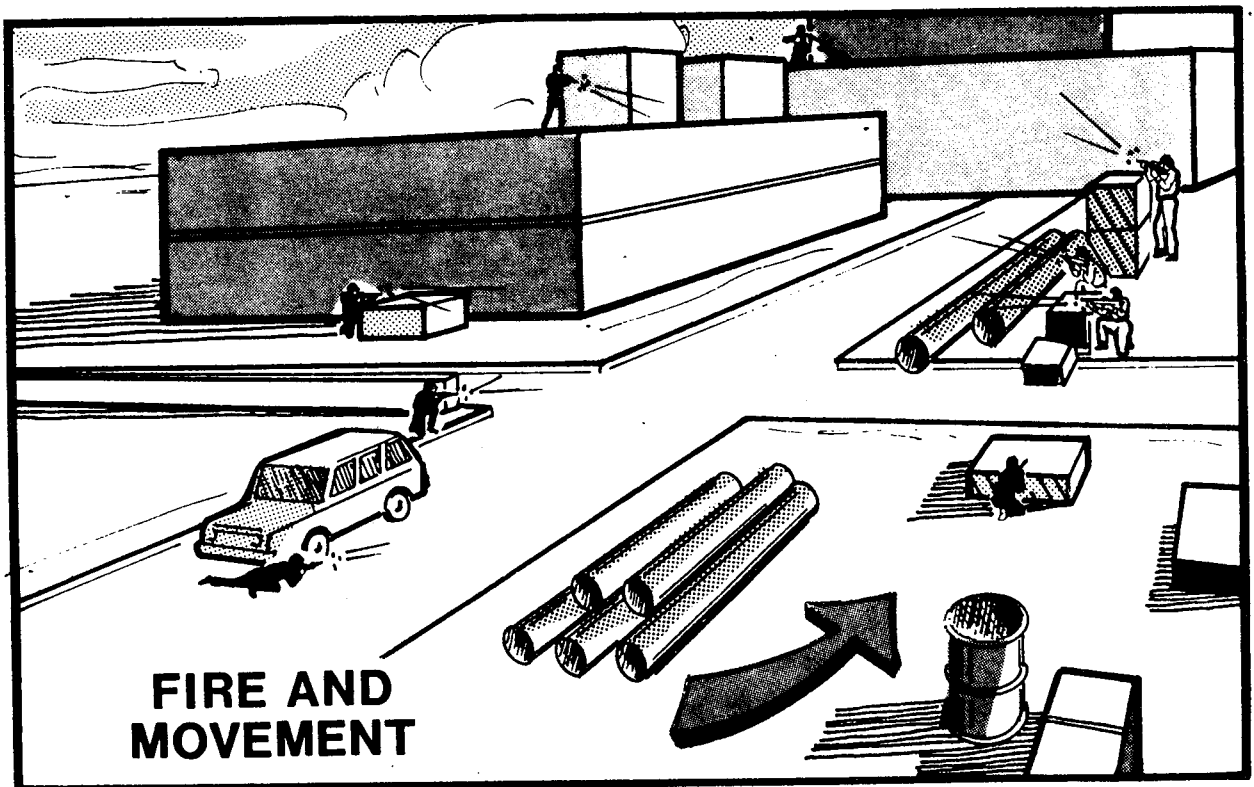

Illustration 8-22.

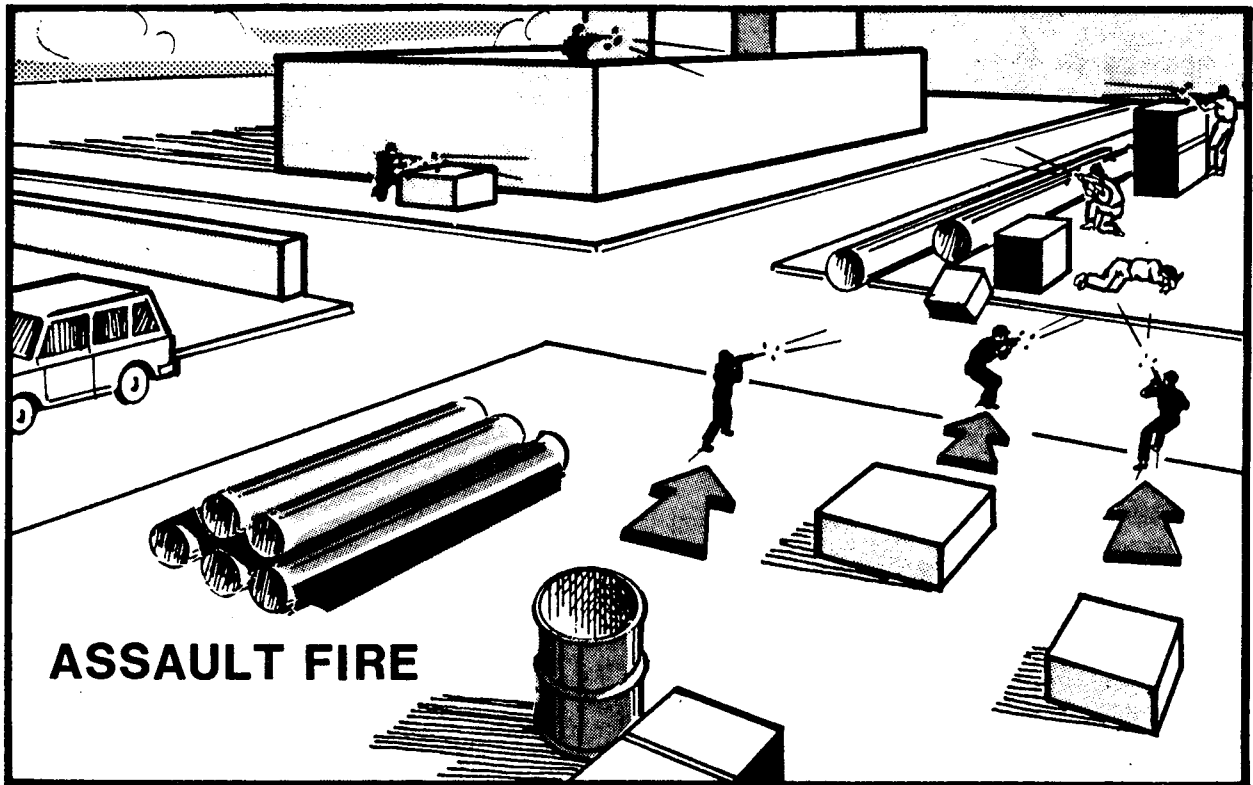

Illustration 8-23.

Once the moving element is as close as it can get to the adversary without being exposed to lethal fire, the responding team leader orders a final assault to neutralize the adversary force. The element in most direct contact conducts the assault while the covering element provides supporting fire.

Section 9. CHAPTER SUMMARY

This chapter has presented the considerations, principles and specific techniques of team tactical movement. The major **Considerations of Team Tactical Movement** covered were

- **Control**
- **Security**
- **Speed**

The basic **Principles of Team Tactical Movement** covered were

- **Never move alone**
- **Use covered and concealed routes**
- **Maintain separation**
- **Provide mutually supporting fire**

The use of the basic wedge formation was described and illustrated.

Tactical movement, based on these considerations and using these principles, was divided into two categories:

- **Movement Prior to Contact With the Adversary**
- **Movement Under Fire**

The techniques described for **movement prior to contact with the adversary** were

- **Traveling Overwatch**
- **Bounding Overwatch**

The techniques described for **movement under fire** were

- **Fire and Maneuver**
- **Fire and Movement**
- **Assault Fire**

A brief section was provided on **tactical withdrawal**. The section explained that the same considerations, principles and techniques that apply to movement toward an adversary also apply to movement away from an adversary.

This chapter's discussion of team tactical movement concluded with an explanation of **immediate-action drill**, the automatic progression from one technique of team tactical movement to another as a hostile-fire situation develops.

Chapter 9

TACTICAL DRIVING

Section 1. INTRODUCTION

NRC licensee security forces operate a variety of vehicles including sedans, vans, pickup trucks and light four-wheel-drive vehicles. These vehicles are not tanks or armored fighting vehicles and are not designed to protect you from weapons fire or to serve as platforms from which you can deliver accurate fire. Yet, since these vehicles are widely used for both patrol and response, they are likely to be employed during a tactical-crisis response. Therefore, you must understand the vulnerabilities of these vehicles, the actions to take if you are attacked while occupying a vehicle and the vehicle employment techniques to use to enhance your own survival and your chances of accomplishing your mission. This chapter will deal with the tactics you can employ when using an ordinary patrol vehicle during an armed encounter.

Section 2. ESCAPING A KILL ZONE

If you are in a vehicle and find yourself suddenly under fire, or in imminent danger of coming under fire, your first reaction must be to stay in the vehicle and **get out of the kill zone** as quickly as possible. The kill zone is the area in which the adversary can effectively deliver fire. Whether you have driven into a planned ambush or stumbled into a chance encounter with an adversary, you will be at a disadvantage and in great peril if you remain in your vehicle in the kill zone. Use the speed and mobility of your vehicle and the physi-

cal protection that it can provide to get safely out of the kill zone to a covered location where you can take appropriate action. There are several possible ways to get out of a kill zone. The best method to use in a particular situation will depend upon the terrain and the location of the adversary.

RIGHT OR LEFT TURN

If the adversary is in front of you, a quick and simple way for you to escape the kill zone is to accelerate and make a right or left turn that will place buildings or other cover between you and the adversary. This maneuver makes use of your forward momentum and allows you to focus your

attention to the front. Of course, this technique requires that a road, alley or other negotiable path that leads to cover be located to the left or right between you and the adversary. Illus. 9-1 depicts this technique.

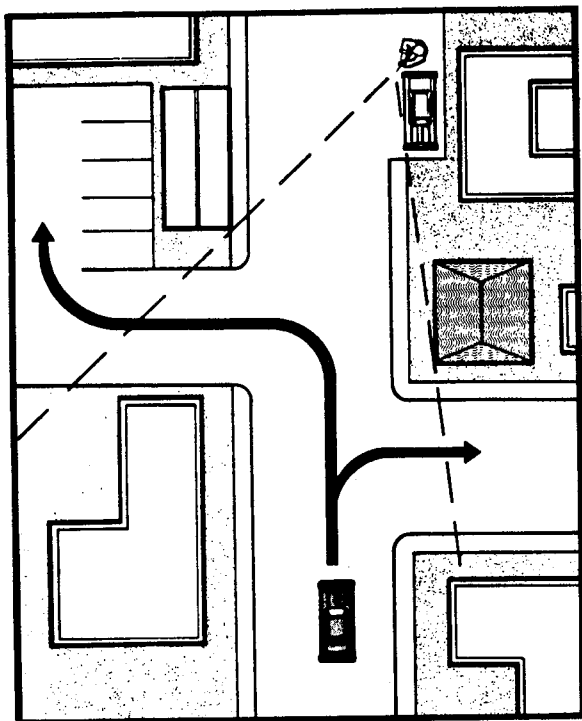

Illustration 9-1. Escaping the kill zone by making a right or left turn.

The driver of the vehicle in the illustration can turn either right or left to find cover. If a right turn is made, the vehicle will exit the kill zone more quickly, so this is probably the better move. The disadvantage of making the right turn is that this maneuver will briefly expose the driver's side of the vehicle to the adversary. If the driver makes the left turn, the vehicle will move somewhat closer to the adversary and will remain in the kill zone slightly longer, but the vehicle will be between the driver and the adversary.

In such a situation, as in any situation in which you use tactical-driving techniques, you can decrease your vulnerability by presenting the smallest target possible. Either slide down in the seat and look through the steering wheel or lie across the front seat and bob your head up to see where you are going. If you are carrying passengers, they should get on the floor and use the radio to report your location and situation and to request help.

REVERSING DIRECTION

If the adversary is in front of you and there are no escape routes to your right or left or there is no cover to the right or left, your best move may be to reverse direction and go back the way you came. There are various ways to accomplish this maneuver.

The simplest way for you to reverse direction is to stop, shift into reverse and **accelerate backward** as fast as possible. You then must turn and seek protection behind the first available cover. Illus. 9-2 depicts this technique, which is most useful if there is cover within a reasonable distance to your rear.

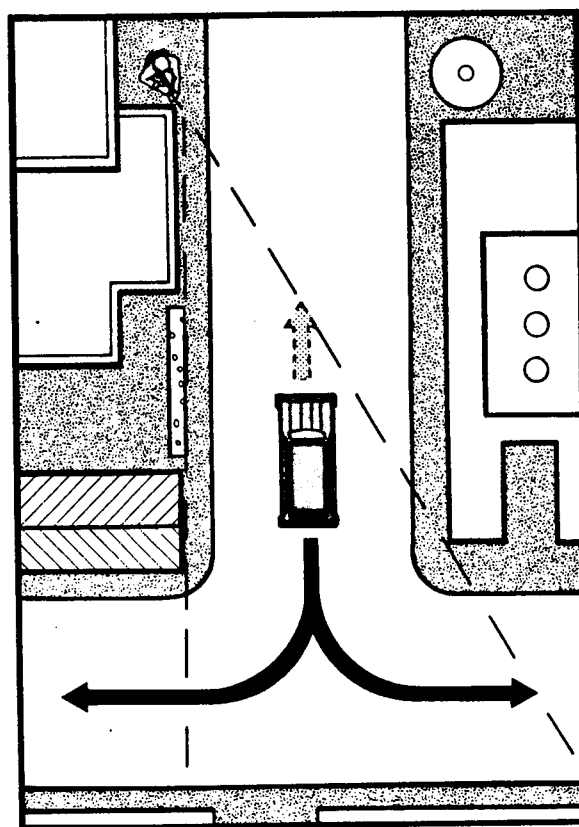

Illustration 9-2. Escaping the kill zone by reversing direction.

Another technique you can use for reversing direction is to initially back away from the source of danger, then quickly spin the vehicle around and drive forward to safety. This technique, called the **J-turn**, is shown in Illus. 9-3 and is executed as follows:

1. From a stop, shift into reverse, and quickly accelerate backward (see Illus. 9-3, Position A).
2. When the vehicle reaches a speed of about 25 miles per hour, turn the steering wheel quickly to the right (or left if you want the vehicle to spin to the right) (see Illus. 9-3, Position B). The combination of rearward acceleration and quick turning of the wheels will cause the vehicle to spin 180 degrees.
3. As the vehicle is spinning (see Illus. 9-3, Position C), shift into first gear or drive.
4. When the front of the car is pointed in the direction in which you want to go, accelerate quickly, and speed to cover or out of range of the adversary's weapons (see Illus. 9-3, Position D).

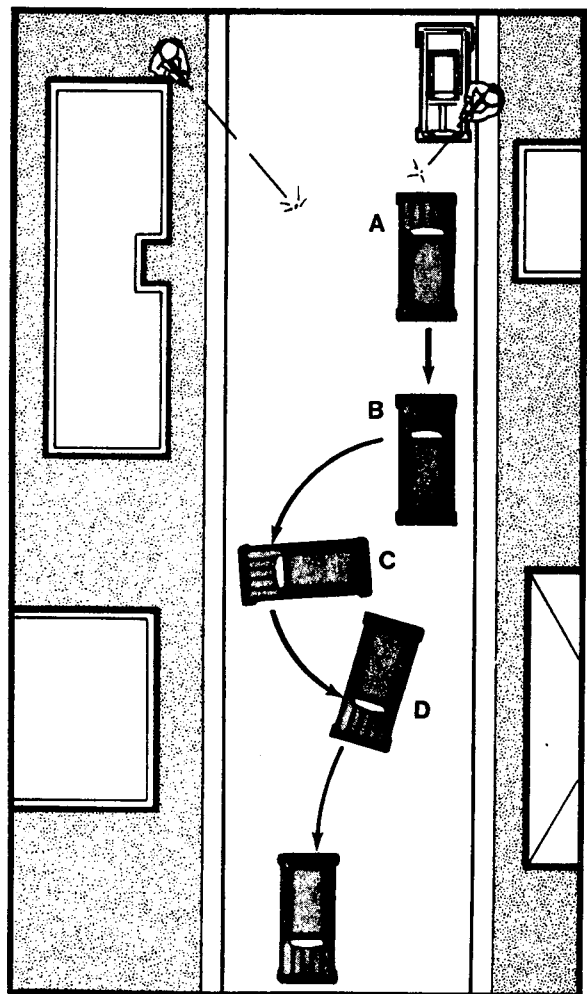

Illustration 9-3. Reversing direction by means of a J-turn.

A third technique allows you to reverse direction without stopping your vehicle and without backing away from the danger. This technique, the **bootlegger's turn**, is shown in Illus. 9-4 and is executed as follows:

1. Your vehicle will be equipped with either a step-on or pull-type emergency brake. If your vehicle has a step-on emergency brake, pull the emergency brake release, and hold it out (see Illus. 9-4, Position A). If your vehicle has a pull-type emergency brake, depending upon the design of the brake release mechanism, either depress the brake release button or twist the brake release handle and push the handle in.
2. Step hard on the emergency brake (if the brake is a pull type, pull it hard), **and** turn the steering wheel 90 degrees in the direction in which you want to turn. (See Illus. 9-4, Position B.) Combined, these actions will cause the front of the vehicle to spin in the direction in which you have turned the wheel.
3. When the front of the car is pointed in the direction in which you want to go (see Illus. 9-4, Position C), release the emergency brake, and accelerate to get to cover or out of range of the adversary's weapons.

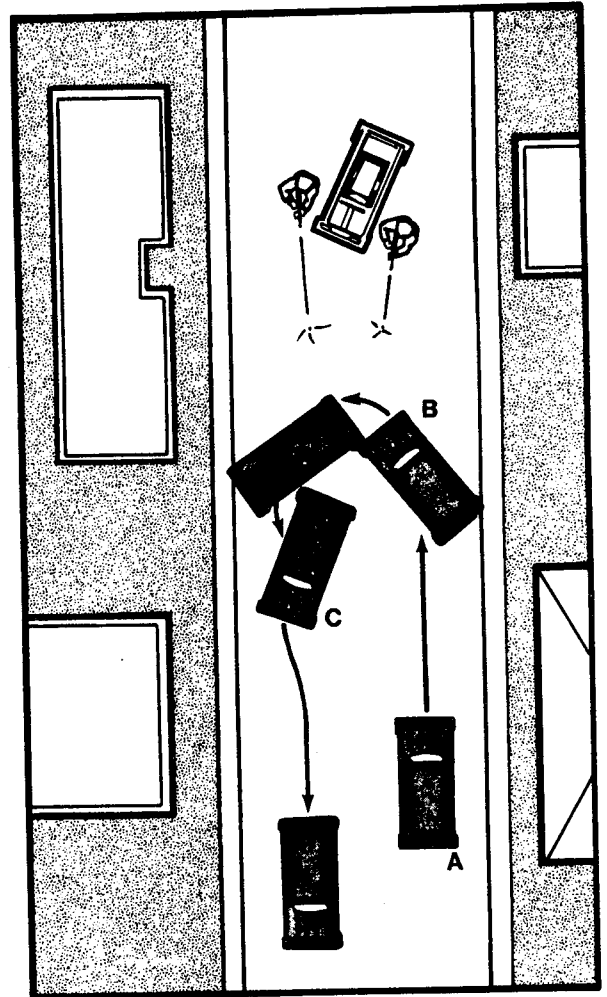

Illustration 9-4. Reversing direction by means of a bootlegger's turn.

By using this maneuver, you will keep the vehicle moving and you will turn the rear of the vehicle toward the adversary as quickly as possible. Because of the vehicle's movement and position, you will be less vulnerable, especially at close ranges, when you execute the bootlegger's turn than when you perform reversing maneuvers that require you to stop and back away from the adversary.

FORWARD SERPENTINE

If the adversary is located to your side or rear (see Illus. 9-5), your safest action may be to drive ahead, through the kill zone, away from the adversary. The safest way to accomplish this action is to

1. Accelerate rapidly, with the gas pedal to the floor.
2. Get down—present the smallest target possible.
3. Drive forward in a weaving, or serpentine pattern.
4. Turn behind the nearest cover.

Illus. 9-5 depicts the execution of this maneuver.

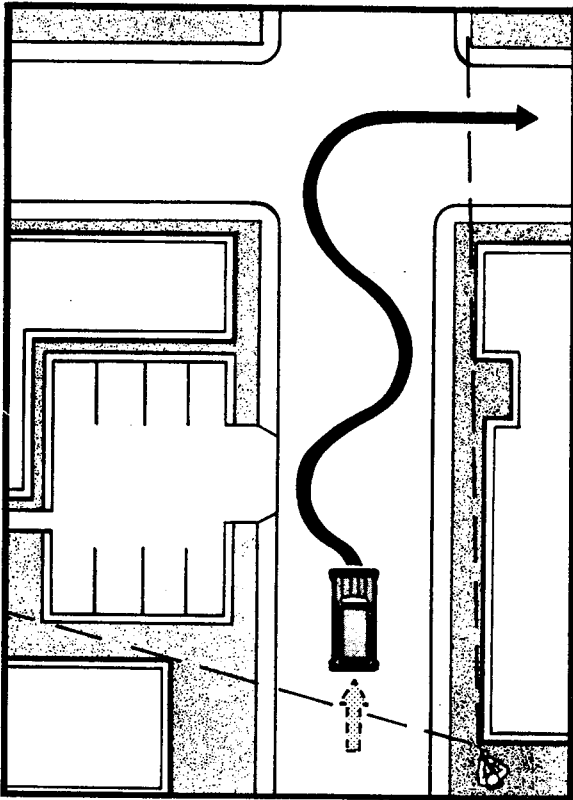

Illustration 9-5. The forward serpentine maneuver.

RAMMING

If the adversary has blocked the road in front of you with a vehicle and also has cut off any other safe means of escape, you may have to ram the blocking vehicle to move it out of your way. If you

use this technique, you will have to do so without causing disabling damage to your own vehicle. This maneuver involves more than just running into the blocking vehicle. For a ramming maneuver to be successful, it must be executed in the following manner:

1. Slow your vehicle down. This action will give the adversary the impression that you are stopping and may cause him to hold his fire.
2. Shift into low gear.
3. Aim your vehicle as described below.
 - a. Try to ram the blocking car at an angle, with your front fender hitting above a rear wheel of the blocking car, as in Illus. 9-6.
 - b. If the blocking car's rear wheels are against the curb or if there is not enough room to get past the rear of the car, as in Illus. 9-7, ram the front of the blocking vehicle. Ram the car at an angle, with your front fender hitting above one of its front wheels.
 - c. Always hit at an angle and over a wheel with your fender. Always hit at the end that allows the most room for you to drive by.
4. Accelerate into and through the blocking vehicle. Do not let up on the accelerator as the vehicles collide.
5. Once you have rammed, accelerate to safety. Do not stop your vehicle until you have reached safety.

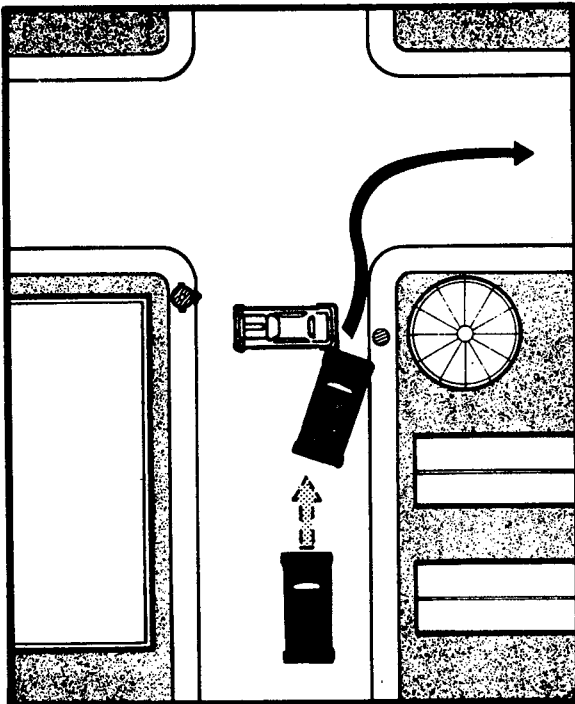

Illustration 9-6. Ramming the rear end of an adversary's vehicle.

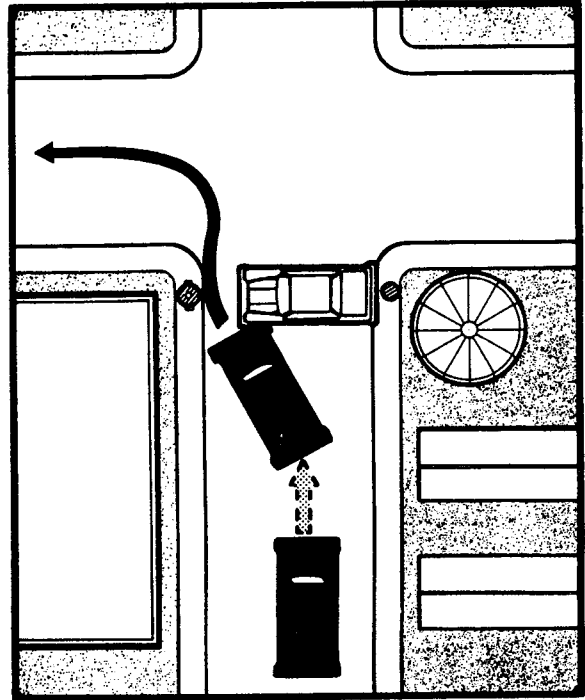

Illustration 9-7. Ramming the front end of an adversary's vehicle.

Section 3. STOPPING AND EXITING UNDER FIRE

It may not always be possible for you to drive out of the kill zone when you are taken under fire while in your vehicle. If you are unable to exit the kill zone, you must quickly get out of your vehicle and behind cover. It is possible that the nearest cover may be your vehicle itself, used from the outside. In order to move safely from inside your vehicle to the street and behind whatever cover is nearest, you must position your vehicle correctly as you stop, and then you must exit your vehicle properly.

POSITIONING

As you maneuver your vehicle into position to stop, stay as low as possible, have passengers get on the floor, and if possible, keep the engine block between yourself and the adversary. Stop your vehicle as close as you can to good cover.

If you have no passengers, stop the vehicle at an angle to the adversary, with the engine block between yourself and the adversary and your door on the protected side (see Illus. 9-8).

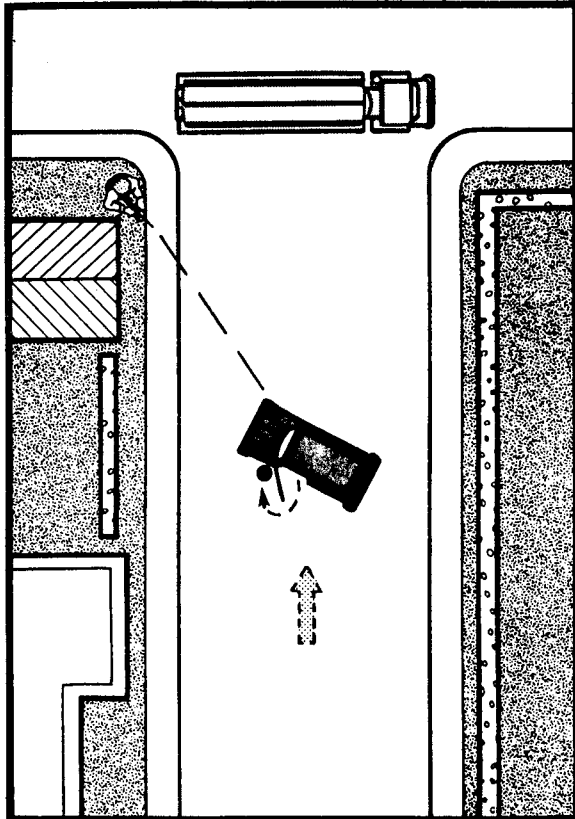

Illustration 9-8. Positioning a vehicle for exit under fire (the vehicle carries a driver only).

If you have a passenger in the vehicle, position the vehicle at an angle to the adversary with the engine block between the adversary and the passenger's seat and with the passenger's door on the protected side (see Illus. 9-9). **Both** you and the passenger will exit on the passenger's side, which normally has less obstructions than the driver's side.

EXITING

Before you stop the vehicle, you must choose the first location you will head for when you exit. Then, when you have properly positioned and stopped your vehicle, you must exit quickly.

If you are alone and exiting on the driver's side, unlatch and open the door with your left hand and knee. You already will be positioned as low as possible. Roll out of the vehicle, keeping low, and land on your hands and toes or hands and knees. Be sure to keep your head below the dashboard/

door window level as you leave the vehicle and hit the ground. Keeping low, move quickly to cover or to an initial position behind the front wheel and engine block of your vehicle (see Illus. 9-8). If you move to the front wheel, keep your head well below the top of the front fender.

If the passenger's side is used for the exit, the passenger exits using the technique just described, except that he uses his right hand and knee to open the door and rolls to his right. As the driver, you lie across the seat, keeping your head and body flat against the seat. Then, you slide yourself across the seat by pushing against the driver's door with your feet and by grabbing and pulling the edge of the seat or door sill on the passenger's side. Keeping your head down, hit the ground on your hands and knees. Each occupant exiting the vehicle must move immediately to cover or must take up an initial position protected by the front or rear wheels of the vehicle (see Illus. 9-9).

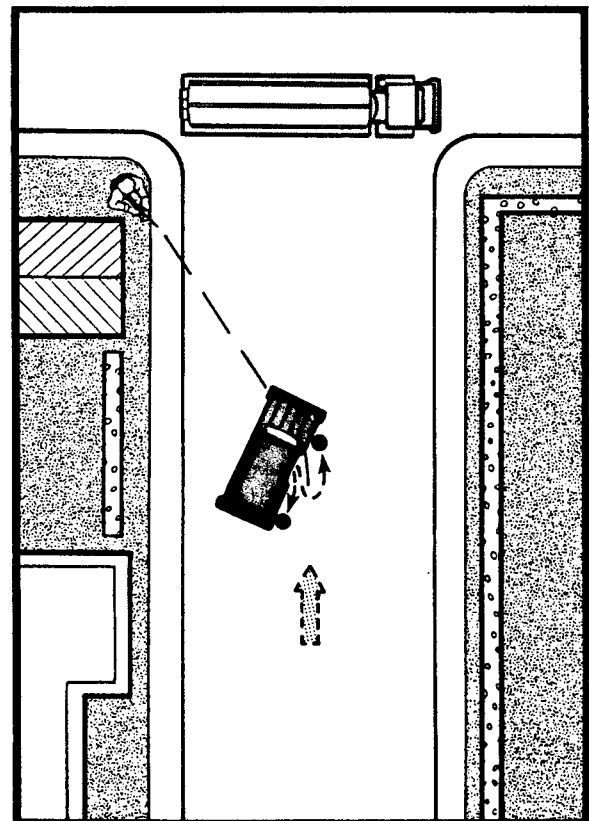

Illustration 9-9. Positioning a vehicle for exit under fire (the vehicle carries a passenger).

Section 4. USE OF THE VEHICLE AS COVER

If you must use your vehicle as cover, be aware that automobiles are not designed to provide protection against bullets. The sheet metal, plastic, glass and vinyl of modern vehicles will provide only minimal protection. Depending upon their caliber and range, the bullets from most handguns that will be used against you will penetrate the skin of any vehicle, including the door. High-powered-rifle fire will go in one door and out the opposite one. The glass is penetrated easily by a variety of calibers of bullets. However, certain portions of a vehicle will protect you better than others will. You must know which portions can be used fairly safely as cover.

DANGEROUS PRACTICES

The following practices, while commonly seen on television (and, unfortunately, often attempted in real life), do not provide you with adequate cover and should be avoided.

- Do not hide behind a vehicle *between* the wheels. Although such a position will conceal most of your body, your feet and legs will be visible *under* the vehicle and vulnerable to ricochet shots bounced off the pavement.
- Do not fire and observe over the hood, trunk or roof of a vehicle. This practice exposes too much of your body to fire.
- Do not take a position behind an open door. Your feet and legs will be exposed *under* the door, your head and shoulders will be exposed *above* the door if you rise to observe and shoot, and the bullets from many weapons, including handguns, will *penetrate* the door anyway. Your entire body will be vulnerable.

SAFE PRACTICES

The portions of a vehicle that provide fairly adequate cover from small-arms fire are the engine block and the wheels (see Illus. 9-10). When you must use a vehicle for cover, assume a position that takes advantage of these portions.

You will obtain the best cover by taking a position behind a front wheel. You may be able to conceal your entire body in this location. The wheel will conceal your feet and legs and provide protec-

tion against ricochet shots and fire delivered under the vehicle. The rest of your body will be behind the engine block, which is not likely to be penetrated by small-arms fire. From this position, you can observe and shoot around the front of the vehicle and around the sides of the wheel under the chassis. You will not be forced to shoot and observe over the hood.

The next best position is behind a rear wheel. The wheel will conceal your legs and protect them from ricochet fire, and the vehicle's rear body panels will provide concealment and some protection for the rest of your body. You will be able to observe and shoot around the wheel and around the rear of the vehicle rather than over the trunk and the body.

If you must take cover at the front of or behind the rear of a vehicle, take a position near a corner so that a wheel will provide some protection for your legs and feet. Observe and shoot around the corner and under the chassis, not over the top of the vehicle.

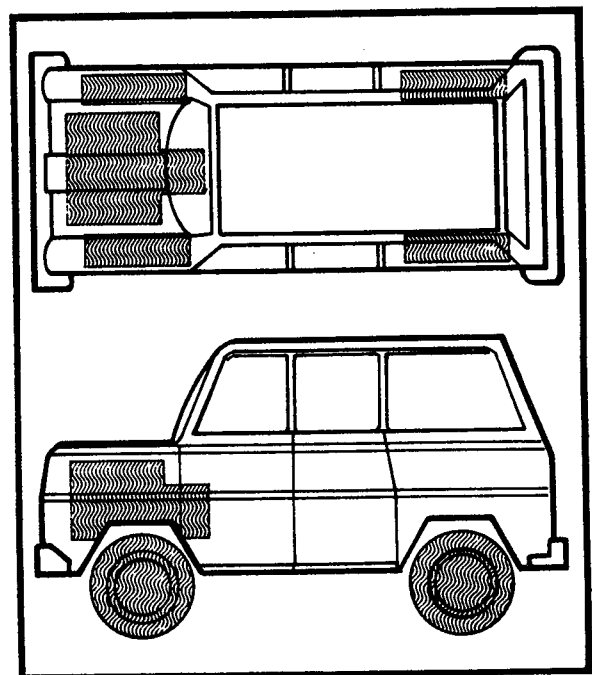

Illustration 9-10. The shaded portions of this vehicle provide fairly adequate cover from small-arms fire.

Section 5. NIGHT-DRIVING TECHNIQUES

Night is perhaps the most dangerous time for you to operate inside a vehicle in a tactical situation. You will have difficulty detecting the adversary at night from inside your vehicle, even at a dangerously close range. Your hearing will be restricted, and your ability to see usually will be limited to the area illuminated by your headlights or by street lights. You, on the other hand, will be detected easily because your vehicle will attract attention due to its size, noise and lights. Although you may have no realistic alternative to using your vehicle at night during a crisis situation, you can take positive steps to minimize the disadvantages of night vehicle use.

LIGHT DISCIPLINE

Vehicle lights may be the most visible objects at your facility at night. Every light on your vehicle can betray your location. In suitable terrain, headlights and taillights can be seen for miles. A sniper can use your headlights and taillights as reference points and aim a round right at you. When you brake, your brake lights, which are brighter than your taillights, will betray your position. Each time you shift into reverse and from drive through reverse into park, your backup lights will come on. Even though they may not be bright enough to allow you to back safely, they can be seen for a considerable distance. When you open a door, the dome light will illuminate everything in the vehicle, including you. Even parking lights and clearance lights are visible at a distance and can give away your location.

An important step that you can take at night to increase your safety is to turn out all vehicle lights well before you enter a danger area. You can control your headlights, taillights and parking lights with a switch. Brake, backup and dome lights work automatically, however. (The dome light may have a switch, **but** you must remember to turn it off **before** you open the door.) You can solve this problem by having a switch installed on the vehicle's dashboard that allows brake, backup and dome lights to be disabled. As another solution, if there is an interior fuse box in your vehicle, you can have a loop of string run behind the fuses that control these lights and in an emergency, you can pull the string, popping out the appropriate fuses. If you are prohibited from making these changes to your vehicle, be aware that every time you step on the

brake, shift into reverse or park or open your door, you may be announcing your location to an adversary in the area.

You do not even have to be in a vehicle for vehicle lights to be a danger to you. If vehicles are left standing with their lights on or if other vehicles are arriving at the scene with their lights on, you must avoid getting between the lights and the adversary or you will become a silhouetted target.

OFFENSIVE USE OF LIGHTS

At times, you can use vehicle headlights or spotlights to your own tactical advantage. If you can bring vehicles into position safely, you can use the bright headlights (and spotlights, if the vehicles are so equipped) to illuminate an adversary's position, blind him and destroy his night vision. When lights are used for these purposes, all members of the security force must stay well away from the vehicles and out of the illumination pattern.

BLACKOUT DRIVING

Responding without lights to an emergency at night presents some obvious safety hazards unrelated to the adversary threat. The degree of difficulty that you will experience when driving without lights will depend upon the level of natural and artificial illumination present, as well as the type of surface upon which you are driving. The following points can help you operate your vehicle safely in the dark:

- **Drive as slowly as you have to in order to remain on the road. Driving slowly also will reduce the tire and engine noise from your vehicle, which normally can be heard at a great distance.**
- **If you must drive a long distance, and particularly if you have to drive off-road, wear night-vision goggles if they are available.**
- **If the color of the road surface contrasts sharply with the roadside terrain, use the roadside line where the contrasting shades meet as a guide.**
- **If there are power lines running alongside and parallel to the road, look up and guide on the wires, which will be silhouetted against the sky.**
- **If there is a visible wall, fence line or line of trees alongside the road, use the line as a guide to keep on the road.**

- **Stop well before you reach your objective. Travel the last 100 meters or more, depending on the terrain, on foot.**

Section 6. ROUTE SELECTION

There often is more than one route connecting any two places at a facility. Before responding to the scene of a crisis you must choose a route that is not only direct but also relatively secure. The following principles can help you choose the best route:

- **Avoid the most obvious and the often-used routes. The adversary may have carried out**

surveillance in advance to determine the most likely route that security personnel will use.

- **Choose a route through terrain that offers the least opportunity for a concealed ambush.**
- **Consider an off-road route if your vehicle is capable of off-road travel.**
- **Choose a route that allows you to make a covered or concealed final approach.**
- **Choose a route that will take you not only close to the action but also to a position from which you can carry out your tactical plan.**

Section 7. CHAPTER SUMMARY

This chapter has explained various tactical-driving techniques that can be used by the drivers and passengers of patrol vehicles during tactical emergencies.

The following techniques for escaping a kill zone were discussed:

- **Right or left turn**
- **Reversing direction**
 - **Backing**
 - **J-turns**
 - **Bootlegger turns**
- **Forward serpentine**
- **Ramming**

Techniques for stopping a vehicle in a proper position when you are under fire and for exiting the vehicle safely were covered.

A section devoted to the **use of the vehicle as cover** described the general unsuitability of a vehicle as a means of cover, the dangerous practices that you must avoid when using a vehicle for cover and the positions you can take to make the best use of what cover a vehicle does provide.

The following aspects of **night driving** in a tactical situation were discussed:

- **Light discipline**
- **Offensive use of lights**
- **Blackout driving**

Principles that apply to **selecting a route** when you respond to a security contingency were covered.

Chapter 10

COUNTERAMBUSH TECHNIQUES

Section 1. INTRODUCTION

Any adversary involved in an armed act against an NRC licensee facility can be expected to employ security elements. That is, in addition to the presence of the main adversary assault force, there probably will be one or more adversary security elements present that will be used to protect the main force. The mission of these security elements is to delay, defeat or destroy responding security forces by means of **ambush**.

This chapter will describe various types of ambushes, ways to avoid them and techniques for dealing with them if they occur. Although ambushes may be directed against individual guards and security vehicles on routine patrol, they are a threat primarily to responding security forces. That threat to responding forces will be discussed in particular in this chapter.

Section 2. AMBUSH CHARACTERISTICS

An ambush is a surprise attack from a concealed position against a moving or temporarily halted target. Ambushes normally are planned in order to immobilize the target force in a kill zone. The following conditions will exist in a typical ambush:

For the Adversary	For the Response Force
Good cover and concealment	Poor cover and concealment
Good observation and fields of fire	Poor observation and fields of fire
Covered withdrawal routes	Poor opportunity for escape
High initial volume of fire	Little chance to return fire

Illus. 10-1 shows a typical layout for an "L"-shaped ambush which normally is employed at a bend in a road or at another type of terrain feature that takes the shape of an "L."

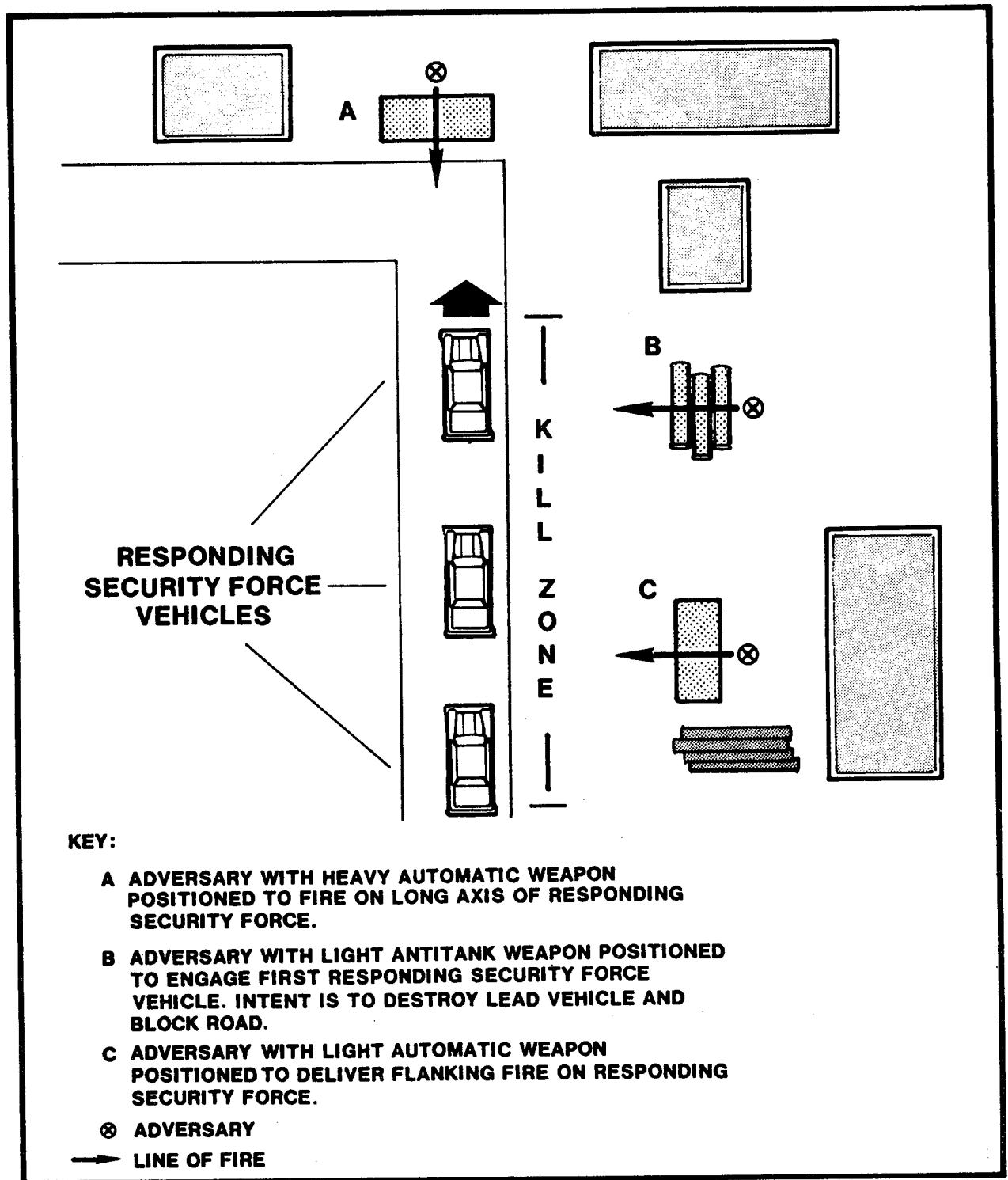

Illustration 10-1. An "L"-shaped ambush.

There are two general types of ambushes. These types are the **deliberate ambush** and the **ambush of opportunity**. The ambush of opportunity is sometimes referred to as a **hasty ambush**. A **deliberate** ambush normally is planned and set up well in advance of the operation in order to deal with an expected responding security force on a known response route. A **hasty** ambush normally is set up with little prior planning and at the first available site where an opportunity to engage responding security forces arises. These definitions are general, and it would be impossible to say exactly how much preparation must be made for an ambush in order for it to be called a deliberate ambush. You should remember that, normally, the more deliberate the ambush is, the more effective it will be against responding security forces.

These two general types of ambushes are categorized further as **near ambushes** and **far ambushes** (see Illus. 10-2). These categories also are somewhat general. Normally, a **near ambush** is considered to be one in which the adversary force fires on responding security forces at a range of 50 meters or less, and a **far ambush** is one in which the range between the adversary and the security force is from 50 meters out to the maximum effective range of the adversary's weapons. In most cases, the nearer the ambush is, the more effective it will be against responding security forces.

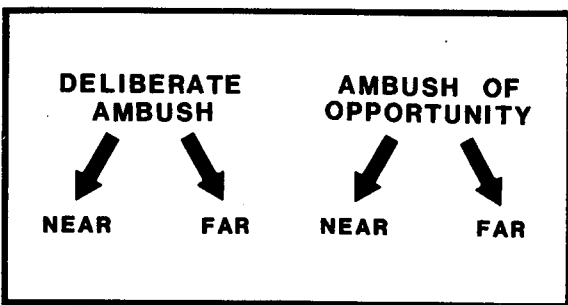

Illustration 10-2. The two general types of ambushes, the deliberate ambush and the ambush of opportunity, are categorized further as near ambushes and far ambushes.

During a near ambush, the adversary directs concentrated, close-range fire onto the kill zone. There is little time and space for security forces to maneuver and to seek cover. The longer you remain in the kill zone, the less chance you will have to survive. The kill zone is brought under heavy fire in a far ambush as well. However, due to the greater distance involved, the fire will not be as effective. Therefore, in a far ambush, you have a better chance of reaching cover safely and of returning fire.

Section 3. ANTICIPATING AND AVOIDING AMBUSHES

Ambushes are like illnesses—the best “treatment” is prevention. You can assume that if an adversary attack occurs at your facility, the responding security forces will be ambushed enroute to their response positions. In addition, you can assume that adversaries have a limited number of forces they can deploy in ambushes while still accomplishing their primary mission. Finally, you can assume that an adversary will prefer to conduct a **deliberate, near ambush** against responding security forces because of the superior effectiveness of this type of ambush. With these assumptions in mind, you can make the following generalizations:

- The fewer the response routes that lead to a target area, the more likely it is that all routes will be covered by ambushes.
- The more direct and obvious a response route is to a target area, the more likely it is that that route will be covered by an ambush.
- The better the cover and concealment are for an ambush force and the nearer the cover and concealment are to a kill zone, the more likely it is that the area having these characteristics will be selected for an ambush.
- The more that terrain causes responding security forces to bunch into a small area, the more likely it is that the area will be selected as a kill zone for an ambush.
- The less cover and concealment an area provides, the more likely it is that the area will be selected as a kill zone for an ambush.

The following rules for avoiding ambushes can be derived from the generalizations just presented:

1. Whenever possible, ensure that every area of potential attack at your facility can be reached by multiple response routes.
2. Avoid the most obvious routes to the target area both during exercises and during an actual alarm response.
3. Avoid routes through flat open areas that are surrounded by good cover and concealment.
4. Select routes that offer the best cover and concealment for responding security forces.
5. Never bunch responding elements so closely together that they can be caught in a single small kill zone.
6. Always maintain sufficient separation to permit the use of mutually supporting fire by separate elements of the responding security force.

In other words, know what an adversary looks for in a good ambush site, and avoid using response routes that pass through potential ambush sites. Make proper use of cover and concealment (described in Chapter 3) and individual and team tactical movement (described in Chapters 7 and 8, respectively) properly. In so doing, you will reduce your chances of being ambushed and increase your chances of surviving if you are ambushed.

Section 4. COUNTERAMBUSH TACTICS

In a well-planned ambush, contact with the adversary will be unexpected, violent, at close range and of very short duration. There will not be time to analyze the situation, make a plan or issue orders. The responding security force, or target, will be destroyed or neutralized within a matter of seconds unless the reactions of security force personnel are immediate and equal or superior in violence to the actions of the adversary force. Such immediate response can be learned only through the practice of **immediate-action drills**. These drills are approved sets of procedures for instantaneous reaction to an ambush situation.

Immediate-action drills must be developed to neutralize the adversary's advantages and to exploit

disadvantages. During the first seconds of the typical ambush that you are likely to encounter during a safeguards contingency, the **adversary** probably will have the following **advantages**:

- **Surprise**
- **Initial fire superiority**
- **Superior cover and concealment**
- **Superior fields of fire**

The **responding security force** probably will have the following **advantages**:

- **Superior numbers**
- **Superior overall fire power**
- **Superior mobility**

You can never completely eliminate the adversary's advantage of surprise. However, by anticipating the ambush and by conducting rigorous, realistic training in immediate-action drills, you can reduce the effect of surprise.

Immediate-action drills must be developed so that they take full advantage of the probable superiority that responding security forces will have in terms of numbers of personnel, overall firepower and mobility. The specific types of immediate-action drills that are described below use these security force advantages to reduce or eliminate the effects of the initial adversary advantages. The specific immediate-action drill used to counter a particular ambush is determined by the type of that ambush as defined in Section 2 of this chapter.

IMMEDIATE-ACTION DRILL FOR A NEAR AMBUSH

During a near ambush, the adversary will direct heavy, concentrated, close-range fire on the kill zone. As explained previously, there will be little time and space in which security forces can maneuver and seek cover. The longer you remain in the kill zone, the less likely it will be that you will survive. Therefore, the following immediate-action drill must be used if you are attacked in a near ambush (see Illus. 10-3):

- **Personnel in the kill zone must immediately return fire and assault the adversary positions without order or signal.**
- **Personnel who are not in the kill zone must**

immediately return fire and maneuver to attack the adversary positions from more advantageous terrain.

- Both elements must continue the attack until the adversary is neutralized.

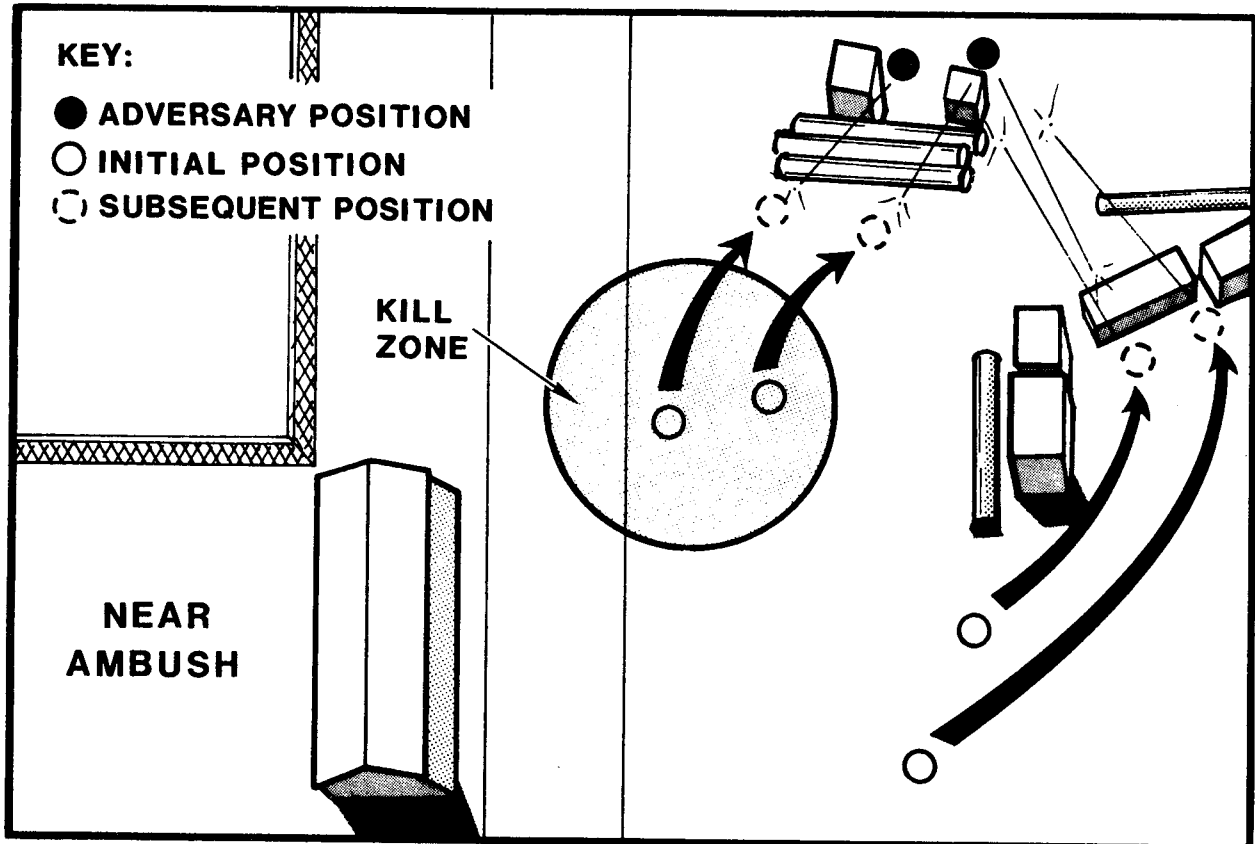

Illustration 10-3. Immediate-action drill for a near ambush.

**IMMEDIATE-ACTION DRILL
FOR A FAR AMBUSH**

During a far ambush, the kill zone will be brought under heavy, concentrated fire but from a greater range than in a near ambush. The greater range will make the adversary's fire less effective. Therefore, security forces will have more space in which to maneuver and some opportunity to seek cover. The following immediate-action drill must be implemented if you are attacked in a far ambush (see Illus. 10-4):

- Personnel in the kill zone must immediately return fire, seek the best cover available and maintain a base of fire without order or signal. If smoke is available, personnel must use it to provide concealment.
- Personnel who are not in the kill zone must immediately return fire and begin maneuvering to attack the adversary positions from more advantageous terrain.
- Both elements must continue the attack until the adversary is neutralized.

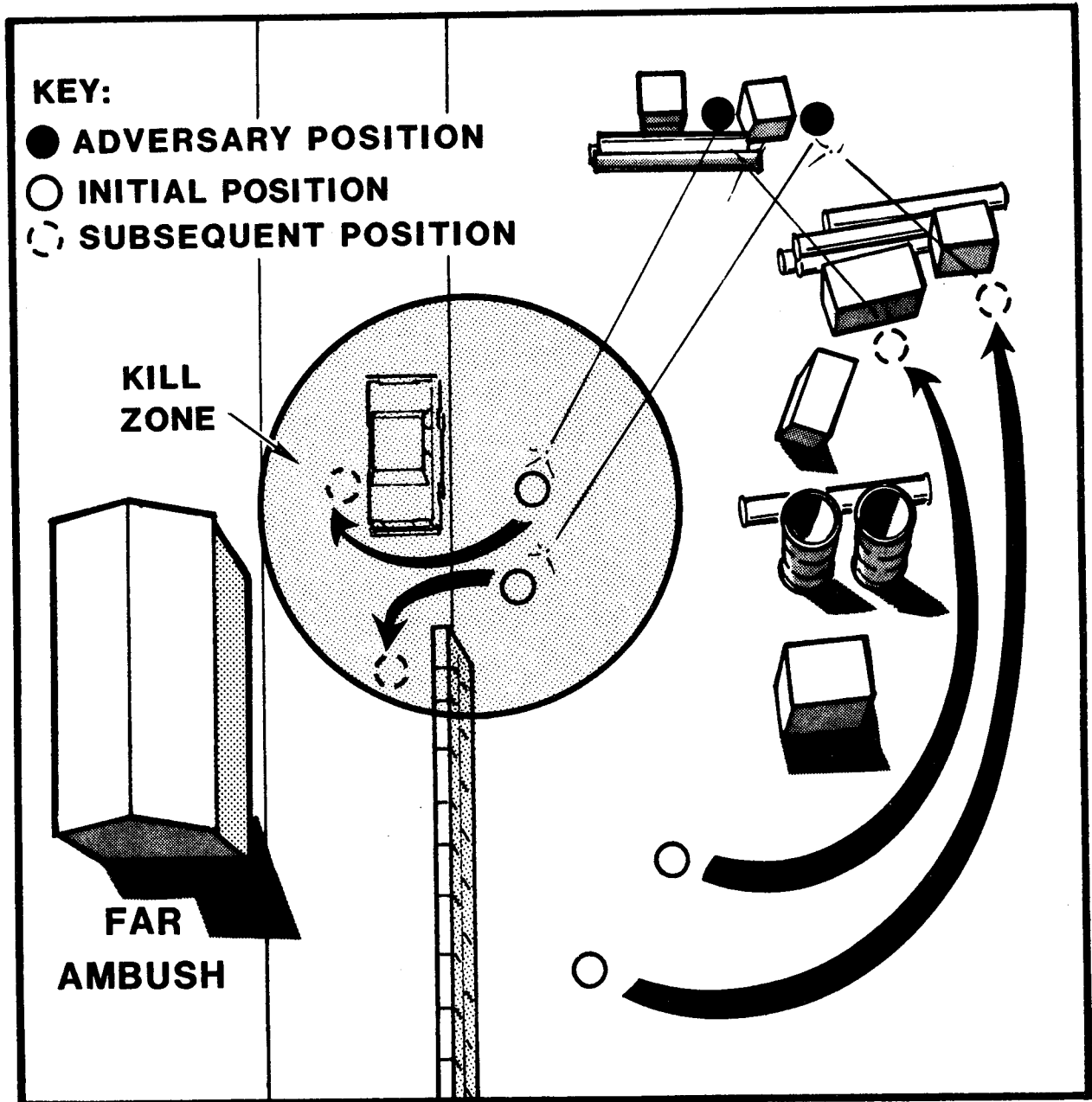

Illustration 10-4. Immediate-action drill for a far ambush.

IMMEDIATE-ACTION DRILLS FOR MOUNTED PERSONNEL

If you are in a vehicle when you are ambushed, avoid stopping in the kill zone if possible. If the route of travel is not blocked, attempt to keep moving, increase your speed, and get out of the kill zone. Even if one vehicle gets through the kill zone safely, no more vehicles should enter the kill zone. If you are forced to stop within the kill zone, dismount immediately on the side opposite the ambush position. If possible, use the vehicle for cover, and return fire. (See Chapter 9, "Tactical Driving.")

Mounted personnel who are not in the kill zone must maneuver the vehicles and/or dismount to attack the ambush position by using fire and maneuver, fire and movement or assault fire techniques (see Chapter 8, "Team Tactical Movement").

Section 5. CHAPTER SUMMARY

In this chapter, the purpose and likely characteristics of the following types of potential adversary ambushes were described:

- **Deliberate ambushes**
- **Ambushes of opportunity**

Each of these types was broken down further into

- **Near ambushes**
- **Far ambushes**

Means of anticipating and avoiding ambushes, based on their likely characteristics, were discussed.

The necessity for developing immediate-action drills that can defeat adversary ambushes was explained. Typical immediate-action drills to be used both by mounted and dismounted forces encountering ambushes were discussed.

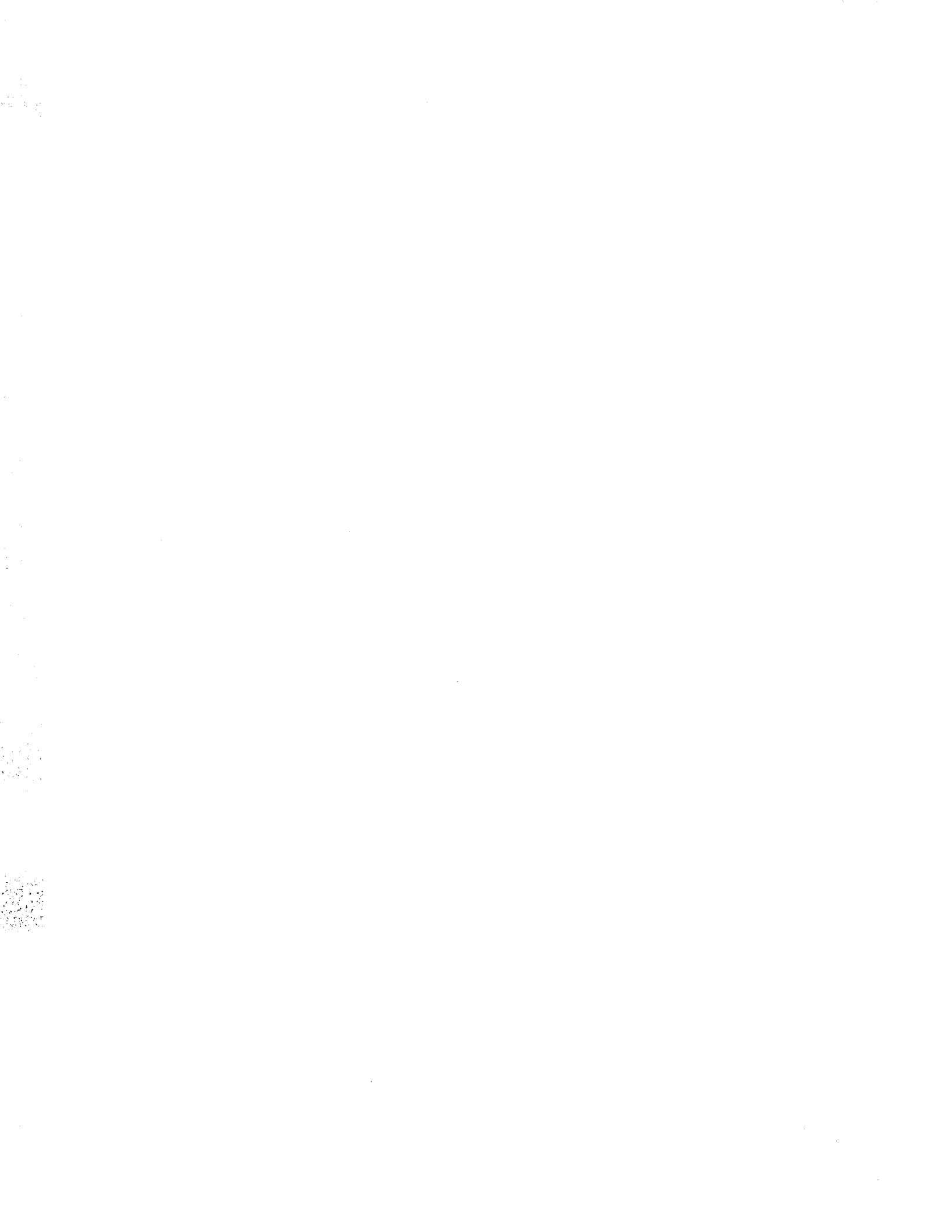

Chapter 11

TACTICAL COMMUNICATIONS

Section 1. INTRODUCTION

Clear, secure and accurate communication is important to the security force at all times and critical in a crisis situation. Control and coordination of tactical operations must be achieved by the most rapid means available so that TRT personnel can function as an effective team. There are many means of communicating during a tactical crisis. You can use radios, telephones, arm and hand signals, pyrotechnics, light and other visual signals, loudspeakers, messengers and sounds. In this chapter, the tactical capabilities, limitations and employment of each communication means will be covered. A special section on the use of duress signals is included.

Section 2. TACTICAL USE OF RADIOS

CAPABILITIES AND LIMITATIONS OF TACTICAL RADIOS

Radios are generally the primary means of communication employed in both routine and tactical security operations.

Tactical radios have many capabilities:

- Radios are mobile. They can be used in

vehicles and by dismounted security personnel.

- Radio communications are less limited by obstacles than are certain other forms of communication.
- Radio communications are instantaneous.
- An unlimited number of personnel can receive radio transmissions at the same time in a variety of locations.
- A large variety of radio equipment, including secure equipment, is available to suit different situations.
- Radio transmissions can span great distances, and radios can be operated remotely.
- Radios can be installed quickly.

Tactical radios also have limitations:

- Radio transmissions can easily be intercepted and exploited by adversaries.
- Tactical radios break down, and skill is needed for their repair.
- Radio transmissions can be blocked by interference from the atmosphere, the terrain and manmade sources (see Illus. 11-1).
- For radios to operate together, common frequencies, common range and compatible equipment are required.

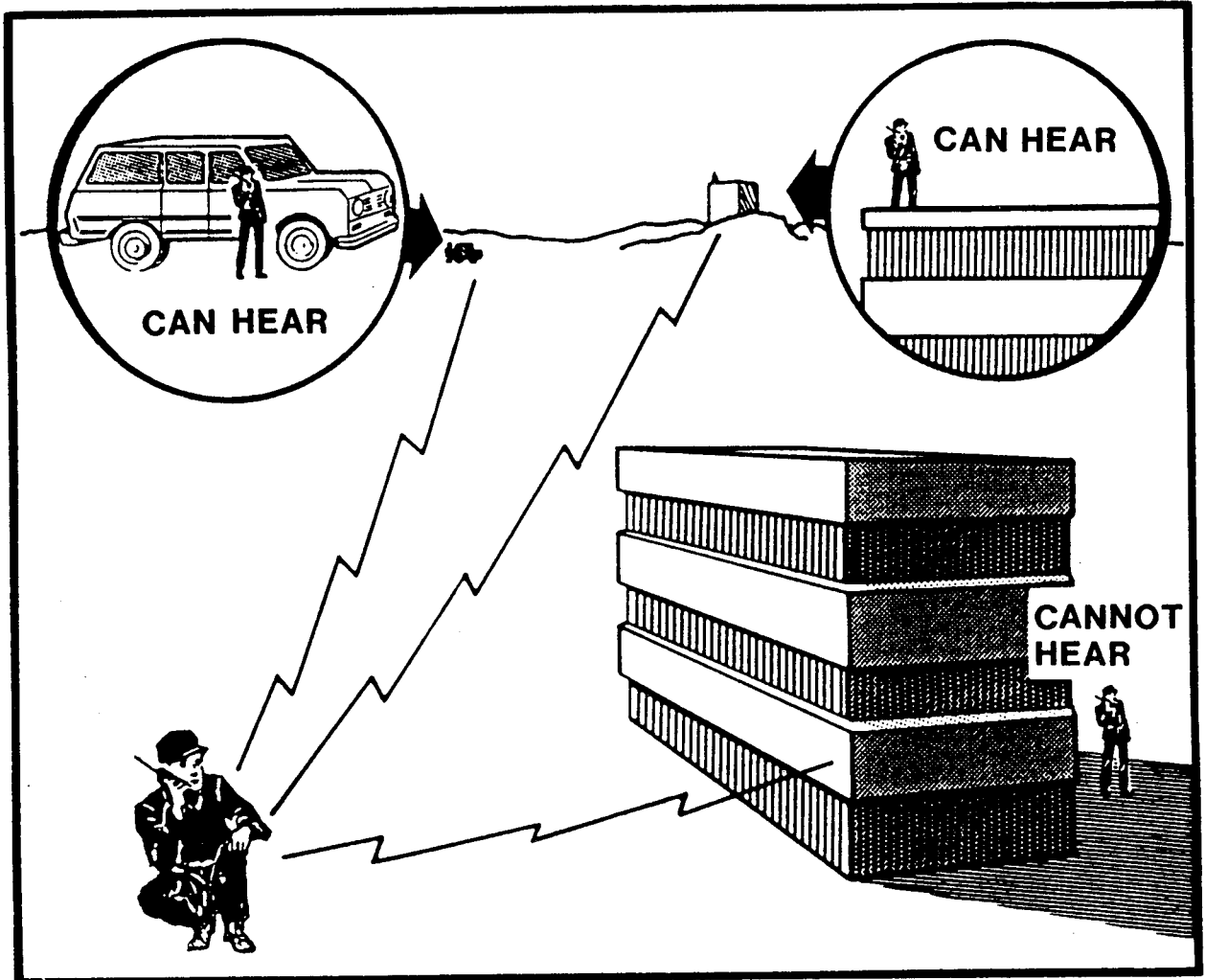

Illustration 11-1. Radio transmissions can be blocked by manmade sources.

FORMS OF ADVERSARY EXPLOITATION OF TACTICAL RADIOS

The most serious limitation of radios in a tactical situation is their **vulnerability to adversary exploitation**. Terrain, range and maintenance restrictions normally can be overcome through the use of repeater stations and through adequate training in the use of equipment. Defeating exploitation is much more sensitive and complicated.

Exploitation can take the form of

- **Monitoring**
- **Deception**
- **Jamming**

The easiest way for an adversary to **monitor** your

radio is by overhearing your radio traffic if you are using an external speaker. Even if no adversary is in your immediate vicinity, your transmissions can be monitored, however, by someone using either a commercial scanner or one of your own radios that has been taken by force. Even if you are using a sophisticated secure voice radio, the adversary can gain important information such as the number and locations of radios in operation.

In addition, you must continually be alert to the possibility that the adversary will use **deception** techniques. By using your radio frequency and pretending to be a security force member, he can give you false information and instructions, tempt you to make unnecessary transmissions and obtain crucial information from you. Deception techniques

are especially easy to use when radio operating techniques are not strictly followed, when action is intense and when radio users show easily imitated peculiarities in operating procedures.

Jamming can be a frustrating and destructive form of exploitation. By using a method as simple as keying a transmitter on your frequency and sending a signal more powerful than yours, the adversary can effectively block your transmission.

MEANS OF PREVENTING ADVERSARY EXPLOITATION OF TACTICAL RADIOS

The danger of having radio traffic monitored externally can be significantly reduced through the use of equipment such as individual radio earpieces and whisper mikes. Ear microphones are available that allow the wearer to transmit as well as receive through the ear. Other microphone models can be clipped to the wearer's collar. These types of microphones are so sensitive that a whisper can be heard by any team member using the radio network involved.

You can further reduce the effects of communications monitoring, deception and jamming by employing **circuit discipline** and **basic radio operating procedures**. These means of defeating adversary exploitation of tactical radio frequencies will be discussed in this section.

Using **circuit discipline** simply means using the radio as little as possible to transmit all necessary information while denying the adversary the opportunity for exploitation. The principles of circuit discipline are the following:

- **Minimize traffic**
- **Make short transmissions**
- **Avoid transmitting sensitive information about security force operations**

In order to **minimize traffic**, decide whether each transmission really is necessary before making it. If an operation is carefully planned in advance, there is no need for radio chatter. Plan to use alternate, nonradio means of communication when possible. Keep radio checks to an absolute minimum. Use the low setting on your radio whenever possible.

To keep **transmissions short** use short words such as "about" and "near" instead of long words and phrases such as "approximately" and "in the vicinity of." Speak clearly, but not too slowly. Only

key your microphone when you are actually speaking, because an adversary can locate you when your radio is keyed even if you are not talking. Spend as little time as possible tuning and adjusting your radio since an adversary also can detect these actions.

Your ability to **avoid transmitting sensitive information about security force operations** depends largely on prior planning. Employing predetermined code names for tactical groups and checkpoints will decrease the amount of information revealed to the adversary. Actual names of individuals should never be revealed in messages.

Once **codes** have been assigned, they must be safeguarded carefully and changed often. Do not give away codes by associating them with a plain-language transmission or with an action. For example, if an adversary is firing on you and hears you say that you are taking fire at "Checkpoint Bravo," the location of "Checkpoint Bravo" will be known to the adversary. For the same reason, information about the adversary, such as location, should not be given in code unless you also use a code to refer to the adversary.

Used along with circuit discipline, **radio operating procedures** will help you to overcome the vulnerability of radio transmissions to exploitation. Basic radio operating procedures include

- **Authentication**
- **Use of procedure words**
- **Use of the phonetic alphabet**

The use of **authentication** systems is a radio operating procedure that can prevent the adversary from making falsified transmissions on your tactical radio frequency. You should assume that deception can happen any time, and you should always expect it. If you suspect deception when you receive a transmission, challenge the sender to authenticate. If you want to prove that your own transmission is authentic, you can include an authentication when you transmit. Never accept voice recognition as a substitute for authentication if you have other reason to believe that a message is false. Be suspicious if the response to your challenge seems slow, and demand authentication again with a new challenge.

A sample authentication table is shown in Illus. 11-2. This type of simple but highly effective table can easily be produced locally.



(CLASSIFICATION) AUTHENTICATION TABLE (1800 24 Nov-1759 25 Nov)							
7	F	R	D	E	S	W	A
6	Q	G	T	H	Y	J	U
5	R	L	D	B	S	V	Z
4	K	I	L	O	P	Z	M
3	X	N	C	R	V	Q	A
2	P	L	E	D	I	J	T
1	H	R	N	W	G	L	E
	1	2	3		5	6	7
(CLASSIFICATION)							

Illustration 11-2. Sample authentication table.

The authentication challenge should be read to the right and up. The authentication is found the same way you would find a location on a map. For instance, you would authenticate 45 as "B."

Never use the same authentication combination twice. Cross out those combinations that have been used by you and other security personnel since the table was issued. If you are careless about repeating combinations, an adversary can make note of the proper reply to a challenge and use the reply for deception.

Like any other code system, authentication tables should be changed frequently and safeguarded carefully. A good way to keep control of tables is to have them turned in along with weapons and radios.

The use of **procedure words**, also known as prowords, is a radio operating procedure that can greatly reduce the length of your transmissions. Standard prowords, used exactly, also will make your messages easy for any trained radio operator to understand. With practice, you will find prowords easy to use.

Standard, frequently used prowords and their meanings are:

PROWORDS LISTED ALPHABETICALLY

PROWORD	EXPLANATION
ALL AFTER	I am referring to the portion of the message that follows _____ (state the word).
ALL BEFORE	I am referring to the portion of the message that precedes _____ (state the word).
AUTHENTICATE	You (station called) must reply to the challenge that follows.
AUTHENTICATION IS	The transmission authentication of this message is _____ (state the word).
CORRECT	You are correct (or) What you have transmitted is correct.

CORRECTION	An error has been made in this transmission. Transmission will continue with the last word correctly transmitted.
DISREGARD THIS TRANSMISSION—OUT	This transmission is in error.
DO NOT ANSWER	You (the stations called) are not to answer this call or otherwise to transmit in connection with this transmission. (When this proword is employed, the transmission shall be ended with the proword "OUT.")
I AUTHENTICATE	The group that follows is the reply to your challenge to authenticate.
I SAY AGAIN	I am repeating transmission or portion indicated.
I SPELL	I shall spell the next word phonetically.
OUT	This is the end of my transmission to you, and no answer is required or expected.
OVER	This is the end of my transmission to you, and a response is necessary. Go ahead: transmit.
ROGER	I have received your last transmission satisfactorily, and I understand it.
SAY AGAIN	Repeat your last transmission. If only a portion of the transmission needs to be completed you can use "SAY AGAIN ALL AFTER/ALL BEFORE _____ (state the word).
THIS IS	This transmission is from the station whose designator immediately follows.
WAIT	I must pause for a few seconds.
WAIT—OUT	I must pause longer than a few seconds.
WILCO	I have received your signal, understand it and will comply. (To be used only by the addressee. Since the meaning of ROGER is included in that of WILCO, the two prowords are never used together.)
WORD AFTER	I am referring to the word that follows _____ (state the word).
WORD BEFORE	I am referring to the word that precedes _____ (state the word).
WRONG	Your last transmission was incorrect. The correct version is _____ (state the word or words).

The use of a **phonetic alphabet** is a basic radio operating procedure that helps to prevent confusion and errors in your radio transmissions. The standard phonetic alphabet is employed to spell difficult words that might not be understood if they were simply spoken over the radio. This alphabet, with correct pronunciations, is shown in the chart that follows.

LETTER	PHONETIC	PRONUNCIATION
A	ALFA	AL FAH
B	BRAVO	BRAH VOH
C	CHARLIE	CHAR LEE
D	DELTA	DELL TAH
E	ECHO	ECK OH
F	FOXTROT	FOKS TROT
G	GOLF	GOLF
H	HOTEL	HOH TELL
I	INDIA	IN DEE AH
J	JULIETT	JEW LEE ETT
K	KILO	KEE LOH
L	LIMA	LEE MAH
M	MIKE	MIKE
N	NOVEMBER	NOH VEM BER
O	OSCAR	OSS CAH
P	PAPA	PAH PAH
Q	QUEBEC	KEH BECK
R	ROMEO	ROW MEE OH
S	SIERRA	SEE AIR RAH
T	TANGO	TANG GOH
U	UNIFORM	YOU NEE FORM
V	VICTOR	VIK TAH
W	WHISKEY	WISS KEE
X	X-RAY	EKS RAY
Y	YANKEE	YANG KEE
Z	ZULU	ZOO LOO

NOTE: Syllables in boldface carry the accent.

Use the proword "I SPELL" before spelling a difficult word or a word you cannot pronounce. If you can pronounce the word, do so before and after spelling it. The following are examples of both techniques:

Example 1: Word cannot be pronounced.

I SPELL—Tango-India-Juliet-
Echo-Romeo-Alpha-Sierra

Example 2: Word can be pronounced.

LEMUR—I SPELL—Lima-Echo-
Mike-Uniform-Romeo—LEMUR

REMEDIAL ANTI-JAMMING MEASURES

Your radio frequency sometimes may be jammed despite the preventive measures that you have taken. Therefore, you must be able to recognize jamming and to take remedial anti-jamming measures. If the signal you receive is distorted by interference, you may suspect that your radio frequency is being jammed. In such a situation, the first thing you need to do is to find out the source of the interference. Not all interference is jamming. If you remove the antenna from your receiver and find that the interference is just as loud, you can assume that the problem is inside your receiver. If the interference becomes weak or disappears, you know the problem is not in your receiver, but this effect does not necessarily prove that you are being jammed. The interference also may be caused by any of the following:

- **Poor insulation on nearby high-power electric lines**
- **Ignition noise from nearby vehicles**
- **Friendly forces using the same frequency**
- **Weather conditions such as lightning or hot, dry wind**
- **A nearby generator**

If you have considered all of these possibilities and still think you are being jammed, there are several **remedial anti-jamming measures** that you can take:

- **Continue to operate.** Conduct your operation in a normal manner so that the adversary will not know that his jamming has been effective. Never mention on an unsecure radio frequency that you are being jammed.
- **Increase transmitting power.** You may be able to transmit with greater power than the jammer.
- **Reduce transmitting speed.** You may be able to talk through the interference.
- **Adjust the finetuner, volume control or other controls your equipment may have.** Be sure that your receiver is tuned as precisely as possible to the desired incoming signal.
- **Adjust your antenna.** If your radio has a directional receiving antenna, position it so that it picks up more energy from the desired sig-

nal than from the jammer.

- **Relocate the radio.** Try to position yourself so that a hill or large building is between yourself and the jammer.
- **Switch to an alternate frequency.** Take this measure only as a last resort. Not only will this action show your adversary that he has been successful in jamming you but it also can create a great deal of confusion among your friendly forces. If possible, another operator should continue dummy operations on the original frequency to trick the adversary.

GENERAL OPERATOR PROCEDURES

In this section on the use of radios, the capabilities and limitations of tactical radio communication have been presented, and techniques for overcoming the limitation of vulnerability to adversary exploitation have been covered. The following additional **general operator procedures** will help you to make the most effective use of your radio:

- **Study the manuals that come with your equipment to become completely familiar with operating and maintenance instructions.**
- **Handle your radio carefully, and keep it clean and dry.**
- **Check your radio routinely to make sure that the plugs and jacks are clean, the connections are tight, the knobs turn easily and if the radio is powered by batteries, that the batteries are fresh.**
- **Remember that poor communication can be caused by too great a distance between radios, terrain obstacles and excessive noise and interference.**
- **Speak distinctly and directly into your microphone.**
- **If your radio is vehicle mounted, be sure the vehicle's battery voltage is up, and run the engine to recharge the battery if the power is low.**

Section 3. TACTICAL USE OF TELEPHONES

Like radios, telephones are employed in both

routine and tactical operations. Telephones have the following capabilities for tactical use:

- Although telephone lines can be tapped, telephone communications are generally more secure than non-encrypted radio communications.
- Telephones allow person-to-person communication with break-in operation. This capability means that the second party can break in without having to wait for the transmission to be completed.
- Telephones are not as likely to be affected by terrain and weather conditions as radios.
- Minimal operator training is required for the use of telephones.

Telephones have the following limitations:

- Telephones lack mobility.
- Although more secure than radios, telephones can be tapped.
- Telephones are more difficult to install than radios.
- Telephone wires can be cut.
- Telephones can easily be jammed if someone calls the number and then leaves the phone off the hook.

Ideally, you will have both radios and telephones available for use in a tactical situation. You can use radios when you require greater mobility and telephones when you need greater security. Closed phone circuits connecting guard posts, prepared defensive positions, alarm stations and other strategic locations will provide a high degree of reliability and security. Of course, these protected circuits must have no dial-in or dial-out capability.

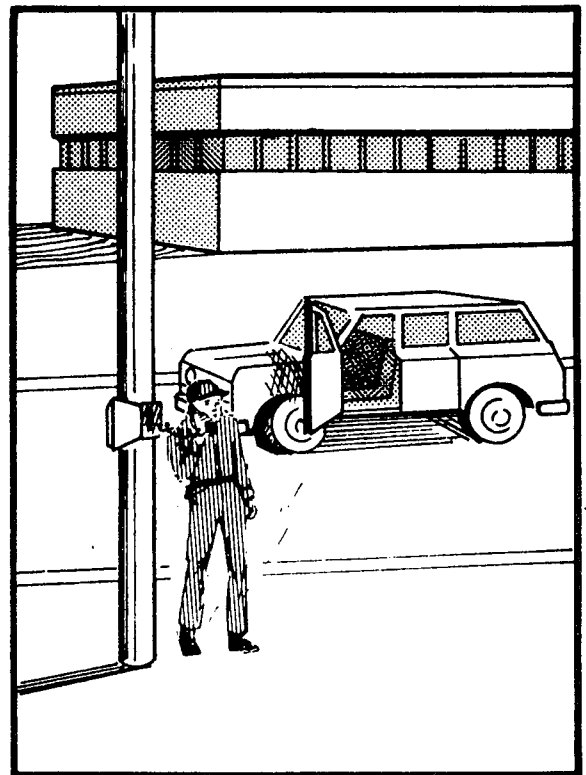

Illustration 11-3. Closed telephone circuits are reliable and secure.

Section 4. ARM AND HAND SIGNALS

Arm and hand signals are an effective means of small-force tactical communication. Using these signals is a good way to cut down on radio use and thus to decrease the chances for adversary exploitation. Such signals offer the following advantages:

- Arm and hand signals require the use of no equipment or power.
- Arm and hand signals cannot be intercepted the way radio and telephone transmissions can. That is, an adversary must be close by in order to observe (intercept) the signals.
- Arm and hand signals are immediately transmitted and received.
- Arm and hand signals can be changed for security purposes, and new ones can be invented to meet new needs.

Arm and hand signals have the following limitations:

- Arm and hand signals can be misunderstood and can be observed by the adversary.
- The adversary may use similar signals for the purposes of deception and confusion.
- The use of arm and hand signals is restricted when line of sight is not available and during times of poor visibility. Even when visibility is good, the distance over which these signals can be used is limited by the capabilities of the human eye.

The number of arm and hand signals that you use and the amount of information that you can convey are limited only by your imagination. All signals must be practiced until they become second nature. Signals must be given clearly and correctly so they will not be misunderstood. If the signal is not intended for everyone in sight, the signaler should point to the individual(s) the signal is for and then execute the signal. Illus. 11-4 through 11-9 provide examples of standard arm and hand signals that you can use or modify to suit your needs.

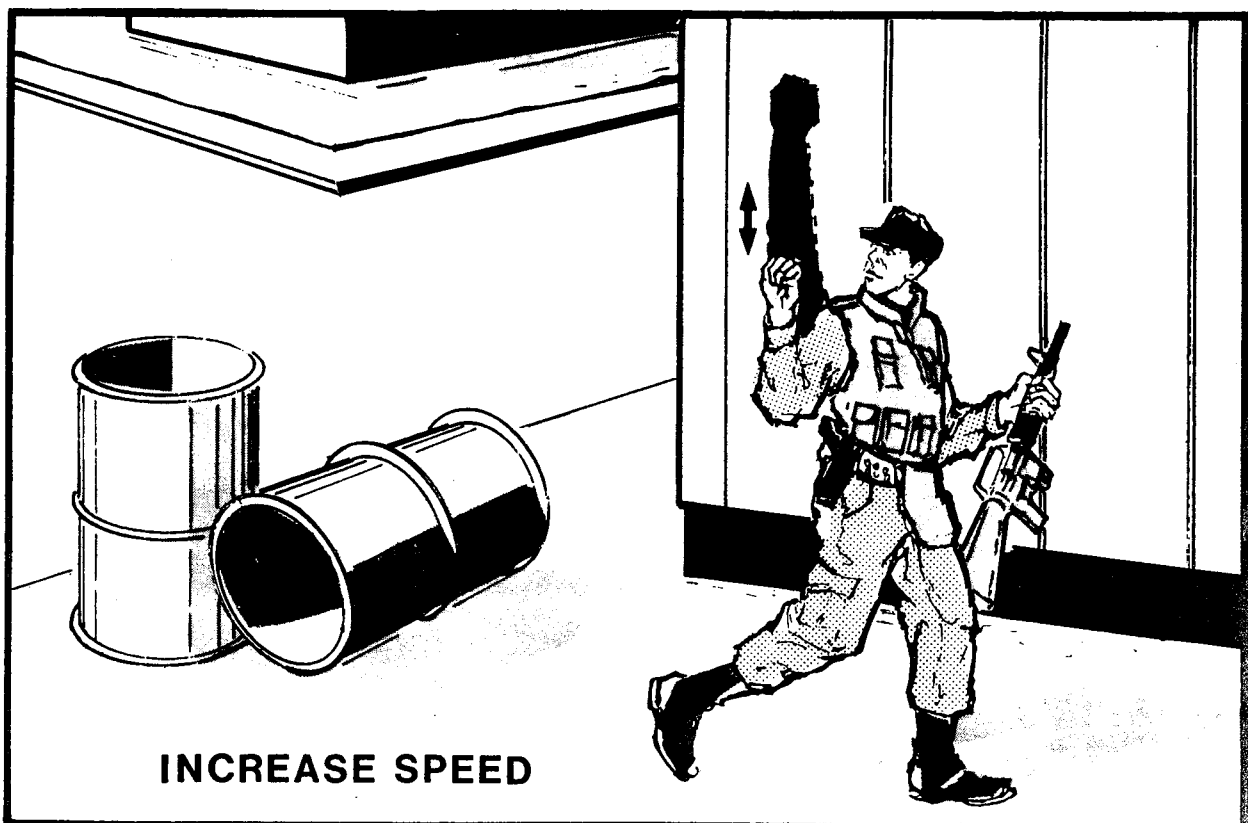

Illustration 11-4.



Illustration 11-5.



Illustration 11-6.



Illustration 11-7.

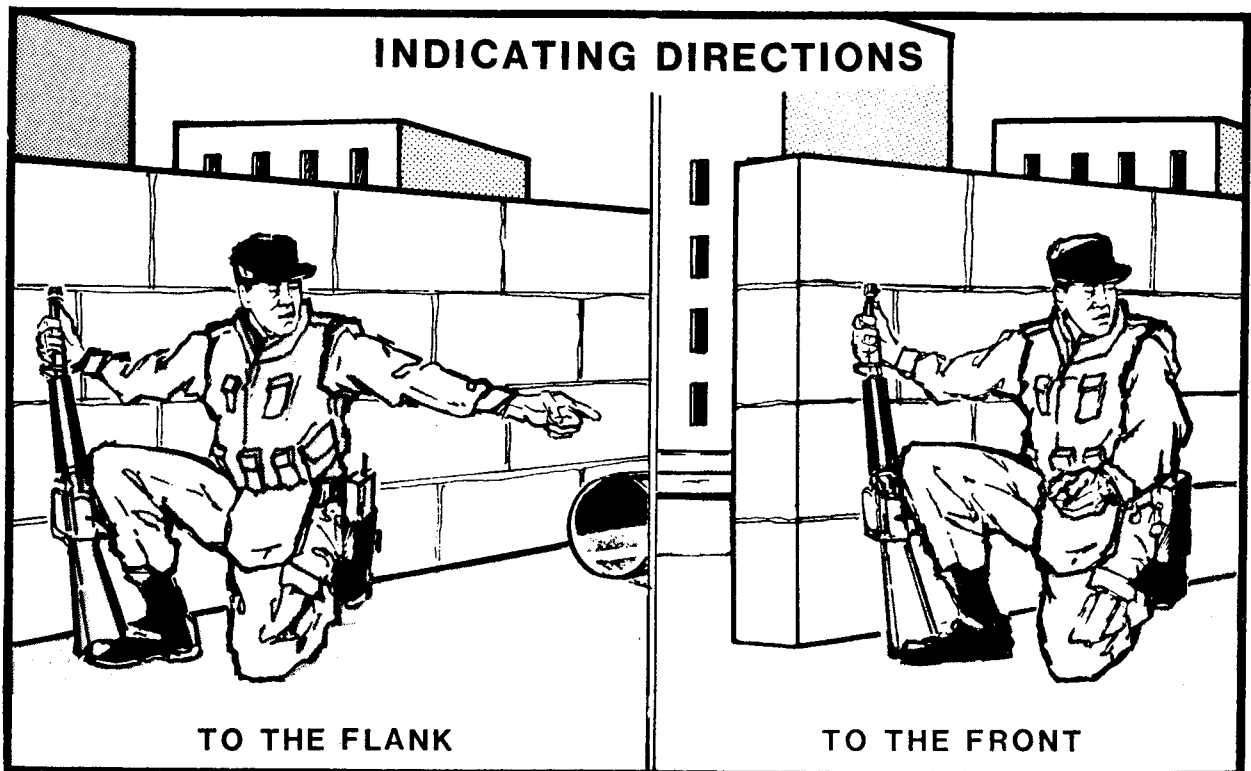

Illustration 11-8.

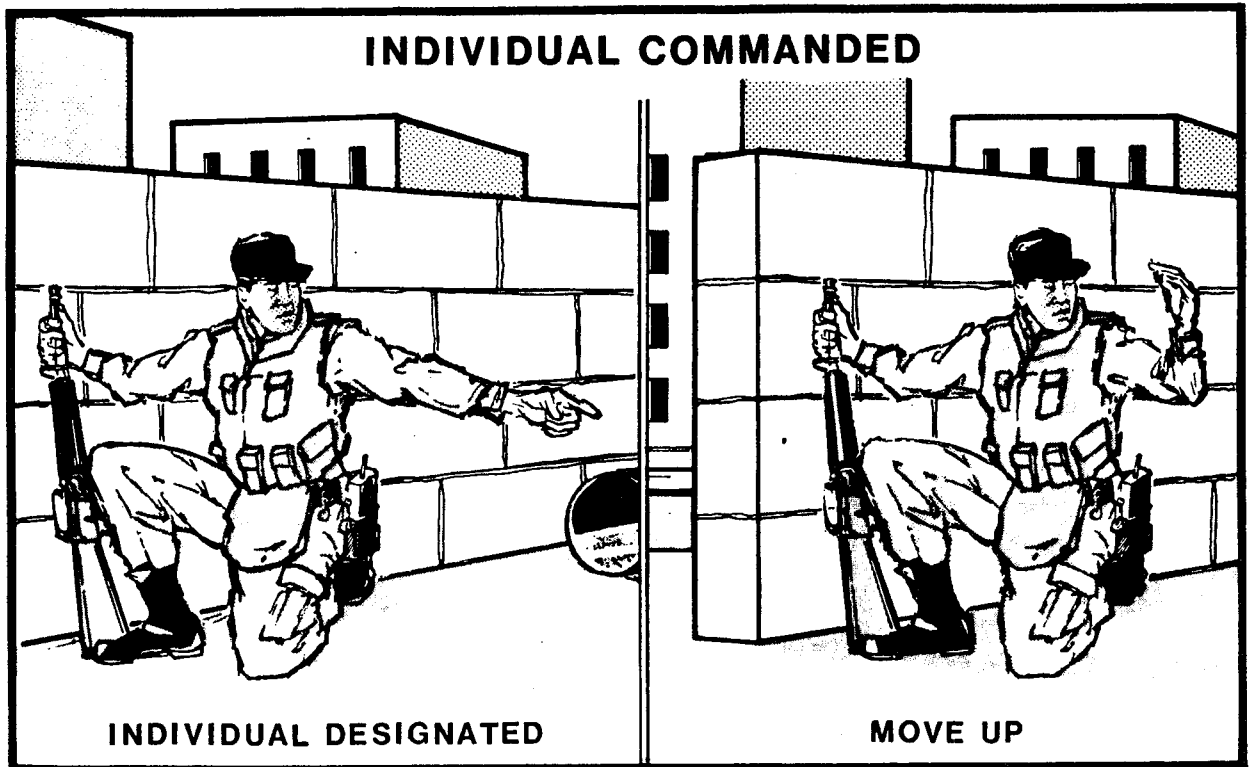

Illustration 11-9.

Section 5. OTHER COMMUNICATION METHODS

There are other, nonroutine, less commonly employed communication methods that, if used properly, can greatly enhance the flexibility, security and effectiveness of your tactical communications. These methods, listed below, will be considered in this section:

- Pyrotechnics
- Light
- Other visuals
- Loudspeaker
- Messengers
- Sounds
- Site specific communications systems

Pyrotechnics are objects used for signaling that produce their effect by burning and that are consumed in the process. A particular pyrotechnic signal may produce light or smoke or both of these effects. Pyrotechnics are useful for marking locations and for communicating prearranged signals. For instance, if radio communications have been knocked out, a command such as "cease fire" can

be sent with a signal rocket. The limitations of pyrotechnics, as in the case of other visual forms of communication, are that they can be seen by the adversary, that they can be used by the adversary for purposes of deception and confusion and that their use is restricted when line of sight is not available or during times of poor visibility.



Illustration 11-10. Pyrotechnics can be used to signal at night.

Light also can be used for sending messages. The primary advantages of **light** signals are that they are silent and easy to send with minimal equipment. Light signals can be produced by a flashlight at night and by sunlight reflected from a mirror during the day. Light signals have limited use, however, because their range is short and they require a prearranged code. Another limitation of light signals is that they can be observed by an adversary. Even if the adversary does not understand the meaning of the signals, he will have learned the location of the sender. You can decrease the probability of having your light signals observed by using a red filter on your light source.

Other visual signals can be used, by prearrangement, in special circumstances. These sig-

nals can be as simple as a person walking across a road, a window left open, or a flag raised. Such signals can be secure since they will not be recognized as signals by the adversary. However, they must be carefully planned and executed and their meaning explained to all security personnel who need to understand them.

Loudspeakers can be useful for quickly disseminating crisis information to large groups. Internal, external and vehicle-mounted loudspeaker systems are available in many facilities. Of course, no information that would be useful to the adversary can be broadcast.

Messenger communication is the most secure of all means of tactical communication. It is reliable, flexible and available to any security force, and it is the best means of delivering such items as maps and lengthy documents. Like other means of communication, however, it has limitations. The speed of messenger communication is dependent on the type of transportation available, for example. Also the messenger is subject to adversary action, and his progress can be restricted by terrain and weather conditions. Messenger communication can be costly in terms of manpower and training required. Another drawback is the lack of person-to-person conversation.



Illustration 11-11. Messenger communication is the most secure form of tactical communication.

Sound communication also is available to all units. Sound signals can be made by whistles, bells, horns, weapons and other noisemaking devices. These signals sometimes can be made to sound like routine noise that will be recognized as a signal only by a trained listener. Normally, sound signals are used to attract attention, to give an alarm and to convey prearranged messages such as "commence firing" or "cease fire." It is important to keep sound signals simple to prevent misunderstanding. An advantage of sound is that it provides rapid communication over short distances. The primary limitations of sound signals are that they can be intercepted by an adversary and that they can be drowned out and distorted by other noise.

Site-specific communications systems that are used during normal facility operations could also be used by security force personnel to transmit and receive vital information during a safeguards contingency situation. Examples of these systems include:

- **Internal facility telephone and radio systems used primarily for operational purposes**
- **Facility intercoms**
- **Facility paging systems**
- **Personnel and vehicle entry control devices or booths that have a voice or visual communication link to the Central Alarm Station (CAS), Secondary Alarm Station (SAS), or other security force locations**
- **Visual surveillance systems, such as closed circuit television (CCTV), used to monitor controlled areas within a facility.**

A survey should be conducted by security force management in conjunction with facility operations personnel to identify site-specific alternate communications systems, their capabilities, and specific locations. Then security force personnel should be thoroughly briefed on the systems identified and their possible use during safeguards contingencies. In addition, this information should then be made a part of the security force training curriculum and updated periodically, as required.

Authentication systems for use with tactical radios, as described in Section 2, should also be

devised for use with these systems, and security force personnel should be briefed on their use. Any communications received via these alternate methods must be authenticated as quickly as possible to verify the identity of the sender and to facilitate any required rapid security force response. As with any other authentication system, these systems must be changed frequently and properly safeguarded to prevent their compromise or use by adversaries for diversionary purposes.

Section 6. DURESS SIGNALS

A special use of the various forms of communication is the alerting of other security force personnel that you are under duress and need help immediately. A **duress signal** can be used if you are being held captive by an adversary and need to call for help without letting your captor know that you are signaling. A primary consideration when you are developing a system of duress signals is that the signals must be properly safeguarded. Even within an organization, different people can be provided with different duress code words that are safeguarded in separate sealed envelopes in a limited-access safe.

Duress signals can be visual, written, spoken and electrical. Visual signals must be planned to appear as natural as possible so as not to be recognized by the adversary as signals. Examples are certain lights being turned on and drapes being pulled back a special way. In written communications, uncharacteristic handwriting, unusual spacing and punctuation and the use of code words can convey messages. Predetermined code words also can be used in spoken messages, as can unnatural pauses and speech patterns, both having been assigned specific meanings. Electrical duress systems such as hidden alarm buttons and switches can be installed within facilities.

A combination of duress signals and procedures can be used for confirmation. For instance, if an electrical signal is activated by a knee switch in a controlled area, security will call in to ask if there is an actual emergency. Policy may state that after the person who answered the call has said that everything is all right, he must call security back to reconfirm within 60 seconds. If there is no return call, security will think that there is a problem and will take appropriate action.

Careful planning and practice are essential to the usefulness of any duress system or combina-

tion of systems. If you only make a casual effort to learn duress codes and signals, it will be easy for you to partially or totally forget them under stress. This can cause dangerous confusion.

Section 7. CHAPTER SUMMARY

This chapter has covered the capabilities, limitations and means of employment of the various types of tactical communication.

The use of radios was emphasized because radios generally are the primary means of communication used by NRC licensee security organizations in both routine and tactical situations. Particular attention was given to the vulnerability of tactical radios to adversary exploitation by the processes of

- **Monitoring**
- **Deception**
- **Jamming**

Two primary means of defeating adversary monitoring, deception and jamming attempts were introduced. These means were

- **Circuit discipline**
- **Basic radio operating procedures**

The following aspects of circuit discipline were explained further:

- **Minimized traffic**

- **Short transmissions**
- **Use of codes and other means to avoid transmitting sensitive information**

The following basic radio operating procedures were covered:

- **Authentication**
- **Use of procedure words**
- **Use of the phonetic alphabet**

Additional techniques for preventing jamming, ways to recognize jamming and remedial anti-jamming measures were discussed.

General operating procedures for effective radio use were then reviewed.

The following additional methods of tactical communication were discussed in detail:

- **Telephones**
- **Arm and hand signals**
- **Pyrotechnics**
- **Light signals**
- **Other visuals**
- **Loudspeakers**
- **Messengers**
- **Sounds**
- **Site-specific communication systems**

The chapter concluded with a discussion of the use of duress signals.



Chapter 12

CHEMICAL AGENTS

Section 1. INTRODUCTION

Chemical agents are among the most common special purpose weapons available during safeguards contingencies and other nonroutine situations. Because chemical agents are not normally used in daily operations, security personnel normally handle them only during specialized training sessions. Chemical agents may be used to augment security force equipment during a crisis; therefore, it is important to understand their capabilities and how to employ them properly. Section 2 of this chapter provides information on the general capabilities and employment techniques for chemical weapons.

Riot control agents are not lethal, but they can be temporarily incapacitating. Incapacitation during a firefight can be lethal. If you are blinded and are having difficulty breathing due to the exposure of your eyes and lungs to a chemical agent, it will be easy for an adversary to overcome you. At the very least, you will not be able to accomplish your mission of facility defense. Therefore, it is important for you to be able to recognize the symptoms produced by these agents and to know how to properly use a protective mask, and proper first aid steps to administer following exposure. Sections 3 through 6 of this chapter deal with these subjects.

Section 2. CHEMICAL WEAPONS

Chemical riot control agents are useful when you want to apply minimal force against an adversary and when you wish to make the adversary move out of a confined area so that you can conduct tactical engagement in a location more to your advantage. If you use chemical agents properly, you can incapacitate the adversary without killing or permanently injuring him/her.

The two chemical weapons, or tear gasses, commonly used in the United States are CN and CS. CN affects the eyes and mucous membranes, causing tears and temporary blindness. CS, which produces more immediate and more intense effects than CN, irritates all moist skin areas—the lungs, eyes, mouth, nose and sinuses—and causes profuse tearing. In recent years, CS has replaced CN as the agent used by the military and by many law enforcement agencies. Both CS and CN are available in all the types of chemical munitions described in this section.

DISSEMINATION METHODS

There are various types of devices that can be used to disseminate chemical agents. The commercially available means of delivery are

- Grenades
- Other projectiles
- Foggers

These devices are described by outline in Illus. 12-1.

Grenades come in various shapes and sizes. They usually are metal containers weighing between 1/2 pound and 1-1/4 pounds. **Pyrotechnic** grenades are the most common type of grenade. The internal charge of a pyrotechnic grenade burns for up to 40 seconds, giving off a smoke cloud that carries the chemical agent. **Blast-dispersion** grenades are another useful type of grenade. They are filled with CS or CN powder, which is expelled explosively when the grenade functions. Grenades can be thrown about 30 meters by hand, depending on the strength of the individual who throws them. They also can be launched up to 114 meters by grenade-launcher attachments to the 37/38mm riot gun, the 12-gauge shotgun and the .38 caliber revolver.

Other projectiles are available for the 37/38mm riot gun and the 12 gauge shotgun. **Nonfined** projectiles are intended for outdoor use and have a range of up to 137 meters. They are pyrotechnic devices. A cartridge for outdoor use fires a blast of CS or CN powder, but no projectile, to about 11 meters from the muzzle. **Finned** projectiles are designed for barrier penetration and for being fired into a building from the outside. These projectiles are more accurate than the nonfined type and have a maximum range of 295 meters. They can

penetrate windows from up to 68 meters away and can penetrate 3/4-inch plywood from up to 45 meters away. Finned projectiles come in either pyrotechnic or liquid-aerosol dispersion types.

Foggers are small, portable, gasoline-powered smoke generators. They utilize a CS- or CN-bearing oil that, when heated, produces a large volume of

smoke containing particles of the chemical agent. This kind of device is normally suitable for outdoor use only due to the high concentration of agent and the oxygen displacement that can result from use in confined areas. It can be operated on the ground, while it is being carried by hand and while it is in a moving vehicle.

● GRENADES

TYPES:

PYROTECHNIC - BURN UP TO 40 SECONDS
BLAST DISPERSION - INSTANTANEOUS EXPULSION

LAUNCH DEVICES:

HAND THROWN - UP TO 30 METERS
LAUNCHER - UP TO 114 METERS
37mm/38 mm RIOT GUN
12-GAUGE SHOTGUN.
.38 CALIBER REVOLVER

● OTHER PROJECTILES

CALIBER:

37mm/38 mm [RIOT GUN]
12-GAUGE [SHOTGUN]

TYPE:

NONFINNED [OUTDOOR]

UP TO 137 METERS
PYROTECHNIC

FINNED [INDOOR, BARRICADE PENETRATING]

UP TO 295 METERS

PYROTECHNIC: LIQUID-AEROSOL DISPERSION

● FOGGER

Illustration 12-1. Tear gas (CS and CN) dissemination methods.

OUTDOOR TACTICAL EMPLOYMENT

Chemical weapons can be used outdoors during a safeguards contingency to incapacitate an adversary, to drive the adversary out of an occupied position and to deny use of an area. Chemicals are useful only if the adversary does not have suitable protection such as a gas mask. When you consider employing chemical agents outdoors, you must take the following factors into account:

- **Appropriateness of the situation**
- **Choice of dissemination device**
- **Placement of the agent**
- **Positioning of security forces**

- **Equipping of security forces**
- **Hazards**

You must determine first whether the use of tear gas is **appropriate to the situation**. Gas provides a minimal-force, nonlethal option that also can be used in conjunction with more forceful methods. For example, if the adversary is entrenched in a well-protected position that would be dangerous to assault, you may be able to incapacitate or drive the adversary out of the position with CS or CN so that you can assault the position or otherwise neutralize the adversary with reduced risk to the security forces. If there is a strong wind or the adversary has protective masks, however, CS or CN will be of little use, and you will have to use more forceful methods.

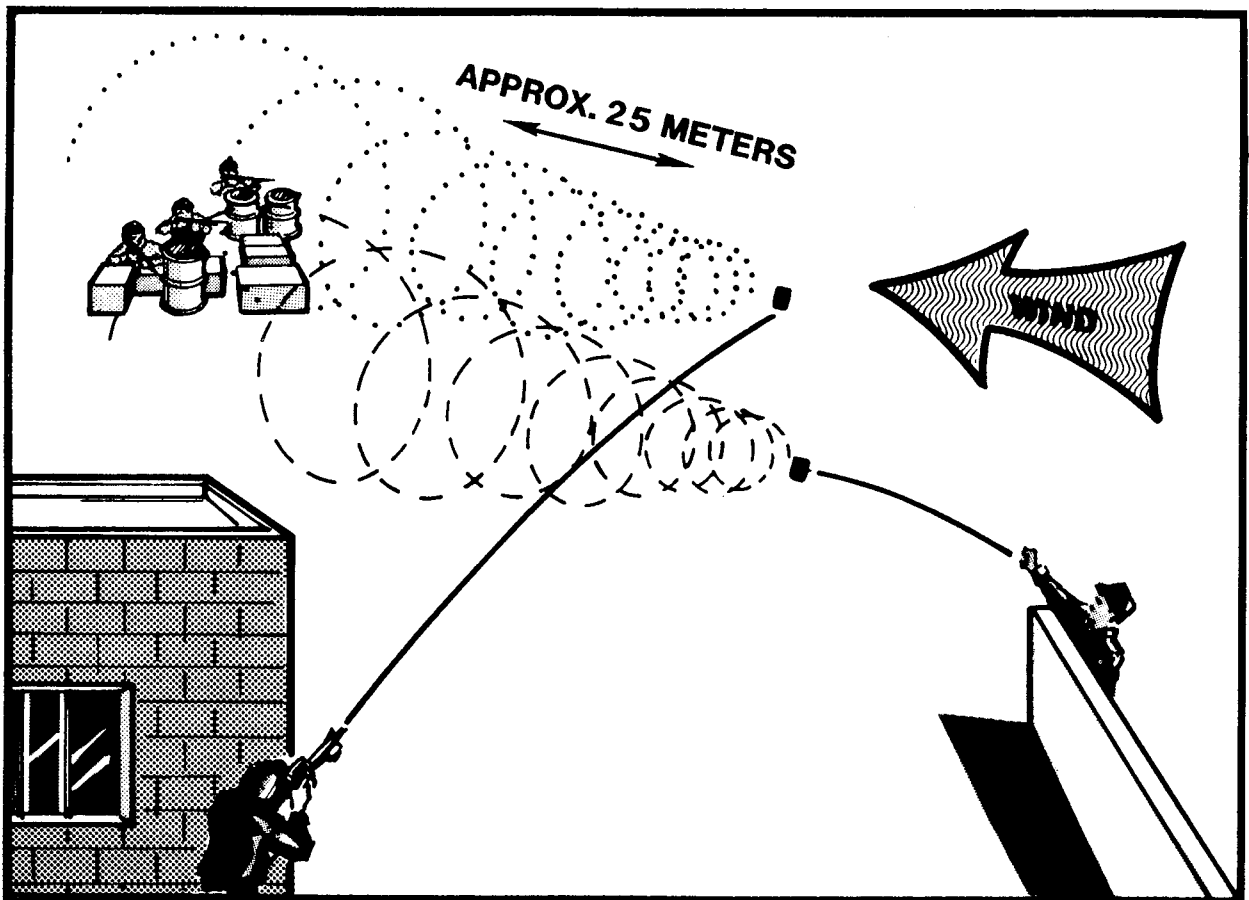

Illustration 12-2. Place chemical dissemination devices upwind of and far enough away from the adversary to allow the agent cloud to spread out before it is carried through the adversary's position.

After you have decided to use a chemical agent, you must determine which **dissemination device** is appropriate. If you have a variety of chemical weapons, you must use those devices that are best suited to the situation. Nonfinned projectiles have the longest range but produce a smaller volume of agent than do other devices. Grenades produce a fairly large volume of agent, but because they have a shorter range even with a launcher, you must get closer to the adversary to use them. Foggers produce the largest volume of agent for an extended period but must be placed into position and set into operation manually.

The dissemination device should be placed upwind of the adversary (see Illus. 12-2) and far enough away to allow the agent cloud to spread out before it is carried through the adversary position. The wind velocity will dictate how far upwind of the adversary position you must discharge the agent. If there is no wind whatsoever, you must discharge the agent directly on the adversary position.

If your purpose is to dislodge the adversary from a position or if there is a possibility that the position will be evacuated, you should **place security personnel** in appropriate locations along the most likely avenues of escape. When you disseminate chemical weapons, always have forces in place to neutralize adversaries before they have a chance to occupy another defensible position.

All security force personnel involved in operations in which chemical agents are used should be **equipped** with protective masks. The personnel in the vicinity of the agent, and particularly the individuals in downwind positions, must wear masks.

Consider all potential **hazards** prior to using chemical agents. For example, pyrotechnic devices can start fires in dry grass and in other combustible materials. The wind can carry the agent cloud into building ventilation and air-conditioning intakes, into populated areas and across heavily traveled public roads. The potential hazards must be weighed against the possible benefits of disseminating chemical agents in any given situation.

INDOOR TACTICAL EMPLOYMENT

Searching and clearing a building occupied by an adversary is one of the most dangerous opera-

tions a security force will ever have to conduct. Sometimes the proper use of chemical agents can force an adversary out of a building and thus make it unnecessary for security forces to carry out a search and clear mission. If you employ CS or CN against an adversary who is hiding in a building, your purpose is to force the adversary out and **not** merely incapacitation. If you only incapacitate the adversary, you still will have to search and clear the building, and your task will be more difficult because you will have to wear gas masks. You must think about the following factors when you consider employing chemical weapons indoors:

- **Appropriateness to the situation**
- **Choice of dissemination device**
- **Placement of the agent**
- **Placement of personnel**
- **Hazards**

Before using chemical weapons against an adversary in a building, you must consider how **appropriate** such weapons are to the situation. It will be difficult to introduce agents into a process building with concrete walls, steel doors and no windows, for example. Similarly, if the adversary has free run of a large multistory office building, you probably will not be able to introduce enough chemicals into the building to force the adversary out unless you can place a fogger in the building's ventilation system. The building (or portion of the building to which the adversary is confined) must be of a size, construction and configuration that make the use of chemical agents feasible.

The **preferred dissemination devices** for indoor use are finned projectiles that are designed for that purpose. They can penetrate windows, some doors and even some light construction materials and can be fired into the building from covered positions some distance away.

The CS or CN should be **placed** in the building in a well-planned sequence. Since your goal is to drive the adversaries out of the building, you must gas all portions of the building to which they have access, but you must leave an escape route clear (see Illus. 12-3). Gas the room where the adversary is located last so there is no choice but to exit along the route that you have left clear of chemicals. Fire only one projectile into each room except in the case of an unusually large room such as an auditorium.

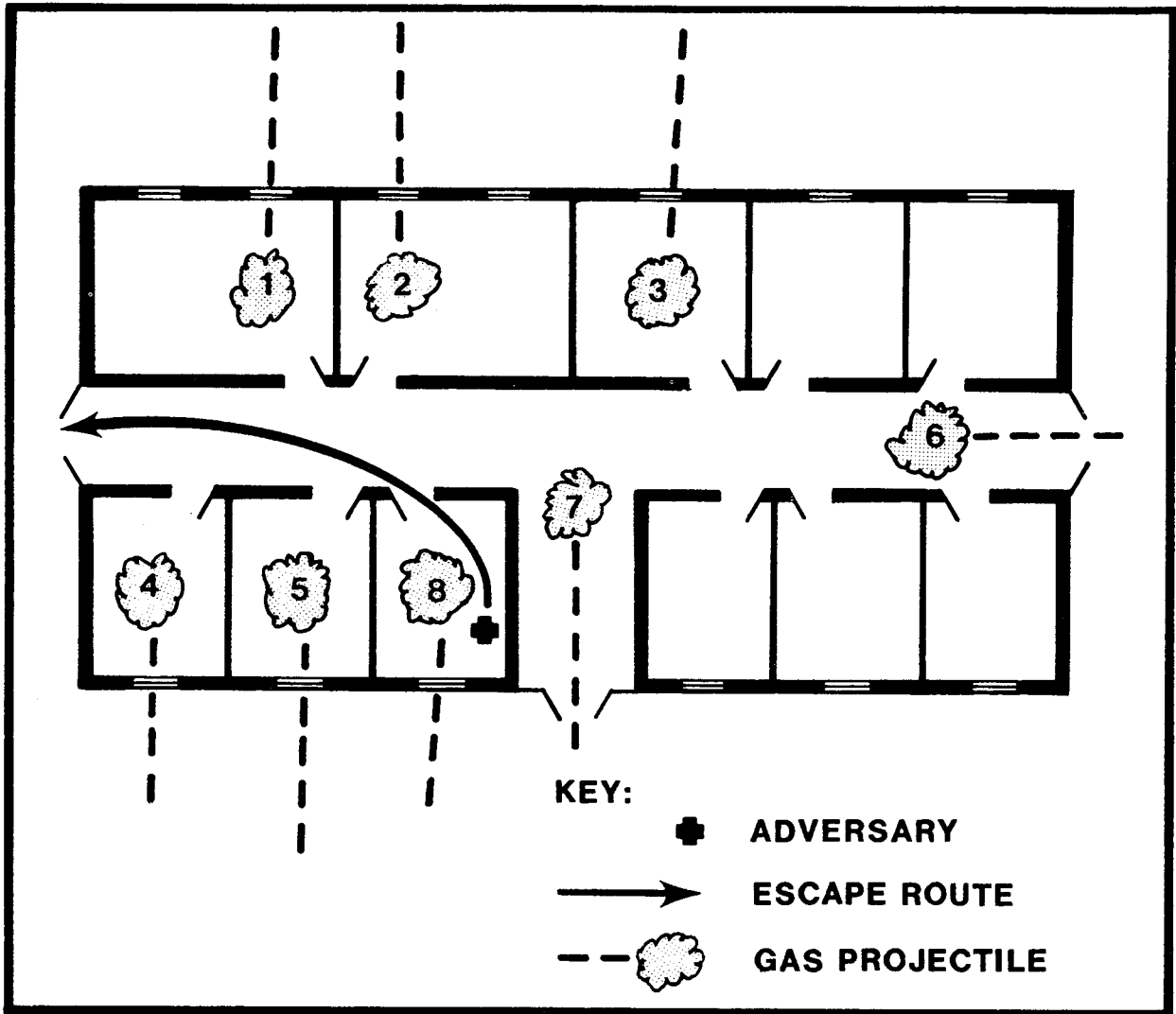

Illustration 12-3. Place CS or CN in a building in a well-planned sequence.

Position security personnel outside the building where they can intercept adversaries who, by following the escape route you have set up, emerge from the building.

You must be aware of the potential **hazards** associated with the indoor use of CS or CN. One danger is that pyrotechnic projectiles can start a fire in the building, although they are designed

to minimize this possibility. Another hazard is that you can place such a heavy concentration of an agent in a small room that the chemical displaces the oxygen in the room, making it impossible for the occupant to breathe at all. Chemical agents also will contaminate the building, which then can remain uninhabitable for days or weeks, depending on the contents and construction materials of the building and on the amount of agent used.

Section 3. DETECTION AND SYMPTOMS

The three most commonly used riot control agents are CS and CN, which are tear agents, and DM, or adamsite, which is a vomiting agent. CS is used by the United States military and by many police departments. CN, the effects of which are generally not as strong as those of CS, is still used by some law enforcement agencies in the United States. In recent years, however, CN has increasingly been replaced by CS. DM is no longer used in the United States due to its severe effects. However, it is still available in other countries.

DETECTION

In order to detect the presence of chemical agents, you have to know what you are looking for. Although these agents commonly are referred to as tear gas, they are not gasses at all. They actually are small particles. The particles can be disseminated in any of three ways: they can be carried in smoke, as with pyrotechnic (burning) grenades; they can be carried in a liquid mist, as with aerosol dispensers; or they can be scattered without a carrier, as with blast-dispersion grenades or manual scattering of the chemical powder.

You must remain alert and use common sense in order to detect the presence of chemical agents

before they affect you. Be suspicious if you notice the following:

- **Adversaries using grenades that produce smoke, which usually is white, or that disperse a powder, which also usually is white.**
- **Adversaries carrying aerosol cans.**
- **Adversaries wearing gas masks.**

SYMPTOMS

A less desirable but sure way of detecting chem-

ical agents is through recognition of the symptoms or exposure in yourself or those around you. You must know the symptoms not only so you can take appropriate first aid and protective action but also so you will know what is happening to you and why and, therefore, will avoid panicking. The chart below explains the symptoms of CS, CN and DM. The severity of the effects will depend upon the concentration of the dose received.

AGENT	SYMPTOMS
CS	Immediate irritation to eyes (causing profuse tears), nose, throat and lungs. Tightness or crushing sensation in chest. Intense irritation (stinging) of moist skin. Runny nose, dizziness. Nausea and vomiting possible in heavy concentrations.
CN	Profuse tearing. Intense irritation of eyes and mucous membranes.
DM	Mucous buildup resulting in stuffed nose. Severe headache, chest pains. Burning feeling in throat, uncontrollable coughing, sneezing. Nausea, vomiting and diarrhea.

Section 4. PROTECTIVE MASKS

Since riot control agents are incapacitating only if they reach the eyes or respiratory system, you will be protected from incapacitation by wearing a protective mask. There are two general types of masks that will provide the needed protection to your eyes, nose and mouth. One type, used by fire departments, comes with its own oxygen supply, usually carried in a tank on a backpack. Although these masks work well, the oxygen system is heavy and cumbersome and thus not suited for use by security personnel during an armed engagement. The other type of mask is the filter type, in which the particles of chemical agent are filtered from the air as it is drawn into the mask. This type of mask generally is suitable to the needs of the security force.

M17 SERIES FIELD PROTECTIVE MASK

The specific type of mask most commonly

employed by security forces is the M17 Series (M17 or M17A1) Field Protective Mask used by the United States military (see Illus. 12-4). This mask was designed for the soldier, who must perform tasks similar to those you may have to perform in a firefight. Some of its beneficial features are that it

- **Is available in three sizes**
- **Is fairly comfortable**
- **Has filters in the cheeks, with no cannister hanging down**
- **Accommodates the aiming of weapons**
- **Accommodates optical inserts for eyeglass wearers**
- **Has a carrier that can be worn in several positions**
- **Protects against all riot control agents**

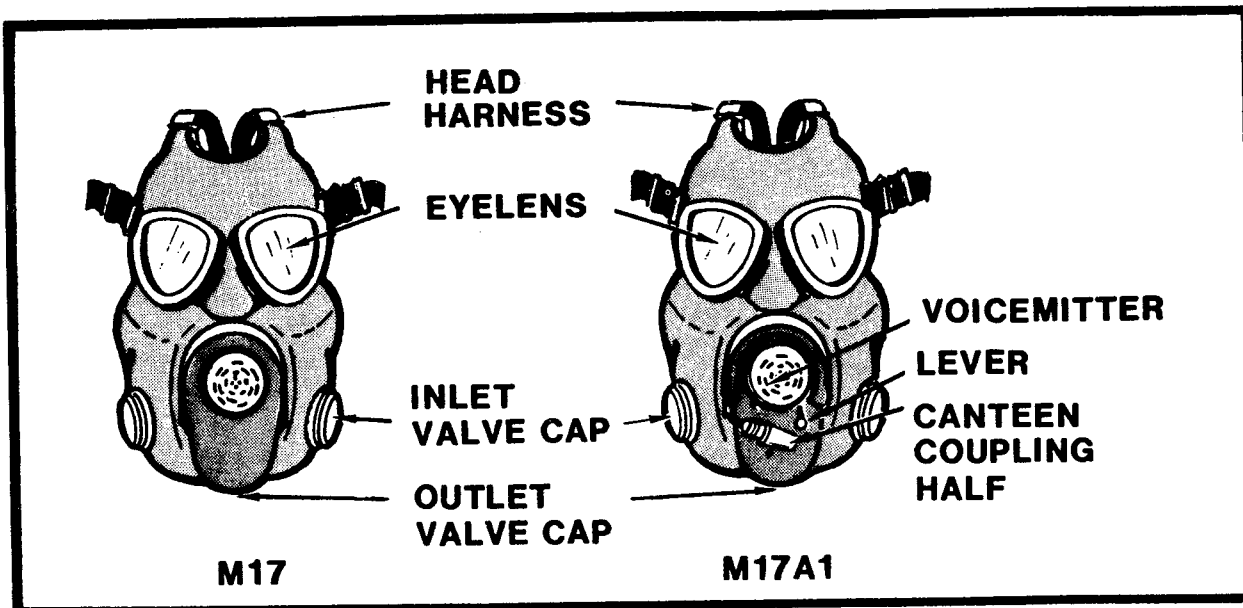

Illustration 12-4. Components of the M17 Series Field Protective Mask.

PUTTING ON THE M17 SERIES MASK

The most efficient way to put on the M17 series mask is explained in the description that follows. If you practice the correct procedure for putting on the mask, you will have no trouble putting it on quickly in an emergency. With practice, you will be able to put your mask on and clear and check it in 9 seconds.

Step 1: Prepare to Put On the Mask.

- Inhale, and then hold your breath.
- Remove your hat.
- Remove your eyeglasses.

- Get your mask out of the carrier.
- Step 2: Put On the Mask (see Illus. 12-5).

- Grasp the facepiece with both hands, slide your thumbs inside the facepiece and open it as wide as you can.
- Put your chin firmly in the chin pocket.
- Pull the harness smoothly over your head. Ensure that the head straps and head pad are flat against your head. Tighten all straps, starting with the lowest strap and moving in sequence to the top strap.



Illustration 12-5. Putting on the M17 series mask.

Step 3: Seal the Mask (see Illus. 12-6).

- Smooth the edges of the facepiece with an upward and backward motion of your hands, pressing out all bulges to get an airtight seal.



Illustration 12-6. Ensuring a proper seal on the M17 series mask.

Step 4: Clear the Mask (see Illus. 12-7).

- Cup your hand over the outlet valve. If you are using an M17A1, also press your other hand over the voice-mitter.
- Blow hard, forcing air out of the edges of the mask. This action removes contaminated air from the mask.



Illustration 12-7. Clearing the M17 series mask.

Step 5: Check for Leaks (see Illus. 12-8).

- Cover the inlet valve caps with the palms of your hands.
- Suck in your breath and hold it. If there are no leaks, your mask will collapse in toward your face and remain that way until you breathe out.

Note: If the mask leaks, check for and remove anything between the face and mask that would prevent a seal. Ensure that the straps are tight and that the straps and head pad are not twisted. Reseal, clear and check for leaks again.



Illustration 12-8. Checking the M17 series mask for leaks.

Step 6: Start Breathing Normally.

Note: If your lenses become fogged, take several deep breaths. This will draw fresh air in over the lenses and should clear the fogging quickly.

CARE AND CLEANING OF THE M17 SERIES MASK

Your gas mask can be just as important to you as your weapon, and you should take proper care of both of them. Keep your gas mask in its carrier, where it will be protected from damage and remain clean and ready for use. Periodically and also after each use, inspect the mask for damage as follows:

- Check the rubber parts for holes, splits, tears and dry rot.
- Check the lenses for cracks and to ensure

that you can see clearly through them.

- Check the harness for dirt and mildew and frayed and broken straps.
- Check for any other obvious damage.
- Check to ensure the filters are in place.

Note: For instructions on detailed inspection and repair of the M17A1 Field Mask, refer to U.S. Army Technical Manual: TM 3-4240-279-10.

After each inspection and also when it is necessary, clean your mask as follows:

- Clean all rubber and lens surfaces, inside and out, by wiping with a soft cloth or sponge and soapy water. Do *not* immerse the mask in water.
- Clean dirt from the harness with a stiff brush.
- Rinse the mask by wiping with a soft cloth or sponge and clear water.
- Dry the mask with a soft cloth, or air-dry.

WARNING: Do not get the filters wet. Water will destroy their effectiveness.

Section 5. MEASURES TO TAKE IF NO MASK IS AVAILABLE

If you find yourself without your gas mask in an area where riot control agents are being used by either side in the conflict, your best move will be to avoid the area if that is tactically possible. Move **upwind** of the chemical cloud if you can do so safely. If, for tactical reasons, you have to pass through the chemical cloud or if you cannot leave the area that is enveloped by the chemical, you can temporarily protect your respiratory system to some degree by placing a damp cloth such as a handkerchief or T-shirt over your mouth and nose. As you breathe through the wet cloth, it will filter out some of the agent. Try to keep your eyes closed as much as possible. Try to position yourself behind a barrier, such as a wall, that might stop some of the agent from reaching you. If there is a positive-pressure, uncontaminated-air source such as a building exhaust vent nearby, put your head into the clean-air stream. Go indoors if the chemical is outdoors or outdoors if it is indoors.

The tactical situation will influence your decision on whether to remain or escape, but remember that if you become incapacitated, you will not be able to contribute much to the situation.

Section 6. FIRST AID

Riot control agents are not lethal, but they can cause extreme discomfort. The first aid measures presented are aimed at relieving that discomfort. The symptoms produced by riot control agents were listed by causative agent in Section 3. In the chart that follows, the symptoms are listed in terms of the parts of the body affected and the first aid measures that should be taken to treat those symptoms.

Body Part	Symptoms	First Aid
Overall	All	Get out of the contaminated area into a clear, upwind area. Keep calm and still.
Eyes	Profuse tears, burning or stinging sensation, cannot keep eyes open	Remove contact lenses and eyeglasses. Keep eyes open, face into the wind. Do not rub eyes. Flush eyes with large amounts of water if necessary.
Skin	Stinging or burning feeling on moist skin	Sit in fresh air, expose affected areas to air. Remain quiet. Flush heavy contamination with clear water for 10 or more minutes. Remove heavily contaminated clothing.
Nose	Irritation, stinging, nasal discharge	Breathe normally, blow nose.
Lungs	Irritation, coughing, tightness in chest	Relax, keep calm

The major discomfort usually is gone 15 to 20 minutes after the victim reaches fresh air, and then he/she is able to function again. In case of prolonged or severe symptoms, seek medical assistance.

Section 7. CHAPTER SUMMARY

This chapter has addressed employment of and defense against commonly used riot control agents.

The chemicals available for security force use were identified, and the methods of disseminating them were described. Factors that must be considered during outdoor and indoor tactical employment of chemical weapons were covered.

The three commonly used riot control agents, CS, CN and DM, were identified. **Detection**

methods, including recognition of symptoms, were explained.

The **principles of the function of protective masks** were outlined, and specific information regarding the **use and care of the M17 Series Field Protective Mask** was provided.

Some **self-protection measures** for use when no mask is available were given.

Finally, **first aid measures** for the treatment of riot control agent symptoms were listed.

Chapter 13

ADVERSARY APPREHENSION TECHNIQUES

Section 1. INTRODUCTION

You might assume that an adversary has only three options during a confrontation—to fight, flee or surrender. That assumption can lead you to make fatal errors. The adversary also can appear to surrender or appear to comply with commands in order to gain an advantage or to improve chances for eventual escape. In fact, you must assume that one of these ploys will be used.

When you confront an adversary in an apprehension situation, your success and survival will depend on your constant alertness and on your ability to carry out previously developed plans. You must know in advance exactly what you want the

adversary to do and how to issue commands to assure that what you want is done. Your plan must cover every step of the apprehension process in detail and must be practiced ahead of time. If you wait until the point of confrontation to develop an arrest plan, you will have waited too long.

Prior to an encounter, you must become skillful in using the best tactical methods for giving commands to an adversary, for carrying out a final approach to the adversary and for disarming, incapacitating, handcuffing and searching the adversary. You also must know how to deal with multiple adversaries, how to approach a vehicle in both a high-risk and a low-risk situation and how to evacuate a prisoner from a high-risk area.

Section 2. GIVING COMMANDS TO THE ADVERSARY

An adversary is more likely to obey you if your voice is authoritative than if you sound nervous and unsure. For this reason, you must be aware of your own voice quality and must develop a "command" voice. You also must be able to issue commands instantly without having to think about what to say. This section will present techniques for developing a command voice and will address in general terms and also with specific examples what you should say to an adversary.

In order to be able to speak with a command voice, you must think consciously, before you are in a confrontation situation, about what you will

say and how your voice should sound. If you plan in advance exactly what to say to an adversary in a given situation, your commands will have a ring of confidence. Even if you know just what to say, however, you naturally will be nervous when the confrontation occurs. To keep nervousness from showing in your voice, take a deep breath before speaking. Deliberately slow down your commands, and give one command at a time. Force your voice a little lower in pitch than normal so that it will not crack on high notes but will still sound natural.

When planning what you will say to an adversary in a given situation, remember that your commands must be brief and easily understood. Always use words that the adversary can understand and relate to. If you think that only street language will be understood, speak on that level.

In almost all circumstances, the first thing you will want an adversary to do is to stop all motion. A short, effective command to use is "Freeze, don't move."

If the adversary is facing toward you after all motion has stopped, you will want his/her back toward you. A clear, simple command is "Slowly turn around, and put your back toward me."

Avoid getting into a conversation with the adversary. If there is an attempt to talk to you, simply repeat your command until it is obeyed. You must remain in control.

Never stand in the open when giving commands to an adversary. Seek cover first to protect yourself from weapons fire. If no cover is available, choose a position that gives you concealment from the adversary who is being apprehended as well as from other adversaries who might be in the area. If neither cover nor concealment is available, at least take up a prone position so that you will not be an easy target for the adversary. Resist the temptation to jump out from behind your cover or even to raise your head up to give commands. Remember that other adversaries may be concealed, just waiting for you to make such a mistake.

In this section, basic principles for giving commands to an adversary during apprehension have been covered, and two examples of proper commands have been given. Further examples will be given throughout the chapter.

Section 3. VISUAL SEARCH AND DISARMING TECHNIQUES

If you are alone when you stop an adversary, you should immediately call for a backup before proceeding with the apprehension. Your next priority after you have stopped the adversary and commanded him/her to turn his/her back toward you is to make a visual search for weapons and to remove those weapons (disarm). To position the adversary so that you can make a visual search, give the command, "Slowly raise your hands high above your head, lock your elbows and spread your fingers."

Never give this command **before** you have ordered the adversary to turn his/her back toward you. If the adversary is facing you, he/she can easily reach for a concealed weapon and shoot you (see Illus. 13-1a through 13-1c). This motion will look the same as if the adversary were complying with your command. Remember that, even though you are holding a gun on the adversary, his/her action will be faster than your reaction. It is safer to first order the adversary to turn around—then have him/her put his/her hands up. The adversary still may try to shoot you, but will have to turn and aim before firing with any chance of hitting you (see Illus. 13-2a through 13-2c). You will have time to react.

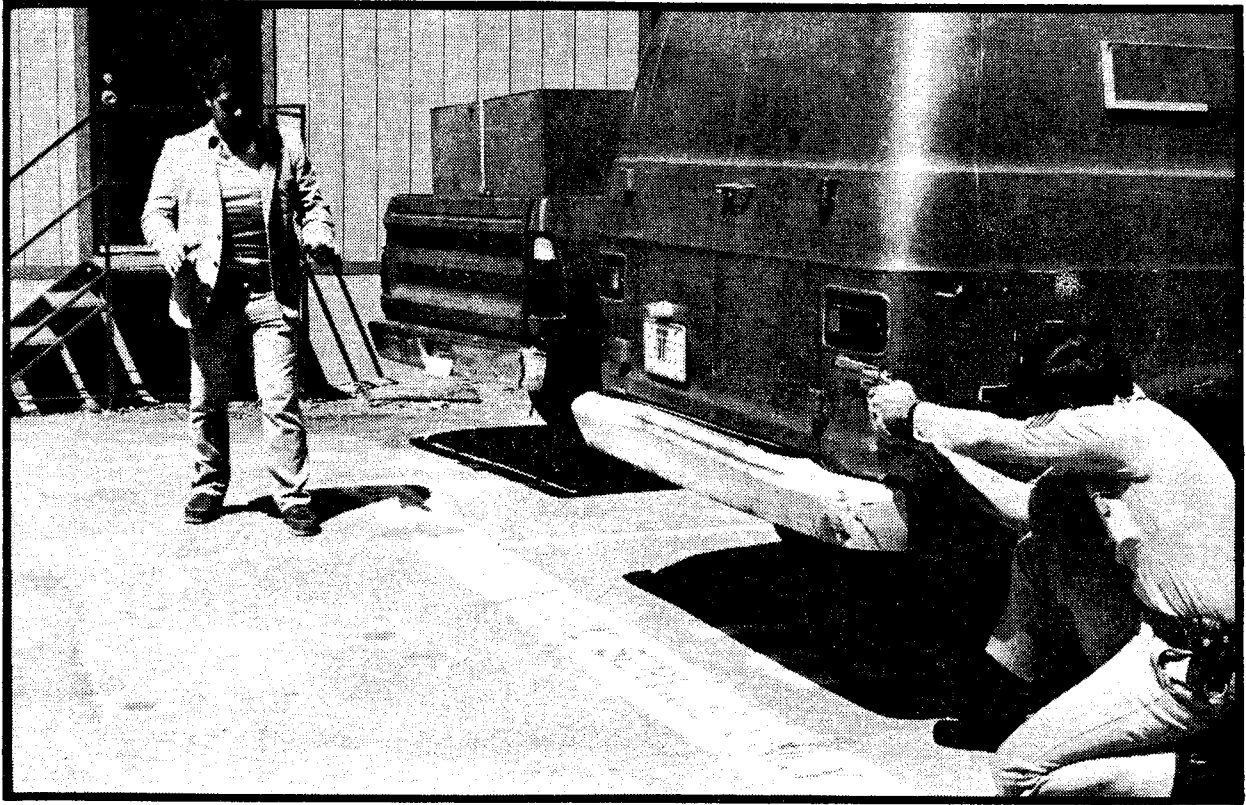

Illustration 13-1a. The adversary is most dangerous while facing you.

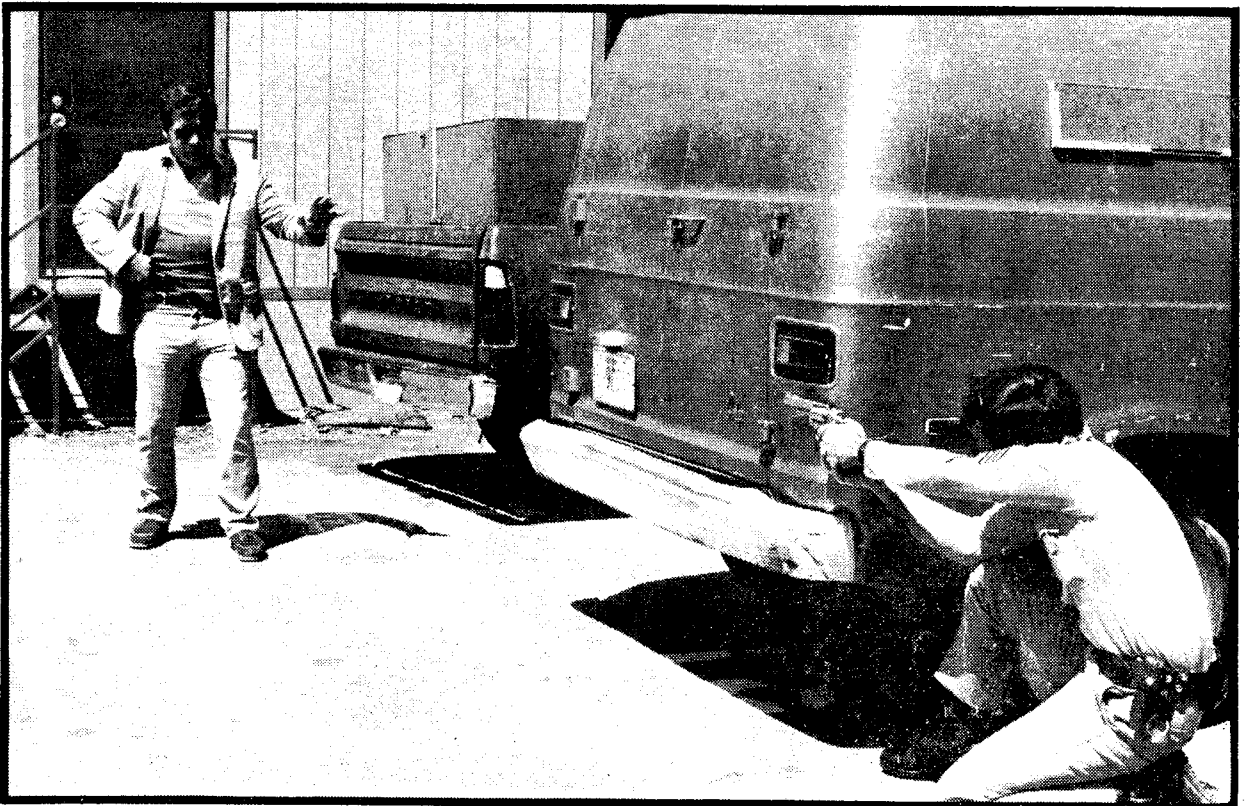

Illustration 13-1b. The adversary can easily reach for a concealed weapon and fire.

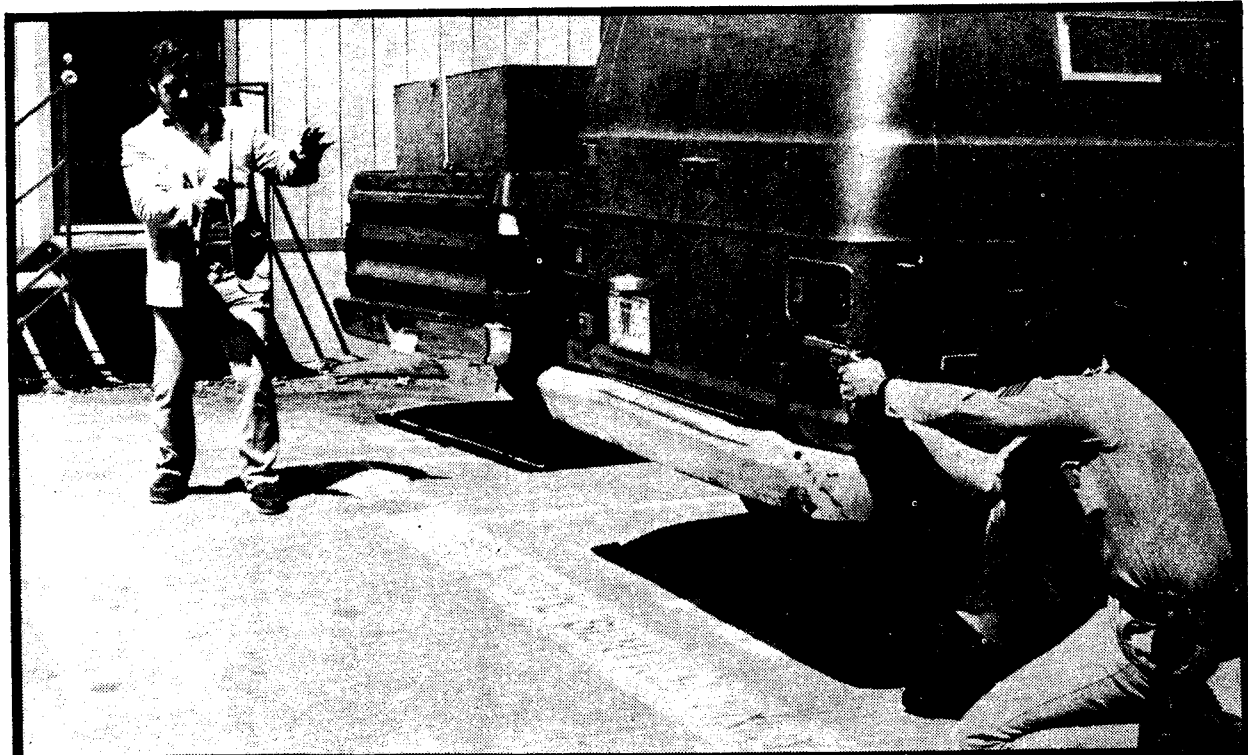

Illustration 13-1c. Never let the adversary use surprise against you.

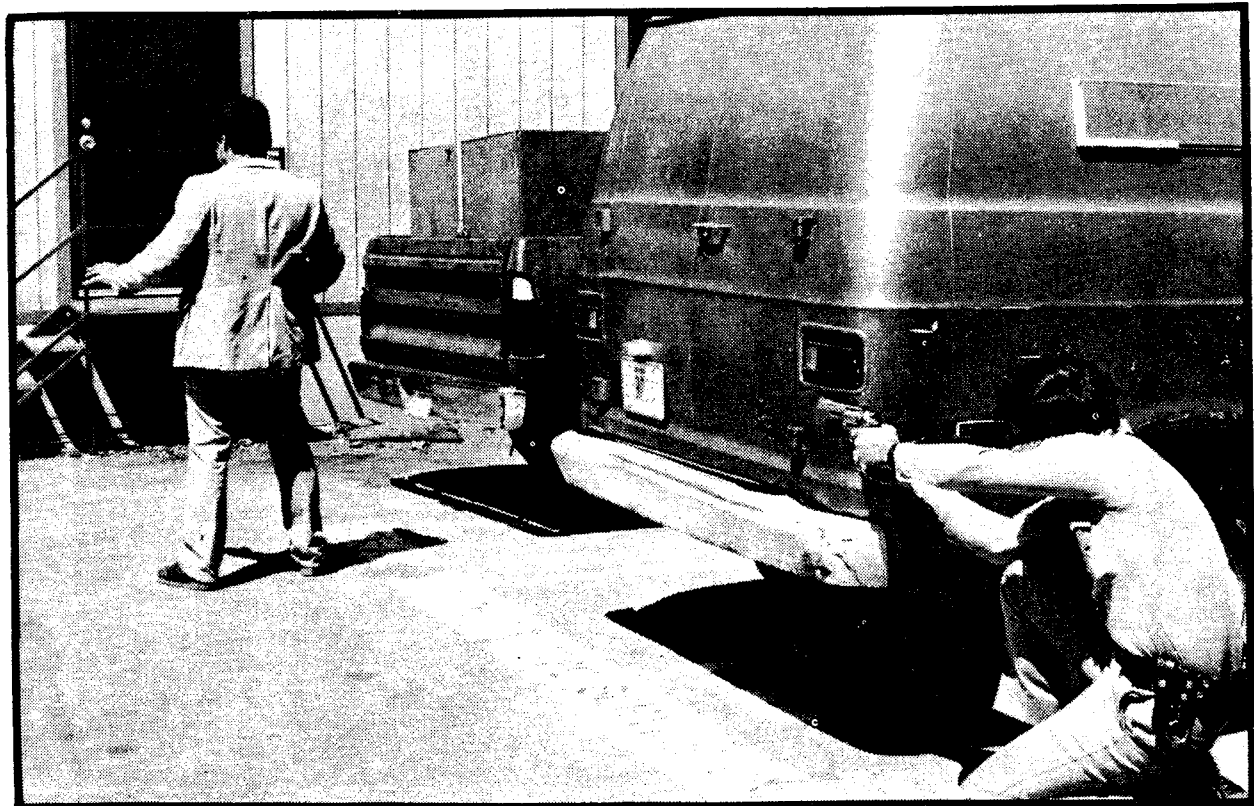

Illustration 13-2a. The adversary is at a disadvantage when his/her back is toward you.

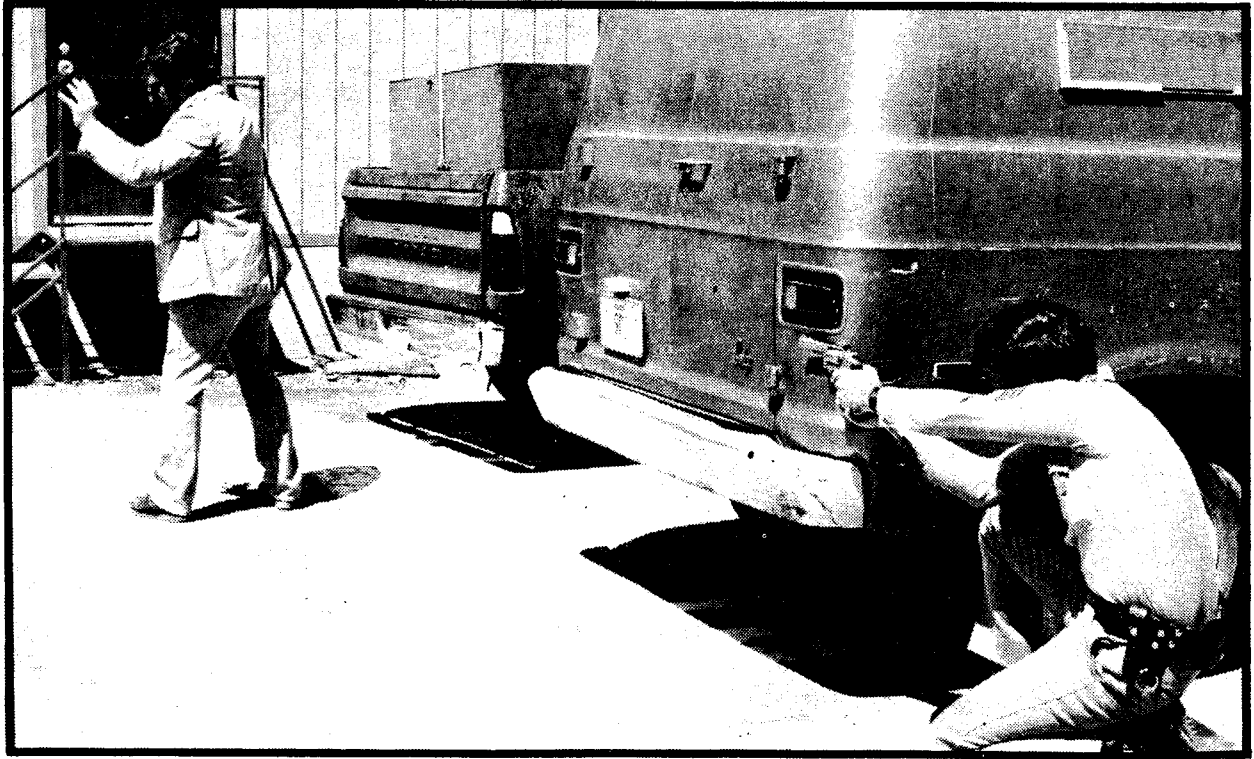

Illustration 13-2b. A weapon might be drawn.

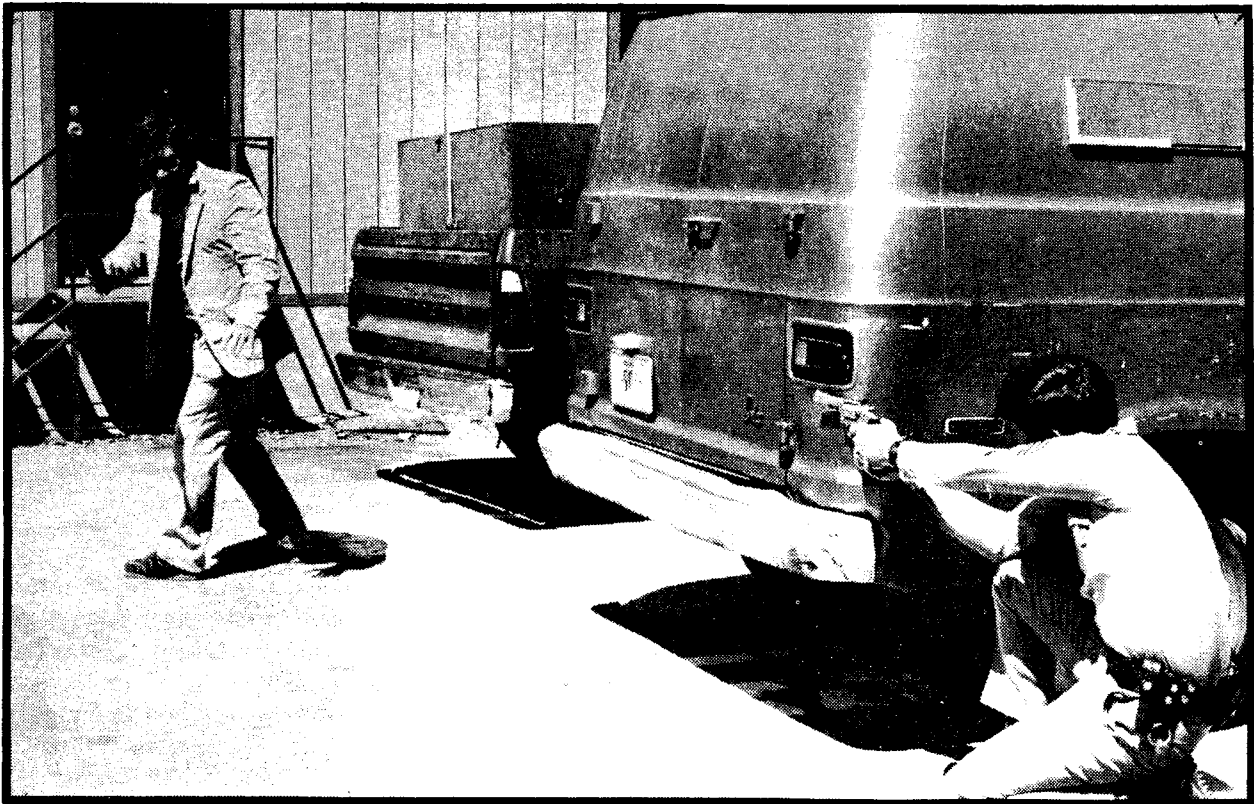

Illustration 13-2c. However, a turn would have to be made to shoot.

When the adversary has raised hands and spread fingers, you will be able to see from your position of cover whether the hands are empty. Also, clothing will be stretched against the body, so that you can visually search the middle torso section, looking for a suspicious bulge that may be a concealed weapon (see Illus. 13-3a and 13-3b).

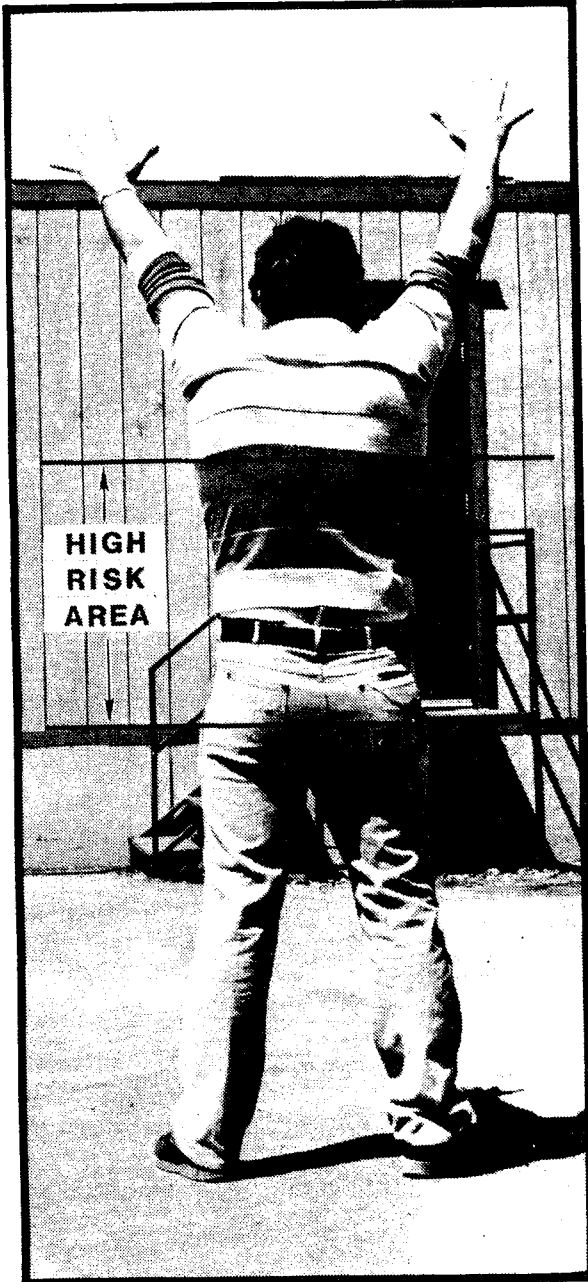

Illustration 13-3a. When performing a visual search, look for a suspicious bulge in the high-risk area.

Although weapons can be concealed on other parts of the adversary's body, you must concentrate first on the middle torso, which is the high-risk area. This hiding area is the most commonly used and the easiest for the adversary to reach to grab a weapon.



Illustration 13-3b. Closeup of the high-risk area showing a concealed weapon.

If the clothing does not stretch tightly over the high-risk area, continue to give commands until you have an adequate view. For example, if a bulky jacket restricts your view, give the command, "Slowly, with your left hand, reach back and pull the **top** of your jacket up." You may even need to have the adversary pull the jacket all the way over the head in order to get a good view of the back (see Illus. 13-4a and 13-4b).



Illustration 13-4a. Have the adversary pull up bulky clothing so that you can visually search the high-risk area.

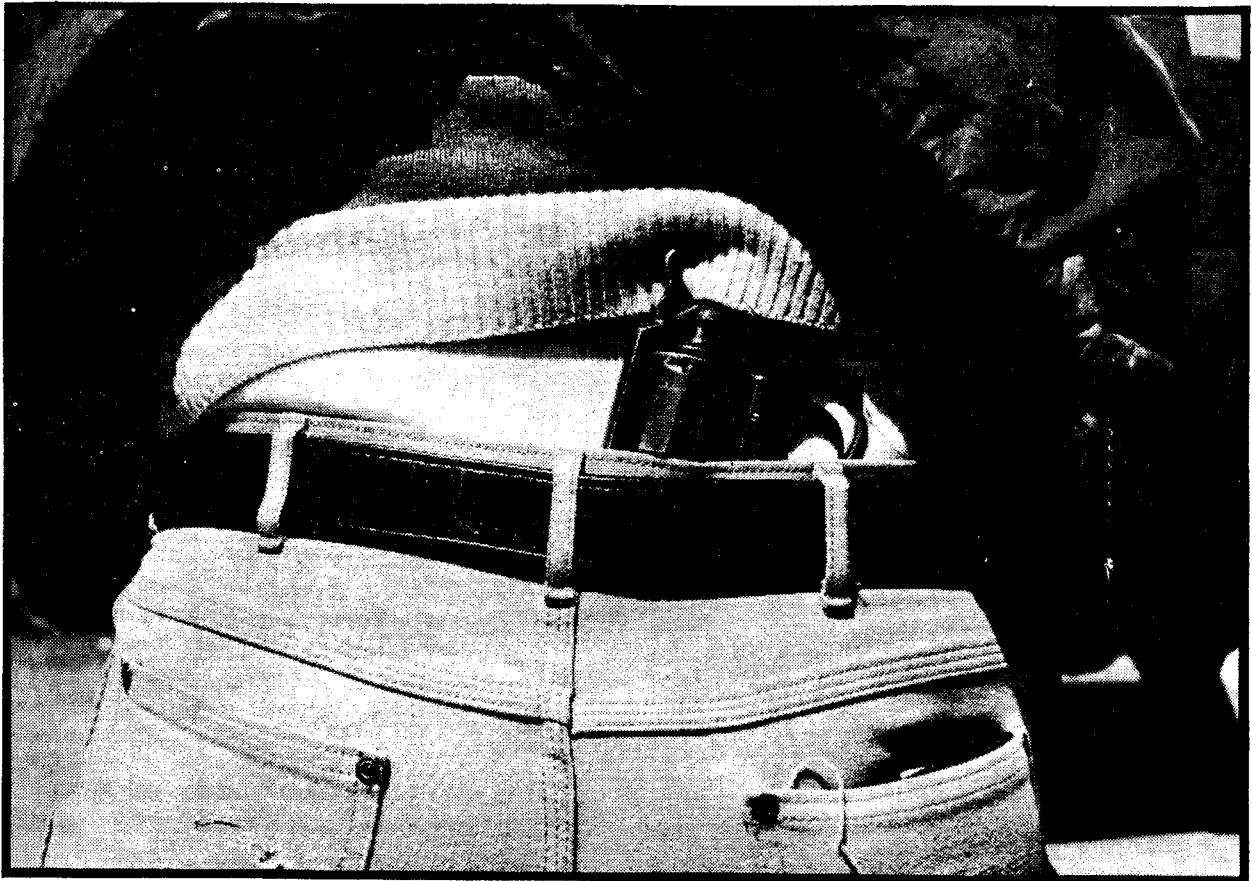

Illustration 13-4b. Closeup showing a weapon that was concealed under a bulky jacket.

Visually search the entire rear side of the adversary's body. If you do not detect any weapons, give the command, "Keep your hands high above your head, and slowly turn and face me." Visually search the front of the adversary's body, focusing particularly on the high-risk area (the middle torso). Give appropriate commands for the adversary to move or to adjust clothing until you have had a 360-degree view of the body.

If you discover a weapon during your visual search, disarm the adversary immediately. For example, you may see a large bulge in the front of the waistline. Order the top of the shirt or jacket to be raised. If you see a weapon, let everyone in earshot, including the adversary, know of your discovery. Announce, "I see the gun. Do exactly what I tell you." Then, order the adversary to slowly turn around again so that his/her back is toward you. Never disarm the adversary while he/she is facing you.

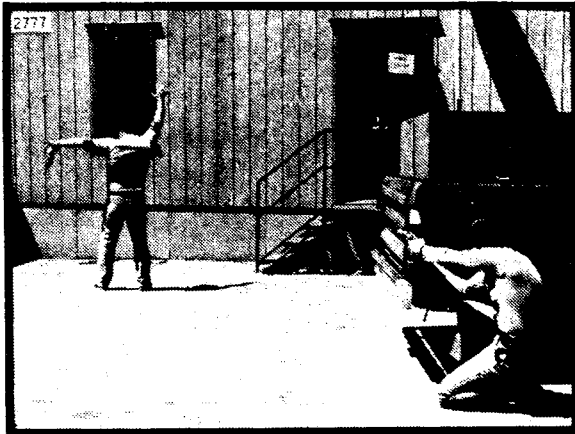

Illustration 13-5a. To disarm an adversary from your position of cover, command him/her to hold the weapon out to the side.



Illustration 13-5b. Then, have the adversary place the weapon gently on the ground.

Since the adversary's back will be turned to you, you will have no way of knowing if he/she is grabbing more than the butt of the gun or using more than the fingertips. But even if the gun is grabbed in a shooting grip, the adversary will have to turn around and aim before he/she can shoot at you. You will have time to react from your position of cover or concealment.

Once the weapon is on the ground, you must move the adversary away from it. Give a command, such as "Move to the right (left, back, forward)." Do not order that the gun be kicked away from the adversary.

The principles of disarming remain the same regardless of where on the adversary's body you have discovered a weapon. Your first step will be to ensure that the adversary's back is toward you. Then, command that the weapon be placed on the ground with the left hand.

If you come across an adversary who appears to be wounded or dead, you should obtain a backup and then proceed to disarm the adversary immediately. Be especially cautious if there is still a weapon in the hand of the adversary. Always choose an approach that allows you to keep the

adversary's weapon in view. Ideally, this approach would be from the adversary's blind side at an angle. Have your backup cover your approach. Hold your own weapon tightly against your body so that it cannot be grabbed away. At such close range, you will rely on the pointing technique of firing. You will not need to aim if you must fire at the adversary, and therefore, there is no reason for you to hold the weapon away from your body as you approach. When you reach the adversary, step on his/her weapon, and then pick it up (see Illus. 13-6). Secure your own weapon and the adversary's, and apply handcuffs. If your cover guard is in an excellent position to react to the slightest overt move, you may want to secure your own weapon prior to obtaining the adversary's in order to avoid introducing two weapons at the same time into a high-risk area.



Illustration 13-6. To disarm a wounded adversary, try to approach from a blind side at an angle with your weapon held close to your body.

Section 4. INCAPACITATION

Even though you have performed a visual search of the adversary and have given a command to remove any weapons that you detected, the adversary still may pose a serious threat to you. In order to place the adversary at a greater disadvantage, you must have him/her assume a position of incapacitation before you proceed further with the apprehension. From such a position the adversary will be unable to move quickly to harm you.

There are three basic positions of incapacitation: standing, kneeling and prone. The selection of a position normally is based on the severity of the crime committed. For example, a police officer will use the standing position in the arrest of a suspect over a minor shoplifting charge. The same police officer may use the prone position to incapacitate a bank robbery suspect. In the nuclear environment, a high-risk crime is the most likely to occur. You, therefore, probably will choose the kneeling or prone position to incapacitate an adversary.

In arrest scenes on television, the suspect often is directed to place hands against a wall with arms and legs spread apart. This position is commonly used in actual arrests for low-level crimes. It is not a position of incapacitation at all. The suspect can easily spring out of the position and attack an unprepared guard.

If you are in a low-risk arrest situation and decide to use the standing position for handcuffing, a modified wall position will be much safer than the standard wall position. Command the adversary to stand about two feet from the wall. Order him/her to lean toward the wall and to place the chest against the wall. Then order that the hands be placed behind the small to the back and that the suspect look straight up (see Illus. 13-7).

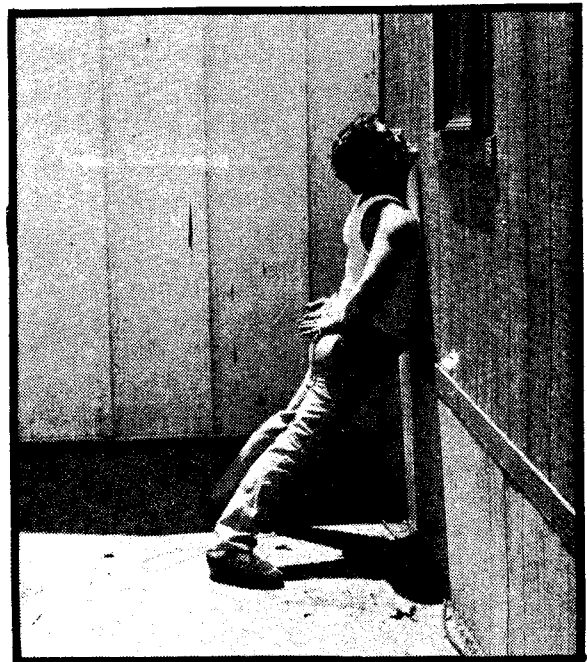

Illustration 13-7. The modified wall position of incapacitation.

An adversary will not be able to move out of this position quickly. With hands behind the back there will be no push off capability. If he/she does turn around, it will take a moment to reorient, giving you time to react.

Another relatively safe technique is to have the adversary lean toward the wall, stretch arms out parallel to the ground, and place the backs of the hands against the wall. Again, the adversary will be unable, in this position, to use the arms for leverage to push away from the wall.

Rather than using the standing position, you will be more likely to use the more severe kneeling position of incapacitation. To move the adversary into this position, first have him/her turn his/her back toward you. Then, order that the hands be held high above the head with the elbow locked and the fingers spread and that the adversary walk backward toward your voice. When you feel that the adversary is too close to remain upright without putting you in unacceptable danger, order the adversary to drop to the knees with the toes pointed to the rear. If you allow the toes to be pointed forward with weight on the balls of the feet, the adversary will be poised like a sprinter at a starting block.

Direct the adversary to cross the lower legs in the form of an "X." If the legs cannot be crossed, you do not have to insist. Some people are not flexible enough to assume this position, and the step is not essential. Have the adversary sit back on the buttocks with the knees spread apart. When you are ready to place handcuffs, have the adversary place both hands behind the small of the back.

The prone position of incapacitation will place the adversary at an even greater disadvantage. To have an adversary assume this position, first command that the kneeling position be assumed. Then direct that the right hand be placed on top of the head and that the left hand be placed on the ground in front.

When the adversary is in this position, direct him/her to lie down on the stomach. It would be safer to have both hands be placed on the head before lying down, but one hand is necessary for support. Since most people are right handed, the left hand should be used for support. The right hand must be kept in your sight at all times (see Illus. 13-8).



Illustration 13-8. To move an adversary from a kneeling position to a prone position of incapacitation, have the right hand be placed on top of the head and the left hand on the ground in front.

The tactical weakness of the prone position is that as the adversary reaches down with the left hand, you have no way of knowing if the adversary is reaching for the ground or for a weapon that you missed in your visual search (see Illus. 13-9a). He/she does not even have to turn around to shoot at you. He/she can see you by looking under the right armpit, and can point the gun at you as well (see Illus. 13-9b). This threat is not great enough to cause you to disregard the prone position entirely, but it should give you added reason to watch every movement the adversary makes.



Illustration 13-9a. An adversary might possibly reach for a weapon while moving into the prone position of incapacitation.

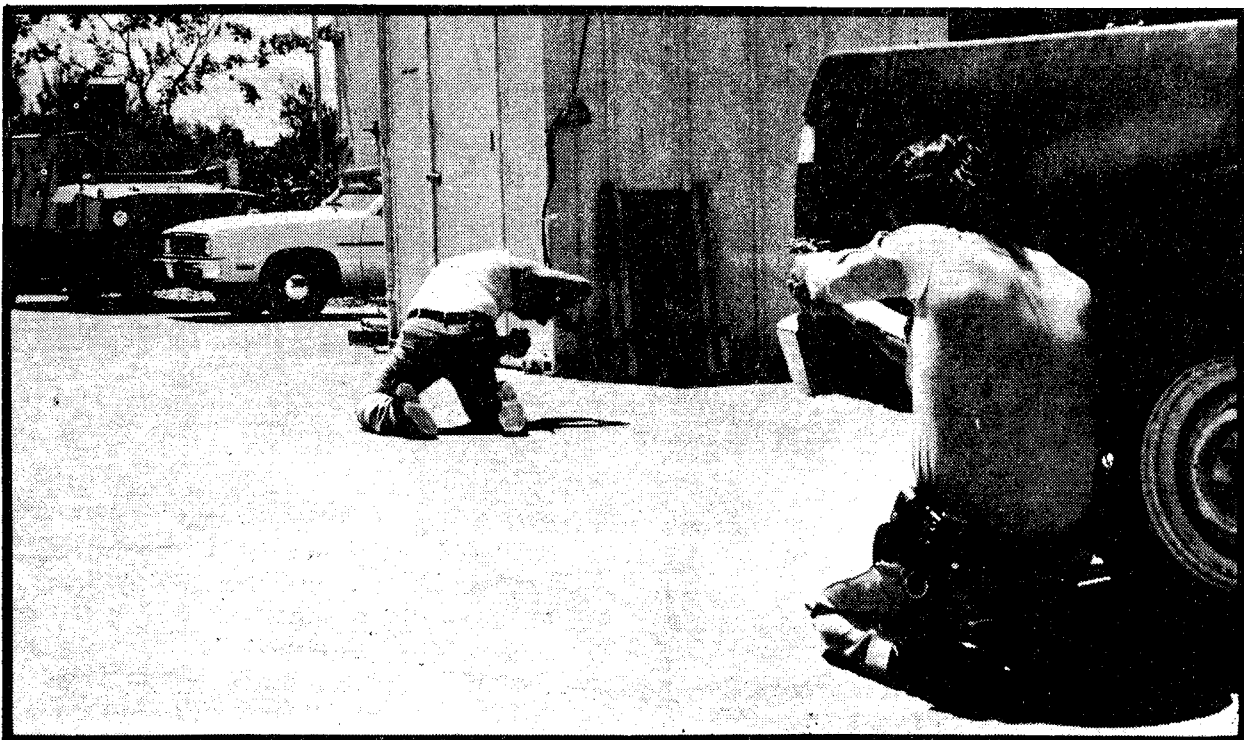

Illustration 13-9b. The adversary can observe and fire under the armpit.

Once the adversary is lying on the stomach, have the arms placed straight out to the sides, palms up, and then command that the legs be spread, toes out. If you are on the left side, have the adversary turn his/her head to the right. If you are on the right side, have the head turned to the left. Remember that you do not want the adversary to see what you are doing (see Illus. 13-10).



Illustration 13-10. When you move the adversary into a prone position, order the head turned so that he/she cannot see you.

You may choose to have the adversary lie down in a prone position with the head toward you. This arrangement will bring the hands closer to your position of cover. Hands may even stretch close enough for you to apply the handcuffs without exposing yourself to fire from other adversaries (see Illus. 13-11). If the hands are not within reach, then have the adversary crawl on the belly until they are within reach. The drawback of using this

arrangement is that the adversary must face you while kneeling in preparation for lying down. While facing you, he/she could draw a weapon and fire at you without having to turn around. You therefore should consider this technique only if your cover is excellent. Since both of the adversary's hands will be in view when he/she is kneeling facing you, both hands can be placed on the ground to ease lowering into the prone position.

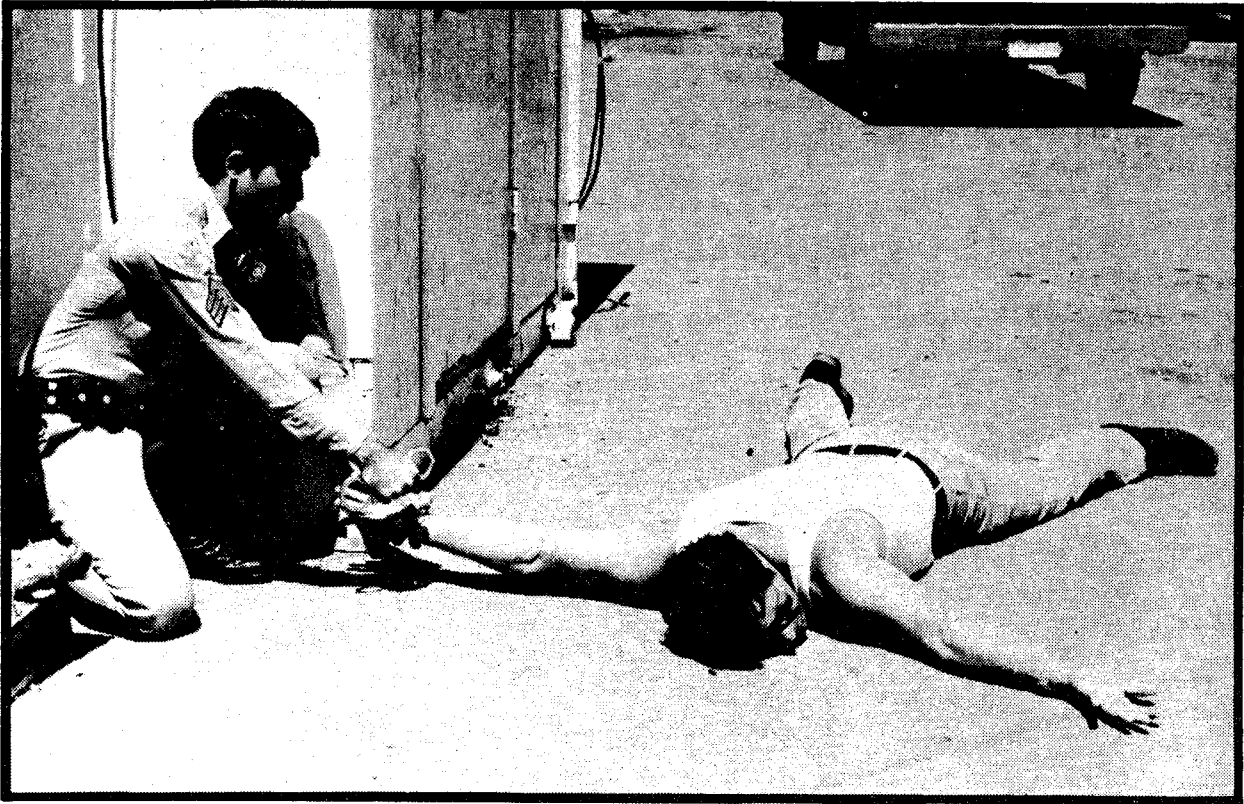

Illustration 13-11. Apply handcuffs from your position of cover to an adversary who is in a prone position.

Section 5. TECHNIQUES FOR ADVERSARY APPROACH

The closer an adversary is to you, the greater the threat posed. This section will cover the special precautions and techniques you should use to ensure your safety as you bring the adversary under actual physical control.

Teamwork is extremely important during the final approach to the adversary. If possible, have another guard provide cover for you as you approach physical contact with the adversary. The cover guard must take a position so that his/her fire will not endanger you. If imaginary lines were drawn from you to the adversary to the cover guard, the lines should form an "L" (see Illus. 13-12 and 13-13). If both you and your cover guard are on the same line, with the adversary in the middle, then neither guard can fire at the adversary without endangering the other guard (see Illus. 13-14). Although the odds would not be good for the adversary, the adversary might be able to reach for a gun and fire on you both.

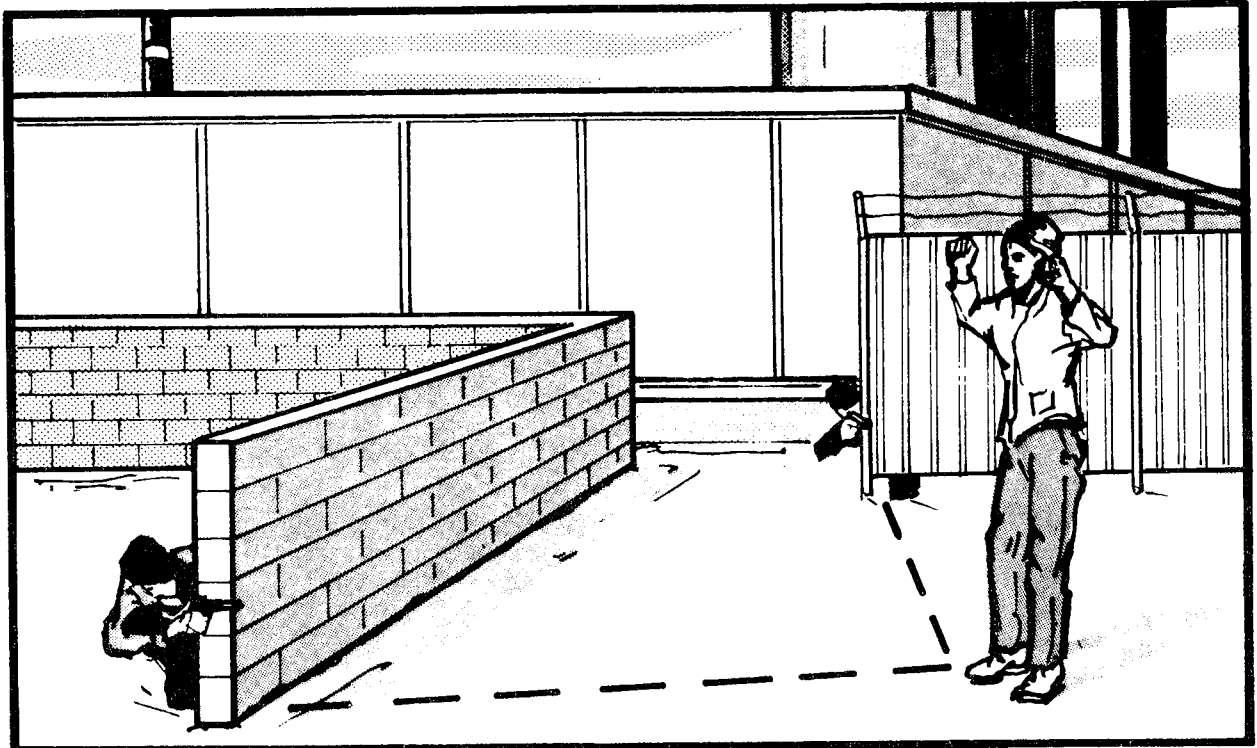

Illustration 13-12. It should be possible to draw an imaginary "L" from one guard to the adversary to the second guard.

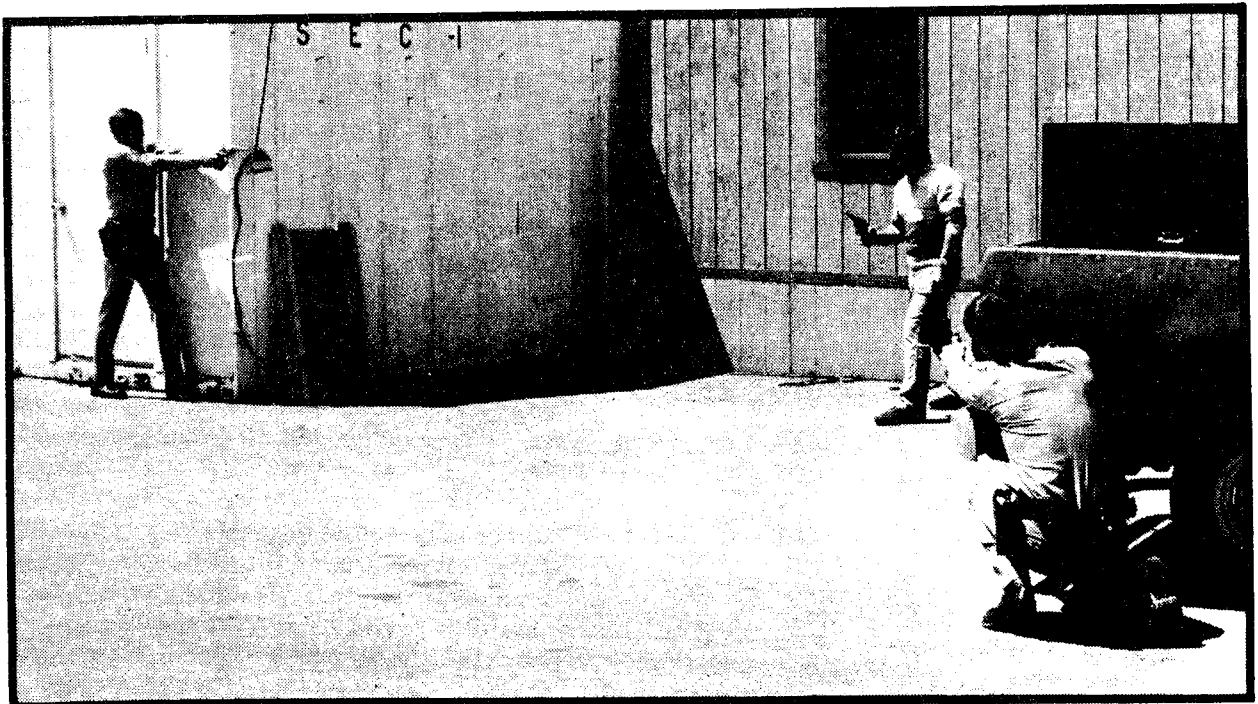

Illustration 13-13. The two guards are properly positioned in relation to the adversary.



Illustration 13-14. These two guards have created a dangerous crossfire situation. The guard on the right is especially vulnerable because he has abandoned his position of cover.

Try not to abandon your position of cover, even during the final approach to the adversary. Make the adversary come to you if possible, even if this requires that the adversary crawl on his/her knees in the kneeling position of incapacitation. Remember that other adversaries may be waiting for you to expose yourself so that they can fire on you (see Illus. 13-15).



Illustration 13-15. Try not to abandon your position of cover, even to apply handcuffs to an adversary. Another adversary could be nearby waiting for an opportunity to fire on you.

If an adversary is asking to surrender from inside a room, have the adversary come out instead of going inside. If you try to enter the room, you will be put in a position of disadvantage. You will not know where the adversary is, the number of adversaries inside and what they are doing. The adversary, on the other hand, knows exactly where you will be coming from.

Your commands to the adversary must be specific. Since hands are the most likely part of the body to be used to harm you, ask to see them first. A good command to give from your position of cover is "Put both hands into the hallway so I can see them." Follow this command by "Keep your hands out, and step into the hallway."

When you finally make actual physical contact with the adversary, avoid a face-to-face, toe-to-toe approach. Position yourself at an angle rather than directly in front of or directly behind the adversary. From an angled position, you can better defend yourself or execute a countermove if the adversary becomes aggressive.

Control your weapon when you are close to the adversary. Techniques for disarming an individual are easy to learn, and if you become careless, the

adversary may grab your weapon and use it against you. Never hold a gun within reach of an adversary during the final approach.

Return your weapon to your holster just before you get close enough to the adversary for the weapon to be grabbed. You will feel less secure at the moment, but you must never apply handcuffs with a weapon in your hand. Your cover guard will provide cover while you apply the handcuffs. During this stage of the apprehension, command the adversary to keep his/her back to you and to keep the eyes straight ahead. The adversary must not see what you are doing. He/she especially must not know that you have secured your weapon.

Section 6. HANDCUFFING

Metal handcuffs must be thought of as temporary restraints that have many vulnerabilities that an adversary can exploit. In this section, the vulnerabilities will be described, and the most secure techniques of handcuff use will be presented.

HANDCUFF VULNERABILITIES

Metal handcuffs are vulnerable in part because of the way in which they are constructed (see Illus. 13-16). The chain that connects the two cuff portions of the handcuff set is one source of this vulnerability. It is possible for the adversary to put the two links of the chain into a bind or kink and then to break the chain by applying pressure on the stress point. The chain is connected to swivels. These parts are another source of vulnerability in that a reasonably strong person can pull a swivel completely out of the cuff housing.

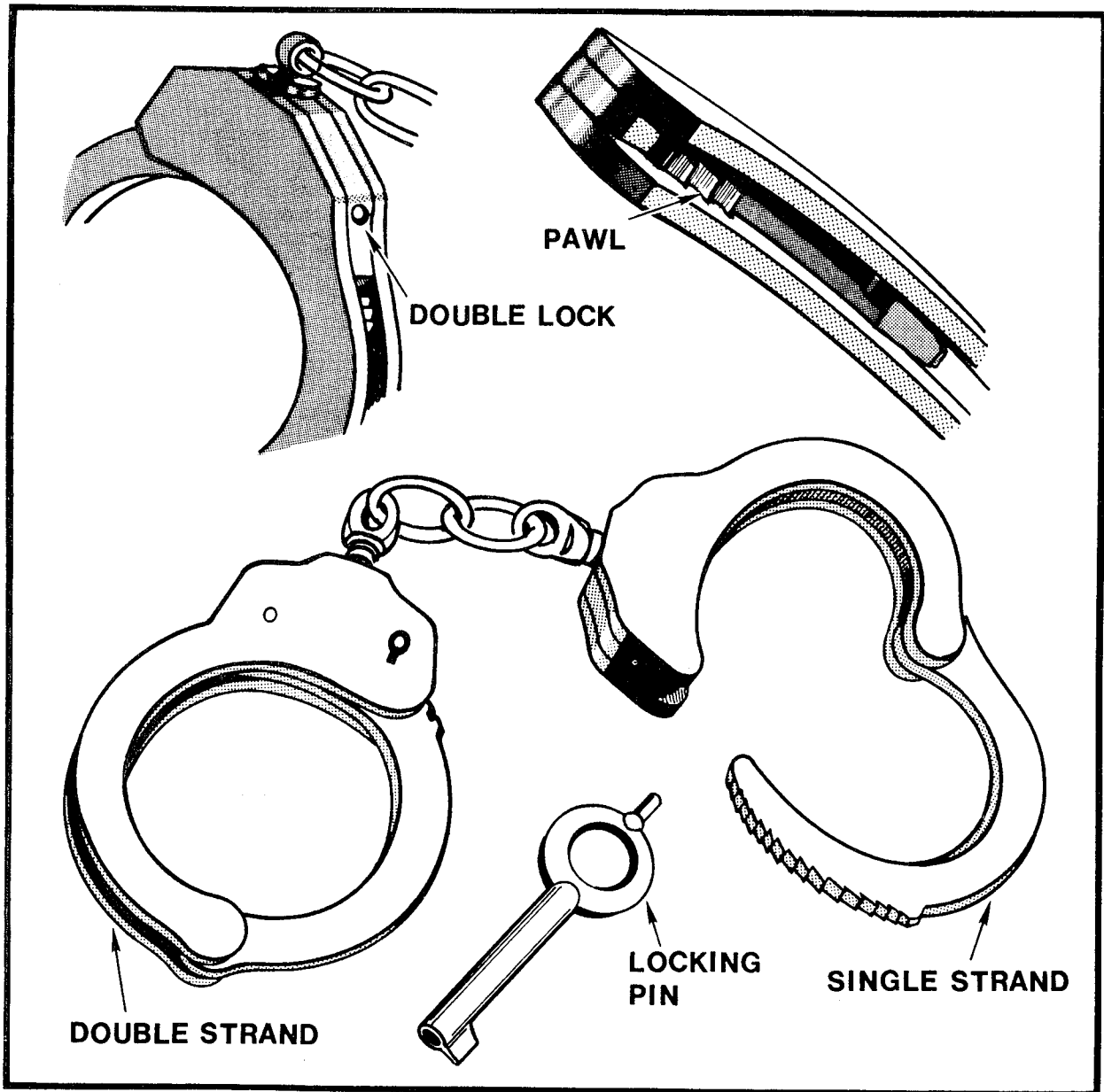

Illustration 13-16. Components of metal handcuffs.

One side of each cuff is called the double strand and the other, the single strand. The single strand is connected with a rivet that allows it to swing into the double strand. If an adversary is able to insert a pry tool into the double strand, the rivet can be popped out.

Metal handcuffs also are vulnerable because of the way in which they function. For example, an adversary can take advantage of the handcuffs' mechanism by using a shim. A bobby pin makes an ideal shim. With the plastic head removed, the bobby pin will fit in the space between the teeth of the single strand and the cuff base. The teeth of the single strand are designed to meet and lock up with the pawl. The pawl consists of three spring-loaded teeth that can be depressed with a pencil point. If the handcuffs are not on double lock, the adversary will be able to insert the bobby pin between the pawl and the single strand, depress the pawl and back the single strand out until the handcuff is open.

Always place the handcuffs on double lock after any handcuff application. This double-lock mech-

anism will prevent the spring-loaded pawl from being depressed, thus preventing the use of a shim. However, even the double lock mechanism has a weakness. If the adversary violently strikes the cuffs against a hard surface, the double-lock mechanism can be knocked off and then a shim can be used.

Metal handcuffs have another vulnerability—to handcuff keys. Adversaries can obtain keys, and many criminals keep them concealed on their bodies. In fact, it is possible to make a workable handcuff key out of the metal refill for a ball point pen (see Illus. 13-17).

Remember that metal handcuffs are only temporary restraints. When you handcuff an adversary, you still are responsible for him/her until you have positively turned him/her over to another person of authority. Unless you have help or until you have turned the adversary over, you cannot go on to arrest other adversaries or otherwise return to the tactical situation. The risk is too high that an unattended adversary will escape and harm you.

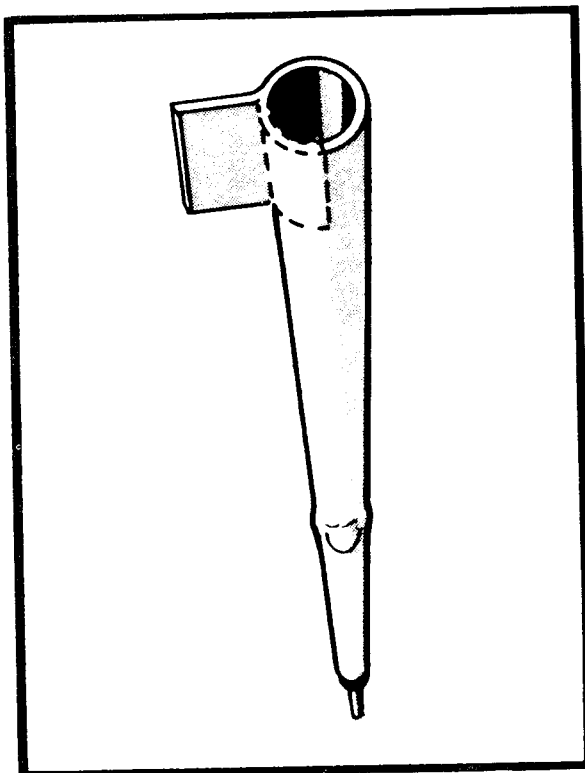

Illustration 13-17. A handcuff key can be made from the metal refill for a ball point pen. A small section at the end of the refill is cut open so that this end can be inserted in the keyhole and turned to spring the lock.

HANDCUFF-APPLICATION TECHNIQUES

You must be able to apply the handcuffs with one hand so that you can control the adversary with the other. The same simple, one-handed, handcuff-application technique can be used regardless of which position you have commanded the adversary to assume.

If you are on the right side of the adversary, apply the handcuffs with your right hand. If you are on the left side, apply them with your left hand. Grip the closed cuffs with your palm facing down and the single strands facing forward. Try to place the bulk of your hand on the chain, thus separating the two cuffs, so that each cuff has some rigidity and strength to it (see Illus. 13-18). Adding strength to the cuffs is important because the cuffs are designed to open when they are pressed firmly against an object. In this case, the object will be the adversary's wrists. A second reason for holding the cuffs rigidly is that you may need to use them as a fighting tool. If you stretch the two-link chain as far as possible, you will be able to apply the maximum force with the cuffs.



Illustration 13-18. Grasp the handcuffs firmly across the chain with your palm facing down and the single strands facing forward.

The instant you make physical contact with the adversary, use a control technique. Imagine that you have made the final approach from the left side with your handcuffs in your left hand. Reach from an angle with your right hand, which will be your controlling hand, to grab the adversary's left hand in a wrist-twist lock. Accomplish this grasp by gathering up the back of the adversary's hand so that your thumb is on top of the adversary's and your fingertips are on the inside of his/her thumb.

The wrist-twist lock is not a traditional "come along" technique. That is, it is not designed to cause extreme pain in order to force an adversary to comply. Instead, you can use this hold to break the adversary's point of balance by applying pressure, or torque, counterclockwise, away from the thumb, thus causing the shoulder to dip dramatically. Apply such pressure the instant you sense the adversary wants to fight instead of to surrender. The wrist-twist lock will not, by itself, win the fight for you, but by breaking the adversary's point of balance, you will have the chance to make countermoves.

Once you have established the wrist-twist lock on the left hand, pull the adversary's arm away

Once you have established the wrist-twist lock on the left hand, pull the adversary's arm away from his/her body, toward you, and apply the single strand of the closed left cuff against the indentation in front of the radial bone of the wrist. This indentation is easy to find and feels much like the separation between a chicken drumstick and thigh bone (see Illus. 13-19).

Make skin contact with the single strand, applying the oval of the left cuff against the oval of the wrist (see Illus. 13-20), and jerk the cuffs straight down toward the ground so that the single strand goes completely around in one smooth motion and catches into the receiving teeth of the pawl. This smooth application is essential because, if the single strand does not catch, you may have to release your hold on the adversary to readjust the cuff. You will then have lost control.

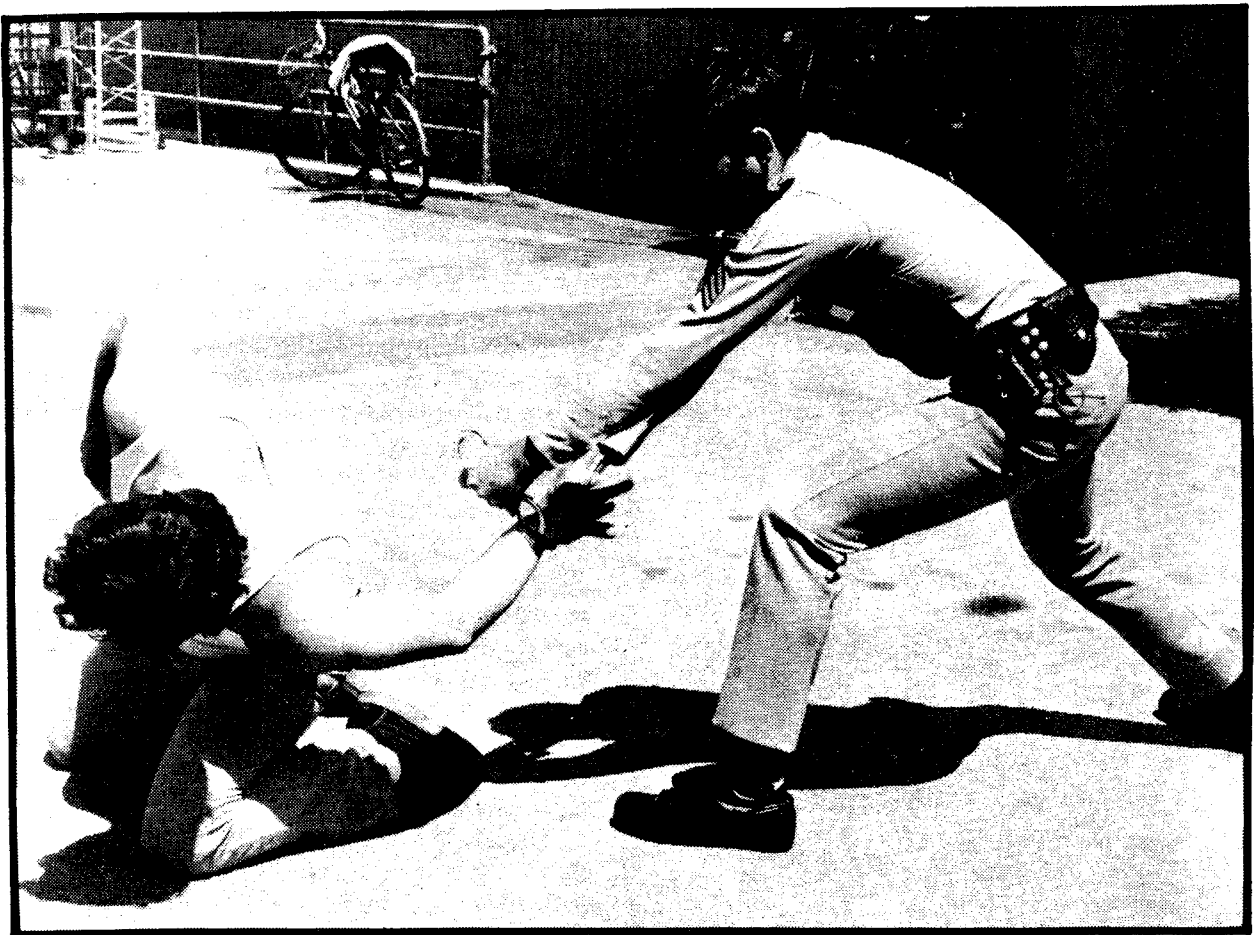

Illustration 13-19. Handcuff application on an adversary who has been placed in the kneeling position of incapacitation. The wrist-twist lock is being used.



Illustration 13-20. Match the oval of the cuff to the oval of the adversary's wrist.

Maintain the wrist-twist lock as you apply the left cuff to the left wrist. Once the left cuff is on, you no longer need this control technique, because the control is now in the handcuff grip itself. If, for instance, the adversary becomes hostile at this point, jerk the handcuffs up beside the right temple. The pain will allow you to assume control.

To apply the second cuff, reach behind the adversary, and grab his/her right hand with your free right hand as if you were going to shake hands. Make sure that the thumb is enclosed in your grip. (See Illus. 13-21). By grasping the hand this way, you can apply the cuffs so that the adversary's hands are back-to-back and behind him/her (see Illus. 13-22). Never handcuff an adversary with the hands in front.



Illustration 13-21. To apply the second cuff, grab the adversary's right hand, making sure that you enclose his/her thumb in your grip.



Illustration 13-22. Apply the cuffs so that the adversary's hands are back-to-back and behind.

Take the single strand of the closed right cuff and place it against the indentation in front of the radial bone on the adversary's right wrist. Once again, match the oval of the cuff to that of the wrist, and with a snap, or jerking motion, force the single strand straight down toward the ground so that it revolves in one smooth motion, catching in a lock position into the pawl.

On each of the adversary's wrists, as soon as the single strand has caught, tighten up the cuffs with the index finger of your controlling hand (see Illus. 13-23). Tighten the cuffs until they are as secure as possible without seriously cutting off circulation to the hands. Double-lock both cuffs. If the adversary is very small and is able to slip out of the tightest handcuff application, you can try applying the handcuffs above the elbows. This is only possible if the adversary is flexible enough to bring his/her elbows together behind the body.



Illustration 13-23. Tighten the cuffs with the index finger of your controlling hand.

This handcuff procedure is easily used on an adversary who is in the standing or kneeling position. The application technique may seem more complicated if the adversary is in the prone position, but the steps are the same. As you approach the adversary, think about which side you are on. If you are on the right side, for example, place the handcuffs in your right hand, and squat—do not bend over—to grasp the right hand with your left. Use your left hand as if it were a scoop shovel and gather up the back of the hand (see Illus. 13-24). Remember, you have commanded that the palms be placed up. Place your thumb on the back of the palm. This wrist-twist lock is the same hold that you use in the standing and kneeling positions.



Illustration 13-24. Grasp the adversary's hand as shown to prepare to apply handcuffs with the adversary in a prone position.



Illustration 13-25. Raise the adversary's hand above the body to apply the first handcuff.

Now, raise the adversary's arm directly over his/her body. Holding the hand high, place the right cuff against the indentation in front of the right radial bone (see Illus. 13-25). Press the single strand straight down on the oval of the wrist, and tighten the cuff with the index finger of your controlling hand.

At this point, bend the handcuffed right arm toward the small of the adversary's back. Now you can move closer, but place your right knee on the base of the neck, and press your left shin firmly against the right elbow so that he/she cannot jab the elbow into your groin (see Illus. 13-26). Order the other hand to be given to you. The adversary will comply because you can exert painful pressure with the handcuff grip by slightly turning the cuff on the right wrist.

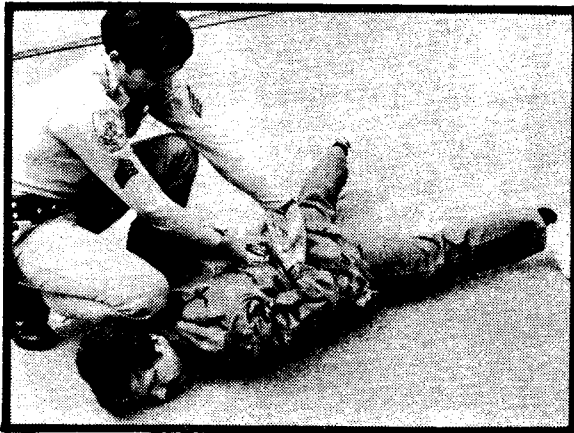

Illustration 13-26. Place your right knee firmly against the base of the adversary's neck and your left shin against the right elbow to prevent the adversary from struggling.

Take his/her left hand as if you were going to shake hands and, as with the standing-and-kneeling application, place the single strand of the left cuff against the indentation in front of the radial bone. With a snap, or jerking motion, push the cuff straight down on the wrist. Double lock both cuffs.

There is a right time and a right way to pull out your handcuffs. If you grab them too soon, you may tend to focus on them instead of concentrating on the adversary. Bring out the cuffs just before the moment of application. Learn to distinguish the single and double strands and to properly arrange the cuffs by touch. Although it is best to apply the handcuffs with the keyholes facing up so that the adversary cannot reach them, do not break your focus on the adversary or waste precious time looking for the keyholes. Your priority in a high-risk situation will be to bring the adversary under complete control as quickly as possible.

HANDCUFF REMOVAL

Taking handcuffs off an adversary is at least as risky as putting them on. The adversary may be just waiting for this chance to try to escape. Remove the handcuffs by reversing the application procedure. Approach from an angle in a tactical manner. Assume a defensive posture, as if you are about to fight. Grab the handcuffs in the handcuff grip. If the keyholes happen to be pointing down, do not bend over to insert your key. This position will break your own physical balance. Instead, pull up on the handcuffs. This movement causes the adversary to bend over and brings the keyholes up to your line of vision (see Illus. 13-27).



Illustration 13-27. To unlock handcuffs, bring the handcuff keyholes up to your line of vision so that you can insert the key easily.

Most handcuff keys are tiny. You may want to buy or make an elongated key that is easier to find on your key ring and to use. If you use the normal, manufactured key, place it on a separate key ring so that you will not waste time fumbling for the right key.

Section 7. BODY-SEARCH TECHNIQUES

Once the adversary has been securely handcuffed, conduct a high-risk search. A thorough search is extremely important. If you make a hasty

search and overlook a weapon, the adversary may use the weapon against you later. This section will describe effective body-search techniques.

The body search conducted at the time of apprehension is primarily an external search for weapons and devices that can help the adversary to escape. A strip search, or body-cavity search, can be performed later. As you conduct the body search, you should look for more than the obvious guns and knives. Adversaries can be very creative about choosing items to conceal and figuring out how to conceal them. Handcuff keys and wire shims often are found stuck in the hair and taped behind the ears, inside the belt line and inside the back of a shoe. Objects that appear innocent often can be dangerous. Belt buckles also can be knives. Pens also can be firearms.

Do not simply pat down the adversary's body. You could easily miss an important item. Instead, use a groping technique. Think in terms of grabbing and squeezing a hunk of bread dough. Be very methodical about your search, covering all parts of the body. Start at the head, removing headgear. Run your fingers through the adversary's hair, and check behind the ears. Reach down the back of the neck, feeling for a necklace. If you find a chain, pull it up to see what is attached. Search the collar of the shirt or jacket carefully.

You cannot search with both hands and still control the adversary. Search with only one hand as you hold the adversary behind the body with the handcuff grip. If you are on the right side, hold the cuff chain with your left hand, and search with your right hand (see Illus. 13-28). If you are on the left side, do the opposite.

Use the button or jacket zipper line of the adversary's clothing to mentally divide the upper torso in half. As you search, overlap this middle line with your grabbing and squeezing. Gather up a ball of clothing in your palm, and consciously feel for objects with your squeeze. Check under the armpit and inside the belt. Use caution when feeling inside of the belt because the adversary may have concealed sharp objects such as razor blades here. Search the rear of the upper torso area as well as the front.

Then, work your way down the adversary's leg. If you feel an object in the pants pocket that you cannot identify by touch, pull it out. Continue down to the shoe or boot, and take it off if necessary. The upper part of a boot and the inner sole and heel of shoes and boots are frequently used

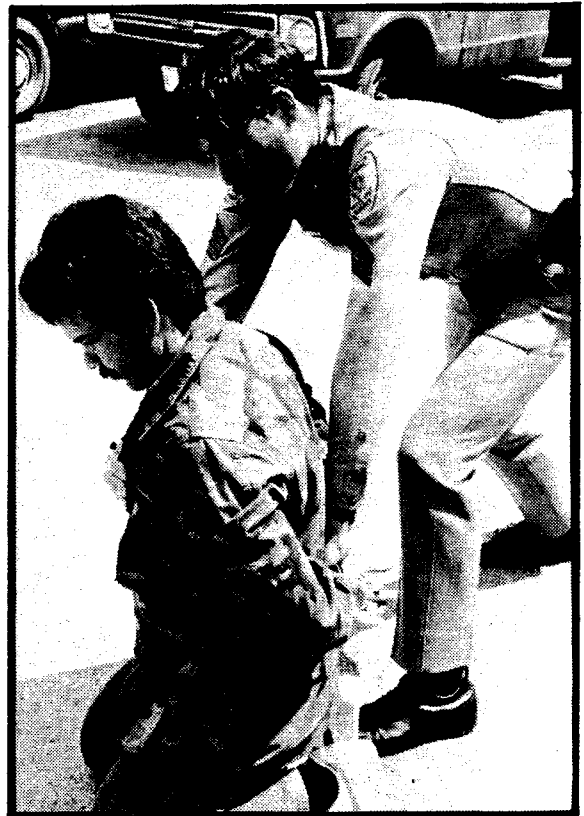

Illustration 13-28. Use a groping technique to search the adversary with one hand while you use a handcuff grip to hold him with your other hand.

as hiding places for weapons and contraband.

When you have completely searched the right side, switch sides by grasping the handcuff chain with your right hand. Then, with your left hand, search the left side of the body, again overlapping the middle line.

You must search the groin area, front and back. This spot is a favorite one for concealing weapons since the adversary knows that most men and women are hesitant about touching another person's crotch, regardless of the gender mix. The adversary may even attempt to keep you from performing a good search by making offensive remarks. Disregard any comments. If you search the area aggressively, not as in an assault but in a forceful, meaningful manner, you usually will stop the remarks before they start. Be sure to check between the buttocks. An easy method is to use the side of your hand in a sliding motion (see Illus. 13-29).



Illustration 13-29. Use the side of your hand in a sliding motion to search between the adversary's buttocks.

It would be ideal to have female guards search female prisoners and males search males. However, in the interest of safety and survival, this consideration must be given secondary importance.

In the standing and kneeling positions, the adversary can be searched fairly easily. The prone position makes searching a little more complicated. After the adversary has been handcuffed and while you still are squatting, roll the adversary toward you onto the side, and search the upper half of the body (see Illus. 13-30). Remember to overlap because, as you roll an adversary toward you, a gun on the high side may slide toward the low side. After you have searched the upper body, continue on that side with the lower body. To search the lower leg, ankle, and foot, have the adversary raise the top leg and bend the knee to bring the lower leg within your reach. When you have finished searching one side of the body, roll him/her back onto the stomach. Get up and walk around either the feet or the head to the other side. Do not step over the adversary. The feet still are weapons, and your groin is a vulnerable target. Roll the adversary toward you again to search the other side.

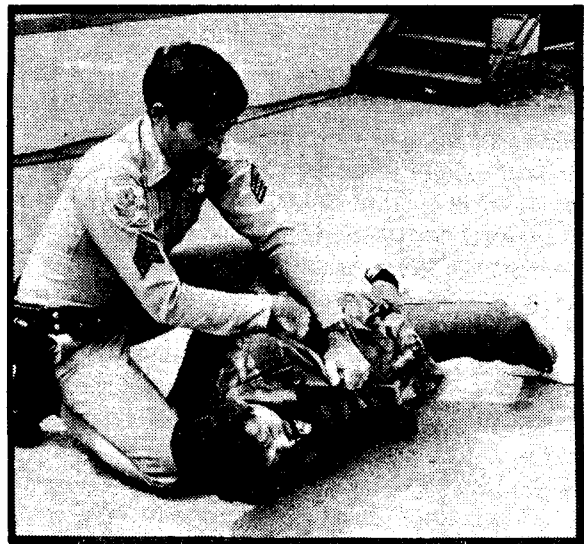

Illustration 13-30. Roll the adversary onto his/her side, and search the upper half of the body.

At some point after you have searched a prone adversary, you may want the adversary to get back up onto his/her feet. The adversary may require some assistance from you in order to do so. When you help, avoid "dead-lifting" the body. Roll the adversary onto his/her back, and lift the head slightly to begin to arrange him/her into a sitting position, and tell him/her to bend one knee. Then simply guide the shoulders over the bent knee. Until the shoulders are positioned over that knee, the adversary will almost certainly be unable to get up. With the shoulders in the proper position, you may have to lift some, but the adversary can do most of the work.

If you receive a handcuffed and searched adversary from another security guard, search the adversary again. The professional security guard will accept this procedure as standard and will not take offense. In the same way, you must expect a prisoner that you hand over to be searched again, even if you have done a thorough search. Where weapons are concerned, it always pays to be cautious. The adversary might not be able to use an undetected weapon or escape tool right away, but it could be used later, when you have relaxed your guard, with disastrous results.

Section 8. MULTIPLE PRISONERS

If you must apprehend more than one adversary at a time, the same general techniques will apply as for a single-adversary apprehension, but additional precautions must be taken. Calling immediately for backup is even more important when there are multiple adversaries than in the case of a single-adversary apprehension. As with a single adversary, your first command to multiple adversaries will be for them to stop all motion. Address further commands to the adversary who poses the greatest threat. If, for example, you confront two adversaries who seem to want to surrender, your first command should be "Freeze, don't move." Then, look for the greatest danger. If one adversary has hands at his/her sides with no weapons and the other has the left hand inside a jacket pocket, you obviously would address the one with the hand in the pocket.

Identify the person you are talking to so that adversaries and your cover guard are not confused. Say something like "You in the blue jacket, slowly turn around, and put your back toward me." Your cover guard then will know that he/she should concentrate on the other adversary.

The cover guard must practice a high degree of discipline and watch only the adversary that the command guard is not addressing. If you are the cover guard, resist the temptation to watch the action. Never divert your eyes from your own adversary.

As the situation becomes more complicated, so does the job of the command guard. Imagine that there are three adversaries who seem to want to surrender. One is holding a rifle high above the head, asking to surrender. Another is simply standing with arms folded, and a third has empty hands held forward in full view (see Illus. 13-31).

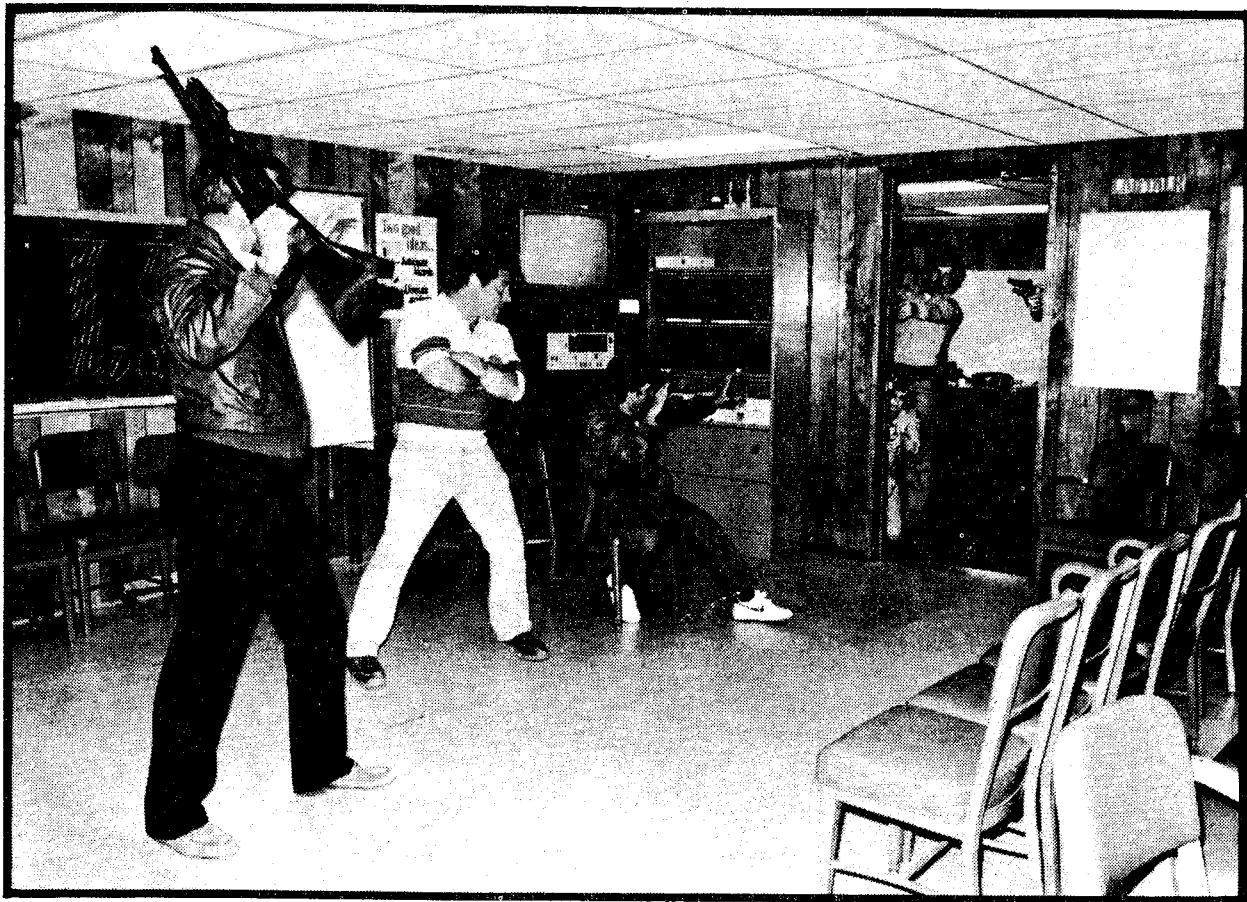

Illustration 13-31. A multiple-adversary situation. Where is the greatest threat?

Give the initial command to the entire group, "Freeze, don't move," and select the greatest threat. Direct your next commands to the adversary with the rifle. "You with the rifle, slowly turn around, and put your back toward me." If you have one cover guard, he/she will know to cover the other two adversaries. If you have two cover guards, you must give them directions so that both of them do not guard the same adversary. When you have disarmed the first adversary, focus on the adversary with the folded arms, since you cannot see the hands. Again, give directions to your cover guards if there are more than two adversaries, so that all of the adversaries are being covered as you deal with the threats by priority.

To make the handcuff applications, do not move out into the open area. Instead, have the adversaries come back to your position of cover or concealment. Have them move one at a time, again starting with the one who appears to be the greatest threat. You may want to reposition the adversaries

so that they can be covered and controlled more easily. For temporary positioning, you can command them into a horizontal line that runs directly in front of you or into a vertical-file line or into a triangle. The arrangement you choose will depend on the environment. Just be certain that each adversary can be seen by the guard who is assigned to cover that adversary. Do not allow the adversaries to be close enough together to touch each other. Try to keep them away from places where weapons could be concealed, such as desks, filing cabinets, building corners and dumpsters.

As you order an adversary to move closer to you, also pay attention to the positions of the other guards relative to that adversary. You should think of an imaginary circle of integrity that encompasses all guards present. The circle of integrity should not be occupied by any adversary who has not been searched and handcuffed. For instance, if a cover guard is in front of you, do not allow an adver-

sary to come back between that guard and yourself (see Illus. 13-32).

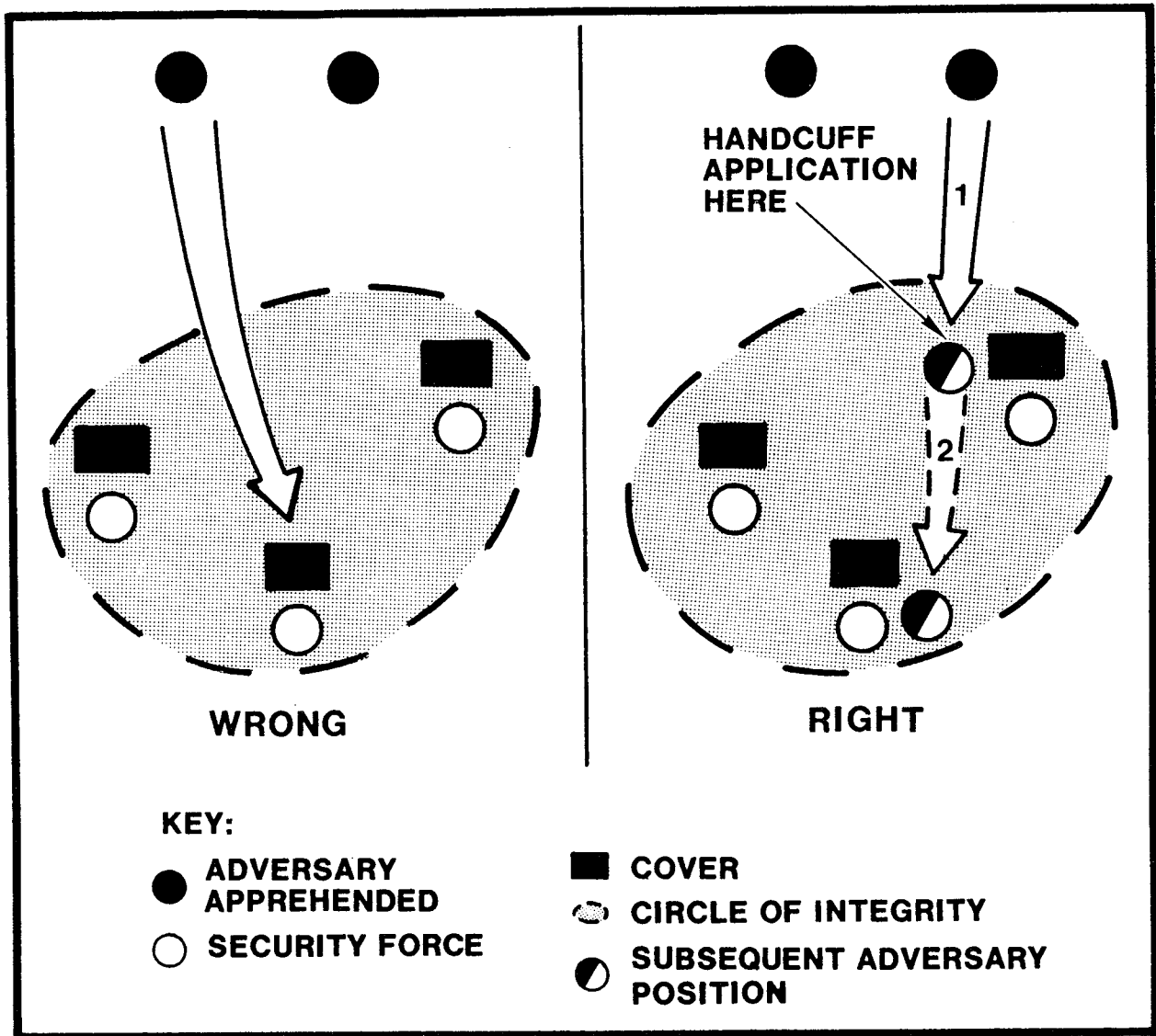

Illustration 13-32. Never bring an adversary within the circle of integrity unless that adversary has been handcuffed and searched.

Section 9. VEHICLE APPROACHES

You may confront an adversary in a vehicle at the termination of a chase. You also may confront an adversary in a parked vehicle. The same requirement to call for backup and the same general techniques for giving commands apply when you are removing an adversary from a vehicle as when you are conducting other types of

apprehensions, and the same general precautions must be taken. Additional techniques and precautions must be applied during a vehicle approach, and because of the potential hazard involved, vehicle-approach techniques must be understood completely and practiced repeatedly. The use of these techniques in relation to specific situations is presented in the remainder of this section.

THE HIGH-RISK APPROACH

You may be the driver of a patrol car in which another guard is riding when you stop a car occupied by two adversaries. In this kind of high-risk situation, the angle at which you stop your own car is important. Try to bring your car to a

stop at the angle shown in Illus. 13-33. Your distance from the adversary vehicle also is important. Try to stop about two car lengths to the rear of the adversary vehicle in order to give yourself the best cover.

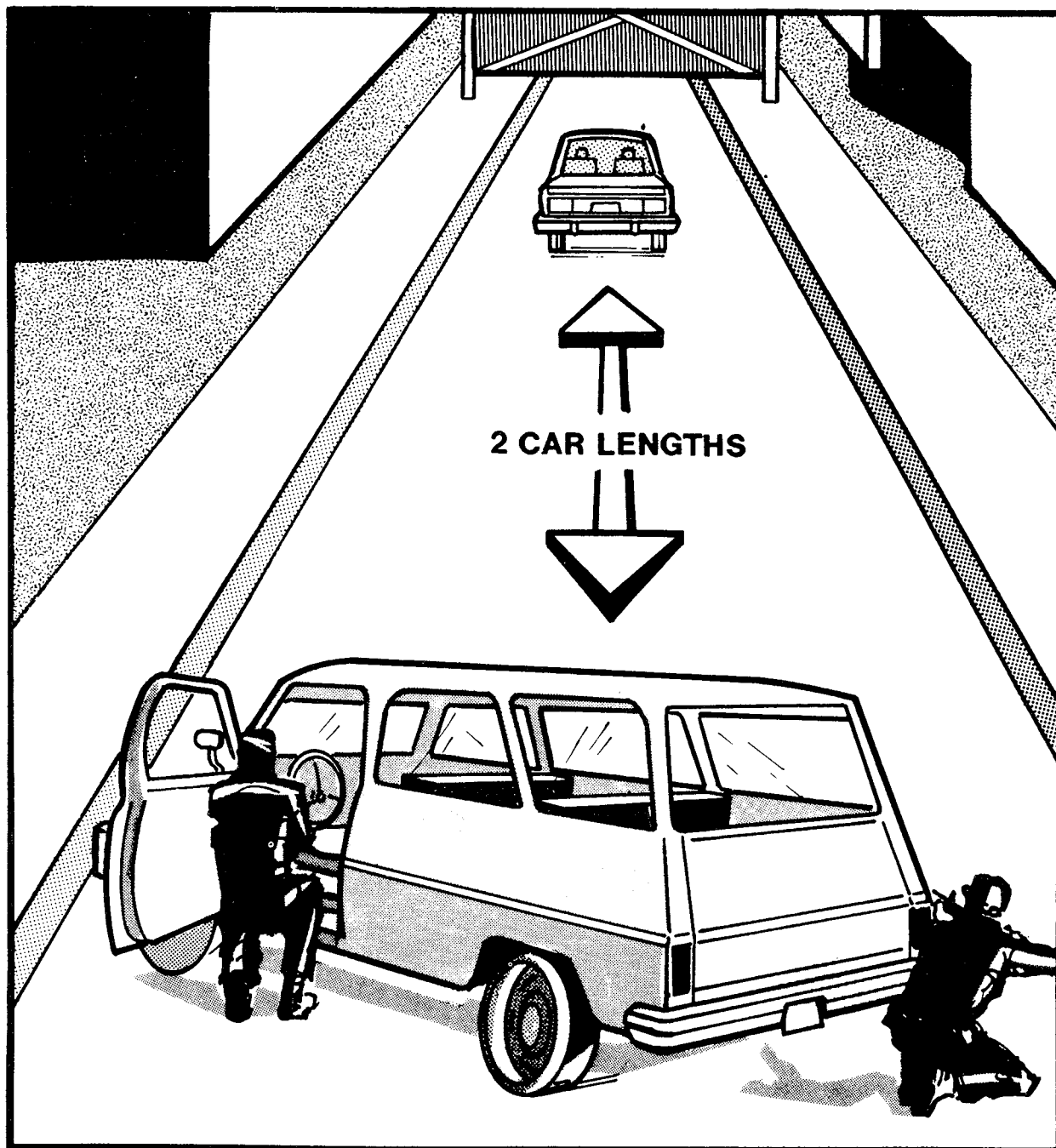

Illustration 13-33. During a high-risk vehicle stop, position the patrol vehicle two car lengths from the adversary vehicle and at an angle.

The first moments of a high-risk vehicle stop are critical. Within four seconds after stopping your vehicle you should have taken a low position behind the left front of your vehicle, you should have the muzzle of your weapon held on the adversary and you should have given an initial command. In your rush to get into position, do not forget to put the car in park, or you may find that your cover is rolling away.

Even if you are not driving, you will have a number of tasks to perform as quickly as possible. If

your patrol vehicle is equipped with a shotgun, the first of your tasks will be to pull the weapon from its rack and exit the car. Move quickly to a position behind the right rear quarter panel of the patrol vehicle, and use the right rear wheel for cover. Aim your weapon from around the side of the patrol car rather than over the top of the trunk in order to expose the smallest amount of your body as is possible while you watch the threat (see Illus. 13-34 and 13-35).



Illustration 13-34. Expose the smallest amount of your body as is possible during a high-risk vehicle stop.



Illustration 13-35. The adversary should be able to see little more than your gun muzzle.

Generally, as soon as the driver of the patrol car reaches cover, the driver gives the initial command, using the vehicle's public address system or a bull-horn if either of these is available. This command, ordering the adversaries to stop all motion, can be "You in the vehicle, freeze, don't move." The guard who gives the command must not divert attention away from the adversaries in order to adjust the address system. If mechanical problems occur, unassisted voice must be used.

All of these initial steps of the high-risk vehicle stop must be accomplished within seconds. If you take more than four seconds to stop your vehicle, exit, aim your weapon and give the first command, you will allow the adversaries too much time for planning and reaction.

As in any high-risk arrest situation, only one person gives commands during a vehicle stop. If one guard were to scream, "Get out of the car," a second, "Place your hands against the windshield" and a third, "Throw the ignition keys out the window," the adversaries would not know which order to comply with. A shooting could result needlessly from the confusion.

Usually, commands are given by the driver of the patrol car, but there are exceptions. The person who pulls the public address microphone out may become the one in charge. If the passenger behind the right rear quarter panel of the patrol car is able to see the adversary better, this guard will direct the commands, and the driver will become the cover guard. Tactical situations can be so varied that it is important for you to be flexible.

After you and your partner have taken cover, taken up and aimed your weapons at the adversaries and stopped all adversary motion, you must direct the adversaries with a sequence of commands to get them out of their car with the minimum danger to yourself and others.

As you do with adversaries who are on foot, you next must check the adversaries' hands, while these individuals are still in their vehicle, to see if their hands are empty. A number of commands can be given to make the adversaries put their hands where you can see them. Examples are

"Put the back of your hands against the windshield."

"Put your hands behind your head."

"Put your hands on top of your head."

Because of the design of the vehicle, you may not be able to see the adversaries' hands if they simply raise their hands up high. Be specific with your directions. For instance, you could say, "Put your hands up where I can see them." If you still cannot see the hands, use commands such as "You driver, move your left hand over to the right." When all hands are in view, direct the adversaries to freeze again (see Illus. 13-36).



Illustration 13-36. Continue to give commands until you can see the hands of all of the adversaries.

The next command should be directed at the adversary driver or at the adversary who presents the greatest threat. Order this adversary to slowly, with the left hand, reach down and pull the ignition keys out, open the window if it is closed and throw the keys out the window.

The next command to the adversary driver will be "Driver, put both of your hands out the window. Now, open the car door from the outside." The principle is the same as the one for bringing an adversary out of a room into a hallway. The hands should be seen first. The rest of the body follows (see Illus. 13-37 and 13-38).

As the driver opens the door, order him/her to step out of the car and to keep his/her back toward you. As he/she steps out of the vehicle, do not let the hands be drawn back out of sight. If you cannot see the hands, order him/her to freeze, and start the process over again by saying, "Put your hands out where I can see them. Now, step out of the vehicle" (see Illus. 13-39 and 13-40).

Order the driver to move far enough away from the car so that it cannot be touched. Perform a visual search of the high-risk area of the body as described in Section 3. Then, have the adversary walk backward toward your voice for the handcuff application (see Illus. 13-41).



Illustration 13-37. Command the adversary driver to put both hands out the window.



Illustration 13-38. Have the adversary driver open the car door from the outside.

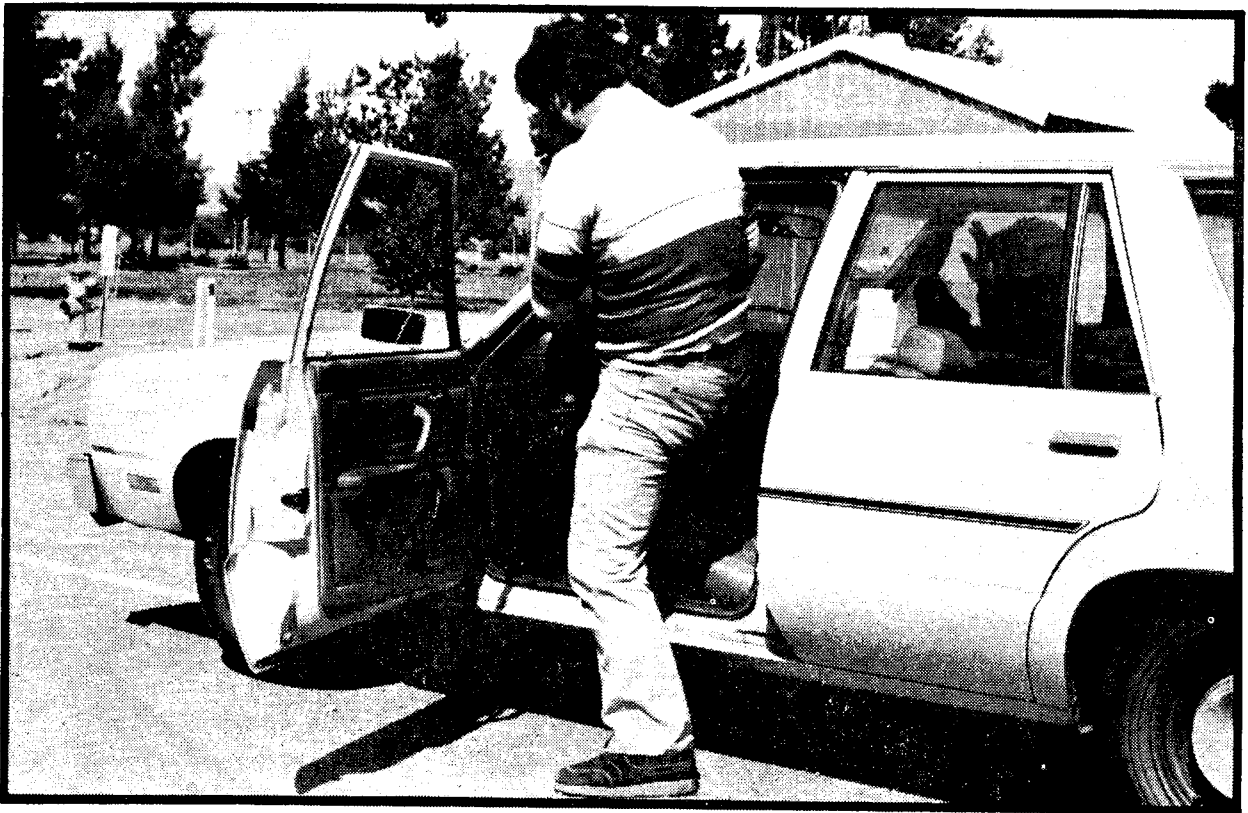

Illustration 13-39. Do not allow the adversary driver to draw his/her hands back out of sight as he/she exits the car.



Illustration 13-40. You must have full view of the adversary driver's hands as the adversary steps from the vehicle.



Illustration 13-41. Perform a visual search of the high-risk area of the adversary driver's body, and then have the adversary walk backward toward you.

Perform the steps leading to the handcuff application and the handcuff application itself behind the cover of your patrol car. Move the adversary up against the left front tire of the patrol car, and give the order to assume a kneeling or prone position of incapacitation before you approach. Do not let the person(s) remaining in the adversary vehicle see you applying the handcuffs (see Illus. 13-42).



Illustration 13-42. Perform the handcuff application behind the cover of your patrol car.

As you are apprehending the adversary driver, the cover guard is aiming his/her weapon and focusing his/her attention on the second adversary. This guard should be positioned so that he/she also can provide you with cover. Once the driver is handcuffed and searched, you can consider removing the second adversary from the adversary vehicle. Your next command should be "You passenger, slide over into the driver's seat." Remove this passenger in the same manner and from the same side as you removed the driver. No matter how many persons there are in the adversary vehicle, attempt to remove all of them from the same side. This side does not necessarily have to be the driver's. If, for example, the driver's door is blocked, all occupants can be removed from the passenger side. In that case, the cover guard, usually in position on the right rear side of the patrol car, may take the role of command guard.

Bring the adversary passenger out with his/her back toward you, and perform a visual search of the high-risk area (see Illus. 13-43). Then, order

him/her to walk backward toward your voice, and make the handcuff application behind the cover of your patrol car.



Illustration 13-43. Bring the adversary passenger out with his/her back toward you, and perform a visual search of the high-risk area.

Either guard can make this second handcuff application. While the command guard retains control of the first handcuffed prisoner, the cover guard can take over command and direct the second adversary to the appropriate position behind the patrol car. Whoever does make the application should be provided cover. Again, be certain that the application is done with the adversary either in the kneeling or prone position and in such a way that no one remaining in the adversary vehicle will be able to see you.

The adversary vehicle now may look empty, but an adversary still could be hiding inside. Since there is no way for you to tell from your position of cover, give the command, "You in the back-seat, put your hands up high so I can see them." This precaution is a good one to take even though there may not be anyone in the car. The vehicle then must be physically searched in the same manner as in a low-risk vehicle search.

THE LOW-RISK APPROACH

Not every vehicle approach must be treated as a high-risk incident. You can decide to perform a low-risk vehicle stop if a vehicle seems to be out of place but not threatening. For example, you might observe a car late at night parked with its lights out near an access post to your facility. The

occupants might appear to be lost travelers rather than potential adversaries.

Even during a low-risk vehicle stop, however, you must take precautions to ensure your own safety and survival. Never approach the vehicle by yourself. Call for a backup or cover guard. When the backup arrives, advise him/her of what you have seen or suspect, and then approach the vehicle alone. If you approach the vehicle together, you both could be in danger. Even if you go to different sides of the car, you will create a cross-fire situation, and in doing so, you could make it extremely hazardous for either of you to shoot an adversary.

At no time should you and your backup stand close together, thus presenting a single target for adversary fire. Instead, you should take up separate positions so that the adversary's points of aim will be split.

The Low-Risk Approach at Night

If you must approach a vehicle at night, illuminate it with every light source available. Use your high beams and your spotlight if you have one. The stronger the light, the more difficult it will be for the vehicle occupant(s) to see any movement to the rear of the vehicle. Always approach from the rear if possible.

The Low-Risk Visual Vehicle Search

While your backup remains behind near the patrol car, you approach to the right side of the vehicle that you want to investigate. It is a natural reaction for the driver of a vehicle to turn to look over the left shoulder to watch an approaching law enforcement officer. You might be able to surprise the potential adversary by approaching from the other side. For your own safety, treat any unknown person as a potential adversary, and perform even routine tasks in a tactical manner. If you run into trouble, your backup can at least react from his position beside the patrol vehicle.

When you reach the right side of the vehicle, check the trunk lid to see if it is securely closed, the floorboard of the rear of the car, the back and front seats, the floorboard of the front of the car and the occupants, especially their hands. You also should check the sun visors because a favorite adversary trick is to place a small pistol in the sun visor in anticipation of the command, "Get your hands up."

After you have completed your visual search to assess the vehicle and the occupants, return to the patrol car. Report your findings to your backup,

and take a position beside your patrol car.

The backup guard will duplicate the visual search process on the left side of the adversary vehicle. If you have been in the backup role, you now will search each of the areas of the vehicle previously mentioned. If you do not see any weapons and do not feel that your safety is threatened, you can make contact with the vehicle's occupants by saying something such as "Good evening, may I help you? Are you lost?" Your partner now is the backup and will provide cover for you.

As you make contact, do not position yourself in front of the door jamb of the driver's door. Force the potential adversary to look over the left shoulder to talk to you. You may have seen traffic officers stand well beyond the door jamb and face oncoming traffic as they issue tickets on the road. This technique may be the best one under highway conditions because more traffic officers are killed and injured by vehicular traffic moving past a car stop than by criminals with guns. Since you as a guard are more likely to be threatened by a hostile adversary than by traffic, however, you should stay to the rear of the door jamb (see Illus. 13-44).

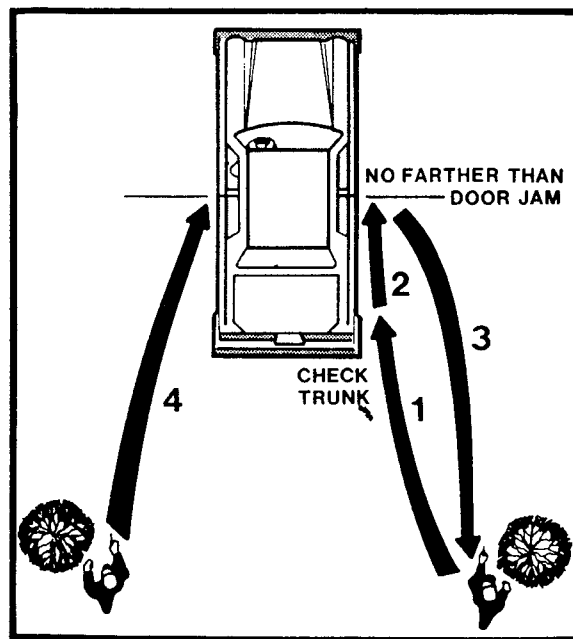

Illustration 13-44. The proper sequence for two guards to use when making a low-risk vehicle approach.

Section 10. EVACUATING PRISONERS

Evacuating a prisoner to a more secure location still is a high-risk operation, even though you have applied handcuffs and made a search. You must know how to control the prisoner, what precautions to take with multiple prisoners and how to respond to prisoners' requests. You also should be able to take advantage of the prisoner as a source of information at this time.

You must use only one hand to control a handcuffed prisoner so that you will have your other hand free to fire your weapon and to take other

necessary action. You can exert this control by using a bent-wrist come-along technique that allows you to inflict great pain if the adversary struggles. If you are right-handed and have moved the adversary to his/her feet from the kneeling or prone position, immediately slip your left arm in between the left arm and upper torso (see Illus. 13-45). Do not use your right arm because this action will place your weapon within reach of the adversary (see Illus. 13-46). Place your left hand on the back of the adversary's left hand, and position your hand so that you will be able to apply pressure in the direction of the adversary's left elbow.



Illustration 13-45. You can control a handcuffed prisoner with one hand by using the bent-wrist come-along technique.

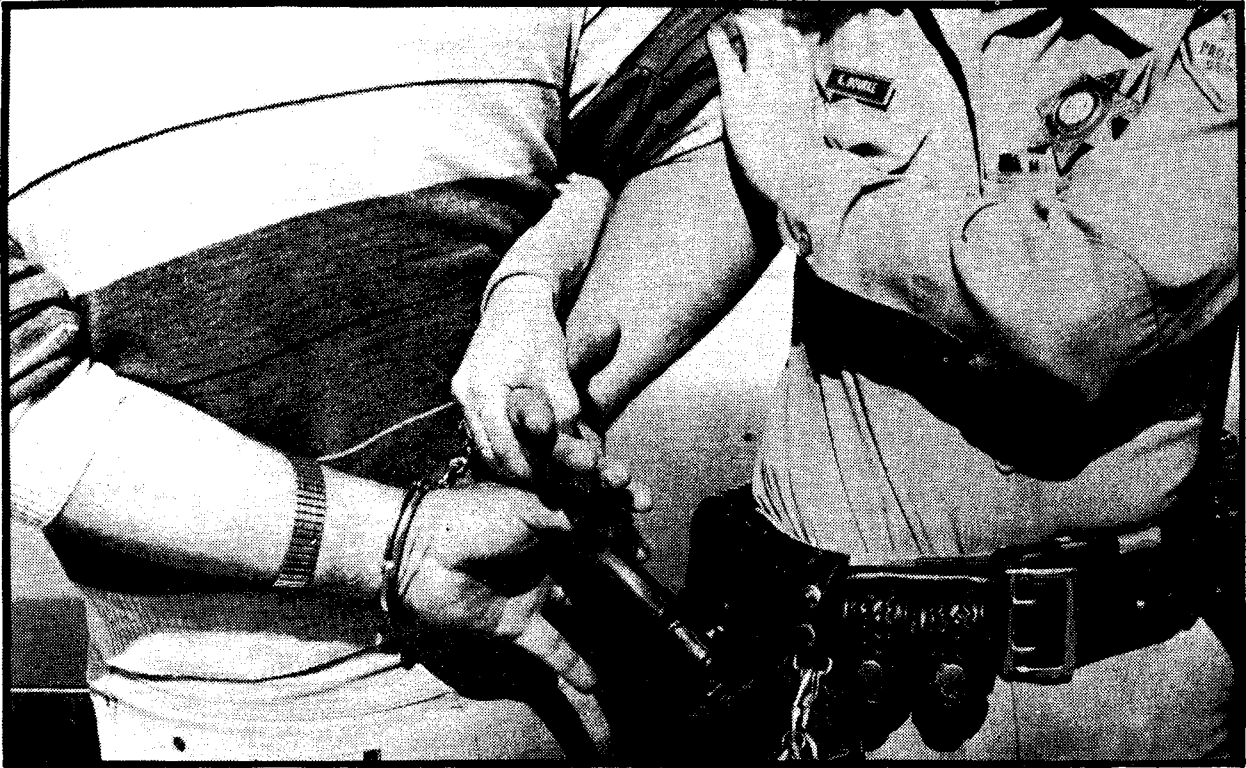
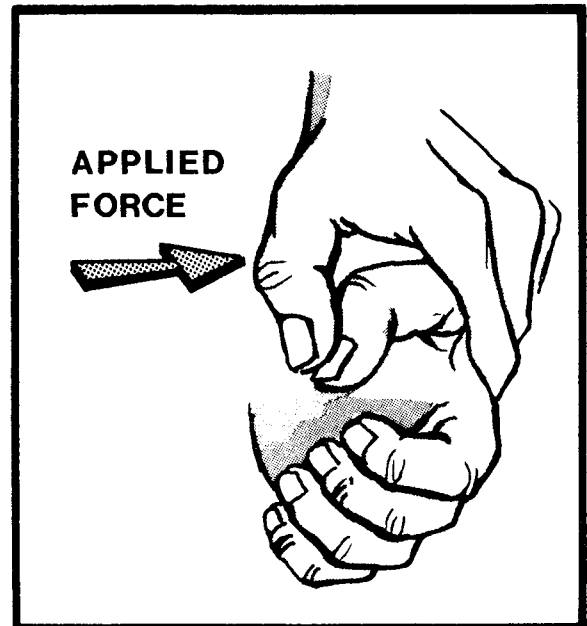

Illustration 13-46. Do not use your right arm to apply the bent-wrist come-along. This could bring your weapon within reach of the adversary.



If you encounter an adversary who continues to display resistance despite your use of the bent-wrist come-along technique, you can inflict even greater pain by using the bent-thumb technique. Apply pressure with your thumb directly against the tip of the adversary's thumb. Bend the thumb into itself. Apply the greatest pressure right on the adversary's thumbnail, and press down and into the base of the thumb (see Illus. 13-47 and 13-48).

Illustration 13-47. To use the bent-thumb technique, apply the greatest pressure on the adversary's thumbnail, and press down and into the base of the thumb.



Illustration 13-48. You can apply the bent-thumb technique in conjunction with the bent-wrist come-along technique.

Always keep prisoners separated. If you place two adversaries together after they are apprehended, they may be able to plan an escape or to create a defensible story for court.

When a prisoner is in your charge, you must think through your responses to any requests. Although it is not necessary or professional to mistreat a prisoner, you must not be overly obliging. For instance, if the prisoner complains that the handcuffs are too tight, check to see if the cuffs are cutting off circulation, but be aware that there may be an attempt to trick you. A person who has been deprived of his/her liberty may react in any number of unpredictable ways, from attempting to escape to attempting to commit suicide. Never let the adversary out of your sight because you have no idea how he/she might act the next minute. If a prisoner asks to go to the bathroom, assure there is an escort.

Remember that your prisoner may be a good source of tactical information. Although not all prisoners respond well to questioning, you may

find that yours is willing to give you valuable information about the remaining adversary force. Start by asking the types of questions that are of immediate tactical concern. For instance, you need to know how many adversaries remain, what weapons they have, what their objective is, where they were last seen and what their escape plan is. These types of questions are of such urgency that they should

be asked while you transport the prisoner or even while you guard the prisoner from a position of cover. Questions of lesser tactical importance, for example those concerning adversary motives and identities, can be saved for later when the prisoner has been moved out of the potential field of fire and into a safe area such as the on-scene command post.

Section 11. CHAPTER SUMMARY

This chapter has described the entire adversary apprehension process and has covered apprehension techniques that you should use from the first moment of confrontation to the final evacuation of prisoners. It has emphasized the importance of having a previously developed arrest plan. You not only must understand the techniques described in this chapter, you also must practice them in advance so that you can apply them with confidence under difficult conditions.

The necessity of giving strong, assertive **commands** during an apprehension to make the adversary do as you wish was explained, and techniques for developing a command voice were given. Initial commands were suggested, and the importance of talking in terms understandable to the adversary was discussed.

The section of the chapter on **visual search and disarming techniques** began with a description of visual search methods of the "high-risk" area of the adversary's body and went on to explain what to do if you detect a weapon during a visual search.

The importance of moving adversaries into **positions of incapacitation** prior to applying handcuffs was covered. Various techniques for incapacitating adversaries were given, and situations were described in which each technique would be appropriate.

Techniques for **approaching the adversary**

were described, and the importance of maintaining good cover was stressed. It was pointed out that the best approach technique to use for your own safety is to have the adversary come to you. Specific commands to the adversary were suggested, and precautions were covered, particularly for the final close approach.

In the section on **handcuffing**, the use and vulnerabilities of metal handcuffs were discussed. Secure methods of handcuff application and removal were described.

Body-search techniques were covered, and the pitfalls of an incomplete search were stressed.

Techniques for dealing with **multiple prisoners** were given, and commands were suggested. The proper physical positioning of adversaries was covered. The assignment of responsibilities to backup guards was described.

Detailed techniques were covered for conducting both high-risk and low-risk **vehicle approaches, nighttime approaches and visual vehicle searches**. Attention was given to secure methods of removing adversaries from a vehicle. The different responsibilities of the command security guard and the backup guard were explained.

Methods of maintaining control while you are **evacuating prisoners** were described. The problem of how to respond to prisoners' requests was addressed, and the importance of questioning prisoners to obtain useful tactical information was discussed.

Chapter 14

RAPPELLING

Section 1. INTRODUCTION

Rappelling is a method that was developed by mountaineers to enable them to descend safely and rapidly from elevated positions. The techniques used in rappelling can be applied to descents made on vertical and near-vertical surfaces and to descents made in midair, away from any surface, such as would occur from overhangs and helicopters.

In rappelling, a climbing rope and one or more connecting links normally are employed. The rappeller uses the friction of the rope that passes through the connecting links and over the surface of his body to provide braking and control. The process is much like sliding down a rope with your hands except that the friction and heat that are generated are absorbed by the connecting links and the body rather than by the hands.

Rappelling has several potential uses in the NRC security environment, particularly for tactical response teams. Perhaps the most familiar use is in helicopter descents for the purpose of entering a building from the roof. However, rappelling can be equally useful in exterior building descents for covert window entry and in interior building descents down elevator shafts and from the roof to the floor in high bay areas.

In this chapter, the most common items of equipment used in rappelling will be described, and the proper care of equipment will be emphasized. A section is devoted to rappelling safety, and this topic is stressed throughout the chapter. The various types of knots that are essential to rappelling are described. Procedures for rappeller hookup and

descent are covered, as are the various aspects of rappelling from helicopters.

Section 2. EQUIPMENT SELECTION AND CARE

To ensure your safety when you are rappelling, you must select your equipment carefully. Although a wide selection of rappelling equipment is available commercially, the quality and safety standards vary considerably among different types of equipment. Mountaineering standards for climbing ropes have been established by *L'Union Internationale des Associations d'Alpinisme* (UIAA), which is an international mountaineering organization. When you select climbing ropes, you should look for a tag that indicates the size, strength and length of the rope and that includes a statement that the rope meets UIAA criteria. No universal standards have been set for other items of rappelling equipment, such as carabiners, sit harnesses and descending devices. When obtaining these pieces of equipment, you should purchase name-brand items from reputable dealers.

Within the scope of this chapter, it would be impractical to describe all rappelling equipment, even by type. Therefore, in this section, the most important items of rappelling equipment will be discussed, and suggestions given for their proper care, storage and inspection. The specific types of equipment described are considered to be of superior quality and well suited for security force use.

CARABINERS

Carabiners, which also are called biners or snap links, are the primary items of equipment that are used to connect ropes to anchor points and descending devices to rappellers. Besides being used as connectors, these items also can be used as descending devices.

Types of Carabiners

Carabiners are manufactured both in oval and in "D" shapes (see Illus. 14-1). The "D"-shaped carabiners are the more useful type because they have a larger internal dimension and therefore can be attached to larger objects.

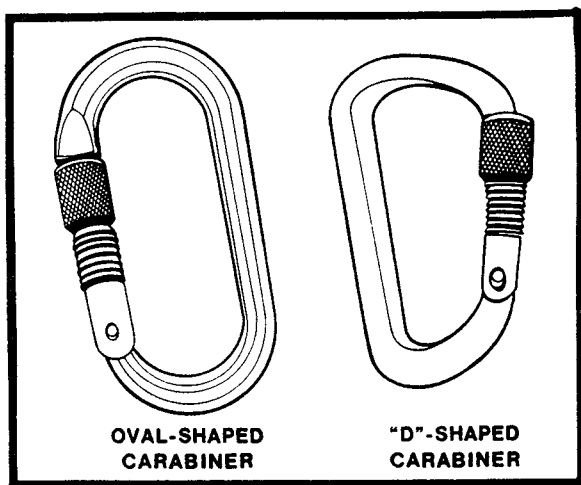

Illustration 14-1. Types of carabiners.

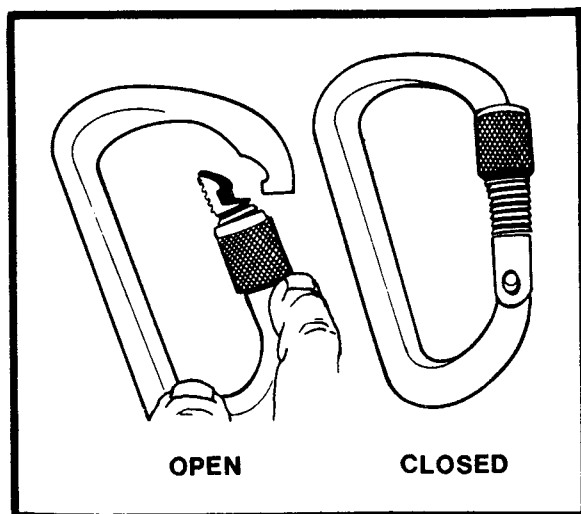

Illustration 14-2. A locking "D"-shaped carabiner.

The carabiner may have either a locking or a nonlocking gate. The locking carabiner has a sleeve with machined threads on the gate. The sleeve can be screwed clockwise to cover the locking notch and pin, thus locking the gate in a closed position (see Illus. 14-2). An attachment made with a locking carabiner obviously is more secure than an attachment made with a nonlocking device.

Carabiner strength ratings are determined by the manufacturer. The breaking strength varies considerably among different types of carabiners. For example, a locking "D" aluminum-alloy carabiner is rated at a maximum of 6,300 pounds while a locking "D" steel carabiner is rated at greater than 11,000 pounds.

Care of Carabiners

Since your life could depend on the strength and smooth functioning of your carabiners, you should use them only for the purpose for which they were designed, and you should care for them properly. You should take the following precautions in dealing with carabiners:

- Do not use carabiners as hammers.
- Do not expose carabiners to stress beyond their maximum rated strength, such as would occur if they were used to tow vehicles.
- Do not drop carabiners. Dropping them on a hard surface can cause small fractures that can lead to equipment failure. If a carabiner falls from a significant height, such as from 15 or 20 feet, onto a hard surface, it should be removed from service.
- Do not stamp or mark carabiners with an engraving tool. This action will change the molecular structure of the metal and can lead to equipment failure. Instead, use colored tape or Teflon paint to mark items. Clean carabiners before you store them, removing all dirt and moisture. You can use a rust-preventing oil to lubricate and protect the carabiners. Store them in a moisture-free environment.

Inspection of Carabiners

Before and after each use, carabiners should be inspected as follows:

- Check to see if moving parts such as gates and locking sleeves operate freely.

- Check to see if locking pins align with the locking notch.
- Check for fracture lines of any size and at any location.
- Check for deeply grooved rope-wear marks.

Any carabiner that does not operate smoothly or that shows signs of wear should be removed from service. When in doubt, remove the carabiner from service.

FIGURE 8 DESCENDERS

Figure 8 descenders are mechanical friction devices that are used for rappelling and belaying. These items are manufactured in various lengths and diameters and are rated individually at between 500 and 8,000 pounds (see Illus. 14-3).

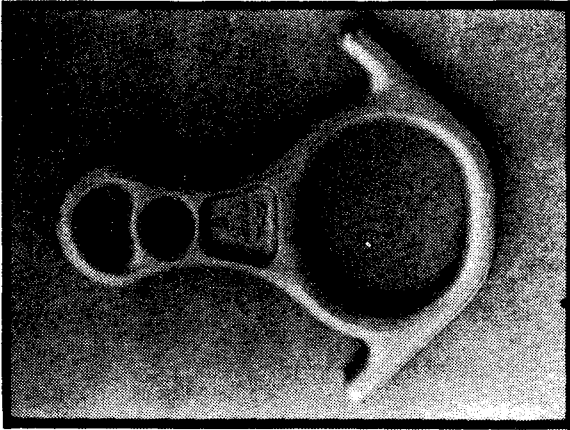

Illustration 14-3. A figure 8 descender.

Care of the Figure 8 Descender

The figure 8 descender, like the carabiner, should be used only for the purpose for which it was designed and should be cared for properly, with the following precautions being taken:

- Do not use as a hammer or pry tool.
- Do not overstress.
- Do not stamp or engrave.
- Do not drop onto hard surfaces.
- Clean and dry before storing, and store in a moisture-free environment.

Inspection of the Figure 8 .

Before and after each use, inspect the figure 8 for dents, nicks and other signs of wear and abuse. If there is noticeable wear or if you are in doubt about the condition of the equipment, take it out of service.

ROPES

Rappelling ropes are available in a wide variety of sizes, lengths and strengths. There are two distinct types of ropes, based on the way they are constructed. These types of ropes, mountain lay and kernmantle, will be described and compared in this subsection. Then, suggestions for the care and inspection of all rappelling ropes will be given.

Mountain Lay Rope

Mountain lay rope, also called hawser laid rope, is constructed by twisting, or laying, three separate nylon strands to form a single rope (see Illus. 14-4). GoldLine™ is a 7/16-inch mountain lay rope that is rated at about 5,000 pounds and is suitable for rappelling.

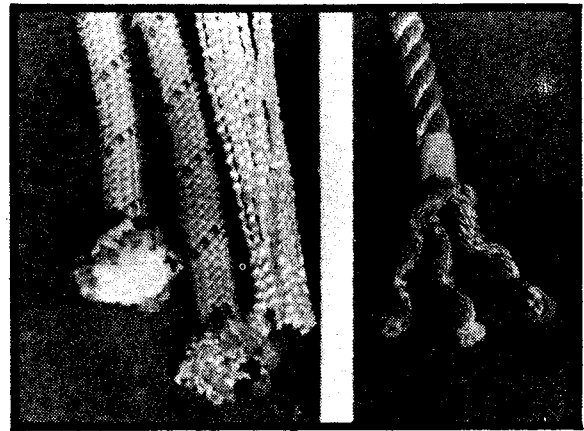

Illustration 14-4. Kernmantle (L) and mountain lay (R) ropes.

Kernmantle Rope

Kernmantle rope, sometimes called sheath rope or braided rope, is constructed of nylon-fiber strands arranged longitudinally to form the core (kern). The core is surrounded by a loosely woven covering, the mantle. The mantle is covered by a tightly interwoven sheath (see Illus. 14-4 and 14-5). Bluewater™ rope is an 11-mm kernmantle rope

that is rated at about 6,000 to 7,000 pounds and is excellent for use in rappelling.

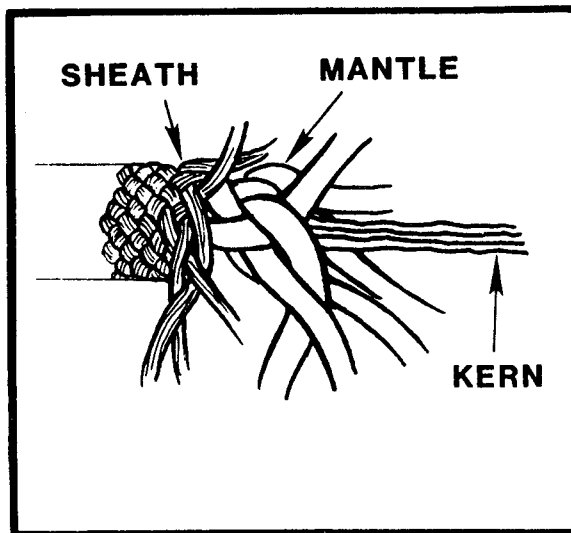

Illustration 14-5. Construction of kernmantle rope.

The following chart compares the handling characteristics of mountain lay rope versus kernmantle rope:

Mountain Lay—7/16 inch	Kernmantle—11 mm
1. Becomes stiff with use.	1. Remains pliable.
2. Knots become difficult to tie and untie due to stiffness.	2. Knots are relatively easy to tie and untie.
3. Tends to cause the rappeller to spin when free rappelling.	3. Does not normally cause the rappeller to spin during free rappelling.
4. Kinks fairly easily.	4. Does not tend to kink.
5. Is more elastic and has a greater stretch factor.	5. Is less elastic. If loaded to more than 50% of its new breaking strength, its elasticity will decrease considerably, and it may be damaged permanently.
6. Picks up more dirt particles, sand, snow and ice.	6. Picks up less dirt particles, sand, snow and ice.
7. Becomes fuzzy with use, and is estimated to lose about 25% to 35% of the new rope rating.	7. Sheath becomes fuzzy with use, but there is no known loss of strength.
8. Is relatively easy to inspect.	8. Is more difficult to inspect.

Care of Ropes

As with other items of rappelling equipment, the proper care of ropes is essential. The following precautions should be taken so that both mountain lay and kernmantle ropes are cared for properly:

- Use the rope only for the purpose for which it was designed.
- Do not bring the rope into contact with sharp and rough surfaces. Pad the surface if necessary.
- Keep the rope dry if possible.
- Avoid exposing the rope to contact with chemicals, fuels, oils and caustic agents.
- Do not step on the rope. This act causes dirt particles to become imbedded in the strands.
- Do not leave a rope knotted or stretched longer than necessary.
- Do not "shock load," or apply sudden weight to, the rope more than is absolutely necessary.
- Do not apply tension to a kinked or snarled rope.
- Store the rope in loose coils in a well-ventilated, moisture-free environment.
- Do not store the rope in direct sunlight.
- Fuse, whip or tape the ends of the rope before use.
- If the rope becomes wet, lay it out on a smooth flat surface, and allow it to dry. Do not put it in a clothes dryer.
- If the rope must be washed, lay it out on a smooth flat surface. Use a broom or brush and a mild soap to scrub it. Then rinse it. Do not put the rope in a washing machine.
- Establish a rope log to record when the rope is placed in service and when and how it is used. Include in the record anything unusual that happens to the rope, such as rappeller falls and exposure to high degrees of tension. You can identify your ropes by applying Teflon-based paint and numbering on the paint with indelible ink.

Inspection of Ropes

Ropes should be inspected before, during and

after use. Although it is not realistic to conduct a complete inspection of the rope immediately prior to each rappeller's descent, an inspection should be conducted if a rappeller falls and shock loads the system.

To inspect the rope, you must pass each foot of the rope through your hands. In the case of a mountain lay rope, all that you normally need to do is to pull the rope through your hand and visually inspect it. The kernmantle must be both visually and physically inspected. Since the kern cannot be seen, you must pass the rope through your fingers and feel for any irregularities. Ropes should be removed from service if

- The rope is subjected to excessive shock loading.
- Even one strand of the lay rope is cut.
- The sheath, mantle or kern of the kernmantle rope is damaged or cut.
- Excessive fraying is present.
- Weakness caused by friction burns is present.
- Ropes are exposed to chemicals.
- Any doubt exists as to the integrity of the rope.

Normal conditions of wear for both types of rope are illustrated in Illus. 14-6 and 14-7.

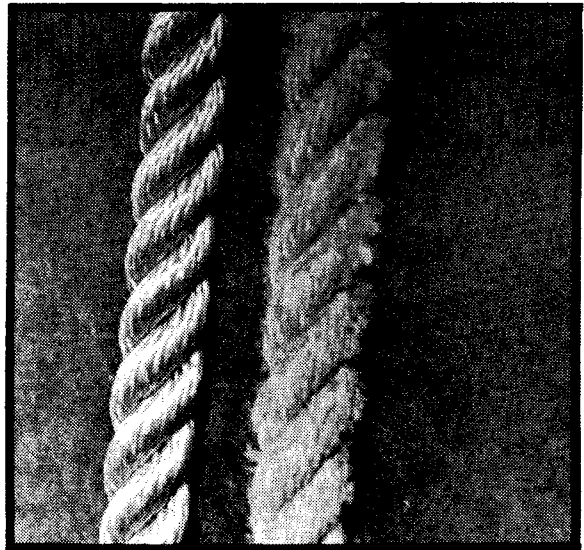

Illustration 14-6. New mountain lay rope (L) and mountain lay rope showing normal wear (R).

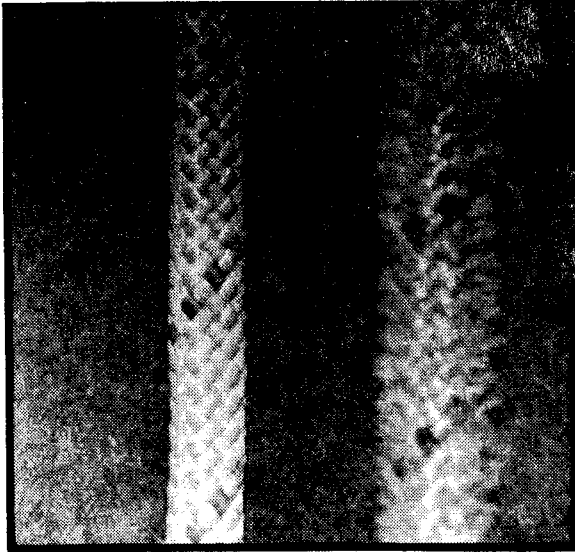

Illustration 14-7. New kernmantle rope (L) and kernmantle rope showing normal wear (R).

Coiling Ropes

Rappelling ropes should be coiled when they are not in use for ease in carrying as well as to prevent damage. The two basic coils are

- The mountain coil
- The birdnest coil

The **mountain coil** is simply a series of loops placed side by side and secured at the top by a series of wraps and a square knot (see Illus. 14-8). The length of the loops will vary according to the desired size of the coil and the length of the rope. When a rope is deployed from this type of coil, it will tend to tangle unless it is fed out gradually.

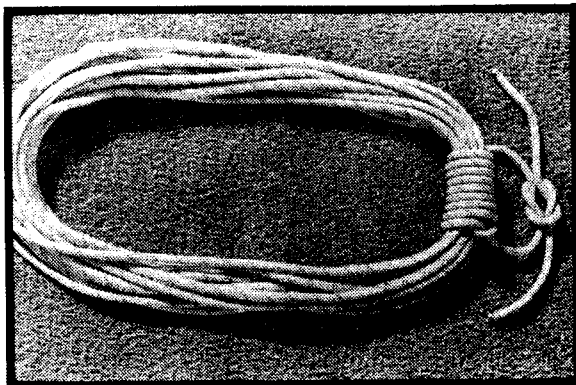

Illustration 14-8. The mountain coil.

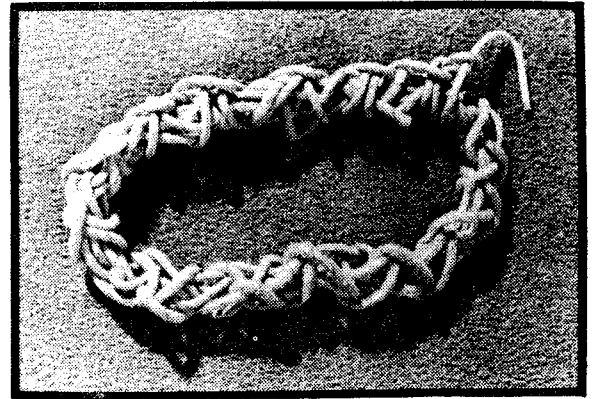

Illustration 14-9. The birdnest coil.

The **birdnest coil**, also called an electrician's wrap, is formed by wrapping successive half hitches around a series of loops (see Illus. 14-9). The coil is easy to form and, if wrapped properly will uncoil automatically without tangling when it is deployed from any height.

The birdnest coil is formed and deployed as follows:

1. Form three or four loops of rope in your hand (see Illus. 14-10).
2. Form a loop on top of the coils by pushing a small section of rope through the center of the circle (see Illus. 14-11).
3. Form a bend in the rope that does not cross itself (this kind of bend is called a bight), and bring the bight up through the formed loop (see Illus. 14-12).
4. Form a second bight, and bring it through the first bight (see Illus. 14-13).
5. Continue this process until only 18 to 24 inches of rope remain free (see Illus. 14-14 through 14-16).
6. Bring the tail of the rope up through the last bight that you formed, and pull the tail tight (see Illus. 14-17 through 14-19).
7. Deploy the rope by removing the tail end from the last bight, securing this end to an anchor point and dropping the coil. (Knots used to secure ropes to anchor points are described in Section 4.)

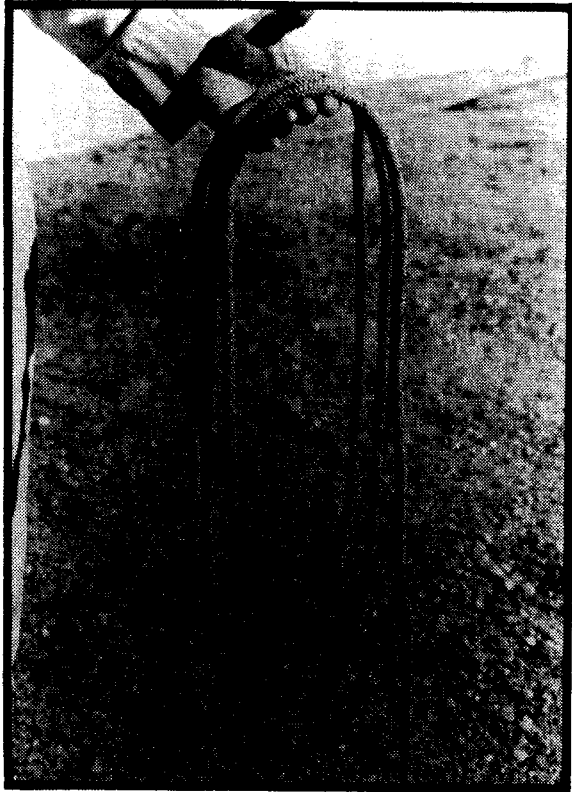

Illustration 14-10.

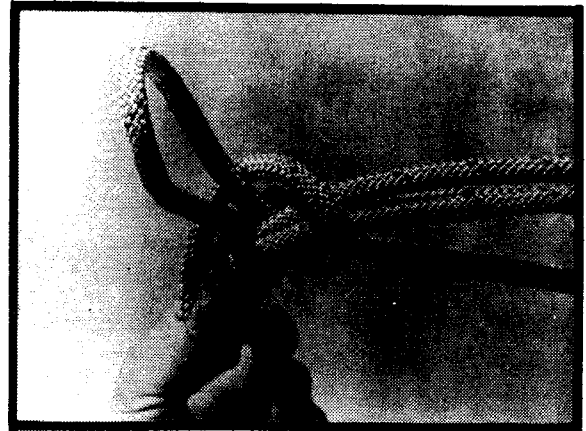

Illustration 14-12.

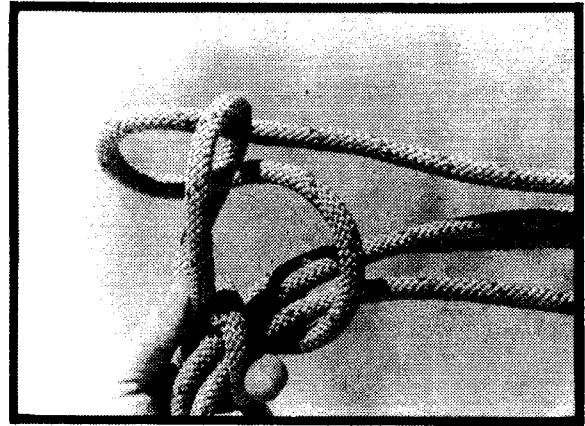

Illustration 14-13.

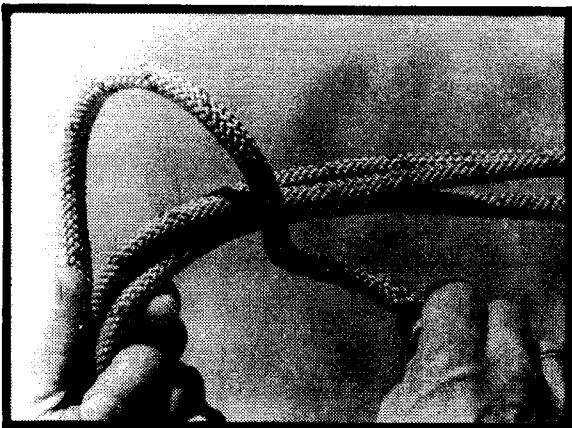

Illustration 14-11.

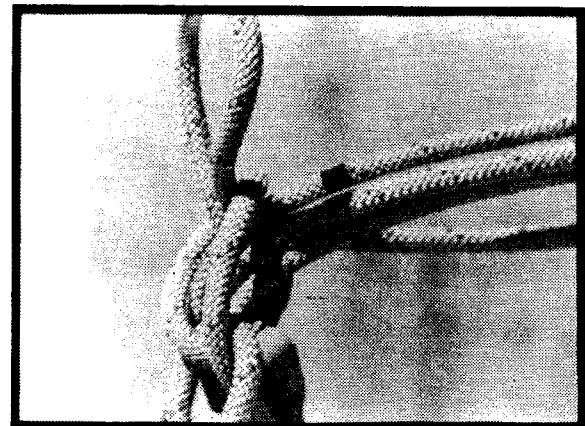

Illustration 14-14.

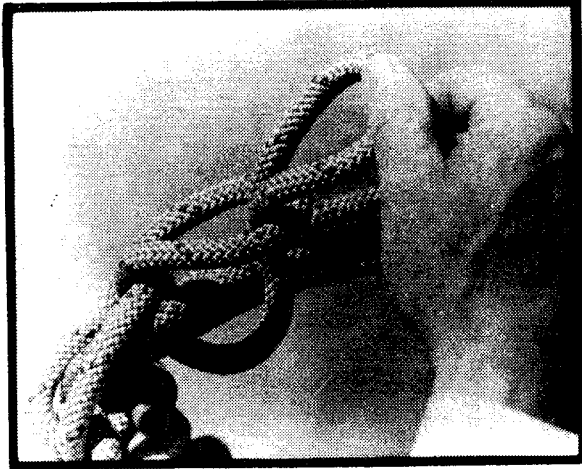

Illustration 14-15.

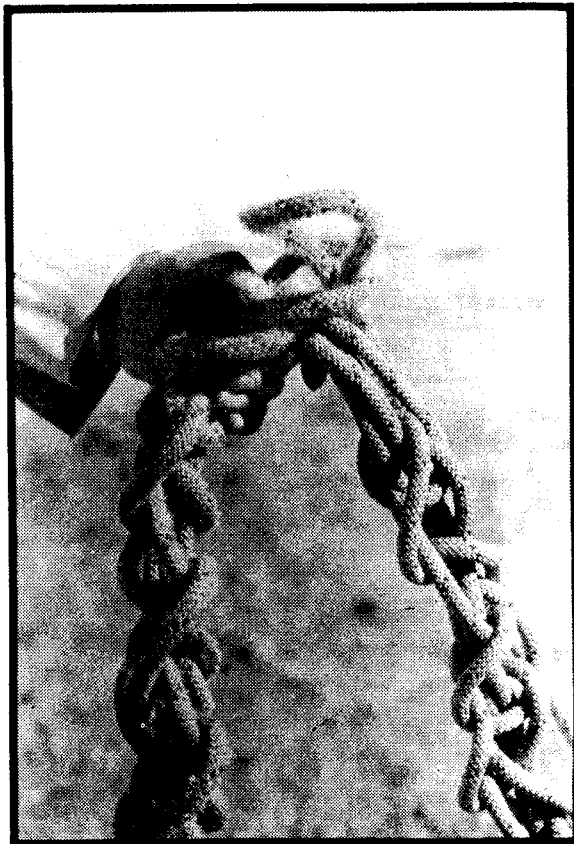

Illustration 14-16.



Illustration 14-17.



Illustration 14-18.



Illustration 14-19.

SIT HARNESES

Rappelling seats are designed to provide centralized support to your body so that your weight will be distributed evenly over your entire pelvis. Even distribution of weight will allow you to remain comfortably upright when your body is suspended by the rappelling rope. A number of types of manufactured rappelling seats called **sit harnesses** are available commercially. You should select one that has both adjustable leg and waist straps and that has at least one fixed "D" ring on the waist band. Illus. 14-20 through 14-22 show a typical commercial sit harness. Although most sit harnesses do not have a specific overall weight rating, the separate components of a given harness usually will be rated. For example, the webbing of a harness may be rated at 2,000 pounds, the buckles at 5,000 pounds and the hardware at 500 pounds.



Illustration 14-20.



Illustration 14-21.



Illustration 14-22.

Care of Sit Harnesses

You should care for your sit harness as follows:

- Use the sit harness only for the purpose for which it was designed.
- If the sit harness becomes wet, allow it to dry before storing it.
- Store the sit harness in a well-ventilated, moisture-free environment.
- Do not store the sit harness in direct sunlight.
- Do not expose the sit harness to contact with chemicals, fuels and caustic agents.

Inspection of Sit Harnesses

Before and after you use the sit harness, you should inspect it to check for excessive fraying, tears, rips, burns and evidence of exposure to chemicals. Examine the buckles and hardware to see if they are free of fracture lines. Check all seams and threads to determine if they are intact. If you discover any problems or have any doubts about the condition of the sit harness, remove it from service.

SWISS SEATS

Constructing a Swiss Seat

If you do not have a sit harness, you can construct your own rappelling seat by using a 12-foot

length of 7/16-inch or 11-mm climbing rope. This type of rappelling seat, called a **Swiss seat**, is constructed as follows:

1. Place the midpoint (the center) of the rope on the hip opposite your brake hand (see Illus. 14-23).
2. Bring the ends of the rope around your waist at belt level (see Illus. 14-24).
3. Cross the ends of the rope in front of your body, and tie a double overhand knot. The rope should be tight around your waist (see Illus. 14-25 through 14-27).
4. Take the two free ends of the rope down between your legs, around and underneath your legs and up over your buttocks. Do not cross the ends of the ropes. Squat down and pull up on the ropes to tighten the seat (see Illus. 14-28 through 14-30).
5. Place both ends of the rope over and around the section of rope that is around your waist (see Illus. 14-31). Squat again, and pull out any slack.
6. Tie the ends of the rope with a square knot on the hip opposite your brake hand. Safety the square knot by tying a half-hitch knot or a fisherman's knot on each side of the square knot (see Illus. 14-32 and 14-33). These knots are described and illustrated in Section 4.
7. Place excess rope in the clothing pocket that is nearest the square knot.

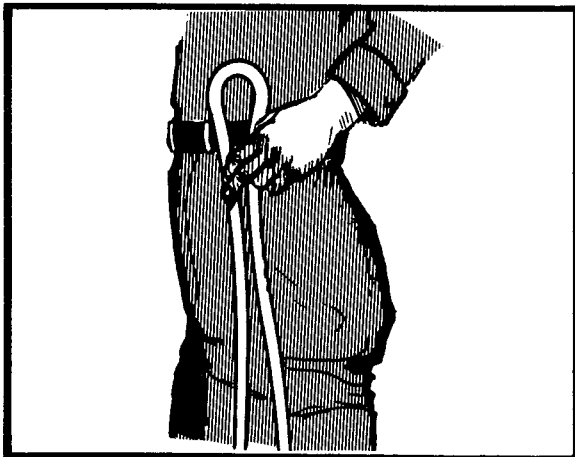

Illustration 14-23.

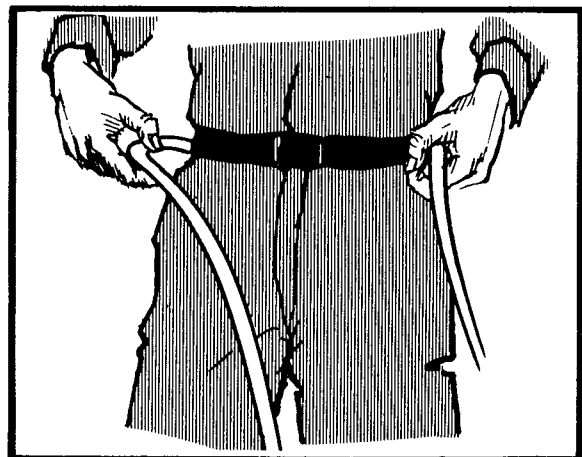

Illustration 14-24.

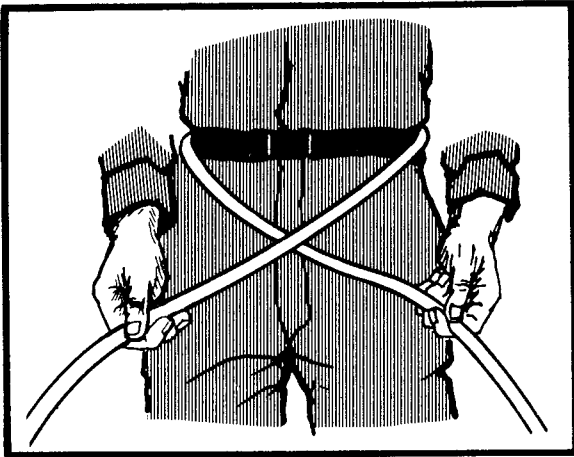

Illustration 14-25.

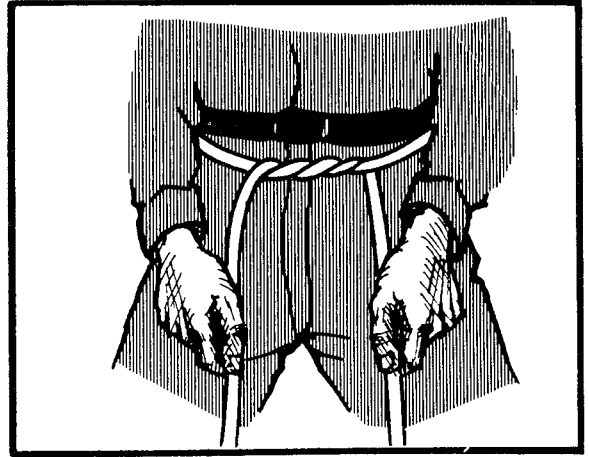

Illustration 14-28.

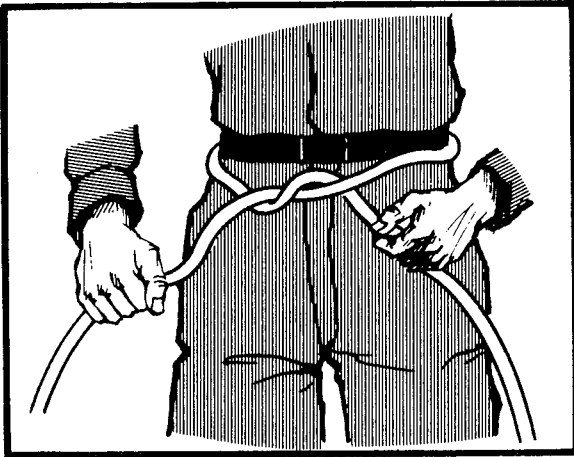

Illustration 14-26.

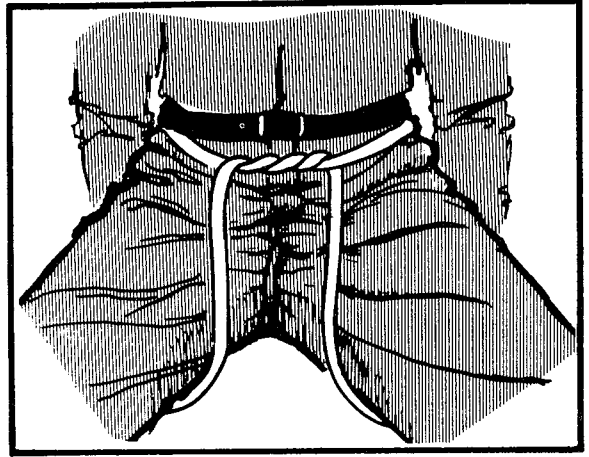

Illustration 14-29.

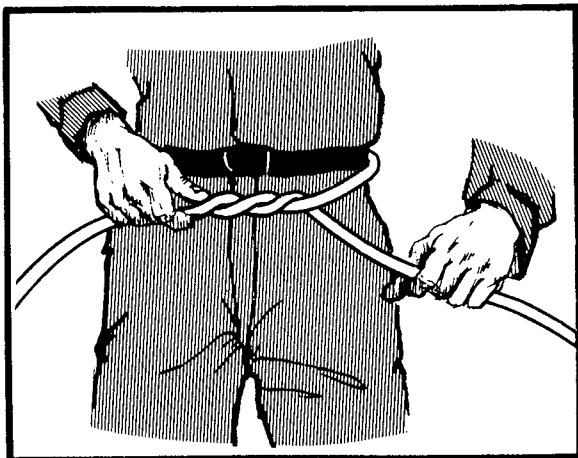

Illustration 14-27.

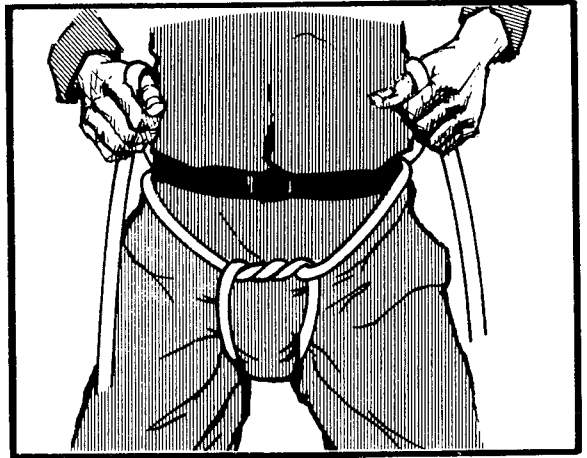

Illustration 14-30.

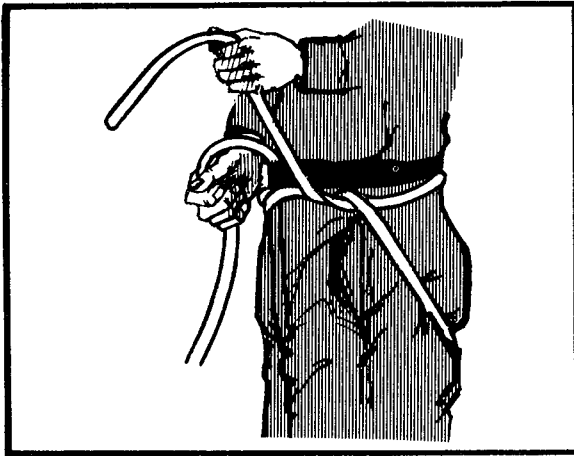

Illustration 14-31.



Illustration 14-32.

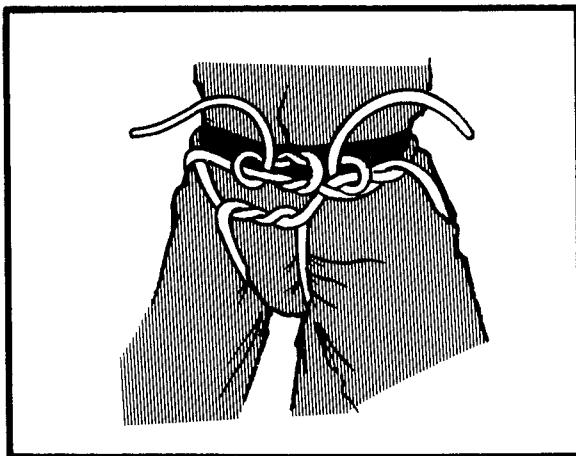

Illustration 14-33.

Care and Inspection of Swiss Seats

You should care for and inspect the rope that you use to construct a Swiss seat in the same way that you care for and inspect other rappelling ropes.

HELMETS

You should wear a helmet during all training sessions. Helmets are in fact recommended for wear when you rappel under any circumstances. A hard-shell helmet will minimize head injuries caused by falls and also will provide protection from objects such as rocks and carabiners that could fall from above. Helmets are available in many models and styles. Your helmet should be constructed as a hard shell that is held away from your head by a suspension system. A "Y"-shaped, lightweight-webbing strap should pass under your chin to hold the helmet on.

Care of Helmets

You should care for your helmet as follows:

- Use the helmet only for the purpose for which it was designed.
- If the helmet becomes wet, allow it to dry before storing it.
- Store the helmet in a well-ventilated, moisture-free environment.
- Do not store the helmet in direct sunlight.

Inspection of Helmets

Before and after each use, you should inspect your helmet as follows:

- Check the hard shell for cracks and breaks.
- Ensure that the suspension system is securely fastened to the shell.
- Ensure that the retaining straps are securely fastened to the helmet, and check the straps for cuts and excessive fraying.

Section 3. RAPPELLING SAFETY

Rappelling procedures are safe when they are performed properly by well-trained individuals using high-quality equipment that is kept in excellent condition. The potential for serious injury always exists during rappelling, however. Consider

the fact that a manmade rope is anchored to a natural or manmade object and tied to an individual who is suspended above the ground. A weak link anywhere in the system can cause a fall. Complacency and lack of attention are the primary causes of rappelling injuries. Each individual who is involved in rappelling in any way must be constantly vigilant and safety conscious during each step of the rappelling process.

The first steps toward rappelling safety are the careful selection, inspection, maintenance and use of equipment. Always purchase quality equipment that is designed for rappelling and manufactured by a reputable firm. Inspect all equipment thoroughly before and after each use, and follow all recommended procedures for the care and use of the equipment. Always wear gloves when rappelling. Wear a helmet both when you are rappelling and when you are in the area below a rappel point.

Proper training also plays an essential role in rappelling safety. All training should be conducted by experienced instructors at a safe location. Seek outside assistance if you do not have sufficient numbers of qualified instructors at your facility. If you do not have access to a rappelling tower, conduct initial training on wall structures that do not have windows.

Safety precautions should be stressed throughout the training process. Students should be required to secure or tuck in all loose clothing and equipment straps. Anchor points must be tested

and retested. Anyone on top of the training tower or building must be secured to a safety line that is attached to an anchor point. One student at a time should be called to the rappel hookup point, and each student should be called immediately prior to his own turn to rappel. No horseplay whatsoever can be permitted.

As another precaution, a **safetyman**, or belayer, should be assigned anytime rappelling is done except in an actual tactical emergency. He should establish a belay on the rappel rope at the lower surface level so that he can stop the descent of a falling rappeller by pulling on the rope, thus applying enough friction to the descent device to stop the fall.

The **rappelmaster**, who is the designated person in charge of all aspects of the rappelling process, has overall responsibility for rappelling safety. This person should be the most experienced and qualified rappeller present. His safety-related duties include

- Ensuring that the rappel site is free of obstacles and debris.
- Checking all equipment for serviceability.
- Checking all knots and anchor points.
- Conducting safety briefings for students and instructors.
- Monitoring the entire rappelling process for safety compliance.

Section 4. KNOTS

As a rappeller, you must be able to tie basic climbers' knots quickly and correctly. It is equally important for you to use the correct knot for its defined purpose. Specific knots have specific functions. For example, a square knot can be used effectively to join the ends of a single rope together to form a Swiss seat. However, if the same type of knot is used to tie two ropes together to extend the length and then is subjected to a weight load, the knot is likely to fail. **You must tie all knots correctly, and you must use each knot for its intended purpose.**

Although ropes can be tied in numerous ways, you can rappel successfully by using a few basic knots. Three categories of basic knots are used in rappelling: anchor knots, joining knots and spe-

cial knots. Simple knots in each of these categories are described and illustrated in this section.

ANCHOR KNOTS

An anchor knot is used to tie one end of a rope to an object. Two types of anchor knots are the **figure 8 knot** and the **bowline knot**.

The Figure 8 Knot

The figure 8 knot, which is among the strongest of all knots, is tied in two ways. When tied in the middle of a rope, this knot is called a double figure 8 knot (see Illus. 14-34). When tied at the end of a rope, the knot is called the figure 8 follow through. The figure 8 follow through is used to tie a rope around an object (see Illus. 14-35).

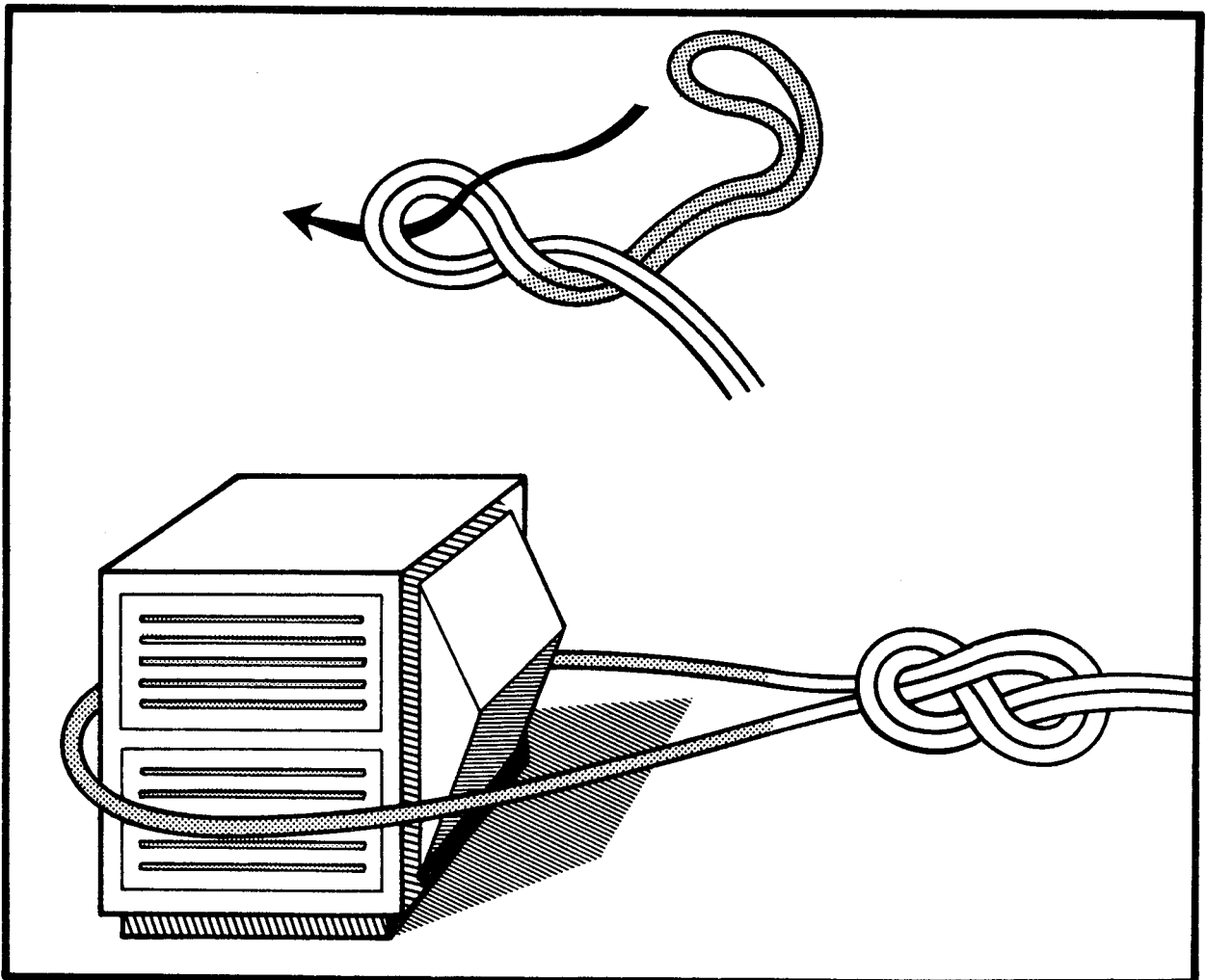

Illustration 14-34. The double figure 8 knot.

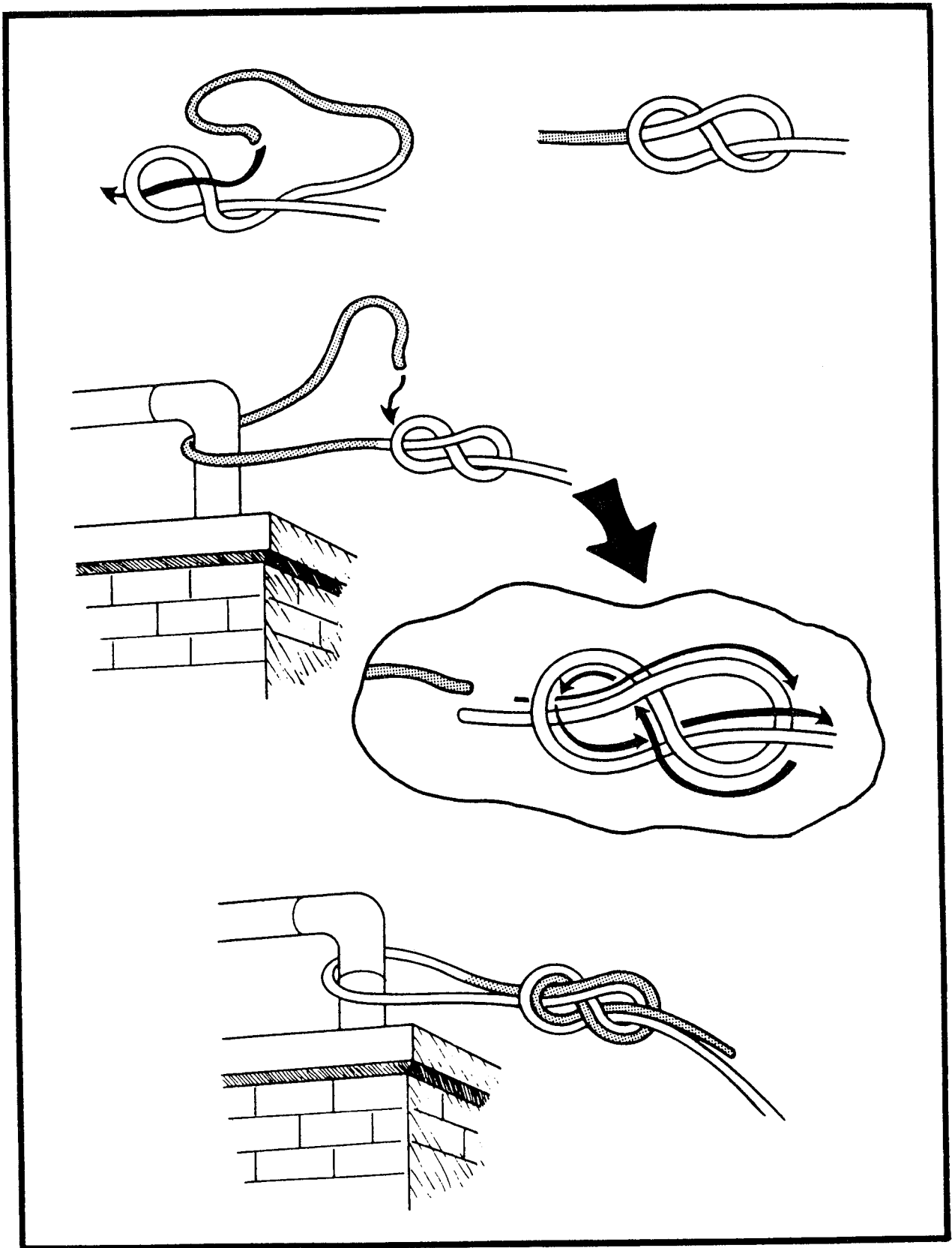

Illustration 14-35. The figure 8 follow through knot.

The Bowline Knot

The bowline knot is not as strong as the figure 8 knot. However, unlike the figure 8 knot, the bowline knot is easy to untie after it has been weight loaded. This knot always must be safetied with a half-hitch knot or a fisherman's knot (see Illus. 14-36).

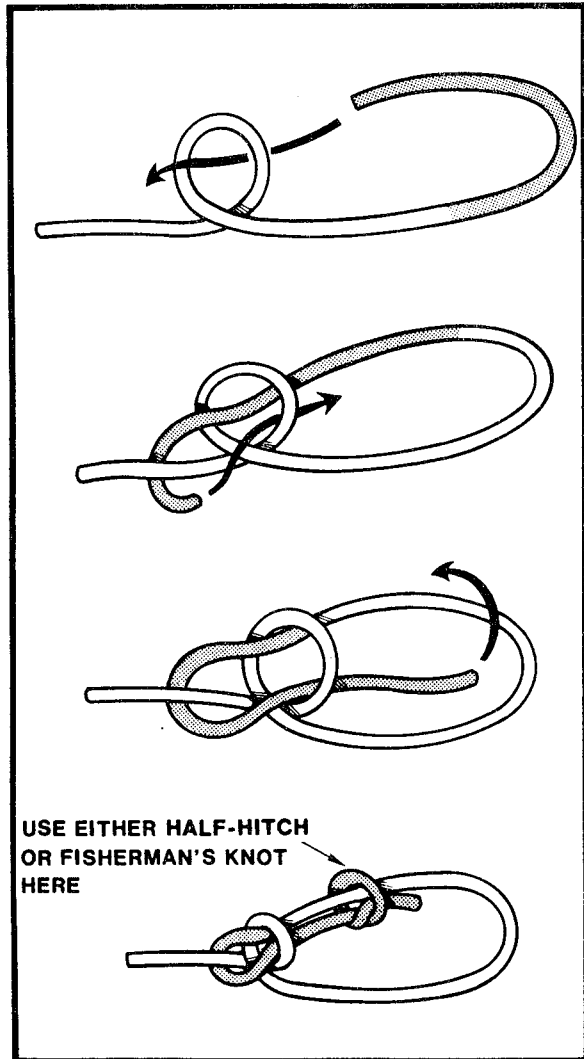

Illustration 14-36. A bowline knot.

JOINING KNOTS

A joining knot is used to join two ropes together. Three types of joining knots are the square knot, the double fisherman's knot and the Flemish bend knot.

The Square Knot

The only way that a square knot should ever be used in rappelling is to join the ends of a Swiss seat together. A square knot must be safetied on both sides with a half-hitch knot or a fisherman's knot (see Illus. 14-37 and 14-38).

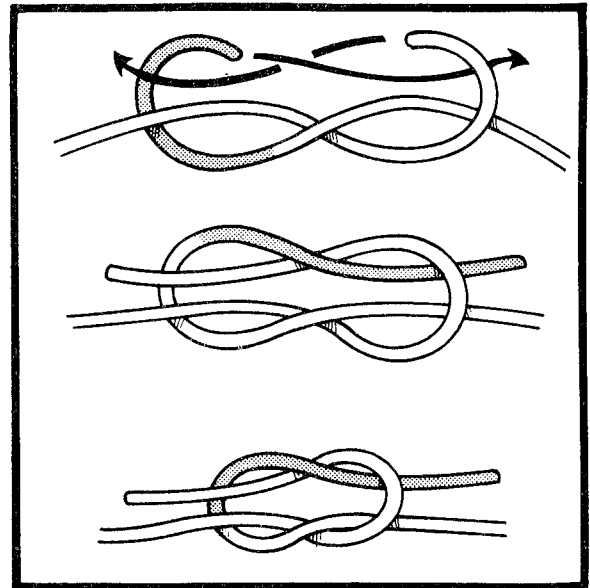

Illustration 14-37. The square knot.

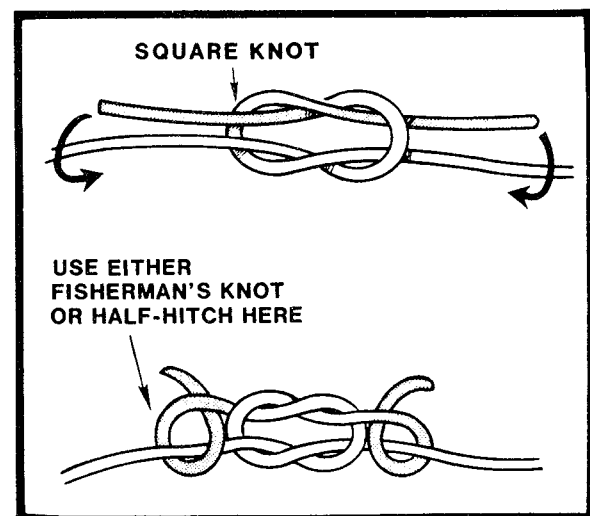

Illustration 14-38. A square knot safetied with a half-hitch knot.

The Double Fisherman's Knot

The double fisherman's knot is used to join two ropes of equal diameter together to extend the length. This knot is rated as being exceptionally strong. However, it is difficult to untie (see Illus. 14-39 and 14-40.)

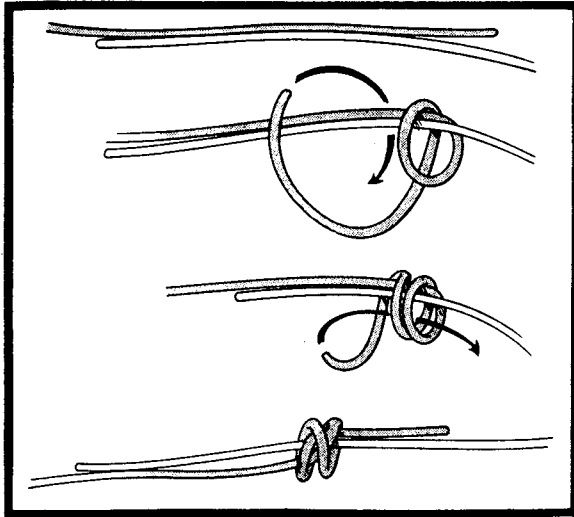

Illustration 14-39. Beginning the double fisherman's knot.

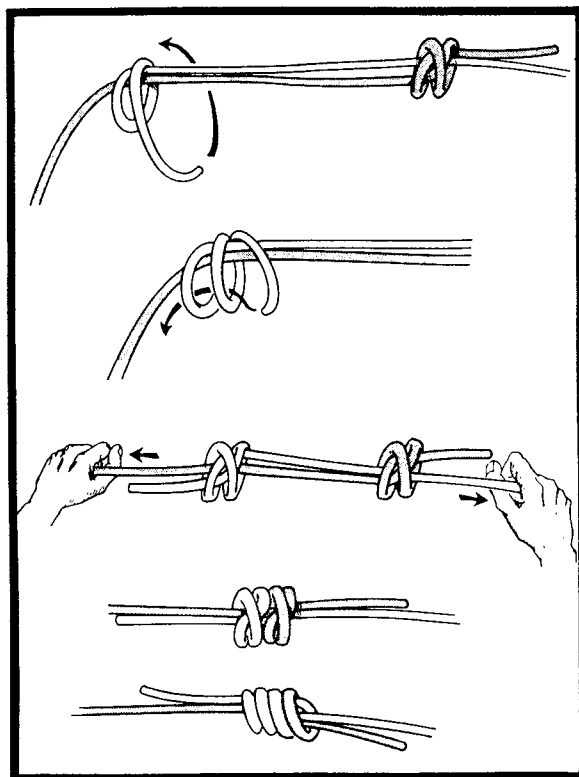

Illustration 14-40. Completing the double fisherman's knot.

The Flemish Bend Knot

The Flemish bend knot is used to join two ropes of equal diameter together to form a loop. This knot should be safetied with a half-hitch knot or a fisherman's knot. Like the double fisherman's knot, the Flemish bend knot is difficult to untie (see Illus. 14-41).

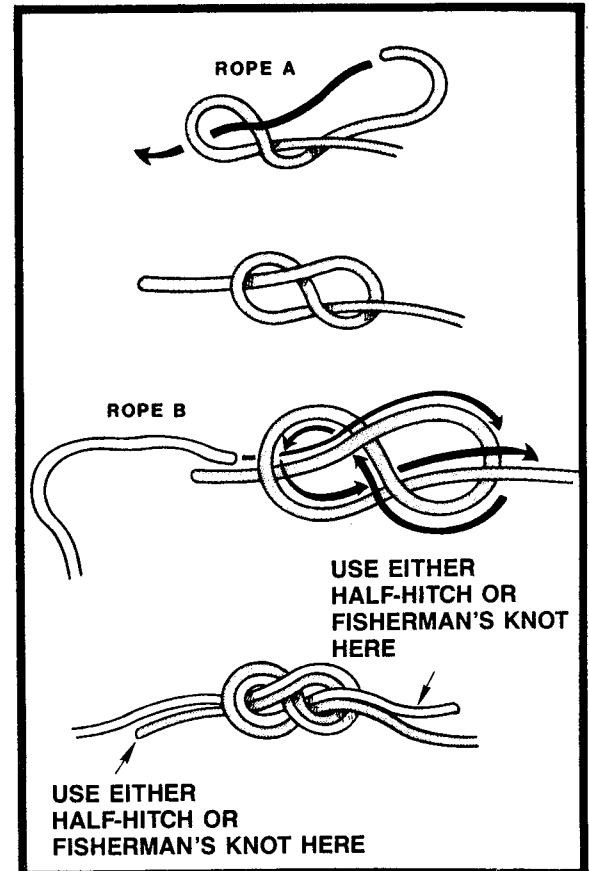

Illustration 14-41. The Flemish bend knot.

SPECIAL KNOTS

Special knots have been developed for use under specific circumstances. Examples of these knots are the double bowline knot and the tape knot.

The Double Bowline Knot

The double bowline is a special kind of anchor knot that is strong and easy to untie after weight loading. The double bowline can be tied at any point in the rope. If it is tied in the end of a rope, the loops that result can be attached to two separate anchor points (see Illus. 14-42 and 14-43).

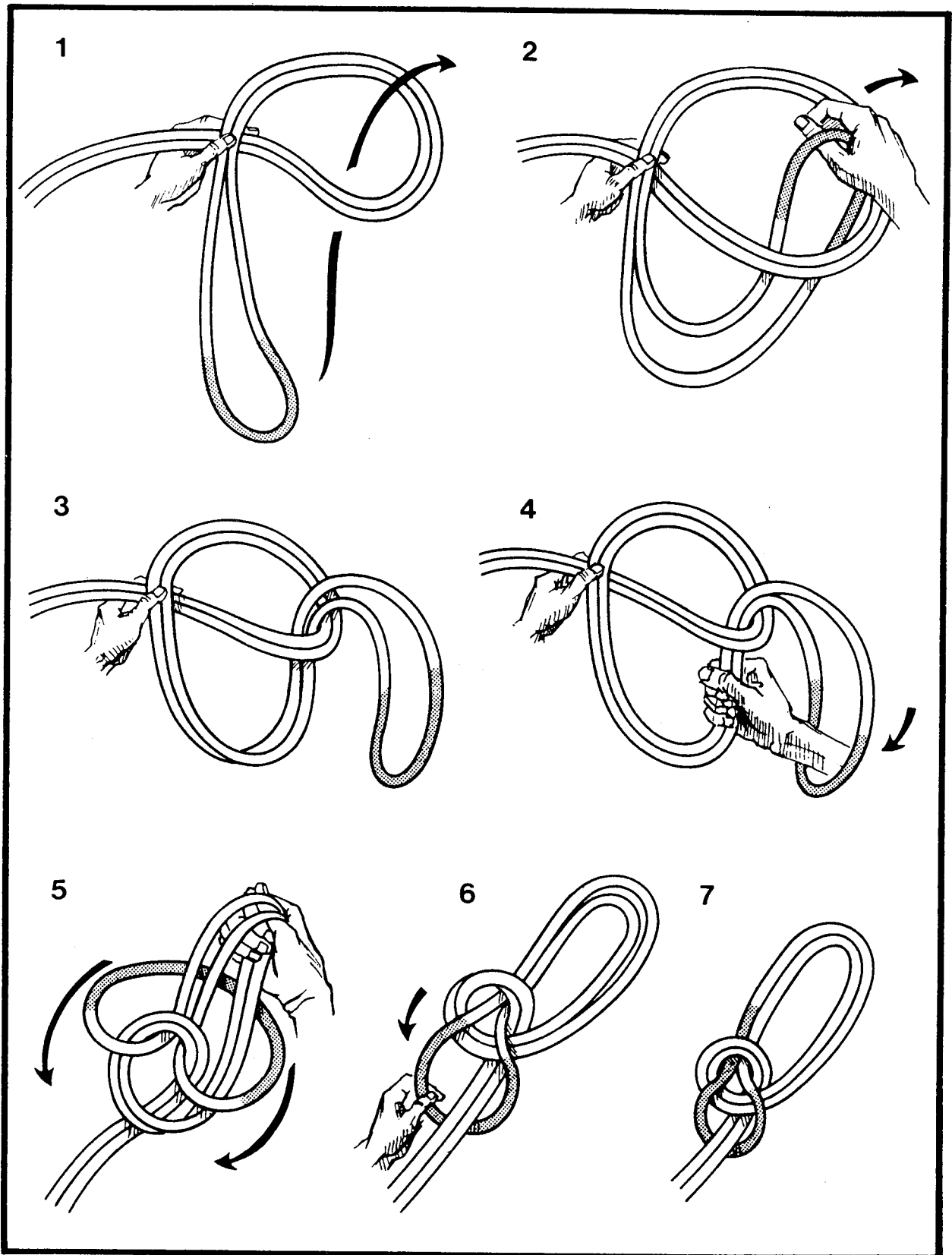

Illustration 14-42. Tying the double bowline knot.

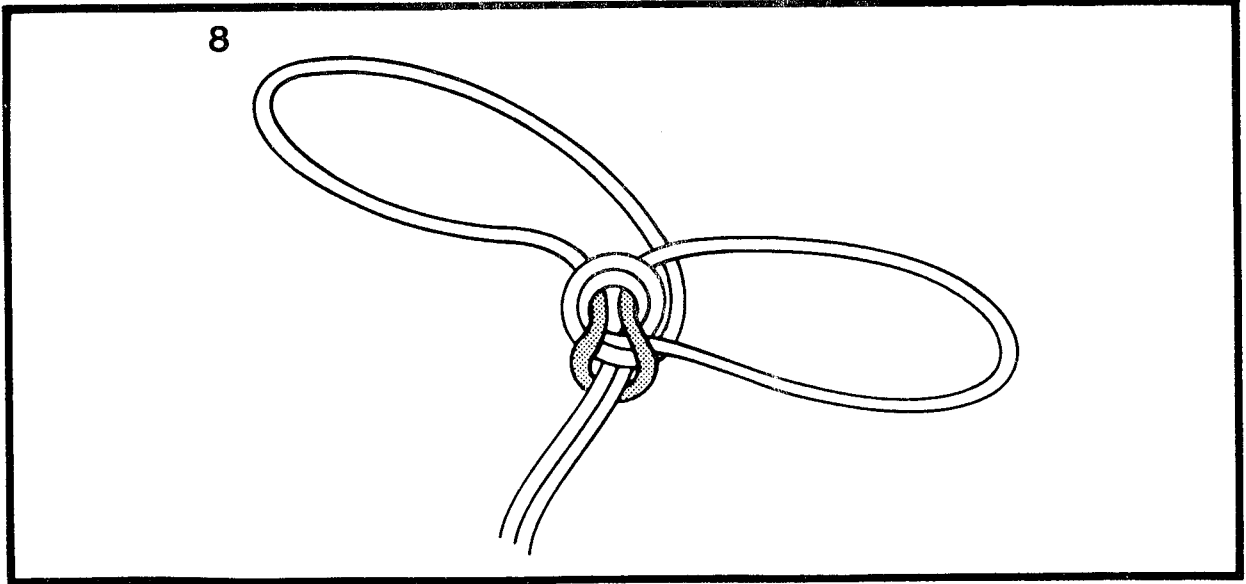

Illustration 14-43. The completed double bowline knot.

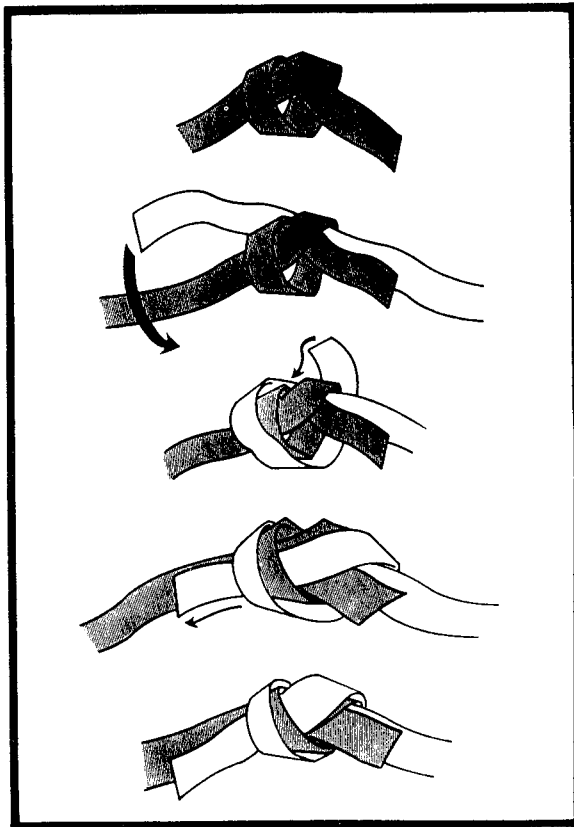

Illustration 14-44. The tape knot.

The Tape Knot

The tape knot, which also is called the water knot or the frost knot, is the only type of knot that should be used to join pieces of nylon tape together. This knot can work itself loose and therefore should be checked prior to and frequently during use. If the knot is to be permanent, sew or tape the ends after the knot has been tied (see Illus. 14-44).

Section 5. ANCHOR PLACEMENT

The selection of anchor points is an essential step in the rappelling process. The anchor system not only must be able to support your weight but also must be strong enough to support your shock weight if you fall. If an anchor point fails, you may be injured seriously.

Although an anchor system can consist of a single anchor point, you may have to select and use multiple anchor points in certain situations in order to achieve the required strength (see Illus. 14-45).

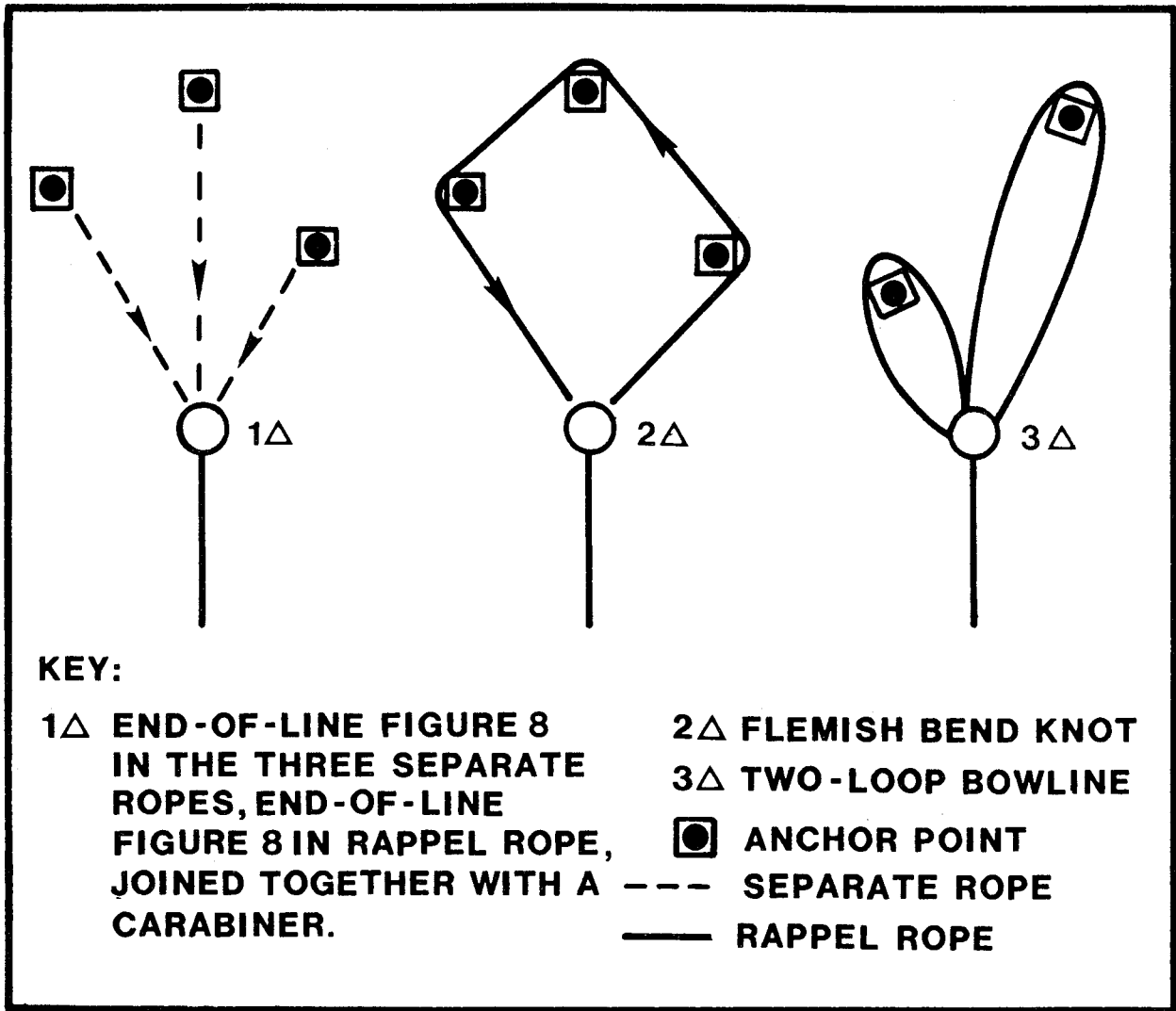

Illustration 14-45. Example multiple anchor systems.

Ideally, you should choose an anchor point that is in a direct line with the desired rappelling location. Placing the anchor in this way is not always possible, however, and sometimes you may have to select an anchor point that is offset and situated at some distance from the desired rappelling location (see Illus. 14-46).

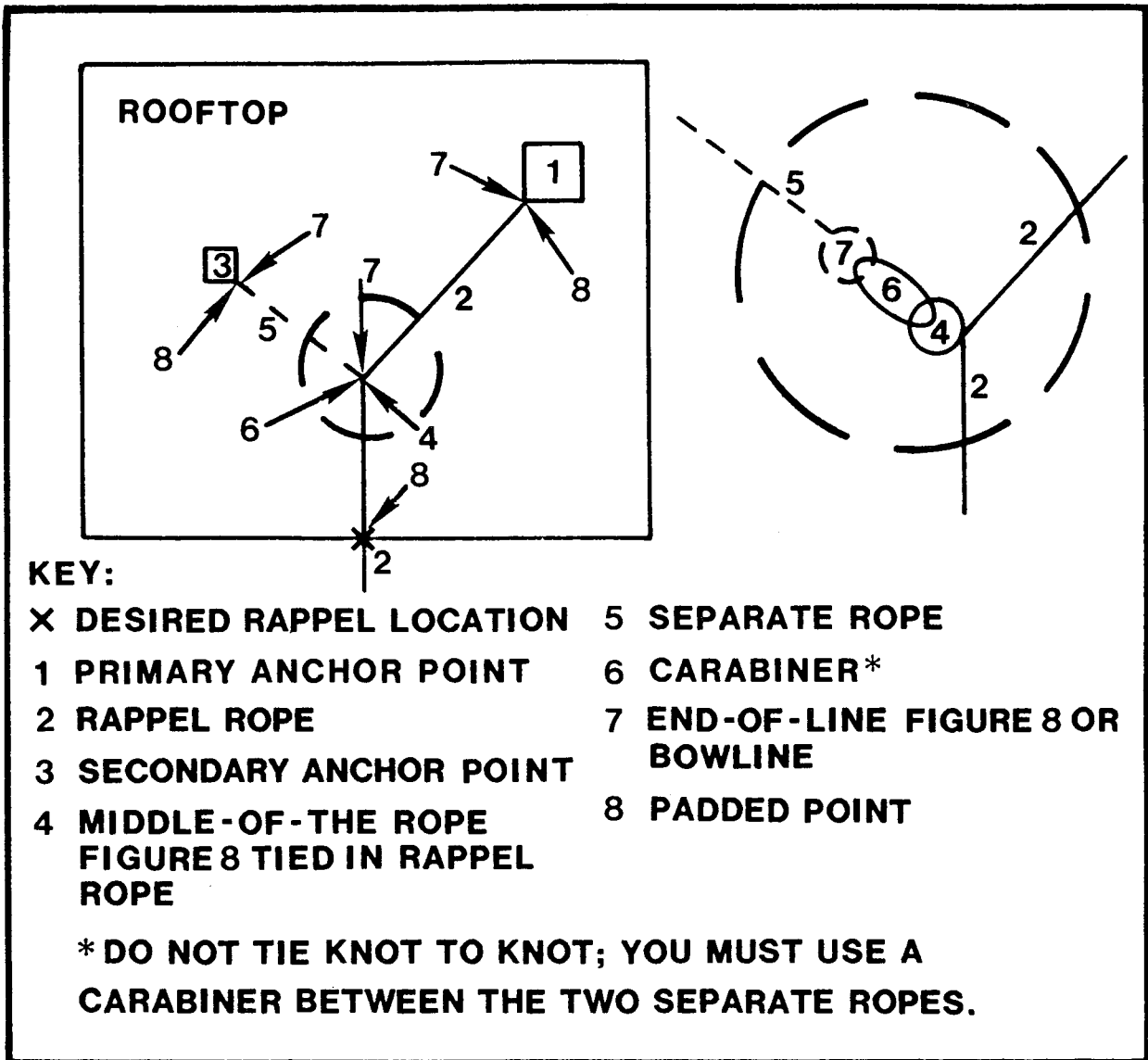

Illustration 14-46. Example off set anchor point.

Anchor points can be either natural or artificial. Artificial anchor points are abundant in the industrial setting. Examples of possible artificial anchor points include air-conditioning and heating units, water pipes, vent pipes and ladders. Always select and inspect anchor points carefully. Many objects, such as vent pipes and water pipes, appear to be much stronger than they are. No matter what anchor point you choose, always **test and retest** it prior to rappelling.

Section 6. RAPPEL HOOKUP PROCEDURES

A proper rappel hookup is the key to a controlled descent. In order to understand why the hookup is so important, it is necessary to understand how the rappelling process works. A rappeller achieves a controlled descent by regulating the amount of friction exerted against the rope, the descending device and the rappeller's body. Such regulation is made possible by the way that the rope is wrapped around and held. It is important for the rope to be wrapped around or through a descending device, which can be either a figure 8 or a carabiner (see Illus. 14-47 and 14-48).

During rappelling, the working end of the rope is brought around by the brake hand to the small of the back (see Illus. 14-49). With the rope and brake hand in position, friction can be created when the brake hand is pressed into the small of the back and the rope is forced against the body and against the descending device. Either hand can be used as the brake hand, and it is important to become proficient with each hand. The nonbraking hand, or guide hand, can be used for such tasks as firing a weapon and operating a radio.

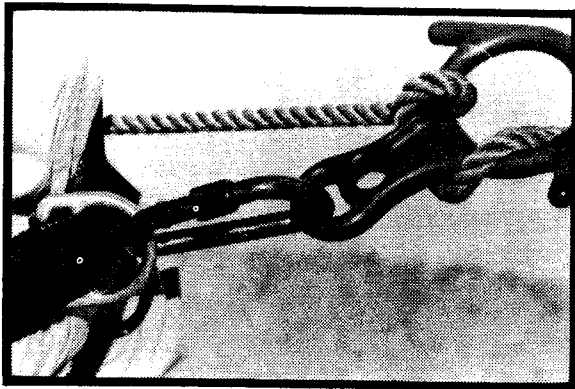

Illustration 14-47. Rappel rope wrapped through a figure 8 descender.

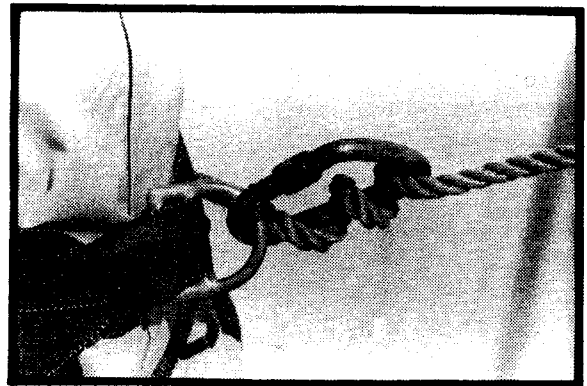

Illustration 14-48. Rappel rope wrapped through a carabiner that will be used as a descending device.

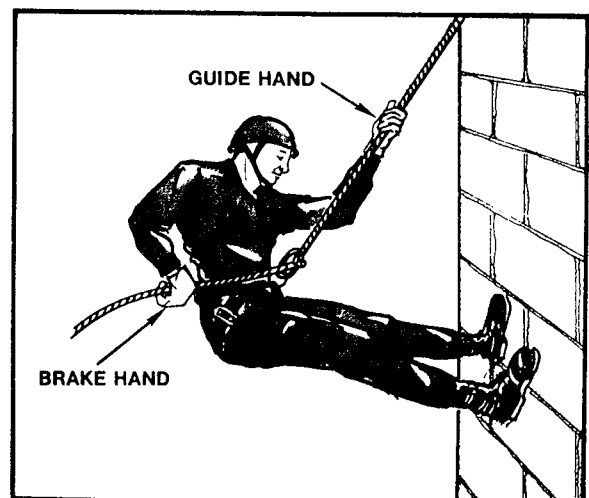

Illustration 14-49. Positioning of the guide hand and the brake hand.

ATTACHING THE FIGURE 8 DESCENDER TO THE ROPE

To achieve a proper hookup, you, the rappeller, must position your body so that the rappel rope is on the same side as your brake hand as you face the anchor point. Then, to attach the figure 8 descender to the rope for a **left-hand brake**, you must complete the following steps:

1. Lay the figure 8 descender on top of the rope (see Illus. 14-50).
2. Pull a bight of rope up through the large hole (see Illus. 14-51).
3. Loop the bight over the small end of the figure 8 descender (see Illus. 14-52 and 14-53).

NOTE: For a **right-hand brake**, place the figure 8 on the same side of the rope as your brake hand, and complete steps 2 and 3.



Illustration 14-50.



Illustration 14-52.

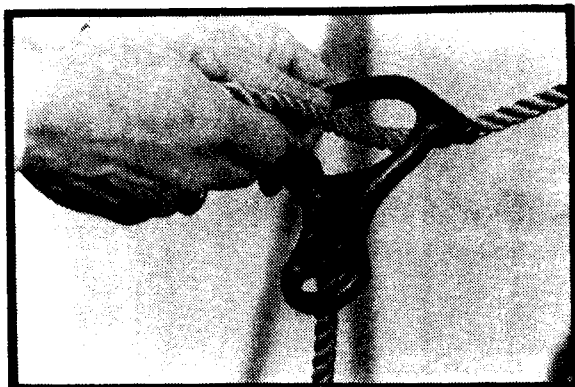

Illustration 14-51.

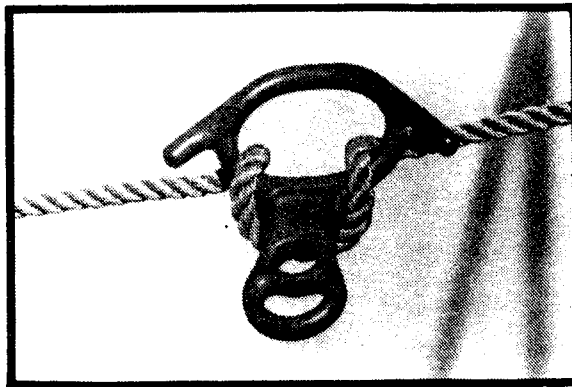

Illustration 14-53.

ATTACHING THE CARABINER TO THE SIT HARNESS

To attach the carabiner to the sit harness for a left-hand brake,

1. Hold the carabiner in your left hand with your fingers on the bar.
2. Depress the gate with your thumb (see Illus. 14-54).
3. Pass the carabiner from right to left through the "D" ring on the sit harness (see Illus. 14-55).
4. Rotate the carabiner 180 degrees so that the gate is on **top** and away from your body (see Illus. 14-56).

NOTE: To attach the carabiner for a right-hand brake, hold it in your right hand, and complete steps 2, 3 and 4, passing the carabiner through the "D" ring of the sit harness from left to right.

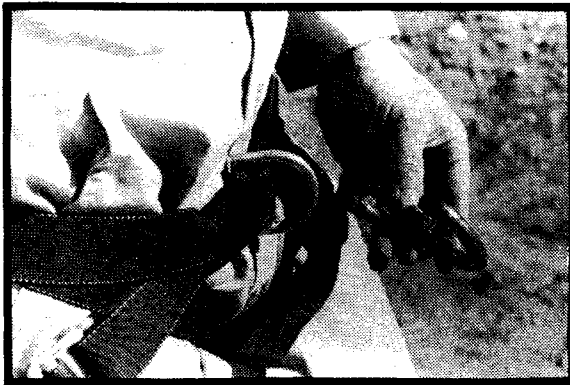

Illustration 14-54.

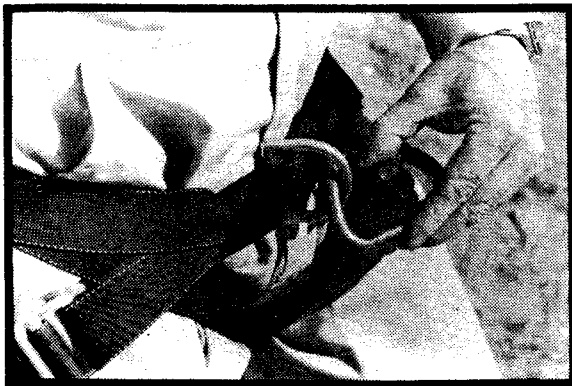

Illustration 14-55.

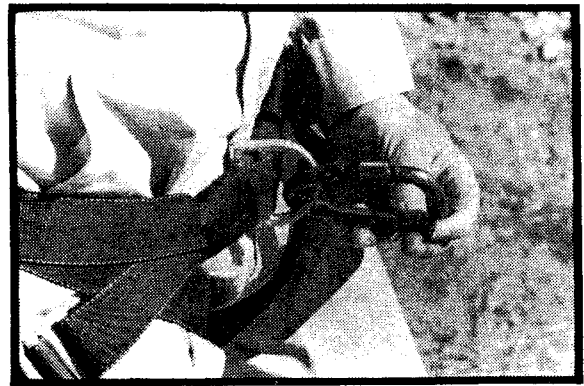

Illustration 14-56.

ATTACHING THE CARABINER TO THE SWISS SEAT

To attach the carabiner to the Swiss seat for a right- or a left-hand brake,

1. Hold the carabiner in your right hand with the opening in the carabiner facing your body, and depress the gate with your thumb (see Illus. 14-57).
2. Hook the top of the carabiner between your body and the rope around your waist (see Illus. 14-58).
3. Rotate the carabiner under the double overhand knot that is at the front of your waist (see Illus. 14-59).
4. Release the gate and continue to rotate the carabiner so that the bar is on the bottom and the gate is on the top. The gate should open away from your body (see Illus. 14-60).



Illustration 14-58.



Illustration 14-57.



Illustration 14-59.



Illustration 14-60.

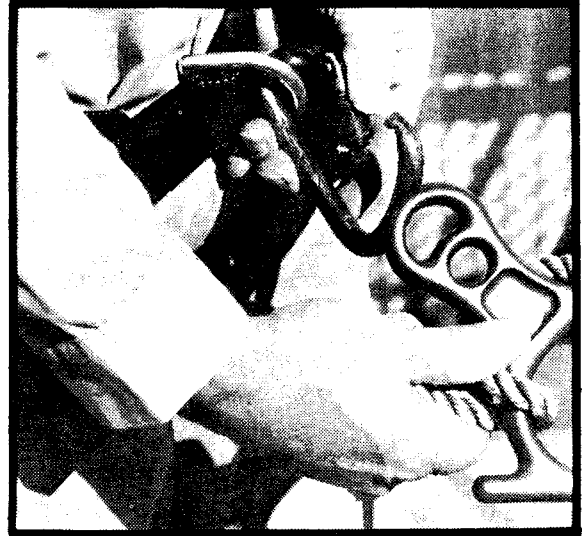

Illustration 14-62.

ATTACHING THE FIGURE 8 DESCENDER TO THE RAPPELLING SEAT

To attach the figure 8 descending device to either the sit harness or the Swiss seat

1. Open the gate of the carabiner on the rappelling seat (see Illus. 14-61).
2. Join the figure 8 and the carabiner by inserting the carabiner through the small hole in the end of the figure 8 (see Illus. 14-62 and 14-63).
3. Release the gate, and turn the gate locking screw of the carabiner clockwise to lock the gate (see Illus. 14-64).

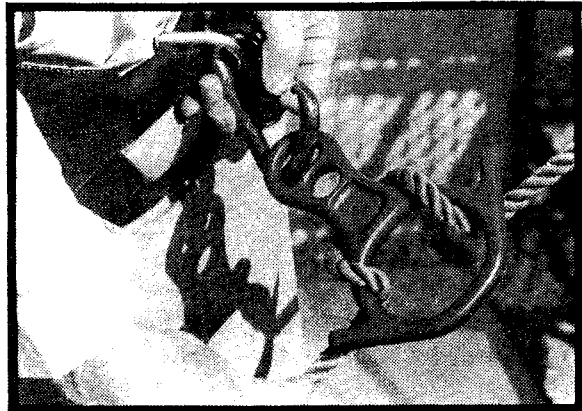

Illustration 14-63.



Illustration 14-61.

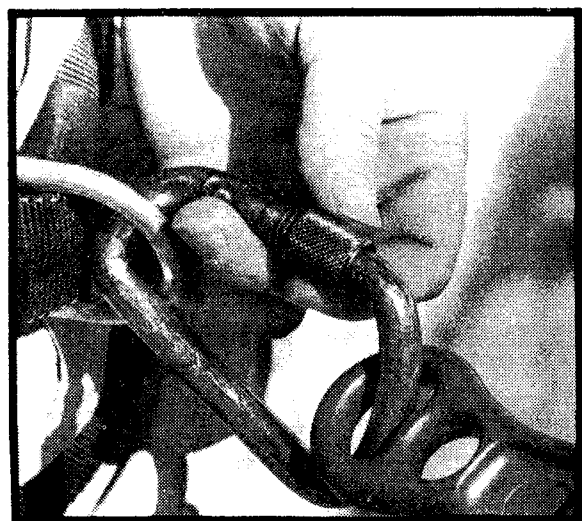

Illustration 14-64.

WRAPPING A CARABINER FOR USE AS A DESCENDING DEVICE

It is possible to use a carabiner as a descending device, although this technique is not as safe as is using a figure 8 descender. Before wrapping the carabiner so that it can be used as a descending device, you must attach it to the rappelling seat as described previously. Perform this step carefully because, if the carabiner is improperly attached, injuries may result.

The carabiner wrap for a **right**-hand brake is completed as follows:

1. Approach the rope, with the rope on your right side. Then turn and face the rope.
2. Grasp the rope with both hands, and drop the rope through the open gate of the carabiner (see Illus. 14-65 and 14-66).
3. Grasp the length of rope **between your body and the anchor point** with your left hand (see Illus. 14-67).
4. Pull out a small amount of slack with your left hand (see Illus. 14-68).
5. Rotate this slack under the bar and back through the gate of the carabiner (see Illus. 14-69).
6. Repeat this process to place a second wrap around the bar of the carabiner (see Illus. 14-70 through 14-72).



Illustration 14-66.

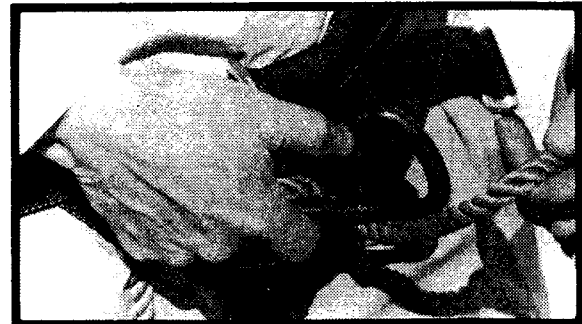

Illustration 14-67.

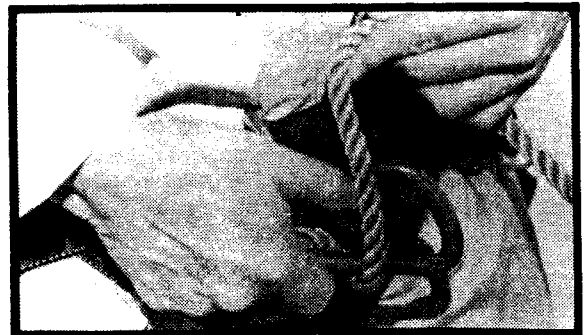

Illustration 14-68.



Illustration 14-65.



Illustration 14-69.



Illustration 14-70.



Illustration 14-71.



Illustration 14-72.

To wrap the carabiner for a **left**-hand brake, start with the rope on your **left** side, and follow the steps just listed. However, use your **right** hand to pull out the slack. Remember that the slack is taken from the length of rope that was **between** your body and the anchor point. Illus. 14-73 and 14-74 show the correctly completed carabiner wraps for a right-hand brake and a left-hand brake, respectively.

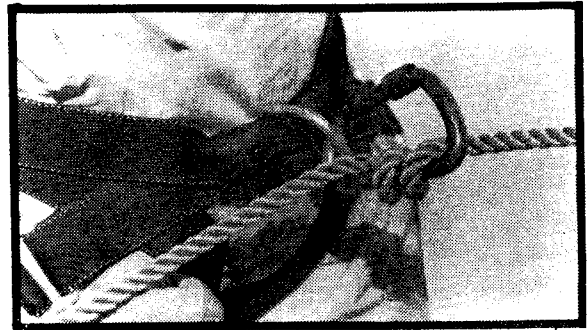

Illustration 14-73. Carabiner wrap for a right-hand brake.

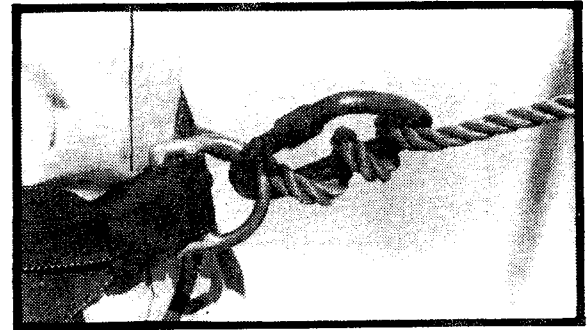

Illustration 14-74. Carabiner wrap for a left-hand brake

Section 7. DESCENT PROCEDURES

In this section, the standard cues and responses that should be understood and used by all rappellers and rappel cadre are introduced. Procedures for a standard descent and for three special types of descents—bounding, Australian and belayed—are described.

STANDARD CUES AND RESPONSES

The use of standard cues and responses is essential to rappelling safety. You should understand and use the following cues and responses:

- **Rappeller to belayer (safetyman):** “(Name) on rappel.” This cue indicates to the belayer that the rappeller is ready for the descent.
- **Belayer to rappeller:** “(Name), on belay.” This response indicates to the rappeller that the belayer is ready for the descent.
- **Belayer to rappeller:** “(Name) stand-by.” This response indicates to the rappeller that the belayer is not ready for the descent.
- **Rappeller to rappellmaster:** “(Name) off rappel.” This cue is given when the rappeller

has removed the descent device from the rope to convey the message that the rope is clear and can be used by the next rappeller.

- **Belayer to rappelmaster: “(Name) off belay.”** This response indicates to the rappelmaster and to the rappeller that the belayer is off belay. The response should not be given until after the rappeller has indicated that he/she is clear of the rope.
-

PREPARATION FOR DESCENT

After you have attached the descent device or the rope to your rappel seat, you should prepare to descend as follows:

1. Face the anchor point, and apply a brake. Lean back, keeping the brake applied, and test the anchor and the knot.
2. Take a few steps backward, releasing the brake slightly, and check the flow of the rope through the descent device.
3. If you are satisfied with the knot, the anchor and the flow of the rope, continue to back to the edge until you can make eye contact with the belayer, who is on the lower surface.
4. Apply the brake, and give the cue “(Name) on rappel.” After the belayer responds, face the anchor point, keeping the brake on.
5. Continue to back with your feet about shoulder width apart until your heels are over the edge, releasing the brake as necessary (see Illus. 14-75a and 14-75b).



Illustrations 14-75a and 14-75b.

6. Release your brake slowly, lock your knees so that your legs will remain straight, and lower your buttocks. Your feet should pivot over the edge (see Illus. 14-76a and 14-76b).
7. Continue to lower your buttocks, pivoting your feet, until your body is in an "L" shape (see Illus. 14-77a, 14-77b and 14-78).

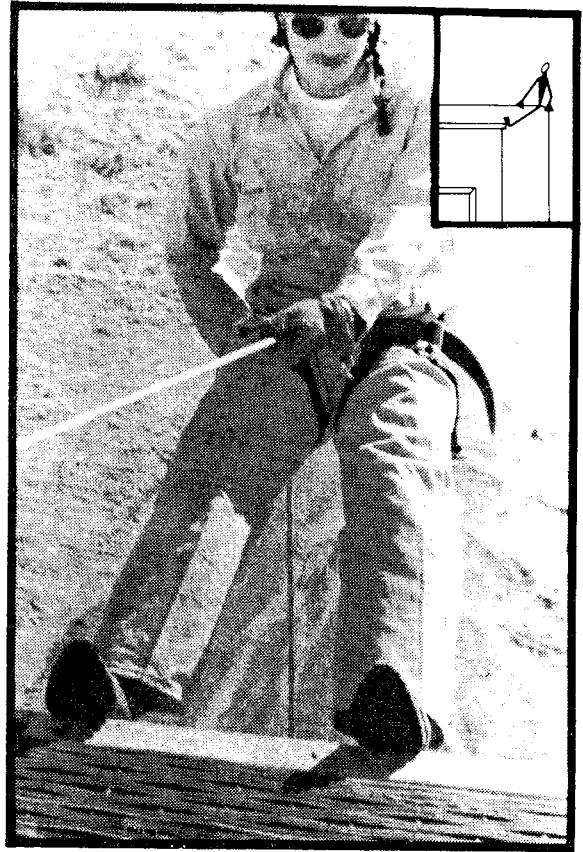

Illustrations 14-77a and 14-77b.

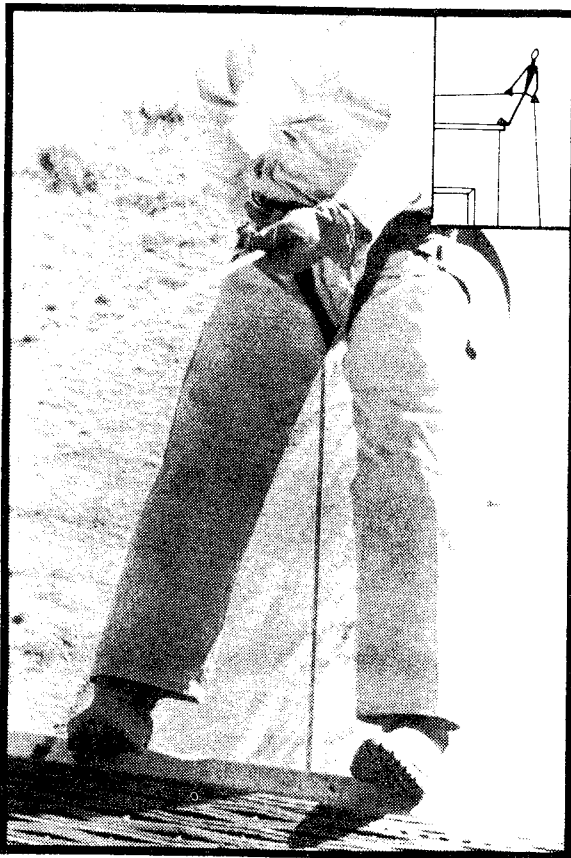

Illustrations 14-76a and 14-76b.



Illustration 14-78.

TYPES OF DESCENTS AND SPECIFIC PROCEDURES

The Controlled Descent

A slow, controlled descent is the safest way to rappel. You can accomplish this type of descent by using the following standard backward technique:

1. Take your first steps down (see Illus. 14-79a and 14-79b). As you descend, keep your body in the "L" shape (see Illus. 14-80 and 14-81).
2. Apply and release pressure with your brake hand in order to control your rate of descent. Keep the brake hand in the small of your back.
3. Do not grip the rope with your guide hand. You do not need to use the guide hand on the rope at all.
4. Turn your head toward your brake hand and look down continuously, watching for obstructions such as window sills and ledges.

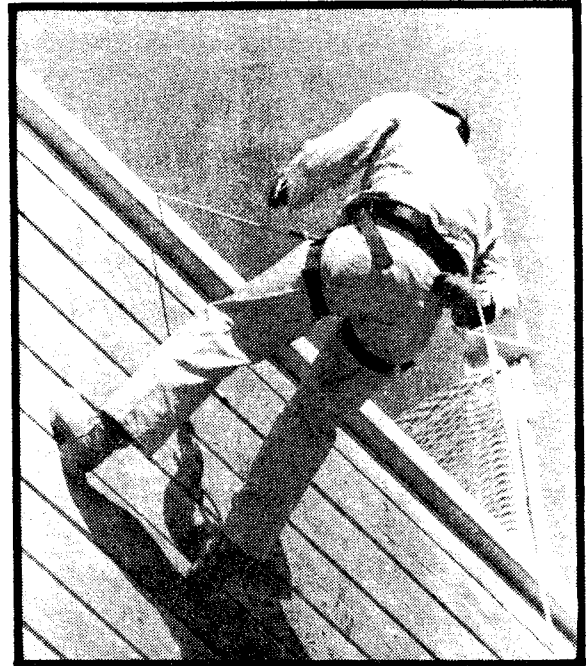
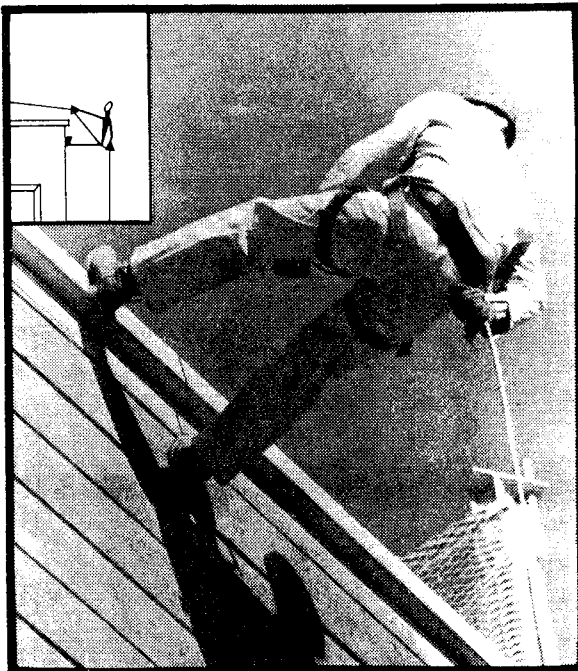

Illustration 14-80.



Illustrations 14-79a and 14-79b.

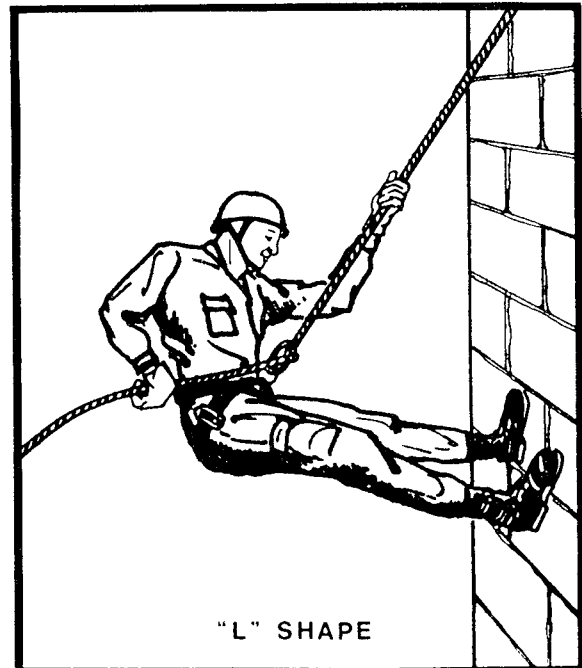

Illustration 14-81. Maintain the "L" shape during descent.

The Bounding Technique

In a tactical situation, it may not be possible for you to make a slow, controlled descent. One way to descend quickly is by the bounding technique, which is accomplished as follows:

1. After you have assumed the "L" position on the wall (see Illus. 14-82), bend your knees, keeping your feet as flat on the wall as possible (see Illus. 14-83).
2. Push out and away with your legs, and at the same time, throw your brake hand away from your body at an angle and release the brake (see Illus. 14-84).
3. To slow or stop the descent and bring yourself back to the wall, slowly bring your brake hand back into the small of your back. The braking action should be accomplished gradually and smoothly.
4. When your feet touch the wall, bend your knees, and push off again.



Illustration 14-83.



Illustration 14-82.

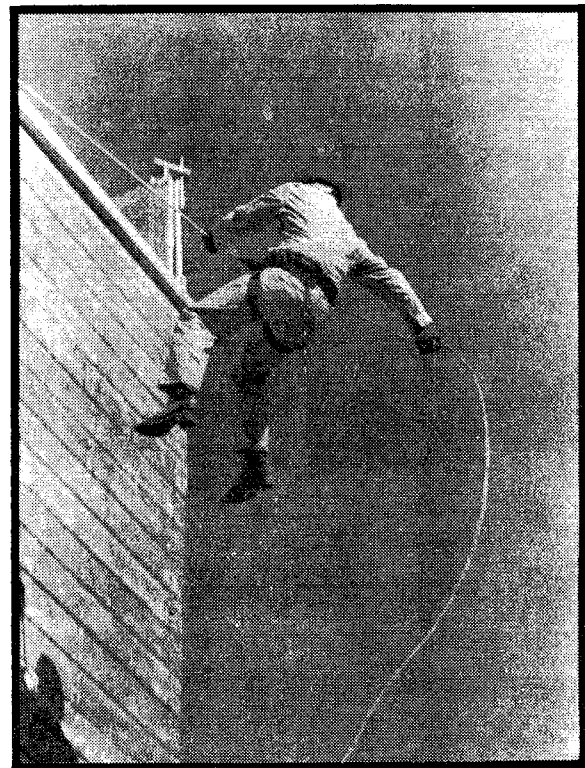

Illustration 14-84.

The Australian Rappel

Another rappelling technique that can be useful in tactical situations is the Australian rappel. This technique is a “front-first, face-down” approach that allows you to observe and possibly to use a weapon as you descend. Mastering the Australian rappel requires a considerable amount of practice. The technique is accomplished as follows:

1. Face away from the anchor point, with the rope positioned on the brake-hand side of your body. As you stand, the rappelmaster or instructor connects the rope to the descent device which is connected to the rappel seat at the middle of your back.
2. Pick up the working end of the rope in your right hand for a right-hand brake or in your left hand for a left-hand brake. You will brake by bringing your brake hand up diagonally across your chest. The guide-hand function remains the same as in other types of descents.

3. Take a few steps forward, releasing the brake as you move. The rappelmaster or instructor will check the flow of the rope through the descent device.
4. Continue to move toward the edge. After you have made eye contact with the belayer, give the “on rappel” cue.
5. Continue to move forward, releasing the brake as necessary, until your toes are over the edge (see Illus. 14-85a and 14-85b).
6. From an upright standing position, lean out, releasing the brake as necessary (see Illus. 14-86a and 14-86b).
7. Continue to lean out, and assume a squatting position (see Illus. 14-87a and 14-87b).
8. Continue to release the rope until your feet are over the edge and flat against the wall (see Illus. 14-88a and 14-88b).
9. Continue the descent. You either can do a slow controlled descent or use the bounding technique (see Illus. 14-89).

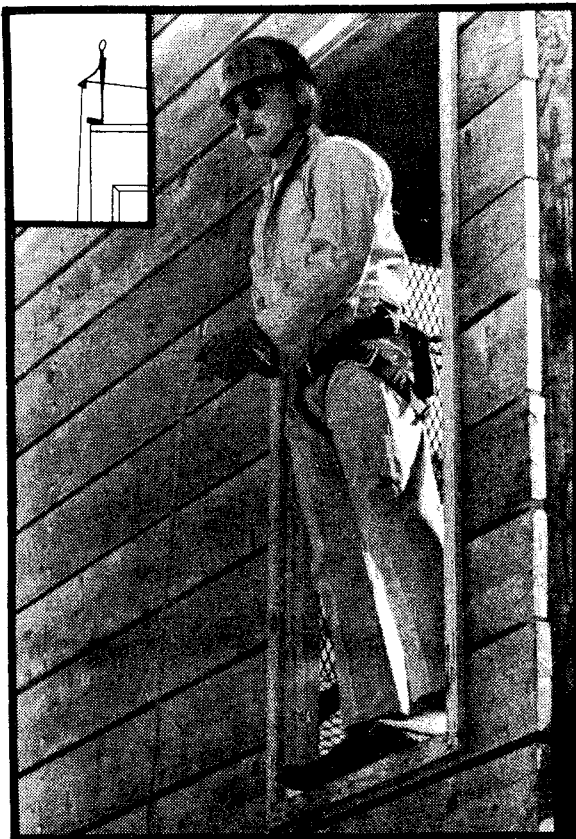

Illustrations 14-85a and 14-85b.

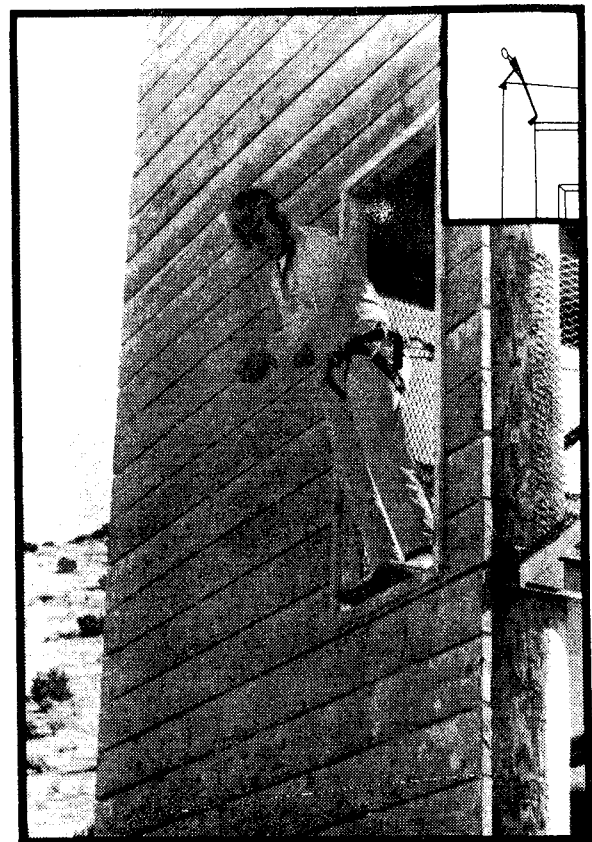

Illustrations 14-86a and 14-86b.

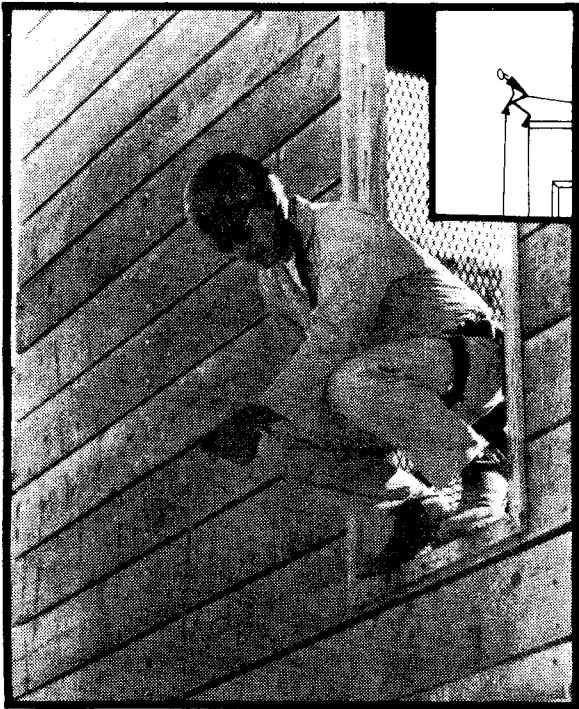

Illustrations 14-87a and 14-87b.

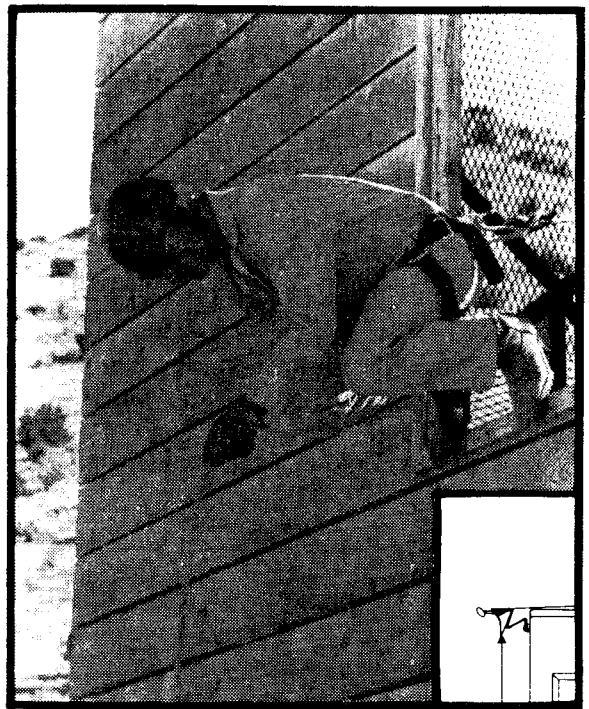

Illustrations 14-88a and 14-88b.

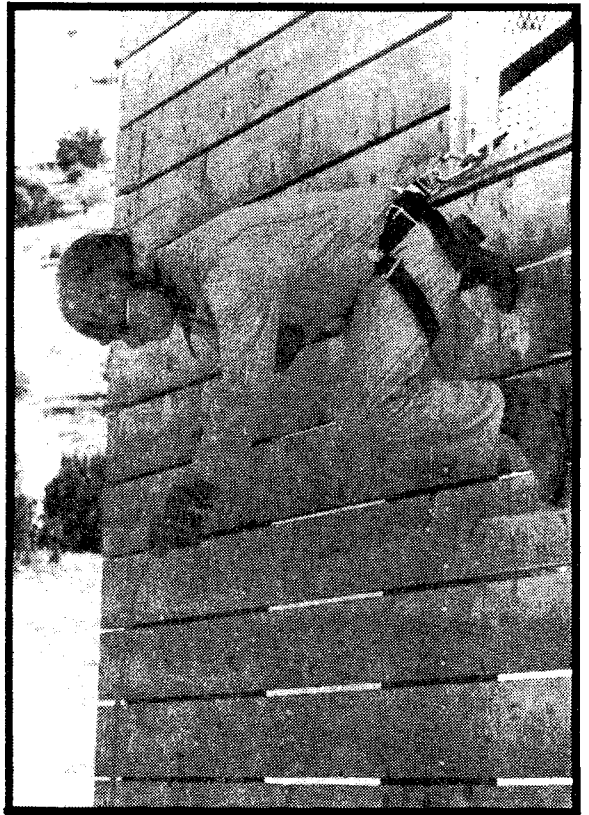

Illustration 14-89.

The Belayed Descent

A controlled descent can be achieved when a person is belayed from above. This technique is easy for the person being belayed to learn, and it allows him to use both hands for tasks other than those needed for rappelling. Even a seriously wounded person can be lowered safely by a belayer. The belayed descent probably is the safest type of descent to use in a tactical situation because the person being lowered has both hands free to shoot, reload and communicate, and can be lowered as quickly or as slowly as he/she dictates. During long descents, communication between the person being lowered and the belayer must be carried on by radio.

To prepare for a belayed descent, the belayer must select a position on the upper surface from which the person being lowered can be observed.

There must be a secure anchor point near this position to which the belayer will attach a safety line. On the upper surface, near the belayer's position, a rope must be backcoiled, or arranged in neat overlapping loops, so that it will flow out freely without forming into knots or kinks. A figure 8 descender is attached to the primary anchor point and is used as a friction device to control the rate of descent.

When the person being belayed is ready to descend, the end of the rope at the top of the backcoil is attached to his rappel seat. The rope then is placed through the figure 8 descender. The person being lowered backs to the edge as if he were rappelling. The belayer controls and feeds the rope from the backcoiled loops as required. The person being lowered assumes the "L" position and begins the descent. (See Illus. 14-90 through 14-94).

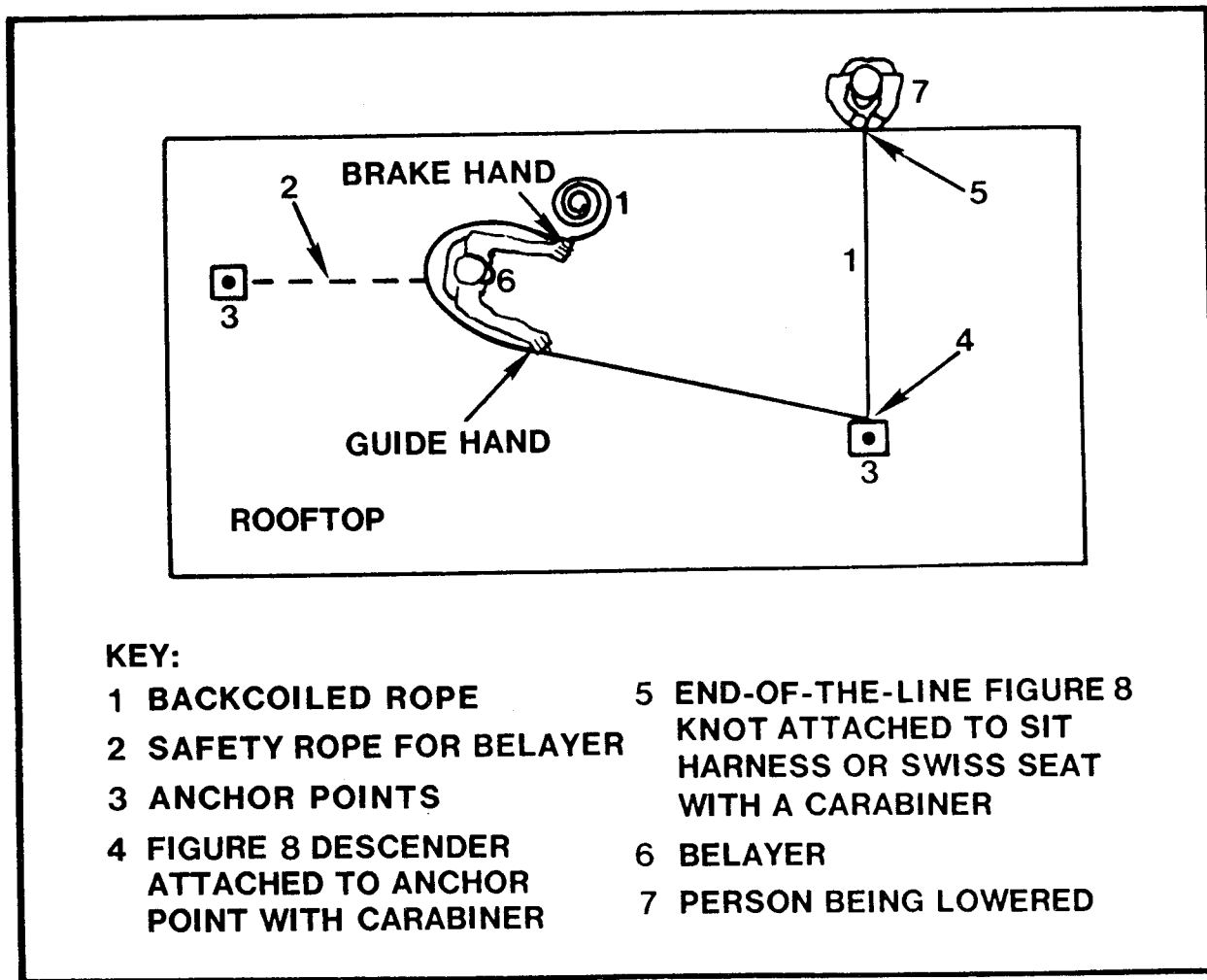

Illustration 14-90. Example belayed descent technique.



Illustration 14-91.

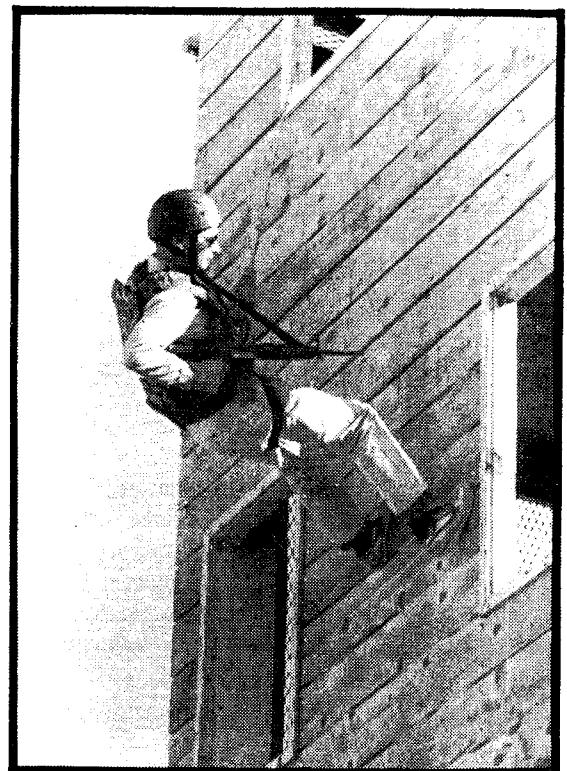

Illustration 14-93.



Illustration 14-92.

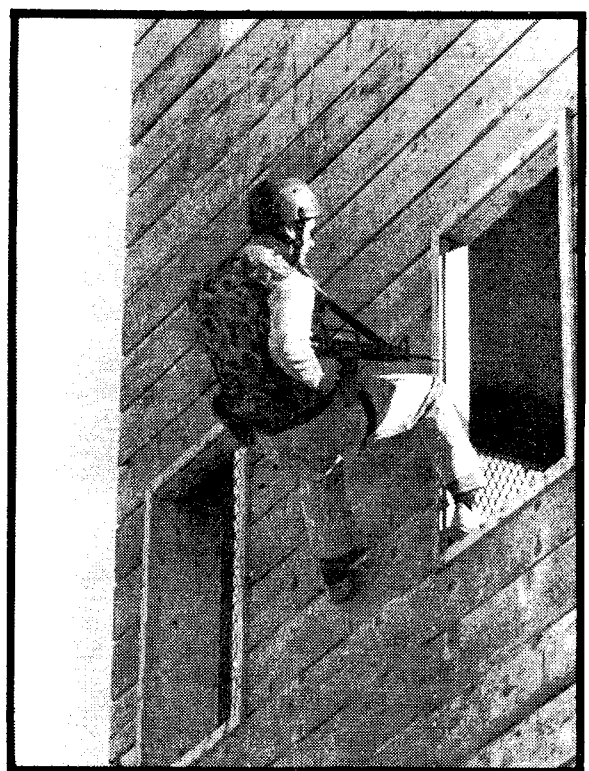

Illustration 14-94.

Section 8. SPECIAL SITUATIONS AND CONSIDERATIONS

In this section, proper methods for retrieving a rappeller are described. The technique of rappelling with two ropes is addressed, and suggestions are given for the placement of rappelling and other equipment on the rappeller's body.

RETRIEVAL OF A RAPPELLER

Occasionally a rappeller will be "stuck" during a descent. This situation can occur as a result of clothing and equipment straps becoming jammed in the descending device. If the rappeller cannot free him/herself, a second rope can be attached by a belayer to an anchor point and lowered to the rappeller. The rappeller attaches the second rope to his/her rappel seat and then cuts or releases the primary rope. The rappeller then is belayed down.

Another method, the belayed-ascent technique, can be used to retrieve a rappeller (see Illus. 14-95). This technique is accomplished as follows:

1. Establish two belay points, each point being a figure 8 descender attached to an anchor point, and fill each belay point with a belayer.
2. Attach a separate backcoiled rope to each

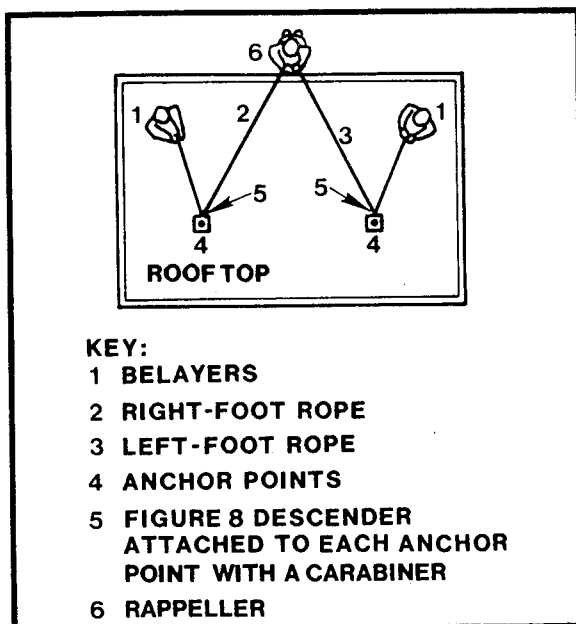

Illustration 14-95. Belayed ascent.

figure 8 descender.

3. Tie an end-of-the-line figure 8 knot to make a foot loop in the end of each rope.
4. Lower the ropes to the rappeller. The rappeller passes one of the ropes between his/her legs, around the back of one knee and around the outside of the same leg and then places that foot in the loop.
5. The rappeller completes the same procedure with the second rope for the other leg. The two ropes that are in front of the body are connected onto the rappel seat with a carabiner or with two carabiners if necessary. This connection prevents the rappeller from turning upside down (see Illus. 14-96).
6. After the rappeller connects the ropes to the rappel seats, slack is created in one rope by stepping up with one foot. Then the rappeller gives the command "up left" or "up right," depending on which foot is raised.
7. The belayer on the side indicated pulls up the slack and establishes a brake.
8. The rappeller steps up with the other foot and again commands "up right" or "up left."
9. The appropriate belayer pulls up the slack.
10. Steps 8 and 9 are repeated until the rappeller is retrieved.

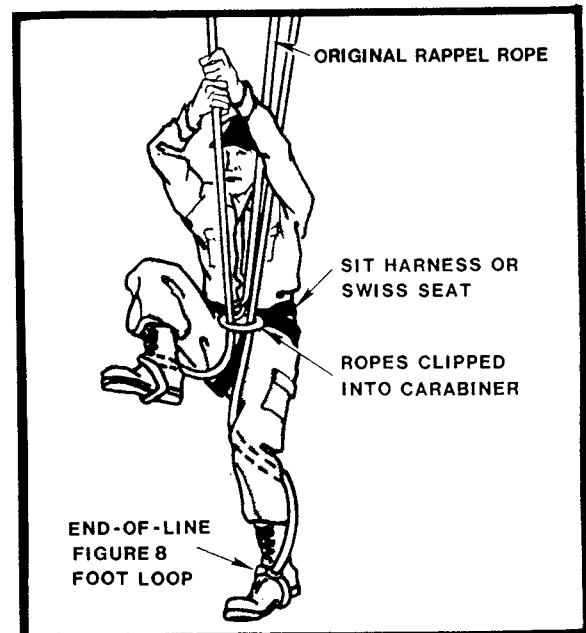

Illustration 14-96. The belayed ascent technique.

RAPPELLING WITH TWO ROPES

Rappelling can be done safely with one high-quality climbing rope that has been used and stored properly. If you desire an additional safety factor, you can rappel with two ropes. The same techniques for attaching descending devices are used for two ropes as for one. The descent will be slightly slower when two ropes are used because more friction will be involved.

PLACEMENT OF EQUIPMENT ON YOUR BODY FOR RAPPELLING

Because there is no standardization of the equipment used by tactical response teams, no attempt is made in this chapter to standardize the place-

ment of equipment on your body for rappelling. Each facility can experiment with the specific equipment on hand to determine the most convenient placement.

When you are working out the best placement of your own required equipment, you should consider certain factors. Be sure that all necessary equipment, especially your weapon and radio, will be accessible as you rappel. Ensure that the rappel rope will not be in contact with your web gear and your leather gear. After you have worked out the placement of your equipment, be sure that when you practice rappelling, you wear all tactical equipment that you will wear during a tactical crisis, so that you can become comfortable with the equipment as you have placed it.

Section 9. RAPPELLING FROM HELICOPTERS

During a tactical crisis, the quickest way for tactical response teams to reach a particular location may be by rappelling from a hovering helicopter. In this section, the general techniques that apply to rappelling from a variety of helicopters are discussed.

PREPARATION OF THE HELICOPTER

Before a helicopter is used for rappelling, it must be cleaned to remove all traces of fuel, oil and hydraulic fluid from the areas where rappelling equipment will be used. These substances can be harmful to rappelling rope. The cargo doors and passenger seats should be removed from the helicopter if possible, to provide more room for personnel and equipment. Tape or padding should be applied to all areas where the rappel rope may come in contact with the airframe, including the landing skids if the vehicle is so equipped.

In addition, you will have to fabricate an anchor system for your specific helicopter, because the procedures for anchoring the rappel rope to the helicopter will vary depending on what type of aircraft is used. Illus. 14-97 depicts the system used in the military UH-1H (the BELL 205).

UH-1H STEEL CABLE DONUT

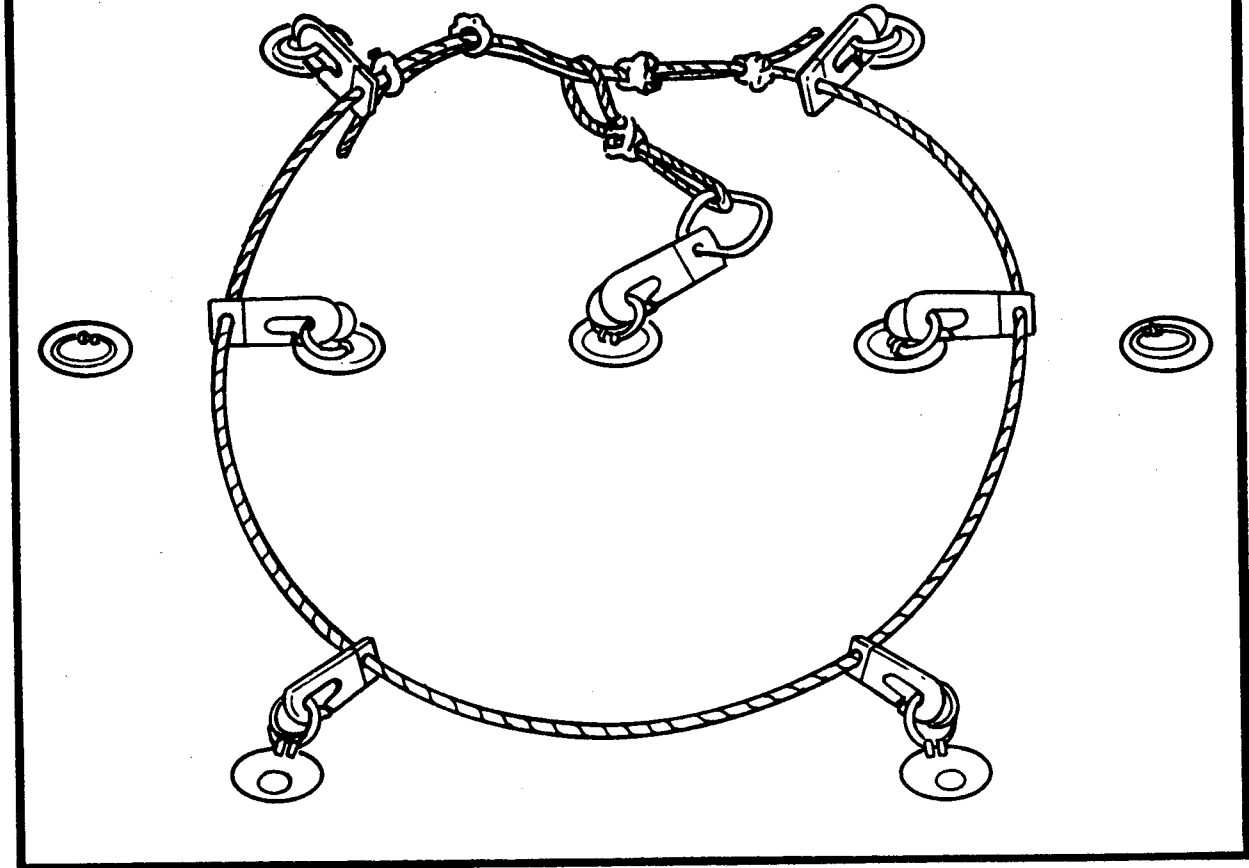

Illustration 14-97. A typical U.S. Army rappel rope anchor system for use in a helicopter.

Many helicopters, including the UH-1H, have floor tiedown rings. Most of these rings are rated at 1,500 pounds. If your helicopter is equipped with the rings, you should design an anchor system that is threaded through or attached to a number of them. A system similar to the one used in the UH-1H can be constructed as shown in Illus. 14-98.

If your helicopter does not have floor tiedown rings, you will have to use other portions of the aircraft as you construct the anchor system. If your helicopter is small and equipped with skids, you can anchor two ropes to the craft as follows: tie one rope to the left aft skid support tube; then, tie the second rope to the right aft skid support

tube. Pass the rope tied to the left side through the cargo compartment and out the right side, and pass the rope tied to the right side through the cargo compartment and out the left side. You should end up with the rope that is attached to the left skid support tube hanging on the right side and the rope that is tied to the right skid support tube hanging on the left side.

The number of rappelling ropes that can be attached and used at one time varies between two and eight, depending upon the type of aircraft used and upon its weight-lifting capability. Illus. 14-98 shows a typical double-rope attachment to the anchor system of a helicopter.

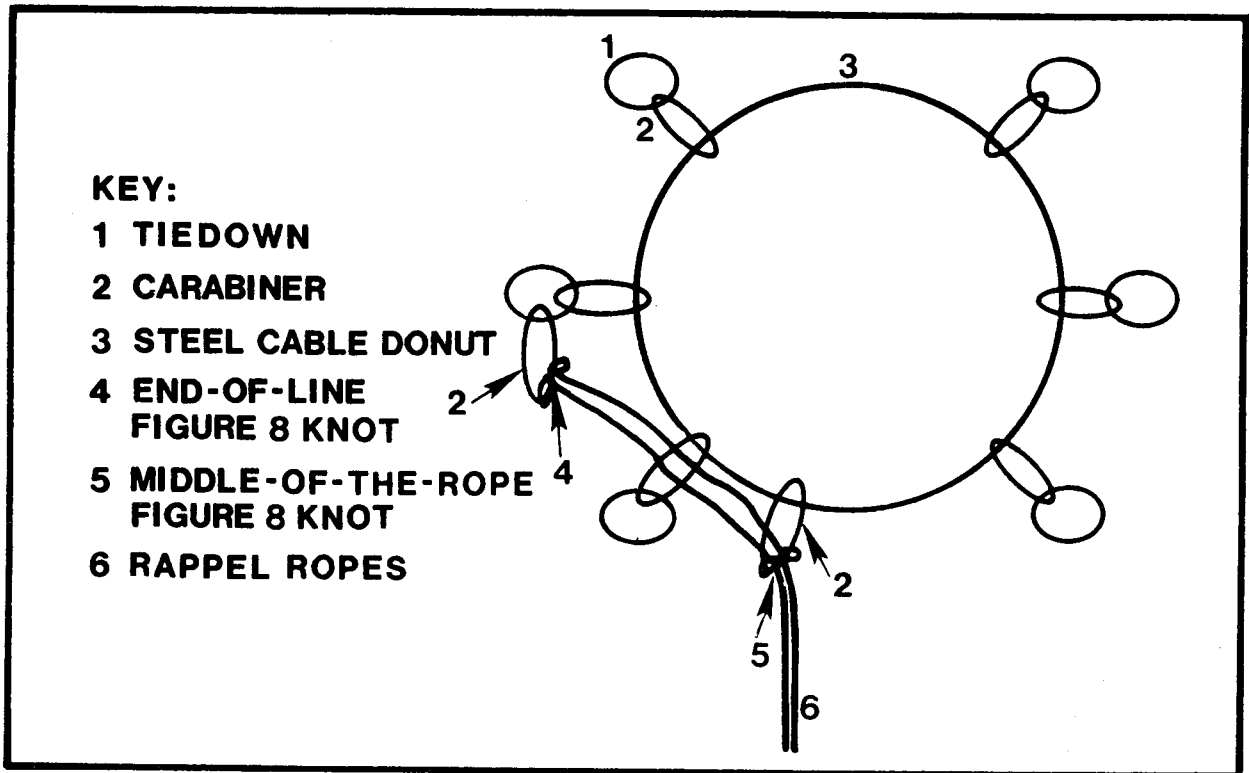

Illustration 14-98. A locally manufactured rappel rope anchor system showing double-rope attachment.

DESCENT PROCEDURES

Before exiting and descending from the aircraft, you must secure all equipment and loose clothing. You should wear a long-sleeved shirt with the sleeves rolled down to provide some protection in the event of an aircraft fire. Always wear a helmet, gloves and ear protection when rappelling from a helicopter.

The simplest way to prepare to rappel from a skid-equipped helicopter is to hook up your rappelling gear prior to takeoff for the rappel. When hookup is complete, you should stand on a skid and lean the upper portion of your body inside the aircraft. For safety purposes you should establish a brake on the rappel rope and keep your upper body leaning inside the aircraft until the designated rappel location and altitude have been reached.

The rappelmaster will instruct you to assume a standing position on the skid immediately prior to the rappel. On command from the rappelmaster,

you will lean back into the "L" position. Then, on the command "Go," flex your knees, and jump vigorously backward, at the same time releasing your brake hand and letting the rope flow freely. Do not brake suddenly or before you are clear of the skid. If you brake suddenly, you could hit the skid or swing under the aircraft and into the rappeller on the opposite side.

If you must be inside the aircraft during takeoff, you can prepare to rappel after the craft takes off: attach your rappel rope to your rappel seat, apply a brake and face out of the aircraft. Then, take a seated position at the edge of the aircraft, swing your legs outside, and rotate your body 180 degrees so that you are standing on a skid and facing into the aircraft. Once you are on the skid, lean your upper body inside the aircraft, establish a brake on the rappel rope, and wait until you are instructed to rappel.

The procedure for exiting an aircraft that does not have skids is similar to the wall descent technique, except that once you are in the "L"

position, you must bend your knees and jump backwards, allowing the rope to flow freely. This action will keep your guide hand from hitting the floor of the aircraft, and it will keep you from hitting the side of the aircraft.

If more than one person is rappelling, the rappellers should exit on alternate sides of the aircraft and should begin their descents at 1-second intervals. All exits and descents should be accomplished on command from the rappelmaster.

RAPPEL CADRE DUTIES

Prior to and during a helicopter rappel, the rappelmaster has the following duties:

- **Inspecting and rigging the aircraft.**
- **Ensuring that the rappel site is free of obstacles or debris.**
- **Inspecting all equipment for serviceability.**
- **Checking each rappeller's hookup to the rope.**
- **Conducting a safety briefing for rappellers.**
- **Maintaining radio or intercom contact with the pilot during flight.**
- **Giving the commands for exit and descent.**
- **Observing the rappellers during descent.**
- **Advising the pilot in the event that the rappellers become entangled.**

A **belayer** will be positioned on each rope to act as a **safetyman** during all training rappels from helicopters.

Also during training rappels, an **observer** equipped with a radio with communication to the pilot should be located at a point on the ground ahead of the aircraft, where the pilot and rappellers can be observed. The observer can notify the pilot of rappellers' problems, and the pilot can notify the observer of mechanical problems.

REACTION TO HELICOPTER EMERGENCIES

Before takeoff, the pilot will provide a briefing on certain emergency-reaction procedures that are established for each particular type of aircraft. Other emergency procedures are applicable regardless of the type of helicopter being used for rappelling.

One generally applicable standard procedure is

that the rappelmaster will instruct the pilot to lower to the surface any rappeller who becomes entangled with equipment or with another rappeller. The procedure to be used if a rope that is not supporting a rappeller becomes entangled with an object on the ground is for the rappelmaster to cut the rope from inside the aircraft. Personnel on the ground should never cut an entangled rope, because a rope under tension could fly up into the rotor system of the helicopter if the rope is cut from below.

If a helicopter loses power or has a mechanical problem, the standard procedure is for the pilot to attempt to fly forward of the rappel location before the aircraft is set down. If a rappeller is on the rope, as soon as his/her feet are on the ground he/she should release his/her brake hand and attempt to get free of the rope and away from the aircraft.

Section 10. CHAPTER SUMMARY

This chapter has provided an overview of the aspects of rappelling that are of interest to tactical response team personnel.

The **selection and care of rappelling equipment** were discussed. The following essential items of equipment were described, and suggestions were given for their proper care, storage and inspection:

- Carabiners
- Figure 8 descenders
- Ropes
- Sit harnesses
- Swiss seats
- Helmets

A section of the chapter was devoted to **rappelling safety**. Various means of achieving safety were covered, and the safety-related duties of the safetyman and rappelmaster were described.

The importance of tying **climbers' knots** correctly and of using them for their intended purposes was emphasized. Simple knots in each of the following three categories of climbers' knots were

described and illustrated:

- Anchor knots
- Joining knots
- Special knots

The proper **placement of anchor points** was covered as were correct **rappel hookup procedures**.

Procedures for descent were described. Standard rappelling **cues** and **responses** were covered, and the steps to be taken in **preparing for any type of descent** were described. Instructions were given for making the following types of descents:

- The controlled descent
- The bounding descent
- The Australian descent
- The belayed descent

In the section on special situations and considerations, the proper methods of **retrieving a rappeller**, of **rappelling with two ropes** and of **placing equipment** on the rappeller's body were addressed.

The final instructional section, concerning **rappelling from helicopters**, included discussions on the preparation of the helicopter and on descent procedures, rappel cadre duties and reaction to helicopter emergencies.

Chapter 15

SEARCH AND CLEAR OPERATIONS

Section 1. INTRODUCTION

During a crisis situation, you may see adversaries entering a building on your facility, or you may have reason to believe that the adversaries have done so. In either case, you must locate the adversaries and then capture or neutralize them. These tasks are accomplished by means of a search and clear operation. Searching and clearing a building where an adversary may be hidden is the most difficult and dangerous task that you ever will face as a tactical response team member. As you approach the situation, you will be at a tremendous disadvantage. You may not have first-hand knowledge of the layout of the building, whereas the adversary will have had the chance to choose hiding places and locations for weapons. Your cover and your ability to observe and to maneuver probably will be limited, and the adversary may have placed obstacles and traps in your path. You will be forced to make the moves while the adversary only needs to hide and wait. The adversary will be much more likely to possess the element of surprise than you will be.

You can approach the task of searching and clearing a building in different ways. You can enter a building rapidly, for example, using substantial firepower in order to forcefully overwhelm the adversary, or you can approach the building very slowly and deliberately, isolating and capturing the adversary and using weapons only as a last resort. This chapter will focus on the **deliberate** approach, which provides more protection for both personnel and property and is more likely to be used at NRC licensee facilities. This approach has another

advantage. If a deliberate search and clear operation is carefully planned and executed by well-trained personnel, the chances are good that the adversary will be captured without the use of deadly force.

The chapter will begin with a discussion of team organization and of the equipment that can be used in a search and clear operation. The steps to be taken in preparation for a deliberate search will be covered. Then, techniques for carrying out approach, entry, room search and adversary contact will be described in detail.

Section 2. TEAM ORGANIZATION AND EQUIPMENT

Search teams can be of different sizes and can be organized in different ways. In this chapter, a standard six-man team organized in the following way will be used as an example:

- Team Leader (Number One Overwatch)
- Assistant Team Leader (Number Two Overwatch)
- Number One Entry Person
- Number Two Entry Person
- Number One Security Person
- Number Two Security Person

The **equipment** available to you will vary from facility to facility. The following items are considered essential to search and clear operations:

- **Gas masks.**
- **Body armor.**
- **Weapons, to include short-barrel or folding-stock shotguns, semi-automatic rifles and pistols. Shotguns or pistols are frequently the weapons of choice in building clearing operations due to their limited penetration power.**
- **Special munitions, to include smoke and tear gas grenades and either concussion grenades or simulators.**

The following items of special equipment are useful in search and clear operations:

- **Pole mirrors**
- **Door stops or wedges**
- **Forcible-entry tools**
- **Climbing and rappelling gear**
- **High-intensity lights**
- **Hand-held loudspeakers**

Section 3. PREPARATION

Because of the extreme risk placed on the lives of participants in a search and clear operation, the decision as to whether or not to send in a search team normally must be made by higher management. Even before a management decision has been made, however, the response force must take the following steps to secure the area and to prepare for a possible search and clear operation:

- **Establish an inner perimeter**
- **Establish an outer perimeter**
- **Evacuate innocent persons**
- **Plan in detail**

You must establish an **inner perimeter** to isolate the immediate target area where the adversary may be hiding. The guards manning the inner perimeter also can provide support to the search team members if the decision is made to conduct a search and clear operation.

An **outer perimeter** also must be established immediately to prevent adversary escape as well

as to prevent the entry of adversary reinforcements and other unwanted parties. You must **evacuate all innocent persons** through this outer perimeter. The number of guards stationed at normal exit points may have to be increased to ensure that an adversary does not leave with the innocent persons. When possible, snipers should be positioned on higher buildings in the area to assist with containment and support.

When the decision to proceed with a search and clear operation has been made, **detailed plans** for the operation must be worked out. If they are available, floor plans of the building that will be searched must be studied carefully. Everything possible must be learned about the layout and structure of the building, with special attention being given to possible entry and escape routes, paths for movement and hiding places. If possible, the following questions concerning the adversaries should be answered:

- **Who are they?**
- **How many are there?**
- **What weapons do they have?**
- **Are they holding hostages?**
- **What are they trying to accomplish?**

Anything you can learn that takes the element of surprise away from the adversary will greatly increase your chances for a successful outcome.

Once a plan has been developed, the search team leader will brief the other team members thoroughly on the following:

- **Route and method of approach**
- **Entry point and method of entry**
- **Search procedures and patterns**
- **Pertinent information about the adversary**

Section 4. APPROACH

Every effort must be made to maintain the element of surprise during the approach to the occupied building. Team members should cover or remove shiny and noisy items, such as handcuffs, keys and badges, that they are wearing. If possible, the building should be approached from a blind side, a side that has no windows or other means of observation. If there is no blind side, the approach least vulnerable to observation by the

adversary should be chosen. Response force snipers positioned on higher rooftops can neutralize adversary observers from the roof of the building that will be approached.

Team members should use covered routes of approach when these routes are available. Such routes can run through secured buildings, in underground passageways and behind vehicles, trash bins and other cover in the streets. Another possible approach route is across rooftops not exposed to adversary fire. If large open spaces must be crossed, portable barricades can be improvised. Examples are trash cans and maintenance carts on wheels and movable construction equipment. The inner-perimeter forces will provide overwatch fire support throughout the approach.

Section 5. ENTRY

You have learned that the detailed planning for a search and clear operation must include a consideration of possible entry points into a building where an adversary may be hiding. Before the operation can begin, a final choice must be made concerning the entry point and the type of entry to be used. This section will begin with a discussion of the factors that will influence the choice of entry point. The possible types of entry then will be covered.

The factors that will influence the choice of entry point include the

- **Location of the adversary**
- **Floor plan of the building**
- **Lighting**

If you know the general **location of the adversary**, consider first the entry point that is the least vulnerable to observation and fire. In other words, normally, plan to enter as far away as possible from the adversary. However, in addition consider how quickly and quietly the entry can be made at the chosen point.

By studying the **floor plan of the building**, you can decide if there is an entry point that will allow your force, with maximum security, to make a complete sweep of the building without having to backtrack. If the building is rectangular, it is better to enter at one end rather than in the middle.

By entering in this manner, you will avoid having to search in two directions at once (see Illus. 15-1).

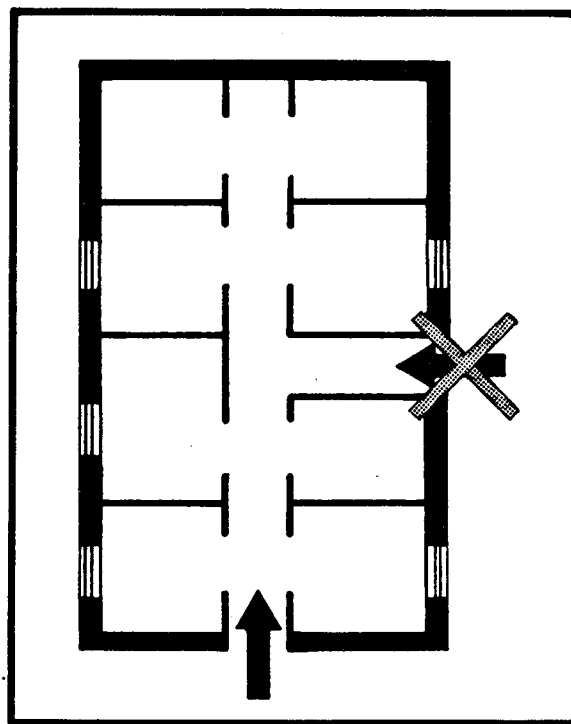

Illustration 15-1. Enter a rectangular building at one end, not in the middle.

If the building has more than one story, it is better to move from the top down. This route will give you both tactical and psychological advantages. Tactically considered, if the adversaries hear you, they may move down and try to escape to the outside, where the inner-perimeter security force can intercept them. Also, fighting downward is easier than fighting upward in terms of observation and movement, and you can go down stairs more quickly than up stairs. From a psychological point of view, by moving down, you also avoid giving the adversary the feeling of being trapped. A trapped person can become violent and difficult to apprehend.

Do not overlook the **lighting** when you choose an entry point. In most cases, you will be moving from a lighted area to a darker area. This difference in lighting puts you at a disadvantage because it is much easier for the adversary to see you silhouetted in the light than it is for you to see the adversary hiding in the dark (see Illus. 15-2). Dur-

ing the day, choose an entry point that is shaded, if possible, to reduce the disadvantage. At night, select unlighted areas for entering.

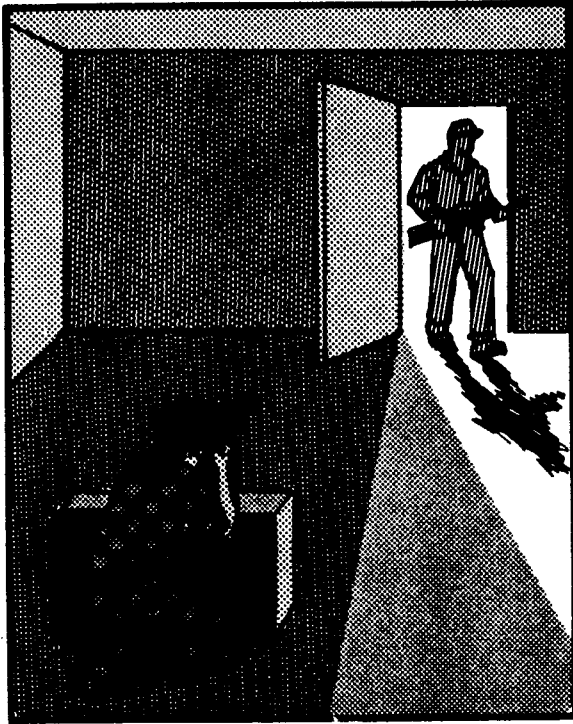

Illustration 15-2. Avoid being silhouetted in the light.

Keeping these influencing factors in mind, you must choose one of the following types of entry before beginning the operation:

- DOOR ENTRY
- WINDOW ENTRY
- ROOF ENTRY
- RAPPEL ENTRY

Regardless of which type of entry you choose, you must be certain that steps have been taken to evacuate all innocent persons before you proceed. Although you will avoid the use of deadly force, you need to know that if you are fired upon, you can fire back. If hostages are known to be involved, management probably will decide to call in negotiators rather than to initiate search and clear operations.

Some sort of diversion should be used at the moment of entry. This diversion can be anything that will distract the attention of the adversary away from the point of entry. Examples are a bull-horn announcement from outside the building, a false entry attempt in another part of the building, a loud noise such as an explosion and a telephone ringing in another part of the building.

DOOR ENTRY

A standard **door entry** is carried out with the two entry personnel opening the door and entering first. The team leader and assistant team leader provide overwatch, and the security team covers the flanks. The overwatch normally will be positioned to the sides of the door and closer to the entry than the position of the security personnel (see Illus. 15-3a). When cover is available, however, one overwatch may take up a position directly in front of the door so that fire can be brought straight into it, in the event that an adversary fires from inside the room (see Illus. 15-3b).

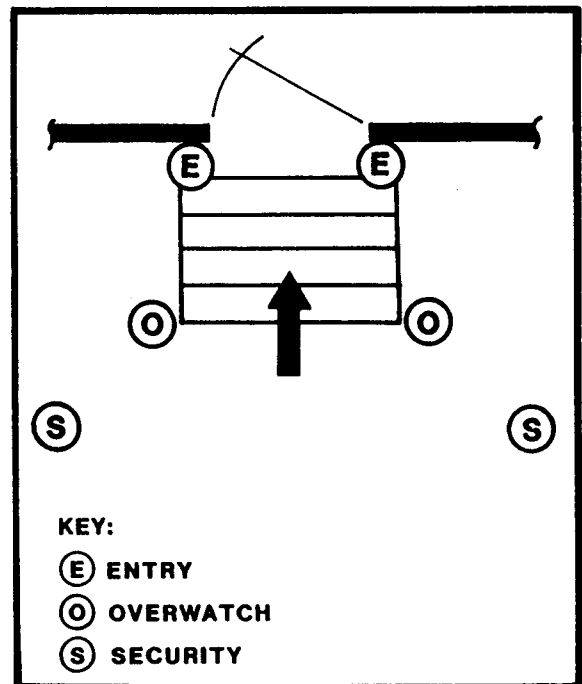

Illustration 15-3a. Possible search team positions for entry.

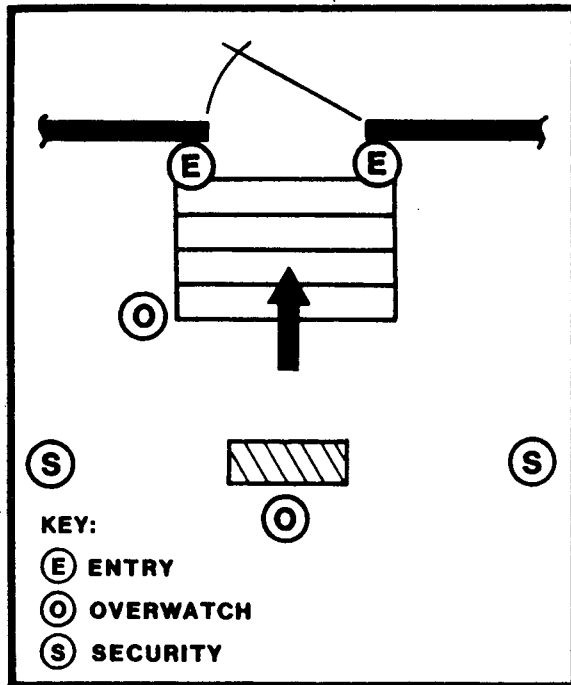

Illustration 15-3b. Alternate search team positions for entry.

Avoid making a forced entry through a door when possible. Doors within a facility's protected area normally can be opened with the keys, electronic openers or other means available to the security force. Use forcible-entry tools only as a last resort.

Before you can decide what technique to use to open a door, you need to know which way the door will open. Normally, this information will be indicated on the blueprint for the building. If you have not been able to determine the way a door will open by studying the blueprints, you need to check the hinges when you approach the door. If the hinge pins are on the outside, the door normally will open out. If the hinge pins are on the inside, the door normally will open in.

Since a turning doorknob may be the first indication of your location to the adversary, stand as far back from the door as possible as you turn the knob. You can use a simple, remote, door-opening technique by quietly wrapping tape around the doorknob and then attaching the tape to a cord, pole or other pulling device. As you pull on the tape from a safe distance, it will unwind, turning the knob at the same time (see Illus. 15-4).



Illustration 15-4. A remote door-opening technique.

If the entry personnel decide not to use a remote technique, the person closest to the doorknob will turn the knob with his/her weak hand while standing as far back from the door as possible (see Illus. 15-5).



Illustration 15-5. An entry person turning a door knob with weak hand.

If the door opens to the outside, it should be pulled open with a loop. To accomplish this technique, the entry person opposite the doorknob can hold on to the free end of a rope and toss the loop end to his/her partner, who can slip the loop over the knob (see Illus. 15-6). If the door opens to the inside, it can be pushed open with a rifle or pole (see Illus. 15-7).

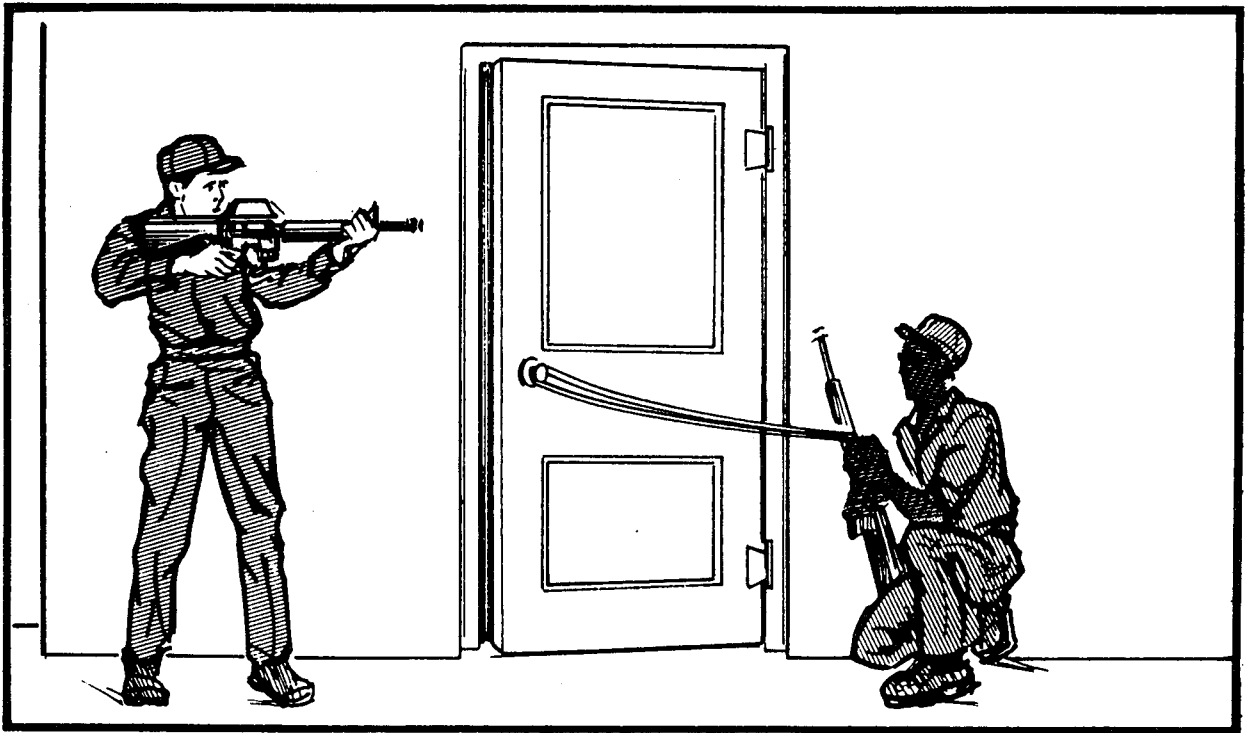

Illustration 15-6. Pulling a door open with a loop.

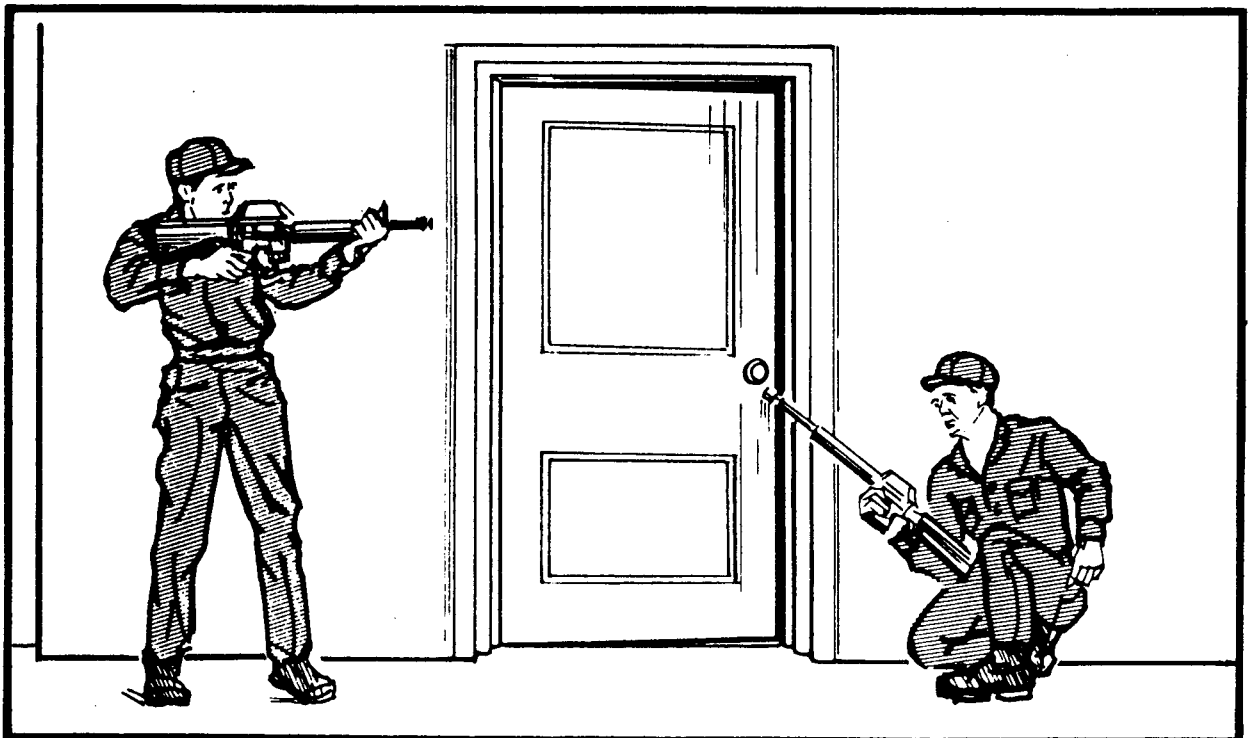

Illustration 15-7. Pushing a door open with a rifle.

In either case, the opening should be accomplished in a quick, smooth motion. Try to push doors in with enough force to make them open all the way. If you open a door all the way, you have a better view of the room, and you will find out if anyone is hiding behind the door.

Use doorstops or wedges to keep doors open. If there are double doors, open both doors so that you can see better into the room and so that you have a larger opening to pass through. As you pass

through a larger opening, it will be more difficult for an adversary to focus on just the right point to fire at you.

Once the door is open, you will have a view of the area in front of the door, but you will not be able to see to the sides of the room. Use a small mirror attached to a pole to scan the room slowly. Move the mirror around the corner of the door-jamb with your weak hand (see Illus. 15-8).

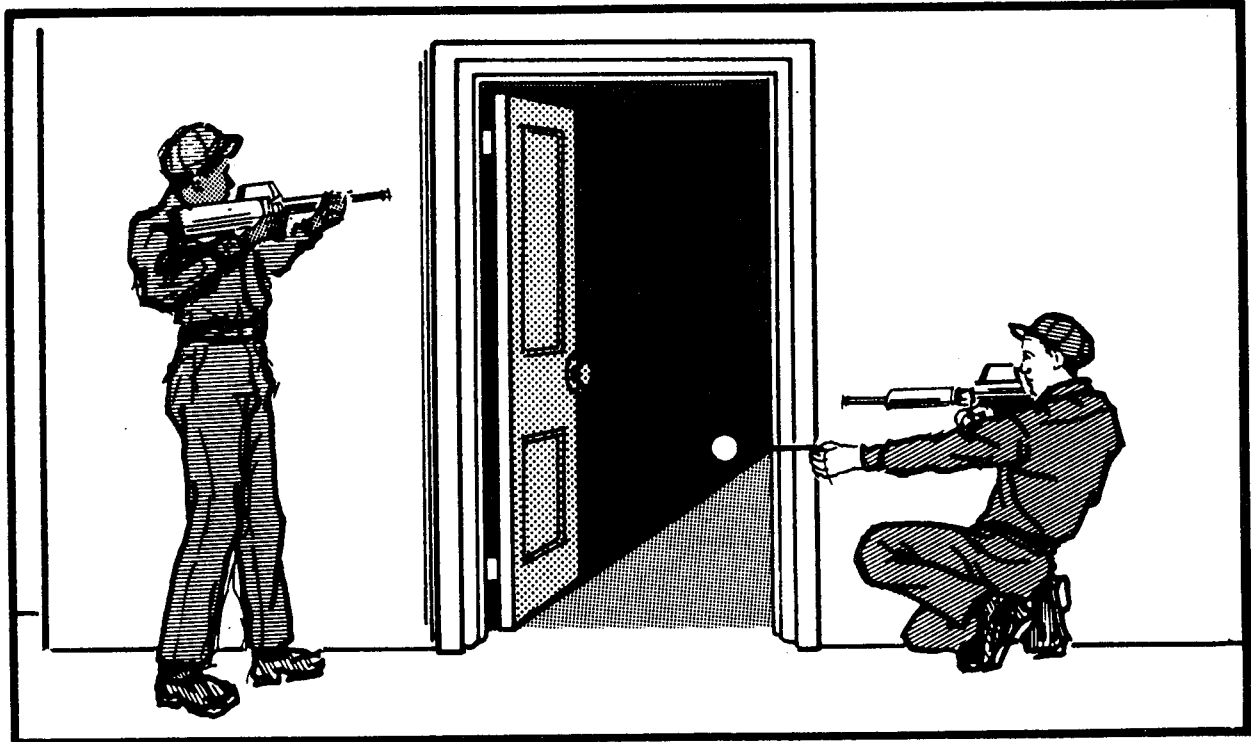

Illustration 15-8. Conducting a pole mirror room search.

Look first for adversaries and for places where adversaries may be hiding. Check for possible booby traps and obstructions. Also, study the total layout of the room and decide upon your first position of cover. Use all of your senses to check out the room before going in. You may be able to hear or even to smell an adversary.

When the entry personnel have done everything possible to ensure that no adversary is in the immediate area, the entire search team must pre-

pare for entry. The overwatch personnel provide high cover with their rifles. On signal, the entry personnel enter low and fast with weapons ready. If the doorway is wide enough, both personnel should enter at the same time. This technique is preferred because two targets moving at once are more difficult to hit with fire than is a single moving target. If the doorway is narrow, the team members should enter in rapid succession. The quickest way to do so is to move crisscross. The person on the left quickly crosses the threshold at an angle and takes cover on the right side of the room, and the person on the right makes the same movement in the opposite direction (see Illus. 15-9).

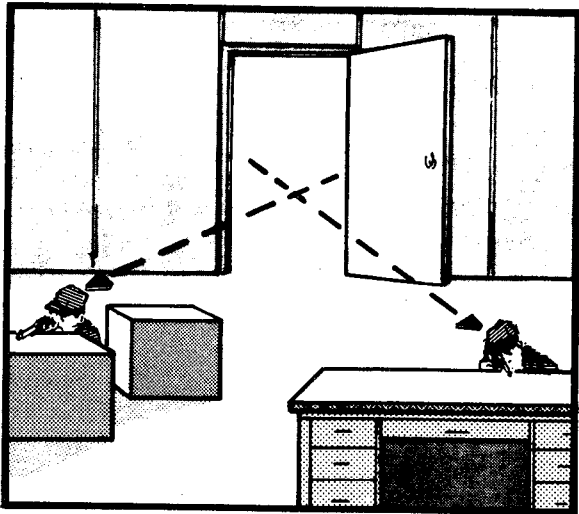

Illustration 15-9. A crisscross room entry.

Whether the entry personnel move together or separately, they must stay low and move as quickly as possible to avoid being silhouetted against the open door. By staying low, you also avoid masking the bullets of the overwatch personnel. As soon as you are inside, take cover and begin a visual search of the area. Use your other senses, too, to try to detect the presence of an adversary.

Once the entry personnel have cleared the immediate area, they can assume temporary overwatch and signal the overwatch personnel to enter. When the overwatch personnel are inside and behind cover, they again take up overwatch while the entry personnel move ahead. Although all search team members must remain alert at all times, the main area of concern to the entry personnel is to the front. The overwatch personnel are more concerned with the flanks and the area overhead. Special attention must be given by the

overwatch personnel to rafters, high shelves, ducts and other elevated areas that are good potential hiding places for the adversary.

Normally, the security personnel should remain outside until the entire first room has been cleared. Then, members of the inner-perimeter force should move into position to cover the entry point, and the security personnel will move forward and take up security positions inside the building to cover the entry through the next doorway. As they enter the building, the security personnel can pick up any special equipment, such as pole mirrors, that the entry personnel have left behind.

WINDOW ENTRY

The team organization for a window entry is the same as for a door entry, and most of the same principles apply to both methods of entry. As is the case in a door entry, you should take every precaution to avoid being detected when you make a window entry. If possible, do a mirror search of the room through the closed window before trying to open it. Since most windows cannot be unlocked from the outside, it is much more likely that you will have to resort to a forced entry through a window than you will through a door.

One method of forcing entry through a window is by breaking a pane of glass. Because this method is noisy, it should be used only as a last resort. If you must break a window, first cover the pane with a blanket or canvas to protect yourself from flying glass. Depending on the structure of the window, it may be easier for you to crawl through the broken window instead of unlocking and opening the frame. In such a case, try to remove the glass completely so that you will not be cut as you climb through.

Once the window is open or the pane is removed, check the room thoroughly again with the mirror to be sure that there is no adversary in the area.

A window entry usually is slower and more difficult to accomplish than a door entry. However, the same principles of rapid movement and minimal exposure apply. Especially if the window is high, entry can be made much more smoothly if other team members give the entry person a boost.

Keep as low a profile as possible while you are in the window. Remember that during this time you will be silhouetted against the light and therefore, you will be an easy target if you move too



Illustration 15-10. Maintain a low profile when entering through a window.

high or remain silhouetted too long (see Illus. 15-10).

Once inside, the number one entry person moves quickly to a preselected covered position. As soon as the entry person has determined that there is no adversary in the immediate area, he/she signals the next person in, and the search proceeds as with a door entry.

ROOF ENTRY

A **roof entry** often is the best choice when you are searching a multistoried building. Entering from the roof will allow you to search the building from the top down. Usually, it is not difficult to gain access to the roof of a building. There may be external fire escape ladders or stairs attached to the building, for instance. If this is the case, your easiest entry could be through the top floor fire escape door. On the other hand, if external ladders or stairwells are not available, you can use grappling hooks or hydraulic lift equipment. Once you have reached the roof, you can enter the building through service doors or skylights. The same general techniques and precautions will be employed for roof entry as for door and window entry.

RAPPEL ENTRY

A **rappel entry** through an upper story window has the advantage that it is likely to be unexpected by the adversary. The number one entry person rappels down to the level of the window and uses the same techniques that would be used for a ground floor window entry to get the window open. Once the window is open, the number one entry person takes up a position at window level, kicks off from the building on the rappel ropes and swings back through the open window. If necessary, the entry person can be guided from above by another team member using a rope to pull the rappeller into position (see Illus. 15-11).

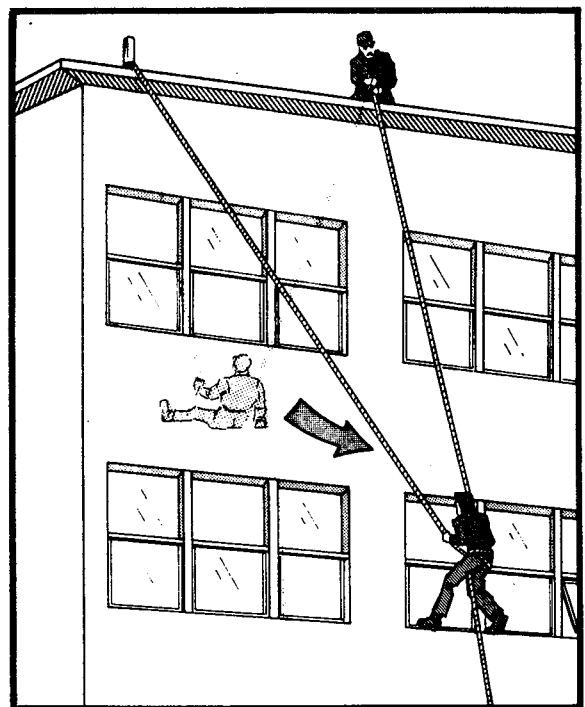

Illustration 15-11. An upper story rappel entry.

As soon as the number one entry person is inside, the number two person enters quickly, and the search proceeds in the same way as it would with other types of entry.

Section 6. ROOM SEARCHES

No matter which method is used to enter the building, the **room searches** within the building are carried out in much the same way as the search

of the first room. The responsibilities of the entry, overwatch and security personnel remain the same.

The same procedures for doorknob turning, door opening, mirror search and actual entry are followed at every door within the building. Above all, the team must guard against becoming careless or moving too quickly. Keep low whenever possible. Crawl, if necessary, to maintain the smallest silhouette possible. Always look to the front, sides and rear and above you—then look again—before moving. Always assume that an adversary or a booby trap may be anywhere. Pick your next exact position of cover before moving. Guard against the false sense of security that you may have in a position of concealment, especially in the dark. Always seek true cover rather than concealment.

It is important for you to know the location of other team members at all times. You must be able to provide cover for each other as well as to avoid

firing on each other. It is best for one team member at a time to move so that the others can provide cover. You also must be able to communicate with each other without drawing attention to yourselves. Arm and hand signals work well in daylight. In the dark, you can use small flashlights with red filters to send signals. Under certain circumstances, you can use an audible signal such as a finger snap to let your partner know that you have reached a position of cover. In all cases, you should use a predetermined communication system that is clear to all team members but that is not likely to alert the adversary to your location.

If the room being searched is small, the overwatch personnel should remain outside to provide cover while the entry personnel conduct the search (see Illus. 15-12a).

If the room is large, the overwatch personnel will move inside to provide cover while the security personnel remain outside (see Illus. 15-12b).

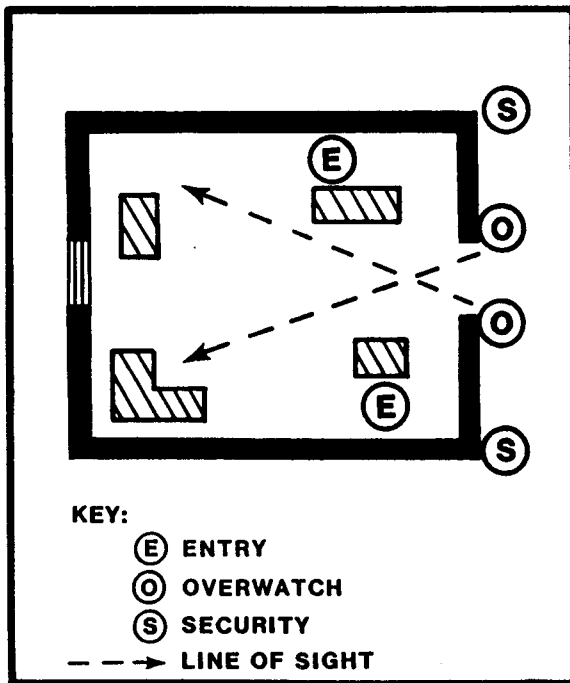

Illustration 15-12a. Search team positions during a small-room search.

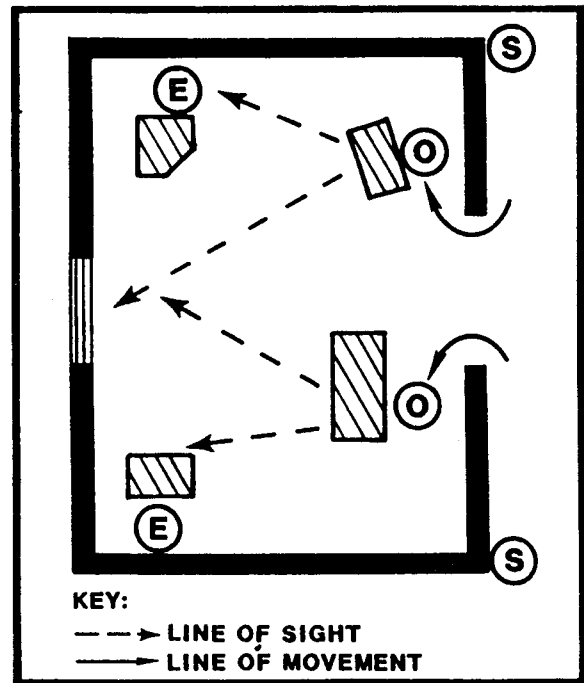

Illustration 15-12b. Search team positions during a large-room search.

A search team member inside the room should signal the security personnel when that room has been cleared. Then, the entry personnel exit and move into position to enter and search the next room. If the building is large, additional members

of the tactical response team may have to be called in to secure the rooms that have been cleared. This procedure will prevent an adversary from sneaking back into a part of the building that already has been searched.

Always clear rooms systematically, moving from one end of a hallway to the other. Clear both sides of the hallway as you move (see Illus. 15-13), and leave someone in place to guard each room that has been cleared.

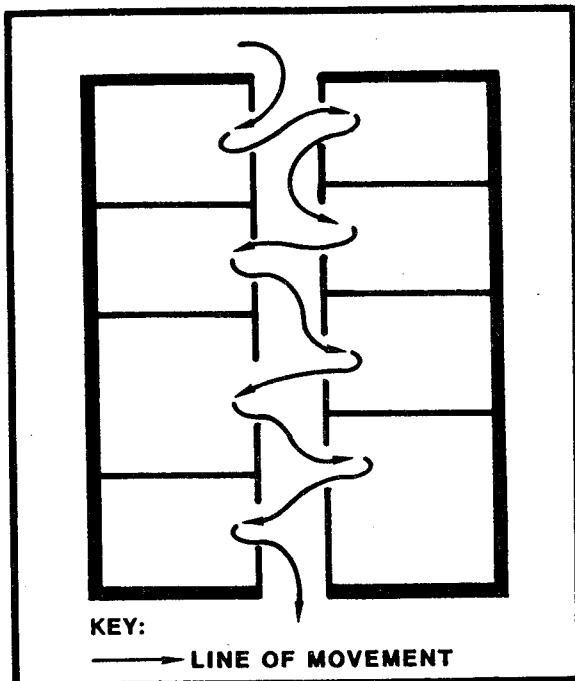

Illustration 15-13. Clear rooms systematically within a building.

If there are connecting doors between certain rooms, it generally is better to enter the next room through the connecting door rather than to return to the hallway and then enter through the main door. Using the connecting door instead of the main door will give you an added element of surprise.

In a multistoried building, always use stairwells instead of elevators. A moving elevator will give away your location and will provide little or no cover. It also is important that you prevent the adversary from using an elevator to escape. You must know where circuit breakers and power switches are located in the building so that you can cut off power to the elevators as soon as you gain entry to the building.

Always clear stairwells from the top to the bottom. Again, it is much easier to observe and fire

down than up. From a prone position at the top of the stairs, you can do a mirror search of the entire stairwell without being vulnerable to adversary observation and fire (see Illus. 15-14). An overwatch person should be safely positioned to provide cover as you clear a stairwell.

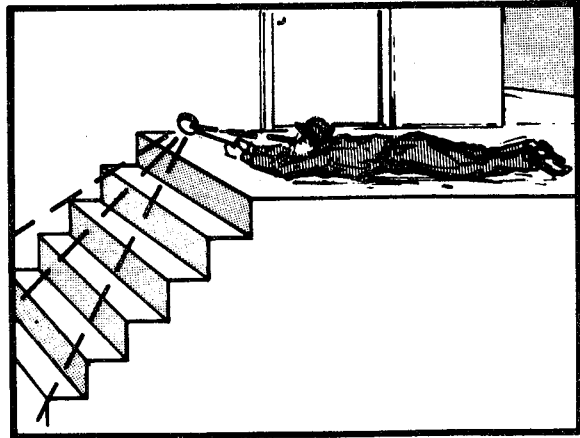

Illustration 15-14. Conducting a mirror search of a stairwell.

In buildings with more than one stairwell, all stairwells should be cleared at one time to ensure that all escape routes are denied to the adversary. This task may require additional search teams as well as additional security forces to secure the stairwells as they are cleared.

When the entire building has been searched and cleared, the search team must signal the outside security forces before exiting the building. If there are other buildings in the area to be searched, the inner perimeter may have to be shifted to cover the building that is the next most likely to be sheltering the adversary. Then, the entire search procedure must be repeated in the next building without search team members becoming rushed or careless.

Section 7. ADVERSARY CONTACT

The desired outcome of a deliberate search is that the adversary will be located and captured without the use of deadly force. It is realistic to expect, however, that if an adversary sees you, especially if he feels trapped, he will fire on you. Your first contact with an adversary may well occur when he takes the search team under fire.

If you are fired upon, dive for cover rather than trying to return fire. The adversary is likely to

be firing from cover, whereas you will be exposed and, therefore, in a position of weakness. The other team members must immediately fire on the adversary to cover the team member who is under fire.

Once an adversary has been located, it is extremely important that he/she be pinned down instead of being allowed to escape. The adversary now knows where you are, and if allowed to withdraw, can take cover and surprise you as you approach.

As you move to pin down the adversary, be alert to movement in other areas. One adversary may be exposed in order to divert your attention so that the other adversaries can escape, or the adversary may have exposed him/herself in order to draw search team members out into the open.

Remove captured adversaries from the building immediately, and turn them over to the security force outside. Captured adversaries probably will be disoriented and in some degree of shock, and they should be interrogated while their guard is down. They should be questioned about the location, size and intentions of the adversary force. Inside the building, meanwhile, the search must continue until all rooms have been cleared. Never conclude the search or let down your guard just because one or several adversaries have been captured. You must search until you are absolutely certain that no adversary remains in the building.

Section 8. CHAPTER SUMMARY

This chapter has examined in detail the most difficult and dangerous of tactical response team operations, searching and clearing a building that may be occupied by adversary forces.

The chapter began with a description of a typical **team organization** for search and clear operations. Then, essential and special items of **equipment** were listed.

The **preliminary steps** that the tactical response team must take if an adversary is inside the facility were covered. These steps, which are taken even before higher management decides whether or not to conduct a search and clear operation, are as follows:

- Establish an inner perimeter
- Establish an outer perimeter
- Evacuate innocent persons

The **detailed planning** that must be done once the decision has been made to conduct a search and clear operation was discussed.

Methods by which to approach a building were described.

The following **factors** that influence the choice of **entry point** were covered:

- Location of the adversary
- Floor plan of the building
- Lighting

The following **types of entry** were described:

- Door entry
- Window entry
- Roof entry
- Rappel entry

Procedures for conducting **room searches** and for handling **adversaries** were covered.

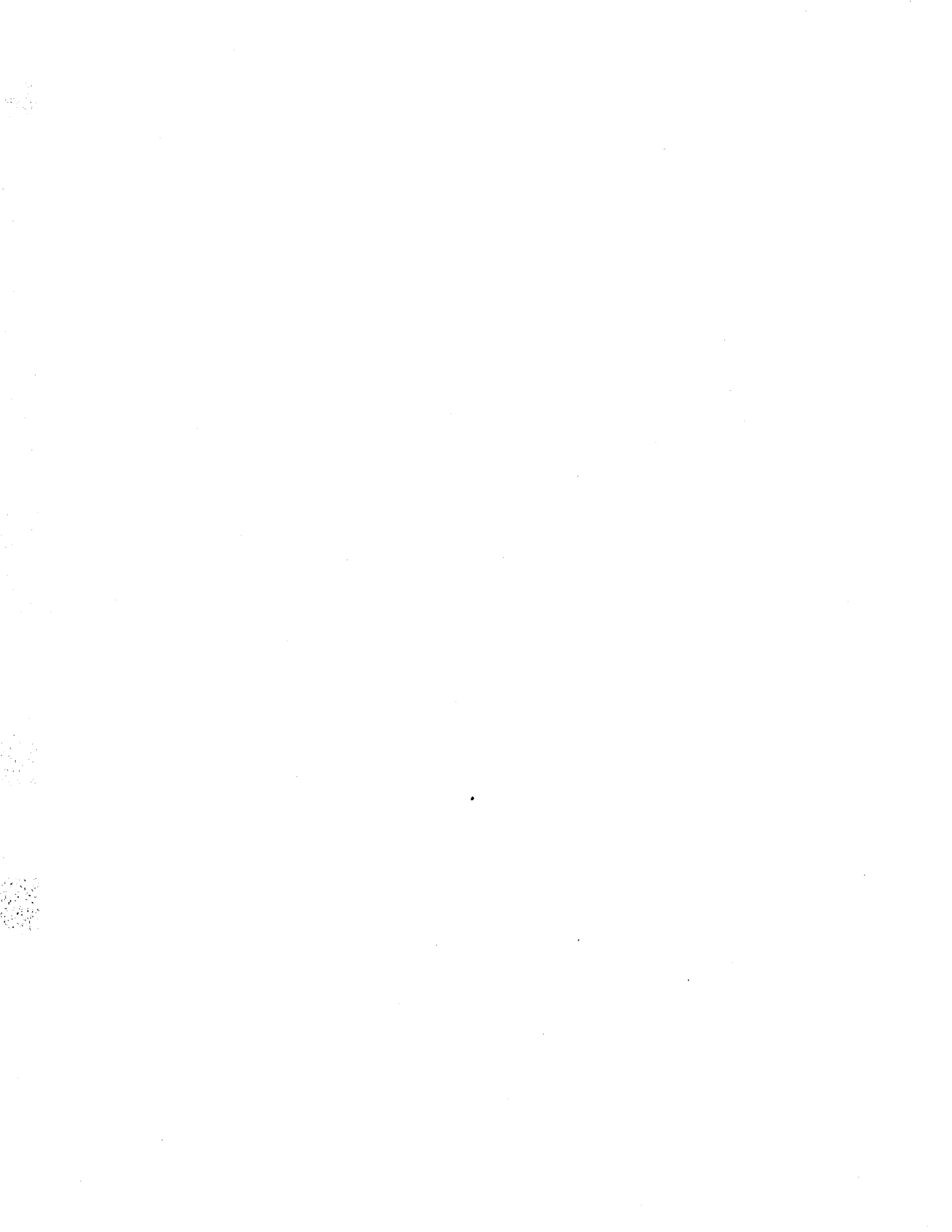

Chapter 16

SNIPER OPERATIONS

Section 1. INTRODUCTION

A sniper is a carefully selected marksman who has had advanced training in marksmanship and observation techniques. The sniper has a dual mission of delivering precision fire on selected targets from concealed positions and of gathering and reporting tactical information. The sniper uses spe-

cial rifles and other equipment to accurately engage targets that are beyond the range of ordinary rifles. The sniper also takes advantage of his/her equipment and location in order to observe adversary activity. The sniper is therefore a valuable asset to the security force (see Illus. 16-1). For the same reasons, an adversary sniper can pose a serious threat to the security force.

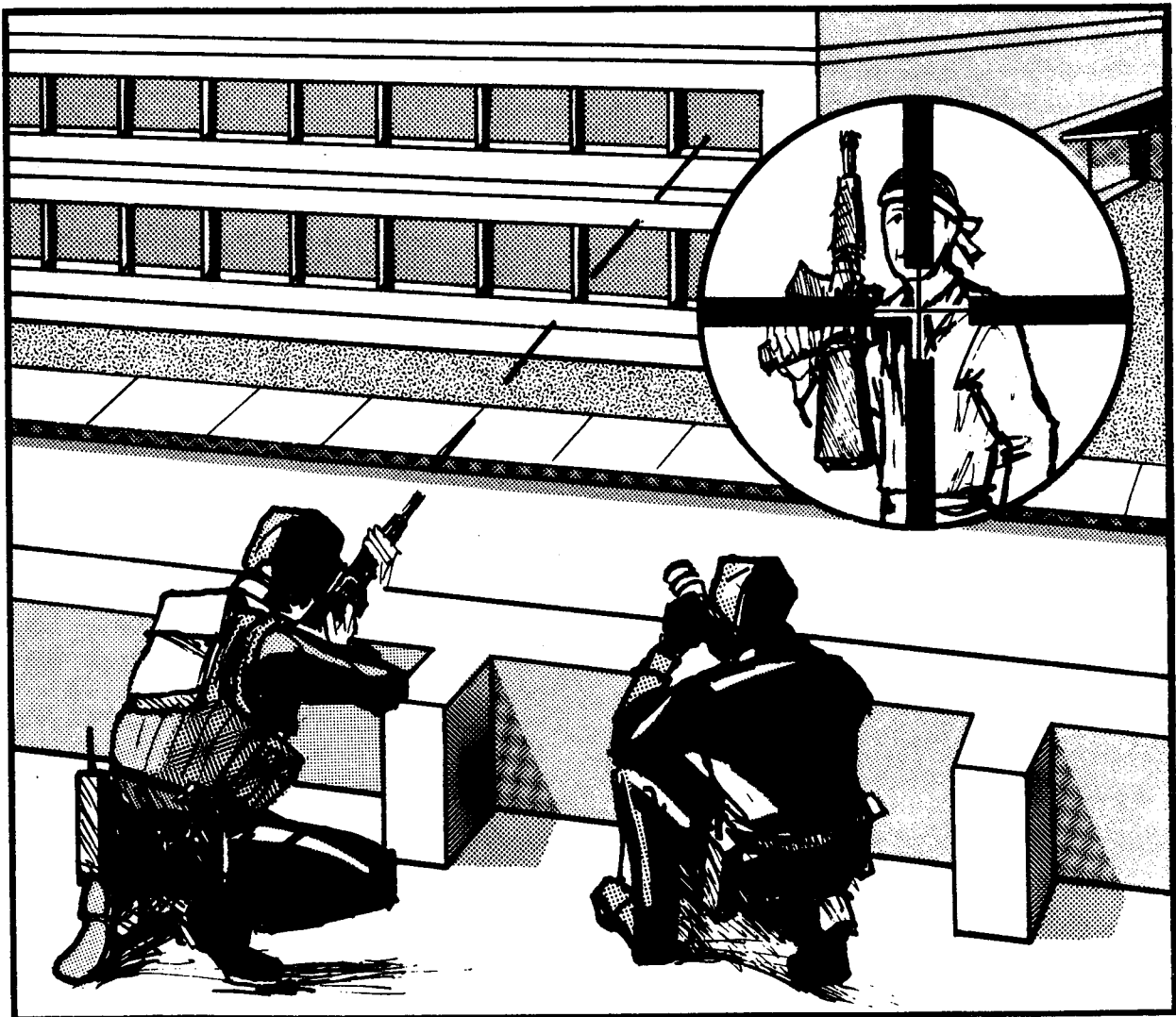

Illustration 16-1. Snipers using special equipment can deliver precision fire on targets that are beyond the range of ordinary rifles.

This chapter will describe the principles and techniques of employing snipers in an offensive role against an adversary. The advantages of employing a two-person team of snipers rather than a single sniper will be covered and sniper positions will be discussed. The final instructional section will address countersniper operations.

Section 2. SNIPER EMPLOYMENT

Snipers can perform a variety of functions during the response to a tactical crisis. Plans for the use of snipers should be incorporated into the tactical-response plans that are developed for your facility. The functions for which snipers are well suited include

- **Engaging targets of opportunity.** Snipers positioned in an area that is known to be occupied or believed to be occupied by an adversary can be ready to fire on the adversary the moment the adversary moves into the line of fire.
- **Carrying out perimeter defense.** Snipers may be integrated into the containment force and assigned the responsibility of protecting the inner and outer perimeters. These forces can cover potential avenues of escape from a distance. If adversaries know that there are snipers on the perimeters, that knowledge alone may be enough to prevent them from attempting to escape.
- **Resolving hostage situations.** Snipers may be used to neutralize the adversaries during a crisis involving hostages. Long-range, accurate weapons fire may be the only practical way to end this type of situation.
- **Conducting countersniper operations.** Snipers are ideally suited for neutralizing other snipers by means of long-range weapons fire.
- **Providing protective fire.** Since snipers can locate and neutralize the adversary from a distance, they can provide protective fire for responding forces from positions of relative safety. For example, snipers can provide protection for responding forces by
 - Neutralizing adversary elements in the path of advancing and of withdrawing security forces.

- Firing on selected targets immediately prior to and during a final assault by security forces.
- Neutralizing adversary elements in the areas where fire, medical and other support personnel will operate.
- Neutralizing adversary elements in an area that is to be used for a helicopter insertion of security forces.

- **Collecting information.** Snipers normally will be located in positions from which they can collect information about the adversary. This information, when reported to management, can be integrated into the response plans.
- **Assisting in the direction of the tactical response.** Because they normally are close to the action and in good positions for observation, snipers may be able to direct fire, recommend avenues of approach and make other suggestions for an effective tactical response.

In any given tactical situation, snipers may perform one or more of these functions. The exact way in which these forces are employed is governed by many factors, such as the characteristics of the terrain, the distance and the obstacles that are present between the friendly forces and the adversary and the environmental conditions involving rain, wind, fog and levels and direction of light. The number of snipers available and the type of adversary activity that occurs also will affect employment. If snipers are to be employed effectively, security force supervisors must have a sound grasp of the tactical situation and a total understanding of the capabilities of the sniper.

Snipers, in turn, must be briefed on their duties and responsibilities prior to being placed in position during a tactical crisis. They should not be required to fire only on command. Once a decision has been made by the management that a particular target should be engaged, the snipers should be given clearance to fire at the earliest opportunity.

If more than one sniper team is employed to engage one or more targets at the same time, the teams must be able to communicate with one another. Wire communication should be established if possible, since this allows the teams to keep a line of communication open without interfering with the tactical radio net.

Section 3. ADVANTAGES OF SNIPER-TEAM EMPLOYMENT

Because of the number and intensity of tasks that snipers must perform, it is extremely difficult for one sniper to operate alone. If a single sniper is employed in a tactical crisis, that sniper must divide attention among the tasks of observation, communication and marksmanship. The sniper also must be concerned with maintaining his/her own physical security. He/she might be able to perform all of these tasks satisfactorily for a short period of time, but the physical and mental strain would be tremendous. Fatigue would have a detrimental effect on marksmanship ability during an extended operation.

The problem of fatigue can be reduced if snipers are employed in teams of two individuals, a sniper and an observer. Each team member has responsibilities as follows:

- **The *sniper* devotes full attention to marksmanship tasks, such as target identification and selection, and to estimating the distance to the target and the effects of the wind.**
- **The *observer* carries out observation of the entire area of operations, provides physical security to the sniper, assists in the identification and selection of targets and communicates.**

Since the sniper who is employed as part of a team is able to concentrate totally on marksmanship tasks, it is much more likely that the team will perform successfully than if the sniper works alone. If both members of the team have equal marksmanship skills, they can alternate duties, thus further reducing the fatigue that normally occurs during an extended sniper operation.

Section 4. SNIPER POSITIONS

After a sniper has been assigned to an area of observation, a position must be selected from which to observe and fire. The characteristics of a good sniper position are much the same as those of any good firing position. The most important characteristics of any good firing position are the presence of maximum fields of fire and observa-

tion and maximum cover and concealment. An ideal sniper position may be difficult to find in an industrial setting, where structures tend to interfere with observation and fire. The sniper must learn to evaluate the advantages and disadvantages of available positions in order to choose and occupy a position from which observation is possible without being fired upon.

POSITION SAFETY

If you have been assigned to a sniper team and must choose a position, remember that cover and concealment at the position will not, by themselves, guarantee your safety. You must take further precautions when choosing, approaching and using a sniper position.

One precaution that you must take when choosing a position is to resist the temptation to immediately pick the highest spot in the area. Choosing the high spot is especially tempting in an industrial setting with high buildings, but this choice can be dangerous for two reasons. First, if a position seems ideal or obvious to you, it probably will appear the same to the adversary, and the adversary may be looking for you there. You should in fact avoid using any prominent, readily identifiable objects and terrain features as sniper positions.

Second, the higher you are, the more your view will be directed out and away from the area directly below you, and the more you will have to lean out from your concealed position to see the field of action. For example, if you establish a sniper position on the eighth floor of a building, you will be forced to lean out a window to see the rooftop of a lower building located near your position. In this leaning posture, you will be exposing yourself to the view of the adversary and possibly to his/her fire.

Another precaution that you must take when you choose a sniper position is that you must be sure that you can approach the position by covered and concealed routes. You must take this precaution because of the likelihood that the adversary can observe the position. For the same reason, you must take the additional precaution of using individual camouflage techniques when you travel these routes and move into the position.

While you are occupying the sniper position, you must continue to take precautions for your own safety. Practice individual camouflage techniques, and avoid making unnecessary noise and move-

ments. Do not betray your position with light or shine.

Before you fire your weapon, you must be aware of other things that can betray your position, and you must take the recommended precautions to prevent that betrayal:

- **Lack of fire discipline.** If you relax your fire discipline and engage in harassing fire, the adversary will have a better chance of locating your position. Practice fire discipline by firing only at specific targets of opportunity.
- **Muzzle flash.** The muzzle flash from your weapon is visible from a great distance, especially in the dark and in dim light. The flash provides an excellent target for the adversary. To reduce the chance that you may be hit when the adversary fires at the flash, change your position somewhat, if possible, after you have fired your weapon. You also can cut down on the visibility of the muzzle flash by moving backward into your position just before you fire so that the muzzle of your weapon is less exposed.
- **Dust and dirt.** If your surroundings are dry and dusty, the blast from the muzzle of your rifle may cause dust to rise, which will reveal your location. Under dry, dusty conditions, dampen the dirt around the muzzle of your weapon before firing. As an alternative, lay a wet towel or cloth under the muzzle. Either of these procedures will eliminate almost all of the movement of dust and dirt that might be caused by the blast.
- **Smoke.** A significant amount of smoke will be discharged when the first round is fired through a heavily oiled barrel. Use oil sparingly in the bore of your weapon.
- **Light reflection.** The lens surfaces of your binoculars and rifle scope as well as other smooth parts of your equipment can reflect light that is visible to the adversary. Keep the lenses shaded when you are using optical aids and covered when you are not using them. Cover those portions of other pieces of equipment that reflect light.

Special precautions must be taken when positions are selected for two or more sniper teams operating within the same area. The teams must never be located directly across from each other with the adversary in the center, since this arrange-

ment could cause a dangerous crossfire situation (see Illus. 16-2).

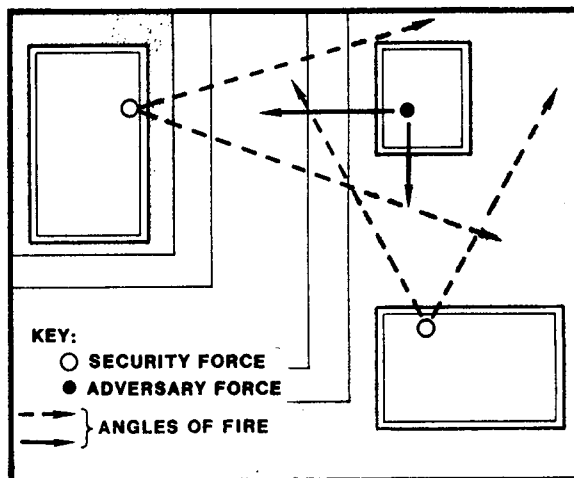

Illustration 16-2. If two sniper teams are operating in the same tactical area, they should be positioned at right angles to each other in relation to the adversary to avoid creating a crossfire situation.

EXPEDIENT METHODS OF INSERTING SNIPERS INTO POSITIONS

In some tactical situations, it is more important to insert snipers quickly than it is to insert them secretly. This condition exists, for example, when an adversary is barricaded in a known location within a building and snipers are brought in to cover the avenues of escape. In such a situation, sniper teams can be transported and inserted by vehicle or by helicopter, if available.

Section 5. COUNTERSNIPER OPERATIONS

It is important for you to be aware, during the course of your daily activities as a guard, that at any moment you may be the victim of a sniper attack (see Illus. 16-3). If an adversary penetration is known to have occurred at your facility, you must remember that there is an increased possibility that you will be attacked by snipers. For your own safety, you must be constantly alert to any indications of sniper activity.

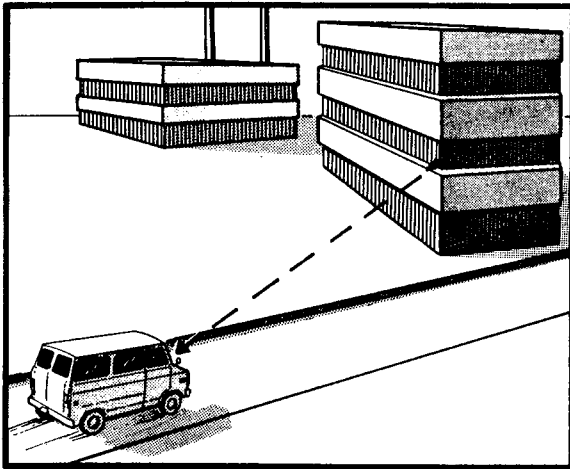

Illustration 16-3. During your daily activities as a guard you may be the victim of a sniper attack at any time.

In an industrial setting, it can be difficult to recognize a sniper attack when it does occur, because the sound of a gunshot can be drowned out by and confused with the sounds from vehicles and machinery. Even if you think that you hear a gunshot, it may be difficult for you to determine what direction it came from and what type of weapon was fired. You may not know for sure that you are under attack unless you see the impact of the bullet. If you think that you are under attack, you must

take immediate action without stopping to analyze the situation. The steps you should take in reaction to sniper activity are much the same whether you are alone or working as part of a security element.

The adversary sniper has one goal—to kill. Therefore, your first reaction to sniper fire must be to **get out of the kill zone and take cover**. Since an attack by sniper fire is similar to an attack by ambush, you can apply the counterambush tactics described in Chapter 10, as you exit the kill zone. You must assume that the sniper is well trained and that you are in immediate danger. Even after you have taken cover, you must proceed with extreme caution as long as you are within possible range of a sniper's weapon.

As soon as you have taken cover, you must **notify security supervisors and ask for assistance** if you need it. Provide as much information as possible concerning the location of the sniper activity, the number of snipers and the type of weapon being fired. You may be able to recommend an approach route for responding forces. Continue to call in information as events occur.

Once you have made a report, you must attempt to locate the sniper or snipers. Pinpointing a sniper's position is sometimes difficult and always dangerous. Remember, **if you can see the sniper, the sniper can see you!** Apply sound techniques of using cover and concealment while you are looking for the sniper. As you search, never look around your cover for more than a few seconds at a time.

To locate the sniper, look first in the obvious places, such as positions that you would choose if you were a sniper. Check the rooflines and other high ground, since snipers tend to choose high positions. Look for broken and open windows in the area, for muzzle flash, for smoke, for dust and dirt kicked up by muzzle blast and for reflections of light from lenses and equipment.

Once the sniper is located, he/she must be **isolated** and contained by means of containment and cordon operations, as described in Part Two, Chapter 19, "Cordon Operations." If you are accompanied by other guards, you can begin containment operations immediately. If you are alone, however, you probably will have to wait for responding forces to arrive, so that you can work with other personnel to contain the sniper. When containment has been achieved, security forces can maneuver to neutralize the sniper.

Section 6. CHAPTER SUMMARY

In this chapter, the principles and techniques have been covered for employing snipers against an adversary and for conducting countersniper operations.

The following functions that snipers can perform were discussed:

- **Engaging targets of opportunity**
- **Carrying out perimeter defense**
- **Resolving hostage situations**
- **Conducting countersniper operations**
- **Providing protective fire**

- **Collecting information**
- **Assisting in the directing of the tactical response**

General principles of sniper employment then were covered.

The advantages of employing snipers in two-person teams were explained, and the basic tasks of each team member were given.

Principles for choosing and using a sniper position were discussed, with the safety of the sniper being emphasized.

In the final instructional section, which concerned countersniper operations, the immediate actions that must be taken by security forces who are attacked by snipers were covered.

PART TWO

Chapter 17

COMMAND, CONTROL, AND ON-SCENE COMMAND CONSIDERATIONS

Section 1. INTRODUCTION

One of the most important pre-crisis functions is the preparation of detailed contingency plans under which security personnel will operate in a crisis. Working within contingency plans during a tactical crisis provides various advantages to security forces. For example, if the security forces know exactly what is expected of them in the event of a security contingency, their reactions will be rapid and effective when such an emergency arises. Also, responding forces are more likely to accomplish a crisis mission successfully if they can act in accordance with a plan than if they must respond to numerous unexpected mid-crisis directions. A further advantage of detailed tactical planning is that it reduces the communications requirements during a crisis.

On a routine basis, command and control of security force personnel is handled through the central or secondary alarm station. In the event of a tactical crisis such as an armed confrontation, greater demands are put on individual security personnel and on the security organization as a whole. In such a situation, a successful response will depend to a large extent on strong command and control that is planned before the crisis occurs. Every plan for tactical action should have provisions for **on-scene command and control** and should identify the **on-scene commander**. Only one person can be in charge during a tactical crisis, and all responding forces must know who that person will be. As soon as adversary containment

has been achieved, the commander establishes the **on-scene command post**. Tactical command and control then normally is exercised directly from the command post rather than from the central or secondary alarm station.

Various aspects of tactical planning applicable to NRC licensed facilities are discussed in NUREG/CR-5081, "*Tactical Exercise Planning Handbook*." Subjects that are covered include:

- **Site-vulnerability analysis**
- **Response and containment planning**
 - **Preselection of containment positions**
 - **Preselection of response routes**
 - **Methods of security force employment**
 - **Provisions for diversionary actions**
 - **Use of checkpoint and grid systems**
- **Reinforcement planning**
 - **Use of reinforcements**
 - **Use of TRT personnel**
 - **Outside assistance**
- **Tactical response exercises**

This chapter discusses other relevant tactical planning considerations not addressed in NUREG/CR-5081, including:

- **Command and control considerations**
 - **Transition of command**

- **On-scene command and control**
 - **Types of on-scene command posts**
 - **On-scene command post functions**
 - **Location of on-scene command post**
 - **Staffing requirements**
- **Rehearsals**

Section 2. TRANSITION OF COMMAND AND CONTROL

Command and control are essential for any successful tactical operation. Every plan for tactical action should identify the on-scene commander, how command and control are transferred to the on-scene commander from the central or secondary alarm station, the role of the Emergency Operations Center (EOC) if it is activated, and the authority of the on-scene commander.

The longer an incident lasts, the greater the possibility of changes in on-scene command responsibility, and the need for on-scene command and coordination with central control points (such as the central or secondary alarm station or EOC).

Site policies and response plans/procedures should clearly indicate the chain of command for safeguards contingencies. Initial on-scene command of a security incident may rest with the first guard to arrive at the scene. As the situation develops, on-scene command may pass to various supervisory personnel on the security force (TRT leader, shift supervisor, facility security manager, etc.). Tactical command may eventually pass to an off-site agency (local law enforcement or the FBI). Tactical planning must include procedures to assure that each change of on-scene command is accomplished smoothly and effectively.

In addition to addressing issues for passing on-scene command, plans must also include provisions for coordination with the central control point or authority. Under normal operations, central control over the security force is exercised through the central or secondary alarm station. At the outset of a safeguards contingency, these stations may relinquish command to the individual in charge at the scene of the incident. As the duration or severity of the incident increases, the EOC may be activated and become the point of central control. Plans and procedures must address command and control issues relative to these circumstances, so that the on-scene commander is aware at all

times of the proper central control authority to which he/she is reporting and from which instructions are to be received.

In order to address these concerns, plans should indicate:

- **Who is the designated on-scene commander and under what conditions and on whose authority command will pass to the on-scene commander**
- **Responsibilities and authority given to the on-scene commander**
- **Procedures for transition of command from the central or secondary alarm station to the on-scene commander or to the EOC**
- **Elements of information to be provided in a situation briefing to the individual assuming on-scene command, members of management, or those personnel performing EOC functions**
- **Procedures for informing all necessary parties of any changes of command**
- **Coordinating instructions for use by the on-scene commander or on-scene command post, if the EOC is activated; and procedures on reporting and command authority when this occurs**

Section 3. TYPES OF ON-SCENE COMMAND POSTS

The essential requirements of a command post are that it be a single, designated location with established communications where information can be gathered, planning can be done and decisions and assignments can be made. The type of command post to be used will depend on the type and expected duration of the crisis. The following general types of command posts will be discussed:

- **Short-term**
- **Long-term**
- **Mobile**

A **short-term command post** can be as simple as a patrol vehicle or the corner of a building if communications are available and if the commander is able to plan, make decisions and make assignments at the location. In such a simple command post, the communications requirements normally are met by radio, preferably backed up by a nearby telephone. If maps, assignment lists

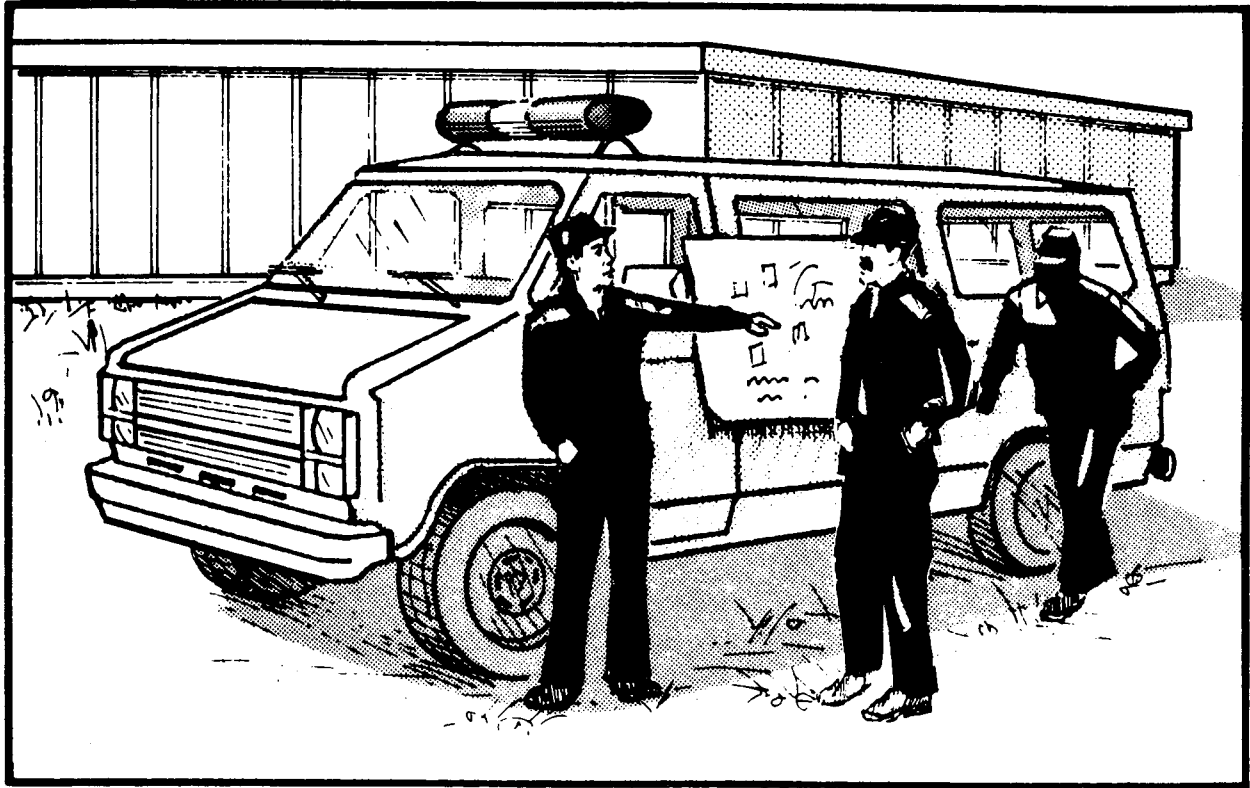

Illustration 17-1. The side of a vehicle can serve as a short-term command post.

and other materials are needed for planning purposes, these items can be taped to the hood of the vehicle or to the wall. All responding forces must be aware of the location of the command post.

A better equipped, **long-term command post** will be needed if the situation is complex and potentially of long duration. For example, a sensitive hostage incident can lead to lengthy negotiations. If this situation occurs, large numbers of people will become involved, extensive information gathering will take place, and communications requirements will be more complex. The same basic command post needs will exist as for a short-term situation, but a larger, more comfortable workplace with adequate communications and support facilities must be chosen.

For some incidents, a **mobile command post** may be required. For example, strong on-site command and control is vitally important in a fast-changing scenario. Several kinds of vehicles make suitable mobile command posts. A patrol vehicle, for instance, is suitable in a short-term situation. Some facilities may have vehicles specifically equipped for use as mobile command posts. A van,

for example, can easily be outfitted to serve this function. Minimum equipment should include communications gear, briefing materials, and office supplies. The van also can have a storage area for special weapons and equipment.

Section 4. ON-SCENE COMMAND POST FUNCTIONS

The **functions** that will be carried out at the command post should be defined during preplanning for a tactical crisis. Procedures must be developed for performing each function.

The functions that normally are performed at the on-scene command post are

- **Intelligence Gathering**
- **Tactical Planning**
- **Resource Management**
- **Deployment of Personnel**
- **Coordination with alarm stations and/or Emergency Operations Center (EOC)**

- **Logging of Activities**
- **Immediate Negotiation**

Intelligence gathering should be continuous throughout the operation. Much of the intelligence data normally will come from the inner perimeter security forces. All available resources should be used to gather information concerning the adversary, the physical environment and the hostages, if any have been taken.

Tactical planning can begin once the threat has been analyzed. General plans for response to any tactical crisis should have been developed and practiced during preplanning. The on-scene commander must select the appropriate plan and make revisions and refinements to suit the situation.

Resource management should be based directly on the tactical plan. The commander must know what weapons, special equipment, medical support and other resources will be required and how they will be obtained.

The **deployment of personnel** should be accomplished by the issuing of orders. The commander must brief all responding personnel concisely and completely concerning their assignments and must be ready to modify orders at any time.

Coordination with alarm stations should take place constantly. Although the on-scene commander is in charge of the tactical situation, he will be in constant contact with the alarm station and will probably receive direction from higher ranking officials either through alarm stations or, if it has been activated, the EOC.

The **logging of activities** is a vital function that must be carried out continuously during a tactical crisis. No detail can be left to memory. It is likely that the actions taken as a result of a tactical crisis will have a greater effect on the long-term operations of the facility than did the crisis itself. Many questions will be asked about the adversary activity and about the response. The activities log may be the only documented proof of what actually occurred.

Because the activities log is so important, a responsible individual must be assigned the task of keeping it, and that person must understand the importance of recording all known details. For instance, if an adversary force has been confronted, the size, location, clothing and equipment of the force will be recorded along with the time and the effects of that force's activity. If chemical muni-

tions have been used, it is important to record the time, location, quantity, type of munition, means of delivery, effect on personnel and equipment and all other available information. The log should not be used to address such areas as possible intentions or probable courses of action. Only the facts should be recorded.

Once containment has been accomplished, **negotiation**, rather than the use of force, is the preferred method of dealing with most confrontations. In some cases, facility personnel should negotiate. In other situations, outside negotiators may be brought in. In all cases, the negotiations should be coordinated with the on-scene commander.

Section 5. LOCATION OF THE ON-SCENE COMMAND POST

The on-scene command post should be located close to the action but outside the inner perimeter, out of the adversary's sight and line of fire.

Potential command post locations should be identified prior to a tactical crisis. A command post location should have sufficient space for working and briefing and for a staging area to accommodate emergency vehicles and other arriving vehicles and personnel (see Illus. 17-2). When choosing a potential location, you also should consider how difficult it will be to provide security for the command post and the staging area. Communications, including telephone lines, should be available. A telephone link between the command post and alarm stations is especially desirable.

Section 6. STAFFING REQUIREMENTS

The size of the staff assigned to assist the on-scene commander in the command post will depend upon the complexity of the situation and upon the availability of personnel. A minor incident that can be resolved quickly may require only the presence of the on-scene commander at the command post. A more complex incident may require a complete staff on a 24-hour basis. A general rule is that the staff should be kept as small as possible. Control and communication become more difficult as the staff expands.



Illustration 17-2. A command post location should include a staging area to accommodate arriving vehicles and personnel.

There are certain responsibilities that the on-scene commander always will want to retain and other responsibilities that are best delegated totally or partially to staff members. The commander should remove him/herself from the tactical action in order to exercise command and control. When making staff assignments, the commander should break tasks down into major areas of responsibility. During any tactical crisis serious enough to require the establishment of a command post, the following major areas of responsibility will exist at the on-scene command post and require staffing:

- Overall Command and Control
- Intelligence Gathering and Analysis
- Tactical Planning
- Resource Management
- Communications and Administrative Support

Section 7. REHEARSALS

No plan can be executed in an optimal fashion unless all of the players have rehearsed. A major

flaw of many rehearsals and response exercises is that they are designed and conducted by security force supervisors for the purpose of training and evaluating individual security guards. This sort of training does little to prepare the force as a whole for successful mission accomplishment. Rehearsals and response exercises should provide for the training and evaluation of supervisors as well as individual security personnel.

A second major flaw of many rehearsals and response exercises is the omission of outside-assistance organizations. Again, if your tactical plans call for significant contributions from outside-assistance agencies, these agencies must be encouraged to take part in your rehearsals and response exercises.

NUREG/CR-5081, *Tactical Exercise Planning Handbook*, provides sample scenarios and support plans for the conduct and evaluation of tactical response exercises. These formats and checklists, or similar ones, should be used to ensure that your exercises are realistic and mission specific and that they provide the maximum value in preparing your total security force for actual tactical operations.

Section 8. CHAPTER SUMMARY

This chapter has provided information on formulating and exercising tactical plans and on-scene command functions. The chapter supplements information provided in NUREG/CR-5081 "*Tactical Exercise Planning Handbook*," which addresses **site-vulnerability analysis based on site-specific applications of the generic threat, and considerations covering response and denial containment planning, reinforcement planning, and tactical response exercises.**

Information concerning planning requirements for **transition of command and command post operations** were provided.

The necessity for establishing a command post during a tactical situation was discussed. The following types of command posts were described:

- **Short-term**
- **Long-term**
- **Mobile**

The importance of preplanning to assure proper command and control during a tactical crisis was emphasized and general guidelines for planning were given.

The following functions that are carried out at the command post were described:

- **Intelligence Gathering**

- **Tactical Planning**
- **Resource Management**
- **Deployment of Personnel**
- **Coordination with Alarm Stations and/or EOC**
- **Logging of Activities**
- **Immediate Negotiation**

Factors to be considered in choosing the location of the command post were covered.

The general staffing requirements for operating from a command post and the responsibilities of the staff were covered. Staffing must accommodate the following major areas of responsibility for the command post:

- **Overall Command and Control**
- **Intelligence Gathering and Analysis**
- **Tactical Planning**
- **Resource Management**
- **Communications and Administrative Support**

The chapter concluded with a discussion of the necessity for **rehearsals and response exercises.** Reference was made to the support materials contained in NUREG/CR-5081.

Chapter 18

TACTICAL ORDERS

Section 1. INTRODUCTION

During a tactical crisis, all responding forces must know exactly what is expected of them. The commander of these forces faces the challenge of converting his ideas and decisions into clear instructions that outline tasks for subordinates. These instructions, or orders, must be short and simple and must follow a logical sequence so the subordinates can understand them and carry them out. Tactical planners have developed standard formats for issuing these orders. By using such formats, the supervisor can be sure that all essential areas have been covered and that orders given can be understood easily by subordinates.

Different types of military orders have been developed to suit different tactical situations. The following types of military orders can be adapted easily for NRC licensee security force use:

- **The operation order**
- **The warning order**
- **The fragmentary order (frag order)**

The operation order is the most comprehensive of the types of orders. It covers all of the factors that the supervisor has to consider as he directs a coordinated tactical response. Before actually issuing an operation order, the supervisor must have a clear understanding of the nature of the threat, a workable overall plan, a good definition of the tasks required of responding forces and a realistic view of the capabilities and limitations of those forces. A map or sketch of the tactical scene may serve as the basis for developing the opera-

tion order and often will accompany the order when it is issued. Much of the content of the operation order can be taken from established safeguards contingency plans.

It is appropriate for an operation order to be written after a crisis situation has stabilized enough so that the supervisor has both the time and the need to gather available information and formalize a plan. In a situation involving a barricaded adversary, for example, it becomes both possible and necessary to make detailed plans for a tactical action such as an assault to retake the facility only after perimeter security has been established.

The warning order is used to give responding forces the earliest possible warning of expected events in order to allow the forces as much time as possible to make necessary preparations. At the beginning of a tactical operation, a warning order normally will be issued before the full operation order has been prepared and distributed. As the tactical situation changes, new warning orders may be issued.

The supervisor will issue a warning order, for example, if a duress signal has been received from a security post. The supervisor must alert security forces to begin preparations for a tactical response, even though insufficient information is available for a complete operation order to be prepared.

The fragmentary order (frag order) is used to provide brief, specific instructions. As the tactical situation develops and additional instructions are required, a new, complete operation order nor-

mally will not be used. Instead, changes and additional instructions will be issued as frag orders. At first, many of the frag orders will refer to the operation order. Later, the operation order no longer may be applicable, and no further reference will be made to it.

A frag order will be issued, for example, if the main attack to retake an occupied building becomes bogged down and a second responding element takes over. A frag order is appropriate any time things are not going as previously planned or ordered.

Section 2. THE OPERATION ORDER

In this section, the format of a full operation order will be presented. The operation order, which has been adapted to security force use, is organized in the following manner:

- **Heading**
- **Task Organization**
- **Situation**
 - **Adversary Information**
 - **Security Force Information**
- **Mission**
- **Execution**
 - **Concept of Operations**
 - **Special Instructions to Separate Units**
 - **Coordinating Instructions**
- **Equipment and Support**
- **Command and Communications**

The content of each of these sections is shown and explained in the annotated operation order that follows. The notes cited in brackets in the right-hand column of the example order (for example, [Note 1]) refer to the numbered notes in the left-hand column.

ANNOTATED EXAMPLE OPERATION ORDER

NOTES

1. All operation orders involving actual security force operations must be classified appropriately. Orders containing information concerning site vulnerabilities are classified "Secret."
2. A copy number is required on all classified documents. Separate copies must be controlled to prevent compromise.
3. Orders normally are numbered consecutively by calendar year.
4. All documents, maps and other references required for a full understanding of the order are listed.
5. All major subordinate security forces and/or outside support agencies having responsibility under the order are listed.
6. All available information concerning adversary weapons, numbers, equipment, locations, intentions and identification is included. The more a situation stabilizes to the point where a full operation order is appropriate, the greater the amount of information that will be available
7. Information should be limited to that which personnel receiving the order will need to know in accomplishing their mission. This information may include team organization and composition and task assignment.

(CLASSIFICATION)

[Note 1]

Copy No. 1 of 12 copies [Note 2] 1 MAR 89

Operation Order 89-3 [Note 3]

References: XYZ Plant Security Plan
Site Map 1602
Communications Plan 89-3-1
XYZ Site Safety Plan [Note 4]

Task Organization: [Note 5]

Shift Security Force

Zone A Security Force
Zone B Security Force
Area Response Force

Tactical Response Teams

TRT 1
TRT 2

LLEA

Johnson County Sheriff Department
Tyler City Police Department

1. SITUATION

a. Adversary Information. [Note 6]

The adversary consists of an unknown number of apparently well-armed hostiles who forced entry at approximately 0200 1 March 1989 and are currently barricaded with at least two hostages in Building 139F. They have established contact and have demanded a helicopter and safe passage for themselves and their hostages. It is assumed that they have gained access to the SSNM vault in Building 139F and are in possession of unknown quantities of U-235. Their criminal or political affiliations are unknown. The deadline on their demand for the helicopter is 2400 hours, 1 MAR 89.

b. Security Force Information. [Note 7]

- (1) Shift Security Forces under the command of CPT Jones maintain containment of Building 139F and Zone A.

(CLASSIFICATION)

8. When the order calls for the attachment of one element to another for the specific purposes of the order, the time and circumstances of the attachment should be explained.
9. The mission is a clear, concise statement of the overall task to be accomplished by the responding forces and of the purpose of the task. The statement must include the answers to WHO, WHAT, WHEN, WHERE and WHY. The paragraph has no subparagraphs. However, reference may be made to maps, charts and other documents.
10. This paragraph describes HOW the mission will be accomplished and has three subordinate paragraphs.
11. This subparagraph gives an overall picture of how the commander expects the mission to be accomplished. Instructions may be given on how to react to potential problem areas. Operations often can best be described using a graphic form such as a site sketch or operation overlay showing blocking positions, routes of advance and other information.
12. Each element affected by the order is listed in turn along with instructions pertaining only to that element. When no specific instructions apply, the element is listed without comment.
13. This subparagraph is used for special instructions that pertain to two or more security elements. Rules of engagement, use of deadly force and other specific mission requirements are covered.

(CLASSIFICATION)

- (2) TRTs 1 and 2 prepare to accomplish forced building entry, search and clear and hostage rescue missions.
- (3) LLEA provides coordinated off-site containment under the overall control of the Johnson County Sheriff.

c. **Attachments and Detachments.** [Note 8]
Johnson County Sheriff Department EOD Team attached to TRT 1 on order.

2. **MISSION** [Note 9]

XYZ Plant Security Forces, supported by LLEA, secure Building 139F and Zone A, beginning immediately and until further order, to prevent the escape of the adversary force. Prepare to retake the building and rescue hostages on order.

3. **EXECUTION** [Note 10]

a. **Concept of Operations:** Annex A (Operations Overlay). [Note 11]

Security forces hold in present positions, with Zone A forces in Sectors Blue and Gold, Zone B forces in Sectors Red and White in order to block adversary escape and Area Response Force with TRTs 1 and 2 in reserve; prepare to retake Building 139F on order.

b. **Special Instructions to Separate Units.** [Note 12]

- (1) Zone A Security Force. Prepare to secure approach routes and assist passage of TRTs 1 and 2.
- (2) Zone B Security Force.
- (3) TRT 1. Prepare to be lead element in assault on Building 139F.
- (4) TRT 2. Provide security to TRT 1 in building clearing operation.
- (5) LLEA.

c. **Coordinating Instructions.** [Note 13]

- (1) Use of deadly force is authorized per XYZ Security SOP 1.6.

(CLASSIFICATION)

14. This paragraph will describe any special equipment needs and will give the sources of additional equipment, supplies or other support. The paragraph may be subdivided into subparagraphs to separate equipment and support.
15. Routine equipment and support information, such as weapons and ammunition available and tactical vehicle assignments, that are provided in the site physical security or safeguards contingency plans need not be repeated if those plans are referenced.
16. This paragraph contains two subparagraphs.
17. This subparagraph contains as a minimum the location of the on-scene command post, other centers of command and the chain of command.
18. This subparagraph provides frequencies, codes and other special communication operations information.
19. Routine information contained in site security plans need not be repeated as long as the appropriate plan is referenced.

(CLASSIFICATION)

- (2) Relay any information gained regarding adversary strength, disposition or intentions to Security Headquarters immediately.
- (3) Priority of mission accomplishment is as follows:
 - (a) Prevent SSNM removal.
 - (b) Rescue hostages.
 - (c) Reduce loss of life.
 - (d) Prevent facility damage.

4. EQUIPMENT AND SUPPORT [Note 14]

- a. XYZ Safeguards Contingency Plan in effect. [Note 15]
- b. Fire and medical support in accordance with XYZ Site Safety Plan.
- c. Johnson County Sheriff Department Bomb Dog Team available on request.

5. COMMAND AND COMMUNICATIONS [Note 16]

a. Command. [Note 17]

- (1) EOC is operational in Building 1627.
- (2) On-scene command post is operational in Building 240F.
- (3) All LLEA coordinated by Johnson County EOC.
- (4) XYZ Plant Security Manager assumes control of all on-site security forces.
- (5) On-scene Commander is CPT Jones.
- (6) TRT Commander is SGT Riley.

b. Communications. [Note 18]

- (1) Communications Plan 89-3-1 in effect. [Note 19]

(CLASSIFICATION)

20. An example operations overlay is presented on the following page.
21. A distribution formula is included in standing operating procedures.

(CLASSIFICATION)

- (2) No routine communications on Tactical Net 1.
- (3) Maximum use of telephones directed.
- (4) Emergency transmissions on Tactical Net 2 only.

CPT Byrd
Security Operations Officer

Annex: A—Operation Overlay [Note 20]
Distribution: A [Note 21]

Copy No. 1 of 12 copies
1 MAR 1989

(CLASSIFICATION)

CLASSIFICATION

**ANNEX A [OPERATION OVERLAY] TO OPOD 89 -3, XYZ
PLANT SECURITY**

REFERENCE: SITE MAP #1602

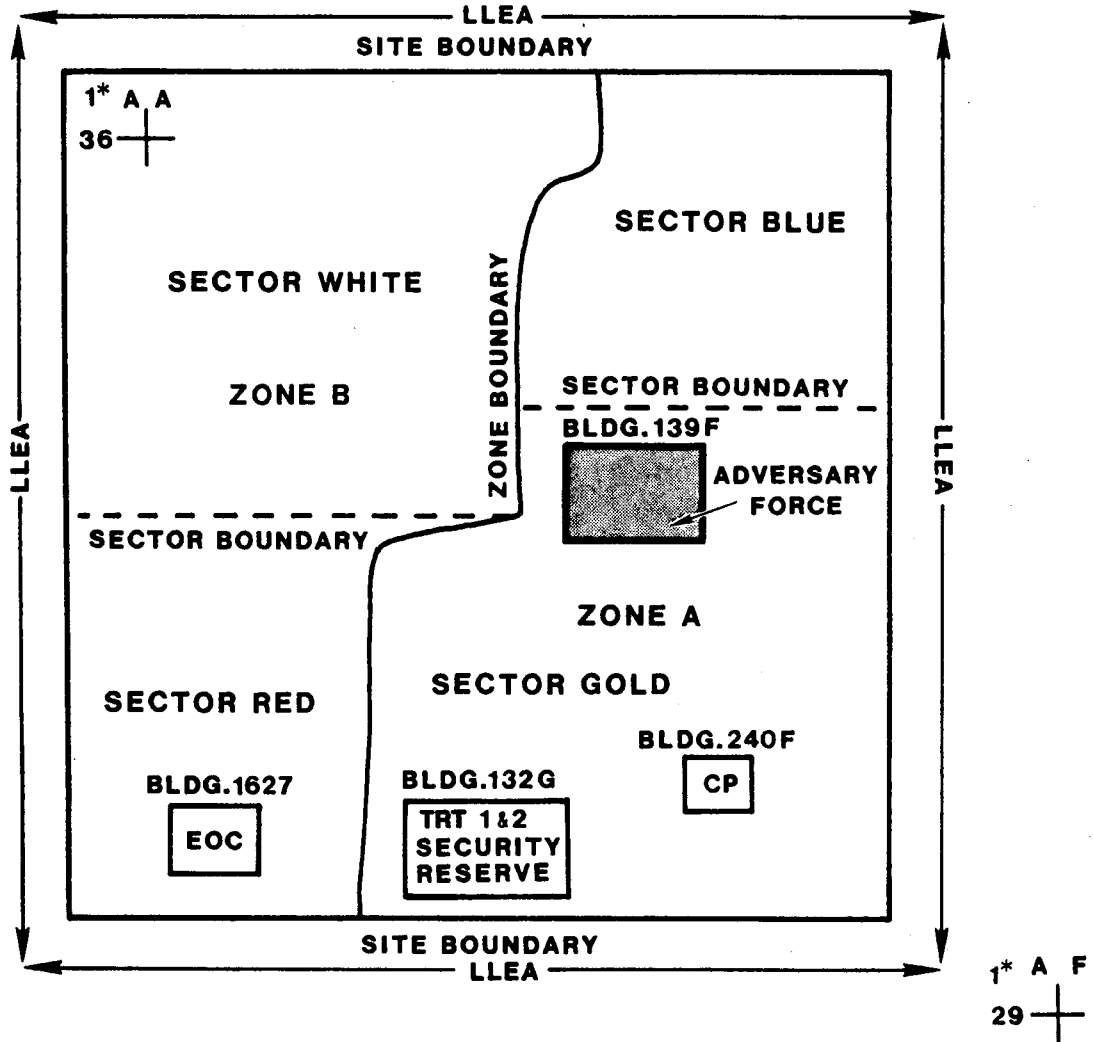

**NOTE 1*: IN ORDER TO PROPERLY ORIENT ON OVERLAY,
REFERENCE TO LOCATOR POINTS SUCH AS GRID SYSTEMS
MUST BE SHOWN.**

CLASSIFICATION

Section 3. THE WARNING ORDER

The warning order should be given at the earliest possible moment to all responding forces. A warning order may be given orally or in written form. This type of order does not necessarily follow a strict format. However, the following elements of information should be included:

- **Situation**
- **Mission**
- **General Instructions**
 - **Organization**
 - **Uniform and Equipment**
 - **Weapons and Ammunition**
 - **Chain of Command**
 - **Time Schedule**
 - **Rehearsals**
- **Specific Instructions**

The content of these sections is shown and explained in the following annotated warning order.

ANNOTATED EXAMPLE WARNING ORDER

NOTES

1. Include only information that responding forces will need in order to make proper preparations. A more complete description of the situation will be included in the operation order.
2. This is a clear, concise statement of what the forces must accomplish. It must tell WHO, WHAT, WHEN, WHERE and WHY and may be similar or identical to the mission statement in the operation order.
3. Include instructions needed by the entire element prior to the issuing of the operation order so that mission preparations can be made.
4. Include information that is specific to this operation and not a matter of routine organization.
5. Omit standard items of uniform and equipment.
6. Omit standard items of weaponry and ammunition.
7. Only include changes from SOP.

(CLASSIFICATION)

Copy No. 1 of 12 copies
1 MAR 1989

Warning Order

1. SITUATION [Note 1]

Zone A has been hit. An adversary force of unknown strength is in control of Building 139F. They are holding at least two hostages.

2. MISSION [Note 2]

Standard response procedures are in effect. TRTs 1 and 2 prepare to retake building 139F on order to neutralize the adversary force and rescue hostages.

3. GENERAL INSTRUCTIONS [Note 3]

a. Organization. [Note 4]

- (1) TRT 1 will lead the assault.
- (2) TRT 2 will provide security.
- (3) Bomb Dog Team and EOD Squad available on request.

b. Uniform and Equipment. [Note 5]

- (1) TRT SOP in effect.
- (2) TRT 1 draw rappelling gear.

c. Weapons and Ammunition. [Note 6]

- (1) TRT SOP in effect.
- (2) TRT 1 draw 2 stun grenades per person during weapons issue.
- (3) TRT 2 auxiliary weapons:
 - (a) 2 38 mm gas grenade guns.
 - (b) 1 30.06 rifle.

d. Chain of Command. [Note 7]

- (1) TRT Commander: CPT Billings
- (2) TRT 1 Commander: SGT Jacobs
- (3) TRT 2 Commander: SGT Turner

(CLASSIFICATION)

8. Include the time the operation order will be available and a schedule of critical events.
9. If there is sufficient time to conduct rehearsals of complex procedures such as building entry, indicate the time and location.
10. Include instructions of interest only to key individuals or specialized elements.

(CLASSIFICATION)

e. Time Schedule. [Note 8]

- (1) Operation order to be issued at rally point 1 at 2200 hours.
- (2) All forces in position by 2230 hours.
- (3) Assault on order.

f. Rehearsals. [Note 9]

TRT 1 will conduct roof entry rehearsals between 2000 and 2100 hours at Building 171, Zone B.

4. SPECIFIC INSTRUCTIONS [Note 10]

- a. TRT 1 provide liaison to Johnson County Sheriff Department for Bomb Dog Team and EOD Team Support.
- b. TRT 2 select sniper positions for occupation by 2230 hours.

CPT T. Byrd
Security Operations Officer

Distribution A.

(CLASSIFICATION)

Section 4. THE FRAG ORDER

Frag orders may be written or oral and do not follow a strict format. These orders will contain some of the same subject headings that are found in the complete operation order. However, sections that are included in the complete operation order will be omitted from a related frag order if

- **There has been no change in the information given in the section.**
- **The information in the section is not essential to the current mission.**
- **The information might needlessly compli-**

cate or delay the order.

- **The information is unavailable or incomplete at the time of issue.**

Unlike the operation and the warning orders, which are sent to all forces, a frag order will be addressed to the person who must take action. This order may be sent to other security force members and to alarm stations as information only, and not as an order to be acted upon. If applicable, the frag order can refer to a previous operation order. An explanation of the situation that created the need for a frag order may be included with the order. A revised mission statement also can be included. An example frag order follows:

EXAMPLE FRAGMENTARY ORDER CHANGE TO OPERATION ORDER

(CLASSIFICATION)

Copy No. 1 of 12 copies

2 MAR '89

Frag Order

Reference: OPORD No 89-3 with overlay

1. **SITUATION:** Adversary demands for safe passage were denied. One hostage was killed, and assault operations were begun. TRT 1 has bogged down in their sweep through Building 139F. Progress has been stalled by determined adversaries using hostages as human shields.
2. **MISSION:** Continue efforts to retake Building 139F, neutralize the adversary force and rescue the hostages.
3. **EXECUTION:**
 - a. Zone A security force assumes TRT support mission from TRT 2.
 - b. TRT 1 continues pressure on adversary force.
 - c. TRT 2 effects second building entry on north side of Building 139F. Clear toward known adversary location on second floor, south wing.
4. **EQUIPMENT AND SUPPORT:** No change.
5. **COMMAND AND COMMUNICATIONS:** No change.

CPT T. BYRD

Security Operations Officer

(CLASSIFICATION)

Section 5. CHAPTER SUMMARY

This chapter has covered the purpose and importance of tactical orders. The general content and the application to security force use of the following types of orders were explained:

- **The operation order**
- **The warning order**
- **The fragmentary order (frag order)**

A section of the chapter was devoted to an explanation of the format and content of each of these types of orders. Examples and annotations were provided to illustrate and clarify the three types.

Chapter 19

CORDON OPERATIONS

Section 1. INTRODUCTION

Adversaries launching a surprise attack on a target within an NRC licensed facility will have an initial tactical advantage in that they can concentrate forces on a single target. Security forces, on the other hand, routinely are spread throughout the facility. It is possible, therefore, that an adversary who has gained access to a facility will be able to occupy a target area or to take up a defensive position in a location such as a building before the security force is able to consolidate and react effectively.

If an adversary has entered your facility and has

reached a target area or been forced into a defensive posture outside a target area, you must take immediate steps to gain control of the situation by initiating a **cordon operation**. The goals of a cordon operation are to contain adversaries in their current location, to isolate them from all outside contact and to slow down the action so that you can plan and prepare to resolve the crisis through negotiation or tactical action.

This chapter will cover steps that can be taken in planning for cordon operations. It also will discuss reasons and techniques for establishing inner and outer containment perimeters and techniques for blocking potential avenues of escape.

Section 2. ESTABLISHING THE INNER PERIMETER

Once adversaries have penetrated a facility, immediate steps should be taken to contain them in the smallest area possible by establishing an **inner perimeter**. Normally, the first security personnel to arrive at the scene of a crisis should establish and occupy the inner perimeter.

Supervisors may not be among the first security personnel to arrive at the scene of a crisis. Therefore all security personnel should know in advance how to establish perimeters so that they can do so in a crisis without needing direct supervision.

A member of the security force arriving alone at the scene can take limited steps toward containment of the adversary. If the adversary happens to be in a building that provides only one escape route, the member of the security force may be able to achieve containment by covering that one route. In most situations, however, a single person will be unable to contain the adversary completely (see Illus. 19-1), but can help to ensure that the adversary will be contained quickly when additional security personnel arrive by

- **Taking cover**
- **Establishing and maintaining communications with the central alarm station**
- **Maintaining surveillance of the adversary if possible**

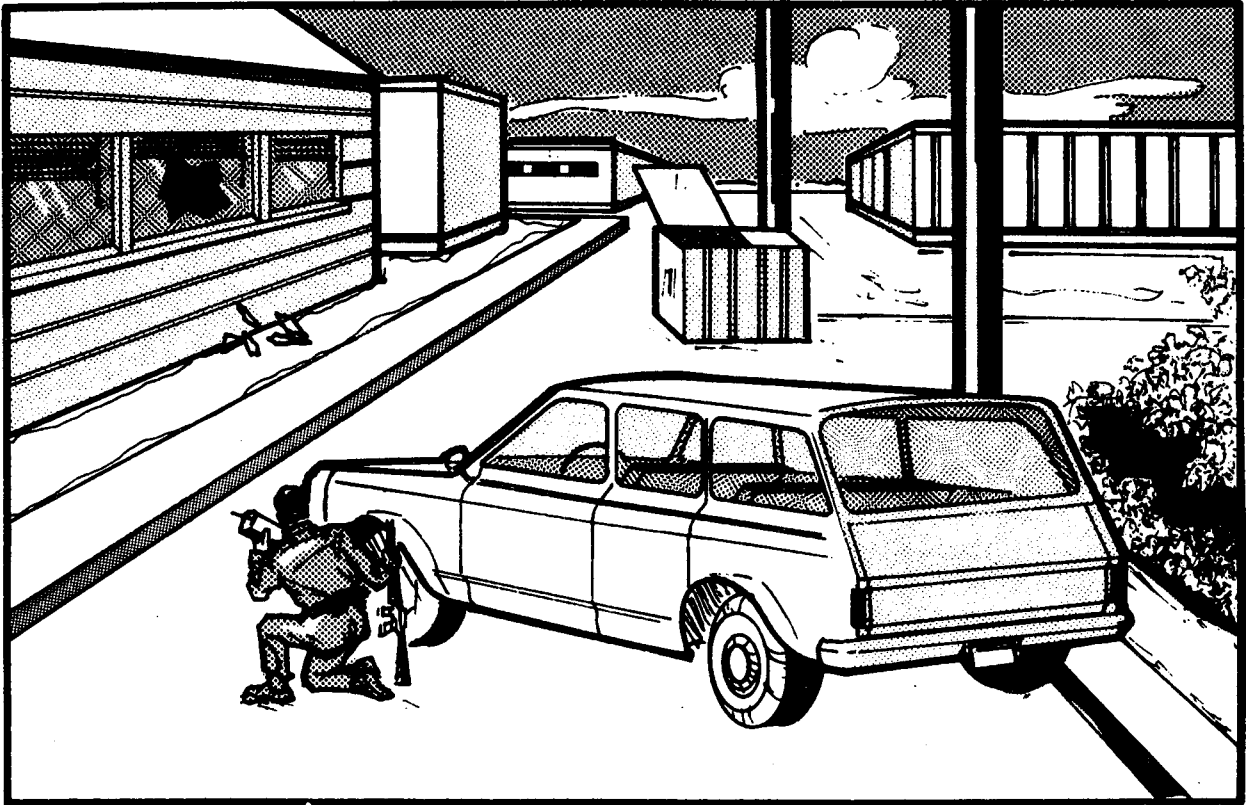

Illustration 19-1. A single security force member arriving at the scene of an adversary penetration should take cover, establish communications with the central alarm station and maintain surveillance of the adversary if possible.

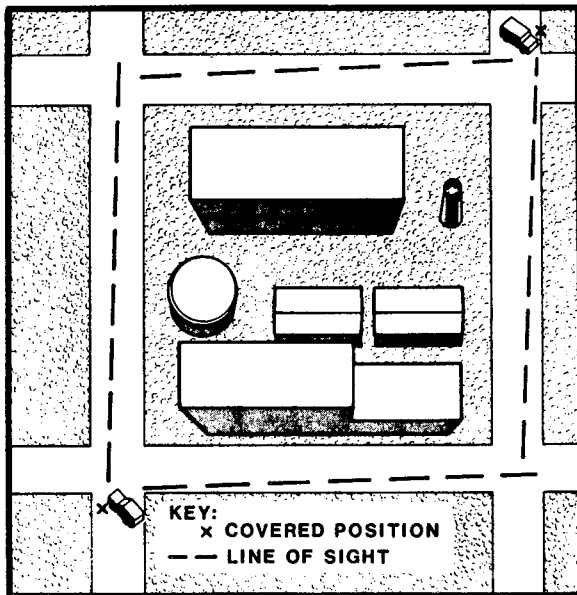

Illustration 19-2. Two security personnel arriving at the scene of an adversary penetration should think of the scene as a rectangle and take up positions on opposite corners of the rectangle.

If the member of the security force on the scene is in an excellent covered position, delaying action may be initiated by engaging the adversary with weapons fire. It should be kept in mind, however, that the most important contribution this individual can make is to stay alive and to act as an intelligence collector until additional security forces arrive.

If just two security personnel are present initially at the scene of an adversary penetration, they should think of the scene as a rectangle and take up positions on diagonally opposed corners of the rectangle. Each person then will be able to observe two sides of the rectangle (see Illus. 19-2).

When a supervisor arrives at the scene of the crisis and as additional security personnel arrive, a more complete inner perimeter will be established. The size and shape of the inner perimeter will be determined by the location of the adversary and by the physical characteristics of the area surrounding that location. Three rules to follow

when establishing the inner perimeter are

- **Cover all possible routes of escape**
- **Position security personnel so that they can safely observe the entire area of interest**
- **Position security personnel so that they can bring effective weapons fire on the adversary if such fire is required**

The first personnel to arrive at the scene should be positioned to cover the adversary's most likely avenues of escape. As personnel continue to arrive, they should be assigned to positions, and should be given clear instructions concerning their duties.

These instructions should include information concerning the type of adversary activity that the perimeter forces should look for and report and the circumstances under which the use of deadly force is appropriate.

All forces occupying the perimeter must be able to communicate with command post personnel and must be kept informed of changes in the tactical situation. These perimeter forces should not be required to assist with building or plant evacuation, since this would distract them from their other duties.

Section 3. ESTABLISHING THE OUTER PERIMETER

During a cordon operation, at least one **outer perimeter** should be established to

- **Isolate the area of operations**
- **Further contain the adversary**

The area of operations becomes isolated when innocent persons are evacuated from the cordoned area and when unauthorized persons are prevented from entering the area. Innocent persons who are within the adversary's line of fire should be evacuated first. If any people remain who cannot be evacuated safely, they should be instructed to stay concealed behind good cover and to remain as far away as possible from the location of the adversary.

Even if adversaries break through the inner perimeter, they will be further contained by forces on the outer perimeter. The outer perimeter should include roadblocks of all roads out of the cordoned area. If the adversaries are in a small facility or in a compound within a larger facility, the existing barriers might be suitable for use as an outer perimeter. Depending on the resources available

and on the existing situation, it may be desirable to establish more than one outer perimeter to provide additional depth of containment.

As with the inner-perimeter forces, personnel carrying out secondary containment must be given clear instructions concerning their duties. They also must be able to communicate directly with personnel in the command post, and they must be kept continually informed of changes in the tactical situation.

Section 4. BLOCKING TECHNIQUES

A containment perimeter actually is made up of a series of blocking positions that are located in such a manner as to close off all routes by which the adversary can attempt to escape (see Illus. 19-3). Blocking positions can be established in two ways

- **With observation and fire**
- **By physical means**

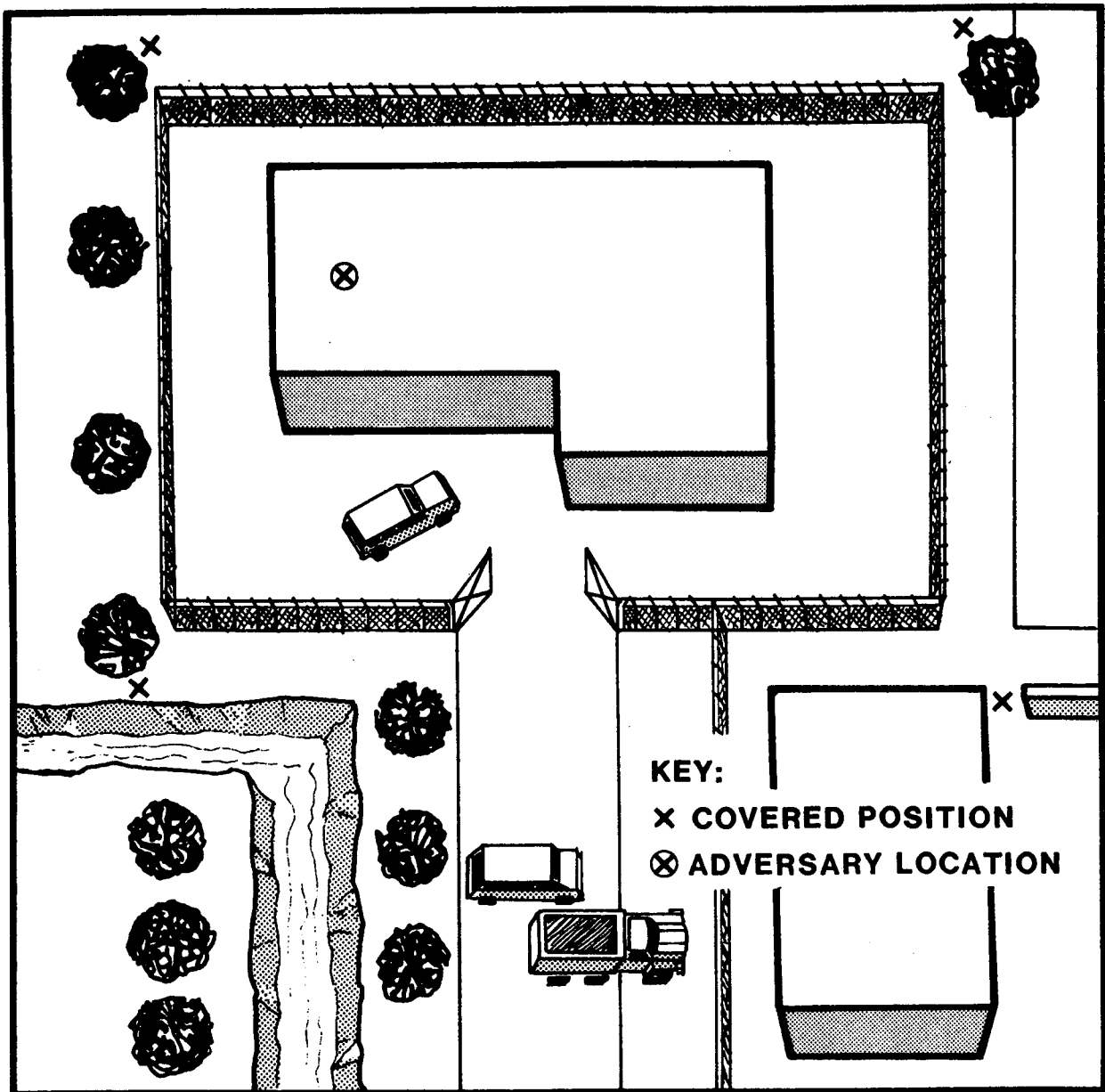

Illustration 19-3. A containment perimeter is made up of a series of blocking positions located so as to seal off the adversary's possible avenues of escape.

One person can block more than one escape route by using **observation and fire**. To effectively carry out this blocking technique, the individual must select an excellent position from which any adversary who tries to move within the sector can be observed and from which there is a clear field of fire. In addition, the escape routes that are

covered must be located well within the range of the guard's weapon. This blocking technique is employed somewhat differently at night due to reduced visibility. The sector that an individual can protect will be smaller than in the daylight, and artificial aids, such as illumination and night-vision devices, may need to be employed.

To **physically** block an escape route, positions should be located astride that route so that the adversary must overrun the position in order to escape. A one-person blocking position is not satisfactory because it can physically block only a very narrow escape route. Blocking positions occupied by more than one person are more effective but may be limited in number by the lack of sufficient manpower. When personnel shortages exist, it may be possible to physically block only the most likely escape routes.

If you expect the adversary to be traveling in a vehicle rather than on foot, you should consider using a roadblock as a physical blocking position.

You can create a blockade with large obstacles that will prevent an adversary vehicle from passing. Dump trucks and other large vehicles are especially well suited for blocking a roadway.

You should set up your blockade so that the road, shoulders and areas beside the road that are passable to vehicles are blocked completely (see Illus. 19-4). You may need to use several vehicles and other obstacles together to prevent passage. After the roadblock is set up, you should choose a position from which you can fire on any vehicle that is stopped by the obstacles. All roadblocks, like other physical barriers, must be covered by observation and fire if they are to be effective.

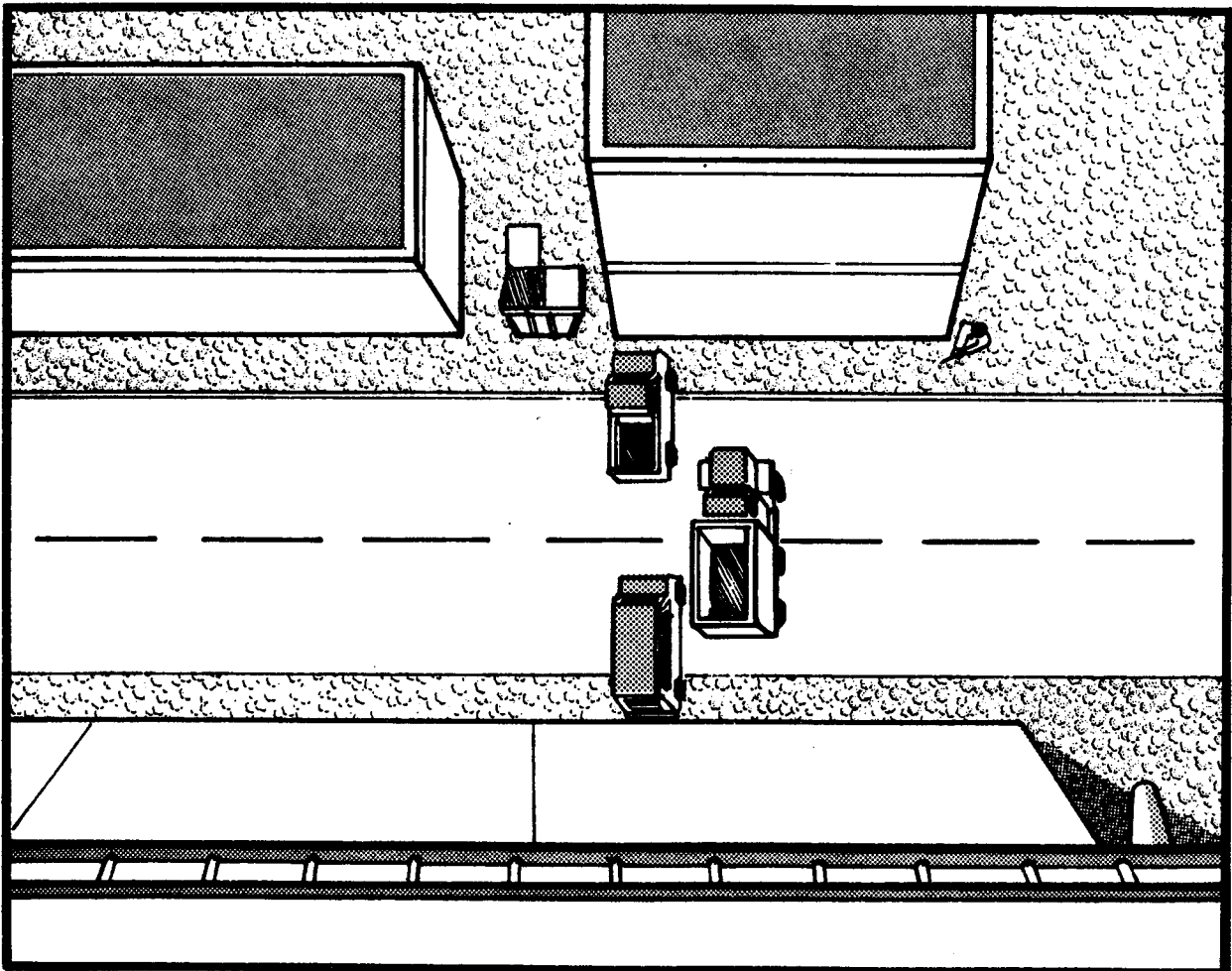

Illustration 19-4. When establishing a roadblock, be sure that the road, shoulders and areas beside the road that are passable to vehicles are blocked completely.

If you do not have enough vehicles available with which to block the road completely, you can use any materials in order to force an adversary driver to slow down so that you can stop his/her vehicle with weapons fire. Illus. 19-5 shows how you can use various objects to construct a series of obsta-

cles that can be used to make the adversary drive more slowly. After the obstacles have been put in place, security personnel should occupy positions from which they can deliver accurate fire on the adversary's vehicle if an attempt is made to negotiate the obstacles.

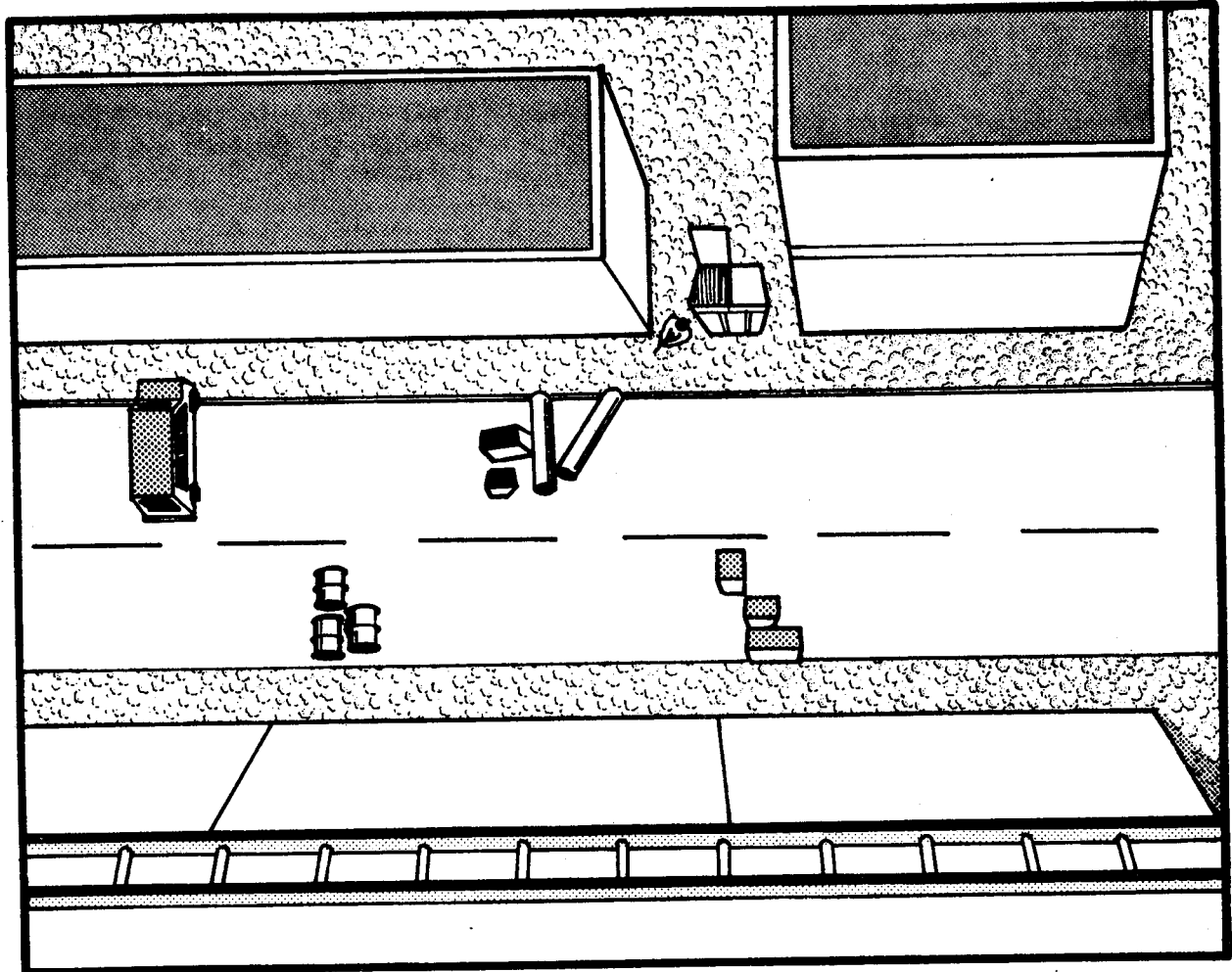

Illustration 19-5. A series of obstacles will slow an adversary.

Section 5. CHAPTER SUMMARY

The principles and techniques of cordon operations were described in this chapter.

The importance of **planning for cordon operations** before a crisis occurs was emphasized. Specific planning steps were covered.

The purpose of the **inner perimeter** and the techniques used for establishing this **perimeter** were described.

Techniques of establishing an **outer perimeter** in order to isolate the area of operations and further contain the adversary also were covered.

The following methods of establishing blocking positions on potential avenues of escape were described:

- **With observation and fire**
- **By physical means**

Chapter 20

ASSAULT OPERATIONS

Section 1. INTRODUCTION

As members of the nuclear security community, your security forces are more likely to carry out defensive than offensive tactical missions. In general, your forces are expected to keep adversaries out of the facilities for which you have security responsibility or, if adversaries do penetrate a facility, to contain them and prevent their escape. Both of these missions are essentially defensive.

However, the time may come when you will need to conduct an assault operation. The purpose of this chapter is to assist you in preparing for that possibility. The following topics will be presented:

- Principles of assault operations
- Elements involved in assault operations
- Special considerations of assault operations
- An example assault operation order

Section 2. PRINCIPLES OF ASSAULT OPERATIONS

Principles of assault operations, sometimes referred to as **fundamentals of the offense**, have been developed over many years, on actual battlefields, by commanders attempting to defeat their enemies with minimum losses to their own forces.

These principles, with only slight modifications, can be applied by NRC licensee security forces.

PRINCIPLES OF ASSAULT OPERATIONS

- See the area of operations
- Concentrate overwhelming power
- Suppress the adversary's fire
- Deceive the adversary
- Shock and overwhelm the adversary
- Maintain containment

SEE THE AREA OF OPERATIONS

Knowledge of the adversary is a prerequisite to tactical success. The planners and leaders of assault operations must know as much as possible about

- The number and locations of the adversary's forces
- The weapons and equipment available to the adversary
- The physical layout of the area in which the assault must be conducted

Every opportunity must be taken during the period prior to an assault to observe the adversary force and the area in which it is located. If the adversary is confined to a single building or an area within a building, covert observation and listening devices should be employed. If the adversary force occupies a larger area, observation posts should be used. If a helicopter is available, it should

be used for continuous observation over the area of operations before and during the assault. If no helicopter is available, a light, fixed-wing aircraft can be used almost as effectively.

CONCENTRATE OVERWHELMING POWER

In order for adversaries to forcibly penetrate your facility, they would have to concentrate superior power at the time and place of penetration. In order for you to eliminate them, you also must concentrate superior power. In the context of assault operations, power is defined as the ability to inflict damage on an opponent. This type of power may be derived from personnel, weapons, vehicles and anything else that you may employ to overwhelm adversary defenses. Although as a general rule minimum force should be exercised during security force operations, maximum force must be brought to bear against the adversary in an assault operation. Once the initial assault has begun, the adversary forces should not be given the opportunity to change their positions or strengthen their defenses.

SUPPRESS THE ADVERSARY'S DEFENSIVE FIRE

The adversary's ability to deliver defensive fire must be suppressed or neutralized, in order to provide protection for the assaulting force. Suppression and neutralization of defensive fire can be accomplished with smoke, incapacitating agents and suppressive fire from the security force fire-support elements. The adversary's fire must be neutralized without endangering the assaulting forces and without interfering with their progress.

DECEIVE THE ADVERSARY

The adversary should be deceived for as long as possible regarding the time and location of the main assault. Security forces can accomplish this deception by conducting a supporting assault at a different location and by using adequate covered and concealed routes for the main assault.

SHOCK AND OVERWHELM THE ADVERSARY

Once an assault is launched, that assault must be vigorously continued until the adversary force is completely neutralized or eliminated. Slowing the momentum of the assault can provide the adversaries with unacceptable opportunities to

react. If they are able to react, they may improve their position, and may inflict unnecessary losses on the assaulting security force.

MAINTAIN CONTAINMENT

During an assault, security forces may unintentionally provide the adversary force with an opportunity to escape by becoming involved in assault activities to the exclusion or detriment of containment. **Containment must be maintained until the adversary force is completely neutralized.**

Section 3. ELEMENTS INVOLVED IN ASSAULT OPERATIONS

A successful assault operation requires four distinct security force elements, each with separate responsibilities. These elements are

- **The command element**
- **The security element**
- **The fire-support element**
- **The assault element**

THE COMMAND ELEMENT

An assault operation, like any type of tactical operation that the security force might conduct, must be under the command and control of a single **command element**. Individuals and separate security elements cannot be allowed to operate independently of each other, nor should they be subject to orders from more than one authority.

The **mission** of the command element is to coordinate all actions of the separate security elements into a single, complex but cohesive action aimed at neutralizing or eliminating the adversary force. The **principle functions** of the command element are communications, command and control. For simple operations, the command element may include just one officer. For more complex operations, the command element may be composed of a commander, several communicators and other subordinate commanders and staff specialists.

The command element may operate in a building adjacent to the area of operations, in a mobile command post vehicle or even in an aircraft above the area of operations. Two essential requirements

dictate the location of this element. First, the commander must be able to observe, either directly or indirectly, the progress of the assault operation. Second, the command element must not become involved in other than command functions. That is, the commander should not be placed in a position where he/she would become involved in the assault or in containment or other support functions. **The commander must remain free to command.**

THE SECURITY ELEMENT

In an assault operation involving nuclear security forces, the **security element** has two functions. The primary task of this element is to provide continuous **containment** of the area of operations. The security element also provides **flank and rear security** for the assault element. The security element usually is the largest force in an assault operation. Normally, because of its size and the complexity of its duties, the security element is supervised by a separate subordinate commander who answers directly to the overall on-scene commander.

THE FIRE-SUPPORT ELEMENT

The **fire-support element** is employed in direct support of the assault element. The fire-support personnel initially are employed in fixed positions and are armed with appropriate weapons, such as semi-automatic rifles with which they can suppress adversary fire.

The fire-support element, like the security element, normally is under the supervision of a subordinate commander who answers directly to the on-scene commander. The on-scene commander, from his command post location, coordinates the actions of the fire-support element in support of the assault.

THE ASSAULT ELEMENT

The **assault element** is the most decisive and, at the same time, the most vulnerable element involved in an assault operation. Compared to the overall force, the assault element may be small in numbers. However, this element should have overwhelming combat power derived from a combination of numbers, weapons and equipment. The assault element also must be highly mobile and sufficiently flexible so that it can react to a rapidly changing tactical environment.

The assault element may assault on a single axis or on multiple axes of advance. The actions of the assault element must always be controlled by a single subordinate commander who answers directly to the overall on-scene commander. The **mission** of the assault element is to close with and neutralize the adversary force through the use of **fire-and-maneuver, fire-and-movement and assault fire techniques**. (See Chapter 8, "Team Tactical Movement.")

Section 4. SPECIAL CONSIDERATIONS OF ASSAULT OPERATIONS

There are several special considerations that are of particular importance during the course of assault operations. These considerations include

- **Mission assignment and division of responsibilities**
- **Fire support and fire control**
- **Coordination of assault and support**
- **Communications**

MISSION ASSIGNMENT AND DIVISION OF RESPONSIBILITIES

The **general** missions, functions and responsibilities of the separate elements of an assault operation were discussed briefly in the preceding section. The **specific** missions, functions and responsibilities must be provided in detail to separate elements, subelements and individuals prior to each assault operation. The division of responsibilities must be clearly stated and understood. Priorities of mission accomplishment must be equally clear. There should be no chance that one element would ever neglect its mission by becoming involved in the mission of another element. For example, unless specifically ordered to do so, members of the **security elements** should never abandon containment positions to join in the assault. Members of the **fire-support element** should never abandon their mission of providing support to the assault element to join in hot pursuit of a fleeing adversary. Finally, members of the **command element** should never neglect their primary leadership responsibilities to become actively involved in a firefight.

FIRE SUPPORT AND FIRE CONTROL

Providing fire support and fire control are important in any hostile-fire situation and become crucial tasks during an assault operation. Fire support must be provided with a degree of intensity sufficient to suppress adversary fire. Intense fire support must continue, possibly in close proximity to the assault element, until the last possible moment.

Supporting fire must be rigidly controlled. If supporting fire is stopped or shifted too soon, the adversary will be able to emerge from cover and fire on advancing assault forces. If supporting fire is stopped or shifted too late, this friendly fire may endanger the assault forces. Fire from assault forces also must be strictly controlled, particularly if the adversary is holding hostages or if the use of gunfire could cause unacceptable damage to the facility.

The lethality of the weapons and munitions currently available to NRC licensee security forces provides the power necessary for successful assault operations. That same lethality makes absolute control of fire essential.

COORDINATION OF ASSAULT AND SUPPORT

In general, it is the responsibility of the overall on-scene commander to coordinate assault and support activities. He/she should ensure that the members of the **fire-support element** are positioned so that they can direct the maximum effective fire on the adversary without endangering the **assault element** or other security forces. This outcome usually is best accomplished by the aligning of the **assault** and **fire-support** elements at right angles to each other, with each element facing the assault objective (see Illus. 20-1).

Support elements normally should not be employed in locations from which they must fire toward or over the heads of members of an advancing assault element (see Illus. 20-2 and 20-3). The single exception to this rule occurs when snipers are employed in elevated positions from which they can provide point-target fire without endangering assaulting forces. Weapons never should be employed either opposite assaulting forces or in the same general direction of approach as assault forces are using.

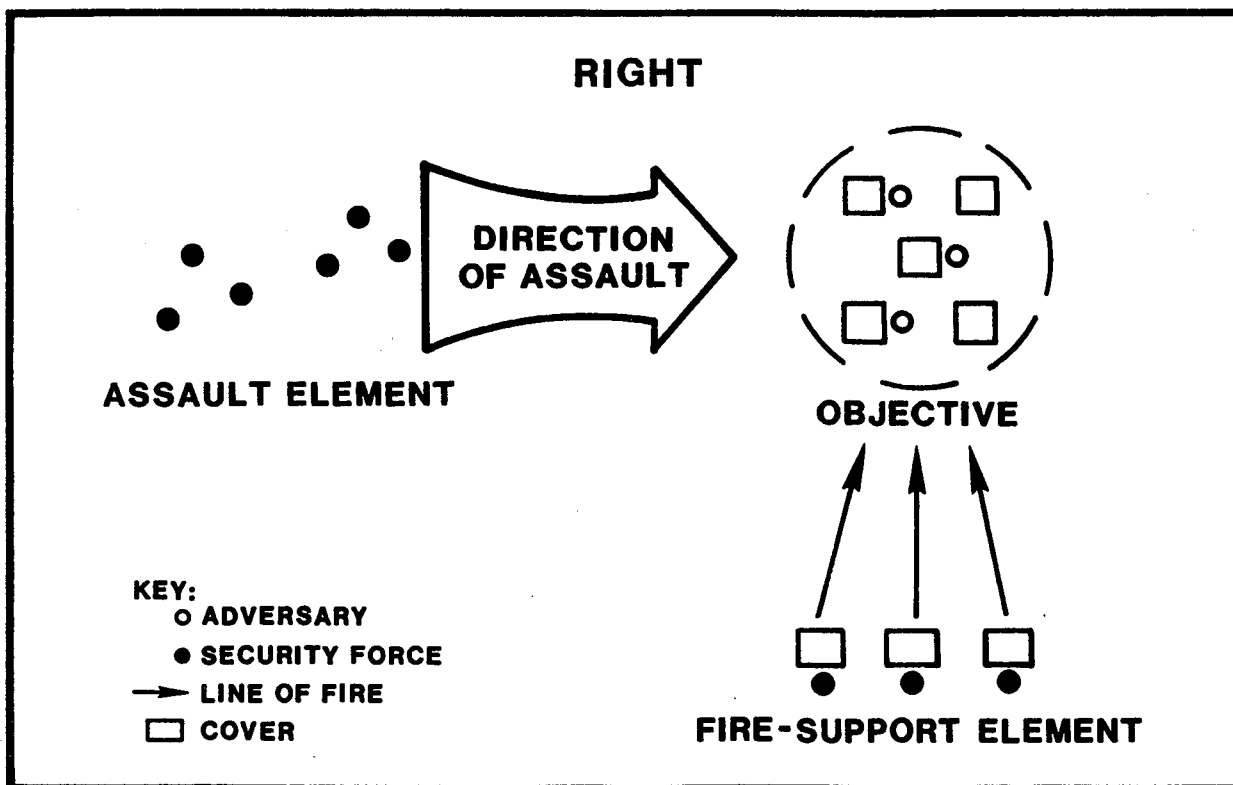

Illustration 20-1. Fire support should be employed at a right angle to the assault.

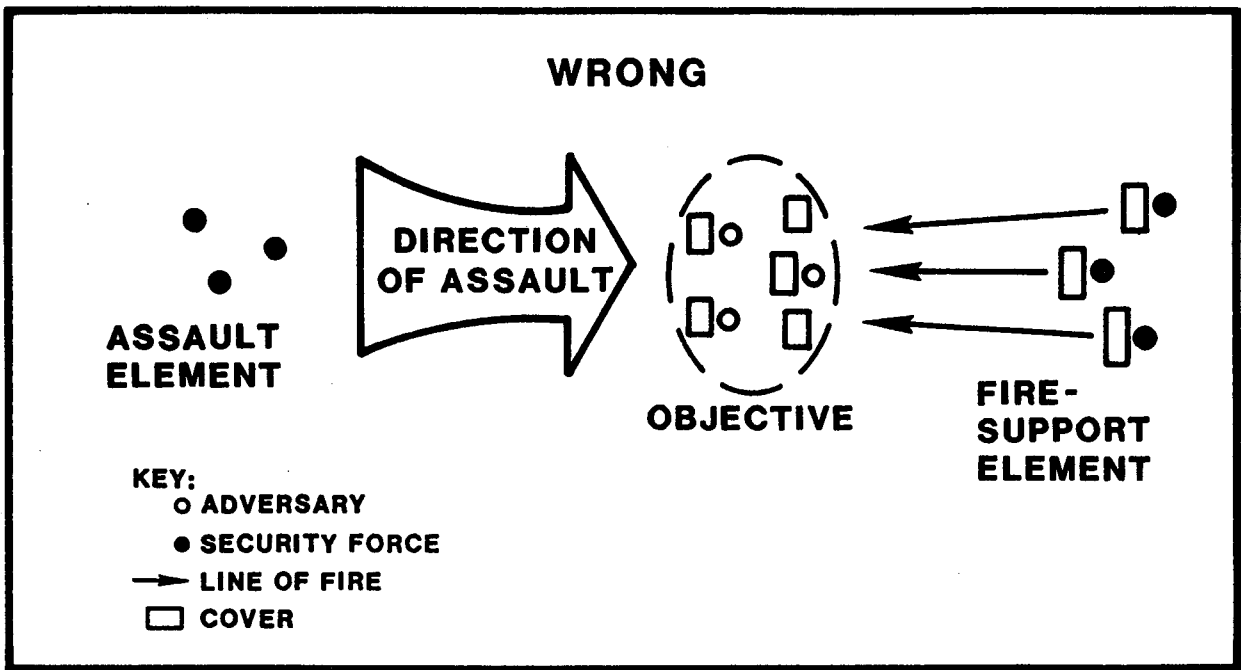

Illustration 20-2. Fire support incorrectly employed opposite the assault.

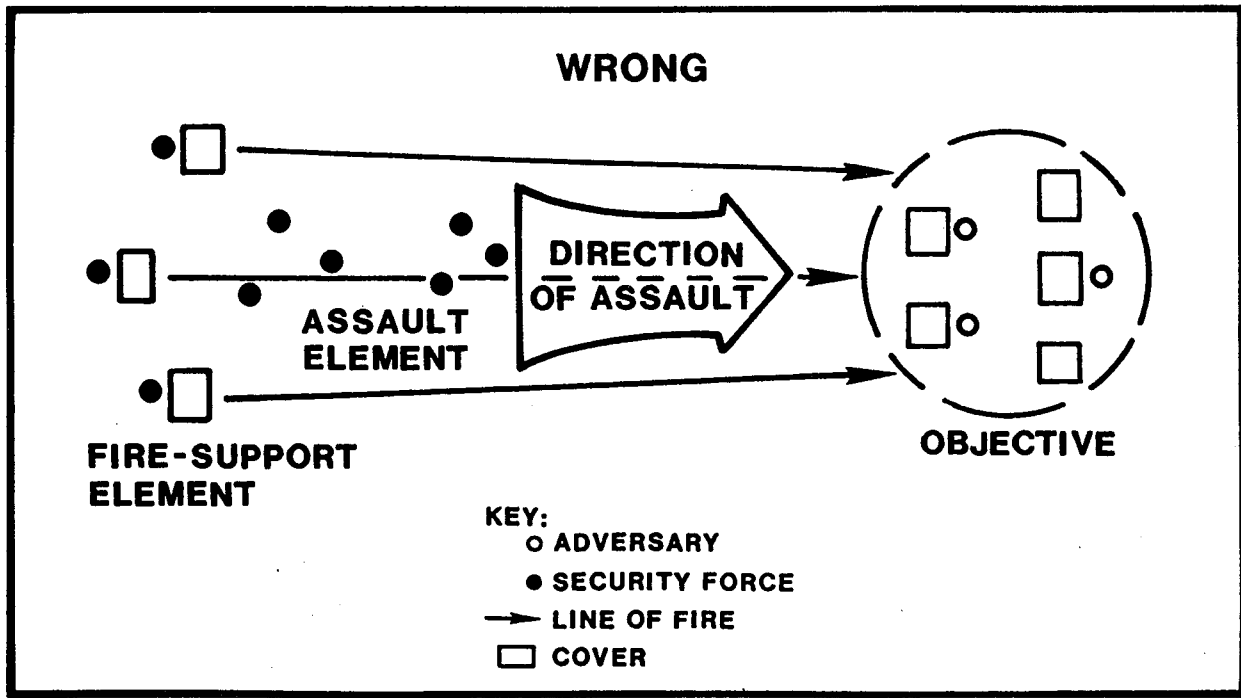

Illustration 20-3. Fire support incorrectly employed on the same axis as the assault.

By the same token, a main assault and a supporting assault never should be conducted from opposite sides of an objective area. If major barriers to fire do not exist between the two assault elements, the danger is unacceptably great that members of the two friendly forces will fire upon each other by accident (see Illus. 20-4 and 20-5).

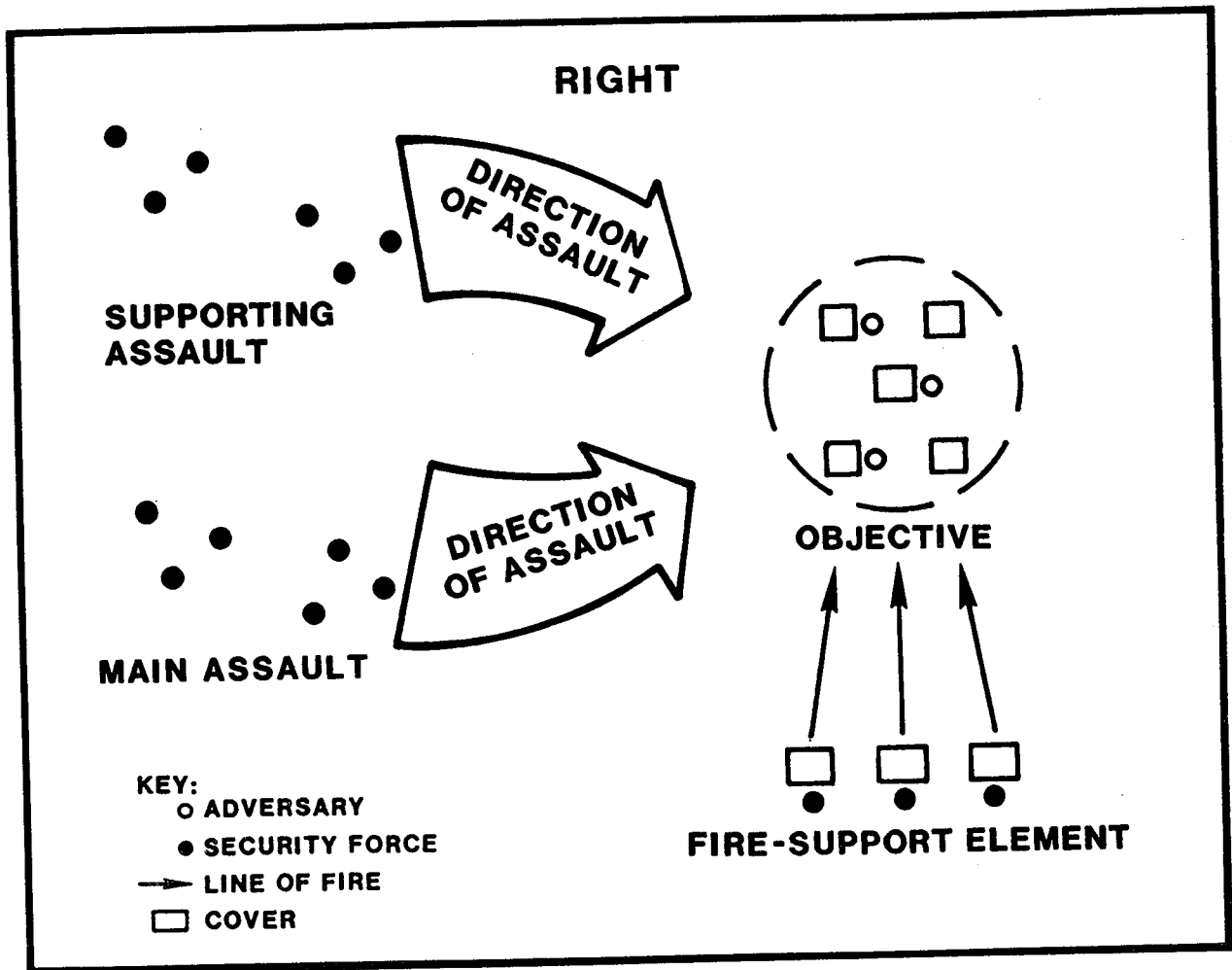

Illustration 20-4. The main and supporting assaults should converge on the objective from the same general direction and at right angles to the fire-support element.

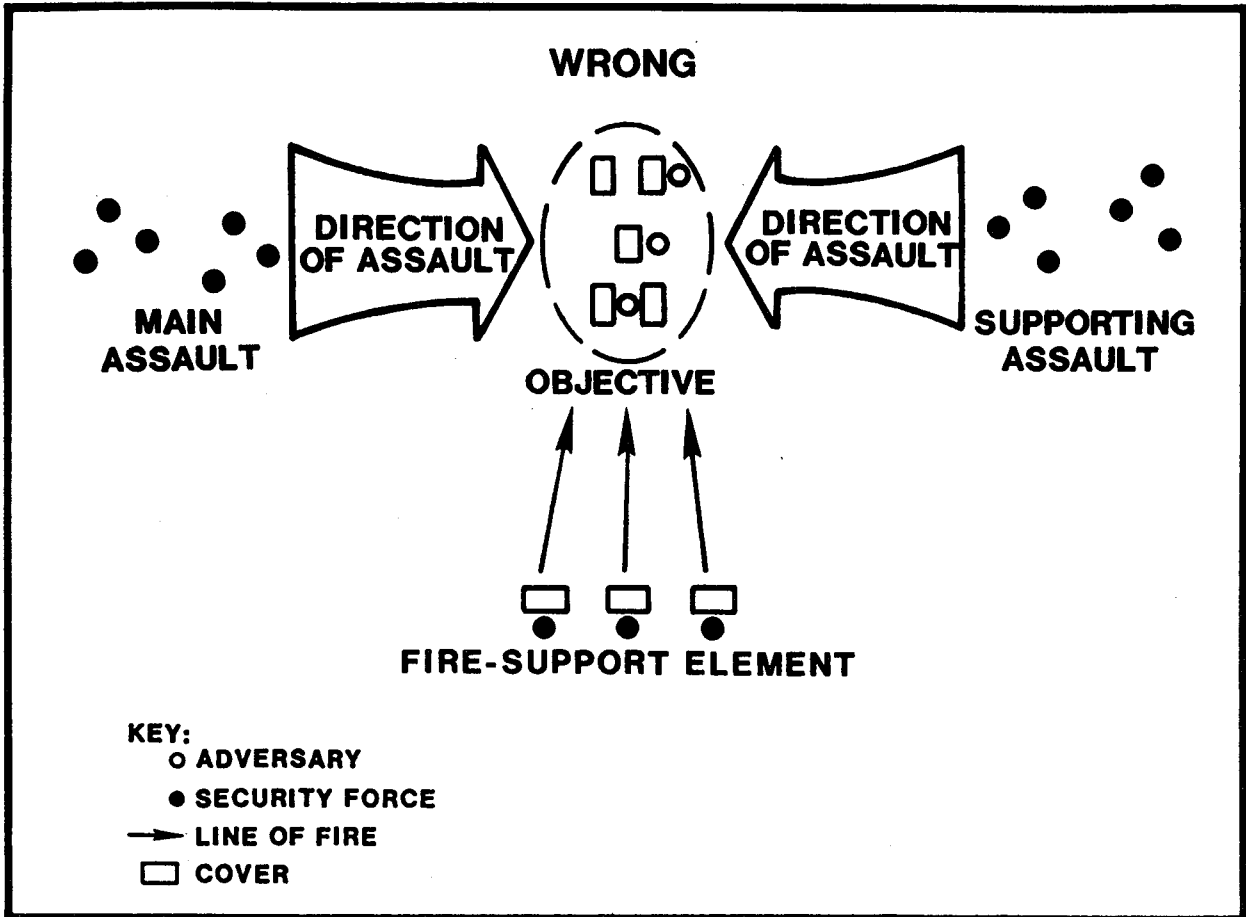

Illustration 20-5. The main and supporting assaults should not be conducted from opposite sides of the objective.

COMMUNICATIONS

Rapid, effective communications are essential to a successful assault operation. No matter how well planned an assault operation may be, the dynamic nature of offensive actions necessitates the timely and effective exchange of information and orders.

Because assault operations are so communications dependent, special attention should be given to the communications section of an assault-operations order. If possible, separate radio nets should be designated for **assault**, **fire-support** and **security** elements, and only the major subordinate leaders of each element should use the command net. (See Chapter 11, "Tactical Communications.") This assignment of radio nets will allow for effec-

tive command and control **within** elements without disrupting effective command and control **among** elements.

Section 5. EXAMPLE ASSAULT OPERATION ORDER

The following example operation order is based on a hypothetical situation in which security management has directed offensive action and authorized the use of deadly force. This order follows the concepts, principles and considerations presented in this chapter and the recommended general operation order format found in Chapter 18, "Tactical Orders."

EXAMPLE ASSAULT OPERATION ORDER

(CLASSIFICATION)

Copy No. 1 of 12 copies
6 MAY 89

Operation Order 89-5

References: XYZ Plant Security Plan
Site Map 1602
Communications Plan 89-3-1
XYZ Site Safety SOP

Task Organization: Command Element

On-Scene Commander
Communications Section 1

Assault Element

Assault Commander
TRT 1
TRT 2

Fire-Support Element

Fire-Support Commander
Sniper Team
Rifle Team

Security Element

Security Commander
Zone Alpha Security Force
Zone Bravo Security Force

Off-Site Security (LLEA)

Johnson County Sheriff Department
Tyler City Police Department

1. SITUATION

a. Adversary Information.

The adversary force consists of an unknown number of apparently well-armed personnel who have forced entry into the C Building where they are currently barricaded. They hold the entire building and have at least two hostages confined in the main conference room.

The adversaries have established contact with security forces and have made certain nonnegotiable demands that are totally unacceptable to site management. The adversaries have threatened to kill their hostages if these demands are not fully met by 1300, 6 MAY 89.

b. Security Force Information.

See Task Organization.

(CLASSIFICATION)

(CLASSIFICATION)

c. Attachments and Detachments.

Johnson County Sheriff Department EOD Team attached to TRT 2 on order.

2. MISSION

XYZ Plant Security Forces supported by LLEA, contain C Building and Zones Alpha and Bravo and assault, beginning at 1230, 6 May 89, through Zone Alpha to capture or neutralize the adversary force, regain control of C Building and rescue hostages.

3. EXECUTION

a. Concept of Operation.

Annex A (Operation Overlay) and Annex B (C Building Floor Plan)

XYZ Plant Security Forces assault with TRT 1 on the north along AXIS UNIFORM providing the main assault to retake the north portion of the objective and TRT 2 on the south along AXIS PAPA providing the supporting assault to retake the south portion of the objective; the Fire-Support Element on the high ground to the north; Security Alpha providing security and containment on the north and northwest; and Security Bravo providing security and containment on the south and southwest.

b. Special Instructions to Separate units.

(1) Command Element.

(2) Assault Element.

(a) TRT 1.

1. Priority of mission accomplishment is as follows:

a. Neutralize adversary forces.

b. Secure main conference room.

c. Rescue hostages.

2. Use minimum essential lethal force in and around conference room.

(b) TRT 2.

1. Priority of mission accomplishment is as follows:

a. Neutralize adversary forces.

b. Secure C Building.

2. County EOD Team available upon request.

(3) Fire-Support Element.

(a) No heavy concentrations of fire in vicinity of conference room.

(b) Sniper fire only, in vicinity of hostages.

(c) Priority of fire support to main assault.

(CLASSIFICATION)

(CLASSIFICATION)

(4) Security Element.

(a) Security Alpha: Priority of security support to TRT 1.

(b) Security Bravo: Priority of security support to TRT 2.

(5) LLEA.

c. **Coordinating Instructions.**

(1) Use of lethal force is authorized.

(2) No uncoordinated fire across security and TRT boundary.

(3) Overall priority of mission accomplishment.

(a) Neutralize adversary forces.

(b) Rescue hostages.

4. EQUIPMENT AND SUPPORT

a. XYZ Plant Security Plan in effect.

b. Fire and medical support in accordance with XYZ Site Safety Plan.

c. Johnson County Hospital MED EVAC helicopter on 10-minute helipad alert.

5. COMMAND AND COMMUNICATIONS

a. **Command.**

(1) EOC is operational in Bldg. 1627.

(2) On-scene command post is operational in Bldg. 205F.

(3) All LLEA coordinated by Johnson County EOC.

b. **Communications**

(1) Communications Plan 89-3-1 in effect.

(2) Net Assignment.

(a) Command Net: Channel 1

(b) Assault Net: Channel 2

(c) Support Net: Channel 3

(d) Security Net: Channel 4

(e) Alternate Command Net: Channel 5

(3) Authentication Table 89-5-6 in effect.

(4) Maximum use of telephones directed.

CPT Byrd
Security Operations Officer

(CLASSIFICATION)

(CLASSIFICATION)

Annexes: A—Operation Overlay
B—C Building Floor Plan

Distribution: A

(CLASSIFICATION)

CLASSIFICATION

ANNEX A [OPERATIONS OVERLAY] TO OPORD 89-5

REFERENCE: SITE MAP #1602

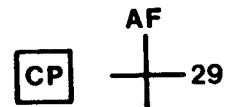
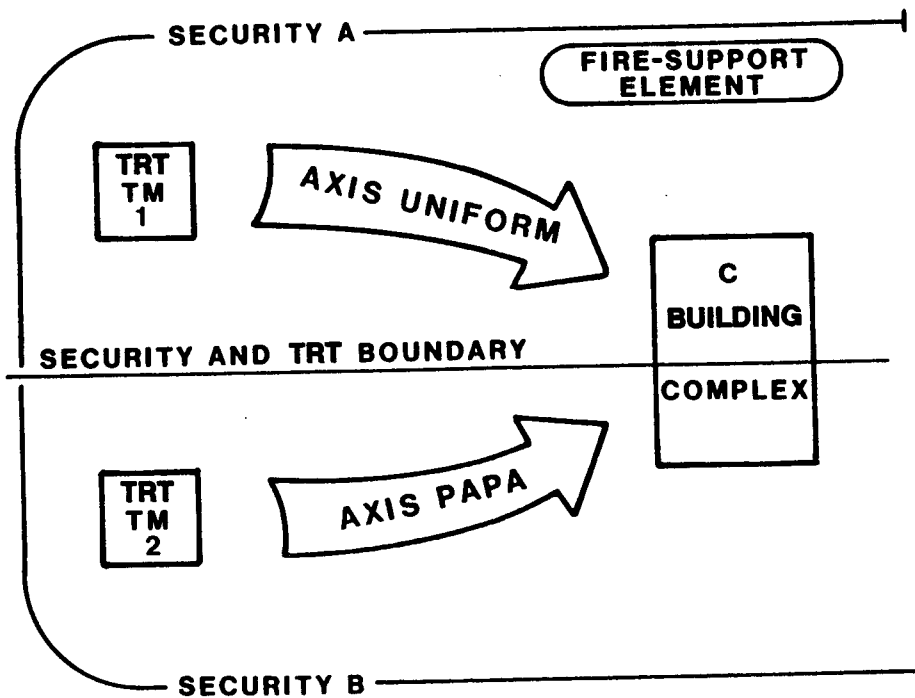
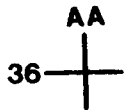

CLASSIFICATION

CLASSIFICATION

ANNEX B [C BUILDING FLOOR PLAN] TO OPORD 89-5

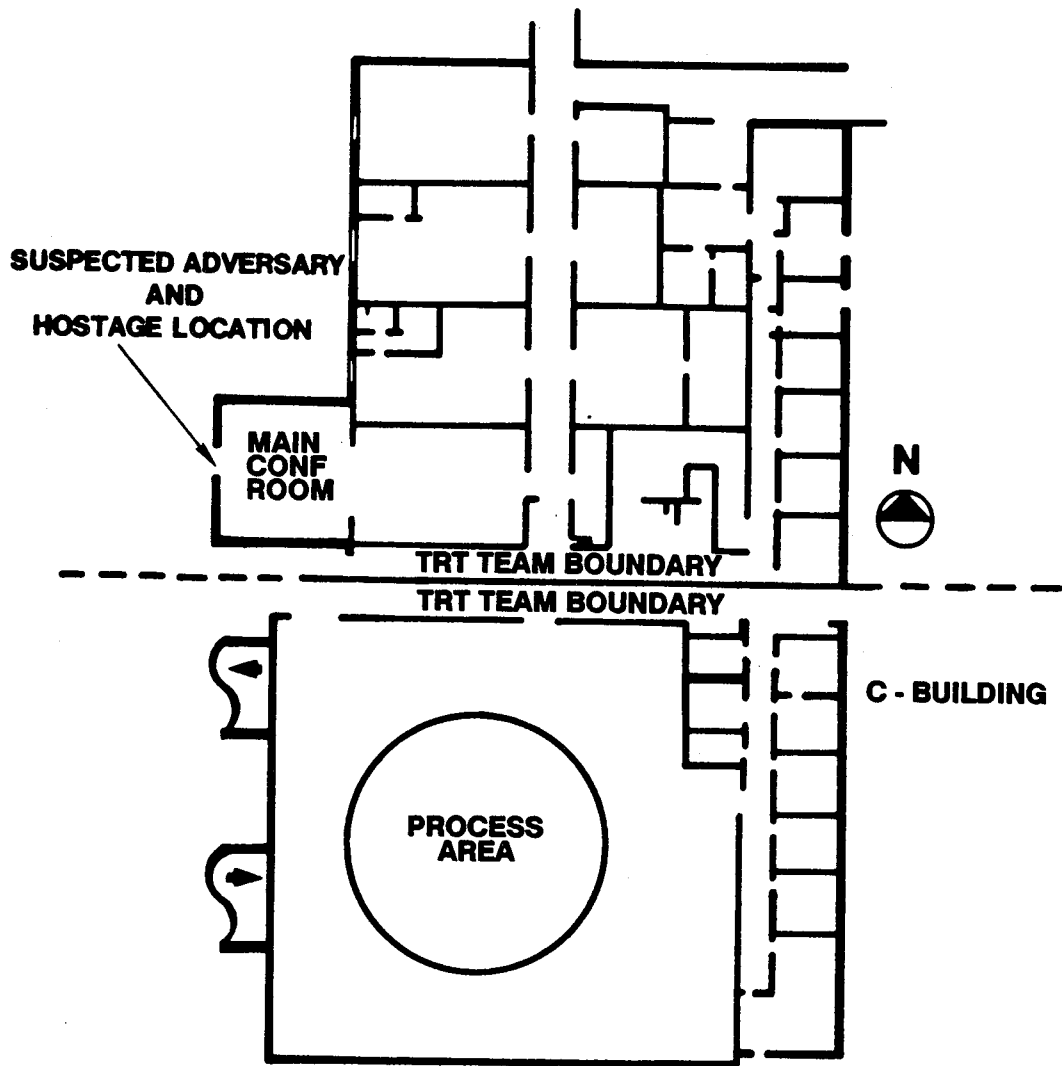

CLASSIFICATION

Section 6. CHAPTER SUMMARY

In this chapter, the following principles of assault operations were presented and discussed:

- See the area of operations
- Concentrate overwhelming power
- Suppress the adversary's defensive fire
- Deceive the adversary
- Shock and overwhelm the adversary
- Maintain containment

The following essential elements involved in assault operations were presented, and the specific missions and functions of each were discussed:

- The command element

- The security element
- The fire-support element
- The assault element

Special considerations applicable to assault operations were presented and discussed. These considerations included

- Mission assignment and division of responsibilities
- Fire support and fire control
- Coordination of assault and support
- Communications

The chapter concluded with an example assault operation order based on a hypothetical nuclear security operation.

APPENDIX A
REFERENCES

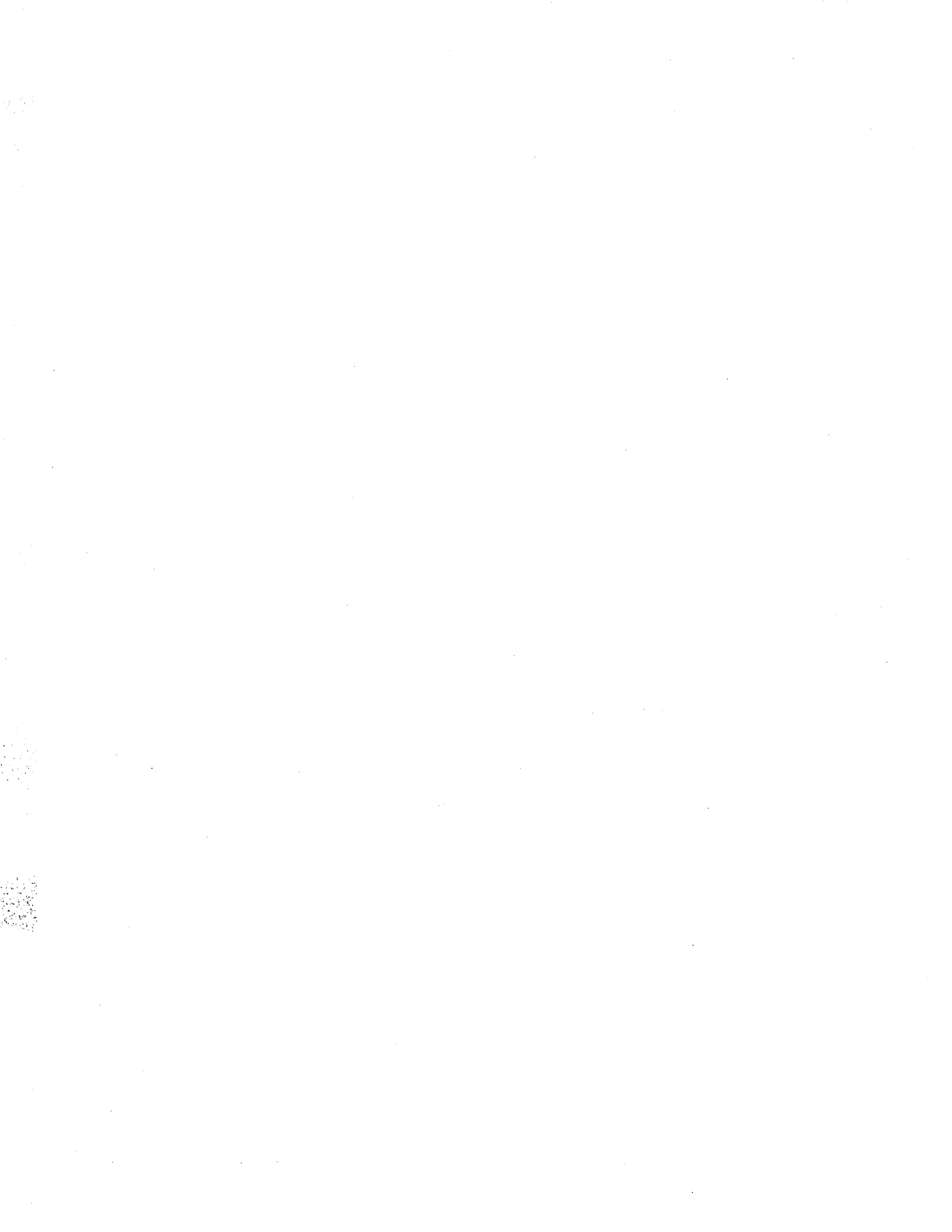

APPENDIX A REFERENCES

FLEET MARINE FORCE MANUALS

- FMFM 1-2, *Marine Troop Leaders Guide*.
- FMFM 1-3, *Basic Marksmanship*.
- FMFM 1-3A, *Field Firing Techniques*.
- FMFM 1-3B, *Sniping*.
- FMFM 6-5, *Marine Rifle Squad*.

U.S. ARMY MANUALS

- FM 7-8, *The Infantry Platoon and Squad (How to Fight)*.
- FM 7-11B, *Soldier's Manual for MOS 11B (Infantryman)*.
- FM 19-30, *Physical Security*.
- FM 19-95b, *Soldier's Manual for MOS 95B (Military Police)*.
- FM 21-2, *Soldier's Manual of Common Tasks (Skill Level 1)*.
- FM 21-3, *Soldier's Manual of Common Tasks (Skill Levels 2, 3 and 4)*.
- FM 21-41, *Individual NBC Defense*.
- FM 21-60, *Visual Signals*.
- FM 21-75, *Combat Training of the Individual Soldier and Patrolling*.
- FM 24-18, *Field Radio Techniques*.
- FM 90-10, *Military Operations on Urbanized Terrain (MOUT)*.

U.S. ARMY TECHNICAL MANUALS

- TM3-4240-279-10 *Operator's Manual, Mask, Chemical-Biological: Field ABC-M17/M17A1 and Accessories*.

NUREG REPORTS

- NUREG-0459, "Generic Adversary Characteristics Summary Report," March 1979.
- NUREG/CR-5081, "Tactical Exercise Planning Handbook," Battelle Columbus Division, April 1989.

RAND PUBLICATIONS

- R-3363-DOE, "A Reassessment of Potential Adversaries to U.S. Nuclear Programs," Santa Monica, CA: Rand, March 1986.
- R-2225-SL, "Attributes of Potential Criminal Adversaries of U.S. Nuclear Programs," Santa Monica, CA: Rand, 1978.
- R-2554-SL, "Motivations and Possible Actions of Potential Criminal Adversaries of U.S. Nuclear Programs," Santa Monica CA: Rand 1980.
- R-2803-SL, "The Appeal of Nuclear Crimes to the Spectrum of Potential Adversaries," Santa Monica, CA: Rand, 1982.

OTHER DOCUMENTS

- Fuselier, G. W., "A Practical Overview of Hostage Negotiations," *FBI Law Enforcement Bulletin*, June/July, 1981.
- Kolman, J. A., *A Guide to the Development of Special Weapons and Tactics Teams*, Springfield, IL: Charles C. Thomas Publishing, 1982.

Reker, J. and P. Shaw, *Executive Protection Manual*, Schiller Park, IL: MTI Teleprograms, Inc., 1980.

Remsburg, C. and R. Gallagher, *Hostage Negotiations for Police*, Schiller Park, IL: Motorola Teleprograms, Inc., 1977.

Telfair, W. and D. Baehr, "Tactical Training Manual 1-I, Basic Tactical Training for the Security Inspector," Criterion Referenced Consultants, Inc., DE-AC01-83DP30319, 1985.

Telfair, W. and D. Baehr, "Tactical Training Manual 1-II, Advanced Training for the Security Force Supervisor," Criterion Referenced Consultants, Inc., DE-AC01-83DP30319, 1985.

Telfair, W. and D. Baehr, "Tactical Training Manual 1-III, "Special Tactical Training for the Response Force," Criterion Referenced Consultants, Inc., DE-AC01-83DP30319, 1985.

APPENDIX B
INDEX

APPENDIX B

INDEX

- Adversaries, characteristics of, 2-1 through 2-7
 - aims, 2-3
 - insiders, 2-2
 - potential types, 2-1, 2-3
 - tactics, 2-4, 2-5
 - threat to communication, 2-5
 - weapons and equipment, 2-3, 2-4
- Ambush, avoiding, 10-3, 10-4
- Ambush, characteristics of, 10-1 through 10-3
- Ambush, immediate-action drills, 10-4 through 10-7
- anchors, rappelling, 14-20 through 14-22
- Apprehension, multiple prisoners, 13-28
- Approach techniques, adversary, 13-13 through 13-16
- Approach techniques, vehicle, 13-30 through 13-39
 - high risk, 13-31 through 13-38
 - low risk, 13-38, 13-39
- Arm and hand signals, 11-9 through 11-12
- Assault fire, (see Fire, assault)
- Assault operations, 20-1 through 20-14
 - elements, 20-2, 20-3
 - order, example, 20-7 through 20-13
 - principles, 20-1, 20-2
 - special considerations, 20-3
- Battlesights, 5-2, 5-3
- Binoculars, use of, 4-10, 4-11
- Camouflage, 3-6 through 3-8
- Chemical agents, 12-1 through 12-11
 - detection and symptoms, 12-6
 - first aid, 12-11
 - protective masks, 12-7 through 12-10
- Chemical weapons, 12-1 through 12-5
- Commands, giving to an adversary, 13-1, 13-2
- Command post, on-scene, 17-1 through 17-6
 - functions, 17-3, 17-4
 - location, 17-4
 - staffing 17-4, 17-5
 - transition of, 17-2
 - types, 17-2, 17-3
- Communications, tactical, 11-1 through 11-15
 - arm and hand signals, 11-9 through 11-12
 - duress signals, 11-14
 - light and other visuals, 11-13
 - loudspeakers, 11-13
 - messengers, 11-13
 - pyrotechnics, 11-12, 11-13
 - radios, 11-1 through 11-7
 - site-specific systems, 11-14
 - telephones, 11-7, 11-8
- Concealment, 3-3 through 3-5
- Cordon operations, 19-1 through 19-6
 - blocking techniques, 19-3 through 19-6
 - inner perimeter, 19-1 through 19-3
 - outer perimeter, 19-3
- Counterambush, techniques, 10-1 through 10-7
- Countersniper operations, 16-5
- Cover, 3-1 through 3-3
- Defensive positions (see Positions, defensive)
- Disarming techniques, 13-8, 13-9
- Driving, tactical, 9-1 through 9-10
 - kill zone, escaping, 9-1 through 9-6
 - night driving, 9-9, 9-10
 - vehicle used as cover, 9-8
 - stopping and exiting under fire, 9-6, 9-7
- Duress signals, 11-14
- Entry techniques, 15-3 through 15-10
 - door entry, 15-4 through 15-9
 - rappel entry, 15-10
 - roof entry, 15-10
 - window entry, 15-9, 15-10
- Equipment, rappelling, 14-1 through 14-13
- Fire, assault, 5-11, 8-11
- Fire control, 5-12
- Fire, coordinated delivery of, 5-10
- Fire discipline, 5-13
- Fire, suppressive, 5-10
- Firing positions (see Positions, firing)
- Fragmentary (Frag) order, 18-10, 18-11
- Handcuffs, 13-16 through 13-25
 - application, 13-18 through 13-25
 - removal, 13-25
 - vulnerabilities, 13-17, 13-18
- Helicopters, adversary use, 2-3, 2-4
- Incapacitation, adversary, 13-9 through 13-13
- Information collection and reporting, 4-16 through 4-18
 - information quality, 4-17, 4-18
 - observer, traits of, 4-17
 - SALUTE method, 4-17
- Location referencing, 4-7, 4-8
 - distance-from-landmark method, 4-7, 4-8
 - landmark method, 4-7

Night firing, 5-9, 5-10
 Night observation, 4-12 through 4-14
 binoculars and scopes, night use, 4-14
 dark adaptation, 4-12, 4-13
 off-center vision, 4-14
 position selection, 4-14
 scanning, 4-13
 Night-vision devices, 4-14 through 4-16
 Observation positions, 4-1 through 4-3
 characteristics of, 4-1 through 4-3
 occupation and use of, 4-4
 Observer, traits of, 4-17
 Optical Aids, 4-9 through 4-11
 Order, assault, 20-7 through 20-13
 Order, operation, 18-1 through 18-7
 Perimeter control, 19-1 through 19-6
 Planning, tactical, 17-1 through 17-3
 Pointing technique, 5-4, 5-5
 Positions, firing, 5-1, 5-2
 Positions, defensive, 6-1 through 6-6
 categories, 6-1, 6-2
 characteristics, 6-3 through 6-6
 selection factors, 6-3
 Positions, sniper, 16-3, 16-4
 Prisoners, evacuating, 13-40 through 13-43
 Prisoners, multiple, 13-28
 Protective masks, chemical, 12-7 through 12-10
 Radios, tactical use of, 11-1 through 11-7
 capabilities and limitations, 11-1
 exploitation, adversary, 11-2, 11-3
 exploitation, prevention of, 11-3 through 11-7
 Rappelling, 14-1 through 14-43
 anchor placement, 14-20 through 14-22
 Australian rappel, 14-34, 14-35
 belayed descent, 14-36, 14-37
 bounding technique, 14-33
 descent, controlled, 14-32
 descent, cues and responses, 14-29
 descent, preparation, 14-30, 14-31
 descent, types and procedures, 14-32 through 14-37
 equipment, placement, 14-39
 equipment, selection and care, 14-1 through 14-13
 from helicopters, 14-39 through 14-42
 hook-up, 14-23 through 14-28
 knots, 14-14 through 14-20
 retrieval, rappeller, 14-38
 safety, 14-13, 14-14
 with two ropes, 14-39
 Response and containment planning, 17-1
 Search and clear operations, 15-1 through 15-13
 adversary contact, 15-12, 15-13
 approach, 15-2, 15-3
 entry, 15-3 through 15-10
 preparation for, 15-2
 room searches, 15-10 through 15-12
 team organization and equipment, 15-1, 15-2
 Search techniques, 13-2
 adversary, visual, 13-2
 body, 13-2
 Site vulnerability analysis, 17-1
 Sniper Operations, 16-1 through 16-6
 countersniper operations, 16-5
 sniper employment, 16-2, 16-3
 sniper positions, 16-3, 16-4
 Suppressive fire (see Fire, suppressive)
 Tactical movement, individual 7-1 through 7-10
 factors affecting, 7-1
 high crawl, 7-3
 low crawl, 7-3
 rush, 7-4, 7-5
 silent walk, 7-3
 techniques for unique circumstances, 7-5 through 7-9
 Tactical movement, team, 8-1 through 8-18
 considerations, 8-1
 formations, 8-2 through 8-5
 immediate-action drill, 8-13 through 8-17
 principles, 8-2
 prior to adversary contact, 8-6 through 8-8
 under fire, 8-9 through 8-12
 withdrawal under fire, 8-13
 Target engagement, special techniques, 5-5
 moving targets, 5-5
 multiple targets, 5-7
 partially hidden targets, 5-8
 ricochet shooting, 5-8
 Target indicators, 4-7
 Telephones, tactical use of, 11-7, 11-8
 Terrain analysis, 3-9, 3-10
 Terrain search, visual, 4-5, 4-6
 detailed search, 4-6
 hasty search, 4-5
 Warning order, 18-8 through 18-10

NRC FORM 335 (2-84) NRCM 1102, 3201, 3202 BIBLIOGRAPHIC DATA SHEET SEE INSTRUCTIONS ON THE REVERSE.		U.S. NUCLEAR REGULATORY COMMISSION		1. REPORT NUMBER (Assigned by TIDC, add Vol. No., if any) NUREG/CR-5172 BMI-2166	
2. TITLE AND SUBTITLE Tactical Training Reference Manual			3. LEAVE BLANK		
5. AUTHOR(S) W. D. Telfair, D. A. Moul, J. W. Klingelhofer, K. M. Jurjevich, and W. R. Leonard			4. DATE REPORT COMPLETED MONTH: November YEAR: 1988		6. DATE REPORT ISSUED MONTH: April YEAR: 1989
7. PERFORMING ORGANIZATION NAME AND MAILING ADDRESS (Include Zip Code) Battelle Columbus Division 505 King Avenue Columbus, Ohio 43201-2693			8. PROJECT/TASK/WORK UNIT NUMBER NMS-87-009		9. FIN OR GRANT NUMBER D2055-7
10. SPONSORING ORGANIZATION NAME AND MAILING ADDRESS (Include Zip Code) Division of Safeguards and Transportation Office of Nuclear Material Safety and Safeguards U. S. Nuclear Regulatory Commission Washington, D. C. 20555			11a. TYPE OF REPORT Final, Technical		b. PERIOD COVERED (Inclusive dates) September 1987-November 1988
12. SUPPLEMENTARY NOTES					
13. ABSTRACT (200 words or less) <p>This Manual provides training information for U. S. Nuclear Regulatory Commission licensees to assist in implementation of the Tactical Response Team (TRT) training and exercise requirements of the revised portions of 10 CFR Part 73, which requires that licensees possessing formula quantities of strategic special nuclear material establish TRTs and conduct tactical response exercises to enhance the capabilities of security forces in protecting NRC licensed fuel facilities from potential adversaries postulated in the design basis threat. Step-by-step illustrated instructional material is provided concerning both individual and team tactics and skills appropriate to meeting these requirements. The Manual consists of two parts. Part One addresses adversary attributes and essential tactical skills that each TRT member should master to assure personal safety and effective response to adversary actions. Part Two discusses more advanced tactics, command, control, and orders.</p>					
14. DOCUMENT ANALYSIS - a. KEYWORDS/DESCRIPTORS Category I Fuel Facilities Security System Performance Testing Security Forces Security Force Tactical Training Tactical Response Exercises Training Tactical Response Teams Tactical Training				15. AVAILABILITY STATEMENT Unlimited	
b. IDENTIFIERS/OPEN-ENDED TERMS				16. SECURITY CLASSIFICATION (This page) Unclassified (This report) Unclassified	
				17. NUMBER OF PAGES	
				18. PRICE	

