

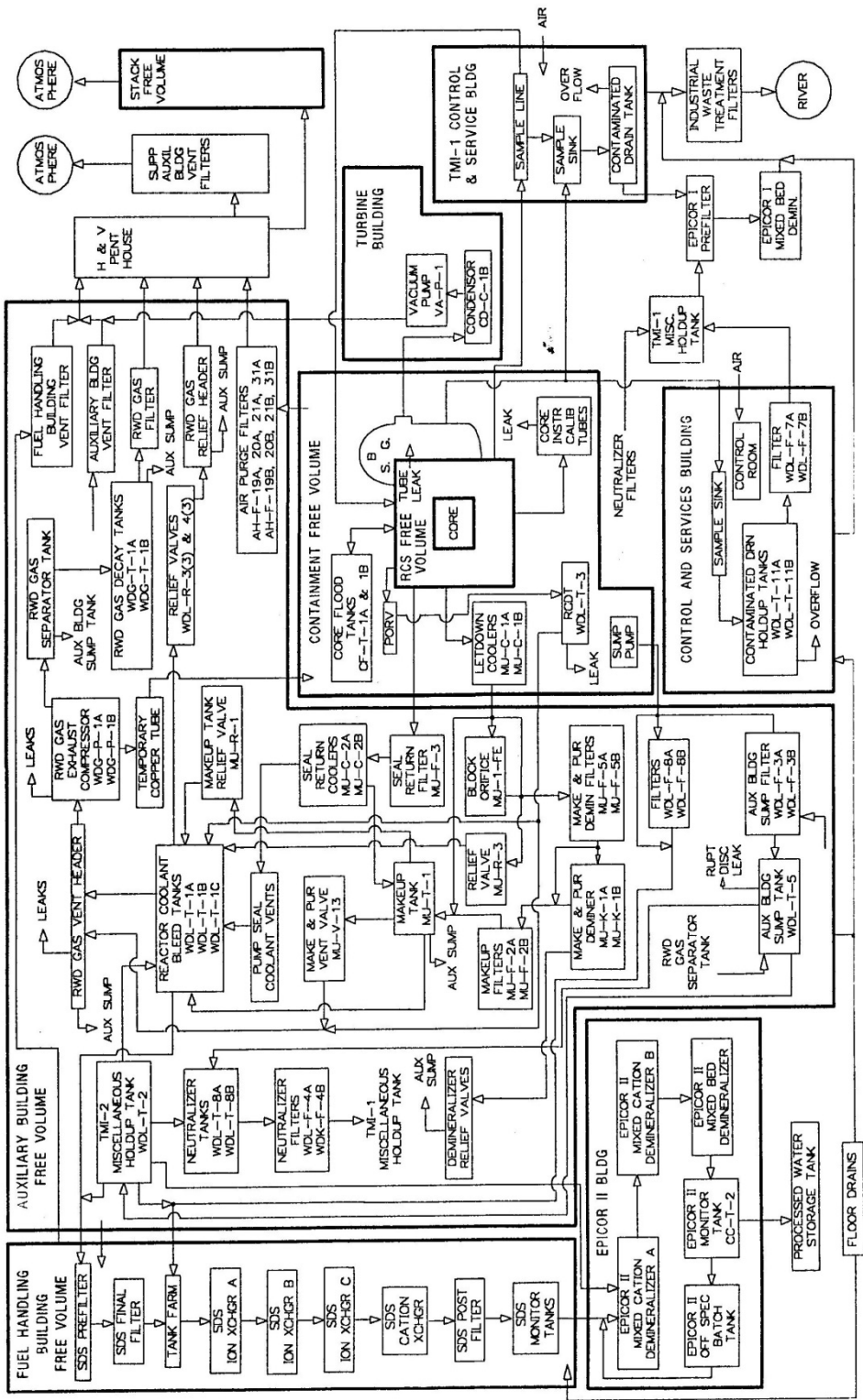

Three Mile Island Accident of 1979 Knowledge Management Digest

Recovery and Cleanup

NUREG/KM-0001, Supplement 1
Office of Nuclear Regulatory Research



TMI-2 radioactive material location map (see GEND-057).

Contents

Digital Versatile Disc (DVD) Contents	v
1 Introduction	1
2 Management and Oversight	7
3 Plant Stabilization	41
4 Worker Protection	69
5 Data Acquisition and Analysis	81
6 Waste Management	101
7 Decontamination	131
8 Defueling	147
9 After Defueling	179
10 Postscript	195
11 DVD Navigation and Interpretation	199
12 Contributions to Supplement 1	203
13 Endnotes	205



On April 15, 1990, the last rail shipment of fuel debris packaged in three Model 125-B shipping casks departs Three Mile Island for the Department of Energy's Idaho National Engineering Laboratory.



Above: First entry into the reactor building (shown) occurred on July 23, 1980. Heavy duty outerwear provided high-energy beta ray protection. Below: Water level in the basement of the reactor building reached the first stairwell landing indicating about 8 feet of water accumulation. One-third of this highly radioactive water came from leakage of non-radioactive river water coolant from a leaking reactor building air-handling cooler.



Digital Versatile Disc (DVD) Contents

Supplement 1, Disc 1 (NUREG/KM-0001, DVD-2) Folder

Status and Summary Reports

TMI Program Office Weekly Status Reports	4a-TMIPO
NRC Preliminary Notifications	4b-PN
Licensee Event Reports	4c-LER
NRC Status Reports	4d-NRC
NRC Annual Reports	4e-Annual
DOE/National Laboratory Status Reports	4f-DOE
DOE/National Laboratory Conference Papers	4g-DOE-CONF
GPU Status Reports	4h-GPU
Other Status Reports	4i-Other

Licensing Actions

Operating License Amendments	5a-OL Amend
Orders	5b-Order
Order Amendments	5c-Order-Amend
Regulation Exemptions	5d-Exemption
Recovery Operations Plan Changes	5e-ROP-Change
Organization Plan Changes	5f-OP-Rev

Management and Oversight

General Management and Oversight	6a-Plans
Commission/Licensee Correspondence	6b-Commission
Commission SECY Papers/Staff Requirements	6c-SECY
Advisory Groups	6d-Advisory
Guidance-PEIS	6e-Guide-PEIS
General Project Design Criteria	6f-Design

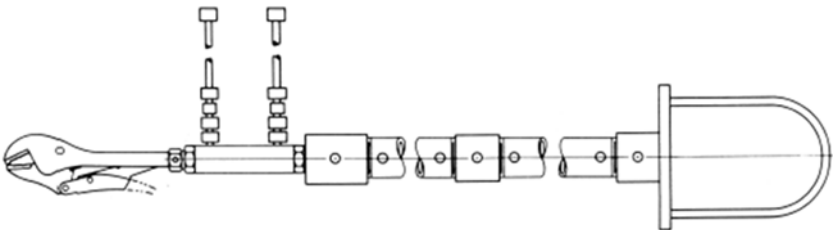

One of many attachments to long-handled defueling tools used to move core debris in the reactor vessel.

Supplement 1, Disc 2 (NUREG/KM-0001, DVD-3) Folder

Plant Stabilization

General Plant Stabilization	7a-Stabilization
Planning Meetings	7b-Meeting
Recovery Procedures	7c-Procedure
Industry Advisory Group Reports	7d-IAG-Report
Reactor Building Entries	7e-RB-Entries

Worker Protection

8a-Protection

Data Acquisition and Analyses

Recovery Data Analyses	9a-Data-Recovery
Accident Data Analyses	9b-Data-Accident
Instrumentation and Electrical Evaluations	9c-Data-Equipmt
Criticality Analyses	9d-Criticality

Decontamination

11a Decon

Supplement 1, Disc 3 (NUREG/KM-0001, DVD-4) Folder

Waste Management

General Waste Management	10a-Waste
Water Processing: EPICOR	10b-EPICOR
Water Processing: SDS	10c-SDS
Solid Waste	10d-Solid

Defueling

12a-Defuel

After Defueling

13a-Post-Defuel

Pre-Accident: Plant References

Final Safety Analysis Report	14a-FSAR
System Descriptions	14b-Sys-Desc
Plant Procedures	14c-Procedure
Other Plant References	14d-Other



Above: Close up view of the upper grid rib section where fuel bundles were once held in place. Indication of melting of the stainless steel ribs was observed during an inspection of the underside of the upper plenum as it was lifted from the reactor vessel. Below: Broken fuel rods in the void area at the top of the damaged reactor core.

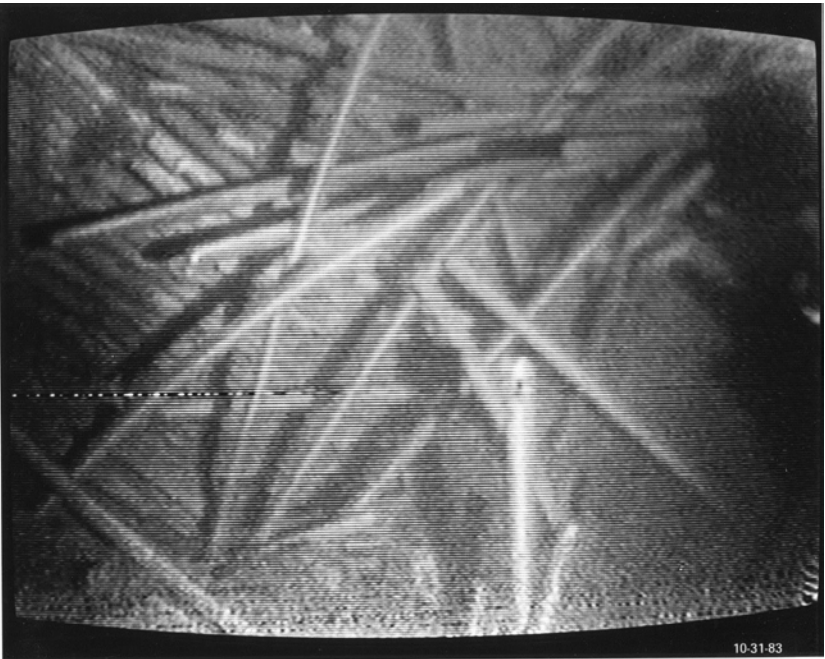

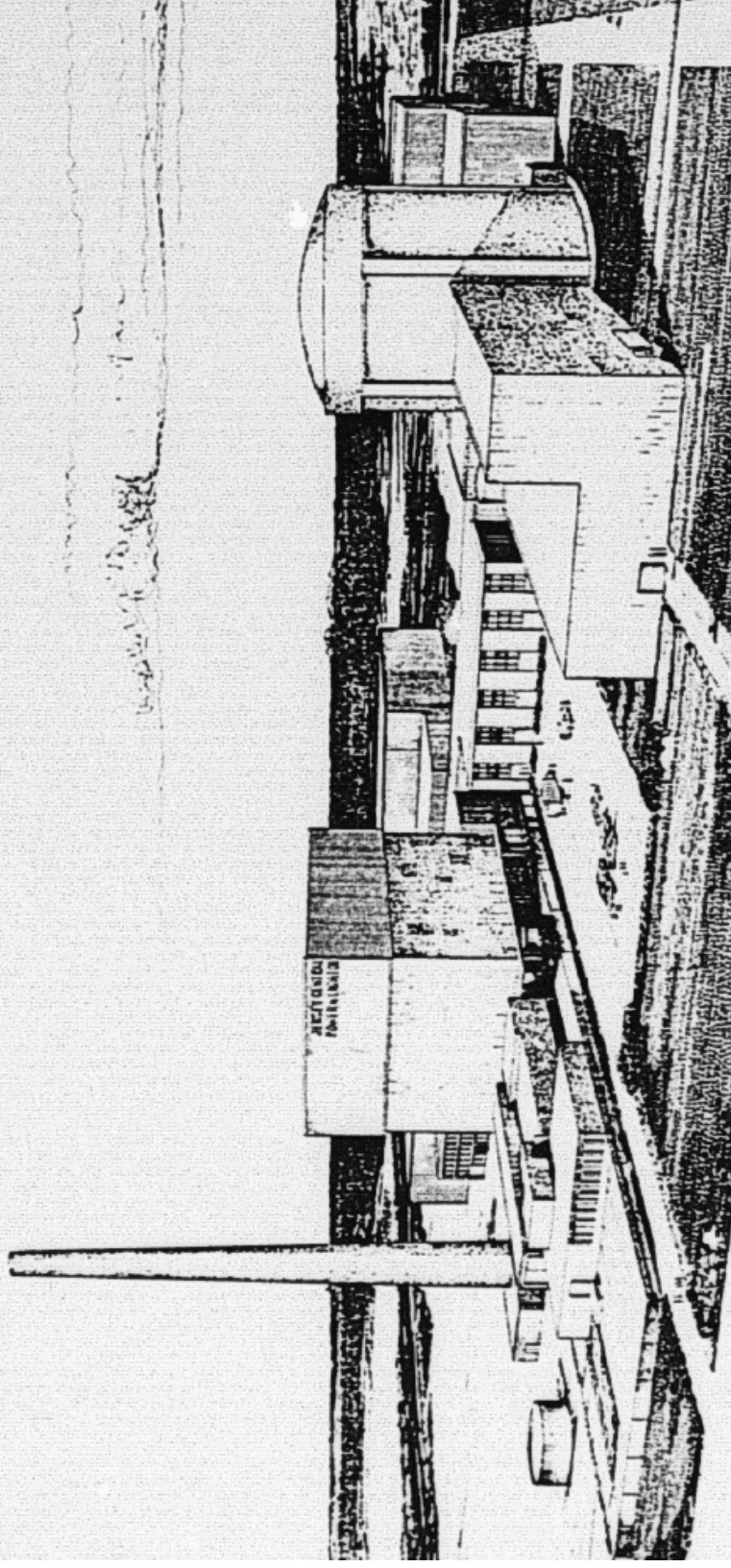

Oyster Creek Unit 1 (left) and the proposed Unit 2. In 1968, Jersey Central Power and Light Company applied for a reactor construction permit for the proposed unit. Instead, the plant was built on Three Mile Island adjacent to Unit 1. The new application included Metropolitan Edison and Pennsylvania Electric as additional owners.

1 Introduction

The safe, expeditious recovery and cleanup of Three Mile Island Unit 2 (TMI-2), including removal of the fuel from the accident-damaged reactor, were necessary for the long-term protection of public health and safety and the environment. The cleanup campaign ensured that the TMI site did not become a long-term or permanent waste repository.¹ The recovery activities that unfolded at TMI-2 in the weeks and months (and then years) after the March 28, 1979 accident were the result of a multi-organizational effort that included hundreds of dedicated and highly-skilled individuals.

Implementation of recovery and cleanup activities was the responsibility of the licensee with support from their many contractors. Organizations that supported the licensee included the original architect engineers of TMI Units 1 and 2 (Gilbert Associates and Burns and Roe, respectively²); the TMI-2 nuclear steam supply system vendor (Babcock & Wilcox); many volunteers from other nuclear power plants; the U.S. nuclear industry; and several international organizations.³

The U.S. Nuclear Regulatory Commission (NRC) was responsible for the regulation of TMI-2 cleanup operations to ensure the health and safety of the public, and the TMI-2 occupational workforce, as well as the protection of the environment.⁴ The U.S. Department of Energy (DOE) was responsible for supporting an extensive research program, as directed by the U.S. Congress. In addition, DOE agreed to the removal and disposition of the entire reactor core for research, as well as certain solid nuclear wastes generated during the cleanup of TMI-2.^{5, 6, 7, 8} The DOE and its national laboratories provided much-needed technical support to the licensee and the NRC in almost every aspect of the many TMI-2 research and recovery programs.⁹ The environmental agencies and nearby communities from the states of Pennsylvania and Maryland were responsible for ensuring that water qualities of the Susquehanna River and the downstream Chesapeake Bay were not adversely impacted by the damaged plant, or by the cleanup activities.¹⁰

Need for Cleanup. The NRC's Programmatic Environmental Impact Statement (PEIS) related to decontamination and disposal of radioactive waste resulting from the TMI accident (NUREG-0683) concluded that the decontamination of the TMI-2 facility, including the removal of the nuclear fuel and radioactive waste from the TMI site, was necessary for the long-term protection of public health and safety. The PEIS also concluded that methods existed, and could be suitably adapted to perform the cleanup operations with minimal releases of radioactivity to the environment.¹¹

The cleanup operations removed sources of potential radiation exposure that posed risks to the health and safety of the workers and the public. Accident-generated radiation sources were present in the form of airborne contamination; contaminated waste water; absorption of radioactive material on building and equipment surfaces; contaminated sludge in tanks, sumps, and building basement floors; contaminated filter cartridges and demineralizer resins; and damaged fuel and reactor components. As long as radioactive water occupied sumps and tanks, there existed a possibility of leakage into the groundwater, and subsequently, into the Susquehanna River. The contaminated water was also a source of direct radiation to workers requiring access to buildings in order to perform critical maintenance and repairs needed to keep the reactor in a safe-shutdown condition.¹²

The PEIS categorized cleanup into four fundamental activities: building and equipment decontamination; fuel removal and decontamination of the

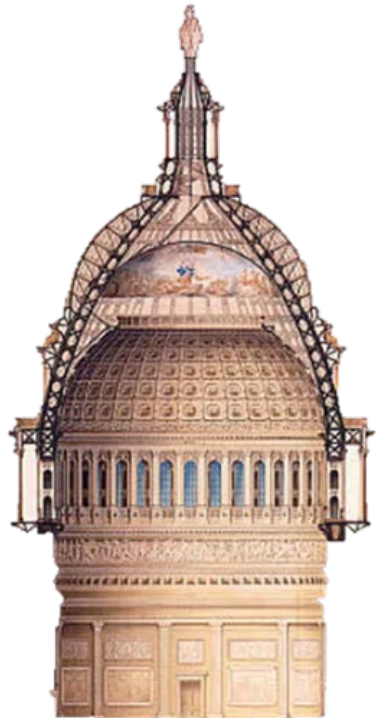
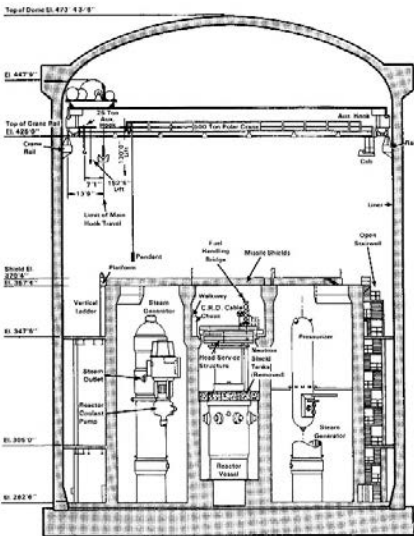

TMI-2 reactor building: a comparison (approximately to scale). The TMI-2 reactor building is 130 feet in diameter and rises 191 feet from the floor to the dome, with a volume of about 2.4 million cubic feet. The U.S. Capitol Rotunda is 96 feet in diameter and rises 180 feet from the floor to the canopy, with a volume of about 1.3 million cubic feet.

primary coolant system; treatment of radioactive liquids; and packaging, handling, storage, and transportation of radioactive solid wastes.¹³

About This Supplement. The main objective of this supplement is to provide key historical documents in electronic format that were issued during the recovery and cleanup efforts. Brief overviews of various structures, systems, equipment, and activities that were associated with the recovery and cleanup of TMI-2 are provided in the written portion of this NUREG/KM to describe the contents of the many document collections in the accompanying DVDs.

Thorough overviews of the TMI-2 recovery and cleanup, including lessons learned, can be found in the Electric Power Research Institute (EPRI) report, “The Cleanup of Three Mile Island Unit 2, A Technical History: 1979 to 1990” and the special volume of the *Nuclear Technology* journal of the American Nuclear Society documenting 138 papers presented at the TMI-2 topical meeting in 1988.^a

The seven major aspects of the recovery and cleanup, as presented in the EPRI report, were used to organize the contents in this supplement into the following sections: management and oversight; plant stabilization; worker protection; data acquisition and analysis; radioactive waste management; decontamination; and defueling; an additional section on after-defueling activities follows. This supplement chronicles those activities, which began a week following the accident, and ended with the completion of disposal of accident-generated water, and entry into post-defueling monitored storage in 1993.

The document collections in this supplement were mainly derived from publicly available correspondence, including attached reports, between the licensee and the NRC, and the results of research activities sponsored by the NRC and DOE. In all, the accompanying DVDs contain about 4,000 documents. Although an attempt was made to find and include a wide range of key documents, the collections provided on the DVDs are not complete. As such, a document collection might not provide a complete chronology of recovery, cleanup, and regulatory actions. A listing of documents in each document-collection folder is provided in spreadsheet format on each DVD (see the DVD folder, [Common](#)). Also, a list of more

^a EPRI-NP-6931 and many of EPRI’s historical reports on the TMI-2 accident and cleanup are currently (at the time of this publication) available from the EPRI’s website. Individual papers from *Nuclear Technology*, Vol. 87, Nos. 1 through 4, are currently available from the American Nuclear Society’s website.

than 25,000 TMI-2 records indexed in the Public Legacy Library, dating from 1979 to 1999, is included in the spreadsheet.^b

How to Use this Supplement. A few suggestions for navigating through this supplement, and the many documents on the enclosed DVDs, are provided at the end of this NUREG/KM (see the section on [DVD Navigation and Interpretation](#)). Documents in the DVD folders, [Status and Summary Reports](#), [Licensing Actions](#), and [Management and Oversight](#), might be applicable to all sections in this supplement. The historical documents provided on the DVDs are for reference only, and are not official NRC records. End notes to this supplement provide filenames of the cited documents on the DVDs. The units of measure used in this NUREG/KM reflect those used in the original source reports. In some cases, conversions were provided in the original reports. Refer to the back cover for conversion factors and formulas.



TMI-2 reactor building under construction. Shown is the top dome of the reactor building. The Susquehanna River can be seen in the background.

^b Public Legacy Library of the NRC Agencywide Documents Access and Management System (ADAMS) provides bibliographic citations for earlier documents during the period from 1979 through 1999, which are available in microfiche formats. This library can be viewed from the NRC public website.

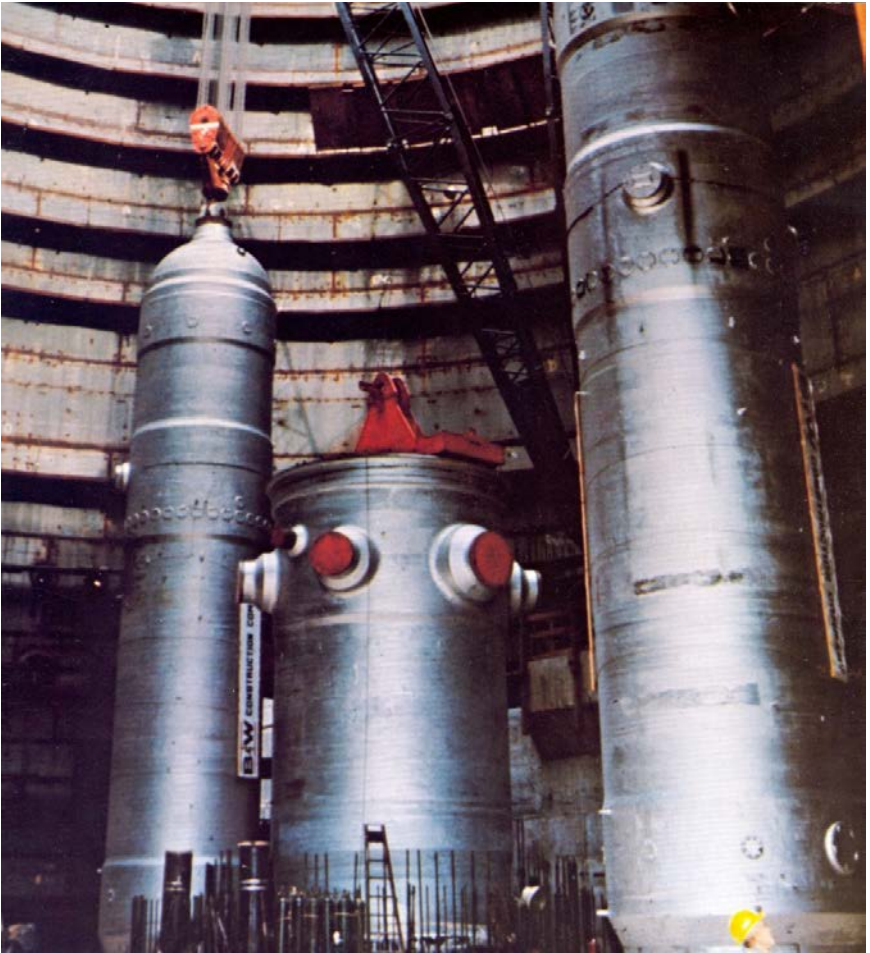

Installation of a reactor vessel and steam generators inside containment similar to the TMI-2 design. Concrete shielding structures will be build around these components. Notice the ladder next to the reactor vessel. (From a training visual aid from the Babcock & Wilcox Company, the fabricator of the primary reactor components at TMI-2.)



Above: NRC's Harold Denton (left) and Victor Stello briefing President Jimmy Carter, Governor Richard Thronburgh, and others at the Air National Guard Facility in Middletown, Pennsylvania. Below: Senior managers from the Office of Nuclear Reactor Regulation in the NRC office trailer at Three Mile Island. Left-to-right: Roger Mattson, Harold Denton, Denwood Ross (on telephone), and Victor Stello.



2 Management and Oversight

The NRC was responsible for the regulation and oversight of TMI-2 cleanup operations to ensure the health and safety of the public, and the TMI-2 occupational workforce, as well as the protection of the environment. Implementation of recovery and cleanup activities was the responsibility of the licensee with support from their many contractors.¹⁴ NRC's involvement covered two major areas: approving the recovery methods employed by the licensee and responding to public concerns over radiation exposure resulting from the accident and cleanup activities.¹⁵ In addition, the TMI-2 license remained under the regulatory requirements of an operating reactor (Title 10, "Energy," of the *Code of Federal Regulations* (10 CFR) Part 50, "Domestic Licensing of Production and Utilization Facilities"); many formal licensing actions were required to modify the pre-accident operating license to reflect the safety requirements of the plant in its unique shutdown condition.¹⁶

Initially, the NRC did not have any specific guidelines or criteria pertaining to the recovery effort but followed its traditional regulatory practices of reacting to licensee proposals. This process sometimes required a time consuming and iterative exchange of written correspondence for questions and answers. Some actions required the majority approval of the NRC Commissioners, even for minor technical and radiological problems.¹⁷ At the end of the first year after the accident, it became apparent that a new approach was needed for maintaining the TMI-2 license during the cleanup and NRC oversight of the licensee. This approach consisted of an increased onsite presence, as well as a new decision-making process for NRC approval of cleanup activities.¹⁸ The PEIS provided the environmental impact bases for all cleanup activities; the Commission policy statement that endorsed the PEIS provided staff with the authority to approve most cleanup activities.¹⁹

The NRC accomplished its regulatory responsibilities for all post-accident operations at TMI 2 through licensing actions; safety evaluations of recovery and cleanup activities; inspections; daily interactions with the licensee and their contractors; communications with State and local governments and the public; coordination with other Federal agencies involved in the cleanup; and sometimes direction from the NRC Commissioners by majority vote. Formal licensing actions were required for proposed changes to NRC orders, the facility license, technical specifications, the recovery operations plan, the organization plan, and exemptions to regulations.²⁰

The licensee’s organizational structure and functions changed as the cleanup progressed through various stages of the recovery effort. Plans, schedules, resources, and cost estimates changed as more information became known about the condition of the damaged reactor core; reliability of plant systems and structures; and radiological characterization of accident-generated water, building structures, reactor components, and systems. Various organizations formed working groups to provide guidance on tackling specific issues, problems, and research activities. Independent oversight groups reviewed, monitored, and advised on the overall direction of recovery and cleanup plans and activities.²¹ NRC staff attended meetings conducted by the licensee’s working groups and independent oversight groups.²²

The licensee and its contractors made changes to the facility in order to stabilize the reactor and clean up the damaged plant. New facilities and systems were built, and existing ones were used in different capacities than

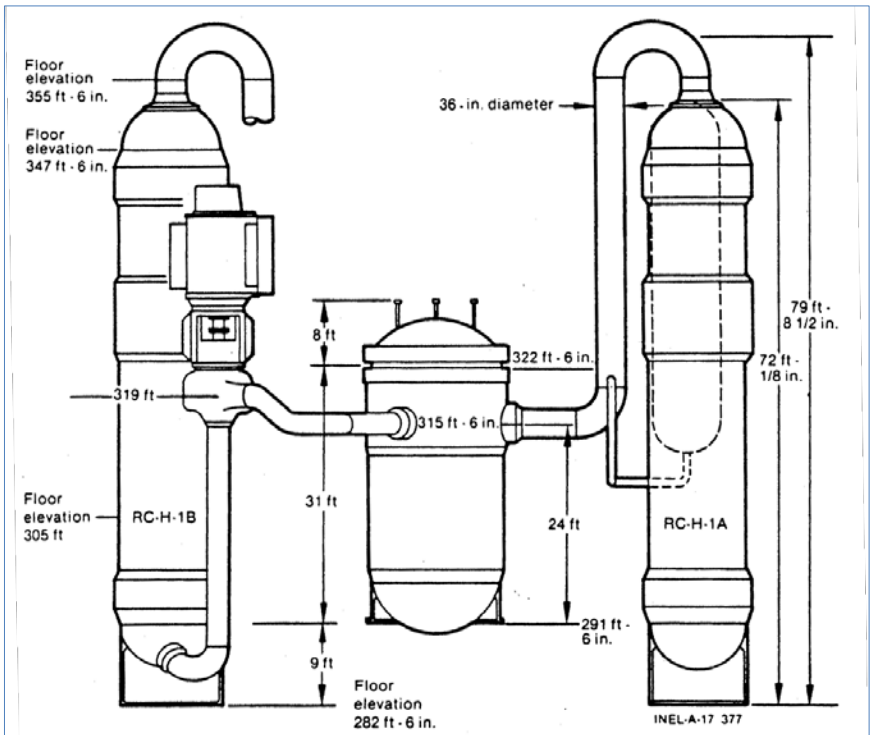

Side view of reactor coolant system components. Shown are the reactor vessel (center), both once-through steam generators (left and right), one of four reactor coolant pumps (upper left), both hot-legs (or “candy canes”) from the reactor vessel to top of the steam generators, and one of four cold-legs (or “J-legs”) from the bottom of the steam generators to the reactor coolant pumps.

those for which they were originally designed and approved. The changing configuration and operation of the damaged plant during the cleanup stages required changes to licensing documents. These changes imposed new requirements to ensure safety and eliminated pre-accident requirements that no longer applied to the shut-down plant.²³ To implement these changes, the licensee developed formal documents such as plans, system description reports, safety analysis reports, technical evaluation reports, environmental assessment reports, experiments, and procedures. Formal documentation was required for most, if not all, data-collection and cleanup activities.

Report of the Special Task Force on TMI Cleanup. Eight weeks before the first anniversary of the accident, a special NRC task force reported a variety of resource, policy, legal, and technical factors that could adversely influence, if left unchanged, the forward motion of the cleanup process and schedule. The task force observed frustration with the pace of the cleanup; the lack of interim criteria for the conduct of daily activities pending completion of the Programmatic Environmental Impact Statement (PEIS); the tedious NRC decision-making process; erosion of what was once a high-priority program; and strong public opinion on cleanup activities. In their report to the NRC Executive Director of Operations (EDO) on February 28, 1980, the task force made 15 recommendations stemming from their quick (9-day) evaluation of cleanup operations.

The next day, the report was endorsed by the EDO and forwarded to the Commissioners with commitments to: (1) establish conservative interim criteria and a proper level of authority for staff decisions to permit small radiological releases associated with plant maintenance and data-gathering activities pending PEIS completion; (2) expedite the completion of assessments supporting the purging of radioactive gases from the reactor building and the completion of the PEIS; (3) increase permanent staffing of the NRC's Middletown office and onsite support group, including a full-time spokesperson to keep State and local government officials and the public informed on a continuing basis about the progress and the status of cleanup operations and about future plans; (4) transfer assignments to prepare environmental assessments to headquarters; and (5) prepare a plan and a schedule of activities for proceeding with the cleanup.²⁴

The NRC Commissioners took actions that addressed other concerns expressed by the Special Task Force. The Commissioners approved by majority vote the interim criteria for radiological releases from data gathering and maintenance activities ([SECY-80-175](#) and [NUREG-0681](#)), a contingency plan for cleanup in case of the financial failure of the licensee ([SECY-80-416A](#) and [NUREG-0689](#)), and the formation of the NRC

Advisory Panel for the Decontamination of TMI-2. In their April 27, 1981 policy statement that endorsed the PEIS, the Commissioners stated how and by whom major cleanup decisions would be made after the PEIS was complete, as well as the expected role of the PEIS in making those decisions. The Commissioners also stated that the licensee should accelerate the pace of the cleanup and that they expected to receive continuous advice from the TMI-2 Advisory Panel on major activities required to accomplish expeditious and safe cleanup of the TMI-2 facility.²⁵

Document collections provided under the Management and Oversight category include Commission Actions, Licensing Actions, Planning and Guidance, and collections from the Advisory Groups and from the NRC's TMI Project Office. Key documents in these document collections are summarized below.

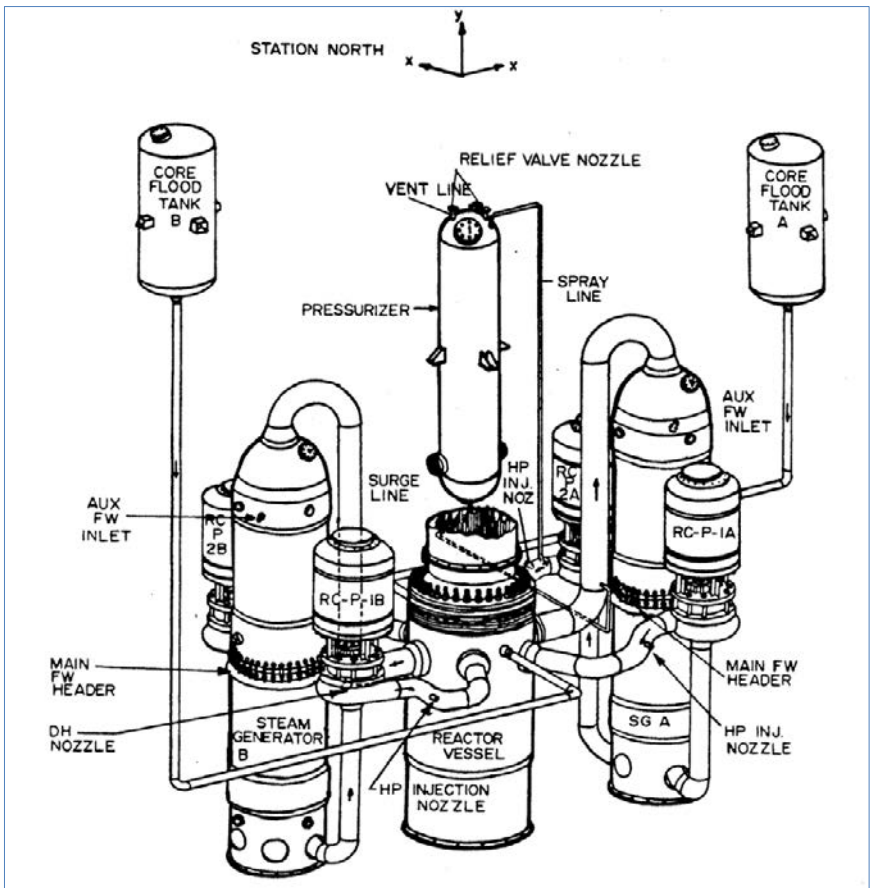

Isometric view of the reactor coolant system components.

Commission Actions. The five NRC Commissioners (also known collectively as the “Commission”) sometimes took actions to direct NRC staff to take certain licensing actions relating to policy issues. Issues before the Commission are decided by majority vote. The Commission’s decision-making tools used during the TMI-2 recovery and cleanup included policy statements, Commission orders, SECY papers, staff requirement memoranda, and general correspondence.

- **Policy statements.** A “Statement of Policy” is not a regulation and does not impose specific regulatory requirements, but rather, provides the Commission’s rationale and motivation for future regulatory positions. Several policy statements that the Commission issued were directly applied to TMI accident investigation and recovery activities. These Commission policy statements (provided in the DVD folder, [Policy Statements](#)) are summarized below:
 - On May 25, 1979, the Commission directed staff to prepare an environmental assessment, with opportunity for public comment, regarding proposals to decontaminate and dispose of radioactive contaminated waste water. The Commission’s statement required assessments on decontamination of intermediate-level waste water using the EPICOR II system; alternatives to discharge of waste water into the Susquehanna River; and decontamination and disposal of high-level waste water. The statement permitted discharge of pre-accident waste water decontaminated by the



The five NRC Commissioners participated in an all-day public hearing in Harrisburg, PA on November 9, 1982. Residents and community groups in the Three Mile Island area were invited to express their views and concerns regarding the future of TMI-2. Shown (left to right), Commissioners Roberts and Ahearne, Chairman Palladino, and Commissioners Gilinsky and Aselstine.

existing EPICOR I decontamination system and discharge of industrial waste water (water slightly contaminated because of leakage from secondary plant service support systems), as consistent with the facility operating license and NRC regulations. However, restrictions were imposed on the allowed discharges of EPICOR I and industrial waste water, the discharge of other (accident) waste water, and the operation of EPICOR II.²⁶

- On November 21, 1979, the Commission directed staff to prepare a programmatic environmental impact statement (PEIS) on the decontamination and disposal of radioactive waste resulting from the accident.²⁷ There were no identifiable legal requirements of the Atomic Energy Act of 1954, as amended, that required different radiological release criteria be applied to the cleanup of TMI-2 than were applied to an operating plant. In keeping with the purposes of the National Environmental Policy Act (NEPA), the Commission decided to prepare a PEIS on the decontamination and disposal of TMI-2 radioactive wastes.²⁸ Under the terms of the policy statement, the Commission stated that development of the

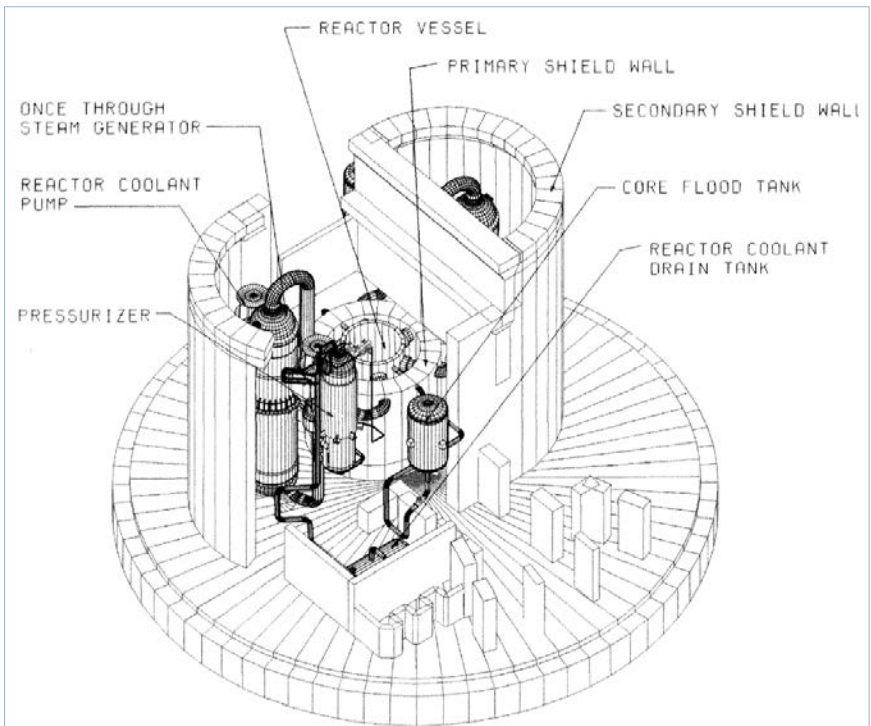

A computer generated cut-away drawing of the reactor building showing reactor coolant system components and "D-Ring" concrete radiation shields.

programmatic statement would not preclude prompt Commission action when needed. Such prompt actions would require consideration of the advice of the Council on Environmental Quality about the Commission's NEPA responsibilities and would require an environmental review with opportunity for public comment (in accordance with the May 25, 1979 policy statement). The policy statement also allowed rapid action for an emergency situation. In this situation, the Commission would consult the Council to the extent practical.²⁹

- On September 26, 1980, the Commission issued a policy statement concerning the Pennsylvania Public Utility Commission's order to the licensee to cease and desist from using any operating revenues for cleanup and restoration costs at TMI-2 which were not covered by insurance. The NRC Commissioners emphasized that all NRC health, safety, and environmental requirements applicable to TMI-2 must be fully complied with by the licensee, regardless of whether or not these requirements appeared to conflict with the Utility Commission's order.^{30, 31}

- On April 27, 1981, the Commission issued a policy statement endorsing the final Programmatic Environmental Impact Statement (NUREG-0683) related to the decontamination and disposal of radioactive wastes resulting from the accident. The Commission stated that the licensee should accelerate the pace of the cleanup to complete expeditiously all decontamination activities, consistent with ensuring protection of public health and safety, and the environment. The policy statement also indicated that, as the licensee proposed specific major decontamination activities, the NRC staff would determine if these proposals, and associated impacts that were predicted to occur, fell within the scope of those already assessed in the PEIS. With the exception of the disposition of processed accident-generated water, (which the Commissioners wanted to decide on later), the staff was allowed to act on each major cleanup activity without the Commission's approval if the activity and associated impacts fell within the scope of those assessed in the PEIS. The policy statement required the staff to keep the Commission informed of staff actions before staff approval of major activities. Further, the statement indicated that the cleanup should be carried out in accordance with the criteria in Appendix R of the PEIS, "Proposed Additions to Technical Specifications for TMI-2 Cleanup Program," as well as in conformance to the existing operating license, and previously-imposed orders. The Commission

expected to receive continuous advice from the Advisory Panel on the Decontamination of TMI-2 regarding major activities required to accomplish expeditious and safe cleanup of the TMI-2 facility.³²

- **Commission orders.** Commission orders address appeals or motions before the Commission in such matters as amendments to nuclear facility licenses, license transfers, license renewals, and enforcement

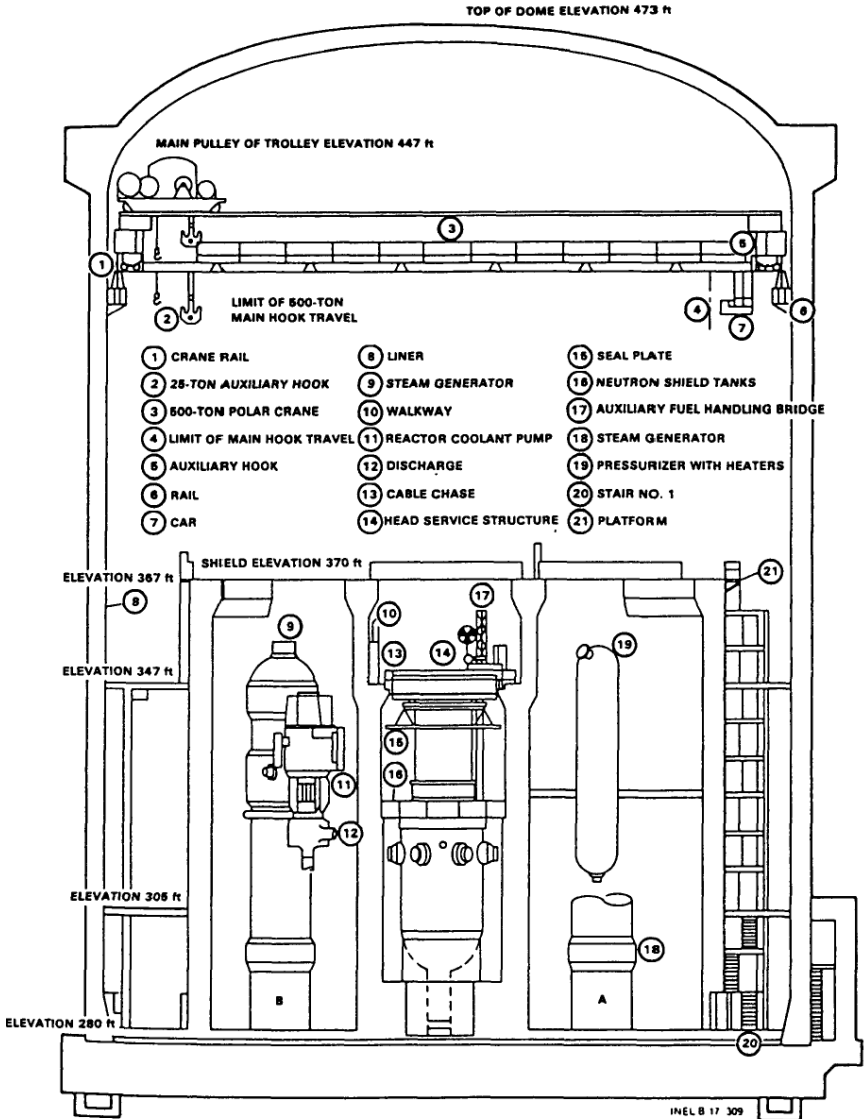

Components inside the reactor building.

matters.³³ Two Commission orders resulted in the modification of the operating license at TMI-2 to require prompt operation of the EPICOR II system to decontaminate intermediate-level radioactive waste water in the auxiliary building, and to release krypton-85 from the reactor building's atmosphere by controlled purging (see discussions below).^{34, 35} These orders also resulted in amendments to the technical specifications. These orders are summarized later in this section and provided on the DVD (see the DVD folder, [Orders](#)).

- ***SECY papers and staff requirements memoranda.*** The primary decision-making tool for the Commission is a written issue paper submitted by NRC staff to the Commission. Policy, security, rulemaking, adjudicatory matters, and general information are provided in a stylized document referred to as a “SECY Paper.” After the Commissioners vote on a SECY Paper, the Office of the Secretary (SECY) records the decision in a memorandum to the staff called a “Staff Requirements Memorandum” (SRM), and also issues a “Commission Voting Record” which includes the record of votes and individual views of the Commissioners.³⁶ SRMs may be issued following Commission meetings to document any discussion or requests made at the meeting. Many of the SECY papers and SRMs related to the TMI-2 recovery and cleanup efforts and found in the public record are provided on the DVD (see the DVD folder, [Commission SECY Papers/Staff Requirements](#)).
- ***General correspondence.*** The Chairman is the official spokesperson for the agency. On a few occasions, the Chairman exchanged correspondence with licensee corporate executives. The examples of such correspondence that were found in the public record are provided on the DVD (see the DVD folder, [Commission/Licensee Correspondence](#)).

One notable letter from the NRC Chairman to the President of General Public Utilities (GPU) Corporation, dated January 12, 1981, responded to an earlier letter from GPU concerning near-term planning of the cleanup of TMI-2 in light of an order issued by the Pennsylvania Public Utility Commission. The State agency ordered the licensee to cease and desist from using any operating revenues for cleanup and restoration costs which were not covered by insurance. The Commission responded by issuing a Statement of Policy on the matter (see above) which was discussed in the Chairman's response. In addition, the response provided a list of activities required to be performed during the period of ongoing discussions between the licensee and the State agency. The

list provided a “road map” of minimum activities required in the near-term to keep the TMI-2 reactor in a safe condition, and activities required to reduce potential threats over a longer term.³⁷

Licensing Actions. Changes in the facility’s post-accident mode of operations required unique regulatory and licensing actions. In order to properly reflect evolving plant status, the NRC issued orders, modified those orders, approved license amendment requests, and granted relief from certain regulatory requirements. Most of the NRC correspondence approving each licensing action (including the correspondence supporting

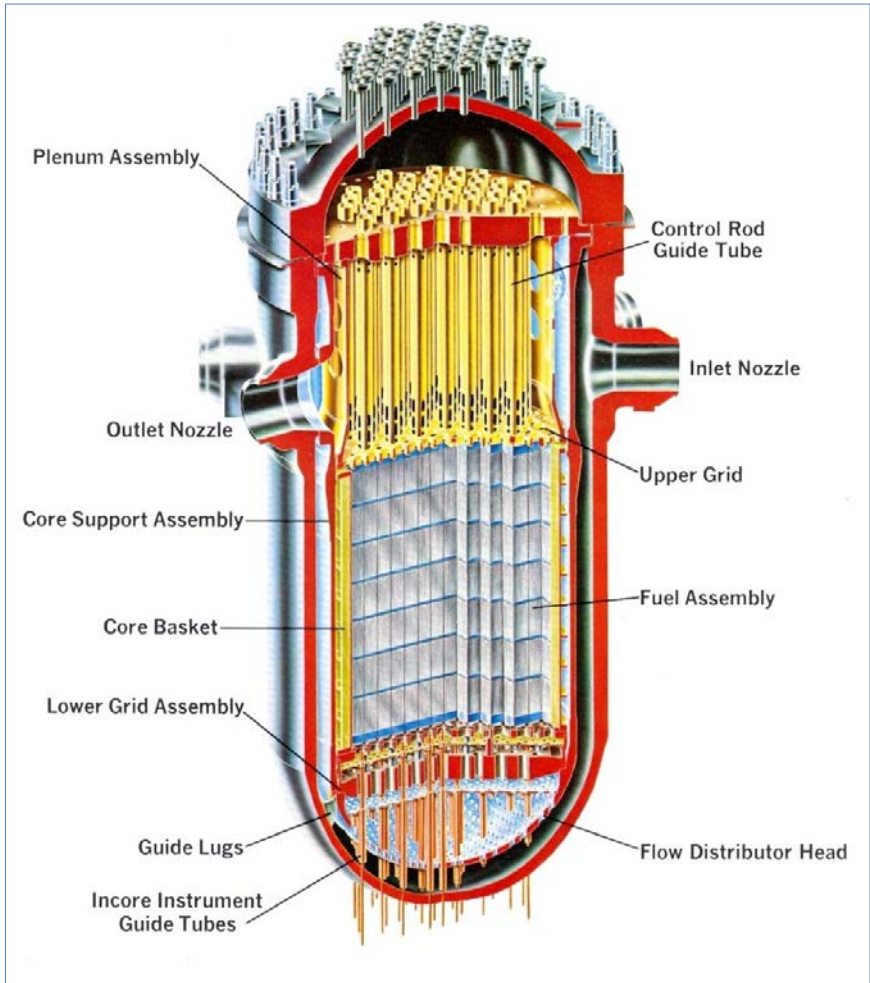

Internal view of the reactor pressure vessel at TMI-2. (From a training visual aid from the Babcock & Wilcox Company, the fabricator of the TMI-2 reactor vessel. This diagram was used to brief President Carter during his visit at TMI on April 1, 1979, see photo at the beginning of this section).

NRC safety evaluations and environmental reviews, where applicable) is provided on the DVD as indicated below:

- **Orders.** The Commissioners (by majority vote), or designated senior-level officials, may issue an order that directs the licensee to take a prescribed action. Key orders related to the recovery effort are summarized below. These orders are provided on the DVD (see the DVD folder, [Orders](#)).
- On July 20, 1979, an Order for Modification of License was issued to suspend the power operation of TMI-2 and require that the facility be kept in a shutdown condition, in accordance with NRC-approved operating and contingency procedures.³⁸
- On October 18, 1979, an Order for Modification of License was issued to require the licensee to promptly operate the EPICOR II filtration and ion-exchange decontamination system to decontaminate intermediate-level radioactive waste water held in tanks in the TMI-2 auxiliary building. The order further required the licensee to monitor EPICOR II discharge paths, maintain suitable tankage in TMI-1 as a contingency, and solidify spent resin before its shipment offsite.^{39, 40} The requirement to solidify resin was later removed in a modification to that order.⁴¹
- On February 11, 1980, an Order for Modification of License established new technical specifications governing operation of the facility in what was called a “recovery mode.” The proposed technical specifications (also known as “recovery technical specifications”) took into account the present condition of plant systems to ensure that the unit would remain in a safe and stable posture during the recovery mode.⁴² The order explicitly prohibited venting or purging, or other treatment of the reactor building’s atmosphere; the discharge of water decontaminated by the EPICOR II system; and the treatment and disposal of high-level, radioactively-contaminated water in the reactor building, until each of these activities had been approved by the NRC, in accordance with the Commission’s November 21, 1979 policy statement. The attached safety evaluation and environmental assessment explained that these activities could have been allowed under the same effluent limitations as would apply in the case of a normally-operating facility, had the Commission not determined that public interest warranted prohibiting these undertakings pending completion of an environmental review. The order provided that the

existing pre-accident technical specifications imposed for the protection of the environment (Appendix B to the facility operating license), including the established limitations on effluent releases and discharges, were unchanged and would remain in effect except as provided in the order. These prohibitions effectively precluded the planned release of any radioactive liquid and gaseous material from TMI-2 without prior Commission approval (by majority vote). Low-level solid waste, such as rags and clothing, generated during cleanup operations in the auxiliary building, was permitted to be transported offsite to a commercial, low-level radioactive waste burial facility.⁴³

The order did not change existing pre-accident Appendix B technical specifications, except that the licensee's pre-accident management organization for activities addressed by those specifications was replaced with sections in the proposed Appendix A technical specifications that addressed current requirements imposed on the licensee's management organization for all post-accident licensed activities.⁴⁴ The order proposed that



The reactor pressure vessel on its way for installation at TMI-2. (This photo was taken either during the loading operation at the Babcock and Wilcox fabrication facility in Mount Vernon, Indiana, or during the unloading near Havre de Grace, Maryland.)

the facility operating license would be formally amended to include the proposed technical specifications. As discussed later, this did not happen until many years later. The technical specifications originally proposed were documented in [NUREG-0432](#).⁴⁵ The related safety evaluation report and environment assessment were documented in [NUREG-0647](#).⁴⁶

- On June 12, 1980, an Order for Temporary Modification of License was issued to require the licensee to release krypton-85 from the reactor building's atmosphere by controlled purge. The order set offsite dose limits for the purge. The related final environmental assessment for the reactor building purge was documented in [NUREG-0662](#).⁴⁷
- On June 18, 1981, an order was issued to require the licensee to promptly operate the submerged demineralizer system with effluent polishing by the EPICOR II system to process the intermediate-level contaminated water in the auxiliary building's tanks, and the highly-contaminated water in the reactor building's sump, and in the reactor coolant system. The related safety evaluation report was documented in [NUREG-0796](#).⁴⁸
- ***Modification of orders.*** From time to time, some orders required modification to clarify language, or reflect changes in plant status, as a result of ongoing decontamination and maintenance efforts. The most overarching order that required numerous amendments was related to the proposed technical specifications. Although the NRC aimed to incorporate the proposed recovery technical specifications in facility operating license (Appendix A technical specifications to the facility operating license), several requests for a hearing were filed in connection with the order. After that time, discussions with the recognized parties led to mutual agreement in the areas of concern, and resulted in the resolution of all outstanding issues and the withdrawal of all petitions. On November 8, 1985, the NRC Atomic Safety Licensing Board issued an order terminating the proceeding. During the pendency of this matter, a number of changes in the proposed technical specifications were necessary, each requiring a Modification of Order.⁴⁹ Most modifications and related safety evaluations are provided on the DVD (see the DVD folder, [Order Amendments](#)).
- ***Changes to the recovery operations plan.*** The recovery operations plan defined the surveillance requirements to be performed to ensure equipment operability as required by the plant's technical specifications.

The recovery operations plan was included as Section 4 of the proposed technical specifications. However, the plan was not considered a part of the proposed technical specifications. As such, changes made to surveillance requirements were approved by NRC staff outside of a Modification of Order.⁵⁰ Some changes were issued concurrently with a Modification of Order, instituting corresponding changes to the proposed technical specifications. Approvals of most changes to the recovery operations plan are provided on the DVD (see the DVD folder, [Recovery Operations Plan Changes](#)).

- ***Changes to the organization plan.*** The licensee’s organization plan provided the organizational structure (e.g., charts) for management of TMI-2 recovery operations, including the support functions of engineering and administration. The plan was cited in the organization section of the proposed technical specifications. The NRC approved the licensee’s concept of providing charts of the TMI-2 recovery management in the organization plan, instead of the proposed technical specifications, so that future changes could be made effective in a timely manner. Changes made to the organization plan required NRC approval, but certain changes did not require a Modification of Order.⁵¹ The approvals of most changes to the organization plan are provided on the DVD (see the DVD folder, [Organization Plan Changes](#)).

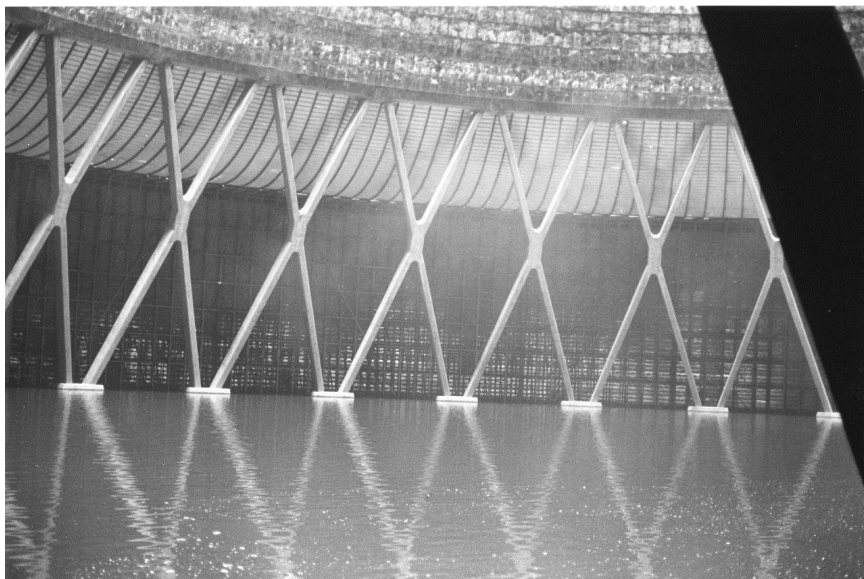

View of the cold-water basin inside a natural draft cooling tower at Three Mile Island. The cross columns support the curved concrete wall of the tower.

- ***Amendments of license.*** The TMI-2 facility operating license, which included the technical specifications, was amended, modified, extended, and transferred during the three decades following the accident. A chronology of key amendments is summarized below. Most amendment actions are provided on the DVD (see the DVD folder, [Operating License Amendments](#)).
- On March 12, 1980, Amendment No. 10 was issued to revise the Appendix B technical specifications relating to the operation of the EPICOR II filtration and ion-exchange decontamination system to decontaminate intermediate-level waste water held in tanks in the TMI-2 auxiliary building. This amendment was approved under the NRC Commissioners’ Order of October 18, 1979.⁵²
- On June 24, 1980, Amendment No. 11 was issued to approve a temporary change to Appendix B technical specifications relating to the bypassing of interlocks between the reactor building exhaust monitors and dampers during purging of the reactor building’s atmosphere. This amendment was approved under the NRC Commissioners’ Order of June 12, 1980.⁵³
- On December 30, 1981, Amendment No. 18 was issued to reflect that GPU Nuclear Corporation was added as the licensee for TMI-2 and replaced Metropolitan Edison Company as the licensee authorized to operate (maintain) TMI-2.⁵⁴
- On January 27, 1986, Amendment No. 26 was issued to formally incorporate the proposed “recovery mode” technical specifications that were established by the February 11, 1980, Order and subsequently modified numerous times. The amendment was allowed by the NRC Atomic Safety Licensing Board following the resolution of all outstanding issues and the withdrawal of all petitions related to the order. Changes to the recovery technical specifications now required a license amendment (except for changes to the recovery operations plan and organization plan, which continued to be approved through a separate process).⁵⁵
- On May 27, 1988, Amendment No. 30 was issued to extensively revise the technical specifications by aligning licensing requirements with appropriate plant conditions, through the remainder of the cleanup operations. Three facility modes were defined in the revision, which allowed transition from the defueling phase by incorporating technical specifications that were applicable

during specific phases or modes of the cleanup. These modes were as follows:⁵⁶

Mode 1: The reactor coolant shall be subcritical, with an average reactor coolant temperature of less than 200 degrees Fahrenheit.

Mode 2: This mode shall exist when the following conditions are met: (a) the reactor vessel and reactor coolant system are defueled to the extent reasonably achievable; (b) the possibility of criticality in the reactor building is precluded; and (c) there are no defueling canisters containing core material in the reactor building.

Mode 3: This mode shall exist when the conditions for Mode 2 are met, and no defueling canisters containing core material are stored on the TMI-2 site.

- On September 11, 1989, Amendment No. 35 was issued to modify the technical specifications, by deleting the prohibition for disposing of accident-generated water. The amendment retained the requirement for prior NRC approval of procedures associated with the disposal of the accident-generated water. The associated NRC safety evaluation approved disposal of the accident-generated water by evaporation, subject to restrictions.⁵⁷

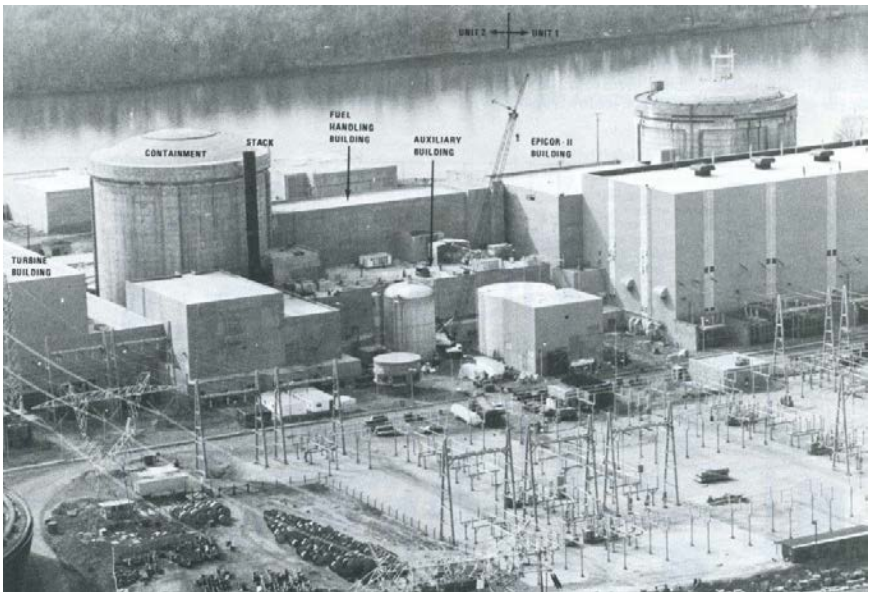

East view of TMI-2 buildings (left of TMI-1).

- On September 14, 1993, Amendment No. 45 was issued to modify the facility operating license to be a possession-only license. The NRC planned to issue the post-defueling monitored storage (PDMS) technical specifications after the licensee substantially satisfied the PDMS commitments and requirements.⁵⁸
- On December 28, 1993, Amendment No. 48 was issued to extensively modify the technical specifications in ways consistent with the licensee’s plans for post-defueling monitoring storage of the facility.⁵⁹
- On June 21, 1995, Amendment No. 49 was issued to extend the license until April 19, 2014, to allow both units at TMI to be decommissioned at the same time.⁶⁰
- **Exemptions.** The NRC granted exemptions from certain requirements of the regulations for nuclear power plants, but only under special circumstances as permitted in the regulation (see Title 10, “Energy,” of the *Code of Federal Regulations* (10 CFR) 50.12, “Specific Exemptions”). Exemptions were necessary at TMI-2 because of the plant’s damaged configuration and changing status during cleanup. The approvals of most exemptions are provided on the DVD (see the DVD folder, [Regulation Exemptions](#)).

Planning and Guidance. Planning and guidance documents that were essential to the formulation of recovery and cleanup plans and activities included the NRC’s Programmatic Environmental Impact Statement (PEIS); the NRC policy statement endorsing the PEIS; the licensee’s planning studies; the recovery quality assurance plan; and the general project design criteria document. These and other planning and guidance documents are summarized below. These documents and others, except as noted in the sections that follow, are provided in the DVD folder, [General Management and Oversight](#).

- **Planning Study for Containment Entry and Decontamination.** The licensee contracted Bechtel Power Corporation to develop a conceptual plan for reentry and decontamination of the reactor building. The primary objective of the July 2, 1979 report was to develop a plan for placing the reactor building in a configuration for removal of the reactor vessel head. The report provided an assessment of the reactor building’s radiation environment and the physical condition of (and degree of damage to) it; evaluated alternatives for reactor building

decontamination and reentry; and provided conceptual designs for new systems that may be needed to support reentry and decontamination.^{61, 62}

- ***Summary Technical Plan for TMI-2 Decontamination and Defueling.*** The licensee's plan for decontamination and defueling at TMI-2 was contained in their December 12, 1979 report, "Summary Technical Plan for TMI-2 Decontamination and Defueling." The technical plan identified the major steps to clean up the plant, which are as follows: (1) decontamination of the auxiliary and fuel handling building, including removal of contaminated water held in storage tanks and sumps; (2) decontamination of the reactor building, including removal of the radioactive, gaseous atmosphere and contaminated water in the sump; (3) reactor examination and defueling; (4) decontamination of the reactor coolant system; (5) radioactive waste processing, including construction of the EPICOR II system, submerged demineralizer system, and evaporator and solidification system; and (6) solid radioactive waste management.⁶³
- ***Interim criteria for radiological effluents from TMI-2 data gathering and maintenance operations (SECY-80-175).*** On April 14, 1980, the Commission approved radiological effluent criteria for the interim period before the issuance of the programmatic environmental impact statement for the purpose of data-gathering and maintenance operations. Releases which were specifically not covered by these criteria were purging of the reactor building's atmosphere, disposal of EPICOR II decontaminated water, and treatment and disposal of high-level, radioactively-contaminated water in the reactor building. The interim criteria provided a mechanism by which the licensee may request to make small radioactive releases resulting in data collection and maintenance operations. These criteria described the information that the licensee must submit to the NRC for approval before performing these operations, and the type of review that the staff will perform to approve each request.^{64, 65}

A lack of definitive release criteria hampered planning and engineering activities, resulted in a dilution of personnel resources to obtain specific Commission approval for activities that have insignificant impacts, and caused public concern over minor unplanned releases that would be inconsequential in a normal operating plant. An example of the former was the perceived need to obtain Commission approval to initially open the outer personnel air lock door which would release about 0.05 curie of radioactive krypton gas (see SECY-80-105⁶⁶). An example of the latter was the occurrence on February 11, 1980, in which the incidental

off-gassing of about 0.3 curie of radioactive krypton gas from a leaked primary water system caused considerable public concern (see NRC Preliminary Notification 80-03⁶⁷). To put these releases in perspective, TMI-2 had been releasing between 65 to 80 curies of krypton gas per month; at that time, a normal operating facility of this type may release over a 1,000 curies of radioactive gasses per month. In 1978, TMI-1 released an average of 1,300 curies of radioactive gasses per month.⁶⁸

- ***Report of the Governor's Commission on Three Mile Island.*** On May 14, 1979, Governor Richard Thornburgh of Pennsylvania established a special commission under the chairmanship of Lieutenant Governor William Scranton III to study and evaluate the consequences of the accident. The results of that commission's work were released on February 26, 1980, in a report entitled, "Report of the Governor's Commission on Three Mile Island." It contained a number of recommendations and findings aimed at protecting public health and safety in the wake of the TMI-2 accident. The seven-month investigation assessed the environmental, economic, health, legal, and social effects of the accident, and made recommendations for action or further study. One of the recommendations submitted to Governor Thornburgh was that Unit 2 be promptly decontaminated, under proper safety controls, in order to avoid possibly serious and uncontrolled releases of radiation.^{69, 70}
- ***Programmatic Environmental Impact Statement (PEIS).*** The NRC's PEIS related to the decontamination and disposal of radioactive wastes resulting from the accident ([NUREG-0683](#)), and three supplements to the PEIS were an important set of guidance documents for the NRC and licensee. The PEIS discussed the options and associated environmental impacts of four fundamental activities necessary to the cleanup: treatment of radioactive liquids; decontamination of the building and equipment; removal of fuel and decontamination of the coolant system; and packaging, handling, storing and transporting nuclear waste. The draft PEIS and supplements underwent comment periods by the licensee, Federal, State and local government agencies, and the public. The final PEIS was issued in March 1981.⁷¹

In terms of radiological health and safety, there was no known technical reason for the radiological release criteria to be more restrictive than had been acceptable at normal operating facilities. However, because of the unique characteristics of the cleanup operation that were not considered and evaluated in the pre-accident safety review of the plant, there was a need to define what keeping radiation exposure "as low as

reasonably achievable” or “ALARA” meant with respect to offsite releases and occupational exposures. The PEIS provided the basis for making that determination.⁷²

The PEIS had three supplements that were considered part of the original PEIS. (See the DVD folder, [Guidance-PEIS](#).)

- *Supplement 1, “Final Supplement Dealing with Occupational Radiation Dose.”* The earlier PEIS stated that the most significant environmental impact of cleanup activities at TMI-2 would result from the radiation dose to the cleanup work force. This supplement was issued in October 1984 to reevaluate the occupational radiation dose and resulting health effects from cleanup and to address additional alternative cleanup approaches using information gathered since the PEIS was prepared in 1980.⁷³
- *Supplement 2, “Final Supplement Dealing with Disposal of Accident-Generated Water.”* This supplement was issued in June 1987 to update the environmental evaluation of accident-generated water disposal alternatives published in the

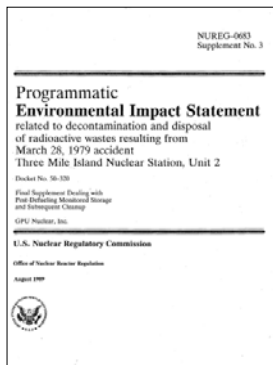
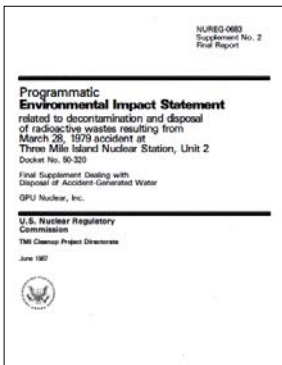
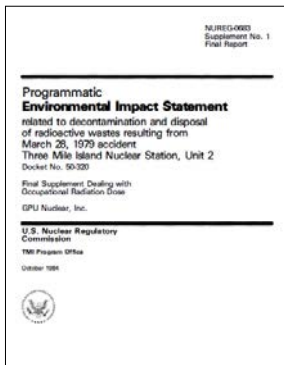
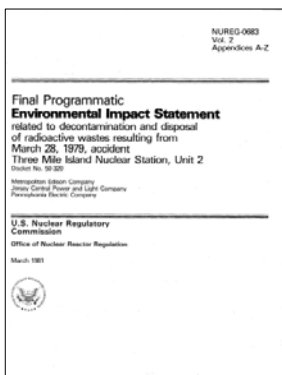
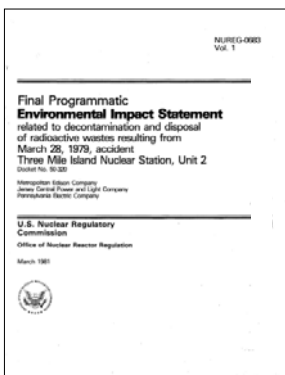

original PEIS, using more complete and current information. Also, the supplement included a specific environmental evaluation of the licensee's proposal for water disposition.⁷⁴

- *Supplement 3, “Final Supplement Dealing with Post-Defueling Monitored Storage and Subsequent Cleanup.”* This supplement was issued in August 1989 to evaluate the licensee's proposal to complete the current cleanup effort and place the facility into monitored storage for an unspecified period of time. The supplement provided an environmental evaluation of the licensee's proposal, and a number of alternative courses of action from the end of current defueling efforts, to the beginning of decommissioning. However, it did not provide an evaluation of the environmental impacts associated with decommissioning.⁷⁵

Because these reports were programmatic in-nature, the reports were not intended to provide a step-by-step work plan. However, the most probable sequences and methods for cleanup had been assumed in order to predict the resulting environmental impacts. The best available information had been used and documented in these impact analyses. Where uncertainties existed, conservative assumptions had been made and documented in the main text and appendixes as appropriate.⁷⁶

- ***NRC policy statement endorsing PEIS.*** On April 27, 1981, the NRC Commissioners issued by majority vote a policy statement endorsing the final PEIS. The policy statement concluded that the PEIS satisfied the NRC's obligations under the National Environmental Policy Act (NEPA). The policy statement also indicated that, as the licensee proposed specific major decontamination activities, the NRC staff would determine whether these proposals, and associated impacts that were predicted to occur, fell within the scope of those already assessed in the PEIS. With the exception of the disposition of processed accident-generated water (the Commissioners wanted to decide this issue later), the staff was allowed to act on each major cleanup activity without Commissioners' approval if the activity and associated impacts fell within the scope of those assessed in the PEIS. The policy statement required the staff to keep the Commissioners informed of staff actions before staff approval of major activities.⁷⁷
- ***TMI-2 Program Strategy.*** In June 1984, the licensee issued an internal technical plan, “TMI-2 Program Strategy,” that provided an overview of the recovery program, established program priorities, established policy and technical guidance, and provided the means for communicating the

program to external people and organizations. The report provided program policies that addressed the following issues: (1) generic issues, such as recovery program objectives; definition of program phases, priorities, and end points; use of the ALARA concept in decisions about radiation exposure; use of remote technology; application of regulations and regulatory guides; preservation of plant equipment and structures; permanence of recovery facilities; sharing of facilities and systems with TMI-1; and opening containment; (2) characterization of plant conditions, including data-gathering; (3) fuel control, such as criticality and reactivity control, accountability of fuel, definition of core waste, and fuel storage and disposal; (4) methods and end points for defueling; (5) disassembly and storage of large radioactive components, including primary system integrity; (6) decontamination and dose reduction, such as decontamination during the fuel-removal stage, criticality prevention during decontamination, worker efficiency, and re-flooding of the reactor building's basement; and (7) waste management, such as storage of waste and closure of commercial disposal sites, abnormal waste, reuse of processed water, and segregation of water at TMI-2.⁷⁸ (Note: The program strategy is not available on the DVDs.)

- ***Post-defueling monitored storage (PDMS) plan.*** This licensee report was submitted to the NRC on December 2, 1986, to provide a plan for plant conditions following completion of the cleanup program.⁷⁹ This initial plan was used to develop the proposed license amendment, proposed technical specifications, and safety analysis report for implementation of the proposed PDMS plant configuration. The request was submitted to NRC on August 16, 1988.⁸⁰ In response to the submittal, the NRC developed and issued Supplement 3 to the Programmatic Environmental Impact Statement (NUREG-0683), which dealt with PDMS and subsequent cleanup.⁸¹ The NRC issued the possession-only license on September 14, 1993, and issued the PDMS technical specifications on December 28, 1993.⁸² See further discussions on PDMS in the section on [After Defueling](#).
- ***Recovery quality assurance plan.*** This licensee plan ensured regulatory compliance for recovery and cleanup activities such as decontamination; assessment of damage; design; procurement; fabrication; handling; shipping; storage; cleaning; construction; installation; inspection; test; operation; maintenance; repair; and modification. This plan was periodically revised.⁸³ (See the DVD folder, [Guidance-PEIS](#).)
- ***TMI-2 radiation protection plan.*** This plan provided the philosophies, basic policies, and objectives of the licensee's program for radiological

controls in accordance with NRC regulations and guidance. The objectives of the radiological controls program were to control radiation hazards in order to avoid accidental radiation exposures, to keep exposures within their regulatory required limits, and to keep exposures of workers and the general population at ALARA levels. The plan was implemented within radiological controls procedures. The TMI-2 radiological controls program was fully-integrated into each phase of the recovery effort at TMI Unit 2. This plan was periodically revised.⁸⁴ (See the DVD folder, [Worker Protection](#).)

- **General project design criteria.** The general project design criteria document was developed by the licensee to provide an adequate basis for the design of recovery facilities and systems. The criteria included a general section that provided information common to all engineering disciplines. The general section defined the regulatory requirements; operating conditions; dose-reduction considerations; environmental considerations; sharing of existing facilities and services; and protection from severe natural phenomena and human-caused events. The discipline-specific sections provided detailed, generic criteria for architectural design; civil-structural design; control-system design; non-safety-related electrical design; mechanical design; and shielding design and access control. To ease the review of future submittals, the licensee requested that the NRC review the general section and subsequent revisions.⁸⁵ (See the DVD folder, [Guidance-PEIS](#). Early revisions of the discipline-specific sections were provided to the NRC for information only in the licensee's submittal dated December 22, 1981.)
- **Special nuclear material (SNM) accountability plan.** This licensee plan identified the methods and sequence of SNM accountability; the quality assurance program that was built into SNM measurement activities; and the areas, systems, and components that had undergone formal SNM measurement and those that did not require SNM assessment. SNM accountability is required of all licensee holders of reactor fuel and other SNM. As the result of the accident, the damaged fuel debris was dispersed throughout the plant, and the origin of the debris could not be traced to specific fuel assemblies. The NRC and DOE (receiver of the fuel debris) allowed the final SNM accountability for TMI-2 to be performed after defueling was completed.⁸⁶ Further, the NRC granted the licensee exemptions regarding regulatory requirements for record keeping, inventorying, and reporting of special nuclear, source, and byproduct materials.⁸⁷ Accountability was based on a thorough post-defueling survey of areas, systems, and components. The

results of materials accountability surveys and analyses were important in evaluating the potential for recriticality of the remaining fuel debris under postulated conditions during the plant's long-term, post-defueling monitored storage.⁸⁸ (See the DVD folder, [Guidance-PEIS](#); see also the DVD folder, [After Defueling](#) for post-defueling survey reports and post-defueling completion reports.)

- ***Licensed operator qualification and training procedures.*** These licensee procedures provided the processes and requirements for the training and certification of licensed operator candidates, and for the renewals of their licenses. Licensed operators included reactor operators, senior reactor operators, and fuel-handling-only (defueling) senior reactor operators. These NRC-approved training and qualification procedures reflected the unique and rapidly-changing plant conditions as recovery and cleanup progressed. As such, licensed operators were trained on new systems and defueling operations as part of their ongoing requalification training.^{89, 90, 91} Training of fuel-handling-only senior reactor operators began in December 1984. NRC granted fuel-handling-only licenses to the first five senior reactor operators in October 1985.⁹² (See the DVD folder, [Guidance-PEIS](#).)

Advisory Groups. Advisory and working groups were formed by GPU, the NRC, and the DOE to provide advice, and sometimes direction, on important recovery activities. Documents included in this collection (see the DVD folder, [Advisory Groups](#)) provide insights into the technical issues and problems encountered during plant recovery and cleanup. Some important advisory and working groups are summarized below:

- ***Industry Advisory Group (March 30 to May 6, 1979).*** The Industry Advisory Group of outside organizations and individuals was formed by the licensee three days after the accident to help determine plant conditions, and evaluate approaches to achieving a stable condition. The scope of the group was expanded to evaluate operations and modifications proposed by the recovery organization; to independently assimilate, integrate, and interpret plant status information and data; and to review detailed procedures for plant recovery operations. Once the formal TMI-2 recovery organization was established on April 4, 1979, the information flow between the Industry Advisory Group and elements of that organization was accommodated through the Technical Working Group (described below). Activities for the Industry Advisory Group were assigned by the Technical Working Group.⁹³ Some reports by the Industry Advisory Group are provided in the DVD folder, [Industry Advisory Group Reports](#).

- ***Technical Working Group (1979)***. The Technical Working Group was an executive-level committee established by the licensee a week after the accident to propose and discuss actions associated with daily operations. The managers of the newly-established TMI-2 recovery organization attended the initial twice-daily meetings to coordinate activities, assign task responsibilities, and obtain general agreement on activities for the 24-hour period following each meeting. Representatives from outside organizations, such as the TMI-2 nuclear steam supply system vendor (Babcock & Wilcox); the original TMI-2 architect engineer (Burns and Roe); the NRC; and the Industry Advisory Group, also attended these meetings. Licensee personnel chaired the meetings and were responsible for making the decisions, and a consensus was achieved in most cases. The NRC, by virtue of its legal authority to issue orders, did have the authority and therefore, the implicit responsibility, to override a decision whenever that seemed necessary.⁹⁴ The Technical Working Group’s daily meeting minutes for the first four months after the accident are provided on the DVD (see the DVD folder, [Planning Meetings](#)).
- ***Advisory Panel for the Decontamination of TMI-2 (1980 to 1993)***. In October 1980, the Commission established a 12-member TMI-2 advisory panel to consult with and provide advice to the NRC Commissioners and staff on major activities related to the decontamination and cleanup of TMI-2. The panel consisted of members from the Commonwealth of Pennsylvania, local government, and the scientific community, as well as residents in the vicinity of TMI. The NRC TMI Program Office (discussed below) acted as a liaison between the NRC and the TMI-2 advisory panel, and also provided information to the panel on the status of the cleanup. Panel meetings were open for the general public to attend and transcriptions were produced for the public record. The panel provided an outlet for the public, a way for the NRC and the utility to report on the progress of the cleanup and to gauge the public’s reaction to various alternative actions. The most crucial panel influence on cleanup activities was the increased public scrutiny of both NRC and licensee decisions and activities. The panel facilitated communication with the public for both the NRC and the licensee. This communication helped sensitize the agency and the licensee to public concerns. It also kept the cleanup before the NRC Commissioners through periodic meetings. Panel members traveled to Washington, DC at least once each year to meet with the Commissioners and provide a report on current panel activities. The last panel meeting, the 78th overall, was held in September 1993.⁹⁵ The “Lessons Learned from the Three Mile Island Unit 2 Advisory Panel”

report (NUREG/CR-6252) provided lessons learned based on interviews of former members and reviews of transcriptions of public meetings (see the DVD folder, [Advisory Groups](#)). Appendix A, “Panel Meeting Dates and Transcript Microfiche Addresses,” to the report listed dates of panel meetings. Panel members were listed in an appendix of the NRC annual reports (see DVD folder, [NRC Annual Reports](#)).



The Advisory Panel for the Decontamination of Three Mile Island Unit 2 held its last meeting on September 23, 1993, in Harrisburg, Pennsylvania (Pa). Panel members attending the final meeting are pictured. They are, left-to-right, front row: Ann Trunk, Resident of Middletown, Pa.; Arthur E. Morris (Panel Chairman), Resident and former Mayor of Lancaster, Pa.; Joel Roth (Panel Vice Chairman), Resident of Harrisburg, Pa.; Elizabeth Marshall, Resident of York, Pa. In the back row, left-to-right, are: Kenneth L. Miller, Director of the Division of Health Physics and Professor of Radiology, Milton S. Hershey Medical Center, Hershey, Pa.; Thomas Smithgall, Resident of Lancaster, Pa.; Lee H. Thonus, Alternate Designated Federal Official, NRC Office of Nuclear Reactor Regulation (Region I); John Leutzelschwab, Professor of Physics, Dickinson College, Carlisle, Pa.; Niel Wald, Professor, Department of Environmental and Occupational Health, University of Pittsburgh, Pittsburgh, Pa.; Michael T. Masnik, Designated Federal Official, NRC Office of Nuclear Reactor Regulation; Frederick S. Rice, Resident of Harrisburg, Pa.; and Gordon Robinson, Associate Professor of Nuclear Engineering, Pennsylvania State University, University Park.

- TMI-2 Safety Advisory Board (1981 to 1989).*** The TMI-2 Safety Advisory Board was established by the licensee on March 16, 1981, to provide the licensee with an independent appraisal of the recovery program that gave particular emphasis to the assurance of public and worker health and safety. The advisory board met every three months, and reviewed many aspects of recovery activities, including regulations; nuclear criticality; safety; risk assessment; project organization; project financing; project procedures; technical planning; and public communications. Additionally, the advisory board regularly expressed its views to the NRC, and to the Board of Directors of GPU. Periodically, the advisory board participated in public hearings, especially those of the NRC’s Advisory Panel for the Decontamination of TMI-2. The first advisory board chairman was Dr. James C. Fletcher, former administrator of the National Aeronautics and Space Administration (NASA). He later resigned as chair of the advisory board at the time of his second appointment as NASA Administrator, following the Challenger space shuttle accident in 1986.⁹⁶ The final report of the Safety Advisory Board summarized its activities during its 8-year period of existence (see the DVD folder, [Advisory Groups](#)). Appendix A, “Possible Research Opportunities as a Result of the TMI-2 Accident and Cleanup,” to that report provided a set of recommendations on possible research opportunities.



TMI-2 Safety Advisory Board. Front row, left-to-right: Bruce Lundin, Robert Marston (Chairman 1986-1989), Jacob Fabrikant, Howard Raiffa. Back row, left-to-right: Lombard Squires, Ronald Fillnow, Norman Rasmussen, Merril Eisenbud, Robert Friedman, William Stratton, John Auxier. Not shown: James Fletcher (Chairman 1981-1986).

- Technical Assistance and Advisory Group (1981 to 1989).** The TMI-2 Technical Advisory and Assistance Group (TAAG) was established by the licensee, with the cooperation of the DOE and NRC, to provide independent technical assessment and advice on the decontamination and defueling of TMI-2. This group ensured that approaches to the various cleanup and defueling operations were technically adequate and that consideration was given to keeping radiation exposures at ALARA levels. The TAAG consisted of approximately 10 permanent members and additional ad hoc members when their special expertise was needed. The group responded to specific requests from the licensee’s recovery organization, the NRC, and DOE. The group’s work was funded through the Idaho National Engineering Laboratory (INEL) by the DOE. Representatives from INEL, DOE, and the NRC attended TAAG meetings as observers. The TAAG reported directly to the president of GPU and documented its results to INEL to assist in execution of the DOE program.^{97, 98} Many of the TAAG reports are provided on the DVD (see the DVD folder, [Advisory Groups](#)).
- Technical Working Group for the TMI Information and Examination Program.** The TMI Information and Examination Program was established to acquire data to improve current understanding of nuclear plant accident environments and of the phenomena which contributed to

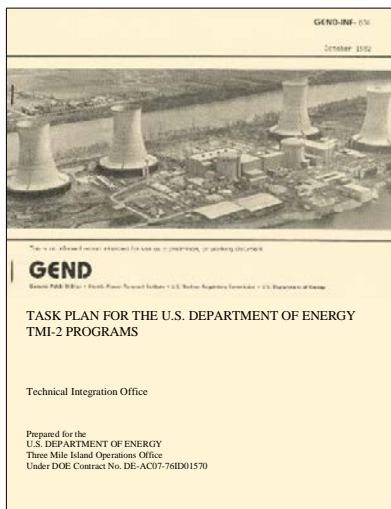
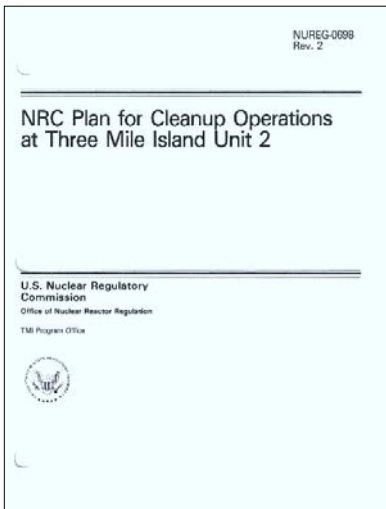

Two key planning documents used by NRC and DOE at TMI-2. NUREG-0698 report defined NRC’s roles in the cleanup operations and associated regulatory responsibilities. GEND-INF-036 report identified tasks to be planned and administered by the DOE to retrieve useful information from the cleanup effort to address key problems and issues in the areas of plant accident response and recovery.

those environments. The licensee (GPU), EPRI, NRC, and DOE (known as “GEND”) signed a coordination agreement on March 26, 1980, to jointly sponsor and participate in this program. The program was administered through DOE’s prime contractor at TMI-2 and was staffed by INEL personnel. In addition to the participation of NRC in the technical working group for this program, the NRC (1) reviewed the data-acquisition tasks to ensure that they were implemented in coordination with ongoing cleanup activities and (2) used the data acquired for the benefit of the cleanup to the maximum possible extent.⁹⁹

Results of this program were summarized in periodic newsletters and annual reports (see the DVD folder, [DOE/National Laboratory Status Reports](#)). Technical details of the results were documented in GEND-series reports, reports from DOE’s national laboratories, the NRC’s NUREG-series reports, and EPRI reports. Most DOE-sponsored reports were digitized by the Idaho National Laboratory (formerly INEL) and the Oak Ridge National Laboratory and are currently available from their public websites. Most of these reports and NUREG-series reports are provided on the DVDs.

NRC’s TMI Program Office. The NRC was responsible for the regulation of TMI-2 cleanup operations. Regulatory objectives were to (1) maintain reactor safety and control of radioactivity; (2) ensure that environmental impacts were minimized and that the radiation exposure of workers, the



NRC office trailers were relocated in late April 1979 from the TMI Visitors’ Center to this location at the south end on Three Mile Island. Another office in nearby Middletown was opened and staffed on a regular basis, including evenings, to provide the public an opportunity to talk with NRC.

public, and the environment was within regulatory limits and were at ALARA levels; and (3) ensure interim safe storage and disposal of radioactive wastes from cleanup operations.¹⁰⁰

On April 7, 1979, the director of the Office of Nuclear Reactor Regulation (NRR) formalized the NRC operations at TMI with three principal organizations: NRR Operations, NRR Technical Review, and the Office of Inspection and Enforcement Operations. The NRR operations function interacted with the NRR staff in the TMI-2 control room and with the GPU Task and Schedule Managerial Team. The GPU managerial team prioritized work and NRR provided liaison. The NRR technical review function provided safety reviews of plant modifications proposed by GPU's Plant Modification Team. Early modifications included the new decay heat removal system, electrical power distribution, primary system instrumentation alternatives, radioactive waste systems, secondary cooling systems, and other plant modifications. The NRR technical review group also provided liaisons to GPU's Industry Advisory Group and the GPU Technical Working Group. The inspection and enforcement function provided surveillance of TMI-2 operations and in-plant health physics and continued monitoring and analysis of the environment.¹⁰¹

The TMI support organization was renamed the TMI Program Office (TMIPO) within NRR on April 1, 1980; it provided the NRC's overall direction of TMI-2 recovery and cleanup operations.^{102, 103} The TMIPO established a staff with management and technical expertise in key TMI-2 cleanup activities such as radiation protection, radiological assessment,



NRC staff suited up for an inspection inside the reactor building. Left: Lake Barrett (onsite TMIPO manager) in 1984. Above: Michael Masnik and Lee Thomus (TMIPO staff and later licensing project managers of TMI-2) in 1993.

radiological waste treatment, and nuclear safety. Support by experts in other disciplines was available from other NRC staff and from contractors, under arrangement with the DOE. The TMIPO coordinated its activities with the licensee, the DOE, other Federal agencies, State and local government officials, and the public.¹⁰⁴

Information flow was a major responsibility of the site office. A weekly status report containing pertinent reactor, radiological, and environmental information was prepared and distributed to all NRC offices. This report was also distributed to the public, with copies available at the Middletown office. The Middletown office was open and staffed on a regular basis, including evening hours, to provide the public an opportunity to remain informed of the cleanup progress. Information was also supplied to the public through press releases, television and radio interviews, and direct responses to both written and oral public concerns. Information-exchange meetings were also held periodically with officials of the DOE and the U.S. Environmental Protection Agency (EPA).¹⁰⁵

The TMIPO had the following regulatory responsibilities: (1) planning and managing all NRC involvement in TMI-2 cleanup activities; (2) obtaining information about and evaluating the current facility status; (3) analyzing and reviewing the licensee's proposed actions and procedures; (4) preparing technical review documents on the safety and environmental impacts of licensee-proposed cleanup actions; (5) approving or disapproving the licensee's proposed actions and procedures; (6) advising the NRC Commissioners on major cleanup actions; (7) coordinating the NRC's TMI-2 cleanup activities with other governmental agencies, as necessary, such as the DOE and EPA; (8) informing State and local governments and the public on the status and plans for cleanup activities; (9) overseeing day-to-day licensee activities to ensure that operations were implemented in accordance with NRC regulations, the facility's operating license, technical specifications, NRC orders, recovery plans, and approved procedures; (10) ensuring that activities are carried out in compliance with approved NRC limits and procedures; and (11) coordinating with the NRC Office of Inspection and Enforcement on its TMI-2 inspection activities.¹⁰⁶

The TMIPO report, "NRC Plan for Cleanup Operations at Three Mile Island Unit 2" ([NUREG-0698, as revised](#)) defined the NRC's role in cleanup operations at TMI-2, outlined the NRC's regulatory responsibilities in fulfilling this role, and provided the NRC's review and decision-making procedures. The TMI-2 Cleanup Project Directorate (formerly TMIPO) was dissolved on February 1, 1988. The NRC's TMI resident inspector office took over the inspection program for TMI-2 and a headquarters project

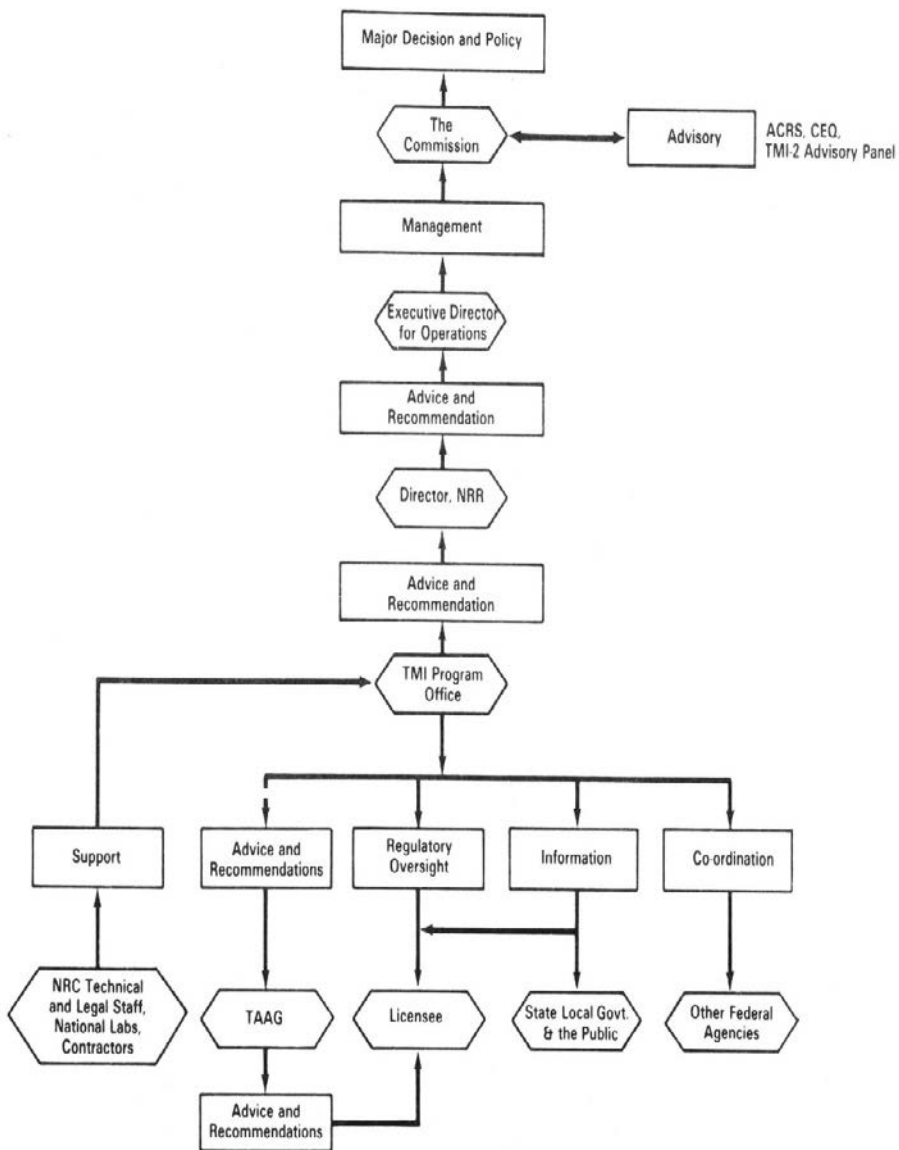

Key: Advisory Committee for Reactor Safeguards (ACRS), President's Council on Environmental Quality (CEQ), Nuclear Reactor Regulation (NRR), Technical Advisory and Assistance Group (TAAG)

Major NRC functional roles in TMI-2 cleanup operations in 1984 (see NUREG-0698, Revision 2).

directorates assumed responsibility for technical review and project management functions.¹⁰⁷

The TMIPO weekly status reports provided a detailed chronology of plant status, environmental monitoring results, the licensee's recovery activities, NRC actions, and public meetings. Reports during the period from 1980 to 1990 are provided on the DVD (see the DVD folder, [TMI Program Office Weekly Status Reports](#)). NUREG reports and other TMIPO-related correspondence are provided on the DVD (see the DVD folder, [General Management and Oversight](#)).

Other Documents. Other documents relating to the management of the recovery and cleanup efforts provided on the DVD (see the DVD folder, [General Management and Oversight](#)) include the following:

- licensee recovery organizations (see also the DVD folder, [Organization Plan Changes](#))
- defueling and decontamination plans, schedules, and cost estimates
- NRC and DOE work plans and agreements



Two diesel generators (center) were temporary installed at TMI-2 to provide diverse backup power to the balance-of-plant (BOP) electrical power buses in the event of a failure of normal offsite power sources. Backup protection was required for new recovery systems and existing BOP systems that were used to keep the plant stable. Many of the safety systems used during normal operations were rendered inoperable or inaccessible due to the accident.



TMI-2 control room after the accident. The plant computer alarm station is shown in the foreground. Core exit thermocouple temperature indication panel which was installed shortly after the accident is shown in the background (center left) behind the hanging sign.

3 Plant Stabilization

The near-term cooling of the reactor core was considered to be stable within the first week after the accident. However, many technical issues involving safety and control were identified in the following weeks and months. In the licensee's report to the NRC, "Interim Report on the Three Mile Island Nuclear Station Unit 2 Accident," dated May 5, 1979,¹⁰⁸ the major near-term objectives of the recovery organization included the following: (1) keep the plant in a stable shutdown condition; (2) control and manage the volumes of existing radioactivity; (3) develop an overall waste-management plan for liquid, gas, and solids; (4) develop a strategy to reach cold shutdown safely and expeditiously; (5) modify the procedures, facilities, and equipment necessary to accomplish the above; and (6) institute the plan for accomplishing a transition into the organization necessary to proceed with the more long-term recovery efforts.

As a result of the degradation of the reactor core and plant equipment, certain equipment, required to be operable, was no longer available. Other non-safety-related systems, not generally relied on for safe shutdown, were used to keep the plant in a stable condition. High radioactivity in containment, reactor coolant, and certain auxiliary building areas limited access to maintain important components needed for safe shutdown. Harsh environmental conditions and high-radiation levels limited the ability of certain components and instrumentation to survive for long periods.¹⁰⁹

Early Plant Status. Maintaining the plant in a stable shutdown condition required: (1) reliable means to remove decay heat from the reactor core to the ultimate heat sink; (2) maintenance of reactor core sub-criticality to limit heat production; and (3) confinement of radioactivity within the reactor building.¹¹⁰ Decay heat removal required the maintenance of critical functions; namely, the reactor coolant system (RCS) flow control; RCS pressure control; RCS water inventory control; and RCS heat removal control. The control of RCS flow initially required the removal of non-compressible gases, such as accident-generated hydrogen, which could potentially block flow at the high points of both hot-legs and damage an operating reactor coolant pump. The removal of gases was successful and one reactor coolant pump provided forced circulation for almost one month, followed by natural circulation.¹¹¹

The control of RCS pressure was important to maintain an adequate net positive suction head to prevent reactor coolant pump damage and to maintain the hot coolant at a subcooled condition to prevent boiling. Pressure was controlled initially by the pressurizer heaters, spray, and

instrumentation. Contingency procedures were developed in the anticipation of failures of heater cable installation due to high radiation levels in the reactor building or failures of pressurizer instrument transmitters located in the flooded basement of the reactor building. Upon the loss of the last pressurizer level instrument channel on April 27, 1979, pressure was controlled with the plant solid for almost a year by manually balancing makeup injection and letdown flows. Letdown flow was fixed at a reduced one-third capacity due to blockages in the system. The desirable pressure was achieved by throttling the manual valves on the reactor coolant pump

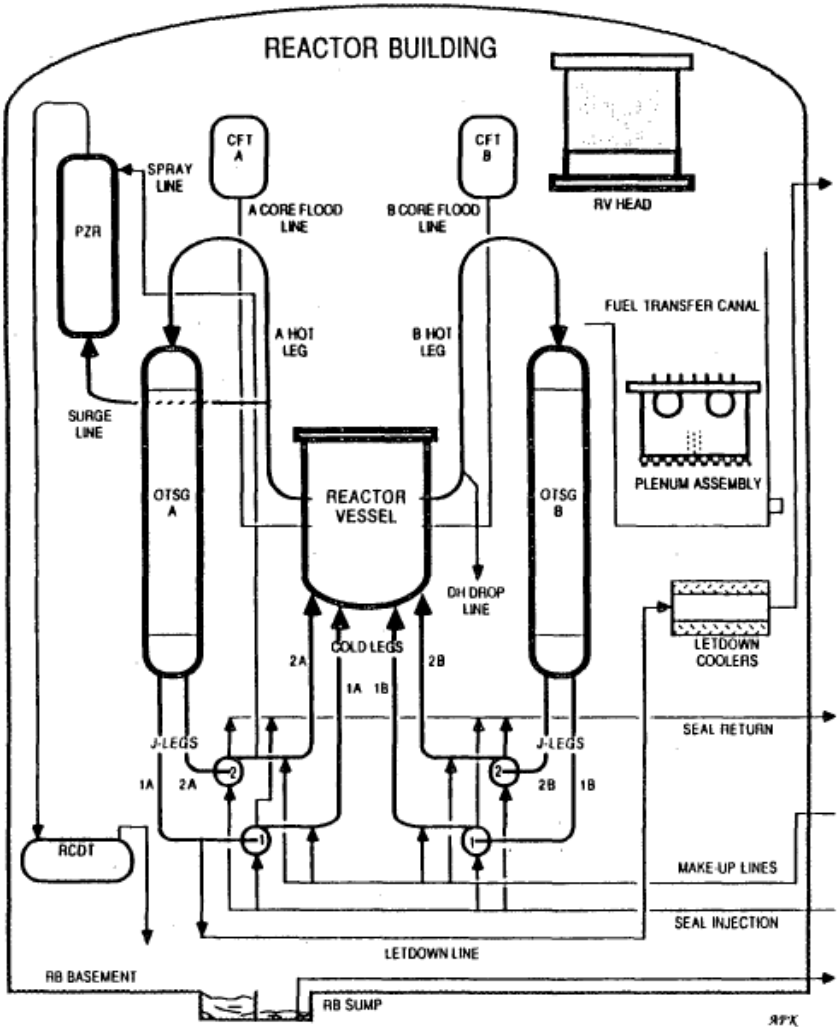

Systems and components inside the reactor building (RB). Key: core flood tank (CFT), decay heat (DH) system, once-through steam generator (OTSG), pressurizer (PZR), reactor coolant drain tank (RCDT), and reactor vessel (RV).

seal injection lines with the makeup injection valve completely closed. The lack of routine maintenance due to adverse radiological conditions inside the auxiliary and fuel handling building contributed to makeup pump failures and valve leaks, which further exuberated radiological contamination and releases inside the building. In March 1980, the makeup system was replaced with the newly-installed reactor coolant pressure control system; this new system was in operation until preparations to remove the reactor vessel head in 1984.¹¹²

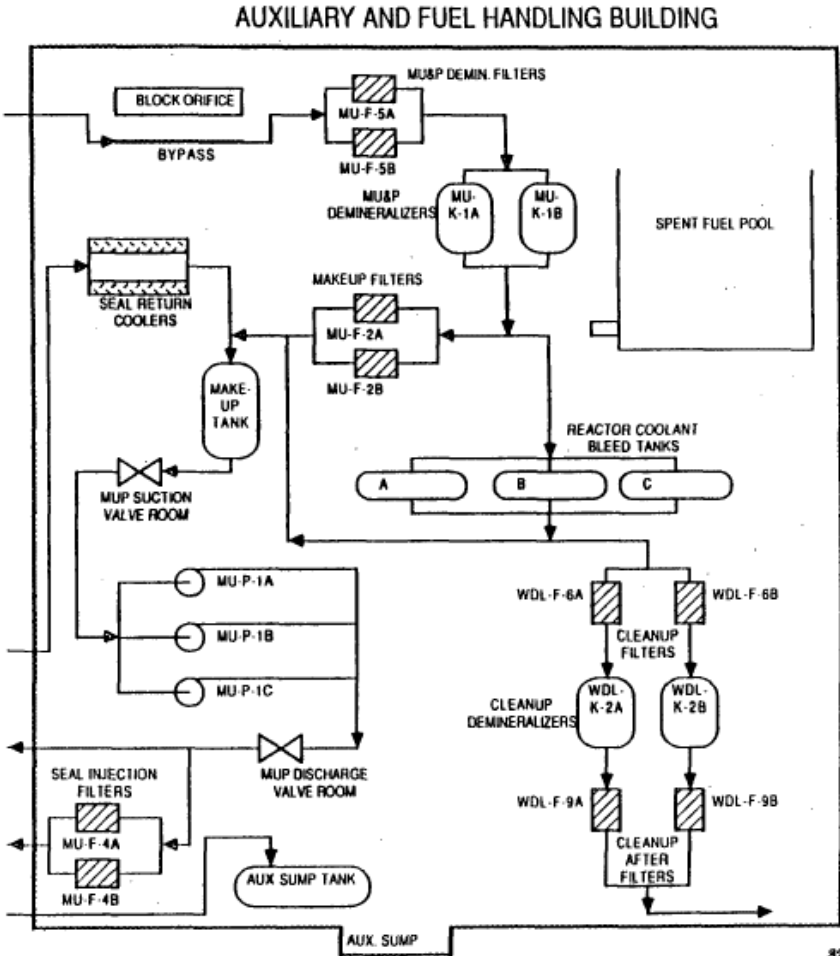

Systems and components inside the auxiliary and fuel handling building. Key: waste disposal liquid (WDL) system, makeup and purification (MU&P) system, makeup filter (MU-F), and makeup pump (MU-P).

The control of RCS heat removal was through the “A” steam generator during the periods of forced and natural circulation cooling. The secondary or steam side of the steam generator was maintained in a partial vacuum by the main condenser mechanical vacuum pumps. A partial vacuum allows boiling and steaming at temperatures below 212 degrees Fahrenheit (°F). Steam flowed from the steam generator to the main condenser through a turbine bypass valve. The condensate system was used to feed water from the main condenser hotwell to the steam generator. The circulating water system removed heat from the condenser to the natural draft cooling towers.¹¹³ The use of secondary systems to achieve and maintain the plant in cold shutdown was never performed in commercial pressurized water reactors, especially for a long period of time. Cold shutdown condition was initially achieved on April 27th when reactor coolant temperature decreased to 188°F.¹¹⁴ Plant modifications improved the reliability of electrical power supplies to non-safety grade secondary system components that provided long-term cooling. A backup mini-condensate system was installed to replace the existing condensate pumps, if needed. Other diverse backup cooling systems were installed, such as the long-term “B” backup cooling system and mini decay heat removal system (discussed later).¹¹⁵

The control of the reactor core sub-criticality was accomplished by increasing the concentration of neutron-absorbing boron solution in the reactor coolant. However, the lack of information on the state of the reactor core and the condition of control rods, caused difficulty in accurately calculating the boron concentration required to maintain subcritical conditions.¹¹⁶ The required minimum boron concentration in the reactor coolant system was increased to account for the potential (actual) melting of control rod materials during the accident and to support defueling operations. Sources of makeup to the reactor vessel were limited and controlled to prevent boron dilution. Nuclear source range instrumentation used to detect re-criticality was down to one operable channel prior to its refurbishment during early reactor building entries.¹¹⁷ The potential for re-criticality of the damaged reactor core, as well as fuel “fines” (very small fuel debris) consolidated in sludge on the reactor building basement floor, and in filters of cleanup systems, remained a concern during the first half of the new decade.¹¹⁸

Large quantities of radioactive krypton-85 gas (about 44,000 curies)¹¹⁹ and highly-contaminated water in the reactor building’s basement (approximately 630,000 gallons of water, which contained about one-half of the core inventory of the radionuclide cesium-137)¹²⁰ prevented personnel access into the reactor building to assess damage and maintain important equipment. Radioactive gas in waste gas decay tanks leaked into the

auxiliary building, causing airborne contamination problems. About 66 to 80 curies of krypton gas was leaking out of the reactor building every month. The partial vacuum on the secondary side of the steam generator caused a pressure difference between the reactor building and turbine building, which enhanced leakage through the packing of various steam valves. These gases were subsequently discharged from the secondary system through the auxiliary building ventilation system to the environment.¹²¹ Waste-water storage at TMI was already at 60 percent (full) capacity before the accident, and that water was subsequently contaminated during the accident.¹²² Operational leakage from support systems located in the auxiliary and fuel handling building added to the mix about 800 to 1,000 gallons a day of mostly uncontaminated water.¹²³

Organizations involved in the early recovery effort tackled many unique technical issues aimed at ensuring the safe shutdown of the reactor core, and ensuring sufficient removal of decay heat from the reactor core to the ultimate heat sink. A number of systems and components were modified in the near-term to maintain a stable plant. Some of these systems were placed in standby readiness and never had to be used. Many new systems and facilities were also built to improve the diversity and reliability of existing systems. These new systems provided capabilities to immediately clean up radioactivity hazards that would help future plant recovery operations. New procedures were developed, (many early ones handwritten), to provide guidance for operating the plant in its degraded condition. First-of-their-kind procedures were written, reviewed, and approved to handle many imaginable contingencies (see the DVD folder, [Recovery Procedures](#)).

The Industry Advisory Group provided the utility with expert advice on many technical issues during the first 5 weeks following the accident (see the DVD folder, [Industry Advisory Group Reports](#)). The NRC extensively studied methods and associated plant modifications for achieving and maintaining cold shutdown. Other early issues and concerns that were studied included recriticality of the reactor core; impact of core damage on decay heat removal; reliability and diversity of decay heat removal, including electrical power; loss of instrumentation; post-accident hydrogen production; mitigation of radiological releases; radioactive waste characterization; contaminated water storage; potential for groundwater contamination; fire protection; quality assurance of plant modifications; radiological protection of plant workers; and safety analysis of the damaged plant (see the DVD folder, [General Plant Stabilization](#)).

Near-Term Recovery Actions. Key systems that were used for near-term plant stabilization are listed below. Some systems were placed in standby

and never had to be used. Summary descriptions of these systems were provided in a series of monthly and quarterly licensee status reports that were submitted to the NRC over the first 18 months following the accident (see the DVD folder, [GPU Status Reports](#)).

- ***Sub-criticality control.*** The reactor core was maintained in a shutdown condition by boron solution that was injected in the reactor coolant system. Since the integrity of the control rods and fuel rods was unknown, the reactor coolant boron concentration was maintained between 3,000 and 4,500 parts per million (ppm). The maximum boron concentration and a minimum reactor coolant temperature of 50 °F were specified in the proposed technical specifications to ensure that boron precipitation blockage would not occur.¹²⁴ Criticality analyses of the reactor core to ensure adequate shutdown margin under worst case conditions had been made by the licensee, NRC, Babcock and Wilcox, Brookhaven National Laboratory, and Oak Ridge National Laboratory. A further evaluation of the risk of recriticality by NRC in April 1980 concluded that the most probable mechanism for criticality was boron dilution and that the process was slow enough to detect and correct the approach to criticality given appropriate instrumentation and procedures.¹²⁵

In April 1984, the maximum allowable boron concentration in the proposed technical specifications was increased to 6,000 ppm to support defueling options that could potentially rearrange the core, or portions of the core, into a more reactive configuration. The increase in boron concentration, if needed, would be buffered by sodium hydroxide addition to maintain the pH in the reactor coolant system between 7.6 and 7.8 for corrosion control. The modification to the technical specifications included an upper pH limit of 8.4 to insure no boron precipitation in the reactor coolant system (RCS) and associated sample lines (solubility of boric acid decreases with increasing pH).¹²⁶ In July 1984, the minimum boron concentration was increased to 3,500 ppm to ensure at least 1 percent shutdown margin, based on all creditable core configurations, including those resulting from a reactor vessel head drop accident. The licensee's criticality analyses conservatively assumed a hypothetical 100 percent fuel failure; no neutron leakage or absorption by structural or poison material; no fuel burnup; maximum fuel enrichment; and optimum fuel-moderator ratio. For the out-of-core criticality model, the analysis assumed that 50 percent of the core formed a hemisphere in the bottom of the reactor vessel.^{127, 128, 129} In April 1985, the technical specifications were modified to increase the minimum boron concentration to 4,350 ppm to ensure that the fuel in

the reactor coolant system would remain subcritical throughout all reactor disassembly and defueling operations. Boron concentration requirements for the spent fuel storage pool “A” and the fuel transfer canal were added in the technical specifications. The values were the same as those required for the reactor coolant system.^{130, 131, 132}

Other criticality analyses were performed to support safety evaluations of defueling systems and equipment, defueling and cleanup operations, and the fuel debris remaining inside and outside the reactor vessel. Other criticality control methods were evaluated in GEND-026, “Addition of Soluble and insoluble Neutron Absorbers to the Reactor Coolant System of TMI-2.” Most criticality safety analysis reports are provided in the DVD folder, [Criticality Analysis](#). Results of criticality analyses that were performed in support of the post-defueling monitored storage licensing application are provided in the DVD folder, [After Defueling](#).

- ***Transition to natural circulation core cooling.*** Since the start of the accident until 8:00 p.m. on the same day when the “1A” reactor coolant pump was restarted, decay heat was primarily removed by the release of reactor coolant to the reactor building through the stuck-open pressurizer pilot-operated relief valve, as the operator opened its block valve to maintain pressure. For about a month, a reactor coolant pump provided forced circulation from the reactor core through the “A” steam generator. The reactor decay heat was transferred from the reactor coolant side of the “A” steam generator tubes, and out to the main turbine condenser in the form of steam, generated in the secondary side of the steam generator tubes.¹³³

On April 27, the failure of the last remaining pressurizer level indication prompted the operators and engineers to enact the emergency procedure to stop the fourth and last remaining reactor coolant pump. That afternoon, the reactor coolant pump was intentionally shut down by a control room operator. The “forward flow” in both of the reactor coolant system loops decreased exponentially, as indicated on the then-operable flow instrumentation. Within a minute, TMI-2 entered smooth, natural circulation without incident. (The driving head for natural circulation was the difference in density between the hot 12-foot core water elevation, against a comparable 12-foot cooler elevation of water in the tubes in either or both of the adjacent steam generators.) The feasibility of long-term, natural circulation as a viable means for placing the damaged reactor core into a long-term, stable condition was extensively studied and evaluated by the licensee, the TMI-2 reactor vendor

(Babcock and Wilcox), and the NRC (see reports in DVD folder, [General Plant Stabilization](#)).¹³⁴

With the passage of time, and the associated reduction of decay heat generation rate (about 75 kilowatts 20 months following the accident), the natural circulation flow slowed and then changed from continuous to cyclic with increasing intervals between the cyclic flow “burps.” When the steam generator and cold-legs gradually cooled until the density was high enough to initiate natural circulation flow, flow then diminished as the warmer coolant from the reactor vessel displaced the colder water in the steam generator and cold-legs.¹³⁵

- **Alternate instrumentation.** Alternate plant and reactor core instruments were used and new ones were installed to replace those that were damaged during the accident, or that failed because of harsh environmental or high-radiation conditions. Instrumentation and electrical equipment were exposed to moderately severe accident conditions, including steam, reactor building spray, high radiation, burning hydrogen, and the resultant overpressure. The equipment that survived the accident was then exposed to long-term moisture



Core flood tank 1A level monitor CF-2-LT2 showing the condition of the enclosed electronic module. There was severe corrosion and degradation of internal components rendering the unit inoperable.

conditions, including high humidity, elevated temperature, and condensation. The TMI-2 Instrumentation and Electrical Program funded by DOE identified and analyzed a number of pre-accident installation problems and instrument response characteristics that led to misleading information and equipment failures. These problems included faulty component seals and inadequate drains and vents to protect enclosed equipment against moisture, anomalous response of radiation monitors, and substantial corrosion of electrical contacts over a period of a few years.¹³⁶ (See the DVD folder, [Instrumentation and Equipment Evaluations](#).)

Emergency procedures were written by the licensee and approved by the NRC to respond to losses of important instrumentation (see the DVD folder, [Recovery Procedures](#)). Indications from other systems were sometimes used to replace similar information from failed instruments. Installation of recovery systems provided alternative means for monitoring conditions of the reactor. Probes were used to measure conditions inside the reactor building through its penetrations before the first reactor building entry in July 1980. Once entrance began, important electronic components were replaced or repaired.

- **Modified decay heat removal system.** Installed to improve the reliability of the existing decay heat removal system in order to reduce its

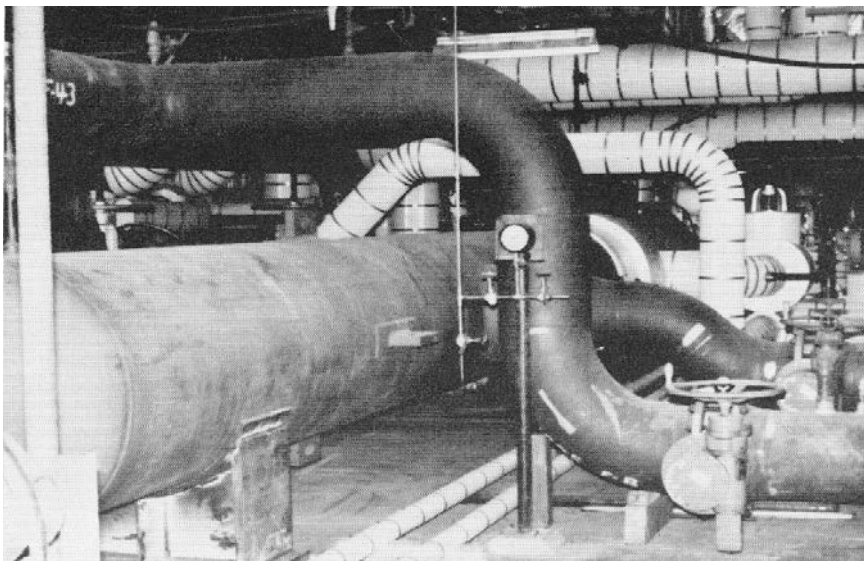

Long-term “B” backup cooling system (horizontal heat exchanger shown) provided a high pressure, closed cooling loop for the water filled “B” steam generator. This backup system was never used.

radiological impact in the auxiliary building and on the environment in the event that the system was needed to cool the core. This system was placed in standby and never had to be used.¹³⁷

- ***Alternate decay heat removal system.*** Intended as a backup to existing and planned decay heat removal capabilities. The new system was to be built outside the fuel handling building and was to include a complete, integral closed-loop system to circulate reactor coolant through connections from the existing decay heat removal system. Heat would be removed through its own intermediate component cooling water system through connections to the existing nuclear services river water system; this ambitious project was never completed.¹³⁸
- ***Long-term “B” backup cooling system.*** Installed to provide a high-pressure, closed cooling loop for the water-filled “B” steam generator. This new system was a planned backup to the preferred steaming of the “A” steam generator to the main condenser. The system was installed in the turbine building and included a new heat exchanger, pump, surge tank, piping, and valves. Heat was transferred from the secondary side of the “B” steam generator to a new heat exchanger. The

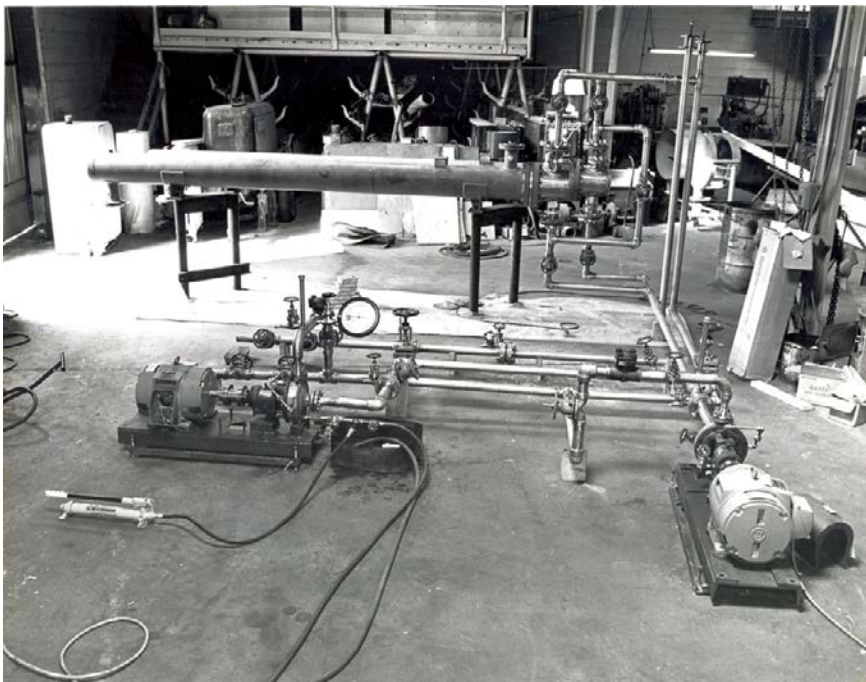

Mini decay heat removal system being fabricated at the Babcock and Wilcox facility. Two heat exchangers on stand in back; two pumps on floor.

heat exchanger was cooled by the existing secondary services closed cooling water system, which was then cooled by water from the existing nuclear services river water system. The system was installed, but never required use. An identical system for steam generator “A” was designed, but never built.¹³⁹

- ***Mini decay heat removal system.*** Installed to replace the decay heat removal system and served as a technical specifications required means for boron injection and makeup to the reactor vessel. It was a skid-mounted system with two pumps and two heat exchangers that was fabricated at the Babcock & Wilcox facility in Lynchburg, Virginia.¹⁴⁰ The system was installed in the fuel handling building with connections to the existing decay heat removal piping. The two heat exchangers were cooled by water from the existing nuclear services closed cooling system. The system was installed but was not used because loss of heat from the reactor coolant system to the reactor building’s ambient environment was shown to be adequate.¹⁴¹ The system became

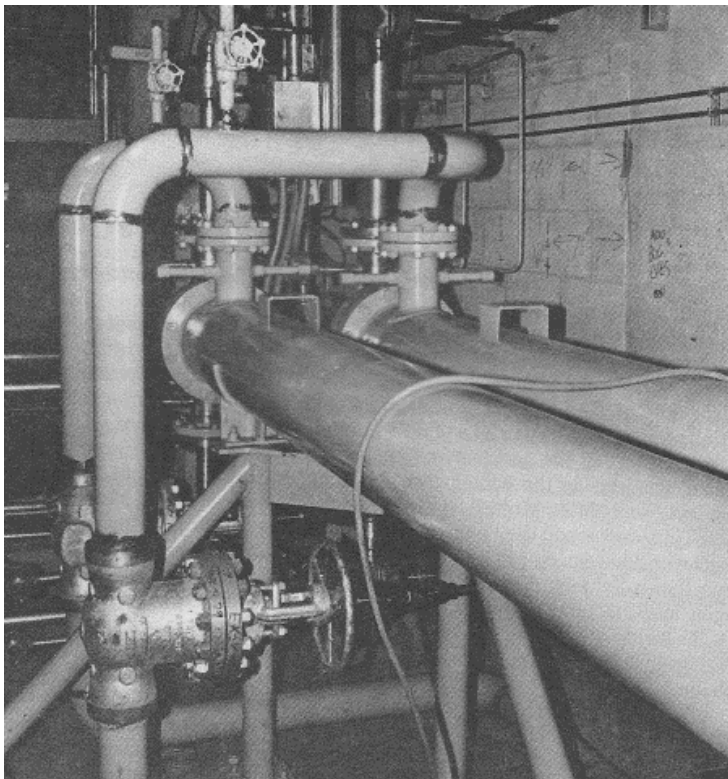

Mini decay heat removal system installed at TMI-2. Both heat exchangers are shown. The system became operational in October 1980.

operational on October 29, 1980,¹⁴² and could also be used during defueling operations when the reactor vessel was not configured to maintain forced cooling. However, loss-to-ambient cooling mode, as described below, was the preferred method to remove the very low decay heat levels.¹⁴³

- **Reactor coolant pressure control system.** Installed to provide long-term reactor coolant system (RCS) pressure control and inventory control. This system kept the RCS in a water-solid condition for natural circulation core cooling; maintained sufficient available net positive suction head for reactor coolant pump operation, if needed; controlled the quality of the makeup water; and maintained pressure while accommodating thermal and volumetric changes in the RCS inventory. The system included a makeup subsystem to maintain the reactor coolant system in a water-solid condition for natural circulation cooling; the makeup subsystem also injected chemically-treated water. A letdown subsystem provided RCS overpressurization protection by increasing letdown. Three surge tanks arranged in series provided RCS pressure control.¹⁴⁴ The system was installed in the fuel handling building and placed in service in March 1980. The existing makeup system and letdown through the reactor coolant pump seal return line were secured to reduce leakage and contamination in the auxiliary and fuel handling building. The new system was no longer needed when the

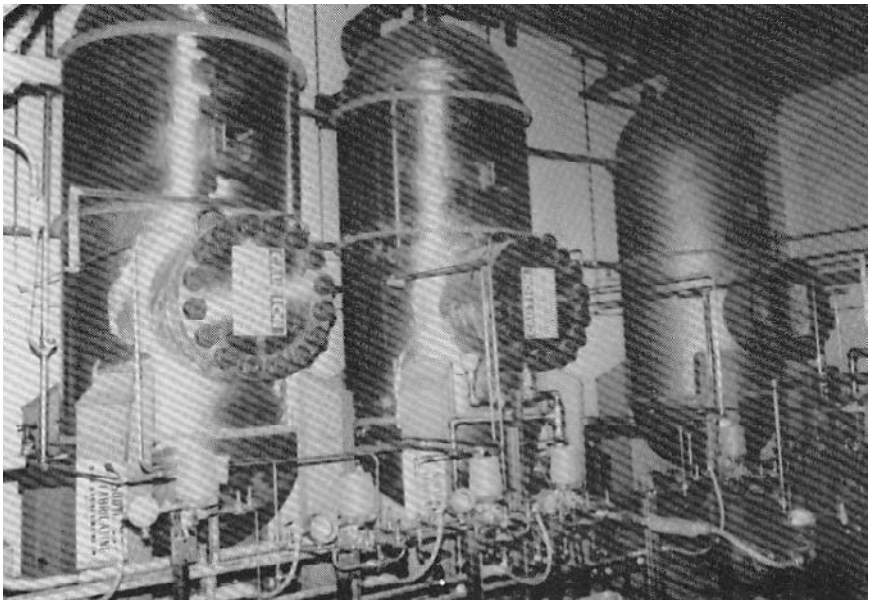

Reactor coolant pressure control system installed in fuel handling building. Three 900-gallon surge tanks shown.

RCS was depressurized in the summer of 1984 in preparation for removal of the reactor vessel head.¹⁴⁵

- **Alternate condensate pumps system.** Installed to provide backup to the existing condensate pumps in order to supply feedwater to the steam generators for decay heat removal. In addition, the system could provide feedwater to the new temporary auxiliary boiler. The system included two 50-gallon-per-minute pumps that took suction from the condenser hotwell and discharged to the steam generator through either of the two newly-installed demineralizers.¹⁴⁶
- **Reliability improvements to balance-of-plant (BOP) electrical distribution.** Modifications to the existing BOP electrical power system provided backup protection in the event of a failure of normal offsite power sources to BOP buses. Backup protection was required for new recovery systems and existing BOP systems that were used to keep the plant stable, such as decay heat removal, pressure control, plant instrumentation, and ventilation. Early modifications included two

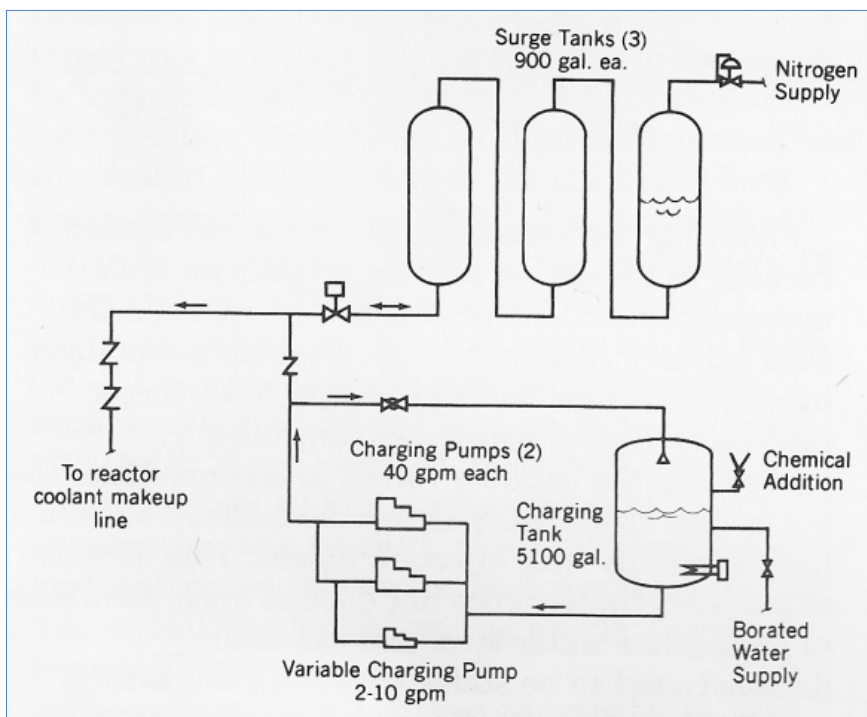

Reactor coolant pressure control system provided long-term reactor coolant system pressure and inventory control. The system became operational in March 1980.

independent power buses, each supplied by a new 2,500-kilowatt-rated diesel generator, and two existing circulating water pump buses supplied by one new 13.2-kilovolt line from a nearby offsite electrical substation.¹⁴⁷ The new diesel generators became available on May 16, 1979.¹⁴⁸ The 13.2-kilovolt line was powered by an offsite 115-kilovolt network which was backed by combustion turbine generators capable of being energized independently of the normal offsite power source from the 230-kilovolt network.¹⁴⁹ Later in 1980, the NRC granted approval for removing the BOP diesel generators given that the improved reliability of the 115-kilovolt network with the combustion turbines allowed the network to be classified as an acceptable backup source of power for decay heat removal.¹⁵⁰

- ***Additional hydrogen recombiner.*** Installed to provide additional capacity to process hydrogen inside the reactor building following the accident, due to uncertainty regarding the quantity of hydrogen being generated. A skid-mounted, thermal-type hydrogen recombiner was installed next to the existing thermal-type hydrogen recombiner located in the fuel handling building.¹⁵¹
- ***Portable disposable demineralizer system.*** Installed to remove radioactive fission products in the “B” steam generator in order to minimize personnel exposure and potential for contamination of the turbine building before the new long-term “B” closed-loop cooling system was placed into service. The system included a disposable demineralizer (18 inches in diameter and 30 inches in height) that was attached to the discharge and suction of the closed-loop pump. The portable disposable demineralizer system was used for wet layup of the long-term “B” cooling system during standby.¹⁵²
- ***Groundwater monitoring system.*** Installed to detect radioactivity leakage in the ground around the reactor building and auxiliary building. The Reactor Building Integrity Assessment Program was established by the licensee, at the direction of the NRC, to monitor potential leakage paths from the TMI-2 reactor building sump. The leakage monitoring points, which were based on engineering evaluations,¹⁵³ included groundwater monitoring wells; storm drainage areas; cork seals (concrete joint seals) in structures surrounding the reactor building; and the tendon access gallery (a passageway surrounding the reactor building below the basement, approximately 20 feet below the water surface in the reactor building.¹⁵⁴) The system initially included eight monitoring wells located around the TMI-2 reactor building and other nearby locations. Seven observation wells

were installed early in 1980 to determine the source of tritium found in the wells. Monitoring wells had pumps; observation wells had grab-sampling capability. Additional wells were installed in later years.¹⁵⁵

The Programmatic Environmental Impact Statement (NUREG-0683) concluded that an accidental release of contaminated water in the basement of the reactor building was highly unlikely. Had this water leaked through the steel-lined concrete base of the reactor building, the wave fronts of tritium, strontium-90, and cesium-137 in the ground would reach the Susquehanna River after a minimum of 350 days, 23 years, and 284 years, respectively; and would continue to enter the river over periods of about 130 days, 8.5 years, and 140 years, respectively. Accounting for radionuclide decay and total mixing of effluents in the river, the peak radionuclide concentrations would be orders of magnitude below concentration limits from 10 CFR Part 20, "Standards for Protection Against Radiation," for liquid effluents released to the general environment. Furthermore, the peaks of these three radionuclides would occur at different times.¹⁵⁶

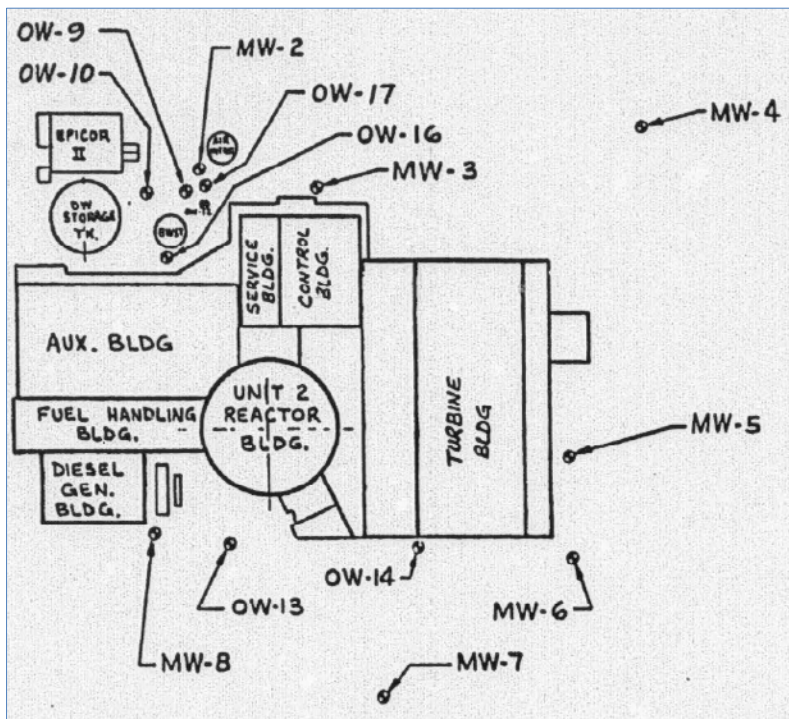

Groundwater monitoring wells (MW) and observation wells (OW) were installed in early 1980 to detect potential radioactivity leakage in the ground around the reactor building and the auxiliary and fuel handling building.

- ***Nuclear sampling system.*** Installed to be used as a temporary liquid-waste sampling facility in TMI-2 without interfering with the existing sampling system that was shared with TMI-1. TMI-2 sample lines were rerouted to a new sample sink located in the fuel handling building. Sampling capabilities were provided for various existing and new storage tanks, the reactor coolant system, and continuous monitoring of boron concentration inside the reactor vessel.¹⁵⁷

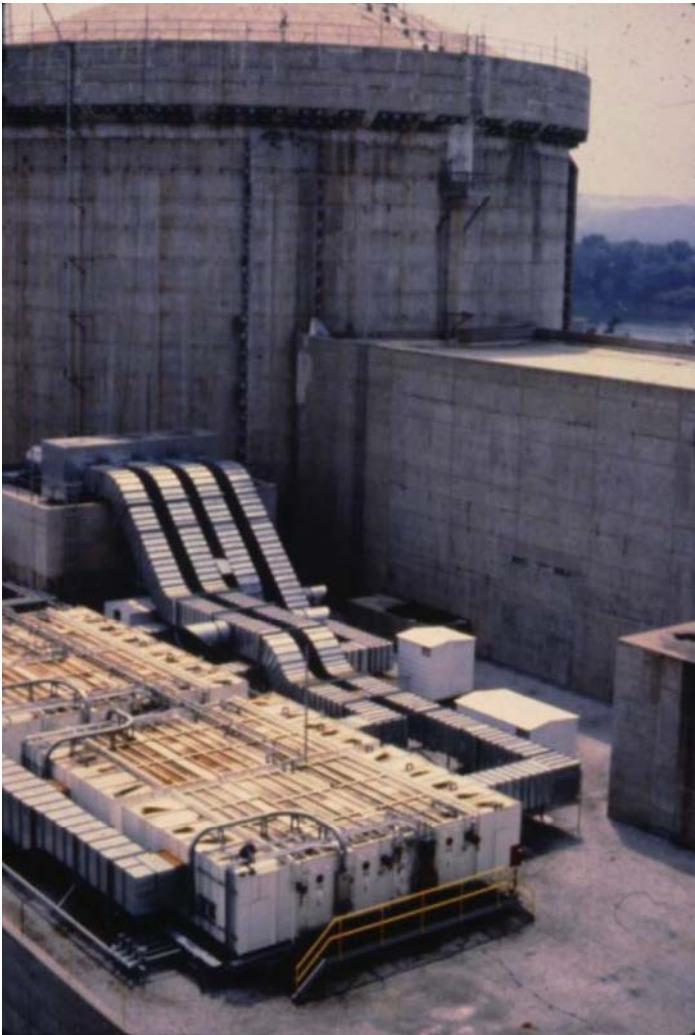

Temporary filtration system for the auxiliary and fuel handling building installed on the auxiliary building roof. TMI-2 reactor building in the background; fuel handling building at center right.

- ***Auxiliary and fuel handling building supplementary air filtration system.*** Installed to temporarily replace the existing charcoal filter trains in order to reduce offsite releases from the auxiliary and fuel handling building. Replacements of the existing filters were not practical because of the high radiation and contamination levels in the filter areas. The new system interfaced with existing ventilation systems and consisted of four parallel filter units. Each unit had an exhaust fan and a filter unit. Each filter unit consisted of a prefilter, a high-efficiency particulate air (HEPA) filter, a charcoal filter, and a second HEPA filter. The ventilation stack was capped to direct ventilation from the buildings into the new filtration units. The filtration units were installed on the roof of the auxiliary building.¹⁵⁸ Both trains of the existing auxiliary building exhaust system were placed back into service by the end of April 1980. The supplementary units were secured and the ventilation stack was uncapped for the upcoming reactor building purge of krypton gas.^{159, 160}
- ***Main condenser air extractor filtration system.*** Installed within two weeks of the accident to remove contamination extracted from the condenser condensate by the mechanical vacuum pumps before discharging to the unfiltered segment of the auxiliary building ventilation stack. The system included a pre-filter, a HEPA filter, a charcoal filter, and a second HEPA filter. The system remained in operation until steam generator cooling was secured in January 1981.¹⁶¹
- ***Fuel pool waste storage system*** (also known as the “tank farm”). Installed to provide temporary storage of 110,000 gallons of radioactive water from the reactor building sump and miscellaneous waste holdup tanks. The system consisted of 4 upper tanks (capable of holding 15,000 gallons each) and 2 lower tanks (25,000 gallons each) forming two separate storage areas located in TMI-2 spent fuel pool “A.”¹⁶² In order to preserve the integrity of the structure, tanks were not attached to the spent fuel pool structure. Therefore, the pool was not filled with water for shielding to prevent the tanks from floating. Installation began on April 6, 1979, and was completed in July 1979. On May 17, 1984, the removal of these tanks started following the cleanup of the highly-contaminated water in the reactor building to make room for the transfer and storage of reactor fuel debris.¹⁶³
- ***Temporary auxiliary boiler system.*** Installed to supply steam to the TMI-2 main turbine gland seals while the existing auxiliary boilers shared with TMI-1 were serviced. Turbine gland seals were needed to maintain condenser vacuum for steam generator heat removal.¹⁶⁴

- **Waste water cleanup systems.** EPICOR I, EPICOR II, and the processed water storage and recycling system are discussed in the section on [Waste Management](#).
- **Solid waste storage facilities.** The interim solid waste staging facility and the solid waste storage facility are discussed in the section on [Waste Management](#).

Longer-Term Recovery Actions. Key activities that were taken to keep the plant stable in the longer term are summarized below:

- **Transition to loss-to-ambient core cooling** On January 5, 1981, the licensee stopped cooling (also known as steaming) the "A" steam generator by shutting a turbine bypass valve to the main condenser. This action put the reactor coolant system (RCS) in a "loss-to-ambient" mode of cooling. Decay heat was then removed by heat losses from the system to the air inside the reactor building without the need of any RCS circulation. A test of the loss-to-ambient cooling mode

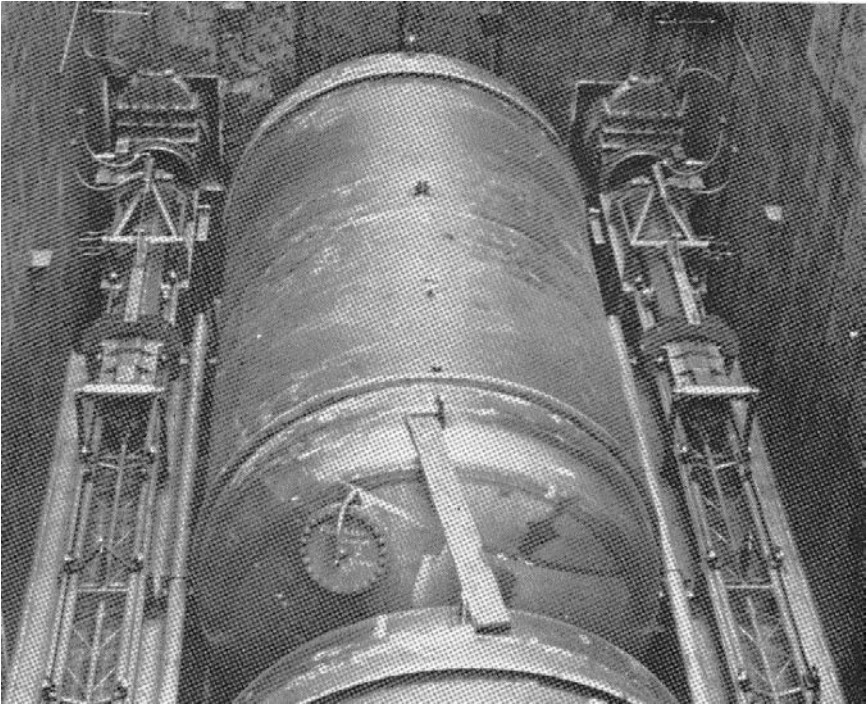

Fuel pool waste storage system or “tank farm” provided temporary storage of 110,000 gallons of radioactive water. Lower tank shown next to inactive fuel transfer upenders (to be used later to move fuel canisters from the reactor building into the spent fuel pool).

commenced on November 6, 1980, for 33 days. Technical specifications were then modified to recognize loss-to-ambient mode as an acceptable means for long-term cooling of the reactor core. Operating procedures were prepared, and loss-to-ambient cooling was subsequently adopted as the primary means for cooling the reactor core. By February 1, 1981, decay heat diminished to about 43 kilowatts of thermal energy.¹⁶⁵ The long-term “B” backup cooling system and the mini decay heat removal system were available as alternative cooling modes. The discontinued use of the “A” steam generator to remove decay heat allowed its removal from service and technical specifications for several major balance-of-plant systems and equipment, such as the circulating water system; main steam system; “A” steam generator; condensate pumps; condensate and feedwater systems; main condenser; and associated support systems.¹⁶⁶

- ***Waste water storage management.*** The storage of pre-accident and accident-generated radioactive water challenged the licensee for many months and years. Before the accident, radioactive waste tanks were already 60 percent full with waste water from the recent TMI-1 shutdown outage.¹⁶⁷ In addition, leakage from various operating systems in the auxiliary and fuel handling building added about 800 to 1,000 gallons per day.¹⁶⁸ On May 25, 1979, the Commission issued a policy statement prohibiting the discharge of accident-generated water into the river. The installation of additional water storage tanks and the start of the EPICOR I and II water cleanup systems provided much-needed relief in storage capacity for varying radioactive concentrations. During the early weeks and months following the accident, plant operators transferred contaminated water between existing tanks (see correspondence in DVD folder, [General Plant Stabilization](#)). The licensee considered using railroad tank cars for onsite storage of low-level radioactive waste water. The licensee asked the NRC to help them find 100 tank cars.¹⁶⁹ Two tank cars were purchased by the licensee; however, they were never used to store contaminated or processed water. In July 1979, the fuel pool waste storage system (“tank farm”) was available with 110,000 gallons of storage capacity. In July 1981, two new processed-water storage tanks were available (each with 500,000 gallons of capacity).¹⁷⁰
- ***Purge of the reactor building’s atmosphere.*** The controlled purging of radioactive krypton gas inside the reactor building was carried out under detailed procedures approved by the NRC staff. The purging began on June 28, 1980, and continued until the morning of July 11. The removal of radioactive krypton-85 gas from the reactor building’s atmosphere

allowed workers to begin work to clean up the reactor building, to maintain instruments and equipment, and to remove the damaged fuel from the reactor vessel.¹⁷¹

The approval process for an environmental assessment of a number of alternatives for the decontamination of the reactor building's atmosphere, began with the issuance of a draft for public comment. Approximately 800 responses were received from various Federal, State, and local agencies and officials, as well as from nongovernmental



The TMI-2 ventilation stack being uncapped for the planned purge of accident-generated radioactive krypton gas from the reactor building. The ventilation stack was previously capped to redirect ventilation from the auxiliary and fuel handling building to the temporary supplementary air filtration system.

organizations and private citizens. Based on the comments received, the “Final Environmental Assessment for Decontamination of the Three Mile Island Unit 2 Reactor Building Atmosphere” (NUREG-0662) was issued in May 1980. Having reviewed the staff assessment and recommendations, along with the comments from the public, the Governor of Pennsylvania, and many others, the Commission issued a Memorandum and Order on June 12, 1980, which authorized the licensee to clean the reactor building's atmosphere by means of a controlled purge. On the same day, the Commission issued

a temporary modification of the TMI operating license setting offsite dose limits for the purge.¹⁷² The order included a one-time waiver of the environmental technical specifications (Appendix B) requirements for the instantaneous and quarterly average limits for the release of noble gases.¹⁷³ On July 24, 1980, Amendment No. 11 to the facility's operating license was issued to allow the bypassing of the interlocks from the reactor building's exhaust radiation monitors to the reactor building's exhaust purge dampers for the duration of the purge.¹⁷⁴

The vented activity was estimated to range from 38,302 to 50,254 curies of krypton-85 with a median value of 44,132 curies during the release period. Environmental monitoring was performed with substantial instrumentation, with both fixed monitors in the ventilation system, and mobile sampling around the plant.¹⁷⁵ Offsite radiation monitoring programs were conducted by the licensee, the NRC, the United States Environmental Protection Agency (EPA), the Department of Environmental Resources of the Commonwealth of Pennsylvania, and also by local citizens working through the Community Radiation Monitoring Program set up by the DOE, and the Commonwealth of Pennsylvania. The maximum cumulative radiation dose and the maximum dose rate measured at offsite locations were a fraction of the limits allowed under NRC regulations.¹⁷⁶ There were subsequent purges to release the krypton gas that was slowly desorbing from the water and walls. The monthly releases that occurred between September 1980 and December 1980 decreased in an approximately exponential manner (emitting 27, 15, 12, and 7.5 curies respectively).¹⁷⁷

- Reactor building entries.** Entries into the reactor building were initially desired for damage assessment, data collection, and equipment maintenance; in support of these entries, a set of experiments was performed to identify any safety issues. Experiments included weekly analyses of airborne samples from the reactor building; a gamma scan

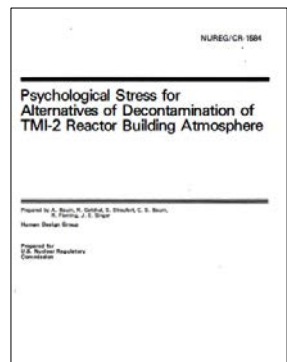
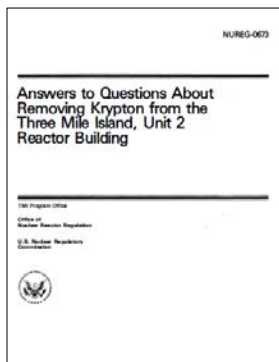
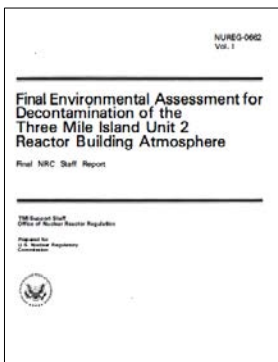

of the equipment hatch; a gamma scan of the basement water through penetration R605; an analysis of samples of the basement water through penetration R401 with support from the Oak Ridge National Laboratory (ORNL); radiation mapping of the no. 2 personnel air lock; plate out analysis of the spool piece from the hydrogen recombiner with ORNL support; analysis of hazardous gas in the reactor building's atmosphere; operating level (347-foot elevation) gamma scan and video survey through penetration R626; and testing of protective clothing, telemetered dosimetry, and dose-rate instrumentation.¹⁷⁸

Entries began on July 23, 1980,¹⁷⁹ after the reactor building's atmosphere was purged of krypton, though initially, the plan was to enter the reactor building prior to purging.¹⁸⁰ An attempt was made on May 20, 1979, but was delayed until after the purging because of a malfunction of the inner door to the reactor building's personnel airlock.¹⁸¹ The initial entries used the following equipment: (1) portable lighting; (2) radios (for communication); (3) respiratory protection, such as self-contained closed-circuit breathing apparatus for the first entry and a positive-pressure filtered breathing air mask for subsequent entries; (4) protective clothing, such as paper overalls, cotton overalls, and a firefighter's suit; (5) protective shoes, such as cloth shoe covers, three pairs of plastic disposable shoe covers, and firefighter's boots;

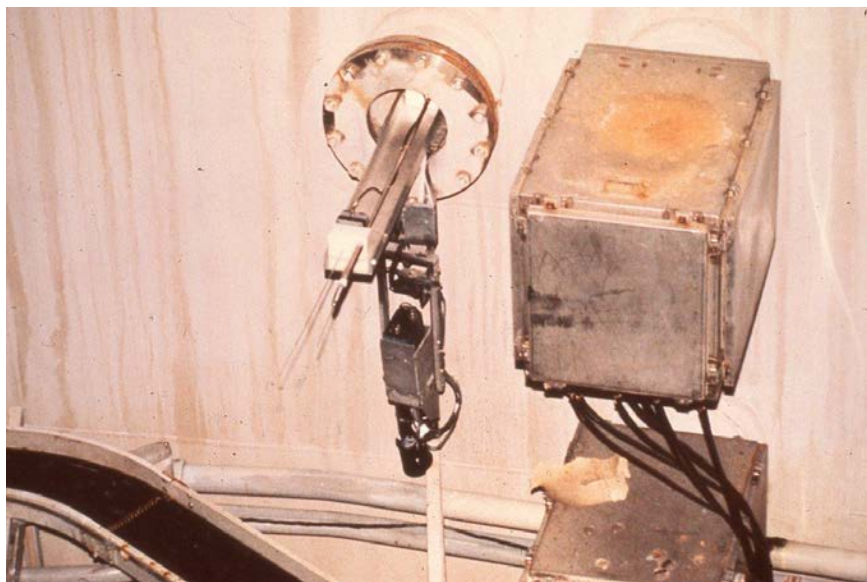

View from inside the reactor building of the inner flange to reactor building penetration R626 with video camera and telemeter dosimetry antennas (center). Initial experiments through this penetration supported the initial reactor building entry program.

(6) protective gloves, such as one pair of latex gloves, two pairs of neoprene gloves, and one pair of electric power lineman's gloves; (7) head protection, such as a cotton hood and a rain suit hood; (8) personnel dosimetry, such as telemetered dosimetry, self-reading digital dosimeters, thermoluminescent dosimeters, and film badges; and (9) handheld radiation instrumentation, such as a telescoping gamma dose-rate meter for taking measures at a distance and a prototype survey meter for taking high-range beta-ray measurements. The heavy-duty outerwear provided high-energy beta-ray protection. During the first 20-minute stay inside the reactor building, each engineer received a whole-body gamma exposure of about 200 millirem with no beta skin exposure.¹⁸² On May 24, 1989, the 2000th reactor building entry was logged by the licensee and support personnel.¹⁸³ Photographs, communication transcripts, and reports of the first six entries are provided in the DVD folder, [Reactor Building Entries](#).

- **Reactor building sump water removal.** By the time cleanup systems were ready to remove contaminated water from the reactor building, about 624,000 gallons of contaminated reactor coolant was standing on the reactor building basement floor. About 264,000 gallons was spilled



Engineers being suited up for the initial entry attempt into the reactor building. The orange underwater diver's dry suit was used to prevent leakage of radioactive material and to provide sufficient density to attenuate the anticipated high-energy beta radiation. The yellow rain suit was used to prevent direct contamination of the dry suit. After the purge of krypton-85 from the reactor building, the dry suit was no longer required.

through the stuck-open pressurizer pilot-operated relief valve during the accident. The pressurizer continued to leak during cooldown operations and contributed another 178,000 gallons. The automatic actuation of the reactor building spray pumps during the hydrogen burn contributed an additional 1,700 gallons of borated water directly into the sump. An additional 180,000 gallons of non-contaminated river water leaked from the river water cooling system through a leaking relief valve on a reactor building cooling unit.¹⁸⁴

Although the contaminated water was safely contained in the reactor building sump, its presence there constituted a continuing risk of leakage to the environment, and prevented or hindered the performance of the major decontamination activities.¹⁸⁵ The potential for this radioactive water to leak into the Susquehanna River, contaminating both the river and the downstream Chesapeake Bay, as well as downstream drinking water supplies, was a major concern for the GPU leadership, the leaders and residents of communities downstream, and the State and local governments of both Pennsylvania and Maryland.¹⁸⁶ Further, an early NRC task force concluded that the greatest risk of loss of containment was a confined leak of the reactor building water to the lower parts of the auxiliary building, where water in the reactor building stood almost 30 feet above the decay heat removal pumps and the reactor building spray pumps. These pumps may have been needed later during the recovery.¹⁸⁷



First entry into the reactor building (shown) occurred on July 23, 1980. Heavy duty outerwear provided beta ray protection.

The reactor building was constructed to prevent water in the sump from leaking into the environment; however, early concerns existed over the long-term storage of the highly-contaminated water in the basement, and the integrity of the containment following the hydrogen burn inside the reactor building during the first day of the accident.¹⁸⁸ The reactor building was designed and fabricated to withstand an internal pressure of 60 psig as well as major earthquakes. A structural integrity test was conducted prior to unit startup to pressurize the containment to 69

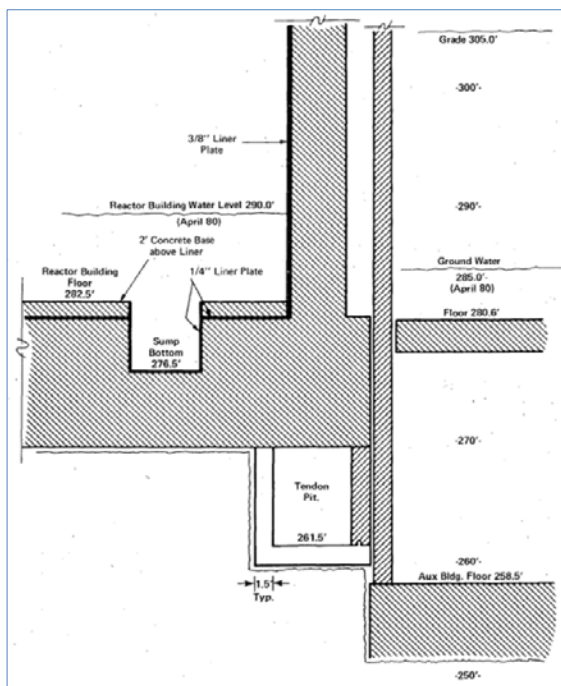

Cross-section view of the reactor building and auxiliary building with water level inside the reactor building as of April 1980. Gound water elevation shown on the right represented the water table outside the buildings.

pounds per square inch, 115 percent of the design pressure.¹⁸⁹ The foundation mat for the reactor building is 11.5-foot-thick and rests on bedrock. The reactor building has a carbon steel liner, 3/8-inch-thick on the sides, 1/2-inch-thick dome, and 1/4-inch-thick base. A concrete slab 2-foot-thick was poured above the liner base plate. The exposed face of the liner was coated with a prime and finish coat of an epoxy lining material. An additional leakage barrier was provided by a 40-mil-thick polyvinyl chloride polymer waterproofing membrane which was installed over the outer surfaces of the foundation mat.¹⁹⁰

The submerged demineralizer system (discussed later) and the surface suction system¹⁹¹ were designed and installed to clean up the highly-contaminated water inside the reactor building. A homemade floating pump, carefully crafted using polystyrene foam, glue, and epoxy from a Corvette repair kit, was designed and tested to initially float at an angle and then lie flat on its side as it approaches the bottom. In 60 roentgen per hour radiation field, a team of four wearing over 100 pounds of anti-

contamination clothing and equipment, dropped the suction pump with rubber hose over the open stairwell into the reactor building basement in less than 60 seconds.¹⁹² Details of this experience are provided in the seminar video, “The 35th Anniversary of the Three Mile Island Nuclear Power Plant Accident of 1979: Working at TMI During and Following the Accident,” (see the first volume of this NUREG/KM).

- Floor expansion joint contamination.** On November 26, 1980, contamination in the cork seam of expansion joints was first discovered during a routine radiation survey in the control and service building area. The seam is a cork-filled construction joint located between major structures to accommodate differential expansion between building structures and to attenuate vibration and wave motions during a seismic event. During the time period following the accident, the cork seam located in the auxiliary building seal injection valve room was saturated with reactor coolant water due to leaking valves. Initial decontamination attempts were not successful. Over the years, the radioactive material had spread along the joint into non-contaminated areas inside the plant. However, the radioactive contamination is prevented from entering the groundwater table by a water-stop barrier. Modifications have been made to the cork seam to allow periodic monitoring of the water levels

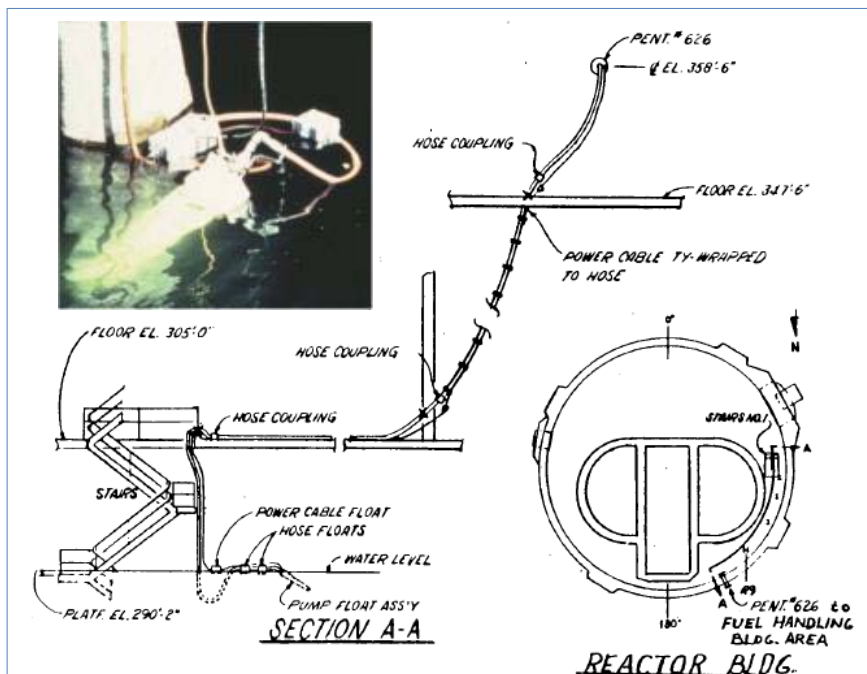

The surface suction system and floating pump. Picture shows a floating pump during a test in the outlet flume between the two natural draft cooling towers.

in the joint, to permit periodic water removal, and to prevent water and contamination migration within the cork-filled joint. ^{193, 194, 195}

- ***Auxiliary and fuel handling building decontamination*** (discussed in the section on [Decontamination](#))

Document Collections. Documents relating to plant stabilization efforts are grouped into five document collections on the DVDs.

- ***Correspondence between the NRC and the licensee*** (i.e., notifications, requests, reviews, and approvals) relating to the installation and operation of plant systems and documents associated with other plant stabilization operations (see the DVD folder, [General Plant Stabilization](#)). Enclosures (such as reports of system descriptions, technical evaluations, and safety evaluations) are included with correspondence. NUREG reports that supported stabilization activities are also included.
- ***Agenda and minutes of daily meetings of the Technical Working Group*** during the first four months after the accident (see the DVD folder, [Planning Meetings](#)). As previously noted, this group was an executive committee established by the licensee within a week after the accident to propose and discuss actions associated with daily operations. Many of the meeting handouts contained notes by NRC staff attending these meetings.
- ***Emergency and special operating procedures*** that were initially developed to cope with the plant's damaged state during the first months after the accident (see the DVD folder, [Recovery Procedures](#)). These procedures were reviewed and approved by NRC staff located at TMI. Many early procedures that were approved for use were handwritten.
- ***Industry Advisory Group task close-out reports*** (see the DVD folder, [Industry Advisory Group Reports](#)). As discussed previously, this group of industry organizations and individuals assisted the licensee to determine plant conditions and evaluate approaches to stabilize the plant. Tasks assigned to the group were documented in these reports.
- ***Photographs, communication transcripts, and reports of the first six reactor building entries*** (see DVD folder, [Reactor Building Entries](#)).



Technicians inside the personnel airlock to the reactor building, as seen through the round window of the outer personnel airlock door.

4 Worker Protection

Post-accident radiological conditions at TMI-2 were substantially different from those normally encountered at commercial operating nuclear plants because of the magnitude and specific mix of the radionuclide contamination. Radiation surveys made shortly after the accident showed that general area radiation readings ranged from 150 to 500 millirem per hour in the fuel handling building, and 50 to 5,000 millirem per hour in the auxiliary building. Hot spots were measured in the auxiliary building reaching up to 125 rem per hour, and exceeding 1,000 rem per hour in some cubicles. The high-energy beta component was up to one hundred times the gamma component.¹⁹⁶

During the first entry into the reactor building in July 1980, dose rates at the 305-foot entry-level elevation ranged from 400 to 600 millirem per hour. Localized areas of high radiation were measured at 18 rem per hour over the open stairwell and 2 to 5 rem per hour at floor drains. The general-area floor and wall beta-radiation readings ranged from 1 to 2 rad per hour.¹⁹⁷ Surveys performed during the second entry at the next-higher level, the 347-foot operating-floor elevation, showed general radiation readings of 100 to 400 millirem per hour.

Below the 305-foot entry level elevation was the 282-foot basement-level elevation, which was flooded with highly-contaminated water and sludge. A telescoping radiation detector was inserted down through one of the reactor building stairwells and measured 40 to 45 rem per hour at 5 to 7 feet from the surface of the basement water.¹⁹⁸ Once the water was drained and processed through the submerged demineralizer system, dose rates from the remaining sludge ranged from 1 to 1,000 rem per hour, depending on location and distance from the floor.¹⁹⁹

A unique concern at TMI-2 was high-energy beta contamination from fission products in the reactor coolant. The generation of activation products from corrosion such as cobalt-60 was minimal because the new plant had less than a year of full-power operation. Areas in the auxiliary building that had experienced coolant leakage were measured in the 10- to 100-rem-per-hour gamma range with associated beta dose rates in the 1,000- to 10,000-rad-per-hour range. Similar gamma-to-beta ratios were measured on surfaces in the reactor building. The cesium isotopes have beta energies in the 0.5-million-electron-volt (0.5-MeV) range; strontium-89, which has the highest concentration of beta emissions, has a maximum energy of about 1.5 MeV; yttrium-90, the decay daughter of strontium-90,

has a 2.3-MeV beta energy.²⁰⁰ Typically, beta radiation from beta-emitting radionuclides at operating plants is low-energy, so protective clothing provides sufficient shielding. The high-energy beta emitters present at TMI-2 required special radiological protection practices, such as monitoring equipment, personnel dosimetry, heavy protective clothing, procedures, and training.²⁰¹ Access into many areas in the plant with high levels of high-energy beta-emitting yttrium-90 required a combination of double-respirator face pieces or face shields and safety glasses.²⁰² The need for these special worker protection practices became clear after several incidents of skin and extremity exposures exceeding regulatory limits.

Radiation Exposure Events. The licensee reported several accident-related exposures to the whole body and extremities during the response to the accident on March 28th and 29th in excess of NRC regulatory limits. During the very early phases of post-accident recovery, about five months after the accident, six workers received overexposures to the skin and extremities. The last extremity overexposure of two workers occurred in 1989. These events are summarized below:

- **Whole-body exposure.** On the evening of March 28, 1979, an auxiliary operator received a collective whole-body exposure in excess of the NRC quarterly limit, while on two tours in the auxiliary building. The auxiliary operator made two entries into the auxiliary building without radiation work permits, a high-range self-reading dosimeter, and proper planning with health physics support. There was no one to challenge the operator's entry and no locked access to restrict entry into the building at that time. Upon exiting the building both times, the operator's low-range, (0 to 200 millirem), self-reading pocket dosimeter read off-scale high. In addition, the operator failed to perform surveys for personal contamination. Upon entering the TMI-2 control room after the first job and then again after the second, a count rate meter on the table alarmed both times. After being told by a radiation protection technician, who happened to see the alarm the first time, to decontaminate, the operator decided to enter the auxiliary building again for a second 10-minute job (the operator reasoned that he was already contaminated). On the operator's return to the control room the second time, the operator told the shift supervisor that the self-reading dosimeter had gone off scale. The shift supervisor told the operator to decontaminate. After decontamination, the operator's personal dosimeter was read, indicating a whole-body gamma exposure of 3.170 rem. An NRC investigation concluded that this entry exemplified the lack of good health physics practices.²⁰³ (See [NUREG-0600](#), Section 3.2.4.8.)

(The NRC radiation protection regulations that were applicable during the first decade of the recovery effort allowed up to 3 rem per calendar quarter for a total of 12 rem in one year with proper documentation of the worker's exposure history. This higher limit is no longer stated in current regulations.²⁰⁴)

- ***Extremity exposures.*** During the afternoon of March 29, 1979, two workers received overexposures to their hands while taking reactor coolant samples to measure boron concentration, in order to ascertain whether the reactor core was still critical. The team discussed the assignment for a period of less than one hour. No one wore extremity monitoring on their hands. Self-reading pocket dosimeters of one worker were worn inside the protective clothing, making them inaccessible for periodic checks. The other worker wore a high-range self-reading pocket dosimeter taped to the forearm, but it was knocked off during collection of the sample. Before taking the sample, the room was surveyed and found to have an average exposure rate of 8 roentgen per hour. About 300 milliliters (ml) was drawn in a sample bottle, of which 100 ml was poured into a graduated cylinder for gross radiation measurement. Using a telescoping radiation-detection instrument, the cylinder measured off-scale high on contact (greater than 1,000 rem per hour), 400 rem per hour at 1 foot, and 10 to 15 rem per hour at 3 feet. A second 40-ml sample was drawn and carried into an adjacent laboratory for boron concentration measurement. The area radiation monitor in the primary sample laboratory increased from 20 to 800 millirem per hour, as the worker entered the room. Both workers handled the sample containers unshielded at contact with gloved hands, while hand-carrying the samples for disposal.²⁰⁵

Both workers and a third worker involved with the boron measurement received contamination on a finger, wrist, and other parts of their bodies. The workers attempted decontamination for several hours. All went home with some areas of their bodies having fixed contamination, such as 50 millirem per hour on a finger and 30 millirem per hour on a wrist. Residual contamination remained on small areas of one worker's skin for over 30 days, which added to the total dose to the skin. Each worker supplied urine samples the next day, but these were not promptly analyzed by the licensee. The doses that the two workers received were later calculated by an NRC radiation specialist. One worker received an estimated exposure of 147 rem to the fingers, a skin dose to the top of the head in the range of 10 to 32 rem, and a whole-body exposure of 4.25 rem. The other worker received an estimated extremity dose in the range of 44 to 54 rem to the forearm

skin and a whole-body exposure of less than 1 rem.²⁰⁶ (See [NUREG-0600](#), Section 3.2.4.10.)

- **Whole-body exposures.** On the evening of March 29, 1979, one of two engineers received whole-body exposure in excess of the quarterly limit while he toured the auxiliary building to check for leaks. Before the tour, the engineers were briefed by a radiation protection foreman, dressed appropriately for the degree of hazard, and were provided with two handheld radiation-detection instruments, one of which was a

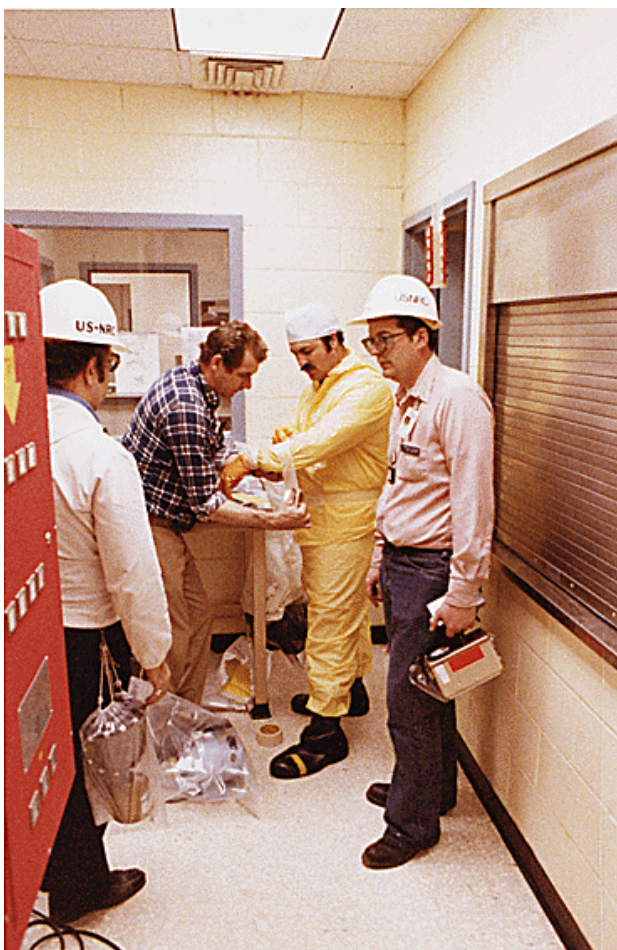

NRC inspectors monitoring radiological controls activities shortly after the accident. On March 30, the NRC became more actively involved in the radiation protection program by assigning NRC radiation specialists to each of the three shifts, providing around the clock coverage.

high-range gamma instrument. Shortly after entering the auxiliary building, the high-range gamma instrument failed. They continued on together noting that the other instrument frequently pegged off-scale high (2 rem per hour). Upon exiting the building, the high-range self-reading pocket dosimeter read about 3 rem for one individual and less than 1 rem for the other. Their personal dosimeters were read and indicated 3.14 rem and 0.170 rem. An NRC investigation concluded that this entry demonstrated a lack of implementation of basic radiation protection training that could have resulted in serious consequences.²⁰⁷ (See [NUREG-0600](#), Section 3.2.4.11.)

- **Whole-body exposures.** On August 28, 1979, six workers entered a room in the TMI-2 fuel handling building to inspect and tighten leaking valves in preparation for decontamination of the area. Reactor coolant water, extremely contaminated from the March 28 accident, was leaking from the valves. The radiation survey instrument used by the workers showed a gamma dose rate in the room of 10 to 15 rem per hour and, in one small zone, 25 rem per hour. It was decided that the time limit on the presence of each worker in the radiation area was four minutes. What the survey instrument failed to disclose was that the beta radiation rates in the room were running as high as 2,500 rem per hour. It was later estimated that the workers had received doses from the beta radiation in excess of regulatory limits. The doses were as high as 166 rem to the whole body in one instance, and 161 rem in another. No indication of medically significant effects on the personnel was identified by medical examination. The causes of the overexposures were determined to be inadequate instrumentation for radiation detection and a failure to require adequately-protective clothing for the workers. Corrective action was taken under NRC direction.²⁰⁸
- **Extremity exposures.** On September 25, 1989, two workers received overexposures to their extremities while unknowingly handling a piece of fuel debris in the TMI-2 reactor building decontamination facility inside the reactor building. Both workers were performing flushing decontamination operations when one worker picked up what was thought to be a nut lying on top of the drain grating in the flush facility. The worker picked up the material and tossed it toward a trash bag, but missed. The other worker picked up the material, presumably to place it in the trash bag, and was told by the first worker to leave it alone. The first worker picked up the debris again and set it down 8 feet away. Management was not informed of this event until the following day when the first worker asked a radiation control technician (RCT) about the implications of handling fuel debris. Fortunately, the RCT realized

from his questions and further discussions that he had handled a piece of corium. The licensee conducted numerous reviews and assessments of the incident, as well as medical examinations of and consultations with the two workers.

A subsequent radiation survey performed on the material indicated contact dose rates of 1,320 rem per hour of gamma radiation, and 11,580 rem per hour of beta radiation. The highly-radioactive material was placed in the reactor vessel using long-handled tools. The dose assessment, including re-enactments using a full-scale mockup of the decontamination facility, estimated that one worker might have experienced an extremity exposure to the hands in the range of 75 to 375 rem, and the second worker might have experienced an exposure to the hands in the range of 18.75 to 75 rem. The wide range of these estimates was attributed to the uncertainty in the estimates of the time that the workers were handling and were near the radioactive source. The licensee instituted a site-wide training program on the appropriate handling of fuel debris.²⁰⁹ The RCT demonstrated an attitude that needed to be fostered for conducting good health physics practices.

Radiological Protection Programs and Activities. Many programs and activities helped to improve radiation protection practices at TMI-2. New approaches were needed in a number of basic worker-protection and dose-reduction areas, including protective clothing, respiratory protection,



Technicians taking radiation readings inside the reactor building. Notice the personnel dosimetry attached to the back of the technician.

dosimetry, radiation field and contamination characterization, exposure-tracking systems, dose-reduction planning, procedures, training, and robotics. In the summer, when the temperature in the reactor building approached 33°C (90°F), an ice vest was commonly used by workers to control heat stress and extend work periods.^{210, 211} Several respiratory protection breathing apparatuses were developed or adapted to extend stay-times in the reactor building, including a power air-purifying respirator and a power air-purifying hood.²¹² Some of the radiological protection programs and activities are summarized below:

- ***Increased radiation protection oversight.*** On March 30, 1979, more control was established by the licensee over in-plant radiation hazards. Radiation protection technicians were being used onsite to establish control points. Temporary dose-accountability forms were implemented that evening at the site access point. The whole-body counter was in operation and individuals were being counted. On the afternoon of March 30, the NRC became more actively involved in the radiation protection program. Five NRC radiation specialists were assigned to each of the three shifts, providing around-the-clock coverage. In addition, two NRC health physicists provided technical guidance.²¹³ A summary of radiation protection findings that were identified by NRC inspectors during the early months of the recovery, were documented in the NRC investigative report, “Investigation into the March 28, 1979 Three Mile Accident by Office of Inspection and Enforcement” (NUREG-0600).²¹⁴
- ***NRC Special Panel on TMI-2 Radiation Protection Program.*** On September 26, 1979, the director of NRC’s Office of Nuclear Reactor Regulation, created a special panel to provide an independent review of the licensee’s existing and planned radiation protection program that was intended to keep personnel’s exposure to radiation at ALARA levels during the recovery and cleanup of Unit 2. The panel of external experts recommended the following in its report (NUREG-0640): an upgraded radiation safety program for major radiological recovery efforts; independent assessment of the proposed upgraded program; and a management plan and firm schedule for resolution of existing technical and management deficiencies in the radiation safety program.²¹⁵
- ***Dose-reduction program.*** Because of the increasing amount of work inside the reactor building, a major effort to reduce dose rates was initiated by the NRC and the licensee in December 1982. The objective of this effort was to identify and eliminate or shield as many sources of

radiation exposure as possible in occupied portions of the reactor building before and during reactor disassembly and defueling. The dose-reduction program initially focused on both the 305-foot entry-level elevation and the 347-foot operating-floor elevation, where most of the defueling work took place.²¹⁶ Dose-reduction techniques included (1) shortening the transit time of workers in the reactor building by opening both personnel airlocks and modifying the ingress/egress paths; (2) decontaminating by water flushing discrete radiation sources, such as the air coolers, elevator shaft, and enclosed stairwell; (3) eliminating other discrete radiation sources by removal of trash and contaminated equipment; and (4) placing shielding at the 305-foot elevation, such as lead curtains around the core flood tank, lead sheets on the covered floor hatch, and water columns and bladder shields around the open stairwell, elevator, and enclosed stairwell.²¹⁷ Some of the more complex dose-reduction activities included extensive pre-task planning and mockup training for each task, decontamination of selected surfaces with chemicals, removal of paint, and scabbling (the mechanical removal of a thin layer) of concrete floors. These efforts resulted in significant reductions in the dose rate in the reactor building.²¹⁸ In July 1984, workers entered the reactor building without respiratory protection for the first time since the accident, and, in accordance with ALARA principles, subsequent entries were made without respirators.²¹⁹ Dose-reduction activities to support defueling operations were completed in March 1985.²²⁰



Protective clothing worn during early entries into the reactor building.

- ***PEIS supplement on occupational radiation dose.*** In October 1984, the NRC TMI Program Office issued Supplement 1 to the Programmatic Environmental Impact Statement or PEIS ([NUREG-0683](#)) after a public comment period. The purpose of this supplement was to re-evaluate the occupational radiation dose, and consequent health effects from cleanup, and address additional alternative cleanup approaches using information gathered since the original PEIS was prepared in 1980. The total radiation dose to cleanup workers was estimated to range between 13,000 and 46,000 person-rem as opposed to earlier estimates of 2,000 to 8,000 person-rem. The higher estimates resulted from a more accurate characterization of radiation fields in the reactor building based on numerous worker entries.²²¹

Radiation Detection Instruments and Systems. Special instrumentation, systems, and techniques were developed or modified to measure and characterize the unique radiation situation at TMI-2 for ensuring worker safety and determining the effectiveness of decontamination processes. Key instruments are summarized below:²²²

- ***Thermoluminescent dosimeter (TLD) pseudo cores*** to take beta radiation measurements of the building floors. This simple device included a beta measuring TLD mounted on top of a plastic ring to shield the TLD from beta radiations coming from the floor area outside



A technician lowering a telescoping radiation detector down into the open stairwell to the reactor building basement. Measurements revealed radiation levels of 40 to 45 rem per hour at 5 to 7 feet from the surface of water.

the ring. TLD pseudo cores replaced the need to manually drill and process concrete core samples.

- **Wall and floor sampler** to mill the concrete surface and collect the sample in a filter for offsite analyses.
- **Modified handheld ion chamber detector** to provide omnidirectional detection for gamma measurements and over 180 degrees for beta measurements. This modification provided a wider field of view for rapid directional exposure measurement of beta and gamma contamination.
- **Modified handheld tungsten-shielded, Geiger-Mueller detector** with a conical lead collimator on the face of the probe to reduce the field of view from 140 degrees to 80-90 degrees. This modification provided rapid and accurate directional exposure measurements.
- **Mobile radiochemistry laboratory** to perform transuranic and radionuclide analyses of high-activity (less than 5 R per hour) liquid and solid samples. Higher activity samples had to be packaged, characterized, and shipped to offsite laboratories for analyses. This mobile laboratory was provided by the DOE.



Water level in the basement reached the first stairwell landing indicating about 8 feet of water accumulation.

- **Radiation mapping and ALARA planning system** to provide 3-dimensional maps of radiation exposures in plant areas and components, and to train and plan for missions in contaminated areas, and track their results.
- **Improved personnel dosimetry system** to approximate in-containment beta source conditions. The system included a modified 4-element dosimeter and an automated system used at TMI-2 each month to process that data from about 6,000 dosimeters.

Cumulative Worker Exposure Over 10 Years. Although worker activities at TMI-2 have been quite different than those at operating power plants, the cumulative doses at TMI-2 since the accident had been lower than the average doses experienced at operating reactors. By the end of 1989, with the cleanup about 99 percent completed, the collective dose to all workers was 6,180 person-rem. This was comparable to the collective occupational radiation exposure that was estimated in the original PEIS (2,000 to 8,000 person-rem).^{223, 224}

Document Collections. Documents relating to worker-protection and dose-reduction activities provided on the DVDs include the following:

- an assortment of documents relating to radiation protection, such as annual reports of personnel exposures; radiation protection plans; dose-reduction plans; radiological training programs; and correspondence (see the DVD folder, [Worker Protection](#))
- an annual summary of dose-reduction activities provided in the NRC’s annual reports (see the DVD folder, [NRC Annual Reports](#))
- the report, “TMI-2: Lessons Learned by the U.S. Department of Energy, A Programmatic Perspective,” which summarizes applications of research and development in the areas of worker protection (see the DVD folder, [DOE/National Laboratory Status Reports](#))

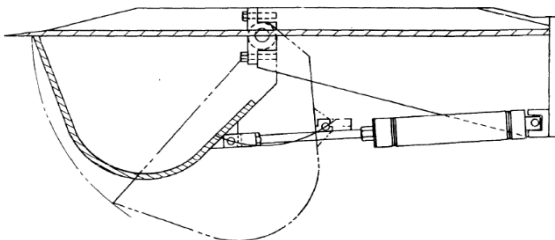

Defueling tool: spade bucket hydraulic attachment.

TMI-2 Core End-State Configuration

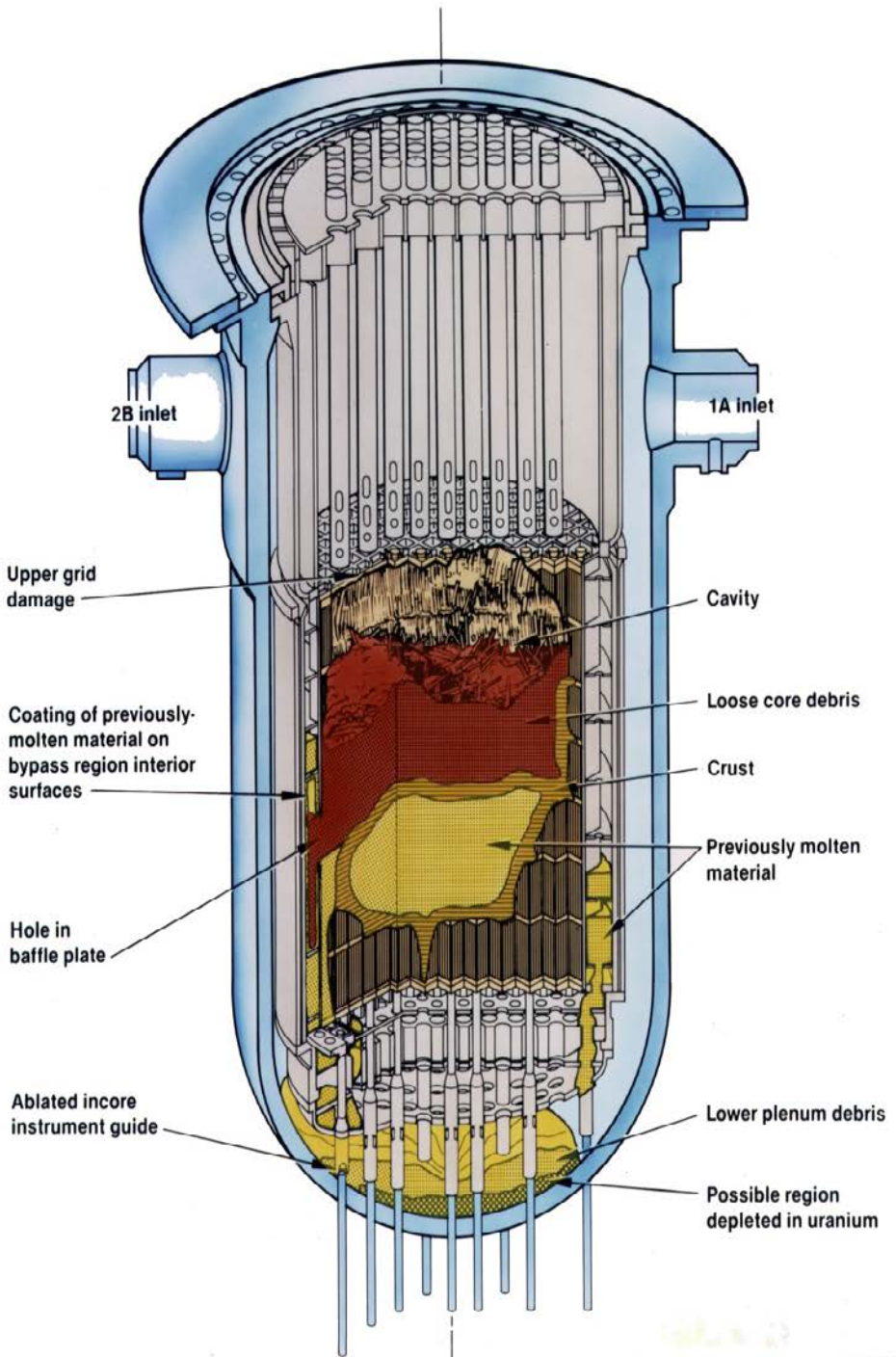

5 Data Acquisition and Analysis

The collection and analysis of data contributed to the safe stabilization of the damaged plant and supported planning of decontamination and defueling activities. The TMI-2 accident also provided research opportunities that added to the knowledge about light-water-reactor behavior following a severe accident. Information that was required to ensure stable plant operations included measurement of reactor core and plant conditions; characterization of radioactivity inside the plant (for the design of recovery systems and planning of activities); and verification of recovery system and activity performance. The characterization of damaged fuel and internal reactor vessel components supported defueling planning, preparations, and operations, as well as interim storage, transportation, final storage, and disposal of fuel debris.

The severe reactor core damage and behavior of fission products within the plant systems at TMI-2 gave government and industry researchers opportunities to: (1) measure the performance of instrumentation and of electrical and mechanical equipment within the reactor building during and after the accident; (2) determine physical damage to surfaces, components, and equipment caused by radiation exposure; (3) assess metallurgical and physical behavior of fuel, clad, and core components during and after the accident; and (4) assess new technologies for decontamination, and the disposal of radioactive waste.²²⁵

The DOE supported an extensive research program as directed by the U.S. Congress. Four organizations with a common interest in obtaining valuable information from the TMI-2 accident jointly established the TMI-2 Information and Examination Program. The GPU, EPRI, NRC and DOE (hence the acronym GEND) signed the Joint Coordination Agreement²²⁶ on March 26, 1980, which identified the objectives and defined methods to implement the TMI-2 Information and Examination Program. The Technical Integration Office was established at TMI according to the terms of the Joint Coordination Agreement, with responsibility for implementation and daily management of the DOE programs. The office was staffed by INEL personnel and reported to DOE's site office. A technical working group (see above section on [Advisory Groups](#)) was formed to coordinate research opportunities and activities.²²⁷ In April 1984, the DOE signed a cooperation agreement with 17 Japanese nuclear power organizations to participate in research and development for recovery activities. As part of the agreement, DOE permitted Japanese organizations to participate in DOE research and development activities. In return, Japanese participants provided funding to

DOE and research staff (up to 22 engineers at a time) at DOE laboratories and the TMI site.^{228, 229}

The NRC was responsible for evaluating and approving proposed in-plant research activities and implementing procedures to ensure that they were conducted in a safe manner.²³⁰

Reactor Core Inspections. Of particular interest to all organizations involved in the cleanup and research, was the extent of damage to the reactor core and internal reactor vessel components. Data acquisition and analysis that were conducted inside the reactor vessel included visual “quick look” inspections using video cameras; ultrasonic measures; radiation dose measurement; grab sampling of loose core debris; and core samples using a core bore drilling machine.²³¹ The most revealing examination, with the most far-reaching implications, was the first “quick look” visual inspection in July 1982, which showed extensive reactor core damage (fuel melting would not be identified and announced until four years later). Up to the time just before the quick look, the licensee had held out hope that the plant would one day be restarted. After quick look, the licensee’s primary focus



The first closed-circuit video inspection of the upper reactor core region was performed on July 21, 1982. A technician sitting on a platform positioned on top of the reactor vessel service structure is inserting a camera, 1.5 inches in diameter and 12 inches long, through an empty leadscrew support tube.

was cleanup.²³² A chronology of the reactor core inspection activities is summarized below:

- ***Insertion test of axial power shaping rods.*** In June 1982,²³³ an axial power shaping rod (APSR) insertion test was performed in an attempt to move each APSR leadscrew inside the control rod drive mechanism to its fully inserted position. During normal power operations, eight APSRs helped shape the power generation (neutron flux) uniformly across the reactor core to ensure even fuel burnup during the core's lifetime. These APSRs do not perform safety functions and do not drop into the reactor core during an automatic reactor shutdown. During the accident, the eight APSRs rods remained at a 25 percent withdrawn position while 75 percent of their length remained inserted in the fuel assemblies. One purpose of the test was thought to provide insight into the extent of damage to the reactor core and upper plenum. The analysis of the data concluded that the test provided little definitive information about the physical condition of the reactor core.²³⁴ (See [GEND-INF-038](#).)
- ***“Quick look” camera inspection.*** The first closed-circuit video inspection of the upper reactor core region was performed on July 21, 1982. A camera 1.5 inches in diameter and 12 inches long was inserted through the empty leadscrew support tube (inside a control rod drive mechanism), and then into a central control rod guide tube (inside the upper plenum). As the camera was lowered into the upper core region, it revealed a bed of rubble approximately five feet below the normal location of the top of the fuel assembly. It was believed that the rubble bed contained oxidized cladding, fuel fragments and/or pellets, poison material, and core structural components. No evidence of melted fuel pellets was found. Another inspection, on August 4, midway between the periphery and the center of the reactor core, also revealed a rubble bed approximately five feet below the top of the core region. Intact pellets, which might have been fuel or poison material, were visible on the top of the rubble. During a third inspection, which took place on August 12, a probe was poked through the rubble and it penetrated approximately one foot below the surface, indicating that the rubble in this region was composed of loose material.²³⁵ The visual inspections did not find any apparent distortion of the upper plenum.²³⁶ (See [GEND-030](#).)

- ***Underhead characterization study.*** In late summer of 1983, a series of activities conducted for the underhead characterization study provided radiological data to support the radiological protection measures that would be needed to conceptualize and plan procedures for removal of the reactor vessel head. Previously, in December 1982, a simple vertical “quick scan” of the underhead region (using an ionization chamber lowered into an empty control rod drive mechanism opening) found higher-than-expected radiation levels, which ranged from 40 to 600 roentgen per hour with an unknown beta-radiation contribution.²³⁷ The results from the quick scan prompted a more detailed study.²³⁸

The initial underhead characterization study obtained dose rates around the reactor vessel head and service structure; re-measured dose rates under the head using a beta-shielded ionization chamber (“quick

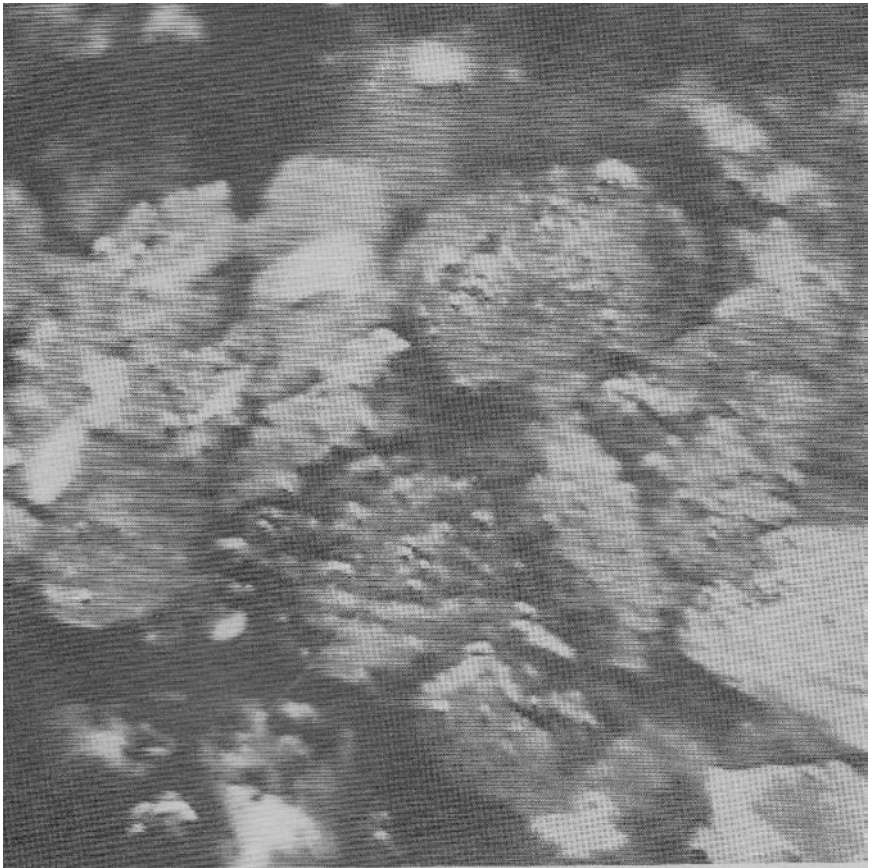

On July 21, 1982, the first video camera was inserted through a control rod drive mechanism motor tube for a “quick look” of the upper reactor core region. Shown is the top of the rubble bed of the reactor core cavity.

scan-2”), and a string of thermoluminescent dosimeters; performed remote visual inspections of the top of the upper plenum and underside of the reactor vessel head; obtained debris samples from the top of the plenum for pyrophoricity tests; examined the lower end of a leadscrew to characterize the stainless steel in the underhead environment; and evaluated the dose rate increase associated with moving several radioactive leadscrews from inside the reactor vessel to a position in the control rod drive mechanism’s motor tubes in the reactor vessel head’s service structure. The study required the depressurization of the reactor coolant system to atmospheric pressure, a slight draindown of the reactor vessel’s water level to uncover the top one foot of the upper plenum (10 feet above the reactor core region), and the removal of a control rod drive mechanism.²³⁹ The NRC established a contract with DOE’s Pacific Northwest Laboratory to review the radiation measurements, fission products plate-out (absorption) on the upper plenum, and other chemical phenomena.²⁴⁰

The results of the data analysis revealed the following: no visual structural damage on the upper plenum; areas inspected on top of the plenum appeared relatively free of debris (though some sedimentation appeared to be present on some horizontal surfaces);²⁴¹ pyrophoricity tests on two samples of material from the plenum surface proved negative;²⁴² gamma radiation fields in the range of 300 to 700 roentgen per hour were measured in the space formed by the underside of the reactor vessel head and the top of the plenum;²⁴³ and no significant dose-rate increase was observed on the service structure platform following the withdrawal of four leadscrews.²⁴⁴ The analysis of the data from the underhead characterization study supported plans to remove the reactor vessel head without flooding the refueling canal (also called “dry lift”).²⁴⁵

- ***Reactor core debris sampling program.*** The safety evaluation report for the underhead characterization study was amended to include two new activities that were sponsored by DOE’s TMI Reactor Evaluation Program: a reactor core debris sampling program and reactor core topography program. The reactor core debris sampling program provided data that was essential to prepare for future reactor vessel defueling activities and for the design of water cleanup systems and defueling canisters. In September and October 1983, the program obtained six specimens of reactor core debris by lowering specially designed tools into the reactor. The tool scooped up small samples of loose debris and transferred them into small shielded casks for offsite shipment and analysis. The analysis of the samples included

determining their particulate composition, particle size, fission-product content, and drying properties, as well as the fission-product leachability from the debris and the pyrophoricity of zirconium hydride or partially unoxidized zirconium fines.²⁴⁶

The first three samples were taken at various depths in the center of the reactor core. The radiation field at one foot from one sampler (which had a capacity of one cubic inch) was approximately 3 roentgen per hour.²⁴⁷ The other three samples were taken midway between the center and the periphery of the reactor core at various depths in the debris bed.²⁴⁸ The six samples obtained during the grab-sample work were analyzed at the INEL and the Babcock & Wilcox (one sample) research facilities.²⁴⁹ Gamma-radiation levels of five samples, using a telescoping radiation instrument from 2.5 cm away, ranged from 3 to 36 roentgen per hour. Particle sizes ranged from about 0.6 cm to a fine debris.²⁵⁰ Five more samples were obtained in March 1984.²⁵¹ Results from the sampling program were documented in the INEL report “TMI-2 Core Debris Grab Samples—Examination and Analysis” ([GEND-INF-075](#)).

- **Reactor core topography program.** In August and September of 1983, the core topography system, designed and built by DOE at INEL, was used to conduct an ultrasonic profile of the void area in the upper

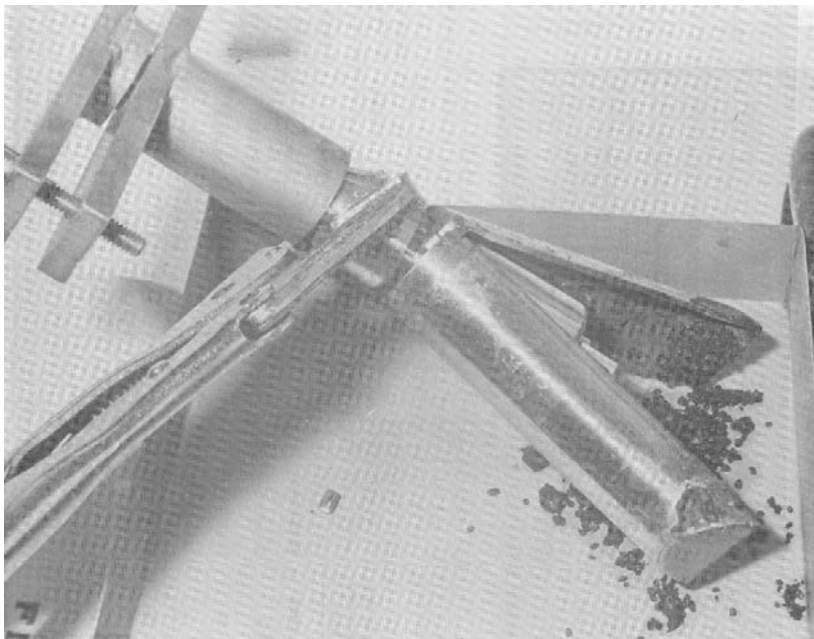

Core grab sample tool with fuel debris from the rubble bed obtained for the reactor core debris sampling program in September 1983.

reactor core region. A total of about 500,000 data points was obtained during system operation.²⁵² The data and information obtained included the radial and axial extent of the reactor core cavity, the location of supported and unsupported fuel assembly end-fittings, and the location of the core cavity boundary with respect to structurally intact fuel assemblies. The analysis of this data supported upper plenum lift and defueling operations.²⁵³

A clear plastic scale model of the damaged upper reactor core region was constructed at INEL in late 1983 based on ultrasonic measurements. This topographic model provided the most accurate indication of the extent of reactor core damage at that time. The volume of the cavity in the damaged area of the reactor core was measured at 330 cubic feet or 26 percent of the original core volume. The bottom of the cavity ranged from 5 to 6 feet below the top of the core. Of the original 177 fuel assemblies, 42 appeared to contain some full-length fuel rods, but 23 of those 42 had less than 50 percent of the rods intact. The sonic mapping also revealed several partial fuel assemblies hanging from the underside of the upper plenum and indicated some distortion of the core former wall.^{254, 255} Each half of the plastic model was transferred to the NRC by DOE and the Smithsonian Institution. The complete model now resides at the NRC at Rockville, Maryland.

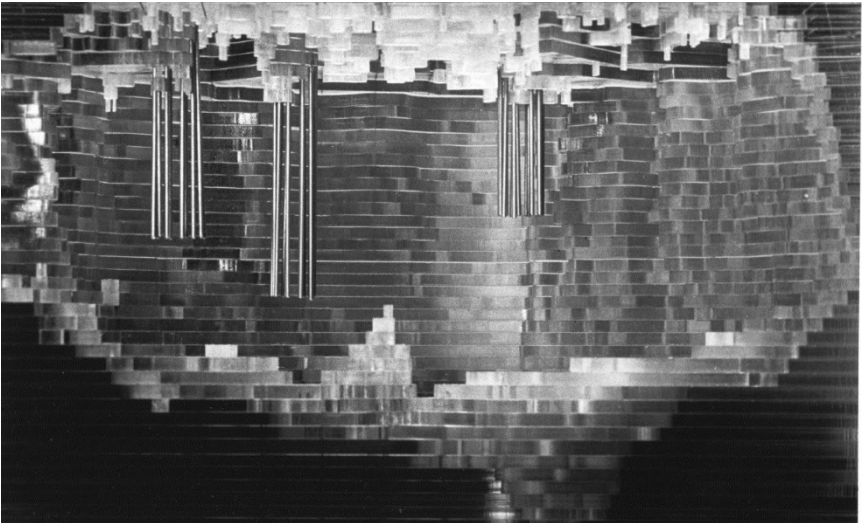

Topographic model of one-half of the cavity in the upper core region based on an ultrasonic profile from the reactor core topography program during August and September of 1983. The individual layers of the model represent 2-inch contours within the cavity. The rods represent the locations and approximate lengths of the axial power shaping rods within the core at the time of measurement. This model is currently located at NRC Headquarters.

- Reactor core video mapping.** In April 1984, a comprehensive video mapping of the upper reactor core region between the plenum and rubble bed was completed. Video snapshots were assembled into a mosaic panoramic view of the rubble bed, core periphery, and the underside of the upper plenum grid section. Videos of the rubble bed showed broken fuel rods scattered around, fuel rod internal springs, intact fuel pellets, control rod assembly end couplings, and partially intact fuel assemblies around the periphery of the reactor core region. The video also showed unsupported partial fuel assemblies hanging from the underside of the upper plenum grid section, which had to be removed before plenum lifting. This map supported defueling operations planning, and eventually the removal of fuel debris.^{256, 257, 258} A few photographs and partial mosaics from the video mapping activity are provided in the DVD folder, [Photo Gallery](#).
- Video inspection of the lower head of the reactor vessel.** In February 1985, the first video inspection of the reactor vessel's lower head region was performed by guiding a small video camera and light through a gap between the upper plenum and core support flange during plenum jacking. The video inspection revealed re-solidified mass in the

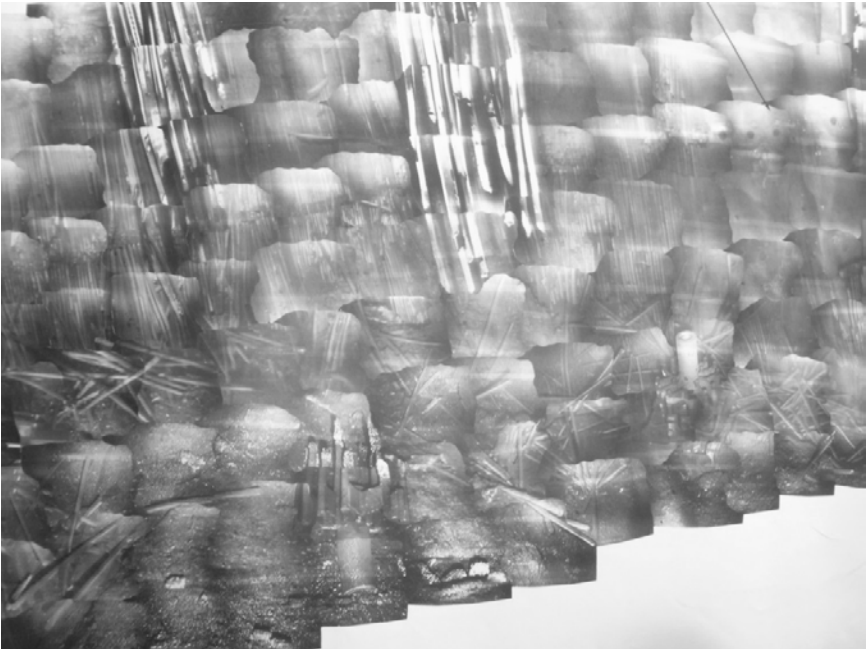

Mosaic panorama of the reactor core cavity from comprehensive video mapping in April 1984. Shown are hanging control rod assemblies, and broken fuel rods and control rod upper end fittings on top of the rubble bed.

reactor vessel lower head on February 20, 1985.²⁵⁹ The camera followed a path down to the lower head region between the reactor vessel wall and the internal thermal shield. The video revealed the accumulation of a substantial quantity (estimated at 10 to 20 tons) of accident-generated debris with the appearance of a gravel pile. Over the next two years, four additional camera inspections of the lower head region were performed at different quadrants in the lower core support assembly (July 1985, December 1985, July 1986, and February 1987). The analysis of the video data documented in the INEL report “TMI-2 Lower Plenum Video Data Summary” (EGG-TMI-7429), revealed that large inhomogeneity existed in the physical appearance of the debris bed, ranging from a very fine dust-like and smooth surface, to a relatively flat, but coarse surface with large chunks, to a solid wall of lava-like debris.²⁶⁰ A few photographs from the video inspections are provided in the DVD folder, [Photo Gallery](#).

- **Vertical gamma profiles of the reactor vessel’s lower head region.** In March 1985, an attempt was made to insert a miniature gamma-radiation sensor into several incore instrument tubes to obtain vertical gamma profiles for characterizing fuel deposits that had settled on the bottom of the reactor vessel.²⁶¹ The incore instrument tubes



In February 1985, the first video inspection of the reactor vessel lower head region revealed a gravel-like pile of core debris. Shown left is an instrument tube penetration.

penetrate the bottom of the reactor vessel, and extend upward into the reactor core region. A dummy detector wire of the same size and stiffness as the actual probes was inserted into 26 of the 52 incore instrument tubes; only one of the 26 wire probes reached the reactor vessel. The remaining 25 wires were blocked at various locations along the 120 feet of pipe between the bottom of the vessel and the pipe access at the incore seal table located in the reactor building. The single wire probe was inserted 22 inches into the lower reactor core region. A gamma sensor with a slightly larger diameter was inserted into the same instrument tube and reached the vicinity of the 5-and-3/8-inch-thick lower head of the reactor vessel.²⁶²

- ***Core stratification sample acquisition program.*** In July 1986, core boring operations were performed using a special computer-controlled drilling machine. The core stratification sample acquisition program was conducted as part of DOE's TMI-2 Accident Evaluation Program to provide data on the material properties of the core debris. The core bore samples provided insights into fission-product release from the fuel, fission-product retention in the core, maximum temperature during the accident, and reactor core material interactions.^{263,264} A special commercially available drilling rig was assembled on top of the defueling work platform to bore into the hard crust. Ten full-length core



A damaged fuel assembly being examined at the INEL.

bore samples were obtained from all regions of the lower reactor core; these samples (approximately 2.5 inches in diameter and eight feet long) were analyzed at INEL, along with earlier samples of debris collected from the reactor vessel's lower head. Video inspections of the reactor core below the debris bed were performed through several of the bore holes created by the drilling operations. Initial inspections indicated that peripheral fuel assemblies were essentially intact below the hard crust layer, but that the central reactor core region consisted largely of a fused mass of material.²⁶⁵ The INEL report "TMI-2 Core Bore Examinations" (GEND-INF-092) documented results of the physical, metallurgical, and radiochemical examinations of the core bore samples and evaluated these results as they relate to the progression of core damage and fission-product behavior in the lower region of the reactor core.^{266, 267}

- **TMI-2 vessel investigation project.** In July 1989, a video inspection of the reactor vessel's lower head revealed several cracks that appeared to be associated with incore instrument penetration nozzles. Higher-quality color videos and a mechanical probe were used in August to obtain

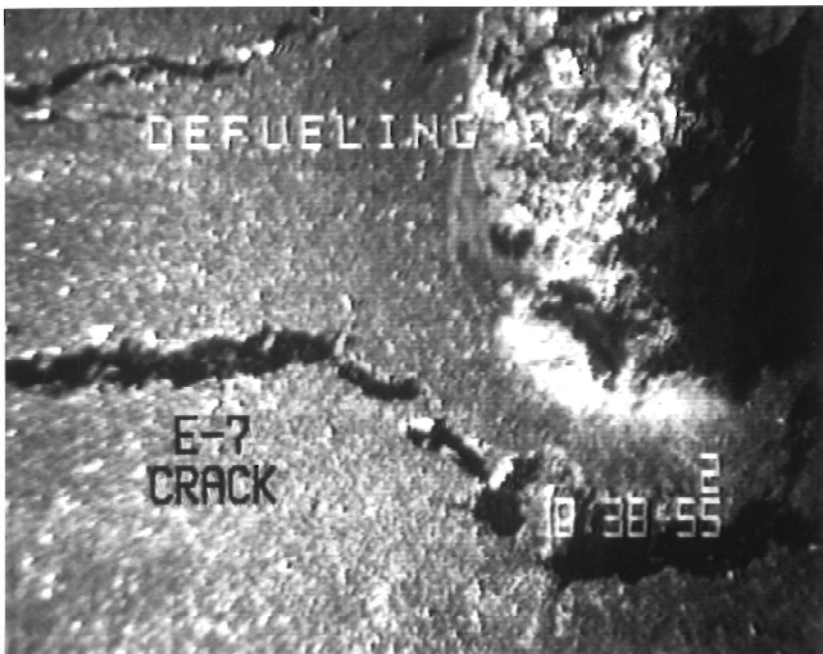

Tears or cracks were found in the cladding of the lower reactor vessel head around nozzle E-7 (instrumentation penetration stub upper right). These cracks were analyzed by Argonne National Laboratory and were attributed to stresses associated with the thermal gradient in the thick-walled carbon steel vessel during the heating and cooling phases of the accident.

better information on the cracks. The cracks appeared to be up to approximately 6 inches in length, 0.25 inches wide, and about 0.19 inches deep.²⁶⁸ Penetration into the thick reactor vessel steel was later determined to be superficial.²⁶⁹

In February 1990, an international research effort obtained metallurgical samples from the reactor vessel's lower head after defueling was completed. The program, which was sponsored by the NRC's Office of Nuclear Regulatory Research and the Organisation for Economic Co-operation and Development, evaluated the potential modes of failure and the reactor vessel's margin of failure during the TMI-2 accident. The condition and properties of material extracted from the reactor vessel's lower head were investigated to determine the extent of damage to the lower head by chemical and thermal attack, the thermal input to the reactor vessel, and the margin of structural integrity that remained during the accident. A total of 15 "boat" samples were obtained from the reactor vessel's lower head. In addition, 14 incore instrument penetration nozzles were cut off 1 to 2 inches above the reactor vessel's lower head, and obtained as samples. Two incore instrument guide tubes were cut free from the flow distributor head as samples.²⁷⁰ Results from

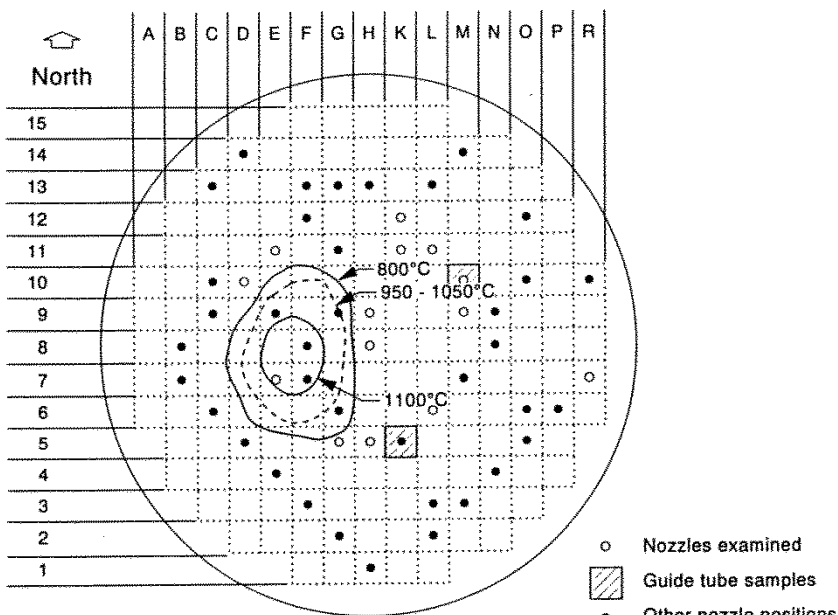

Investigations from the TMI-2 Vessel Investigation Project identified the location of a hot spot in the lower reactor vessel head, but concluded that the hot spot would unlikely have caused vessel failure due to creep rupture for the temperatures and pressures that occurred during the accident.

the reactor vessel investigation project were documented in a series of NRC reports by the INEL and Argonne National Laboratory. (See the DVD folder, [Accident Data Analysis](#).)

Fuel Detection Techniques. Various fuel detection techniques were used to measure fuel debris and deposits internal and external to the reactor vessel. The licensee was required to document the measurements and calculations that were performed to ensure that the plant had been defueled to the extent reasonably achievable, and that the potential for a nuclear criticality had been precluded during normal and accident conditions.²⁷¹ Measurements of residual fuel were required before the plant could begin post-defueling monitored storage (see section on [After Defueling](#)). Five general methods were used for fuel detection (detection of gamma rays, neutrons, alpha particles; sample and analysis; visual evidence). Key detection methods are summarized below:^{272, 273}

- *Sodium iodide (NaI) gamma spectrometer* was used to survey much of the fuel deposits outside of the reactor building. This detector measured Ce-144 from fission products.
- *Other gamma spectrometers* were used to measure fuel deposits in the auxiliary building. A high-purity germanium (HPGe) detector measured gamma radiation emitted from both Cerium-144 (Ce-144) and Europium-154 with improved energy resolution capability. A silicon lithium Si(Li) Compton recoil gamma ray spectrometer measured Ce-144 gamma radiation in the A and B makeup and purification system demineralizer cubicles.
- *Solid-state track recorders* were used to measure residual fuel in demineralizer cubicles and to profile fuel distribution within the reactor vessel from the annular gap outside the vessel. This passive detector used 93 percent enriched Uranium-235 fissile isotope foils to emit induced fast fission neutrons that created visible tracks in adjacent acrylic sheets.
- *Copper activation coupons* that become irradiated in the presence of a neutron flux. This method is insensitive to high gamma radiation fields.
- *Boron trifluoride (BF₃) neutron detection system* that thermalized fast neutrons from fissions for efficient counting in high gamma fields.
- *Alpha fuel detectors* were used to measure thin films of fuel debris on steam generator tube surfaces and on reactor coolant system surfaces.

- *Active neutron detection technique* was used to quantify smaller quantities of residual fuel. This photo neutron interrogation method used an antimony-beryllium neutron source to induce fission neutrons in the fuel that were measured by a helium-4 fast neutron recoil proportional counter. This method was more sensitive than passive counting for quantifying small deposits of fuel.

Document Collections. Research tasks funded by NRC were documented in NUREG reports. Research results from the TMI-2 Information and Examination Program were documented in the GEND-series reports and DOE laboratory reports. GPU and EPRI documented the data acquisition and analysis tasks they performed in their own reports. Most reports from Government-sponsored work are provided on the DVDs. The EPRI report “TMI-2 Post-accident Data Acquisition and Analysis Experience” (NP-7156s) provides a concise overview of data activities during the TMI-2 cleanup (not provided on the DVDs).

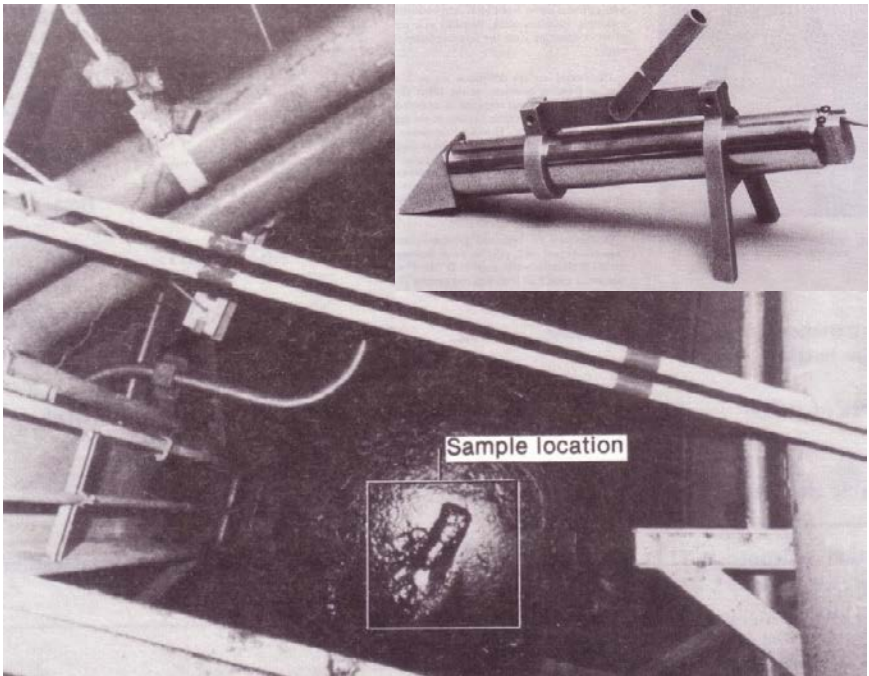

The first sample of sludge from the reactor building basement was taken using a small scoop in June 1982. Later in 1982, three additional samples were taken from different locations using solenoid-operated samplers (top right).

Document collections relating to data acquisition and analysis tasks are listed below:

- Tasks that generally supported plant recovery and cleanup activities are provided in the DVD folder, [Recovery Data Analysis](#). Research topics included the following:
 - pyrophoricity studies of potentially combustible core debris materials
 - examination of debris on the reactor vessel's lower head
 - examination of fuel assembly components
 - criticality studies of the reactor core, reactor vessel, reactor coolant system, reactor building sludge, and cleanup system filters
 - the reactor building entry program
 - the dose-rate reduction program (see the section on [Worker Protection](#) above)



A highly-radioactive EPICOR II prefilter liner being examined in a hot cell at the Battelle Columbus Laboratory. This examination and research at other national laboratories provided information on the processing of contaminated ion exchange media and on the degradation of these media and liners.

- polar crane refurbishment
- characterization of the sludge in the reactor building's basement
- radiation and contamination surveys of building surfaces and internal to system components
- characterization of the reactor building's atmosphere
- the reactor building gross decontamination experiment
- the fission-product inventory program, which included radionuclide mass balance in the plant
- characterization of accident-generated water samples in various systems and components
- sample acquisition from reactor building concrete surfaces
- characterization of and accountability for fuel deposits outside the reactor vessel
- the citizen radiation-monitoring program



A telephone inside the reactor building during the accident was determined by INEL to sustain high temperatures from the hydrogen burn of 200 to 220 degrees Fahrenheit. The telephone case, numeral ring, and dial were distorted and the cord coils relaxed.

- characterization of radioactive waste forms
- hydrogen production in spent filter canisters
- effects of radiation on organic ion-exchange resins
- characterization and testing of EPICOR II waste form, resin, and liner integrity
- Tasks that improved the understanding of severe core damage accident phenomenology and its effects are provided in the DVD folder, [Accident Data Analysis](#). Research topics included the following:
 - TMI-2 accident forensic investigations
 - benchmark thermal-hydraulic and severe-accident computer analysis codes with TMI-2 data
 - external influences affecting the accident
 - core relocation and debris-bed coolability



55-gallon drums were partially collapsed by the external pressure caused by the hydrogen burn inside the reactor building. This drum damage and lack of air duct damage (upper right) was consistent with a pressure pulse that developed over seconds by a deflagration and not by the passage of a detonation wave. (The undamaged drum on the left was open to the atmosphere, thus did not experience a crushing differential pressure.)

- radionuclide (source term) behavior inside the plant
- in-vessel fuel distribution characterization using gamma-ray and neutron dosimetry
- response of nuclear and non-nuclear instrumentation during the accident
- hydrogen generation and burning inside the reactor building

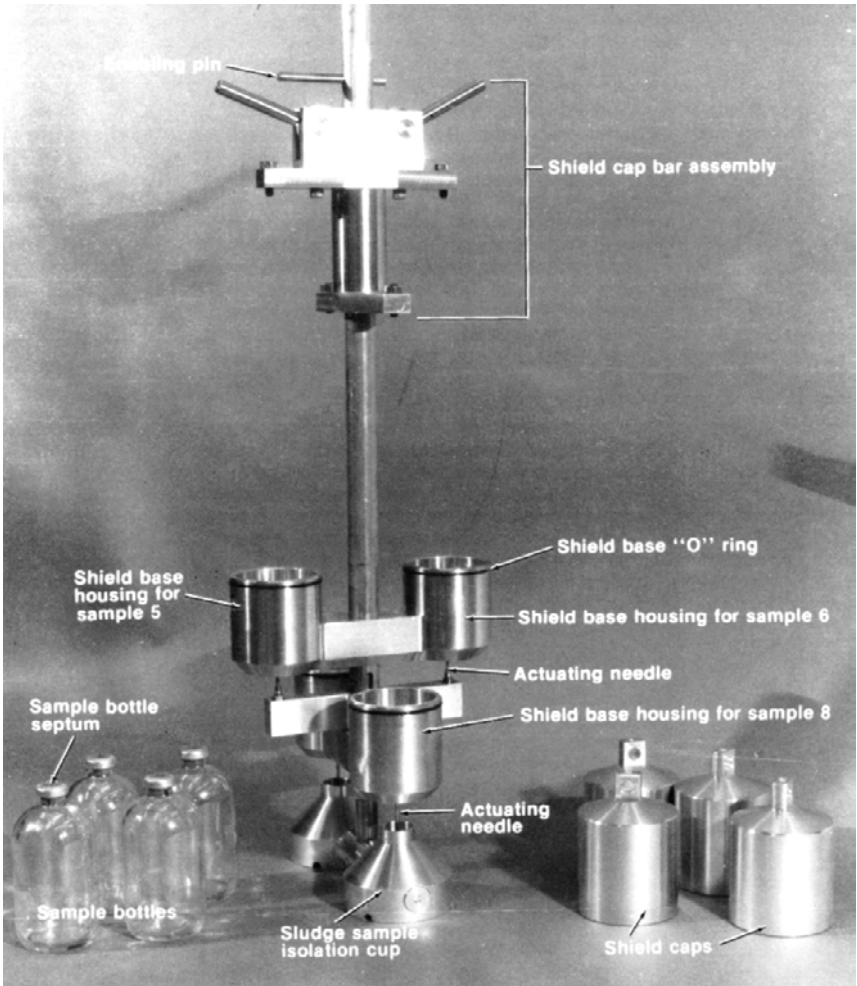

A sampler, called a water and sludge sampling device, was designed to simultaneously draw eight samples from the reactor building basement water.

- Tasks that were associated with the DOE-sponsored TMI-2 Instrumentation and Electrical Program are provided in the DVD folder, [Instrumentation and Electrical Evaluations](#). The program evaluated instrumentation and electrical equipment for the effects of exposure to steam, spray, radiation, hydrogen burning, and resultant overpressure, as well as long-term exposure to moisture. Components inside the reactor building that were studied included radiation monitors, pressure transmitters, loose-parts monitors, various switches and contacts, solenoid operators for valves, and various other devices that suffered moisture intrusion. Summary reports are also provided in the DVD folder.



Several electrical components from the reactor building were retrieved and examined as part of the DOE-sponsored Instrumentation and Electrical Program. Shown is the removal of an area radiation monitor (HP-R-211) from the northeast elevator wall.

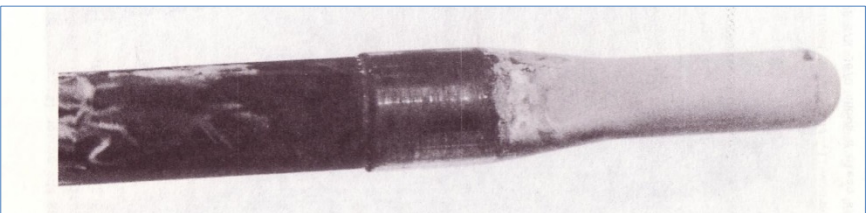

Thermowell of a “worst case” platinum resistance thermometer removed from the reactor coolant system hot-leg showed radioactive surface deposits (right). This device was exposed to superheated steam during the accident; however, its calibration or its time response was not adversely affected by the accident.



Submerged demineralizer system inside the spent fuel pool.

6 Waste Management

The TMI-2 accident and subsequent cleanup challenged the management of various forms and concentrations of radioactive waste. The management of highly contaminated water, fuel debris, and related solid-waste byproducts included handling, processing, temporary onsite storage, transportation, and final disposal. Decontamination activities resulted in substantial quantities of contaminated water and organic resins and inorganic zeolites produced from water-processing systems. Fuel debris that spread throughout the plant created unique radiological waste characteristics. Also, some waste did not fit into established regulatory waste-classification categories for transportation and disposal, while the possible generation of flammable gases inside sealed radioactive waste containers was a potential hazard.

As part of the TMI-2 Information and Examination Program, DOE and the NRC sponsored research and development in the areas of volume-reduction techniques, performance of ion-exchange media, control of combustible gases, waste-disposal techniques, and radioactive material shipping cask designs.²⁷⁴ The NRC and DOE signed a memorandum of understanding (MOU) that specified interagency procedures for the removal and disposition of nuclear waste resulting from the cleanup, including fuel debris. The memorandum and addendum ensured that the TMI site did not become a long-term waste disposal facility.²⁷⁵

Key Actions. A chronology of key NRC and DOE actions related to waste management is provided below. Most actions required research, development, safety evaluations, reviews, and approvals. Thorough overviews of waste management and transportation at TMI-2 are provided in the EPRI report, “TMI-2 Waste Management Experience” (EPRI TR-100640) and the DOE-sponsored reports, “Historical Summary of the Fuel and Waste Handling and Disposition Activities of the TMI-2 Information and Examination Program: 1980–1988” (EGG-2529), and “Historical Summary of the Three Mile Island Unit 2 Core Debris Transportation Campaign” (DOE-ID-10400). Commission policy statements and NRC orders relating to waste management are further discussed in the prior section on [Management and Oversight](#).

- **Policy statement on environmental assessments.** On May 25, 1979, the Commission issued a policy statement directing NRC staff to prepare an environmental assessment regarding proposals to decontaminate and dispose of radioactively contaminated waste water. The policy required assessments on the decontamination of intermediate-level waste water

using the EPICOR II system, alternatives to discharge of waste water into the Susquehanna River, and decontamination and disposal of high-level waste water.²⁷⁶

- ***EPICOR II environmental assessment.*** On August 14, 1979, in response to the Commission policy statement of May 25, 1979, NRC staff prepared and sent out for public comment an environmental assessment for the use of the EPICOR II filtration and ion-exchange decontamination system to remove radionuclides from intermediate-level radioactive waste water held in storage tanks in the TMI-2 auxiliary building (NUREG-0591). The proposed action was limited to cleanup and storage of waste water. The action also included the impacts of wet solid waste generated from EPICOR II operation, such as temporary storage, packaging, handling, transportation, and burial.²⁷⁷
- ***Order to operate EPICOR II.*** On October 16, 1979, the Commission issued a “Memorandum and Order” directing the licensee to operate the EPICOR II to decontaminate intermediate-level radioactive waste water held in storage tanks in the TMI-2 auxiliary building. In response to that



The basement in the reactor building contained about 8 feet of highly contaminated water. The submerged demineralizer system started processing basement water on September 9, 1981.

order, NRC staff issued an “Order for Modification of License” two days later to permit EPICOR II system operations. EPICOR II began operation on October 22.²⁷⁸

- ***City of Lancaster agreement.*** On February 27, 1980, the NRC and the City of Lancaster, Pennsylvania, signed a litigation settlement agreement that prohibited the discharge of accident-generated water in the Susquehanna River until December 31, 1981, or until NRC completed necessary environmental reviews.²⁷⁹
- ***GEND research coordination agreement.*** On March 26, 1980, the coordination agreement for the TMI-2 Information and Examination Program was signed by GPU, EPRI, NRC, and DOE (also known as GEND) to provide research and development coordination on efforts to manage wastes at TMI-2.²⁸⁰
- ***Final PEIS.*** On March 9, 1981, the NRC staff issued the Final Programmatic Environmental Impact Statement (PEIS) relating to the decontamination and disposal of radioactive wastes resulting from the TMI-2 accident ([NUREG-0683](#)). The PEIS was an overall study of the activities necessary for decontamination of the facility, defueling, and disposition of the radioactive wastes.²⁸¹
- ***Policy statement endorsing PEIS.*** On April 27, 1981, the Commission issued a policy statement endorsing the final PEIS. With the exception of the disposition of processed accident-generated water (the Commission wanted to decide this issue later), the Commission directed the staff to act on each major cleanup activity (without further Commission direction) if the activity and associated impacts fell within the scope of those assessed in the PEIS.²⁸²
- ***Order to operate the submerged demineralizer system (SDS).*** On June 18, 1981, the NRC staff issued an order to direct the licensee to promptly commence the operation of SDS with effluent polishing by the EPICOR II system. The order directed the complete processing of the remaining intermediate-level contaminated water in the auxiliary building tanks (100,000 gallons), and the highly contaminated water in the reactor building sump (700,000 gallons) and the reactor coolant system (95,000 gallons). The approval to operate SDS did not include water disposal. All processed water had to be stored in existing onsite tanks; however, portions were allowed to be cycled for reuse within the plant. The order required that decisions related to the disposition of processed water be made by the Commission at a future date.²⁸³ The

NRC review of the SDS formally started when the licensee submitted their technical evaluation report on April 10, 1980. After a number of design changes by the licensee and technical questions from the NRC, the NRC safety evaluation report (NUREG-0796) was issued in June 1981.²⁸⁴ In its review, the NRC determined that the potential environmental impacts from the proposed operation of the SDS were within the scope of the PEIS. On July 10, 1981, the SDS began processing water from the reactor coolant bleed tanks. On September 22, 1981, the water from the reactor building sump and basement was pumped to the SDS feed tanks located outside the reactor building. The following day, the SDS began processing this water. The processing of water from the reactor building's basement was completed in May 1982. In June 1981, the NRC issued the certificate of compliance for the shipping cask that was designed and fabricated to transport spent SDS vessels at first to a DOE research facility and subsequently to a commercial low-level radioactive waste burial facility.²⁸⁵

- NRC-DOE MOU.** On July 15, 1981, the NRC and DOE signed MOU to formalize the working relationship between the two agencies with respect to the removal and disposition of solid nuclear wastes generated during the cleanup of TMI-2. The DOE agreed to carry out research and

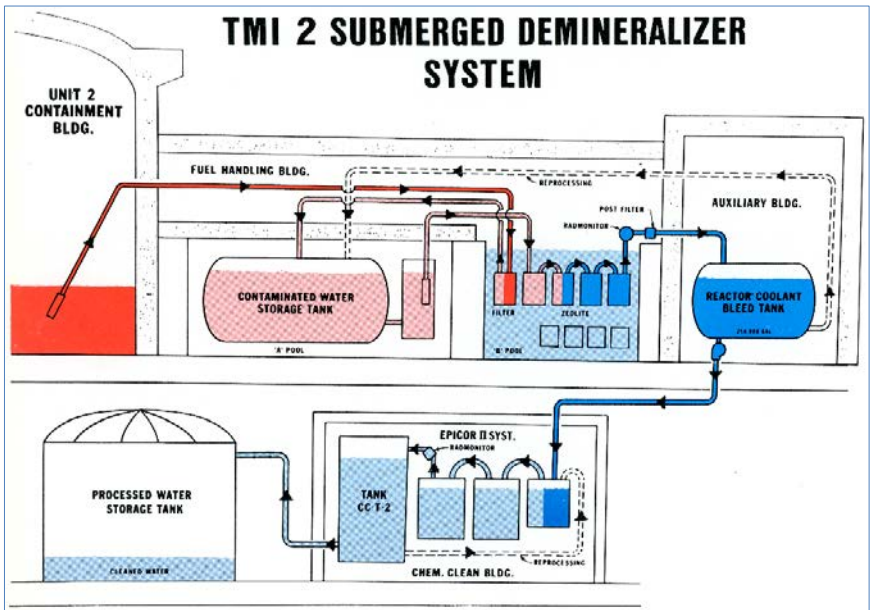

Submerged demineralizer system started processing highly contaminated water in June 1981 from the reactor building basement, reactor coolant system, and auxiliary building tanks.

conduct tests on solid wastes shipped from the plant to DOE facilities that had generic information value. DOE also agreed to accept other waste that were too highly radioactive for disposal in commercial facilities and provided no research value. The licensee provided reimbursement to the DOE for the shipment, storage, and disposal of such waste. Most low-level waste associated with decontamination, such as some ion-exchange media, boots, gloves, and trash, was disposed of by the utility in licensed commercial low-level radioactive waste burial facilities. The original MOU provided plans for DOE to accept some fuel assemblies and samples for analysis characterization and archiving. Moreover, the original plan was to place the remaining balance of the reactor core in fuel storage containers and store the fuel in the TMI-2 spent fuel storage pool to await resolution of the commercial nuclear power spent fuel storage issue.²⁸⁶ However, this MOU was formulated before the first “quick look” inside the reactor vessel that revealed a severely damaged reactor core.

- ***NRC-DOE MOU addendum.*** On March 15, 1982, the NRC and the DOE signed a revision to the MOU. The DOE agreed to accept the entire reactor core for research and development and for temporary storage at a DOE facility.²⁸⁷ During the first decade after the accident, the DOE accepted 50 EPICOR II pre-filters during the initial processing of radioactive waste water from the auxiliary building, 19 highly loaded SDS vessels, 3 SDS vessels with highly loaded cartridge filters, cut control rod leadscrew segments, and original cartridge filters from the makeup and purification system that filtered reactor coolant system letdown during the accident. The disposal by DOE of waste products that were not useful for research was funded by the licensee.²⁸⁸
- ***DOE-GPU agreement.*** On March 19, 1982, the DOE and GPU signed an agreement for the acquisition of the damaged TMI-2 reactor core by DOE. In the agreement, DOE acquired ownership of the damage core from GPU and arranged for the shipment of the entire core to a DOE facility for research. GPU reimbursed DOE for shipping, storage after the research period, and ultimate disposal.²⁸⁹
- ***Environmental assessment for processed water disposal.*** In June 1987, the NRC issued Final Supplement No. 2 to the Programmatic Environmental Impact Statement ([NUREG-0683](#)) dealing with disposal of accident-generated water. The supplement presented NRC’s evaluation of the licensee’s July 1986 proposal for disposing of approximately 2.3 million gallons of slightly radioactive water. This water was contaminated either during the accident or during subsequent

cleanup operations. The proposed method involved the forced evaporation of the water at the TMI site over a period of two and one-half years. The residue from this operation contained small amounts of the radioactive isotopes tritium (hydrogen-3), cesium-137, and strontium-90 and larger amounts of nonradioactive boric acid and sodium hydroxide. This residue required solidification and disposal as

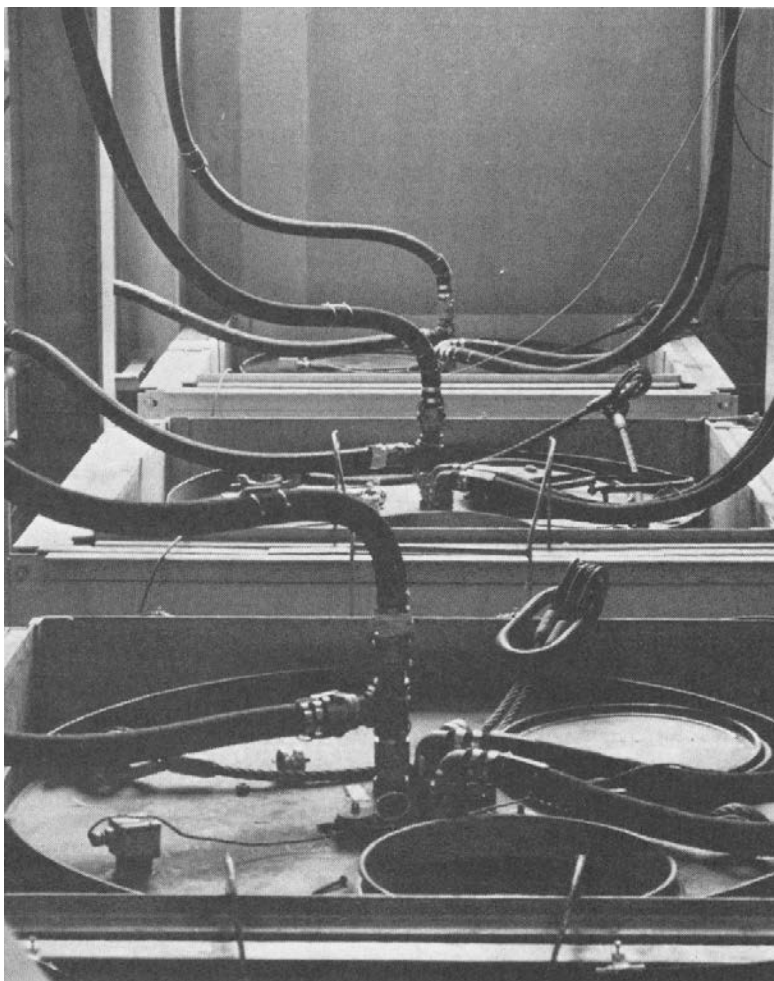

EPICOR II system originally decontaminated 380,000 gallons of intermediate-level radioactive water held in the auxiliary building tanks. Each vessel contained ion-exchange resin. The vessel at the top of the photo was the prefilter demineralizer, the center vessel was a cation ion-exchanger, and the third vessel was a mixed-bed polishing ion-exchanger. Each was fitted with three quick-disconnect hoses: a liquid waste influent line, a processed waste effluent line, and a vent line with attached overflow hose.

low-level waste. The NRC evaluated the licensee's proposal together with eight alternative approaches, giving consideration to the risk of radiation exposure to workers and to the general public; the probability and consequences of potential accidents; the necessary commitment of resources, including costs; and regulatory constraints. The NRC concluded in the supplement that the licensee's proposal to dispose of the water by forced evaporation to the atmosphere, followed by onsite solidification of the remaining solids and their disposal at a commercial low-level radioactive waste burial facility, was an acceptable plan. The supplement also established that no alternative method of disposing of the contaminated water was without question, clearly preferable to the licensee's proposal.^{290, 291}

Public hearings on the licensee's proposal to evaporate 2.3 million gallons of accident-generated water were held by an NRC Atomic Safety and Licensing Board, and concluded on November 15, 1988. On February 3, 1989, the Board issued a decision finding in favor of the licensee on all relevant issues. On April 13, 1989, the Commission upheld the Board's decision. Construction of the evaporator system began in August 1989.²⁹²

- ***License amendment permitting processed water disposal.*** On September 11, 1989, the NRC issued Amendment No. 35 to the facility's operating license, modifying the plant's technical specifications by deleting the prohibition for disposing of accident-generated water. Disposal was allowed in accordance with NRC-approved procedures.²⁹³ The evaporator system began vaporizing accident-generated water on January 24, 1991, after a prolonged period of system testing, modification, and repair.²⁹⁴ On August 12, 1993, the decontamination and evaporation of 2.23 million gallons of accident-generated water was completed.²⁹⁵ The system evaporated about 99 percent of the initial pre-processing volume of 2.3 million gallons. The residual volume that remained in various tanks and building sumps was estimated to be about 18,500 gallons.²⁹⁶ The evaporator system was disassembled and shipped offsite by the owner and operator of the system.²⁹⁷

Water Processing and Storage Systems. Before defueling operations could begin, pre-accident and accident-generated waste water required decontamination of low, intermediate, and high levels of radioactivity. Additional holding tanks were constructed and existing tanks were managed to maximize storage capacity. After decontamination, the slightly radioactive water (still contaminated with tritium, a radioisotope of

hydrogen, and traces of fission products) had to be stored onsite until the NRC Commissioners decided the ultimate disposal requirements. Until then, the NRC permitted the licensee to reuse this water for surface and equipment decontamination activities inside the auxiliary and fuel handling building and reactor building. This water was reprocessed through water cleanup systems and stored onsite in large carbon-steel plate-welded tanks.

During defueling operations, several water cleanup systems were designed and installed to maintain water clarity for the manual removal of fuel debris inside the reactor vessel and remove fuel debris contamination resulting from the movement of defueling canisters from the reactor vessel to the spent fuel storage pool. Keeping the water inside the reactor vessel free of microorganisms was a complex technical problem that hampered visibility and eventually disrupted defueling operations for a period of time.

More than 2.3 million gallons of processed accident-generated waste water that were stored in various tanks at TMI-2 was disposed of by evaporation over a 31-month period. The systems and facilities that were reviewed and approved by the NRC to store and process waste water are described below:

- The fuel pool waste storage system** (also known as the “tank farm”) was installed to provide feed staging for the processing of the water from the reactor building’s basement by the EPICOR II system and submerged demineralizer system. (See [Plant Stabilization](#) section.)

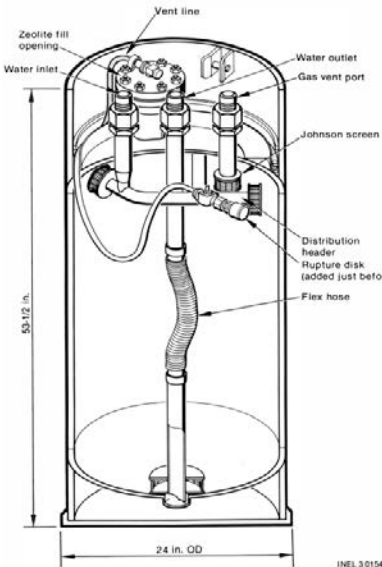

Typical SDS vessel.

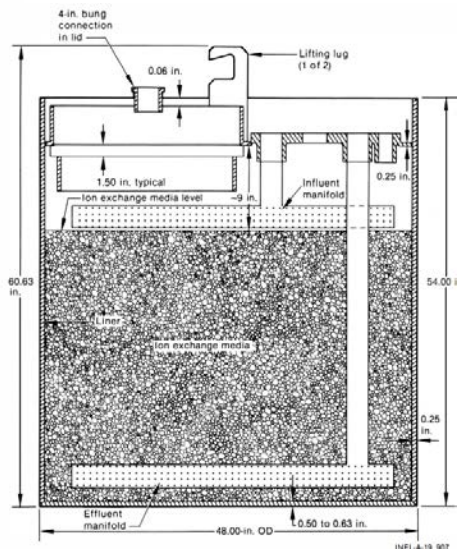

Typical EPICOR II liner.

- The EPICOR I system** was installed within a week after the accident to process low-activity, non-accident-generated liquid waste water, mainly generated from the TMI-1 outage. The system included one pre-filter liner, one demineralizer liner, and two receiving tanks. Each 6-foot-by-6-foot liner was made of carbon steel. Over its 19-month lifetime, EPICOR I processed over 1.3 million gallons at an average flow rate of 10 gallons per minute.²⁹⁸
- The auxiliary building emergency liquid cleanup system** (also known as “EPICOR II”) was designed and installed after the accident to clean up about 450,000 gallons of intermediate-level waste water. This water was held in various storage tanks and sumps inside the auxiliary and fuel handling building. The EPICOR II system was a liquid waste processing system to decontaminate water by filtration and ion-exchange demineralization. This process for treatment of radioactive water was (and currently is) standard practice in nuclear power plants. The EPICOR II system was housed in an existing onsite building that was originally intended for chemical cleaning of the steam generators for TMI Units 1 and 2.²⁹⁹

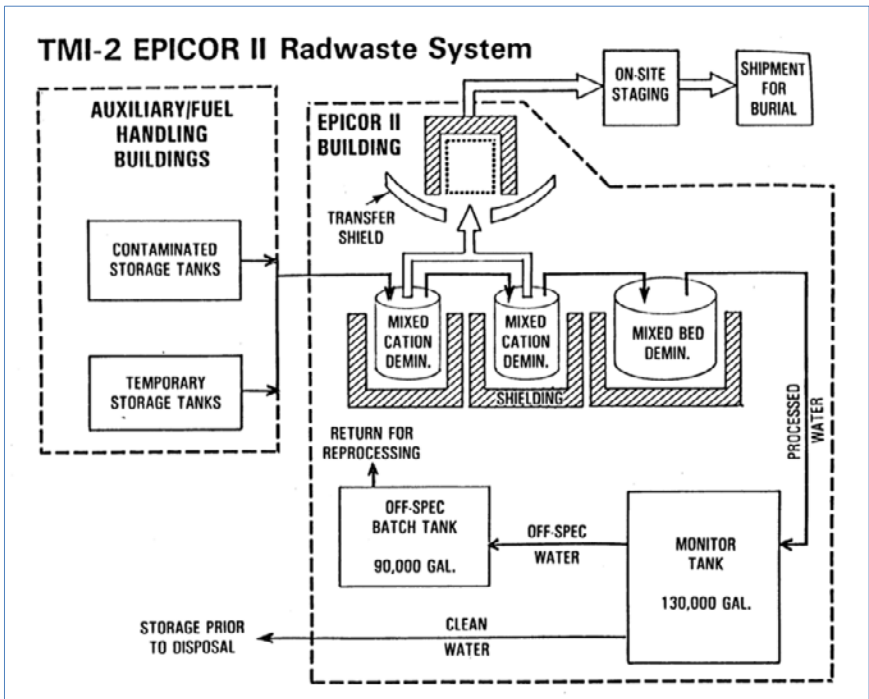

EPICOR II system originally decontaminated 380,000 gallons of intermediate-level radioactive water held in auxiliary building tanks. Shown is the schematic of the flow path in 1980.

The EPICOR II system operated in three main configurations during its service life at TMI-2.

- The original configuration included one pre-filter liner followed by two demineralizer liners and cartridge filters to retain any resin fines and particulates. The 4-foot-by-4-foot carbon-steel pre-filter liner contained a pre-coat material to remove particulate radioactive waste, such as activated corrosion products, and other suspended solids. The pre-filter also contained cation resin which was highly efficient for the removal of cesium and other cationic radionuclides from the waste stream. The first demineralizer (a 4-foot-by-4-foot carbon-steel liner) contained cation resins to remove cesium. The second demineralizer (a 6-foot-by-6-foot carbon-steel liner) contained mixed cation and anion resins to remove cesium and iodine, respectively. After processing, the water was collected in a clean water receiving tank for sample measurements of radionuclide concentrations. The water could be reprocessed as necessary to achieve the desired concentration of radionuclides.^{300, 301} The processing of intermediate-level waste water inside the auxiliary building began on October 22, 1979, and was completed on December 2, 1980. During this period, a total of 1,051,047 gallons of water was processed, with about half of this amount being recycled processing.³⁰²
- EPICOR II was used to remove residual radioactivity from submerged demineralizer system (SDS) effluents and to process miscellaneous wastes from September 11, 1981, to April 1987.³⁰³ This configuration included two 6-foot-by-6-foot liners in series followed by one 4-foot-by-4-foot liner. The first-stage demineralizer generally removed sodium and other non-radioactive chemicals, although low concentrations of radionuclides were also removed. (SDS removed most of the gross cesium and strontium.) The second demineralizer reduced radioactive concentrations through ion exchange and filtering. The last liner refined the effluent water and caught resins that broke through the second liner's retention screens.³⁰⁴
- After the SDS was removed from operation in 1988, EPICOR II was the primary system to clean up waste water that was mainly generated from building decontamination activities. The system configuration was the same as before; however, a high-integrity container (HIC) loaded with zeolite resins was placed in the first position to act as a roughing filter to remove gross cesium and

strontium radionuclides. The HIC was followed by the two standard EPICOR II carbon-steel liners. This configuration allowed EPICOR II to replace the aging SDS. The HIC was similar in size to the carbon-steel 4-foot-by-4-foot liner, but the HIC was constructed from very high-grade stainless steel. The HIC allowed the loading of higher concentrations of radionuclides for burial at a commercial low-level radioactive waste burial facility.³⁰⁵

Upon completion of the TMI-2 cleanup activities, the EPICOR II system was released to general site use and included under the TMI-1 facility operating license.³⁰⁶

- The submerged demineralizer system (SDS)** was designed and installed in the TMI-2 spent fuel pool to clean up high-level radioactive accident-generated waste water from the reactor building's basement, reactor coolant system, and reactor coolant bleed tanks. Processed water from the processed water storage tanks was used to fill the spent fuel pool for shielding of the highly radioactive spent filters. The SDS consisted of a liquid waste treatment subsystem, a gaseous waste treatment subsystem, and a solid waste handling subsystem. The liquid waste treatment subsystem was designed to remove cesium and

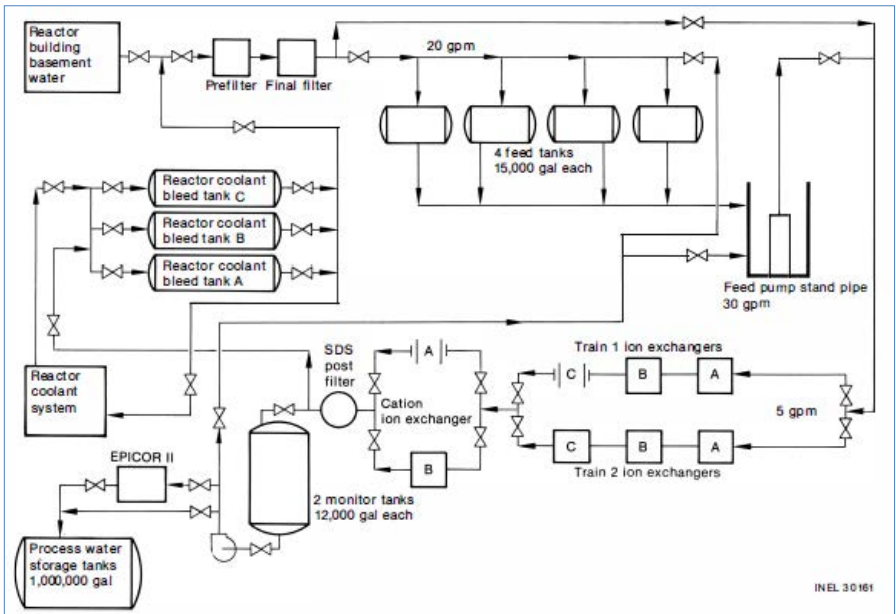

Submerged demineralizer system started processing highly contaminated water in June 1981 from the reactor building basement, reactor coolant system, and auxiliary building tanks.

strontium from the high-activity waste water by filtration and ion exchange. The liquid waste treatment subsystem included the following primary components (in the order of the flow path):³⁰⁷

- Pre-filter and final filter consisting of sand to remove particulates.
- Feed tank system (known as the “tank farm”) of four 15,000-gallon storage tanks to hold contaminated water before processing it in the ion-exchange vessels.

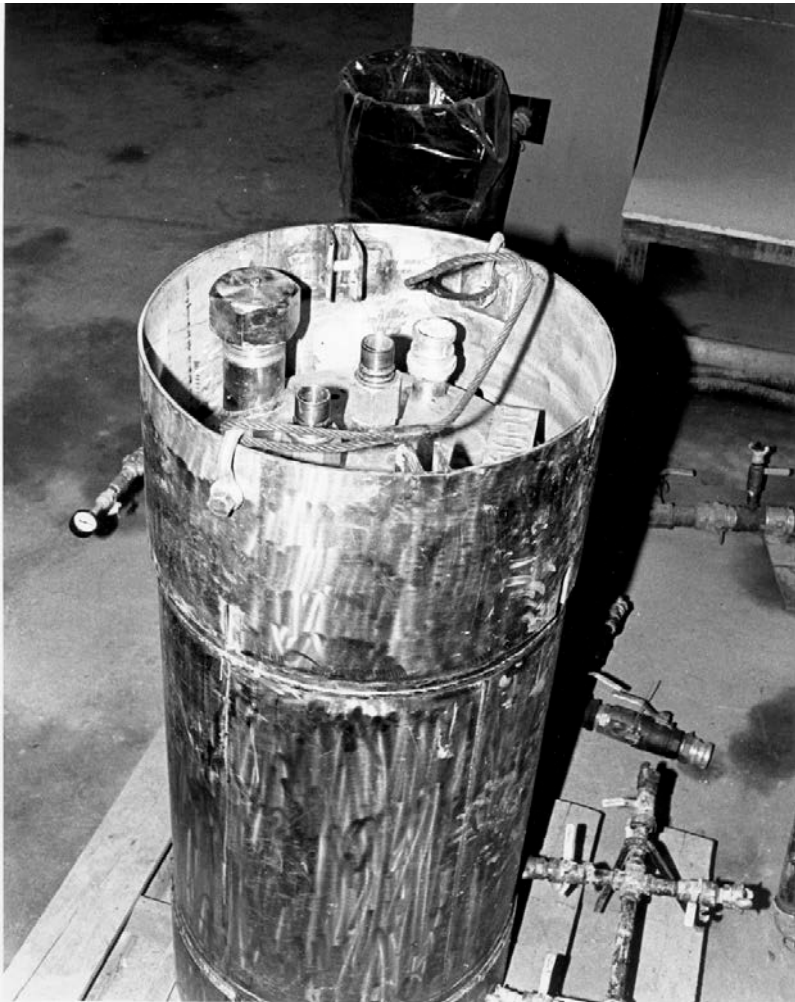

A typical submerged demineralizer system ion exchange vessel. About 4.5 feet in height and 2 feet in diameter, each vessel included five nozzles on the top: inlet, outlet, vent, and general vessel access (two nozzles) for loading and unloading the ion exchange media.

- A 30-gallon-per-minute pump.
- Two parallel trains of identical inorganic zeolite-filled ion-exchange vessels. The first train included two vessels to process water from the reactor coolant system and reactor coolant bleed tanks. The second train included four vessels to process the highly contaminated water from the reactor building’s basement. Each of these vessels was a stainless steel pressure vessel two feet in diameter and four feet tall. Each vessel also contained a catalyst bed to recombine the available hydrogen and oxygen (generated by radiolysis of water) back into water.
- Post-filter to retain zeolite fines from new zeolite beds.
- Two 12,000-gallon monitoring tanks to hold processed water for measurement. SDS effluents in the tanks could be reprocessed or sent to the EPICOR II system to remove residual contamination (a process known as “polishing”). The final processed water was transferred from the monitoring tanks to the processed water storage tanks for reuse or deposition.
- Sample connections, sample glove boxes, and a continuous in-line radiation monitor to estimate curie loadings and monitor vessel efficiency for process control.

The first vessel in a train upstream was the first to be removed from service. A spent vessel was moved to the dewatering station and then to the storage rack in the spent fuel pool using the fuel handling building’s crane. Downstream vessels were disconnected and moved upstream one position. A new vessel was installed at the last open position. Spent ion-exchange resins and filters were loaded into a shielded transportation cask underwater. The cask with the vessel inside was moved from the spent fuel pool, sealed, decontaminated, and loaded onto a truck trailer for shipment.³⁰⁸

DOE national laboratories provided technical assistance to the licensee and their contractors to develop the SDS.³⁰⁹ The SDS started testing on July 12, 1981, started processing reactor building basement water on September 9, 1981, and started processing reactor coolant system water on May 21, 1982.³¹⁰ During its 7-year service life, SDS processed 4,566,000 gallons of water.³¹¹ Details of the SDS design, installation, and testing were documented in the INEL report “Submerged Demineralizer System Processing of TMI-2 Waste Water” ([GEND-31](#)).

Following the initial SDS pumping of 50,000 gallons of water from the reactor building sump on September 27, 1981, the incore thermocouple temperatures increased. On September 28, 1981, the temperatures stabilized and started a slight downward trend. The licensee reported that the temperature change appeared to have occurred as a result of lowering the water level in the reactor building's basement below the point at which the water was in contact with the lower dome of the reactor vessel. The heat-transfer characteristics had changed because heat might no longer be conducted to the water in contact with the vessel and the temperatures would change until equilibrium conditions were established. The highest temperature of an incore thermocouple was approximately 147°F (a 12°F increase) and the calculated average temperature was 117°F (a 2°F increase).³¹²

- ***The processed-water storage and recycling system*** was installed to hold processed water from the EPICOR II and SDS cleanup systems. The processed water was stored onsite in two 500,000-gallon tanks. The tanks became operational on July 8, 1981.³¹³ A recycling system was later installed to transfer the processed water into the reactor building for decontamination activities. This water was subsequently reprocessed by the SDS and returned back to the processed water storage tanks for further use or to await ultimate disposal. The storage system included two steel plate-welded tanks that were epoxy-lined and insulated.

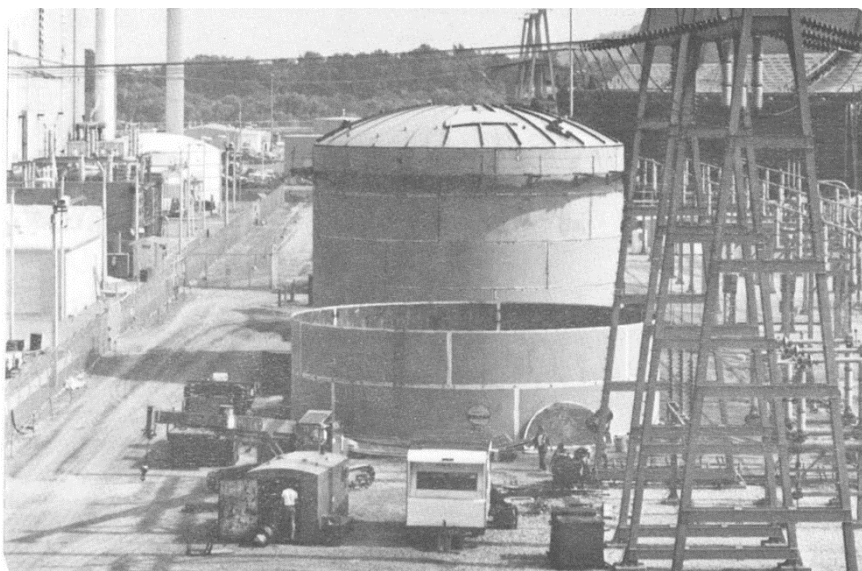

Processed water storage tanks, each with 500,000-gallon capacity, were installed to hold processed water from EPICOR-II and SDS cleanup systems. Insulation and heat tracing were installed for freeze protection (not shown).

A heat-traced subsystem prevented freezing in winter months. Two transfer pumps were used to transfer water from the processed water tanks.³¹⁴ A decision was made not to build a dike around the tanks for water retention because it was determined that any liquid spillage from a tank rupture would not represent a significant radiological health, safety, or environmental hazard.^{315, 316} On completion of the TMI-2 cleanup activities, the processed water storage system was released to general site use and included under the TMI-1 facility operating license.³¹⁷

- ***The internals indexing fixture (IIF) processing system*** provided interim reactor coolant system processing capability following reactor vessel head removal to minimize radiation dose rates around the IIF. The IIF cylinder was mounted on the reactor vessel's flange and the reactor coolant level was raised to partially fill the IIF. The IIF processing system consisted of a submersible pump located inside the IIF which transferred water from the IIF through the submerged demineralizer system to a reactor coolant bleed holdup tank. Reactor coolant-grade water was concurrently returned to the reactor vessel from a second bleed tank by a waste transfer pump to maintain the IIF level.³¹⁸ The system was placed in operation in August 1984 and was replaced by the defueling water cleanup system in November 1985.³¹⁹
- ***The defueling water cleanup system (DWCS)*** was used to remove organic carbon, soluble fission products, and particulate matter from the fuel transfer canal (FTC), spent fuel pool "A" (SFP-A), and the reactor vessel. The DWCS system was composed of two independent systems: the reactor vessel cleanup system and the FTC/SFP-A cleanup system. Each system included four modified defueling canisters (filter canisters) with sintered metal filter media to remove debris, mainly fuel fines (uranium oxide) and core debris (zirconium oxide), down to a 0.5-micron rating. Each system had either one (FTC/SFP-A cleanup) or two (reactor vessel cleanup) 4-foot-by-4-foot demineralizer liners filled with zeolite resins to remove cesium. The liners were high-integrity containers, similar to those later used in the EPICOR II system. Each system had two submersible pumps that fed two filter canisters (two trains of two filters each), followed by one or two demineralizers.³²⁰ The FTC/SFP-A cleanup system was ready when the upper plenum was moved from the reactor vessel to the deep end of the refueling canal in May 1985. The startup of the reactor vessel cleanup system followed in November 1985.³²¹

- **Treatment of microorganisms.** Problems plagued the cleanup systems early because of microorganism growth in the reactor coolant. In January 1986, a filamentous growth was observed on surfaces inside the reactor vessel. A rapid growth occurred when hydraulic fluid from the defueling tools was inadvertently spilled into the reactor vessel, along with the use of lighting in the reactor vessel, use of biologically contaminated water for makeup, and aeration of the coolant by the movement of tools in and out of the water and by startup of water cleanup systems. The resulting loss of visibility halted all defueling operations. Principal microorganisms found in the reactor coolant were bacteria and fungi, which were common in river water sediment. During the months following the accident, a large volume of river water entered into the reactor building through a leaking air cooler. River water and accident-generated water on the reactor building's basement floor were processed by the submerged demineralizer system and stored in the processed water storage tanks. The biologically contaminated, processed water was reused for reactor coolant makeup. The hydraulic fluid used in defueling tools was also found to be contaminated. These microorganisms were resistant to high radiation fields, borated reactor coolant chemistry, and biocides.³²²

Considerable time was spent attempting to control visibility inside the reactor vessel. Numerous techniques, with varying degrees of success, were evaluated serially to bring microorganism growth under control and to improve clarity by the end of 1986.³²³ As the result of extensive research and testing, the NRC approved 200 parts per million hydrogen peroxide as the biocide. NRC's evaluation concluded that the biocide concentration was compatible with existing water chemistry and water processing systems, as well as the effects on criticality, defueling canister catalytic hydrogen recombiners, and waste disposal. In addition, the increase in reactor coolant activity levels due to the increase in rate of cesium leaching from the debris bed would not impose a significant impact on worker safety with the implementation of normal radiological control practices.³²⁴ Inspections, corrosion studies, and laboratory tests found no microbial-induced corrosion of components and defueling equipment in the reactor vessel.³²⁵

- **The modified DWCS.** In addition to the microorganisms being filtered by the DWCS, colloidal suspensions of fine particles of silicon and iron oxides caused premature plugging of the sintered metal filter media in the filter canisters. A temporary reactor vessel water filtration system (see below) was installed until solutions to stop the microorganism growth and remove the colloidal material could be incorporated in the

DWCS design. Under normal conditions, the filter efficiency increases as a cake is built up on the surface of the media. However, the suspended colloids were plugging the pores of the sintered stainless steel filter media before the filter cake could form. Modifications to the DWCS included a filter-aid feed system that injected a coagulant with body-feed material into the filter canisters to agglomerate the colloids to filterable sizes and promote cake buildup on filter media.^{326, 327} The modified reactor vessel cleanup system was restarted on January 8, 1987.³²⁸ Later in 1987, a crosstie was installed between the FTC/SFP-A cleanup system and the “B” train of the reactor vessel cleanup system that was modified with the coagulant and filter-aid feed system. This crosstie permitted the processing of FTC and SFP-A water without the need to make a similar modification in the FTC/SFP cleanup system located in the fuel handling building.³²⁹ Other operational improvements were made to the DWCS during its service lifetime.³³⁰

- ***The temporary reactor vessel water filtration system*** was used to clean up reactor vessel water above the rubble bed and to maintain an adequate visibility for defueling. The system took suction from the internals indexing fixture and pumped the water back to the fixture through a filter assembly. The temporary system was installed after discovering difficulties that the defueling water cleanup system was having with cleaning up reactor vessel water. The system included a filter, a pump, and a “knockout” canister. (The knockout canister, filter canister, and fuel canister were specifically designed and fabricated to contain fuel debris.) The filter was a diatomaceous-earth pre-coat filter. A loaded filter was backwashed of diatomaceous earth and debris into a knockout canister or filter canister for disposal. The system was restored by establishing flow and injecting six pounds of clean diatomaceous earth into the pump suction to coat the filter’s internal leaves.³³¹ The temporary system operated from February 1986 to May 1987, after which the improved defueling water cleanup system took over the water filtration function.³³²
- ***The in-vessel filtration system*** was a modified defueling water cleanup system that supported vacuuming operations for final cleanup of the defueled reactor vessel. The in-vessel vacuum system used a knockout canister and filter canister in series.³³³

- **The processed water disposal system** (evaporator) was used to dispose of 2.3 million gallons (8.7 million liters) of processed accident-generated water. The system processed the water through a closed-cycle evaporator. The purified distillate was reheated and discharged into the atmosphere as a vapor, using the 100-foot-high TMI-2 exhaust stack. The vapor contained essentially all of the water's tritium and a small fraction of its particulate contamination. The vapor was released to the atmosphere in a controlled and monitored manner. The remaining particulate contamination was concentrated in the evaporator bottoms, collected, and further concentrated to a dry solid. A packaging system prepared the dry solid waste in containers acceptable for shipment and burial in a commercial low-level radioactive waste burial facility.³³⁴ The 2.3 million gallons of processed water (influent) contained about 1,020 curies of tritium and about 2.3 curies of all other radionuclides, such as 42 percent strontium-90, 38 percent carbon-14, and 14 percent cesium-137. The water also contained nonradioactive contaminants, such as 150 tons (136,000 kilograms) of boric acid and 11 tons (10,000 kilograms) of sodium hydroxide.³³⁵ About 99.9 percent of the dissolved radioactive contaminants (other than tritium) contained in the evaporator influent were collected as dry solid waste.³³⁶

Temporary Solid Waste Storage. The NRC stated in its Programmatic Environmental Impact Statement (PEIS) that the TMI site should not



Processed water disposal system disposed of 2.3 million gallons of processed accident-generated water by evaporation and disposal of solid residue.

become a permanent radioactive waste disposal site. This statement was based on the conclusion that TMI did not meet the criteria for a safe long-term waste disposal facility for storing damaged fuel and radioactive waste.³³⁷ (The Commission endorsed the PEIS in their April 27, 1981, policy statement.³³⁸) The objective of the memorandum of understanding between the NRC and DOE, as amended, for the removal and disposition of radiological waste resulting from the cleanup of TMI-2 was to ensure that the TMI site did not become a long-term waste disposal facility.^{339, 340} Several onsite facilities were constructed for temporary storage of solid radioactive waste products from cleanup activities that were being readied for transportation. Solid waste included spent EPICOR I and EPICOR II resin liners; contaminated clothing, tools, and equipment; and decontamination materials.

- ***The interim storage facility*** was built to temporarily store EPICOR resin liners and filters until the construction of the solid waste staging facility was completed. The earthen facility was constructed underground from corrugated galvanized cylinders with a welded bottom. A 3-foot-thick concrete cover provided shielding at the top. The ground provided radial shielding. The loaded liners were placed on a galvanized drip pan. The design requirements for the facility were provided to the licensee by the NRC³⁴¹. The facility was ready for use on November 5, 1979.³⁴² The facility was abandoned in place after the liners were relocated to the new solid waste staging facility.³⁴³
- ***The interim solid waste staging facility*** (also known as the “car port”³⁴⁴) was used to collect and temporarily store (stage) low-level solid waste packages from both Units 1 and 2. All waste packages placed in the facility, such as liners, drums, and metal boxes, were already prepared for shipment. The facility performed passive functions of protecting waste packages from precipitation and provided the means to load packages onto trucks. The facility included a truck bay for loading and unloading. The facility was originally sized to accommodate the waste generated by both units over a 6-month period. Waste packages could be stored for up to 5 years.³⁴⁵ The facility was ready for use on December 16, 1982.³⁴⁶
- ***The solid waste staging facility*** was used to collect and temporarily stage radioactive waste, such as dewatered resins, filters, and sludge from both Units 1 and 2 before shipment. Two of six planned concrete storage modules were built, each consisting of 60 cells. Each cell was constructed of galvanized corrugated steel cylinders with a welded steel base plate, and was sized to accommodate any combination of waste

containers, such as resin liners, metal boxes, and drums. A concrete cover 3-feet-thick and weighing about 14 tons covered each cell. Both modules shared a sump compartment to collect drainage. The facility performed no active function other than storage.^{347, 348} Storage Module “A” went into service in January 1980.³⁴⁹

- ***The waste handling and packing facility*** was used to process and package solid radioactive waste, such as contaminated clothing, tools, and equipment. Processing of contaminated material consisted of compaction, size reduction, and sometimes decontamination for reuse. No radioactive waste was stored in this facility.³⁵⁰ The facility was ready for use in January 1987.³⁵¹
- ***The TMI-2 spent fuel pools “A” and “B”*** were used to stage spent resin vessels from the submerged demineralizer system and loaded defueling canisters. The spent fuel pools were filled with water for shielding. The submerged demineralizer system’s liners were prepared for shipment and lowered into the shipping cask underwater. The loaded shipping cask was lifted out of the “B” spent fuel pool, moved by crane over to the truck bay in the fuel handling building, and lowered onto the truck bed. Defueling canisters had to be loaded individually into the shipping cask located on a special stand in the truck bay. The weight of

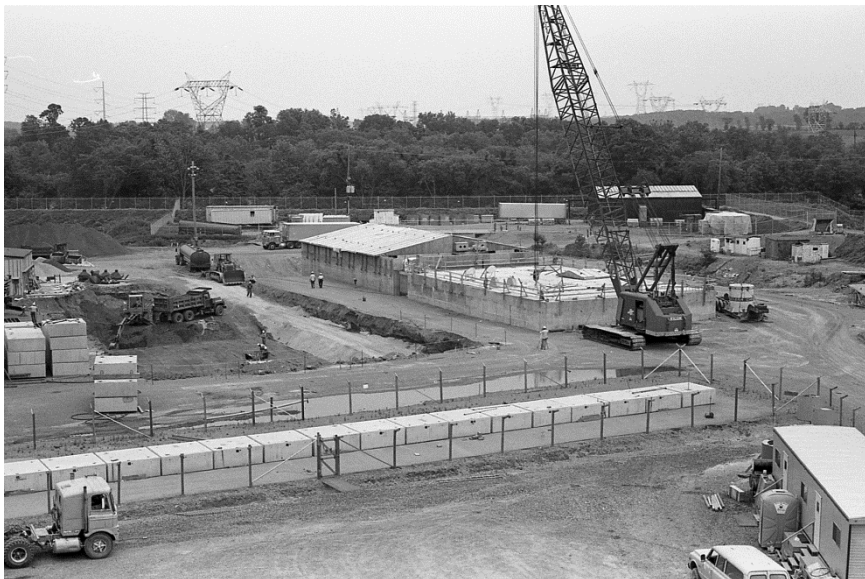

Solid waste staging facility was constructed to temporarily store radioactive wastes, such as dewatered resins, prior to shipment. Two module structures were built (center). The crane is loading a spent liner in a shipping cask. The temporary interim liner staging modules shown along the bottom.

the shipping cask prohibited loading it inside the “A” spent fuel pool where the defueling canisters were stored. Each defueling canister was lifted out of the pool, raised into the fuel transfer cask, moved to the truck bay, and lowered into one of seven canister slots in the shipping cask. The loaded shipping cask was then lowered horizontally and mounted onto a railroad car. Each fuel shipment took about 1,000 person-hours to prepare.³⁵²

Packaging and Transportation. The NRC regulates packaging for the transport, storage, and disposal of nuclear materials and waste. In addition, the NRC regulates the design, fabrication, use, and maintenance of containers for high-level radioactive shipments, including spent nuclear fuel. The U.S. Department of Transportation (DOT) regulates packaging for the transport of lower-level radioactive materials and waste. In addition, DOT regulates shippers of all types of radioactive material and oversees vehicle safety, routing, shipping papers, emergency response, and shipper training requirements. The NRC requires its licensees to comply with DOT’s safety regulations in addition to the NRC’s own requirements. NRC regulations for the safety of transport and certification of packages for large quantities of radioactive materials, including spent nuclear fuel, can be found in 10 CFR Part 71, “Packaging and Transport of Radioactive Material.”^{353, 354} Also, NRC regulations under 10 CFR Part 61, “Licensing Requirements for Land Disposal of Radioactive Waste,” provide requirements for shipments of radioactive waste to commercial land disposal facilities. These regulations provide limits on radionuclide concentrations and requirements for the long-term structural stability of the disposal container.³⁵⁵ State regulatory agencies, responsible for land disposal facilities, and the DOE, responsible for accepting certain wastes from TMI-2, also provided additional requirements.

The shipment of radioactive waste from TMI-2 by the licensee was required to follow general regulatory requirements that applied to all licensees of nuclear power plants. The NRC certified new shipping casks that were designed and fabricated for the transportation of unique high-level waste that came out of TMI-2 during cleanup. The NRC issued a “certificate of compliance” for each new shipping cask or reissued an existing certificate of compliance for a modified cask. The certificate of compliance provides the terms and conditions under which the cask can be used, such as the type, form, and quantity of material authorized for shipment in the cask, as well as hardware specifications and internal packaging requirements. A user of a cask must be certified by the NRC as a registered user. To become a registered user, an applicant must have a quality assurance program in accordance with 10 CFR 71 and a copy of the certificate of compliance

(from the holder/owner of the cask), and must maintain maintenance records on its casks. The NRC also reviewed and approved special waste containers that were required to be shipped inside a shipping cask that provided special safety features during transportation. In addition, the NRC reviewed containers that were required to meet regulatory requirements (e.g., those of 10 CFR 61 and the NRC Technical Position Paper on Waste Forms³⁵⁶) for disposal in commercial low-level radioactive waste burial facilities. The types of shipping casts used at TMI-2 are summarized below:

- ***NRC Certificate of Compliance No. 9152/B, Revision 0, Model CNS 1-13C II Type B Shipping Cask*** was issued on



Model CNS 1-13C-II shipping cask on the truck transporter.

April 4, 1982, and subsequently revised. This new cask was developed for the transport of spent SDS vessels with dewatered resins. The cask consisted of a cylinder made of lead and steel lining, a bolted lid, and two impact limiters (upper and lower) made of steel-lined rigid polyurethane foam.³⁵⁷ This cask was later modified and recertified for the transport of core debris samples to a DOE laboratory (Revision 8, dated August 14, 1985). The modification included a secondary package to fill the void of the cask, a DOT Specification 2R container to provide secondary containment for the samples, a limit of total fissile material to a subcritical quantity, and a restriction to the transport of only TMI-2 fuel debris.^{358, 359}

- ***NRC Certificate of Compliance No. 5026, Revision 10, Model CNS 14-190 Shipping Cask*** was reissued in January 1984. This existing cask was recertified to transport a high-integrity container that was used as an overpack (or outer container) for an EPICOR II pre-filter liner. The cask was used by the DOE to ship EPICOR II liners from

INEL to the commercial low-level radioactive waste burial facility near Richland, Washington. The shipments began in May 1984 and were completed in February 1985.^{360, 361, 362}

- ***NRC Certificate of Compliance No. 9200, Revision 0, Model No. 125-B Shipping Cask*** was issued on April 11, 1986, and subsequently revised. The new cask was designed specifically to transport the loaded defueling canisters. Given that DOE took possession (ownership) of the fuel debris in its agreement with GPU, DOE had authority under DOT regulations to self-certify its own radioactive material shipping packages. Further, DOT regulations required that DOE packages meet the requirements and standards of 10 CFR 71. DOE chose the NRC to be the regulator for approval of the Model 125-B shipping cask. Its design provided two testable levels of leak-tight containment in accordance with NRC regulations. NRC regulations also required the cask to provide protection against any radiological release during normal conditions of transport and during hypothetical accident conditions. The cask safety analysis report was independently evaluated by the NRC in accordance with regulatory requirements of 10 CFR 71. The NRC issued the certificate of compliance for the rail cask to DOE on April 21, 1986. Three casks were fabricated for the exclusive shipment of TMI-2 fuel debris. Two casks were purchased and owned by DOE. The third cask was owned by the fabricator and leased to GPU.³⁶³



Model 125-B rail shipping cask used to transport seven defueling canisters loaded with core debris. Impact limiters shown with flags.

The Model 125-B fuel cask consisted of five major components: the outer containment vessel, inner containment vessel, upper and lower canister impact limiters, canister shield plugs, and cask impact limiters. Each cask had its own transportation system of a skid and rail car. Gross shipping weight of the shipping cask was about 183,000 pounds. The primary and secondary containment lids weighed 3,000 and 5,200 pounds respectively. The cask impact limiters weighed about 11,700 pounds each and the sunshield weighed about 500 pounds.³⁶⁴ Up

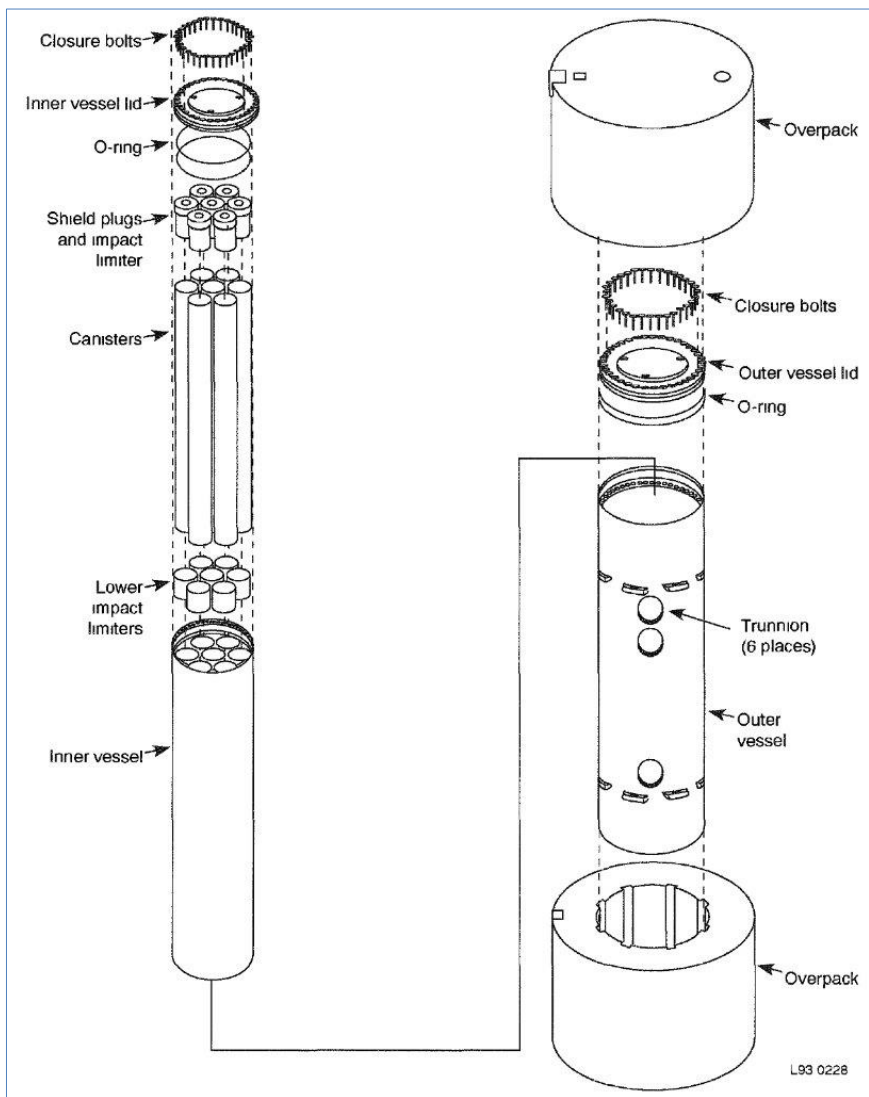

Exploded view of the Model No. 125-B Shipping Cask. Fuel debris was contained in the seven defueling canisters.

to 21 defueling canisters could be sent in a single rail shipment (seven canisters per cask, three casks per shipment). The fuel shipments began on July 20, 1986, and were completed on May 9, 1990. There were 22 rail shipments for a total of 342 canisters of core debris transported to the INEL. The total number of canisters shipped included 286 fuel canisters (which contained partially intact fuel assemblies and large debris picked up from the reactor vessel), 12 knockout canisters (containing core debris vacuumed from the reactor vessel and reactor coolant system), and 62 filter canisters (containing fine debris that passed through the knockout canisters).³⁶⁵

- ***HIC overpacks to dispose of EPICOR II pre-filter liners.*** A special high-integrity container (HIC) was designed and fabricated for DOE to dispose of the original 45 highly loaded EPICOR II pre-filter liners at the commercial low-level radioactive waste burial facility near Richland, Washington. The HIC was an overpack (EPICOR II liner sealed inside the HIC) that would remain stable below ground for a minimum of 300 years (about 10 half-lives of the predominant isotopes). The HIC consisted of a cylinder made of reinforced concrete and a permanently sealed lid. A vent system cast in the lid provided passive venting of the container. This HIC was restricted for use with only EPICOR II pre-filter liners generated at TMI-2. Certificate of Compliance No. WN-HIC-01 was issued for this HIC by the State of Washington on March 23, 1984.^{366, 367}
- ***HIC overpacks to dispose of SDS vessels.*** After an unsuccessful attempt to qualify the design of the SDS pressure vessel as a HIC, SDS vessels were shipped and buried inside a polyethylene HIC. These poly HICs were permitted exclusively at the commercial low-level radioactive waste burial facility in Barnwell, South Carolina. A concrete liner was inserted between the SDS vessel and the poly HIC to provide the shielding necessary to ensure the authorized service life of the poly material.³⁶⁸
- ***Commercial metal HIC.*** A commercially available HIC was used at TMI-2 to dispose of radioactive waste that contained high concentrations of strontium-90 and transuranic material. (At high concentrations, the waste classification system of 10 CFR 61 required stabilization of the waste either by solidification or HIC.) The metallic HICs were made of a corrosion-resistant alloy material. In 1984, the State of Washington granted interim authorization for the first shipment to the commercial low-level radioactive waste burial facility near Richland before the NRC completed its review of the technical

evaluation report for these HICs. In April 1988, NRC completed its review and concluded that the HIC met or exceeded all of the requirements of 10 CFR Part 61 and the recommendations of the NRC Technical Position Paper on Waste Forms. The metallic HICs were modified and qualified to function as demineralizer vessels in the defueling water cleanup system and later in the last EPICOR II configuration.³⁶⁹

Hydrogen Generation in Waste Containers. Generation of flammable gases inside sealed radioactive waste containers was a potential hazard. Two reactions contribute to gas generation: (1) the reaction between metals and water, which oxidizes the metal and releases hydrogen gas; and (2) long-term exposure of water and organic materials to ionizing radiation (radiolysis). Because many TMI-2 wastes—particularly SDS zeolites and canisters of fuel debris—were loaded with high concentrations of radioactivity, the latter reaction was a potential source of flammable gaseous mixtures (oxygen plus hydrogen).³⁷⁰

- **EPICOR II liners.** A unique gas sampler and vent tool was designed by DOE to remotely remove the vent plug from the EPICOR II ion exchange resin liner, sample the gas content, vent the container, purge



Demonstration high integrity container (HIC) being covered in the trench at the commercial radioactive waste disposal site near Richland, Washington. The HIC contained the highly loaded EPICOR II prefilter No. 18. The demonstration set the precedent for disposing of the remaining EPICOR II prefilters that were temporarily stored at INEL.

the container with inert gas, and reinstall the vent plug. The venting of the liners was performed at the Solid Waste Storage Facility in the individual cells where EPICOR liners were stored. All operations were done remotely under a portable concrete shielding blockhouse over the storage cell. A portable remote support trailer that was located on top of the storage modules contained the gas circulator for purging the atmosphere of a storage cell with inert gas, a gas chromatograph for on-line sampling, controls for the gas sampler including TV monitors.^{371, 372} Laboratory analysis of several highly loaded EPICOR II pre-filter liners identified the average hydrogen production rate of a 2000 Curie liner would generate a 4 percent mixture of hydrogen in a nitrogen and carbon dioxide atmosphere in about 100 days. The vent tool lowered the content that would be generated during shipment to less than the flammable limit of 4 percent.³⁷³

- **SDS vessels.** Radiolytic gas generation in highly loaded SDS vessels was calculated to be significant. Measurements of gas buildup confirmed that this could be a problem during storage and transportation. A DOE research program developed a number of techniques to deal with the problem. To reduce buildup of flammable gas during transport and storage, the vessels were drained and vacuum pumped to remove free water. A catalyst was added to each vessel to recombine the hydrogen and oxygen as it was generated. A pressure relief system, consisting of a burst diaphragm and micropore graphite filter, was also added to each vessel to prevent uncontrolled, long-term buildup of non-recombinable gas mixtures. (A net hydrogen buildup can occur due to oxygen scavenging by various chemical reactions, such as the formation of carbon monoxide and carbon dioxide from oxidation of organic materials trapped within the zeolites.)^{374, 375}
- **Defueling canisters.** Catalyst beds were used in the TMI-2 core debris canisters to recombine radiolytic hydrogen and oxygen and prevent buildup of combustible mixtures of gases. Each canister contained a recombiner catalyst package incorporated into the upper and lower heads. The catalyst bed was designed with porous metal filters at each end to contain the panicles while allowing gases to flow to and through the catalyst.^{376, 377, 378, 379}

Document Collections. Documents relating to waste management activities are grouped into the following document collections on the DVDs:

- EPICOR II system (see the DVD folder, [Water Processing: EPICOR](#))

- submerged demineralizer system (see the DVD folder, [Water Processing: SDS](#))
- solid waste processing and storage (see the DVD folder, [Solid Waste](#))
- other waste-related processing systems and activities (see the DVD folder, [General Waste Management](#))
- status and lessons learned reports (see the DVD folders under the [Status and Summary Reports](#) collection)
- incidents and deficiencies (see the DVD folder, [NRC Preliminary Notifications](#))

The following types of documents are included in the above document collections:

- system and facility description reports
- technical evaluation reports and safety evaluation reports
- certificates of compliance for shipping casks (current at the time of first shipments)
- research reports, NRC technical NUREG reports, GEND reports, and technical reports from DOE national laboratories
- other correspondence between the NRC and the licensee relating to the waste management systems and activities, such as notifications, requests, reviews, and approvals

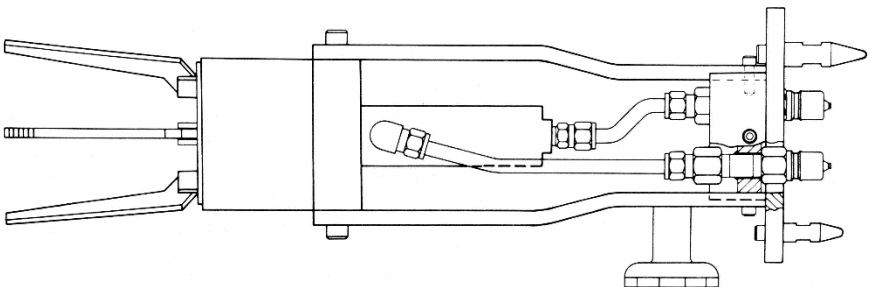

Defueling tool: three point gripper hydraulic attachment.



Spent EPICOR II resin liner inside the shielded transfer cask (yellow) being lowered into a shipping cask.



A highly radioactive spent SDS resin liner (center) being transferred into a shipping cask (lower center) while underwater in the spent fuel pool.

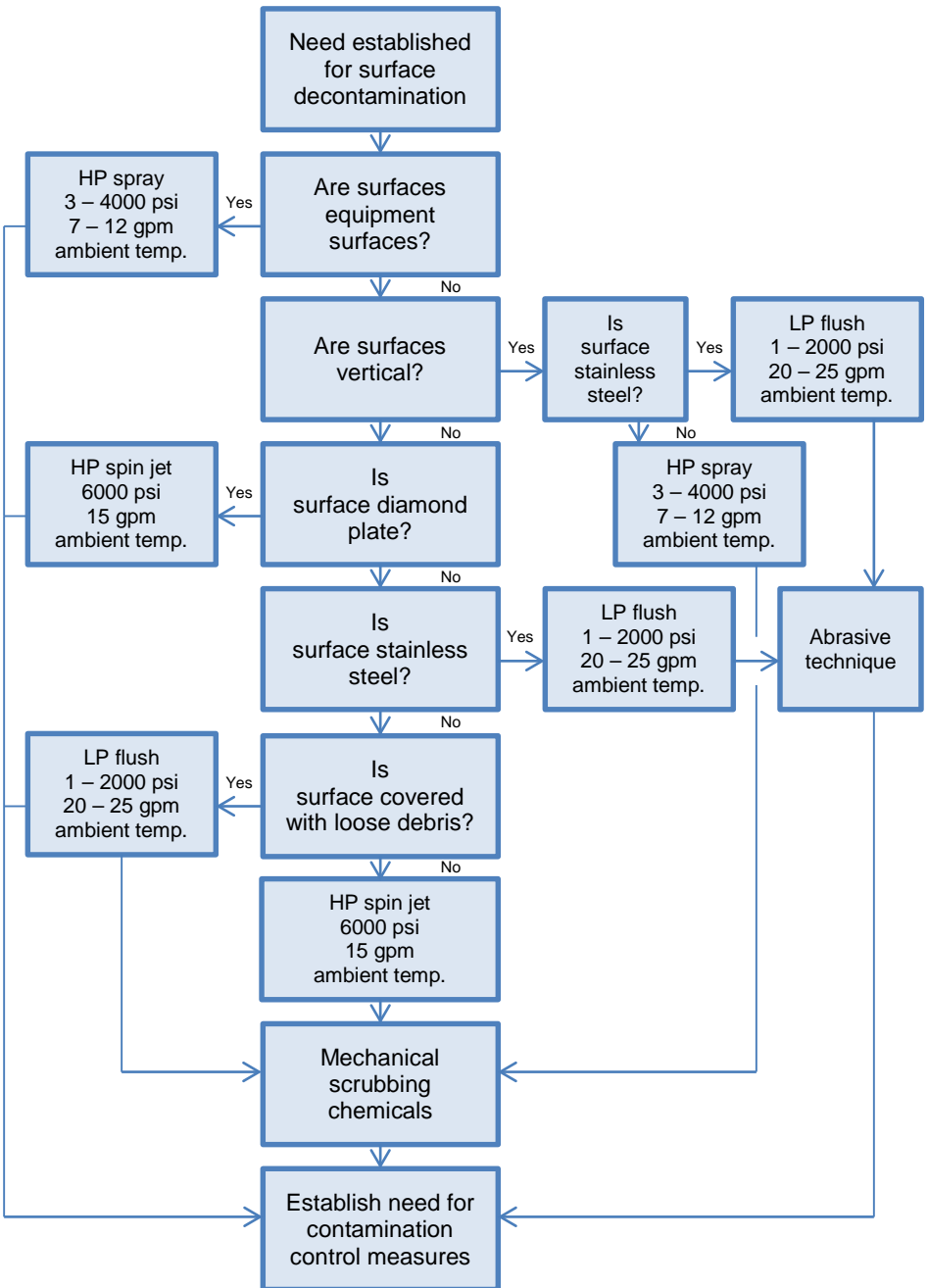

(Abbreviations: Gallons per minute---gpm, high pressure---HP, low pressure---LP, pounds per inch---psi, temperature---temp)

Decontamination logic diagram based on results of the gross decontamination experiment in March 1982 (see GEND-034).

7 Decontamination

The 1979 accident involved a loss of reactor coolant and resulted in severe damage to the reactor fuel. When the reactor coolant pump flow was restored, radioactive contamination in the form of fuel debris and fission products was distributed by the coolant throughout the reactor coolant system. Reactor coolant, carrying fuel debris and fission products as dissolved and particulate material, flowed out of the reactor coolant system through the stuck-open pressurizer pilot-operated relief valve and into the reactor building's basement and sump. During the first hour of the accident, spilled reactor coolant in the reactor building sump was automatically pumped into the auxiliary building holding tanks, which then overflowed along with the sumps. Although this radioactive water did not initially contain damaged fuel, later, equipment leakage from the makeup and purification system did contain fuel debris and fission products which mixed with the water in tanks, sumps, and floor drains. Exposed surfaces in the reactor building and the auxiliary and fuel handling building were contaminated with radionuclides in the reactor coolant, as well as radionuclides that became airborne, as hot reactor coolant flashed into steam. Airborne contamination entered the ventilation systems and spread throughout the auxiliary and fuel handling building.³⁸⁰ For some unknown reason, the ventilation systems stopped several times, which diverted airborne radionuclides to unintended areas.³⁸¹ After the accident, the water in the reactor building's basement was heated by residual heat from the reactor vessel, evaporated, condensed on the cooler walls, and drained down onto the floors and back into the basement.³⁸²

Cleanup of the auxiliary and fuel handling building started shortly after the accident. Airborne releases contaminated surfaces on the upper-level floor (at the 328-foot elevation) and mid-level floor (at the 305-foot elevation) of the auxiliary building, and liquid releases to the drain system contaminated surfaces on the basement-level floor (at the 280-foot elevation). The interior of the building, including 26 piping systems, was contaminated by radioactive material, though less severely than the interior of the reactor building; because most of the interior surfaces, such as walls and floors, were constructed of uncoated concrete, radioactive materials penetrated the surfaces to varying depths. Approximately 510,000 square feet of surface in the auxiliary and fuel handling building required decontamination when cleanup operations began.^{383, 384}

The decontamination experience at TMI-2 differed from past experience in the nuclear industry in that cleanup of the reactor building did not begin immediately. During the time between the accident and the start of the

cleanup, the humidity in the reactor building was 100 percent, causing precipitation in the form of rain (steadily dripping condensation) inside the reactor building. One result of the rain was that dose rates during the initial personnel entries into the reactor building 14 months after the accident were lower than expected because radionuclides had been rinsed downward. A second result was that radionuclides permeated into porous surfaces such as uncoated concrete, were incorporated in corrosion layers as iron surfaces rusted, and were trapped in paint layers. Re-cleaning of previously cleaned areas was still required during the cleanup period, with concomitant exposure of workers.³⁸⁵

Reactor coolant containing core debris and fission products was discharged on the reactor building's basement floor through the stuck-open pressurizer pilot-operated relief valve when the block valve was periodically opened to control pressure. Consequently, these areas were covered with radioactive sediments, consisting primarily of river water sediment from a leaking air cooler inside the reactor building, concrete dust, and dirt.³⁸⁶

Decontamination Objectives. The overall objectives of the TMI-2 decontamination efforts were to maintain access to and operability of plant systems, to support defueling preparations and operations, and to permit the transition of the facility to a long-term storage condition. Shorter-term decontamination objectives focused on the removal or stabilization of



Decontamination using high-pressure spray.

contamination in order to reduce occupational exposure and to prevent release of contamination to the environment. Longer-term decontamination objectives ensured that any remaining contamination was stable and sufficiently isolated for long-term storage.³⁸⁷

The initial decontamination objectives in the auxiliary and fuel handling building were to permit access without restriction because of surface or airborne contamination, to reduce radiation exposure from gamma sources to ALARA levels, and to prevent recontamination from other cleanup activities or system leaks. Decontamination of cubicles was required to permit access for inspection and maintenance of plant equipment, which had been deferred since the accident. In addition, decontamination of systems and equipment in the auxiliary and fuel handling building were required for activities to decontaminate the reactor building and defuel the reactor vessel and primary coolant system.³⁸⁸ The initial decontamination objective in the reactor building working areas (at the 305-foot and 347-foot elevations) was to reduce radiological conditions (general area radiation, airborne gaseous and particulate activities, and surface contamination levels) to ALARA levels and to maintain those conditions in a way that would permit defueling operations.³⁸⁹ The objective in the basement was to remove sludge from all accessible areas and stabilize contamination during long-term storage.³⁹⁰

The final decontamination objective was to stabilize localized radiological conditions in the plant, regardless of whether or not access was required for cleanup activities. The associated decontamination efforts were focused on meeting the specified goals (such as general-area dose rate, surface contamination level, and hot-spot dose rate) required to place the facility in long-term storage after defueling completion. Long-term storage would allow decay of the radionuclides that remained in the facility so that workers would be exposed to lower levels of radiation during future decontamination and decommissioning.^{391, 392}

Decontamination Criteria and Goals. The safety analysis report for post-defueling monitored storage (PDMS) provided a set of decontamination *objectives* (see above), baseline radiological *criteria*, and decontamination end-point *goals* for the decontamination program. Two of many prerequisites that were required for entering PDMS included (1) contamination reduction consistent with ALARA principles to meet established contamination-level goals in each of the areas of the auxiliary and fuel handling building and (2) radiation reductions consistent with ALARA principles, as necessary, to levels which would allow necessary plant monitoring, maintenance, and inspections.³⁹³

that required routine access (40 hours per week) were less than 2.5 mR/hr for the general-area dose rate, 10 mR/hr for the maximum hot-spot dose rate, and less than 1,000 dpm/100 cm² for surface contamination within 7 feet of the floor. The specific *goals* for the seal injection filter room in the auxiliary building that may require weekly access, were less than 500 mR/hr for the general-area dose rate, less than 1,000 mR/hr for maximum hot-spot dose rate, and less than 50,000 dpm/100 cm² for surface contamination. General decontamination criteria for piping systems, equipment, and components were based solely on their contribution to area dose rates. Specific decontamination *goals* are listed in the PDMS safety analysis report (refer to DVD folder, [After Defueling](#)).³⁹⁵

Cleanup Activities. Decontamination of building surfaces, systems, and equipment included multiple activities across the following categories:³⁹⁶

- ***Loose equipment.*** Removal of miscellaneous equipment and debris that were in the facility at the time of the accident, such as ladders, scaffolding, tools, and portable equipment.
- ***Installed equipment.*** Decontamination or removal of installed equipment, such as piping systems, air conditioning and exhaust equipment, cable trays, and electrical and lighting equipment.
- ***Interior surfaces.*** Decontamination of interior building surfaces consisting of metal and concrete materials.
- ***Sludge.*** Removal of contaminated sediment (sludge) from tanks and sumps in the auxiliary and fuel handling building and from the reactor building's basement floor and sump. The sediment was transferred to the spent resin storage tanks for processing. Concentrated solids were transferred to a disposal container for cement solidification.³⁹⁷
- ***Resins.*** Removal of highly contaminated resins from the makeup and purification system demineralizers located in the auxiliary building. This system cleaned up the reactor coolant system during normal plant operations. During the accident and thereafter, about six kilograms of fuel and fission products were deposited in system filters and demineralizers.³⁹⁸
- ***Recovery and cleanup equipment.*** Decontamination of systems and equipment used for cleanup and defueling activities. Gross decontamination of refueling tools and cleanup equipment for reuse or disposal was performed in two temporary equipment decontamination

facilities located in the auxiliary building and reactor building. In 1987, the waste handling and packaging facility became operational, which provided a permanent facility for integrated equipment decontamination. This new facility also processed and packaged discarded equipment for disposal.³⁹⁹ Following defueling operations, equipment located in the TMI-2 spent fuel pools was removed and pools were emptied of water and decontaminated. Spent fuel pool and the fuel transfer canal contained fuel debris that was carried out on the surface of the defueling canisters.

- **Support activities.** Various support activities to ensure worker safety and to measure the effectiveness of the cleanup.

The decontamination of the reactor building's atmosphere and accident-generated waste water are discussed in previous sections.



Workers decontaminating the auxiliary building using the manually applied scrubbing method.

Decontamination Methods. Combinations of well-known methods were used in the decontamination of building and equipment surfaces in the auxiliary and fuel handling building. Methods used for decontamination of surfaces inside the reactor building were based on the results of the gross decontamination experiment and subsequent experience gained in decontamination of the auxiliary and fuel handling building. The following decontamination methods have been reviewed by the NRC and saw at least limited use:^{400, 401, 402}

- ***Abrasive blasting*** of steel surfaces with particulate driven at high velocity to remove contamination. This method was especially suited for small or irregular surfaces that were not compatible with other decontamination techniques.
- ***Chemical decontamination*** of external surfaces of pipes, tanks, and system internals. The gross use of chemical agents was limited because of the potential for drain-off of such agents to damage water processing systems.
- ***Dry vacuuming*** to remove powdered contaminants and dried residue. This method was used especially for water-sensitive components that could not be flushed with water.
- ***Low-pressure water flush*** at levels between 100 to 1,000 pounds per square inch (psi), flow rates up to 25 gallons per minute (gpm), and water temperatures up to 170 degrees Fahrenheit. This method was used to clean equipment and loose surface debris. Examples included the polar crane, steam generator housing structures (“D-rings”), missile shields, refueling canal, and refueling bridge.
- ***High-pressure water flush*** to remove unbonded surface coatings at pressures between 2,000 to 10,000 psi and flow rates of 4 to 30 gpm.
- ***Ultrahigh-pressure water flush*** to remove rust, scale, nuclear-grade coatings, and surface concrete at pressures up to 60,000 psi and flow rates of 1 to 2 gpm.
- ***“Scabbling”*** of walls and floors to aggressively remove concrete surfaces and surface coatings. The scabblers used pneumatically operated reciprocating pistons equipped with tungsten carbide bits to pulverize the concrete surface. A vacuum system with a high-efficiency particulate air filter was attached. A major scabbling campaign began in the reactor building in October 1984.⁴⁰³

- ***A steam and vacuum decontamination system*** was used throughout the TMI-2 cleanup to decontaminate painted and uncoated concrete, ductwork, diamond deck plates, lead bricks, penetration covers, piping, conduit cable trays, and drain covers. The system used a single-head machine that minimized the spread of contamination and impairment of vision from sprayback.⁴⁰⁴ The system was first tested in the auxiliary building on June 14, 1984, and decontamination in the reactor building began in March 1985.⁴⁰⁵
- ***Strippable coatings*** that involved the application of an organic coating which contained chemicals to aid in the removal of radioactive contaminants from the surface. As the coating dried, it cracked and peeled away from the surface.
- ***Scrubbing*** to remove loosely held contamination on floors and walls using manually applied or mechanically driven rags, absorbent cloths, brushes, pads, grit, and chemical agents.
- ***Wet vacuum*** to remove puddles of contaminated cleaning fluids after flushing.

Remote Robotic Equipment. Remote-controlled robotic vehicles and supporting control equipment were used extensively to perform work in the reactor building's basement, the makeup demineralizer room in the auxiliary building, the reactor coolant pump seal injection valve room in the fuel handling building, and the reactor vessel. These vehicles were both versatile

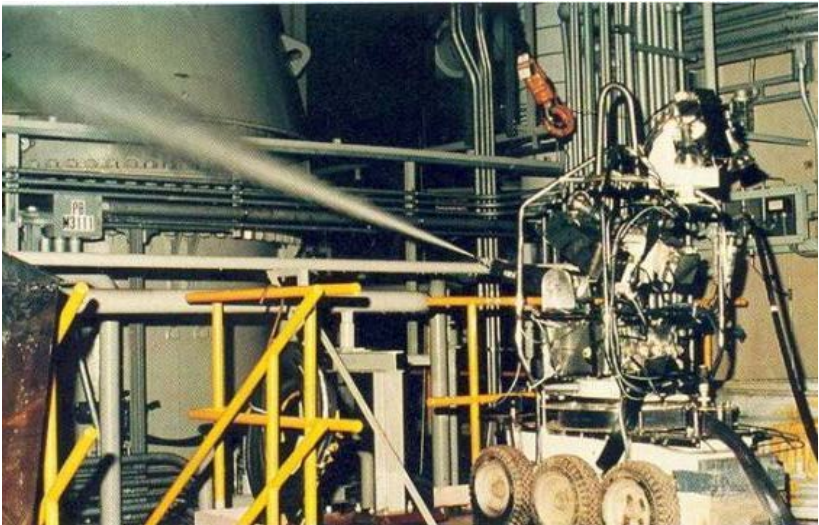

Remote control robotic high-pressure spray washing system.

and productive, and proved useful in many different tasks, including video camera inspections, radiation monitoring, sediment sampling, acquisition of concrete core samples, high pressure water flushing, concrete scabbling and scarification, and debris pickup and removal. In addition to the remote vehicles, fixed-position, remotely operated tools were developed for work inside the reactor vessel. The tools included a plasma arc cutting system to remove the stainless steel core support assembly, and several manipulator arms for handling damaged fuel and structural components.⁴⁰⁶ The use of robots at TMI-2 did not require any NRC licensing actions; however, activities in which robots were used, like most recovery and cleanup activities, required safety evaluations by the licensee and the NRC. Key robots used at TMI-2 are summarized below:

- ***ROVER or remote reconnaissance vehicle (RRV)*** was used in the reactor building's basement to perform video and radiation surveys, collect sludge samples from the floor, collect core samples from the wall surface, flush walls with high-pressure water, remove the surface of the walls using an ultrahigh-pressure scarification system, and remove sludge. The RRV was a tether-controlled, six-wheeled work platform with multiple attachments or modules to perform the various tasks. ROVER was operated by two operators in a control room located outside the reactor building.^{407, 408}
- ***LOUIE I remote vehicle*** was used to measure the radiation profiles of the two makeup demineralizer vessels, and to remove loose pre-accident debris and salt deposits on the floor inside the seal injection valve room. On loan from DOE, LOUIE I was a tether-controlled, tracked work platform with a telescoping boom-mounted manipulator that had been in use at DOE's Hanford Site since the 1950s. The control console was setup in the accessible hallway near the entrance to the room.⁴⁰⁹
- ***LOUIE II remote vehicle*** was used to perform remote floor scabbling in the seal injection valve room. An attached 3-piston pneumatic scabbler was used to pulverize the floor surface while vacuuming loose concrete. LOUIE II was a tether-controlled, six-wheeled work platform with a heavy frame to withstand the stresses of the scabbler. The control console was setup in the accessible hallway near the entrance to the room.^{410, 411}
- ***WORKHORSE or remote work vehicle (RWV)*** was a large, heavy-duty robot built for decontamination and demolition work in the basement of the reactor building. WORKHORSE was a tether-controlled, six-wheeled work platform that was 10 times heavier than the RRV and had

a boom with a seven-meter vertical reach. A two-level control building was built in the turbine building for three operators and support staff to operate the RWV and manage the work activities. The RWV was successfully tested in mockups, but never used due to changes in cleanup direction.⁴¹²

- **Mini-Rover** was a commercial submarine vehicle modified to remove larger fuel debris inside the pressurizer. The Mini-Rover had a color camera, pincer arm to break apart debris, and a scope. The submarine was fitted with a ballast tank to improve mobility.⁴¹³
- **Remote manipulator** performed defueling operations in areas of the reactor vessel that were not directly below the defueling work platform's working slots. The manipulator could handle defueling tools and the in-vessel video viewing system, and pickup fuel debris. The manipulator was mounted to the manual tool positioner on the defueling work platform and had a 4-foot reach and six degrees of freedom of motion. The manipulator could be controlled from inside or outside the reactor building.⁴¹⁴
- **ACES or automated cutting equipment system** was a remote-controlled plasma arc torch installed in the reactor vessel to cut the multi-layered lower core support assembly following bulk defueling. ACES consisted of a support bridge with a carriage and trolley to provide horizontal X-Y plane movement. A manipulator arm provided motion in the vertical Z-axis direction, including rotation and bending motions. At the lower end of the manipulator arm was a pneumatically operated gripper with a plasma torch and effector for cutting. A high-velocity stream of high-temperature ionized nitrogen gas plasma transferred an electric arc to melt the cut area.^{415, 416} The two control consoles (one for the manipulator subsystem and the other for plasma subsystem) were located in the turbine building.⁴¹⁷
- **MANFRED or manipulators for reactor defueling** was a robot manipulator system designed and built for underwater disassembly and defueling of reactor vessel components. MANFRED consisted of a manipulator with various work attachments and grabber manipulators. The system was tested but never used due to the success of ACES (above) and manual handling of component pieces and loose fuel debris.⁴¹⁸

Additional information on the uses of remote equipment at TMI-2 are provided in the following documents: International Atomic Energy Agency

report “Catalogue of Methods, Tools and Techniques for Recovery from Fuel Damage Events” ([IAEA-TECDOC-627](#)); the DOE report “TMI 2: Lessons Learned by the U.S. Department of Energy, A Programmatic Perspective” ([DOE-ID-10276](#)); the American Nuclear Society’s *Nuclear Technology* journal (Volume 87; not included in the DVDs); and the EPRI report “Final TMI-2 Technology Transfer Progress Report” (EPRI-TR-100643; not included on the DVDs).

Key Actions. By the end of the cleanup program, the floor contamination levels in most areas of the auxiliary and fuel handling building were reduced to those typical of pre-accident conditions. In the reactor building, radiation levels in frequently accessed areas were reduced by 85 percent by scabbling accessible areas and shielding finite radiation sources. A selection of other key actions during the cleanup period is summarized below:

- ***First decontamination workshop.*** On November 27–29, 1979, the Facility Decontamination Technology Workshop, sponsored by DOE, was held in Hershey, Pennsylvania. The workshop provided those involved with the cleanup at TMI-2 a summary of experience regarding events and incidents at other facilities that necessitated decontamination and dose-reduction activities (see [GEND-002](#)).⁴¹⁹
- ***Gross decontamination experiment.*** In March 1982, the gross decontamination experiment was conducted on various levels and surfaces inside the reactor building. The objectives of this experiment were to evaluate several decontamination techniques and to decontaminate the reactor building surfaces. Results of the experiment showed that gross decontamination could achieve the goal of reducing smearable contamination (see [GEND-034](#)).⁴²⁰ In addition, experiments showed that surface contamination contributed much less to general-area exposure rates, whereas rusty metal surfaces, large equipment, and bags of garbage contributed far more. Findings also indicated that recontamination was a problem; high-pressure flushing, mechanical scrubbing, and strip coating provided higher decontamination factors; residual water from flushing must be removed (such as by squeegeeing or vacuuming) to prevent recontamination from suspended contaminants; and complex surfaces and equipment were harder to clean.⁴²¹
- ***Gross reactor building decontamination.*** On September 17, 1982, gross decontamination began in the reactor building at the 305-foot entry-level elevation, and at the operating floor on the next level above. The effort was designed to reduce smearable levels of contamination to

the point that workers would be able to remove much of their bulky protective clothing and their respirators.⁴²²

- ***Worker protection restrictions lifted in areas of the auxiliary building.*** In November 1982, upper-level corridors of the auxiliary building became accessible to workers without the need to wear anti-contamination clothing. (Respirators had not been required for entry into the upper corridors since October 1979.) The following month, the auxiliary building's corridors in the basement (at the 281-foot elevation) became accessible without the need to wear respiratory protection masks.⁴²³ Overhead areas, such as ceiling and cable trays, were decontaminated only to the extent that they would not re-contaminate the floor below. In such cases, a radiation work permit was required to access ceiling areas.⁴²⁴
- ***Respiratory protection restrictions lifted in areas of the reactor building.*** On June 28, 1984, workers entered the reactor building without respiratory protection for the first time since the accident, and subsequent entries were made without respirators, in accordance with ALARA principles.^{425, 426}



The command center for the gross decontamination experiment in March 1982 contained the control functions for entry into the reactor building with positions for safety, radiological engineering, operations, entry coordinator, and command center management.

- **GPU's Decontamination Task Force Report.** On December 18, 1985, the licensee issued the Decontamination Task Force Report. The report provided a review of the effort required to decontaminate TMI-2 and an evaluation of the reduction in occupational exposure during post-defueling monitored storage (PDMS). The objective of the task force was to arrive at a consensus technical approach to each of the major areas of decontamination work: remote-equipment development; sludge transfer and disposal; D-ring dose reduction and decontamination; recovery of the reactor building's basement; auxiliary and fuel handling building surface decontamination; non-reactor coolant systems decontamination; reactor building ventilation modifications; reactor building surface decontamination; reactor coolant system decontamination, and waste management for the decontamination of the reactor building.

The task force estimated that final decontamination, as part of future decommissioning, would result in a total occupational exposure in the range of 2,710 to 5,770 person-rem, assuming that further decontamination was deferred until after a 30-year period of PDMS.



A radiation work permit (RWP) was required to access contaminated ceiling areas above the clean areas of the auxiliary building main corridors.

The task force concluded that deferring decontamination for a period of 30 years would result in a potential occupational exposure savings in the range of 4,500 to 9,800 person-rem. This savings was based, in part, on reduction in radiation dose rates due to the natural decay of radioactive materials, and advances in both remote cleanup technology, and chemical decontamination methods.⁴²⁷ Results from the task force report were documented in Appendix 5A of the PDMS safety analysis report, “Potential Reductions in Occupational Exposure Due to Post-Defueling Monitored Storage,” (see the DVD folder, [After Defueling](#); the task force report itself, however, is not available on the DVD).

- **Reactor building sludge removal.** On March 31, 1987, the robotic removal of sediment in the reactor building's basement began and was

completed in July 1987.⁴²⁸ Approximately 10,800 pounds (4,900 kilograms) of wet sludge, which contained about 4 kilograms of fuel debris, was removed from the reactor building's basement floor, pumped into a tank located in the auxiliary building, and solidified for burial at a low-level radioactive waste disposal site. A robotic desludging system was used to vacuum about 40 percent of the basement floor area which was the only area accessible to the robot. The removal efficiency of desludging was greater than 90 percent.⁴²⁹ The robotic flushing of the basement floor was completed 3 months later.⁴³⁰

- ***NRC's PEIS supplement for completing cleanup.*** In August 1989, the NRC issued the final supplement to the Programmatic Environmental Impact Statement (PEIS), [NUREG-0683, Supplement 3](#), which evaluated the potential environmental impacts of alternative approaches to completing the TMI-2 cleanup. The supplement examined the estimated occupational radiation doses associated with the licensee's proposal for delayed decommissioning and five NRC-identified alternatives that were evaluated quantitatively. The dose estimates were based on a task analysis of the cleanup work to be performed. (See Supplement 3 of the PEIS in the DVD folder, [Guidance-PEIS](#).)



Highly radioactive sludge on the basement floor of the reactor building as viewed from an upper level. A robotic desludging system was used to vacuum the 40 percent of the basement floor area that was accessible to the robot.

- ***Plant-entered PDMS.*** On December 28, 1993, the NRC granted an amendment to permit the licensee to place the plant in a long-term PDMS; the amendment also provided the PDMS technical specifications. The NRC safety evaluation concluded that the routine release of any significant quantity of radioactive material during PDMS had been minimized, in part, by the decontamination of large sections of the reactor building, auxiliary and fuel handling building surfaces, equipment, and piping. In addition, the NRC concluded that radiation levels within the facility had been reduced to such an extent that plant monitoring, maintenance, and inspection could be performed.⁴³¹ (See section on [After Defueling.](#))

Document Collections. Documents relating to decontamination activities are provided in the following DVD folders:

- documents relating to technical evaluation reports of decontamination activities; decontamination schedules; NRC safety evaluation reports; NRC technical NUREG reports; GEND reports and technical reports documenting research results from DOE national laboratories; and other correspondence between the NRC and the licensee, such as notifications, requests, reviews, and approvals (see the DVD folder, [Decontamination](#))
- DOE summary reports, such as annual and lessons-learned reports, and periodical publications (see the DVD folder, [DOE/National Laboratory Status Reports](#))
- NRC TMI Program Office (TMIPO) weekly status reports (see the DVD folder, [TMI Program Office Weekly Status Reports](#))
- post-defueling monitored storage safety analysis reports and documents relating to decontamination requirements (see the DVD folder, [After Defueling](#))

Project schedules for decontamination activities are provided in the DVD folder [General Management and Oversight](#).

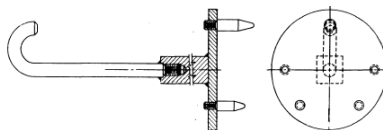

Defueling tool: hook attachment.

Technicians on the defueling work platform.



8 Defueling

The TMI-2 accident resulted in severe reactor core damage and migration of molten core materials onto the reactor vessel's lower head. Core damage and relocation occurred within four hours of the accident initiation, after which long-term cooling stabilized the damaged reactor core. Various reactor core inspections (see the section on [Data Acquisition and Analysis](#)) and observations from early defueling activities provided information to estimate the end-state core configuration. The INEL report "TMI-2 Accident Scenario Update" ([EGG-TMI-7489](#)) identified four regions within the original core volume, as shown in its iconic figure of the damaged reactor core (see Section 5): upper cavity void region, debris bed region, previously molten region, and partially standing fuel assemblies (or "stubs") region. Molten reactor core broke through the hard crust of the melt region at 224 to 230 minutes into the accident, penetrated some of the baffle plates, flowed through the complex five-layered lower core support assembly, and settled onto the reactor vessel's lower head.⁴³² The results of inspections and early defueling that were cited in the INEL report (1986) and the earlier [GEND-007](#) report (1981) provided the technical basis for planning defueling approaches and necessary equipment. During the period of exploration of the damaged reactor core, information from new inspections and observations altered defueling strategies and tool designs.⁴³³

The TMI-2 cleanup effort took ten years with a collective manpower effort of over 3.6 million person-hours to complete. The reactor vessel defueling operations spanned a five-year period from October 1985 through January 1990 and involved over two million person-hours. A total of about 133,000 kilograms of fuel, cladding, structural, and control materials were removed from the reactor vessel during the five-year effort. During July and August of 1991, the reactor vessel was drained to make final measurements of the residual fuel remaining in the vessel. An estimated residual fuel quantity that remained in the reactor vessel following defueling was approximately 1 percent of the original 94,000 kilograms of uranium oxide fuel inventory. The total occupational dose resulting from all cleanup activities was less than 6,500 person-rem over the first 10-year period. The cumulative occupational dose for defueling and defueling support activities was below 2,000 person-rem.⁴³⁴ The exposure rate to defueling workers averaged less than 10 millirem per hour.⁴³⁵

Reactor Core Damage. The final defueling report, which was submitted by the licensee in 1990 for NRC review, provided the complete picture of the end-state configuration of the core. This report was based on actual

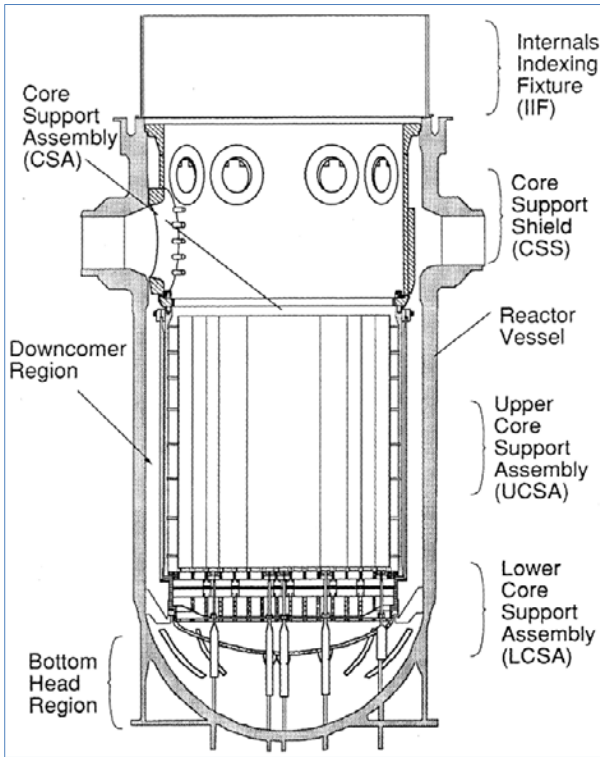

Reactor vessel with upper plenum removed and internals indexing fixture installed.

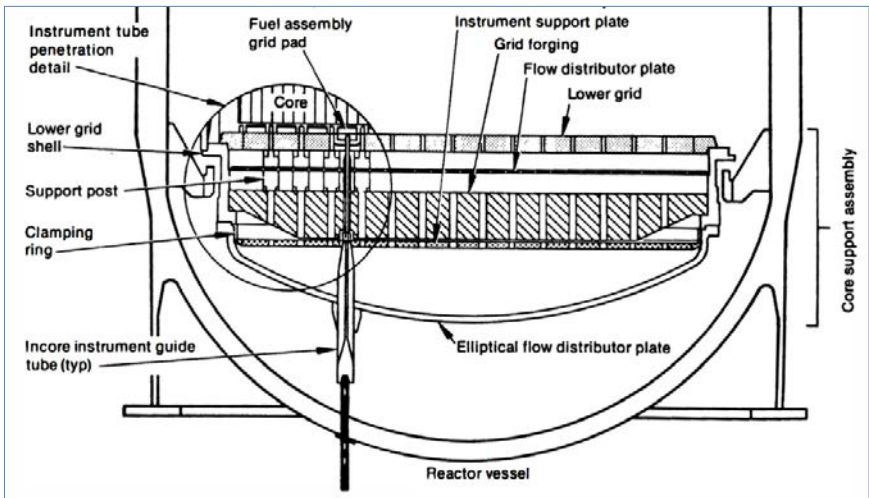

Lower core support assembly inside reactor vessel. This massive, five-layered structure was cut into pieces to allow access to the fuel debris in the lower head. Pieces are stored in the reactor building.

defueling experience during the five-year defueling period. The final report indicated that the original core inventory included about 94,000 kilograms of uranium oxide (fuel) and 35,000 kilograms of cladding, structure, and control (neutron-absorption) material. The total amount of core debris was estimated to be 133,000 kilograms, accounting for oxidation of core components and melt from part of the upper plenum grid plate. About 50 percent of the original core melted. The defueling program had to consider how to remove the fuel debris to the extent that inadvertent criticality was precluded in each confined area.⁴³⁶ The distribution of core material as documented in the final defueling report is summarized below:

- **Upper core void.** The upper core void or cavity consisted of only 42 partially intact fuel assemblies standing at the periphery of the void. Only 2 fuel assemblies of the original 177 assemblies still had most of their fuel rods intact. The void was about 26 percent of the original core volume and measured 1.5 meters deep from the top of the original core to the debris bed.⁴³⁷
- **Upper debris bed.** The debris bed consisted of 26,000 kilograms of core material, such as whole and fractured fuel pellets, control rod spiders, fuel assembly end fittings, broken fuel rods, and resolidified debris. The bed rested on top of the resolidified, hardened mass and was about 0.6 meter to 1 meter deep.⁴³⁸
- **Resolidified mass.** The solid metallic and ceramic mass consisted of about 33,000 kilograms of core material. The mass rested on partially intact fuel assembly “stubs.” The mass measured about 3 meters in diameter, 1.5 meters deep in the center, and 0.25 meter deep around the edges.⁴³⁹
- **Intact assemblies.** Partially intact fuel assembly stubs located under the resolidified mass and the peripheral standing assemblies comprised about 45,000 kilograms of core material. The standing stubs varied in length from about 0.2 meters in the center to 1.5 meters at the periphery. The stubs extended from the lower grid plate to the bottom of the resolidified mass.⁴⁴⁰
- **Upper core support assembly.** The upper core support assembly included vertical baffle plates that formed the peripheral boundary of the core, horizontal core former plates to which the baffle plates were bolted, the core barrel to which the core formers were attached, and the thermal shield. The assembly retained about 4,000 kilograms of loose debris and resolidified material. Loose debris ranging from 1.5 meters to

a few millimeters deep settled behind the baffle plate circumference. A resolidified crust ranging from 0.5 to 4 centimeters thick was attached to the bottom of three core former plates.⁴⁴¹

- **Lower core support assembly.** The lower core support assembly included five layers (top to bottom): the lower grid rib section that supported fuel assemblies; lower grid flow distributor plate; lower grid forging (attach point for the complete lower core support assembly to the reactor vessel wall); incore guide support plate; and elliptical flow distributor head. The layers were supported by the outer circumferential shell. The assembly structures retained about 6,000 kilograms of resolidified material around the circumference of the structures.⁴⁴²
- **Lower head region.** The reactor vessel's lower head region contained about 12,000 kilograms of loose core debris and 7,000 kilograms of agglomerated core debris. The debris on the lower head was 4 meters in diameter and 0.75 to 1 meter deep. The surface debris had particle sizes which varied from those of large agglomerated debris (up to 0.20 meter) to those of granular particles. Resolidified material existed on the reactor vessel's lower head, underneath the loose debris. This material was approximately 0.5 meters deep in the center and 1.7 meters in diameter.⁴⁴³



Reactor building polar crane being inspected for use in defueling preparations.

- ***Fuel debris distribution outside the reactor vessel.*** A total of about 228 kilograms of fuel debris were transported through the reactor coolant system. About 95 percent of the debris settled in the “B” loop where a reactor coolant pump was initially turned on at 174 minutes into the accident. Several minutes of pump operation quenched the hot oxidized reactor fuel and caused it to shatter. Other pumps were operated sequentially until the last pump was secured in response to an emergency procedure on April 27, 1979, when the final pressurizer level instrument failed. Most of the debris inside the reactor coolant system settled on the upper tube sheet of the “B” steam generator (about 125 kilograms). Smaller amounts settled in the decay heat system suction piping or “drop line” (30 kilograms), reactor coolant pumps (a total of 20 kilograms), and pressurizer (12 kilograms). Approximately 10 kilograms total were deposited in the reactor building on the basement floor and sump (5 kilograms) and makeup and purification system letdown coolers (4 kilograms). A total of 23 kilograms entered the auxiliary building, mainly deposited in the three reactor coolant bleed tanks (a total of 15 kilograms) and in the makeup and purification system (6 kilograms).⁴⁴⁴

Preparation of the Reactor Vessel. Before core debris could be removed from the reactor vessel, preparations were required to allow direct access to the damaged reactor core. While many of these activities were routine during normal refueling operations, the effects of the severe accident on reactor vessel components, the reactor building’s environment, and occupational radiation exposures presented complex challenges. Preparations included consideration of numerous potential safety issues; for example, occupational exposures; decay heat removal; criticality control; boron dilution; radioactivity releases; hydrogen evolution inside the reactor coolant system; pyrophoricity (spontaneous ignition in air) of zirconium fines in the reactor vessel; heavy load drops; polar crane failure; reactor vessel draining; and fire protection. Technical considerations included potential distortion; warping or physical dislocation of the reactor vessel’s head or upper plenum; reactor coolant cleanup; reactor coolant system depressurization; and lowering of reactor coolant level.^{445, 446, 447, 448} In addition, cleanup of the reactor building, which included atmospheric gases, basement water, and surface contamination, was an important prerequisite to ensure lower radiation exposures. Key milestones for reactor vessel preparation activities are summarized as follows:

- ***Leadscrew uncoupling.*** The last of the lead screws attached to the 61 control rod and 8 axial power shaping rod spider assemblies were uncoupled in November 1982. The 22-foot long lead screw was a

component of each control rod drive mechanism. Verification was performed in December 1982 to ensure that no partial fuel or control rod assemblies were attached to the lead screw.⁴⁴⁹

- ***Polar crane refurbishment and testing.*** The reactor building's polar crane was needed to remove the reactor vessel head and upper plenum. The polar crane was refurbished because of the harsh environmental conditions inside the reactor building during the accident (such as steam, burning hydrogen, and containment spray) and following the accident (such as high humidity and high radiation). The NRC safety review of the use of the polar crane was delayed several months to investigate allegations made by a contractor about the safety of the polar crane. Six months later, a NRC investigation cited deficiencies in the administrative and procedural aspects of the polar crane repair. The NRC concluded that the specific deficiencies cited did not result in a significant increase in risk to the public health and safety. On November 18, 1983, the staff approved the licensee's safety evaluation for the refurbishment and use of the reactor building polar crane. Load-testing



Reactor vessel head and service structure resting on its stand surrounded by shielding. Shown are white tubes filled with sand and yellow lead blankets.

of the polar crane was successfully completed on February 29, 1984, when a test assembly weighing 214 tons was lifted and moved along predetermined test paths.⁴⁵⁰ Various configurations and uses of the polar crane were approved by the NRC throughout the defueling and cleanup efforts.

- **Canal seal plate installation.** A modified canal seal plate was installed on April 13, 1984, to ensure a long-term positive seal between the reactor vessel and refueling canal. The seal allowed the contingency for flooding the refueling canal during head removal.⁴⁵¹
- **Reactor coolant system draindown.** The reactor coolant system was partially drained and depressurized to allow for the reactor vessel head lift on June 24, 1984. The water level was then raised to cover the control rod guide tubes after head lift and installation of the internals indexing fixture (discussed below).⁴⁵²
- **Removal of reactor vessel studs.** Sixty reactor vessel studs were cleaned, detensioned, removed from the reactor vessel, and stored in racks in the reactor building. This activity was completed on July 6, 1984. The first of the two detensioning passes had been performed months earlier to identify and correct stuck studs.⁴⁵³
- **Leadscrew parking.** The last leadscrew to the control rod drive mechanism was “parked” on July 21, 1984. Parking refers to raising a leadscrew to its uppermost position using a heavy-duty lifting tool. The leadscrew was then secured in place with a parking tool so that it would not extend below the head flange level and interfere with lateral movement of the reactor vessel head during the lifting operation.⁴⁵⁴
- **Reactor vessel head lift.** The reactor vessel head and the attached service structure were removed and placed in shielded storage on July 25, 1984. The reactor building’s polar crane was used to lift the head and place it on its storage stand located in the reactor building. The actual lifting operation took over five hours. Sand-filled columns were placed around the head stand for shielding. Lead blankets were placed around the service structure. Before the lift operation, training exercises were performed using a set of mockups.⁴⁵⁵
- **Internals indexing fixture installation.** The modified cylindrical internals indexing fixture (IIF) with a watertight gasket system was placed on the open reactor vessel flange by the polar crane on July 26, 1984. The IIF was normally used to guide the upper plenum

and core support assembly during installation and removal. The IIF was modified to allow the installation of a shielded work platform above the reactor vessel to support future operations. Before the installation of the work platform, the IIF was filled with five feet of borated water to provide radiation shielding over the exposed upper plenum in the reactor vessel.⁴⁵⁶

- ***Upper plenum assembly transfer.*** The last major structural obstacle to defueling was removed on May 15, 1985, when the upper plenum assembly was lifted from its jacked position in the reactor vessel, raised through the water-filled internals indexing fixture, and transferred to its storage stand in the deep end of the fuel transfer canal. Before plenum transfer, a six-foot-high dam was constructed, allowing the deep end of the canal to be flooded to a level sufficient to provide adequate shielding for the stored plenum. Major preparatory activities included in-vessel inspection of the plenum, separation of damaged fuel assemblies hanging from the bottom of the plenum, and the initial lifting of the plenum by a system of four hydraulic jacks. The precautionary jacking ensured that there was no binding during plenum lift by the reactor building's polar crane. Before the lift operation, training exercises were performed using a set of mockups.⁴⁵⁷

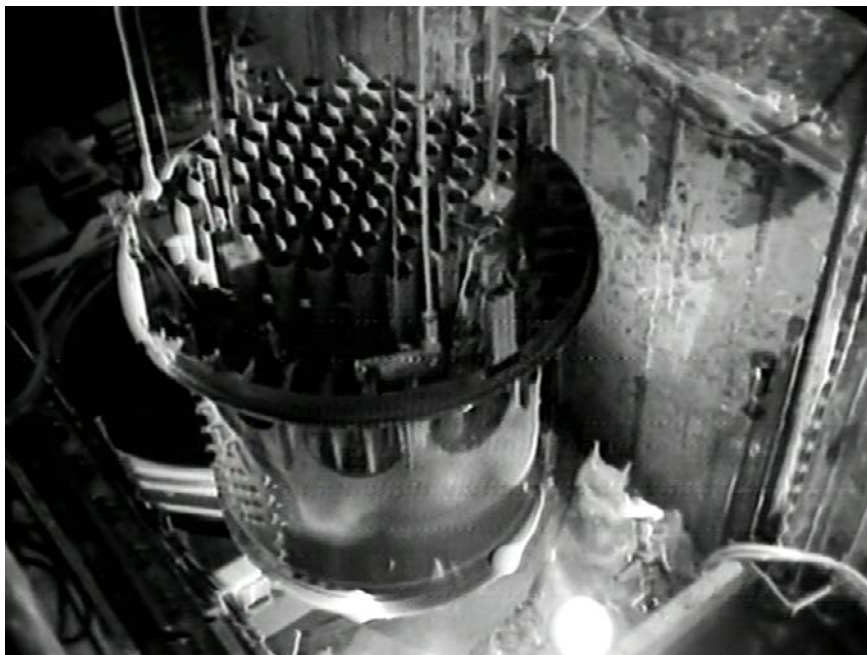

Upper plenum being transferred from the reactor vessel (shown) to the partially flooded deep end of the fuel transfer canal (not shown).

- **Pyrophoric issue.** The issue of pyrophoricity was addressed in the Programmatic Environment Impact Statement (PEIS) for defueling activities and in the safety evaluation of the underhead characterization study. This issue was based on the concern that appreciable amounts of zirconium hydrides might have been formed during the accident when hot dry hydrogen reacted with zirconium surface. At high temperatures, zirconium hydrides react with steam to form zirconium oxide and hydrogen gas. In a finely divided form, zirconium hydrides can be pyrophoric out of water. The PEIS concluded that it was unlikely a zirconium hydride ignition would occur given that defueling operations were planned underwater. However, the underhead characterization study required lowering the reactor coolant level in the reactor vessel and uncovering some of the vessel internals, such as leadscrew support tubes, control rod guide assembly tubes, and upper plenum cover plate. Given that these internal surfaces and fuel debris samples would be exposed to air, the issue of pyrophoricity was addressed by the licensee and NRC in the characterization study's safety evaluation.⁴⁵⁸



Internals indexing fixture with its temporary cover mounted on the reactor vessel flange. This fixture would eventually be mated to the defueling work platform.

NRC determined in its safety evaluation that (1) the presence of steam as an oxidizing agent and the temperature condition during the accident would not likely produce significant quantities of zirconium hydride in a pyrophoric condition; (2) the primary system flow dynamics during the accident would not likely transport large quantities of pyrophoric material, if formed, to the top of the plenum; and (3) any pyrophoric materials in finely divided form would be dispersed and mixed with inert materials of core debris which would prevent the development of pyrophoric conditions. The results of the underhead characterization study supported the conclusions in the NRC safety evaluation that there was little potential for a pyrophoric reaction with the plenum cover exposed to air. Results were based on visual observations of the reactor vessel underhead conditions and laboratory analyses of the chemical and pyrophoric properties of samples obtained from components within the reactor vessel and from solids filtered from the reactor coolant.⁴⁵⁹

Defueling Systems and Equipment. Unique systems and equipment were designed and installed to remove damaged fuel and structural debris from the reactor vessel. In the early defueling phase, tools were designed for “pick-and-place” in which debris was picked up and placed into fuel containers (baskets) or specially engineered defueling canisters. Some long-handled tools had various hydraulically actuated fittings to tackle the larger pieces and smaller bits of debris. The core bore machine was placed



Defueling operations from the rotating defueling work platform with a worker holding a long-handled defueling tool down through the slit into the reactor vessel. Two jib cranes at each end of the slit were used to lower larger tools.

back into service to bore holes in the resolidified mass to help break apart the previously molten reactor core. Combinations of tools were used to assist defueling the lower reactor vessel region, such as the core bore machine and plasma arc torch. Three types of defueling canisters and associated support equipment were specially designed to remove the fuel debris from the reactor vessel and package it for transportation. Water cleanup systems were installed to ensure water clarity in the reactor vessel for removing debris and in the “A” spent fuel pool for processing defueling canisters.

The defueling systems were designed before the extent of core damage and radiological conditions were fully understood. The design of the canisters was decided upon early in the cleanup and dictated the design of the defueling platform and the shipping cask. The design of the canisters was based on the removal of intact fuel assemblies. Ultimately, very few if any intact fuel assemblies were removed. The narrow inside dimensions of the cylindrical canister design necessitated substantial cutting of distorted fuel debris in order to load through the opening of the canister. A radiation analysis program⁴⁶⁰ was undertaken to identify and quantify possible radiation sources and to design defueling equipment to achieve dose-rate goals in the defueling area. Specific safety issues were addressed in NRC evaluations of defueling equipment, systems, and operations. Safety issues that were considered in the evaluations were similar to those addressed in the preparation of the reactor vessel for defueling (as listed above). Lessons learned from experience using defueling equipment were documented in the *Nuclear Technology* journal paper “Fuel Removal Equipment for Three Mile Island Unit 2” (Vol. 87, No. 3; not available on the DVDs).⁴⁶¹ Examples of systems and equipment used for defueling the reactor vessel are summarized below (see [GEND-INF-073](#)):

- **Defueling work platform.** A shielded work platform and support structure was installed over the water-filled internals indexing fixture (IIF) in August 1985. The support structure circumscribed the IIF and extended upward from the refueling canal floor to the work platform. The shielded work platform was located 9 feet above the reactor vessel flange. The work platform included a defueling work platform with a rotatable surface 17 feet in diameter with a 6 inch thick steel plate shield. The platform provided a shielded work area for defueling operations; a support for manual, hydraulic, and mechanical defueling tools; and a method for removing defueling canisters. An adjustable slot and hand rail spanning the diameter provided access to the reactor core. Various lines for water treatment and air ventilation to control off-gassing were routed into and out of the reactor vessel through the

platform support structure. A decontamination spray system flushed radioactive debris from the surface of the canisters, long-handled tools, and other equipment as each item was removed from the reactor vessel. Two jib cranes were mounted on the defueling work platform to aid the operators in manipulating the long-handled tools in the long-handled tool slot.⁴⁶²

A full-scale mockup duplicated the rotating work platform, the tool racks, and the overhead crane required to handle the 40-foot-long tools. The defueling crew developed their sense of feel for the tools, the balance of the tools, and the effort required to pull or shear fuel while working on the mockup.⁴⁶³ Operator training and tool testing on the mockup contributed to effective defueling operations.⁴⁶⁴

- **Off-gas system.** The off-gas system created airflow through the defueling work platform, into the internals indexing fixture enclosure, and out to the reactor building's atmosphere through a filtration unit. The airflow through the platform prevented radioactive gases that collected under the platform from reaching personnel working on the platform.⁴⁶⁵
- **Defueling water cleanup system (DWCS).** The DWCS was used to process water in the reactor vessel, in the deep end of the fuel transfer canal, and in the "A" spent fuel pool. The system was designed to

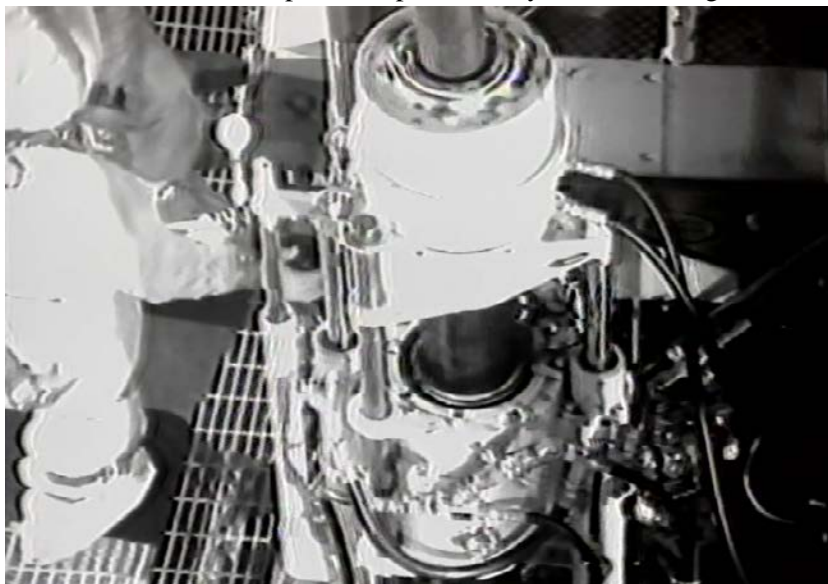

Core bore drilling machine, mounted on a platform over the defueling work platform, was used to drill holes and break apart the resolidified mass.

reduce radioactivity and improve water clarity for defueling operations. The DWCS was composed of two systems: the reactor vessel cleanup system and the fuel transfer canal/spent fuel pool cleanup system. The cleanup of the reactor vessel water proved to be more difficult than originally anticipated. (See further discussion in the prior section on [Waste Management](#).)

- ***Long-handled defueling tools.*** Numerous manual and hydraulically powered long-handled tools were used to perform a variety of functions, such as pulling, grappling, cutting, scooping, and breaking up the core debris. These “pick-and-place” tools were used to load debris into fuel canisters positioned underwater in the reactor vessel. The “working end” of the long-handled tool was one of many kinds of end effector attachments. Powered end effectors were hydraulically operated. The operators relied on the video viewing system to monitor their work as they manipulated the tools through the tool slot in the defueling work platform. Most tools were supported by an overhead service crane to provide vertical and lateral motion, although some lightweight tools could be handheld for picking smaller debris. End effectors could be detached from their handles and stored in a tool rack located under the defueling work platform, or in a rack outside the reactor vessel.⁴⁶⁶ A few of the numerous end effector attachments are summarized below. See [GEND-INF-073](#) for a catalog of early defueling tools.
 - *Hydraulic cutoff saw.* An hydraulically driven hacksaw was used for sizing structural material or other debris (that is, reducing it to pieces of smaller size) to facilitate the loading of debris into fuel canisters or debris baskets.^{467, 468}
 - *Hydraulic impact chisel.* The impact chisel was a hydraulically actuated miniature jackhammer-type tool for use in breaking apart hard materials. The chisel’s angle of attack could be varied remotely to achieve any position from vertical to horizontal. Different bit types were provided for the various anticipated chiseling operations.^{469, 470}
 - *Hydraulic shredder.* The hydraulic shredder was used to reduce fuel pins (with and without fuel pellets) and spacer grids to sizes which would facilitate their placement into fuel canisters or debris baskets. The shredder was suspended below the defueling work platform using the support structure attached to the platform. The fuel debris was loaded into an inlet hopper and the shredder output was discharged to a transfer container which was then emptied into a

fuel canister or debris basket; discharge from the shredder could also be directed to the debris bed. Non-shreddable material lodged in the shredder was retrieved through manual manipulations using other long-handled tools.^{471, 472}

- *Remote manipulator.* Refer to the discussion on [Remote Robotic Equipment](#) in the section on [Decontamination](#).
- *Water-jet cutting system.* The water-jet cutting system performed remote underwater cutting of hard materials with and without the use of abrasives. The equipment was designed to be positioned at the cutting location with the remote manipulator.⁴⁷³
- *Core bore machine.* The core bore machine, which was used to extract core stratification samples in 1985, was used during defueling to break up the solidified monolith (melted-together core materials) in the core region.^{474, 475} The machine was used again to drill through and cut portions of the lower core support assembly.^{476, 477, 478} The drill was reinstalled on its elevated mount over the defueling work platform.⁴⁷⁹
- *Automatic cutting equipment system (ACES) or plasma arc torch.* Refer to the discussion on [Remote Robotic Equipment](#) in the section on [Decontamination](#).
- *Defueling canisters.* The defueling canisters were designed to accept and confine core debris ranging in size from particles (known as fines) of about 0.5 microns in diameter up to partial-length fuel assemblies of full cross-section. The canisters were intended to provide confinement for offsite transport using a shipping cask and long-term storage of core debris. Three types of defueling canisters were designed and fabricated: a fuel canister, knockout canister, and filter canister. Each canister required fixed neutron-absorber material for criticality control; catalytic recombiners to control the concentration of combustible gas mixtures generated from radiolytic decomposition of water; and appropriate process connections for fillings, closing, dewatering, inerting, and monitoring. All three canisters were 150 inches long, 14 inches in diameter, and ¼ inch thick.^{480, 481} As a result of a request from DOE, the NRC performed inspections of defueling canisters during the fabrication process, which included inspectors observing welding, non-destructive examinations, and fitting of components.⁴⁸²
 - The *fuel canister* was designed as a receptacle for large pieces of core material, which were picked up and placed either directly into

the canisters, or into other containers which would then be inserted into the canister.⁴⁸³ One lesson learned was reported on the difficulty of placing distorted debris in the fuel canister due to the narrow inside dimensions of the canister.⁴⁸⁴

- The “*knockout*” canister was designed for use in the fuel debris vacuum system to separate debris particles ranging from about 140 microns up to full pellet size or larger. The process inlet line entered the top of the canister and bent to direct the flow tangentially along the inner circumference of the shell, creating a swirling action that caused the entrained debris to settle out in the canister vessel. The water then exited through an 850-micron screen to a process connection in the top of the canister. The knockout canister had a capacity of about 1,800 pounds of fuel debris.⁴⁸⁵
- The *filter canister* was designed for use in the fuel debris vacuum system, the defueling water cleanup system, and the canister dewatering system. The filter captured debris fines larger than 0.5 microns on sintered metal filters.⁴⁸⁶
- **Debris buckets.** Debris buckets were used to configure the debris before insertion into the fuel canister, to maximize the packing density in a canister, and to eliminate many 10-foot vertical trips to load small pieces in a canister. Two types of disposal buckets, the top loading

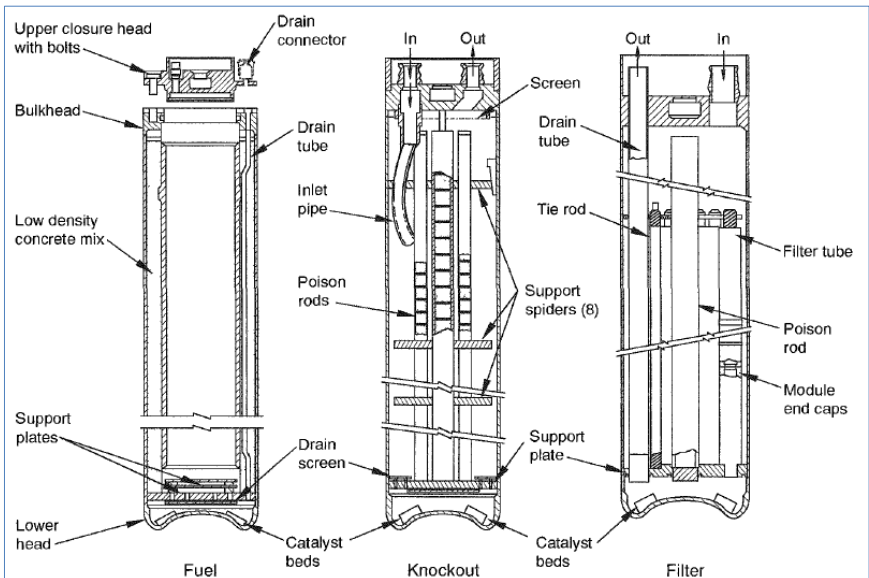

Three types of defueling canisters for containing large fuel debris (fuel), vacuuming fractured fuel pellets (knockout), and filtering fuel fines (filter).

debris bucket and side loading debris bucket, were designed to fit into the fuel canisters. A reusable debris bucket fitted to the inside of a fuel canister also had a remotely operated trap door on the bottom for unloading into the canister. Accessories included a funnel, handling tool, and stand.⁴⁸⁷

- ***In-vessel vacuum system.*** The in-vessel vacuum system was designed to remove small loose debris as large as the approximate size of a fuel pellet maximally. The vacuum system was supported from the underside of the defueling work platform and was controlled from the console on the south auxiliary work platform. The vacuum pickup nozzle was connected to a canister by a flexible hose and was manipulated using a long-handled tool. Debris was picked up and passed first through a

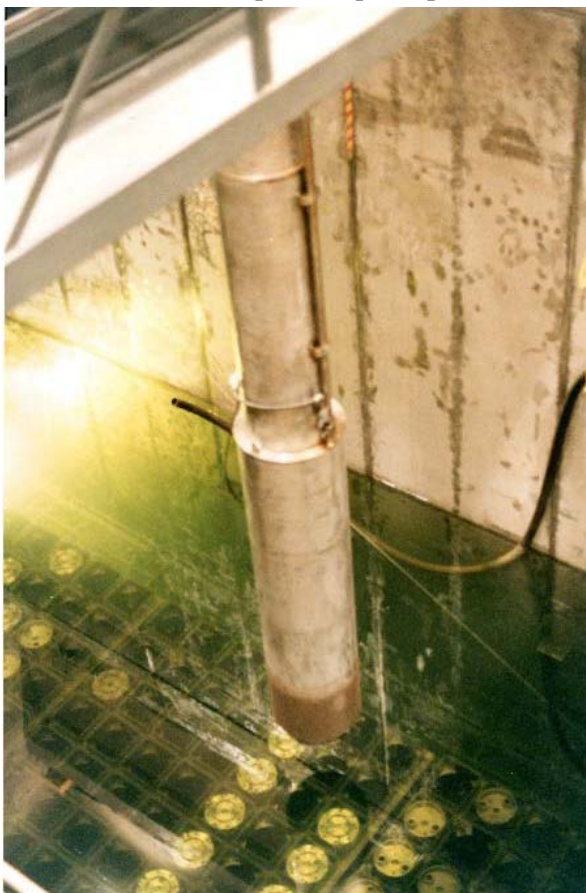

The canister handling bridge was used to stage defueling canisters in a submerged storage rack in the “A” spent fuel pool. Shown is the canister transfer shield and defueling canisters in the pool.

knockout canister; any remaining debris larger than 0.5 microns was collected in a filter canister.⁴⁸⁸ Vacuum defueling began on December 31, 1985, in which about 300 pounds of debris was loaded into the knockout canister.⁴⁸⁹

- ***Airlift vacuum system.*** The airlift vacuum system was used to lift debris as large as 5 centimeters from the core region rubble bed and the lower head region of the reactor vessel. The system included an air compressor, airlift pipe, and a fuel canister. Compressed air was injected at the bottom or suction end of the pipe to draw water into the pipe along with entrained fuel debris. Debris was deposited into a fuel canister located at the top of the airlift piping. The airlift increased packing efficiency in fuel canisters already containing oddly shaped pieces of debris, such as partial fuel assemblies and end fittings.⁴⁹⁰
- ***Pressurizer defueling system.*** The pressurizer defueling system was designed to remove fine fuel debris from the pressurizer. The system included a submersible vacuum pump, a knockout canister, a filter canister, and an agitation nozzle. The defueling water cleanup system injected water through an agitation nozzle to suspend debris in the water-filled pressurizer. Water was pumped from the pressurizer, through the canisters, and into the reactor vessel. Larger debris was pickup with the use of a robotic submarine.⁴⁹¹
- ***Once-through steam generator (OTSG) defueling system.*** The OTSG defueling system was designed to vacuum loose fuel debris from the upper tube sheets. The dry vacuum system included a vacuum head on a handling pole, vacuum canister, high-efficiency particulate air filter, a vacuum breaker, and vacuum pump. Larger debris was manually removed using long-handled tongs.⁴⁹²
- ***Canister positioning system.*** The canister positioning system was a rotating carousel installed in the reactor vessel that could hold up to five fuel and knockout canisters, including knockout canisters for use with the vacuum system. The height of canisters in the canister positioning system could be adjusted to three discrete elevations to allow them to be placed more closely to the debris bed as the bed got lower.⁴⁹³
- ***Canister handling bridges.*** Existing fuel handling bridges located in the reactor building and fuel handling building were modified with canister handling trolleys and canister transfer shields. The reactor building's canister handling bridge was used to lift loaded canisters into a canister transfer shield, and to move the shielded canister from the reactor vessel

through the air to the flooded deep end of the fuel transfer canal. The fuel handling building's canister handling bridge lifted the canister from the fuel transfer system to a submerged storage rack or to the canister dewatering station in the "A" spent fuel pool.⁴⁹⁴

- **Canister storage racks.** The defueling canister storage racks provided storage for loaded defueling canisters. Storage for a total of 263 canisters was available in the racks located within the deep end of the fuel transfer canal inside the reactor building (11 canisters) and in the "A" spent fuel pool inside the fuel handling building (252 canisters).^{495, 496}
- **Fuel transfer system.** The existing fuel transfer system was modified to transfer defueling canisters from inside the reactor building to the adjoining fuel handling building. Canisters were handled in a way similar to normal fuel assemblies during refueling operations. A canister was lowered into a modified "upender" in the flooded deep end of the fuel transfer canal, turned to a horizontal position, and moved through one of the fuel transfer tubes into the "A" spent fuel pool. A second "upender" at the other end raised the canister to a vertical position.⁴⁹⁷
- **Canister dewatering systems.** The canister dewatering systems were used to purge water from submerged defueling canisters in order to sufficiently expose the recombiner catalysts and prevent the buildup of combustible gases in the canisters. Inert-gas injection systems displaced water from the canisters. Dewatering stations were installed in the reactor vessel and the "A" spent fuel pool. Typically, a loaded canister was partially dewatered in the reactor vessel using bottled inert gas located at the defueling work platform. Water discharged from the canister during in-vessel dewatering remained in the reactor vessel. Any inert gas released by dewatering process was vented through the off-gas system. The fuel handling building's dewatering station was also located underwater to shield workers from radiation.⁴⁹⁸
- **Fuel transfer cask.** The fuel transfer cask used to transfer a defueling canister from the "A" spent fuel pool to the shipping cask was both cylindrical and bottom-loaded; the transfer cask weighed about 40,600 pounds when loaded with a defueling canister. The cask was suspended from the fuel handling building's overhead crane, whose integral grapple and hoisting mechanism engaged a defueling canister and lifted the canister out of the water through a shielded platform into the shielded transfer cask. The bottom door of the cask was closed and the entire unit was moved with the overhead crane to the Model 125-B

shipping cask located in the truck bay where it mated with the shipping cask's loading tower.⁴⁹⁹

- ***Model 125-B shipping cask.*** The Model 125-B shipping cask was designed specifically to transport the loaded defueling canisters. The rail (train) cask could carry up to seven defueling canisters. (See further discussion in the prior section on [Waste Management](#).)
- ***Core flood tank modifications.*** The top of the “A” core flood tank was removed to allow the storage of cut lower core support assembly component pieces. The piping from the “A” core flood tank to the reactor vessel was cut and capped to prevent the possibility of fuel transport.⁵⁰⁰
- ***Containment air control envelope (CACE).*** The CACE was a new building external to the reactor building that enclosed the equipment hatch and backup personnel airlock. Access to the CACE from the outside was provided by a personnel door and a 27-foot-wide roll-up truck door. The building provided an area where cleanup equipment and materials could be assembled and staged prior to transfer into the reactor building, thus reducing worker stay times in radiation areas, resulting in occupational exposure savings. The CACE also functioned as a staging area for contaminated material removed from the reactor building, but was not designed to be a storage area for radioactive wastes. When both equipment hatch personnel airlock doors were opened, the reactor building purge system induced air flow from the outside through the CACE and the CACE aided in controlling and confining potential airborne releases from the reactor building. The CACE included a HVAC system, consisting of two filtered exhaust trains and associated radioactive effluent release monitor, which operated to reduce airborne particulate contamination in the building and to protect the building from overpressurization. The HVAC system was operated to maintain net airflow into the CACE when isolated from the reactor building. Normally, the CACE was maintained at a slightly negative pressure, relative to the outside, to limit exfiltration from the building, except when the roll up door was open for staging equipment and materials into or out of the CACE in support of cleanup activities. Periodic monitoring of the CACE atmosphere was performed to ensure that potential airborne releases were within regulatory limits.⁵⁰¹ The CACE was intended to support recovery activities through defueling only and was not designed to satisfy the criteria for a permanent TMI-2 facility.⁵⁰² The CACE was available for use in June 1986.⁵⁰³

Reactor Vessel Defueling. Removal of damaged fuel and structural debris from the reactor vessel started on November 12, 1985, six and one-half years after the accident. Numerous manual and hydraulically powered long-handled tools were used to perform a variety of functions, such as pulling, grappling, cutting, scooping and breaking up the core debris. Eventually, more powerful tools were used to disassemble or cut apart reactor vessel components and break up resolidified core material, such as the core bore machine, plasma arc torch, and water-jet cutting system. After breaking up and sectioning of oversized debris, long-handled tools were used to manually load debris into defueling canisters positioned under water in the reactor vessel. The larger pieces of vessel internal components, such as lower core support assembly sections, were lifted out of the vessel by crane and stored in the modified "A" core flood tank. Smaller pieces or "fines" were vacuumed into specially designed knockout canisters and filter canisters. Other defueling activities included transferring the loaded defueling canisters from the reactor building to the fuel handling building, dewatering the filled canisters, and placing canisters into the canister storage racks located in the "A" spent fuel pool.⁵⁰⁴



Problems plagued the cleanup systems early because of microorganism growth in the reactor coolant. The resulting loss of visibility halted all defueling operations for a few months. Shown is a view down into the reactor vessel annulus region between the core support assembly and the vessel wall. (A light hanging at the lower right.)

Removal of fuel and structural material from the reactor vessel was completed in stages. The plan for each stage incorporated experience gained from previous stages and activities, including in-vessel examinations. The NRC site office provided reviews and approvals of the licensee's technical evaluation reports and procedures. Defueling included the following stages:

- **Preliminary defueling.** Preliminary defueling involved the rearrangement of core debris material within the reactor vessel to allow complete installation and rotation of the canister positioning system and to provide access for defueling tools. The preliminary activities also included identification and positioning of core debris samples in the reactor vessel. General movement of the core debris included loading of debris baskets (or containers), but not loading defueling canisters.^{505, 506} Preliminary defueling operations started on October 31, 1985.⁵⁰⁷
- **Early defueling.** Early defueling involved depositing loose core debris into defueling canisters and removing loaded canisters from the reactor vessel. The loaded canisters were placed in canister storage racks located in the fuel transfer canal in the reactor building and the "A" spent fuel pool in the fuel handling building. The debris consisted of partial fuel assemblies, fuel rods, end fittings, structural materials, and loose granular fuel and structural fines. The debris was packaged into fuel canisters by defueling operators using long-handled tools and



First loading of debris into a fuel canister started on January 12, 1986. Shown is an upper fitting of a control rod cluster being dropped into a

the in-vessel vacuum system. During canister loading, defueling personnel were supervised by a specially trained and NRC-licensed fuel handling senior reactor operator. Physical and administrative controls were implemented to prevent the inadvertent lifting of core debris out of the reactor vessel.^{508, 509} On November 12, 1985, the licensee received permission from the NRC onsite office to start loading the fuel canisters with fuel debris. Using the vise-grip long-handled tool, the defueling workers placed the first piece of debris, a broken piece of fuel rod, into the fuel canister.⁵¹⁰ On January 12, 1986, the first three loaded fuel canisters of core debris were transferred from the reactor vessel to the submerged canister storage rack in the “A” spent fuel pool in the fuel handling building.⁵¹¹

- Bulk defueling of the core region.** Bulk defueling involved reinstallation of the core boring machine (which had previously been used to obtain core samples) over the reactor vessel to perform additional drilling operations into the resolidified mass in order to facilitate defueling. The drilling operations were permitted on the monolith in the core region above the lower core support assembly.^{512, 513, 514, 515, 516} A total of 409 closely spaced holes in the resolidified material were started on October 20, 1986, and completed on November 14. After completion of the drilling, the drill rig was removed and the defueling work platform was reconfigured to support manual debris-removal activities.^{517, 518, 519} Equipment used during bulk defueling included “pick-and-place” long-handled tools, air-operated

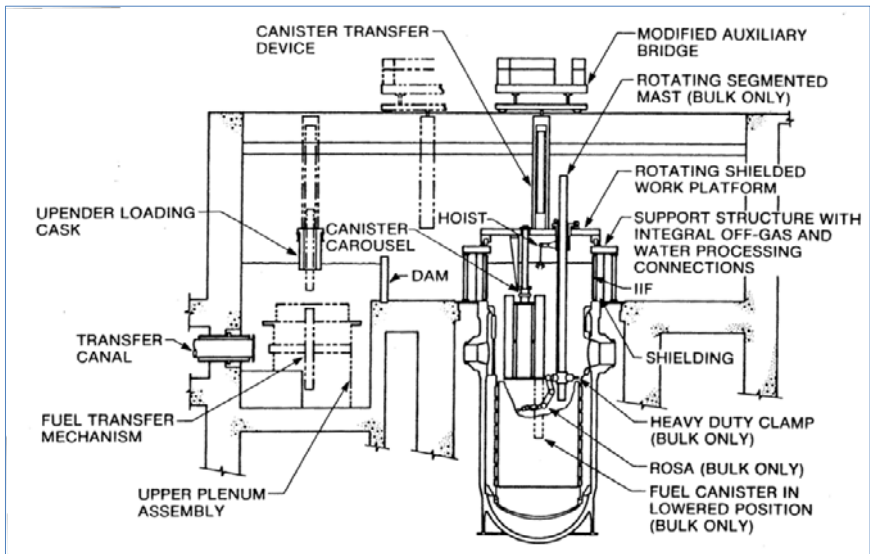

Bulk defueling system arrangement.

chisels, and specially designed fuel-assembly pulling and grasping tools. Removal of the stub end fuel assemblies from the reactor vessel using custom tools started in March 1987 and was completed in September 1987. By September 1988, the entire original core region had been defueled.⁵²⁰

- ***Removal of the lower core support assembly.*** This activity required three years of planning, inspection, research, and development to access the debris on the reactor vessel's lower head. This massive assembly included the following layers (from top to bottom): lower grid rib section, lower grid flow distributor plate, lower grid forging, incore guide support plate, and elliptical flow distributor head. Defueling preparations required the use of the core bore machine, plasma arc cutting torch (also called the automated cutting equipment system), cavitating water jet, and other equipment to dismantle the multi-layered lower core support assembly. The core bore machine was used to cut assembly support posts and incore instrumentation guide tubes. The plasma torch was used to cut straight vertical and horizontal segments in the plates.⁵²¹ Pieces of the assembly plates were stored inside the modified "A" core flood tank. Sections that did not contain incore guide

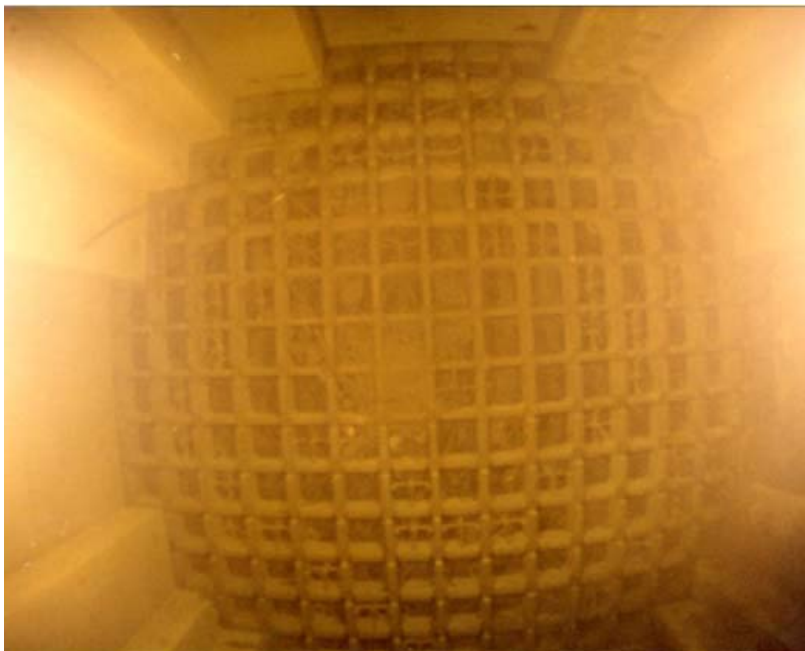

By September 1988, the entire original core region had been defueled. Shown is a view down into the water-filled reactor vessel of the lower grid rib section of the lower core support assembly. Vertical baffle plates formed the peripheral boundary of the core.

tubes were bagged and stored inside the “A” steam generator’s D-ring. All pieces will remain inside the reactor building until the future decommissioning of TMI-2. Equipment used to remove loose and resolidified debris that remained on the sectioned remnants included a high-volume low-pressure water flush and a low-volume high-pressure cavitating water-jet flush. Displaced debris was collected on the reactor vessel’s lower head for eventual removal. Work was started in January 1988 and completed by March 1989.^{522, 523, 524}

- Defueling of the upper core support assembly.** This defueling activity involved the removal of core debris from between the baffle plates and core former plates. Defueling preparations required the use of the plasma arc torch to cut the baffle plates in order to enable access to the core debris on the core former plates.^{525, 526} The baffle plates were cut into eight pieces. An untorquing tool and a drilling tool were used to

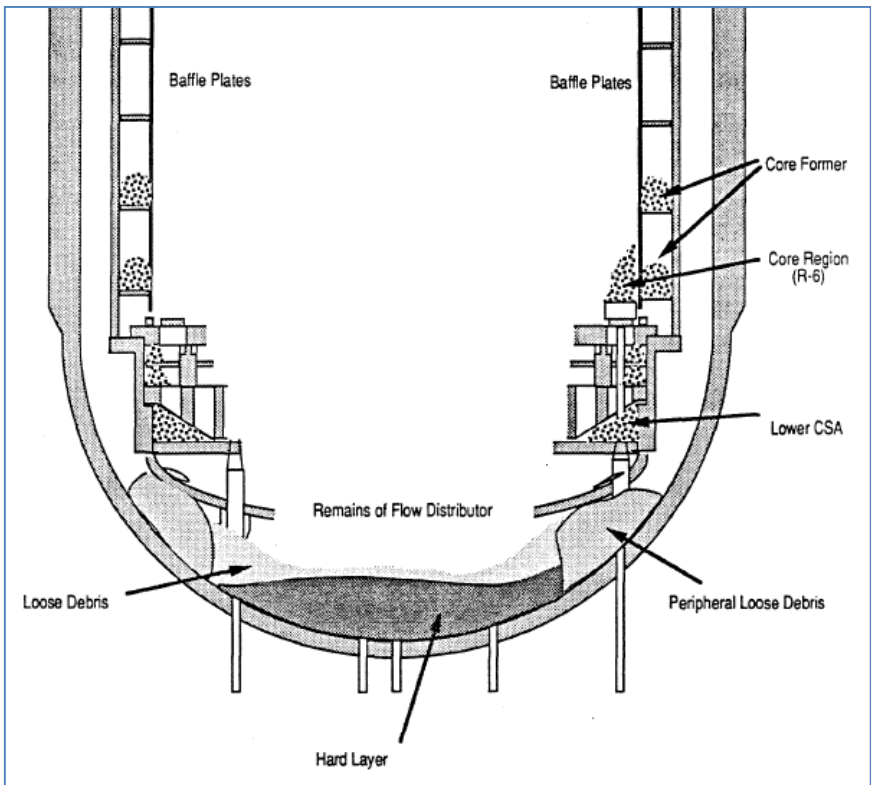

Fuel debris at the bottom of the reactor vessel. The lower core support assembly structures originally retained about 6,000 kilograms of resolidified material around the circumference of the structures. The reactor vessel’s lower head region below the assembly contained about 12,000 kilograms of loose core debris and 7,000 kilograms of agglomerated core debris.

remove 864 bolts that held the baffle plates to the core barrel. Equipment used to remove loose debris from within the assembly included hydraulically powered counter-rotating brushes mounted on a pivoting deployment end effector and the in-vessel vacuum system. Resolidified debris was removed using mechanical methods and the cavitating water jet. Defueling of the assembly was completed in October 1989.⁵²⁷

- ***Defueling of the reactor vessel's lower head.*** This defueling activity involved removal of core debris from the reactor vessel's lower head. Defueling preparations required the removal of the gusseted incore guide tubes and sections of the elliptical flow distributor head. Equipment used to dismantle the lower core support assembly was also used in this activity.^{528, 529, 530} Equipment used to remove loose debris on the lower head included an airlift, long-handled tools, and the in-vessel vacuum system. The cavitating water jet and an impact hammer with a chisel point were used to break up the resolidified debris attached to the lower head. The removal of about 30 tons of core debris from the lower head was completed in November 1989.⁵³¹
- ***Final cleanup of the reactor vessel.*** Defueling of the reactor vessel was completed in December 1989. A video inspection inside the reactor vessel, in conjunction with sample analysis, was completed in January 1990 to determine the quantity of residual core debris in the vessel.⁵³² Final reactor vessel re-flushing and re-vacuuming for loose, dust-like debris was completed in March 1990. The remaining quantity of fuel in the reactor vessel was less than 900 kilograms (or less than one percent of the original inventory). The residual fuel consisted primarily of finely divided sediment with small particle sizes in inaccessible holes, crevices, corners, and surface films, as well as resolidified material either tightly adherent to the reactor vessel's components or inaccessible for defueling. The final defueling report concluded that the residual fuel was not readily transportable between locations and, therefore, that criticality would be precluded under postulated worst-case conditions.⁵³³ (See further discussion in the section on [After Defueling.](#))

Defueling Outside the Reactor Vessel. The licensee estimated that about 260 pounds of fuel debris was transported outside the reactor vessel during the course of the accident. Additionally, about the same amount was relocated outside the reactor vessel because of cleanup and defueling operations, mostly in the reactor coolant system. The remaining fuel in hard-to-reach locations will be removed during the future decommissioning

of TMI-2. An extensive program of fuel measurements was implemented, which included direct measurement by instrumentation, visual inspection, and sample collection and analysis. The results from this program were reviewed by the NRC to ensure that no amount could achieve criticality under worst-case conditions. (See further discussion in the section on [After Defueling](#).) Defueling outside the reactor vessel included the following activities:

- **Reactor coolant system (RCS).** The two methods of fuel transport to locations outside the vessel were from sequential operation of the four reactor coolant pumps and the “burping” phenomenon during natural circulation. About 228 kilograms of fuel debris was transported from the reactor vessel into the RCS during the accident. An estimated 170 kilograms was added to the RCS during defueling operations. The reactor coolant system defueling activities removed more than 90 percent of the debris in the pressurizer, decay heat system suction piping (also known as the “drop line”), and hot-leg piping; and approximately 70 percent of the debris on the steam generator’s upper tube sheets.⁵³⁴ The following techniques were used to defuel reactor coolant system components:
 - *Hot-leg piping.* The two hot-legs were initially defueled using a combination scraper-and-vacuuming tool. Additional residual core debris in the “B” hot-leg was scraped, flushed, and vacuumed into defueling canisters as part of reactor vessel defueling.⁵³⁵ Defueling of both hot-legs was completed on August 10, 1988.⁵³⁶
 - *Pressurizer.* Initially, the pressurizer was defueled using a submersible pump, knockout canister, filter canister, and agitation nozzle. The second phase of pressurizer defueling used a remotely operated submersible vehicle equipped with an articulating claw and a scoop to remove larger pieces of debris located on the bottom head of the pressurizer.^{537, 538, 539} Defueling of the pressurizer using the vacuum system started in November 1987 and was completed using the submersible vehicle on June 14, 1988.⁵⁴⁰
 - *Pressurizer spray line.* The pressurizer spray line defueling system was used to flush water from the defueling water cleanup system into the pressurizer and reactor coolant system “2A” cold-leg.⁵⁴¹
 - *Decay heat drop line.* The in-vessel vacuum system was used to defuel the decay heat system suction piping drop line. A tool was developed to guide the vacuum hose into the vertical portion of the

drop line from the “B” hot-leg. A plumber’s drain-cleaning machine was used to break apart a hard, compacted region of debris below the loose debris so vacuuming could continue. The material was airlifted into the “B” hot-leg and was removed as part of the hot-leg defueling.⁵⁴²

- *Steam generators’ upper tube sheets.* Pick-and-place and vacuuming techniques were principally used to defuel the upper tube sheets in both steam generators. A vacuum system removed the smaller debris.⁵⁴³ The defueling of the “A” and “B” steam generator upper tube sheets was completed in September 1987 and October 1987, respectively.⁵⁴⁴
- **Reactor building.** A small quantity of fuel was released to the reactor building as a result of leakage through the pressurizer pilot-operated relief valve during the course of the accident. The licensee estimated that the scarification and desludging activities in the reactor building’s basement had removed approximately 4,900 kilograms of sediment which contained approximately 4 kilograms of fuel. Sediment included mostly river water sediment from a leaking air cooler inside the reactor building, concrete dust, and dirt. A robotic desludging system removed about 40 percent of the basement floor area that was accessible. The removal efficiency of desludging was greater than 90 percent. About 75 kilograms of fuel remain outside the reactor vessel in the reactor building, with the largest quantity attached to dismantled reactor vessel

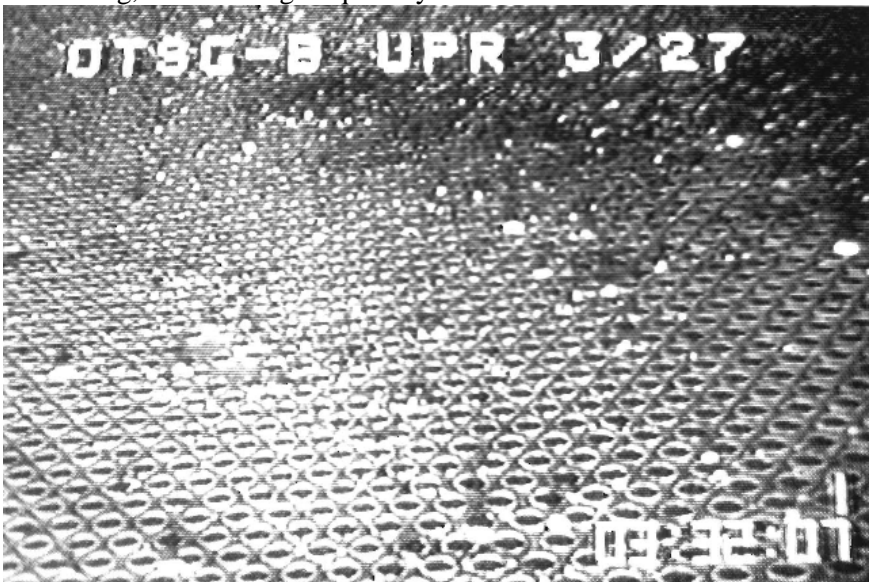

Fuel debris on the upper tube sheet of “B” steam generator.

components that were relocated for storage inside the “A” steam generator’s D-ring shield structure and the modified “A” core flood tank.⁵⁴⁵

- ***Auxiliary and fuel handling building.*** A small quantity of fuel debris was transported into the auxiliary building, principally through the reactor coolant bleed tanks and the makeup and purification system during the accident. Additionally, a smaller amount of fuel might have been relocated into the auxiliary building as part of the post-accident water processing, cleanup, and defueling activities. About 3 kilograms of fuel was removed from the makeup and purification system demineralizers and 370 grams of fuel was removed from the block orifice assembly positioned upstream of the demineralizers. The total quantity of fuel material remaining in the auxiliary building was estimated to be less than 17 kilograms. Removal of resins from the makeup and purification system demineralizers started in October 1987 and completed in September 1988 after limited success.



Remotely operated submersible vehicle equipped with an articulating claw and a scoop was used to remove larger pieces of debris that were located on the bottom head of the pressurizer.

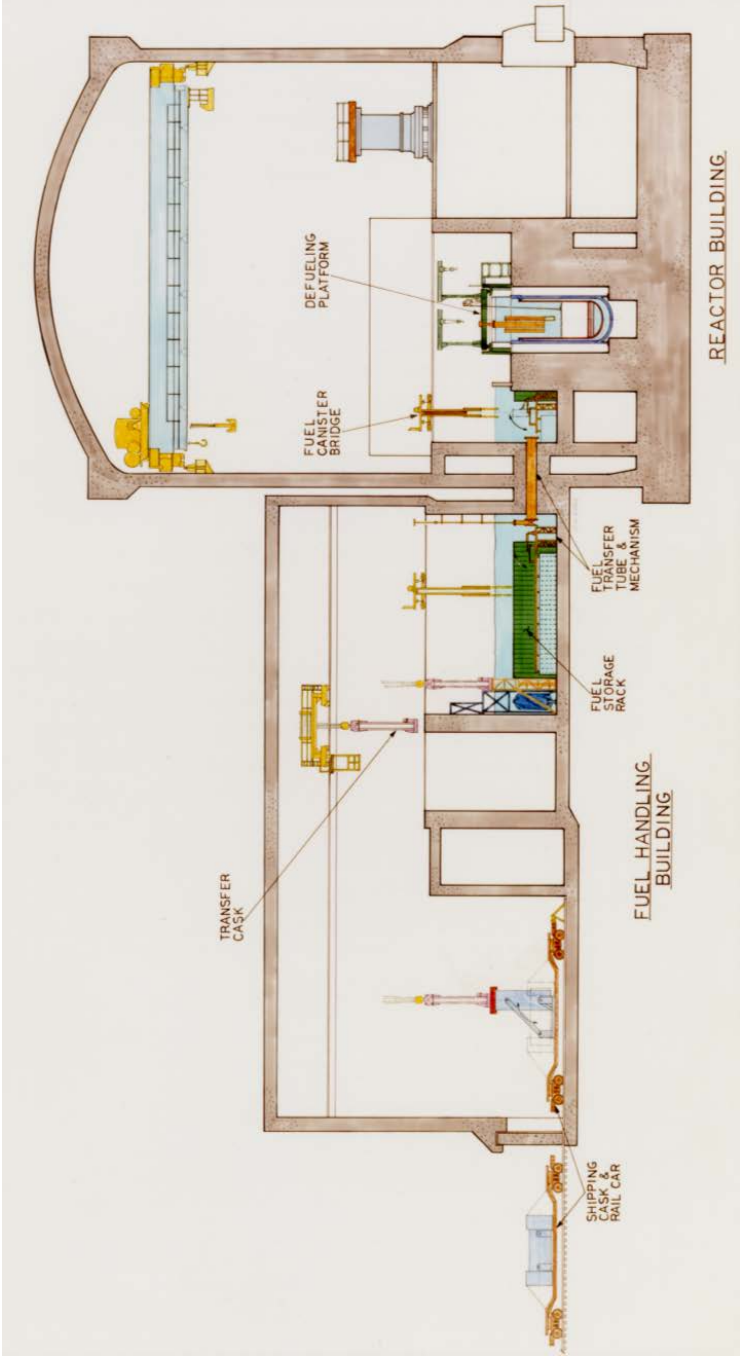

Defueling arrangement: workers on the defueling platform loaded fuel canisters; a fuel canister bridge transferred a canister from the reactor vessel to the fuel transfer tube and mechanism inside the reactor building; another fuel canister bridge in the fuel handling building loaded the canister into the fuel storage rack in the spent fuel pool; the fuel canister cask and building crane transferred the processed canister from the pool to the shipping cask loading station; and the Model 125-B shipping cask was lowered from its upright position onto the rail car and prepared for shipment.

Shipments of Core Debris. The first shipment of core debris to INEL began in July 1986. The core debris transportation campaign consisted of 22 rail shipments by dedicated train which resulted in the transport of a total of 49 casks loaded with 342 defueling canisters. The final fuel shipment from Three Mile Island to the INEL started on April 15, 1990.⁵⁴⁶

The canister handling and preparation for shipment program included all activities necessary to prepare and transfer a loaded defueling canister from its storage rack in the “A” spent fuel pool to the shipping cask; to insert the canister into the shipping cask; and to verify that the shipping cask was prepared for transport in accordance with its NRC-issued certificate of compliance. The preparation of canisters for shipment required several activities using custom-designed equipment. Canister preparations included dewatering and purging the defueling canister with an inert cover gas, verification of final canister weights, verification that the catalytic

recombiners installed inside the canister were functioning, and verification that the canister had been dewatered sufficiently to ensure that the catalytic recombiners remained operable regardless of canister orientation.^{547, 548}

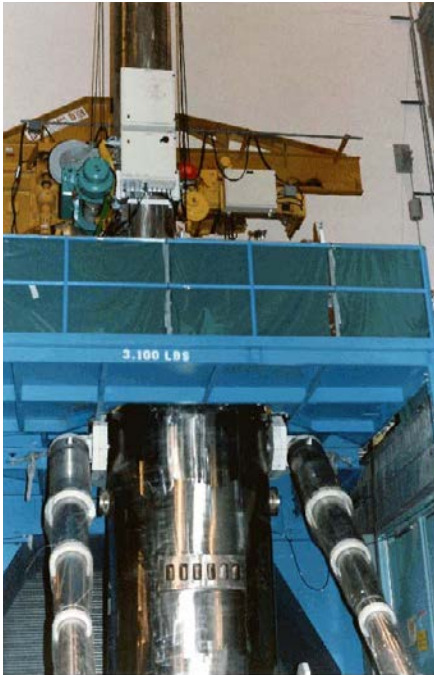

Model 125-B shipping cask loading tower. A fuel canister was lowered into the shipping cask (lower center) from the fuel transfer cask (not shown). The loading tower lowered the shipping cask to a horizontal position onto a skid that would be attached to the rail car.

Following final preparations and checks, the canister handling bridge moved the defueling canister to the fuel transfer cask (FTC) loading station in the “A” spent fuel pool. The fuel handling building’s crane lowered the FTC onto the loading station platform over the pool where the FTC lifted the canister from the water by a grapple. As the canister breached the surface of the pool water, a spray of borated demineralized water washed the canister. The fuel handling building’s crane then transferred the loaded FTC from the spent fuel pool and to the fuel handling building’s truck bay for loading into the shipping cask. After verifying its conformance to its NRC-approved shipping cask

certificate of compliance, the loaded shipping cask was transported out of the fuel handling building and off the island by rail. A dedicated train transported up to three casks at a time to INEL.⁵⁴⁹ One shipment carrying two shipping casks experienced a minor accident as the train engine struck a car while traveling at slow speed. The engine received minor damage, but the shipping casks were not damaged.⁵⁵⁰

Once a rail shipment arrived at the Central Facilities Area at INEL, both impact limiters were removed from each end of the shipping cask and the cask and skid were lifted from the rail car and placed on a tractor trailer. The cask was then transported 42 kilometers (26 miles) to wet storage at the INEL Test Area North. Here each canister was removed from the shipping cask, filled with water, placed into a storage module, and transferred to the storage pool in a designated location. A vent tube was installed on each canister for continuous venting. The empty shipping cask was surveyed for contamination and prepared for rail shipment as regular freight back to TMI-2.^{551, 552} A detailed account of fuel shipments, including public outreach, was provided in the DOE report “Historical Summary of the Three Mile Island Unit-2 Core Debris Transportation Campaign” ([DOE-ID-10400](#)).

The 342 stainless steel fuel canisters of core debris were stored in underwater storage from 1986 to 2001 at the INEL.⁵⁵³ During the 2000 to 2001 period, these canisters were transferred to the TMI-2 Independent Spent Fuel Storage Installation, also located at INEL, for interim storage of the TMI-2 core debris.⁵⁵⁴

Document Collections. Those documents discussed above and many other documents relating to defueling activities are provided in the DVD folder, [Defueling](#). The following types of documents are included in this collection:

- system description, technical evaluation, and safety evaluation reports
- research reports, NRC technical NUREG reports, GEND reports, and technical reports from DOE national laboratories
- other correspondence between the NRC and the licensee relating to defueling systems, equipment, and activities, such as notifications, requests, reviews, and approvals

Project schedules for defueling activities are provided in the DVD folder [General Management and Oversight](#).



Above: The Model 125-B shipping cask being removed from the rail car at the Central Facilities Area at INEL. Both impact limiters are shown removed from the ends of the cask. Below: Defueling canisters in the temporary storage pool at INEL. A vent tube was installed on each canister for continuous venting.



9 After Defueling

Defueling activities were considered complete with the shipment of the last remaining defueling canisters containing core material from the TMI site on April 15, 1990. The major objective of TMI-2 post-defueling activities focused on preparing the plant for long-term storage. The licensee called the period preceding the ultimate disposition (either refurbishment and restart or decommissioning) of the plant “post-defueling monitored storage” or “PDMS.” Long-term storage was proposed by the licensee on December 2, 1986.⁵⁵⁵ However, the concept of PDMS was first introduced by the NRC Advisory Panel for the Decommissioning of TMI-2 on April 12, 1984.⁵⁵⁶ The approach to PDMS was expanded when the licensee submitted its environmental evaluation of PDMS on March 11, 1987.⁵⁵⁷ During PDMS, the TMI-2 facility would be in long-term monitored storage, similar to the decommissioning mode SAFSTOR (mothballing with delayed dismantling), in which the facility is secured, monitored, and maintained in a manner that ensures the protection of the public health and safety for an extended period.⁵⁵⁸

The licensee stated in its December 2, 1986, post-defueling monitored storage plan that a monitored storage period would be beneficial for the following reasons: (1) occupational dose in the plant would be reduced during monitored storage because of natural decay of radioactive contamination; (2) a monitored storage period would allow time for continued development of decontamination technology; (3) further reduction of occupational exposure would be achieved through the use of advanced robotic technology, automatic cleaning and chemical cleaning techniques, and advanced waste treatment methods; and (4) developing technology for radioactive waste packaging and volume reduction could result in a reduction in the total volume of radioactive waste generated following PDMS. In addition, the licensee had stated that placing the TMI-2 facility in storage would eliminate any possible impact of TMI-2 decontamination and decommissioning efforts on the operating TMI-1 facility.^{559, 560}

Prerequisites for PDMS. The requirements for transition to PDMS were contained in the TMI-2 possession-only license and the NRC-approved list of PDMS requirements and commitments.⁵⁶¹ The basic criterion for transition to PDMS was assurance that the health and safety of the public was protected by conformance to all applicable NRC regulations.⁵⁶² Transitioning to PDMS required the following conditions: (1) criticality was no longer possible; (2) potential for fission-product movement was eliminated; (3) fuel was removed and shipped offsite; (4) radioactive waste

was shipped or stored; (5) radiation levels were reduced commensurately with the need for access to permit continued plant monitoring and to support plant-disposition decisions; (6) water was removed from plant systems and spaces, and the potential for reintroduction of water was precluded; and (7) a safe, monitored plant condition was established.⁵⁶³

PDMS Environmental Protection Systems. The principle safety concern during PDMS was the inadvertent release of radioactive material into the environment. For this reason, the NRC identified structures, systems, and components that provided reasonable assurance that the facility could be maintained in a defueled condition without undue risk to the health and safety of the public. These systems, called PDMS environmental protection systems, included the following:⁵⁶⁴

- **Reactor vessel.** Maintained residual debris geometry, precluding the possibility of an inadvertent criticality. To keep the residual fuel in the reactor vessel in the analyzed geometry during PDMS, the PDMS technical specifications limited activities that could alter the geometry of the fuel debris in the reactor vessel by controlling excess loads over the reactor vessel, limiting movement of remaining fuel debris outside analyzed geometries, and minimizing the potential for water accumulation in the reactor vessel.⁵⁶⁵ As a conservative measure, the licensee added 1,700 pounds of insoluble neutron poison in the form of borosilicate glass shards to the bottom of the reactor vessel to ensure long-term subcriticality of the residual fuel in the reactor vessel.⁵⁶⁶
- **Containment structure.** Ensured containment of the remaining radioactive contamination during the PDMS period. To maintain the integrity of the environmental barrier, inactive penetrations were closed off with isolation valves or with welded or bolted blind flanges. In addition, the PDMS technical specifications required routine surveillance inspections of containment penetration isolation. Isolation valves on active containment penetrations used by the containment atmospheric breather and the reactor building's purge system would close on a high containment pressure.⁵⁶⁷
- **Purge, breather, ventilation, and filtration systems.** Controlled radioactive effluents from the reactor building and the auxiliary and fuel handling building. Existing systems used during PDMS included the reactor building's ventilation and purge system, the auxiliary building's ventilation and filtration system, and the fuel handling building's ventilation and filtration system. These systems would not be operated continuously, but on an as-needed basis. A passive containment

atmospheric “breather” was installed for PDMS to maintain pressure equilibrium between the auxiliary and fuel handling building and the reactor building. A differential pressure would develop when the auxiliary building’s ventilation system was operating and the reactor building’s ventilation system was not operating. The containment atmospheric breather also provided a HEPA-filtered pathway for any effluent from the containment.⁵⁶⁸

- ***Fire protection system.*** Detected and mitigated any effects of a fire within the facility. The original TMI-2 system of fire protection had been modified to address the reduced functional requirements for fire protection for PDMS. The PDMS fire protection program consists of fire detection and alarm capability, manual suppression by fire brigade, removal of most flammable and combustible liquids and materials, control of transient combustibles, and deenergization of most electrical circuits.⁵⁶⁹
- ***Flood protection system.*** Minimized the intrusion of water in the facility and movement of radioactive contamination to the environment. The existing unit flood protection capabilities were maintained for PDMS, such as protective island dikes, flood panels, watertight doors, and an early warning system of flooding conditions.⁵⁷⁰
- ***Support and monitoring systems.*** Supported PDMS configuration to ensure personnel and environmental protection and surveillance. Systems included (1) electrical systems, such as area lighting, fire detection, radiation monitoring, PDMS support systems, and communications; (2) effluent monitoring systems for the reactor building’s purge system and ventilation systems; (3) environmental monitoring systems, such as radiation monitoring, sample collection and analysis, rodent carcass analysis, and pest control; (4) administrative systems, such as organizational structure, staff qualifications, records, independent safety reviews, procedures, occupational radiation protection, quality assurance plan, and emergency plan; and (5) surveillance programs, such as maintenance of reactor vessel geometry, reactor building isolation, the reactor building’s breather and ventilation system, the auxiliary and fuel handling building’s ventilation system, fire protection, flood protection, support and monitoring systems, and radiological surveys.⁵⁷¹

Key Reports. Reports that supported the licensee’s request and the NRC’s approval of the proposed license amendments for PDMS (issuance of the possession-only license and issuance of the PDMS technical specifications)

are summarized below. Issue dates and report conclusions are further summarized in the key actions section that follow.

- ***Defueling completion report.*** This report was developed by the licensee to document the measurements and calculations that were performed to ensure that the plant had been defueled to the extent reasonably achievable and that the potential for a nuclear criticality had been precluded during normal and accident conditions.⁵⁷² The report was required by the plant technical specifications (shown in Table 1.1 of Amendment No. 30) to document the basis for the TMI-2 facility transition to Mode 2. (For transition from Mode 1 to Mode 2, the licensee was required to demonstrate that the reactor vessel and reactor coolant system had been defueled to the extent reasonably achievable, that the possibility of criticality in the reactor building was precluded, and that there were no defueling canisters containing core material remaining in the reactor building.)⁵⁷³ In addition, this report and subsequent reports provided the criticality safety analyses to support the proposed license amendment for the possession-only license and issuance of the PDMS technical specifications.⁵⁷⁴

The contents of the report included the following sections: overviews of defueling objectives and guidelines and residual fuel characterization (Section 1); detailed discussions of the post-accident fuel transport and dispersion conditions (Section 2); survey techniques used for residual fuel measurements (Section 3); major fuel-removal accomplishments and methods (Section 4); residual fuel quantification, by location, and criticality analyses for each fuel location, as appropriate (Section 5); an assessment of possible alternatives and projected occupational doses associated with attempts to remove the remaining fuel (Section 6); cumulative occupational exposures during defueling-related activities (Section 7); licensee conclusions (Section 8); and criticality safety evaluation for the TMI-2 safe fuel mass limit (Appendix B).⁵⁷⁵ Some analyses and data in the report were later revised in the reactor vessel criticality safety analysis report and the reactor vessel post-defueling survey report.^{576, 577}

- ***PDMS requirements and commitments list.*** This document was developed and revised by the NRC and the licensee to list the requirements and commitments needed to place the facility into PDMS. The document provided requirements for the final PDMS configuration to support the proposed license amendment for the possession-only license, the PDMS technical specifications, and license conditions contained in the requirements for entry into PDMS. This list was

generated from the PDMS safety analysis report that was submitted by the licensee in support of their license amendment request, as amended; the associated safety evaluation issued by the NRC on February 20, 1992; and several public meetings at TMI.⁵⁷⁸ The NRC approved a process to allow changes to the list of requirements and commitments in recognition of the difficulties associated with readying the facility for long-term storage and the dynamic nature of the effort. Deviation requests by the licensee had to include a safety analysis evaluating each proposed change.⁵⁷⁹ The list was incorporated in Amendment 45 to the facility license that modified the original operating license to a possession-only license.⁵⁸⁰

- ***PDMS safety analysis report.*** This report was developed and revised by the licensee to document the facility description and safety analysis of the PDMS configuration. The report provided the basis for long-term stability and safety of the proposed facility license amendment for the possession-only license and the PDMS technical specifications.⁵⁸¹ The report is the current licensing-basis document for PDMS and is periodically updated to reflect current plant conditions.

The contents of the original report included: description of the current status of the plant after extensive decontamination (Section 1); site characteristics (Section 2); regulatory review of conformance of the TMI-2 facility to 10 CFR Part 50 (Section 3); description of fuel-removal activities and special nuclear materials accountability (Section 4); enumeration of the radiological status of the plant and radiological goals to be attained before entry into PDMS (Section 5); list of deactivated systems and facilities (Section 6); description of operational systems and facilities (Section 7); identification and quantification of routine and unanticipated releases during PDMS (Section 8); description of the proposed changes to the technical specifications to permit entry into PDMS (Section 9); and primary administrative functions for the management of TMI-2 during PDMS, such as quality assurance, security, emergency preparedness, radiation protection, and organizational responsibilities (Section 10). The original submittal reflected the anticipated facility conditions at the beginning of PDMS. The report was amended several times based on new information, responses to formal questions from the NRC, and changes in specifications for the facility. Routine updates are required by regulatory requirements.⁵⁸²

- ***Post-defueling survey reports.*** A series of 10 reports were developed by the licensee to document the assessment of special nuclear material

(SNM) remaining in the plant following the completion of the defueling effort. A report was issued for the following reactor components: upper plenum, letdown coolers, pressurizer, reactor vessel head, reactor building basement, both steam generators, auxiliary and fuel handling building, miscellaneous components in the reactor building, reactor coolant system, and reactor vessel.⁵⁸³

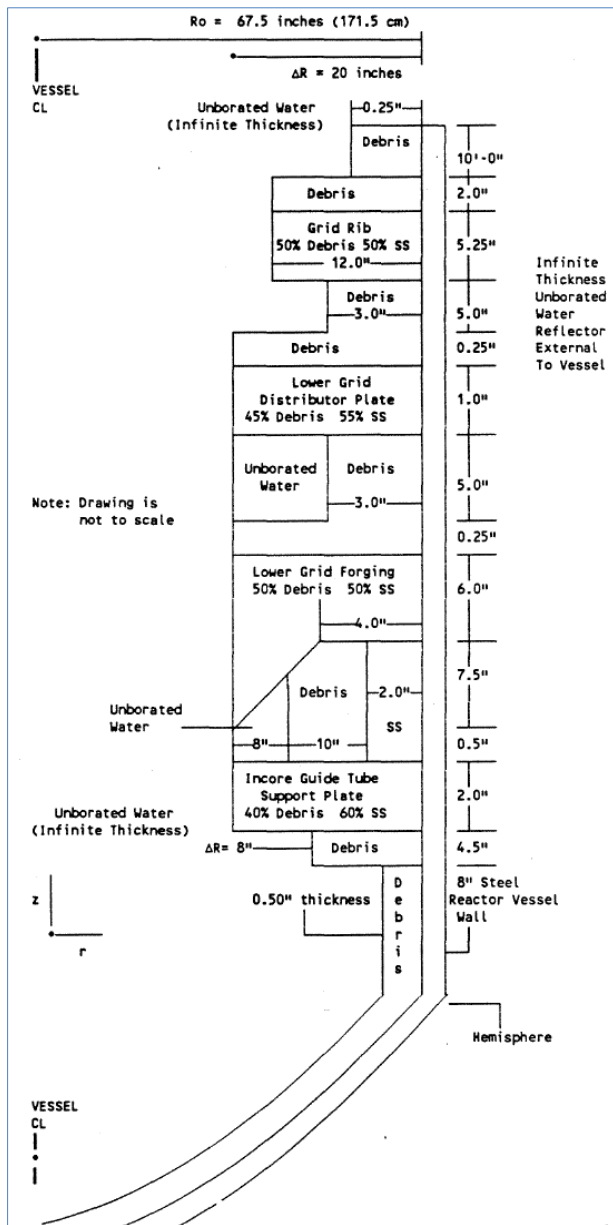

The geometric model that was used to conduct the criticality safety analysis of the residual fuel in the reactor vessel. An annular ring, representing the vessel internals and postulated debris accumulations located along the outer periphery of the vessel, was conservatively assumed to go 360 degrees around the vessel. The analysis used in-vessel inspections of debris locations and some conservative estimates of the remaining fuel to develop a specific three-dimensional analytical model of the reactor vessel end-state configuration. Criticality calculations were performed by the Oak Ridge National Laboratory. A separate criticality assessment was performed for accident scenarios. (See defueling completion report for additional information.)

On October 17, 1985, the licensee was granted an exemption from certain requirements for periodic inventory and reporting of SNM (e.g., uranium-235 and plutonium) balance for TMI-2. As a condition of the exemption, the licensee was required to conduct an assessment of the SNM remaining at TMI-2 following the completion of the defueling effort.⁵⁸⁴ The compilation of the individual survey reports provided the basis for the final assessment of the quantity of residual SNM for accountability purposes.⁵⁸⁵ In addition, the reactor vessel post-defueling survey report provided the basis for satisfying the criticality determination requirement for entry into PDMS.⁵⁸⁶

The contents of each report included: (1) a detailed description of the area, system, or component; (2) its role in the accident and/or cleanup activities; (3) the methodology used to determine the quantity of SNM; (4) the rationale supporting a conclusion as to whether the area, system, or component contained residual SNM and, if so, a summary of the appropriate SNM engineering calculations; (5) applicable drawings of the area; and (6) an assessment of residual fuel.⁵⁸⁷ Because of the complex structure of the components surveyed, the assessment of the residual SNM used a combination of direct measurements, sample analyses, volumetric measurements, and engineering analyses. The survey reports were supported by detailed engineering calculations, contractor reports, and research data.⁵⁸⁸

- ***Programmatic Environmental Impact Statement (PEIS)***
Supplement 3. The last supplement to the initial PEIS (NUREG-0683) was developed by the NRC to document the environmental evaluation of the licensee's proposal to complete the current cleanup effort and place the facility into monitored storage for an unspecified period of time. This supplement was used by the NRC to evaluate the licensee's proposed facility license amendment for the possession-only license and the proposed PDMS technical specifications. The supplement provided an environmental evaluation of the licensee's proposal and a number of alternative courses of action from the end of the current defueling effort to the beginning of decommissioning. However, the objective of the report was not to provide an evaluation of the environmental impacts associated with the decommissioning.

The contents of the report included: status of the cleanup activities and conditions in the plant, including radiation-source characteristics (Section 2); evaluation of the licensee's proposal and NRC-identified alternatives for potential environmental impacts, such as the offsite population's exposure to radiation from routine and accidental releases,

occupational radiation dose, waste management impacts, transportation impacts, socioeconomic impacts, commitment of resources, and regulatory considerations (Section 3); description of the environment and population that could be affected by the licensee's proposed action and alternatives (Section 4); comparison of environmental impacts of the proposal and alternatives (Section 5); discussion of the potential for human health effects from both offsite and onsite occupational radiation exposures as a result of TMI-2 cleanup (Section 5.2); discussion of nonradiological impacts identified, such as the cost of implementation, long-term commitment of land and burial-ground space, and socioeconomic effects (Section 5.3); discussion of postulated accidents, such as radiological impacts resulting from accidents onsite and offsite during waste transportation, and nonradiological impacts including traffic accidents, injuries, and fatalities (Section 5.4); NRC conclusions (Section 6); and NRC responses to public comments on the draft supplement (Section 7).

- ***PDMS technical evaluation report.*** This report was developed by the NRC to document the technical evaluation of the licensee's proposal to place the TMI-2 facility into PDMS. The report provided the basis for the requirements and controls to be maintained during PDMS. The report also provided the basis for approving amendments to the facility license that issued the possession-only license (Amendment No. 45) and the PDMS technical specification (Amendment No. 48).⁵⁸⁹

The contents of the report included a brief regulatory history of the TMI-2 facility (Section 2); description of PDMS (Section 3); status of the facility before entry into PDMS (Section 4); description of the major prerequisites for facility configuration at the start of PDMS (Section 5); discussion of the structures, systems, and components for environmental protection during PDMS (Section 6); and conclusions (Section 7).⁵⁹⁰

- ***PDMS safety evaluation report.*** This report was developed and revised by the NRC to document the safety evaluation of the licensee's proposal to place the TMI-2 facility in PDMS. The report provided the basis for approving amendments to the facility license that issued the possession-only license (Amendment No. 45) and the PDMS technical specifications (Amendment No. 48). The initial safety evaluation report was issued in February 1992 in response to the initial licensee application in August 1988. This safety evaluation was updated to account for revisions to the licensee application.^{591, 592}

The contents of the report included: a summary of licensee submittals and NRC actions associated with the licensee's initial amendment request in 1988 (Section 2); review of licensee actions that satisfied the license condition for entry into PDMS specified by the possession-only license (Section 3); and evaluation of the proposed PDMS technical specifications, as revised, and comparison to the existing TMI-2 technical specifications, as amended (Section 4). The technical evaluation report (see above) was issued concurrently with this document to provide additional details. Both documents were prepared by the Pacific Northwest Laboratory (currently Pacific Northwest National Laboratory) under the direction of the NRC.^{593, 594}

Key Actions. In August 1988, the licensee submitted a safety analysis report that documented and supported their proposal to amend the TMI-2 license to a "possession-only" license and to allow the facility to enter PDMS. In response to the request, the NRC issued Final Supplement 3 to the Programmatic Environmental Impact Statement for the TMI-2 decontamination and cleanup in August 1989. In February 1992, the NRC issued a safety evaluation report regarding the PDMS license amendment and a technical evaluation report regarding PDMS. These three NRC documents formed the basis for the position on the acceptability of PDMS. The NRC issued a possession-only license in September 1993 and approved the PDMS technical specifications three months later. Key post-defueling activities and actions are summarized as follows:

- ***Licensee submitted license amendment request.*** On August 16, 1988, the licensee submitted a request to amend the operating license to a possession-only license and to extensively modify the technical specifications in ways consistent with the licensee plans for long-term storage at the facility. The request included the proposed amended facility license for PDMS, proposed PDMS technical specifications, and the PDMS safety analysis report.⁵⁹⁵ The pre-accident and recovery technical specifications consisted of two parts: Appendix A, which pertained to the facility and recovery, and Appendix B, which pertained to the environment. The licensee proposed combining these two documents into one set of technical specifications for PDMS. Also, the licensee proposed placing the remaining surveillance requirements for PDMS, which were in the recovery operations plan, back into the technical specifications.⁵⁹⁶
- ***NRC issued PEIS Supplement 3.*** In August 1989, the NRC published Final Supplement No. 3 to the Programmatic Environmental Impact Statement (NUREG-0683), which dealt with PDMS and subsequent

cleanup. The NRC assessed the licensee's proposal and six alternatives. The licensee's proposal and one of the alternatives (continuing and completing the cleanup without a storage period) were evaluated in detail. The NRC concluded that both the licensee's proposed plan and the NRC staff-identified alternative for completion of cleanup were within the applicable regulatory limits, and each could be implemented without significant environmental impact. Neither alternative was found to be clearly preferable from an environmental impact perspective.^{597, 598}

- ***Defueling completed.*** In April 1990, the TMI-2 facility transitioned from Mode 1 to Modes 2 and 3, in accordance with the transition requirements set forth in Table 1.1 in the recovery technical specification. In Mode 2, it was recognized that defueling was completed and, thus, boration of the reactor coolant system and staffing of the control room by licensed operators were no longer required. In Mode 3, it was recognized that offsite shipment of the fuel was completed and boration of the spent fuel storage pools was no longer required. The three criteria for changing from Mode 1 to Mode 2 were as follows: (1) the reactor vessel and reactor coolant system were defueled to the extent reasonably achievable; (2) the possibility of a criticality in the reactor building was precluded; and (3) there were no defueling canisters containing core material in the reactor building. The additional requirement for transition to Mode 3 was that no defueling canisters containing core material remained on the TMI site. The NRC and consultants from the Pacific Northwest Laboratory performed a detailed technical review and inspection to verify that the criteria were met. The facility made the transition from Mode 1 to Mode 2 on April 26, 1990, and to Mode 3 the following day.^{599, 600, 601}
- ***Reactor vessel drained down.*** During July and August of 1991, the reactor vessel was drained to make final measurements of residual fuel remaining in the vessel. The reactor vessel fuel-measurement program was the final step in the special nuclear materials accountability program at TMI-2.⁶⁰²
- ***Petition to intervene in the PDMS license amendment request.*** On April 25, 1991, the NRC published a notice of opportunity for a prior public hearing regarding the license change to implement PDMS. One individual petitioned to intervene. The petitioner, the licensee, and the NRC staff reached a settlement on September 25, 1992, and the request to intervene was withdrawn; on October 16, 1992, the NRC Atomic Safety and Licensing Board dismissed the proceeding.⁶⁰³

- ***NRC issued safety evaluation of PDMS.*** On February 20, 1992, the NRC issued a safety evaluation addressing the license conditions and technical specifications necessary to implement PDMS. As part of the evaluation, the staff published a technical evaluation report which appraised PDMS as an integrated process and assessed licensee commitments that were not in the technical specifications. The safety and technical evaluation reports and Supplement 3 to the NRC's Final Programmatic Environmental Impact Statement formed the basis for the staff's position on the acceptability of PDMS.^{604, 605}
- ***Decision not to restart.*** On October 26, 1992, the licensee informed NRC of its intention to discontinue maintaining the TMI-2 restart list that included a list of NRC generic communications (bulletins, generic letters, and information notices) that would be reviewed for applicability and required action if a decision was made to refurbish TMI-2 for operation. The licensee had publicly acknowledged that TMI-2 would not be refurbished as a nuclear power generation facility, but instead, TMI-2 would be kept in a monitored storage condition until decommissioning of Units 1 and 2 simultaneously.⁶⁰⁶
- ***Licensee issued PDMS requirements and commitments.*** On January 15, 1993, the licensee provided a proposed list of remaining PDMS requirements and commitments that had to be completed before issuance of the possession-only license and PDMS technical specifications. This list was generated from the PDMS safety analysis report; the NRC's February 20, 1992 safety evaluation report; and several public meetings at the nearby TMI training facility. The NRC approved this list on May 19, 1993, and approved subsequent revisions to the list, as well.
- ***Licensee issued the reactor vessel post-defueling survey report.*** On February 1, 1993, the licensee notified the NRC in its last post-defueling survey report that the current best estimate of the residual fuel remaining in the reactor vessel was 925 kilograms with an uncertainty of plus or minus 40 percent as one standard deviation. The estimate of remaining fuel in the reactor vessel was based on underwater video inspections and passive neutron measurements. Video inspections were used to divide the reactor vessel into nine zones which separated the major fuel deposits by elevation. An array of helium-filled detectors were used to measure fast neutrons produced by the residual fuel as water was removed from the vessel in stages so that the water could be used as a shadow shield to separate the fuel deposits by zone. The estimate was derived from calculations made by onsite staff and an

independent review by an offsite group headed by Dr. Norman Rasmussen of the Massachusetts Institute of Technology. The total residual fuel estimate (925 kilograms) from fast-neutron measurements was about 50 percent larger than the less accurate video estimate.⁶⁰⁷

For the balance of the facility outside the reactor vessel, earlier licensee estimates based on measurements, sample analyses, and visual observations indicated that no more than 385 pounds (174.6 kilograms) of residual fuel remained.^{608, 609}

- ***NRC issued safety evaluation of reactor vessel criticality analysis.*** On July 6, 1993, the NRC issued a safety evaluation confirming earlier analyses done by the licensee which indicated that the fuel remaining in the TMI-2 reactor vessel would remain subcritical, with an adequate margin of safety, during PDMS. The NRC and consultants from Pacific Northwest Laboratory performed independent evaluations and made independent measurements of earlier fuel measurements in the auxiliary and reactor buildings. The NRC concluded that the fuel remaining in the reactor vessel would be subcritical under both steady-state and accident conditions. The NRC also found that there were insufficient discrete quantities of fuel in areas other than the reactor vessel to sustain a criticality.^{610, 611, 612}
- ***NRC issued possession-only license.*** On September 14, 1993, the NRC issued a possession-only license in Amendment 45 to the facility operating license without modification of existing recovery technical specifications. The PDMS technical specifications would be issued after the licensee had completed the final stages of the cleanup effort; the NRC had verified the implementation of the PDMS commitments and requirements; and the licensee had satisfied a number of PDMS license conditions. These license conditions included (1) completion of a special study of the ventilation in the auxiliary and fuel handling building that monitored airborne levels for one year before termination of the continuous operation of the ventilation systems; (2) development of an NRC-approved surveillance requirement for the unfiltered leak-rate test in the reactor building; and (3) submittal and implementation of a site flood protection plan, a site radiation protection plan, an offsite-dose calculation manual, a PDMS fire protection program evaluation, a PDMS quality assurance plan, and a radiological environmental monitoring plan. In addition, the licensee was required to submit the results of the completed plant radiation and contamination surveys before entry into PDMS.⁶¹³

- ***PDMS requirements and commitments completed.*** On November 12, 1993, the licensee informed the NRC that all of the requirements and commitments for entry into PDMS had been satisfied and that they would be ready to transition to PDMS within the next 30 days. The licensee's letter to the NRC provided a list of all PDMS entry requirements along with references to the licensee letters that provided closeout documentation.^{614, 615} The NRC independently verified that the licensee had satisfied all the PDMS requirements and commitments.⁶¹⁶
- ***NRC issued PDMS technical specifications.*** On December 28, 1993, the NRC issued Amendment 48 to the facility operating license to incorporate the PDMS technical specifications. The PDMS technical specifications replaced the technical specifications that pertained to the facility and recovery (Appendix A to the facility operating license); technical specifications that pertained to the environment (Appendix B); and the recovery operations plan that pertained to surveillance. The license amendment also included an update of the safety evaluation report for PDMS that was first issued on February 20, 1992. In the safety evaluation, the NRC evaluated the potential for the routine and accidental releases of any significant quantity of radioactive material during PDMS. The NRC performed independent evaluations of eight potential accidents: vacuum canister failure, spraying of concentrated contamination with high-pressure spray, cutting of contaminated pipe, break of contaminated pipe, elevator/stairwell fire in containment, D-ring compartment fire in containment, containment penetration failure, and the rupture and release of resins from the makeup and purification demineralizers.⁶¹⁷

During the safety evaluation, the NRC reviewed the final defueling completion report (1990) and the PDMS safety analysis report, as amended. The following conclusions of the NRC's safety evaluation were based on the information from the licensee's reports, the NRC's PEIS Supplement 3 (1989), and the NRC's PDMS technical evaluation report (1992):⁶¹⁸

- Defueling of the reactor had been accomplished to the extent reasonably achievable.
- All fuel and core debris removed from the reactor and associated systems had been shipped offsite.

- Results of analyses indicated that there was no potential for criticality in the fuel remaining in the TMI-2 facility during either normal or accident conditions.
- Remaining radioactive waste from the major TMI-2 decontamination activities had been shipped offsite or packaged and staged (prepared) for shipment offsite.
- Radiation levels within the facility had been reduced to the extent that plant monitoring, maintenance and inspections could be performed.
- Radiological surveillance of activities during PDMS could be conducted in accordance with the approved offsite-dose calculation manual and in compliance with the regulatory requirements of 10 CFR Part 20, “Standards for Protection against Radiation,” which would, with the approved radiation protection plan, ensure adequate control of occupational exposure and protection of workers.
- The surveillance program proposed by the licensee would adequately monitor the PDMS environmental protection systems.



Independent spent fuel storage installation (ISFSI) for the dry storage of TMI-2 fuel debris located at the INEL. The TMI-2 defueling canisters were removed from the storage pool, dewatered, dried, and placed in a dry shielded canister. The dry shielded canister with up to 12 defueling canisters was placed inside a reinforced concrete horizontal storage module. The ISFSI was certified and licensed by the NRC.

- Environmental monitoring activities for TMI-2 during PDMS, included in the TMI site radiological environmental monitoring plan, would ensure adequate environmental surveillance and control.
- Fire prevention, detection, and control as specified by the approved fire protection program evaluation would ensure adequate reduction of fire potential, as well as detection and control during PDMS.
- Requirements delineated in the proposed PDMS technical specifications provided assurance that the facility would be maintained in a safe condition that would not negatively impact the environment.

Document Collections. Those documents discussed above and many other documents relating to post-defueling activities are provided in the DVD folder, [After Defueling](#).



TMI-2 independent spent fuel storage installation located at INEL for interim storage of the TMI-2 core debris.



(FirstEnergy, 2015)

10 Postscript

In 2001, FirstEnergy acquired TMI-2 from GPU. FirstEnergy contracted the monitoring of TMI-2 to Exelon, the current owner and operator of TMI-1. The companies plan to keep the TMI-2 facility in long-term, monitored storage until the operating license for the TMI-1 plant expires, at which time both plants would be decommissioned. On-site NRC resident inspectors and inspectors from the regional office in King of Prussia, PA continue to monitor the operations at TMI-1 and the conditions at TMI-2.

This knowledge management volume ends with the licensing of the PDMS configuration and the issuance of the PDMS technical specifications at the end of 1993. Activities to maintain and oversee the TMI-2 facility in PDMS will continue until the decommissioning of both units on Three Mile Island. Documents and correspondence pertaining to the maintenance of PDMS, plans for decommissioning, and associated regulatory activities can be accessed electronically from the NRC public website (www.nrc.gov).

The Agencywide Documents Access and Management System (ADAMS) is the official recordkeeping system through which the NRC provides access to collections or “libraries” of publicly available documents. The NRC’s Publicly Available Records System (PARS) Library provides full-text documents dating from about April 2000 onward (and some earlier documents). The Public Legacy Library contains bibliographic citations (some with abstracts and full text) for earlier documents, including pre- and post-accident time periods. Documents relating to TMI-2 can be found in the ADAMS libraries by searching the TMI-2 Docket Number 0500302. Most documents prior to April 2000 are only available in microfiche format. Refer to the NRC Public Document Room webpage for instructions for obtaining documents from the microfiche collection. NRC staff can access legacy documents from microfiche stations located at headquarters and regional offices.

Other sources of documents relating to TMI-2 can be currently found from the sources listed below.

- **American Nuclear Society** (www.ans.org) maintains an extensive collection of their journal articles and proceedings on every aspect of the TMI-2 accident. In particular, the proceedings of the topical meeting “The TMI-2 Accident: Materials Behavior and Plant Recovery Technology,” held in Washington, DC in 1988 were published in the

special volume of the *Nuclear Technology* journal. The papers in the proceedings and other papers may be purchased from their website.

- **Department of Energy's Office of Scientific and Technical Information** website (www.osti.gov) contains over 1,000 electronic full text reports and papers relating to DOE-funded research in support of the recovery and cleanup efforts at TMI-2. Most of these documents are provided on the DVDs to this NUREG/KM.
- **Dickinson College** maintains the Three Mile Island website (www.threemileisland.org) that contains a collection of documents relating to the accident, including transcripts and audio recordings of interviews collected at the time, government and industry documents, photographs, and newspaper coverage.
- **Electric Power Research Institute** (www.epri.com) made available on their website many of their research reports that supported the cleanup and understanding the accident. Four comprehensive reports on the accident, recovery, and cleanup include “Analysis of Three Mile Island - Unit 2 Accident” (NSAC-80-1), “The Cleanup of Three Mile Island Unit 2, A Technical History: 1979 to 1990” (EPRI-NP-6931), “TMI-2



Left: The TMI-2 Investigation Center was established on June 2, 1979, at the Commission's Washington, DC office to provide a facility for investigators from congressional committees and the president's commission to access all pre- and post-accident documentation concerning the plant. Right: A technical information assistant uses the first generation automated Document Control System (DCS) to search NRC documents since 1978, and all TMI-related documents. Each document received or generated by the NRC was indexed by bibliographic elements and microfiched for storage and use. The early DCS was replaced with the Nuclear Documents System (NUDOCS) in 1987 with text search capability of abstracts and select full-text documents. The Agencywide Documents Access and Management System (ADAMS) replaced NUDOCS in April 2000 with full-text storage and retrieval of all NRC records and documents that were entered into ADAMS.

Waste Management Experience” (EPRI-TR-100640), and “TMI-2 Post-Accident Data Acquisition and Analysis Experience” (EPRI-NP-7156).

- **Idaho National Laboratory** of the Department of Energy maintains a collection of research reports in their INL Knowledge eRepository (<http://keros.inl.gov>). Most of these documents are provided on the DVDs to this NUREG/KM.
- **International Atomic Energy Agency** (www.iaea.org) made available on their website technical reports that incorporated lessons from the response to the accident and the cleanup. Key reports include “Catalogue of Methods, Tools and Techniques for Recovery from Fuel Damage Events” (IAEA-TECDOC-627), “Issues and Decisions for Nuclear Power Plant Management after Fuel Damage Events” (IAEA-TECDOC-935), “Management of Severely Damaged Nuclear Fuel and Related Waste” (IAEA-TRS-321), and “Cleanup and Decommissioning of a Nuclear Reactor after a Severe Accident” (IAEA-TRS-346).
- **National Technical Information Service** of the U.S. Department of Commerce serves as the largest central resource for government-funded scientific, technical, and engineering information. Formal government reports not available elsewhere can be purchased from their website (www.ntis.gov).
- **Pennsylvania State University Libraries**’ maintains the TMI-2 Recovery and Decontamination Collection that contains several thousand videotapes, reports, and photographs of the recovery and cleanup during the 1979–1990 time period (www.libraries.psu.edu). The GPU Nuclear, EPRI, NRC, and DOE (GEND) co-sponsored a project with the University to catalog and maintain the extensive videotape library for future researchers.
- **WM Symposia** (www.wmsym.org) holds an annual international Waste Management conference covering the management of radioactive waste and related topics. Past proceedings of their annual conferences dating back to 1975 are available from their website (www.wmsym.org). Many papers relating to the TMI-2 cleanup were presented during the 1980s.
- **Books about TMI-2** by NRC staff include “Three Mile Island: A Nuclear Crisis in Historical Perspective” by J. Samuel Walker (2006)⁶¹⁹ and “TMI 25 Years Later: The Three Mile Island Nuclear Power Plant Accident and Its Impact” by Bonnie A. Osif, Anthony J. Baratta, and Thomas W. Conkling (2004)⁶²⁰.

Knowledge Management Library for the Three Mile Island Unit 2 Accident of 1979



Search Document Titles



Welcome (Home)

Timeline

Photos and Videos

Response to the Accident

Investigations and Lessons Learned

Industry-Wide Regulatory Actions

Status and Summary Reports

Licensing Actions

Management & Oversight

Plant Stabilization

Worker Protection

Data Acquisition and Analysis

Decommissionation

Waste Management

Defueling

After Defueling

Pre-Accident Plant References

Document Folder Index

Welcome to the TMI-2 Knowledge Management Library

Presented by the Office of Nuclear Regulatory Research

This library supplements NUREG/KM-0001, "Three Mile Island Accident of 1979 Knowledge Management Digest", with access to over 4,000 digitized documents spanning the period from days after the accident to the end of 1995. The accompanying DVDs contain the most important documents that the NRC, U.S. Department of Energy, the licensee, and other government organizations have collected and digitized. The documents are organized into folders that correspond to the major areas of investigation. The library also provides several multimedia presentations, including two special NRC events, "The Accident at Three Mile Island—A Look Back: Preserving the Institutional Memory after 30 Years," and "The 35th Anniversary of the Three Mile Island Nuclear Power Plant Accident of 1979: Working at TMI during and Following the Accident."

Contributors

Knowledge • Harold Denton • Edward Frederick • Gary Holahan • Don Markoberry • Jessica Matthews • Brian Sherm • Gordon Stillman • Governor Richard Thornburgh • J. Samuel Walker • Thomas Willock
 Management • Don Markoberry • Felicit Gonzalez • Kenneth Harberger • Ainsie Atkins-Affia • Theodore Smith • Jinita Poole • Robert Norman • Tom Willock • Andrew Bites • Brian McGrath
 • David Altst • Carolyn Sitt • Amy Resneckowicz • Tom Kuratians • Mark Henry Salsky • The NRC Print Shop and Publications Staff

Document Collections • Publications Branch of the NRC's Office of Administration • NRC's Office of the Secretary • U.S. Department of Energy • Idaho National Laboratory • Dickinson College
 Community Studies Center • The Pennsylvania State University Engineering Library • National Archives and Records Administration • NRC's Agencywide Documents Access and Management System (Public Legacy Library)

Version Date: 5/1/2016



Please "click" the photograph for an introduction from Dr. Thomas Willock, NRC Historian



"Kernery Report" President's Commission



"Rogovin Report" NRC's Independent Investigation



Programmatic Environmental Impact Statement



NUREG/KM-0001: Overview



NUREG/KM-0001: Supplement: Recovery and Cleanup

11 DVD Navigation and Interpretation

This knowledge management guide is an HTML-based collection of information, documents, videos, and photos related to the 1979 accident at the Three Mile Island nuclear power plant. This interactive feature is provided on the DVD to help you navigate through the historical records. Refer to the “Readme” file located on any DVD for viewing instructions.

Navigation

- **Main welcome page.** From the welcome page, you can navigate the different sections of the guide using the blue tabs from the menu on the left side of the page. Each tab is linked to a page that contains one or more subtabs that appear to the right of the tab. Each tab corresponds to a document collection and each subtab links to a folder of documents. This interactive feature will prompt you to load the appropriate DVD to retrieve the document, if necessary. Additionally, there is a photo gallery, interactive timeline, and a document index (green tab). You may also click on the text box on the timeline for a short description.
- **Document retrieval.** Documents can be accessed from the document page (see figure below) linked to the subtab. Next to each document is a hyperlink which will display the associated document, photo, or video. Because the document collection spans several DVDs, you may be prompted to insert a different DVD as you navigate the guide. A sorting feature is provide on select columns on the document page.
- **Document searches.** A simple keyword search feature is provided on the welcome page and each document page. A search is applied to a list of all documents on all DVDs in this NUREG/KM. This feature searches words in the file name.
- **Document lists.** Several convenient lists of documents on the DVD can be viewed from the “Document Folder Index” tab. These lists are also provided in spreadsheet format in the “Common” folder on the DVD (located in the "Documents" folder). A list of more than 25,000 TMI-2 records in the Public Legacy Library is included in the spreadsheet.
- **Alternative.** Documents are titled and arranged in topical folders on the DVD (located in the "Documents" folder) to provide a usable alternative to the interactive guide. The document can be accessed directly on the DVD using a file explorer.

Things to Keep in Mind

- **Legacy documents.** Many of the documents on the DVD are historical in nature and might contain information that is obsolete or superseded by current regulations and research results. The historical documents provided on the DVDs are for historical reference only and are not official NRC records. Please refer to the NRC's public website (<http://www.nrc.gov>) for current information on regulations, policy statements, regulatory guidelines, regulatory processes, and research results.
- **Units of measure.** The unit of measure (in English units or the International System of Units) that was used in the original source document was used in this digest. A conversion chart is provided on the back cover.
- **Abbreviations.** A small set of abbreviations was used throughout this report in order to improve readability: ALARA, CFR, DOE, DVD, EPRI, GEND, GPU, INEL, NRC, NUREG, NUREG/CR, NUREG/KM, PDMS, and TMI-2. Others that were less frequently repeated in the report were spelled out at the beginning of each subsection or paragraph that contained them.
- **Recovery vs. cleanup.** The term “recovery” is used in this NUREG/KM to mean actions taken to keep the plant in a stable condition and to prevent the inadvertent release of radioactivity. The term “cleanup” is used to mean actions taken to decontaminate and defuel the plant and dispose of radioactive waste. These two terms are often used interchangeably for certain actions.
- **EPRI and GPU documents.** Documents generated by EPRI and GPU are generally not provided on the DVDs unless the documents were submitted to the NRC or funded by DOE.
- **“GPU” and “licensee.”** Unless otherwise noted, the GPU Corporation and its subsidiaries (including GPU Service Corporation, GPU Nuclear Corporation, and Metropolitan Edison Company) are referred to collectively in a historical context as “GPU” or the “licensee” in the text of this NUREG/KM and document filenames.
- **Document accession number.** Each document and each enclosure of a document that was cataloged in the Agencywide Documents Access and Management System (ADAMS) Public Legacy Library was assigned a

unique accession number. This number can be found on the first page of each document. Each enclosure to a transmittal letter was typically assigned its own accession number.

- Document filename.** The filenames used on the DVDs typically contain the date of the document (generally the date of the transmittal letter); originating organization (e.g., NRC or GPU); document type (e.g., safety evaluation or system description); short title; document revision, if any; and reference date of previous correspondence, if any. Technical reports by the NRC (e.g., NUREGs), DOE, and national laboratories start with the report's identification number, short title, and year and month issued. See examples below.

(1990-01-18) GPU, Defueling Completion Report, Rev. 3 (re 08-18, 10-09-1989)
 NUREG-0698, Rev. 2, NRC Plan for Cleanup Operations at TMI-2 (1984-03)

- Documents, photographs, and diagrams** in this NUREG/KM and DVDs were copied from the best available (surviving) sources. Photographs were generally taken by GPU and DOE contractors.

The screenshot shows a web browser window displaying the 'Knowledge Management Portal for the Three Mile Island Unit 2 Accident of 1979'. The page includes a search bar with the text '2c-L2-NUREG' and a table listing various document folders. The table has columns for Date, Folder, Title, Link, Type, and DVD. The entries in the table are as follows:

Date	Folder	Title	Link	Type	DVD
1978-12-01	2c-L2-NUREG	NUREG-0396, Planning Basis of Development of State and Local Government Radiological Emergency Response Plans (1978-12)	Link	Technical Report	1
1979-07-01	2c-L2-NUREG	NUREG-0578 ERRATA (re 08-20-1979 EDO Letter) (1979-07)	Link	Technical Report	1
1979-07-01	2c-L2-NUREG	NUREG-0578, TMI-2 Lessons Learned Task Force Status Report and Short-Term Recommendations (1979-07)	Link	Technical Report	1
1979-07-01	2c-L2-NUREG	NUREG-0585, TMI-2 Lessons Learned Task Force Final Report (1979-07)	Link	Technical Report	1
1979-08-01	2c-L2-NUREG	NUREG-0600, Investigation into the 03-28-1979 TMI Accident by the Office of IE (1979-08)	Link	Technical Report	1
1979-12-01	2c-L2-NUREG	NUREG-0616, Report of Special Review Group, Office IE on Lessons Learned From TMI (1979-12)	Link	Technical Report	1
1979-11-01	2c-L2-NUREG	NUREG-0632, NRC Views and Analysis of Recommendations of President's Commission on the Accident at TMI (1979-11)	Link	Technical Report	1
1980-01-01	2c-L2-NUREG	NUREG-0637, Report to the NRC from the Staff Panel on Determination of an Extraordinary Nuclear Occurrence (1980-01)	Link	Technical Report	1
1979-12-01	2c-L2-NUREG	NUREG-0640, TMI-2, Radiation Protection Program Report of the Special Panel (1979-12)	Link	Technical Report	1
1980-01-01	2c-L2-NUREG	NUREG-0645, Vol. 1, Report of the Bulletins and Orders Task Force (1980-01)	Link	Technical Report	1

A typical document page listing the contents of a document folder. Columns can be sorted. Keywords in document file names can be searched. The hyperlink directs you to the document, photo, or video.

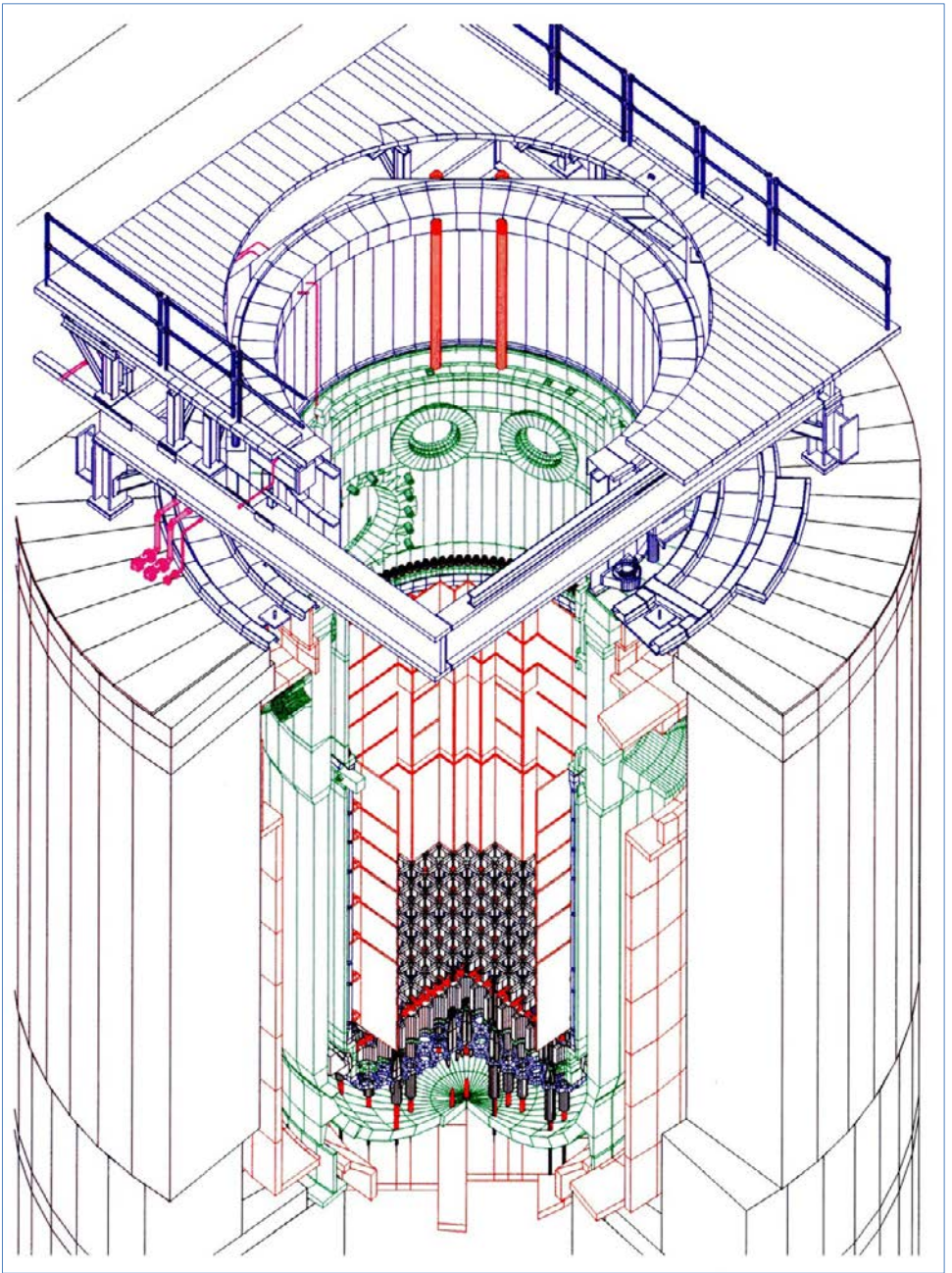

Computer-aided design cut-away drawing showing the defueling work platform support structure and internals indexing fixture (purple), reactor vessel (green), upper core support assembly (red), and lower core support assembly (bottom inside vessel).

12 Contributions to Supplement 1 (NUREG/KM-0001, Recovery and Cleanup)

Knowledge

Don Marksberry
Gordon Skillman
Michael Masnik

Management

Don Marksberry
Felix Gonzalez
Kenneth Hamburger
Theodore Smith
Anita Aikins-Afful
Robert Norman
Thomas Wellock
Andrew Bates
Justin Poole
David Aird
Ian Gifford
Tom Kardaras
Mark Henry Salley
and
The NRC Print Shop and Publications Staff

Document Collections

NRC's Agencywide Documents Access and Management System
Publications Branch of the NRC's Office of Administration
NRC's Office of the Secretary
U.S. Department of Energy
Idaho National Laboratory
Electric Power Research Institute
Dickinson College Community Studies Center
Pennsylvania State University Engineering Library
National Archives and Records Administration

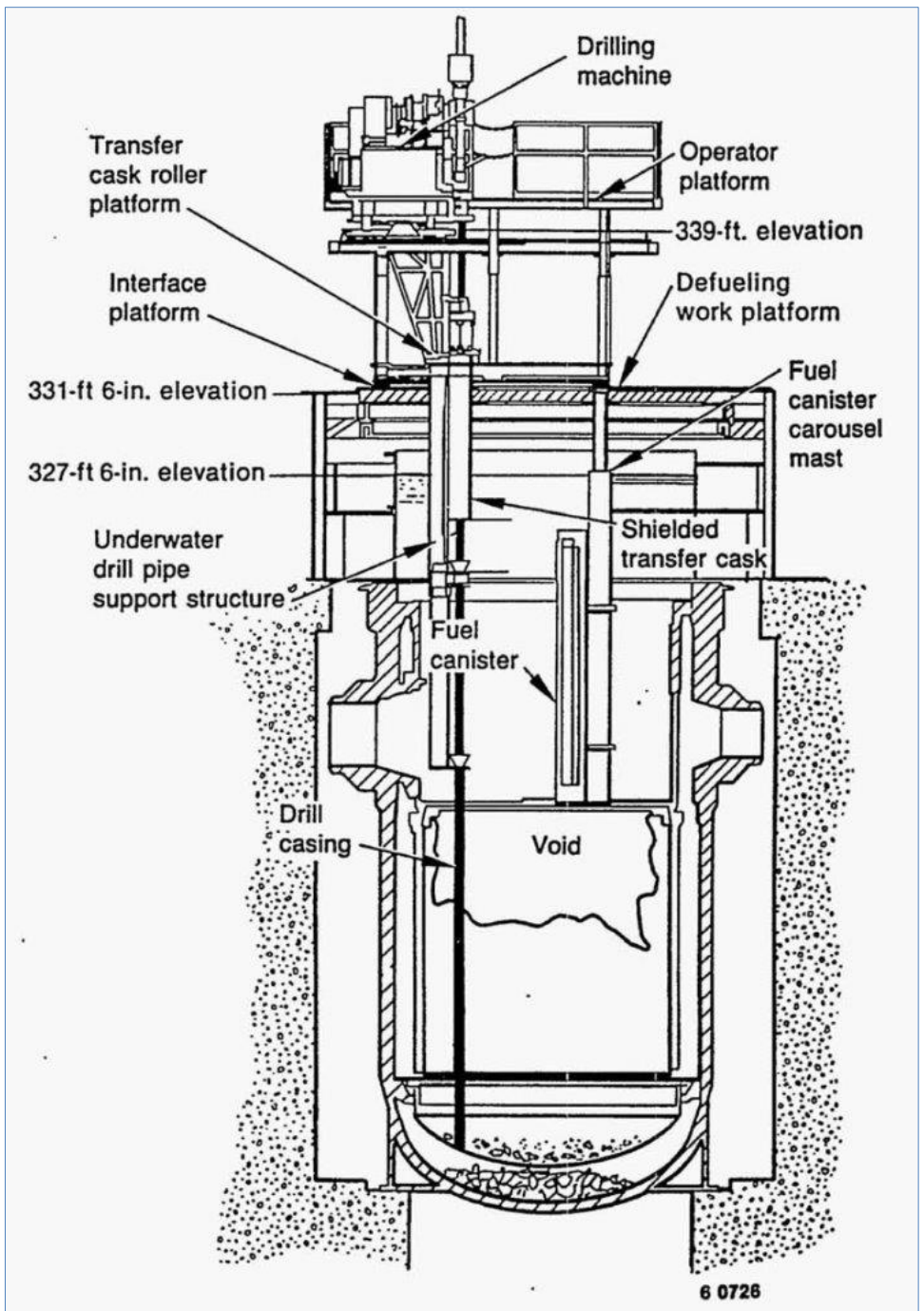

Cross-sectional view of the core bore drilling machine mounted on a platform over the defueling work platform. The core bore machine was originally used to extract core stratification samples in 1985 and later to break up the solidified monolith in the core region during defueling. The machine was used again to drill through and cut portions of the lower core support assembly.

13 Endnotes

Note: Endnote citations are file names of documents on the DVD, except for EPRI reports and journal papers.

-
- ¹ NUREG-0683, Vol. 1, PEIS-Decontamination and Disposal of Radioactive Wastes Resulting from TMI-2 (1981-03)
 - ² NUREG-1350, Vol. 25, Information Digest, 2013–2014
 - ³ (2014-03-25) Text, TMI-2 35th Anniversary Presentation (GSkillman)
 - ⁴ NUREG-0698, Rev. 2
 - ⁵ DOE-ID-10276, TMI-2 Lessons Learned by the DOE 1979-1990 (1990-03)
 - ⁶ (1980-03-26) Coordination Agreement, TMI Information and Examination Program (DOE-NRC-GPU-EPRI)
 - ⁷ (1982-03-19) DOE-GPU Agreement, Acquisition of Damaged TMI-2 Reactor Core by DOE
 - ⁸ (1982-04-19) NRC-DOE Revised MOU, Removal and Disposition of Solid Nuclear Waste from TMI-2 (SECY-82-165)
 - ⁹ DOE-ID-10276, TMI-2: Lessons Learned by the U.S. Department of Energy, A Programmatic Perspective, March 1990
 - ¹⁰ NUREG/CR-1250, Vol. 2, Part 3 (Rogovin Report)
 - ¹¹ NUREG-0683, Vol. 1, PEIS-Decontamination and Disposal of Radioactive Wastes Resulting from TMI-2 (1981-03)
 - ¹² NUREG-0683, Vol. 1, PEIS-Decontamination and Disposal of Radioactive Wastes Resulting from TMI-2 (1981-03)
 - ¹³ NUREG-0683, Vol. 1, PEIS-Decontamination and Disposal of Radioactive Wastes Resulting from TMI-2 (1981-03)
 - ¹⁴ NUREG-0698, Rev. 2
 - ¹⁵ (1981-08-26) GAO-EMD-81-106, Greater Commitment Needed to Solve Continuing Problems at TMI
 - ¹⁶ (1986-01-26) Operating License Amendment 26 (Fully incorporates Recovery Mode Proposed Technical Specifications)
 - ¹⁷ (1981-08-26) GAO-EMD-81-106, Greater Commitment Needed to Solve Continuing Problems at TMI
 - ¹⁸ (1980-02-28) NRC, Report of Special Task Force on TMI Cleanup
 - ¹⁹ NUREG-0698, Rev. 2
 - ²⁰ NUREG-0698, Rev. 2
 - ²¹ EPRI, “The Cleanup of Three Mile Island Unit 2, A Technical History: 1979 to 1990,” EPRI-NP-6931, September 1990
 - ²² NUREG-0698, Rev. 2
 - ²³ (1980-02-13) NRC Order (2-11-1980), Provides TMI-2 Recovery Technical Specifications
 - ²⁴ (1980-02-28) NRC, Report of Special Task Force on TMI Cleanup
 - ²⁵ (1980-02-28) NRC, Report of Special Task Force on TMI Cleanup
 - ²⁶ (1979-05-26) NRC Policy, NRC to Advise Use of EPICOR-II After Public Comment
 - ²⁷ (1979-11-21) NRC Policy, Notice of Intent to Prepare Programmatic EIS (TMI-2)
 - ²⁸ (1980-02-28) NRC, Report of Special Task Force on TMI Cleanup
 - ²⁹ (1979-11-21) NRC Policy, Notice of Intent to Prepare Programmatic EIS (TMI-2)
 - ³⁰ (1980-09-26) NRC Policy, State (Pennsylvania) Requirements at TMI
 - ³¹ 1980 NRC Annual Report (NUREG-0774)
 - ³² (1981-04-27) NRC Policy, Programmatic Environmental Impact Statement of the Cleanup of TMI-2 (46 FR 24764)

-
- ³³ <http://www.nrc.gov/about-nrc/policymaking.html> (accessed July 28, 2014)
- ³⁴ (1979-10-22) NRC Order (10-18-1979), Operation of EPICOR II to Decontaminate Rad Waste Water in Auxiliary Building
- ³⁵ (1980-06-13) NRC Order (6-12-1980), Orders Release Krypton-85 from the Reactor Building Atmosphere by Controlled Purge
- ³⁶ <http://www.nrc.gov/about-nrc/policymaking.html> (accessed July 28, 2014)
- ³⁷ (1981-01-12) NRC Chairman to GPU, NRC Activities Required to be Performed by the TMI Licensee (re 09-12-1980)
- ³⁸ (1979-07-20) NRC Order, Suspends Facility Operating License No. DPR-73 to Operate TMI-2
- ³⁹ (1979-10-22) NRC Order (10-18-1979), Operation of EPICOR II to Decontaminate Rad Waste Water in Auxiliary Building
- ⁴⁰ (1979-10-26) NRC Order Amend, Clarifies Order dated 10-26-1979 Concerning the Operation of EPICOR-II
- ⁴¹ (1981-03-25) OL Amend 13
- ⁴² (1980-02-13) NRC Order (2-11-1980), Provides TMI-2 Recovery Technical Specifications
- ⁴³ (1980-02-28) NRC, Report of Special Task Force on TMI Cleanup
- ⁴⁴ (1980-02-13) NRC Order (2-11-1980), Provides TMI-2 Recovery Technical Specifications
- ⁴⁵ NUREG-0432, TMI-2 Recovery Technical Specifications (1980-02-13)
- ⁴⁶ NUREG-0647, Safety Evaluation and Environmental Assessment, TMI-2 (1980-02)
- ⁴⁷ (1980-06-13) NRC Order (6-12-1980), Orders Release Krypton-85 from the Reactor Building Atmosphere by Controlled Purge
- ⁴⁸ (1981-06-18) NRC Order, Operation of SDS and EPICOR-II to Process Reactor Building Sump and RCS Water
- ⁴⁹ (1986-01-26) OL Amend 26 (Fully incorporates Recovery Mode Proposed Technical Specifications)
- ⁵⁰ (1980-02-13) NRC Order (2-11-1980), Provides TMI-2 Recovery Technical Specifications
- ⁵¹ (1980-01-14) NRC Review, Proposed Organization Plan (re 12-11-1979)
- ⁵² (1980-03-12) OL Amend 10
- ⁵³ (1980-06-24) OL Amend 11
- ⁵⁴ (1981-12-30) OL Amend 18 (concurrent with modification of Order)
- ⁵⁵ (1986-01-26) OL Amend 26 (Fully incorporates Recovery Mode Proposed Technical Specifications)
- ⁵⁶ (1988-05-25) OL Amend 30
- ⁵⁷ (1989-09-11) OL Amend 35
- ⁵⁸ (1993-09-14) OL Amend 45 (Possession Only License)
- ⁵⁹ (1993-12-28) OL Amend 48 (TS for PDMS)
- ⁶⁰ (1995-06-21) OL Amend 49
- ⁶¹ (1979-07-02) GPU, Planning Study for Containment Entry and Decontamination
- ⁶² (1979-08-13) GPU, Entry and Decontamination of Reactor Building, Highlights of a Planning Study
- ⁶³ (1979-12-12) GPU, Summary Technical Plan for TMI-2 Decontamination and Defueling
- ⁶⁴ SECY-80-175 (Interim criteria for radiological effluents from TMI-2 data gathering and Maintenance operations, April 4, 1980)
- ⁶⁵ SECY-80-175-SRM (Staff Requirements – Discussion of Interim Criteria for Radiation Release at TMI, April 14, 1980)
- ⁶⁶ SECY-80-105 (Release of Krypton Gas in Reactor Building Personnel Air Lock at TMI-2, February 20, 1980)
- ⁶⁷ PNO-TMI-80-03 (Primary Water Leak, February 11, 1980)
- ⁶⁸ (1980-02-28) NRC, Report of Special Task Force on TMI Cleanup

-
- ⁶⁹ (1980-02-26) Report of The Governor's Commission on TMI
- ⁷⁰ (1980-02-28) NRC, Report of Special Task Force on TMI Cleanup
- ⁷¹ NUREG-0683, Vol. 1, PEIS-Decontamination and Disposal of Radioactive Wastes Resulting from TMI-2 (1981-03)
- ⁷² (1980-02-28) NRC, Report of Special Task Force on TMI Cleanup
- ⁷³ NUREG-0683, SUPP. 1, PEIS, Occupational Radiation Dose (1984-10)
- ⁷⁴ NUREG-0683, SUPP. 2, PEIS, Disposal of Accident-Generated Water (1987-06)
- ⁷⁵ NUREG-0683, SUPP. 3, PEIS, Post-Defueling Storage and Cleanup (1989-08)
- ⁷⁶ NUREG-0683, SUPP. 3, PEIS, Post-Defueling Storage and Cleanup (1989-08)
- ⁷⁷ 1981 NRC Annual Report (NUREG-0920)
- ⁷⁸ EPRI, "The Cleanup of Three Mile Island Unit 2, A Technical History: 1979 to 1990," EPRI-NP-6931, September 1990
- ⁷⁹ (1986-12-02) GPU, Post-Defueling Monitored Storage Plan
- ⁸⁰ (1988-08-16) GPU, PDMS Proposed License Amendment and Safety Analysis Report (wo SAR) (re 12-02-1986)
- ⁸¹ NUREG-0683, SUPP. 3, PEIS, Post-Defueling Storage and Cleanup (1989-08)
- ⁸² (1993-12-28) Operating License Amendment 48 (TS for PDMS)
- ⁸³ (1985-10-14) GPU, Recovery Quality Assurance Plan, Rev. 4
- ⁸⁴ (1980-01-24) GPU, TMI-2 Radiation Protection Plan, Rev. 1
- ⁸⁵ (1984-10-30) GPU, General Project Design Criteria, Rev. 5
- ⁸⁶ (1987-04-14) GPU, Special Nuclear Material Accountability Plan
- ⁸⁷ (1985-10-17) NRC Exempt, 30.51, 40.61, 70.51(d), 70.53 Regarding Reporting Core Special Material
- ⁸⁸ (1987-04-14) GPU, Special Nuclear Material Accountability Plan
- ⁸⁹ (1985-06-06) GPU Procedure, Licensed Operator Requalification Program Unit 2, Rev. 3
- ⁹⁰ (1985-05-29) GPU Procedure, Fuel Handling Senior Reactor Operator Training Program Unit 2, Rev. 1
- ⁹¹ (1984-02-10) GPU Procedure, Requirements for Certification of Candidates for NRC Operator License, Rev. 0
- ⁹² EPRI, "The Cleanup of Three Mile Island Unit 2, A Technical History: 1979 to 1990," EPRI-NP-6931, September 1990
- ⁹³ NUREGCR-1250V2PT3, TMI, A Report To The Commissioners And To The Public (Rogovin Report), Vol. II, Part 3
- ⁹⁴ NUREGCR-1250V2PT3, TMI, A Report To The Commissioners And To The Public (Rogovin Report), Vol. II, Part 3
- ⁹⁵ NUREGCR-6252, Lessons learned from the Three Mile Island Unit 2 Advisory Panel (1994)
- ⁹⁶ (1990-03-00) Final Report, Three Mile Island Unit 2 Safety Advisory Board
- ⁹⁷ (1981-12-09) NRC Review, Endorses Concept of Technical Assessment and Advisory Group
- ⁹⁸ GEND-INF-036, Task Plan for the U.S. DOE TMI-2 Programs (1982)
- ⁹⁹ GEND-INF-036, Task Plan for the U.S. DOE TMI-2 Programs (1982)
- ¹⁰⁰ NUREG-0698, Rev. 0, NRC Plan for Cleanup Operations at TMI-2 (1980)
- ¹⁰¹ (1979-04-06) NRC (Internal), Staffing Report and Reorganization at TMI
- ¹⁰² (1980-03-31) NRC (Internal), Name Change of NRC TMI Organization to TMI Program Office
- ¹⁰³ (1980-04-01) NRC, Change of NRC-TMI Organization
- ¹⁰⁴ NUREG-0698, Rev. 0, NRC Plan for Cleanup Operations at TMI-2 (1980-03)
- ¹⁰⁵ 1981 NRC Annual Report (NUREG-0920)
- ¹⁰⁶ NUREG-0698, Rev. 2, NRC Plan for Cleanup Operations at TMI-2 (1984-03)

-
- ¹⁰⁷ 1988 NRC Annual Report (NUREG-1145, Vol. 5)
- ¹⁰⁸ (1979-05-15) GPU, Interim Report on TMI-2 Accident (re 04-11-1979)
- ¹⁰⁹ NUREG-0432, Proposed Technical Specifications
- ¹¹⁰ NUREG-0683, Vol. 1, PEIS-Decontamination and Disposal of Radioactive Wastes Resulting from TMI-2 (1981-03)
- ¹¹¹ EPRI, "The Cleanup of Three Mile Island Unit 2, A Technical History: 1979 to 1990," EPRI-NP-6931, September 1990
- ¹¹² EPRI, "The Cleanup of Three Mile Island Unit 2, A Technical History: 1979 to 1990," EPRI-NP-6931, September 1990
- ¹¹³ NUREG-0683, Vol. 1, PEIS-Decontamination and Disposal of Radioactive Wastes Resulting from TMI-2 (1981-03)
- ¹¹⁴ EPRI, "The Cleanup of Three Mile Island Unit 2, A Technical History: 1979 to 1990," EPRI-NP-6931, September 1990
- ¹¹⁵ NUREG-0683, Vol. 1, PEIS-Decontamination and Disposal of Radioactive Wastes Resulting from TMI-2 (1981-03)
- ¹¹⁶ NUREG-0683, Vol. 1, PEIS-Decontamination and Disposal of Radioactive Wastes Resulting from TMI-2 (1981-03)
- ¹¹⁷ NUREG-0683, Vol. 1, PEIS-Decontamination and Disposal of Radioactive Wastes Resulting from TMI-2 (1981-03)
- ¹¹⁸ (2014-03-25) Text, TMI-2 35th Anniversary Presentation (GSkillman)
- ¹¹⁹ NUREG-0683, Vol. 1, PEIS-Decontamination and Disposal of Radioactive Wastes Resulting from TMI-2 (1981-03)
- ¹²⁰ DOE-ID-10276
- ¹²¹ NUREG-0683, Vol. 1, PEIS-Decontamination and Disposal of Radioactive Wastes Resulting from TMI-2 (1981-03)
- ¹²² NUREG/CR-1250, Vol. 2, Part 2 (Rogovin Report) p.348
- ¹²³ (1979-10-01) GPU, Water Storage Assessment
- ¹²⁴ (1980-02-13) NRC Order (2-11-1980), Provides TMI-2 Recovery Technical Specifications
- ¹²⁵ (1980-04-04) NRC Review, A Further Evaluation of Risk of Recriticality at TMI-2 (re 03-06-1980)
- ¹²⁶ (1984-04-24) Order Amendment (also ROP-19)
- ¹²⁷ (1984-07-17) Order Amendment (also ROP-20)
- ¹²⁸ (1984-03-09) GPU Safety Evaluation, Head Removal, Rev. 5
- ¹²⁹ (1984-07-17) NRC Safety Evaluation, Reactor Pressure Vessel Head Lift (re -3-09-1984)
- ¹³⁰ (1985-04-23) Order Amendment (see ROP-27)
- ¹³¹ (1984-11-08) GPU, Criticality Report, Reactor Coolant System
- ¹³² (1985-03-15) NRC Safety Evaluation, Reactor Coolant System Criticality Report (re 11-08-1984)
- ¹³³ NUREG-0683, Vol. 1, PEIS-Decontamination and Disposal of Radioactive Wastes Resulting from TMI-2 (1981-03)
- ¹³⁴ (2014-03-25) Text, TMI-2 35th Anniversary Presentation (GSkillman)
- ¹³⁵ (1980-11-14) Order Amendment (also ROP-4)
- ¹³⁶ GEND-056, TMI-2 Instrumentation and Electrical Program Final Evaluation Report (1986)
- ¹³⁷ (1980-10-15) GPU, TMI-2 Quarterly Report No. 5 (Followup Report No. 8), Period Ending 09-30-1980
- ¹³⁸ (2014-03-25) Text, TMI-2 35th Anniversary Presentation (GSkillman)
- ¹³⁹ (1979-05-15) GPU, Interim Report on TMI-2 Accident (re 04-11-1979)
- ¹⁴⁰ (2014-03-25) Text, TMI-2 35th Anniversary Presentation (GSkillman)

-
- ¹⁴¹ (1980-01-15) GPU, TMI-2 Quarterly Report No. 2 (Followup Report No. 5), Period Ending 01-15-1980
- ¹⁴² EPRI, "The Cleanup of Three Mile Island Unit 2, A Technical History: 1979 to 1990," EPRI-NP-6931, September 1990
- ¹⁴³ NUREG-0683, Vol. 1, PEIS-Decontamination and Disposal of Radioactive Wastes Resulting from TMI-2 (1981-03)
- ¹⁴⁴ (1979-05-15) GPU, Interim Report on TMI-2 Accident
- ¹⁴⁵ EPRI, "The Cleanup of Three Mile Island Unit 2, A Technical History: 1979 to 1990," EPRI-NP-6931, September 1990
- ¹⁴⁶ (1979-10-15) GPU, TMI-2 Quarterly Report No. 1 (Followup Report No. 4), Period Ending 10-15-1979
- ¹⁴⁷ (1979-05-15) GPU, Interim Report on TMI-2 Accident
- ¹⁴⁸ EPRI, "The Cleanup of Three Mile Island Unit 2, A Technical History: 1979 to 1990," EPRI-NP-6931, September 1990
- ¹⁴⁹ (1979-05-15) GPU, Interim Report on TMI-2 Accident
- ¹⁵⁰ (1980-03-04) GPU, BOP Diesel Generators
- ¹⁵¹ (1979-05-15) GPU, Interim Report on TMI-2 Accident
- ¹⁵² (1980-07-15) GPU, TMI-2 Quarterly Report No. 4 (Followup Report No. 7), Period Ending 06-30-1980
- ¹⁵³ (1979-04-19) NRC, TMI-2 Ground Water Study.pdf
- ¹⁵⁴ (1981-09-28) TMIPO Weekly
- ¹⁵⁵ (2013-04-00) Exelon, TMI Annual Radiological Groundwater Protection Program Report for 2012
- ¹⁵⁶ NUREG-0683, Vol. 1, PEIS-Decontamination and Disposal of Radioactive Wastes Resulting from TMI-2 (1981-03)
- ¹⁵⁷ (1980-01-15) GPU, TMI-2 Quarterly Report No. 2 (Followup Report No. 5), Period Ending 01-15-1980
- ¹⁵⁸ (1980-01-15) GPU, TMI-2 Quarterly Report No. 2 (Followup Report No. 5), Period Ending 01-15-1980
- ¹⁵⁹ (1980-07-15) GPU, TMI-2 Quarterly Report No. 4 (Followup Report No. 7), Period Ending 06-30-1980
- ¹⁶⁰ (1980-06-04) GPU, Plans to Discontinue Use of Supplemental Ventilation System Atop of Aux. Building
- ¹⁶¹ EPRI, "The Cleanup of Three Mile Island Unit 2, A Technical History: 1979 to 1990," EPRI-NP-6931, September 1990
- ¹⁶² (1979-05-15) GPU, Interim Report on TMI-2 Accident
- ¹⁶³ EPRI, "The Cleanup of Three Mile Island Unit 2, A Technical History: 1979 to 1990," EPRI-NP-6931, September 1990
- ¹⁶⁴ (1980-01-15) GPU, TMI-2 Quarterly Report No. 2 (Followup Report No. 5), Period Ending 01-15-1980
- ¹⁶⁵ NUREG-0683, Vol. 1, PEIS-Decontamination and Disposal of Radioactive Wastes Resulting from TMI-2 (1981-03)
- ¹⁶⁶ (1980-08-11) Order Amendment (also ROP-3)
- ¹⁶⁷ NUREG/CR-1250, Vol. 2, Part 2 (Rogovin Report)
- ¹⁶⁸ (1979-10-01) GPU, Water Storage Assessment
- ¹⁶⁹ (1979-04-11) NRC to FDAA, Request to Locate Railway Cars to Store Low Level Waste from TMI-2
- ¹⁷⁰ EPRI, "The Cleanup of Three Mile Island Unit 2, A Technical History: 1979 to 1990," EPRI-NP-6931, September 1990
- ¹⁷¹ NUREG-0774, U.S. NRC Annual Report: 1980

-
- ¹⁷² NUREG-0774, U.S. NRC Annual Report: 1980
- ¹⁷³ (1980-06-13) NRC Order, Orders Release Krypton-85 from the Reactor Building Atmosphere by Controlled Purge
- ¹⁷⁴ (1980-06-24) OL Amend 11
- ¹⁷⁵ (1980-10-15) GPU, TMI-2 Quarterly Report No. 5 (Followup Report No. 8), Period Ending 09-30-1980
- ¹⁷⁶ NUREG-0774, U.S. NRC Annual Report: 1980
- ¹⁷⁷ NUREG-0683, Vol. 1, PEIS-Decontamination and Disposal of Radioactive Wastes Resulting from TMI-2 (1981-03)
- ¹⁷⁸ Langenbach, J. W., Three Mile Island Unit 2 Reactor Building Entry Program,” Nuclear Technology, Vol. 87, No. 2, pp. 368-382, October 1989
- ¹⁷⁹ 1980 NRC Annual Report (NUREG-0774)
- ¹⁸⁰ (1980-03-21) GPU, Initial Reactor Building Entry Program
- ¹⁸¹ (1980-07-15) GPU, Planned Reactor Building Entry (re 05-16-1980)
- ¹⁸² Langenbach, J. W., Three Mile Island Unit 2 Reactor Building Entry Program,” Nuclear Technology, Vol. 87, No. 2, pp. 368-382, October 1989
- ¹⁸³ EPRI, “The Cleanup of Three Mile Island Unit 2, A Technical History: 1979 to 1990,” EPRI-NP-6931, September 1990
- ¹⁸⁴ GEND-INF-011-VOL-3, REACTOR BUILDING BASEMENT RADIONUCLIDE DISTRIBUTION STUDIES (1983-06)
- ¹⁸⁵ (1981-06-18) NRC Order, Operation of SDS and EPICOR-II to Process Reactor Building Sump and RCS Water
- ¹⁸⁶ (2014-03-25) Text, TMI-2 35th Anniversary Presentation (GSkillman)
- ¹⁸⁷ (1980-02-28) NRC, Report of Special Task Force on TMI Cleanup
- ¹⁸⁸ (2014-03-25) Text, TMI-2 35th Anniversary Presentation (GSkillman)
- ¹⁸⁹ (1979-07-02) GPU, Planning Study for Containment Entry and Decontamination
- ¹⁹⁰ (1981-06-18) NRC Order, Operation of SDS and EPICOR-II to Process Reactor Building Sump and RCS Water
- ¹⁹¹ (1981-05-11) GPU System Description, SDS, Rev. 2
- ¹⁹² (2014-03-25) Text, TMI-2 35th Anniversary Presentation (GSkillman)
- ¹⁹³ (1981-02-27) GPU, Cork Seal Contamination Report (re 01-19-1981)
- ¹⁹⁴ (2013-03-22) GPU, TMI-2 Update 9 of the Post-Defueling Monitored Storage Safety Analysis Report
- ¹⁹⁵ (1994-06-02) GPU Response to NRC (Discussions), Actions Taken to Modify Cork Joint at TMI-2
- ¹⁹⁶ DOE-ID-10276, TMI-2 Lessons Learned by the DOE 1979-1990
- ¹⁹⁷ GEND-INF-001, QUICK LOOK REPORT ENTRY 1 (1981)
- ¹⁹⁸ GEND-INF-002, QUICK LOOK REPORT ENTRY 2 (1981)
- ¹⁹⁹ NUREG-0683, SUPP. 1, PEIS-Decontamination and Disposal of Rad Wastes at TMI-2, Occupational Radiation Dose (1984)
- ²⁰⁰ GEND-002, Vol. 1, Facility Decontamination Technology Workshop, Presentations (1979)
- ²⁰¹ DOE-ID-10276, TMI-2 Lessons Learned by the DOE 1979-1990
- ²⁰² Merchant, D. J., “Worker Exposures During the Three Mile Island Unit 2 Recovery,” Nuclear Technology, Vol. 87, No. 4, pp. 1099-1105, December 1989
- ²⁰³ NUREG-0600, Investigation into the 03-28-1979 TMI Accident by the Office of IE (1979-08)
- ²⁰⁴ 1990 NRC Annual Report (NUREG-1145, Vol. 7)
- ²⁰⁵ NUREG-0600, Investigation into the 03-28-1979 TMI Accident by the Office of IE (1979-08)

-
- ²⁰⁶ NUREG-0600, Investigation into the 03-28-1979 TMI Accident by the Office of IE (1979-08)
- ²⁰⁷ NUREG-0600, Investigation into the 03-28-1979 TMI Accident by the Office of IE (1979-08)
- ²⁰⁸ NUREG-0774, U.S. NRC Annual Report: 1980
- ²⁰⁹ Licensee Event Report LER-89-006; NRC Preliminary Notification PNO-I-89-81
- ²¹⁰ DOE-ID-10276, TMI-2 Lessons Learned by the DOE 1979-1990
- ²¹¹ International Atomic Energy Agency, "Catalogue of Methods, Tools and Techniques for Recovery from Fuel Damage Events," IAEA-TECDOC-627, October 1991
- ²¹² International Atomic Energy Agency, "Catalogue of Methods, Tools and Techniques for Recovery from Fuel Damage Events," IAEA-TECDOC-627, October 1991
- ²¹³ NUREG-0600, Investigation into the 03-28-1979 TMI Accident by the Office of IE (1979-08)
- ²¹⁴ NUREG-0600, Investigation into the 03-28-1979 TMI Accident by the Office of IE (1979-08)
- ²¹⁵ NUREG-0640, TMI-2, Radiation Protection Program Report of the Special Panel (1979-12)
- ²¹⁶ NUREG-0683, SUPP. 1, PEIS-Decontamination and Disposal of Rad Wastes at TMI-2, Occupational Radiation Dose (1984)
- ²¹⁷ NUREG-1090, U.S. NRC Annual Report: 1983
- ²¹⁸ NUREG-1145, Vol. 2, U.S. NRC Annual Report: 1985
- ²¹⁹ NUREG-1145, Vol. 1, U.S. NRC Annual Report: 1984
- ²²⁰ EPRI, "The Cleanup of Three Mile Island Unit 2, A Technical History: 1979 to 1990," EPRI-NP-6931, September 1990
- ²²¹ NUREG-0683, SUPP. 1, PEIS, Occupational Radiation Dose (1984-10)
- ²²² International Atomic Energy Agency, Catalogue of Methods, Tools and Techniques for Recovery from Fuel Damage Events, IAEA-TECDOC-627, October 1991
- ²²³ (1989-02-16) NRC IR 88-20 (See Encl. 2, TMI-2 Clean-Up Program Status Update)
- ²²⁴ EPRI, "The Cleanup of Three Mile Island Unit 2, A Technical History: 1979 to 1990," EPRI-NP-6931, September 1990
- ²²⁵ EGG, Vol. 1, No. 1, TMI Unit-2 Technical Information and Examination Program, Update (4-15-1980)
- ²²⁶ (1980-03-26) Coordination Agreement, TMI Information and Examination Program (DOE-NRC-GPU-EPRI)
- ²²⁷ GEND-INF-036, Task Plan for the U.S. DOE TMI-2 Programs (1982)
- ²²⁸ (1984-04-16) DOE, Agreement with DOE for Japanese Participation in the TMI-2 Research and Development
- ²²⁹ Tabata, N., F. Masuda, "Utilization of Three Mile Island Unit 2 Research and Development Information in Japan," Nuclear Technology, Vol. 87, No. 4, pp. 814-823, December 1989.
- ²³⁰ NUREG-0698, Rev. 0, NRC Plan for Cleanup Operations at TMI-2 (1980)
- ²³¹ EPRI, "The Cleanup of Three Mile Island Unit 2, A Technical History: 1979 to 1990," EPRI-NP-6931, September 1990
- ²³² (2014-03-25) Text, TMI-2 35th Anniversary Presentation (GSkillman)
- ²³³ NRC Preliminary Notification PNO-TMI-82-015
- ²³⁴ GEND-INF-038, Assessment of the TMI-2 Axial Power Shaping Rod Dynamic Test Results (1983-04)
- ²³⁵ NUREG-0998, U.S. NRC Annual Report: 1982
- ²³⁶ GEND-030, Quick Look Inspection Report on the Insertion of a Camera into the TMI-2 Reactor Vessel (1983)

-
- ²³⁷ (1983-06-27) TMIPO Weekly
- ²³⁸ (1983-05-25) GPU Safety Analysis, Radiation Characterization Under the Reactor Vessel Head, Rev. 0
- ²³⁹ (1983-05-25) GPU Safety Analysis, Radiation Characterization Under the Reactor Vessel Head, Rev. 0
- ²⁴⁰ 1983 NRC Annual Report (NUREG-1090)
- ²⁴¹ (1983-08-15) TMIPO Weekly
- ²⁴² (1983-08-22) TMIPO Weekly
- ²⁴³ (1983-09-12) TMIPO Weekly
- ²⁴⁴ (1983-10-24) TMIPO Weekly
- ²⁴⁵ (1983-09-12) TMIPO Weekly
- ²⁴⁶ (1983-07-20) GPU Safety Evaluation, Underhead Characterization, Core Sampling Addendum
- ²⁴⁷ (1983-09-19) TMIPO Weekly
- ²⁴⁸ (1983-10-03) TMIPO Weekly
- ²⁴⁹ EGG, Vol. 4, No. 1, TMI Unit-2 Technical Information and Examination Program, Update (12-15-1983)
- ²⁵⁰ EGG, Vol. 4, No. 2, TMI Unit-2 Technical Information and Examination Program, Update (06-15-1984)
- ²⁵¹ Marley, A. W., "Sampling and Examination Methods Used for the Three Mile Island Unit 2," Nuclear Technology, Vol. 87, No. 4, pp. 845-856, December 1989
- ²⁵² EGG, Vol. 4, No. 1, TMI Unit-2 Technical Information and Examination Program, Update (12-15-1983)
- ²⁵³ (1983-05-26) GPU Safety Evaluation, Underhead Characterization, Core Topography Addendum
- ²⁵⁴ NUREG-1145, Vol. 1, U.S. NRC Annual Report: 1984
- ²⁵⁵ EGG, Vol. 4, No. 2, TMI Unit-2 Technical Information and Examination Program, Update (06-15-1984)
- ²⁵⁶ NUREG-1145, Vol. 1, U.S. NRC Annual Report: 1984
- ²⁵⁷ (1984-04-02) TMIPO Weekly
- ²⁵⁸ EGG, Vol. 4, No. 2, TMI Unit-2 Technical Information and Examination Program, Update (06-15-1984)
- ²⁵⁹ EPRI, "The Cleanup of Three Mile Island Unit 2, A Technical History: 1979 to 1990," EPRI-NP-6931, September 1990
- ²⁶⁰ EGG-TMI-7429, TMI-2 Lower Plenum Video Data Summary (1987)
- ²⁶¹ (1985-01-03) GPU Safety Analysis, Measuring Uranium Fuel Material in Lower Reactor Vessel Region, Rev. 0
- ²⁶² (1985-03-25) TMIPO Weekly
- ²⁶³ (1986-06-11) GPU Safety Evaluation, Core Stratification Sample Acquisition, Rev. 4
- ²⁶⁴ GEND-INF-092-VOL-1, TMI-2 CORE BORE EXAMINATIONS (1990)
- ²⁶⁵ NUREG-1145, Vol. 3, U.S. NRC Annual Report: 1986
- ²⁶⁶ GEND-INF-092-VOL-1, TMI-2 CORE BORE EXAMINATIONS (1990)
- ²⁶⁷ Marley, A. W., "Sampling and Examination Methods Used for the Three Mile Island Unit 2," Nuclear Technology, Vol. 87, No. 4, pp. 845-856, December 1989
- ²⁶⁸ NUREG-1145, Vol. 6, U.S. NRC Annual Report: 1989
- ²⁶⁹ NUREGCR-6197, TMI-2 Vessel Investigation Project Integration Report (1994-03)
- ²⁷⁰ NUREG-1145, Vol. 7, U.S. NRC Annual Report: 1990
- ²⁷¹ (1992-02-20) NRC Safety Evaluation, Post Defueling Monitored Storage (re 02-20-1992)
- ²⁷² International Atomic Energy Agency, Catalogue of Methods, Tools and Techniques for Recovery from Fuel Damage Events, IAEA-TECDOC-627, October 1991

-
- ²⁷³ (1990-02-22) GPU, Defueling Completion Report, Final Submittal
- ²⁷⁴ GEND-001, GEND Planning Report (1980)
- ²⁷⁵ (1982-03-15) NRC-DOE Revised MOU, Removal and Disposition of Solid Nuclear Waste from TMI-2 (Signed)
- ²⁷⁶ (1979-11-21) NRC Policy, Notice of Intent to Prepare Programmatic EIS
- ²⁷⁷ NUREG-0591, Environmental Assessment, Use of EPICOR-II at TMI-2
- ²⁷⁸ (1979-10-22) NRC Order (10-18-1979), Operation of EPICOR II to Decontaminate Rad Waste Water in Auxiliary Building
- ²⁷⁹ (1980-02-29) City of Lancaster Settlement Agreement
- ²⁸⁰ (1980-03-26) Coordination Agreement, TMI Information and Examination Program (DOE-NRC-GPU-EPRI)
- ²⁸¹ NUREG-0683, Vol. 1, PEIS-Decontamination and Disposal of Radioactive Wastes Resulting from TMI-2 (1981)
- ²⁸² (1981-04-27) NRC Policy, Programmatic Environmental Impact Statement of the Cleanup of TMI-2 (46 FR 24764)
- ²⁸³ (1981-06-18) NRC Order, Operation of SDS and EPICOR-II to Process Reactor Building Sump and RCS Water
- ²⁸⁴ NUREG-0796, Operation of the Submerged Demineralizer System at TMI-2 (1981)
- ²⁸⁵ 1981 NRC Annual Report (NUREG-0920)
- ²⁸⁶ (1980-03-26) Coordination Agreement, TMI Information and Examination Program (DOE-NRC-GPU-EPRI)
- ²⁸⁷ (1982-03-15) NRC-DOE Revised MOU, Removal and Disposition of Solid Nuclear Waste from TMI-2 (Signed)
- ²⁸⁸ EPRI, "TMI-2 Waste Management Experience," EPRI TR-100640, 1992
- ²⁸⁹ DOE-ID-10400, Historical Summary of the TMI-2 Core Debris Transportation Campaign (1993)
- ²⁹⁰ 1987 NRC Annual Report (NUREG-1145, Vol. 4)
- ²⁹¹ NUREG-0683, SUPP. 2, PEIS-Decontamination and Disposal of Rad Wastes at TMI-2, Post-Defueling Storage and Cleanup (1987)
- ²⁹² 1988 NRC Annual Report (NUREG-1145, Vol. 5)
- ²⁹³ (1989-09-11) OL Amend 35
- ²⁹⁴ 1991 NRC Annual Report (NUREG-1145, Vol. 8)
- ²⁹⁵ 1993 NRC Annual Report (NUREG-1145, Vol. 10)
- ²⁹⁶ (1993-08-05) GPU, Accident Generated Water Disposal Completion Report
- ²⁹⁷ (1993-08-17) GPU, Completion of Accident Generated Water Disposal
- ²⁹⁸ EPRI, "TMI-2 Waste Management Experience," EPRI-TR-100640, April 1992
- ²⁹⁹ NUREG-0591, Environmental Assessment, Use of EPICOR-II at TMI-2
- ³⁰⁰ NUREG-0591, Environmental Assessment, Use of EPICOR-II at TMI-2
- ³⁰¹ EPRI, "TMI-2 Waste Management Experience," EPRI-TR-100640, April 1992
- ³⁰² EPRI, "TMI-2 Waste Management Experience," EPRI-TR-100640, April 1992
- ³⁰³ EPRI, "TMI-2 Waste Management Experience," EPRI-TR-100640, April 1992
- ³⁰⁴ (1987-05-14) GPU System Description, EPICOR II, Rev. 5
- ³⁰⁵ (1989-07-24) GPU System Description, EPICOR II, Rev. 7
- ³⁰⁶ (2013-03-22) GPU, TMI-2 Update 9 of the Post-Defueling Monitored Storage Safety Analysis Report
- ³⁰⁷ GEND-031, Submerged Demineralizer System Processing of TMI-2 Waste Water (1983-02)
- ³⁰⁸ GEND-031, Submerged Demineralizer System Processing of TMI-2 Waste Water (1983-02)
- ³⁰⁹ GEND-031, Submerged Demineralizer System Processing of TMI-2 Waste Water (1983)
- ³¹⁰ EPRI, "The Cleanup of Three Mile Island Unit 2, A Technical History: 1979 to 1990," EPRI-NP-6931, September 1990

-
- ³¹¹ 1988 NRC Annual Report (NUREG-1145, Vol. 5)
- ³¹² (1981-10-05) TMIPO Weekly
- ³¹³ EPRI, "The Cleanup of Three Mile Island Unit 2, A Technical History: 1979 to 1990," EPRI-NP-6931, September 1990
- ³¹⁴ (1983-10-31) GPU System Description, Processed Water Storage and Recycle System, Rev. 0
- ³¹⁵ (1980-01-24) GPU, Processed Water Storage Tank Dikes (re 12-13-1979)
- ³¹⁶ (1980-02-01) NRC Review, Design Criteria for Processed Water Storage Tanks (re 01-24-1980)
- ³¹⁷ (2013-03-22) GPU, TMI-2 Update 9 of the Post-Defueling Monitored Storage Safety Analysis Report
- ³¹⁸ (1985-05-17) GPU Safety Evaluation, Operation of Internal Indexing Fixture Processing System, Rev. 3
- ³¹⁹ EPRI, "The Cleanup of Three Mile Island Unit 2, A Technical History: 1979 to 1990," EPRI-NP-6931, September 1990
- ³²⁰ (1989-05-12) GPU Technical Evaluation, Defueling Water Cleanup System, Rev. 12
- ³²¹ EPRI, "The Cleanup of Three Mile Island Unit 2, A Technical History: 1979 to 1990," EPRI-NP-6931, September 1990
- ³²² Hofstetter, K. J., and B. S. Ausmus, "The Identification and Control of Microorganisms at Three Mile Island," Nuclear Technology, Vol. 87, No. 4, pp. 814-823, December 1989.
- ³²³ 1987 NRC Annual Report (NUREG-1145, Vol. 4)
- ³²⁴ (1986-05-06) NRC Review, Addition of a Biocide to the TMI-2 Reactor Coolant System (re 05-05-1986)
- ³²⁵ Hofstetter, K. J., and B. S. Ausmus, "The Identification and Control of Microorganisms at Three Mile Island," Nuclear Technology, Vol. 87, No. 4, pp. 814-823, December 1989
- ³²⁶ (1986-07-09) NRC Review, Operation of Filter-Aid Feed System, Use of Diatomaceous Earth as Feed (re various letter)
- ³²⁷ (1987-04-29) GPU Technical Evaluation, Defueling Water Cleanup System, Rev. 10
- ³²⁸ EPRI, "The Cleanup of Three Mile Island Unit 2, A Technical History: 1979 to 1990," EPRI-NP-6931, September 1990
- ³²⁹ (1987-06-11) NRC Review, DWCS Cross-Connect to Reactor Vessel Cleanup System (re 05-21-1987)
- ³³⁰ (1989-05-12) GPU Technical Evaluation, Defueling Water Cleanup System, Rev. 12
- ³³¹ (1986-11-17) GPU Safety Evaluation, TMI-2 Temporary Reactor Vessel Filtration System, Rev. 3
- ³³² EPRI, "The Cleanup of Three Mile Island Unit 2, A Technical History: 1979 to 1990," EPRI-NP-6931, September 1990
- ³³³ (1990-02-22) GPU, Defueling Completion Report, Final Submittal
- ³³⁴ (1992-05-12) GPU Technical Evaluation, Processed Water Disposal System, Rev. 4
- ³³⁵ NUREG-0683, SUPP. 2, PEIS, Disposal of Accident-Generated Water (1987-06)
- ³³⁶ (1993-08-05) GPU, Accident Generated Water Disposal Completion Report
- ³³⁷ NUREG-0683, Vol. 1, PEIS-Decontamination and Disposal of Radioactive Wastes Resulting from TMI-2 (1981)
- ³³⁸ (1981-04-27) NRC Policy, Programmatic Environmental Impact Statement of the Cleanup of TMI-2 (46 FR 24764)
- ³³⁹ (1981-07-15) NRC-DOE MOU, Removal and Disposition of Solid Nuclear Waste from TMI-2 (Signed)
- ³⁴⁰ (1982-03-15) NRC-DOE Revised MOU, Removal and Disposition of Solid Nuclear Waste from TMI-2 (Signed)
- ³⁴¹ (1979-05-11) NRC, Design Criteria for Interim Storage or Solid Waste

-
- ³⁴² EPRI, "The Cleanup of Three Mile Island Unit 2, A Technical History: 1979 to 1990," EPRI-NP-6931, September 1990
- ³⁴³ EPRI, "TMI-2 Waste Management Experience," EPRI-TR-100640, April 1992
- ³⁴⁴ EPRI, "TMI-2 Waste Management Experience," EPRI-TR-100640, April 1992
- ³⁴⁵ (1993-06-29) GPU Technical Evaluation, Interim Solid Waste Staging Facility, Rev. 10
- ³⁴⁶ EPRI, "The Cleanup of Three Mile Island Unit 2, A Technical History: 1979 to 1990," EPRI-NP-6931, September 1990
- ³⁴⁷ (1993-09-13) GPU System Description, Solid Waste Staging Facility, Rev. 6
- ³⁴⁸ EPRI, "TMI-2 Waste Management Experience," EPRI-TR-100640, April 1992
- ³⁴⁹ (1981-08-17) TMIPO Weekly
- ³⁵⁰ (1992-07-29) GPU Technical Evaluation, Waste Handling and Packaging Facility, Rev. 8
- ³⁵¹ EPRI, "The Cleanup of Three Mile Island Unit 2, A Technical History: 1979 to 1990," EPRI-NP-6931, September 1990
- ³⁵² EPRI-TR-100640, TMI-2 Waste Management Experience (1992)
- ³⁵³ NRC Backgrounder, Transportation of Spent Fuel and Radioactive Materials (2014)
- ³⁵⁴ NUREG/BR-0216, Rev. 2, Radioactive Waste Production, Storage, Disposal (2002)
- ³⁵⁵ *U.S. Code of Federal Regulations*, "Licensing Requirements for Land Disposal of Radioactive Waste," Part 61, Chapter I, Title 10, "Energy" (10 CFR 61)
- ³⁵⁶ (1983-05-11) NRC, Final Waste Classification and Waste Form Technical Position Papers
- ³⁵⁷ (1982-05-21) NRC, Certificate of Compliance 9152, Rev. 1, for Model CNS-1-13C II Shipping Cask
- ³⁵⁸ EPRI, "TMI-2 Waste Management Experience," EPRI-TR-100640, April 1992
- ³⁵⁹ (1985-08-14) NRC, Certificate of Compliance 9152, Rev. 8, for Model CNS-1-13C II Shipping Cask
- ³⁶⁰ EGG-TMI-6304, Design Analysis, High-Integrity Container for Disposal of EPICOR-II Prefilter Liners (1983)
- ³⁶¹ GEND-045, Disposal Demo of High Integrity Container with an EPICOR II Prefilter from TMI (1985)
- ³⁶² (1984-01-24) NRC, Certificate of Compliance 5026, Rev. 10, for Model CNS-14-190 Shipping Cask
- ³⁶³ DOE-ID-10400, Historical Summary of the TMI-2 Core Debris Transportation Campaign (1993)
- ³⁶⁴ (1986-06-11) GPU Safety Evaluation, Canister Handling and Preparation for Shipment SER
- ³⁶⁵ INL-CON-12-26246 (CONF), Lessons from TMI Packaging, Transport and Disposition that Apply to Fukushima (2012)
- ³⁶⁶ EGG-TMI-6304, Design Analysis, High-Integrity Container for Disposal of EPICOR-II Prefilter Liners (1983)
- ³⁶⁷ GEND-045, Disposal Demo of High Integrity Container with an EPICOR II Prefilter from TMI (1985)
- ³⁶⁸ EPRI, "TMI-2 Waste Management Experience," EPRI-TR-100640, April 1992
- ³⁶⁹ EPRI, "TMI-2 Waste Management Experience," EPRI-TR-100640, April 1992
- ³⁷⁰ DOE-ID-10276, TMI-2 Lessons Learned by the DOE 1979-1990 (1990-03)
- ³⁷¹ GEND-032, TMI-2 Technical Information and Examination Program Annual Report 1982 (1983-04)
- ³⁷² GEND-INF-025, Development of a Prototype Gas Sampler for EPICOR II Prefilter Liners (1982-09)
- ³⁷³ GEND-029, Preparations to Ship EPICOR Liners (1983-06)
- ³⁷⁴ DOE-ID-10276, TMI-2 Lessons Learned by the DOE 1979-1990 (1990-03)

-
- ³⁷⁵ GEND-052, Hydrogen Control in Handling, Shipping, and Storage of Wet Radioactive Waste (1986-02)
- ³⁷⁶ DOE-ID-10276, TMI-2 Lessons Learned by the DOE 1979-1990 (1990-03)
- ³⁷⁷ GEND-062, Catalyst Tests for Hydrogen Control in Canisters of Wet Rad Waste (1987-08).pdf
- ³⁷⁸ (1985-11-05) NRC Safety Evaluation, Defueling Canisters (re various letters)
- ³⁷⁹ GEND-051, Evaluation of Special Safety Issues Associated with Handling the TMI-2 Core Debris (1985-06).pdf
- ³⁸⁰ NUREG-0683, SUPP. 3, PEIS-Decontamination and Disposal of Rad Wastes Resulting from TMI-2 (1989)
- ³⁸¹ Ruhter, P. E., W. G. Zurliene, "Radiological Conditions and Experiences in the Three Mile Island Unit 2 Auxiliary Building," Nuclear Technology, Vol. 87, No. 2, pp. 361-366, October 1989
- ³⁸² NUREG-0683, SUPP. 3, PEIS-Decontamination and Disposal of Rad Wastes Resulting from TMI-2 (1989)
- ³⁸³ NUREG-0683, SUPP. 1, PEIS-Decontamination and Disposal of Rad Wastes at TMI-2, Occupational Radiation Dose (1984)
- ³⁸⁴ NUREG-0683, SUPP. 3, PEIS-Decontamination and Disposal of Rad Wastes Resulting from TMI-2 (1989)
- ³⁸⁵ NUREG-0683, SUPP. 1, PEIS-Decontamination and Disposal of Rad Wastes at TMI-2, Occupational Radiation Dose (1984)
- ³⁸⁶ (1990-02-22) GPU, Defueling Completion Report, Final Submittal
- ³⁸⁷ (2013-03-22) GPU, TMI-2 Update 9 of the Post-Defueling Monitored Storage Safety Analysis Report
- ³⁸⁸ NUREG-0683, SUPP. 3, PEIS-Decontamination and Disposal of Rad Wastes Resulting from TMI-2 (1989)
- ³⁸⁹ NUREG-0683, Vol. 1, PEIS-Decontamination and Disposal of Radioactive Wastes Resulting from TMI-2 (1981)
- ³⁹⁰ (2013-03-22) GPU, TMI-2 Update 9 of the Post-Defueling Monitored Storage Safety Analysis Report
- ³⁹¹ NUREG-0683, SUPP. 3, PEIS-Decontamination and Disposal of Rad Wastes Resulting from TMI-2 (1989)
- ³⁹² (2013-03-22) GPU, TMI-2 Update 9 of the Post-Defueling Monitored Storage Safety Analysis Report
- ³⁹³ (1993-11-12) GPU, Transition to PDMS
- ³⁹⁴ (2013-03-22) GPU, TMI-2 Update 9 of the Post-Defueling Monitored Storage Safety Analysis Report
- ³⁹⁵ (2013-03-22) GPU, TMI-2 Update 9 of the Post-Defueling Monitored Storage Safety Analysis Report
- ³⁹⁶ NUREG-0683, SUPP. 1, PEIS-Decontamination and Disposal of Rad Wastes at TMI-2, Occupational Radiation Dose (1984)
- ³⁹⁷ (1989-01-10) GPU Safety Evaluation, Sediment Transfer and Processing Operations, Rev. 4
- ³⁹⁸ (1990-02-22) GPU, Defueling Completion Report, Final Submittal
- ³⁹⁹ EPRI, "TMI-2 Waste Management Experience," EPRI-TR-100640, April 1992
- ⁴⁰⁰ (1985-03-25) GPU Safety Evaluation, Reactor Building Decontamination and Dose Reduction Activities for 1985, Supp. 1
- ⁴⁰¹ (1985-09-25) NRC Safety Evaluation, Reactor Building Decontamination and Dose Reduction for 1985 (re 02-08, 03-25-1985)
- ⁴⁰² DOE-ID-10276, TMI-2 Lessons Learned by the DOE 1979-1990

-
- ⁴⁰³ EPRI, "The Cleanup of Three Mile Island Unit 2, A Technical History: 1979 to 1990," EPRI-NP-6931, September 1990
- ⁴⁰⁴ International Atomic Energy Agency, "Catalogue of methods, tools and techniques for recovery from fuel damage events," IAEA-TECDOC-627, October 1991
- ⁴⁰⁵ EPRI, "The Cleanup of Three Mile Island Unit 2, A Technical History: 1979 to 1990," EPRI-NP-6931, September 1990
- ⁴⁰⁶ DOE-ID-10276, TMI-2 Lessons Learned by the DOE 1979-1990 (1990-03)
- ⁴⁰⁷ Pavelek II, M.D., "Operations and Achievements of Remote Equipment at Three Mile Island," Nuclear Technology, Vol. 87, No. 4, pp. 1122-1133, December 1989
- ⁴⁰⁸ Giefer, D. L., A. B. Jeffries, "Implementation of Remote Equipment at Three Mile Island Unit 2," Nuclear Technology, Vol. 87, No. 3, pp. 641-700, November 1989
- ⁴⁰⁹ Giefer, D. L., A. B. Jeffries, "Implementation of Remote Equipment at Three Mile Island Unit 2," Nuclear Technology, Vol. 87, No. 3, pp. 641-700, November 1989
- ⁴¹⁰ International Atomic Energy Agency, Catalogue of Methods, Tools and Techniques for Recovery from Fuel Damage Events, IAEA-TECDOC-627, October 1991
- ⁴¹¹ Pavelek II, M.D., "Operations and Achievements of Remote Equipment at Three Mile Island," Nuclear Technology, Vol. 87, No. 4, pp. 1122-1133, December 1989
- ⁴¹² Giefer, D. L., A. B. Jeffries, "Implementation of Remote Equipment at Three Mile Island Unit 2," Nuclear Technology, Vol. 87, No. 3, pp. 641-700, November 1989
- ⁴¹³ EPRI, "Final TMI-2 Technology Transfer Progress Report," EPRI-TR-100643, May 1992
- ⁴¹⁴ (1986-05-15) GPU Safety Evaluation, Defueling SER, Rev. 10
- ⁴¹⁵ GEND-INF-093, Lower Core Support Assembly Defueling Planning and Tools (1988)
- ⁴¹⁶ (1989-01-31) NRC Safety Evaluation, Criticality Assessment for Plasma Arc Torch to Cut Vessel Internals (08-11, 12-27-1988)
- ⁴¹⁷ Giefer, D. L., A. B. Jeffries, "Implementation of Remote Equipment at Three Mile Island Unit 2," Nuclear Technology, Vol. 87, No. 3, pp. 641-700, November 1989
- ⁴¹⁸ International Atomic Energy Agency, Catalogue of Methods, Tools and Techniques for Recovery from Fuel Damage Events, IAEA-TECDOC-627, October 1991
- ⁴¹⁹ GEND-002, Vol. 1, Facility Decontamination Technology Workshop, Presentations (1979)
- ⁴²⁰ GEND-034, Gross Decontamination Experiment Report (1983)
- ⁴²¹ Lazo, E. N., The Three Mile Island Unit 2 Reactor Building Gross Decontamination Experiment: Effects on Loose Surface Contamination Levels," Nuclear Technology, Vol. 87, No. 2, pp. 407-420, October 1989.
- ⁴²² NUREGCR-3381, Evaluation of the TMI-2 Reactor Building Decontamination Process (1983)
- ⁴²³ EPRI, "The Cleanup of Three Mile Island Unit 2, A Technical History: 1979 to 1990," EPRI-NP-6931, September 1990
- ⁴²⁴ Ruhter, P.E., and W.G. Zurliene, "Radiological Conditions and Experiences in the Three Mile Island Unit 2 Auxiliary Building," *Nuclear Technology*, Vol. 87, No. 2, pp. 361-366, October 1989
- ⁴²⁵ 1984 NRC Annual Report (NUREG-1145, Vol. 1)
- ⁴²⁶ (1984-07-02) TMIPO Weekly
- ⁴²⁷ (2013-03-22) GPU, TMI-2 Update 9 of the Post-Defueling Monitored Storage Safety Analysis Report
- ⁴²⁸ EPRI, "The Cleanup of Three Mile Island Unit 2, A Technical History: 1979 to 1990," EPRI-NP-6931, September 1990
- ⁴²⁹ (1990-02-22) GPU, Defueling Completion Report, Final Submittal
- ⁴³⁰ EPRI, "The Cleanup of Three Mile Island Unit 2, A Technical History: 1979 to 1990," EPRI-NP-6931, September 1990

-
- ⁴³¹ (1993-12-28) OL Amend 48 (TS for PDMS)
- ⁴³² EGG-TMI-7489, TMI-2 Accident Scenario Update (1986)
- ⁴³³ (1990-02-22) GPU, Defueling Completion Report, Final Submittal
- ⁴³⁴ (1990-02-22) GPU, Defueling Completion Report, Final Submittal
- ⁴³⁵ Calhoun, G. L., "Fuel Removal Equipment for Three Mile Island," *Nuclear Technology*, Vol. 87, No. 3, pp. 587-594, November 1989
- ⁴³⁶ (1990-02-22) GPU, Defueling Completion Report, Final Submittal
- ⁴³⁷ (1990-02-22) GPU, Defueling Completion Report, Final Submittal
- ⁴³⁸ (1990-02-22) GPU, Defueling Completion Report, Final Submittal
- ⁴³⁹ (1990-02-22) GPU, Defueling Completion Report, Final Submittal
- ⁴⁴⁰ (1990-02-22) GPU, Defueling Completion Report, Final Submittal
- ⁴⁴¹ (1990-02-22) GPU, Defueling Completion Report, Final Submittal
- ⁴⁴² (1990-02-22) GPU, Defueling Completion Report, Final Submittal
- ⁴⁴³ (1990-02-22) GPU, Defueling Completion Report, Final Submittal
- ⁴⁴⁴ (1990-02-22) GPU, Defueling Completion Report, Final Submittal
- ⁴⁴⁵ (1985-05-07) NRC Safety Evaluation, Lifting, Transfer, and Storage of Plenum Assembly (re various letters)
- ⁴⁴⁶ (1985-05-01) GPU Safety Evaluation, Plenum Removal and Transfer, Rev. 3
- ⁴⁴⁷ (1984-11-27) NRC Safety Evaluation, Initial Plenum Lift (re various letters)
- ⁴⁴⁸ (1984-03-09) GPU Safety Evaluation, Head Removal, Rev. 5
- ⁴⁴⁹ GEND-044, TMI-2 Reactor Vessel Head Removal (1985)
- ⁴⁵⁰ 1984 NRC Annual Report (NUREG-1145, Vol. 1)
- ⁴⁵¹ GEND-044, TMI-2 Reactor Vessel Head Removal (1985)
- ⁴⁵² (1984-03-09) GPU Safety Evaluation, Head Removal, Rev. 5
- ⁴⁵³ (1984-07-09) TMIPO Weekly
- ⁴⁵⁴ GEND-044, TMI-2 Reactor Vessel Head Removal (1985)
- ⁴⁵⁵ GEND-044, TMI-2 Reactor Vessel Head Removal (1985)
- ⁴⁵⁶ GEND-044, TMI-2 Reactor Vessel Head Removal (1985)
- ⁴⁵⁷ GEND-054, TMI-2 Reactor Vessel Plenum Final Lift (1986)
- ⁴⁵⁸ (1984-02-17) NRC, Directors Decision Under 10 CFR 2.206 Regarding Pyrophoric Reaction of Zirconium Fines
- ⁴⁵⁹ (1984-02-17) NRC, Directors Decision Under 10 CFR 2.206 Regarding Pyrophoric Reaction of Zirconium Fines
- ⁴⁶⁰ Osgood, N.L., et al., "Review of Radiation Shielding Concerns Associated with the Three Mile Island Unit 2 Defueling Systems," *Nuclear Technology*, Vol. 87, No. 2, pp. 556-56, October 1989
- ⁴⁶¹ Calhoun, G.L., "Fuel Removal Equipment for Three Mile Island," *Nuclear Technology*, Vol. 87, No. 3, pp. 587-594, November 1989
- ⁴⁶² GEND-INF-065, TMI-2 Defueling System Design Description (1985)
- ⁴⁶³ (2014-03-25) Text, TMI-2 35th Anniversary Presentation (GSkillman)
- ⁴⁶⁴ Calhoun, G. L., "Fuel Removal Equipment for Three Mile Island," *Nuclear Technology*, Vol. 87, No. 3, pp. 587-594, November 1989
- ⁴⁶⁵ (1986-05-15) GPU Safety Evaluation, Defueling SER, Rev. 10
- ⁴⁶⁶ GEND-INF-073, TMI-2 Defueling Tools Engineering Report (1986-02)
- ⁴⁶⁷ (1986-02-06) NRC Review, Use of Hydraulic Cutoff Saw (re 02-03-1986)
- ⁴⁶⁸ (1986-02-03) GPU, Plan to Use Hydraulic Cutoff Saw for Sizing Operations in the Reactor Vessel
- ⁴⁶⁹ (1986-06-04) NRC Safety Evaluation, Heavy Duty Tong Tool, Spade Bucket, Hydraulic Impact Chisel (re various letters)
- ⁴⁷⁰ (1986-01-22) GPU, Plan to Use Hydraulic Impact Chisel to Separate Fused Material

-
- 471 (1986-04-16) NRC Review, Use of Hydraulic Shredder
- 472 (1986-03-26) GPU, Plan to Use Hydraulic Shredder to Reduce Core Debris
- 473 (1986-05-15) GPU Safety Evaluation, Defueling SER, Rev. 10
- 474 (1986-10-16) NRC Safety Evaluation, Core Bore Operations (re 09-18-1986)
- 475 (1986-09-19) GPU, Core Bore Operations
- 476 GEND-INF-093, Lower Core Support Assembly Defueling Planning and Tools (1988)
- 477 (1988-03-25) NRC Review, Use of Core Bore Machine for Dismantling Lower Core Support Assembly (re various letters)
- 478 (1988-03-25) GPU, Use of Core Bore Machine for Dismantling the Lower Core Support Assembly Defueling
- 479 (1985-12-31) GPU Safety Evaluation, Core Stratification Sample Acquisition, Rev. 3
- 480 (1985-09-10) GPU Technical Evaluation, Defueling Canister TER (re 08-15-1985)
- 481 (1985-11-05) NRC Safety Evaluation, Defueling Canisters (re various letters)
- 482 Abbate, C.M., and J.W. Craig, "U.S. Nuclear Regulatory Commission Inspection of Transportation Casks," *Nuclear Technology*, Vol. 87, No. 4, pp. 755-758, December 1989.
- 483 (1985-09-10) GPU Technical Evaluation, Defueling Canister TER (re 08-15-1985)
- 484 Calhoun, G.L., "Fuel Removal Equipment for Three Mile Island," *Nuclear Technology*, Vol. 87, No. 3, pp. 587-594, November 1989
- 485 (1985-09-10) GPU Technical Evaluation, Defueling Canister TER (re 08-15-1985)
- 486 (1985-09-10) GPU Technical Evaluation, Defueling Canister TER (re 08-15-1985)
- 487 GEND-INF-065, TMI-2 Defueling System Design Description (1985-03)
- 488 (1986-05-15) GPU Safety Evaluation, Defueling SER, Rev. 10
- 489 (1986-01-06) TMIPO Weekly
- 490 International Atomic Energy Agency, Catalogue of Methods, Tools and Techniques for Recovery from Fuel Damage Events, IAEA-TECDOC-627, October 1991
- 491 International Atomic Energy Agency, Catalogue of Methods, Tools and Techniques for Recovery from Fuel Damage Events, IAEA-TECDOC-627, October 1991
- 492 International Atomic Energy Agency, Catalogue of Methods, Tools and Techniques for Recovery from Fuel Damage Events, IAEA-TECDOC-627, October 1991
- 493 (1986-05-15) GPU Safety Evaluation, Defueling SER, Rev. 10
- 494 (1986-05-15) GPU Safety Evaluation, Defueling SER, Rev. 10
- 495 (1986-05-29) GPU Technical Evaluation, Fuel Canister Storage Racks, Rev. 1
- 496 (1986-09-16) NRC Review, Fuel Canister Storage Racks TER (re various letters)
- 497 (1986-05-15) GPU Safety Evaluation, Defueling SER, Rev. 10
- 498 (1986-05-15) GPU Safety Evaluation, Defueling SER, Rev. 10
- 499 (1986-05-15) GPU Safety Evaluation, Defueling SER, Rev. 10
- 500 (1990-02-22) GPU, Defueling Completion Report, Final Submittal
- 501 (1984-12-04) NRC Safety Evaluation, Containment Air Control Envelope Design (re 07-22-1983, 10-30-1984)
- 502 (1984-10-30) GPU Technical Evaluation, Containment Air Control Envelope Design Criteria (Rev. 4), TER (Rev. 2)
- 503 EPRI, "The Cleanup of Three Mile Island Unit 2, A Technical History: 1979 to 1990," EPRI-NP-6931, September 1990
- 504 (1990-02-22) GPU, Defueling Completion Report, Final Submittal
- 505 (1985-10-29) NRC Safety Evaluation, Commencement of TMI-2 Preliminary Defueling Operations (re 10-24-1985)
- 506 (1985-10-24) GPU, Commencement of Preliminary Defueling Operations
- 507 (1985-11-04) TMIPO Weekly
- 508 (1985-11-12) NRC Safety Evaluation, Early Defueling of the TMI-2 Reactor Vessel (10-10-1985)

-
- 509 (1985-10-10) GPU Safety Evaluation, Early Defueling of the TMI-2 Reactor Vessel, Rev. 4
- 510 (1985-11-18) TMIPO Weekly
- 511 (1986-01-13) TMIPO Weekly
- 512 (1986-05-15) GPU Safety Evaluation, Defueling SER, Rev. 10
- 513 (1986-05-20) GPU Safety Evaluation, Defueling SER, Rev. 10 (Correction)
- 514 (1986-08-14) NRC Review, Defueling Safety Evaluation Report, Rev. 10 (re 05-15, 07-24, 02-21-1986)
- 515 (1986-07-23) GPU, Plan to Use Core Bore Tooling as Defueling Tool
- 516 (1986-07-24) NRC Review, Core Region Bulk Defueling Operations Limited to the Core Region (re 05-15, 07-23-1986)
- 517 (1986-10-20) TMIPO Weekly
- 518 (1986-11-17) TMIPO Weekly
- 519 (1990-02-22) GPU, Defueling Completion Report, Final Submittal
- 520 (1990-02-22) GPU, Defueling Completion Report, Final Submittal
- 521 Porter, L.H., and E.E. Austin, "Disassembly and Defueling of the Three Mile Island Unit 2 Reactor Vessel Lower Core Support Assembly," *Nuclear Technology*, Vol. 87, No. 3, pp. 587-594, November 1989
- 522 (1988-04-01) NRC Safety Evaluation, Lower Core Support Assembly Defueling (re 01-18-1988)
- 523 (1988-01-18) GPU Safety Evaluation, Lower Core Support Assembly Defueling, Rev. 2
- 524 (1990-02-22) GPU, Defueling Completion Report, Final Submittal
- 525 (1989-04-04) NRC Safety Evaluation, Completion of Upper Core Support Assembly Defueling (re 9-15-1988)
- 526 (1988-09-15) GPU Safety Evaluation, Completion of Upper Support Core Assembly Defueling, Rev. 0
- 527 (1990-02-22) GPU, Defueling Completion Report, Final Submittal
- 528 (1988-12-01) NRC Safety Evaluation, Lower Core Support and Lower Head Defueling (re 06-06-1988)
- 529 (1988-06-06) GPU Safety Evaluation, Completion of Lower Core Support and Lower Head Defueling, Rev. 0
- 530 (1988-06-27) GPU Safety Evaluation, Completion of Lower Core Support and Lower Head Defueling, Rev. 1
- 531 (1990-02-22) GPU, Defueling Completion Report, Final Submittal
- 532 (1990-02-22) GPU, Defueling Completion Report, Final Submittal
- 533 1990 NRC Annual Report (NUREG-1145, Vol. 7)
- 534 (1990-02-22) GPU, Defueling Completion Report, Final Submittal
- 535 (1990-02-22) GPU, Defueling Completion Report, Final Submittal
- 536 EPRI, "The Cleanup of Three Mile Island Unit 2, A Technical History: 1979 to 1990," EPRI-NP-6931, September 1990
- 537 (1990-02-22) GPU, Defueling Completion Report, Final Submittal
- 538 (1987-08-28) GPU Safety Analysis, Pressurizer Defueling System, Rev. 4
- 539 (1987-10-21) NRC Review, Pressurizer Defueling System, Rev. 4 (re 08-28, 10-13-1987)
- 540 EPRI, "The Cleanup of Three Mile Island Unit 2, A Technical History: 1979 to 1990," EPRI-NP-6931, September 1990
- 541 (1990-02-22) GPU, Defueling Completion Report, Final Submittal
- 542 (1990-02-22) GPU, Defueling Completion Report, Final Submittal
- 543 (1990-02-22) GPU, Defueling Completion Report, Final Submittal
- 544 EPRI, "The Cleanup of Three Mile Island Unit 2, A Technical History: 1979 to 1990," EPRI-NP-6931, September 1990

-
- ⁵⁴⁵ (1990-02-22) GPU, Defueling Completion Report, Final Submittal
- ⁵⁴⁶ DOE-ID-10400, Historical Summary of the TMI-2 Core Debris Transportation Campaign (1993)
- ⁵⁴⁷ (1986-06-20) NRC Safety Evaluation, Canister Handling and Preparation for Shipment Program (re 02-17, 06-11-1986)
- ⁵⁴⁸ (1986-06-11) GPU Safety Evaluation, Canister Handling and Preparation for Shipment SER
- ⁵⁴⁹ (1986-06-11) GPU Safety Evaluation, Canister Handling and Preparation for Shipment SER
- ⁵⁵⁰ PNO-TMI-87-02
- ⁵⁵¹ DOE-ID-10400, Historical Summary of the TMI-2 Core Debris Transportation Campaign (1993-03)
- ⁵⁵² INL-CON-12-26246 (CONF), Lessons from TMI Packaging, Transport and Disposition that Apply to Fukushima (2012)
- ⁵⁵³ INL-CON-12-26246 (CONF), Lessons from TMI Packaging, Transport and Disposition that Apply to Fukushima (2012-07)
- ⁵⁵⁴ DOE-ID-10739, Annual Radiological Environmental Monitoring Program Report for the TMI-2, ISFS Installation (2002-02)
- ⁵⁵⁵ (1986-12-02) GPU, Post-Defueling Monitored Storage Plan
- ⁵⁵⁶ (1992-02-20) NRC Technical Evaluation, Post Defueling Monitored Storage (re 02-20-1992)
- ⁵⁵⁷ (1987-03-11) GPU, Environmental Evaluation for TMI-2 PDMS
- ⁵⁵⁸ (1992-02-20) NRC Technical Evaluation, Post Defueling Monitored Storage (re 02-20-1992)
- ⁵⁵⁹ (1986-12-02) GPU, Post-Defueling Monitored Storage Plan
- ⁵⁶⁰ (1992-02-20) NRC Technical Evaluation, Post Defueling Monitored Storage (re 02-20-1992)
- ⁵⁶¹ (1993-09-14) Operating License Amendment 45 (Possession Only License)
- ⁵⁶² (1992-02-20) NRC Technical Evaluation, Post Defueling Monitored Storage (re 02-20-1992)
- ⁵⁶³ (2013-03-22) GPU, TMI-2 Update 9 of the Post-Defueling Monitored Storage Safety Analysis Report
- ⁵⁶⁴ (1992-02-20) NRC Technical Evaluation, Post Defueling Monitored Storage (re 02-20-1992)
- ⁵⁶⁵ (1992-02-20) NRC Technical Evaluation, Post Defueling Monitored Storage (re 02-20-1992)
- ⁵⁶⁶ (1992-01-23) GPU, Addition of Borosilicate Glass to the Reactor Vessel
- ⁵⁶⁷ (1992-02-20) NRC Technical Evaluation, Post Defueling Monitored Storage (re 02-20-1992)
- ⁵⁶⁸ (1992-02-20) NRC Technical Evaluation, Post Defueling Monitored Storage (re 02-20-1992)
- ⁵⁶⁹ (1992-02-20) NRC Technical Evaluation, Post Defueling Monitored Storage (re 02-20-1992)
- ⁵⁷⁰ (1992-02-20) NRC Technical Evaluation, Post Defueling Monitored Storage (re 02-20-1992)
- ⁵⁷¹ (1992-02-20) NRC Technical Evaluation, Post Defueling Monitored Storage (re 02-20-1992)
- ⁵⁷² (1992-02-20) NRC Safety Evaluation, Post Defueling Monitored Storage (re 02-20-1992)
- ⁵⁷³ (1990-02-22) GPU, Defueling Completion Report, Final Submittal
- ⁵⁷⁴ (1988-08-16) GPU, PDMS Proposed License Amendment and Safety Analysis Report (wo SAR) (re 12-02-1986)
- ⁵⁷⁵ (1990-02-22) GPU, Defueling Completion Report, Final Submittal
- ⁵⁷⁶ (1992-12-18) GPU, Criticality Safety Analysis for the Reactor Vessel
- ⁵⁷⁷ (1993-02-01) GPU, Post-Defueling Survey Report, Reactor Vessel
- ⁵⁷⁸ (1993-01-15) GPU, Proposed List of PDMS Requirements and Commitments (re 12-07-1992)
- ⁵⁷⁹ (1993-05-19) NRC Review, List of PDMS Requirements and Commitments (re 01-15-1993)
- ⁵⁸⁰ (1993-09-14) Operating License Amendment 45 (Possession Only License)
- ⁵⁸¹ (1988-08-16) GPU, PDMS Proposed License Amendment and Safety Analysis Report (wo SAR) (re 12-02-1986)
- ⁵⁸² (1992-02-20) NRC Safety Evaluation, Post Defueling Monitored Storage (re 02-20-1992)
- ⁵⁸³ (1994-11-04) NRC Review, Post-Defueling Survey Reports (PNL)

⁵⁸⁴ (1985-10-17) NRC Exempt, 30.51, 40.61, 70.51(d), 70.53 Regarding Reporting Core Special Material

⁵⁸⁵ (1993-02-01) GPU, Post-Defueling Survey Report, Reactor Vessel

⁵⁸⁶ (2013-03-22) GPU, TMI-2 Update 9 of the Post-Defueling Monitored Storage Safety Analysis Report

⁵⁸⁷ (2013-03-22) GPU, TMI-2 Update 9 of the Post-Defueling Monitored Storage Safety Analysis Report

⁵⁸⁸ (1988-09-30) GPU, Post-Defueling Survey Report, Plenum and Letdown Coolers (letter)

⁵⁸⁹ (1992-02-20) NRC Technical Evaluation, Post Defueling Monitored Storage (re 02-20-1992)

⁵⁹⁰ (1992-02-20) NRC Technical Evaluation, Post Defueling Monitored Storage (re 02-20-1992)

⁵⁹¹ (1992-02-20) NRC Technical Evaluation, Post Defueling Monitored Storage (re 02-20-1992)

⁵⁹² (1993-12-28) Operating License Amendment 48 (TS for PDMS)

⁵⁹³ (1992-02-20) NRC Safety Evaluation, Post Defueling Monitored Storage (re 02-20-1992)

⁵⁹⁴ (1993-12-28) Operating License Amendment 48 (TS for PDMS)

⁵⁹⁵ (1993-09-14) Operating License Amendment 45 (Possession Only License)

⁵⁹⁶ (1993-12-28) Operating License Amendment 48 (TS for PDMS)

⁵⁹⁷ 1988 NRC Annual Report (NUREG-1145, Vol. 5)

⁵⁹⁸ NUREG-0683, SUPP. 3, PEIS, Post-Defueling Storage and Cleanup (1989-08)

⁵⁹⁹ 1990 NRC Annual Report (NUREG-1145, Vol. 7)

⁶⁰⁰ (1990-04-20) GPU, Transition to Facility Mode 3

⁶⁰¹ (1990-04-26) NRC Review, Transitioning Plant from Mode 2 to Mode 3 on 4-27-1990 (re 04-12-1990)

⁶⁰² 1991 NRC Annual Report (NUREG-1145, Vol. 8)

⁶⁰³ 1992 NRC Annual Report (NUREG-1145, Vol. 9)

⁶⁰⁴ 1993 NRC Annual Report (NUREG-1145, Vol. 10)

⁶⁰⁵ (1993-12-28) Operating License Amendment 48 (TS for PDMS)

⁶⁰⁶ (1992-10-26) GPU, Discontinuation of TMI-2 Restart Punchlist

⁶⁰⁷ (1993-02-01) GPU, Post-Defueling Survey Report, Reactor Vessel

⁶⁰⁸ 1993 NRC Annual Report (NUREG-1145, Vol. 10)

⁶⁰⁹ (1993-09-14) Operating License Amendment 45 (Possession Only License)

⁶¹⁰ 1993 NRC Annual Report (NUREG-1145, Vol. 10)

⁶¹¹ (1993-07-06) NRC Safety Analysis, Reactor Vessel Criticality (re various letter)

⁶¹² (1993-09-14) Operating License Amendment 45 (Possession Only License)

⁶¹³ (1993-09-14) Operating License Amendment 45 (Possession Only License)

⁶¹⁴ (1993-11-12) GPU, Completed PDMS Requirements and Commitments (re various letters)

⁶¹⁵ (1993-11-12) GPU, Transition to PDMS

⁶¹⁶ (1993-12-28) Operating License Amendment 48 (TS for PDMS)

⁶¹⁷ (1993-12-28) Operating License Amendment 48 (TS for PDMS)

⁶¹⁸ (1993-12-28) Operating License Amendment 48 (TS for PDMS)

⁶¹⁹ Berkeley CA: University of California Press, 2004. Dr. Walker joined the NRC History Program in 1979 and retired as the NRC historian in 2010.

⁶²⁰ University Park, PA: Penn State Press, 2004. Dr. Baratta was appointed the Associate Chief Administrative Judge (Technical) on the NRC Atomic Safety and Licensing Board Panel in 2003 and retired in 2014.

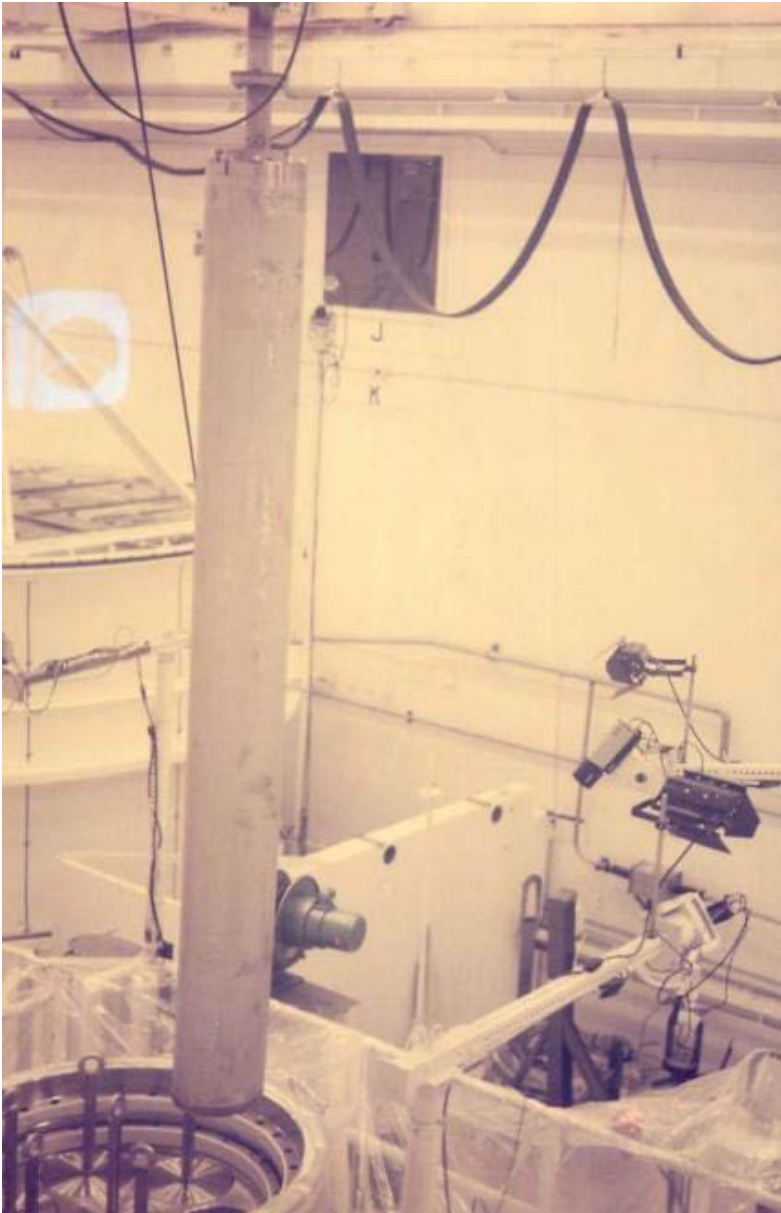

A loaded defueling canister being remotely lifted from the shipping cask at the INEL receiving facility. The 12.5-foot long canister was filled with water, placed in a storage module, and transferred to the storage pool for temporary storage at the INEL.

NRC FORM 335 (12-2010) NRCMD 3.7	U.S. NUCLEAR REGULATORY COMMISSION BIBLIOGRAPHIC DATA SHEET <i>(See instructions on the reverse)</i>	1. REPORT NUMBER <i>(Assigned by NRC, Add Vol., Supp., Rev., and Addendum Numbers, if any.)</i> NUREG/KM-0001, Supp. 1
2. TITLE AND SUBTITLE Three Mile Island Accident of 1979 Knowledge Management Digest, Recovery and Cleanup	3. DATE REPORT PUBLISHED	
	MONTH June	YEAR 2016
5. AUTHOR(S) Don Marksberry, RES/DRA Felix Gonzalez, RES/DRA Kenneth Hamburger, RES/DRA	6. TYPE OF REPORT Technical	
	7. PERIOD COVERED (Inclusive Dates) 1979-1993	
8. PERFORMING ORGANIZATION - NAME AND ADDRESS (If NRC, provide Division, Office or Region, U. S. Nuclear Regulatory Commission, and mailing address; if contractor, provide name and mailing address.) Division of Risk Analysis Office of Nuclear Regulatory Research U.S. Nuclear Regulatory Commission Washington, DC 20555-0001		
9. SPONSORING ORGANIZATION - NAME AND ADDRESS (If NRC, type "Same as above", if contractor, provide NRC Division, Office or Region, U. S. Nuclear Regulatory Commission, and mailing address.) Same as 8, above		
10. SUPPLEMENTARY NOTES Prepared in conjunction with several video presentations provided on a DVD. Three DVDs to this supplement provided separately.		
11. ABSTRACT (200 words or less) The accident at the Three Mile Island, Unit 2 (TMI-2) nuclear power plant was the most serious incident in U.S. commercial nuclear power history. The safe, expeditious recovery and cleanup of TMI 2, including removal of the fuel from the accident damaged reactor, were necessary for the long term protection of public health and safety and the environment. This knowledge management digest and supporting DVD contain the most important documents that the NRC, the licensee, and other government organizations issued following investigations and cleanup of the accident. The latest revision of NUREG/KM-0001 has evolved into two volumes. The first volume presents overviews of the accident: emergency response, investigations, regulatory implications, and accident recovery. The second volume (Supplement 1) expounds upon the technical details of recovery and cleanup activities: management and oversight, plant stabilization, worker protection, data acquisition and analysis, waste management, decontamination, defueling, and after defueling. The document collections are derived from correspondence between the utility and NRC, and from the results of research activities sponsored by the NRC and DOE. The accompanying DVDs contain over 120,000 pages in over 4,000 documents, over 500 photographs and diagrams, and three NRC video presentations about the accident and recovery activities. A HTML-based interactive feature is provided on the DVD to help you navigate through the historical records.		
12. KEY WORDS/DESCRIPTORS (List words or phrases that will assist researchers in locating the report.) Three Mile Island Unit 2 TMI-2 Knowledge Management Emergency Response Reactor Core Damage Accident Recovery Accident Cleanup	13. AVAILABILITY STATEMENT unlimited	
	14. SECURITY CLASSIFICATION <i>(This Page)</i> unclassified	
	<i>(This Report)</i> unclassified	
	15. NUMBER OF PAGES	
16. PRICE		

CONVERSIONS

Radiation Dose

1 mrem (1 millirem, 10^{-3}) = *10 microsieverts (10 μ Sv, 10^{-5})

100 mrem = *1 millisievert (1 MSv)

1 rem = *10 mSv

100 rem = *1 Sv

Radioactive Concentration

27 picocuries (27 pCi, 2.7×10^{-11}) = *1 becquerel (1 Bq)

1 millicurie (1 mCi, 0.001) = *37 megabecquerels (37 MBq, 3.7×10^7)

1 curie (1 Ci) = *37 gigabecquerels (37 GBq, 3.7×10^{10})

Radiation Absorbed Energy

1 roentgen = *0.877 rad = *0.00877 Gy

100 rad = *1 gray (Gy)

Length

1 inch (in) = *2.54 centimeters (cm)

1 foot (ft) = 0.3048 meter (m)

Volume and Weight

1 gallon (gal) = 3.7854 liters (l)

1 pound (lb) = 0.4536 kilograms (kg)

1 ton (U.S.) = *2000 lb = 907.1847 kg

Pressure

1 pound per square inch (psi) = 6.8948 kilopascals (kPa)

1 atmosphere (atm) = *101.325 kPa

Temperature

Degrees Celsius ($^{\circ}$ C) = $5/9 \times (^{\circ}$ F - 32)

Degrees Fahrenheit ($^{\circ}$ F) = $(9/5 \times ^{\circ}$ C) + 32

* Exact conversion factors



NUREG/KM-0001, Supplement 1

June 2016



©NRCgov

