

Impact of Variation in Environmental Conditions on the Thermal Performance of Dry Storage Casks

Final Report

Office of Nuclear Material Safety and Safeguards

Office of Nuclear Regulatory Research

AVAILABILITY OF REFERENCE MATERIALS IN NRC PUBLICATIONS

NRC Reference Material

As of November 1999, you may electronically access NUREG-series publications and other NRC records at NRC's Library at www.nrc.gov/reading-rm.html. Publicly released records include, to name a few, NUREG-series publications; *Federal Register* notices; applicant, licensee, and vendor documents and correspondence; NRC correspondence and internal memoranda; bulletins and information notices; inspection and investigative reports; licensee event reports; and Commission papers and their attachments.

NRC publications in the NUREG series, NRC regulations, and Title 10, "Energy," in the *Code of Federal Regulations* may also be purchased from one of these two sources.

1. The Superintendent of Documents

U.S. Government Publishing Office
Mail Stop IDCC
Washington, DC 20402-0001
Internet: bookstore.gpo.gov
Telephone: (202) 512-1800
Fax: (202) 512-2104

2. The National Technical Information Service

5301 Shawnee Rd., Alexandria, VA 22312-0002
www.ntis.gov
1-800-553-6847 or, locally, (703) 605-6000

A single copy of each NRC draft report for comment is available free, to the extent of supply, upon written request as follows:

Address: **U.S. Nuclear Regulatory Commission**
Office of Administration
Publications Branch
Washington, DC 20555-0001
E-mail: distribution.resource@nrc.gov
Facsimile: (301) 415-2289

Some publications in the NUREG series that are posted at NRC's Web site address www.nrc.gov/reading-rm/doc-collections/nuregs are updated periodically and may differ from the last printed version. Although references to material found on a Web site bear the date the material was accessed, the material available on the date cited may subsequently be removed from the site.

Non-NRC Reference Material

Documents available from public and special technical libraries include all open literature items, such as books, journal articles, transactions, *Federal Register* notices, Federal and State legislation, and congressional reports. Such documents as theses, dissertations, foreign reports and translations, and non-NRC conference proceedings may be purchased from their sponsoring organization.

Copies of industry codes and standards used in a substantive manner in the NRC regulatory process are maintained at—

The NRC Technical Library

Two White Flint North
11545 Rockville Pike
Rockville, MD 20852-2738

These standards are available in the library for reference use by the public. Codes and standards are usually copyrighted and may be purchased from the originating organization or, if they are American National Standards, from—

American National Standards Institute

11 West 42nd Street
New York, NY 10036-8002
www.ansi.org
(212) 642-4900

Legally binding regulatory requirements are stated only in laws; NRC regulations; licenses, including technical specifications; or orders, not in NUREG-series publications. The views expressed in contractor prepared publications in this series are not necessarily those of the NRC.

The NUREG series comprises (1) technical and administrative reports and books prepared by the staff (NUREG-XXXX) or agency contractors (NUREG/CR-XXXX), (2) proceedings of conferences (NUREG/CP-XXXX), (3) reports resulting from international agreements (NUREG/IA-XXXX), (4) brochures (NUREG/BR-XXXX), and (5) compilations of legal decisions and orders of the Commission and Atomic and Safety Licensing Boards and of Directors' decisions under Section 2.206 of NRC's regulations (NUREG-0750).

DISCLAIMER: Where the papers in these proceedings have been authored by contractors of the U.S. Government, neither the U.S. Government nor any agency thereof, nor any U.S. employee makes any warranty, expressed or implied, or assumes any legal liability or responsibility for any third party's use or the results of such use, of any information, apparatus, product, or process disclosed in these proceedings, or represents that its use by such third party would not infringe privately owned rights. The views expressed in these proceedings are not necessarily those of the U.S. Regulatory Commission.

Impact of Variation in Environmental Conditions on the Thermal Performance of Dry Storage Casks

Final Report

Manuscript Completed: December 2014
Date Published: March 2016

Prepared by:
Jorge Solis and Ghani Zigh

Office of Nuclear Material Safety and Safeguards

Office of Nuclear Regulatory Research

ABSTRACT

During the certification review of the underground long-term spent fuel dry storage cask design, the Office of Nuclear Material Safety and Safeguards (NMSS) and the Office of Nuclear Regulatory Research of the U.S. Nuclear Regulatory Commission (NRC), identified low-speed wind as an environmental factor that may affect the thermal performance of this type of design. This led NMSS to investigate the impact of wind and other environmental variables on the thermal performance of different spent fuel dry storage cask designs.

During normal conditions of storage, environmental variables, such as ambient temperature, solar heating, relative humidity, elevation, and wind speed and direction, may affect the thermal performance of a ventilated dry storage cask. The thermal evaluation of a dry storage cask generally assumes a set of fixed environmental factors (e.g., average annual ambient temperature, quiescent conditions, sea level) that will bound all sites in the continental United States. However, for some sites, using average values may not be adequate, because more adverse ambient conditions could exist for prolonged periods of time, allowing a storage system to reach new steady-state conditions that could result in higher spent fuel cladding temperatures as compared to the steady-state conditions analyzed in the cask's safety analysis report (SAR) for normal conditions of storage. For cases with predicted small thermal margin, these adverse ambient conditions could result in peak cladding temperatures exceeding recommended limits for normal conditions of storage.

This report evaluates the thermal impact of varying environmental conditions on spent fuel dry storage casks. In addition, the report investigated the transient thermal behavior of a dry storage cask when it is subjected to a sudden boundary condition change, starting from the bounding conditions described in the SAR.

The results showed that, for the underground cask design, the peak temperature in the fuel package region, represented by a homogenous composite of the gas region, the fuel, and the cladding (hereafter referred to as the peak cladding temperature (PCT)) increases for low-speed wind, as compared to quiescent conditions. The analysis also showed that the PCT starts to decrease at higher wind speeds. For vertical aboveground casks with four vents, the PCT decreased as wind speed increased. For a postulated two-air-vent vertical dry storage cask, when wind direction is normal to the air vents, the PCT decreased as the wind speed increased. When wind direction is parallel to the air vents of the two-air-vent cask, the PCT increased as the wind speed increased. For horizontal aboveground casks with air vents located on the side, the wind speed and direction did not have any significant effect on the thermal performance of the cask, as the vents are not located normal to wind. For horizontal aboveground casks with inlet vents located on the front, when wind direction is facing the front of the cask, the thermal performance of the cask was improved, but when wind direction was parallel to the cask front, no significant effect was observed.

The NRC staff should consider the analysis results in this report when performing technical reviews, applicants should consider them when applying for cask certification, and the technical reviewer should consider them for applicability to a specific design. The results can also be used as additional guidance when considering the thermal impact of the environmental factors in the thermal performance of spent fuel dry storage systems.

CONTENTS

ABSTRACT	iii
FIGURES	vii
TABLES	ix
ACRONYMS AND ABBREVIATIONS	xi
1.0 INTRODUCTION	1
1.1 Scope	1
1.2 Structure.....	2
2.0 ENVIRONMENTAL VARIABLES	3
2.1 Introduction.....	3
2.2 Ambient Temperature	3
2.3 Humidity	3
2.4 Elevation.....	3
2.5 Wind.....	4
2.6 Measured Factors.....	4
3.0 GEOMETRY AND METHOD OF ANALYSIS	5
3.1 Vertical Aboveground Designs.....	5
3.2 Vertical Underground Designs	5
3.3 Horizontal Aboveground Designs	5
3.4 Method of Analysis	6
4.0 ANALYZED CASES	7
4.1 Introduction.....	7
4.2 General Description of the Analyzed Casks	7
4.3 Three-Dimensional Cases	9
4.4 Axisymmetric Model.....	22
4.5 Flow Resistance	24
4.6 Material Properties	24
4.7 Analyzed Cases and Applied Boundary Conditions	25
4.7.1 Analyzed Three-Dimensional Cases	25
4.7.2 Applied Boundary Conditions for Three-Dimensional Analyses	25
4.7.3 Analyzed Axisymmetric Cases	26
4.7.4 Applied Boundary Conditions for the Axisymmetric Model.....	26
4.8 Discussion of Results	32
4.8.1 Wind Effect on the Underground Casks	33
4.8.2 Wind Effect on the Vertical Aboveground Casks	33
4.8.3 Wind Effect on the Horizontal Aboveground Casks	34
4.8.4 Aboveground Vertical Cask Axisymmetric Model	35
5.0 CONCLUSIONS	43
6.0 REFERENCES	45
APPENDIX A: EFFECTIVE THERMAL CONDUCTIVITY	A-1
APPENDIX B: FLOW RESISTANCE	B-1
APPENDIX C: PUBLIC COMMENTS RECEIVED AND THEIR DISPOSITION	C-1

FIGURES

4-1	Homogenization of the storage cell cross-section	11
4-2	Geometry and boundary conditions for HI-STORM 100 cask with four vents	12
4-3	Aboveground vertical cask with two vents (wind perpendicular to vents).....	13
4-4	Aboveground vertical cask with two vents (wind parallel to vents).....	14
4-5	Geometry and boundary conditions for the HI-STORM 100U cask.....	16
4-6	Geometry of the standardized NUHOMS cask	18
4-7	Standardized NUHOMS cask boundary conditions	19
4-8	Advanced NUHOMS cask with frontal and backward wind.....	20
4-9	Advanced NUHOMS cask with side wind	21
4-10	Homogenization of the MPC cross-section into an equivalent two-zone axisymmetric model	22
4-11	HI-STORM 100 axisymmetric model	23
4-12	Mesh generated for the air annular gap of the axisymmetric model.....	29

TABLES

2-1	Range of Environmental Variables	4
4-1	Three-Dimensional Cases Used To Study the Wind Effect	7
4-2	Axisymmetric Cases Used To Study Environmental Parameters	7
4-3	Decay Heat Values for Analyzed Casks	10
4-4	Thermo-Physical Properties of Materials Used in the Analyses.....	25
4-5	Mass Fraction Specified at Inlet Vent for Humidity Analyses.....	32
4-6	Effect of Wind Speed on Predicted PCT for HI-STORM 100U Cask.....	36
4-7	Effect of Wind Speed on Predicted PCT for HI-STORM 100 Cask with Four Vents	36
4-8	Effect of Wind Speed on Predicted PCT for HI-STORM 100 Cask with Two Vents (Wind Perpendicular to Air Vents)	36
4-9	Effect of Wind Speed on Predicted PCT for HI-STORM 100 Cask with Two Vents (Wind Parallel to Air Vents)	36
4-10	Effect of Wind Speed on Predicted PCT for Standardized NUHOMS Cask (Frontal Wind Direction)	37
4-11	Effect of Wind Speed on Predicted PCT for Standardized NUHOMS Cask (Side Wind Direction)	37
4-12	Effect of Wind Speed on Predicted PCT for Advanced NUHOMS Cask (Frontal Wind Direction)	37
4-13	Effect of Wind Speed on Predicted PCT for Advanced NUHOMS Cask (Back Wind Direction).....	37
4-14	Effect of Wind Speed on Predicted PCT for Advanced NUHOMS Cask (Side Wind Direction)	37
4-15	Transient PCT for Advanced NUHOMS Cask During Worst-Case Scenario (Back Wind Direction).....	38
4-16	Advanced NUHOMS Worst-Case Transient Scenario	38
4-17	Aboveground Vertical Cask with Two Vents—Transient Scenario.....	39
4-18	Aboveground Vertical Cask with Two Vents—Worst-Case Transient Scenario	39
4-19	Effect of Ambient Temperature on Predicted PCT (Steady-State Analysis).....	40
4-20	Transient PCT for the Effect of Ambient Temperature.....	40
4-21	Effect of Ambient Temperature on Predicted PCT (Transient Analysis)	40
4-22	Effect of Elevation on Predicted PCT (Steady-State Analysis)	40
4-23	Effect of Total Decay Heat on Predicted PCT (Steady-State Analysis).....	41
4-24	Effect of Humidity on Predicted PCT at Ambient Temperature of 300 K (Steady-State Analysis).....	41
4-25	Effect of Humidity on Predicted PCT at Ambient Temperature of 323 K (Steady-State Analysis).....	41
A-1	Spent Fuel Radial and Axial K_{eff} for the 3-D Model of the Aboveground Vertical Cask	A-1
A-2	Spent Fuel Radial and Axial K_{eff} for the 3-D Model of the Underground Vertical Cask	A-1
A-3	Spent Fuel Radial and Axial K_{eff} for the 3-D Model of the Horizontal Cask.....	A-2
A-4	Spent Fuel Axial and Radial K_{eff} for the Axisymmetric Model.....	A-2
B-1	Frictional Porous Media Flow Resistance Factors Used in ANSYS FLUENT	B-3

ACRONYMS AND ABBREVIATIONS

ASHRAE	American Society of Heating, Refrigerating and Air-Conditioning Engineers
ASME	American Society of Mechanical Engineers
BWR	boiling-water reactor
CEC	cavity enclosure container
CFD	computational fluid dynamics
CFR	<i>Code of Federal Regulations</i>
CPU	central processing unit
DO	discrete ordinates
DSC	dry-shielded canister
F	Fahrenheit
ft	feet
ISFSI	independent spent fuel storage installation
GTCC	greater than Class C
HSM	horizontal storage module
K	kelvin
kg	kilogram
km	kilometers
kW	kilowatt
m	meters
MPC	multi-purpose canister
NOAA	National Oceanic and Atmospheric Administration
NRC	U.S. Nuclear Regulatory Commission
NUHOMS	Nuclear Horizontal Modular Storage
PCT	peak cladding temperature
PWR	pressurized-water reactor
s	second
SAR	safety analysis report
SNF	spent nuclear fuel
SRP	Standard Review Plan
VVM	vertical-ventilated module
2-D	two-dimensional
3-D	three-dimensional

1.0 INTRODUCTION

The U.S. Nuclear Regulatory Commission (NRC) certifies spent fuel dry storage systems according to Title 10 of the *Code of Federal Regulations* (10 CFR) Part 72, "Licensing Requirements for the Independent Storage of Spent Nuclear Fuel, High-Level Radioactive Waste, and Reactor-Related Greater Than Class C (GTCC) Waste." The review guidance documented in "Standard Review Plan [SRP] for Spent Fuel Dry Storage Systems at a General License Facility," issued July 2010, requires a thermal evaluation for the spent fuel dry storage system to confirm that the spent fuel cladding temperatures will be maintained below recommended limits throughout the storage period, to protect the cladding against degradation that could lead to gross rupture. The thermal evaluation should identify the boundary conditions for normal, loading, off-normal, and accident conditions. The required boundary conditions include the external conditions on the cask. External ambient conditions that have a major effect on the cask's thermal performance include ambient temperature, solar heating, relative humidity, elevation, and wind speed and direction.

The cask's thermal evaluation generally assumes a set of fixed environmental factors (e.g., average annual ambient temperature, quiescent conditions, sea level) that will bound all sites in the continental United States. However, for some sites, using average values may not be adequate, because more adverse ambient conditions could exist for prolonged periods of time (for example, more than a month, as reported by the National Oceanic and Atmospheric Administration (NOAA) (NOAA Web site, www.noaa.gov) and the American Society of Heating, Refrigerating and Air-Conditioning Engineers (ASHRAE) (ASHRAE, 1997)), allowing a storage system to reach new steady-state conditions that could result in higher spent fuel cladding temperatures as compared to the steady-state conditions analyzed in the applicant's safety analysis report (SAR) for normal conditions of storage. For cases with small thermal margin, these adverse ambient conditions could result in peak cladding temperatures (PCTs) being higher than the SRP-recommended limits, which could create thermal conditions such that spent fuel could degrade and lead to gross rupture. The 10 CFR Part 72 licensing requirements mandate that storage systems be designed to allow ready retrieval of spent fuel, high-level radioactive waste, and reactor-related GTCC waste for further processing or disposal. Therefore, to comply with the applicable regulations for safe storage of spent nuclear fuel, the thermal design of a dry storage cask should demonstrate that temperatures are kept below recommended limits by considering all factors that may have an impact on the cask's thermal performance.

1.1 Scope

This document evaluates the thermal impact of varying environmental conditions on spent fuel dry storage casks. The primary goal is to examine the natural variation of the major environmental factors (ambient temperature, wind conditions, and elevation, among others) that could lead to higher spent fuel cladding temperatures as compared to the bounding thermal evaluation provided in SARs. The evaluation includes different designs to determine how the parameters considered in the evaluation affect the thermal performance of a specific design. The majority of dry storage casks that have been certified or are currently under review by the NRC include vertical and horizontal casks located aboveground and vertical underground casks (located mostly underground, except for the cask lid). Therefore, to include most of the certified designs, the study considered three casks: vertical aboveground, horizontal aboveground, and vertical underground.

1.2 Structure

This document begins with a definition of the various environmental factors that affect the cask's thermal performance and how these factors have been traditionally applied to perform the thermal evaluation of spent fuel dry storage systems. The report includes several references on the variation of these factors and how this variation affects the thermal performance of the storage systems.

This is followed by a description of the storage systems considered in the evaluation and the method of analysis used to perform the evaluation. Next, the analyzed cases are discussed, along with the results. The study concludes with recommendations on how to consider these environmental factors in the evaluation.

2.0 ENVIRONMENTAL VARIABLES

2.1 Introduction

Among the environmental variables that have a major effect on the thermal performance of a spent fuel storage system are ambient temperature, humidity, elevation, and wind magnitude and direction. Solar heating also has some effect and should be considered in the analysis. However, solar insolation values are well established and typical values are applied. NUREG-1536 states that, for storage casks, the NRC staff accepts a treatment of insolation similar to that prescribed in Title 10 of the *Code of Federal Regulations* (10 CFR) Part 71, "Packaging and Transportation of Radioactive Material," for transportation casks. Since the values specified in 10 CFR Part 71 are considered bounding, solar insolation is not considered in this study, and the investigation focuses only on the other factors (i.e., ambient temperature, humidity, elevation, and wind).

2.2 Ambient Temperature

Currently, the dry storage cask thermal evaluation includes maximum and minimum ambient temperatures as defined in the SRP (NUREG-1536, 2010). The SRP states that the NRC accepts, as the maximum and minimum "normal" temperatures, the highest and lowest ambient temperatures recorded in each year, averaged over the years of record. However, this definition does not consider seasonal variations that may result in higher maximum and minimum values. In this case, a monthly averaged value may be more appropriate for the hottest months (summer season). Measured monthly temperatures at some sites (ASHRAE, 1997) show that the annual average ambient temperature of 300 Kelvin (K) [80 degree (°) Fahrenheit (F)] could be easily exceeded for about 4 months. An ambient temperature of 300 K (80°F) is typically considered in the thermal evaluation for most of the dry casks certified by the NRC. However, the measured ambient temperatures suggest that, to bound all sites, the SAR thermal evaluation should consider seasonal variations since, during the hot months, the dry cask reaches a new steady state that the SAR has not analyzed. This study considered variations in the ambient temperature in the range of 300 to 322 K (80 to 120°F), which seems to envelope the natural variation of the ambient temperature during the hot season, according to measured data.

2.3 Humidity

Traditionally, the thermal evaluation for design certification assumes dry air, which is conservative, since humidity will increase the air heat capacity. Therefore, this study considers relative humidity in the range of 0 to 90 percent for ambient temperatures of 300 and 323 K (80 and 120°F). However, high relative humidity values do not seem to persist for the prolonged periods of time necessary for the dry cask to reach a new steady state. Therefore, this study assumes that dry air will continue to be an adequate approach, a slightly conservative assumption, as demonstrated in this evaluation.

2.4 Elevation

The thermal evaluation of dry storage casks currently assumes that the cask is located at sea level. However, the location of the dry storage cask site may have an impact on the operating pressure used to calculate the air density at the inlet vents. This, in turn, will have a direct

impact on the calculated PCT. This study considers site location in the range of 0 to 1500 meters (m) (4921.5 ft)

2.5 Wind

The thermal evaluation of dry storage casks currently assumes quiescent conditions. However, when performing the technical review of an underground dry storage cask, the staff noticed that low-speed wind [2.235 m/s (5 mph)] has a negative effect on the cask’s thermal performance, as compared to quiescent conditions. Therefore, low-speed wind is considered in this study in the range of 0 to 6.706 m/s (15 mph). Reported measured values by NOAA (NOAA, www.noaa.gov) show that low-speed wind could exist for the prolonged periods of time necessary for a dry storage cask to reach a new steady state. The study considers both aboveground and underground designs and, for aboveground designs, it includes vertical and horizontal orientations to determine how low wind speed affects the thermal performance of these casks.

2.6 Measured Factors

The magnitude of the environmental variables was selected using available data from NOAA and *ASHRAE Handbook Fundamentals* (ASHRAE, 1997). Table 2-1 shows the range of the environmental variables used to investigate the effect of these factors on the thermal performance of the dry storage cask. The effect of decay heat on the dry storage cask’s thermal response was also investigated, using heat sources in the range of 22 to 34 kilowatts (kW) for a specific vertical cask, as described later in this report.

Table 2-1 Range of Environmental Variables

Environmental Variable	Range
Wind Speed m/s (mph)	0–6.706 (0–15)
Ambient Temperature K (°F)	300–322 (80–120)
Humidity (%) at Ambient Temperature of 300 K (80°F)	0–90
Humidity (%) at Ambient Temperature of 323 K (120°F)	0–90
Elevation m (ft)	0–1500 (0–4921.5)

3.0 GEOMETRY AND METHOD OF ANALYSIS

3.1 Vertical Aboveground Designs

In a vertical-ventilated aboveground spent fuel storage cask design, a spent fuel canister is typically stored in a concrete overpack, with the canister bottom resting on some type of base normal to the ground. Air vents are located in the bottom and top of the overpack, so air can flow freely through the gap between the canister and the overpack to cool the canister's outer surface, thus keeping the cladding temperature below Standard Review Plan (SRP)-recommended limits (NUREG-1536, 2010). Since the inlet and outlet air vents are separated by the cask's height, thermal mixing due to low-speed wind may not have an impact on the cask's thermal performance because of the physical separation of the air vents. This separation will prevent hot air coming from the outlet vents to mix with the cooler air at the bottom of the cask. Also, hot air coming out of the outlet vents will tend to flow up into the ambient air surrounding the cask. However, low-speed wind could block the air vents, which could have an impact on the cooling effect by reducing the mass flow rate through the annular gap. Therefore, this study includes this cask to determine the effect of other environmental factors and to conclusively determine how low-speed wind affects this design.

3.2 Vertical Underground Designs

In an underground design, the canister is stored inside some type of enclosure that is buried almost entirely, except for the overpack lid, which is located aboveground and includes the air vents. In this design, air needs to flow downwards into the enclosure container and then upwards in contact with the canister's outer shell. Decay heat from the spent fuel assemblies stored in the canister is thus dissipated through the canister's outer wall by a combination of convection, radiation, and conduction to flowing air. Finally, hot air exits through the outlet vent, which is located on top of the cask lid. For this design, the inlet and outlet vents are located in proximity to each other. These design features represent a challenge from the analysis point of view since, in addition to the typical environmental factors used in the thermal evaluation (e.g., ambient temperature, ambient pressure), the analysis must include other factors such as low wind speed. This increases both the complexity and the computational times, since usually three-dimensional (3-D) thermal models are needed to properly capture the heat transfer and flow characteristics of this design.

3.3 Horizontal Aboveground Designs

In a horizontal spent fuel storage cask, a spent fuel canister is typically stored in a concrete overpack with the canister side resting on some type of base, normal to the ground. Inlet vents are located on the front or side of the bottom of the overpack. Outlet vents are located on the top side of the overpack or on the roof. Decay heat from the spent fuel assemblies stored in the canister is thus dissipated through the canister's outer wall by a combination of convection, radiation, and conduction to flowing air.

The heat transfer characteristics of these designs are almost identical, except for the vertical configuration, where convection heat transfer inside the canister plays an important role, especially for pressurized canisters. Since the geometry is different for the three designs, some of the environmental variables (especially low-speed wind) will affect the thermal performance in a different manner (due to the design and location of the air vents).

3.4 Method of Analysis

The analysis used computational fluid dynamics (CFD) methods, using the ANSYS FLUENT software as the primary analytical tool. ANSYS FLUENT (Fluent, 2006) is a CFD code that solves the governing equations for the conservation of mass and momentum and (when necessary) for energy and other scalar quantities, such as turbulence and chemical species concentrations. ANSYS FLUENT uses a control-volume-based technique to convert a general scalar transport equation to an algebraic equation that is solved numerically. The following steps are used to solve the algebraic equations:

- (a) division of the domain into discrete control volumes using a computational grid
- (b) integration of the governing equations on the individual control volumes to construct algebraic equations for the discrete dependent variables (“unknowns”), such as velocities, pressure, temperature, and conserved scalars
- (c) linearization of the discretized equations and solution of the resultant linear equation system to yield updated values of the dependent variables

Two-dimensional (2-D) and 3-D thermal models can be built and a solution obtained using the ANSYS FLUENT CFD code. This study considered both 2-D axisymmetric and 3-D thermal models to study the impact of a variety of environmental conditions on the thermal performance of spent fuel dry storage casks. Wind studies used both axisymmetric and 3-D thermal models to perform both steady-state and transient analyses. For the other environmental parameters, only axisymmetric steady-state and transient analyses were applied to reduce the central processing unit (CPU) time to perform the analyses. Chapter 4 contains specific details of the developed thermal models used in this evaluation.

4.0 ANALYZED CASES

4.1 Introduction

The NRC developed two types of thermal models to study the environmental variables: a 3-D model for the wind study and a 2-D axisymmetric model to study the effect of the other parameters. Table 4-1 shows the cask systems selected to analyze the effect of wind on the dry storage cask's thermal performance. Table 4-2 shows the 2-D axisymmetric cases used to investigate the effect of humidity, ambient temperature, altitude, decay heat, and wind. In this study, the axisymmetric model is a representation of an aboveground vertical storage system.

Table 4-1 Three-Dimensional Cases Used To Study the Wind Effect

Orientation	Location	Dimensions	Mode of Analysis
Vertical (HI-STORM 100)	Aboveground	3-D	Steady
Vertical (HI-STORM 100U)	Underground	3-D	Steady
Horizontal (Standardized NUHOMS)	Aboveground	3-D	Steady
Horizontal (Advanced NUHOMS)	Aboveground	3-D	Steady & Transient

Table 4-2 Axisymmetric Cases Used To Study Environmental Parameters

Variable	Dimensions	Mode of Analysis
Ambient Temperature	2-D	Steady & Transient
Humidity	2-D	Steady
Altitude	2-D	Steady
Heat load	2-D	Steady
Wind	2-D	Transient

4.2 General Description of the Analyzed Casks

Three different spent fuel dry cask designs, HI-STORM 100, HI-STORM 100U, and NUHOMS, were selected to develop the thermal models used in this study. These casks cover the variety of designs to determine the effect of different environmental factors, especially the effect of wind. These designs also cover the different geometries of interest (i.e., vertical, horizontal, aboveground, and underground designs). The analysis results can be used to evaluate similar designs (e.g., vertical orientation, number of air vents). The environmental factors considered in this study affect all storage systems, and low-speed wind only affects ventilated storage

systems because of the presence of discrete vents, in the case of aboveground designs, or blockage of the air vents and the proximity of the inlet and outlet vents, in the case of underground designs.

HI-STORM 100

The HI-STORM 100 (Holtec Storage and Transfer Operation Reinforced Module) spent fuel cask storage system consists of a sealed canister positioned inside a vertical ventilated storage overpack (Holtec International, 2005). Four inlet and outlet ducts that allow for air cooling of the stored multipurpose canister (MPC) are located at the bottom and top, respectively, of the storage overpack. The spent nuclear fuel (SNF) assemblies are located inside the MPC, which is sealed with a welded lid to form the confinement boundary. The MPC contains an all-alloy honeycomb basket structure with square-shaped compartments of appropriate dimensions to allow insertion of the spent fuel assemblies before welding the MPC. The MPC basket designs are designated as MPC-32 (for holding up to 32 pressurized-water reactor (PWR) spent fuel assemblies), MPC-24 (for holding up to 24 PWR spent fuel assemblies) and MPC-68 (for holding up to 68 boiling-water reactor (BWR) spent fuel assemblies). After vacuum drying, the MPC is backfilled with helium to provide a stable, inert environment for long-term storage of the SNF. The helium gas fills all the space between the solid components and provides an improved conduction medium for dissipating decay heat in the MPC. During normal storage conditions in the HI-STORM 100 storage system, heat is rejected from the SNF to the environment by passive heat transfer mechanisms only.

HI-STORM 100U

The HI-STORM 100U spent fuel storage system (Holtec International, 2007) uses an underground vertical-ventilated module (VVM) designed to accept all MPC models (e.g., MPC-24, MPC-32) for storage at an independent spent fuel storage installation (ISFSI). The VVM provides for storage of MPCs in a vertical configuration inside a subterranean cylindrical cavity entirely below the top-of-the-grade of the ISFSI. The MPC storage cavity is defined by the cavity enclosure container (CEC), consisting of the container shell integrally welded to the bottom plate. The top of the container shell is stiffened by the container flange (a ring-shaped flange) that is also integrally welded. All of the constituent parts of the CEC are made of thick low-carbon steel plate. In its installed configuration, the CEC is interfaced with the surrounding subgrade for most of its height, except for the top region, where it is girdled by the top ISFSI pad. The cylindrical surface of the divider shell is equipped with insulation to ensure that the heated air streaming up around the MPC in the inner coolant air space causes minimal preheating of the air streaming down the intake plenum. After vacuum drying, the MPC is backfilled with helium to provide a stable, inert environment for long-term storage of the SNF. In the HI-STORM 100U system, heat is rejected from the SNF to the environment by passive heat transfer mechanisms only. Air intake and outlet vents are located on the cask lid. The VVM is engineered for outdoor below-grade storage for the duration of its design life, and it is designed to withstand normal, off-normal, and extreme environmental phenomena as well as accident storage conditions.

STANDARDIZED AND ADVANCED NUHOMS

The standardized and advanced horizontal storage module (HSM), the NUHOMS (Nuclear Horizontal Modular Storage) spent fuel storage system, provides for the horizontal storage of

irradiated fuel in a dry-shielded canister (DSC) that is placed in a concrete horizontal storage module (Transnuclear, Inc., 2006, 2008). Decay heat is removed from the spent fuel by conduction and radiation within the DSC and by convection and radiation from the surface of the DSC. The natural circulation flow of air through the HSM and the conduction of heat through concrete provide the mechanisms of heat removal from the HSM.

Spent fuel assemblies are loaded into the DSC while it is inside a transfer cask in the spent fuel pool at the reactor site. The transfer cask containing the loaded DSC is removed from the pool, dried, purged, backfilled with helium, and sealed. The loaded DSC inside the transfer cask is moved to the HSM, where it is pushed into the HSM by a horizontal hydraulic ram. The DSC is constructed from stainless-steel plates and contains a basket consisting of a number of square cells in either the PWR or the BWR design. An intact spent fuel assembly is loaded into each cell yielding a capacity of 24, 32, and 37 PWR or 52, 61, and 69 BWR spent fuel assemblies per DSC. Spacer disks are used for structural support. The DSC has double seal welds at each end and rests on two steel rails when placed in the HSM.

The HSM is constructed from reinforced concrete, carbon steel, and stainless steel. Passageways for air flow through the HSM are designed to minimize the escape of radiation from the HSM but also to permit adequate cooling air flow. Decay heat from the spent fuel assemblies within the canister is removed from the DSC by natural draft convection and radiation. Air enters along the bottom of each side of the HSM, flows around the canister, and exits through flow channels along the top sides of the module. Heat is also radiated from the DSC to the inner surface of the HSM walls where, again, natural convection air flow removes the heat. Some heat is also removed by conduction through the concrete.

The horizontal NUHOMS casks are designed to passively remove heat from the DSC by natural circulation of airflow through the cask. The NUHOMS casks are located on a reinforced concrete pad and fastened to adjacent HSM casks. For design-basis seismic events, a minimum of three casks must be fastened together. In the analysis, the main difference between the two types of NUHOMS horizontal casks is the placement of the vents and the airflow path inside the cask. The standardized NUHOMS cask has two inlet vents on both sides at the bottom of the cask and two outlet vents on both sides at the top. The Advanced HSM has one inlet air vent at the bottom on the front of the cask and one outlet air vent on the roof of the cask.

4.3 Three-Dimensional Cases

For long-term storage conditions, the cask's thermal evaluation follows the guidelines of NUREG-1536, with the canister cavity backfilled with helium. Thermal analysis results for the long-term storage scenarios and short-term transient conditions are obtained and presented in this report, focusing on the effect of varying environmental conditions on the thermal performance of the spent fuel dry storage cask. The boundary condition used to represent wind is located at an adequate distance to prevent any interference with the cask vents and walls. The distance of the velocity and pressure boundaries is carefully selected to obtain physically meaningful results. If these boundaries are too close to the cask boundaries (external walls, air vents), unrealistic air velocities would be developed, which would affect the analysis results (American Society of Mechanical Engineers (ASME), "Standard for Verification and Validation in Computational Fluid Dynamics and Heat Transfer," 2009).

HI-STORM 100

The MPC basket that holds the spent fuel assemblies is a matrix of interconnected square compartments designed to hold the spent fuel assemblies in a vertical position under long-term storage conditions. The basket is a honeycomb structure of stainless-steel plates with full-length welded intersections to form an integral basket configuration. All individual cell walls, except outer periphery cell walls, are provided with neutron absorber plates sandwiched between the box wall and a stainless-steel sheathing plate over the full length of the active spent fuel region. The neutron absorber plates used in all MPCs are made of an aluminum-based material containing boron carbide to provide criticality control while maximizing heat conduction capabilities. Heat generation in the MPC is axially nonuniform because of nonuniform axial burnup profiles in the spent fuel assemblies. Table 4-3 shows the design-basis decay heat for long-term normal storage for the analyzed casks. The decay heat is conservatively considered to be nonuniformly distributed over the active spent fuel length, based on a prescribed axial burnup distribution.

Table 4-3 Decay Heat Values for Analyzed Casks

Cask Type	Decay Heat (kW)
HI-STORM 100	34
HI-STORM 100U	36.9
Standardized NUHOMS	24
Advanced NUHOMS	24

The thermal analysis used two different thermal models: a half-symmetry 3-D model and a 2-D axisymmetric model. Both models use porous media to represent the flow through the spent fuel rods. Porous media are used to represent the spent fuel assembly in the 3-D model, as shown in Figure 4-1. Flow resistance factors that characterize the spent fuel regions are obtained from separate calculations using CFD. These calculations include all important features that contribute to flow resistance (e.g., spent fuel rods, spacers, water rods). Other than representing the spent fuel assemblies using porous media, the 3-D model explicitly represents all major components (e.g., spent fuel basket, helium inside the cavity, MPC shell, air gap between the MPC shell and overpack, concrete overpack). Figures 4-2, 4-3, and 4-4 show the model graphically. The two-vent 3-D thermal model is identical to the four-vent model, except for the number of vents.

Thermal analysis results from a 3-D model were used to evaluate the effect of wind on the different cask configurations, as shown in Table 4-1. The analyses considered wind velocities varying between 0 and 6.706 m/s (0 and 15 mph). The analyses also considered bounding wind directions for wind approaching the air vents (e.g., parallel to vent, normal to vent). For the 0 m/s wind case that represents normal quiescent conditions, the pressure boundary was specified all around the dry storage cask control volume. For nonquiescent conditions (low-speed wind), inlet velocity [varying between 0 and 6.706 m/s (0 and 15 mph)] was applied on the wind side and pressure boundary on the opposite side.

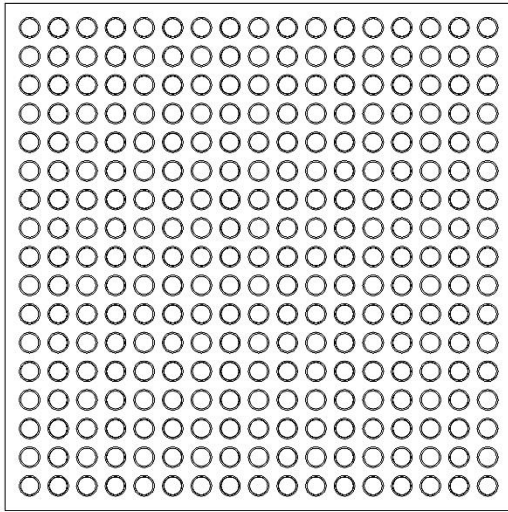

(a) Detailed spent fuel cell



(b) Homogenized cross-section

Figure 4-1 Homogenization of the storage cell cross-section

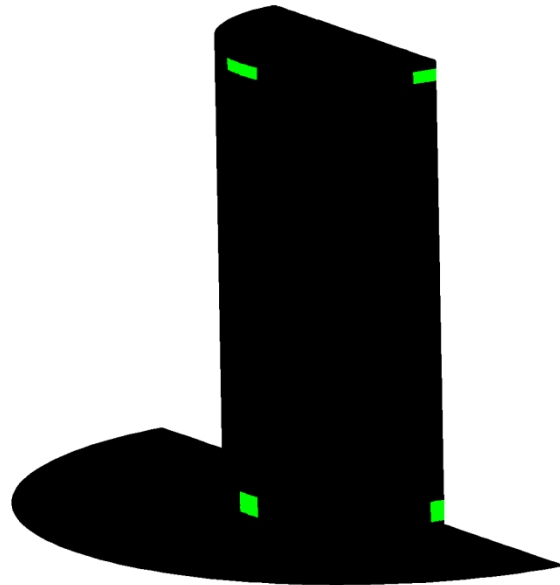
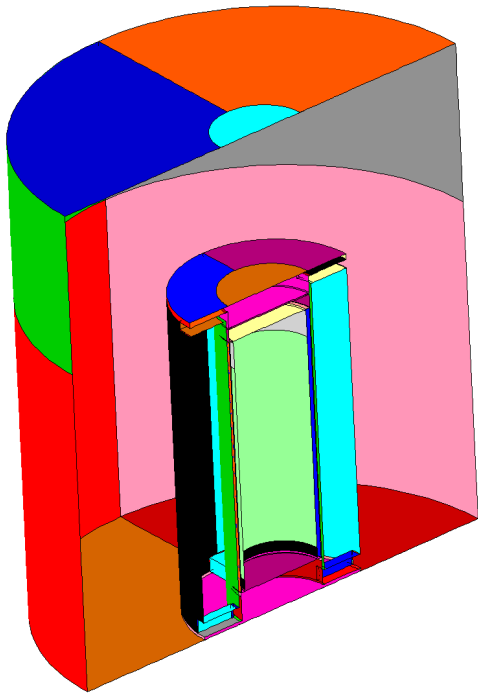

(a) Geometry

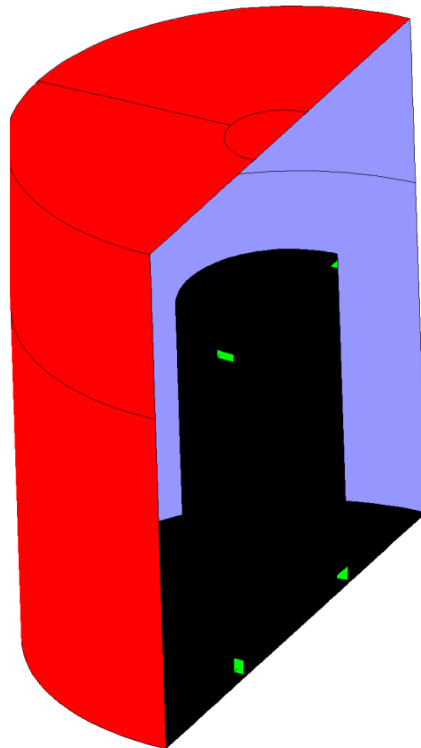
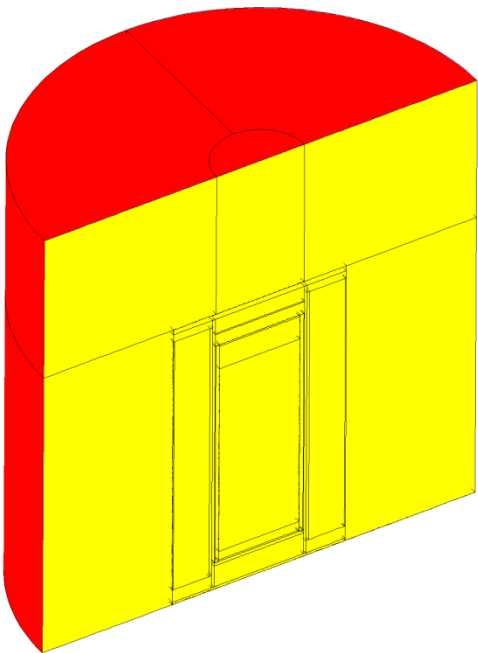

(b) Boundary Conditions

Figure 4-2 Geometry and boundary conditions for HI-STORM 100 cask with four vents

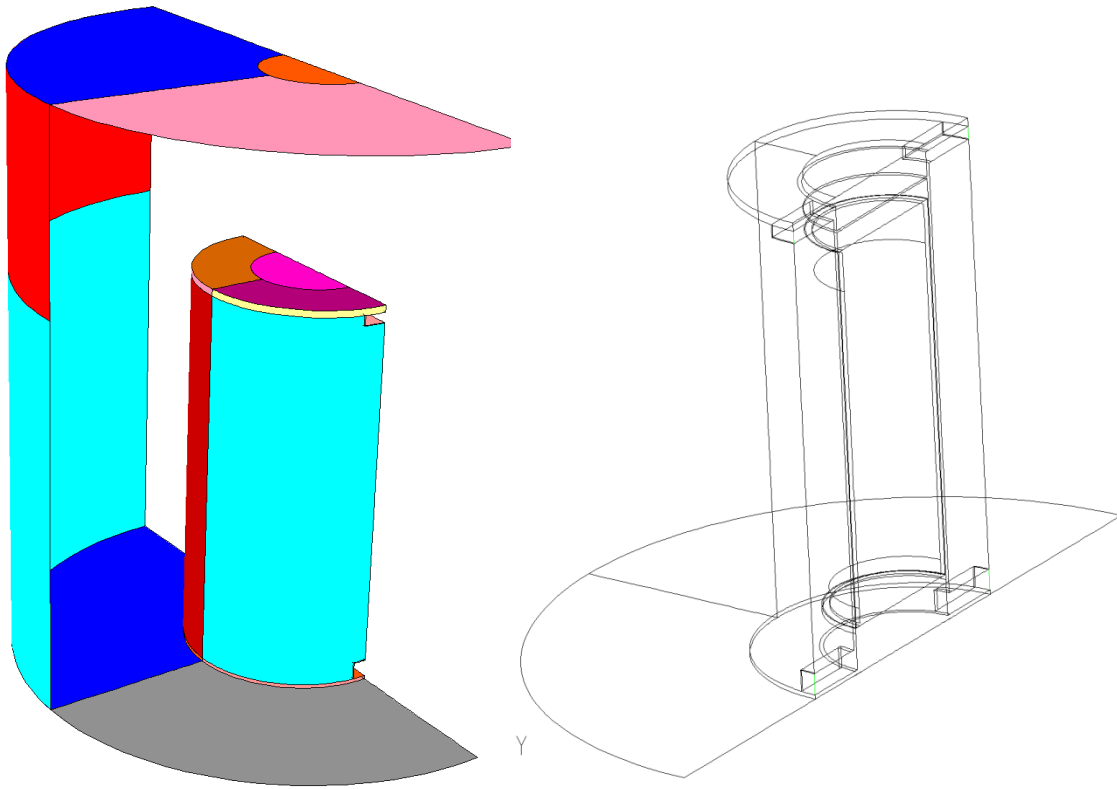

(a) Geometry

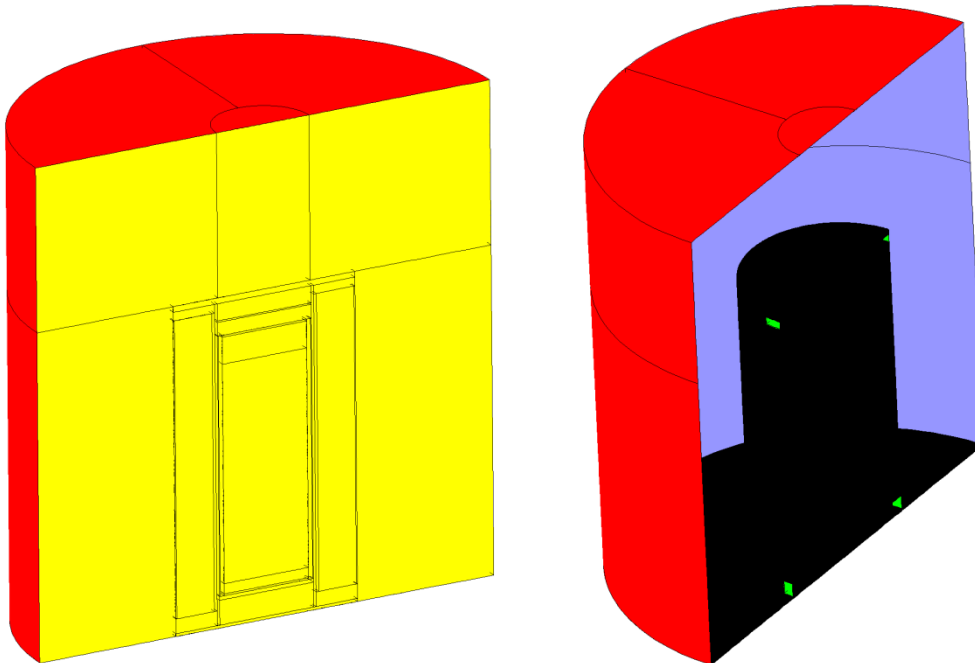

(b) Boundary conditions

Figure 4-3 Aboveground vertical cask with two vents (wind perpendicular to vents)

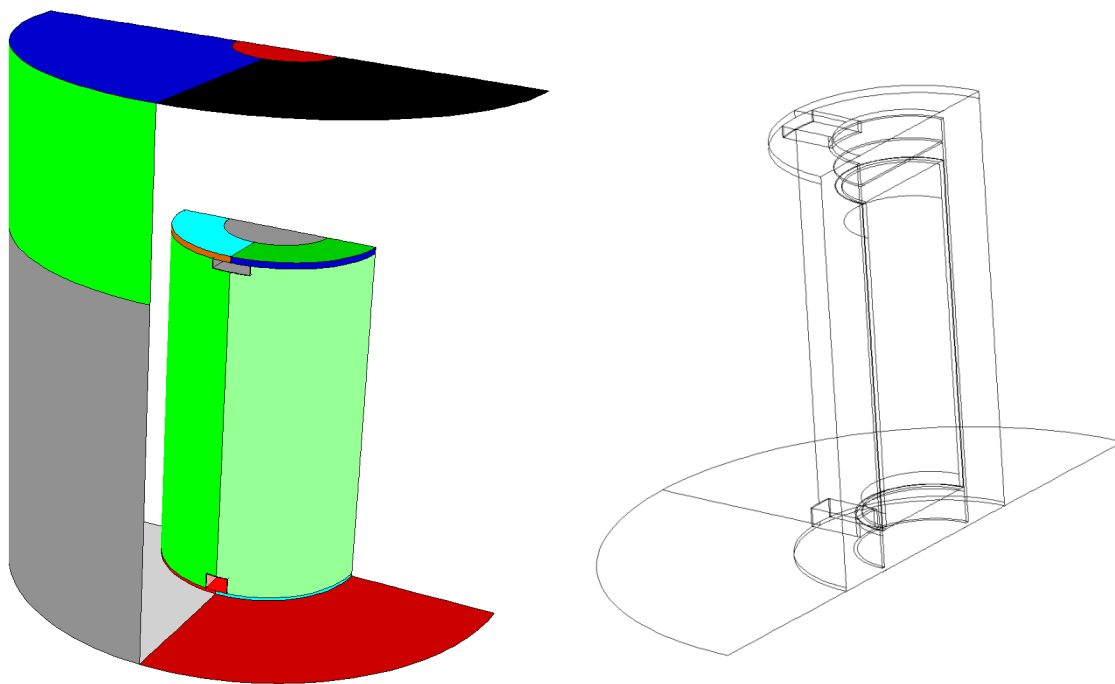

(a) Geometry

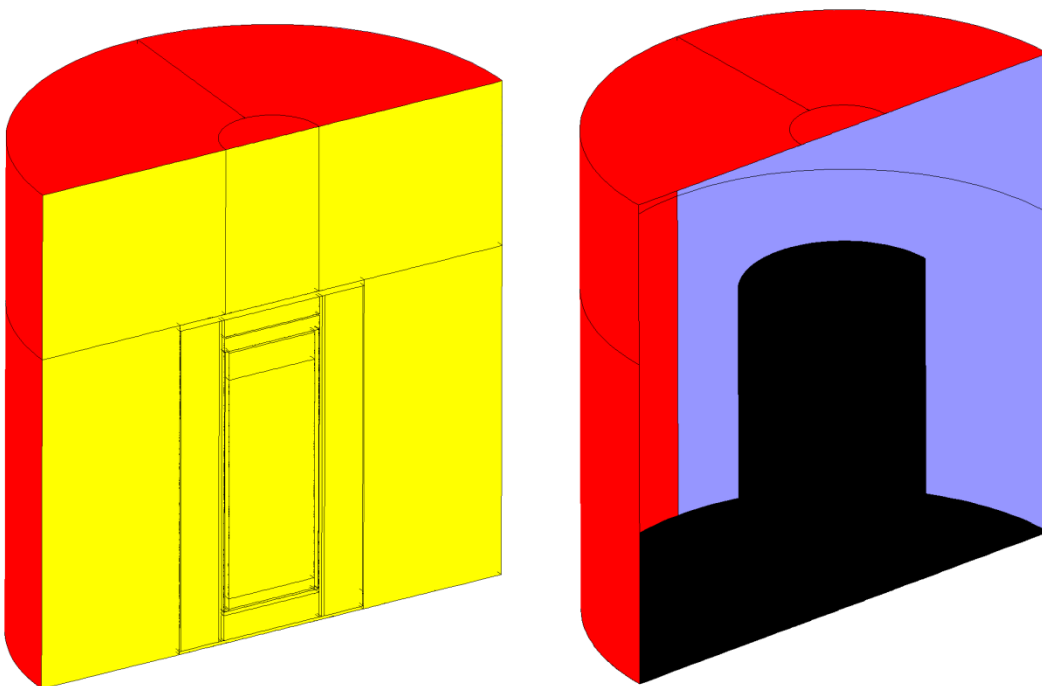

(b) Boundary conditions

Figure 4-4 Aboveground vertical cask with two vents (wind parallel to vents)

HI-STORM 100U

A one-half symmetry 3-D thermal model was developed to perform the environmental study, as seen in Figure 4-5, which shows that, except for the spent fuel region, all major components are represented explicitly in the thermal model. As described earlier, the spent fuel assembly is represented using porous media characterized by flow resistance factors calculated separately and effective thermal conductivity, as described in Appendix A, "Effective Thermal Conductivity" (TRW report, "Spent Nuclear Fuel Effective Thermal Conductivity Report," 1996). Figure 4-5(a) shows the pictorial representation of the cask and the environment associated with it. Figure 4-5(b) shows the boundary conditions used in the model. Applied boundary conditions include symmetry, velocity inlet (to represent wind), and pressure inlet (to represent the boundary limits on the environmental side). A wall is used to represent the top of the ground and the enclosure wall of the cask cavity.

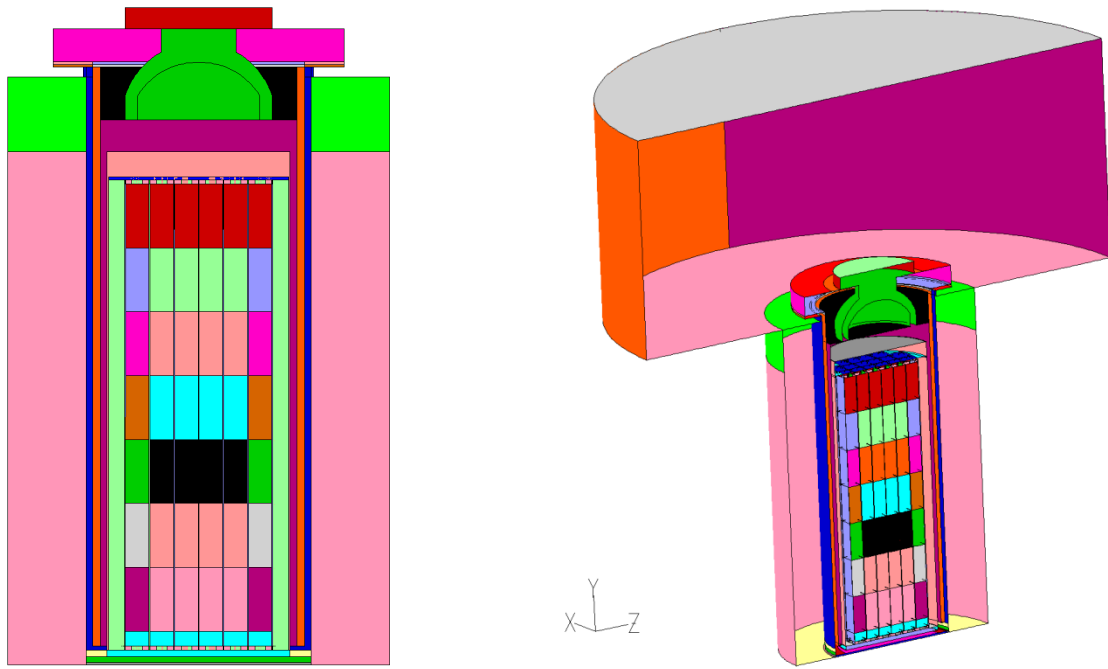

(a) Geometry

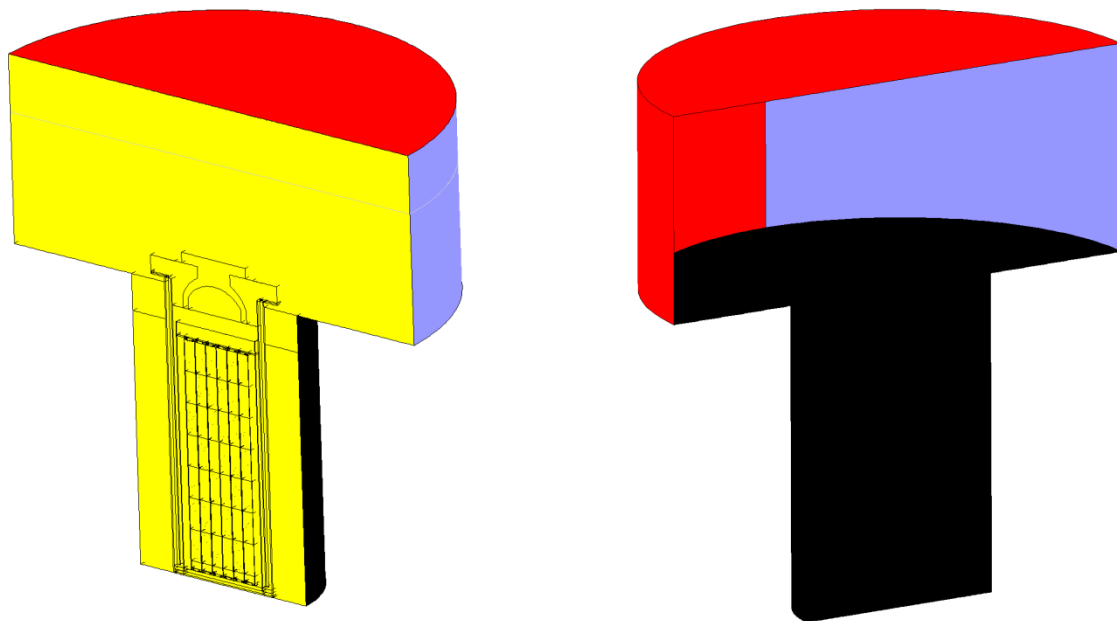

(b) Boundary conditions

Figure 4-5 Geometry and boundary conditions for the HI-STORM 100U cask

NUHOMS

A full geometry thermal model was built to represent this system. This study considered two versions of the cask design: standardized and advanced. The location of the air vents is the main difference between these versions from the point of view of wind effect. The developed models are shown in Figures 4-6 and 4-7 for the standardized version and Figures 4-8 and 4-9 for the advanced version. The thermal models developed for the NUHOMS casks include all important features that play a role in determining the effect of wind. For example, the DSC is represented as a solid body with heat generation distribution approximated to a standard axial power profile. The model includes all internal main features of the horizontal overpack except the cask support structures, since they have a minor effect. The main objective of this study was to obtain the relative effect on the PCT and not the approximate PCT value. The thermal results from the wind study are compared to quiescent conditions.

Figure 4-6 shows the standardized NUHOMS casks' geometry as represented in the thermal model and the boundary conditions applied to the analysis. Since the model is assumed to be located in a row of casks, symmetry boundary conditions are applied to both sides of the extended model, along with the wall represented by an adjacent cask (symmetry: yellow and wall: black). The velocity inlet boundary is located at a sufficient distance to allow the development of the air flow and avoid any effect on the cask air vents (inlet velocity: blue). The top of the cask is represented as a pressure boundary (red) and the back is partly represented with an adiabatic wall to represent an adjacent cask. The part of the back of the control volume that is part of the back wall is assigned a pressure boundary to represent the environment. Figure 4-7 shows the boundary conditions applied to the standardized NUHOMS model to analyze the wind effect. Two bounding directions were considered: frontal wind and side wind (shown in blue).

The boundary conditions applied to the thermal model of the advanced NUHOMS cask are shown in Figures 8 and 9. The main difference between this design and the standardized version is the location of the air vents. In the standardized version, the vents are located on the side of the cask while, for the advanced NUHOMS cask, they are located on the front and top (towards the back). The wind study considered three cases: whether the wind was blowing towards the front, back, or side of the cask.

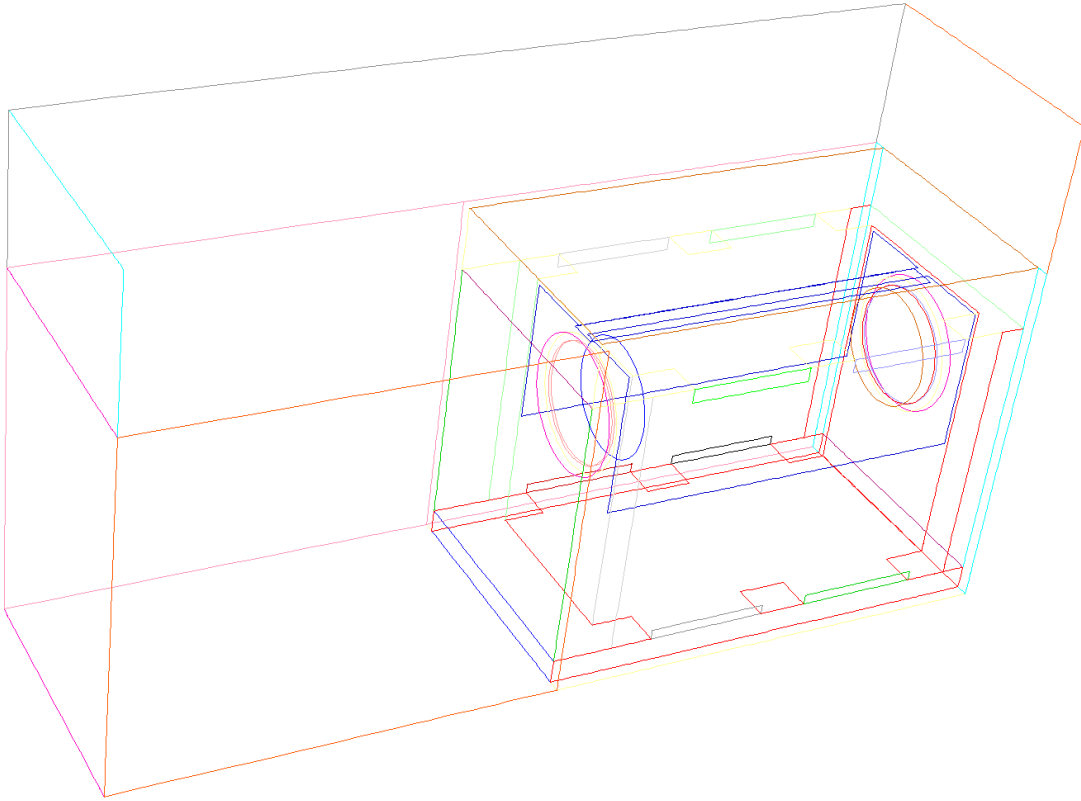

(a) Geometry

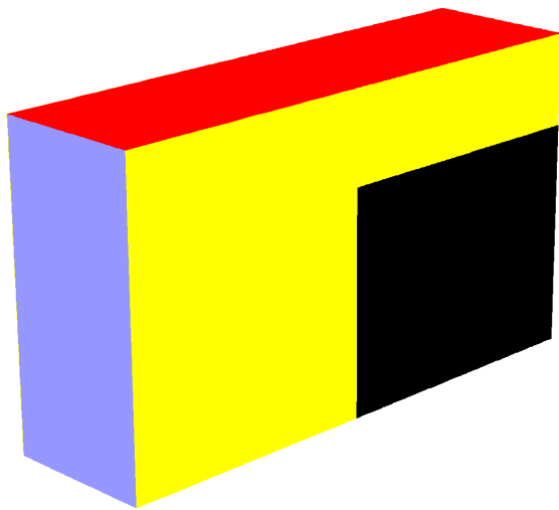

(b) Boundary Conditions

Figure 4-6 Geometry of the standardized NUHOMS cask

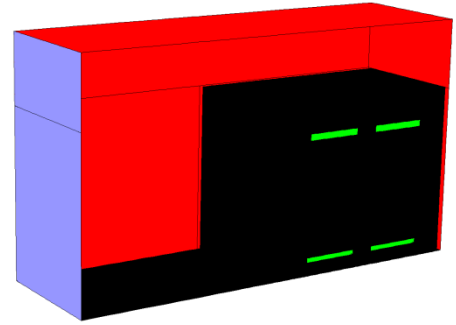
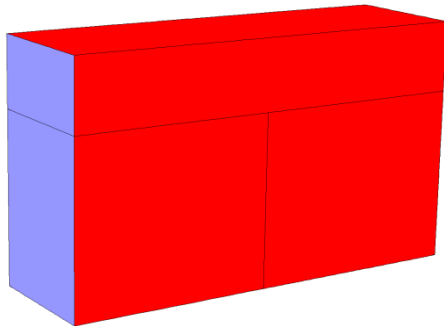

(a) Frontal wind

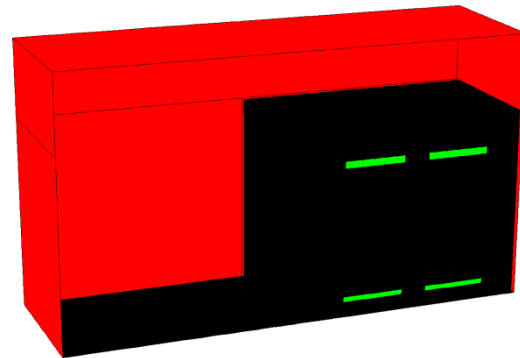
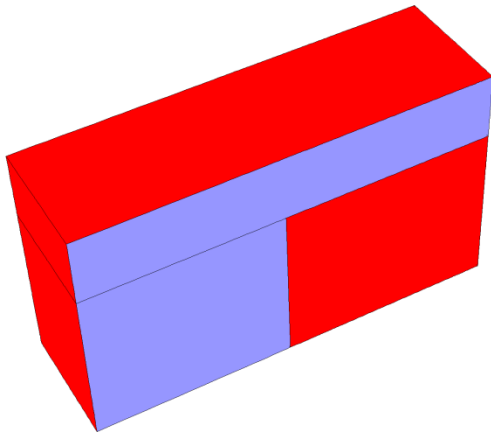

(b) Side wind

Figure 4-7 Standardized NUHOMS cask boundary conditions

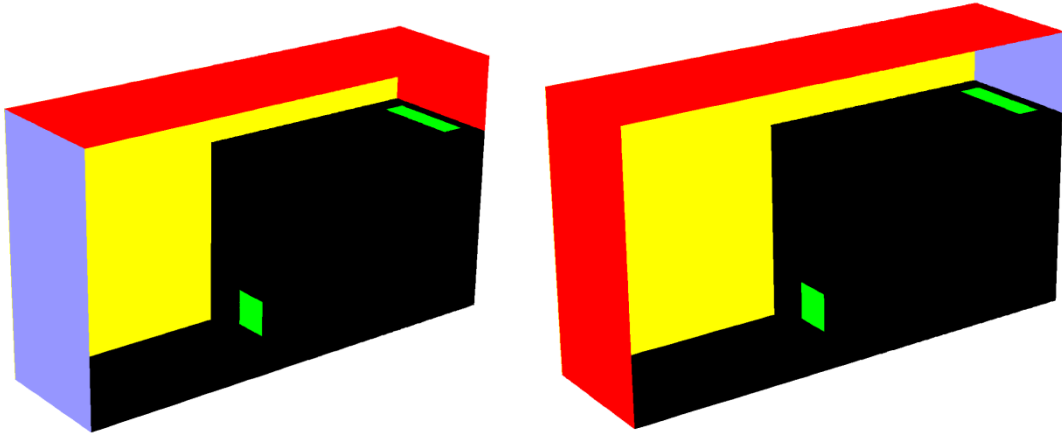
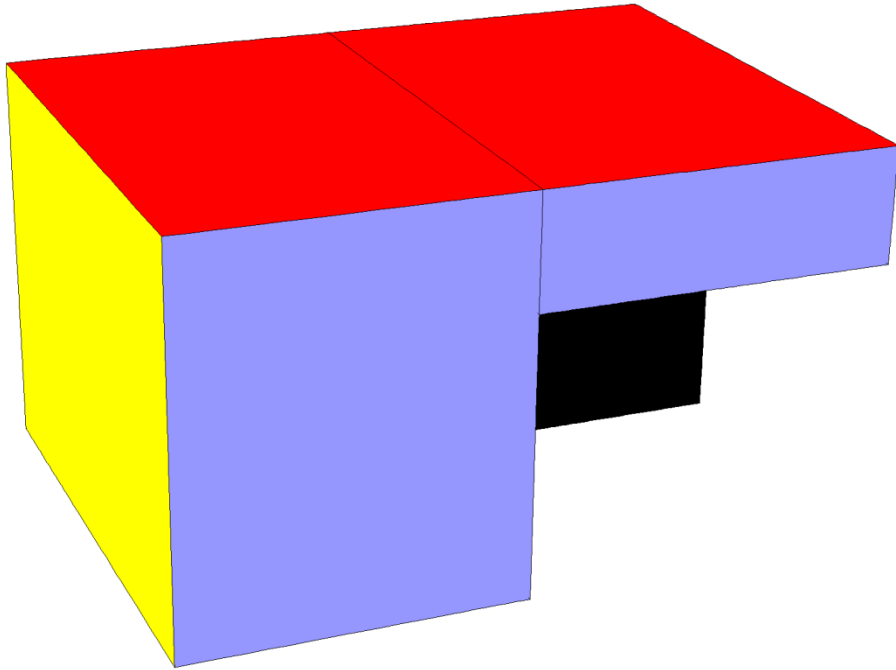
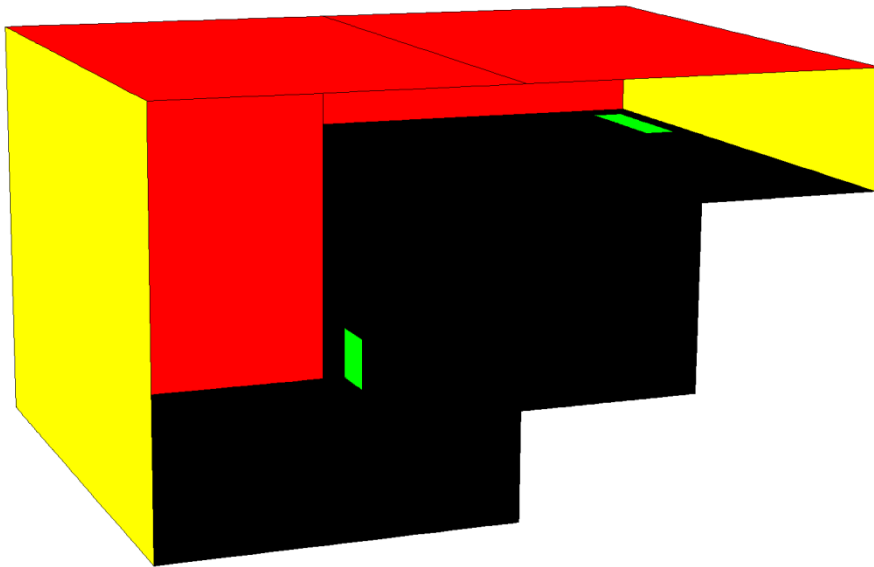

Figure 4-8 Advanced NUHOMS cask with frontal and backward wind



(a) External boundary



(b) Air vents

Figure 4-9 Advanced NUHOMS cask with side wind

4.4 Axisymmetric Model

For the HI-STORM 100 axisymmetric thermal model, the basket is homogenized into an equivalent cylindrical volume, as shown in Figure 4-10. The spent fuel basket and the spent fuel assemblies are homogenized, and the equivalent thermal properties and flow resistance factors are calculated separately and used in the axisymmetric model. Figure 4-11 shows an axial representation of the axisymmetric model with its main features (homogenized basket with axial power distribution, upper plenum, downcomer, lower plenums, MPC, air gap between the MPC shell and the concrete overpack, inlet and outlet vents, and overpack).

The axisymmetric model was used to analyze the steady-state effect of the ambient temperature, humidity, elevation, and heat load, as shown in Table 4-2. The axisymmetric model was also used to study the transient dry storage cask thermal response for the worst-case wind scenario (i.e., two-vent vertical dry storage cask with wind parallel to air vents), as well as the transient thermal behavior during a sudden change in the ambient temperature.

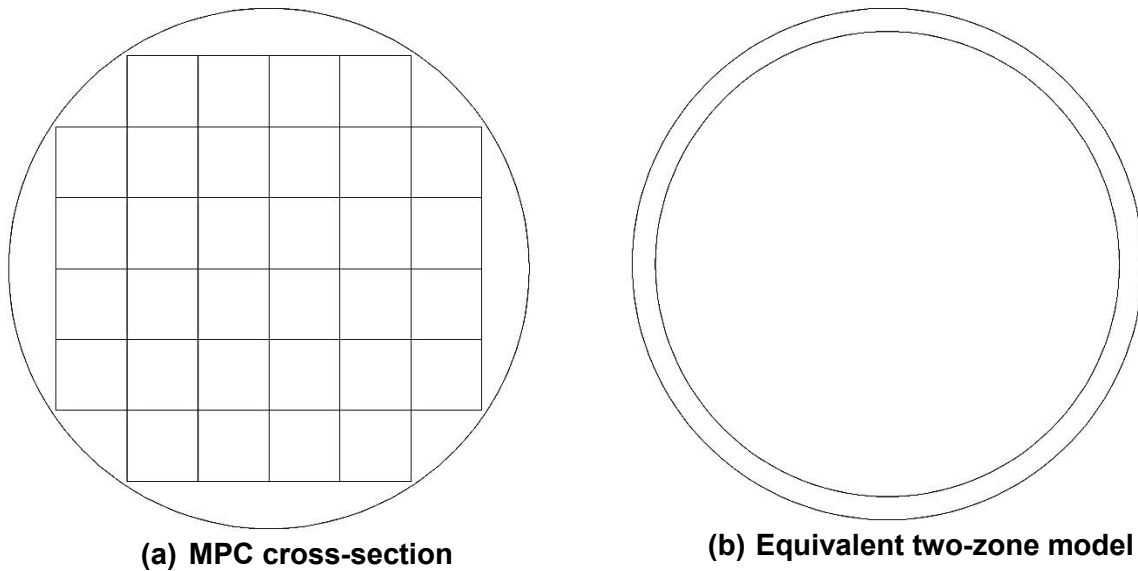

Figure 4-10 Homogenization of the MPC cross-section into an equivalent two-zone axisymmetric model

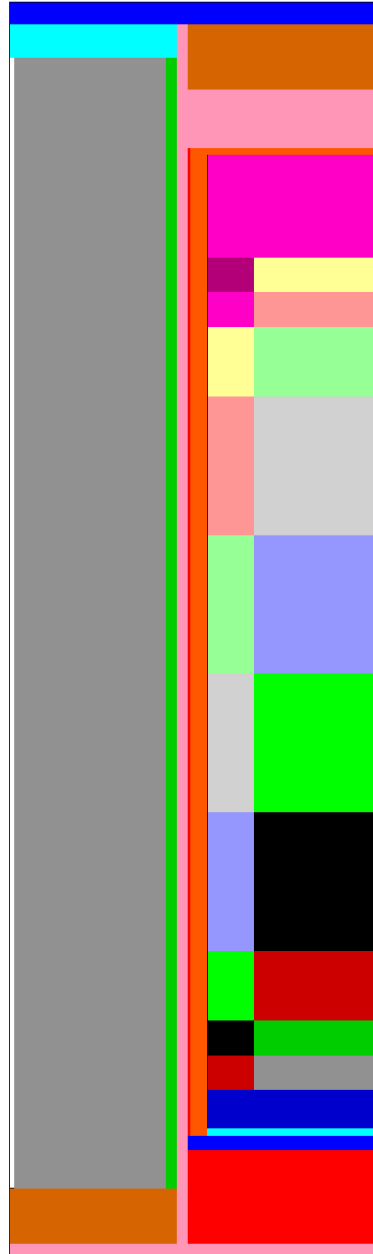
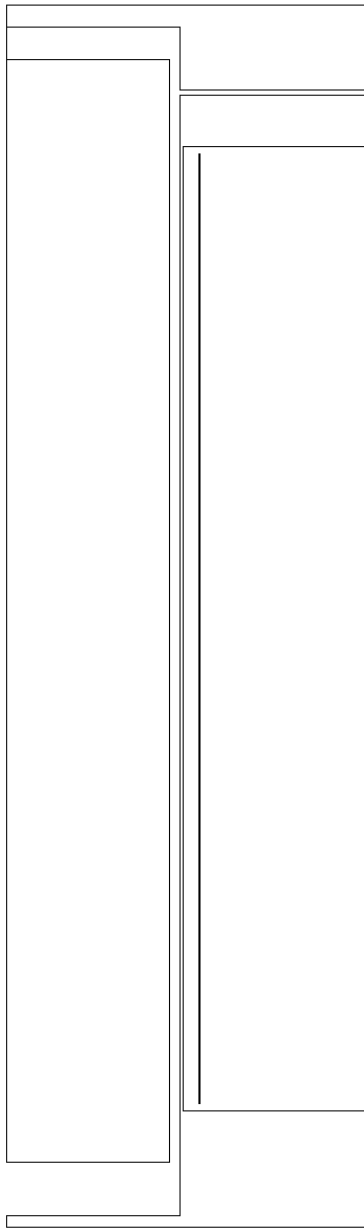

Figure 4-11 HI-STORM 100 axisymmetric model

4.5 Flow Resistance

The casks are evaluated for storing a specific arrangement of either BWR or PWR spent fuel assemblies. During spent fuel storage in the vertical configuration, helium enters the basket storage cells from the bottom plenum, flows upward through the open spaces in the spent fuel storage cells, and exits through the top plenum. The top and bottom plenums are essentially open spaces engineered in the spent fuel basket ends to enable helium circulation. In the case of BWR spent fuel storage, a channel enveloping the spent fuel bundle divides the flow into two parallel paths. One flow path is through the in-channel or rodded region of the storage cell, and the other flow path is in the square annulus outside the channel. The two modeling approaches below simulate heat transfer and fluid flow in the dry storage cask.

The first approach uses a 3-D representation of the dry storage cask. In this model, the spent fuel basket was modeled using porous media inside the spent fuel storage cells (for the PWR spent fuel assemblies) and porous media inside the spent fuel channel (for the BWR spent fuel assemblies). For the BWR spent fuel storage configuration, the square annular gap between the spent fuel channel and the basket storage cell is represented explicitly as a helium flow path. Therefore, the canister is modeled as a 3-D array of square-shaped cells (basket) inside a cylindrical canister shell.

The second approach uses an axisymmetric model to represent the entire cask. To avoid modeling the individual spent fuel rods, porous media were used to represent any volume enclosing the spent fuel rods.

In the ANSYS FLUENT CFD code, porous media viscous flow resistance is modeled as follows:

$$\Delta P = D\mu VL$$

Where ΔP is the hydraulic pressure loss, D is the flow-resistance coefficient, μ is the fluid viscosity, V is the superficial fluid velocity, and L is the porous media length. In the model, the spent fuel storage cell length between the bottom and top plenums is replaced by porous media.

To characterize the flow resistance of spent fuel assemblies inside the spent fuel basket region, a 3-D model of either PWR or BWR spent fuel assemblies is constructed using the ANSYS FLUENT CFD program (NUREG-2152, "Computational Fluid Dynamics Best Practice Guidelines for Dry Cask Applications," issued March 2013). In this model, the spent fuel rods, water rods, and grid spacers are represented explicitly. The 3-D flow-resistance model used two approaches to calculate the flow resistance. The first approach is the pressure-drop method and the second is the shear-stress method. Both methods are applied for sections without flow area changes (i.e., no contractions or expansions). Both approaches are related and should lead to the same values (Appendix B, "Flow Resistance"). Table B-1 of Appendix B shows the obtained resistance values used in both the 3-D models and the axisymmetric model.

4.6 Material Properties

Materials present in the storage canisters include stainless steel, neutron absorber (Boral or METAMIC), and helium. Materials present in the storage cask overpacks include carbon steel and concrete. Table 4-4 presents a summary of material properties used for performing all thermal analyses.

Table 4-4 Thermo-Physical Properties of Materials Used in the Analyses

Material	Emissivity	Conductivity	Heat Capacity	Density
Helium	n/a	Kinetic Theory [Robert C Reid et al., 1977]	Cp(T) [JANAF, 1985]	Ideal gas law
Air	n/a	Kinetic theory [Robert C Reid et al., 1977]	Cp(T) [JANAF, 1985]	Ideal gas law
Carbon Steel	0.85	42.2	n/a	n/a
Alloy X	0.587	K(T) [Holtec International, 2005]	n/a	n/a
Concrete	n/a	1.81	n/a	n/a
Zircaloy	0.8	K(T) [Holtec International, 2005]	n/a	n/a

4.7 Analyzed Cases and Applied Boundary Conditions

4.7.1 Analyzed Three-Dimensional Cases

The wind-effect analysis used half-symmetry models to minimize CPU time and effort to analyze the HI-STORM 100 and HI-STORM 100U dry storage casks. Due to the lack of symmetry, full symmetry models were used to analyze the NUHOMS dry storage casks for wind studies. However, to simplify the analysis, the canister was modeled as a solid cylinder with a decay heat power profile representative of the type of fuel stored in the horizontal canisters. Turbulence was modeled using the low Reynolds $k-\epsilon$ model. The discrete ordinate (DO) thermal radiation model was selected to model the radiative transfer equation. Table 4-1 shows the different 3-D cases that were considered to analyze the effect of wind on the thermal performance of different cask designs and configurations.

4.7.2 Applied Boundary Conditions for Three-Dimensional Analyses

The modeled cask will be located inside a control volume that represents the environment. Therefore, the external boundary conditions (environment surrounding the dry storage cask) were represented in the ANSYS FLUENT model by specifying appropriate inlet velocities (wind side) or pressures (wind opposite side) and ambient temperature.

As stated previously, the external boundary conditions on the modeled dry storage cask consisted of a velocity inlet on the direction of wind side, a pressure outlet on the side opposing wind direction and the top sides, and symmetry for the sides that are orthogonal to the wind direction, as shown in Figures 4-2 through 4-9. When only half of the cask was modeled, as in the HI-STORM 100U and HI-STORM 100 (with four vents and two vents), symmetry was assumed on the plane dividing the cask in half. Thermal radiation properties and resolution control for the view factor calculations were set in ANSYS FLUENT via internal boundary

conditions on solid cells adjacent to fluid cells. The rest of the specified boundary conditions to perform the wind analysis are summarized below:

- ambient temperature of 300 K (80°F)
- no solar insolation (nonconservative assumption but irrelevant to the temperature differential)
- velocity inlet specified on the side of the wind
- pressure outlet specified on the opposing side of the wind
- wind velocity varied in the range of 0 to 6.706 m/s (0 to 15 mph)
- wind direction assumed parallel and orthogonal to the air vents
- adiabatic boundary assumed on the cask's bottom surface
- symmetry used when applicable
- surface emissivities set to 0.587 for stainless-steel surfaces inside the storage canister and 0.85 for carbon-steel surfaces outside the canister and for concrete surfaces

Figures 4-2 through 4-9 show the external boundary conditions. Each color in these figures refers to the type of applied boundary. Blue represents a velocity inlet, red represents a pressure boundary, yellow represents symmetry, black represents a wall, and green shows the cask vents used as interior cells, per ANSYS FLUENT nomenclature.

The ANSYS FLUENT porous media model requires the input of spent fuel effective thermal conductivity and flow resistance factors. Tables A-1 through A-3 of Appendix A and Table B-1 of Appendix B provide the values used for spent fuel effective thermal conductivity and flow resistance factors for the 3-D thermal models. Table 4-3 shows the total decay heat used in the analysis for the different casks considered in the evaluation.

4.7.3 Analyzed Axisymmetric Cases

The analyzed cases included low Reynolds k - ϵ to model the air flow turbulence between the liner and the MPC wall. For the helium flow inside the MPC, the calculated Reynolds and Rayleigh numbers are too low to consider a turbulent flow regime. Instead, a laminar regime was considered. DO was used to model the radiation transfer equation between the walls. Also, the effect of helium pressure inside the MPC was investigated. The control volume used the dry storage cask boundaries. In this control volume, the inlet and outlet ducts use either pressure or velocity boundaries, depending on the investigated case. In addition, a total decay heat load of 34 kW was assumed for all the axisymmetric cases. Table 4-2 shows the axisymmetric cases considered in the evaluation.

4.7.4 Applied Boundary Conditions for the Axisymmetric Model

A 2-D axisymmetric thermal model was used to analyze the thermal response of the HI-STORM 100 dry storage cask, as shown in Figures 4-10 and 4-11. A 2-D polar coordinate system is used to represent the dry storage cask system where only radial and axial directions are considered. The MPC section consists of two discrete regions—the basket region and the

peripheral region. The inner basket region represents the spent fuel storage basket, and the outer peripheral region represents the MPC downcomer. As shown in Figure 4-11, the inner region consists of three distinct regions—the spent fuel region, the bottom plenum, and the top plenum.

Porous media were used to model the spent fuel region, as well as the top and bottom plenums located in the center of the MPC. Flow-resistance factors (i.e., frictional and inertial) and temperature-dependent equivalent thermal conductivity (i.e., includes radiation and conduction heat transfer) are used to characterize the flow and heat transfer in the porous media regions. A laminar regime is used to model the flow of helium in this inner zone with a uniform porosity specified in ANSYS FLUENT. In the downcomer region (outer zone of the MPC model), a laminar regime is also considered. Helium at a pressure of about 7.2 bars is modeled as flowing from top to bottom in the downcomer region and from bottom to top in the spent fuel region.

For the air flow in the annular gap between the MPC and the overpack, the transitional low Reynolds k - ϵ turbulence model is used. Both the turbulent kinetic energy and its dissipation are used to model the average length and time scales of turbulence. Temperature-dependent equivalent thermal conductivity in the radial and axial directions, specific heat, density, porosity, and hydraulic losses are used to characterize the porous media. The calculated input values for the equivalent thermal conductivities in the radial and axial directions included the effect of both radiation and conduction heat transfer.

The ANSYS FLUENT CFD code was used to predict the spent fuel basket planar (radial) effective thermal conductivity (NUREG-2152, 2013). The effective axial thermal conductivity is estimated by area averaging the thermal conductivity of each material in a spent fuel basket cross-section. As a result, radiation heat transfer was not accounted for in the ANSYS FLUENT analysis, and zero values for the wall emissivities inside the canister were specified in the boundary conditions panel. DO was used to model radiation between walls in the axisymmetric model. A heat source was added to the cells representing the active spent fuel region. The local volumetric heat source term in each segment was determined by multiplying the basket active spent fuel length average source term with an axial power peaking factor. The four vents in the bottom and top of the cask, respectively, were represented by one continuous inlet at the bottom and one continuous outlet at the top. The model used the exact height for the inlet and outlet vents as in the physical model. As a result, the air vents flow area in the computational model was larger than the actual flow area specified in the physical model. As a remedy, porous media were used to introduce flow resistance along the channels to correct for the mass flow rate and the balance of momentum.

The HI-STORM 100 axisymmetric thermal model requires several simplifications. The most important step requires that the planar section of the MPC be homogenized. With each spent fuel storage cell replaced with an equivalent solid square, the MPC cross-section consists of a metallic grid (i.e., basket cell walls with each square cell space containing a solid storage cell square of temperature-dependent effective thermal conductivity) circumscribed by a circular ring (MPC shell). The four distinct materials in this section are homogenized spent fuel storage cell squares, stainless-steel structural material in the MPC (including neutron absorber sheathing), neutron absorber, and helium gas. Each of the four constituent materials in this section has a different conductivity.

In the axisymmetric model, the required simplification is performed by replacing the thermally heterogeneous spent fuel basket section by an equivalent conduction-only region using a 2-D CFD analysis (NUREG-2152, 2013). Because the rate of transport of heat in the spent fuel basket is influenced by radiation, which is a temperature-dependent effect, the equivalent conductivity of the spent fuel basket region must also be computed as a function of temperature. Also, it is recognized that the MPC section consists of two discrete regions; namely, the basket region and the peripheral region. The peripheral region is the space between the peripheral storage cells and the MPC shell. This is a helium-filled space surrounded by stainless-steel plates. Accordingly, as shown in Figure 4-10 for the vertical storage cask, the MPC cross-section is replaced by two homogenized regions with temperature-dependent conductivities. Temperature-dependent spent fuel effective thermal conductivity has been used to characterize the equivalent area that represents the spent fuel basket.

The two principal components of a loaded spent fuel basket are sandwich panels and SNF. These components have unequal conduction properties in the planar and axial directions. The spent fuel basket thermal modeling properly recognizes these differences by characterizing the effective conductivities in the two (planar and axial) directions. For computing the planar spent fuel basket conductivity, either a finite element-based model, such as the ANSYS code, or a finite volume-based CFD code, such as ANSYS FLUENT, can be employed. The principal inputs to the models are the spent fuel planar conductivities and the sandwich panel conductivities. The spent fuel basket axial conductivity is computed by an area-weighted sum of the cladding, helium, neutron absorber, and steel (box wall and sheathing) conductivities. In this evaluation, spent fuel pellet axial conduction and axial dissipation of heat by radiation are neglected in the calculation of the effective thermal conductivity in the axial direction.

Finally, the cask is simulated as being radially symmetric, having annular vents at the bottom and top with a buoyancy-induced flow in the annular space surrounding the heat-generating MPC cylinder. The annular gap between the MPC and the overpack is modeled explicitly, and the cask vents are represented by porous media, which specified effective inlet and outlet duct flow-resistance factors that are calculated separately.

Internal circulation of helium in the sealed MPC is modeled as flow in a porous media in the spent fuel basket region containing the SNF (including top and bottom plenum). The basket-to-MPC shell clearance is modeled as a helium-filled radial gap to include the downcomer flow in the thermal model. The downcomer region, as illustrated in Figure 4-10(a), consists of an azimuthally varying gap formed by the square-celled basket outline and the cylindrical MPC shell. In the FLUENT axisymmetric model, a single effective gap is used to model the downcomer region, as shown in Figures 4-10(b) and 4-11.

A low Reynolds k - ϵ model was used to represent turbulence in the air flow region (the annular gap formed by the MPC shell and overpack). Guidelines on the proper use of the low Reynolds k - ϵ turbulence model require the use of a finer mesh near the enclosing walls. As shown in Figure 4-12, a mesh was generated for this region such that the dimensionless distance y^+ , for the cells close to the wall, is close to unity for the axisymmetric model, thus fulfilling the requirements for the proper use of the low Reynolds k - ϵ turbulence model. The integration is performed all the way to the wall using an adequate fine generated mesh (as shown in Figure 4-12).

As mentioned earlier, the 2-D axisymmetric ANSYS FLUENT porous media model requires the input of effective thermal conductivity and flow-resistance factors. The effective thermal conductivity values used in the axisymmetric cases are shown in Table A-4 of Appendix A, and the flow-resistance factors are shown in Table B-1 of Appendix B.

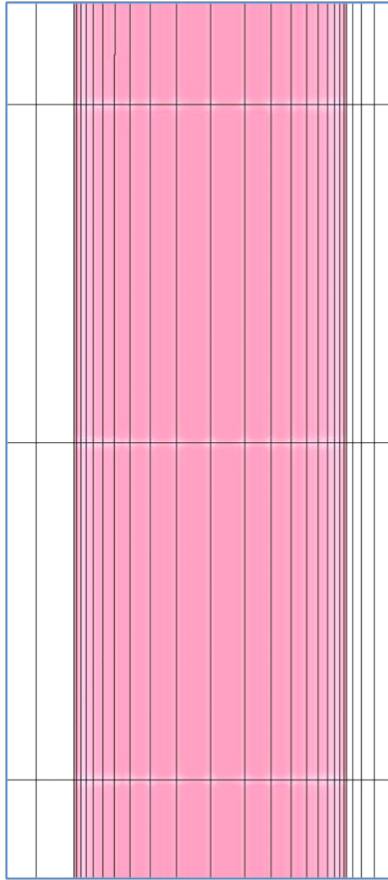

Figure 4-12 Mesh generated for the air annular gap of the axisymmetric model

Cases to Model the Effect of Humidity

As shown in Table 2-1, the effect of humidity was examined at ambient temperatures of 300 and 323 K, assuming a relative humidity of 0 percent, 50 percent, 70 percent, and 90 percent (for each temperature). For the calculations of the effect of humidity on air, ANSYS FLUENT requires the input of mass fractions of water vapor and air at the inlet boundary (inlet vent). These parameters are calculated as follows and provided to ANSYS FLUENT for each case.

For moist air, the total pressure is expressed as:

$$P_T = P_a + P_v \quad (1)$$

Where

P_T is the total pressure.

P_v is the partial pressure of water vapor.

P_a is the partial pressure of air.

The humidity ratio (sometimes called the specific humidity) is defined as:

$$W = \frac{m_v}{m_a} \quad (2)$$

Where m_v and m_a are the water vapor mass and air mass, respectively.

Also, relative humidity (Φ) is defined as the mole fraction of the water vapor (X_v) in a mixture to the mole fraction of the water vapor in a saturated mixture (X_s) at the same temperature and pressure:

$$\Phi = \frac{X_v}{X_s} \quad (3)$$

Using Dalton's law (Reid, "The Properties of Gases and Liquids," 1977) for a mixture of perfect gases, the mole fraction is equal to the ratio of the partial pressure to the total pressure.

$$X_v = \frac{P_v}{P_T} \quad (4)$$

Using Equations (3) and (4), one gets

$$\Phi = \frac{\frac{P_v}{P_T}}{\frac{P_s}{P_T}} = \frac{P_v}{P_s} \quad (5)$$

And from Equation (5)

$$P_v = \Phi P_s \quad (6)$$

From the ideal gas law:

$$m_v = \frac{P_v V M_v}{RT} \quad (7)$$

$$m_a = \frac{P_a V M_a}{RT} \quad (8)$$

Where

V is the total volume of the mixture.

M_v and M_a are the molecular weights of water and air, respectively.

\bar{R} is the universal gas constant.

T is the temperature.

Knowing that $M_v=18$ g/gmol and $M_a = 28.97$ g/gmol, using Equations (2), (7), and (8), one gets

$$W = \frac{m_v}{m_a} = \frac{P_v M_v}{P_a M_a} = 0.6219 \frac{P_v}{P_a} = 0.6219 \frac{P_v}{P_T - P_v} \quad (9)$$

For the axisymmetric thermal model, ANSYS FLUENT's boundary condition at the inlet vent used a pressure inlet with the following mass fractions of water vapor (mf_v) and air (mf_a):

$$mf_v = \frac{m_v}{m_a + m_v} = \frac{\frac{m_v}{m_a}}{\frac{m_a}{m_a} + \frac{m_v}{m_a}} = \frac{W}{W + 1} \quad (10)$$

$$mf_a = 1 - mf_v = \frac{1}{W + 1} \quad (11)$$

As such, the inlet water vapor and air mass fraction were specified in ANSYS FLUENT, as shown in Table 4-5 at the two different assumed ambient temperatures of 300 and 323 K. As can be seen from Table 4-5, water vapor increases as air humidity is increased from 0 to 90 percent.

Table 4-5 Mass Fraction Specified at Inlet Vent for Humidity Analyses

Ambient Temperature K (°F)	Φ (%)	P_s (Pa)	P_v (Pa)	W kg of water vapor/kg of air	mf_v (%)	mf_a (%)
300 (80)	0	3,567	0	0	0	1
-	50	3,567	1,784	0.011	0.011	0.989
-	70	3,567	2,497	0.016	0.015	0.985
-	90	3,567	3,210	0.020	0.020	0.98
323 (120)	0	12,350	0	0	0	1.
-	50	12,350	6,175	0.040	0.039	0.961
-	70	12,350	8,645	0.058	0.055	0.945
-	90	12,350	11,115	0.077	0.071	0.929

As shown in Table 2-1, the effect of ambient temperature was examined assuming ambient temperatures of 300 K (80°F), 305 K (90°F), 311 K (100°F), 316 K (110°F), and 322 K (120°F) using a steady-state analysis. This study used a transient analysis to investigate the transient thermal response of a dry storage cask to a sudden change in the ambient temperature. In the transient analysis, the ambient temperature was suddenly changed from 300 K (80°F) to 322 K (120°F). The transient analysis examined the time it took the dry storage cask to reach a new steady state.

The investigation of the effect of the heat load assumed total decay heats of 22, 24, 26, 28, 30, 32, and 34 kW. The pressure inlet and pressure outlet were specified at the inlet and outlet vents of the axisymmetric ANSYS FLUENT thermal model and steady-state analyses were performed to determine the effect of the total decay heat on the predicted PCT.

The investigation of the effect of the dry storage cask elevation (i.e., ambient pressure) assumed the dry storage cask was located at elevations of 0, 500, 1,000, and 1,500 m above sea level. Steady-state analyses used in this investigation specify the pressure inlet and pressure outlet at the inlet and outlet vent, respectively. The analysis examined the effect of the air density at the inlet vents (as it varies with ambient pressure) on the predicted PCT.

As mentioned earlier, the effect of the worst-case wind scenario was also studied using the axisymmetric model. The 3-D analyses determined that the worst-case scenario was for an aboveground vertical cask with two vents (postulated case). In this case, the wind is assumed to be blowing at 4.4703 m/s (10 mph), with wind direction parallel to the air vents. Using the 3-D worst-case scenario, an equivalent axisymmetric steady-state case was found by comparing the PCT. Then, a transient case scenario was performed using the inlet mass flow rate (determined by comparing the 3-D and 2-D cases, which resulted in the same PCT) and the pressure outlet for the inlet and outlet vents, respectively. The transient analysis examined the time it took the dry storage cask to reach a new steady state.

4.8 Discussion of Results

An analysis of the results from the 3-D thermal models described in previous sections for the different cask configurations determined the effect of wind magnitude and direction on the cask's thermal performance. Specifically, it determined the effect of low-speed wind (wind in the range of 0 to 6.706 m/s (0 to 15 mph) and wind direction (parallel and orthogonal to air vents) on

the predicted PCT. Tables 4-6 through 4-15 summarize the effect of wind magnitude and direction on the thermal performance of dry storage casks (predicted PCT) considered in this evaluation. Results from the axisymmetric model of the vertical aboveground cask described in previous sections were analyzed to determine the effect of ambient temperature, air humidity, elevation, wind, and total decay heat in the cask on the cask's thermal performance. Specifically, they determined the effect of these parameters on the predicted PCT. The following sections discuss the results from these analyses.

4.8.1 Wind Effect on the Underground Casks

Table 4-6 shows how the thermal performance of underground casks is affected by the magnitude of wind. The predicted PCT increases as wind speed increases until wind speed reaches about 2.235 m/s (5 mph). Table 4-6 also shows that PCT starts to decrease with a further increase in wind speed. This behavior is explained by examining how the air mass flow rate varies in the air-cooling channel. As the air mass flow rate increases, PCT decreases because of the improved cooling effect by convection. The air vents in the underground cask occupy the entire cask perimeter. The flow rate of the air mass moving through the cask is directly proportional to the pressure difference between the inlet and outlet vents. As wind speed increases from quiescent conditions to 2.235 m/s (5 mph), air blowing at the outlet vent acts as flow resistance by increasing the pressure at the exit. Examination of the air mass flow rate in Table 4-6 shows that the flow resistance at the exit reaches its maximum at a wind speed of 2.235 m/s (5 mph) (lowest air mass flow rate). As such, the air mass flow rate reaches its minimum and the PCT reaches its maximum at 2.235 m/s (5 mph). The pressure difference between the inlet and the outlet vents decreases between 0 and 2.235 (5 mph). Then, as wind speed increases beyond 2.235 m/s (5 mph), the pressure difference starts to increase. As a result, the mass flow increases (improving convective cooling) and the PCT decreases.

4.8.2 Wind Effect on the Vertical Aboveground Casks

Table 4-7 shows the effect of wind speed on the vertical dry storage cask with four inlet and four outlet vents (like the HI-STORM 100). Overall, the analysis shows that wind had a slight positive effect on the cask's thermal performance for average wind speed [wind speed of about 2.235–3.576 (5–8 mph)], as reported by NOAA (NOAA, www.noaa.gov). As the wind speed increases, the cooling air mass flow rate increases and the PCT decreases. It should be noted that the calculated temperatures for the base case (quiescent conditions) and windy conditions are only shown to illustrate the effect of wind on the cask's thermal performance. The predicted PCT may be higher than the NRC's recommended limit for normal storage, but it is only because the analysis was intentionally set up this way to produce conservative results. This may also apply to the results presented for other casks in this study. Also, the objective of these analyses was to determine the relative increase, as compared to the base cases.

For the case of a postulated two-vent vertical dry storage cask design, when wind direction is normal to the air vents, the thermal performance was positively affected as wind speed increased. As the wind speed increased, the mass flow rate through the air vents increased and the PCT decreased, as shown in Table 4-8. When wind direction is parallel to the air vents, the magnitude of the wind adversely affects the thermal performance of the cask. The parallel wind at the inlet and exit vents acts as flow blockage. When wind is parallel to the inlet vents, as the wind speed increases, less air flows into the inlet vents (since wind acts as a flow blockage). Similarly, when wind is parallel to the outlet vents, as the wind speed increases, the

air acts as a flow blockage and less air flows through the outlet vents. As such, when wind direction is parallel to the vents, air flow through the duct is decreased and the PCT is increased, as shown in Table 4-9. It should be mentioned that this analysis corresponds to an extreme case, because the NRC has not certified a cask design with only two air vents. The case was included in the study to determine how wind affects the thermal performance of this design. The wind analysis results from a two-vent vertical cask show that this design is very sensitive to low-speed wind and that parallel wind has a strong negative effect on the cask's thermal performance.

The effect of wind on the thermal performance of the cask was noticeably high in the case of the two-vent cask design with a 4.4703-m/s (10-mph) wind parallel to the cask vents. The analysis of the 4.4703-m/s (10-mph) wind case used a steady-state approach. To further investigate this scenario, a transient analysis of the case was undertaken using an axisymmetric representation of the cask. First, an equivalent axisymmetric model was built to reproduce the same PCT as the 3-D base-case model and the worst-case scenario [4.4703-m/s (10-mph) wind], as shown in Table 4-9. The transient analysis first assigned the initial condition of the equivalent base case and then applied a sudden change reflecting the conditions from the worst-case scenario at the cask boundaries (air vents). As shown in Tables 4-17 and 4-18, 95 percent of the PCT change between the base case and the worst-case scenario was reached after 256.5 hours (about 10.68 days).

4.8.3 Wind Effect on the Horizontal Aboveground Casks

The wind study for horizontal aboveground casks used standardized and advanced NUHOMS casks. For the standardized cask, the analyses results showed that the magnitude and direction of wind did not have any significant effect on the thermal performance of the cask, as shown in Tables 4-10 and 4-11. Neither the magnitude nor the direction of the wind is expected to affect the thermal performance of the cask because of the placement of the vents. As described in Section 4.3.1, the vents in the standardized NUHOMS casks are located on the sides of the cask and are not in direct contact with either parallel or normal wind. The normal wind (wind blowing perpendicular to the air vents) will not be a factor on the thermal performance because of the presence of either another cask on the side or a wall at the end of a row of casks located in an ISFSI.

For the advanced aboveground horizontal NUHOMS casks, the inlet vent is located on the front of the cask and the outlet vent is located on the roof, as described in Section 4.3.1. For the case of wind parallel to the vents, the thermal performance of the dry storage cask was not significantly affected, as shown in Table 4-14. When the wind is blowing towards the front of the cask (wind direction perpendicular to the inlet vent), more air is admitted to the cask and the thermal performance of the cask is improved, as shown in Table 4-12.

Since the advanced cask design locates the air outlet vent on top of the cask, the study also included the case for wind blowing perpendicular to the back of the cask to determine how this affects the cask's thermal performance. Table 4-13 shows the steady-state analysis results with wind directed to the back of the cask for wind speed varying in the range of 0 to 6.706 m/s (0 to 15 mph). As the wind speed increased, less air flowed through the cask and the PCT increased. The predicted PCT reached its maximum at a wind speed of 4.4703 m/s (10 mph) and then declined as the air flow rate through the cooling channel started to increase. To further investigate this case, a transient analysis was performed. The case used steady base

case results as the initial conditions, as shown in Table 4-13. Then, using the worst-case scenario, the environmental conditions suddenly changed, with wind blowing towards the back of the storage cask at 10 mph, as shown in Table 4-13. Tables 4-15 and 4-16 show a 95 percent PCT change between the base case and the worst-case scenario after 10 days. The transient analysis results indicate that steady-state conditions will be reached after 10 days of windy conditions with wind speed remaining constant for 10 days.

4.8.4 Aboveground Vertical Cask Axisymmetric Model

The study used an axisymmetric model to investigate the effect of the ambient temperature, using steady-state simulations. Table 4-19 shows the effect of the ambient temperature on the predicted PCT in the dry storage cask. The PCT increases by 8 K (14.4°F) for every 5.6 K (10°F) increase in the ambient temperature.

In the transient analysis, used to study the effect of ambient temperature, the initial condition set the ambient temperature at 300 K (80°F). Then the ambient temperature was suddenly changed to 322 K (120°F). As shown in Tables 4-20 and 4-21, 95 percent of the PCT change between 300 and 322 K (80 and 120°F) was reached after 7 days.

The effect of elevation was investigated using a steady-state analysis based on the axisymmetric model. The analyses varied the elevation from 0 to 1500 m (0 to 4921.5 ft). As the elevation is increased, the air density decreases due to the decrease in the ambient pressure. As a result, the mass flow rate decreased and the PCT increased. As shown in Table 4-22, the PCT increases by about 6 K (11°F) for every 500 m (1640.5 ft) of increased elevation.

To study the effect of heat load, steady-state analyses, based on the axisymmetric model, varied heat loads in the range of 20 to 34 kW. As the decay heat increased, the PCT also increased. As shown in Table 4-23, the PCT increases by about 22 K (40°F) for every 2 kW increase in heat load.

The effect of ambient air humidity was investigated using a steady-state analysis based on the axisymmetric model. The analyses were performed at ambient temperatures of 300 K (80°F) and 323 K (120°F) with a relative humidity of 0, 50 percent, 70 percent, and 90 percent. As the humidity increases, the ambient air contains more water vapor. As water vapor has larger thermal conductivity and heat capacity than dry air, more heat is absorbed from the cask by humid air. As such, the PCT will decrease as the relative humidity is increased for both ambient temperatures considered in this study. At an ambient temperature of 300 K (80°F), the PCT decreased by 0.6 K (1°F) for every 20 percent increase in the relative humidity (in the 50 to 90 percent range). At an ambient temperature of 323 K (120°F), the PCT decreased by 2.2 K (4°F) for every 20-percent increase in relative humidity (in the 50 to 90 percent range). The rate of decrease in the predicted PCT is higher for the ambient temperature 323 K (120°F) case than for the ambient temperature 300 K (80°F) case because of the higher moisture content change for every 20 percent change in relative humidity in the latter, as shown in Tables 4-24 and 4-25.

Table 4-6 Effect of Wind Speed on Predicted PCT for HI-STORM 100U Cask

Wind Speed m/s (mph)	Air Mass Flow Rate (kg/s)	Peak Cladding Temperature (K)
0 (0)	0.227	646
1.3411 (3)	0.189	675
2.235 (5)	0.152	693
3.1292 (7)	0.168	684
4.4703 (10)	0.192	677
6.706 (15)	0.218	661

Table 4-7 Effect of Wind Speed on Predicted PCT for HI-STORM 100 Cask with Four Vents

Wind Speed m/s (mph)	Mass Flow Rate (kg/s)	Peak Cladding Temperature (K)
Base Case	0.156	712
0.8941 (2)	0.146	713
2.235 (5)	0.166	710
3.1292 (7)	0.204	703
4.4703 (10)	0.267	690
6.706 (15)	0.409	669

Table 4-8 Effect of Wind Speed on Predicted PCT for HI-STORM 100 Cask with Two Vents (Wind Perpendicular to Air Vents)

Wind Speed m/s (mph)	Mass Flow Rate (kg/s)	PCT (K)
Base case	0.0958	744.6
2.235 (5)	0.1003	737.4
4.4703 (10)	0.1389	733.8
6.706 (15)	0.2320	714.5

Table 4-9 Effect of Wind Speed on Predicted PCT for HI-STORM 100 Cask with Two Vents (Wind Parallel to Air Vents)

Wind Speed (mph)	Mass Flow Rate (kg/s)	PCT (K)
Base case	0.0958	744.6
2.235 (5)	0.0531	787.2
4.4703 (10)	0.0165	886.5
6.706 (15)	0.0388	879

Table 4-10 Effect of Wind Speed on Predicted PCT for Standardized NUHOMS Cask (Frontal Wind Direction)

Wind Speed m/s (mph)	Mass Flow Rate (kg/s)	PCT (K)
Base Case	0.2512	680.4
2.235 (5)	0.2486	679.6
4.4703 (10)	0.2522	680.4
6.706 (15)	0.2539	679.9

Table 4-11 Effect of Wind Speed on Predicted PCT for Standardized NUHOMS Cask (Side Wind Direction)

Wind Speed m/s (mph)	Mass Flow Rate (kg/s)	PCT (K)
Base Case	0.2512	680.4
2.235 (5)	0.2536	679.9
4.4703 (10)	0.2536	679.6
6.706 (15)	0.2518	679.8

Table 4-12 Effect of Wind Speed on Predicted PCT for Advanced NUHOMS Cask (Frontal Wind Direction)

Wind Speed m/s (mph)	Mass Flow Rate (kg/s)	PCT (K)
Base Case	0.3495	675
2.235 (5)	0.7875	666
4.4703 (10)	1.509	661
6.706 (15)	2.2569	657

Table 4-13 Effect of Wind Speed on Predicted PCT for Advanced NUHOMS Cask (Back Wind Direction)

Wind Speed m/s (mph)	Mass Flow Rate (kg/s)	PCT (K)
Base Case	0.3495	675
2.235 (5)	0.2789	680.6
4.4703 (10)	0.23	689.9
6.706 (15)	0.26	683

Table 4-14 Effect of Wind Speed on Predicted PCT for Advanced NUHOMS Cask (Side Wind Direction)

Wind Speed m/s (mph)	Mass Flow Rate (kg/s)	PCT (K)
Base Case	0.3495	675
2.235 (5)	0.3009	677
4.4703 (10)	0.2902	677
6.706 (15)	0.2959	677

Table 4-15 Transient PCT for Advanced NUHOMS Cask During Worst-Case Scenario (Back Wind Direction)

Time (Days)	Mass Flow Rate (kg/s)	PCT (K)
0	0.3495	675.0
1	0.19	677.8
2	0.20	680.6
3	0.20	682.9
4	0.21	684.8
5	0.21	686.2
6	0.21	687.3
7	0.22	688.2
8	0.22	688.6
9	0.22	688.8
10	0.22	689.1
11	0.22	689.4
12	0.23	689.5

Table 4-16 Advanced NUHOMS Worst-Case Transient Scenario

Case	Mode of Analysis	Wind Conditions	PCT (K)	Time to Reach 95 % of PCT
Advanced TN Back Wind Base Case	Steady	No Wind	675	N/A
Advanced TN Back Wind Worst-Case Scenario	Steady	4.4703 m/s (10 mph) Wind	689.9	N/A
Two Vents Worst-Case Scenario	Transient	4.4703 m/s (10 mph) Wind	$675 + 0.95(689.9 - 675) = 689.1$	10 days

Table 4.17 Aboveground Vertical Cask with Two Vents—Transient Scenario

Time (Days)	PCT (K)
0	744.6
1	779.5
2	810.4
3	829.2
4	842.7
5	852.9
6	860.7
7	866.7
8	871.4
9	875
10	877.9
11	880
12	881.7
13	883.1
14	884.1
15	884.9
16	885.5
17	885.9
18	886.2
19	886.4
20	886.6
21	886.7

Table 4-18 Aboveground Vertical Cask with Two Vents—Worst-Case Transient Scenario

Case	Mode of Analysis	Wind Conditions	PCT (K)	Time to Reach 95% of PCT
Two Vents Base Case	Steady	No Wind	744.6	N/A
Two Vents Worst-Case Scenario	Steady	4.4703 m/s (10 mph) Wind	886.5	N/A
Two Vents Worst-Case Scenario	Transient	4.4703 m/s (10 mph) Wind	$744.6 + 0.95(886.5 - 744.6) = 879.4$	256.4 hrs (10.68 days)

Table 4-19 Effect of Ambient Temperature on Predicted PCT (Steady-State Analysis)

Ambient Temperature K (°F)	Air Inlet Density (kg/m ³)	PCT (K)
300 (80)	1.1766	712
305 (90)	1.1559	720
311 (100)	1.1353	728
316 (110)	1.1153	736
322 (120)	1.0961	744

Table 4-20 Transient PCT for the Effect of Ambient Temperature

Time (Days)	PCT (K)
0	712
1	721.5
2	729.8
3	734.9
4	738.1
5	740.2
6	741.6
7	742.4
8	743
9	743.3

Table 4-21 Effect of Ambient Temperature on Predicted PCT (Transient Analysis)

Case	Mode of Analysis	Ambient Temperature K (°F)	PCT (K)	Time to Reach 95% of PCT
Base Case	Steady	300 (80)	712	N/A
Worst-Case Scenario	Steady	322 (120)	744	N/A
Worst-Case Scenario	Transient	Step change 300 (80) → 322 (120)	$712 + 0.95(744 - 712) = 742.4$	167.83hrs (~7 days)

Table 4-22 Effect of Elevation on Predicted PCT (Steady-State Analysis)

Elevation (m)	Inlet Air Density (kg/m ³)	PCT (K)
0	1.1766	712
500	1.11	718
1,000	1.0434	724
1,500	0.9767	731

Table 4-23 Effect of Total Decay Heat on Predicted PCT (Steady-State Analysis)

Q (kW)	PCT (K)
20	556
22	578
24	600
26	623
28	645
30	668
32	690
34	712

Table 4-24 Effect of Humidity on Predicted PCT at Ambient Temperature of 300 K (Steady-State Analysis)

Ambient Temperature K (°F)	Density (kg/m³)	Φ (%)	PCT (K)
300 (80)	1.177	0	712.6
	mixture	50	710.9
	mixture	70	710.3
	mixture	90	709.7

Table 4-25 Effect of Humidity on Predicted PCT at Ambient Temperature of 323 K (Steady-State Analysis)

Ambient Temperature K (°F)	Density (kg/m³)	Φ (%)	PCT (K)
323 (120)	1.0928	0	745
	Mixture	50	739
	Mixture	70	737
	Mixture	90	734.7

5.0 CONCLUSIONS

This report describes the application of the ANSYS FLUENT commercial computational fluid dynamics (CFD) code to examine the effect of environmental conditions on the thermal performance of dry storage casks. The research included the effect of wind speed and direction, elevation, total decay heat, air humidity, and ambient temperature. The magnitude of the environmental variables was selected using available data from National Oceanic and Atmospheric Administration (NOAA) and *ASHRAE Handbook Fundamentals* (ASHRAE, 1997). Thermal analyses used thermal models of underground casks, aboveground vertical casks, and aboveground horizontal casks. These analyses included the use of 3-D models as well as axisymmetric representation of a vertical-ventilated cask. Based on the analysis results, the report reached the following conclusions:

- Wind magnitude mainly affects the underground cask design included in this study. As wind speed increases, predicted peak cladding temperature (PCT) increases for a range of wind speeds of 0 to 2.235 meters per second (m/s) [0 to 5 miles per hour (mph)], as compared to quiescent conditions. At a wind speed of about 2.235 m/s (5 mph), the PCT reached the maximum predicted value. At higher wind speeds, the PCT starts to decrease. Therefore, low wind speed should be considered in the thermal evaluation as a normal environmental variable. This specific analysis examined the effect on this type of underground design and determined that a wind speed of 2.235 m/s (5 mph) will result in the maximum predicted cladding temperature. A thermal evaluation should be performed for other underground designs to determine how wind affects the cask's thermal performance, as part of the thermal evaluation for normal storage conditions.
- Wind slightly enhanced the thermal performance of an aboveground vertical cask with at least four air vents. The predicted PCT decreases as wind speed increases.
- Wind enhanced the thermal performance of a postulated two-vent cask design when the wind blows in the direction normal (perpendicular) to the air vents. The predicted PCT decreases as wind speed increases.
- Wind negatively affected the thermal performance of a postulated two-vent vertical cask design when wind blew parallel to the air vents. At a wind speed of 4.4703 m/s (10 mph), the PCT reaches its maximum predicted value and then starts to decrease at higher values.
- For the postulated two-vent vertical aboveground cask, about 95 percent of PCT change was reached in 10 days for the case where wind direction is parallel to the air vents (worst-case scenario).
- Wind does not significantly affect the performance of the aboveground horizontal standardized NUHOMS casks. The vents in the standardized NUHOMS overpack are located on the sides of the overpack and therefore are not in direct contact with either parallel or normal wind.

- Wind does not significantly affect the advanced NUHOMS casks when the wind direction is blowing parallel to the air vents.
- Wind enhances the thermal performance of the advanced NUHOMS cask when wind blows in the direction normal (perpendicular) to the cask front. The predicted PCT decreases as wind speed increases.
- Wind affects the thermal performance of the advanced NUHOMS casks when the wind direction is normal (perpendicular) to the back of the cask. The PCT reaches its maximum predicted value at a wind speed of 4.4702 m/s (10 mph) and then starts to decrease.
- Based on a transient analysis, about 95 percent of PCT change is reached in 10 days when the wind direction is normal (perpendicular) to the back of the advanced NUHOMS cask with a magnitude of 10 mph. For this design, the applicant should include the effect of back wind when there is no sufficient margin.
- Ambient temperature inversely affects the thermal performance of a spent fuel dry storage cask. The PCT increases by 8 Kelvin (K) [14.4 degrees (°) Fahrenheit (F)] for every 5.6 K (10°F) increase in ambient temperature.
- Based on a transient analysis, about 95 percent of the PCT change between the 300 and 322 K (80 and 120°F) steady-state cases is reached after 7 days. Measured temperatures suggest that, to bound all sites, the SAR thermal evaluation should consider seasonal variations.
- Elevation inversely affects the thermal performance of a spent fuel dry storage cask. The PCT increased by 6 K (11°F) for every 500 m increase in elevation.
- Ambient air humidity enhances the thermal performance of a spent fuel dry storage cask. At an ambient temperature of 300 K (80°F), the PCT decreased by 0.6 K (1°F) for every 20 percent relative humidity increase in the range of 50 to 90 percent. At an ambient temperature of 323 K (122°F), the PCT decreased by 2.2 K for every 20 percent relative humidity increase in the range of 50 to 90 percent.
- As the total decay heat is increased, the PCT is negatively affected. The PCT increases by 22 K (40°F) for every 2 kW increase in the total heat load of the cask.

6.0 REFERENCES

ASHRAE Handbook Fundamentals, Atlanta, GA, 1997.

American Society of Mechanical Engineers (ASME), "Standard for Verification and Validation in Computational Fluid Dynamics and Heat Transfer," V&V 20-2009.

Fluent User Guide Version 6, Fluent Inc., New Hampshire, 2006.

Holtec International, HI-STORM 100 Final Safety Analysis Report, December 2005.

Holtec International, HI-STORM 100 Final Safety Analysis Report, December 2007.

Idelchik, I.E., "Handbook of Hydraulic Resistance," 3rd edition, CRC Press, 1993.

JANAF Thermochemical Tables, Third Edition, published by the American Chemical Society and the American Institute of Physics for the National Bureau of Standards, Volume 14, 1985.

NOAA, National Oceanic and Atmospheric Administration, Web page: www.noaa.gov.

NUREG-1536, "Standard Review Plan for Spent Fuel Dry Storage Systems at a General License Facility," Washington, DC, July 2010.

Reid, Robert C, John M. Prausnitz, and Thomas K. Sherwood, *The Properties of Gases and Liquids*, McGraw-Hill Book Company, Inc, 3rd edition, 1977.

Sparrow, E. M. and A. L. Loeffler, Jr., "Longitudinal laminar flow between cylinders arranged in regular array," *A.I.Ch.E. Journal*, Volume 5, No. 3, pp. 3253–30, 1959.

TRW Environmental Safety Systems, Inc., "Spent Nuclear Fuel Effective Thermal Conductivity Report," Prepared for U.S. Department of Energy, July 11, 1996.

Transnuclear, Inc., Standardized NUHOMS Final Safety Analysis Report, January 2006.

Transnuclear, Inc., Standardized Advanced NUHOMS Final Safety Analysis Report, August 2008.

NUREG-2152, "Computational Fluid Dynamics Best Practice Guidelines for Dry Cask Applications," Washington, DC, March 2013.

Title 10, "Energy," of the *Code of Federal Regulations*, Part 71, "Packaging and Transportation of Radioactive Material."

Title 10, "Energy," of the *Code of Federal Regulations*, Part 72, "Licensing Requirements for the Independent Storage of Spent Nuclear Fuel, High-Level Radioactive Waste, and Reactor-Related Greater Than Class C (GTCC) Waste."

APPENDIX A

EFFECTIVE THERMAL CONDUCTIVITY

The tightly packed spent fuel rods within the stainless-steel spent fuel canisters are modeled as a homogeneous solid material region with a specified uniform heat generation rate and an effective thermal conductivity. The anisotropic thermal conductivity option in the ANSYS FLUENT code was used to represent the different effective conductivities of the spent fuel region in the axial and radial directions. The effective conductivity in the axial direction was represented as an area-weighted fraction of the conductivity of Zircaloy-4, using an area-weighted ratio of the cladding to the total cross-section of the homogeneous region. This relationship was implemented in ANSYS FLUENT, based on the temperature-dependent thermal conductivity of Zircaloy-4. The effective thermal conductivity (k -effective (k_{eff})) values in the radial direction of the spent fuel region were obtained as a function of temperature using the standard k_{eff} methodology (TRW report, 1996). The k_{eff} values used in the canister are based on a calculational “database” generated by a separate two-dimensional (2-D) ANSYS FLUENT analysis for unconsolidated spent fuel using a detailed 2-D model (NUREG-2152, 2013).

The radial and axial k_{eff} values calculated for a helium environment inside the canister are shown in Tables A-1 through A-4 for the different configurations used in this report. This is the approach generally employed in a typical spent fuel dry storage cask safety analysis report (SAR) to determine peak cladding temperatures in spent fuel dry storage casks when the spent fuel assemblies are modeled as a homogeneous material (i.e., porous media). Following the documented form of the basic k_{eff} model, this approach produced an effective thermal conductivity for the homogeneous spent fuel region as a function of the local temperature on the computational domain. The model is implemented in ANSYS FLUENT as temperature-dependent k_{eff} values.

Table A-1 Spent Fuel Radial and Axial K_{eff} for the 3-D Model of the Aboveground Vertical Cask

Temperature (K)	K radial (W/(m-K))	K axial (W/(m-K))
366	2.0738	7.39
505	2.5507	8.01
644	3.0976	8.54
783	3.5783	9.089

Table A-2 Spent Fuel Radial and Axial K_{eff} for 3-D Model of the Underground Vertical Cask

Temperature (K)	K radial (W/(m-K))	K axial (W/(m-K))
366	0.445	1.35
505	0.703	1.268
644	1.045	1.431

Table A-3 Spent Fuel Radial and Axial K_{eff} for the 3-D Model of the Horizontal Cask

Temperature (K)	K radial (W/(m-K))	K axial (W/(m-K))
366	1.3	1.27
505	2.3	2.04
644	3.3	2.278

Table A-4 Spent Fuel Axial and Radial K_{eff} for the Axisymmetric Model

Temperature (K)	K radial (W/(m-K))	K axial (W/(m-K))
366	2.0738	7.39
505	2.5507	8.01
644	3.0976	8.54

APPENDIX B

FLOW RESISTANCE

To obtain the porous media flow-resistance parameters (frictional and inertial losses), three-dimensional (3-D) computational fluid dynamics calculations are performed (NUREG-2152, 2013). The analyzed control volume consists of the assembly walls surrounding the spent fuel rods and associated grid spacers. All flow areas and passages are modeled explicitly. The case should reflect and model flow losses in the expected operating conditions (pressure and average gas temperature) when spent fuel is inside the dry storage cask. The present analysis used a total pressure of 7 atmospheres (atm) and a temperature of 505 K.

The ANSYS FLUENT code (FLUENT, 2006) defined the porous media flow-resistance model as:

$$\frac{\Delta P}{L} = D\mu V + C\left(\frac{1}{2}\rho V^2\right) \quad (1)$$

Where

ΔP is the porous media pressure drop.

V is the superficial fluid velocity.

L is the length of porous media.

μ is the fluid viscosity.

ρ is the fluid density.

D is the viscous resistance parameter.

C is the inertial resistance parameter.

In dry cask applications, the C factor is not as dominant as the D factor because of the low fluid velocity that exists inside the canister. As such, the entire pressure drop was assumed to be entirely caused by frictional losses. As a verification, the inertial coefficient (C) can be computed from correlations using area contractions and expansion (Idelchik, 1993) in the assembly to show that the second term in Equation (1) is negligible. Additionally, it would be conservative to neglect C , because predicted peak cladding temperatures will be slightly higher.

By definition, the frictional pressure drop is:

$$\frac{\Delta P}{L} = \frac{f}{D_h} \frac{1}{2} \rho V^2 \quad (2)$$

Where D_h is the hydraulic diameter.

Knowing that:

$$\text{Re} = \frac{\rho V D_h}{\mu}$$

We get:

$$\frac{\Delta P}{L} = \frac{f \text{Re}}{2} \frac{\mu}{D_h^2} V$$

Usually the friction factor in the laminar regime as shown in a Moody diagram will have the following form:

$$f = \frac{A}{\text{Re}} \quad (3)$$

As an illustration, the frictional coefficient due to the pressure drop for laminar flow in a pipe has been experimentally determined to correspond to the following expression:

$$f = \frac{64}{\text{Re}}$$

Thus:

$$\frac{\Delta P}{L} = \frac{32\mu}{D_h^2} V$$

For an array of solid rods, as is the case of a nuclear spent fuel assembly from a boiling-water or a pressurized-water reactor, the value of the factor “A” can be determined from available literature (Sparrow, 1959). The “A” factor has been found to have a value around 100, depending on the pitch-to-diameter ratio and the porosity of the array.

Using Equation (1) and neglecting the inertial term because of the low fluid velocities existing inside the storage canister, the dominant contributor to pressure drop is the viscous effect. The pressure drop through the rod array can be simplified to:

$$\frac{\Delta P}{L} = D\mu V \quad (4)$$

Then

$$D = \frac{A}{2D_h^2} \quad (5)$$

For laminar flow inside a pipe, $A = 64$, and the input frictional resistance in ANSYS FLUENT should be:

$$D = \frac{32}{D_h^2}$$

Also, by definition:

$$f = \frac{4\tau_w}{\frac{1}{2}\rho V^2} \quad (6)$$

Where τ_w is the wall shear stress.

The porous media frictional flow-resistance values for D were calculated using both pressure drop and shear stress. Both methods should lead to similar results. Using the shear stress ANSYS FLUENT output data, the viscous resistance parameter D is obtained using the combination of Equations (2), (4), and (6). The following expression is obtained:

$$D = \frac{4\tau_w}{\mu V D_h} \quad (7)$$

If the pressure loss data were used, the expression for D is obtained from Equation (4) as follows;

$$D = \frac{\Delta P}{L\mu V} \quad (8)$$

From the CFD calculations of the spent fuel assembly, the wall shear stresses or pressure drop values should be obtained separately for bare fuel rods and fuel rods plus grid straps. Depending on the approach used to calculate the friction factors, Equation (7) or (8) is used to obtain the parameter D. Table B-1 provides the calculated frictional porous media flow resistance parameters.

Table B-1 Frictional Porous Media Flow Resistance Factors Used in ANSYS FLUENT

Region	HI-STORM 100U 3-D Model (1/m ²)	HI-STORM 100 Model (1/m ²)	HI-STORM 100 Axisymmetric Model (1/m ²)
Active region	7.41E5	1.7E6	1.7E6
Bottom inactive region	8.82E5	1.7E6	1.7E6
Top inactive region	4.4E5	1.7E6	1.7E6

APPENDIX C

PUBLIC COMMENTS RECEIVED AND THEIR DISPOSITION

The purpose of this appendix is to list all the public comments received on draft NUREG-2174, "Impact of Variation in Environmental Conditions on the Thermal Performance of Dry Storage Casks". The NRC issued draft NUREG-2174 (Agencywide Documents Access and Management System (ADAMS) ML No. 15054A207) for public comment on March 5, 2015, for a 60-day period and received comments from the following nine sources:

- 1) Donna Gilmore, SanOnofreSafety.org, San Clemente, CA
- 2) Linda Seeley, 384 Henrietta Avenue, Los Osos, CA
- 3) Pia Jensen
- 4) Raymond Lutz, 771 Jamacha Rd. # 148, El Cajon, CA
- 5) Susan Shapiro, Indian Point Safe Energy Coalition, Council on Intelligent Energy & Conservation Policy (CIECP), Public Health and Sustainable Energy (PHASE)
- 6) Nuclear Energy Institute, 1201 F Street, NW, Suite 1100 Washington, DC
- 7) Holtec International, Holtec Center, One Holtec Drive, Marlton, NJ
- 8) Anonymous 1
- 9) Anonymous 2

The staff's resolution and any associated changes to the standard review plan are listed for each comment.

Donna Gilmore, SanOnofreSafety.org, San Clemente, CA

DG-1. Analyze partial or full blockage of air vents.

Resolution:

This event does not apply to this report. As required by applicable NRC staff guidance, the NRC evaluates the event in the application under off-normal and accident condition standards.

DG-2. Address underground system that is actually being used in the U.S., especially since the underground system has thermal challenges and is a new experimental system, never used anywhere in the world. The HI-STORM UMAX system was recently installed at Callaway and has been proposed for San Onofre, although it is not yet approved for high seismic areas, such as San Onofre. Here is link to UMAX technical documents for easy reference: Holtec Intl [sic], Certificate of Compliance No. 1040 for the HI-STORM UMAX Cask Storage System (TAC No. L24664) Docket No. 72-1040 <http://pbadupws.nrc.gov/docs/ML1509/ML15093A498.html>

Resolution:

This system has been reviewed as part of a normal application. Also, the findings from the HI-STORM 100U cask system are applicable to this cask.

DG-3. Following information from HI-STORM UMAX CoC Appendix B that would be useful to address in NUREG 2174, since it identifies additional environmental variables that would be affected by the wind variables you analyzed. See CoC Appendix B, Approved Contents and Design, HI-STORM UMAX Canister System, April 6, 2015
<http://pbadupws.nrc.gov/docs/ML1509/ML15093A514.pdf> Maximum heat load is 37.06 Address blockage of any VVM inlet or outlet air ducts for extended period of time

Resolution:

See NRC staff responses to comments DG-1 and DG-2.

DG-4.a. Address climate change to ensure the most conservative thermal margins are used. NOAA Southwest Extremes in Maximum Temperature, Summer 1910-2014, <http://www.ncdc.noaa.gov/extremes/cei/graph/sw/1/06-08>, Maximum Temperature for All States <https://sanonofresafety.files.wordpress.com/2015/05/noaamaximumtemDeratures2015-05-04.pdf>

Resolution:

A maximum ambient temperature of 120°F was considered in this report. This value is arbitrary and does not necessarily reflect the maximum for all states. The conclusions are valid for this value.

DG-4.b. Use maximum rather than average temperatures. Historical data for maximum temperature is 134F (56.7C). NOAA U.S. Climate Extremes
<http://www.ncdc.noaa.gov/extremes/ncec/records>

Resolution:

The study considered a temperature range of 80-120°F. Site-specific analysis should be performed for higher values. The intent of the report was not to consider the maximum ever recorded but the relative effect on the predicted peak cladding temperature.

DG-4.c. Analyze maximum ground temperatures and concrete temperatures, since this could affect the peak cladding temperatures.

<http://earthobservatory.nasa.gov/Features/HottestSpot/page1.php>

Resolution:

These components are included in the analysis. The heat exchange between these components, the cask itself, and the ambient temperature is included in the analytical model.

DG-5. Include definition of long term storage. 2014 NRC decision on Continued Storage has definitions.

Resolution:

Long-term storage in dry casks is addressed in Title 10 of the *Code of Federal Regulation* Part 72, "Licensing Requirements for the Independent Storage of Spent Nuclear Fuel, High-Level Radioactive Waste, and Reactor-Related Greater Than Class C Waste," under the guidance for receiving a general license and certificate of compliance.

DG-6. Recommend reevaluating approved and pending dry cask designs to address the potential need for lower thermal limits. The critical information provided here could create thermal conditions such that spent fuel could degrade and lead to gross rupture.

Resolution:

For each certificate application, the NRC staff is addressing the parameters considered in this NUREG.

DG-7. Recommend identifying existing loaded canisters that may have thermal conditions such that spent fuel could degrade and lead to gross rupture.

Resolution:

The staff is not aware of any such cases.

DG-8. Is there any remediation that should or could be done if any existing loaded canisters may have thermal conditions such that spent fuel could degrade and lead to gross rupture?

Resolution:

If such conditions existed, the U.S. Nuclear Regulatory Commission would not issue the certificate of compliance. During the technical review, the staff makes sure adequate margins exist.

DG-9. What is the range of additional time the fuel would need to remain in the pools to minimize or avoid this problem? Recommend minimum time fuel should cool in the pool for lower burnup and another for higher burnup fuel. The high burnup fuel at San Onofre in existing NUHOMS 24PTH2 canisters requires 9 to 15 years to cool. The newer model NUHOMS-32PTH2 which holds more fuel assemblies requires just a few years.

Resolution:

See the NRC staff response to Comment DG-8.

DG-10. Are we pushing the thermal limits on what is safe, especially since we're dealing with climate change and longer storage requirements in environments and with canisters not designed for long term storage and are subject to corrosion and cracking? These canisters cannot be inspected for cracks, cannot be repaired or maintained. There is no early warning, prior to a radiation leak and no plan to deal with a failed canister (especially if there is no spent fuel pool, as is allowed in decommissioned plants).

Resolution:

See the NRC staff response to Comment DG-8.

DG-11. A comparable stainless steel welded container at the Koeberg nuclear power plant, had a 0.6" deep crack in 17 years from chloride-induced stress corrosion cracking. Most canisters are only 0.5 0.625. San Onofre has the same environment as Koeberg -- on shore winds, high surf, and daily fog most of the year. Because canisters at San Onofre are filled with spent fuel, crack growth rate will be higher from higher heat. The Koeberg container was at ambient temperatures. We don't know when a crack may initiate, but we know we have all the conditions for cracking. We are not prepared for this. If a canister has cracks, how will this affect your heat load calculations and do we run a higher risk of faster crack growth with these higher temperatures?

Resolution:

This comment is out of scope. These conditions were not envisioned in this study and are not applicable.

DG-12. What are the environmental consequences of a microscopic through-wall crack? Dr. Singh, Holtec President, said a microscopic crack will release millions of curies of radiation and its not feasible to repair these canisters.

<https://www.youtube.com/watch?v=euaFZtOYPi4&feature=youtu.be>

Resolution:

This comment is out of scope.

DG-13. San Onofre has over 95 damaged fuel assemblies in canisters. Fuel was loaded in canisters starting in 2003. If we have a similar timeline for cracking as Koeberg, we only have 8 years before one or more canisters fails. What is the plan to deal with this? Will the NRC continue to permit these higher heat loads that allows cracks to grow faster, yet with no plan for how to remediate a failed canister?

Resolution:

This comment is out of scope.

Linda Seeley, 384 Henrietta Avenue, Los Osos, CA

LS-1. The issue of climate change does not appear to be addressed. Using historical data is important. However, given that climate change will create more extreme conditions, this should be considered to ensure the most conservative thermal margins are used, especially since you are considering this for long term storage.

Resolution:

The NRC selected this range based on meteorological observations.

LS-2. Please include the definition of "long term storage" as used in this NUREG. The 2014 NRC decision on Continued Storage has some specific definitions of time periods. It is not clear how these relate to this NUREG. The NRC Continued Storage decision referred to short term as being about 100 years (60 years after end of operating license). Or maybe 120 years, if it includes a 20-year license extension.

Resolution:

Long-term storage in dry casks is addressed in Title 10 of the *Code of Federal Regulation* Part 72, "Licensing Requirements for the Independent Storage of Spent Nuclear Fuel, High-Level Radioactive Waste, and Reactor-Related Greater Than Class C Waste," under guidance for receiving a general license and certificate of compliance.

LS-3. Should there be a recommendation in this NUREG to consider reevaluating approved and pending dry cask designs to address the potential need for lower thermal limits, since the critical information you are providing here could create thermal conditions such that spent fuel could degrade and lead to gross rupture?

Resolution:

For each certificate application, the NRC staff are addressing the parameters considered in this NUREG.

LS-4. Should there be a recommendation in this NUREG to identify existing loaded canisters that may have thermal conditions such that spent fuel could degrade and lead to gross rupture?

Resolution:

The staff is not aware of any such cases.

LS-5. Is there any remediation that should or could be done if any existing loaded canisters may have thermal conditions such that spent fuel could degrade and lead to gross rupture?

Resolution:

If such conditions existed, the U.S. Nuclear Regulatory Commission would not issue the certificate of compliance. During the technical review, the staff makes sure adequate margins exist.

LS-6. There should be a recommended minimum time that fuel should cool in the pool for lower burnup and another for high burnup fuel. The high burnup fuel at Diablo Canyon in existing canisters requires 9 to 15 years to cool.

Resolution:

The NRC staff addresses this during the technical review of the application. The certificate of compliance or license specifies these parameters based on the technical review.

LS-7. Are you pushing the thermal limits on what is safe, especially with the information about climate change and longer on-site storage requirements. Canisters that were not intended for long term storage and are subject to corrosion and cracking and other degradation mechanisms are being used at Diablo Canyon. These thin canisters cannot be inspected for cracks and cannot be repaired or maintained. There is no early warning, prior to a radiation leak and no plan in place to deal with a failed canister (especially if there is no spent fuel pool, as is allowed in decommissioned plants).

Resolution:

See NRC staff response to Comment LS-5.

LS-8. A comparable stainless steel welded container at the Koeberg nuclear power plant, had a 0.6" deep crack in 17 years from chloride-induced stress corrosion cracking. Most of US canisters are thinner than this crack (1/2" to 5/8"). Diablo Canyon has the same environment as Koeberg -- on shore winds, high surf and daily morning or evening fog most of the year. And because the canisters at Diablo Canyon are filled with spent nuclear fuel, the crack growth rate will be higher from higher heat. The Koeberg container was at ambient temperatures. We don't know when a crack may initiate, but we know we have all the conditions for cracking. We don't appear to be prepared for this. If a canister has cracks, how will this affect your heat load

calculations and do we run a higher risk of faster crack growth with these higher temperatures (once the temperature is below 85 degrees C)?

Resolution:

This comment is out of scope.

LS-9. What are the range of environmental consequences of a microscopic through-wall crack in one of these thin canisters with gross ruptured spent fuel? Dr. Singh, Holtec President and CEO, said a microscopic crack will release millions of curies of radiation and its not feasible to repair these canisters. <https://www.youtube.com/watch?v=euaFZtOYPi4&feature=youtu.be>

Resolution:

This comment is out of scope.

Pia Jensen

PJ-1. Under what environmental waste storage guidance is averaging allowed in storage of chemical or other toxic waste (NRC, USEPA, USDA)? There are variables - some materials can withstand high heat for days on end without transformation:

Resolution:

Specific guidance can be found in Section 2.5.2.2 of NUREG-1536 "Standard Review Plan for Spent Fuel Dry Storage Systems at a General License Facility."

PJ-2. Nuclear waste is not a material that can withstand prolonged periods of high temperatures (exceeding small thermal margins) without compositional changes occurring.

Resolution:

Thermal margins are not being exceeded. This additional guidance is provided for cases where the effect of the considered parameters is critical. Therefore, applicants should consider the findings in the final safety analysis report.

PJ-3. How will handlers compensate for summer time periods of prolonged heat exceeding "acceptable" temperatures? At what point do monitoring personnel decide risk exists due to prolonged hours of excessive heat? What response plans are in place for managing high temperature days to avoid peak cladding temperatures?

Resolution:

They should not go beyond acceptable limits as specified in the Standard Review Plan.

PJ-4. Please explain assumptions leading to decisions about averaging temperatures.

Resolution:

See the NRC staff's response to Comment PJ-1.

Raymond Lutz, 771 Jamacha Rd. # 148, El Cajon, CA

RL-1. Conclusions of this document only made comments regarding out PCT (peak cladding temperature) changes with regard to environmental conditions, but did not go on to say what are the limiting conditions where each configuration was found to be always within operational limits. Thus THE EXPECTED FINAL CONCLUSIONS IN THIS DOCUMENT ARE MISSING!

For example, considering worst case environmental conditions, i.e. 120 degrees F, reasonable high altitude (say 1000 ft elevation), 0 percent RH, 5 mph wind, do the various dry cask configurations perform adequately given a range of heat source levels (such as a mixture of 25% high burn up fuel and 75% standard fuel, after being stored in a fuel pool for the minimum time, say five years.)

Thus, given worst case conditions, we need to ask: DO THE DRY CASK SYSTEMS KEEP PCT BELOW CRITICAL LEVELS?

WE MUST DETERMINE if these systems are right on the bitter edge of functioning, or if there is adequate margin in the operational thermal dissipation design. The detailed analysis is of little use if the system has decent margin, and if it does not have decent margin, then the designs need to serious design review. These systems should not be only barely within margin!

What worries me is that these dry cask systems have apparently been designed without reviewing the worst-case environmental conditions.

You also decided without any rationale to disregard solar heating of the dry cask systems. This could have serious impact particularly in the UMAX (underground design) if placed in a desert region with intense solar heating of metallic components on the surface. It seems this parameter cannot be disregarded UNLESS there is plenty of margin in the overall calculation, which was missing, as stated.

The vertical configuration (Holtec UMAX) could be seriously impacted by the intrusion of water into the bottom of the well, thereby not allowing air currents to flow down and then turn around the bottom and the up and out. A small amount of water, say as little as 12 inches in the bottom of the well could seal off air flow.

Thus, the worst case calculations should include what will happen not just if there is a slight wind, but if there is a flash flood where water intrudes into the well and seals airflow completely

Then, we need to know how much time do we have to pump the water out of the well and re-establish air flow.

Is it necessary to shield canisters from the wind? not answered.

Are there places in the country which have temps too high and humidity too low such that these will not work?

The Palo Verde plant west of Phoenix AZ is in a desert region and temperatures are frequently well over 100 degrees F, and very dry. Will the designs reviewed operate with adequate margin in those conditions? Not answered.

Although this paper did provide useful information, it is a long way from being useful, particularly by the general public. The primary question is not asked or answered: Do these dry cask systems provide adequate margin for heat dissipation even in worst case conditions?

Resolution:

The report states that the objective of the study was to obtain the relative effect on the peak cladding temperature from the different variables considered in the analyses.

Susan Shapiro, Indian Point Safe Energy Coalition, Council on Intelligent Energy & Conservation Policy (CIECP), Public Health and Sustainable Energy (PHASE)

SS-1. Climate Change

Climate change will undoubtedly stress dry cask systems and all infrastructures that support their operation. These stresses include: drought; severe and extended heat waves; storm surges; extreme precipitation events; increased precipitation; flooding; altered chemical environments; and changing geological and hydrological conditions. In coastal and low-lying areas, risks include sea level rise.

Climate change conditions will also impact regional systems, which can drastically alter site locations and compromise the integrity of foundations and other cask system structures - potentially in ways that prevent mitigation of problems. An example would be the catastrophic failure of a dam or levy.

Sea level rise and increases in the frequency and severity of major storm events can also lead to changes in the forcing of groundwater flow beneath dry cask structures. This can, in turn, impact the integrity of the dry cask system foundations. Forcing events include diurnal tides, storms, and periods of high rainfall. (The impact of forcing is evident at the damaged Fukushima and Runit Dome sites.)

Another significant stressor tied to climate is the likely increase of the intensity and number of freeze-thaw cycles.

Impacts of warming, water source depletion and prolonged droughts, particularly in the Southwestern United States, will also substantially raise the risk of large long-lasting forest fires.

Notably the effects and impacts of climate change will interact. Just as more extreme weather will increasingly stress engineered systems, the consequences of engineered system failures will increasingly stress the environment. Even small mechanistic failures (e.g., radiation leaks) might have large scale impacts. This is particularly true of regions already burdened by decades of radioactive pollutant releases from uranium mining, milling, and enrichment operations (e.g., Navajo lands). Minor additional alteration or degradation of aquifers in those lands could have enormous negative consequences for those environments and regional populations. Due to the growing pressure on clean drinking water supplies it is imperative that all dry casks contain radiation leaks from groundwater, as groundwater is future drinking water.

The impact of dry cask storage systems upon the climate itself is another factor mandating analysis. These systems will place a very long term thermal load upon the environment (again, a problem particularly serious in areas afflicted by drought). The continuous CO₂ and methane emissions of new produced Carbon-14 is an additional factor requiring assessment and continuous realtime monitoring and reporting.

SS-2. Anthropogenic Environmental Factors

Anthropogenic environmental conditions also require assessment. Such factors include infrastructure risks which could significantly impact cask behavior. One example is nearby gas pipelines. Pipeline ruptures are a well recognized cause of gas explosions and fires which can burn for extended periods. The Algonquin Incremental Market Project (AIM) includes a two-mile section of 42 inch pipe, which will be carrying gas under extremely high pressure. A segment of this pipeline is planned to be situated in close proximity to the Indian Point nuclear power plant and dry cask storage installation in Buchanan, New York, 24 miles from New York City. The Indian Point plant is already identified as vulnerable to seismic activity and has degraded fire protection standards. Dry casks at this site are therefore obviously at risk should a catastrophic pipeline rupture occur. A second example of man-made hazard is increased seismic activity in regions with fracking wells. A third is the possibility of malicious activity aimed at exploiting weaknesses in cask structures.

SS-3. Damaged Fuel Rods and Assemblies

Specific engineering considerations which need to be addressed are the behaviors of already materially compromised spent fuel rods and/or assemblies, as well as increased amounts of high burnup fuel which must be stored as damaged fuel requiring additional engineered barriers to prevent radiation leaks into the environment.

SS-4. The Effects of Time

It is important to include in modeling the likely combined realities that adverse ambient conditions may exist for very prolonged periods and engineered systems will deteriorate.

Modeling should not assume cask structures many decades from now will conform to design basis. In other words, design basis conditions are a false starting point when the timeline is a century or more. A system which may be robust over a period of 20 years is likely to be far less robust in 120 years. Real world conditions are likely to deliver many decades of low level stressors likely to result in many incremental decreases in the integrity of all structures. This must either be considered in the analysis, or - at the very least - clearly identified as an uncertainty.

SS-5. Complex Interactions of all Variables

Modeling must incorporate the many feedback loops between climate change, infrastructure, weathering and deterioration of engineered systems. Risk can spread in a cascading manner. While no model can incorporate all risks, the excluded variables need to be clearly identified as unexamined.

SS-6. Funding Mechanisms for Replacement Cask Structures

Modelling must assume future generations which will not benefit from the storage nuclear fuel and may not require continued funding for replacement of cask structures every 100 or so years, for the next 2400 years. Given that the United States is only 239 years old and that no one predict the future, it cannot be assumed that the current legislative and administrative system will remain functional in the future to require such replacement of nuclear fuel waste storage systems.

Acceptance of subpar systems for currently existing nuclear waste, cannot be used to justified additional production of nuclear waste. No more production of nuclear waste should be enabled until there is full assurance that such nuclear waste streams will be contained from the environment for the many centuries it remains toxic and mutagenic to human and reproductive health.

SS-7. Use of Best Technology Available

High quality dry cask storage systems are currently available in use in Germany and Japan, yet the NRC has failed to require the use of these safer casks and has not required the use of the Best Technology Available in the dry cask systems. The current systems approved by the NRC do not meet the Best Technology Available and therefore do not meet the regulatory environmental protection standards required by the Clean Water Act.

Resolution:

Comments SS-1 through SS-7 are out of scope. The analyzed variables were used to investigate the effect on the cask thermal performance so applicants could use the conclusions of the report as guidance when applying for a certificate of compliance or license.

Nuclear Energy Institute, 1201 F Street, NW, Suite 1100 Washington, DC

NEI-1. There are statements in the draft NUREG that appear to inappropriately state new requirements. Industry's position on these statements is detailed in the attachment to this letter. If the NRC intends to incorporate the technical information from the draft NUREG into the CoC application review process, then it would be more appropriate for this information to be directly incorporated into NUREG-1536, in a manner consistent with the objectives of NUREG-1536.

Resolution:

This draft NUREG report does not add any new requirements. The draft NUREG report provides additional guidance to raise awareness. The guidance is being incorporated as a reference in the next revision of NUREG-1536 "Standard Review Plan for Spent Fuel Dry Storage Systems at a General License Facility" or any other applicable Standard Review Plan.

NEI-2. There are a number of considerations regarding conservatisms in the analysis in the draft NUREG and licensing basis thermal calculations that should be factored into the determination that a given cask system will satisfy the peak cladding temperature limits with reasonable assurance that are not fully recognized in the results presented in Section 4. These considerations are explained in the attachment to this letter.

Resolution:

Regardless of the thermal model conservatism or nonconservatisms, the environmental variables affect the cask thermal performance and therefore, should be considered in the cask thermal design.

NEI-3. In most cases the analysis performed in the draft NUREG was based on steady state conditions (i.e., long-term environmental conditions) and did not consider the effect of nearby buildings, other casks, or topography. Industry believes that this approach is overly conservative. Our position in this regard is discussed in the attachment to this letter.

Resolution:

See response to Comment NEI-2.

NEI-4. The report includes a statement about the significance and impact of the results presented in the draft NUREG that is not substantiated with experimental data or operational experience. Our specific concerns with this statement is discussed in the attachment to this letter.

Resolution:

Both these results and licensing basis results are based on analyses where lack of experimental data is evident. While the staff always welcomes new experimental data to validate the

analytical tools, data is limited and the acceptance of the thermal design relies heavily on computer simulations, adequate margins, and determination of the numerical uncertainty of the thermal models.

Holtec International, Holtec Center, One Holtec Drive, Marlton, NJ

HI-1. Table B-1 reports the flow resistance factors used in ANSYS FLUENT model for HISTORM 100 and HI-STORM 100U. The text indicates that these values are calculated from NUREG-2152; however, based on a review of NUREG-2152, it is observed that the flow resistance values reported therein are not consistent with those presented in this proposed draft report (NUREG-2174). It is therefore unclear how these values were calculated.

Resolution:

The values used in the analysis do not affect the results since the objective is to compare the relative effect of the environmental variables. In this case, the values are kept fixed during the analysis.

HI-2. The evaluations in the draft NUREG considered variations in the normal ambient temperature in the range of 80°F to 120°F. It is stated that this range seems to envelope the natural variation of ambient temperature during the hot season. It is recommended in the report that seasonally averaged values of ambient temperature are the most appropriate values to be used for normal condition analysis – both for maximum and minimum temperatures.

The fuel cladding temperature limit per the ISG-11, Rev. 3 for normal long-term storage is 752°F, which is primarily based on creep behavior of fuel over a long period of time. If the average ambient temperature for a short duration (couple of months in the hot season in United States) is slightly higher than 80°F, it will result in a slightly higher fuel cladding temperature for an extremely short duration. However, this does not cause a significant increase in fuel cladding creep. All the thermal analyses have inherent conservatism which render conservative peak cladding temperatures. Based on currently loaded canisters, the actual heat load in a canister is always less than the licensing basis heat loads, providing additional margins to PCT limit. Moreover, the heat load of a system reduces with time thereby nullifying the effect of ambient temperature for short durations.

Most of the thermal analyses performed on dry storage cask systems are based on steady state conditions assuming that all the boundary conditions in the analyses remain constant for a long time. In fact, there are changes in the ambient temperature during a span of 24 hours, let alone 7 days, which is approximately the time it takes for a typical dry storage system to reach steady state.

Based on all the above facts, it seems more reasonable to consider a yearly average temperature of 80°F, which bounds all sites in the United States.

Resolution:

The staff does not agree that 2 or 3 months is an extremely short period of time. The stored spent fuel would be experiencing higher temperatures during this time. This would indicate that for cask designs with small margin, the Standard Review Plan allowable limit would be exceeded during this time which would increase fuel cladding creep.

HI-3. Is the intent that the draft NUREG's proposed ambient temperature of 120°F the average of temperatures during days and nights for the duration of the time considered? Ambient temperature data suggests that using 120°F for a day and night average over an entire month itself is very high for locations in the United States.

Resolution:

The intent is to use more realistic values based on seasonal variation for a specific region. The study considered this range to obtain the impact on the peak cladding temperature.

HI-4. The effect of elevation on the thermal performance of a dry storage cask system is evaluated and presented in Section 4.8.4 of the draft report. It is a known fact that the ambient temperature decreases due to an increase in elevation. It is not evident from the report if the analysis to evaluate the effect of elevation also includes this consideration. If the reduction in ambient temperature has not been included, then it aggravates the effect of elevation. Therefore, it must be clarified in the report whether change in ambient temperature is considered or not and also that this effect may be considered when evaluating the effect of elevation.

Resolution:

The applicant should consider this in the thermal evaluation. The intent of the report is to show the effect of elevation on the cask thermal performance.

HI-5. The report finds that an increase of the air temperature by 10°F results in an increase of the peak cladding temperature (PCT) by 14°F (Table 4-19 of the draft report) i.e. the cladding temperature increases more than the increase in ambient temperature. The reason for this observation should be clarified in the draft report (for example: are there computational uncertainties that may have resulted in this increase?).

Resolution:

Based on the results, the effect of the ambient temperature is not one-to-one; as ambient temperature increases, air density decreases, and the inlet air is hotter, which makes its cooling ability more limited. The results of the analysis show the overall effect.

Anonymous 1

A1-1. It calculates max heat load as 34 kW (p. 10) whereas Holtec, 2014, gives it as 47.05 kW, which is 13.05kW higher, leading to a peak fuel cladding (PFC) temp approximately 255 F higher than stated. Failure to consider sun means the PFC temp may be 100 F or higher than stated. This is an underestimation of at least 355 F.

Resolution:

The purpose of the study was to use this specific decay heat to calculate the effect on peak cladding temperatures by varying the environmental parameters considered in the study. Therefore, the total decay used in the analysis is irrelevant for the study.

A1-2. These casks have metal exteriors and sit in the sun on concrete or pavement. 120 F does not consider this. 120 F can be ambient temperature in shade. Low level wind is a mostly bogus concern.

Resolution:

The effect of the sun is not a concern when investigating the effect on temperature variation. Low-speed wind is a parameter that affects the cask thermal performance, as demonstrated by the study.

A1-3. The authors do not model real vent size for the casks. They pretend vents extend across top and bottom, which is false: The four vents in the bottom and top of the cask, respectively, were represented by one continuous inlet at the bottom and one continuous outlet at the top. (p. 27) The larger vents would mean better cooling than reality. For underground casks it fails to consider ground temp and impact of sun on lid and cask stacking. Holtec wants reduced helium circulation and broken fuel. This does not seem modeled. Was high bum-up fuel considered?

Resolution:

For wind studies, a three-dimensional model is used with vents modeled correctly. For the axisymmetric model used in the sensitivity study, an equivalent area was obtained to develop the two-dimensional model. This approximation does not affect the results because the staff made sure the response of the axisymmetric model is equivalent to a three-dimensional thermal model.

A1-4. Humidity is modeled backwards. Humid air will make the casks more difficult to cool. The humidity has already absorbed heat, which is why it is in vapor form. It is why there are nuclear reactors - to boil water. Lack of common sense and basic thermodynamics by the authors is frightening, the [thermal] conductivity of water vapour is actually much less than that of dry air. So, if humidity (i.e. water vapour) has any effect on the conductivity of air, it would make it less conductive, not more.

http://www.weather.gov.hk/education/edu06nature/ele_air_e.htm steam does not transfer heat as well as liquid water, <http://en.wikipedia.org/wiki/Boilingwater-reactor>.

Resolution:

The staff agrees that the conductivity of humid air is smaller than dry air, but the heat capacity of humid air is larger than dry air. As such, the cooling capacity of humid air will be higher.

A1-5. With errors corrected the temperatures may exceed service temperature of new steel casks. With radiation and corrosion induced material degradation the risk of exceeding it increases.

Resolution:

See responses to comments A1-2, A1-3, and A1-4.

A1-6. Evaluations for sun need to be extremes and near summer solstice and in the hottest month (or modeled in this way).

Resolution:

Solar insolation was not considered in the study as the objective of the study was to look at the differences in the peak cladding temperature with change in the environmental parameters. See also responses to comments A1-1, A1-2, A1-3, and A1-4.

A1-7. This is not even as sophisticated as WetBulb Globe Temperature (WBGT), which takes into account: temperature, humidity, wind speed, sun angle and cloud cover (solar radiation). Limitations of WBGT are low air movement and high humidity which are problems with dry casks and their small, poorly placed vents and waterfront locations.

Resolution:

Computational fluid dynamics methods are used, and the NRC considers these effects in the developed model.

A1-8. It says peak cladding temperature (PCT) increases 14.4F per 1 OF ambient temp. 80F in the sun metal adds approx. 68F, making temp 148 F. 100 F plus sun would add 168F and probably more from outside. Using the 14.4 to 10 ratio the spent fuel would be 100 F hotter (or more) US max of 134 F plus sun plus humidity plus contingency needs to be correctly modeled.

Resolution:

The aim of the study was not to take a particular value. The study selected a realistic temperature range to observe the effect on the peak cladding temperature.

A1-9. Table 4.17 day 21 PCT is 886.7 K (minus 272.15: 613.55 C / 1136.39 F) plus 255 F fuel temp kW underestimation is 1391.39 F; solar underestimation of 100 F or more is 1491.39 F

plus, which is dangerously close to 316 steel max service temp of 1598 F (800 C) and can easily be exceeded by sun.

Resolution:

See responses to Comments A1-1 through A1-8.

A1-10. The authors are clueless re averages. Averaging the maximum temperatures for each year will be a higher number than averaging within summer months. The all time max in the sun, however, is the right number to use, plus contingency.

In the midday sun, the temperature 0.4 cm below soil surface may be 161 F, when air temp 4 ft above ground was 108.5F <http://earthobservatory.nasa.gov/Features/HottestSpot/page1.php>. This is soil. Concrete is hotter. This has not been considered for the underground cask lids or lower vents of above ground casks.

The transport rules discussed only consider -29C (-20F) and +38C (+ 100F), in the shade, which are not extreme conditions in North America, and are routine temperatures in parts of N. America. The record maximum in the US is 134 F and the record minimum is minus 70. Transport temperatures are inappropriate, because they are only very short-term. The old NRC Reg Guide from May 1977 called for 130F (54 C) in direct sunlight and - 40F (-40C) in shade. The decade of the 2000s was about 1.5F warmer than the 1970s.

Resolution:

As stated in previous responses, the objective of the study was to look at the effect of the ambient temperature on the predicted peak cladding temperature (as an environmental parameter) and other listed factors in the report.

Anonymous 2

A2-1. This NUREG calculated max heat load as 34 kW, whereas Holtec, 2014, states that it is 47.05 kW, which is 13.05kW higher, leading to a peak fuel cladding temp approximately 255 F higher than they state. Failure to use the right kW and failure to consider sun makes the NUREG draft calculations of peak fuel cladding temp off by around 355 F or more. False assumptions regarding humidity cause further underestimations of peak fuel cladding temperature.

Resolution:

The purpose of the study was to use this specific decay heat and look at the differences on peak cladding temperature as a result of the variation of environmental parameters. Therefore, the total decay used is irrelevant for the study.

A2-2. The only thing which the NUREG extensively evaluates is low level wind, and it doesn't do a proper job of that. The authors (Solis and Zigh) cheat on vent size in their model by

pretending that they are all the way across (p. 27) whereas they are not, in reality. This would give some cross ventilation, which is sorely lacking in reality and is needed. The analysis of low level wind on underground casks fails to consider the impacts of ground type, container stacking or sun on the lid. Imagining that these casks will vent much to the air, unless it's cold, without forced ventilation is downright silly.

Resolution:

For wind studies, a three-dimensional model is used with vents modeled correctly. For the axisymmetric model used in the sensitivity study, an equivalent area was obtained to develop the two-dimensional model. This approximation does not affect the results because the staff made sure the response of the axisymmetric model is equivalent to a three-dimensional thermal model.

A2-3. Holtec has requested exemptions which reduce space for circulation of helium; Holtec has requested packing of broken fuel; and other things which may reduce internal cooling. These impact cooling and temperature and have not been modeled.

Resolution:

This comment is not related to the objective of the study provided in this NUREG and is considered out of scope.

A2-4. Although these metal casks, with metal-concrete covers, remain outside, in direct sunlight, in often blistering environmental condition, the impact of sun is not taken into consideration. The impact of humidity is based on backwards-upside down assumptions. The impact of heat radiating off concrete into the lower vents which are supposed to be cooling does not seem to have been considered.

Resolution:

The objective of the study was to obtain the net effect of the listed environmental factors. The staff agrees that the conductivity of humid air is smaller than dry air, but the heat capacity of humid air is larger than dry air. As such, the cooling capacity of humid air will be higher.

A2-5. This NUREG draft assumes maximum kilowatts loaded in Holtec casks as significantly under what Holtec's 2014 document indicates. Holtec gives max decay heat values in kW as 47.05 kW and whereas this NUREG draft atrocity, written by Solis and Zigh, assumes max decay heat values in kW as 34 and 36.9 kW. Furthermore, in more than one location, the Holtec casks have been loaded with broken fuel and/or hotter fuel than allowed and given exemptions. Flimsy thin 1/2 inch Holtec inner casks have no safety margin for either routine material aging nor for accelerated aging due to neutron bombardment, hydrogen attack, internal and external corrosion. Once some of the errors in this NUREG draft are corrected, the temperature may be dangerously close to or exceed the service temperature of new steel, which could lead to a major nuclear disaster. what in the hell they are doing.

Resolution:

See the NRC staff's response to Comment A2-1.

A2-6. The NUREG draft states that peak cladding temperature (PCT) increases 14.4F for every 10F ambient temperature. It can be estimated that at 80F the added external temperature to Holtec casks, in the sun, would be around 68F, thus the temperature would be like 148 F. The NRC insanely only evaluates for 100 F in the shade, even though this is frequently exceeded throughout most of America. At 100 F the temperature added to the cask from the outside would be at least 168F in the sun, probably higher. Thus the spent fuel would be around 100 F hotter than in the shade (divide 68 by 10 and multiply by 14.4). The US max temp. of 134 F should be used, plus a value added for the sun on the casks near summer solstice. If the number were 68 F (it will surely be higher), then this would be around 202F. Contingency should be added.

Table 4.17 has day 21 peak cladding temperature as 886.7 K. Plus the 143.55 K gives a total of 1030.25 K, which minus 273.15 is 757.1 degrees Celsius [C] and 1394.78 degrees F. NUREG draft peak temperature day 21 of 886.7 K was 613.55 C or 1136.39 degrees F. This leaves a difference of around 258 F. Solar temperature eats even further into the margin, by perhaps 100 F or more.

The maximum service temperature for 316 steel is around 870 C or 1598 F. Were Holtec and the NUREG considering the hotter high burnup fuel?

Also they state that the PCT increases 14.4 F for every 10 F ambient temp. The max which they seem to have considered was 120 F, and due to faulty assumptions re humidity may be the equivalent of less hot. Based on their 14.4 to 10 formula, 100 more degrees of sun-ambient temperature would actually be equivalent to 144 F or more. The maximum service temperature of even new steel could be easily exceeded. The service temperature will decrease under the influence of neutron and other degradation.

This NUREG calculated max heat load as 34 kW, whereas Holtec, 2014, states that it is 47.05 kW, which is 13.05kW higher, leading to a peak fuel cladding temp approximately 255 F higher than they state. This makes the NUREG calculations off by around 355 F or more, if you add the est. 100 F for the sun. Their false assumptions regarding humidity cause a further underestimation of peak fuel cladding temperature.

Whereas Holtec's 2014 Tables 1.2.2, 1.2.3, 1.2.4, pp. I 51-53, say PWR max total heat load is 47.05 kW (MPC 37; 37 cells); and BWR (MPC 89; 89 cells) is 46.36 kW. (See: "FINAL SAFETY ANALYSIS REPORT ON THE HI-STORM FW MPC STORAGE SYSTEM, Holtec Project 5018 Holtec Report No. HI-2114830 Safety Category: Safety Significant, Revision 2", February 18, 2014 <http://pbadupws.nrc.gov/docs/ML1405/ML14052A369.pdf>)

This NUREG draft (NRC: Zigh and Solis) (p. 10) states:
Table 4-3 Decay Heat Values for Analyzed Casks Cask Type Decay Heat (kW):
HI-STORM 100 34 kW (Holtec)

HI-STORM 100U 36.9 kW (Holtec)

Resolution:

The purpose of the study was to use this specific decay heat and look at the differences on peak cladding temperature as a result of the variation of environmental parameters. Therefore, the total decay used is irrelevant for the study.

A2-7. The only thing which the NUREG evaluates is low level wind, and it doesn't do a proper job of that. They cheat on vent size by pretending that they are all the way across, whereas they are not, in reality. This would give some cross ventilation, which is sorely lacking in reality and is needed. The analysis of low level wind on underground casks fails to consider the impacts of ground type, container stacking or sun on the lid. Imagining that these casks will vent much to the air, unless it's cold, without forced ventilation is downright silly.

Resolution:

See the NRC staff's response to Comment A2-2.

A2-8. The US NRC allows Holtec to assume a temperature of 100 F at Grand Gulf NPS, even though Vicksburg Mississippi, near Grand Gulf, has exceeded 100 F over 100 times in the shade, according to NOAA. In nearby Natchez, Mississippi, the temperature in the sun in 1799 - probably in March - was 120F. This NUREG says that peak cladding temperature (PCT) increases 14.4F for every 10F ambient temperature. Thus, these underestimations matter. Some states can actually be much hotter in the summer.

Resolution:

This is the reason why the NRC performed the study. The agency wanted to help applicants consider temperature variations and their effect on calculated peak cladding temperature.

A2-9. The Executive Summary says: "using average values may not be adequate, because more adverse ambient conditions could exist for prolonged periods of time, allowing a storage system to reach new steady-state conditions that could result in higher spent fuel cladding temperatures as compared to the steady-state conditions analyzed in the cask's safety analysis report (SAR) for normal conditions of storage. For cases with predicted small thermal margin, these adverse ambient conditions could result in peak cladding temperatures exceeding recommended limits for normal conditions of storage." Not only is there a risk of cladding rupture, but possibly of cask rupture, as they may also exceed the recommended service temperatures for the metal casks. This needs to be taken seriously.

Resolution:

This is the reason why the NRC undertook this study. The agency wanted to help applicants be aware of the effect of the ambient temperature.

A2-10. Suspiciously, the NRC, and other nuclear researchers, seem to evaluate casks at the most ideal time of year of not too cold, not too hot, such as visiting casks at Diablo Canyon in California on the 25-26th of December when the sun is at its weakest.

The ambient temperature considered should be the maximum extremes ever at the location, with contingency, and not the average of the maximums, as the NRC uses. The temperature should be of the casks in the sun. However, since the dry casks may be moved, it is probably best to use the US extreme for hot air temperature of 134 F, with the heat of the sun added. The minimum would be minus 70 F.

Resolution:

The study considered an adequate range to investigate the ambient temperature variation. Applicants should consider what a realistic value would be for their specific design.

A2-11. In the midday sun, the temperature 0.4 centimeters below the soil surface was 71.5°C(160.7°F). The air temperature, measured four feet above the ground, was 42.5°C (108.5°F)." <http://earthobservatory.nasa.gov/Features/HottestSpot/page1.php> Note that the above temperature is earth. Pavement or concrete would be hotter. This has not been considered for either the underground cask lids, nor for the lower vents of the above ground casks. 108.5F is not that unusual anymore.

Resolution:

The boundary conditions are well specified and applicable physical models selected to properly represent the phenomena. Computational fluid dynamics analyses are performed to evaluate the overall cask performance.

A2-12. According to NUREG 1536 cited by the current NUREG draft: "(1) Normal Conditions [...] The NRC accepts as the maximum and minimum "normal" temperatures the highest and lowest ambient temperatures recorded in each year, averaged over the years of record. For the SAR, the applicant may select any design-basis temperatures as long as the restrictions they impose are acceptable to both the applicant and the NRC." "NUREG-1 536 Revision 1 Standard Review Plan for Spent Fuel Dry Storage Systems at a General License Facility Final Report Manuscript Completed: July 2010 Date Published: July 2010 Office of Nuclear Material Safety and Safeguards" THIS IS NON-SENSE. THE TEMPERATURE MUST BE THE MAXIMUM EVER IN THE SUN, PLUS CONTINGENCY. IT'S NOT AN ANYTHING GOES AS THIS SAYS. IT'S NOT NEGOTIATING A CAR PRICE, IT'S ABOUT TEMPERATURE AND RISK TO PUBLIC HEALTH AND SAFETY.

THIS CURRENT NUREG ADDS NUTTIER TO NUTTY BY TRYING TO MAKE SOMETHING OF THE AVERAGES WITHIN THE YEAR, WHICH IS AN EVEN LOWER TEMPERATURE. WE NEED TO BE LOOKING AT MAXIMUM TEMPS POSSIBLE, EVER.

The transport rules discussed only consider -29°C (-20°F) and +38°C (+100°F), in the shade, which are not extreme conditions in North America, and are routine temperatures in parts of N. America. The record maximum in the US is 134 F and the record minimum is minus 70.

Resolution:

See the NRC staff's response to Comment A2-10.

A2-13. Here's what the NRC rule "Part 71, Subpart F-Package, Special Form, and LSA-111 Tests § 71.71 Normal conditions of transport" (discussed by this NUREG draft) says: "...(b) Initial conditions. With respect to the initial conditions for the tests in this section, the demonstration of compliance with the requirements of this part must be based on the ambient temperature preceding and following the tests remaining constant at that value between -29°C (-20°F) and +38°C (+100°F) which is most unfavorable for the feature under consideration. The initial internal pressure within the containment system must be considered to be the maximum normal operating pressure, unless a lower internal pressure consistent with the ambient temperature considered to precede and follow the tests is more unfavorable. (c) Conditions and tests. (1) Heat. An ambient temperature of 38°C (100°F) in still air, and insolation according to the following table:...2) Cold. An ambient temperature of -40°C (-40°F) in still air and shade".

Transport temperatures are inappropriate, because they are only very short-term. What resists for the very short-term, may not for short, medium or long term. Apparently insulation, in this context, means concrete? What insulator would help keep dry casks cool on concrete or asphalt, without trees, in sunshine and sweltering heat? The dry casks need to put them under an open-sided shed or tent of some type to block the sun. Better, in an air conditioned building with solar panels and maybe back-up windows.

The 1970s are considered to have been exceptionally cold. Yet, the old USNRC Regulatory Guide from 1977 called for shipping casks designed for more extreme temperatures than the current one, even though weather was cooler: "REGULATORY GUIDE 7.8LOAD COMBINATIONS FOR THE STRUCTURAL ANALYSIS OF SHIPPING CASKS, May 1977": "Regulatory Position C.1 .a of this guide mentions environmental initial conditions. The external thermal environmental limits for which a shipping cask must be designed are stated in Appendix A of 10 CFR Part 71 as being 130°F (54°C) in direct sunlight and -40°F (-40°C) in shade." http://rampac.energy.gov/docs/nrcinfo/RegGuide_7-5.pdf NOAA says regarding the 1970s: "Comparing these decades using our best dataset for climate change analysis, the USHCN, we find that the decade of the 2000s was about 1.50°F warmer than the 1970s. For maximum, minimum, and mean temperature the difference, respectively, was 1.37°F, 1.55°F, and 1.46°F." <http://www.ncdc.noaa.gov/data-access/land-based-station-data/land-based-datasets/climate-normals/1981-2010-normals-data>

Resolution:

The study is related to normal conditions of storage. Transportation is not addressed in this NUREG.

A2-14. Here is one of the most outrageous stupidities from this NUREG draft (p. 3): "Currently, the dry storage cask thermal evaluation includes maximum and minimum ambient temperatures as defined in the SRP (NUREG-1536, 2010). The SRP states that the NRC accepts, as the maximum and minimum "normal" temperatures, the highest and lowest ambient temperatures recorded in each year, averaged over the years of record. However, this definition does not consider seasonal variations that may result in higher maximum and minimum values. In this case, a monthly averaged value may be more appropriate for the hottest months (summer season)." The averages of the maximum of each year, currently used by the NRC, would be the higher than what this proposes. Seasonal averages within one year might be higher, depending on which years are included, but overall the highest in any year will be the highest! The authors need to be fired, stripped of their degrees and sent to cleanup WIPP or Fukushima. The NUREG draft further states: "Measured monthly temperatures at some sites (ASHRAE, 1997) show that the annual average ambient temperature of 300 Kelvin (K) [80 degree (0) Fahrenheit (F)] could be easily exceeded for about 4 months." (This is the understatement of the millennia. Of course it will be exceeded. Firstly it is an average; apparently the mean or arithmetic average. An average will be exceeded, unless every temperature reading is the same. Secondly, because yearly average, the maximum and minimum, is largely irrelevant to the maximum temperature. And the average (high and low) given for June, July, August runs as high as 85 or more, in places with nuclear reactors. But, they should not be using the average, anyway, but rather the maximum temperature ever, plus contingency. Then they must add the impacts of sun and humidity and yes, wind and do it properly. Dew point should be examined for impacts on temperature and corrosion, as well.

In fact, where is discussion of corrosion in this NUREG draft document? It's supposed to be about the environment and thermal performance, and environmentally induced corrosion would have a negative impact on thermal performance.

In the 1950s, the US military came up with a more complex system called the Wet Bulb Globe Temperature. At least this level of complex analysis is needed. Instead the NRC delivers exemptions to Holtec and other stupidities too long to name or even recall. "The WetBulb Globe Temperature (WBGT) is a measure of the heat stress in direct sunlight, which takes into account: temperature, humidity, wind speed, sun angle and cloud cover (solar radiation). This differs from the heat index, which takes into consideration temperature and humidity and is calculated for shady areas. If you work or exercise in direct sunlight, this is a good element to monitor. Military agencies, OSHA and many nations use the WBGT as a guide to managing workload in direct sunlight." <http://www.srh.noaa.gov/tsa/?n=wbqt>

The limitations of the WBGT are low air movement and high humidity which are most certainly problems with the dry casks: "WBGT's most serious limitation is that environments at a given level of the index are more stressful when the evaporation of sweat is restricted (by high humidity or low air movement) than when evaporation is free". "J Sci Med Sport. 2008 Jan;11(1):20-32. "Wet-bulb globe temperature (WBGT)-its history and its limitations." Budd GM. <http://www.ncbi.nlm.nih.gov/pubmed/17765661>

For dry casks this low air movement and high humidity would have a negative impact on heat removal, but also cause material sweating, corrosion, and degradation. Many, or even most, of the nuclear reactors are close enough to the ocean to have chloride induced corrosion-degradation issues too. Mold induced degradation is probably an issue at the sites, especially as mold is highly radiation resistant. Where in this NUREG is discussion of the impact (and causes) of degradation on structural-mechanical integrity of multi-purpose canisters and the overpack? Neutron embrittlement; possible hydrogen attack; corrosion, exacerbated by salt in the air, even some distance inland, will all impact the strength and integrity of the dry casks, over time. For these dry casks there would also be the issue of dampness, fog, condensate from high humidity levels and their impacts on corrosion and even mold. Mold could damage concrete and is radiation resistant. Dew Point seems important in this context.

According to the draft NUREG: "An ambient temperature of 300.K (80°F) is typically considered in the thermal evaluation for most of the dry casks certified by the NRC." THIS IS RIDICULOUS. YOU KNOW THIS IS FALSE. WHY ARE YOU TRYING TO KILL EVERYONE AND EVERYTHING?

Your NUREG draft states: "However, the measured ambient temperatures suggest that, to bound all sites, the SAR thermal evaluation should consider seasonal variations since, during the hot months, the dry cask reaches a new steady state that the SAR has not analyzed." While it may be true that the steady state has not been analyzed, the annual maximum temps is better and the maximum ever is better still and maximum ever in the USA with contingency and including sun is best. They state that "This study considered variations in the ambient temperature in the range of 300 to 322 K (80 to 120°F), which seems to envelope the natural variation of the ambient temperature during the hot season, according to measured data."

Furthermore, Solis-Zigh-NRC NUREG excludes the temperature impact of sun on metal, which as has been seen exceeds this amount. They excluded the full heat load. They put the humidity impacts upside down. And, they don't seem to have considered this except for low speed wind. This low speed wind issue seems to be a false debate. Put solar powered exhaust fans and open sided sheds to cover the casks from the sun or solar powered air conditioned sheds, would be better. Roof Vent Turbines would be a huge improvement over nothing, though may still be inadequate in some climates: [http://wiki.smc.org.in/index.php?title=Roof Vent Turbines](http://wiki.smc.org.in/index.php?title=Roof_Vent_Turbines), is it affordable ?]

Solis-Zigh-NRC NUREG state:

"2.3 Humidity

Traditionally, the thermal evaluation for design certification assumes dry air, which is conservative, since humidity will increase the air thermal conductivity and heat capacity." (p. 3) (Conservative? Conservative is less safe now? Whose stupid "tradition" is this? If humidity makes it hold more heat then it is important! The humidity decreases thermal conductivity but has heat capacity - it is already full of heat, which is why it is vapor!) They continue: "Therefore, this study considers relative humidity in the range of 0 to 90 percent for ambient temperatures of 300 and 323 K (80 and 120°F)." (Where is 100% humidity? Sun impact? Plus they are only concerned with wind) They say: "However, high relative humidity values do not seem to persist

for the prolonged periods of time necessary for the dry cask to reach a new steady state." They are on water and often in swampland and sub-tropical climates). "Therefore, this study assumes that dry air will continue to be an adequate approach, a slightly conservative assumption, as demonstrated in this evaluation." (p. 3) This means that their result could be right simply because they did it backwards. It is humid; they assume dry; they falsely assume that humidity is cooling rather than blocking cooling; they apparently believe that dry is hotter. So, by getting everything backwards that might be right. However, they have to put it going the right direction! It is humid and the humidity inhibits cooling.

The most silly assumption of all is that cool air will enter the vents at the bottom of the casks when the casks are sitting on concrete or asphalt, uncovered. Where was the consideration of this point? Heat from the concrete-asphalt will radiate up, especially after sunset and as ambient temperature drops. While this will probably be cooler than the spent fuel, it won't be very cool. Plus, any serious ventilation needs to be cross ventilation. Common sense suggests a solar powered fan, as well.

Resolution:

The study considered an adequate range to investigate the ambient temperature variation. Applicants should consider what a realistic value would be for their specific design. The staff agrees that the conductivity of humid air is less than that of dry air, but the heat capacity of humid air is also greater than that of dry air. As such, the cooling capacity of humid air will be higher. Corrosion is out of scope on the study. Regarding the wet bulb globe temperature, the developed model uses computational fluid dynamics methods, and the ambient temperature is specified as a boundary condition in conjunction with other boundary conditions and material properties.

A2-15. Zigh and Solis, authors of this NUREG draft, cheat in their model: "The four vents in the bottom and top of the cask, respectively, were represented by one continuous inlet at the bottom and one continuous outlet at the top." (p. 27) They can't change the venting system like that in the model, without changing it in reality! Obviously this will increase air flow. A continuous inlet will let in more air! As we noted yesterday, the fuel temperature modeled is not the same as the newer Holtec specifications, either, but is much less.

Resolution:

See the NRC staff's response to Comment A2-2.

A2-16. A most important point remains that heat diffuses toward a new equilibrium and if it is hot outside, the spent fuel won't cool very much. "Heat transfer always occurs from a region of high temperature to another region of lower temperature."

http://en.wikipedia.org/wiki/Heat_transfer

"As the second law of thermodynamics shows, in an isolated system internal portions at different temperatures will tend to adjust to a single uniform temperature and thus produce equilibrium." http://en.wikipedia.org/wiki/Entropy#Energy_dispersal Ventilation or a fan could speed up air

exchange and the fan cool the air to some extent, but there won't be much cooling in hot weather, period.

Resolution:

The staff agrees with second law of thermodynamics. This is considered in the computational fluid dynamics models used to perform the study.

A2-17. From the NUREG draft:

"3.0 GEOMETRY AND METHOD OF ANALYSIS

3.1 Vertical Aboveground Designs

In a vertical-ventilated aboveground spent fuel storage cask design, a spent fuel canister is typically stored in a concrete overpack, with the canister bottom resting on some type of base normal to the ground. Air vents are located in the bottom and top of the overpack, so air can flow freely through the gap between the canister and the overpack to cool the canister's outer surface, thus keeping the cladding temperature below Standard Review Plan (SRP)-recommended limits (NUREG-1536, 2010). Since the inlet and outlet air vents are separated by the cask's height, thermal mixing due to low-speed wind may not have an impact on the cask's thermal performance because of the physical separation of the air vents. This separation will prevent hot air coming from the outlet vents to mix with the cooler air at the bottom of the cask. Also, hot air coming out of the outlet vents will tend to flow up into the ambient air surrounding the cask. However, low-speed wind could block the air vents, which could have an impact on the cooling effect by reducing the mass flow rate through the annular gap. Therefore, this study includes this cask to determine the effect of other environmental factors and to conclusively determine how low-speed wind affects this design." (p.5) WHAT COOLER AIR? IT'S ON CONCRETE IN THE SUN!

Resolution:

Air going into the inlet vents is cooler than the air coming out of the outlet vents due to heating in the annular gap.

A2-18. Where is consideration of underground temperature? There won't be much cooling in hot weather by venting out the top! The underground temperature would be cooler than ambient air. Adiabatic boundary conditions was assumed, as described in the report. This would make the results slightly conservative.

"3.2 Vertical Underground Designs

In an underground design, the canister is stored inside some type of enclosure that is buried almost entirely, except for the overpack lid, which is located aboveground and includes the air vents. In this design, air needs to flow downwards into the enclosure container and then upwards in contact with the canister's outer shell. Decay heat from the spent fuel assemblies stored in the canister is thus dissipated through the canister's outer wall by a combination of convection,

radiation, and conduction to flowing air. Finally, hot air exits through the outlet vent, which is located on top of the cask lid. For this design, the inlet and outlet vents are located in proximity to each other. These design features represent a challenge from the analysis point of view since, in addition to the typical environmental factors used in the thermal evaluation (e.g., ambient temperature, ambient pressure), the analysis must include other factors such as low wind speed. This increases both the complexity and the computational times, since usually three-dimensional (3-D) thermal models are needed to properly capture the heat transfer and flow characteristics of this design." (p.5)

"Heat transfer always occurs from a region of high temperature to another region of lower temperature". http://en.wikipedia.org/wiki/Heat_transfer". As the second law of thermodynamics shows, in an isolated system internal portions at different temperatures will tend to adjust to a single uniform temperature and thus produce equilibrium."
http://en.wikipedia.org/wiki/Entropy#Energy_dispersal "the [thermal] conductivity of water vapour is actually much less than that of dry air. So, if humidity (i.e. water vapour) has any effect on the conductivity of air, it would make it less conductive, not more."
http://www.weather.gov.hk/education/edu06nature/ele_air_e.htm "steam does not transfer heat as well as liquid water,..." http://en.wikipedia.org/wiki/Boiling_water_reactor

Resolution:

The staff agrees that the conductivity of humid air is less than that of dry air, but the heat capacity of humid air is greater than that of dry air. As such, the cooling capacity of humid air will be higher.

A2-19. Thus Solis-Zigh NUREG assumptions regarding humidity effects are false, as common sense also tells us. On p. 35, they falsely state that "water vapor has larger thermal conductivity" As just seen above, water vapor has less thermal conductivity. Then they say "and heat capacity than dry air, more heat is absorbed from the cask by humid air." Yes it has more heat capacity but it's already full of the heat! Thus they mix true and false in one sentence.

Solis-Zigh NUREG started off the sentence stating the obvious that "As the humidity increases, the ambient air contains more water vapor." (p. 35) And, while yes the water vapor has more heat capacity, it is already holding that heat-energy, which is why it is in vapor form. This is why it takes energy input to boil water. And, this, in fact, is what nuclear reactors are - deadly ways to get energy input to make water vapor!

By inverting their humidity assumptions, they have underestimated temperature to unknown degrees. Due to their faulty assumptions their worst case scenario might be worse than what they have presented: "As such, the PCT will decrease as the relative humidity is increased for both ambient temperatures considered in this study." [NOT!] "At an ambient temperature of 300 K (80°F), the PCT decreased by 0.6 K (1°F) for every 20 percent increase in the relative humidity (in the 50 to 90 percent range)." Since this was calculated upside down the opposite is probably true, meaning that at 80F and 100% humidity, would be about 3 degrees F higher.

They state that "At an ambient temperature of 323 K (120°F), the PCT decreased by 2.2 K (4°F) for every 20-percent increase in relative humidity (in the 50 to 90 percent range)." At higher temperatures the upside down nature of their assumptions becomes even more problematic. Though it is unlikely that there would be both 120F and 90% humidity for ambient air, due to the sun and absorption of heat by the concrete-metal, it could be even higher: "The rate of decrease in the predicted PCT is higher for the ambient temperature 323 K (120°F) case than for the ambient temperature 300 K (80°F) case because of the higher moisture content change for every 20 percent change in relative humidity in the latter, as shown in Tables 4-24 and 4-25". THIS GOES AGAINST COMMON SENSE PLUS THERMODYNAMICS. It should read "The rate of increase". They need to reevaluate all for both assumptions and kW inputs.

Resolution:

The staff agrees that the conductivity of humid air is less than that of dry air, but the heat capacity of humid air is greater than that of dry air. As such, the cooling capacity of humid air will be higher.

A2-20. They should not be doing this in Kelvin, either.
[Temperature intervals: 22 Kelvin [K] is 22 Celsius [C] is 39.6 Fahrenheit [F] <http://en.wikipedia.org/wiki/Kelvin%5D>

Resolution:

The staff does not see any valid concern with the units used for temperature.

<p>NRC FORM 335 (12-2010) NRCMD 3.7</p> <p style="text-align: center;">U.S. NUCLEAR REGULATORY COMMISSION</p> <p style="text-align: center;">BIBLIOGRAPHIC DATA SHEET <i>(See instructions on the reverse)</i></p>	<p>1. REPORT NUMBER (Assigned by NRC, Add Vol., Supp., Rev., and Addendum Numbers, if any.)</p> <p style="text-align: center;">NUREG-2174 FINAL</p>				
<p>2. TITLE AND SUBTITLE</p> <p>Impact of Variation in Environmental Conditions on the Thermal Performance of Dry Storage Casks</p>	<p>3. DATE REPORT PUBLISHED</p> <table border="1"> <tr> <td>MONTH</td> <td>YEAR</td> </tr> <tr> <td>March</td> <td>2016</td> </tr> </table>	MONTH	YEAR	March	2016
	MONTH	YEAR			
March	2016				
<p>4. FIN OR GRANT NUMBER</p>					
<p>5. AUTHOR(S)</p> <p>Jorge Solis and Ghani Zigh</p>	<p>6. TYPE OF REPORT</p> <p style="text-align: center;">Technical</p>				
	<p>7. PERIOD COVERED (Inclusive Dates)</p>				
<p>8. PERFORMING ORGANIZATION - NAME AND ADDRESS (If NRC, provide Division, Office or Region, U. S. Nuclear Regulatory Commission, and mailing address; if contractor, provide name and mailing address.)</p> <p>Division of Spent Fuel Management Office of Nuclear Material Safety and Safeguards U.S. Nuclear Regulatory Commission Washington, D.C. 20555-0001</p>					
<p>9. SPONSORING ORGANIZATION - NAME AND ADDRESS (If NRC, type "Same as above", if contractor, provide NRC Division, Office or Region, U. S. Nuclear Regulatory Commission, and mailing address.)</p> <p>Same as above.</p>					
<p>10. SUPPLEMENTARY NOTES</p>					
<p>11. ABSTRACT (200 words or less)</p> <p>This report evaluates spent fuel dry storage cask thermal impact of varying environmental conditions and transient thermal behavior when subjected to a sudden boundary condition change. The results showed that, for the underground cask design, the peak cladding temperature (PCT) increases for low-speed wind and starts to decrease at higher speed. For vertical aboveground casks with four vents, PCT decreased as wind speed increased. For a postulated two-air-vent vertical dry storage cask, when wind direction is normal to the air vents, PCT decreased as the wind speed increased. When wind direction is parallel to the air vents of the two-air-vent cask, PCT increased as the wind speed increased. For horizontal aboveground casks with air vents located on the side, the wind speed and direction did not have any significant impact. For horizontal aboveground casks with inlet vents located on the front, when wind direction is facing the front of the cask, the thermal performance of the cask was improved, but when wind direction was parallel to the cask front, no significant effect was observed. These results can be used as additional guidance when considering the thermal impact of the environmental factors in the thermal performance of dry storage systems.</p>					
<p>12. KEY WORDS/DESCRIPTORS (List words or phrases that will assist researchers in locating the report.)</p> <p>Spent Fuel Environmental Variables Wind Speed CFD Best Practice Guidelines Standard Review Plan SRP CFD</p>	<p>13. AVAILABILITY STATEMENT</p> <p style="text-align: center;">unlimited</p>				
	<p>14. SECURITY CLASSIFICATION</p> <p><i>(This Page)</i></p> <p style="text-align: center;">unclassified</p>				
	<p><i>(This Report)</i></p> <p style="text-align: center;">unclassified</p>				
	<p>15. NUMBER OF PAGES</p>				
<p>16. PRICE</p>					



Federal Recycling Program



**UNITED STATES
NUCLEAR REGULATORY COMMISSION**
WASHINGTON, DC 20555-0001

OFFICIAL BUSINESS



**NUREG-2174
Final**

**Impact of Variation in Environmental Conditions on the Thermal
Performance of Dry Storage Casks**

March 2016