



Entergy Operations, Inc.
17265 River Road
Killona, LA 70057-3093
Tel 504 739 6685
Fax 504 739 6698
jjarrel@entergy.com

John P. Jarrell III
Manager – Regulatory Assurance
Waterford 3

W3F1-2015-0033

April 29, 2015

U.S. Nuclear Regulatory Commission
Attn: Document Control Desk
Washington, DC 20555-0001

Subject: Annual Radiological Effluent Release Report -2014
Waterford Steam Electric Station, Unit 3 (Waterford 3)
Docket No. 50-382
License No. NPF-38

Dear Sir or Madam:

Attached is the Annual Radiological Effluent Release Report for the period of January 1 through December 31, 2014, which includes a copy of the revised Offsite Dose Calculation Manual (ODCM). This report is submitted pursuant to the requirements of Waterford 3 Technical Specification Sections 6.9.1.8 and 6.14.2.c.

This report contains no new commitments. Please contact John P. Jarrell, Regulatory Assurance Manager, at (504) 739-6685 if you have questions regarding this information.

Sincerely,

A large, stylized handwritten signature in black ink, appearing to read "JPJ/LLB".

JPJ/LLB

Enclosure: Annual Radiological Effluent Release Report – 2014

A009
IE48
NRK

cc: Mr. Marc L. Dapas
Regional Administrator
U. S. Nuclear Regulatory Commission
Region IV
RidsRgn4MailCenter@nrc.gov

NRC Senior Resident Inspector
Waterford Steam Electric Station Unit 3
Frances.Ramirez@nrc.gov
Chris.Speer@nrc.gov

NRC/NRR Project Manager for Waterford 3
Michael.Orenak@nrc.gov

Allyson Howie
Entergy Legal, General Sr Counsel
AHowie@entergy.com

Bill Nestel
Principal Evaluator, Chemistry, INPO
NESTELWA@INPO.ORG

Enclosure to

W3F1-2015-0033

Annual Radiological Effluent Release Report - 2014

(383 pages)



**Annual
Radioactive Effluent Release
Report**

January 1, 2014 - December 31, 2014



**Waterford 3 SES
Entergy Operations, Inc.**

Docket Number 50-382

License Number NPF-38

Originator: *Danielle Breaud* 4-23-15

Danielle Breaud
Chemistry Specialist
Waterford 3 SES

Date

Reviewed By: *Clay* 4-23-15

Clay Benton
Chemistry Supervisor
Waterford 3 SES

Date

Approved By: *Nicole K. Lawless* 4-23-15

Nicole Lawless
Chemistry Manager
Waterford 3 SES

Date

Table of Contents

1.0 Introduction	1
2.0 Supplemental Information	2
2.1 Regulatory Limits	2
2.1.1 Fission and Activation Gases (Noble Gases)	2
2.1.2 Iodines, Particulates with Half Lives > Eight (8) Days, and Tritium	3
2.1.3 Liquid Effluents	3
2.1.4 Uranium Fuel Cycle Sources	4
2.2 Maximum Permissible Concentrations	4
2.2.1 Fission and Activation Gases, Iodines, and Particulates, With Half Lives > Eight (8) Days	4
2.2.2 Liquid Effluents	4
2.3 Average Energy (E-Bar)	4
2.4 Measurements and Approximations of Total Radioactivity	5
2.4.1 Fission and Activation Gases (Noble Gases)	5
2.4.2 Iodines, Particulates, and Tritium	5
2.4.3 Liquid Effluents	6
2.5 Batch Releases	6
2.6 Unplanned/Abnormal Releases	6
2.6.1 Unplanned/Abnormal Gaseous Releases	6
2.6.2 Unplanned/Abnormal Liquid Releases	6
3.0 Gaseous Effluents	7
4.0 Liquid Effluents	7
5.0 Solid Wastes	7
6.0 Meteorological Data	8
7.0 Assessment of Doses	9
7.1 Dose Due to Gaseous Effluents	9
7.1.1 Air Doses at the Site Boundary	9
7.1.2 Maximum Organ Dose to the Critical Receptor	10
7.2 Doses Due to Liquid Effluents	11
7.3 40 CFR Part 190 Dose Evaluation	11

Table of Contents

7.4 Doses to Public Inside the Site Boundary	12
8.0 Related Information	13
8.1 Changes to the Process Control Program.....	13
8.2 Changes to the Offsite Dose Calculation Manual	13
8.3 Unavailability of REMP Milk Samples.....	13
8.4 Report of Required Effluent Instrument Inoperability	13
8.5 Activity Released Via Secondary Pathways	14
8.6 Missed Effluent Samples	14
8.7 Major Changes to Radioactive Waste Systems	14
8.8 Biennial Land Use Census	14
8.9 Gaseous Storage Tank Total Radioactivity Limit.....	15
8.10 Unprotected Outside Tank Total Radioactivity Limit.....	15
9.0 Additional Information	15
9.1 Reactor Coolant System Average Energy (E-Bar)	15
9.2 Groundwater Initiative Data.....	15
10.0 Tables	16
11.0 Attachments	17

1.0 Introduction

This Annual Radioactive Effluent Release Report is submitted as required by Waterford 3 Technical Specification 6.9.1.8. It covers the period from January 1, 2014 through December 31, 2014. Information in this report is presented in the format outlined in Appendix B of Regulatory Guide 1.21 and in Section 5.8.1 of the Offsite Dose Calculation Manual (UNT-005-014).

The information contained in this report includes:

- A summary of the quantities of radioactive liquid and gaseous effluents and solid wastes released from the plant during the reporting period.
- A summary of the meteorological data collected during 2014.
- Assessment of radiation doses due to liquid and gaseous radioactive effluents released during 2014.
- A discussion of Unplanned/Abnormal releases that occurred during the reporting period.
- A submittal of changes to the Offsite Dose Calculation Manual and Process Control Program during this reporting period.
- A discussion of why required radioactive effluent monitoring instrumentation was not returned to service within the time specified.
- A discussion of any instances in which effluent samples were not collected within the required frequency.

2.0 Supplemental Information

2.1 Regulatory Limits

The limits applicable to the release of radioactive material in liquid and gaseous effluents are described in the following sections. These limits are addressed by reference in UNT-005-014, Offsite Dose Calculation Manual, and directly in the Technical Requirements Manual (TRM).

2.1.1 Fission and Activation Gases (Noble Gases)

The dose rate due to radioactive noble gases released in gaseous effluents from the site to areas at and beyond the site boundary shall be limited to less than or equal to:

- 500 mrem/yr to the total body; and,
- 3000 mrem/yr to the skin.

The air dose due to noble gases released in gaseous effluents from the site to areas at or beyond the site boundary shall be limited to the following:

- ◆ During any calendar quarter, Less than or equal to:
 - 5 mrad for gamma radiation; and,
 - 10 mrad for beta radiation.
- ◆ During any calendar year, Less than or equal to:
 - 10 mrad for gamma radiation; and,
 - 20 mrad for beta radiation.

2.1.2 Iodines, Particulates with Half Lives > Eight (8) Days, and Tritium

The dose rate due to Iodine-131 and 133, tritium, and all radionuclides in particulate form with half lives greater than eight (8) days, released in gaseous effluents from the site to areas at and beyond the site boundary, shall be limited to less than or equal to:

- 1500 mrem/yr to any organ.

The dose to a member of the public from Iodine-131 and 133, tritium, and all radionuclides in particulate form with half lives greater than eight (8) days in gaseous effluents released to areas at and beyond the site boundary shall be limited to the following:

- ◆ During any calendar quarter, less than or equal to:
 - 7.5 mrem to any organ.
- ◆ During any calendar year, less than or equal to:
 - 15 mrem to any organ.

2.1.3 Liquid Effluents

The concentration of radioactive material released in liquid effluents to unrestricted areas shall be limited to ten times the concentrations specified in 10 CFR Part 20, Appendix B, Table 2, Column 2 for radionuclides other than dissolved or entrained noble gases. For dissolved or entrained noble gases, the concentration shall be limited to $2.0E-4$ $\mu\text{Ci/ml}$.

The dose or dose commitment to a member of the public from radioactive materials in liquid effluents released to unrestricted areas shall be limited to the following:

During any calendar quarter, less than or equal to:

- 1.5 mrem to the total body; and,
- 5 mrem to any organ, and

During any calendar year, less than or equal to

- 3 mrem to the total body; and,
- 10 mrem to any organ.

2.1.4 Uranium Fuel Cycle Sources

The dose or dose commitment to any member of the public due to releases of radioactivity and radiation from uranium fuel cycle sources over 12 consecutive months shall be limited to less than or equal to:

- 25 mrem to the Total Body or any organ (except thyroid); and,
- 75 mrem to the thyroid

2.2 Maximum Permissible Concentrations

2.2.1 Fission and Activation Gases, Iodines, and Particulates, With Half Lives > Eight (8) Days

For gaseous effluents, maximum permissible concentrations are not directly used in release rate calculations since the applicable limits are expressed in terms of dose rate at the site boundary.

2.2.2 Liquid Effluents

Ten times the effluent concentration (EC) values specified in 10 CFR Part 20, Appendix B, Table 2, Column 2 are used as the permissible concentrations of liquid radioactive effluents at the unrestricted area boundary. A value of $2.0E-4$ $\mu\text{Ci/ml}$ is used as the concentration limit for dissolved and entrained noble gases in liquid effluents.

2.3 Average Energy (E-Bar)

This is not applicable to Waterford 3 effluent specifications. E-Bar is not required to be calculated from effluent release data. The average energy (E-Bar) for the Reactor Coolant System (RCS) is supplied as additional information in the report further below.

2.4 Measurements and Approximations of Total Radioactivity

The quantification of radioactivity in liquid and gaseous effluents was accomplished by performing the sampling and radiological analysis of effluents in accordance with the requirements of Tables 4.11-1 and 4.11-2 of the Technical Requirements Manual (TRM).

2.4.1 Fission and Activation Gases (Noble Gases)

For continuous releases, a gas grab sample was analyzed at least monthly for noble gases. Each week a Gas Ratio (GR) was calculated according to the following equation:

$$GR = \frac{\text{Average Weekly Noble Gas Monitor Reading}}{\text{Monitor Reading During Noble Gas Sampling}}$$

The monthly sample analysis and weekly Gas Ratio were then used to determine noble gases discharged continuously for the previous week. For gas decay tank and containment purge batch releases, a gas grab sample was analyzed prior to release to determine noble gas concentrations in the batch. In all cases, the total radioactivity in gaseous effluents was determined from measured concentrations of each radionuclide present and the total volume discharged.

2.4.2 Iodines, Particulates, and Tritium

Iodines and particulates discharged were sampled using a continuous sampler which contained a charcoal cartridge and a particulate filter. Each week the charcoal cartridge and particulate filter were analyzed for gamma emitters using gamma spectroscopy. The determined radionuclide concentrations and effluent volumes discharged were used to calculate the previous week's activity released. The particulate samples were composited and analyzed quarterly for Sr-89 and Sr-90 by a contract laboratory (GEL Laboratories). Particulate gross alpha activity was measured weekly using alpha scintillation or gas-flow proportional counting techniques. The determined activities were used to estimate effluent concentrations in subsequent releases until the next scheduled analysis was performed. Annual Carbon-14 release estimate was obtained from the Waterford 3 Final Safety Analysis Report. Release of Carbon-14 was assumed to be continuous.

Grab samples of continuous releases were analyzed at least monthly for tritium. Containment purge batch releases are analyzed prior to release. The determined concentrations were used to estimate tritium activity in subsequent releases until the next scheduled analysis was performed.

2.4.3 Liquid Effluents

For continuous releases, samples were collected weekly and analyzed using gamma spectroscopy. The measured concentrations were used to determine radionuclide concentrations in the following week's releases. For batch releases, gamma analysis was performed on the sample prior to release.

For both continuous and batch releases, composite samples were analyzed quarterly by a contract laboratory (GEL Laboratories) for Sr-89, Sr-90, and Fe-55. Samples were composited and analyzed monthly for tritium and gross alpha using liquid scintillation and gas flow proportional counting techniques, respectively. For radionuclides measured in the composite samples, the measured concentrations in the composite samples from the previous month or quarter were used to estimate released quantities of these isotopes in liquid effluents during the current month or quarter when the analysis results became available.

The total radioactivity in liquid effluent releases was determined from the measured and estimated concentrations of each radionuclide present and the total volume of the effluent discharged.

2.5 Batch Releases

A summary of information for gaseous and liquid batch releases is included in Table 1.

2.6 Unplanned/Abnormal Releases

2.6.1 Unplanned/Abnormal Gaseous Releases

There were no unplanned/abnormal gaseous releases during the reporting period.

2.6.2 Unplanned/Abnormal Liquid Releases

There were no unplanned/abnormal liquid releases during this reporting period.

3.0 Gaseous Effluents

The quantities of radioactive material released in gaseous effluents are summarized in Tables 1A, 1B, and 1C. Note that there were no elevated releases, since all Waterford 3 releases are considered to be at ground level. The estimated total error in % is based upon several statistical uncertainties due to sample counting, efficiency, volume, etc.

4.0 Liquid Effluents

The quantities of radioactive material released in liquid effluents are summarized in Tables 2A and 2B. The estimated total error in % is based upon several statistical uncertainties due to sample counting, efficiency, volume, etc.

5.0 Solid Wastes

The summary of radioactive solid wastes shipped offsite for disposal is listed in Table 3. For certain waste forms, Waterford 3 uses volume reduction services provided by a contractor. These waste forms are included in Table 3 and the volumes reported reflect the volume of waste shipped offsite, not final disposal volumes. Final disposal volumes for wastes compacted offsite are available upon request. The estimated total error in % is based upon several statistical uncertainties due to sample counting, efficiency, volume, etc.

6.0 Meteorological Data

In Table 4, the hourly meteorological data from January 1, 2014 through December 31, 2014, is presented in the form of a joint frequency distribution of wind speed, wind direction, and atmospheric stability (hourly data is also available upon request). The standard Pasquill classification scheme, as presented in Regulatory Guide 1.23, is used to determine stability class from differential temperature measurements. The Waterford-3 data recovery results by parameter are as follows:

Differential Temp.	99.40%
Wind Speed	99.40%
Wind Direction	99.40%
<u>Overall*</u>	<u>99.40%</u>

A. * Simultaneous occurrence of valid data for all three parameters.

Dispersion and deposition values were determined from the 2014 data and used in the assessment of doses due to gaseous effluents released from site during the 2014 period.

7.0 Assessment of Doses

7.1 Dose Due to Gaseous Effluents

7.1.1 Air Doses at the Site Boundary

Air doses from gaseous effluents were evaluated at the closest offsite location that could be occupied continuously during the term of plant operation and that would result in the highest dose. This location was determined by examining the atmospheric dispersion parameters (χ/Q) at the closest offsite locations that could be continuously occupied during plant operation in each of the meteorological sectors surrounding the plant. The location that would have the highest dose would be that location having the most restrictive (largest) χ/Q value.

Based on actual meteorological data collected during 2014, this location was determined to be in the NE sector ($\chi/Q = 2.4E-05 \text{ sec/m}^3$) at a distance of 869 meters (0.54 miles) from the reactor building. Doses were assessed at this location in accordance with the methodology described in the Waterford 3 Offsite Dose Calculation Manual considering only beta and gamma exposures in air due to noble gas. The results of these assessments for the year 2014 are summarized as follows:

Beta air dose: 7.80E-02 mrad

Gamma air dose: 3.21E-02 mrad

The above beta and gamma air doses represent the following percentage of the annual dose limits:

0.39% of the Beta air dose limit (20 mrad)

0.32% of the Gamma air dose limit (10 mrad)

Dose calculation results are summarized by quarters in Table 5A. The doses were calculated in accordance with the methodology described in the Waterford 3 Offsite Dose Calculation Manual.

7.1.2 Maximum Organ Dose to the Critical Receptor

The maximum organ dose to a MEMBER OF THE PUBLIC from I-131, I-133, tritium, and all radionuclides in particulate form with half-lives greater than eight (8) days in gaseous effluents released to areas at and beyond the site boundary was determined for 2014.

An assessment of the maximum organ dose was performed for the critical receptor. The critical receptor was assumed to be located at the nearest residence to the plant having the most restrictive atmospheric dispersion (χ/Q) and deposition (D/Q) parameters. Furthermore, it was assumed that the receptor living at this residence consumed food products that were either raised or produced at this residence.

Using land use census and meteorological data for 2014 the residence with the highest χ/Q value ($9.0E-06 \text{ sec/m}^3$) and the highest D/Q value ($1.9E-08 \text{ m}^{-2}$) was determined to be in the NE sector at a distance of 1432 meters (0.89 miles) from the reactor building. The dose calculation was performed in accordance with the methodology described in the Waterford 3 Offsite Dose Calculation Manual considering the inhalation, ground plane exposure, and ingestion pathways. The maximum organ dose to the critical receptor excluding C-14 was determined for historical trending to be:

0.119 mrem to the child thyroid.

This represents 0.79% of the Annual Organ Dose limit (15 mrem).

The maximum organ dose to the critical receptor including C-14 was determined to be:

4.57 mrem to the child bone.

This represents 30.5% of the Annual Organ Dose limit (15 mrem).

Dose calculation results are summarized by quarters in Table 5A. The doses were calculated in accordance with the methodology described in the Waterford 3 Offsite Dose Calculation Manual.

7.2 Doses Due to Liquid Effluents

The annual doses to the maximum exposed individual, an adult, resulting from exposure to liquid effluents released during 2014 from Waterford 3 were:

8.12E-4 mrem to the Total Body.

1.07E-3 mrem to the maximum exposed organ (Thyroid)

The above doses represent the following percentage of the Annual Dose limits:

0.03% of the Total Body Dose Limit (3 mrem), and

0.01% of the Organ Dose Limit (10 mrem).

Dose calculation results are summarized by quarter in Table 5B. The doses were calculated in accordance with the methodology described in the Waterford 3 Offsite Dose Calculation Manual.

7.3 40 CFR Part 190 Dose Evaluation

In accordance with Technical Requirements Manual (TRM), Specification 3/4.11.4, Total Dose, dose evaluations to demonstrate compliance with Surveillance Requirements 4.11.4.1 and 4.11.4.2 of the Technical Requirements Manual (TRM), dealing with dose from the uranium fuel cycle, need to be performed only if quarterly doses exceed 3 mrem to the total body (liquid releases), 10 mrem to any organ (liquid releases), 10 mrad gamma air dose, 20 mrad beta air dose, or 15 mrem to any organ from radioiodines and particulates.

At no time during 2014 were any of these limits exceeded.

Direct shine dose was considered using the area monitoring DLR results in the 2013 Waterford 3 Area Monitoring Program Report. The highest perimeter DLR badge dose located nearest a critical receptor did not result in any additional dose to the critical receptor.

7.4 Doses to Public Inside the Site Boundary

The Member of the Public inside the site boundary expected to have the maximum exposure due to gaseous effluents would be an employee at the Waterford 1 and 2 fossil fuel plants, located in the NW sector at a distance of approximately 670 meters (0.42 miles) from the reactor building.

The doses for such an individual were determined by scaling the full-time occupancy doses due to airborne effluents by the occupancy time due to a normal working year. Based on an assumed occupancy of 25% (40 hour work week) and the fact that all employees are adults, the calculated doses were determined to be less than:

0.013 mrem to the maximum exposed organ (thyroid)

All doses for receptors inside the site boundary were calculated according to the methodology described in the Waterford 3 Offsite Dose Calculation Manual considering only the inhalation and ground plane exposure pathways.

8.0 Related Information

8.1 Changes to the Process Control Program

There was a minor editorial change to EN-RW-105 in 2014:

Step 5.1[1](b) was revised to clarify that all radioactive waste processed on-site **OR** off-site by vendors must be processed or packaged to meet the minimum requirements listed in 10CFR Part 61.

8.2 Changes to the Offsite Dose Calculation Manual

There were minor editorial changes to the ODCM in 2014:

The drawing in Attachment 7.11 page 2 was updated to reflect modified discharge pathways as represented in FSAR drawings. Reference T.S. 6.8.4.f was added. The symbol "e" was changed to "E" in equations on pages 14, 25, and 28 and "MPC" was changed to "10EC" on page 19 for consistency as used elsewhere in the ODCM.

8.3 Unavailability of REMP Milk Samples

Due to the unavailability of three milk sampling locations within five kilometers of the plant, Broad Leaf sampling is performed in accordance with Technical Requirements Manual (TRM) Table 3.12-1. Milk is collected, when available, from the control location and one identified sampling location as indicated in UNT-005-014, Offsite Dose Calculation Manual, Attachment 7.13.

8.4 Report of Required Effluent Instrument Inoperability

Technical Requirements Manual (TRM) Specifications 3.3.3.10 and 3.3.3.11 require reporting in the Annual Radioactive Effluent Release Report of why designated inoperable effluent monitoring instrumentation was not restored to operability within the time specified in the Action Statement.

During the reporting period, all instrumentation was restored to operability within the time specified.

8.5 Activity Released Via Secondary Pathways

The following secondary release paths were continuously monitored for radioactivity:

- The Hot Machine Shop Exhaust (AH-35),
- Decontamination Shop Exhaust (AH-34),
- The RAB H&V Equipment Room Ventilation System Exhaust (E-41A and E-41B); and,
- The Switchgear/Cable Vault Area Ventilation System (AH-25).

Continuous sampling for these areas is maintained in order to demonstrate the operability of installed treatment systems and to verify integrity of barriers separating primary and secondary ventilation systems. Sampling for these areas was limited to continuous particulate and iodine sampling and monthly noble gas grab sampling. The activity released via these secondary pathways resulted from routine operations and remained below significant levels.

8.6 Missed Effluent Samples

During the reporting period, no incident occurred for which effluent samples were not sampled and/or analyzed as required by the ODCM/TRM.

8.7 Major Changes to Radioactive Waste Systems

During the reporting period, no major changes were made to any Radioactive Waste Systems. All major changes to Radioactive Waste Systems are included in Waterford 3's FSAR updates.

8.8 Biennial Land Use Census

A land use census was last performed in 2014. The land use census performed in 2014 did not identify the need for any changes to locations being used for effluent dose calculations or radiological environmental sampling.

8.9 Gaseous Storage Tank Total Radioactivity Limit

Technical Specification 3/4.11.2.6 specifies that the quantity of radioactivity contained in each gas storage tank be maintained less than or equal to $8.5E+04$ Curies noble gas (considered as Xe-133 equivalent). At no time during the reporting period was this value exceeded.

8.10 Unprotected Outside Tank Total Radioactivity Limit

Technical Specification 3/4.11.1.4 specifies that the quantity of radioactive material contained in each unprotected outdoor tank be maintained less than or equal to $7.85E-04$ Curies (excluding tritium and dissolved and entrained noble gases). During this reporting period, there were no instances in which this limit was exceeded.

9.0 Additional Information

9.1 Reactor Coolant System Average Energy (E-Bar)

Reactor Coolant System E-Bar calculations were done on 2/19/14 and 8/18/14 with values of 0.1235 and 0.0815 Mev/disintegration, respectively. Reactor Coolant System E-Bar is supplied for information only and is not used for effluent dose calculations.

9.2 Groundwater Initiative Data

Groundwater wells were monitored at Waterford 3 during 2014 as part of the NEI Groundwater Initiative. Sampling of the ten installed wells was conducted on a quarterly basis. All results were less than minimum detectable activity for gamma emitters and tritium during 2014. A summary of all groundwater monitoring well sample results for 2014 is presented in Table 6.

10.0 Tables

Table 1, Batch Release Summary	18
Table 1A, Annual Summation of All Releases by Quarter All Airborne Effluents	19
Table 1B, Annual Airborne Continuous Elevated and Ground Level Releases Totals for Each Nuclide Released	20
Table 1C, Annual Airborne Batch Elevated and Ground Level Releases Totals for Each Nuclide Released	21
Table 2, Annual Summation of All Releases by Quarter All Liquid Effluents	22
Table 2B, Annual Liquid Continuous and Batch Releases Totals for Each Nuclide Released	23
Table 3, Solid Waste Shipped Offsite for Burial or Disposal.....	24
Table 4, Joint Frequency Distribution of Meteorological Data.....	30
Table 5A, Doses Due to Gaseous Radioactive Effluents	34
Table 5B, Doses Due to Liquid Radioactive Effluents.....	35
Table 6, Doses Due to Liquid Radioactive Effluents.....	33

11.0 Attachments

11.1 Copy of UNT-005-014, "Offsite Dose Calculation Manual" Revision 305.

11.2 Copy of EN-RW-105, "Process Control Program" Revision 4.

Table 1
Batch Release Summary

Batch Release Summary information for 2014 Report Period.

Report Category : Batch Release Summary
Release Point : All
Type of Release : Batch Liquid and Gaseous
Period Start Time : 01-jan-2014 00:00:00
Period End Time : 31-dec-2014 23:59:59

Liquid Releases

Number of Releases : 104
Total Time for All Releases : 27838.0 Minutes
Maximum Time for a Release : 325.0 Minutes
Average Time for a Release : 267.7 Minutes
Minimum Time for a Release : 40.0 Minutes
Average Stream Flow : 481625 ft³/s

Gaseous Releases

Number of Releases : 7
Total Time for All Releases : 1492.0 Minutes
Maximum Time for a Release : 600.0 Minutes
Average Time for a Release : 213.1 Minutes
Minimum Time for a Release : 25.0 Minutes

Batch Release Summary information for 2014 by Quarter.

Report Category : Batch Release Summary
Release Point : All
Type of Release : Batch Liquid and Gaseous
Period Start Time : 01-jan-2014 00:00:00
Period End Time : 31-dec-2014 23:59:59

Liquid Releases

	Qtr 1	Qtr 2	Qtr 3	Qtr 4
Number of Releases :	25	42	18	19
Total Time for All Releases :	6582.0	11164.0	4950.0	5142.0 Minutes
Maximum Time for a Release :	301.0	320.0	317.0	325.0 Minutes
Average Time for a Release :	263.3	265.8	275.0	270.6 Minutes
Minimum Time for a Release :	214.0	40.0	191.0	243.0 Minutes
Average Stream Flow :	551533	626833	402567	345567 ft ³ /s

Gaseous Releases

	Qtr 1	Qtr 2	Qtr 3	Qtr 4
Number of Releases :	2	4	0	1
Total Time for All Releases :	299.0	1166.0	0	27.0 Minutes
Maximum Time for a Release :	274.0	600.0	0	27.0 Minutes
Average Time for a Release :	149.5	291.5	0	27.0 Minutes
Minimum Time for a Release :	25.0	25.0	0	27.0 Minutes

Table 1A
Annual Summation of All Releases by Quarter
All Airborne Effluents

Report Category : Summation of All Releases
Type of Activity : All Airborne Effluents
Period Start Time : 01-jan-2014 00:00:00
Period End Time : 31-dec-2014 23:59:59

Type of Effluent	Units	Qtr 1	Qtr 2	Qtr 3	Qtr 4	Est.Total Error %
A. Fission and Activation Gases						
1. Total Release	Curies	5.35E+01	3.61E+01	0.00E+00	8.18E-03	1.50E+01
2. Average Release Rate for Period	uCi/sec	6.88E+00	4.60E+00	0.00E+00	1.03E-03	
3. Percent of Applicable Limit	%	n/a	n/a	n/a	n/a	
B. Radioiodines						
1. Total Iodine-131	Curies	0.00E+00	8.38E-05	0.00E+00	0.00E+00	1.50E+01
2. Average Release Rate for Period	uCi/sec	0.00E+00	1.07E-05	0.00E+00	0.00E+00	
3. Percent of Applicable Limit	%	n/a	n/a	n/a	n/a	
C. Particulates						
1. Particulates (Half-lives > 8 Days)	Curies	5.68E-07	7.35E-06	1.35E-07	2.54E-07	1.50E+01
2. Average Release Rate for Period	uCi/sec	7.30E-08	9.35E-07	1.70E-08	3.20E-08	
3. Percent of Applicable Limit	%	n/a	n/a	n/a	n/a	
4. Gross Alpha Radioactivity	Curies	2.45E-07	1.33E-07	5.12E-07	2.49E-07	1.50E+01
5. Carbon-14	Curies	2.53E+00	2.53E+00	2.53E+00	2.53E+00	
D. Tritium						
1. Total Release	Curies	3.46E+01	2.80E+01	8.33E+00	1.66E+01	1.50E+01
2. Average Release Rate for Period	uCi/sec	4.45E+00	3.56E+00	1.05E+00	2.09E+00	
3. Percent of Applicable Limit	%	n/a	n/a	n/a	n/a	

Table 1B
Annual Airborne Continuous Elevated and Ground Level Releases
Totals for Each Nuclide Released

Report Category : Airborne Continuous Elevated and Ground Level Releases.
: Totals for Each Nuclide Released.
Type of Activity : Fission Gases, Iodines, and Particulates
Period Start Time : 01-jan-2014 00:00:00
Period End Time : 31-dec-2014 23:59:59

Nuclide	Units	Elevated Releases				Ground Releases			
		Qtr 1	Qtr 2	Qtr 3	Qtr 4	Qtr 1	Qtr 2	Qtr 3	Qtr 4
Fission and Activation Gases									
Xe-133	Curies	0.00E+00	0.00E+00	0.00E+00	0.00E+00	4.92E+01	2.29E+01	0.00E+00	0.00E+00
Xe-135	Curies	0.00E+00	0.00E+00	0.00E+00	0.00E+00	4.29E+00	1.18E+00	0.00E+00	0.00E+00
Total for Period	Curies	0.00E+00	0.00E+00	0.00E+00	0.00E+00	5.34E+01	2.41E+01	0.00E+00	0.00E+00
Radioiodines									
I-131	Curies	0.00E+00	0.00E+00	0.00E+00	0.00E+00	0.00E+00	7.95E-05	0.00E+00	0.00E+00
I-133	Curies	0.00E+00	0.00E+00	0.00E+00	0.00E+00	0.00E+00	4.27E-06	0.00E+00	0.00E+00
Total for Period	Curies	0.00E+00	0.00E+00	0.00E+00	0.00E+00	0.00E+00	8.38E-05	0.00E+00	0.00E+00
Particulates									
H-3	Curies	0.00E+00	0.00E+00	0.00E+00	0.00E+00	3.46E+01	2.58E+01	8.33E+00	1.66E+01
Co-60	Curies	0.00E+00	0.00E+00	0.00E+00	0.00E+00	0.00E+00	2.93E-07	0.00E+00	0.00E+00
Cs-137	Curies	0.00E+00	0.00E+00	0.00E+00	0.00E+00	5.68E-07	4.01E-07	1.35E-07	2.54E-07
Os-191	Curies	0.00E+00	0.00E+00	0.00E+00	0.00E+00	0.00E+00	3.97E-06	0.00E+00	0.00E+00
Ru-103	Curies	0.00E+00	0.00E+00	0.00E+00	0.00E+00	0.00E+00	2.69E-06	0.00E+00	0.00E+00
Gralpha	Curies	0.00E+00	0.00E+00	0.00E+00	0.00E+00	2.45E-07	1.33E-07	5.12E-07	2.49E-07
C-14	Curies	0.00E+00	0.00E+00	0.00E+00	0.00E+00	2.53E+00	2.53E+00	2.53E+00	2.53E+00
Total for Period	Curies	0.00E+00	0.00E+00	0.00E+00	0.00E+00	3.71E+01	2.83E+01	1.09E+01	1.91E+01

Table 1C
Annual Airborne Batch Elevated and Ground Level Releases
Totals for Each Nuclide Released

Report Category : Airborne Batch Elevated and Ground Level Releases.
: Totals for Each Nuclide Released.
Type of Activity : Fission Gases, Iodines, and Particulates
Period Start Time : 01-jan-2014 00:00:00
Period End Time : 31-dec-2014 23:59:59

Nuclide	Units	Elevated Releases				Ground Releases			
		Qtr 1	Qtr 2	Qtr 3	Qtr 4	Qtr 1	Qtr 2	Qtr 3	Qtr 4
Fission and Activation Gases									
Ar-41	Curies	0.00E+00	0.00E+00	0.00E+00	0.00E+00	1.09E-02	1.98E-01	0.00E+00	8.18E-03
Kr-85	Curies	0.00E+00	0.00E+00	0.00E+00	0.00E+00	0.00E+00	1.32E-01	0.00E+00	0.00E+00
Kr-89	Curies	0.00E+00	0.00E+00	0.00E+00	0.00E+00	0.00E+00	1.94E-03	0.00E+00	0.00E+00
Xe-131m	Curies	0.00E+00	0.00E+00	0.00E+00	0.00E+00	0.00E+00	1.50E-01	0.00E+00	0.00E+00
Xe-133	Curies	0.00E+00	0.00E+00	0.00E+00	0.00E+00	5.67E-02	1.14E+01	0.00E+00	0.00E+00
Xe-133m	Curies	0.00E+00	0.00E+00	0.00E+00	0.00E+00	0.00E+00	7.97E-02	0.00E+00	0.00E+00
Xe-135	Curies	0.00E+00	0.00E+00	0.00E+00	0.00E+00	3.90E-04	1.56E-02	0.00E+00	0.00E+00
Total for Period	Curies	0.00E+00	0.00E+00	0.00E+00	0.00E+00	6.81E-02	1.20E+01	0.00E+00	8.18E-03
Radioiodines									
Total for Period	Curies	0.00E+00	0.00E+00	0.00E+00	0.00E+00	0.00E+00	0.00E+00	0.00E+00	0.00E+00
Particulates									
H-3	Curies	0.00E+00	0.00E+00	0.00E+00	0.00E+00	9.98E-03	2.16E+00	0.00E+00	8.44E-02
Total for Period	Curies	0.00E+00	0.00E+00	0.00E+00	0.00E+00	9.98E-03	2.16E+00	0.00E+00	8.44E-02

Table 2A
Annual Summation of All Releases by Quarter
All Liquid Effluents

Report Category : Summation of All Releases
Type of Activity : All Liquid Effluents
Period Start Time : 01-jan-2014 00:00:00
Period End Time : 31-dec-2014 23:59:59

Type of Effluent	Units	Qtr 1	Qtr 2	Qtr 3	Qtr 4	Est.Total Error %
A. Fission and Activation Products						
1. Total Release (Not Including Tritium, Gases, and Alpha)	Curies	2.17E-03	6.97E-03	1.73E-03	4.09E-03	2.50E+01
2. Average Diluted Concentration During Period	uCi/mL	6.63E-11	1.53E-10	4.53E-11	1.59E-10	
3. Percent of Applicable Limit	%	n/a	n/a	n/a	n/a	
B. Tritium						
1. Total Release	Curies	1.03E+02	5.62E+02	3.12E+01	2.81E+01	2.50E+01
2. Average Diluted Concentration During Period	uCi/mL	3.15E-06	1.23E-05	8.15E-07	1.09E-06	
3. Percent of Applicable Limit	%	n/a	n/a	n/a	n/a	
C. Dissolved and Entrained Gases						
1. Total Release	Curies	5.25E-01	1.03E+00	3.03E-05	7.41E-06	2.50E+01
2. Average Diluted Concentration During Period	uCi/mL	1.60E-08	2.27E-08	7.92E-13	2.87E-13	
3. Percent of Applicable Limit	%	n/a	n/a	n/a	n/a	
D. Gross Alpha Radioactivity						
1. Total Release	Curies	0.00E+00	0.00E+00	0.00E+00	0.00E+00	2.50E+01
E. Waste Volume Released (Pre-Dilution)						
1. Waste Volume Released (Pre-Dilution)	Liters	8.72E+06	1.44E+07	9.25E+06	6.38E+06	2.50E+01
F. Volume of Dilution Water Used						
1. Volume of Dilution Water Used	Liters	3.27E+10	4.55E+10	3.83E+10	2.58E+10	2.50E+01

Table 2B
Annual Liquid Continuous and Batch Releases
Totals for Each Nuclide Released

Report Category : Liquid Continuous and Batch Releases.
: Totals for Each Nuclide Released.
Type of Activity : All Radionuclides
Period Start Time : 01-jan-2014 00:00:00
Period End Time : 31-dec-2014 23:59:59

Nuclide	Units	Continuous Releases				Batch Releases			
		Qtr 1	Qtr 2	Qtr 3	Qtr 4	Qtr 1	Qtr 2	Qtr 3	Qtr 4
All Nuclides									
Ag-110m	Curies	0.00E+00	0.00E+00	0.00E+00	0.00E+00	2.58E-05	1.25E-05	0.00E+00	1.62E-04
Co-57	Curies	0.00E+00	0.00E+00	0.00E+00	0.00E+00	0.00E+00	6.39E-06	0.00E+00	0.00E+00
Co-58	Curies	0.00E+00	0.00E+00	0.00E+00	0.00E+00	1.74E-04	2.53E-03	1.56E-04	3.58E-04
Co-60	Curies	0.00E+00	0.00E+00	0.00E+00	0.00E+00	7.42E-04	6.93E-04	4.04E-04	2.47E-04
Cr-51	Curies	0.00E+00	0.00E+00	0.00E+00	0.00E+00	0.00E+00	9.51E-04	0.00E+00	0.00E+00
Cs-134	Curies	0.00E+00	0.00E+00	0.00E+00	0.00E+00	6.76E-06	0.00E+00	0.00E+00	0.00E+00
Cs-136	Curies	0.00E+00	0.00E+00	0.00E+00	0.00E+00	0.00E+00	0.00E+00	0.00E+00	2.59E-06
Cs-137	Curies	0.00E+00	0.00E+00	0.00E+00	0.00E+00	2.05E-05	3.58E-06	0.00E+00	0.00E+00
Fe-55	Curies	0.00E+00	0.00E+00	0.00E+00	0.00E+00	1.09E-03	1.37E-03	9.68E-04	1.15E-03
Fe-59	Curies	0.00E+00	0.00E+00	0.00E+00	0.00E+00	0.00E+00	2.27E-04	0.00E+00	4.31E-05
H-3	Curies	1.03E-01	4.82E-01	2.39E-02	4.55E-02	1.03E+02	5.62E+02	3.12E+01	2.81E+01
I-131	Curies	0.00E+00	1.32E-05	0.00E+00	0.00E+00	0.00E+00	6.12E-04	0.00E+00	0.00E+00
I-132	Curies	0.00E+00	0.00E+00	0.00E+00	0.00E+00	0.00E+00	1.99E-05	0.00E+00	0.00E+00
Kr-85	Curies	0.00E+00	0.00E+00	0.00E+00	0.00E+00	4.51E-03	1.81E-02	0.00E+00	0.00E+00
Mn-54	Curies	0.00E+00	0.00E+00	0.00E+00	0.00E+00	5.22E-05	5.64E-05	5.11E-05	2.44E-05
Nb-95	Curies	0.00E+00	0.00E+00	0.00E+00	0.00E+00	1.77E-05	6.54E-05	2.20E-05	3.72E-05
Ni-56	Curies	0.00E+00	0.00E+00	0.00E+00	0.00E+00	0.00E+00	0.00E+00	0.00E+00	0.00E+00
Np-239	Curies	0.00E+00	0.00E+00	0.00E+00	0.00E+00	0.00E+00	1.06E-04	0.00E+00	0.00E+00
Sb-125	Curies	0.00E+00	0.00E+00	0.00E+00	0.00E+00	3.56E-05	2.82E-04	1.16E-04	2.05E-03
Sn-113	Curies	0.00E+00	0.00E+00	0.00E+00	0.00E+00	0.00E+00	0.00E+00	4.75E-06	0.00E+00
Xe-131m	Curies	0.00E+00	0.00E+00	0.00E+00	0.00E+00	7.84E-03	2.28E-02	0.00E+00	0.00E+00
Xe-133	Curies	0.00E+00	0.00E+00	0.00E+00	0.00E+00	5.09E-01	9.86E-01	3.03E-05	7.41E-06
Xe-133m	Curies	0.00E+00	0.00E+00	0.00E+00	0.00E+00	3.30E-03	5.03E-03	0.00E+00	0.00E+00
Xe-135	Curies	0.00E+00	0.00E+00	0.00E+00	0.00E+00	1.98E-05	1.24E-04	0.00E+00	0.00E+00
Zr-95	Curies	0.00E+00	0.00E+00	0.00E+00	0.00E+00	6.17E-06	2.68E-05	8.18E-06	1.94E-05
Zr-97	Curies	0.00E+00	0.00E+00	0.00E+00	0.00E+00	0.00E+00	0.00E+00	1.70E-06	0.00E+00
Total for Period	Curies	1.03E-01	4.82E-01	2.39E-02	4.55E-02	1.04E+02	5.63E+02	3.12E+01	2.81E+01

Table 3
Solid Waste Shipped Offsite for Burial or Disposal

SUMMARY BY MAJOR WASTE TYPES**Waste Stream : Resins, Filters, and Evaporator Bottoms ♦**

Waste Class	Volume Ft ³	Volume M ³	Curies Shipped	%Error (Ci)
A	1.35E+03	3.81E+01	5.66E-03	+/-25%
B	2.45E+02	6.94E+00	3.70E+02	+/-25%
C	0.00E+00	0.00E+00	0.00E+00	+/-25%
ALL	1.59E+03	4.51E+01	3.70E+02	+/-25%

Waste Stream : Dry Active Waste ♣

Waste Class	Volume Ft ³	Volume M ³	Curies Shipped	%Error (Ci)
A	1.40E+04	3.96E+02	6.04E-01	+/-25%
B	0.00E+00	0.00E+00	0.00E+00	+/-25%
C	0.00E+00	0.00E+00	0.00E+00	+/-25%
ALL	1.40E+04	3.96E+02	6.04E-01	+/-25%

Waste Stream : Irradiated Components

Waste Class	Volume Ft ³	Volume M ³	Curies Shipped	%Error (Ci)
A	0.00E+00	0.00E+00	0.00E+00	+/-25%
B	0.00E+00	0.00E+00	0.00E+00	+/-25%
C	0.00E+00	0.00E+00	0.00E+00	+/-25%
ALL	0.00E+00	0.00E+00	0.00E+00	+/-25%

Waste Stream : Other Waste

Waste Class	Volume Ft ³	Volume M ³	Curies Shipped	%Error (Ci)
A	2.58E+02	7.31E+00	1.04E-01	+/-25%
B	0.00E+00	0.00E+00	0.00E+00	+/-25%
C	0.00E+00	0.00E+00	0.00E+00	+/-25%
ALL	2.58E+02	7.31E+00	1.04E-01	+/-25%

Waste Stream : Sum of All 4 Categories

Waste Class	Volume Ft ³	Volume M ³	Curies Shipped	%Error (Ci)
A	1.56E+04	4.41E+02	7.13E-01	+/-25%
B	2.45E+02	6.94E+00	3.70E+02	+/-25%
C	0.00E+00	0.00E+00	0.00E+00	+/-25%
ALL	1.58E+04	4.48E+02	3.70E+02	+/-25%

♣ Activity determined by estimations

♦ Activity determined by measurements

Table 3

Estimate of major nuclide composition (by waste type)

Waste Stream : Resins, Filters, and Evap Bottoms

Nuclide Name	Percent Abundance	Curies
H-3	0.002%	6.15E-03
C-14	0.007%	2.77E-02
Cr-51	0.009%	3.18E-02
Mn-54	1.456%	5.39E+00
Fe-55	7.853%	2.90E+01
Fe-59	0.000%	0.00E+00
Co-57	0.338%	1.25E+00
Co-58	0.708%	2.62E+00
Co-60	14.724%	5.44E+01
Ni-59	0.331%	1.22E+00
Ni-63	58.854%	2.18E+02
Zn-65	0.018%	6.51E-02
Sr-89	0.000%	2.72E-05
Sr-90	0.052%	1.92E-01
Zr-95	0.000%	2.14E-04
Nb-94	0.000%	1.95E-06
Nb-95	0.000%	1.07E-03
Tc-99	0.000%	1.26E-03
Sn-113	0.000%	0.00E+00
Sb-125	0.944%	3.49E+00
Cs-134	2.137%	7.90E+00
Cs-137	12.529%	4.63E+01
Ce-141	0.001%	4.80E-03
Ce-144	0.030%	1.12E-01
Np-239	0.000%	4.88E-28
Pu-238	0.000%	4.56E-04
Pu-239	0.000%	9.63E-05
Pu-240	0.000%	9.66E-05
Pu-241	0.004%	1.59E-02
Am-241	0.000%	3.95E-04
Cm-242	0.000%	1.09E-04
Cm-243	0.000%	4.13E-04
Cm-244	0.000%	4.09E-04

Estimate of major nuclide composition (by waste type)

Waste Stream : Dry Active Waste

Nuclide Name	Percent Abundance	Curies
H-3	0.210%	1.27E-03
C-14	0.426%	2.57E-03
Mn-54	1.843%	1.11E-02
Fe-55	30.655%	1.85E-01
Co-57	0.182%	1.10E-03
Co-58	3.558%	2.15E-02
Co-60	23.448%	1.42E-01
Ni-63	25.917%	1.56E-01
Zr-95	0.034%	2.07E-04
Nb-94	0.055%	3.32E-04
Nb-95	0.067%	4.04E-04
Sb-125	2.056%	1.24E-02
Cs-134	2.145%	1.29E-02
Cs-137	8.984%	5.42E-02
Ce-144	0.353%	2.13E-03
Pu-238	0.032%	1.90E-04
Am-241	0.014%	8.68E-05
Cm-243	0.011%	6.80E-05
Cm-244	0.011%	6.79E-05

Estimate of major nuclide composition (by waste type)

Waste Stream : Irradiated Components

N/A - None Shipped in 2014.

Estimate of major nuclide composition (by waste type)**Waste Stream : Other Waste (Combined Packages)**

Nuclide Name	Percent Abundance	Curies
H-3	0.001%	1.39E-06
C-14	0.004%	3.83E-06
Mn-54	2.144%	2.22E-03
Fe-55	2.786%	2.88E-03
Co-57	0.234%	2.42E-04
Co-58	51.785%	5.36E-02
Co-60	1.318%	1.36E-03
Ni-59	0.100%	1.04E-04
Ni-63	9.461%	9.80E-03
Sr-89	0.039%	4.04E-05
Sr-90	0.005%	5.37E-06
Tc-99	0.000%	8.28E-10
Sb-125	0.247%	2.56E-04
Cs-134	17.428%	1.80E-02
Cs-137	14.386%	1.49E-02
Ce-144	0.060%	6.24E-05
Pu-238	0.000%	1.23E-08
Pu-239	0.000%	1.13E-08
Pu-241	0.001%	7.62E-07
Am-241	0.000%	1.98E-09
Cm-242	0.000%	1.21E-08
Cm-243	0.000%	4.51E-09

Estimate of major nuclide composition (by waste type)**Waste Stream : Sum of All 4 Categories**

Nuclide Name	Percent Abundance	Curies
H-3	0.002%	7.41E-03
C-14	0.008%	3.02E-02
Cr-51	0.009%	3.18E-02
Mn-54	1.457%	5.40E+00
Fe-55	7.889%	2.92E+01
Fe-59	0.000%	0.00E+00
Co-57	0.338%	1.25E+00
Co-58	0.727%	2.69E+00
Co-60	14.735%	5.46E+01
Ni-59	0.331%	1.22E+00
Ni-63	58.786%	2.18E+02
Zn-65	0.018%	6.51E-02
Sr-89	0.000%	6.76E-05
Sr-90	0.052%	1.92E-01
Zr-95	0.000%	4.21E-04
Nb-94	0.000%	3.34E-04
Nb-95	0.000%	1.47E-03
Tc-99	0.000%	1.26E-03
Sn-113	0.000%	0.00E+00
Sb-125	0.946%	3.50E+00
Cs-134	2.142%	7.93E+00
Cs-137	12.524%	4.64E+01
Ce-141	0.001%	4.80E-03
Ce-144	0.031%	1.14E-01
Np-239	0.000%	4.88E-28
Pu-238	0.000%	6.47E-04
Pu-239	0.000%	9.63E-05
Pu-240	0.000%	9.66E-05
Pu-241	0.004%	1.59E-02
Am-241	0.000%	4.82E-04
Cm-242	0.000%	1.09E-04
Cm-243	0.000%	4.81E-04
Cm-244	0.000%	4.77E-04

Table 3

Solid Waste Disposition

Number of Shipments	Mode of Transportation	Destination
13	Hittman Transport Services	EnergySolutions Services
2	Hittman Transport Services	Erwin Resinsolutions, LLC

Irradiated Fuel Shipments (Disposition)

Number of Shipments	Mode of Transportation	Destination
None	N/A	N/A

Table 4
Joint Frequency Distribution of Meteorological Data

JOINT FREQUENCY DISTRIBUTION OF WIND SPEED AND DIRECTION IN HOURS 01/01/2014 00:00:00 TO 12/31/2014 23:59:59 PASQUILL CLASS A

Wind Direction	Wind Speed (M/S) at 10-m Level												Total
	.22-.50	.51-.75	.76-1.0	1.1-1.5	1.6-2.0	2.1-3.0	3.1-5.0	5.1-7.0	7.1-10.	10.1-13	13.1-18.0	>18.0	
N	0	0	0	0	0	2	20	5	11	0	0	0	38
NNE	0	0	0	0	0	3	14	3	0	0	0	0	20
NE	0	0	0	0	0	13	89	7	0	0	0	0	109
ENE	0	0	0	0	0	5	10	0	0	0	0	0	15
E	0	0	0	0	0	3	0	0	0	0	0	0	3
ESE	0	0	0	0	0	3	0	0	0	0	0	0	3
SE	0	0	0	0	0	2	14	10	0	0	0	0	26
SSE	0	0	0	0	0	6	25	17	0	0	0	0	48
S	0	0	0	0	0	3	35	12	-2	0	0	0	52
SSW	0	0	0	0	0	5	6	9	1	0	0	0	21
SW	0	0	0	0	0	10	22	2	0	0	0	0	34
WSW	0	0	0	0	0	10	5	0	0	0	0	0	15
W	0	0	0	0	0	1	6	0	0	0	0	0	7
WNW	0	0	0	0	0	2	10	0	0	0	0	0	12
NW	0	0	0	0	0	0	6	0	0	0	0	0	6
NNW	0	0	0	0	0	1	13	1	4	0	0	0	19
Total	0	0	0	0	0	69	275	66	18	0	0	0	428

Number of calms for A Stability: 0

JOINT FREQUENCY DISTRIBUTION OF WIND SPEED AND DIRECTION IN HOURS 01/01/2014 00:00:00 TO 12/31/2014 23:59:59 PASQUILL CLASS B

Wind Direction	Wind Speed (M/S) at 10-m Level												Total
	.22-.50	.51-.75	.76-1.0	1.1-1.5	1.6-2.0	2.1-3.0	3.1-5.0	5.1-7.0	7.1-10.	10.1-13	13.1-18.0	>18.0	
N	0	0	0	0	1	5	6	2	10	0	0	0	24
NNE	0	0	0	0	1	7	7	4	0	0	0	0	19
NE	0	0	0	0	1	22	69	6	0	0	0	0	98
ENE	0	0	0	0	0	2	7	1	0	0	0	0	10
E	0	0	0	0	0	0	0	0	0	0	0	0	0
ESE	0	0	0	0	1	1	1	0	0	0	0	0	3
SE	0	0	0	0	1	1	12	1	0	0	0	0	15
SSE	0	0	0	0	1	9	27	15	1	0	0	0	53
S	0	0	0	0	3	15	24	17	7	0	0	0	66
SSW	0	0	0	1	3	10	16	4	1	0	0	0	35
SW	0	0	0	0	2	10	15	3	0	0	0	0	30
WSW	0	0	0	0	0	13	11	0	0	0	0	0	24
W	0	0	0	0	1	3	3	0	0	0	0	0	7
WNW	0	0	0	0	1	9	12	0	0	0	0	0	22
NW	0	0	0	0	0	3	9	2	0	0	0	0	14
NNW	0	0	0	0	0	2	3	3	1	0	0	0	9
Total	0	0	0	1	16	112	222	58	20	0	0	0	429

Annual Radioactive
Effluent Release Report

2014
Waterford 3 Steam Electric Station

Number of calms for B Stability: 0

JOINT FREQUENCY DISTRIBUTION OF WIND SPEED AND DIRECTION IN HOURS 01/01/2014 00:00:00 TO 12/31/2014 23:59:59 PASQUILL CLASS C

Wind Direction	Wind Speed (M/S) at 10-m Level											Total	
	.22-.50	.51-.75	.76-1.0	1.1-1.5	1.6-2.0	2.1-3.0	3.1-5.0	5.1-7.0	7.1-10.	10.1-13	13.1-18.0		>18.0
N	0	0	0	0	3	19	18	10	3	0	0	0	53
NNE	0	0	0	1	10	30	10	2	0	0	0	0	53
NE	0	0	0	1	3	34	58	8	0	0	0	0	104
ENE	0	0	0	0	2	11	18	2	0	0	0	0	33
E	0	0	0	0	2	2	5	0	0	0	0	0	9
ESE	0	0	0	0	0	1	2	1	0	0	0	0	4
SE	0	0	0	0	0	6	17	6	0	0	0	0	29
SSE	0	0	0	1	2	16	34	20	0	0	0	0	73
S	0	0	0	2	2	17	32	18	6	0	0	0	77
SSW	0	0	0	2	5	6	11	2	2	0	0	0	28
SW	0	0	0	1	4	16	9	1	0	0	0	0	31
WSW	0	0	0	0	2	19	6	0	0	0	0	0	27
W	0	0	0	2	10	11	10	0	0	0	0	0	33
WNW	0	0	0	0	7	15	6	0	0	0	0	0	28
NW	0	0	0	0	5	8	10	0	0	0	0	0	23
NNW	0	0	0	0	4	12	9	9	3	0	0	0	37
Total	0	0	0	10	61	223	255	79	14	0	0	0	642

Number of calms for C Stability: 0

JOINT FREQUENCY DISTRIBUTION OF WIND SPEED AND DIRECTION IN HOURS 01/01/2014 00:00:00 TO 12/31/2014 23:59:59 PASQUILL CLASS D

Wind Direction	Wind Speed (M/S) at 10-m Level											Total	
	.22-.50	.51-.75	.76-1.0	1.1-1.5	1.6-2.0	2.1-3.0	3.1-5.0	5.1-7.0	7.1-10.	10.1-13	13.1-18.0		>18.0
N	0	0	1	7	22	55	126	101	12	0	0	0	324
NNE	0	0	0	16	29	50	143	74	10	0	0	0	322
NE	0	0	0	4	18	100	202	38	0	0	0	0	362
ENE	0	0	2	4	8	27	82	13	0	0	0	0	136
E	0	0	0	3	4	11	17	1	0	0	0	0	36
ESE	0	0	0	5	7	11	30	8	0	0	0	0	61
SE	0	0	0	6	5	19	86	17	1	0	0	0	134
SSE	0	0	1	3	6	54	155	27	1	0	0	0	247
S	0	0	1	1	12	50	88	51	15	0	0	0	218
SSW	0	0	0	5	14	32	37	44	13	0	0	0	145
SW	0	0	2	5	8	40	40	15	2	0	0	0	112
WSW	0	0	1	12	17	34	17	3	0	0	0	0	84
W	0	1	2	8	22	26	18	0	0	0	0	0	77
WNW	1	1	1	7	17	29	28	1	0	0	0	0	85
NW	0	0	1	7	16	23	48	2	0	0	0	0	97
NNW	0	0	1	5	10	52	111	59	17	0	0	0	255
Total	1	2	13	98	215	613	1228	454	71	0	0	0	2695

Number of calms for D Stability: 6

JOINT FREQUENCY DISTRIBUTION OF WIND SPEED AND DIRECTION IN HOURS 01/01/2014 00:00:00 TO 12/31/2014 23:59:59 PASQUILL CLASS E

Wind Direction	Wind Speed (M/S) at 10-m Level											Total	
	.22-.50	.51-.75	.76-1.0	1.1-1.5	1.6-2.0	2.1-3.0	3.1-5.0	5.1-7.0	7.1-10.	10.1-13	13.1-18.0		>18.0
N	0	1	3	22	21	76	65	20	5	0	0	0	213
NNE	0	3	4	17	33	84	63	9	1	0	0	0	214
NE	0	4	6	9	23	100	91	2	0	0	0	0	235
ENE	1	1	1	12	14	37	72	5	0	0	0	0	143
E	0	0	1	8	11	23	25	2	0	0	0	0	70
ESE	0	0	1	4	5	16	52	3	0	0	0	0	81
SE	0	3	2	7	7	47	73	4	0	0	0	0	143
SSE	1	0	3	10	46	212	82	1	0	0	0	0	355
S	2	1	3	30	45	92	67	7	0	0	0	0	247
SSW	0	3	4	39	46	75	27	6	0	0	0	0	200
SW	0	4	9	44	39	34	17	1	0	0	0	0	148
WSW	1	3	10	37	37	27	8	0	0	0	0	0	123
W	0	2	10	37	13	16	2	0	0	0	0	0	80
WNW	0	4	6	24	15	13	7	1	0	0	0	0	70
NW	0	2	4	23	14	24	8	3	0	0	0	0	78
NNW	0	0	5	15	27	51	26	12	1	0	0	0	137
Total	5	31	72	338	396	927	685	76	7	0	0	0	2537

Number of calms for E Stability: 0

JOINT FREQUENCY DISTRIBUTION OF WIND SPEED AND DIRECTION IN HOURS 01/01/2014 00:00:00 TO 12/31/2014 23:59:59 PASQUILL CLASS F

Wind Direction	Wind Speed (M/S) at 10-m Level											Total	
	.22-.50	.51-.75	.76-1.0	1.1-1.5	1.6-2.0	2.1-3.0	3.1-5.0	5.1-7.0	7.1-10.	10.1-13	13.1-18.0		>18.0
N	1	1	6	11	10	11	1	1	0	0	0	0	42
NNE	0	3	3	9	12	8	0	0	0	0	0	0	35
NE	2	0	2	7	8	18	6	0	0	0	0	0	43
ENE	0	1	4	5	6	9	2	0	0	0	0	0	27
E	0	0	0	2	0	2	0	0	0	0	0	0	4
ESE	1	2	1	5	2	3	1	1	0	0	0	0	16
SE	1	1	2	1	2	6	1	0	0	0	0	0	14
SSE	2	3	4	11	63	88	10	0	0	0	0	0	181
S	1	1	12	45	53	28	0	0	0	0	0	0	140
SSW	0	8	21	84	42	7	1	0	0	0	0	0	163
SW	1	13	38	80	32	5	0	0	0	0	0	0	169
WSW	1	17	29	59	14	1	0	0	0	0	0	0	121
W	1	12	27	28	12	0	0	0	0	0	0	0	80
WNW	0	6	17	30	5	1	0	0	0	0	0	0	59
NW	1	6	6	20	17	2	0	0	0	0	0	0	52
NNW	1	5	6	12	18	8	0	0	0	0	0	0	50
Total	13	79	178	409	296	197	22	2	0	0	0	0	1196

Number of calms for F Stability: 0

JOINT FREQUENCY DISTRIBUTION OF WIND SPEED AND DIRECTION IN HOURS 01/01/2014 00:00:00 TO 12/31/2014 23:59:59 PASQUILL CLASS G

Wind Direction	Wind Speed (M/S) at 10-m Level											Total	
	.22-.50	.51-.75	.76-1.0	1.1-1.5	1.6-2.0	2.1-3.0	3.1-5.0	5.1-7.0	7.1-10.	10.1-13	13.1-18.0		>18.0
N	2	2	4	12	3	0	0	0	0	0	0	0	23
NNE	4	1	1	6	1	0	0	0	0	0	0	0	13
NE	1	2	0	1	2	1	1	0	0	0	0	0	8
ENE	2	0	0	2	0	0	0	0	0	0	0	0	4
E	0	2	1	0	0	0	0	0	0	0	0	0	3
ESE	0	2	0	0	0	0	0	0	0	0	0	0	2
SE	2	0	0	1	0	0	0	0	0	0	0	0	3
SSE	0	2	1	1	6	18	1	0	0	0	0	0	29
S	0	3	11	36	27	7	0	0	0	0	0	0	84
SSW	1	17	13	86	21	1	0	0	0	0	0	0	139
SW	5	15	37	54	11	0	0	0	0	0	0	0	122
WSW	7	42	41	33	2	0	0	0	0	0	0	0	125
W	10	32	36	26	2	0	0	0	0	0	0	0	106
WNW	1	21	17	25	0	0	0	0	0	0	0	0	64
NW	3	9	6	11	1	0	0	0	0	0	0	0	30
NNW	3	5	4	8	2	0	0	0	0	0	0	0	22
Total	41	155	172	302	78	27	2	0	0	0	0	0	777

Number of calms for G Stability: 0

Total valid hours for all stabilities = 8710
Total invalid hours for all stabilities = 0

Table 5A
Doses Due to Gaseous Radioactive Effluents

Doses due to Noble Gases (mRad or mrem)

Age Group : All

Organ	Qtr 1	Qtr 2	Qtr 3	Qtr 4	Year Total
Total-body	1.70E-02	1.07E-02	0.00E+00	5.50E-05	2.78E-02
Skin	3.91E-02	2.41E-02	0.00E+00	8.05E-05	6.32E-02
Air Beta	4.74E-02	3.06E-02	0.00E+00	2.04E-05	7.80E-02
Air Gamma	1.96E-02	1.24E-02	0.00E+00	5.79E-05	3.21E-02

Doses due to Radioiodines/Particulates/Tritium Excluding C-14 (mrem)

Age Group : Adult

	Bone	Liver	T. Body	Thyroid	Kidney	Lung	GI-LLI	Skin
Period	mrem	mrem	mrem	mrem	mrem	mrem	mrem	mrem
Qtr 1	8.30E-06	2.41E-02	2.41E-02	2.41E-02	2.41E-02	2.41E-02	2.41E-02	4.11E-06
Qtr 2	2.93E-05	1.96E-02	1.95E-02	2.83E-02	1.96E-02	1.95E-02	1.95E-02	8.59E-06
Qtr 3	1.98E-06	5.81E-03	5.81E-03	5.81E-03	5.81E-03	5.81E-03	5.81E-03	9.81E-07
Qtr 4	3.71E-06	1.16E-02	1.16E-02	1.16E-02	1.16E-02	1.16E-02	1.16E-02	1.84E-06
Year	4.33E-05	6.11E-02	6.11E-02	6.98E-02	6.11E-02	6.10E-02	6.11E-02	1.55E-05

Age Group : Teen

	Bone	Liver	T. Body	Thyroid	Kidney	Lung	GI-LLI	Skin
Period	mrem	mrem	mrem	mrem	mrem	mrem	mrem	mrem
Qtr 1	1.17E-05	2.73E-02	2.73E-02	2.73E-02	2.73E-02	2.73E-02	2.73E-02	4.11E-06
Qtr 2	4.33E-05	2.22E-02	2.21E-02	3.45E-02	2.22E-02	2.21E-02	2.21E-02	8.59E-06
Qtr 3	2.78E-06	6.58E-03	6.58E-03	6.57E-03	6.58E-03	6.57E-03	6.57E-03	9.81E-07
Qtr 4	5.22E-06	1.31E-02	1.31E-02	1.31E-02	1.31E-02	1.31E-02	1.31E-02	1.84E-06
Year	6.30E-05	6.92E-02	6.91E-02	8.15E-02	6.92E-02	6.91E-02	6.91E-02	1.55E-05

Age Group : Child

	Bone	Liver	T. Body	Thyroid	Kidney	Lung	GI-LLI	Skin
Period	mrem	mrem	mrem	mrem	mrem	mrem	mrem	mrem
Qtr 1	2.29E-05	3.78E-02	3.78E-02	3.78E-02	3.78E-02	3.78E-02	3.78E-02	4.11E-06
Qtr 2	9.14E-05	3.07E-02	3.06E-02	5.40E-02	3.07E-02	3.06E-02	3.06E-02	8.59E-06
Qtr 3	5.46E-06	9.10E-03	9.10E-03	9.10E-03	9.10E-03	9.10E-03	9.10E-03	9.81E-07
Qtr 4	1.02E-05	1.82E-02	1.82E-02	1.82E-02	1.82E-02	1.82E-02	1.82E-02	1.84E-06
Year	1.30E-04	9.57E-02	9.57E-02	1.19E-01	9.58E-02	9.56E-02	9.56E-02	1.55E-05

Age Group : Infant

	Bone	Liver	T. Body	Thyroid	Kidney	Lung	GI-LLI	Skin
Period	mrem	mrem	mrem	mrem	mrem	mrem	mrem	mrem
Qtr 1	2.12E-05	1.71E-02	1.71E-02	1.71E-02	1.71E-02	1.71E-02	1.71E-02	4.11E-06
Qtr 2	1.51E-04	1.40E-02	1.39E-02	6.46E-02	1.40E-02	1.38E-02	1.38E-02	8.59E-06
Qtr 3	5.06E-06	4.12E-03	4.11E-03	4.11E-03	4.11E-03	4.11E-03	4.11E-03	9.81E-07
Qtr 4	9.49E-06	8.22E-03	8.22E-03	8.22E-03	8.22E-03	8.22E-03	8.22E-03	1.84E-06
Year	1.87E-04	4.34E-02	4.33E-02	9.40E-02	4.34E-02	4.32E-02	4.32E-02	1.55E-05

Table 5A (continued)
Critical Dose due to Radioiodines/Particulates/Tritium Including C-14 (mrem)

Age Group : Child

Organ	Qtr 1	Qtr 2	Qtr 3	Qtr 4	Year Total
Bone	1.14E+00	1.14E+00	1.14E+00	1.14E+00	4.57E+00
Total-body	2.28E-01	2.28E-01	2.28E-01	2.28E-01	9.13E-01

Table 5B
Doses Due to Liquid Radioactive Effluents

Cumulative Dose Information for 2014 (mrem)

	Parameter	Max Receptor	Dose	Dose Limit	% of Limit
Qtr 1	Max Organ Dose (mrem)	Adult - Liver	1.64E-04	5.00E+00	0.00
	Total Body Dose (mrem)	Adult - Total Body	1.42E-04	1.50E+00	0.01
Qtr 2	Max Organ Dose (mrem)	Adult - Thyroid	9.34E-04	5.00E+00	0.02
	Total Body Dose (mrem)	Adult - Total Body	6.23E-04	1.50E+00	0.04
Qtr 3	Max Organ Dose (mrem)	Adult - Gi-LLi	3.64E-05	5.00E+00	0.00
	Total Body Dose (mrem)	Adult - Total Body	2.27E-05	1.50E+00	0.00
Qtr 4	Max Organ Dose (mrem)	Adult - Gi-LLi	3.93E-05	5.00E+00	0.00
	Total Body Dose (mrem)	Adult - Total Body	2.45E-05	1.50E+00	0.00
Year	Max Organ Dose (mrem)	Adult - Thyroid	1.07E-03	1.00E+01	0.01
	Total Body Dose (mrem)	Adult - Total Body	8.12E-04	3.00E+00	0.03

Table 6
2014 Groundwater Monitoring Well Results (pCi/L)

Sample Date Time	Well	Tritium	Mn-54	Co-58	Fe-59	Co-60	Zn-65	Nb-95	Zr-95	I-131	Cs-134	Cs-137	Ba-140	La-140
3/19/2014 14:30	MW-3	< 708.00	< 4.51	< 5.69	< 11.10	< 6.97	< 12.90	< 5.78	<10.2	< 13.70	< 4.99	< 5.80	< 35.20	< 12.80
3/19/2014 15:15	MW-3 DUP	< 704.00	< 4.88	< 5.04	< 11.10	< 5.62	<10.1	< 5.60	< 8.56	< 12.80	< 4.80	< 4.87	< 29.20	<10.3
6/4/2014 15:15	MW-3	< 616.00	< 4.70	< 4.85	< 9.40	< 4.59	<10.5	< 5.34	< 9.29	< 9.98	< 5.29	< 5.55	< 28.10	< 7.14
8/12/2014 9:25	MW-3	< 579.00	< 4.94	< 5.47	< 9.66	< 4.69	< 11.00	< 5.33	< 8.76	< 8.99	< 5.21	< 5.29	< 26.60	< 7.80
12/2/2014 14:30	MW-3	< 575.00	< 3.08	< 3.26	< 6.24	< 3.07	< 6.36	< 3.34	< 6.17	< 6.39	< 2.79	< 3.20	< 16.60	< 4.66
3/20/2014 10:00	MW-4	< 707.00	< 4.84	< 5.31	<10.6	< 6.58	< 12.10	< 5.46	< 11.20	< 11.60	< 4.64	< 4.87	< 34.20	<10.2
6/4/2014 16:15	MW-4	< 617.00	< 5.28	< 4.28	< 9.70	< 4.73	<10	< 5.03	< 8.30	< 9.58	< 4.83	< 5.06	< 27.50	< 7.55
8/12/2014 10:30	MW-4	< 586.00	< 4.23	< 5.14	< 11.10	< 4.53	<10.9	< 5.57	< 8.00	< 9.28	< 4.66	< 5.71	< 25.00	< 8.58
8/12/2014 11:05	MW-4 DUP	< 593.00	< 3.07	< 2.73	< 6.01	< 2.56	< 5.77	< 3.24	< 5.12	< 5.62	< 2.60	< 3.01	< 14.10	< 4.98
12/2/2014 13:05	MW-4	< 585.00	< 5.44	< 5.48	<10.7	< 7.48	<10.9	< 5.29	< 13.90	<10.7	< 5.18	< 5.94	< 27.50	< 9.77
3/20/2014 9:00	MW-5	< 712.00	< 5.04	< 4.69	< 11.90	< 4.75	< 9.38	< 5.89	<10.3	< 11.20	< 4.40	< 5.21	< 32.10	<10.8
6/4/2014 17:20	MW-5	< 620.00	< 4.22	< 4.83	< 9.12	< 4.36	< 9.21	< 4.53	< 7.68	< 8.72	< 4.50	< 4.57	< 22.00	< 8.53
6/4/2014 17:50	MW-5 DUP	< 620.00	< 4.51	< 4.93	< 11.40	< 4.61	<10.6	< 4.79	< 8.61	< 9.42	< 4.69	< 5.65	< 27.20	< 9.15
8/12/2014 8:15	MW-5	< 593.00	< 5.21	< 4.53	< 11.20	< 4.91	<10.7	< 5.63	< 9.74	< 8.59	< 4.58	< 4.93	< 28.40	< 8.86
12/2/2014 15:30	MW-5	< 581.00	< 5.57	< 4.71	< 12.20	< 5.15	<10.4	< 5.43	< 9.87	< 8.90	< 4.83	< 5.73	< 24.00	< 7.50
3/20/2014 13:50	MW-6	< 718.00	< 4.04	< 4.28	< 8.44	< 4.45	< 6.77	< 4.51	< 7.91	< 10.1	< 4.31	< 4.08	< 24.00	< 7.58
6/4/2014 18:45	MW-6	< 613.00	< 4.43	< 5.25	< 9.53	< 5.58	< 7.43	< 4.73	< 9.77	< 10.2	< 4.79	< 6.03	< 28.90	< 6.53
8/12/2014 13:30	MW-6	< 590.00	< 3.68	< 4.13	< 8.53	< 4.48	< 8.22	< 3.98	< 7.20	< 6.86	< 3.34	< 4.10	< 15.40	< 6.30
12/2/2014 11:55	MW-6	< 569.00	< 7.19	< 7.21	< 13.30	< 6.95	< 13.20	< 7.35	<10.8	< 14.40	< 6.77	< 5.96	< 35.50	< 8.58
3/20/2014 11:55	MW-7	< 715.00	< 3.43	< 4.09	< 7.66	< 3.32	< 8.43	< 4.50	< 6.64	<10.7	< 3.64	< 3.97	< 22.70	< 6.69
6/5/2014 8:25	MW-7	< 613.00	< 4.93	< 5.65	< 12.70	< 5.50	<10.8	< 6.07	<10.4	< 11.10	< 5.89	< 5.78	< 28.00	< 9.86
8/11/2014 17:55	MW-7	< 597.00	< 5.33	< 5.41	< 12.00	< 6.30	< 11.20	< 6.59	< 9.46	< 9.05	< 5.55	< 6.49	< 28.60	< 9.62
12/2/2014 10:20	MW-7	< 578.00	< 5.33	< 5.61	< 6.60	< 3.98	< 11.50	< 5.63	< 8.38	<10.2	< 5.47	< 4.89	< 21.80	< 6.18

Annual Radioactive
Effluent Release Report

2014
Waterford 3 Steam Electric Station

Sample Date Time	Well	Tritium	Mn-54	Co-58	Fe-59	Co-60	Zn-65	Nb-95	Zr-95	I-131	Cs-134	Cs-137	Ba-140	La-140
3/20/2014 15:00	MW-8	< 714.00	< 5.17	< 5.44	< 9.39	< 5.16	< 9.57	< 4.34	< 9.88	< 11.20	< 4.59	< 4.39	< 31.10	< 8.41
6/5/2014 9:35	MW-8	< 620.00	< 4.50	< 4.59	< 8.98	< 5.48	< 8.10	< 4.33	< 6.98	< 8.88	< 4.14	< 5.05	< 26.30	< 6.84
8/11/2014 16:55	MW-8	< 585.00	< 3.35	< 3.73	< 8.02	< 3.98	< 7.49	< 4.53	< 6.78	< 7.64	< 3.33	< 3.80	< 19.30	< 6.62
12/2/2014 9:15	MW-8	< 571.00	< 5.18	< 4.86	< 10.8	< 4.89	< 8.74	< 5.08	< 7.46	< 10.4	< 3.86	< 5.20	< 31.00	< 7.38
3/20/2014 16:10	MW-9	< 722.00	< 4.13	< 3.51	< 7.41	< 3.48	< 8.07	< 4.02	< 6.11	< 9.39	< 3.73	< 4.08	< 23.90	< 7.19
6/5/2014 10:40	MW-9	< 617.00	< 3.89	< 4.74	< 9.63	< 4.74	< 8.95	< 4.13	< 8.72	< 9.51	< 4.32	< 3.97	< 23.80	< 4.61
8/11/2014 16:05	MW-9	< 588.00	< 5.86	< 5.60	< 11.60	< 6.74	< 12.50	< 5.78	< 8.65	< 11.50	< 5.00	< 5.55	< 27.40	< 7.43
12/2/2014 8:15	MW-9	< 573.00	< 5.50	< 5.46	< 11.20	< 6.61	< 12.80	< 6.04	< 11.20	< 12.90	< 6.39	< 6.28	< 36.00	< 10.6
3/19/2014 16:30	MW-10	< 696.00	< 4.27	< 4.09	< 8.30	< 5.15	< 8.42	< 3.59	< 7.18	< 11.20	< 3.77	< 4.53	< 24.40	< 9.44
6/5/2014 12:30	MW-10	< 626.00	< 5.48	< 5.91	< 10.7	< 5.82	< 11.20	< 6.54	< 10.7	< 10.8	< 5.97	< 5.83	< 31.90	< 9.31
8/11/2014 15:05	MW-10	< 593.00	< 5.76	< 5.72	< 11.30	< 6.74	< 13.10	< 6.33	< 9.77	< 11.60	< 5.62	< 6.23	< 30.1	< 9.02
12/1/2014 15:30	MW-10	< 568.00	< 6.60	< 6.81	< 12.80	< 6.43	< 12.50	< 6.81	< 11.40	< 13.50	< 6.13	< 7.76	< 35.10	< 8.61
3/19/2014 17:30	MW-11	< 703.00	< 4.57	< 4.65	< 10.3	< 4.90	< 9.90	< 5.43	< 9.85	< 14.80	< 4.27	< 4.79	< 27.90	< 8.64
6/5/2014 13:20	MW-11	< 608.00	< 4.08	< 3.90	< 6.02	< 3.82	< 8.61	< 4.80	< 7.48	< 8.16	< 3.61	< 4.15	< 21.00	< 8.32
8/11/2014 13:45	MW-11	< 593.00	< 4.33	< 4.50	< 10.4	< 4.34	< 8.97	< 4.29	< 8.17	< 9.01	< 3.72	< 5.20	< 22.70	< 8.00
12/1/2014 14:55	MW-11	< 573.00	< 3.51	< 3.29	< 7.78	< 4.29	< 7.67	< 4.08	< 6.55	< 8.12	< 3.61	< 3.99	< 19.90	< 6.35
3/19/2014 13:10	MW-12	< 523.00	< 3.99	< 4.20	< 8.88	< 3.76	< 7.35	< 4.37	< 7.24	< 11.30	< 4.69	< 4.03	< 25.80	< 7.11
6/4/2014 13:25	MW-12	< 615.00	< 4.20	< 4.02	< 8.24	< 4.42	< 7.41	< 3.74	< 6.71	< 8.40	< 3.75	< 4.39	< 21.70	< 6.63
8/11/2014 11:50	MW-12	< 600.00	< 2.72	< 2.92	< 7.57	< 3.27	< 6.81	< 3.81	< 6.11	< 7.15	< 3.18	< 3.76	< 19.70	< 4.54
12/1/2014 12:40	MW-12	< 565.00	< 6.03	< 6.29	< 11.70	< 7.08	< 10.9	< 5.90	< 12.20	< 13.10	< 6.30	< 7.68	< 33.40	< 10.8
12/1/2014 13:10	MW-12 DUP	< 570.00	< 5.30	< 5.72	< 13.70	< 6.68	< 14.00	< 5.41	< 11.30	< 10.7	< 6.34	< 6.00	< 27.30	< 10.8

Attachment 11.1 to

W3F1-2015-0033 Enclosure, Annual Radiological Effluent Release Report – 2014

Copy of UNT-005-014, "Offsite Dose Calculation Manual" Revision 304

REQUEST/APPROVAL PAGE

<h1>SAFETY RELATED PROCEDURE</h1>		Normal Review Class (check one): <input checked="" type="checkbox"/> OSRC <input type="checkbox"/> QUALIFIED REVIEW	
PROCEDURE NUMBER: UNT-005-014		REVISION: 305	
TITLE: Offsite Dose Calculation Manual			
PROCEDURE OWNER (Position Title): Chemistry Manager			
TERM (check one): <input checked="" type="checkbox"/> PERMANENT <input type="checkbox"/> TEMPORARY			
Effective Date / Milestone (if applicable):			
Expiration Date / Milestone (if applicable): n/a			
PROCEDURE ACTION (check one): <input checked="" type="checkbox"/> Revision <input type="checkbox"/> Deletion <input type="checkbox"/> New Procedure			
DESCRIPTION AND JUSTIFICATION: Updated Attachment 7.11 page 2 to reflect modified discharge pathways as represented in FSAR drawings in accordance with CR-WF3-2013-4547. Added Tech Spec reference T.S. 6.8.4.f to page 19. Changed "e" to "E" in equations on pages 14, 25, and 28 for consistency when using the mathematical symbol. Corrected typo "MPC" on page 19 to "10EC" as used elsewhere in the ODCM. This revisions scope, intended results, non conservative changes and manner of operation have not been affected. Changes are made to match technical specifications and minor editorial corrections. Attachment 7.9 of W2.109 has been satisfied to meet editorial correction classification.			
<input type="checkbox"/> Request/Approval Page Continuation Sheet(s) attached.			
REVIEW PROCESS (check one): <input type="checkbox"/> Normal <input checked="" type="checkbox"/> Editorial Correction (Revisions only) <input type="checkbox"/> Technical Verification (Revisions only)			
REVIEW AND APPROVAL ACTIVITIES		PRINT NAME OR SIGNATURE	DATE
PREPARER		Danielle Breaud	01/9/2014
EC SUPERVISOR Administrative Review and Approval		(sign) <i>Nicole K. Carlier</i>	11/13/14
CROSS-DISCIPLINE and INTERNAL REVIEWS (List Groups, Functions, Positions, etc.)		n/a	n/a
		n/a	n/a
		n/a	n/a
		n/a	n/a
		n/a	n/a
PROCESS APPLICABILITY DETERMINATION	Performed <input type="checkbox"/> PA Exclusion <input type="checkbox"/>	n/a	n/a
TECHNICAL	Review <input type="checkbox"/> Verification <input type="checkbox"/>	n/a	n/a
QUALIFIED REVIEWER	Review <input type="checkbox"/>	n/a	n/a
GROUP/DEPT. HEAD	Review <input type="checkbox"/> Approval <input type="checkbox"/>	(sign) n/a	n/a
GM, PLANT OPERATIONS	Review <input type="checkbox"/> Approval <input type="checkbox"/>	(sign) n/a	n/a
VICE PRESIDENT, OPERATIONS	Approval <input type="checkbox"/>	(sign) n/a	n/a

TABLE OF CONTENTS

1.0 PURPOSE----- 3

2.0 REFERENCES----- 4

3.0 DEFINITIONS----- 6

4.0 RESPONSIBILITIES----- 8

5.0 PROCEDURE ----- 9

5.1 SITE CHARACTERISTICS----- 9

5.2 SPECIFICATIONS AND SURVEILLANCE REQUIREMENTS-----10

5.3 LIQUID EFFLUENTS -----11

5.4 GASEOUS EFFLUENTS -----21

5.5 40 CFR190 DOSE EVALUATION -----37

5.6 LIQUID AND GASEOUS RADWASTE PROCESSES-----38

5.7 RADIOLOGICAL ENVIRONMENTAL MONITORING PROGRAM
 REQUIREMENTS -----39

5.8 ROUTINE EFFLUENT RELEASE REPORTS-----42

5.9 SPECIAL EFFLUENT REPORTS -----51

5.10 SECONDARY RELEASE PATHS -----55

6.0 RECORDS-----56

7.0 ATTACHMENTS-----56

7.1 BOUNDARIES FOR RADIOACTIVE GASEOUS AND LIQUID
 EFFLUENTS-----57

7.2 HISTORICAL AVERAGE DISPERSION AND DEPOSITION PARAMETERS
 FOR AREAS AT OR BEYOND THE UNRESTRICTED AREA BOUNDARY -----58

7.3 SITE RELATED LIQUID INGESTION DOSE COMMITMENT FACTORS (A_i)
 FOR INDIVIDUAL NUCLIDES -----59

7.4 DOSE FACTORS FOR EXPOSURE TO A SEMI-INFINITE CLOUD OF
 NOBLE GASES-----71

7.5 INHALATION PATHWAY DOSES DUE TO RADIONUCLIDES OTHER
 THAN NOBLE GASES, R_i -----72

7.6 GROUND - PLANE DEPOSITION PATHWAY DOSE FACTORS DUE TO
 RADIONUCLIDES OTHER THAN NOBLE GASES, R_i -----96

7.7 COW'S MILK PATHWAY DOSE FACTORS DUE TO RADIONUCLIDES
 OTHER THAN NOBLE GASES, R_i -----102

7.8 MEAT PATHWAY DOSE FACTORS DUE TO RADIONUCLIDES OTHER
 THAN NOBLE GASES, R_i -----126

INFORMATIONAL USE

7.9	LEAFY VEGETABLE PATHWAY DOSE FACTORS DUE TO RADIONUCLIDES OTHER THAN NOBLE GASES, RI-----	150
7.10	GOAT'S MILK PATHWAY DOSE FACTORS DUE TO RADIONUCLIDES OTHER THAN NOBLE GASES, RI-----	174
7.11	LIQUID WASTE MANAGEMENT SYSTEM EFFLUENT SOURCES AND RELEASE PATHWAYS AND POINTS-----	198
7.12	GASEOUS EFFLUENT SOURCES, GASEOUS WASTE MANAGEMENT SYSTEM EFFLUENT SOURCES AND EXHAUST RELEASE POINTS-----	200
7.13	RADIOLOGICAL ENVIRONMENTAL MONITORING PROGRAM-----	201
7.14	SAMPLE LOCATION TABLE-----	204
7.15	SECTOR AND ZONE DESIGNATORS FOR RADIOLOGICAL SAMPLING AND MONITORING POINTS-----	216
7.16	REMP SAMPLES WITHIN 2 MILES OF WATERFORD 3-----	217
7.17	REMP SAMPLES 2 TO 10 MILES FROM WATERFORD 3-----	218
7.18	REMP SAMPLES 10 TO 50 MILES FROM WATERFORD 3-----	219
7.19	DOSE FACTORS DUE TO RADIONUCLIDES OTHER THAN NOBLE GASES, P _i -----	220
7.20	DOSE CONVERSION FACTORS ALL AGE GROUPS BY NUCLIDE (GROUND PLANE)-----	274
7.21	DOSE CONVERSION FACTORS FOR ALL AGE GROUPS BY NUCLIDE (INHALATION AND INGESTION)-----	280
7.22	SPECIFIC FACTORS USED TO DETERMINE A _i , P _i AND R _i VALUES FOR THE OFFSITE DOSE CALCULATION MANUAL-----	328
7.23	ODCM SPECIFICATIONS CONTAINED IN THE WATERFORD III TECHNICAL REQUIREMENTS MANUAL-----	346

LIST OF EFFECTIVE PAGES

1-346

Revision 305

INFORMATIONAL USE

1.0 PURPOSE

1.1 The Offsite Dose Calculation Manual (ODCM) is a supporting document of the Waterford 3 Technical Specifications. The ODCM provides:

- (1) The Radiological Effluent Specifications and Radiological Environmental Monitoring Program required by Technical Specification 6.8.4
- (2) The detailed Radiological Environmental Monitoring Program (REMP)
- (3) The description of the Radiological Environmental Monitoring Interlaboratory Comparison Program
- (4) The liquid and gaseous radwaste block flow diagram
- (5) The Radioactive Liquid and Gaseous Waste Sampling and Analysis Programs
- (6) The general methodology to be used to calculate dose to individuals due to releases of radioactive gaseous and liquid effluents from the Waterford 3 site
- (7) The general methodology to be used to calculate effluent monitor setpoints and allowable release rates to ensure compliance with the Radiological Effluent Controls, 10CFR20, and 10CFR50 criteria
- (8) The methodology to be used to ensure representative sampling of liquids
- (9) The methodology to be used to comply with 40CFR190 criteria
- (10) The methodology to be used to comply with 72.104 criteria

2.0 REFERENCES

- 2.1 EN-LI-102, Corrective Action Process
- 2.2 UNT-006-010, Event Notification and Reporting
- 2.3 Waterford 3 FSAR Chapter 2
- 2.4 Waterford 3 Technical Requirements Manual (TRM)
- 2.5 Waterford 3 Technical Specifications (T.S.)
 - 2.5.1 T.S. 3/4.11.1.4, Liquid Holdup Tanks
 - 2.5.2 T.S. 3/4.11.2.6, Gas Storage Tanks
 - 2.5.3 T.S. 5.1.3, Map Defining Unrestricted Areas for Radioactive Gaseous and Liquid Effluents
 - 2.5.4 T.S. 6.9.1.7, Annual Radiological Environmental Operating Report
 - 2.5.5 T.S. 6.9.1.8, Annual Radioactive Effluent Release Report
 - 2.5.6 T.S. 6.9.2, Special Reports
 - 2.5.7 T.S. 6.13, Process Control Program
 - 2.5.8 T.S. 6.14, Offsite Dose Calculation Manual
 - 2.5.9 T.S.6.8.4.f, Radioactive Effluent Control Program
- 2.6 Code of Federal Regulations: Title 10, Parts 20, 40, 50 and 100; Title 40, Part 190 and 302
- 2.7 HASL-300, HASL Procedures Manual; Currie, L.A., "Limits for Qualitative Detection and Quantitative Determination Application to Radiochemistry", Anal Chem. 40, 586-93, (1968)

01/2014

- 2.8 International Atomic Energy Agency (IAEA) Safety Series No.57, Generic Models and Parameters for Assessing the Environmental Transfer of Radionuclides from Routine Releases, Exposures of Critical Groups
- 2.9 NUREG/CR-1276, Users Manual for LADTAP II – A computer program for calculating radiation exposure to man from routine release of nuclear reactor liquid effluents
- 2.10 NUREG/CR-4007, Currie, L.A., "Lower Limit of Detection; Definition and Elaboration of a Proposed Position for Radiological Effluent and Environmental Measurements", (September 1984)
- 2.11 NUREG-0172, Age Specific Radiation Dose Commitment Factors for a One Year Chronic Intake
- 2.12 NUREG-1301, Offsite Dose Calculation Manual Guidance: Standard Radiological Effluent Controls for Pressurized Water Reactors, Generic Letter 89-01, Supplement No. 1. (November 1990)
- 2.13 Radiological Health Handbook, U.S. Department of Health, Education and Welfare, January 1970
- 2.14 USNRC Generic Letter 89-01, Implementation of Programmatic Controls for Radiological Effluent Technical Specifications in the Administrative Controls Section of the Technical Specifications and the Relocation of Procedural Details of RETS to the Offsite Dose Calculation Manual or to the Process Control Program
- 2.15 USNRC NUREG 0133, Preparation of Radiological Effluent Technical Specifications for Nuclear Power Plants, October 1978
- 2.16 USNRC Regulatory Guide 1.21, Measuring, Evaluating, and Reporting Radioactivity in Solid Wastes and Releases of Radioactive Materials in Liquid and Gaseous Effluents from Light-Water-Cooled Nuclear Power Plants, Revision 1, June, 1974

- 2.17 USNRC Regulatory Guide 1.109, Calculation of Annual Doses to Man from Routine Releases of Reactor Effluents for the Purpose of Evaluating Compliance with 10CFR Part 50, Appendix I, Revision 1, October, 1977
- 2.18 USNRC Regulatory Guide 1.111, Methods for Estimating Atmospheric Transport and Dispersion of Gaseous Effluents in Routine Releases from Gaseous-Effluents from Light-Water-Cooled Reactors, July 1977
- 2.19 USNRC Regulatory Guide 1.113, Estimating Aquatic Dispersion of Effluents from Accidental and Routine Reactor Releases for the Purpose of Implementing Appendix I, April 1977
- 2.20 USNRC 72.104, Criteria for Radioactive Materials in Effluents and Direct Radiation from an ISFSI or MRS.

3.0 DEFINITIONS

- OFFSITE DOSE CALCULATION MANUAL (ODCM) shall be comprised of the radiological effluent technical specifications and methodology contained within this procedure and applicable sections of the Technical Requirements Manual (TRM) as listed on Attachment 7.23 of this procedure.
- UNRESTRICTED AREA (T.S. 1.36) shall be any area to which access is neither limited nor controlled by the licensee. The definition of UNRESTRICTED AREA used in implementing these Technical Specifications has been expanded over that in 10 CFR 20.1003. The UNRESTRICTED AREA boundary may coincide with the Exclusion (fenced) Area boundary, as defined in 10 CFR 100.3(a), but the UNRESTRICTED AREA does not include areas over water bodies. For calculations performed pursuant to 10 CFR 50.36a, the concept of UNRESTRICTED AREAS, established at or beyond the SITE BOUNDARY, is utilized in the Controls to keep levels of radioactive materials in liquid and gaseous effluents as low as is reasonably achievable, see Attachment 7.1.
- LIQUID RADWASTE TREATMENT SYSTEM shall be any system designed and installed to reduce radioactive material in effluents by passing liquid waste through filters and/or absorption or exchange media (e.g. Ion Exchanger Resin, Charcoal etc) and/or other reduction processes (e.g. reverse osmosis, etc) for the purpose of

removing radioactive materials from the liquid system prior to the release to the environment.

- A MAJOR CHANGE to a radioactive waste system shall be any alteration or modification to the system that causes waste characteristics (e.g. chemical composition, pH, etc.), waste form or waste activity (e.g. equipment decontamination factor change) in liquid, gaseous, or solid effluents to change, thereby requiring a re-evaluation of the effluent source terms.
- LOWER LIMITS OF DETECTION (LLD) is defined, for purposes of these specifications, as the smallest concentration of radioactive material in a sample that will yield a net count, above system background, that will be detected with 95% probability with only 5% probability of falsely concluding that a blank observation represents a "real" signal.

It should be recognized that the LLD is defined as an a priori (before the fact) limit representing the capability of a measurement system and not as an posteriori (after the fact) limit for a particular measurement.

For a particular measurement system, which may include radiochemical separation:

$$LLD = \frac{4.66 s_b}{E \cdot V \cdot 2.22 \times 10^6 \cdot Y \cdot e^{-\lambda \Delta t}}$$

Where:

LLD is the "a priori" lower limit of detection as defined above, as microcuries per unit mass or volume,

S_b is the standard deviation of the background counting rate or of the counting rate of a blank sample as appropriate, as counts per minute,

E is the counting efficiency, as counts per disintegration,

V is the sample size in units of mass or volume,

2.22×10^6 is the number of disintegrations per minute per microcurie,

Y is the fraction radiochemical yield, when applicable,

λ is the radioactive decay constant for the particular radionuclide, and

Δt for plant effluents is the elapsed time between the midpoint of sample collection and the time of counting. For environmental samples it is the elapsed time between sample collection, or end of the sample collection period, and time of counting. Typical values of E, V, Y, and Δt should be used in the calculation.

- An UNPLANNED/ABNORMAL RELEASE is defined as any unplanned, uncontrolled or unmonitored release of radioactive material to the UNRESTRICTED AREA for liquids or to the SITE BOUNDARY for gases. This includes any unplanned, uncontrolled or unmonitored releases where the radiological consequences may be minimal but where the potential exists for more serious radiological consequences if allowed to recur. Incidents that are to be classified as UNPLANNED/ABNORMAL RELEASES do not include releases that fall within the guidelines of a Secondary Release Pathway. Secondary Release Pathways are usually known and have been previously evaluated or considered.
- ISFSI is defined as Independent Spent Fuel Storage Installation.

4.0 RESPONSIBILITIES

- General Manager, Plant Operations has lead responsibility for ensuring implementation of the Radiological Effluent Specifications and Radiological Environmental Monitoring Program.
- The Chemistry Superintendent is responsible for
 - a) ensuring Radiological Effluent Specifications, the Radiological Effluent Monitoring Program and Radiological Environmental Monitoring Program (REMP) is performed as required according to procedures and methodologies established by this document.
 - b) ensuring the Annual Effluent Release Report and the Annual Radiological Environmental Operating Report are performed and issued as required.
 - c) ensuring the Land Use Census is performed as required.

5.0 PROCEDURE

5.1 SITE CHARACTERISTICS

Waterford 3 SES Site Characteristics is provided in Chapter 2 of Waterford 3 FSAR (Sections 2.1.1, 2.1.2 and 2.1.3).

A map of the SITE BOUNDARIES for establishing effluent release limits along with radioactive effluent release points are given in Attachment 7.1. The release point elevations for gaseous effluents are also provided in Attachment 7.1. The nearest distances to the boundary line are shown in Attachment 7.2 of this procedure.

5.2 SPECIFICATIONS AND SURVEILLANCE REQUIREMENTS

- a. Compliance with the SPECIFICATIONS contained in this procedure and the TRM is required during the conditions specified therein; except that failure to meet the SPECIFICATIONS requires that the associated ACTION requirements shall be met.
- b. Noncompliance with this procedure and the TRM shall exist when the requirements of the SPECIFICATION and/or associated ACTION requirements are not met within the specified time intervals. If the SPECIFICATION is restored prior to expiration of the specified time intervals, completion of the ACTION requirements is not required.
- c. Surveillance Requirements shall be applicable during all conditions specified for individual systems unless otherwise stated in an individual Surveillance Requirement.
- d. Each Surveillance Requirement shall be performed within the specified time interval with a maximum allowable extension not to exceed 25% of the surveillance interval.
- e. Failure to perform a Surveillance Requirement within the specified time interval shall constitute a failure to meet the OPERABILITY requirements for a Specific System for Operation. Exceptions to these requirements are stated in the individual specifications. Surveillance Requirements do not have to be performed on inoperable equipment.
- f. Failure to comply with the compensatory ACTION requirements or failure to complete the surveillance requirements within the specified time shall be documented and evaluated in accordance with LI-102 the Corrective Action Process, Condition Report and UNT-006-010, Event Notification and Reporting procedures.

5.3 LIQUID EFFLUENTS

5.3.1 Liquid Effluent Dose Calculation

NOTE

The Offsite Dose Calculation Manual (ODCM) follows the general models suggested by NUREG 0133 and Regulatory Guide 1.109. However, alternate calculation methods from those presented may be used provided the overall methodology is acceptable and consistent with regulation or provided the alternate methodology is conservative. In addition, the most up-to-date dose conversion factors and bioaccumulation factors may be substituted in lieu of Regulatory Guide 1.109 values.

NOTE

Actual step-by-step dose calculations will be performed by in-plant procedures which are consistent with the methodology presented in this document.

- 5.3.1.1 The dose commitment to an individual from radioactive materials in liquid effluents released to unrestricted areas are calculated for the purpose of implementing Section 5.3.2 using the following expression:

$$D_{te} = \Delta t_e F_e \sum_{i=1}^n A_{it} C_{iie} \quad (1)$$

$$D_t = \sum_{e=1}^m D_{te} \quad (2)$$

5.3 LIQUID EFFLUENTS (cont'd)

- $D_{t\ell}$ = the cumulative dose commitment to the total body or any organ (t) from the liquid effluents for each liquid release in mrem during time period (ℓ);
- D_t = the cumulative dose commitment to the total body or any organ (t) from the liquid effluents for all (ℓ) time periods;
- Δt_ℓ = the length of the ℓ th time period over which the release is made, in hours;
- $C_{i\ell}$ = the concentration of radionuclide (i) in undiluted liquid effluent during time period Δt_ℓ from any liquid release, in $\mu\text{Ci/ml}$;
- A_{it} = the site-related liquid ingestion dose commitment factor to the total body or any organ (t) for each identified nuclide (i) in mrem-ml/hr- μCi (Attachment 7.3), and;

5.3 LIQUID EFFLUENTS (cont'd)

F_r = the near field average dilution factor for $C_{i,t}$ during any liquid effluent release. Defined as the ratio of the undiluted liquid waste flow during release to the average flow from the site discharge structure to site boundary receiving waters.

$$= \frac{\text{liquid radioactive waste flow}}{\text{discharge structure exit flow}}$$

The liquid radioactive waste flow is the maximum flow from the effluent release. The discharge structure exit flow is the flow during disposal from the discharge structure release point into the receiving water body. For radionuclides not determined in each batch or weekly composite, the dose contribution to the current calendar quarter cumulative summation may be approximated by using a ratio of concentrations based on the previous monthly or quarterly composite analyses.

5.3 LIQUID EFFLUENTS (cont'd)

5.3.1.2 Equation (1) above for calculating the dose contributions requires the use of a dose factor, A_{it} , for each nuclide (i) which embodies the dose factors and dilution factors for the points of pathway origin. The adult total body dose factor and the adult organ dose factor for each radionuclide will be used from Table E-11 of Regulatory Guide 1.109; thus the list contains critical organ dose factors for various organs. The dose factor is written:

$$A_{it} = K_o \left(\frac{U_w}{D_w} + U_e B E_i \right) DCF_{it} \quad (3)$$

where:

A_{it} = Composite dose parameter for the total body or critical organ (t) of an adult for nuclide (i) for all appropriate pathways (mrem-ml/hr- μ Ci);

K_o = Unit conversion factor;

$$= 1.14E+5 = 10^6 \frac{\mu\text{Ci}}{\mu\text{Ci}} \cdot 10^3 \frac{\text{ml}}{\text{l}} \div 8760 \frac{\text{hr}}{\text{yr}}$$

U_w = 730 l/yr adult water consumption (Reg. Guide 1.109, Table E-5);

01/2014

5.3 LIQUID EFFLUENTS (cont'd)

- D_w = Dilution factor from near field area to potable water intake;
- = 220
for discharges from the circulating water discharge into the Mississippi River (based on the ratio of the average Mississippi River flow to the maximum discharge flow);
- = 1
for discharges into the 40 Arpent Canal (based on the assumption that dilution from the near field area to a potable water intake is negligible);
- U_f = 21 kg/yr, adult fish consumption (Reg. Guide 1.109, Table E-5);
- BF_i = Bioaccumulation factor for nuclide (i) in fish (pCi/kg per pCi/l) from Attachment 7.22 and;
- DCF_{it} = Ingestion Dose conversion factor for nuclide (i) and organ (t) for adults (mrem/pCi), from Attachment 7.21.

5.3 LIQUID EFFLUENTS (cont'd)

5.3.2 Liquid Effluent Monitor Setpoint Calculation Methodology

TRM specifications 3/4.11.1.1 and 3/4.3.3.10 require that the liquid effluent monitoring instrumentation alarm/trip setpoints be set so that the concentration of radioactive material released from the site is limited to 10 times the Effluent concentration values in 10CFR20, Appendix B, Table 2, Column 2 for radionuclides other than dissolved or entrained noble gases. For dissolved or entrained noble gases, the concentration shall be limited to 2E-4 $\mu\text{Ci/ml}$ total activity. This section presents the method to be used for determining setpoints in accordance with TRM surveillance requirements 3/4.11.1.1 and 3/4.3.3.10.

5.3.2.1 The calculated setpoints for the liquid effluent monitors satisfy the following equation:

$$C = \frac{(SF) (RF) (F + f) \sum_{i=1}^n C_i}{(TEC)(f + F')} \quad (4)$$

5.3 LIQUID EFFLUENTS (cont'd)

where;

- c = the setpoint, in $\mu\text{Ci/ml}$, of the liquid effluent monitor measuring the radioactivity concentration in the effluent line prior to complete dilution and subsequent release. This setpoint represents a value which, if exceeded would result in concentrations exceeding 10 times the Effluent concentration values of 10CFR20, Appendix B, Table 2. Column 2, to an UNRESTRICTED AREA;
- SF = Safety Factor to ensure that the effluent limit is not exceeded. A value of 0.8 is normally used for SF;
- RF = Release Fraction allocated to this release (to be used only in situations of simultaneous or concurrent release);
- f = the undiluted liquid effluents flow as measured at the liquid effluent monitor location in gpm;
- F = the dilution water flow as determined via pump curves or other appropriate measures that determine correct plant operating configuration in gpm;

NOTE

If F is large compared to f then $F + f \simeq F$. If there is no additional dilution, $F' = 0$.

- $F' =$ additional dilution flow at the radiation monitor for liquid effluent radiation monitors that have additional dilution prior to actual withdrawal of the monitored fluid, in gpm.
- $=$ 1000 (maximum) for Steam Generator Blowdown or Auxiliary Component Cooling Water releases to the circulating water system.
- $=$ 0 for all other liquid release points.

5.3 LIQUID EFFLUENTS (cont'd)

C_i = the undiluted concentration in $\mu\text{Ci/ml}$ for all gamma emitting radionuclides (i). The value will be derived from radioanalysis of liquid effluent to be released. This value will be supplied for each liquid release;

$$TEC = \sum_{i=1}^n \frac{C_i}{10EC_i} + \sum_{j=1}^m \frac{C_j}{10EC_j}$$

C_j = the undiluted concentration, in $\mu\text{Ci/ml}$, for all non-gamma emitting radionuclides (j). This value will be derived from radioanalysis of composite liquid effluents released. This value will be supplied for each liquid release based upon the most recent analysis results.

$\frac{C_i}{10EC_i}$ = the undiluted gamma EC_i fraction for all gamma emitting radionuclides (i)

$\frac{C_j}{10EC_j}$ = the undiluted non-gamma EC_j fraction for all non-gamma emitting radionuclides (j)

01/2014

$10EC_i$ = 10 times the Effluent Concentration for the applicable gamma-emitting isotopes (i) from 10CFR20, Appendix B, Table 2, Column 2; and

$10EC_j$ = 10 times the Effluent Concentration for the applicable non-gamma emitting isotopes (j) from 10CFR20, Appendix B, Table 2, Column 2

5.3.2.2 The values of C_i and C_j will be measured for each release as appropriate and the parameters for f , F' and F will be supplied based on current plant operating configurations. The setpoint will be calculated in terms of $\mu\text{Ci/ml}$ and the liquid effluent monitor will be adjusted as necessary to ensure that liquid releases are secured prior to exceeding 10 times the Effluent concentration values specified in 10CFR20, Appendix B, Table 2, Column 2 to an UNRESTRICTED AREA.

5.3 LIQUID EFFLUENTS (cont'd)

5.3.3 Representative Liquid Sampling

Prior to grab sampling liquid waste tanks, methods should be used to guarantee representative sampling. Large volumes of liquid waste should be mixed in as short a time as possible and uniformly distributed prior to sampling. To determine the minimum mixing time for tanks from which releases are made, the following tests were performed prior to initial use for release purposes.

- a. The tank was filled to a known volume.
- b. A specific quantity of a selected chemical and/or sediments was added to the tank.
- c. Recirculation was initiated through the normal path.
- d. Periodic samples were taken until equilibrium was reached.
- e. The time observed to completely mix the tank is used as a minimum recirculation time prior to effluent sampling. Records of the test will be maintained.

5.3.4 Dose Projection for Liquid Effluents

At least once every 31 days, the total dose from all liquid releases for the quarter-to-date will be divided by the number of days expired in the quarter and multiplied by 31.

5.4 GASEOUS EFFLUENTS

NOTE

The Offsite Dose Calculation Manual (ODCM) follows the general models suggested by NUREG 0133 and Regulatory Guide 1.109. However, alternate calculation methods from those presented may be used provided the overall methodology is acceptable and consistent with regulation or provided the alternate methodology is conservative. In addition, the most up-to-date dose conversion factors and bioaccumulation factors may be substituted in lieu of Regulatory Guide 1.109 values.

NOTE

Actual step-by-step dose calculations will be performed by in-plant procedures which are consistent with the methodology presented in this document.

5.4.1 Calculational Methodology for Gaseous Effluent Dose Rate

This section presents the calculational methods used for calculating gaseous effluent doses in fulfillment of Specification

- The dose rate due to the radioactive materials released in gaseous effluents from the site to areas at and beyond the SITE BOUNDARY shall be limited to the following values and expressions:

5.4 GASEOUS EFFLUENTS (cont'd)

Release rate limit for Noble Gases:

$$K(\overline{X/Q})_v \sum_{i=1}^n K_i Q_{iv} \leq 500 \frac{\text{mrem}}{\text{yr}} \text{ total body} \quad (5)$$

$$(\overline{X/Q})_v \sum_{i=1}^n (L_i + 1.1M_i) Q_{iv} \leq 3000 \frac{\text{mrem}}{\text{yr}} \text{ skin} \quad (6)$$

Release rate limit for Iodine-131, Iodine-133, Tritium and for all radionuclides in particulate form with half-lives greater than 8 days:

$$(\overline{X/Q})_v \sum_{i=1}^n P_{it} Q_{iv} \leq 1500 \frac{\text{mrem}}{\text{yr}} \text{ any organ} \quad (7)$$

Where:

$\overline{(X/Q)}_v = 1.1\text{E-}5 \text{ sec/m}^3$ in the ESE sector at 0.6 mile for all vent releases (v) (the highest calculated annual average dispersion factor at the SITE BOUNDARY based on historical data Attachment 7.2). The actual X/Q for the time of release may be determined and used under certain circumstances;

$\sum_{i=1}^n$ = summation for all identified radionuclides;

5.4 GASEOUS EFFLUENTS (cont'd)

- K_i = the total body dose factor due to gamma emissions for each identified radionuclide (i) in units of mrem/yr per $\mu\text{Ci}/\text{m}^3$ (Attachment 7.4);
- L_i = the skin dose factor due to beta emissions for each identified radionuclide (i) in units of mrad/yr per $\mu\text{Ci}/\text{m}^3$ (Attachment 7.4);
- M_i = the air dose factor due to gamma emissions for each identified radionuclide (i) in units of mrad/yr per $\mu\text{Ci}/\text{m}^3$ (Attachment 7.4). The constant 1.1 converts air dose to skin dose;
- P_{it} = the thyroid dose parameter for Iodine-131, Iodine-133, tritium, and radionuclides in particulate form with half-lives greater than 8 days (i) for the inhalation pathway only, in mrem/yr per $\mu\text{Ci}/\text{m}^3$ (Attachment 7.19). The dose factor is based on the most restrictive age group (child) and most restrictive organ at the SITE BOUNDARY; and

5.4 GASEOUS EFFLUENTS (cont'd)

NOTE

All radioiodines are assumed to be released in elemental form.

Q_{iv} = the average release rate of radionuclides (i)
(either noble gas or Iodine-131, Iodine-133, tritium, and radionuclides in the particulate form with half-lives greater than 8 days, as appropriate) during the time of release from all vent releases (v). Value is averaged over one hour and is in units of $\mu\text{Ci}/\text{sec}$.

5.4 GASEOUS EFFLUENTS (cont'd)

5.4.2 Calculational Methodology for Noble Gas Doses

The air dose due to noble gases released in gaseous effluents to areas at or beyond the SITE BOUNDARY will be determined by the following expressions:

a. During any calendar quarter,

for gamma radiation:

$$D_{\gamma} = (1.14E + 2) \left(\frac{\bar{X}}{Q} \right)_v \sum_{i=1}^n M_i \sum_{j=1}^m \Delta t_j Q_{ijv} \quad (8)$$

for beta radiation:

$$D_{\beta} = (1.14E + 2) \left(\frac{\bar{X}}{Q} \right)_v \sum_{i=1}^n N_i \sum_{j=1}^m \Delta t_j Q_{ijv} \quad (9)$$

b. During any calendar year,

for gamma radiation:

$$D_{\gamma} = (1.14E + 2) \left(\frac{\bar{X}}{Q} \right)_v \sum_{i=1}^n M_i \sum_{j=1}^m \Delta t_j Q_{ijv} \quad (10)$$

for beta radiation:

$$D_{\beta} = (1.14E + 2) \left(\frac{\bar{X}}{Q} \right)_v \sum_{i=1}^n N_i \sum_{j=1}^m \Delta t_j Q_{ijv} \quad (11)$$

5.4 GASEOUS EFFLUENTS (cont'd)

Where: .

D_γ = the total gamma (γ) air dose from gaseous effluents for
the total time period and not to exceed 5 mrad quarterly and 10 mrad yearly;

D_β = the total beta (β) air dose from gaseous effluents for
the total time period and not to exceed 10 mrad quarterly and 20 mrad yearly;

$1.14E-04$ = a constant of (1 yr/8760 hr);

$\overline{(X/Q)}_v = 1.1E-5$ sec/m³ in the ESE sector at 0.6 mile
for all vent releases (v). The actual X/Q for the time of release may be
determined and used under certain circumstances;

5.4 GASEOUS EFFLUENTS (cont'd)

M_i and N_i = the gamma and beta air dose factors
(respectively) for a uniform semi-infinite cloud of radionuclide (i) in
mrad/yr per $\mu\text{Ci}/\text{m}^3$ (Attachment 7.4);

Δt_j = the length of the jth time period over which Q_{ijv} are accumulated for all
gaseous releases in hours; and

Q_{ijv} = the average release rate of radionuclides (i) in gaseous effluent from all
vent releases (v) in $\mu\text{Ci}/\text{sec}$ during the time period Δt_j .

5.4 GASEOUS EFFLUENTS (cont'd)

5.4.3 Calculational Methodology for Doses Due to Radioiodines, Tritium, and Radioactive Materials in Particulate Form

The dose to an individual from iodine-131, iodine-133, tritium, and radionuclides in particulate form with half-lives greater than 8 days in gaseous effluents released to areas at and beyond the SITE BOUNDARY will be determined by the following expressions:

During any calendar quarter:

$$D_{ita} = 1.14E - 4 \Delta t \sum_{i=1}^n R_{ita} W_v Q_{iv} \quad (12)$$

During any calendar year:

$$D_{ita} = 1.14E - 4 \Delta t \sum_{i=1}^n R_{ita} W_v Q_{iv} \quad (13)$$

01/2014

5.4 GASEOUS EFFLUENTS (cont'd)

Where:

D_{ita} = the cumulative dose to an organ (t), age group (a),
due to radionuclides (i) in gaseous effluents; not to exceed 7.5 mrem
quarterly or 15 mrem yearly;

$1.14E-4$ = a constant of unit conversion

$$= 1 \text{ yr}/8760 \text{ hr};$$

Δt = the time required for the release in hours for all
releases per quarter or per year.

W_v = the dispersion parameter for estimating the dose to
an individual at the controlling location for long term vent releases (v);

= $\overline{(\frac{x}{\rho})}_v$ for the inhalation pathway from vent releases (v) in sec/m^3 , from
historical data, at the location of the critical receptor (Attachment 7.2);

= $\overline{(\frac{v}{\rho})}_v$ for the food and ground plane pathways
from vent releases (v) in $1/\text{m}^2$, from historical data at the location of the
critical receptor (Attachment 7.2), with the exception of tritium, which shall
use $W_v = \overline{(\frac{x}{\rho})}_v$;

5.4 GASEOUS EFFLUENTS (cont'd)

R_{ita} = the dose factor from each identified radionuclide (i), for each applicable organ (t), and age group (a), in mrem/yr per $\mu\text{Ci}/\text{m}^3$ for the inhalation pathway (Attachment 7.5) and in mrem/yr per $\text{uCi}/\text{m}^2\text{-sec}$ for the food and ground plane pathways (Attachments 7.6, 7.7, 7.8, 7.9, and 7.10). For sectors with real pathways within 5 miles of the plant, the values of R_i are used based on these real pathways. (R_i 's were calculated using the methodology found in NUREG 0133 (pages 31-36.); and

Q_{iv} = the average release rate of radionuclides (i) in gaseous effluent from all vent releases (v) in $\mu\text{Ci}/\text{sec}$.

5.4 GASEOUS EFFLUENTS (cont'd)

5.4.4 Gaseous Effluent Monitor Setpoint Calculational Methodology

- 5.4.4.1 The calculated high alarm/flow termination setpoint is the maximum value for that particular release. An administrative Safety Factor (SF) will be utilized in the setpoint calculation. To allow for simultaneous releases from common or different release points a Release Fraction (RF) may be used to allocate percentages of the total allowable release.

- 5.4.4.2 Since the noble gas dose rates are more limiting than the radioiodine dose rate, gaseous setpoints will be based on noble gas dose rates (less than or equal to 500 mrem/yr total body, and less than or equal to 3000 mrem/yr skin). Specifically, gaseous setpoints will be based on the most limiting of the following equations:

5.4 GASEOUS EFFLUENTS (cont'd)

a. Total body (Q_{tb}):

$$Q_{tb} = \frac{(500 \frac{mrem}{yr})(RF)(SF)}{(\overline{X/Q})_v \left[\frac{\sum_{i=1}^n K_i Q_{iv}}{\sum_{i=1}^n Q_{iv}} \right]} \quad (14)$$

Where:

Q_{tb} = maximum release rate allowed to give a limiting total body dose rate of 500 mrem/yr in $\mu\text{Ci}/\text{sec}$;

$\sum_{i=1}^n$ = summation of all nuclides considered;

K_i = the total body dose factor due to gamma emissions for each identified radionuclide (i) in units of mrem/yr per $\mu\text{Ci}/\text{m}^3$ (Attachment 7.4);

5.4 GASEOUS EFFLUENTS (cont'd)

Q_{iv} = average release rate of isotope (i) from the release point (v) in $\mu\text{Ci}/\text{sec}$;

$\overline{(x/q)}_v = 1.1\text{E-}5 \text{ sec}/\text{m}^3$ (in the ESE sector at 0.6 mile). The sector with highest value of annual average atmospheric dispersion factor at the site boundary for the release point (v) in question;

RF = release fraction allotted to release point in consideration; and

SF = administrative safety factor to account for uncontrollable variables (sampling, monitoring errors, etc.). A value of 0.8 is normally used for SF.

5.4 GASEOUS EFFLUENTS (cont'd)

b. For Skin (Q_{skin}):

$$Q_{skin} = \frac{(3000 \frac{mrem}{yr})(RF)(SF)}{\overline{(\%Q)}_v \left[\sum_{i=1}^n (L_i + 1.1M_i)Q_{iv} \right] \left[\sum_{i=1}^n Q_{iv} \right]} \quad (15)$$

Where:

all terms are as defined in Step (a) for Q_{tb} ,
 except:

Q_{skin} = maximum release rate allowed to give a limiting skin dose of
 3000 mrem/yr in $\mu Ci/sec$;

L_i = skin dose factor due to beta emissions for each identified radionuclide
 (i) in units of mrem/yr per $\mu Ci/m^3$ (Attachment 7.4);

1.1 = conversion factor to convert from air to skin dose; and

M_i = air dose factor due to gamma emissions for identified noble gas isotope
 (i) in units of mrad/yr per $\mu Ci/m^3$ (Attachment 7.4).

5.4 GASEOUS EFFLUENTS (cont'd)

5.4.4.3 The monitor setpoint is calculated in the following manner:

$$SN = \frac{Q}{(F_{\max})(472)} \quad (16)$$

Where:

SN = maximum monitor setpoint in $\mu\text{Ci}/\text{cm}^3$;

Q = Minimum value of Q_{tb} or Q_{skin} ($\mu\text{Ci}/\text{sec}$).

F_{\max} = maximum effluent flow rate (cfm); and

472 = Unit conversion, CFM to cm^3/sec

5.4 GASEOUS EFFLUENTS (cont'd)

5.4.5 Dose Projection due to Gaseous Effluents

- 5.4.5.1 At least once every 31 days the gamma air dose, beta air dose and the maximum organ dose for the month-to-quarter will be divided by the number of days into the quarter and multiplied by 31.

5.5 40 CFR190 DOSE EVALUATION

For the evaluation of doses to real individuals from liquid releases, the same calculational methods as employed in Section 5.3.4 will be used. However, more encompassing and realistic assumptions will be made concerning the dilution and ingestion of radionuclides by individuals who live and fish in the Waterford 3 area.

The results of the Radiological Environmental Monitoring Program will be used in determining the realistic dose based on actual measured radionuclide concentrations. For the evaluation of doses to real individuals from gaseous releases, the same calculational methods as employed in sections 5.4.6 and 5.4.7 will be used. The total body dose factor should be substituted for the gamma air dose factor (M_i) to determine the total body dose. Otherwise, the same calculational sequence applies. More realistic assumptions will be made concerning the actual location of real individuals, the meteorological conditions, and the consumption of food. Data obtained from the latest land use census should be used to determine locations for evaluating doses. The results of the Radiological Environmental Monitoring Program will be included in determining more realistic doses based on actual measured radionuclide concentrations.

Cumulative dose contributions from direct radiation, from the reactor unit, from ISFSI operations, and from Radwaste Storage Tanks shall be determined utilizing the results of routine plant perimeter surveys, TLD data, or a combination of both when necessary.

5.6 LIQUID AND GASEOUS RADWASTE PROCESSES

The block flow diagrams of the radwaste systems are shown in Attachments 7.11 and 7.12. In order to obtain a more detailed description, see the appropriate sections of the FSAR.

5.7 RADIOLOGICAL ENVIRONMENTAL MONITORING PROGRAM REQUIREMENTS

5.7.1 Description of the Radiological Environmental Monitoring Program

The Radiological Environmental Monitoring Program (REMP) is expounded on in Attachment 7.13, and the Sample Location Table, Attachment 7.14. Attachment 7.15 explains the sector and zone designations for the sample locations. Attachments 7.16, 7.17 and 7.18 show the sample locations within the 2,10, and 50 mile radius of Waterford 3.

Deviations are permitted from the required sampling schedule if specimens are unobtainable due to hazardous conditions, seasonal unavailability, malfunction of automatic sampling equipment and other legitimate reasons. If specimens are unobtainable due to sampling equipment malfunction, every effort shall be made to complete corrective action prior to the end of the next sampling period. All deviations from the sampling schedule shall be documented in the Annual Radiological Environmental Operating Report. It is recognized that, at times, it may not be possible or practical to continue to obtain samples of the media of choice at the most desired location or time. In these instances, suitable alternative media and locations may be chosen for the particular pathway in question and appropriate substitutions made within 30 days in the Radiological Environmental Monitoring Programs.

5.7 RADIOLOGICAL ENVIRONMENTAL MONITORING PROGRAM REQUIREMENTS (Cont'd)

5.7.2 Description of the Interlaboratory Comparison Program

Quality assurance in radiological environmental sampling will be maintained through participation in a selected Radiological Laboratory Quality Assurance Program. The summary of results will be presented in tabular form and will include the type of analysis, the preparation (collection) date, the date the results are returned, the mean of the analyses (usually triplicate), the standard deviation, the date the values are released for information, the known value, the three standard deviation limit, and a two standard deviation/three standard deviation warning/action flag. If the sample analysis indicates results outside the three standard deviation range, then the corrective actions taken to prevent a recurrence will be documented and submitted along with all results when the Annual Radiological Environmental Operating Report is submitted.

5.7 RADIOLOGICAL ENVIRONMENTAL MONITORING PROGRAM REQUIREMENTS (Cont'd)

5.7.3 Dispersion Parameters For Critical Locations

The dispersion parameters for the site boundary and where necessary, as identified by the Land Use Census, are listed in Attachment 7.2. This table will be subject to changes based on the Land Use Census and historical data.

5.8 ROUTINE EFFLUENT RELEASE REPORTS

5.8.1 Annual Radioactive Effluent Release Report

A routine Radioactive Effluent Release Report covering the operation of the unit during the previous Twelve months shall be submitted as specified in Waterford 3 SES, Technical Specification 6.9.1.8 prior to May 1 of each year. The radioactive effluent release report shall include:

- 5.8.1.1 A summary of the quantities of radioactive liquid and gaseous effluents and solid waste released from the units as outlined in Regulatory Guide 1.21, with data summarized on a quarterly basis following the format of Appendix B thereof.
- 5.8.1.2 An annual summary of hourly meteorological data collected over the previous year. This annual summary may be either in the form of an hour-by-hour listing of wind speed, wind direction, and atmospheric stability, and precipitation (if measured) on magnetic tape, or in the form of joint frequency distributions of wind speed, wind direction, and atmospheric stability.

5.8 ROUTINE EFFLUENT RELEASE REPORTS (cont'd)

In lieu of submission with the Radioactive Effluent Release Report, the summary of required meteorological data may be filed on site and shall be provided to the NRC upon request. This same report shall include an assessment of the radiation doses due to the radioactive liquid and gaseous effluents released from the unit or station during the previous calendar year. This same report shall also include an assessment of the radiation doses from radioactive liquid and gaseous effluents to MEMBERS OF THE PUBLIC due to their activities inside the SITE BOUNDARY (Attachment 7.1) during the reporting period. All assumptions used in making these assessments (i.e., specific activity, exposure time and location) shall be included in these reports. The meteorological conditions concurrent with the time of release of radioactive materials in gaseous effluents, as determined by sampling frequency and measurement, shall be used for determining the gaseous pathway doses. The assessment of radiation doses shall be performed in accordance with the methodology and parameters in this manual.

5.8 ROUTINE EFFLUENT RELEASE REPORTS (cont'd)

- 5.8.1.3 An assessment of radiation doses to the likely most exposed MEMBER OF THE PUBLIC from reactor releases and other nearby uranium fuel cycle sources, including doses from primary effluent pathways and direct radiation, for the previous calendar year to show conformance with 40CFR190, "Environmental Radiation Standards for Nuclear Power Operation" and 72.104, "Criteria for Radioactive Materials in Effluents and Direct Radiation from an ISFSI or MRS". Acceptable methods for calculating the dose contribution from liquid and gaseous effluents are given in Regulatory Guide 1.109, Rev. 1, October 1977, and NUREG-0133.
- 5.8.1.4 The following information for each class of solid waste (as defined by 10CFR 61) shipped off site during the report period:
- A. Container volume
 - B. Total curie quantity (specify whether determined by measurement or estimate),
 - C. Principal radionuclides (specify whether determined by measurement or estimate),
 - D. Source of waste and processing employed (e.g., dewatered spent resin, compacted dry waste, evaporator bottoms),
 - E. Type of container (e.g., LSA, Type A, Type B Large Quantity), and
 - F. Solidification agent or absorbent (e.g., cement, urea formaldehyde).

5.8 ROUTINE EFFLUENT RELEASE REPORTS (cont'd)

- 5.8.1.5 A list and description of unplanned releases from the site to UNRESTRICTED AREAS of radioactive materials in gaseous and liquid effluents made during the reporting period.
- 5.8.1.6 Any changes to the Process Control Program (PCP) or the Offsite Dose Calculation Manual (ODCM), pursuant to Technical Specification 6.13 and 6.14, as well as a listing of new locations for dose calculations and/or environmental monitoring identified by the land use census. It shall also include information of any MAJOR CHANGES to Radioactive Waste Systems if the information is not submitted as part of the annual FSAR update. Any changes made to the sections of the Waterford III TRM listed on Attachment 7.23 shall be included as part of submittal of the changes made to the ODCM.

5.8 ROUTINE EFFLUENT RELEASE REPORTS (cont'd)

- A. The submittal providing information on ODCM changes shall contain:
1. Sufficiently detailed information to totally support the rationale for the change without benefit of additional or supplemental information. Information submitted should consist of a complete legible copy of the ODCM including the sections of the TRM listed on Attachment 7.23 together with appropriate analyses or evaluations justifying the change(s), if applicable.
 2. A determination that the change did not reduce the accuracy or reliability of dose calculations or setpoint determinations.
 3. Documentation of the fact that the change has been reviewed and found acceptable by the Onsite Safety Review Committee (OSRC).

5.8 ROUTINE EFFLUENT RELEASE REPORTS (cont'd)

- B. The submittal providing information on PCP changes shall contain:
1. Information submitted should consist of a complete legible copy of the PCP, together with appropriate analyses or evaluations, justifying the changes(s), if applicable.
 2. Documentation of the fact that the change has been reviewed and found acceptable by the OSRC.

NOTE

Radioactive Waste System change information may be submitted as part of the annual FSAR update in lieu of the Annual Radioactive Effluent Release Report.

- C. The submittal providing information on licensee initiated MAJOR CHANGES to the radioactive waste systems (liquid, gaseous, and solid) shall contain:
1. A summary of the evaluation that led to the determination that the change could be made in accordance with 10CFR50.59
 2. Sufficient detailed information to totally support the reason for the change without benefit of additional or supplemental information.
 3. A detailed description of the equipment, components and processes involved and the interfaces with other plant systems.
 4. An evaluation of the change which shows the predicted releases of radioactive materials in liquid and gaseous effluents and/or quantity of solid waste that differ from those previously predicted in the license application and amendments thereto.
 5. An evaluation of the change which shows the expected maximum exposures a member of the Public in the unrestricted area and to the general population that differ from those previously estimated in the license application and amendments thereto.

5.8 ROUTINE EFFLUENT RELEASE REPORTS (cont'd)

6. A comparison of the predicted releases of radioactive materials, in liquid and gaseous effluents and in solid waste, to the actual releases for the period before the changes are to be made.
7. An estimate of the exposure to plant operating personnel as a result of the change.
8. Documentation of the fact that the change was reviewed and found acceptable by the OSRC.
9. Changes to Radioactive Waste Systems performed using the plant design change process will be reported as per design change procedures.

5.8.1.7 If applicable, a description of events which led to exceeding the following limiting condition for operation:

- A. The dose rate due to radioactive materials released in gaseous effluents from the site to areas at and beyond the site boundary shall be limited to TRM specification 3/4.11.2.1.
- B. The quantity of radioactive material contained in each unprotected tank shall be limited to Technical Specification 3/4.11.1.4.

5.8 ROUTINE EFFLUENT RELEASE REPORTS (cont'd)

- 5.8.1.8 If applicable, identify the cause of the unavailability of milk or fresh leafy vegetable samples at locations required by TRM specification Table 3.12-1. The new location(s) for obtaining replacement samples shall be identified. Revised figure(s) and table for the ODCM reflecting the new locations shall be included in the report.
- 5.8.1.9 Identify the new location(s), if a land use census identifies an environmental sampling location that yields a calculated dose or dose commitment greater than the values currently being calculated pursuant to TRM Specification 3/4.11.2.3.
- 5.8.1.10 Identify the new location(s), and include a revised figure(s) and table for the ODCM reflecting the new location(s) if a land use census identifies an environmental sampling location(s) that yields a calculated dose or dose commitment (via the same exposure pathway) 20% greater than at a location from which samples are currently being obtained pursuant to TRM Specification 3/4.12.1.

5.8 ROUTINE EFFLUENT RELEASE REPORTS (cont'd)

- 5.8.1.11 With less than the minimum number of radioactive liquid or gaseous effluent monitoring instrumentation channels operable for 30 days or longer, as required by TRM Specification Table 3.3-12 or 3.3-13, explain in the next Annual Radioactive Effluent Release Report, pursuant to Technical Specification 6.9.1.8, why this inoperability was not corrected within the time specified.

NOTE

The Shift Manager shall be immediately notified and a Condition Report promptly initiated whenever an effluent sample is late or missing in accordance with applicable Specifications.

- 5.8.1.12 Identify any missing or late analysis results for radioactive effluent samples collected during the reporting period.

5.9 SPECIAL EFFLUENT REPORTS

5.9.1 The Shift Manager shall be immediately notified and a Condition Report promptly initiated whenever any of the following specifications have been exceeded. A Special Report shall be prepared for submittal to the NRC within 30 day period, as per the ACTION requirement of the specification that has been exceeded.

- TRM Radioactive Liquid Effluent Dose Specification 3/4.11.1.2
- TRM Radioactive Liquid Waste Treatment System Specification 3/4.11.1.3
- TRM Radioactive Gaseous Effluent Dose, Noble Gas Specification 3/4.11.2.2
- TRM Radioactive Gaseous Effluent Dose, Iodine 131, I-133, Tritium, and Radionuclides in Particulate Form Specification 3/4.11.2.3
- TRM Radioactive Gaseous Waste Treatment System Specification 3/4.11.2.4
- TRM Radioactive Effluent Total Dose Specification 3/4.11.4

5.9 SPECIAL EFFLUENT REPORTS (cont'd)

5.9.2 Environmental Protection Agency Reportable Quantities

If any of TRM specifications 3/4.11.1.1, 3/4.11.1.2, 3/4.11.2.1, 3/4.11.2.2, 3/4.11.2.3 have been exceeded, an evaluation of the Radioactivity released verses EPA Reportable Quantities (RQ's) shall be performed as soon as practical.

The Shift Manager shall be immediately notified and a Condition Report promptly initiated whenever any radionuclide released over a 24 hour period is greater than or equal to the EPA RQ. Notification requirements shall be performed as per UNT-006-010, Event Evaluation and Reporting. Recipients of notification are: The National Response Center, the State Emergency Response Commission, and the Local Emergency Planning Committee. Methods for determination of reportability and the Reportable Quantities values for radionuclides are contained within 40CFR302.

5.9 SPECIAL EFFLUENT REPORTS (cont'd)

5.9.3 Unplanned/Abnormal Effluent Releases

5.9.3.1 A Condition Report should be initiated, in accordance with LI-102, for an UNPLANNED/ABNORMAL RELEASE to ensure that reporting requirements are determined. The Condition Report shall also serve to document causes and corrective actions. Major liquid spills or gaseous releases can occur through improper valve line-up, pipe breakage, or leakage. Each incident should be treated on a case-by-case basis.

The Condition Report shall include:

- a description of the event and equipment involved,
- cause(s) for the release,
- consequences of the release (if known or available)
- actions taken to prevent recurrence.

It is recognized that all elements that are to be included in the Condition Report (listed above) may not be known when the Condition Report is initiated. These items should be included while using the normal Condition Reporting process.

All Condition Reports for UNPLANNED/ABNORMAL RELEASES shall be reviewed by:

- OSRC
- SRC
- The Vice President - Operations

The OSRC shall review evaluations, recommendations, and the disposition of corrective action(s) to prevent recurrence as documented in the Condition Report. These reports will be forwarded to the Safety Review Committee and the Vice President - Operations for additional review.

5.9 SPECIAL EFFLUENT REPORTS (cont'd)

5.9.3.2 Prepare an effluent assessment report for each occurrence of an UNPLANNED/ABNORMAL RELEASE of radioactive materials. The purpose of this report is to document offsite impacts due to radioactive effluent releases. This report should include a description of the event, remedial actions, results of sampling and analysis (if applicable). The assessment should include evaluations of the following:

- concentrations of radioactive materials in unrestricted areas
- doses to the most likely exposed member of the public
- any environmental impacts due to radioactivity in the environment.

All assumptions and calculations used should be described and provided when necessary to support the conclusions. Doses should be calculated in accordance with the methods and parameters contained within the ODCM. Each occurrence of an UNPLANNED/ABNORMAL RELEASE should also be included in the Annual Effluent Release Report covering the period for which the event occurred as per step 5.8.1.5.

Each effluent assessment report shall be reviewed by:

- OSRC
- SRC
- The Vice President - Operations

5.10 SECONDARY RELEASE PATHS

5.10.1 This section addresses potential release pathways which should not contribute more than 10% of the annual doses evaluated in this manual. The ODCM methodology for calculation of doses will be applied to an applicable release path if a likely potential arises for contributing more than 10% of the annual doses evaluated in this manual.

5.10.2 Secondary Release Paths are expected to release trivial quantities of radionuclides. Some examples of Secondary Release Paths are listed below:

- Unmonitored Secondary System Steam Vents/Reliefs
- Decon Shop/Hot Machine Shop Exhaust
- Turbine Building Ventilation Exhaust
- Unmonitored Tank Atmospheric Vents
- Radioactive Waste Compactor Building
- Radioactive Waste Solidification Building
- Cooling Tower Atmospheric Entrainment

6.0 RECORDS

None

7.0 ATTACHMENTS

Refer to Table of Contents

BOUNDARIES FOR RADIOACTIVE GASEOUS AND LIQUID EFFLUENTS

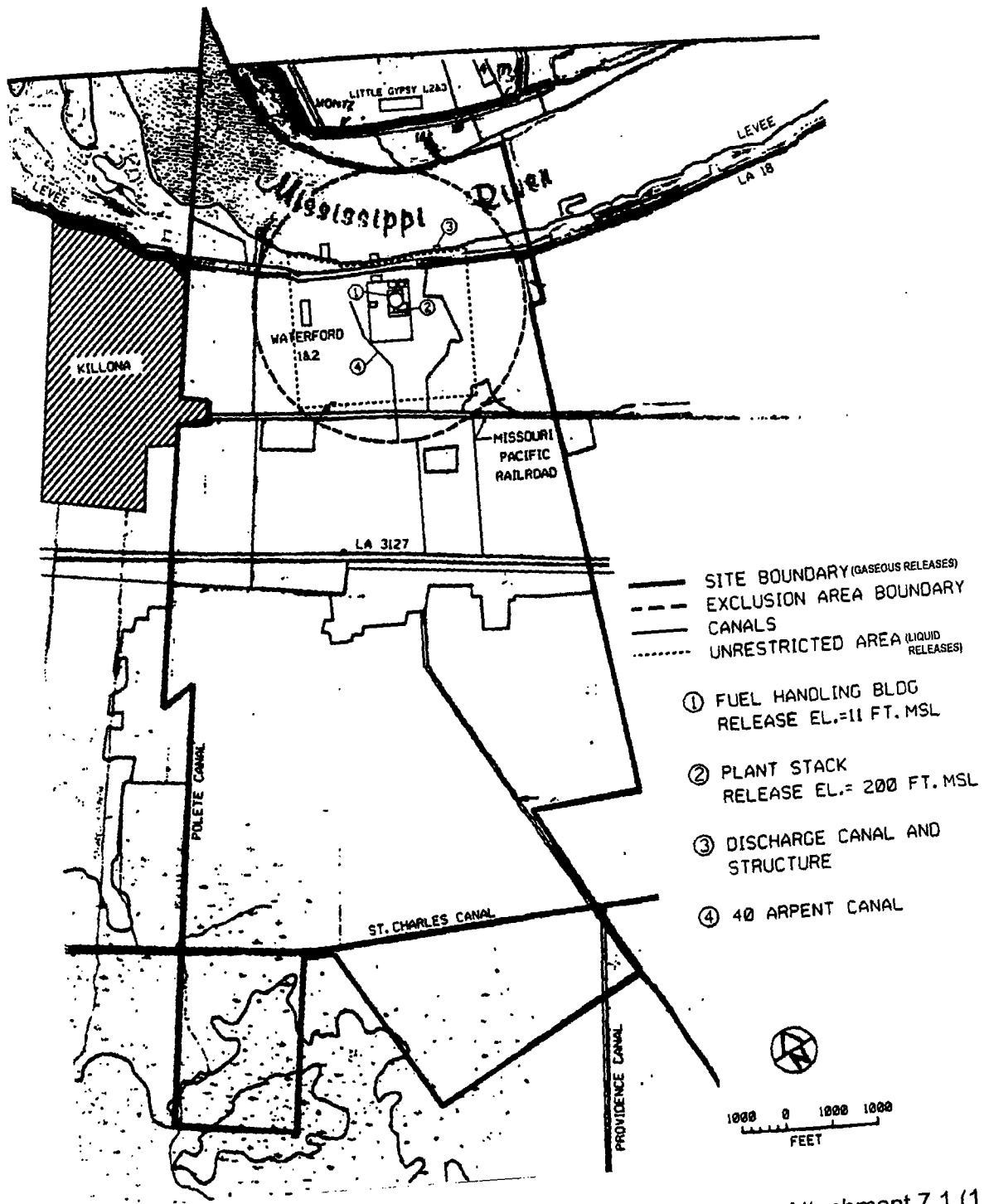

Attachment 7.1 (1 of 1)

UNT-005-014 Revision 305

HISTORICAL AVERAGE DISPERSION AND DEPOSITION PARAMETERS FOR AREAS AT OR BEYOND THE UNRESTRICTED AREA BOUNDARY

ANNUAL AVERAGE ATMOSPHERIC DISPERSION AND DEPOSITION PARAMETERS
BASED ON HISTORICAL METEOROLOGICAL DATA AND CURRENT LAND USE CENSUS

Receptor Type or Location	Direction from Site	Sector Location	Distance from Site		X/Q No Decay Undepleted (sec/m3)	D/Q (1/m2)	
			(miles)	(meters)			
Site Boundary	N ^a	A	0.8	1287	1.0e-05	2.4e-08	
	NNE ^a	B	0.6	966	1.6e-05	3.4e-08	
	NE ^a	C	0.6	966	1.5e-05	2.8e-08	
	ENE ^a	D	0.6	966	1.6e-05	2.5e-08	
	E	E	0.8	1287	6.9e-06	1.3e-08	
	ESE	F	0.6	966	1.1e-05	2.3e-08	
	SE	G	0.6	966	1.1e-05	3.1e-08	
	SSE	H	0.8	1287	6.3e-06	2.4e-08	
	S	J	1.6	2575	8.9e-07	2.7e-09	
	SSW	K	3.1	4989	3.0e-07	7.9e-10	
	SW	L	3.4	5472	3.3e-07	9.1e-10	
	WSW	M	1.5	2414	1.7e-06	4.9e-09	
	W	N	1.0	1609	2.3e-06	7.3e-09	
	WNW	P	0.8	1287	7.5e-06	2.7e-08	
	NW	Q	0.8	1287	1.0e-05	3.2e-08	
	NNW	R	0.9	1448	9.4e-06	2.4e-08	
Residence	N	A	0.9	1448	7.8e-06	1.8e-08	
	NNE	B	1.3	2092	3.0e-06	5.8e-09	
	NE	C	0.9	1448	6.3e-06	1.2e-08	
	ENE	D	0.9	1448	6.8e-06	1.1e-08	
	E	E	2.2	3541	7.4e-07	1.0e-09	
	ESE	F	3.1	4989	3.7e-07	4.8e-10	
	SE	G	4.0	6437	2.3e-07	3.6e-10	
	W	N	1.0	1609	2.3e-06	7.3e-09	
	WNW	P	0.9	1448	5.6e-06	2.0e-08	
	NW	Q	0.9	1448	7.7e-06	2.3e-08	
	NNW	R	3.0	4828	7.7e-07	1.3e-09	
	Milk Cow	NW ^b	Q	0.9	1448	7.7e-06	2.3e-08
		NW	Q	4.9	7886	2.6e-07	4.1e-10
Vegetable Garden	N	A	1.0	1609	6.1e-06	1.4e-08	
	NNE	B	1.3	2092	3.0e-06	5.8e-09	
	NE	C	0.9	1448	6.3e-06	1.2e-08	
	ENE	D	0.9	1448	6.8e-06	1.1e-08	
	E	E	2.2	3541	7.4e-07	1.0e-09	
	ESE	F	2.2	3541	7.0e-07	1.1e-09	
	SE	G	2.3	3701	6.2e-07	1.3e-09	
	WSW	M	1.5	2414	1.7e-06	4.9e-09	
	W	N	1.1	1770	1.9e-06	5.7e-09	
	WNW	P	0.9	1448	5.6e-06	2.0e-08	
	NW	Q	0.9	1448	7.7e-06	2.3e-08	
	NNW	R	3.0	4828	7.7e-06	1.3e-09	
	Beef Cow	E	E	3.2	5150	3.7e-07	4.2e-10
ESE		F	3.5	5633	3.0e-07	3.6e-10	
SE		G	4.5	7242	1.9e-07	2.8e-10	
WSW		M	1.2	1931	2.7e-06	8.6e-09	
WNW		P	0.9	1448	5.6e-06	2.0e-08	
NW		Q	0.9	1448	7.7e-06	2.3e-08	
NNW		R	2.3	3701	1.3e-06	2.4e-09	

Notes: ^a The site boundary in this sector is located over water. The location cannot be occupied continuously for the life of the plant.

^b The animals at this location do not produce milk for human consumption.

**SITE RELATED LIQUID INGESTION DOSE COMMITMENT
FACTORS (A_i) FOR INDIVIDUAL NUCLIDES**

A_i factors for Adult age group by nuclide.
 Waterford Steam Electric Station Unit III
 Discharge point : Circulating Water Discharge to Mississippi River
 Dilution Factor DW = 220.0

Nuclide	Organ Dose Conversion Factors						
	Bone	Liver	T. Body	Thyroid	Kidney	Lung	GI-LLI
H-3	0.00e+00	1.52e-01	1.52e-01	1.52e-01	1.52e-01	1.52e-01	1.52e-01
Be-10	1.64e+01	2.54e+00	4.10e-01	0.00e+00	1.92e+00	0.00e+00	1.38e+02
C-14	3.13e+04	6.26e+03	6.26e+03	6.26e+03	6.26e+03	6.26e+03	6.26e+03
N-13	3.00e+03	3.00e+03	3.00e+03	3.00e+03	3.00e+03	3.00e+03	3.00e+03
F-18	1.52e+01	0.00e+00	1.68e+00	0.00e+00	0.00e+00	0.00e+00	4.50e-01
Na-22	4.17e+03	4.17e+03	4.17e+03	4.17e+03	4.17e+03	4.17e+03	4.17e+03
Na-24	4.08e+02	4.08e+02	4.08e+02	4.08e+02	4.08e+02	4.08e+02	4.08e+02
P-32	4.62e+07	2.87e+06	1.79e+06	0.00e+00	0.00e+00	0.00e+00	5.19e+06
Ca-41	1.78e+04	0.00e+00	1.92e+03	0.00e+00	0.00e+00	0.00e+00	1.77e+01
Sc-46	2.85e-02	5.53e-02	1.61e-02	0.00e+00	5.16e-02	0.00e+00	2.69e+02
Cr-51	0.00e+00	0.00e+00	1.27e+00	7.62e-01	2.81e-01	1.69e+00	3.21e+02
Mn-54	0.00e+00	4.38e+03	8.35e+02	0.00e+00	1.30e+03	0.00e+00	1.34e+04
Mn-56	0.00e+00	1.10e+02	1.95e+01	0.00e+00	1.40e+02	0.00e+00	3.52e+03
Fe-55	6.59e+02	4.56e+02	1.06e+02	0.00e+00	0.00e+00	2.54e+02	2.61e+02
Fe-59	1.04e+03	2.45e+03	9.38e+02	0.00e+00	0.00e+00	6.83e+02	8.15e+03
Co-57	0.00e+00	2.10e+01	3.49e+01	0.00e+00	0.00e+00	0.00e+00	5.33e+02
Co-58	0.00e+00	8.95e+01	2.01e+02	0.00e+00	0.00e+00	0.00e+00	1.81e+03
Co-60	0.00e+00	2.57e+02	5.67e+02	0.00e+00	0.00e+00	0.00e+00	4.83e+03
Ni-59	2.34e+03	8.03e+02	3.91e+02	0.00e+00	0.00e+00	0.00e+00	1.65e+02
Ni-63	3.12e+04	2.16e+03	1.05e+03	0.00e+00	0.00e+00	0.00e+00	4.51e+02
Ni-65	1.27e+02	1.64e+01	7.51e+00	0.00e+00	0.00e+00	0.00e+00	4.17e+02
Cu-64	0.00e+00	1.00e+01	4.70e+00	0.00e+00	2.52e+01	0.00e+00	8.53e+02
Zn-65	2.32e+04	7.37e+04	3.33e+04	0.00e+00	4.93e+04	0.00e+00	4.64e+04
Zn-69	4.93e+01	9.43e+01	6.56e+00	0.00e+00	6.13e+01	0.00e+00	1.42e+01
Zn-69m	8.14e+02	1.95e+03	1.79e+02	0.00e+00	1.18e+03	0.00e+00	1.19e+05
Se-79	0.00e+00	1.07e+03	1.79e+02	0.00e+00	1.85e+03	0.00e+00	2.19e+02
Br-82	0.00e+00	0.00e+00	2.27e+03	0.00e+00	0.00e+00	0.00e+00	2.61e+03
Br-83	0.00e+00	0.00e+00	4.04e+01	0.00e+00	0.00e+00	0.00e+00	5.82e+01
Br-84	0.00e+00	0.00e+00	5.24e+01	0.00e+00	0.00e+00	0.00e+00	4.11e-04
Br-85	0.00e+00	0.00e+00	2.15e+00	0.00e+00	0.00e+00	0.00e+00	0.00e+00

Conversion factors are in units of mrem/hr per uCi/ml.

**SITE RELATED LIQUID INGESTION DOSE COMMITMENT
FACTORS (A_i) FOR INDIVIDUAL NUCLIDES**

A_i factors for Adult age group by nuclide.
Waterford Steam Electric Station Unit III
Discharge point : Circulating Water Discharge to Mississippi River
Dilution Factor DW = 220.0

Nuclide	Organ Dose Conversion Factors						
	Bone	Liver	T. Body	Thyroid	Kidney	Lung	GI-LLI
Rb-86	0.00e+00	1.01e+05	4.71e+04	0.00e+00	0.00e+00	0.00e+00	1.99e+04
Rb-87	0.00e+00	5.89e+04	2.05e+04	0.00e+00	0.00e+00	0.00e+00	2.76e+03
Rb-88	0.00e+00	2.90e+02	1.54e+02	0.00e+00	0.00e+00	0.00e+00	4.00e-09
Rb-89	0.00e+00	1.92e+02	1.35e+02	0.00e+00	0.00e+00	0.00e+00	1.12e-11
Sr-89	2.22e+04	0.00e+00	6.38e+02	0.00e+00	0.00e+00	0.00e+00	3.57e+03
Sr-90	6.29e+05	0.00e+00	1.26e+04	0.00e+00	0.00e+00	0.00e+00	1.58e+04
Sr-91	4.09e+02	0.00e+00	1.65e+01	0.00e+00	0.00e+00	0.00e+00	1.95e+03
Sr-92	1.55e+02	0.00e+00	6.71e+00	0.00e+00	0.00e+00	0.00e+00	3.08e+03
Y-90	5.79e-01	0.00e+00	1.55e-02	0.00e+00	0.00e+00	0.00e+00	6.14e+03
Y-91	8.49e+00	0.00e+00	2.27e-01	0.00e+00	0.00e+00	0.00e+00	4.67e+03
Y-91m	5.47e-03	0.00e+00	2.12e-04	0.00e+00	0.00e+00	0.00e+00	1.61e-02
Y-92	5.09e-02	0.00e+00	1.49e-03	0.00e+00	0.00e+00	0.00e+00	8.91e+02
Y-93	1.61e-01	0.00e+00	4.46e-03	0.00e+00	0.00e+00	0.00e+00	5.12e+03
Zr-93	3.46e-01	1.94e-02	9.02e-03	0.00e+00	7.34e-02	0.00e+00	2.01e+01
Zr-95	2.52e-01	8.07e-02	5.46e-02	0.00e+00	1.27e-01	0.00e+00	2.56e+02
Zr-97	1.39e-02	2.81e-03	1.28e-03	0.00e+00	4.24e-03	0.00e+00	8.69e+02
Nb-93m	1.83e+01	5.98e+00	1.47e+00	0.00e+00	6.88e+00	0.00e+00	2.76e+03
Nb-95	4.47e+00	2.49e+00	1.34e+00	0.00e+00	2.46e+00	0.00e+00	1.51e+04
Nb-97	3.75e-02	9.49e-03	3.46e-03	0.00e+00	1.11e-02	0.00e+00	3.50e+01
Mo-93	0.00e+00	1.83e+02	4.94e+00	0.00e+00	5.18e+01	0.00e+00	2.97e+01
Mo-99	0.00e+00	1.05e+02	1.99e+01	0.00e+00	2.37e+02	0.00e+00	2.43e+02
Tc-101	9.22e-03	1.33e-02	1.30e-01	0.00e+00	2.39e-01	6.79e-03	3.99e-14
Tc-99	4.54e+00	6.75e+00	1.82e+00	0.00e+00	8.49e+01	5.73e-01	2.21e+02
Tc-99m	8.96e-03	2.53e-02	3.23e-01	0.00e+00	3.85e-01	1.24e-02	1.50e+01
Ru-103	4.50e+00	0.00e+00	1.94e+00	0.00e+00	1.72e+01	0.00e+00	5.25e+02
Ru-105	3.75e-01	0.00e+00	1.48e-01	0.00e+00	4.84e+00	0.00e+00	2.29e+02
Ru-106	6.69e+01	0.00e+00	8.46e+00	0.00e+00	1.29e+02	0.00e+00	4.33e+03
Rh-105	2.94e+00	2.15e+00	1.42e+00	0.00e+00	9.14e+00	0.00e+00	3.43e+02
Pd-107	0.00e+00	3.57e+00	2.29e-01	0.00e+00	3.21e+01	0.00e+00	2.22e+01
Pd-109	0.00e+00	4.30e+00	9.70e-01	0.00e+00	2.46e+01	0.00e+00	4.77e+02

Conversion factors are in units of mrem/hr per uCi/ml.

**SITE RELATED LIQUID INGESTION DOSE COMMITMENT
FACTORS (A_i) FOR INDIVIDUAL NUCLIDES**

A_i factors for Adult age group by nuclide.
 Waterford Steam Electric Station Unit III
 Discharge point : Circulating Water Discharge to Mississippi River
 Dilution Factor DW = 220.0

Nuclide	Organ Dose Conversion Factors						
	Bone	Liver	T. Body	Thyroid	Kidney	Lung	GI-LLI
Ag-110m	9.42e-01	8.71e-01	5.17e-01	0.00e+00	1.71e+00	0.00e+00	3.55e+02
Ag-111	3.42e-01	1.43e-01	7.12e-02	0.00e+00	4.61e-01	0.00e+00	2.62e+02
Cd-113m	0.00e+00	1.52e+03	4.89e+01	0.00e+00	1.68e+03	0.00e+00	1.23e+04
Cd-115m	0.00e+00	8.82e+02	2.81e+01	0.00e+00	7.00e+02	0.00e+00	3.71e+04
Sn-123	2.23e+05	3.70e+03	5.45e+03	3.15e+03	0.00e+00	0.00e+00	4.55e+05
Sn-125	5.98e+04	1.21e+03	2.71e+03	9.98e+02	0.00e+00	0.00e+00	7.47e+05
Sn-126	6.07e+05	1.20e+04	1.72e+04	3.53e+03	0.00e+00	0.00e+00	1.75e+05
Sb-124	7.76e+00	1.47e-01	3.08e+00	1.88e-02	0.00e+00	6.04e+00	2.20e+02
Sb-125	4.96e+00	5.54e-02	1.18e+00	5.05e-03	0.00e+00	3.83e+00	5.46e+01
Sb-126	3.19e+00	6.49e-02	1.15e+00	1.95e-02	0.00e+00	1.95e+00	2.61e+02
Sb-127	7.15e-01	1.57e-02	2.74e-01	8.59e-03	0.00e+00	4.24e-01	1.64e+02
Te-125m	2.57e+03	9.30e+02	3.44e+02	7.72e+02	1.04e+04	0.00e+00	1.03e+04
Te-127	1.05e+02	3.78e+01	2.28e+01	7.81e+01	4.29e+02	0.00e+00	8.32e+03
Te-127m	6.49e+03	2.32e+03	7.90e+02	1.66e+03	2.63e+04	0.00e+00	2.17e+04
Te-129	3.01e+01	1.13e+01	7.33e+00	2.31e+01	1.26e+02	0.00e+00	2.27e+01
Te-129m	1.10e+04	4.11e+03	1.74e+03	3.78e+03	4.60e+04	0.00e+00	5.55e+04
Te-131	1.89e+01	7.88e+00	5.96e+00	1.55e+01	8.27e+01	0.00e+00	2.67e+00
Te-131m	1.66e+03	8.10e+02	6.75e+02	1.28e+03	8.21e+03	0.00e+00	8.05e+04
Te-132	2.41e+03	1.56e+03	1.47e+03	1.72e+03	1.50e+04	0.00e+00	7.39e+04
Te-133m	4.43e+01	2.59e+01	2.49e+01	3.75e+01	2.56e+02	0.00e+00	8.87e+00
Te-134	3.10e+01	2.03e+01	1.25e+01	2.71e+01	1.96e+02	0.00e+00	3.44e-02
I-129	1.19e+02	1.02e+02	3.34e+02	2.62e+05	2.19e+02	0.00e+00	1.61e+01
I-130	2.74e+01	8.09e+01	3.19e+01	6.86e+03	1.26e+02	0.00e+00	6.97e+01
I-131	1.51e+02	2.16e+02	1.24e+02	7.08e+04	3.70e+02	0.00e+00	5.70e+01
I-132	7.37e+00	1.97e+01	6.89e+00	6.89e+02	3.14e+01	0.00e+00	3.70e+00
I-133	5.15e+01	8.96e+01	2.73e+01	1.32e+04	1.56e+02	0.00e+00	8.06e+01
I-134	3.85e+00	1.05e+01	3.74e+00	1.81e+02	1.66e+01	0.00e+00	9.11e-03
I-135	1.61e+01	4.21e+01	1.55e+01	2.78e+03	6.75e+01	0.00e+00	4.75e+01
Cs-134	2.98e+05	7.09e+05	5.79e+05	0.00e+00	2.29e+05	7.61e+04	1.24e+04
Cs-134m	1.02e+02	2.15e+02	1.10e+02	0.00e+00	1.16e+02	1.83e+01	7.57e+01

Conversion factors are in units of mrem/hr per uCi/ml.

**SITE RELATED LIQUID INGESTION DOSE COMMITMENT
FACTORS (A_i) FOR INDIVIDUAL NUCLIDES**

Ai factors for Adult age group by nuclide.
Waterford Steam Electric Station Unit III
Discharge point : Circulating Water Discharge to Mississippi River
Dilution Factor DW = 220.0

Nuclide	Organ Dose Conversion Factors						
	Bone	Liver	T. Body	Thyroid	Kidney	Lung	GI-LLI
Cs-135	9.34e+04	8.62e+04	3.83e+04	0.00e+00	3.26e+04	9.77e+03	2.02e+03
Cs-136	3.12e+04	1.23e+05	8.86e+04	0.00e+00	6.85e+04	9.39e+03	1.40e+04
Cs-137	3.82e+05	5.22e+05	3.42e+05	0.00e+00	1.77e+05	5.89e+04	1.01e+04
Cs-138	2.64e+02	5.22e+02	2.59e+02	0.00e+00	3.84e+02	3.79e+01	2.23e-03
Cs-139	1.63e+02	2.43e+02	8.86e+01	0.00e+00	1.95e+02	1.77e+01	5.27e-21
Ba-139	9.66e-01	6.88e-04	2.83e-02	0.00e+00	6.43e-04	3.90e-04	1.71e+00
Ba-140	2.02e+02	2.54e-01	1.32e+01	0.00e+00	8.63e-02	1.45e-01	4.16e+02
Ba-141	4.69e-01	3.54e-04	1.58e-02	0.00e+00	3.29e-04	2.01e-04	2.21e-10
Ba-142	2.12e-01	2.18e-04	1.33e-02	0.00e+00	1.84e-04	1.23e-04	2.99e-19
La-140	1.51e-01	7.59e-02	2.01e-02	0.00e+00	0.00e+00	0.00e+00	5.57e+03
La-141	1.92e-02	5.96e-03	9.76e-04	0.00e+00	0.00e+00	0.00e+00	7.11e+02
La-142	7.71e-03	3.51e-03	8.73e-04	0.00e+00	0.00e+00	0.00e+00	2.56e+01
Ce-141	2.59e-02	1.75e-02	1.99e-03	0.00e+00	8.15e-03	0.00e+00	6.71e+01
Ce-143	4.57e-03	3.38e+00	3.74e-04	0.00e+00	1.49e-03	0.00e+00	1.26e+02
Ce-144	1.35e+00	5.66e-01	7.26e-02	0.00e+00	3.35e-01	0.00e+00	4.57e+02
Pr-143	5.54e-01	2.22e-01	2.75e-02	0.00e+00	1.28e-01	0.00e+00	2.43e+03
Pr-144	1.81e-03	7.53e-04	9.21e-05	0.00e+00	4.25e-04	0.00e+00	2.61e-10
Nd-147	3.79e-01	4.38e-01	2.62e-02	0.00e+00	2.56e-01	0.00e+00	2.10e+03
Pm-147	4.54e+00	4.27e-01	1.73e-01	0.00e+00	8.07e-01	0.00e+00	5.38e+02
Pm-148	4.32e-01	7.17e-02	3.61e-02	0.00e+00	1.36e-01	0.00e+00	5.63e+03
Pm-148m	1.85e+00	4.79e-01	3.66e-01	0.00e+00	7.23e-01	0.00e+00	4.06e+03
Pm-149	9.15e-02	1.29e-02	5.29e-03	0.00e+00	2.45e-02	0.00e+00	2.43e+03
Pm-151	4.20e-02	7.05e-03	3.56e-03	0.00e+00	1.26e-02	0.00e+00	1.94e+03
Sm-151	4.16e+00	7.17e-01	1.72e-01	0.00e+00	8.01e-01	0.00e+00	3.16e+02
Sm-153	5.16e-02	4.31e-02	3.14e-03	0.00e+00	1.39e-02	0.00e+00	1.54e+03
Eu-152	1.17e+01	2.67e+00	2.35e+00	0.00e+00	1.66e+01	0.00e+00	1.54e+03
Eu-154	3.70e+01	4.55e+00	3.24e+00	0.00e+00	2.18e+01	0.00e+00	3.30e+03
Eu-155	5.18e+00	7.35e-01	4.74e-01	0.00e+00	3.39e+00	0.00e+00	5.78e+02
Eu-156	8.25e-01	6.38e-01	1.03e-01	0.00e+00	4.26e-01	0.00e+00	4.37e+03
Tb-160	2.83e+00	0.00e+00	3.53e-01	0.00e+00	1.17e+00	0.00e+00	2.61e+03

Conversion factors are in units of mrem/hr per uCi/ml.

SITE RELATED LIQUID INGESTION DOSE COMMITMENT FACTORS (A_i) FOR INDIVIDUAL NUCLIDES

A_i factors for Adult age group by nuclide.
 Waterford Steam Electric Station Unit III
 Discharge point : Circulating Water Discharge to Mississippi River
 Dilution Factor DW = 220.0

Nuclide	Organ Dose Conversion Factors						
	Bone	Liver	T. Body	Thyroid	Kidney	Lung	GI-LLI
Ho-166m	1.63e+01	5.08e+00	3.85e+00	0.00e+00	7.59e+00	0.00e+00	1.54e+03
W-181	2.85e+01	9.28e+00	9.94e-01	0.00e+00	0.00e+00	0.00e+00	1.06e+03
W-185	1.16e+03	3.88e+02	4.08e+01	0.00e+00	0.00e+00	0.00e+00	4.48e+04
W-187	2.96e+02	2.47e+02	8.65e+01	0.00e+00	0.00e+00	0.00e+00	8.10e+04
Pb-210	3.67e+06	1.05e+06	1.30e+05	0.00e+00	2.95e+06	0.00e+00	5.37e+02
Bi-210	1.67e+01	1.15e+02	9.58e+00	0.00e+00	1.39e+03	0.00e+00	1.72e+03
Po-210	4.26e+05	9.05e+05	1.03e+05	0.00e+00	3.02e+06	0.00e+00	7.62e+04
Ra-223	5.97e+05	9.19e+02	1.19e+05	0.00e+00	2.61e+04	0.00e+00	3.85e+04
Ra-224	1.93e+05	4.68e+02	3.88e+04	0.00e+00	1.32e+04	0.00e+00	4.08e+04
Ra-225	7.88e+05	9.34e+02	1.57e+05	0.00e+00	2.65e+04	0.00e+00	3.67e+04
Ra-226	3.63e+07	6.89e+02	2.64e+07	0.00e+00	1.96e+04	0.00e+00	3.99e+04
Ra-228	1.34e+07	3.75e+02	1.45e+07	0.00e+00	1.06e+04	0.00e+00	6.77e+03
Ac-225	2.65e+02	3.65e+02	1.78e+01	0.00e+00	4.16e+01	0.00e+00	2.45e+04
Ac-227	1.13e+05	1.49e+04	6.69e+03	0.00e+00	4.82e+03	0.00e+00	4.93e+03
Th-227	9.89e+02	1.79e+01	2.85e+01	0.00e+00	1.02e+02	0.00e+00	3.90e+04
Th-228	3.58e+04	6.06e+02	1.21e+03	0.00e+00	3.37e+03	0.00e+00	4.06e+04
Th-229	9.82e+05	2.81e+04	1.62e+04	0.00e+00	1.36e+05	0.00e+00	5.64e+03
Th-230	1.49e+05	8.45e+03	4.12e+03	0.00e+00	4.08e+04	0.00e+00	4.35e+03
Th-232	1.66e+05	7.22e+03	1.08e+02	0.00e+00	3.48e+04	0.00e+00	3.70e+03
Th-234	5.78e+00	3.40e-01	1.67e-01	0.00e+00	1.93e+00	0.00e+00	8.16e+03
Pa-231	1.10e+05	4.11e+03	4.25e+03	0.00e+00	2.31e+04	0.00e+00	1.92e+03
Pa-233	1.41e-01	2.83e-02	2.44e-02	0.00e+00	1.07e-01	0.00e+00	4.38e+02
U-232	2.13e+04	0.00e+00	1.52e+03	0.00e+00	2.31e+03	0.00e+00	3.50e+02
U-233	4.50e+03	0.00e+00	2.73e+02	0.00e+00	1.05e+03	0.00e+00	3.24e+02
U-234	4.32e+03	0.00e+00	2.67e+02	0.00e+00	1.03e+03	0.00e+00	3.17e+02
U-235	4.14e+03	0.00e+00	2.51e+02	0.00e+00	9.66e+02	0.00e+00	4.03e+02
U-236	4.14e+03	0.00e+00	2.56e+02	0.00e+00	9.87e+02	0.00e+00	2.98e+02
U-237	2.85e-01	0.00e+00	7.59e-02	0.00e+00	1.17e+00	0.00e+00	1.00e+02
U-238	3.96e+03	0.00e+00	2.35e+02	0.00e+00	9.04e+02	0.00e+00	2.84e+02
Np-237	3.06e+04	2.18e+03	1.35e+03	0.00e+00	1.00e+04	0.00e+00	1.93e+03

Conversion factors are in units of mrem/hr per uCi/ml.

**SITE RELATED LIQUID INGESTION DOSE COMMITMENT
FACTORS (A_i) FOR INDIVIDUAL NUCLIDES**

A_i factors for Adult age group by nuclide.
 Waterford Steam Electric Station Unit III
 Discharge point : Circulating Water Discharge to Mississippi River
 Dilution Factor DW = 220.0

Nuclide	Organ Dose Conversion Factors						
	Bone	Liver	T. Body	Thyroid	Kidney	Lung	GI-LLI
Np-238	3.33e-01	8.97e-03	5.18e-03	0.00e+00	3.04e-02	0.00e+00	8.34e+02
Np-239	2.89e-02	2.85e-03	1.57e-03	0.00e+00	8.88e-03	0.00e+00	5.84e+02
Pu-238	5.52e+03	6.99e+02	1.50e+02	0.00e+00	6.41e+02	0.00e+00	6.39e+02
Pu-239	6.35e+03	7.63e+02	1.67e+02	0.00e+00	7.10e+02	0.00e+00	5.83e+02
Pu-240	6.34e+03	7.62e+02	1.67e+02	0.00e+00	7.09e+02	0.00e+00	5.94e+02
Pu-241	1.37e+02	6.52e+00	2.91e+00	0.00e+00	1.34e+01	0.00e+00	1.23e+01
Pu-242	5.88e+03	7.35e+02	1.61e+02	0.00e+00	6.84e+02	0.00e+00	5.72e+02
Pu-244	6.87e+03	8.42e+02	1.85e+02	0.00e+00	7.84e+02	0.00e+00	8.52e+02
Am-241	4.55e+04	4.25e+04	3.26e+03	0.00e+00	2.45e+04	0.00e+00	4.47e+03
Am-242m	4.58e+04	3.99e+04	3.27e+03	0.00e+00	2.44e+04	0.00e+00	5.63e+03
Am-243	4.54e+04	4.16e+04	3.19e+03	0.00e+00	2.40e+04	0.00e+00	5.24e+03
Cm-242	1.24e+03	1.32e+03	8.25e+01	0.00e+00	3.75e+02	0.00e+00	4.77e+03
Cm-243	3.61e+04	3.31e+04	2.26e+03	0.00e+00	1.05e+04	0.00e+00	4.70e+03
Cm-244	2.75e+04	2.57e+04	1.73e+03	0.00e+00	8.07e+03	0.00e+00	4.55e+03
Cm-245	5.65e+04	4.92e+04	3.47e+03	0.00e+00	1.62e+04	0.00e+00	4.24e+03
Cm-246	5.60e+04	4.91e+04	3.46e+03	0.00e+00	1.61e+04	0.00e+00	4.16e+03
Cm-247	5.46e+04	4.84e+04	3.41e+03	0.00e+00	1.59e+04	0.00e+00	5.47e+03
Cm-248	4.54e+05	3.99e+05	2.81e+04	0.00e+00	1.31e+05	0.00e+00	8.85e+04
Cf-252	1.57e+04	0.00e+00	3.79e+02	0.00e+00	0.00e+00	0.00e+00	1.73e+04

Conversion factors are in units of mrem/hr per uCi/ml.

**SITE RELATED LIQUID INGESTION DOSE COMMITMENT
FACTORS (A_i) FOR INDIVIDUAL NUCLIDES**

A_i factors for Adult age group by nuclide.
Waterford Steam Electric Station Unit III
Discharge point : 40 Arpent Canal
Dilution Factor DW = 1.0

Nuclide	Organ Dose Conversion Factors						
	Bone	Liver	T. Body	Thyroid	Kidney	Lung	GI-LLI
H-3	0.00e+00	1.29e-01	1.29e-01	1.29e-01	1.29e-01	1.29e-01	1.29e-01
Be-10	1.52e+01	2.35e+00	3.80e-01	0.00e+00	1.78e+00	0.00e+00	1.28e+02
C-14	3.13e+04	6.26e+03	6.26e+03	6.26e+03	6.26e+03	6.26e+03	6.26e+03
N-13	3.00e+03	3.00e+03	3.00e+03	3.00e+03	3.00e+03	3.00e+03	3.00e+03
F-18	1.49e+01	0.00e+00	1.66e+00	0.00e+00	0.00e+00	0.00e+00	4.43e-01
Na-22	4.17e+03	4.17e+03	4.17e+03	4.17e+03	4.17e+03	4.17e+03	4.17e+03
Na-24	4.07e+02	4.07e+02	4.07e+02	4.07e+02	4.07e+02	4.07e+02	4.07e+02
P-32	4.62e+07	2.87e+06	1.79e+06	0.00e+00	0.00e+00	0.00e+00	5.19e+06
Ca-41	1.77e+04	0.00e+00	1.92e+03	0.00e+00	0.00e+00	0.00e+00	1.76e+01
Sc-46	2.64e-02	5.12e-02	1.49e-02	0.00e+00	4.78e-02	0.00e+00	2.49e+02
Cr-51	0.00e+00	0.00e+00	1.27e+00	7.61e-01	2.81e-01	1.69e+00	3.20e+02
Mn-54	0.00e+00	4.38e+03	8.35e+02	0.00e+00	1.30e+03	0.00e+00	1.34e+04
Mn-56	0.00e+00	1.10e+02	1.95e+01	0.00e+00	1.40e+02	0.00e+00	3.51e+03
Fe-55	6.58e+02	4.55e+02	1.06e+02	0.00e+00	0.00e+00	2.54e+02	2.61e+02
Fe-59	1.04e+03	2.44e+03	9.36e+02	0.00e+00	0.00e+00	6.82e+02	8.14e+03
Co-57	0.00e+00	2.09e+01	3.48e+01	0.00e+00	0.00e+00	0.00e+00	5.31e+02
Co-58	0.00e+00	8.92e+01	2.00e+02	0.00e+00	0.00e+00	0.00e+00	1.81e+03
Co-60	0.00e+00	2.56e+02	5.65e+02	0.00e+00	0.00e+00	0.00e+00	4.81e+03
Ni-59	2.34e+03	8.02e+02	3.90e+02	0.00e+00	0.00e+00	0.00e+00	1.65e+02
Ni-63	3.11e+04	2.16e+03	1.04e+03	0.00e+00	0.00e+00	0.00e+00	4.50e+02
Ni-65	1.26e+02	1.64e+01	7.49e+00	0.00e+00	0.00e+00	0.00e+00	4.17e+02
Cu-64	0.00e+00	9.97e+00	4.68e+00	0.00e+00	2.51e+01	0.00e+00	8.50e+02
Zn-65	2.32e+04	7.37e+04	3.33e+04	0.00e+00	4.93e+04	0.00e+00	4.64e+04
Zn-69	4.93e+01	9.43e+01	6.56e+00	0.00e+00	6.13e+01	0.00e+00	1.42e+01
Zn-69m	8.14e+02	1.95e+03	1.79e+02	0.00e+00	1.18e+03	0.00e+00	1.19e+05
Se-79	0.00e+00	1.07e+03	1.79e+02	0.00e+00	1.85e+03	0.00e+00	2.19e+02
Br-82	0.00e+00	0.00e+00	2.27e+03	0.00e+00	0.00e+00	0.00e+00	2.60e+03
Br-83	0.00e+00	0.00e+00	4.04e+01	0.00e+00	0.00e+00	0.00e+00	5.82e+01
Br-84	0.00e+00	0.00e+00	5.24e+01	0.00e+00	0.00e+00	0.00e+00	4.11e-04
Br-85	0.00e+00	0.00e+00	2.15e+00	0.00e+00	0.00e+00	0.00e+00	0.00e+00

Conversion factors are in units of mrem/hr per uCi/ml.

**SITE RELATED LIQUID INGESTION DOSE COMMITMENT
FACTORS (A_i) FOR INDIVIDUAL NUCLIDES**

Ai factors for Adult age group by nuclide.
Waterford Steam Electric Station Unit III
Discharge point : 40 Arpent Canal
Dilution Factor DW = 1.0

Nuclide	Organ Dose Conversion Factors						
	Bone	Liver	T. Body	Thyroid	Kidney	Lung	GI-LLI
Rb-86	0.00e+00	1.01e+05	4.71e+04	0.00e+00	0.00e+00	0.00e+00	1.99e+04
Rb-87	0.00e+00	5.89e+04	2.05e+04	0.00e+00	0.00e+00	0.00e+00	2.76e+03
Rb-88	0.00e+00	2.90e+02	1.54e+02	0.00e+00	0.00e+00	0.00e+00	4.00e-09
Rb-89	0.00e+00	1.92e+02	1.35e+02	0.00e+00	0.00e+00	0.00e+00	1.12e-11
Sr-89	2.21e+04	0.00e+00	6.35e+02	0.00e+00	0.00e+00	0.00e+00	3.55e+03
Sr-90	6.26e+05	0.00e+00	1.26e+04	0.00e+00	0.00e+00	0.00e+00	1.57e+04
Sr-91	4.07e+02	0.00e+00	1.64e+01	0.00e+00	0.00e+00	0.00e+00	1.94e+03
Sr-92	1.54e+02	0.00e+00	6.68e+00	0.00e+00	0.00e+00	0.00e+00	3.06e+03
Y-90	5.76e-01	0.00e+00	1.54e-02	0.00e+00	0.00e+00	0.00e+00	6.10e+03
Y-91	8.44e+00	0.00e+00	2.26e-01	0.00e+00	0.00e+00	0.00e+00	4.64e+03
Y-91m	5.44e-03	0.00e+00	2.11e-04	0.00e+00	0.00e+00	0.00e+00	1.60e-02
Y-92	5.06e-02	0.00e+00	1.48e-03	0.00e+00	0.00e+00	0.00e+00	8.86e+02
Y-93	1.60e-01	0.00e+00	4.43e-03	0.00e+00	0.00e+00	0.00e+00	5.09e+03
Zr-93	3.30e-01	1.85e-02	8.61e-03	0.00e+00	7.01e-02	0.00e+00	1.92e+01
Zr-95	2.40e-01	7.70e-02	5.21e-02	0.00e+00	1.21e-01	0.00e+00	2.44e+02
Zr-97	1.33e-02	2.68e-03	1.22e-03	0.00e+00	4.04e-03	0.00e+00	8.30e+02
Nb-93m	1.83e+01	5.98e+00	1.47e+00	0.00e+00	6.87e+00	0.00e+00	2.76e+03
Nb-95	4.47e+00	2.48e+00	1.34e+00	0.00e+00	2.46e+00	0.00e+00	1.51e+04
Nb-97	3.75e-02	9.48e-03	3.46e-03	0.00e+00	1.11e-02	0.00e+00	3.50e+01
Mo-93	0.00e+00	1.80e+02	4.86e+00	0.00e+00	5.10e+01	0.00e+00	2.92e+01
Mo-99	0.00e+00	1.03e+02	1.96e+01	0.00e+00	2.34e+02	0.00e+00	2.39e+02
Tc-101	9.12e-03	1.31e-02	1.29e-01	0.00e+00	2.37e-01	6.72e-03	3.95e-14
Tc-99	4.49e+00	6.68e+00	1.80e+00	0.00e+00	8.40e+01	5.67e-01	2.18e+02
Tc-99m	8.87e-03	2.51e-02	3.19e-01	0.00e+00	3.81e-01	1.23e-02	1.48e+01
Ru-103	4.43e+00	0.00e+00	1.91e+00	0.00e+00	1.69e+01	0.00e+00	5.17e+02
Ru-105	3.69e-01	0.00e+00	1.46e-01	0.00e+00	4.76e+00	0.00e+00	2.26e+02
Ru-106	6.58e+01	0.00e+00	8.33e+00	0.00e+00	1.27e+02	0.00e+00	4.26e+03
Rh-105	2.90e+00	2.12e+00	1.40e+00	0.00e+00	9.00e+00	0.00e+00	3.38e+02
Pd-107	0.00e+00	3.52e+00	2.25e-01	0.00e+00	3.16e+01	0.00e+00	2.18e+01
Pd-109	0.00e+00	4.24e+00	9.55e-01	0.00e+00	2.42e+01	0.00e+00	4.69e+02

Conversion factors are in units of mrem/hr per uCi/ml.

**SITE RELATED LIQUID INGESTION DOSE COMMITMENT
FACTORS (A_i) FOR INDIVIDUAL NUCLIDES**

Ai factors for Adult age group by nuclide.
Waterford Steam Electric Station Unit III
Discharge point : 40 Arpent Canal
Dilution Factor DW = 1.0

Nuclide	Organ Dose Conversion Factors						
	Bone	Liver	T. Body	Thyroid	Kidney	Lung	GI-LLI
Ag-110m	8.81e-01	8.15e-01	4.84e-01	0.00e+00	1.60e+00	0.00e+00	3.33e+02
Ag-111	3.20e-01	1.34e-01	6.66e-02	0.00e+00	4.32e-01	0.00e+00	2.46e+02
Cd-113m	0.00e+00	1.52e+03	4.88e+01	0.00e+00	1.68e+03	0.00e+00	1.23e+04
Cd-115m	0.00e+00	8.81e+02	2.81e+01	0.00e+00	6.99e+02	0.00e+00	3.71e+04
Sn-123	2.23e+05	3.70e+03	5.45e+03	3.15e+03	0.00e+00	0.00e+00	4.55e+05
Sn-125	5.98e+04	1.21e+03	2.71e+03	9.98e+02	0.00e+00	0.00e+00	7.47e+05
Sn-126	6.07e+05	1.20e+04	1.72e+04	3.53e+03	0.00e+00	0.00e+00	1.75e+05
Sb-124	6.70e+00	1.27e-01	2.66e+00	1.63e-02	0.00e+00	5.22e+00	1.90e+02
Sb-125	4.29e+00	4.79e-02	1.02e+00	4.36e-03	0.00e+00	3.30e+00	4.72e+01
Sb-126	2.75e+00	5.60e-02	9.94e-01	1.69e-02	0.00e+00	1.69e+00	2.25e+02
Sb-127	6.18e-01	1.35e-02	2.37e-01	7.42e-03	0.00e+00	3.66e-01	1.41e+02
Te-125m	2.57e+03	9.30e+02	3.44e+02	7.72e+02	1.04e+04	0.00e+00	1.02e+04
Te-127	1.05e+02	3.78e+01	2.28e+01	7.80e+01	4.29e+02	0.00e+00	8.31e+03
Te-127m	6.48e+03	2.32e+03	7.90e+02	1.66e+03	2.63e+04	0.00e+00	2.17e+04
Te-129	3.01e+01	1.13e+01	7.33e+00	2.31e+01	1.26e+02	0.00e+00	2.27e+01
Te-129m	1.10e+04	4.11e+03	1.74e+03	3.78e+03	4.60e+04	0.00e+00	5.54e+04
Te-131	1.89e+01	7.88e+00	5.96e+00	1.55e+01	8.26e+01	0.00e+00	2.67e+00
Te-131m	1.66e+03	8.10e+02	6.75e+02	1.28e+03	8.21e+03	0.00e+00	8.04e+04
Te-132	2.41e+03	1.56e+03	1.47e+03	1.72e+03	1.50e+04	0.00e+00	7.38e+04
Te-133m	4.42e+01	2.59e+01	2.49e+01	3.74e+01	2.56e+02	0.00e+00	8.87e+00
Te-134	3.10e+01	2.03e+01	1.24e+01	2.71e+01	1.96e+02	0.00e+00	3.44e-02
I-129	1.17e+02	1.01e+02	3.31e+02	2.60e+05	2.17e+02	0.00e+00	1.59e+01
I-130	2.71e+01	8.01e+01	3.16e+01	6.79e+03	1.25e+02	0.00e+00	6.89e+01
I-131	1.49e+02	2.14e+02	1.22e+02	7.00e+04	3.66e+02	0.00e+00	5.64e+01
I-132	7.29e+00	1.95e+01	6.82e+00	6.82e+02	3.11e+01	0.00e+00	3.66e+00
I-133	5.10e+01	8.87e+01	2.70e+01	1.30e+04	1.55e+02	0.00e+00	7.97e+01
I-134	3.81e+00	1.03e+01	3.70e+00	1.79e+02	1.64e+01	0.00e+00	9.01e-03
I-135	1.59e+01	4.17e+01	1.54e+01	2.75e+03	6.68e+01	0.00e+00	4.70e+01
Cs-134	2.98e+05	7.09e+05	5.79e+05	0.00e+00	2.29e+05	7.61e+04	1.24e+04
Cs-134m	1.02e+02	2.15e+02	1.10e+02	0.00e+00	1.16e+02	1.83e+01	7.57e+01

Conversion factors are in units of mrem/hr per uCi/ml.

**SITE RELATED LIQUID INGESTION DOSE COMMITMENT
FACTORS (A_i) FOR INDIVIDUAL NUCLIDES**

A_i factors for Adult age group by nuclide.
Waterford Steam Electric Station Unit III
Discharge point : 40 Arpent Canal
Dilution Factor DW = 1.0

Nuclide	Organ Dose Conversion Factors						
	Bone	Liver	T. Body	Thyroid	Kidney	Lung	GI-LLI
Cs-135	9.34e+04	8.62e+04	3.83e+04	0.00e+00	3.26e+04	9.77e+03	2.02e+03
Cs-136	3.12e+04	1.23e+05	8.86e+04	0.00e+00	6.85e+04	9.38e+03	1.40e+04
Cs-137	3.82e+05	5.22e+05	3.42e+05	0.00e+00	1.77e+05	5.89e+04	1.01e+04
Cs-138	2.64e+02	5.22e+02	2.59e+02	0.00e+00	3.84e+02	3.79e+01	2.23e-03
Cs-139	1.63e+02	2.43e+02	8.86e+01	0.00e+00	1.95e+02	1.77e+01	5.27e-21
Ba-139	9.29e-01	6.62e-04	2.72e-02	0.00e+00	6.19e-04	3.75e-04	1.65e+00
Ba-140	1.94e+02	2.44e-01	1.27e+01	0.00e+00	8.30e-02	1.40e-01	4.00e+02
Ba-141	4.51e-01	3.41e-04	1.52e-02	0.00e+00	3.17e-04	1.93e-04	2.13e-10
Ba-142	2.04e-01	2.10e-04	1.28e-02	0.00e+00	1.77e-04	1.19e-04	2.87e-19
La-140	1.50e-01	7.54e-02	1.99e-02	0.00e+00	0.00e+00	0.00e+00	5.54e+03
La-141	1.91e-02	5.93e-03	9.70e-04	0.00e+00	0.00e+00	0.00e+00	7.06e+02
La-142	7.66e-03	3.48e-03	8.68e-04	0.00e+00	0.00e+00	0.00e+00	2.54e+01
Ce-141	2.24e-02	1.52e-02	1.72e-03	0.00e+00	7.04e-03	0.00e+00	5.79e+01
Ce-143	3.95e-03	2.92e+00	3.23e-04	0.00e+00	1.29e-03	0.00e+00	1.09e+02
Ce-144	1.17e+00	4.88e-01	6.27e-02	0.00e+00	2.90e-01	0.00e+00	3.95e+02
Pr-143	5.51e-01	2.21e-01	2.73e-02	0.00e+00	1.27e-01	0.00e+00	2.41e+03
Pr-144	1.80e-03	7.48e-04	9.16e-05	0.00e+00	4.22e-04	0.00e+00	2.59e-10
Nd-147	3.76e-01	4.35e-01	2.60e-02	0.00e+00	2.54e-01	0.00e+00	2.09e+03
Pm-147	4.51e+00	4.24e-01	1.72e-01	0.00e+00	8.02e-01	0.00e+00	5.34e+02
Pm-148	4.29e-01	7.12e-02	3.59e-02	0.00e+00	1.35e-01	0.00e+00	5.60e+03
Pm-148m	1.84e+00	4.76e-01	3.64e-01	0.00e+00	7.18e-01	0.00e+00	4.03e+03
Pm-149	9.10e-02	1.29e-02	5.25e-03	0.00e+00	2.43e-02	0.00e+00	2.41e+03
Pm-151	4.17e-02	7.00e-03	3.54e-03	0.00e+00	1.25e-02	0.00e+00	1.93e+03
Sm-151	4.13e+00	7.12e-01	1.71e-01	0.00e+00	7.96e-01	0.00e+00	3.14e+02
Sm-153	5.13e-02	4.28e-02	3.12e-03	0.00e+00	1.38e-02	0.00e+00	1.53e+03
Eu-152	1.17e+01	2.66e+00	2.33e+00	0.00e+00	1.65e+01	0.00e+00	1.53e+03
Eu-154	3.68e+01	4.52e+00	3.22e+00	0.00e+00	2.17e+01	0.00e+00	3.28e+03
Eu-155	5.15e+00	7.30e-01	4.71e-01	0.00e+00	3.37e+00	0.00e+00	5.75e+02
Eu-156	8.20e-01	6.34e-01	1.02e-01	0.00e+00	4.24e-01	0.00e+00	4.35e+03
Tb-160	2.81e+00	0.00e+00	3.51e-01	0.00e+00	1.16e+00	0.00e+00	2.59e+03

Conversion factors are in units of mrem/hr per uCi/ml.

**SITE RELATED LIQUID INGESTION DOSE COMMITMENT
FACTORS (A_i) FOR INDIVIDUAL NUCLIDES**

Ai factors for Adult age group by nuclide.
Waterford Steam Electric Station Unit III
Discharge point : 40 Arpent Canal
Dilution Factor DW = 1.0

Nuclide	Organ Dose Conversion Factors						
	Bone	Liver	T. Body	Thyroid	Kidney	Lung	GI-LLI
Ho-166m	1.62e+01	5.05e+00	3.83e+00	0.00e+00	7.54e+00	0.00e+00	1.53e+03
W-181	2.85e+01	9.28e+00	9.94e-01	0.00e+00	0.00e+00	0.00e+00	1.06e+03
W-185	1.16e+03	3.88e+02	4.08e+01	0.00e+00	0.00e+00	0.00e+00	4.48e+04
W-187	2.96e+02	2.47e+02	8.65e+01	0.00e+00	0.00e+00	0.00e+00	8.10e+04
Pb-210	3.66e+06	1.05e+06	1.30e+05	0.00e+00	2.94e+06	0.00e+00	5.36e+02
Bi-210	1.66e+01	1.14e+02	9.48e+00	0.00e+00	1.38e+03	0.00e+00	1.71e+03
Po-210	4.26e+05	9.05e+05	1.03e+05	0.00e+00	3.02e+06	0.00e+00	7.61e+04
Ra-223	5.95e+05	9.16e+02	1.19e+05	0.00e+00	2.60e+04	0.00e+00	3.84e+04
Ra-224	1.93e+05	4.67e+02	3.87e+04	0.00e+00	1.32e+04	0.00e+00	4.07e+04
Ra-225	7.85e+05	9.31e+02	1.57e+05	0.00e+00	2.65e+04	0.00e+00	3.66e+04
Ra-226	3.61e+07	6.87e+02	2.63e+07	0.00e+00	1.95e+04	0.00e+00	3.97e+04
Ra-228	1.34e+07	3.73e+02	1.45e+07	0.00e+00	1.06e+04	0.00e+00	6.75e+03
Ac-225	2.63e+02	3.63e+02	1.77e+01	0.00e+00	4.13e+01	0.00e+00	2.44e+04
Ac-227	1.12e+05	1.48e+04	6.64e+03	0.00e+00	4.79e+03	0.00e+00	4.90e+03
Th-227	9.84e+02	1.78e+01	2.84e+01	0.00e+00	1.01e+02	0.00e+00	3.88e+04
Th-228	3.56e+04	6.03e+02	1.21e+03	0.00e+00	3.35e+03	0.00e+00	4.04e+04
Th-229	9.77e+05	2.79e+04	1.62e+04	0.00e+00	1.35e+05	0.00e+00	5.61e+03
Th-230	1.48e+05	8.40e+03	4.09e+03	0.00e+00	4.06e+04	0.00e+00	4.32e+03
Th-232	1.65e+05	7.18e+03	1.08e+02	0.00e+00	3.46e+04	0.00e+00	3.68e+03
Th-234	5.75e+00	3.38e-01	1.66e-01	0.00e+00	1.92e+00	0.00e+00	8.12e+03
Pa-231	1.08e+05	4.06e+03	4.19e+03	0.00e+00	2.28e+04	0.00e+00	1.89e+03
Pa-233	1.39e-01	2.79e-02	2.40e-02	0.00e+00	1.05e-01	0.00e+00	4.32e+02
U-232	1.98e+04	0.00e+00	1.41e+03	0.00e+00	2.14e+03	0.00e+00	3.25e+02
U-233	4.17e+03	0.00e+00	2.53e+02	0.00e+00	9.72e+02	0.00e+00	3.00e+02
U-234	4.00e+03	0.00e+00	2.48e+02	0.00e+00	9.53e+02	0.00e+00	2.94e+02
U-235	3.84e+03	0.00e+00	2.33e+02	0.00e+00	8.95e+02	0.00e+00	3.74e+02
U-236	3.84e+03	0.00e+00	2.37e+02	0.00e+00	9.15e+02	0.00e+00	2.76e+02
U-237	2.64e-01	0.00e+00	7.04e-02	0.00e+00	1.09e+00	0.00e+00	9.29e+01
U-238	3.67e+03	0.00e+00	2.17e+02	0.00e+00	8.38e+02	0.00e+00	2.63e+02
Np-237	3.02e+04	2.15e+03	1.33e+03	0.00e+00	9.86e+03	0.00e+00	1.90e+03

Conversion factors are in units of mrem/hr per uCi/ml.

**SITE RELATED LIQUID INGESTION DOSE COMMITMENT
FACTORS (A_i) FOR INDIVIDUAL NUCLIDES**

A_i factors for Adult age group by nuclide.
Waterford Steam Electric Station Unit III
Discharge point : 40 Arpent Canal
Dilution Factor DW = 1.0

Nuclide	Organ Dose Conversion Factors						
	Bone	Liver	T. Body	Thyroid	Kidney	Lung	GI-LLI
Np-238	3.28e-01	8.83e-03	5.10e-03	0.00e+00	2.99e-02	0.00e+00	8.21e+02
Np-239	2.85e-02	2.80e-03	1.54e-03	0.00e+00	8.74e-03	0.00e+00	5.75e+02
Pu-238	5.28e+03	6.69e+02	1.43e+02	0.00e+00	6.13e+02	0.00e+00	6.12e+02
Pu-239	6.07e+03	7.30e+02	1.60e+02	0.00e+00	6.80e+02	0.00e+00	5.58e+02
Pu-240	6.07e+03	7.29e+02	1.60e+02	0.00e+00	6.79e+02	0.00e+00	5.68e+02
Pu-241	1.32e+02	6.24e+00	2.78e+00	0.00e+00	1.28e+01	0.00e+00	1.17e+01
Pu-242	5.63e+03	7.03e+02	1.54e+02	0.00e+00	6.54e+02	0.00e+00	5.47e+02
Pu-244	6.57e+03	8.05e+02	1.77e+02	0.00e+00	7.50e+02	0.00e+00	8.15e+02
Am-241	4.52e+04	4.22e+04	3.24e+03	0.00e+00	2.44e+04	0.00e+00	4.44e+03
Am-242m	4.55e+04	3.97e+04	3.25e+03	0.00e+00	2.42e+04	0.00e+00	5.59e+03
Am-243	4.51e+04	4.13e+04	3.17e+03	0.00e+00	2.39e+04	0.00e+00	5.21e+03
Cm-242	1.23e+03	1.31e+03	8.20e+01	0.00e+00	3.72e+02	0.00e+00	4.74e+03
Cm-243	3.59e+04	3.29e+04	2.24e+03	0.00e+00	1.05e+04	0.00e+00	4.67e+03
Cm-244	2.73e+04	2.56e+04	1.72e+03	0.00e+00	8.02e+03	0.00e+00	4.52e+03
Cm-245	5.61e+04	4.89e+04	3.45e+03	0.00e+00	1.61e+04	0.00e+00	4.21e+03
Cm-246	5.57e+04	4.88e+04	3.44e+03	0.00e+00	1.60e+04	0.00e+00	4.14e+03
Cm-247	5.43e+04	4.81e+04	3.39e+03	0.00e+00	1.58e+04	0.00e+00	5.44e+03
Cm-248	4.51e+05	3.97e+05	2.79e+04	0.00e+00	1.30e+05	0.00e+00	8.80e+04
Cf-252	1.56e+04	0.00e+00	3.76e+02	0.00e+00	0.00e+00	0.00e+00	1.72e+04

Conversion factors are in units of mrem/hr per uCi/ml.

DOSE FACTORS FOR EXPOSURE TO A SEMI-INFINITE CLOUD OF NOBLE GASES

Nuclide	(N _i) β-air*	(L _i) β-Skin**	(M _i) γ-air*	(K _i) γ-Body**
Kr-83m	2.88E+02	---	1.93E+01	7.56E-02
Kr-85m	1.97E+03	1.46E+03	1.23E+03	1.17E+03
Kr-85	1.95E+03	1.34E+03	1.72E+01	1.61E+01
Kr-87	1.03E+04	9.73E+03	6.17E+03	5.92E+03
Kr-88	2.93E+03	2.37E+03	1.52E+04	1.47E+04
Kr-89	1.06E+04	1.01E+04	1.73E+04	1.66E+04
Kr-90	7.83E+03	7.29E+03	1.63E+04	1.56E+04
Xe-131m	1.11E+03	4.76E+02	1.56E+02	9.15E+01
Xe-133m	1.48E+03	9.94E+02	3.27E+02	2.51E+02
Xe-133	1.05E+03	3.06E+02	3.53E+02	2.94E+02
Xe-135m	7.39E+02	7.11E+02	3.36E+03	3.12E+03
Xe-135	2.46E+03	1.86E+03	1.92E+03	1.81E+03
Xe-137	1.27E+04	1.22E+04	1.51E+03	1.42E+03
Xe-138	4.75E+03	4.13E+03	9.21E+03	8.83E+03
Ar-41	3.28E+03	2.69E+03	9.30E+03	8.84E+03

$$* \frac{mrad - m^3}{\mu Ci - yr}$$

$$** \frac{mrem - m^3}{\mu Ci - yr}$$

Extracted from Table B-1 of Regulatory Guide 1.109, Revision 1, 1977
multiplied by 1E6 pCi/μCi.

**INHALATION PATHWAY DOSES DUE TO
RADIONUCLIDES OTHER THAN NOBLE GASES, R_i**

R_i factors for Adult age group by nuclide.
Waterford Steam Electric Station
Pathway : Gaseous Release Inhalation Pathway R_i

Nuclide	Organ Dose Conversion Factors						
	Bone	Liver	T. Body	Thyroid	Kidney	Lung	GI-LLI
H-3	0.00e+00	7.18e+02	7.18e+02	7.18e+02	7.18e+02	7.18e+02	7.18e+02
Be-10	1.58e+06	2.45e+05	3.97e+04	0.00e+00	0.00e+00	1.78e+06	1.34e+05
C-14	1.82e+04	3.41e+03	3.41e+03	3.41e+03	3.41e+03	3.41e+03	3.41e+03
N-13	5.02e+01	5.02e+01	5.02e+01	5.02e+01	5.02e+01	5.02e+01	5.02e+01
F-18	3.77e+03	0.00e+00	4.15e+02	0.00e+00	0.00e+00	0.00e+00	7.39e+01
Na-22	1.04e+05	1.04e+05	1.04e+05	1.04e+05	1.04e+05	1.04e+05	1.04e+05
Na-24	1.02e+04	1.02e+04	1.02e+04	1.02e+04	1.02e+04	1.02e+04	1.02e+04
P-32	1.32e+06	7.71e+04	5.01e+04	0.00e+00	0.00e+00	0.00e+00	8.64e+04
Ca-41	3.06e+05	0.00e+00	3.30e+04	0.00e+00	0.00e+00	3.06e+04	2.29e+03
Sc-46	4.41e+05	8.56e+05	2.49e+05	0.00e+00	7.99e+05	0.00e+00	2.58e+05
Cr-51	0.00e+00	0.00e+00	1.00e+02	5.95e+01	2.28e+01	1.44e+04	3.32e+03
Mn-54	0.00e+00	3.96e+04	6.30e+03	0.00e+00	9.84e+03	1.40e+06	7.74e+04
Mn-56	0.00e+00	1.24e+00	1.83e-01	0.00e+00	1.30e+00	9.44e+03	2.02e+04
Fe-55	2.46e+04	1.70e+04	3.94e+03	0.00e+00	0.00e+00	7.21e+04	6.03e+03
Fe-59	1.18e+04	2.78e+04	1.06e+04	0.00e+00	0.00e+00	1.02e+06	1.88e+05
Co-57	0.00e+00	6.92e+02	6.71e+02	0.00e+00	0.00e+00	3.70e+05	3.14e+04
Co-58	0.00e+00	1.58e+03	2.07e+03	0.00e+00	0.00e+00	9.28e+05	1.06e+05
Co-60	0.00e+00	1.15e+04	1.48e+04	0.00e+00	0.00e+00	5.97e+06	2.85e+05
Ni-59	3.25e+04	1.17e+04	5.42e+03	0.00e+00	0.00e+00	6.56e+04	4.89e+03
Ni-63	4.32e+05	3.14e+04	1.45e+04	0.00e+00	0.00e+00	1.78e+05	1.34e+04
Ni-65	1.54e+00	2.10e-01	9.12e-02	0.00e+00	0.00e+00	5.60e+03	1.23e+04
Cu-64	0.00e+00	1.46e+00	6.15e-01	0.00e+00	4.62e+00	6.78e+03	4.90e+04
Zn-65	3.24e+04	1.03e+05	4.66e+04	0.00e+00	6.90e+04	8.64e+05	5.34e+04
Zn-69	3.38e-02	6.51e-02	4.52e-03	0.00e+00	4.22e-02	9.20e+02	1.63e+01
Zn-69m	8.16e+00	1.96e+01	1.79e+00	0.00e+00	1.18e+01	1.90e+04	1.37e+05
Se-79	0.00e+00	3.06e+03	4.87e+02	0.00e+00	4.55e+03	3.58e+05	2.66e+04
Br-82	0.00e+00	0.00e+00	1.35e+04	0.00e+00	0.00e+00	0.00e+00	1.04e+04
Br-83	0.00e+00	0.00e+00	2.41e+02	0.00e+00	0.00e+00	0.00e+00	2.32e+02
Br-84	0.00e+00	0.00e+00	3.13e+02	0.00e+00	0.00e+00	0.00e+00	1.64e-03
Br-85	0.00e+00	0.00e+00	1.28e+01	0.00e+00	0.00e+00	0.00e+00	0.00e+00

Conversion factors are in units of mrem/yr per uCi/cubic meter.

**INHALATION PATHWAY DOSES DUE TO
RADIONUCLIDES OTHER THAN NOBLE GASES, R_i**

R_i factors for Adult age group by nuclide.
Waterford Steam Electric Station
Pathway : Gaseous Release Inhalation Pathway R_i

Nuclide	Organ Dose Conversion Factors						
	Bone	Liver	T. Body	Thyroid	Kidney	Lung	GI-LLI
Rb-86	0.00e+00	1.35e+05	5.90e+04	0.00e+00	0.00e+00	0.00e+00	1.66e+04
Rb-87	0.00e+00	7.89e+04	2.57e+04	0.00e+00	0.00e+00	0.00e+00	2.30e+03
Rb-88	0.00e+00	3.87e+02	1.93e+02	0.00e+00	0.00e+00	0.00e+00	3.34e-09
Rb-89	0.00e+00	2.56e+02	1.70e+02	0.00e+00	0.00e+00	0.00e+00	9.28e-12
Sr-89	3.04e+05	0.00e+00	8.72e+03	0.00e+00	0.00e+00	1.40e+06	3.50e+05
Sr-90	2.87e+07	0.00e+00	5.77e+05	0.00e+00	0.00e+00	9.60e+06	7.22e+05
Sr-91	6.19e+01	0.00e+00	2.50e+00	0.00e+00	0.00e+00	3.65e+04	1.91e+05
Sr-92	6.74e+00	0.00e+00	2.91e-01	0.00e+00	0.00e+00	1.65e+04	4.30e+04
Y-90	2.09e+03	0.00e+00	5.61e+01	0.00e+00	0.00e+00	1.70e+05	5.06e+05
Y-91	4.62e+05	0.00e+00	1.24e+04	0.00e+00	0.00e+00	1.70e+06	3.85e+05
Y-91m	2.61e-01	0.00e+00	1.02e-02	0.00e+00	0.00e+00	1.92e+03	1.33e+00
Y-92	1.03e+01	0.00e+00	3.02e-01	0.00e+00	0.00e+00	1.57e+04	7.35e+04
Y-93	9.44e+01	0.00e+00	2.61e+00	0.00e+00	0.00e+00	4.85e+04	4.22e+05
Zr-93	4.18e+05	2.34e+04	1.10e+04	0.00e+00	8.88e+04	1.70e+05	1.21e+04
Zr-95	1.07e+05	3.44e+04	2.33e+04	0.00e+00	5.42e+04	1.77e+06	1.50e+05
Zr-97	9.68e+01	1.96e+01	9.04e+00	0.00e+00	2.97e+01	7.87e+04	5.23e+05
Nb-93m	2.48e+05	8.08e+04	1.99e+04	0.00e+00	9.28e+04	2.49e+05	1.90e+04
Nb-95	1.41e+04	7.82e+03	4.21e+03	0.00e+00	7.74e+03	5.05e+05	1.04e+05
Nb-97	2.22e-01	5.62e-02	2.05e-02	0.00e+00	6.54e-02	2.40e+03	2.42e+02
Mo-93	0.00e+00	9.36e+03	2.54e+02	0.00e+00	2.84e+03	4.09e+05	3.03e+04
Mo-99	0.00e+00	1.21e+02	2.30e+01	0.00e+00	2.91e+02	9.12e+04	2.48e+05
Tc-101	4.18e-05	6.02e-05	5.90e-04	0.00e+00	1.08e-03	3.99e+02	1.09e-11
Tc-99	2.50e+02	3.71e+02	1.00e+02	0.00e+00	4.68e+03	8.08e+05	6.03e+04
Tc-99m	1.03e-03	2.91e-03	3.70e-02	0.00e+00	4.42e-02	7.64e+02	4.16e+03
Ru-103	1.53e+03	0.00e+00	6.58e+02	0.00e+00	5.83e+03	5.05e+05	1.10e+05
Ru-105	7.90e-01	0.00e+00	3.11e-01	0.00e+00	1.02e+00	1.10e+04	4.82e+04
Ru-106	6.91e+04	0.00e+00	8.72e+03	0.00e+00	1.34e+05	9.36e+06	9.12e+05
Rh-105	7.39e+00	5.38e+00	3.54e+00	0.00e+00	2.29e+01	1.93e+04	8.72e+04
Pd-107	0.00e+00	6.62e+02	4.70e+01	0.00e+00	5.26e+03	7.58e+04	5.65e+03
Pd-109	0.00e+00	3.70e+00	9.28e-01	0.00e+00	1.88e+01	1.48e+04	1.22e+05

Conversion factors are in units of mrem/yr per uCi/cubic meter.

**INHALATION PATHWAY DOSES DUE TO
RADIONUCLIDES OTHER THAN NOBLE GASES, R_i**

Ri factors for Adult age group by nuclide.
Waterford Steam Electric Station
Pathway : Gaseous Release Inhalation Pathway Ri

Nuclide	Organ Dose Conversion Factors						
	Bone	Liver	T. Body	Thyroid	Kidney	Lung	GI-LLI
Ag-110m	1.08e+04	1.00e+04	5.94e+03	0.00e+00	1.97e+04	4.63e+06	3.02e+05
Ag-111	3.40e+02	1.42e+02	7.10e+01	0.00e+00	4.59e+02	1.86e+05	2.23e+05
Cd-113m	0.00e+00	1.23e+06	3.98e+04	0.00e+00	1.37e+06	1.66e+06	1.27e+05
Cd-115m	0.00e+00	1.97e+05	6.36e+03	0.00e+00	1.58e+05	1.41e+06	3.84e+05
Sn-123	2.42e+05	5.34e+03	7.86e+03	4.54e+03	0.00e+00	2.30e+06	3.14e+05
Sn-125	9.28e+03	2.50e+02	5.62e+02	2.07e+02	0.00e+00	5.90e+05	5.45e+05
Sn-126	1.26e+06	3.34e+04	4.80e+04	9.84e+03	0.00e+00	9.36e+06	1.27e+05
Sb-124	3.12e+04	5.89e+02	1.24e+04	7.55e+01	0.00e+00	2.48e+06	4.06e+05
Sb-125	5.34e+04	5.95e+02	1.26e+04	5.40e+01	0.00e+00	1.74e+06	1.01e+05
Sb-126	3.60e+03	7.30e+01	1.30e+03	2.20e+01	0.00e+00	7.66e+05	4.81e+05
Sb-127	2.64e+02	5.78e+00	1.02e+02	3.18e+00	0.00e+00	1.64e+05	3.02e+05
Te-125m	3.42e+03	1.58e+03	4.67e+02	1.05e+03	1.24e+04	3.14e+05	7.06e+04
Te-127	1.40e+00	6.42e-01	3.10e-01	1.06e+00	5.10e+00	6.51e+03	5.74e+04
Te-127m	1.26e+04	5.77e+03	1.57e+03	3.29e+03	4.58e+04	9.60e+05	1.50e+05
Te-129	4.98e-02	2.39e-02	1.24e-02	3.90e-02	1.87e-01	1.94e+03	1.57e+02
Te-129m	9.76e+03	4.67e+03	1.58e+03	3.44e+03	3.66e+04	1.16e+06	3.83e+05
Te-131	1.11e-02	5.95e-03	3.59e-03	9.36e-03	4.37e-02	1.39e+03	1.84e+01
Te-131m	6.99e+01	4.36e+01	2.90e+01	5.50e+01	3.09e+02	1.46e+05	5.56e+05
Te-132	2.60e+02	2.15e+02	1.62e+02	1.90e+02	1.46e+03	2.88e+05	5.10e+05
Te-133m	5.79e-02	4.32e-02	3.34e-02	5.02e-02	2.99e-01	4.41e+03	6.12e+01
Te-134	3.07e-02	2.58e-02	1.26e-02	2.75e-02	1.74e-01	3.47e+03	2.38e-01
I-129	1.98e+04	1.69e+04	5.53e+04	4.43e+07	3.62e+04	0.00e+00	1.78e+03
I-130	4.58e+03	1.34e+04	5.28e+03	1.14e+06	2.09e+04	0.00e+00	7.69e+03
I-131	2.52e+04	3.58e+04	2.05e+04	1.19e+07	6.13e+04	0.00e+00	6.28e+03
I-132	1.16e+03	3.26e+03	1.16e+03	1.14e+05	5.18e+03	0.00e+00	4.06e+02
I-133	8.64e+03	1.48e+04	4.52e+03	2.15e+06	2.58e+04	0.00e+00	8.88e+03
I-134	6.44e+02	1.73e+03	6.15e+02	2.98e+04	2.75e+03	0.00e+00	1.01e+00
I-135	2.68e+03	6.98e+03	2.57e+03	4.48e+05	1.11e+04	0.00e+00	5.25e+03
Cs-134	3.73e+05	8.48e+05	7.28e+05	0.00e+00	2.87e+05	9.76e+04	1.04e+04
Cs-134m	1.27e+02	2.56e+02	1.38e+02	0.00e+00	1.46e+02	2.34e+01	6.34e+01

Conversion factors are in units of mrem/yr per uCi/cubic meter.

INHALATION PATHWAY DOSES DUE TO RADIONUCLIDES OTHER THAN NOBLE GASES, R_i

R_i factors for Adult age group by nuclide.
Waterford Steam Electric Station
Pathway : Gaseous Release Inhalation Pathway R_i

Nuclide	Organ Dose Conversion Factors						
	Bone	Liver	T. Body	Thyroid	Kidney	Lung	GI-LLI
Cs-135	1.17e+05	1.03e+05	4.79e+04	0.00e+00	4.09e+04	1.26e+04	1.69e+03
Cs-136	3.90e+04	1.46e+05	1.10e+05	0.00e+00	8.56e+04	1.20e+04	1.17e+04
Cs-137	4.78e+05	6.21e+05	4.28e+05	0.00e+00	2.22e+05	7.52e+04	8.40e+03
Cs-138	3.31e+02	6.21e+02	3.24e+02	0.00e+00	4.80e+02	4.86e+01	1.86e-03
Cs-139	2.05e+02	2.90e+02	1.11e+02	0.00e+00	2.44e+02	2.27e+01	4.39e-21
Ba-139	9.36e-01	6.66e-04	2.74e-02	0.00e+00	6.22e-04	3.76e+03	8.96e+02
Ba-140	3.90e+04	4.90e+01	2.57e+03	0.00e+00	1.67e+01	1.27e+06	2.18e+05
Ba-141	1.00e-01	7.53e-05	3.36e-03	0.00e+00	7.00e-05	1.94e+03	1.16e-07
Ba-142	2.63e-02	2.70e-05	1.66e-03	0.00e+00	2.29e-05	1.19e+03	1.57e-16
La-140	3.44e+02	1.74e+02	4.58e+01	0.00e+00	0.00e+00	1.36e+05	4.58e+05
La-141	4.27e+00	1.33e+00	2.17e-01	0.00e+00	0.00e+00	1.08e+04	5.85e+04
La-142	6.83e-01	3.10e-01	7.72e-02	0.00e+00	0.00e+00	6.33e+03	2.11e+03
Ce-141	1.99e+04	1.35e+04	1.53e+03	0.00e+00	6.26e+03	3.62e+05	1.20e+05
Ce-143	1.86e+02	1.38e+02	1.53e+01	0.00e+00	6.08e+01	7.98e+04	2.26e+05
Ce-144	3.43e+06	1.43e+06	1.84e+05	0.00e+00	8.48e+05	7.78e+06	8.16e+05
Pr-143	9.36e+03	3.75e+03	4.64e+02	0.00e+00	2.16e+03	2.81e+05	2.00e+05
Pr-144	3.01e-02	1.25e-02	1.53e-03	0.00e+00	7.05e-03	1.02e+03	2.15e-08
Nd-147	5.27e+03	6.10e+03	3.65e+02	0.00e+00	3.56e+03	2.21e+05	1.73e+05
Pm-147	6.70e+05	6.30e+04	2.55e+04	0.00e+00	1.19e+05	5.28e+05	4.43e+04
Pm-148	3.07e+03	5.10e+02	2.56e+02	0.00e+00	9.60e+02	3.13e+05	4.64e+05
Pm-148m	7.86e+04	2.03e+04	1.55e+04	0.00e+00	3.08e+04	1.71e+06	3.34e+05
Pm-149	2.75e+02	3.90e+01	1.59e+01	0.00e+00	7.35e+01	5.77e+04	2.00e+05
Pm-151	6.80e+01	1.14e+01	5.77e+00	0.00e+00	2.04e+01	3.15e+04	1.60e+05
Sm-151	6.87e+05	1.18e+05	2.84e+04	0.00e+00	1.33e+05	3.56e+05	2.60e+04
Sm-153	1.36e+02	1.14e+02	8.32e+00	0.00e+00	3.67e+01	3.31e+04	1.26e+05
Eu-152	1.90e+06	4.33e+05	3.81e+05	0.00e+00	2.68e+06	2.74e+06	1.27e+05
Eu-154	5.92e+06	7.28e+05	5.18e+05	0.00e+00	3.49e+06	4.67e+06	2.72e+05
Eu-155	8.08e+05	1.14e+05	7.37e+04	0.00e+00	5.27e+05	7.57e+05	4.76e+04
Eu-156	1.54e+04	1.18e+04	1.92e+03	0.00e+00	7.96e+03	6.85e+05	3.60e+05
Tb-160	1.77e+05	0.00e+00	2.20e+04	0.00e+00	7.28e+04	1.54e+06	2.14e+05

Conversion factors are in units of mrem/yr per uCi/cubic meter.

**INHALATION PATHWAY DOSES DUE TO
RADIONUCLIDES OTHER THAN NOBLE GASES, R_i**

R_i factors for Adult age group by nuclide.
Waterford Steam Electric Station
Pathway : Gaseous Release Inhalation Pathway R_i

Nuclide	Organ Dose Conversion Factors						
	Bone	Liver	T. Body	Thyroid	Kidney	Lung	GI-LLI
Ho-166m	2.70e+06	8.40e+05	6.40e+05	0.00e+00	1.26e+06	3.15e+06	1.27e+05
W-181	4.98e+01	1.62e+01	1.74e+00	0.00e+00	0.00e+00	1.37e+04	2.02e+03
W-185	1.56e+03	5.18e+02	5.45e+01	0.00e+00	0.00e+00	4.46e+05	8.56e+04
W-187	8.48e+00	7.08e+00	2.48e+00	0.00e+00	0.00e+00	2.90e+04	1.55e+05
Pb-210	2.11e+08	5.38e+07	6.70e+06	0.00e+00	1.70e+08	2.10e+08	1.21e+04
Bi-210	1.85e+03	1.27e+04	1.06e+03	0.00e+00	1.54e+05	8.88e+06	2.36e+05
Po-210	3.18e+06	6.88e+06	7.66e+05	0.00e+00	2.36e+07	2.51e+08	3.35e+05
Ra-223	1.44e+06	2.22e+03	2.88e+05	0.00e+00	6.28e+04	2.04e+08	2.27e+06
Ra-224	1.58e+05	3.82e+02	3.17e+04	0.00e+00	1.08e+04	7.02e+07	2.41e+06
Ra-225	2.40e+06	2.85e+03	4.79e+05	0.00e+00	8.08e+04	2.34e+08	2.17e+06
Ra-226	1.00e+09	1.91e+04	7.31e+08	0.00e+00	5.42e+05	9.36e+08	2.35e+06
Ra-228	3.53e+08	9.84e+03	3.82e+08	0.00e+00	2.78e+05	1.29e+09	4.00e+05
Ac-225	3.38e+06	4.66e+06	2.27e+05	0.00e+00	5.30e+05	1.77e+08	2.02e+06
Ac-227	1.84e+10	2.44e+09	1.09e+09	0.00e+00	7.86e+08	1.93e+09	4.06e+05
Th-227	1.74e+06	3.14e+04	5.00e+04	0.00e+00	1.78e+05	3.02e+08	2.67e+06
Th-228	1.60e+09	2.71e+07	5.42e+07	0.00e+00	1.51e+08	8.08e+09	2.79e+06
Th-229	1.21e+11	3.47e+09	2.01e+09	0.00e+00	1.70e+10	2.90e+10	3.86e+05
Th-230	1.83e+10	1.05e+09	5.09e+08	0.00e+00	5.12e+09	4.97e+09	2.98e+05
Th-232	2.05e+10	8.96e+08	7.23e+06	0.00e+00	4.38e+09	4.77e+09	2.54e+05
Th-234	1.30e+04	7.65e+02	3.76e+02	0.00e+00	4.33e+03	1.51e+06	5.62e+05
Pa-231	4.06e+10	1.53e+09	1.58e+09	0.00e+00	8.56e+09	4.60e+08	3.55e+05
Pa-233	9.68e+03	1.94e+03	1.67e+03	0.00e+00	7.32e+03	2.82e+05	8.16e+04
U-232	4.11e+08	0.00e+00	2.93e+07	0.00e+00	4.45e+07	1.78e+09	3.37e+05
U-233	8.72e+07	0.00e+00	5.28e+06	0.00e+00	2.03e+07	4.26e+08	3.11e+05
U-234	8.32e+07	0.00e+00	5.17e+06	0.00e+00	1.99e+07	4.18e+08	3.05e+05
U-235	8.00e+07	0.00e+00	4.86e+06	0.00e+00	1.87e+07	3.92e+08	3.87e+05
U-236	8.00e+07	0.00e+00	4.96e+06	0.00e+00	1.91e+07	4.00e+08	2.86e+05
U-237	2.94e+02	0.00e+00	7.82e+01	0.00e+00	1.21e+03	8.16e+04	9.60e+04
U-238	7.66e+07	0.00e+00	4.54e+06	0.00e+00	1.74e+07	3.66e+08	2.73e+05
Np-237	1.25e+10	8.00e+09	5.50e+08	0.00e+00	4.08e+09	4.18e+08	3.94e+05

Conversion factors are in units of mrem/yr per uCi/cubic meter.

**INHALATION PATHWAY DOSES DUE TO
RADIONUCLIDES OTHER THAN NOBLE GASES, R_i**

R_i factors for Adult age group by nuclide.
Waterford Steam Electric Station
Pathway : Gaseous Release Inhalation Pathway R_i

Nuclide	Organ Dose Conversion Factors						
	Bone	Liver	T. Body	Thyroid	Kidney	Lung	GI-LLI
Np-238	2.37e+03	5.76e+02	3.69e+01	0.00e+00	2.18e+02	8.16e+04	1.70e+05
Np-239	2.30e+02	2.03e+02	1.24e+01	0.00e+00	7.00e+01	3.76e+04	1.19e+05
Pu-238	1.14e+10	7.77e+09	5.52e+08	0.00e+00	2.37e+09	1.46e+09	3.62e+05
Pu-239	1.33e+10	8.56e+09	6.20e+08	0.00e+00	2.64e+09	1.38e+09	3.30e+05
Pu-240	1.32e+10	8.56e+09	6.18e+08	0.00e+00	2.63e+09	1.38e+09	3.37e+05
Pu-241	2.74e+08	6.95e+07	1.03e+07	0.00e+00	4.74e+07	1.22e+06	6.92e+03
Pu-242	1.22e+10	8.24e+09	5.97e+08	0.00e+00	2.54e+09	1.32e+09	3.24e+05
Pu-244	1.43e+10	9.44e+09	6.83e+08	0.00e+00	2.91e+09	1.51e+09	4.82e+05
Am-241	1.34e+10	9.04e+09	5.37e+08	0.00e+00	4.03e+09	4.85e+08	3.68e+05
Am-242m	1.36e+10	8.48e+09	5.38e+08	0.00e+00	4.01e+09	1.95e+08	4.63e+05
Am-243	1.34e+10	8.80e+09	5.26e+08	0.00e+00	3.96e+09	4.60e+08	4.32e+05
Cm-242	1.78e+08	1.42e+08	7.87e+06	0.00e+00	3.58e+07	3.14e+08	3.93e+05
Cm-243	8.80e+09	6.09e+09	3.69e+08	0.00e+00	1.72e+09	5.05e+08	3.87e+05
Cm-244	6.70e+09	4.70e+09	2.81e+08	0.00e+00	1.31e+09	4.85e+08	3.74e+05
Cm-245	1.39e+10	9.12e+09	5.71e+08	0.00e+00	2.66e+09	4.68e+08	3.49e+05
Cm-246	1.38e+10	9.12e+09	5.70e+08	0.00e+00	2.66e+09	4.77e+08	3.43e+05
Cm-247	1.34e+10	8.96e+09	5.62e+08	0.00e+00	2.62e+09	4.68e+08	4.50e+05
Cm-248	1.12e+11	7.41e+10	4.63e+09	0.00e+00	2.16e+10	3.86e+09	7.27e+06
Cf-252	4.34e+09	0.00e+00	1.86e+08	0.00e+00	0.00e+00	1.59e+09	1.42e+06

Conversion factors are in units of mrem/yr per uCi/cubic meter.

INHALATION PATHWAY DOSES DUE TO RADIONUCLIDES OTHER THAN NOBLE GASES, R_i

R_i factors for Teen age group by nuclide.
Waterford Steam Electric Station
Pathway : Gaseous Release Inhalation Pathway R_i

Nuclide	Organ Dose Conversion Factors						
	Bone	Liver	T. Body	Thyroid	Kidney	Lung	GI-LLI
H-3	0.00e+00	7.25e+02	7.25e+02	7.25e+02	7.25e+02	7.25e+02	7.25e+02
Be-10	2.22e+06	3.46e+05	5.67e+04	0.00e+00	0.00e+00	3.07e+06	1.42e+05
C-14	2.60e+04	4.87e+03	4.87e+03	4.87e+03	4.87e+03	4.87e+03	4.87e+03
N-13	6.92e+01	6.92e+01	6.92e+01	6.92e+01	6.92e+01	6.92e+01	6.92e+01
F-18	5.22e+03	0.00e+00	5.68e+02	0.00e+00	0.00e+00	0.00e+00	3.11e+02
Na-22	1.41e+05	1.41e+05	1.41e+05	1.41e+05	1.41e+05	1.41e+05	1.41e+05
Na-24	1.38e+04	1.38e+04	1.38e+04	1.38e+04	1.38e+04	1.38e+04	1.38e+04
P-32	1.89e+06	1.10e+05	7.16e+04	0.00e+00	0.00e+00	0.00e+00	9.28e+04
Ca-41	3.24e+05	0.00e+00	3.50e+04	0.00e+00	0.00e+00	8.08e+08	2.42e+03
Sc-46	5.79e+05	1.13e+06	3.34e+05	0.00e+00	1.08e+06	0.00e+00	2.38e+05
Cr-51	0.00e+00	0.00e+00	1.35e+02	7.50e+01	3.07e+01	2.10e+04	3.00e+03
Mn-54	0.00e+00	5.11e+04	8.40e+03	0.00e+00	1.27e+04	1.98e+06	6.68e+04
Mn-56	0.00e+00	1.70e+00	2.52e-01	0.00e+00	1.79e+00	1.52e+04	5.74e+04
Fe-55	3.34e+04	2.38e+04	5.54e+03	0.00e+00	0.00e+00	1.24e+05	6.39e+03
Fe-59	1.59e+04	3.70e+04	1.43e+04	0.00e+00	0.00e+00	1.53e+06	1.78e+05
Co-57	0.00e+00	9.44e+02	9.20e+02	0.00e+00	0.00e+00	5.86e+05	3.14e+04
Co-58	0.00e+00	2.07e+03	2.78e+03	0.00e+00	0.00e+00	1.34e+06	9.52e+04
Co-60	0.00e+00	1.51e+04	1.98e+04	0.00e+00	0.00e+00	8.72e+06	2.59e+05
Ni-59	4.35e+04	1.62e+04	7.39e+03	0.00e+00	0.00e+00	1.13e+05	5.18e+03
Ni-63	5.80e+05	4.34e+04	1.98e+04	0.00e+00	0.00e+00	3.07e+05	1.42e+04
Ni-65	2.18e+00	2.93e-01	1.27e-01	0.00e+00	0.00e+00	9.36e+03	3.67e+04
Cu-64	0.00e+00	2.03e+00	8.48e-01	0.00e+00	6.41e+00	1.11e+04	6.14e+04
Zn-65	3.86e+04	1.34e+05	6.24e+04	0.00e+00	8.64e+04	1.24e+06	4.66e+04
Zn-69	4.83e-02	9.20e-02	6.46e-03	0.00e+00	6.02e-02	1.58e+03	2.85e+02
Zn-69m	1.15e+01	2.71e+01	2.49e+00	0.00e+00	1.65e+01	3.14e+04	1.71e+05
Se-79	0.00e+00	4.34e+03	6.97e+02	0.00e+00	6.50e+03	6.17e+05	2.82e+04
Br-82	0.00e+00	0.00e+00	1.82e+04	0.00e+00	0.00e+00	0.00e+00	0.00e+00
Br-83	0.00e+00	0.00e+00	3.44e+02	0.00e+00	0.00e+00	0.00e+00	0.00e+00
Br-84	0.00e+00	0.00e+00	4.33e+02	0.00e+00	0.00e+00	0.00e+00	0.00e+00
Br-85	0.00e+00	0.00e+00	1.83e+01	0.00e+00	0.00e+00	0.00e+00	0.00e+00

Conversion factors are in units of mrem/yr per uCi/cubic meter.

INHALATION PATHWAY DOSES DUE TO RADIONUCLIDES OTHER THAN NOBLE GASES, R_i

R_i factors for Teen age group by nuclide.
Waterford Steam Electric Station
Pathway : Gaseous Release Inhalation Pathway R_i

Nuclide	Organ Dose Conversion Factors						
	Bone	Liver	T. Body	Thyroid	Kidney	Lung	GI-LLI
Rb-86	0.00e+00	1.90e+05	8.40e+04	0.00e+00	0.00e+00	0.00e+00	1.77e+04
Rb-87	0.00e+00	1.12e+05	3.66e+04	0.00e+00	0.00e+00	0.00e+00	2.44e+03
Rb-88	0.00e+00	5.46e+02	2.72e+02	0.00e+00	0.00e+00	0.00e+00	2.92e-05
Rb-89	0.00e+00	3.52e+02	2.33e+02	0.00e+00	0.00e+00	0.00e+00	3.38e-07
Sr-89	4.34e+05	0.00e+00	1.25e+04	0.00e+00	0.00e+00	2.42e+06	3.71e+05
Sr-90	3.31e+07	0.00e+00	6.66e+05	0.00e+00	0.00e+00	1.65e+07	7.65e+05
Sr-91	8.80e+01	0.00e+00	3.51e+00	0.00e+00	0.00e+00	6.07e+04	2.59e+05
Sr-92	9.52e+00	0.00e+00	4.06e-01	0.00e+00	0.00e+00	2.74e+04	1.19e+05
Y-90	2.98e+03	0.00e+00	8.00e+01	0.00e+00	0.00e+00	2.93e+05	5.59e+05
Y-91	6.61e+05	0.00e+00	1.77e+04	0.00e+00	0.00e+00	2.94e+06	4.09e+05
Y-91m	3.70e-01	0.00e+00	1.42e-02	0.00e+00	0.00e+00	3.20e+03	3.02e+01
Y-92	1.47e+01	0.00e+00	4.29e-01	0.00e+00	0.00e+00	2.68e+04	1.65e+05
Y-93	1.35e+02	0.00e+00	3.72e+00	0.00e+00	0.00e+00	8.32e+04	5.79e+05
Zr-93	5.46e+05	2.70e+04	1.47e+04	0.00e+00	9.28e+04	2.94e+05	1.28e+04
Zr-95	1.46e+05	4.58e+04	3.15e+04	0.00e+00	6.74e+04	2.69e+06	1.49e+05
Zr-97	1.38e+02	2.72e+01	1.26e+01	0.00e+00	4.12e+01	1.30e+05	6.30e+05
Nb-93m	3.31e+05	1.09e+05	2.73e+04	0.00e+00	1.27e+05	4.29e+05	2.02e+04
Nb-95	1.86e+04	1.03e+04	5.66e+03	0.00e+00	1.00e+04	7.51e+05	9.68e+04
Nb-97	3.14e-01	7.78e-02	2.84e-02	0.00e+00	9.12e-02	3.93e+03	2.17e+03
Mo-93	0.00e+00	1.33e+04	3.62e+02	0.00e+00	4.05e+03	7.05e+05	3.19e+04
Mo-99	0.00e+00	1.69e+02	3.22e+01	0.00e+00	4.11e+02	1.54e+05	2.69e+05
Tc-101	5.92e-05	8.40e-05	8.24e-04	0.00e+00	1.52e-03	6.67e+02	8.72e-07
Tc-99	3.58e+02	5.26e+02	1.43e+02	0.00e+00	6.68e+03	1.39e+06	6.39e+04
Tc-99m	1.38e-03	3.86e-03	4.99e-02	0.00e+00	5.76e-02	1.15e+03	6.13e+03
Ru-103	2.10e+03	0.00e+00	8.96e+02	0.00e+00	7.43e+03	7.83e+05	1.09e+05
Ru-105	1.12e+00	0.00e+00	4.34e-01	0.00e+00	1.41e+00	1.82e+04	9.04e+04
Ru-106	9.84e+04	0.00e+00	1.24e+04	0.00e+00	1.90e+05	1.61e+07	9.60e+05
Rh-105	1.06e+01	7.58e+00	4.99e+00	0.00e+00	3.23e+01	3.27e+04	9.84e+04
Pd-107	0.00e+00	9.36e+02	6.71e+01	0.00e+00	7.51e+03	1.30e+05	5.99e+03
Pd-109	0.00e+00	5.25e+00	1.33e+00	0.00e+00	2.69e+01	2.55e+04	1.57e+05

Conversion factors are in units of mrem/yr per uCi/cubic meter.

INHALATION PATHWAY DOSES DUE TO RADIONUCLIDES OTHER THAN NOBLE GASES, R_i

R_i factors for Teen age group by nuclide.
Waterford Steam Electric Station
Pathway : Gaseous Release Inhalation Pathway R_i

Nuclide	Organ Dose Conversion Factors						
	Bone	Liver	T. Body	Thyroid	Kidney	Lung	GI-LLI
Ag-110m	1.38e+04	1.31e+04	7.99e+03	0.00e+00	2.50e+04	6.75e+06	2.73e+05
Ag-111	4.86e+02	2.02e+02	1.01e+02	0.00e+00	6.54e+02	3.20e+05	2.40e+05
Cd-113m	0.00e+00	1.74e+06	5.68e+04	0.00e+00	1.94e+06	2.87e+06	1.34e+05
Cd-115m	0.00e+00	2.78e+05	9.12e+03	0.00e+00	2.26e+05	2.42e+06	4.08e+05
Sn-123	3.45e+05	7.55e+03	1.12e+04	6.04e+03	0.00e+00	3.97e+06	3.33e+05
Sn-125	1.33e+04	3.54e+02	7.99e+02	2.76e+02	0.00e+00	1.01e+06	5.83e+05
Sn-126	1.74e+06	4.31e+04	6.59e+04	1.14e+04	0.00e+00	1.38e+07	1.34e+05
Sb-124	4.30e+04	7.94e+02	1.68e+04	9.76e+01	0.00e+00	3.85e+06	3.98e+05
Sb-125	7.38e+04	8.08e+02	1.72e+04	7.04e+01	0.00e+00	2.74e+06	9.92e+04
Sb-126	4.95e+03	1.02e+02	1.78e+03	2.80e+01	0.00e+00	1.24e+06	4.81e+05
Sb-127	3.71e+02	7.94e+00	1.40e+02	4.17e+00	0.00e+00	2.65e+05	3.15e+05
Te-125m	4.88e+03	2.24e+03	6.67e+02	1.40e+03	0.00e+00	5.36e+05	7.50e+04
Te-127	2.01e+00	9.12e-01	4.42e-01	1.42e+00	7.28e+00	1.12e+04	8.08e+04
Te-127m	1.80e+04	8.16e+03	2.18e+03	4.38e+03	6.54e+04	1.66e+06	1.59e+05
Te-129	7.10e-02	3.38e-02	1.76e-02	5.18e-02	2.66e-01	3.30e+03	1.62e+03
Te-129m	1.39e+04	6.58e+03	2.25e+03	4.58e+03	5.19e+04	1.98e+06	4.05e+05
Te-131	1.58e-02	8.32e-03	5.04e-03	1.24e-02	6.18e-02	2.34e+03	1.51e+01
Te-131m	9.84e+01	6.01e+01	4.02e+01	7.25e+01	4.39e+02	2.38e+05	6.21e+05
Te-132	3.60e+02	2.90e+02	2.19e+02	2.46e+02	1.95e+03	4.49e+05	4.63e+05
Te-133m	8.08e-02	5.86e-02	4.57e-02	6.54e-02	4.06e-01	6.97e+03	9.84e+02
Te-134	4.25e-02	3.48e-02	2.91e-02	3.57e-02	2.33e-01	5.40e+03	1.10e+01
I-129	2.82e+04	2.35e+04	3.92e+04	2.93e+07	4.21e+04	0.00e+00	1.83e+03
I-130	6.24e+03	1.79e+04	7.17e+03	1.49e+06	2.75e+04	0.00e+00	9.12e+03
I-131	3.54e+04	4.91e+04	2.64e+04	1.46e+07	8.40e+04	0.00e+00	6.49e+03
I-132	1.59e+03	4.38e+03	1.58e+03	1.51e+05	6.92e+03	0.00e+00	1.27e+03
I-133	1.22e+04	2.05e+04	6.22e+03	2.92e+06	3.59e+04	0.00e+00	1.03e+04
I-134	8.88e+02	2.32e+03	8.40e+02	3.95e+04	3.66e+03	0.00e+00	2.04e+01
I-135	3.70e+03	9.44e+03	3.49e+03	6.21e+05	1.49e+04	0.00e+00	6.95e+03
Cs-134	5.02e+05	1.13e+06	5.49e+05	0.00e+00	3.75e+05	1.46e+05	9.76e+03
Cs-134m	1.76e+02	3.48e+02	1.88e+02	0.00e+00	2.03e+02	3.65e+01	1.62e+02

Conversion factors are in units of mrem/yr per uCi/cubic meter.

**INHALATION PATHWAY DOSES DUE TO
RADIONUCLIDES OTHER THAN NOBLE GASES, R_i**

R_i factors for Teen age group by nuclide.
Waterford Steam Electric Station
Pathway : Gaseous Release Inhalation Pathway R_i

Nuclide	Organ Dose Conversion Factors						
	Bone	Liver	T. Body	Thyroid	Kidney	Lung	GI-LLI
Cs-135	1.66e+05	1.46e+05	3.58e+04	0.00e+00	5.84e+04	2.16e+04	1.78e+03
Cs-136	5.15e+04	1.94e+05	1.37e+05	0.00e+00	1.10e+05	1.78e+04	1.09e+04
Cs-137	6.70e+05	8.48e+05	3.11e+05	0.00e+00	3.04e+05	1.21e+05	8.48e+03
Cs-138	4.66e+02	8.56e+02	4.46e+02	0.00e+00	6.62e+02	7.87e+01	2.70e-01
Cs-139	2.92e+02	4.10e+02	1.58e+02	0.00e+00	3.47e+02	3.89e+01	1.33e-13
Ba-139	1.34e+00	9.44e-04	3.90e-02	0.00e+00	8.88e-04	6.46e+03	6.45e+03
Ba-140	5.47e+04	6.70e+01	3.52e+03	0.00e+00	2.28e+01	2.03e+06	2.29e+05
Ba-141	1.42e-01	1.06e-04	4.74e-03	0.00e+00	9.84e-05	3.29e+03	7.46e-04
Ba-142	3.70e-02	3.70e-05	2.27e-03	0.00e+00	3.14e-05	1.91e+03	4.79e-10
La-140	4.79e+02	2.36e+02	6.26e+01	0.00e+00	0.00e+00	2.14e+05	4.87e+05
La-141	6.10e+00	1.88e+00	3.10e-01	0.00e+00	0.00e+00	1.85e+04	1.23e+05
La-142	9.60e-01	4.25e-01	1.06e-01	0.00e+00	0.00e+00	1.02e+04	1.20e+04
Ce-141	2.84e+04	1.90e+04	2.17e+03	0.00e+00	8.88e+03	6.14e+05	1.26e+05
Ce-143	2.66e+02	1.94e+02	2.16e+01	0.00e+00	8.64e+01	1.30e+05	2.55e+05
Ce-144	4.89e+06	2.02e+06	2.62e+05	0.00e+00	1.21e+06	1.34e+07	8.64e+05
Pr-143	1.34e+04	5.31e+03	6.62e+02	0.00e+00	3.09e+03	4.83e+05	2.14e+05
Pr-144	4.30e-02	1.76e-02	2.18e-03	0.00e+00	1.01e-02	1.75e+03	2.35e-04
Nd-147	7.86e+03	8.56e+03	5.13e+02	0.00e+00	5.02e+03	3.72e+05	1.82e+05
Pm-147	9.20e+05	8.80e+04	3.60e+04	0.00e+00	1.68e+05	9.12e+05	4.70e+04
Pm-148	4.35e+03	7.10e+02	3.58e+02	0.00e+00	1.28e+03	5.22e+05	4.91e+05
Pm-148m	1.06e+05	2.68e+04	2.10e+04	0.00e+00	4.06e+04	2.56e+06	3.28e+05
Pm-149	3.93e+02	5.51e+01	2.27e+01	0.00e+00	1.05e+02	9.92e+04	2.23e+05
Pm-151	9.60e+01	1.59e+01	8.08e+00	0.00e+00	2.86e+01	5.25e+04	1.82e+05
Sm-151	8.56e+05	1.68e+05	3.89e+04	0.00e+00	1.82e+05	6.14e+05	2.82e+04
Sm-153	1.94e+02	1.61e+02	1.18e+01	0.00e+00	5.25e+01	5.69e+04	1.42e+05
Eu-152	2.37e+06	5.75e+05	5.04e+05	0.00e+00	2.67e+06	4.01e+06	1.08e+05
Eu-154	7.54e+06	9.84e+05	6.88e+05	0.00e+00	4.35e+06	7.30e+06	2.67e+05
Eu-155	1.60e+06	1.57e+05	9.68e+04	0.00e+00	6.12e+05	1.21e+07	4.78e+05
Eu-156	2.16e+04	1.62e+04	2.64e+03	0.00e+00	1.09e+04	1.10e+06	3.65e+05
Tb-160	2.43e+05	0.00e+00	3.03e+04	0.00e+00	9.60e+04	2.38e+06	2.08e+05

Conversion factors are in units of mrem/yr per uCi/cubic meter.

INHALATION PATHWAY DOSES DUE TO RADIONUCLIDES OTHER THAN NOBLE GASES, R_i

R_i factors for Teen age group by nuclide.
Waterford Steam Electric Station
Pathway : Gaseous Release Inhalation Pathway R_i

Nuclide	Organ Dose Conversion Factors						
	Bone	Liver	T. Body	Thyroid	Kidney	Lung	GI-LLI
Ho-166m	3.52e+06	1.09e+06	7.90e+05	0.00e+00	1.60e+06	4.99e+06	1.34e+05
W-181	7.12e+01	2.30e+01	2.41e+00	0.00e+00	0.00e+00	2.36e+04	2.15e+03
W-185	2.22e+03	7.34e+02	7.78e+01	0.00e+00	0.00e+00	7.68e+05	9.12e+04
W-187	1.20e+01	9.76e+00	3.43e+00	0.00e+00	0.00e+00	4.74e+04	1.77e+05
Pb-210	2.47e+08	6.62e+07	8.56e+06	0.00e+00	2.36e+08	3.62e+08	1.28e+04
Bi-210	2.64e+03	1.81e+04	1.51e+03	0.00e+00	2.19e+05	1.53e+07	2.55e+05
Po-210	4.54e+06	9.76e+06	1.10e+06	0.00e+00	3.37e+07	4.33e+08	3.56e+05
Ra-223	2.06e+06	3.14e+03	4.11e+05	0.00e+00	8.96e+04	3.51e+08	2.43e+06
Ra-224	2.26e+05	5.42e+02	4.52e+04	0.00e+00	1.54e+04	1.21e+08	2.63e+06
Ra-225	3.42e+06	4.03e+03	6.85e+05	0.00e+00	1.15e+05	4.03e+08	2.31e+06
Ra-226	1.06e+09	2.70e+04	7.90e+08	0.00e+00	7.74e+05	1.62e+09	2.49e+06
Ra-228	4.27e+08	1.39e+04	4.70e+08	0.00e+00	3.98e+05	2.22e+09	4.24e+05
Ac-225	4.83e+06	6.60e+06	3.25e+05	0.00e+00	7.58e+05	3.05e+08	2.16e+06
Ac-227	1.99e+10	2.95e+09	1.18e+09	0.00e+00	8.56e+08	3.33e+09	4.30e+05
Th-227	2.47e+06	4.45e+04	7.14e+04	0.00e+00	2.54e+05	5.20e+08	2.86e+06
Th-228	2.08e+09	3.50e+07	7.02e+07	0.00e+00	1.96e+08	1.35e+10	2.96e+06
Th-229	1.23e+11	3.55e+09	2.05e+09	0.00e+00	1.74e+10	4.19e+10	4.10e+05
Th-230	1.87e+10	1.07e+09	5.19e+08	0.00e+00	5.24e+09	7.18e+09	3.16e+05
Th-232	2.09e+10	9.12e+08	7.37e+06	0.00e+00	4.48e+09	6.88e+09	2.69e+05
Th-234	1.86e+04	1.08e+03	5.37e+02	0.00e+00	6.18e+03	2.61e+06	5.99e+05
Pa-231	4.26e+10	1.60e+09	1.66e+09	0.00e+00	8.96e+09	7.93e+08	3.77e+05
Pa-233	1.34e+04	2.59e+03	2.31e+03	0.00e+00	9.76e+03	4.31e+05	8.00e+04
U-232	5.85e+08	0.00e+00	4.18e+07	0.00e+00	6.35e+07	3.07e+09	3.57e+05
U-233	1.24e+08	0.00e+00	7.54e+06	0.00e+00	2.90e+07	7.34e+08	3.30e+05
U-234	1.18e+08	0.00e+00	7.38e+06	0.00e+00	2.84e+07	7.19e+08	3.23e+05
U-235	1.14e+08	0.00e+00	6.94e+06	0.00e+00	2.67e+07	6.75e+08	4.10e+05
U-236	1.14e+08	0.00e+00	7.09e+06	0.00e+00	2.73e+07	6.90e+08	3.03e+05
U-237	4.20e+02	0.00e+00	1.12e+02	0.00e+00	1.73e+03	1.41e+05	1.03e+05
U-238	1.09e+08	0.00e+00	6.48e+06	0.00e+00	2.50e+07	6.31e+08	2.90e+05
Np-237	1.31e+10	8.48e+09	5.77e+08	0.00e+00	4.28e+09	7.19e+08	4.18e+05

Conversion factors are in units of mrem/yr per uCi/cubic meter.

**INHALATION PATHWAY DOSES DUE TO
RADIONUCLIDES OTHER THAN NOBLE GASES, R_i**

Ri factors for Teen age group by nuclide.
Waterford Steam Electric Station
Pathway : Gaseous Release Inhalation Pathway Ri

Nuclide	Organ Dose Conversion Factors						
	Bone	Liver	T. Body	Thyroid	Kidney	Lung	GI-LLI
Np-238	3.38e+03	8.16e+02	5.27e+01	0.00e+00	3.10e+02	1.40e+05	1.90e+05
Np-239	3.38e+02	2.88e+02	1.77e+01	0.00e+00	1.00e+02	6.49e+04	1.32e+05
Pu-238	1.20e+10	8.24e+09	5.78e+08	0.00e+00	2.48e+09	2.50e+09	3.83e+05
Pu-239	1.38e+10	8.96e+09	6.44e+08	0.00e+00	2.75e+09	2.34e+09	3.50e+05
Pu-240	1.38e+10	8.96e+09	6.43e+08	0.00e+00	2.74e+09	2.34e+09	3.57e+05
Pu-241	2.99e+08	7.65e+07	1.12e+07	0.00e+00	5.18e+07	2.08e+06	7.34e+03
Pu-242	1.28e+10	8.64e+09	6.20e+08	0.00e+00	2.65e+09	2.26e+09	3.43e+05
Pu-244	1.50e+10	9.92e+09	7.10e+08	0.00e+00	3.03e+09	2.58e+09	5.11e+05
Am-241	1.42e+10	9.60e+09	5.68e+08	0.00e+00	4.26e+09	8.40e+08	3.90e+05
Am-242m	1.43e+10	9.04e+09	5.72e+08	0.00e+00	4.24e+09	3.37e+08	4.91e+05
Am-243	1.42e+10	9.36e+09	5.56e+08	0.00e+00	4.17e+09	7.93e+08	4.58e+05
Cm-242	2.54e+08	2.01e+08	1.13e+07	0.00e+00	5.12e+07	5.41e+08	4.17e+05
Cm-243	9.52e+09	6.64e+09	4.00e+08	0.00e+00	1.87e+09	8.72e+08	4.10e+05
Cm-244	7.35e+09	5.22e+09	3.10e+08	0.00e+00	1.45e+09	8.40e+08	3.97e+05
Cm-245	1.46e+10	9.76e+09	6.02e+08	0.00e+00	2.82e+09	8.08e+08	3.70e+05
Cm-246	1.45e+10	9.76e+09	6.02e+08	0.00e+00	2.81e+09	8.24e+08	3.63e+05
Cm-247	1.42e+10	9.52e+09	5.93e+08	0.00e+00	2.77e+09	8.08e+08	4.78e+05
Cm-248	1.18e+11	7.86e+10	4.89e+09	0.00e+00	2.28e+10	6.66e+09	7.70e+06
Cf-252	5.73e+09	0.00e+00	2.46e+08	0.00e+00	0.00e+00	2.74e+09	1.51e+06

Conversion factors are in units of mrem/yr per uCi/cubic meter.

INHALATION PATHWAY DOSES DUE TO RADIONUCLIDES OTHER THAN NOBLE GASES, R_i

R_i factors for Child age group by nuclide.
Waterford Steam Electric Station
Pathway : Gaseous Release Inhalation Pathway R_i

Nuclide	Organ Dose Conversion Factors						
	Bone	Liver	T. Body	Thyroid	Kidney	Lung	GI-LLI
H-3	0.00e+00	6.40e+02	6.40e+02	6.40e+02	6.40e+02	6.40e+02	6.40e+02
Be-10	3.12e+06	3.64e+05	7.84e+04	0.00e+00	0.00e+00	2.74e+06	6.36e+04
C-14	3.59e+04	6.73e+03	6.73e+03	6.73e+03	6.73e+03	6.73e+03	6.73e+03
N-13	8.62e+01	8.62e+01	8.62e+01	8.62e+01	8.62e+01	8.62e+01	8.62e+01
F-18	6.96e+03	0.00e+00	6.84e+02	0.00e+00	0.00e+00	0.00e+00	1.25e+03
Na-22	1.63e+05	1.63e+05	1.63e+05	1.63e+05	1.63e+05	1.63e+05	1.63e+05
Na-24	1.61e+04	1.61e+04	1.61e+04	1.61e+04	1.61e+04	1.61e+04	1.61e+04
P-32	2.60e+06	1.14e+05	9.88e+04	0.00e+00	0.00e+00	0.00e+00	4.22e+04
Ca-41	2.61e+05	0.00e+00	2.85e+04	0.00e+00	0.00e+00	2.67e+08	1.09e+03
Sc-46	7.29e+05	9.99e+05	3.85e+05	0.00e+00	8.84e+05	0.00e+00	9.06e+04
Cr-51	0.00e+00	0.00e+00	1.54e+02	8.55e+01	2.43e+01	1.70e+04	1.08e+03
Mn-54	0.00e+00	4.29e+04	9.51e+03	0.00e+00	1.00e+04	1.58e+06	2.29e+04
Mn-56	0.00e+00	1.66e+00	3.12e-01	0.00e+00	1.67e+00	1.31e+04	1.23e+05
Fe-55	4.74e+04	2.52e+04	7.77e+03	0.00e+00	0.00e+00	1.11e+05	2.87e+03
Fe-59	2.07e+04	3.34e+04	1.67e+04	0.00e+00	0.00e+00	1.27e+06	7.07e+04
Co-57	0.00e+00	9.03e+02	1.07e+03	0.00e+00	0.00e+00	5.07e+05	1.32e+04
Co-58	0.00e+00	1.77e+03	3.16e+03	0.00e+00	0.00e+00	1.11e+06	3.44e+04
Co-60	0.00e+00	1.31e+04	2.26e+04	0.00e+00	0.00e+00	7.07e+06	9.62e+04
Ni-59	6.14e+04	1.73e+04	1.05e+04	0.00e+00	0.00e+00	1.01e+05	2.33e+03
Ni-63	8.21e+05	4.62e+04	2.80e+04	0.00e+00	0.00e+00	2.75e+05	6.33e+03
Ni-65	2.99e+00	2.96e-01	1.64e-01	0.00e+00	0.00e+00	8.18e+03	8.40e+04
Cu-64	0.00e+00	1.99e+00	1.07e+00	0.00e+00	6.03e+00	9.58e+03	3.67e+04
Zn-65	4.26e+04	1.13e+05	7.03e+04	0.00e+00	7.14e+04	9.95e+05	1.63e+04
Zn-69	6.70e-02	9.66e-02	8.92e-03	0.00e+00	5.85e-02	1.42e+03	1.02e+04
Zn-69m	1.58e+01	2.69e+01	3.18e+00	0.00e+00	1.56e+01	2.72e+04	1.00e+05
Se-79	0.00e+00	4.55e+03	9.62e+02	0.00e+00	6.33e+03	5.51e+05	1.27e+04
Br-82	0.00e+00	0.00e+00	2.09e+04	0.00e+00	0.00e+00	0.00e+00	0.00e+00
Br-83	0.00e+00	0.00e+00	4.74e+02	0.00e+00	0.00e+00	0.00e+00	0.00e+00
Br-84	0.00e+00	0.00e+00	5.48e+02	0.00e+00	0.00e+00	0.00e+00	0.00e+00
Br-85	0.00e+00	0.00e+00	2.53e+01	0.00e+00	0.00e+00	0.00e+00	0.00e+00

Conversion factors are in units of mrem/yr per uCi/cubic meter.

INHALATION PATHWAY DOSES DUE TO RADIONUCLIDES OTHER THAN NOBLE GASES, R_i

R_i factors for Child age group by nuclide.
Waterford Steam Electric Station
Pathway : Gaseous Release Inhalation Pathway R_i

Nuclide	Organ Dose Conversion Factors						
	Bone	Liver	T. Body	Thyroid	Kidney	Lung	GI-LLI
Rb-86	0.00e+00	1.98e+05	1.14e+05	0.00e+00	0.00e+00	0.00e+00	7.99e+03
Rb-87	0.00e+00	1.17e+05	5.07e+04	0.00e+00	0.00e+00	0.00e+00	1.10e+03
Rb-88	0.00e+00	5.62e+02	3.66e+02	0.00e+00	0.00e+00	0.00e+00	1.72e+01
Rb-89	0.00e+00	3.45e+02	2.90e+02	0.00e+00	0.00e+00	0.00e+00	1.89e+00
Sr-89	5.99e+05	0.00e+00	1.72e+04	0.00e+00	0.00e+00	2.16e+06	1.67e+05
Sr-90	3.85e+07	0.00e+00	7.66e+05	0.00e+00	0.00e+00	1.48e+07	3.43e+05
Sr-91	1.21e+02	0.00e+00	4.59e+00	0.00e+00	0.00e+00	5.33e+04	1.74e+05
Sr-92	1.31e+01	0.00e+00	5.25e-01	0.00e+00	0.00e+00	2.40e+04	2.42e+05
Y-90	4.11e+03	0.00e+00	1.11e+02	0.00e+00	0.00e+00	2.62e+05	2.68e+05
Y-91	9.14e+05	0.00e+00	2.44e+04	0.00e+00	0.00e+00	2.63e+06	1.84e+05
Y-91m	5.07e-01	0.00e+00	1.84e-02	0.00e+00	0.00e+00	2.81e+03	1.72e+03
Y-92	2.03e+01	0.00e+00	5.81e-01	0.00e+00	0.00e+00	2.39e+04	2.39e+05
Y-93	1.86e+02	0.00e+00	5.11e+00	0.00e+00	0.00e+00	7.44e+04	3.88e+05
Zr-93	7.66e+05	2.89e+04	2.05e+04	0.00e+00	1.11e+05	2.63e+05	5.44e+03
Zr-95	1.90e+05	4.18e+04	3.70e+04	0.00e+00	5.96e+04	2.23e+06	6.11e+04
Zr-97	1.88e+02	2.72e+01	1.60e+01	0.00e+00	3.88e+01	1.13e+05	3.51e+05
Nb-93m	4.70e+05	1.17e+05	3.85e+04	0.00e+00	1.27e+05	3.85e+05	9.06e+03
Nb-95	2.35e+04	9.18e+03	6.55e+03	0.00e+00	8.62e+03	6.14e+05	3.70e+04
Nb-97	4.29e-01	7.70e-02	3.60e-02	0.00e+00	8.55e-02	3.42e+03	2.78e+04
Mo-93	0.00e+00	1.39e+04	5.00e+02	0.00e+00	3.92e+03	6.29e+05	1.40e+04
Mo-99	0.00e+00	1.72e+02	4.26e+01	0.00e+00	3.92e+02	1.35e+05	1.27e+05
Tc-101	8.10e-05	8.51e-05	1.08e-03	0.00e+00	1.45e-03	5.85e+02	1.63e+01
Tc-99	4.96e+02	5.51e+02	1.98e+02	0.00e+00	6.48e+03	1.25e+06	2.87e+04
Tc-99m	1.78e-03	3.48e-03	5.77e-02	0.00e+00	5.07e-02	9.51e+02	4.81e+03
Ru-103	2.79e+03	0.00e+00	1.07e+03	0.00e+00	7.03e+03	6.62e+05	4.48e+04
Ru-105	1.53e+00	0.00e+00	5.55e-01	0.00e+00	1.34e+00	1.59e+04	9.95e+04
Ru-106	1.36e+05	0.00e+00	1.69e+04	0.00e+00	1.84e+05	1.43e+07	4.29e+05
Rh-105	1.45e+01	7.77e+00	6.62e+00	0.00e+00	3.10e+01	2.89e+04	4.92e+04
Pd-107	0.00e+00	9.80e+02	9.29e+01	0.00e+00	7.29e+03	1.17e+05	2.69e+03
Pd-109	0.00e+00	5.48e+00	1.83e+00	0.00e+00	2.61e+01	2.28e+04	9.58e+04

Conversion factors are in units of mrem/yr per uCi/cubic meter.

INHALATION PATHWAY DOSES DUE TO RADIONUCLIDES OTHER THAN NOBLE GASES, R_i

R_i factors for Child age group by nuclide.
Waterford Steam Electric Station
Pathway : Gaseous Release Inhalation Pathway R_i

Nuclide	Organ Dose Conversion Factors						
	Bone	Liver	T. Body	Thyroid	Kidney	Lung	GI-LLI
Ag-110m	1.69e+04	1.14e+04	9.14e+03	0.00e+00	2.12e+04	5.48e+06	1.00e+05
Ag-111	6.70e+02	2.10e+02	1.39e+02	0.00e+00	6.33e+02	2.86e+05	1.10e+05
Cd-113m	0.00e+00	1.82e+06	7.84e+04	0.00e+00	1.90e+06	2.57e+06	6.03e+04
Cd-115m	0.00e+00	2.92e+05	1.25e+04	0.00e+00	2.19e+05	2.17e+06	1.84e+05
Sn-123	4.77e+05	7.92e+03	1.55e+04	8.40e+03	0.00e+00	3.55e+06	1.50e+05
Sn-125	1.83e+04	3.68e+02	1.09e+03	3.81e+02	0.00e+00	8.99e+05	2.65e+05
Sn-126	2.31e+06	3.85e+04	8.73e+04	1.05e+04	0.00e+00	1.12e+07	6.03e+04
Sb-124	5.74e+04	7.40e+02	2.00e+04	1.26e+02	0.00e+00	3.24e+06	1.64e+05
Sb-125	9.84e+04	7.58e+02	2.07e+04	9.10e+01	0.00e+00	2.32e+06	4.03e+04
Sb-126	6.36e+03	9.69e+01	2.28e+03	3.70e+01	0.00e+00	1.06e+06	2.10e+05
Sb-127	5.03e+02	7.73e+00	1.74e+02	5.59e+00	0.00e+00	2.28e+05	1.41e+05
Te-125m	6.73e+03	2.33e+03	9.14e+02	1.92e+03	0.00e+00	4.77e+05	3.38e+04
Te-127	2.77e+00	9.51e-01	6.10e-01	1.96e+00	7.07e+00	1.00e+04	5.62e+04
Te-127m	2.49e+04	8.55e+03	3.02e+03	6.07e+03	6.36e+04	1.48e+06	7.14e+04
Te-129	9.77e-02	3.50e-02	2.38e-02	7.14e-02	2.57e-01	2.93e+03	2.55e+04
Te-129m	1.92e+04	6.84e+03	3.04e+03	6.33e+03	5.03e+04	1.76e+06	1.82e+05
Te-131	2.17e-02	8.44e-03	6.59e-03	1.70e-02	5.88e-02	2.05e+03	1.33e+03
Te-131m	1.34e+02	5.92e+01	5.07e+01	9.77e+01	4.00e+02	2.06e+05	3.08e+05
Te-132	4.81e+02	2.72e+02	2.63e+02	3.17e+02	1.77e+03	3.77e+05	1.38e+05
Te-133m	1.08e-01	5.59e-02	5.55e-02	8.58e-02	3.74e-01	5.92e+03	1.76e+04
Te-134	5.66e-02	3.26e-02	3.48e-02	4.59e-02	2.11e-01	4.55e+03	1.80e+03
I-129	3.88e+04	2.37e+04	2.11e+04	1.58e+07	4.00e+04	0.00e+00	7.96e+02
I-130	8.18e+03	1.64e+04	8.44e+03	1.85e+06	2.45e+04	0.00e+00	5.11e+03
I-131	4.81e+04	4.81e+04	2.73e+04	1.62e+07	7.88e+04	0.00e+00	2.84e+03
I-132	2.12e+03	4.07e+03	1.88e+03	1.94e+05	6.25e+03	0.00e+00	3.20e+03
I-133	1.66e+04	2.03e+04	7.70e+03	3.85e+06	3.38e+04	0.00e+00	5.48e+03
I-134	1.17e+03	2.16e+03	9.95e+02	5.07e+04	3.30e+03	0.00e+00	9.55e+02
I-135	4.92e+03	8.73e+03	4.14e+03	7.92e+05	1.34e+04	0.00e+00	4.44e+03
Cs-134	6.51e+05	1.01e+06	2.25e+05	0.00e+00	3.30e+05	1.21e+05	3.85e+03
Cs-134m	2.34e+02	3.30e+02	2.26e+02	0.00e+00	1.83e+02	3.09e+01	2.93e+02

Conversion factors are in units of mrem/yr per uCi/cubic meter.

INHALATION PATHWAY DOSES DUE TO RADIONUCLIDES OTHER THAN NOBLE GASES, R_i

R_i factors for Child age group by nuclide.
Waterford Steam Electric Station
Pathway : Gaseous Release Inhalation Pathway R_i

Nuclide	Organ Dose Conversion Factors						
	Bone	Liver	T. Body	Thyroid	Kidney	Lung	GI-LLI
Cs-135	2.31e+05	1.53e+05	1.65e+04	0.00e+00	5.66e+04	1.93e+04	8.03e+02
Cs-136	6.51e+04	1.71e+05	1.16e+05	0.00e+00	9.55e+04	1.45e+04	4.18e+03
Cs-137	9.06e+05	8.25e+05	1.28e+05	0.00e+00	2.82e+05	1.04e+05	3.62e+03
Cs-138	6.33e+02	8.40e+02	5.55e+02	0.00e+00	6.22e+02	6.81e+01	2.70e+02
Cs-139	4.03e+02	4.26e+02	2.15e+02	0.00e+00	3.36e+02	3.46e+01	2.68e-02
Ba-139	1.84e+00	9.84e-04	5.36e-02	0.00e+00	8.62e-04	5.77e+03	5.77e+04
Ba-140	7.40e+04	6.48e+01	4.33e+03	0.00e+00	2.11e+01	1.74e+06	1.02e+05
Ba-141	1.96e-01	1.09e-04	6.36e-03	0.00e+00	9.47e-05	2.92e+03	2.75e+02
Ba-142	5.00e-02	3.60e-05	2.79e-03	0.00e+00	2.91e-05	1.64e+03	2.74e+00
La-140	6.44e+02	2.25e+02	7.55e+01	0.00e+00	0.00e+00	1.83e+05	2.26e+05
La-141	8.44e+00	1.96e+00	4.26e-01	0.00e+00	0.00e+00	1.66e+04	1.62e+05
La-142	1.30e+00	4.11e-01	1.29e-01	0.00e+00	0.00e+00	8.70e+03	7.58e+04
Ce-141	3.92e+04	1.95e+04	2.90e+03	0.00e+00	8.55e+03	5.44e+05	5.66e+04
Ce-143	3.66e+02	1.99e+02	2.87e+01	0.00e+00	8.36e+01	1.15e+05	1.27e+05
Ce-144	6.77e+06	2.12e+06	3.61e+05	0.00e+00	1.17e+06	1.20e+07	3.88e+05
Pr-143	1.85e+04	5.55e+03	9.14e+02	0.00e+00	3.00e+03	4.33e+05	9.73e+04
Pr-144	5.96e-02	1.85e-02	3.00e-03	0.00e+00	9.77e-03	1.57e+03	1.97e+02
Nd-147	1.08e+04	8.73e+03	6.81e+02	0.00e+00	4.81e+03	3.28e+05	8.21e+04
Pm-147	1.30e+06	9.32e+04	5.03e+04	0.00e+00	1.65e+05	8.14e+05	2.11e+04
Pm-148	5.96e+03	7.18e+02	4.62e+02	0.00e+00	1.22e+03	4.59e+05	2.22e+05
Pm-148m	1.22e+05	2.42e+04	2.42e+04	0.00e+00	3.60e+04	2.12e+06	1.32e+05
Pm-149	5.44e+02	5.77e+01	3.13e+01	0.00e+00	1.02e+02	8.88e+04	1.08e+05
Pm-151	1.32e+02	1.60e+01	1.04e+01	0.00e+00	2.72e+01	4.59e+04	9.25e+04
Sm-151	1.16e+06	1.76e+05	5.51e+04	0.00e+00	1.81e+05	5.48e+05	1.27e+04
Sm-153	2.68e+02	1.67e+02	1.61e+01	0.00e+00	5.07e+01	5.07e+04	6.92e+04
Eu-152	2.75e+06	5.07e+05	5.96e+05	0.00e+00	2.12e+06	3.33e+06	4.22e+04
Eu-154	1.01e+07	9.21e+05	8.40e+05	0.00e+00	4.03e+06	6.14e+06	1.10e+05
Eu-155	2.07e+06	1.50e+05	1.18e+05	0.00e+00	5.59e+05	1.03e+06	1.99e+05
Eu-156	2.92e+04	1.57e+04	3.24e+03	0.00e+00	1.01e+04	9.40e+05	1.57e+05
Tb-160	2.88e+05	0.00e+00	3.58e+04	0.00e+00	8.58e+04	1.98e+06	8.44e+04

Conversion factors are in units of mrem/yr per uCi/cubic meter.

INHALATION PATHWAY DOSES DUE TO RADIONUCLIDES OTHER THAN NOBLE GASES, R_i

R_i factors for Child age group by nuclide.
Waterford Steam Electric Station
Pathway : Gaseous Release Inhalation Pathway R_i

Nuclide	Organ Dose Conversion Factors						
	Bone	Liver	T. Body	Thyroid	Kidney	Lung	GI-LLI
Ho-166m	4.96e+06	1.04e+06	8.77e+05	0.00e+00	1.48e+06	4.18e+06	6.03e+04
W-181	9.84e+01	2.41e+01	3.33e+00	0.00e+00	0.00e+00	2.11e+04	9.66e+02
W-185	3.07e+03	7.70e+02	1.08e+02	0.00e+00	0.00e+00	6.88e+05	4.11e+04
W-187	1.63e+01	9.66e+00	4.33e+00	0.00e+00	0.00e+00	4.11e+04	9.10e+04
Pb-210	2.97e+08	6.84e+07	1.18e+07	0.00e+00	2.33e+08	3.23e+08	5.74e+03
Bi-210	3.64e+03	1.89e+04	2.09e+03	0.00e+00	2.13e+05	1.37e+07	1.19e+05
Po-210	6.29e+06	1.02e+07	1.51e+06	0.00e+00	3.27e+07	3.88e+08	1.60e+05
Ra-223	2.85e+06	3.29e+03	5.70e+05	0.00e+00	8.73e+04	3.14e+08	1.11e+06
Ra-224	3.12e+05	5.66e+02	6.25e+04	0.00e+00	1.50e+04	1.08e+08	1.24e+06
Ra-225	4.74e+06	4.22e+03	9.47e+05	0.00e+00	1.12e+05	3.60e+08	1.05e+06
Ra-226	8.66e+08	2.83e+04	7.10e+08	0.00e+00	7.51e+05	1.44e+09	1.12e+06
Ra-228	5.51e+08	1.46e+04	6.22e+08	0.00e+00	3.85e+05	1.99e+09	1.90e+05
Ac-225	6.70e+06	6.92e+06	4.48e+05	0.00e+00	7.36e+05	2.73e+08	9.88e+05
Ac-227	1.84e+10	2.98e+09	1.14e+09	0.00e+00	6.55e+08	2.97e+09	1.93e+05
Th-227	3.42e+06	4.66e+04	9.88e+04	0.00e+00	2.47e+05	4.66e+08	1.29e+06
Th-228	2.98e+09	3.85e+07	1.01e+08	0.00e+00	2.00e+08	1.24e+10	1.33e+06
Th-229	8.07e+10	2.12e+09	1.34e+09	0.00e+00	1.05e+10	4.00e+10	1.85e+05
Th-230	1.22e+10	6.40e+08	3.40e+08	0.00e+00	3.15e+09	6.84e+09	1.42e+05
Th-232	1.36e+10	5.44e+08	4.74e+06	0.00e+00	2.69e+09	6.55e+09	1.21e+05
Th-234	2.57e+04	1.14e+03	7.40e+02	0.00e+00	5.99e+03	2.33e+06	2.71e+05
Pa-231	3.19e+10	1.06e+09	1.27e+09	0.00e+00	5.77e+09	7.10e+08	1.69e+05
Pa-233	1.53e+04	2.40e+03	2.68e+03	0.00e+00	8.81e+03	3.61e+05	3.31e+04
U-232	8.10e+08	0.00e+00	5.77e+07	0.00e+00	6.18e+07	2.75e+09	1.60e+05
U-233	1.72e+08	0.00e+00	1.04e+07	0.00e+00	2.82e+07	6.55e+08	1.48e+05
U-234	1.65e+08	0.00e+00	1.02e+07	0.00e+00	2.76e+07	6.44e+08	1.45e+05
U-235	1.58e+08	0.00e+00	9.58e+06	0.00e+00	2.59e+07	6.03e+08	1.84e+05
U-236	1.58e+08	0.00e+00	9.80e+06	0.00e+00	2.65e+07	6.18e+08	1.36e+05
U-237	5.81e+02	0.00e+00	1.54e+02	0.00e+00	1.68e+03	1.26e+05	4.77e+04
U-238	1.51e+08	0.00e+00	8.95e+06	0.00e+00	2.42e+07	5.66e+08	1.30e+05
Np-237	1.01e+10	5.99e+09	4.40e+08	0.00e+00	2.74e+09	6.44e+08	1.87e+05

Conversion factors are in units of mrem/yr per uCi/cubic meter.

**INHALATION PATHWAY DOSES DUE TO
RADIONUCLIDES OTHER THAN NOBLE GASES, R_i**

R_i factors for Child age group by nuclide.
Waterford Steam Electric Station
Pathway : Gaseous Release Inhalation Pathway R_i

Nuclide	Organ Dose Conversion Factors						
	Bone	Liver	T. Body	Thyroid	Kidney	Lung	GI-LLI
Np-238	4.66e+03	8.51e+02	7.29e+01	0.00e+00	3.02e+02	1.25e+05	9.25e+04
Np-239	4.66e+02	3.01e+02	2.35e+01	0.00e+00	9.73e+01	5.81e+04	6.40e+04
Pu-238	9.44e+09	5.92e+09	4.48e+08	0.00e+00	1.65e+09	2.25e+09	1.72e+05
Pu-239	1.03e+10	6.22e+09	4.74e+08	0.00e+00	1.77e+09	2.12e+09	1.57e+05
Pu-240	1.03e+10	6.22e+09	4.70e+08	0.00e+00	1.76e+09	2.11e+09	1.60e+05
Pu-241	2.94e+08	6.48e+07	1.08e+07	0.00e+00	4.07e+07	1.87e+06	3.29e+03
Pu-242	9.58e+09	5.99e+09	4.55e+08	0.00e+00	1.70e+09	2.04e+09	1.54e+05
Pu-244	1.12e+10	6.84e+09	5.22e+08	0.00e+00	1.95e+09	2.33e+09	2.29e+05
Am-241	1.10e+10	6.81e+09	4.59e+08	0.00e+00	2.82e+09	7.47e+08	1.75e+05
Am-242m	1.14e+10	6.51e+09	4.70e+08	0.00e+00	2.85e+09	3.01e+08	2.21e+05
Am-243	1.09e+10	6.59e+09	4.44e+08	0.00e+00	2.75e+09	7.10e+08	2.05e+05
Cm-242	3.51e+08	2.10e+08	1.55e+07	0.00e+00	4.96e+07	4.85e+08	1.87e+05
Cm-243	8.58e+09	5.25e+09	3.68e+08	0.00e+00	1.38e+09	7.77e+08	1.84e+05
Cm-244	7.18e+09	4.37e+09	3.07e+08	0.00e+00	1.13e+09	7.47e+08	1.78e+05
Cm-245	1.13e+10	6.81e+09	4.74e+08	0.00e+00	1.86e+09	7.22e+08	1.66e+05
Cm-246	1.12e+10	6.81e+09	4.74e+08	0.00e+00	1.86e+09	7.36e+08	1.63e+05
Cm-247	1.09e+10	6.73e+09	4.66e+08	0.00e+00	1.83e+09	7.22e+08	2.15e+05
Cm-248	9.06e+10	5.55e+10	3.85e+09	0.00e+00	1.51e+10	5.96e+09	3.46e+06
Cf-252	8.07e+09	0.00e+00	3.45e+08	0.00e+00	0.00e+00	2.45e+09	6.81e+05

Conversion factors are in units of mrem/yr per uCi/cubic meter.

INHALATION PATHWAY DOSES DUE TO RADIONUCLIDES OTHER THAN NOBLE GASES, R_i

R_i factors for Infant age group by nuclide.
Waterford Steam Electric Station
Pathway : Gaseous Release Inhalation Pathway R_i

Nuclide	Organ Dose Conversion Factors						
	Bone	Liver	T. Body	Thyroid	Kidney	Lung	GI-LLI
H-3	0.00e+00	3.68e+02	3.68e+02	3.68e+02	3.68e+02	3.68e+02	3.68e+02
Be-10	1.33e+06	1.75e+05	3.71e+04	0.00e+00	0.00e+00	2.09e+06	2.42e+04
C-14	2.65e+04	5.31e+03	5.31e+03	5.31e+03	5.31e+03	5.31e+03	5.31e+03
N-13	6.15e+01	6.15e+01	6.15e+01	6.15e+01	6.15e+01	6.15e+01	6.15e+01
F-18	5.49e+03	0.00e+00	4.66e+02	0.00e+00	0.00e+00	0.00e+00	8.54e+02
Na-22	1.03e+05	1.03e+05	1.03e+05	1.03e+05	1.03e+05	1.03e+05	1.03e+05
Na-24	1.06e+04	1.06e+04	1.06e+04	1.06e+04	1.06e+04	1.06e+04	1.06e+04
P-32	2.03e+06	1.12e+05	7.74e+04	0.00e+00	0.00e+00	0.00e+00	1.61e+04
Ca-41	1.05e+05	0.00e+00	1.14e+04	0.00e+00	0.00e+00	9.72e+07	4.14e+02
Sc-46	5.25e+05	7.57e+05	2.37e+05	0.00e+00	4.98e+05	0.00e+00	3.07e+04
Cr-51	0.00e+00	0.00e+00	8.95e+01	5.75e+01	1.32e+01	1.28e+04	3.57e+02
Mn-54	0.00e+00	2.53e+04	4.98e+03	0.00e+00	4.98e+03	1.00e+06	7.06e+03
Mn-56	0.00e+00	1.54e+00	2.21e-01	0.00e+00	1.10e+00	1.25e+04	7.17e+04
Fe-55	1.97e+04	1.17e+04	3.33e+03	0.00e+00	0.00e+00	8.69e+04	1.09e+03
Fe-59	1.36e+04	2.35e+04	9.48e+03	0.00e+00	0.00e+00	1.01e+06	2.48e+04
Co-57	0.00e+00	6.51e+02	6.41e+02	0.00e+00	0.00e+00	3.79e+05	4.86e+03
Co-58	0.00e+00	1.22e+03	1.82e+03	0.00e+00	0.00e+00	7.77e+05	1.11e+04
Co-60	0.00e+00	8.02e+03	1.18e+04	0.00e+00	0.00e+00	4.51e+06	3.19e+04
Ni-59	2.53e+04	7.62e+03	4.34e+03	0.00e+00	0.00e+00	7.67e+04	8.88e+02
Ni-63	3.39e+05	2.04e+04	1.16e+04	0.00e+00	0.00e+00	2.09e+05	2.42e+03
Ni-65	2.39e+00	2.84e-01	1.23e-01	0.00e+00	0.00e+00	8.12e+03	5.01e+04
Cu-64	0.00e+00	1.88e+00	7.74e-01	0.00e+00	3.98e+00	9.30e+03	1.50e+04
Zn-65	1.93e+04	6.26e+04	3.11e+04	0.00e+00	3.25e+04	6.47e+05	5.14e+04
Zn-69	5.39e-02	9.67e-02	7.18e-03	0.00e+00	4.02e-02	1.47e+03	1.32e+04
Zn-69m	1.26e+01	2.58e+01	2.34e+00	0.00e+00	1.04e+01	2.67e+04	4.09e+04
Se-79	0.00e+00	3.15e+03	5.88e+02	0.00e+00	3.46e+03	4.19e+05	4.84e+03
Br-82	0.00e+00	0.00e+00	1.33e+04	0.00e+00	0.00e+00	0.00e+00	0.00e+00
Br-83	0.00e+00	0.00e+00	3.81e+02	0.00e+00	0.00e+00	0.00e+00	0.00e+00
Br-84	0.00e+00	0.00e+00	4.00e+02	0.00e+00	0.00e+00	0.00e+00	0.00e+00
Br-85	0.00e+00	0.00e+00	2.04e+01	0.00e+00	0.00e+00	0.00e+00	0.00e+00

Conversion factors are in units of mrem/yr per uCi/cubic meter.

**INHALATION PATHWAY DOSES DUE TO
RADIONUCLIDES OTHER THAN NOBLE GASES, R_i**

R_i factors for Infant age group by nuclide.
Waterford Steam Electric Station
Pathway : Gaseous Release Inhalation Pathway R_i

Nuclide	Organ Dose Conversion Factors						
	Bone	Liver	T. Body	Thyroid	Kidney	Lung	GI-LLI
Rb-86	0.00e+00	1.90e+05	8.82e+04	0.00e+00	0.00e+00	0.00e+00	3.04e+03
Rb-87	0.00e+00	9.95e+04	3.70e+04	0.00e+00	0.00e+00	0.00e+00	4.19e+02
Rb-88	0.00e+00	5.57e+02	2.87e+02	0.00e+00	0.00e+00	0.00e+00	3.39e+02
Rb-89	0.00e+00	3.21e+02	2.06e+02	0.00e+00	0.00e+00	0.00e+00	6.82e+01
Sr-89	3.98e+05	0.00e+00	1.14e+04	0.00e+00	0.00e+00	2.03e+06	6.40e+04
Sr-90	1.55e+07	0.00e+00	3.12e+05	0.00e+00	0.00e+00	1.12e+07	1.31e+05
Sr-91	9.56e+01	0.00e+00	3.46e+00	0.00e+00	0.00e+00	5.26e+04	7.34e+04
Sr-92	1.05e+01	0.00e+00	3.91e-01	0.00e+00	0.00e+00	2.38e+04	1.40e+05
Y-90	3.29e+03	0.00e+00	8.82e+01	0.00e+00	0.00e+00	2.69e+05	1.04e+05
Y-91	5.88e+05	0.00e+00	1.57e+04	0.00e+00	0.00e+00	2.45e+06	7.03e+04
Y-91m	4.07e-01	0.00e+00	1.39e-02	0.00e+00	0.00e+00	2.79e+03	2.35e+03
Y-92	1.64e+01	0.00e+00	4.61e-01	0.00e+00	0.00e+00	2.45e+04	1.27e+05
Y-93	1.50e+02	0.00e+00	4.07e+00	0.00e+00	0.00e+00	7.64e+04	1.67e+05
Zr-93	3.14e+05	1.33e+04	8.65e+03	0.00e+00	4.47e+04	1.92e+05	2.07e+03
Zr-95	1.15e+05	2.79e+04	2.03e+04	0.00e+00	3.11e+04	1.75e+06	2.17e+04
Zr-97	1.50e+02	2.56e+01	1.17e+01	0.00e+00	2.59e+01	1.10e+05	1.40e+05
Nb-93m	1.93e+05	5.03e+04	1.61e+04	0.00e+00	5.15e+04	2.93e+05	3.46e+03
Nb-95	1.57e+04	6.43e+03	3.78e+03	0.00e+00	4.72e+03	4.79e+05	1.27e+04
Nb-97	3.42e-01	7.29e-02	2.63e-02	0.00e+00	5.70e-02	3.32e+03	2.69e+04
Mo-93	0.00e+00	9.04e+03	3.11e+02	0.00e+00	2.16e+03	4.76e+05	5.26e+03
Mo-99	0.00e+00	1.65e+02	3.23e+01	0.00e+00	2.65e+02	1.35e+05	4.87e+04
Tc-101	6.51e-05	8.23e-05	8.12e-04	0.00e+00	9.79e-04	5.84e+02	8.44e+02
Tc-99	2.93e+02	3.75e+02	1.24e+02	0.00e+00	3.49e+03	9.48e+05	1.09e+04
Tc-99m	1.40e-03	2.88e-03	3.72e-02	0.00e+00	3.11e-02	8.11e+02	2.03e+03
Ru-103	2.02e+03	0.00e+00	6.79e+02	0.00e+00	4.24e+03	5.52e+05	1.61e+04
Ru-105	1.22e+00	0.00e+00	4.10e-01	0.00e+00	8.99e-01	1.57e+04	4.84e+04
Ru-106	8.68e+04	0.00e+00	1.09e+04	0.00e+00	1.07e+05	1.16e+07	1.64e+05
Rh-105	1.16e+01	7.57e+00	5.08e+00	0.00e+00	2.10e+01	2.91e+04	1.92e+04
Pd-107	0.00e+00	6.89e+02	5.75e+01	0.00e+00	3.85e+03	8.88e+04	1.03e+03
Pd-109	0.00e+00	5.49e+00	1.47e+00	0.00e+00	1.79e+01	2.35e+04	3.99e+04

Conversion factors are in units of mrem/yr per uCi/cubic meter.

**INHALATION PATHWAY DOSES DUE TO
RADIONUCLIDES OTHER THAN NOBLE GASES, R_i**

R_i factors for Infant age group by nuclide.
Waterford Steam Electric Station
Pathway : Gaseous Release Inhalation Pathway R_i

Nuclide	Organ Dose Conversion Factors						
	Bone	Liver	T. Body	Thyroid	Kidney	Lung	GI-LLI
Ag-110m	9.98e+03	7.22e+03	5.00e+03	0.00e+00	1.09e+04	3.67e+06	3.30e+04
Ag-111	5.25e+02	2.03e+02	1.08e+02	0.00e+00	4.27e+02	2.88e+05	4.23e+04
Cd-113m	0.00e+00	9.34e+05	3.70e+04	0.00e+00	8.12e+05	1.96e+06	2.31e+04
Cd-115m	0.00e+00	2.42e+05	8.67e+03	0.00e+00	1.32e+05	2.06e+06	7.03e+04
Sn-123	2.93e+05	5.89e+03	1.02e+04	5.98e+03	0.00e+00	3.11e+06	5.71e+04
Sn-125	1.41e+04	3.51e+02	8.40e+02	3.46e+02	0.00e+00	9.00e+05	1.02e+05
Sn-126	1.16e+06	2.02e+04	4.93e+04	5.38e+03	0.00e+00	6.90e+06	2.31e+04
Sb-124	3.79e+04	5.56e+02	1.20e+04	1.01e+02	0.00e+00	2.65e+06	5.91e+04
Sb-125	5.17e+04	4.77e+02	1.09e+04	6.23e+01	0.00e+00	1.64e+06	1.47e+04
Sb-126	4.31e+03	8.41e+01	1.55e+03	3.29e+01	0.00e+00	9.63e+05	7.46e+04
Sb-127	3.95e+02	7.06e+00	1.23e+02	5.04e+00	0.00e+00	2.16e+05	5.29e+04
Te-125m	4.76e+03	1.99e+03	6.58e+02	1.62e+03	0.00e+00	4.47e+05	1.29e+04
Te-127	2.23e+00	9.53e-01	4.89e-01	1.85e+00	4.86e+00	1.03e+04	2.44e+04
Te-127m	1.67e+04	6.90e+03	2.07e+03	4.87e+03	3.75e+04	1.31e+06	2.73e+04
Te-129	7.88e-02	3.47e-02	1.88e-02	6.75e-02	1.75e-01	3.00e+03	2.63e+04
Te-129m	1.41e+04	6.09e+03	2.23e+03	5.47e+03	3.18e+04	1.68e+06	6.90e+04
Te-131	1.74e-02	8.22e-03	5.00e-03	1.58e-02	3.99e-02	2.06e+03	8.22e+03
Te-131m	1.07e+02	5.50e+01	3.63e+01	8.93e+01	2.65e+02	1.99e+05	1.19e+05
Te-132	3.72e+02	2.37e+02	1.76e+02	2.79e+02	1.03e+03	3.40e+05	4.41e+04
Te-133m	8.58e-02	5.03e-02	3.84e-02	7.73e-02	2.41e-01	5.49e+03	2.23e+04
Te-134	4.45e-02	2.86e-02	2.35e-02	4.07e-02	1.34e-01	4.10e+03	3.54e+03
I-129	3.02e+04	2.23e+04	1.62e+04	1.46e+07	2.63e+04	0.00e+00	2.97e+02
I-130	6.36e+03	1.39e+04	5.57e+03	1.60e+06	1.53e+04	0.00e+00	1.99e+03
I-131	3.79e+04	4.44e+04	1.96e+04	1.48e+07	5.18e+04	0.00e+00	1.06e+03
I-132	1.69e+03	3.54e+03	1.26e+03	1.69e+05	3.95e+03	0.00e+00	1.90e+03
I-133	1.32e+04	1.92e+04	5.60e+03	3.56e+06	2.24e+04	0.00e+00	2.16e+03
I-134	9.21e+02	1.88e+03	6.65e+02	4.45e+04	2.09e+03	0.00e+00	1.29e+03
I-135	3.86e+03	7.60e+03	2.77e+03	6.96e+05	8.47e+03	0.00e+00	1.83e+03
Cs-134	3.96e+05	7.03e+05	7.45e+04	0.00e+00	1.90e+05	7.97e+04	1.33e+03
Cs-134m	1.85e+02	2.94e+02	1.55e+02	0.00e+00	1.19e+02	2.80e+01	1.62e+02

Conversion factors are in units of mrem/yr per uCi/cubic meter.

**INHALATION PATHWAY DOSES DUE TO
RADIONUCLIDES OTHER THAN NOBLE GASES, R_i**

R_i factors for Infant age group by nuclide.
Waterford Steam Electric Station
Pathway : Gaseous Release Inhalation Pathway R_i

Nuclide	Organ Dose Conversion Factors						
	Bone	Liver	T. Body	Thyroid	Kidney	Lung	GI-LLI
Cs-135	1.40e+05	1.21e+05	6.62e+03	0.00e+00	3.61e+04	1.41e+04	3.05e+02
Cs-136	4.83e+04	1.35e+05	5.29e+04	0.00e+00	5.64e+04	1.18e+04	1.43e+03
Cs-137	5.49e+05	6.12e+05	4.55e+04	0.00e+00	1.72e+05	7.13e+04	1.33e+03
Cs-138	5.05e+02	7.81e+02	3.98e+02	0.00e+00	4.10e+02	6.54e+01	8.76e+02
Cs-139	3.25e+02	4.24e+02	1.71e+02	0.00e+00	2.31e+02	3.54e+01	1.86e+01
Ba-139	1.48e+00	9.84e-04	4.30e-02	0.00e+00	5.92e-04	5.95e+03	5.10e+04
Ba-140	5.60e+04	5.60e+01	2.90e+03	0.00e+00	1.34e+01	1.60e+06	3.84e+04
Ba-141	1.57e-01	1.08e-04	4.97e-03	0.00e+00	6.50e-05	2.97e+03	4.75e+03
Ba-142	3.98e-02	3.30e-05	1.96e-03	0.00e+00	1.90e-05	1.55e+03	6.93e+02
La-140	5.05e+02	2.00e+02	5.15e+01	0.00e+00	0.00e+00	1.68e+05	8.48e+04
La-141	6.79e+00	1.96e+00	3.43e-01	0.00e+00	0.00e+00	1.71e+04	8.34e+04
La-142	1.03e+00	3.77e-01	9.04e-02	0.00e+00	0.00e+00	8.22e+03	5.95e+04
Ce-141	2.77e+04	1.67e+04	1.99e+03	0.00e+00	5.25e+03	5.17e+05	2.16e+04
Ce-143	2.93e+02	1.93e+02	2.21e+01	0.00e+00	5.64e+01	1.16e+05	4.97e+04
Ce-144	3.19e+06	1.21e+06	1.76e+05	0.00e+00	5.38e+05	9.84e+06	1.48e+05
Pr-143	1.40e+04	5.24e+03	6.99e+02	0.00e+00	1.97e+03	4.33e+05	3.72e+04
Pr-144	4.79e-02	1.85e-02	2.41e-03	0.00e+00	6.72e-03	1.61e+03	4.28e+03
Nd-147	7.94e+03	8.13e+03	5.00e+02	0.00e+00	3.15e+03	3.22e+05	3.12e+04
Pm-147	5.47e+05	4.30e+04	2.18e+04	0.00e+00	6.90e+04	6.37e+05	8.05e+03
Pm-148	4.68e+03	6.75e+02	3.42e+02	0.00e+00	8.06e+02	4.48e+05	8.46e+04
Pm-148m	7.00e+04	1.74e+04	1.39e+04	0.00e+00	2.03e+04	1.71e+06	4.72e+04
Pm-149	4.34e+02	5.71e+01	2.49e+01	0.00e+00	6.94e+01	9.10e+04	4.21e+04
Pm-151	1.05e+02	1.54e+01	7.77e+00	0.00e+00	1.82e+01	4.55e+04	3.61e+04
Sm-151	4.73e+05	9.03e+04	2.28e+04	0.00e+00	7.34e+04	4.17e+05	4.84e+03
Sm-153	2.14e+02	1.65e+02	1.27e+01	0.00e+00	3.46e+01	5.18e+04	2.70e+04
Eu-152	1.10e+06	2.48e+05	2.41e+05	0.00e+00	8.32e+05	2.07e+06	1.38e+04
Eu-154	4.14e+06	4.84e+05	3.43e+05	0.00e+00	1.60e+06	4.27e+06	3.98e+04
Eu-155	8.36e+05	8.01e+04	4.84e+04	0.00e+00	2.21e+05	7.28e+05	7.27e+04
Eu-156	2.18e+04	1.34e+04	2.16e+03	0.00e+00	6.27e+03	8.57e+05	5.80e+04
Tb-160	1.57e+05	0.00e+00	1.96e+04	0.00e+00	4.48e+04	1.55e+06	3.00e+04

Conversion factors are in units of mrem/yr per uCi/cubic meter.

**INHALATION PATHWAY DOSES DUE TO
RADIONUCLIDES OTHER THAN NOBLE GASES, R_i**

R_i factors for Infant age group by nuclide.
Waterford Steam Electric Station
Pathway : Gaseous Release Inhalation Pathway R_i

Nuclide	Organ Dose Conversion Factors						
	Bone	Liver	T. Body	Thyroid	Kidney	Lung	GI-LLI
Ho-166m	2.03e+06	4.30e+05	3.51e+05	0.00e+00	5.91e+05	2.87e+06	2.31e+04
W-181	6.80e+01	2.04e+01	2.34e+00	0.00e+00	0.00e+00	1.86e+04	3.68e+02
W-185	2.20e+03	6.76e+02	7.81e+01	0.00e+00	0.00e+00	6.27e+05	1.57e+04
W-187	1.30e+01	9.02e+00	3.12e+00	0.00e+00	0.00e+00	3.96e+04	3.56e+04
Pb-210	1.21e+08	2.83e+07	4.80e+06	0.00e+00	9.59e+07	2.46e+08	2.20e+03
Bi-210	2.88e+03	1.86e+04	1.65e+03	0.00e+00	1.44e+05	1.39e+07	4.58e+04
Po-210	4.17e+06	7.88e+06	9.97e+05	0.00e+00	1.82e+07	3.36e+08	6.10e+04
Ra-223	2.18e+06	3.16e+03	4.37e+05	0.00e+00	5.82e+04	3.15e+08	4.26e+05
Ra-224	2.48e+05	5.60e+02	4.96e+04	0.00e+00	1.02e+04	1.11e+08	4.79e+05
Ra-225	3.60e+06	4.03e+03	7.18e+05	0.00e+00	7.43e+04	3.60e+08	4.02e+05
Ra-226	3.47e+08	2.04e+04	2.87e+08	0.00e+00	4.12e+05	1.10e+09	4.27e+05
Ra-228	2.24e+08	1.07e+04	2.52e+08	0.00e+00	2.14e+05	1.53e+09	7.27e+04
Ac-225	5.17e+06	6.61e+06	3.47e+05	0.00e+00	4.89e+05	2.74e+08	3.79e+05
Ac-227	7.41e+09	1.23e+09	4.59e+08	0.00e+00	2.60e+08	2.27e+09	7.38e+04
Th-227	2.55e+06	4.24e+04	7.34e+04	0.00e+00	1.58e+05	4.58e+08	4.94e+05
Th-228	1.18e+09	1.54e+07	4.00e+07	0.00e+00	7.85e+07	6.51e+09	5.07e+05
Th-229	3.19e+10	8.32e+08	5.33e+08	0.00e+00	1.30e+09	1.78e+10	7.03e+04
Th-230	4.84e+09	2.51e+08	1.35e+08	0.00e+00	1.23e+09	3.05e+09	5.42e+04
Th-232	5.40e+09	2.14e+08	3.21e+06	0.00e+00	1.06e+09	2.93e+09	4.61e+04
Th-234	1.86e+04	1.00e+03	5.38e+02	0.00e+00	3.78e+03	2.27e+06	1.04e+05
Pa-231	1.27e+10	4.20e+08	5.07e+08	0.00e+00	2.27e+09	5.39e+08	6.45e+04
Pa-233	9.58e+03	1.85e+03	1.67e+03	0.00e+00	5.15e+03	3.07e+05	1.27e+04
U-232	3.60e+08	0.00e+00	2.98e+07	0.00e+00	3.36e+07	2.09e+09	6.10e+04
U-233	7.62e+07	0.00e+00	5.36e+06	0.00e+00	1.53e+07	4.98e+08	5.64e+04
U-234	7.31e+07	0.00e+00	5.25e+06	0.00e+00	1.50e+07	4.89e+08	5.53e+04
U-235	7.01e+07	0.00e+00	4.93e+06	0.00e+00	1.41e+07	4.59e+08	7.03e+04
U-236	7.01e+07	0.00e+00	5.04e+06	0.00e+00	1.44e+07	4.69e+08	5.19e+04
U-237	4.55e+02	0.00e+00	1.21e+02	0.00e+00	1.13e+03	1.28e+05	1.83e+04
U-238	6.71e+07	0.00e+00	4.61e+06	0.00e+00	1.32e+07	4.28e+08	4.96e+04
Np-237	4.03e+09	2.39e+09	1.76e+08	0.00e+00	1.08e+09	4.89e+08	7.14e+04

Conversion factors are in units of mrem/yr per uCi/cubic meter.

INHALATION PATHWAY DOSES DUE TO RADIONUCLIDES OTHER THAN NOBLE GASES, R_i

R_i factors for Infant age group by nuclide.
Waterford Steam Electric Station
Pathway : Gaseous Release Inhalation Pathway R_i

Nuclide	Organ Dose Conversion Factors						
	Bone	Liver	T. Body	Thyroid	Kidney	Lung	GI-LLI
Np-238	3.74e+03	8.47e+02	5.82e+01	0.00e+00	2.06e+02	1.29e+05	3.61e+04
Np-239	3.71e+02	2.98e+02	1.88e+01	0.00e+00	6.62e+01	5.95e+04	2.49e+04
Pu-238	3.77e+09	2.35e+09	1.78e+08	0.00e+00	6.50e+08	1.26e+09	6.57e+04
Pu-239	4.10e+09	2.46e+09	1.88e+08	0.00e+00	6.93e+08	1.19e+09	5.99e+04
Pu-240	4.10e+09	2.45e+09	1.88e+08	0.00e+00	6.92e+08	1.19e+09	6.10e+04
Pu-241	1.18e+08	2.59e+07	4.35e+06	0.00e+00	1.61e+07	1.07e+06	1.26e+03
Pu-242	3.81e+09	2.37e+09	1.81e+08	0.00e+00	6.68e+08	1.14e+09	5.88e+04
Pu-244	4.44e+09	2.72e+09	2.07e+08	0.00e+00	7.64e+08	1.31e+09	8.76e+04
Am-241	4.41e+09	2.73e+09	1.83e+08	0.00e+00	1.11e+09	5.68e+08	6.69e+04
Am-242m	4.55e+09	2.60e+09	1.89e+08	0.00e+00	1.12e+09	2.30e+08	8.41e+04
Am-243	4.34e+09	2.63e+09	1.78e+08	0.00e+00	1.08e+09	5.39e+08	7.84e+04
Cm-242	1.79e+08	1.21e+08	7.98e+06	0.00e+00	2.37e+07	4.16e+08	7.14e+04
Cm-243	3.46e+09	2.13e+09	1.48e+08	0.00e+00	5.47e+08	5.94e+08	7.03e+04
Cm-244	2.90e+09	1.78e+09	1.24e+08	0.00e+00	4.49e+08	5.71e+08	6.80e+04
Cm-245	4.51e+09	2.74e+09	1.90e+08	0.00e+00	7.32e+08	5.49e+08	6.34e+04
Cm-246	4.48e+09	2.74e+09	1.90e+08	0.00e+00	7.32e+08	5.59e+08	6.23e+04
Cm-247	4.35e+09	2.70e+09	1.86e+08	0.00e+00	7.21e+08	5.49e+08	8.19e+04
Cm-248	3.61e+10	2.23e+10	1.54e+09	0.00e+00	5.94e+09	4.52e+09	1.32e+06
Cf-252	3.32e+09	0.00e+00	1.41e+08	0.00e+00	0.00e+00	1.92e+09	2.59e+05

Conversion factors are in units of mrem/yr per uCi/cubic meter.

**GROUND - PLANE DEPOSITION PATHWAY
DOSE FACTORS DUE TO RADIONUCLIDES OTHER THAN NOBLE GASES, R_i**

R_i factors for all age groups by nuclide.
Waterford Steam Electric Station
Pathway : Gaseous Release Ground Plane Exposure Pathway R_i

Nuclide	Organ Dose Conversion Factors	
	T. Body	Skin
H-3	0.00e+00	0.00e+00
Be-10	0.00e+00	0.00e+00
C-14	0.00e+00	0.00e+00
N-13	4.02e+04	4.66e+04
F-18	3.96e+05	4.66e+05
Na-22	1.14e+10	1.28e+10
Na-24	1.19e+07	1.39e+07
P-32	0.00e+00	0.00e+00
Ca-41	9.89e+09	1.16e+10
Sc-46	8.33e+08	9.61e+08
Cr-51	4.66e+06	5.51e+06
Mn-54	1.39e+09	1.63e+09
Mn-56	9.02e+05	1.07e+06
Fe-55	0.00e+00	0.00e+00
Fe-59	2.73e+08	3.21e+08
Co-57	1.88e+08	2.06e+08
Co-58	3.79e+08	4.44e+08
Co-60	2.15e+10	2.53e+10
Ni-59	0.00e+00	0.00e+00
Ni-63	0.00e+00	0.00e+00
Ni-65	2.97e+05	3.45e+05
Cu-64	6.07e+05	6.88e+05
Zn-65	7.47e+08	8.59e+08
Zn-69	0.00e+00	0.00e+00
Zn-69m	1.27e+06	1.49e+06
Se-79	0.00e+00	0.00e+00
Br-82	2.13e+07	2.47e+07
Br-83	4.87e+03	7.08e+03
Br-84	2.03e+05	2.36e+05
Br-85	0.00e+00	0.00e+00

Conversion factors are in units of square meter-mrem/yr per uCi/sec.

**GROUND - PLANE DEPOSITION PATHWAY
DOSE FACTORS DUE TO RADIONUCLIDES OTHER THAN NOBLE GASES, R_i**

R_i factors for all age groups by nuclide.
Waterford Steam Electric Station
Pathway : Gaseous Release Ground Plane Exposure Pathway R_i

Nuclide	Organ Dose Conversion Factors	
	T. Body	Skin
Rb-86	8.99e+06	1.03e+07
Rb-87	0.00e+00	0.00e+00
Rb-88	3.31e+04	3.78e+04
Rb-89	1.23e+05	1.48e+05
Sr-89	2.16e+04	2.51e+04
Sr-90	0.00e+00	0.00e+00
Sr-91	2.15e+06	2.51e+06
Sr-92	7.77e+05	8.63e+05
Y-90	4.49e+03	5.31e+03
Y-91	1.07e+06	1.21e+06
Y-91m	1.00e+05	1.16e+05
Y-92	1.80e+05	2.14e+05
Y-93	1.83e+05	2.51e+05
Zr-93	0.00e+00	0.00e+00
Zr-95	2.45e+08	2.84e+08
Zr-97	2.96e+06	3.44e+06
Nb-93m	1.66e+06	2.03e+08
Nb-95	1.37e+08	1.61e+08
Nb-97	1.80e+05	2.12e+05
Mo-93	6.63e+07	2.70e+09
Mo-99	3.99e+06	4.63e+06
Tc-101	2.04e+04	2.26e+04
Tc-99	0.00e+00	0.00e+00
Tc-99m	1.84e+05	2.11e+05
Ru-103	1.08e+08	1.26e+08
Ru-105	6.36e+05	7.21e+05
Ru-106	4.22e+08	5.07e+08
Rh-105	7.42e+05	8.65e+05
Pd-107	0.00e+00	0.00e+00
Pd-109	1.50e+04	1.72e+04

Conversion factors are in units of square meter-mrem/yr per uCi/sec.

**GROUND - PLANE DEPOSITION PATHWAY
DOSE FACTORS DUE TO RADIONUCLIDES OTHER THAN NOBLE GASES, R_i**

R_i factors for all age groups by nuclide.
Waterford Steam Electric Station
Pathway : Gaseous Release Ground Plane Exposure Pathway R_i

Nuclide	Organ Dose Conversion Factors	
	T. Body	Skin
Ag-110m	3.44e+09	4.01e+09
Ag-111	1.02e+06	1.20e+06
Cd-113m	4.77e+06	5.39e+06
Cd-115m	0.00e+00	0.00e+00
Sn-123	0.00e+00	6.37e+09
Sn-125	4.19e+06	4.85e+06
Sn-126	2.61e+10	2.90e+10
Sb-124	5.98e+08	6.90e+08
Sb-125	2.34e+09	2.64e+09
Sb-126	8.50e+07	9.55e+07
Sb-127	1.69e+07	1.95e+07
Te-125m	1.55e+06	2.13e+06
Te-127	2.98e+03	3.28e+03
Te-127m	9.16e+04	1.08e+05
Te-129	2.62e+04	3.10e+04
Te-129m	1.98e+07	2.31e+07
Te-131	2.92e+04	3.45e+07
Te-131m	8.03e+06	9.46e+06
Te-132	4.23e+06	4.98e+06
Te-133m	4.41e+05	5.00e+05
Te-134	2.22e+04	2.66e+04
I-129	1.31e+09	2.18e+09
I-130	5.51e+06	6.69e+06
I-131	1.72e+07	2.09e+07
I-132	1.25e+06	1.46e+06
I-133	2.45e+06	2.98e+06
I-134	4.47e+05	5.30e+05
I-135	2.53e+06	2.95e+06
Cs-134	6.86e+09	8.00e+09
Cs-134m	5.73e+04	6.74e+04

Conversion factors are in units of square meter-mrem/yr per uCi/sec.

**GROUND - PLANE DEPOSITION PATHWAY
DOSE FACTORS DUE TO RADIONUCLIDES OTHER THAN NOBLE GASES, R_i**

R_i factors for all age groups by nuclide.
Waterford Steam Electric Station
Pathway : Gaseous Release Ground Plane Exposure Pathway R_i

Nuclide	Organ Dose Conversion Factors	
	T. Body	Skin
Cs-135	0.00e+00	0.00e+00
Cs-136	1.51e+08	1.71e+08
Cs-137	1.03e+10	1.20e+10
Cs-138	3.59e+05	4.10e+05
Cs-139	3.14e+04	3.59e+04
Ba-139	1.06e+05	1.19e+05
Ba-140	2.05e+07	2.35e+07
Ba-141	4.17e+04	4.75e+04
Ba-142	4.49e+04	5.11e+04
La-140	1.92e+07	2.18e+07
La-141	3.13e+04	3.50e+04
La-142	7.60e+05	9.11e+05
Ce-141	1.37e+07	1.54e+07
Ce-143	2.31e+06	2.63e+06
Ce-144	6.95e+07	8.04e+07
Pr-143	0.00e+00	0.00e+00
Pr-144	1.83e+03	2.11e+03
Nd-147	8.39e+06	1.01e+07
Pm-147	0.00e+00	0.00e+00
Pm-148	1.89e+07	2.18e+07
Pm-148m	4.45e+08	2.58e+09
Pm-149	4.22e+04	4.90e+04
Pm-151	1.98e+06	2.07e+06
Sm-151	1.32e+08	5.76e+08
Sm-153	4.02e+05	4.47e+05
Eu-152	1.46e+10	1.69e+10
Eu-154	2.19e+10	2.53e+10
Eu-155	1.91e+08	2.17e+08
Eu-156	8.83e+07	1.01e+08
Tb-160	4.74e+08	5.51e+08

Conversion factors are in units of square meter-mrem/yr per uCi/sec.

**GROUND - PLANE DEPOSITION PATHWAY
DOSE FACTORS DUE TO RADIONUCLIDES OTHER THAN NOBLE GASES, R_i**

R_i factors for all age groups by nuclide.
Waterford Steam Electric Station
Pathway : Gaseous Release Ground Plane Exposure Pathway R_i

Nuclide	Organ Dose Conversion Factors	
	T. Body	Skin
Ho-166m	2.57e+10	2.89e+10
W-181	1.94e+05	2.59e+05
W-185	0.00e+00	0.00e+00
W-187	2.35e+06	2.73e+06
Pb-210	2.95e+07	3.86e+07
Bi-210	0.00e+00	0.00e+00
Po-210	5.70e+03	6.54e+03
Ra-223	1.31e+07	1.57e+07
Ra-224	2.49e+07	2.80e+07
Ra-225	9.50e+05	1.36e+06
Ra-226	1.85e+10	2.14e+10
Ra-228	1.61e+10	1.88e+10
Ac-225	1.22e+07	1.38e+07
Ac-227	4.61e+09	5.54e+09
Th-227	7.21e+06	8.91e+06
Th-228	4.72e+09	5.31e+09
Th-229	6.38e+09	7.83e+09
Th-230	1.89e+10	2.18e+10
Th-232	8.70e+09	1.16e+10
Th-234	2.03e+06	2.39e+06
Pa-231	6.38e+09	7.83e+09
Pa-233	2.72e+07	3.14e+07
U-232	7.00e+06	7.27e+07
U-233	6.67e+09	8.12e+09
U-234	1.83e+06	4.61e+08
U-235	9.28e+09	1.16e+10
U-236	6.09e+04	5.22e+07
U-237	5.16e+06	6.71e+06
U-238	3.19e+08	4.35e+08
Np-237	4.06e+09	4.64e+09

Conversion factors are in units of square meter-mrem/yr per uCi/sec.

**GROUND - PLANE DEPOSITION PATHWAY
DOSE FACTORS DUE TO RADIONUCLIDES OTHER THAN NOBLE GASES, R_i**

Ri factors for all age groups by nuclide.
Waterford Steam Electric Station
Pathway : Gaseous Release Ground Plane Exposure Pathway Ri

Nuclide	Organ Dose Conversion Factors	
	T. Body	Skin
Np-238	4.54e+06	5.19e+06
Np-239	1.71e+06	1.98e+06
Pu-238	3.56e+06	4.92e+07
Pu-239	2.29e+06	2.23e+07
Pu-240	3.77e+06	5.22e+07
Pu-241	9.66e+06	1.43e+07
Pu-242	3.19e+06	4.64e+07
Pu-244	2.60e+09	2.79e+09
Am-241	1.98e+08	2.86e+08
Am-242m	7.29e+07	5.05e+08
Am-243	3.77e+09	4.35e+09
Cm-242	6.85e+05	2.87e+06
Cm-243	5.59e+09	7.05e+09
Cm-244	6.40e+06	3.97e+07
Cm-245	2.75e+09	3.48e+09
Cm-246	2.90e+06	4.35e+07
Cm-247	6.38e+09	7.54e+09
Cm-248	1.98e+10	1.52e+10
Cf-252	4.46e+10	4.87e+10

Conversion factors are in units of square meter-mrem/yr per uCi/sec.

**COW'S MILK PATHWAY DOSE FACTORS DUE TO RADIONUCLIDES
OTHER THAN NOBLE GASES, R_i**

Ri factors for Adult age group by nuclide.
Waterford Steam Electric Station
Pathway : Gaseous Release Cow's Milk Pathway Ri

Nuclide	Organ Dose Conversion Factors						
	Bone	Liver	T. Body	Thyroid	Kidney	Lung	GI-LLI
H-3	0.00e+00	4.35e+02	4.35e+02	4.35e+02	4.35e+02	4.35e+02	4.35e+02
Be-10	2.46e+06	3.79e+05	6.14e+04	0.00e+00	2.87e+05	0.00e+00	2.07e+07
C-14	2.63e+08	5.27e+07	5.27e+07	5.27e+07	5.27e+07	5.27e+07	5.27e+07
N-13	0.00e+00	0.00e+00	0.00e+00	0.00e+00	0.00e+00	0.00e+00	0.00e+00
F-18	4.65e-03	0.00e+00	5.15e-04	0.00e+00	0.00e+00	0.00e+00	1.38e-04
Na-22	5.29e+09	5.29e+09	5.29e+09	5.29e+09	5.29e+09	5.29e+09	5.29e+09
Na-24	2.44e+06	2.44e+06	2.44e+06	2.44e+06	2.44e+06	2.44e+06	2.44e+06
P-32	1.71e+10	1.06e+09	6.61e+08	0.00e+00	0.00e+00	0.00e+00	1.92e+09
Ca-41	1.14e+10	0.00e+00	1.24e+09	0.00e+00	0.00e+00	0.00e+00	1.14e+07
Sc-46	1.79e+02	3.48e+02	1.01e+02	0.00e+00	3.25e+02	0.00e+00	1.70e+06
Cr-51	0.00e+00	0.00e+00	2.86e+04	1.71e+04	6.30e+03	3.79e+04	7.19e+06
Mn-54	0.00e+00	8.41e+06	1.61e+06	0.00e+00	2.50e+06	0.00e+00	2.58e+07
Mn-56	0.00e+00	4.15e-03	7.37e-04	0.00e+00	5.27e-03	0.00e+00	1.33e-01
Fe-55	2.51e+07	1.73e+07	4.05e+06	0.00e+00	0.00e+00	9.68e+06	9.95e+06
Fe-59	2.97e+07	6.98e+07	2.68e+07	0.00e+00	0.00e+00	1.95e+07	2.33e+08
Co-57	0.00e+00	1.28e+06	2.13e+06	0.00e+00	0.00e+00	0.00e+00	3.25e+07
Co-58	0.00e+00	4.71e+06	1.06e+07	0.00e+00	0.00e+00	0.00e+00	9.55e+07
Co-60	0.00e+00	1.64e+07	3.62e+07	0.00e+00	0.00e+00	0.00e+00	3.08e+08
Ni-59	5.05e+08	1.73e+08	8.44e+07	0.00e+00	0.00e+00	0.00e+00	3.57e+07
Ni-63	6.73e+09	4.66e+08	2.26e+08	0.00e+00	0.00e+00	0.00e+00	9.73e+07
Ni-65	3.76e-01	4.88e-02	2.23e-02	0.00e+00	0.00e+00	0.00e+00	1.24e+00
Cu-64	0.00e+00	2.39e+04	1.12e+04	0.00e+00	6.03e+04	0.00e+00	2.04e+06
Zn-65	1.37e+09	4.37e+09	1.97e+09	0.00e+00	2.92e+09	0.00e+00	2.75e+09
Zn-69	2.18e-12	4.17e-12	2.90e-13	0.00e+00	2.71e-12	0.00e+00	6.26e-13
Zn-69m	1.81e+05	4.35e+05	3.98e+04	0.00e+00	2.64e+05	0.00e+00	2.66e+07
Se-79	0.00e+00	9.15e+08	1.53e+08	0.00e+00	1.58e+09	0.00e+00	1.87e+08
Br-82	0.00e+00	0.00e+00	3.23e+07	0.00e+00	0.00e+00	0.00e+00	3.70e+07
Br-83	0.00e+00	0.00e+00	9.87e-02	0.00e+00	0.00e+00	0.00e+00	1.42e-01
Br-84	0.00e+00	0.00e+00	1.73e-23	0.00e+00	0.00e+00	0.00e+00	1.36e-28
Br-85	0.00e+00	0.00e+00	0.00e+00	0.00e+00	0.00e+00	0.00e+00	0.00e+00

Conversion factors are in units of square meter-mrem/yr per uCi/sec for all nuclides except H-3, which is in units of mrem/yr per uCi/cubic meter.

**COW'S MILK PATHWAY DOSE FACTORS DUE TO RADIONUCLIDES
OTHER THAN NOBLE GASES, R_i**

R_i factors for Adult age group by nuclide.
Waterford Steam Electric Station
Pathway : Gaseous Release Cow's Milk Pathway R_i

Nuclide	Organ Dose Conversion Factors						
	Bone	Liver	T. Body	Thyroid	Kidney	Lung	GI-LLI
Rb-86	0.00e+00	2.59e+09	1.21e+09	0.00e+00	0.00e+00	0.00e+00	5.12e+08
Rb-87	0.00e+00	2.85e+09	9.92e+08	0.00e+00	0.00e+00	0.00e+00	1.34e+08
Rb-88	0.00e+00	0.00e+00	0.00e+00	0.00e+00	0.00e+00	0.00e+00	0.00e+00
Rb-89	0.00e+00	0.00e+00	0.00e+00	0.00e+00	0.00e+00	0.00e+00	0.00e+00
Sr-89	1.45e+09	0.00e+00	4.16e+07	0.00e+00	0.00e+00	0.00e+00	2.33e+08
Sr-90	5.38e+10	0.00e+00	1.08e+09	0.00e+00	0.00e+00	0.00e+00	1.35e+09
Sr-91	2.90e+04	0.00e+00	1.17e+03	0.00e+00	0.00e+00	0.00e+00	1.38e+05
Sr-92	4.95e-01	0.00e+00	2.14e-02	0.00e+00	0.00e+00	0.00e+00	9.81e+00
Y-90	7.09e+01	0.00e+00	1.90e+00	0.00e+00	0.00e+00	0.00e+00	7.52e+05
Y-91	8.59e+03	0.00e+00	2.30e+02	0.00e+00	0.00e+00	0.00e+00	4.73e+06
Y-91m	6.27e-20	0.00e+00	2.43e-21	0.00e+00	0.00e+00	0.00e+00	1.84e-19
Y-92	5.64e-05	0.00e+00	1.65e-06	0.00e+00	0.00e+00	0.00e+00	9.88e-01
Y-93	2.24e-01	0.00e+00	6.19e-03	0.00e+00	0.00e+00	0.00e+00	7.11e+03
Zr-93	1.62e+03	9.04e+01	4.21e+01	0.00e+00	3.43e+02	0.00e+00	9.39e+04
Zr-95	9.43e+02	3.03e+02	2.05e+02	0.00e+00	4.75e+02	0.00e+00	9.59e+05
Zr-97	4.34e-01	8.76e-02	4.01e-02	0.00e+00	1.32e-01	0.00e+00	2.71e+04
Nb-93m	4.91e+05	1.60e+05	3.95e+04	0.00e+00	1.84e+05	0.00e+00	7.40e+07
Nb-95	8.26e+04	4.59e+04	2.47e+04	0.00e+00	4.54e+04	0.00e+00	2.79e+08
Nb-97	6.58e-12	1.66e-12	6.07e-13	0.00e+00	1.94e-12	0.00e+00	6.14e-09
Mo-93	0.00e+00	4.35e+08	1.18e+07	0.00e+00	1.23e+08	0.00e+00	7.07e+07
Mo-99	0.00e+00	2.48e+07	4.72e+06	0.00e+00	5.61e+07	0.00e+00	5.74e+07
Tc-101	0.00e+00	0.00e+00	0.00e+00	0.00e+00	0.00e+00	0.00e+	0.00e+00
Tc-99	2.42e+07	3.59e+07	9.70e+06	0.00e+00	4.52e+08	3.05e+00	1.17e+09
Tc-99m	3.34e+00	9.44e+00	1.20e+02	0.00e+00	1.43e+02	4.63e+00	5.59e+03
Ru-103	1.02e+03	0.00e+00	4.39e+02	0.00e+00	3.89e+03	0.00e+00	1.19e+05
Ru-105	8.64e-04	0.00e+00	3.41e-04	0.00e+00	1.12e-02	0.00e+00	5.29e-01
Ru-106	2.04e+04	0.00e+00	2.58e+03	0.00e+00	3.94e+04	0.00e+00	1.32e+06
Rh-105	3.46e+05	2.53e+05	1.67e+05	0.00e+00	1.08e+06	0.00e+00	4.03e+07
Pd-107	0.00e+00	1.14e+07	7.26e+05	0.00e+00	1.02e+08	0.00e+00	7.04e+07
Pd-109	0.00e+00	4.49e+04	1.01e+04	0.00e+00	2.56e+05	0.00e+00	4.98e+06

Conversion factors are in units of square meter-mrem/yr per uCi/sec for all nuclides except H-3, which is in units of mrem/yr per uCi/cubic meter.

**COW'S MILK PATHWAY DOSE FACTORS DUE TO RADIONUCLIDES
OTHER THAN NOBLE GASES, R_i**

R_i factors for Adult age group by nuclide.
Waterford Steam Electric Station
Pathway : Gaseous Release Cow's Milk Pathway R_i

Nuclide	Organ Dose Conversion Factors						
	Bone	Liver	T. Body	Thyroid	Kidney	Lung	GI-LLI
Ag-110m	5.82e+07	5.39e+07	3.20e+07	0.00e+00	1.06e+08	0.00e+00	2.20e+10
Ag-111	6.47e+06	2.71e+06	1.35e+06	0.00e+00	8.74e+06	0.00e+00	4.97e+09
Cd-113m	0.00e+00	2.94e+06	9.43e+04	0.00e+00	3.24e+06	0.00e+00	2.37e+07
Cd-115m	0.00e+00	1.26e+06	4.02e+04	0.00e+00	9.99e+05	0.00e+00	5.30e+07
Sn-123	5.36e+08	8.88e+06	1.31e+07	7.55e+06	0.00e+00	0.00e+00	1.09e+09
Sn-125	5.68e+07	1.14e+06	2.58e+06	9.47e+05	0.00e+00	0.00e+00	7.09e+08
Sn-126	1.63e+09	3.23e+07	4.64e+07	9.51e+06	0.00e+00	0.00e+00	4.69e+08
Sb-124	2.57e+07	4.86e+05	1.02e+07	6.24e+04	0.00e+00	2.00e+07	7.31e+08
Sb-125	2.04e+07	2.28e+05	4.86e+06	2.08e+04	0.00e+00	1.58e+07	2.25e+08
Sb-126	5.63e+06	1.15e+05	2.03e+06	3.45e+04	0.00e+00	3.45e+06	4.60e+08
Sb-127	4.53e+05	9.93e+03	1.74e+05	5.45e+03	0.00e+00	2.69e+05	1.04e+08
Te-125m	1.63e+07	5.90e+06	2.18e+06	4.90e+06	6.63e+07	0.00e+00	6.50e+07
Te-127	6.56e+02	2.35e+02	1.42e+02	4.86e+02	2.67e+03	0.00e+00	5.17e+04
Te-127m	4.58e+07	1.64e+07	5.58e+06	1.17e+07	1.86e+08	0.00e+00	1.53e+08
Te-129	2.92e-10	1.10e-10	7.11e-11	2.24e-10	1.23e-09	0.00e+00	2.20e-10
Te-129m	6.02e+07	2.25e+07	9.53e+06	2.07e+07	2.51e+08	0.00e+00	3.03e+08
Te-131	3.95e-33	1.65e-33	1.25e-33	3.25e-33	1.73e-32	0.00e+00	5.60e-34
Te-131m	3.62e+05	1.77e+05	1.47e+05	2.80e+05	1.79e+06	0.00e+00	1.76e+07
Te-132	2.40e+06	1.55e+06	1.46e+06	1.72e+06	1.50e+07	0.00e+00	7.35e+07
Te-133m	2.19e-13	1.28e-13	1.24e-13	1.86e-13	1.27e-12	0.00e+00	4.40e-14
Te-134	9.41e-19	6.16e-19	3.78e-19	8.22e-19	5.95e-18	0.00e+00	1.04e-21
I-129	7.58e+08	6.51e+08	2.14e+09	1.68e+12	1.40e+09	0.00e+00	1.03e+08
I-130	4.21e+05	1.24e+06	4.90e+05	1.05e+08	1.94e+06	0.00e+00	1.07e+06
I-131	2.96e+08	4.24e+08	2.43e+08	1.39e+11	7.26e+08	0.00e+00	1.12e+08
I-132	1.67e-01	4.47e-01	1.56e-01	1.56e+01	7.12e-01	0.00e+00	8.39e-02
I-133	3.88e+06	6.74e+06	2.06e+06	9.91e+08	1.18e+07	0.00e+00	6.06e+06
I-134	2.11e-12	5.72e-12	2.05e-12	9.92e-11	9.10e-12	0.00e+00	4.99e-15
I-135	1.29e+04	3.38e+04	1.25e+04	2.23e+06	5.42e+04	0.00e+00	3.82e+04
Cs-134	5.65e+09	1.34e+10	1.10e+10	0.00e+00	4.35e+09	1.44e+09	2.35e+08
Cs-134m	1.76e-01	3.70e-01	1.89e-01	0.00e+00	2.01e-01	3.16e-02	1.31e-01

Conversion factors are in units of square meter-mrem/yr per uCi/sec for all nuclides except H-3, which is in units of mrem/yr per uCi/cubic meter.

**COW'S MILK PATHWAY DOSE FACTORS DUE TO RADIONUCLIDES
OTHER THAN NOBLE GASES, R_i**

R_i factors for Adult age group by nuclide.
Waterford Steam Electric Station
Pathway : Gaseous Release Cow's Milk Pathway R_i

Nuclide	Organ Dose Conversion Factors						
	Bone	Liver	T. Body	Thyroid	Kidney	Lung	GI-LLI
Cs-135	1.81e+09	1.67e+09	7.41e+08	0.00e+00	6.32e+08	1.89e+08	3.90e+07
Cs-136	2.63e+08	1.04e+09	7.48e+08	0.00e+00	5.78e+08	7.93e+07	1.18e+08
Cs-137	7.38e+09	1.01e+10	6.61e+09	0.00e+00	3.43e+09	1.14e+09	1.95e+08
Cs-138	9.72e-24	1.92e-23	9.50e-24	0.00e+00	1.41e-23	1.39e-24	8.18e-29
Cs-139	0.00e+00	0.00e+00	0.00e+00	0.00e+00	0.00e+00	0.00e+00	0.00e+00
Ba-139	4.54e-08	3.24e-11	1.33e-09	0.00e+00	3.03e-11	1.84e-11	8.06e-08
Ba-140	2.69e+07	3.38e+04	1.76e+06	0.00e+00	1.15e+04	1.93e+04	5.54e+07
Ba-141	0.00e+00	0.00e+00	0.00e+00	0.00e+00	0.00e+00	0.00e+00	0.00e+00
Ba-142	0.00e+00	0.00e+00	0.00e+00	0.00e+00	0.00e+00	0.00e+00	0.00e+00
La-140	4.52e+00	2.28e+00	6.01e-01	0.00e+00	0.00e+00	0.00e+00	1.67e+05
La-141	3.00e-05	9.31e-06	1.52e-06	0.00e+00	0.00e+00	0.00e+00	1.11e+00
La-142	1.90e-11	8.66e-12	2.16e-12	0.00e+00	0.00e+00	0.00e+00	6.32e-08
Ce-141	4.84e+03	3.28e+03	3.72e+02	0.00e+00	1.52e+03	0.00e+00	1.25e+07
Ce-143	4.16e+01	3.08e+04	3.40e+00	0.00e+00	1.35e+01	0.00e+00	1.15e+06
Ce-144	3.58e+05	1.50e+05	1.92e+04	0.00e+00	8.87e+04	0.00e+00	1.21e+08
Pr-143	1.58e+02	6.33e+01	7.83e+00	0.00e+00	3.66e+01	0.00e+00	6.92e+05
Pr-144	0.00e+00	0.00e+00	0.00e+00	0.00e+00	0.00e+00	0.00e+00	0.00e+00
Nd-147	9.42e+01	1.09e+02	6.51e+00	0.00e+00	6.36e+01	0.00e+00	5.22e+05
Pm-147	2.87e+03	2.70e+02	1.09e+02	0.00e+00	5.10e+02	0.00e+00	3.40e+05
Pm-148	5.93e+01	9.85e+00	4.96e+00	0.00e+00	1.86e+01	0.00e+00	7.74e+05
Pm-148m	8.57e+02	2.22e+02	1.70e+02	0.00e+00	3.35e+02	0.00e+00	1.88e+06
Pm-149	4.28e+00	6.05e-01	2.47e-01	0.00e+00	1.14e+00	0.00e+00	1.13e+05
Pm-151	6.47e-01	1.09e-01	5.48e-02	0.00e+00	1.94e-01	0.00e+00	2.99e+04
Sm-151	2.67e+03	4.60e+02	1.10e+02	0.00e+00	5.14e+02	0.00e+00	2.03e+05
Sm-153	1.99e+00	1.66e+00	1.21e-01	0.00e+00	5.36e-01	0.00e+00	5.92e+04
Eu-152	7.51e+03	1.71e+03	1.50e+03	0.00e+00	1.06e+04	0.00e+00	9.86e+05
Eu-154	2.38e+04	2.92e+03	2.08e+03	0.00e+00	1.40e+04	0.00e+00	2.12e+06
Eu-155	3.25e+03	4.61e+02	2.97e+02	0.00e+00	2.13e+03	0.00e+00	3.62e+05
Eu-156	2.52e+02	1.95e+02	3.14e+01	0.00e+00	1.30e+02	0.00e+00	1.33e+06
Tb-160	1.49e+03	0.00e+00	1.86e+02	0.00e+00	6.16e+02	0.00e+00	1.37e+06

Conversion factors are in units of square meter-mrem/yr per uCi/sec for all nuclides except H-3, which is in units of mrem/yr per uCi/cubic meter.

**COW'S MILK PATHWAY DOSE FACTORS DUE TO RADIONUCLIDES
OTHER THAN NOBLE GASES, R_i**

R_i factors for Adult age group by nuclide.
Waterford Steam Electric Station
Pathway : Gaseous Release Cow's Milk Pathway R_i

Nuclide	Organ Dose Conversion Factors						
	Bone	Liver	T. Body	Thyroid	Kidney	Lung	GI-LLI
Ho-166m	1.04e+04	3.26e+03	2.47e+03	0.00e+00	4.87e+03	0.00e+00	9.89e+05
W-181	3.39e+04	1.11e+04	1.18e+03	0.00e+00	0.00e+00	0.00e+00	1.26e+06
W-185	1.29e+06	4.32e+05	4.54e+04	0.00e+00	0.00e+00	0.00e+00	4.99e+07
W-187	6.52e+03	5.45e+03	1.91e+03	0.00e+00	0.00e+00	0.00e+00	1.79e+06
Pb-210	7.32e+10	2.09e+10	2.60e+09	0.00e+00	5.88e+10	0.00e+00	1.07e+07
Bi-210	3.56e+05	2.46e+06	2.04e+05	0.00e+00	2.96e+07	0.00e+00	3.67e+07
Po-210	7.42e+08	1.58e+09	1.79e+08	0.00e+00	5.25e+09	0.00e+00	1.33e+08
Ra-223	1.22e+11	1.88e+08	2.44e+10	0.00e+00	5.33e+09	0.00e+00	7.89e+09
Ra-224	1.41e+10	3.42e+07	2.83e+09	0.00e+00	9.65e+08	0.00e+00	2.98e+09
Ra-225	1.90e+11	2.25e+08	3.79e+10	0.00e+00	6.39e+09	0.00e+00	8.85e+09
Ra-226	1.87e+13	3.55e+08	1.36e+13	0.00e+00	1.01e+10	0.00e+00	2.05e+10
Ra-228	6.87e+12	1.91e+08	7.43e+12	0.00e+00	5.42e+09	0.00e+00	3.46e+09
Ac-225	6.17e+04	8.49e+04	4.15e+03	0.00e+00	9.67e+03	0.00e+00	5.70e+06
Ac-227	7.21e+07	9.56e+06	4.28e+06	0.00e+00	3.09e+06	0.00e+00	3.16e+06
Th-227	2.80e+05	5.06e+03	8.06e+03	0.00e+00	2.88e+04	0.00e+00	1.10e+07
Th-228	1.88e+07	3.18e+05	6.35e+05	0.00e+00	1.77e+06	0.00e+00	2.13e+07
Th-229	5.26e+08	1.50e+07	8.69e+06	0.00e+00	7.26e+07	0.00e+00	3.02e+06
Th-230	7.96e+07	4.52e+06	2.20e+06	0.00e+00	2.18e+07	0.00e+00	2.33e+06
Th-232	8.89e+07	3.86e+06	5.80e+04	0.00e+00	1.86e+07	0.00e+00	1.98e+06
Th-234	1.85e+03	1.09e+02	5.33e+01	0.00e+00	6.16e+02	0.00e+00	2.61e+06
Pa-231	1.58e+08	5.95e+06	6.14e+06	0.00e+00	3.34e+07	0.00e+00	2.77e+06
Pa-233	1.28e+02	2.58e+01	2.22e+01	0.00e+00	9.70e+01	0.00e+00	3.99e+05
U-232	1.59e+10	0.00e+00	1.14e+09	0.00e+00	1.73e+09	0.00e+00	2.62e+08
U-233	3.37e+09	0.00e+00	2.04e+08	0.00e+00	7.84e+08	0.00e+00	2.42e+08
U-234	3.23e+09	0.00e+00	2.00e+08	0.00e+00	7.69e+08	0.00e+00	2.37e+08
U-235	3.10e+09	0.00e+00	1.88e+08	0.00e+00	7.23e+08	0.00e+00	3.02e+08
U-236	3.10e+09	0.00e+00	1.92e+08	0.00e+00	7.38e+08	0.00e+00	2.23e+08
U-237	5.65e+04	0.00e+00	1.50e+04	0.00e+00	2.32e+05	0.00e+00	1.99e+07
U-238	2.96e+09	0.00e+00	1.75e+08	0.00e+00	6.76e+08	0.00e+00	2.13e+08
Np-237	4.87e+07	3.46e+06	2.14e+06	0.00e+00	1.59e+07	0.00e+00	3.07e+06

Conversion factors are in units of square meter-mrem/yr per uCi/sec for all nuclides except H-3, which is in units of mrem/yr per uCi/cubic meter.

**COW'S MILK PATHWAY DOSE FACTORS DUE TO RADIONUCLIDES
OTHER THAN NOBLE GASES, R_i**

R_i factors for Adult age group by nuclide.
Waterford Steam Electric Station
Pathway : Gaseous Release Cow's Milk Pathway R_i

Nuclide	Organ Dose Conversion Factors						
	Bone	Liver	T. Body	Thyroid	Kidney	Lung	GI-LLI
Np-238	3.62e+01	9.75e-01	5.63e-01	0.00e+00	3.30e+00	0.00e+00	9.06e+04
Np-239	3.68e+00	3.61e-01	1.99e-01	0.00e+00	1.13e+00	0.00e+00	7.41e+04
Pu-238	9.73e+06	1.23e+06	2.64e+05	0.00e+00	1.13e+06	0.00e+00	1.13e+06
Pu-239	1.12e+07	1.35e+06	2.95e+05	0.00e+00	1.25e+06	0.00e+00	1.03e+06
Pu-240	1.12e+07	1.34e+06	2.95e+05	0.00e+00	1.25e+06	0.00e+00	1.05e+06
Pu-241	2.42e+05	1.15e+04	5.12e+03	0.00e+00	2.36e+04	0.00e+00	2.16e+04
Pu-242	1.04e+07	1.30e+06	2.84e+05	0.00e+00	1.21e+06	0.00e+00	1.01e+06
Pu-244	1.21e+07	1.49e+06	3.26e+05	0.00e+00	1.38e+06	0.00e+00	1.50e+06
Am-241	2.89e+07	2.70e+07	2.07e+06	0.00e+00	1.56e+07	0.00e+00	2.84e+06
Am-242m	2.94e+07	2.56e+07	2.10e+06	0.00e+00	1.56e+07	0.00e+00	3.61e+06
Am-243	2.91e+07	2.67e+07	2.05e+06	0.00e+00	1.54e+07	0.00e+00	3.36e+06
Cm-242	7.27e+05	7.73e+05	4.83e+04	0.00e+00	2.19e+05	0.00e+00	2.79e+06
Cm-243	2.31e+07	2.12e+07	1.45e+06	0.00e+00	6.75e+06	0.00e+00	3.01e+06
Cm-244	1.76e+07	1.65e+07	1.11e+06	0.00e+00	5.17e+06	0.00e+00	2.91e+06
Cm-245	3.62e+07	3.16e+07	2.23e+06	0.00e+00	1.04e+07	0.00e+00	2.72e+06
Cm-246	3.59e+07	3.15e+07	2.22e+06	0.00e+00	1.04e+07	0.00e+00	2.67e+06
Cm-247	3.50e+07	3.11e+07	2.19e+06	0.00e+00	1.02e+07	0.00e+00	3.51e+06
Cm-248	2.91e+08	2.56e+08	1.80e+07	0.00e+00	8.42e+07	0.00e+00	5.68e+07
Cf-252	9.92e+06	0.00e+00	2.39e+05	0.00e+00	0.00e+00	0.00e+00	1.09e+07

Conversion factors are in units of square meter-mrem/yr per uCi/sec for all nuclides except H-3, which is in units of mrem/yr per uCi/cubic meter.

**COW'S MILK PATHWAY DOSE FACTORS DUE TO RADIONUCLIDES
OTHER THAN NOBLE GASES, R_i**

Ri factors for Teen age group by nuclide.
Waterford Steam Electric Station
Pathway : Gaseous Release Cow's Milk Pathway Ri

Nuclide	Organ Dose Conversion Factors						
	Bone	Liver	T. Body	Thyroid	Kidney	Lung	GI-LLI
H-3	0.00e+00	5.66e+02	5.66e+02	5.66e+02	5.66e+02	5.66e+02	5.66e+02
Be-10	4.47e+06	6.92e+05	1.13e+05	0.00e+00	5.29e+05	0.00e+00	2.83e+07
C-14	4.86e+08	9.72e+07	9.72e+07	9.72e+07	9.72e+07	9.72e+07	9.72e+07
N-13	0.00e+00	0.00e+00	0.00e+00	0.00e+00	0.00e+00	0.00e+00	0.00e+00
F-18	8.30e-03	0.00e+00	9.10e-04	0.00e+00	0.00e+00	0.00e+00	7.48e-04
Na-22	9.18e+09	9.18e+09	9.18e+09	9.18e+09	9.18e+09	9.18e+09	9.18e+09
Na-24	4.27e+06	4.27e+06	4.27e+06	4.27e+06	4.27e+06	4.27e+06	4.27e+06
P-32	3.15e+10	1.95e+09	1.22e+09	0.00e+00	0.00e+00	0.00e+00	2.65e+09
Ca-41	1.57e+10	0.00e+00	1.70e+09	0.00e+00	0.00e+00	0.00e+00	1.56e+07
Sc-46	3.04e+02	5.92e+02	1.76e+02	0.00e+00	5.67e+02	0.00e+00	2.02e+06
Cr-51	0.00e+00	0.00e+00	4.99e+04	2.77e+04	1.09e+04	7.13e+04	8.39e+06
Mn-54	0.00e+00	1.40e+07	2.78e+06	0.00e+00	4.18e+06	0.00e+00	2.87e+07
Mn-56	0.00e+00	7.36e-03	1.31e-03	0.00e+00	9.32e-03	0.00e+00	4.85e-01
Fe-55	4.45e+07	3.16e+07	7.36e+06	0.00e+00	0.00e+00	2.00e+07	1.37e+07
Fe-59	5.18e+07	1.21e+08	4.67e+07	0.00e+00	0.00e+00	3.81e+07	2.86e+08
Co-57	0.00e+00	2.24e+06	3.76e+06	0.00e+00	0.00e+00	0.00e+00	4.19e+07
Co-58	0.00e+00	7.94e+06	1.83e+07	0.00e+00	0.00e+00	0.00e+00	1.09e+08
Co-60	0.00e+00	2.78e+07	6.26e+07	0.00e+00	0.00e+00	0.00e+00	3.62e+08
Ni-59	8.82e+08	3.11e+08	1.50e+08	0.00e+00	0.00e+00	0.00e+00	4.88e+07
Ni-63	1.18e+10	8.35e+08	4.01e+08	0.00e+00	0.00e+00	0.00e+00	1.33e+08
Ni-65	6.87e-01	8.78e-02	4.00e-02	0.00e+00	0.00e+00	0.00e+00	4.76e+00
Cu-64	0.00e+00	4.26e+04	2.00e+04	0.00e+00	1.08e+05	0.00e+00	3.30e+06
Zn-65	2.11e+09	7.32e+09	3.41e+09	0.00e+00	4.68e+09	0.00e+00	3.10e+09
Zn-69	4.01e-12	7.65e-12	5.35e-13	0.00e+00	5.00e-12	0.00e+00	1.41e-11
Zn-69m	3.30e+05	7.79e+05	7.15e+04	0.00e+00	4.74e+05	0.00e+00	4.28e+07
Se-79	0.00e+00	1.67e+09	2.81e+08	0.00e+00	2.92e+09	0.00e+00	2.56e+08
Br-82	0.00e+00	0.00e+00	5.61e+07	0.00e+00	0.00e+00	0.00e+00	0.00e+00
Br-83	0.00e+00	0.00e+00	1.82e-01	0.00e+00	0.00e+00	0.00e+00	0.00e+00
Br-84	0.00e+00	0.00e+00	3.09e-23	0.00e+00	0.00e+00	0.00e+00	0.00e+00
Br-85	0.00e+00	0.00e+00	0.00e+00	0.00e+00	0.00e+00	0.00e+00	0.00e+00

Conversion factors are in units of square meter-mrem/yr per uCi/sec for all nuclides except H-3, which is in units of mrem/yr per uCi/cubic meter.

**COW'S MILK PATHWAY DOSE FACTORS DUE TO RADIONUCLIDES
OTHER THAN NOBLE GASES, R_i**

R_i factors for Teen age group by nuclide.
Waterford Steam Electric Station
Pathway : Gaseous Release Cow's Milk Pathway R_i

Nuclide	Organ Dose Conversion Factors						
	Bone	Liver	T. Body	Thyroid	Kidney	Lung	GI-LLI
Rb-86	0.00e+00	4.73e+09	2.22e+09	0.00e+00	0.00e+00	0.00e+00	7.00e+08
Rb-87	0.00e+00	5.24e+09	1.83e+09	0.00e+00	0.00e+00	0.00e+00	1.83e+08
Rb-88	0.00e+00	0.00e+00	0.00e+00	0.00e+00	0.00e+00	0.00e+00	0.00e+00
Rb-89	0.00e+00	0.00e+00	0.00e+00	0.00e+00	0.00e+00	0.00e+00	0.00e+00
Sr-89	2.67e+09	0.00e+00	7.66e+07	0.00e+00	0.00e+00	0.00e+00	3.19e+08
Sr-90	8.13e+10	0.00e+00	1.63e+09	0.00e+00	0.00e+00	0.00e+00	1.86e+09
Sr-91	5.33e+04	0.00e+00	2.12e+03	0.00e+00	0.00e+00	0.00e+00	2.42e+05
Sr-92	9.07e-01	0.00e+00	3.86e-02	0.00e+00	0.00e+00	0.00e+00	2.31e+01
Y-90	1.30e+02	0.00e+00	3.51e+00	0.00e+00	0.00e+00	0.00e+00	1.07e+06
Y-91	1.58e+04	0.00e+00	4.24e+02	0.00e+00	0.00e+00	0.00e+00	6.48e+06
Y-91m	1.15e-19	0.00e+00	4.39e-21	0.00e+00	0.00e+00	0.00e+00	5.42e-18
Y-92	1.04e-04	0.00e+00	3.01e-06	0.00e+00	0.00e+00	0.00e+00	2.86e+00
Y-93	4.13e-01	0.00e+00	1.13e-02	0.00e+00	0.00e+00	0.00e+00	1.26e+04
Zr-93	2.76e+03	1.36e+02	7.43e+01	0.00e+00	4.81e+02	0.00e+00	1.29e+05
Zr-95	1.65e+03	5.20e+02	3.58e+02	0.00e+00	7.65e+02	0.00e+00	1.20e+06
Zr-97	7.90e-01	1.56e-01	7.20e-02	0.00e+00	2.37e-01	0.00e+00	4.23e+04
Nb-93m	8.55e+05	2.81e+05	7.03e+04	0.00e+00	3.28e+05	0.00e+00	1.01e+08
Nb-95	1.41e+05	7.81e+04	4.30e+04	0.00e+00	7.57e+04	0.00e+00	3.34e+08
Nb-97	1.20e-11	2.98e-12	1.09e-12	0.00e+00	3.48e-12	0.00e+00	7.11e-08
Mo-93	0.00e+00	7.93e+08	2.17e+07	0.00e+00	2.27e+08	0.00e+00	9.65e+07
Mo-99	0.00e+00	4.47e+07	8.53e+06	0.00e+00	1.02e+08	0.00e+00	8.01e+07
Tc-101	0.00e+00	0.00e+00	0.00e+00	0.00e+00	0.00e+00	0.00e+00	0.00e+00
Tc-99	4.46e+07	6.56e+07	1.79e+07	0.00e+00	8.33e+08	6.78e+06	1.61e+09
Tc-99m	5.80e+00	1.62e+01	2.10e+02	0.00e+00	2.41e+02	8.97e+00	1.06e+04
Ru-103	1.81e+03	0.00e+00	7.74e+02	0.00e+00	6.38e+03	0.00e+00	1.51e+05
Ru-105	1.58e-03	0.00e+00	6.13e-04	0.00e+00	1.99e-02	0.00e+00	1.27e+00
Ru-106	3.75e+04	0.00e+00	4.73e+03	0.00e+00	7.24e+04	0.00e+00	1.80e+06
Rh-105	6.38e+05	4.61e+05	3.03e+05	0.00e+00	1.96e+06	0.00e+00	5.87e+07
Pd-107	0.00e+00	2.07e+07	1.34e+06	0.00e+00	1.87e+08	0.00e+00	9.63e+07
Pd-109	0.00e+00	8.22e+04	1.87e+04	0.00e+00	4.75e+05	0.00e+00	8.29e+06

Conversion factors are in units of square meter-mrem/yr per uCi/sec for all nuclides except H-3, which is in units of mrem/yr per uCi/cubic meter.

**COW'S MILK PATHWAY DOSE FACTORS DUE TO RADIONUCLIDES
OTHER THAN NOBLE GASES, R_i**

Ri factors for Teen age group by nuclide.
Waterford Steam Electric Station
Pathway : Gaseous Release Cow's Milk Pathway Ri

Nuclide	Organ Dose Conversion Factors						
	Bone	Liver	T. Body	Thyroid	Kidney	Lung	GI-LLI
Ag-110m	9.63e+07	9.11e+07	5.54e+07	0.00e+00	1.74e+08	0.00e+00	2.56e+10
Ag-111	1.19e+07	4.95e+06	2.49e+06	0.00e+00	1.61e+07	0.00e+00	6.90e+09
Cd-113m	0.00e+00	5.38e+06	1.73e+05	0.00e+00	5.95e+06	0.00e+00	3.23e+07
Cd-115m	0.00e+00	2.30e+06	7.41e+04	0.00e+00	1.84e+06	0.00e+00	7.27e+07
Sn-123	9.88e+08	1.62e+07	2.40e+07	1.30e+07	0.00e+00	0.00e+00	1.49e+09
Sn-125	1.05e+08	2.08e+06	4.72e+06	1.64e+06	0.00e+00	0.00e+00	9.85e+08
Sn-126	2.89e+09	5.38e+07	8.23e+07	1.42e+07	0.00e+00	0.00e+00	6.43e+08
Sb-124	4.59e+07	8.46e+05	1.79e+07	1.04e+05	0.00e+00	4.01e+07	9.25e+08
Sb-125	3.65e+07	3.99e+05	8.55e+06	3.49e+04	0.00e+00	3.21e+07	2.84e+08
Sb-126	1.00e+07	2.05e+05	3.61e+06	5.68e+04	0.00e+00	7.20e+06	5.94e+08
Sb-127	8.23e+05	1.76e+04	3.11e+05	9.25e+03	0.00e+00	5.60e+05	1.40e+08
Te-125m	3.00e+07	1.08e+07	4.02e+06	8.39e+06	0.00e+00	0.00e+00	8.86e+07
Te-127	1.22e+03	4.31e+02	2.61e+02	8.38e+02	4.92e+03	0.00e+00	9.38e+04
Te-127m	8.44e+07	2.99e+07	1.00e+07	2.01e+07	3.42e+08	0.00e+00	2.10e+08
Te-129	5.37e-10	2.00e-10	1.31e-10	3.84e-10	2.25e-09	0.00e+00	2.94e-09
Te-129m	1.10e+08	4.09e+07	1.74e+07	3.55e+07	4.61e+08	0.00e+00	4.13e+08
Te-131	7.22e-33	2.98e-33	2.26e-33	5.57e-33	3.16e-32	0.00e+00	5.93e-34
Te-131m	6.58e+05	3.15e+05	2.63e+05	4.75e+05	3.29e+06	0.00e+00	2.53e+07
Te-132	4.29e+06	2.72e+06	2.56e+06	2.87e+06	2.61e+07	0.00e+00	8.61e+07
Te-133m	3.95e-13	2.24e-13	2.18e-13	3.13e-13	2.22e-12	0.00e+00	9.07e-13
Te-134	1.68e-18	1.08e-18	1.12e-18	1.38e-18	1.03e-17	0.00e+00	6.22e-20
I-129	1.39e+09	1.17e+09	1.96e+09	1.43e+12	2.10e+09	0.00e+00	1.37e+08
I-130	7.41e+05	2.14e+06	8.56e+05	1.75e+08	3.30e+06	0.00e+00	1.65e+06
I-131	5.37e+08	7.52e+08	4.04e+08	2.20e+11	1.30e+09	0.00e+00	1.49e+08
I-132	2.96e-01	7.75e-01	2.78e-01	2.61e+01	1.22e+00	0.00e+00	3.38e-01
I-133	7.08e+06	1.20e+07	3.66e+06	1.68e+09	2.11e+07	0.00e+00	9.09e+06
I-134	3.74e-12	9.92e-12	3.56e-12	1.65e-10	1.56e-11	0.00e+00	1.31e-13
I-135	2.29e+04	5.90e+04	2.19e+04	3.80e+06	9.33e+04	0.00e+00	6.54e+04
Cs-134	9.81e+09	2.31e+10	1.07e+10	0.00e+00	7.34e+09	2.80e+09	2.87e+08
Cs-134m	3.13e-01	6.49e-01	3.34e-01	0.00e+00	3.61e-01	6.34e-02	4.32e-01

Conversion factors are in units of square meter-mrem/yr per uCi/sec for all nuclides except H-3, which is in units of mrem/yr per uCi/cubic meter.

**COW'S MILK PATHWAY DOSE FACTORS DUE TO RADIONUCLIDES
OTHER THAN NOBLE GASES, R_i**

R_i factors for Teen age group by nuclide.
Waterford Steam Electric Station
Pathway : Gaseous Release Cow's Milk Pathway R_i

Nuclide	Organ Dose Conversion Factors						
	Bone	Liver	T. Body	Thyroid	Kidney	Lung	GI-LLI
Cs-135	3.33e+09	3.05e+09	7.13e+08	0.00e+00	1.16e+09	4.21e+08	5.34e+07
Cs-136	4.48e+08	1.76e+09	1.18e+09	0.00e+00	9.60e+08	1.51e+08	1.42e+08
Cs-137	1.34e+10	1.78e+10	6.20e+09	0.00e+00	6.06e+09	2.35e+09	2.53e+08
Cs-138	1.76e-23	3.38e-23	1.69e-23	0.00e+00	2.50e-23	2.91e-24	1.54e-26
Cs-139	0.00e+00	0.00e+00	0.00e+00	0.00e+00	0.00e+00	0.00e+00	0.00e+00
Ba-139	8.40e-08	5.91e-11	2.45e-09	0.00e+00	5.57e-11	4.07e-11	7.50e-07
Ba-140	4.85e+07	5.95e+04	3.13e+06	0.00e+00	2.02e+04	4.00e+04	7.48e+07
Ba-141	0.00e+00	0.00e+00	0.00e+00	0.00e+00	0.00e+00	0.00e+00	0.00e+00
Ba-142	0.00e+00	0.00e+00	0.00e+00	0.00e+00	0.00e+00	0.00e+00	0.00e+00
La-140	8.11e+00	3.99e+00	1.06e+00	0.00e+00	0.00e+00	0.00e+00	2.29e+05
La-141	5.52e-05	1.70e-05	2.80e-06	0.00e+00	0.00e+00	0.00e+00	3.01e+00
La-142	3.43e-11	1.53e-11	3.80e-12	0.00e+00	0.00e+00	0.00e+00	4.64e-07
Ce-141	8.88e+03	5.93e+03	6.81e+02	0.00e+00	2.79e+03	0.00e+00	1.70e+07
Ce-143	7.65e+01	5.56e+04	6.21e+00	0.00e+00	2.50e+01	0.00e+00	1.67e+06
Ce-144	6.58e+05	2.72e+05	3.54e+04	0.00e+00	1.63e+05	0.00e+00	1.66e+08
Pr-143	2.90e+02	1.16e+02	1.44e+01	0.00e+00	6.73e+01	0.00e+00	9.55e+05
Pr-144	0.00e+00	0.00e+00	0.00e+00	0.00e+00	0.00e+00	0.00e+00	0.00e+00
Nd-147	1.81e+02	1.97e+02	1.18e+01	0.00e+00	1.16e+02	0.00e+00	7.11e+05
Pm-147	5.15e+03	4.89e+02	1.99e+02	0.00e+00	9.32e+02	0.00e+00	4.65e+05
Pm-148	1.09e+02	1.77e+01	8.93e+00	0.00e+00	3.20e+01	0.00e+00	1.06e+06
Pm-148m	1.49e+03	3.78e+02	2.96e+02	0.00e+00	5.73e+02	0.00e+00	2.38e+06
Pm-149	7.88e+00	1.11e+00	4.54e-01	0.00e+00	2.11e+00	0.00e+00	1.63e+05
Pm-151	1.18e+00	1.95e-01	9.88e-02	0.00e+00	3.51e-01	0.00e+00	4.38e+04
Sm-151	4.35e+03	8.37e+02	1.96e+02	0.00e+00	9.17e+02	0.00e+00	2.84e+05
Sm-153	3.65e+00	3.02e+00	2.22e-01	0.00e+00	9.88e-01	0.00e+00	8.53e+04
Eu-152	1.22e+04	2.93e+03	2.58e+03	0.00e+00	1.36e+04	0.00e+00	1.08e+06
Eu-154	3.94e+04	5.08e+03	3.58e+03	0.00e+00	2.27e+04	0.00e+00	2.69e+06
Eu-155	8.48e+03	8.18e+02	5.07e+02	0.00e+00	3.20e+03	0.00e+00	4.69e+06
Eu-156	4.55e+02	3.41e+02	5.57e+01	0.00e+00	2.30e+02	0.00e+00	1.74e+06
Tb-160	2.65e+03	0.00e+00	3.31e+02	0.00e+00	1.05e+03	0.00e+00	1.72e+06

Conversion factors are in units of square meter-mrem/yr per uCi/sec for all nuclides except H-3, which is in units of mrem/yr per uCi/cubic meter.

**COW'S MILK PATHWAY DOSE FACTORS DUE TO RADIONUCLIDES
OTHER THAN NOBLE GASES, R_i**

R_i factors for Teen age group by nuclide.
Waterford Steam Electric Station
Pathway : Gaseous Release Cow's Milk Pathway R_i

Nuclide	Organ Dose Conversion Factors						
	Bone	Liver	T. Body	Thyroid	Kidney	Lung	GI-LLI
Ho-166m	1.78e+04	5.48e+03	3.97e+03	0.00e+00	8.03e+03	0.00e+00	1.35e+06
W-181	6.27e+04	2.02e+04	2.12e+03	0.00e+00	0.00e+00	0.00e+00	1.72e+06
W-185	2.39e+06	7.88e+05	8.33e+04	0.00e+00	0.00e+00	0.00e+00	6.81e+07
W-187	1.19e+04	9.73e+03	3.41e+03	0.00e+00	0.00e+00	0.00e+00	2.63e+06
Pb-210	1.12e+11	3.36e+10	4.33e+09	0.00e+00	1.06e+11	0.00e+00	1.46e+07
Bi-210	6.57e+05	4.49e+06	3.76e+05	0.00e+00	5.46e+07	0.00e+00	5.13e+07
Po-210	1.37e+09	2.88e+09	3.31e+08	0.00e+00	9.68e+09	0.00e+00	1.81e+08
Ra-223	2.25e+11	3.42e+08	4.50e+10	0.00e+00	9.83e+09	0.00e+00	1.09e+10
Ra-224	2.62e+10	6.25e+07	5.22e+09	0.00e+00	1.79e+09	0.00e+00	4.20e+09
Ra-225	3.50e+11	4.11e+08	6.98e+10	0.00e+00	1.18e+10	0.00e+00	1.22e+10
Ra-226	2.57e+13	6.49e+08	1.91e+13	0.00e+00	1.85e+10	0.00e+00	2.80e+10
Ra-228	1.08e+13	3.49e+08	1.20e+13	0.00e+00	9.98e+09	0.00e+00	4.74e+09
Ac-225	1.14e+05	1.55e+05	7.63e+03	0.00e+00	1.78e+04	0.00e+00	7.89e+06
Ac-227	1.02e+08	1.51e+07	6.07e+06	0.00e+00	4.38e+06	0.00e+00	4.32e+06
Th-227	5.16e+05	9.27e+03	1.49e+04	0.00e+00	5.29e+04	0.00e+00	1.51e+07
Th-228	3.32e+07	5.56e+05	1.12e+06	0.00e+00	3.13e+06	0.00e+00	2.91e+07
Th-229	7.13e+08	2.05e+07	1.18e+07	0.00e+00	9.92e+07	0.00e+00	4.13e+06
Th-230	1.08e+08	6.13e+06	2.99e+06	0.00e+00	2.99e+07	0.00e+00	3.18e+06
Th-232	1.21e+08	5.24e+06	8.13e+04	0.00e+00	2.55e+07	0.00e+00	2.71e+06
Th-234	3.39e+03	1.99e+02	9.86e+01	0.00e+00	1.13e+03	0.00e+00	3.60e+06
Pa-231	2.15e+08	8.08e+06	8.38e+06	0.00e+00	4.54e+07	0.00e+00	3.79e+06
Pa-233	2.30e+02	4.42e+01	3.95e+01	0.00e+00	1.67e+02	0.00e+00	5.05e+05
U-232	2.94e+10	0.00e+00	2.10e+09	0.00e+00	3.18e+09	0.00e+00	3.58e+08
U-233	6.18e+09	0.00e+00	3.76e+08	0.00e+00	1.45e+09	0.00e+00	3.32e+08
U-234	5.93e+09	0.00e+00	3.68e+08	0.00e+00	1.42e+09	0.00e+00	3.25e+08
U-235	5.68e+09	0.00e+00	3.46e+08	0.00e+00	1.33e+09	0.00e+00	4.13e+08
U-236	5.68e+09	0.00e+00	3.54e+08	0.00e+00	1.36e+09	0.00e+00	3.05e+08
U-237	1.04e+05	0.00e+00	2.77e+04	0.00e+00	4.28e+05	0.00e+00	2.76e+07
U-238	5.43e+09	0.00e+00	3.24e+08	0.00e+00	1.25e+09	0.00e+00	2.91e+08
Np-237	6.63e+07	4.76e+06	2.92e+06	0.00e+00	2.16e+07	0.00e+00	4.19e+06

Conversion factors are in units of square meter-mrem/yr per uCi/sec for all nuclides except H-3, which is in units of mrem/yr per uCi/cubic meter.

**COW'S MILK PATHWAY DOSE FACTORS DUE TO RADIONUCLIDES
OTHER THAN NOBLE GASES, R_i**

Ri factors for Teen age group by nuclide.
Waterford Steam Electric Station
Pathway : Gaseous Release Cow's Milk Pathway Ri

Nuclide	Organ Dose Conversion Factors						
	Bone	Liver	T. Body	Thyroid	Kidney	Lung	GI-LLI
Np-238	6.65e+01	1.78e+00	1.04e+00	0.00e+00	6.10e+00	0.00e+00	1.31e+05
Np-239	7.01e+00	6.62e-01	3.67e-01	0.00e+00	2.08e+00	0.00e+00	1.06e+05
Pu-238	1.34e+07	1.71e+06	3.63e+05	0.00e+00	1.55e+06	0.00e+00	1.54e+06
Pu-239	1.53e+07	1.85e+06	4.01e+05	0.00e+00	1.71e+06	0.00e+00	1.41e+06
Pu-240	1.52e+07	1.85e+06	4.01e+05	0.00e+00	1.71e+06	0.00e+00	1.43e+06
Pu-241	3.48e+05	1.67e+04	7.34e+03	0.00e+00	3.40e+04	0.00e+00	2.94e+04
Pu-242	1.41e+07	1.78e+06	3.87e+05	0.00e+00	1.65e+06	0.00e+00	1.38e+06
Pu-244	1.65e+07	2.03e+06	4.43e+05	0.00e+00	1.88e+06	0.00e+00	2.05e+06
Am-241	3.94e+07	3.72e+07	2.84e+06	0.00e+00	2.13e+07	0.00e+00	3.89e+06
Am-242m	4.02e+07	3.54e+07	2.89e+06	0.00e+00	2.14e+07	0.00e+00	4.93e+06
Am-243	3.97e+07	3.66e+07	2.80e+06	0.00e+00	2.10e+07	0.00e+00	4.60e+06
Cm-242	1.34e+06	1.41e+06	8.88e+04	0.00e+00	4.05e+05	0.00e+00	3.82e+06
Cm-243	3.24e+07	3.00e+07	2.04e+06	0.00e+00	9.51e+06	0.00e+00	4.12e+06
Cm-244	2.51e+07	2.37e+07	1.59e+06	0.00e+00	7.41e+06	0.00e+00	3.98e+06
Cm-245	4.94e+07	4.34e+07	3.04e+06	0.00e+00	1.42e+07	0.00e+00	3.72e+06
Cm-246	4.90e+07	4.34e+07	3.04e+06	0.00e+00	1.42e+07	0.00e+00	3.65e+06
Cm-247	4.77e+07	4.27e+07	2.99e+06	0.00e+00	1.40e+07	0.00e+00	4.80e+06
Cm-248	3.96e+08	3.52e+08	2.47e+07	0.00e+00	1.15e+08	0.00e+00	7.73e+07
Cf-252	1.70e+07	0.00e+00	4.10e+05	0.00e+00	0.00e+00	0.00e+00	1.50e+07

Conversion factors are in units of square meter-mrem/yr per uCi/sec for all nuclides except H-3, which is in units of mrem/yr per uCi/cubic meter.

**COW'S MILK PATHWAY DOSE FACTORS DUE TO RADIONUCLIDES
OTHER THAN NOBLE GASES, R_i**

R_i factors for Child age group by nuclide.
Waterford Steam Electric Station
Pathway : Gaseous Release Cow's Milk Pathway R_i

Nuclide	Organ Dose Conversion Factors						
	Bone	Liver	T. Body	Thyroid	Kidney	Lung	GI-LLI
H-3	0.00e+00	8.97e+02	8.97e+02	8.97e+02	8.97e+02	8.97e+02	8.97e+02
Be-10	1.11e+07	1.29e+06	2.79e+05	0.00e+00	9.13e+05	0.00e+00	2.26e+07
C-14	1.19e+09	2.39e+08	2.39e+08	2.39e+08	2.39e+08	2.39e+08	2.39e+08
N-13	0.00e+00	0.00e+00	0.00e+00	0.00e+00	0.00e+00	0.00e+00	0.00e+00
F-18	1.97e-02	0.00e+00	1.96e-03	0.00e+00	0.00e+00	0.00e+00	5.34e-03
Na-22	1.90e+10	1.90e+10	1.90e+10	1.90e+10	1.90e+10	1.90e+10	1.90e+10
Na-24	8.88e+06	8.88e+06	8.88e+06	8.88e+06	8.88e+06	8.88e+06	8.88e+06
P-32	7.78e+10	3.64e+09	3.00e+09	0.00e+00	0.00e+00	0.00e+00	2.15e+09
Ca-41	2.28e+10	0.00e+00	2.49e+09	0.00e+00	0.00e+00	0.00e+00	1.25e+07
Sc-46	6.83e+02	9.36e+02	3.61e+02	0.00e+00	8.29e+02	0.00e+00	1.37e+06
Cr-51	0.00e+00	0.00e+00	1.02e+05	5.65e+04	1.54e+04	1.03e+05	5.40e+06
Mn-54	0.00e+00	2.10e+07	5.59e+06	0.00e+00	5.88e+06	0.00e+00	1.76e+07
Mn-56	0.00e+00	1.28e-02	2.90e-03	0.00e+00	1.55e-02	0.00e+00	1.86e+00
Fe-55	1.12e+08	5.93e+07	1.84e+07	0.00e+00	0.00e+00	3.35e+07	1.10e+07
Fe-59	1.20e+08	1.95e+08	9.69e+07	0.00e+00	0.00e+00	5.64e+07	2.03e+08
Co-57	0.00e+00	3.84e+06	7.77e+06	0.00e+00	0.00e+00	0.00e+00	3.14e+07
Co-58	0.00e+00	1.21e+07	3.71e+07	0.00e+00	0.00e+00	0.00e+00	7.07e+07
Co-60	0.00e+00	4.32e+07	1.27e+08	0.00e+00	0.00e+00	0.00e+00	2.39e+08
Ni-59	2.22e+09	5.90e+08	3.76e+08	0.00e+00	0.00e+00	0.00e+00	3.91e+07
Ni-63	2.96e+10	1.59e+09	1.01e+09	0.00e+00	0.00e+00	0.00e+00	1.07e+08
Ni-65	1.68e+00	1.58e-01	9.24e-02	0.00e+00	0.00e+00	0.00e+00	1.94e+01
Cu-64	0.00e+00	7.49e+04	4.52e+04	0.00e+00	1.81e+05	0.00e+00	3.51e+06
Zn-65	4.13e+09	1.10e+10	6.85e+09	0.00e+00	6.94e+09	0.00e+00	1.93e+09
Zn-69	9.87e-12	1.43e-11	1.32e-12	0.00e+00	8.65e-12	0.00e+00	8.99e-10
Zn-69m	8.06e+05	1.37e+06	1.62e+05	0.00e+00	7.98e+05	0.00e+00	4.47e+07
Se-79	0.00e+00	3.12e+09	6.92e+08	0.00e+00	5.07e+09	0.00e+00	2.05e+08
Br-82	0.00e+00	0.00e+00	1.15e+08	0.00e+00	0.00e+00	0.00e+00	0.00e+00
Br-83	0.00e+00	0.00e+00	4.47e-01	0.00e+00	0.00e+00	0.00e+00	0.00e+00
Br-84	0.00e+00	0.00e+00	7.00e-23	0.00e+00	0.00e+00	0.00e+00	0.00e+00
Br-85	0.00e+00	0.00e+00	0.00e+00	0.00e+00	0.00e+00	0.00e+00	0.00e+00

Conversion factors are in units of square meter-mrem/yr per uCi/sec for all nuclides except H-3, which is in units of mrem/yr per uCi/cubic meter.

**COW'S MILK PATHWAY DOSE FACTORS DUE TO RADIONUCLIDES
OTHER THAN NOBLE GASES, R_i**

R_i factors for Child age group by nuclide.
Waterford Steam Electric Station
Pathway : Gaseous Release Cow's Milk Pathway R_i

Nuclide	Organ Dose Conversion Factors						
	Bone	Liver	T. Body	Thyroid	Kidney	Lung	GI-LLI
Rb-86	0.00e+00	8.77e+09	5.39e+09	0.00e+00	0.00e+00	0.00e+00	5.64e+08
Rb-87	0.00e+00	9.75e+09	4.52e+09	0.00e+00	0.00e+00	0.00e+00	1.46e+08
Rb-88	0.00e+00	0.00e+00	0.00e+00	0.00e+00	0.00e+00	0.00e+00	0.00e+00
Rb-89	0.00e+00	0.00e+00	0.00e+00	0.00e+00	0.00e+00	0.00e+00	0.00e+00
Sr-89	6.62e+09	0.00e+00	1.89e+08	0.00e+00	0.00e+00	0.00e+00	2.56e+08
Sr-90	1.68e+11	0.00e+00	3.38e+09	0.00e+00	0.00e+00	0.00e+00	1.50e+09
Sr-91	1.31e+05	0.00e+00	4.94e+03	0.00e+00	0.00e+00	0.00e+00	2.89e+05
Sr-92	2.21e+00	0.00e+00	8.88e-02	0.00e+00	0.00e+00	0.00e+00	4.19e+01
Y-90	3.22e+02	0.00e+00	8.63e+00	0.00e+00	0.00e+00	0.00e+00	9.18e+05
Y-91	3.90e+04	0.00e+00	1.04e+03	0.00e+00	0.00e+00	0.00e+00	5.20e+06
Y-91m	2.80e-19	0.00e+00	1.02e-20	0.00e+00	0.00e+00	0.00e+00	5.49e-16
Y-92	2.56e-04	0.00e+00	7.32e-06	0.00e+00	0.00e+00	0.00e+00	7.39e+00
Y-93	1.02e+00	0.00e+00	2.79e-02	0.00e+00	0.00e+00	0.00e+00	1.51e+04
Zr-93	6.87e+03	2.57e+02	1.83e+02	0.00e+00	9.95e+02	0.00e+00	9.75e+04
Zr-95	3.83e+03	8.42e+02	7.50e+02	0.00e+00	1.21e+03	0.00e+00	8.79e+05
Zr-97	1.92e+00	2.78e-01	1.64e-01	0.00e+00	3.99e-01	0.00e+00	4.21e+04
Nb-93m	2.15e+06	5.37e+05	1.77e+05	0.00e+00	5.80e+05	0.00e+00	8.10e+07
Nb-95	3.18e+05	1.24e+05	8.84e+04	0.00e+00	1.16e+05	0.00e+00	2.29e+08
Nb-97	2.91e-11	5.26e-12	2.46e-12	0.00e+00	5.84e-12	0.00e+00	1.62e-06
Mo-93	0.00e+00	1.49e+09	5.34e+07	0.00e+00	3.92e+08	0.00e+00	7.53e+07
Mo-99	0.00e+00	8.14e+07	2.01e+07	0.00e+00	1.74e+08	0.00e+00	6.73e+07
Tc-101	0.00e+00	0.00e+00	0.00e+00	0.00e+00	0.00e+00	0.00e+00	0.00e+00
Tc-99	1.10e+08	1.23e+08	4.40e+07	0.00e+00	1.44e+09	1.08e+07	1.29e+09
Tc-99m	1.33e+01	2.61e+01	4.32e+02	0.00e+00	3.79e+02	1.32e+01	1.48e+04
Ru-103	4.28e+03	0.00e+00	1.65e+03	0.00e+00	1.08e+04	0.00e+00	1.11e+05
Ru-105	3.85e-03	0.00e+00	1.40e-03	0.00e+00	3.39e-02	0.00e+00	2.51e+00
Ru-106	9.24e+04	0.00e+00	1.15e+04	0.00e+00	1.25e+05	0.00e+00	1.44e+06
Rh-105	1.56e+06	8.40e+05	7.18e+05	0.00e+00	3.35e+06	0.00e+00	5.21e+07
Pd-107	0.00e+00	3.88e+07	3.30e+06	0.00e+00	3.25e+08	0.00e+00	7.71e+07
Pd-109	0.00e+00	1.53e+05	4.59e+04	0.00e+00	8.22e+05	0.00e+00	9.05e+06

Conversion factors are in units of square meter-mrem/yr per uCi/sec for all nuclides except H-3, which is in units of mrem/yr per uCi/cubic meter.

**COW'S MILK PATHWAY DOSE FACTORS DUE TO RADIONUCLIDES
OTHER THAN NOBLE GASES, R_i**

R_i factors for Child age group by nuclide.
Waterford Steam Electric Station
Pathway : Gaseous Release Cow's Milk Pathway R_i

Nuclide	Organ Dose Conversion Factors						
	Bone	Liver	T. Body	Thyroid	Kidney	Lung	GI-LLI
Ag-110m	2.09e+08	1.41e+08	1.13e+08	0.00e+00	2.63e+08	0.00e+00	1.68e+10
Ag-111	2.94e+07	9.20e+06	6.07e+06	0.00e+00	2.78e+07	0.00e+00	5.63e+09
Cd-113m	0.00e+00	1.00e+07	4.27e+05	0.00e+00	1.03e+07	0.00e+00	2.59e+07
Cd-115m	0.00e+00	4.29e+06	1.83e+05	0.00e+00	3.19e+06	0.00e+00	5.83e+07
Sn-123	2.44e+09	3.03e+07	5.95e+07	3.21e+07	0.00e+00	0.00e+00	1.20e+09
Sn-125	2.57e+08	3.88e+06	1.15e+07	4.03e+06	0.00e+00	0.00e+00	7.98e+08
Sn-126	6.85e+09	8.54e+07	1.95e+08	2.34e+07	0.00e+00	0.00e+00	5.14e+08
Sb-124	1.09e+08	1.41e+06	3.81e+07	2.40e+05	0.00e+00	6.03e+07	6.79e+08
Sb-125	8.70e+07	6.71e+05	1.82e+07	8.06e+04	0.00e+00	4.85e+07	2.08e+08
Sb-126	2.29e+07	3.51e+05	8.23e+06	1.34e+05	0.00e+00	1.09e+07	4.62e+08
Sb-127	1.98e+06	3.07e+04	6.88e+05	2.21e+04	0.00e+00	8.60e+05	1.12e+08
Te-125m	7.38e+07	2.00e+07	9.84e+06	2.07e+07	0.00e+00	0.00e+00	7.12e+07
Te-127	2.99e+03	8.06e+02	6.41e+02	2.07e+03	8.50e+03	0.00e+00	1.17e+05
Te-127m	2.08e+08	5.60e+07	2.47e+07	4.97e+07	5.93e+08	0.00e+00	1.68e+08
Te-129	1.33e-09	3.70e-10	3.15e-10	9.46e-10	3.88e-09	0.00e+00	8.25e-08
Te-129m	2.71e+08	7.58e+07	4.21e+07	8.75e+07	7.97e+08	0.00e+00	3.31e+08
Te-131	1.77e-32	5.40e-33	5.27e-33	1.36e-32	5.36e-32	0.00e+00	9.31e-32
Te-131m	1.60e+06	5.54e+05	5.89e+05	1.14e+06	5.36e+06	0.00e+00	2.25e+07
Te-132	1.03e+07	4.54e+06	5.48e+06	6.61e+06	4.21e+07	0.00e+00	4.57e+07
Te-133m	9.46e-13	3.82e-13	4.74e-13	7.33e-13	3.63e-12	0.00e+00	2.92e-11
Te-134	3.99e-18	1.79e-18	2.39e-18	3.15e-18	1.66e-17	0.00e+00	1.82e-17
I-129	3.43e+09	2.11e+09	1.88e+09	1.38e+12	3.55e+09	0.00e+00	1.06e+08
I-130	1.73e+06	3.50e+06	1.80e+06	3.86e+08	5.23e+06	0.00e+00	1.64e+06
I-131	1.30e+09	1.31e+09	7.45e+08	4.33e+11	2.15e+09	0.00e+00	1.17e+08
I-132	7.01e-01	1.29e+00	5.92e-01	5.97e+01	1.97e+00	0.00e+00	1.52e+00
I-133	1.72e+07	2.13e+07	8.05e+06	3.95e+09	3.55e+07	0.00e+00	8.57e+06
I-134	8.87e-12	1.65e-11	7.57e-12	3.79e-10	2.52e-11	0.00e+00	1.09e-11
I-135	5.43e+04	9.77e+04	4.62e+04	8.66e+06	1.50e+05	0.00e+00	7.45e+04
Cs-134	2.26e+10	3.71e+10	7.84e+09	0.00e+00	1.15e+10	4.13e+09	2.00e+08
Cs-134m	7.42e-01	1.10e+00	7.18e-01	0.00e+00	5.80e-01	9.59e-02	1.39e+00

Conversion factors are in units of square meter-mrem/yr per uCi/sec for all nuclides except H-3, which is in units of mrem/yr per uCi/cubic meter.

**COW'S MILK PATHWAY DOSE FACTORS DUE TO RADIONUCLIDES
OTHER THAN NOBLE GASES, R_i**

R_i factors for Child age group by nuclide.
Waterford Steam Electric Station
Pathway : Gaseous Release Cow's Milk Pathway R_i

Nuclide	Organ Dose Conversion Factors						
	Bone	Liver	T. Body	Thyroid	Kidney	Lung	GI-LLI
Cs-135	8.19e+09	5.71e+09	5.85e+08	0.00e+00	2.01e+09	6.72e+08	4.27e+07
Cs-136	1.01e+09	2.78e+09	1.80e+09	0.00e+00	1.48e+09	2.21e+08	9.77e+07
Cs-137	3.22e+10	3.09e+10	4.55e+09	0.00e+00	1.01e+10	3.62e+09	1.93e+08
Cs-138	4.27e-23	5.94e-23	3.77e-23	0.00e+00	4.18e-23	4.50e-24	2.74e-23
Cs-139	0.00e+00	0.00e+00	0.00e+00	0.00e+00	0.00e+00	0.00e+00	0.00e+00
Ba-139	2.06e-07	1.10e-10	5.98e-09	0.00e+00	9.62e-11	6.48e-11	1.19e-05
Ba-140	1.17e+08	1.03e+05	6.84e+06	0.00e+00	3.34e+04	6.12e+04	5.93e+07
Ba-141	0.00e+00	0.00e+00	0.00e+00	0.00e+00	0.00e+00	0.00e+00	0.00e+00
Ba-142	0.00e+00	0.00e+00	0.00e+00	0.00e+00	0.00e+00	0.00e+00	0.00e+00
La-140	1.94e+01	6.79e+00	2.29e+00	0.00e+00	0.00e+00	0.00e+00	1.89e+05
La-141	1.36e-04	3.17e-05	6.89e-06	0.00e+00	0.00e+00	0.00e+00	7.06e+00
La-142	8.30e-11	2.64e-11	8.28e-12	0.00e+00	0.00e+00	0.00e+00	5.24e-06
Ce-141	2.19e+04	1.09e+04	1.62e+03	0.00e+00	4.78e+03	0.00e+00	1.36e+07
Ce-143	1.88e+02	1.02e+05	1.47e+01	0.00e+00	4.27e+01	0.00e+00	1.49e+06
Ce-144	1.62e+06	5.09e+05	8.66e+04	0.00e+00	2.82e+05	0.00e+00	1.33e+08
Pr-143	7.18e+02	2.16e+02	3.56e+01	0.00e+00	1.17e+02	0.00e+00	7.75e+05
Pr-144	0.00e+00	0.00e+00	0.00e+00	0.00e+00	0.00e+00	0.00e+00	0.00e+00
Nd-147	4.45e+02	3.60e+02	2.79e+01	0.00e+00	1.98e+02	0.00e+00	5.71e+05
Pm-147	1.29e+04	9.19e+02	4.94e+02	0.00e+00	1.62e+03	0.00e+00	3.72e+05
Pm-148	2.66e+02	3.20e+01	2.07e+01	0.00e+00	5.44e+01	0.00e+00	8.54e+05
Pm-148m	3.06e+03	6.09e+02	6.09e+02	0.00e+00	9.03e+02	0.00e+00	1.72e+06
Pm-149	1.94e+01	2.07e+00	1.12e+00	0.00e+00	3.65e+00	0.00e+00	1.41e+05
Pm-151	2.88e+00	3.51e-01	2.28e-01	0.00e+00	5.95e-01	0.00e+00	3.98e+04
Sm-151	1.05e+04	1.57e+03	4.93e+02	0.00e+00	1.62e+03	0.00e+00	2.27e+05
Sm-153	9.02e+00	5.61e+00	5.41e-01	0.00e+00	1.71e+00	0.00e+00	7.46e+04
Eu-152	2.52e+04	4.59e+03	5.45e+03	0.00e+00	1.94e+04	0.00e+00	7.54e+05
Eu-154	9.46e+04	8.51e+03	7.77e+03	0.00e+00	3.74e+04	0.00e+00	1.98e+06
Eu-155	1.94e+04	1.39e+03	1.09e+03	0.00e+00	5.22e+03	0.00e+00	3.49e+06
Eu-156	1.10e+03	5.88e+02	1.22e+02	0.00e+00	3.79e+02	0.00e+00	1.33e+06
Tb-160	5.61e+03	0.00e+00	6.96e+02	0.00e+00	1.67e+03	0.00e+00	1.24e+06

Conversion factors are in units of square meter-mrem/yr per uCi/sec for all nuclides except H-3, which is in units of mrem/yr per uCi/cubic meter.

**COW'S MILK PATHWAY DOSE FACTORS DUE TO RADIONUCLIDES
OTHER THAN NOBLE GASES, R_i**

R_i factors for Child age group by nuclide.
Waterford Steam Electric Station
Pathway : Gaseous Release Cow's Milk Pathway R_i

Nuclide	Organ Dose Conversion Factors						
	Bone	Liver	T. Body	Thyroid	Kidney	Lung	GI-LLI
Ho-166m	4.44e+04	9.30e+03	7.86e+03	0.00e+00	1.32e+04	0.00e+00	1.08e+06
W-181	1.54e+05	3.79e+04	5.21e+03	0.00e+00	0.00e+00	0.00e+00	1.38e+06
W-185	5.89e+06	1.47e+06	2.06e+05	0.00e+00	0.00e+00	0.00e+00	5.48e+07
W-187	2.89e+04	1.71e+04	7.69e+03	0.00e+00	0.00e+00	0.00e+00	2.41e+06
Pb-210	2.42e+11	6.21e+10	1.06e+10	0.00e+00	1.87e+11	0.00e+00	1.17e+07
Bi-210	1.62e+06	8.38e+06	9.29e+05	0.00e+00	9.45e+07	0.00e+00	4.25e+07
Po-210	3.37e+09	5.39e+09	8.14e+08	0.00e+00	1.68e+10	0.00e+00	1.45e+08
Ra-223	5.55e+11	6.41e+08	1.11e+11	0.00e+00	1.70e+10	0.00e+00	8.84e+09
Ra-224	6.43e+10	1.17e+08	1.29e+10	0.00e+00	3.09e+09	0.00e+00	3.53e+09
Ra-225	8.62e+11	7.70e+08	1.72e+11	0.00e+00	2.04e+10	0.00e+00	9.89e+09
Ra-226	3.78e+13	1.21e+09	3.11e+13	0.00e+00	3.21e+10	0.00e+00	2.24e+10
Ra-228	2.52e+13	6.53e+08	2.82e+13	0.00e+00	1.73e+10	0.00e+00	3.80e+09
Ac-225	2.81e+05	2.89e+05	1.88e+04	0.00e+00	3.09e+04	0.00e+00	6.43e+06
Ac-227	1.69e+08	2.72e+07	1.05e+07	0.00e+00	5.99e+06	0.00e+00	3.46e+06
Th-227	1.27e+06	1.73e+04	3.67e+04	0.00e+00	9.17e+04	0.00e+00	1.22e+07
Th-228	8.33e+07	1.07e+06	2.82e+06	0.00e+00	5.55e+06	0.00e+00	2.33e+07
Th-229	9.67e+08	2.43e+07	1.61e+07	0.00e+00	1.19e+08	0.00e+00	3.31e+06
Th-230	1.46e+08	7.32e+06	4.08e+06	0.00e+00	3.57e+07	0.00e+00	2.55e+06
Th-232	1.63e+08	6.25e+06	1.24e+05	0.00e+00	3.05e+07	0.00e+00	2.17e+06
Th-234	8.40e+03	3.71e+02	2.43e+02	0.00e+00	1.97e+03	0.00e+00	2.90e+06
Pa-231	2.91e+08	9.63e+06	1.16e+07	0.00e+00	5.27e+07	0.00e+00	3.03e+06
Pa-233	4.68e+02	7.30e+01	8.18e+01	0.00e+00	2.69e+02	0.00e+00	3.73e+05
U-232	7.24e+10	0.00e+00	5.18e+09	0.00e+00	5.51e+09	0.00e+00	2.87e+08
U-233	1.53e+10	0.00e+00	9.26e+08	0.00e+00	2.51e+09	0.00e+00	2.65e+08
U-234	1.47e+10	0.00e+00	9.09e+08	0.00e+00	2.46e+09	0.00e+00	2.60e+08
U-235	1.41e+10	0.00e+00	8.51e+08	0.00e+00	2.31e+09	0.00e+00	3.30e+08
U-236	1.41e+10	0.00e+00	8.72e+08	0.00e+00	2.36e+09	0.00e+00	2.44e+08
U-237	2.57e+05	0.00e+00	6.83e+04	0.00e+00	7.42e+05	0.00e+00	2.27e+07
U-238	1.35e+10	0.00e+00	7.98e+08	0.00e+00	2.16e+09	0.00e+00	2.33e+08
Np-237	9.17e+07	6.05e+06	4.03e+06	0.00e+00	2.49e+07	0.00e+00	3.36e+06

Conversion factors are in units of square meter-mrem/yr per uCi/sec for all nuclides except H-3, which is in units of mrem/yr per uCi/cubic meter.

**COW'S MILK PATHWAY DOSE FACTORS DUE TO RADIONUCLIDES
OTHER THAN NOBLE GASES, R_i**

R_i factors for Child age group by nuclide.
Waterford Steam Electric Station
Pathway : Gaseous Release Cow's Milk Pathway R_i

Nuclide	Organ Dose Conversion Factors						
	Bone	Liver	T. Body	Thyroid	Kidney	Lung	GI-LLI
Np-238	1.64e+02	3.32e+00	2.55e+00	0.00e+00	1.06e+01	0.00e+00	1.14e+05
Np-239	1.73e+01	1.24e+00	8.71e-01	0.00e+00	3.58e+00	0.00e+00	9.17e+04
Pu-238	1.96e+07	2.27e+06	5.20e+05	0.00e+00	1.89e+06	0.00e+00	1.23e+06
Pu-239	2.12e+07	2.27e+06	5.45e+05	0.00e+00	2.01e+06	0.00e+00	1.13e+06
Pu-240	2.11e+07	2.35e+06	5.45e+05	0.00e+00	2.01e+06	0.00e+00	1.15e+06
Pu-241	6.35e+05	2.59e+04	1.32e+04	0.00e+00	4.86e+04	0.00e+00	2.36e+04
Pu-242	1.96e+07	2.27e+06	5.25e+05	0.00e+00	1.93e+06	0.00e+00	1.10e+06
Pu-244	2.29e+07	2.60e+07	6.01e+05	0.00e+00	2.22e+06	0.00e+00	1.65e+06
Am-241	5.54e+07	4.77e+07	4.16e+06	0.00e+00	2.54e+07	0.00e+00	3.11e+06
Am-242m	5.76e+07	4.61e+07	4.28e+06	0.00e+00	2.59e+07	0.00e+00	3.95e+06
Am-243	5.51e+07	4.65e+07	4.04e+06	0.00e+00	2.49e+07	0.00e+00	3.68e+06
Cm-242	3.30e+06	2.63e+06	2.19e+05	0.00e+00	7.02e+05	0.00e+00	3.06e+06
Cm-243	5.26e+07	4.27e+07	3.38e+06	0.00e+00	1.27e+07	0.00e+00	3.30e+06
Cm-244	4.43e+07	3.59e+07	2.84e+06	0.00e+00	1.04e+07	0.00e+00	3.19e+06
Cm-245	6.87e+07	5.51e+07	4.32e+06	0.00e+00	1.69e+07	0.00e+00	2.98e+06
Cm-246	6.79e+07	5.51e+07	4.32e+06	0.00e+00	1.69e+07	0.00e+00	2.92e+06
Cm-247	6.62e+07	5.43e+07	4.24e+06	0.00e+00	1.66e+07	0.00e+00	3.85e+06
Cm-248	5.51e+08	4.48e+08	3.50e+07	0.00e+00	1.37e+08	0.00e+00	6.21e+07
Cf-252	4.25e+07	0.00e+00	1.03e+06	0.00e+00	0.00e+00	0.00e+00	1.20e+07

Conversion factors are in units of square meter-mrem/yr per uCi/sec for all nuclides except H-3, which is in units of mrem/yr per uCi/cubic meter.

**COW'S MILK PATHWAY DOSE FACTORS DUE TO RADIONUCLIDES
OTHER THAN NOBLE GASES, R_i**

R_i factors for Infant age group by nuclide.
Waterford Steam Electric Station
Pathway : Gaseous Release Cow's Milk Pathway R_i

Nuclide	Organ Dose Conversion Factors						
	Bone	Liver	T. Body	Thyroid	Kidney	Lung	GI-LLI
H-3	0.00e+00	1.36e+03	1.36e+03	1.36e+03	1.36e+03	1.36e+03	1.36e+03
Be-10	1.41e+07	2.05e+06	4.25e+05	0.00e+00	1.35e+06	0.00e+00	2.29e+07
C-14	2.34e+09	5.00e+08	5.00e+08	5.00e+08	5.00e+08	5.00e+08	5.00e+08
N-13	0.00e+00	0.00e+00	0.00e+00	0.00e+00	0.00e+00	0.00e+00	0.00e+00
F-18	4.12e-02	0.00e+00	3.51e-03	0.00e+00	0.00e+00	0.00e+00	9.67e-03
Na-22	3.18e+10	3.18e+10	3.18e+10	3.18e+10	3.18e+10	3.18e+10	3.18e+10
Na-24	1.55e+07	1.55e+07	1.55e+07	1.55e+07	1.55e+07	1.55e+07	1.55e+07
P-32	1.60e+11	9.43e+09	6.21e+09	0.00e+00	0.00e+00	0.00e+00	2.17e+09
Ca-41	2.46e+10	0.00e+00	2.69e+09	0.00e+00	0.00e+00	0.00e+00	1.26e+07
Sc-46	1.30e+03	1.88e+03	5.86e+02	0.00e+00	1.23e+03	0.00e+00	1.22e+06
Cr-51	0.00e+00	0.00e+00	1.61e+05	1.05e+05	2.30e+04	2.05e+05	4.70e+06
Mn-54	0.00e+00	3.90e+07	8.84e+06	0.00e+00	8.64e+06	0.00e+00	1.43e+07
Mn-56	0.00e+00	3.14e-02	5.42e-03	0.00e+00	2.70e-02	0.00e+00	2.86e+00
Fe-55	1.35e+08	8.73e+07	2.33e+07	0.00e+00	0.00e+00	4.27e+07	1.11e+07
Fe-59	2.24e+08	3.92e+08	1.54e+08	0.00e+00	0.00e+00	1.16e+08	1.87e+08
Co-57	0.00e+00	8.95e+06	1.46e+07	0.00e+00	0.00e+00	0.00e+00	3.05e+07
Co-58	0.00e+00	2.42e+07	6.05e+07	0.00e+00	0.00e+00	0.00e+00	6.04e+07
Co-60	0.00e+00	8.81e+07	2.08e+08	0.00e+00	0.00e+00	0.00e+00	2.10e+08
Ni-59	2.61e+09	7.99e+08	4.50e+08	0.00e+00	0.00e+00	0.00e+00	3.95e+07
Ni-63	3.49e+10	2.16e+09	1.21e+09	0.00e+00	0.00e+00	0.00e+00	1.07e+08
Ni-65	3.56e+00	4.03e-01	1.83e-01	0.00e+00	0.00e+00	0.00e+00	3.07e+01
Cu-64	0.00e+00	1.86e+05	8.62e+04	0.00e+00	3.15e+05	0.00e+00	3.82e+06
Zn-65	5.55e+09	1.90e+10	8.78e+09	0.00e+00	9.23e+09	0.00e+00	1.61e+10
Zn-69	2.10e-11	3.79e-11	2.82e-12	0.00e+00	1.57e-11	0.00e+00	3.09e-09
Zn-69m	1.70e+06	3.48e+06	3.17e+05	0.00e+00	1.41e+06	0.00e+00	4.82e+07
Se-79	0.00e+00	7.77e+09	1.44e+09	0.00e+00	9.00e+09	0.00e+00	2.07e+08
Br-82	0.00e+00	0.00e+00	1.93e+08	0.00e+00	0.00e+00	0.00e+00	0.00e+00
Br-83	0.00e+00	0.00e+00	9.49e-01	0.00e+00	0.00e+00	0.00e+00	0.00e+00
Br-84	0.00e+00	0.00e+00	1.35e-22	0.00e+00	0.00e+00	0.00e+00	0.00e+00
Br-85	0.00e+00	0.00e+00	0.00e+00	0.00e+00	0.00e+00	0.00e+00	0.00e+00

Conversion factors are in units of square meter-mrem/yr per uCi/sec for all nuclides except H-3, which is in units of mrem/yr per uCi/cubic meter.

**COW'S MILK PATHWAY DOSE FACTORS DUE TO RADIONUCLIDES
OTHER THAN NOBLE GASES, R_i**

Ri factors for Infant age group by nuclide.
Waterford Steam Electric Station
Pathway : Gaseous Release Cow's Milk Pathway Ri

Nuclide	Organ Dose Conversion Factors						
	Bone	Liver	T. Body	Thyroid	Kidney	Lung	GI-LLI
Rb-86	0.00e+00	2.23e+10	1.10e+10	0.00e+00	0.00e+00	0.00e+00	5.69e+08
Rb-87	0.00e+00	2.19e+10	8.69e+09	0.00e+00	0.00e+00	0.00e+00	1.48e+08
Rb-88	0.00e+00	0.00e+00	0.00e+00	0.00e+00	0.00e+00	0.00e+00	0.00e+00
Rb-89	0.00e+00	0.00e+00	0.00e+00	0.00e+00	0.00e+00	0.00e+00	0.00e+00
Sr-89	1.26e+10	0.00e+00	3.61e+08	0.00e+00	0.00e+00	0.00e+00	2.59e+08
Sr-90	1.86e+11	0.00e+00	3.77e+09	0.00e+00	0.00e+00	0.00e+00	1.52e+09
Sr-91	2.73e+05	0.00e+00	9.87e+03	0.00e+00	0.00e+00	0.00e+00	3.23e+05
Sr-92	4.71e+00	0.00e+00	1.75e-01	0.00e+00	0.00e+00	0.00e+00	5.08e+01
Y-90	6.82e+02	0.00e+00	1.83e+01	0.00e+00	0.00e+00	0.00e+00	9.41e+05
Y-91	7.33e+04	0.00e+00	1.95e+03	0.00e+00	0.00e+00	0.00e+00	5.25e+06
Y-91m	5.94e-19	0.00e+00	2.03e-20	0.00e+00	0.00e+00	0.00e+00	1.98e-15
Y-92	5.44e-04	0.00e+00	1.53e-05	0.00e+00	0.00e+00	0.00e+00	1.04e+01
Y-93	2.16e+00	0.00e+00	5.90e-02	0.00e+00	0.00e+00	0.00e+00	1.71e+04
Zr-93	7.94e+03	3.78e+02	2.28e+02	0.00e+00	1.11e+03	0.00e+00	9.83e+04
Zr-95	6.80e+03	1.66e+03	1.18e+03	0.00e+00	1.79e+03	0.00e+00	8.26e+05
Zr-97	4.07e+00	6.99e-01	3.19e-01	0.00e+00	7.04e-01	0.00e+00	4.46e+04
Nb-93m	2.52e+06	6.83e+05	2.13e+05	0.00e+00	6.66e+05	0.00e+00	8.16e+07
Nb-95	5.93e+05	2.44e+05	1.41e+05	0.00e+00	1.75e+05	0.00e+00	2.06e+08
Nb-97	6.16e-11	1.31e-11	4.74e-12	0.00e+00	1.03e-11	0.00e+00	4.15e-06
Mo-93	0.00e+00	3.49e+09	1.12e+08	0.00e+00	6.97e+08	0.00e+00	7.47e+07
Mo-99	0.00e+00	2.08e+08	4.06e+07	0.00e+00	3.11e+08	0.00e+00	6.86e+07
Tc-101	0.00e+00	0.00e+00	0.00e+00	0.00e+00	0.00e+00	0.00e+00	0.00e+00
Tc-99	2.22e+08	3.00e+08	9.36e+07	0.00e+00	2.53e+09	2.92e+07	1.30e+09
Tc-99m	2.77e+01	5.70e+01	7.35e+02	0.00e+00	6.14e+02	2.98e+01	1.66e+04
Ru-103	8.67e+03	0.00e+00	2.90e+03	0.00e+00	1.80e+04	0.00e+00	1.05e+05
Ru-105	8.12e-03	0.00e+00	2.74e-03	0.00e+00	5.97e-02	0.00e+00	3.23e+00
Ru-106	1.90e+05	0.00e+00	2.38e+04	0.00e+00	2.25e+05	0.00e+00	1.44e+06
Rh-105	3.32e+06	2.17e+06	1.46e+06	0.00e+00	6.03e+06	0.00e+00	5.39e+07
Pd-107	0.00e+00	9.79e+07	6.95e+06	0.00e+00	5.59e+08	0.00e+00	7.78e+07
Pd-109	0.00e+00	4.05e+05	9.78e+04	0.00e+00	1.49e+06	0.00e+00	9.95e+06

Conversion factors are in units of square meter-mrem/yr per uCi/sec for all nuclides except H-3, which is in units of mrem/yr per uCi/cubic meter.

**COW'S MILK PATHWAY DOSE FACTORS DUE TO RADIONUCLIDES
OTHER THAN NOBLE GASES, R_i**

Ri factors for Infant age group by nuclide.
Waterford Steam Electric Station
Pathway : Gaseous Release Cow's Milk Pathway Ri

Nuclide	Organ Dose Conversion Factors						
	Bone	Liver	T. Body	Thyroid	Kidney	Lung	GI-LLI
Ag-110m	3.86e+08	2.82e+08	1.86e+08	0.00e+00	4.03e+08	0.00e+00	1.46e+10
Ag-111	6.17e+07	2.40e+07	1.27e+07	0.00e+00	5.01e+07	0.00e+00	5.72e+09
Cd-113m	0.00e+00	1.74e+07	6.42e+05	0.00e+00	1.32e+07	0.00e+00	2.62e+07
Cd-115m	0.00e+00	1.03e+07	3.59e+05	0.00e+00	5.40e+06	0.00e+00	5.89e+07
Sn-123	4.57e+09	7.14e+07	1.19e+08	7.18e+07	0.00e+00	0.00e+00	1.21e+09
Sn-125	5.37e+08	1.00e+07	2.39e+07	9.86e+06	0.00e+00	0.00e+00	8.05e+08
Sn-126	1.14e+10	1.49e+08	3.70e+08	3.93e+07	0.00e+00	0.00e+00	5.18e+08
Sb-124	2.09e+08	3.08e+06	6.49e+07	5.56e+05	0.00e+00	1.31e+08	6.46e+08
Sb-125	1.50e+08	1.45e+06	3.08e+07	1.87e+05	0.00e+00	8.65e+07	1.99e+08
Sb-126	4.20e+07	8.23e+05	1.52e+07	3.22e+05	0.00e+00	2.64e+07	4.35e+08
Sb-127	4.17e+06	7.44e+04	1.29e+06	5.31e+04	0.00e+00	2.15e+06	1.11e+08
Te-125m	1.51e+08	5.04e+07	2.04e+07	5.07e+07	0.00e+00	0.00e+00	7.18e+07
Te-127	6.34e+03	2.13e+03	1.36e+03	5.16e+03	1.55e+04	0.00e+00	1.33e+05
Te-127m	4.21e+08	1.40e+08	5.10e+07	1.22e+08	1.04e+09	0.00e+00	1.70e+08
Te-129	2.81e-09	9.69e-10	6.56e-10	2.36e-09	7.00e-09	0.00e+00	2.25e-07
Te-129m	5.57e+08	1.91e+08	8.58e+07	2.14e+08	1.39e+09	0.00e+00	3.33e+08
Te-131	3.76e-32	1.39e-32	1.05e-32	3.35e-32	9.61e-32	0.00e+00	1.52e-30
Te-131m	3.38e+06	1.36e+06	1.12e+06	2.76e+06	9.36e+06	0.00e+00	2.29e+07
Te-132	2.11e+07	1.05e+07	9.75e+06	1.54e+07	6.54e+07	0.00e+00	3.87e+07
Te-133m	1.98e-12	9.05e-13	8.65e-13	1.74e-12	6.17e-12	0.00e+00	9.76e-11
Te-134	8.25e-18	4.14e-18	4.27e-18	7.39e-18	2.79e-17	0.00e+00	9.46e-17
I-129	7.06e+09	5.23e+09	3.83e+09	3.36e+12	6.19e+09	0.00e+00	1.05e+08
I-130	3.56e+06	7.83e+06	3.14e+06	8.78e+08	8.60e+06	0.00e+00	1.68e+06
I-131	2.72e+09	3.21e+09	1.41e+09	1.05e+12	3.74e+09	0.00e+00	1.14e+08
I-132	1.45e+00	2.95e+00	1.05e+00	1.38e+02	3.29e+00	0.00e+00	2.39e+00
I-133	3.63e+07	5.29e+07	1.55e+07	9.62e+09	6.22e+07	0.00e+00	8.95e+06
I-134	1.84e-11	3.77e-11	1.34e-11	8.78e-10	4.21e-11	0.00e+00	3.89e-11
I-135	1.13e+05	2.25e+05	8.19e+04	2.01e+07	2.50e+05	0.00e+00	8.13e+04
Cs-134	3.65e+10	6.80e+10	6.87e+09	0.00e+00	1.75e+10	7.18e+09	1.85e+08
Cs-134m	1.55e+00	2.58e+00	1.30e+00	0.00e+00	9.94e-01	2.29e-01	2.04e+00

Conversion factors are in units of square meter-mrem/yr per uCi/sec for all nuclides except H-3, which is in units of mrem/yr per uCi/cubic meter.

**COW'S MILK PATHWAY DOSE FACTORS DUE TO RADIONUCLIDES
OTHER THAN NOBLE GASES, R_i**

R_i factors for Infant age group by nuclide.
Waterford Steam Electric Station
Pathway : Gaseous Release Cow's Milk Pathway R_i

Nuclide	Organ Dose Conversion Factors						
	Bone	Liver	T. Body	Thyroid	Kidney	Lung	GI-LLI
Cs-135	1.31e+10	1.19e+10	6.22e+08	0.00e+00	3.40e+09	1.29e+09	4.31e+07
Cs-136	1.98e+09	5.81e+09	2.17e+09	0.00e+00	2.32e+09	4.74e+08	8.83e+07
Cs-137	5.15e+10	6.02e+10	4.27e+09	0.00e+00	1.62e+10	6.55e+09	1.88e+08
Cs-138	9.01e-23	1.47e-22	7.10e-23	0.00e+00	7.31e-23	1.14e-23	2.34e-22
Cs-139	0.00e+00	0.00e+00	0.00e+00	0.00e+00	0.00e+00	0.00e+00	0.00e+00
Ba-139	4.39e-07	2.91e-10	1.27e-08	0.00e+00	1.75e-10	1.77e-10	2.78e-05
Ba-140	2.41e+08	2.41e+05	1.24e+07	0.00e+00	5.72e+04	1.48e+05	5.92e+07
Ba-141	0.00e+00	0.00e+00	0.00e+00	0.00e+00	0.00e+00	0.00e+00	0.00e+00
Ba-142	0.00e+00	0.00e+00	0.00e+00	0.00e+00	0.00e+00	0.00e+00	0.00e+00
La-140	4.06e+01	1.60e+01	4.11e+00	0.00e+00	0.00e+00	0.00e+00	1.88e+05
La-141	2.89e-04	8.39e-05	1.46e-05	0.00e+00	0.00e+00	0.00e+00	9.62e+00
La-142	1.74e-10	6.40e-11	1.53e-11	0.00e+00	0.00e+00	0.00e+00	1.09e-05
Ce-141	4.34e+04	2.64e+04	3.11e+03	0.00e+00	8.15e+03	0.00e+00	1.37e+07
Ce-143	3.97e+02	2.64e+05	3.01e+01	0.00e+00	7.68e+01	0.00e+00	1.54e+06
Ce-144	2.33e+06	9.52e+05	1.30e+05	0.00e+00	3.85e+05	0.00e+00	1.33e+08
Pr-143	1.49e+03	5.55e+02	7.36e+01	0.00e+00	2.06e+02	0.00e+00	7.84e+05
Pr-144	0.00e+00	0.00e+00	0.00e+00	0.00e+00	0.00e+00	0.00e+00	0.00e+00
Nd-147	8.81e+02	9.05e+02	5.55e+01	0.00e+00	3.49e+02	0.00e+00	5.74e+05
Pm-147	1.57e+04	1.32e+03	6.44e+02	0.00e+00	1.98e+03	0.00e+00	3.75e+05
Pm-148	5.57e+02	8.04e+01	4.05e+01	0.00e+00	9.60e+01	0.00e+00	8.58e+05
Pm-148m	4.90e+03	1.24e+03	9.74e+02	0.00e+00	1.43e+03	0.00e+00	1.62e+06
Pm-149	4.13e+01	5.42e+00	2.37e+00	0.00e+00	6.59e+00	0.00e+00	1.46e+05
Pm-151	6.10e+00	8.90e-01	4.50e-01	0.00e+00	1.06e+00	0.00e+00	4.12e+04
Sm-151	1.19e+04	2.74e+03	5.92e+02	0.00e+00	1.86e+03	0.00e+00	2.29e+05
Sm-153	1.91e+01	1.47e+01	1.13e+00	0.00e+00	3.09e+00	0.00e+00	7.71e+04
Eu-152	2.76e+04	7.34e+03	6.19e+03	0.00e+00	2.06e+04	0.00e+00	6.52e+05
Eu-154	1.09e+05	1.51e+04	9.05e+03	0.00e+00	4.09e+04	0.00e+00	1.88e+06
Eu-155	2.18e+04	2.51e+03	1.30e+03	0.00e+00	5.63e+03	0.00e+00	3.36e+06
Eu-156	2.23e+03	1.38e+03	2.19e+02	0.00e+00	6.37e+02	0.00e+00	1.30e+06
Tb-160	8.75e+03	0.00e+00	1.09e+03	0.00e+00	2.49e+03	0.00e+00	1.17e+06

Conversion factors are in units of square meter-mrem/yr per uCi/sec for all nuclides except H-3, which is in units of mrem/yr per uCi/cubic meter.

**COW'S MILK PATHWAY DOSE FACTORS DUE TO RADIONUCLIDES
OTHER THAN NOBLE GASES, R_i**

Ri factors for Infant age group by nuclide.
Waterford Steam Electric Station
Pathway : Gaseous Release Cow's Milk Pathway Ri

Nuclide	Organ Dose Conversion Factors						
	Bone	Liver	T. Body	Thyroid	Kidney	Lung	GI-LLI
Ho-166m	5.14e+04	1.11e+04	8.76e+03	0.00e+00	1.47e+04	0.00e+00	1.09e+06
W-181	3.23e+05	9.91e+04	1.11e+04	0.00e+00	0.00e+00	0.00e+00	1.39e+06
W-185	1.23e+07	3.85e+06	4.39e+05	0.00e+00	0.00e+00	0.00e+00	5.51e+07
W-187	6.09e+04	4.23e+04	1.46e+04	0.00e+00	0.00e+00	0.00e+00	2.49e+06
Pb-210	2.69e+11	7.23e+10	1.21e+10	0.00e+00	2.20e+11	0.00e+00	1.18e+07
Bi-210	3.42e+06	2.20e+07	1.96e+06	0.00e+00	1.71e+08	0.00e+00	4.33e+07
Po-210	6.88e+09	1.32e+10	1.64e+09	0.00e+00	2.80e+10	0.00e+00	1.47e+08
Ra-223	1.15e+12	1.68e+09	2.31e+11	0.00e+00	3.06e+10	0.00e+00	8.97e+09
Ra-224	1.36e+11	3.07e+08	2.72e+10	0.00e+00	5.60e+09	0.00e+00	3.60e+09
Ra-225	1.78e+12	2.01e+09	3.54e+11	0.00e+00	3.66e+10	0.00e+00	9.98e+09
Ra-226	4.08e+13	3.13e+09	3.38e+13	0.00e+00	5.73e+10	0.00e+00	2.26e+10
Ra-228	2.82e+13	1.69e+09	3.18e+13	0.00e+00	3.09e+10	0.00e+00	3.83e+09
Ac-225	5.85e+05	7.51e+05	3.92e+04	0.00e+00	5.51e+04	0.00e+00	6.51e+06
Ac-227	1.84e+08	3.15e+07	1.15e+07	0.00e+00	6.40e+06	0.00e+00	3.49e+06
Th-227	2.61e+06	4.37e+04	7.49e+04	0.00e+00	1.61e+05	0.00e+00	1.24e+07
Th-228	9.94e+07	1.36e+06	3.36e+06	0.00e+00	6.36e+06	0.00e+00	2.35e+07
Th-229	1.04e+09	2.60e+07	1.73e+07	0.00e+00	1.25e+08	0.00e+00	3.33e+06
Th-230	1.56e+08	7.82e+06	4.36e+06	0.00e+00	3.75e+07	0.00e+00	2.57e+06
Th-232	1.74e+08	6.70e+06	6.79e+04	0.00e+00	3.20e+07	0.00e+00	2.18e+06
Th-234	1.70e+04	9.26e+02	4.91e+02	0.00e+00	3.41e+03	0.00e+00	2.92e+06
Pa-231	3.11e+08	1.03e+07	1.24e+07	0.00e+00	5.51e+07	0.00e+00	3.06e+06
Pa-233	8.05e+02	1.58e+02	1.41e+02	0.00e+00	4.32e+02	0.00e+00	3.78e+05
U-232	9.95e+10	0.00e+00	8.88e+09	0.00e+00	9.74e+09	0.00e+00	2.89e+08
U-233	2.09e+10	0.00e+00	1.59e+09	0.00e+00	4.44e+09	0.00e+00	2.68e+08
U-234	2.01e+10	0.00e+00	1.56e+09	0.00e+00	4.36e+09	0.00e+00	2.62e+08
U-235	1.92e+10	0.00e+00	1.46e+09	0.00e+00	4.08e+09	0.00e+00	3.33e+08
U-236	1.92e+10	0.00e+00	1.50e+09	0.00e+00	4.15e+09	0.00e+00	2.46e+08
U-237	5.39e+05	0.00e+00	1.44e+05	0.00e+00	1.34e+06	0.00e+00	2.30e+07
U-238	1.84e+10	0.00e+00	1.37e+09	0.00e+00	3.82e+09	0.00e+00	2.35e+08
Np-237	9.87e+07	6.54e+06	4.32e+06	0.00e+00	2.61e+07	0.00e+00	3.39e+06

Conversion factors are in units of square meter-mrem/yr per uCi/sec for all nuclides except H-3, which is in units of mrem/yr per uCi/cubic meter.

**COW'S MILK PATHWAY DOSE FACTORS DUE TO RADIONUCLIDES
OTHER THAN NOBLE GASES, R_i**

R_i factors for Infant age group by nuclide.
Waterford Steam Electric Station
Pathway : Gaseous Release Cow's Milk Pathway R_i

Nuclide	Organ Dose Conversion Factors						
	Bone	Liver	T. Body	Thyroid	Kidney	Lung	GI-LLI
Np-238	3.49e+02	8.78e+00	5.40e+00	0.00e+00	1.92e+01	0.00e+00	1.17e+05
Np-239	3.65e+01	3.26e+00	1.84e+00	0.00e+00	6.51e+00	0.00e+00	9.44e+04
Pu-238	2.11e+07	2.47e+06	5.59e+05	0.00e+00	1.99e+06	0.00e+00	1.24e+06
Pu-239	2.27e+07	2.55e+06	5.82e+05	0.00e+00	2.11e+06	0.00e+00	1.14e+06
Pu-240	2.27e+07	2.55e+06	5.82e+05	0.00e+00	2.11e+06	0.00e+00	1.16e+06
Pu-241	6.97e+05	2.89e+04	1.45e+04	0.00e+00	5.20e+04	0.00e+00	2.38e+04
Pu-242	2.11e+07	2.45e+06	5.61e+05	0.00e+00	2.02e+06	0.00e+00	1.11e+06
Pu-244	2.45e+07	2.81e+06	6.43e+05	0.00e+00	2.32e+06	0.00e+00	1.66e+06
Am-241	5.95e+07	5.17e+07	4.44e+06	0.00e+00	2.67e+07	0.00e+00	3.14e+06
Am-242m	6.21e+07	5.02e+07	4.65e+06	0.00e+00	2.73e+07	0.00e+00	3.98e+06
Am-243	5.92e+07	5.06e+07	4.36e+06	0.00e+00	2.62e+07	0.00e+00	3.71e+06
Cm-242	5.15e+06	4.77e+06	3.42e+05	0.00e+00	9.84e+05	0.00e+00	3.09e+06
Cm-243	5.75e+07	4.72e+07	3.69e+06	0.00e+00	1.34e+07	0.00e+00	3.33e+06
Cm-244	4.84e+07	3.98e+07	3.11e+06	0.00e+00	1.11e+07	0.00e+00	3.22e+06
Cm-245	7.36e+07	5.96e+07	4.65e+06	0.00e+00	1.78e+07	0.00e+00	3.00e+06
Cm-246	7.28e+07	5.96e+07	4.65e+06	0.00e+00	1.77e+07	0.00e+00	2.95e+06
Cm-247	7.12e+07	5.88e+07	4.57e+06	0.00e+00	1.74e+07	0.00e+00	3.88e+06
Cm-248	5.88e+08	4.85e+08	3.77e+07	0.00e+00	1.44e+08	0.00e+00	6.25e+07
Cf-252	4.93e+07	0.00e+00	1.19e+06	0.00e+00	0.00e+00	0.00e+00	1.21e+07

Conversion factors are in units of square meter-mrem/yr per uCi/sec for all nuclides except H-3, which is in units of mrem/yr per uCi/cubic meter.

**MEAT PATHWAY DOSE FACTORS DUE TO RADIONUCLIDES
OTHER THAN NOBLE GASES, R_i**

R_i factors for Adult age group by nuclide.
Waterford Steam Electric Station
Pathway : Gaseous Release Meat & Poultry Pathway R_i

Nuclide	Organ Dose Conversion Factors						
	Bone	Liver	T. Body	Thyroid	Kidney	Lung	GI-LLI
H-3	0.00e+00	1.85e+02	1.85e+02	1.85e+02	1.85e+02	1.85e+02	1.85e+02
Be-10	8.72e+06	1.35e+06	2.18e+05	0.00e+00	1.02e+06	0.00e+00	7.35e+07
C-14	2.41e+08	4.83e+07	4.83e+07	4.83e+07	4.83e+07	4.83e+07	4.83e+07
N-13	0.00e+00	0.00e+00	0.00e+00	0.00e+00	0.00e+00	0.00e+00	0.00e+00
F-18	0.00e+00	0.00e+00	0.00e+00	0.00e+00	0.00e+00	0.00e+00	0.00e+00
Na-22	1.39e+09	1.39e+09	1.39e+09	1.39e+09	1.39e+09	1.39e+09	1.39e+09
Na-24	1.39e-03	1.39e-03	1.39e-03	1.39e-03	1.39e-03	1.39e-03	1.39e-03
P-32	4.66e+09	2.90e+08	1.80e+08	0.00e+00	0.00e+00	0.00e+00	5.24e+08
Ca-41	2.03e+09	0.00e+00	2.19e+08	0.00e+00	0.00e+00	0.00e+00	2.02e+06
Sc-46	1.76e+05	3.41e+05	9.91e+04	0.00e+00	3.18e+05	0.00e+00	1.66e+09
Cr-51	0.00e+00	0.00e+00	7.05e+03	4.21e+03	1.55e+03	9.36e+03	1.77e+06
Mn-54	0.00e+00	9.18e+06	1.75e+06	0.00e+00	2.73e+06	0.00e+00	2.81e+07
Mn-56	0.00e+00	0.00e+00	0.00e+00	0.00e+00	0.00e+00	0.00e+00	0.00e+00
Fe-55	2.93e+08	2.03e+08	4.72e+07	0.00e+00	0.00e+00	1.13e+08	1.16e+08
Fe-59	2.66e+08	6.24e+08	2.39e+08	0.00e+00	0.00e+00	1.74e+08	2.08e+09
Co-57	0.00e+00	5.63e+06	9.37e+06	0.00e+00	0.00e+00	0.00e+00	1.43e+08
Co-58	0.00e+00	1.82e+07	4.09e+07	0.00e+00	0.00e+00	0.00e+00	3.70e+08
Co-60	0.00e+00	7.52e+07	1.66e+08	0.00e+00	0.00e+00	0.00e+00	1.41e+09
Ni-59	1.42e+08	4.87e+07	2.37e+07	0.00e+00	0.00e+00	0.00e+00	1.00e+07
Ni-63	1.89e+09	1.31e+08	6.33e+07	0.00e+00	0.00e+00	0.00e+00	2.73e+07
Ni-65	0.00e+00	0.00e+00	0.00e+00	0.00e+00	0.00e+00	0.00e+00	0.00e+00
Cu-64	0.00e+00	2.80e-07	1.31e-07	0.00e+00	7.05e-07	0.00e+00	2.38e-05
Zn-65	3.56e+08	1.13e+09	5.12e+08	0.00e+00	7.57e+08	0.00e+00	7.13e+08
Zn-69	0.00e+00	0.00e+00	0.00e+00	0.00e+00	0.00e+00	0.00e+00	0.00e+00
Zn-69m	1.87e-05	4.48e-05	4.10e-06	0.00e+00	2.71e-05	0.00e+00	2.73e-03
Se-79	0.00e+00	1.08e+08	1.81e+07	0.00e+00	1.87e+08	0.00e+00	2.21e+07
Br-82	0.00e+00	0.00e+00	1.23e+03	0.00e+00	0.00e+00	0.00e+00	1.41e+03
Br-83	0.00e+00	0.00e+00	0.00e+00	0.00e+00	0.00e+00	0.00e+00	0.00e+00
Br-84	0.00e+00	0.00e+00	0.00e+00	0.00e+00	0.00e+00	0.00e+00	0.00e+00
Br-85	0.00e+00	0.00e+00	0.00e+00	0.00e+00	0.00e+00	0.00e+00	0.00e+00

Conversion factors are in units of square meter-mrem/yr per uCi/sec for all nuclides except H-3, which is in units of mrem/yr per uCi/cubic meter.

**MEAT PATHWAY DOSE FACTORS DUE TO RADIONUCLIDES
OTHER THAN NOBLE GASES, R_i**

R_i factors for Adult age group by nuclide.
Waterford Steam Electric Station
Pathway : Gaseous Release Meat & Poultry Pathway R_i

Nuclide	Organ Dose Conversion Factors						
	Bone	Liver	T. Body	Thyroid	Kidney	Lung	GI-LLI
Rb-86	0.00e+00	4.88e+08	2.27e+08	0.00e+00	0.00e+00	0.00e+00	9.61e+07
Rb-87	0.00e+00	1.05e+09	3.64e+08	0.00e+00	0.00e+00	0.00e+00	4.90e+07
Rb-88	0.00e+00	0.00e+00	0.00e+00	0.00e+00	0.00e+00	0.00e+00	0.00e+00
Rb-89	0.00e+00	0.00e+00	0.00e+00	0.00e+00	0.00e+00	0.00e+00	0.00e+00
Sr-89	3.02e+08	0.00e+00	8.66e+06	0.00e+00	0.00e+00	0.00e+00	4.84e+07
Sr-90	1.43e+10	0.00e+00	2.87e+08	0.00e+00	0.00e+00	0.00e+00	3.59e+08
Sr-91	1.58e-10	0.00e+00	6.39e-12	0.00e+00	0.00e+00	0.00e+00	7.53e-10
Sr-92	0.00e+00	0.00e+00	0.00e+00	0.00e+00	0.00e+00	0.00e+00	0.00e+00
Y-90	1.08e+02	0.00e+00	2.90e+00	0.00e+00	0.00e+00	0.00e+00	1.15e+06
Y-91	1.13e+06	0.00e+00	3.03e+04	0.00e+00	0.00e+00	0.00e+00	6.23e+08
Y-91m	0.00e+00	0.00e+00	0.00e+00	0.00e+00	0.00e+00	0.00e+00	0.00e+00
Y-92	1.69e-39	0.00e+00	0.00e+00	0.00e+00	0.00e+00	0.00e+00	2.96e-35
Y-93	4.87e-12	0.00e+00	1.35e-13	0.00e+00	0.00e+00	0.00e+00	1.55e-07
Zr-93	3.90e+06	2.18e+05	1.02e+05	0.00e+00	8.27e+05	0.00e+00	2.27e+08
Zr-95	1.87e+06	6.01e+05	4.07e+05	0.00e+00	9.43e+05	0.00e+00	1.90e+09
Zr-97	2.11e-05	4.27e-06	1.95e-06	0.00e+00	6.44e-06	0.00e+00	1.32e+00
Nb-93m	1.95e+07	6.35e+06	1.57e+06	0.00e+00	7.31e+06	0.00e+00	2.93e+09
Nb-95	2.30e+06	1.28e+06	6.87e+05	0.00e+00	1.26e+06	0.00e+00	7.76e+09
Nb-97	0.00e+00	0.00e+00	0.00e+00	0.00e+00	0.00e+00	0.00e+00	0.00e+00
Mo-93	0.00e+00	1.65e+08	4.45e+06	0.00e+00	4.67e+07	0.00e+00	2.68e+07
Mo-99	0.00e+00	1.01e+05	1.91e+04	0.00e+00	2.28e+05	0.00e+00	2.33e+05
Tc-101	0.00e+00	0.00e+00	0.00e+00	0.00e+00	0.00e+00	0.00e+00	0.00e+00
Tc-99	1.37e+08	2.04e+08	5.51e+07	0.00e+00	2.57e+09	1.73e+07	6.67e+09
Tc-99m	4.74e-21	1.34e-20	1.71e-19	0.00e+00	2.04e-19	6.57e-21	7.93e-18
Ru-103	1.05e+08	0.00e+00	4.53e+07	0.00e+00	4.02e+08	0.00e+00	1.23e+10
Ru-105	6.30e-28	0.00e+00	2.49e-28	0.00e+00	8.14e-27	0.00e+00	3.85e-25
Ru-106	2.80e+09	0.00e+00	3.54e+08	0.00e+00	5.40e+09	0.00e+00	1.81e+11
Rh-105	3.79e+00	2.78e+00	1.83e+00	0.00e+00	1.18e+01	0.00e+00	4.42e+02
Pd-107	0.00e+00	1.61e+06	1.03e+05	0.00e+00	1.45e+07	0.00e+00	9.99e+06
Pd-109	0.00e+00	1.49e-06	3.35e-07	0.00e+00	8.47e-06	0.00e+00	1.64e-04

Conversion factors are in units of square meter-mrem/yr per uCi/sec for all nuclides except H-3, which is in units of mrem/yr per uCi/cubic meter.

**MEAT PATHWAY DOSE FACTORS DUE TO RADIONUCLIDES
OTHER THAN NOBLE GASES, R_i**

R_i factors for Adult age group by nuclide.
Waterford Steam Electric Station
Pathway : Gaseous Release Meat & Poultry Pathway R_i

Nuclide	Organ Dose Conversion Factors						
	Bone	Liver	T. Body	Thyroid	Kidney	Lung	GI-LLI
Ag-110m	6.68e+06	6.18e+06	3.67e+06	0.00e+00	1.22e+07	0.00e+00	2.52e+09
Ag-111	1.46e+05	6.12e+04	3.05e+04	0.00e+00	1.97e+05	0.00e+00	1.12e+08
Cd-113m	0.00e+00	4.60e+06	1.47e+05	0.00e+00	5.06e+06	0.00e+00	3.70e+07
Cd-115m	0.00e+00	1.49e+06	4.76e+04	0.00e+00	1.18e+06	0.00e+00	6.27e+07
Sn-123	5.53e+09	9.15e+07	1.35e+08	7.78e+07	0.00e+00	0.00e+00	1.13e+10
Sn-125	1.76e+08	3.55e+06	7.99e+06	2.94e+06	0.00e+00	0.00e+00	2.20e+09
Sn-126	1.85e+10	3.66e+08	5.27e+08	1.08e+08	0.00e+00	0.00e+00	5.33e+09
Sb-124	1.98e+07	3.74e+05	7.85e+06	4.80e+04	0.00e+00	1.54e+07	5.62e+08
Sb-125	1.91e+07	2.13e+05	4.55e+06	1.94e+04	0.00e+00	1.47e+07	2.10e+08
Sb-126	1.96e+06	3.99e+04	7.08e+05	1.20e+04	0.00e+00	1.20e+06	1.60e+08
Sb-127	1.71e+04	3.75e+02	6.58e+03	2.06e+02	0.00e+00	1.02e+04	3.92e+06
Te-125m	3.59e+08	1.30e+08	4.81e+07	1.08e+08	1.46e+09	0.00e+00	1.43e+09
Te-127	2.21e-10	7.94e-11	4.78e-11	1.64e-10	9.01e-10	0.00e+00	1.74e-08
Te-127m	1.12e+09	3.99e+08	1.36e+08	2.85e+08	4.53e+09	0.00e+00	3.74e+09
Te-129	0.00e+00	0.00e+00	0.00e+00	0.00e+00	0.00e+00	0.00e+00	0.00e+00
Te-129m	1.13e+09	4.23e+08	1.80e+08	3.90e+08	4.74e+09	0.00e+00	5.71e+09
Te-131	0.00e+00	0.00e+00	0.00e+00	0.00e+00	0.00e+00	0.00e+00	0.00e+00
Te-131m	4.57e+02	2.23e+02	1.86e+02	3.54e+02	2.26e+03	0.00e+00	2.22e+04
Te-132	1.43e+06	9.23e+05	8.66e+05	1.02e+06	8.89e+06	0.00e+00	4.36e+07
Te-133m	0.00e+00	0.00e+00	0.00e+00	0.00e+00	0.00e+00	0.00e+00	0.00e+00
Te-134	0.00e+00	0.00e+00	0.00e+00	0.00e+00	0.00e+00	0.00e+00	0.00e+00
I-129	1.30e+08	1.12e+08	3.66e+08	2.87e+11	2.40e+08	0.00e+00	1.77e+07
I-130	2.18e-06	6.42e-06	2.53e-06	5.44e-04	1.00e-05	0.00e+00	5.52e-06
I-131	1.08e+07	1.54e+07	8.82e+06	5.04e+09	2.64e+07	0.00e+00	4.06e+06
I-132	0.00e+00	0.00e+00	0.00e+00	0.00e+00	0.00e+00	0.00e+00	0.00e+00
I-133	3.72e-01	6.47e-01	1.97e-01	9.51e+01	1.13e+00	0.00e+00	5.82e-01
I-134	0.00e+00	0.00e+00	0.00e+00	0.00e+00	0.00e+00	0.00e+00	0.00e+00
I-135	4.69e-17	1.23e-16	4.53e-17	8.10e-15	1.97e-16	0.00e+00	1.39e-16
Cs-134	6.58e+08	1.56e+09	1.28e+09	0.00e+00	5.06e+08	1.68e+08	2.74e+07
Cs-134m	0.00e+00	0.00e+00	0.00e+00	0.00e+00	0.00e+00	0.00e+00	0.00e+00

Conversion factors are in units of square meter-mrem/yr per uCi/sec for all nuclides except H-3, which is in units of mrem/yr per uCi/cubic meter.

**MEAT PATHWAY DOSE FACTORS DUE TO RADIONUCLIDES
OTHER THAN NOBLE GASES, R_i**

R_i factors for Adult age group by nuclide.
Waterford Steam Electric Station
Pathway : Gaseous Release Meat & Poultry Pathway R_i

Nuclide	Organ Dose Conversion Factors						
	Bone	Liver	T. Body	Thyroid	Kidney	Lung	GI-LLI
Cs-135	2.14e+08	1.97e+08	8.76e+07	0.00e+00	7.47e+07	2.24e+07	4.62e+06
Cs-136	1.21e+07	4.76e+07	3.43e+07	0.00e+00	2.65e+07	3.63e+06	5.41e+06
Cs-137	8.72e+08	1.19e+09	7.81e+08	0.00e+00	4.05e+08	1.35e+08	2.31e+07
Cs-138	0.00e+00	0.00e+00	0.00e+00	0.00e+00	0.00e+00	0.00e+00	0.00e+00
Cs-139	0.00e+00	0.00e+00	0.00e+00	0.00e+00	0.00e+00	0.00e+00	0.00e+00
Ba-139	0.00e+00	0.00e+00	0.00e+00	0.00e+00	0.00e+00	0.00e+00	0.00e+00
Ba-140	2.88e+07	3.61e+04	1.88e+06	0.00e+00	1.23e+04	2.07e+04	5.92e+07
Ba-141	0.00e+00	0.00e+00	0.00e+00	0.00e+00	0.00e+00	0.00e+00	0.00e+00
Ba-142	0.00e+00	0.00e+00	0.00e+00	0.00e+00	0.00e+00	0.00e+00	0.00e+00
La-140	3.75e-02	1.89e-02	4.99e-03	0.00e+00	0.00e+00	0.00e+00	1.39e+03
La-141	3.46e-37	1.07e-37	1.76e-38	0.00e+00	0.00e+00	0.00e+00	1.28e-32
La-142	0.00e+00	0.00e+00	0.00e+00	0.00e+00	0.00e+00	0.00e+00	0.00e+00
Ce-141	1.41e+04	9.50e+03	1.08e+03	0.00e+00	4.41e+03	0.00e+00	3.63e+07
Ce-143	2.03e-02	1.50e+01	1.66e-03	0.00e+00	6.61e-03	0.00e+00	5.61e+02
Ce-144	1.46e+06	6.09e+05	7.83e+04	0.00e+00	3.61e+05	0.00e+00	4.93e+08
Pr-143	2.10e+04	8.42e+03	1.04e+03	0.00e+00	4.86e+03	0.00e+00	9.19e+07
Pr-144	0.00e+00	0.00e+00	0.00e+00	0.00e+00	0.00e+00	0.00e+00	0.00e+00
Nd-147	7.08e+03	8.18e+03	4.90e+02	0.00e+00	4.78e+03	0.00e+00	3.93e+07
Pm-147	9.64e+05	9.07e+04	3.67e+04	0.00e+00	1.71e+05	0.00e+00	1.14e+08
Pm-148	1.98e+03	3.29e+02	1.65e+02	0.00e+00	6.21e+02	0.00e+00	2.58e+07
Pm-148m	2.16e+05	5.59e+04	4.27e+04	0.00e+00	8.43e+04	0.00e+00	4.74e+08
Pm-149	5.15e+00	7.28e-01	2.97e-01	0.00e+00	1.37e+00	0.00e+00	1.36e+05
Pm-151	5.64e-03	9.46e-04	4.78e-04	0.00e+00	1.69e-03	0.00e+00	2.60e+02
Sm-151	9.45e+05	1.63e+05	3.90e+04	0.00e+00	1.82e+05	0.00e+00	7.19e+07
Sm-153	1.17e+00	9.80e-01	7.15e-02	0.00e+00	3.17e-01	0.00e+00	3.49e+04
Eu-152	2.55e+06	5.81e+05	5.10e+05	0.00e+00	3.60e+06	0.00e+00	3.35e+08
Eu-154	8.09e+06	9.95e+05	7.08e+05	0.00e+00	4.76e+06	0.00e+00	7.21e+08
Eu-155	1.09e+06	1.54e+05	9.93e+04	0.00e+00	7.10e+05	0.00e+00	1.21e+08
Eu-156	3.77e+04	2.92e+04	4.71e+03	0.00e+00	1.95e+04	0.00e+00	2.00e+08
Tb-160	3.92e+05	0.00e+00	4.89e+04	0.00e+00	1.62e+05	0.00e+00	3.61e+08

Conversion factors are in units of square meter-mrem/yr per uCi/sec for all nuclides except H-3, which is in units of mrem/yr per uCi/cubic meter.

**MEAT PATHWAY DOSE FACTORS DUE TO RADIONUCLIDES
OTHER THAN NOBLE GASES, R_i**

R_i factors for Adult age group by nuclide.

Waterford Steam Electric Station

Pathway : Gaseous Release Meat & Poultry Pathway R_i

Nuclide	Organ Dose Conversion Factors						
	Bone	Liver	T. Body	Thyroid	Kidney	Lung	GI-LLI
Ho-166m	3.26e+06	1.02e+06	7.72e+05	0.00e+00	1.52e+06	0.00e+00	3.09e+08
W-181	3.02e+04	9.84e+03	1.05e+03	0.00e+00	0.00e+00	0.00e+00	1.12e+06
W-185	1.08e+06	3.61e+05	3.79e+04	0.00e+00	0.00e+00	0.00e+00	4.17e+07
W-187	2.25e-02	1.88e-02	6.56e-03	0.00e+00	0.00e+00	0.00e+00	6.15e+00
Pb-210	1.21e+10	3.46e+09	4.31e+08	0.00e+00	9.75e+09	0.00e+00	1.77e+06
Bi-210	2.72e+05	1.88e+06	1.56e+05	0.00e+00	2.26e+07	0.00e+00	2.80e+07
Po-210	9.62e+09	2.04e+10	2.32e+09	0.00e+00	6.81e+10	0.00e+00	1.72e+09
Ra-223	6.16e+10	9.49e+07	1.23e+10	0.00e+00	2.69e+09	0.00e+00	3.98e+09
Ra-224	7.05e+08	1.71e+06	1.41e+08	0.00e+00	4.81e+07	0.00e+00	1.49e+08
Ra-225	1.23e+11	1.46e+08	2.46e+10	0.00e+00	4.15e+09	0.00e+00	5.75e+09
Ra-226	2.82e+13	5.35e+08	2.05e+13	0.00e+00	1.52e+10	0.00e+00	3.10e+10
Ra-228	1.03e+13	2.87e+08	1.11e+13	0.00e+00	8.12e+09	0.00e+00	5.19e+09
Ac-225	7.54e+07	1.04e+08	5.07e+06	0.00e+00	1.18e+07	0.00e+00	6.98e+09
Ac-227	3.07e+11	4.07e+10	1.82e+10	0.00e+00	1.31e+10	0.00e+00	1.34e+10
Th-227	2.02e+06	3.66e+04	5.83e+04	0.00e+00	2.08e+05	0.00e+00	7.97e+07
Th-228	2.61e+08	4.43e+06	8.85e+06	0.00e+00	2.46e+07	0.00e+00	2.97e+08
Th-229	7.46e+09	2.13e+08	1.23e+08	0.00e+00	1.03e+09	0.00e+00	4.28e+07
Th-230	1.13e+09	6.42e+07	3.13e+07	0.00e+00	3.10e+08	0.00e+00	3.30e+07
Th-232	1.26e+09	5.48e+07	8.23e+05	0.00e+00	2.64e+08	0.00e+00	2.81e+07
Th-234	1.56e+04	9.19e+02	4.51e+02	0.00e+00	5.21e+03	0.00e+00	2.21e+07
Pa-231	8.99e+15	3.38e+14	3.49e+14	0.00e+00	1.90e+15	0.00e+00	1.57e+14
Pa-233	4.60e+09	9.28e+08	7.98e+08	0.00e+00	3.49e+09	0.00e+00	1.44e+13
U-232	3.85e+09	0.00e+00	2.75e+08	0.00e+00	4.16e+08	0.00e+00	6.31e+07
U-233	8.12e+08	0.00e+00	4.92e+07	0.00e+00	1.89e+08	0.00e+00	5.85e+07
U-234	7.79e+08	0.00e+00	4.82e+07	0.00e+00	1.86e+08	0.00e+00	5.72e+07
U-235	7.47e+08	0.00e+00	4.53e+07	0.00e+00	1.74e+08	0.00e+00	7.28e+07
U-236	7.47e+08	0.00e+00	4.62e+07	0.00e+00	1.78e+08	0.00e+00	5.37e+07
U-237	2.15e+03	0.00e+00	5.72e+02	0.00e+00	8.83e+03	0.00e+00	7.55e+05
U-238	7.15e+08	0.00e+00	4.23e+07	0.00e+00	1.63e+08	0.00e+00	5.13e+07
Np-237	6.91e+08	4.91e+07	3.04e+07	0.00e+00	2.26e+08	0.00e+00	4.35e+07

Conversion factors are in units of square meter-mrem/yr per uCi/sec for all nuclides except H-3, which is in units of mrem/yr per uCi/cubic meter.

**MEAT PATHWAY DOSE FACTORS DUE TO RADIONUCLIDES
OTHER THAN NOBLE GASES, R_i**

R_i factors for Adult age group by nuclide.
Waterford Steam Electric Station
Pathway : Gaseous Release Meat & Poultry Pathway R_i

Nuclide	Organ Dose Conversion Factors						
	Bone	Liver	T. Body	Thyroid	Kidney	Lung	GI-LLI
Np-238	1.43e+00	3.85e-02	2.22e-02	0.00e+00	1.30e-01	0.00e+00	3.58e+03
Np-239	2.61e-01	2.57e-02	1.41e-02	0.00e+00	8.00e-02	0.00e+00	5.26e+03
Pu-238	2.42e+07	3.06e+06	6.56e+05	0.00e+00	2.81e+06	0.00e+00	2.80e+06
Pu-239	2.78e+07	3.34e+06	7.33e+05	0.00e+00	3.11e+06	0.00e+00	2.56e+06
Pu-240	2.78e+07	3.34e+06	7.33e+05	0.00e+00	3.11e+06	0.00e+00	2.60e+06
Pu-241	6.00e+05	2.85e+04	1.27e+04	0.00e+00	5.84e+04	0.00e+00	5.35e+04
Pu-242	2.58e+07	3.22e+06	7.06e+05	0.00e+00	3.00e+06	0.00e+00	2.51e+06
Pu-244	3.01e+07	3.69e+06	8.10e+05	0.00e+00	3.44e+06	0.00e+00	3.74e+06
Am-241	4.07e+08	3.80e+08	2.92e+07	0.00e+00	2.19e+08	0.00e+00	4.00e+07
Am-242m	4.17e+08	3.63e+08	2.98e+07	0.00e+00	2.22e+08	0.00e+00	5.12e+07
Am-243	4.14e+08	3.78e+08	2.91e+07	0.00e+00	2.19e+08	0.00e+00	4.77e+07
Cm-242	9.56e+06	1.02e+07	6.36e+05	0.00e+00	2.89e+06	0.00e+00	3.67e+07
Cm-243	3.28e+08	3.00e+08	2.05e+07	0.00e+00	9.57e+07	0.00e+00	4.27e+07
Cm-244	2.49e+08	2.33e+08	1.57e+07	0.00e+00	7.32e+07	0.00e+00	4.12e+07
Cm-245	5.14e+08	4.48e+08	3.16e+07	0.00e+00	1.48e+08	0.00e+00	3.86e+07
Cm-246	5.10e+08	4.48e+08	3.15e+07	0.00e+00	1.47e+08	0.00e+00	3.79e+07
Cm-247	4.97e+08	4.41e+08	3.11e+07	0.00e+00	1.45e+08	0.00e+00	4.99e+07
Cm-248	4.14e+09	3.64e+09	2.56e+08	0.00e+00	1.20e+09	0.00e+00	8.06e+08
Cf-252	1.39e+08	0.00e+00	3.34e+06	0.00e+00	0.00e+00	0.00e+00	1.53e+08

Conversion factors are in units of square meter-mrem/yr per uCi/sec for all nuclides except H-3, which is in units of mrem/yr per uCi/cubic meter.

**MEAT PATHWAY DOSE FACTORS DUE TO RADIONUCLIDES
OTHER THAN NOBLE GASES, R_i**

R_i factors for Teen age group by nuclide.
Waterford Steam Electric Station
Pathway : Gaseous Release Meat & Poultry Pathway R_i

Nuclide	Organ Dose Conversion Factors						
	Bone	Liver	T. Body	Thyroid	Kidney	Lung	GI-LLI
H-3	0.00e+00	1.10e+02	1.10e+02	1.10e+02	1.10e+02	1.10e+02	1.10e+02
Be-10	7.26e+06	1.12e+06	1.83e+05	0.00e+00	8.59e+05	0.00e+00	4.60e+07
C-14	2.04e+08	4.08e+07	4.08e+07	4.08e+07	4.08e+07	4.08e+07	4.08e+07
N-13	0.00e+00	0.00e+00	0.00e+00	0.00e+00	0.00e+00	0.00e+00	0.00e+00
F-18	0.00e+00	0.00e+00	0.00e+00	0.00e+00	0.00e+00	0.00e+00	0.00e+00
Na-22	1.10e+09	1.10e+09	1.10e+09	1.10e+09	1.10e+09	1.10e+09	1.10e+09
Na-24	1.11e-03	1.11e-03	1.11e-03	1.11e-03	1.11e-03	1.11e-03	1.11e-03
P-32	3.94e+09	2.44e+08	1.53e+08	0.00e+00	0.00e+00	0.00e+00	3.31e+08
Ca-41	1.28e+09	0.00e+00	1.38e+08	0.00e+00	0.00e+00	0.00e+00	1.26e+06
Sc-46	1.36e+05	2.65e+05	7.87e+04	0.00e+00	2.54e+05	0.00e+00	9.04e+08
Cr-51	0.00e+00	0.00e+00	5.64e+03	3.13e+03	1.24e+03	8.05e+03	9.48e+05
Mn-54	0.00e+00	7.00e+06	1.39e+06	0.00e+00	2.09e+06	0.00e+00	1.44e+07
Mn-56	0.00e+00	0.00e+00	0.00e+00	0.00e+00	0.00e+00	0.00e+00	0.00e+00
Fe-55	2.38e+08	1.69e+08	3.94e+07	0.00e+00	0.00e+00	1.07e+08	7.31e+07
Fe-59	2.12e+08	4.95e+08	1.91e+08	0.00e+00	0.00e+00	1.56e+08	1.17e+09
Co-57	0.00e+00	4.53e+06	7.59e+06	0.00e+00	0.00e+00	0.00e+00	8.45e+07
Co-58	0.00e+00	1.41e+07	3.24e+07	0.00e+00	0.00e+00	0.00e+00	1.94e+08
Co-60	0.00e+00	5.83e+07	1.31e+08	0.00e+00	0.00e+00	0.00e+00	7.60e+08
Ni-59	1.13e+08	4.00e+07	1.92e+07	0.00e+00	0.00e+00	0.00e+00	6.28e+06
Ni-63	1.52e+09	1.07e+08	5.15e+07	0.00e+00	0.00e+00	0.00e+00	1.71e+07
Ni-65	0.00e+00	0.00e+00	0.00e+00	0.00e+00	0.00e+00	0.00e+00	0.00e+00
Cu-64	0.00e+00	2.28e-07	1.07e-07	0.00e+00	5.77e-07	0.00e+00	1.77e-05
Zn-65	2.50e+08	8.69e+08	4.05e+08	0.00e+00	5.56e+08	0.00e+00	3.68e+08
Zn-69	0.00e+00	0.00e+00	0.00e+00	0.00e+00	0.00e+00	0.00e+00	0.00e+00
Zn-69m	1.56e-05	3.67e-05	3.37e-06	0.00e+00	2.23e-05	0.00e+00	2.02e-03
Se-79	0.00e+00	9.07e+07	1.52e+07	0.00e+00	1.58e+08	0.00e+00	1.39e+07
Br-82	0.00e+00	0.00e+00	9.76e+02	0.00e+00	0.00e+00	0.00e+00	0.00e+00
Br-83	0.00e+00	0.00e+00	0.00e+00	0.00e+00	0.00e+00	0.00e+00	0.00e+00
Br-84	0.00e+00	0.00e+00	0.00e+00	0.00e+00	0.00e+00	0.00e+00	0.00e+00
Br-85	0.00e+00	0.00e+00	0.00e+00	0.00e+00	0.00e+00	0.00e+00	0.00e+00

Conversion factors are in units of square meter-mrem/yr per uCi/sec for all nuclides except H-3, which is in units of mrem/yr per uCi/cubic meter.

**MEAT PATHWAY DOSE FACTORS DUE TO RADIONUCLIDES
OTHER THAN NOBLE GASES, R_i**

R_i factors for Teen age group by nuclide.
Waterford Steam Electric Station
Pathway : Gaseous Release Meat & Poultry Pathway R_i

Nuclide	Organ Dose Conversion Factors						
	Bone	Liver	T. Body	Thyroid	Kidney	Lung	GI-LLI
Rb-86	0.00e+00	4.07e+08	1.91e+08	0.00e+00	0.00e+00	0.00e+00	6.02e+07
Rb-87	0.00e+00	8.79e+08	3.07e+08	0.00e+00	0.00e+00	0.00e+00	3.07e+07
Rb-88	0.00e+00	0.00e+00	0.00e+00	0.00e+00	0.00e+00	0.00e+00	0.00e+00
Rb-89	0.00e+00	0.00e+00	0.00e+00	0.00e+00	0.00e+00	0.00e+00	0.00e+00
Sr-89	2.55e+08	0.00e+00	7.29e+06	0.00e+00	0.00e+00	0.00e+00	3.03e+07
Sr-90	9.89e+09	0.00e+00	1.98e+08	0.00e+00	0.00e+00	0.00e+00	2.26e+08
Sr-91	1.33e-10	0.00e+00	5.29e-12	0.00e+00	0.00e+00	0.00e+00	6.03e-10
Sr-92	0.00e+00	0.00e+00	0.00e+00	0.00e+00	0.00e+00	0.00e+00	0.00e+00
Y-90	9.11e+01	0.00e+00	2.45e+00	0.00e+00	0.00e+00	0.00e+00	7.52e+05
Y-91	9.54e+05	0.00e+00	2.56e+04	0.00e+00	0.00e+00	0.00e+00	3.91e+08
Y-91m	0.00e+00	0.00e+00	0.00e+00	0.00e+00	0.00e+00	0.00e+00	0.00e+00
Y-92	1.43e-39	0.00e+00	0.00e+00	0.00e+00	0.00e+00	0.00e+00	3.93e-35
Y-93	4.11e-12	0.00e+00	1.13e-13	0.00e+00	0.00e+00	0.00e+00	1.26e-07
Zr-93	3.05e+06	1.50e+05	8.21e+04	0.00e+00	5.32e+05	0.00e+00	1.42e+08
Zr-95	1.50e+06	4.73e+05	3.25e+05	0.00e+00	6.95e+05	0.00e+00	1.09e+09
Zr-97	1.76e-05	3.49e-06	1.61e-06	0.00e+00	5.29e-06	0.00e+00	9.44e-01
Nb-93m	1.55e+07	5.10e+06	1.28e+06	0.00e+00	5.96e+06	0.00e+00	1.84e+09
Nb-95	1.79e+06	9.96e+05	5.48e+05	0.00e+00	9.65e+05	0.00e+00	4.26e+09
Nb-97	0.00e+00	0.00e+00	0.00e+00	0.00e+00	0.00e+00	0.00e+00	0.00e+00
Mo-93	0.00e+00	1.37e+08	3.76e+06	0.00e+00	3.94e+07	0.00e+00	1.67e+07
Mo-99	0.00e+00	8.31e+04	1.59e+04	0.00e+00	1.90e+05	0.00e+00	1.49e+05
Tc-101	0.00e+00	0.00e+00	0.00e+00	0.00e+00	0.00e+00	0.00e+00	0.00e+00
Tc-99	1.16e+08	1.70e+08	4.65e+07	0.00e+00	2.16e+09	1.76e+07	4.17e+09
Tc-99m	3.77e-21	1.05e-20	1.36e-19	0.00e+00	1.57e-19	5.83e-21	6.90e-18
Ru-103	8.57e+07	0.00e+00	3.66e+07	0.00e+00	3.02e+08	0.00e+00	7.16e+09
Ru-105	5.27e-28	0.00e+00	2.04e-28	0.00e+00	6.65e-27	0.00e+00	4.25e-25
Ru-106	2.36e+09	0.00e+00	2.97e+08	0.00e+00	4.55e+09	0.00e+00	1.13e+11
Rh-105	3.21e+00	2.32e+00	1.52e+00	0.00e+00	9.84e+00	0.00e+00	2.95e+02
Pd-107	0.00e+00	1.35e+06	8.69e+04	0.00e+00	1.22e+07	0.00e+00	6.26e+06
Pd-109	0.00e+00	1.24e-06	2.83e-07	0.00e+00	7.19e-06	0.00e+00	1.25e-04

Conversion factors are in units of square meter-mrem/yr per uCi/sec for all nuclides except H-3, which is in units of mrem/yr per uCi/cubic meter.

**MEAT PATHWAY DOSE FACTORS DUE TO RADIONUCLIDES
OTHER THAN NOBLE GASES, R_i**

Ri factors for Teen age group by nuclide.
Waterford Steam Electric Station
Pathway : Gaseous Release Meat & Poultry Pathway Ri

Nuclide	Organ Dose Conversion Factors						
	Bone	Liver	T. Body	Thyroid	Kidney	Lung	GI-LLI
Ag-110m	5.06e+06	4.79e+06	2.91e+06	0.00e+00	9.13e+06	0.00e+00	1.34e+09
Ag-111	1.23e+05	5.12e+04	2.57e+04	0.00e+00	1.67e+05	0.00e+00	7.14e+07
Cd-113m	0.00e+00	3.85e+06	1.24e+05	0.00e+00	4.26e+06	0.00e+00	2.32e+07
Cd-115m	0.00e+00	1.25e+06	4.02e+04	0.00e+00	9.96e+05	0.00e+00	3.94e+07
Sn-123	4.66e+09	7.66e+07	1.13e+08	6.13e+07	0.00e+00	0.00e+00	7.05e+09
Sn-125	1.49e+08	2.96e+06	6.71e+06	2.32e+06	0.00e+00	0.00e+00	1.40e+09
Sn-126	1.50e+10	2.80e+08	4.28e+08	7.38e+07	0.00e+00	0.00e+00	3.34e+09
Sb-124	1.62e+07	2.98e+05	6.31e+06	3.67e+04	0.00e+00	1.41e+07	3.26e+08
Sb-125	1.56e+07	1.71e+05	3.66e+06	1.49e+04	0.00e+00	1.37e+07	1.22e+08
Sb-126	1.60e+06	3.28e+04	5.76e+05	9.07e+03	0.00e+00	1.15e+06	9.49e+07
Sb-127	1.43e+04	3.05e+02	5.38e+03	1.60e+02	0.00e+00	9.70e+03	2.42e+06
Te-125m	3.03e+08	1.09e+08	4.05e+07	8.47e+07	0.00e+00	0.00e+00	8.94e+08
Te-127	1.88e-10	6.65e-11	4.04e-11	1.29e-10	7.60e-10	0.00e+00	1.45e-08
Te-127m	9.42e+08	3.34e+08	1.12e+08	2.24e+08	3.82e+09	0.00e+00	2.35e+09
Te-129	0.00e+00	0.00e+00	0.00e+00	0.00e+00	0.00e+00	0.00e+00	0.00e+00
Te-129m	9.50e+08	3.53e+08	1.50e+08	3.07e+08	3.98e+09	0.00e+00	3.57e+09
Te-131	0.00e+00	0.00e+00	0.00e+00	0.00e+00	0.00e+00	0.00e+00	0.00e+00
Te-131m	3.81e+02	1.83e+02	1.52e+02	2.75e+02	1.90e+03	0.00e+00	1.47e+04
Te-132	1.17e+06	7.39e+05	6.96e+05	7.79e+05	7.09e+06	0.00e+00	2.34e+07
Te-133m	0.00e+00	0.00e+00	0.00e+00	0.00e+00	0.00e+00	0.00e+00	0.00e+00
Te-134	0.00e+00	0.00e+00	0.00e+00	0.00e+00	0.00e+00	0.00e+00	0.00e+00
I-129	1.09e+08	9.21e+07	1.54e+08	1.12e+11	1.65e+08	0.00e+00	1.07e+07
I-130	1.75e-06	5.07e-06	2.02e-06	4.13e-04	7.80e-06	0.00e+00	3.89e-06
I-131	8.94e+06	1.25e+07	6.72e+06	3.65e+09	2.15e+07	0.00e+00	2.48e+06
I-132	0.00e+00	0.00e+00	0.00e+00	0.00e+00	0.00e+00	0.00e+00	0.00e+00
I-133	3.11e-01	5.28e-01	1.61e-01	7.37e+01	9.26e-01	0.00e+00	3.99e-01
I-134	0.00e+00	0.00e+00	0.00e+00	0.00e+00	0.00e+00	0.00e+00	0.00e+00
I-135	3.82e-17	9.82e-17	3.64e-17	6.32e-15	1.55e-16	0.00e+00	1.09e-16
Cs-134	5.23e+08	1.23e+09	5.71e+08	0.00e+00	3.91e+08	1.49e+08	1.53e+07
Cs-134m	0.00e+00	0.00e+00	0.00e+00	0.00e+00	0.00e+00	0.00e+00	0.00e+00

Conversion factors are in units of square meter-mrem/yr per uCi/sec for all nuclides except H-3, which is in units of mrem/yr per uCi/cubic meter.

**MEAT PATHWAY DOSE FACTORS DUE TO RADIONUCLIDES
OTHER THAN NOBLE GASES, R_i**

R_i factors for Teen age group by nuclide.
Waterford Steam Electric Station
Pathway : Gaseous Release Meat & Poultry Pathway R_i

Nuclide	Organ Dose Conversion Factors						
	Bone	Liver	T. Body	Thyroid	Kidney	Lung	GI-LLI
Cs-135	1.80e+08	1.65e+08	3.86e+07	0.00e+00	6.31e+07	2.28e+07	2.89e+06
Cs-136	9.41e+06	3.70e+07	2.49e+07	0.00e+00	2.02e+07	3.18e+06	2.98e+06
Cs-137	7.24e+08	9.63e+08	3.36e+08	0.00e+00	3.28e+08	1.27e+08	1.37e+07
Cs-138	0.00e+00	0.00e+00	0.00e+00	0.00e+00	0.00e+00	0.00e+00	0.00e+00
Cs-139	0.00e+00	0.00e+00	0.00e+00	0.00e+00	0.00e+00	0.00e+00	0.00e+00
Ba-139	0.00e+00	0.00e+00	0.00e+00	0.00e+00	0.00e+00	0.00e+00	0.00e+00
Ba-140	2.38e+07	2.91e+04	1.53e+06	0.00e+00	9.88e+03	1.96e+04	3.67e+07
Ba-141	0.00e+00	0.00e+00	0.00e+00	0.00e+00	0.00e+00	0.00e+00	0.00e+00
Ba-142	0.00e+00	0.00e+00	0.00e+00	0.00e+00	0.00e+00	0.00e+00	0.00e+00
La-140	3.08e-02	1.51e-02	4.03e-03	0.00e+00	0.00e+00	0.00e+00	8.69e+02
La-141	2.92e-37	8.97e-38	1.48e-38	0.00e+00	0.00e+00	0.00e+00	1.59e-32
La-142	0.00e+00	0.00e+00	0.00e+00	0.00e+00	0.00e+00	0.00e+00	0.00e+00
Ce-141	1.18e+04	7.88e+03	9.05e+02	0.00e+00	3.71e+03	0.00e+00	2.25e+07
Ce-143	1.71e-02	1.24e+01	1.39e-03	0.00e+00	5.58e-03	0.00e+00	3.74e+02
Ce-144	1.23e+06	5.08e+05	6.60e+04	0.00e+00	3.04e+05	0.00e+00	3.09e+08
Pr-143	1.77e+04	7.05e+03	8.79e+02	0.00e+00	4.10e+03	0.00e+00	5.81e+07
Pr-144	0.00e+00	0.00e+00	0.00e+00	0.00e+00	0.00e+00	0.00e+00	0.00e+00
Nd-147	6.24e+03	6.78e+03	4.06e+02	0.00e+00	3.98e+03	0.00e+00	2.45e+07
Pm-147	7.93e+05	7.53e+04	3.07e+04	0.00e+00	1.44e+05	0.00e+00	7.16e+07
Pm-148	1.66e+03	2.71e+02	1.36e+02	0.00e+00	4.89e+02	0.00e+00	1.62e+07
Pm-148m	1.72e+05	4.36e+04	3.41e+04	0.00e+00	6.60e+04	0.00e+00	2.74e+08
Pm-149	4.34e+00	6.10e-01	2.50e-01	0.00e+00	1.16e+00	0.00e+00	8.98e+04
Pm-151	4.72e-03	7.79e-04	3.94e-04	0.00e+00	1.40e-03	0.00e+00	1.75e+02
Sm-151	7.07e+05	1.36e+05	3.19e+04	0.00e+00	1.49e+05	0.00e+00	4.61e+07
Sm-153	9.88e-01	8.18e-01	6.02e-02	0.00e+00	2.67e-01	0.00e+00	2.31e+04
Eu-152	1.89e+06	4.56e+05	4.02e+05	0.00e+00	2.12e+06	0.00e+00	1.68e+08
Eu-154	6.15e+06	7.93e+05	5.59e+05	0.00e+00	3.55e+06	0.00e+00	4.19e+08
Eu-155	1.30e+06	1.25e+05	7.76e+04	0.00e+00	4.90e+05	0.00e+00	7.18e+08
Eu-156	3.12e+04	2.34e+04	3.82e+03	0.00e+00	1.58e+04	0.00e+00	1.20e+08
Tb-160	3.19e+05	0.00e+00	3.98e+04	0.00e+00	1.26e+05	0.00e+00	2.06e+08

Conversion factors are in units of square meter-mrem/yr per uCi/sec for all nuclides except H-3, which is in units of mrem/yr per uCi/cubic meter.

**MEAT PATHWAY DOSE FACTORS DUE TO RADIONUCLIDES
OTHER THAN NOBLE GASES, R_i**

R_i factors for Teen age group by nuclide.
Waterford Steam Electric Station
Pathway : Gaseous Release Meat & Poultry Pathway R_i

Nuclide	Organ Dose Conversion Factors						
	Bone	Liver	T. Body	Thyroid	Kidney	Lung	GI-LLI
Ho-166m	2.55e+06	7.84e+05	5.68e+05	0.00e+00	1.15e+06	0.00e+00	1.93e+08
W-181	2.56e+04	8.25e+03	8.62e+02	0.00e+00	0.00e+00	0.00e+00	7.02e+05
W-185	9.14e+05	3.01e+05	3.19e+04	0.00e+00	0.00e+00	0.00e+00	2.60e+07
W-187	1.88e-02	1.53e-02	5.37e-03	0.00e+00	0.00e+00	0.00e+00	4.15e+00
Pb-210	8.47e+09	2.55e+09	3.28e+08	0.00e+00	8.05e+09	0.00e+00	1.11e+06
Bi-210	2.30e+05	1.57e+06	1.32e+05	0.00e+00	1.91e+07	0.00e+00	1.80e+07
Po-210	8.13e+09	1.71e+10	1.96e+09	0.00e+00	5.75e+10	0.00e+00	1.08e+09
Ra-223	5.21e+10	7.92e+07	1.04e+10	0.00e+00	2.27e+09	0.00e+00	2.51e+09
Ra-224	5.97e+08	1.43e+06	1.19e+08	0.00e+00	4.09e+07	0.00e+00	9.59e+07
Ra-225	1.04e+11	1.22e+08	2.08e+10	0.00e+00	3.50e+09	0.00e+00	3.63e+09
Ra-226	1.77e+13	4.48e+08	1.32e+13	0.00e+00	1.28e+10	0.00e+00	1.93e+10
Ra-228	7.45e+12	2.40e+08	8.21e+12	0.00e+00	6.85e+09	0.00e+00	3.25e+09
Ac-225	6.37e+07	8.70e+07	4.27e+06	0.00e+00	9.98e+06	0.00e+00	4.42e+09
Ac-227	1.99e+11	2.94e+10	1.18e+10	0.00e+00	8.54e+09	0.00e+00	8.41e+09
Th-227	1.71e+06	3.07e+04	4.93e+04	0.00e+00	1.75e+05	0.00e+00	5.01e+07
Th-228	2.12e+08	3.55e+06	7.16e+06	0.00e+00	2.00e+07	0.00e+00	1.86e+08
Th-229	4.63e+09	1.33e+08	7.68e+07	0.00e+00	6.45e+08	0.00e+00	2.68e+07
Th-230	7.00e+08	3.99e+07	1.94e+07	0.00e+00	1.94e+08	0.00e+00	2.07e+07
Th-232	7.84e+08	3.40e+07	5.28e+05	0.00e+00	1.66e+08	0.00e+00	1.76e+07
Th-234	1.31e+04	7.70e+02	3.82e+02	0.00e+00	4.39e+03	0.00e+00	1.40e+07
Pa-231	5.59e+15	2.10e+14	2.18e+14	0.00e+00	1.18e+15	0.00e+00	9.85e+13
Pa-233	3.79e+09	7.29e+08	6.52e+08	0.00e+00	2.75e+09	0.00e+00	8.33e+12
U-232	3.24e+09	0.00e+00	2.32e+08	0.00e+00	3.51e+08	0.00e+00	3.96e+07
U-233	6.83e+08	0.00e+00	4.15e+07	0.00e+00	1.60e+08	0.00e+00	3.66e+07
U-234	6.56e+08	0.00e+00	4.07e+07	0.00e+00	1.57e+08	0.00e+00	3.59e+07
U-235	6.28e+08	0.00e+00	3.82e+07	0.00e+00	1.47e+08	0.00e+00	4.56e+07
U-236	6.28e+08	0.00e+00	3.91e+07	0.00e+00	1.50e+08	0.00e+00	3.37e+07
U-237	1.81e+03	0.00e+00	4.83e+02	0.00e+00	7.45e+03	0.00e+00	4.80e+05
U-238	6.01e+08	0.00e+00	3.58e+07	0.00e+00	1.38e+08	0.00e+00	3.21e+07
Np-237	4.31e+08	3.10e+07	1.90e+07	0.00e+00	1.40e+08	0.00e+00	2.73e+07

Conversion factors are in units of square meter-mrem/yr per uCi/sec for all nuclides except H-3, which is in units of mrem/yr per uCi/cubic meter.

**MEAT PATHWAY DOSE FACTORS DUE TO RADIONUCLIDES
OTHER THAN NOBLE GASES, R_i**

Ri factors for Teen age group by nuclide.

Waterford Steam Electric Station

Pathway : Gaseous Release Meat & Poultry Pathway Ri

Nuclide	Organ Dose Conversion Factors						
	Bone	Liver	T. Body	Thyroid	Kidney	Lung	GI-LLI
Np-238	1.20e+00	3.22e-02	1.87e-02	0.00e+00	1.10e-01	0.00e+00	2.36e+03
Np-239	2.28e-01	2.15e-02	1.19e-02	0.00e+00	6.75e-02	0.00e+00	3.46e+03
Pu-238	1.52e+07	1.94e+06	4.13e+05	0.00e+00	1.77e+06	0.00e+00	1.75e+06
Pu-239	1.74e+07	2.11e+06	4.56e+05	0.00e+00	1.94e+06	0.00e+00	1.60e+06
Pu-240	1.73e+07	2.10e+06	4.56e+05	0.00e+00	1.94e+06	0.00e+00	1.63e+06
Pu-241	3.95e+05	1.90e+04	8.33e+03	0.00e+00	3.86e+04	0.00e+00	3.34e+04
Pu-242	1.61e+07	2.03e+06	4.40e+05	0.00e+00	1.87e+06	0.00e+00	1.57e+06
Pu-244	1.88e+07	2.31e+06	5.04e+05	0.00e+00	2.14e+06	0.00e+00	2.34e+06
Am-241	2.54e+08	2.40e+08	1.83e+07	0.00e+00	1.37e+08	0.00e+00	2.51e+07
Am-242m	2.61e+08	2.30e+08	1.88e+07	0.00e+00	1.39e+08	0.00e+00	3.21e+07
Am-243	2.58e+08	2.38e+08	1.82e+07	0.00e+00	1.37e+08	0.00e+00	2.99e+07
Cm-242	8.06e+06	8.50e+06	5.35e+05	0.00e+00	2.44e+06	0.00e+00	2.30e+07
Cm-243	2.10e+08	1.95e+08	1.32e+07	0.00e+00	6.17e+07	0.00e+00	2.68e+07
Cm-244	1.63e+08	1.54e+08	1.03e+07	0.00e+00	4.81e+07	0.00e+00	2.58e+07
Cm-245	3.21e+08	2.82e+08	1.98e+07	0.00e+00	9.24e+07	0.00e+00	2.42e+07
Cm-246	3.18e+08	2.82e+08	1.97e+07	0.00e+00	9.20e+07	0.00e+00	2.38e+07
Cm-247	3.10e+08	2.78e+08	1.94e+07	0.00e+00	9.07e+07	0.00e+00	3.12e+07
Cm-248	2.58e+09	2.29e+09	1.60e+08	0.00e+00	7.49e+08	0.00e+00	5.02e+08
Cf-252	1.09e+08	0.00e+00	2.63e+06	0.00e+00	0.00e+00	0.00e+00	9.58e+07

Conversion factors are in units of square meter-mrem/yr per uCi/sec for all nuclides except H-3, which is in units of mrem/yr per uCi/cubic meter.

**MEAT PATHWAY DOSE FACTORS DUE TO RADIONUCLIDES
OTHER THAN NOBLE GASES, R_i**

R_i factors for Child age group by nuclide.
Waterford Steam Electric Station
Pathway : Gaseous Release Meat & Poultry Pathway R_i

Nuclide	Organ Dose Conversion Factors						
	Bone	Liver	T. Body	Thyroid	Kidney	Lung	GI-LLI
H-3	0.00e+00	1.34e+02	1.34e+02	1.34e+02	1.34e+02	1.34e+02	1.34e+02
Be-10	1.38e+07	1.60e+06	3.46e+05	0.00e+00	1.13e+06	0.00e+00	2.81e+07
C-14	3.83e+08	7.67e+07	7.67e+07	7.67e+07	7.67e+07	7.67e+07	7.67e+07
N-13	0.00e+00	0.00e+00	0.00e+00	0.00e+00	0.00e+00	0.00e+00	0.00e+00
F-18	0.00e+00	0.00e+00	0.00e+00	0.00e+00	0.00e+00	0.00e+00	0.00e+00
Na-22	1.75e+09	1.75e+09	1.75e+09	1.75e+09	1.75e+09	1.75e+09	1.75e+09
Na-24	1.77e-03	1.77e-03	1.77e-03	1.77e-03	1.77e-03	1.77e-03	1.77e-03
P-32	7.43e+09	3.47e+08	2.86e+08	0.00e+00	0.00e+00	0.00e+00	2.05e+08
Ca-41	1.42e+09	0.00e+00	1.55e+08	0.00e+00	0.00e+00	0.00e+00	7.77e+05
Sc-46	2.34e+05	3.21e+05	1.24e+05	0.00e+00	2.84e+05	0.00e+00	4.69e+08
Cr-51	0.00e+00	0.00e+00	8.79e+03	4.88e+03	1.33e+03	8.91e+03	4.66e+05
Mn-54	0.00e+00	8.01e+06	2.13e+06	0.00e+00	2.25e+06	0.00e+00	6.72e+06
Mn-56	0.00e+00	0.00e+00	0.00e+00	0.00e+00	0.00e+00	0.00e+00	0.00e+00
Fe-55	4.57e+08	2.42e+08	7.51e+07	0.00e+00	0.00e+00	1.37e+08	4.49e+07
Fe-59	3.76e+08	6.09e+08	3.03e+08	0.00e+00	0.00e+00	1.77e+08	6.34e+08
Co-57	0.00e+00	5.92e+06	1.20e+07	0.00e+00	0.00e+00	0.00e+00	4.85e+07
Co-58	0.00e+00	1.64e+07	5.03e+07	0.00e+00	0.00e+00	0.00e+00	9.58e+07
Co-60	0.00e+00	6.93e+07	2.04e+08	0.00e+00	0.00e+00	0.00e+00	3.84e+08
Ni-59	2.18e+08	5.80e+07	3.69e+07	0.00e+00	0.00e+00	0.00e+00	3.85e+06
Ni-63	2.91e+09	1.56e+08	9.91e+07	0.00e+00	0.00e+00	0.00e+00	1.05e+07
Ni-65	0.00e+00	0.00e+00	0.00e+00	0.00e+00	0.00e+00	0.00e+00	0.00e+00
Cu-64	0.00e+00	3.07e-07	1.85e-07	0.00e+00	7.41e-07	0.00e+00	1.44e-05
Zn-65	3.75e+08	1.00e+09	6.22e+08	0.00e+00	6.30e+08	0.00e+00	1.76e+08
Zn-69	0.00e+00	0.00e+00	0.00e+00	0.00e+00	0.00e+00	0.00e+00	0.00e+00
Zn-69m	2.91e-05	4.95e-05	5.85e-06	0.00e+00	2.88e-05	0.00e+00	1.61e-03
Se-79	0.00e+00	1.29e+08	2.87e+07	0.00e+00	2.10e+08	0.00e+00	8.48e+06
Br-82	0.00e+00	0.00e+00	1.53e+03	0.00e+00	0.00e+00	0.00e+00	0.00e+00
Br-83	0.00e+00	0.00e+00	0.00e+00	0.00e+00	0.00e+00	0.00e+00	0.00e+00
Br-84	0.00e+00	0.00e+00	0.00e+00	0.00e+00	0.00e+00	0.00e+00	0.00e+00
Br-85	0.00e+00	0.00e+00	0.00e+00	0.00e+00	0.00e+00	0.00e+00	0.00e+00

Conversion factors are in units of square meter-mrem/yr per uCi/sec for all nuclides except H-3, which is in units of mrem/yr per uCi/cubic meter.

**MEAT PATHWAY DOSE FACTORS DUE TO RADIONUCLIDES
OTHER THAN NOBLE GASES, R_i**

R_i factors for Child age group by nuclide.
Waterford Steam Electric Station
Pathway : Gaseous Release Meat & Poultry Pathway R_i

Nuclide	Organ Dose Conversion Factors						
	Bone	Liver	T. Body	Thyroid	Kidney	Lung	GI-LLI
Rb-86	0.00e+00	5.77e+08	3.55e+08	0.00e+00	0.00e+00	0.00e+00	3.71e+07
Rb-87	0.00e+00	1.25e+09	5.80e+08	0.00e+00	0.00e+00	0.00e+00	1.88e+07
Rb-88	0.00e+00	0.00e+00	0.00e+00	0.00e+00	0.00e+00	0.00e+00	0.00e+00
Rb-89	0.00e+00	0.00e+00	0.00e+00	0.00e+00	0.00e+00	0.00e+00	0.00e+00
Sr-89	4.82e+08	0.00e+00	1.38e+07	0.00e+00	0.00e+00	0.00e+00	1.87e+07
Sr-90	1.57e+10	0.00e+00	3.15e+08	0.00e+00	0.00e+00	0.00e+00	1.40e+08
Sr-91	2.50e-10	0.00e+00	9.42e-12	0.00e+00	0.00e+00	0.00e+00	5.51e-10
Sr-92	0.00e+00	0.00e+00	0.00e+00	0.00e+00	0.00e+00	0.00e+00	0.00e+00
Y-90	1.72e+02	0.00e+00	4.61e+00	0.00e+00	0.00e+00	0.00e+00	4.91e+05
Y-91	1.80e+06	0.00e+00	4.82e+04	0.00e+00	0.00e+00	0.00e+00	2.40e+08
Y-91m	0.00e+00	0.00e+00	0.00e+00	0.00e+00	0.00e+00	0.00e+00	0.00e+00
Y-92	2.69e-39	0.00e+00	0.00e+00	0.00e+00	0.00e+00	0.00e+00	7.76e-35
Y-93	7.73e-12	0.00e+00	2.12e-13	0.00e+00	0.00e+00	0.00e+00	1.15e-07
Zr-93	5.80e+06	2.17e+05	1.55e+05	0.00e+00	8.41e+05	0.00e+00	8.24e+07
Zr-95	2.66e+06	5.86e+05	5.21e+05	0.00e+00	8.38e+05	0.00e+00	6.11e+08
Zr-97	3.28e-05	4.74e-06	2.80e-06	0.00e+00	6.80e-06	0.00e+00	7.18e-01
Nb-93m	2.99e+07	7.46e+06	2.45e+06	0.00e+00	8.05e+06	0.00e+00	1.12e+09
Nb-95	3.10e+06	1.21e+06	8.62e+05	0.00e+00	1.13e+06	0.00e+00	2.23e+09
Nb-97	0.00e+00	0.00e+00	0.00e+00	0.00e+00	0.00e+00	0.00e+00	0.00e+00
Mo-93	0.00e+00	1.97e+08	7.07e+06	0.00e+00	5.19e+07	0.00e+00	9.98e+06
Mo-99	0.00e+00	1.16e+05	2.86e+04	0.00e+00	2.47e+05	0.00e+00	9.57e+04
Tc-101	0.00e+00	0.00e+00	0.00e+00	0.00e+00	0.00e+00	0.00e+00	0.00e+00
Tc-99	2.19e+08	2.44e+08	8.75e+07	0.00e+00	2.87e+09	2.15e+07	2.56e+09
Tc-99m	6.61e-21	1.30e-20	2.15e-19	0.00e+00	1.88e-19	6.58e-21	7.37e-18
Ru-103	1.55e+08	0.00e+00	5.96e+07	0.00e+00	3.90e+08	0.00e+00	4.01e+09
Ru-105	9.83e-28	0.00e+00	3.57e-28	0.00e+00	8.64e-27	0.00e+00	6.42e-25
Ru-106	4.44e+09	0.00e+00	5.54e+08	0.00e+00	5.99e+09	0.00e+00	6.90e+10
Rh-105	6.01e+00	3.23e+00	2.76e+00	0.00e+00	1.29e+01	0.00e+00	2.00e+02
Pd-107	0.00e+00	1.93e+06	1.64e+05	0.00e+00	1.61e+07	0.00e+00	3.83e+06
Pd-109	0.00e+00	1.77e-06	5.32e-07	0.00e+00	9.51e-06	0.00e+00	1.05e-04

Conversion factors are in units of square meter-mrem/yr per uCi/sec for all nuclides except H-3, which is in units of mrem/yr per uCi/cubic meter.

**MEAT PATHWAY DOSE FACTORS DUE TO RADIONUCLIDES
OTHER THAN NOBLE GASES, R_i**

R_i factors for Child age group by nuclide.
Waterford Steam Electric Station
Pathway : Gaseous Release Meat & Poultry Pathway R_i

Nuclide	Organ Dose Conversion Factors						
	Bone	Liver	T. Body	Thyroid	Kidney	Lung	GI-LLI
Ag-110m	8.39e+06	5.67e+06	4.53e+06	0.00e+00	1.06e+07	0.00e+00	6.74e+08
Ag-111	2.33e+05	7.28e+04	4.81e+04	0.00e+00	2.20e+05	0.00e+00	4.46e+07
Cd-113m	0.00e+00	5.50e+06	2.34e+05	0.00e+00	5.66e+06	0.00e+00	1.42e+07
Cd-115m	0.00e+00	1.78e+06	7.58e+04	0.00e+00	1.32e+06	0.00e+00	2.42e+07
Sn-123	8.81e+09	1.09e+08	2.15e+08	1.16e+08	0.00e+00	0.00e+00	4.32e+09
Sn-125	2.80e+08	4.22e+06	1.25e+07	4.37e+06	0.00e+00	0.00e+00	8.67e+08
Sn-126	2.72e+10	3.39e+08	7.74e+08	9.32e+07	0.00e+00	0.00e+00	2.04e+09
Sb-124	2.92e+07	3.79e+05	1.02e+07	6.46e+04	0.00e+00	1.62e+07	1.83e+08
Sb-125	2.85e+07	2.20e+05	5.97e+06	2.64e+04	0.00e+00	1.59e+07	6.80e+07
Sb-126	2.80e+06	4.28e+04	1.01e+06	1.64e+04	0.00e+00	1.34e+06	5.64e+07
Sb-127	2.63e+04	4.06e+02	9.11e+03	2.92e+02	0.00e+00	1.14e+04	1.48e+06
Te-125m	5.69e+08	1.54e+08	7.59e+07	1.60e+08	0.00e+00	0.00e+00	5.49e+08
Te-127	3.53e-10	9.51e-11	7.57e-11	2.44e-10	1.00e-09	0.00e+00	1.38e-08
Te-127m	1.77e+09	4.78e+08	2.11e+08	4.24e+08	5.06e+09	0.00e+00	1.44e+09
Te-129	0.00e+00	0.00e+00	0.00e+00	0.00e+00	0.00e+00	0.00e+00	0.00e+00
Te-129m	1.79e+09	5.00e+08	2.78e+08	5.77e+08	5.26e+09	0.00e+00	2.18e+09
Te-131	0.00e+00	0.00e+00	0.00e+00	0.00e+00	0.00e+00	0.00e+00	0.00e+00
Te-131m	7.09e+02	2.45e+02	2.61e+02	5.04e+02	2.37e+03	0.00e+00	9.94e+03
Te-132	2.13e+06	9.43e+05	1.14e+06	1.37e+06	8.76e+06	0.00e+00	9.49e+06
Te-133m	0.00e+00	0.00e+00	0.00e+00	0.00e+00	0.00e+00	0.00e+00	0.00e+00
Te-134	0.00e+00	0.00e+00	0.00e+00	0.00e+00	0.00e+00	0.00e+00	0.00e+00
I-129	2.06e+08	1.26e+08	1.13e+08	8.27e+10	2.13e+08	0.00e+00	6.36e+06
I-130	3.13e-06	6.33e-06	3.26e-06	6.97e-04	9.46e-06	0.00e+00	2.96e-06
I-131	1.66e+07	1.67e+07	9.48e+06	5.51e+09	2.74e+07	0.00e+00	1.48e+06
I-132	0.00e+00	0.00e+00	0.00e+00	0.00e+00	0.00e+00	0.00e+00	0.00e+00
I-133	5.78e-01	7.15e-01	2.70e-01	1.33e+02	1.19e+00	0.00e+00	2.88e-01
I-134	0.00e+00	0.00e+00	0.00e+00	0.00e+00	0.00e+00	0.00e+00	0.00e+00
I-135	6.91e-17	1.24e-16	5.88e-17	1.10e-14	1.91e-16	0.00e+00	9.47e-17
Cs-134	9.22e+08	1.51e+09	3.19e+08	0.00e+00	4.69e+08	1.68e+08	8.16e+06
Cs-134m	0.00e+00	0.00e+00	0.00e+00	0.00e+00	0.00e+00	0.00e+00	0.00e+00

Conversion factors are in units of square meter-mrem/yr per uCi/sec for all nuclides except H-3, which is in units of mrem/yr per uCi/cubic meter.

**MEAT PATHWAY DOSE FACTORS DUE TO RADIONUCLIDES
OTHER THAN NOBLE GASES, R_i**

R_i factors for Child age group by nuclide.
Waterford Steam Electric Station
Pathway : Gaseous Release Meat & Poultry Pathway R_i

Nuclide	Organ Dose Conversion Factors						
	Bone	Liver	T. Body	Thyroid	Kidney	Lung	GI-LLI
Cs-135	3.39e+08	2.36e+08	2.42e+07	0.00e+00	8.34e+07	2.78e+07	1.77e+06
Cs-136	1.62e+07	4.46e+07	2.89e+07	0.00e+00	2.38e+07	3.54e+06	1.57e+06
Cs-137	1.33e+09	1.28e+09	1.88e+08	0.00e+00	4.16e+08	1.50e+08	7.99e+06
Cs-138	0.00e+00	0.00e+00	0.00e+00	0.00e+00	0.00e+00	0.00e+00	0.00e+00
Cs-139	0.00e+00	0.00e+00	0.00e+00	0.00e+00	0.00e+00	0.00e+00	0.00e+00
Ba-139	0.00e+00	0.00e+00	0.00e+00	0.00e+00	0.00e+00	0.00e+00	0.00e+00
Ba-140	4.39e+07	3.85e+04	2.56e+06	0.00e+00	1.25e+04	2.29e+04	2.22e+07
Ba-141	0.00e+00	0.00e+00	0.00e+00	0.00e+00	0.00e+00	0.00e+00	0.00e+00
Ba-142	0.00e+00	0.00e+00	0.00e+00	0.00e+00	0.00e+00	0.00e+00	0.00e+00
La-140	5.64e-02	1.97e-02	6.64e-03	0.00e+00	0.00e+00	0.00e+00	5.49e+02
La-141	5.50e-37	1.28e-37	2.78e-38	0.00e+00	0.00e+00	0.00e+00	2.85e-32
La-142	0.00e+00	0.00e+00	0.00e+00	0.00e+00	0.00e+00	0.00e+00	0.00e+00
Ce-141	2.22e+04	1.11e+04	1.65e+03	0.00e+00	4.86e+03	0.00e+00	1.38e+07
Ce-143	3.21e-02	1.74e+01	2.52e-03	0.00e+00	7.29e-03	0.00e+00	2.55e+02
Ce-144	2.32e+06	7.26e+05	1.24e+05	0.00e+00	4.02e+05	0.00e+00	1.89e+08
Pr-143	3.34e+04	1.00e+04	1.66e+03	0.00e+00	5.43e+03	0.00e+00	3.61e+07
Pr-144	0.00e+00	0.00e+00	0.00e+00	0.00e+00	0.00e+00	0.00e+00	0.00e+00
Nd-147	1.17e+04	9.48e+03	7.34e+02	0.00e+00	5.20e+03	0.00e+00	1.50e+07
Pm-147	1.52e+06	1.08e+05	5.81e+04	0.00e+00	1.91e+05	0.00e+00	4.38e+07
Pm-148	3.11e+03	3.74e+02	2.42e+02	0.00e+00	6.35e+02	0.00e+00	9.98e+06
Pm-148m	2.70e+05	5.37e+04	5.37e+04	0.00e+00	7.96e+04	0.00e+00	1.51e+08
Pm-149	8.19e+00	8.71e-01	4.72e-01	0.00e+00	1.54e+00	0.00e+00	5.94e+04
Pm-151	8.80e-03	1.07e-03	6.96e-04	0.00e+00	1.81e-03	0.00e+00	1.21e+02
Sm-151	1.31e+06	1.95e+05	6.13e+04	0.00e+00	2.01e+05	0.00e+00	2.82e+07
Sm-153	1.86e+00	1.16e+00	1.12e-01	0.00e+00	3.53e-01	0.00e+00	1.54e+04
Eu-152	3.00e+06	5.46e+05	6.49e+05	0.00e+00	2.31e+06	0.00e+00	8.97e+07
Eu-154	1.13e+07	1.02e+06	9.27e+05	0.00e+00	4.46e+06	0.00e+00	2.36e+08
Eu-155	2.27e+06	1.63e+05	1.28e+05	0.00e+00	6.11e+05	0.00e+00	4.09e+08
Eu-156	5.77e+04	3.09e+04	6.39e+03	0.00e+00	1.99e+04	0.00e+00	7.01e+07
Tb-160	5.16e+05	0.00e+00	6.40e+04	0.00e+00	1.54e+05	0.00e+00	1.14e+08

Conversion factors are in units of square meter-mrem/yr per uCi/sec for all nuclides except H-3, which is in units of mrem/yr per uCi/cubic meter.

**MEAT PATHWAY DOSE FACTORS DUE TO RADIONUCLIDES
OTHER THAN NOBLE GASES, R_i**

R_i factors for Child age group by nuclide.
Waterford Steam Electric Station
Pathway : Gaseous Release Meat & Poultry Pathway R_i

Nuclide	Organ Dose Conversion Factors						
	Bone	Liver	T. Body	Thyroid	Kidney	Lung	GI-LLI
Ho-166m	4.86e+06	1.02e+06	8.59e+05	0.00e+00	1.45e+06	0.00e+00	1.18e+08
W-181	4.80e+04	1.18e+04	1.62e+03	0.00e+00	0.00e+00	0.00e+00	4.30e+05
W-185	1.72e+06	4.30e+05	6.02e+04	0.00e+00	0.00e+00	0.00e+00	1.60e+07
W-187	3.49e-02	2.06e-02	9.27e-03	0.00e+00	0.00e+00	0.00e+00	2.90e+00
Pb-210	1.40e+10	3.60e+09	6.17e+08	0.00e+00	1.08e+10	0.00e+00	6.79e+05
Bi-210	4.34e+05	2.24e+06	2.49e+05	0.00e+00	2.53e+07	0.00e+00	1.14e+07
Po-210	1.53e+10	2.45e+10	3.70e+09	0.00e+00	7.61e+10	0.00e+00	6.60e+08
Ra-223	9.80e+10	1.13e+08	1.96e+10	0.00e+00	3.00e+09	0.00e+00	1.56e+09
Ra-224	1.12e+09	2.04e+06	2.25e+08	0.00e+00	5.40e+07	0.00e+00	6.17e+07
Ra-225	1.96e+11	1.75e+08	3.91e+10	0.00e+00	4.63e+09	0.00e+00	2.25e+09
Ra-226	2.00e+13	6.39e+08	1.64e+13	0.00e+00	1.70e+10	0.00e+00	1.18e+10
Ra-228	1.32e+13	3.43e+08	1.48e+13	0.00e+00	9.09e+09	0.00e+00	1.99e+09
Ac-225	1.20e+08	1.24e+08	8.05e+06	0.00e+00	1.32e+07	0.00e+00	2.75e+09
Ac-227	2.52e+11	4.05e+10	1.56e+10	0.00e+00	8.92e+09	0.00e+00	5.15e+09
Th-227	3.22e+06	4.38e+04	9.30e+04	0.00e+00	2.32e+05	0.00e+00	3.10e+07
Th-228	4.07e+08	5.21e+06	1.38e+07	0.00e+00	2.71e+07	0.00e+00	1.14e+08
Th-229	4.80e+09	1.21e+08	8.01e+07	0.00e+00	5.91e+08	0.00e+00	1.64e+07
Th-230	7.26e+08	3.64e+07	2.03e+07	0.00e+00	1.77e+08	0.00e+00	1.27e+07
Th-232	8.10e+08	3.11e+07	6.15e+05	0.00e+00	1.51e+08	0.00e+00	1.08e+07
Th-234	2.49e+04	1.10e+03	7.19e+02	0.00e+00	5.83e+03	0.00e+00	8.58e+06
Pa-231	5.78e+15	1.91e+14	2.30e+14	0.00e+00	1.05e+15	0.00e+00	6.03e+13
Pa-233	5.91e+09	9.20e+08	1.03e+09	0.00e+00	3.39e+09	0.00e+00	4.70e+12
U-232	6.11e+09	0.00e+00	4.37e+08	0.00e+00	4.65e+08	0.00e+00	2.42e+07
U-233	1.29e+09	0.00e+00	7.82e+07	0.00e+00	2.12e+08	0.00e+00	2.24e+07
U-234	1.24e+09	0.00e+00	7.68e+07	0.00e+00	2.08e+08	0.00e+00	2.20e+07
U-235	1.19e+09	0.00e+00	7.19e+07	0.00e+00	1.95e+08	0.00e+00	2.79e+07
U-236	1.19e+09	0.00e+00	7.37e+07	0.00e+00	1.99e+08	0.00e+00	2.06e+07
U-237	3.42e+03	0.00e+00	9.09e+02	0.00e+00	9.87e+03	0.00e+00	3.02e+05
U-238	1.14e+09	0.00e+00	6.74e+07	0.00e+00	1.82e+08	0.00e+00	1.97e+07
Np-237	4.56e+08	3.01e+07	2.00e+07	0.00e+00	1.24e+08	0.00e+00	1.67e+07

Conversion factors are in units of square meter-mrem/yr per uCi/sec for all nuclides except H-3, which is in units of mrem/yr per uCi/cubic meter.

**MEAT PATHWAY DOSE FACTORS DUE TO RADIONUCLIDES
OTHER THAN NOBLE GASES, R_i**

R_i factors for Child age group by nuclide.
Waterford Steam Electric Station
Pathway : Gaseous Release Meat & Poultry Pathway R_i

Nuclide	Organ Dose Conversion Factors						
	Bone	Liver	T. Body	Thyroid	Kidney	Lung	GI-LLI
Np-238	2.27e+00	4.59e-02	3.53e-02	0.00e+00	1.46e-01	0.00e+00	1.57e+03
Np-239	4.29e-01	3.08e-02	2.17e-02	0.00e+00	8.91e-02	0.00e+00	2.28e+03
Pu-238	1.70e+07	1.97e+06	4.52e+05	0.00e+00	1.64e+06	0.00e+00	1.07e+06
Pu-239	1.85e+07	1.97e+06	4.74e+05	0.00e+00	1.75e+06	0.00e+00	9.80e+05
Pu-240	1.83e+07	2.05e+06	4.74e+05	0.00e+00	1.75e+06	0.00e+00	9.99e+05
Pu-241	5.51e+05	2.25e+04	1.14e+04	0.00e+00	4.21e+04	0.00e+00	2.05e+04
Pu-242	1.70e+07	1.97e+06	4.56e+05	0.00e+00	1.67e+06	0.00e+00	9.60e+05
Pu-244	1.99e+07	2.26e+07	5.22e+05	0.00e+00	1.93e+06	0.00e+00	1.43e+06
Am-241	2.73e+08	2.35e+08	2.05e+07	0.00e+00	1.25e+08	0.00e+00	1.53e+07
Am-242m	2.86e+08	2.29e+08	2.12e+07	0.00e+00	1.29e+08	0.00e+00	1.96e+07
Am-243	2.74e+08	2.31e+08	2.01e+07	0.00e+00	1.24e+08	0.00e+00	1.83e+07
Cm-242	1.52e+07	1.21e+07	1.01e+06	0.00e+00	3.23e+06	0.00e+00	1.41e+07
Cm-243	2.61e+08	2.12e+08	1.68e+07	0.00e+00	6.28e+07	0.00e+00	1.64e+07
Cm-244	2.20e+08	1.78e+08	1.41e+07	0.00e+00	5.17e+07	0.00e+00	1.58e+07
Cm-245	3.41e+08	2.74e+08	2.15e+07	0.00e+00	8.40e+07	0.00e+00	1.48e+07
Cm-246	3.37e+08	2.74e+08	2.15e+07	0.00e+00	8.38e+07	0.00e+00	1.45e+07
Cm-247	3.29e+08	2.70e+08	2.11e+07	0.00e+00	8.26e+07	0.00e+00	1.91e+07
Cm-248	2.74e+09	2.23e+09	1.74e+08	0.00e+00	6.81e+08	0.00e+00	3.09e+08
Cf-252	2.08e+08	0.00e+00	5.03e+06	0.00e+00	0.00e+00	0.00e+00	5.87e+07

Conversion factors are in units of square meter-mrem/yr per uCi/sec for all nuclides except H-3, which is in units of mrem/yr per uCi/cubic meter.

**MEAT PATHWAY DOSE FACTORS DUE TO RADIONUCLIDES
OTHER THAN NOBLE GASES, R_i**

R_i factors for Infant age group by nuclide.
Waterford Steam Electric Station
Pathway : Gaseous Release Meat & Poultry Pathway R_i

Nuclide	Organ Dose Conversion Factors						
	Bone	Liver	T. Body	Thyroid	Kidney	Lung	GI-LLI
H-3	0.00e+00	0.00e+00	0.00e+00	0.00e+00	0.00e+00	0.00e+00	0.00e+00
Be-10	0.00e+00	0.00e+00	0.00e+00	0.00e+00	0.00e+00	0.00e+00	0.00e+00
C-14	0.00e+00	0.00e+00	0.00e+00	0.00e+00	0.00e+00	0.00e+00	0.00e+00
N-13	0.00e+00	0.00e+00	0.00e+00	0.00e+00	0.00e+00	0.00e+00	0.00e+00
F-18	0.00e+00	0.00e+00	0.00e+00	0.00e+00	0.00e+00	0.00e+00	0.00e+00
Na-22	0.00e+00	0.00e+00	0.00e+00	0.00e+00	0.00e+00	0.00e+00	0.00e+00
Na-24	0.00e+00	0.00e+00	0.00e+00	0.00e+00	0.00e+00	0.00e+00	0.00e+00
P-32	0.00e+00	0.00e+00	0.00e+00	0.00e+00	0.00e+00	0.00e+00	0.00e+00
Ca-41	0.00e+00	0.00e+00	0.00e+00	0.00e+00	0.00e+00	0.00e+00	0.00e+00
Sc-46	0.00e+00	0.00e+00	0.00e+00	0.00e+00	0.00e+00	0.00e+00	0.00e+00
Cr-51	0.00e+00	0.00e+00	0.00e+00	0.00e+00	0.00e+00	0.00e+00	0.00e+00
Mn-54	0.00e+00	0.00e+00	0.00e+00	0.00e+00	0.00e+00	0.00e+00	0.00e+00
Mn-56	0.00e+00	0.00e+00	0.00e+00	0.00e+00	0.00e+00	0.00e+00	0.00e+00
Fe-55	0.00e+00	0.00e+00	0.00e+00	0.00e+00	0.00e+00	0.00e+00	0.00e+00
Fe-59	0.00e+00	0.00e+00	0.00e+00	0.00e+00	0.00e+00	0.00e+00	0.00e+00
Co-57	0.00e+00	0.00e+00	0.00e+00	0.00e+00	0.00e+00	0.00e+00	0.00e+00
Co-58	0.00e+00	0.00e+00	0.00e+00	0.00e+00	0.00e+00	0.00e+00	0.00e+00
Co-60	0.00e+00	0.00e+00	0.00e+00	0.00e+00	0.00e+00	0.00e+00	0.00e+00
Ni-59	0.00e+00	0.00e+00	0.00e+00	0.00e+00	0.00e+00	0.00e+00	0.00e+00
Ni-63	0.00e+00	0.00e+00	0.00e+00	0.00e+00	0.00e+00	0.00e+00	0.00e+00
Ni-65	0.00e+00	0.00e+00	0.00e+00	0.00e+00	0.00e+00	0.00e+00	0.00e+00
Cu-64	0.00e+00	0.00e+00	0.00e+00	0.00e+00	0.00e+00	0.00e+00	0.00e+00
Zn-65	0.00e+00	0.00e+00	0.00e+00	0.00e+00	0.00e+00	0.00e+00	0.00e+00
Zn-69	0.00e+00	0.00e+00	0.00e+00	0.00e+00	0.00e+00	0.00e+00	0.00e+00
Zn-69m	0.00e+00	0.00e+00	0.00e+00	0.00e+00	0.00e+00	0.00e+00	0.00e+00
Se-79	0.00e+00	0.00e+00	0.00e+00	0.00e+00	0.00e+00	0.00e+00	0.00e+00
Br-82	0.00e+00	0.00e+00	0.00e+00	0.00e+00	0.00e+00	0.00e+00	0.00e+00
Br-83	0.00e+00	0.00e+00	0.00e+00	0.00e+00	0.00e+00	0.00e+00	0.00e+00
Br-84	0.00e+00	0.00e+00	0.00e+00	0.00e+00	0.00e+00	0.00e+00	0.00e+00
Br-85	0.00e+00	0.00e+00	0.00e+00	0.00e+00	0.00e+00	0.00e+00	0.00e+00

Conversion factors are in units of square meter-mrem/yr per uCi/sec for all nuclides except H-3, which is in units of mrem/yr per uCi/cubic meter.

**MEAT PATHWAY DOSE FACTORS DUE TO RADIONUCLIDES
OTHER THAN NOBLE GASES, R_i**

R_i factors for Infant age group by nuclide.
Waterford Steam Electric Station
Pathway : Gaseous Release Meat & Poultry Pathway R_i

Nuclide	Organ Dose Conversion Factors						
	Bone	Liver	T. Body	Thyroid	Kidney	Lung	GI-LLI
Rb-86	0.00e+00	0.00e+00	0.00e+00	0.00e+00	0.00e+00	0.00e+00	0.00e+00
Rb-87	0.00e+00	0.00e+00	0.00e+00	0.00e+00	0.00e+00	0.00e+00	0.00e+00
Rb-88	0.00e+00	0.00e+00	0.00e+00	0.00e+00	0.00e+00	0.00e+00	0.00e+00
Rb-89	0.00e+00	0.00e+00	0.00e+00	0.00e+00	0.00e+00	0.00e+00	0.00e+00
Sr-89	0.00e+00	0.00e+00	0.00e+00	0.00e+00	0.00e+00	0.00e+00	0.00e+00
Sr-90	0.00e+00	0.00e+00	0.00e+00	0.00e+00	0.00e+00	0.00e+00	0.00e+00
Sr-91	0.00e+00	0.00e+00	0.00e+00	0.00e+00	0.00e+00	0.00e+00	0.00e+00
Sr-92	0.00e+00	0.00e+00	0.00e+00	0.00e+00	0.00e+00	0.00e+00	0.00e+00
Y-90	0.00e+00	0.00e+00	0.00e+00	0.00e+00	0.00e+00	0.00e+00	0.00e+00
Y-91	0.00e+00	0.00e+00	0.00e+00	0.00e+00	0.00e+00	0.00e+00	0.00e+00
Y-91m	0.00e+00	0.00e+00	0.00e+00	0.00e+00	0.00e+00	0.00e+00	0.00e+00
Y-92	0.00e+00	0.00e+00	0.00e+00	0.00e+00	0.00e+00	0.00e+00	0.00e+00
Y-93	0.00e+00	0.00e+00	0.00e+00	0.00e+00	0.00e+00	0.00e+00	0.00e+00
Zr-93	0.00e+00	0.00e+00	0.00e+00	0.00e+00	0.00e+00	0.00e+00	0.00e+00
Zr-95	0.00e+00	0.00e+00	0.00e+00	0.00e+00	0.00e+00	0.00e+00	0.00e+00
Zr-97	0.00e+00	0.00e+00	0.00e+00	0.00e+00	0.00e+00	0.00e+00	0.00e+00
Nb-93m	0.00e+00	0.00e+00	0.00e+00	0.00e+00	0.00e+00	0.00e+00	0.00e+00
Nb-95	0.00e+00	0.00e+00	0.00e+00	0.00e+00	0.00e+00	0.00e+00	0.00e+00
Nb-97	0.00e+00	0.00e+00	0.00e+00	0.00e+00	0.00e+00	0.00e+00	0.00e+00
Mo-93	0.00e+00	0.00e+00	0.00e+00	0.00e+00	0.00e+00	0.00e+00	0.00e+00
Mo-99	0.00e+00	0.00e+00	0.00e+00	0.00e+00	0.00e+00	0.00e+00	0.00e+00
Tc-101	0.00e+00	0.00e+00	0.00e+00	0.00e+00	0.00e+00	0.00e+00	0.00e+00
Tc-99	0.00e+00	0.00e+00	0.00e+00	0.00e+00	0.00e+00	0.00e+00	0.00e+00
Tc-99m	0.00e+00	0.00e+00	0.00e+00	0.00e+00	0.00e+00	0.00e+00	0.00e+00
Ru-103	0.00e+00	0.00e+00	0.00e+00	0.00e+00	0.00e+00	0.00e+00	0.00e+00
Ru-105	0.00e+00	0.00e+00	0.00e+00	0.00e+00	0.00e+00	0.00e+00	0.00e+00
Ru-106	0.00e+00	0.00e+00	0.00e+00	0.00e+00	0.00e+00	0.00e+00	0.00e+00
Rh-105	0.00e+00	0.00e+00	0.00e+00	0.00e+00	0.00e+00	0.00e+00	0.00e+00
Pd-107	0.00e+00	0.00e+00	0.00e+00	0.00e+00	0.00e+00	0.00e+00	0.00e+00
Pd-109	0.00e+00	0.00e+00	0.00e+00	0.00e+00	0.00e+00	0.00e+00	0.00e+00

Conversion factors are in units of square meter-mrem/yr per uCi/sec for all nuclides except H-3, which is in units of mrem/yr per uCi/cubic meter.

**MEAT PATHWAY DOSE FACTORS DUE TO RADIONUCLIDES
OTHER THAN NOBLE GASES, R_i**

R_i factors for Infant age group by nuclide.
Waterford Steam Electric Station
Pathway : Gaseous Release Meat & Poultry Pathway R_i

Nuclide	Organ Dose Conversion Factors						
	Bone	Liver	T. Body	Thyroid	Kidney	Lung	GI-LLI
Ag-110m	0.00e+00	0.00e+00	0.00e+00	0.00e+00	0.00e+00	0.00e+00	0.00e+00
Ag-111	0.00e+00	0.00e+00	0.00e+00	0.00e+00	0.00e+00	0.00e+00	0.00e+00
Cd-113m	0.00e+00	0.00e+00	0.00e+00	0.00e+00	0.00e+00	0.00e+00	0.00e+00
Cd-115m	0.00e+00	0.00e+00	0.00e+00	0.00e+00	0.00e+00	0.00e+00	0.00e+00
Sn-123	0.00e+00	0.00e+00	0.00e+00	0.00e+00	0.00e+00	0.00e+00	0.00e+00
Sn-125	0.00e+00	0.00e+00	0.00e+00	0.00e+00	0.00e+00	0.00e+00	0.00e+00
Sn-126	0.00e+00	0.00e+00	0.00e+00	0.00e+00	0.00e+00	0.00e+00	0.00e+00
Sb-124	0.00e+00	0.00e+00	0.00e+00	0.00e+00	0.00e+00	0.00e+00	0.00e+00
Sb-125	0.00e+00	0.00e+00	0.00e+00	0.00e+00	0.00e+00	0.00e+00	0.00e+00
Sb-126	0.00e+00	0.00e+00	0.00e+00	0.00e+00	0.00e+00	0.00e+00	0.00e+00
Sb-127	0.00e+00	0.00e+00	0.00e+00	0.00e+00	0.00e+00	0.00e+00	0.00e+00
Te-125m	0.00e+00	0.00e+00	0.00e+00	0.00e+00	0.00e+00	0.00e+00	0.00e+00
Te-127	0.00e+00	0.00e+00	0.00e+00	0.00e+00	0.00e+00	0.00e+00	0.00e+00
Te-127m	0.00e+00	0.00e+00	0.00e+00	0.00e+00	0.00e+00	0.00e+00	0.00e+00
Te-129	0.00e+00	0.00e+00	0.00e+00	0.00e+00	0.00e+00	0.00e+00	0.00e+00
Te-129m	0.00e+00	0.00e+00	0.00e+00	0.00e+00	0.00e+00	0.00e+00	0.00e+00
Te-131	0.00e+00	0.00e+00	0.00e+00	0.00e+00	0.00e+00	0.00e+00	0.00e+00
Te-131m	0.00e+00	0.00e+00	0.00e+00	0.00e+00	0.00e+00	0.00e+00	0.00e+00
Te-132	0.00e+00	0.00e+00	0.00e+00	0.00e+00	0.00e+00	0.00e+00	0.00e+00
Te-133m	0.00e+00	0.00e+00	0.00e+00	0.00e+00	0.00e+00	0.00e+00	0.00e+00
Te-134	0.00e+00	0.00e+00	0.00e+00	0.00e+00	0.00e+00	0.00e+00	0.00e+00
I-129	0.00e+00	0.00e+00	0.00e+00	0.00e+00	0.00e+00	0.00e+00	0.00e+00
I-130	0.00e+00	0.00e+00	0.00e+00	0.00e+00	0.00e+00	0.00e+00	0.00e+00
I-131	0.00e+00	0.00e+00	0.00e+00	0.00e+00	0.00e+00	0.00e+00	0.00e+00
I-132	0.00e+00	0.00e+00	0.00e+00	0.00e+00	0.00e+00	0.00e+00	0.00e+00
I-133	0.00e+00	0.00e+00	0.00e+00	0.00e+00	0.00e+00	0.00e+00	0.00e+00
I-134	0.00e+00	0.00e+00	0.00e+00	0.00e+00	0.00e+00	0.00e+00	0.00e+00
I-135	0.00e+00	0.00e+00	0.00e+00	0.00e+00	0.00e+00	0.00e+00	0.00e+00
Cs-134	0.00e+00	0.00e+00	0.00e+00	0.00e+00	0.00e+00	0.00e+00	0.00e+00
Cs-134m	0.00e+00	0.00e+00	0.00e+00	0.00e+00	0.00e+00	0.00e+00	0.00e+00

Conversion factors are in units of square meter-mrem/yr per uCi/sec for all nuclides except H-3, which is in units of mrem/yr per uCi/cubic meter.

**MEAT PATHWAY DOSE FACTORS DUE TO RADIONUCLIDES
OTHER THAN NOBLE GASES, R_i**

R_i factors for Infant age group by nuclide.
Waterford Steam Electric Station
Pathway : Gaseous Release Meat & Poultry Pathway R_i

Nuclide	Organ Dose Conversion Factors						
	Bone	Liver	T. Body	Thyroid	Kidney	Lung	GI-LLI
Cs-135	0.00e+00	0.00e+00	0.00e+00	0.00e+00	0.00e+00	0.00e+00	0.00e+00
Cs-136	0.00e+00	0.00e+00	0.00e+00	0.00e+00	0.00e+00	0.00e+00	0.00e+00
Cs-137	0.00e+00	0.00e+00	0.00e+00	0.00e+00	0.00e+00	0.00e+00	0.00e+00
Cs-138	0.00e+00	0.00e+00	0.00e+00	0.00e+00	0.00e+00	0.00e+00	0.00e+00
Cs-139	0.00e+00	0.00e+00	0.00e+00	0.00e+00	0.00e+00	0.00e+00	0.00e+00
Ba-139	0.00e+00	0.00e+00	0.00e+00	0.00e+00	0.00e+00	0.00e+00	0.00e+00
Ba-140	0.00e+00	0.00e+00	0.00e+00	0.00e+00	0.00e+00	0.00e+00	0.00e+00
Ba-141	0.00e+00	0.00e+00	0.00e+00	0.00e+00	0.00e+00	0.00e+00	0.00e+00
Ba-142	0.00e+00	0.00e+00	0.00e+00	0.00e+00	0.00e+00	0.00e+00	0.00e+00
La-140	0.00e+00	0.00e+00	0.00e+00	0.00e+00	0.00e+00	0.00e+00	0.00e+00
La-141	0.00e+00	0.00e+00	0.00e+00	0.00e+00	0.00e+00	0.00e+00	0.00e+00
La-142	0.00e+00	0.00e+00	0.00e+00	0.00e+00	0.00e+00	0.00e+00	0.00e+00
Ce-141	0.00e+00	0.00e+00	0.00e+00	0.00e+00	0.00e+00	0.00e+00	0.00e+00
Ce-143	0.00e+00	0.00e+00	0.00e+00	0.00e+00	0.00e+00	0.00e+00	0.00e+00
Ce-144	0.00e+00	0.00e+00	0.00e+00	0.00e+00	0.00e+00	0.00e+00	0.00e+00
Pr-143	0.00e+00	0.00e+00	0.00e+00	0.00e+00	0.00e+00	0.00e+00	0.00e+00
Pr-144	0.00e+00	0.00e+00	0.00e+00	0.00e+00	0.00e+00	0.00e+00	0.00e+00
Nd-147	0.00e+00	0.00e+00	0.00e+00	0.00e+00	0.00e+00	0.00e+00	0.00e+00
Pm-147	0.00e+00	0.00e+00	0.00e+00	0.00e+00	0.00e+00	0.00e+00	0.00e+00
Pm-148	0.00e+00	0.00e+00	0.00e+00	0.00e+00	0.00e+00	0.00e+00	0.00e+00
Pm-148m	0.00e+00	0.00e+00	0.00e+00	0.00e+00	0.00e+00	0.00e+00	0.00e+00
Pm-149	0.00e+00	0.00e+00	0.00e+00	0.00e+00	0.00e+00	0.00e+00	0.00e+00
Pm-151	0.00e+00	0.00e+00	0.00e+00	0.00e+00	0.00e+00	0.00e+00	0.00e+00
Sm-151	0.00e+00	0.00e+00	0.00e+00	0.00e+00	0.00e+00	0.00e+00	0.00e+00
Sm-153	0.00e+00	0.00e+00	0.00e+00	0.00e+00	0.00e+00	0.00e+00	0.00e+00
Eu-152	0.00e+00	0.00e+00	0.00e+00	0.00e+00	0.00e+00	0.00e+00	0.00e+00
Eu-154	0.00e+00	0.00e+00	0.00e+00	0.00e+00	0.00e+00	0.00e+00	0.00e+00
Eu-155	0.00e+00	0.00e+00	0.00e+00	0.00e+00	0.00e+00	0.00e+00	0.00e+00
Eu-156	0.00e+00	0.00e+00	0.00e+00	0.00e+00	0.00e+00	0.00e+00	0.00e+00
Tb-160	0.00e+00	0.00e+00	0.00e+00	0.00e+00	0.00e+00	0.00e+00	0.00e+00

Conversion factors are in units of square meter-mrem/yr per uCi/sec for all nuclides except H-3, which is in units of mrem/yr per uCi/cubic meter.

**MEAT PATHWAY DOSE FACTORS DUE TO RADIONUCLIDES
OTHER THAN NOBLE GASES, R_i**

R_i factors for Infant age group by nuclide.
Waterford Steam Electric Station
Pathway : Gaseous Release Meat & Poultry Pathway R_i

Nuclide	Organ Dose Conversion Factors						
	Bone	Liver	T. Body	Thyroid	Kidney	Lung	GI-LLI
Ho-166m	0.00e+00	0.00e+00	0.00e+00	0.00e+00	0.00e+00	0.00e+00	0.00e+00
W-181	0.00e+00	0.00e+00	0.00e+00	0.00e+00	0.00e+00	0.00e+00	0.00e+00
W-185	0.00e+00	0.00e+00	0.00e+00	0.00e+00	0.00e+00	0.00e+00	0.00e+00
W-187	0.00e+00	0.00e+00	0.00e+00	0.00e+00	0.00e+00	0.00e+00	0.00e+00
Pb-210	0.00e+00	0.00e+00	0.00e+00	0.00e+00	0.00e+00	0.00e+00	0.00e+00
Bi-210	0.00e+00	0.00e+00	0.00e+00	0.00e+00	0.00e+00	0.00e+00	0.00e+00
Po-210	0.00e+00	0.00e+00	0.00e+00	0.00e+00	0.00e+00	0.00e+00	0.00e+00
Ra-223	0.00e+00	0.00e+00	0.00e+00	0.00e+00	0.00e+00	0.00e+00	0.00e+00
Ra-224	0.00e+00	0.00e+00	0.00e+00	0.00e+00	0.00e+00	0.00e+00	0.00e+00
Ra-225	0.00e+00	0.00e+00	0.00e+00	0.00e+00	0.00e+00	0.00e+00	0.00e+00
Ra-226	0.00e+00	0.00e+00	0.00e+00	0.00e+00	0.00e+00	0.00e+00	0.00e+00
Ra-228	0.00e+00	0.00e+00	0.00e+00	0.00e+00	0.00e+00	0.00e+00	0.00e+00
Ac-225	0.00e+00	0.00e+00	0.00e+00	0.00e+00	0.00e+00	0.00e+00	0.00e+00
Ac-227	0.00e+00	0.00e+00	0.00e+00	0.00e+00	0.00e+00	0.00e+00	0.00e+00
Th-227	0.00e+00	0.00e+00	0.00e+00	0.00e+00	0.00e+00	0.00e+00	0.00e+00
Th-228	0.00e+00	0.00e+00	0.00e+00	0.00e+00	0.00e+00	0.00e+00	0.00e+00
Th-229	0.00e+00	0.00e+00	0.00e+00	0.00e+00	0.00e+00	0.00e+00	0.00e+00
Th-230	0.00e+00	0.00e+00	0.00e+00	0.00e+00	0.00e+00	0.00e+00	0.00e+00
Th-232	0.00e+00	0.00e+00	0.00e+00	0.00e+00	0.00e+00	0.00e+00	0.00e+00
Th-234	0.00e+00	0.00e+00	0.00e+00	0.00e+00	0.00e+00	0.00e+00	0.00e+00
Pa-231	0.00e+00	0.00e+00	0.00e+00	0.00e+00	0.00e+00	0.00e+00	0.00e+00
Pa-233	0.00e+00	0.00e+00	0.00e+00	0.00e+00	0.00e+00	0.00e+00	0.00e+00
U-232	0.00e+00	0.00e+00	0.00e+00	0.00e+00	0.00e+00	0.00e+00	0.00e+00
U-233	0.00e+00	0.00e+00	0.00e+00	0.00e+00	0.00e+00	0.00e+00	0.00e+00
U-234	0.00e+00	0.00e+00	0.00e+00	0.00e+00	0.00e+00	0.00e+00	0.00e+00
U-235	0.00e+00	0.00e+00	0.00e+00	0.00e+00	0.00e+00	0.00e+00	0.00e+00
U-236	0.00e+00	0.00e+00	0.00e+00	0.00e+00	0.00e+00	0.00e+00	0.00e+00
U-237	0.00e+00	0.00e+00	0.00e+00	0.00e+00	0.00e+00	0.00e+00	0.00e+00
U-238	0.00e+00	0.00e+00	0.00e+00	0.00e+00	0.00e+00	0.00e+00	0.00e+00
Np-237	0.00e+00	0.00e+00	0.00e+00	0.00e+00	0.00e+00	0.00e+00	0.00e+00

Conversion factors are in units of square meter-mrem/yr per uCi/sec for all nuclides except H-3, which is in units of mrem/yr per uCi/cubic meter.

**MEAT PATHWAY DOSE FACTORS DUE TO RADIONUCLIDES
OTHER THAN NOBLE GASES, R_i**

Ri factors for Infant age group by nuclide.
Waterford Steam Electric Station
Pathway : Gaseous Release Meat & Poultry Pathway Ri

Nuclide	Organ Dose Conversion Factors						
	Bone	Liver	T. Body	Thyroid	Kidney	Lung	GI-LLI
Np-238	0.00e+00	0.00e+00	0.00e+00	0.00e+00	0.00e+00	0.00e+00	0.00e+00
Np-239	0.00e+00	0.00e+00	0.00e+00	0.00e+00	0.00e+00	0.00e+00	0.00e+00
Pu-238	0.00e+00	0.00e+00	0.00e+00	0.00e+00	0.00e+00	0.00e+00	0.00e+00
Pu-239	0.00e+00	0.00e+00	0.00e+00	0.00e+00	0.00e+00	0.00e+00	0.00e+00
Pu-240	0.00e+00	0.00e+00	0.00e+00	0.00e+00	0.00e+00	0.00e+00	0.00e+00
Pu-241	0.00e+00	0.00e+00	0.00e+00	0.00e+00	0.00e+00	0.00e+00	0.00e+00
Pu-242	0.00e+00	0.00e+00	0.00e+00	0.00e+00	0.00e+00	0.00e+00	0.00e+00
Pu-244	0.00e+00	0.00e+00	0.00e+00	0.00e+00	0.00e+00	0.00e+00	0.00e+00
Am-241	0.00e+00	0.00e+00	0.00e+00	0.00e+00	0.00e+00	0.00e+00	0.00e+00
Am-242m	0.00e+00	0.00e+00	0.00e+00	0.00e+00	0.00e+00	0.00e+00	0.00e+00
Am-243	0.00e+00	0.00e+00	0.00e+00	0.00e+00	0.00e+00	0.00e+00	0.00e+00
Cm-242	0.00e+00	0.00e+00	0.00e+00	0.00e+00	0.00e+00	0.00e+00	0.00e+00
Cm-243	0.00e+00	0.00e+00	0.00e+00	0.00e+00	0.00e+00	0.00e+00	0.00e+00
Cm-244	0.00e+00	0.00e+00	0.00e+00	0.00e+00	0.00e+00	0.00e+00	0.00e+00
Cm-245	0.00e+00	0.00e+00	0.00e+00	0.00e+00	0.00e+00	0.00e+00	0.00e+00
Cm-246	0.00e+00	0.00e+00	0.00e+00	0.00e+00	0.00e+00	0.00e+00	0.00e+00
Cm-247	0.00e+00	0.00e+00	0.00e+00	0.00e+00	0.00e+00	0.00e+00	0.00e+00
Cm-248	0.00e+00	0.00e+00	0.00e+00	0.00e+00	0.00e+00	0.00e+00	0.00e+00
Cf-252	0.00e+00	0.00e+00	0.00e+00	0.00e+00	0.00e+00	0.00e+00	0.00e+00

Conversion factors are in units of square meter-mrem/yr per uCi/sec for all nuclides except H-3, which is in units of mrem/yr per uCi/cubic meter.

**LEAFY VEGETABLE PATHWAY DOSE FACTORS DUE TO
RADIONUCLIDES OTHER THAN NOBLE GASES, R_i**

R_i factors for Adult age group by nuclide.
Waterford Steam Electric Station
Pathway : Gaseous Release Leafy/Produce Vegetation Pathway R_i

Nuclide	Organ Dose Conversion Factors						
	Bone	Liver	T. Body	Thyroid	Kidney	Lung	GI-LLI
H-3	0.00e+00	1.29e+03	1.29e+03	1.29e+03	1.29e+03	1.29e+03	1.29e+03
Be-10	2.55e+08	3.93e+07	6.36e+06	0.00e+00	2.97e+07	0.00e+00	2.15e+09
C-14	2.28e+08	4.55e+07	4.55e+07	4.55e+07	4.55e+07	4.55e+07	4.55e+07
N-13	0.00e+00	0.00e+00	0.00e+00	0.00e+00	0.00e+00	0.00e+00	0.00e+00
F-18	4.26e+00	0.00e+00	4.72e-01	0.00e+00	0.00e+00	0.00e+00	1.26e-01
Na-22	1.32e+09	1.32e+09	1.32e+09	1.32e+09	1.32e+09	1.32e+09	1.32e+09
Na-24	2.68e+05	2.68e+05	2.68e+05	2.68e+05	2.68e+05	2.68e+05	2.68e+05
P-32	1.40e+09	8.73e+07	5.42e+07	0.00e+00	0.00e+00	0.00e+00	1.58e+08
Ca-41	1.48e+10	0.00e+00	1.60e+09	0.00e+00	0.00e+00	0.00e+00	1.47e+07
Sc-46	2.51e+05	4.86e+05	1.41e+05	0.00e+00	4.54e+05	0.00e+00	2.37e+09
Cr-51	0.00e+00	0.00e+00	4.64e+04	2.77e+04	1.02e+04	6.16e+04	1.17e+07
Mn-54	0.00e+00	3.13e+08	5.97e+07	0.00e+00	9.31e+07	0.00e+00	9.58e+08
Mn-56	0.00e+00	1.53e+01	2.72e+00	0.00e+00	1.94e+01	0.00e+00	4.89e+02
Fe-55	2.10e+08	1.45e+08	3.38e+07	0.00e+00	0.00e+00	8.08e+07	8.31e+07
Fe-59	1.26e+08	2.96e+08	1.14e+08	0.00e+00	0.00e+00	8.28e+07	9.88e+08
Co-57	0.00e+00	1.17e+07	1.94e+07	0.00e+00	0.00e+00	0.00e+00	2.97e+08
Co-58	0.00e+00	3.07e+07	6.89e+07	0.00e+00	0.00e+00	0.00e+00	6.23e+08
Co-60	0.00e+00	1.67e+08	3.69e+08	0.00e+00	0.00e+00	0.00e+00	3.14e+09
Ni-59	7.82e+08	2.68e+08	1.31e+08	0.00e+00	0.00e+00	0.00e+00	5.53e+07
Ni-63	1.04e+10	7.21e+08	3.49e+08	0.00e+00	0.00e+00	0.00e+00	1.50e+08
Ni-65	5.96e+01	7.75e+00	3.54e+00	0.00e+00	0.00e+00	0.00e+00	1.97e+02
Cu-64	0.00e+00	9.15e+03	4.29e+03	0.00e+00	2.31e+04	0.00e+00	7.79e+05
Zn-65	3.17e+08	1.01e+09	4.56e+08	0.00e+00	6.75e+08	0.00e+00	6.36e+08
Zn-69	5.06e-06	9.67e-06	6.72e-07	0.00e+00	6.28e-06	0.00e+00	1.45e-06
Zn-69m	2.24e+04	5.38e+04	4.92e+03	0.00e+00	3.26e+04	0.00e+00	3.29e+06
Se-79	0.00e+00	2.11e+08	3.52e+07	0.00e+00	3.65e+08	0.00e+00	4.31e+07
Br-82	0.00e+00	0.00e+00	1.50e+06	0.00e+00	0.00e+00	0.00e+00	1.72e+06
Br-83	0.00e+00	0.00e+00	3.01e+00	0.00e+00	0.00e+00	0.00e+00	4.33e+00
Br-84	0.00e+00	0.00e+00	2.14e-11	0.00e+00	0.00e+00	0.00e+00	1.68e-16
Br-85	0.00e+00	0.00e+00	0.00e+00	0.00e+00	0.00e+00	0.00e+00	0.00e+00

Conversion factors are in units of square meter-mrem/yr per uCi/sec for all nuclides except H-3, which is in units of mrem/yr per uCi/cubic meter.

**LEAFY VEGETABLE PATHWAY DOSE FACTORS DUE TO
RADIONUCLIDES OTHER THAN NOBLE GASES, R_i**

R_i factors for Adult age group by nuclide.

Waterford Steam Electric Station

Pathway : Gaseous Release Leafy/Produce Vegetation Pathway R_i

Nuclide	Organ Dose Conversion Factors						
	Bone	Liver	T. Body	Thyroid	Kidney	Lung	GI-LLI
Rb-86	0.00e+00	2.19e+08	1.02e+08	0.00e+00	0.00e+00	0.00e+00	4.32e+07
Rb-87	0.00e+00	9.86e+08	3.43e+08	0.00e+00	0.00e+00	0.00e+00	4.62e+07
Rb-88	0.00e+00	2.64e-22	1.40e-22	0.00e+00	0.00e+00	0.00e+00	3.65e-33
Rb-89	0.00e+00	2.88e-26	2.03e-26	0.00e+00	0.00e+00	0.00e+00	1.67e-39
Sr-89	9.96e+09	0.00e+00	2.86e+08	0.00e+00	0.00e+00	0.00e+00	1.60e+09
Sr-90	6.95e+11	0.00e+00	1.40e+10	0.00e+00	0.00e+00	0.00e+00	1.75e+10
Sr-91	3.02e+05	0.00e+00	1.22e+04	0.00e+00	0.00e+00	0.00e+00	1.44e+06
Sr-92	4.15e+02	0.00e+00	1.79e+01	0.00e+00	0.00e+00	0.00e+00	8.21e+03
Y-90	1.33e+04	0.00e+00	3.56e+02	0.00e+00	0.00e+00	0.00e+00	1.41e+08
Y-91	5.11e+06	0.00e+00	1.37e+05	0.00e+00	0.00e+00	0.00e+00	2.81e+09
Y-91m	4.76e-09	0.00e+00	1.84e-10	0.00e+00	0.00e+00	0.00e+00	1.40e-08
Y-92	8.96e-01	0.00e+00	2.62e-02	0.00e+00	0.00e+00	0.00e+00	1.57e+04
Y-93	1.68e+02	0.00e+00	4.65e+00	0.00e+00	0.00e+00	0.00e+00	5.34e+06
Zr-93	3.35e+06	1.88e+05	8.73e+04	0.00e+00	7.11e+05	0.00e+00	1.95e+08
Zr-95	1.17e+06	3.77e+05	2.55e+05	0.00e+00	5.91e+05	0.00e+00	1.19e+09
Zr-97	3.36e+02	6.78e+01	3.10e+01	0.00e+00	1.02e+02	0.00e+00	2.10e+07
Nb-93m	2.02e+06	6.60e+05	1.63e+05	0.00e+00	7.59e+05	0.00e+00	3.05e+08
Nb-95	1.42e+05	7.91e+04	4.25e+04	0.00e+00	7.82e+04	0.00e+00	4.80e+08
Nb-97	2.84e-06	7.19e-07	2.63e-07	0.00e+00	8.39e-07	0.00e+00	2.65e-03
Mo-93	0.00e+00	6.02e+08	1.63e+07	0.00e+00	1.71e+08	0.00e+00	9.78e+07
Mo-99	0.00e+00	6.14e+06	1.17e+06	0.00e+00	1.39e+07	0.00e+00	1.42e+07
Tc-101	5.93e-31	8.55e-31	8.39e-30	0.00e+00	1.54e-29	4.37e-31	0.00e+00
Tc-99	1.00e+07	1.49e+07	4.02e+06	0.00e+00	1.88e+08	1.27e+06	4.87e+08
Tc-99m	3.06e+00	8.66e+00	1.10e+02	0.00e+00	1.31e+02	4.24e+00	5.12e+03
Ru-103	4.77e+06	0.00e+00	2.05e+06	0.00e+00	1.82e+07	0.00e+00	5.57e+08
Ru-105	5.29e+01	0.00e+00	2.09e+01	0.00e+00	6.84e+02	0.00e+00	3.24e+04
Ru-106	1.93e+08	0.00e+00	2.44e+07	0.00e+00	3.72e+08	0.00e+00	1.25e+10
Rh-105	8.01e+04	5.86e+04	3.86e+04	0.00e+00	2.49e+05	0.00e+00	9.34e+06
Pd-107	0.00e+00	1.18e+07	7.53e+05	0.00e+00	1.06e+08	0.00e+00	7.30e+07
Pd-109	0.00e+00	2.23e+04	5.02e+03	0.00e+00	1.27e+05	0.00e+00	2.47e+06

Conversion factors are in units of square meter-mrem/yr per uCi/sec for all nuclides except H-3, which is in units of mrem/yr per uCi/cubic meter.

**LEAFY VEGETABLE PATHWAY DOSE FACTORS DUE TO
RADIONUCLIDES OTHER THAN NOBLE GASES, R_i**

R_i factors for Adult age group by nuclide.

Waterford Steam Electric Station

Pathway : Gaseous Release Leafy/Produce Vegetation Pathway R_i

Nuclide	Organ Dose Conversion Factors						
	Bone	Liver	T. Body	Thyroid	Kidney	Lung	GI-LLI
Ag-110m	1.05e+07	9.74e+06	5.79e+06	0.00e+00	1.92e+07	0.00e+00	3.98e+09
Ag-111	2.11e+05	8.81e+04	4.39e+04	0.00e+00	2.84e+05	0.00e+00	1.62e+08
Cd-113m	0.00e+00	2.52e+08	8.10e+06	0.00e+00	2.78e+08	0.00e+00	2.03e+09
Cd-115m	0.00e+00	5.34e+07	1.70e+06	0.00e+00	4.24e+07	0.00e+00	2.25e+09
Sn-123	1.71e+09	2.84e+07	4.18e+07	2.41e+07	0.00e+00	0.00e+00	3.49e+09
Sn-125	3.84e+07	7.74e+05	1.74e+06	6.40e+05	0.00e+00	0.00e+00	4.79e+08
Sn-126	6.77e+09	1.34e+08	1.92e+08	3.94e+07	0.00e+00	0.00e+00	1.95e+09
Sb-124	1.04e+08	1.96e+06	4.11e+07	2.51e+05	0.00e+00	8.07e+07	2.94e+09
Sb-125	1.37e+08	1.53e+06	3.25e+07	1.39e+05	0.00e+00	1.05e+08	1.50e+09
Sb-126	7.07e+06	1.44e+05	2.55e+06	4.33e+04	0.00e+00	4.34e+06	5.78e+08
Sb-127	5.22e+05	1.14e+04	2.00e+05	6.28e+03	0.00e+00	3.10e+05	1.19e+08
Te-125m	9.65e+07	3.50e+07	1.29e+07	2.90e+07	3.93e+08	0.00e+00	3.85e+08
Te-127	5.61e+03	2.02e+03	1.21e+03	4.16e+03	2.29e+04	0.00e+00	4.43e+05
Te-127m	3.49e+08	1.25e+08	4.25e+07	8.92e+07	1.42e+09	0.00e+00	1.17e+09
Te-129	7.13e-04	2.68e-04	1.74e-04	5.48e-04	3.00e-03	0.00e+00	5.38e-04
Te-129m	2.51e+08	9.37e+07	3.98e+07	8.63e+07	1.05e+09	0.00e+00	1.26e+09
Te-131	1.25e-15	5.21e-16	3.94e-16	1.03e-15	5.47e-15	0.00e+00	1.77e-16
Te-131m	9.10e+05	4.45e+05	3.71e+05	7.05e+05	4.51e+06	0.00e+00	4.42e+07
Te-132	4.30e+06	2.78e+06	2.61e+06	3.07e+06	2.68e+07	0.00e+00	1.31e+08
Te-133m	2.12e-05	1.24e-05	1.19e-05	1.79e-05	1.22e-04	0.00e+00	4.24e-06
Te-134	3.19e-08	2.09e-08	1.28e-08	2.79e-08	2.02e-07	0.00e+00	3.54e-11
I-129	1.31e+09	1.13e+09	3.69e+09	2.90e+12	2.42e+09	0.00e+00	1.78e+08
I-130	3.90e+05	1.15e+06	4.54e+05	9.75e+07	1.79e+06	0.00e+00	9.90e+05
I-131	8.07e+07	1.15e+08	6.62e+07	3.78e+10	1.98e+08	0.00e+00	3.05e+07
I-132	5.57e+01	1.49e+02	5.21e+01	5.21e+03	2.37e+02	0.00e+00	2.80e+01
I-133	2.08e+06	3.61e+06	1.10e+06	5.31e+08	6.31e+06	0.00e+00	3.25e+06
I-134	8.84e-05	2.40e-04	8.59e-05	4.16e-03	3.82e-04	0.00e+00	2.09e-07
I-135	3.85e+04	1.01e+05	3.72e+04	6.65e+06	1.62e+05	0.00e+00	1.14e+05
Cs-134	4.67e+09	1.11e+10	9.08e+09	0.00e+00	3.59e+09	1.19e+09	1.94e+08
Cs-134m	6.57e+00	1.38e+01	7.06e+00	0.00e+00	7.49e+00	1.18e+00	4.87e+00

Conversion factors are in units of square meter-mrem/yr per uCi/sec for all nuclides except H-3, which is in units of mrem/yr per uCi/cubic meter.

**LEAFY VEGETABLE PATHWAY DOSE FACTORS DUE TO
RADIONUCLIDES OTHER THAN NOBLE GASES, R_i**

R_i factors for Adult age group by nuclide.

Waterford Steam Electric Station

Pathway : Gaseous Release Leafy/Produce Vegetation Pathway R_i

Nuclide	Organ Dose Conversion Factors						
	Bone	Liver	T. Body	Thyroid	Kidney	Lung	GI-LLI
Cs-135	1.56e+09	1.44e+09	6.40e+08	0.00e+00	5.46e+08	1.63e+08	3.37e+07
Cs-136	4.26e+07	1.68e+08	1.21e+08	0.00e+00	9.37e+07	1.28e+07	1.91e+07
Cs-137	6.36e+09	8.70e+09	5.70e+09	0.00e+00	2.95e+09	9.81e+08	1.68e+08
Cs-138	3.39e-11	6.70e-11	3.32e-11	0.00e+00	4.92e-11	4.86e-12	2.86e-16
Cs-139	0.00e+00	0.00e+00	0.00e+00	0.00e+00	0.00e+00	0.00e+00	0.00e+00
Ba-139	2.70e-02	1.92e-05	7.91e-04	0.00e+00	1.80e-05	1.09e-05	4.79e-02
Ba-140	1.28e+08	1.61e+05	8.41e+06	0.00e+00	5.48e+04	9.23e+04	2.64e+08
Ba-141	8.94e-22	6.76e-25	3.02e-23	0.00e+00	6.28e-25	3.83e-25	4.21e-31
Ba-142	3.88e-39	0.00e+00	2.44e-40	0.00e+00	0.00e+00	0.00e+00	0.00e+00
La-140	1.97e+03	9.95e+02	2.63e+02	0.00e+00	0.00e+00	0.00e+00	7.30e+07
La-141	5.98e-01	1.85e-01	3.04e-02	0.00e+00	0.00e+00	0.00e+00	2.21e+04
La-142	1.92e-04	8.75e-05	2.18e-05	0.00e+00	0.00e+00	0.00e+00	6.39e-01
Ce-141	1.97e+05	1.33e+05	1.51e+04	0.00e+00	6.19e+04	0.00e+00	5.09e+08
Ce-143	9.95e+02	7.36e+05	8.14e+01	0.00e+00	3.24e+02	0.00e+00	2.75e+07
Ce-144	3.29e+07	1.38e+07	1.77e+06	0.00e+00	8.16e+06	0.00e+00	1.11e+10
Pr-143	6.26e+04	2.51e+04	3.10e+03	0.00e+00	1.45e+04	0.00e+00	2.74e+08
Pr-144	2.36e-26	9.81e-27	1.20e-27	0.00e+00	5.53e-27	0.00e+00	3.40e-33
Nd-147	3.33e+04	3.85e+04	2.30e+03	0.00e+00	2.25e+04	0.00e+00	1.85e+08
Pm-147	5.74e+06	5.39e+05	2.18e+05	0.00e+00	1.02e+06	0.00e+00	6.79e+08
Pm-148	1.96e+04	3.25e+03	1.64e+03	0.00e+00	6.14e+03	0.00e+00	2.55e+08
Pm-148m	8.29e+05	2.15e+05	1.64e+05	0.00e+00	3.24e+05	0.00e+00	1.82e+09
Pm-149	1.69e+03	2.39e+02	9.77e+01	0.00e+00	4.52e+02	0.00e+00	4.48e+07
Pm-151	3.36e+02	5.65e+01	2.85e+01	0.00e+00	1.01e+02	0.00e+00	1.55e+07
Sm-151	5.52e+06	9.52e+05	2.28e+05	0.00e+00	1.06e+06	0.00e+00	4.20e+08
Sm-153	8.20e+02	6.84e+02	5.00e+01	0.00e+00	2.21e+02	0.00e+00	2.44e+07
Eu-152	1.55e+07	3.52e+06	3.09e+06	0.00e+00	2.18e+07	0.00e+00	2.03e+09
Eu-154	4.92e+07	6.05e+06	4.31e+06	0.00e+00	2.90e+07	0.00e+00	4.39e+09
Eu-155	6.39e+06	9.07e+05	5.85e+05	0.00e+00	4.18e+06	0.00e+00	7.13e+08
Eu-156	1.08e+05	8.35e+04	1.35e+04	0.00e+00	5.58e+04	0.00e+00	5.72e+08
Tb-160	1.96e+06	0.00e+00	2.44e+05	0.00e+00	8.09e+05	0.00e+00	1.81e+09

Conversion factors are in units of square meter-mrem/yr per uCi/sec for all nuclides except H-3, which is in units of mrem/yr per uCi/cubic meter.

**LEAFY VEGETABLE PATHWAY DOSE FACTORS DUE TO
RADIONUCLIDES OTHER THAN NOBLE GASES, R_i**

R_i factors for Adult age group by nuclide.

Waterford Steam Electric Station

Pathway : Gaseous Release Leafy/Produce Vegetation Pathway R_i

Nuclide	Organ Dose Conversion Factors						
	Bone	Liver	T. Body	Thyroid	Kidney	Lung	GI-LLI
Ho-166m	2.16e+07	6.75e+06	5.13e+06	0.00e+00	1.01e+07	0.00e+00	2.05e+09
W-181	5.33e+05	1.74e+05	1.86e+04	0.00e+00	0.00e+00	0.00e+00	1.98e+07
W-185	1.73e+07	5.77e+06	6.07e+05	0.00e+00	0.00e+00	0.00e+00	6.67e+08
W-187	3.79e+04	3.17e+04	1.11e+04	0.00e+00	0.00e+00	0.00e+00	1.04e+07
Pb-210	1.22e+12	3.48e+11	4.33e+10	0.00e+00	9.79e+11	0.00e+00	1.78e+08
Bi-210	1.18e+06	8.17e+06	6.78e+05	0.00e+00	9.83e+07	0.00e+00	1.22e+08
Po-210	2.01e+10	4.26e+10	4.85e+09	0.00e+00	1.42e+11	0.00e+00	3.59e+09
Ra-223	2.74e+10	4.23e+07	5.49e+09	0.00e+00	1.20e+09	0.00e+00	1.77e+09
Ra-224	3.08e+09	7.47e+06	6.19e+08	0.00e+00	2.11e+08	0.00e+00	6.51e+08
Ra-225	4.99e+10	5.92e+07	9.97e+09	0.00e+00	1.68e+09	0.00e+00	2.33e+09
Ra-226	2.42e+13	4.60e+08	1.76e+13	0.00e+00	1.31e+10	0.00e+00	2.66e+10
Ra-228	8.76e+12	2.44e+08	9.47e+12	0.00e+00	6.91e+09	0.00e+00	4.41e+09
Ac-225	2.11e+07	2.90e+07	1.42e+06	0.00e+00	3.31e+06	0.00e+00	1.95e+09
Ac-227	1.49e+11	1.97e+10	8.84e+09	0.00e+00	6.37e+09	0.00e+00	6.52e+09
Th-227	1.41e+08	2.55e+06	4.06e+06	0.00e+00	1.45e+07	0.00e+00	5.55e+09
Th-228	3.70e+10	6.27e+08	1.25e+09	0.00e+00	3.49e+09	0.00e+00	4.20e+10
Th-229	1.09e+12	3.12e+10	1.80e+10	0.00e+00	1.51e+11	0.00e+00	6.26e+09
Th-230	1.65e+11	9.38e+09	4.57e+09	0.00e+00	4.53e+10	0.00e+00	4.82e+09
Th-232	1.84e+11	8.01e+09	1.20e+08	0.00e+00	3.86e+10	0.00e+00	4.10e+09
Th-234	1.17e+06	6.89e+04	3.38e+04	0.00e+00	3.91e+05	0.00e+00	1.65e+09
Pa-231	3.29e+11	1.23e+10	1.27e+10	0.00e+00	6.92e+10	0.00e+00	5.75e+09
Pa-233	9.05e+04	1.82e+04	1.57e+04	0.00e+00	6.87e+04	0.00e+00	2.82e+08
U-232	3.30e+11	0.00e+00	2.36e+10	0.00e+00	3.58e+10	0.00e+00	5.42e+09
U-233	6.98e+10	0.00e+00	4.23e+09	0.00e+00	1.63e+10	0.00e+00	5.02e+09
U-234	6.70e+10	0.00e+00	4.14e+09	0.00e+00	1.59e+10	0.00e+00	4.92e+09
U-235	6.42e+10	0.00e+00	3.89e+09	0.00e+00	1.50e+10	0.00e+00	6.26e+09
U-236	6.42e+10	0.00e+00	3.97e+09	0.00e+00	1.53e+10	0.00e+00	4.62e+09
U-237	1.84e+05	0.00e+00	4.89e+04	0.00e+00	7.55e+05	0.00e+00	6.45e+07
U-238	6.15e+10	0.00e+00	3.64e+09	0.00e+00	1.40e+10	0.00e+00	4.41e+09
Np-237	1.01e+11	7.18e+09	4.44e+09	0.00e+00	3.30e+10	0.00e+00	6.36e+09

Conversion factors are in units of square meter-mrem/yr per uCi/sec for all nuclides except H-3, which is in units of mrem/yr per uCi/cubic meter.

**LEAFY VEGETABLE PATHWAY DOSE FACTORS DUE TO
RADIONUCLIDES OTHER THAN NOBLE GASES, R_i**

R_i factors for Adult age group by nuclide.
Waterford Steam Electric Station
Pathway : Gaseous Release Leafy/Produce Vegetation Pathway R_i

Nuclide	Organ Dose Conversion Factors						
	Bone	Liver	T. Body	Thyroid	Kidney	Lung	GI-LLI
Np-238	1.45e+04	3.91e+02	2.26e+02	0.00e+00	1.32e+03	0.00e+00	3.63e+07
Np-239	1.43e+03	1.40e+02	7.73e+01	0.00e+00	4.37e+02	0.00e+00	2.88e+07
Pu-238	5.04e+10	6.38e+09	1.37e+09	0.00e+00	5.86e+09	0.00e+00	5.84e+09
Pu-239	5.81e+10	6.98e+09	1.53e+09	0.00e+00	6.50e+09	0.00e+00	5.34e+09
Pu-240	5.80e+10	6.97e+09	1.53e+09	0.00e+00	6.49e+09	0.00e+00	5.43e+09
Pu-241	1.25e+09	5.92e+07	2.64e+07	0.00e+00	1.22e+08	0.00e+00	1.11e+08
Pu-242	5.39e+10	6.72e+09	1.47e+09	0.00e+00	6.26e+09	0.00e+00	5.23e+09
Pu-244	6.28e+10	7.70e+09	1.69e+09	0.00e+00	7.17e+09	0.00e+00	7.80e+09
Am-241	5.86e+10	5.47e+10	4.20e+09	0.00e+00	3.16e+10	0.00e+00	5.76e+09
Am-242m	6.09e+10	5.31e+10	4.35e+09	0.00e+00	3.24e+10	0.00e+00	7.48e+09
Am-243	6.04e+10	5.53e+10	4.25e+09	0.00e+00	3.20e+10	0.00e+00	6.97e+09
Cm-242	1.22e+09	1.30e+09	8.14e+07	0.00e+00	3.70e+08	0.00e+00	4.71e+09
Cm-243	4.78e+10	4.38e+10	2.99e+09	0.00e+00	1.40e+10	0.00e+00	6.23e+09
Cm-244	3.63e+10	3.40e+10	2.28e+09	0.00e+00	1.07e+10	0.00e+00	6.00e+09
Cm-245	7.52e+10	6.55e+10	4.62e+09	0.00e+00	2.16e+10	0.00e+00	5.64e+09
Cm-246	7.45e+10	6.54e+10	4.61e+09	0.00e+00	2.15e+10	0.00e+00	5.54e+09
Cm-247	7.27e+10	6.44e+10	4.54e+09	0.00e+00	2.12e+10	0.00e+00	7.28e+09
Cm-248	6.04e+11	5.31e+11	3.74e+10	0.00e+00	1.75e+11	0.00e+00	1.18e+11
Cf-252	1.98e+10	0.00e+00	4.77e+08	0.00e+00	0.00e+00	0.00e+00	2.18e+10

Conversion factors are in units of square meter-mrem/yr per uCi/sec for all nuclides except H-3, which is in units of mrem/yr per uCi/cubic meter.

**LEAFY VEGETABLE PATHWAY DOSE FACTORS DUE TO
RADIONUCLIDES OTHER THAN NOBLE GASES, R_i**

R_i factors for Teen age group by nuclide.

Waterford Steam Electric Station

Pathway : Gaseous Release Leafy/Produce Vegetation Pathway R_i

Nuclide	Organ Dose Conversion Factors						
	Bone	Liver	T. Body	Thyroid	Kidney	Lung	GI-LLI
H-3	0.00e+00	1.47e+03	1.47e+03	1.47e+03	1.47e+03	1.47e+03	1.47e+03
Be-10	4.07e+08	6.31e+07	1.03e+07	0.00e+00	4.82e+07	0.00e+00	2.58e+09
C-14	3.69e+08	7.38e+07	7.38e+07	7.38e+07	7.38e+07	7.38e+07	7.38e+07
N-13	0.00e+00	0.00e+00	0.00e+00	0.00e+00	0.00e+00	0.00e+00	0.00e+00
F-18	3.87e+00	0.00e+00	4.24e-01	0.00e+00	0.00e+00	0.00e+00	3.48e-01
Na-22	2.01e+09	2.01e+09	2.01e+09	2.01e+09	2.01e+09	2.01e+09	2.01e+09
Na-24	2.38e+05	2.38e+05	2.38e+05	2.38e+05	2.38e+05	2.38e+05	2.38e+05
P-32	1.61e+09	9.96e+07	6.23e+07	0.00e+00	0.00e+00	0.00e+00	1.35e+08
Ca-41	1.79e+10	0.00e+00	1.94e+09	0.00e+00	0.00e+00	0.00e+00	1.77e+07
Sc-46	3.61e+05	7.02e+05	2.08e+05	0.00e+00	6.72e+05	0.00e+00	2.39e+09
Cr-51	0.00e+00	0.00e+00	6.16e+04	3.42e+04	1.35e+04	8.80e+04	1.04e+07
Mn-54	0.00e+00	4.54e+08	9.01e+07	0.00e+00	1.36e+08	0.00e+00	9.32e+08
Mn-56	0.00e+00	1.38e+01	2.46e+00	0.00e+00	1.75e+01	0.00e+00	9.09e+02
Fe-55	3.26e+08	2.31e+08	5.39e+07	0.00e+00	0.00e+00	1.47e+08	1.00e+08
Fe-59	1.79e+08	4.18e+08	1.62e+08	0.00e+00	0.00e+00	1.32e+08	9.90e+08
Co-57	0.00e+00	1.79e+07	2.99e+07	0.00e+00	0.00e+00	0.00e+00	3.33e+08
Co-58	0.00e+00	4.36e+07	1.00e+08	0.00e+00	0.00e+00	0.00e+00	6.01e+08
Co-60	0.00e+00	2.49e+08	5.60e+08	0.00e+00	0.00e+00	0.00e+00	3.24e+09
Ni-59	1.20e+09	4.24e+08	2.04e+08	0.00e+00	0.00e+00	0.00e+00	6.64e+07
Ni-63	1.61e+10	1.13e+09	5.45e+08	0.00e+00	0.00e+00	0.00e+00	1.81e+08
Ni-65	5.55e+01	7.09e+00	3.23e+00	0.00e+00	0.00e+00	0.00e+00	3.85e+02
Cu-64	0.00e+00	8.29e+03	3.90e+03	0.00e+00	2.10e+04	0.00e+00	6.43e+05
Zn-65	4.24e+08	1.47e+09	6.86e+08	0.00e+00	9.42e+08	0.00e+00	6.23e+08
Zn-69	4.73e-06	9.02e-06	6.31e-07	0.00e+00	5.89e-06	0.00e+00	1.66e-05
Zn-69m	2.08e+04	4.90e+04	4.50e+03	0.00e+00	2.98e+04	0.00e+00	2.69e+06
Se-79	0.00e+00	3.39e+08	5.70e+07	0.00e+00	5.91e+08	0.00e+00	5.18e+07
Br-82	0.00e+00	0.00e+00	1.32e+06	0.00e+00	0.00e+00	0.00e+00	0.00e+00
Br-83	0.00e+00	0.00e+00	2.82e+00	0.00e+00	0.00e+00	0.00e+00	0.00e+00
Br-84	0.00e+00	0.00e+00	1.95e-11	0.00e+00	0.00e+00	0.00e+00	0.00e+00
Br-85	0.00e+00	0.00e+00	0.00e+00	0.00e+00	0.00e+00	0.00e+00	0.00e+00

Conversion factors are in units of square meter-mrem/yr per uCi/sec for all nuclides except H-3, which is in units of mrem/yr per uCi/cubic meter.

**LEAFY VEGETABLE PATHWAY DOSE FACTORS DUE TO
RADIONUCLIDES OTHER THAN NOBLE GASES, R_i**

Ri factors for Teen age group by nuclide.
Waterford Steam Electric Station
Pathway : Gaseous Release Leafy/Produce Vegetation Pathway Ri

Nuclide	Organ Dose Conversion Factors						
	Bone	Liver	T. Body	Thyroid	Kidney	Lung	GI-LLI
Rb-86	0.00e+00	2.73e+08	1.28e+08	0.00e+00	0.00e+00	0.00e+00	4.05e+07
Rb-87	0.00e+00	1.59e+09	5.55e+08	0.00e+00	0.00e+00	0.00e+00	5.55e+07
Rb-88	0.00e+00	2.44e-22	1.30e-22	0.00e+00	0.00e+00	0.00e+00	2.09e-29
Rb-89	0.00e+00	2.59e-26	1.83e-26	0.00e+00	0.00e+00	0.00e+00	3.98e-35
Sr-89	1.51e+10	0.00e+00	4.33e+08	0.00e+00	0.00e+00	0.00e+00	1.80e+09
Sr-90	9.22e+11	0.00e+00	1.84e+10	0.00e+00	0.00e+00	0.00e+00	2.11e+10
Sr-91	2.82e+05	0.00e+00	1.12e+04	0.00e+00	0.00e+00	0.00e+00	1.28e+06
Sr-92	3.86e+02	0.00e+00	1.65e+01	0.00e+00	0.00e+00	0.00e+00	9.83e+03
Y-90	1.24e+04	0.00e+00	3.34e+02	0.00e+00	0.00e+00	0.00e+00	1.02e+08
Y-91	7.83e+06	0.00e+00	2.10e+05	0.00e+00	0.00e+00	0.00e+00	3.21e+09
Y-91m	4.43e-09	0.00e+00	1.69e-10	0.00e+00	0.00e+00	0.00e+00	2.09e-07
Y-92	8.42e-01	0.00e+00	2.43e-02	0.00e+00	0.00e+00	0.00e+00	2.31e+04
Y-93	1.58e+02	0.00e+00	4.33e+00	0.00e+00	0.00e+00	0.00e+00	4.82e+06
Zr-93	5.03e+06	2.48e+05	1.35e+05	0.00e+00	8.77e+05	0.00e+00	2.34e+08
Zr-95	1.72e+06	5.43e+05	3.73e+05	0.00e+00	7.98e+05	0.00e+00	1.25e+09
Zr-97	3.11e+02	6.15e+01	2.83e+01	0.00e+00	9.33e+01	0.00e+00	1.67e+07
Nb-93m	3.09e+06	1.02e+06	2.55e+05	0.00e+00	1.19e+06	0.00e+00	3.66e+08
Nb-95	1.92e+05	1.07e+05	5.87e+04	0.00e+00	1.03e+05	0.00e+00	4.56e+08
Nb-97	2.63e-06	6.54e-07	2.39e-07	0.00e+00	7.65e-07	0.00e+00	1.56e-02
Mo-93	0.00e+00	9.63e+08	2.64e+07	0.00e+00	2.76e+08	0.00e+00	1.17e+08
Mo-99	0.00e+00	5.64e+06	1.08e+06	0.00e+00	1.29e+07	0.00e+00	1.01e+07
Tc-101	5.52e-31	7.85e-31	7.71e-30	0.00e+00	1.42e-29	4.78e-31	1.34e-37
Tc-99	1.63e+07	2.39e+07	6.52e+06	0.00e+00	3.04e+08	2.47e+06	5.85e+08
Tc-99m	2.70e+00	7.54e+00	9.77e+01	0.00e+00	1.12e+02	4.18e+00	4.95e+03
Ru-103	6.82e+06	0.00e+00	2.91e+06	0.00e+00	2.40e+07	0.00e+00	5.69e+08
Ru-105	4.92e+01	0.00e+00	1.91e+01	0.00e+00	6.20e+02	0.00e+00	3.97e+04
Ru-106	3.09e+08	0.00e+00	3.90e+07	0.00e+00	5.97e+08	0.00e+00	1.48e+10
Rh-105	7.52e+04	5.43e+04	3.56e+04	0.00e+00	2.31e+05	0.00e+00	6.91e+06
Pd-107	0.00e+00	1.89e+07	1.22e+06	0.00e+00	1.71e+08	0.00e+00	8.78e+07
Pd-109	0.00e+00	2.07e+04	4.71e+03	0.00e+00	1.20e+05	0.00e+00	2.09e+06

Conversion factors are in units of square meter-mrem/yr per uCi/sec for all nuclides except H-3, which is in units of mrem/yr per uCi/cubic meter.

**LEAFY VEGETABLE PATHWAY DOSE FACTORS DUE TO
RADIONUCLIDES OTHER THAN NOBLE GASES, R_i**

R_i factors for Teen age group by nuclide.
Waterford Steam Electric Station
Pathway : Gaseous Release Leafy/Produce Vegetation Pathway R_i

Nuclide	Organ Dose Conversion Factors						
	Bone	Liver	T. Body	Thyroid	Kidney	Lung	GI-LLI
Ag-110m	1.52e+07	1.43e+07	8.72e+06	0.00e+00	2.73e+07	0.00e+00	4.03e+09
Ag-111	2.01e+05	8.35e+04	4.20e+04	0.00e+00	2.72e+05	0.00e+00	1.17e+08
Cd-113m	0.00e+00	4.06e+08	1.30e+07	0.00e+00	4.49e+08	0.00e+00	2.44e+09
Cd-115m	0.00e+00	7.94e+07	2.56e+06	0.00e+00	6.35e+07	0.00e+00	2.51e+09
Sn-123	2.72e+09	4.46e+07	6.61e+07	3.57e+07	0.00e+00	0.00e+00	4.11e+09
Sn-125	3.84e+07	7.65e+05	1.73e+06	6.01e+05	0.00e+00	0.00e+00	3.62e+08
Sn-126	1.05e+10	1.96e+08	3.00e+08	5.17e+07	0.00e+00	0.00e+00	2.34e+09
Sb-124	1.54e+08	2.84e+06	6.02e+07	3.50e+05	0.00e+00	1.35e+08	3.11e+09
Sb-125	2.14e+08	2.34e+06	5.01e+07	2.05e+05	0.00e+00	1.88e+08	1.67e+09
Sb-126	7.45e+06	1.52e+05	2.68e+06	4.21e+04	0.00e+00	5.34e+06	4.41e+08
Sb-127	4.82e+05	1.03e+04	1.82e+05	5.42e+03	0.00e+00	3.28e+05	8.19e+07
Te-125m	1.48e+08	5.34e+07	1.98e+07	4.14e+07	0.00e+00	0.00e+00	4.37e+08
Te-127	5.29e+03	1.88e+03	1.14e+03	3.65e+03	2.14e+04	0.00e+00	4.09e+05
Te-127m	5.51e+08	1.96e+08	6.56e+07	1.31e+08	2.23e+09	0.00e+00	1.37e+09
Te-129	6.68e-04	2.49e-04	1.63e-04	4.77e-04	2.80e-03	0.00e+00	3.65e-03
Te-129m	3.61e+08	1.34e+08	5.72e+07	1.17e+08	1.51e+09	0.00e+00	1.36e+09
Te-131	1.16e-15	4.78e-16	3.62e-16	8.93e-16	5.07e-15	0.00e+00	9.52e-17
Te-131m	8.42e+05	4.04e+05	3.37e+05	6.07e+05	4.21e+06	0.00e+00	3.24e+07
Te-132	3.90e+06	2.47e+06	2.33e+06	2.61e+06	2.37e+07	0.00e+00	7.83e+07
Te-133m	1.94e-05	1.10e-05	1.07e-05	1.54e-05	1.09e-04	0.00e+00	4.45e-05
Te-134	2.89e-08	1.85e-08	1.94e-08	2.37e-08	1.77e-07	0.00e+00	1.07e-09
I-129	2.12e+09	1.78e+09	2.97e+09	2.17e+12	3.19e+09	0.00e+00	2.08e+08
I-130	3.49e+05	1.01e+06	4.03e+05	8.22e+07	1.55e+06	0.00e+00	7.75e+05
I-131	7.68e+07	1.08e+08	5.78e+07	3.14e+10	1.85e+08	0.00e+00	2.13e+07
I-132	5.02e+01	1.31e+02	4.72e+01	4.43e+03	2.07e+02	0.00e+00	5.72e+01
I-133	1.93e+06	3.27e+06	9.99e+05	4.57e+08	5.74e+06	0.00e+00	2.48e+06
I-134	7.99e-05	2.12e-04	7.61e-05	3.53e-03	3.34e-04	0.00e+00	2.79e-06
I-135	3.48e+04	8.96e+04	3.32e+04	5.76e+06	1.42e+05	0.00e+00	9.93e+04
Cs-134	7.10e+09	1.67e+10	7.75e+09	0.00e+00	5.31e+09	2.03e+09	2.08e+08
Cs-134m	5.95e+00	1.23e+01	6.33e+00	0.00e+00	6.86e+00	1.20e+00	8.20e+00

Conversion factors are in units of square meter-mrem/yr per uCi/sec for all nuclides except H-3, which is in units of mrem/yr per uCi/cubic meter.

**LEAFY VEGETABLE PATHWAY DOSE FACTORS DUE TO
RADIONUCLIDES OTHER THAN NOBLE GASES, R_i**

R_i factors for Teen age group by nuclide.

Waterford Steam Electric Station

Pathway : Gaseous Release Leafy/Produce Vegetation Pathway R_i

Nuclide	Organ Dose Conversion Factors						
	Bone	Liver	T. Body	Thyroid	Kidney	Lung	GI-LLI
Cs-135	2.53e+09	2.32e+09	5.42e+08	0.00e+00	8.84e+08	3.20e+08	4.05e+07
Cs-136	4.37e+07	1.72e+08	1.15e+08	0.00e+00	9.36e+07	1.48e+07	1.38e+07
Cs-137	1.01e+10	1.35e+10	4.69e+09	0.00e+00	4.59e+09	1.78e+09	1.92e+08
Cs-138	3.13e-11	6.01e-11	3.00e-11	0.00e+00	4.44e-11	5.16e-12	2.73e-14
Cs-139	0.00e+00	0.00e+00	0.00e+00	0.00e+00	0.00e+00	0.00e+00	0.00e+00
Ba-139	2.54e-02	1.79e-05	7.40e-04	0.00e+00	1.69e-05	1.23e-05	2.27e-01
Ba-140	1.38e+08	1.69e+05	8.89e+06	0.00e+00	5.73e+04	1.14e+05	2.13e+08
Ba-141	8.36e-22	6.24e-25	2.79e-23	0.00e+00	5.79e-25	4.27e-25	1.78e-27
Ba-142	3.57e-39	0.00e+00	2.20e-40	0.00e+00	0.00e+00	0.00e+00	0.00e+00
La-140	1.80e+03	8.86e+02	2.36e+02	0.00e+00	0.00e+00	0.00e+00	5.09e+07
La-141	5.59e-01	1.72e-01	2.84e-02	0.00e+00	0.00e+00	0.00e+00	3.05e+04
La-142	1.77e-04	7.84e-05	1.95e-05	0.00e+00	0.00e+00	0.00e+00	2.39e+00
Ce-141	2.83e+05	1.89e+05	2.17e+04	0.00e+00	8.89e+04	0.00e+00	5.40e+08
Ce-143	9.30e+02	6.77e+05	7.56e+01	0.00e+00	3.04e+02	0.00e+00	2.04e+07
Ce-144	5.27e+07	2.18e+07	2.83e+06	0.00e+00	1.30e+07	0.00e+00	1.33e+10
Pr-143	7.00e+04	2.79e+04	3.48e+03	0.00e+00	1.62e+04	0.00e+00	2.30e+08
Pr-144	2.22e-26	9.07e-27	1.12e-27	0.00e+00	5.20e-27	0.00e+00	2.44e-29
Nd-147	3.62e+04	3.93e+04	2.36e+03	0.00e+00	2.31e+04	0.00e+00	1.42e+08
Pm-147	9.04e+06	8.57e+05	3.49e+05	0.00e+00	1.64e+06	0.00e+00	8.15e+08
Pm-148	1.83e+04	2.98e+03	1.50e+03	0.00e+00	5.39e+03	0.00e+00	1.78e+08
Pm-148m	1.17e+06	2.96e+05	2.31e+05	0.00e+00	4.48e+05	0.00e+00	1.86e+09
Pm-149	1.58e+03	2.23e+02	9.13e+01	0.00e+00	4.24e+02	0.00e+00	3.28e+07
Pm-151	3.13e+02	5.16e+01	2.61e+01	0.00e+00	9.28e+01	0.00e+00	1.16e+07
Sm-151	7.92e+06	1.52e+06	3.58e+05	0.00e+00	1.67e+06	0.00e+00	5.17e+08
Sm-153	7.66e+02	6.34e+02	4.67e+01	0.00e+00	2.07e+02	0.00e+00	1.79e+07
Eu-152	2.20e+07	5.30e+06	4.67e+06	0.00e+00	2.46e+07	0.00e+00	1.95e+09
Eu-154	7.18e+07	9.26e+06	6.53e+06	0.00e+00	4.14e+07	0.00e+00	4.89e+09
Eu-155	1.46e+07	1.41e+06	8.73e+05	0.00e+00	5.52e+06	0.00e+00	8.09e+09
Eu-156	1.24e+05	9.31e+04	1.52e+04	0.00e+00	6.26e+04	0.00e+00	4.76e+08
Tb-160	2.94e+06	0.00e+00	3.66e+05	0.00e+00	1.16e+06	0.00e+00	1.90e+09

Conversion factors are in units of square meter-mrem/yr per uCi/sec for all nuclides except H-3, which is in units of mrem/yr per uCi/cubic meter.

**LEAFY VEGETABLE PATHWAY DOSE FACTORS DUE TO
RADIONUCLIDES OTHER THAN NOBLE GASES, R_i**

R_i factors for Teen age group by nuclide.
Waterford Steam Electric Station
Pathway : Gaseous Release Leafy/Produce Vegetation Pathway R_i

Nuclide	Organ Dose Conversion Factors						
	Bone	Liver	T. Body	Thyroid	Kidney	Lung	GI-LLI
Ho-166m	3.24e+07	1.00e+07	7.23e+06	0.00e+00	1.46e+07	0.00e+00	2.46e+09
W-181	8.47e+05	2.73e+05	2.86e+04	0.00e+00	0.00e+00	0.00e+00	2.33e+07
W-185	2.70e+07	8.90e+06	9.41e+05	0.00e+00	0.00e+00	0.00e+00	7.69e+08
W-187	3.53e+04	2.87e+04	1.01e+04	0.00e+00	0.00e+00	0.00e+00	7.78e+06
Pb-210	1.63e+12	4.91e+11	6.33e+10	0.00e+00	1.55e+12	0.00e+00	2.14e+08
Bi-210	1.11e+06	7.61e+06	6.36e+05	0.00e+00	9.25e+07	0.00e+00	8.69e+07
Po-210	3.19e+10	6.71e+10	7.72e+09	0.00e+00	2.26e+11	0.00e+00	4.24e+09
Ra-223	2.90e+10	4.40e+07	5.78e+09	0.00e+00	1.26e+09	0.00e+00	1.40e+09
Ra-224	2.90e+09	6.94e+06	5.80e+08	0.00e+00	1.99e+08	0.00e+00	4.66e+08
Ra-225	5.79e+10	6.80e+07	1.16e+10	0.00e+00	1.95e+09	0.00e+00	2.02e+09
Ra-226	2.93e+13	7.39e+08	2.17e+13	0.00e+00	2.11e+10	0.00e+00	3.19e+10
Ra-228	1.21e+13	3.91e+08	1.34e+13	0.00e+00	1.12e+10	0.00e+00	5.30e+09
Ac-225	2.13e+07	2.91e+07	1.43e+06	0.00e+00	3.34e+06	0.00e+00	1.48e+09
Ac-227	1.85e+11	2.74e+10	1.10e+10	0.00e+00	7.95e+09	0.00e+00	7.84e+09
Th-227	1.77e+08	3.18e+06	5.11e+06	0.00e+00	1.82e+07	0.00e+00	5.20e+09
Th-228	5.74e+10	9.62e+08	1.94e+09	0.00e+00	5.41e+09	0.00e+00	5.04e+10
Th-229	1.30e+12	3.74e+10	2.15e+10	0.00e+00	1.81e+11	0.00e+00	7.53e+09
Th-230	1.96e+11	1.12e+10	5.45e+09	0.00e+00	5.44e+10	0.00e+00	5.80e+09
Th-232	2.20e+11	9.54e+09	1.48e+08	0.00e+00	4.64e+10	0.00e+00	4.93e+09
Th-234	1.59e+06	9.30e+04	4.61e+04	0.00e+00	5.30e+05	0.00e+00	1.68e+09
Pa-231	3.92e+11	1.47e+10	1.53e+10	0.00e+00	8.27e+10	0.00e+00	6.91e+09
Pa-233	1.24e+05	2.38e+04	2.12e+04	0.00e+00	8.96e+04	0.00e+00	2.71e+08
U-232	5.34e+11	0.00e+00	3.82e+10	0.00e+00	5.79e+10	0.00e+00	6.52e+09
U-233	1.13e+11	0.00e+00	6.85e+09	0.00e+00	2.64e+10	0.00e+00	6.04e+09
U-234	1.08e+11	0.00e+00	6.72e+09	0.00e+00	2.59e+10	0.00e+00	5.92e+09
U-235	1.04e+11	0.00e+00	6.31e+09	0.00e+00	2.43e+10	0.00e+00	7.53e+09
U-236	1.04e+11	0.00e+00	6.44e+09	0.00e+00	2.48e+10	0.00e+00	5.55e+09
U-237	1.74e+05	0.00e+00	4.64e+04	0.00e+00	7.16e+05	0.00e+00	4.62e+07
U-238	9.91e+10	0.00e+00	5.90e+09	0.00e+00	2.27e+10	0.00e+00	5.30e+09
Np-237	1.21e+11	8.68e+09	5.32e+09	0.00e+00	3.94e+10	0.00e+00	7.64e+09

Conversion factors are in units of square meter-mrem/yr per uCi/sec for all nuclides except H-3, which is in units of mrem/yr per uCi/cubic meter.

**LEAFY VEGETABLE PATHWAY DOSE FACTORS DUE TO
RADIONUCLIDES OTHER THAN NOBLE GASES, R_i**

R_i factors for Teen age group by nuclide.

Waterford Steam Electric Station

Pathway : Gaseous Release Leafy/Produce Vegetation Pathway R_i

Nuclide	Organ Dose Conversion Factors						
	Bone	Liver	T. Body	Thyroid	Kidney	Lung	GI-LLI
Np-238	1.36e+04	3.63e+02	2.11e+02	0.00e+00	1.24e+03	0.00e+00	2.66e+07
Np-239	1.38e+03	1.31e+02	7.25e+01	0.00e+00	4.10e+02	0.00e+00	2.10e+07
Pu-238	6.08e+10	7.79e+09	1.65e+09	0.00e+00	7.08e+09	0.00e+00	7.01e+09
Pu-239	6.95e+10	8.44e+09	1.83e+09	0.00e+00	7.79e+09	0.00e+00	6.42e+09
Pu-240	6.94e+10	8.42e+09	1.83e+09	0.00e+00	7.78e+09	0.00e+00	6.53e+09
Pu-241	1.58e+09	7.56e+07	3.32e+07	0.00e+00	1.54e+08	0.00e+00	1.33e+08
Pu-242	6.44e+10	8.13e+09	1.76e+09	0.00e+00	7.50e+09	0.00e+00	6.29e+09
Pu-244	7.53e+10	9.27e+09	2.02e+09	0.00e+00	8.59e+09	0.00e+00	9.36e+09
Am-241	7.02e+10	6.62e+10	5.06e+09	0.00e+00	3.79e+10	0.00e+00	6.92e+09
Am-242m	7.33e+10	6.46e+10	5.27e+09	0.00e+00	3.90e+10	0.00e+00	8.99e+09
Am-243	7.23e+10	6.68e+10	5.11e+09	0.00e+00	3.84e+10	0.00e+00	8.39e+09
Cm-242	1.95e+09	2.06e+09	1.29e+08	0.00e+00	5.90e+08	0.00e+00	5.57e+09
Cm-243	5.88e+10	5.45e+10	3.70e+09	0.00e+00	1.73e+10	0.00e+00	7.49e+09
Cm-244	4.54e+10	4.30e+10	2.88e+09	0.00e+00	1.34e+10	0.00e+00	7.21e+09
Cm-245	9.00e+10	7.92e+10	5.54e+09	0.00e+00	2.59e+10	0.00e+00	6.78e+09
Cm-246	8.92e+10	7.91e+10	5.53e+09	0.00e+00	2.58e+10	0.00e+00	6.66e+09
Cm-247	8.70e+10	7.79e+10	5.45e+09	0.00e+00	2.54e+10	0.00e+00	8.75e+09
Cm-248	7.23e+11	6.42e+11	4.50e+10	0.00e+00	2.10e+11	0.00e+00	1.41e+11
Cf-252	2.98e+10	0.00e+00	7.18e+08	0.00e+00	0.00e+00	0.00e+00	2.62e+10

Conversion factors are in units of square meter-mrem/yr per uCi/sec for all nuclides except H-3, which is in units of mrem/yr per uCi/cubic meter.

**LEAFY VEGETABLE PATHWAY DOSE FACTORS DUE TO
RADIONUCLIDES OTHER THAN NOBLE GASES, R_i**

R_i factors for Child age group by nuclide.
Waterford Steam Electric Station
Pathway : Gaseous Release Leafy/Produce Vegetation Pathway R_i

Nuclide	Organ Dose Conversion Factors						
	Bone	Liver	T. Body	Thyroid	Kidney	Lung	GI-LLI
H-3	0.00e+00	2.29e+03	2.29e+03	2.29e+03	2.29e+03	2.29e+03	2.29e+03
Be-10	9.92e+08	1.15e+08	2.49e+07	0.00e+00	8.16e+07	0.00e+00	2.02e+09
C-14	8.89e+08	1.78e+08	1.78e+08	1.78e+08	1.78e+08	1.78e+08	1.78e+08
N-13	0.00e+00	0.00e+00	0.00e+00	0.00e+00	0.00e+00	0.00e+00	0.00e+00
F-18	6.90e+00	0.00e+00	6.84e-01	0.00e+00	0.00e+00	0.00e+00	1.87e+00
Na-22	4.09e+09	4.09e+09	4.09e+09	4.09e+09	4.09e+09	4.09e+09	4.09e+09
Na-24	3.71e+05	3.71e+05	3.71e+05	3.71e+05	3.71e+05	3.71e+05	3.71e+05
P-32	3.37e+09	1.58e+08	1.30e+08	0.00e+00	0.00e+00	0.00e+00	9.30e+07
Ca-41	2.55e+10	0.00e+00	2.79e+09	0.00e+00	0.00e+00	0.00e+00	1.40e+07
Sc-46	7.85e+05	1.08e+06	4.14e+05	0.00e+00	9.52e+05	0.00e+00	1.57e+09
Cr-51	0.00e+00	0.00e+00	1.17e+05	6.50e+04	1.78e+04	1.19e+05	6.21e+06
Mn-54	0.00e+00	6.65e+08	1.77e+08	0.00e+00	1.86e+08	0.00e+00	5.58e+08
Mn-56	0.00e+00	1.81e+01	4.08e+00	0.00e+00	2.19e+01	0.00e+00	2.62e+03
Fe-55	8.01e+08	4.25e+08	1.32e+08	0.00e+00	0.00e+00	2.40e+08	7.87e+07
Fe-59	3.97e+08	6.43e+08	3.20e+08	0.00e+00	0.00e+00	1.86e+08	6.69e+08
Co-57	0.00e+00	2.98e+07	6.04e+07	0.00e+00	0.00e+00	0.00e+00	2.44e+08
Co-58	0.00e+00	6.44e+07	1.97e+08	0.00e+00	0.00e+00	0.00e+00	3.75e+08
Co-60	0.00e+00	3.78e+08	1.12e+09	0.00e+00	0.00e+00	0.00e+00	2.10e+09
Ni-59	2.95e+09	7.86e+08	5.01e+08	0.00e+00	0.00e+00	0.00e+00	5.22e+07
Ni-63	3.95e+10	2.11e+09	1.34e+09	0.00e+00	0.00e+00	0.00e+00	1.42e+08
Ni-65	1.02e+02	9.59e+00	5.60e+00	0.00e+00	0.00e+00	0.00e+00	1.17e+03
Cu-64	0.00e+00	1.09e+04	6.60e+03	0.00e+00	2.64e+04	0.00e+00	5.13e+05
Zn-65	8.12e+08	2.16e+09	1.35e+09	0.00e+00	1.36e+09	0.00e+00	3.80e+08
Zn-69	8.73e-06	1.26e-05	1.17e-06	0.00e+00	7.66e-06	0.00e+00	7.96e-04
Zn-69m	3.81e+04	6.49e+04	7.67e+03	0.00e+00	3.77e+04	0.00e+00	2.11e+06
Se-79	0.00e+00	6.20e+08	1.37e+08	0.00e+00	1.01e+09	0.00e+00	4.06e+07
Br-82	0.00e+00	0.00e+00	2.03e+06	0.00e+00	0.00e+00	0.00e+00	0.00e+00
Br-83	0.00e+00	0.00e+00	5.20e+00	0.00e+00	0.00e+00	0.00e+00	0.00e+00
Br-84	0.00e+00	0.00e+00	3.30e-11	0.00e+00	0.00e+00	0.00e+00	0.00e+00
Br-85	0.00e+00	0.00e+00	0.00e+00	0.00e+00	0.00e+00	0.00e+00	0.00e+00

Conversion factors are in units of square meter-mrem/yr per uCi/sec for all nuclides except H-3, which is in units of mrem/yr per uCi/cubic meter.

**LEAFY VEGETABLE PATHWAY DOSE FACTORS DUE TO
RADIONUCLIDES OTHER THAN NOBLE GASES, R_i**

R_i factors for Child age group by nuclide.

Waterford Steam Electric Station

Pathway : Gaseous Release Leafy/Produce Vegetation Pathway R_i

Nuclide	Organ Dose Conversion Factors						
	Bone	Liver	T. Body	Thyroid	Kidney	Lung	GI-LLI
Rb-86	0.00e+00	4.52e+08	2.78e+08	0.00e+00	0.00e+00	0.00e+00	2.90e+07
Rb-87	0.00e+00	2.90e+09	1.35e+09	0.00e+00	0.00e+00	0.00e+00	4.35e+07
Rb-88	0.00e+00	3.37e-22	2.34e-22	0.00e+00	0.00e+00	0.00e+00	1.65e-23
Rb-89	0.00e+00	3.42e-26	3.04e-26	0.00e+00	0.00e+00	0.00e+00	2.98e-28
Sr-89	3.59e+10	0.00e+00	1.03e+09	0.00e+00	0.00e+00	0.00e+00	1.39e+09
Sr-90	1.87e+12	0.00e+00	3.77e+10	0.00e+00	0.00e+00	0.00e+00	1.67e+10
Sr-91	5.20e+05	0.00e+00	1.96e+04	0.00e+00	0.00e+00	0.00e+00	1.15e+06
Sr-92	7.07e+02	0.00e+00	2.84e+01	0.00e+00	0.00e+00	0.00e+00	1.34e+04
Y-90	2.30e+04	0.00e+00	6.17e+02	0.00e+00	0.00e+00	0.00e+00	6.56e+07
Y-91	1.86e+07	0.00e+00	4.98e+05	0.00e+00	0.00e+00	0.00e+00	2.48e+09
Y-91m	8.12e-09	0.00e+00	2.95e-10	0.00e+00	0.00e+00	0.00e+00	1.59e-05
Y-92	1.55e+00	0.00e+00	4.43e-02	0.00e+00	0.00e+00	0.00e+00	4.48e+04
Y-93	2.91e+02	0.00e+00	7.98e+00	0.00e+00	0.00e+00	0.00e+00	4.34e+06
Zr-93	1.23e+07	4.59e+05	3.27e+05	0.00e+00	1.78e+06	0.00e+00	1.74e+08
Zr-95	3.86e+06	8.48e+05	7.54e+05	0.00e+00	1.21e+06	0.00e+00	8.84e+08
Zr-97	5.68e+02	8.20e+01	4.84e+01	0.00e+00	1.18e+02	0.00e+00	1.24e+07
Nb-93m	7.64e+06	1.91e+06	6.26e+05	0.00e+00	2.06e+06	0.00e+00	2.87e+08
Nb-95	4.10e+05	1.60e+05	1.14e+05	0.00e+00	1.50e+05	0.00e+00	2.95e+08
Nb-97	4.80e-06	8.68e-07	4.05e-07	0.00e+00	9.63e-07	0.00e+00	2.68e-01
Mo-93	0.00e+00	1.77e+09	6.36e+07	0.00e+00	4.67e+08	0.00e+00	8.97e+07
Mo-99	0.00e+00	7.70e+06	1.91e+06	0.00e+00	1.64e+07	0.00e+00	6.37e+06
Tc-101	1.02e-30	1.06e-30	1.35e-29	0.00e+00	1.81e-29	5.62e-31	3.38e-30
Tc-99	3.93e+07	4.38e+07	1.57e+07	0.00e+00	5.16e+08	3.87e+06	4.59e+08
Tc-99m	4.65e+00	9.12e+00	1.51e+02	0.00e+00	1.32e+02	4.63e+00	5.19e+03
Ru-103	1.53e+07	0.00e+00	5.89e+06	0.00e+00	3.86e+07	0.00e+00	3.96e+08
Ru-105	9.01e+01	0.00e+00	3.27e+01	0.00e+00	7.92e+02	0.00e+00	5.88e+04
Ru-106	7.45e+08	0.00e+00	9.30e+07	0.00e+00	1.01e+09	0.00e+00	1.16e+10
Rh-105	1.38e+05	7.43e+04	6.35e+04	0.00e+00	2.96e+05	0.00e+00	4.60e+06
Pd-107	0.00e+00	3.47e+07	2.95e+06	0.00e+00	2.90e+08	0.00e+00	6.89e+07
Pd-109	0.00e+00	2.90e+04	8.69e+03	0.00e+00	1.55e+05	0.00e+00	1.71e+06

Conversion factors are in units of square meter-mrem/yr per uCi/sec for all nuclides except H-3, which is in units of mrem/yr per uCi/cubic meter.

**LEAFY VEGETABLE PATHWAY DOSE FACTORS DUE TO
RADIONUCLIDES OTHER THAN NOBLE GASES, R_i**

R_i factors for Child age group by nuclide.
Waterford Steam Electric Station
Pathway : Gaseous Release Leafy/Produce Vegetation Pathway R_i

Nuclide	Organ Dose Conversion Factors						
	Bone	Liver	T. Body	Thyroid	Kidney	Lung	GI-LLI
Ag-110m	3.21e+07	2.17e+07	1.73e+07	0.00e+00	4.04e+07	0.00e+00	2.58e+09
Ag-111	3.78e+05	1.18e+05	7.81e+04	0.00e+00	3.57e+05	0.00e+00	7.25e+07
Cd-113m	0.00e+00	7.42e+08	3.16e+07	0.00e+00	7.64e+08	0.00e+00	1.91e+09
Cd-115m	0.00e+00	1.42e+08	6.04e+06	0.00e+00	1.05e+08	0.00e+00	1.93e+09
Sn-123	6.54e+09	8.11e+07	1.59e+08	8.60e+07	0.00e+00	0.00e+00	3.20e+09
Sn-125	7.43e+07	1.12e+06	3.33e+06	1.16e+06	0.00e+00	0.00e+00	2.30e+08
Sn-126	2.45e+10	3.05e+08	6.95e+08	8.38e+07	0.00e+00	0.00e+00	1.84e+09
Sb-124	3.52e+08	4.56e+06	1.23e+08	7.76e+05	0.00e+00	1.95e+08	2.20e+09
Sb-125	4.99e+08	3.85e+06	1.05e+08	4.62e+05	0.00e+00	2.78e+08	1.19e+09
Sb-126	1.40e+07	2.15e+05	5.04e+06	8.24e+04	0.00e+00	6.70e+06	2.83e+08
Sb-127	8.72e+05	1.35e+04	3.03e+05	9.71e+03	0.00e+00	3.78e+05	4.91e+07
Te-125m	3.50e+08	9.50e+07	4.67e+07	9.83e+07	0.00e+00	0.00e+00	3.38e+08
Te-127	9.76e+03	2.63e+03	2.09e+03	6.76e+03	2.78e+04	0.00e+00	3.81e+05
Te-127m	1.32e+09	3.56e+08	1.57e+08	3.16e+08	3.77e+09	0.00e+00	1.07e+09
Te-129	1.24e-03	3.45e-04	2.94e-04	8.82e-04	3.62e-03	0.00e+00	7.70e-02
Te-129m	8.40e+08	2.35e+08	1.30e+08	2.71e+08	2.47e+09	0.00e+00	1.03e+09
Te-131	2.14e-15	6.51e-16	6.35e-16	1.63e-15	6.46e-15	0.00e+00	1.12e-14
Te-131m	1.54e+06	5.32e+05	5.66e+05	1.09e+06	5.15e+06	0.00e+00	2.16e+07
Te-132	6.99e+06	3.10e+06	3.74e+06	4.51e+06	2.87e+07	0.00e+00	3.12e+07
Te-133m	3.48e-05	1.41e-05	1.74e-05	2.70e-05	1.34e-04	0.00e+00	1.07e-03
Te-134	5.16e-08	2.32e-08	3.10e-08	4.08e-08	2.15e-07	0.00e+00	2.36e-07
I-129	5.11e+09	3.13e+09	2.80e+09	2.05e+12	5.29e+09	0.00e+00	1.58e+08
I-130	6.12e+05	1.24e+06	6.37e+05	1.36e+08	1.85e+06	0.00e+00	5.78e+05
I-131	1.43e+08	1.44e+08	8.16e+07	4.75e+10	2.36e+08	0.00e+00	1.28e+07
I-132	8.91e+01	1.64e+02	7.53e+01	7.60e+03	2.51e+02	0.00e+00	1.93e+02
I-133	3.52e+06	4.35e+06	1.65e+06	8.08e+08	7.25e+06	0.00e+00	1.75e+06
I-134	1.42e-04	2.64e-04	1.21e-04	6.07e-03	4.03e-04	0.00e+00	1.75e-04
I-135	6.18e+04	1.11e+05	5.26e+04	9.86e+06	1.71e+05	0.00e+00	8.48e+04
Cs-134	1.60e+10	2.63e+10	5.55e+09	0.00e+00	8.15e+09	2.93e+09	1.42e+08
Cs-134m	1.06e+01	1.57e+01	1.02e+01	0.00e+00	8.26e+00	1.37e+00	1.98e+01

Conversion factors are in units of square meter-mrem/yr per uCi/sec for all nuclides except H-3, which is in units of mrem/yr per uCi/cubic meter.

**LEAFY VEGETABLE PATHWAY DOSE FACTORS DUE TO
RADIONUCLIDES OTHER THAN NOBLE GASES, R_i**

R_i factors for Child age group by nuclide.

Waterford Steam Electric Station

Pathway : Gaseous Release Leafy/Produce Vegetation Pathway R_i

Nuclide	Organ Dose Conversion Factors						
	Bone	Liver	T. Body	Thyroid	Kidney	Lung	GI-LLI
Cs-135	6.10e+09	4.25e+09	4.36e+08	0.00e+00	1.50e+09	5.01e+08	3.18e+07
Cs-136	8.23e+07	2.26e+08	1.46e+08	0.00e+00	1.21e+08	1.80e+07	7.95e+06
Cs-137	2.39e+10	2.29e+10	3.38e+09	0.00e+00	7.46e+09	2.68e+09	1.43e+08
Cs-138	5.69e-11	7.91e-11	5.02e-11	0.00e+00	5.57e-11	5.99e-12	3.64e-11
Cs-139	0.00e+00	0.00e+00	0.00e+00	0.00e+00	0.00e+00	0.00e+00	0.00e+00
Ba-139	4.69e-02	2.50e-05	1.36e-03	0.00e+00	2.18e-05	1.47e-05	2.70e+00
Ba-140	2.76e+08	2.42e+05	1.61e+07	0.00e+00	7.88e+04	1.44e+05	1.40e+08
Ba-141	1.54e-21	8.64e-25	5.02e-23	0.00e+00	7.47e-25	5.07e-24	8.79e-22
Ba-142	6.46e-39	0.00e+00	3.61e-40	0.00e+00	0.00e+00	0.00e+00	0.00e+00
La-140	3.24e+03	1.13e+03	3.82e+02	0.00e+00	0.00e+00	0.00e+00	3.16e+07
La-141	1.04e+00	2.41e-01	5.24e-02	0.00e+00	0.00e+00	0.00e+00	5.37e+04
La-142	3.20e-04	1.02e-04	3.19e-05	0.00e+00	0.00e+00	0.00e+00	2.02e+01
Ce-141	6.55e+05	3.27e+05	4.85e+04	0.00e+00	1.43e+05	0.00e+00	4.08e+08
Ce-143	1.71e+03	9.29e+05	1.35e+02	0.00e+00	3.90e+02	0.00e+00	1.36e+07
Ce-144	1.27e+08	3.98e+07	6.78e+06	0.00e+00	2.21e+07	0.00e+00	1.04e+10
Pr-143	1.45e+05	4.37e+04	7.22e+03	0.00e+00	2.36e+04	0.00e+00	1.57e+08
Pr-144	4.11e-26	1.27e-26	2.07e-27	0.00e+00	6.73e-27	0.00e+00	2.74e-23
Nd-147	7.14e+04	5.78e+04	4.48e+03	0.00e+00	3.17e+04	0.00e+00	9.16e+07
Pm-147	2.21e+07	1.58e+06	8.48e+05	0.00e+00	2.79e+06	0.00e+00	6.39e+08
Pm-148	3.36e+04	4.04e+03	2.62e+03	0.00e+00	6.87e+03	0.00e+00	1.08e+08
Pm-148m	2.28e+06	4.54e+05	4.54e+05	0.00e+00	6.73e+05	0.00e+00	1.28e+09
Pm-149	2.93e+03	3.12e+02	1.69e+02	0.00e+00	5.52e+02	0.00e+00	2.13e+07
Pm-151	5.72e+02	6.96e+01	4.53e+01	0.00e+00	1.18e+02	0.00e+00	7.90e+06
Sm-151	1.88e+07	2.80e+06	8.81e+05	0.00e+00	2.89e+06	0.00e+00	4.06e+08
Sm-153	1.42e+03	8.83e+02	8.51e+01	0.00e+00	2.69e+02	0.00e+00	1.17e+07
Eu-152	4.47e+07	8.14e+06	9.66e+06	0.00e+00	3.44e+07	0.00e+00	1.34e+09
Eu-154	1.69e+08	1.52e+07	1.39e+07	0.00e+00	6.68e+07	0.00e+00	3.53e+09
Eu-155	3.27e+07	2.35e+06	1.84e+06	0.00e+00	8.82e+06	0.00e+00	5.89e+09
Eu-156	2.58e+05	1.38e+05	2.86e+04	0.00e+00	8.89e+04	0.00e+00	3.13e+08
Tb-160	6.01e+06	0.00e+00	7.46e+05	0.00e+00	1.79e+06	0.00e+00	1.33e+09

Conversion factors are in units of square meter-mrem/yr per uCi/sec for all nuclides except H-3, which is in units of mrem/yr per uCi/cubic meter.

**LEAFY VEGETABLE PATHWAY DOSE FACTORS DUE TO
RADIONUCLIDES OTHER THAN NOBLE GASES, R_i**

R_i factors for Child age group by nuclide.

Waterford Steam Electric Station

Pathway : Gaseous Release Leafy/Produce Vegetation Pathway R_i

Nuclide	Organ Dose Conversion Factors						
	Bone	Liver	T. Body	Thyroid	Kidney	Lung	GI-LLI
Ho-166m	7.94e+07	1.66e+07	1.40e+07	0.00e+00	2.37e+07	0.00e+00	1.93e+09
W-181	2.03e+06	4.98e+05	6.85e+04	0.00e+00	0.00e+00	0.00e+00	1.81e+07
W-185	6.44e+07	1.61e+07	2.25e+06	0.00e+00	0.00e+00	0.00e+00	5.99e+08
W-187	6.41e+04	3.80e+04	1.70e+04	0.00e+00	0.00e+00	0.00e+00	5.34e+06
Pb-210	3.47e+12	8.90e+11	1.53e+11	0.00e+00	2.68e+12	0.00e+00	1.68e+08
Bi-210	2.06e+06	1.07e+07	1.18e+06	0.00e+00	1.20e+08	0.00e+00	5.41e+07
Po-210	7.66e+10	1.23e+11	1.85e+10	0.00e+00	3.81e+11	0.00e+00	3.30e+09
Ra-223	5.77e+10	6.67e+07	1.15e+10	0.00e+00	1.77e+09	0.00e+00	9.20e+08
Ra-224	5.36e+09	9.73e+06	1.07e+09	0.00e+00	2.58e+08	0.00e+00	2.94e+08
Ra-225	1.22e+11	1.09e+08	2.44e+10	0.00e+00	2.89e+09	0.00e+00	1.40e+09
Ra-226	4.23e+13	1.35e+09	3.47e+13	0.00e+00	3.59e+10	0.00e+00	2.51e+10
Ra-228	2.76e+13	7.16e+08	3.10e+13	0.00e+00	1.90e+10	0.00e+00	4.16e+09
Ac-225	4.16e+07	4.29e+07	2.79e+06	0.00e+00	4.58e+06	0.00e+00	9.54e+08
Ac-227	3.01e+11	4.84e+10	1.86e+10	0.00e+00	1.07e+10	0.00e+00	6.16e+09
Th-227	3.88e+08	5.28e+06	1.12e+07	0.00e+00	2.80e+07	0.00e+00	3.73e+09
Th-228	1.41e+11	1.81e+09	4.77e+09	0.00e+00	9.40e+09	0.00e+00	3.95e+10
Th-229	1.73e+12	4.34e+10	2.88e+10	0.00e+00	2.12e+11	0.00e+00	5.91e+09
Th-230	2.61e+11	1.31e+10	7.28e+09	0.00e+00	6.37e+10	0.00e+00	4.55e+09
Th-232	2.91e+11	1.12e+10	2.21e+08	0.00e+00	5.45e+10	0.00e+00	3.87e+09
Th-234	3.61e+06	1.59e+05	1.04e+05	0.00e+00	8.46e+05	0.00e+00	1.25e+09
Pa-231	5.20e+11	1.72e+10	2.07e+10	0.00e+00	9.41e+10	0.00e+00	5.42e+09
Pa-233	2.34e+05	3.65e+04	4.09e+04	0.00e+00	1.34e+05	0.00e+00	1.86e+08
U-232	1.29e+12	0.00e+00	9.24e+10	0.00e+00	9.83e+10	0.00e+00	5.12e+09
U-233	2.73e+11	0.00e+00	1.65e+10	0.00e+00	4.48e+10	0.00e+00	4.74e+09
U-234	2.62e+11	0.00e+00	1.62e+10	0.00e+00	4.40e+10	0.00e+00	4.65e+09
U-235	2.51e+11	0.00e+00	1.52e+10	0.00e+00	4.12e+10	0.00e+00	5.90e+09
U-236	2.51e+11	0.00e+00	1.56e+10	0.00e+00	4.21e+10	0.00e+00	4.35e+09
U-237	3.26e+05	0.00e+00	8.65e+04	0.00e+00	9.39e+05	0.00e+00	2.87e+07
U-238	2.40e+11	0.00e+00	1.43e+10	0.00e+00	3.85e+10	0.00e+00	4.16e+09
Np-237	1.64e+11	1.08e+10	7.20e+09	0.00e+00	4.45e+10	0.00e+00	6.00e+09

Conversion factors are in units of square meter-mrem/yr per uCi/sec for all nuclides except H-3, which is in units of mrem/yr per uCi/cubic meter.

**LEAFY VEGETABLE PATHWAY DOSE FACTORS DUE TO
RADIONUCLIDES OTHER THAN NOBLE GASES, R_i**

R_i factors for Child age group by nuclide.

Waterford Steam Electric Station

Pathway : Gaseous Release Leafy/Produce Vegetation Pathway R_i

Nuclide	Organ Dose Conversion Factors						
	Bone	Liver	T. Body	Thyroid	Kidney	Lung	GI-LLI
Np-238	2.51e+04	5.08e+02	3.91e+02	0.00e+00	1.62e+03	0.00e+00	1.74e+07
Np-239	2.56e+03	1.84e+02	1.29e+02	0.00e+00	5.31e+02	0.00e+00	1.36e+07
Pu-238	8.73e+10	1.01e+10	2.32e+09	0.00e+00	8.44e+09	0.00e+00	5.50e+09
Pu-239	9.48e+10	1.01e+10	2.43e+09	0.00e+00	8.97e+09	0.00e+00	5.03e+09
Pu-240	9.41e+10	1.05e+10	2.43e+09	0.00e+00	8.97e+09	0.00e+00	5.13e+09
Pu-241	2.82e+09	1.15e+08	5.85e+07	0.00e+00	2.15e+08	0.00e+00	1.05e+08
Pu-242	8.75e+10	1.01e+10	2.34e+09	0.00e+00	8.60e+09	0.00e+00	4.93e+09
Pu-244	1.02e+11	1.16e+11	2.68e+09	0.00e+00	9.92e+09	0.00e+00	7.35e+09
Am-241	9.67e+10	8.32e+10	7.25e+09	0.00e+00	4.43e+10	0.00e+00	5.43e+09
Am-242m	1.03e+11	8.22e+10	7.64e+09	0.00e+00	4.63e+10	0.00e+00	7.06e+09
Am-243	9.85e+10	8.31e+10	7.23e+09	0.00e+00	4.45e+10	0.00e+00	6.58e+09
Cm-242	4.69e+09	3.74e+09	3.12e+08	0.00e+00	9.98e+08	0.00e+00	4.35e+09
Cm-243	9.36e+10	7.61e+10	6.03e+09	0.00e+00	2.25e+10	0.00e+00	5.87e+09
Cm-244	7.87e+10	6.37e+10	5.05e+09	0.00e+00	1.85e+10	0.00e+00	5.67e+09
Cm-245	1.23e+11	9.85e+10	7.72e+09	0.00e+00	3.02e+10	0.00e+00	5.32e+09
Cm-246	1.21e+11	9.85e+10	7.72e+09	0.00e+00	3.01e+10	0.00e+00	5.23e+09
Cm-247	1.18e+11	9.70e+10	7.57e+09	0.00e+00	2.97e+10	0.00e+00	6.87e+09
Cm-248	9.85e+11	8.01e+11	6.26e+10	0.00e+00	2.45e+11	0.00e+00	1.11e+11
Cf-252	7.28e+10	0.00e+00	1.76e+09	0.00e+00	0.00e+00	0.00e+00	2.05e+10

Conversion factors are in units of square meter-mrem/yr per uCi/sec for all nuclides except H-3, which is in units of mrem/yr per uCi/cubic meter.

**LEAFY VEGETABLE PATHWAY DOSE FACTORS DUE TO
RADIONUCLIDES OTHER THAN NOBLE GASES, R_i**

R_i factors for Infant age group by nuclide.
Waterford Steam Electric Station
Pathway : Gaseous Release Leafy/Produce Vegetation Pathway R_i

Nuclide	Organ Dose Conversion Factors						
	Bone	Liver	T. Body	Thyroid	Kidney	Lung	GI-LLI
H-3	0.00e+00	0.00e+00	0.00e+00	0.00e+00	0.00e+00	0.00e+00	0.00e+00
Be-10	0.00e+00	0.00e+00	0.00e+00	0.00e+00	0.00e+00	0.00e+00	0.00e+00
C-14	0.00e+00	0.00e+00	0.00e+00	0.00e+00	0.00e+00	0.00e+00	0.00e+00
N-13	0.00e+00	0.00e+00	0.00e+00	0.00e+00	0.00e+00	0.00e+00	0.00e+00
F-18	0.00e+00	0.00e+00	0.00e+00	0.00e+00	0.00e+00	0.00e+00	0.00e+00
Na-22	0.00e+00	0.00e+00	0.00e+00	0.00e+00	0.00e+00	0.00e+00	0.00e+00
Na-24	0.00e+00	0.00e+00	0.00e+00	0.00e+00	0.00e+00	0.00e+00	0.00e+00
P-32	0.00e+00	0.00e+00	0.00e+00	0.00e+00	0.00e+00	0.00e+00	0.00e+00
Ca-41	0.00e+00	0.00e+00	0.00e+00	0.00e+00	0.00e+00	0.00e+00	0.00e+00
Sc-46	0.00e+00	0.00e+00	0.00e+00	0.00e+00	0.00e+00	0.00e+00	0.00e+00
Cr-51	0.00e+00	0.00e+00	0.00e+00	0.00e+00	0.00e+00	0.00e+00	0.00e+00
Mn-54	0.00e+00	0.00e+00	0.00e+00	0.00e+00	0.00e+00	0.00e+00	0.00e+00
Mn-56	0.00e+00	0.00e+00	0.00e+00	0.00e+00	0.00e+00	0.00e+00	0.00e+00
Fe-55	0.00e+00	0.00e+00	0.00e+00	0.00e+00	0.00e+00	0.00e+00	0.00e+00
Fe-59	0.00e+00	0.00e+00	0.00e+00	0.00e+00	0.00e+00	0.00e+00	0.00e+00
Co-57	0.00e+00	0.00e+00	0.00e+00	0.00e+00	0.00e+00	0.00e+00	0.00e+00
Co-58	0.00e+00	0.00e+00	0.00e+00	0.00e+00	0.00e+00	0.00e+00	0.00e+00
Co-60	0.00e+00	0.00e+00	0.00e+00	0.00e+00	0.00e+00	0.00e+00	0.00e+00
Ni-59	0.00e+00	0.00e+00	0.00e+00	0.00e+00	0.00e+00	0.00e+00	0.00e+00
Ni-63	0.00e+00	0.00e+00	0.00e+00	0.00e+00	0.00e+00	0.00e+00	0.00e+00
Ni-65	0.00e+00	0.00e+00	0.00e+00	0.00e+00	0.00e+00	0.00e+00	0.00e+00
Cu-64	0.00e+00	0.00e+00	0.00e+00	0.00e+00	0.00e+00	0.00e+00	0.00e+00
Zn-65	0.00e+00	0.00e+00	0.00e+00	0.00e+00	0.00e+00	0.00e+00	0.00e+00
Zn-69	0.00e+00	0.00e+00	0.00e+00	0.00e+00	0.00e+00	0.00e+00	0.00e+00
Zn-69m	0.00e+00	0.00e+00	0.00e+00	0.00e+00	0.00e+00	0.00e+00	0.00e+00
Se-79	0.00e+00	0.00e+00	0.00e+00	0.00e+00	0.00e+00	0.00e+00	0.00e+00
Br-82	0.00e+00	0.00e+00	0.00e+00	0.00e+00	0.00e+00	0.00e+00	0.00e+00
Br-83	0.00e+00	0.00e+00	0.00e+00	0.00e+00	0.00e+00	0.00e+00	0.00e+00
Br-84	0.00e+00	0.00e+00	0.00e+00	0.00e+00	0.00e+00	0.00e+00	0.00e+00
Br-85	0.00e+00	0.00e+00	0.00e+00	0.00e+00	0.00e+00	0.00e+00	0.00e+00

Conversion factors are in units of square meter-mrem/yr per uCi/sec for all nuclides except H-3, which is in units of mrem/yr per uCi/cubic meter.

**LEAFY VEGETABLE PATHWAY DOSE FACTORS DUE TO
RADIONUCLIDES OTHER THAN NOBLE GASES, R_i**

R_i factors for Infant age group by nuclide.
Waterford Steam Electric Station
Pathway : Gaseous Release Leafy/Produce Vegetation Pathway R_i

Nuclide	Organ Dose Conversion Factors						
	Bone	Liver	T. Body	Thyroid	Kidney	Lung	GI-LLI
Rb-86	0.00e+00	0.00e+00	0.00e+00	0.00e+00	0.00e+00	0.00e+00	0.00e+00
Rb-87	0.00e+00	0.00e+00	0.00e+00	0.00e+00	0.00e+00	0.00e+00	0.00e+00
Rb-88	0.00e+00	0.00e+00	0.00e+00	0.00e+00	0.00e+00	0.00e+00	0.00e+00
Rb-89	0.00e+00	0.00e+00	0.00e+00	0.00e+00	0.00e+00	0.00e+00	0.00e+00
Sr-89	0.00e+00	0.00e+00	0.00e+00	0.00e+00	0.00e+00	0.00e+00	0.00e+00
Sr-90	0.00e+00	0.00e+00	0.00e+00	0.00e+00	0.00e+00	0.00e+00	0.00e+00
Sr-91	0.00e+00	0.00e+00	0.00e+00	0.00e+00	0.00e+00	0.00e+00	0.00e+00
Sr-92	0.00e+00	0.00e+00	0.00e+00	0.00e+00	0.00e+00	0.00e+00	0.00e+00
Y-90	0.00e+00	0.00e+00	0.00e+00	0.00e+00	0.00e+00	0.00e+00	0.00e+00
Y-91	0.00e+00	0.00e+00	0.00e+00	0.00e+00	0.00e+00	0.00e+00	0.00e+00
Y-91m	0.00e+00	0.00e+00	0.00e+00	0.00e+00	0.00e+00	0.00e+00	0.00e+00
Y-92	0.00e+00	0.00e+00	0.00e+00	0.00e+00	0.00e+00	0.00e+00	0.00e+00
Y-93	0.00e+00	0.00e+00	0.00e+00	0.00e+00	0.00e+00	0.00e+00	0.00e+00
Zr-93	0.00e+00	0.00e+00	0.00e+00	0.00e+00	0.00e+00	0.00e+00	0.00e+00
Zr-95	0.00e+00	0.00e+00	0.00e+00	0.00e+00	0.00e+00	0.00e+00	0.00e+00
Zr-97	0.00e+00	0.00e+00	0.00e+00	0.00e+00	0.00e+00	0.00e+00	0.00e+00
Nb-93m	0.00e+00	0.00e+00	0.00e+00	0.00e+00	0.00e+00	0.00e+00	0.00e+00
Nb-95	0.00e+00	0.00e+00	0.00e+00	0.00e+00	0.00e+00	0.00e+00	0.00e+00
Nb-97	0.00e+00	0.00e+00	0.00e+00	0.00e+00	0.00e+00	0.00e+00	0.00e+00
Mo-93	0.00e+00	0.00e+00	0.00e+00	0.00e+00	0.00e+00	0.00e+00	0.00e+00
Mo-99	0.00e+00	0.00e+00	0.00e+00	0.00e+00	0.00e+00	0.00e+00	0.00e+00
Tc-101	0.00e+00	0.00e+00	0.00e+00	0.00e+00	0.00e+00	0.00e+00	0.00e+00
Tc-99	0.00e+00	0.00e+00	0.00e+00	0.00e+00	0.00e+00	0.00e+00	0.00e+00
Tc-99m	0.00e+00	0.00e+00	0.00e+00	0.00e+00	0.00e+00	0.00e+00	0.00e+00
Ru-103	0.00e+00	0.00e+00	0.00e+00	0.00e+00	0.00e+00	0.00e+00	0.00e+00
Ru-105	0.00e+00	0.00e+00	0.00e+00	0.00e+00	0.00e+00	0.00e+00	0.00e+00
Ru-106	0.00e+00	0.00e+00	0.00e+00	0.00e+00	0.00e+00	0.00e+00	0.00e+00
Rh-105	0.00e+00	0.00e+00	0.00e+00	0.00e+00	0.00e+00	0.00e+00	0.00e+00
Pd-107	0.00e+00	0.00e+00	0.00e+00	0.00e+00	0.00e+00	0.00e+00	0.00e+00
Pd-109	0.00e+00	0.00e+00	0.00e+00	0.00e+00	0.00e+00	0.00e+00	0.00e+00

Conversion factors are in units of square meter-mrem/yr per uCi/sec for all nuclides except H-3, which is in units of mrem/yr per uCi/cubic meter.

**LEAFY VEGETABLE PATHWAY DOSE FACTORS DUE TO
RADIONUCLIDES OTHER THAN NOBLE GASES, R_i**

R_i factors for Infant age group by nuclide.

Waterford Steam Electric Station

Pathway : Gaseous Release Leafy/Produce Vegetation Pathway R_i

Nuclide	Organ Dose Conversion Factors						
	Bone	Liver	T. Body	Thyroid	Kidney	Lung	GI-LLI
Ag-110m	0.00e+00	0.00e+00	0.00e+00	0.00e+00	0.00e+00	0.00e+00	0.00e+00
Ag-111	0.00e+00	0.00e+00	0.00e+00	0.00e+00	0.00e+00	0.00e+00	0.00e+00
Cd-113m	0.00e+00	0.00e+00	0.00e+00	0.00e+00	0.00e+00	0.00e+00	0.00e+00
Cd-115m	0.00e+00	0.00e+00	0.00e+00	0.00e+00	0.00e+00	0.00e+00	0.00e+00
Sn-123	0.00e+00	0.00e+00	0.00e+00	0.00e+00	0.00e+00	0.00e+00	0.00e+00
Sn-125	0.00e+00	0.00e+00	0.00e+00	0.00e+00	0.00e+00	0.00e+00	0.00e+00
Sn-126	0.00e+00	0.00e+00	0.00e+00	0.00e+00	0.00e+00	0.00e+00	0.00e+00
Sb-124	0.00e+00	0.00e+00	0.00e+00	0.00e+00	0.00e+00	0.00e+00	0.00e+00
Sb-125	0.00e+00	0.00e+00	0.00e+00	0.00e+00	0.00e+00	0.00e+00	0.00e+00
Sb-126	0.00e+00	0.00e+00	0.00e+00	0.00e+00	0.00e+00	0.00e+00	0.00e+00
Sb-127	0.00e+00	0.00e+00	0.00e+00	0.00e+00	0.00e+00	0.00e+00	0.00e+00
Te-125m	0.00e+00	0.00e+00	0.00e+00	0.00e+00	0.00e+00	0.00e+00	0.00e+00
Te-127	0.00e+00	0.00e+00	0.00e+00	0.00e+00	0.00e+00	0.00e+00	0.00e+00
Te-127m	0.00e+00	0.00e+00	0.00e+00	0.00e+00	0.00e+00	0.00e+00	0.00e+00
Te-129	0.00e+00	0.00e+00	0.00e+00	0.00e+00	0.00e+00	0.00e+00	0.00e+00
Te-129m	0.00e+00	0.00e+00	0.00e+00	0.00e+00	0.00e+00	0.00e+00	0.00e+00
Te-131	0.00e+00	0.00e+00	0.00e+00	0.00e+00	0.00e+00	0.00e+00	0.00e+00
Te-131m	0.00e+00	0.00e+00	0.00e+00	0.00e+00	0.00e+00	0.00e+00	0.00e+00
Te-132	0.00e+00	0.00e+00	0.00e+00	0.00e+00	0.00e+00	0.00e+00	0.00e+00
Te-133m	0.00e+00	0.00e+00	0.00e+00	0.00e+00	0.00e+00	0.00e+00	0.00e+00
Te-134	0.00e+00	0.00e+00	0.00e+00	0.00e+00	0.00e+00	0.00e+00	0.00e+00
I-129	0.00e+00	0.00e+00	0.00e+00	0.00e+00	0.00e+00	0.00e+00	0.00e+00
I-130	0.00e+00	0.00e+00	0.00e+00	0.00e+00	0.00e+00	0.00e+00	0.00e+00
I-131	0.00e+00	0.00e+00	0.00e+00	0.00e+00	0.00e+00	0.00e+00	0.00e+00
I-132	0.00e+00	0.00e+00	0.00e+00	0.00e+00	0.00e+00	0.00e+00	0.00e+00
I-133	0.00e+00	0.00e+00	0.00e+00	0.00e+00	0.00e+00	0.00e+00	0.00e+00
I-134	0.00e+00	0.00e+00	0.00e+00	0.00e+00	0.00e+00	0.00e+00	0.00e+00
I-135	0.00e+00	0.00e+00	0.00e+00	0.00e+00	0.00e+00	0.00e+00	0.00e+00
Cs-134	0.00e+00	0.00e+00	0.00e+00	0.00e+00	0.00e+00	0.00e+00	0.00e+00
Cs-134m	0.00e+00	0.00e+00	0.00e+00	0.00e+00	0.00e+00	0.00e+00	0.00e+00

Conversion factors are in units of square meter-mrem/yr per uCi/sec for all nuclides except H-3, which is in units of mrem/yr per uCi/cubic meter.

**LEAFY VEGETABLE PATHWAY DOSE FACTORS DUE TO
RADIONUCLIDES OTHER THAN NOBLE GASES, R_i**

R_i factors for Infant age group by nuclide.
Waterford Steam Electric Station
Pathway : Gaseous Release Leafy/Produce Vegetation Pathway R_i

Nuclide	Organ Dose Conversion Factors						
	Bone	Liver	T. Body	Thyroid	Kidney	Lung	GI-LLI
Cs-135	0.00e+00	0.00e+00	0.00e+00	0.00e+00	0.00e+00	0.00e+00	0.00e+00
Cs-136	0.00e+00	0.00e+00	0.00e+00	0.00e+00	0.00e+00	0.00e+00	0.00e+00
Cs-137	0.00e+00	0.00e+00	0.00e+00	0.00e+00	0.00e+00	0.00e+00	0.00e+00
Cs-138	0.00e+00	0.00e+00	0.00e+00	0.00e+00	0.00e+00	0.00e+00	0.00e+00
Cs-139	0.00e+00	0.00e+00	0.00e+00	0.00e+00	0.00e+00	0.00e+00	0.00e+00
Ba-139	0.00e+00	0.00e+00	0.00e+00	0.00e+00	0.00e+00	0.00e+00	0.00e+00
Ba-140	0.00e+00	0.00e+00	0.00e+00	0.00e+00	0.00e+00	0.00e+00	0.00e+00
Ba-141	0.00e+00	0.00e+00	0.00e+00	0.00e+00	0.00e+00	0.00e+00	0.00e+00
Ba-142	0.00e+00	0.00e+00	0.00e+00	0.00e+00	0.00e+00	0.00e+00	0.00e+00
La-140	0.00e+00	0.00e+00	0.00e+00	0.00e+00	0.00e+00	0.00e+00	0.00e+00
La-141	0.00e+00	0.00e+00	0.00e+00	0.00e+00	0.00e+00	0.00e+00	0.00e+00
La-142	0.00e+00	0.00e+00	0.00e+00	0.00e+00	0.00e+00	0.00e+00	0.00e+00
Ce-141	0.00e+00	0.00e+00	0.00e+00	0.00e+00	0.00e+00	0.00e+00	0.00e+00
Ce-143	0.00e+00	0.00e+00	0.00e+00	0.00e+00	0.00e+00	0.00e+00	0.00e+00
Ce-144	0.00e+00	0.00e+00	0.00e+00	0.00e+00	0.00e+00	0.00e+00	0.00e+00
Pr-143	0.00e+00	0.00e+00	0.00e+00	0.00e+00	0.00e+00	0.00e+00	0.00e+00
Pr-144	0.00e+00	0.00e+00	0.00e+00	0.00e+00	0.00e+00	0.00e+00	0.00e+00
Nd-147	0.00e+00	0.00e+00	0.00e+00	0.00e+00	0.00e+00	0.00e+00	0.00e+00
Pm-147	0.00e+00	0.00e+00	0.00e+00	0.00e+00	0.00e+00	0.00e+00	0.00e+00
Pm-148	0.00e+00	0.00e+00	0.00e+00	0.00e+00	0.00e+00	0.00e+00	0.00e+00
Pm-148m	0.00e+00	0.00e+00	0.00e+00	0.00e+00	0.00e+00	0.00e+00	0.00e+00
Pm-149	0.00e+00	0.00e+00	0.00e+00	0.00e+00	0.00e+00	0.00e+00	0.00e+00
Pm-151	0.00e+00	0.00e+00	0.00e+00	0.00e+00	0.00e+00	0.00e+00	0.00e+00
Sm-151	0.00e+00	0.00e+00	0.00e+00	0.00e+00	0.00e+00	0.00e+00	0.00e+00
Sm-153	0.00e+00	0.00e+00	0.00e+00	0.00e+00	0.00e+00	0.00e+00	0.00e+00
Eu-152	0.00e+00	0.00e+00	0.00e+00	0.00e+00	0.00e+00	0.00e+00	0.00e+00
Eu-154	0.00e+00	0.00e+00	0.00e+00	0.00e+00	0.00e+00	0.00e+00	0.00e+00
Eu-155	0.00e+00	0.00e+00	0.00e+00	0.00e+00	0.00e+00	0.00e+00	0.00e+00
Eu-156	0.00e+00	0.00e+00	0.00e+00	0.00e+00	0.00e+00	0.00e+00	0.00e+00
Tb-160	0.00e+00	0.00e+00	0.00e+00	0.00e+00	0.00e+00	0.00e+00	0.00e+00

Conversion factors are in units of square meter-mrem/yr per uCi/sec for all nuclides except H-3, which is in units of mrem/yr per uCi/cubic meter.

**LEAFY VEGETABLE PATHWAY DOSE FACTORS DUE TO
RADIONUCLIDES OTHER THAN NOBLE GASES, R_i**

R_i factors for Infant age group by nuclide.

Waterford Steam Electric Station

Pathway : Gaseous Release Leafy/Produce Vegetation Pathway R_i

Nuclide	Organ Dose Conversion Factors						
	Bone	Liver	T. Body	Thyroid	Kidney	Lung	GI-LLI
Ho-166m	0.00e+00	0.00e+00	0.00e+00	0.00e+00	0.00e+00	0.00e+00	0.00e+00
W-181	0.00e+00	0.00e+00	0.00e+00	0.00e+00	0.00e+00	0.00e+00	0.00e+00
W-185	0.00e+00	0.00e+00	0.00e+00	0.00e+00	0.00e+00	0.00e+00	0.00e+00
W-187	0.00e+00	0.00e+00	0.00e+00	0.00e+00	0.00e+00	0.00e+00	0.00e+00
Pb-210	0.00e+00	0.00e+00	0.00e+00	0.00e+00	0.00e+00	0.00e+00	0.00e+00
Bi-210	0.00e+00	0.00e+00	0.00e+00	0.00e+00	0.00e+00	0.00e+00	0.00e+00
Po-210	0.00e+00	0.00e+00	0.00e+00	0.00e+00	0.00e+00	0.00e+00	0.00e+00
Ra-223	0.00e+00	0.00e+00	0.00e+00	0.00e+00	0.00e+00	0.00e+00	0.00e+00
Ra-224	0.00e+00	0.00e+00	0.00e+00	0.00e+00	0.00e+00	0.00e+00	0.00e+00
Ra-225	0.00e+00	0.00e+00	0.00e+00	0.00e+00	0.00e+00	0.00e+00	0.00e+00
Ra-226	0.00e+00	0.00e+00	0.00e+00	0.00e+00	0.00e+00	0.00e+00	0.00e+00
Ra-228	0.00e+00	0.00e+00	0.00e+00	0.00e+00	0.00e+00	0.00e+00	0.00e+00
Ac-225	0.00e+00	0.00e+00	0.00e+00	0.00e+00	0.00e+00	0.00e+00	0.00e+00
Ac-227	0.00e+00	0.00e+00	0.00e+00	0.00e+00	0.00e+00	0.00e+00	0.00e+00
Th-227	0.00e+00	0.00e+00	0.00e+00	0.00e+00	0.00e+00	0.00e+00	0.00e+00
Th-228	0.00e+00	0.00e+00	0.00e+00	0.00e+00	0.00e+00	0.00e+00	0.00e+00
Th-229	0.00e+00	0.00e+00	0.00e+00	0.00e+00	0.00e+00	0.00e+00	0.00e+00
Th-230	0.00e+00	0.00e+00	0.00e+00	0.00e+00	0.00e+00	0.00e+00	0.00e+00
Th-232	0.00e+00	0.00e+00	0.00e+00	0.00e+00	0.00e+00	0.00e+00	0.00e+00
Th-234	0.00e+00	0.00e+00	0.00e+00	0.00e+00	0.00e+00	0.00e+00	0.00e+00
Pa-231	0.00e+00	0.00e+00	0.00e+00	0.00e+00	0.00e+00	0.00e+00	0.00e+00
Pa-233	0.00e+00	0.00e+00	0.00e+00	0.00e+00	0.00e+00	0.00e+00	0.00e+00
U-232	0.00e+00	0.00e+00	0.00e+00	0.00e+00	0.00e+00	0.00e+00	0.00e+00
U-233	0.00e+00	0.00e+00	0.00e+00	0.00e+00	0.00e+00	0.00e+00	0.00e+00
U-234	0.00e+00	0.00e+00	0.00e+00	0.00e+00	0.00e+00	0.00e+00	0.00e+00
U-235	0.00e+00	0.00e+00	0.00e+00	0.00e+00	0.00e+00	0.00e+00	0.00e+00
U-236	0.00e+00	0.00e+00	0.00e+00	0.00e+00	0.00e+00	0.00e+00	0.00e+00
U-237	0.00e+00	0.00e+00	0.00e+00	0.00e+00	0.00e+00	0.00e+00	0.00e+00
U-238	0.00e+00	0.00e+00	0.00e+00	0.00e+00	0.00e+00	0.00e+00	0.00e+00
Np-237	0.00e+00	0.00e+00	0.00e+00	0.00e+00	0.00e+00	0.00e+00	0.00e+00

Conversion factors are in units of square meter-mrem/yr per uCi/sec for all nuclides except H-3, which is in units of mrem/yr per uCi/cubic meter.

**LEAFY VEGETABLE PATHWAY DOSE FACTORS DUE TO
RADIONUCLIDES OTHER THAN NOBLE GASES, R_i**

R_i factors for Infant age group by nuclide.

Waterford Steam Electric Station

Pathway : Gaseous Release Leafy/Produce Vegetation Pathway R_i

Nuclide	Organ Dose Conversion Factors						
	Bone	Liver	T. Body	Thyroid	Kidney	Lung	GI-LLI
Np-238	0.00e+00	0.00e+00	0.00e+00	0.00e+00	0.00e+00	0.00e+00	0.00e+00
Np-239	0.00e+00	0.00e+00	0.00e+00	0.00e+00	0.00e+00	0.00e+00	0.00e+00
Pu-238	0.00e+00	0.00e+00	0.00e+00	0.00e+00	0.00e+00	0.00e+00	0.00e+00
Pu-239	0.00e+00	0.00e+00	0.00e+00	0.00e+00	0.00e+00	0.00e+00	0.00e+00
Pu-240	0.00e+00	0.00e+00	0.00e+00	0.00e+00	0.00e+00	0.00e+00	0.00e+00
Pu-241	0.00e+00	0.00e+00	0.00e+00	0.00e+00	0.00e+00	0.00e+00	0.00e+00
Pu-242	0.00e+00	0.00e+00	0.00e+00	0.00e+00	0.00e+00	0.00e+00	0.00e+00
Pu-244	0.00e+00	0.00e+00	0.00e+00	0.00e+00	0.00e+00	0.00e+00	0.00e+00
Am-241	0.00e+00	0.00e+00	0.00e+00	0.00e+00	0.00e+00	0.00e+00	0.00e+00
Am-242m	0.00e+00	0.00e+00	0.00e+00	0.00e+00	0.00e+00	0.00e+00	0.00e+00
Am-243	0.00e+00	0.00e+00	0.00e+00	0.00e+00	0.00e+00	0.00e+00	0.00e+00
Cm-242	0.00e+00	0.00e+00	0.00e+00	0.00e+00	0.00e+00	0.00e+00	0.00e+00
Cm-243	0.00e+00	0.00e+00	0.00e+00	0.00e+00	0.00e+00	0.00e+00	0.00e+00
Cm-244	0.00e+00	0.00e+00	0.00e+00	0.00e+00	0.00e+00	0.00e+00	0.00e+00
Cm-245	0.00e+00	0.00e+00	0.00e+00	0.00e+00	0.00e+00	0.00e+00	0.00e+00
Cm-246	0.00e+00	0.00e+00	0.00e+00	0.00e+00	0.00e+00	0.00e+00	0.00e+00
Cm-247	0.00e+00	0.00e+00	0.00e+00	0.00e+00	0.00e+00	0.00e+00	0.00e+00
Cm-248	0.00e+00	0.00e+00	0.00e+00	0.00e+00	0.00e+00	0.00e+00	0.00e+00
Cf-252	0.00e+00	0.00e+00	0.00e+00	0.00e+00	0.00e+00	0.00e+00	0.00e+00

Conversion factors are in units of square meter-mrem/yr per uCi/sec for all nuclides except H-3, which is in units of mrem/yr per uCi/cubic meter.

**GOAT's MILK PATHWAY DOSE FACTORS DUE TO
RADIONUCLIDES OTHER THAN NOBLE GASES, R_i**

R_i factors for Adult age group by nuclide.
Waterford Steam Electric Station
Pathway : Gaseous Release Goat's Milk Pathway R_i

Nuclide	Organ Dose Conversion Factors						
	Bone	Liver	T. Body	Thyroid	Kidney	Lung	GI-LLI
H-3	0.00e+00	8.88e+02	8.88e+02	8.88e+02	8.88e+02	8.88e+02	8.88e+02
Be-10	2.95e+05	4.55e+04	7.36e+03	0.00e+00	3.44e+04	0.00e+00	2.49e+06
C-14	2.63e+08	5.27e+07	5.27e+07	5.27e+07	5.27e+07	5.27e+07	5.27e+07
N-13	0.00e+00	0.00e+00	0.00e+00	0.00e+00	0.00e+00	0.00e+00	0.00e+00
F-18	5.58e-04	0.00e+00	6.19e-05	0.00e+00	0.00e+00	0.00e+00	1.65e-05
Na-22	6.35e+08	6.35e+08	6.35e+08	6.35e+08	6.35e+08	6.35e+08	6.35e+08
Na-24	2.93e+05	2.93e+05	2.93e+05	2.93e+05	2.93e+05	2.93e+05	2.93e+05
P-32	2.05e+10	1.28e+09	7.93e+08	0.00e+00	0.00e+00	0.00e+00	2.31e+09
Ca-41	1.37e+09	0.00e+00	1.48e+08	0.00e+00	0.00e+00	0.00e+00	1.37e+06
Sc-46	2.15e+01	4.18e+01	1.22e+01	0.00e+00	3.90e+01	0.00e+00	2.04e+05
Cr-51	0.00e+00	0.00e+00	3.43e+03	2.05e+03	7.55e+02	4.55e+03	8.62e+05
Mn-54	0.00e+00	1.01e+06	1.93e+05	0.00e+00	3.00e+05	0.00e+00	3.09e+06
Mn-56	0.00e+00	4.98e-04	8.84e-05	0.00e+00	6.33e-04	0.00e+00	1.59e-02
Fe-55	3.26e+05	2.26e+05	5.26e+04	0.00e+00	0.00e+00	1.26e+05	1.29e+05
Fe-59	3.86e+05	9.07e+05	3.48e+05	0.00e+00	0.00e+00	2.54e+05	3.02e+06
Co-57	0.00e+00	1.54e+05	2.55e+05	0.00e+00	0.00e+00	0.00e+00	3.89e+06
Co-58	0.00e+00	5.66e+05	1.27e+06	0.00e+00	0.00e+00	0.00e+00	1.15e+07
Co-60	0.00e+00	1.97e+06	4.34e+06	0.00e+00	0.00e+00	0.00e+00	3.70e+07
Ni-59	6.06e+07	2.08e+07	1.01e+07	0.00e+00	0.00e+00	0.00e+00	4.29e+06
Ni-63	8.07e+08	5.60e+07	2.71e+07	0.00e+00	0.00e+00	0.00e+00	1.17e+07
Ni-65	4.51e-02	5.86e-03	2.67e-03	0.00e+00	0.00e+00	0.00e+00	1.49e-01
Cu-64	0.00e+00	2.66e+03	1.25e+03	0.00e+00	6.72e+03	0.00e+00	2.27e+05
Zn-65	1.65e+08	5.24e+08	2.37e+08	0.00e+00	3.50e+08	0.00e+00	3.30e+08
Zn-69	2.62e-13	5.00e-13	3.48e-14	0.00e+00	3.25e-13	0.00e+00	7.52e-14
Zn-69m	2.18e+04	5.22e+04	4.78e+03	0.00e+00	3.16e+04	0.00e+00	3.19e+06
Se-79	0.00e+00	1.10e+08	1.83e+07	0.00e+00	1.90e+08	0.00e+00	2.25e+07
Br-82	0.00e+00	0.00e+00	3.88e+06	0.00e+00	0.00e+00	0.00e+00	4.44e+06
Br-83	0.00e+00	0.00e+00	1.18e-02	0.00e+00	0.00e+00	0.00e+00	1.71e-02
Br-84	0.00e+00	0.00e+00	2.08e-24	0.00e+00	0.00e+00	0.00e+00	1.63e-29
Br-85	0.00e+00	0.00e+00	0.00e+00	0.00e+00	0.00e+00	0.00e+00	0.00e+00

Conversion factors are in units of square meter-mrem/yr per uCi/sec for all nuclides except H-3, which is in units of mrem/yr per uCi/cubic meter.

**GOAT's MILK PATHWAY DOSE FACTORS DUE TO
RADIONUCLIDES OTHER THAN NOBLE GASES, R_i**

Ri factors for Adult age group by nuclide.
Waterford Steam Electric Station
Pathway : Gaseous Release Goat's Milk Pathway Ri

Nuclide	Organ Dose Conversion Factors						
	Bone	Liver	T. Body	Thyroid	Kidney	Lung	GI-LLI
Rb-86	0.00e+00	3.11e+08	1.45e+08	0.00e+00	0.00e+00	0.00e+00	6.14e+07
Rb-87	0.00e+00	3.42e+08	1.19e+08	0.00e+00	0.00e+00	0.00e+00	1.60e+07
Rb-88	0.00e+00	0.00e+00	0.00e+00	0.00e+00	0.00e+00	0.00e+00	0.00e+00
Rb-89	0.00e+00	0.00e+00	0.00e+00	0.00e+00	0.00e+00	0.00e+00	0.00e+00
Sr-89	3.05e+09	0.00e+00	8.74e+07	0.00e+00	0.00e+00	0.00e+00	4.89e+08
Sr-90	1.13e+11	0.00e+00	2.27e+09	0.00e+00	0.00e+00	0.00e+00	2.84e+09
Sr-91	6.10e+04	0.00e+00	2.46e+03	0.00e+00	0.00e+00	0.00e+00	2.90e+05
Sr-92	1.04e+00	0.00e+00	4.50e-02	0.00e+00	0.00e+00	0.00e+00	2.06e+01
Y-90	8.51e+00	0.00e+00	2.28e-01	0.00e+00	0.00e+00	0.00e+00	9.02e+04
Y-91	1.03e+03	0.00e+00	2.76e+01	0.00e+00	0.00e+00	0.00e+00	5.67e+05
Y-91m	7.52e-21	0.00e+00	2.91e-22	0.00e+00	0.00e+00	0.00e+00	2.21e-20
Y-92	6.77e-06	0.00e+00	1.98e-07	0.00e+00	0.00e+00	0.00e+00	1.19e-01
Y-93	2.69e-02	0.00e+00	7.43e-04	0.00e+00	0.00e+00	0.00e+00	8.53e+02
Zr-93	1.94e+02	1.09e+01	5.05e+00	0.00e+00	4.11e+01	0.00e+00	1.13e+04
Zr-95	1.13e+02	3.63e+01	2.46e+01	0.00e+00	5.70e+01	0.00e+00	1.15e+05
Zr-97	5.21e-02	1.05e-02	4.81e-03	0.00e+00	1.59e-02	0.00e+00	3.26e+03
Nb-93m	5.89e+04	1.92e+04	4.74e+03	0.00e+00	2.21e+04	0.00e+00	8.88e+06
Nb-95	9.91e+03	5.51e+03	2.96e+03	0.00e+00	5.45e+03	0.00e+00	3.34e+07
Nb-97	7.89e-13	2.00e-13	7.29e-14	0.00e+00	2.33e-13	0.00e+00	7.37e-10
Mo-93	0.00e+00	5.22e+07	1.41e+06	0.00e+00	1.48e+07	0.00e+00	8.49e+06
Mo-99	0.00e+00	2.97e+06	5.66e+05	0.00e+00	6.73e+06	0.00e+00	6.89e+06
Tc-101	0.00e+00	0.00e+00	0.00e+00	0.00e+00	0.00e+00	0.00e+00	0.00e+00
Tc-99	2.90e+06	4.31e+06	1.16e+06	0.00e+00	5.43e+07	3.66e+05	1.41e+08
Tc-99m	4.01e-01	1.13e+00	1.44e+01	0.00e+00	1.72e+01	5.55e-01	6.71e+02
Ru-103	1.22e+02	0.00e+00	5.26e+01	0.00e+00	4.66e+02	0.00e+00	1.43e+04
Ru-105	1.04e-04	0.00e+00	4.09e-05	0.00e+00	1.34e-03	0.00e+00	6.34e-02
Ru-106	2.45e+03	0.00e+00	3.10e+02	0.00e+00	4.73e+03	0.00e+00	1.58e+05
Rh-105	4.15e+04	3.04e+04	2.00e+04	0.00e+00	1.29e+05	0.00e+00	4.84e+06
Pd-107	0.00e+00	1.36e+06	8.72e+04	0.00e+00	1.22e+07	0.00e+00	8.45e+06
Pd-109	0.00e+00	5.39e+03	1.22e+03	0.00e+00	3.08e+04	0.00e+00	5.97e+05

Conversion factors are in units of square meter-mrem/yr per uCi/sec for all nuclides except H-3, which is in units of mrem/yr per uCi/cubic meter.

**GOAT's MILK PATHWAY DOSE FACTORS DUE TO
RADIONUCLIDES OTHER THAN NOBLE GASES, R_i**

R_i factors for Adult age group by nuclide.
Waterford Steam Electric Station
Pathway : Gaseous Release Goat's Milk Pathway R_i

Nuclide	Organ Dose Conversion Factors						
	Bone	Liver	T. Body	Thyroid	Kidney	Lung	GI-LLI
Ag-110m	6.99e+06	6.46e+06	3.84e+06	0.00e+00	1.27e+07	0.00e+00	2.64e+09
Ag-111	7.77e+05	3.25e+05	1.62e+05	0.00e+00	1.05e+06	0.00e+00	5.96e+08
Cd-113m	0.00e+00	3.53e+05	1.13e+04	0.00e+00	3.88e+05	0.00e+00	2.84e+06
Cd-115m	0.00e+00	1.51e+05	4.82e+03	0.00e+00	1.20e+05	0.00e+00	6.36e+06
Sn-123	6.43e+07	1.07e+06	1.57e+06	9.06e+05	0.00e+00	0.00e+00	1.31e+08
Sn-125	6.81e+06	1.37e+05	3.09e+05	1.14e+05	0.00e+00	0.00e+00	8.50e+07
Sn-126	1.96e+08	3.87e+06	5.56e+06	1.14e+06	0.00e+00	0.00e+00	5.63e+07
Sb-124	3.09e+06	5.83e+04	1.22e+06	7.49e+03	0.00e+00	2.40e+06	8.77e+07
Sb-125	2.45e+06	2.74e+04	5.84e+05	2.49e+03	0.00e+00	1.89e+06	2.70e+07
Sb-126	6.75e+05	1.37e+04	2.44e+05	4.13e+03	0.00e+00	4.14e+05	5.52e+07
Sb-127	5.44e+04	1.19e+03	2.09e+04	6.54e+02	0.00e+00	3.23e+04	1.24e+07
Te-125m	1.95e+06	7.08e+05	2.62e+05	5.88e+05	7.95e+06	0.00e+00	7.80e+06
Te-127	7.87e+01	2.82e+01	1.70e+01	5.83e+01	3.20e+02	0.00e+00	6.21e+03
Te-127m	5.49e+06	1.96e+06	6.69e+05	1.40e+06	2.23e+07	0.00e+00	1.84e+07
Te-129	3.50e-11	1.32e-11	8.53e-12	2.69e-11	1.47e-10	0.00e+00	2.64e-11
Te-129m	7.22e+06	2.69e+06	1.14e+06	2.48e+06	3.02e+07	0.00e+00	3.64e+07
Te-131	4.74e-34	1.98e-34	1.50e-34	3.90e-34	2.08e-33	0.00e+00	6.72e-35
Te-131m	4.34e+04	2.12e+04	1.77e+04	3.36e+04	2.15e+05	0.00e+00	2.11e+06
Te-132	2.88e+05	1.86e+05	1.75e+05	2.06e+05	1.80e+06	0.00e+00	8.82e+06
Te-133m	2.63e-14	1.54e-14	1.48e-14	2.23e-14	1.52e-13	0.00e+00	5.28e-15
Te-134	1.13e-19	7.39e-20	4.53e-20	9.86e-20	7.14e-19	0.00e+00	1.25e-22
I-129	9.10e+07	7.82e+07	2.56e+08	2.01e+11	1.68e+08	0.00e+00	1.24e+07
I-130	5.06e+04	1.49e+05	5.89e+04	1.26e+07	2.33e+05	0.00e+00	1.28e+05
I-131	3.55e+07	5.08e+07	2.91e+07	1.67e+10	8.71e+07	0.00e+00	1.34e+07
I-132	2.00e-02	5.36e-02	1.88e-02	1.88e+00	8.54e-02	0.00e+00	1.01e-02
I-133	4.65e+05	8.09e+05	2.47e+05	1.19e+08	1.41e+06	0.00e+00	7.27e+05
I-134	2.53e-13	6.87e-13	2.46e-13	1.19e-11	1.09e-12	0.00e+00	5.99e-16
I-135	1.55e+03	4.06e+03	1.50e+03	2.68e+05	6.51e+03	0.00e+00	4.58e+03
Cs-134	1.70e+10	4.03e+10	3.30e+10	0.00e+00	1.31e+10	4.33e+09	7.06e+08
Cs-134m	5.28e-01	1.11e+00	5.68e-01	0.00e+00	6.02e-01	9.49e-02	3.92e-01

Conversion factors are in units of square meter-mrem/yr per uCi/sec for all nuclides except H-3, which is in units of mrem/yr per uCi/cubic meter.

**GOAT's MILK PATHWAY DOSE FACTORS DUE TO
RADIONUCLIDES OTHER THAN NOBLE GASES, R_i**

R_i factors for Adult age group by nuclide.
Waterford Steam Electric Station
Pathway : Gaseous Release Goat's Milk Pathway R_i

Nuclide	Organ Dose Conversion Factors						
	Bone	Liver	T. Body	Thyroid	Kidney	Lung	GI-LLI
Cs-135	5.43e+09	5.01e+09	2.22e+09	0.00e+00	1.89e+09	5.68e+08	1.17e+08
Cs-136	7.90e+08	3.12e+09	2.24e+09	0.00e+00	1.73e+09	2.38e+08	3.54e+08
Cs-137	2.21e+10	3.03e+10	1.98e+10	0.00e+00	1.03e+10	3.42e+09	5.86e+08
Cs-138	2.91e-23	5.76e-23	2.85e-23	0.00e+00	4.23e-23	4.18e-24	2.46e-28
Cs-139	0.00e+00	0.00e+00	0.00e+00	0.00e+00	0.00e+00	0.00e+00	0.00e+00
Ba-139	5.45e-09	3.88e-12	1.60e-10	0.00e+00	3.63e-12	2.20e-12	9.67e-09
Ba-140	3.23e+06	4.05e+03	2.11e+05	0.00e+00	1.38e+03	2.32e+03	6.64e+06
Ba-141	0.00e+00	0.00e+00	0.00e+00	0.00e+00	0.00e+00	0.00e+00	0.00e+00
Ba-142	0.00e+00	0.00e+00	0.00e+00	0.00e+00	0.00e+00	0.00e+00	0.00e+00
La-140	5.42e-01	2.73e-01	7.22e-02	0.00e+00	0.00e+00	0.00e+00	2.00e+04
La-141	3.60e-06	1.12e-06	1.83e-07	0.00e+00	0.00e+00	0.00e+00	1.33e-01
La-142	2.28e-12	1.04e-12	2.59e-13	0.00e+00	0.00e+00	0.00e+00	7.58e-09
Ce-141	5.81e+02	3.93e+02	4.46e+01	0.00e+00	1.83e+02	0.00e+00	1.50e+06
Ce-143	4.99e+00	3.69e+03	4.09e-01	0.00e+00	1.63e+00	0.00e+00	1.38e+05
Ce-144	4.29e+04	1.79e+04	2.30e+03	0.00e+00	1.06e+04	0.00e+00	1.45e+07
Pr-143	1.89e+01	7.60e+00	9.39e-01	0.00e+00	4.39e+00	0.00e+00	8.30e+04
Pr-144	0.00e+00	0.00e+00	0.00e+00	0.00e+00	0.00e+00	0.00e+00	0.00e+00
Nd-147	1.13e+01	1.31e+01	7.81e-01	0.00e+00	7.63e+00	0.00e+00	6.27e+04
Pm-147	3.44e+02	3.24e+01	1.31e+01	0.00e+00	6.11e+01	0.00e+00	4.08e+04
Pm-148	7.12e+00	1.18e+00	5.95e-01	0.00e+00	2.23e+00	0.00e+00	9.28e+04
Pm-148m	1.03e+02	2.66e+01	2.04e+01	0.00e+00	4.02e+01	0.00e+00	2.26e+05
Pm-149	5.13e-01	7.26e-02	2.96e-02	0.00e+00	1.37e-01	0.00e+00	1.36e+04
Pm-151	7.76e-02	1.30e-02	6.58e-03	0.00e+00	2.33e-02	0.00e+00	3.58e+03
Sm-151	3.20e+02	5.52e+01	1.32e+01	0.00e+00	6.16e+01	0.00e+00	2.43e+04
Sm-153	2.39e-01	1.99e-01	1.45e-02	0.00e+00	6.43e-02	0.00e+00	7.10e+03
Eu-152	9.01e+02	2.05e+02	1.80e+02	0.00e+00	1.27e+03	0.00e+00	1.18e+05
Eu-154	2.85e+03	3.50e+02	2.49e+02	0.00e+00	1.68e+03	0.00e+00	2.54e+05
Eu-155	3.90e+02	5.53e+01	3.57e+01	0.00e+00	2.55e+02	0.00e+00	4.35e+04
Eu-156	3.02e+01	2.34e+01	3.77e+00	0.00e+00	1.56e+01	0.00e+00	1.60e+05
Tb-160	1.79e+02	0.00e+00	2.23e+01	0.00e+00	7.39e+01	0.00e+00	1.65e+05

Conversion factors are in units of square meter-mrem/yr per uCi/sec for all nuclides except H-3, which is in units of mrem/yr per uCi/cubic meter.

**GOAT's MILK PATHWAY DOSE FACTORS DUE TO
RADIONUCLIDES OTHER THAN NOBLE GASES, R_i**

R_i factors for Adult age group by nuclide.
Waterford Steam Electric Station
Pathway : Gaseous Release Goat's Milk Pathway R_i

Nuclide	Organ Dose Conversion Factors						
	Bone	Liver	T. Body	Thyroid	Kidney	Lung	GI-LLI
Ho-166m	1.25e+03	3.91e+02	2.97e+02	0.00e+00	5.84e+02	0.00e+00	1.19e+05
W-181	4.07e+03	1.33e+03	1.42e+02	0.00e+00	0.00e+00	0.00e+00	1.51e+05
W-185	1.55e+05	5.18e+04	5.45e+03	0.00e+00	0.00e+00	0.00e+00	5.99e+06
W-187	7.83e+02	6.54e+02	2.29e+02	0.00e+00	0.00e+00	0.00e+00	2.14e+05
Pb-210	8.78e+09	2.51e+09	3.12e+08	0.00e+00	7.06e+09	0.00e+00	1.29e+06
Bi-210	4.27e+04	2.95e+05	2.45e+04	0.00e+00	3.55e+06	0.00e+00	4.40e+06
Po-210	8.90e+07	1.89e+08	2.15e+07	0.00e+00	6.30e+08	0.00e+00	1.59e+07
Ra-223	1.47e+10	2.26e+07	2.93e+09	0.00e+00	6.40e+08	0.00e+00	9.46e+08
Ra-224	1.70e+09	4.11e+06	3.40e+08	0.00e+00	1.16e+08	0.00e+00	3.58e+08
Ra-225	2.28e+10	2.70e+07	4.55e+09	0.00e+00	7.67e+08	0.00e+00	1.06e+09
Ra-226	2.24e+12	4.26e+07	1.63e+12	0.00e+00	1.21e+09	0.00e+00	2.46e+09
Ra-228	8.25e+11	2.30e+07	8.91e+11	0.00e+00	6.50e+08	0.00e+00	4.15e+08
Ac-225	7.40e+03	1.02e+04	4.98e+02	0.00e+00	1.16e+03	0.00e+00	6.85e+05
Ac-227	8.65e+06	1.15e+06	5.14e+05	0.00e+00	3.70e+05	0.00e+00	3.79e+05
Th-227	3.36e+04	6.07e+02	9.67e+02	0.00e+00	3.45e+03	0.00e+00	1.32e+06
Th-228	2.25e+06	3.81e+04	7.62e+04	0.00e+00	2.12e+05	0.00e+00	2.55e+06
Th-229	6.31e+07	1.80e+06	1.04e+06	0.00e+00	8.72e+06	0.00e+00	3.62e+05
Th-230	9.55e+06	5.43e+05	2.64e+05	0.00e+00	2.62e+06	0.00e+00	2.79e+05
Th-232	1.07e+07	4.64e+05	6.96e+03	0.00e+00	2.24e+06	0.00e+00	2.37e+05
Th-234	2.22e+02	1.30e+01	6.40e+00	0.00e+00	7.39e+01	0.00e+00	3.13e+05
Pa-231	1.90e+07	7.14e+05	7.37e+05	0.00e+00	4.01e+06	0.00e+00	3.32e+05
Pa-233	1.53e+01	3.09e+00	2.66e+00	0.00e+00	1.16e+01	0.00e+00	4.78e+04
U-232	1.91e+09	0.00e+00	1.37e+08	0.00e+00	2.07e+08	0.00e+00	3.14e+07
U-233	4.04e+08	0.00e+00	2.45e+07	0.00e+00	9.41e+07	0.00e+00	2.91e+07
U-234	3.88e+08	0.00e+00	2.40e+07	0.00e+00	9.23e+07	0.00e+00	2.85e+07
U-235	3.71e+08	0.00e+00	2.25e+07	0.00e+00	8.67e+07	0.00e+00	3.62e+07
U-236	3.71e+08	0.00e+00	2.30e+07	0.00e+00	8.86e+07	0.00e+00	2.67e+07
U-237	6.78e+03	0.00e+00	1.81e+03	0.00e+00	2.79e+04	0.00e+00	2.38e+06
U-238	3.56e+08	0.00e+00	2.11e+07	0.00e+00	8.11e+07	0.00e+00	2.55e+07
Np-237	5.84e+06	4.15e+05	2.57e+05	0.00e+00	1.91e+06	0.00e+00	3.68e+05

Conversion factors are in units of square meter-mrem/yr per uCi/sec for all nuclides except H-3, which is in units of mrem/yr per uCi/cubic meter.

**GOAT's MILK PATHWAY DOSE FACTORS DUE TO
RADIONUCLIDES OTHER THAN NOBLE GASES, R_i**

R_i factors for Adult age group by nuclide.
Waterford Steam Electric Station
Pathway : Gaseous Release Goat's Milk Pathway R_i

Nuclide	Organ Dose Conversion Factors						
	Bone	Liver	T. Body	Thyroid	Kidney	Lung	GI-LLI
Np-238	4.34e+00	1.17e-01	6.75e-02	0.00e+00	3.96e-01	0.00e+00	1.09e+04
Np-239	4.41e-01	4.34e-02	2.39e-02	0.00e+00	1.35e-01	0.00e+00	8.89e+03
Pu-238	1.17e+06	1.48e+05	3.17e+04	0.00e+00	1.36e+05	0.00e+00	1.35e+05
Pu-239	1.34e+06	1.62e+05	3.54e+04	0.00e+00	1.50e+05	0.00e+00	1.24e+05
Pu-240	1.34e+06	1.61e+05	3.54e+04	0.00e+00	1.50e+05	0.00e+00	1.26e+05
Pu-241	2.90e+04	1.38e+03	6.14e+02	0.00e+00	2.83e+03	0.00e+00	2.59e+03
Pu-242	1.25e+06	1.56e+05	3.41e+04	0.00e+00	1.45e+05	0.00e+00	1.21e+05
Pu-244	1.45e+06	1.78e+05	3.91e+04	0.00e+00	1.66e+05	0.00e+00	1.80e+05
Am-241	3.47e+06	3.24e+06	2.48e+05	0.00e+00	1.87e+06	0.00e+00	3.41e+05
Am-242m	3.53e+06	3.07e+06	2.52e+05	0.00e+00	1.88e+06	0.00e+00	4.33e+05
Am-243	3.50e+06	3.20e+06	2.46e+05	0.00e+00	1.85e+06	0.00e+00	4.03e+05
Cm-242	8.72e+04	9.27e+04	5.80e+03	0.00e+00	2.63e+04	0.00e+00	3.35e+05
Cm-243	2.77e+06	2.54e+06	1.74e+05	0.00e+00	8.10e+05	0.00e+00	3.62e+05
Cm-244	2.11e+06	1.98e+06	1.33e+05	0.00e+00	6.20e+05	0.00e+00	3.49e+05
Cm-245	4.35e+06	3.79e+06	2.67e+05	0.00e+00	1.25e+06	0.00e+00	3.26e+05
Cm-246	4.31e+06	3.78e+06	2.67e+05	0.00e+00	1.24e+06	0.00e+00	3.20e+05
Cm-247	4.21e+06	3.73e+06	2.63e+05	0.00e+00	1.22e+06	0.00e+00	4.21e+05
Cm-248	3.50e+07	3.07e+07	2.17e+06	0.00e+00	1.01e+07	0.00e+00	6.82e+06
Cf-252	1.19e+06	0.00e+00	2.87e+04	0.00e+00	0.00e+00	0.00e+00	1.31e+06

Conversion factors are in units of square meter-mrem/yr per uCi/sec for all nuclides except H-3, which is in units of mrem/yr per uCi/cubic meter.

**GOAT's MILK PATHWAY DOSE FACTORS DUE TO
RADIONUCLIDES OTHER THAN NOBLE GASES, R_i**

Ri factors for Teen age group by nuclide.
Waterford Steam Electric Station
Pathway : Gaseous Release Goat's Milk Pathway Ri

Nuclide	Organ Dose Conversion Factors						
	Bone	Liver	T. Body	Thyroid	Kidney	Lung	GI-LLI
H-3	0.00e+00	1.16e+03	1.16e+03	1.16e+03	1.16e+03	1.16e+03	1.16e+03
Be-10	5.36e+05	8.30e+04	1.35e+04	0.00e+00	6.34e+04	0.00e+00	3.40e+06
C-14	4.86e+08	9.72e+07	9.72e+07	9.72e+07	9.72e+07	9.72e+07	9.72e+07
N-13	0.00e+00	0.00e+00	0.00e+00	0.00e+00	0.00e+00	0.00e+00	0.00e+00
F-18	9.97e-04	0.00e+00	1.09e-04	0.00e+00	0.00e+00	0.00e+00	8.97e-05
Na-22	1.10e+09	1.10e+09	1.10e+09	1.10e+09	1.10e+09	1.10e+09	1.10e+09
Na-24	5.12e+05	5.12e+05	5.12e+05	5.12e+05	5.12e+05	5.12e+05	5.12e+05
P-32	3.79e+10	2.35e+09	1.47e+09	0.00e+00	0.00e+00	0.00e+00	3.18e+09
Ca-41	1.89e+09	0.00e+00	2.04e+08	0.00e+00	0.00e+00	0.00e+00	1.87e+06
Sc-46	3.65e+01	7.11e+01	2.11e+01	0.00e+00	6.81e+01	0.00e+00	2.42e+05
Cr-51	0.00e+00	0.00e+00	5.99e+03	3.33e+03	1.31e+03	8.55e+03	1.01e+06
Mn-54	0.00e+00	1.68e+06	3.34e+05	0.00e+00	5.02e+05	0.00e+00	3.45e+06
Mn-56	0.00e+00	8.83e-04	1.57e-04	0.00e+00	1.12e-03	0.00e+00	5.81e-02
Fe-55	5.79e+05	4.10e+05	9.57e+04	0.00e+00	0.00e+00	2.60e+05	1.78e+05
Fe-59	6.74e+05	1.57e+06	6.07e+05	0.00e+00	0.00e+00	4.96e+05	3.72e+06
Co-57	0.00e+00	2.69e+05	4.52e+05	0.00e+00	0.00e+00	0.00e+00	5.03e+06
Co-58	0.00e+00	9.52e+05	2.19e+06	0.00e+00	0.00e+00	0.00e+00	1.31e+07
Co-60	0.00e+00	3.34e+06	7.51e+06	0.00e+00	0.00e+00	0.00e+00	4.34e+07
Ni-59	1.06e+08	3.74e+07	1.80e+07	0.00e+00	0.00e+00	0.00e+00	5.86e+06
Ni-63	1.42e+09	1.00e+08	4.81e+07	0.00e+00	0.00e+00	0.00e+00	1.59e+07
Ni-65	8.25e-02	1.05e-02	4.80e-03	0.00e+00	0.00e+00	0.00e+00	5.72e-01
Cu-64	0.00e+00	4.75e+03	2.23e+03	0.00e+00	1.20e+04	0.00e+00	3.68e+05
Zn-65	2.53e+08	8.78e+08	4.09e+08	0.00e+00	5.62e+08	0.00e+00	3.72e+08
Zn-69	4.82e-13	9.18e-13	6.42e-14	0.00e+00	6.00e-13	0.00e+00	1.69e-12
Zn-69m	3.96e+04	9.35e+04	8.57e+03	0.00e+00	5.68e+04	0.00e+00	5.14e+06
Se-79	0.00e+00	2.01e+08	3.38e+07	0.00e+00	3.50e+08	0.00e+00	3.07e+07
Br-82	0.00e+00	0.00e+00	6.73e+06	0.00e+00	0.00e+00	0.00e+00	0.00e+00
Br-83	0.00e+00	0.00e+00	2.18e-02	0.00e+00	0.00e+00	0.00e+00	0.00e+00
Br-84	0.00e+00	0.00e+00	3.71e-24	0.00e+00	0.00e+00	0.00e+00	0.00e+00
Br-85	0.00e+00	0.00e+00	0.00e+00	0.00e+00	0.00e+00	0.00e+00	0.00e+00

Conversion factors are in units of square meter-mrem/yr per uCi/sec for all nuclides except H-3, which is in units of mrem/yr per uCi/cubic meter.

**GOAT's MILK PATHWAY DOSE FACTORS DUE TO
RADIONUCLIDES OTHER THAN NOBLE GASES, R_i**

Ri factors for Teen age group by nuclide.
Waterford Steam Electric Station
Pathway : Gaseous Release Goat's Milk Pathway Ri

Nuclide	Organ Dose Conversion Factors						
	Bone	Liver	T. Body	Thyroid	Kidney	Lung	GI-LLI
Rb-86	0.00e+00	5.67e+08	2.67e+08	0.00e+00	0.00e+00	0.00e+00	8.40e+07
Rb-87	0.00e+00	6.28e+08	2.19e+08	0.00e+00	0.00e+00	0.00e+00	2.19e+07
Rb-88	0.00e+00	0.00e+00	0.00e+00	0.00e+00	0.00e+00	0.00e+00	0.00e+00
Rb-89	0.00e+00	0.00e+00	0.00e+00	0.00e+00	0.00e+00	0.00e+00	0.00e+00
Sr-89	5.62e+09	0.00e+00	1.61e+08	0.00e+00	0.00e+00	0.00e+00	6.69e+08
Sr-90	1.71e+11	0.00e+00	3.41e+09	0.00e+00	0.00e+00	0.00e+00	3.90e+09
Sr-91	1.12e+05	0.00e+00	4.46e+03	0.00e+00	0.00e+00	0.00e+00	5.08e+05
Sr-92	1.90e+00	0.00e+00	8.11e-02	0.00e+00	0.00e+00	0.00e+00	4.85e+01
Y-90	1.56e+01	0.00e+00	4.21e-01	0.00e+00	0.00e+00	0.00e+00	1.29e+05
Y-91	1.90e+03	0.00e+00	5.08e+01	0.00e+00	0.00e+00	0.00e+00	7.77e+05
Y-91m	1.38e-20	0.00e+00	5.26e-22	0.00e+00	0.00e+00	0.00e+00	6.50e-19
Y-92	1.25e-05	0.00e+00	3.62e-07	0.00e+00	0.00e+00	0.00e+00	3.43e-01
Y-93	4.96e-02	0.00e+00	1.36e-03	0.00e+00	0.00e+00	0.00e+00	1.52e+03
Zr-93	3.31e+02	1.63e+01	8.91e+00	0.00e+00	5.77e+01	0.00e+00	1.54e+04
Zr-95	1.98e+02	6.25e+01	4.30e+01	0.00e+00	9.18e+01	0.00e+00	1.44e+05
Zr-97	9.48e-02	1.88e-02	8.64e-03	0.00e+00	2.84e-02	0.00e+00	5.08e+03
Nb-93m	1.03e+05	3.37e+04	8.44e+03	0.00e+00	3.94e+04	0.00e+00	1.21e+07
Nb-95	1.69e+04	9.37e+03	5.16e+03	0.00e+00	9.08e+03	0.00e+00	4.01e+07
Nb-97	1.44e-12	3.57e-13	1.30e-13	0.00e+00	4.18e-13	0.00e+00	8.53e-09
Mo-93	0.00e+00	9.51e+07	2.60e+06	0.00e+00	2.73e+07	0.00e+00	1.16e+07
Mo-99	0.00e+00	5.37e+06	1.02e+06	0.00e+00	1.23e+07	0.00e+00	9.62e+06
Tc-101	0.00e+00	0.00e+00	0.00e+00	0.00e+00	0.00e+00	0.00e+00	0.00e+00
Tc-99	5.35e+06	7.87e+06	2.14e+06	0.00e+00	9.99e+07	8.14e+05	1.93e+08
Tc-99m	6.96e-01	1.94e+00	2.51e+01	0.00e+00	2.89e+01	1.08e+00	1.27e+03
Ru-103	2.17e+02	0.00e+00	9.29e+01	0.00e+00	7.66e+02	0.00e+00	1.81e+04
Ru-105	1.89e-04	0.00e+00	7.35e-05	0.00e+00	2.39e-03	0.00e+00	1.53e-01
Ru-106	4.50e+03	0.00e+00	5.67e+02	0.00e+00	8.68e+03	0.00e+00	2.16e+05
Rh-105	7.66e+04	5.54e+04	3.63e+04	0.00e+00	2.35e+05	0.00e+00	7.04e+06
Pd-107	0.00e+00	2.49e+06	1.60e+05	0.00e+00	2.25e+07	0.00e+00	1.16e+07
Pd-109	0.00e+00	9.87e+03	2.24e+03	0.00e+00	5.70e+04	0.00e+00	9.95e+05

Conversion factors are in units of square meter-mrem/yr per uCi/sec for all nuclides except H-3, which is in units of mrem/yr per uCi/cubic meter.

**GOAT'S MILK PATHWAY DOSE FACTORS DUE TO
RADIONUCLIDES OTHER THAN NOBLE GASES, R_i**

Ri factors for Teen age group by nuclide.
Waterford Steam Electric Station
Pathway : Gaseous Release Goat's Milk Pathway Ri

Nuclide	Organ Dose Conversion Factors						
	Bone	Liver	T. Body	Thyroid	Kidney	Lung	GI-LLI
Ag-110m	1.16e+07	1.09e+07	6.65e+06	0.00e+00	2.08e+07	0.00e+00	3.07e+09
Ag-111	1.43e+06	5.93e+05	2.98e+05	0.00e+00	1.93e+06	0.00e+00	8.28e+08
Cd-113m	0.00e+00	6.46e+05	2.08e+04	0.00e+00	7.14e+05	0.00e+00	3.88e+06
Cd-115m	0.00e+00	2.75e+05	8.89e+03	0.00e+00	2.20e+05	0.00e+00	8.72e+06
Sn-123	1.19e+08	1.95e+06	2.88e+06	1.56e+06	0.00e+00	0.00e+00	1.79e+08
Sn-125	1.26e+07	2.50e+05	5.66e+05	1.96e+05	0.00e+00	0.00e+00	1.18e+08
Sn-126	3.47e+08	6.46e+06	9.87e+06	1.70e+06	0.00e+00	0.00e+00	7.72e+07
Sb-124	5.51e+06	1.01e+05	2.15e+06	1.25e+04	0.00e+00	4.81e+06	1.11e+08
Sb-125	4.38e+06	4.79e+04	1.03e+06	4.19e+03	0.00e+00	3.85e+06	3.41e+07
Sb-126	1.20e+06	2.46e+04	4.33e+05	6.81e+03	0.00e+00	8.64e+05	7.13e+07
Sb-127	9.88e+04	2.11e+03	3.73e+04	1.11e+03	0.00e+00	6.72e+04	1.68e+07
Te-125m	3.60e+06	1.30e+06	4.82e+05	1.01e+06	0.00e+00	0.00e+00	1.06e+07
Te-127	1.46e+02	5.17e+01	3.14e+01	1.01e+02	5.91e+02	0.00e+00	1.13e+04
Te-127m	1.01e+07	3.59e+06	1.20e+06	2.41e+06	4.10e+07	0.00e+00	2.52e+07
Te-129	6.45e-11	2.40e-11	1.57e-11	4.61e-11	2.71e-10	0.00e+00	3.53e-10
Te-129m	1.32e+07	4.90e+06	2.09e+06	4.26e+06	5.53e+07	0.00e+00	4.96e+07
Te-131	8.67e-34	3.57e-34	2.71e-34	6.68e-34	3.79e-33	0.00e+00	7.11e-35
Te-131m	7.89e+04	3.79e+04	3.16e+04	5.69e+04	3.95e+05	0.00e+00	3.04e+06
Te-132	5.15e+05	3.26e+05	3.07e+05	3.44e+05	3.13e+06	0.00e+00	1.03e+07
Te-133m	4.74e-14	2.69e-14	2.62e-14	3.76e-14	2.66e-13	0.00e+00	1.09e-13
Te-134	2.01e-19	1.29e-19	1.35e-19	1.65e-19	1.23e-18	0.00e+00	7.47e-21
I-129	1.67e+08	1.41e+08	2.35e+08	1.71e+11	2.52e+08	0.00e+00	1.64e+07
I-130	8.89e+04	2.57e+05	1.03e+05	2.10e+07	3.96e+05	0.00e+00	1.98e+05
I-131	6.45e+07	9.03e+07	4.85e+07	2.63e+10	1.55e+08	0.00e+00	1.79e+07
I-132	3.55e-02	9.30e-02	3.34e-02	3.13e+00	1.47e-01	0.00e+00	4.05e-02
I-133	8.50e+05	1.44e+06	4.40e+05	2.01e+08	2.53e+06	0.00e+00	1.09e+06
I-134	4.49e-13	1.19e-12	4.28e-13	1.98e-11	1.88e-12	0.00e+00	1.57e-14
I-135	2.75e+03	7.09e+03	2.63e+03	4.56e+05	1.12e+04	0.00e+00	7.85e+03
Cs-134	2.94e+10	6.93e+10	3.22e+10	0.00e+00	2.20e+10	8.41e+09	8.62e+08
Cs-134m	9.40e-01	1.95e+00	1.00e+00	0.00e+00	1.08e+00	1.90e-01	1.30e+00

Conversion factors are in units of square meter-mrem/yr per uCi/sec for all nuclides except H-3, which is in units of mrem/yr per uCi/cubic meter.

**GOAT's MILK PATHWAY DOSE FACTORS DUE TO
RADIONUCLIDES OTHER THAN NOBLE GASES, R_i**

R_i factors for Teen age group by nuclide.
Waterford Steam Electric Station
Pathway : Gaseous Release Goat's Milk Pathway R_i

Nuclide	Organ Dose Conversion Factors						
	Bone	Liver	T. Body	Thyroid	Kidney	Lung	GI-LLI
Cs-135	9.98e+09	9.15e+09	2.14e+09	0.00e+00	3.49e+09	1.26e+09	1.60e+08
Cs-136	1.34e+09	5.29e+09	3.55e+09	0.00e+00	2.88e+09	4.54e+08	4.26e+08
Cs-137	4.02e+10	5.34e+10	1.86e+10	0.00e+00	1.82e+10	7.06e+09	7.60e+08
Cs-138	5.29e-23	1.02e-22	5.08e-23	0.00e+00	7.49e-23	8.72e-24	4.61e-26
Cs-139	0.00e+00	0.00e+00	0.00e+00	0.00e+00	0.00e+00	0.00e+00	0.00e+00
Ba-139	1.01e-08	7.09e-12	2.94e-10	0.00e+00	6.69e-12	4.89e-12	8.99e-08
Ba-140	5.82e+06	7.14e+03	3.75e+05	0.00e+00	2.42e+03	4.80e+03	8.98e+06
Ba-141	0.00e+00	0.00e+00	0.00e+00	0.00e+00	0.00e+00	0.00e+00	0.00e+00
Ba-142	0.00e+00	0.00e+00	0.00e+00	0.00e+00	0.00e+00	0.00e+00	0.00e+00
La-140	9.73e-01	4.78e-01	1.27e-01	0.00e+00	0.00e+00	0.00e+00	2.75e+04
La-141	6.63e-06	2.04e-06	3.36e-07	0.00e+00	0.00e+00	0.00e+00	3.61e-01
La-142	4.12e-12	1.83e-12	4.56e-13	0.00e+00	0.00e+00	0.00e+00	5.57e-08
Ce-141	1.07e+03	7.12e+02	8.17e+01	0.00e+00	3.35e+02	0.00e+00	2.04e+06
Ce-143	9.18e+00	6.68e+03	7.46e-01	0.00e+00	2.99e+00	0.00e+00	2.01e+05
Ce-144	7.90e+04	3.27e+04	4.24e+03	0.00e+00	1.95e+04	0.00e+00	1.99e+07
Pr-143	3.48e+01	1.39e+01	1.73e+00	0.00e+00	8.08e+00	0.00e+00	1.15e+05
Pr-144	0.00e+00	0.00e+00	0.00e+00	0.00e+00	0.00e+00	0.00e+00	0.00e+00
Nd-147	2.17e+01	2.36e+01	1.42e+00	0.00e+00	1.39e+01	0.00e+00	8.53e+04
Pm-147	6.18e+02	5.86e+01	2.39e+01	0.00e+00	1.12e+02	0.00e+00	5.58e+04
Pm-148	1.31e+01	2.13e+00	1.07e+00	0.00e+00	3.84e+00	0.00e+00	1.27e+05
Pm-148m	1.79e+02	4.54e+01	3.55e+01	0.00e+00	6.87e+01	0.00e+00	2.86e+05
Pm-149	9.45e-01	1.33e-01	5.45e-02	0.00e+00	2.53e-01	0.00e+00	1.96e+04
Pm-151	1.42e-01	2.34e-02	1.19e-02	0.00e+00	4.21e-02	0.00e+00	5.26e+03
Sm-151	5.22e+02	1.00e+02	2.36e+01	0.00e+00	1.10e+02	0.00e+00	3.41e+04
Sm-153	4.38e-01	3.63e-01	2.67e-02	0.00e+00	1.19e-01	0.00e+00	1.02e+04
Eu-152	1.46e+03	3.52e+02	3.10e+02	0.00e+00	1.63e+03	0.00e+00	1.29e+05
Eu-154	4.73e+03	6.10e+02	4.30e+02	0.00e+00	2.73e+03	0.00e+00	3.22e+05
Eu-155	1.02e+03	9.82e+01	6.08e+01	0.00e+00	3.84e+02	0.00e+00	5.63e+05
Eu-156	5.46e+01	4.09e+01	6.68e+00	0.00e+00	2.75e+01	0.00e+00	2.09e+05
Tb-160	3.18e+02	0.00e+00	3.97e+01	0.00e+00	1.26e+02	0.00e+00	2.06e+05

Conversion factors are in units of square meter-mrem/yr per uCi/sec for all nuclides except H-3, which is in units of mrem/yr per uCi/cubic meter.

**GOAT's MILK PATHWAY DOSE FACTORS DUE TO
RADIONUCLIDES OTHER THAN NOBLE GASES, R_i**

Ri factors for Teen age group by nuclide.
Waterford Steam Electric Station
Pathway : Gaseous Release Goat's Milk Pathway Ri

Nuclide	Organ Dose Conversion Factors						
	Bone	Liver	T. Body	Thyroid	Kidney	Lung	GI-LLI
Ho-166m	2.14e+03	6.58e+02	4.76e+02	0.00e+00	9.63e+02	0.00e+00	1.62e+05
W-181	7.53e+03	2.43e+03	2.54e+02	0.00e+00	0.00e+00	0.00e+00	2.07e+05
W-185	2.87e+05	9.46e+04	1.00e+04	0.00e+00	0.00e+00	0.00e+00	8.17e+06
W-187	1.43e+03	1.17e+03	4.09e+02	0.00e+00	0.00e+00	0.00e+00	3.16e+05
Pb-210	1.34e+10	4.03e+09	5.19e+08	0.00e+00	1.27e+10	0.00e+00	1.75e+06
Bi-210	7.88e+04	5.39e+05	4.51e+04	0.00e+00	6.55e+06	0.00e+00	6.16e+06
Po-210	1.64e+08	3.45e+08	3.97e+07	0.00e+00	1.16e+09	0.00e+00	2.18e+07
Ra-223	2.71e+10	4.11e+07	5.40e+09	0.00e+00	1.18e+09	0.00e+00	1.30e+09
Ra-224	3.14e+09	7.50e+06	6.26e+08	0.00e+00	2.15e+08	0.00e+00	5.04e+08
Ra-225	4.20e+10	4.93e+07	8.38e+09	0.00e+00	1.41e+09	0.00e+00	1.46e+09
Ra-226	3.08e+12	7.78e+07	2.29e+12	0.00e+00	2.22e+09	0.00e+00	3.36e+09
Ra-228	1.30e+12	4.19e+07	1.44e+12	0.00e+00	1.20e+09	0.00e+00	5.68e+08
Ac-225	1.37e+04	1.86e+04	9.16e+02	0.00e+00	2.14e+03	0.00e+00	9.46e+05
Ac-227	1.22e+07	1.81e+06	7.29e+05	0.00e+00	5.26e+05	0.00e+00	5.18e+05
Th-227	6.19e+04	1.11e+03	1.79e+03	0.00e+00	6.35e+03	0.00e+00	1.82e+06
Th-228	3.98e+06	6.67e+04	1.35e+05	0.00e+00	3.75e+05	0.00e+00	3.49e+06
Th-229	8.56e+07	2.46e+06	1.42e+06	0.00e+00	1.19e+07	0.00e+00	4.95e+05
Th-230	1.29e+07	7.36e+05	3.59e+05	0.00e+00	3.58e+06	0.00e+00	3.82e+05
Th-232	1.45e+07	6.28e+05	9.75e+03	0.00e+00	3.06e+06	0.00e+00	3.25e+05
Th-234	4.07e+02	2.39e+01	1.18e+01	0.00e+00	1.36e+02	0.00e+00	4.32e+05
Pa-231	2.58e+07	9.69e+05	1.01e+06	0.00e+00	5.44e+06	0.00e+00	4.55e+05
Pa-233	2.76e+01	5.31e+00	4.74e+00	0.00e+00	2.00e+01	0.00e+00	6.06e+04
U-232	3.52e+09	0.00e+00	2.52e+08	0.00e+00	3.82e+08	0.00e+00	4.30e+07
U-233	7.42e+08	0.00e+00	4.51e+07	0.00e+00	1.74e+08	0.00e+00	3.98e+07
U-234	7.12e+08	0.00e+00	4.42e+07	0.00e+00	1.71e+08	0.00e+00	3.90e+07
U-235	6.82e+08	0.00e+00	4.15e+07	0.00e+00	1.60e+08	0.00e+00	4.95e+07
U-236	6.82e+08	0.00e+00	4.24e+07	0.00e+00	1.63e+08	0.00e+00	3.66e+07
U-237	1.25e+04	0.00e+00	3.33e+03	0.00e+00	5.14e+04	0.00e+00	3.31e+06
U-238	6.52e+08	0.00e+00	3.88e+07	0.00e+00	1.50e+08	0.00e+00	3.49e+07
Np-237	7.96e+06	5.71e+05	3.50e+05	0.00e+00	2.59e+06	0.00e+00	5.03e+05

Conversion factors are in units of square meter-mrem/yr per uCi/sec for all nuclides except H-3, which is in units of mrem/yr per uCi/cubic meter.

**GOAT's MILK PATHWAY DOSE FACTORS DUE TO
RADIONUCLIDES OTHER THAN NOBLE GASES, R_i**

Ri factors for Teen age group by nuclide.
Waterford Steam Electric Station
Pathway : Gaseous Release Goat's Milk Pathway Ri

Nuclide	Organ Dose Conversion Factors						
	Bone	Liver	T. Body	Thyroid	Kidney	Lung	GI-LLI
Np-238	7.98e+00	2.14e-01	1.24e-01	0.00e+00	7.32e-01	0.00e+00	1.57e+04
Np-239	8.42e-01	7.94e-02	4.41e-02	0.00e+00	2.49e-01	0.00e+00	1.28e+04
Pu-238	1.60e+06	2.05e+05	4.35e+04	0.00e+00	1.87e+05	0.00e+00	1.85e+05
Pu-239	1.83e+06	2.22e+05	4.81e+04	0.00e+00	2.05e+05	0.00e+00	1.69e+05
Pu-240	1.83e+06	2.22e+05	4.81e+04	0.00e+00	2.05e+05	0.00e+00	1.72e+05
Pu-241	4.18e+04	2.00e+03	8.81e+02	0.00e+00	4.08e+03	0.00e+00	3.53e+03
Pu-242	1.70e+06	2.14e+05	4.64e+04	0.00e+00	1.97e+05	0.00e+00	1.66e+05
Pu-244	1.98e+06	2.44e+05	5.31e+04	0.00e+00	2.26e+05	0.00e+00	2.47e+05
Am-241	4.73e+06	4.46e+06	3.41e+05	0.00e+00	2.55e+06	0.00e+00	4.66e+05
Am-242m	4.83e+06	4.25e+06	3.47e+05	0.00e+00	2.57e+06	0.00e+00	5.92e+05
Am-243	4.76e+06	4.40e+06	3.36e+05	0.00e+00	2.52e+06	0.00e+00	5.52e+05
Cm-242	1.61e+05	1.69e+05	1.07e+04	0.00e+00	4.86e+04	0.00e+00	4.59e+05
Cm-243	3.88e+06	3.60e+06	2.44e+05	0.00e+00	1.14e+06	0.00e+00	4.95e+05
Cm-244	3.01e+06	2.85e+06	1.90e+05	0.00e+00	8.89e+05	0.00e+00	4.78e+05
Cm-245	5.92e+06	5.21e+06	3.65e+05	0.00e+00	1.71e+06	0.00e+00	4.46e+05
Cm-246	5.88e+06	5.21e+06	3.64e+05	0.00e+00	1.70e+06	0.00e+00	4.39e+05
Cm-247	5.73e+06	5.13e+06	3.59e+05	0.00e+00	1.68e+06	0.00e+00	5.76e+05
Cm-248	4.76e+07	4.22e+07	2.96e+06	0.00e+00	1.38e+07	0.00e+00	9.27e+06
Cf-252	2.04e+06	0.00e+00	4.92e+04	0.00e+00	0.00e+00	0.00e+00	1.79e+06

Conversion factors are in units of square meter-mrem/yr per uCi/sec for all nuclides except H-3, which is in units of mrem/yr per uCi/cubic meter.

**GOAT's MILK PATHWAY DOSE FACTORS DUE TO
RADIONUCLIDES OTHER THAN NOBLE GASES, R_i**

Ri factors for Child age group by nuclide.
Waterford Steam Electric Station
Pathway : Gaseous Release Goat's Milk Pathway Ri

Nuclide	Organ Dose Conversion Factors						
	Bone	Liver	T. Body	Thyroid	Kidney	Lung	GI-LLI
H-3	0.00e+00	1.83e+03	1.83e+03	1.83e+03	1.83e+03	1.83e+03	1.83e+03
Be-10	1.33e+06	1.55e+05	3.35e+04	0.00e+00	1.10e+05	0.00e+00	2.71e+06
C-14	1.19e+09	2.39e+08	2.39e+08	2.39e+08	2.39e+08	2.39e+08	2.39e+08
N-13	0.00e+00	0.00e+00	0.00e+00	0.00e+00	0.00e+00	0.00e+00	0.00e+00
F-18	2.37e-03	0.00e+00	2.35e-04	0.00e+00	0.00e+00	0.00e+00	6.41e-04
Na-22	2.28e+09	2.28e+09	2.28e+09	2.28e+09	2.28e+09	2.28e+09	2.28e+09
Na-24	1.07e+06	1.07e+06	1.07e+06	1.07e+06	1.07e+06	1.07e+06	1.07e+06
P-32	9.33e+10	4.37e+09	3.60e+09	0.00e+00	0.00e+00	0.00e+00	2.58e+09
Ca-41	2.74e+09	0.00e+00	2.99e+08	0.00e+00	0.00e+00	0.00e+00	1.50e+06
Sc-46	8.20e+01	1.12e+02	4.33e+01	0.00e+00	9.94e+01	0.00e+00	1.64e+05
Cr-51	0.00e+00	0.00e+00	1.22e+04	6.78e+03	1.85e+03	1.24e+04	6.48e+05
Mn-54	0.00e+00	2.52e+06	6.70e+05	0.00e+00	7.06e+05	0.00e+00	2.11e+06
Mn-56	0.00e+00	1.54e-03	3.48e-04	0.00e+00	1.86e-03	0.00e+00	2.23e-01
Fe-55	1.45e+06	7.71e+05	2.39e+05	0.00e+00	0.00e+00	4.36e+05	1.43e+05
Fe-59	1.56e+06	2.53e+06	1.26e+06	0.00e+00	0.00e+00	7.33e+05	2.63e+06
Co-57	0.00e+00	4.60e+05	9.32e+05	0.00e+00	0.00e+00	0.00e+00	3.77e+06
Co-58	0.00e+00	1.45e+06	4.45e+06	0.00e+00	0.00e+00	0.00e+00	8.49e+06
Co-60	0.00e+00	5.18e+06	1.53e+07	0.00e+00	0.00e+00	0.00e+00	2.87e+07
Ni-59	2.66e+08	7.08e+07	4.51e+07	0.00e+00	0.00e+00	0.00e+00	4.70e+06
Ni-63	3.56e+09	1.90e+08	1.21e+08	0.00e+00	0.00e+00	0.00e+00	1.28e+07
Ni-65	2.02e-01	1.90e-02	1.11e-02	0.00e+00	0.00e+00	0.00e+00	2.33e+00
Cu-64	0.00e+00	8.34e+03	5.04e+03	0.00e+00	2.02e+04	0.00e+00	3.92e+05
Zn-65	4.96e+08	1.32e+09	8.22e+08	0.00e+00	8.33e+08	0.00e+00	2.32e+08
Zn-69	1.18e-12	1.71e-12	1.58e-13	0.00e+00	1.04e-12	0.00e+00	1.08e-10
Zn-69m	9.68e+04	1.65e+05	1.95e+04	0.00e+00	9.58e+04	0.00e+00	5.37e+06
Se-79	0.00e+00	3.75e+08	8.31e+07	0.00e+00	6.09e+08	0.00e+00	2.46e+07
Br-82	0.00e+00	0.00e+00	1.38e+07	0.00e+00	0.00e+00	0.00e+00	0.00e+00
Br-83	0.00e+00	0.00e+00	5.36e-02	0.00e+00	0.00e+00	0.00e+00	0.00e+00
Br-84	0.00e+00	0.00e+00	8.40e-24	0.00e+00	0.00e+00	0.00e+00	0.00e+00
Br-85	0.00e+00	0.00e+00	0.00e+00	0.00e+00	0.00e+00	0.00e+00	0.00e+00

Conversion factors are in units of square meter-mrem/yr per uCi/sec for all nuclides except H-3, which is in units of mrem/yr per uCi/cubic meter.

**GOAT's MILK PATHWAY DOSE FACTORS DUE TO
RADIONUCLIDES OTHER THAN NOBLE GASES, R_i**

R_i factors for Child age group by nuclide.
Waterford Steam Electric Station
Pathway : Gaseous Release Goat's Milk Pathway R_i

Nuclide	Organ Dose Conversion Factors						
	Bone	Liver	T. Body	Thyroid	Kidney	Lung	GI-LLI
Rb-86	0.00e+00	1.05e+09	6.47e+08	0.00e+00	0.00e+00	0.00e+00	6.77e+07
Rb-87	0.00e+00	1.17e+09	5.42e+08	0.00e+00	0.00e+00	0.00e+00	1.75e+07
Rb-88	0.00e+00	0.00e+00	0.00e+00	0.00e+00	0.00e+00	0.00e+00	0.00e+00
Rb-89	0.00e+00	0.00e+00	0.00e+00	0.00e+00	0.00e+00	0.00e+00	0.00e+00
Sr-89	1.39e+10	0.00e+00	3.97e+08	0.00e+00	0.00e+00	0.00e+00	5.38e+08
Sr-90	3.53e+11	0.00e+00	7.11e+09	0.00e+00	0.00e+00	0.00e+00	3.16e+09
Sr-91	2.75e+05	0.00e+00	1.04e+04	0.00e+00	0.00e+00	0.00e+00	6.07e+05
Sr-92	4.65e+00	0.00e+00	1.86e-01	0.00e+00	0.00e+00	0.00e+00	8.81e+01
Y-90	3.87e+01	0.00e+00	1.04e+00	0.00e+00	0.00e+00	0.00e+00	1.10e+05
Y-91	4.68e+03	0.00e+00	1.25e+02	0.00e+00	0.00e+00	0.00e+00	6.24e+05
Y-91m	3.36e-20	0.00e+00	1.22e-21	0.00e+00	0.00e+00	0.00e+00	6.59e-17
Y-92	3.07e-05	0.00e+00	8.78e-07	0.00e+00	0.00e+00	0.00e+00	8.87e-01
Y-93	1.22e-01	0.00e+00	3.35e-03	0.00e+00	0.00e+00	0.00e+00	1.82e+03
Zr-93	8.24e+02	3.09e+01	2.20e+01	0.00e+00	1.19e+02	0.00e+00	1.17e+04
Zr-95	4.60e+02	1.01e+02	9.00e+01	0.00e+00	1.45e+02	0.00e+00	1.05e+05
Zr-97	2.31e-01	3.33e-02	1.97e-02	0.00e+00	4.79e-02	0.00e+00	5.05e+03
Nb-93m	2.58e+05	6.45e+04	2.12e+04	0.00e+00	6.96e+04	0.00e+00	9.72e+06
Nb-95	3.81e+04	1.49e+04	1.06e+04	0.00e+00	1.40e+04	0.00e+00	2.75e+07
Nb-97	3.49e-12	6.31e-13	2.95e-13	0.00e+00	7.00e-13	0.00e+00	1.95e-07
Mo-93	0.00e+00	1.78e+08	6.40e+06	0.00e+00	4.70e+07	0.00e+00	9.03e+06
Mo-99	0.00e+00	9.77e+06	2.42e+06	0.00e+00	2.09e+07	0.00e+00	8.08e+06
Tc-101	0.00e+00	0.00e+00	0.00e+00	0.00e+00	0.00e+00	0.00e+00	0.00e+00
Tc-99	1.32e+07	1.47e+07	5.28e+06	0.00e+00	1.73e+08	1.30e+06	1.54e+08
Tc-99m	1.60e+00	3.13e+00	5.19e+01	0.00e+00	4.55e+01	1.59e+00	1.78e+03
Ru-103	5.14e+02	0.00e+00	1.98e+02	0.00e+00	1.29e+03	0.00e+00	1.33e+04
Ru-105	4.62e-04	0.00e+00	1.68e-04	0.00e+00	4.06e-03	0.00e+00	3.02e-01
Ru-106	1.11e+04	0.00e+00	1.38e+03	0.00e+00	1.50e+04	0.00e+00	1.72e+05
Rh-105	1.88e+05	1.01e+05	8.62e+04	0.00e+00	4.02e+05	0.00e+00	6.25e+06
Pd-107	0.00e+00	4.66e+06	3.96e+05	0.00e+00	3.90e+07	0.00e+00	9.25e+06
Pd-109	0.00e+00	1.84e+04	5.51e+03	0.00e+00	9.86e+04	0.00e+00	1.09e+06

Conversion factors are in units of square meter-mrem/yr per uCi/sec for all nuclides except H-3, which is in units of mrem/yr per uCi/cubic meter.

**GOAT's MILK PATHWAY DOSE FACTORS DUE TO
RADIONUCLIDES OTHER THAN NOBLE GASES, R_i**

R_i factors for Child age group by nuclide.
Waterford Steam Electric Station
Pathway : Gaseous Release Goat's Milk Pathway R_i

Nuclide	Organ Dose Conversion Factors						
	Bone	Liver	T. Body	Thyroid	Kidney	Lung	GI-LLI
Ag-110m	2.51e+07	1.69e+07	1.35e+07	0.00e+00	3.15e+07	0.00e+00	2.01e+09
Ag-111	3.53e+06	1.10e+06	7.29e+05	0.00e+00	3.33e+06	0.00e+00	6.76e+08
Cd-113m	0.00e+00	1.20e+06	5.13e+04	0.00e+00	1.24e+06	0.00e+00	3.11e+06
Cd-115m	0.00e+00	5.15e+05	2.19e+04	0.00e+00	3.83e+05	0.00e+00	7.00e+06
Sn-123	2.93e+08	3.63e+06	7.14e+06	3.85e+06	0.00e+00	0.00e+00	1.44e+08
Sn-125	3.09e+07	4.66e+05	1.38e+06	4.83e+05	0.00e+00	0.00e+00	9.57e+07
Sn-126	8.22e+08	1.02e+07	2.33e+07	2.81e+06	0.00e+00	0.00e+00	6.17e+07
Sb-124	1.30e+07	1.69e+05	4.57e+06	2.88e+04	0.00e+00	7.23e+06	8.15e+07
Sb-125	1.04e+07	8.05e+04	2.19e+06	9.67e+03	0.00e+00	5.82e+06	2.49e+07
Sb-126	2.75e+06	4.21e+04	9.88e+05	1.61e+04	0.00e+00	1.31e+06	5.55e+07
Sb-127	2.38e+05	3.68e+03	8.26e+04	2.65e+03	0.00e+00	1.03e+05	1.34e+07
Te-125m	8.85e+06	2.40e+06	1.18e+06	2.48e+06	0.00e+00	0.00e+00	8.54e+06
Te-127	3.59e+02	9.67e+01	7.69e+01	2.48e+02	1.02e+03	0.00e+00	1.40e+04
Te-127m	2.50e+07	6.72e+06	2.96e+06	5.97e+06	7.12e+07	0.00e+00	2.02e+07
Te-129	1.59e-10	4.44e-11	3.78e-11	1.14e-10	4.65e-10	0.00e+00	9.90e-09
Te-129m	3.26e+07	9.09e+06	5.06e+06	1.05e+07	9.56e+07	0.00e+00	3.97e+07
Te-131	2.13e-33	6.48e-34	6.33e-34	1.63e-33	6.43e-33	0.00e+00	1.12e-32
Te-131m	1.92e+05	6.65e+04	7.07e+04	1.37e+05	6.43e+05	0.00e+00	2.70e+06
Te-132	1.23e+06	5.44e+05	6.58e+05	7.93e+05	5.05e+06	0.00e+00	5.48e+06
Te-133m	1.13e-13	4.59e-14	5.69e-14	8.80e-14	4.36e-13	0.00e+00	3.50e-12
Te-134	4.79e-19	2.15e-19	2.87e-19	3.78e-19	1.99e-18	0.00e+00	2.19e-18
I-129	4.12e+08	2.53e+08	2.26e+08	1.65e+11	4.26e+08	0.00e+00	1.27e+07
I-130	2.08e+05	4.20e+05	2.16e+05	4.63e+07	6.28e+05	0.00e+00	1.97e+05
I-131	1.56e+08	1.57e+08	8.94e+07	5.20e+10	2.58e+08	0.00e+00	1.40e+07
I-132	8.41e-02	1.54e-01	7.10e-02	7.17e+00	2.36e-01	0.00e+00	1.82e-01
I-133	2.06e+06	2.55e+06	9.66e+05	4.74e+08	4.25e+06	0.00e+00	1.03e+06
I-134	1.06e-12	1.98e-12	9.09e-13	4.54e-11	3.02e-12	0.00e+00	1.31e-12
I-135	6.52e+03	1.17e+04	5.55e+03	1.04e+06	1.80e+04	0.00e+00	8.94e+03
Cs-134	6.79e+10	1.11e+11	2.35e+10	0.00e+00	3.45e+10	1.24e+10	6.01e+08
Cs-134m	2.23e+00	3.30e+00	2.15e+00	0.00e+00	1.74e+00	2.88e-01	4.17e+00

Conversion factors are in units of square meter-mrem/yr per uCi/sec for all nuclides except H-3, which is in units of mrem/yr per uCi/cubic meter.

**GOAT's MILK PATHWAY DOSE FACTORS DUE TO
RADIONUCLIDES OTHER THAN NOBLE GASES, R_i**

R_i factors for Child age group by nuclide.
Waterford Steam Electric Station
Pathway : Gaseous Release Goat's Milk Pathway R_i

Nuclide	Organ Dose Conversion Factors						
	Bone	Liver	T. Body	Thyroid	Kidney	Lung	GI-LLI
Cs-135	2.46e+10	1.71e+10	1.76e+09	0.00e+00	6.04e+09	2.02e+09	1.28e+08
Cs-136	3.04e+09	8.34e+09	5.40e+09	0.00e+00	4.44e+09	6.63e+08	2.93e+08
Cs-137	9.67e+10	9.26e+10	1.37e+10	0.00e+00	3.02e+10	1.09e+10	5.80e+08
Cs-138	1.28e-22	1.78e-22	1.13e-22	0.00e+00	1.25e-22	1.35e-23	8.21e-23
Cs-139	0.00e+00	0.00e+00	0.00e+00	0.00e+00	0.00e+00	0.00e+00	0.00e+00
Ba-139	2.48e-08	1.32e-11	7.18e-10	0.00e+00	1.15e-11	7.78e-12	1.43e-06
Ba-140	1.41e+07	1.23e+04	8.20e+05	0.00e+00	4.01e+03	7.34e+03	7.12e+06
Ba-141	0.00e+00	0.00e+00	0.00e+00	0.00e+00	0.00e+00	0.00e+00	0.00e+00
Ba-142	0.00e+00	0.00e+00	0.00e+00	0.00e+00	0.00e+00	0.00e+00	0.00e+00
La-140	2.33e+00	8.15e-01	2.75e-01	0.00e+00	0.00e+00	0.00e+00	2.27e+04
La-141	1.63e-05	3.81e-06	8.27e-07	0.00e+00	0.00e+00	0.00e+00	8.47e-01
La-142	9.95e-12	3.17e-12	9.94e-13	0.00e+00	0.00e+00	0.00e+00	6.29e-07
Ce-141	2.62e+03	1.31e+03	1.94e+02	0.00e+00	5.74e+02	0.00e+00	1.63e+06
Ce-143	2.25e+01	1.22e+04	1.77e+00	0.00e+00	5.12e+00	0.00e+00	1.79e+05
Ce-144	1.95e+05	6.10e+04	1.04e+04	0.00e+00	3.38e+04	0.00e+00	1.59e+07
Pr-143	8.62e+01	2.59e+01	4.28e+00	0.00e+00	1.40e+01	0.00e+00	9.30e+04
Pr-144	0.00e+00	0.00e+00	0.00e+00	0.00e+00	0.00e+00	0.00e+00	0.00e+00
Nd-147	5.34e+01	4.32e+01	3.35e+00	0.00e+00	2.37e+01	0.00e+00	6.85e+04
Pm-147	1.54e+03	1.10e+02	5.93e+01	0.00e+00	1.95e+02	0.00e+00	4.46e+04
Pm-148	3.19e+01	3.84e+00	2.48e+00	0.00e+00	6.52e+00	0.00e+00	1.03e+05
Pm-148m	3.67e+02	7.31e+01	7.31e+01	0.00e+00	1.08e+02	0.00e+00	2.06e+05
Pm-149	2.33e+00	2.48e-01	1.34e-01	0.00e+00	4.38e-01	0.00e+00	1.69e+04
Pm-151	3.46e-01	4.21e-02	2.74e-02	0.00e+00	7.13e-02	0.00e+00	4.78e+03
Sm-151	1.26e+03	1.88e+02	5.92e+01	0.00e+00	1.94e+02	0.00e+00	2.73e+04
Sm-153	1.08e+00	6.73e-01	6.49e-02	0.00e+00	2.05e-01	0.00e+00	8.95e+03
Eu-152	3.03e+03	5.51e+02	6.54e+02	0.00e+00	2.33e+03	0.00e+00	9.05e+04
Eu-154	1.14e+04	1.02e+03	9.33e+02	0.00e+00	4.49e+03	0.00e+00	2.37e+05
Eu-155	2.32e+03	1.67e+02	1.31e+02	0.00e+00	6.27e+02	0.00e+00	4.19e+05
Eu-156	1.32e+02	7.06e+01	1.46e+01	0.00e+00	4.55e+01	0.00e+00	1.60e+05
Tb-160	6.73e+02	0.00e+00	8.35e+01	0.00e+00	2.00e+02	0.00e+00	1.49e+05

Conversion factors are in units of square meter-mrem/yr per uCi/sec for all nuclides except H-3, which is in units of mrem/yr per uCi/cubic meter.

**GOAT's MILK PATHWAY DOSE FACTORS DUE TO
RADIONUCLIDES OTHER THAN NOBLE GASES, R_i**

Ri factors for Child age group by nuclide.
Waterford Steam Electric Station
Pathway : Gaseous Release Goat's Milk Pathway Ri

Nuclide	Organ Dose Conversion Factors						
	Bone	Liver	T. Body	Thyroid	Kidney	Lung	GI-LLI
Ho-166m	5.33e+03	1.12e+03	9.43e+02	0.00e+00	1.59e+03	0.00e+00	1.30e+05
W-181	1.85e+04	4.55e+03	6.25e+02	0.00e+00	0.00e+00	0.00e+00	1.66e+05
W-185	7.07e+05	1.76e+05	2.47e+04	0.00e+00	0.00e+00	0.00e+00	6.58e+06
W-187	3.47e+03	2.06e+03	9.22e+02	0.00e+00	0.00e+00	0.00e+00	2.89e+05
Pb-210	2.90e+10	7.45e+09	1.28e+09	0.00e+00	2.24e+10	0.00e+00	1.40e+06
Bi-210	1.94e+05	1.01e+06	1.11e+05	0.00e+00	1.13e+07	0.00e+00	5.10e+06
Po-210	4.05e+08	6.47e+08	9.77e+07	0.00e+00	2.01e+09	0.00e+00	1.74e+07
Ra-223	6.65e+10	7.69e+07	1.33e+10	0.00e+00	2.04e+09	0.00e+00	1.06e+09
Ra-224	7.72e+09	1.40e+07	1.55e+09	0.00e+00	3.71e+08	0.00e+00	4.24e+08
Ra-225	1.03e+11	9.24e+07	2.07e+10	0.00e+00	2.45e+09	0.00e+00	1.19e+09
Ra-226	4.54e+12	1.45e+08	3.73e+12	0.00e+00	3.85e+09	0.00e+00	2.69e+09
Ra-228	3.02e+12	7.83e+07	3.39e+12	0.00e+00	2.08e+09	0.00e+00	4.56e+08
Ac-225	3.37e+04	3.47e+04	2.26e+03	0.00e+00	3.71e+03	0.00e+00	7.72e+05
Ac-227	2.03e+07	3.27e+06	1.26e+06	0.00e+00	7.19e+05	0.00e+00	4.15e+05
Th-227	1.53e+05	2.08e+03	4.41e+03	0.00e+00	1.10e+04	0.00e+00	1.47e+06
Th-228	1.00e+07	1.28e+05	3.38e+05	0.00e+00	6.66e+05	0.00e+00	2.80e+06
Th-229	1.16e+08	2.92e+06	1.93e+06	0.00e+00	1.43e+07	0.00e+00	3.97e+05
Th-230	1.75e+07	8.79e+05	4.89e+05	0.00e+00	4.28e+06	0.00e+00	3.06e+05
Th-232	1.95e+07	7.50e+05	1.49e+04	0.00e+00	3.66e+06	0.00e+00	2.60e+05
Th-234	1.01e+03	4.45e+01	2.91e+01	0.00e+00	2.36e+02	0.00e+00	3.48e+05
Pa-231	3.49e+07	1.16e+06	1.39e+06	0.00e+00	6.32e+06	0.00e+00	3.64e+05
Pa-233	5.62e+01	8.76e+00	9.81e+00	0.00e+00	3.23e+01	0.00e+00	4.47e+04
U-232	8.68e+09	0.00e+00	6.22e+08	0.00e+00	6.61e+08	0.00e+00	3.44e+07
U-233	1.84e+09	0.00e+00	1.11e+08	0.00e+00	3.01e+08	0.00e+00	3.18e+07
U-234	1.76e+09	0.00e+00	1.09e+08	0.00e+00	2.95e+08	0.00e+00	3.12e+07
U-235	1.69e+09	0.00e+00	1.02e+08	0.00e+00	2.77e+08	0.00e+00	3.96e+07
U-236	1.69e+09	0.00e+00	1.05e+08	0.00e+00	2.83e+08	0.00e+00	2.92e+07
U-237	3.09e+04	0.00e+00	8.20e+03	0.00e+00	8.90e+04	0.00e+00	2.72e+06
U-238	1.61e+09	0.00e+00	9.58e+07	0.00e+00	2.59e+08	0.00e+00	2.79e+07
Np-237	1.10e+07	7.26e+05	4.83e+05	0.00e+00	2.99e+06	0.00e+00	4.03e+05

Conversion factors are in units of square meter-mrem/yr per uCi/sec for all nuclides except H-3, which is in units of mrem/yr per uCi/cubic meter.

**GOAT's MILK PATHWAY DOSE FACTORS DUE TO
RADIONUCLIDES OTHER THAN NOBLE GASES, R_i**

Ri factors for Child age group by nuclide.
Waterford Steam Electric Station
Pathway : Gaseous Release Goat's Milk Pathway Ri

Nuclide	Organ Dose Conversion Factors						
	Bone	Liver	T. Body	Thyroid	Kidney	Lung	GI-LLI
Np-238	1.97e+01	3.98e-01	3.07e-01	0.00e+00	1.27e+00	0.00e+00	1.36e+04
Np-239	2.07e+00	1.49e-01	1.05e-01	0.00e+00	4.30e-01	0.00e+00	1.10e+04
Pu-238	2.35e+06	2.72e+05	6.24e+04	0.00e+00	2.27e+05	0.00e+00	1.48e+05
Pu-239	2.55e+06	2.72e+05	6.54e+04	0.00e+00	2.41e+05	0.00e+00	1.35e+05
Pu-240	2.53e+06	2.82e+05	6.54e+04	0.00e+00	2.41e+05	0.00e+00	1.38e+05
Pu-241	7.62e+04	3.11e+03	1.58e+03	0.00e+00	5.83e+03	0.00e+00	2.84e+03
-----77-----							
Pu-242	2.35e+06	2.72e+05	6.30e+04	0.00e+00	2.31e+05	0.00e+00	1.32e+05
Pu-244	2.74e+06	3.12e+06	7.21e+04	0.00e+00	2.67e+05	0.00e+00	1.97e+05
Am-241	6.65e+06	5.72e+06	4.99e+05	0.00e+00	3.05e+06	0.00e+00	3.73e+05
Am-242m	6.91e+06	5.53e+06	5.13e+05	0.00e+00	3.11e+06	0.00e+00	4.74e+05
Am-243	6.61e+06	5.58e+06	4.85e+05	0.00e+00	2.99e+06	0.00e+00	4.42e+05
Cm-242	3.96e+05	3.16e+05	2.63e+04	0.00e+00	8.43e+04	0.00e+00	3.68e+05
Cm-243	6.31e+06	5.13e+06	4.06e+05	0.00e+00	1.52e+06	0.00e+00	3.96e+05
Cm-244	5.32e+06	4.30e+06	3.41e+05	0.00e+00	1.25e+06	0.00e+00	3.83e+05
Cm-245	8.24e+06	6.61e+06	5.18e+05	0.00e+00	2.03e+06	0.00e+00	3.57e+05
Cm-246	8.14e+06	6.61e+06	5.18e+05	0.00e+00	2.02e+06	0.00e+00	3.51e+05
Cm-247	7.95e+06	6.52e+06	5.08e+05	0.00e+00	1.99e+06	0.00e+00	4.62e+05
Cm-248	6.61e+07	5.38e+07	4.21e+06	0.00e+00	1.64e+07	0.00e+00	7.45e+06
Cf-252	5.10e+06	0.00e+00	1.23e+05	0.00e+00	0.00e+00	0.00e+00	1.44e+06

Conversion factors are in units of square meter-mrem/yr per uCi/sec for all nuclides except H-3, which is in units of mrem/yr per uCi/cubic meter.

**GOAT's MILK PATHWAY DOSE FACTORS DUE TO
RADIONUCLIDES OTHER THAN NOBLE GASES, R_i**

R_i factors for Infant age group by nuclide.
Waterford Steam Electric Station
Pathway : Gaseous Release Goat's Milk Pathway R_i

Nuclide	Organ Dose Conversion Factors						
	Bone	Liver	T. Body	Thyroid	Kidney	Lung	GI-LLI
H-3	0.00e+00	2.78e+03	2.78e+03	2.78e+03	2.78e+03	2.78e+03	2.78e+03
Be-10	1.69e+06	2.46e+05	5.09e+04	0.00e+00	1.62e+05	0.00e+00	2.74e+06
C-14	2.34e+09	5.00e+08	5.00e+08	5.00e+08	5.00e+08	5.00e+08	5.00e+08
N-13	0.00e+00	0.00e+00	0.00e+00	0.00e+00	0.00e+00	0.00e+00	0.00e+00
F-18	4.94e-03	0.00e+00	4.22e-04	0.00e+00	0.00e+00	0.00e+00	1.16e-03
Na-22	3.82e+09	3.82e+09	3.82e+09	3.82e+09	3.82e+09	3.82e+09	3.82e+09
Na-24	1.85e+06	1.85e+06	1.85e+06	1.85e+06	1.85e+06	1.85e+06	1.85e+06
P-32	1.92e+11	1.13e+10	7.46e+09	0.00e+00	0.00e+00	0.00e+00	2.60e+09
Ca-41	2.95e+09	0.00e+00	3.22e+08	0.00e+00	0.00e+00	0.00e+00	1.51e+06
Sc-46	1.56e+02	2.25e+02	7.03e+01	0.00e+00	1.48e+02	0.00e+00	1.47e+05
Cr-51	0.00e+00	0.00e+00	1.94e+04	1.26e+04	2.76e+03	2.46e+04	5.64e+05
Mn-54	0.00e+00	4.68e+06	1.06e+06	0.00e+00	1.04e+06	0.00e+00	1.72e+06
Mn-56	0.00e+00	3.77e-03	6.50e-04	0.00e+00	3.24e-03	0.00e+00	3.43e-01
Fe-55	1.76e+06	1.13e+06	3.03e+05	0.00e+00	0.00e+00	5.55e+05	1.44e+05
Fe-59	2.92e+06	5.10e+06	2.01e+06	0.00e+00	0.00e+00	1.51e+06	2.43e+06
Co-57	0.00e+00	1.07e+06	1.75e+06	0.00e+00	0.00e+00	0.00e+00	3.66e+06
Co-58	0.00e+00	2.91e+06	7.26e+06	0.00e+00	0.00e+00	0.00e+00	7.25e+06
Co-60	0.00e+00	1.06e+07	2.50e+07	0.00e+00	0.00e+00	0.00e+00	2.52e+07
Ni-59	3.13e+08	9.59e+07	5.40e+07	0.00e+00	0.00e+00	0.00e+00	4.74e+06
Ni-63	4.19e+09	2.59e+08	1.45e+08	0.00e+00	0.00e+00	0.00e+00	1.29e+07
Ni-65	4.27e-01	4.83e-02	2.20e-02	0.00e+00	0.00e+00	0.00e+00	3.68e+00
Cu-64	0.00e+00	2.07e+04	9.60e+03	0.00e+00	3.51e+04	0.00e+00	4.26e+05
Zn-65	6.66e+08	2.28e+09	1.05e+09	0.00e+00	1.11e+09	0.00e+00	1.93e+09
Zn-69	2.52e-12	4.54e-12	3.38e-13	0.00e+00	1.89e-12	0.00e+00	3.70e-10
Zn-69m	2.04e+05	4.17e+05	3.80e+04	0.00e+00	1.69e+05	0.00e+00	5.78e+06
Se-79	0.00e+00	9.33e+08	1.73e+08	0.00e+00	1.08e+09	0.00e+00	2.48e+07
Br-82	0.00e+00	0.00e+00	2.32e+07	0.00e+00	0.00e+00	0.00e+00	0.00e+00
Br-83	0.00e+00	0.00e+00	1.14e-01	0.00e+00	0.00e+00	0.00e+00	0.00e+00
Br-84	0.00e+00	0.00e+00	1.62e-23	0.00e+00	0.00e+00	0.00e+00	0.00e+00
Br-85	0.00e+00	0.00e+00	0.00e+00	0.00e+00	0.00e+00	0.00e+00	0.00e+00

Conversion factors are in units of square meter-mrem/yr per uCi/sec for all nuclides except H-3, which is in units of mrem/yr per uCi/cubic meter.

**GOAT's MILK PATHWAY DOSE FACTORS DUE TO
RADIONUCLIDES OTHER THAN NOBLE GASES, R_i**

Ri factors for Infant age group by nuclide.
Waterford Steam Electric Station
Pathway : Gaseous Release Goat's Milk Pathway Ri

Nuclide	Organ Dose Conversion Factors						
	Bone	Liver	T. Body	Thyroid	Kidney	Lung	GI-LLI
Rb-86	0.00e+00	2.67e+09	1.32e+09	0.00e+00	0.00e+00	0.00e+00	6.83e+07
Rb-87	0.00e+00	2.63e+09	1.04e+09	0.00e+00	0.00e+00	0.00e+00	1.77e+07
Rb-88	0.00e+00	0.00e+00	0.00e+00	0.00e+00	0.00e+00	0.00e+00	0.00e+00
Rb-89	0.00e+00	0.00e+00	0.00e+00	0.00e+00	0.00e+00	0.00e+00	0.00e+00
Sr-89	2.64e+10	0.00e+00	7.58e+08	0.00e+00	0.00e+00	0.00e+00	5.43e+08
Sr-90	3.91e+11	0.00e+00	7.92e+09	0.00e+00	0.00e+00	0.00e+00	3.19e+09
Sr-91	5.73e+05	0.00e+00	2.07e+04	0.00e+00	0.00e+00	0.00e+00	6.78e+05
Sr-92	9.89e+00	0.00e+00	3.67e-01	0.00e+00	0.00e+00	0.00e+00	1.07e+02
Y-90	8.18e+01	0.00e+00	2.19e+00	0.00e+00	0.00e+00	0.00e+00	1.13e+05
Y-91	8.79e+03	0.00e+00	2.34e+02	0.00e+00	0.00e+00	0.00e+00	6.30e+05
Y-91m	7.13e-20	0.00e+00	2.43e-21	0.00e+00	0.00e+00	0.00e+00	2.38e-16
Y-92	6.52e-05	0.00e+00	1.83e-06	0.00e+00	0.00e+00	0.00e+00	1.24e+00
Y-93	2.60e-01	0.00e+00	7.08e-03	0.00e+00	0.00e+00	0.00e+00	2.05e+03
Zr-93	9.53e+02	4.54e+01	2.73e+01	0.00e+00	1.34e+02	0.00e+00	1.18e+04
Zr-95	8.16e+02	1.99e+02	1.41e+02	0.00e+00	2.14e+02	0.00e+00	9.91e+04
Zr-97	4.89e-01	8.38e-02	3.83e-02	0.00e+00	8.45e-02	0.00e+00	5.35e+03
Nb-93m	3.03e+05	8.19e+04	2.56e+04	0.00e+00	8.00e+04	0.00e+00	9.79e+06
Nb-95	7.12e+04	2.93e+04	1.70e+04	0.00e+00	2.10e+04	0.00e+00	2.48e+07
Nb-97	7.39e-12	1.58e-12	5.68e-13	0.00e+00	1.23e-12	0.00e+00	4.97e-07
Mo-93	0.00e+00	4.18e+08	1.35e+07	0.00e+00	8.37e+07	0.00e+00	8.96e+06
Mo-99	0.00e+00	2.50e+07	4.87e+06	0.00e+00	3.73e+07	0.00e+00	8.23e+06
Tc-101	0.00e+00	0.00e+00	0.00e+00	0.00e+00	0.00e+00	0.00e+00	0.00e+00
Tc-99	2.67e+07	3.60e+07	1.12e+07	0.00e+00	3.04e+08	3.50e+06	1.56e+08
Tc-99m	3.32e+00	6.84e+00	8.82e+01	0.00e+00	7.36e+01	3.58e+00	1.99e+03
Ru-103	1.04e+03	0.00e+00	3.48e+02	0.00e+00	2.17e+03	0.00e+00	1.27e+04
Ru-105	9.75e-04	0.00e+00	3.28e-04	0.00e+00	7.17e-03	0.00e+00	3.88e-01
Ru-106	2.28e+04	0.00e+00	2.85e+03	0.00e+00	2.70e+04	0.00e+00	1.73e+05
Rh-105	3.98e+05	2.60e+05	1.75e+05	0.00e+00	7.23e+05	0.00e+00	6.47e+06
Pd-107	0.00e+00	1.17e+07	8.34e+05	0.00e+00	6.70e+07	0.00e+00	9.34e+06
Pd-109	0.00e+00	4.86e+04	1.17e+04	0.00e+00	1.79e+05	0.00e+00	1.19e+06

Conversion factors are in units of square meter-mrem/yr per uCi/sec for all nuclides except H-3, which is in units of mrem/yr per uCi/cubic meter.

**GOAT's MILK PATHWAY DOSE FACTORS DUE TO
RADIONUCLIDES OTHER THAN NOBLE GASES, R_i**

Ri factors for Infant age group by nuclide.
Waterford Steam Electric Station
Pathway : Gaseous Release Goat's Milk Pathway Ri

Nuclide	Organ Dose Conversion Factors						
	Bone	Liver	T. Body	Thyroid	Kidney	Lung	GI-LLI
Ag-110m	4.63e+07	3.38e+07	2.24e+07	0.00e+00	4.83e+07	0.00e+00	1.75e+09
Ag-111	7.40e+06	2.88e+06	1.52e+06	0.00e+00	6.01e+06	0.00e+00	6.86e+08
Cd-113m	0.00e+00	2.09e+06	7.70e+04	0.00e+00	1.58e+06	0.00e+00	3.14e+06
Cd-115m	0.00e+00	1.24e+06	4.31e+04	0.00e+00	6.48e+05	0.00e+00	7.07e+06
Sn-123	5.48e+08	8.57e+06	1.43e+07	8.61e+06	0.00e+00	0.00e+00	1.45e+08
Sn-125	6.45e+07	1.20e+06	2.86e+06	1.18e+06	0.00e+00	0.00e+00	9.66e+07
Sn-126	1.36e+09	1.79e+07	4.44e+07	4.71e+06	0.00e+00	0.00e+00	6.22e+07
Sb-124	2.51e+07	3.70e+05	7.78e+06	6.67e+04	0.00e+00	1.57e+07	7.75e+07
Sb-125	1.79e+07	1.74e+05	3.69e+06	2.25e+04	0.00e+00	1.04e+07	2.39e+07
Sb-126	5.04e+06	9.88e+04	1.82e+06	3.87e+04	0.00e+00	3.17e+06	5.22e+07
Sb-127	5.01e+05	8.93e+03	1.55e+05	6.37e+03	0.00e+00	2.58e+05	1.33e+07
Te-125m	1.81e+07	6.05e+06	2.45e+06	6.09e+06	0.00e+00	0.00e+00	8.62e+06
Te-127	7.61e+02	2.55e+02	1.64e+02	6.20e+02	1.86e+03	0.00e+00	1.60e+04
Te-127m	5.05e+07	1.68e+07	6.12e+06	1.46e+07	1.24e+08	0.00e+00	2.04e+07
Te-129	3.37e-10	1.16e-10	7.87e-11	2.83e-10	8.40e-10	0.00e+00	2.70e-08
Te-129m	6.69e+07	2.29e+07	1.03e+07	2.57e+07	1.67e+08	0.00e+00	3.99e+07
Te-131	4.51e-33	1.67e-33	1.27e-33	4.02e-33	1.15e-32	0.00e+00	1.82e-31
Te-131m	4.06e+05	1.63e+05	1.35e+05	3.31e+05	1.12e+06	0.00e+00	2.75e+06
Te-132	2.53e+06	1.25e+06	1.17e+06	1.85e+06	7.84e+06	0.00e+00	4.64e+06
Te-133m	2.37e-13	1.09e-13	1.04e-13	2.09e-13	7.40e-13	0.00e+00	1.17e-11
Te-134	9.91e-19	4.97e-19	5.12e-19	8.87e-19	3.35e-18	0.00e+00	1.14e-17
I-129	8.47e+08	6.28e+08	4.59e+08	4.03e+11	7.43e+08	0.00e+00	1.26e+07
I-130	4.27e+05	9.40e+05	3.77e+05	1.05e+08	1.03e+06	0.00e+00	2.01e+05
I-131	3.26e+08	3.85e+08	1.69e+08	1.26e+11	4.49e+08	0.00e+00	1.37e+07
I-132	1.74e-01	3.54e-01	1.26e-01	1.66e+01	3.95e-01	0.00e+00	2.87e-01
I-133	4.36e+06	6.35e+06	1.86e+06	1.15e+09	7.46e+06	0.00e+00	1.07e+06
I-134	2.21e-12	4.52e-12	1.61e-12	1.05e-10	5.05e-12	0.00e+00	4.67e-12
I-135	1.36e+04	2.70e+04	9.83e+03	2.42e+06	3.00e+04	0.00e+00	9.76e+03
Cs-134	1.09e+11	2.04e+11	2.06e+10	0.00e+00	5.25e+10	2.15e+10	5.54e+08
Cs-134m	4.64e+00	7.73e+00	3.90e+00	0.00e+00	2.98e+00	6.86e-01	6.12e+00

Conversion factors are in units of square meter-mrem/yr per uCi/sec for all nuclides except H-3, which is in units of mrem/yr per uCi/cubic meter.

**GOAT's MILK PATHWAY DOSE FACTORS DUE TO
RADIONUCLIDES OTHER THAN NOBLE GASES, R_i**

Ri factors for Infant age group by nuclide.
Waterford Steam Electric Station
Pathway : Gaseous Release Goat's Milk Pathway Ri

Nuclide	Organ Dose Conversion Factors						
	Bone	Liver	T. Body	Thyroid	Kidney	Lung	GI-LLI
Cs-135	3.94e+10	3.58e+10	1.87e+09	0.00e+00	1.02e+10	3.88e+09	1.29e+08
Cs-136	5.93e+09	1.74e+10	6.51e+09	0.00e+00	6.95e+09	1.42e+09	2.65e+08
Cs-137	1.54e+11	1.81e+11	1.28e+10	0.00e+00	4.85e+10	1.96e+10	5.65e+08
Cs-138	2.70e-22	4.40e-22	2.13e-22	0.00e+00	2.19e-22	3.42e-23	7.03e-22
Cs-139	0.00e+00	0.00e+00	0.00e+00	0.00e+00	0.00e+00	0.00e+00	0.00e+00
Ba-139	5.27e-08	3.49e-11	1.53e-09	0.00e+00	2.10e-11	2.12e-11	3.34e-06
Ba-140	2.89e+07	2.89e+04	1.49e+06	0.00e+00	6.87e+03	1.78e+04	7.10e+06
Ba-141	0.00e+00	0.00e+00	0.00e+00	0.00e+00	0.00e+00	0.00e+00	0.00e+00
Ba-142	0.00e+00	0.00e+00	0.00e+00	0.00e+00	0.00e+00	0.00e+00	0.00e+00
La-140	4.87e+00	1.92e+00	4.94e-01	0.00e+00	0.00e+00	0.00e+00	2.25e+04
La-141	3.47e-05	1.01e-05	1.75e-06	0.00e+00	0.00e+00	0.00e+00	1.15e+00
La-142	2.09e-11	7.67e-12	1.84e-12	0.00e+00	0.00e+00	0.00e+00	1.30e-06
Ce-141	5.20e+03	3.17e+03	3.74e+02	0.00e+00	9.79e+02	0.00e+00	1.64e+06
Ce-143	4.77e+01	3.16e+04	3.61e+00	0.00e+00	9.21e+00	0.00e+00	1.85e+05
Ce-144	2.79e+05	1.14e+05	1.56e+04	0.00e+00	4.62e+04	0.00e+00	1.60e+07
Pr-143	1.78e+02	6.67e+01	8.84e+00	0.00e+00	2.48e+01	0.00e+00	9.41e+04
Pr-144	0.00e+00	0.00e+00	0.00e+00	0.00e+00	0.00e+00	0.00e+00	0.00e+00
Nd-147	1.06e+02	1.09e+02	6.65e+00	0.00e+00	4.19e+01	0.00e+00	6.88e+04
Pm-147	1.88e+03	1.59e+02	7.72e+01	0.00e+00	2.37e+02	0.00e+00	4.50e+04
Pm-148	6.68e+01	9.65e+00	4.86e+00	0.00e+00	1.15e+01	0.00e+00	1.03e+05
Pm-148m	5.88e+02	1.49e+02	1.17e+02	0.00e+00	1.71e+02	0.00e+00	1.94e+05
Pm-149	4.96e+00	6.50e-01	2.84e-01	0.00e+00	7.91e-01	0.00e+00	1.75e+04
Pm-151	7.32e-01	1.07e-01	5.40e-02	0.00e+00	1.27e-01	0.00e+00	4.94e+03
Sm-151	1.43e+03	3.29e+02	7.10e+01	0.00e+00	2.24e+02	0.00e+00	2.75e+04
Sm-153	2.29e+00	1.77e+00	1.36e-01	0.00e+00	3.71e-01	0.00e+00	9.25e+03
Eu-152	3.32e+03	8.81e+02	7.43e+02	0.00e+00	2.47e+03	0.00e+00	7.82e+04
Eu-154	1.30e+04	1.81e+03	1.09e+03	0.00e+00	4.91e+03	0.00e+00	2.26e+05
Eu-155	2.61e+03	3.01e+02	1.56e+02	0.00e+00	6.75e+02	0.00e+00	4.04e+05
Eu-156	2.67e+02	1.66e+02	2.63e+01	0.00e+00	7.65e+01	0.00e+00	1.56e+05
Tb-160	1.05e+03	0.00e+00	1.31e+02	0.00e+00	2.99e+02	0.00e+00	1.40e+05

Conversion factors are in units of square meter-mrem/yr per uCi/sec for all nuclides except H-3, which is in units of mrem/yr per uCi/cubic meter.

**GOAT's MILK PATHWAY DOSE FACTORS DUE TO
RADIONUCLIDES OTHER THAN NOBLE GASES, R_i**

Ri factors for Infant age group by nuclide.
Waterford Steam Electric Station
Pathway : Gaseous Release Goat's Milk Pathway Ri

Nuclide	Organ Dose Conversion Factors						
	Bone	Liver	T. Body	Thyroid	Kidney	Lung	GI-LLI
Ho-166m	6.17e+03	1.33e+03	1.05e+03	0.00e+00	1.76e+03	0.00e+00	1.31e+05
W-181	3.87e+04	1.19e+04	1.33e+03	0.00e+00	0.00e+00	0.00e+00	1.67e+05
W-185	1.48e+06	4.62e+05	5.27e+04	0.00e+00	0.00e+00	0.00e+00	6.62e+06
W-187	7.31e+03	5.08e+03	1.76e+03	0.00e+00	0.00e+00	0.00e+00	2.99e+05
Pb-210	3.23e+10	8.67e+09	1.45e+09	0.00e+00	2.64e+10	0.00e+00	1.42e+06
Bi-210	4.10e+05	2.64e+06	2.36e+05	0.00e+00	2.05e+07	0.00e+00	5.20e+06
Po-210	8.25e+08	1.58e+09	1.97e+08	0.00e+00	3.35e+09	0.00e+00	1.76e+07
Ra-223	1.38e+11	2.02e+08	2.77e+10	0.00e+00	3.67e+09	0.00e+00	1.08e+09
Ra-224	1.64e+10	3.69e+07	3.26e+09	0.00e+00	6.72e+08	0.00e+00	4.33e+08
Ra-225	2.14e+11	2.41e+08	4.25e+10	0.00e+00	4.40e+09	0.00e+00	1.20e+09
Ra-226	4.90e+12	3.76e+08	4.06e+12	0.00e+00	6.88e+09	0.00e+00	2.72e+09
Ra-228	3.39e+12	2.02e+08	3.81e+12	0.00e+00	3.71e+09	0.00e+00	4.59e+08
Ac-225	7.02e+04	9.01e+04	4.71e+03	0.00e+00	6.61e+03	0.00e+00	7.81e+05
Ac-227	2.21e+07	3.78e+06	1.37e+06	0.00e+00	7.69e+05	0.00e+00	4.19e+05
Th-227	3.13e+05	5.24e+03	8.99e+03	0.00e+00	1.93e+04	0.00e+00	1.49e+06
Th-228	1.19e+07	1.63e+05	4.04e+05	0.00e+00	7.63e+05	0.00e+00	2.82e+06
Th-229	1.24e+08	3.12e+06	2.07e+06	0.00e+00	1.50e+07	0.00e+00	4.00e+05
Th-230	1.88e+07	9.38e+05	5.23e+05	0.00e+00	4.50e+06	0.00e+00	3.08e+05
Th-232	2.09e+07	8.05e+05	8.14e+03	0.00e+00	3.85e+06	0.00e+00	2.62e+05
Th-234	2.04e+03	1.11e+02	5.90e+01	0.00e+00	4.10e+02	0.00e+00	3.51e+05
Pa-231	3.74e+07	1.23e+06	1.49e+06	0.00e+00	6.61e+06	0.00e+00	3.67e+05
Pa-233	9.66e+01	1.89e+01	1.69e+01	0.00e+00	5.19e+01	0.00e+00	4.53e+04
U-232	1.19e+10	0.00e+00	1.07e+09	0.00e+00	1.17e+09	0.00e+00	3.47e+07
U-233	2.51e+09	0.00e+00	1.91e+08	0.00e+00	5.33e+08	0.00e+00	3.21e+07
U-234	2.41e+09	0.00e+00	1.88e+08	0.00e+00	5.23e+08	0.00e+00	3.14e+07
U-235	2.31e+09	0.00e+00	1.76e+08	0.00e+00	4.90e+08	0.00e+00	4.00e+07
U-236	2.31e+09	0.00e+00	1.80e+08	0.00e+00	4.99e+08	0.00e+00	2.95e+07
U-237	6.47e+04	0.00e+00	1.73e+04	0.00e+00	1.61e+05	0.00e+00	2.76e+06
U-238	2.21e+09	0.00e+00	1.64e+08	0.00e+00	4.58e+08	0.00e+00	2.82e+07
Np-237	1.18e+07	7.85e+05	5.18e+05	0.00e+00	3.13e+06	0.00e+00	4.06e+05

Conversion factors are in units of square meter-mrem/yr per uCi/sec for all nuclides except H-3, which is in units of mrem/yr per uCi/cubic meter.

**GOAT's MILK PATHWAY DOSE FACTORS DUE TO
RADIONUCLIDES OTHER THAN NOBLE GASES, R_i**

R_i factors for Infant age group by nuclide.
Waterford Steam Electric Station
Pathway : Gaseous Release Goat's Milk Pathway R_i

Nuclide	Organ Dose Conversion Factors						
	Bone	Liver	T. Body	Thyroid	Kidney	Lung	GI-LLI
Np-238	4.19e+01	1.05e+00	6.48e-01	0.00e+00	2.30e+00	0.00e+00	1.41e+04
Np-239	4.38e+00	3.92e-01	2.21e-01	0.00e+00	7.81e-01	0.00e+00	1.13e+04
Pu-238	2.53e+06	2.96e+05	6.71e+04	0.00e+00	2.39e+05	0.00e+00	1.49e+05
Pu-239	2.72e+06	3.06e+05	6.99e+04	0.00e+00	2.53e+05	0.00e+00	1.36e+05
Pu-240	2.72e+06	3.06e+05	6.99e+04	0.00e+00	2.53e+05	0.00e+00	1.39e+05
Pu-241	8.37e+04	3.47e+03	1.74e+03	0.00e+00	6.24e+03	0.00e+00	2.86e+03
Pu-242	2.53e+06	2.94e+05	6.73e+04	0.00e+00	2.43e+05	0.00e+00	1.34e+05
Pu-244	2.94e+06	3.38e+05	7.72e+04	0.00e+00	2.78e+05	0.00e+00	1.99e+05
Am-241	7.14e+06	6.21e+06	5.33e+05	0.00e+00	3.20e+06	0.00e+00	3.76e+05
Am-242m	7.45e+06	6.02e+06	5.58e+05	0.00e+00	3.28e+06	0.00e+00	4.78e+05
Am-243	7.11e+06	6.07e+06	5.23e+05	0.00e+00	3.14e+06	0.00e+00	4.46e+05
Cm-242	6.17e+05	5.72e+05	4.10e+04	0.00e+00	1.18e+05	0.00e+00	3.71e+05
Cm-243	6.90e+06	5.67e+06	4.43e+05	0.00e+00	1.61e+06	0.00e+00	3.99e+05
Cm-244	5.81e+06	4.78e+06	3.74e+05	0.00e+00	1.33e+06	0.00e+00	3.86e+05
Cm-245	8.84e+06	7.16e+06	5.58e+05	0.00e+00	2.13e+06	0.00e+00	3.60e+05
Cm-246	8.74e+06	7.16e+06	5.58e+05	0.00e+00	2.13e+06	0.00e+00	3.54e+05
Cm-247	8.54e+06	7.06e+06	5.48e+05	0.00e+00	2.09e+06	0.00e+00	4.65e+05
Cm-248	7.06e+07	5.82e+07	4.52e+06	0.00e+00	1.73e+07	0.00e+00	7.50e+06
Cf-252	5.92e+06	0.00e+00	1.43e+05	0.00e+00	0.00e+00	0.00e+00	1.45e+06

Conversion factors are in units of square meter-mrem/yr per uCi/sec for all nuclides except H-3, which is in units of mrem/yr per uCi/cubic meter.

LIQUID WASTE MANAGEMENT SYSTEM EFFLUENT SOURCES AND RELEASE PATHWAYS AND POINTS

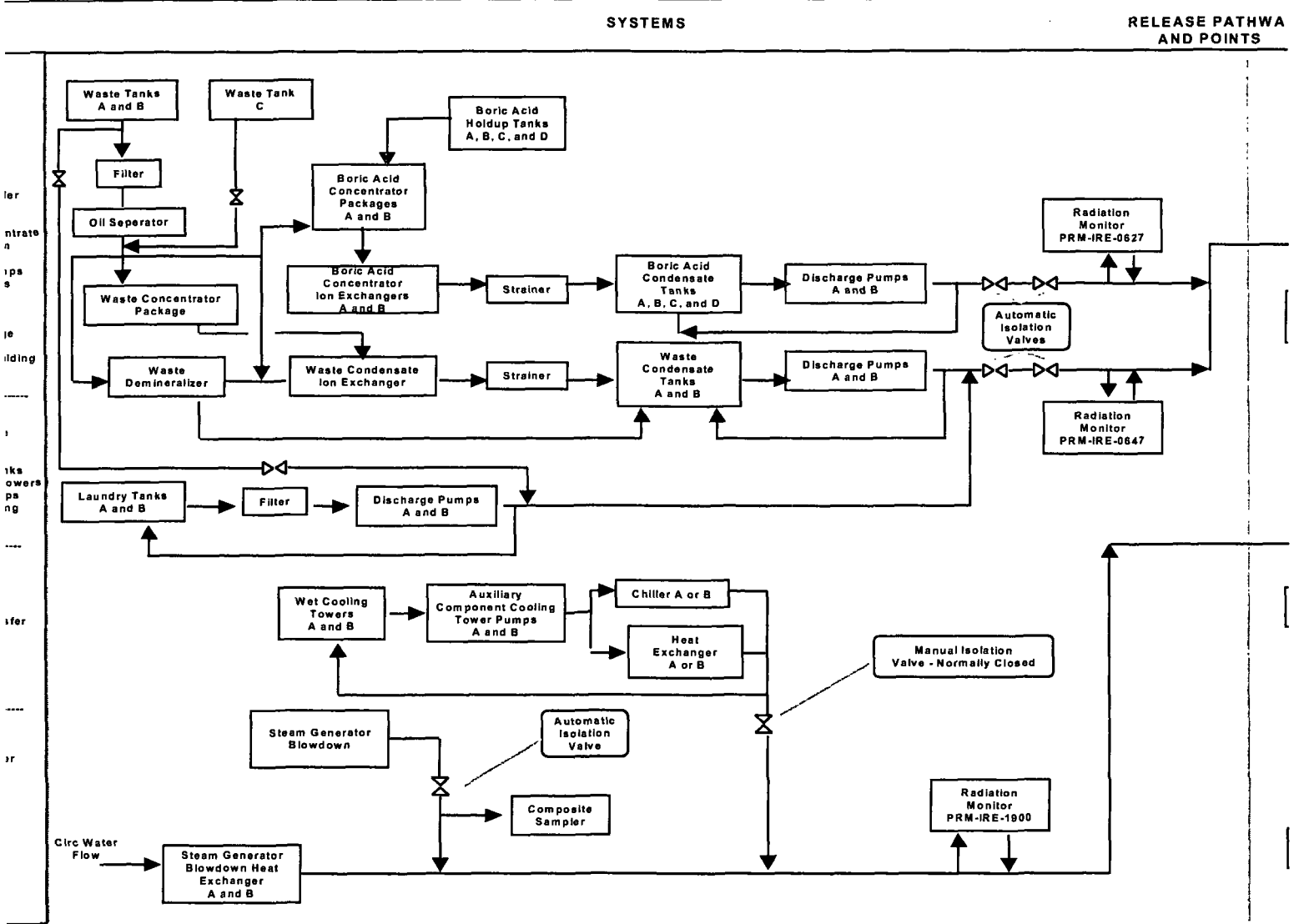

LIQUID WASTE MANAGEMENT SYSTEM EFFLUENT SOURCES AND RELEASE PATHWAYS AND POINTS

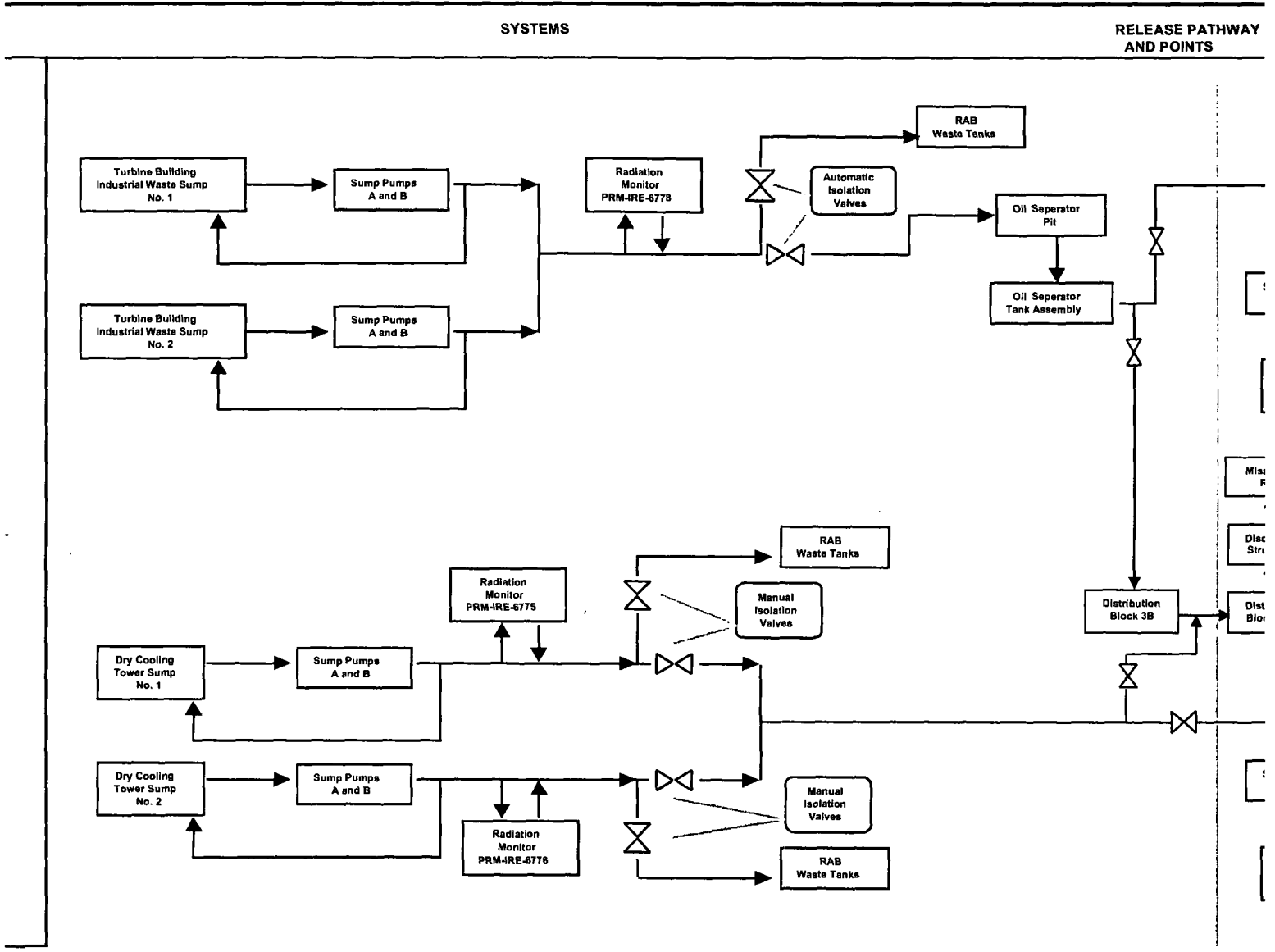

GASEOUS EFFLUENT SOURCES, GASEOUS WASTE MANAGEMENT SYSTEM EFFLUENT SOURCES AND EXHAUST RELEASE POINTS

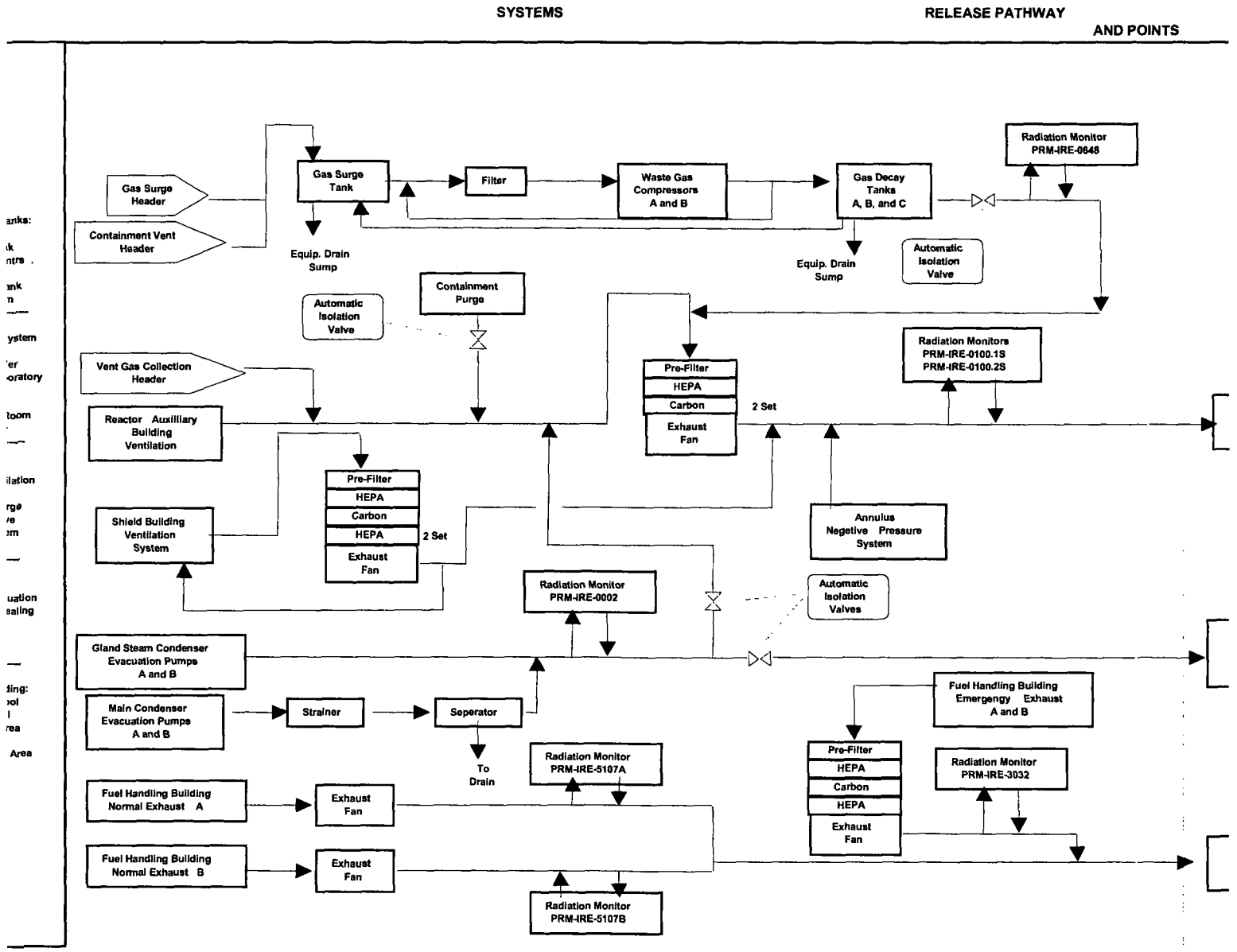

RADIOLOGICAL ENVIRONMENTAL MONITORING PROGRAM

EXPOSURE PATHWAY / SAMPLE	NUMBER OF REPRESENTATIVE SAMPLES AND SAMPLE LOCATIONS	SAMPLING AND COLLECTION FREQUENCY*	TYPE AND FREQUENCY OF ANALYSIS	VOLUME**
TLD	A-2, B-1, C-1, D-2, E-1, F-2, G-2, H-2, J-2, K-1, L-1, M-1, N-1, P-1, Q-1, R-1, A-5, B-4, D-5, E-5, F-4, G-4, H-8, P-6, Q-5, R-6, F-9, G-8, E-15, J-15, E-30	Quarterly	TLD ⁽¹⁾ gamma dose quarterly	N/A
DIET AND CULINARY	APF-1, APQ-1, APP-1 APC-1, APE-30	Bi-Weekly Quarterly Composite	gross beta ⁽²⁾ , I-131 bi-weekly gamma isotopic ⁽²⁾ quarterly	285 m ³ /wk 3700 m ³ / qtr
DRINKING WATER / BATHING WATER ⁽³⁾	DWF-2 ⁽⁴⁾ / SWF-2 ⁽⁴⁾ DWE-5 ⁽⁴⁾ / SWE-5 ⁽⁴⁾ DWP-7 / SWP-7 SWK-1 ⁽¹²⁾⁽¹³⁾	Quarterly Composite ⁽⁵⁾ Monthly Composite ⁽¹⁰⁾	H-3 gross beta, gamma isotopic quarterly I-131 ⁽⁷⁾ monthly	Homogeneous 8 liters
SOIL SEDIMENT	SHWK-1, SHWE-3, SHWQ-6	Annually	gamma isotopic annually	2 kilograms
MILK	MKE-3, MKA-31	Quarterly	gamma isotopic, I-131 quarterly	8 liters
FISH	FH-1, FH-2, FH-3	In season or Annually ⁽⁹⁾	gamma isotopic annually	500 grams
WIND BLOWN LEAF	BLQ-1, BLB-1, BLE-20	Quarterly	gamma isotopic, I-131 quarterly	500 grams
WASTEWATER TREATMENT SYSTEM ⁽¹¹⁾	SWR-1	Monthly Composite ⁽¹⁰⁾ Quarterly Composite ⁽⁵⁾	gamma isotopic monthly H-3 quarterly	Homogeneous 4 liters

*Collection at specific locations may be increased at any time in order to increase the effectiveness of the REMP.

**Are typical volumes used to meet LLDs. Actual volumes are used in the calculations.

RADIOLOGICAL ENVIRONMENTAL MONITORING PROGRAM

more instrument, such as a pressurized ion chamber, for measuring and recording dose rate continuously be used in place of, or in addition to, integrating dosimeters. A TLD is considered one phosphor, two or more phosphors in a packet are considered two or more dosimeters. Geographical limitations affect siting of dosimeters.

Air particulate sample filters shall be analyzed for gross beta radioactivity 24 hours or more after sampling to allow for radon and thoron daughter decay. If gross beta activity in air particulate samples is more than ten times the yearly mean of control samples, gamma isotopic analysis shall be performed on the duplicate samples. Gamma isotopic analysis means the identification and quantification of gamma-emitting radionuclides that may be attributable to the effluents from the facility.

Ground Water and Surface Water samples are identical where designated.

Downstream sample is beyond the mixing zone.

Composite sample will contain aliquots of sample taken proportional to the quantity of flowing liquid that is in a specimen representative of the liquid flow.

TEXT

Analysis will be performed when the dose calculated for the consumption of water is greater than 1 mrem per year as calculated for maximum organ and age group.

TEXT

Bluegill, mullet, gizzard shad, freshwater drum, and catfish will be collected. If they are not available, then alternate species will be collected and identified in reporting.

RADIOLOGICAL ENVIRONMENTAL MONITORING PROGRAM

014 Revision 305

Attachment 7.

Analysis frequency of every 4 weeks satisfies this requirement. The maximum frequency is monthly.

gamma System Sampling and analysis performed additionally for this location. This sampling requirement derived directly from REMP requirements, but it represents another possible environmental interface to the plant. Information from this sample location will not normally be included in the Annual Radiological Environmental Monitoring Report.

gamma composite is analyzed for gamma isotopic.

beta is not required for surface water in accordance with TRM Table 3.12-1.

014 Revision 305

Attachment 7.

SAMPLE LOCATION TABLE

LOCATION NUMBER	LOCATION DESCRIPTION	BEARING/ MILES TO PLANT	sition Latitude Longitude
DIRECT RADIATION (TLD)			
A-2	(Eastbank) Located on pole on LA 628 at Zephirin L. Periloux Fire House.	188° 1.27	N 30.01381 W 90.46780
B-1	(Eastbank) Located on fence west of Little Gypsy.	200° 0.75	N 30.00576 W 90.46672
C-1	(Eastbank) Located on fence at Little Gypsy Cooling Water Intake structure.	219° 0.67	N 30.00307 W 90.46401
D-2	(Eastbank) Located on pole on levee at west entrance to Bonnet Carre Spillway.	238° 1.24	N 30.00471 W 90.45343

RADIOLOGICAL ENVIRONMENTAL MONITORING PROGRAM

SAMPLE LOCATION TABLE (Continued)

LOCATION NUMBER	LOCATION DESCRIPTION	BEARING/ MILES TO PLANT	Position Latitude Longitude
	<u>DIRECT RADIATION (TLD) (continued)</u>		
E-1	(Westbank) Located on pole on LA 18 east of Waterford 3 plant entrance.	277° 0.41	N 29.99468 W 90.46437
F-2	(Westbank) Located on fence on LA 3142 south of LA 18.	294° 1.15	N 29.98842 W 90.45387
G-2	(Westbank) Located on fence on LA 3142 north of railroad overpass.	309° 1.26	N 29.98371 W 90.45498
H-2	(Westbank) Located on fence on LA 3142 north of LA 3127/3142 intersection.	327° 1.54	N 29.97659 W 90.45753

RADIOLOGICAL ENVIRONMENTAL MONITORING PROGRAM

SAMPLE LOCATION TABLE (Continued)

LOCATION NUMBER	LOCATION DESCRIPTION	BEARING/ MILES TO PLANT	Position Latitude Longitude
	<u>DIRECT RADIATION (TLD) (continued)</u>		
J-2	(Westbank) Located on fence south of LA 3127 west of LA 3127/3142 intersection.	356° 1.38	N 29.97546 W 90.47003
K-1	(Westbank) Located on stop sign at entrance to Entergy Education Center on LA 3127.	23° 1.06	N 29.98153 W 90.47843
L-1	(Westbank) Located on gate on LA 3127 west of LA 3127/3142 intersection.	42° 1.06	N 29.98427 W 90.48314
M-1	(Westbank) Located on south gate of Waterford 1 and 2.	67° 0.76	N 29.99148 W 90.48286
N-1	(Westbank) Located on pole at corner of Railroad Avenue and School House Road.	93° 0.98	N 29.99649 W 90.48739

RADIOLOGICAL ENVIRONMENTAL MONITORING PROGRAM

SAMPLE LOCATION TABLE (Continued)

LOCATION NUMBER	LOCATION DESCRIPTION	BEARING/ MILES TO PLANT	Position Latitude Longitude
	<u>DIRECT RADIATION (TLD) (continued)</u>		
P-1	(Westbank) Located on fence enclosing air sample station APP-1.	119° 0.84	N 30.00158 W 90.48323
Q-1	(Westbank) Located on fence enclosing air sample station APQ-1.	132° 0.81	N 30.00355 W 90.48091
R-1	(Westbank) Located at Waterford 1 and 2 Cooling Water Intake Structure.	147° 0.51	N 30.00181 W 90.47564
A-5	(Eastbank) Located on pole at intersection of Oswald Avenue and US 61.	177° 4.59	N 30.06212 W 90.47334
B-4	(Eastbank) Located on pole near weigh station on US 61.	197° 3.75	N 30.04717 W 90.45130

RADIOLOGICAL ENVIRONMENTAL MONITORING PROGRAM

SAMPLE LOCATION TABLE (Continued)

LOCATION NUMBER	LOCATION DESCRIPTION	BEARING/ MILES TO PLANT	Position Latitude Longitude
	<u>DIRECT RADIATION (TLD) (continued)</u>		
D-5	(Eastbank) Located on gate on shell road north of US 61/LA 48 intersection.	249° 4.09	N 30.01628 W 90.40730
E-5	(Eastbank) Located on fence on Wesco St. off LA 48.	266° 4.08	N 29.99840 W 90.40314
F-4	(Westbank) Located on pole behind house at 646 Aquarius St. in Hahnville.	289° 3.53	N 29.97818 W 90.41582
G-4	(Westbank) Located on pole on LA 3160 north of railroad track.	309° 3.30	N 29.96507 W 90.42867

RADIOLOGICAL ENVIRONMENTAL MONITORING PROGRAM

SAMPLE LOCATION TABLE (Continued)

LOCATION NUMBER	LOCATION DESCRIPTION	BEARING/ MILES TO PLANT	Position Latitude Longitude
	<u>DIRECT RADIATION (TLD) (continued)</u>		
H-8	(Westbank) Located on pole in front of Hahnville High School.	331° 8.13	N 29.89178 W 90.40725
P-6	(Westbank) Located on fence at LA 640/railroad track intersection.	107° 5.58	N 30.02121 W 90.55941
Q-5	(Westbank) Located on pole on LA 18 across from Mississippi River marker 137.	129° 5.01	N 30.04274 W 90.53464
R-6	(Eastbank) Located on fence on LA 3223 near railroad crossing.	160° 5.52	N 30.07108 W 90.50183
F-9	(Eastbank) Located on fence north of railroad tracks on Jonathan St.	294° 8.18	N 29.94563 W 90.34739

RADIOLOGICAL ENVIRONMENTAL MONITORING PROGRAM

SAMPLE LOCATION TABLE (Continued)

LOCATION NUMBER	LOCATION DESCRIPTION	BEARING/ MILES TO PLANT	Position Latitude Longitude
	<u>DIRECT RADIATION (TLD) (continued)</u>		
G-8	(Westbank) Located on back fence of Luling Entergy office.	305° 7.74	N 29.93055 W 90.36592
E-15	(Eastbank) Located on fence on Alliance Avenue.	275° 11.7	N 29.97695 W 90.27658
J-15	(Westbank) Located on pole near LA 631/Hwy 90 intersection in Des Allemands.	357° 11.7	N 29.82575 W 90.46457
E-30*	(Westbank) Located at entrance to Entergy office on Delaronde St. in Algiers.	276° 25.2	N 29.95233 W 90.05441

* DENOTES CONTROL LOCATIONS

RADIOLOGICAL ENVIRONMENTAL MONITORING PROGRAM

SAMPLE LOCATION TABLE (Continued)

LOCATION NUMBER	LOCATION DESCRIPTION	BEARING/ MILES TO PLANT	Position Latitude Longitude
AIRBORNE			
APP-1	(Westbank) Located in soybean/sugarcane field on Short St. in Killona.	119° 0.84	N 30.00158 W 90.48323
APQ-1	(Westbank) Located in soybean/sugarcane field off LA 18 east of LA 18/3141 intersection.	132° 0.81	N 30.00356 W 90.48093
APF-1	(Westbank) Located on north side of Secondary Meteorological Tower.	299° 0.35	N 29.99302 W 90.46601
APC-1	(Eastbank) Located inside Little Gypsy Cooling Water Intake Structure fence.	219° 0.67	N 30.00307 W 90.46401
APE-30*	(Westbank) Located on roof of Energy office building on Delaronde St. in Algiers.	276° 25.2	N 29.95289 W 90.05430

* DENOTES CONTROL LOCATIONS

RADIOLOGICAL ENVIRONMENTAL MONITORING PROGRAM

SAMPLE LOCATION TABLE (Continued)

LOCATION NUMBER	LOCATION DESCRIPTION	BEARING/ MILES TO PLANT	Position Latitude Longitude
	<u>BROAD LEAF</u>		
BLQ-1	(Westbank) Located near air sample station APQ-1.	132° 0.83	N 30.00367 W 90.48132
BLB-1	(Eastbank) Located west of Little Gypsy on LA 628.	197° 0.81	N 30.00665 W 90.46691
BLE-20*	(Westbank) Located on property of Nine Mile Point in Westwego.	280° 19.7	N 29.94142 W 90.14909

* DENOTES CONTROL LOCATION(S)

RADIOLOGICAL ENVIRONMENTAL MONITORING PROGRAM

SAMPLE LOCATION TABLE (Continued)

LOCATION NUMBER	LOCATION DESCRIPTION	BEARING/ MILES TO PLANT	Position Latitude Longitude
	INGESTION		
	MILK		
MKE-3	(Westbank) Located at the Zeringue's house on LA 18 in Taft.	279° 2.35	N 29.98926 W 90.43243
MKA-31*	(Eastbank) Located at 18736 Sisters Road, Ponchatoula, LA.	3° 31.2	N 30.50439 W 90.25114
	FISH		
FH-1*	Upstream of the plant intake structure.	N/A	N/A
FH-2	Downstream of the plant discharge structure.	N/A	N/A
FH-3	(Westbank) Waterways downstream of plant discharge directed to 40 Arpent Canal.	N/A	N/A

* DENOTES CONTROL LOCATIONS

N/A - Not Applicable for this sampling location.

RADIOLOGICAL ENVIRONMENTAL MONITORING PROGRAM

SAMPLE LOCATION TABLE (Continued)

LOCATION NUMBER	LOCATION DESCRIPTION	BEARING/ MILES TO PLANT	Position Latitude Longitude
<u>WATERBORNE</u>			
SWK-1	(Westbank) Located at 40 Arpent Canal south of the plant.	14° 0.49	N 29.98866 W 90.47324
SHWE-3	(Westbank) Located at Foot Ferry Landing on LA 18.	276° 2.99	N 29.99063 W 90.42151
SHWK-1	(Westbank) Located at 40 Arpent Canal south of plant.	14° 0.49	N 29.98866 W 90.47324
SHWQ-6*	(Eastbank) Located on LA 628 east of Reserve ferry landing.	129° 5.99	N 30.05154 W 90.54748
DWE-5 SWE-5	(Eastbank) Located at St. Charles Parish Waterworks in New Sarpy.	277° 4.59	N 29.98622 W 90.39525
DWP-7* SWP-7*	(Westbank) Located at St. John Parish Waterworks in Edgard.	117° 7.37	N 30.04629 W 90.57931
DWF-2 SWF-2	(Westbank) Located at Dow Chemical Plant drinking water canal.	302° 1.51	N 29.98371 W 90.44989

* DENOTES CONTROL LOCATIONS

RADIOLOGICAL ENVIRONMENTAL MONITORING PROGRAM

SAMPLE LOCATION TABLE (Continued)

LOCATION NUMBER	LOCATION DESCRIPTION	BEARING/ MILES TO PLANT	Position Latitude Longitude
	<u>SANITARY SYSTEM</u>		
SWR-1**	Sewage lift station Northwest of MSB.	153° 0.10	N 29.99684 W 90.47184

** Sampling requirements are not derived directly from REMP requirements therefore results will not appear in the annual report. However, it represents another possible environmental interface with the plant.

SECTOR AND ZONE DESIGNATORS FOR RADIOLOGICAL SAMPLING
AND MONITORING POINTS

SECTOR NOMENCLATURE		ZONE NOMENCLATURE	
INTERLINE OF SECTOR DEGREES TRUE NORTH FROM FACILITY	22 1/2° SECTOR	MILES FROM FACILITY	ZONE
& 360	*A N	0-1	1
22 1/2	B NNE	1-2	2
45	C NE	2-3	3
67 1/2	D ENE	3-4	4
90	E E	4-5	5
112 1/2	F ESE	5-6	6
135	G SE	6-7	7
157 1/2	H OR SSE	7-8	8
180	J S	8-9	9
202 1/2	K SSW	9-10	10
225	L SW	10-15	15
247 1/2	M WSW	15-20	20
270	N W	20-25	25
292 1/2	P WNW	25-30	30
315	Q NW	30-35	35
337 1/2	R NNW	35-40	40
		40-45	45
		45-50	50

COMMENT - An area is identified by a Sector and Zone designator. Thus, area N-1 is that area which lies between 0 and 11¼ degrees true north from the facility out to a radius of 1 mile. Area G-4 would be that area between 146¼ degrees and the 3- and 4-mile arcs from the facility. For Airborne, Ingestion (milk), and Food Products pathway designator will be preceded by acronyms AP, MK, and FP, respectively. Letters I and O have been omitted from these sector designators so as to eliminate possible confusion between letters A and O.

REMP SAMPLING LOCATIONS WITHIN 2 MILES OF WATERFORD 3

**VP Samples Within
files of Waterford-3**

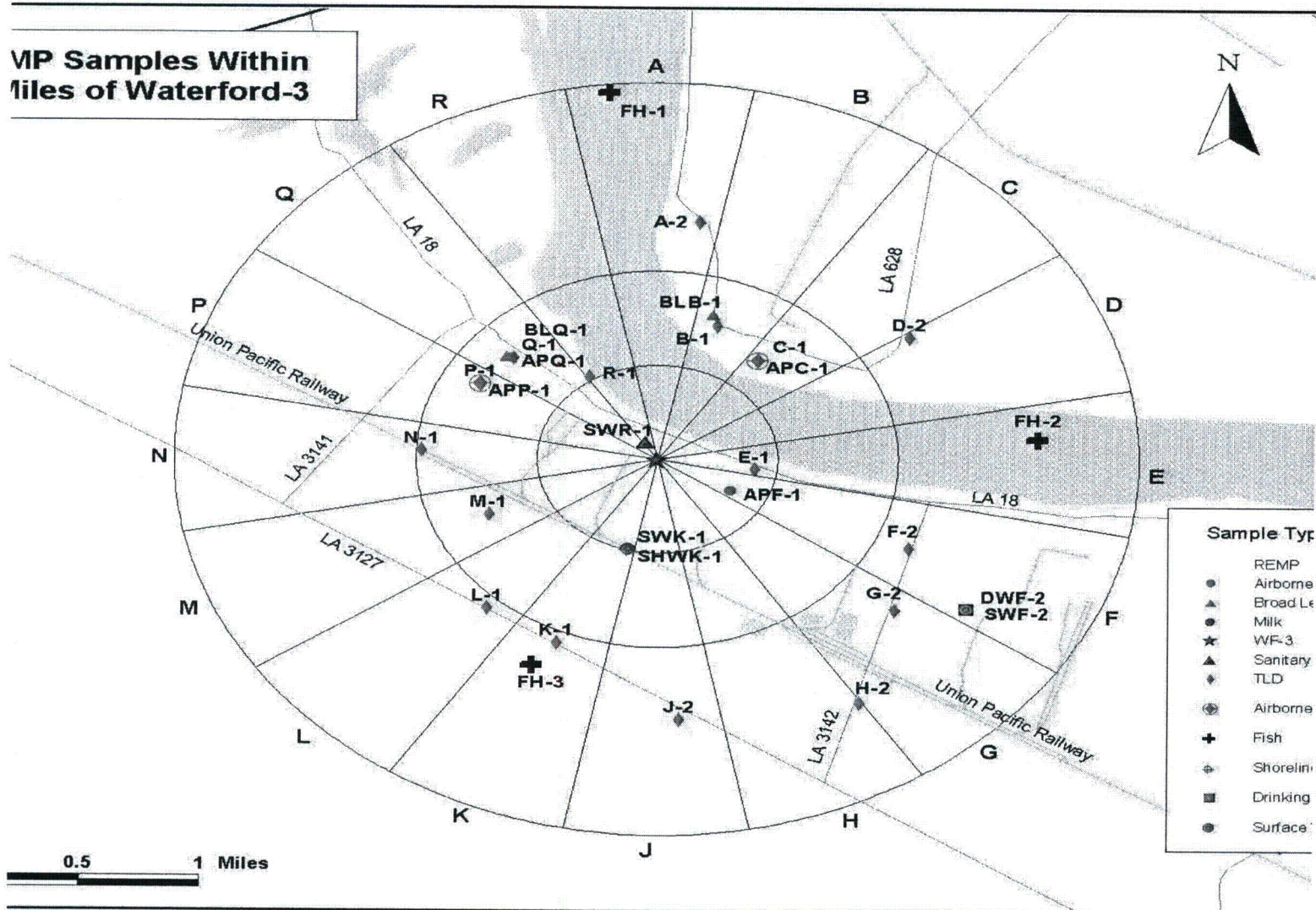

014 Revision 305

Attachment 7.1

REMP SAMPLES 2 TO 10 MILES
FROM WATERFORD 3

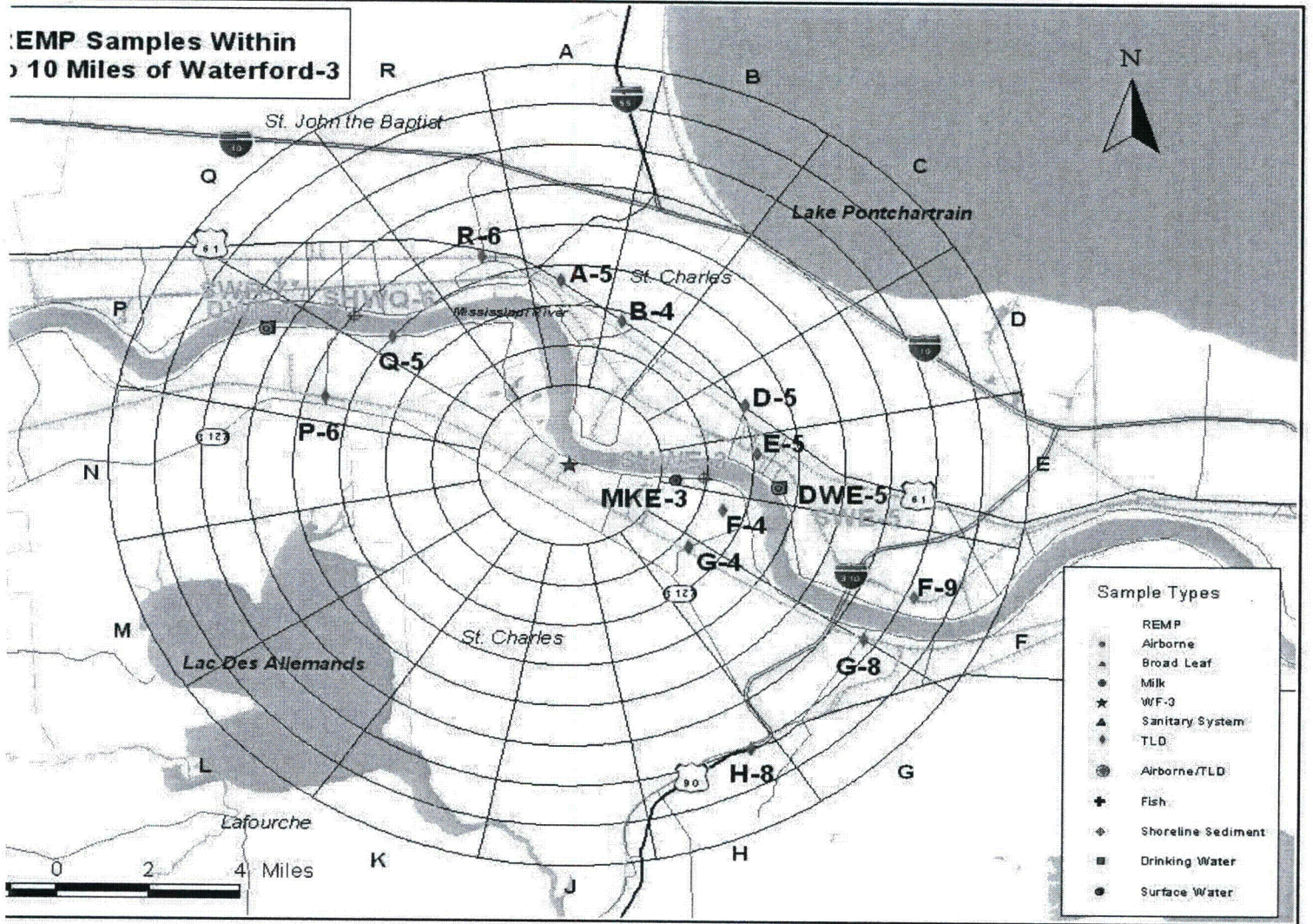

014 Revision 305

Attachment 7.

REMP SAMPLES 10 TO 50 MILES
FROM WATERFORD 3

IP Samples Within
0 Miles of Waterford-3

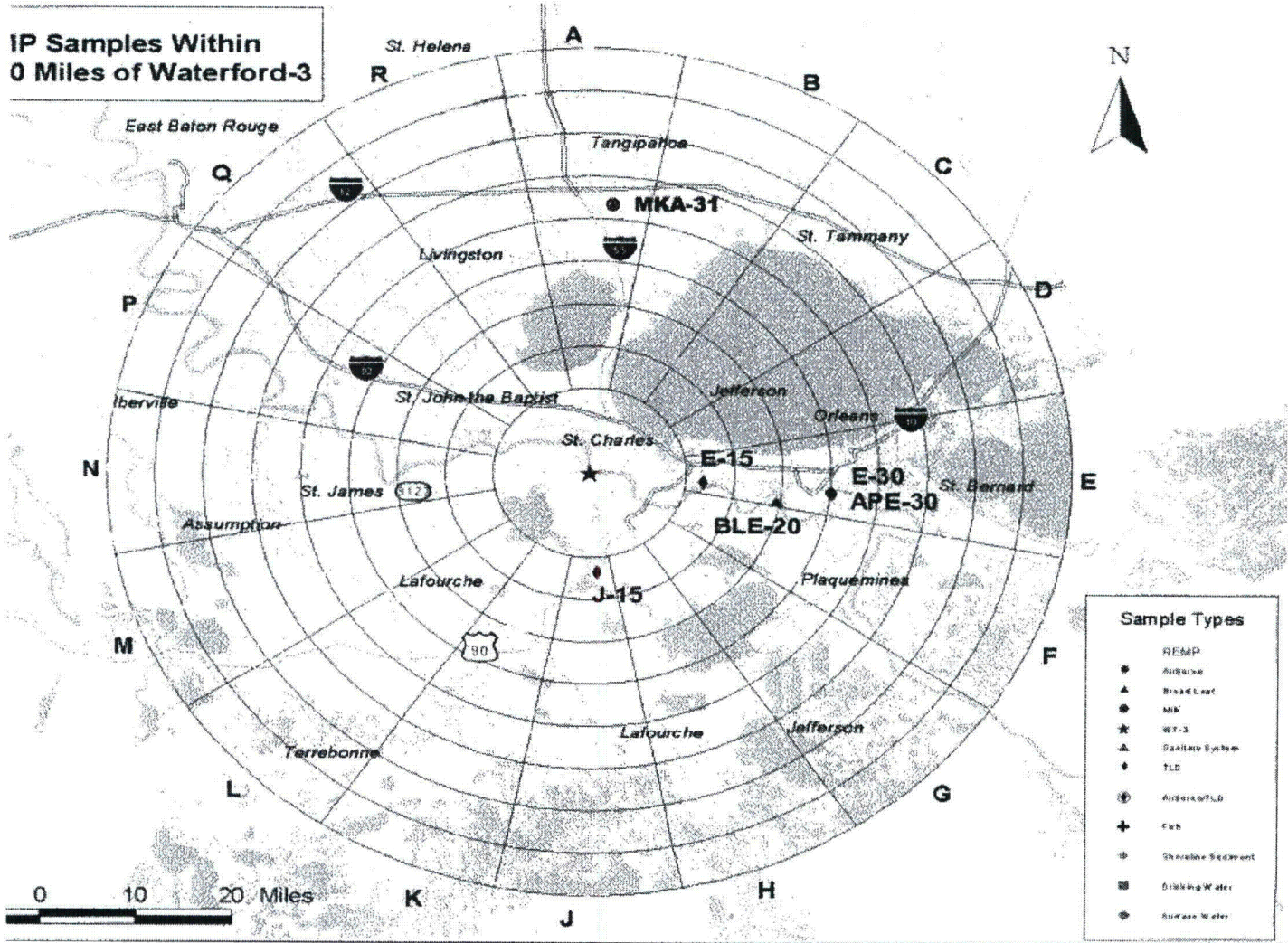

JNT-005-014 Revision 305

Attachment 7.1

**DOSE FACTORS DUE TO RADIONUCLIDES
OTHER THAN NOBLE GASES; P_i**

Pi factors for Adult age group by nuclide.
Waterford Steam Electric Station
Pathway : Inhalation Pathway for Pi

Nuclide	Organ Dose Conversion Factors						
	Bone	Liver	T. Body	Thyroid	Kidney	Lung	GI-LLI
H-3	0.00e+00	7.18e+02	7.18e+02	7.18e+02	7.18e+02	7.18e+02	7.18e+02
Be-10	1.58e+06	2.45e+05	3.97e+04	0.00e+00	0.00e+00	1.78e+06	1.34e+05
C-14	1.82e+04	3.41e+03	3.41e+03	3.41e+03	3.41e+03	3.41e+03	3.41e+03
N-13	5.02e+01	5.02e+01	5.02e+01	5.02e+01	5.02e+01	5.02e+01	5.02e+01
F-18	3.77e+03	0.00e+00	4.15e+02	0.00e+00	0.00e+00	0.00e+00	7.39e+01
Na-22	1.04e+05	1.04e+05	1.04e+05	1.04e+05	1.04e+05	1.04e+05	1.04e+05
Na-24	1.02e+04	1.02e+04	1.02e+04	1.02e+04	1.02e+04	1.02e+04	1.02e+04
P-32	1.32e+06	7.71e+04	5.01e+04	0.00e+00	0.00e+00	0.00e+00	8.64e+04
Ca-41	3.06e+05	0.00e+00	3.30e+04	0.00e+00	0.00e+00	3.06e+04	2.29e+03
Sc-46	4.41e+05	8.56e+05	2.49e+05	0.00e+00	7.99e+05	0.00e+00	2.58e+05
Cr-51	0.00e+00	0.00e+00	1.00e+02	5.95e+01	2.28e+01	1.44e+04	3.32e+03
Mn-54	0.00e+00	3.96e+04	6.30e+03	0.00e+00	9.84e+03	1.40e+06	7.74e+04
Mn-56	0.00e+00	1.24e+00	1.83e-01	0.00e+00	1.30e+00	9.44e+03	2.02e+04
Fe-55	2.46e+04	1.70e+04	3.94e+03	0.00e+00	0.00e+00	7.21e+04	6.03e+03
Fe-59	1.18e+04	2.78e+04	1.06e+04	0.00e+00	0.00e+00	1.02e+06	1.88e+05
Co-57	0.00e+00	6.92e+02	6.71e+02	0.00e+00	0.00e+00	3.70e+05	3.14e+04
Co-58	0.00e+00	1.58e+03	2.07e+03	0.00e+00	0.00e+00	9.28e+05	1.06e+05
Co-60	0.00e+00	1.15e+04	1.48e+04	0.00e+00	0.00e+00	5.97e+06	2.85e+05
Ni-59	3.25e+04	1.17e+04	5.42e+03	0.00e+00	0.00e+00	6.56e+04	4.89e+03
Ni-63	4.32e+05	3.14e+04	1.45e+04	0.00e+00	0.00e+00	1.78e+05	1.34e+04
Ni-65	1.54e+00	2.10e-01	9.12e-02	0.00e+00	0.00e+00	5.60e+03	1.23e+04
Cu-64	0.00e+00	1.46e+00	6.15e-01	0.00e+00	4.62e+00	6.78e+03	4.90e+04
Zn-65	3.24e+04	1.03e+05	4.66e+04	0.00e+00	6.90e+04	8.64e+05	5.34e+04
Zn-69	3.38e-02	6.51e-02	4.52e-03	0.00e+00	4.22e-02	9.20e+02	1.63e+01
Zn-69m	8.16e+00	1.96e+01	1.79e+00	0.00e+00	1.18e+01	1.90e+04	1.37e+05
Se-79	0.00e+00	3.06e+03	4.87e+02	0.00e+00	4.55e+03	3.58e+05	2.66e+04
Br-82	0.00e+00	0.00e+00	1.35e+04	0.00e+00	0.00e+00	0.00e+00	1.04e+04
Br-83	0.00e+00	0.00e+00	2.41e+02	0.00e+00	0.00e+00	0.00e+00	2.32e+02
Br-84	0.00e+00	0.00e+00	3.13e+02	0.00e+00	0.00e+00	0.00e+00	1.64e-03
Br-85	0.00e+00	0.00e+00	1.28e+01	0.00e+00	0.00e+00	0.00e+00	0.00e+00

Conversion factors are in units of mrem/yr per uCi/cubic meter.

**DOSE FACTORS DUE TO RADIONUCLIDES
OTHER THAN NOBLE GASES; P_i**

Pi factors for Adult age group by nuclide.
Waterford Steam Electric Station
Pathway : Inhalation Pathway for Pi

Nuclide	Organ Dose Conversion Factors						
	Bone	Liver	T. Body	Thyroid	Kidney	Lung	GI-LLI
Rb-86	0.00e+00	1.35e+05	5.90e+04	0.00e+00	0.00e+00	0.00e+00	1.66e+04
Rb-87	0.00e+00	7.89e+04	2.57e+04	0.00e+00	0.00e+00	0.00e+00	2.30e+03
Rb-88	0.00e+00	3.87e+02	1.93e+02	0.00e+00	0.00e+00	0.00e+00	3.34e-09
Rb-89	0.00e+00	2.56e+02	1.70e+02	0.00e+00	0.00e+00	0.00e+00	9.28e-12
Sr-89	3.04e+05	0.00e+00	8.72e+03	0.00e+00	0.00e+00	1.40e+06	3.50e+05
Sr-90	2.87e+07	0.00e+00	5.77e+05	0.00e+00	0.00e+00	9.60e+06	7.22e+05
Sr-91	6.19e+01	0.00e+00	2.50e+00	0.00e+00	0.00e+00	3.65e+04	1.91e+05
Sr-92	6.74e+00	0.00e+00	2.91e-01	0.00e+00	0.00e+00	1.65e+04	4.30e+04
Y-90	2.09e+03	0.00e+00	5.61e+01	0.00e+00	0.00e+00	1.70e+05	5.06e+05
Y-91	4.62e+05	0.00e+00	1.24e+04	0.00e+00	0.00e+00	1.70e+06	3.85e+05
Y-91m	2.61e-01	0.00e+00	1.02e-02	0.00e+00	0.00e+00	1.92e+03	1.33e+00
Y-92	1.03e+01	0.00e+00	3.02e-01	0.00e+00	0.00e+00	1.57e+04	7.35e+04
Y-93	9.44e+01	0.00e+00	2.61e+00	0.00e+00	0.00e+00	4.85e+04	4.22e+05
Zr-93	4.18e+05	2.34e+04	1.10e+04	0.00e+00	8.88e+04	1.70e+05	1.21e+04
Zr-95	1.07e+05	3.44e+04	2.33e+04	0.00e+00	5.42e+04	1.77e+06	1.50e+05
Zr-97	9.68e+01	1.96e+01	9.04e+00	0.00e+00	2.97e+01	7.87e+04	5.23e+05
Nb-93m	2.48e+05	8.08e+04	1.99e+04	0.00e+00	9.28e+04	2.49e+05	1.90e+04
Nb-95	1.41e+04	7.82e+03	4.21e+03	0.00e+00	7.74e+03	5.05e+05	1.04e+05
Nb-97	2.22e-01	5.62e-02	2.05e-02	0.00e+00	6.54e-02	2.40e+03	2.42e+02
Mo-93	0.00e+00	9.36e+03	2.54e+02	0.00e+00	2.84e+03	4.09e+05	3.03e+04
Mo-99	0.00e+00	1.21e+02	2.30e+01	0.00e+00	2.91e+02	9.12e+04	2.48e+05
Tc-101	4.18e-05	6.02e-05	5.90e-04	0.00e+00	1.08e-03	3.99e+02	1.09e-11
Tc-99	2.50e+02	3.71e+02	1.00e+02	0.00e+00	4.68e+03	8.08e+05	6.03e+04
Tc-99m	1.03e-03	2.91e-03	3.70e-02	0.00e+00	4.42e-02	7.64e+02	4.16e+03
Ru-103	1.53e+03	0.00e+00	6.58e+02	0.00e+00	5.83e+03	5.05e+05	1.10e+05
Ru-105	7.90e-01	0.00e+00	3.11e-01	0.00e+00	1.02e+00	1.10e+04	4.82e+04
Ru-106	6.91e+04	0.00e+00	8.72e+03	0.00e+00	1.34e+05	9.36e+06	9.12e+05
Rh-105	7.39e+00	5.38e+00	3.54e+00	0.00e+00	2.29e+01	1.93e+04	8.72e+04
Pd-107	0.00e+00	6.62e+02	4.70e+01	0.00e+00	5.26e+03	7.58e+04	5.65e+03
Pd-109	0.00e+00	3.70e+00	9.28e-01	0.00e+00	1.88e+01	1.48e+04	1.22e+05

Conversion factors are in units of mrem/yr per uCi/cubic meter.

**DOSE FACTORS DUE TO RADIONUCLIDES
OTHER THAN NOBLE GASES; P_i**

Pi factors for Adult age group by nuclide.
Waterford Steam Electric Station
Pathway : Inhalation Pathway for Pi

Nuclide	Organ Dose Conversion Factors						
	Bone	Liver	T. Body	Thyroid	Kidney	Lung	GI-LLI
Ag-110m	1.08e+04	1.00e+04	5.94e+03	0.00e+00	1.97e+04	4.63e+06	3.02e+05
Ag-111	3.40e+02	1.42e+02	7.10e+01	0.00e+00	4.59e+02	1.86e+05	2.23e+05
Cd-113m	0.00e+00	1.23e+06	3.98e+04	0.00e+00	1.37e+06	1.66e+06	1.27e+05
Cd-115m	0.00e+00	1.97e+05	6.36e+03	0.00e+00	1.58e+05	1.41e+06	3.84e+05
Sn-123	2.42e+05	5.34e+03	7.86e+03	4.54e+03	0.00e+00	2.30e+06	3.14e+05
Sn-125	9.28e+03	2.50e+02	5.62e+02	2.07e+02	0.00e+00	5.90e+05	5.45e+05
Sn-126	1.26e+06	3.34e+04	4.80e+04	9.84e+03	0.00e+00	9.36e+06	1.27e+05
Sb-124	3.12e+04	5.89e+02	1.24e+04	7.55e+01	0.00e+00	2.48e+06	4.06e+05
Sb-125	5.34e+04	5.95e+02	1.26e+04	5.40e+01	0.00e+00	1.74e+06	1.01e+05
Sb-126	3.60e+03	7.30e+01	1.30e+03	2.20e+01	0.00e+00	7.66e+05	4.81e+05
Sb-127	2.64e+02	5.78e+00	1.02e+02	3.18e+00	0.00e+00	1.64e+05	3.02e+05
Te-125m	3.42e+03	1.58e+03	4.67e+02	1.05e+03	1.24e+04	3.14e+05	7.06e+04
Te-127	1.40e+00	6.42e-01	3.10e-01	1.06e+00	5.10e+00	6.51e+03	5.74e+04
Te-127m	1.26e+04	5.77e+03	1.57e+03	3.29e+03	4.58e+04	9.60e+05	1.50e+05
Te-129	4.98e-02	2.39e-02	1.24e-02	3.90e-02	1.87e-01	1.94e+03	1.57e+02
Te-129m	9.76e+03	4.67e+03	1.58e+03	3.44e+03	3.66e+04	1.16e+06	3.83e+05
Te-131	1.11e-02	5.95e-03	3.59e-03	9.36e-03	4.37e-02	1.39e+03	1.84e+01
Te-131m	6.99e+01	4.36e+01	2.90e+01	5.50e+01	3.09e+02	1.46e+05	5.56e+05
Te-132	2.60e+02	2.15e+02	1.62e+02	1.90e+02	1.46e+03	2.88e+05	5.10e+05
Te-133m	5.79e-02	4.32e-02	3.34e-02	5.02e-02	2.99e-01	4.41e+03	6.12e+01
Te-134	3.07e-02	2.58e-02	1.26e-02	2.75e-02	1.74e-01	3.47e+03	2.38e-01
I-129	1.98e+04	1.69e+04	5.53e+04	4.43e+07	3.62e+04	0.00e+00	1.78e+03
I-130	4.58e+03	1.34e+04	5.28e+03	1.14e+06	2.09e+04	0.00e+00	7.69e+03
I-131	2.52e+04	3.58e+04	2.05e+04	1.19e+07	6.13e+04	0.00e+00	6.28e+03
I-132	1.16e+03	3.26e+03	1.16e+03	1.14e+05	5.18e+03	0.00e+00	4.06e+02
I-133	8.64e+03	1.48e+04	4.52e+03	2.15e+06	2.58e+04	0.00e+00	8.88e+03
I-134	6.44e+02	1.73e+03	6.15e+02	2.98e+04	2.75e+03	0.00e+00	1.01e+00
I-135	2.68e+03	6.98e+03	2.57e+03	4.48e+05	1.11e+04	0.00e+00	5.25e+03
Cs-134	3.73e+05	8.48e+05	7.28e+05	0.00e+00	2.87e+05	9.76e+04	1.04e+04
Cs-134m	1.27e+02	2.56e+02	1.38e+02	0.00e+00	1.46e+02	2.34e+01	6.34e+01

Conversion factors are in units of mrem/yr per uCi/cubic meter.

**DOSE FACTORS DUE TO RADIONUCLIDES
OTHER THAN NOBLE GASES; P_i**

Pi factors for Adult age group by nuclide.
Waterford Steam Electric Station
Pathway : Inhalation Pathway for Pi

Nuclide	Organ Dose Conversion Factors						
	Bone	Liver	T. Body	Thyroid	Kidney	Lung	GI-LLI
Cs-135	1.17e+05	1.03e+05	4.79e+04	0.00e+00	4.09e+04	1.26e+04	1.69e+03
Cs-136	3.90e+04	1.46e+05	1.10e+05	0.00e+00	8.56e+04	1.20e+04	1.17e+04
Cs-137	4.78e+05	6.21e+05	4.28e+05	0.00e+00	2.22e+05	7.52e+04	8.40e+03
Cs-138	3.31e+02	6.21e+02	3.24e+02	0.00e+00	4.80e+02	4.86e+01	1.86e-03
Cs-139	2.05e+02	2.90e+02	1.11e+02	0.00e+00	2.44e+02	2.27e+01	4.39e-21
Ba-139	9.36e-01	6.66e-04	2.74e-02	0.00e+00	6.22e-04	3.76e+03	8.96e+02
Ba-140	3.90e+04	4.90e+01	2.57e+03	0.00e+00	1.67e+01	1.27e+06	2.18e+05
Ba-141	1.00e-01	7.53e-05	3.36e-03	0.00e+00	7.00e-05	1.94e+03	1.16e-07
Ba-142	2.63e-02	2.70e-05	1.66e-03	0.00e+00	2.29e-05	1.19e+03	1.57e-16
La-140	3.44e+02	1.74e+02	4.58e+01	0.00e+00	0.00e+00	1.36e+05	4.58e+05
La-141	4.27e+00	1.33e+00	2.17e-01	0.00e+00	0.00e+00	1.08e+04	5.85e+04
La-142	6.83e-01	3.10e-01	7.72e-02	0.00e+00	0.00e+00	6.33e+03	2.11e+03
Ce-141	1.99e+04	1.35e+04	1.53e+03	0.00e+00	6.26e+03	3.62e+05	1.20e+05
Ce-143	1.86e+02	1.38e+02	1.53e+01	0.00e+00	6.08e+01	7.98e+04	2.26e+05
Ce-144	3.43e+06	1.43e+06	1.84e+05	0.00e+00	8.48e+05	7.78e+06	8.16e+05
Pr-143	9.36e+03	3.75e+03	4.64e+02	0.00e+00	2.16e+03	2.81e+05	2.00e+05
Pr-144	3.01e-02	1.25e-02	1.53e-03	0.00e+00	7.05e-03	1.02e+03	2.15e-08
Nd-147	5.27e+03	6.10e+03	3.65e+02	0.00e+00	3.56e+03	2.21e+05	1.73e+05
Pm-147	6.70e+05	6.30e+04	2.55e+04	0.00e+00	1.19e+05	5.28e+05	4.43e+04
Pm-148	3.07e+03	5.10e+02	2.56e+02	0.00e+00	9.60e+02	3.13e+05	4.64e+05
Pm-148m	7.86e+04	2.03e+04	1.55e+04	0.00e+00	3.08e+04	1.71e+06	3.34e+05
Pm-149	2.75e+02	3.90e+01	1.59e+01	0.00e+00	7.35e+01	5.77e+04	2.00e+05
Pm-151	6.80e+01	1.14e+01	5.77e+00	0.00e+00	2.04e+01	3.15e+04	1.60e+05
Sm-151	6.87e+05	1.18e+05	2.84e+04	0.00e+00	1.33e+05	3.56e+05	2.60e+04
Sm-153	1.36e+02	1.14e+02	8.32e+00	0.00e+00	3.67e+01	3.31e+04	1.26e+05
Eu-152	1.90e+06	4.33e+05	3.81e+05	0.00e+00	2.68e+06	2.74e+06	1.27e+05
Eu-154	5.92e+06	7.28e+05	5.18e+05	0.00e+00	3.49e+06	4.67e+06	2.72e+05
Eu-155	8.08e+05	1.14e+05	7.37e+04	0.00e+00	5.27e+05	7.57e+05	4.76e+04
Eu-156	1.54e+04	1.18e+04	1.92e+03	0.00e+00	7.96e+03	6.85e+05	3.60e+05
Tb-160	1.77e+05	0.00e+00	2.20e+04	0.00e+00	7.28e+04	1.54e+06	2.14e+05

Conversion factors are in units of mrem/yr per uCi/cubic meter.

**DOSE FACTORS DUE TO RADIONUCLIDES
OTHER THAN NOBLE GASES; P_i**

Pi factors for Adult age group by nuclide.
Waterford Steam Electric Station
Pathway : Inhalation Pathway for Pi

Nuclide	Organ Dose Conversion Factors						
	Bone	Liver	T. Body	Thyroid	Kidney	Lung	GI-LLI
Ho-166m	2.70e+06	8.40e+05	6.40e+05	0.00e+00	1.26e+06	3.15e+06	1.27e+05
W-181	4.98e+01	1.62e+01	1.74e+00	0.00e+00	0.00e+00	1.37e+04	2.02e+03
W-185	1.56e+03	5.18e+02	5.45e+01	0.00e+00	0.00e+00	4.46e+05	8.56e+04
W-187	8.48e+00	7.08e+00	2.48e+00	0.00e+00	0.00e+00	2.90e+04	1.55e+05
Pb-210	2.11e+08	5.38e+07	6.70e+06	0.00e+00	1.70e+08	2.10e+08	1.21e+04
Bi-210	1.85e+03	1.27e+04	1.06e+03	0.00e+00	1.54e+05	8.88e+06	2.36e+05
Po-210	3.18e+06	6.88e+06	7.66e+05	0.00e+00	2.36e+07	2.51e+08	3.35e+05
Ra-223	1.44e+06	2.22e+03	2.88e+05	0.00e+00	6.28e+04	2.04e+08	2.27e+06
Ra-224	1.58e+05	3.82e+02	3.17e+04	0.00e+00	1.08e+04	7.02e+07	2.41e+06
Ra-225	2.40e+06	2.85e+03	4.79e+05	0.00e+00	8.08e+04	2.34e+08	2.17e+06
Ra-226	1.00e+09	1.91e+04	7.31e+08	0.00e+00	5.42e+05	9.36e+08	2.35e+06
Ra-228	3.53e+08	9.84e+03	3.82e+08	0.00e+00	2.78e+05	1.29e+09	4.00e+05
Ac-225	3.38e+06	4.66e+06	2.27e+05	0.00e+00	5.30e+05	1.77e+08	2.02e+06
Ac-227	1.84e+10	2.44e+09	1.09e+09	0.00e+00	7.86e+08	1.93e+09	4.06e+05
Th-227	1.74e+06	3.14e+04	5.00e+04	0.00e+00	1.78e+05	3.02e+08	2.67e+06
Th-228	1.60e+09	2.71e+07	5.42e+07	0.00e+00	1.51e+08	8.08e+09	2.79e+06
Th-229	1.21e+11	3.47e+09	2.01e+09	0.00e+00	1.70e+10	2.90e+10	3.86e+05
Th-230	1.83e+10	1.05e+09	5.09e+08	0.00e+00	5.12e+09	4.97e+09	2.98e+05
Th-232	2.05e+10	8.96e+08	7.23e+06	0.00e+00	4.38e+09	4.77e+09	2.54e+05
Th-234	1.30e+04	7.65e+02	3.76e+02	0.00e+00	4.33e+03	1.51e+06	5.62e+05
Pa-231	4.06e+10	1.53e+09	1.58e+09	0.00e+00	8.56e+09	4.60e+08	3.55e+05
Pa-233	9.68e+03	1.94e+03	1.67e+03	0.00e+00	7.32e+03	2.82e+05	8.16e+04
U-232	4.11e+08	0.00e+00	2.93e+07	0.00e+00	4.45e+07	1.78e+09	3.37e+05
U-233	8.72e+07	0.00e+00	5.28e+06	0.00e+00	2.03e+07	4.26e+08	3.11e+05
U-234	8.32e+07	0.00e+00	5.17e+06	0.00e+00	1.99e+07	4.18e+08	3.05e+05
U-235	8.00e+07	0.00e+00	4.86e+06	0.00e+00	1.87e+07	3.92e+08	3.87e+05
U-236	8.00e+07	0.00e+00	4.96e+06	0.00e+00	1.91e+07	4.00e+08	2.86e+05
U-237	2.94e+02	0.00e+00	7.82e+01	0.00e+00	1.21e+03	8.16e+04	9.60e+04
U-238	7.66e+07	0.00e+00	4.54e+06	0.00e+00	1.74e+07	3.66e+08	2.73e+05
Np-237	1.25e+10	8.00e+09	5.50e+08	0.00e+00	4.08e+09	4.18e+08	3.94e+05

Conversion factors are in units of mrem/yr per uCi/cubic meter.

**DOSE FACTORS DUE TO RADIONUCLIDES
OTHER THAN NOBLE GASES; P_i**

Pi factors for Adult age group by nuclide.
Waterford Steam Electric Station
Pathway : Inhalation Pathway for Pi

Nuclide	Organ Dose Conversion Factors						
	Bone	Liver	T. Body	Thyroid	Kidney	Lung	GI-LLI
Np-238	2.37e+03	5.76e+02	3.69e+01	0.00e+00	2.18e+02	8.16e+04	1.70e+05
Np-239	2.30e+02	2.03e+02	1.24e+01	0.00e+00	7.00e+01	3.76e+04	1.19e+05
Pu-238	1.14e+10	7.77e+09	5.52e+08	0.00e+00	2.37e+09	1.46e+09	3.62e+05
Pu-239	1.33e+10	8.56e+09	6.20e+08	0.00e+00	2.64e+09	1.38e+09	3.30e+05
Pu-240	1.32e+10	8.56e+09	6.18e+08	0.00e+00	2.63e+09	1.38e+09	3.37e+05
Pu-241	2.74e+08	6.95e+07	1.03e+07	0.00e+00	4.74e+07	1.22e+06	6.92e+03
Pu-242	1.22e+10	8.24e+09	5.97e+08	0.00e+00	2.54e+09	1.32e+09	3.24e+05
Pu-244	1.43e+10	9.44e+09	6.83e+08	0.00e+00	2.91e+09	1.51e+09	4.82e+05
Am-241	1.34e+10	9.04e+09	5.37e+08	0.00e+00	4.03e+09	4.85e+08	3.68e+05
Am-242m	1.36e+10	8.48e+09	5.38e+08	0.00e+00	4.01e+09	1.95e+08	4.63e+05
Am-243	1.34e+10	8.80e+09	5.26e+08	0.00e+00	3.96e+09	4.60e+08	4.32e+05
Cm-242	1.78e+08	1.42e+08	7.87e+06	0.00e+00	3.58e+07	3.14e+08	3.93e+05
Cm-243	8.80e+09	6.09e+09	3.69e+08	0.00e+00	1.72e+09	5.05e+08	3.87e+05
Cm-244	6.70e+09	4.70e+09	2.81e+08	0.00e+00	1.31e+09	4.85e+08	3.74e+05
Cm-245	1.39e+10	9.12e+09	5.71e+08	0.00e+00	2.66e+09	4.68e+08	3.49e+05
Cm-246	1.38e+10	9.12e+09	5.70e+08	0.00e+00	2.66e+09	4.77e+08	3.43e+05
Cm-247	1.34e+10	8.96e+09	5.62e+08	0.00e+00	2.62e+09	4.68e+08	4.50e+05
Cm-248	1.12e+11	7.41e+10	4.63e+09	0.00e+00	2.16e+10	3.86e+09	7.27e+06
Cf-252	4.34e+09	0.00e+00	1.86e+08	0.00e+00	0.00e+00	1.59e+09	1.42e+06

Conversion factors are in units of mrem/yr per uCi/cubic meter.

**DOSE FACTORS DUE TO RADIONUCLIDES
OTHER THAN NOBLE GASES; P_i**

Pi factors for Teen age group by nuclide.
Waterford Steam Electric Station
Pathway : Inhalation Pathway for Pi

Nuclide	Organ Dose Conversion Factors						
	Bone	Liver	T. Body	Thyroid	Kidney	Lung	GI-LLI
H-3	0.00e+00	7.25e+02	7.25e+02	7.25e+02	7.25e+02	7.25e+02	7.25e+02
Be-10	2.22e+06	3.46e+05	5.67e+04	0.00e+00	0.00e+00	3.07e+06	1.42e+05
C-14	2.60e+04	4.87e+03	4.87e+03	4.87e+03	4.87e+03	4.87e+03	4.87e+03
N-13	6.92e+01	6.92e+01	6.92e+01	6.92e+01	6.92e+01	6.92e+01	6.92e+01
F-18	5.22e+03	0.00e+00	5.68e+02	0.00e+00	0.00e+00	0.00e+00	3.11e+02
Na-22	1.41e+05	1.41e+05	1.41e+05	1.41e+05	1.41e+05	1.41e+05	1.41e+05
Na-24	1.38e+04	1.38e+04	1.38e+04	1.38e+04	1.38e+04	1.38e+04	1.38e+04
P-32	1.89e+06	1.10e+05	7.16e+04	0.00e+00	0.00e+00	0.00e+00	9.28e+04
Ca-41	3.24e+05	0.00e+00	3.50e+04	0.00e+00	0.00e+00	8.08e+08	2.42e+03
Sc-46	5.79e+05	1.13e+06	3.34e+05	0.00e+00	1.08e+06	0.00e+00	2.38e+05
Cr-51	0.00e+00	0.00e+00	1.35e+02	7.50e+01	3.07e+01	2.10e+04	3.00e+03
Mn-54	0.00e+00	5.11e+04	8.40e+03	0.00e+00	1.27e+04	1.98e+06	6.68e+04
Mn-56	0.00e+00	1.70e+00	2.52e-01	0.00e+00	1.79e+00	1.52e+04	5.74e+04
Fe-55	3.34e+04	2.38e+04	5.54e+03	0.00e+00	0.00e+00	1.24e+05	6.39e+03
Fe-59	1.59e+04	3.70e+04	1.43e+04	0.00e+00	0.00e+00	1.53e+06	1.78e+05
Co-57	0.00e+00	9.44e+02	9.20e+02	0.00e+00	0.00e+00	5.86e+05	3.14e+04
Co-58	0.00e+00	2.07e+03	2.78e+03	0.00e+00	0.00e+00	1.34e+06	9.52e+04
Co-60	0.00e+00	1.51e+04	1.98e+04	0.00e+00	0.00e+00	8.72e+06	2.59e+05
Ni-59	4.35e+04	1.62e+04	7.39e+03	0.00e+00	0.00e+00	1.13e+05	5.18e+03
Ni-63	5.80e+05	4.34e+04	1.98e+04	0.00e+00	0.00e+00	3.07e+05	1.42e+04
Ni-65	2.18e+00	2.93e-01	1.27e-01	0.00e+00	0.00e+00	9.36e+03	3.67e+04
Cu-64	0.00e+00	2.03e+00	8.48e-01	0.00e+00	6.41e+00	1.11e+04	6.14e+04
Zn-65	3.86e+04	1.34e+05	6.24e+04	0.00e+00	8.64e+04	1.24e+06	4.66e+04
Zn-69	4.83e-02	9.20e-02	6.46e-03	0.00e+00	6.02e-02	1.58e+03	2.85e+02
Zn-69m	1.15e+01	2.71e+01	2.49e+00	0.00e+00	1.65e+01	3.14e+04	1.71e+05
Se-79	0.00e+00	4.34e+03	6.97e+02	0.00e+00	6.50e+03	6.17e+05	2.82e+04
Br-82	0.00e+00	0.00e+00	1.82e+04	0.00e+00	0.00e+00	0.00e+00	0.00e+00
Br-83	0.00e+00	0.00e+00	3.44e+02	0.00e+00	0.00e+00	0.00e+00	0.00e+00
Br-84	0.00e+00	0.00e+00	4.33e+02	0.00e+00	0.00e+00	0.00e+00	0.00e+00
Br-85	0.00e+00	0.00e+00	1.83e+01	0.00e+00	0.00e+00	0.00e+00	0.00e+00

Conversion factors are in units of mrem/yr per uCi/cubic meter.

**DOSE FACTORS DUE TO RADIONUCLIDES
OTHER THAN NOBLE GASES; P_i**

Pi factors for Teen age group by nuclide.
Waterford Steam Electric Station
Pathway : Inhalation Pathway for Pi

Nuclide	Organ Dose Conversion Factors						
	Bone	Liver	T. Body	Thyroid	Kidney	Lung	GI-LLI
Rb-86	0.00e+00	1.90e+05	8.40e+04	0.00e+00	0.00e+00	0.00e+00	1.77e+04
Rb-87	0.00e+00	1.12e+05	3.66e+04	0.00e+00	0.00e+00	0.00e+00	2.44e+03
Rb-88	0.00e+00	5.46e+02	2.72e+02	0.00e+00	0.00e+00	0.00e+00	2.92e-05
Rb-89	0.00e+00	3.52e+02	2.33e+02	0.00e+00	0.00e+00	0.00e+00	3.38e-07
Sr-89	4.34e+05	0.00e+00	1.25e+04	0.00e+00	0.00e+00	2.42e+06	3.71e+05
Sr-90	3.31e+07	0.00e+00	6.66e+05	0.00e+00	0.00e+00	1.65e+07	7.65e+05
Sr-91	8.80e+01	0.00e+00	3.51e+00	0.00e+00	0.00e+00	6.07e+04	2.59e+05
Sr-92	9.52e+00	0.00e+00	4.06e-01	0.00e+00	0.00e+00	2.74e+04	1.19e+05
Y-90	2.98e+03	0.00e+00	8.00e+01	0.00e+00	0.00e+00	2.93e+05	5.59e+05
Y-91	6.61e+05	0.00e+00	1.77e+04	0.00e+00	0.00e+00	2.94e+06	4.09e+05
Y-91m	3.70e-01	0.00e+00	1.42e-02	0.00e+00	0.00e+00	3.20e+03	3.02e+01
Y-92	1.47e+01	0.00e+00	4.29e-01	0.00e+00	0.00e+00	2.68e+04	1.65e+05
Y-93	1.35e+02	0.00e+00	3.72e+00	0.00e+00	0.00e+00	8.32e+04	5.79e+05
Zr-93	5.46e+05	2.70e+04	1.47e+04	0.00e+00	9.28e+04	2.94e+05	1.28e+04
Zr-95	1.46e+05	4.58e+04	3.15e+04	0.00e+00	6.74e+04	2.69e+06	1.49e+05
Zr-97	1.38e+02	2.72e+01	1.26e+01	0.00e+00	4.12e+01	1.30e+05	6.30e+05
Nb-93m	3.31e+05	1.09e+05	2.73e+04	0.00e+00	1.27e+05	4.29e+05	2.02e+04
Nb-95	1.86e+04	1.03e+04	5.66e+03	0.00e+00	1.00e+04	7.51e+05	9.68e+04
Nb-97	3.14e-01	7.78e-02	2.84e-02	0.00e+00	9.12e-02	3.93e+03	2.17e+03
Mo-93	0.00e+00	1.33e+04	3.62e+02	0.00e+00	4.05e+03	7.05e+05	3.19e+04
Mo-99	0.00e+00	1.69e+02	3.22e+01	0.00e+00	4.11e+02	1.54e+05	2.69e+05
Tc-101	5.92e-05	8.40e-05	8.24e-04	0.00e+00	1.52e-03	6.67e+02	8.72e-07
Tc-99	3.58e+02	5.26e+02	1.43e+02	0.00e+00	6.68e+03	1.39e+06	6.39e+04
Tc-99m	1.38e-03	3.86e-03	4.99e-02	0.00e+00	5.76e-02	1.15e+03	6.13e+03
Ru-103	2.10e+03	0.00e+00	8.96e+02	0.00e+00	7.43e+03	7.83e+05	1.09e+05
Ru-105	1.12e+00	0.00e+00	4.34e-01	0.00e+00	1.41e+00	1.82e+04	9.04e+04
Ru-106	9.84e+04	0.00e+00	1.24e+04	0.00e+00	1.90e+05	1.61e+07	9.60e+05
Rh-105	1.06e+01	7.58e+00	4.99e+00	0.00e+00	3.23e+01	3.27e+04	9.84e+04
Pd-107	0.00e+00	9.36e+02	6.71e+01	0.00e+00	7.51e+03	1.30e+05	5.99e+03
Pd-109	0.00e+00	5.25e+00	1.33e+00	0.00e+00	2.69e+01	2.55e+04	1.57e+05

Conversion factors are in units of mrem/yr per uCi/cubic meter.

**DOSE FACTORS DUE TO RADIONUCLIDES
OTHER THAN NOBLE GASES; P_i**

Pi factors for Teen age group by nuclide.
Waterford Steam Electric Station
Pathway : Inhalation Pathway for Pi

Nuclide	Organ Dose Conversion Factors						
	Bone	Liver	T. Body	Thyroid	Kidney	Lung	GI-LLI
Ag-110m	1.38e+04	1.31e+04	7.99e+03	0.00e+00	2.50e+04	6.75e+06	2.73e+05
Ag-111	4.86e+02	2.02e+02	1.01e+02	0.00e+00	6.54e+02	3.20e+05	2.40e+05
Cd-113m	0.00e+00	1.74e+06	5.68e+04	0.00e+00	1.94e+06	2.87e+06	1.34e+05
Cd-115m	0.00e+00	2.78e+05	9.12e+03	0.00e+00	2.26e+05	2.42e+06	4.08e+05
Sn-123	3.45e+05	7.55e+03	1.12e+04	6.04e+03	0.00e+00	3.97e+06	3.33e+05
Sn-125	1.33e+04	3.54e+02	7.99e+02	2.76e+02	0.00e+00	1.01e+06	5.83e+05
Sn-126	1.74e+06	4.31e+04	6.59e+04	1.14e+04	0.00e+00	1.38e+07	1.34e+05
Sb-124	4.30e+04	7.94e+02	1.68e+04	9.76e+01	0.00e+00	3.85e+06	3.98e+05
Sb-125	7.38e+04	8.08e+02	1.72e+04	7.04e+01	0.00e+00	2.74e+06	9.92e+04
Sb-126	4.95e+03	1.02e+02	1.78e+03	2.80e+01	0.00e+00	1.24e+06	4.81e+05
Sb-127	3.71e+02	7.94e+00	1.40e+02	4.17e+00	0.00e+00	2.65e+05	3.15e+05
Te-125m	4.88e+03	2.24e+03	6.67e+02	1.40e+03	0.00e+00	5.36e+05	7.50e+04
Te-127	2.01e+00	9.12e-01	4.42e-01	1.42e+00	7.28e+00	1.12e+04	8.08e+04
Te-127m	1.80e+04	8.16e+03	2.18e+03	4.38e+03	6.54e+04	1.66e+06	1.59e+05
Te-129	7.10e-02	3.38e-02	1.76e-02	5.18e-02	2.66e-01	3.30e+03	1.62e+03
Te-129m	1.39e+04	6.58e+03	2.25e+03	4.58e+03	5.19e+04	1.98e+06	4.05e+05
Te-131	1.58e-02	8.32e-03	5.04e-03	1.24e-02	6.18e-02	2.34e+03	1.51e+01
Te-131m	9.84e+01	6.01e+01	4.02e+01	7.25e+01	4.39e+02	2.38e+05	6.21e+05
Te-132	3.60e+02	2.90e+02	2.19e+02	2.46e+02	1.95e+03	4.49e+05	4.63e+05
Te-133m	8.08e-02	5.86e-02	4.57e-02	6.54e-02	4.06e-01	6.97e+03	9.84e+02
Te-134	4.25e-02	3.48e-02	2.91e-02	3.57e-02	2.33e-01	5.40e+03	1.10e+01
I-129	2.82e+04	2.35e+04	3.92e+04	2.93e+07	4.21e+04	0.00e+00	1.83e+03
I-130	6.24e+03	1.79e+04	7.17e+03	1.49e+06	2.75e+04	0.00e+00	9.12e+03
I-131	3.54e+04	4.91e+04	2.64e+04	1.46e+07	8.40e+04	0.00e+00	6.49e+03
I-132	1.59e+03	4.38e+03	1.58e+03	1.51e+05	6.92e+03	0.00e+00	1.27e+03
I-133	1.22e+04	2.05e+04	6.22e+03	2.92e+06	3.59e+04	0.00e+00	1.03e+04
I-134	8.88e+02	2.32e+03	8.40e+02	3.95e+04	3.66e+03	0.00e+00	2.04e+01
I-135	3.70e+03	9.44e+03	3.49e+03	6.21e+05	1.49e+04	0.00e+00	6.95e+03
Cs-134	5.02e+05	1.13e+06	5.49e+05	0.00e+00	3.75e+05	1.46e+05	9.76e+03
Cs-134m	1.76e+02	3.48e+02	1.88e+02	0.00e+00	2.03e+02	3.65e+01	1.62e+02

Conversion factors are in units of mrem/yr per uCi/cubic meter.

**DOSE FACTORS DUE TO RADIONUCLIDES
OTHER THAN NOBLE GASES; P_i**

Pi factors for Teen age group by nuclide.
Waterford Steam Electric Station
Pathway : Inhalation Pathway for Pi

Nuclide	Organ Dose Conversion Factors						
	Bone	Liver	T. Body	Thyroid	Kidney	Lung	GI-LLI
Cs-135	1.66e+05	1.46e+05	3.58e+04	0.00e+00	5.84e+04	2.16e+04	1.78e+03
Cs-136	5.15e+04	1.94e+05	1.37e+05	0.00e+00	1.10e+05	1.78e+04	1.09e+04
Cs-137	6.70e+05	8.48e+05	3.11e+05	0.00e+00	3.04e+05	1.21e+05	8.48e+03
Cs-138	4.66e+02	8.56e+02	4.46e+02	0.00e+00	6.62e+02	7.87e+01	2.70e-01
Cs-139	2.92e+02	4.10e+02	1.58e+02	0.00e+00	3.47e+02	3.89e+01	1.33e-13
Ba-139	1.34e+00	9.44e-04	3.90e-02	0.00e+00	8.88e-04	6.46e+03	6.45e+03
Ba-140	5.47e+04	6.70e+01	3.52e+03	0.00e+00	2.28e+01	2.03e+06	2.29e+05
Ba-141	1.42e-01	1.06e-04	4.74e-03	0.00e+00	9.84e-05	3.29e+03	7.46e-04
Ba-142	3.70e-02	3.70e-05	2.27e-03	0.00e+00	3.14e-05	1.91e+03	4.79e-10
La-140	4.79e+02	2.36e+02	6.26e+01	0.00e+00	0.00e+00	2.14e+05	4.87e+05
La-141	6.10e+00	1.88e+00	3.10e-01	0.00e+00	0.00e+00	1.85e+04	1.23e+05
La-142	9.60e-01	4.25e-01	1.06e-01	0.00e+00	0.00e+00	1.02e+04	1.20e+04
Ce-141	2.84e+04	1.90e+04	2.17e+03	0.00e+00	8.88e+03	6.14e+05	1.26e+05
Ce-143	2.66e+02	1.94e+02	2.16e+01	0.00e+00	8.64e+01	1.30e+05	2.55e+05
Ce-144	4.89e+06	2.02e+06	2.62e+05	0.00e+00	1.21e+06	1.34e+07	8.64e+05
Pr-143	1.34e+04	5.31e+03	6.62e+02	0.00e+00	3.09e+03	4.83e+05	2.14e+05
Pr-144	4.30e-02	1.76e-02	2.18e-03	0.00e+00	1.01e-02	1.75e+03	2.35e-04
Nd-147	7.86e+03	8.56e+03	5.13e+02	0.00e+00	5.02e+03	3.72e+05	1.82e+05
Pm-147	9.20e+05	8.80e+04	3.60e+04	0.00e+00	1.68e+05	9.12e+05	4.70e+04
Pm-148	4.35e+03	7.10e+02	3.58e+02	0.00e+00	1.28e+03	5.22e+05	4.91e+05
Pm-148m	1.06e+05	2.68e+04	2.10e+04	0.00e+00	4.06e+04	2.56e+06	3.28e+05
Pm-149	3.93e+02	5.51e+01	2.27e+01	0.00e+00	1.05e+02	9.92e+04	2.23e+05
Pm-151	9.60e+01	1.59e+01	8.08e+00	0.00e+00	2.86e+01	5.25e+04	1.82e+05
Sm-151	8.56e+05	1.68e+05	3.89e+04	0.00e+00	1.82e+05	6.14e+05	2.82e+04
Sm-153	1.94e+02	1.61e+02	1.18e+01	0.00e+00	5.25e+01	5.69e+04	1.42e+05
Eu-152	2.37e+06	5.75e+05	5.04e+05	0.00e+00	2.67e+06	4.01e+06	1.08e+05
Eu-154	7.54e+06	9.84e+05	6.88e+05	0.00e+00	4.35e+06	7.30e+06	2.67e+05
Eu-155	1.60e+06	1.57e+05	9.68e+04	0.00e+00	6.12e+05	1.21e+07	4.78e+05
Eu-156	2.16e+04	1.62e+04	2.64e+03	0.00e+00	1.09e+04	1.10e+06	3.65e+05
Tb-160	2.43e+05	0.00e+00	3.03e+04	0.00e+00	9.60e+04	2.38e+06	2.08e+05

Conversion factors are in units of mrem/yr per uCi/cubic meter.

**DOSE FACTORS DUE TO RADIONUCLIDES
OTHER THAN NOBLE GASES; P_i**

Pi factors for Teen age group by nuclide.
Waterford Steam Electric Station
Pathway : Inhalation Pathway for Pi

Nuclide	Organ Dose Conversion Factors						
	Bone	Liver	T. Body	Thyroid	Kidney	Lung	GI-LLI
Ho-166m	3.52e+06	1.09e+06	7.90e+05	0.00e+00	1.60e+06	4.99e+06	1.34e+05
W-181	7.12e+01	2.30e+01	2.41e+00	0.00e+00	0.00e+00	2.36e+04	2.15e+03
W-185	2.22e+03	7.34e+02	7.78e+01	0.00e+00	0.00e+00	7.68e+05	9.12e+04
W-187	1.20e+01	9.76e+00	3.43e+00	0.00e+00	0.00e+00	4.74e+04	1.77e+05
Pb-210	2.47e+08	6.62e+07	8.56e+06	0.00e+00	2.36e+08	3.62e+08	1.28e+04
Bi-210	2.64e+03	1.81e+04	1.51e+03	0.00e+00	2.19e+05	1.53e+07	2.55e+05
Po-210	4.54e+06	9.76e+06	1.10e+06	0.00e+00	3.37e+07	4.33e+08	3.56e+05
Ra-223	2.06e+06	3.14e+03	4.11e+05	0.00e+00	8.96e+04	3.51e+08	2.43e+06
Ra-224	2.26e+05	5.42e+02	4.52e+04	0.00e+00	1.54e+04	1.21e+08	2.63e+06
Ra-225	3.42e+06	4.03e+03	6.85e+05	0.00e+00	1.15e+05	4.03e+08	2.31e+06
Ra-226	1.06e+09	2.70e+04	7.90e+08	0.00e+00	7.74e+05	1.62e+09	2.49e+06
Ra-228	4.27e+08	1.39e+04	4.70e+08	0.00e+00	3.98e+05	2.22e+09	4.24e+05
Ac-225	4.83e+06	6.60e+06	3.25e+05	0.00e+00	7.58e+05	3.05e+08	2.16e+06
Ac-227	1.99e+10	2.95e+09	1.18e+09	0.00e+00	8.56e+08	3.33e+09	4.30e+05
Th-227	2.47e+06	4.45e+04	7.14e+04	0.00e+00	2.54e+05	5.20e+08	2.86e+06
Th-228	2.08e+09	3.50e+07	7.02e+07	0.00e+00	1.96e+08	1.35e+10	2.96e+06
Th-229	1.23e+11	3.55e+09	2.05e+09	0.00e+00	1.74e+10	4.19e+10	4.10e+05
Th-230	1.87e+10	1.07e+09	5.19e+08	0.00e+00	5.24e+09	7.18e+09	3.16e+05
Th-232	2.09e+10	9.12e+08	7.37e+06	0.00e+00	4.48e+09	6.88e+09	2.69e+05
Th-234	1.86e+04	1.08e+03	5.37e+02	0.00e+00	6.18e+03	2.61e+06	5.99e+05
Pa-231	4.26e+10	1.60e+09	1.66e+09	0.00e+00	8.96e+09	7.93e+08	3.77e+05
Pa-233	1.34e+04	2.59e+03	2.31e+03	0.00e+00	9.76e+03	4.31e+05	8.00e+04
U-232	5.85e+08	0.00e+00	4.18e+07	0.00e+00	6.35e+07	3.07e+09	3.57e+05
U-233	1.24e+08	0.00e+00	7.54e+06	0.00e+00	2.90e+07	7.34e+08	3.30e+05
U-234	1.18e+08	0.00e+00	7.38e+06	0.00e+00	2.84e+07	7.19e+08	3.23e+05
U-235	1.14e+08	0.00e+00	6.94e+06	0.00e+00	2.67e+07	6.75e+08	4.10e+05
U-236	1.14e+08	0.00e+00	7.09e+06	0.00e+00	2.73e+07	6.90e+08	3.03e+05
U-237	4.20e+02	0.00e+00	1.12e+02	0.00e+00	1.73e+03	1.41e+05	1.03e+05
U-238	1.09e+08	0.00e+00	6.48e+06	0.00e+00	2.50e+07	6.31e+08	2.90e+05
Np-237	1.31e+10	8.48e+09	5.77e+08	0.00e+00	4.28e+09	7.19e+08	4.18e+05

Conversion factors are in units of mrem/yr per uCi/cubic meter.

**DOSE FACTORS DUE TO RADIONUCLIDES
OTHER THAN NOBLE GASES; P_i**

Pi factors for Teen age group by nuclide.
Waterford Steam Electric Station
Pathway : Inhalation Pathway for Pi

Nuclide	Organ Dose Conversion Factors						
	Bone	Liver	T. Body	Thyroid	Kidney	Lung	GI-LLI
Np-238	3.38e+03	8.16e+02	5.27e+01	0.00e+00	3.10e+02	1.40e+05	1.90e+05
Np-239	3.38e+02	2.88e+02	1.77e+01	0.00e+00	1.00e+02	6.49e+04	1.32e+05
Pu-238	1.20e+10	8.24e+09	5.78e+08	0.00e+00	2.48e+09	2.50e+09	3.83e+05
Pu-239	1.38e+10	8.96e+09	6.44e+08	0.00e+00	2.75e+09	2.34e+09	3.50e+05
Pu-240	1.38e+10	8.96e+09	6.43e+08	0.00e+00	2.74e+09	2.34e+09	3.57e+05
Pu-241	2.99e+08	7.65e+07	1.12e+07	0.00e+00	5.18e+07	2.08e+06	7.34e+03
Pu-242	1.28e+10	8.64e+09	6.20e+08	0.00e+00	2.65e+09	2.26e+09	3.43e+05
Pu-244	1.50e+10	9.92e+09	7.10e+08	0.00e+00	3.03e+09	2.58e+09	5.11e+05
Am-241	1.42e+10	9.60e+09	5.68e+08	0.00e+00	4.26e+09	8.40e+08	3.90e+05
Am-242m	1.43e+10	9.04e+09	5.72e+08	0.00e+00	4.24e+09	3.37e+08	4.91e+05
Am-243	1.42e+10	9.36e+09	5.56e+08	0.00e+00	4.17e+09	7.93e+08	4.58e+05
Cm-242	2.54e+08	2.01e+08	1.13e+07	0.00e+00	5.12e+07	5.41e+08	4.17e+05
Cm-243	9.52e+09	6.64e+09	4.00e+08	0.00e+00	1.87e+09	8.72e+08	4.10e+05
Cm-244	7.35e+09	5.22e+09	3.10e+08	0.00e+00	1.45e+09	8.40e+08	3.97e+05
Cm-245	1.46e+10	9.76e+09	6.02e+08	0.00e+00	2.82e+09	8.08e+08	3.70e+05
Cm-246	1.45e+10	9.76e+09	6.02e+08	0.00e+00	2.81e+09	8.24e+08	3.63e+05
Cm-247	1.42e+10	9.52e+09	5.93e+08	0.00e+00	2.77e+09	8.08e+08	4.78e+05
Cm-248	1.18e+11	7.86e+10	4.89e+09	0.00e+00	2.28e+10	6.66e+09	7.70e+06
Cf-252	5.73e+09	0.00e+00	2.46e+08	0.00e+00	0.00e+00	2.74e+09	1.51e+06

Conversion factors are in units of mrem/yr per uCi/cubic meter.

**DOSE FACTORS DUE TO RADIONUCLIDES
OTHER THAN NOBLE GASES; P_i**

Pi factors for Child age group by nuclide.
Waterford Steam Electric Station
Pathway : Inhalation Pathway for Pi

Nuclide	Organ Dose Conversion Factors						
	Bone	Liver	T. Body	Thyroid	Kidney	Lung	GI-LLI
H-3	0.00e+00	6.40e+02	6.40e+02	6.40e+02	6.40e+02	6.40e+02	6.40e+02
Be-10	3.12e+06	3.64e+05	7.84e+04	0.00e+00	0.00e+00	2.74e+06	6.36e+04
C-14	3.59e+04	6.73e+03	6.73e+03	6.73e+03	6.73e+03	6.73e+03	6.73e+03
N-13	8.62e+01	8.62e+01	8.62e+01	8.62e+01	8.62e+01	8.62e+01	8.62e+01
F-18	6.96e+03	0.00e+00	6.84e+02	0.00e+00	0.00e+00	0.00e+00	1.25e+03
Na-22	1.63e+05	1.63e+05	1.63e+05	1.63e+05	1.63e+05	1.63e+05	1.63e+05
Na-24	1.61e+04	1.61e+04	1.61e+04	1.61e+04	1.61e+04	1.61e+04	1.61e+04
P-32	2.60e+06	1.14e+05	9.88e+04	0.00e+00	0.00e+00	0.00e+00	4.22e+04
Ca-41	2.61e+05	0.00e+00	2.85e+04	0.00e+00	0.00e+00	2.67e+08	1.09e+03
Sc-46	7.29e+05	9.99e+05	3.85e+05	0.00e+00	8.84e+05	0.00e+00	9.06e+04
Cr-51	0.00e+00	0.00e+00	1.54e+02	8.55e+01	2.43e+01	1.70e+04	1.08e+03
Mn-54	0.00e+00	4.29e+04	9.51e+03	0.00e+00	1.00e+04	1.58e+06	2.29e+04
Mn-56	0.00e+00	1.66e+00	3.12e-01	0.00e+00	1.67e+00	1.31e+04	1.23e+05
Fe-55	4.74e+04	2.52e+04	7.77e+03	0.00e+00	0.00e+00	1.11e+05	2.87e+03
Fe-59	2.07e+04	3.34e+04	1.67e+04	0.00e+00	0.00e+00	1.27e+06	7.07e+04
Co-57	0.00e+00	9.03e+02	1.07e+03	0.00e+00	0.00e+00	5.07e+05	1.32e+04
Co-58	0.00e+00	1.77e+03	3.16e+03	0.00e+00	0.00e+00	1.11e+06	3.44e+04
Co-60	0.00e+00	1.31e+04	2.26e+04	0.00e+00	0.00e+00	7.07e+06	9.62e+04
Ni-59	6.14e+04	1.73e+04	1.05e+04	0.00e+00	0.00e+00	1.01e+05	2.33e+03
Ni-63	8.21e+05	4.62e+04	2.80e+04	0.00e+00	0.00e+00	2.75e+05	6.33e+03
Ni-65	2.99e+00	2.96e-01	1.64e-01	0.00e+00	0.00e+00	8.18e+03	8.40e+04
Cu-64	0.00e+00	1.99e+00	1.07e+00	0.00e+00	6.03e+00	9.58e+03	3.67e+04
Zn-65	4.26e+04	1.13e+05	7.03e+04	0.00e+00	7.14e+04	9.95e+05	1.63e+04
Zn-69	6.70e-02	9.66e-02	8.92e-03	0.00e+00	5.85e-02	1.42e+03	1.02e+04
Zn-69m	1.58e+01	2.69e+01	3.18e+00	0.00e+00	1.56e+01	2.72e+04	1.00e+05
Se-79	0.00e+00	4.55e+03	9.62e+02	0.00e+00	6.33e+03	5.51e+05	1.27e+04
Br-82	0.00e+00	0.00e+00	2.09e+04	0.00e+00	0.00e+00	0.00e+00	0.00e+00
Br-83	0.00e+00	0.00e+00	4.74e+02	0.00e+00	0.00e+00	0.00e+00	0.00e+00
Br-84	0.00e+00	0.00e+00	5.48e+02	0.00e+00	0.00e+00	0.00e+00	0.00e+00
Br-85	0.00e+00	0.00e+00	2.53e+01	0.00e+00	0.00e+00	0.00e+00	0.00e+00

Conversion factors are in units of mrem/yr per uCi/cubic meter.

**DOSE FACTORS DUE TO RADIONUCLIDES
OTHER THAN NOBLE GASES; P_i**

Pi factors for Child age group by nuclide.
Waterford Steam Electric Station
Pathway : Inhalation Pathway for Pi

Nuclide	Organ Dose Conversion Factors						
	Bone	Liver	T. Body	Thyroid	Kidney	Lung	GI-LLI
Rb-86	0.00e+00	1.98e+05	1.14e+05	0.00e+00	0.00e+00	0.00e+00	7.99e+03
Rb-87	0.00e+00	1.17e+05	5.07e+04	0.00e+00	0.00e+00	0.00e+00	1.10e+03
Rb-88	0.00e+00	5.62e+02	3.66e+02	0.00e+00	0.00e+00	0.00e+00	1.72e+01
Rb-89	0.00e+00	3.45e+02	2.90e+02	0.00e+00	0.00e+00	0.00e+00	1.89e+00
Sr-89	5.99e+05	0.00e+00	1.72e+04	0.00e+00	0.00e+00	2.16e+06	1.67e+05
Sr-90	3.85e+07	0.00e+00	7.66e+05	0.00e+00	0.00e+00	1.48e+07	3.43e+05
Sr-91	1.21e+02	0.00e+00	4.59e+00	0.00e+00	0.00e+00	5.33e+04	1.74e+05
Sr-92	1.31e+01	0.00e+00	5.25e-01	0.00e+00	0.00e+00	2.40e+04	2.42e+05
Y-90	4.11e+03	0.00e+00	1.11e+02	0.00e+00	0.00e+00	2.62e+05	2.68e+05
Y-91	9.14e+05	0.00e+00	2.44e+04	0.00e+00	0.00e+00	2.63e+06	1.84e+05
Y-91m	5.07e-01	0.00e+00	1.84e-02	0.00e+00	0.00e+00	2.81e+03	1.72e+03
Y-92	2.03e+01	0.00e+00	5.81e-01	0.00e+00	0.00e+00	2.39e+04	2.39e+05
Y-93	1.86e+02	0.00e+00	5.11e+00	0.00e+00	0.00e+00	7.44e+04	3.88e+05
Zr-93	7.66e+05	2.89e+04	2.05e+04	0.00e+00	1.11e+05	2.63e+05	5.44e+03
Zr-95	1.90e+05	4.18e+04	3.70e+04	0.00e+00	5.96e+04	2.23e+06	6.11e+04
Zr-97	1.88e+02	2.72e+01	1.60e+01	0.00e+00	3.88e+01	1.13e+05	3.51e+05
Nb-93m	4.70e+05	1.17e+05	3.85e+04	0.00e+00	1.27e+05	3.85e+05	9.06e+03
Nb-95	2.35e+04	9.18e+03	6.55e+03	0.00e+00	3.62e+03	6.14e+05	3.70e+04
Nb-97	4.29e-01	7.70e-02	3.60e-02	0.00e+00	8.55e-02	3.42e+03	2.78e+04
Mo-93	0.00e+00	1.39e+04	5.00e+02	0.00e+00	3.92e+03	6.29e+05	1.40e+04
Mo-99	0.00e+00	1.72e+02	4.26e+01	0.00e+00	3.92e+02	1.35e+05	1.27e+05
Tc-101	8.10e-05	8.51e-05	1.08e-03	0.00e+00	1.45e-03	5.85e+02	1.63e+01
Tc-99	4.96e+02	5.51e+02	1.98e+02	0.00e+00	6.48e+03	1.25e+06	2.87e+04
Tc-99m	1.78e-03	3.48e-03	5.77e-02	0.00e+00	5.07e-02	9.51e+02	4.81e+03
Ru-103	2.79e+03	0.00e+00	1.07e+03	0.00e+00	7.03e+03	6.62e+05	4.48e+04
Ru-105	1.53e+00	0.00e+00	5.55e-01	0.00e+00	1.34e+00	1.59e+04	9.95e+04
Ru-106	1.36e+05	0.00e+00	1.69e+04	0.00e+00	1.84e+05	1.43e+07	4.29e+05
Rh-105	1.45e+01	7.77e+00	6.62e+00	0.00e+00	3.10e+01	2.89e+04	4.92e+04
Pd-107	0.00e+00	9.80e+02	9.29e+01	0.00e+00	7.29e+03	1.17e+05	2.69e+03
Pd-109	0.00e+00	5.48e+00	1.83e+00	0.00e+00	2.61e+01	2.28e+04	9.58e+04

Conversion factors are in units of mrem/yr per uCi/cubic meter.

**DOSE FACTORS DUE TO RADIONUCLIDES
OTHER THAN NOBLE GASES; P_i**

Pi factors for Child age group by nuclide.
Waterford Steam Electric Station
Pathway : Inhalation Pathway for Pi

Nuclide	Organ Dose Conversion Factors						
	Bone	Liver	T. Body	Thyroid	Kidney	Lung	GI-LLI
Ag-110m	1.69e+04	1.14e+04	9.14e+03	0.00e+00	2.12e+04	5.48e+06	1.00e+05
Ag-111	6.70e+02	2.10e+02	1.39e+02	0.00e+00	6.33e+02	2.86e+05	1.10e+05
Cd-113m	0.00e+00	1.82e+06	7.84e+04	0.00e+00	1.90e+06	2.57e+06	6.03e+04
Cd-115m	0.00e+00	2.92e+05	1.25e+04	0.00e+00	2.19e+05	2.17e+06	1.84e+05
Sn-123	4.77e+05	7.92e+03	1.55e+04	8.40e+03	0.00e+00	3.55e+06	1.50e+05
Sn-125	1.83e+04	3.68e+02	1.09e+03	3.81e+02	0.00e+00	8.99e+05	2.65e+05
Sn-126	2.31e+06	3.85e+04	8.73e+04	1.05e+04	0.00e+00	1.12e+07	6.03e+04
Sb-124	5.74e+04	7.40e+02	2.00e+04	1.26e+02	0.00e+00	3.24e+06	1.64e+05
Sb-125	9.84e+04	7.58e+02	2.07e+04	9.10e+01	0.00e+00	2.32e+06	4.03e+04
Sb-126	6.36e+03	9.69e+01	2.28e+03	3.70e+01	0.00e+00	1.06e+06	2.10e+05
Sb-127	5.03e+02	7.73e+00	1.74e+02	5.59e+00	0.00e+00	2.28e+05	1.41e+05
Te-125m	6.73e+03	2.33e+03	9.14e+02	1.92e+03	0.00e+00	4.77e+05	3.38e+04
Te-127	2.77e+00	9.51e-01	6.10e-01	1.96e+00	7.07e+00	1.00e+04	5.62e+04
Te-127m	2.49e+04	8.55e+03	3.02e+03	6.07e+03	6.36e+04	1.48e+06	7.14e+04
Te-129	9.77e-02	3.50e-02	2.38e-02	7.14e-02	2.57e-01	2.93e+03	2.55e+04
Te-129m	1.92e+04	6.84e+03	3.04e+03	6.33e+03	5.03e+04	1.76e+06	1.82e+05
Te-131	2.17e-02	8.44e-03	6.59e-03	1.70e-02	5.88e-02	2.05e+03	1.33e+03
Te-131m	1.34e+02	5.92e+01	5.07e+01	9.77e+01	4.00e+02	2.06e+05	3.08e+05
Te-132	4.81e+02	2.72e+02	2.63e+02	3.17e+02	1.77e+03	3.77e+05	1.38e+05
Te-133m	1.08e-01	5.59e-02	5.55e-02	8.58e-02	3.74e-01	5.92e+03	1.76e+04
Te-134	5.66e-02	3.26e-02	3.48e-02	4.59e-02	2.11e-01	4.55e+03	1.80e+03
I-129	3.88e+04	2.37e+04	2.11e+04	1.58e+07	4.00e+04	0.00e+00	7.96e+02
I-130	8.18e+03	1.64e+04	8.44e+03	1.85e+06	2.45e+04	0.00e+00	5.11e+03
I-131	4.81e+04	4.81e+04	2.73e+04	1.62e+07	7.88e+04	0.00e+00	2.84e+03
I-132	2.12e+03	4.07e+03	1.88e+03	1.94e+05	6.25e+03	0.00e+00	3.20e+03
I-133	1.66e+04	2.03e+04	7.70e+03	3.85e+06	3.38e+04	0.00e+00	5.48e+03
I-134	1.17e+03	2.16e+03	9.95e+02	5.07e+04	3.30e+03	0.00e+00	9.55e+02
I-135	4.92e+03	8.73e+03	4.14e+03	7.92e+05	1.34e+04	0.00e+00	4.44e+03
Cs-134	6.51e+05	1.01e+06	2.25e+05	0.00e+00	3.30e+05	1.21e+05	3.85e+03
Cs-134m	2.34e+02	3.30e+02	2.26e+02	0.00e+00	1.83e+02	3.09e+01	2.93e+02

Conversion factors are in units of mrem/yr per uCi/cubic meter.

**DOSE FACTORS DUE TO RADIONUCLIDES
OTHER THAN NOBLE GASES; P_i**

Pi factors for Child age group by nuclide.
Waterford Steam Electric Station
Pathway : Inhalation Pathway for Pi

Nuclide	Organ Dose Conversion Factors						
	Bone	Liver	T. Body	Thyroid	Kidney	Lung	GI-LLI
Cs-135	2.31e+05	1.53e+05	1.65e+04	0.00e+00	5.66e+04	1.93e+04	8.03e+02
Cs-136	6.51e+04	1.71e+05	1.16e+05	0.00e+00	9.55e+04	1.45e+04	4.18e+03
Cs-137	9.06e+05	8.25e+05	1.28e+05	0.00e+00	2.82e+05	1.04e+05	3.62e+03
Cs-138	6.33e+02	8.40e+02	5.55e+02	0.00e+00	6.22e+02	6.81e+01	2.70e+02
Cs-139	4.03e+02	4.26e+02	2.15e+02	0.00e+00	3.36e+02	3.46e+01	2.68e-02
Ba-139	1.84e+00	9.84e-04	5.36e-02	0.00e+00	8.62e-04	5.77e+03	5.77e+04
Ba-140	7.40e+04	6.48e+01	4.33e+03	0.00e+00	2.11e+01	1.74e+06	1.02e+05
Ba-141	1.96e-01	1.09e-04	6.36e-03	0.00e+00	9.47e-05	2.92e+03	2.75e+02
Ba-142	5.00e-02	3.60e-05	2.79e-03	0.00e+00	2.91e-05	1.64e+03	2.74e+00
La-140	6.44e+02	2.25e+02	7.55e+01	0.00e+00	0.00e+00	1.83e+05	2.26e+05
La-141	8.44e+00	1.96e+00	4.26e-01	0.00e+00	0.00e+00	1.66e+04	1.62e+05
La-142	1.30e+00	4.11e-01	1.29e-01	0.00e+00	0.00e+00	8.70e+03	7.58e+04
Ce-141	3.92e+04	1.95e+04	2.90e+03	0.00e+00	8.55e+03	5.44e+05	5.66e+04
Ce-143	3.66e+02	1.99e+02	2.87e+01	0.00e+00	8.36e+01	1.15e+05	1.27e+05
Ce-144	6.77e+06	2.12e+06	3.61e+05	0.00e+00	1.17e+06	1.20e+07	3.88e+05
Pr-143	1.85e+04	5.55e+03	9.14e+02	0.00e+00	3.00e+03	4.33e+05	9.73e+04
Pr-144	5.96e-02	1.85e-02	3.00e-03	0.00e+00	9.77e-03	1.57e+03	1.97e+02
Nd-147	1.08e+04	8.73e+03	6.81e+02	0.00e+00	4.81e+03	3.28e+05	8.21e+04
Pm-147	1.30e+06	9.32e+04	5.03e+04	0.00e+00	1.65e+05	8.14e+05	2.11e+04
Pm-148	5.96e+03	7.18e+02	4.62e+02	0.00e+00	1.22e+03	4.59e+05	2.22e+05
Pm-148m	1.22e+05	2.42e+04	2.42e+04	0.00e+00	3.60e+04	2.12e+06	1.32e+05
Pm-149	5.44e+02	5.77e+01	3.13e+01	0.00e+00	1.02e+02	8.88e+04	1.08e+05
Pm-151	1.32e+02	1.60e+01	1.04e+01	0.00e+00	2.72e+01	4.59e+04	9.25e+04
Sm-151	1.16e+06	1.76e+05	5.51e+04	0.00e+00	1.81e+05	5.48e+05	1.27e+04
Sm-153	2.68e+02	1.67e+02	1.61e+01	0.00e+00	5.07e+01	5.07e+04	6.92e+04
Eu-152	2.75e+06	5.07e+05	5.96e+05	0.00e+00	2.12e+06	3.33e+06	4.22e+04
Eu-154	1.01e+07	9.21e+05	8.40e+05	0.00e+00	4.03e+06	6.14e+06	1.10e+05
Eu-155	2.07e+06	1.50e+05	1.18e+05	0.00e+00	5.59e+05	1.03e+06	1.99e+05
Eu-156	2.92e+04	1.57e+04	3.24e+03	0.00e+00	1.01e+04	9.40e+05	1.57e+05
Tb-160	2.88e+05	0.00e+00	3.58e+04	0.00e+00	8.58e+04	1.98e+06	8.44e+04

Conversion factors are in units of mrem/yr per uCi/cubic meter.

**DOSE FACTORS DUE TO RADIONUCLIDES
OTHER THAN NOBLE GASES; P_i**

Pi factors for Child age group by nuclide.
Waterford Steam Electric Station
Pathway : Inhalation Pathway for Pi

Nuclide	Organ Dose Conversion Factors						
	Bone	Liver	T. Body	Thyroid	Kidney	Lung	GI-LLI
Ho-166m	4.96e+06	1.04e+06	8.77e+05	0.00e+00	1.48e+06	4.18e+06	6.03e+04
W-181	9.84e+01	2.41e+01	3.33e+00	0.00e+00	0.00e+00	2.11e+04	9.66e+02
W-185	3.07e+03	7.70e+02	1.08e+02	0.00e+00	0.00e+00	6.88e+05	4.11e+04
W-187	1.63e+01	9.66e+00	4.33e+00	0.00e+00	0.00e+00	4.11e+04	9.10e+04
Pb-210	2.97e+08	6.84e+07	1.18e+07	0.00e+00	2.33e+08	3.23e+08	5.74e+03
Bi-210	3.64e+03	1.89e+04	2.09e+03	0.00e+00	2.13e+05	1.37e+07	1.19e+05
Po-210	6.29e+06	1.02e+07	1.51e+06	0.00e+00	3.27e+07	3.88e+08	1.60e+05
Ra-223	2.85e+06	3.29e+03	5.70e+05	0.00e+00	8.73e+04	3.14e+08	1.11e+06
Ra-224	3.12e+05	5.66e+02	6.25e+04	0.00e+00	1.50e+04	1.08e+08	1.24e+06
Ra-225	4.74e+06	4.22e+03	9.47e+05	0.00e+00	1.12e+05	3.60e+08	1.05e+06
Ra-226	8.66e+08	2.83e+04	7.10e+08	0.00e+00	7.51e+05	1.44e+09	1.12e+06
Ra-228	5.51e+08	1.46e+04	6.22e+08	0.00e+00	3.85e+05	1.99e+09	1.90e+05
Ac-225	6.70e+06	6.92e+06	4.48e+05	0.00e+00	7.36e+05	2.73e+08	9.88e+05
Ac-227	1.84e+10	2.98e+09	1.14e+09	0.00e+00	6.55e+08	2.97e+09	1.93e+05
Th-227	3.42e+06	4.66e+04	9.88e+04	0.00e+00	2.47e+05	4.66e+08	1.29e+06
Th-228	2.98e+09	3.85e+07	1.01e+08	0.00e+00	2.00e+08	1.24e+10	1.33e+06
Th-229	8.07e+10	2.12e+09	1.34e+09	0.00e+00	1.05e+10	4.00e+10	1.85e+05
Th-230	1.22e+10	6.40e+08	3.40e+08	0.00e+00	3.15e+09	6.84e+09	1.42e+05
Th-232	1.36e+10	5.44e+08	4.74e+06	0.00e+00	2.69e+09	6.55e+09	1.21e+05
Th-234	2.57e+04	1.14e+03	7.40e+02	0.00e+00	5.99e+03	2.33e+06	2.71e+05
Pa-231	3.19e+10	1.06e+09	1.27e+09	0.00e+00	5.77e+09	7.10e+08	1.69e+05
Pa-233	1.53e+04	2.40e+03	2.68e+03	0.00e+00	8.81e+03	3.61e+05	3.31e+04
U-232	8.10e+08	0.00e+00	5.77e+07	0.00e+00	6.18e+07	2.75e+09	1.60e+05
U-233	1.72e+08	0.00e+00	1.04e+07	0.00e+00	2.82e+07	6.55e+08	1.48e+05
U-234	1.65e+08	0.00e+00	1.02e+07	0.00e+00	2.76e+07	6.44e+08	1.45e+05
U-235	1.58e+08	0.00e+00	9.58e+06	0.00e+00	2.59e+07	6.03e+08	1.84e+05
U-236	1.58e+08	0.00e+00	9.80e+06	0.00e+00	2.65e+07	6.18e+08	1.36e+05
U-237	5.81e+02	0.00e+00	1.54e+02	0.00e+00	1.68e+03	1.26e+05	4.77e+04
U-238	1.51e+08	0.00e+00	8.95e+06	0.00e+00	2.42e+07	5.66e+08	1.30e+05
Np-237	1.01e+10	5.99e+09	4.40e+08	0.00e+00	2.74e+09	6.44e+08	1.87e+05

Conversion factors are in units of mrem/yr per uCi/cubic meter.

**DOSE FACTORS DUE TO RADIONUCLIDES
OTHER THAN NOBLE GASES; P_i**

Pi factors for Child age group by nuclide.
Waterford Steam Electric Station
Pathway : Inhalation Pathway for Pi

Nuclide	Organ Dose Conversion Factors						
	Bone	Liver	T. Body	Thyroid	Kidney	Lung	GI-LLI
Np-238	4.66e+03	8.51e+02	7.29e+01	0.00e+00	3.02e+02	1.25e+05	9.25e+04
Np-239	4.66e+02	3.01e+02	2.35e+01	0.00e+00	9.73e+01	5.81e+04	6.40e+04
Pu-238	9.44e+09	5.92e+09	4.48e+08	0.00e+00	1.65e+09	2.25e+09	1.72e+05
Pu-239	1.03e+10	6.22e+09	4.74e+08	0.00e+00	1.77e+09	2.12e+09	1.57e+05
Pu-240	1.03e+10	6.22e+09	4.70e+08	0.00e+00	1.76e+09	2.11e+09	1.60e+05
Pu-241	2.94e+08	6.48e+07	1.08e+07	0.00e+00	4.07e+07	1.87e+06	3.29e+03
Pu-242	9.58e+09	5.99e+09	4.55e+08	0.00e+00	1.70e+09	2.04e+09	1.54e+05
Pu-244	1.12e+10	6.84e+09	5.22e+08	0.00e+00	1.95e+09	2.33e+09	2.29e+05
Am-241	1.10e+10	6.81e+09	4.59e+08	0.00e+00	2.82e+09	7.47e+08	1.75e+05
Am-242m	1.14e+10	6.51e+09	4.70e+08	0.00e+00	2.85e+09	3.01e+08	2.21e+05
Am-243	1.09e+10	6.59e+09	4.44e+08	0.00e+00	2.75e+09	7.10e+08	2.05e+05
Cm-242	3.51e+08	2.10e+08	1.55e+07	0.00e+00	4.96e+07	4.85e+08	1.87e+05
Cm-243	8.58e+09	5.25e+09	3.68e+08	0.00e+00	1.38e+09	7.77e+08	1.84e+05
Cm-244	7.18e+09	4.37e+09	3.07e+08	0.00e+00	1.13e+09	7.47e+08	1.78e+05
Cm-245	1.13e+10	6.81e+09	4.74e+08	0.00e+00	1.86e+09	7.22e+08	1.66e+05
Cm-246	1.12e+10	6.81e+09	4.74e+08	0.00e+00	1.86e+09	7.36e+08	1.63e+05
Cm-247	1.09e+10	6.73e+09	4.66e+08	0.00e+00	1.83e+09	7.22e+08	2.15e+05
Cm-248	9.06e+10	5.55e+10	3.85e+09	0.00e+00	1.51e+10	5.96e+09	3.46e+06
Cf-252	8.07e+09	0.00e+00	3.45e+08	0.00e+00	0.00e+00	2.45e+09	6.81e+05

Conversion factors are in units of mrem/yr per uCi/cubic meter.

**DOSE FACTORS DUE TO RADIONUCLIDES
OTHER THAN NOBLE GASES; P_i**

Pi factors for Infant age group by nuclide.
Waterford Steam Electric Station
Pathway : Inhalation Pathway for Pi

Nuclide	Organ Dose Conversion Factors						
	Bone	Liver	T. Body	Thyroid	Kidney	Lung	GI-LLI
H-3	0.00e+00	3.68e+02	3.68e+02	3.68e+02	3.68e+02	3.68e+02	3.68e+02
Be-10	1.33e+06	1.75e+05	3.71e+04	0.00e+00	0.00e+00	2.09e+06	2.42e+04
C-14	2.65e+04	5.31e+03	5.31e+03	5.31e+03	5.31e+03	5.31e+03	5.31e+03
N-13	6.15e+01	6.15e+01	6.15e+01	6.15e+01	6.15e+01	6.15e+01	6.15e+01
F-18	5.49e+03	0.00e+00	4.66e+02	0.00e+00	0.00e+00	0.00e+00	8.54e+02
Na-22	1.03e+05	1.03e+05	1.03e+05	1.03e+05	1.03e+05	1.03e+05	1.03e+05
Na-24	1.06e+04	1.06e+04	1.06e+04	1.06e+04	1.06e+04	1.06e+04	1.06e+04
P-32	2.03e+06	1.12e+05	7.74e+04	0.00e+00	0.00e+00	0.00e+00	1.61e+04
Ca-41	1.05e+05	0.00e+00	1.14e+04	0.00e+00	0.00e+00	9.72e+07	4.14e+02
Sc-46	5.25e+05	7.57e+05	2.37e+05	0.00e+00	4.98e+05	0.00e+00	3.07e+04
Cr-51	0.00e+00	0.00e+00	8.95e+01	5.75e+01	1.32e+01	1.28e+04	3.57e+02
Mn-54	0.00e+00	2.53e+04	4.98e+03	0.00e+00	4.98e+03	1.00e+06	7.06e+03
Mn-56	0.00e+00	1.54e+00	2.21e-01	0.00e+00	1.10e+00	1.25e+04	7.17e+04
Fe-55	1.97e+04	1.17e+04	3.33e+03	0.00e+00	0.00e+00	8.69e+04	1.09e+03
Fe-59	1.36e+04	2.35e+04	9.48e+03	0.00e+00	0.00e+00	1.01e+06	2.48e+04
Co-57	0.00e+00	6.51e+02	6.41e+02	0.00e+00	0.00e+00	3.79e+05	4.86e+03
Co-58	0.00e+00	1.22e+03	1.82e+03	0.00e+00	0.00e+00	7.77e+05	1.11e+04
Co-60	0.00e+00	8.02e+03	1.18e+04	0.00e+00	0.00e+00	4.51e+06	3.19e+04
Ni-59	2.53e+04	7.62e+03	4.34e+03	0.00e+00	0.00e+00	7.67e+04	8.88e+02
Ni-63	3.39e+05	2.04e+04	1.16e+04	0.00e+00	0.00e+00	2.09e+05	2.42e+03
Ni-65	2.39e+00	2.84e-01	1.23e-01	0.00e+00	0.00e+00	8.12e+03	5.01e+04
Cu-64	0.00e+00	1.88e+00	7.74e-01	0.00e+00	3.98e+00	9.30e+03	1.50e+04
Zn-65	1.93e+04	6.26e+04	3.11e+04	0.00e+00	3.25e+04	6.47e+05	5.14e+04
Zn-69	5.39e-02	9.67e-02	7.18e-03	0.00e+00	4.02e-02	1.47e+03	1.32e+04
Zn-69m	1.26e+01	2.58e+01	2.34e+00	0.00e+00	1.04e+01	2.67e+04	4.09e+04
Se-79	0.00e+00	3.15e+03	5.88e+02	0.00e+00	3.46e+03	4.19e+05	4.84e+03
Br-82	0.00e+00	0.00e+00	1.33e+04	0.00e+00	0.00e+00	0.00e+00	0.00e+00
Br-83	0.00e+00	0.00e+00	3.81e+02	0.00e+00	0.00e+00	0.00e+00	0.00e+00
Br-84	0.00e+00	0.00e+00	4.00e+02	0.00e+00	0.00e+00	0.00e+00	0.00e+00
Br-85	0.00e+00	0.00e+00	2.04e+01	0.00e+00	0.00e+00	0.00e+00	0.00e+00

Conversion factors are in units of mrem/yr per uCi/cubic meter.

**DOSE FACTORS DUE TO RADIONUCLIDES
OTHER THAN NOBLE GASES; P_i**

Pi factors for Infant age group by nuclide.
Waterford Steam Electric Station
Pathway : Inhalation Pathway for Pi

Nuclide	Organ Dose Conversion Factors						
	Bone	Liver	T. Body	Thyroid	Kidney	Lung	GI-LLI
Rb-86	0.00e+00	1.90e+05	8.82e+04	0.00e+00	0.00e+00	0.00e+00	3.04e+03
Rb-87	0.00e+00	9.95e+04	3.70e+04	0.00e+00	0.00e+00	0.00e+00	4.19e+02
Rb-88	0.00e+00	5.57e+02	2.87e+02	0.00e+00	0.00e+00	0.00e+00	3.39e+02
Rb-89	0.00e+00	3.21e+02	2.06e+02	0.00e+00	0.00e+00	0.00e+00	6.82e+01
Sr-89	3.98e+05	0.00e+00	1.14e+04	0.00e+00	0.00e+00	2.03e+06	6.40e+04
Sr-90	1.55e+07	0.00e+00	3.12e+05	0.00e+00	0.00e+00	1.12e+07	1.31e+05
Sr-91	9.56e+01	0.00e+00	3.46e+00	0.00e+00	0.00e+00	5.26e+04	7.34e+04
Sr-92	1.05e+01	0.00e+00	3.91e-01	0.00e+00	0.00e+00	2.38e+04	1.40e+05
Y-90	3.29e+03	0.00e+00	8.82e+01	0.00e+00	0.00e+00	2.69e+05	1.04e+05
Y-91	5.88e+05	0.00e+00	1.57e+04	0.00e+00	0.00e+00	2.45e+06	7.03e+04
Y-91m	4.07e-01	0.00e+00	1.39e-02	0.00e+00	0.00e+00	2.79e+03	2.35e+03
Y-92	1.64e+01	0.00e+00	4.61e-01	0.00e+00	0.00e+00	2.45e+04	1.27e+05
Y-93	1.50e+02	0.00e+00	4.07e+00	0.00e+00	0.00e+00	7.64e+04	1.67e+05
Zr-93	3.14e+05	1.33e+04	8.65e+03	0.00e+00	4.47e+04	1.92e+05	2.07e+03
Zr-95	1.15e+05	2.79e+04	2.03e+04	0.00e+00	3.11e+04	1.75e+06	2.17e+04
Zr-97	1.50e+02	2.56e+01	1.17e+01	0.00e+00	2.59e+01	1.10e+05	1.40e+05
Nb-93m	1.93e+05	5.03e+04	1.61e+04	0.00e+00	5.15e+04	2.93e+05	3.46e+03
Nb-95	1.57e+04	6.43e+03	3.78e+03	0.00e+00	4.72e+03	4.79e+05	1.27e+04
Nb-97	3.42e-01	7.29e-02	2.63e-02	0.00e+00	5.70e-02	3.32e+03	2.69e+04
Mo-93	0.00e+00	9.04e+03	3.11e+02	0.00e+00	2.16e+03	4.76e+05	5.26e+03
Mo-99	0.00e+00	1.65e+02	3.23e+01	0.00e+00	2.65e+02	1.35e+05	4.87e+04
Tc-101	6.51e-05	8.23e-05	8.12e-04	0.00e+00	9.79e-04	5.84e+02	8.44e+02
Tc-99	2.93e+02	3.75e+02	1.24e+02	0.00e+00	3.49e+03	9.48e+05	1.09e+04
Tc-99m	1.40e-03	2.88e-03	3.72e-02	0.00e+00	3.11e-02	8.11e+02	2.03e+03
Ru-103	2.02e+03	0.00e+00	6.79e+02	0.00e+00	4.24e+03	5.52e+05	1.61e+04
Ru-105	1.22e+00	0.00e+00	4.10e-01	0.00e+00	8.99e-01	1.57e+04	4.84e+04
Ru-106	8.68e+04	0.00e+00	1.09e+04	0.00e+00	1.07e+05	1.16e+07	1.64e+05
Rh-105	1.16e+01	7.57e+00	5.08e+00	0.00e+00	2.10e+01	2.91e+04	1.92e+04
Pd-107	0.00e+00	6.89e+02	5.75e+01	0.00e+00	3.85e+03	8.88e+04	1.03e+03
Pd-109	0.00e+00	5.49e+00	1.47e+00	0.00e+00	1.79e+01	2.35e+04	3.99e+04

Conversion factors are in units of mrem/yr per uCi/cubic meter.

**DOSE FACTORS DUE TO RADIONUCLIDES
OTHER THAN NOBLE GASES; P_i**

Pi factors for Infant age group by nuclide.
Waterford Steam Electric Station
Pathway : Inhalation Pathway for Pi

Nuclide	Organ Dose Conversion Factors						
	Bone	Liver	T. Body	Thyroid	Kidney	Lung	GI-LLI
Ag-110m	9.98e+03	7.22e+03	5.00e+03	0.00e+00	1.09e+04	3.67e+06	3.30e+04
Ag-111	5.25e+02	2.03e+02	1.08e+02	0.00e+00	4.27e+02	2.88e+05	4.23e+04
Cd-113m	0.00e+00	9.34e+05	3.70e+04	0.00e+00	8.12e+05	1.96e+06	2.31e+04
Cd-115m	0.00e+00	2.42e+05	8.67e+03	0.00e+00	1.32e+05	2.06e+06	7.03e+04
Sn-123	2.93e+05	5.89e+03	1.02e+04	5.98e+03	0.00e+00	3.11e+06	5.71e+04
Sn-125	1.41e+04	3.51e+02	8.40e+02	3.46e+02	0.00e+00	9.00e+05	1.02e+05
Sn-126	1.16e+06	2.02e+04	4.93e+04	5.38e+03	0.00e+00	6.90e+06	2.31e+04
Sb-124	3.79e+04	5.56e+02	1.20e+04	1.01e+02	0.00e+00	2.65e+06	5.91e+04
Sb-125	5.17e+04	4.77e+02	1.09e+04	6.23e+01	0.00e+00	1.64e+06	1.47e+04
Sb-126	4.31e+03	8.41e+01	1.55e+03	3.29e+01	0.00e+00	9.63e+05	7.46e+04
Sb-127	3.95e+02	7.06e+00	1.23e+02	5.04e+00	0.00e+00	2.16e+05	5.29e+04
Te-125m	4.76e+03	1.99e+03	6.58e+02	1.62e+03	0.00e+00	4.47e+05	1.29e+04
Te-127	2.23e+00	9.53e-01	4.89e-01	1.85e+00	4.86e+00	1.03e+04	2.44e+04
Te-127m	1.67e+04	6.90e+03	2.07e+03	4.87e+03	3.75e+04	1.31e+06	2.73e+04
Te-129	7.88e-02	3.47e-02	1.88e-02	6.75e-02	1.75e-01	3.00e+03	2.63e+04
Te-129m	1.41e+04	6.09e+03	2.23e+03	5.47e+03	3.18e+04	1.68e+06	6.90e+04
Te-131	1.74e-02	8.22e-03	5.00e-03	1.58e-02	3.99e-02	2.06e+03	8.22e+03
Te-131m	1.07e+02	5.50e+01	3.63e+01	8.93e+01	2.65e+02	1.99e+05	1.19e+05
Te-132	3.72e+02	2.37e+02	1.76e+02	2.79e+02	1.03e+03	3.40e+05	4.41e+04
Te-133m	8.58e-02	5.03e-02	3.84e-02	7.73e-02	2.41e-01	5.49e+03	2.23e+04
Te-134	4.45e-02	2.86e-02	2.35e-02	4.07e-02	1.34e-01	4.10e+03	3.54e+03
I-129	3.02e+04	2.23e+04	1.62e+04	1.46e+07	2.63e+04	0.00e+00	2.97e+02
I-130	6.36e+03	1.39e+04	5.57e+03	1.60e+06	1.53e+04	0.00e+00	1.99e+03
I-131	3.79e+04	4.44e+04	1.96e+04	1.48e+07	5.18e+04	0.00e+00	1.06e+03
I-132	1.69e+03	3.54e+03	1.26e+03	1.69e+05	3.95e+03	0.00e+00	1.90e+03
I-133	1.32e+04	1.92e+04	5.60e+03	3.56e+06	2.24e+04	0.00e+00	2.16e+03
I-134	9.21e+02	1.88e+03	6.65e+02	4.45e+04	2.09e+03	0.00e+00	1.29e+03
I-135	3.86e+03	7.60e+03	2.77e+03	6.96e+05	8.47e+03	0.00e+00	1.83e+03
Cs-134	3.96e+05	7.03e+05	7.45e+04	0.00e+00	1.90e+05	7.97e+04	1.33e+03
Cs-134m	1.85e+02	2.94e+02	1.55e+02	0.00e+00	1.19e+02	2.80e+01	1.62e+02

Conversion factors are in units of mrem/yr per uCi/cubic meter.

**DOSE FACTORS DUE TO RADIONUCLIDES
OTHER THAN NOBLE GASES; P_i**

Pi factors for Infant age group by nuclide.
Waterford Steam Electric Station
Pathway : Inhalation Pathway for Pi

Nuclide	Organ Dose Conversion Factors						
	Bone	Liver	T. Body	Thyroid	Kidney	Lung	GI-LLI
Cs-135	1.40e+05	1.21e+05	6.62e+03	0.00e+00	3.61e+04	1.41e+04	3.05e+02
Cs-136	4.83e+04	1.35e+05	5.29e+04	0.00e+00	5.64e+04	1.18e+04	1.43e+03
Cs-137	5.49e+05	6.12e+05	4.55e+04	0.00e+00	1.72e+05	7.13e+04	1.33e+03
Cs-138	5.05e+02	7.81e+02	3.98e+02	0.00e+00	4.10e+02	6.54e+01	8.76e+02
Cs-139	3.25e+02	4.24e+02	1.71e+02	0.00e+00	2.31e+02	3.54e+01	1.86e+01
Ba-139	1.48e+00	9.84e-04	4.30e-02	0.00e+00	5.92e-04	5.95e+03	5.10e+04
Ba-140	5.60e+04	5.60e+01	2.90e+03	0.00e+00	1.34e+01	1.60e+06	3.84e+04
Ba-141	1.57e-01	1.08e-04	4.97e-03	0.00e+00	6.50e-05	2.97e+03	4.75e+03
Ba-142	3.98e-02	3.30e-05	1.96e-03	0.00e+00	1.90e-05	1.55e+03	6.93e+02
La-140	5.05e+02	2.00e+02	5.15e+01	0.00e+00	0.00e+00	1.68e+05	8.48e+04
La-141	6.79e+00	1.96e+00	3.43e-01	0.00e+00	0.00e+00	1.71e+04	8.34e+04
La-142	1.03e+00	3.77e-01	9.04e-02	0.00e+00	0.00e+00	8.22e+03	5.95e+04
Ce-141	2.77e+04	1.67e+04	1.99e+03	0.00e+00	5.25e+03	5.17e+05	2.16e+04
Ce-143	2.93e+02	1.93e+02	2.21e+01	0.00e+00	5.64e+01	1.16e+05	4.97e+04
Ce-144	3.19e+06	1.21e+06	1.76e+05	0.00e+00	5.38e+05	9.84e+06	1.48e+05
Pr-143	1.40e+04	5.24e+03	6.99e+02	0.00e+00	1.97e+03	4.33e+05	3.72e+04
Pr-144	4.79e-02	1.85e-02	2.41e-03	0.00e+00	6.72e-03	1.61e+03	4.28e+03
Nd-147	7.94e+03	8.13e+03	5.00e+02	0.00e+00	3.15e+03	3.22e+05	3.12e+04
Pm-147	5.47e+05	4.30e+04	2.18e+04	0.00e+00	6.90e+04	6.37e+05	8.05e+03
Pm-148	4.68e+03	6.75e+02	3.42e+02	0.00e+00	8.06e+02	4.48e+05	8.46e+04
Pm-148m	7.00e+04	1.74e+04	1.39e+04	0.00e+00	2.03e+04	1.71e+06	4.72e+04
Pm-149	4.34e+02	5.71e+01	2.49e+01	0.00e+00	6.94e+01	9.10e+04	4.21e+04
Pm-151	1.05e+02	1.54e+01	7.77e+00	0.00e+00	1.82e+01	4.55e+04	3.61e+04
Sm-151	4.73e+05	9.03e+04	2.28e+04	0.00e+00	7.34e+04	4.17e+05	4.84e+03
Sm-153	2.14e+02	1.65e+02	1.27e+01	0.00e+00	3.46e+01	5.18e+04	2.70e+04
Eu-152	1.10e+06	2.48e+05	2.41e+05	0.00e+00	8.32e+05	2.07e+06	1.38e+04
Eu-154	4.14e+06	4.84e+05	3.43e+05	0.00e+00	1.60e+06	4.27e+06	3.98e+04
Eu-155	8.36e+05	8.01e+04	4.84e+04	0.00e+00	2.21e+05	7.28e+05	7.27e+04
Eu-156	2.18e+04	1.34e+04	2.16e+03	0.00e+00	6.27e+03	8.57e+05	5.80e+04
Tb-160	1.57e+05	0.00e+00	1.96e+04	0.00e+00	4.48e+04	1.55e+06	3.00e+04

Conversion factors are in units of mrem/yr per uCi/cubic meter.

**DOSE FACTORS DUE TO RADIONUCLIDES
OTHER THAN NOBLE GASES; P_i**

Pi factors for Infant age group by nuclide.
Waterford Steam Electric Station
Pathway : Inhalation Pathway for Pi

Nuclide	Organ Dose Conversion Factors						
	Bone	Liver	T. Body	Thyroid	Kidney	Lung	GI-LLI
Ho-166m	2.03e+06	4.30e+05	3.51e+05	0.00e+00	5.91e+05	2.87e+06	2.31e+04
W-181	6.80e+01	2.04e+01	2.34e+00	0.00e+00	0.00e+00	1.86e+04	3.68e+02
W-185	2.20e+03	6.76e+02	7.81e+01	0.00e+00	0.00e+00	6.27e+05	1.57e+04
W-187	1.30e+01	9.02e+00	3.12e+00	0.00e+00	0.00e+00	3.96e+04	3.56e+04
Pb-210	1.21e+08	2.83e+07	4.80e+06	0.00e+00	9.59e+07	2.46e+08	2.20e+03
Bi-210	2.88e+03	1.86e+04	1.65e+03	0.00e+00	1.44e+05	1.39e+07	4.58e+04
Po-210	4.17e+06	7.88e+06	9.97e+05	0.00e+00	1.82e+07	3.36e+08	6.10e+04
Ra-223	2.18e+06	3.16e+03	4.37e+05	0.00e+00	5.82e+04	3.15e+08	4.26e+05
Ra-224	2.48e+05	5.60e+02	4.96e+04	0.00e+00	1.02e+04	1.11e+08	4.79e+05
Ra-225	3.60e+06	4.03e+03	7.18e+05	0.00e+00	7.43e+04	3.60e+08	4.02e+05
Ra-226	3.47e+08	2.04e+04	2.87e+08	0.00e+00	4.12e+05	1.10e+09	4.27e+05
Ra-228	2.24e+08	1.07e+04	2.52e+08	0.00e+00	2.14e+05	1.53e+09	7.27e+04
Ac-225	5.17e+06	6.61e+06	3.47e+05	0.00e+00	4.89e+05	2.74e+08	3.79e+05
Ac-227	7.41e+09	1.23e+09	4.59e+08	0.00e+00	2.60e+08	2.27e+09	7.38e+04
Th-227	2.55e+06	4.24e+04	7.34e+04	0.00e+00	1.58e+05	4.58e+08	4.94e+05
Th-228	1.18e+09	1.54e+07	4.00e+07	0.00e+00	7.85e+07	6.51e+09	5.07e+05
Th-229	3.19e+10	8.32e+08	5.33e+08	0.00e+00	1.30e+09	1.78e+10	7.03e+04
Th-230	4.84e+09	2.51e+08	1.35e+08	0.00e+00	1.23e+09	3.05e+09	5.42e+04
Th-232	5.40e+09	2.14e+08	3.21e+06	0.00e+00	1.06e+09	2.93e+09	4.61e+04
Th-234	1.86e+04	1.00e+03	5.38e+02	0.00e+00	3.78e+03	2.27e+06	1.04e+05
Pa-231	1.27e+10	4.20e+08	5.07e+08	0.00e+00	2.27e+09	5.39e+08	6.45e+04
Pa-233	9.58e+03	1.85e+03	1.67e+03	0.00e+00	5.15e+03	3.07e+05	1.27e+04
U-232	3.60e+08	0.00e+00	2.98e+07	0.00e+00	3.36e+07	2.09e+09	6.10e+04
U-233	7.62e+07	0.00e+00	5.36e+06	0.00e+00	1.53e+07	4.98e+08	5.64e+04
U-234	7.31e+07	0.00e+00	5.25e+06	0.00e+00	1.50e+07	4.89e+08	5.53e+04
U-235	7.01e+07	0.00e+00	4.93e+06	0.00e+00	1.41e+07	4.59e+08	7.03e+04
U-236	7.01e+07	0.00e+00	5.04e+06	0.00e+00	1.44e+07	4.69e+08	5.19e+04
U-237	4.55e+02	0.00e+00	1.21e+02	0.00e+00	1.13e+03	1.28e+05	1.83e+04
U-238	6.71e+07	0.00e+00	4.61e+06	0.00e+00	1.32e+07	4.28e+08	4.96e+04
Np-237	4.03e+09	2.39e+09	1.76e+08	0.00e+00	1.08e+09	4.89e+08	7.14e+04

Conversion factors are in units of mrem/yr per uCi/cubic meter.

**DOSE FACTORS DUE TO RADIONUCLIDES
OTHER THAN NOBLE GASES; P_i**

Pi factors for Infant age group by nuclide.
Waterford Steam Electric Station
Pathway : Inhalation Pathway for Pi

Nuclide	Organ Dose Conversion Factors						
	Bone	Liver	T. Body	Thyroid	Kidney	Lung	GI-LLI
Np-238	3.74e+03	8.47e+02	5.82e+01	0.00e+00	2.06e+02	1.29e+05	3.61e+04
Np-239	3.71e+02	2.98e+02	1.88e+01	0.00e+00	6.62e+01	5.95e+04	2.49e+04
Pu-238	3.77e+09	2.35e+09	1.78e+08	0.00e+00	6.50e+08	1.26e+09	6.57e+04
Pu-239	4.10e+09	2.46e+09	1.88e+08	0.00e+00	6.93e+08	1.19e+09	5.99e+04
Pu-240	4.10e+09	2.45e+09	1.88e+08	0.00e+00	6.92e+08	1.19e+09	6.10e+04
Pu-241	1.18e+08	2.59e+07	4.35e+06	0.00e+00	1.61e+07	1.07e+06	1.26e+03
Pu-242	3.81e+09	2.37e+09	1.81e+08	0.00e+00	6.68e+08	1.14e+09	5.88e+04
Pu-244	4.44e+09	2.72e+09	2.07e+08	0.00e+00	7.64e+08	1.31e+09	8.76e+04
Am-241	4.41e+09	2.73e+09	1.83e+08	0.00e+00	1.11e+09	5.68e+08	6.69e+04
Am-242m	4.55e+09	2.60e+09	1.89e+08	0.00e+00	1.12e+09	2.30e+08	8.41e+04
Am-243	4.34e+09	2.63e+09	1.78e+08	0.00e+00	1.08e+09	5.39e+08	7.84e+04
Cm-242	1.79e+08	1.21e+08	7.98e+06	0.00e+00	2.37e+07	4.16e+08	7.14e+04
Cm-243	3.46e+09	2.13e+09	1.48e+08	0.00e+00	5.47e+08	5.94e+08	7.03e+04
Cm-244	2.90e+09	1.78e+09	1.24e+08	0.00e+00	4.49e+08	5.71e+08	6.80e+04
Cm-245	4.51e+09	2.74e+09	1.90e+08	0.00e+00	7.32e+08	5.49e+08	6.34e+04
Cm-246	4.48e+09	2.74e+09	1.90e+08	0.00e+00	7.32e+08	5.59e+08	6.23e+04
Cm-247	4.35e+09	2.70e+09	1.86e+08	0.00e+00	7.21e+08	5.49e+08	8.19e+04
Cm-248	3.61e+10	2.23e+10	1.54e+09	0.00e+00	5.94e+09	4.52e+09	1.32e+06
Cf-252	3.32e+09	0.00e+00	1.41e+08	0.00e+00	0.00e+00	1.92e+09	2.59e+05

Conversion factors are in units of mrem/yr per uCi/cubic meter.

**DOSE FACTORS DUE TO RADIONUCLIDES
OTHER THAN NOBLE GASES; P_i**

Pi factors for Adult age group by nuclide.
Waterford Steam Electric Station
Pathway : Cow's Milk (food) Pathway for Pi

Nuclide	Organ Dose Conversion Factors						
	Bone	Liver	T. Body	Thyroid	Kidney	Lung	GI-LLI
H-3	0.00e+00	4.35e+02	4.35e+02	4.35e+02	4.35e+02	4.35e+02	4.35e+02
Be-10	2.46e+06	3.79e+05	6.14e+04	0.00e+00	2.87e+05	0.00e+00	2.07e+07
C-14	2.63e+08	5.27e+07	5.27e+07	5.27e+07	5.27e+07	5.27e+07	5.27e+07
N-13	0.00e+00	0.00e+00	0.00e+00	0.00e+00	0.00e+00	0.00e+00	0.00e+00
F-18	4.65e-03	0.00e+00	5.15e-04	0.00e+00	0.00e+00	0.00e+00	1.38e-04
Na-22	5.29e+09	5.29e+09	5.29e+09	5.29e+09	5.29e+09	5.29e+09	5.29e+09
Na-24	2.44e+06	2.44e+06	2.44e+06	2.44e+06	2.44e+06	2.44e+06	2.44e+06
P-32	1.71e+10	1.06e+09	6.61e+08	0.00e+00	0.00e+00	0.00e+00	1.92e+09
Ca-41	1.14e+10	0.00e+00	1.24e+09	0.00e+00	0.00e+00	0.00e+00	1.14e+07
Sc-46	1.79e+02	3.48e+02	1.01e+02	0.00e+00	3.25e+02	0.00e+00	1.70e+06
Cr-51	0.00e+00	0.00e+00	2.86e+04	1.71e+04	6.30e+03	3.79e+04	7.19e+06
Mn-54	0.00e+00	8.41e+06	1.61e+06	0.00e+00	2.50e+06	0.00e+00	2.58e+07
Mn-56	0.00e+00	4.15e-03	7.37e-04	0.00e+00	5.27e-03	0.00e+00	1.33e-01
Fe-55	2.51e+07	1.73e+07	4.05e+06	0.00e+00	0.00e+00	9.68e+06	9.95e+06
Fe-59	2.97e+07	6.98e+07	2.68e+07	0.00e+00	0.00e+00	1.95e+07	2.33e+08
Co-57	0.00e+00	1.28e+06	2.13e+06	0.00e+00	0.00e+00	0.00e+00	3.25e+07
Co-58	0.00e+00	4.71e+06	1.06e+07	0.00e+00	0.00e+00	0.00e+00	9.55e+07
Co-60	0.00e+00	1.64e+07	3.62e+07	0.00e+00	0.00e+00	0.00e+00	3.08e+08
Ni-59	5.05e+08	1.73e+08	8.44e+07	0.00e+00	0.00e+00	0.00e+00	3.57e+07
Ni-63	6.73e+09	4.66e+08	2.26e+08	0.00e+00	0.00e+00	0.00e+00	9.73e+07
Ni-65	3.76e-01	4.88e-02	2.23e-02	0.00e+00	0.00e+00	0.00e+00	1.24e+00
Cu-64	0.00e+00	2.39e+04	1.12e+04	0.00e+00	6.03e+04	0.00e+00	2.04e+06
Zn-65	1.37e+09	4.37e+09	1.97e+09	0.00e+00	2.92e+09	0.00e+00	2.75e+09
Zn-69	2.18e-12	4.17e-12	2.90e-13	0.00e+00	2.71e-12	0.00e+00	6.26e-13
Zn-69m	1.81e+05	4.35e+05	3.98e+04	0.00e+00	2.64e+05	0.00e+00	2.66e+07
Se-79	0.00e+00	9.15e+08	1.53e+08	0.00e+00	1.58e+09	0.00e+00	1.87e+08
Br-82	0.00e+00	0.00e+00	3.23e+07	0.00e+00	0.00e+00	0.00e+00	3.70e+07
Br-83	0.00e+00	0.00e+00	9.87e-02	0.00e+00	0.00e+00	0.00e+00	1.42e-01
Br-84	0.00e+00	0.00e+00	1.73e-23	0.00e+00	0.00e+00	0.00e+00	1.36e-28
Br-85	0.00e+00	0.00e+00	0.00e+00	0.00e+00	0.00e+00	0.00e+00	0.00e+00

Conversion factors are in units of square meter-mrem/yr per uCi/sec for all nuclides except H-3, which is in units of mrem/yr per uCi/cubic meter.

**DOSE FACTORS DUE TO RADIONUCLIDES
OTHER THAN NOBLE GASES; P_i**

Pi factors for Adult age group by nuclide.
Waterford Steam Electric Station
Pathway : Cow's Milk (food) Pathway for Pi

Nuclide	Organ Dose Conversion Factors						
	Bone	Liver	T. Body	Thyroid	Kidney	Lung	GI-LLI
Rb-86	0.00e+00	2.59e+09	1.21e+09	0.00e+00	0.00e+00	0.00e+00	5.12e+08
Rb-87	0.00e+00	2.85e+09	9.92e+08	0.00e+00	0.00e+00	0.00e+00	1.34e+08
Rb-88	0.00e+00	0.00e+00	0.00e+00	0.00e+00	0.00e+00	0.00e+00	0.00e+00
Rb-89	0.00e+00	0.00e+00	0.00e+00	0.00e+00	0.00e+00	0.00e+00	0.00e+00
Sr-89	1.45e+09	0.00e+00	4.16e+07	0.00e+00	0.00e+00	0.00e+00	2.33e+08
Sr-90	5.38e+10	0.00e+00	1.08e+09	0.00e+00	0.00e+00	0.00e+00	1.35e+09
Sr-91	2.90e+04	0.00e+00	1.17e+03	0.00e+00	0.00e+00	0.00e+00	1.38e+05
Sr-92	4.95e-01	0.00e+00	2.14e-02	0.00e+00	0.00e+00	0.00e+00	9.81e+00
Y-90	7.09e+01	0.00e+00	1.90e+00	0.00e+00	0.00e+00	0.00e+00	7.52e+05
Y-91	8.59e+03	0.00e+00	2.30e+02	0.00e+00	0.00e+00	0.00e+00	4.73e+06
Y-91m	6.27e-20	0.00e+00	2.43e-21	0.00e+00	0.00e+00	0.00e+00	1.84e-19
Y-92	5.64e-05	0.00e+00	1.65e-06	0.00e+00	0.00e+00	0.00e+00	9.88e-01
Y-93	2.24e-01	0.00e+00	6.19e-03	0.00e+00	0.00e+00	0.00e+00	7.11e+03
Zr-93	1.62e+03	9.04e+01	4.21e+01	0.00e+00	3.43e+02	0.00e+00	9.39e+04
Zr-95	9.43e+02	3.03e+02	2.05e+02	0.00e+00	4.75e+02	0.00e+00	9.59e+05
Zr-97	4.34e-01	8.76e-02	4.01e-02	0.00e+00	1.32e-01	0.00e+00	2.71e+04
Nb-93m	4.91e+05	1.60e+05	3.95e+04	0.00e+00	1.84e+05	0.00e+00	7.40e+07
Nb-95	8.26e+04	4.59e+04	2.47e+04	0.00e+00	4.54e+04	0.00e+00	2.79e+08
Nb-97	6.58e-12	1.66e-12	6.07e-13	0.00e+00	1.94e-12	0.00e+00	6.14e-09
Mo-93	0.00e+00	4.35e+08	1.18e+07	0.00e+00	1.23e+08	0.00e+00	7.07e+07
Mo-99	0.00e+00	2.48e+07	4.72e+06	0.00e+00	5.61e+07	0.00e+00	5.74e+07
Tc-101	0.00e+00	0.00e+00	0.00e+00	0.00e+00	0.00e+00	0.00e+00	0.00e+00
Tc-99	2.42e+07	3.59e+07	9.70e+06	0.00e+00	4.52e+08	3.05e+06	1.17e+09
Tc-99m	3.34e+00	9.44e+00	1.20e+02	0.00e+00	1.43e+02	4.63e+00	5.59e+03
Ru-103	1.02e+03	0.00e+00	4.39e+02	0.00e+00	3.89e+03	0.00e+00	1.19e+05
Ru-105	8.64e-04	0.00e+00	3.41e-04	0.00e+00	1.12e-02	0.00e+00	5.29e-01
Ru-106	2.04e+04	0.00e+00	2.58e+03	0.00e+00	3.94e+04	0.00e+00	1.32e+06
Rh-105	3.46e+05	2.53e+05	1.67e+05	0.00e+00	1.08e+06	0.00e+00	4.03e+07
Pd-107	0.00e+00	1.14e+07	7.26e+05	0.00e+00	1.02e+08	0.00e+00	7.04e+07
Pd-109	0.00e+00	4.49e+04	1.01e+04	0.00e+00	2.56e+05	0.00e+00	4.98e+06

Conversion factors are in units of square meter-mrem/yr per uCi/sec for all nuclides except H-3, which is in units of mrem/yr per uCi/cubic meter.

**DOSE FACTORS DUE TO RADIONUCLIDES
OTHER THAN NOBLE GASES; P_i**

Pi factors for Adult age group by nuclide.
Waterford Steam Electric Station
Pathway : Cow's Milk (food) Pathway for Pi

Nuclide	Organ Dose Conversion Factors						
	Bone	Liver	T. Body	Thyroid	Kidney	Lung	GI-LLI
Ag-110m	5.82e+07	5.39e+07	3.20e+07	0.00e+00	1.06e+08	0.00e+00	2.20e+10
Ag-111	6.47e+06	2.71e+06	1.35e+06	0.00e+00	8.74e+06	0.00e+00	4.97e+09
Cd-113m	0.00e+00	2.94e+06	9.43e+04	0.00e+00	3.24e+06	0.00e+00	2.37e+07
Cd-115m	0.00e+00	1.26e+06	4.02e+04	0.00e+00	9.99e+05	0.00e+00	5.30e+07
Sn-123	5.36e+08	8.88e+06	1.31e+07	7.55e+06	0.00e+00	0.00e+00	1.09e+09
Sn-125	5.68e+07	1.14e+06	2.58e+06	9.47e+05	0.00e+00	0.00e+00	7.09e+08
Sn-126	1.63e+09	3.23e+07	4.64e+07	9.51e+06	0.00e+00	0.00e+00	4.69e+08
Sb-124	2.57e+07	4.86e+05	1.02e+07	6.24e+04	0.00e+00	2.00e+07	7.31e+08
Sb-125	2.04e+07	2.28e+05	4.86e+06	2.08e+04	0.00e+00	1.58e+07	2.25e+08
Sb-126	5.63e+06	1.15e+05	2.03e+06	3.45e+04	0.00e+00	3.45e+06	4.60e+08
Sb-127	4.53e+05	9.93e+03	1.74e+05	5.45e+03	0.00e+00	2.69e+05	1.04e+08
Te-125m	1.63e+07	5.90e+06	2.18e+06	4.90e+06	6.63e+07	0.00e+00	6.50e+07
Te-127	6.56e+02	2.35e+02	1.42e+02	4.86e+02	2.67e+03	0.00e+00	5.17e+04
Te-127m	4.58e+07	1.64e+07	5.58e+06	1.17e+07	1.86e+08	0.00e+00	1.53e+08
Te-129	2.92e-10	1.10e-10	7.11e-11	2.24e-10	1.23e-09	0.00e+00	2.20e-10
Te-129m	6.02e+07	2.25e+07	9.53e+06	2.07e+07	2.51e+08	0.00e+00	3.03e+08
Te-131	3.95e-33	1.65e-33	1.25e-33	3.25e-33	1.73e-32	0.00e+00	5.60e-34
Te-131m	3.62e+05	1.77e+05	1.47e+05	2.80e+05	1.79e+06	0.00e+00	1.76e+07
Te-132	2.40e+06	1.55e+06	1.46e+06	1.72e+06	1.50e+07	0.00e+00	7.35e+07
Te-133m	2.19e-13	1.28e-13	1.24e-13	1.86e-13	1.27e-12	0.00e+00	4.40e-14
Te-134	9.41e-19	6.16e-19	3.78e-19	8.22e-19	5.95e-18	0.00e+00	1.04e-21
I-129	7.58e+08	6.51e+08	2.14e+09	1.68e+12	1.40e+09	0.00e+00	1.03e+08
I-130	4.21e+05	1.24e+06	4.90e+05	1.05e+08	1.94e+06	0.00e+00	1.07e+06
I-131	2.96e+08	4.24e+08	2.43e+08	1.39e+11	7.26e+08	0.00e+00	1.12e+08
I-132	1.67e-01	4.47e-01	1.56e-01	1.56e+01	7.12e-01	0.00e+00	8.39e-02
I-133	3.88e+06	6.74e+06	2.06e+06	9.91e+08	1.18e+07	0.00e+00	6.06e+06
I-134	2.11e-12	5.72e-12	2.05e-12	9.92e-11	9.10e-12	0.00e+00	4.99e-15
I-135	1.29e+04	3.38e+04	1.25e+04	2.23e+06	5.42e+04	0.00e+00	3.82e+04
Cs-134	5.65e+09	1.34e+10	1.10e+10	0.00e+00	4.35e+09	1.44e+09	2.35e+08
Cs-134m	1.76e-01	3.70e-01	1.89e-01	0.00e+00	2.01e-01	3.16e-02	1.31e-01

Conversion factors are in units of square meter-mrem/yr per uCi/sec for all nuclides except H-3, which is in units of mrem/yr per uCi/cubic meter.

**DOSE FACTORS DUE TO RADIONUCLIDES
OTHER THAN NOBLE GASES; P_i**

Pi factors for Adult age group by nuclide.
Waterford Steam Electric Station
Pathway : Cow's Milk (food) Pathway for Pi

Nuclide	Organ Dose Conversion Factors						
	Bone	Liver	T. Body	Thyroid	Kidney	Lung	GI-LLI
Cs-135	1.81e+09	1.67e+09	7.41e+08	0.00e+00	6.32e+08	1.89e+08	3.90e+07
Cs-136	2.63e+08	1.04e+09	7.48e+08	0.00e+00	5.78e+08	7.93e+07	1.18e+08
Cs-137	7.38e+09	1.01e+10	6.61e+09	0.00e+00	3.43e+09	1.14e+09	1.95e+08
Cs-138	9.72e-24	1.92e-23	9.50e-24	0.00e+00	1.41e-23	1.39e-24	8.18e-29
Cs-139	0.00e+00	0.00e+00	0.00e+00	0.00e+00	0.00e+00	0.00e+00	0.00e+00
Ba-139	4.54e-08	3.24e-11	1.33e-09	0.00e+00	3.03e-11	1.84e-11	8.06e-08
Ba-140	2.69e+07	3.38e+04	1.76e+06	0.00e+00	1.15e+04	1.93e+04	5.54e+07
Ba-141	0.00e+00	0.00e+00	0.00e+00	0.00e+00	0.00e+00	0.00e+00	0.00e+00
Ba-142	0.00e+00	0.00e+00	0.00e+00	0.00e+00	0.00e+00	0.00e+00	0.00e+00
La-140	4.52e+00	2.28e+00	6.01e-01	0.00e+00	0.00e+00	0.00e+00	1.67e+05
La-141	3.00e-05	9.31e-06	1.52e-06	0.00e+00	0.00e+00	0.00e+00	1.11e+00
La-142	1.90e-11	8.66e-12	2.16e-12	0.00e+00	0.00e+00	0.00e+00	6.32e-08
Ce-141	4.84e+03	3.28e+03	3.72e+02	0.00e+00	1.52e+03	0.00e+00	1.25e+07
Ce-143	4.16e+01	3.08e+04	3.40e+00	0.00e+00	1.35e+01	0.00e+00	1.15e+06
Ce-144	3.58e+05	1.50e+05	1.92e+04	0.00e+00	8.87e+04	0.00e+00	1.21e+08
Pr-143	1.58e+02	6.33e+01	7.83e+00	0.00e+00	3.66e+01	0.00e+00	6.92e+05
Pr-144	0.00e+00	0.00e+00	0.00e+00	0.00e+00	0.00e+00	0.00e+00	0.00e+00
Nd-147	9.42e+01	1.09e+02	6.51e+00	0.00e+00	6.36e+01	0.00e+00	5.22e+05
Pm-147	2.87e+03	2.70e+02	1.09e+02	0.00e+00	5.10e+02	0.00e+00	3.40e+05
Pm-148	5.93e+01	9.85e+00	4.96e+00	0.00e+00	1.86e+01	0.00e+00	7.74e+05
Pm-148m	8.57e+02	2.22e+02	1.70e+02	0.00e+00	3.35e+02	0.00e+00	1.88e+06
Pm-149	4.28e+00	6.05e-01	2.47e-01	0.00e+00	1.14e+00	0.00e+00	1.13e+05
Pm-151	6.47e-01	1.09e-01	5.48e-02	0.00e+00	1.94e-01	0.00e+00	2.99e+04
Sm-151	2.67e+03	4.60e+02	1.10e+02	0.00e+00	5.14e+02	0.00e+00	2.03e+05
Sm-153	1.99e+00	1.66e+00	1.21e-01	0.00e+00	5.36e-01	0.00e+00	5.92e+04
Eu-152	7.51e+03	1.71e+03	1.50e+03	0.00e+00	1.06e+04	0.00e+00	9.86e+05
Eu-154	2.38e+04	2.92e+03	2.08e+03	0.00e+00	1.40e+04	0.00e+00	2.12e+06
Eu-155	3.25e+03	4.61e+02	2.97e+02	0.00e+00	2.13e+03	0.00e+00	3.62e+05
Eu-156	2.52e+02	1.95e+02	3.14e+01	0.00e+00	1.30e+02	0.00e+00	1.33e+06
Tb-160	1.49e+03	0.00e+00	1.86e+02	0.00e+00	6.16e+02	0.00e+00	1.37e+06

Conversion factors are in units of square meter-mrem/yr per uCi/sec for all nuclides except H-3, which is in units of mrem/yr per uCi/cubic meter.

**DOSE FACTORS DUE TO RADIONUCLIDES
OTHER THAN NOBLE GASES; P_i**

Pi factors for Adult age group by nuclide.
Waterford Steam Electric Station
Pathway : Cow's Milk (food) Pathway for Pi

Nuclide	Organ Dose Conversion Factors						
	Bone	Liver	T. Body	Thyroid	Kidney	Lung	GI-LLI
Ho-166m	1.04e+04	3.26e+03	2.47e+03	0.00e+00	4.87e+03	0.00e+00	9.89e+05
W-181	3.39e+04	1.11e+04	1.18e+03	0.00e+00	0.00e+00	0.00e+00	1.26e+06
W-185	1.29e+06	4.32e+05	4.54e+04	0.00e+00	0.00e+00	0.00e+00	4.99e+07
W-187	6.52e+03	5.45e+03	1.91e+03	0.00e+00	0.00e+00	0.00e+00	1.79e+06
Pb-210	7.32e+10	2.09e+10	2.60e+09	0.00e+00	5.88e+10	0.00e+00	1.07e+07
Bi-210	3.56e+05	2.46e+06	2.04e+05	0.00e+00	2.96e+07	0.00e+00	3.67e+07
Po-210	7.42e+08	1.58e+09	1.79e+08	0.00e+00	5.25e+09	0.00e+00	1.33e+08
Ra-223	1.22e+11	1.88e+08	2.44e+10	0.00e+00	5.33e+09	0.00e+00	7.89e+09
Ra-224	1.41e+10	3.42e+07	2.83e+09	0.00e+00	9.65e+08	0.00e+00	2.98e+09
Ra-225	1.90e+11	2.25e+08	3.79e+10	0.00e+00	6.39e+09	0.00e+00	8.85e+09
Ra-226	1.87e+13	3.55e+08	1.36e+13	0.00e+00	1.01e+10	0.00e+00	2.05e+10
Ra-228	6.87e+12	1.91e+08	7.43e+12	0.00e+00	5.42e+09	0.00e+00	3.46e+09
Ac-225	6.17e+04	8.49e+04	4.15e+03	0.00e+00	9.67e+03	0.00e+00	5.70e+06
Ac-227	7.21e+07	9.56e+06	4.28e+06	0.00e+00	3.09e+06	0.00e+00	3.16e+06
Th-227	2.80e+05	5.06e+03	8.06e+03	0.00e+00	2.88e+04	0.00e+00	1.10e+07
Th-228	1.88e+07	3.18e+05	6.35e+05	0.00e+00	1.77e+06	0.00e+00	2.13e+07
Th-229	5.26e+08	1.50e+07	8.69e+06	0.00e+00	7.26e+07	0.00e+00	3.02e+06
Th-230	7.96e+07	4.52e+06	2.20e+06	0.00e+00	2.18e+07	0.00e+00	2.33e+06
Th-232	8.89e+07	3.86e+06	5.80e+04	0.00e+00	1.86e+07	0.00e+00	1.98e+06
Th-234	1.85e+03	1.09e+02	5.33e+01	0.00e+00	6.16e+02	0.00e+00	2.61e+06
Pa-231	1.58e+08	5.95e+06	6.14e+06	0.00e+00	3.34e+07	0.00e+00	2.77e+06
Pa-233	1.28e+02	2.58e+01	2.22e+01	0.00e+00	9.70e+01	0.00e+00	3.99e+05
U-232	1.59e+10	0.00e+00	1.14e+09	0.00e+00	1.73e+09	0.00e+00	2.62e+08
U-233	3.37e+09	0.00e+00	2.04e+08	0.00e+00	7.84e+08	0.00e+00	2.42e+08
U-234	3.23e+09	0.00e+00	2.00e+08	0.00e+00	7.69e+08	0.00e+00	2.37e+08
U-235	3.10e+09	0.00e+00	1.88e+08	0.00e+00	7.23e+08	0.00e+00	3.02e+08
U-236	3.10e+09	0.00e+00	1.92e+08	0.00e+00	7.38e+08	0.00e+00	2.23e+08
U-237	5.65e+04	0.00e+00	1.50e+04	0.00e+00	2.32e+05	0.00e+00	1.99e+07
U-238	2.96e+09	0.00e+00	1.75e+08	0.00e+00	6.76e+08	0.00e+00	2.13e+08
Np-237	4.87e+07	3.46e+06	2.14e+06	0.00e+00	1.59e+07	0.00e+00	3.07e+06

Conversion factors are in units of square meter-mrem/yr per uCi/sec for all nuclides except H-3, which is in units of mrem/yr per uCi/cubic meter.

**DOSE FACTORS DUE TO RADIONUCLIDES
OTHER THAN NOBLE GASES; P_i**

Pi factors for Adult age group by nuclide.
Waterford Steam Electric Station
Pathway : Cow's Milk (food) Pathway for Pi

Nuclide	Organ Dose Conversion Factors						
	Bone	Liver	T. Body	Thyroid	Kidney	Lung	GI-LLI
Np-238	3.62e+01	9.75e-01	5.63e-01	0.00e+00	3.30e+00	0.00e+00	9.06e+04
Np-239	3.68e+00	3.61e-01	1.99e-01	0.00e+00	1.13e+00	0.00e+00	7.41e+04
Pu-238	9.73e+06	1.23e+06	2.64e+05	0.00e+00	1.13e+06	0.00e+00	1.13e+06
Pu-239	1.12e+07	1.35e+06	2.95e+05	0.00e+00	1.25e+06	0.00e+00	1.03e+06
Pu-240	1.12e+07	1.34e+06	2.95e+05	0.00e+00	1.25e+06	0.00e+00	1.05e+06
Pu-241	2.42e+05	1.15e+04	5.12e+03	0.00e+00	2.36e+04	0.00e+00	2.16e+04
Pu-242	1.04e+07	1.30e+06	2.84e+05	0.00e+00	1.21e+06	0.00e+00	1.01e+06
Pu-244	1.21e+07	1.49e+06	3.26e+05	0.00e+00	1.38e+06	0.00e+00	1.50e+06
Am-241	2.89e+07	2.70e+07	2.07e+06	0.00e+00	1.56e+07	0.00e+00	2.84e+06
Am-242m	2.94e+07	2.56e+07	2.10e+06	0.00e+00	1.56e+07	0.00e+00	3.61e+06
Am-243	2.91e+07	2.67e+07	2.05e+06	0.00e+00	1.54e+07	0.00e+00	3.36e+06
Cm-242	7.27e+05	7.73e+05	4.83e+04	0.00e+00	2.19e+05	0.00e+00	2.79e+06
Cm-243	2.31e+07	2.12e+07	1.45e+06	0.00e+00	6.75e+06	0.00e+00	3.01e+06
Cm-244	1.76e+07	1.65e+07	1.11e+06	0.00e+00	5.17e+06	0.00e+00	2.91e+06
Cm-245	3.62e+07	3.16e+07	2.23e+06	0.00e+00	1.04e+07	0.00e+00	2.72e+06
Cm-246	3.59e+07	3.15e+07	2.22e+06	0.00e+00	1.04e+07	0.00e+00	2.67e+06
Cm-247	3.50e+07	3.11e+07	2.19e+06	0.00e+00	1.02e+07	0.00e+00	3.51e+06
Cm-248	2.91e+08	2.56e+08	1.80e+07	0.00e+00	8.42e+07	0.00e+00	5.68e+07
Cf-252	9.92e+06	0.00e+00	2.39e+05	0.00e+00	0.00e+00	0.00e+00	1.09e+07

Conversion factors are in units of square meter-mrem/yr per uCi/sec for all nuclides except H-3, which is in units of mrem/yr per uCi/cubic meter.

**DOSE FACTORS DUE TO RADIONUCLIDES
OTHER THAN NOBLE GASES; P_i**

Pi factors for Teen age group by nuclide.
Waterford Steam Electric Station
Pathway : Cow's Milk (food) Pathway for Pi

Nuclide	Organ Dose Conversion Factors						
	Bone	Liver	T. Body	Thyroid	Kidney	Lung	GI-LLI
H-3	0.00e+00	5.66e+02	5.66e+02	5.66e+02	5.66e+02	5.66e+02	5.66e+02
Be-10	4.47e+06	6.92e+05	1.13e+05	0.00e+00	5.29e+05	0.00e+00	2.83e+07
C-14	4.86e+08	9.72e+07	9.72e+07	9.72e+07	9.72e+07	9.72e+07	9.72e+07
N-13	0.00e+00	0.00e+00	0.00e+00	0.00e+00	0.00e+00	0.00e+00	0.00e+00
F-18	8.30e-03	0.00e+00	9.10e-04	0.00e+00	0.00e+00	0.00e+00	7.48e-04
Na-22	9.18e+09	9.18e+09	9.18e+09	9.18e+09	9.18e+09	9.18e+09	9.18e+09
Na-24	4.27e+06	4.27e+06	4.27e+06	4.27e+06	4.27e+06	4.27e+06	4.27e+06
P-32	3.15e+10	1.95e+09	1.22e+09	0.00e+00	0.00e+00	0.00e+00	2.65e+09
Ca-41	1.57e+10	0.00e+00	1.70e+09	0.00e+00	0.00e+00	0.00e+00	1.56e+07
Sc-46	3.04e+02	5.92e+02	1.76e+02	0.00e+00	5.67e+02	0.00e+00	2.02e+06
Cr-51	0.00e+00	0.00e+00	4.99e+04	2.77e+04	1.09e+04	7.13e+04	8.39e+06
Mn-54	0.00e+00	1.40e+07	2.78e+06	0.00e+00	4.18e+06	0.00e+00	2.87e+07
Mn-56	0.00e+00	7.36e-03	1.31e-03	0.00e+00	9.32e-03	0.00e+00	4.85e-01
Fe-55	4.45e+07	3.16e+07	7.36e+06	0.00e+00	0.00e+00	2.00e+07	1.37e+07
Fe-59	5.18e+07	1.21e+08	4.67e+07	0.00e+00	0.00e+00	3.81e+07	2.86e+08
Co-57	0.00e+00	2.24e+06	3.76e+06	0.00e+00	0.00e+00	0.00e+00	4.19e+07
Co-58	0.00e+00	7.94e+06	1.83e+07	0.00e+00	0.00e+00	0.00e+00	1.09e+08
Co-60	0.00e+00	2.78e+07	6.26e+07	0.00e+00	0.00e+00	0.00e+00	3.62e+08
Ni-59	8.82e+08	3.11e+08	1.50e+08	0.00e+00	0.00e+00	0.00e+00	4.88e+07
Ni-63	1.18e+10	8.35e+08	4.01e+08	0.00e+00	0.00e+00	0.00e+00	1.33e+08
Ni-65	6.87e-01	8.78e-02	4.00e-02	0.00e+00	0.00e+00	0.00e+00	4.76e+00
Cu-64	0.00e+00	4.26e+04	2.00e+04	0.00e+00	1.08e+05	0.00e+00	3.30e+06
Zn-65	2.11e+09	7.32e+09	3.41e+09	0.00e+00	4.68e+09	0.00e+00	3.10e+09
Zn-69	4.01e-12	7.65e-12	5.35e-13	0.00e+00	5.00e-12	0.00e+00	1.41e-11
Zn-69m	3.30e+05	7.79e+05	7.15e+04	0.00e+00	4.74e+05	0.00e+00	4.28e+07
Se-79	0.00e+00	1.67e+09	2.81e+08	0.00e+00	2.92e+09	0.00e+00	2.56e+08
Br-82	0.00e+00	0.00e+00	5.61e+07	0.00e+00	0.00e+00	0.00e+00	0.00e+00
Br-83	0.00e+00	0.00e+00	1.82e-01	0.00e+00	0.00e+00	0.00e+00	0.00e+00
Br-84	0.00e+00	0.00e+00	3.09e-23	0.00e+00	0.00e+00	0.00e+00	0.00e+00
Br-85	0.00e+00	0.00e+00	0.00e+00	0.00e+00	0.00e+00	0.00e+00	0.00e+00

Conversion factors are in units of square meter-mrem/yr per uCi/sec for all nuclides except H-3, which is in units of mrem/yr per uCi/cubic meter.

**DOSE FACTORS DUE TO RADIONUCLIDES
OTHER THAN NOBLE GASES; P_i**

Pi factors for Teen age group by nuclide.
Waterford Steam Electric Station
Pathway : Cow's Milk (food) Pathway for Pi

Nuclide	Organ Dose Conversion Factors						
	Bone	Liver	T. Body	Thyroid	Kidney	Lung	GI-LLI
Rb-86	0.00e+00	4.73e+09	2.22e+09	0.00e+00	0.00e+00	0.00e+00	7.00e+08
Rb-87	0.00e+00	5.24e+09	1.83e+09	0.00e+00	0.00e+00	0.00e+00	1.83e+08
Rb-88	0.00e+00	0.00e+00	0.00e+00	0.00e+00	0.00e+00	0.00e+00	0.00e+00
Rb-89	0.00e+00	0.00e+00	0.00e+00	0.00e+00	0.00e+00	0.00e+00	0.00e+00
Sr-89	2.67e+09	0.00e+00	7.66e+07	0.00e+00	0.00e+00	0.00e+00	3.19e+08
Sr-90	8.13e+10	0.00e+00	1.63e+09	0.00e+00	0.00e+00	0.00e+00	1.86e+09
Sr-91	5.33e+04	0.00e+00	2.12e+03	0.00e+00	0.00e+00	0.00e+00	2.42e+05
Sr-92	9.07e-01	0.00e+00	3.86e-02	0.00e+00	0.00e+00	0.00e+00	2.31e+01
Y-90	1.30e+02	0.00e+00	3.51e+00	0.00e+00	0.00e+00	0.00e+00	1.07e+06
Y-91	1.58e+04	0.00e+00	4.24e+02	0.00e+00	0.00e+00	0.00e+00	6.48e+06
Y-91m	1.15e-19	0.00e+00	4.39e-21	0.00e+00	0.00e+00	0.00e+00	5.42e-18
Y-92	1.04e-04	0.00e+00	3.01e-06	0.00e+00	0.00e+00	0.00e+00	2.86e+00
Y-93	4.13e-01	0.00e+00	1.13e-02	0.00e+00	0.00e+00	0.00e+00	1.26e+04
Zr-93	2.76e+03	1.36e+02	7.43e+01	0.00e+00	4.81e+02	0.00e+00	1.29e+05
Zr-95	1.65e+03	5.20e+02	3.58e+02	0.00e+00	7.65e+02	0.00e+00	1.20e+06
Zr-97	7.90e-01	1.56e-01	7.20e-02	0.00e+00	2.37e-01	0.00e+00	4.23e+04
Nb-93m	8.55e+05	2.81e+05	7.03e+04	0.00e+00	3.28e+05	0.00e+00	1.01e+08
Nb-95	1.41e+05	7.81e+04	4.30e+04	0.00e+00	7.57e+04	0.00e+00	3.34e+08
Nb-97	1.20e-11	2.98e-12	1.09e-12	0.00e+00	3.48e-12	0.00e+00	7.11e-08
Mo-93	0.00e+00	7.93e+08	2.17e+07	0.00e+00	2.27e+08	0.00e+00	9.65e+07
Mo-99	0.00e+00	4.47e+07	8.53e+06	0.00e+00	1.02e+08	0.00e+00	8.01e+07
Tc-101	0.00e+00	0.00e+00	0.00e+00	0.00e+00	0.00e+00	0.00e+00	0.00e+00
Tc-99	4.46e+07	6.56e+07	1.79e+07	0.00e+00	8.33e+08	6.78e+06	1.61e+09
Tc-99m	5.80e+00	1.62e+01	2.10e+02	0.00e+00	2.41e+02	8.97e+00	1.06e+04
Ru-103	1.81e+03	0.00e+00	7.74e+02	0.00e+00	6.38e+03	0.00e+00	1.51e+05
Ru-105	1.58e-03	0.00e+00	6.13e-04	0.00e+00	1.99e-02	0.00e+00	1.27e+00
Ru-106	3.75e+04	0.00e+00	4.73e+03	0.00e+00	7.24e+04	0.00e+00	1.80e+06
Rh-105	6.38e+05	4.61e+05	3.03e+05	0.00e+00	1.96e+06	0.00e+00	5.87e+07
Pd-107	0.00e+00	2.07e+07	1.34e+06	0.00e+00	1.87e+08	0.00e+00	9.63e+07
Pd-109	0.00e+00	8.22e+04	1.87e+04	0.00e+00	4.75e+05	0.00e+00	8.29e+06

Conversion factors are in units of square meter-mrem/yr per uCi/sec for all nuclides except H-3, which is in units of mrem/yr per uCi/cubic meter.

**DOSE FACTORS DUE TO RADIONUCLIDES
OTHER THAN NOBLE GASES; P_i**

Pi factors for Teen age group by nuclide.
Waterford Steam Electric Station
Pathway : Cow's Milk (food) Pathway for Pi

Nuclide	Organ Dose Conversion Factors						
	Bone	Liver	T. Body	Thyroid	Kidney	Lung	GI-LLI
Ag-110m	9.63e+07	9.11e+07	5.54e+07	0.00e+00	1.74e+08	0.00e+00	2.56e+10
Ag-111	1.19e+07	4.95e+06	2.49e+06	0.00e+00	1.61e+07	0.00e+00	6.90e+09
Cd-113m	0.00e+00	5.38e+06	1.73e+05	0.00e+00	5.95e+06	0.00e+00	3.23e+07
Cd-115m	0.00e+00	2.30e+06	7.41e+04	0.00e+00	1.84e+06	0.00e+00	7.27e+07
Sn-123	9.88e+08	1.62e+07	2.40e+07	1.30e+07	0.00e+00	0.00e+00	1.49e+09
Sn-125	1.05e+08	2.08e+06	4.72e+06	1.64e+06	0.00e+00	0.00e+00	9.85e+08
Sn-126	2.89e+09	5.38e+07	8.23e+07	1.42e+07	0.00e+00	0.00e+00	6.43e+08
Sb-124	4.59e+07	8.46e+05	1.79e+07	1.04e+05	0.00e+00	4.01e+07	9.25e+08
Sb-125	3.65e+07	3.99e+05	8.55e+06	3.49e+04	0.00e+00	3.21e+07	2.84e+08
Sb-126	1.00e+07	2.05e+05	3.61e+06	5.68e+04	0.00e+00	7.20e+06	5.94e+08
Sb-127	8.23e+05	1.76e+04	3.11e+05	9.25e+03	0.00e+00	5.60e+05	1.40e+08
Te-125m	3.00e+07	1.08e+07	4.02e+06	8.39e+06	0.00e+00	0.00e+00	8.86e+07
Te-127	1.22e+03	4.31e+02	2.61e+02	8.38e+02	4.92e+03	0.00e+00	9.38e+04
Te-127m	8.44e+07	2.99e+07	1.00e+07	2.01e+07	3.42e+08	0.00e+00	2.10e+08
Te-129	5.37e-10	2.00e-10	1.31e-10	3.84e-10	2.25e-09	0.00e+00	2.94e-09
Te-129m	1.10e+08	4.09e+07	1.74e+07	3.55e+07	4.61e+08	0.00e+00	4.13e+08
Te-131	7.22e-33	2.98e-33	2.26e-33	5.57e-33	3.16e-32	0.00e+00	5.93e-34
Te-131m	6.58e+05	3.15e+05	2.63e+05	4.75e+05	3.29e+06	0.00e+00	2.53e+07
Te-132	4.29e+06	2.72e+06	2.56e+06	2.87e+06	2.61e+07	0.00e+00	8.61e+07
Te-133m	3.95e-13	2.24e-13	2.18e-13	3.13e-13	2.22e-12	0.00e+00	9.07e-13
Te-134	1.68e-18	1.08e-18	1.12e-18	1.38e-18	1.03e-17	0.00e+00	6.22e-20
I-129	1.39e+09	1.17e+09	1.96e+09	1.43e+12	2.10e+09	0.00e+00	1.37e+08
I-130	7.41e+05	2.14e+06	8.56e+05	1.75e+08	3.30e+06	0.00e+00	1.65e+06
I-131	5.37e+08	7.52e+08	4.04e+08	2.20e+11	1.30e+09	0.00e+00	1.49e+08
I-132	2.96e-01	7.75e-01	2.78e-01	2.61e+01	1.22e+00	0.00e+00	3.38e-01
I-133	7.08e+06	1.20e+07	3.66e+06	1.68e+09	2.11e+07	0.00e+00	9.09e+06
I-134	3.74e-12	9.92e-12	3.56e-12	1.65e-10	1.56e-11	0.00e+00	1.31e-13
I-135	2.29e+04	5.90e+04	2.19e+04	3.80e+06	9.33e+04	0.00e+00	6.54e+04
Cs-134	9.81e+09	2.31e+10	1.07e+10	0.00e+00	7.34e+09	2.80e+09	2.87e+08
Cs-134m	3.13e-01	6.49e-01	3.34e-01	0.00e+00	3.61e-01	6.34e-02	4.32e-01

Conversion factors are in units of square meter-mrem/yr per uCi/sec for all nuclides except H-3, which is in units of mrem/yr per uCi/cubic meter.

**DOSE FACTORS DUE TO RADIONUCLIDES
OTHER THAN NOBLE GASES; P_i**

Pi factors for Teen age group by nuclide.
Waterford Steam Electric Station
Pathway : Cow's Milk (food) Pathway for Pi

Nuclide	Organ Dose Conversion Factors						
	Bone	Liver	T. Body	Thyroid	Kidney	Lung	GI-LLI
Cs-135	3.33e+09	3.05e+09	7.13e+08	0.00e+00	1.16e+09	4.21e+08	5.34e+07
Cs-136	4.48e+08	1.76e+09	1.18e+09	0.00e+00	9.60e+08	1.51e+08	1.42e+08
Cs-137	1.34e+10	1.78e+10	6.20e+09	0.00e+00	6.06e+09	2.35e+09	2.53e+08
Cs-138	1.76e-23	3.38e-23	1.69e-23	0.00e+00	2.50e-23	2.91e-24	1.54e-26
Cs-139	0.00e+00	0.00e+00	0.00e+00	0.00e+00	0.00e+00	0.00e+00	0.00e+00
Ba-139	8.40e-08	5.91e-11	2.45e-09	0.00e+00	5.57e-11	4.07e-11	7.50e-07
Ba-140	4.85e+07	5.95e+04	3.13e+06	0.00e+00	2.02e+04	4.00e+04	7.48e+07
Ba-141	0.00e+00	0.00e+00	0.00e+00	0.00e+00	0.00e+00	0.00e+00	0.00e+00
Ba-142	0.00e+00	0.00e+00	0.00e+00	0.00e+00	0.00e+00	0.00e+00	0.00e+00
La-140	8.11e+00	3.99e+00	1.06e+00	0.00e+00	0.00e+00	0.00e+00	2.29e+05
La-141	5.52e-05	1.70e-05	2.80e-06	0.00e+00	0.00e+00	0.00e+00	3.01e+00
La-142	3.43e-11	1.53e-11	3.80e-12	0.00e+00	0.00e+00	0.00e+00	4.64e-07
Ce-141	8.88e+03	5.93e+03	6.81e+02	0.00e+00	2.79e+03	0.00e+00	1.70e+07
Ce-143	7.65e+01	5.56e+04	6.21e+00	0.00e+00	2.50e+01	0.00e+00	1.67e+06
Ce-144	6.58e+05	2.72e+05	3.54e+04	0.00e+00	1.63e+05	0.00e+00	1.66e+08
Pr-143	2.90e+02	1.16e+02	1.44e+01	0.00e+00	6.73e+01	0.00e+00	9.55e+05
Pr-144	0.00e+00	0.00e+00	0.00e+00	0.00e+00	0.00e+00	0.00e+00	0.00e+00
Nd-147	1.81e+02	1.97e+02	1.18e+01	0.00e+00	1.16e+02	0.00e+00	7.11e+05
Pm-147	5.15e+03	4.89e+02	1.99e+02	0.00e+00	9.32e+02	0.00e+00	4.65e+05
Pm-148	1.09e+02	1.77e+01	8.93e+00	0.00e+00	3.20e+01	0.00e+00	1.06e+06
Pm-148m	1.49e+03	3.78e+02	2.96e+02	0.00e+00	5.73e+02	0.00e+00	2.38e+06
Pm-149	7.88e+00	1.11e+00	4.54e-01	0.00e+00	2.11e+00	0.00e+00	1.63e+05
Pm-151	1.18e+00	1.95e-01	9.88e-02	0.00e+00	3.51e-01	0.00e+00	4.38e+04
Sm-151	4.35e+03	8.37e+02	1.96e+02	0.00e+00	9.17e+02	0.00e+00	2.84e+05
Sm-153	3.65e+00	3.02e+00	2.22e-01	0.00e+00	9.88e-01	0.00e+00	8.53e+04
Eu-152	1.22e+04	2.93e+03	2.58e+03	0.00e+00	1.36e+04	0.00e+00	1.08e+06
Eu-154	3.94e+04	5.08e+03	3.58e+03	0.00e+00	2.27e+04	0.00e+00	2.69e+06
Eu-155	8.48e+03	8.18e+02	5.07e+02	0.00e+00	3.20e+03	0.00e+00	4.69e+06
Eu-156	4.55e+02	3.41e+02	5.57e+01	0.00e+00	2.30e+02	0.00e+00	1.74e+06
Tb-160	2.65e+03	0.00e+00	3.31e+02	0.00e+00	1.05e+03	0.00e+00	1.72e+06

Conversion factors are in units of square meter-mrem/yr per uCi/sec for all nuclides except H-3, which is in units of mrem/yr per uCi/cubic meter.

**DOSE FACTORS DUE TO RADIONUCLIDES
OTHER THAN NOBLE GASES; P_i**

Pi factors for Teen age group by nuclide.
Waterford Steam Electric Station
Pathway : Cow's Milk (food) Pathway for Pi

Nuclide	Organ Dose Conversion Factors						
	Bone	Liver	T. Body	Thyroid	Kidney	Lung	GI-LLI
Ho-166m	1.78e+04	5.48e+03	3.97e+03	0.00e+00	8.03e+03	0.00e+00	1.35e+06
W-181	6.27e+04	2.02e+04	2.12e+03	0.00e+00	0.00e+00	0.00e+00	1.72e+06
W-185	2.39e+06	7.88e+05	8.33e+04	0.00e+00	0.00e+00	0.00e+00	6.81e+07
W-187	1.19e+04	9.73e+03	3.41e+03	0.00e+00	0.00e+00	0.00e+00	2.63e+06
Pb-210	1.12e+11	3.36e+10	4.33e+09	0.00e+00	1.06e+11	0.00e+00	1.46e+07
Bi-210	6.57e+05	4.49e+06	3.76e+05	0.00e+00	5.46e+07	0.00e+00	5.13e+07
Po-210	1.37e+09	2.88e+09	3.31e+08	0.00e+00	9.68e+09	0.00e+00	1.81e+08
Ra-223	2.25e+11	3.42e+08	4.50e+10	0.00e+00	9.83e+09	0.00e+00	1.09e+10
Ra-224	2.62e+10	6.25e+07	5.22e+09	0.00e+00	1.79e+09	0.00e+00	4.20e+09
Ra-225	3.50e+11	4.11e+08	6.98e+10	0.00e+00	1.18e+10	0.00e+00	1.22e+10
Ra-226	2.57e+13	6.49e+08	1.91e+13	0.00e+00	1.85e+10	0.00e+00	2.80e+10
Ra-228	1.08e+13	3.49e+08	1.20e+13	0.00e+00	9.98e+09	0.00e+00	4.74e+09
Ac-225	1.14e+05	1.55e+05	7.63e+03	0.00e+00	1.78e+04	0.00e+00	7.89e+06
Ac-227	1.02e+08	1.51e+07	6.07e+06	0.00e+00	4.38e+06	0.00e+00	4.32e+06
Th-227	5.16e+05	9.27e+03	1.49e+04	0.00e+00	5.29e+04	0.00e+00	1.51e+07
Th-228	3.32e+07	5.56e+05	1.12e+06	0.00e+00	3.13e+06	0.00e+00	2.91e+07
Th-229	7.13e+08	2.05e+07	1.18e+07	0.00e+00	9.92e+07	0.00e+00	4.13e+06
Th-230	1.08e+08	6.13e+06	2.99e+06	0.00e+00	2.99e+07	0.00e+00	3.18e+06
Th-232	1.21e+08	5.24e+06	8.13e+04	0.00e+00	2.55e+07	0.00e+00	2.71e+06
Th-234	3.39e+03	1.99e+02	9.86e+01	0.00e+00	1.13e+03	0.00e+00	3.60e+06
Pa-231	2.15e+08	8.08e+06	8.38e+06	0.00e+00	4.54e+07	0.00e+00	3.79e+06
Pa-233	2.30e+02	4.42e+01	3.95e+01	0.00e+00	1.67e+02	0.00e+00	5.05e+05
U-232	2.94e+10	0.00e+00	2.10e+09	0.00e+00	3.18e+09	0.00e+00	3.58e+08
U-233	6.18e+09	0.00e+00	3.76e+08	0.00e+00	1.45e+09	0.00e+00	3.32e+08
U-234	5.93e+09	0.00e+00	3.68e+08	0.00e+00	1.42e+09	0.00e+00	3.25e+08
U-235	5.68e+09	0.00e+00	3.46e+08	0.00e+00	1.33e+09	0.00e+00	4.13e+08
U-236	5.68e+09	0.00e+00	3.54e+08	0.00e+00	1.36e+09	0.00e+00	3.05e+08
U-237	1.04e+05	0.00e+00	2.77e+04	0.00e+00	4.28e+05	0.00e+00	2.76e+07
U-238	5.43e+09	0.00e+00	3.24e+08	0.00e+00	1.25e+09	0.00e+00	2.91e+08
Np-237	6.63e+07	4.76e+06	2.92e+06	0.00e+00	2.16e+07	0.00e+00	4.19e+06

Conversion factors are in units of square meter-mrem/yr per uCi/sec for all nuclides except H-3, which is in units of mrem/yr per uCi/cubic meter.

**DOSE FACTORS DUE TO RADIONUCLIDES
OTHER THAN NOBLE GASES; P_i**

Pi factors for Teen age group by nuclide.
Waterford Steam Electric Station
Pathway : Cow's Milk (food) Pathway for Pi

Nuclide	Organ Dose Conversion Factors						
	Bone	Liver	T. Body	Thyroid	Kidney	Lung	GI-LLI
Np-238	6.65e+01	1.78e+00	1.04e+00	0.00e+00	6.10e+00	0.00e+00	1.31e+05
Np-239	7.01e+00	6.62e-01	3.67e-01	0.00e+00	2.08e+00	0.00e+00	1.06e+05
Pu-238	1.34e+07	1.71e+06	3.63e+05	0.00e+00	1.55e+06	0.00e+00	1.54e+06
Pu-239	1.53e+07	1.85e+06	4.01e+05	0.00e+00	1.71e+06	0.00e+00	1.41e+06
Pu-240	1.52e+07	1.85e+06	4.01e+05	0.00e+00	1.71e+06	0.00e+00	1.43e+06
Pu-241	3.48e+05	1.67e+04	7.34e+03	0.00e+00	3.40e+04	0.00e+00	2.94e+04
Pu-242	1.41e+07	1.78e+06	3.87e+05	0.00e+00	1.65e+06	0.00e+00	1.38e+06
Pu-244	1.65e+07	2.03e+06	4.43e+05	0.00e+00	1.88e+06	0.00e+00	2.05e+06
Am-241	3.94e+07	3.72e+07	2.84e+06	0.00e+00	2.13e+07	0.00e+00	3.89e+06
Am-242m	4.02e+07	3.54e+07	2.89e+06	0.00e+00	2.14e+07	0.00e+00	4.93e+06
Am-243	3.97e+07	3.66e+07	2.80e+06	0.00e+00	2.10e+07	0.00e+00	4.60e+06
Cm-242	1.34e+06	1.41e+06	8.88e+04	0.00e+00	4.05e+05	0.00e+00	3.82e+06
Cm-243	3.24e+07	3.00e+07	2.04e+06	0.00e+00	9.51e+06	0.00e+00	4.12e+06
Cm-244	2.51e+07	2.37e+07	1.59e+06	0.00e+00	7.41e+06	0.00e+00	3.98e+06
Cm-245	4.94e+07	4.34e+07	3.04e+06	0.00e+00	1.42e+07	0.00e+00	3.72e+06
Cm-246	4.90e+07	4.34e+07	3.04e+06	0.00e+00	1.42e+07	0.00e+00	3.65e+06
Cm-247	4.77e+07	4.27e+07	2.99e+06	0.00e+00	1.40e+07	0.00e+00	4.80e+06
Cm-248	3.96e+08	3.52e+08	2.47e+07	0.00e+00	1.15e+08	0.00e+00	7.73e+07
Cf-252	1.70e+07	0.00e+00	4.10e+05	0.00e+00	0.00e+00	0.00e+00	1.50e+07

Conversion factors are in units of square meter-mrem/yr per uCi/sec for all nuclides except H-3, which is in units of mrem/yr per uCi/cubic meter.

**DOSE FACTORS DUE TO RADIONUCLIDES
OTHER THAN NOBLE GASES; P_i**

Pi factors for Child age group by nuclide.
Waterford Steam Electric Station
Pathway : Cow's Milk (food) Pathway for Pi

Nuclide	Organ Dose Conversion Factors						
	Bone	Liver	T. Body	Thyroid	Kidney	Lung	GI-LLI
H-3	0.00e+00	8.97e+02	8.97e+02	8.97e+02	8.97e+02	8.97e+02	8.97e+02
Be-10	1.11e+07	1.29e+06	2.79e+05	0.00e+00	9.13e+05	0.00e+00	2.26e+07
C-14	1.19e+09	2.39e+08	2.39e+08	2.39e+08	2.39e+08	2.39e+08	2.39e+08
N-13	0.00e+00	0.00e+00	0.00e+00	0.00e+00	0.00e+00	0.00e+00	0.00e+00
F-18	1.97e-02	0.00e+00	1.96e-03	0.00e+00	0.00e+00	0.00e+00	5.34e-03
Na-22	1.90e+10	1.90e+10	1.90e+10	1.90e+10	1.90e+10	1.90e+10	1.90e+10
Na-24	8.88e+06	8.88e+06	8.88e+06	8.88e+06	8.88e+06	8.88e+06	8.88e+06
P-32	7.78e+10	3.64e+09	3.00e+09	0.00e+00	0.00e+00	0.00e+00	2.15e+09
Ca-41	2.28e+10	0.00e+00	2.49e+09	0.00e+00	0.00e+00	0.00e+00	1.25e+07
Sc-46	6.83e+02	9.36e+02	3.61e+02	0.00e+00	8.29e+02	0.00e+00	1.37e+06
Cr-51	0.00e+00	0.00e+00	1.02e+05	5.65e+04	1.54e+04	1.03e+05	5.40e+06
Mn-54	0.00e+00	2.10e+07	5.59e+06	0.00e+00	5.88e+06	0.00e+00	1.76e+07
Mn-56	0.00e+00	1.28e-02	2.90e-03	0.00e+00	1.55e-02	0.00e+00	1.86e+00
Fe-55	1.12e+08	5.93e+07	1.84e+07	0.00e+00	0.00e+00	3.35e+07	1.10e+07
Fe-59	1.20e+08	1.95e+08	9.69e+07	0.00e+00	0.00e+00	5.64e+07	2.03e+08
Co-57	0.00e+00	3.84e+06	7.77e+06	0.00e+00	0.00e+00	0.00e+00	3.14e+07
Co-58	0.00e+00	1.21e+07	3.71e+07	0.00e+00	0.00e+00	0.00e+00	7.07e+07
Co-60	0.00e+00	4.32e+07	1.27e+08	0.00e+00	0.00e+00	0.00e+00	2.39e+08
Ni-59	2.22e+09	5.90e+08	3.76e+08	0.00e+00	0.00e+00	0.00e+00	3.91e+07
Ni-63	2.96e+10	1.59e+09	1.01e+09	0.00e+00	0.00e+00	0.00e+00	1.07e+08
Ni-65	1.68e+00	1.58e-01	9.24e-02	0.00e+00	0.00e+00	0.00e+00	1.94e+01
Cu-64	0.00e+00	7.49e+04	4.52e+04	0.00e+00	1.81e+05	0.00e+00	3.51e+06
Zn-65	4.13e+09	1.10e+10	6.85e+09	0.00e+00	6.94e+09	0.00e+00	1.93e+09
Zn-69	9.87e-12	1.43e-11	1.32e-12	0.00e+00	8.65e-12	0.00e+00	8.99e-10
Zn-69m	8.06e+05	1.37e+06	1.62e+05	0.00e+00	7.98e+05	0.00e+00	4.47e+07
Se-79	0.00e+00	3.12e+09	6.92e+08	0.00e+00	5.07e+09	0.00e+00	2.05e+08
Br-82	0.00e+00	0.00e+00	1.15e+08	0.00e+00	0.00e+00	0.00e+00	0.00e+00
Br-83	0.00e+00	0.00e+00	4.47e-01	0.00e+00	0.00e+00	0.00e+00	0.00e+00
Br-84	0.00e+00	0.00e+00	7.00e-23	0.00e+00	0.00e+00	0.00e+00	0.00e+00
Br-85	0.00e+00	0.00e+00	0.00e+00	0.00e+00	0.00e+00	0.00e+00	0.00e+00

Conversion factors are in units of square meter-mrem/yr per uCi/sec for all nuclides except H-3, which is in units of mrem/yr per uCi/cubic meter.

**DOSE FACTORS DUE TO RADIONUCLIDES
OTHER THAN NOBLE GASES; P_i**

Pi factors for Child age group by nuclide.
Waterford Steam Electric Station
Pathway : Cow's Milk (food) Pathway for Pi

Nuclide	Organ Dose Conversion Factors						
	Bone	Liver	T. Body	Thyroid	Kidney	Lung	GI-LLI
Rb-86	0.00e+00	8.77e+09	5.39e+09	0.00e+00	0.00e+00	0.00e+00	5.64e+08
Rb-87	0.00e+00	9.75e+09	4.52e+09	0.00e+00	0.00e+00	0.00e+00	1.46e+08
Rb-88	0.00e+00	0.00e+00	0.00e+00	0.00e+00	0.00e+00	0.00e+00	0.00e+00
Rb-89	0.00e+00	0.00e+00	0.00e+00	0.00e+00	0.00e+00	0.00e+00	0.00e+00
Sr-89	6.62e+09	0.00e+00	1.89e+08	0.00e+00	0.00e+00	0.00e+00	2.56e+08
Sr-90	1.68e+11	0.00e+00	3.38e+09	0.00e+00	0.00e+00	0.00e+00	1.50e+09
Sr-91	1.31e+05	0.00e+00	4.94e+03	0.00e+00	0.00e+00	0.00e+00	2.89e+05
Sr-92	2.21e+00	0.00e+00	8.88e-02	0.00e+00	0.00e+00	0.00e+00	4.19e+01
Y-90	3.22e+02	0.00e+00	8.63e+00	0.00e+00	0.00e+00	0.00e+00	9.18e+05
Y-91	3.90e+04	0.00e+00	1.04e+03	0.00e+00	0.00e+00	0.00e+00	5.20e+06
Y-91m	2.80e-19	0.00e+00	1.02e-20	0.00e+00	0.00e+00	0.00e+00	5.49e-16
Y-92	2.56e-04	0.00e+00	7.32e-06	0.00e+00	0.00e+00	0.00e+00	7.39e+00
Y-93	1.02e+00	0.00e+00	2.79e-02	0.00e+00	0.00e+00	0.00e+00	1.51e+04
Zr-93	6.87e+03	2.57e+02	1.83e+02	0.00e+00	9.95e+02	0.00e+00	9.75e+04
Zr-95	3.83e+03	8.42e+02	7.50e+02	0.00e+00	1.21e+03	0.00e+00	8.79e+05
Zr-97	1.92e+00	2.78e-01	1.64e-01	0.00e+00	3.99e-01	0.00e+00	4.21e+04
Nb-93m	2.15e+06	5.37e+05	1.77e+05	0.00e+00	5.80e+05	0.00e+00	8.10e+07
Nb-95	3.18e+05	1.24e+05	8.84e+04	0.00e+00	1.16e+05	0.00e+00	2.29e+08
Nb-97	2.91e-11	5.26e-12	2.46e-12	0.00e+00	5.84e-12	0.00e+00	1.62e-06
Mo-93	0.00e+00	1.49e+09	5.34e+07	0.00e+00	3.92e+08	0.00e+00	7.53e+07
Mo-99	0.00e+00	8.14e+07	2.01e+07	0.00e+00	1.74e+08	0.00e+00	6.73e+07
Tc-101	0.00e+00	0.00e+00	0.00e+00	0.00e+00	0.00e+00	0.00e+00	0.00e+00
Tc-99	1.10e+08	1.23e+08	4.40e+07	0.00e+00	1.44e+09	1.08e+07	1.29e+09
Tc-99m	1.33e+01	2.61e+01	4.32e+02	0.00e+00	3.79e+02	1.32e+01	1.48e+04
Ru-103	4.28e+03	0.00e+00	1.65e+03	0.00e+00	1.08e+04	0.00e+00	1.11e+05
Ru-105	3.85e-03	0.00e+00	1.40e-03	0.00e+00	3.39e-02	0.00e+00	2.51e+00
Ru-106	9.24e+04	0.00e+00	1.15e+04	0.00e+00	1.25e+05	0.00e+00	1.44e+06
Rh-105	1.56e+06	8.40e+05	7.18e+05	0.00e+00	3.35e+06	0.00e+00	5.21e+07
Pd-107	0.00e+00	3.88e+07	3.30e+06	0.00e+00	3.25e+08	0.00e+00	7.71e+07
Pd-109	0.00e+00	1.53e+05	4.59e+04	0.00e+00	8.22e+05	0.00e+00	9.05e+06

Conversion factors are in units of square meter-mrem/yr per uCi/sec for all nuclides except H-3, which is in units of mrem/yr per uCi/cubic meter.

**DOSE FACTORS DUE TO RADIONUCLIDES
OTHER THAN NOBLE GASES; P_i**

Pi factors for Child age group by nuclide.
Waterford Steam Electric Station
Pathway : Cow's Milk (food) Pathway for Pi

Nuclide	Organ Dose Conversion Factors						
	Bone	Liver	T. Body	Thyroid	Kidney	Lung	GI-LLI
Ag-110m	2.09e+08	1.41e+08	1.13e+08	0.00e+00	2.63e+08	0.00e+00	1.68e+10
Ag-111	2.94e+07	9.20e+06	6.07e+06	0.00e+00	2.78e+07	0.00e+00	5.63e+09
Cd-113m	0.00e+00	1.00e+07	4.27e+05	0.00e+00	1.03e+07	0.00e+00	2.59e+07
Cd-115m	0.00e+00	4.29e+06	1.83e+05	0.00e+00	3.19e+06	0.00e+00	5.83e+07
Sn-123	2.44e+09	3.03e+07	5.95e+07	3.21e+07	0.00e+00	0.00e+00	1.20e+09
Sn-125	2.57e+08	3.88e+06	1.15e+07	4.03e+06	0.00e+00	0.00e+00	7.98e+08
Sn-126	6.85e+09	8.54e+07	1.95e+08	2.34e+07	0.00e+00	0.00e+00	5.14e+08
Sb-124	1.09e+08	1.41e+06	3.81e+07	2.40e+05	0.00e+00	6.03e+07	6.79e+08
Sb-125	8.70e+07	6.71e+05	1.82e+07	8.06e+04	0.00e+00	4.85e+07	2.08e+08
Sb-126	2.29e+07	3.51e+05	8.23e+06	1.34e+05	0.00e+00	1.09e+07	4.62e+08
Sb-127	1.98e+06	3.07e+04	6.88e+05	2.21e+04	0.00e+00	8.60e+05	1.12e+08
Te-125m	7.38e+07	2.00e+07	9.84e+06	2.07e+07	0.00e+00	0.00e+00	7.12e+07
Te-127	2.99e+03	8.06e+02	6.41e+02	2.07e+03	8.50e+03	0.00e+00	1.17e+05
Te-127m	2.08e+08	5.60e+07	2.47e+07	4.97e+07	5.93e+08	0.00e+00	1.68e+08
Te-129	1.33e-09	3.70e-10	3.15e-10	9.46e-10	3.88e-09	0.00e+00	8.25e-08
Te-129m	2.71e+08	7.58e+07	4.21e+07	8.75e+07	7.97e+08	0.00e+00	3.31e+08
Te-131	1.77e-32	5.40e-33	5.27e-33	1.36e-32	5.36e-32	0.00e+00	9.31e-32
Te-131m	1.60e+06	5.54e+05	5.89e+05	1.14e+06	5.36e+06	0.00e+00	2.25e+07
Te-132	1.03e+07	4.54e+06	5.48e+06	6.61e+06	4.21e+07	0.00e+00	4.57e+07
Te-133m	9.46e-13	3.82e-13	4.74e-13	7.33e-13	3.63e-12	0.00e+00	2.92e-11
Te-134	3.99e-18	1.79e-18	2.39e-18	3.15e-18	1.66e-17	0.00e+00	1.82e-17
I-129	3.43e+09	2.11e+09	1.88e+09	1.38e+12	3.55e+09	0.00e+00	1.06e+08
I-130	1.73e+06	3.50e+06	1.80e+06	3.86e+08	5.23e+06	0.00e+00	1.64e+06
I-131	1.30e+09	1.31e+09	7.45e+08	4.33e+11	2.15e+09	0.00e+00	1.17e+08
I-132	7.01e-01	1.29e+00	5.92e-01	5.97e+01	1.97e+00	0.00e+00	1.52e+00
I-133	1.72e+07	2.13e+07	8.05e+06	3.95e+09	3.55e+07	0.00e+00	8.57e+06
I-134	8.87e-12	1.65e-11	7.57e-12	3.79e-10	2.52e-11	0.00e+00	1.09e-11
I-135	5.43e+04	9.77e+04	4.62e+04	8.66e+06	1.50e+05	0.00e+00	7.45e+04
Cs-134	2.26e+10	3.71e+10	7.84e+09	0.00e+00	1.15e+10	4.13e+09	2.00e+08
Cs-134m	7.42e-01	1.10e+00	7.18e-01	0.00e+00	5.80e-01	9.59e-02	1.39e+00

Conversion factors are in units of square meter-mrem/yr per uCi/sec for all nuclides except H-3, which is in units of mrem/yr per uCi/cubic meter.

**DOSE FACTORS DUE TO RADIONUCLIDES
OTHER THAN NOBLE GASES; P_i**

Pi factors for Child age group by nuclide.
Waterford Steam Electric Station
Pathway : Cow's Milk (food) Pathway for Pi

Nuclide	Organ Dose Conversion Factors						
	Bone	Liver	T. Body	Thyroid	Kidney	Lung	GI-LLI
Cs-135	8.19e+09	5.71e+09	5.85e+08	0.00e+00	2.01e+09	6.72e+08	4.27e+07
Cs-136	1.01e+09	2.78e+09	1.80e+09	0.00e+00	1.48e+09	2.21e+08	9.77e+07
Cs-137	3.22e+10	3.09e+10	4.55e+09	0.00e+00	1.01e+10	3.62e+09	1.93e+08
Cs-138	4.27e-23	5.94e-23	3.77e-23	0.00e+00	4.18e-23	4.50e-24	2.74e-23
Cs-139	0.00e+00	0.00e+00	0.00e+00	0.00e+00	0.00e+00	0.00e+00	0.00e+00
Ba-139	2.06e-07	1.10e-10	5.98e-09	0.00e+00	9.62e-11	6.48e-11	1.19e-05
Ba-140	1.17e+08	1.03e+05	6.84e+06	0.00e+00	3.34e+04	6.12e+04	5.93e+07
Ba-141	0.00e+00	0.00e+00	0.00e+00	0.00e+00	0.00e+00	0.00e+00	0.00e+00
Ba-142	0.00e+00	0.00e+00	0.00e+00	0.00e+00	0.00e+00	0.00e+00	0.00e+00
La-140	1.94e+01	6.79e+00	2.29e+00	0.00e+00	0.00e+00	0.00e+00	1.89e+05
La-141	1.36e-04	3.17e-05	6.89e-06	0.00e+00	0.00e+00	0.00e+00	7.06e+00
La-142	8.30e-11	2.64e-11	8.28e-12	0.00e+00	0.00e+00	0.00e+00	5.24e-06
Ce-141	2.19e+04	1.09e+04	1.62e+03	0.00e+00	4.78e+03	0.00e+00	1.36e+07
Ce-143	1.88e+02	1.02e+05	1.47e+01	0.00e+00	4.27e+01	0.00e+00	1.49e+06
Ce-144	1.62e+06	5.09e+05	8.66e+04	0.00e+00	2.82e+05	0.00e+00	1.33e+08
Pr-143	7.18e+02	2.16e+02	3.56e+01	0.00e+00	1.17e+02	0.00e+00	7.75e+05
Pr-144	0.00e+00	0.00e+00	0.00e+00	0.00e+00	0.00e+00	0.00e+00	0.00e+00
Nd-147	4.45e+02	3.60e+02	2.79e+01	0.00e+00	1.98e+02	0.00e+00	5.71e+05
Pm-147	1.29e+04	9.19e+02	4.94e+02	0.00e+00	1.62e+03	0.00e+00	3.72e+05
Pm-148	2.66e+02	3.20e+01	2.07e+01	0.00e+00	5.44e+01	0.00e+00	8.54e+05
Pm-148m	3.06e+03	6.09e+02	6.09e+02	0.00e+00	9.03e+02	0.00e+00	1.72e+06
Pm-149	1.94e+01	2.07e+00	1.12e+00	0.00e+00	3.65e+00	0.00e+00	1.41e+05
Pm-151	2.88e+00	3.51e-01	2.28e-01	0.00e+00	5.95e-01	0.00e+00	3.98e+04
Sm-151	1.05e+04	1.57e+03	4.93e+02	0.00e+00	1.62e+03	0.00e+00	2.27e+05
Sm-153	9.02e+00	5.61e+00	5.41e-01	0.00e+00	1.71e+00	0.00e+00	7.46e+04
Eu-152	2.52e+04	4.59e+03	5.45e+03	0.00e+00	1.94e+04	0.00e+00	7.54e+05
Eu-154	9.46e+04	8.51e+03	7.77e+03	0.00e+00	3.74e+04	0.00e+00	1.98e+06
Eu-155	1.94e+04	1.39e+03	1.09e+03	0.00e+00	5.22e+03	0.00e+00	3.49e+06
Eu-156	1.10e+03	5.88e+02	1.22e+02	0.00e+00	3.79e+02	0.00e+00	1.33e+06
Tb-160	5.61e+03	0.00e+00	6.96e+02	0.00e+00	1.67e+03	0.00e+00	1.24e+06

Conversion factors are in units of square meter-mrem/yr per uCi/sec for all nuclides except H-3, which is in units of mrem/yr per uCi/cubic meter.

**DOSE FACTORS DUE TO RADIONUCLIDES
OTHER THAN NOBLE GASES; P_i**

Pi factors for Child age group by nuclide.
Waterford Steam Electric Station
Pathway : Cow's Milk (food) Pathway for Pi

Nuclide	Organ Dose Conversion Factors						
	Bone	Liver	T. Body	Thyroid	Kidney	Lung	GI-LLI
Ho-166m	4.44e+04	9.30e+03	7.86e+03	0.00e+00	1.32e+04	0.00e+00	1.08e+06
W-181	1.54e+05	3.79e+04	5.21e+03	0.00e+00	0.00e+00	0.00e+00	1.38e+06
W-185	5.89e+06	1.47e+06	2.06e+05	0.00e+00	0.00e+00	0.00e+00	5.48e+07
W-187	2.89e+04	1.71e+04	7.69e+03	0.00e+00	0.00e+00	0.00e+00	2.41e+06
Pb-210	2.42e+11	6.21e+10	1.06e+10	0.00e+00	1.87e+11	0.00e+00	1.17e+07
Bi-210	1.62e+06	8.38e+06	9.29e+05	0.00e+00	9.45e+07	0.00e+00	4.25e+07
Po-210	3.37e+09	5.39e+09	8.14e+08	0.00e+00	1.68e+10	0.00e+00	1.45e+08
Ra-223	5.55e+11	6.41e+08	1.11e+11	0.00e+00	1.70e+10	0.00e+00	8.84e+09
Ra-224	6.43e+10	1.17e+08	1.29e+10	0.00e+00	3.09e+09	0.00e+00	3.53e+09
Ra-225	8.62e+11	7.70e+08	1.72e+11	0.00e+00	2.04e+10	0.00e+00	9.89e+09
Ra-226	3.78e+13	1.21e+09	3.11e+13	0.00e+00	3.21e+10	0.00e+00	2.24e+10
Ra-228	2.52e+13	6.53e+08	2.82e+13	0.00e+00	1.73e+10	0.00e+00	3.80e+09
Ac-225	2.81e+05	2.89e+05	1.88e+04	0.00e+00	3.09e+04	0.00e+00	6.43e+06
Ac-227	1.69e+08	2.72e+07	1.05e+07	0.00e+00	5.99e+06	0.00e+00	3.46e+06
Th-227	1.27e+06	1.73e+04	3.67e+04	0.00e+00	9.17e+04	0.00e+00	1.22e+07
Th-228	8.33e+07	1.07e+06	2.82e+06	0.00e+00	5.55e+06	0.00e+00	2.33e+07
Th-229	9.67e+08	2.43e+07	1.61e+07	0.00e+00	1.19e+08	0.00e+00	3.31e+06
Th-230	1.46e+08	7.32e+06	4.08e+06	0.00e+00	3.57e+07	0.00e+00	2.55e+06
Th-232	1.63e+08	6.25e+06	1.24e+05	0.00e+00	3.05e+07	0.00e+00	2.17e+06
Th-234	8.40e+03	3.71e+02	2.43e+02	0.00e+00	1.97e+03	0.00e+00	2.90e+06
Pa-231	2.91e+08	9.63e+06	1.16e+07	0.00e+00	5.27e+07	0.00e+00	3.03e+06
Pa-233	4.68e+02	7.30e+01	8.18e+01	0.00e+00	2.69e+02	0.00e+00	3.73e+05
U-232	7.24e+10	0.00e+00	5.18e+09	0.00e+00	5.51e+09	0.00e+00	2.87e+08
U-233	1.53e+10	0.00e+00	9.26e+08	0.00e+00	2.51e+09	0.00e+00	2.65e+08
U-234	1.47e+10	0.00e+00	9.09e+08	0.00e+00	2.46e+09	0.00e+00	2.60e+08
U-235	1.41e+10	0.00e+00	8.51e+08	0.00e+00	2.31e+09	0.00e+00	3.30e+08
U-236	1.41e+10	0.00e+00	8.72e+08	0.00e+00	2.36e+09	0.00e+00	2.44e+08
U-237	2.57e+05	0.00e+00	6.83e+04	0.00e+00	7.42e+05	0.00e+00	2.27e+07
U-238	1.35e+10	0.00e+00	7.98e+08	0.00e+00	2.16e+09	0.00e+00	2.33e+08
Np-237	9.17e+07	6.05e+06	4.03e+06	0.00e+00	2.49e+07	0.00e+00	3.36e+06

Conversion factors are in units of square meter-mrem/yr per uCi/sec for all nuclides except H-3, which is in units of mrem/yr per uCi/cubic meter.

**DOSE FACTORS DUE TO RADIONUCLIDES
OTHER THAN NOBLE GASES; P_i**

Pi factors for Child age group by nuclide.
Waterford Steam Electric Station
Pathway : Cow's Milk (food) Pathway for Pi

Nuclide	Organ Dose Conversion Factors						
	Bone	Liver	T. Body	Thyroid	Kidney	Lung	GI-LLI
Np-238	1.64e+02	3.32e+00	2.55e+00	0.00e+00	1.06e+01	0.00e+00	1.14e+05
Np-239	1.73e+01	1.24e+00	8.71e-01	0.00e+00	3.58e+00	0.00e+00	9.17e+04
Pu-238	1.96e+07	2.27e+06	5.20e+05	0.00e+00	1.89e+06	0.00e+00	1.23e+06
Pu-239	2.12e+07	2.27e+06	5.45e+05	0.00e+00	2.01e+06	0.00e+00	1.13e+06
Pu-240	2.11e+07	2.35e+06	5.45e+05	0.00e+00	2.01e+06	0.00e+00	1.15e+06
Pu-241	6.35e+05	2.59e+04	1.32e+04	0.00e+00	4.86e+04	0.00e+00	2.36e+04
Pu-242	1.96e+07	2.27e+06	5.25e+05	0.00e+00	1.93e+06	0.00e+00	1.10e+06
Pu-244	2.29e+07	2.60e+07	6.01e+05	0.00e+00	2.22e+06	0.00e+00	1.65e+06
Am-241	5.54e+07	4.77e+07	4.16e+06	0.00e+00	2.54e+07	0.00e+00	3.11e+06
Am-242m	5.76e+07	4.61e+07	4.28e+06	0.00e+00	2.59e+07	0.00e+00	3.95e+06
Am-243	5.51e+07	4.65e+07	4.04e+06	0.00e+00	2.49e+07	0.00e+00	3.68e+06
Cm-242	3.30e+06	2.63e+06	2.19e+05	0.00e+00	7.02e+05	0.00e+00	3.06e+06
Cm-243	5.26e+07	4.27e+07	3.38e+06	0.00e+00	1.27e+07	0.00e+00	3.30e+06
Cm-244	4.43e+07	3.59e+07	2.84e+06	0.00e+00	1.04e+07	0.00e+00	3.19e+06
Cm-245	6.87e+07	5.51e+07	4.32e+06	0.00e+00	1.69e+07	0.00e+00	2.98e+06
Cm-246	6.79e+07	5.51e+07	4.32e+06	0.00e+00	1.69e+07	0.00e+00	2.92e+06
Cm-247	6.62e+07	5.43e+07	4.24e+06	0.00e+00	1.66e+07	0.00e+00	3.85e+06
Cm-248	5.51e+08	4.48e+08	3.50e+07	0.00e+00	1.37e+08	0.00e+00	6.21e+07
Cf-252	4.25e+07	0.00e+00	1.03e+06	0.00e+00	0.00e+00	0.00e+00	1.20e+07

Conversion factors are in units of square meter-mrem/yr per uCi/sec for all nuclides except H-3, which is in units of mrem/yr per uCi/cubic meter.

**DOSE FACTORS DUE TO RADIONUCLIDES
OTHER THAN NOBLE GASES; P_i**

Pi factors for Infant age group by nuclide.
Waterford Steam Electric Station
Pathway : Cow's Milk (food) Pathway for Pi

Nuclide	Organ Dose Conversion Factors						
	Bone	Liver	T. Body	Thyroid	Kidney	Lung	GI-LLI
H-3	0.00e+00	1.36e+03	1.36e+03	1.36e+03	1.36e+03	1.36e+03	1.36e+03
Be-10	1.41e+07	2.05e+06	4.25e+05	0.00e+00	1.35e+06	0.00e+00	2.29e+07
C-14	2.34e+09	5.00e+08	5.00e+08	5.00e+08	5.00e+08	5.00e+08	5.00e+08
N-13	0.00e+00	0.00e+00	0.00e+00	0.00e+00	0.00e+00	0.00e+00	0.00e+00
F-18	4.12e-02	0.00e+00	3.51e-03	0.00e+00	0.00e+00	0.00e+00	9.67e-03
Na-22	3.18e+10	3.18e+10	3.18e+10	3.18e+10	3.18e+10	3.18e+10	3.18e+10
Na-24	1.55e+07	1.55e+07	1.55e+07	1.55e+07	1.55e+07	1.55e+07	1.55e+07
P-32	1.60e+11	9.43e+09	6.21e+09	0.00e+00	0.00e+00	0.00e+00	2.17e+09
Ca-41	2.46e+10	0.00e+00	2.69e+09	0.00e+00	0.00e+00	0.00e+00	1.26e+07
Sc-46	1.30e+03	1.88e+03	5.86e+02	0.00e+00	1.23e+03	0.00e+00	1.22e+06
Cr-51	0.00e+00	0.00e+00	1.61e+05	1.05e+05	2.30e+04	2.05e+05	4.70e+06
Mn-54	0.00e+00	3.90e+07	8.84e+06	0.00e+00	8.64e+06	0.00e+00	1.43e+07
Mn-56	0.00e+00	3.14e-02	5.42e-03	0.00e+00	2.70e-02	0.00e+00	2.86e+00
Fe-55	1.35e+08	8.73e+07	2.33e+07	0.00e+00	0.00e+00	4.27e+07	1.11e+07
Fe-59	2.24e+08	3.92e+08	1.54e+08	0.00e+00	0.00e+00	1.16e+08	1.87e+08
Co-57	0.00e+00	8.95e+06	1.46e+07	0.00e+00	0.00e+00	0.00e+00	3.05e+07
Co-58	0.00e+00	2.42e+07	6.05e+07	0.00e+00	0.00e+00	0.00e+00	6.04e+07
Co-60	0.00e+00	8.81e+07	2.08e+08	0.00e+00	0.00e+00	0.00e+00	2.10e+08
Ni-59	2.61e+09	7.99e+08	4.50e+08	0.00e+00	0.00e+00	0.00e+00	3.95e+07
Ni-63	3.49e+10	2.16e+09	1.21e+09	0.00e+00	0.00e+00	0.00e+00	1.07e+08
Ni-65	3.56e+00	4.03e-01	1.83e-01	0.00e+00	0.00e+00	0.00e+00	3.07e+01
Cu-64	0.00e+00	1.86e+05	8.62e+04	0.00e+00	3.15e+05	0.00e+00	3.82e+06
Zn-65	5.55e+09	1.90e+10	8.78e+09	0.00e+00	9.23e+09	0.00e+00	1.61e+10
Zn-69	2.10e-11	3.79e-11	2.82e-12	0.00e+00	1.57e-11	0.00e+00	3.09e-09
Zn-69m	1.70e+06	3.48e+06	3.17e+05	0.00e+00	1.41e+06	0.00e+00	4.82e+07
Se-79	0.00e+00	7.77e+09	1.44e+09	0.00e+00	9.00e+09	0.00e+00	2.07e+08
Br-82	0.00e+00	0.00e+00	1.93e+08	0.00e+00	0.00e+00	0.00e+00	0.00e+00
Br-83	0.00e+00	0.00e+00	9.49e-01	0.00e+00	0.00e+00	0.00e+00	0.00e+00
Br-84	0.00e+00	0.00e+00	1.35e-22	0.00e+00	0.00e+00	0.00e+00	0.00e+00
Br-85	0.00e+00	0.00e+00	0.00e+00	0.00e+00	0.00e+00	0.00e+00	0.00e+00

Conversion factors are in units of square meter-mrem/yr per uCi/sec for all nuclides except H-3, which is in units of mrem/yr per uCi/cubic meter.

**DOSE FACTORS DUE TO RADIONUCLIDES
OTHER THAN NOBLE GASES; P_i**

Pi factors for Infant age group by nuclide.
Waterford Steam Electric Station
Pathway : Cow's Milk (food) Pathway for Pi

Nuclide	Organ Dose Conversion Factors						
	Bone	Liver	T. Body	Thyroid	Kidney	Lung	GI-LLI
Rb-86	0.00e+00	2.23e+10	1.10e+10	0.00e+00	0.00e+00	0.00e+00	5.69e+08
Rb-87	0.00e+00	2.19e+10	8.69e+09	0.00e+00	0.00e+00	0.00e+00	1.48e+08
Rb-88	0.00e+00	0.00e+00	0.00e+00	0.00e+00	0.00e+00	0.00e+00	0.00e+00
Rb-89	0.00e+00	0.00e+00	0.00e+00	0.00e+00	0.00e+00	0.00e+00	0.00e+00
Sr-89	1.26e+10	0.00e+00	3.61e+08	0.00e+00	0.00e+00	0.00e+00	2.59e+08
Sr-90	1.86e+11	0.00e+00	3.77e+09	0.00e+00	0.00e+00	0.00e+00	1.52e+09
Sr-91	2.73e+05	0.00e+00	9.87e+03	0.00e+00	0.00e+00	0.00e+00	3.23e+05
Sr-92	4.71e+00	0.00e+00	1.75e-01	0.00e+00	0.00e+00	0.00e+00	5.08e+01
Y-90	6.82e+02	0.00e+00	1.83e+01	0.00e+00	0.00e+00	0.00e+00	9.41e+05
Y-91	7.33e+04	0.00e+00	1.95e+03	0.00e+00	0.00e+00	0.00e+00	5.25e+06
Y-91m	5.94e-19	0.00e+00	2.03e-20	0.00e+00	0.00e+00	0.00e+00	1.98e-15
Y-92	5.44e-04	0.00e+00	1.53e-05	0.00e+00	0.00e+00	0.00e+00	1.04e+01
Y-93	2.16e+00	0.00e+00	5.90e-02	0.00e+00	0.00e+00	0.00e+00	1.71e+04
Zr-93	7.94e+03	3.78e+02	2.28e+02	0.00e+00	1.11e+03	0.00e+00	9.83e+04
Zr-95	6.80e+03	1.66e+03	1.18e+03	0.00e+00	1.79e+03	0.00e+00	8.26e+05
Zr-97	4.07e+00	6.99e-01	3.19e-01	0.00e+00	7.04e-01	0.00e+00	4.46e+04
Nb-93m	2.52e+06	6.83e+05	2.13e+05	0.00e+00	6.66e+05	0.00e+00	8.16e+07
Nb-95	5.93e+05	2.44e+05	1.41e+05	0.00e+00	1.75e+05	0.00e+00	2.06e+08
Nb-97	6.16e-11	1.31e-11	4.74e-12	0.00e+00	1.03e-11	0.00e+00	4.15e-06
Mo-93	0.00e+00	3.49e+09	1.12e+08	0.00e+00	6.97e+08	0.00e+00	7.47e+07
Mo-99	0.00e+00	2.08e+08	4.06e+07	0.00e+00	3.11e+08	0.00e+00	6.86e+07
Tc-101	0.00e+00	0.00e+00	0.00e+00	0.00e+00	0.00e+00	0.00e+00	0.00e+00
Tc-99	2.22e+08	3.00e+08	9.36e+07	0.00e+00	2.53e+09	2.92e+07	1.30e+09
Tc-99m	2.77e+01	5.70e+01	7.35e+02	0.00e+00	6.14e+02	2.98e+01	1.66e+04
Ru-103	8.67e+03	0.00e+00	2.90e+03	0.00e+00	1.80e+04	0.00e+00	1.05e+05
Ru-105	8.12e-03	0.00e+00	2.74e-03	0.00e+00	5.97e-02	0.00e+00	3.23e+00
Ru-106	1.90e+05	0.00e+00	2.38e+04	0.00e+00	2.25e+05	0.00e+00	1.44e+06
Rh-105	3.32e+06	2.17e+06	1.46e+06	0.00e+00	6.03e+06	0.00e+00	5.39e+07
Pd-107	0.00e+00	9.79e+07	6.95e+06	0.00e+00	5.59e+08	0.00e+00	7.78e+07
Pd-109	0.00e+00	4.05e+05	9.78e+04	0.00e+00	1.49e+06	0.00e+00	9.95e+06

Conversion factors are in units of square meter-mrem/yr per uCi/sec for all nuclides except H-3, which is in units of mrem/yr per uCi/cubic meter.

**DOSE FACTORS DUE TO RADIONUCLIDES
OTHER THAN NOBLE GASES; P_i**

Pi factors for Infant age group by nuclide.
Waterford Steam Electric Station
Pathway : Cow's Milk (food) Pathway for Pi

Nuclide	Organ Dose Conversion Factors						
	Bone	Liver	T. Body	Thyroid	Kidney	Lung	GI-LLI
Ag-110m	3.86e+08	2.82e+08	1.86e+08	0.00e+00	4.03e+08	0.00e+00	1.46e+10
Ag-111	6.17e+07	2.40e+07	1.27e+07	0.00e+00	5.01e+07	0.00e+00	5.72e+09
Cd-113m	0.00e+00	1.74e+07	6.42e+05	0.00e+00	1.32e+07	0.00e+00	2.62e+07
Cd-115m	0.00e+00	1.03e+07	3.59e+05	0.00e+00	5.40e+06	0.00e+00	5.89e+07
Sn-123	4.57e+09	7.14e+07	1.19e+08	7.18e+07	0.00e+00	0.00e+00	1.21e+09
Sn-125	5.37e+08	1.00e+07	2.39e+07	9.86e+06	0.00e+00	0.00e+00	8.05e+08
Sn-126	1.14e+10	1.49e+08	3.70e+08	3.93e+07	0.00e+00	0.00e+00	5.18e+08
Sb-124	2.09e+08	3.08e+06	6.49e+07	5.56e+05	0.00e+00	1.31e+08	6.46e+08
Sb-125	1.50e+08	1.45e+06	3.08e+07	1.87e+05	0.00e+00	8.65e+07	1.99e+08
Sb-126	4.20e+07	8.23e+05	1.52e+07	3.22e+05	0.00e+00	2.64e+07	4.35e+08
Sb-127	4.17e+06	7.44e+04	1.29e+06	5.31e+04	0.00e+00	2.15e+06	1.11e+08
Te-125m	1.51e+08	5.04e+07	2.04e+07	5.07e+07	0.00e+00	0.00e+00	7.18e+07
Te-127	6.34e+03	2.13e+03	1.36e+03	5.16e+03	1.55e+04	0.00e+00	1.33e+05
Te-127m	4.21e+08	1.40e+08	5.10e+07	1.22e+08	1.04e+09	0.00e+00	1.70e+08
Te-129	2.81e-09	9.69e-10	6.56e-10	2.36e-09	7.00e-09	0.00e+00	2.25e-07
Te-129m	5.57e+08	1.91e+08	8.58e+07	2.14e+08	1.39e+09	0.00e+00	3.33e+08
Te-131	3.76e-32	1.39e-32	1.05e-32	3.35e-32	9.61e-32	0.00e+00	1.52e-30
Te-131m	3.38e+06	1.36e+06	1.12e+06	2.76e+06	9.36e+06	0.00e+00	2.29e+07
Te-132	2.11e+07	1.05e+07	9.75e+06	1.54e+07	6.54e+07	0.00e+00	3.87e+07
Te-133m	1.98e-12	9.05e-13	8.65e-13	1.74e-12	6.17e-12	0.00e+00	9.76e-11
Te-134	8.25e-18	4.14e-18	4.27e-18	7.39e-18	2.79e-17	0.00e+00	9.46e-17
I-129	7.06e+09	5.23e+09	3.83e+09	3.36e+12	6.19e+09	0.00e+00	1.05e+08
I-130	3.56e+06	7.83e+06	3.14e+06	8.78e+08	8.60e+06	0.00e+00	1.68e+06
I-131	2.72e+09	3.21e+09	1.41e+09	1.05e+12	3.74e+09	0.00e+00	1.14e+08
I-132	1.45e+00	2.95e+00	1.05e+00	1.38e+02	3.29e+00	0.00e+00	2.39e+00
I-133	3.63e+07	5.29e+07	1.55e+07	9.62e+09	6.22e+07	0.00e+00	8.95e+06
I-134	1.84e-11	3.77e-11	1.34e-11	8.78e-10	4.21e-11	0.00e+00	3.89e-11
I-135	1.13e+05	2.25e+05	8.19e+04	2.01e+07	2.50e+05	0.00e+00	8.13e+04
Cs-134	3.65e+10	6.80e+10	6.87e+09	0.00e+00	1.75e+10	7.18e+09	1.85e+08
Cs-134m	1.55e+00	2.58e+00	1.30e+00	0.00e+00	9.94e-01	2.29e-01	2.04e+00

Conversion factors are in units of square meter-mrem/yr per uCi/sec for all nuclides except H-3, which is in units of mrem/yr per uCi/cubic meter.

**DOSE FACTORS DUE TO RADIONUCLIDES
OTHER THAN NOBLE GASES; P_i**

Pi factors for Infant age group by nuclide.
Waterford Steam Electric Station
Pathway : Cow's Milk (food) Pathway for Pi

Nuclide	Organ Dose Conversion Factors						
	Bone	Liver	T. Body	Thyroid	Kidney	Lung	GI-LLI
Cs-135	1.31e+10	1.19e+10	6.22e+08	0.00e+00	3.40e+09	1.29e+09	4.31e+07
Cs-136	1.98e+09	5.81e+09	2.17e+09	0.00e+00	2.32e+09	4.74e+08	8.83e+07
Cs-137	5.15e+10	6.02e+10	4.27e+09	0.00e+00	1.62e+10	6.55e+09	1.88e+08
Cs-138	9.01e-23	1.47e-22	7.10e-23	0.00e+00	7.31e-23	1.14e-23	2.34e-22
Cs-139	0.00e+00	0.00e+00	0.00e+00	0.00e+00	0.00e+00	0.00e+00	0.00e+00
Ba-139	4.39e-07	2.91e-10	1.27e-08	0.00e+00	1.75e-10	1.77e-10	2.78e-05
Ba-140	2.41e+08	2.41e+05	1.24e+07	0.00e+00	5.72e+04	1.48e+05	5.92e+07
Ba-141	0.00e+00	0.00e+00	0.00e+00	0.00e+00	0.00e+00	0.00e+00	0.00e+00
Ba-142	0.00e+00	0.00e+00	0.00e+00	0.00e+00	0.00e+00	0.00e+00	0.00e+00
La-140	4.06e+01	1.60e+01	4.11e+00	0.00e+00	0.00e+00	0.00e+00	1.88e+05
La-141	2.89e-04	8.39e-05	1.46e-05	0.00e+00	0.00e+00	0.00e+00	9.62e+00
La-142	1.74e-10	6.40e-11	1.53e-11	0.00e+00	0.00e+00	0.00e+00	1.09e-05
Ce-141	4.34e+04	2.64e+04	3.11e+03	0.00e+00	8.15e+03	0.00e+00	1.37e+07
Ce-143	3.97e+02	2.64e+05	3.01e+01	0.00e+00	7.68e+01	0.00e+00	1.54e+06
Ce-144	2.33e+06	9.52e+05	1.30e+05	0.00e+00	3.85e+05	0.00e+00	1.33e+08
Pr-143	1.49e+03	5.55e+02	7.36e+01	0.00e+00	2.06e+02	0.00e+00	7.84e+05
Pr-144	0.00e+00	0.00e+00	0.00e+00	0.00e+00	0.00e+00	0.00e+00	0.00e+00
Nd-147	8.81e+02	9.05e+02	5.55e+01	0.00e+00	3.49e+02	0.00e+00	5.74e+05
Pm-147	1.57e+04	1.32e+03	6.44e+02	0.00e+00	1.98e+03	0.00e+00	3.75e+05
Pm-148	5.57e+02	8.04e+01	4.05e+01	0.00e+00	9.60e+01	0.00e+00	8.58e+05
Pm-148m	4.90e+03	1.24e+03	9.74e+02	0.00e+00	1.43e+03	0.00e+00	1.62e+06
Pm-149	4.13e+01	5.42e+00	2.37e+00	0.00e+00	6.59e+00	0.00e+00	1.46e+05
Pm-151	6.10e+00	8.90e-01	4.50e-01	0.00e+00	1.06e+00	0.00e+00	4.12e+04
Sm-151	1.19e+04	2.74e+03	5.92e+02	0.00e+00	1.86e+03	0.00e+00	2.29e+05
Sm-153	1.91e+01	1.47e+01	1.13e+00	0.00e+00	3.09e+00	0.00e+00	7.71e+04
Eu-152	2.76e+04	7.34e+03	6.19e+03	0.00e+00	2.06e+04	0.00e+00	6.52e+05
Eu-154	1.09e+05	1.51e+04	9.05e+03	0.00e+00	4.09e+04	0.00e+00	1.88e+06
Eu-155	2.18e+04	2.51e+03	1.30e+03	0.00e+00	5.63e+03	0.00e+00	3.36e+06
Eu-156	2.23e+03	1.38e+03	2.19e+02	0.00e+00	6.37e+02	0.00e+00	1.30e+06
Tb-160	8.75e+03	0.00e+00	1.09e+03	0.00e+00	2.49e+03	0.00e+00	1.17e+06

Conversion factors are in units of square meter-mrem/yr per uCi/sec for all nuclides except H-3, which is in units of mrem/yr per uCi/cubic meter.

**DOSE FACTORS DUE TO RADIONUCLIDES
OTHER THAN NOBLE GASES; P_i**

Pi factors for Infant age group by nuclide.
Waterford Steam Electric Station
Pathway : Cow's Milk (food) Pathway for Pi

Nuclide	Organ Dose Conversion Factors						
	Bone	Liver	T. Body	Thyroid	Kidney	Lung	GI-LLI
Ho-166m	5.14e+04	1.11e+04	8.76e+03	0.00e+00	1.47e+04	0.00e+00	1.09e+06
W-181	3.23e+05	9.91e+04	1.11e+04	0.00e+00	0.00e+00	0.00e+00	1.39e+06
W-185	1.23e+07	3.85e+06	4.39e+05	0.00e+00	0.00e+00	0.00e+00	5.51e+07
W-187	6.09e+04	4.23e+04	1.46e+04	0.00e+00	0.00e+00	0.00e+00	2.49e+06
Pb-210	2.69e+11	7.23e+10	1.21e+10	0.00e+00	2.20e+11	0.00e+00	1.18e+07
Bi-210	3.42e+06	2.20e+07	1.96e+06	0.00e+00	1.71e+08	0.00e+00	4.33e+07
Po-210	6.88e+09	1.32e+10	1.64e+09	0.00e+00	2.80e+10	0.00e+00	1.47e+08
Ra-223	1.15e+12	1.68e+09	2.31e+11	0.00e+00	3.06e+10	0.00e+00	8.97e+09
Ra-224	1.36e+11	3.07e+08	2.72e+10	0.00e+00	5.60e+09	0.00e+00	3.60e+09
Ra-225	1.78e+12	2.01e+09	3.54e+11	0.00e+00	3.66e+10	0.00e+00	9.98e+09
Ra-226	4.08e+13	3.13e+09	3.38e+13	0.00e+00	5.73e+10	0.00e+00	2.26e+10
Ra-228	2.82e+13	1.69e+09	3.18e+13	0.00e+00	3.09e+10	0.00e+00	3.83e+09
Ac-225	5.85e+05	7.51e+05	3.92e+04	0.00e+00	5.51e+04	0.00e+00	6.51e+06
Ac-227	1.84e+08	3.15e+07	1.15e+07	0.00e+00	6.40e+06	0.00e+00	3.49e+06
Th-227	2.61e+06	4.37e+04	7.49e+04	0.00e+00	1.61e+05	0.00e+00	1.24e+07
Th-228	9.94e+07	1.36e+06	3.36e+06	0.00e+00	6.36e+06	0.00e+00	2.35e+07
Th-229	1.04e+09	2.60e+07	1.73e+07	0.00e+00	1.25e+08	0.00e+00	3.33e+06
Th-230	1.56e+08	7.82e+06	4.36e+06	0.00e+00	3.75e+07	0.00e+00	2.57e+06
Th-232	1.74e+08	6.70e+06	6.79e+04	0.00e+00	3.20e+07	0.00e+00	2.18e+06
Th-234	1.70e+04	9.26e+02	4.91e+02	0.00e+00	3.41e+03	0.00e+00	2.92e+06
Pa-231	3.11e+08	1.03e+07	1.24e+07	0.00e+00	5.51e+07	0.00e+00	3.06e+06
Pa-233	8.05e+02	1.58e+02	1.41e+02	0.00e+00	4.32e+02	0.00e+00	3.78e+05
U-232	9.95e+10	0.00e+00	8.88e+09	0.00e+00	9.74e+09	0.00e+00	2.89e+08
U-233	2.09e+10	0.00e+00	1.59e+09	0.00e+00	4.44e+09	0.00e+00	2.68e+08
U-234	2.01e+10	0.00e+00	1.56e+09	0.00e+00	4.36e+09	0.00e+00	2.62e+08
U-235	1.92e+10	0.00e+00	1.46e+09	0.00e+00	4.08e+09	0.00e+00	3.33e+08
U-236	1.92e+10	0.00e+00	1.50e+09	0.00e+00	4.15e+09	0.00e+00	2.46e+08
U-237	5.39e+05	0.00e+00	1.44e+05	0.00e+00	1.34e+06	0.00e+00	2.30e+07
U-238	1.84e+10	0.00e+00	1.37e+09	0.00e+00	3.82e+09	0.00e+00	2.35e+08
Np-237	9.87e+07	6.54e+06	4.32e+06	0.00e+00	2.61e+07	0.00e+00	3.39e+06

Conversion factors are in units of square meter-mrem/yr per uCi/sec for all nuclides except H-3, which is in units of mrem/yr per uCi/cubic meter.

**DOSE FACTORS DUE TO RADIONUCLIDES
OTHER THAN NOBLE GASES; P_i**

Pi factors for Infant age group by nuclide.
Waterford Steam Electric Station
Pathway : Cow's Milk (food) Pathway for Pi

Nuclide	Organ Dose Conversion Factors						
	Bone	Liver	T. Body	Thyroid	Kidney	Lung	GI-LLI
Np-238	3.49e+02	8.78e+00	5.40e+00	0.00e+00	1.92e+01	0.00e+00	1.17e+05
Np-239	3.65e+01	3.26e+00	1.84e+00	0.00e+00	6.51e+00	0.00e+00	9.44e+04
Pu-238	2.11e+07	2.47e+06	5.59e+05	0.00e+00	1.99e+06	0.00e+00	1.24e+06
Pu-239	2.27e+07	2.55e+06	5.82e+05	0.00e+00	2.11e+06	0.00e+00	1.14e+06
Pu-240	2.27e+07	2.55e+06	5.82e+05	0.00e+00	2.11e+06	0.00e+00	1.16e+06
Pu-241	6.97e+05	2.89e+04	1.45e+04	0.00e+00	5.20e+04	0.00e+00	2.38e+04
Pu-242	2.11e+07	2.45e+06	5.61e+05	0.00e+00	2.02e+06	0.00e+00	1.11e+06
Pu-244	2.45e+07	2.81e+06	6.43e+05	0.00e+00	2.32e+06	0.00e+00	1.66e+06
Am-241	5.95e+07	5.17e+07	4.44e+06	0.00e+00	2.67e+07	0.00e+00	3.14e+06
Am-242m	6.21e+07	5.02e+07	4.65e+06	0.00e+00	2.73e+07	0.00e+00	3.98e+06
Am-243	5.92e+07	5.06e+07	4.36e+06	0.00e+00	2.62e+07	0.00e+00	3.71e+06
Cm-242	5.15e+06	4.77e+06	3.42e+05	0.00e+00	9.84e+05	0.00e+00	3.09e+06
Cm-243	5.75e+07	4.72e+07	3.69e+06	0.00e+00	1.34e+07	0.00e+00	3.33e+06
Cm-244	4.84e+07	3.98e+07	3.11e+06	0.00e+00	1.11e+07	0.00e+00	3.22e+06
Cm-245	7.36e+07	5.96e+07	4.65e+06	0.00e+00	1.78e+07	0.00e+00	3.00e+06
Cm-246	7.28e+07	5.96e+07	4.65e+06	0.00e+00	1.77e+07	0.00e+00	2.95e+06
Cm-247	7.12e+07	5.88e+07	4.57e+06	0.00e+00	1.74e+07	0.00e+00	3.88e+06
Cm-248	5.88e+08	4.85e+08	3.77e+07	0.00e+00	1.44e+08	0.00e+00	6.25e+07
Cf-252	4.93e+07	0.00e+00	1.19e+06	0.00e+00	0.00e+00	0.00e+00	1.21e+07

Conversion factors are in units of square meter-mrem/yr per uCi/sec for all nuclides except H-3, which is in units of mrem/yr per uCi/cubic meter.

**DOSE FACTORS DUE TO RADIONUCLIDES
OTHER THAN NOBLE GASES; P_i**

Pi factors for all age groups by nuclide.
Waterford Steam Electric Station
Pathway : Ground Plane Pathway for Pi

Nuclide	Organ Dose Conversion Factors	
	T. Body	Skin
H-3	0.00e+00	0.00e+00
Be-10	0.00e+00	0.00e+00
C-14	0.00e+00	0.00e+00
N-13	5.75e+04	6.65e+04
F-18	5.66e+05	6.66e+05
Na-22	3.88e+09	4.36e+09
Na-24	1.71e+07	1.98e+07
P-32	0.00e+00	0.00e+00
Ca-41	9.42e+08	1.11e+09
Sc-46	1.13e+09	1.31e+09
Cr-51	6.65e+06	7.86e+06
Mn-54	1.10e+09	1.29e+09
Mn-56	1.29e+06	1.52e+06
Fe-55	0.00e+00	0.00e+00
Fe-59	3.89e+08	4.57e+08
Co-57	1.63e+08	1.79e+08
Co-58	5.26e+08	6.16e+08
Co-60	4.40e+09	5.18e+09
Ni-59	0.00e+00	0.00e+00
Ni-63	0.00e+00	0.00e+00
Ni-65	4.24e+05	4.93e+05
Cu-64	8.67e+05	9.82e+05
Zn-65	6.88e+08	7.92e+08
Zn-69	0.00e+00	0.00e+00
Zn-69m	1.82e+06	2.13e+06
Se-79	0.00e+00	0.00e+00
Br-82	3.05e+07	3.53e+07
Br-83	6.96e+03	1.01e+04
Br-84	2.89e+05	3.38e+05
Br-85	0.00e+00	0.00e+00

Conversion factors are in units of square meter-mrem/yr per uCi/sec.

**DOSE FACTORS DUE TO RADIONUCLIDES
OTHER THAN NOBLE GASES; P_i**

Pi factors for all age groups by nuclide.
Waterford Steam Electric Station
Pathway : Ground Plane Pathway for Pi

Nuclide	Organ Dose Conversion Factors	
	T. Body	Skin
Rb-86	1.28e+07	1.47e+07
Rb-87	0.00e+00	0.00e+00
Rb-88	4.72e+04	5.40e+04

Rb-89	1.76e+05	2.11e+05
Sr-89	3.07e+04	3.56e+04
Sr-90	0.00e+00	0.00e+00

Sr-91	3.07e+06	3.59e+06
Sr-92	1.11e+06	1.23e+06
Y-90	6.42e+03	7.58e+03

Y-91	1.51e+06	1.70e+06
Y-91m	1.43e+05	1.66e+05
Y-92	2.58e+05	3.06e+05

Y-93	2.62e+05	3.58e+05
Zr-93	0.00e+00	0.00e+00
Zr-95	3.43e+08	3.98e+08

Zr-97	4.23e+06	4.92e+06
Nb-93m	2.21e+05	2.69e+07
Nb-95	1.95e+08	2.30e+08

Nb-97	2.57e+05	3.02e+05
Mo-93	6.33e+06	2.57e+08
Mo-99	5.71e+06	6.61e+06

Tc-101	2.91e+04	3.23e+04
Tc-99	0.00e+00	0.00e+00
Tc-99m	2.63e+05	3.01e+05

Ru-103	1.54e+08	1.80e+08
Ru-105	9.09e+05	1.03e+06
Ru-106	3.00e+08	3.60e+08

Rh-105	1.06e+06	1.24e+06
Pd-107	0.00e+00	0.00e+00
Pd-109	2.15e+04	2.46e+04

Conversion factors are in units of square meter-mrem/yr per uCi/sec.

**DOSE FACTORS DUE TO RADIONUCLIDES
OTHER THAN NOBLE GASES; P_i**

Pi factors for all age groups by nuclide.
Waterford Steam Electric Station
Pathway : Ground Plane Pathway for Pi

Nuclide	Organ Dose Conversion Factors	
	T. Body	Skin
Ag-110m	3.13e+09	3.65e+09
Ag-111	1.46e+06	1.71e+06
Cd-113m	6.21e+05	7.01e+05
Cd-115m	0.00e+00	0.00e+00
Sn-123	0.00e+00	7.82e+09
Sn-125	5.99e+06	6.93e+06
Sn-126	2.49e+09	2.76e+09
Sb-124	8.42e+08	9.71e+08
Sb-125	7.58e+08	8.55e+08
Sb-126	1.21e+08	1.36e+08
Sb-127	2.41e+07	2.79e+07
Te-125m	2.19e+06	3.00e+06
Te-127	4.25e+03	4.68e+03
Te-127m	1.18e+05	1.40e+05
Te-129	3.75e+04	4.43e+04
Te-129m	2.82e+07	3.30e+07
Te-131	4.17e+04	4.93e+07
Te-131m	1.15e+07	1.35e+07
Te-132	6.05e+06	7.12e+06
Te-133m	6.30e+05	7.14e+05
Te-134	3.17e+04	3.80e+04
I-129	1.24e+08	2.07e+08
I-130	7.87e+06	9.56e+06
I-131	2.46e+07	2.98e+07
I-132	1.78e+06	2.09e+06
I-133	3.50e+06	4.26e+06
I-134	6.38e+05	7.58e+05
I-135	3.61e+06	4.21e+06
Cs-134	2.82e+09	3.28e+09
Cs-134m	8.18e+04	9.63e+04

Conversion factors are in units of square meter-mrem/yr per uCi/sec.

**DOSE FACTORS DUE TO RADIONUCLIDES
OTHER THAN NOBLE GASES; P_i**

Pi factors for all age groups by nuclide.
Waterford Steam Electric Station
Pathway : Ground Plane Pathway for Pi

Nuclide	Organ Dose Conversion Factors	
	T. Body	Skin
Cs-135	0.00e+00	0.00e+00
Cs-136	2.16e+08	2.44e+08
Cs-137	1.15e+09	1.34e+09
Cs-138	5.13e+05	5.86e+05
Cs-139	4.49e+04	5.13e+04
Ba-139	1.51e+05	1.70e+05
Ba-140	2.93e+07	3.35e+07
Ba-141	5.96e+04	6.79e+04
Ba-142	6.41e+04	7.30e+04
La-140	2.74e+07	3.11e+07
La-141	4.47e+04	5.01e+04
La-142	1.09e+06	1.30e+06
Ce-141	1.95e+07	2.20e+07
Ce-143	3.30e+06	3.75e+06
Ce-144	5.85e+07	6.77e+07
Pr-143	0.00e+00	0.00e+00
Pr-144	2.62e+03	3.01e+03
Nd-147	1.20e+07	1.44e+07
Pm-147	0.00e+00	0.00e+00
Pm-148	2.70e+07	3.11e+07
Pm-148m	6.34e+08	3.67e+09
Pm-149	6.03e+04	7.00e+04
Pm-151	2.83e+06	2.96e+06
Sm-151	1.32e+07	5.78e+07
Sm-153	5.75e+05	6.39e+05
Eu-152	1.98e+09	2.29e+09
Eu-154	2.15e+09	2.48e+09
Eu-155	8.74e+07	9.93e+07
Eu-156	1.26e+08	1.44e+08
Tb-160	6.57e+08	7.64e+08

Conversion factors are in units of square meter-mrem/yr per uCi/sec.

**DOSE FACTORS DUE TO RADIONUCLIDES
OTHER THAN NOBLE GASES; P_i**

Pi factors for all age groups by nuclide.
Waterford Steam Electric Station
Pathway : Ground Plane Pathway for Pi

Nuclide	Organ Dose Conversion Factors	
	T. Body	Skin
Ho-166m	2.46e+09	2.76e+09
W-181	2.43e+05	3.24e+05
W-185	0.00e+00	0.00e+00
W-187	3.36e+06	3.90e+06
Pb-210	3.53e+06	4.62e+06
Bi-210	0.00e+00	0.00e+00
Po-210	6.84e+03	7.85e+03
Ra-223	1.87e+07	2.24e+07
Ra-224	3.56e+07	4.00e+07
Ra-225	1.36e+06	1.94e+06
Ra-226	1.77e+09	2.04e+09
Ra-228	3.12e+09	3.64e+09
Ac-225	1.75e+07	1.97e+07
Ac-227	5.44e+08	6.53e+08
Th-227	1.03e+07	1.27e+07
Th-228	2.06e+09	2.32e+09
Th-229	6.08e+08	7.46e+08
Th-230	1.80e+09	2.07e+09
Th-232	8.29e+08	1.11e+09
Th-234	2.89e+06	3.42e+06
Pa-231	6.08e+08	7.46e+08
Pa-233	3.89e+07	4.49e+07
U-232	7.12e+05	7.40e+06
U-233	6.35e+08	7.74e+08
U-234	1.75e+05	4.39e+07
U-235	8.84e+08	1.11e+09
U-236	5.80e+03	4.97e+06
U-237	7.37e+06	9.58e+06
U-238	3.04e+07	4.14e+07
Np-237	3.87e+08	4.42e+08

Conversion factors are in units of square meter-mrem/yr per uCi/sec.

**DOSE FACTORS DUE TO RADIONUCLIDES
OTHER THAN NOBLE GASES; P_i**

Pi factors for all age groups by nuclide.
Waterford Steam Electric Station
Pathway : Ground Plane Pathway for Pi

Nuclide	Organ Dose Conversion Factors	
	T. Body	Skin
Np-238	6.48e+06	7.41e+06
Np-239	2.44e+06	2.83e+06
Pu-238	3.58e+05	4.95e+06
Pu-239	2.18e+05	2.13e+06
Pu-240	3.59e+05	4.97e+06
Pu-241	1.24e+06	1.84e+06
Pu-242	3.04e+05	4.42e+06
Pu-244	2.47e+08	2.66e+08
Am-241	4.60e+07	6.64e+07
Am-242m	7.17e+06	4.96e+07
Am-243	3.59e+08	4.14e+08
Cm-242	7.72e+05	3.23e+06
Cm-243	6.28e+08	7.91e+08
Cm-244	7.86e+05	4.88e+06
Cm-245	2.62e+08	3.31e+08
Cm-246	2.76e+05	4.14e+06
Cm-247	6.08e+08	7.18e+08
Cm-248	1.88e+09	1.44e+09
Cf-252	1.59e+10	1.73e+10

Conversion factors are in units of square meter-mrem/yr per uCi/sec.

**DOSE CONVERSION FACTORS ALL AGE GROUPS
BY NUCLIDE (GROUND PLANE)**

Ground Plane Dose Conversion factors for all age groups by nuclide.
Waterford Steam Electric Station

Nuclide	Organ Dose Conversion Factors	
	T. Body	Skin
H-3	0.00e+00	0.00e+00
Be-10	0.00e+00	0.00e+00
C-14	0.00e+00	0.00e+00

N-13	7.60e-09	8.80e-09
F-18	6.80e-09	8.00e-09
Na-22	1.60e-08	1.80e-08

Na-24	2.50e-08	2.90e-08
P-32	0.00e+00	0.00e+00
Ca-41	3.41e-09	4.01e-09

Sc-46	1.30e-08	1.50e-08
Cr-51	2.20e-10	2.60e-10
Mn-54	5.80e-09	6.80e-09

Mn-56	1.10e-08	1.30e-08
Fe-55	0.00e+00	0.00e+00
Fe-59	8.00e-09	9.40e-09

Co-57	9.10e-10	1.00e-09
Co-58	7.00e-09	8.20e-09
Co-60	1.70e-08	2.00e-08

Ni-59	0.00e+00	0.00e+00
Ni-63	0.00e+00	0.00e+00
Ni-65	3.70e-09	4.30e-09

Cu-64	1.50e-09	1.70e-09
Zn-65	4.00e-09	4.60e-09
Zn-69	0.00e+00	0.00e+00

Zn-69m	2.90e-09	3.40e-09
Se-79	0.00e+00	0.00e+00
Br-82	1.90e-08	2.20e-08

Br-83	6.40e-11	9.30e-11
Br-84	1.20e-08	1.40e-08
Br-85	0.00e+00	0.00e+00

Conversion factors are in units of mrem/hr per pCi/square meter.

**DOSE CONVERSION FACTORS ALL AGE GROUPS
BY NUCLIDE (GROUND PLANE)**

Ground Plane Dose Conversion factors for all age groups by nuclide.
Waterford Steam Electric Station

Nuclide	Organ Dose Conversion Factors	
	T. Body	Skin
Rb-86	6.30e-10	7.20e-10
Rb-87	0.00e+00	0.00e+00
Rb-88	3.50e-09	4.00e-09
Rb-89	1.50e-08	1.80e-08
Sr-89	5.60e-13	6.50e-13
Sr-90	0.00e+00	0.00e+00
Sr-91	7.10e-09	8.30e-09
Sr-92	9.00e-09	1.00e-08
Y-90	2.20e-12	2.60e-12
Y-91	2.40e-11	2.70e-11
Y-91m	3.80e-09	4.40e-09
Y-92	1.60e-09	1.90e-09
Y-93	5.70e-10	7.80e-10
Zr-93	0.00e+00	0.00e+00
Zr-95	5.00e-09	5.80e-09
Zr-97	5.50e-09	6.40e-09
Nb-93m	8.20e-13	1.00e-10
Nb-95	5.10e-09	6.00e-09
Nb-97	4.60e-09	5.40e-09
Mo-93	2.29e-11	9.32e-10
Mo-99	1.90e-09	2.20e-09
Tc-101	2.70e-09	3.00e-09
Tc-99	0.00e+00	0.00e+00
Tc-99m	9.60e-10	1.10e-09
Ru-103	3.60e-09	4.20e-09
Ru-105	4.50e-09	5.10e-09
Ru-106	1.50e-09	1.80e-09
Rh-105	6.60e-10	7.70e-10
Pd-107	0.00e+00	0.00e+00
Pd-109	3.50e-11	4.00e-11

Conversion factors are in units of mrem/hr per pCi/square meter.

**DOSE CONVERSION FACTORS ALL AGE GROUPS
BY NUCLIDE (GROUND PLANE)**

Ground Plane Dose Conversion factors for all age groups by nuclide.
Waterford Steam Electric Station

Nuclide	Organ Dose Conversion Factors	
	T. Body	Skin
Ag-110m	1.80e-08	2.10e-08
Ag-111	1.80e-10	2.10e-10
Cd-113m	2.30e-12	2.60e-12
Cd-115m	0.00e+00	0.00e+00
Sn-123	0.00e+00	6.46e-08
Sn-125	5.70e-10	6.60e-10
Sn-126	9.00e-09	1.00e-08
Sb-124	1.30e-08	1.50e-08
Sb-125	3.10e-09	3.50e-09
Sb-126	8.90e-09	1.00e-08
Sb-127	5.70e-09	6.60e-09
Te-125m	3.50e-11	4.80e-11
Te-127	1.00e-11	1.10e-11
Te-127m	1.10e-12	1.30e-12
Te-129	7.10e-10	8.40e-10
Te-129m	7.70e-10	9.00e-10
Te-131	2.20e-09	2.60e-06
Te-131m	8.40e-09	9.90e-09
Te-132	1.70e-09	2.00e-09
Te-133m	1.50e-08	1.70e-08
Te-134	1.00e-09	1.20e-09
I-129	4.50e-10	7.50e-10
I-130	1.40e-08	1.70e-08
I-131	2.80e-09	3.40e-09
I-132	1.70e-08	2.00e-08
I-133	3.70e-09	4.50e-09
I-134	1.60e-08	1.90e-08
I-135	1.20e-08	1.40e-08
Cs-134	1.20e-08	1.40e-08
Cs-134m	6.20e-10	7.30e-10

Conversion factors are in units of mrem/hr per pCi/square meter.

**DOSE CONVERSION FACTORS ALL AGE GROUPS
BY NUCLIDE (GROUND PLANE)**

Ground Plane Dose Conversion factors for all age groups by nuclide.
Waterford Steam Electric Station

Nuclide	Organ Dose Conversion Factors	
	T. Body	Skin
Cs-135	0.00e+00	0.00e+00
Cs-136	1.50e-08	1.70e-08
Cs-137	4.20e-09	4.90e-09
Cs-138	2.10e-08	2.40e-08
Cs-139	6.30e-09	7.20e-09
Ba-139	2.40e-09	2.70e-09
Ba-140	2.10e-09	2.40e-09
Ba-141	4.30e-09	4.90e-09
Ba-142	7.90e-09	9.00e-09
La-140	1.50e-08	1.70e-08
La-141	2.50e-10	2.80e-10
La-142	1.50e-08	1.80e-08
Ce-141	5.50e-10	6.20e-10
Ce-143	2.20e-09	2.50e-09
Ce-144	3.20e-10	3.70e-10
Pr-143	0.00e+00	0.00e+00
Pr-144	2.00e-10	2.30e-10
Nd-147	1.00e-09	1.20e-09
Pm-147	0.00e+00	0.00e+00
Pm-148	4.60e-09	5.30e-09
Pm-148m	1.41e-08	8.16e-08
Pm-149	2.50e-11	2.90e-11
Pm-151	2.20e-09	2.30e-09
Sm-151	4.80e-11	2.10e-10
Sm-153	2.70e-10	3.00e-10
Eu-152	7.37e-09	8.53e-09
Eu-154	7.80e-09	9.00e-09
Eu-155	3.81e-10	4.33e-10
Eu-156	7.60e-09	8.70e-09
Tb-160	8.60e-09	1.00e-08

Conversion factors are in units of mrem/hr per pCi/square meter.

**DOSE CONVERSION FACTORS ALL AGE GROUPS
BY NUCLIDE (GROUND PLANE)**

Ground Plane Dose Conversion factors for all age groups by nuclide.
Waterford Steam Electric Station

Nuclide	Organ Dose Conversion Factors	
	T. Body	Skin
Ho-166m	8.90e-09	1.00e-08
W-181	2.10e-12	2.80e-12
W-185	0.00e+00	0.00e+00
W-187	3.10e-09	3.60e-09
Pb-210	1.30e-11	1.70e-11
Bi-210	0.00e+00	0.00e+00
Po-210	5.40e-14	6.20e-14
Ra-223	1.50e-09	1.80e-09
Ra-224	8.90e-09	1.00e-08
Ra-225	8.40e-11	1.20e-10
Ra-226	6.40e-09	7.40e-09
Ra-228	1.20e-08	1.40e-08
Ac-225	1.60e-09	1.80e-09
Ac-227	2.00e-09	2.40e-09
Th-227	5.10e-10	6.30e-10
Th-228	8.90e-09	1.00e-08
Th-229	2.20e-09	2.70e-09
Th-230	6.50e-09	7.50e-09
Th-232	3.00e-09	4.00e-09
Th-234	1.10e-10	1.30e-10
Pa-231	2.20e-09	2.70e-09
Pa-233	1.30e-09	1.50e-09
U-232	2.59e-12	2.69e-11
U-233	2.30e-09	2.80e-09
U-234	6.32e-13	1.59e-10
U-235	3.20e-09	4.00e-09
U-236	2.10e-14	1.80e-11
U-237	1.00e-09	1.30e-09
U-238	1.10e-10	1.50e-10
Np-237	1.40e-09	1.60e-09

Conversion factors are in units of mrem/hr per pCi/square meter.

**DOSE CONVERSION FACTORS ALL AGE GROUPS
BY NUCLIDE (GROUND PLANE)**

Ground Plane Dose Conversion factors for all age groups by nuclide.
Waterford Steam Electric Station

Nuclide	Organ Dose Conversion Factors	
	T. Body	Skin
Np-238	2.80e-09	3.20e-09
Np-239	9.50e-10	1.10e-09
Pu-238	1.30e-12	1.80e-11
Pu-239	7.90e-13	7.70e-12
Pu-240	1.30e-12	1.80e-11
Pu-241	4.60e-12	6.80e-12
Pu-242	1.10e-12	1.60e-11
Pu-244	8.95e-10	9.62e-10
Am-241	1.80e-10	2.60e-10
Am-242m	2.60e-11	1.80e-10
Am-243	1.30e-09	1.50e-09
Cm-242	5.50e-12	2.30e-11
Cm-243	2.30e-09	2.90e-09
Cm-244	2.90e-12	1.80e-11
Cm-245	9.50e-10	1.20e-09
Cm-246	1.00e-12	1.50e-11
Cm-247	2.20e-09	2.60e-09
Cm-248	6.81e-09	5.23e-09
Cf-252	6.60e-08	7.20e-08

Conversion factors are in units of mrem/hr per pCi/square meter.

**DOSE CONVERSION FACTORS ALL AGE GROUPS
BY NUCLIDE (INHALATION AND INGESTION)**

Inhalation Dose Conversion factors for Adult age group by nuclide.
Waterford Steam Electric Station

Nuclide	Organ Dose Conversion Factors						
	Bone	Liver	T. Body	Thyroid	Kidney	Lung	GI-LLI
H-3	0.00e+00	8.98e-08	8.98e-08	8.98e-08	8.98e-08	8.98e-08	8.98e-08
Be-10	1.98e-04	3.06e-05	4.96e-06	0.00e+00	0.00e+00	2.22e-04	1.67e-05
C-14	2.27e-06	4.26e-07	4.26e-07	4.26e-07	4.26e-07	4.26e-07	4.26e-07
N-13	6.27e-09	6.27e-09	6.27e-09	6.27e-09	6.27e-09	6.27e-09	6.27e-09
F-18	4.71e-07	0.00e+00	5.19e-08	0.00e+00	0.00e+00	0.00e+00	9.24e-09
Na-22	1.30e-05	1.30e-05	1.30e-05	1.30e-05	1.30e-05	1.30e-05	1.30e-05
Na-24	1.28e-06	1.28e-06	1.28e-06	1.28e-06	1.28e-06	1.28e-06	1.28e-06
P-32	1.65e-04	9.64e-06	6.26e-06	0.00e+00	0.00e+00	0.00e+00	1.08e-05
Ca-41	3.83e-05	0.00e+00	4.13e-06	0.00e+00	0.00e+00	3.83e-06	2.86e-07
Sc-46	5.51e-05	1.07e-04	3.11e-05	0.00e+00	9.99e-05	0.00e+00	3.23e-05
Cr-51	0.00e+00	0.00e+00	1.25e-08	7.44e-09	2.85e-09	1.80e-06	4.15e-07
Mn-54	0.00e+00	4.95e-06	7.87e-07	0.00e+00	1.23e-06	1.75e-04	9.67e-06
Mn-56	0.00e+00	1.55e-10	2.29e-11	0.00e+00	1.63e-10	1.18e-06	2.53e-06
Fe-55	3.07e-06	2.12e-06	4.93e-07	0.00e+00	0.00e+00	9.01e-06	7.54e-07
Fe-59	1.47e-06	3.47e-06	1.32e-06	0.00e+00	0.00e+00	1.27e-04	2.35e-05
Co-57	0.00e+00	8.65e-08	8.39e-08	0.00e+00	0.00e+00	4.62e-05	3.93e-06
Co-58	0.00e+00	1.98e-07	2.59e-07	0.00e+00	0.00e+00	1.16e-04	1.33e-05
Co-60	0.00e+00	1.44e-06	1.85e-06	0.00e+00	0.00e+00	7.46e-04	3.56e-05
Ni-59	4.06e-06	1.46e-06	6.77e-07	0.00e+00	0.00e+00	8.20e-06	6.11e-07
Ni-63	5.40e-05	3.93e-06	1.81e-06	0.00e+00	0.00e+00	2.23e-05	1.67e-06
Ni-65	1.92e-10	2.62e-11	1.14e-11	0.00e+00	0.00e+00	7.00e-07	1.54e-06
Cu-64	0.00e+00	1.83e-10	7.69e-11	0.00e+00	5.78e-10	8.48e-07	6.12e-06
Zn-65	4.05e-06	1.29e-05	5.82e-06	0.00e+00	8.62e-06	1.08e-04	6.68e-06
Zn-69	4.23e-12	8.14e-12	5.65e-13	0.00e+00	5.27e-12	1.15e-07	2.04e-09
Zn-69m	1.02e-09	2.45e-09	2.24e-10	0.00e+00	1.48e-09	2.38e-06	1.71e-05
Se-79	0.00e+00	3.83e-07	6.09e-08	0.00e+00	5.69e-07	4.47e-05	3.33e-06
Br-82	0.00e+00	0.00e+00	1.69e-06	0.00e+00	0.00e+00	0.00e+00	1.30e-06
Br-83	0.00e+00	0.00e+00	3.01e-08	0.00e+00	0.00e+00	0.00e+00	2.90e-08
Br-84	0.00e+00	0.00e+00	3.91e-08	0.00e+00	0.00e+00	0.00e+00	2.05e-13
Br-85	0.00e+00	0.00e+00	1.60e-09	0.00e+00	0.00e+00	0.00e+00	0.00e+00

Conversion factors are in units of mrem per pCi inhaled.

**DOSE CONVERSION FACTORS ALL AGE GROUPS
BY NUCLIDE (INHALATION AND INGESTION)**

Inhalation Dose Conversion factors for Adult age group by nuclide.
Waterford Steam Electric Station

Nuclide	Organ Dose Conversion Factors						
	Bone	Liver	T. Body	Thyroid	Kidney	Lung	GI-LLI
Rb-86	0.00e+00	1.69e-05	7.37e-06	0.00e+00	0.00e+00	0.00e+00	2.08e-06
Rb-87	0.00e+00	9.86e-06	3.21e-06	0.00e+00	0.00e+00	0.00e+00	2.88e-07
Rb-88	0.00e+00	4.84e-08	2.41e-08	0.00e+00	0.00e+00	0.00e+00	4.18e-19
Rb-89	0.00e+00	3.20e-08	2.12e-08	0.00e+00	0.00e+00	0.00e+00	1.16e-21
Sr-89	3.80e-05	0.00e+00	1.09e-06	0.00e+00	0.00e+00	1.75e-04	4.37e-05
Sr-90	3.59e-03	0.00e+00	7.21e-05	0.00e+00	0.00e+00	1.20e-03	9.02e-05
Sr-91	7.74e-09	0.00e+00	3.13e-10	0.00e+00	0.00e+00	4.56e-06	2.39e-05
Sr-92	8.43e-10	0.00e+00	3.64e-11	0.00e+00	0.00e+00	2.06e-06	5.38e-06
Y-90	2.61e-07	0.00e+00	7.01e-09	0.00e+00	0.00e+00	2.12e-05	6.32e-05
Y-91	5.78e-05	0.00e+00	1.55e-06	0.00e+00	0.00e+00	2.13e-04	4.81e-05
Y-91m	3.26e-11	0.00e+00	1.27e-12	0.00e+00	0.00e+00	2.40e-07	1.66e-10
Y-92	1.29e-09	0.00e+00	3.77e-11	0.00e+00	0.00e+00	1.96e-06	9.19e-06
Y-93	1.18e-08	0.00e+00	3.26e-10	0.00e+00	0.00e+00	6.06e-06	5.27e-05
Zr-93	5.22e-05	2.92e-06	1.37e-06	0.00e+00	1.11e-05	2.13e-05	1.51e-06
Zr-95	1.34e-05	4.30e-06	2.91e-06	0.00e+00	6.77e-06	2.21e-04	1.88e-05
Zr-97	1.21e-08	2.45e-09	1.13e-09	0.00e+00	3.71e-09	9.84e-06	6.54e-05
Nb-93m	3.10e-05	1.01e-05	2.49e-06	0.00e+00	1.16e-05	3.11e-05	2.38e-06
Nb-95	1.76e-06	9.77e-07	5.26e-07	0.00e+00	9.67e-07	6.31e-05	1.30e-05
Nb-97	2.78e-11	7.03e-12	2.56e-12	0.00e+00	8.18e-12	3.00e-07	3.02e-08
Mo-93	0.00e+00	1.17e-06	3.17e-08	0.00e+00	3.55e-07	5.11e-05	3.79e-06
Mo-99	0.00e+00	1.51e-08	2.87e-09	0.00e+00	3.64e-08	1.14e-05	3.10e-05
Tc-101	5.22e-15	7.52e-15	7.38e-14	0.00e+00	1.35e-13	4.99e-08	1.36e-21
Tc-99	3.13e-08	4.64e-08	1.25e-08	0.00e+00	5.85e-07	1.01e-04	7.54e-06
Tc-99m	1.29e-13	3.64e-13	4.63e-12	0.00e+00	5.52e-12	9.55e-08	5.20e-07
Ru-103	1.91e-07	0.00e+00	8.23e-08	0.00e+00	7.29e-07	6.31e-05	1.38e-05
Ru-105	9.88e-11	0.00e+00	3.89e-11	0.00e+00	1.27e-10	1.37e-06	6.02e-06
Ru-106	8.64e-06	0.00e+00	1.09e-06	0.00e+00	1.67e-05	1.17e-03	1.14e-04
Rh-105	9.24e-10	6.73e-10	4.43e-10	0.00e+00	2.86e-09	2.41e-06	1.09e-05
Pd-107	0.00e+00	8.27e-08	5.87e-09	0.00e+00	6.57e-07	9.47e-06	7.06e-07
Pd-109	0.00e+00	4.63e-10	1.16e-10	0.00e+00	2.35e-09	1.85e-06	1.52e-05

Conversion factors are in units of mrem per pCi inhaled.

**DOSE CONVERSION FACTORS ALL AGE GROUPS
BY NUCLIDE (INHALATION AND INGESTION)**

Inhalation Dose Conversion factors for Adult age group by nuclide.
Waterford Steam Electric Station

Nuclide	Organ Dose Conversion Factors						
	Bone	Liver	T. Body	Thyroid	Kidney	Lung	GI-LLI
Ag-110m	1.35e-06	1.25e-06	7.43e-07	0.00e+00	2.46e-06	5.79e-04	3.78e-05
Ag-111	4.25e-08	1.78e-08	8.87e-09	0.00e+00	5.74e-08	2.33e-05	2.79e-05
Cd-113m	0.00e+00	1.54e-04	4.97e-06	0.00e+00	1.71e-04	2.08e-04	1.59e-05
Cd-115m	0.00e+00	2.46e-05	7.95e-07	0.00e+00	1.98e-05	1.76e-04	4.80e-05
Sn-123	3.02e-05	6.67e-07	9.82e-07	5.67e-07	0.00e+00	2.88e-04	3.92e-05
Sn-125	1.16e-06	3.12e-08	7.03e-08	2.59e-08	0.00e+00	7.37e-05	6.81e-05
Sn-126	1.58e-04	4.18e-06	6.00e-06	1.23e-06	0.00e+00	1.17e-03	1.59e-05
Sb-124	3.90e-06	7.36e-08	1.55e-06	9.44e-09	0.00e+00	3.10e-04	5.08e-05
Sb-125	6.67e-06	7.44e-08	1.58e-06	6.75e-09	0.00e+00	2.18e-04	1.26e-05
Sb-126	4.50e-07	9.13e-09	1.62e-07	2.75e-09	0.00e+00	9.57e-05	6.01e-05
Sb-127	3.30e-08	7.22e-10	1.27e-08	3.97e-10	0.00e+00	2.05e-05	3.77e-05
Te-125m	4.27e-07	1.98e-07	5.84e-08	1.31e-07	1.55e-06	3.92e-05	8.83e-06
Te-127	1.75e-10	8.03e-11	3.87e-11	1.32e-10	6.37e-10	8.14e-07	7.17e-06
Te-127m	1.58e-06	7.21e-07	1.96e-07	4.11e-07	5.72e-06	1.20e-04	1.87e-05
Te-129	6.22e-12	2.99e-12	1.55e-12	4.87e-12	2.34e-11	2.42e-07	1.96e-08
Te-129m	1.22e-06	5.84e-07	1.98e-07	4.30e-07	4.57e-06	1.45e-04	4.79e-05
Te-131	1.39e-12	7.44e-13	4.49e-13	1.17e-12	5.46e-12	1.74e-07	2.30e-09
Te-131m	8.74e-09	5.45e-09	3.63e-09	6.88e-09	3.86e-08	1.82e-05	6.95e-05
Te-132	3.25e-08	2.69e-08	2.02e-08	2.37e-08	1.82e-07	3.60e-05	6.37e-05
Te-133m	7.24e-12	5.40e-12	4.17e-12	6.27e-12	3.74e-11	5.51e-07	7.65e-09
Te-134	3.84e-12	3.22e-12	1.57e-12	3.44e-12	2.18e-11	4.34e-07	2.97e-11
I-129	2.48e-06	2.11e-06	6.91e-06	5.54e-03	4.53e-06	0.00e+00	2.22e-07
I-130	5.72e-07	1.68e-06	6.60e-07	1.42e-04	2.61e-06	0.00e+00	9.61e-07
I-131	3.15e-06	4.47e-06	2.56e-06	1.49e-03	7.66e-06	0.00e+00	7.85e-07
I-132	1.45e-07	4.07e-07	1.45e-07	1.43e-05	6.48e-07	0.00e+00	5.08e-08
I-133	1.08e-06	1.85e-06	5.65e-07	2.69e-04	3.23e-06	0.00e+00	1.11e-06
I-134	8.05e-08	2.16e-07	7.69e-08	3.73e-06	3.44e-07	0.00e+00	1.26e-10
I-135	3.35e-07	8.73e-07	3.21e-07	5.60e-05	1.39e-06	0.00e+00	6.56e-07
Cs-134	4.66e-05	1.06e-04	9.10e-05	0.00e+00	3.59e-05	1.22e-05	1.30e-06
Cs-134m	1.59e-08	3.20e-08	1.72e-08	0.00e+00	1.83e-08	2.93e-09	7.92e-09

Conversion factors are in units of mrem per pCi inhaled.

**DOSE CONVERSION FACTORS ALL AGE GROUPS
BY NUCLIDE (INHALATION AND INGESTION)**

Inhalation Dose Conversion factors for Adult age group by nuclide.
Waterford Steam Electric Station

Nuclide	Organ Dose Conversion Factors						
	Bone	Liver	T. Body	Thyroid	Kidney	Lung	GI-LLI
Cs-135	1.46e-05	1.29e-05	5.99e-06	0.00e+00	5.11e-06	1.57e-06	2.11e-07
Cs-136	4.88e-06	1.83e-05	1.38e-05	0.00e+00	1.07e-05	1.50e-06	1.46e-06
Cs-137	5.98e-05	7.76e-05	5.35e-05	0.00e+00	2.78e-05	9.40e-06	1.05e-06
Cs-138	4.14e-08	7.76e-08	4.05e-08	0.00e+00	6.00e-08	6.07e-09	2.33e-13
Cs-139	2.56e-08	3.63e-08	1.39e-08	0.00e+00	3.05e-08	2.84e-09	5.49e-31
Ba-139	1.17e-10	8.32e-14	3.42e-12	0.00e+00	7.78e-14	4.70e-07	1.12e-07
Ba-140	4.88e-06	6.13e-09	3.21e-07	0.00e+00	2.09e-09	1.59e-04	2.73e-05
Ba-141	1.25e-11	9.41e-15	4.20e-13	0.00e+00	8.75e-15	2.42e-07	1.45e-17
Ba-142	3.29e-12	3.38e-15	2.07e-13	0.00e+00	2.86e-15	1.49e-07	1.96e-26
La-140	4.30e-08	2.17e-08	5.73e-09	0.00e+00	0.00e+00	1.70e-05	5.73e-05
La-141	5.34e-10	1.66e-10	2.71e-11	0.00e+00	0.00e+00	1.35e-06	7.31e-06
La-142	8.54e-11	3.88e-11	9.65e-12	0.00e+00	0.00e+00	7.91e-07	2.64e-07
Ce-141	2.49e-06	1.69e-06	1.91e-07	0.00e+00	7.83e-07	4.52e-05	1.50e-05
Ce-143	2.33e-08	1.72e-08	1.91e-09	0.00e+00	7.60e-09	9.97e-06	2.83e-05
Ce-144	4.29e-04	1.79e-04	2.30e-05	0.00e+00	1.06e-04	9.72e-04	1.02e-04
Pr-143	1.17e-06	4.69e-07	5.80e-08	0.00e+00	2.70e-07	3.51e-05	2.50e-05
Pr-144	3.76e-12	1.56e-12	1.91e-13	0.00e+00	8.81e-13	1.27e-07	2.69e-18
Nd-147	6.59e-07	7.62e-07	4.56e-08	0.00e+00	4.45e-07	2.76e-05	2.16e-05
Pm-147	8.37e-05	7.87e-06	3.19e-06	0.00e+00	1.49e-05	6.60e-05	5.54e-06
Pm-148	3.84e-07	6.37e-08	3.20e-08	0.00e+00	1.20e-07	3.91e-05	5.80e-05
Pm-148m	9.82e-06	2.54e-06	1.94e-06	0.00e+00	3.85e-06	2.14e-04	4.18e-05
Pm-149	3.44e-08	4.87e-09	1.99e-09	0.00e+00	9.19e-09	7.21e-06	2.50e-05
Pm-151	8.50e-09	1.42e-09	7.21e-10	0.00e+00	2.55e-09	3.94e-06	2.00e-05
Sm-151	8.59e-05	1.48e-05	3.55e-06	0.00e+00	1.66e-05	4.45e-05	3.25e-06
Sm-153	1.70e-08	1.42e-08	1.04e-09	0.00e+00	4.59e-09	4.14e-06	1.58e-05
Eu-152	2.38e-04	5.41e-05	4.76e-05	0.00e+00	3.35e-04	3.43e-04	1.59e-05
Eu-154	7.40e-04	9.10e-05	6.48e-05	0.00e+00	4.36e-04	5.84e-04	3.40e-05
Eu-155	1.01e-04	1.43e-05	9.21e-06	0.00e+00	6.59e-05	9.46e-05	5.95e-06
Eu-156	1.93e-06	1.48e-06	2.40e-07	0.00e+00	9.95e-07	8.56e-05	4.50e-05
Tb-160	2.21e-05	0.00e+00	2.75e-06	0.00e+00	9.10e-06	1.92e-04	2.68e-05

Conversion factors are in units of mrem per pCi inhaled.

**DOSE CONVERSION FACTORS ALL AGE GROUPS
BY NUCLIDE (INHALATION AND INGESTION)**

Inhalation Dose Conversion factors for Adult age group by nuclide.
Waterford Steam Electric Station

Nuclide	Organ Dose Conversion Factors						
	Bone	Liver	T. Body	Thyroid	Kidney	Lung	GI-LLI
Ho-166m	3.37e-04	1.05e-04	8.00e-05	0.00e+00	1.57e-04	3.94e-04	1.59e-05
W-181	6.23e-09	2.03e-09	2.17e-10	0.00e+00	0.00e+00	1.71e-06	2.53e-07
W-185	1.95e-07	6.47e-08	6.81e-09	0.00e+00	0.00e+00	5.57e-05	1.07e-05
W-187	1.06e-09	8.85e-10	3.10e-10	0.00e+00	0.00e+00	3.63e-06	1.94e-05
Pb-210	2.64e-02	6.73e-03	8.37e-04	0.00e+00	2.12e-02	2.62e-02	1.51e-06
Bi-210	2.31e-07	1.59e-06	1.32e-07	0.00e+00	1.92e-05	1.11e-03	2.95e-05
Po-210	3.97e-04	8.60e-04	9.58e-05	0.00e+00	2.95e-03	3.14e-02	4.19e-05
Ra-223	1.80e-04	2.77e-07	3.60e-05	0.00e+00	7.85e-06	2.55e-02	2.84e-04
Ra-224	1.98e-05	4.78e-08	3.96e-06	0.00e+00	1.35e-06	8.77e-03	3.01e-04
Ra-225	3.00e-04	3.56e-07	5.99e-05	0.00e+00	1.01e-05	2.92e-02	2.71e-04
Ra-226	1.25e-01	2.39e-06	9.14e-02	0.00e+00	6.77e-05	1.17e-01	2.94e-04
Ra-228	4.41e-02	1.23e-06	4.78e-02	0.00e+00	3.48e-05	1.61e-01	5.00e-05
Ac-225	4.23e-04	5.82e-04	2.84e-05	0.00e+00	6.63e-05	2.21e-02	2.52e-04
Ac-227	2.30e+00	3.05e-01	1.36e-01	0.00e+00	9.82e-02	2.41e-01	5.08e-05
Th-227	2.17e-04	3.92e-06	6.25e-06	0.00e+00	2.22e-05	3.77e-02	3.34e-04
Th-228	2.00e-01	3.39e-03	6.77e-03	0.00e+00	1.89e-02	1.01e+00	3.49e-04
Th-229	1.51e+01	4.34e-01	2.51e-01	0.00e+00	2.13e+00	3.62e+00	4.83e-05
Th-230	2.29e+00	1.31e-01	6.36e-02	0.00e+00	6.40e-01	6.21e-01	3.73e-05
Th-232	2.56e+00	1.12e-01	9.04e-04	0.00e+00	5.47e-01	5.96e-01	3.17e-05
Th-234	1.63e-06	9.56e-08	4.70e-08	0.00e+00	5.41e-07	1.89e-04	7.03e-05
Pa-231	5.08e+00	1.91e-01	1.98e-01	0.00e+00	1.07e+00	5.75e-02	4.44e-05
Pa-233	1.21e-06	2.42e-07	2.09e-07	0.00e+00	9.15e-07	3.52e-05	1.02e-05
U-232	5.14e-02	0.00e+00	3.66e-03	0.00e+00	5.56e-03	2.22e-01	4.21e-05
U-233	1.09e-02	0.00e+00	6.60e-04	0.00e+00	2.54e-03	5.32e-02	3.89e-05
U-234	1.04e-02	0.00e+00	6.46e-04	0.00e+00	2.49e-03	5.22e-02	3.81e-05
U-235	1.00e-02	0.00e+00	6.07e-04	0.00e+00	2.34e-03	4.90e-02	4.84e-05
U-236	1.00e-02	0.00e+00	6.20e-04	0.00e+00	2.39e-03	5.00e-02	3.57e-05
U-237	3.67e-08	0.00e+00	9.77e-09	0.00e+00	1.51e-07	1.02e-05	1.20e-05
U-238	9.58e-03	0.00e+00	5.67e-04	0.00e+00	2.18e-03	4.58e-02	3.41e-05
Np-237	1.56e+00	1.00e+00	6.87e-02	0.00e+00	5.10e-01	5.22e-02	4.92e-05

Conversion factors are in units of mrem per pCi inhaled.

**DOSE CONVERSION FACTORS ALL AGE GROUPS
BY NUCLIDE (INHALATION AND INGESTION)**

Inhalation Dose Conversion factors for Adult age group by nuclide.
Waterford Steam Electric Station

Nuclide	Organ Dose Conversion Factors						
	Bone	Liver	T. Body	Thyroid	Kidney	Lung	GI-LLI
Np-238	2.96e-07	7.20e-08	4.61e-09	0.00e+00	2.72e-08	1.02e-05	2.13e-05
Np-239	2.87e-08	2.54e-08	1.55e-09	0.00e+00	8.75e-09	4.70e-06	1.49e-05
Pu-238	1.43e+00	9.71e-01	6.90e-02	0.00e+00	2.96e-01	1.82e-01	4.52e-05
Pu-239	1.66e+00	1.07e+00	7.75e-02	0.00e+00	3.30e-01	1.72e-01	4.13e-05
Pu-240	1.65e+00	1.07e+00	7.73e-02	0.00e+00	3.29e-01	1.72e-01	4.21e-05
Pu-241	3.42e-02	8.69e-03	1.29e-03	0.00e+00	5.93e-03	1.52e-04	8.65e-07
Pu-242	1.53e+00	1.03e+00	7.46e-02	0.00e+00	3.17e-01	1.65e-01	4.05e-05
Pu-244	1.79e+00	1.18e+00	8.54e-02	0.00e+00	3.64e-01	1.89e-01	6.03e-05
Am-241	1.68e+00	1.13e+00	6.71e-02	0.00e+00	5.04e-01	6.06e-02	4.60e-05
Am-242m	1.70e+00	1.06e+00	6.73e-02	0.00e+00	5.01e-01	2.44e-02	5.79e-05
Am-243	1.68e+00	1.10e+00	6.57e-02	0.00e+00	4.95e-01	5.75e-02	5.40e-05
Cm-242	2.22e-02	1.77e-02	9.84e-04	0.00e+00	4.48e-03	3.92e-02	4.91e-05
Cm-243	1.10e+00	7.61e-01	4.61e-02	0.00e+00	2.15e-01	6.31e-02	4.84e-05
Cm-244	8.37e-01	5.88e-01	3.51e-02	0.00e+00	1.64e-01	6.06e-02	4.68e-05
Cm-245	1.74e+00	1.14e+00	7.14e-02	0.00e+00	3.33e-01	5.85e-02	4.36e-05
Cm-246	1.73e+00	1.14e+00	7.13e-02	0.00e+00	3.33e-01	5.96e-02	4.29e-05
Cm-247	1.68e+00	1.12e+00	7.03e-02	0.00e+00	3.28e-01	5.85e-02	5.63e-05
Cm-248	1.40e+01	9.26e+00	5.79e-01	0.00e+00	2.70e+00	4.82e-01	9.09e-04
Cf-252	5.43e-01	0.00e+00	2.33e-02	0.00e+00	0.00e+00	1.99e-01	1.78e-04

Conversion factors are in units of mrem per pCi inhaled.

**DOSE CONVERSION FACTORS ALL AGE GROUPS
BY NUCLIDE (INHALATION AND INGESTION)**

Inhalation Dose Conversion factors for Teen age group by nuclide.
Waterford Steam Electric Station

Nuclide	Organ Dose Conversion Factors						
	Bone	Liver	T. Body	Thyroid	Kidney	Lung	GI-LLI
H-3	0.00e+00	9.06e-08	9.06e-08	9.06e-08	9.06e-08	9.06e-08	9.06e-08
Be-10	2.78e-04	4.33e-05	7.09e-06	0.00e+00	0.00e+00	3.84e-04	1.77e-05
C-14	3.25e-06	6.09e-07	6.09e-07	6.09e-07	6.09e-07	6.09e-07	6.09e-07
N-13	8.65e-09	8.65e-09	8.65e-09	8.65e-09	8.65e-09	8.65e-09	8.65e-09
F-18	6.52e-07	0.00e+00	7.10e-08	0.00e+00	0.00e+00	0.00e+00	3.89e-08
Na-22	1.76e-05	1.76e-05	1.76e-05	1.76e-05	1.76e-05	1.76e-05	1.76e-05
Na-24	1.72e-06	1.72e-06	1.72e-06	1.72e-06	1.72e-06	1.72e-06	1.72e-06
P-32	2.36e-04	1.37e-05	8.95e-06	0.00e+00	0.00e+00	0.00e+00	1.16e-05
Ca-41	4.05e-05	0.00e+00	4.38e-06	0.00e+00	0.00e+00	1.01e-01	3.03e-07
Sc-46	7.24e-05	1.41e-04	4.18e-05	0.00e+00	1.35e-04	0.00e+00	2.98e-05
Cr-51	0.00e+00	0.00e+00	1.69e-08	9.37e-09	3.84e-09	2.62e-06	3.75e-07
Mn-54	0.00e+00	6.39e-06	1.05e-06	0.00e+00	1.59e-06	2.48e-04	8.35e-06
Mn-56	0.00e+00	2.12e-10	3.15e-11	0.00e+00	2.24e-10	1.90e-06	7.18e-06
Fe-55	4.18e-06	2.98e-06	6.93e-07	0.00e+00	0.00e+00	1.55e-05	7.99e-07
Fe-59	1.99e-06	4.62e-06	1.79e-06	0.00e+00	0.00e+00	1.91e-04	2.23e-05
Co-57	0.00e+00	1.18e-07	1.15e-07	0.00e+00	0.00e+00	7.33e-05	3.93e-06
Co-58	0.00e+00	2.59e-07	3.47e-07	0.00e+00	0.00e+00	1.68e-04	1.19e-05
Co-60	0.00e+00	1.89e-06	2.48e-06	0.00e+00	0.00e+00	1.09e-03	3.24e-05
Ni-59	5.44e-06	2.02e-06	9.24e-07	0.00e+00	0.00e+00	1.41e-05	6.48e-07
Ni-63	7.25e-05	5.43e-06	2.47e-06	0.00e+00	0.00e+00	3.84e-05	1.77e-06
Ni-65	2.73e-10	3.66e-11	1.59e-11	0.00e+00	0.00e+00	1.17e-06	4.59e-06
Cu-64	0.00e+00	2.54e-10	1.06e-10	0.00e+00	8.01e-10	1.39e-06	7.68e-06
Zn-65	4.82e-06	1.67e-05	7.80e-06	0.00e+00	1.08e-05	1.55e-04	5.83e-06
Zn-69	6.04e-12	1.15e-11	8.07e-13	0.00e+00	7.53e-12	1.98e-07	3.56e-08
Zn-69m	1.44e-09	3.39e-09	3.11e-10	0.00e+00	2.06e-09	3.92e-06	2.14e-05
Se-79	0.00e+00	5.43e-07	8.71e-08	0.00e+00	8.13e-07	7.71e-05	3.53e-06
Br-82	0.00e+00	0.00e+00	2.28e-06	0.00e+00	0.00e+00	0.00e+00	0.00e+00
Br-83	0.00e+00	0.00e+00	4.30e-08	0.00e+00	0.00e+00	0.00e+00	0.00e+00
Br-84	0.00e+00	0.00e+00	5.41e-08	0.00e+00	0.00e+00	0.00e+00	0.00e+00
Br-85	0.00e+00	0.00e+00	2.29e-09	0.00e+00	0.00e+00	0.00e+00	0.00e+00

Conversion factors are in units of mrem per pCi inhaled.

**DOSE CONVERSION FACTORS ALL AGE GROUPS
BY NUCLIDE (INHALATION AND INGESTION)**

Inhalation Dose Conversion factors for Teen age group by nuclide.
Waterford Steam Electric Station

Nuclide	Organ Dose Conversion Factors						
	Bone	Liver	T. Body	Thyroid	Kidney	Lung	GI-LLI
Rb-86	0.00e+00	2.38e-05	1.05e-05	0.00e+00	0.00e+00	0.00e+00	2.21e-06
Rb-87	0.00e+00	1.40e-05	4.58e-06	0.00e+00	0.00e+00	0.00e+00	3.05e-07
Rb-88	0.00e+00	6.82e-08	3.40e-08	0.00e+00	0.00e+00	0.00e+00	3.65e-15
Rb-89	0.00e+00	4.40e-08	2.91e-08	0.00e+00	0.00e+00	0.00e+00	4.22e-17
Sr-89	5.43e-05	0.00e+00	1.56e-06	0.00e+00	0.00e+00	3.02e-04	4.64e-05
Sr-90	4.14e-03	0.00e+00	8.33e-05	0.00e+00	0.00e+00	2.06e-03	9.56e-05
Sr-91	1.10e-08	0.00e+00	4.39e-10	0.00e+00	0.00e+00	7.59e-06	3.24e-05
Sr-92	1.19e-09	0.00e+00	5.08e-11	0.00e+00	0.00e+00	3.43e-06	1.49e-05
Y-90	3.73e-07	0.00e+00	1.00e-08	0.00e+00	0.00e+00	3.66e-05	6.99e-05
Y-91	8.26e-05	0.00e+00	2.21e-06	0.00e+00	0.00e+00	3.67e-04	5.11e-05
Y-91m	4.63e-11	0.00e+00	1.77e-12	0.00e+00	0.00e+00	4.00e-07	3.77e-09
Y-92	1.84e-09	0.00e+00	5.36e-11	0.00e+00	0.00e+00	3.35e-06	2.06e-05
Y-93	1.69e-08	0.00e+00	4.65e-10	0.00e+00	0.00e+00	1.04e-05	7.24e-05
Zr-93	6.83e-05	3.38e-06	1.84e-06	0.00e+00	1.16e-05	3.67e-05	1.60e-06
Zr-95	1.82e-05	5.73e-06	3.94e-06	0.00e+00	8.42e-06	3.36e-04	1.86e-05
Zr-97	1.72e-08	3.40e-09	1.57e-09	0.00e+00	5.15e-09	1.62e-05	7.88e-05
Nb-93m	4.14e-05	1.36e-05	3.41e-06	0.00e+00	1.59e-05	5.36e-05	2.52e-06
Nb-95	2.32e-06	1.29e-06	7.08e-07	0.00e+00	1.25e-06	9.39e-05	1.21e-05
Nb-97	3.92e-11	9.72e-12	3.55e-12	0.00e+00	1.14e-11	4.91e-07	2.71e-07
Mo-93	0.00e+00	1.66e-06	4.52e-08	0.00e+00	5.06e-07	8.81e-05	3.99e-06
Mo-99	0.00e+00	2.11e-08	4.03e-09	0.00e+00	5.14e-08	1.92e-05	3.36e-05
Tc-101	7.40e-15	1.05e-14	1.03e-13	0.00e+00	1.90e-13	8.34e-08	1.09e-16
Tc-99	4.48e-08	6.58e-08	1.79e-08	0.00e+00	8.35e-07	1.74e-04	7.99e-06
Tc-99m	1.73e-13	4.83e-13	6.24e-12	0.00e+00	7.20e-12	1.44e-07	7.66e-07
Ru-103	2.63e-07	0.00e+00	1.12e-07	0.00e+00	9.29e-07	9.79e-05	1.36e-05
Ru-105	1.40e-10	0.00e+00	5.42e-11	0.00e+00	1.76e-10	2.27e-06	1.13e-05
Ru-106	1.23e-05	0.00e+00	1.55e-06	0.00e+00	2.38e-05	2.01e-03	1.20e-04
Rh-105	1.32e-09	9.48e-10	6.24e-10	0.00e+00	4.04e-09	4.09e-06	1.23e-05
Pd-107	0.00e+00	1.17e-07	8.39e-09	0.00e+00	9.39e-07	1.63e-05	7.49e-07
Pd-109	0.00e+00	6.56e-10	1.66e-10	0.00e+00	3.36e-09	3.19e-06	1.96e-05

Conversion factors are in units of mrem per pCi inhaled.

**DOSE CONVERSION FACTORS ALL AGE GROUPS
BY NUCLIDE (INHALATION AND INGESTION)**

Inhalation Dose Conversion factors for Teen age group by nuclide.
Waterford Steam Electric Station

Nuclide	Organ Dose Conversion Factors						
	Bone	Liver	T. Body	Thyroid	Kidney	Lung	GI-LLI
Ag-110m	1.73e-06	1.64e-06	9.99e-07	0.00e+00	3.13e-06	8.44e-04	3.41e-05
Ag-111	6.07e-08	2.52e-08	1.26e-08	0.00e+00	8.17e-08	4.00e-05	3.00e-05
Cd-113m	0.00e+00	2.17e-04	7.10e-06	0.00e+00	2.43e-04	3.59e-04	1.68e-05
Cd-115m	0.00e+00	3.48e-05	1.14e-06	0.00e+00	2.82e-05	3.03e-04	5.10e-05
Sn-123	4.31e-05	9.44e-07	1.40e-06	7.55e-07	0.00e+00	4.96e-04	4.16e-05
Sn-125	1.66e-06	4.42e-08	9.99e-08	3.45e-08	0.00e+00	1.26e-04	7.29e-05
Sn-126	2.18e-04	5.39e-06	8.24e-06	1.42e-06	0.00e+00	1.72e-03	1.68e-05
Sb-124	5.38e-06	9.92e-08	2.10e-06	1.22e-08	0.00e+00	4.81e-04	4.98e-05
Sb-125	9.23e-06	1.01e-07	2.15e-06	8.80e-09	0.00e+00	3.42e-04	1.24e-05
Sb-126	6.19e-07	1.27e-08	2.23e-07	3.50e-09	0.00e+00	1.55e-04	6.01e-05
Sb-127	4.64e-08	9.92e-10	1.75e-08	5.21e-10	0.00e+00	3.31e-05	3.94e-05
Te-125m	6.10e-07	2.80e-07	8.34e-08	1.75e-07	0.00e+00	6.70e-05	9.38e-06
Te-127	2.51e-10	1.14e-10	5.52e-11	1.77e-10	9.10e-10	1.40e-06	1.01e-05
Te-127m	2.25e-06	1.02e-06	2.73e-07	5.48e-07	8.17e-06	2.07e-04	1.99e-05
Te-129	8.87e-12	4.22e-12	2.20e-12	6.48e-12	3.32e-11	4.12e-07	2.02e-07
Te-129m	1.74e-06	8.23e-07	2.81e-07	5.72e-07	6.49e-06	2.47e-04	5.06e-05
Te-131	1.97e-12	1.04e-12	6.30e-13	1.55e-12	7.72e-12	2.92e-07	1.89e-09
Te-131m	1.23e-08	7.51e-09	5.03e-09	9.06e-09	5.49e-08	2.97e-05	7.76e-05
Te-132	4.50e-08	3.63e-08	2.74e-08	3.07e-08	2.44e-07	5.61e-05	5.79e-05
Te-133m	1.01e-11	7.33e-12	5.71e-12	8.18e-12	5.07e-11	8.71e-07	1.23e-07
Te-134	5.31e-12	4.35e-12	3.64e-12	4.46e-12	2.91e-11	6.75e-07	1.37e-09
I-129	3.53e-06	2.94e-06	4.90e-06	3.66e-03	5.26e-06	0.00e+00	2.29e-07
I-130	7.80e-07	2.24e-06	8.96e-07	1.86e-04	3.44e-06	0.00e+00	1.14e-06
I-131	4.43e-06	6.14e-06	3.30e-06	1.83e-03	1.05e-05	0.00e+00	8.11e-07
I-132	1.99e-07	5.47e-07	1.97e-07	1.89e-05	8.65e-07	0.00e+00	1.59e-07
I-133	1.52e-06	2.56e-06	7.78e-07	3.65e-04	4.49e-06	0.00e+00	1.29e-06
I-134	1.11e-07	2.90e-07	1.05e-07	4.94e-06	4.58e-07	0.00e+00	2.55e-09
I-135	4.62e-07	1.18e-06	4.36e-07	7.76e-05	1.86e-06	0.00e+00	8.69e-07
Cs-134	6.28e-05	1.41e-04	6.86e-05	0.00e+00	4.69e-05	1.83e-05	1.22e-06
Cs-134m	2.20e-08	4.35e-08	2.35e-08	0.00e+00	2.54e-08	4.56e-09	2.02e-08

Conversion factors are in units of mrem per pCi inhaled.

**DOSE CONVERSION FACTORS ALL AGE GROUPS
BY NUCLIDE (INHALATION AND INGESTION)**

Inhalation Dose Conversion factors for Teen age group by nuclide.
Waterford Steam Electric Station

Nuclide	Organ Dose Conversion Factors						
	Bone	Liver	T. Body	Thyroid	Kidney	Lung	GI-LLI
Cs-135	2.08e-05	1.82e-05	4.47e-06	0.00e+00	7.30e-06	2.70e-06	2.23e-07
Cs-136	6.44e-06	2.42e-05	1.71e-05	0.00e+00	1.38e-05	2.22e-06	1.36e-06
Cs-137	8.38e-05	1.06e-04	3.89e-05	0.00e+00	3.80e-05	1.51e-05	1.06e-06
Cs-138	5.82e-08	1.07e-07	5.58e-08	0.00e+00	8.28e-08	9.84e-09	3.38e-11
Cs-139	3.65e-08	5.12e-08	1.97e-08	0.00e+00	4.34e-08	4.86e-09	1.66e-23
Ba-139	1.67e-10	1.18e-13	4.87e-12	0.00e+00	1.11e-13	8.08e-07	8.06e-07
Ba-140	6.84e-06	8.38e-09	4.40e-07	0.00e+00	2.85e-09	2.54e-04	2.86e-05
Ba-141	1.78e-11	1.32e-14	5.93e-13	0.00e+00	1.23e-14	4.11e-07	9.33e-14
Ba-142	4.62e-12	4.63e-15	2.84e-13	0.00e+00	3.92e-15	2.39e-07	5.99e-20
La-140	5.99e-08	2.95e-08	7.82e-09	0.00e+00	0.00e+00	2.68e-05	6.09e-05
La-141	7.63e-10	2.35e-10	3.87e-11	0.00e+00	0.00e+00	2.31e-06	1.54e-05
La-142	1.20e-10	5.31e-11	1.32e-11	0.00e+00	0.00e+00	1.27e-06	1.50e-06
Ce-141	3.55e-06	2.37e-06	2.71e-07	0.00e+00	1.11e-06	7.67e-05	1.58e-05
Ce-143	3.32e-08	2.42e-08	2.70e-09	0.00e+00	1.08e-08	1.63e-05	3.19e-05
Ce-144	6.11e-04	2.53e-04	3.28e-05	0.00e+00	1.51e-04	1.67e-03	1.08e-04
Pr-143	1.67e-06	6.64e-07	8.28e-08	0.00e+00	3.86e-07	6.04e-05	2.67e-05
Pr-144	5.37e-12	2.20e-12	2.72e-13	0.00e+00	1.26e-12	2.19e-07	2.94e-14
Nd-147	9.83e-07	1.07e-06	6.41e-08	0.00e+00	6.28e-07	4.65e-05	2.28e-05
Pm-147	1.15e-04	1.10e-05	4.50e-06	0.00e+00	2.10e-05	1.14e-04	5.87e-06
Pm-148	5.44e-07	8.88e-08	4.48e-08	0.00e+00	1.60e-07	6.52e-05	6.14e-05
Pm-148m	1.32e-05	3.35e-06	2.62e-06	0.00e+00	5.07e-06	3.20e-04	4.10e-05
Pm-149	4.91e-08	6.89e-09	2.84e-09	0.00e+00	1.31e-08	1.24e-05	2.79e-05
Pm-151	1.20e-08	1.99e-09	1.01e-09	0.00e+00	3.57e-09	6.56e-06	2.27e-05
Sm-151	1.07e-04	2.10e-05	4.86e-06	0.00e+00	2.27e-05	7.68e-05	3.53e-06
Sm-153	2.43e-08	2.01e-08	1.47e-09	0.00e+00	6.56e-09	7.11e-06	1.77e-05
Eu-152	2.96e-04	7.19e-05	6.30e-05	0.00e+00	3.34e-04	5.01e-04	1.35e-05
Eu-154	9.43e-04	1.23e-04	8.60e-05	0.00e+00	5.44e-04	9.12e-04	3.34e-05
Eu-155	2.00e-04	1.96e-05	1.21e-05	0.00e+00	7.65e-05	1.51e-03	5.97e-05
Eu-156	2.70e-06	2.03e-06	3.30e-07	0.00e+00	1.36e-06	1.37e-04	4.56e-05
Tb-160	3.04e-05	0.00e+00	3.79e-06	0.00e+00	1.20e-05	2.97e-04	2.60e-05

Conversion factors are in units of mrem per pCi inhaled.

**DOSE CONVERSION FACTORS ALL AGE GROUPS
BY NUCLIDE (INHALATION AND INGESTION)**

Inhalation Dose Conversion factors for Teen age group by nuclide.
Waterford Steam Electric Station

Nuclide	Organ Dose Conversion Factors						
	Bone	Liver	T. Body	Thyroid	Kidney	Lung	GI-LLI
Ho-166m	4.40e-04	1.36e-04	9.87e-05	0.00e+00	2.00e-04	6.24e-04	1.68e-05
W-181	8.90e-09	2.88e-09	3.01e-10	0.00e+00	0.00e+00	2.95e-06	2.69e-07
W-185	2.78e-07	9.17e-08	9.73e-09	0.00e+00	0.00e+00	9.60e-05	1.14e-05
W-187	1.50e-09	1.22e-09	4.29e-10	0.00e+00	0.00e+00	5.92e-06	2.21e-05
Pb-210	3.09e-02	8.28e-03	1.07e-03	0.00e+00	2.95e-02	4.52e-02	1.60e-06
Bi-210	3.30e-07	2.26e-06	1.89e-07	0.00e+00	2.74e-05	1.91e-03	3.19e-05
Po-210	5.68e-04	1.22e-03	1.37e-04	0.00e+00	4.21e-03	5.41e-02	4.45e-05
Ra-223	2.57e-04	3.93e-07	5.14e-05	0.00e+00	1.12e-05	4.39e-02	3.04e-04
Ra-224	2.83e-05	6.77e-08	5.65e-06	0.00e+00	1.93e-06	1.51e-02	3.29e-04
Ra-225	4.28e-04	5.04e-07	8.56e-05	0.00e+00	1.44e-05	5.04e-02	2.89e-04
Ra-226	1.33e-01	3.38e-06	9.87e-02	0.00e+00	9.67e-05	2.02e-01	3.11e-04
Ra-228	5.34e-02	1.74e-06	5.88e-02	0.00e+00	4.97e-05	2.78e-01	5.30e-05
Ac-225	6.04e-04	8.25e-04	4.06e-05	0.00e+00	9.47e-05	3.81e-02	2.70e-04
Ac-227	2.49e+00	3.69e-01	1.48e-01	0.00e+00	1.07e-01	4.16e-01	5.38e-05
Th-227	3.09e-04	5.56e-06	8.93e-06	0.00e+00	3.18e-05	6.50e-02	3.57e-04
Th-228	2.60e-01	4.37e-03	8.78e-03	0.00e+00	2.45e-02	1.69e+00	3.70e-04
Th-229	1.54e+01	4.44e-01	2.56e-01	0.00e+00	2.18e+00	5.24e+00	5.12e-05
Th-230	2.34e+00	1.34e-01	6.49e-02	0.00e+00	6.55e-01	8.98e-01	3.95e-05
Th-232	2.61e+00	1.14e-01	9.21e-04	0.00e+00	5.60e-01	8.60e-01	3.36e-05
Th-234	2.32e-06	1.35e-07	6.71e-08	0.00e+00	7.73e-07	3.26e-04	7.49e-05
Pa-231	5.32e+00	2.00e-01	2.07e-01	0.00e+00	1.12e+00	9.91e-02	4.71e-05
Pa-233	1.68e-06	3.24e-07	2.89e-07	0.00e+00	1.22e-06	5.39e-05	1.00e-05
U-232	7.31e-02	0.00e+00	5.23e-03	0.00e+00	7.94e-03	3.84e-01	4.46e-05
U-233	1.55e-02	0.00e+00	9.42e-04	0.00e+00	3.63e-03	9.18e-02	4.12e-05
U-234	1.48e-02	0.00e+00	9.23e-04	0.00e+00	3.55e-03	8.99e-02	4.04e-05
U-235	1.42e-02	0.00e+00	8.67e-04	0.00e+00	3.34e-03	8.44e-02	5.13e-05
U-236	1.42e-02	0.00e+00	8.86e-04	0.00e+00	3.41e-03	8.62e-02	3.79e-05
U-237	5.25e-08	0.00e+00	1.40e-08	0.00e+00	2.16e-07	1.76e-05	1.29e-05
U-238	1.36e-02	0.00e+00	8.10e-04	0.00e+00	3.12e-03	7.89e-02	3.62e-05
Np-237	1.64e+00	1.06e+00	7.21e-02	0.00e+00	5.35e-01	8.99e-02	5.22e-05

Conversion factors are in units of mrem per pCi inhaled.

**DOSE CONVERSION FACTORS ALL AGE GROUPS
BY NUCLIDE (INHALATION AND INGESTION)**

Inhalation Dose Conversion factors for Teen age group by nuclide.
Waterford Steam Electric Station

Nuclide	Organ Dose Conversion Factors						
	Bone	Liver	T. Body	Thyroid	Kidney	Lung	GI-LLI
Np-238	4.23e-07	1.02e-07	6.59e-09	0.00e+00	3.88e-08	1.75e-05	2.38e-05
Np-239	4.23e-08	3.60e-08	2.21e-09	0.00e+00	1.25e-08	8.11e-06	1.65e-05
Pu-238	1.50e+00	1.03e+00	7.22e-02	0.00e+00	3.10e-01	3.12e-01	4.79e-05
Pu-239	1.73e+00	1.12e+00	8.05e-02	0.00e+00	3.44e-01	2.93e-01	4.37e-05
Pu-240	1.72e+00	1.12e+00	8.04e-02	0.00e+00	3.43e-01	2.93e-01	4.46e-05
Pu-241	3.74e-02	9.56e-03	1.40e-03	0.00e+00	6.47e-03	2.60e-04	9.17e-07
Pu-242	1.60e+00	1.08e+00	7.75e-02	0.00e+00	3.31e-01	2.82e-01	4.29e-05
Pu-244	1.87e+00	1.24e+00	8.88e-02	0.00e+00	3.79e-01	3.23e-01	6.39e-05
Am-241	1.77e+00	1.20e+00	7.10e-02	0.00e+00	5.32e-01	1.05e-01	4.88e-05
Am-242m	1.79e+00	1.13e+00	7.15e-02	0.00e+00	5.30e-01	4.21e-02	6.14e-05
Am-243	1.77e+00	1.17e+00	6.95e-02	0.00e+00	5.21e-01	9.91e-02	5.72e-05
Cm-242	3.17e-02	2.51e-02	1.41e-03	0.00e+00	6.40e-03	6.76e-02	5.21e-05
Cm-243	1.19e+00	8.30e-01	5.00e-02	0.00e+00	2.34e-01	1.09e-01	5.13e-05
Cm-244	9.19e-01	6.53e-01	3.88e-02	0.00e+00	1.81e-01	1.05e-01	4.96e-05
Cm-245	1.83e+00	1.22e+00	7.53e-02	0.00e+00	3.52e-01	1.01e-01	4.63e-05
Cm-246	1.81e+00	1.22e+00	7.52e-02	0.00e+00	3.51e-01	1.03e-01	4.54e-05
Cm-247	1.77e+00	1.19e+00	7.41e-02	0.00e+00	3.46e-01	1.01e-01	5.97e-05
Cm-248	1.47e+01	9.83e+00	6.11e-01	0.00e+00	2.85e+00	8.32e-01	9.63e-04
Cf-252	7.16e-01	0.00e+00	3.07e-02	0.00e+00	0.00e+00	3.43e-01	1.89e-04

Conversion factors are in units of mrem per pCi inhaled.

**DOSE CONVERSION FACTORS ALL AGE GROUPS
BY NUCLIDE (INHALATION AND INGESTION)**

Inhalation Dose Conversion factors for Child age group by nuclide.
Waterford Steam Electric Station

Nuclide	Organ Dose Conversion Factors						
	Bone	Liver	T. Body	Thyroid	Kidney	Lung	GI-LLI
H-3	0.00e+00	1.73e-07	1.73e-07	1.73e-07	1.73e-07	1.73e-07	1.73e-07
Be-10	8.43e-04	9.83e-05	2.12e-05	0.00e+00	0.00e+00	7.41e-04	1.72e-05
C-14	9.70e-06	1.82e-06	1.82e-06	1.82e-06	1.82e-06	1.82e-06	1.82e-06
N-13	2.33e-08	2.33e-08	2.33e-08	2.33e-08	2.33e-08	2.33e-08	2.33e-08
F-18	1.88e-06	0.00e+00	1.85e-07	0.00e+00	0.00e+00	0.00e+00	3.37e-07
Na-22	4.41e-05	4.41e-05	4.41e-05	4.41e-05	4.41e-05	4.41e-05	4.41e-05
Na-24	4.35e-06	4.35e-06	4.35e-06	4.35e-06	4.35e-06	4.35e-06	4.35e-06
P-32	7.04e-04	3.09e-05	2.67e-05	0.00e+00	0.00e+00	0.00e+00	1.14e-05
Ca-41	7.06e-05	0.00e+00	7.70e-06	0.00e+00	0.00e+00	7.21e-02	2.94e-07
Sc-46	1.97e-04	2.70e-04	1.04e-04	0.00e+00	2.39e-04	0.00e+00	2.45e-05
Cr-51	0.00e+00	0.00e+00	4.17e-08	2.31e-08	6.57e-09	4.59e-06	2.93e-07
Mn-54	0.00e+00	1.16e-05	2.57e-06	0.00e+00	2.71e-06	4.26e-04	6.19e-06
Mn-56	0.00e+00	4.48e-10	8.43e-11	0.00e+00	4.52e-10	3.55e-06	3.33e-05
Fe-55	1.28e-05	6.80e-06	2.10e-06	0.00e+00	0.00e+00	3.00e-05	7.75e-07
Fe-59	5.59e-06	9.04e-06	4.51e-06	0.00e+00	0.00e+00	3.43e-04	1.91e-05
Co-57	0.00e+00	2.44e-07	2.88e-07	0.00e+00	0.00e+00	1.37e-04	3.58e-06
Co-58	0.00e+00	4.79e-07	8.55e-07	0.00e+00	0.00e+00	2.99e-04	9.29e-06
Co-60	0.00e+00	3.55e-06	6.12e-06	0.00e+00	0.00e+00	1.91e-03	2.60e-05
Ni-59	1.66e-05	4.67e-06	2.83e-06	0.00e+00	0.00e+00	2.73e-05	6.29e-07
Ni-63	2.22e-04	1.25e-05	7.56e-06	0.00e+00	0.00e+00	7.43e-05	1.71e-06
Ni-65	8.08e-10	7.99e-11	4.44e-11	0.00e+00	0.00e+00	2.21e-06	2.27e-05
Cu-64	0.00e+00	5.39e-10	2.90e-10	0.00e+00	1.63e-09	2.59e-06	9.92e-06
Zn-65	1.15e-05	3.06e-05	1.90e-05	0.00e+00	1.93e-05	2.69e-04	4.41e-06
Zn-69	1.81e-11	2.61e-11	2.41e-12	0.00e+00	1.58e-11	3.84e-07	2.75e-06
Zn-69m	4.26e-09	7.28e-09	8.59e-10	0.00e+00	4.22e-09	7.36e-06	2.71e-05
Se-79	0.00e+00	1.23e-06	2.60e-07	0.00e+00	1.71e-06	1.49e-04	3.43e-06
Br-82	0.00e+00	0.00e+00	5.66e-06	0.00e+00	0.00e+00	0.00e+00	0.00e+00
Br-83	0.00e+00	0.00e+00	1.28e-07	0.00e+00	0.00e+00	0.00e+00	0.00e+00
Br-84	0.00e+00	0.00e+00	1.48e-07	0.00e+00	0.00e+00	0.00e+00	0.00e+00
Br-85	0.00e+00	0.00e+00	6.84e-09	0.00e+00	0.00e+00	0.00e+00	0.00e+00

Conversion factors are in units of mrem per pCi inhaled.

**DOSE CONVERSION FACTORS ALL AGE GROUPS
BY NUCLIDE (INHALATION AND INGESTION)**

Inhalation Dose Conversion factors for Child age group by nuclide.
Waterford Steam Electric Station

Nuclide	Organ Dose Conversion Factors						
	Bone	Liver	T. Body	Thyroid	Kidney	Lung	GI-LLI
Rb-86	0.00e+00	5.36e-05	3.09e-05	0.00e+00	0.00e+00	0.00e+00	2.16e-06
Rb-87	0.00e+00	3.16e-05	1.37e-05	0.00e+00	0.00e+00	0.00e+00	2.96e-07
Rb-88	0.00e+00	1.52e-07	9.90e-08	0.00e+00	0.00e+00	0.00e+00	4.66e-09
Rb-89	0.00e+00	9.33e-08	7.83e-08	0.00e+00	0.00e+00	0.00e+00	5.11e-10
Sr-89	1.62e-04	0.00e+00	4.66e-06	0.00e+00	0.00e+00	5.83e-04	4.52e-05
Sr-90	1.04e-02	0.00e+00	2.07e-04	0.00e+00	0.00e+00	3.99e-03	9.28e-05
Sr-91	3.28e-08	0.00e+00	1.24e-09	0.00e+00	0.00e+00	1.44e-05	4.70e-05
Sr-92	3.54e-09	0.00e+00	1.42e-10	0.00e+00	0.00e+00	6.49e-06	6.55e-05
Y-90	1.11e-06	0.00e+00	2.99e-08	0.00e+00	0.00e+00	7.07e-05	7.24e-05
Y-91	2.47e-04	0.00e+00	6.59e-06	0.00e+00	0.00e+00	7.10e-04	4.97e-05
Y-91m	1.37e-10	0.00e+00	4.98e-12	0.00e+00	0.00e+00	7.60e-07	4.64e-07
Y-92	5.50e-09	0.00e+00	1.57e-10	0.00e+00	0.00e+00	6.46e-06	6.46e-05
Y-93	5.04e-08	0.00e+00	1.38e-09	0.00e+00	0.00e+00	2.01e-05	1.05e-04
Zr-93	2.07e-04	7.80e-06	5.55e-06	0.00e+00	3.00e-05	7.10e-05	1.47e-06
Zr-95	5.13e-05	1.13e-05	1.00e-05	0.00e+00	1.61e-05	6.03e-04	1.65e-05
Zr-97	5.07e-08	7.34e-09	4.32e-09	0.00e+00	1.05e-08	3.06e-05	9.49e-05
Nb-93m	1.27e-04	3.17e-05	1.04e-05	0.00e+00	3.44e-05	1.04e-04	2.45e-06
Nb-95	6.35e-06	2.48e-06	1.77e-06	0.00e+00	2.33e-06	1.66e-04	1.00e-05
Nb-97	1.16e-10	2.08e-11	9.74e-12	0.00e+00	2.31e-11	9.23e-07	7.52e-06
Mo-93	0.00e+00	3.76e-06	1.35e-07	0.00e+00	1.06e-06	1.70e-04	3.78e-06
Mo-99	0.00e+00	4.66e-08	1.15e-08	0.00e+00	1.06e-07	3.66e-05	3.42e-05
Tc-101	2.19e-14	2.30e-14	2.91e-13	0.00e+00	3.92e-13	1.58e-07	4.41e-09
Tc-99	1.34e-07	1.49e-07	5.35e-08	0.00e+00	1.75e-06	3.37e-04	7.75e-06
Tc-99m	4.81e-13	9.41e-13	1.56e-11	0.00e+00	1.37e-11	2.57e-07	1.30e-06
Ru-103	7.55e-07	0.00e+00	2.90e-07	0.00e+00	1.90e-06	1.79e-04	1.21e-05
Ru-105	4.13e-10	0.00e+00	1.50e-10	0.00e+00	3.63e-10	4.30e-06	2.69e-05
Ru-106	3.68e-05	0.00e+00	4.57e-06	0.00e+00	4.97e-05	3.87e-03	1.16e-04
Rh-105	3.91e-09	2.10e-09	1.79e-09	0.00e+00	8.39e-09	7.82e-06	1.33e-05
Pd-107	0.00e+00	2.65e-07	2.51e-08	0.00e+00	1.97e-06	3.16e-05	7.26e-07
Pd-109	0.00e+00	1.48e-09	4.95e-10	0.00e+00	7.06e-09	6.16e-06	2.59e-05

Conversion factors are in units of mrem per pCi inhaled.

**DOSE CONVERSION FACTORS ALL AGE GROUPS
BY NUCLIDE (INHALATION AND INGESTION)**

Inhalation Dose Conversion factors for Child age group by nuclide.
Waterford Steam Electric Station

Nuclide	Organ Dose Conversion Factors						
	Bone	Liver	T. Body	Thyroid	Kidney	Lung	GI-LLI
Ag-110m	4.56e-06	3.08e-06	2.47e-06	0.00e+00	5.74e-06	1.48e-03	2.71e-05
Ag-111	1.81e-07	5.68e-08	3.75e-08	0.00e+00	1.71e-07	7.73e-05	2.98e-05
Cd-113m	0.00e+00	4.93e-04	2.12e-05	0.00e+00	5.13e-04	6.94e-04	1.63e-05
Cd-115m	0.00e+00	7.88e-05	3.39e-06	0.00e+00	5.93e-05	5.86e-04	4.97e-05
Sn-123	1.29e-04	2.14e-06	4.19e-06	2.27e-06	0.00e+00	9.59e-04	4.05e-05
Sn-125	4.95e-06	9.94e-08	2.95e-07	1.03e-07	0.00e+00	2.43e-04	7.17e-05
Sn-126	6.23e-04	1.04e-05	2.36e-05	2.84e-06	0.00e+00	3.02e-03	1.63e-05
Sb-124	1.55e-05	2.00e-07	5.41e-06	3.41e-08	0.00e+00	8.76e-04	4.43e-05
Sb-125	2.66e-05	2.05e-07	5.59e-06	2.46e-08	0.00e+00	6.27e-04	1.09e-05
Sb-126	1.72e-06	2.62e-08	6.16e-07	1.00e-08	0.00e+00	2.86e-04	5.67e-05
Sb-127	1.36e-07	2.09e-09	4.70e-08	1.51e-09	0.00e+00	6.17e-05	3.82e-05
Te-125m	1.82e-06	6.29e-07	2.47e-07	5.20e-07	0.00e+00	1.29e-04	9.13e-06
Te-127	7.49e-10	2.57e-10	1.65e-10	5.30e-10	1.91e-09	2.71e-06	1.52e-05
Te-127m	6.72e-06	2.31e-06	8.16e-07	1.64e-06	1.72e-05	4.00e-04	1.93e-05
Te-129	2.64e-11	9.45e-12	6.44e-12	1.93e-11	6.94e-11	7.93e-07	6.89e-06
Te-129m	5.19e-06	1.85e-06	8.22e-07	1.71e-06	1.36e-05	4.76e-04	4.91e-05
Te-131	5.87e-12	2.28e-12	1.78e-12	4.59e-12	1.59e-11	5.55e-07	3.60e-07
Te-131m	3.63e-08	1.60e-08	1.37e-08	2.64e-08	1.08e-07	5.56e-05	8.32e-05
Te-132	1.30e-07	7.36e-08	7.12e-08	8.58e-08	4.79e-07	1.02e-04	3.72e-05
Te-133m	2.93e-11	1.51e-11	1.50e-11	2.32e-11	1.01e-10	1.60e-06	4.77e-06
Te-134	1.53e-11	8.81e-12	9.40e-12	1.24e-11	5.71e-11	1.23e-06	4.87e-07
I-129	1.05e-05	6.40e-06	5.71e-06	4.28e-03	1.08e-05	0.00e+00	2.15e-07
I-130	2.21e-06	4.43e-06	2.28e-06	4.99e-04	6.61e-06	0.00e+00	1.38e-06
I-131	1.30e-05	1.30e-05	7.37e-06	4.39e-03	2.13e-05	0.00e+00	7.68e-07
I-132	5.72e-07	1.10e-06	5.07e-07	5.23e-05	1.69e-06	0.00e+00	8.65e-07
I-133	4.48e-06	5.49e-06	2.08e-06	1.04e-03	9.13e-06	0.00e+00	1.48e-06
I-134	3.17e-07	5.84e-07	2.69e-07	1.37e-05	8.92e-07	0.00e+00	2.58e-07
I-135	1.33e-06	2.36e-06	1.12e-06	2.14e-04	3.62e-06	0.00e+00	1.20e-06
Cs-134	1.76e-04	2.74e-04	6.07e-05	0.00e+00	8.93e-05	3.27e-05	1.04e-06
Cs-134m	6.33e-08	8.92e-08	6.12e-08	0.00e+00	4.94e-08	8.35e-09	7.92e-08

Conversion factors are in units of mrem per pCi inhaled.

**DOSE CONVERSION FACTORS ALL AGE GROUPS
BY NUCLIDE (INHALATION AND INGESTION)**

Inhalation Dose Conversion factors for Child age group by nuclide.
Waterford Steam Electric Station

Nuclide	Organ Dose Conversion Factors						
	Bone	Liver	T. Body	Thyroid	Kidney	Lung	GI-LLI
Cs-135	6.23e-05	4.13e-05	4.45e-06	0.00e+00	1.53e-05	5.22e-06	2.17e-07
Cs-136	1.76e-05	4.62e-05	3.14e-05	0.00e+00	2.58e-05	3.93e-06	1.13e-06
Cs-137	2.45e-04	2.23e-04	3.47e-05	0.00e+00	7.63e-05	2.81e-05	9.78e-07
Cs-138	1.71e-07	2.27e-07	1.50e-07	0.00e+00	1.68e-07	1.84e-08	7.29e-08
Cs-139	1.09e-07	1.15e-07	5.80e-08	0.00e+00	9.08e-08	9.36e-09	7.23e-12
Ba-139	4.98e-10	2.66e-13	1.45e-11	0.00e+00	2.33e-13	1.56e-06	1.56e-05
Ba-140	2.00e-05	1.75e-08	1.17e-06	0.00e+00	5.71e-09	4.71e-04	2.75e-05
Ba-141	5.29e-11	2.95e-14	1.72e-12	0.00e+00	2.56e-14	7.89e-07	7.44e-08
Ba-142	1.35e-11	9.73e-15	7.54e-13	0.00e+00	7.87e-15	4.44e-07	7.41e-10
La-140	1.74e-07	6.08e-08	2.04e-08	0.00e+00	0.00e+00	4.94e-05	6.10e-05
La-141	2.28e-09	5.31e-10	1.15e-10	0.00e+00	0.00e+00	4.48e-06	4.37e-05
La-142	3.50e-10	1.11e-10	3.49e-11	0.00e+00	0.00e+00	2.35e-06	2.05e-05
Ce-141	1.06e-05	5.28e-06	7.83e-07	0.00e+00	2.31e-06	1.47e-04	1.53e-05
Ce-143	9.89e-08	5.37e-08	7.77e-09	0.00e+00	2.26e-08	3.12e-05	3.44e-05
Ce-144	1.83e-03	5.72e-04	9.77e-05	0.00e+00	3.17e-04	3.23e-03	1.05e-04
Pr-143	4.99e-06	1.50e-06	2.47e-07	0.00e+00	8.11e-07	1.17e-04	2.63e-05
Pr-144	1.61e-11	4.99e-12	8.10e-13	0.00e+00	2.64e-12	4.23e-07	5.32e-08
Nd-147	2.92e-06	2.36e-06	1.84e-07	0.00e+00	1.30e-06	8.87e-05	2.22e-05
Pm-147	3.52e-04	2.52e-05	1.36e-05	0.00e+00	4.45e-05	2.20e-04	5.70e-06
Pm-148	1.61e-06	1.94e-07	1.25e-07	0.00e+00	3.30e-07	1.24e-04	6.01e-05
Pm-148m	3.31e-05	6.55e-06	6.55e-06	0.00e+00	9.74e-06	5.72e-04	3.58e-05
Pm-149	1.47e-07	1.56e-08	8.45e-09	0.00e+00	2.75e-08	2.40e-05	2.92e-05
Pm-151	3.57e-08	4.33e-09	2.82e-09	0.00e+00	7.35e-09	1.24e-05	2.50e-05
Sm-151	3.14e-04	4.75e-05	1.49e-05	0.00e+00	4.89e-05	1.48e-04	3.43e-06
Sm-153	7.24e-08	4.51e-08	4.35e-09	0.00e+00	1.37e-08	1.37e-05	1.87e-05
Eu-152	7.42e-04	1.37e-04	1.61e-04	0.00e+00	5.73e-04	9.00e-04	1.14e-05
Eu-154	2.74e-03	2.49e-04	2.27e-04	0.00e+00	1.09e-03	1.66e-03	2.98e-05
Eu-155	5.60e-04	4.05e-05	3.18e-05	0.00e+00	1.51e-04	2.79e-04	5.39e-05
Eu-156	7.89e-06	4.23e-06	8.75e-07	0.00e+00	2.72e-06	2.54e-04	4.24e-05
Tb-160	7.79e-05	0.00e+00	9.67e-06	0.00e+00	2.32e-05	5.34e-04	2.28e-05

Conversion factors are in units of mrem per pCi inhaled.

**DOSE CONVERSION FACTORS ALL AGE GROUPS
BY NUCLIDE (INHALATION AND INGESTION)**

Inhalation Dose Conversion factors for Child age group by nuclide.
Waterford Steam Electric Station

Nuclide	Organ Dose Conversion Factors						
	Bone	Liver	T. Body	Thyroid	Kidney	Lung	GI-LLI
Ho-166m	1.34e-03	2.81e-04	2.37e-04	0.00e+00	4.01e-04	1.13e-03	1.63e-05
W-181	2.66e-08	6.52e-09	8.99e-10	0.00e+00	0.00e+00	5.71e-06	2.61e-07
W-185	8.31e-07	2.08e-07	2.91e-08	0.00e+00	0.00e+00	1.86e-04	1.11e-05
W-187	4.41e-09	2.61e-09	1.17e-09	0.00e+00	0.00e+00	1.11e-05	2.46e-05
Pb-210	8.03e-02	1.85e-02	3.18e-03	0.00e+00	6.31e-02	8.74e-02	1.55e-06
Bi-210	9.85e-07	5.11e-06	5.65e-07	0.00e+00	5.76e-05	3.70e-03	3.21e-05
Po-210	1.70e-03	2.76e-03	4.09e-04	0.00e+00	8.85e-03	1.05e-01	4.32e-05
Ra-223	7.69e-04	8.89e-07	1.54e-04	0.00e+00	2.36e-05	8.48e-02	3.00e-04
Ra-224	8.44e-05	1.53e-07	1.69e-05	0.00e+00	4.06e-06	2.92e-02	3.34e-04
Ra-225	1.28e-03	1.14e-06	2.56e-04	0.00e+00	3.02e-05	9.74e-02	2.84e-04
Ra-226	2.34e-01	7.66e-06	1.92e-01	0.00e+00	2.03e-04	3.90e-01	3.02e-04
Ra-228	1.49e-01	3.94e-06	1.68e-01	0.00e+00	1.04e-04	5.37e-01	5.14e-05
Ac-225	1.81e-03	1.87e-03	1.21e-04	0.00e+00	1.99e-04	7.37e-02	2.67e-04
Ac-227	4.96e+00	8.05e-01	3.07e-01	0.00e+00	1.77e-01	8.04e-01	5.22e-05
Th-227	9.24e-04	1.26e-05	2.67e-05	0.00e+00	6.67e-05	1.26e-01	3.49e-04
Th-228	8.06e-01	1.04e-02	2.72e-02	0.00e+00	5.41e-02	3.34e+00	3.59e-04
Th-229	2.18e+01	5.74e-01	3.63e-01	0.00e+00	2.83e+00	1.08e+01	4.99e-05
Th-230	3.30e+00	1.73e-01	9.20e-02	0.00e+00	8.52e-01	1.85e+00	3.84e-05
Th-232	3.68e+00	1.47e-01	1.28e-03	0.00e+00	7.28e-01	1.77e+00	3.27e-05
Th-234	6.94e-06	3.07e-07	2.00e-07	0.00e+00	1.62e-06	6.31e-04	7.32e-05
Pa-231	8.62e+00	2.86e-01	3.43e-01	0.00e+00	1.56e+00	1.92e-01	4.57e-05
Pa-233	4.14e-06	6.48e-07	7.25e-07	0.00e+00	2.38e-06	9.77e-05	8.95e-06
U-232	2.19e-01	0.00e+00	1.56e-02	0.00e+00	1.67e-02	7.42e-01	4.33e-05
U-233	4.64e-02	0.00e+00	2.82e-03	0.00e+00	7.62e-03	1.77e-01	4.00e-05
U-234	4.46e-02	0.00e+00	2.76e-03	0.00e+00	7.47e-03	1.74e-01	3.92e-05
U-235	4.27e-02	0.00e+00	2.59e-03	0.00e+00	7.01e-03	1.63e-01	4.98e-05
U-236	4.27e-02	0.00e+00	2.65e-03	0.00e+00	7.16e-03	1.67e-01	3.67e-05
U-237	1.57e-07	0.00e+00	4.17e-08	0.00e+00	4.53e-07	3.40e-05	1.29e-05
U-238	4.09e-02	0.00e+00	2.42e-03	0.00e+00	6.55e-03	1.53e-01	3.51e-05
Np-237	2.72e+00	1.62e+00	1.19e-01	0.00e+00	7.41e-01	1.74e-01	5.06e-05

Conversion factors are in units of mrem per pCi inhaled.

**DOSE CONVERSION FACTORS ALL AGE GROUPS
BY NUCLIDE (INHALATION AND INGESTION)**

Inhalation Dose Conversion factors for Child age group by nuclide.
Waterford Steam Electric Station

Nuclide	Organ Dose Conversion Factors						
	Bone	Liver	T. Body	Thyroid	Kidney	Lung	GI-LLI
Np-238	1.26e-06	2.30e-07	1.97e-08	0.00e+00	8.16e-08	3.39e-05	2.50e-05
Np-239	1.26e-07	8.14e-08	6.35e-09	0.00e+00	2.63e-08	1.57e-05	1.73e-05
Pu-238	2.55e+00	1.60e+00	1.21e-01	0.00e+00	4.47e-01	6.08e-01	4.65e-05
Pu-239	2.79e+00	1.68e+00	1.28e-01	0.00e+00	4.78e-01	5.72e-01	4.24e-05
Pu-240	2.79e+00	1.68e+00	1.27e-01	0.00e+00	4.77e-01	5.71e-01	4.33e-05
Pu-241	7.94e-02	1.75e-02	2.93e-03	0.00e+00	1.10e-02	5.06e-04	8.90e-07
Pu-242	2.59e+00	1.62e+00	1.23e-01	0.00e+00	4.60e-01	5.50e-01	4.16e-05
Pu-244	3.02e+00	1.85e+00	1.41e-01	0.00e+00	5.27e-01	6.30e-01	6.20e-05
Am-241	2.97e+00	1.84e+00	1.24e-01	0.00e+00	7.63e-01	2.02e-01	4.73e-05
Am-242m	3.07e+00	1.76e+00	1.27e-01	0.00e+00	7.71e-01	8.14e-02	5.96e-05
Am-243	2.94e+00	1.78e+00	1.20e-01	0.00e+00	7.42e-01	1.92e-01	5.55e-05
Cm-242	9.48e-02	5.68e-02	4.20e-03	0.00e+00	1.34e-02	1.31e-01	5.06e-05
Cm-243	2.32e+00	1.42e+00	9.95e-02	0.00e+00	3.74e-01	2.10e-01	4.98e-05
Cm-244	1.94e+00	1.18e+00	8.31e-02	0.00e+00	3.06e-01	2.02e-01	4.82e-05
Cm-245	3.05e+00	1.84e+00	1.28e-01	0.00e+00	5.03e-01	1.95e-01	4.49e-05
Cm-246	3.02e+00	1.84e+00	1.28e-01	0.00e+00	5.03e-01	1.99e-01	4.41e-05
Cm-247	2.94e+00	1.82e+00	1.26e-01	0.00e+00	4.95e-01	1.95e-01	5.80e-05
Cm-248	2.45e+01	1.50e+01	1.04e+00	0.00e+00	4.08e+00	1.61e+00	9.35e-04
Cf-252	2.18e+00	0.00e+00	9.33e-02	0.00e+00	0.00e+00	6.62e-01	1.84e-04

Conversion factors are in units of mrem per pCi inhaled.

**DOSE CONVERSION FACTORS ALL AGE GROUPS
BY NUCLIDE (INHALATION AND INGESTION)**

Inhalation Dose Conversion factors for Infant age group by nuclide.
Waterford Steam Electric Station

Nuclide	Organ Dose Conversion Factors						
	Bone	Liver	T. Body	Thyroid	Kidney	Lung	GI-LLI
H-3	0.00e+00	2.63e-07	2.63e-07	2.63e-07	2.63e-07	2.63e-07	2.63e-07
Be-10	9.49e-04	1.25e-04	2.65e-05	0.00e+00	0.00e+00	1.49e-03	1.73e-05
C-14	1.89e-05	3.79e-06	3.79e-06	3.79e-06	3.79e-06	3.79e-06	3.79e-06
N-13	4.39e-08	4.39e-08	4.39e-08	4.39e-08	4.39e-08	4.39e-08	4.39e-08
F-18	3.92e-06	0.00e+00	3.33e-07	0.00e+00	0.00e+00	0.00e+00	6.10e-07
Na-22	7.37e-05	7.37e-05	7.37e-05	7.37e-05	7.37e-05	7.37e-05	7.37e-05
Na-24	7.54e-06	7.54e-06	7.54e-06	7.54e-06	7.54e-06	7.54e-06	7.54e-06
P-32	1.45e-03	8.03e-05	5.53e-05	0.00e+00	0.00e+00	0.00e+00	1.15e-05
Ca-41	7.48e-05	0.00e+00	8.16e-06	0.00e+00	0.00e+00	6.94e-02	2.96e-07
Sc-46	3.75e-04	5.41e-04	1.69e-04	0.00e+00	3.56e-04	0.00e+00	2.19e-05
Cr-51	0.00e+00	0.00e+00	6.39e-08	4.11e-08	9.45e-09	9.17e-06	2.55e-07
Mn-54	0.00e+00	1.81e-05	3.56e-06	0.00e+00	3.56e-06	7.14e-04	5.04e-06
Mn-56	0.00e+00	1.10e-09	1.58e-10	0.00e+00	7.86e-10	8.95e-06	5.12e-05
Fe-55	1.41e-05	8.39e-06	2.38e-06	0.00e+00	0.00e+00	6.21e-05	7.82e-07
Fe-59	9.69e-06	1.68e-05	6.77e-06	0.00e+00	0.00e+00	7.25e-04	1.77e-05
Co-57	0.00e+00	4.65e-07	4.58e-07	0.00e+00	0.00e+00	2.71e-04	3.47e-06
Co-58	0.00e+00	8.71e-07	1.30e-06	0.00e+00	0.00e+00	5.55e-04	7.95e-06
Co-60	0.00e+00	5.73e-06	8.41e-06	0.00e+00	0.00e+00	3.22e-03	2.28e-05
Ni-59	1.81e-05	5.44e-06	3.10e-06	0.00e+00	0.00e+00	5.48e-05	6.34e-07
Ni-63	2.42e-04	1.46e-05	8.29e-06	0.00e+00	0.00e+00	1.49e-04	1.73e-06
Ni-65	1.71e-09	2.03e-10	8.79e-11	0.00e+00	0.00e+00	5.80e-06	3.58e-05
Cu-64	0.00e+00	1.34e-09	5.53e-10	0.00e+00	2.84e-09	6.64e-06	1.07e-05
Zn-65	1.38e-05	4.47e-05	2.22e-05	0.00e+00	2.32e-05	4.62e-04	3.67e-05
Zn-69	3.85e-11	6.91e-11	5.13e-12	0.00e+00	2.87e-11	1.05e-06	9.44e-06
Zn-69m	8.98e-09	1.84e-08	1.67e-09	0.00e+00	7.45e-09	1.91e-05	2.92e-05
Se-79	0.00e+00	2.25e-06	4.20e-07	0.00e+00	2.47e-06	2.99e-04	3.46e-06
Br-82	0.00e+00	0.00e+00	9.49e-06	0.00e+00	0.00e+00	0.00e+00	0.00e+00
Br-83	0.00e+00	0.00e+00	2.72e-07	0.00e+00	0.00e+00	0.00e+00	0.00e+00
Br-84	0.00e+00	0.00e+00	2.86e-07	0.00e+00	0.00e+00	0.00e+00	0.00e+00
Br-85	0.00e+00	0.00e+00	1.46e-08	0.00e+00	0.00e+00	0.00e+00	0.00e+00

Conversion factors are in units of mrem per pCi inhaled.

**DOSE CONVERSION FACTORS ALL AGE GROUPS
BY NUCLIDE (INHALATION AND INGESTION)**

Inhalation Dose Conversion factors for Infant age group by nuclide.
Waterford Steam Electric Station

Nuclide	Organ Dose Conversion Factors						
	Bone	Liver	T. Body	Thyroid	Kidney	Lung	GI-LLI
Rb-86	0.00e+00	1.36e-04	6.30e-05	0.00e+00	0.00e+00	0.00e+00	2.17e-06
Rb-87	0.00e+00	7.11e-05	2.64e-05	0.00e+00	0.00e+00	0.00e+00	2.99e-07
Rb-88	0.00e+00	3.98e-07	2.05e-07	0.00e+00	0.00e+00	0.00e+00	2.42e-07
Rb-89	0.00e+00	2.29e-07	1.47e-07	0.00e+00	0.00e+00	0.00e+00	4.87e-08
Sr-89	2.84e-04	0.00e+00	8.15e-06	0.00e+00	0.00e+00	1.45e-03	4.57e-05
Sr-90	1.11e-02	0.00e+00	2.23e-04	0.00e+00	0.00e+00	8.03e-03	9.36e-05
Sr-91	6.83e-08	0.00e+00	2.47e-09	0.00e+00	0.00e+00	3.76e-05	5.24e-05
Sr-92	7.50e-09	0.00e+00	2.79e-10	0.00e+00	0.00e+00	1.70e-05	1.00e-04
Y-90	2.35e-06	0.00e+00	6.30e-08	0.00e+00	0.00e+00	1.92e-04	7.43e-05
Y-91	4.20e-04	0.00e+00	1.12e-05	0.00e+00	0.00e+00	1.75e-03	5.02e-05
Y-91m	2.91e-10	0.00e+00	9.90e-12	0.00e+00	0.00e+00	1.99e-06	1.68e-06
Y-92	1.17e-08	0.00e+00	3.29e-10	0.00e+00	0.00e+00	1.75e-05	9.04e-05
Y-93	1.07e-07	0.00e+00	2.91e-09	0.00e+00	0.00e+00	5.46e-05	1.19e-04
Zr-93	2.24e-04	9.51e-06	6.18e-06	0.00e+00	3.19e-05	1.37e-04	1.48e-06
Zr-95	8.24e-05	1.99e-05	1.45e-05	0.00e+00	2.22e-05	1.25e-03	1.55e-05
Zr-97	1.07e-07	1.83e-08	8.36e-09	0.00e+00	1.85e-08	7.88e-05	1.00e-04
Nb-93m	1.38e-04	3.59e-05	1.15e-05	0.00e+00	3.68e-05	2.09e-04	2.47e-06
Nb-95	1.12e-05	4.59e-06	2.70e-06	0.00e+00	3.37e-06	3.42e-04	9.05e-06
Nb-97	2.44e-10	5.21e-11	1.88e-11	0.00e+00	4.07e-11	2.37e-06	1.92e-05
Mo-93	0.00e+00	6.46e-06	2.22e-07	0.00e+00	1.54e-06	3.40e-04	3.76e-06
Mo-99	0.00e+00	1.18e-07	2.31e-08	0.00e+00	1.89e-07	9.63e-05	3.48e-05
Tc-101	4.65e-14	5.88e-14	5.80e-13	0.00e+00	6.99e-13	4.17e-07	6.03e-07
Tc-99	2.09e-07	2.68e-07	8.85e-08	0.00e+00	2.49e-06	6.77e-04	7.82e-06
Tc-99m	9.98e-13	2.06e-12	2.66e-11	0.00e+00	2.22e-11	5.79e-07	1.45e-06
Ru-103	1.44e-06	0.00e+00	4.85e-07	0.00e+00	3.03e-06	3.94e-04	1.15e-05
Ru-105	8.74e-10	0.00e+00	2.93e-10	0.00e+00	6.42e-10	1.12e-05	3.46e-05
Ru-106	6.20e-05	0.00e+00	7.77e-06	0.00e+00	7.61e-05	8.26e-03	1.17e-04
Rh-105	8.26e-09	5.41e-09	3.63e-09	0.00e+00	1.50e-08	2.08e-05	1.37e-05
Pd-107	0.00e+00	4.92e-07	4.11e-08	0.00e+00	2.75e-06	6.34e-05	7.33e-07
Pd-109	0.00e+00	3.92e-09	1.05e-09	0.00e+00	1.28e-08	1.68e-05	2.85e-05

Conversion factors are in units of mrem per pCi inhaled.

**DOSE CONVERSION FACTORS ALL AGE GROUPS
BY NUCLIDE (INHALATION AND INGESTION)**

Inhalation Dose Conversion factors for Infant age group by nuclide.
Waterford Steam Electric Station

Nuclide	Organ Dose Conversion Factors						
	Bone	Liver	T. Body	Thyroid	Kidney	Lung	GI-LLI
Ag-110m	7.13e-06	5.16e-06	3.57e-06	0.00e+00	7.80e-06	2.62e-03	2.36e-05
Ag-111	3.75e-07	1.45e-07	7.75e-08	0.00e+00	3.05e-07	2.06e-04	3.02e-05
Cd-113m	0.00e+00	6.67e-04	2.64e-05	0.00e+00	5.80e-04	1.40e-03	1.65e-05
Cd-115m	0.00e+00	1.73e-04	6.19e-06	0.00e+00	9.41e-05	1.47e-03	5.02e-05
Sn-123	2.09e-04	4.21e-06	7.28e-06	4.27e-06	0.00e+00	2.22e-03	4.08e-05
Sn-125	1.01e-05	2.51e-07	6.00e-07	2.47e-07	0.00e+00	6.43e-04	7.26e-05
Sn-126	8.30e-04	1.44e-05	3.52e-05	3.84e-06	0.00e+00	4.93e-03	1.65e-05
Sb-124	2.71e-05	3.97e-07	8.56e-06	7.18e-08	0.00e+00	1.89e-03	4.22e-05
Sb-125	3.69e-05	3.41e-07	7.78e-06	4.45e-08	0.00e+00	1.17e-03	1.05e-05
Sb-126	3.08e-06	6.01e-08	1.11e-06	2.35e-08	0.00e+00	6.88e-04	5.33e-05
Sb-127	2.82e-07	5.04e-09	8.76e-08	3.60e-09	0.00e+00	1.54e-04	3.78e-05
Te-125m	3.40e-06	1.42e-06	4.70e-07	1.16e-06	0.00e+00	3.19e-04	9.22e-06
Te-127	1.59e-09	6.81e-10	3.49e-10	1.32e-09	3.47e-09	7.39e-06	1.74e-05
Te-127m	1.19e-05	4.93e-06	1.48e-06	3.48e-06	2.68e-05	9.37e-04	1.95e-05
Te-129	5.63e-11	2.48e-11	1.34e-11	4.82e-11	1.25e-10	2.14e-06	1.88e-05
Te-129m	1.01e-05	4.35e-06	1.59e-06	3.91e-06	2.27e-05	1.20e-03	4.93e-05
Te-131	1.24e-11	5.87e-12	3.57e-12	1.13e-11	2.85e-11	1.47e-06	5.87e-06
Te-131m	7.62e-08	3.93e-08	2.59e-08	6.38e-08	1.89e-07	1.42e-04	8.51e-05
Te-132	2.66e-07	1.69e-07	1.26e-07	1.99e-07	7.39e-07	2.43e-04	3.15e-05
Te-133m	6.13e-11	3.59e-11	2.74e-11	5.52e-11	1.72e-10	3.92e-06	1.59e-05
Te-134	3.18e-11	2.04e-11	1.68e-11	2.91e-11	9.59e-11	2.93e-06	2.53e-06
I-129	2.16e-05	1.59e-05	1.16e-05	1.04e-02	1.88e-05	0.00e+00	2.12e-07
I-130	4.54e-06	9.91e-06	3.98e-06	1.14e-03	1.09e-05	0.00e+00	1.42e-06
I-131	2.71e-05	3.17e-05	1.40e-05	1.06e-02	3.70e-05	0.00e+00	7.56e-07
I-132	1.21e-06	2.53e-06	8.99e-07	1.21e-04	2.82e-06	0.00e+00	1.36e-06
I-133	9.46e-06	1.37e-05	4.00e-06	2.54e-03	1.60e-05	0.00e+00	1.54e-06
I-134	6.58e-07	1.34e-06	4.75e-07	3.18e-05	1.49e-06	0.00e+00	9.21e-07
I-135	2.76e-06	5.43e-06	1.98e-06	4.97e-04	6.05e-06	0.00e+00	1.31e-06
Cs-134	2.83e-04	5.02e-04	5.32e-05	0.00e+00	1.36e-04	5.69e-05	9.53e-07
Cs-134m	1.32e-07	2.10e-07	1.11e-07	0.00e+00	8.50e-08	2.00e-08	1.16e-07

Conversion factors are in units of mrem per pCi inhaled.

**DOSE CONVERSION FACTORS ALL AGE GROUPS
BY NUCLIDE (INHALATION AND INGESTION)**

Inhalation Dose Conversion factors for Infant age group by nuclide.
Waterford Steam Electric Station

Nuclide	Organ Dose Conversion Factors						
	Bone	Liver	T. Body	Thyroid	Kidney	Lung	GI-LLI
Cs-135	1.00e-04	8.66e-05	4.73e-06	0.00e+00	2.58e-05	1.01e-05	2.18e-07
Cs-136	3.45e-05	9.61e-05	3.78e-05	0.00e+00	4.03e-05	8.40e-06	1.02e-06
Cs-137	3.92e-04	4.37e-04	3.25e-05	0.00e+00	1.23e-04	5.09e-05	9.53e-07
Cs-138	3.61e-07	5.58e-07	2.84e-07	0.00e+00	2.93e-07	4.67e-08	6.26e-07
Cs-139	2.32e-07	3.03e-07	1.22e-07	0.00e+00	1.65e-07	2.53e-08	1.33e-08
Ba-139	1.06e-09	7.03e-13	3.07e-11	0.00e+00	4.23e-13	4.25e-06	3.64e-05
Ba-140	4.00e-05	4.00e-08	2.07e-06	0.00e+00	9.59e-09	1.14e-03	2.74e-05
Ba-141	1.12e-10	7.70e-14	3.55e-12	0.00e+00	4.64e-14	2.12e-06	3.39e-06
Ba-142	2.84e-11	2.36e-14	1.40e-12	0.00e+00	1.36e-14	1.11e-06	4.95e-07
La-140	3.61e-07	1.43e-07	3.68e-08	0.00e+00	0.00e+00	1.20e-04	6.06e-05
La-141	4.85e-09	1.40e-09	2.45e-10	0.00e+00	0.00e+00	1.22e-05	5.96e-05
La-142	7.36e-10	2.69e-10	6.46e-11	0.00e+00	0.00e+00	5.87e-06	4.25e-05
Ce-141	1.98e-05	1.19e-05	1.42e-06	0.00e+00	3.75e-06	3.69e-04	1.54e-05
Ce-143	2.09e-07	1.38e-07	1.58e-08	0.00e+00	4.03e-08	8.30e-05	3.55e-05
Ce-144	2.28e-03	8.65e-04	1.26e-04	0.00e+00	3.84e-04	7.03e-03	1.06e-04
Pr-143	1.00e-05	3.74e-06	4.99e-07	0.00e+00	1.41e-06	3.09e-04	2.66e-05
Pr-144	3.42e-11	1.32e-11	1.72e-12	0.00e+00	4.80e-12	1.15e-06	3.06e-06
Nd-147	5.67e-06	5.81e-06	3.57e-07	0.00e+00	2.25e-06	2.30e-04	2.23e-05
Pm-147	3.91e-04	3.07e-05	1.56e-05	0.00e+00	4.93e-05	4.55e-04	5.75e-06
Pm-148	3.34e-06	4.82e-07	2.44e-07	0.00e+00	5.76e-07	3.20e-04	6.04e-05
Pm-148m	5.00e-05	1.24e-05	9.94e-06	0.00e+00	1.45e-05	1.22e-03	3.37e-05
Pm-149	3.10e-07	4.08e-08	1.78e-08	0.00e+00	4.96e-08	6.50e-05	3.01e-05
Pm-151	7.52e-08	1.10e-08	5.55e-09	0.00e+00	1.30e-08	3.25e-05	2.58e-05
Sm-151	3.38e-04	6.45e-05	1.63e-05	0.00e+00	5.24e-05	2.98e-04	3.46e-06
Sm-153	1.53e-07	1.18e-07	9.06e-09	0.00e+00	2.47e-08	3.70e-05	1.93e-05
Eu-152	7.83e-04	1.77e-04	1.72e-04	0.00e+00	5.94e-04	1.48e-03	9.88e-06
Eu-154	2.96e-03	3.46e-04	2.45e-04	0.00e+00	1.14e-03	3.05e-03	2.84e-05
Eu-155	5.97e-04	5.72e-05	3.46e-05	0.00e+00	1.58e-04	5.20e-04	5.19e-05
Eu-156	1.56e-05	9.59e-06	1.54e-06	0.00e+00	4.48e-06	6.12e-04	4.14e-05
Tb-160	1.12e-04	0.00e+00	1.40e-05	0.00e+00	3.20e-05	1.11e-03	2.14e-05

Conversion factors are in units of mrem per pCi inhaled.

**DOSE CONVERSION FACTORS ALL AGE GROUPS
BY NUCLIDE (INHALATION AND INGESTION)**

Inhalation Dose Conversion factors for Infant age group by nuclide.
Waterford Steam Electric Station

Nuclide	Organ Dose Conversion Factors						
	Bone	Liver	T. Body	Thyroid	Kidney	Lung	GI-LLI
Ho-166m	1.45e-03	3.07e-04	2.51e-04	0.00e+00	4.22e-04	2.05e-03	1.65e-05
W-181	4.86e-08	1.46e-08	1.67e-09	0.00e+00	0.00e+00	1.33e-05	2.63e-07
W-185	1.57e-06	4.83e-07	5.58e-08	0.00e+00	0.00e+00	4.48e-04	1.12e-05
W-187	9.26e-09	6.44e-09	2.23e-09	0.00e+00	0.00e+00	2.83e-05	2.54e-05
Pb-210	8.62e-02	2.02e-02	3.43e-03	0.00e+00	6.85e-02	1.76e-01	1.57e-06
Bi-210	2.06e-06	1.33e-05	1.18e-06	0.00e+00	1.03e-04	9.96e-03	3.27e-05
Po-210	2.98e-03	5.63e-03	7.12e-04	0.00e+00	1.30e-02	2.40e-01	4.36e-05
Ra-223	1.56e-03	2.26e-06	3.12e-04	0.00e+00	4.16e-05	2.25e-01	3.04e-04
Ra-224	1.77e-04	4.00e-07	3.54e-05	0.00e+00	7.30e-06	7.91e-02	3.42e-04
Ra-225	2.57e-03	2.88e-06	5.13e-04	0.00e+00	5.31e-05	2.57e-01	2.87e-04
Ra-226	2.48e-01	1.46e-05	2.05e-01	0.00e+00	2.94e-04	7.83e-01	3.05e-04
Ra-228	1.60e-01	7.61e-06	1.80e-01	0.00e+00	1.53e-04	1.09e+00	5.19e-05
Ac-225	3.69e-03	4.72e-03	2.48e-04	0.00e+00	3.49e-04	1.96e-01	2.71e-04
Ac-227	5.29e+00	8.76e-01	3.28e-01	0.00e+00	1.86e-01	1.62e+00	5.27e-05
Th-227	1.82e-03	3.03e-05	5.24e-05	0.00e+00	1.13e-04	3.27e-01	3.53e-04
Th-228	8.46e-01	1.10e-02	2.86e-02	0.00e+00	5.61e-02	4.65e+00	3.62e-04
Th-229	2.28e+01	5.94e-01	3.81e-01	0.00e+00	9.32e-01	1.27e+01	5.02e-05
Th-230	3.46e+00	1.79e-01	9.65e-02	0.00e+00	8.82e-01	2.18e+00	3.87e-05
Th-232	3.86e+00	1.53e-01	2.29e-03	0.00e+00	7.54e-01	2.09e+00	3.29e-05
Th-234	1.33e-05	7.17e-07	3.84e-07	0.00e+00	2.70e-06	1.62e-03	7.40e-05
Pa-231	9.10e+00	3.00e-01	3.62e-01	0.00e+00	1.62e+00	3.85e-01	4.61e-05
Pa-233	6.84e-06	1.32e-06	1.19e-06	0.00e+00	3.68e-06	2.19e-04	9.04e-06
U-232	2.57e-01	0.00e+00	2.13e-02	0.00e+00	2.40e-02	1.49e+00	4.36e-05
U-233	5.44e-02	0.00e+00	3.83e-03	0.00e+00	1.09e-02	3.56e-01	4.03e-05
U-234	5.22e-02	0.00e+00	3.75e-03	0.00e+00	1.07e-02	3.49e-01	3.95e-05
U-235	5.01e-02	0.00e+00	3.52e-03	0.00e+00	1.01e-02	3.28e-01	5.02e-05
U-236	5.01e-02	0.00e+00	3.60e-03	0.00e+00	1.03e-02	3.35e-01	3.71e-05
U-237	3.25e-07	0.00e+00	8.65e-08	0.00e+00	8.08e-07	9.13e-05	1.31e-05
U-238	4.79e-02	0.00e+00	3.29e-03	0.00e+00	9.40e-03	3.06e-01	3.54e-05
Np-237	2.88e+00	1.71e+00	1.26e-01	0.00e+00	7.69e-01	3.49e-01	5.10e-05

Conversion factors are in units of mrem per pCi inhaled.

**DOSE CONVERSION FACTORS ALL AGE GROUPS
BY NUCLIDE (INHALATION AND INGESTION)**

Inhalation Dose Conversion factors for Infant age group by nuclide.
Waterford Steam Electric Station

Nuclide	Organ Dose Conversion Factors						
	Bone	Liver	T. Body	Thyroid	Kidney	Lung	GI-LLI
Np-238	2.67e-06	6.05e-07	4.16e-08	0.00e+00	1.47e-07	9.19e-05	2.58e-05
Np-239	2.65e-07	2.13e-07	1.34e-08	0.00e+00	4.73e-08	4.25e-05	1.78e-05
Pu-238	2.69e+00	1.68e+00	1.27e-01	0.00e+00	4.64e-01	9.03e-01	4.69e-05
Pu-239	2.93e+00	1.76e+00	1.34e-01	0.00e+00	4.95e-01	8.47e-01	4.28e-05
Pu-240	2.93e+00	1.75e+00	1.34e-01	0.00e+00	4.94e-01	8.47e-01	4.36e-05
Pu-241	8.43e-02	1.85e-02	3.11e-03	0.00e+00	1.15e-02	7.62e-04	8.97e-07
Pu-242	2.72e+00	1.69e+00	1.29e-01	0.00e+00	4.77e-01	8.15e-01	4.20e-05
Pu-244	3.17e+00	1.94e+00	1.48e-01	0.00e+00	5.46e-01	9.33e-01	6.26e-05
Am-241	3.15e+00	1.95e+00	1.31e-01	0.00e+00	7.94e-01	4.06e-01	4.78e-05
Am-242m	3.25e+00	1.86e+00	1.35e-01	0.00e+00	8.03e-01	1.64e-01	6.01e-05
Am-243	3.10e+00	1.88e+00	1.27e-01	0.00e+00	7.72e-01	3.85e-01	5.60e-05
Cm-242	1.28e-01	8.65e-02	5.70e-03	0.00e+00	1.69e-02	2.97e-01	5.10e-05
Cm-243	2.47e+00	1.52e+00	1.06e-01	0.00e+00	3.91e-01	4.24e-01	5.02e-05
Cm-244	2.07e+00	1.27e+00	8.89e-02	0.00e+00	3.21e-01	4.08e-01	4.86e-05
Cm-245	3.22e+00	1.96e+00	1.36e-01	0.00e+00	5.23e-01	3.92e-01	4.53e-05
Cm-246	3.20e+00	1.96e+00	1.36e-01	0.00e+00	5.23e-01	3.99e-01	4.45e-05
Cm-247	3.11e+00	1.93e+00	1.33e-01	0.00e+00	5.15e-01	3.92e-01	5.85e-05
Cm-248	2.58e+01	1.59e+01	1.10e+00	0.00e+00	4.24e+00	3.23e+00	9.43e-04
Cf-252	2.37e+00	0.00e+00	1.01e-01	0.00e+00	0.00e+00	1.37e+00	1.85e-04

Conversion factors are in units of mrem per pCi inhaled.

**DOSE CONVERSION FACTORS ALL AGE GROUPS
BY NUCLIDE (INHALATION AND INGESTION)**

Ingestion Dose Conversion factors for Adult age group by nuclide.
Waterford Steam Electric Station

Nuclide	Organ Dose Conversion Factors						
	Bone	Liver	T. Body	Thyroid	Kidney	Lung	GI-LLI
H-3	0.00e+00	5.99e-08	5.99e-08	5.99e-08	5.99e-08	5.99e-08	5.99e-08
Be-10	3.18e-06	4.91e-07	7.94e-08	0.00e+00	3.71e-07	0.00e+00	2.68e-05
C-14	2.84e-06	5.68e-07	5.68e-07	5.68e-07	5.68e-07	5.68e-07	5.68e-07
N-13	8.36e-09	8.36e-09	8.36e-09	8.36e-09	8.36e-09	8.36e-09	8.36e-09
F-18	6.24e-07	0.00e+00	6.92e-08	0.00e+00	0.00e+00	0.00e+00	1.85e-08
Na-22	1.74e-05	1.74e-05	1.74e-05	1.74e-05	1.74e-05	1.74e-05	1.74e-05
Na-24	1.70e-06	1.70e-06	1.70e-06	1.70e-06	1.70e-06	1.70e-06	1.70e-06
P-32	1.93e-04	1.20e-05	7.46e-06	0.00e+00	0.00e+00	0.00e+00	2.17e-05
Ca-41	1.85e-04	0.00e+00	2.00e-05	0.00e+00	0.00e+00	0.00e+00	1.84e-07
Sc-46	5.51e-09	1.07e-08	3.11e-09	0.00e+00	9.99e-09	0.00e+00	5.21e-05
Cr-51	0.00e+00	0.00e+00	2.66e-09	1.59e-09	5.86e-10	3.53e-09	6.69e-07
Mn-54	0.00e+00	4.57e-06	8.72e-07	0.00e+00	1.36e-06	0.00e+00	1.40e-05
Mn-56	0.00e+00	1.15e-07	2.04e-08	0.00e+00	1.46e-07	0.00e+00	3.67e-06
Fe-55	2.75e-06	1.90e-06	4.43e-07	0.00e+00	0.00e+00	1.06e-06	1.09e-06
Fe-59	4.34e-06	1.02e-05	3.91e-06	0.00e+00	0.00e+00	2.85e-06	3.40e-05
Co-57	0.00e+00	1.75e-07	2.91e-07	0.00e+00	0.00e+00	0.00e+00	4.44e-06
Co-58	0.00e+00	7.45e-07	1.67e-06	0.00e+00	0.00e+00	0.00e+00	1.51e-05
Co-60	0.00e+00	2.14e-06	4.72e-06	0.00e+00	0.00e+00	0.00e+00	4.02e-05
Ni-59	9.76e-06	3.35e-06	1.63e-06	0.00e+00	0.00e+00	0.00e+00	6.90e-07
Ni-63	1.30e-04	9.01e-06	4.36e-06	0.00e+00	0.00e+00	0.00e+00	1.88e-06
Ni-65	5.28e-07	6.86e-08	3.13e-08	0.00e+00	0.00e+00	0.00e+00	1.74e-06
Cu-64	0.00e+00	8.33e-08	3.91e-08	0.00e+00	2.10e-07	0.00e+00	7.10e-06
Zn-65	4.84e-06	1.54e-05	6.96e-06	0.00e+00	1.03e-05	0.00e+00	9.70e-06
Zn-69	1.03e-08	1.97e-08	1.37e-09	0.00e+00	1.28e-08	0.00e+00	2.96e-09
Zn-69m	1.70e-07	4.08e-07	3.73e-08	0.00e+00	2.47e-07	0.00e+00	2.49e-05
Se-79	0.00e+00	2.63e-06	4.39e-07	0.00e+00	4.55e-06	0.00e+00	5.38e-07
Br-82	0.00e+00	0.00e+00	2.26e-06	0.00e+00	0.00e+00	0.00e+00	2.59e-06
Br-83	0.00e+00	0.00e+00	4.02e-08	0.00e+00	0.00e+00	0.00e+00	5.79e-08
Br-84	0.00e+00	0.00e+00	5.21e-08	0.00e+00	0.00e+00	0.00e+00	4.09e-13
Br-85	0.00e+00	0.00e+00	2.14e-09	0.00e+00	0.00e+00	0.00e+00	0.00e+00

Conversion factors are in units of mrem per pCi ingested.

**DOSE CONVERSION FACTORS ALL AGE GROUPS
BY NUCLIDE (INHALATION AND INGESTION)**

Ingestion Dose Conversion factors for Adult age group by nuclide.
Waterford Steam Electric Station

Nuclide	Organ Dose Conversion Factors						
	Bone	Liver	T. Body	Thyroid	Kidney	Lung	GI-LLI
Rb-86	0.00e+00	2.11e-05	9.83e-06	0.00e+00	0.00e+00	0.00e+00	4.16e-06
Rb-87	0.00e+00	1.23e-05	4.28e-06	0.00e+00	0.00e+00	0.00e+00	5.76e-07
Rb-88	0.00e+00	6.05e-08	3.21e-08	0.00e+00	0.00e+00	0.00e+00	8.36e-19
Rb-89	0.00e+00	4.01e-08	2.82e-08	0.00e+00	0.00e+00	0.00e+00	2.33e-21
Sr-89	3.08e-04	0.00e+00	8.84e-06	0.00e+00	0.00e+00	0.00e+00	4.94e-05
Sr-90	8.71e-03	0.00e+00	1.75e-04	0.00e+00	0.00e+00	0.00e+00	2.19e-04
Sr-91	5.67e-06	0.00e+00	2.29e-07	0.00e+00	0.00e+00	0.00e+00	2.70e-05
Sr-92	2.15e-06	0.00e+00	9.30e-08	0.00e+00	0.00e+00	0.00e+00	4.26e-05
Y-90	9.62e-09	0.00e+00	2.58e-10	0.00e+00	0.00e+00	0.00e+00	1.02e-04
Y-91	1.41e-07	0.00e+00	3.77e-09	0.00e+00	0.00e+00	0.00e+00	7.76e-05
Y-91m	9.09e-11	0.00e+00	3.52e-12	0.00e+00	0.00e+00	0.00e+00	2.67e-10
Y-92	8.45e-10	0.00e+00	2.47e-11	0.00e+00	0.00e+00	0.00e+00	1.48e-05
Y-93	2.68e-09	0.00e+00	7.40e-11	0.00e+00	0.00e+00	0.00e+00	8.50e-05
Zr-93	4.18e-08	2.34e-09	1.09e-09	0.00e+00	8.87e-09	0.00e+00	2.43e-06
Zr-95	3.04e-08	9.75e-09	6.60e-09	0.00e+00	1.53e-08	0.00e+00	3.09e-05
Zr-97	1.68e-09	3.39e-10	1.55e-10	0.00e+00	5.12e-10	0.00e+00	1.05e-04
Nb-93m	2.55e-08	8.32e-09	2.05e-09	0.00e+00	9.57e-09	0.00e+00	3.84e-06
Nb-95	6.22e-09	3.46e-09	1.86e-09	0.00e+00	3.42e-09	0.00e+00	2.10e-05
Nb-97	5.22e-11	1.32e-11	4.82e-12	0.00e+00	1.54e-11	0.00e+00	4.87e-08
Mo-93	0.00e+00	7.51e-06	2.03e-07	0.00e+00	2.13e-06	0.00e+00	1.22e-06
Mo-99	0.00e+00	4.31e-06	8.20e-07	0.00e+00	9.76e-06	0.00e+00	9.99e-06
Tc-101	2.54e-10	3.66e-10	3.59e-09	0.00e+00	6.59e-09	1.87e-10	1.10e-21
Tc-99	1.25e-07	1.86e-07	5.02e-08	0.00e+00	2.34e-06	1.58e-08	6.08e-06
Tc-99m	2.47e-10	6.98e-10	8.89e-09	0.00e+00	1.06e-08	3.42e-10	4.13e-07
Ru-103	1.85e-07	0.00e+00	7.97e-08	0.00e+00	7.06e-07	0.00e+00	2.16e-05
Ru-105	1.54e-08	0.00e+00	6.08e-09	0.00e+00	1.99e-07	0.00e+00	9.42e-06
Ru-106	2.75e-06	0.00e+00	3.48e-07	0.00e+00	5.31e-06	0.00e+00	1.78e-04
Rh-105	1.21e-07	8.85e-08	5.83e-08	0.00e+00	3.76e-07	0.00e+00	1.41e-05
Pd-107	0.00e+00	1.47e-07	9.40e-09	0.00e+00	1.32e-06	0.00e+00	9.11e-07
Pd-109	0.00e+00	1.77e-07	3.99e-08	0.00e+00	1.01e-06	0.00e+00	1.96e-05

Conversion factors are in units of mrem per pCi ingested.

**DOSE CONVERSION FACTORS ALL AGE GROUPS
BY NUCLIDE (INHALATION AND INGESTION)**

Ingestion Dose Conversion factors for Adult age group by nuclide.
Waterford Steam Electric Station

Nuclide	Organ Dose Conversion Factors						
	Bone	Liver	T. Body	Thyroid	Kidney	Lung	GI-LLI
Ag-110m	1.60e-07	1.48e-07	8.79e-08	0.00e+00	2.91e-07	0.00e+00	6.04e-05
Ag-111	5.81e-08	2.43e-08	1.21e-08	0.00e+00	7.84e-08	0.00e+00	4.46e-05
Cd-113m	0.00e+00	3.18e-06	1.02e-07	0.00e+00	3.50e-06	0.00e+00	2.56e-05
Cd-115m	0.00e+00	1.84e-06	5.87e-08	0.00e+00	1.46e-06	0.00e+00	7.74e-05
Sn-123	3.11e-05	5.15e-07	7.59e-07	4.38e-07	0.00e+00	0.00e+00	6.33e-05
Sn-125	8.33e-06	1.68e-07	3.78e-07	1.39e-07	0.00e+00	0.00e+00	1.04e-04
Sn-126	8.45e-05	1.67e-06	2.40e-06	4.92e-07	0.00e+00	0.00e+00	2.43e-05
Sb-124	2.80e-06	5.29e-08	1.11e-06	6.79e-09	0.00e+00	2.18e-06	7.95e-05
Sb-125	1.79e-06	2.00e-08	4.26e-07	1.82e-09	0.00e+00	1.38e-06	1.97e-05
Sb-126	1.15e-06	2.34e-08	4.15e-07	7.04e-09	0.00e+00	7.05e-07	9.40e-05
Sb-127	2.58e-07	5.65e-09	9.90e-08	3.10e-09	0.00e+00	1.53e-07	5.90e-05
Te-125m	2.68e-06	9.71e-07	3.59e-07	8.06e-07	1.09e-05	0.00e+00	1.07e-05
Te-127	1.10e-07	3.95e-08	2.38e-08	8.15e-08	4.48e-07	0.00e+00	8.68e-06
Te-127m	6.77e-06	2.42e-06	8.25e-07	1.73e-06	2.75e-05	0.00e+00	2.27e-05
Te-129	3.14e-08	1.18e-08	7.65e-09	2.41e-08	1.32e-07	0.00e+00	2.37e-08
Te-129m	1.15e-05	4.29e-06	1.82e-06	3.95e-06	4.80e-05	0.00e+00	5.79e-05
Te-131	1.97e-08	8.23e-09	6.22e-09	1.62e-08	8.63e-08	0.00e+00	2.79e-09
Te-131m	1.73e-06	8.46e-07	7.05e-07	1.34e-06	8.57e-06	0.00e+00	8.40e-05
Te-132	2.52e-06	1.63e-06	1.53e-06	1.80e-06	1.57e-05	0.00e+00	7.71e-05
Te-133m	4.62e-08	2.70e-08	2.60e-08	3.91e-08	2.67e-07	0.00e+00	9.26e-09
Te-134	3.24e-08	2.12e-08	1.30e-08	2.83e-08	2.05e-07	0.00e+00	3.59e-11
I-129	3.27e-06	2.81e-06	9.21e-06	7.23e-03	6.04e-06	0.00e+00	4.44e-07
I-130	7.56e-07	2.23e-06	8.80e-07	1.89e-04	3.48e-06	0.00e+00	1.92e-06
I-131	4.16e-06	5.95e-06	3.41e-06	1.95e-03	1.02e-05	0.00e+00	1.57e-06
I-132	2.03e-07	5.43e-07	1.90e-07	1.90e-05	8.65e-07	0.00e+00	1.02e-07
I-133	1.42e-06	2.47e-06	7.53e-07	3.63e-04	4.31e-06	0.00e+00	2.22e-06
I-134	1.06e-07	2.88e-07	1.03e-07	4.99e-06	4.58e-07	0.00e+00	2.51e-10
I-135	4.43e-07	1.16e-06	4.28e-07	7.65e-05	1.86e-06	0.00e+00	1.31e-06
Cs-134	6.22e-05	1.48e-04	1.21e-04	0.00e+00	4.79e-05	1.59e-05	2.59e-06
Cs-134m	2.13e-08	4.48e-08	2.29e-08	0.00e+00	2.43e-08	3.83e-09	1.58e-08

Conversion factors are in units of mrem per pCi ingested.

**DOSE CONVERSION FACTORS ALL AGE GROUPS
BY NUCLIDE (INHALATION AND INGESTION)**

Ingestion Dose Conversion factors for Adult age group by nuclide.
Waterford Steam Electric Station

Nuclide	Organ Dose Conversion Factors						
	Bone	Liver	T. Body	Thyroid	Kidney	Lung	GI-LLI
Cs-135	1.95e-05	1.80e-05	7.99e-06	0.00e+00	6.81e-06	2.04e-06	4.21e-07
Cs-136	6.51e-06	2.57e-05	1.85e-05	0.00e+00	1.43e-05	1.96e-06	2.92e-06
Cs-137	7.97e-05	1.09e-04	7.14e-05	0.00e+00	3.70e-05	1.23e-05	2.11e-06
Cs-138	5.52e-08	1.09e-07	5.40e-08	0.00e+00	8.01e-08	7.91e-09	4.65e-13
Cs-139	3.41e-08	5.08e-08	1.85e-08	0.00e+00	4.07e-08	3.70e-09	1.10e-30
Ba-139	9.70e-08	6.91e-11	2.84e-09	0.00e+00	6.46e-11	3.92e-11	1.72e-07
Ba-140	2.03e-05	2.55e-08	1.33e-06	0.00e+00	8.67e-09	1.46e-08	4.18e-05
Ba-141	4.71e-08	3.56e-11	1.59e-09	0.00e+00	3.31e-11	2.02e-11	2.22e-17
Ba-142	2.13e-08	2.19e-11	1.34e-09	0.00e+00	1.85e-11	1.24e-11	3.00e-26
La-140	2.50e-09	1.26e-09	3.33e-10	0.00e+00	0.00e+00	0.00e+00	9.25e-05
La-141	3.19e-10	9.90e-11	1.62e-11	0.00e+00	0.00e+00	0.00e+00	1.18e-05
La-142	1.28e-10	5.82e-11	1.45e-11	0.00e+00	0.00e+00	0.00e+00	4.25e-07
Ce-141	9.36e-09	6.33e-09	7.18e-10	0.00e+00	2.94e-09	0.00e+00	2.42e-05
Ce-143	1.65e-09	1.22e-06	1.35e-10	0.00e+00	5.37e-10	0.00e+00	4.56e-05
Ce-144	4.88e-07	2.04e-07	2.62e-08	0.00e+00	1.21e-07	0.00e+00	1.65e-04
Pr-143	9.20e-09	3.69e-09	4.56e-10	0.00e+00	2.13e-09	0.00e+00	4.03e-05
Pr-144	3.01e-11	1.25e-11	1.53e-12	0.00e+00	7.05e-12	0.00e+00	4.33e-18
Nd-147	6.29e-09	7.27e-09	4.35e-10	0.00e+00	4.25e-09	0.00e+00	3.49e-05
Pm-147	7.54e-08	7.09e-09	2.87e-09	0.00e+00	1.34e-08	0.00e+00	8.93e-06
Pm-148	7.17e-09	1.19e-09	5.99e-10	0.00e+00	2.25e-09	0.00e+00	9.35e-05
Pm-148m	3.07e-08	7.95e-09	6.08e-09	0.00e+00	1.20e-08	0.00e+00	6.74e-05
Pm-149	1.52e-09	2.15e-10	8.78e-11	0.00e+00	4.06e-10	0.00e+00	4.03e-05
Pm-151	6.97e-10	1.17e-10	5.91e-11	0.00e+00	2.09e-10	0.00e+00	3.22e-05
Sm-151	6.90e-08	1.19e-08	2.85e-09	0.00e+00	1.33e-08	0.00e+00	5.25e-06
Sm-153	8.57e-10	7.15e-10	5.22e-11	0.00e+00	2.31e-10	0.00e+00	2.55e-05
Eu-152	1.95e-07	4.44e-08	3.90e-08	0.00e+00	2.75e-07	0.00e+00	2.56e-05
Eu-154	6.15e-07	7.56e-08	5.38e-08	0.00e+00	3.62e-07	0.00e+00	5.48e-05
Eu-155	8.60e-08	1.22e-08	7.87e-09	0.00e+00	5.63e-08	0.00e+00	9.60e-06
Eu-156	1.37e-08	1.06e-08	1.71e-09	0.00e+00	7.08e-09	0.00e+00	7.26e-05
Tb-160	4.70e-08	0.00e+00	5.86e-09	0.00e+00	1.94e-08	0.00e+00	4.33e-05

Conversion factors are in units of mrem per pCi ingested.

**DOSE CONVERSION FACTORS ALL AGE GROUPS
BY NUCLIDE (INHALATION AND INGESTION)**

Ingestion Dose Conversion factors for Adult age group by nuclide.
Waterford Steam Electric Station

Nuclide	Organ Dose Conversion Factors						
	Bone	Liver	T. Body	Thyroid	Kidney	Lung	GI-LLI
Ho-166m	2.70e-07	8.43e-08	6.40e-08	0.00e+00	1.26e-07	0.00e+00	2.56e-05
W-181	9.91e-09	3.23e-09	3.46e-10	0.00e+00	0.00e+00	0.00e+00	3.68e-07
W-185	4.05e-07	1.35e-07	1.42e-08	0.00e+00	0.00e+00	0.00e+00	1.56e-05
W-187	1.03e-07	8.61e-08	3.01e-08	0.00e+00	0.00e+00	0.00e+00	2.82e-05
Pb-210	1.53e-02	4.37e-03	5.44e-04	0.00e+00	1.23e-02	0.00e+00	2.24e-06
Bi-210	4.61e-07	3.18e-06	2.64e-07	0.00e+00	3.83e-05	0.00e+00	4.75e-05
Po-210	3.56e-04	7.56e-04	8.59e-05	0.00e+00	2.52e-03	0.00e+00	6.36e-05
Ra-223	4.97e-03	7.65e-06	9.94e-04	0.00e+00	2.17e-04	0.00e+00	3.21e-04
Ra-224	1.61e-03	3.90e-06	3.23e-04	0.00e+00	1.10e-04	0.00e+00	3.40e-04
Ra-225	6.56e-03	7.78e-06	1.31e-03	0.00e+00	2.21e-04	0.00e+00	3.06e-04
Ra-226	3.02e-01	5.74e-06	2.20e-01	0.00e+00	1.63e-04	0.00e+00	3.32e-04
Ra-228	1.12e-01	3.12e-06	1.21e-01	0.00e+00	8.83e-05	0.00e+00	5.64e-05
Ac-225	4.40e-06	6.06e-06	2.96e-07	0.00e+00	6.90e-07	0.00e+00	4.07e-04
Ac-227	1.87e-03	2.48e-04	1.11e-04	0.00e+00	8.00e-05	0.00e+00	8.19e-05
Th-227	1.37e-05	2.48e-07	3.95e-07	0.00e+00	1.41e-06	0.00e+00	5.40e-04
Th-228	4.96e-04	8.40e-06	1.68e-05	0.00e+00	4.67e-05	0.00e+00	5.63e-04
Th-229	1.36e-02	3.89e-04	2.25e-04	0.00e+00	1.88e-03	0.00e+00	7.81e-05
Th-230	2.06e-03	1.17e-04	5.70e-05	0.00e+00	5.65e-04	0.00e+00	6.02e-05
Th-232	2.30e-03	1.00e-04	1.50e-06	0.00e+00	4.82e-04	0.00e+00	5.12e-05
Th-234	8.01e-08	4.71e-09	2.31e-09	0.00e+00	2.67e-08	0.00e+00	1.13e-04
Pa-231	4.10e-03	1.54e-04	1.59e-04	0.00e+00	8.64e-04	0.00e+00	7.17e-05
Pa-233	5.26e-09	1.06e-09	9.12e-10	0.00e+00	3.99e-09	0.00e+00	1.64e-05
U-232	4.13e-03	0.00e+00	2.95e-04	0.00e+00	4.47e-04	0.00e+00	6.78e-05
U-233	8.71e-04	0.00e+00	5.28e-05	0.00e+00	2.03e-04	0.00e+00	6.27e-05
U-234	8.36e-04	0.00e+00	5.17e-05	0.00e+00	1.99e-04	0.00e+00	6.14e-05
U-235	8.01e-04	0.00e+00	4.86e-05	0.00e+00	1.87e-04	0.00e+00	7.81e-05
U-236	8.01e-04	0.00e+00	4.96e-05	0.00e+00	1.91e-04	0.00e+00	5.76e-05
U-237	5.52e-08	0.00e+00	1.47e-08	0.00e+00	2.27e-07	0.00e+00	1.94e-05
U-238	7.67e-04	0.00e+00	4.54e-05	0.00e+00	1.75e-04	0.00e+00	5.50e-05
Np-237	1.26e-03	8.96e-05	5.54e-05	0.00e+00	4.12e-04	0.00e+00	7.94e-05

Conversion factors are in units of mrem per pCi ingested.

**DOSE CONVERSION FACTORS ALL AGE GROUPS
BY NUCLIDE (INHALATION AND INGESTION)**

Ingestion Dose Conversion factors for Adult age group by nuclide.
Waterford Steam Electric Station

Nuclide	Organ Dose Conversion Factors						
	Bone	Liver	T. Body	Thyroid	Kidney	Lung	GI-LLI
Np-238	1.37e-08	3.69e-10	2.13e-10	0.00e+00	1.25e-09	0.00e+00	3.43e-05
Np-239	1.19e-09	1.17e-10	6.45e-11	0.00e+00	3.65e-10	0.00e+00	2.40e-05
Pu-238	6.30e-04	7.98e-05	1.71e-05	0.00e+00	7.32e-05	0.00e+00	7.30e-05
Pu-239	7.25e-04	8.71e-05	1.91e-05	0.00e+00	8.11e-05	0.00e+00	6.66e-05
Pu-240	7.24e-04	8.70e-05	1.91e-05	0.00e+00	8.10e-05	0.00e+00	6.78e-05
Pu-241	1.57e-05	7.45e-07	3.32e-07	0.00e+00	1.53e-06	0.00e+00	1.40e-06
Pu-242	6.72e-04	8.39e-05	1.84e-05	0.00e+00	7.81e-05	0.00e+00	6.53e-05
Pu-244	7.84e-04	9.61e-05	2.11e-05	0.00e+00	8.95e-05	0.00e+00	9.73e-05
Am-241	7.55e-04	7.05e-04	5.41e-05	0.00e+00	4.07e-04	0.00e+00	7.42e-05
Am-242m	7.61e-04	6.63e-04	5.43e-05	0.00e+00	4.05e-04	0.00e+00	9.34e-05
Am-243	7.54e-04	6.90e-04	5.30e-05	0.00e+00	3.99e-04	0.00e+00	8.70e-05
Cm-242	2.06e-05	2.19e-05	1.37e-06	0.00e+00	6.22e-06	0.00e+00	7.92e-05
Cm-243	5.99e-04	5.49e-04	3.75e-05	0.00e+00	1.75e-04	0.00e+00	7.81e-05
Cm-244	4.56e-04	4.27e-04	2.87e-05	0.00e+00	1.34e-04	0.00e+00	7.55e-05
Cm-245	9.38e-04	8.17e-04	5.76e-05	0.00e+00	2.69e-04	0.00e+00	7.04e-05
Cm-246	9.30e-04	8.16e-04	5.75e-05	0.00e+00	2.68e-04	0.00e+00	6.91e-05
Cm-247	9.07e-04	8.04e-04	5.67e-05	0.00e+00	2.64e-04	0.00e+00	9.09e-05
Cm-248	7.54e-03	6.63e-03	4.67e-04	0.00e+00	2.18e-03	0.00e+00	1.47e-03
Cf-252	2.61e-04	0.00e+00	6.29e-06	0.00e+00	0.00e+00	0.00e+00	2.88e-04

Conversion factors are in units of mrem per pCi ingested.

**DOSE CONVERSION FACTORS ALL AGE GROUPS
BY NUCLIDE (INHALATION AND INGESTION)**

Ingestion Dose Conversion factors for Teen age group by nuclide.
Waterford Steam Electric Station

Nuclide	Organ Dose Conversion Factors						
	Bone	Liver	T. Body	Thyroid	Kidney	Lung	GI-LLI
H-3	0.00e+00	6.04e-08	6.04e-08	6.04e-08	6.04e-08	6.04e-08	6.04e-08
Be-10	4.48e-06	6.94e-07	1.13e-07	0.00e+00	5.30e-07	0.00e+00	2.84e-05
C-14	4.06e-06	8.12e-07	8.12e-07	8.12e-07	8.12e-07	8.12e-07	8.12e-07
N-13	1.15e-08	1.15e-08	1.15e-08	1.15e-08	1.15e-08	1.15e-08	1.15e-08
F-18	8.64e-07	0.00e+00	9.47e-08	0.00e+00	0.00e+00	0.00e+00	7.78e-08
Na-22	2.34e-05	2.34e-05	2.34e-05	2.34e-05	2.34e-05	2.34e-05	2.34e-05
Na-24	2.30e-06	2.30e-06	2.30e-06	2.30e-06	2.30e-06	2.30e-06	2.30e-06
P-32	2.76e-04	1.71e-05	1.07e-05	0.00e+00	0.00e+00	0.00e+00	2.32e-05
Ca-41	1.97e-04	0.00e+00	2.13e-05	0.00e+00	0.00e+00	0.00e+00	1.95e-07
Sc-46	7.24e-09	1.41e-08	4.18e-09	0.00e+00	1.35e-08	0.00e+00	4.80e-05
Cr-51	0.00e+00	0.00e+00	3.60e-09	2.00e-09	7.89e-10	5.14e-09	6.05e-07
Mn-54	0.00e+00	5.90e-06	1.17e-06	0.00e+00	1.76e-06	0.00e+00	1.21e-05
Mn-56	0.00e+00	1.58e-07	2.81e-08	0.00e+00	2.00e-07	0.00e+00	1.04e-05
Fe-55	3.78e-06	2.68e-06	6.25e-07	0.00e+00	0.00e+00	1.70e-06	1.16e-06
Fe-59	5.87e-06	1.37e-05	5.29e-06	0.00e+00	0.00e+00	4.32e-06	3.24e-05
Co-57	0.00e+00	2.38e-07	3.99e-07	0.00e+00	0.00e+00	0.00e+00	4.44e-06
Co-58	0.00e+00	9.72e-07	2.24e-06	0.00e+00	0.00e+00	0.00e+00	1.34e-05
Co-60	0.00e+00	2.81e-06	6.33e-06	0.00e+00	0.00e+00	0.00e+00	3.66e-05
Ni-59	1.32e-05	4.66e-06	2.24e-06	0.00e+00	0.00e+00	0.00e+00	7.31e-07
Ni-63	1.77e-04	1.25e-05	6.00e-06	0.00e+00	0.00e+00	0.00e+00	1.99e-06
Ni-65	7.49e-07	9.57e-08	4.36e-08	0.00e+00	0.00e+00	0.00e+00	5.19e-06
Cu-64	0.00e+00	1.15e-07	5.41e-08	0.00e+00	2.91e-07	0.00e+00	8.92e-06
Zn-65	5.76e-06	2.00e-05	9.33e-06	0.00e+00	1.28e-05	0.00e+00	8.47e-06
Zn-69	1.47e-08	2.80e-08	1.96e-09	0.00e+00	1.83e-08	0.00e+00	5.16e-08
Zn-69m	2.40e-07	5.66e-07	5.19e-08	0.00e+00	3.44e-07	0.00e+00	3.11e-05
Se-79	0.00e+00	3.73e-06	6.27e-07	0.00e+00	6.50e-06	0.00e+00	5.70e-07
Br-82	0.00e+00	0.00e+00	3.04e-06	0.00e+00	0.00e+00	0.00e+00	0.00e+00
Br-83	0.00e+00	0.00e+00	5.74e-08	0.00e+00	0.00e+00	0.00e+00	0.00e+00
Br-84	0.00e+00	0.00e+00	7.22e-08	0.00e+00	0.00e+00	0.00e+00	0.00e+00
Br-85	0.00e+00	0.00e+00	3.05e-09	0.00e+00	0.00e+00	0.00e+00	0.00e+00

Conversion factors are in units of mrem per pCi ingested.

**DOSE CONVERSION FACTORS ALL AGE GROUPS
BY NUCLIDE (INHALATION AND INGESTION)**

Ingestion Dose Conversion factors for Teen age group by nuclide.
Waterford Steam Electric Station

Nuclide	Organ Dose Conversion Factors						
	Bone	Liver	T. Body	Thyroid	Kidney	Lung	GI-LLI
Rb-86	0.00e+00	2.98e-05	1.40e-05	0.00e+00	0.00e+00	0.00e+00	4.41e-06
Rb-87	0.00e+00	1.75e-05	6.11e-06	0.00e+00	0.00e+00	0.00e+00	6.11e-07
Rb-88	0.00e+00	8.52e-08	4.54e-08	0.00e+00	0.00e+00	0.00e+00	7.30e-15
Rb-89	0.00e+00	5.50e-08	3.89e-08	0.00e+00	0.00e+00	0.00e+00	8.43e-17
Sr-89	4.40e-04	0.00e+00	1.26e-05	0.00e+00	0.00e+00	0.00e+00	5.24e-05
Sr-90	1.02e-02	0.00e+00	2.04e-04	0.00e+00	0.00e+00	0.00e+00	2.33e-04
Sr-91	8.07e-06	0.00e+00	3.21e-07	0.00e+00	0.00e+00	0.00e+00	3.66e-05
Sr-92	3.05e-06	0.00e+00	1.30e-07	0.00e+00	0.00e+00	0.00e+00	7.77e-05
Y-90	1.37e-08	0.00e+00	3.69e-10	0.00e+00	0.00e+00	0.00e+00	1.13e-04
Y-91	2.01e-07	0.00e+00	5.39e-09	0.00e+00	0.00e+00	0.00e+00	8.24e-05
Y-91m	1.29e-10	0.00e+00	4.93e-12	0.00e+00	0.00e+00	0.00e+00	6.09e-09
Y-92	1.21e-09	0.00e+00	3.50e-11	0.00e+00	0.00e+00	0.00e+00	3.32e-05
Y-93	3.83e-09	0.00e+00	1.05e-10	0.00e+00	0.00e+00	0.00e+00	1.17e-04
Zr-93	5.53e-08	2.73e-09	1.49e-09	0.00e+00	9.65e-09	0.00e+00	2.58e-06
Zr-95	4.12e-08	1.30e-08	8.94e-09	0.00e+00	1.91e-08	0.00e+00	3.00e-05
Zr-97	2.37e-09	4.69e-10	2.16e-10	0.00e+00	7.11e-10	0.00e+00	1.27e-04
Nb-93m	3.44e-08	1.13e-08	2.83e-09	0.00e+00	1.32e-08	0.00e+00	4.07e-06
Nb-95	8.22e-09	4.56e-09	2.51e-09	0.00e+00	4.42e-09	0.00e+00	1.95e-05
Nb-97	7.37e-11	1.83e-11	6.68e-12	0.00e+00	2.14e-11	0.00e+00	4.37e-07
Mo-93	0.00e+00	1.06e-05	2.90e-07	0.00e+00	3.04e-06	0.00e+00	1.29e-06
Mo-99	0.00e+00	6.03e-06	1.15e-06	0.00e+00	1.38e-05	0.00e+00	1.08e-05
Tc-101	3.60e-10	5.12e-10	5.03e-09	0.00e+00	9.26e-09	3.12e-10	8.75e-17
Tc-99	1.79e-07	2.63e-07	7.17e-08	0.00e+00	3.34e-06	2.72e-08	6.44e-06
Tc-99m	3.32e-10	9.26e-10	1.20e-08	0.00e+00	1.38e-08	5.14e-10	6.08e-07
Ru-103	2.55e-07	0.00e+00	1.09e-07	0.00e+00	8.99e-07	0.00e+00	2.13e-05
Ru-105	2.18e-08	0.00e+00	8.46e-09	0.00e+00	2.75e-07	0.00e+00	1.76e-05
Ru-106	3.92e-06	0.00e+00	4.94e-07	0.00e+00	7.56e-06	0.00e+00	1.88e-04
Rh-105	1.73e-07	1.25e-07	8.20e-08	0.00e+00	5.31e-07	0.00e+00	1.59e-05
Pd-107	0.00e+00	2.08e-07	1.34e-08	0.00e+00	1.88e-06	0.00e+00	9.66e-07
Pd-109	0.00e+00	2.51e-07	5.70e-08	0.00e+00	1.45e-06	0.00e+00	2.53e-05

Conversion factors are in units of mrem per pCi ingested.

**DOSE CONVERSION FACTORS ALL AGE GROUPS
BY NUCLIDE (INHALATION AND INGESTION)**

Ingestion Dose Conversion factors for Teen age group by nuclide.
Waterford Steam Electric Station

Nuclide	Organ Dose Conversion Factors						
	Bone	Liver	T. Body	Thyroid	Kidney	Lung	GI-LLI
Ag-110m	2.05e-07	1.94e-07	1.18e-07	0.00e+00	3.70e-07	0.00e+00	5.45e-05
Ag-111	8.29e-08	3.44e-08	1.73e-08	0.00e+00	1.12e-07	0.00e+00	4.80e-05
Cd-113m	0.00e+00	4.51e-06	1.45e-07	0.00e+00	4.99e-06	0.00e+00	2.71e-05
Cd-115m	0.00e+00	2.60e-06	8.39e-08	0.00e+00	2.08e-06	0.00e+00	8.23e-05
Sn-123	4.44e-05	7.29e-07	1.08e-06	5.84e-07	0.00e+00	0.00e+00	6.71e-05
Sn-125	1.19e-05	2.37e-07	5.37e-07	1.86e-07	0.00e+00	0.00e+00	1.12e-04
Sn-126	1.16e-04	2.16e-06	3.30e-06	5.69e-07	0.00e+00	0.00e+00	2.58e-05
Sb-124	3.87e-06	7.13e-08	1.51e-06	8.78e-09	0.00e+00	3.38e-06	7.80e-05
Sb-125	2.48e-06	2.71e-08	5.80e-07	2.37e-09	0.00e+00	2.18e-06	1.93e-05
Sb-126	1.59e-06	3.25e-08	5.71e-07	8.99e-09	0.00e+00	1.14e-06	9.41e-05
Sb-127	3.63e-07	7.76e-09	1.37e-07	4.08e-09	0.00e+00	2.47e-07	6.16e-05
Te-125m	3.83e-06	1.38e-06	5.12e-07	1.07e-06	0.00e+00	0.00e+00	1.13e-05
Te-127	1.58e-07	5.60e-08	3.40e-08	1.09e-07	6.40e-07	0.00e+00	1.22e-05
Te-127m	9.67e-06	3.43e-06	1.15e-06	2.30e-06	3.92e-05	0.00e+00	2.41e-05
Te-129	4.48e-08	1.67e-08	1.09e-08	3.20e-08	1.88e-07	0.00e+00	2.45e-07
Te-129m	1.63e-05	6.05e-06	2.58e-06	5.26e-06	6.82e-05	0.00e+00	6.12e-05
Te-131	2.79e-08	1.15e-08	8.72e-09	2.15e-08	1.22e-07	0.00e+00	2.29e-09
Te-131m	2.44e-06	1.17e-06	9.76e-07	1.76e-06	1.22e-05	0.00e+00	9.39e-05
Te-132	3.49e-06	2.21e-06	2.08e-06	2.33e-06	2.12e-05	0.00e+00	7.00e-05
Te-133m	6.44e-08	3.66e-08	3.56e-08	5.11e-08	3.62e-07	0.00e+00	1.48e-07
Te-134	4.47e-08	2.87e-08	3.00e-08	3.67e-08	2.74e-07	0.00e+00	1.66e-09
I-129	4.66e-06	3.92e-06	6.54e-06	4.77e-03	7.01e-06	0.00e+00	4.57e-07
I-130	1.03e-06	2.98e-06	1.19e-06	2.43e-04	4.59e-06	0.00e+00	2.29e-06
I-131	5.85e-06	8.19e-06	4.40e-06	2.39e-03	1.41e-05	0.00e+00	1.62e-06
I-132	2.79e-07	7.30e-07	2.62e-07	2.46e-05	1.15e-06	0.00e+00	3.18e-07
I-133	2.01e-06	3.41e-06	1.04e-06	4.76e-04	5.98e-06	0.00e+00	2.58e-06
I-134	1.46e-07	3.87e-07	1.39e-07	6.45e-06	6.10e-07	0.00e+00	5.10e-09
I-135	6.10e-07	1.57e-06	5.82e-07	1.01e-04	2.48e-06	0.00e+00	1.74e-06
Cs-134	8.37e-05	1.97e-04	9.14e-05	0.00e+00	6.26e-05	2.39e-05	2.45e-06
Cs-134m	2.94e-08	6.09e-08	3.13e-08	0.00e+00	3.39e-08	5.95e-09	4.05e-08

Conversion factors are in units of mrem per pCi ingested.

**DOSE CONVERSION FACTORS ALL AGE GROUPS
BY NUCLIDE (INHALATION AND INGESTION)**

Ingestion Dose Conversion factors for Teen age group by nuclide.
Waterford Steam Electric Station

Nuclide	Organ Dose Conversion Factors						
	Bone	Liver	T. Body	Thyroid	Kidney	Lung	GI-LLI
Cs-135	2.78e-05	2.55e-05	5.96e-06	0.00e+00	9.73e-06	3.52e-06	4.46e-07
Cs-136	8.59e-06	3.38e-05	2.27e-05	0.00e+00	1.84e-05	2.90e-06	2.72e-06
Cs-137	1.12e-04	1.49e-04	5.19e-05	0.00e+00	5.07e-05	1.97e-05	2.12e-06
Cs-138	7.76e-08	1.49e-07	7.45e-08	0.00e+00	1.10e-07	1.28e-08	6.76e-11
Cs-139	4.87e-08	7.17e-08	2.63e-08	0.00e+00	5.79e-08	6.34e-09	3.33e-23
Ba-139	1.39e-07	9.78e-11	4.05e-09	0.00e+00	9.22e-11	6.74e-11	1.24e-06
Ba-140	2.84e-05	3.48e-08	1.83e-06	0.00e+00	1.18e-08	2.34e-08	4.38e-05
Ba-141	6.71e-08	5.01e-11	2.24e-09	0.00e+00	4.65e-11	3.43e-11	1.43e-13
Ba-142	2.99e-08	2.99e-11	1.84e-09	0.00e+00	2.53e-11	1.99e-11	9.18e-20
La-140	3.48e-09	1.71e-09	4.55e-10	0.00e+00	0.00e+00	0.00e+00	9.82e-05
La-141	4.55e-10	1.40e-10	2.31e-11	0.00e+00	0.00e+00	0.00e+00	2.48e-05
La-142	1.79e-10	7.95e-11	1.98e-11	0.00e+00	0.00e+00	0.00e+00	2.42e-06
Ce-141	1.33e-08	8.88e-09	1.02e-09	0.00e+00	4.18e-09	0.00e+00	2.54e-05
Ce-143	2.35e-09	1.71e-06	1.91e-10	0.00e+00	7.67e-10	0.00e+00	5.14e-05
Ce-144	6.96e-07	2.88e-07	3.74e-08	0.00e+00	1.72e-07	0.00e+00	1.75e-04
Pr-143	1.31e-08	5.23e-09	6.52e-10	0.00e+00	3.04e-09	0.00e+00	4.31e-05
Pr-144	4.30e-11	1.76e-11	2.18e-12	0.00e+00	1.01e-11	0.00e+00	4.74e-14
Nd-147	9.38e-09	1.02e-08	6.11e-10	0.00e+00	5.99e-09	0.00e+00	3.68e-05
Pm-147	1.05e-07	9.96e-09	4.06e-09	0.00e+00	1.90e-08	0.00e+00	9.47e-06
Pm-148	1.02e-08	1.66e-09	8.36e-10	0.00e+00	3.00e-09	0.00e+00	9.90e-05
Pm-148m	4.14e-08	1.05e-08	8.21e-09	0.00e+00	1.59e-08	0.00e+00	6.61e-05
Pm-149	2.17e-09	3.05e-10	1.25e-10	0.00e+00	5.81e-10	0.00e+00	4.49e-05
Pm-151	9.87e-10	1.63e-10	8.25e-11	0.00e+00	2.93e-10	0.00e+00	3.66e-05
Sm-151	8.73e-08	1.68e-08	3.94e-09	0.00e+00	1.84e-08	0.00e+00	5.70e-06
Sm-153	1.22e-09	1.01e-09	7.43e-11	0.00e+00	3.30e-10	0.00e+00	2.85e-05
Eu-152	2.45e-07	5.90e-08	5.20e-08	0.00e+00	2.74e-07	0.00e+00	2.17e-05
Eu-154	7.91e-07	1.02e-07	7.19e-08	0.00e+00	4.56e-07	0.00e+00	5.39e-05
Eu-155	1.74e-07	1.68e-08	1.04e-08	0.00e+00	6.57e-08	0.00e+00	9.63e-05
Eu-156	1.92e-08	1.44e-08	2.35e-09	0.00e+00	9.69e-09	0.00e+00	7.36e-05
Tb-160	6.47e-08	0.00e+00	8.07e-09	0.00e+00	2.56e-08	0.00e+00	4.19e-05

Conversion factors are in units of mrem per pCi ingested.

**DOSE CONVERSION FACTORS ALL AGE GROUPS
BY NUCLIDE (INHALATION AND INGESTION)**

Ingestion Dose Conversion factors for Teen age group by nuclide.
Waterford Steam Electric Station

Nuclide	Organ Dose Conversion Factors						
	Bone	Liver	T. Body	Thyroid	Kidney	Lung	GI-LLI
Ho-166m	3.57e-07	1.10e-07	7.96e-08	0.00e+00	1.61e-07	0.00e+00	2.71e-05
W-181	1.42e-08	4.58e-09	4.79e-10	0.00e+00	0.00e+00	0.00e+00	3.90e-07
W-185	5.79e-07	1.91e-07	2.02e-08	0.00e+00	0.00e+00	0.00e+00	1.65e-05
W-187	1.46e-07	1.19e-07	4.17e-08	0.00e+00	0.00e+00	0.00e+00	3.22e-05
Pb-210	1.81e-02	5.44e-03	7.01e-04	0.00e+00	1.72e-02	0.00e+00	2.37e-06
Bi-210	6.59e-07	4.51e-06	3.77e-07	0.00e+00	5.48e-05	0.00e+00	5.15e-05
Po-210	5.09e-04	1.07e-03	1.23e-04	0.00e+00	3.60e-03	0.00e+00	6.75e-05
Ra-223	7.11e-03	1.08e-05	1.42e-03	0.00e+00	3.10e-04	0.00e+00	3.43e-04
Ra-224	2.31e-03	5.52e-06	4.61e-04	0.00e+00	1.58e-04	0.00e+00	3.71e-04
Ra-225	9.37e-03	1.10e-05	1.87e-03	0.00e+00	3.15e-04	0.00e+00	3.27e-04
Ra-226	3.22e-01	8.13e-06	2.39e-01	0.00e+00	2.32e-04	0.00e+00	3.51e-04
Ra-228	1.37e-01	4.41e-06	1.51e-01	0.00e+00	1.26e-04	0.00e+00	5.98e-05
Ac-225	6.29e-06	8.59e-06	4.22e-07	0.00e+00	9.85e-07	0.00e+00	4.36e-04
Ac-227	2.05e-03	3.03e-04	1.22e-04	0.00e+00	8.81e-05	0.00e+00	8.68e-05
Th-227	1.96e-05	3.52e-07	5.65e-07	0.00e+00	2.01e-06	0.00e+00	5.75e-04
Th-228	6.80e-04	1.14e-05	2.30e-05	0.00e+00	6.41e-05	0.00e+00	5.97e-04
Th-229	1.43e-02	4.11e-04	2.37e-04	0.00e+00	1.99e-03	0.00e+00	8.28e-05
Th-230	2.16e-03	1.23e-04	6.00e-05	0.00e+00	5.99e-04	0.00e+00	6.38e-05
Th-232	2.42e-03	1.05e-04	1.63e-06	0.00e+00	5.11e-04	0.00e+00	5.43e-05
Th-234	1.14e-07	6.68e-09	3.31e-09	0.00e+00	3.81e-08	0.00e+00	1.21e-04
Pa-231	4.31e-03	1.62e-04	1.68e-04	0.00e+00	9.10e-04	0.00e+00	7.60e-05
Pa-233	7.33e-09	1.41e-09	1.26e-09	0.00e+00	5.32e-09	0.00e+00	1.61e-05
U-232	5.89e-03	0.00e+00	4.21e-04	0.00e+00	6.38e-04	0.00e+00	7.19e-05
U-233	1.24e-03	0.00e+00	7.54e-05	0.00e+00	2.90e-04	0.00e+00	6.65e-05
U-234	1.19e-03	0.00e+00	7.39e-05	0.00e+00	2.85e-04	0.00e+00	6.51e-05
U-235	1.14e-03	0.00e+00	6.94e-05	0.00e+00	2.67e-04	0.00e+00	8.28e-05
U-236	1.14e-03	0.00e+00	7.09e-05	0.00e+00	2.73e-04	0.00e+00	6.11e-05
U-237	7.89e-08	0.00e+00	2.10e-08	0.00e+00	3.24e-07	0.00e+00	2.09e-05
U-238	1.09e-03	0.00e+00	6.49e-05	0.00e+00	2.50e-04	0.00e+00	5.83e-05
Np-237	1.33e-03	9.55e-05	5.85e-05	0.00e+00	4.33e-04	0.00e+00	8.41e-05

Conversion factors are in units of mrem per pCi ingested.

**DOSE CONVERSION FACTORS ALL AGE GROUPS
BY NUCLIDE (INHALATION AND INGESTION)**

Ingestion Dose Conversion factors for Teen age group by nuclide.
Waterford Steam Electric Station

Nuclide	Organ Dose Conversion Factors						
	Bone	Liver	T. Body	Thyroid	Kidney	Lung	GI-LLI
Np-238	1.95e-08	5.22e-10	3.04e-10	0.00e+00	1.79e-09	0.00e+00	3.83e-05
Np-239	1.76e-09	1.66e-10	9.22e-11	0.00e+00	5.21e-10	0.00e+00	2.67e-05
Pu-238	6.70e-04	8.58e-05	1.82e-05	0.00e+00	7.80e-05	0.00e+00	7.73e-05
Pu-239	7.65e-04	9.29e-05	2.01e-05	0.00e+00	8.57e-05	0.00e+00	7.06e-05
Pu-240	7.64e-04	9.27e-05	2.01e-05	0.00e+00	8.56e-05	0.00e+00	7.19e-05
Pu-241	1.75e-05	8.40e-07	3.69e-07	0.00e+00	1.71e-06	0.00e+00	1.48e-06
Pu-242	7.09e-04	8.94e-05	1.94e-05	0.00e+00	8.25e-05	0.00e+00	6.92e-05
Pu-244	8.28e-04	1.02e-04	2.22e-05	0.00e+00	9.45e-05	0.00e+00	1.03e-04
Am-241	7.98e-04	7.53e-04	5.75e-05	0.00e+00	4.31e-04	0.00e+00	7.87e-05
Am-242m	8.07e-04	7.11e-04	5.80e-05	0.00e+00	4.30e-04	0.00e+00	9.90e-05
Am-243	7.96e-04	7.35e-04	5.62e-05	0.00e+00	4.22e-04	0.00e+00	9.23e-05
Cm-242	2.94e-05	3.10e-05	1.95e-06	0.00e+00	8.89e-06	0.00e+00	8.40e-05
Cm-243	6.50e-04	6.03e-04	4.09e-05	0.00e+00	1.91e-04	0.00e+00	8.28e-05
Cm-244	5.04e-04	4.77e-04	3.19e-05	0.00e+00	1.49e-04	0.00e+00	8.00e-05
Cm-245	9.90e-04	8.71e-04	6.10e-05	0.00e+00	2.85e-04	0.00e+00	7.46e-05
Cm-246	9.82e-04	8.70e-04	6.09e-05	0.00e+00	2.84e-04	0.00e+00	7.33e-05
Cm-247	9.57e-04	8.57e-04	6.00e-05	0.00e+00	2.80e-04	0.00e+00	9.63e-05
Cm-248	7.95e-03	7.06e-03	4.95e-04	0.00e+00	2.31e-03	0.00e+00	1.55e-03
Cf-252	3.47e-04	0.00e+00	8.37e-06	0.00e+00	0.00e+00	0.00e+00	3.05e-04

Conversion factors are in units of mrem per pCi ingested.

**DOSE CONVERSION FACTORS ALL AGE GROUPS
BY NUCLIDE (INHALATION AND INGESTION)**

Ingestion Dose Conversion factors for Child age group by nuclide.
Waterford Steam Electric Station

Nuclide	Organ Dose Conversion Factors						
	Bone	Liver	T. Body	Thyroid	Kidney	Lung	GI-LLI
H-3	0.00e+00	1.16e-07	1.16e-07	1.16e-07	1.16e-07	1.16e-07	1.16e-07
Be-10	1.35e-05	1.57e-06	3.39e-07	0.00e+00	1.11e-06	0.00e+00	2.75e-05
C-14	1.21e-05	2.42e-06	2.42e-06	2.42e-06	2.42e-06	2.42e-06	2.42e-06
N-13	3.10e-08	3.10e-08	3.10e-08	3.10e-08	3.10e-08	3.10e-08	3.10e-08
F-18	2.49e-06	0.00e+00	2.47e-07	0.00e+00	0.00e+00	0.00e+00	6.74e-07
Na-22	5.88e-05	5.88e-05	5.88e-05	5.88e-05	5.88e-05	5.88e-05	5.88e-05
Na-24	5.80e-06	5.80e-06	5.80e-06	5.80e-06	5.80e-06	5.80e-06	5.80e-06
P-32	8.25e-04	3.86e-05	3.18e-05	0.00e+00	0.00e+00	0.00e+00	2.28e-05
Ca-41	3.47e-04	0.00e+00	3.79e-05	0.00e+00	0.00e+00	0.00e+00	1.90e-07
Sc-46	1.97e-08	2.70e-08	1.04e-08	0.00e+00	2.39e-08	0.00e+00	3.95e-05
Cr-51	0.00e+00	0.00e+00	8.90e-09	4.94e-09	1.35e-09	9.02e-09	4.72e-07
Mn-54	0.00e+00	1.07e-05	2.85e-06	0.00e+00	3.00e-06	0.00e+00	8.98e-06
Mn-56	0.00e+00	3.34e-07	7.54e-08	0.00e+00	4.04e-07	0.00e+00	4.84e-05
Fe-55	1.15e-05	6.10e-06	1.89e-06	0.00e+00	0.00e+00	3.45e-06	1.13e-06
Fe-59	1.65e-05	2.67e-05	1.33e-05	0.00e+00	0.00e+00	7.74e-06	2.78e-05
Co-57	0.00e+00	4.93e-07	9.98e-07	0.00e+00	0.00e+00	0.00e+00	4.04e-06
Co-58	0.00e+00	1.80e-06	5.51e-06	0.00e+00	0.00e+00	0.00e+00	1.05e-05
Co-60	0.00e+00	5.29e-06	1.56e-05	0.00e+00	0.00e+00	0.00e+00	2.93e-05
Ni-59	4.02e-05	1.07e-05	6.82e-06	0.00e+00	0.00e+00	0.00e+00	7.10e-07
Ni-63	5.38e-04	2.88e-05	1.83e-05	0.00e+00	0.00e+00	0.00e+00	1.94e-06
Ni-65	2.22e-06	2.09e-07	1.22e-07	0.00e+00	0.00e+00	0.00e+00	2.56e-05
Cu-64	0.00e+00	2.45e-07	1.48e-07	0.00e+00	5.92e-07	0.00e+00	1.15e-05
Zn-65	1.37e-05	3.65e-05	2.27e-05	0.00e+00	2.30e-05	0.00e+00	6.41e-06
Zn-69	4.38e-08	6.33e-08	5.85e-09	0.00e+00	3.84e-08	0.00e+00	3.99e-06
Zn-69m	7.10e-07	1.21e-06	1.43e-07	0.00e+00	7.03e-07	0.00e+00	3.94e-05
Se-79	0.00e+00	8.43e-06	1.87e-06	0.00e+00	1.37e-05	0.00e+00	5.53e-07
Br-82	0.00e+00	0.00e+00	7.55e-06	0.00e+00	0.00e+00	0.00e+00	0.00e+00
Br-83	0.00e+00	0.00e+00	1.71e-07	0.00e+00	0.00e+00	0.00e+00	0.00e+00
Br-84	0.00e+00	0.00e+00	1.98e-07	0.00e+00	0.00e+00	0.00e+00	0.00e+00
Br-85	0.00e+00	0.00e+00	9.12e-09	0.00e+00	0.00e+00	0.00e+00	0.00e+00

Conversion factors are in units of mrem per pCi ingested.

**DOSE CONVERSION FACTORS ALL AGE GROUPS
BY NUCLIDE (INHALATION AND INGESTION)**

Ingestion Dose Conversion factors for Child age group by nuclide.
Waterford Steam Electric Station

Nuclide	Organ Dose Conversion Factors						
	Bone	Liver	T. Body	Thyroid	Kidney	Lung	GI-LLI
Rb-86	0.00e+00	6.70e-05	4.12e-05	0.00e+00	0.00e+00	0.00e+00	4.31e-06
Rb-87	0.00e+00	3.95e-05	1.83e-05	0.00e+00	0.00e+00	0.00e+00	5.92e-07
Rb-88	0.00e+00	1.90e-07	1.32e-07	0.00e+00	0.00e+00	0.00e+00	9.32e-09
Rb-89	0.00e+00	1.17e-07	1.04e-07	0.00e+00	0.00e+00	0.00e+00	1.02e-09
Sr-89	1.32e-03	0.00e+00	3.77e-05	0.00e+00	0.00e+00	0.00e+00	5.11e-05
Sr-90	2.56e-02	0.00e+00	5.15e-04	0.00e+00	0.00e+00	0.00e+00	2.29e-04
Sr-91	2.40e-05	0.00e+00	9.06e-07	0.00e+00	0.00e+00	0.00e+00	5.30e-05
Sr-92	9.03e-06	0.00e+00	3.62e-07	0.00e+00	0.00e+00	0.00e+00	1.71e-04
Y-90	4.11e-08	0.00e+00	1.10e-09	0.00e+00	0.00e+00	0.00e+00	1.17e-04
Y-91	6.02e-07	0.00e+00	1.61e-08	0.00e+00	0.00e+00	0.00e+00	8.02e-05
Y-91m	3.82e-10	0.00e+00	1.39e-11	0.00e+00	0.00e+00	0.00e+00	7.48e-07
Y-92	3.60e-09	0.00e+00	1.03e-10	0.00e+00	0.00e+00	0.00e+00	1.04e-04
Y-93	1.14e-08	0.00e+00	3.13e-10	0.00e+00	0.00e+00	0.00e+00	1.70e-04
Zr-93	1.67e-07	6.25e-09	4.45e-09	0.00e+00	2.42e-08	0.00e+00	2.37e-06
Zr-95	1.16e-07	2.55e-08	2.27e-08	0.00e+00	3.65e-08	0.00e+00	2.66e-05
Zr-97	6.99e-09	1.01e-09	5.96e-10	0.00e+00	1.45e-09	0.00e+00	1.53e-04
Nb-93m	1.05e-07	2.62e-08	8.61e-09	0.00e+00	2.83e-08	0.00e+00	3.95e-06
Nb-95	2.25e-08	8.76e-09	6.26e-09	0.00e+00	8.23e-09	0.00e+00	1.62e-05
Nb-97	2.17e-10	3.92e-11	1.83e-11	0.00e+00	4.35e-11	0.00e+00	1.21e-05
Mo-93	0.00e+00	2.41e-05	8.65e-07	0.00e+00	6.35e-06	0.00e+00	1.22e-06
Mo-99	0.00e+00	1.33e-05	3.29e-06	0.00e+00	2.84e-05	0.00e+00	1.10e-05
Tc-101	1.07e-09	1.12e-09	1.42e-08	0.00e+00	1.91e-08	5.92e-10	3.56e-09
Tc-99	5.35e-07	5.96e-07	2.14e-07	0.00e+00	7.02e-06	5.27e-08	6.25e-06
Tc-99m	9.23e-10	1.81e-09	3.00e-08	0.00e+00	2.63e-08	9.19e-10	1.03e-06
Ru-103	7.31e-07	0.00e+00	2.81e-07	0.00e+00	1.84e-06	0.00e+00	1.89e-05
Ru-105	6.45e-08	0.00e+00	2.34e-08	0.00e+00	5.67e-07	0.00e+00	4.21e-05
Ru-106	1.17e-05	0.00e+00	1.46e-06	0.00e+00	1.58e-05	0.00e+00	1.82e-04
Rh-105	5.14e-07	2.76e-07	2.36e-07	0.00e+00	1.10e-06	0.00e+00	1.71e-05
Pd-107	0.00e+00	4.72e-07	4.01e-08	0.00e+00	3.95e-06	0.00e+00	9.37e-07
Pd-109	0.00e+00	5.67e-07	1.70e-07	0.00e+00	3.04e-06	0.00e+00	3.35e-05

Conversion factors are in units of mrem per pCi ingested.

**DOSE CONVERSION FACTORS ALL AGE GROUPS
BY NUCLIDE (INHALATION AND INGESTION)**

Ingestion Dose Conversion factors for Child age group by nuclide.
Waterford Steam Electric Station

Nuclide	Organ Dose Conversion Factors						
	Bone	Liver	T. Body	Thyroid	Kidney	Lung	GI-LLI
Ag-110m	5.39e-07	3.64e-07	2.91e-07	0.00e+00	6.78e-07	0.00e+00	4.33e-05
Ag-111	2.48e-07	7.76e-08	5.12e-08	0.00e+00	2.34e-07	0.00e+00	4.75e-05
Cd-113m	0.00e+00	1.02e-05	4.34e-07	0.00e+00	1.05e-05	0.00e+00	2.63e-05
Cd-115m	0.00e+00	5.89e-06	2.51e-07	0.00e+00	4.38e-06	0.00e+00	8.01e-05
Sn-123	1.33e-04	1.65e-06	3.24e-06	1.75e-06	0.00e+00	0.00e+00	6.52e-05
Sn-125	3.55e-05	5.35e-07	1.59e-06	5.55e-07	0.00e+00	0.00e+00	1.10e-04
Sn-126	3.33e-04	4.15e-06	9.46e-06	1.14e-06	0.00e+00	0.00e+00	2.50e-05
Sb-124	1.11e-05	1.44e-07	3.89e-06	2.45e-08	0.00e+00	6.16e-06	6.94e-05
Sb-125	7.16e-06	5.52e-08	1.50e-06	6.63e-09	0.00e+00	3.99e-06	1.71e-05
Sb-126	4.40e-06	6.73e-08	1.58e-06	2.58e-08	0.00e+00	2.10e-06	8.87e-05
Sb-127	1.06e-06	1.64e-08	3.68e-07	1.18e-08	0.00e+00	4.60e-07	5.97e-05
Te-125m	1.14e-05	3.09e-06	1.52e-06	3.20e-06	0.00e+00	0.00e+00	1.10e-05
Te-127	4.71e-07	1.27e-07	1.01e-07	3.26e-07	1.34e-06	0.00e+00	1.84e-05
Te-127m	2.89e-05	7.78e-06	3.43e-06	6.91e-06	8.24e-05	0.00e+00	2.34e-05
Te-129	1.34e-07	3.74e-08	3.18e-08	9.56e-08	3.92e-07	0.00e+00	8.34e-06
Te-129m	4.87e-05	1.36e-05	7.56e-06	1.57e-05	1.43e-04	0.00e+00	5.94e-05
Te-131	8.30e-08	2.53e-08	2.47e-08	6.35e-08	2.51e-07	0.00e+00	4.36e-07
Te-131m	7.20e-06	2.49e-06	2.65e-06	5.12e-06	2.41e-05	0.00e+00	1.01e-04
Te-132	1.01e-05	4.47e-06	5.40e-06	6.51e-06	4.15e-05	0.00e+00	4.50e-05
Te-133m	1.87e-07	7.56e-08	9.37e-08	1.45e-07	7.18e-07	0.00e+00	5.77e-06
Te-134	1.29e-07	5.80e-08	7.74e-08	1.02e-07	5.37e-07	0.00e+00	5.89e-07
I-129	1.39e-05	8.53e-06	7.62e-06	5.58e-03	1.44e-05	0.00e+00	4.29e-07
I-130	2.92e-06	5.90e-06	3.04e-06	6.50e-04	8.82e-06	0.00e+00	2.76e-06
I-131	1.72e-05	1.73e-05	9.83e-06	5.72e-03	2.84e-05	0.00e+00	1.54e-06
I-132	8.00e-07	1.47e-06	6.76e-07	6.82e-05	2.25e-06	0.00e+00	1.73e-06
I-133	5.92e-06	7.32e-06	2.77e-06	1.36e-03	1.22e-05	0.00e+00	2.95e-06
I-134	4.19e-07	7.78e-07	3.58e-07	1.79e-05	1.19e-06	0.00e+00	5.16e-07
I-135	1.75e-06	3.15e-06	1.49e-06	2.79e-04	4.83e-06	0.00e+00	2.40e-06
Cs-134	2.34e-04	3.84e-04	8.10e-05	0.00e+00	1.19e-04	4.27e-05	2.07e-06
Cs-134m	8.44e-08	1.25e-07	8.16e-08	0.00e+00	6.59e-08	1.09e-08	1.58e-07

Conversion factors are in units of mrem per pCi ingested.

**DOSE CONVERSION FACTORS ALL AGE GROUPS
BY NUCLIDE (INHALATION AND INGESTION)**

Ingestion Dose Conversion factors for Child age group by nuclide.
Waterford Steam Electric Station

Nuclide	Organ Dose Conversion Factors						
	Bone	Liver	T. Body	Thyroid	Kidney	Lung	GI-LLI
Cs-135	8.30e-05	5.78e-05	5.93e-06	0.00e+00	2.04e-05	6.81e-06	4.33e-07
Cs-136	2.35e-05	6.46e-05	4.18e-05	0.00e+00	3.44e-05	5.13e-06	2.27e-06
Cs-137	3.27e-04	3.13e-04	4.62e-05	0.00e+00	1.02e-04	3.67e-05	1.96e-06
Cs-138	2.28e-07	3.17e-07	2.01e-07	0.00e+00	2.23e-07	2.40e-08	1.46e-07
Cs-139	1.45e-07	1.61e-07	7.74e-08	0.00e+00	1.21e-07	1.22e-08	1.45e-11
Ba-139	4.14e-07	2.21e-10	1.20e-08	0.00e+00	1.93e-10	1.30e-10	2.39e-05
Ba-140	8.31e-05	7.28e-08	4.85e-06	0.00e+00	2.37e-08	4.34e-08	4.21e-05
Ba-141	2.00e-07	1.12e-10	6.51e-09	0.00e+00	9.69e-11	6.58e-10	1.14e-07
Ba-142	8.74e-08	6.29e-11	4.88e-09	0.00e+00	5.09e-11	3.70e-11	1.14e-09
La-140	1.01e-08	3.53e-09	1.19e-09	0.00e+00	0.00e+00	0.00e+00	9.84e-05
La-141	1.36e-09	3.17e-10	6.88e-11	0.00e+00	0.00e+00	0.00e+00	7.05e-05
La-142	5.24e-10	1.67e-10	5.23e-11	0.00e+00	0.00e+00	0.00e+00	3.31e-05
Ce-141	3.97e-08	1.98e-08	2.94e-09	0.00e+00	8.68e-09	0.00e+00	2.47e-05
Ce-143	6.99e-09	3.79e-06	5.49e-10	0.00e+00	1.59e-09	0.00e+00	5.55e-05
Ce-144	2.08e-06	6.52e-07	1.11e-07	0.00e+00	3.61e-07	0.00e+00	1.70e-04
Pr-143	3.93e-08	1.18e-08	1.95e-09	0.00e+00	6.39e-09	0.00e+00	4.24e-05
Pr-144	1.29e-10	3.99e-11	6.49e-12	0.00e+00	2.11e-11	0.00e+00	8.59e-08
Nd-147	2.79e-08	2.26e-08	1.75e-09	0.00e+00	1.24e-08	0.00e+00	3.58e-05
Pm-147	3.18e-07	2.27e-08	1.22e-08	0.00e+00	4.01e-08	0.00e+00	9.19e-06
Pm-148	3.02e-08	3.63e-09	2.35e-09	0.00e+00	6.17e-09	0.00e+00	9.70e-05
Pm-148m	1.03e-07	2.05e-08	2.05e-08	0.00e+00	3.04e-08	0.00e+00	5.78e-05
Pm-149	6.49e-09	6.90e-10	3.74e-10	0.00e+00	1.22e-09	0.00e+00	4.71e-05
Pm-151	2.92e-09	3.55e-10	2.31e-10	0.00e+00	6.02e-10	0.00e+00	4.03e-05
Sm-151	2.56e-07	3.81e-08	1.20e-08	0.00e+00	3.94e-08	0.00e+00	5.53e-06
Sm-153	3.65e-09	2.27e-09	2.19e-10	0.00e+00	6.91e-10	0.00e+00	3.02e-05
Eu-152	6.15e-07	1.12e-07	1.33e-07	0.00e+00	4.73e-07	0.00e+00	1.84e-05
Eu-154	2.30e-06	2.07e-07	1.89e-07	0.00e+00	9.09e-07	0.00e+00	4.81e-05
Eu-155	4.82e-07	3.47e-08	2.72e-08	0.00e+00	1.30e-07	0.00e+00	8.69e-05
Eu-156	5.62e-08	3.01e-08	6.23e-09	0.00e+00	1.94e-08	0.00e+00	6.83e-05
Tb-160	1.66e-07	0.00e+00	2.06e-08	0.00e+00	4.94e-08	0.00e+00	3.68e-05

Conversion factors are in units of mrem per pCi ingested.

**DOSE CONVERSION FACTORS ALL AGE GROUPS
BY NUCLIDE (INHALATION AND INGESTION)**

Ingestion Dose Conversion factors for Child age group by nuclide.
Waterford Steam Electric Station

Nuclide	Organ Dose Conversion Factors						
	Bone	Liver	T. Body	Thyroid	Kidney	Lung	GI-LLI
Ho-166m	1.08e-06	2.26e-07	1.91e-07	0.00e+00	3.22e-07	0.00e+00	2.63e-05
W-181	4.23e-08	1.04e-08	1.43e-09	0.00e+00	0.00e+00	0.00e+00	3.79e-07
W-185	1.73e-06	4.32e-07	6.05e-08	0.00e+00	0.00e+00	0.00e+00	1.61e-05
W-187	4.29e-07	2.54e-07	1.14e-07	0.00e+00	0.00e+00	0.00e+00	3.57e-05
Pb-210	4.75e-02	1.22e-02	2.09e-03	0.00e+00	3.67e-02	0.00e+00	2.30e-06
Bi-210	1.97e-06	1.02e-05	1.13e-06	0.00e+00	1.15e-04	0.00e+00	5.17e-05
Po-210	1.52e-03	2.43e-03	3.67e-04	0.00e+00	7.56e-03	0.00e+00	6.55e-05
Ra-223	2.12e-02	2.45e-05	4.24e-03	0.00e+00	6.50e-04	0.00e+00	3.38e-04
Ra-224	6.89e-03	1.25e-05	1.38e-03	0.00e+00	3.31e-04	0.00e+00	3.78e-04
Ra-225	2.80e-02	2.50e-05	5.59e-03	0.00e+00	6.62e-04	0.00e+00	3.21e-04
Ra-226	5.75e-01	1.84e-05	4.72e-01	0.00e+00	4.88e-04	0.00e+00	3.41e-04
Ra-228	3.85e-01	9.99e-06	4.32e-01	0.00e+00	2.65e-04	0.00e+00	5.81e-05
Ac-225	1.88e-05	1.94e-05	1.26e-06	0.00e+00	2.07e-06	0.00e+00	4.31e-04
Ac-227	4.12e-03	6.63e-04	2.55e-04	0.00e+00	1.46e-04	0.00e+00	8.43e-05
Th-227	5.85e-05	7.96e-07	1.69e-06	0.00e+00	4.22e-06	0.00e+00	5.63e-04
Th-228	2.07e-03	2.65e-05	7.00e-05	0.00e+00	1.38e-04	0.00e+00	5.79e-04
Th-229	2.35e-02	5.91e-04	3.92e-04	0.00e+00	2.89e-03	0.00e+00	8.04e-05
Th-230	3.55e-03	1.78e-04	9.91e-05	0.00e+00	8.67e-04	0.00e+00	6.19e-05
Th-232	3.96e-03	1.52e-04	3.01e-06	0.00e+00	7.41e-04	0.00e+00	5.27e-05
Th-234	3.42e-07	1.51e-08	9.88e-09	0.00e+00	8.01e-08	0.00e+00	1.18e-04
Pa-231	7.07e-03	2.34e-04	2.81e-04	0.00e+00	1.28e-03	0.00e+00	7.37e-05
Pa-233	1.81e-08	2.82e-09	3.16e-09	0.00e+00	1.04e-08	0.00e+00	1.44e-05
U-232	1.76e-02	0.00e+00	1.26e-03	0.00e+00	1.34e-03	0.00e+00	6.98e-05
U-233	3.72e-03	0.00e+00	2.25e-04	0.00e+00	6.10e-04	0.00e+00	6.45e-05
U-234	3.57e-03	0.00e+00	2.21e-04	0.00e+00	5.98e-04	0.00e+00	6.32e-05
U-235	3.42e-03	0.00e+00	2.07e-04	0.00e+00	5.61e-04	0.00e+00	8.03e-05
U-236	3.42e-03	0.00e+00	2.12e-04	0.00e+00	5.73e-04	0.00e+00	5.92e-05
U-237	2.36e-07	0.00e+00	6.27e-08	0.00e+00	6.81e-07	0.00e+00	2.08e-05
U-238	3.27e-03	0.00e+00	1.94e-04	0.00e+00	5.24e-04	0.00e+00	5.66e-05
Np-237	2.23e-03	1.47e-04	9.79e-05	0.00e+00	6.05e-04	0.00e+00	8.16e-05

Conversion factors are in units of mrem per pCi ingested.

**DOSE CONVERSION FACTORS ALL AGE GROUPS
BY NUCLIDE (INHALATION AND INGESTION)**

Ingestion Dose Conversion factors for Child age group by nuclide.
Waterford Steam Electric Station

Nuclide	Organ Dose Conversion Factors						
	Bone	Liver	T. Body	Thyroid	Kidney	Lung	GI-LLI
Np-238	5.83e-08	1.18e-09	9.08e-10	0.00e+00	3.76e-09	0.00e+00	4.04e-05
Np-239	5.25e-09	3.77e-10	2.65e-10	0.00e+00	1.09e-09	0.00e+00	2.79e-05
Pu-238	1.19e-03	1.38e-04	3.16e-05	0.00e+00	1.15e-04	0.00e+00	7.50e-05
Pu-239	1.29e-03	1.38e-04	3.31e-05	0.00e+00	1.22e-04	0.00e+00	6.85e-05
Pu-240	1.28e-03	1.43e-04	3.31e-05	0.00e+00	1.22e-04	0.00e+00	6.98e-05
Pu-241	3.87e-05	1.58e-06	8.04e-07	0.00e+00	2.96e-06	0.00e+00	1.44e-06
Pu-242	1.19e-03	1.38e-04	3.19e-05	0.00e+00	1.17e-04	0.00e+00	6.71e-05
Pu-244	1.39e-03	1.58e-03	3.65e-05	0.00e+00	1.35e-04	0.00e+00	1.00e-04
Am-241	1.36e-03	1.17e-03	1.02e-04	0.00e+00	6.23e-04	0.00e+00	7.64e-05
Am-242m	1.40e-03	1.12e-03	1.04e-04	0.00e+00	6.30e-04	0.00e+00	9.61e-05
Am-243	1.34e-03	1.13e-03	9.83e-05	0.00e+00	6.06e-04	0.00e+00	8.95e-05
Cm-242	8.78e-05	7.01e-05	5.84e-06	0.00e+00	1.87e-05	0.00e+00	8.16e-05
Cm-243	1.28e-03	1.04e-03	8.24e-05	0.00e+00	3.08e-04	0.00e+00	8.03e-05
Cm-244	1.08e-03	8.74e-04	6.93e-05	0.00e+00	2.54e-04	0.00e+00	7.77e-05
Cm-245	1.67e-03	1.34e-03	1.05e-04	0.00e+00	4.11e-04	0.00e+00	7.24e-05
Cm-246	1.65e-03	1.34e-03	1.05e-04	0.00e+00	4.10e-04	0.00e+00	7.11e-05
Cm-247	1.61e-03	1.32e-03	1.03e-04	0.00e+00	4.04e-04	0.00e+00	9.35e-05
Cm-248	1.34e-02	1.09e-02	8.52e-04	0.00e+00	3.33e-03	0.00e+00	1.51e-03
Cf-252	1.05e-03	0.00e+00	2.54e-05	0.00e+00	0.00e+00	0.00e+00	2.96e-04

Conversion factors are in units of mrem per pCi ingested.

**DOSE CONVERSION FACTORS ALL AGE GROUPS
BY NUCLIDE (INHALATION AND INGESTION)**

Ingestion Dose Conversion factors for Infant age group by nuclide.
Waterford Steam Electric Station

Nuclide	Organ Dose Conversion Factors						
	Bone	Liver	T. Body	Thyroid	Kidney	Lung	GI-LLI
H-3	0.00e+00	1.76e-07	1.76e-07	1.76e-07	1.76e-07	1.76e-07	1.76e-07
Be-10	1.71e-05	2.49e-06	5.16e-07	0.00e+00	1.64e-06	0.00e+00	2.78e-05
C-14	2.37e-05	5.06e-06	5.06e-06	5.06e-06	5.06e-06	5.06e-06	5.06e-06
N-13	5.85e-08	5.85e-08	5.85e-08	5.85e-08	5.85e-08	5.85e-08	5.85e-08
F-18	5.19e-06	0.00e+00	4.43e-07	0.00e+00	0.00e+00	0.00e+00	1.22e-06
Na-22	9.83e-05	9.83e-05	9.83e-05	9.83e-05	9.83e-05	9.83e-05	9.83e-05
Na-24	1.01e-05	1.01e-05	1.01e-05	1.01e-05	1.01e-05	1.01e-05	1.01e-05
P-32	1.70e-03	1.00e-04	6.59e-05	0.00e+00	0.00e+00	0.00e+00	2.30e-05
Ca-41	3.74e-04	0.00e+00	4.08e-05	0.00e+00	0.00e+00	0.00e+00	1.91e-07
Sc-46	3.75e-08	5.41e-08	1.69e-08	0.00e+00	3.56e-08	0.00e+00	3.53e-05
Cr-51	0.00e+00	0.00e+00	1.41e-08	9.20e-09	2.01e-09	1.79e-08	4.11e-07
Mn-54	0.00e+00	1.99e-05	4.51e-06	0.00e+00	4.41e-06	0.00e+00	7.31e-06
Mn-56	0.00e+00	8.18e-07	1.41e-07	0.00e+00	7.03e-07	0.00e+00	7.43e-05
Fe-55	1.39e-05	8.98e-06	2.40e-06	0.00e+00	0.00e+00	4.39e-06	1.14e-06
Fe-59	3.08e-05	5.38e-05	2.12e-05	0.00e+00	0.00e+00	1.59e-05	2.57e-05
Co-57	0.00e+00	1.15e-06	1.87e-06	0.00e+00	0.00e+00	0.00e+00	3.92e-06
Co-58	0.00e+00	3.60e-06	8.98e-06	0.00e+00	0.00e+00	0.00e+00	8.97e-06
Co-60	0.00e+00	1.08e-05	2.55e-05	0.00e+00	0.00e+00	0.00e+00	2.57e-05
Ni-59	4.73e-05	1.45e-05	8.17e-06	0.00e+00	0.00e+00	0.00e+00	7.16e-07
Ni-63	6.34e-04	3.92e-05	2.20e-05	0.00e+00	0.00e+00	0.00e+00	1.95e-06
Ni-65	4.70e-06	5.32e-07	2.42e-07	0.00e+00	0.00e+00	0.00e+00	4.05e-05
Cu-64	0.00e+00	6.09e-07	2.82e-07	0.00e+00	1.03e-06	0.00e+00	1.25e-05
Zn-65	1.84e-05	6.31e-05	2.91e-05	0.00e+00	3.06e-05	0.00e+00	5.33e-05
Zn-69	9.33e-08	1.68e-07	1.25e-08	0.00e+00	6.98e-08	0.00e+00	1.37e-05
Zn-69m	1.50e-06	3.06e-06	2.79e-07	0.00e+00	1.24e-06	0.00e+00	4.24e-05
Se-79	0.00e+00	2.10e-05	3.90e-06	0.00e+00	2.43e-05	0.00e+00	5.58e-07
Br-82	0.00e+00	0.00e+00	1.27e-05	0.00e+00	0.00e+00	0.00e+00	0.00e+00
Br-83	0.00e+00	0.00e+00	3.63e-07	0.00e+00	0.00e+00	0.00e+00	0.00e+00
Br-84	0.00e+00	0.00e+00	3.82e-07	0.00e+00	0.00e+00	0.00e+00	0.00e+00
Br-85	0.00e+00	0.00e+00	1.94e-08	0.00e+00	0.00e+00	0.00e+00	0.00e+00

Conversion factors are in units of mrem per pCi ingested.

**DOSE CONVERSION FACTORS ALL AGE GROUPS
BY NUCLIDE (INHALATION AND INGESTION)**

Ingestion Dose Conversion factors for Infant age group by nuclide.
Waterford Steam Electric Station

Nuclide	Organ Dose Conversion Factors						
	Bone	Liver	T. Body	Thyroid	Kidney	Lung	GI-LLI
Rb-86	0.00e+00	1.70e-04	8.40e-05	0.00e+00	0.00e+00	0.00e+00	4.35e-06
Rb-87	0.00e+00	8.88e-05	3.52e-05	0.00e+00	0.00e+00	0.00e+00	5.98e-07
Rb-88	0.00e+00	4.98e-07	2.73e-07	0.00e+00	0.00e+00	0.00e+00	4.85e-07
Rb-89	0.00e+00	2.86e-07	1.97e-07	0.00e+00	0.00e+00	0.00e+00	9.74e-08
Sr-89	2.51e-03	0.00e+00	7.20e-05	0.00e+00	0.00e+00	0.00e+00	5.16e-05
Sr-90	2.83e-02	0.00e+00	5.74e-04	0.00e+00	0.00e+00	0.00e+00	2.31e-04
Sr-91	5.00e-05	0.00e+00	1.81e-06	0.00e+00	0.00e+00	0.00e+00	5.92e-05
Sr-92	1.92e-05	0.00e+00	7.13e-07	0.00e+00	0.00e+00	0.00e+00	2.07e-04
Y-90	8.69e-08	0.00e+00	2.33e-09	0.00e+00	0.00e+00	0.00e+00	1.20e-04
Y-91	1.13e-06	0.00e+00	3.01e-08	0.00e+00	0.00e+00	0.00e+00	8.10e-05
Y-91m	8.10e-10	0.00e+00	2.76e-11	0.00e+00	0.00e+00	0.00e+00	2.70e-06
Y-92	7.65e-09	0.00e+00	2.15e-10	0.00e+00	0.00e+00	0.00e+00	1.46e-04
Y-93	2.43e-08	0.00e+00	6.62e-10	0.00e+00	0.00e+00	0.00e+00	1.92e-04
Zr-93	1.93e-07	9.19e-09	5.54e-09	0.00e+00	2.71e-08	0.00e+00	2.39e-06
Zr-95	2.06e-07	5.02e-08	3.56e-08	0.00e+00	5.41e-08	0.00e+00	2.50e-05
Zr-97	1.48e-08	2.54e-09	1.16e-09	0.00e+00	2.56e-09	0.00e+00	1.62e-04
Nb-93m	1.23e-07	3.33e-08	1.04e-08	0.00e+00	3.25e-08	0.00e+00	3.98e-06
Nb-95	4.20e-08	1.73e-08	1.00e-08	0.00e+00	1.24e-08	0.00e+00	1.46e-05
Nb-97	4.59e-10	9.79e-11	3.53e-11	0.00e+00	7.65e-11	0.00e+00	3.09e-05
Mo-93	0.00e+00	5.65e-05	1.82e-06	0.00e+00	1.13e-05	0.00e+00	1.21e-06
Mo-99	0.00e+00	3.40e-05	6.63e-06	0.00e+00	5.08e-05	0.00e+00	1.12e-05
Tc-101	2.27e-09	2.86e-09	2.83e-08	0.00e+00	3.40e-08	1.56e-09	4.86e-07
Tc-99	1.08e-06	1.46e-06	4.55e-07	0.00e+00	1.23e-05	1.42e-07	6.31e-06
Tc-99m	1.92e-09	3.96e-09	5.10e-08	0.00e+00	4.26e-08	2.07e-09	1.15e-06
Ru-103	1.48e-06	0.00e+00	4.95e-07	0.00e+00	3.08e-06	0.00e+00	1.80e-05
Ru-105	1.36e-07	0.00e+00	4.58e-08	0.00e+00	1.00e-06	0.00e+00	5.41e-05
Ru-106	2.41e-05	0.00e+00	3.01e-06	0.00e+00	2.85e-05	0.00e+00	1.83e-04
Rh-105	1.09e-06	7.13e-07	4.79e-07	0.00e+00	1.98e-06	0.00e+00	1.77e-05
Pd-107	0.00e+00	1.19e-06	8.45e-08	0.00e+00	6.79e-06	0.00e+00	9.46e-07
Pd-109	0.00e+00	1.50e-06	3.62e-07	0.00e+00	5.51e-06	0.00e+00	3.68e-05

Conversion factors are in units of mrem per pCi ingested.

**DOSE CONVERSION FACTORS ALL AGE GROUPS
BY NUCLIDE (INHALATION AND INGESTION)**

Ingestion Dose Conversion factors for Infant age group by nuclide.
Waterford Steam Electric Station

Nuclide	Organ Dose Conversion Factors						
	Bone	Liver	T. Body	Thyroid	Kidney	Lung	GI-LLI
Ag-110m	9.96e-07	7.27e-07	4.81e-07	0.00e+00	1.04e-06	0.00e+00	3.77e-05
Ag-111	5.20e-07	2.02e-07	1.07e-07	0.00e+00	4.22e-07	0.00e+00	4.82e-05
Cd-113m	0.00e+00	1.77e-05	6.52e-07	0.00e+00	1.34e-05	0.00e+00	2.66e-05
Cd-115m	0.00e+00	1.42e-05	4.93e-07	0.00e+00	7.41e-06	0.00e+00	8.09e-05
Sn-123	2.49e-04	3.89e-06	6.50e-06	3.91e-06	0.00e+00	0.00e+00	6.58e-05
Sn-125	7.41e-05	1.38e-06	3.29e-06	1.36e-06	0.00e+00	0.00e+00	1.11e-04
Sn-126	5.53e-04	7.26e-06	1.80e-05	1.91e-06	0.00e+00	0.00e+00	2.52e-05
Sb-124	2.14e-05	3.15e-07	6.63e-06	5.68e-08	0.00e+00	1.34e-05	6.60e-05
Sb-125	1.23e-05	1.19e-07	2.53e-06	1.54e-08	0.00e+00	7.12e-06	1.64e-05
Sb-126	8.06e-06	1.58e-07	2.91e-06	6.19e-08	0.00e+00	5.07e-06	8.35e-05
Sb-127	2.23e-06	3.98e-08	6.90e-07	2.84e-08	0.00e+00	1.15e-06	5.91e-05
Te-125m	2.33e-05	7.79e-06	3.15e-06	7.84e-06	0.00e+00	0.00e+00	1.11e-05
Te-127	1.00e-06	3.35e-07	2.15e-07	8.14e-07	2.44e-06	0.00e+00	2.10e-05
Te-127m	5.85e-05	1.94e-05	7.08e-06	1.69e-05	1.44e-04	0.00e+00	2.36e-05
Te-129	2.84e-07	9.79e-08	6.63e-08	2.38e-07	7.07e-07	0.00e+00	2.27e-05
Te-129m	1.00e-04	3.43e-05	1.54e-05	3.84e-05	2.50e-04	0.00e+00	5.97e-05
Te-131	1.76e-07	6.50e-08	4.94e-08	1.57e-07	4.50e-07	0.00e+00	7.11e-06
Te-131m	1.52e-05	6.12e-06	5.05e-06	1.24e-05	4.21e-05	0.00e+00	1.03e-04
Te-132	2.08e-05	1.03e-05	9.61e-06	1.52e-05	6.44e-05	0.00e+00	3.81e-05
Te-133m	3.91e-07	1.79e-07	1.71e-07	3.45e-07	1.22e-06	0.00e+00	1.93e-05
Te-134	2.67e-07	1.34e-07	1.38e-07	2.39e-07	9.03e-07	0.00e+00	3.06e-06
I-129	2.86e-05	2.12e-05	1.55e-05	1.36e-02	2.51e-05	0.00e+00	4.24e-07
I-130	6.00e-06	1.32e-05	5.30e-06	1.48e-03	1.45e-05	0.00e+00	2.83e-06
I-131	3.59e-05	4.23e-05	1.86e-05	1.39e-02	4.94e-05	0.00e+00	1.51e-06
I-132	1.66e-06	3.37e-06	1.20e-06	1.58e-04	3.76e-06	0.00e+00	2.73e-06
I-133	1.25e-05	1.82e-05	5.33e-06	3.31e-03	2.14e-05	0.00e+00	3.08e-06
I-134	8.69e-07	1.78e-06	6.33e-07	4.15e-05	1.99e-06	0.00e+00	1.84e-06
I-135	3.64e-06	7.24e-06	2.64e-06	6.49e-04	8.07e-06	0.00e+00	2.62e-06
Cs-134	3.77e-04	7.03e-04	7.10e-05	0.00e+00	1.81e-04	7.42e-05	1.91e-06
Cs-134m	1.76e-07	2.93e-07	1.48e-07	0.00e+00	1.13e-07	2.60e-08	2.32e-07

Conversion factors are in units of mrem per pCi ingested.

**DOSE CONVERSION FACTORS ALL AGE GROUPS
BY NUCLIDE (INHALATION AND INGESTION)**

Ingestion Dose Conversion factors for Infant age group by nuclide.
Waterford Steam Electric Station

Nuclide	Organ Dose Conversion Factors						
	Bone	Liver	T. Body	Thyroid	Kidney	Lung	GI-LLI
Cs-135	1.33e-04	1.21e-04	6.30e-06	0.00e+00	3.44e-05	1.31e-05	4.37e-07
Cs-136	4.59e-05	1.35e-04	5.04e-05	0.00e+00	5.38e-05	1.10e-05	2.05e-06
Cs-137	5.22e-04	6.11e-04	4.33e-05	0.00e+00	1.64e-04	6.64e-05	1.91e-06
Cs-138	4.81e-07	7.82e-07	3.79e-07	0.00e+00	3.90e-07	6.09e-08	1.25e-06
Cs-139	3.10e-07	4.24e-07	1.62e-07	0.00e+00	2.19e-07	3.30e-08	2.66e-08
Ba-139	8.81e-07	5.84e-10	2.55e-08	0.00e+00	3.51e-10	3.54e-10	5.58e-05
Ba-140	1.71e-04	1.71e-07	8.81e-06	0.00e+00	4.06e-08	1.05e-07	4.20e-05
Ba-141	4.25e-07	2.91e-10	1.34e-08	0.00e+00	1.75e-10	1.77e-10	5.19e-06
Ba-142	1.84e-07	1.53e-10	9.06e-09	0.00e+00	8.81e-11	9.26e-11	7.59e-07
La-140	2.11e-08	8.32e-09	2.14e-09	0.00e+00	0.00e+00	0.00e+00	9.77e-05
La-141	2.89e-09	8.38e-10	1.46e-10	0.00e+00	0.00e+00	0.00e+00	9.61e-05
La-142	1.10e-09	4.04e-10	9.67e-11	0.00e+00	0.00e+00	0.00e+00	6.86e-05
Ce-141	7.87e-08	4.80e-08	5.65e-09	0.00e+00	1.48e-08	0.00e+00	2.48e-05
Ce-143	1.48e-08	9.82e-06	1.12e-09	0.00e+00	2.86e-09	0.00e+00	5.73e-05
Ce-144	2.98e-06	1.22e-06	1.67e-07	0.00e+00	4.93e-07	0.00e+00	1.71e-04
Pr-143	8.13e-08	3.04e-08	4.03e-09	0.00e+00	1.13e-08	0.00e+00	4.29e-05
Pr-144	2.74e-10	1.06e-10	1.38e-11	0.00e+00	3.84e-11	0.00e+00	4.93e-06
Nd-147	5.53e-08	5.68e-08	3.48e-09	0.00e+00	2.19e-08	0.00e+00	3.60e-05
Pm-147	3.88e-07	3.27e-08	1.59e-08	0.00e+00	4.88e-08	0.00e+00	9.27e-06
Pm-148	6.32e-08	9.13e-09	4.60e-09	0.00e+00	1.09e-08	0.00e+00	9.74e-05
Pm-148m	1.65e-07	4.18e-08	3.28e-08	0.00e+00	4.80e-08	0.00e+00	5.44e-05
Pm-149	1.38e-08	1.81e-09	7.90e-10	0.00e+00	2.20e-09	0.00e+00	4.86e-05
Pm-151	6.18e-09	9.01e-10	4.56e-10	0.00e+00	1.07e-09	0.00e+00	4.17e-05
Sm-151	2.90e-07	6.67e-08	1.44e-08	0.00e+00	4.53e-08	0.00e+00	5.58e-06
Sm-153	7.72e-09	5.97e-09	4.58e-10	0.00e+00	1.25e-09	0.00e+00	3.12e-05
Eu-152	6.74e-07	1.79e-07	1.51e-07	0.00e+00	5.02e-07	0.00e+00	1.59e-05
Eu-154	2.64e-06	3.67e-07	2.20e-07	0.00e+00	9.95e-07	0.00e+00	4.58e-05
Eu-155	5.42e-07	6.25e-08	3.23e-08	0.00e+00	1.40e-07	0.00e+00	8.37e-05
Eu-156	1.14e-07	7.06e-08	1.12e-08	0.00e+00	3.26e-08	0.00e+00	6.67e-05
Tb-160	2.59e-07	0.00e+00	3.24e-08	0.00e+00	7.37e-08	0.00e+00	3.45e-05

Conversion factors are in units of mrem per pCi ingested.

**DOSE CONVERSION FACTORS ALL AGE GROUPS
BY NUCLIDE (INHALATION AND INGESTION)**

Ingestion Dose Conversion factors for Infant age group by nuclide.
Waterford Steam Electric Station

Nuclide	Organ Dose Conversion Factors						
	Bone	Liver	T. Body	Thyroid	Kidney	Lung	GI-LLI
Ho-166m	1.25e-06	2.69e-07	2.13e-07	0.00e+00	3.57e-07	0.00e+00	2.66e-05
W-181	8.85e-08	2.72e-08	3.04e-09	0.00e+00	0.00e+00	0.00e+00	3.82e-07
W-185	3.62e-06	1.13e-06	1.29e-07	0.00e+00	0.00e+00	0.00e+00	1.62e-05
W-187	9.03e-07	6.28e-07	2.17e-07	0.00e+00	0.00e+00	0.00e+00	3.69e-05
Pb-210	5.28e-02	1.42e-02	2.38e-03	0.00e+00	4.33e-02	0.00e+00	2.32e-06
Bi-210	4.16e-06	2.68e-05	2.39e-06	0.00e+00	2.08e-04	0.00e+00	5.27e-05
Po-210	3.10e-03	5.93e-03	7.41e-04	0.00e+00	1.26e-02	0.00e+00	6.61e-05
Ra-223	4.41e-02	6.42e-05	8.82e-03	0.00e+00	1.17e-03	0.00e+00	3.43e-04
Ra-224	1.46e-02	3.29e-05	2.91e-03	0.00e+00	6.00e-04	0.00e+00	3.86e-04
Ra-225	5.78e-02	6.52e-05	1.15e-02	0.00e+00	1.19e-03	0.00e+00	3.24e-04
Ra-226	6.20e-01	4.76e-05	5.14e-01	0.00e+00	8.71e-04	0.00e+00	3.44e-04
Ra-228	4.32e-01	2.58e-05	4.86e-01	0.00e+00	4.73e-04	0.00e+00	5.86e-05
Ac-225	3.92e-05	5.03e-05	2.63e-06	0.00e+00	3.69e-06	0.00e+00	4.36e-04
Ac-227	4.49e-03	7.67e-04	2.79e-04	0.00e+00	1.56e-04	0.00e+00	8.50e-05
Th-227	1.20e-04	2.01e-06	3.45e-06	0.00e+00	7.41e-06	0.00e+00	5.70e-04
Th-228	2.47e-03	3.38e-05	8.36e-05	0.00e+00	1.58e-04	0.00e+00	5.84e-04
Th-229	2.52e-02	6.33e-04	4.20e-04	0.00e+00	3.03e-03	0.00e+00	8.10e-05
Th-230	3.80e-03	1.90e-04	1.06e-04	0.00e+00	9.12e-04	0.00e+00	6.24e-05
Th-232	4.24e-03	1.63e-04	1.65e-06	0.00e+00	7.79e-04	0.00e+00	5.31e-05
Th-234	6.92e-07	3.77e-08	2.00e-08	0.00e+00	1.39e-07	0.00e+00	1.19e-04
Pa-231	7.57e-03	2.50e-04	3.02e-04	0.00e+00	1.34e-03	0.00e+00	7.44e-05
Pa-233	3.11e-08	6.09e-09	5.43e-09	0.00e+00	1.67e-08	0.00e+00	1.46e-05
U-232	2.42e-02	0.00e+00	2.16e-03	0.00e+00	2.37e-03	0.00e+00	7.04e-05
U-233	5.08e-03	0.00e+00	3.87e-04	0.00e+00	1.08e-03	0.00e+00	6.51e-05
U-234	4.88e-03	0.00e+00	3.80e-04	0.00e+00	1.06e-03	0.00e+00	6.37e-05
U-235	4.67e-03	0.00e+00	3.56e-04	0.00e+00	9.93e-04	0.00e+00	8.10e-05
U-236	4.67e-03	0.00e+00	3.64e-04	0.00e+00	1.01e-03	0.00e+00	5.98e-05
U-237	4.95e-07	0.00e+00	1.32e-07	0.00e+00	1.23e-06	0.00e+00	2.11e-05
U-238	4.47e-03	0.00e+00	3.33e-04	0.00e+00	9.28e-04	0.00e+00	5.71e-05
Np-237	2.40e-03	1.59e-04	1.05e-04	0.00e+00	6.34e-04	0.00e+00	8.23e-05

Conversion factors are in units of mrem per pCi ingested.

**DOSE CONVERSION FACTORS ALL AGE GROUPS
BY NUCLIDE (INHALATION AND INGESTION)**

Ingestion Dose Conversion factors for Infant age group by nuclide.
Waterford Steam Electric Station

Nuclide	Organ Dose Conversion Factors						
	Bone	Liver	T. Body	Thyroid	Kidney	Lung	GI-LLI
Np-238	1.24e-07	3.12e-09	1.92e-09	0.00e+00	6.81e-09	0.00e+00	4.17e-05
Np-239	1.11e-08	9.93e-10	5.61e-10	0.00e+00	1.98e-09	0.00e+00	2.87e-05
Pu-238	1.28e-03	1.50e-04	3.40e-05	0.00e+00	1.21e-04	0.00e+00	7.57e-05
Pu-239	1.38e-03	1.55e-04	3.54e-05	0.00e+00	1.28e-04	0.00e+00	6.91e-05
Pu-240	1.38e-03	1.55e-04	3.54e-05	0.00e+00	1.28e-04	0.00e+00	7.04e-05
Pu-241	4.25e-05	1.76e-06	8.82e-07	0.00e+00	3.17e-06	0.00e+00	1.45e-06
Pu-242	1.28e-03	1.49e-04	3.41e-05	0.00e+00	1.23e-04	0.00e+00	6.77e-05
Pu-244	1.49e-03	1.71e-04	3.91e-05	0.00e+00	1.41e-04	0.00e+00	1.01e-04
Am-241	1.46e-03	1.27e-03	1.09e-04	0.00e+00	6.55e-04	0.00e+00	7.70e-05
Am-242m	1.51e-03	1.22e-03	1.13e-04	0.00e+00	6.64e-04	0.00e+00	9.69e-05
Am-243	1.44e-03	1.23e-03	1.06e-04	0.00e+00	6.36e-04	0.00e+00	9.03e-05
Cm-242	1.37e-04	1.27e-04	9.10e-06	0.00e+00	2.62e-05	0.00e+00	8.23e-05
Cm-243	1.40e-03	1.15e-03	8.98e-05	0.00e+00	3.27e-04	0.00e+00	8.10e-05
Cm-244	1.18e-03	9.70e-04	7.59e-05	0.00e+00	2.71e-04	0.00e+00	7.84e-05
Cm-245	1.79e-03	1.45e-03	1.13e-04	0.00e+00	4.32e-04	0.00e+00	7.30e-05
Cm-246	1.77e-03	1.45e-03	1.13e-04	0.00e+00	4.31e-04	0.00e+00	7.17e-05
Cm-247	1.73e-03	1.43e-03	1.11e-04	0.00e+00	4.24e-04	0.00e+00	9.43e-05
Cm-248	1.43e-02	1.18e-02	9.16e-04	0.00e+00	3.50e-03	0.00e+00	1.52e-03
Cf-252	1.22e-03	0.00e+00	2.95e-05	0.00e+00	0.00e+00	0.00e+00	2.99e-04

Conversion factors are in units of mrem per pCi ingested.

SPECIFIC FACTORS USED TO DETERMINE A_i , P_i , R_i , VALUES FOR THE OFFSITE DOSE CALCULATION MANUAL

Values for A_i , P_i , and R_i were calculated as per NUREG-0133. Recommended values for various factors in the calculations were as specified in NUREG-0133. The location of most of the recommended factors are contained in USNRC Regulatory Guide 1.109, NUREG 0172, and NUREG/CR 1276. All factors used in Waterford-3 SES's calculations are for the maximum individual and are not site specific. The various factors are discussed below.

- Stable element transfer coefficients for vegetation, cow's milk, goat's milk and meat (Attachment 7.22, pages 10 - 12) were obtained from NUREG/CR 1276.
- Animal consumption rates (Attachment 7.22, page 2) were obtained from USNRC Regulatory Guide 1.109.
- Usage or consumption rates for adult, teen, child, and infant age groups (Attachment 7.22, page 3) were obtained from USNRC Regulatory Guide 1.109. These values are for the maximum exposed individual.
- External dose factors for standing on contaminated ground (Attachment 7.20) were obtained from NUREG/CR 1276.
- Bioaccumulation factors for freshwater and saltwater vertebrates and invertebrates (Attachment 7.22, page 13 - 15) were obtained from NUREG/CR 1276.
- Inhalation and ingestion dose factors for adult, teen, child, and infant age groups (Attachment 7.21) were obtained from NUREG/CR 1276.
- Radionuclide half-lives and decay constants are included Attachment 7.22, pages 4 - 9.
- Other factors (Attachment 7.22, page 16 - 18) used were obtained from USNRC Regulatory Guide 1.109 for various parameters,.

SPECIFIC FACTORS USED TO DETERMINE A_i , P_i , R_i , VALUES FOR THE
OFFSITE DOSE CALCULATION MANUAL

Animal Consumption rates.
Waterford Steam Electric Station

Milk cow's feed intake rate	:	50.00	kg/day
Milk cow's water intake rate	:	60.00	l/day
Beef cow's feed intake rate	:	50.00	kg/day
Beef cow's water intake rate	:	50.00	l/day
Goat's feed intake rate	:	6.00	kg/day
Goat's water intake rate	:	8.00	l/day

**SPECIFIC FACTORS USED TO DETERMINE A_i , P_i , R_i , VALUES FOR THE
OFFSITE DOSE CALCULATION MANUAL**

Consumption rates for MAXIMAL individuals.
Waterford Steam Electric Station

produce veg	usage rate for the Adult	:	520.0	kg/yr
produce veg	usage rate for the Teen	:	630.0	kg/yr
produce veg	usage rate for the Child	:	520.0	kg/yr
produce veg	usage rate for the Infant	:	0.0	kg/yr

leafy veg	usage rate for the Adult	:	64.0	kg/yr
leafy veg	usage rate for the Teen	:	42.0	kg/yr
leafy veg	usage rate for the Child	:	26.0	kg/yr
leafy veg	usage rate for the Infant	:	0.0	kg/yr

milk	usage rate for the Adult	:	310.0	l/yr
milk	usage rate for the Teen	:	400.0	l/yr
milk	usage rate for the Child	:	330.0	l/yr
milk	usage rate for the Infant	:	330.0	l/yr

meat/poultry	usage rate for the Adult	:	110.0	kg/yr
meat/poultry	usage rate for the Teen	:	65.0	kg/yr
meat/poultry	usage rate for the Child	:	41.0	kg/yr
meat/poultry	usage rate for the Infant	:	0.0	kg/yr

fish	usage rate for the Adult	:	21.0	kg/yr
fish	usage rate for the Teen	:	16.0	kg/yr
fish	usage rate for the Child	:	6.9	kg/yr
fish	usage rate for the Infant	:	0.0	kg/yr

seafood	usage rate for the Adult	:	5.0	kg/yr
seafood	usage rate for the Teen	:	3.8	kg/yr
seafood	usage rate for the Child	:	1.7	kg/yr
seafood	usage rate for the Infant	:	0.0	kg/yr

drink h2o	usage rate for the Adult	:	730.0	l/yr
drink h2o	usage rate for the Teen	:	510.0	l/yr
drink h2o	usage rate for the Child	:	510.0	l/yr
drink h2o	usage rate for the Infant	:	330.0	l/yr

shore rec	usage rate for the Adult	:	12.0	hr/yr
shore rec	usage rate for the Teen	:	67.0	hr/yr
shore rec	usage rate for the Child	:	14.0	hr/yr
shore rec	usage rate for the Infant	:	0.0	hr/yr

inhalation	usage rate for the Adult	:	8000.0	m3/yr
inhalation	usage rate for the Teen	:	8000.0	m3/yr
inhalation	usage rate for the Child	:	3700.0	m3/yr
inhalation	usage rate for the Infant	:	1400.0	m3/yr

**SPECIFIC FACTORS USED TO DETERMINE A_i , P_i , R_i , VALUES FOR THE
OFFSITE DOSE CALCULATION MANUAL**

Radionuclide Parameters used.
Waterford Steam Electric Station

Nuclide	Parameters	
	Half-life	Decay constant
H-3	1.2280e+01 years	1.7899e-09 1/seconds
Be-10	1.6000e+06 years	1.3737e-14 1/seconds
C-14	5.7300e+03 years	3.8359e-12 1/seconds
N-13	9.9700e+00 minutes	1.1587e-03 1/seconds
F-18	1.8300e+00 hours	1.0521e-04 1/seconds
Na-22	2.6000e+00 years	8.4537e-09 1/seconds
Na-24	1.5000e+01 hours	1.2836e-05 1/seconds
P-32	1.4290e+01 days	5.6141e-07 1/seconds
Ca-41	1.3000e+05 years	1.6907e-13 1/seconds
Sc-46	8.3800e+01 days	9.5734e-08 1/seconds
Cr-51	2.7704e+01 days	2.8958e-07 1/seconds
Mn-54	3.1270e+02 days	2.5656e-08 1/seconds
Mn-56	2.5758e+00 hours	7.4750e-05 1/seconds
Fe-55	2.7000e+00 years	8.1406e-09 1/seconds
Fe-59	4.4630e+01 days	1.7976e-07 1/seconds
Co-57	2.7000e+02 days	2.9713e-08 1/seconds
Co-58	7.0800e+01 days	1.1331e-07 1/seconds
Co-60	5.2710e+00 years	4.1699e-09 1/seconds
Ni-59	7.5000e+04 years	2.9306e-13 1/seconds
Ni-63	1.0010e+02 years	2.1958e-10 1/seconds
Ni-65	2.5200e+00 hours	7.6405e-05 1/seconds
Cu-64	1.2701e+01 hours	1.5160e-05 1/seconds
Zn-65	2.4440e+02 days	3.2825e-08 1/seconds
Zn-69	5.5600e+01 minutes	2.0778e-04 1/seconds
Zn-69m	1.3800e+01 hours	1.3952e-05 1/seconds
Se-79	6.5000e+04 years	3.3815e-13 1/seconds
Br-82	1.4700e+00 days	5.4575e-06 1/seconds
Br-83	2.3900e+00 hours	8.0561e-05 1/seconds
Br-84	3.1800e+01 minutes	3.6328e-04 1/seconds
Br-85	1.7200e+02 seconds	4.0299e-03 1/seconds

**SPECIFIC FACTORS USED TO DETERMINE A_i, P_i, R_i, VALUES FOR THE
OFFSITE DOSE CALCULATION MANUAL**

Radionuclide Parameters used.
Waterford Steam Electric Station

Nuclide	Parameters	
	Half-life	Decay constant
Rb-86	1.8660e+01 days	4.2993e-07 1/seconds
Rb-87	4.6000e+10 years	4.7782e-19 1/seconds
Rb-88	1.7800e+01 minutes	6.4901e-04 1/seconds
Rb-89	1.5440e+01 minutes	7.4822e-04 1/seconds
Sr-89	5.0550e+01 days	1.5870e-07 1/seconds
Sr-90	2.8600e+01 years	7.6852e-10 1/seconds
Sr-91	9.5000e+00 hours	2.0267e-05 1/seconds
Sr-92	2.7100e+00 hours	7.1048e-05 1/seconds
Y-90	6.4100e+01 hours	3.0038e-06 1/seconds
Y-91	5.8510e+01 days	1.3711e-07 1/seconds
Y-91m	4.9710e+01 minutes	2.3240e-04 1/seconds
Y-92	3.5400e+00 hours	5.4390e-05 1/seconds
Y-93	1.0100e+01 hours	1.9063e-05 1/seconds
Zr-93	1.5000e+06 years	1.4653e-14 1/seconds
Zr-95	6.4020e+01 days	1.2531e-07 1/seconds
Zr-97	1.6900e+01 hours	1.1393e-05 1/seconds
Nb-93m	1.3600e+01 years	1.6161e-09 1/seconds
Nb-95	3.5060e+01 days	2.2882e-07 1/seconds
Nb-97	1.2300e+00 hours	1.5654e-04 1/seconds
Mo-93	3.5000e+03 years	6.2799e-12 1/seconds
Mo-99	6.6020e+01 hours	2.9164e-06 1/seconds
Tc-101	1.4200e+01 minutes	8.1355e-04 1/seconds
Tc-99	2.1400e+05 years	1.0271e-13 1/seconds
Tc-99m	6.0200e+00 hours	3.1984e-05 1/seconds
Ru-103	3.9350e+01 days	2.0388e-07 1/seconds
Ru-105	4.4400e+00 hours	4.3365e-05 1/seconds
Ru-106	3.6820e+02 days	2.1789e-08 1/seconds
Rh-105	1.4700e+00 days	5.4575e-06 1/seconds
Pd-107	6.5000e+06 years	3.3815e-15 1/seconds
Pd-109	1.3500e+01 hours	1.4262e-05 1/seconds

**SPECIFIC FACTORS USED TO DETERMINE A_i , P_i , R_i , VALUES FOR THE
OFFSITE DOSE CALCULATION MANUAL**

Radionuclide Parameters used.
Waterford Steam Electric Station

Nuclide	Parameters	
	Half-life	Decay constant
Ag-110m	2.4985e+02 days	3.2109e-08 1/seconds
Ag-111	7.4500e+00 days	1.0769e-06 1/seconds
Cd-113m	1.4600e+01 years	1.5054e-09 1/seconds
Cd-115m	4.4600e+01 days	1.7988e-07 1/seconds
Sn-123	1.2900e+02 days	6.2190e-08 1/seconds
Sn-125	9.6200e+00 days	8.3394e-07 1/seconds
Sn-126	1.0000e+05 years	2.1980e-13 1/seconds
Sb-124	6.0200e+01 days	1.3326e-07 1/seconds
Sb-125	2.7700e+00 years	7.9349e-09 1/seconds
Sb-126	1.2500e+01 days	6.4180e-07 1/seconds
Sb-127	9.3000e+01 hours	2.0703e-06 1/seconds
Te-125m	5.8000e+01 days	1.3832e-07 1/seconds
Te-127	9.3500e+00 hours	2.0593e-05 1/seconds
Te-127m	1.0900e+02 days	7.3601e-08 1/seconds
Te-129	6.9600e+01 minutes	1.6598e-04 1/seconds
Te-129m	3.3600e+01 days	2.3877e-07 1/seconds
Te-131	2.5000e+01 minutes	4.6210e-04 1/seconds
Te-131m	3.0000e+01 hours	6.4180e-06 1/seconds
Te-132	7.8200e+01 hours	2.4622e-06 1/seconds
Te-133m	5.5400e+01 minutes	2.0853e-04 1/seconds
Te-134	4.1800e+01 minutes	2.7637e-04 1/seconds
I-129	1.5700e+07 years	1.4000e-15 1/seconds
I-130	1.2360e+01 hours	1.5578e-05 1/seconds
I-131	8.0400e+00 days	9.9783e-07 1/seconds
I-132	2.3000e+00 hours	8.3713e-05 1/seconds
I-133	2.0800e+01 hours	9.2568e-06 1/seconds
I-134	5.2600e+01 minutes	2.1963e-04 1/seconds
I-135	6.6100e+00 hours	2.9129e-05 1/seconds
Cs-134	2.0620e+00 years	1.0659e-08 1/seconds
Cs-134m	2.9000e+00 hours	6.6393e-05 1/seconds

**SPECIFIC FACTORS USED TO DETERMINE A_i , P_i , R_i VALUES FOR THE
OFFSITE DOSE CALCULATION MANUAL**

Radionuclide Parameters used.
Waterford Steam Electric Station

Nuclide	Parameters	
	Half-life	Decay constant
Cs-135	2.0000e+06 years	1.0990e-14 1/seconds
Cs-136	1.3160e+01 days	6.0962e-07 1/seconds
Cs-137	3.0170e+01 years	7.2852e-10 1/seconds
Cs-138	3.2200e+01 minutes	3.5877e-04 1/seconds
Cs-139	9.4000e+00 minutes	1.2290e-03 1/seconds
Ba-139	8.3100e+01 minutes	1.3902e-04 1/seconds
Ba-140	1.2789e+01 days	6.2730e-07 1/seconds
Ba-141	1.8270e+01 minutes	6.3232e-04 1/seconds
Ba-142	1.0700e+01 minutes	1.0797e-03 1/seconds
La-140	4.0220e+01 hours	4.7872e-06 1/seconds
La-141	3.9300e+00 hours	4.8993e-05 1/seconds
La-142	9.5400e+01 minutes	1.2109e-04 1/seconds
Ce-141	3.2500e+01 days	2.4685e-07 1/seconds
Ce-143	3.3000e+01 hours	5.8346e-06 1/seconds
Ce-144	2.8430e+02 days	2.8219e-08 1/seconds
Pr-143	1.3560e+01 days	5.9163e-07 1/seconds
Pr-144	1.7280e+01 minutes	6.6854e-04 1/seconds
Nd-147	1.0980e+01 days	7.3065e-07 1/seconds
Pm-147	2.6200e+00 years	8.3891e-09 1/seconds
Pm-148	5.3700e+00 days	1.4940e-06 1/seconds
Pm-148m	4.1300e+01 days	1.9425e-07 1/seconds
Pm-149	2.2100e+00 days	3.6301e-06 1/seconds
Pm-151	1.1800e+00 days	6.7988e-06 1/seconds
Sm-151	9.3000e+01 years	2.3634e-10 1/seconds
Sm-153	1.9500e+00 days	4.1141e-06 1/seconds
Eu-152	1.2700e+01 years	1.7307e-09 1/seconds
Eu-154	1.6000e+02 years	1.3737e-10 1/seconds
Eu-155	1.8000e+00 years	1.2211e-08 1/seconds
Eu-156	1.5200e+01 days	5.2780e-07 1/seconds
Tb-160	7.2100e+01 days	1.1127e-07 1/seconds

**SPECIFIC FACTORS USED TO DETERMINE A_i, P_i, R_i, VALUES FOR THE
OFFSITE DOSE CALCULATION MANUAL**

Radionuclide Parameters used.
Waterford Steam Electric Station

Nuclide	Parameters	
	Half-life	Decay constant
Ho-166m	1.2000e+03 years	1.8316e-11 1/seconds
W-181	1.2100e+02 days	6.6302e-08 1/seconds
W-185	7.5100e+01 days	1.0682e-07 1/seconds
W-187	2.3830e+01 hours	8.0798e-06 1/seconds
Pb-210	2.0400e+01 years	1.0774e-09 1/seconds
Bi-210	5.0100e+00 days	1.6013e-06 1/seconds
Po-210	1.3800e+02 days	5.8134e-08 1/seconds
Ra-223	1.1400e+01 days	7.0373e-07 1/seconds
Ra-224	3.6600e+00 days	2.1919e-06 1/seconds
Ra-225	1.4800e+01 days	5.4206e-07 1/seconds
Ra-226	1.6000e+03 years	1.3737e-11 1/seconds
Ra-228	5.7500e+00 years	3.8225e-09 1/seconds
Ac-225	1.0000e+01 days	8.0225e-07 1/seconds
Ac-227	2.1800e+01 years	1.0082e-09 1/seconds
Th-227	1.8500e+01 days	4.3365e-07 1/seconds
Th-228	1.9100e+00 years	1.1508e-08 1/seconds
Th-229	7.3400e+03 years	2.9945e-12 1/seconds
Th-230	7.7000e+04 years	2.8545e-13 1/seconds
Th-232	1.4100e+10 years	1.5588e-18 1/seconds
Th-234	2.4100e+01 days	3.3289e-07 1/seconds
Pa-231	3.2800e+04 years	6.7011e-13 1/seconds
Pa-233	2.7400e+01 days	2.9279e-07 1/seconds
U-232	7.2000e+01 years	3.0527e-10 1/seconds
U-233	1.5800e+05 years	1.3911e-13 1/seconds
U-234	2.4800e+05 years	8.8627e-14 1/seconds
U-235	7.0400e+08 years	3.1221e-17 1/seconds
U-236	3.3400e+07 years	6.5807e-16 1/seconds
U-237	6.7500e+00 days	1.1885e-06 1/seconds
U-238	4.7000e+09 years	4.6765e-18 1/seconds
Np-237	2.1400e+06 years	1.0271e-14 1/seconds

SPECIFIC FACTORS USED TO DETERMINE A_i , P_i , R_i , VALUES FOR THE
OFFSITE DOSE CALCULATION MANUAL

Radionuclide Parameters used.
Waterford Steam Electric Station

Nuclide	Parameters	
	Half-life	Decay constant
Np-238	2.1200e+00 days	3.7842e-06 1/seconds
Np-239	2.3550e+00 days	3.4066e-06 1/seconds
Pu-238	8.7800e+01 years	2.5034e-10 1/seconds
Pu-239	2.4100e+04 years	9.1201e-13 1/seconds
Pu-240	6.5400e+03 years	3.3608e-12 1/seconds
Pu-241	1.5200e+01 years	1.4460e-09 1/seconds
Pu-242	3.8700e+05 years	5.6795e-14 1/seconds
Pu-244	8.2600e+07 years	2.6610e-16 1/seconds
Am-241	4.3300e+00 years	5.0761e-09 1/seconds
Am-242m	1.5200e+02 years	1.4460e-10 1/seconds
Am-243	7.3800e+03 years	2.9783e-12 1/seconds
Cm-242	1.6300e+02 days	4.9218e-08 1/seconds
Cm-243	2.8500e+01 years	7.7121e-10 1/seconds
Cm-244	1.8100e+01 years	1.2143e-09 1/seconds
Cm-245	8.5000e+03 years	2.5858e-12 1/seconds
Cm-246	4.8200e+03 years	4.5601e-12 1/seconds
Cm-247	1.5600e+07 years	1.4089e-15 1/seconds
Cm-248	3.6100e+05 years	6.0885e-14 1/seconds
Cf-252	2.4600e+00 years	8.9348e-09 1/seconds

SPECIFIC FACTORS USED TO DETERMINE A_i , P_i , R_i , VALUES FOR THE OFFSITE DOSE CALCULATION MANUAL

Stable Element Transfer Coefficients by nuclide.
Waterford Steam Electric Station

Element	Stable Element Transfer Data			
	Biv Veg/Soil	Fm Cow Milk	Ff Meat	Fm Goat Milk
H	4.80e+00	1.00e-02	1.20e-02	1.70e-01
He	5.00e-02	2.00e-02	2.00e-02	2.00e-02
Li	8.30e-04	5.00e-02	1.00e-02	5.00e-02
Be	4.20e-04	1.00e-04	1.00e-03	1.00e-04
B	1.20e-01	2.70e-03	8.00e-04	2.70e-03
C	5.50e+00	1.20e-02	3.10e-02	1.00e-01
N	7.50e+00	2.20e-02	7.70e-02	2.20e-02
O	1.60e+00	2.00e-02	1.60e-02	2.00e-02
F	6.50e-04	1.40e-02	1.50e-01	1.40e-02
Ne	1.40e-01	2.00e-02	2.00e-02	2.00e-02
Na	5.20e-02	4.00e-02	3.00e-02	4.00e-02
Mg	1.30e-01	1.00e-02	5.00e-03	1.00e-02
Al	1.80e-04	5.00e-04	1.50e-03	5.00e-04
Si	1.50e-04	1.00e-04	4.00e-05	1.00e-04
P	1.10e+00	2.50e-02	4.60e-02	2.50e-01
S	5.90e-01	1.80e-02	1.00e-01	1.80e-02
Cl	5.00e+00	5.00e-02	8.00e-02	5.00e-02
Ar	6.00e-01	2.00e-02	2.00e-02	2.00e-02
K	3.70e-01	1.00e-02	1.20e-02	1.00e-02
Ca	3.60e-02	8.00e-03	4.00e-03	8.00e-03
Sc	1.10e-03	5.00e-06	1.60e-02	5.00e-06
Ti	5.40e-05	5.00e-06	3.10e-02	5.00e-06
V	1.30e-03	1.00e-03	2.30e-03	1.00e-03
Cr	2.50e-04	2.20e-03	2.40e-03	2.20e-03
Mn	2.90e-02	2.50e-04	8.00e-04	2.50e-04
Fe	6.60e-04	1.20e-03	4.00e-02	1.30e-04
Co	9.40e-03	1.00e-03	1.30e-02	1.00e-03
Ni	1.90e-02	6.70e-03	5.30e-03	6.70e-03
Cu	1.20e-01	1.40e-02	8.00e-03	1.30e-02
Zn	4.00e-01	3.90e-02	3.00e-02	3.90e-02
Ga	2.50e-04	5.00e-05	1.30e+00	5.00e-05
Ge	1.00e-01	5.00e-04	2.00e+01	5.00e-04
As	1.00e-02	6.00e-03	2.00e-03	6.00e-03
Se	1.30e+00	4.50e-02	1.50e-02	4.50e-02
Br	7.60e-01	5.00e-02	2.60e-02	5.00e-02

Units for transfer data are derived as follows:

Biv -> pCi/kg in vegetation per pCi/kg in soil (no units),

Fm -> pCi/liter in milk per pCi/day ingested by animal (days/liter),

Ff -> pCi/kg in meat per pCi/day ingested by animal (days/kg).

**SPECIFIC FACTORS USED TO DETERMINE A_i , P_i , R_i , VALUES FOR THE
OFFSITE DOSE CALCULATION MANUAL**

Stable Element Transfer Coefficients by nuclide.
Waterford Steam Electric Station

Element	Stable Element Transfer Data			
	Biv Veg/Soil	Fm Cow Milk	Ff Meat	Fm Goat Milk
Kr	3.00e+00	2.00e-02	2.00e-02	2.00e-02
Rb	1.30e-01	3.00e-02	3.10e-02	3.00e-02
Sr	1.70e-02	8.00e-04	6.00e-04	1.40e-02
Y	2.60e-03	1.00e-05	4.60e-03	1.00e-05
Zr	1.70e-04	5.00e-06	3.40e-02	5.00e-06
Nb	9.40e-03	2.50e-03	2.80e-01	2.50e-03
Mo	1.20e-01	7.50e-03	8.00e-03	7.50e-03
Tc	2.50e-01	2.50e-02	4.00e-01	2.50e-02
Ru	5.00e-02	1.00e-06	4.00e-01	1.00e-06
Rh	1.30e+01	1.00e-02	1.50e-03	1.00e-02
Pd	5.00e+00	1.00e-02	4.00e-03	1.00e-02
Ag	1.50e-01	5.00e-02	1.70e-02	5.00e-02
Cd	3.00e-01	1.20e-04	5.30e-04	1.20e-04
In	2.50e-01	1.00e-04	8.00e-03	1.00e-04
Sn	2.50e-03	2.50e-03	8.00e-02	2.50e-03
Sb	1.10e-02	1.50e-03	4.00e-03	1.50e-03
Te	1.30e+00	1.00e-03	7.70e-02	1.00e-03
I	2.00e-02	6.00e-03	2.90e-03	6.00e-03
Xe	1.00e+01	2.00e-02	2.00e-02	2.00e-02
Cs	1.00e-02	1.20e-02	4.00e-03	3.00e-01
Ba	5.00e-03	4.00e-04	3.20e-03	4.00e-04
La	2.50e-03	5.00e-06	2.00e-04	5.00e-06
Ce	2.50e-03	1.00e-04	1.20e-03	1.00e-04
Pr	2.50e-03	5.00e-06	4.70e-03	5.00e-06
Nd	2.40e-03	5.00e-06	3.30e-03	5.00e-06
Pm	2.50e-03	5.00e-06	4.80e-03	5.00e-06
Sm	2.50e-03	5.00e-06	5.00e-03	5.00e-06
Eu	2.50e-03	5.00e-06	4.80e-03	5.00e-06
Gd	2.60e-03	5.00e-06	3.60e-03	5.00e-06
Tb	2.60e-03	5.00e-06	4.40e-03	5.00e-06
Dy	2.50e-03	5.00e-06	5.30e-03	5.00e-06
Ho	2.60e-03	5.00e-06	4.40e-03	5.00e-06
Er	2.50e-03	5.00e-06	4.00e-03	5.00e-06
Tm	2.60e-03	5.00e-06	4.40e-03	5.00e-06
Yb	2.50e-03	5.00e-06	4.00e-03	5.00e-06

Units for transfer data are derived as follows:

Biv -> pCi/kg in vegetation per pCi/kg in soil (no units),

Fm -> pCi/liter in milk per pCi/day ingested by animal (days/liter),

Ff -> pCi/kg in meat per pCi/day ingested by animal (days/kg).

SPECIFIC FACTORS USED TO DETERMINE A_i, P_i, R_i, VALUES FOR THE OFFSITE DOSE CALCULATION MANUAL

Stable Element Transfer Coefficients by nuclide.
Waterford Steam Electric Station

Element	Stable Element Transfer Data			
	Biv Veg/Soil	Fm Cow Milk	Ff Meat	Fm Goat Milk
Lu	2.60e-03	5.00e-06	4.40e-03	5.00e-06
Hf	1.70e-04	5.00e-06	4.00e-01	5.00e-06
Ta	6.30e-03	2.50e-02	1.60e+00	2.50e-02
W	1.80e-02	5.00e-04	1.39e-03	5.00e-04
Re	2.50e-01	2.50e-02	8.00e-03	2.50e-02
Os	5.00e-02	5.00e-03	4.00e-01	5.00e-03
Ir	1.30e+01	5.00e-03	1.50e-03	5.00e-03
Pt	5.00e-01	5.00e-03	4.00e-03	5.00e-03
Au	2.50e-03	5.00e-03	8.00e-03	5.00e-03
Hg	3.80e-01	3.80e-02	2.60e-01	3.80e-02
Tl	2.50e-01	2.20e-02	4.00e-02	2.20e-02
Pb	6.80e-02	6.20e-04	2.90e-04	6.20e-04
Bi	1.50e-01	5.00e-04	1.30e-02	5.00e-04
Po	1.50e-01	3.00e-04	1.20e-02	3.00e-04
At	2.50e-01	5.00e-02	8.00e+00	5.00e-02
Rn	3.50e+00	2.00e-02	2.00e-02	2.00e-02
Fr	1.00e-02	5.00e-02	2.00e-02	5.00e-02
Ra	3.10e-04	8.00e-03	3.40e-02	8.00e-03
Ac	2.50e-03	5.00e-06	6.00e-02	5.00e-06
Th	4.20e-03	5.00e-06	2.00e-04	5.00e-06
Pa	2.50e-03	5.00e-06	8.00e+02	5.00e-06
U	2.50e-03	5.00e-04	3.40e-04	5.00e-04
Np	2.50e-03	5.00e-06	2.00e-04	5.00e-06
Pu	2.50e-04	2.00e-06	1.40e-05	2.00e-06
Am	2.50e-04	5.00e-06	2.00e-04	5.00e-06
Cm	2.50e-03	5.00e-06	2.00e-04	5.00e-06
Bk	2.50e-03	5.00e-06	2.00e-04	5.00e-06
Cf	2.50e-03	5.00e-06	2.00e-04	5.00e-06
Es	2.50e-03	5.00e-06	2.00e-04	5.00e-06
Fm	2.50e-03	5.00e-06	2.00e-04	5.00e-06

Units for transfer data are derived as follows:

Biv -> pCi/kg in vegetation per pCi/kg in soil (no units),

Fm -> pCi/liter in milk per pCi/day ingested by animal (days/liter),

Ff -> pCi/kg in meat per pCi/day ingested by animal (days/kg).

**SPECIFIC FACTORS USED TO DETERMINE A_i, P_i, R_i, VALUES FOR THE
OFFSITE DOSE CALCULATION MANUAL**

Bioaccumulation Factors for Aquatic Organisms by element.
Waterford Steam Electric Station

Element	Bioaccumulation Factors			
	Fresh Water Fish	Fresh Water Invert.	Salt Water Fish	Salt Water Invert.
H	9.00e-01	9.00e-01	9.00e-01	9.30e-01
He	1.00e+00	1.00e+00	1.00e+00	1.00e+00
Li	5.00e-01	4.00e+01	5.00e-01	5.00e-01
Be	2.00e+00	1.00e+01	2.00e+02	2.00e+02
B	2.20e-01	5.00e+01	2.20e-01	4.40e-01
C	4.60e+03	9.10e+03	1.80e+03	1.40e+03
N	1.50e+05	1.50e+05	6.00e+04	1.70e+04
O	9.20e-01	9.20e-01	9.60e-01	9.60e-01
F	1.00e+01	1.00e+02	3.60e+00	3.60e+00
Ne	1.00e+00	1.00e+00	1.00e+00	1.00e+00
Na	1.00e+02	2.00e+02	6.70e-02	1.90e-01
Mg	5.00e+01	1.00e+02	7.70e-01	7.70e-01
Al	1.00e+01	6.30e+01	1.00e+01	6.00e+01
Si	2.50e+00	2.50e+01	1.00e+01	3.30e+01
P	1.00e+05	2.00e+04	2.90e+04	3.00e+04
S	7.50e+02	1.00e+02	1.70e+00	4.40e-01
Cl	5.00e+01	1.00e+02	1.30e-02	1.90e-02
Ar	1.00e+00	1.00e+00	1.00e+00	1.00e+00
K	1.00e+03	8.30e+02	1.10e+01	6.60e+00
Ca	4.00e+01	3.30e+02	5.00e-01	1.30e+01
Sc	2.00e+00	1.00e+03	2.00e+00	1.00e+04
Ti	1.00e+03	3.00e+03	1.00e+03	1.00e+03
V	1.00e+01	3.00e+03	1.00e+01	5.00e+01
Cr	2.00e+02	2.00e+03	4.00e+02	2.00e+03
Mn	4.00e+02	9.00e+04	5.50e+02	4.00e+02
Fe	1.00e+02	3.20e+03	3.00e+03	2.00e+04
Co	5.00e+01	2.00e+02	1.00e+02	1.00e+03
Ni	1.00e+02	1.00e+02	1.00e+02	2.50e+02
Cu	5.00e+01	4.00e+02	6.70e+02	1.70e+03
Zn	2.00e+03	1.00e+04	2.00e+03	5.00e+04
Ga	3.30e+02	6.70e+02	3.30e+02	6.70e+02
Ge	3.30e+03	3.30e+01	3.30e+03	1.70e+04
As	1.00e+02	4.00e+01	3.30e+02	3.30e+02
Se	1.70e+02	1.70e+02	4.00e+03	1.00e+03
Br	4.20e+02	3.30e+02	1.50e-02	3.10e+00
Kr	1.00e+00	1.00e+00	1.00e+00	1.00e+00
Rb	2.00e+03	1.00e+03	8.30e+00	1.70e+01

Bioaccumulation factors in units of pCi/kg per pCi/liter.

**SPECIFIC FACTORS USED TO DETERMINE A_i, P_i, R_i VALUES FOR THE
OFFSITE DOSE CALCULATION MANUAL**

Bioaccumulation Factors for Aquatic Organisms by element.
Waterford Steam Electric Station

Element	Bioaccumulation Factors			
	Fresh Water Fish	Fresh Water Invert.	Salt Water Fish	Salt Water Invert.
Sr	3.00e+01	1.00e+02	2.00e+00	2.00e+01
Y	2.50e+01	1.00e+03	2.50e+01	1.00e+03
Zr	3.30e+00	6.70e+00	2.00e+02	8.00e+01
Nb	3.00e+02	1.00e+02	3.00e+04	1.00e+02
Mo	1.00e+01	1.00e+01	1.00e+01	1.00e+01
Tc	1.50e+01	5.00e+00	1.00e+01	5.00e+01
Ru	1.00e+01	3.00e+02	3.00e+00	1.00e+03
Rh	1.00e+01	3.00e+02	1.00e+01	2.00e+03
Pd	1.00e+01	3.00e+02	1.00e+01	2.00e+03
Ag	2.30e+00	7.70e+02	3.30e+03	3.30e+03
Cd	2.00e+02	2.00e+03	3.00e+03	2.50e+05
In	1.00e+05	1.00e+05	1.00e+05	1.00e+05
Sn	3.00e+03	1.00e+03	3.00e+03	1.00e+03
Sb	1.00e+00	1.00e+01	4.00e+01	5.00e+00
Te	4.00e+02	6.10e+03	1.00e+01	1.00e+02
I	1.50e+01	5.00e+00	1.00e+01	5.00e+01
Xe	1.00e+00	1.00e+00	1.00e+00	1.00e+00
Cs	2.00e+03	1.00e+03	4.00e+01	2.50e+01
Ba	4.00e+00	2.00e+02	1.00e+01	1.00e+02
La	2.50e+01	1.00e+03	2.50e+01	1.00e+03
Ce	1.00e+00	1.00e+03	1.00e+01	6.00e+02
Pr	2.50e+01	1.00e+03	2.50e+01	1.00e+03
Nd	2.50e+01	1.00e+03	2.50e+01	1.00e+03
Pm	2.50e+01	1.00e+03	2.50e+01	1.00e+03
Sm	2.50e+01	1.00e+03	2.50e+01	1.00e+03
Eu	2.50e+01	1.00e+03	2.50e+01	1.00e+03
Gd	2.50e+01	1.00e+03	2.50e+01	1.00e+03
Tb	2.50e+01	1.00e+03	2.50e+01	1.00e+03
Dy	2.50e+01	1.00e+03	2.50e+01	1.00e+03
Ho	2.50e+01	1.00e+03	2.50e+01	1.00e+03
Er	2.50e+01	1.00e+03	2.50e+01	1.00e+03
Tm	2.50e+01	1.00e+03	2.50e+01	1.00e+03
Yb	2.50e+01	1.00e+03	2.50e+01	1.00e+03
Lu	2.50e+01	1.00e+03	2.50e+01	1.00e+03
Hf	3.30e+00	6.70e+00	2.00e+02	2.00e+01
Ta	3.00e+04	6.70e+02	3.00e+04	1.70e+04
W	1.20e+03	1.00e+01	3.00e+01	3.00e+01

Bioaccumulation factors in units of pCi/kg per pCi/liter.

SPECIFIC FACTORS USED TO DETERMINE A_i , P_i , R_i , VALUES FOR THE
OFFSITE DOSE CALCULATION MANUAL

Bioaccumulation Factors for Aquatic Organisms by element.
Waterford Steam Electric Station

Element	Bioaccumulation Factors			
	Fresh Water Fish	Fresh Water Invert.	Salt Water Fish	Salt Water Invert.
Re	1.20e+02	6.00e+01	4.80e+00	6.00e+01
Os	1.00e+01	3.00e+02	1.00e+01	2.00e+03
Ir	1.00e+01	3.00e+02	1.00e+01	2.00e+03
Pt	1.00e+02	3.00e+02	1.00e+02	2.00e+03
Au	3.30e+01	5.00e+01	3.30e+01	3.30e+01
Hg	1.00e+03	1.00e+05	1.70e+03	3.30e+04
Tl	1.00e+04	1.50e+04	1.00e+04	1.50e+04
Pb	1.00e+02	1.00e+02	3.00e+02	1.00e+03
Bi	1.50e+01	2.40e+01	1.50e+01	2.40e+01
Po	5.00e+02	2.00e+04	3.00e+02	5.00e+03
At	1.50e+01	5.00e+00	1.00e+01	5.00e+01
Rn	1.00e+00	1.00e+00	1.00e+00	1.00e+00
Fr	4.00e+02	1.00e+02	3.00e+01	2.00e+01
Ra	5.00e+01	2.50e+02	5.00e+01	1.00e+02
Ac	2.50e+01	1.00e+03	2.50e+01	1.00e+03
Th	3.00e+01	5.00e+02	1.00e+04	2.00e+03
Pa	1.10e+01	1.10e+02	1.00e+01	1.00e+01
U	2.00e+00	6.00e+01	1.00e+01	1.00e+01
Np	1.00e+01	4.00e+02	1.00e+01	1.00e+01
Pu	3.50e+00	1.00e+02	3.00e+00	2.00e+02
Am	2.50e+01	1.00e+03	2.50e+01	1.00e+03
Cm	2.50e+01	1.00e+03	2.50e+01	1.00e+03
Bk	2.50e+01	1.00e+03	2.50e+01	1.00e+03
Cf	2.50e+01	1.00e+03	2.50e+01	1.00e+03
Es	1.00e+01	1.00e+02	1.00e+01	1.00e+01
Fm	1.00e+01	1.00e+02	1.00e+01	1.00e+01

Bioaccumulation factors in units of pCi/kg per pCi/liter.

**SPECIFIC FACTORS USED TO DETERMINE A_i , P_i , R_i , VALUES FOR THE
OFFSITE DOSE CALCULATION MANUAL**

Site Specific Parameters used.

Parameter No. : 1
Description : fraction of ingested produce grown in region
Formula Symbol : fg
Value : 0.760
Units : none

Parameter No. : 2
Description : fraction of leafy vegetables grown in region
Formula Symbol : fL
Value : 1.000
Units : none

Parameter No. : 4
Description : fraction of activity retained on crops for airborne
particulates
Formula Symbol : r
Value : 0.200
Units : none

Parameter No. : 5
Description : fraction of activity retained on crops for airborne
radioiodines
Formula Symbol : r
Value : 1.000
Units : none

Parameter No. : 6
Description : building shielding factor for maximum individuals
Formula Symbol : SF
Value : 0.700
Units : none

Parameter No. : 11
Description : period of long term buildup of activity in soil or sediment
Formula Symbol : t
Value : 131400.000
Units : hr

Parameter No. : 12
Description : transport time from animal feed-milk-man max individuals
Formula Symbol : tf
Value : 2.000
Units : days

Parameter No. : 15
Description : time delay for harvest of veg/crops and ingestion by
animals - stored feed
Formula Symbol : th
Value : 2160.000
Units : hr

SPECIFIC FACTORS USED TO DETERMINE A_i , P_i , R_i , VALUES FOR THE
OFFSITE DOSE CALCULATION MANUAL

Paramater No. : 16
Description : time delay for harvest of veg/crops and ingestion by
man - leafy veg max indivd
Formula Symbol : tL
Value : 24.000
Units : hr

Paramater No. : 17
Description : time delay for harvest of veg/crops and ingestion by
man - produce veg max ind
Formula Symbol : th
Value : 1440.000
Units : hr

Paramater No. : 37
Description : agricultural productivity by unit area stored feed
feed-animal-man
Formula Symbol : Ys
Value : 2.000
Units : kg/m2

Paramater No. : 38
Description : agricultural productivity by unit area pasture grass
feed-animal-man
Formula Symbol : Yp
Value : 0.700
Units : kg/m2

Paramater No. : 41
Description : time from slaughter of meat animal to consumption
Formula Symbol : tf
Value : 20.000
Units : days

Paramater No. : 43
Description : agricultural productivity by unit area crops/veg-man
Formula Symbol : Yv
Value : 2.000
Units : kg/m2

Paramater No. : 44
Description : rate constant for removal of activity on plants by weathering
Formula Symbol : lambda-w
Value : 2.062938e-3
Units : hr-1

Paramater No. : 69
Description : fraction of year that milk cows are on pasture
Formula Symbol : fp
Value : 1.000
Units : none

**SPECIFIC FACTORS USED TO DETERMINE A_i, P_i, R_i, VALUES FOR THE
OFFSITE DOSE CALCULATION MANUAL**

Paramater No. : 70
Description : fraction of year that milk goats are on pasture
Formula Symbol : fp
Value : 1.000
Units : none

Paramater No. : 71
Description : fraction of year that beef cows are on pasture
Formula Symbol : fp
Value : 1.000
Units : none

Paramater No. : 73
Description : fraction of milk cow's intake from pasture
Formula Symbol : fs
Value : 1.000
Units : none

Paramater No. : 74
Description : fraction of milk goat's intake from pasture
Formula Symbol : fs
Value : 1.000
Units : none

Paramater No. : 75
Description : fraction of beef cow's intake from pasture
Formula Symbol : fs
Value : 1.000
Units : none

Paramater No. : 88
Description : absolute relative humidity in the atmosphere
Formula Symbol : H
Value : 8.000
Units : g/m³

ODCM SPECIFICATIONS CONTAINED IN THE
WATERFORD III TECHNICAL REQUIREMENTS MANUAL

TRM SPECIFICATION	TRM TABLE OR SECTION	DESCRIPTION
3.11.1.1	Section 3/4.11.1	Liquid Effluents - Concentration
4.11.1.1.1	Table 4.11-1	Radioactive Liquid Waste Sampling and Analysis Program
3.11.1.2	Section 3/4.11.1	Liquid Effluents - Dose
3.11.1.3	Section 3/4.11.1	Liquid Radwaste Treatment System
3.11.2.1	Section 3/4.11.2	Gaseous Effluents - Dose Rate
4.11.2.1.2	Table 4.11-2	Radioactive Gaseous Waste Sampling and Analysis Program
3.11.2.2	Section 3/4.11.2	Gaseous Effluents - Dose Rate (Noble Gases)
3.11.2.3	Section 3/4.11.2	Gaseous Effluents - Dose Rate (I-131, I-133, Tritium and Particulates)
3.11.2.4	Section 3/4.11.2	Gaseous Radwaste Treatment
3.11.4	Section 3/4.11.4	Total Dose
3.3.3.10	Section 3/4.3.3	Radioactive Liquid Effluent Monitoring Instrumentation
4.3.3.10	Table 3.3-12	Radioactive Liquid Effluent Monitoring Instrumentation
3.3.3.11	Section 3/4.3.3	Radioactive Gaseous Effluent Monitoring Instrumentation
4.3.3.11	Table 3.3-12	Radioactive Gaseous Effluent Monitoring Instrumentation
3.12.1	Section 3/4.12.1	Radiological Environmental Monitoring Program
3.12.1	Table 3.12-1	Radiological Environmental Monitoring Program
3.12.2	Table 3.12-2	Reporting Levels For Radioactivity Concentrations in Environmental Samples
3.12.2	Table 4.12-1	Detection Capabilities For Environmental Sample Analysis Lower Limits of Detection
3.12.2	Section 3/4.12.2	Land Use Census
3.12.3	Section 3/4.12.3	Interlaboratory Comparison Program
3/4.3.3.10	Section 3/4.3	Radioactive Liquid Effluent Monitoring Instrumentation Basis
3/4.3.3.11	Section 3/4.3	Radioactive Gaseous Effluent Monitoring Instrumentation Basis
3/4.11.1.1	Section 3/4.11	Liquid Effluents Concentration Basis
3/4.11.1.2	Section 3/4.11	Liquid Effluents Dose Basis
3/4.11.1.3	Section 3/4.11	Liquid Radwaste Treatment System Basis
3/4.11.2.1	Section 3/4.11	Gaseous Effluents Dose Rate Basis
3/4.11.2.2	Section 3/4.11	Gaseous Effluents Dose - Noble Gases Basis
3/4.11.2.3	Section 3/4.11	Gaseous Effluents Dose - I-131, I-133, Tritium and Particulates Basis
3/4.11.2.4	Section 3/4.11	Gaseous Radwaste Treatment System Basis
3/4.11.4	Section 3/4.11	Total Dose Basis
3/4.12.1	Section 3/4.12	Radiological Environmental Monitoring Program Basis
3/4.12.2	Section 3/4.12	Land Use Census Basis
3/4.12.3	Section 3/4.12	Interlaboratory Comparison Program Basis

Attachment 11.2 to

W3F1-2015-0033 Enclosure, Annual Radiological Effluent Release Report – 2014

Copy of EN-RW-105, "Process Control Program" Revision 3

Procedure Contains NMM ECH eB REFLIB Forms: YES NO

HQN Effective Date 3/25/14	Procedure Owner: Title: Site:	Donnie Marvel Manager, RP ANO	Governance Owner: Title: Site:	David Moore Manager, Fleet RP HQN
--------------------------------------	--	-------------------------------------	---	---

Site	Site Procedure Champion	Title
ANO	Donnie Marvel	Manager, RP
BRP	N/A	N/A
CNS	Bob Beilke	Manager, RP
GGNS	Roy Miller	Manager, RP
IPEC	Frank Mitchell	Manager, RP
JAF	Robert Brown	Manager, RP
PLP	Doug Watkins	Manager, RP
PNPS	Steven Brewer	Manager, RP
RBS	Jim Hogan	Manager, RP (acting)
VY	David Tkatch	Manager, RP
W3	Daniel Frey	Manager, RP
HQN	David Moore	Manager, Fleet RP

For site implementation dates see ECH eB REFLIB using site tree view (Navigation panel).

Site and NMM Procedures Canceled or Superseded By This Revision

None

Process Applicability Exclusion: All Sites:

Specific Sites: ANO BRP CNS GGNS IPEC JAF PLP PNPS RBS VY W3

Change Statement

Editorial revision to address the issue identified in CR-HQN-2013-00858, CA-02 (Develop a draft procedure that includes instructions for vendors processing waste still owned by Entergy to comply with the PCP program.)

Reworded Step 5.1[1](b) to improve clarity: inserted text "processed on-site OR off-site by vendors"

Associated PRHQN #: PR-PRHQN-2014-00048

TABLE OF CONTENTS

<u>Section</u>	<u>Title</u>	<u>Page</u>
1.0	PURPOSE.....	3
2.0	REFERENCES.....	3
3.0	DEFINITIONS.....	6
4.0	RESPONSIBILITIES.....	9
5.0	DETAILS.....	10
6.0	INTERFACES.....	20
7.0	RECORDS.....	20
8.0	SITE SPECIFIC COMMITMENTS.....	21
9.0	ATTACHMENTS.....	21

	NUCLEAR MANAGEMENT MANUAL	QUALITY RELATED	EN-RW-105	REV. 4
		INFORMATIONAL USE	PAGE 3 OF 21	
PROCESS CONTROL PROGRAM				

1.0 PURPOSE

The Process Control Program (PCP) requires formulas, sampling, analyses, test and determinations to be made to ensure that the processing and packing of solid radioactive wastes based on demonstrated processing of actual or simulated wet solid wastes will be accomplished in such a way as to assure compliance with 10 CFR Parts 20, 61 and 71, State Regulations, burial ground requirements, and other requirements governing the disposal of solid radioactive waste. The scope of a PCP is to assure that radioactive waste will be handled, shipped, and disposed of in a safe manner in accordance with approved site or vendor procedures, whichever is applicable. **[GGNS UFSAR, Chapter 16B.1 / TRM – 7.6.3.8 paragraph 1]**

- 1.1 The purpose of this document is to provide a description of the solid radioactive waste Process Control Program (PCP) at all the Entergy fleet sites. The PCP describes the methods used for processing, classification and packaging low-level wet radioactive waste into a form acceptable for interim on-site storage, shipping and disposal, in accordance with 10 CFR Part 61 and current disposal site criteria.
- 1.2 To ensure the safe operation of the solid radwaste system, the solid radwaste system will be used in accordance with this Process Control Program to process radioactive wastes to meet interim on-site storage, shipping and burial ground requirements.
- 1.3 This document addresses the process control program in the context of disposal criteria, on-site processing and vendor processing requirements.
- 1.4 The Process Control Program implements the requirements of 10CFR50.36a and General Design Criteria 60 of Appendix A to 10CFR Part 50. The process parameters included in the Process Control Program may include but are not limited to waste type, waste pH, waste/liquid/solidification agent/catalyst ratios, waste oil content, waste principal chemical constituents, and mixing and curing times.
- 1.5 This document does NOT address the requirements for 10CFR Part 61.56 (waste characteristics) for material sent to intermediate processors, because the final treatment and packaging is performed at the vendor facilities.

2.0 REFERENCES

- [1] EN-QV-104, "Entergy Quality Assurance Program Manual Control"
- [2] Title 49, Code of Federal Regulations
- [3] Title 10, Code of Federal Regulations, Part 20

	NUCLEAR MANAGEMENT MANUAL	QUALITY RELATED	EN-RW-105	REV. 4
		INFORMATIONAL USE	PAGE 4 OF 21	
PROCESS CONTROL PROGRAM				

2.0 continued

- [4] Title 10, Code of Federal Regulations, Part 61
- [5] Title 10, Code of Federal Regulations, Part 71, Appendix H **[QAPM, Section A.1.c]**
- [6] Low-Level Waste Licensing Branch Technical Position on Radioactive Waste Classification, 11 May 1983
- [7] Disposal Site Criteria and License
- [8] Waste Processor Acceptance Criteria
- [9] EN-LI-100, "Process Applicability Determination"
- [10] NRC Information and Enforcement Bulletins
 - NRC Information Notice 79-19: Packaging of Low-Level Radioactive Waste for Transport and Burial.
 - NRC Information Notice 80-24: Low-Level Radioactive Waste Burial Criteria.
 - NRC Information Notice 80-32: Clarification of Certain Requirements for Exclusive-Use Shipments of Radioactive Materials.
 - NRC Information Notice 80-32, Rev. 1: Clarification of Certain Requirements for Exclusive-Use Shipments of Radioactive Materials.
 - NRC Information Notice 83-05: Obtaining Approval for Disposing of Very-Low-Level Radioactive Waste - 10CFR Section 20.302.
 - NRC Information Notice 83-10: Clarification of Several Aspects Relating to Use of NRC-Certified Transport Packages.
 - NRC Information Notice 83-33: Non-Representative Sampling of Contaminated Oil.
 - NRC Information Notice 84-50: Clarification of Scope of Quality Assurance Programs for Transport Packages Pursuant to 10CFR 50 Appendix B.
 - NRC Information Notice 84-72: Clarification of Conditions for Waste Shipments Subject to Hydrogen Gas Generation.
 - NRC Information Notice 85-92: Surveys of Wastes Before Disposal from Nuclear Reactor Facilities.
 - NRC Information Notice 86-20: Low-Level Radioactive Waste Scaling Factors, 10CFR 61.
 - NRC Information Notice 86-90: Requests to Dispose of Very Low-Level Radioactive Waste Pursuant 10CFR 20.302

	NUCLEAR MANAGEMENT MANUAL	QUALITY RELATED	EN-RW-105	REV. 4
		INFORMATIONAL USE	PAGE 5 OF 21	
PROCESS CONTROL PROGRAM				

2.0[10], continued

- NRC Information Notice 87-03: Segregation of Hazardous and Low-Level Radioactive Wastes
 - NRC Information Notice 87-07: Quality Control of On-Site Dewatering/ Solidification Operations by Outside Contractors
- [11] NRC Information and Enforcement Bulletins (continued)
- NRC Information Notice 89-27: Limitations on the Use of Waste Forms and High Integrity Containers for the Disposal of Low-Level Radioactive Waste
 - NRC Information Notice 92-62: Emergency Response Information Requirements for Radioactive Material Shipments
 - NRC Information Notice 92-72: Employee Training and Shipper Registration Requirements for Transporting Radioactive Materials
 - NRC Generic Letter 89-01, "Implementation of Programmatic Controls for Radiological Effluent Technical Specifications in the Administrative Controls Section of the Technical Specifications and the Relocation of Procedural Details of RETS to the Offsite Dose Calculation Manual or to the Process Control Program".
- [12] Nureg-0800 Standard Review Plan Section 11.4 Revision 2, Solid Waste Management Systems.
- [13] NRC Waste Form Technical Position, Revision 1 Jan 24 1991.
- [14] NRC SECY 94-198 Review of Existing Guidance Concerning the Extended Storage of Low-Level Radioactive Waste.
- [15] EPRI TR-106925 Rev-1, Interim On-Site Storage of Low Level Waste: Guidelines for Extended Storage - October 1996
- [16] NRC Branch Technical Position On Concentration Averaging And Encapsulation Jan 17 1995
- [17] Commitment Documents (U-2 and U-3)
- IPN-99-079, "Supplement to Proposed Changes to Technical Specifications Incorporating Recommendations of Generic Letter 89-01 and the Revised 10 CFR Part 20 and 10 CFR Part 50.36a.
 - Appendix B Technical Specifications, Section 4.5 **[IP, RECS ODCM Part 1]**

	NUCLEAR MANAGEMENT MANUAL	QUALITY RELATED	EN-RW-105	REV. 4
		INFORMATIONAL USE	PAGE 6 OF 21	
PROCESS CONTROL PROGRAM				

3.0 **DEFINITIONS**

- [1] **Batch** – A quantity of waste to be processed having essentially consistent physical and chemical characteristics as determined through past experience or system operation knowledge by the Radwaste Shipping Specialist. A batch could be a waste tank, several waste tanks grouped together or a designated time period such as between outages as with the DAW waste stream. An isolated quantity of feed waste to be processed having essentially constant physical and chemical characteristics. (The addition or removal of water will not be considered to create a new batch).
- [2] **Certificate of Compliance** - Document issued by the USNRC regulating use of a NRC licensed cask or issued by (SCDHEC) South Carolina Department of Health and Environmental Conservation regulating a High Integrity Container.
- [3] **Chelating Agents** - EDTA, DTPA, hydroxy-carboxylic acids, citric acid, carboic acid and glucinic acid.
- [4] **Compaction** - The process of volume reducing solid waste by applying external pressure.
- [5] **Confirmatory Analysis** - The practice of verifying that gross radioactivity measurements using MCA are reasonably consistent with independent laboratory sample data.
- [6] **Dewatered Waste** - Wet waste that has been processed by means other than solidification, encapsulation, or absorption to meet the free standing liquid requirements of 10CFR Part 61.56 (a)(3) and (b)(2).
- [7] **De-watering** - The removal of water or liquid from a waste form, usually by gravity or pumping.
- [8] **Dilution Factor** - The RADMAN computer code factor to account for the non-radioactive binder added to the waste stream in the final product when waste is solidified.
- [9] **Dry Waste** - Radioactive waste which exist primarily in a non-liquid form and includes such items as dry materials, metals, resins, filter media and sludges.
- [10] **Encapsulation** - Encapsulation is a means of providing stability for certain types of waste by surrounding the waste by an appropriate encapsulation media.
- [11] **Gamma-Spectral-Analysis** - Also known as IG, MCA, Ge/Li and gamma spectroscopy.
- [12] **Gross Radioactivity Measurements** - More commonly known as dose to curie conversion for packaged waste characterization and classification.

	NUCLEAR MANAGEMENT MANUAL	QUALITY RELATED	EN-RW-105	REV. 4
		INFORMATIONAL USE	PAGE 7 OF 21	
PROCESS CONTROL PROGRAM				

3.0 continued

- [13] **Homogeneous** - Of the same kind or nature; essentially alike. Most Volumetric waste streams are considered homogeneous for purposes of waste classification.
- [14] **Incineration** – The process of burning a combustible material to reduce its volume and yield an ash residue.
- [15] **Liquid Waste** - Radioactive waste that exist primarily in a liquid form and is contained in other than installed plant systems, to include such items as oil, EHC fluid, and other liquids. This waste is normally processed off-site.
- [16] **Low-Level Radioactive Waste (LLW)** - Those wastes containing source, special nuclear, or by-product material that are acceptable for disposal in a land disposal facility. For the purposes of this definition, low-level radioactive waste has the same meaning as in the Low-Level Waste Policy Act, that is, radioactive waste not classified as high-level radioactive waste, transuranic waste, spent nuclear fuel, or by-product material as defined in section 11e.(2) of the Atomic Energy Act (uranium or thorium tailings and waste).
- [17] **Measurement of Specific Radionuclides** - More commonly known as direct sample or container sample using MCA data for packaged waste characterization and classification.
- [18] **Operable** - A system, subsystem, train, component or device SHALL be OPERABLE or have OPERABILITY when it is capable of performing its specified function(s), and when all necessary attendant instrumentation, controls, electrical power, cooling or seal water, lubrication or other auxiliary equipment that are required for the system, subsystem, train, component, or device to perform its function(s) are also capable of performing their related support function(s).
- [19] **Prequalification Program** - The testing program implemented to demonstrate that the proposed method of wet waste processing will result in a waste form acceptable to the land disposal facility and the NRC.
- [20] **Processing** - Changing, modifying, and/or packaging radioactive waste into a form that is acceptable to a disposal facility.
- [21] **Quality Assurance/Quality Control** - As used in this document, "quality assurance" comprises all those planned and systematic actions necessary to provide adequate confidence that a structure, system, or component will perform satisfactorily in service. Quality assurance includes quality control, which comprises those quality assurance actions related to the physical characteristics of a material structure, component, or system to predetermined requirements.

	NUCLEAR MANAGEMENT MANUAL	QUALITY RELATED	EN-RW-105	REV. 4
		INFORMATIONAL USE	PAGE 8 OF 21	
PROCESS CONTROL PROGRAM				

3.0, continued

- [22] **Reportable Quantity Radionuclides (RQ)** - Any radionuclide listed in column (1) of Table 2 of 49CFR Part 172.101 which is present in quantities as listed in column (3) of Table 2 of 49CFR Part 172.101.
- [23] **Sampling Plan** - A program to ensure that representative samples from the feed waste and the final waste form are obtained and tested for conformance with parameters stated in the PCP and waste form acceptance criteria.
- [24] **Scaling Factor** - A dimensionless number which relates the concentration of an easy to measure radionuclide (gamma emitter) to one which is difficult to measure (beta and/or alpha emitters).
- [25] **Significant Quantity** - For purposes of waste classification all the following radionuclide values SHALL be considered significant and must be reported on the disposal manifest.
- Any value (real or LLD) for radionuclides listed in Appendix G to 10CFR20 (H-3, C-14, I-129, Tc-99).
 - Greater than or equal to 1 percent of the concentration limits as listed in 10CFR Part 61.55 Table 1.
 - Greater than or equal to 1 percent of the Class A concentration limits listed in 10CFR Part 61.55 Table 2.
 - Greater than or equal to 1 percent of the total activity.
 - Greater than or equal to 1 percent of the Reportable Quantity limits listed on 49CFR Part 172.101 Table 2.
- [26] **Solidification** - The conversion of wet waste into a free-standing monolith by the addition of an agent so that the waste meets the stability and free-standing liquid requirements of the disposal site.
- [27] **Special Radionuclides** - The RADMAN computer code term for radionuclides listed in Appendix G to 10CFR20 (i.e., H-3, C-14, I-129 & Tc-99)
- [28] **Stability** – Structural stability per 10CFR61.2, Waste Form Technical Position, and Waste Form Technical Position Revision 1. This can be provided by the waste form, or by placing the waste in a disposal container or structure that provides stability after disposal. Stability requires that the waste form maintain its structural integrity under the expected disposal conditions.

	NUCLEAR MANAGEMENT MANUAL	QUALITY RELATED	EN-RW-105	REV. 4
		INFORMATIONAL USE	PAGE 9 OF 21	
PROCESS CONTROL PROGRAM				

3.0, continued

- [29] **Training** - A systematic program that ensures a person has knowledge of hazardous materials and hazardous materials regulations.
- [30] **Type A Package** - Is the packaging together with its radioactive contents limited to A1 or A2 as appropriate that meets the requirements of 49CFR Part 173.410 and Part 173.412, and is designed to retain the integrity of containment and shielding under normal conditions of transport as demonstrated by the tests set forth in 49CFR Part 173.465 or Part 173.466 as appropriate.
- [31] **Type B Package** - Is the packaging together with its radioactive contents that is designed to retain the integrity of containment and shielding when subjected to the normal conditions of transport and hypothetical accident test conditions set forth in 10CFR Part 71.
- [32] **Volume Reduction** – any process that reduces the volume of waste. This includes but is not limited to, compaction and incineration.
- [33] **Waste Container** - A vessel of any shape, size, and composition used to contain the waste media.
- [34] **Waste Form** - Waste in a waste container acceptable for disposal at a licensed disposal facility.
- [35] **Waste Stream** - A Plant specific and constant source of waste with a distinct radionuclide content and distribution.
- [36] **Waste Type** – A single packaging configuration and waste form tied to a specific waste stream.

4.0 **RESPONSIBILITIES**

- [1] The **Vice President Operations Support (VPOS)** is responsible for the implementation of this procedure.
- [2] Each site **Senior Nuclear Executive (SNE)** is responsible for ensuring that necessary site staff implements this procedure.
- [3] The **Low Level RadWaste (LLRW) Focus Group** is responsible for evaluating and recommending changes and revisions to this procedure.

	NUCLEAR MANAGEMENT MANUAL	QUALITY RELATED	EN-RW-105	REV. 4
		INFORMATIONAL USE	PAGE 10 OF 21	
PROCESS CONTROL PROGRAM				

4.0, continued

[4] Each site **RP Department – Radwaste Supervisor / Specialist** (title may vary at the site's respectively) has the overall responsibility for implementing the PCP and is responsible for processing and transportation is tasked with the day-to-day responsibilities for the following:

- Implementing the requirements of this document.
- Ensuring that radioactive waste is characterized and classified in accordance with 10CFR Part 61.55 and Part 61.56.
- Ensuring that radioactive waste is characterized and classified in accordance with volume reduction facility and disposal site licenses and other requirements.
- Designating other approved procedures (if required) to be implemented in the packaging of any specific batch of waste.
- Providing a designated regulatory point of contact between the Plant and the NRC, volume reduction facility or disposal site.
- Maintaining records of on-site and off-site waste stream sample analysis and Plant evaluations.
- Suspending shipments of defectively processed or defectively packaged radioactive wastes from the site when the provisions of this process control program are not satisfied.

5.0 **DETAILS**

An isotopic analysis SHALL be performed on every batch for each waste stream so that the waste can be classified in accordance with 10CFR61. The isotopic and curie content of each shipping container SHALL be determined in accordance with 49CFR packaging requirements. The total activity in the container may be determined by either isotopic analysis or by dose-rate-to-curie conversion.

5.1. **Precautions and Limitations**

[1] **Precautions**

- (a) Radioactive materials SHALL be handled in accordance with applicable radiation protection procedures.
- (b) All radioactive waste processed on-site **OR** off-site by vendors must be processed or packaged to meet the minimum requirements listed in 10CFR Part 61.56 (a) (1) through (8).

	NUCLEAR MANAGEMENT MANUAL	QUALITY RELATED	EN-RW-105	REV. 4
		INFORMATIONAL USE	PAGE 11 OF 21	
PROCESS CONTROL PROGRAM				

5.1[1], continued

- (c) If the provisions of the Process Control Program are not satisfied, suspend shipment of the defectively processed or defectively packaged waste from the site. Shipment may be accomplished when the waste is processed / packaged in accordance with the Process Control Program.
- (d) The generation of combustible gases is dependent on the waste form, radioactive concentration and accumulated dose in the waste. Changes to organic inputs (e.g. oil) to waste stream may change biogas generation rates.

[2] Limitations

- (a) Only qualified personnel will characterize OR package radioactive waste OR radioactive materials for transportation or disposal.
- (b) All site personnel that have any involvement with radioactive waste management computer software SHALL be familiar with its functions, operation and maintenance.

5.2. Waste Management Practices

[1] Waste processing methods include the following:

- (a) Present and planned practice is NOT to solidify or encapsulate any waste streams.
- (b) Waste being shipped directly for burial in a HIC (High Integrity Container) is dewatered to less than 1 percent by volume prior to shipment.
- (c) Waste being shipped directly for burial in a container other than a HIC is dewatered to less than 0.5 percent by volume prior to shipment.
- (d) IF solidification is required in the future, THEN at least one representative test specimen from at least every 10th batch of each type of radioactive waste will be checked to verify solidification.
 - (1) IF any specimen fails to verify solidification, THEN the solidification of the batch under test SHALL be suspended until such time as additional test specimens can be obtained, alternative solidification parameters can be determined, and a subsequent test verifies solidification. If alternative parameters are determined, the subsequent tests shall be verified using the alternative parameters determined.

	NUCLEAR MANAGEMENT MANUAL	QUALITY RELATED	EN-RW-105	REV. 4
		INFORMATIONAL USE	PAGE 12 OF 21	
PROCESS CONTROL PROGRAM				

5.2[1](d), continued

- (2) IF the initial test specimen from a batch of waste fails to verify solidification, THEN provide for the collection and testing of representative test specimens from each consecutive batch of the same type of waste until at least 3 consecutive initial test specimens demonstrates solidification. The process **SHALL** be modified as required to assure solidification of subsequent batches of waste.

- [2] Operation and maintenance of dewatering systems and equipment include the following:
- (a) Present and planned practice is to utilize plant personnel supplemented by vendor personnel or contracted vendor personnel, to operate AND maintain dewatering systems and equipment (as needed to meet disposal site requirements).
 - (b) All disposal liners are manufactured by and purchased from QA-approved vendors.
- [3] ALARA considerations are addressed in all phases of the processes involving handling, packaging AND transfer of any type OR form of radioactive waste (dewatered or dry). Resin, charcoal media, spent filter cartridges AND sludges are typically processed within shields. Sluicible demineralizers are shielded when in service. Radiation exposure and other health physics requirements are controlled by the issuance of a Radiation Work Permit (RWP) for each task.

5.3. Waste Stream Sampling Methods and Frequency

- [1] The following general requirements apply to Plant waste stream sampling:
- (a) Treat each waste stream separately for classification purposes.
 - (b) Ensure samples are representative of or can be correlated to the final waste form.
 - (c) Determine the density for each new waste stream initially or as needed (not applicable for DAW and filters).
 - (d) Perform an in-house analysis for gamma-emitting radionuclides for each sample sent to an independent laboratory.
 - (e) Periodically perform in-house analysis for gamma emitting radionuclides for comparison to the current data base values for gamma emitters. (The current database is usually based on the most recent independent laboratory results.)
 - (f) Resolve any discrepancies between in-house results AND the independent laboratory results for the same or replicate sample as soon as possible.
 - (g) Maintain records of on-site and off-site waste stream sample analysis and evaluations.

	NUCLEAR MANAGEMENT MANUAL	QUALITY RELATED	EN-RW-105	REV. 4
		INFORMATIONAL USE	PAGE 13 OF 21	
PROCESS CONTROL PROGRAM				

5.3, continued

- [2] When required, waste stream samples should be analyzed, re-evaluated and if necessary, shipped to a vendor laboratory for additional analysis. The same is true when there is a reason to believe that an equipment or process change has significantly altered the previously determined scaling factors by a factor of 10.

Specific examples include but are not limited to:

- Changes in oxidation reduction methods such as zinc, injection, hydrogen water chemistry,
- Changes in purification methods including media specialization, media distribution, ion/cation ratios,
- Changes in fuel performance criteria including fuel leaks
- Other changes in reactor coolant chemistry.
- Sustained, unexplained, changes in the routinely monitored Beta/Alpha ratios, as determined by Radiation Protection,
- When there is an extended reactor shutdown (> 90 days).
- When there are changes to liquid waste processing, such as bypassing filters, utilizing filters or a change in ion exchange media.
- When there are changes to the waste stream that could change the biogas generation rate.

- [3] The following requirements apply to infrequent or abnormal waste types:
- (a) Infrequent OR abnormal waste types that may be generated must be evaluated on a case-by-case basis.
 - (b) The RP Department Supervisor / Specialist responsible for processing AND shipping will determine if the waste can be correlated to an existing waste stream.
 - (c) IF the radioactive waste cannot be correlated to an existing waste stream, THEN the RP Department Supervisor / Specialist responsible for processing and shipping SHALL determine specific off-site sampling and analysis requirements necessary to properly classify the material.
- [4] Specific sampling methods and data evaluation criteria are detailed in EN-RW-104 for specific waste streams.

	NUCLEAR MANAGEMENT MANUAL	QUALITY RELATED	EN-RW-105	REV. 4
		INFORMATIONAL USE	PAGE 14 OF 21	
PROCESS CONTROL PROGRAM				

5.4. Waste Classification

- [1] General requirements for scaling factors include the following:
- (a) The Plant has established an inferential measurement program whereby concentrations of radionuclides which cannot be readily measured are estimated through ratio-ing with radionuclides which can be readily measured.
 - (b) Scaling factor relationships are developed on a waste stream-specific basis. These relationships are periodically revised to reflect current independent lab data from direct measurement of samples. The scaling factor relationships currently used by the sites are as follows:
 - Hard to detect ACTIVATION product radionuclides and C-14 are estimated by using scaling factors with measured Co-60 activities.
 - Hard to detect FISSION product radionuclides and H-3, Tc-99 and I-129 are estimated by using scaling factors with measured Cs-137 activities.
 - Hard to detect TRANSURANIC radionuclides are estimated by using scaling factors with measured Ce-144 activities. Where Ce-144 cannot be readily measured, transuranics are estimated by using scaling factors with measured Cs-137 activities. Second order scaling of transuranics is acceptable when Cs-137 and Ce-144 are not readily measurable.
- [2] General requirements for the determination of total activity and radionuclide concentrations include the following:
- (a) The activity for the waste streams is estimated by using either Gross Radioactivity Measurement OR Direct Measurement of Radionuclides. Current specific practices are as follows:
 - DAW - Gross radioactivity measurement in conjunction with the RADMAN computer codes, other approved computer codes or hand calculation.
 - Filters - Gross radioactivity measurement in conjunction with the FILTRK computer code, other approved computer codes or hand calculation.
 - All Other Waste Streams - Direct measurement of radionuclides in conjunction with the RADMAN computer codes, other approved computer codes or hand calculation.
 - (b) Determination of the NRC waste classification is performed by comparing the measured or calculated concentrations of significant radionuclides in the final waste form to those listed in 10CFR Part 61.55.

	NUCLEAR MANAGEMENT MANUAL	QUALITY RELATED	EN-RW-105	REV. 4
		INFORMATIONAL USE	PAGE 15 OF 21	
PROCESS CONTROL PROGRAM				

5.5. Quality Control

- [1] The RADMAN computer code provides a mechanism to assist the Plant in conducting a quality control program in accordance with the waste classification requirements listed in 10CFR Part 61.55. All waste stream sample data changes are written to a computer data file for future review and reference.
- [2] Audits and Management Review includes the following:
- (a) Appendix G to 10CFR20 requires conduct of a QC program which must include management review of audits.
 - (b) Management audits of the Plant Sampling and Classification Program SHALL be periodically performed to verify the adequacy of maintenance sampling and analysis.
 - (c) Audits and assessments are performed and documented by any of the following:
 - Radiation Protection Department
 - Quality Assurance Department
 - Qualified Vendors
 - (d) Certain elements of the Entergy Quality Assurance Program Manual are applied to the Process Control Program. **[QAPM, Section A.1.c]**

5.6. Dewatering Operations

- [1] Processing requirements during dewatering operations include the following:
- (a) All dewatering operations are performed per approved Plant or vendor operating procedures and instructions.
 - (b) Dewatering limitations and capabilities are verified by vendor Topical Reports or Operating and Testing Procedures.
- [2] Dewatered resin activity limitations include the following:
- (a) Dewatered resins will not be shipped off-site that have activities which will produce greater than 1.0E+8 rads total accumulated dose over 300 years. This is usually verified by comparing the container specific activity at the time of shipment to the following concentration limits for radionuclides with a half-life greater than five years:
 - 10 Ci (0.37 TBq) per cubic foot.
 - 350 uCi (12.95 MBq) per cubic centimeter

	NUCLEAR MANAGEMENT MANUAL	QUALITY RELATED	EN-RW-105	REV. 4
		INFORMATIONAL USE	PAGE 16 OF 21	
PROCESS CONTROL PROGRAM				

5.7. Waste Packaging

Waste in final form will be packaged in accordance with Title 10 and Title 49 of the Code of federal regulations and in accordance with current burial site criteria as is detailed in EN-RW-102.

5.8. Administrative Controls

- [1] Information on solid radioactive waste shipped off-site is reported annually to the Nuclear Regulatory Commission in the Annual Radioactive Effluent Release Report as specified by the Offsite Dose Calculation Manual (ODCM) or Technical Specification. **[ANO1 Technical Specifications - 5.6.3] [ANO2 Technical Specifications – 6.6.3] [WF3 Technical Specifications – 6.9.18] [GGNS ODCM – 5.6.3.c] [JAF Technical Specifications – 5.6.3] [PLP ODCM, Appendix A – IV. A].**
- [2] All changes to the PCP SHALL be documented. All records of reviews performed SHALL be retained as required by the Quality Assurance Program. The documentation of the changes **SHALL [GGNS UFSAR, Chapter 16B.1 / TRM – 7.6.3.8 paragraph 2]:**
- (a) Contain sufficient information to support the change with appropriate analyses or evaluations justifying the change.
 - (b) Include a determination that the change will maintain the overall conformance of the solidified waste product (if applicable) to existing requirements of Federal, State or other applicable regulations.
- [3] All changes in the Process Control Program and supporting documentation are included in each site's next Annual Radiological Effluent Release Report to the Nuclear Regulatory Commission. **[ANO ODCM - L3.2.1.C] [VTY TRM 6.12]**
- [4] The changes to EN-RW-105 SHALL become effective upon review and acceptance by the site's General Plant Manager (equivalent title at Palisades is Plant Superintendent) except as listed below:
- (a) For Grand Gulf Nuclear Station, the changes to RW-105 SHALL be accomplished as specified in Grand Gulf Nuclear Station Technical Requirements Manual (TRM) Section 7.6.3.8. The changes SHALL become effective upon review and acceptance by the On-site Safety Review Committee (OSRC) and the approval of the GGNS Plant General Manager. **[GGNS UFSAR, Chapter 16B.1 / TRM – 7.6.3.8 paragraph 2]**

	NUCLEAR MANAGEMENT MANUAL	QUALITY RELATED	EN-RW-105	REV. 4
		INFORMATIONAL USE	PAGE 17 OF 21	
PROCESS CONTROL PROGRAM				

5.8[4], continued

- (b) For River Bend Nuclear Station, the procedure approval along with changes to RW-105 SHALL be accomplished per the River Bend Nuclear Station Technical Requirements, Section 5.5.14.1. The changes SHALL become effective upon review and acceptance by approval from the River Bend Nuclear Station Plant Manager or Radiation Protection Manager. **[RBS Technical Requirements – 5.5.14.1, 5.5.14.2 & 5.8.2]**
- (c) For Waterford 3, the procedure approval along with changes to RW-105 SHALL be accomplished per Waterford 3 Technical Specifications 6.13.2. The changes SHALL become effective upon review and acceptance by the Waterford 3 General Plant Manager. **[WF3 Technical Specifications – 6.13.2.b]**
- (d) For James A. FitzPatrick Nuclear Station, the procedure approval along with changes to EN-RW-105 SHALL be accomplished per the James A. FitzPatrick Station Technical Specifications, Section 5.6.3. The changes SHALL become effective upon review and acceptance through approval from the James A. FitzPatrick Nuclear Station On-Site Safety Review Committee. **[JAF UFSAR, Chapter 11.3.5]**
- (e) For Vermont Yankee, Changes to the Process Control Program SHALL become effective after review and acceptance by the (OSRC) On-Site Safety Review Committee and the Site VP.
- (f) For IPEC, Changes to the Process Control Program SHALL become effective after final review and acceptance by the On-Site Safety Review Committee (OSRC).

5.9. Vendor Requirements

- [1] Vendors performing radwaste services under 10CFR61 and 10CFR71 requirements will be on the Entergy Qualified Supplier's List (QSL). **[QAPM, Section A.1.c]**
- [2] Vendors performing radwaste services on-site are to comply with the following:
 - (a) Dewatering and solidification services SHALL have a NRC-approved Topical Report or other form of certification documenting NRC approval of the processes and associated equipment/containers.
 - (b) All vendor procedures utilized for performing on-site radwaste processing services (to assure compliance with 10 CFR Parts 20, 61 and 71, State Regulations, burial ground requirements, and other requirements governing the disposal of solid radioactive waste) will be reviewed per the requirements of EN-LI-100, technically by the applicable site's Radiation Protection organization and only be accepted per the approvals specified in Section 5.8 [4].

	NUCLEAR MANAGEMENT MANUAL	QUALITY RELATED	EN-RW-105	REV. 4
		INFORMATIONAL USE	PAGE 18 OF 21	
PROCESS CONTROL PROGRAM				

5.9[2], continued

- (c) All changes to vendor procedures for ongoing on-site radwaste services will be reviewed technically by the site's Radiation Protection organization and screened per the requirements of EN-LI-100. Significant procedural changes will require the approvals specified in Section 5.8 [4]. During screening, the level of significance for procedural changes on equipment and process parameters may warrant the full 10CFR50.59 documentation and approval process.
- (d) Plant management SHALL review vendor(s) topical reports and test procedures per applicable requirements in Section 5.8.

NOTE

The PCP does not have to include the vendor's Topical Report if it has NRC approval, or has been previously submitted to the NRC.

- (e) Plant management review will assure that the vendor's operations and requirements are compatible with the responsibilities and operation of the Plant.
- (f) Training requirements and records listed in Section 5.10 also apply to contracted vendors.

5.10. Miscellaneous

[1] Special tools and equipment

- (a) Frequency of Use and Descriptions

Required tools and equipment will vary depending on the specific process and waste container that is used. The various tools and equipment which may be required are detailed in specific procedures developed to govern activities described in this document.

[2] Pre-requisites

- (a) Maintenance of Regulatory Material

Ensure that a current set of DOT, NRC, EPA and applicable State regulations, vendor processing facility and disposal site regulations and requirements are maintained at the site and are readily available for reference. The use of web based regulations is acceptable.

	NUCLEAR MANAGEMENT MANUAL	QUALITY RELATED	EN-RW-105	REV. 4
		INFORMATIONAL USE	PAGE 19 OF 21	
PROCESS CONTROL PROGRAM				

5.10[2], continued

(b) Representative Radionuclide Sample Data

Ensure that representative radionuclide sample data is on file for each active waste stream. Unless operation conditions or changes in processing methods require increased sample frequency, data is considered to be current if it meets the requirements of EN-RW-104.

(c) Initial and Cyclic Training

- A training program SHALL be developed, implemented and maintained for all personnel involved in processing, packaging, handling and transportation of radioactive waste to ensure radwaste operations are performed within the requirements of NRC Information Bulletin 79-19 and 49CFR Part 172.700 through Part 172.704.
- Training requirements and documentation also apply to contracted on-site vendors.

NOTE

Cyclic training is defined as within three years for DOT, and two years for IATA

(d) Specific employee training is required for each person who performs the following job functions [172.702(b)].

- Classifies hazardous materials.
- Packages hazardous materials.
- Fills, loads and/or closes packages.
- Marks and labels packages containing hazardous materials.
- Prepares shipping papers for hazardous materials.
- Offers or accepts hazardous materials for transportation.
- Handles hazardous materials.
- Marks or placards transport vehicles.
- Operates transport vehicles.
- Works in a transportation facility and performs functions in proximity to hazardous materials which are to be transported.
- Inspects or tests packages.

	NUCLEAR MANAGEMENT MANUAL	QUALITY RELATED	EN-RW-105	REV. 4
		INFORMATIONAL USE	PAGE 20 OF 21	
PROCESS CONTROL PROGRAM				

5.10[2] *continued*

- (e) Cyclic training is defined as within three years for DOT & within two years for IATA.

Copies of training records are required for as long as a person is employed and 90 days thereafter. The records should include, as a minimum, the following:

- Trainee's name and signature
- Training dates
- Training material or source reference
- Trainer's information

6.0 INTERFACES

- [1] EN-LI-100, "Process Applicability Determination"
- [2] EN-RW-104, "Scaling Factors"
- [3] EN-QV-104, "Entergy Quality Assurance Program Manual Control"

7.0 RECORDS

- [1] Documentation of pertinent data required to classify waste and verify solidification will be maintained on each batch of processed waste as required by approved procedures.
- [2] Documentation will also be maintained to ensure that containers, shipping casks, and methods of packaging wastes meet applicable Federal regulations and disposal site criteria. The records of reviews performed and documents associated with these reviews will be maintained as QA records.

	NUCLEAR MANAGEMENT MANUAL	QUALITY RELATED	EN-RW-105	REV. 4
		INFORMATIONAL USE	PAGE 21 OF 21	
PROCESS CONTROL PROGRAM				

8.0 SITE SPECIFIC COMMITMENTS

Document	Document Section	NMM Procedure Section	Site Applicability
ANO ODCM	L3.2.1.C	5.8 [3]	ANO
ANO1 Technical Specifications	5.6.3	5.8 [1]	ANO
ANO2 Technical Specifications	6.6.3	5.8 [1]	ANO
RBS Technical Requirements	5.5.14	*	RBS
RBS Technical Requirements	5.5.14.1	5.8 [3] 5.8 [4] (b)	RBS
RBS Technical Requirements	5.5.14.2	5.8 [4] (b)	RBS
RBS Technical Requirements	5.8.2	5.8 [4] (b)	RBS
WF3 Technical Specifications	1.22	*	WF3
WF3 Technical Specifications	6.9.18	5.8 [1]	WF3
WF3 Technical Specifications	6.13.2.b	5.8 [4] (c)	WF3
JAF ODCM	6.2.1	5.8 [1]	JAF
JAF Technical Specifications	5.6.3	5.8 [1], 5.8 [4]	JAF
JAF FSAR	Chapters 7 and 11	5.8 [4]	JAF
11759 – NRC IN 79-19	All	*	WF3
GGNS UFSAR, Chapter 16B.1 / TRM	7.6.3.8 paragraph 1	1.0	GGNS
GGNS ODCM	5.6.3.c	5.8 [1]	GGNS
GGNS FSAR	11.4.5.S2	5.9 [2](a)	GGNS
GGNS FSAR	11.4.2.3AS7	5.9 [2](a)	GGNS
IPN-99-079	All	*	IPEC
Appendix B Technical Specifications	Section 4.5, RECS ODCM Part 1	*	IPEC
PLP Technical Specifications	5.5.15	5.8 [4]	PLP
PLP ODCM	Appendix A – IV. A	5.8 [1]	PLP
NRC Letter 1.98.091	All	*	PNPS
NRC Letter 1.88.078	All	*	PNPS
VY Technical Specifications	6.4.H	*	VY
VY ODCM	10.1	5.8 [1]	VY
VY TRM	6.12	5.8 (3)	VY
QAPM	Section A.1.c	*	All

* Covered by directive as a whole or by various paragraphs of the directive.

9.0 ATTACHMENTS

None