

Susceptibility of Nuclear Stations to External Faults

AVAILABILITY OF REFERENCE MATERIALS IN NRC PUBLICATIONS

NRC Reference Material

As of November 1999, you may electronically access NUREG-series publications and other NRC records at NRC's Public Electronic Reading Room at <http://www.nrc.gov/reading-rm.html>. Publicly released records include, to name a few, NUREG-series publications; *Federal Register* notices; applicant, licensee, and vendor documents and correspondence; NRC correspondence and internal memoranda; bulletins and information notices; inspection and investigative reports; licensee event reports; and Commission papers and their attachments.

NRC publications in the NUREG series, NRC regulations, and Title 10, "Energy," in the *Code of Federal Regulations* may also be purchased from one of these two sources.

1. The Superintendent of Documents
U.S. Government Printing Office
Mail Stop SSOP
Washington, DC 20402-0001
Internet: bookstore.gpo.gov
Telephone: 202-512-1800
Fax: 202-512-2250
2. The National Technical Information Service
Springfield, VA 22161-0002
www.ntis.gov
1-800-553-6847 or, locally, 703-605-6000

A single copy of each NRC draft report for comment is available free, to the extent of supply, upon written request as follows:

Address: U.S. Nuclear Regulatory Commission
Office of Administration
Publications Branch
Washington, DC 20555-0001

E-mail: DISTRIBUTION.RESOURCE@NRC.GOV
Facsimile: 301-415-2289

Some publications in the NUREG series that are posted at NRC's Web site address <http://www.nrc.gov/reading-rm/doc-collections/nuregs> are updated periodically and may differ from the last printed version. Although references to material found on a Web site bear the date the material was accessed, the material available on the date cited may subsequently be removed from the site.

Non-NRC Reference Material

Documents available from public and special technical libraries include all open literature items, such as books, journal articles, transactions, *Federal Register* notices, Federal and State legislation, and congressional reports. Such documents as theses, dissertations, foreign reports and translations, and non-NRC conference proceedings may be purchased from their sponsoring organization.

Copies of industry codes and standards used in a substantive manner in the NRC regulatory process are maintained at—

The NRC Technical Library
Two White Flint North
11545 Rockville Pike
Rockville, MD 20852-2738

These standards are available in the library for reference use by the public. Codes and standards are usually copyrighted and may be purchased from the originating organization or, if they are American National Standards, from—

American National Standards Institute
11 West 42nd Street
New York, NY 10036-8002
www.ansi.org
212-642-4900

Legally binding regulatory requirements are stated only in laws; NRC regulations; licenses, including technical specifications; or orders, not in NUREG-series publications. The views expressed in contractor-prepared publications in this series are not necessarily those of the NRC.

The NUREG series comprises (1) technical and administrative reports and books prepared by the staff (NUREG-XXXX) or agency contractors (NUREG/CR-XXXX), (2) proceedings of conferences (NUREG/CP-XXXX), (3) reports resulting from international agreements (NUREG/IA-XXXX), (4) brochures (NUREG/BR-XXXX), and (5) compilations of legal decisions and orders of the Commission and Atomic and Safety Licensing Boards and of Directors' decisions under Section 2.206 of NRC's regulations (NUREG-0750).

DISCLAIMER: This report was prepared as an account of work sponsored by an agency of the U.S. Government. Neither the U.S. Government nor any agency thereof, nor any employee, makes any warranty, expressed or implied, or assumes any legal liability or responsibility for any third party's use, or the results of such use, of any information, apparatus, product, or process disclosed in this publication, or represents that its use by such third party would not infringe privately owned rights.

Susceptibility of Nuclear Stations of External Faults

Manuscript Completed: July 2012
Date Published: September 2014

Prepared by:
Michael Villaran and Meng Yue

Nuclear Science and Technology Department
Brookhaven National Laboratory
Upton, New York 11973-5000

Darrell Murdock, NRC Project Manager

NRC Job Code N6838

Office of Nuclear Regulatory Research

ABSTRACT

The offsite electric power supply, delivered via the electrical transmission grid and nuclear power plant (NPP) switchyard, is the preferred source of power for normal and emergency NPP shutdown. Since the deregulation of the electric power industry, NPP electrical distribution systems have become more vulnerable to the effects of external transmission system faults because most of those switchyards and transmission lines are no longer owned, operated, or maintained by the same companies that own and operate the nuclear plants. Also, with the exception of the North America Electric Reliability Corporation (NERC) standard NUC-001-2, there is a lack of detailed industry-wide technical standards for (1) the interface between NPPs and transmission/subtransmission networks; (2) the protection systems for the interface; and (3) the maintenance of the primary and secondary equipment in the interface.

As part of a research program sponsored by the NRC Office of Nuclear Regulatory Research, the effects that electrical faults and other disturbances originating on the electric power grid can have on the availability of offsite power sources and the performance of the NPP are studied. A review of NPP switchyard configurations, transmission grid interface configurations, and their electrical protection systems was undertaken to better understand the dynamics of the interconnection between the NPP onsite and offsite power systems.

Several simulation models were developed based upon actual NPP power distribution systems, their transmission system interfaces, and electrical protection systems using power system analysis software. An event tree type approach was followed in developing the simulation study scenarios and contingencies in the analyses. The importance of maintenance on the response of the electrical protection systems to external fault events was considered.

Conclusions and observations are presented for improving the response of electrical protection systems to an external fault in order to minimize the occurrence of a loss-of-offsite power and nuclear plant trip.

FOREWORD

The offsite electric power supply, delivered via the electrical transmission grid and nuclear power plant (NPP) switchyard, is considered to be the most reliable electric power source for safe operation and accident mitigation in nuclear power plants (NPPs). It is also the preferred source of power for normal and emergency NPP shutdown. If the loss of the offsite electric power system is concurrent with a main turbine trip and unavailability of the onsite emergency ac power system, a total loss of ac power occurs, resulting in a station blackout (SBO) condition, which is one of the significant contributors to reactor core damage frequency.

Since the deregulation of the electric power industry, NPP electrical distribution systems have become more vulnerable to the effects of external transmission system faults because most of those switchyards and transmission lines are no longer owned, operated, or maintained by companies that have an ownership interest in the nuclear plants. Instead, the switchyards are now maintained by local transmission and distribution companies, which may not fully appreciate the issues and regulatory requirements associated with NPP safety and security. Maintenance practices may also be inconsistent among these companies. In addition, circuit breaker components (i.e., relays, contacts, and circuit breaker opening/closing mechanisms) and other Transmission and Distribution (T&D) equipment may not have the level of maintenance that would be available through a NPP owner/operator. Inadequate maintenance of these components could affect the detection and mitigation of faults, which could, in turn, delay protective actions at NPPs.

A review of NPP switchyard configurations, transmission grid interface configurations, and their electrical protection systems was undertaken to better understand the dynamics of the interconnection between the NPP onsite and offsite power systems. In addition, the various types of protection systems for the main generators, electrical buses, power transformers, and electrical transmission lines were reviewed.

Examples of recent transmission system fault events that resulted in NPP trips and/or Loss of Offsite Power (LOOP) were studied in detail to identify the potential system design, operation and maintenance vulnerabilities that may have contributed to these outcomes. Several of these examples were selected for more detailed study using power system analysis software tools. Simulation models were developed using Electric Transient and Analysis Program (ETAP) software based upon the actual plant distribution systems, switchyard design, and transmission system interconnections. An event tree type approach was followed in developing the simulation study scenarios and potential contingencies.

The Federal Energy Regulatory Commission (FERC) is the federal agency responsible for the regulation of wholesale interstate electric power transactions on the transmission system. In this role FERC approves and enforces the electric reliability standards developed by the North American Electric Reliability Corporation (NERC). NERC provided input to this report.

NERC Standard NUC-001-2 specifically requires coordination agreements between the operators of nuclear generating stations and transmission owners/operators for the purpose of ensuring that reliable sources of offsite power are available for the safe operation and shutdown of NPPs. The conclusions and observations in this NUREG/CR will serve as a reference to NERC in the future development and revision of standards that address the interface between nuclear power plants and the electric power grid.

In light of the above issues, this research evaluates the effects that electrical faults originating on the offsite electric power grid can have on the availability of offsite power sources and the performance of the NPP. The objectives of this research project are to: 1) develop a better understanding of the current power system protection in NPP electrical switchyards, 2) identify the electrical system vulnerabilities that contribute to electrical fault propagation into the nuclear plant's switchyard, and 3) serve as a knowledge base for NRC staff to evaluate events that take place on the electric transmission system beyond the regulatory reach of the Nuclear Regulatory Commission (NRC).

TABLE OF CONTENTS

<u>Section</u>	<u>Page</u>
ABSTRACT.....	iii
FOREWORD	v
LIST OF FIGURES	ix
LIST OF TABLES.....	x
ABBREVIATIONS AND ACRONYMS	xi
EXECUTIVE SUMMARY	xiii
ACKNOWLEDGMENTS.....	xix
1 INTRODUCTION.....	1
1.1 Background.....	1
1.1.1 Deregulation of the Electric Utility Industry	2
1.1.2 Operating Experience – Examples of Grid Disturbances Affecting NPPs.....	3
1.2 Purpose and Scope	5
1.3 Organization of this Report	6
2 NUCLEAR PLANT OFFSITE POWER SYSTEM	9
2.1 NPP Electric Power Distribution Systems	9
2.1.1 Onsite Power System	9
2.1.2 Offsite Power System.....	11
2.2 Switchyard Bus Arrangements	12
2.3 Electrical Protection Systems.....	12
2.3.1 Transmission Line Protection Systems.....	13
2.3.2 Switchyard Bus Protection.....	21
2.3.3 Onsite Medium-voltage Bus Protection.....	24
2.3.4 Power Transformers Protection	25
2.3.5 Protection for the Main Generator and Unit-Connected Step-up Transformer.....	25
3 ANALYTICAL APPROACH TO STUDYING THE IMPACT OF PROTECTION SETTINGS ON NPP RESPONSE TO AN EXTERNAL FAULT.....	27
3.1 Overview.....	27
3.2 A Generic Approach to Evaluate Impacts of Protection Settings/Schemes on NPP Response	28
3.2.1 An Event Tree Type Approach	28
3.2.2 Development of Contingencies.....	29
3.2.3 Development of Simulation Scenarios	30
3.3 Discussion and Remarks	32

4	NPP MODELS AND ANALYSES.....	35
4.1	Overview.....	35
4.2	ETAP Model Description of NPPs.....	35
4.2.1	Modeling Approach and Assumptions.....	35
4.2.2	Overview of the NPP Models.....	36
4.3	Scenario Definition, Simulation, and Analysis.....	41
4.3.1	Comparison of Grid Responses to Faults at Different Locations.....	41
4.3.2	Comparison of Grid Responses to Faults with Different Protection Schemes.....	50
4.3.3	Interactions between Protection Systems of Switchyards Close to Each Other.....	79
4.3.4	Plant Responses to an External Fault with Disabled Zones 1, 2, and 3 Protection Relays.....	85
4.4	Summary and Discussions.....	85
5	IMPORTANCE OF PROTECTION SYSTEMS MAINTENANCE.....	89
5.1	Applicability of Maintenance Requirements to Offsite Power Systems.....	89
5.2	NPP Offsite Power Fault Events Affected by Inadequate Maintenance.....	90
5.3	Benefits of Improving Offsite Power System Maintenance.....	94
6	SUMMARY AND CONCLUSIONS.....	97
6.1	Summary.....	97
6.2	Conclusions.....	98
7	REFERENCES.....	103
APPENDIX A	SCENARIOS FOR COMPARING GRID RESPONSES TO FAULTS AT DIFFERENT LOCATIONS FOR PLANTS B AND C.....	A-1
APPENDIX B	DEREGULATION OF THE ELECTRIC UTILITY INDUSTRY.....	B-1
APPENDIX C	COMMON SWITCHYARD BUS ARRANGEMENTS.....	C-1
APPENDIX D	TYPICAL UNIT-CONNECTED MAIN GENERATOR & TRANSFORMER PROTECTION.....	D-1

LIST OF FIGURES

<u>Figure</u>		<u>Page</u>
Figure 1	Typical NPP electrical distribution system.....	10
Figure 2	Breaker-and-a-half switchyard with main generators connected in a double-bus, double-breaker arrangement.....	13
Figure 3	Typical protective relaying schematic at one end of a high-voltage transmission line.....	14
Figure 4	A Distance Relaying Scheme.....	16
Figure 5	A Permissive Overreaching Relaying Scheme.....	18
Figure 6	A Directional Comparison Protective Scheme Using Telecommunications.....	19
Figure 7	An Example Transmission Line Protection System.....	21
Figure 8	Distribution of faults on the CEGB system [Lindahl–2011].....	30
Figure 9	One-line Diagram for Plant A.....	38
Figure 10	One-line Diagram for Plant B.....	39
Figure 11	One-line Diagram for Plant C.....	40
Figure 12	CBA-Case-1 for Bus SWYDBus-1 Permanent Fault (Near).....	43
Figure 13	Plant A-Case-2 for Bus Sub1-1 Permanent Fault (Medium).....	44
Figure 14	Plant A-Case-3 for Bus Bus20 Permanent Fault (Far).....	45
Figure 15	Plant A-Case-4 for Line12 Permanent Fault (Near).....	46
Figure 16	Plant A-Case-5 for Line10 Permanent Fault (Far).....	47
Figure 17	Plant A-Case-6 for Line12 Transient Fault (Near).....	48
Figure 18	Plant A -Case-7 for Line10 Transient Fault (Far).....	49
Figure 19	Example Scenario 1 for Plant A Model for Distance Relaying.....	54
Figure 20	Example Scenario 2 for Plant A Model for Distance Relaying with Remote Breaker Failure Backup Protection.....	55
Figure 21	Example Scenario 3 for Plant A Model for Distance Relaying with Remote Breaker Failure Backup Protection.....	56
Figure 22	Example Scenario 4 for Plant A Model for Telecommunications-based Relaying.....	57
Figure 23	Example Scenario 5 for Plant A Model for Telecommunications-based Relaying with Remote Breaker Failure Backup Protection.....	58
Figure 24	Example Scenario 6 for Plant A Model for Telecommunications-based Relaying with Remote Breaker Failure Backup Protection.....	59
Figure 25	Example Scenario 1 for Plant B Model for Distance Relaying.....	61
Figure 26	Example Scenario 2 for Plant B Model for Distance Relaying with Remote Breaker Failure Backup Protection.....	62
Figure 27	Example Scenario 3 for Plant B Model for Distance Relaying with Remote Breaker Failure Backup Protection.....	63
Figure 28	Example Scenario 4 for Plant B Model for Telecom-based Relaying.....	64
Figure 29	Example Scenario 5 for Plant B Model for Telecommunications-based Relaying with Remote Breaker Failure Backup Protection.....	65
Figure 30	Example Scenario 6 for Plant B Model for Telecommunications-based Relaying with Remote Breaker Failure Backup Protection.....	66
Figure 31	Example Scenario 1 for Plant C Model for Distance Relaying.....	68
Figure 32	Example Scenario 2 for Plant C Model for Distance Relaying with Remote Breaker Failure Backup Protection.....	69
Figure 33	Example Scenario 3 for Plant C Model for Distance Relaying with Remote Breaker Failure Backup Protection.....	70

Figure 34	Example Scenario 4 for Plant C Model for Telecom-based Relaying	71
Figure 35	Example Scenario 5 for Plant C Model for Telecommunications-based Relaying with Remote Breaker Failure Backup Protection	72
Figure 36	Example Scenario 6 for Plant C Model for Telecommunications-based Relaying with Remote Breaker Failure Backup Protection	73
Figure 37	Switchyards of Plant A and a Neighboring Substation.....	75
Figure 38	Line31 – Scenario 1 for Zone 3 Anticipatory Trip (0.4 Seconds Delay)	76
Figure 39	Line31 – Scenario 2 for Zone 3 Anticipatory Trip (0.9 Seconds Delay)	77
Figure 40	Line31 – Scenario 3 for Zone 3 Anticipatory Trip (1.4 Seconds Delay)	78
Figure 41	Switchyards of Plant A and a Neighboring Substation.....	79
Figure 42	Example Scenario 1 for Interaction between Protection Schemes of Two Switchyards	81
Figure 43	Example Scenario 2 for Interaction between Protection Schemes of Two Switchyards	82
Figure 44	Example Scenario 3 for Interaction between Protection Schemes of Two Switchyards	83
Figure 45	Example Scenario 4 for Interaction between Protection Schemes of Two Switchyards	84
Figure A-1	Plant B-Case-1 for Bus EB Permanent Fault (Near)	A-2
Figure A-2	Plant B-Case-2 for Bus Sub2 Permanent Fault (Medium)	A-3
Figure A-3	Plant B-Case-3 for Bus Sub6 Permanent Fault (Far)	A-4
Figure A-4	Plant B-Case-4 for Line 12 Permanent Fault (Near).....	A-5
Figure A-5	Plant B-Case-5 for Line 2 Permanent Fault (Medium).....	A-6
Figure A-6	Plant B-Case-5 for Line 12 Transient Fault (Far).....	A-7
Figure A-7	Plant B-Case-6 for Line 2 Transient Fault (Near)	A-8
Figure A-8	Plant C-Case-1 for Bus77 Permanent Fault (Near)	A-9
Figure A-9	Plant C-Case-2 for Bus Sub1 Permanent Fault (Far)	A-10
Figure A-10	Plant C-Case-3 for Line 3 Permanent Fault (Near)	A-11
Figure A-11	Plant C-Case-4 for Line 220 32 Permanent Fault (Medium).....	A-12
Figure A-12	Plant C-Case-5 for Line 220 31 Permanent Fault (Near).....	A-13
Figure A-13	Plant C-Case-6 for Line 3 Transient Fault (Near).....	A-14
Figure A-14	Plant C-Case-8 for Line 220 32 Transient Fault (Medium)	A-15
Figure A-15	Plant C-Case-8 for Line 220 31 Transient Fault (Far).....	A-16
Figure C-1	Common high-voltage switchyard bus arrangements.....	C-1

LIST OF TABLES

<u>Table</u>	<u>Page</u>	
Table 4-1	Scenarios for Comparing Grid Responses to Faults at Different Locations	42
Table 4-2	Generic Parameters for Simulating the Responses to a Fault with Different Protective Schemes	51
Table D-1	Typical Main Generator & Transformer Protective Devices & Functions	D-1

ABBREVIATIONS AND ACRONYMS

AAC	Alternate AC (source)
AIT	Augmented Inspection Team (USNRC)
AUT	Auxiliary Unit Transformer
BF	Breaker Failure (protection scheme)
BNL	Brookhaven National Laboratory
BWR	Boiling Water Reactor
CB	Circuit Breaker
CEII	Critical Energy Infrastructure Information
CT	Current Transformer
DR	Distance Relay(ing)
DRBF	Distance Relaying Breaker Failure (protection scheme)
EDG	Emergency Diesel Generator
EMF	Electromotive Force
ETAP	Electric Transients Analysis Program
FERC	Federal Energy Regulatory Commission
FSAR	Final Safety Analysis Report
GDC	General Design Criterion (10 CFR 50, Appendix A)
IEC	International Electrotechnical Commission
IEEE	Institute of Electrical and Electronics Engineers
IN	Information Notice (USNRC)
ISO	Independent System Operator (electrical transmission system)
LER	Licensee Event Report
LOOP	Loss Of Offsite Power
LV	Low-Voltage
MCC	Motor Control Center
MVA	Megavolt-Amperes
MV	Medium-Voltage
MW	Megawatts
NRC	Nuclear Regulatory Commission
NERC	North American Electric Reliability Corporation
NPIR	Nuclear Plant Interface Requirements
NPP	Nuclear Power Plant
POTT	Permissive Overreaching Transfer Trip
PPS	Preferred Power Supply
PR	Protective Relay(ing) using telecommunications (pilot relaying)
PRBF	telecommunications-based (Pilot Relaying) Breaker Failure protection
PT	Potential Transformer
PRA	Probabilistic Risk Assessment
PWR	Pressurized Water Reactor
RCP	Reactor Coolant Pump
RCS	Reactor Coolant System
RG	Regulatory Guide (USNRC)
SBO	Station Blackout
SRP	Standard Review Plan (NUREG-0800)
SST	Station Startup Transformer
T&D	Transmission and Distribution
USNRC	United States Nuclear Regulatory Commission
UAT	Unit Auxiliary Transformer

VAR Volt-Amperes-Reactive
X/R Ratio Ratio of Reactance to Resistance

EXECUTIVE SUMMARY

The offsite electric power supply, delivered via the electrical transmission grid and nuclear power plant (NPP) switchyard, is considered to be the most reliable electric power source for safe operation and accident mitigation in nuclear power plants (NPPs). It is also the preferred source of power for normal and emergency NPP shutdown. When offsite power is lost, standby power supplies, such as emergency diesel generators, provide onsite emergency alternating current (ac) power. If the loss of the offsite electric power system is concurrent with a main turbine trip and unavailability of the onsite emergency ac power system, a total loss of ac power occurs, resulting in a station blackout (SBO) condition, which is one of the significant contributors to reactor core damage frequency.

Since the deregulation of the electric power industry, NPP electrical distribution systems have become more vulnerable to the effects of external transmission system faults because most of those switchyards and transmission lines are no longer owned, operated, or maintained by companies that have an ownership interest in the nuclear plants. Instead, the switchyards are now maintained by local transmission and distribution companies, which may not fully appreciate the issues and regulatory requirements associated with NPP safety and security. Maintenance practices may also be inconsistent among these companies. In addition, circuit breaker components (i.e., relays, contacts, and circuit breaker opening/closing mechanisms) and other T&D equipment may not have the level of maintenance available through a NPP owner/operator. Inadequate maintenance of these components could affect the detection and mitigation of faults, which could, in turn, delay protective actions at NPPs.

The current research project, being performed under contract to the United States Nuclear Regulatory Commission's Office of Nuclear Regulatory Research (NRC/RES), takes a detailed look at the effects that electrical faults and other disturbances originating on the offsite electric power grid can have on the availability of offsite power sources and the performance of the NPP. The objectives of this research project are to: 1) develop a better understanding of the current power system protection in NPP electrical switchyards and 2) to identify the electrical system vulnerabilities that contribute to electrical fault propagation into the nuclear plant's switchyard.

The purpose of this study is to demonstrate and verify through modeling and simulation that precise and faster clearing of faults can in fact limit damage and improve plant ride-through, which is one of the main reasons for developing and deploying telecommunication-based relay schemes. The practical application of this approach into an existing protection scheme, which would be the equivalent of upgrading to a faster protective relay, would of course have to be analyzed carefully to take into consideration the coordination of all affected protection system timing intervals as well as the effects that the tripping of transmission element(s) can have on system stability. The high speed, precision, and reliability of telecommunication-based protection now being deployed allows ISOs, utilities, and NPP operators to take advantage of the potential improvements that faster clearing times can provide as we have shown in the study.

A review of NPP switchyard configurations, transmission grid interface configurations, and their electrical protection systems was undertaken to better understand the dynamics of the interconnection between the NPP onsite and offsite power systems. In addition, the various types of protection systems for the main generators, electrical buses, power transformers, and electrical transmission lines were reviewed.

Examples of recent transmission system fault events that resulted in NPP trips and/or LOOPs were studied in detail to identify the potential system design, operation and maintenance

vulnerabilities that may have contributed to these outcomes. Several of these examples were selected for more detailed study using power system analysis software tools. Simulation models were developed using ETAP[®] power system analysis software based upon the actual plant distribution systems, switchyard design, and transmission system interconnections. An event tree type approach was followed in developing the simulation study scenarios and potential contingencies. Typical protection schemes were assumed for comparison when performing the simulation scenario analyses.

In addition, the importance of electrical protection system maintenance on the performance of the electrical protection system response to external fault events was considered. Several of the recent operating experience examples of significant NPP trip and LOOP that were studied during this project were the result of inadequate electrical protection system maintenance.

Several of the important observations and conclusions that were identified during the NPP reviews and the power systems modeling and analyses conducted for this project are:

- Simulation studies confirmed that the faster an external transmission grid fault could be detected and isolated (without compromising the balance between security and dependability), the less severe the effect of the transient experienced at the NPP switchyard bus. The closer a fault is to the NPP switchyard the greater the effect on the NPP.
- Rapid detection and clearing of grid electrical faults helps to minimize the effects of a prolonged electrical transient that could lead to a NPP trip. The sudden loss of the voltage and real/reactive power support provided by the nuclear plant's main generator is itself a potentially destabilizing event that can potentially lead to an extended degradation of system voltage at the NPP switchyard and resulting in a LOOP following a trip of the plant.
- Electrical protection schemes using telecommunications (pilot relay schemes) provided the fastest and most reliable protection for transmission line circuits, and per the results of the simulation studies, they helped to minimize the effects of external faults as seen from the NPP switchyard. Improvements in the performance and reliability of multi-function digital protective devices, together with the lower costs and high reliability of the various modern communications links that are currently available, have made relaying protection schemes using telecommunications the preferred method for transmission protection.
- In general, protective schemes have already been designed and coordinated to detect and isolate faults as rapidly as the equipment will allow. It may be possible to adjust the settings of existing Zone 2 and Zone 3 protective relays and minimize intentional time delays in the protective schemes to achieve a more rapid protection system response. In this case, Zone 3 protective schemes will function as an anticipatory trip, as discussed in Section 4.3.2.3. As a point of emphasis, consideration of anticipatory Zone 3 protection schemes must be very carefully analyzed to be balanced against coordination with neighboring protection schemes to ensure that disruption to the system is minimized.

Based on the reviews and analyses of the simulation model studies with regard to the effects of external electrical faults on nuclear power stations, the following observations are offered to maintain the highest reliability of the electric power grid while continuing to maintain and improve the safe and reliable operation of nuclear power plants. Any change or actions taken on the bases of the conclusions and observations put forward in this document must be

carefully analyzed for the specific application to assure that the balance between security and dependability is not compromised.

- Simulation studies confirmed that the faster an external transmission grid fault could be detected and isolated, the less is the effect of the transient experienced at the NPP switchyard bus. Reviewing the settings of protective relays and intentional time delays in existing electrical protection schemes may be practical to determine whether modifications can be made to achieve a more rapid protection system response without compromising the balance between security and dependability. In particular, when the primary protection scheme fails, the backup scheme becomes critical to isolate the fault(s) and the intentionally built-in time delay of the backup scheme significantly prolongs the clearing time. Under this situation, if the time delay can be minimized, the impact that a fault at or close to the NPP switchyard will have on the normal operation of NPPs can be significantly reduced.
- In general, analyzing the impacts that various protection system scenarios will have on the ability to meet the Nuclear Power Interface Requirements (NPIRs) presented in NUC-001-2 for nuclear power plants may improve the technical basis when altering or upgrading existing electrical system protection schemes. Faster fault clearing generally results in improved system performance, but this enhancement may only be valid if other transmission system elements are not tripped in addition to the faulted element. Therefore, careful consideration must be given to the proper setting and coordination of the time delays for tripping transmission and switchyard components to ensure a balance between security and dependability.
- Electrical protection schemes using telecommunications (pilot relay schemes) provide the fastest and most reliable protection for transmission line circuits, and per the results of the simulation studies, they helped to minimize the effects of external faults as seen from the NPP switchyard. Therefore, incorporating protection schemes using telecommunications is an option worth considering when replacing or upgrading existing transmission line protection systems, particularly for lines that are in the zone of influence of the NPPs.
- The use of electrical protection systems using telecommunications as part of the breaker failure and backup protection schemes for NPP switchyards and associated transmission circuits may improve the reliability of the protection system. The high speed, sensitivity, and reliability of protective relaying using telecommunications in backup protection helps to minimize the effects of primary protection failures.
- Reliability in switchyards incorporating the breaker-and-a-half bus arrangement could be improved for the most critical transmission circuits and the main generator connection by modifying the circuit breaker arrangement for those connections to a full double-bus, double-breaker arrangement.
- Incorporating the NPIRs into transmission system studies affecting NPPs as stated in NERC Reliability Standard NUC-001-2 may identify and address contingencies that require the application of mitigation plans to avoid loss of offsite power events (LOOPs).
- Improving the reliability of primary protection of the NPP switchyard protection systems can help them cope with the fault more effectively. This can be achieved by using redundant protective equipment such as dual relays, circuit-breakers, and telecommunication channels.

- It also needs to be pointed out that redundancy is often defeated by common cause failures even for the redundant equipment of diverse designs. Hence, adjusting the settings of existing protection systems to reduce and/or avoid time delays, especially those of the backup protection schemes, is still considered necessary and very important even while increasing the redundancy of NPP switchyard protection systems.
- Conducting grid transient analyses to identify those relays and contacts that can have a significant impact on conditions at the NPP switchyard buses may provide valuable insights when reviewing or updating the protection schemes at or near the NPP switchyard.
- As a consequence of the above observations, it follows that protection systems and equipment in selected nearby switchyards, transmission lines, substations, and large generating units (that have been shown by analysis to have a significant impact on nearby NPPs), may be subjected to a more frequent and augmented level of inspection, testing, and preventive maintenance without compromising the balance between security and dependability. This would be in keeping with the offsite power reliability and grid stability objectives that NRC, in cooperation with FERC and NERC, has been trying to achieve.
- Several recent events examined as part of this study were caused by or exacerbated by inadequate protection system maintenance. A comprehensive review of external fault events may be worthwhile to update the results of earlier studies that compared grid reliability and performance prior to, and after deregulation of the electric utility industry. This would help to verify the effectiveness of FERC and NERC efforts to improve grid reliability through standards, regulatory enforcement, and cooperative activities with NRC. It would also provide a quantitative measure of the current status and performance trends of the electrical transmission grid with respect to the negative effects of aging T&D components and equipment, overloading of limited existing transmission resources, aging degradation electrical protection systems, increased overall demand, increased peak demand, and inadequate development of new transmission system capacity.
- Efforts to identify necessary changes to the FERC/NERC standards that address protective relaying schemes and the nuclear plant interface with the transmission grid may be worthwhile. Combined efforts from the NRC, FERC/NERC, the nuclear industry, and affected transmission system operators could lead to the development of industry-wide standards for: 1) the interface between NPPs and the transmission (or subtransmission) networks, 2) the electrical protection schemes for the interface, and 3) the maintenance of the primary and secondary protection equipment at the interface.
- In this study, blocking of automatic reclosing of circuit breakers in the electrical protection zones immediately adjacent to the NPP was found to minimize the risk of tripping the NPP due to an uncleared permanent fault. Experience has shown that in many applications automatic reclosing, when supervised by a synchronism check relay, may improve electrical grid stability and continuity of the offsite power supply by improving the availability of stabilizing transmission system elements. In practical application, the decision to enable or block automatic reclosing in the vicinity of a NPP should be based upon a technical analysis and evaluation of the risks of reclosing into a fault versus the risks of prolonged operation with a transmission line out of service.

- Monitoring the switchyard and transmission line protection system relays and fuses that would alert operators of the occurrence of failures in the protection system may lead to a more robust level of protection. Several of the operating experience examples of NPP trip and LOOP in this study could have been avoided if circuit failures in the protection system had been detected immediately and corrected before they were challenged.
- It is important that the NPP switchyards be reviewed and treated differently than the regular switchyards/substations in the transmission network in terms of design, operation, and maintenance in order to achieve improvement in the reliability of the NPPs and subsequently reducing the risk associated with tripping NPPs due to external electrical faults.

Since the transmission system and the grid are owned and operated by other entities, it is the responsibility of the NPP owners to ensure that NPP design requirements, modification, and enhancements required to maintain a reliable and stable electric power system including inadvertent trip of NPPs are identified and communicated promptly to the respective transmission and grid operating entities.

ACKNOWLEDGMENTS

The authors would like to thank the NRC Program Manager, Darrell Murdock, for his technical guidance in the performance of this research program and in the review of this document. We would also like to thank Thomas Koshy of the NRC, Frank Koza and his staff at Pennsylvania-New Jersey-Maryland Interconnection (PJM), along with William Horak, David Diamond, and James Higgins of Brookhaven National Laboratory for their technical review and comments on this and past documents, as well as their managerial direction and support which enabled the successful completion of this research program.

Special thanks and acknowledgment are extended to Dr. Sture Lindahl, of Gothia Power AB, Göteborg, Sweden, for his technical insights, comments, and information on nuclear plant electrical distribution systems. We also appreciate Dr. Lindahl's insights and comments regarding the effects of electrical faults on nuclear power stations, maintenance and operation of switchyards and transmission lines associated with nuclear power stations, and the development and analysis of simulation models for NPPs and their grid connections.

The authors wish to express their special thanks and acknowledgement to Robert W. Cummings, Director of System Analysis and Reliability Initiatives at NERC, and his staff for their insightful technical comments, suggestions, and supporting information on this project.

The authors would like to acknowledge David Burnham of FERC for his technical support and guidance on this project.

The authors extend their thanks and acknowledgment to Kenneth Sullivan, Edward Grove, and Mano Subudhi of Brookhaven National Laboratory for their technical insights, comments, and information on nuclear plant electrical distribution systems. We also appreciate their insights and comments regarding maintenance, operation, and aging management of electrical distribution equipment.

The authors wish to extend their thanks to Maryann Julian, Donna Storan, Maria Anzaldi, and Jean Frejka for their assistance in the preparation of this document and their continued administrative support throughout the performance of this research program.

1 INTRODUCTION

The offsite electric power supply, delivered via the electrical transmission grid and nuclear power plant (NPP) switchyard, is considered to be the most reliable electric power source for safe operation and accident mitigation in NPPs. It is also the preferred source of power for normal and emergency NPP shutdown. When offsite power is lost, standby power supplies, such as emergency diesel generators, provide onsite emergency alternating current (ac) power. If the loss of the offsite electric power system is concurrent with a main turbine trip and unavailability of the onsite emergency ac power system, a total loss of ac power occurs, resulting in a station blackout (SBO) condition [10 CFR 50.63], which is one of the significant contributors to reactor core damage frequency.

Since the deregulation of the electric power industry, NPP switchyards have become more vulnerable to the effects of external transmission system faults because most of those switchyards are no longer owned, operated, or maintained by companies that have an ownership interest in the nuclear plants. Instead, the switchyards are maintained by local transmission and distribution companies, which may not fully appreciate the issues and regulatory requirements associated with NPP safety and security. Maintenance practices may also be inconsistent among these companies. In addition, circuit breaker components (i.e., relays, contacts, and circuit breaker opening/closing mechanisms) and other T&D equipment may not have the level of maintenance available through a NPP owner/operator. Inadequate maintenance of these components could affect the detection and mitigation of faults, which could, in turn, delay or fail protective actions at NPPs.

The electrical transmission grid protection system is designed to isolate or clear electrical faults as rapidly as possible in order to prevent the propagation of a minor electrical disturbance into a more serious and wide-reaching system transient that challenges system stability and affects large portions of the transmission grid. Severe system transients can potentially lead to tripping of nuclear generating units and/or losses-of-offsite power (LOOPs), which are the preferred power source during normal and emergency NPP operation. Mitigating the effects of external electrical faults is therefore an important factor in maintaining nuclear plant safety. This study will examine electrical protection schemes in NPP switchyards in order to identify ways to more rapidly identify and isolate external electrical transmission system faults to improve NPP plant safety and help to maintain system stability. Rapid detection and isolation of remote electrical faults by the grid electrical protection system without the unnecessary actuation and response of the NPP electrical protection system can potentially reduce the number of unnecessary nuclear plant trips and/or LOOP events.

1.1 Background

The current fleet of nuclear power plants designed, built, and licensed prior to deregulation of the electric utility industry were exclusively owned and operated by the same utility company that owned and operated the NPP switchyard and the local transmission grid. A single utility therefore maintained direct control over the nuclear plant operation, the configuration of the transmission grid, operation of other nearby non-nuclear generation, the delivery of electric power, and the design and coordination of the electrical protection system for the grid, the NPP switchyard, and the NPP distribution systems. The single utility operator could thus provide assurance that the regulatory requirements for the supply of electric power to the nuclear station were satisfied.

The design criteria requirements for supply of electric power to NPPs, GDC 17, “Electric power systems,” are set forth in Appendix A to 10 CFR 50 [10 CFR 50, Appendix A, GDC 17], which states, in part, that:

“An onsite electric power system and an offsite electric power system shall be provided to permit functioning of structures, systems, and components important to safety. The safety function for each system (assuming the other system is not functioning) shall be to provide sufficient capacity and capability to assure that (1) specified acceptable fuel design limits and design conditions of the reactor coolant pressure boundary are not exceeded as a result of anticipated operational occurrences and (2) the core is cooled and containment integrity and other vital functions are maintained in the event of postulated accidents...

“Electric power from the transmission network for the onsite electric distribution system shall be supplied by two physically independent circuits... Each of these circuits shall be designed to be available in sufficient time following a loss of all onsite alternating current power supplies... One of these circuits shall be designed to be available within a few seconds following a loss-of-coolant accident to assure that core cooling, containment integrity, and other vital safety functions are maintained...”

In addition, pursuant to the “station blackout (SBO) rule,” 10 CFR 50.63, “Loss of all alternating current power,” licensed NPPs are required to be able to withstand a SBO for a specified duration and recover from the SBO [10 CFR 50.63]. NRC Regulatory Guide 1.155 [USNRC RG 1.155] provides guidance for licensees to use in developing their approach for complying with 10 CFR 50.63. A series of tables in the RG define a set of pertinent plant and plant site parameters that have been found to affect the likelihood of a plant experiencing an SBO event of a given duration. Using the tables, a licensee can determine their plant’s relative vulnerability to SBO events of a given duration and identify an acceptable minimum SBO coping duration for the plant. Typically, NPP coping times range from 4 hours up to 8 hours. The use of an alternate ac source was indicated in sites where the coping and recovery of offsite power exceeded 4 hours.

1.1.1 Deregulation of the Electric Utility Industry

Following deregulation of the electric utility industry via the National Energy Policy Act of 1992 and FERC Order 888 in 1996, NRC expressed concerns that, “Deregulation has the potential to challenge operating and reliability limits on the transmission system and could affect the reliability of the electric power system including the reliability of offsite power to nuclear plants [SECY-99-129 – May 1999].” Under a deregulated electric utility industry, the compliance with regulatory requirements of GDC 17, for the electric power system, and for 10 CFR 50.63, addressing station blackout became dependent on entities that were outside of the direct regulatory jurisdiction of the US NRC.

In 2003, NRC Office of Nuclear Regulatory Research (RES) completed an assessment of the performance of the electric power grid with respect to its effect on NPPs [Raughley – April 29, 2003]. The RES assessment compared the performance of the grid before and after deregulation of the electric utility industry to identify changes in grid operation and to determine the impact that deregulation has had on the supply of electric power to NPPs. Some of the major post-deregulation changes in the electric grid related to LOOPs included the following:

- 1) “the frequency of LOOP events at NPPs has decreased,

- 2) the average duration of LOOP events has increased – the percentage of LOOPS longer than four hours has increased from approximately 17 percent to 67 percent,
- 3) where before LOOPS occurred more or less randomly throughout the year, for 1997-2001, most LOOP events occurred during the summer, and
- 4) the probability of a LOOP as a consequence of a reactor trip has increased by a factor of 5 (from 0.002 to 0.01).”

NRC continues to address the problems of deregulation and grid reliability through

- regular interaction with grid regulators, FERC and NERC,
- information notices (e.g., IN 1998-07, IN 2004-15, IN 2005-15, IN 2005-21, IN 2006-06, IN 2006-18, IN 2007-14, IN 2008-12),
- generic letter correspondence (e.g. GL 2006-02),
- revisions to Chapter 8 (Electric Power) of the Standard Review Plan [NUREG-0800, Revision 4, March 2007],
- the Maintenance Rule [10 CFR 50.65], and
- regulatory guidance (e.g. RG 1.155, RG 1.180, and RG 1.182).

In RIS 2004-05, the NRC indicated the importance of grid reliability issues because of the impact on plant risk and the operability of the offsite power system.

Combined efforts by the NRC, FERC/NERC, the nuclear industry, and affected transmission system operators could lead to the development of industry-wide standards for: 1) the interface between NPPs and the transmission (or subtransmission) networks, 2) the electrical protection schemes for the interface, and 3) the maintenance of the primary and secondary protection equipment at the interface [Lindahl-2011].

Further details on the deregulation of the electric utility industry and the resulting nuclear regulatory concerns stemming from this action are described in Appendix B.

1.1.2 Operating Experience – Examples of Grid Disturbances Affecting NPPs

The aforementioned 2003 NRC/RES study assessing the performance of the electric power grid with respect to its effect on NPPs [Raughley – April 29, 2003] presented numerous examples of grid disturbance events occurring before and after the deregulation of the electric industry up through 2001. Since that time, several notable grid transient events have occurred that had a significant impact on NPP performance. This subsection describes several of these events.

On August 14, 2003, an electrical power disturbance in the northeastern part of the United States caused nine NPPs in the US to trip because of voltage and frequency fluctuations experienced in the initial stages of the blackout [Kirby, Kueck, et. al. ORNL 2007]. Eight of these plants, along with one other nuclear plant that was already shutdown at the time, experienced a loss of offsite power (LOOP). Several of these nuclear plants were located in transmission corridors operating at that time under conditions of inadequate reactive power and were thus required to supply reactive power at their maximum capability in order to support grid voltage. Because the regional power grid was operating at the limits of its capacity and capability, the trip of a large nuclear generating unit and the resulting sudden removal of the local reactive power support it had been providing to the transmission grid inevitably led to

degradation of voltage at the NPP switchyard below Technical Specification limits. The August 2003 event, which was initiated by an overgrown tree coming into contact with electrical transmission lines, resulted in cascading outages, caused trips of nuclear stations, and disabled offsite power supplies. The incident highlighted the importance of the design and maintenance practices for NPP switchyard protection systems and demonstrated how the operational interaction between the power grid and large nuclear generating units can affect the reliability and availability of NPP offsite power sources.

The significance of external transmission system electrical faults affecting the safe operation of nuclear power stations is substantial. As an example, the licensee event report (LER) for Event Number 40815, "Reactor Trip Due to Loss of Offsite Power," which occurred on June 14, 2004, reported the occurrence of a ground fault to one phase (C) of a 230 kilovolt (kV) transmission line between two substations located 47 miles from the Palo Verde Nuclear Generating Station. That fault cascaded and caused a number of 230kV and 500kV transmission lines to trip protectively, leading to concurrent trips of all three Palo Verde units and a loss of all offsite power sources to the site [IN 2005-15; LER 40815; & Lindahl – Comments to BNL 9/17/2010].

Another example of a remote transmission line fault resulting in losses of offsite power sources occurred on September 15, 2003, at the Peach Bottom Atomic Power Station. In this event, offsite power to the emergency buses at Peach Bottom Units 2 and 3 was lost for about 16 seconds when two of the three offsite power sources were briefly lost as well as the station blackout power source. All four emergency diesel generators (EDGs) automatically started and supplied power to the emergency buses. The third offsite power source remained available to two of the four non-emergency plant buses throughout the event. Both units automatically tripped when power was lost to the reactor protection system motor generator sets. Prior to the event, Unit 2 was operating at full power and Unit 3 was operating at 91 percent of full power. It was later determined that the loss of offsite power was the result of a lightning strike on a transmission line approximately 35 miles northeast of the site that did not clear properly due to malfunctions in the protection system [IN 2004-15; AIT 05000277&278/203013; LER 277/2003-004].

On May 20, 2006, both units of Catawba Nuclear Station tripped automatically from 100% power following a LOOP event (See the LER for Event Number 413/2006001, "Loss of Offsite Power Event Resulted in Reactor Trip of Both Catawba Units from 100% Power"). That event began when an electrical fault occurred within a current transformer associated with one of the switchyard power circuit breakers. A second current transformer failure, along with the actuation of the bus differential relays associated with both switchyard buses de-energized both switchyard buses and separated both of the nuclear units from the grid [IN 2007-14; AIT 05000413&414/2006009].

On February 15, 2007, a breaker failure occurred in the Jocassee Hydroelectric Station switchyard causing one phase to fault to ground (see Event Number 43169 and LER 269/2007001). The Oconee Nuclear Station has two switchyards that contain transmission lines that interconnect to other switchyards on the Duke Power Company electric grid. The phase-to-ground fault was isolated by protective relays at the Oconee 230 kV switchyard, but the resulting prolonged (less than 1 second) grid disturbance unexpectedly resulted in a main generator lockout, main turbine trip, and bus transfer from normal to startup sources at unit 1 and unit 2. [LER 269/2007-001]

On February 26, 2008, Turkey Point Nuclear Plant unit 3 and unit 4 automatically tripped from 100% power due to a momentary power fluctuation caused by grid instabilities. Each reactor

tripped when both channels of safety-related 4 kV bus undervoltage relays actuated after a one second time delay. Protection against a momentary grid disturbance is a feature of Turkey Point's electrical system; however, the duration of the condition exceeded the time delay resulting in the actuation of the 4 kV bus undervoltage relays. The source of the grid disturbance was a short circuit to ground on a substation in Dade County, Florida, compounded by human error in troubleshooting the substation protection system [LER 250/2008-001-00].

In addition to the aforementioned examples of domestic power transmission grid transient events, there have been numerous occurrences outside of the US involving external electrical faults that resulted in NPP trips. Notable examples include the Forsmark Nuclear Power Station – Unit 1 (Forsmark-1) in Sweden on July 25, 2006, and the Maanshan Nuclear Power Station – Unit 1 (Maanshan-1) in Taiwan on March 17 and 18, 2001. The Forsmark-1 event was initiated by a line-to-line arcing fault on a 400kV disconnect switch that was erroneously opened under load during maintenance activity at the offsite 400kV switchyard. The ensuing transient caused the generator bus voltage to drop as low as 50 percent of nominal voltage for approximately 300 milliseconds until power circuit breakers on the high-voltage side of the main transformers tripped on low voltage. The load dump caused the main generator bus voltage to surge to 120 percent of nominal voltage for approximately one second, seriously challenging the voltage limits of solid-state UPS systems in multiple redundant reactor safety trains [IN 2006-18; IN 2006-18, Supplement 1].

In the Maanshan-1 incident in Taiwan, fog and misty weather acting on salt-contaminated insulators caused the interruption transfer of the normal offsite power source resulting in an automatic reactor shutdown and transfer from its preferred 345kV offsite system to the backup 161kV system on March 17, 2001. Maanshan-1 is a PWR plant designed to and built to US standards. On March 18, with the reactor shutdown, the 345kV transmission system serving the plant was restored; during subsequent bus transfer operations to realign the plant's safety buses from the 161kV backup to the 345kV preferred source, an insulator failure on the supply side of one of the 4160V safety-related switchgear buses resulted in a high-energy arcing fault [IN 2002-01, January 8, 2002]. The explosion, fire, and smoke accompanying the energetic arcing switchgear fault resulted in a LOOP, loss of one EDG, and extensive damage to the switchgear supply breakers and five adjacent switchgear compartments, electrical buses, and supply cables [Roughley & Lanik, February 2002; NUREG/CR-6850, October 2007].

1.2 Purpose and Scope

The purpose of this research project is to: 1) develop a better understanding of the current power system protection in NPP electrical switchyards and 2) to identify the electrical system vulnerabilities that contribute to electrical fault propagation into the nuclear plant's switchyard causing plant trips and LOOP.

From the regulatory viewpoint, the tripping of a NPP as a result of distant electrical faults on the electrical grid should be avoided for the following reasons: 1) it challenges the safety systems/equipment of the NPP and therefore, increases the overall risk and 2) it may worsen the electrical transmission grid conditions due to a sudden loss of a significant amount of real and reactive power generation. Recent operating experience, including the examples described above, has shown that the mitigation of external electrical faults is important to nuclear plant safety because external faults can cause nuclear plant trips and have had an adverse effect upon the availability of offsite power, which is the preferred source of power for NPP core cooling systems for both normal and emergency shutdown. Many electrical grid transient events indicate that disturbances originating in the grid often were not identified and isolated

rapidly enough by the grid protection systems, due to various reasons (e.g., failure of protection relays), to avoid a nuclear unit trip or a loss of one or both of the offsite power sources.

This study has reviewed the typical configurations of NPP switchyards and their interface with the offsite power grid to try to identify significant specific events, categories of events, or other factors that may involve similarities to the adverse grid transient events described above in the operating experience discussion. Quite often, the response of the NPP switchyard protection systems to a persistent external electrical fault is to quickly isolate the switchyard from the grid upon sensing the transients; unfortunately, this can have a further destabilizing effect on the electric power grid due to the sudden removal of the significant reactive power support provided by the nuclear station generator. The result can be further degraded local grid voltage and grid voltage instability as the system tries to compensate for the sudden demand for reactive and real power. This can lead to losses-of-offsite power sources and potentially cause tripping of other nuclear plants connected to the regional grid that is being affected by the transient event [Russell & Kueck – Dec 91]. The operation parameters of electrical protection systems associated with NPP switchyards and transmission connections were studied to determine whether the response of the NPP switchyard protection system can be augmented or improved to minimize the number of nuclear plant trips and losses-of-offsite power (LOOPs).

Analytical models were developed for selected nuclear power stations and their grid interconnections using the ETAP software tool. These models were then used to study the operation of the NPP electrical protection systems during grid transients in order to identify the causes, vulnerabilities, unusual configurations, or operational parameters that may have contributed to the tripping of the nuclear plant and/or the loss-of-offsite power sources. The models were also used to demonstrate the effects of external grid faults and transients on the voltage and frequency conditions at the nuclear plant switchyard buses, main generator bus, and safety systems buses. The effects of proposed protection system improvements on the response of the NPP switchyard protection system to external electrical system faults and disturbances were evaluated using sensitivity studies and system simulations.

The purpose of this study is to demonstrate and verify through modeling and simulation that precise and faster clearing of faults can in fact limit damage and improve plant ride-through, which is the one of the main reasons for developing and deploying telecommunication-based relay schemes. The practical application of this approach into an existing protection scheme, which would be the equivalent of upgrading to a faster protective relay, would of course have to be analyzed carefully to take into consideration the coordination of all affected protection system timing intervals as well as the effects that the tripping of transmission element(s) can have on system stability. The high speed, precision, and reliability of telecommunication-based protection now being deployed allows ISOs, utilities, and NPP operators to take advantage of the potential improvements that faster clearing times can provide as we have shown in our study.

1.3 Organization of this Report

Section 1 of the report provides brief introductory remarks about the purpose and functional requirements of the offsite power system serving a NPP. This includes a discussion of the regulatory requirements for NPP offsite electric power systems and a description of the station blackout rule and its purpose. A condensed history of the deregulation of electric utility industry is presented along with a summary of the concerns of NRC about the possible erosion of the reliability of the electric power transmission grid and the potential effect that it may have on nuclear safety. Several examples are presented of recent incidents in which electrical faults

originating on the transmission grid have had a significant impact on NPP safety, operation, and performance.

The offsite power system is described in Section 2. This covers the regulatory requirements of the offsite power system, common nuclear plant switchyard bus arrangements, and typical electrical protection systems for switchyard buses, transmission lines, power transformers, and the main generator.

Section 3 presents BNL's approach to studying the impact that the response and timing of the electrical protection system can have on the NPP response to external fault events. The event fault tree analytical approach is described which involves the creation of sets of contingency scenarios, transient simulations to study grid response, identification of grid responses that affect NPP performance (plant trips and/or LOOP), and evaluation of potential protection system improvements to avoid NPP trips and/or LOOP.

The development and analysis of three selected NPP simulation models are covered in Section 4. The details of the individual models are described along with the definition of sets of analytical scenarios, transient stability simulations that were conducted, and analyses of the results of the simulation studies. Transient analyses are presented and the resulting responses of the grid and the electrical protection system are demonstrated. In this section a discussion is provided of the parameters that are varied to demonstrate the value of proposed protection system modifications and improvements.

The importance of rigorous periodic maintenance for electrical protection systems and equipment associated with NPPs and their offsite power supplies is emphasized in Section 5. During the review of operating experience it was noted that many of the external fault events that affected NPPs were directly attributable to or were exacerbated by inadequate transmission system maintenance. Consequently, examples are given in this section of inadequate maintenance as a cause of external faults events that have affected NPPs. The importance of cooperative agreements for operation and maintenance, between nuclear plant operators and transmission ISOs is discussed, including the implementation of the NERC/FERC requirements for grid reliability as it applies to NPPs.

Section 6 presents a summary and conclusions of the study.

2 NUCLEAR PLANT OFFSITE POWER SYSTEM

This section provides a basic description of the offsite power system of a typical NPP and its interface with the electric power transmission grid. The major electrical equipment, the plant switchyard arrangement, transmission interconnections, and their electrical protection systems are presented. These main electrical system components will be incorporated into the analytical models, using the ETAP software, to perform the simulations of the plant electrical distribution systems and grid interfaces for several nuclear power stations as described in Sections 3 and 4 of this report.

The general requirements for nuclear plant electric power systems are presented in General Design Criterion (GDC) 17 of Appendix A to 10 CFR 50 [10 CFR 50, Appendix A, GDC-17], regarding on-site and offsite power supplies, independence and redundancy, safety functions, and design basis accident performance. In addition, certain nuclear station electrical systems will often include provisions for an alternate ac (AAC) power source to satisfy the requirements of the station blackout (SBO) rule, 10 CFR 50.63, "Loss of all alternating current power," [10 CFR 50.63] which are further described in Regulatory Guide 1.155, "Station Blackout," [RG 1.155]. IEEE Std 765-2006 [IEEE Std. 765-2006], "Preferred Power Supply (PPS) for Nuclear Generating Stations" provides detailed design criteria for the preferred power supply used in NPP electrical supply and distribution systems, and the interface with the NPP's Class 1E distribution system whose criteria are described in IEEE Std. 308-2001 [IEEE Std. 308-2001]. In most cases, to satisfy the specific design requirements of GDC 17 and the aforementioned regulations and IEEE standards, NPP distribution system configurations will incorporate the basic features and characteristics suggested in IEEE Std. 765-1995, with minor variations due to plant-specific transmission system interfaces and voltage levels, multiple-unit plants, and the incorporation of increased levels of redundancy.

2.1 NPP Electric Power Distribution Systems

The electrical power distribution system in a NPP consists of three interfacing systems: the low-voltage system, the medium-voltage system, and the high-voltage system. The low-voltage system and the medium-voltage system are usually referred to as the onsite power system, as described in Chapter 8 of the Standard Review Plan [NUREG-0800], which includes the Class 1E, redundant, safety-related power systems and standby emergency generators. The offsite power system is comprised of the plant's main generator and its connections to the high-voltage power system. A typical NPP electrical distribution system is illustrated in the one-line diagram in Figure 1.

2.1.1 Onsite Power System

The low-voltage electrical distribution system in a nuclear power station supplies plant loads having operating voltages of 600 V or lower, e.g. 480 V, 240 V, 208 V, and 120 V. The low-voltage system typically includes 480 V electrical buses that are fed from the medium-voltage distribution system via 4160 V/480 V transformers. These 480 V buses supply power to the majority of the in-plant electrical equipment.

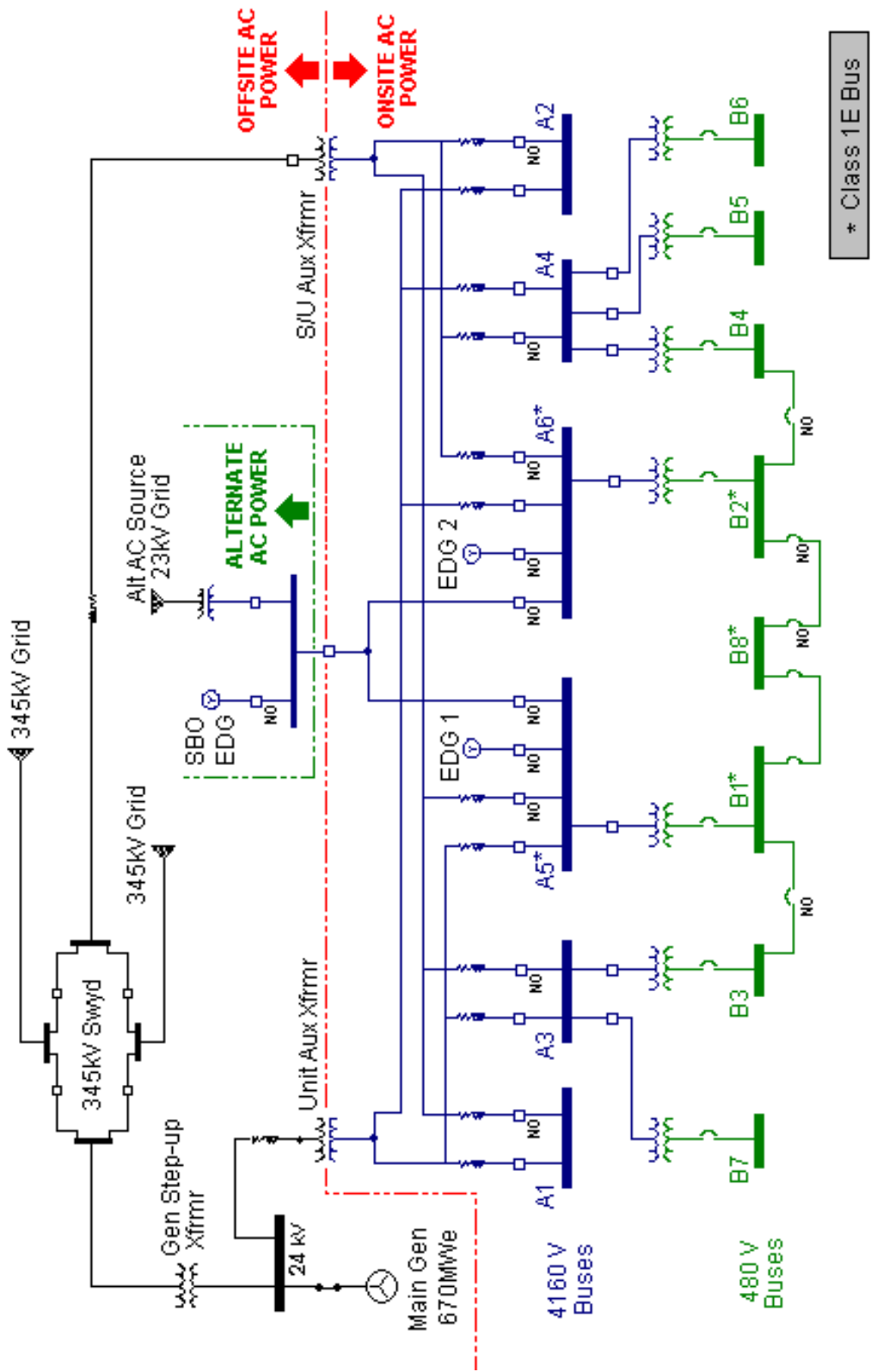

Figure 1 Typical NPP electrical distribution system

The medium-voltage distribution system supplies plant loads ranging from 600V up to 35 kV. Typically this will include equipment operating at 6.9/13.5 kV, such as the reactor coolant pumps, as well as other large plant electrical loads that operate at 4160 V. It also supplies power to the low-voltage distribution system. The preferred source of electrical power for the medium-voltage system can be the output from the plant's main generator during normal power operation, through the unit auxiliary transformer(s), or the offsite power grid, via the startup transformer(s), during plant startup or shutdown. In the event of the loss of offsite ac power, on-site emergency diesel generators (EDGs) are used to supply medium-voltage power to selected Class 1E safety-related equipment. To satisfy the requirements of the station blackout rule, a separate independent SBO generator and/or an alternate ac (AAC) power source may be included in the system, as shown in Figure 1.

The boundary between the nuclear power station's onsite power distribution system and the offsite power system is the interface of the medium-voltage in-plant distribution system with the high-voltage portions of the plant's distribution system. As seen in Figure 1, this typically occurs at the unit auxiliary transformer(s) and the startup transformer(s). Note that the NPP main generator and its step-up transformer are considered part of the offsite ac power system as described in Section 8.2 of the Standard Review Plan [NUREG-0800]. As described in the SBO Rule [10 CFR 50.63], IEEE Std. 765-2006, and Chapter 8 of the Standard Review Plan [NUREG-0800] the AAC source(s) for SBO are considered separately for adequacy and independence from both the onsite and offsite power systems of the nuclear plant.

2.1.2 Offsite Power System

The offsite power system is comprised of the electric power grid, the NPP high-voltage distribution system, and the unit main generator. The high-voltage portions of the nuclear plant electrical distribution system include the components in the plant's switchyard, e.g., power circuit breakers, disconnect switches, and buses, and the short transmission link that connects the main generator to the electrical transmission grid outside the plant. This system operates at very high voltages to minimize current flow and, thus, minimize transmission line losses.

The output of the plant's main generator is lower than the transmission grid voltage. Typical generator output voltage may be 22 kV to 25 kV. The plant's main generator typically is connected via an isolated-phase bus duct to a main step-up power transformer to match the grid operating voltage. The step-up transformer output is fed through high-voltage power circuit breakers via a short transmission link to the nuclear plant's high-voltage switchyard.

The utility power grid is the normal preferred source of offsite power, via two or more physically independent transmission circuits to the plant's medium-voltage distribution system, in accordance with GDC 17. In some plant designs, such as the one shown in Figure 1, offsite power is delivered to the plant electrical distribution system via a startup auxiliary transformer during plant shutdown and startup modes, before the plant is able to supply its own power needs; once the unit generator is producing power, the plant can transfer its source of power from the startup supply over to its unit generator output bus via a unit auxiliary transformer. In other nuclear station designs, plant loads always remain connected to the offsite power sources under all plant operating modes, thereby avoiding the need for a manual bus transfer during startup and shutdown operations, or a fast bus transfer in the event of a generator trip [NUREG/CR-6950 and Mazumdar & Chiramal-Oct 1991].

2.2 Switchyard Bus Arrangements

There are four basic switchyard bus arrangements that may be found in nuclear power station high-voltage switchyards: 1) the main and transfer bus, 2) the ring bus, 3) the breaker-and-a-half bus, and 4) the double-bus, double-breaker arrangement. Detailed descriptions of these switchyard configurations are provided in Appendix C.

Most NPPs have incorporated either the ring bus or the breaker-and-a-half configuration into their basic switchyard arrangements. In the ring bus arrangement, such as the 345kV plant switchyard shown in the example NPP electrical distribution system in Figure 1, each circuit breaker is shared by adjacent transmission line connections. With this arrangement, it is possible to perform maintenance on any circuit breaker without interrupting service to the transmission line or transformer on either side of it.

In the breaker-and-a-half switchyard arrangement, for every pair of circuits there are three power circuit breakers, with the center circuit breaker being shared by the two circuits in each substation bay. This arrangement allows any circuit breaker to be removed from service without interrupting service to the circuits in the affected substation bay. Reliability and operational flexibility are improved because there is a double feed to every circuit and a fault on either of the buses can be isolated without losing any circuit. Another advantage of the breaker-and-a-half arrangement is that all switching operations may be accomplished using power circuit breakers.

These two switchyard arrangements are commonly utilized in NPP applications because they offer the best combination of operational flexibility, high reliability, and reasonable cost. Typically, the cost of a breaker-and-a-half bus arrangement is about the same as an equivalent switchyard using a ring bus arrangement and these are about 12%-15% more expensive than an equivalent switchyard using a main and transfer bus arrangement [McDonald – 2003].

In special cases where it is necessary to assure higher reliability for one or more extremely critical transmission circuits or generator connections in a breaker-and-a-half switchyard, the switchyard bay(s) containing the critical connections can be modified to a double bus, double-breaker arrangement. In this way, each of the critical circuits is served by two circuit breakers, such as shown in Figure 2. A higher level of reliability and operational flexibility is thus provided for the two critical main generator connections in Figure 2 while the overall cost of the switchyard is held in check by utilizing the breaker-and-a-half arrangement for the remainder of the transmission connections.

2.3 Electrical Protection Systems

The analyses performed for this study concentrate on the electrical protection systems found on the offsite power system and how the protective relays and control schemes that comprise these systems will respond to external electrical faults. The study will examine how the speed and sensitivity of the protection system in the detection and isolation of switchyard and transmission system faults can affect the magnitude and duration of the voltage, current, and frequency transient conditions that appear at the nuclear station switchyard buses, at the plant's safety-related buses, and at critical non safety-related buses, such as those supplying the reactor coolant pump (RCP) motors.

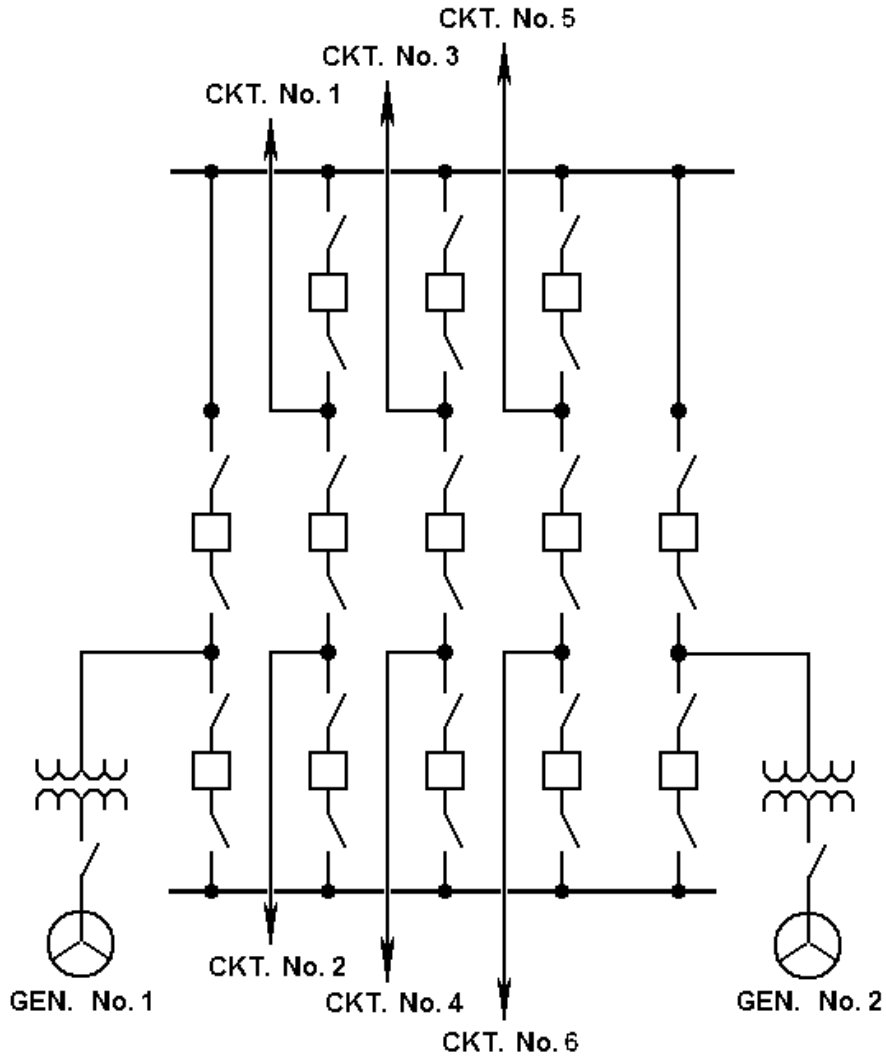

Figure 2 Breaker-and-a-half switchyard with main generators connected in a double-bus, double-breaker arrangement

This subsection will describe the basic protective relaying and controls for offsite power system components, such as the transmission lines, switchyard buses, power transformers, and the main generator. The various types of transmission line protection systems will be described in the most detail since these devices will be a focus of the analytical study. Some of the onsite power system protective devices for the plant's medium-voltage safety-related buses, and at critical medium-voltage non safety-related buses will be discussed briefly with respect to their plant safety response.

2.3.1 Transmission Line Protection Systems

Most electrical faults (60% or more, depending on the isokeraunic level) occurring on power systems will be located along the transmission lines connecting generating sources to their electrical loads. The characteristics of these lines vary in length, configuration, capacity, effect

on grid stability, and importance. Consequently, there are a number of different transmission line protection schemes that may be applied to their protection. These may include: 1) overcurrent protection schemes, e.g., instantaneous/time-overcurrent or directional instantaneous/time-overcurrent protection, typically used for simple radial lines, on subtransmission or distribution circuits, or simple transmission loops with a single generating source; 2) distance relaying, in which impedance relays, reactance relays, or mho relays are applied where the trip settings of these types of relays correspond to the effective impedance of the line being protected; and 3) electrical protection systems using telecommunications, in which a telecommunications circuit (such as a power line carrier signal, a dedicated wire or fiber optic communication link, or a radio transmission signal) is used to compare system conditions at both ends of a transmission line to initiate selective high speed clearing of all faults on the protected line.

A typical transmission line protection scheme may apply a combination of zone distance relaying phase protection and directional ground overcurrent protection, with auxiliary protective features such as automatic reclosing or a breaker failure scheme, as presented in Figure 3, depicting a typical protective relaying schematic diagram for a transmission line at its substation terminus. In this example, an automatic reclosing scheme (Device 79) is included that will, after a suitable delay, reclose the circuit breaker that has just been tripped. Experience has shown that reclosing transmission and distribution circuits following a protective trip has a success rate of 80% on the first attempt and 5% on the second attempt; single-line-to-ground faults have a higher reclosing success rate than 3 phase faults [Daume – Feb2007]. The reclose delay should be long enough to allow arc deionization at the site of the fault and provide enough time for the remote terminal to clear: a suitable reclose delay should at least be greater than $(10.5 + kV/34.5)$ cycles [Daume – Feb2007]. The line protection scheme in Figure 3 also includes breaker failure protection (Device 50BF). In the event that the local circuit breaker protecting the transmission line fails to trip to isolate a fault on line, the breaker failure scheme will initiate the tripping of backup circuit breakers at the substation to interrupt the fault current.

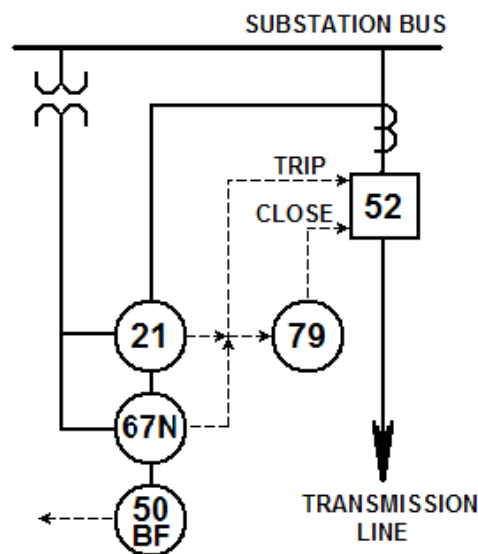

Figure 3 Typical protective relaying schematic at one end of a high-voltage transmission line

2.3.1.1 Distance Relaying Schemes

Distance relays, which calculate the impedance of the line by measuring the voltage and current, are the most commonly used relays to protect relatively long transmission lines. Distance relays, which may include impedance relays, reactance relays, and mho relays, are usually configured to include three sets of relays at each end of a transmission line to provide for three protective zones [Kundur 1993 & IEEE Std. C37.113-1999]. Zones 1 and 2 are used to provide the primary protection of the transmission line while Zone 3 acts as a remote backup for the adjacent line(s). The typical parameter settings for the Zones 1 - 3 relays installed at each end, or terminal bus, of the transmission line are the following:

- *Zone 1 relays:* A Zone 1 relay usually covers from 80% to 90% of the line length or the impedance from the bus where the relay is installed, and there is no intentional time delay to open the circuit breaker once the fault is detected;
- *Zone 2 relays:* A Zone 2 relay covers around 120% of the protected line length (i.e., beyond the end of the protected line), and a typical time delay of between 0.3 and 0.5 seconds is set for the relay to open the circuit breaker once the fault is detected. A Zone 2 relay is mainly used to protect the rest of the line beyond the reach of the Zone 1 relays and should be adjusted such that it can respond to even an arcing fault at the end of the line [Mason 1956].
- *Zone 3 relays:* A Zone 3 relay overreaches the adjacent transmission line(s) as the remote backup for the protection system of the adjacent line(s); a typical 2 second delay is set for the Zone 3 relay if the fault occurring on the adjacent line(s) is not cleared in time.

Note, Zones 1, 2, and 3 relays located at the two ends of a transmission line reach in the opposite direction, i.e., they “look” out onto the transmission line from the two opposite end terminals. Therefore, it can be seen that if the Zone 1 relays at both ends of a line fail, the Zone 2 relays are expected to respond to the uncleared fault (within the range of the Zone 1 relays at both ends) and open the circuit breakers after a time delay of between 0.3 and 0.5 seconds. If the fault occurred beyond the range of the Zone 1 relay at one end, the failure of the Zone 1 relay at the other end will lead to the response of the Zone 2 relays at both ends, which will again open the circuit breakers after the time delay of between 0.3 and 0.5 seconds. Therefore, it is a reasonable assumption that a transmission line fault that was not cleared by the Zone 1 relays will be cleared within 0.5 seconds (which may include the opening time of the circuit breakers) by the Zone 2 relays.

Depending on the types of faults (e.g., three phase, phase-to-phase, phase-to-ground, and double phase-to-phase) to be covered by the distance relaying, the number of relays at each end of the line changes. In general, one set of relays is provided for phase faults and one for ground faults, respectively [Kundur 1993].

For distance relaying, if a fault occurs near one end of the line (i.e., less than 20% of the distance of the line from that end), the fault should be cleared at the near end instantaneously, i.e., without any intentional time delay, but with a time delay of between 0.3 and 0.5 seconds at the far end bus. The reason for this is that the difference of the measured impedances for faults near a bus but on different sides of the bus, e.g., faults F_2 and F_3 in Figure 4.

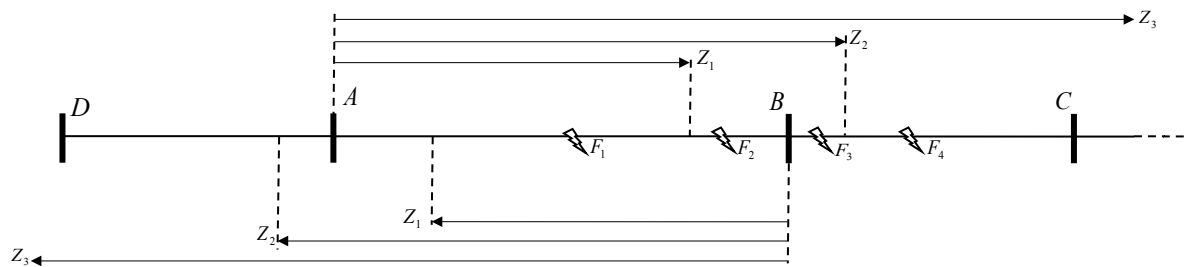

Figure 4 A Distance Relaying Scheme

To summarize the protective response of a distance relaying scheme, the fault F_1 will be cleared instantaneously by Zone 1 relays at both ends. The fault F_2 will be cleared instantaneously by Zone 1 relays at end B and with a time delay of between 0.3 and 0.5 seconds by Zone 2 relays at end A. For the fault F_3 between ends B and C, the Zone 2 relays at end A will respond to it with a time delay of between 0.3 and 0.5 seconds if it is not cleared by the protection relays of line BC. For the fault F_4 , the Zone 3 relays at end A will clear it with a time delay of around 2.0 seconds if it is not cleared by the protection relays of line BC.

Note, for fault F_4 , Zone 3 relays at bus A will clear the fault after 2 seconds of its occurrence if the primary relays (Zone 1 and Zone 2 relays) at bus A are failed. This apparently has more severe impact than a case where the time delay of Zone 3 relays at bus A is shorter. Reducing the time delay effectively makes the protection devices operate in a less coordinated manner but may benefit the capability of fault rejection in the sense that primary relays of line BC may malfunction. This anticipatory trip scheme of Zone 3 relays will be further discussed and demonstrated in Section 4.

From the above description, it is easy to conclude that, in case of no breaker failure protection scheme if the circuit breakers and/or Zone 1 relays at the near end should fail:

1. the fault clearing time for the fault F_2 is between 0.3 and 0.5 seconds because the fault has to be cleared by the zone relays at end A and the Zone 2 relays at end C (CBs and/or Zone 1 relays on line AB near B fail);
2. the fault clearing time for fault F_3 is also between 0.3 and 0.5 seconds because it has to be cleared by Zone 2 relays at end A and the Zone 2 relays at end C (CBs and/or Zone 1 relays on line BC near B fail);

Similarly, it can be further concluded that, in case of no breaker failure protection scheme, if the circuit breakers at both ends of the protected line fail:

3. the clearing time of fault F_1 (or F_4) is around 2 seconds.

If simultaneous high-speed tripping at both ends is required or in an application where a distance relaying scheme is very difficult to apply (e.g., a very short transmission line), a telecommunications-based relaying scheme, with telecommunication channels between the

relaying equipment at the two ends of the protected line, is a more suitable choice. This scheme will be discussed in detail in the next subsection.

2.3.1.2 Electrical Protection Schemes Using Telecommunications

The high speed simultaneous clearing of all line terminals provided by an electrical protection scheme using telecommunications (pilot relaying) has a number of important advantages. The possibility of electrical overload damage to transmission line conductors, and to all components of the transmission line, in general, is minimized by rapid isolation of the fault. The fast clearing of faults by the telecommunications-based relaying also helps to improve transmission grid stability by minimizing the magnitude and duration of transient events. High speed clearing of transmission line faults provided by telecommunications-based relaying in turn permits rapid reclosing, which if successful, also helps to improve transmission grid stability and to minimize the adverse effects caused by electrical disturbances on the power system.

The principle of operation for telecommunications-based relaying is that the circuit breakers at all ends of the protected lines will trip for an internal fault but will not (i.e., the tripping is blocked) for an external fault. Whether a fault is internal or external is determined by the relays at both ends of the protected line using either the directional comparison (by using distance relays and directional relays) or phase comparison (by comparing the relative phase displacement of currents entering and leaving the protected line). Due to the fast development of modern communication technologies and reductions in costs, protective relaying using telecommunications has become increasingly popular in transmission system protection. The high speed and reliability of telecommunications links are an important part of achieving the rapid fault clearing times offered by telecommunications-based protection schemes. Signal propagation time in these systems is typically only a very small part of the overall clearing time for most applications. For example, if a power line carrier signal over the transmission line is used for communication, each 186 miles of transmission line will only introduce about 1 ms delay [GER-3965] (note, this 1 ms is only a minor part of the operating time of a telecommunication-based protection system). Dedicated fiber optic communication links or radio signal transmission can potentially yield even faster communications.

A number of electrical transmission protection schemes using telecommunications links have evolved in the industry. The most important of these schemes include: 1) intertripping underreach protection, 2) permissive overreach protection, 3) accelerating underreach protection, 4) permissive overreach protection, 5) blocking overreach protection, 6) deblocking overreach protection [CIGRE JWG 34/35.11-2001 & Lindahl-2011]. Some of these are described in the following subsections.

2.3.1.2.1 A Permissive Overreaching Scheme

An example of the permissive overreaching scheme is described in [Kundur 1993], which is similar to the distance relaying scheme. The differences between the permissive overreaching scheme and the aforementioned distance relaying are that: 1) the permissive overreaching scheme does not have Zone 3 relays and 2) if a fault occurred, such as F_2 shown above in Figure 4, the circuit breakers at both ends of the protected line will be tripped without any intentional time delay, i.e., circuit breakers at both ends will be opened at high speed.

This permissive overreaching scheme is better illustrated in the example presented in Figure 5. The fault F_1 is picked up by Zone 1 relays at both ends and will be tripped immediately and no

communication is involved. The fault F_2 is picked up by the Zone 1 relays at end B and the circuit breakers will trip instantaneously. The fault F_2 is also picked up by the Zone 2 relays at both ends and permissive signals will be sent to each other. The Zone 2 relays will trip the circuit breakers at end A upon receiving the permissive signal (the communication channel time is usually less than 20 ms). The Zone 2 relays at end A picks up the fault F_3 but will not open the circuit breakers since the Zone 2 relays at end B is not picked up and do not send any permissive signal to the Zone 2 relays at end A . However, the Zone 2 relays at end A will trip the circuit breakers if fault F_3 lasts more than 0.4 seconds (e.g., if the circuit breakers of line BC near B fail to open). Fault F_4 will only be picked up by protection relays of line BC .

1. Therefore, for fault, F_1 failures of Zone 1 relays at both ends have very minor impact on the clearing time because Zone 2 relays will trip the circuit breakers almost instantaneously (with a delay of communication channel time).
2. A time delay of around 0.4 seconds is expected if both zones 1 and 2 relays at both ends fail for fault F_2 in case of no breaker failure protection scheme.

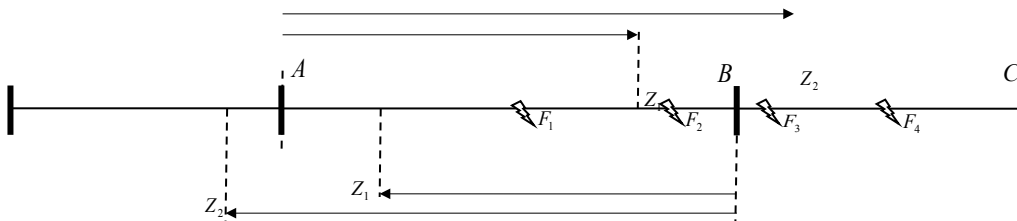

Figure 5 A Permissive Overreaching Relaying Scheme

2.3.1.2.2 Blocking-type Relaying Scheme

A blocking-type relaying scheme is the most preferable of the telecommunications-based relaying methods and the directional comparison scheme, shown in Figure 6 is the most popular application of this approach. An example of telecommunications-based blocking-type protection with a directional comparison scheme is also presented in [Kundur 1993]. By default, the relays will trip the breakers once an internal fault is detected unless a blocking signal is received for a blocking-type relaying scheme. In general, the Zone 1 and Zone 2 relay settings are similar to the permissive overreaching relaying scheme previously shown in Figure 5 except that the Zone 2 relays will trip if a blocking signal is not received within 25 ms (the communication channel time). The Zone 3 relays, which are reverse blocking directional relays set in a direction opposite to the protected line to detect whether the fault is external or internal, will generate and send a blocking signal to the Zone 2 directional relays at the remote end once it is determined that the fault is external to the protected line. The Zone 2 relays will trip anyway irrespective of any blocking signal if the fault lasts for more than 0.4 seconds.

As shown in Figure 6, fault F_1 will be detected and cleared by Zone 1 relays at both ends A and B (Z_1^A and Z_1^B). Fault F_2 will be cleared by Zone 1 relays at end B (Z_1^B) and Zone 2 relays at end A (Z_2^A) after 25 ms since there is no blocking signal from Zone 3 relays of end B

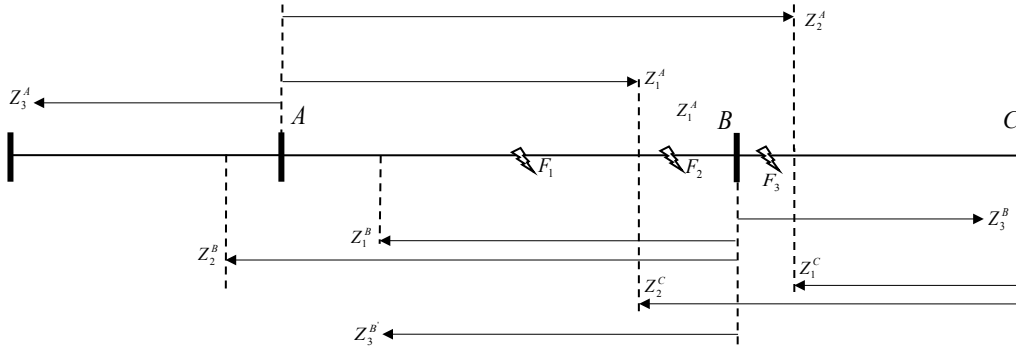

Figure 6 A Directional Comparison Protective Scheme Using Telecommunications

(Z_3^B). Note, the same fault is also seen by Zone 2 relays at end C (Z_2^C) but Z_2^C relays tripping will be blocked by the Zone 3 relays at end B watching the opposite direction of line BC (Z_3^B), unless the fault lasts more than 0.4 seconds. Although the Zone 2 relays at end A (Z_2^A) sees fault F_3 , they will not trip since they are blocked by the Zone 3 relays at end B (Z_3^B) watching the opposite direction of line AB.

1. Therefore, for fault F_1 , failures of Zone 1 relays at both ends have very minor impact on the clearing time because Zone 2 relays will trip the circuit breakers almost instantaneously (with a delay of communication channel time).
2. A time delay of around 0.4 seconds is expected if both zones 1 and 2 relays at both ends fail for fault F_2 in case of no breaker failure protection scheme.

Blocking overreach protection systems have been one of the most frequently applied schemes in the past but more recently a potential disadvantage of this type of protection system has been observed more and more. There is a risk that the blocking signal, particularly when the signal is transmitted over a power line carrier link, can be interrupted by disturbances resulting from electrical faults or transients on adjacent transmission lines. As a result, there is the chance that the blocking signal transmitted over a functional transmission line can be interrupted by an adjacent line disturbance causing the overreaching protection to actuate and inadvertently trip the healthy transmission line. [Lindahl-2001]

2.3.1.3 Breaker Failure Backup Protection

Breaker failure protection schemes were not considered in the above discussions. Breaker failure protection is relied on to take appropriate action to clear a fault when the circuit breaker(s) that is expected to clear the fault fails to do so [IEEE C37.119-2005]. A breaker failure protection can either be a local backup (i.e., on the same substation or busbar as the primary protection) or a remote backup protection. A local breaker failure protection receives a signal directly from the protection relays at the same busbar or substation as the faulted circuit breaker and needs only to wait for the breaker (the faulted one) interrupting time to trip the local backup breakers.

For a remote breaker failure protection, an intentional time delay (usually 0.5 seconds or 30 cycles) has to be set before the remote backup breakers are opened without a communication channel. Also, a separate set of relays has to be installed at the substation or the busbar where

the impaired breaker is located in order to detect the fault and signal the remote circuit breakers to trip [IEEE C37.119-2005].

A communication channel that can directly send trip signals generated by the local relays at the busbar or substation of the impaired breaker(s) to the remote breakers can be used in remote breaker failure protection scheme and allows for high speed remote clearing. With the assistance of the communication channel, the breaker failure timer setting does not need to be as long as 0.5 seconds. Instead, it is typically assumed to be 90 ms for a 2-cycle circuit breaker and 150 ms for a 3-cycle circuit breaker [Kundur 1993].

For a typical distance relaying scheme, as shown in Figure 4, a communication-based remote breaker failure protection is unnecessary considering the time delay setting of between 0.3 and 0.5 seconds for the Zone 2 relays. For the telecommunications-based protection scheme like the directional comparison blocking scheme shown in Figure 6, breaker failure at any end will cause the fault clearing time near that end to be delayed for a sum of communication channel time and the intentional time delay between 90 ms and 150 ms. In addition, depending upon the remedial trips specified in a particular breaker failure scheme, a larger number of components need to be tripped as a result of the breaker failure. An example of such a breaker failure scheme can be found in [Kundur 1993] and further details will not be discussed here.

2.3.1.4 An Example Transmission Line Protection System

A modern transmission line protection system is often equipped with duplicated distance and/or differential protection relays [Lindahl-2011], as shown in Figure 7.

Block 1 in Figure 7 represents the first main protection zone, Main 1, while Block 2 represents the second main protection zone, Main 2. One core of the common current transformer feeds Main 1 and another core feeds Main 2. A common voltage transformer feeds both Main 1 and Main 2 but there are two separately fused groups. One group feeds Main 1 and the other one feeds Main 2. Block 3 represents the teleprotection equipment for Main 1 while Block 4 represents the teleprotection equipment for Main 2. Block 5 represents the telecommunication equipment for Main 1 while Block 6 represents the telecommunication equipment for Main 2. The network owner may use: (1) power line carrier links, (2) radio links, (3) microwave links, or (4) fiber optical links for the transfer of information between the terminals of a transmission line. Often there are two telecommunication links between the terminals of a transmission line. If there are two telecommunication links, Main 1 uses one link while Main 2 uses the other one.

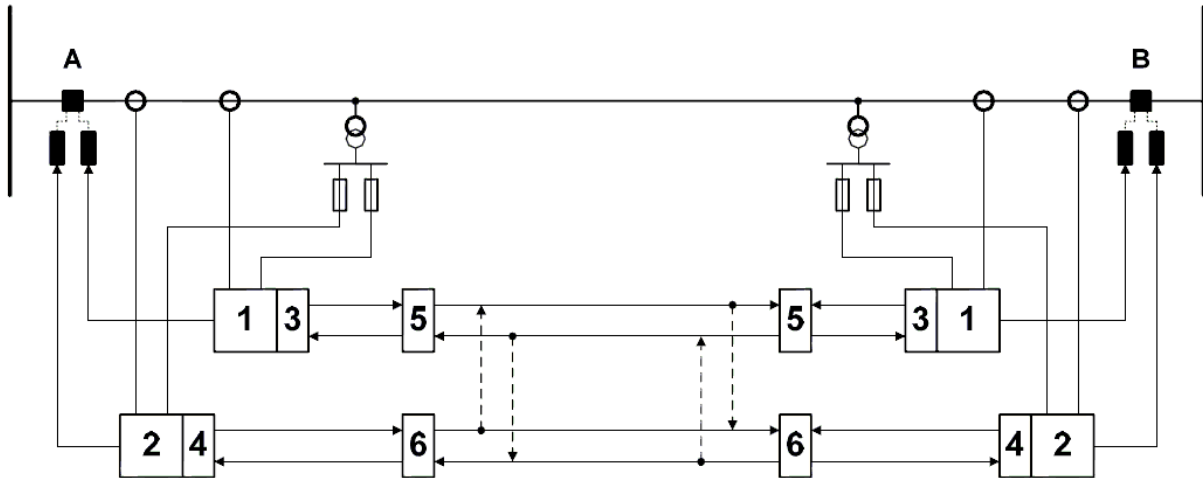

Figure 7 An Example Transmission Line Protection System

A breaker failure protection element is included in the line protection system. Such a protection system provides instantaneous trip of the line circuit-breakers even if one element in the protection system fails to operate. The fault clearing time will be about 80 milliseconds for close-up faults and about 100 milliseconds for faults near the remote end if the line circuit-breakers operate correctly. The fault clearing time may range from 200 to 250 milliseconds if one of the line circuit-breakers fails to operate. The backup clearing time depends on the delay in the breaker failure protection. The setting of the delay in the breaker failure protection is the result of balancing the advantage of having a short backup clearing time and the risk of having an unwanted operation when the circuit-breaker operates and interrupts the current.

The delay of Zone 2 and Zone 3 may not be as important in such a protection system as that in the protection systems without redundancy. However, redundancy is often defeated by common cause failures even for the redundant equipment of diverse designs. Hence, adjusting the settings of existing protection systems, especially those time delay of the secondary and/or backup protection systems or the breaker failure schemes, is still considered necessary and valuable.

2.3.2 Switchyard Bus Protection

The most sensitive and reliable method for the protection of switchyard buses is differential protection. The basic principle in this approach is to measure the net flow of current into and away from the station bus that is being protected. The net current measured by the differential protection relays will balance out to zero for all conditions unless a fault condition exists anywhere on the station bus within the zone of the monitoring current transformers. This method is very reliable and can operate very fast. Details of the application of bus differential relaying to actual station switchyard bus protection can be found in several sources on the subject, such as the Westinghouse "Applied Protective Relaying" [Blackburn, et. al. – 1976], General Electric's "The Art and Science of Protective Relaying" [Mason – 1956], and IEEE Std. C37.234-2009, "IEEE Guide for Protective Relay Applications to Power Systems Buses" [IEEE C37.234-2009].

Electrical protection specialists recommend that duplicate bus protection be provided in substations using the double-bus, double-breaker arrangement and the breaker-and-a-half arrangement. This is necessary to avoid the severe consequences that might occur in the event of a bus fault at a substation with a non-redundant bus protection scheme, should the bus fault be combined with a failure to operate of the non-redundant bus protection system. The bus fault would then be detected by Zone 2 protection of the distance relays in the adjacent substations and would therefore not be cleared for perhaps 450 to 500 milliseconds. All transmission lines connected to the substation would be tripped at their remote ends to finally clear the fault. [Lindahli – 2011]

The type and location of the current transformers must be considered when establishing the protection coverage for substation buses. Dead-tank circuit breakers, in which the circuit breaking mechanism is contained within the enclosure tank that is connected to electrical ground, are usually equipped with a pair of bushing current transformers. With this CT arrangement, overlapping protection zones at the bushing transformers provide complete coverage for the substation buses. Live-tank circuit breakers, where the enclosure is at line potential, are not usually equipped with bushing CTs instead being used in conjunction with single freestanding current transformers. It is possible, particularly on substations using the main and transfer bus arrangement, to incur a fault between the freestanding CT and the circuit breaker that could initiate primary protection zone tripping of all circuit breakers in the substation without interrupting the fault. The fault would then not be cleared until the backup protection initiates and opens remote circuit breakers. [Lindahli – 2011].

A potential vulnerability in the bus protection of substations using the double-bus, double-breaker arrangement was identified by B. Svensson in 2005 [Svensson-2005 and Lindahl-2011] related to freestanding current transformers as discussed above. There is a small risk in this bus arrangement that a single fault occurring between the circuit breaker and the freestanding current transformer combined with a failure to operate of the circuit breaker would trip out the entire substation. Breaker failure protection would correctly trip all circuit breakers in the substation. However, because of the location of the fault, fault current would continue to flow via the transmission line to the adjacent remote substation until Zone 2 transmission line protection tripped the line at the remote adjacent substation end. Depending on the time-delay setting of breaker failure protection, the backup clearing time would be on the order of 400 milliseconds before the remote line end circuit breaker trips. Comparative reliability studies between the double-bus, double-breaker arrangement and the breaker-and-a-half arrangement, performed by Gothia Power AB in Sweden, have indicated that for certain NPP switchyard configurations, the breaker-and-a-half arrangement can be more reliable [Lindahli-2011].

In addition to the station bus differential relaying, the switchyard bus and circuit breakers will also fall into the various overlapping protective zones for the transmission lines that originate in the switchyard. These transmission line protective zones were described previously in subsection 2.3.1.

Most nuclear plant switchyards will incorporate a breaker failure protection scheme for the circuit breakers connected to the switchyard bus, as described above in subsection 2.3.1.3. The failure of a switchyard circuit breaker to trip in the presence of an electrical fault on any of

the feeders into or out of the switchyard is a severe challenge to the power grid with several adverse consequences:

- it can have a severe impact on power system stability,
- can exacerbate the damage to electrical conductors and equipment caused by a fault,
- can spread the effects of a fault-related outage to a larger area of the transmission system, and
- can lengthen the outage time required to implement repairs and restore service due to excessive damage.

Normally, transmission line relaying located at the switchyard will detect a fault on the line and actuate the trip coil of the local circuit breaker. Should the circuit breaker at the plant switchyard fail to operate, the breaker failure relaying will detect continued fault current and initiate a retrip signal to the second trip coil of the breaker (if so equipped). After a time delay (equal to the normal trip time of the local circuit breaker), breaker failure relaying also will initiate trip signals to adjacent local circuit breakers at the switchyard, to remote circuit breakers at the far end of the faulted line, and any other remedial actuations associated with the specific application.

Stability analyses for some system configurations may indicate that the maintenance of system stability demands rapid clearing time for transmission faults in proximity to the NPP substation. In some cases, the clearing time resulting from the actuation of backup protection schemes, such as breaker failure protection, is longer than the clearing time necessary to maintain system stability [Lindahl-2011]. This condition is addressed in IEEE Std C37.119-2005, "Guide for Breaker Failure Protection of Power Circuit Breakers" [IEEE C37.119-205] as follows:

In those cases where stability studies show that the critical clearing time is less than the shortest backup clearing time attainable with high-speed breaker failure protection schemes, the only solution may be to install two identical breakers in series, with both breakers being tripped simultaneously by the protection schemes. With this arrangement, and fully redundant protection schemes, instrument transformers, and control power sources, it can be assumed that at least one of the breakers will successfully interrupt the fault. Thus, the total clearing time will be the same as the primary clearing time, and no breaker failure scheme is necessary.

The NERC report, "Technical Paper on Protection System Reliability-Redundancy of Protection System Elements" [NERC-Jan 2009], compiled by the System Protection and Control Subcommittee of NERC, states:

Breaker Failure clearing time is a mode of operation that considers the Protection System to be fully functional and will operate as designed and intended. However, it also considers that a breaker needed to isolate the fault failed to operate (remained closed or stuck). Planning engineers determine the critical clearing time for stuck breaker and/or breaker failure conditions. The protection engineer will account for this time when designing the breaker failure relaying protection. For example, the planning engineer might determine that the critical breaker failure clearing time is 12 cycles and this might result in the protection engineer setting the breaker failure timer at 8 cycles (2 cycles for relay time, 8 cycles for the breaker failure timer, and 2 cycles for breaker tripping). In some cases the protection engineer may determine that the critical clearing time cannot be achieved without compromising security of the Protection System. In such cases, the planning engineer must design the electric system around this constraint

(e.g., installing two breakers in series to eliminate the breaker failure contingency or constructing additional transmission elements to improve system performance, thereby increasing the critical clearing time) [Lindahl-2011].

Consequently, in such cases as described above where the fault clearing time, and in particular the response of the backup protection, is determined to be a critical factor in system stability, "...the installation of two circuit breakers in series would reduce the backup clearing time to approximately 100 milliseconds, which is very desirable for transmission (subtransmission) lines connected to NPP substations" [Lindahl-2011].

2.3.3 Onsite Medium-voltage Bus Protection

One of the main areas studied in this research program is the effect that external faults can have on conditions at the onsite medium-voltage buses. Specifically, this will include voltage and frequency at the plant's safety-related buses and at critical non-safety buses, such as the reactor coolant pump buses. This subsection describes some of the bus protection features that are applied on these buses.

Each division of the Class 1E medium voltage system is provided with an independent scheme for the detection of degraded voltage and loss of voltage detected directly from the bus that is connected to the standby power source. Degraded voltage relays (DVRs) will sense degradation of the voltage on the preferred power supply and should initiate an alarm in the NPP main control room to alert the operators of the condition. The operator's response to this alarm will vary according to specific system design and plant operating philosophy. If the DVRs sense that the voltage of the preferred power supply has degraded to an unacceptable level, i.e., the Technical Specifications allowable values and time delays for degraded voltage function and loss of voltage function, the affected preferred power source shall be disconnected from the Class 1E buses.

Considerations regarding the selection of DVR setpoints and operator responses to degraded voltage conditions are discussed in various technical articles, such as "A Discussion of Degraded Voltage Relaying for Nuclear Generating Stations" [Kueck, et. al. – 1998], [SRP BTP 8-6], and [RIS 2011-12]. (note that IEEE Std. 741-2007, Annex A, discusses degraded voltage protection in NPPs but this standard has not been endorsed by the USNRC.) Note: Alarms setpoints associated with DVR actuation (dropout) indicates voltages well below normal grid voltages and are generally indicative of a collapsing grid such that operator actions are limited. Alarm setpoints set at higher voltages (associated with grid normal voltage) would allow operators time to actually take actions concerning voltage recovery to prevent separation from the offsite power system.

Similarly, some plants may include overvoltage sensing relays on the preferred power supply to monitor for the occurrence of excessively high voltage on the Class 1E buses. The overvoltage monitoring relays typically initiate an alarm in the main control room, but no automatic actions are initiated.

Critical non-safety buses, such as the power supply bus to the reactor coolant pumps (RCPs) may be monitored for degraded voltage and/or frequency. These degraded power conditions can affect the capability of the RCPs to supply rated flow and could potentially cause a reactor trip. In particular, PWR plants cannot tolerate much voltage and frequency variations from nominal values since it can cause flow-biased reactor trips. Typically, monitoring for these

parameters will initiate an alarm in the main control room to alert the operators to the condition, but no automatic actions are initiated.

2.3.4 Power Transformers Protection

Typical protection and control relaying for the unit auxiliary transformers (UATs) and the station startup transformers (SSTs) include differential relaying, sudden pressure relaying, hot spot alarms, and loss of cooling alarms. The isolated phase bus duct feeds directly to the primary side of the UAT at the output voltage level of the main generator. Because of the close proximity of the high output main generator (and associated high available fault current), and the excellent physical protection afforded by the isolated phase bus duct, there is no circuit breaker on the primary side of the UAT. Phase overcurrent, ground overcurrent, and bus differential relaying provide fault protection for the isolated phase bus up to the primary side terminals of the UAT. Transformer differential and sudden pressure relaying protect the UAT against internal faults. UAT faults will cause a main generator trip, opening of the generator output circuit breaker at the high-voltage switchyard, and opening of the MV supply breaker (on the secondary side of the UAT) after a time delay to prevent spurious tripping of the main generator. [NUREG/CR-6950 and IEEE C37.91-2008]

The SSTs are connected via disconnect switches to a local terminal overhead bus structure which in turn is supplied from the main switchyard by way of a short length of overhead transmission line. This interconnecting line is protected by phase overcurrent relaying and differential relaying from the switchyard circuit breaker to the primary side of the SST. Transformer differential and sudden pressure relaying protect the SST against internal faults. Internal SST faults and faults on the short overhead interconnecting transmission line from the switchyard will cause a trip of the high-voltage circuit breaker at the station high-voltage switchyard. The station electrical distribution system is protected from overvoltage surges originating on the external transmission grid, the station switchyard, or the short overhead interconnecting transmission line by lightning arresters located at the primary (high-voltage) side of each of the startup transformers. [NUREG/CR-6950 and IEEE C37.91-2008]

The medium-voltage feeder cables from the secondary side of the UATs and SSTs, typically consisting of multiple paralleled power cables (for example, 2 - 3/C #750 MCM cables), are routed through metallic conduits and cable raceways to the individual medium-voltage switchgear enclosures. Fault protection for the UAT and SST feeder cables is provided by telecommunications-based differential relaying and/or overcurrent relaying. [NUREG/CR-6950]

2.3.5 Protection for the Main Generator and Unit-Connected Step-up Transformer

In most nuclear power stations, the main generator is linked to its unit-connected step-up transformer via isolated phase bus duct with no automatic power circuit breaker between them. Consequently, the electrical protection scheme for the main generator and the unit transformer will treat these components together as a unit. For example, current differential relaying will be provided for the main generator and main transformer separately to detect internal faults, but a differential monitoring scheme may also be applied that encompasses both the generator and its transformer together.

Typical NPP main generator and output transformer protection, operating, and control relaying devices and their functions are tabulated in Appendix D, Table D-1, for a 1525 MW generator at a BWR plant. These devices protect the generator against problems such as, internal faults in the generator winding, overload, overheating of windings and bearings, overspeed, phase

sequence, directional power flow, loss of excitation, motoring, and single-phasing or unbalanced operation [NUREG/CR-6950].

Some of these problems do not require tripping of the generator since adjustments may be made by station operators while the unit is operating to correct the off-normal condition. In a unit-connected generating station, electrical faults occurring at the generator output bus, main generator transformer, main switchyard, and unit-connected auxiliary transformers (i.e., those faults occurring between the generator and the circuit breakers at main switchyard) will usually require prompt tripping of the main generator.

The electric power output from the main generator is typically transmitted to the main generator step-up transformers and the unit auxiliary transformers via isolated phase bus ducts. In an isolated phase bus duct, the bus conductor for each phase is enclosed in an individual metal housing separated from the other adjacent conductor housings by an air space. The bus may be self-cooled or, more typically for the high output NPP generators, forced-cooled by circulating air, gas, or liquid. Because of this physical arrangement, phase-to-phase bus faults cannot occur unless there is catastrophic damage inflicted on the entire bus duct structure. Phase-to-ground faults within the bus duct are detected by main generator protective relaying, isolated phase bus differential relaying, and directional overcurrent relaying at the switchyard. Even with the isolated phase bus duct, there always a minute chance that an electrical fault could occur at the termination enclosures at the main generator, step-up transformer(s), and auxiliary transformers. The nuclear power station electrical distribution system is protected from lightning and transient overvoltage surges originating on the external transmission grid or the station switchyard by lightning arresters located at the high voltage side of the main generator output transformer.

3 ANALYTICAL APPROACH TO STUDYING THE IMPACT OF PROTECTION SETTINGS ON NPP RESPONSE TO AN EXTERNAL FAULT

3.1 Overview

The objectives of the electrical protection systems in NPPs are to: (1) detect and isolate external transmission grid faults as quickly as possible; (2) maintain the availability of both offsite ac power sources (or at least one) to the nuclear plant during the transmission system protective response; and (3) minimize the grid transient to the NPP to the extent that NPP protective relaying is not actuated resulting in a trip or any other protective action.

It is desirable that the protection system in a NPP switchyard isolate faults as rapidly as possible so that the nuclear station can ride through transients caused by faults external to the NPP switchyard without a nuclear unit trip. It is thus suggested that protective relaying at NPP substations/switchyards and associated transmission lines be treated differently than transmission line and substation relaying on the general transmission grid because a longer clearing time for a fault at or near the NPP switchyard has more negative impact on the system operation. The protective logic and schemes proposed to achieve these objectives, which may differ from the basic objectives of traditional transmission system protection logic and protection schemes, must be constrained by the requirements of the nuclear plant operational requirements and the design basis accident analyses for the plant.

Transmission system equipment and substation configurations at NPP switchyards may also incorporate design features to improve the reliability and response time of the power system and the electrical protection system. These may include: dual voltage check and synchrocheck equipment at both ends of lines originating at the NPP substation; breaker-and-a-half or double-bus, double-breaker bus arrangements; and dual series power circuit breakers to assure rapid fault clearing times and improve system stability. In addition, upgrading to newer high-speed protection system equipment and redundant transmission system equipment and component configurations can also improve reliability and fault clearing times. These improvements and upgrades may include: redundant substation bus protection schemes; redundant high-speed digital transmission line protection; redundant telecommunications channels for transmission line protection systems; dual breaker failure protection schemes; redundant independent dc power control power; and redundant circuit breaker trip coils. The overall goal of these upgrades is to assure that, when required, the protection system will initiate a trip signal to at least one of the two circuit breaker trip coils within 20 ms for faults in close proximity to the NPP substation and within 30 ms for remote faults, even if a single element of the electrical protection system fails to operate [Lindahl - 2011].

An analytical approach is proposed in this study in order to verify the hypothesis that shortening the delay time of the primary and backup protection systems in the switchyard and/or the neighboring substations can significantly reduce the chance of NPP tripping without affecting the protective performance across the rest of the grid. The approach is implemented by evaluating the impacts of varying the settings and/or schemes of the protection systems in the switchyard and/or neighboring transmission network of a NPP and its responses to faults occurring in the switchyard or nearby transmission systems.

3.2 A Generic Approach to Evaluate Impacts of Protection Settings/Schemes on NPP Response

3.2.1 An Event Tree Type Approach

A general approach has been proposed to perform the detailed study based on the plant models. An initial state is assumed for the NPP as the starting point. Subsequently, one additional component failure is considered each time. Availability of individual systems that are needed for mitigating the fault may change the impact that the event will have on NPPs and the offsite power system.

A reasonable assumption for the initial state of NPPs can be a steady-state at full power operation without any failure. For each of the selected sets of power system components that are considered critical to the normal grid operation, faults may be postulated. The grid responses can then be evaluated under the postulated faults by considering the availability and settings of the required protection and control systems. The steady-state of NPP post-fault response directly reflects the performance of the protection/control systems.

The suggested approach is similar to the event tree (ET) method used in probabilistic risk assessment (PRA) and the faults and abnormal conditions are characterized by the conditions and events below [Lindahl 2010]:

Operating state of the power system, such as: (a) all relevant power system components are in service, (b) one generating unit is out of service, (c) one busbar is out of service, (d) one network (system) transformer is out of service, or (e) one transmission line is out of service.

Fault location, such as (a) generator faults, (b) generator step-up transformer faults, (c) busbar faults, or (e) line faults.

Fault type or failure mode of components [Lindahl, 2010], such as: (a) three-phase faults, (b) phase-to-phase-to-earth faults, (c) phase-to-phase faults, (d) phase-to-earth faults, (e) no power system fault.

Operation and failure modes of the protection system, such as: (a) correct operation of all elements in the protection system, (b) failure to operate of one protective relay, (c) failure to operate of a tele-protection channel, or (d) unwanted operation of a protection system.

Operation and failure modes of the circuit-breakers, such as: (a) correct operation of all circuit breakers, (b) failure to interrupt the fault current in all three phases, (c) failure to interrupt the fault current in one phase, or (d) unwanted operation of a circuit-breaker.

The approach in fact suggests that the analysis be performed in an exhaustive manner. Depending on the level of detail of the analysis, i.e., treating the protection system as an entity or decomposing the protection system further into relays, circuit breakers, and communication channels, etc., when considering failure modes, the analysis can be of completely different complexity. As can be easily seen, the branches of the event tree, i.e., the number of scenarios, can be expanded exponentially with consideration of more options and/or failure modes of the protection systems and will soon make the evaluation very different to handle. Therefore, it is

necessary to limit the scenarios to be included in the study. Some engineering judgment has to be exercised for this purpose. The selection of contingencies should be based on: (1) susceptible components, (2) failure rate of the power system components, (3) properties of the power system components, (4) design of the protection systems, (5) the probability of failure to operate of protective relays, tele-protection channels, and circuit-breakers, and (6) frequency of unwanted operation of protective relays or circuit-breakers.

In this study, the number of scenarios that need to be included is further limited by considering the goal and scope of the study and a simplified generic approach is adopted. Starting from the normal state of an NPP, a component fault is assumed to each of the selected grid components (mainly the high voltage components). The conventionally equipped control systems such as, turbine governors and power system stabilizers, are assumed available all the time but the major issue here is to evaluate the grid responses for different fault clearing times that are directly related to the protection schemes/settings.

Therefore, the proposed approach for this study includes: (1) creation of a set of contingency scenarios (i.e., a fault in transient analysis), which represent the progressively degraded grid conditions as a result of the fault occurrence and malfunction of the associated protection relays of concern for the NPP normal operation; (2) performing transient simulation to obtain the grid responses; (3) review of the grid transient responses, especially the measurements at places where a degraded voltage or frequency condition or other conditions (e.g., a reverse power flow at a generator) might cause a reactor trip; and (4) identify and evaluate potential feasible changes of the protection settings that will isolate the faults more quickly and delay the reactor trip such that the reactor is more likely to ride-through the fault without violating the operational requirements in plant technical specifications.

The implementation of the approach heavily relies on the NPP model that contains sufficient details to capture both the NPP onsite distribution network and the neighboring transmission network nearby the NPP, which will be elaborated in Section 4. The details of the approach are further discussed in the following sections.

3.2.2 Development of Contingencies

To implement the proposed approach, the first step is to identify all the credible component faults that pertain to the study. As an example, the distribution of faults that occurred during a five-year period on the CEGB (Central Electricity Generating Board, UK) system [Lindahl-2011] is shown in Figure 3-1, where it can be seen that more 60% of the faults are associated with overhead transmission lines and cables. The percentage of faults on transmission lines in the US should be higher because the isokeraunic level in the US is between 10 and 100 thunderstorm-days per year while it ranges only from 5 to 10 in England and Wales[Lindahl-2011]. Therefore, the faults of interest are mainly related to the transmission grid and the NPP switchyards, i.e., faults at high voltage levels. Faults of interest are all assumed to be permanent ones, i.e., the faults will persist unless being isolated by the protection systems.

The major components include the generators, transformers, bus bars, and transmission lines. Each type of component may have different failure modes. A generation unit may experience a three-phase or a phase-to-ground fault, a loss of generation (or deletion of the generator), or a loss of excitation system.

It is assumed that a generator step-up transformer consists of three single-phase transformers connected to the generator by means of an isolated phase bus duct. Each phase conductor is

enclosed by an individual metal housing separated from adjacent conductor housings by an air space. This means that a three-phase fault on the generator side (or the primary side) winding or on the isolated phase bus duct is not a credible fault. It is assumed that phase-to-phase-to-earth faults and phase-to-phase faults on the primary winding of the generator step-up transformer are less severe than and covered by the umbrella of a three-phase fault on the generator terminal. However, a three-phase fault at the secondary winding, i.e., the side of the switchyard, is a credible fault.

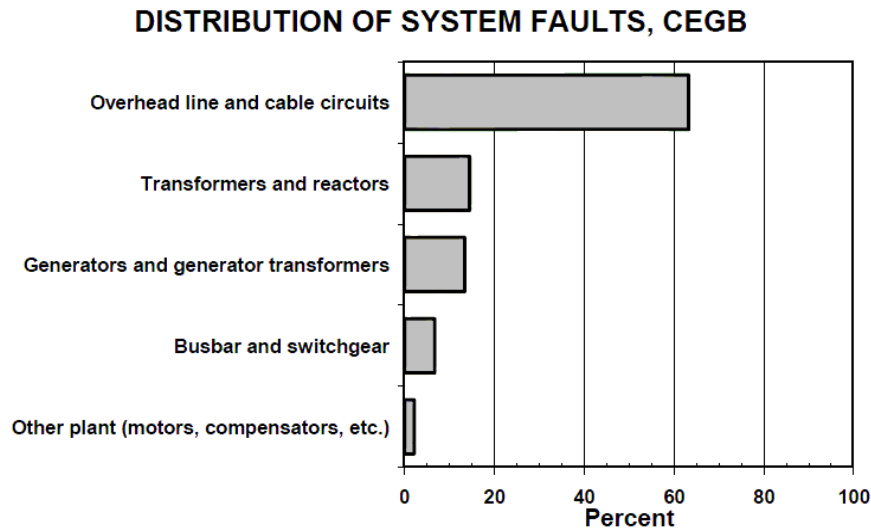

Figure 8 Distribution of faults on the CEGB system [Lindahl–2011]

A busbar and transmission line may undergo a three-phase, a single-phase-to-ground, or a phase-to-phase-to-ground fault. For a transmission line fault, the location of the fault may also be variable along the transmission line.

For a generator fault or a transformer fault on the generator side, clearing the fault always means that the generator has to be taken offline, which will directly lead a turbine trip and thus a NPP tripping event. For a transformer fault on the switchyard side, it may be considered the same type of faults as the switchyard busbar faults and are thus covered by the busbar fault scenarios to be studied. Since the purpose of this study is to study how to improve the fault ride-through capability of a NPP, only the faults of busbars and transmission lines will be further studied in detailed.

These credible component faults are considered the single contingencies that must be evaluated in the study.

3.2.3 Development of Simulation Scenarios

The N-1 criterion is required to be satisfied in power system design. The single contingencies identified in Section 3.2.2 or sometimes even double contingencies would not cause any issue with the grid operation provided that the associated protected systems work properly. On the other hand, high order failures are less likely to occur simultaneously. Therefore, the major challenge is a single contingency combined with the failure of the primary protection system or

by the failure-to-operate of a circuit-breaker [LER 40815, AIT 05000277&278/2003013], which not only prolongs the fault clearing time, but also leads to disconnection of more components and makes the power system even weaker. Many NPP tripping events are caused by such combinations (see Section 1.1.3). The failure of the protection system is the major consideration in developing the contingency simulation scenarios for the study.

When developing simulation scenarios, typical protection relaying schemes are assumed for faulted transmission lines and busbars such as, distance relaying and telecommunications-based relaying, and will guarantee transient stability of the system upon a single contingency. The single contingencies are considered Type I scenarios in this study. The protection system failure then needs to be included in the simulation of the single contingencies, which are considered the Type II scenarios in this study. Based on different protection schemes, the fault clearing time and the extra components that have to be isolated will be different and need to be accounted for. As a potential improvement to the existing protection schemes, breaker failure protection is assumed to be available and will also be included in the simulation. The additional failure of the breaker failure protection scheme constitutes Type III scenarios, which basically assume that all the components that are immediately connected to the faulted component will be isolated within a certain time period determined by the protection schemes/settings.

The scenario development process indicates that the critical variables that must be considered, regardless of the types of component faults and protection schemes, are the fault-clearing times of various protective relays and circuit breakers that are determined by utility-specific practices and the circuit breakers that must be opened. Including these critical variables in simulation gives the grid responses for different types of scenarios. Accounting for these variables in scenario simulation is equivalent to modeling the relaying schemes and the actual settings and the current/voltage measurements used to detect a fault and open the circuit breakers in the right places.

Depending on the transmission voltage level, there are generically accepted values for fault-clearing times that vary with voltage levels. Take a typical distance relaying protection scheme as an example: in the faulted zone, the normal relay times range from 1 to 2 cycles and circuit breaker times range from 2 to 4 cycles on high voltage and extra-high voltage transmission systems. For the Zone 2 protection that overreaches the faulted zone, their relays are generally set to trip after a time delay of a typical value between 0.3 and 0.5 seconds. For effective protection system time coordination, usually a 2.0-second-delay is set for the Zone 3 protective relays. Therefore, if the utility-specific protection settings are not available, the above generic distance relaying settings can be used in the study and the results are not expected to deviate too much from the protection system response that would actually occur.

For a transmission line with distance relaying scheme, Type I scenario considers just the fault with the correct operation of the relays and circuit breakers. The Type II scenario considers the additional breaker failure (failure of the breaker at the near end bus is preferred in the study since failure of clearing fault at near end bus has a more severe impact on the system and the response of the remote backup while the Type III scenario will simulate the grid responses after isolating of all components that are immediately connected to the faulted line after two seconds delay). Scenarios can be created for other types of relaying schemes of transmission lines and busbars.

In order to bound the number of cases that had to be considered, the detailed evaluations performed in this study were limited to Type III scenarios because of the exponentially increasing number of scenarios and an assumption that higher order failures are much less

likely to occur simultaneously. Note, Type I scenarios should not have any negative impact on the normal NPP operation, according to plant FSARs. Performing Type I scenarios is considered a part of the model validation process as well as providing the basis for understanding and building upon our analyses of Type II and III scenarios.

3.3 Discussion and Remarks

Note, the proposed approach is a natural solution to the unavailability of the details of the utility/plant-specific settings for their protection systems across the transmission grid. It is also believed that, even with all of the actual settings, not every single type of power system relay and/or circuit breaker model is available in a particular power system simulation software. In addition, since we are interested in how the fault clearing time may affect the NPP responses, knowing all of setting information and modeling every single protective relay and/or circuit breaker becomes unnecessary. More importantly, sensitivity studies of the response times of protection relays in different zones can be and were performed.

Since the majority of the grid-related NPP events [LER 40815, AIT 05000277&278/2003013] are due to combinations of a single contingency and failure of protection system relays, the first step of the proposed approach for each NPP that we are evaluating is to create: (a) basic single contingencies, Type I scenarios, i.e., a complete set of single contingency scenarios for all of the high-voltage level faults, which will be cleared by the primary/backup protections in the faulted zone according to their settings; (b) Type II scenarios, i.e., variations of Type I scenarios containing the same contingencies that are not cleared by the protection systems due to the breaker failure in the faulted zones but instead are picked up by the breaker failure backup protections of the immediate neighboring zones; and (c) Type III scenarios, i.e., the scenarios with the same single contingencies but the faults are cleared after a sufficient long time delay by isolating all the components that are immediately connected to the faulted component. For both Types II and III scenarios, additional components have to be tripped as well as the faulted one in the simulation.

If the settings of the time delays for protective relaying in zones that are close to the NPP switchyard are reduced, the impact of the faults occurring in transmission system nearby NPPs can be reduced. Even if one of the primary offsite power supplies has to be disconnected in order to isolate the fault, the alternate offsite power source may still be maintained to minimize the chance of tripping the NPP. In this study we are proposing that in the overall approach to transmission system protection, NPP switchyards be considered as a special case compared to transmission substations located away from the NPP.

An example is the ongoing project of refurbishing and upgrading of two NPP substations in Sweden [Lindahl – 2011]. A double-bus double-breaker arrangement with disconnecting circuit-breakers will be used in the two ongoing projects. This will be the standard arrangement, which will replace the double-bus single-breaker arrangement that was used previously, in all NPP substations when refurbishing, or building new, substations in Sweden. The protection system will be upgraded as follows:

- Dual busbar protection systems will replace single busbar protection systems
- New dual digital line protections will replace line protection systems consisting of one electromechanical line protection system and one static line protection system or one first generation digital line protection system

- Dual teleprotection channels will replace single (common for both Main 1 and Main 2 line protection system) teleprotection channels
- Dual circuit-breaker failure protections will be used
- Dual DC systems completely isolated from each other and with some degree of physical separation will be used as previously
- Circuit-breakers with two trip-coils will be used as previously

The philosophy is that the line protection system should issue a trip signal to at least one of the two trip coils of the associated circuit-breaker within 20 milliseconds for close-up faults, and within 30 milliseconds for remote faults even if one element of the protection system fails to operate.

In general, by reducing fault clearing time at or near the NPP substation we hope to achieve a reduction in the number of reactor trips while reducing the number of losses of offsite power sources during transmission system transients. More specifically, in order to reduce the fault clearing times, fast response relays/breakers, telecommunications-based protective relaying, and breaker failure backup protection are obviously preferred. In keeping with the philosophy of upgrading the reliability and protection system response times at NPPs, the relatively small cost of including the breaker failure protection element in a modern protection system terminal is easily justified. For Zone 2, Zone 3, or breaker failure backup protection, time delay is intentionally built into the relay setting in order to coordinate with each other and with the Zone 1 protection. To address the issue of Zone 1 protection failure, more cost-effective options could be: (1) a reduction in the built-in time delays in the Zone 2 relays; (2) an anticipatory trip by the Zone 3 relays, i.e., significantly decrease the time delay of the Zone 3 relay settings; (3) a shorter time delay in the breaker failure backup protection; and (4) a more comprehensive and rigorous maintenance program, on an optimized scheduled frequency, including rigorous inspection, test, calibration, etc., to reduce the failure probability of the protective devices at the NPP switchyards. The rationales behind the first three options is that, regardless of the issues of (1) the potential racing between Zone 1 and Zone 2 and Zone 3 protection and/or (2) the potential disconnection of more components between the NPP switchyard and the fault location, the impact of primary protection failure can be less severe. Even if the primary offsite power supply is lost due to tripping of extra components, the chance of the alternative offsite power supply being available could be high. Also note that an anticipatory Zone 3 trip scheme, depending on the settings of time delay relative to those of primary relays, does not have to trip more components than necessary when primary protective relays function properly. Utilities may be more receptive to the concept of modifying protection settings at the NPP switchyards for not requiring the changes to the rest of the transmission system protection schemes that are traditionally used by individual utilities.

The simulation tool ETAP provides the capability of simulating a large number of pre-defined scenarios in a batch mode, based on the fault scenario Types I, II, and III discussed previously, and generating reports for each scenario, as defined. The various scenarios have to be created manually within the simulation model as we consider the occurrences of faults at each possible location in the power transmission grid around the nuclear plant.

4 NPP MODELS AND ANALYSES

4.1 Overview

Realistic models of NPPs are needed for performing the study of the electrical responses. The plant models were created using ETAP software developed by Operations Technology Inc. (OTI) based on electrical system information from various sources including the Federal Energy Regulatory Commission (FERC), NPP Final Safety Analysis Reports (FSARs), plant inspection reports and documentation, individual plant examinations (IPEs), information obtained from the Internet, and other sources. A total number of three plant models, designated A, B, and C in this report, were created. Based on the approach proposed in Section 3, a set of Types I, II, and III scenarios have been defined for each of the plant models. Example results of the typical scenarios are shown and briefly discussed for each plant model.

The general modeling approach and assumptions that are used throughout the studies are discussed and an overview of modeling selected NPPs is provided in Section 4.2. Section 4.3 focuses on defining and simulating scenarios and analyzing the simulation results. In Section 4.3.2, the faults for both buses and lines at different distances from the NPP switchyards of the selected plant models are evaluated to determine the severity of their impacts. The comparison of grid responses to faults under different protection schemes is studied in detail in Section 4.3.2. Section 4.3.2.1 describes parameters for generic protection schemes including distance relaying (DR), distance relaying with breaker failure protection (DRBF), protective relaying using telecommunications (PR), and telecommunications-based breaker failure protection (PRBF). A set of scenarios is defined for each of the three NPP plant models. The simulation results of these scenarios are presented in Section 4.3.2.2. An anticipatory Zone 3 protection scheme is evaluated in Section 4.3.2.3 by a simulation using Plant B as an example. More scenarios are postulated and analyzed without simulation in Section 4.3.2.4 but these analyses also provide important insights on how to improve the performance of NPP switchyards by identifying the most critical circuit breaker(s) under certain fault conditions. A preliminary study of the interaction between two NPP switchyards that are electrically close to each other is performed in Section 4.3.3. The modeling and simulation studies are summarized in Section 4.4.

4.2 ETAP Model Description of NPPs

4.2.1 Modeling Approach and Assumptions

The following general assumptions were made in modeling the NPPs for this study:

1. The scope of an NPP model includes the NPP 480V or above distribution network (both class 1E and non-class 1E), generators, switchyards, all offsite power supplies, neighboring substations and generating units (both nuclear and non-nuclear units nearby);
2. All 4kV or above voltage level buses and generation of an NPP are modeled in detail;
3. The onsite distribution network is modeled down to the voltage level that is immediately below the 4 kV buses, which could be 480 V or 600 V depending on the plant's design.
4. All 480V (or 600 V) or below voltage level buses and the associated loads powered by a 4kV or 13 kV bus are aggregated based on the observation that losses of these loads or faults at these buses do not lead to a reactor trip. Where exact loads were unknown, bus loading was estimated from information that was available for an equivalent plant.

5. All loads are grouped according to type (e.g., inductive motors or static loads);
6. In general, neighboring substations are modeled as buses that are powered by a utility grid except in the model that was used for studying the interaction between protection systems of multiple NPPs. The rest of the power system, the utility grid, is modeled as short-circuit capacity (steady-state basis) of utility supply [IEEE Std. 399, Brown Book];
7. Sub-transient generator models are used and the generators are assumed to be equipped with necessary control systems including excitation, turbine governor, and power system stabilizers;
8. The switchyard of a substation is assumed to be of a breaker-and-a-half configuration when performing transient analyses unless other bus and circuit breaker arrangement information is available;
9. Typical parameter values were used if system-specific information could not be obtained. Typical parameter values include 1) the typical short-circuit capacity of a 220 kV utility can be between 4,000 and 10,000 MVA with an X/R ratio of 20 [IEEE Std 399-1997, "IEEE Recommended Practice for Industrial and Commercial Power Systems Analysis (Brown Book)"]; 2) a damping ratio of 5% [Kundur 1993]; (3) an inertia constant between 4 and 10 seconds for a 4-pole 1,800 rpm thermal unit, and between 2 and 4 seconds for a hydraulic unit [Kundur 1993]; 4) the sample data for various control systems associated with a generator provided by ETAP; and 5) bundled 2,500 kcmil conductors for 230 kV cables [Seman 1995].

In general, this study used these assumptions when detailed information about the specific NPP distribution network and grid was not available. Aggregating the low voltage loads (and separating the dynamic and static loads) is a common practice in simulation studies of power systems. The difference in the system responses between the load aggregation and separate modeling of various loads is trivial based on some preliminary simulation results performed in this study. The breaker-and-a-half switchyard described in Section 2.2 is commonly adopted in NPP designs. Although the specific plant and utility grid data differ from each other, it is anticipated that these assumed data, based on general principles in power engineering, will not deviate significantly from the typical data that have been widely adopted in power industries.

4.2.2 Overview of the NPP Models

For the Plant A model, the switchyard is of a breaker-and-a-half configuration. A portion for the switchyard of each of nearby NPPs (i.e., plants D and E) including one generator of each NPP has been modeled in order to study the interactions between switchyards of different NPPs that are close to each other. The two 1,450 MW generation units at Plant A are modeled in detail. Each generator is connected to the switchyard via two 750 MVA transformers. The generator also provides power supply to the onsite load during normal operation. The 4.16 kV Class 1E buses of each unit may also be powered from 4.16 kV Class 1E buses of the other unit. There are four 6.9 kV RCP pumps for each unit. Four emergency diesel generators are connected to four 4.16 kV buses (two for each unit). Note, the onsite distribution network and load of plants D and E are not explicitly modeled considering the purpose of this study. The nearby substations are also modeled either as a switchyard or a single bus. For the substations, the neighboring generation units are modeled as a single generator with an aggregated generating capacity, as shown in Figure 4-1.

Plant B consists of three generation units with a capacity of 1,560 MVA each. A single 525 kV switchyard of a breaker-and-a-half configuration interfaces the transmission network with the NPP. Each generator terminal bus (24 kV) is connected to the switchyard via a main transformer and feeds partial onsite loads including 13.8 kV reactor coolant pumps (RCPs) via a unit auxiliary transformer while the majority of the distribution network for a single unit is supplied by the offsite power system via a startup transformer connected to the switchyard. Note, the startup transformers can cross feed each other via bus transfer. There are a total number of eleven (11) 525 kV transmission lines from the neighboring substations to the Plant B switchyard. Four generators of a total capacity of 3,130 MVA near the NPP were modeled. In addition, two utility grids of 230 kV and 525 kV, respectively, were modeled to power the neighboring substations. The detailed model of Plant B is shown in Figure 4-2.

Plant C model has two 1,112 MW generation units; each with a 500 kV switchyard of a ring-bus configuration, as shown in Figure 4-3. The two switchyards are cross-connected to each other. The majority of the non-safety related loads for each unit including two 13.8 kV RCPs are powered by one generation unit. In case of the generation unit tripping, a bus transfer can continue to power the non-safety related loads from the offsite power system via the start-up transformer. In general, the two offsite power supplies (one of 230 kV and another one of 500 kV) provide the ac power source to the safety-related loads of the two units, respectively. The two power supplies cross-tie to each other at the secondary and tertiary windings of the startup transformers with the circuit breakers normally open. In case of loss of one offsite power supply, the safety-related loads can be cross-fed by the other one. Four 2.6 MW emergency diesel generators are shared by the distribution network of the two units. A total number of four generators including a hydro plant near the Plant C plant were included in the model. Five 500 kV transmission lines are connected to the two switchyards from the transmission network.

All of models were created using ETAP software. The detailed parameters for all of the components and control systems utilized in the simulation model cannot all be shown here, which, in general, are typical values for the type of component/control systems that are extracted from manufacturers' data and provided as part of the ETAP software package. Based on detailed system information and data collected from various sources such as FERC and plant documentation, the models developed in this study are expected to be very close to the operating NPPs and the grid.

Note that the generator output circuit breakers shown in the model do not represent actual circuit breakers in the plants that are modeled. In other words, these breakers will not be opened in any of the simulation studies if the installation of such breakers on the specific generators is not confirmed. In addition, it is understood that a switchyard with breaker-and-a-half configuration has three breakers and five disconnected switches (disconnect switches are not modeled in our study) per switchyard bay. In the ETAP model for this kind of switchyard, sometimes five breakers were modeled. The reason is that a bus must be inserted between two breakers in order to connect to another bus, and a bus cannot be connected without a breaker (or a transmission line) between them. When performing simulation, attention has been paid to this issue to avoid any violation.

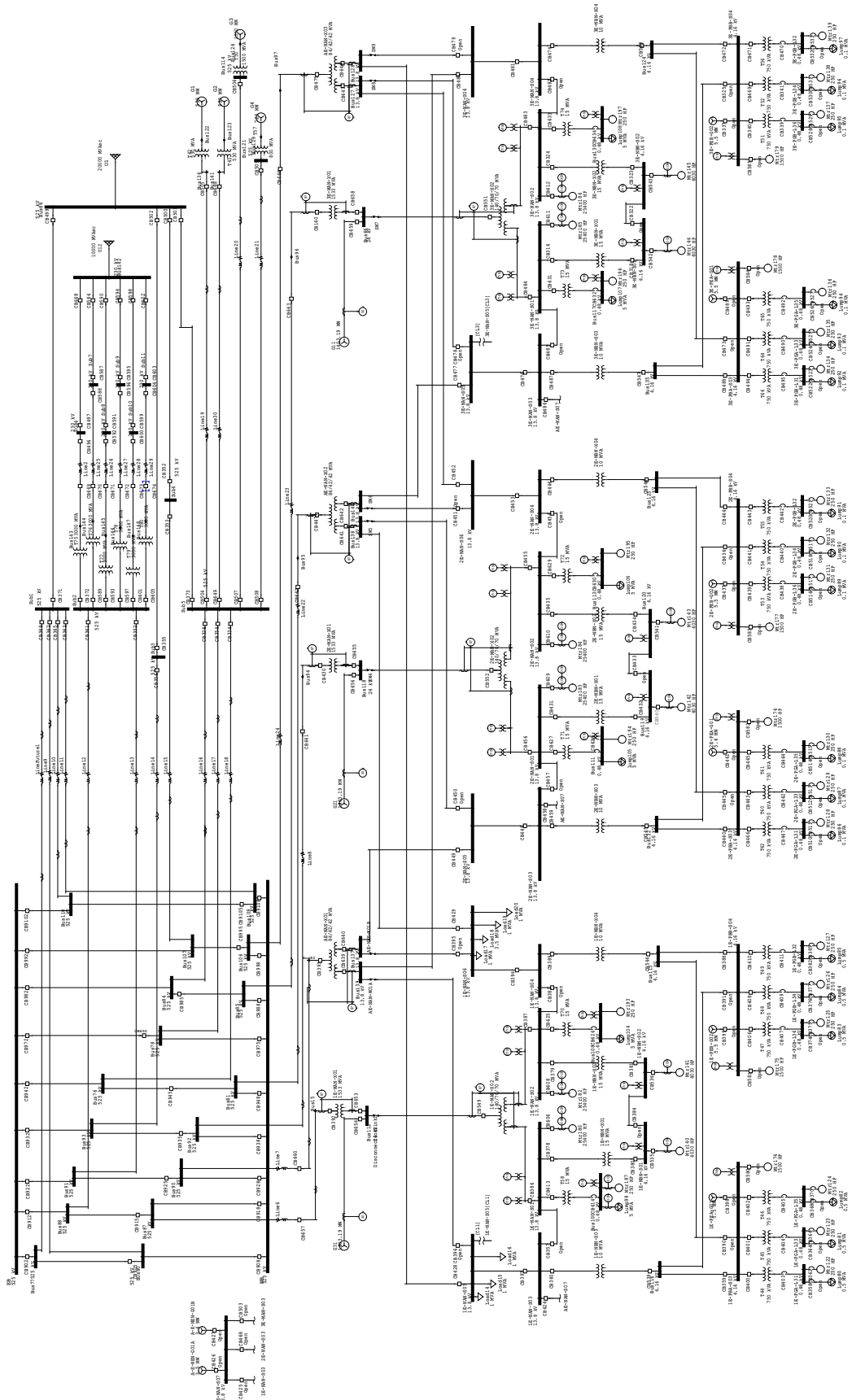

Figure 10 One-line Diagram for Plant B

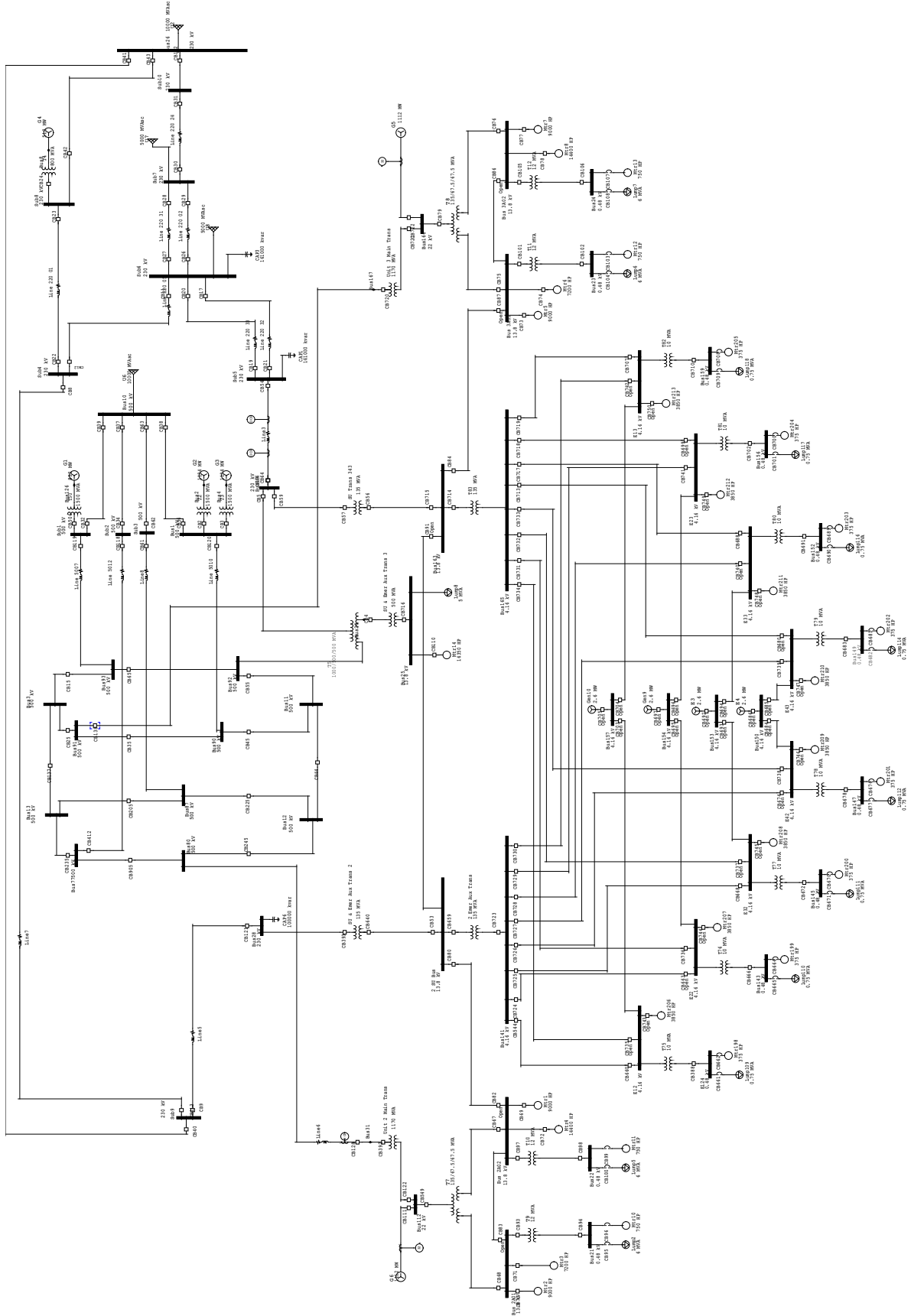

Figure 11 One-line Diagram for Plant C

4.3 Scenario Definition, Simulation, and Analysis

4.3.1 Comparison of Grid Responses to Faults at Different Locations

In this section, sets of scenarios are defined for the individual plant models representing the same type of faults at different locations measured in terms of distance from the switchyards. The developed scenarios are defined in Table 4-1. For each plant model, both permanent and transient faults are defined for the selected lines. For buses, only permanent faults are defined since the selected buses are all part of the switchyard buses. Failed bus will be taken over by the other bus for a breaker-and-a-half configuration. Therefore, permanent faults for these buses should not make any difference from the transient faults as long as the failed bus is isolated. For plants of breaker-and-a-half configuration switchyards, i.e., Plant A and Plant B models, the frequency and voltage at the two buses of the switchyards are plotted in the figures. For the plant of a ring-bus configuration switchyard, i.e., Plant C model, the frequency and voltage at two of the ring buses are plotted in the figures.

The simulation results for Plant A Cases 1 - 6 are shown in Figures 4-4 through 4-10. The voltage and frequency transients at two switchyard buses SWYDBus-1 and SWYDBus-2 were plotted such that the responses to faults at different distances from the switchyard can be compared meaningfully. The simulation results for the rest of the scenarios defined in Table 4-1 can be found in Figures A-1 through A-15 Appendix A.

Table 4-1 Scenarios for Comparing Grid Responses to Faults at Different Locations

Plant Models	Bus Permanent Faults (3-phase)	Line Permanent Faults (50% three phase)	Line Transient Faults (50% three phase)	Fault Clearing Actions	Distance From the Plant	Case ID
Plant A	SWYDBus-1			Fault cleared after 0.08 (s)	Near	Plt. A -Case-1
	Sub1-1				Medium	Plt. A -Case-2
	Bus 20	Line 12		Open CB49 and CB 50 after 0.08 (s)	Far	Plt. A -Case-3
		Line 10			Near	Plt. A -Case-4
Plant B				Open CB47 and CB109 after 0.08 (s)	Far	Plt. A -Case5
			Line 12	Fault cleared after 0.08 (s)	Near	Plt. A -Case-6
			Line 10		Far	Plt. A -Case-7
	EB			Fault cleared after 0.08 (s)	Near	Plt. B -Case-1
	Sub2				Medium	Plt. B -Case-2
	Sub6				Far	Plt. B -Case-3
		Line 12		Open CB361 and CB414 after 0.08 (s)	Near	Plt. B -Case-4
		Line 2		Open CB496 and CB669 after 0.08 (s)	Far	Plt. B -Case-5
Plant C			Line 12	Fault cleared after 0.08 (s)	Near	Plt. B -Case-6
			Line 2		Far	Plt. B -Case-7
	Bus 77			Fault cleared after 0.08 (s)	Near	Plt. C -Case-1
	Sub 1				Far	Plt. C -Case-2
		Line 3		Open CB64 and CB 54 after 0.08 (s)	Near	Plt. C -Case-3
		Line 220 32		Open CB17 and CB21 after 0.08 (s)	Medium	Plt. C -Case-4
		Line 220 31		Open CB27 and CB28 after 0.08 (s)	Far	Plt. C -Case-5
			Line 3	Fault cleared after 0.08 (s)	Near	Plt. C -Case-6
			Line 220 32		Medium	Plt. C -Case-7
			Line 220 31		Far	Plt. C -Case-8

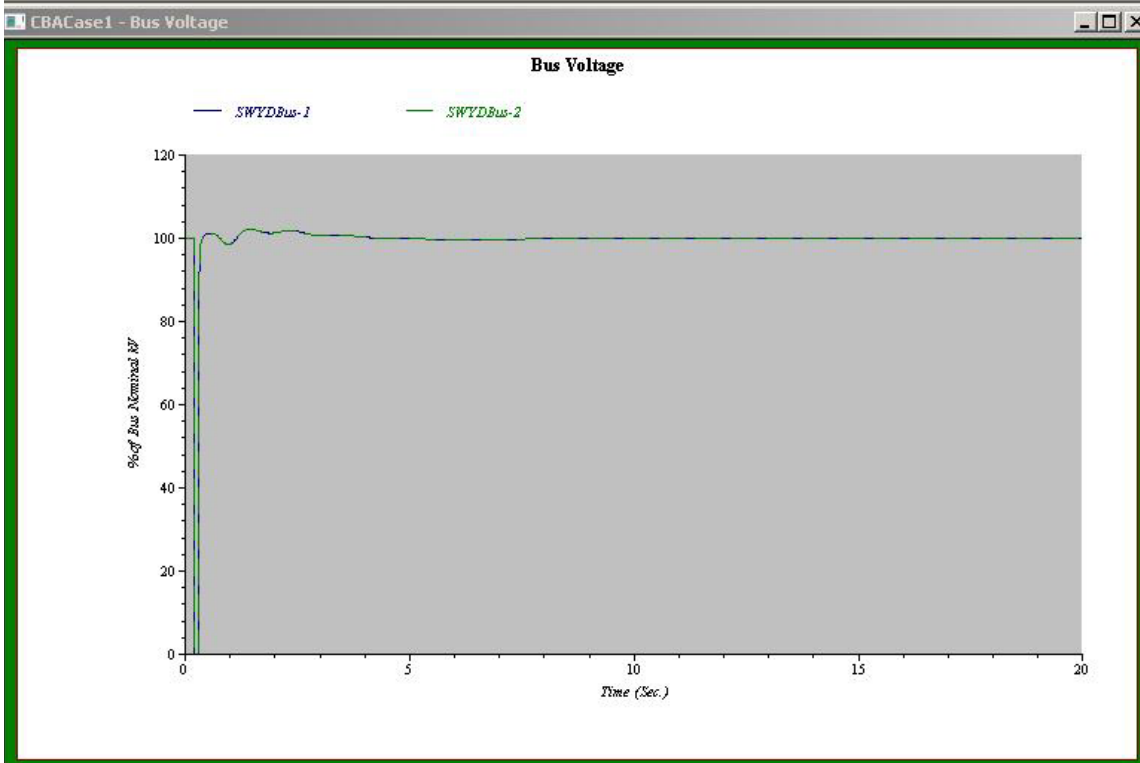
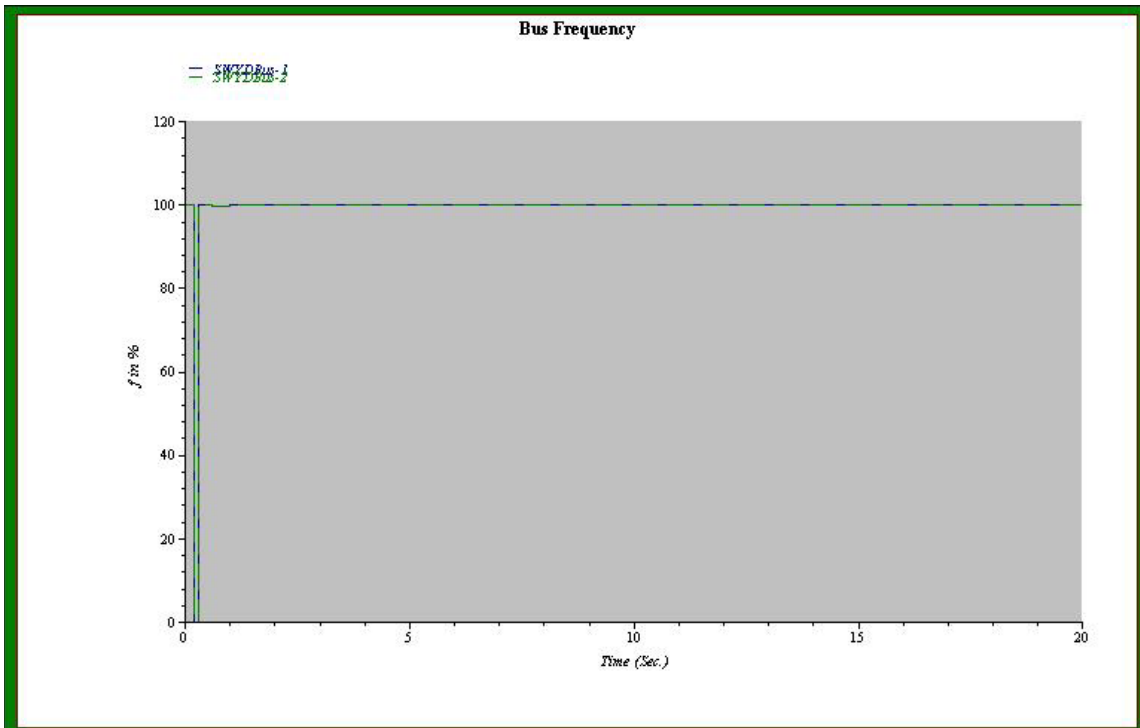

Figure 12 CBA-Case-1 for Bus SWYDBus-1 Permanent Fault (Near)

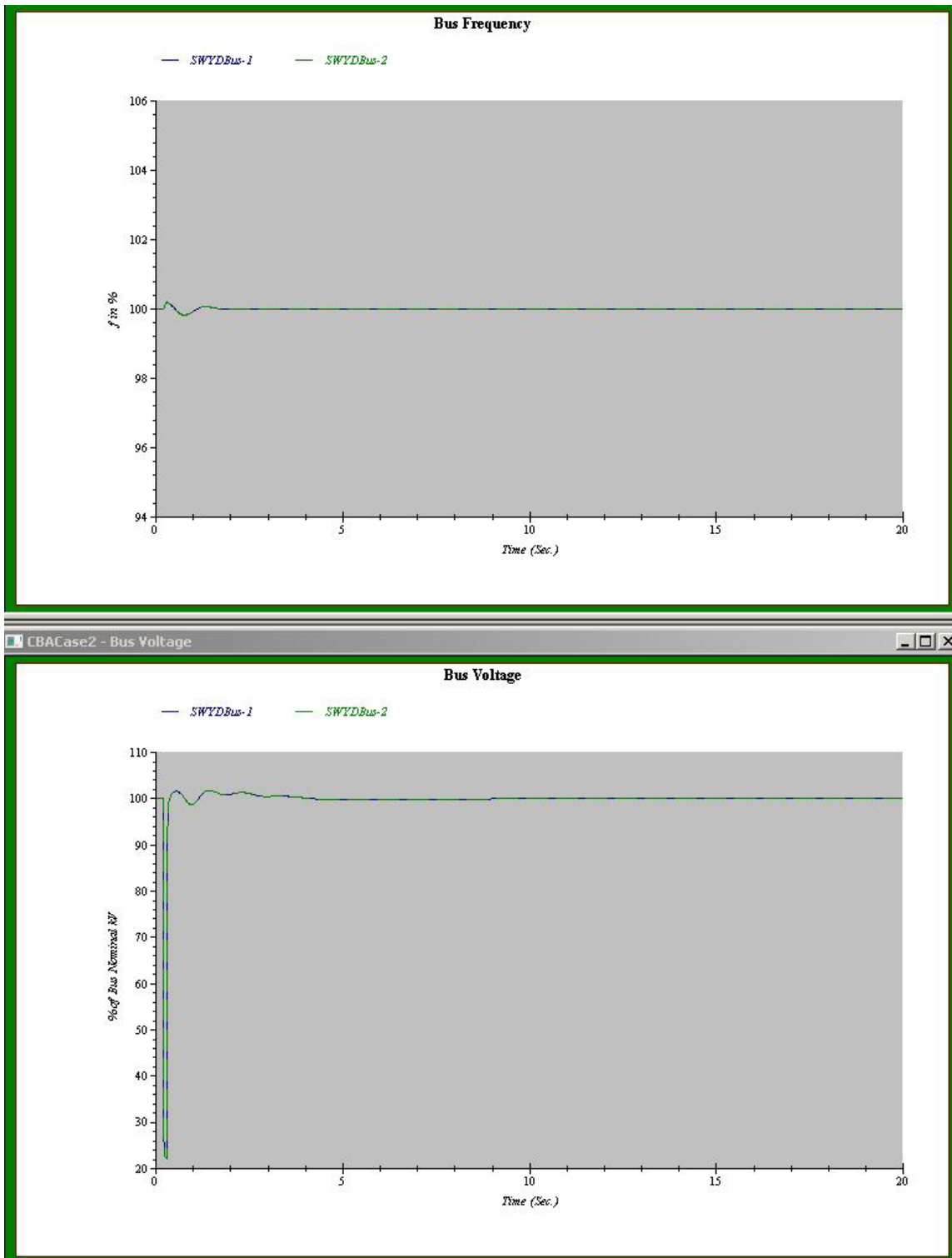

Figure 13 Plant A-Case-2 for Bus Sub1-1 Permanent Fault (Medium)

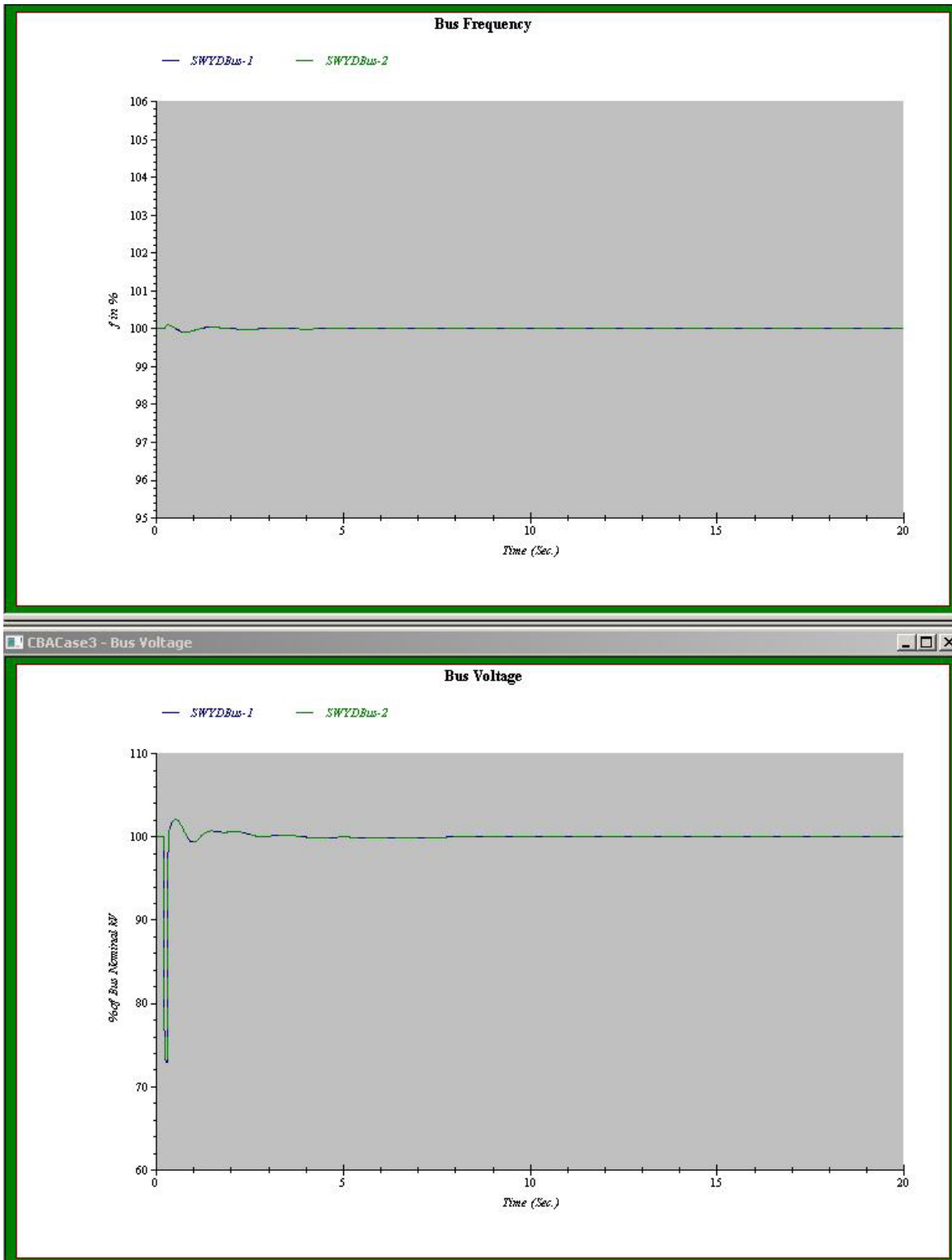

Figure 14 Plant A-Case-3 for Bus Bus20 Permanent Fault (Far)

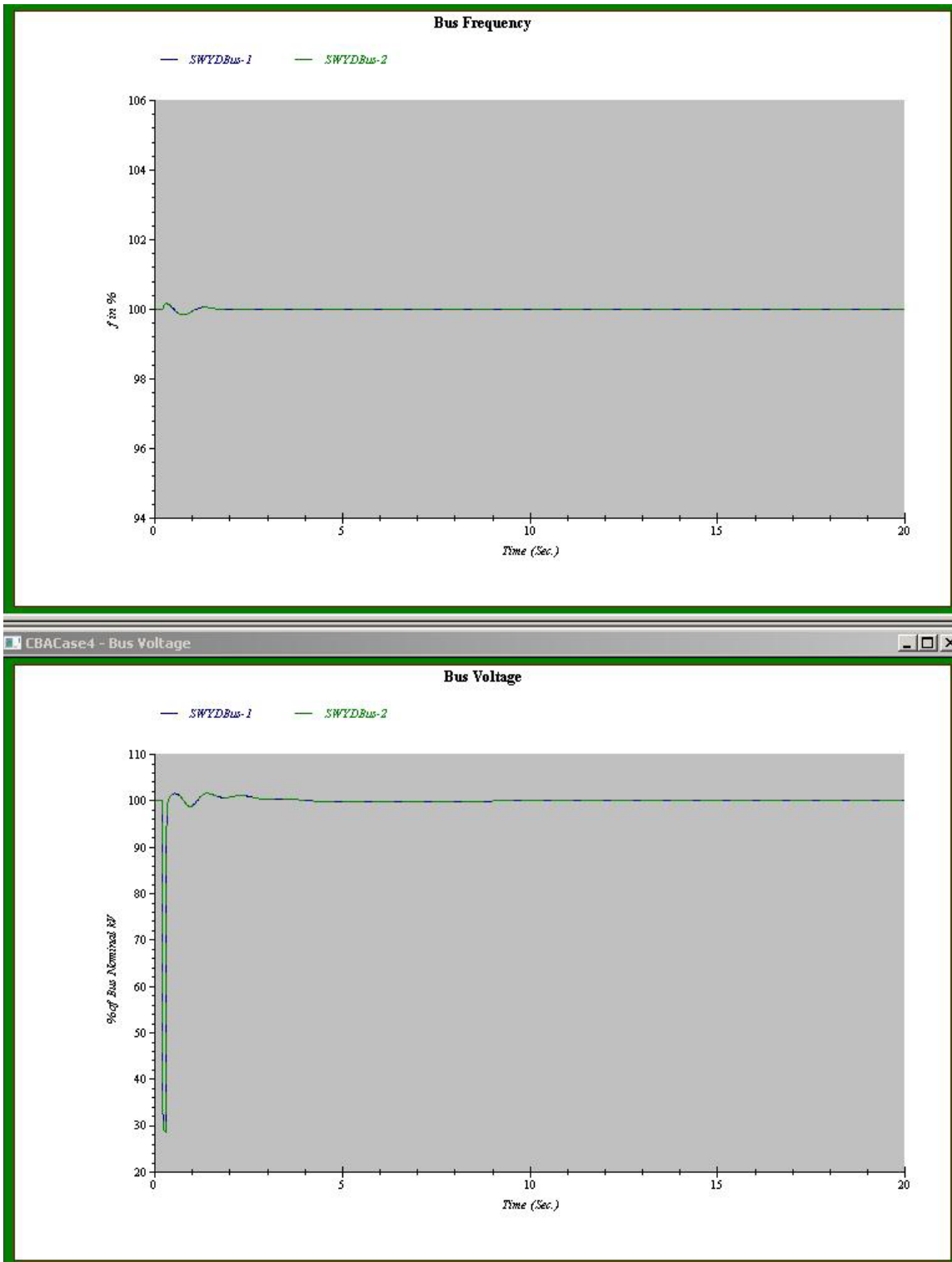

Figure 15 Plant A-Case-4 for Line12 Permanent Fault (Near)

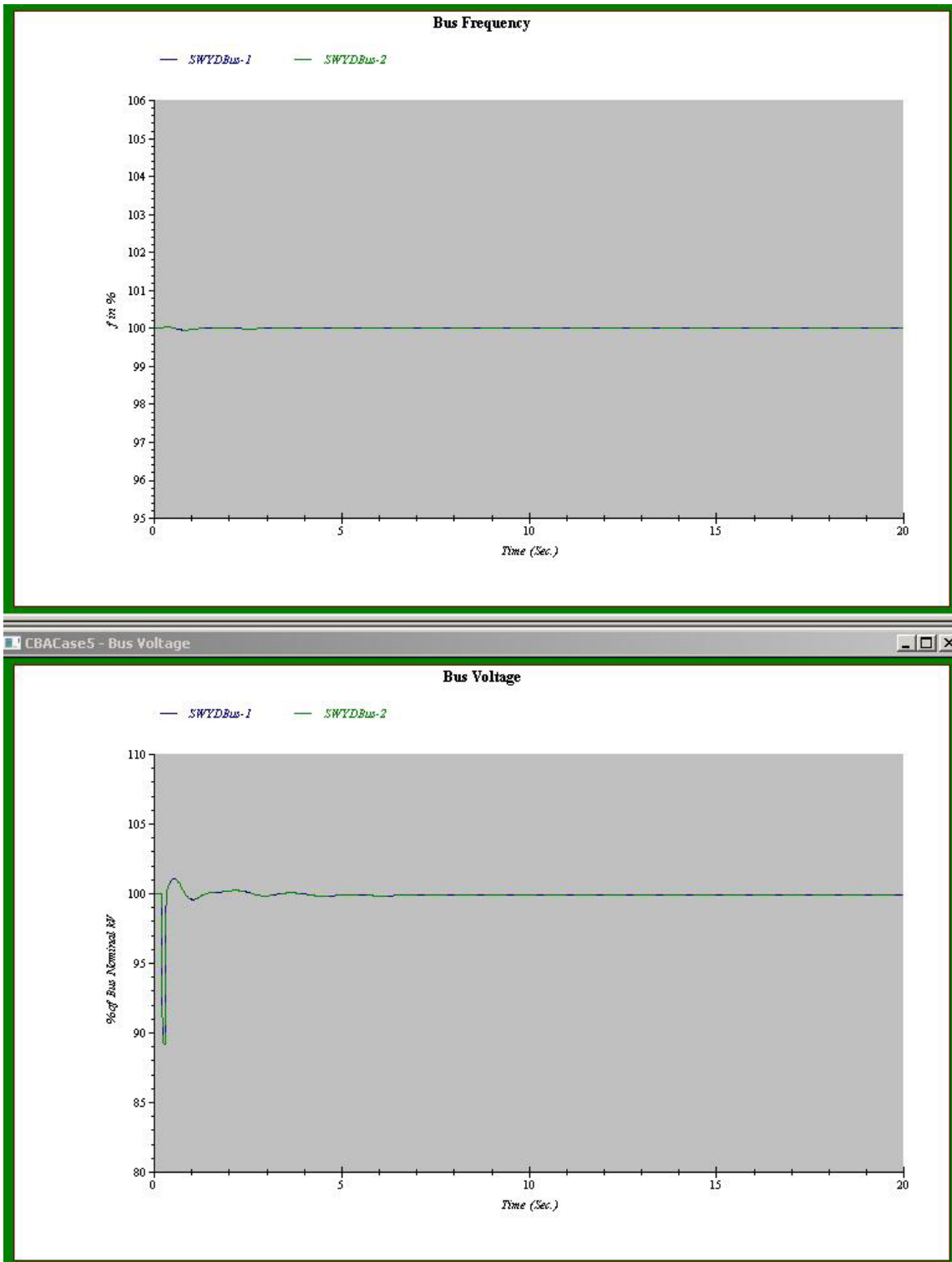

Figure 16 Plant A-Case-5 for Line10 Permanent Fault (Far)

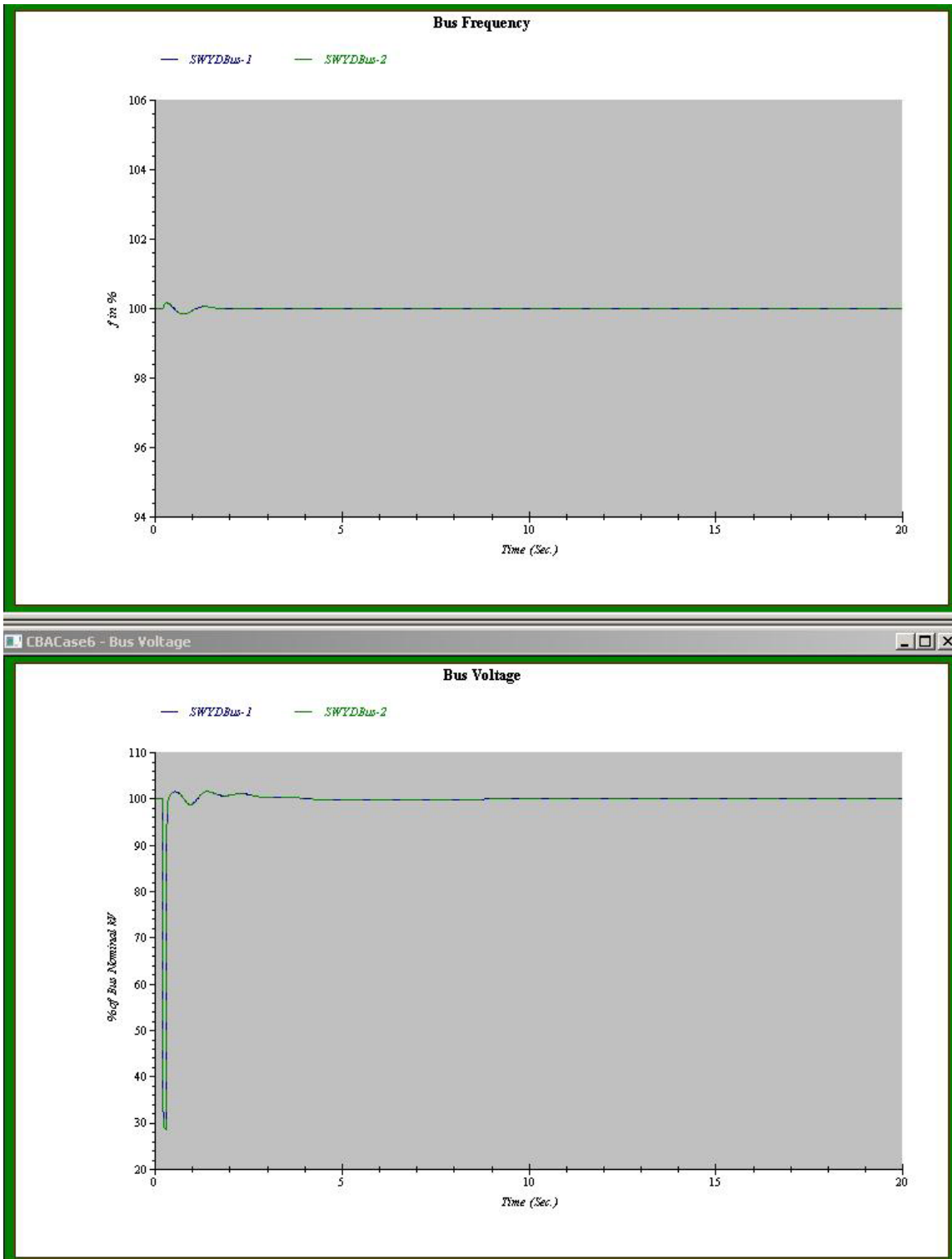

Figure 17 Plant A-Case-6 for Line12 Transient Fault (Near)

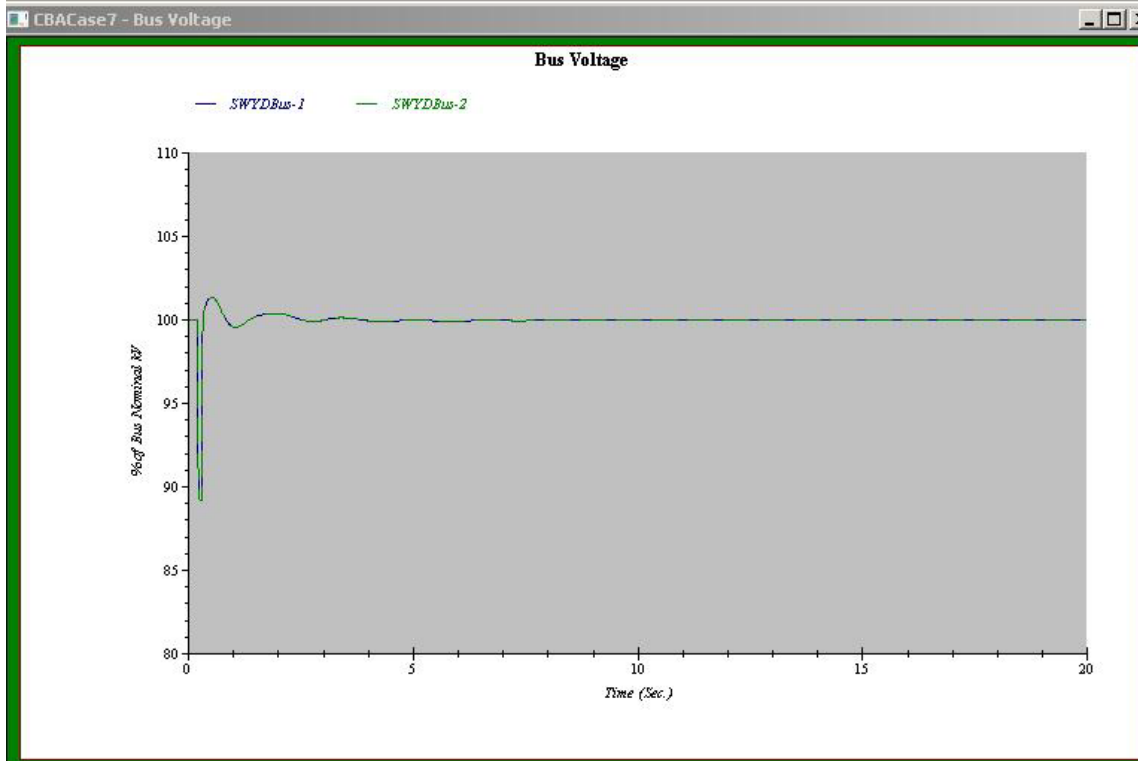
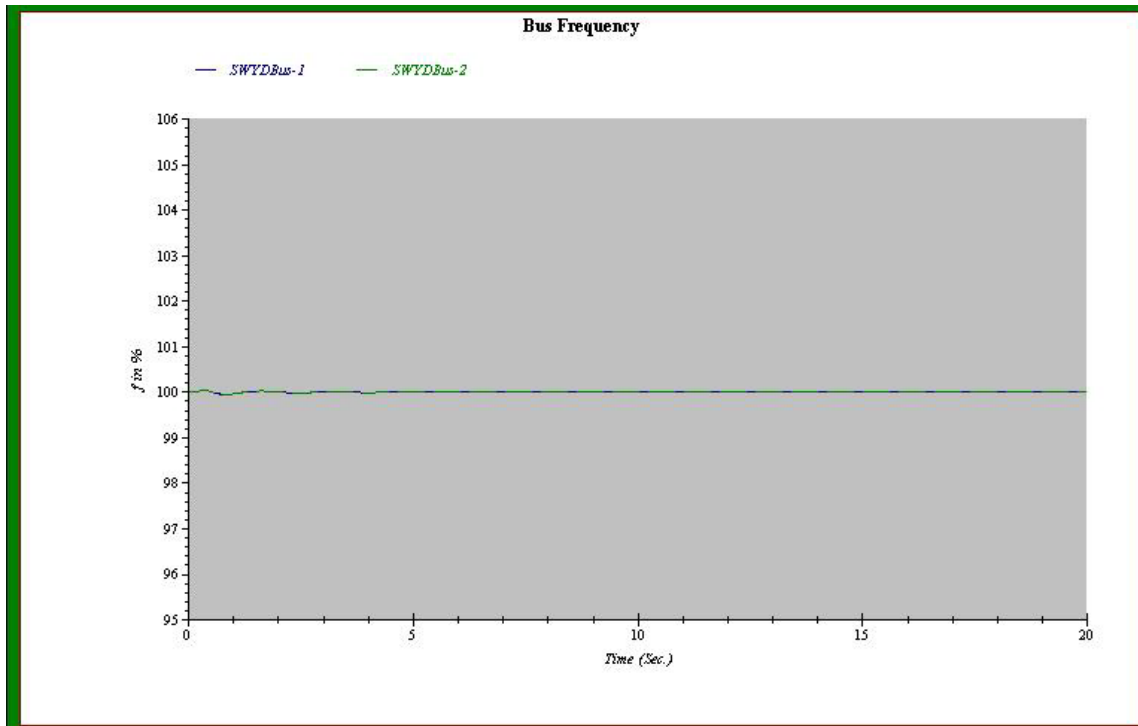

Figure 18 Plant A -Case-7 for Line10 Transient Fault (Far)

From the simulation results shown in Figures 4-4 through 4-10 (also the simulation results of similar cases for Plants B and C, as shown Figures A-1 through A-15), it can be concluded that it is generally true that for a fault originated in the transmission network, the closer the fault is to the NPP switchyard, the more severe impact it has on the NPP. While this might be well-known, it may not be common for a NPP switchyard owner or a transmission network owner to recognize that a different or a tighter protection scheme is warranted for the NPP switchyard or transmission lines/substations nearby a NPP switchyard considering the fact that a utility tends to use the uniform protective schemes settings across the entire network owned by the utility.

The performance variation of different protective schemes/settings becomes obvious in the next section, especially when an additional breaker failure is considered following a fault occurrence. Note, a transmission line fault followed by the failure of the protection system is not rare at all, e.g., see Section 1.1.3.

Also, note that none of the fault scenarios indicates that the NPP will be challenged under the faulted conditions considered above. This also partially serves the purpose of validating the NPP plant models created in the study.

4.3.2 Comparison of Grid Responses to Faults with Different Protection Schemes

4.3.2.1 Parameters for Generic Protective Schemes

The scenarios of interest are developed to study the grid responses to individual faults under different protection schemes. As shown in Section 4.3.1, the closer the faults originated in the transmission network to the NPP switchyard, the more severe are the impacts that a longer fault clearing time has on the plant responses. Therefore, clearing the faults with minimum or without any intentional time delay becomes critical in order to reduce the NPP susceptibility to the external faults.

For transmission line protection schemes, as described in Section 2, the primary protection relaying scheme using telecommunications does not have any intentional time delay once an internal fault is detected. The only intentional time delay is built into the remote breaker failure protection scheme, which is also considered to be required for protective relaying coordination. For a telecommunication-based remote breaker failure backup scheme, this time delay is very small, i.e., around 90 ms, as shown in Section 2. Considering the severity of the impact of the fault that is near the NPP switchyard, the postulation is that it is therefore ideal to apply the telecommunications-based protective relaying in conjunction with the telecommunications based breaker failure backup schemes on the transmission lines at and/or near the NPP switchyard, as will be shown in this section.

The parameters used in the study for different protection schemes are summarized in Table 4-2. The parameters defined in the table are generic and can be basically applied to develop scenarios that can be simulated to compare the performance evaluation of the protection schemes for different plant models.

Table 4-2 Generic Parameters for Simulating the Responses to a Fault with Different Protective Schemes

Protective Types	Near End Bus Clearing Time(s)	Far End Bus Clearing Time(s)	Near End Breaker Failure	Remote Backup Breaker(s) Opening Time(s)
Distance Relaying (DR)	0.08	0.58	None	--
Distance Relaying with Breaker Failure Protection (DRBF)	0.58	--	Yes	0.58
Telecom-based protective Relaying (PR)	0.08	0.1	None	
Protective Relaying with Telecommunication-based Breaker Failure Protection (PRBF)	0.19	--	Yes	0.1

Table 4-2 provides generic parameters for simulating the responses to a fault with the transmission line and/or with the failure of an additional breaker at one end (the near end) of the transmission line for different protection schemes that are popular in HV/EHV transmission protection. The clearing time in the table refers to the total time it takes for the circuit breakers to actuate and clear a fault after the fault has occurred. Note, the fault assumed here is detectable by the near end Zone 1 relays and the far end Zone 2 relays, e.g., a fault at 90% of the line length. The reason we are interested in this type of faults is that a transmission line fault near a bus is more severe than the fault in the middle of a transmission line because the power flow at the bus will be almost totally blocked for the former case. If the fault is detectable by both of the Zone 1 relays at the two ends of a transmission line, e.g., a fault at 50% of the line length, the time it takes to clear the fault is different. This kind of situation is not considered in this study.

Also note, if multiple lines are connected to one end of a transmission line, that end has multiple circuit breakers. Failure of each breaker may have to be considered due to the different effects it may have, as will be illustrated in Examples 2, 3, 5, and 6 in Section 4.3.2.2.

4.3.2.2 Example Scenario Definition for NPP Models and Simulation Results

Three sets of example scenarios were developed for the three NPP models and the simulation results are presented and briefly discussed in this section.

A set of example scenarios was developed to simulate the grid responses to a 90% three-phase transmission line (Line 13 of a length of 24.5 miles in the model) fault with the switchyard bus SWYDBus-1 of Plant A as the near end bus of the fault under different assumptions of protection schemes. The fault is assumed to occur at 0.2 seconds.

In the first example, it is assumed that a distance relaying scheme (DR) is used with three protection zones defined. The fault at the near end bus (bus 14) is assumed to be cleared in 80 ms (relay time 30 ms plus circuit breaker clearing time 50 ms), i.e., the circuit breakers CB16 and CB18 are opened at 0.28 seconds. Since the fault is out of the reach of the Zone 1 relays at bus 14, the fault is detected by the Zone 2 relays at substation Sub3 in the model and will be cleared with an intentional time delay of 0.5 seconds, i.e., CB54 is opened at 0.78 seconds. The frequency and voltage transients at buses SWYDBus-1 and Sub3 are shown in Figure 4-11.

The second example assumes a remote breaker failure protection scheme (no communication channel) as a backup protection of the distance relaying scheme, i.e., DRBF scheme. In this simulation, it is assumed that circuit breaker CB16 fails (CB18 still opens correctly) to open such that the fault cannot be cleared at the near end in time. The fault will still be cleared at the far end bus Sub3 at 0.78 seconds since the Zone 2 relays there are not affected. The relays of the breaker failure protection scheme, which are installed also on bus 14, detect the fault and send trip signals to circuit breakers CB1, CB4, CB7, CB10, CB13, CB 19, and CB22. After an intentional time delay of around 0.5 seconds, i.e., at 0.78 seconds, CB16 and CB18 will trip to clear the fault. Note, since many circuit breakers are tripped and bus SWYDBus-1 is lost, the induced transient might be severe although the other bus SWYDBus-2 is capable of taking over immediately. The switchyard bus responses are shown in Figure 4-12.

The third example is similar to the second one but with the assumption of CB18 failure instead of CB16. In this situation, CB17, as the remote backup circuit breaker for CB18 failure, will be tripped with an intentional time delay of 0.5 seconds. Note, another transmission line, line 12, is also connected and will be affected. Since distance scheme is assumed here, it is expected that the Zone 2 relay at the other end of line 12, bus Sub5, will detect the fault current and trip the circuit breaker CB140 with an intentional time delay of 0.5 seconds. This is a less severe scenario, although fewer numbers of breakers are tripped, compared to the second one because tripping circuit breakers CB17 and CB140 will cause a loss of another transmission line, line 12, between buses Bus13 and Sub5 in the Plant A model. The simulation results are shown in Figure 4-13.

Example 4 assumes a protective relaying scheme using telecommunications (PR) for the transmission line 13 between bus 14 and Sub3 in the Plant A-R0 model. The Zone 1 relays at bus 14 will detect the fault and open the circuit breakers CB16 and CB18 to clear the fault at near end at 0.28 seconds. In the mean time, the Zone 2 relays at bus Sub3 also detect the fault immediately and will open circuit breaker CB54 after an intentional time delay of 20 ms (this time delay is to accommodate the communication time of the tripping signal or blocking signal depending on whether it is a permissive or blocking-type protection scheme). Therefore, the fault at the far end will be cleared at 0.3 seconds. The switchyard bus responses are shown in Figure 4-14.

In Example 5, a communication-based remote breaker failure protection scheme, i.e., PRBF scheme, is adopted. In this example, breaker CB16 is assumed to fail to open and breaker CB18 will still open at 0.28 seconds. The far end fault will still be cleared at 0.3 seconds, the same as that in example 3. The Zone 1 relays at bus 14 detect the fault and send a trip signal to the remote backup circuit breakers CB1, CB4, CB7, CB10, CB13, CB19, and CB22 via communication channels. Again, a 20 ms communication time and an intentional time delay of 90 ms are assumed. Therefore, CB1, CB4, CB7, CB10, CB13, CB 19, and CB22 will open at 0.39 seconds. See Figure 4-15 for detailed switchyard bus responses.

Similar to Examples 2 and 3 for the distance relaying schemes, a variation of Example 4 is to fail circuit breakers CB18 while CB16 still opens at 0.28 seconds. CB17 is one of the remote backup breakers for CB18 and therefore, will be opened at 0.39 seconds. Note, the circuit breaker CB140 at the other end of line 12 also serves as the backup breaker for CB18. A protective relaying scheme using telecommunications is also assumed for line 12. This fault is anticipated to be detected by the Zone 2 relays at bus Sub5 and thus the circuit breaker CB140 is expected to be opened by these relays at 0.39 seconds. Again, this causes a loss of line 12, between buses Bus13 and Sub5 in the Plant A model and is a more severe scenario than Example 5.

In a summary, the frequency and voltage responses at buses SWYDBus-2 and SWYDBus-1 are shown in Figures 4-11 through 4-16. The resulting performance variations for each of the proposed example protection schemes are evident in the accompanying figures.

The bus frequency and voltage plots for Example 1 are shown in Figure 4-11. Figure 4-11 shows that, under the conventional distance relaying scheme, the magnitude of the deviation is acceptable and the transient responses after clearing the line 13 fault are quickly dampened out. Note, there is no failure associated with the protection system for line 13.

Example 2 results are shown in Figure 4-12 for the frequency and voltage responses at the selected buses SWYDBus-1 and SWYDBus-2. While some oscillations of frequency and voltage level are observed at bus SWYDBus-2, i.e., the far end of line 13, the oscillations will be suppressed, as shown in the figure. The switchyard bus SWYDBus-1 is isolated, as expected. The oscillations at bus SWYDBus-2, although dampened out eventually, are significantly more severe, especially in the beginning of the transient, where the frequency deviation at the bus is also severe. The voltage responses at the bus are also significantly degraded in terms of oscillation magnitude.

For Example 3, the responses shown in Figure 4-13 at buses SWYDBus-1 and SWYDBus-2 are apparently worse compared to Example 2 results although in Example 2. However, it can be seen that each of the cases presents a significant challenge to the NPP by inspecting the frequency and voltage responses at the switchyard buses.

Example 4 results are shown in Figure 4-14, where the improved responses are obvious compared to those shown in Figure 4-11 under distance relaying scheme. The responses for the Example 4 scenario and the Example 5 scenario (Figure 4-15) are similar to each other. Although the responses for Examples 5 and 6 (Figure 4-16) are worse than that in Example 4, as expected, much better responses are observed than those in Examples 2 and 3. In all cases, the oscillations of both frequency and voltage are quickly removed, which indicates that the NPP will experience no significant issue and should be able to ride through the transmission line fault and the primary protection failure.

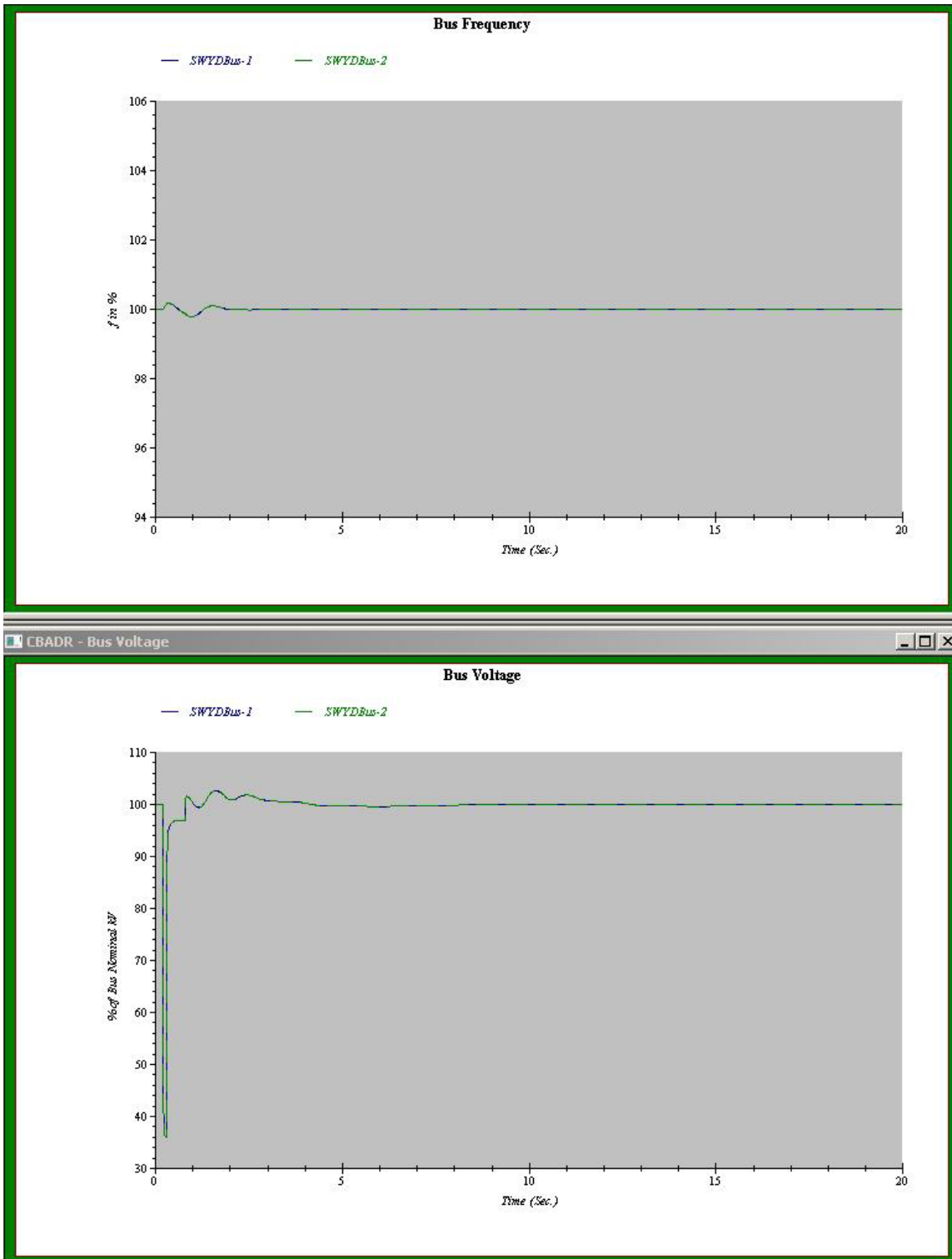

Figure 19 Example Scenario 1 for Plant A Model for Distance Relaying

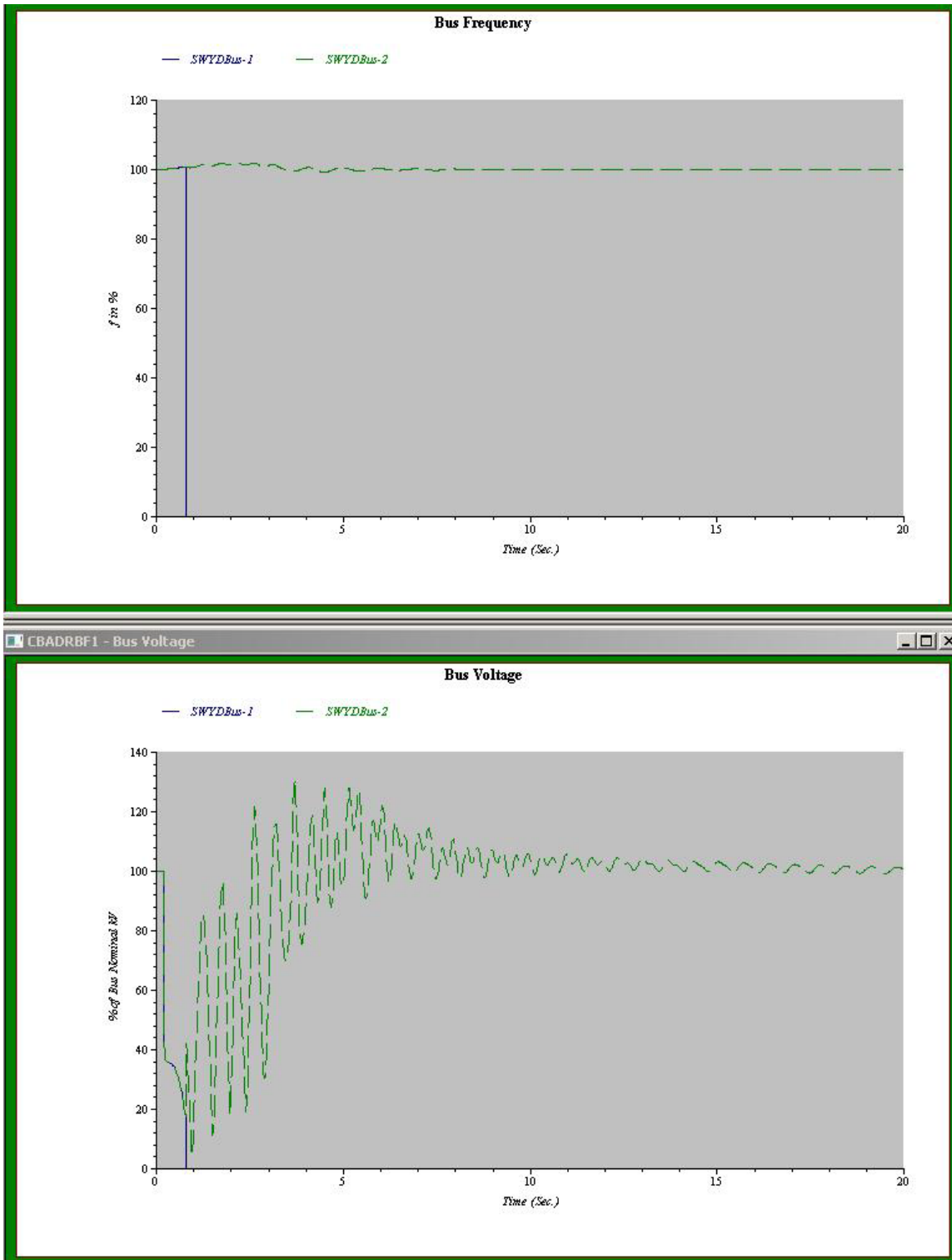

Figure 20 Example Scenario 2 for Plant A Model for Distance Relaying with Remote Breaker Failure Backup Protection

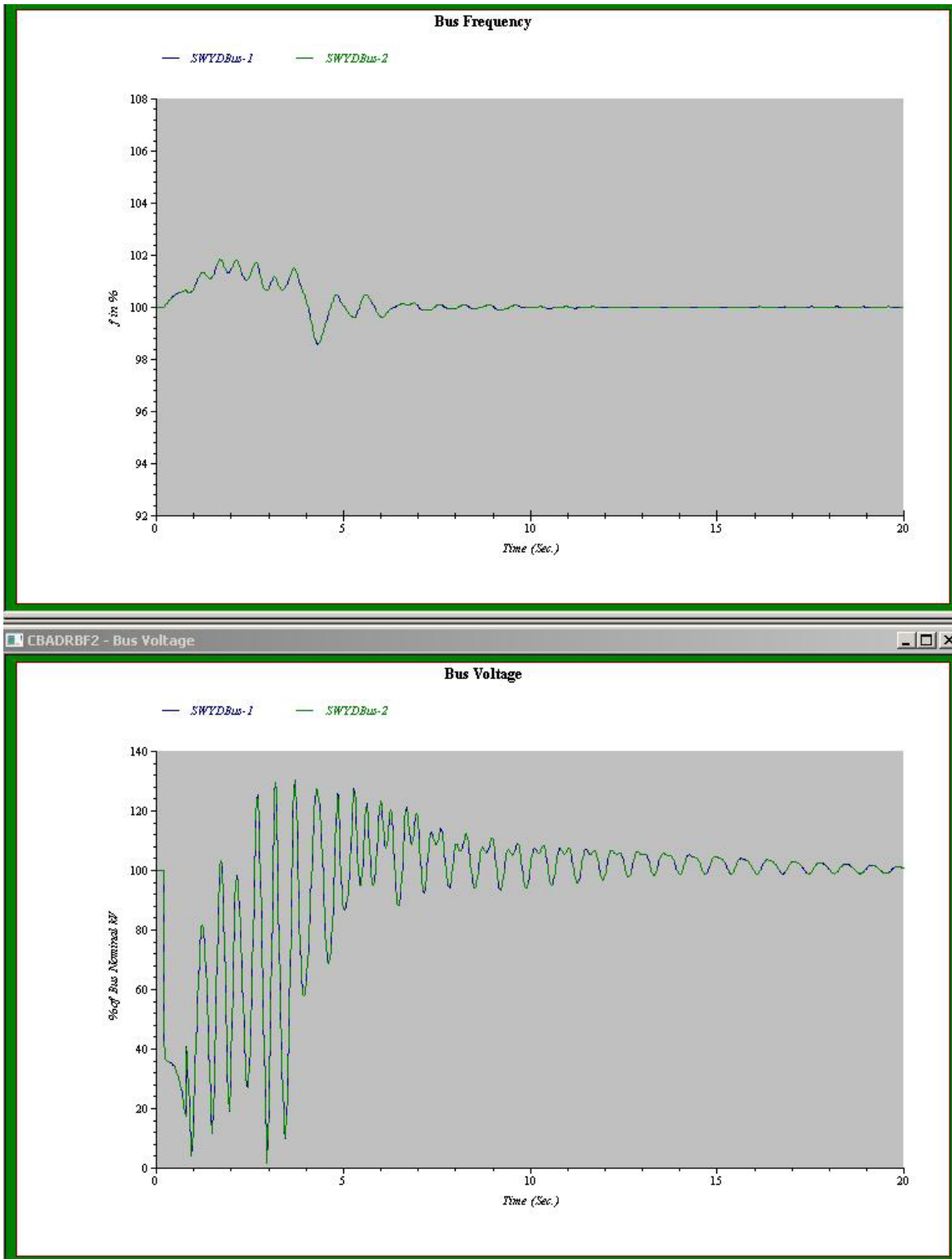

Figure 21 Example Scenario 3 for Plant A Model for Distance Relaying with Remote Breaker Failure Backup Protection

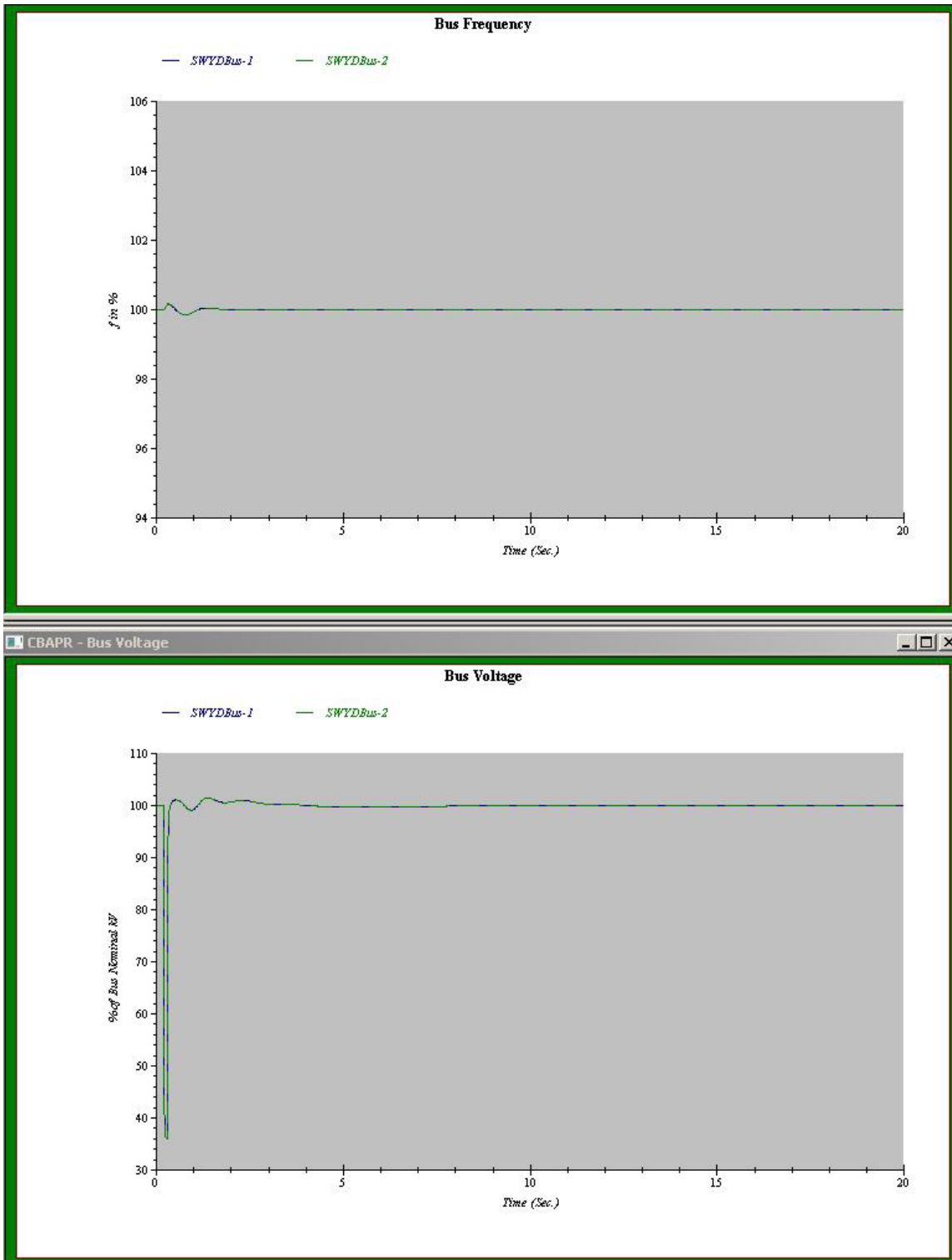

Figure 22 Example Scenario 4 for Plant A Model for Telecommunications-based Relaying

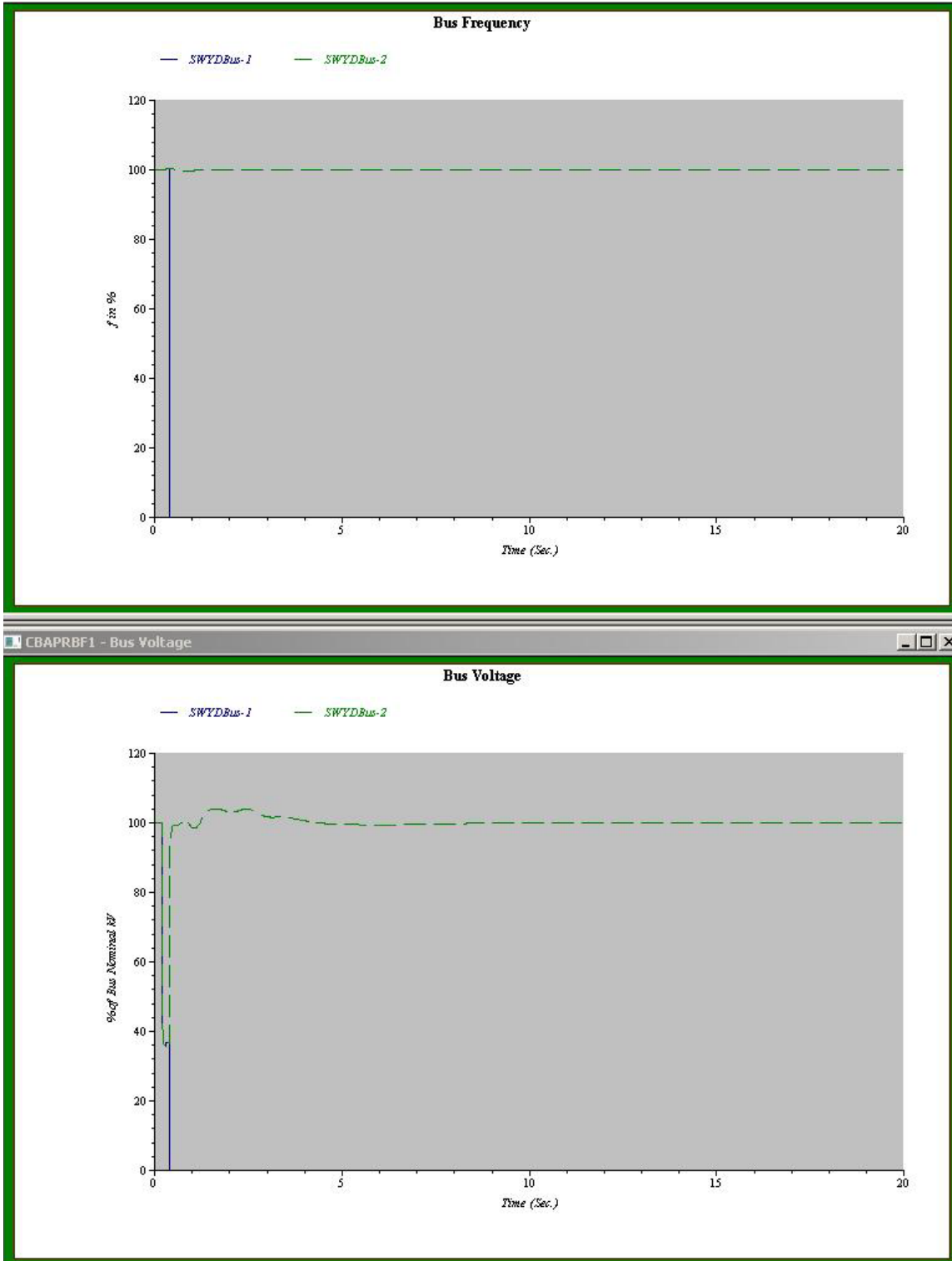

Figure 23 Example Scenario 5 for Plant A Model for Telecommunications-based Relaying with Remote Breaker Failure Backup Protection

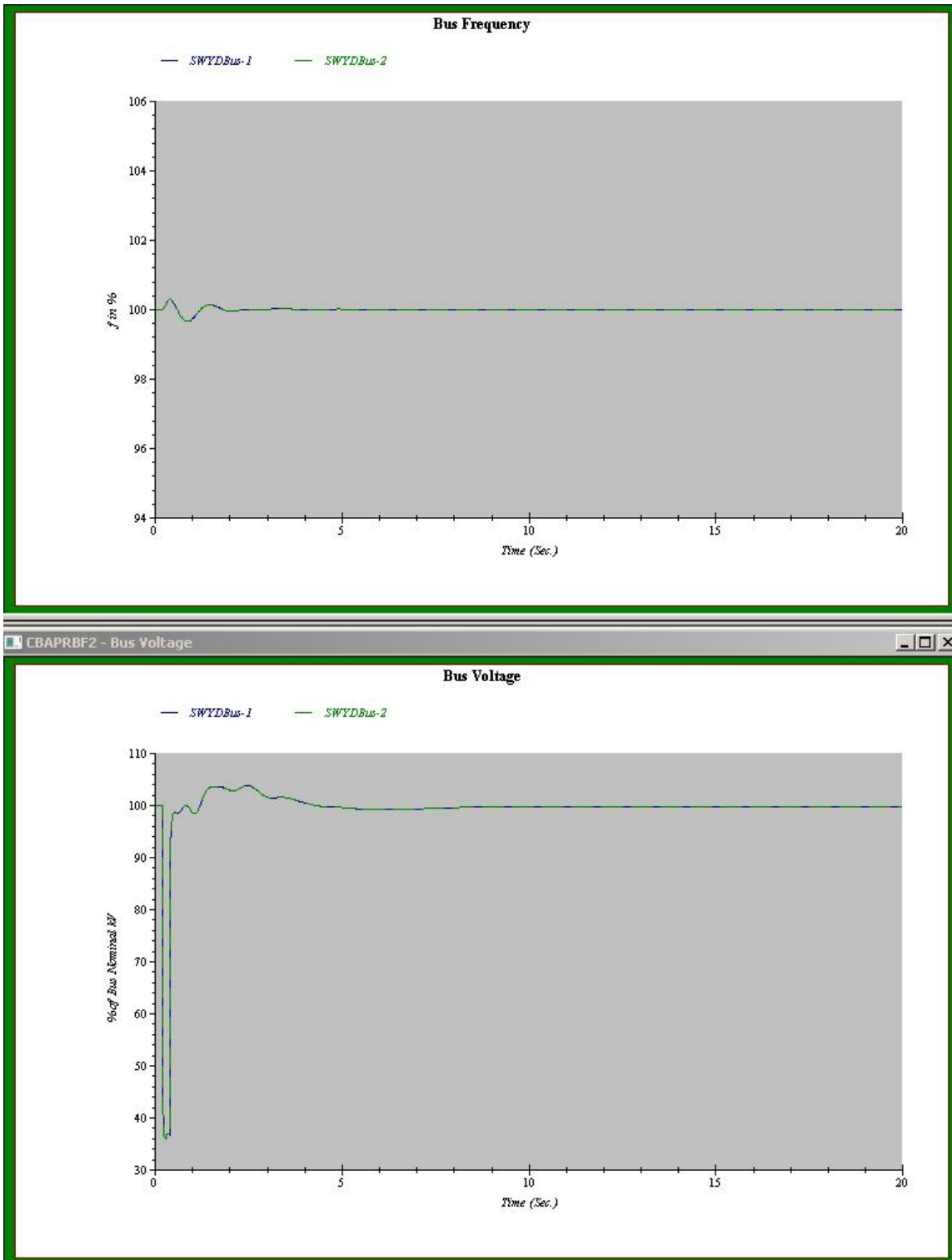

Figure 24 Example Scenario 6 for Plant A Model for Telecommunications-based Relaying with Remote Breaker Failure Backup Protection

Similar scenarios are defined for line 13 (44 miles) of Plant B model and line 5007 (105 miles) of Plant C model.

For line 13 of Plant B fault with DR scheme, CB922 and CB925 (near end) and CB332 (far end) will open 0.08 s and 0.58 s after the fault, respectively. This is called Example 1 for Plant B model.

For the DRBF scheme, it is first assumed that CB922 fails and CB925 still open correctly. As the remote breaker failure backup, CB902, CB912, CB932, CB942, CB972, CB982, CB992, and CB9102 will open after 0.58 seconds of the fault occurrence. The far end circuit breaker CB332 also open 0.58 seconds after the fault. This is indicated as Example 2 for Plant B model.

In Example 3 for Plant B model, the DR scheme is still used but it is assumed that CB925 fails to open. As the breaker failure backup, CB928 and CB660 will be opened 0.58 seconds after the fault occurrence. Opening CB660 will lead to a loss of power supply to the onsite 525 kV/13.8 kV transformer AE-NAN-X01 that supplies power to 13.8 kV buses 2E-NAN-S05 and 3E-NAN-S06. The power will be provided by their backup power supply via bus switching scheme. A typical bus switching time is assumed to be 5 cycles or around 80 ms [Trehan 2003]. Therefore, 0.66 seconds after the fault, circuit breakers CB396 and CB450 will be closed to continue the power supply to buses 2E-NAN-S05 and 3E-NAN-S06 (See Figure 4-2).

In Example 4, the PR scheme is used. Therefore, CB922 and CB925 (near end) and CB332 (far end) will open 0.08 s and 0.3 s after the fault, respectively. Example 5 assumes the PR scheme with remote breaker failure backup. It is also assumed that CB922 fails to open. Therefore, CB925 will open at 0.28 seconds. CB332 still opens at 0.3 seconds. CB902, CB912, CB932, CB942, CB972, CB982, CB992, and CB9102 will open after 0.19 seconds of the fault occurrence, i.e., 0.39 seconds.

In Example 6, CB925 is assumed to fail instead. CB922 and CB332 will open at 0.28 and 0.3 seconds, respectively. CB928 and CB660 will also open, similar to Example 3, but at 0.39 seconds. In the mean time, CB396 and CB450 will close 0.08 seconds (the bus switching time) after the opening of CB660.

The frequency and voltage responses at the two switchyard buses EB and WB for the six examples scenarios are shown in Figures 4-17 through 4-22. Note that in Example scenarios 2 and 3, i.e., under DRBF scheme, both frequency and voltage responses of the switchyard buses are unacceptable due to continuous oscillations. While it is understood that the response in the simulation model may deviate the response that might occur at the real plant, it is certain that additional breaker failure under a distance relaying scheme may pose much more significant challenge to the NPP. For the protective relaying scheme using telecommunications, on the other hand, none of the three scenarios raise any issue to the plant operation, as shown in Figures 4-20 through 4-22.

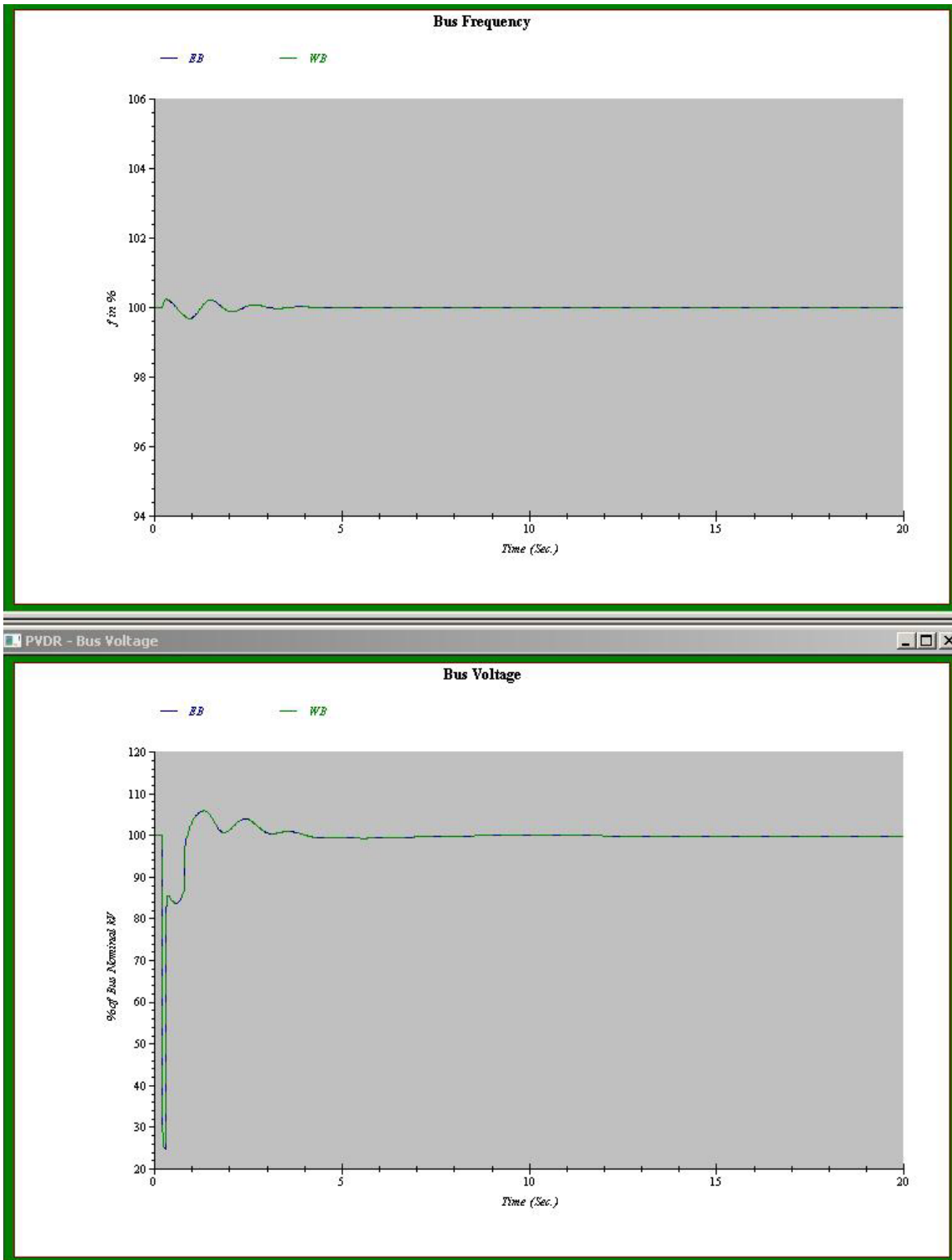

Figure 25 Example Scenario 1 for Plant B Model for Distance Relaying

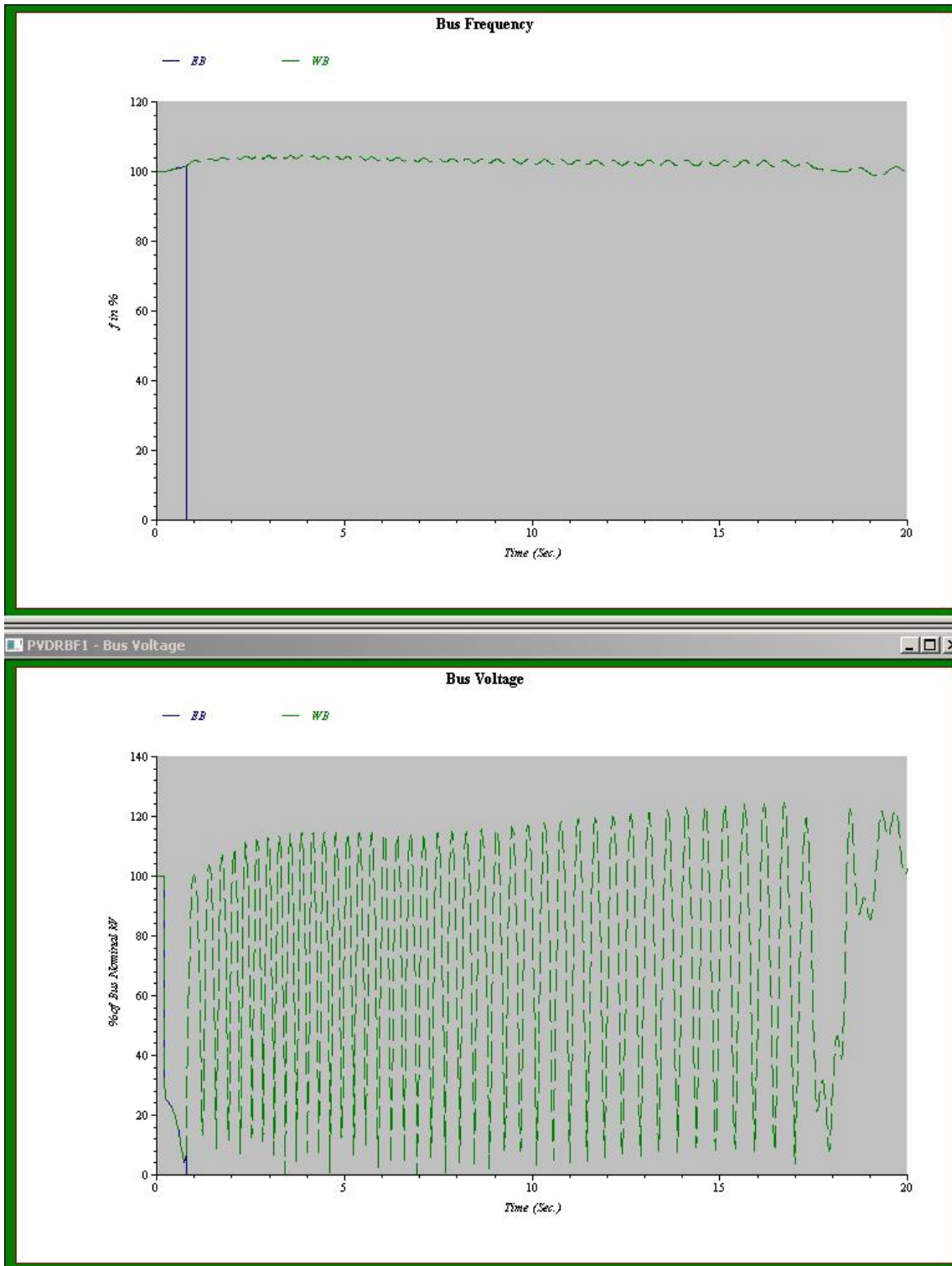

Figure 26 Example Scenario 2 for Plant B Model for Distance Relaying with Remote Breaker Failure Backup Protection

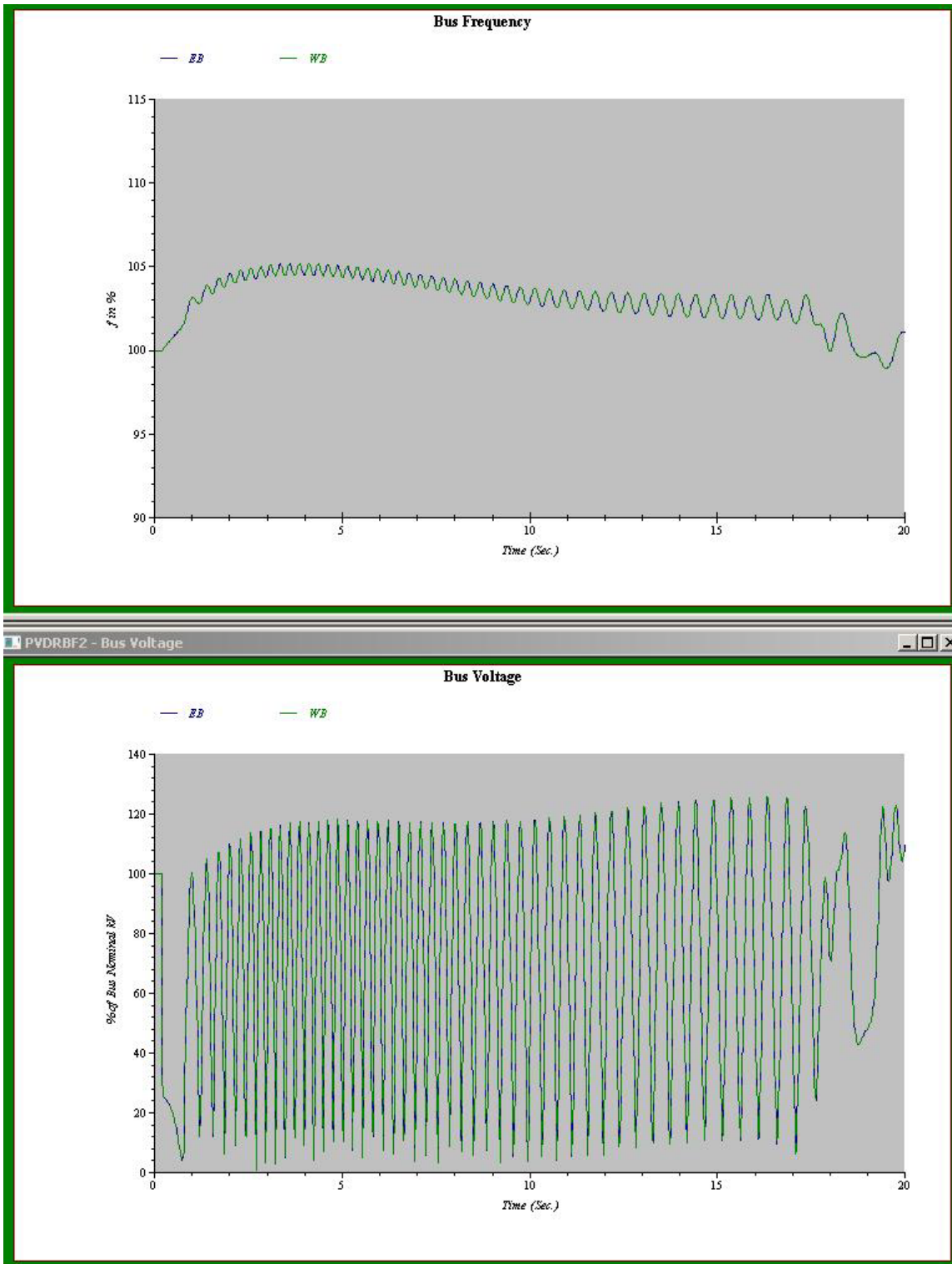

Figure 27 Example Scenario 3 for Plant B Model for Distance Relaying with Remote Breaker Failure Backup Protection

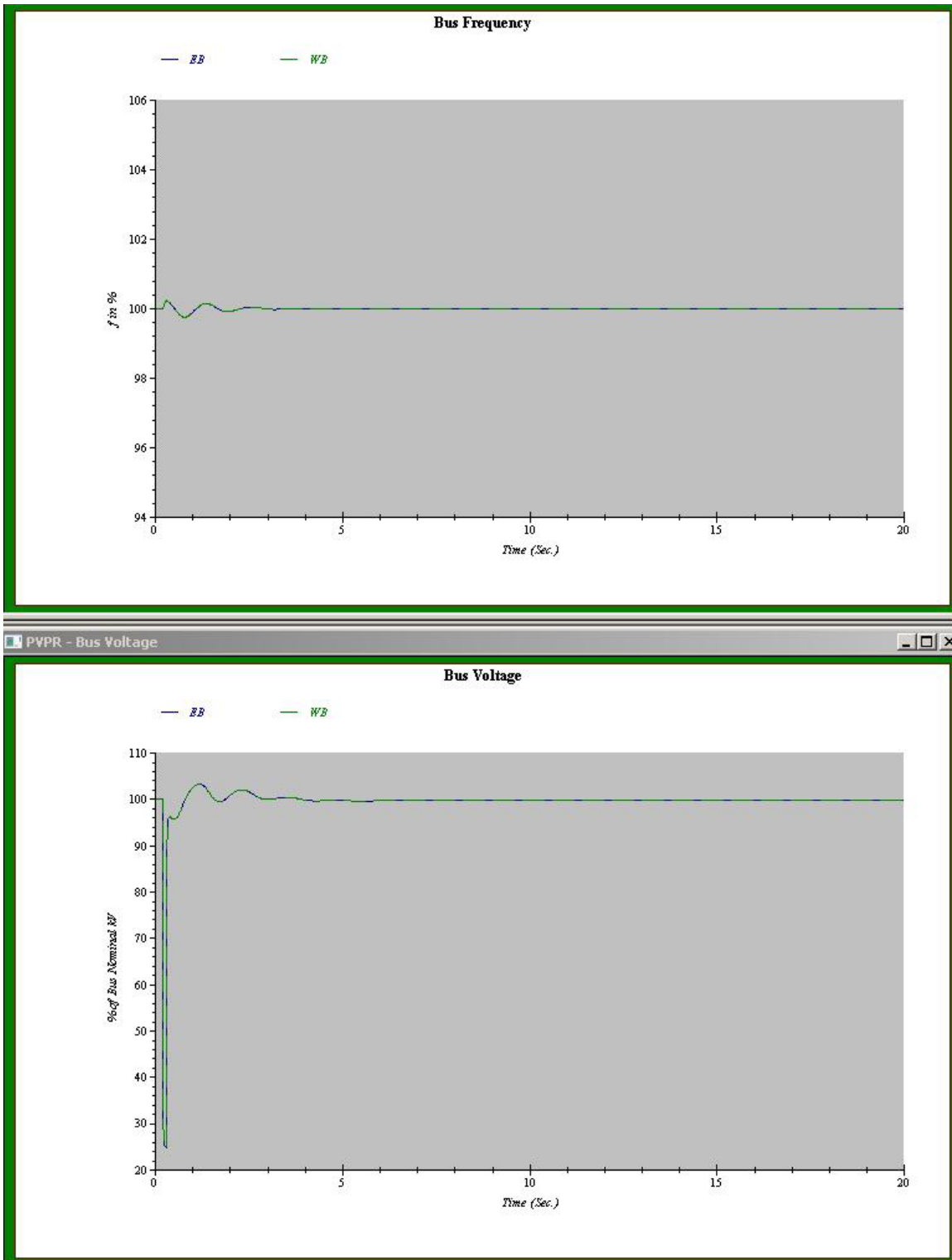

Figure 28 Example Scenario 4 for Plant B Model for Telecom-based Relaying

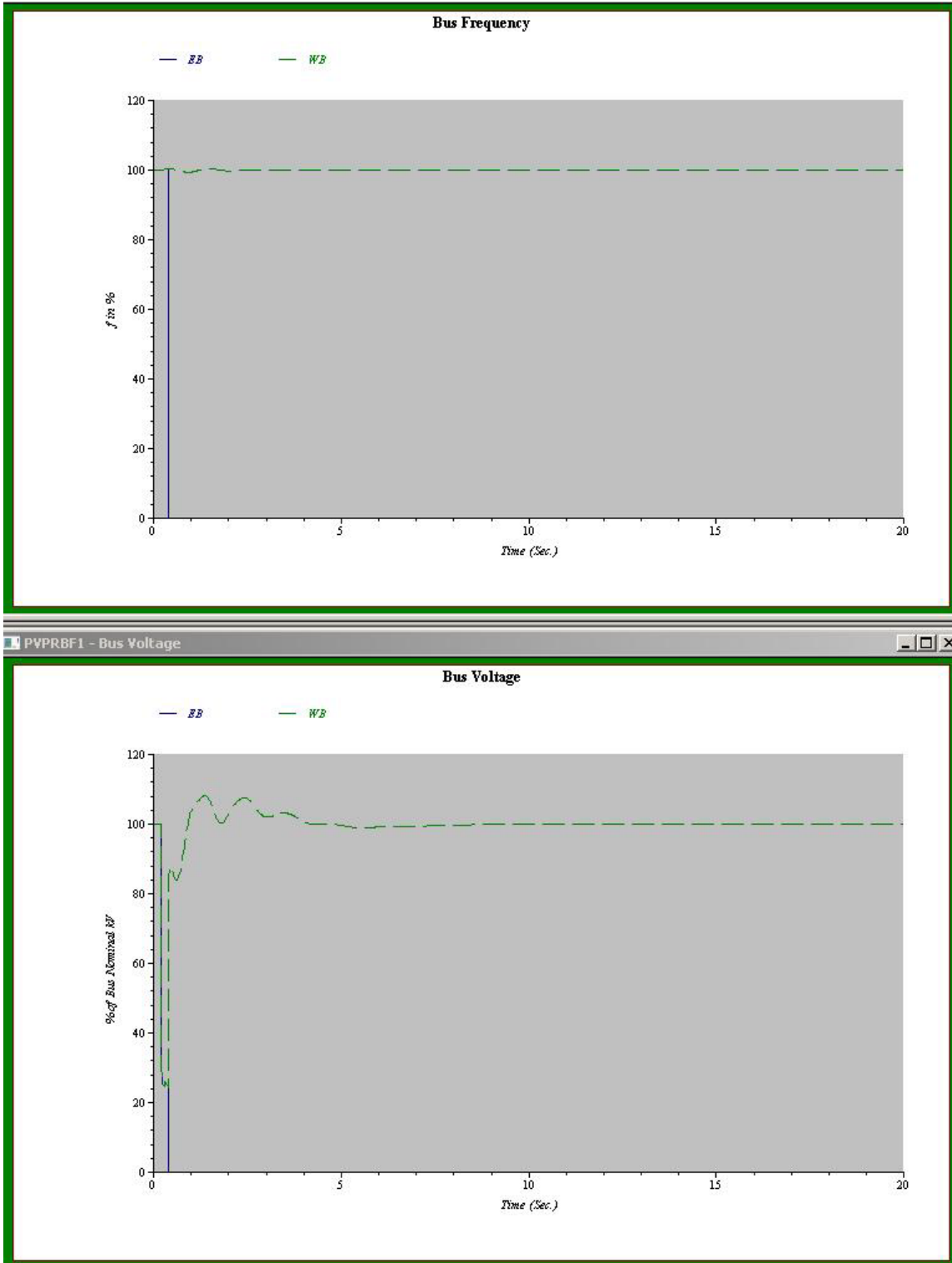

Figure 29 Example Scenario 5 for Plant B Model for Telecommunications-based Relaying with Remote Breaker Failure Backup Protection

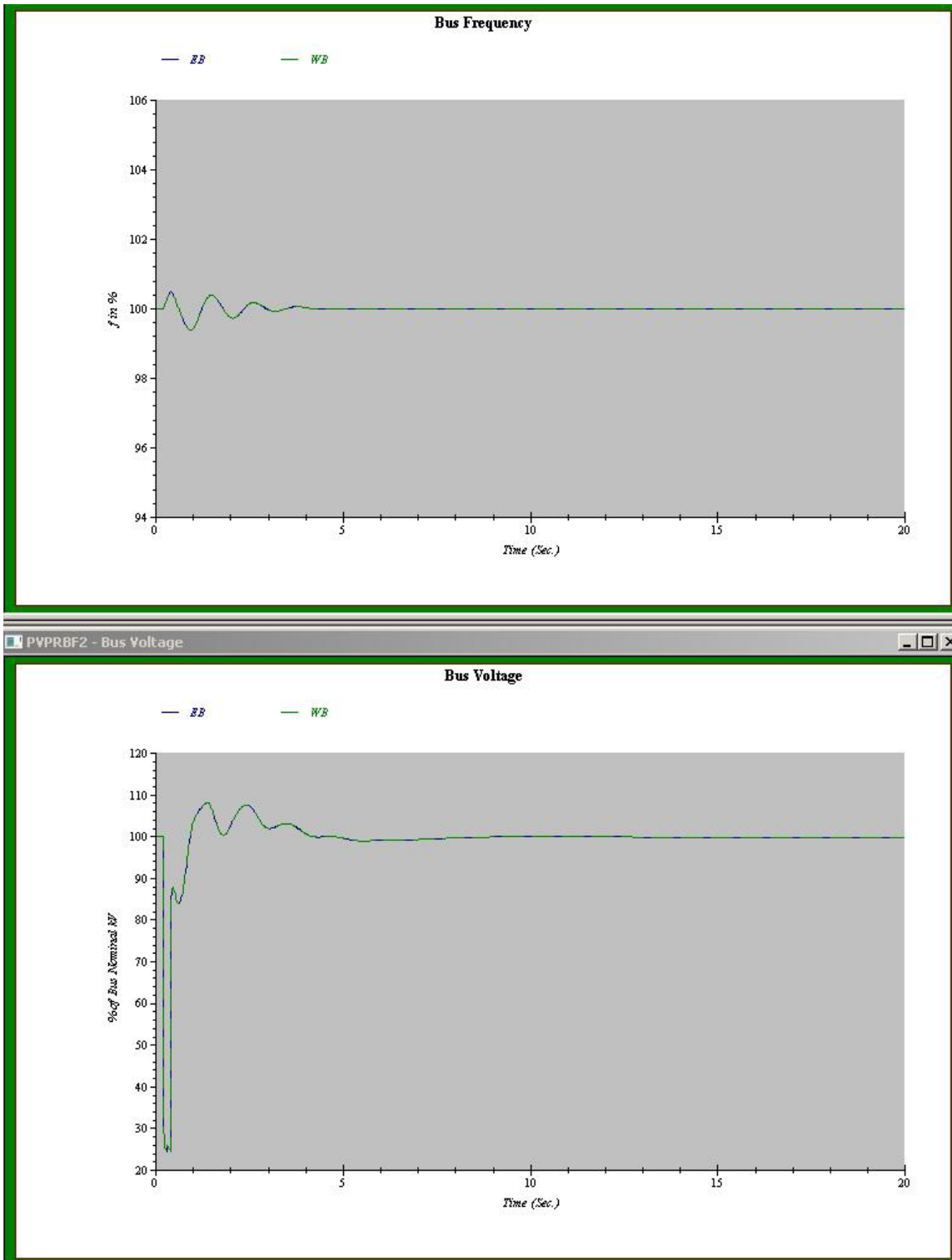

Figure 30 Example Scenario 6 for Plant B Model for Telecommunications-based Relaying with Remote Breaker Failure Backup Protection

Finally, six scenarios are defined for Line 5007 of Plant C model. For 105 mile Line 5007 between buses Bus93 and Sub1, a 90% three phase fault occurs near Bus93, one of the ring buses of the Plant C switchyard. The near end circuit breakers are CB15 and CB65 while the far end breaker is CB119.

For Example 1, a DR is assumed. Therefore, CB15 and CB65 will open around 80 ms after the fault occurrence and the far end CB119 will open at 0.78 seconds. Two of the switchyard buses are selected and the frequency and voltage responses of theirs are shown in Figure 4-23. With the prompt fault clearing at the near end, the NPP should not have any issue with its normal operation.

Example 2 uses the DRBF scheme and one of the near end circuit breakers CB15 is assumed to fail. CB65 and CB119 will open at 0.28 and 0.78 seconds, respectively. As the remote breaker failure backup, CB25, CB205, and CB235 at the switchyard will open after 0.5 seconds delay. The two switchyard bus responses are shown in Figure 4-24.

Example 3 again uses DRBF scheme but the failure of CB65 is assumed here. CB15 and CB119 will open at 0.28 and 0.78 seconds. The backup breakers for the failure of CB65 are CB4, CB5, and CB55, which will be opened also 0.78 seconds. The responses are shown in Figure 4-25. The degraded grid responses for Example scenarios 2 and 3 are clear compared to Example 1 results.

For Example 4, the near end circuit breakers CB15 and CB65 will open at 0.28 seconds and the far end CB119 will be opened at 0.3 seconds.

In Example 5, the PRBF scheme is used and one of the near end breakers CB15 is assumed to fail. CB65 will open at 0.28 seconds while CB119 opens at 0.3 seconds. The remote backup breakers for CB15 are CB25, CB205, and CB235, which will be opened at 0.39 seconds.

Example 6 again assumes PRBF scheme and CB65 is assumed to fail to open. CB15 will be opened at 0.28 seconds and CB119 still opens at 0.3 seconds. The remote backup circuit breakers CB4, CB5, and CB55 are opened at 0.39 seconds, as scheduled.

The switchyard buses responses for Examples 4, 5, and 6 are shown in Figures 4-23 to 4-28.

A review of all of the example scenarios for the three plants indicates that the same conclusions can be drawn, i.e., the tighter protective schemes at the NPP switchyard will enhance the capability of the NPP to ride through the faults originated in the transmission grid. Considering the impact severity of the faults at different distances from the NPP switchyard, as shown in Section 4.3.1, making the protective schemes nearby a NPP tighter will serve the same purpose.

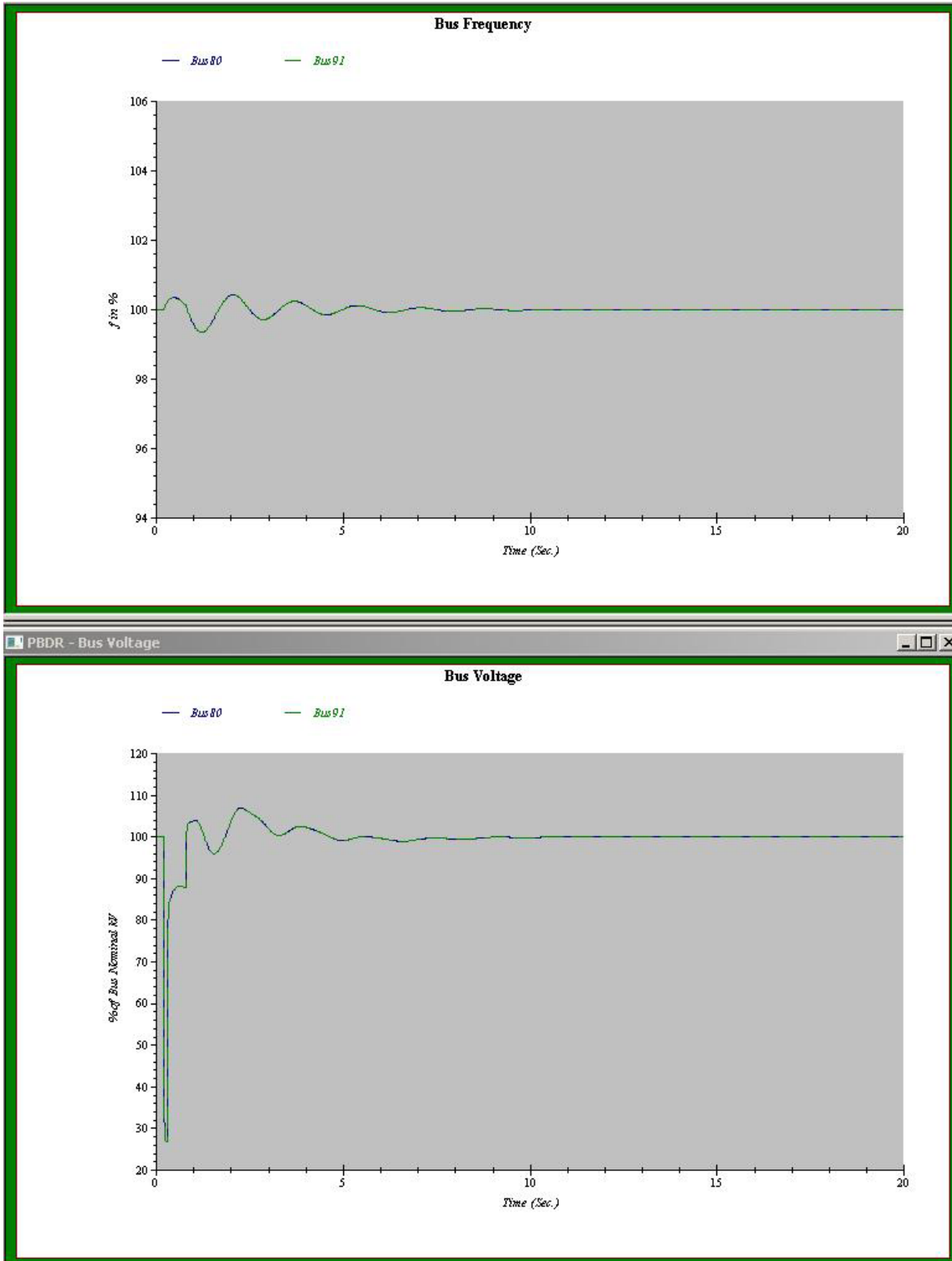

Figure 31 Example Scenario 1 for Plant C Model for Distance Relaying

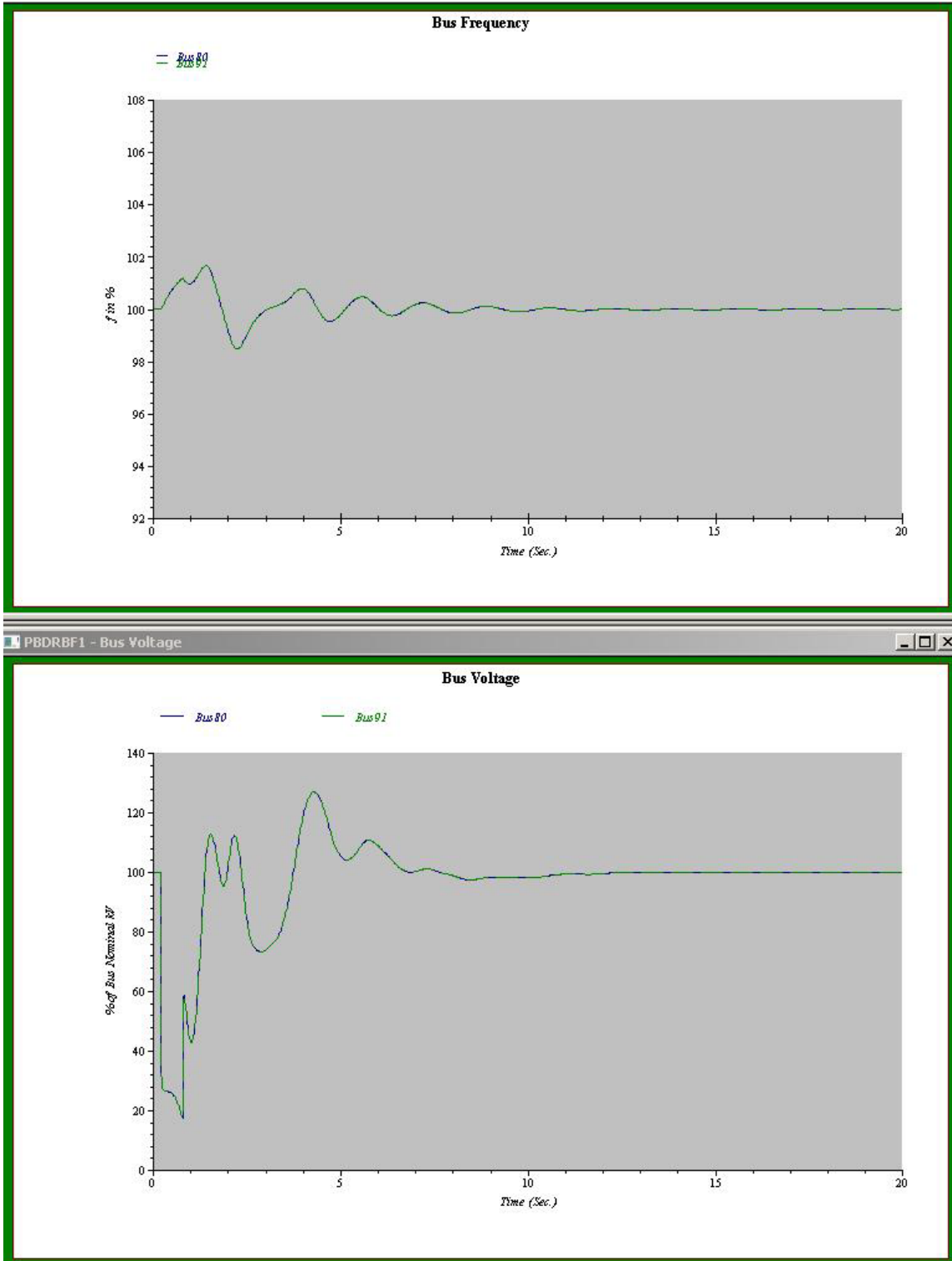

Figure 32 Example Scenario 2 for Plant C Model for Distance Relaying with Remote Breaker Failure Backup Protection

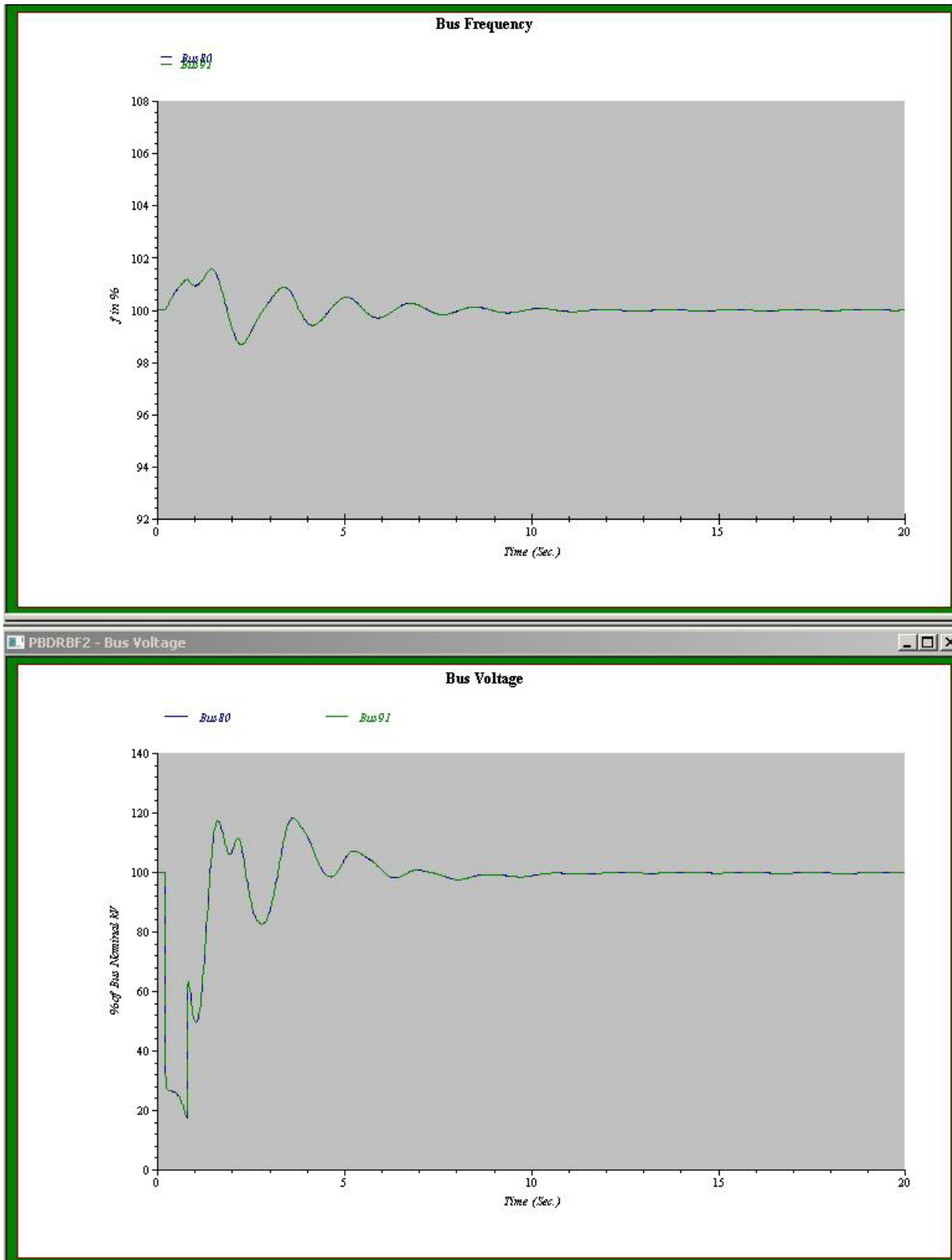

Figure 33 Example Scenario 3 for Plant C Model for Distance Relaying with Remote Breaker Failure Backup Protection

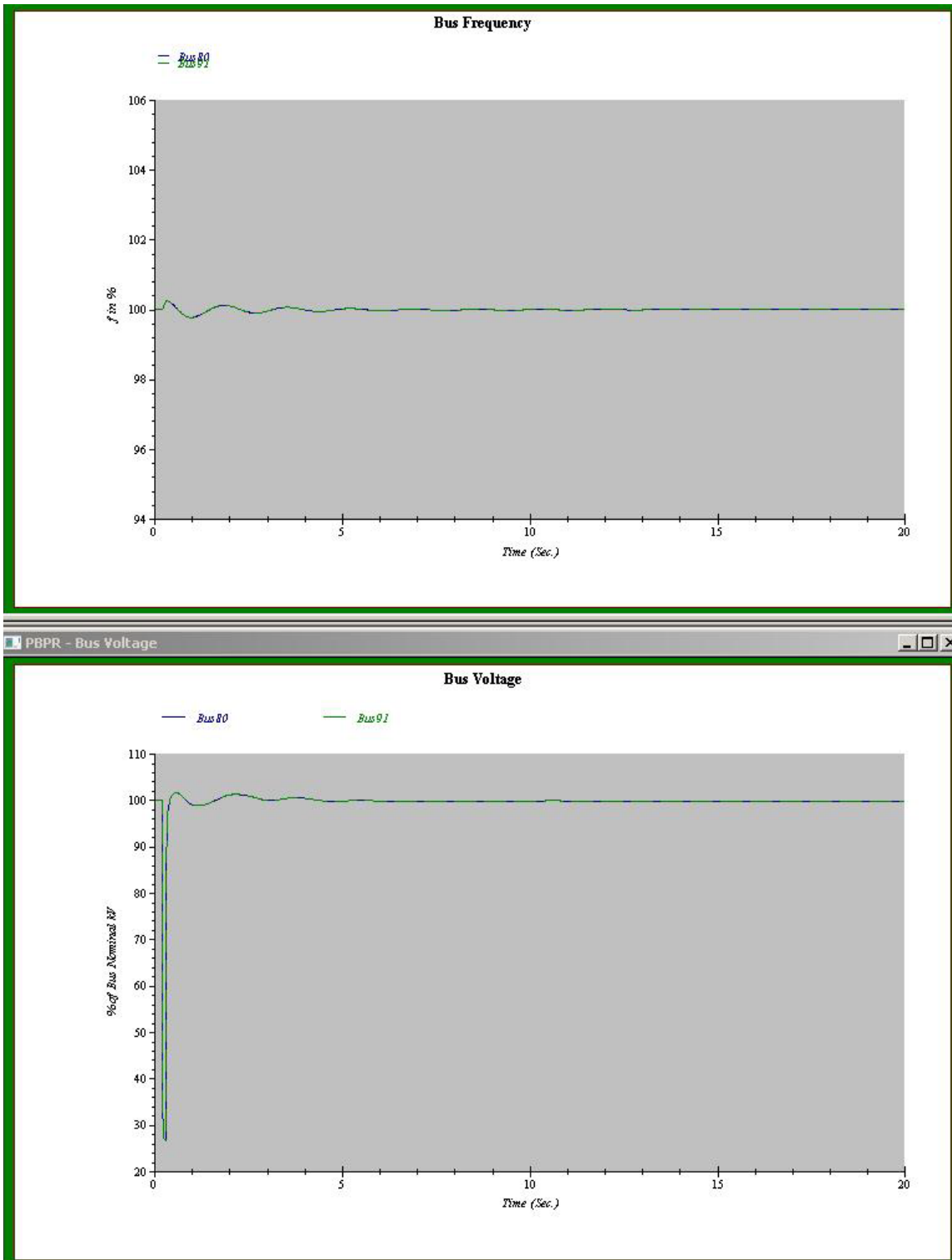

Figure 34 Example Scenario 4 for Plant C Model for Telecom-based Relaying

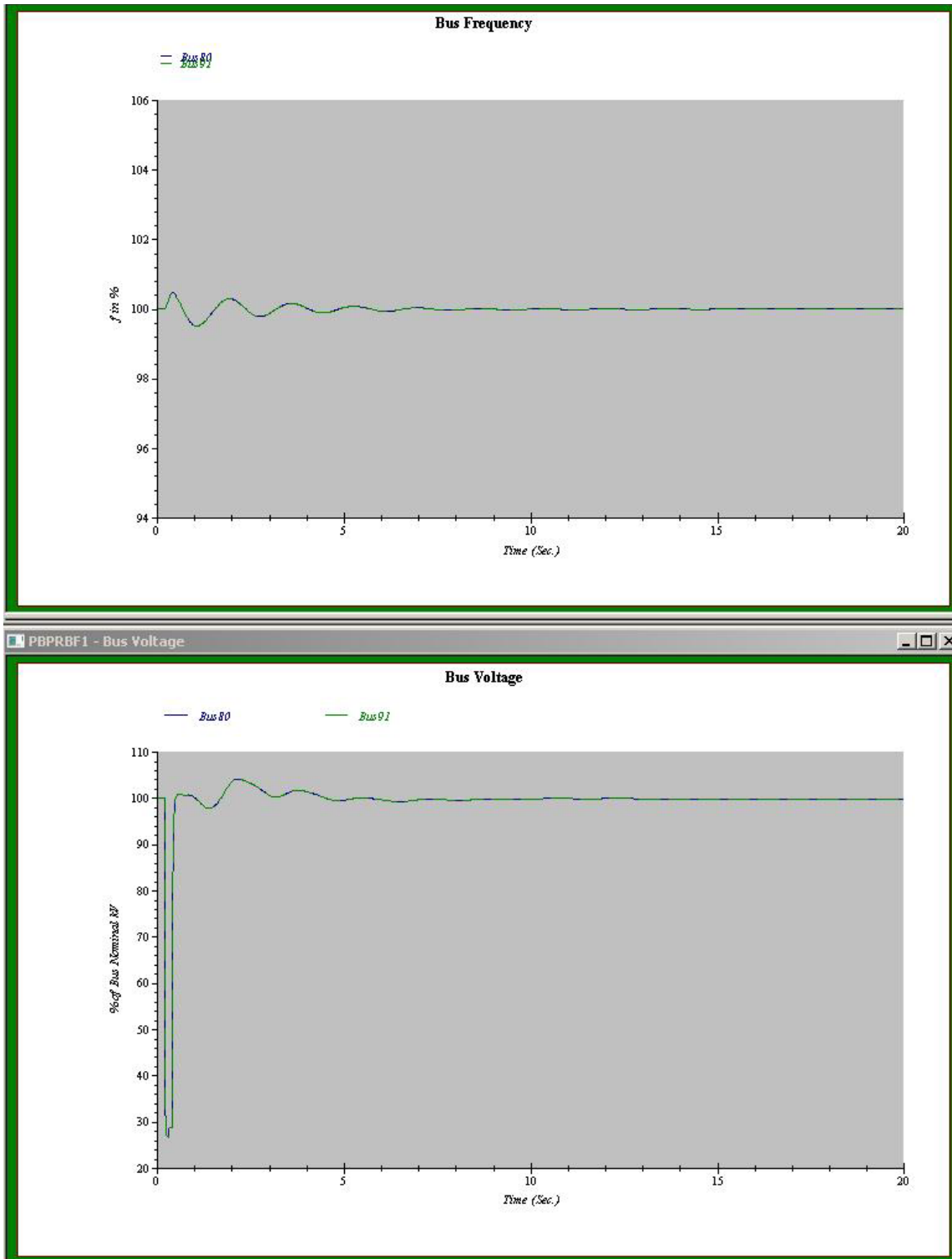

Figure 35 Example Scenario 5 for Plant C Model for Telecommunications-based Relaying with Remote Breaker Failure Backup Protection

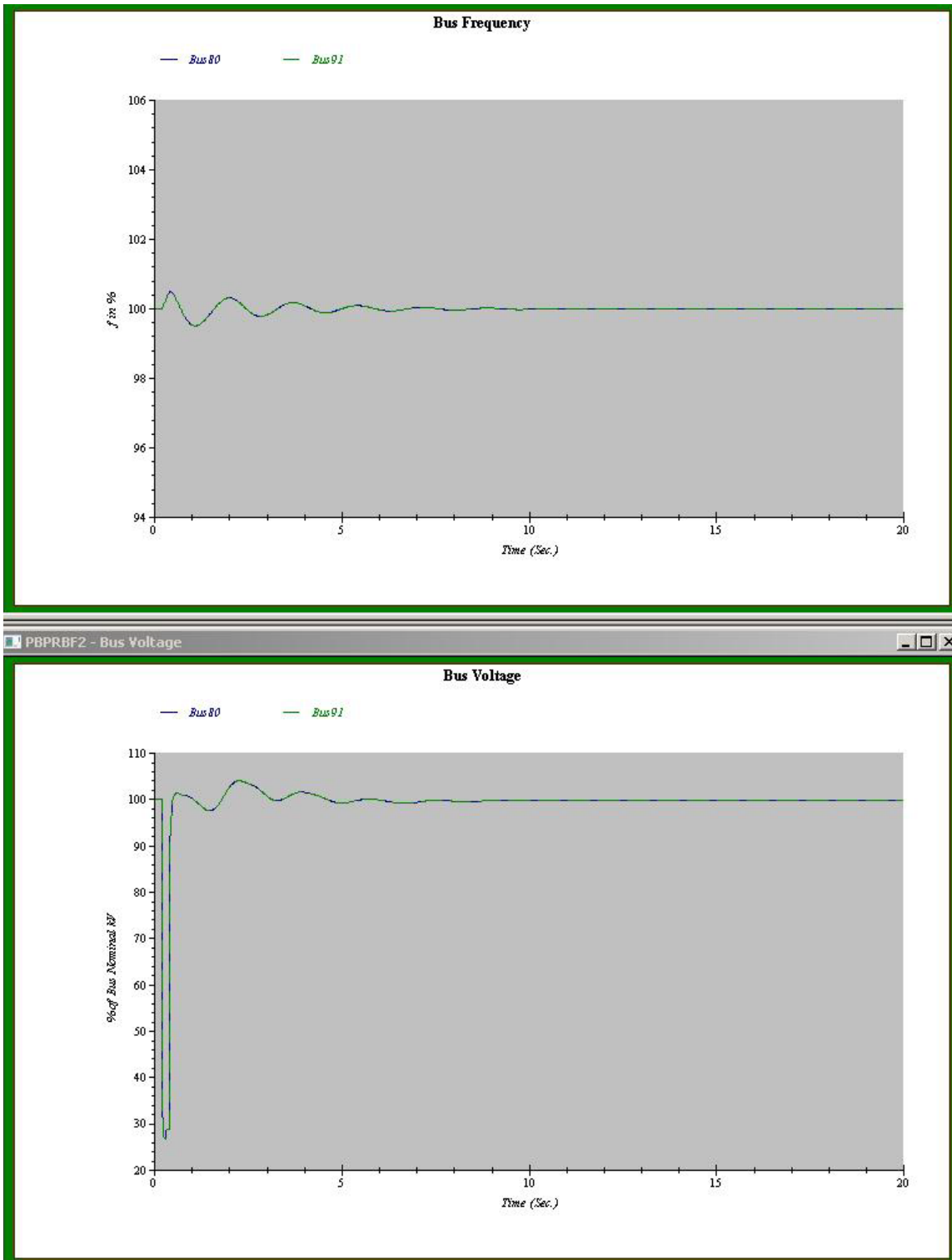

Figure 36 Example Scenario 6 for Plant C Model for Telecommunications-based Relaying with Remote Breaker Failure Backup Protection

The range of a tighter protective scheme is plant-specific. A simulation of scenarios similar to those defined in Section 4.3.1 in an exhaustive manner would need to be performed to evaluate the effect of tighter protective system settings. However, the number of scenarios needed to be simulated should not be very difficult to handle as the effects of faults that are relatively far from the NPP switchyard should not be very different.

The focus of this section is on the evaluation of protection schemes for transmission lines. For bus protection, similar scenarios can be defined. As indicated in Section 2, a differential relaying scheme is most commonly used for a bus protection. For any internal fault, it is desired that the bus be isolated instantaneously without any intentional time delay. If one of the breakers fails, its backup breaker(s) may be activated by the differential relays at the bus with intentional time delay that changes, e.g., a short time delay for a telecommunications-based breaker failure backup scheme.

4.3.2.3 Anticipatory Trip of Zone 3 Relays

In this section, an investigation of anticipatory trip by reducing the time delay of Zone 3 relays of the faulted zone and tripping the breakers connected to the switchyard is presented. As indicated in Section 2.3.1.1, e.g., in Figure 2-4, if fault F_4 were not cleared by the primary protection (i.e., the Zone 1 and Zone 2 protection) of line BC , Zone 3 relays at bus A will open the breaker near bus C at line BC after approximately two seconds of the fault occurrence. The anticipatory Zone 3 protection is similar to the concept of a Zone 3 protection but with a probably much shorter time delay. Note that the purpose of having two seconds delay is to coordinate with the primary protection of line BC . Reduction in the time delay means a loss (or a partial loss) of this coordination between them. Compared to the breaker failure backup protection scheme, an anticipatory Zone 3 protection has the advantage that it does not trip additional components. Furthermore, if the Zone 3 protection relays were installed at switchyard buses watching only the adjacent lines providing offsite power, a reduced time delay with Zone 3 relays to isolate the fault with the adjacent line(s) will certainly alleviate the adverse effect of the primary protection failure. Note that the anticipatory trip of Zone 3 is similar to the breaker failure backup protection scheme in the sense that Zone 3 relays may trip extra components.

Scenarios are developed here by using Plant B as an example system. To better illustrate the concept, a postulated transmission line of a length 10 miles, Line31, is added between bus Sub3 and bus Bus86 in Figure 4-2. A 10% three-phase fault is postulated for Line31 at 0.2 seconds. It is also postulated that Zone 1 and Zone 2 relays at Sub3 are watching Line31. In this scenario, Zone 2 relays at Bus93 cannot reach the fault and Zone 3 relays at Bus93 becomes critical in terms of fault clearing (see the diagram in Figure 4-29 for the configuration of the components involved). Considering a typical protection scheme using telecommunications as shown in Figure 5, scenarios with different time delays, namely 1.4, 0.9, and 0.4 seconds, with the Zone 3 relays installed at Bus93 are developed and simulated. Note, the minimum delay of 0.4 seconds is selected because the Zone 2 relaying at Sub3, if it functions properly, will open breaker CB355 to isolate the fault if the fault lasts longer than 0.4 seconds. Therefore, three scenarios of an anticipatory Zone 3 trip correspond to, by assuming that Zone 1 relays at Bus86 work properly (i.e., CB500 opens at 0.28 seconds), the opening of circuit breakers CB932 and CB935 at 1.6, 1.1, and 0.6 seconds, respectively. These three scenarios are indicated as Line31-Scenario 1, 2, and 3, respectively. The voltage and frequency responses at switchyard buses EB and WB are shown in Figures 4-30 through 4-32. The simulation results show that, with anticipatory Zone 3 relays enabled at the switchyard,

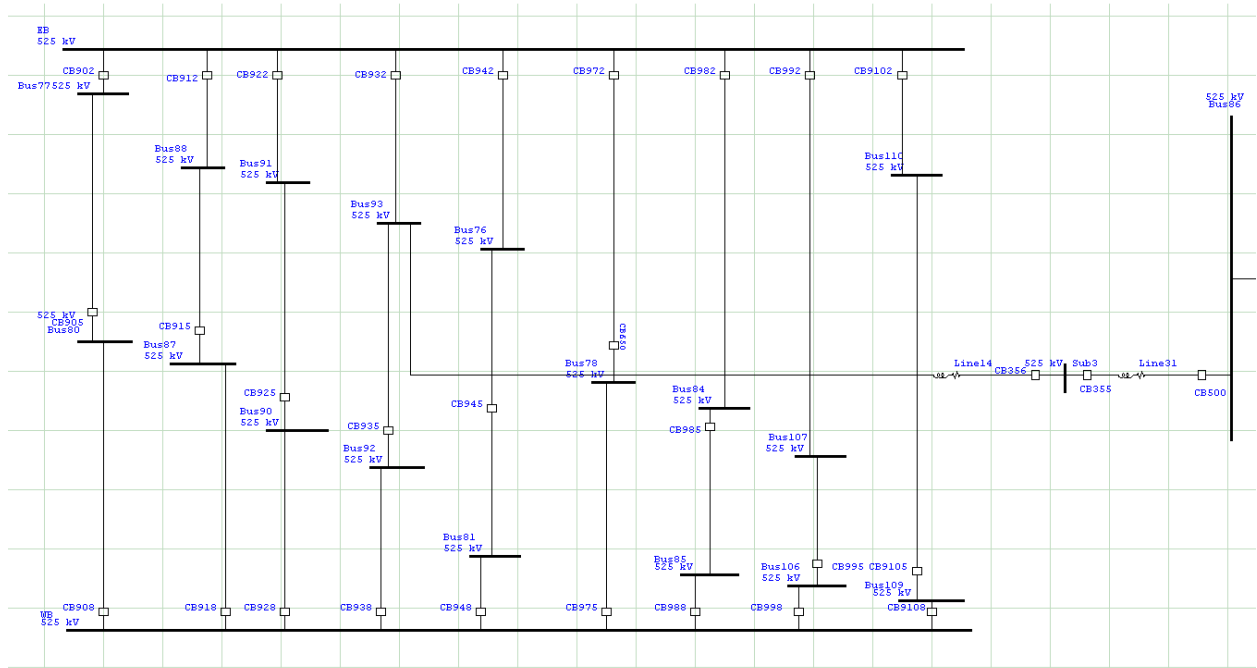

Figure 37 Switchyards of Plant A and a Neighboring Substation

reducing the time delay can significantly improve the switchyard bus responses. Note, if time delay is set longer than 0.4 seconds, the Zone 3 relay does not trip components that do not have to even if the primary protective relays function properly.

4.3.2.4 More Postulated Scenarios without Simulation

This section discusses some additional postulated scenarios. For these scenarios, simulation is not necessary and analyses are provided based on the one-line diagram of the plant model. It is well-known that a turbine trip will lead to a reactor trip directly. A turbine trip could be immediately caused if the generator has to be taken off-line. Taking the switchyard of the Plant B model as an example, generator G31 is connected to the switchyard between two circuit breakers CB915 and CB918. A postulated scenario is a three-phase 90% fault with Line 12 followed by the failure of breaker CB915 when attempting to clear the fault. An immediate effect of this breaker failure is that the generator G31 will directly feed the fault. It is very likely that the generator will soon be taken offline by its protection systems, e.g., the generator negative phase sequence relays or volts per Hertz relays described in Section 2 and Appendix D. The above analysis of this postulated scenario implies that the middle circuit breaker CB915 (and the relay(s) associated with it) is critical and needs to be highly reliable in order to enhance the fault ride-through capability of the generator. Breakers CB935 and CB985 play the same role as they are connected to generators G21 and G11, respectively. CB918, CB938, and CB988 can be used to isolate the fault with bus WB and their failure may result in the same impact on the generator operations. This can be seen from Figure 4-2.

Similar analysis can be performed for a ring-bus configuration switchyard, e.g., the Plant C model. Circuit breakers CB905 and CB245 that are connected to generator G6.

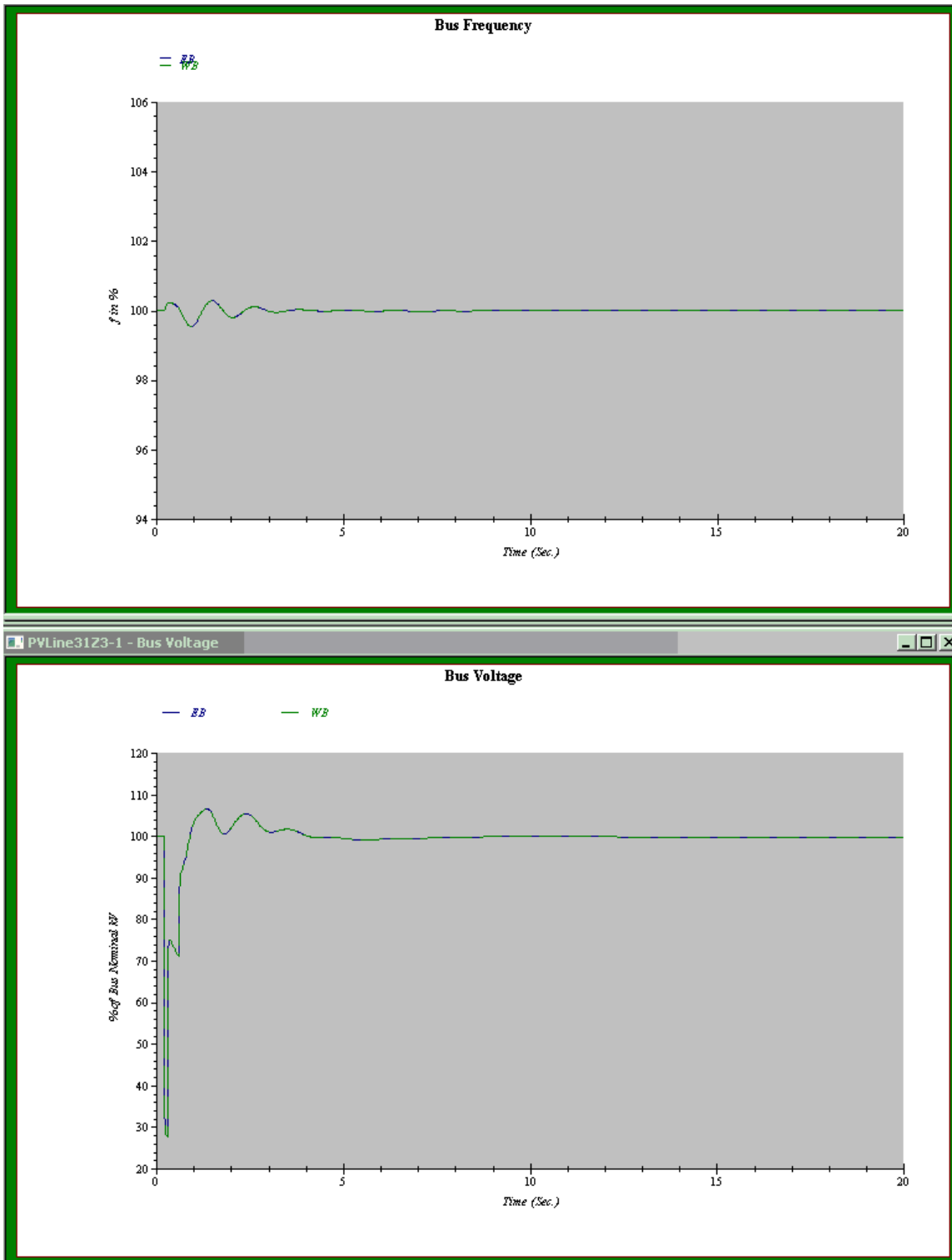

Figure 38 Line31 – Scenario 1 for Zone 3 Anticipatory Trip (0.4 Seconds Delay)

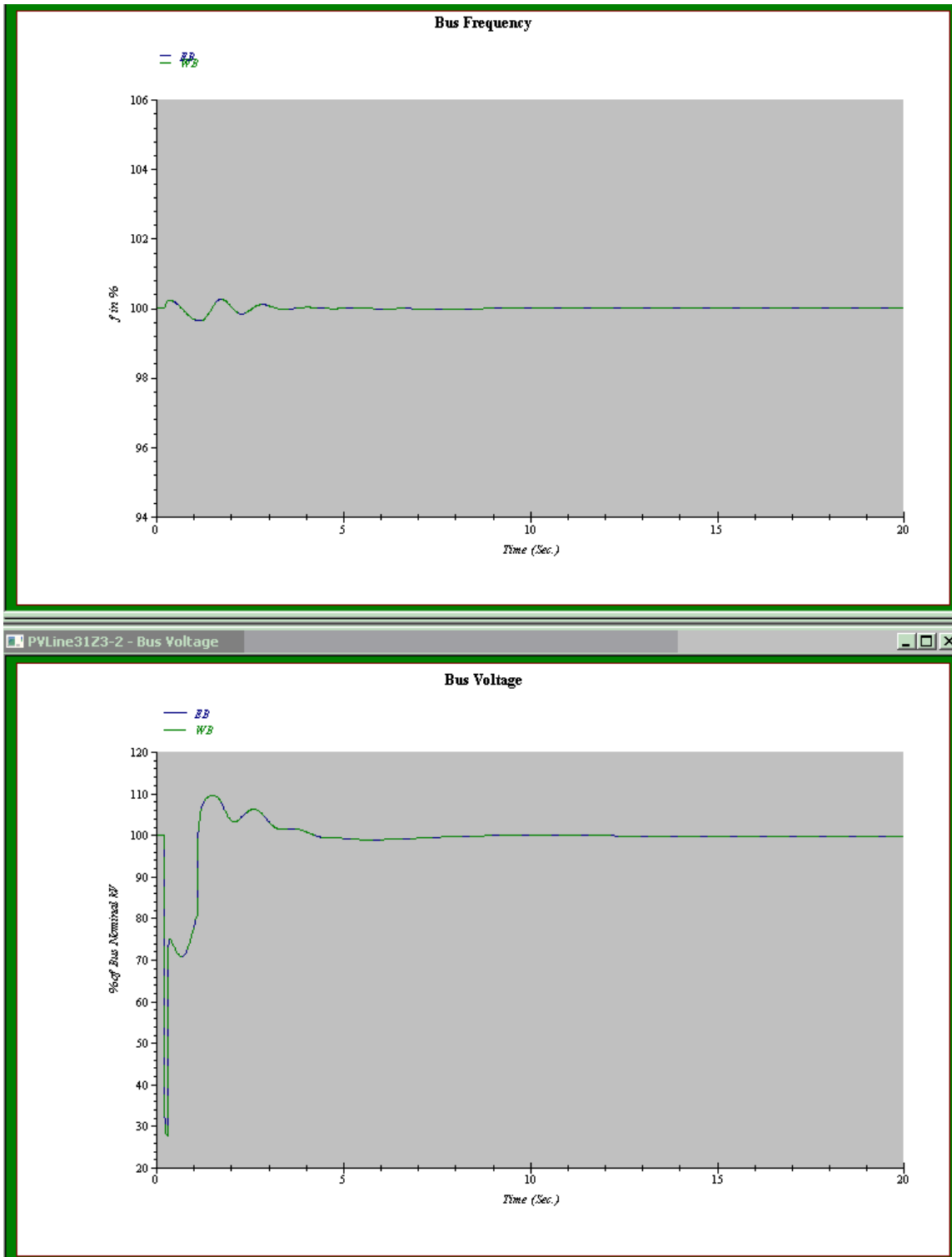

Figure 39 Line31 – Scenario 2 for Zone 3 Anticipatory Trip (0.9 Seconds Delay)

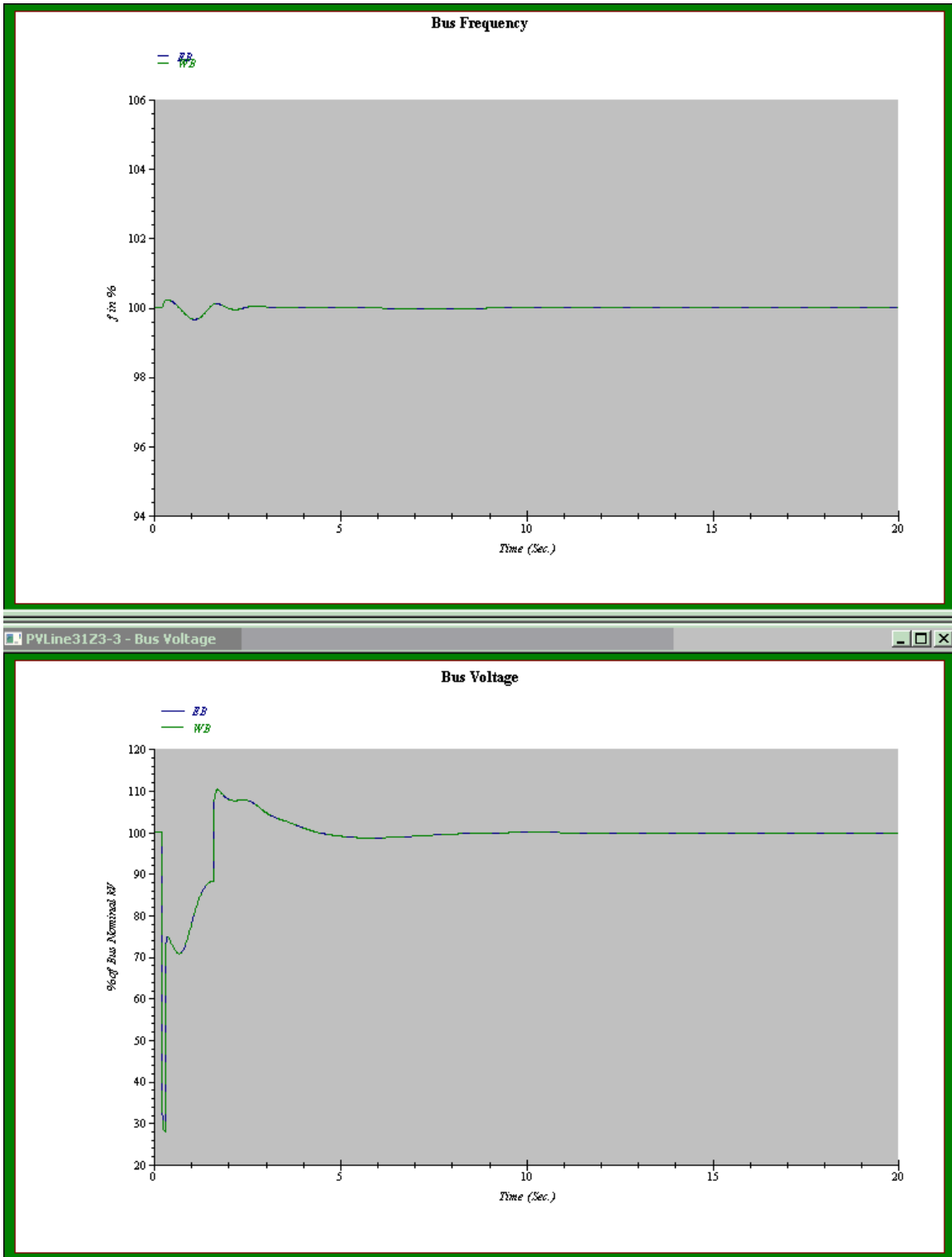

Figure 40 Line31 – Scenario 3 for Zone 3 Anticipatory Trip (1.4 Seconds Delay)

4.3.3 Interactions between Protection Systems of Switchyards Close to Each Other

As shown in the Plant A model (Figure 4-1), another switchyard of breaker-and-a-half configuration with buses Sub1-1 and Sub1-2 is directly connected to the switchyard of Plant A. There are four transmission lines between the two switchyards. In particular, line 11 and line 12 share the three circuit breakers CB1, CB2, and CB3 in the Plant A switchyard while other end of line 11 is connected to CB87 and CB88, and line 23 is connected to CB82 and CB83. See Figure 4-33 for this portion of the Plant A model.

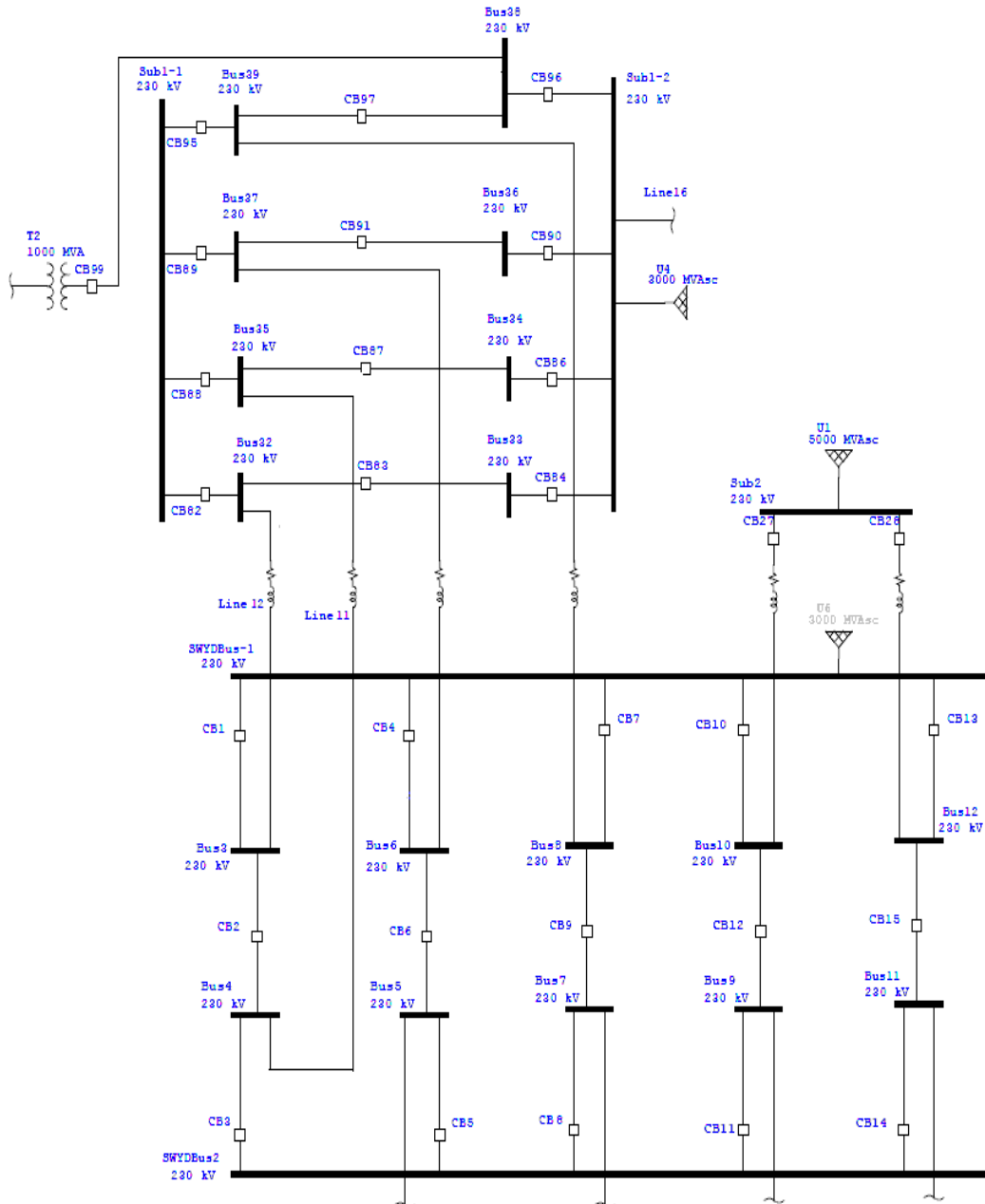

Figure 41 Switchyards of Plant A and a Neighboring Substation

The interaction between the two switchyards is illustrated by using a postulated scenario of a 90% fault (with near end circuit breakers CB2 and CB3) with line 11 followed by a failure of breaker CB2 while the rest of the associated breakers open properly according to the adopted protection scheme. If a breaker failure protection scheme is available, the backup breakers for the failed CB2 are CB1, CB82, and CB83. Opening CB82 and CB83 will remove line 12 from the model. This actually indicates that the postulated scenario, i.e., a line fault plus a breaker failure will lead to a loss of two transmission lines connecting the two switchyards in the manner shown in Figure 4-33. Note, such an issue does not exist for other two transmission lines, line 7 and line 8. Depending on how much the transmission system power delivery relies on these two transmission lines, this loss might have severe impact on the plant operation. A more detailed study of this scenario might become necessary.

The study can be carried on by defining example scenarios similar to the approach described in Section 4.3.2.2, i.e., by assuming different types of protection schemes.

Example 1 assumes that a DR scheme is adopted. For the fault that occurred at 0.2 seconds, CB2 and CB3 will open at 0.28 seconds and CB87 and CB88 open at 0.78 seconds. The resulting frequency and voltage responses at buses SWYDBus-1 and SWYDBus-2 are shown in Figure 4-34.

In Example 2, a DR scheme is again used and a breaker failure backup scheme is available, which means that CB3 will open promptly at 0.28 seconds and CB87 and CB88 open at 0.78 seconds. The backup circuit breakers CB1, CB82, and CB83 will be opened by the near end relay of line 11 with an intentional time delay of 0.5 seconds, i.e., they open at 0.78 seconds. See Figure 4-35 for the Plant A switchyard bus responses.

Example 3 is similar to Example 1 except that a PR is used here. Therefore, CB2 and CB3 still open at 0.28 seconds and CB87 and CB88 will open at 0.3 seconds. The simulation results are shown Figure 4-36.

Finally, A PR and a breaker failure backup scheme are assumed in Example 4. The opening times are 0.28 seconds for CB3, 0.3 seconds for CB87 and CB88, and 0.39 seconds for CB1, CB82, and CB83. The switchyard bus responses can be seen in Figure 4-37.

The switchyard bus responses in Example 2 indicate that the NPP operation may be significantly challenged for the distance relaying protection scheme. However, from the design point of the view, the arrangement of the connection of line 11 and line 12 may need to be avoided because the postulated scenario here suggests that two lines may be lost.

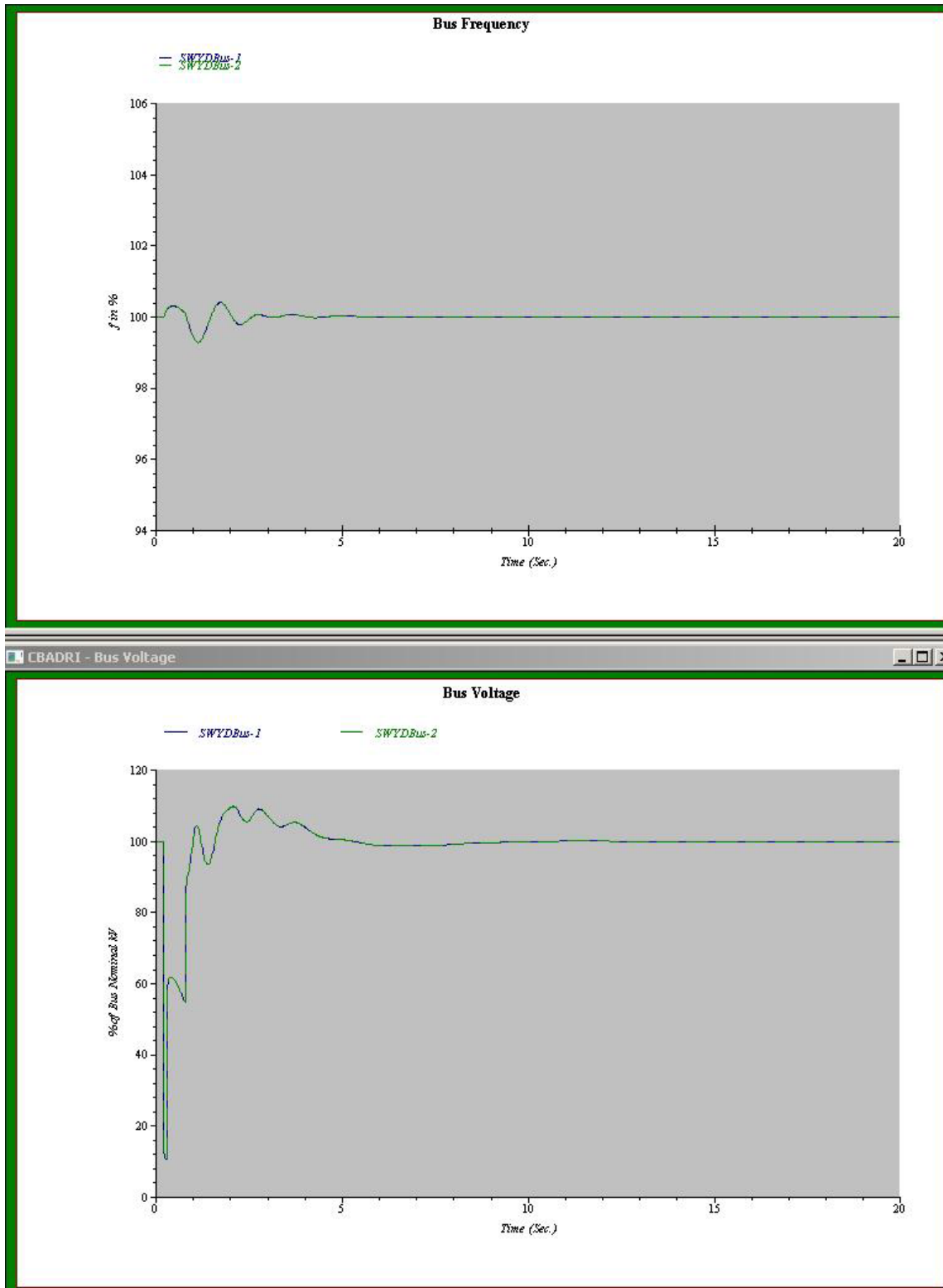

Figure 42 Example Scenario 1 for Interaction between Protection Schemes of Two Switchyards

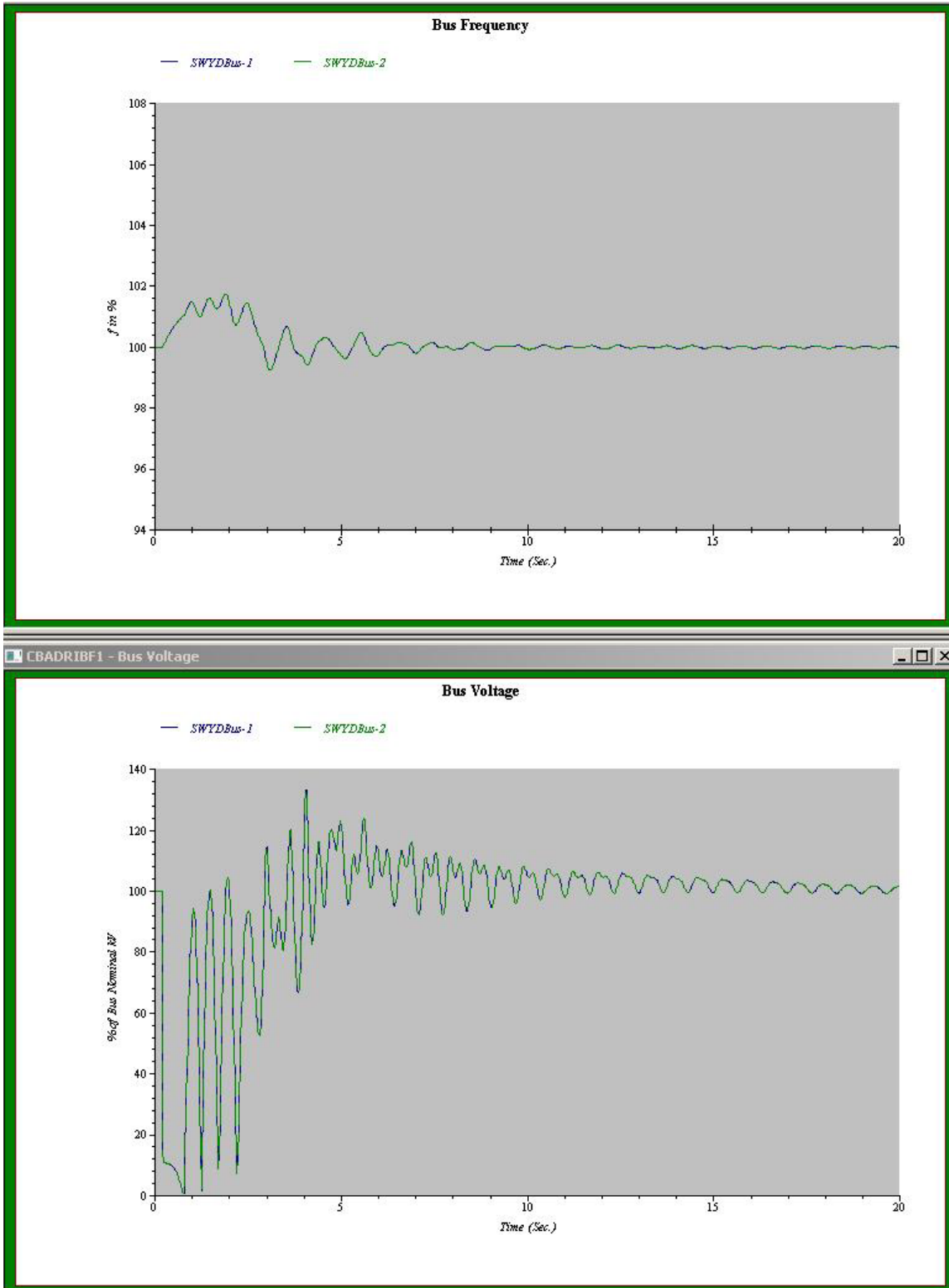

Figure 43 Example Scenario 2 for Interaction between Protection Schemes of Two Switchyards

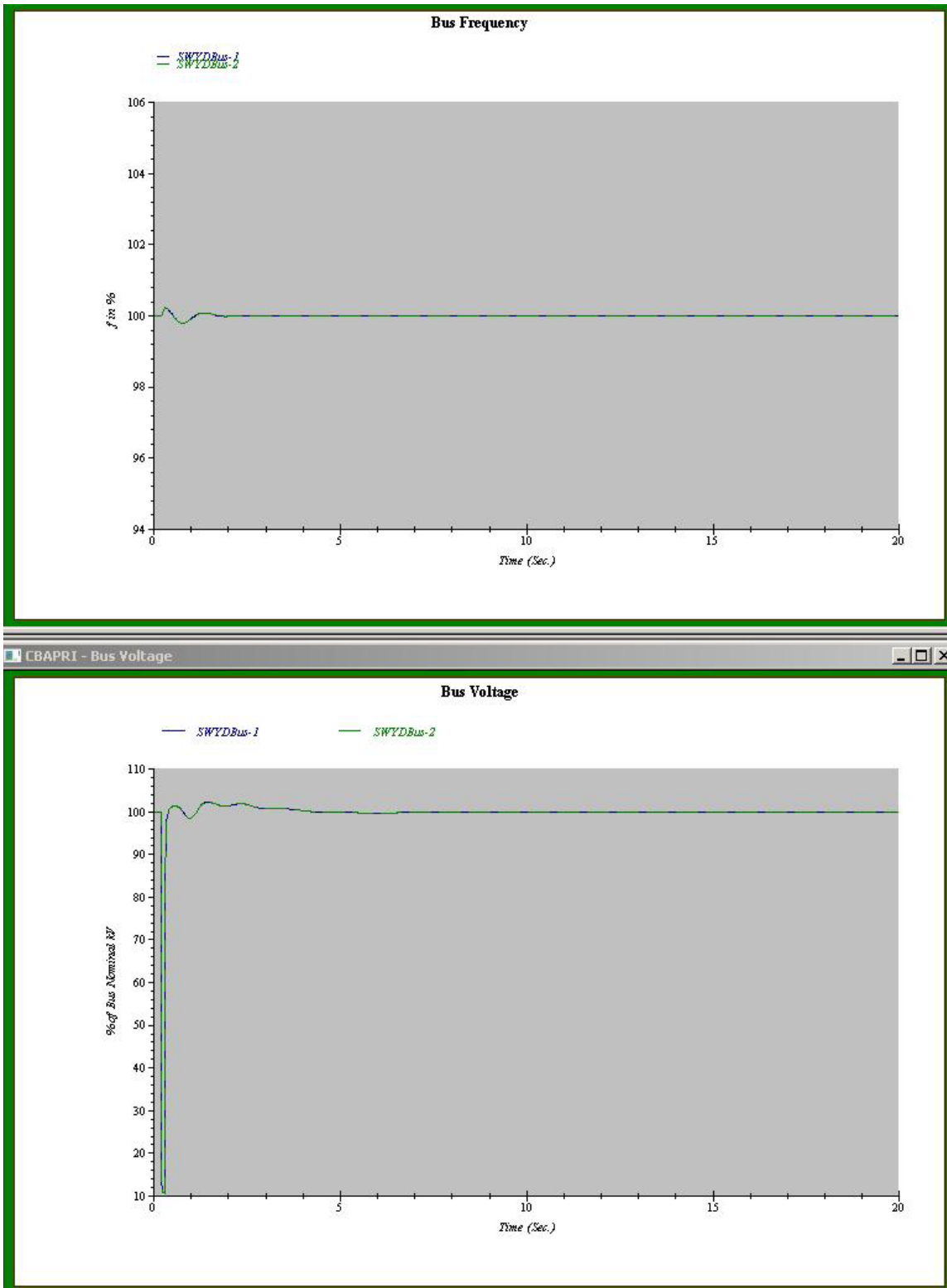

Figure 44 Example Scenario 3 for Interaction between Protection Schemes of Two Switchyards

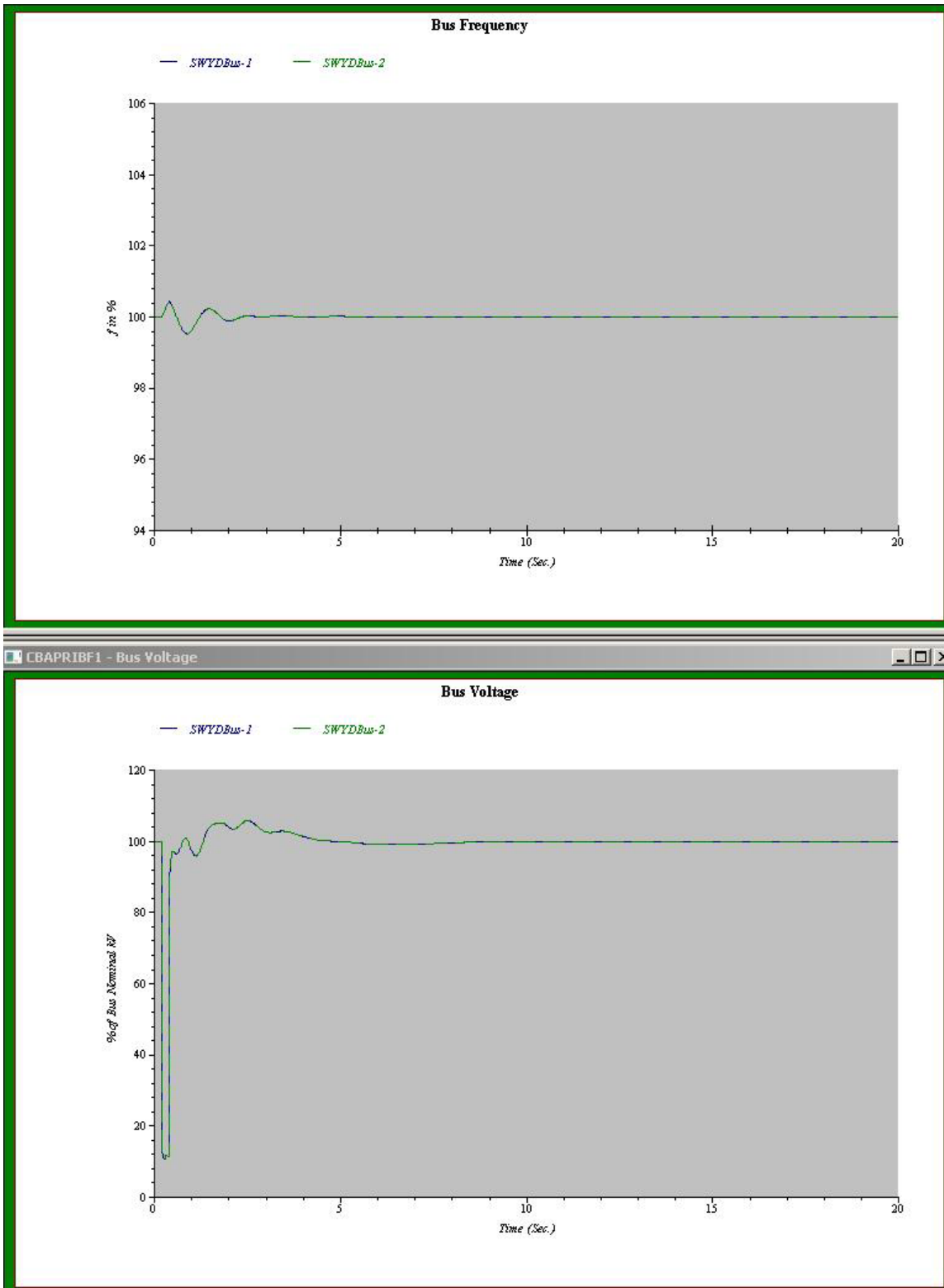

Figure 45 Example Scenario 4 for Interaction between Protection Schemes of Two Switchyards

4.3.4 Plant Responses to an External Fault with Disabled Zones 1, 2, and 3 Protection Relays

In the previous sections, the plant responses to a fault when first or second or third zone protection is disabled were not studied. The past experiences have shown that many NPP trip events were caused by a single fault and the (inadvertently) disabled zone protection relays. Section 1.1.2 provides such an example event that occurred to the Peach Bottom Atomic Power Station on September 15, 2003. Examples 1 and 4 defined for each plant in Section 4.3.2.2 are actually equivalent to scenarios where Zone 1 protection relays at both ends of a transmission line are (inadvertently) disabled for the 90% 3-phase transmission line faults. In the first example, the protection relays are distance type while the relays are telecommunication-based in the fourth example. The faults are subsequently picked up by Zone 2 protection relays. The simulation results for example scenarios 1 and 4 of each plant indicate that, in this kind of situation, i.e., disabling Zone 1 protection relays, the transmission line fault was cleared effectively by the Zone 2 protection relays and does not have severe impact on the response, as expected. If protection relays of Zones 1 and 2 (and possibly Zone 3) were disabled, the fault impact could be much more significant (an example is shown below) and can potentially cause a plant trip, as confirmed by the NPP operating experience.

A scenario is briefly described here using Plant A as an example. The same fault discussed in example 1 for Plant A is assumed. The switchyard bus responses were simulated and are shown in Figure A-16 assuming that Zones 1, 2, and 3 protection relays were disabled. The fault was cleared by the neighboring Zone 2 protection relays that have to open a number of circuit breakers including CB1, CB4, CB7, CB10, CB13, CB19, CB22, CB20, (the breakers for SWYDBus1), CB140 (the breaker for bus Sub5), CB3, CB5, CB8, CB11, CB14, CB17, CB20, and CB23 (the breakers for SWYDBus2) after an intentional time delay of 0.5 seconds. The simulation is not necessary because this will cause a loss of the entire switchyard and the all the reactors have to be tripped. The fault is close to the NPP switchyard and is extremely detrimental to the NPP if all of Zones 1, 2, and 3 protection is disabled.

4.4 Summary and Discussions

As seen in Section 4.3.1, for a fault originated in the transmission network, the closer the fault is to the NPP switchyard, the more severe impact it has on the NPP. While this might be well-known, it may not be common for a NPP switchyard owner or a transmission network owner to recognize that a different or a tighter protection scheme is warranted for the NPP switchyard or transmission lines/substations nearby the NPP switchyard considering the fact that a utility tends to use the uniform protective schemes settings across the entire network owned and operated by the utility.

The performance variation of adopting different protective schemes/settings is significant, as shown by the simulation results presented in Section 4.3.2, especially when an additional breaker failure is considered following a fault occurrence. This clearly indicates that a tighter protective system applied at the NPP switchyard or the grid components close to the switchyard can enhance the fault ride-through capability of a NPP while the existing protection systems for the rest of the grid remain untouched. Therefore, it is desirable that the protection systems for the NPP switchyard be designed such that the backup clearing by the secondary protection system is instantaneous (e.g., without any intentional delay the backup clearing time can be less than 100 ms) even if one element of the protection system fails to operate and less than Zone 2 time (e.g., less than 200 ms) even if one circuit-breaker fails to operate. If the critical clearing

time is longer than the backup clearing time it may be necessary to install dual circuit-breakers in series to reduce the likelihood of protection system malfunction due to the circuit-breaker failure. The analysis performed in Section 4.3.2.3 shows that simply making the circuit breaker associated with the main generator and another grid component more reliable (e.g., by incorporating a double-bus-double-breaker structure into the breaker-and-a-half configuration, as shown in Section 2) in most cases can certainly improve the fault ride-through capability of a NPP.

While the analyses performed in Section 4.3.2 for this study show that the impact of protection system failures can be mitigated by minimizing the fault clearing time of backup protection systems, in actual practice, the effect that these protection system responses can have on overall power system stability and operating characteristics must also be analyzed. For example, the change in system impedance that results from disconnecting one or more system elements at a nuclear power plant may have an effect on the unit stability and system performance that is more severe than an extended fault clearing time. In some cases, disconnecting two or more elements at the NPP switchyard can result in unit instability even without the presence of a fault.

Another protection scheme is to use the anticipatory Zone 3 scheme, i.e., tripping selected healthy components that are connected to the faulted transmission line by using the Zone 3 relays at the terminals of the faulted line. The anticipatory Zone 3 scheme will be beneficial when the primary protection system and the remote breaker failure backup protection fail since, otherwise, a much longer time delay is anticipated to clear the fault. However, this might be considered overly conservative because failures of both the primary and the backup protection are not always encountered and the tripping of healthy components may also adversely affect the normal operation of the grid. Based on this consideration, the anticipatory Zone 3 protection scheme is not included in the study.

The interaction between two NPP switchyards that are electrically located in close proximity to each other on the transmission grid is illustrated in subsection 4.3.3 by using a postulated scenario of a 90% fault of a transmission line followed by a breaker failure. The postulated scenarios shows that if a breaker failure protection scheme is available, the line fault plus the breaker failure will lead a loss of two transmission lines connecting the two switchyards in the manner shown in Figure 4-33. This kind of design may need to be reviewed carefully.

Reclosing is often used in transmission systems for the purpose of maintaining system integrity by reconnecting the isolated components back to the grid after a brief time delay provided that the fault is of the transient-type. Again, the selection of time delay settings of when to perform a reclosing is a utility-specific process. The reclosing issue is not studied in this report because we are focusing on the permanent-type faults. Attempts at reclosing will eventually fail under these kinds of fault situations. Therefore, in this study, blocking of automatic reclosing of circuit breakers in the electrical protection zones immediately adjacent to the NPP was found to minimize the risk of tripping the NPP due to an uncleared permanent fault. However, experience has shown that in many applications automatic reclosing, when supervised by a synchronism check relay, may improve electrical grid stability and continuity of the offsite power supply by improving the availability of stabilizing transmission system elements. Consequently, in practical application, the decision to enable or block automatic reclosing in the vicinity of a NPP should be based upon a technical analysis and evaluation of the risks of reclosing into a fault versus the risks of prolonged operation with a transmission line out of service.

The results in Section 4.3.4 are consistent with many of the past operating experiences, which the cause of NPP trip or LOOP or blackout was found to be caused by inadvertently disabling some of the protective relays (maintenance errors). One of possible solutions is still the idea of having tighter protection schemes, i.e., by reducing the intentional time delay of the Zone 2 or Zone 3 relays. In this case, if the neighboring Zone 2 protection relays are actuated with a shorter time delay, the plant responses should be improved. Another potential solution is to install online monitoring devices on the more important relays and warn the load dispatcher or NPP operators.

The models used for the simulation are different and yet still show the same trends in terms of the plant responses to the faults at different locations. This indicates that the results obtained here should be somewhat independent of plant-specific models and can be generalized.

5 IMPORTANCE OF PROTECTION SYSTEMS MAINTENANCE

The general requirements for nuclear plant electric power systems are stated in 10CFR50-Appdx A GDC-17, as they apply to the onsite and offsite power sources, their independence and redundancy, safety functions, and performance during design basis events. Furthermore, 10CFR50.63, the station blackout rule requires plants to establish coping strategies for events involving the loss of preferred offsite power sources concurrent with a turbine trip and the unavailability of the onsite emergency ac power system.

During the review of operating experience regarding fault events that affected NPPs, it was noted that inadequate maintenance was frequently a cause or major contributor to the event. Personnel or maintenance/relay testing errors also caused blackout and disabled primary and/or backup protection design features. Circuit breaker failure, relay failures, setpoint drift or incorrectly set relays, wiring degradation, and degraded connectors were some of the conditions described that could be addressed by improved maintenance activities.

As shown by the analyses in Section 4, failure of protection system components, which is often caused by inadequate maintenance, was found to be a significant contributor to prolonging fault clearing time. This sometimes resulted in tripping of backup protection systems, which caused the loss of larger sections of the electrical system, that would otherwise not have been required had the primary protection system functioned properly.

5.1 Applicability of Maintenance Requirements to Offsite Power Systems

10CFR50-Appdx A GDC-18, "Inspection and testing of electric power systems," requires that the electric power systems important to safety be designed in such a way as to permit the appropriate periodic inspection and testing of important areas and features, such as wiring, insulation, connections, and switchboards, to assess the continuity of the systems and the condition of their components. Specifically, GDC-18 states, in part, that:

"The systems shall be designed with a capability to test periodically (1) the operability and functional performance of the components of the systems, such as onsite power sources, relays, switches, and buses, and (2) the operability of the systems as a whole and, under conditions as close to design as practical, the full operation sequence that brings the systems into operation, including operation of applicable portions of the protection system, and the transfer of power among the nuclear power unit, the offsite power system, and the onsite power system."

In addition, 10CFR50.65, the maintenance rule, requires that licensees "monitor the performance or condition of structures, systems, or components...in a manner sufficient to provide reasonable assurance that these structures, systems, or components...are capable of performing their intended functions." Periodic inspection, monitoring, and functional testing is accomplished for the onsite power distribution system, main generator and step-up transformer, and auxiliary transformers, that are included as part of the licensing basis of the NPP, through technical specifications surveillance testing and periodic preventive maintenance programs.

However, those structures, systems, and components comprising the offsite power system in the NPP switchyard, transmission lines, and external power grid, in general, reside outside of the jurisdiction of NRC regulatory requirements. As discussed previously in subsection 1.1.2

(and Appendix B), the deregulation of the electric utility industry raised concerns about maintaining the reliability of the power grid as the preferred power source for NPPs in a post-deregulation environment in which the NPP, its switchyard, and the electrical transmission grid might be owned, operated, and maintained by different entities. The independent transmission system operators might not fully appreciate the regulatory requirements for offsite power sources as applied to NPPs and the operating and maintenance priorities of the independent transmission system operators would not necessarily coincide with those of the NPPs that they serviced.

The Federal Energy Regulatory Commission (FERC) is the federal agency responsible for the regulation of wholesale interstate electric power transactions. In this role it approves as mandatory and enforces the electric reliability standards developed by the North American Electric Reliability Corporation (NERC). As described in Appendix B of this report, NERC Standard NUC-001-2 specifically requires coordination agreements between the operators of nuclear generating stations and transmission owners/operators for the purpose of ensuring that reliable sources offsite power are available for the safe operation and shutdown of NPPs. These agreements identify nuclear plant interface requirements (NPIRs) which include operations and maintenance coordination activities, such as identification of maintenance requirements for equipment not under the ownership or control of the nuclear generating station operator and coordination of testing, calibration, and maintenance of onsite and offsite power supply systems and related components [NUC-001-02].

The documentation and implementation of programs specifically focused on the maintenance of all protection systems affecting the reliability of the bulk transmission grid are addressed in NERC Standard PRC-005-2, "Protection System Maintenance" [PRC-005-2]. While NUC-001-2 directly covers the interface requirements between the electrical transmission system and nuclear power plants, the specific protection system maintenance activities governed by PRC-005-2 are equally important because of the critical role that reliable and efficient operation of the interfacing transmission grid protection system can play in supporting the safe and reliable operation of nuclear power plants.

5.2 NPP Offsite Power Fault Events Affected by Inadequate Maintenance

The analyses presented in Section 4 of this report, demonstrate that the rapid identification and isolation of transmission system electrical faults by the electrical protection systems was of key importance in minimizing the effects of grid transients on a NPP. The more rapid the response of the protection system, the more likely it was for the protective relaying to minimize the magnitude and duration of electrical disturbances cause by external faults. This in turn serves to further improve power system stability by maintaining local grid voltage and VAR support.

The Section 4 analyses show that if the protection system operates as designed, the adverse effects of external faults on nuclear plant performance can be minimized. A critical factor in ensuring the rapid and reliable operation of the electrical protection system is good maintenance. Thus, the benefit of frequent rigorous periodic inspection, maintenance, calibration and functional testing is that it provides assurance that the grid protection systems, backup protection systems, reclosing relaying schemes, and breaker failure protection schemes will operate as designed when challenged by an electrical fault or other grid transient event.

Several of the external grid events, in Subsection 1.1.3, that propagated into widespread power system disturbances that significantly affected NPPs, could in fact have been completely avoided, or at least mitigated, if adequate periodic calibration and functional testing of the transmission grid electrical protection systems had been taking place. That is, the protection systems, as designed, would probably have been able to minimize or, completely avoid, the resulting nuclear plant trips and losses-of-offsite power, had they operated correctly.

For example, the external fault event at the Palo Verde Nuclear Generating Station (PVNGS) on June 14, 2004 was initiated by single-line-to-ground failure on a contaminated phase conductor insulator string along the 230kV West-Wing to Liberty transmission line approximately 47 miles from the plant. The breaker at the remote end of the line tripped. The protective relaying scheme at the near end substation received a transfer trip signal actuating an auxiliary relay (Westinghouse, Type AR) in the tripping scheme for the two breakers connected to the faulted line. The AR relay had two redundant pairs of contacts connected to two redundant trip coils in the breaker at each end of the faulted line. Unfortunately, both pairs of contacts were actuated by a single non-redundant lever arm in the AR relay and only one or two of the contacts for the remote end breaker made up. Due to misalignment of the AR relay contacts, the near end breaker did not receive a trip signal and the line fault persisted for approximately 38 seconds as the fault cascaded into the protective tripping of a number of 230kV and 525kV transmission lines, which ultimately led to the Loss of Offsite Power (LOOP) at the Palo Verde switchyard and the tripping of all three nuclear units. [IN2005-15, and PVNGS LER 50-528/2004-006-00] Thus, the root causes for the event were improperly adjusted contacts in the non-redundant AR relay tripping scheme design. At least one, and perhaps both, of these inadequacies could have been detected by more frequent and rigorous protection system inspection and maintenance.

Another example, affecting the Peach Bottom Atomic Generating Station (PBAGS), occurred on September 15, 2003 when a lightning strike on one phase of a 230kV transmission line, approximately 35 miles northeast of the plant, arced to ground for more than 2.5 seconds damaging the insulator [IN 2004-15]. The fault condition was cleared upon the second attempt at automatic reclosing when the line was re-energized and did not trip out in spite of the thermal damage to the insulator. The two independent protection schemes provided to isolate faults of this type had failed to function. The NRC Augmented Inspection Team report [AIT 05000277&278/2003013] noted that:

“The primary and backup protection from the directional ground fault relay used fault current and locally generated polarizing voltage to determine fault condition. The primary relay utilized a signal from the bus potential device and the backup relay utilized a signal from the line potential device. The primary protection circuit was found to have a mechanically failed fuse and the backup protection circuit had a loose connection on a screw terminal block.

“Because the primary and backup protection in the faulted zone did not isolate the fault, the faulted condition was sensed at a greater distance and the automatic isolation expanded to a larger zone. The system outage spread through several other substations for periods up to 4 hours and 43 minutes. The Nottingham substation did not isolate the spread at that substation because the directional ground relay protection was not activated when the new protective relay system was put into service.”

The cascading trips that spread throughout the grid resulted in a loss of 3 of the 4 offsite power sources supplying the PBAGS site as well as the power source designated for station blackout recovery, for more than 16 seconds, causing both nuclear units to trip automatically. The

mechanically failed fuse and loose connection on the backup protection circuit for the faulted transmission line would have been detected by timely periodic inspection and maintenance for the protection system. Similarly, more frequent inspection and maintenance would have detected the inactive directional ground relay protection at the Nottingham substation that could have stemmed the further spread of the disturbance.

A LOOP and two-unit trip from full power occurred at the Catawba Nuclear Generating Station on May 20, 2006 as a result of an initial phase-to-ground fault on a current transformer (CT) in the 230kV switchyard associated with the Unit 1A main step-up transformer differential protection followed almost immediately by a second CT fault on the switchyard bus differential protection CT [IN 2007-14]. The Catawba switchyard is configured in a breaker-and-a-half arrangement and is protected by a bus differential protection scheme. It was subsequently determined by the NRC Augmented Inspection Team [AIT 05000413&414/2006009] that certain switchyard bus differential relay tap settings were set at a value too low to handle the fault currents experienced during this transient. Modifications to the original switchyard bus differential relay tap settings were made by the relay engineering department in 1979 and again in 1981. However, as a result of inadequate maintenance/modification procedures and human error, the correct revised settings were never properly implemented at the Catawba switchyard protective relaying [IN 2007-14 and AIT 5000413 & 414/2006009].

The AIT determined that:

“If the actual relay settings in the switchyard had been set appropriately, the event would have been limited to the actuation of main step-up transformer 1A differential protective relaying and...[one] bus differential protective relaying to address the fault on the X-phase of the CT associated with PCB 18. Actuation of the main step-up transformer 2B differential protective relaying would have occurred to address the fault on the Y-phase of the CT associated with PCB 23.”

This would have limited the effects of the transient such that:

“...both units would have runback to 48% main generator electrical output. In combination with the number of transmission lines available, the design of the switchyard should have prevented Units 1 and 2 from losing offsite power.”

On February 15, 2007, the failure of a power circuit breaker in the Jocassee Hydro Station switchyard caused a single-line-to-ground failure, that was detected and isolated by relaying at the Oconee Nuclear Station switchyard. However, the resulting prolonged (less than 1 second) grid disturbance led to a trip of Oconee Units 1 and 2. A wiring design error on the loss-of-excitation relays caused a main generator lock-out, turbine trip, and bus transfer from normal to startup sources on Oconee Units 1 and 2. Both reactors were subsequently tripped by the reactor coolant pump power monitors, which correctly sensed the voltage transient and resultant power sag. Incorrect settings on the auxiliary switch fast contacts of the normal main feeder bus breakers caused a slow bus transfer of 4160 volt loads on Oconee Unit 1, leading to a loss of normal feedwater flow. This necessitated reactor cool down to Mode 4, which was accomplished by procedure with emergency feedwater and atmospheric dump valves. [LER 269/2007-01-01]

The licensee reported in the LER analysis of the event [LER 269/2007-01-01] that protection system errors had remained undetected since their original installation:

“A properly designed protective relaying scheme should have enabled the units to withstand a switchyard transient of this magnitude and duration. However, a wiring design error in the loss-of-excitation relay (40-1) caused the relay to trip the Unit 1 and 2 generators and turbines through the generator lockout scheme. A latent design error existed in this relay and its leads were installed according to this error at initial installation (i.e., rolled leads). Had this error not been present, testing has shown that the relay would not have tripped the unit.

“The slow bus transfer was caused by incorrect setting of the fast contacts located on the auxiliary switches on the Main Feeder Bus Normal Breakers (N-Breakers). This error has been present since original installation. The incorrect setting caused the fast contacts to operate slower than designed. The slower operation of the fast contacts prevented completion of a fast transfer in less than 60 milliseconds as designed.”

On August 25, 2007, both Unit 1 and Unit 2 at the Catawba Nuclear Station experienced a voltage dip of approximately 0.462 second duration when a main step-up transformer at a merchant generating plant connected to Duke's 230kV grid faulted. The transformer differential protection at the merchant plant failed to isolate the faulted equipment. Electrically, the faulted transformer was three switchyards away from the Catawba switchyard. The electrical grid disturbance caused all four Emergency Diesel Generators (EDGs) to start but ran unloaded, as designed, because the condition existed for less than the 8.5 seconds required for separation from offsite power. After an hour and a half, the local transmission operator notified the plant that the faulted transformer had been isolated from the transmission system and the plant's EDGs were secured and returned to standby. [LER 413/2007-003-00]

The response of plant equipment to this electrical grid disturbance was as expected. The transmission system relaying also operated as designed. Failure of the local protection at the merchant generating plant to detect and promptly isolate the faulted transformer produced an unbalanced system disturbance that was of a large enough magnitude and duration to actuate degraded grid protection at the Catawba plant, that was three switchyards away from the initiating disturbance.

In an event on February 26, 2008, Turkey Point Nuclear Plant units 3 and 4 automatically tripped from 100% power due to a momentary power fluctuation caused by grid instabilities. Each reactor tripped when both channels of safety-related 4 kV bus undervoltage relays actuated after a one second time delay. Protection against a momentary grid disturbance is a feature of Turkey Point's electrical system; however, the duration of the condition exceeded the time delay resulting in the actuation of the 4 kV bus undervoltage relays. The source of the grid disturbance was a short circuit to ground on a substation in Dade County, Florida, compounded by human error in troubleshooting the substation protection system [LER 250/2008-001-00].

Finally, on August 14, 2003, an electrical power disturbance in the northeastern part of the United States caused nine NPPs in the US to trip as a result of voltage and frequency fluctuations experienced in the initial stages of the blackout [Kirby, Kueck, et. al. ORNL 2007]. Eight of these plants, along with one other nuclear plant that was already shutdown at the time, experienced a loss of offsite power (LOOP). Several of these nuclear plants were located in transmission corridors operating at that time under conditions of inadequate reactive power and were thus required to supply reactive power at their maximum capability in order to support grid voltage. As a consequence of the regional power grid operating at the limits of its capacity and capability, the trip of a large nuclear generating unit and the resulting sudden removal of the local reactive power support it has been providing to the transmission grid inevitably led to the

degradation of voltage at the NPP switchyard below Technical Specification limits. The August 2003 event, which was initiated by an overgrown tree coming into contact with electrical transmission lines, resulted in cascading outages, caused trips of nuclear stations, and disabled offsite power supplies. The incident highlighted the importance of the design and maintenance practices for NPP switchyard protection systems and demonstrated how the operational interaction between the power grid and large nuclear generating units can affect the reliability and availability of the nuclear plants' offsite power sources.

These selected examples demonstrate the importance of the proper operation of the electric protection equipment on grid transmission lines, transmission grid substations, and nuclear plant switchyards. Several of these grid disturbance events originated at physically remote locations away from the nuclear plants, but had a significant electrical impact that affected nuclear plant performance and the integrity of their offsite power sources. Consequently, it is suggested that the electrical protection systems serving transmission lines, substations, nuclear plant switchyards, and local generating units (both nuclear and non-nuclear) that are shown, through power system analysis (See Regulatory Issue Summary 2004-05 and Regulatory Guides 1.160 and 1.182) and operating experience, to have a significant influence on the reliability and integrity of the offsite power sources and electric grid conditions at the NPP switchyard buses be considered for augmented periodic inspection, calibration, and maintenance.

5.3 Benefits of Improving Offsite Power System Maintenance

When one considers the tremendous cost of a single NPP trip event in terms of the immediate lost generation revenue, cost of more expensive replacement generation for the duration of the outage, additional challenges to nuclear safety systems, additional challenges and wear on electrical transmission system equipment in response to the transient, and the potential damaging effects of widespread electrical grid disturbance, it is easy to see that measures to reduce the occurrence of NPP trips and loss-of-offsite power events would be extremely beneficial.

As seen in the examples provided in subsection 5.2 above, inadequate inspection and maintenance of electrical protection systems serving transmission lines, substations, nuclear plant switchyards, and local generating units (both nuclear and non-nuclear) that had a significant influence on electrical conditions at the switchyard buses of NPPs can lead to unnecessary LOOPs and plant trips. Incorrect relay settings, damaged or degraded protection systems, design inadequacies, and other protection system malfunctions would be revealed by more rigorous and more frequent protection system inspection, calibration and functional testing, and preventive maintenance. Many of the LOOPs and plant trips, such as those in the above examples, would otherwise have been avoided if the existing properly-designed protection systems had operated as originally intended.

The analytical examples presented in Section 4 of this report clearly demonstrate that the more rapidly the protection system can identify the occurrence of an electrical fault and isolate it, the lesser the magnitude of the disturbance and the shorter the duration of the transient as experienced at the nuclear plant switchyard buses. Therefore, it is of utmost importance that the electrical protection systems operate as designed to assure that faults are detected and cleared as rapidly as possible. It is suggested, that in some cases it may be possible to reduce the time delays for backup protection or breaker failure schemes to reduce or mitigate the effects of electrical transient events. By minimizing the magnitude and duration of a disturbance at the NPP switchyard, it may even be possible to allow the plant to remain on line, or "ride

through,” some disturbances to maintain the beneficial voltage and VAR support the nuclear plant generator is supplying to the grid, thereby contributing to the overall stability of the transmission system.

A critical factor, therefore, in ensuring the rapid and reliable operation of the electrical protection system is good maintenance. Thus, the benefit of frequent rigorous periodic inspection, maintenance, and calibration and functional testing is that it provides assurance that the grid protection systems, backup protection systems, reclosing relaying schemes, and breaker failure breaker protection schemes will operate as designed when challenged by an electrical fault or other grid transient event. Of course, an evaluation should be made of the benefits of an increased schedule of maintenance activities against the risk of potential system trips resulting from carrying out this maintenance work.

It is suggested that the NPP switchyards, and the transmission lines, critical nearby electrical substations, and nearby generating units that support the offsite power supply to NPPs be given priority consideration with regards to reliability importance, operating activities, and periodic protection system inspection, maintenance, and testing. This is justified by analytical examples in Section 4 that demonstrate the importance of protection system timing on the effects of external fault events on NPP performance, reliability of offsite power, and local grid voltage and VAR support.

It should be noted that NERC Standard PRC-005-2, “Protection System Maintenance” [PRC-005-2], was approved by the NERC Board of Trustees on November 7, 2012 and is awaiting follow on regulatory action by FERC. PRC-005-2 consolidates several previous NREC protection system standards and incorporates the findings and recommendations of the NERC System Protection and Control Task Force report “Protection System Maintenance,” (September 13, 2007). By considering frequency-based as well as performance-based approaches to protection system maintenance programs, PRC-005-2 seeks to strike an optimum balance between security and dependability. Once approved for implementation by FERC, PRC-005-2, together with the interfacing requirements of NUC-001-2 should help to improve transmission grid protection system maintenance practices and potentially avoid or mitigate the types of problems described in subsection 5.2.

The case for effective protection system maintenance is strongly insinuated by the several examples examined as part of this study, although a comprehensive review of external transmission system fault events was not performed as part of this study. It is suggested that a thorough review of external fault events be performed in the future to update earlier studies that compared grid reliability and performance prior to, and after deregulation of the electric utility industry. This would help to verify whether FERC and NERC efforts to improve grid reliability through standards such as NUC-001-02, regulatory enforcement, and cooperative activities with NRC, have in fact achieved measurable improvements. Counter to these efforts, however, are the negative effects of aging T&D components and equipment, overloading of limited existing transmission resources, aging degradation electrical protection systems, increased overall demand, increased peak demand, and inadequate development of new transmission capacity. An updated comprehensive review and assessment of grid related disturbances that affected NPPs would provide a quantitative measure of the trends in transmission grid and offsite power reliability and external faults effects.

6 SUMMARY AND CONCLUSIONS

6.1 Summary

The important observations and conclusions that were identified during the NPP reviews and the systems modeling and analyses in this study are summarized below:

- Most of the NPP switchyards reviewed used the breaker-and-a-half bus arrangement which provides a high level of reliability and flexibility. The most critical circuits were modified to a full double breaker arrangement in some applications to provide an even higher level of reliability. See subsection 2.2 and 4.3.2.4.
- The primary switchyard bus protective scheme was the current differential protection scheme with various breaker failure schemes typically serving as backup.
- Circuit breakers at the switchyard terminals of departing transmission line circuits were incorporated into the overlapping protective zones of the transmission lines. They were protected by electrical protection schemes using telecommunications or distance relaying. The switchyard circuit breakers were also generally incorporated into breaker failure protection schemes for the individual transmission lines.
- Simulation studies confirmed that the faster an external transmission grid fault could be detected and isolated, the lesser is the effect of the transient experienced at the NPP switchyard bus. The closer a fault is to the NPP switchyard the greater the effect on the NPP.
- Rapid detection and clearing of grid electrical faults helps to minimize the effects of a prolonged electrical transient that could lead to a NPP trip. The sudden loss of the voltage and real/reactive power support provided by the nuclear plant's main generator is itself a destabilizing event that can potentially lead to an extended degradation of system voltage at the NPP switchyard and resulting in a LOOP following a trip of the plant.
- In general, protective schemes have already been designed and coordinated to detect and isolate faults as rapidly as the equipment will allow. It may be possible to adjust the settings of existing Zone 2 and Zone 3 protective relays and minimize intentional time delays in the protective schemes to achieve a more rapid protection system response. In this case, Zone 3 protective schemes will function as an anticipatory trip, as discussed in Section 4.3.2.3. As a point of emphasis, consideration of anticipatory Zone 3 protection schemes must be very carefully analyzed to be balanced against coordination with neighboring protection schemes to ensure that disruption to the system is minimized.
- A more effective approach is to perform more frequent and rigorous inspection, preventive maintenance, and testing of the most critical protection system components to assure that they will function as designed when required.
- Electrical protection schemes using telecommunications (pilot relay schemes) provided the fastest and most reliable protection for transmission line circuits, and per the results of the simulation studies, they helped to minimize the effects of external faults as seen from the NPP switchyard. Improvements in the performance and reliability of multi-function digital protective devices, together with the lower costs and high reliability of various modern telecommunications links that are currently available, have made the

telecommunications-based electrical protection schemes the preferred method for transmission protection, particularly for lines that are associated with NPPs.

- The use of telecommunications-based relaying as part of the breaker failure and backup protection schemes for NPP switchyards and associated transmission circuits is also highly desirable. The high speed, sensitivity, and reliability of telecommunications-based relaying in backup protection helps to minimize the effects of primary protection failures.

6.2 Conclusions

The purpose of this study is to demonstrate and verify through modeling and simulation that precise and faster clearing of faults can in fact limit damage and improve plant ride-through, which is one of the main reasons for developing and deploying telecommunication-based relay schemes. The practical application of this approach into an existing protection scheme, which would be the equivalent of upgrading to a faster protective relay, would of course have to be analyzed carefully to take into consideration the coordination of all affected protection system timing intervals as well as the effects that the tripping of transmission element(s) can have on system stability. The high speed, precision, and reliability of telecommunication-based protection now being deployed allows ISOs, utilities, and NPP operators to take advantage of the potential improvements that faster clearing times can provide as we have shown in our study.

A review of NPP switchyards and protection systems was performed as part of this project. Design features and configurations identified in the review were used to develop simulation models, using ETAP[®] power system analysis software tools, for several NPP distribution systems, their high voltage switchyards, and their transmission interfaces with the electric power grid. Based on the reviews and analyses described herein on the effects of external electrical faults on NPPs, the following conclusions are offered to maintain the highest reliability of the electric power grid while continuing to maintain and improve the safe and reliable operation of nuclear power plants:

- Simulation studies confirmed that the faster an external transmission grid fault could be detected and isolated, the less is the effect of the transient experienced at the NPP switchyard bus. Reviewing the settings of protective relays and intentional time delays in existing electrical protection schemes may be practical to determine whether modifications can be made to achieve a more rapid protection system response without compromising the balance between security and dependability. In particular, when the primary protection scheme fails, the backup scheme becomes critical to isolate the fault(s) and the intentionally built-in time delay of the backup scheme significantly prolongs the clearing time. Under this situation, if the time delay can be minimized, the impact that a fault at or close to the NPP switchyard will have on the normal operation of NPPs can be significantly reduced.

In general, analyzing the impacts that various protection system scenarios will have on the ability to meet the NPIRs presented in NUC-001-2 for nuclear power plants may improve the technical basis when altering or upgrading existing electrical system protection schemes. Faster fault clearing generally results in improved system performance, but this enhancement may only be valid if other transmission system elements are not tripped in addition to the faulted element. Therefore, careful consideration must be given to the proper setting and coordination of the time delays for

tripping transmission and switchyard components to ensure a balance between security and dependability.

- Electrical protection schemes using telecommunications (pilot relay schemes) provide the fastest and most reliable protection for transmission line circuits, and per the results of the simulation studies, they helped to minimize the effects of external faults as seen from the NPP switchyard. Therefore, incorporating protection schemes using telecommunications is an option worth considering when replacing or upgrading existing transmission line protection systems, particularly for lines that are in the zone of influence of the NPPs.
- The use of electrical protection using telecommunications as part of the breaker failure and backup protection schemes for NPP switchyards and associated transmission circuits may improve the reliability of the protection system. The high speed, sensitivity, and reliability of protective relaying using telecommunications in backup protection helps to minimize the effects of primary protection failures.
- Reliability in switchyards incorporating the breaker-and-a-half bus arrangement could be improved for the most critical transmission circuits and the main generator connection by modifying the circuit breaker arrangement for those connections to a full double-bus, double-breaker arrangement.
- Improving the reliability of primary protection of the NPP switchyard protection systems can help them cope with the fault more effectively. This can be achieved by using redundant protective equipment such as dual relays, circuit-breakers, and telecommunication channels.
- Incorporating the NPIR into transmission system studies affecting NPPs as stated by NERC Reliability Standard NUC-001-2 may identify and address contingencies that require the application of mitigation plans to avoid loss of offsite power events (LOOPs).
- It also needs to be pointed out that redundancy is often defeated by common cause failures even for the redundant equipment of diverse designs. Hence, adjusting the settings of existing protection systems to reduce and/or avoid time delays, especially those of the backup protection schemes, is still considered necessary and very important even while increasing the redundancy of NPP switchyard protection systems.
- Conducting grid transient analyses to identify those relays and contacts that can have a significant impact on conditions at the NPP switchyard buses may provide valuable insights when reviewing and/or updating the protection schemes at or near the NPP switchyard.
- As a consequence of the above observations, it follows that protection systems and equipment in selected nearby switchyards, transmission lines, substations, and large generating units (that have been shown by analysis to have a significant impact on nearby NPPs), may be subjected to a more frequent and augmented level of inspection, testing, and preventive maintenance.
- Several recent events examined as part of this study were caused by or exacerbated by inadequate protection system maintenance. A comprehensive review of external fault

events may be worthwhile to update the results of earlier studies that compared grid reliability and performance prior to, and after deregulation of the electric utility industry. This would help to verify the effectiveness of FERC and NERC efforts to improve grid reliability through standards, regulatory enforcement, and cooperative activities with NRC. It would also provide a quantitative measure of the current status and performance trends of the electrical transmission grid with respect to the negative effects of aging T&D components and equipment, overloading of limited existing transmission resources, aging degradation electrical protection systems, increased overall demand, increased peak demand, and inadequate development of new transmission system capacity.

- Efforts to identify necessary changes to the FERC/NERC standards that address protective relaying schemes and the nuclear plant interface with the transmission grid may be worthwhile. Combined efforts from the NRC, FERC/NERC, the nuclear industry, and affected transmission system operators could lead to the development of industry-wide standards for: 1) the interface between NPPs and the transmission (or subtransmission) networks, 2) the electrical protection schemes for the interface, and 3) the maintenance of the primary and secondary protection equipment at the interface.
- In this study, blocking of automatic reclosing of circuit breakers in the electrical protection zones immediately adjacent to the NPP was found to minimize the risk of tripping the NPP due to an uncleared permanent fault. Experience has shown that in many applications automatic reclosing, when supervised by a synchronism check relay, may improve electrical grid stability and continuity of the offsite power supply by improving the availability of stabilizing transmission system elements. In practical application, the decision to enable or block automatic reclosing in the vicinity of a NPP should be based upon a technical analysis and evaluation of the risks of reclosing into a fault versus the risks of prolonged operation with a transmission line out of service.
- Monitoring the switchyard and transmission line protection system relays and fuses that would alert operators to the occurrence of failures in protection system circuits may enhance the reliability of the protection system. Several of the operating experience examples of NPP trip and LOOP in this study could have been avoided if circuit failures in the protection system had been detected immediately and corrected before they were challenged.
- It is important that the NPP switchyards be reviewed and treated differently than the regular switchyards/substations in the transmission network in terms of design, operation, and maintenance in order to achieve improvement in the reliability of the NPPs and subsequently reducing the risk associated with tripping NPPs due to external electrical faults.
- Since the transmission system and the grid are owned and operated by other entities, it is NPP owners' responsibilities to ensure that NPP design requirements, modification, and enhancements required to maintain a reliable and stable electric power system including inadvertent trip of NPPs are identified and communicated promptly to the respective transmission and grid operating entities.

Three detailed analytical models of nuclear plant electrical systems, switchyards, and their interfacing connections with the local electric power transmission grid were developed as part of

this project to study effects of electrical transients and other disturbances on the NPP performance. One of these models also included interconnections with two other nuclear generating stations so that detailed analysis of the electrical interactions between nearby nuclear units could be undertaken. The models were developed using the ETAP[®] power system analysis software. The simulations provide accurate representations of actual NPP configurations and power grid interconnections, and as such, have provided important insights into the effects of electrical faults on the performance of plant safety systems and other critical non-safety equipment.

The three NPP simulation models developed for this project, along with detailed in-plant electrical distribution models for a BWR plant and a PWR plant developed previously for an earlier project [NUREG/CR-6950], are very powerful simulation tools that can be used to study a variety of important contemporary power grid degradation issues affecting NPPs. Among these issues that can be studied are:

- Electric power transmission grid reliability performance and the effect on offsite power sources,
- Interactions between multiple NPPs under transient conditions,
- Interactions between NPPs and large non-nuclear generating stations under transient conditions,
- NPP operational considerations during overloaded grid conditions,
- Power quality issues with offsite power sources, and
- Distribution system performance during sustained grid undervoltage and underfrequency conditions
- Class 1E motor starting during off-normal grid conditions
- Class 1E motor starting during off-normal plant operating configurations
- Arcing fault studies (medium-voltage and low-voltage) and the development of improved switchgear energetic fault/fire damage models
- Verification of reliability assumptions for the Class 1E electrical system
- Effects of aging degradation on electrical system grounding performance

Power system analyses using these detailed power system simulation models would be quite beneficial in evaluating the performance of nuclear plant electrical distribution systems under a variety of power system contingencies, plant operating configurations, and plant operating conditions as noted above.

7 REFERENCES

Section 1 – Introduction

- [Lindahl-2011] S. Lindahl, SLi-2011-009, Version B, “Comments to Susceptibility of Nuclear Stations to External Faults,” May 18, 2011.
- [10 CFR 50.2] Title 10 of the Code of Federal Regulations, Part 50.2 “Definitions.”
- [10 CFR 50, Appendix A, GDC 17] Title 10 of the Code of Federal Regulations, Part 50, Appendix A, “General Design Criteria for Nuclear Power Plants,” Criterion 17 - Electric Power Systems.
- [10 CFR 50.63] Title 10 of the Code of Federal Regulations, Part 50.63 “Loss of all alternating current power.”
- [USNRC RG 1.155] Regulatory Guide 1.155, “Station Blackout.”
- [FERC Order No. 888] FERC Order No. 888, “Promoting Wholesale Competition Through Open Access Non-discriminatory Transmission Services by Utility Companies, Recovery of Stranded Costs by Public Utilities and Transmitting Utilities,” 1996.
- [FERC Order No. 889] FERC Order No. 889, “Open Access Same-time Information System (OASIS) Rule and Standards of Conduct,” 1996.
- [Trehan – Jan 2000] N. Trehan, “The Impact of System Security in an Open Market on Nuclear Power Generating Stations,” January 2000.
- [NERC Std. NUC-001, Rev 2 – Aug 2009] NERC Standard, NUC-001-2, “Nuclear Plant Interface Coordination,” August 2009.
- [SECY-99-129 – May 1999] “Effects of Electric Power Industry Deregulation on Electric Grid Reliability and Nuclear Safety,” US NRC, May 11, 1999.
- [Raughley – April 29, 2003] W. Raughley, “Operating Experience Assessment-Effects of Grid Events on Nuclear Power Plant Performance,” US NRC, ML031220116, April 29, 2003.
- [Inside NRC – Sept. 14, 2009] “NRC, FERC Agree to Cooperate on Grid Cybersecurity Issues,” *Inside NRC*, Sept. 14, 2009.
- [IN 1998-07] NRC Information Notice IN 1998-07, “Offsite Power Reliability Challenges from Industry Deregulation,” US NRC, February 27, 1998.

- [IN 2004-15] NRC Information Notice IN 2004-15, "DUAL-UNIT SCRAM AT PEACH BOTTOM UNITS 2 AND 3," US NRC, July 22, 2004.
- [IN 2005-15] NRC Information Notice IN 2005-15, "THREE-UNIT TRIP AND LOSS OF OFFSITE POWER AT PALO VERDE NUCLEAR GENERATING STATION," US NRC, June 1, 2005.
- [IN 2005-21] NRC Information Notice IN 2005-21, "PLANT TRIP AND LOSS OF PREFERRED AC POWER FROM INADEQUATE SWITCHYARD MAINTENANCE," US NRC, July 21, 2005.
- [IN 2006-06] NRC Information Notice IN 2006-06, "LOSS OF OFFSITE POWER AND STATION BLACKOUT ARE MORE PROBABLE DURING SUMMER PERIOD," US NRC, March 3, 2006.
- [IN 2006-18] NRC Information Notice IN 2006-18, "SIGNIFICANT LOSS OF SAFETY-RELATED ELECTRICAL POWER AT FORSMARK, UNIT 1, IN SWEDEN," US NRC, August 17, 2006.
- [IN 2007-14] NRC Information Notice IN 2007-14, "LOSS OF OFFSITE POWER AND DUAL-UNIT TRIP AT CATAWBA NUCLEAR GENERATING STATION," US NRC, March 30, 2007.
- [IN 2008-12] NRC Information Notice IN 2008-12, "BRAIDWOOD UNIT 1 REACTOR TRIP DUE TO OFF-SITE POWER FLUCTUATION," US NRC, July 7, 2008.
- [GL 2006-02] NRC Generic Letter GL 2006-02, "GRID RELIABILITY AND THE IMPACT ON PLANT RISK AND THE OPERABILITY OF OFFSITE POWER," US NRC, February 1, 2006.
- [10 CFR 50.65] Title 10 of the Code of Federal Regulations, Part 50.65 "Requirements for monitoring the effectiveness of maintenance at nuclear power plants."
- [NUREG-0800, Revision 4, March 2007] US NRC NUREG-0800, "Standard Review Plan," Chapter 8, "Electric Power," Revision 4, March 2007.
- [USNRC RG 1.160] Regulatory Guide 1.160, "Monitoring the Effectiveness of Maintenance at Nuclear Power Plants," Revision 2, March 1997.
- [USNRC RG 1.182] Regulatory Guide 1.182, "Assessing and Managing Risk Before Maintenance," May 2000.
- [RIS 2004-05] US NRC Regulatory Issue Summary 2004-05, "Grid Reliability and the Impact on Plant Risk and the Operability of Offsite Power," April 15, 2004.

- [Kirby, Kueck, et. al. ORNL 2007]
B. Kirby, J. Kueck, et. al., Nuclear Generating Stations and Transmission Grid Reliability,” ORNL, 2007.
- [LER 40815] US NRC Licensee Event Report (LER) 50-528/2004-006-00, “Loss of Offsite Power – Three Unit Trip,” Palo Verde Nuclear Generating Station, June 14, 2004.
- [Lindahl – Comments to BNL - 9/17/2010]
Lindahl, Sture, Comments to "Description of NPP Modeling and Analytical Approach to Studying Impacts of Protection Settings on NPP Responses to External Faults," September 17, 2010.
- [AIT 05000277&278/2003013]
US NRC Augmented Inspection Team Report, “NRC Augmented Inspection Team (AIT) 05000277/2003013 and 05000278/2003013, and Preliminary White Finding - Peach Bottom Atomic Power Station,” December 18, 2003.
- [AIT 05000413 & 414/2006009]
US NRC Augmented Inspection Team Report, “Catawba Nuclear Station - NRC Integrated Inspection Report 05000413/2006003 and 05000414/2006003,” July 28, 2006.
- [LER 277/2003-004-00] US NRC Licensee Event Report (LER) 50-277/2003-004-0, “Units 2 and 3 Automatic Scrams Resulting from an Off-Site Electrical Grid Disturbance,” Peach Bottom Atomic Power Station, Units 2 & 3, September 15, 2003.
- [LER 269/2007-001-01] US NRC Licensee Event Report (LER) 50-269/2007-001-01, “Dual Unit Trip from Jocassee Breaker Failure,” Oconee Nuclear Station, Unit 1, February 15, 2007.
- [LER 250/2008-001-00] US NRC Licensee Event Report (LER) 50-250/2008-001, “Human Error Causes Grid Disturbance Resulting in a Dual Unit Trip,” Turkey Point Unit 3, February 26, 2008.
- [IN 2006-18] NRC Information Notice IN 2006-18, “SIGNIFICANT LOSS OF SAFETY-RELATED ELECTRICAL POWER AT FORSMARK, UNIT 1, IN SWEDEN,” US NRC, August 17, 2006.
- [IN 2006-18, Supplement 1] NRC Information Notice IN 2006-18, Supplement 1, “SIGNIFICANT LOSS OF SAFETY-RELATED ELECTRICAL POWER AT FORSMARK, UNIT 1, IN SWEDEN,” US NRC, August 10, 2007.
- [Raughley & Lanik, February 2002]
W. Raughley and G. Lanik, “Operating Experience Assessment - Energetic Faults in 4.16 kV to 13.8 kV Switchgear and Bus Ducts that Caused Fires in Nuclear Power Plants 1986–2001,” US NRC, February 2002.

[NUREG/CR-6950, October 2007]

NUREG/CR-6950, "Effects of Switchgear Aging on Energetic Faults," Brookhaven National Laboratory for NRC/RES, October 2007.

[Russell & Kueck – Dec 91]

W. Russell & J. Kueck, "Considerations for Improving the Reliability of the Off-Site Power Supply for Nuclear Generating Stations," IEEE Transactions on Energy Conversion, Vol. 6, No. 4, December 1991.

Section 2 – Distance relaying, protection systems using telecommunications, and breaker failure:

[10 CFR 50, Appendix A, GDC 17]

Title 10 of the Code of Federal Regulations, Part 50, Appendix A, "General Design Criteria for Nuclear Power Plants," Criterion 17 - Electric Power Systems.

[10 CFR 50.63]

Title 10 of the Code of Federal Regulations, Part 50.63 "Loss of all alternating current power."

[USNRC RG 1.155]

Regulatory Guide 1.155, "Station Blackout."

[IEEE Std. 765-2006]

IEEE Std. 765-2006, "Preferred Power Supply (PPS) for Nuclear Generating Stations," Institute of Electrical and Electronics Engineers, New York, 2006.

[IEEE Std. 308-2001]

IEEE Std. 308-2001, "Standard Criteria for Class 1E Power Systems for Nuclear Generating Stations," Institute of Electrical and Electronics Engineers, New York, 2001.

[NUREG-0800, Revision 4, March 2007]

US NRC NUREG-0800, "Standard Review Plan," Chapter 8, "Electric Power," Revision 4, March 2007.

[NUREG/CR-6950, October 2007]

NUREG/CR-6950, "Effects of Switchgear Aging on Energetic Faults," Brookhaven National Laboratory for NRC/RES, October 2007.

[Mazumdar & Chiramal, Oct 1991]

S. Mazumdar & M. Chiramal, "Bus Transfer Practices at Nuclear Plants," IEEE Transactions on Power Delivery, Vol. 6, No. 4, October 1991.

[MacDonald 2003]

McDonald, John D., "Electric Power Substations Engineering," CRC Press, New York, 2003.

- [Daume – Feb 2007] J. Daume, “High Voltage Transmission Practices,” Presentation, Bonneville Power Association, February 2, 2007.
- [GER-3965] G. E. Alexander and J. G. Andrichak, Evaluating Line Relaying Schemes in Terms of Speed, Security and Dependability, GER-3965, GE Power Management.
- [Kundur 1993] P. Kundur, Power System Stability and Control, McGraw-Hill, Inc, 1993.
- [IEEE Std. C37.113-1999] IEEE Std. C37.113-1999 “Guide for Protective Relay Applications to Transmission Lines,” Institute of Electrical and Electronics Engineers, New York, 1999.
- [CIGRE JWG 34/35.11-2001] “Protection Using Telecommunications,” Technical Brochure No. 192, CIGRE JWG 34/35.11, Paris 2001.
- [Lindahl-2011] S. Lindahl, SLi-2011-009, Version B, “Comments to Susceptibility of Nuclear Stations to External Faults,” May 18, 2011.
- [IEEE C37.91-2008] IEEE Std C37.91-2008, “Guide for Protecting Power Transformers,” Institute of Electrical and Electronics Engineers, New York, May 30, 2008.
- [IEEE PC37.119-2005] IEEE Std 37.119-2005, “Guide for Breaker Failure Protection of Power Circuit Breakers,” Institute of Electrical and Electronics Engineers, New York, 2005.
- [IEEE Std. C37.234-2009] IEEE Std. C37.234-2009, “Guide for Protective Relay Applications to Power System Buses,” Institute of Electrical and Electronics Engineers, New York, 2009.
- [Mason 1956] C. Russell Mason, “The Art and Science of Protective Relaying.” Engineering Planning and Development Section, General Electric Co., John Wiley & Sons, New York, 1956.
- [Blackburn, et. al. – 1976] J. L. Blackburn, et. al., “Applied Protective Relaying,” Westinghouse Electric Corp., Relay Instrument Division, Newark, NJ, 1976.
- [Svensson, B.] “Tolkning av SvKFS 2005:2 relaterat till påbörjat projekt Puls för effekthöjning av O3 (Interpretation of the regulation SvSKFS 2005.2 related to Project Puls for the power uprating of Oskarshamn 3),” slide presentation at Svenska Kraftnöt (Swedish National Grid), January 2006.
- [NERC-Jan 2009] “NERC Technical Paper on Protection System Reliability – Redundancy of Protection System Elements,” North American Electric Reliability Corporation, Princeton, New Jersey, January 2009.

- [IEEE Std. C37.91-2008] IEEE Std. C37.91-2008, "Guide for Protective Relay Applications to Power Transformers," Institute of Electrical and Electronics Engineers, New York, 2008.
- [SRP BTP 8-6] US NRC NUREG-0800, Chapter 8, "Standard Review Plan for the Review of Safety Analysis Reports for Nuclear Power Plants: LWR Edition — Electric Power," Rev. 4, February 2012.
- [RIS 2011-12] US NRC, "NRC Regulatory Issue Summary 2011-12 Adequacy of Station Electric Distribution System Voltages," Revision 1, December 29, 2011.
- [Kueck, et. al. – 1998] J. Kueck, et. al., "A Discussion of Degraded Voltage Relaying for Nuclear Generating Stations," IEEE, 1998.
- [Jancauskas – 1994] J. R. Jancauskas, "A Recommended Approach for Calculating Degraded Voltage Relay Setpoints for Nuclear Generating Stations," IEEE Transactions on Energy Conversion, Vol. 9, No. 1, March 1994.

Section 3 – Analytical Approach to Studying the Impacts of Protection Settings on NPP Responses to External Faults

- [Lindahl – 2010] S. Lindahl, Comments to "Description of NPP Modeling and Analytical Approach to Studying Impacts of Protection Settings on NPP Responses to External Faults," September 17, 2010.
- [Lindahl – 2011] S. Lindahl, SLi-2011-009, Version B, "Comments to Susceptibility of Nuclear Stations to External Faults," May 18, 2011.

Section 4 – NPP Models and Analyses

- [IEEE Brown Book] IEEE Std. 399-1990, "IEEE Recommended Practices for Power System Analysis," Institute of Electrical and Electronics Engineers, New York, 1990.
- [Kundur 1993] P. Kundur, Power System Stability and Control, McGraw-Hill, Inc, 1993.
- [Seman 1995] G. W. Seman, C. Katz, and S. V. Pancholi, "Evaluation of 230 kV HPFF Pipe-type Cable with Wrinkled and Creased Insulating Tapes," IEEE Transactions on Power Delivery, Vol. 10, No. 1, Jan, 1995.
- [Trehan 2002] N. K. Trehan, "Fast Bus Transfer Scheme and Its Performance in Nuclear Power Generating Stations," SNPS Paper P-3-1, Norfolk, Virginia, 2002.

Section 5 – Importance of Protection Systems Maintenance

- [10 CFR 50, Appendix A, GDC 17] Title 10 of the Code of Federal Regulations, Part 50, Appendix A, “General Design Criteria for Nuclear Power Plants,” Criterion 17 - Electric Power Systems.
- [10 CFR 50, Appendix A, GDC 18] Title 10 of the Code of Federal Regulations, Part 50, Appendix A, “General Design Criteria for Nuclear Power Plants,” Criterion 18 – Inspection and testing of electric power systems.
- [10 CFR 50.65] Title 10 of the Code of Federal Regulations, Part 50.65 “Requirements for monitoring the effectiveness of maintenance at nuclear power plants.”
- [NUC-001-2] North American Electric Reliability Corporation (NERC) Standard, NUC-001-2, “Nuclear Plant Interface Coordination,” August 2009.
- [PRC-005-2] North American Electric Reliability Corporation (NERC) Standard, PRC-005-2, “Protection System Maintenance,” approved by the NERC Board of Trustees, November 7, 2012. Awaiting FERC action.
- [IN 2005-15] NRC Information Notice IN 2005-15, “Three-Unit Trip and Loss of Offsite Power at Palo Verde Nuclear Generating Station,” US NRC, June 1, 2005.
- [LER 40815] US NRC Licensee Event Report (LER) 50-528/2004-006-00, “Loss of Offsite Power – Three Unit Trip,” Palo Verde Nuclear Generating Station, June 14, 2004.
- [IN 2004-15] NRC Information Notice IN 2004-15, “Dual-Unit Scram at Peach Bottom Units 2 and 3,” US NRC, July 22, 2004.
- [AIT 05000277&278/2003013] US NRC Augmented Inspection Team Report, “NRC Augmented Inspection Team (Ait) 05000277/2003013 and 05000278/2003013, and Preliminary White Finding - Peach Bottom Atomic Power Station,” December 18, 2003.
- [IN 2007-14] NRC Information Notice IN 2007-14, “Loss Of Offsite Power and Dual-Unit Trip at Catawba Nuclear Generating Station,” US NRC, March 30, 2007.
- [AIT 05000413 & 414/2006009] US NRC Augmented Inspection Team Report, “Catawba Nuclear Station - NRC Integrated Inspection Report 05000413/2006003 and 05000414/2006003,” July 28, 2006.

- [LER 269/2007-001-01] US NRC Licensee Event Report (LER) 50-269/2007-001-01, "Dual Unit Trip from Jocassee Breaker Failure," Oconee Nuclear Station, Unit 1, February 15, 2007.
- [LER 250/2008-001-00] US NRC Licensee Event Report (LER) 50-250/2008-001, "Human Error Causes Grid Disturbance Resulting in a Dual Unit Trip," Turkey Point Unit 3, February 26, 2008.
- [Kirby, Kueck, et. al. ORNL 2007] B. Kirby, J. Kueck, et. al., "Nuclear Generating Stations and Transmission Grid Reliability," ORNL, 2007.

**APPENDIX A SCENARIOS FOR COMPARING GRID RESPONSES
TO FAULTS AT DIFFERENT LOCATIONS FOR
PLANTS B AND C**

**(Scenarios Plant B Cases 1 - 7 and Plant C Cases 1 - 8 Defined in
Table 4-1)**

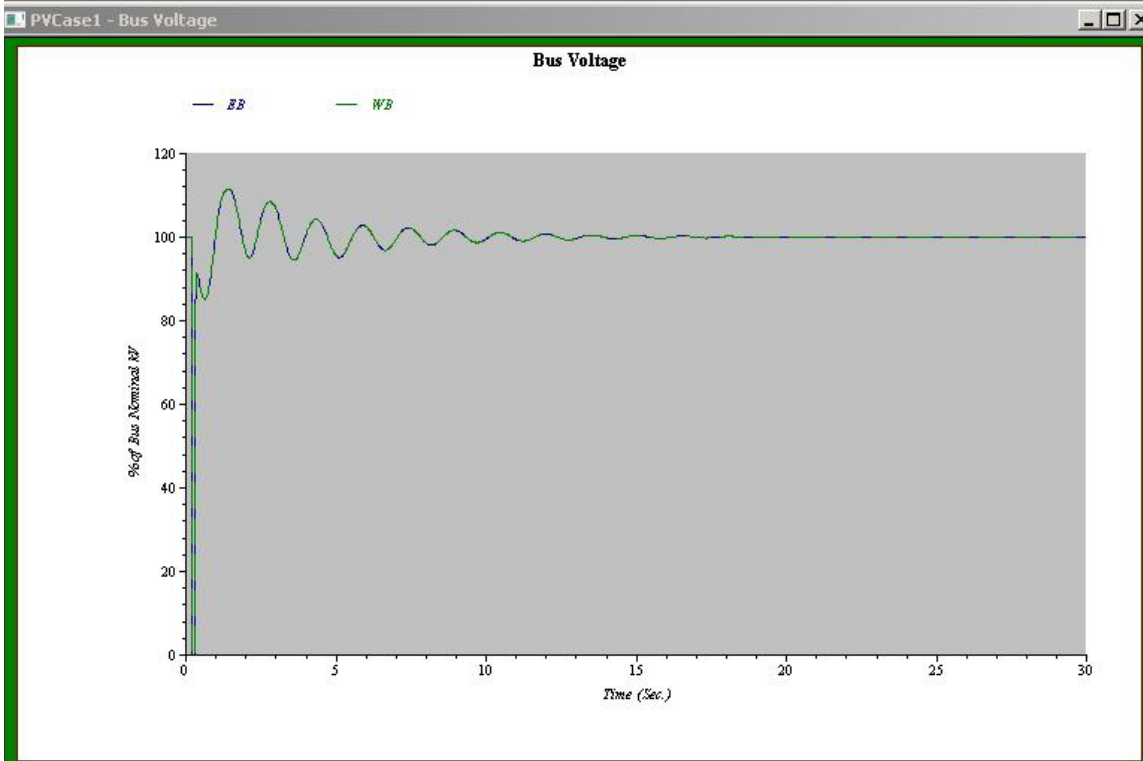
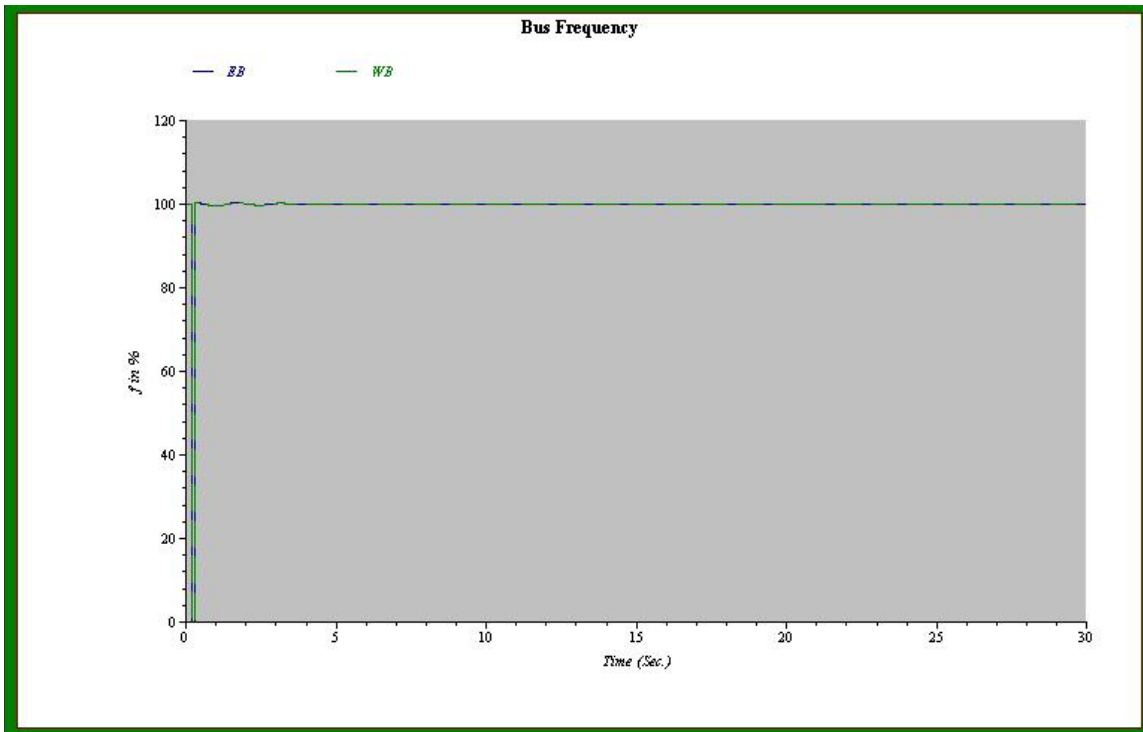

Figure A-1 Plant B-Case-1 for Bus EB Permanent Fault (Near)

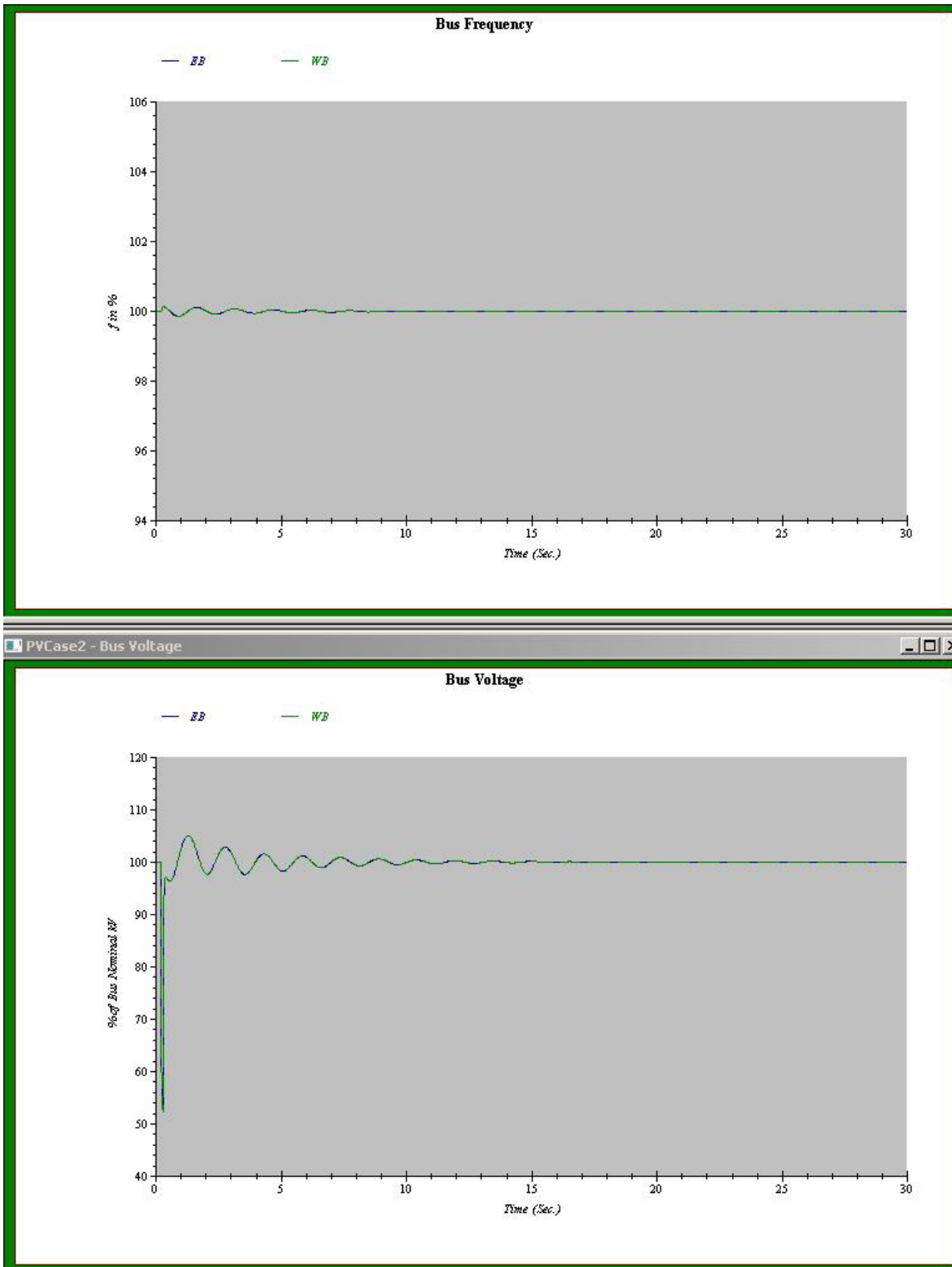

Figure A-2 Plant B-Case-2 for Bus Sub2 Permanent Fault (Medium)

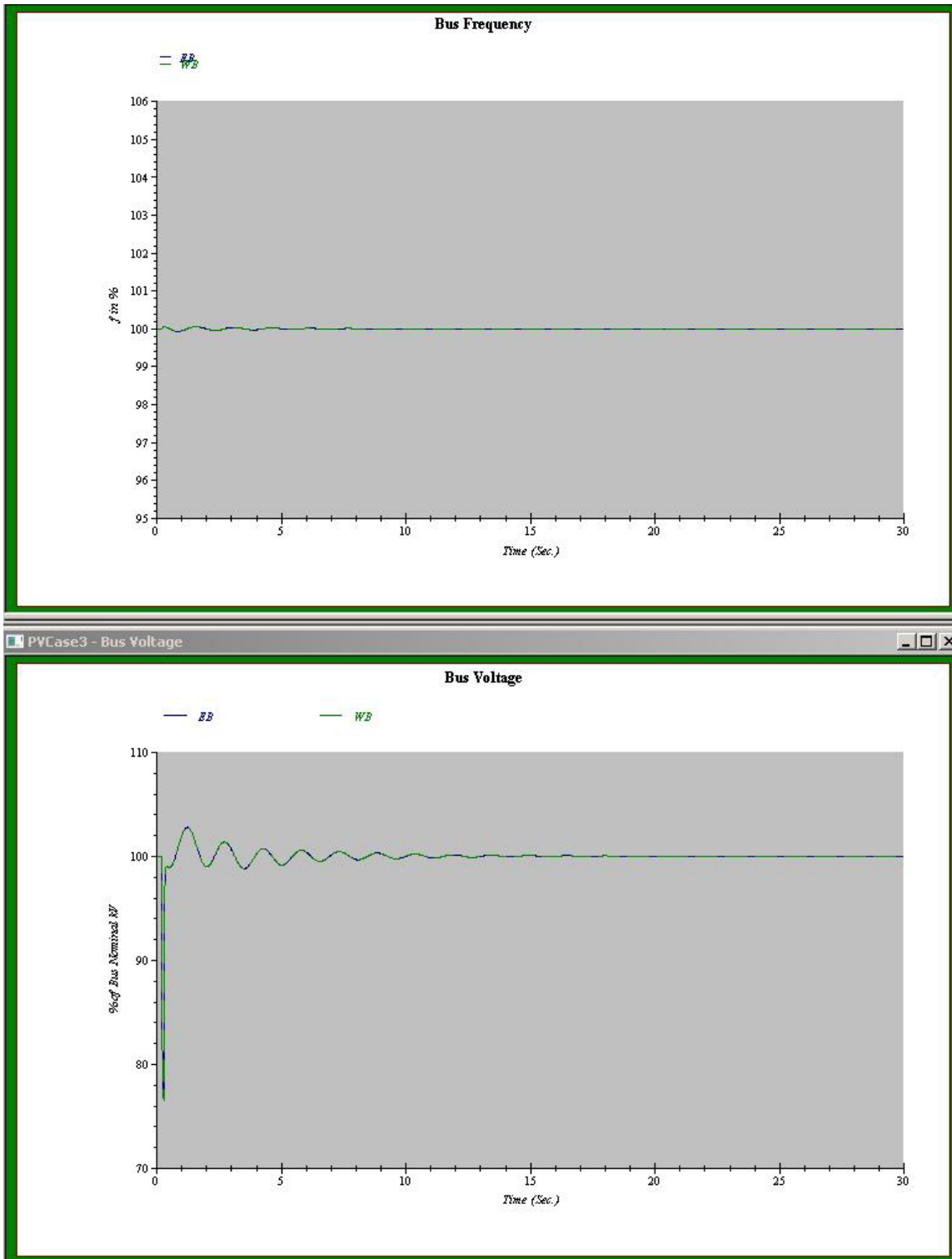

Figure A-3 Plant B-Case-3 for Bus Sub6 Permanent Fault (Far)

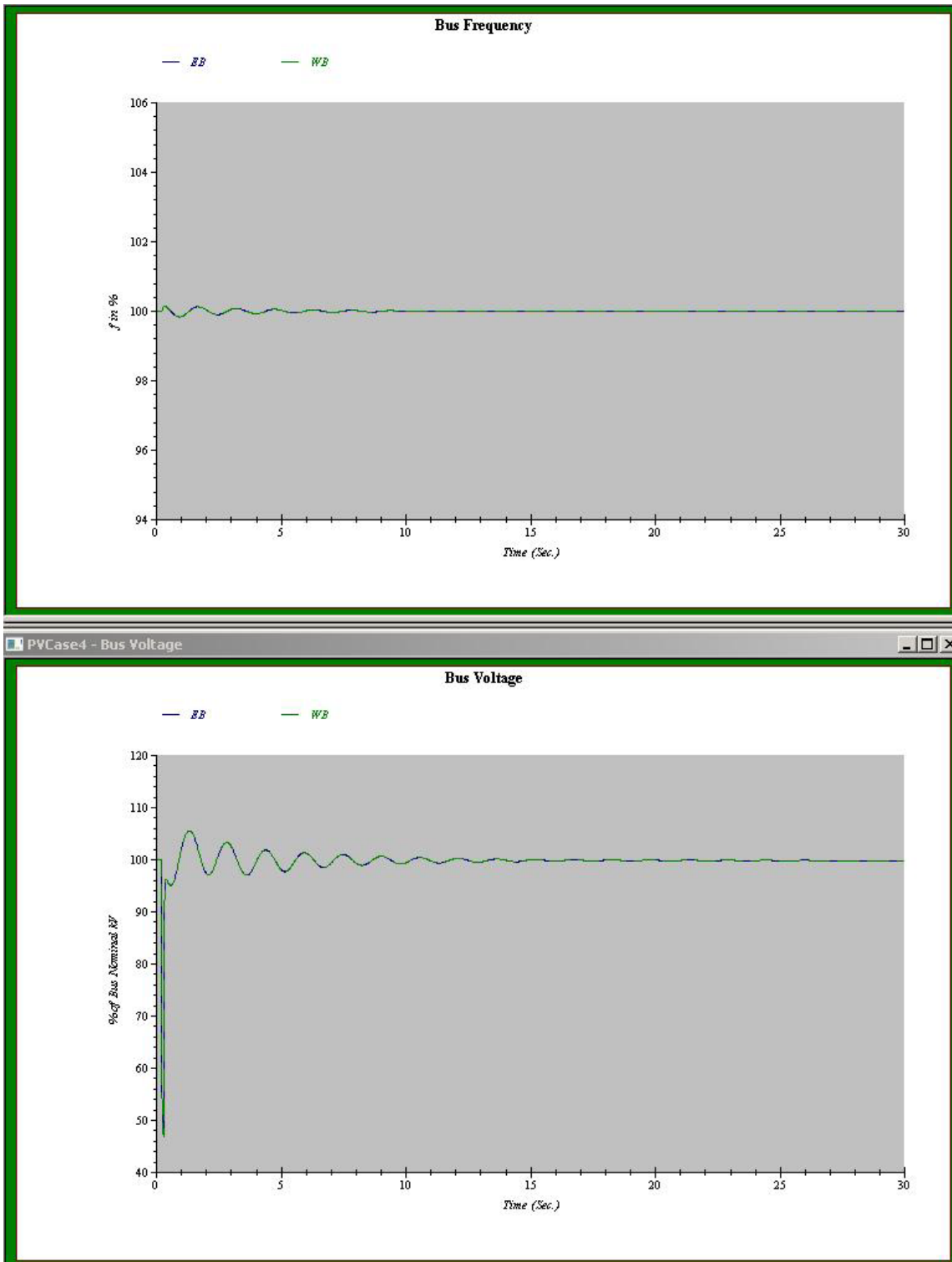

Figure A-4 Plant B-Case-4 for Line 12 Permanent Fault (Near)

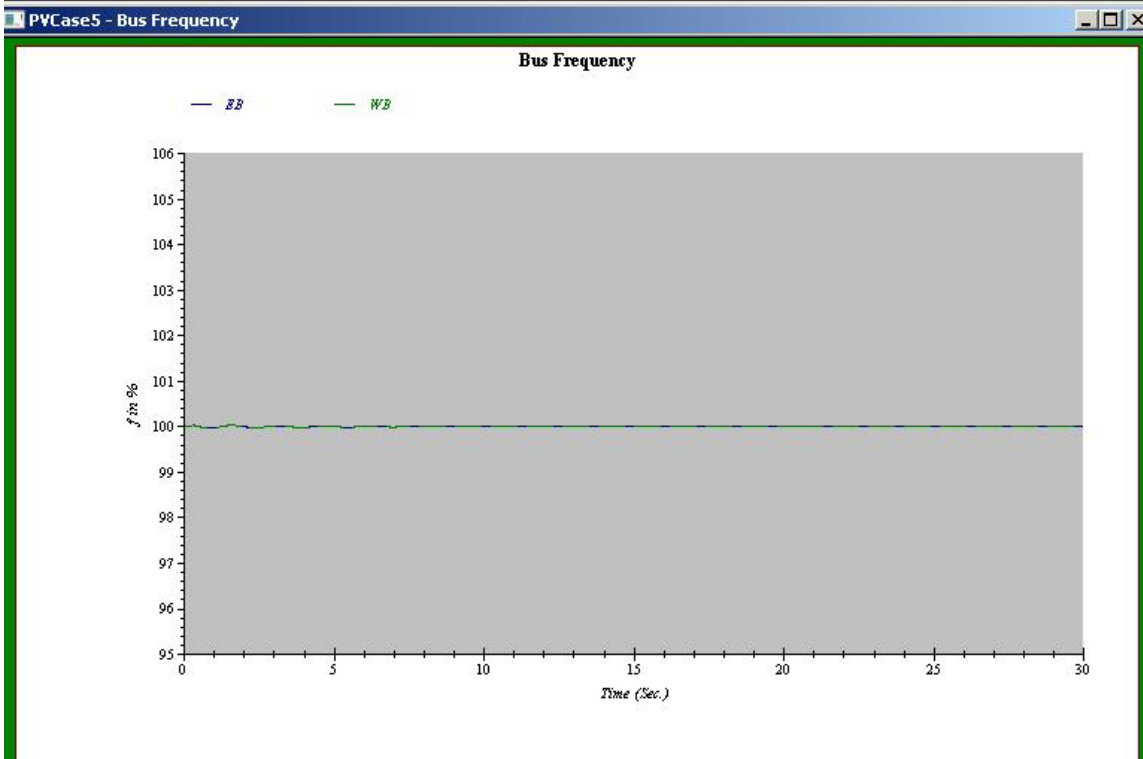
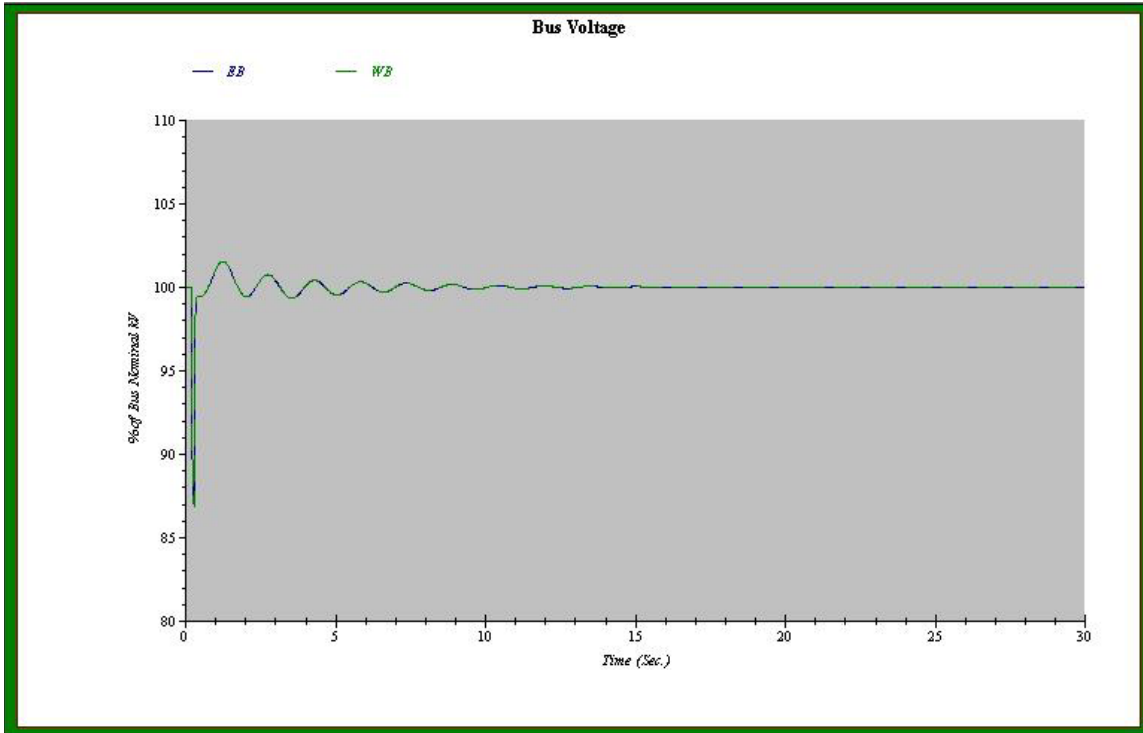

Figure A-5 Plant B-Case-5 for Line 2 Permanent Fault (Medium)

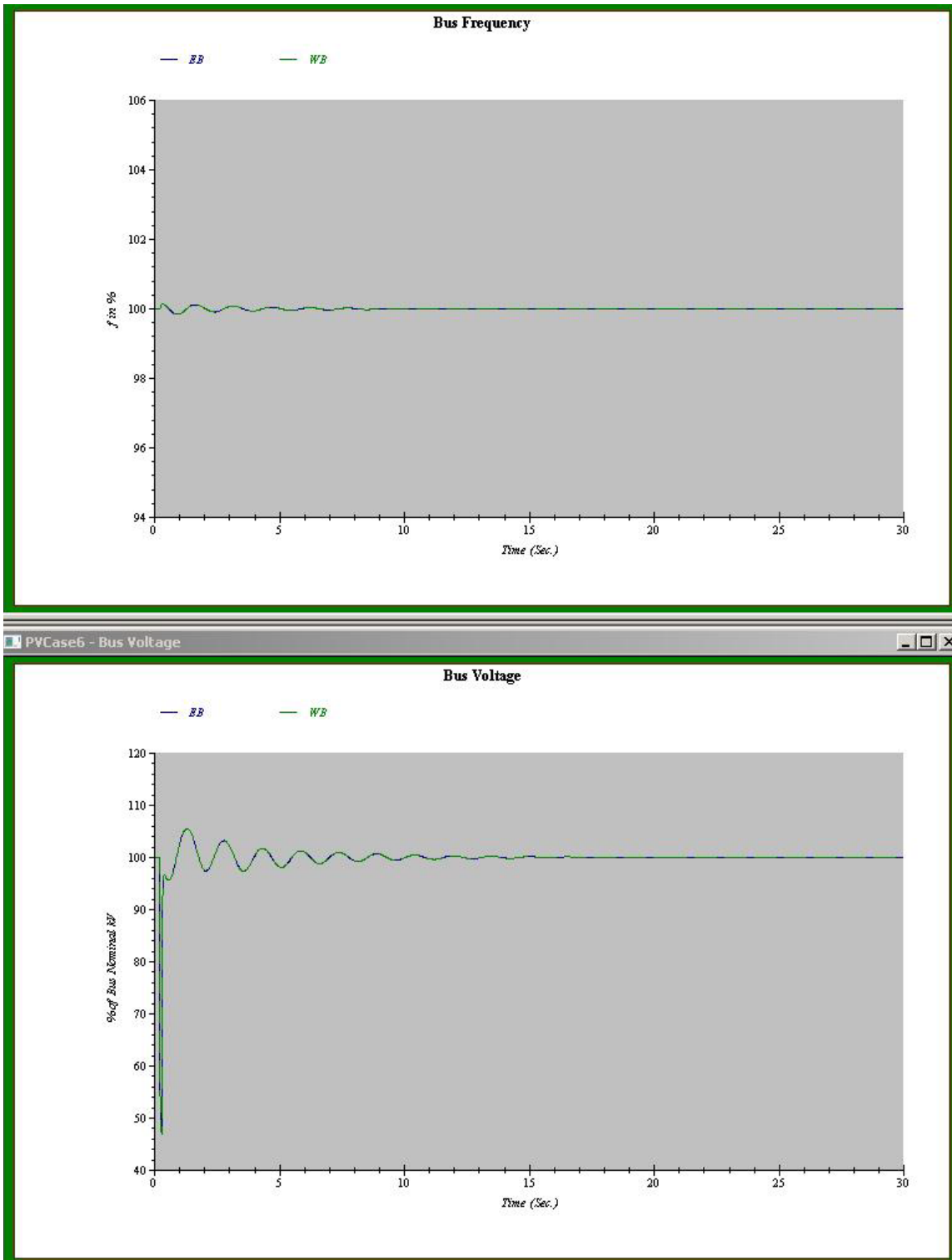

Figure A-6 Plant B-Case-5 for Line 12 Transient Fault (Far)

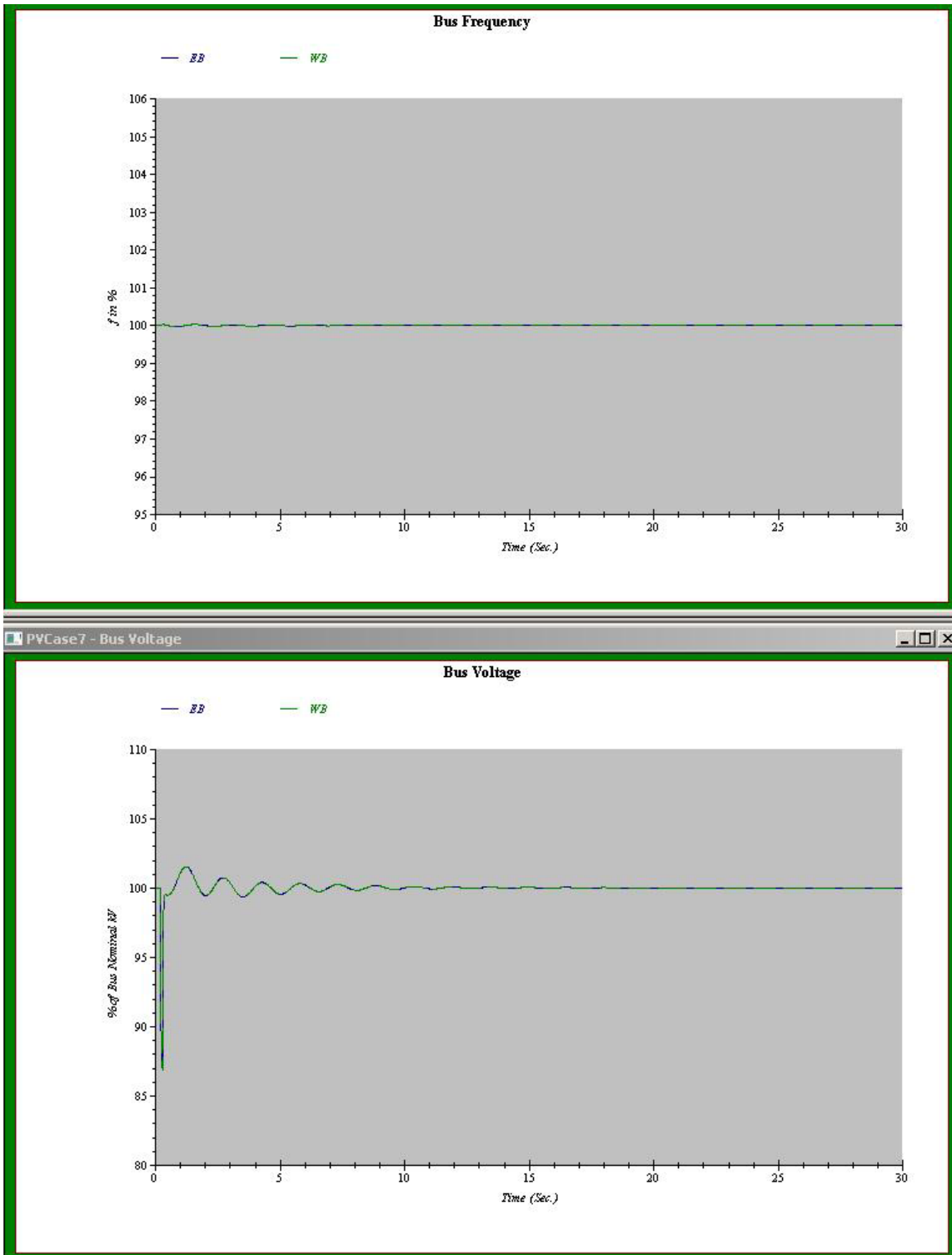

Figure A-7 Plant B-Case-6 for Line 2 Transient Fault (Near)

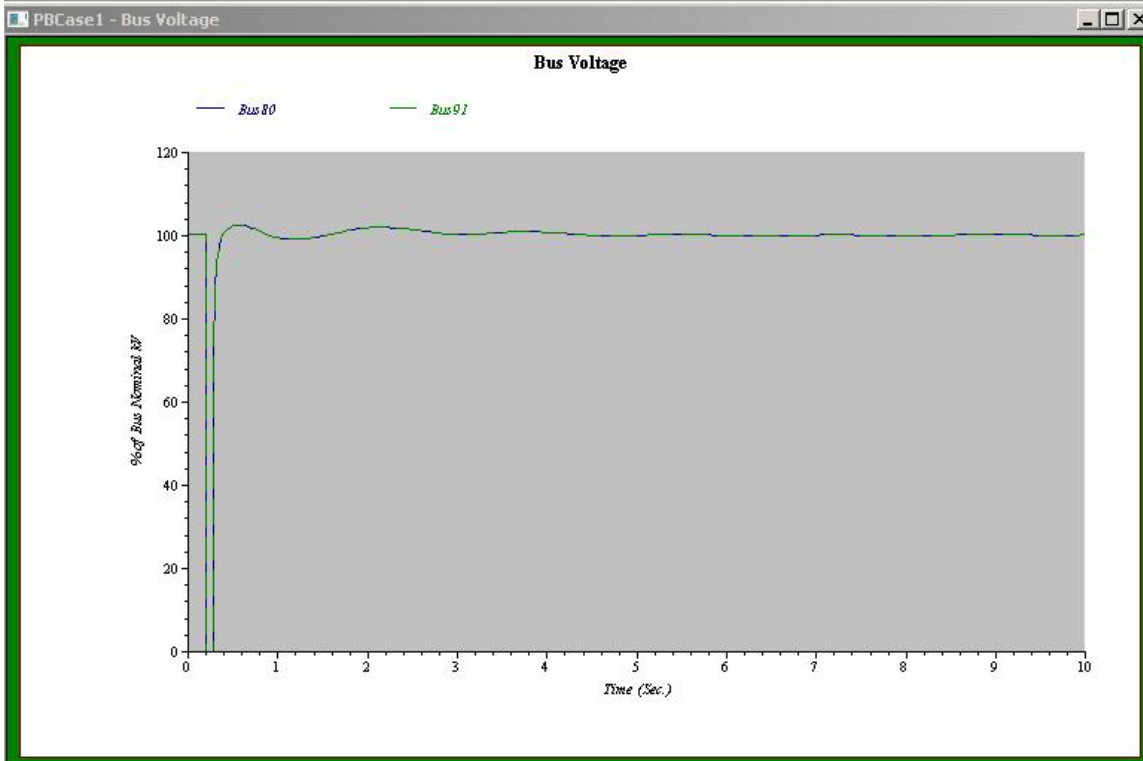
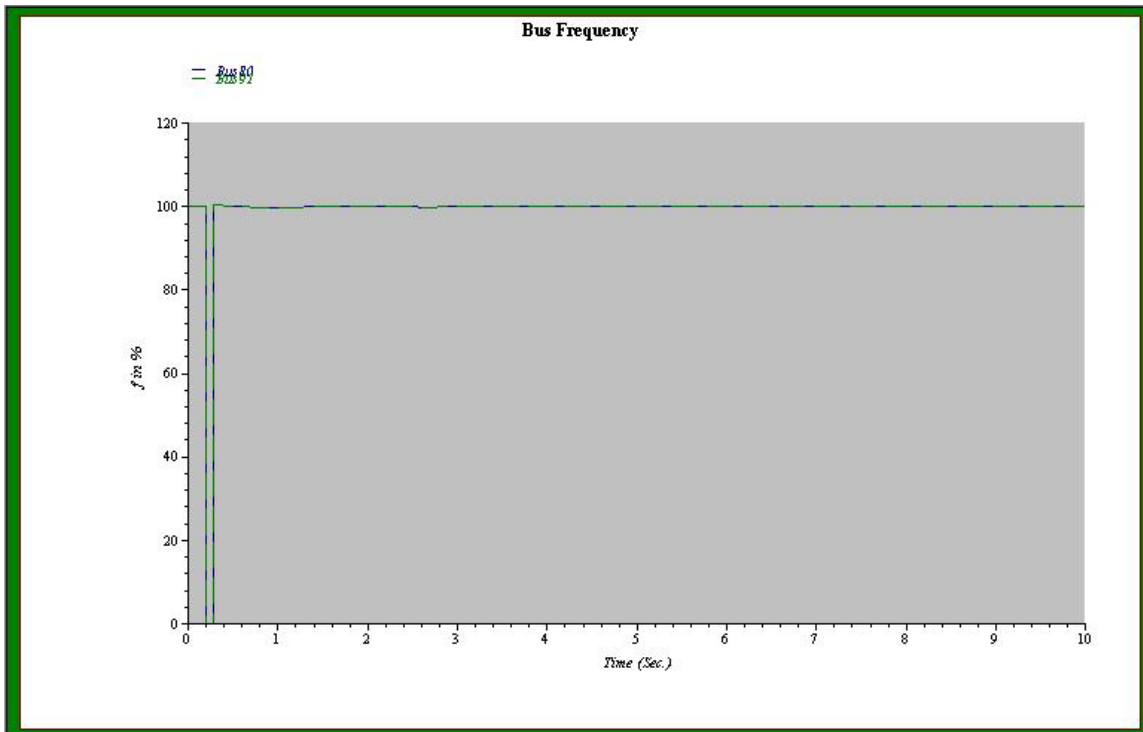

Figure A-8 Plant C-Case-1 for Bus77 Permanent Fault (Near)

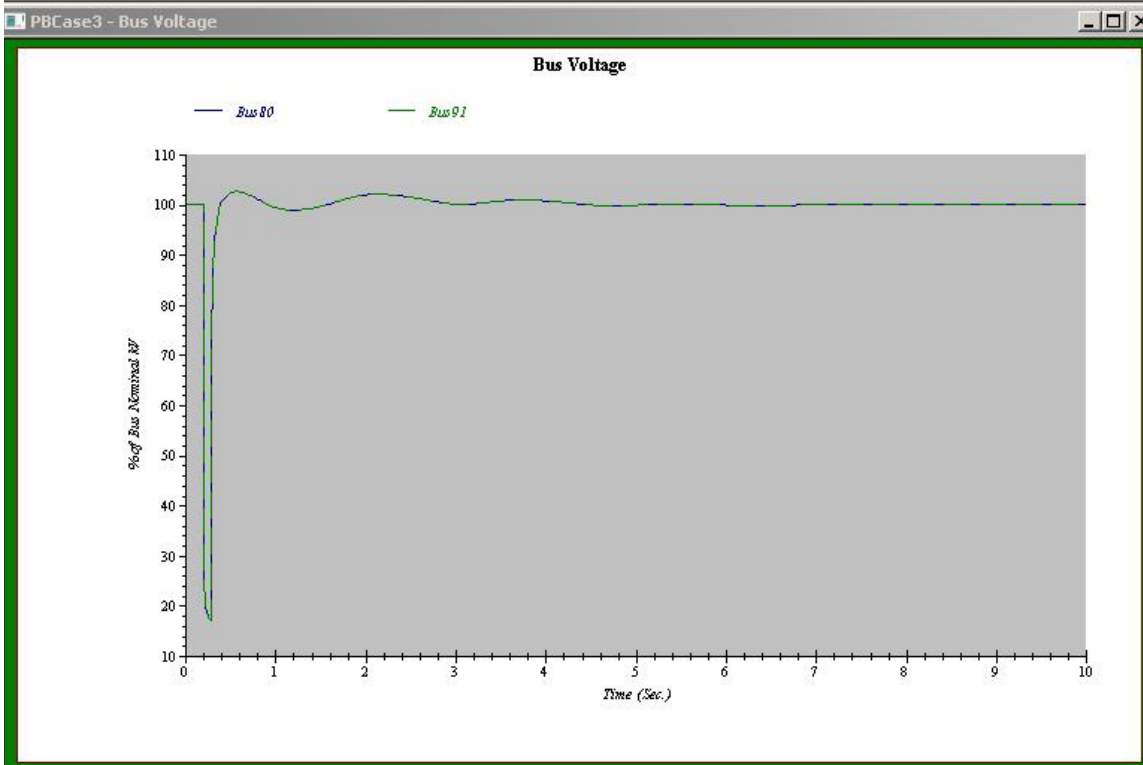
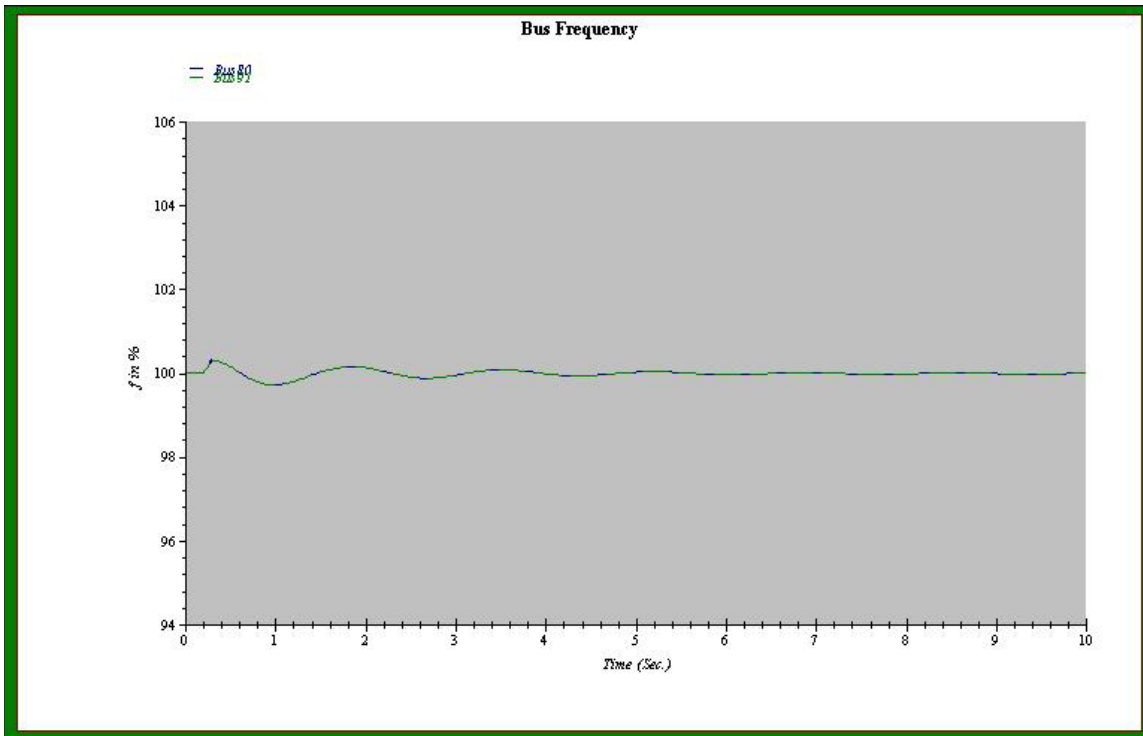

Figure A-9 Plant C-Case-2 for Bus Sub1 Permanent Fault (Far)

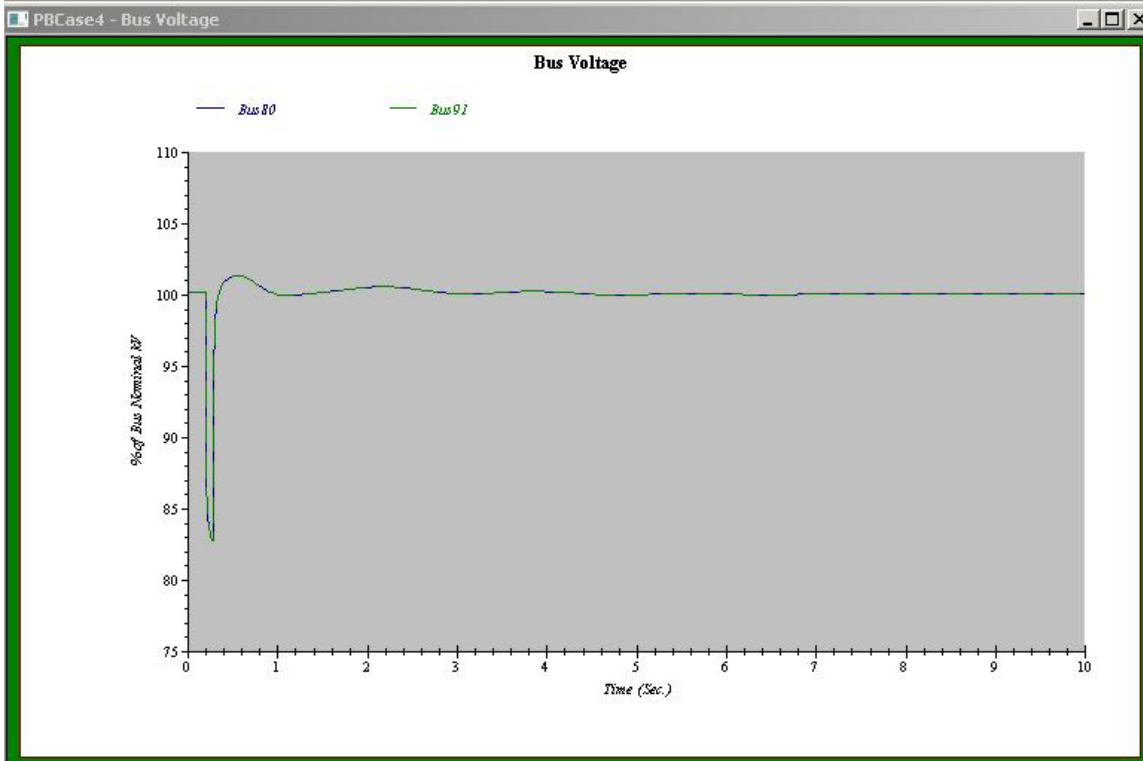
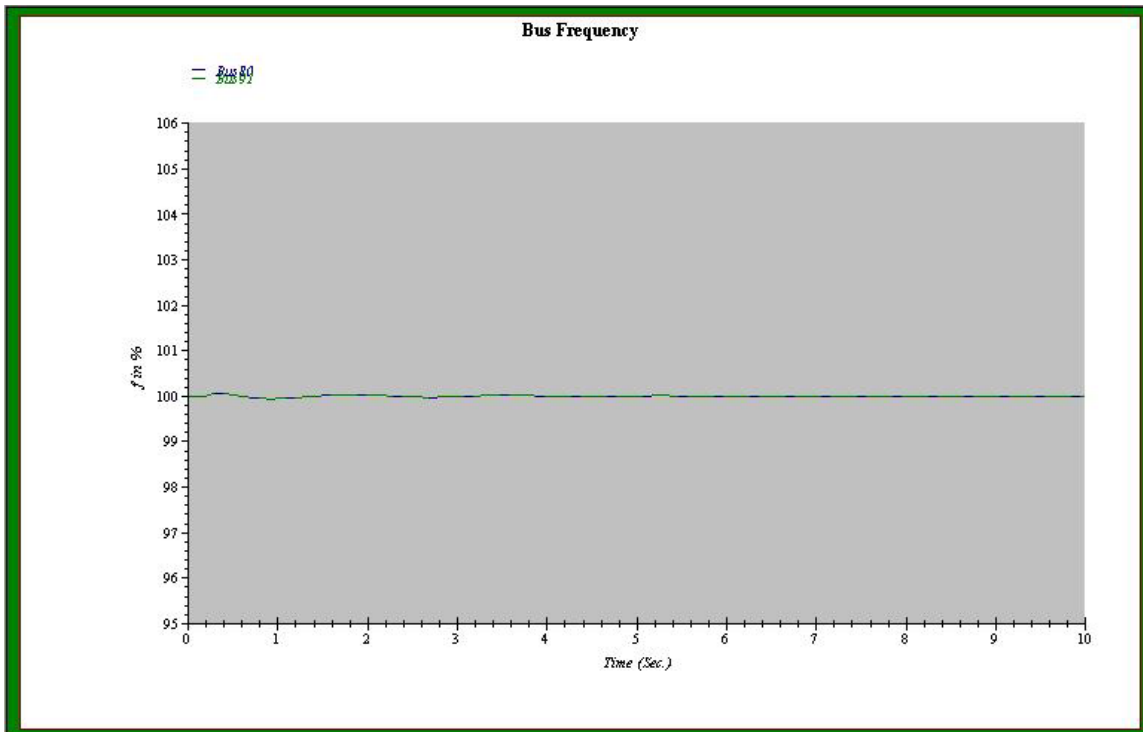

Figure A-10 Plant C-Case-3 for Line 3 Permanent Fault (Near)

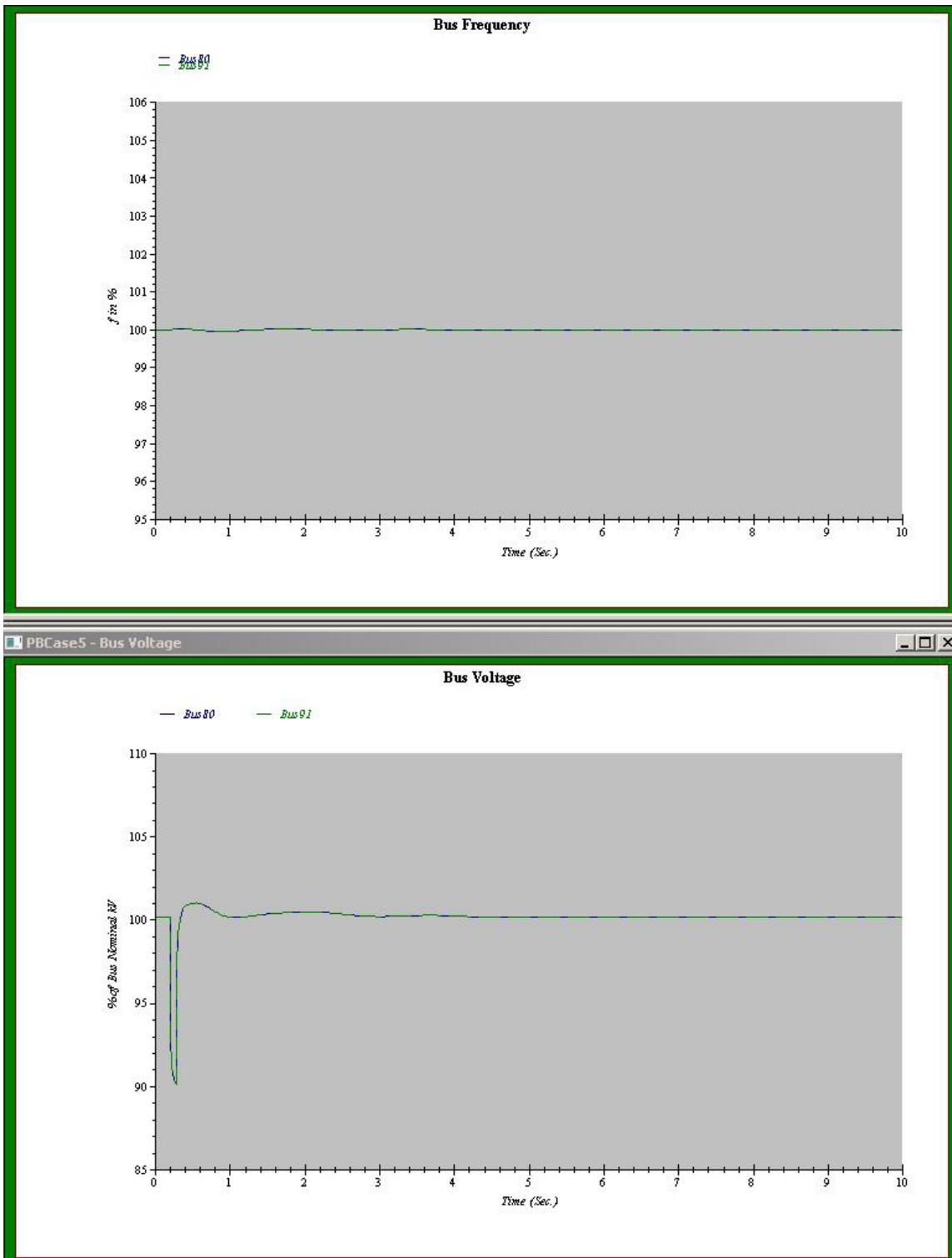
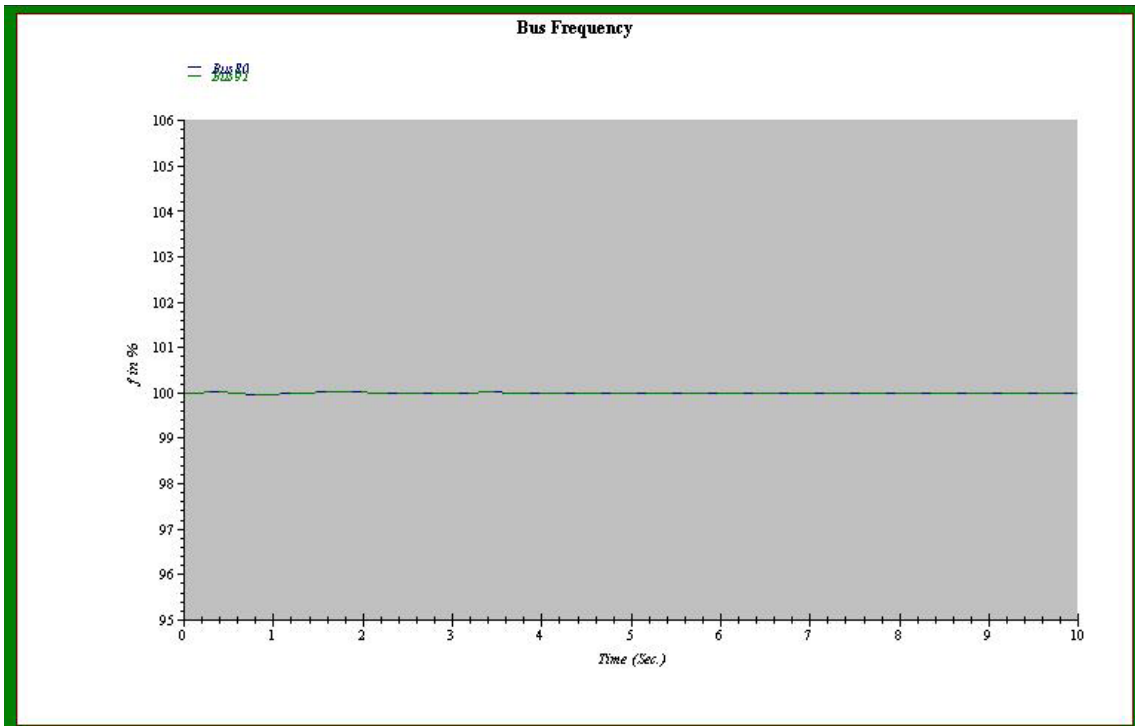

Figure A-11 Plant C-Case-4 for Line 220 32 Permanent Fault (Medium)



PBCase6 - Bus Voltage

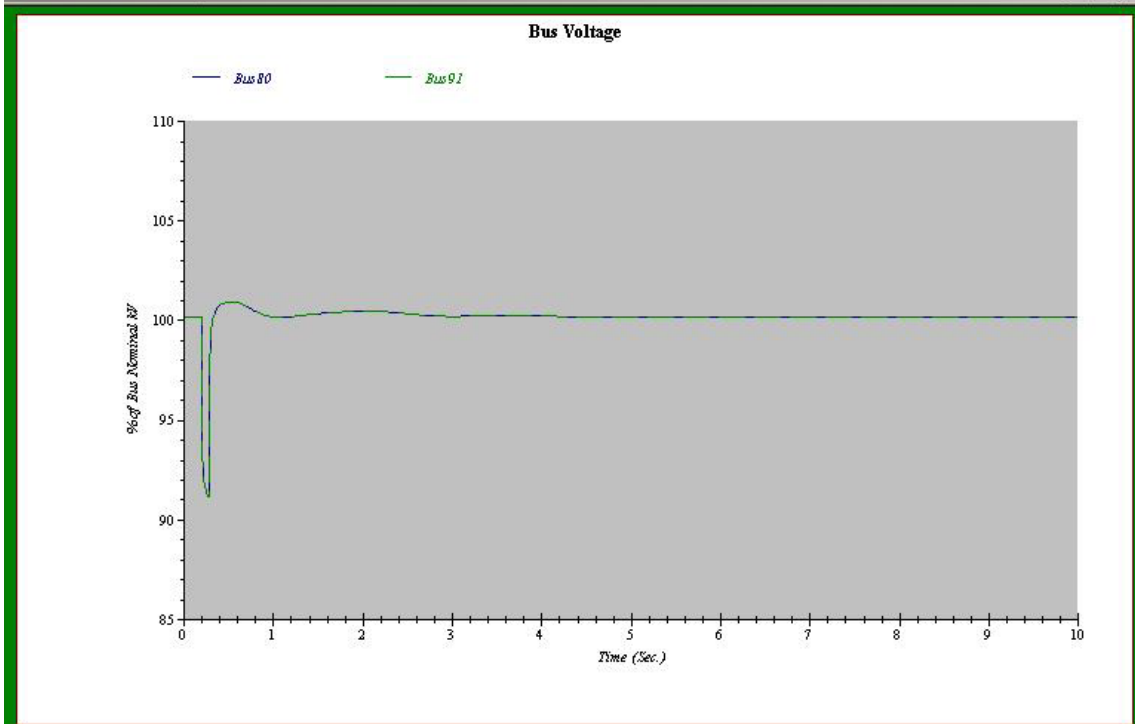

Figure A-12 Plant C-Case-5 for Line 220 31 Permanent Fault (Near)

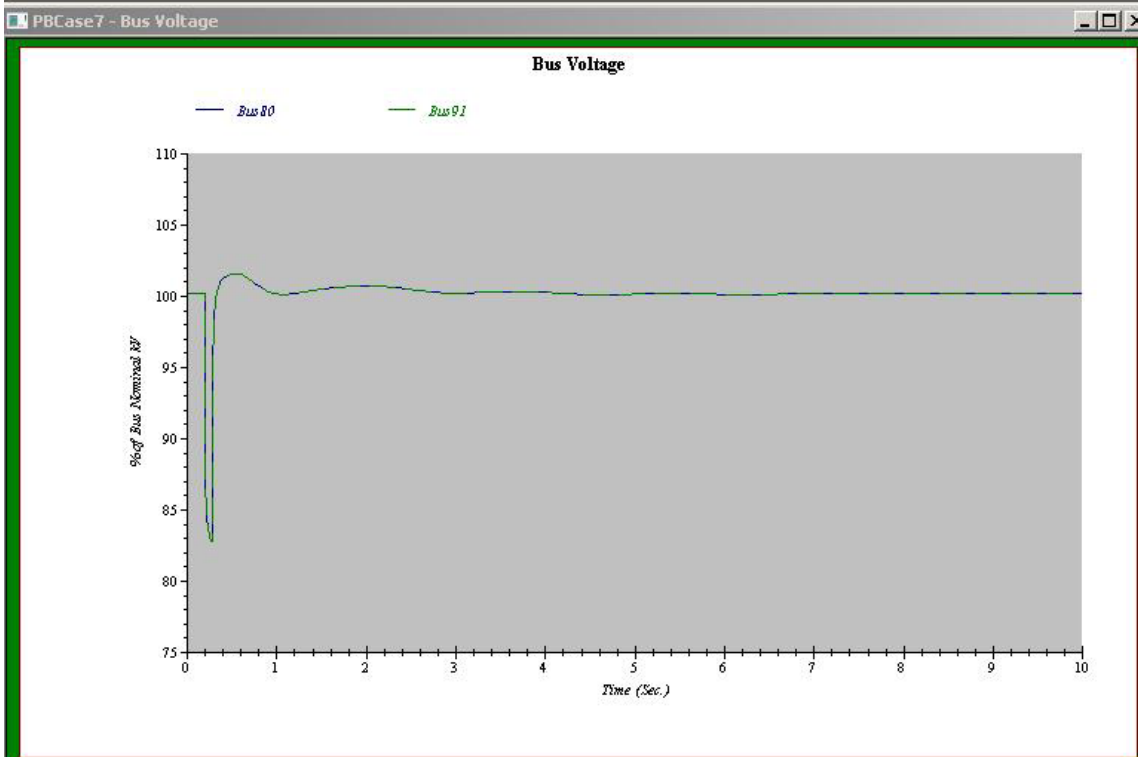
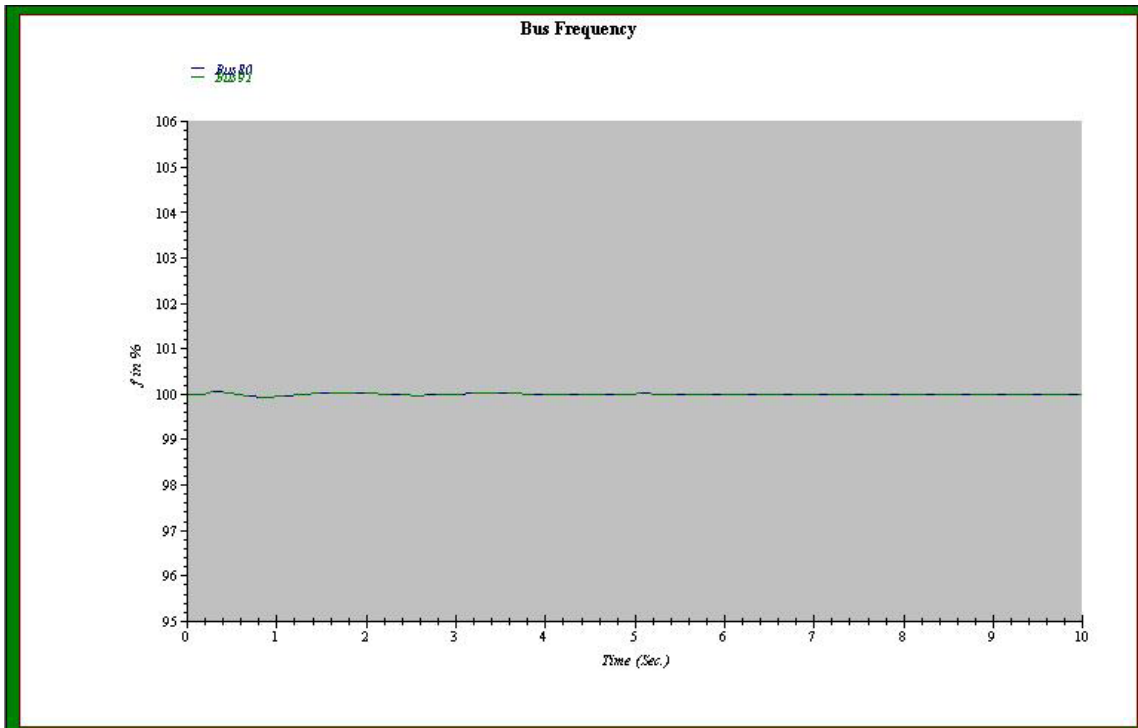

Figure A-13 Plant C-Case-6 for Line 3 Transient Fault (Near)

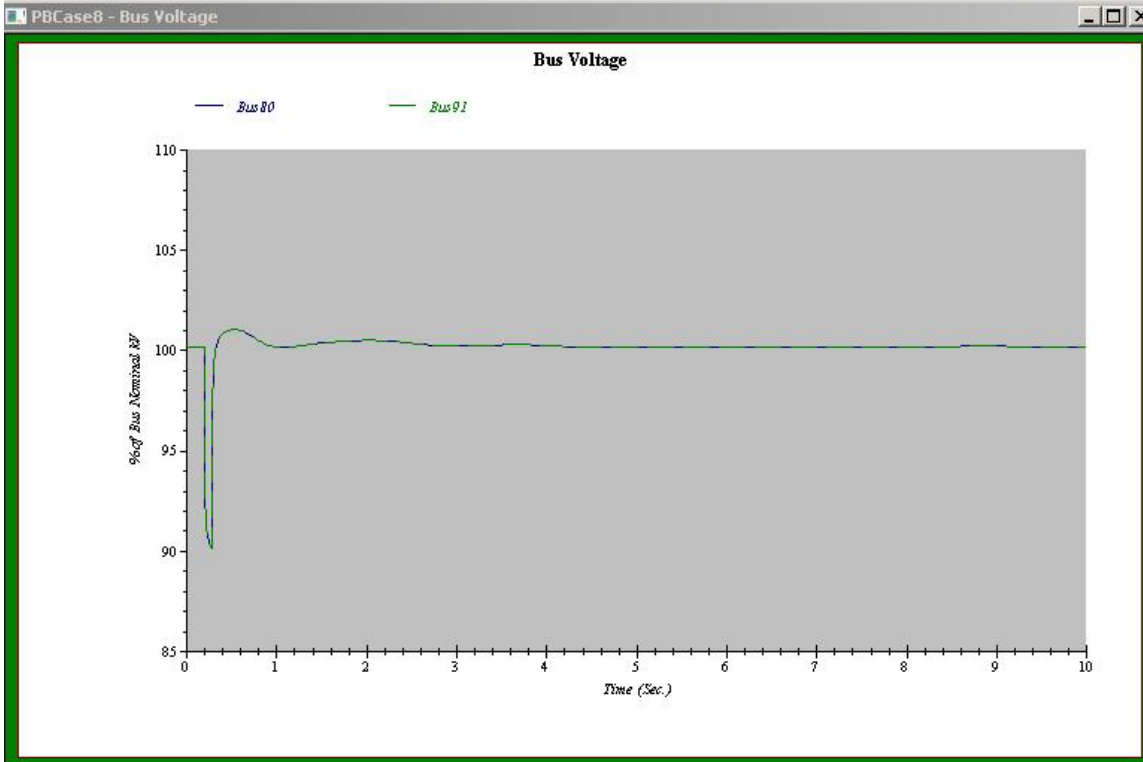
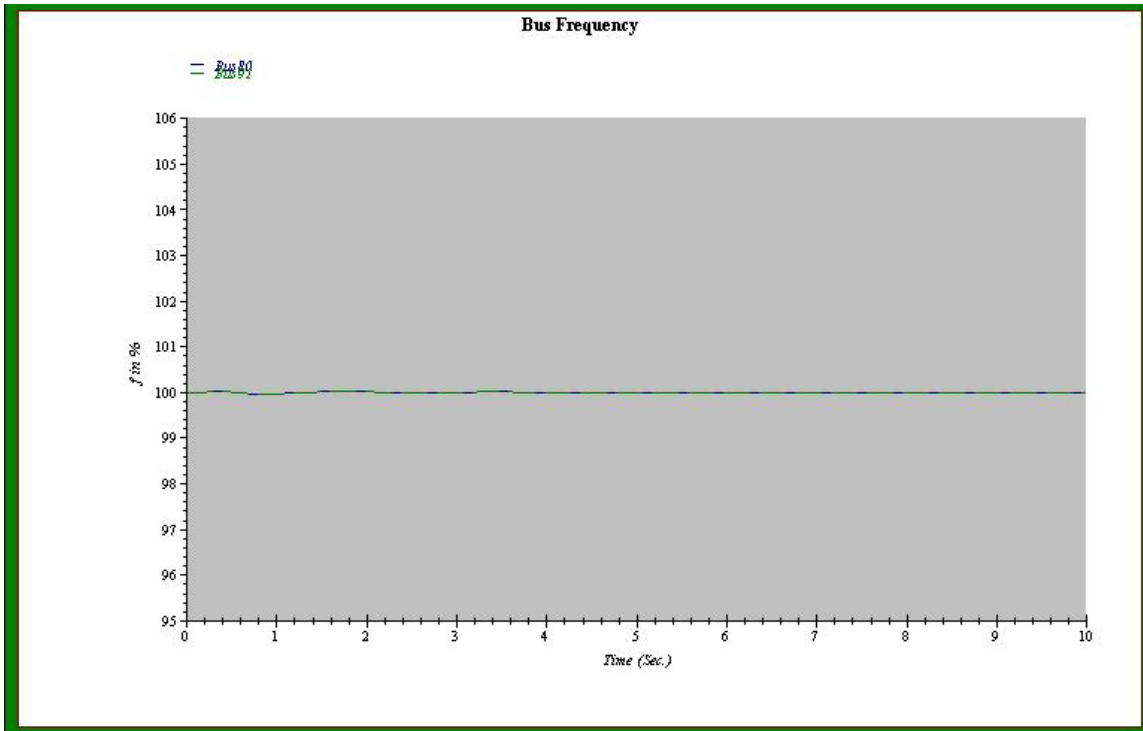

Figure A-14 Plant C-Case-8 for Line 220 32 Transient Fault (Medium)

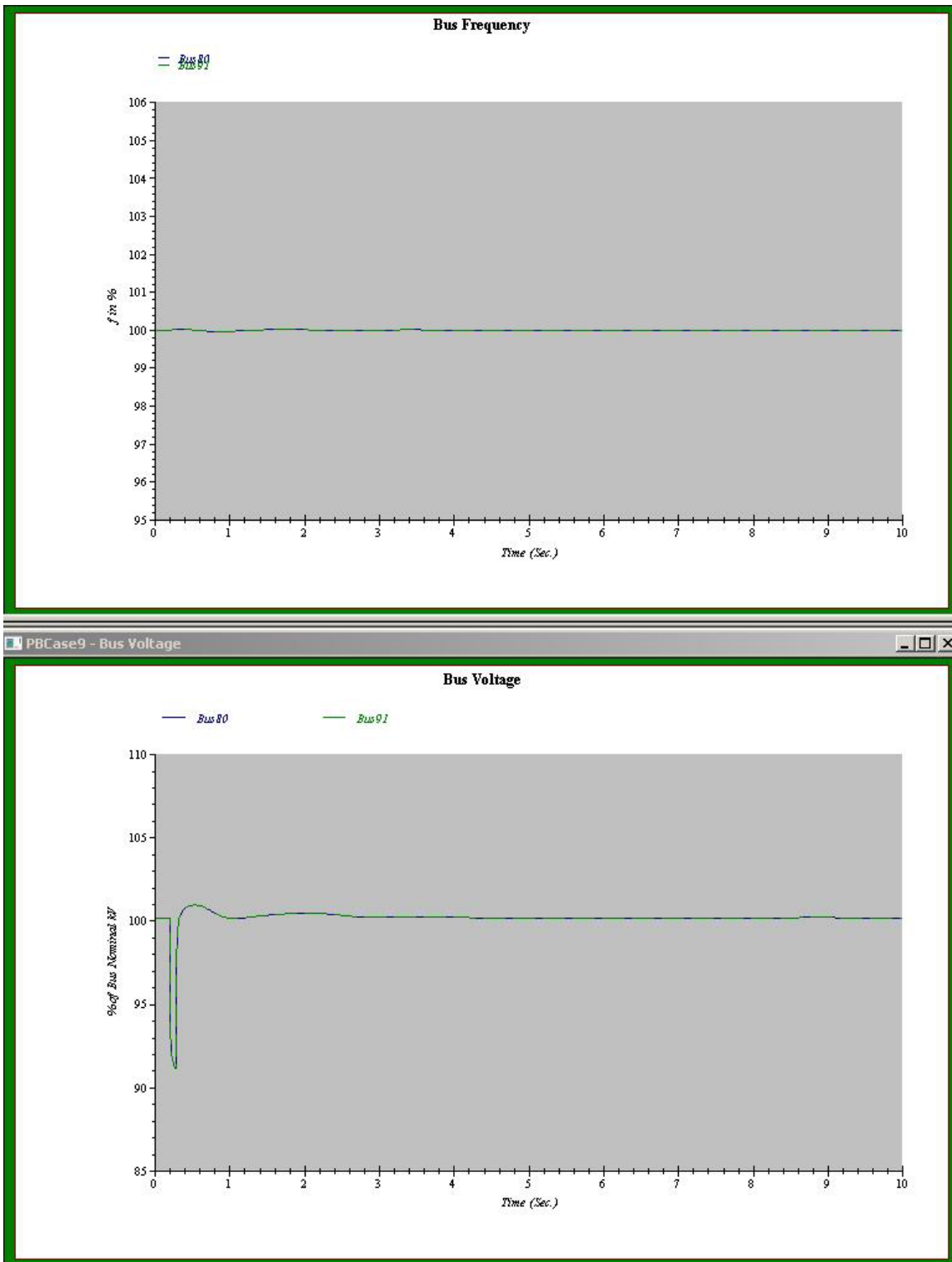

Figure A-15 Plant C-Case-8 for Line 220 31 Transient Fault (Far)

APPENDIX B **DEREGULATION OF THE ELECTRIC UTILITY INDUSTRY**

- 1 As part of the ongoing national trend to deregulate major interstate industries, the National Energy Policy Act of 1992 allows for the competitive sale of electricity on the open market and for individual customers to choose their electric supplier. The Federal Energy Regulatory Commission (FERC) is the regulatory body responsible for the regulation of wholesale interstate electric power transactions.

More specifically, FERC issued Order No. 888, “Promoting Wholesale Competition Through Open Access Non-discriminatory Transmission Services by Utility Companies, Recovery of Stranded Costs by Public Utilities and Transmitting Utilities,” in 1996 that required both utility generators and non-utility generators (merchant power plants) to have open access to the electric transmission grid [FERC Order No. 888]. Further, FERC Order No. 889, “Open Access Same-time Information System (OASIS) Rule and Standards of Conduct,” guaranteed equal access rights to all parties who wish to use the transmission grid [FERC Order No. 889].

The North American Electric Reliability Corporation (NERC) is responsible for the reliable operation of the integrated electric transmission grid in North America. Ten Regional Reliability Councils have been established under NERC consisting of generation and transmission electric utilities, independent power producers, power marketers, and federal power agencies in the US, Canada, and northern Mexico. NERC, through the regional member reliability councils, manages the decentralized operation of the generation in individual operating areas to assure: the adequacy and reliability of the transmission grid, the ability of the regional generation to meet system demand, and the fulfillment of electric power exchange obligations [Trehan – Jan 2000]. NERC is responsible for assuring the implementation of FERC regulatory requirements among its regional reliability councils.

Specifically, with regard to the electric power transmission grid interface with NPPs, NERC Standard, NUC-001-2, “Nuclear Plant Interface Coordination,” requires the coordination between nuclear plant operators and transmission entities (transmission, distribution, and generation owners, operators, and reliability coordinators) for the purpose of ensuring the safe operation and shutdown of NPPs [NERC Std. NUC-001, Rev 2 – Aug 2009]. The standard requires formal agreements to be put in place between nuclear plant operators and transmission entities regarding electric grid reliability requirements, technical interface requirements, communications, operations and maintenance coordination, and transmission grid planning. The implementation of NUC-001-2 assures that the offsite electric power requirements are satisfied for the safe operation and shutdown of a NPP and for the recovery from nuclear station blackout (SBO), as established in GDC 17 and 10 CFR 50.63, respectively. In addition, the standard is intended to address nuclear plant licensing requirements regarding the interface between the nuclear plant and the electric power transmission grid that are included as part of the licensing design basis of the plant and are statutorily mandated for operation of the plant.

B.1 Nuclear Regulatory Concerns

APPENDIX A Following deregulation of the electric utility industry via the National Energy Policy Act of 1992 and FERC Order 888 in 1996, NRC expressed concerns that, “Deregulation has the potential to

challenge operating and reliability limits on the transmission system and could affect the reliability of the electric power system including the reliability of offsite power to nuclear plants [SECY-99-129 – May 1999].” Under a deregulated electric utility industry, compliance with the regulatory requirements of GDC 17 for the electric power system, and for 10 CFR 50.63, addressing station blackout, would be dependent on entities that are outside of the direct regulatory jurisdiction of the US NRC.

The NRC’s concerns regarding the effects of electric utility industry deregulation on nuclear plant safety are summarized in SECY-99-129 [SECY-99-129 – May 1999], which states, in part:

Many utilities are now divesting themselves of their generating units and the transmission systems are coming under the control of a new system control entity or an independent system operator. In addition, a power market has emerged to sell electricity. The fact that utilities may no longer have direct control of the offsite power supplies and transmission system could decrease the reliability of the grid and increase the time to restore electric power following a loss of offsite power (LOOP).

The deregulation of the electric power industry could be an important concern in the evaluation of potential SBO accidents at NPPs. The expected frequency of the LOOP, the probable time needed to restore offsite power, and the redundancy and reliability of the emergency ac power sources are key factors in the determination of risk from potential SBO accidents. As deregulation proceeds it is anticipated that more entities will enter the electrical power generation and transmission business resulting in a potential decrease in the reliability of the offsite power system during the transition period.

In 2003, NRC Office of Nuclear Regulatory Research (RES) completed an assessment of the performance of the electric power grid with respect to its effect on NPPs [Raughley – April 29, 2003]. The RES assessment compared the performance of the grid before and after deregulation of the electric utility industry to identify changes in grid operation and to determine the impact that deregulation has had on the supply of electric power to NPPs. The pre-deregulation period considered included events from 1985–1996 [Raughley – June 30, 1999] and the post-deregulation period studied covered the 5-year period from 1997-2001. The final report, “Operating Experience Assessment-Effects of Grid Events on Nuclear Power Plant Performance” validated several of the NRC’s concerns expressed in SECY-99-129. Some of the major post-deregulation changes in the electric grid related to LOOPS included the following:

1) the frequency of LOOP events at NPPs has decreased, 2) the average duration of LOOP events has increased – the percentage of LOOPS longer than four hours has increased from approximately 17 percent to 67 percent, 3) where before LOOPS occurred more or less randomly throughout the year, for 1997-2001, most LOOP events occurred during the summer, and 4) the probability of a LOOP as a consequence of a reactor trip has increased by a factor of 5 (from 0.002 to 0.01).

NRC continues to address the problems of deregulation and grid reliability through regular interaction with FERC and NERC [Inside NRC – Sept. 14, 2009], information notices (e.g., IN 1998-07, IN 2004-15, IN 2005-15, IN 2005-21, IN 2006-06, IN 2006-18, IN 2007-14, and IN 2008-12), generic regulatory correspondence (e.g. GL 2006-02), revisions to Chapter 8 (Electric Power) of the Standard Review Plan [NUREG-0800, Revision 4, March 2007], the Maintenance Rule [10 CFR 50.65], and regulatory guidance (e.g. RG 1.155, RG 1.180, and RG 1.182).

In RIS 2004-05, the NRC indicated the importance of grid reliability issues because of the impact on plant risk and the operability of the offsite power system. The RIS summarized the regulatory requirements GDC-17, the maintenance rule, the SBO rule, and plant technical specifications regarding the operability of offsite power.

B.2 References

- [FERC Order No. 888] FERC Order No. 888, “Promoting Wholesale Competition Through Open Access Non-discriminatory Transmission Services by Utility Companies, Recovery of Stranded Costs by Public Utilities and Transmitting Utilities,” 1996.
- [FERC Order No. 889] FERC Order No. 889, “Open Access Same-time Information System (OASIS) Rule and Standards of Conduct,” 1996.
- [Trehan – Jan 2000] N. Trehan, “The Impact of System Security in an Open Market on Nuclear Power Generating Stations,” January 2000.
- [NERC Std. NUC-001, Rev 2 – Aug 2009] NERC Standard, NUC-001-2, “Nuclear Plant Interface Coordination,” August 2009.
- [SECY-99-129 – May 1999] “Effects of Electric Power Industry Deregulation on Electric Grid Reliability and Nuclear Safety,” US NRC, May 11, 1999.
- [Raughley – June 30, 1999] W. Raughley, “The Effects of Deregulation of the Electric Power Industry on The Nuclear Plant Offsite Power System: An Evaluation,” US NRC, ML003743741, June 30, 1999.
- [Raughley – April 29, 2003] W. Raughley, “Operating Experience Assessment-Effects of Grid Events on Nuclear Power Plant Performance,” US NRC, ML031220116, April 29, 2003.
- [Inside NRC – Sept. 14, 2009] “NRC, FERC Agree to Cooperate on Grid Cybersecurity Issues,” *Inside NRC*, Sept. 14, 2009.
- [IN 1998-07] NRC Information Notice IN 1998-07, “Offsite Power Reliability Challenges from Industry Deregulation,” US NRC, February 27, 1998.

APPENDIX C COMMON SWITCHYARD BUS ARRANGEMENTS

This subsection briefly describes the following four basic switchyard bus arrangements in nuclear power station high-voltage switchyards: 1) the main and transfer bus, 2) the ring bus, 3) the breaker-and-a-half bus, and 4) the double-bus, double-breaker arrangement. Figure C-1 illustrates these bus arrangements.

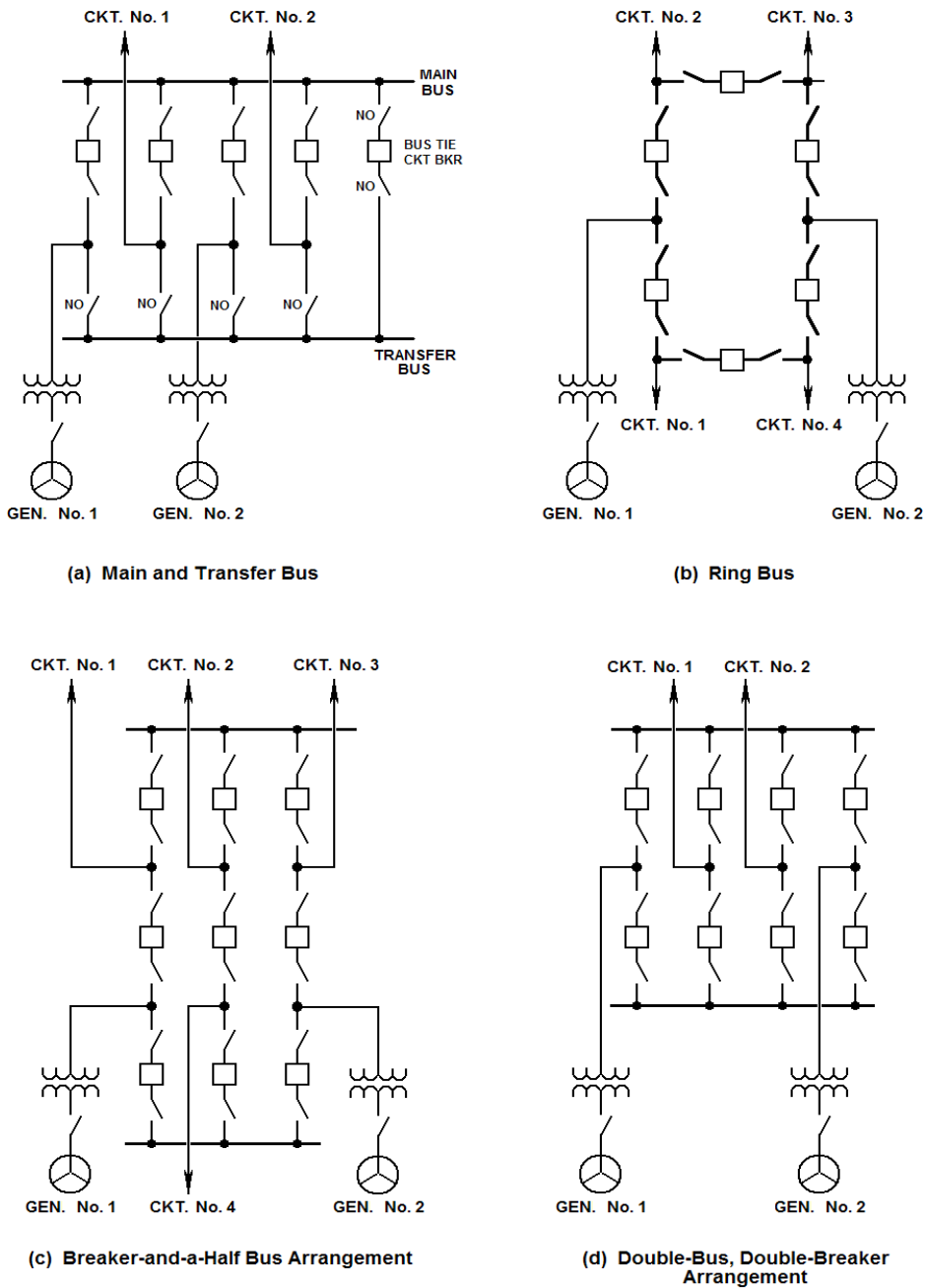

Figure C-1 Common high-voltage switchyard bus arrangements

C.1 Main and Transfer Bus

In the main and transfer bus arrangement, two independent electrical buses are used, as depicted in Figure C-1a. The main bus remains energized during normal operation and all transmission lines and transformers are electrically connected to it. In the event that maintenance is required on a power circuit breaker, the transfer bus is energized through the bus-tie breaker by closing its isolation switches and then closing the bypass isolation switch for the circuit breaker that is to be isolated, thereby paralleling the transmission line or power transformer to both the main and transfer bus. The bypassed circuit breaker and its isolation switches may then be opened, removing the main bus breaker from service. The transmission line or transformer is then supplied via the bus tie breaker and protected by the bus tie breaker's protective relaying.

The advantages of the main and transfer bus arrangement are: 1) circuit breaker maintenance may be performed without loss of transmission line or transformer service; 2) the arrangement has relatively small physical size and a moderate cost; and 3) the switchyard can be expanded without removal of the entire station from service.

The disadvantages of the arrangement are: 1) an additional bus-tie circuit breaker is required with protective relaying capability to protect any transmission line or transformer in the station; 2) the tie-breaker relay settings must be changed to match the protection scheme for which it is being substituted; and 3) somewhat complicated switching is required to remove a breaker from service for maintenance. These reliability and operational limitations make this arrangement generally unsuitable for use in a NPP switchyard.

C.2 Ring Bus

The ring bus arrangement is shown in Figure C-1b. The arrangement consists of a closed loop electrical bus in which each transmission line or transformer connection is flanked by a pair of circuit breakers. Since each circuit breaker in the ring bus arrangement is shared, it is possible to perform maintenance on any circuit breaker without interrupting service to the transmission line or transformer on either side of it. The cost of a ring bus is about 12%-15% less than an equivalent switchyard using a main and transfer bus arrangement [McDonald – 2003].

The advantages of a ring bus scheme are

- low cost because the bus requires only one breaker per circuit;
- high reliability and operational flexibility because there is a double feed to each circuit;
- switchyard bus differential protection is not required because each section of the bus is protected by the relaying for that circuit or transformer;
- service is not interrupted during circuit breaker maintenance; and
- the switchyard can be readily expanded to a breaker-and-a-half scheme if properly anticipated in the design planning.

The disadvantages of a ring bus are

- each circuit must have a separate potential transformer for protective relaying;
- the bus is limited to no more than four to six transmission line or transformer circuits due to reliability concerns as well as ampacity and short circuit duty limitations; and
- a fault can open the ring and cause undesirable circuit combinations.

Due to its high reliability, operational flexibility, and other desirable characteristics mentioned above, the ring bus arrangement is sometimes used for NPP switchyards. The nuclear plant distribution system shown in the one-line diagram in Figure 1 utilizes a ring bus in its switchyard.

C.3 Breaker-and-a-Half Bus Arrangement

The breaker-and-a-half bus arrangement, depicted in Figure C-1c, utilizes two buses, but unlike the main and transfer bus arrangement in subsection 2.2.1 above, both of the buses remain energized during normal operation. In this arrangement, for every pair of circuits there are three power circuit breakers, with the center circuit breaker being shared by the two circuits in each substation bay. The cost of a breaker-and-a-half bus arrangement is about the same as an equivalent switchyard using a ring bus arrangement [McDonald – 2003].

The advantages of the breaker-and-a-half bus arrangement are

- any circuit breaker to be removed from service without interrupting service to the circuits in the affected substation bay;
- reliability and operational flexibility are improved because there is a double feed to every circuit and a fault on either of the buses can be isolated without losing any circuit; and
- all switching operations may be accomplished using power circuit breakers.

The disadvantages of the breaker-and-a-half arrangement are

- each circuit must have a separate potential transformer for protective relaying;
- the cost and size of the substation are affected because one-and-a-half breakers are needed for each circuit; and
- protective relaying for the center shared circuit breaker in each bay must be able to protect either of the two circuits in the bay in which it is located.

Due to its high reliability, operational flexibility, reasonable cost, and other desirable characteristics mentioned above, the breaker-and-a-half bus arrangement is very frequently used for NPP switchyards.

C.4 Double-Bus Double-Breaker Arrangement

The double-bus, double-breaker arrangement, shown in Figure C-1d, uses two normally energized buses with two power circuit breakers flanking a single circuit in each bay between the two buses. Switchyards using this arrangement will offer the highest level of reliability and availability since two buses and two breakers are associated with each circuit. The high reliability of the double-bus, double-breaker arrangement comes at price that is nearly 40% greater than an equivalent switchyard using a ring bus or breaker-and-a-half bus arrangement [McDonald – 2003].

Some advantages of the double-bus, double-breaker arrangement are

- very high reliability and operational flexibility;
- since there are two breakers feeding each circuit, any circuit breaker can be removed from service without affecting its circuit;
- either bus can be removed from service without affecting any circuit in the switchyard;
- a fault on either of the main busses will not affect any circuit in the switchyard;
- all switching operations can be performed using circuit breakers;
- protection and control schemes are simplified compared to the ring bus and breaker-and-a-half bus arrangements; and
- a breaker failure protective response will only interrupt service from one circuit.

The disadvantage of the double-bus, double-breaker arrangement is the very high cost of providing two power circuit breakers for each circuit in the switchyard. Although this bus arrangement is very desirable for a nuclear station switchyard from a reliability standpoint, the extra cost of the added reliability cannot be justified in most cases.

The double-bus, double-breaker can be incorporated into selected bays of a breaker-and-a-half switchyard arrangement in order to improve the reliability of the most critical connections (e.g., the main generator connection, the station auxiliary power feed, or one or more important transmission line circuits).

C.5 References

- [NUREG/CR-6950, October 2007] NUREG/CR-6950, "Effects of Switchgear Aging on Energetic Faults," Brookhaven National Laboratory for NRC/RES, October 2007.
- [Mazumdar & Chiramal, Oct 1991] S. Mazumdar & M. Chiramal, "Bus Transfer Practices at Nuclear Plants," IEEE Transactions on Power Delivery, Vol. 6, No. 4, October 1991.
- [MacDonald 2003] McDonald, John D., "Electric Power Substations Engineering," CRC Press, New York, 2003.
- [Daume – Feb 2007] J. Daume, "High Voltage Transmission Practices," Presentation, Bonneville Power Association, February 2, 2007.
- [GER-3965] G. E. Alexander and J. G. Andrichak, Evaluating Line Relaying Schemes in Terms of Speed, Security and Dependability, GER-3965, GE Power Management.
- [Kundur 1993] P. Kundur, Power System Stability and Control, McGraw-Hill, Inc, 1993.
- [Mason 1956] C. Russell Mason, The Art and Science of Protective Relaying. Engineering Planning and Development Section, General Electric Co., John Wiley & Sons, New York, 1956.
- [Blackburn, et. al. – 1976] J. L. Blackburn, et. al., Applied Protective Relaying," Westinghouse Electric Corp., Relay Instrument Division, Newark, NJ, 1976.
- [IEEE PC37.119-2005] IEEE Std 37.119-2005, "Guide for Breaker Failure Protection of Power Circuit Breakers," Institute of Electrical and Electronics Engineers, New York, 2005.
- [IEEE Std. C37.234-2009] IEEE Std. C37.234-2009, "Guide for Protective Relay Applications to Power System Buses," Institute of Electrical and Electronics Engineers, New York, 2009. Typical Unit-connected Main Generator & Transformer Protection

APPENDIX D TYPICAL UNIT-CONNECTED MAIN GENERATOR & TRANSFORMER PROTECTION

Typical NPP main generator and output transformer protection, operating, and control relaying devices and their functions are tabulated in Table D-1 for a 1525 MW generator at a BWR plant. These devices protect the generator against problems such as, internal faults in the generator winding, overload, overheating of windings and bearings, overspeed, phase sequence, directional power flow, loss of excitation, motoring, and single-phasing or unbalanced operation [NUREG/CR-6950].

Table D-1 Typical Main Generator & Transformer Protective Devices & Functions

Device/ID No.	Description	Mfg	Type	Function
786/UT11	Unit Lockout	GE	HEA61C	trip and lockout unit
763/UT11	Main Transformer Sudden Pressure	GE	900-1	trip lockout relay 763X/UT11
763/786/UT11	Main Transformer Sudden Pressure Lockout	GE	HEA61A	trip lockout relay 786/UT11
751N/UT11	Main Transformer Ground Overcurrent	GE	IAC51A	trip lockout relay 786/UT11
787/G11	Main Transformer Differential	GE	BDD16B	trip lockout relay 486/G11
787/UT11	Unit Differential	GE	BDD15B	trip lockout relay 786/UT11
486/G11	Unit Lockout	GE	HEA61C	trip and lockout unit
487/G11	Generator Differential	GE	CFD22B	trip lockout relay 486/G11
464N/G11	Generator Ground Fault	GE	IAV51K	trip lockout relay 486/G11
464LF/G11	Low Frequency Generator Ground Fault	W	SV	trip lockout relay 486/G11
451N/G11	Generator Neutral Time Overcurrent	GE	IAC51A	trip lockout relay 786/UT11
486/G12	Unit Lockout	GE	HEA61C	trip and lockout unit
763X/UT11	Main Transformer Sudden Pressure Aux Relay	GE	HAA16B	trip main transformer sudden pressure lockout annunciator
432/G12	Generator Power Directional	GE	GGP53B	trip lockout relay 486/G12
460/G11	Voltage Balance	GE	CFVB11B	Monitor PT fuses, alarm, interlocks
440-1/G12	Generator Loss of Field	GE	CEH51A	trip lockout relay 486/G12
440-1/G12	Generator Negative Phase Sequence	GE	STV11A1A	trip lockout relay 486/G12
459-1/481/G11	Generator Volts/Hertz	GE	CEH51A	trip lockout relay 486/G11
421/G12	Generator Phase Distance	GE	CEB18C	trip lockout relay 486/G12
427/G11	Generator Undervoltage	GE	NGV	alarm
481-1/G12	Generator Underfrequency	GE	CFF23A	trip lockout relay 486/G12
481-2/G12	Generator Underfrequency	GE	CFF23A	trip lockout relay 486/G12
460/G12	Voltage Balance	GE	CFVB11B	Monitor PT fuses, blocks LRR
726/UT11	Hot Spot Temperature Detector	---	internal	start 2 nd bank mn xfmr cing fans

Table D-1 Typical Main Generator & Transformer Protective Devices & Functions

Device/ID No.	Description	Mfg	Type	Function
LRR	Load Rejection Relay	Sie	7UO2182	MHC control
459-2/481/G11	Generator Volts/Hertz	GE	STV11A2A	trip lockout relay 486/G11
432/G12	Generator Power Directional	GE	GGP53B	trip lockout relay 786/UT11

D.1 References

- [NUREG/CR-6950] NUREG/CR-6950, "Effects of Switchgear Aging on Energetic Faults," Brookhaven National Laboratory for NRC/RES, October 2007.
- [IEEE PC37.102-2006] IEEE Std. 37.102-2006, "Guide for AC Generator Protection," Institute of Electrical and Electronics Engineers, New York, 2006.
- [IEEE Std. C37.101-2006] IEEE Std. C37.101-2006, "Guide for Generator Ground Protection," Institute of Electrical and Electronics Engineers, New York, 2006.
- [IEEE Std. C37.91-2008] IEEE Std. C37.91-2008, "Guide for Protective Relay Applications to Power Transformers," Institute of Electrical and Electronics Engineers, New York, 2008.

BIBLIOGRAPHIC DATA SHEET

(See instructions on the reverse)

NUREG/CR-7175

2. TITLE AND SUBTITLE

Susceptibility Of Nuclear Stations To External Faults

3. DATE REPORT PUBLISHED

MONTH

YEAR

September

2014

4. FIN OR GRANT NUMBER

N-6838

5. AUTHOR(S)

Michael Villaran & Meng Yue

6. TYPE OF REPORT

Final

7. PERIOD COVERED (Inclusive Dates)

09/09 - 09/14

8. PERFORMING ORGANIZATION - NAME AND ADDRESS (If NRC, provide Division, Office or Region, U. S. Nuclear Regulatory Commission, and mailing address; if contractor, provide name and mailing address.)

Nuclear Science and Technology Department
Brookhaven National Laboratory
Upton, New York 11973

9. SPONSORING ORGANIZATION - NAME AND ADDRESS (If NRC, type "Same as above", if contractor, provide NRC Division, Office or Region, U. S. Nuclear Regulatory Commission, and mailing address.)

Division Of Engineering
Office of Research
US Nuclear Regulatory Commission
Washington, DC 20555

10. SUPPLEMENTARY NOTES

11. ABSTRACT (200 words or less)

The offsite electric power supply, delivered via the electrical transmission grid and nuclear power plant (NPP) switchyard, is the preferred source of power for normal and emergency NPP shutdown. Since the deregulation of the electric power industry, NPP electrical distribution systems have become more vulnerable to the effects of external transmission system faults because most of those switchyards and transmission lines are no longer owned, operated, or maintained by the same companies that own and operate the nuclear plants. Also, with the exception of NERC standard NUC-001, there is a lack of detailed industry-wide technical standards for (1) the interface between NPPs and transmission/subtransmission networks; (2) the protection systems for the interface; and (3) the maintenance of the primary and secondary equipment in the interface. As part of a research program sponsored by the NRC Office of Nuclear Regulatory Research, the effects that electrical faults and other disturbances originating on the electric power grid can have on the availability of offsite power sources and the performance of the NPP are studied. A review of NPP switchyard configurations, transmission grid interface configurations, and their electrical protection systems was undertaken to better understand the dynamics of the interconnection between the NPP onsite and offsite power systems. Several simulation models were developed based upon actual NPP power distribution systems, their transmission system interfaces, and electrical protection systems using power system analysis software. An event tree type approach was followed in developing the simulation study scenarios and contingencies in the analyses. The importance of maintenance on the response of the electrical protection systems to external fault events was considered.

12. KEY WORDS/DESCRIPTORS (List words or phrases that will assist researchers in locating the report.)

13. AVAILABILITY STATEMENT

unlimited

14. SECURITY CLASSIFICATION

(This Page)

unclassified

(This Report)

unclassified

15. NUMBER OF PAGES

16. PRICE



Federal Recycling Program



**UNITED STATES
NUCLEAR REGULATORY COMMISSION**
WASHINGTON, DC 20555-0001

OFFICIAL BUSINESS



NUREG/CR-7175

Susceptibility of Nuclear Stations to External Faults

September 2014