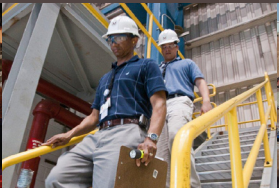
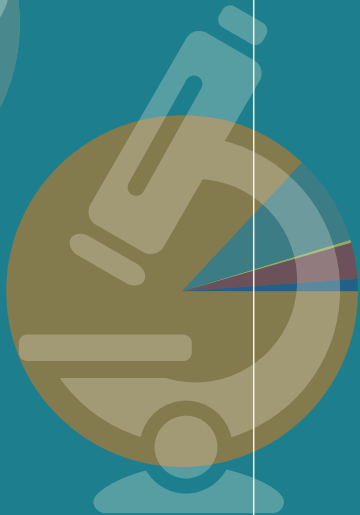
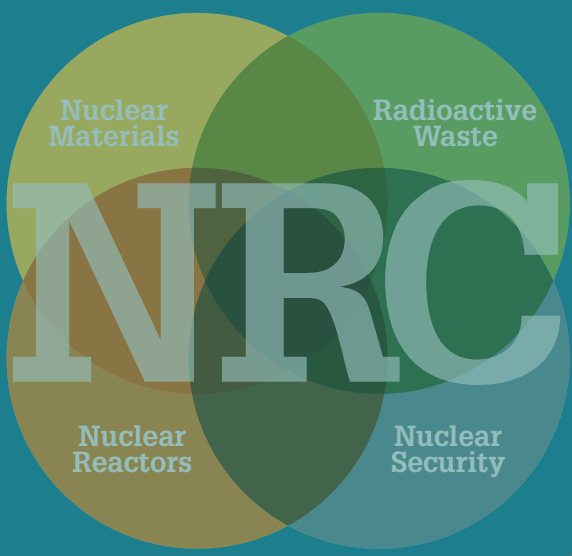


# 2013-2014

## Information Digest



NUREG-1350, Volume 25  
Manuscript Completed: July 2013  
Date Published: August 2013  
U.S. Nuclear Regulatory Commission  
Office of Public Affairs  
Washington, DC 20555-0001  
[www.nrc.gov](http://www.nrc.gov)

*Cover and section spread art reflects infographics found within the Digest.*

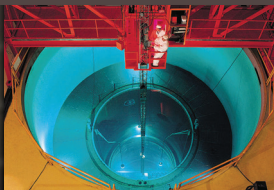
*Cover Photos Front: (from left to right)*

- 1. Resident Inspectors walk through a plant site and inspect plant facilities and operations.*
- 2. A dry cask transported to a storage site.*
- 3. NRC staff provides support during a emergency preparedness exercise at the NRC Operational Center.*
- 4. NRC inspectors conduct seismic walkdowns at a nuclear plant.*

*Spine: A reactor vessel head.*

*Cover Photos Back: (from left to right)*

- 1. Resident Inspector examines equipment at a nuclear power plant.*
- 2. A nuclear reactor core containment.*
- 3. Employees examine a centrifuge assembly*
- 4. A blue glow of radiation, known as the "Cerenkov effect," from nuclear fuel in a nuclear reactor.*



## Mission

The mission of the U.S. Nuclear Regulatory Commission (NRC) is to license and regulate the Nation's civilian use of byproduct, source, and special nuclear materials to ensure adequate protection of public health and safety, to promote the common defense and security, and to protect the environment.

## Commission

Chairman Allison M. Macfarlane  
Term Ends June 30, 2018  
Commissioner Kristine L. Svinicki  
Term Ends June 30, 2017  
Commissioner George Apostolakis  
Term Ends June 30, 2014  
Commissioner William D. Magwood, IV  
Term Ends June 30, 2015  
Commissioner William C. Ostendorff  
Term Ends June 30, 2016

## Locations

### Headquarters:

U.S. Nuclear Regulatory Commission  
Rockville, MD, 301-415-7000, 1-800-368-5642  
One White Flint North: 11555 Rockville Pike  
Two White Flint North: 11545 Rockville Pike  
Three White Flint North: 11601 Landsdown St.

### Headquarters Operations Center:

Rockville, MD, 301-816-5100  
The NRC maintains a staffed, 24-hour, Operations Center that is used to coordinate incident response concerns during an event with State, local, and Federal agencies.

### Regional Offices:

<b>Region I</b> King of Prussia, PA 610-337-5000	<b>Region III</b> Lisle, IL 630-829-9500
<b>Region II</b> Atlanta, GA 404-997-4000	<b>Region IV</b> Arlington, TX 817-860-8100

### Training and Professional Development:

Technical Training Center, Chattanooga, TN  
423-855-6500  
Professional Development Center, Rockville, MD  
301-492-2000

### Resident Sites:

At least two NRC resident inspectors, who report to the appropriate regional office, are located at each nuclear power plant site.

### Mailing Address

U.S. Nuclear Regulatory Commission  
Washington, DC 20555-0001

### Delivery Address

11555 Rockville Pike, Rockville, MD 20852

## NRC Budget

- Total authority: \$985.6 million
- Total staff: 3,931
- Budget amount expected to be recovered by annual fees to licensees: \$864 million
- NRC research program support: \$34.2 million

## NRC Regulatory Activities

- Regulation and guidance—rulemaking
- Policymaking
- Licensing, decommissioning, and certification
- Research
- Oversight and enforcement
- Emergency preparedness and response
- Support of Commission decisions

## NRC Governing Legislation

The NRC was established by the Energy Reorganization Act of 1974. A summary of laws that govern the agency's operations is provided below. NRC's regulations are found in Title 10 of the *Code of Federal Regulations*. The text of other laws may be found in NUREG-0980, "Nuclear Regulatory Legislation."

### Fundamental Laws Governing Civilian Uses of Radioactive Materials

- Nuclear Materials and Facilities
- Atomic Energy Act of 1954, as amended
- Energy Reorganization Act of 1974

### Radioactive Waste

- Nuclear Waste Policy Act of 1982, as amended
- Low-Level Radioactive Waste Policy Amendments Act of 1985
- Uranium Mill Tailings Radiation Control Act of 1978

### Nonproliferation

- Nuclear Non-Proliferation Act of 1978

### Fundamental Laws Governing the Processes of Regulatory Agencies

- Administrative Procedure Act (5 U.S.C. Chapters 5 through 8)
- National Environmental Policy Act

### Treaties and Agreements

- Nuclear Non-Proliferation Treaty
- International Atomic Energy Agency and U.S. Safeguards Agreement
- Convention on the Physical Protection of Nuclear Material
- Convention on Early Notification of a Nuclear Accident
- Convention on Assistance in Case of a Nuclear Accident and Radiological Emergency
- Convention on Nuclear Safety
- Joint Convention on the Safety of Spent Fuel Management and the Safety of Radioactive Waste Management



## Contact Us

### U.S. Nuclear Regulatory Commission

1-800-368-5642, 301-415-7000, TTD: 301-415-5575

### Public Affairs

301-415-8200, Fax: 301-415-3716,  
e-mail: opa.resource@nrc.gov

### Public Document Room

1-800-397-4209, Fax: 301-415-3548  
TDD: 1-800-635-4512

### Employment

Human Resources 301-415-7400  
General Counsel Intern Program or Honor Law  
Graduate Programs 301-415-1515

### Contracting Opportunities

Small Business 1-800-903-7227

## Report a Concern

### Emergency

Involving a nuclear facility or radioactive materials,  
including:

- any accident involving a nuclear reactor, nuclear fuel facility, or radioactive materials
- lost or damaged radioactive materials
- any threat, theft, smuggling, vandalism, or terrorist activity involving a nuclear facility or radioactive materials

**Call the NRC's 24-Hour  
Headquarters Operations Center:  
301-816-5100**

We accept collect calls, and all calls to this number are recorded.

### Non-Emergency

Including any concern involving a nuclear reactor, nuclear fuel facility, or radioactive materials.

You may send an e-mail to [allegations@nrc.gov](mailto:allegations@nrc.gov). However, because e-mail transmission may not be completely secure, if you are concerned about protecting your identity, it is preferable that you contact us by telephone or in person. You may contact any NRC employee (including a resident inspector) or call:

**the NRC's Toll-Free Safety Hotline:  
800-695-7403**

Calls to this number **are not recorded between the hours of 7:00 a.m. and 5:00 p.m. EST.** However, calls received outside these hours are answered by the Incident Response Operations Center on a recorded line.

Some materials and activities are regulated by Agreement States, and concerns should be directed by contacting the appropriate State Radiation Control Program.

## NRC's Office of the Inspector General

The Office of the Inspector General (OIG) at the NRC established the Hotline program to provide the NRC employee, other government employee, licensee and utility employee, contractor employee, and the public with a confidential means of reporting incidences of suspicious activity to OIG concerning fraud, waste, abuse, and employee or management misconduct. Mismanagement of agency programs or danger to public health and safety may also be reported through the Hotline.

It is not OIG policy to attempt to identify people contacting the Hotline. People may contact OIG by telephone, through an online form, or by mail. There is no caller identification feature associated with the Hotline or any other telephone line in the Inspector General's office. No identifying information is captured when you submit an online form. You may provide your name, address, or telephone number, if you wish.

### Call the OIG Hotline:

**1-800-233-3497, TDD: 1-800-270-2787  
7:00 a.m.-4:00 p.m. (EST)**

**After hours, please leave a message.**

## Stay Connected

### NRC Blog



<http://public-blog.nrc-gateway.gov/>

### Chat



<http://chat.nrc-gateway.gov>

### Twitter



<https://twitter.com/#!/nrcgov>

### YouTube



<http://www.youtube.com/user/NRCgov>

### Flickr



<http://www.flickr.com/photos/nrcgov>

### GovDelivery



<http://www.nrc.gov/public-involve/listserver.htm#gov>

### RSS



<http://www.nrc.gov/public-involve/listserver.htm#rss>



# NRC FACTS AT A GLANCE (Continued)

AS OF JUNE 30, 2013

## U.S. Commercial Nuclear Power Reactors

- Generate about 20 percent of the Nation's electricity
- 31 States with operating reactors
- 100 nuclear power plants licensed to operate in the United States: 65 pressurized-water reactors  
35 boiling-water reactors
- 4 reactor fuel vendors
- 26 parent companies
- About 80 different designs
- 62 commercial reactor sites
- 21 power reactors undergoing decommissioning
- About 6,600 total inspection hours at operating reactors in calendar year (CY) 2012
- Approximately 3,000 inspection documents concerning events reviewed

### Reactor License Renewal

Commercial power reactor operating licenses are valid for 40 years and may be renewed for up to an additional 20 years.

- 28 units with original license
- 43 sites comprised of 72 units issued renewal licenses
- 9 sites with license renewal applications in review
- 11 sites with letters of intent to submit renewal license applications

### New Reactor License Process

#### Early Site Permit (ESP)

- 4 ESPs issued and 2 applications in review

#### Combined License—Construction and Operating (COL)

- 4 COLs issued and 16 applications received and docketed for 24 units; of these, 10 applications are under active review

#### Reactor Design Certification (DC)

- 4 DCs issued and 3 applications in review

### Nuclear Research and Test Reactors

#### 39 licensed research reactors and test reactors

- 31 reactors operating in 21 States
- 8 reactors permanently shut down and in various stages of decommissioning (since 1958, a total of 83 licensed research and test reactors have been decommissioned)

### Nuclear Security and Safeguards

- Once every 2 years, each nuclear power plant performs full-scale emergency preparedness exercises.
- Plants also conduct additional emergency drills between full-scale exercises. The NRC and FEMA evaluate emergency exercises and drills.

## Nuclear Materials

- The NRC and the Agreement States have issued 21,800 licenses for medical, academic, industrial, and general uses of nuclear materials a year.
- The NRC oversees approximately 2,900 licenses.
- 37 Agreement States oversee approximately 18,900 licenses.

### 18 Uranium Recovery Sites Licensed by the NRC

- 7 in situ recovery sites
- 11 conventional mills (10 undergoing decommissioning)

### 14 Fuel Cycle Facilities

- 1 uranium hexafluoride production facility
- 6 uranium fuel fabrication facilities (1 inactive)
- 1 gaseous diffusion uranium enrichment facility (scheduled shutdown)
- 3 gas centrifuge uranium enrichment facilities (1 operating and 2 construction pending)
- 1 mixed-oxide fuel fabrication facility (under construction and review)
- 1 laser separation enrichment facility (construction pending)
- 1 uranium hexafluoride deconversion facility (construction pending)
- 180 NRC-licensed facilities authorized to possess plutonium and enriched uranium with inventory registered in the Nuclear Material Management and Safeguards System database

## Radioactive Waste

### Low-Level Radioactive Waste

- 10 regional compacts
- 4 active licensed disposal facilities
- 4 closed disposal facilities

### High-Level Radioactive Waste Management

#### Disposal and Storage

There are no active high-level radioactive waste disposal facilities. In September 2011, the NRC completed an orderly closure of its Yucca Mountain, NV, activities.

#### Spent Nuclear Fuel Storage

- 69 licensed and/or operating independent spent fuel storage installations in 34 States
- 15 site-specific licenses
- 54 general licenses

#### Transportation—Principal Licensing and Inspection Activities

- The NRC examines transport-related safety during approximately 1,000 safety inspections of fuel, reactor, and materials licensees annually.
- The NRC reviews, evaluates, and certifies approximately 70 new, renewal, or amended container-design applications for the transport of nuclear materials annually.



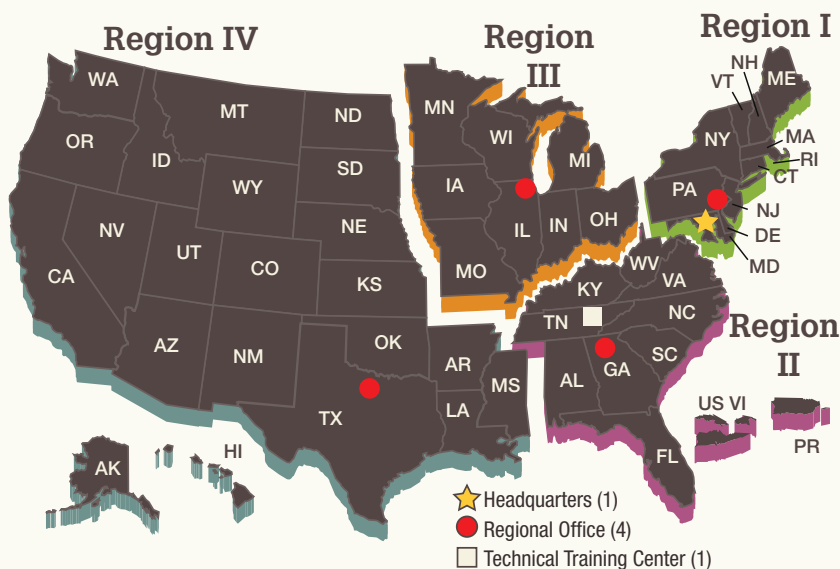
- The NRC reviews and evaluates approximately 150 license applications for the import and export of nuclear materials from the United States annually.
- The NRC inspects about 28 dry storage and transport package licensees annually.

#### Decommissioning

Approximately 150 materials licenses are terminated each year. The NRC's decommissioning program focuses on the termination of licenses that are not routine and that require complex activities.

- 29 nuclear power reactors permanently shut down
- 12 nuclear reactors completely decommissioned and licenses terminated
- 21 nuclear reactors in various stages of decommissioning (DECON, SAFSTOR, or ENTOMB)
- 8 research and test reactors
- 18 complex material sites
- 1 fuel cycle facility (partial decommissioning)
- 11 uranium recovery facilities in safe storage under NRC jurisdiction

## NRC Regions



#### Nuclear Power Plants

- Each regional office oversees the plants in its region except the Callaway plant in Missouri, which Region IV oversees.

#### Materials Licensees

- Region I oversees licensees and Federal facilities located geographically in Region I and Region II.
- Region III oversees licensees and Federal facilities located geographically in Region III.
- Region IV oversees licensees and Federal facilities located geographically in Region IV.

#### Nuclear Fuel Processing Facilities

- Region II oversees all the fuel processing facilities in the region and those in Illinois, New Mexico, and Washington.
- In addition, Region II handles all construction inspectors' activities for new nuclear power plants and fuel cycle facilities in all regions.

## Public Meetings and Involvement

- The NRC conducts more than 1,000 public meetings annually.
- The NRC hosts both the Regulatory Information Conference and the Fuel Cycle Information Exchange annually, where thousands of participants from around the world discuss the latest technical issues.
- The Advisory Committee on Reactor Safeguards held 10 full committee meetings and approximately 70 subcommittee meetings in CY 2012.
- The Advisory Committee on Medical Uses of Isotopes typically holds public meetings twice a year.

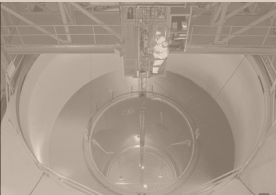
## News and Information

- NRC news releases are available through a free listserv subscription at [www.nrc.gov/public-involve/listserver.html](http://www.nrc.gov/public-involve/listserver.html).
- The NRC uses social media as a communication tool to allow the public to stay connected through the NRC Blog, Twitter, Flickr, and YouTube.

# Abstract

The U.S. Nuclear Regulatory Commission (NRC) 2013–2014 Information Digest provides a summary of information about the NRC and the industries it regulates. It describes the agency's regulatory responsibilities and licensing activities, and provides general information on nuclear-related topics. It is updated annually. The Information Digest includes NRC and industry data in a quick-reference format for activities through 2012, or the most recent information available at manuscript completion. The Digest also includes information graphics to help explain the data and expand the agency's transparency and public-outreach. The Web Link Index provides Web addresses for more information on major topics. The Digest also includes the NRC Facts at a Glance tear-out reference sheet. The NRC reviewed information from industry and international sources but did not perform an independent verification. This edition contains adjustments to preliminary figures from the previous year. All information is final unless otherwise noted. The NRC is the source for all photographs, graphics, and tables unless otherwise noted. The agency welcomes comments or suggestions on the Information Digest. Please contact the Office of Public Affairs by mail at U.S. Nuclear Regulatory Commission, Washington, DC 20555-0001, by e-mail at [OPA.Resource@nrc.gov](mailto:OPA.Resource@nrc.gov), or post comments on the NRC Blog's Open Forum category at <http://public-blog.nrc-gateway.gov/>.







# Contents

<b>NRC Facts at a Glance</b>	<b>tear-out</b>
<b>Abstract</b>	<b>iii</b>
<b>NRC: An Independent Regulatory Agency</b>	<b>x</b>
Mission	2
Major Activities	5
FY 2012 Accomplishment Highlights	7
Organizations and Functions	9
Budget	13
<b>U.S. and Worldwide Nuclear Energy</b>	<b>18</b>
International Activities	20
Worldwide Electricity Generated by Commercial Nuclear Power	26
<b>Nuclear Reactors</b>	<b>28</b>
U.S. Electricity Generated by Commercial Nuclear Power	30
U.S. Commercial Nuclear Power Reactors	33
Oversight of U.S. Commercial Nuclear Power Reactors	40
Reactor License Renewal	45
Research and Test Reactors	48
New Commercial Nuclear Power Reactor Licensing	50
Nuclear Regulatory Research	57
<b>Nuclear Materials</b>	<b>62</b>
Materials Licenses	64
Medical and Academic	64
Industrial	68
Transportation	71
Material Security	71
Nuclear Fuel Cycle	72
Fuel Cycle Facilities	76



<b>Radioactive Waste</b>	<b>82</b>
Low-Level Radioactive Waste Disposal	84
High-Level Radioactive Waste Management	87
Transportation	93
Decommissioning	94
<b>Security &amp; Emergency Preparedness</b>	<b>98</b>
Overview	100
Facility Security	100
Cyber Security	102
Materials Security	103
Emergency Preparedness	103
Incident Response	107
Emergency Classifications	109
<b>Appendices</b>	<b>112</b>
<b>Abbreviations</b>	<b>114</b>
APPENDIX A: U.S. Commercial Nuclear Power Reactors	116
APPENDIX B: U.S. New Nuclear Power Plant Applications	132
APPENDIX C: U.S. Commercial Nuclear Power Reactors Permanently Shut Down— Formerly Licensed To Operate	133
APPENDIX D: Cancelled U.S. Commercial Nuclear Power Reactors	137
APPENDIX E: Projected Electric Capacity Dependent on License Renewals	142
APPENDIX F: U.S. Commercial Nuclear Power Reactors by Parent Company	143
APPENDIX G: U.S. Commercial Nuclear Power Reactor Operating Licenses— Issued by Year	145
APPENDIX H: U.S. Commercial Nuclear Power Reactor Operating Licenses— Expiration by Year, 2013–2049	145
APPENDIX I: Industry Performance Indicators: Annual Industry Averages, FYs 2003–2012	146
APPENDIX J: Operating U.S. Nuclear Research and Test Reactors Regulated by the NRC	149
APPENDIX K: U.S. Nuclear Research and Test Reactors under Decommissioning Regulated by the NRC	151



APPENDIX L: Agreement States	152
APPENDIX M: Radiation Doses and Regulatory Limits	152
APPENDIX N: Major U.S. Fuel Cycle Facility Sites	153
APPENDIX O: Dry Spent Fuel Storage Designs: NRC-Approved for Use by General Licensees	154
APPENDIX P: Dry Cask Spent Fuel Storage Licensees	155
APPENDIX Q: U.S. Low-Level Radioactive Waste Compacts	159
APPENDIX R: Storage of Commercial Spent Fuel by State through 2012	160
APPENDIX S: NRC-Regulated Complex Material Sites Undergoing Decommissioning	161
APPENDIX T: Nuclear Power Units by Nation	162
APPENDIX U: Nuclear Power Units by Reactor Type, Worldwide	163
APPENDIX V: Native American Reservations and Trust Land within a 50-Mile Radius of a Nuclear Power Plant	164
APPENDIX W: Regulatory Research Cooperative Agreements and Grants	165
APPENDIX X: Significant Enforcement Actions Issued, 2012	168
APPENDIX Y: Quick-Reference Metric Conversion Tables	169
APPENDIX Z: Progress List of 2012 Rulemaking for Nuclear Material and Waste	171
APPENDIX AA: International Activities	172

**Glossary** **178**

**Web Link Index** **206**

**Index** **212**

**Figures**

**NRC: An Independent Regulatory Agency**

Figure 1. How We Regulate	3
Figure 2. NRC Organizational Chart	10
Figure 3. NRC Regions	12
Figure 4. NRC Budget Authority and Personnel Ceiling, FYs 2003–2013	14
Figure 5. NRC FY 2013 Distribution of Budget Authority and Staff; Recovery of NRC Budget	15
Figure 6. NRC Public Participation and Interaction	16



## U.S. and Worldwide Nuclear Energy

Figure 7. Bilateral Information Exchange and Cooperation Agreements with the NRC	23
Figure 8. Operating Nuclear Power Plants Worldwide	27
Figure 9. Nuclear Share of Electricity Generated by Country	27

## Nuclear Reactors

Figure 10. U.S. Net Electric Generation by Energy Source, 2012	31
Figure 11. U.S. Net Electric Generation by Energy Source, 2003–2012	31
Figure 12. Net Electricity Generated in Each State by Nuclear Power	32
Figure 13. Power Uprates: Past, Current, and Future	32
Figure 14. Typical Pressurized-Water Reactor	34
Figure 15. Typical Boiling-Water Reactor	35
Figure 16. U.S. Operating Commercial Nuclear Power Reactors	36
Figure 17. Day in the Life of an NRC Resident Inspector	37
Figure 18. NRC Post-Fukushima Safety Enhancements	39
Figure 19. NRC Inspection Effort at Operating Reactors, 2012	39
Figure 20. Reactor Oversight Action Matrix Performance Indicators	42
Figure 21. Reactor Oversight Framework	42
Figure 22. Industry Performance Indicators: FYs 2003–2012 Averages	43
Figure 23. License Renewals Granted for Operating Nuclear Power Reactors	46
Figure 24. U.S. Commercial Nuclear Power Reactors— Years of Operation by the End of 2013	46
Figure 25. U.S. Commercial Nuclear Power Reactor Operating Licenses— Expiration by Year	47
Figure 26. License Renewal Process	47
Figure 27. U.S. Nuclear Research and Test Reactors	49
Figure 28. New Reactor Licensing Process	51
Figure 29. Locations of New Nuclear Power Reactors Applications	51
Figure 30. New Reactor Licensing Schedule of Applications by Design	53
Figure 31. NRC Research Funding, FY 2013	58



## Nuclear Materials

Figure 32. Moisture Density Gauge	70
Figure 33. Commercial Irradiator	70
Figure 34. Life-Cycle Approach to Source Security	73
Figure 35. The Nuclear Fuel Cycle	73
Figure 36. The Heap Leach Recovery Process	75
Figure 37. The In Situ Uranium Recovery Process	75
Figure 38. Locations of NRC-Licensed Uranium Recovery Facility Sites	77
Figure 39. Locations of Fuel Cycle Facilities	78
Figure 40. Enrichment Processes	79
Figure 41. Simplified Fuel Fabrication Process	80

## Radioactive Waste

Figure 42. Low-Level Waste Disposal	85
Figure 43. Spent Fuel Generation and Storage after Use	88
Figure 44. Dry Storage of Spent Nuclear Fuel	90
Figure 45. Licensed and Operating Independent Spent Fuel Storage Installations by State	92
Figure 46. Ensuring Safe Spent Fuel Shipping Containers	95
Figure 47. Locations of NRC-Regulated Complex Material Sites Undergoing Decommissioning	97
Figure 48. Facilities Undergoing Decommissioning Under NRC Jurisdiction	97

## Security and Emergency Preparedness

Figure 49. Security Components	101
Figure 50. Industry Performance Indicators: FYs 2003–2012 Averages for 104 Plants	104
Figure 51. Emergency Planning Zones	104
Figure 52. Emergency Classifications for Nuclear Reactor Events, 2012	110
Figure 53. The International Nuclear and Radiological Event Scale	111

## Tables

### Nuclear Materials

Table 1. U.S. Materials Licenses by State	65
Table 2. Locations of NRC-Licensed Uranium Recovery Facilities	77



# NRC: An Inde

Safety  
Nuclear  
Protection  
Organizations  
Agency  
Nuclear Materials  
Research  
U.S. Public Meeting  
Energy Affairs  
Environment  
Members  
Mission  
NRC  
Federal  
Budget  
Reactor  
Occurrence  
Power  
NRC Licensed  
Information  
Radioactive  
Activities  
Authority  
Public Program  
International Activities  
Functions  
Responsibility  
Radiation  
Leads  
Independent  
Allegations  
Staff  
Construction  
Ruling  
Commission  
Civilian  
Facilities  
Regulate  
Policy



# Independent Regulatory Agency

How We Regulate

Leadership Important Orders Emergency Industrial Congress

Commercial Security Atomic Work Operations

Protect Highlights Goals Applicants Waste Detail

Inspectors Public Involvement Regulatory Uranium Organizations Major Activities



## Mission

The U.S. Nuclear Regulatory Commission (NRC) is an independent agency created by Congress. Its mission is to license and regulate the Nation's civilian use of radioactive materials to protect public health and safety, promote the common defense and security, and protect the environment. Specifically, the NRC regulates commercial nuclear power plants; research, test, and training reactors; nuclear fuel cycle facilities; and the use of radioactive materials in medical, academic, and industrial settings. The agency also regulates the transport, storage, and disposal of radioactive materials and waste, and licenses the export and import of radioactive materials. The NRC regulates industries within the United States and works with agencies around the world to enhance global nuclear safety and security. (See Figure 1: How We Regulate.)

## Values

The NRC adheres to the principles of good regulation—independence, openness, efficiency, clarity, and reliability. The agency puts these principles into practice with effective, realistic, and timely actions.

## Strategic Goals

**Safety:** Ensure the safe use of radioactive materials.

**Security:** Ensure protection in the secure use and management of radioactive materials.

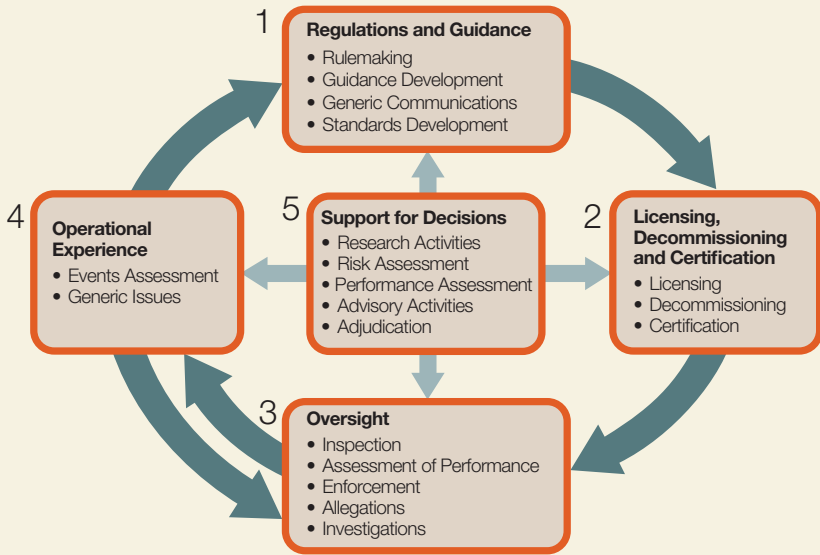
## Strategic Outcomes

- Prevent nuclear reactor accidents.
- Prevent inadvertent criticality events.
- Prevent acute radiation exposures resulting in deaths.
- Prevent releases of radioactive materials that cause significant radiation exposures or adverse environmental impacts.
- Prevent licensed radioactive materials from being used domestically in a way hostile to the United States.
- Prevent unauthorized public disclosures of classified or safeguards information.
- Prevent unauthorized access and damage to the NRC's automated information systems.





**Figure 1. How We Regulate**



1. Developing regulations and guidance for applicants and licensees.
2. Licensing or certifying applicants to use nuclear materials, operate nuclear facilities, and decommission facilities.
3. Inspecting and assessing licensee operations and facilities to ensure licensees comply with NRC requirements, investigating allegations of wrong-doing and taking appropriate followup or enforcement actions when necessary.
4. Evaluating operational experience of licensed facilities and activities.
5. Conducting research, holding hearings, and obtaining independent reviews to support regulatory decisions.



## Statutory Authority

The Energy Reorganization Act of 1974 created the NRC from a portion of the former Atomic Energy Commission. The new agency was to independently oversee—but not promote—the commercial nuclear industry so the Nation could use radioactive materials to benefit the country while also protecting the American people and the environment. The agency began operations on January 18, 1975. The NRC's regulations can be found in Title 10, "Energy," of the *Code of Federal Regulations* (10 CFR). The principal statutory authorities that govern the NRC's work can be found on the NRC's Web site (see the Web Link Index for more information).

- Atomic Energy Act of 1954, as amended (Pub. L. 83–703)
- Energy Reorganization Act of 1974, as amended (Pub. L. 93–438)
- Uranium Mill Tailings Radiation Control Act of 1978, as amended (Pub. L. 95–604)
- Nuclear Non-Proliferation Act of 1978 (Pub. L. 95–242)
- West Valley Demonstration Project Act of 1980 (Pub. L. 96–368)
- Nuclear Waste Policy Act of 1982, as amended (Pub. L. 97–425)
- Low-Level Radioactive Waste Policy Amendments Act of 1985 (Pub. L. 99–240)
- Energy Policy Act of 1992 (Pub. L. 102–486)
- Energy Policy Act of 2005 (Pub. L. 109–58)

The NRC, its licensees (those licensed by the NRC to use radioactive materials), and the Agreement States (States that assume regulatory authority over certain nuclear materials) share a responsibility to protect public health and safety and the environment. Federal regulations and the NRC's regulatory program play a key role in protecting the public and the environment, but ultimately the licensees bear the primary responsibility for safely handling and using these materials.



## Major Activities

The NRC fulfills its responsibilities through such activities as:

- licensing the design, construction, operation, and decommissioning of commercial nuclear power plants and other nuclear facilities
- licensing the possession, use, processing, handling, exporting, and importing of nuclear materials
- licensing the siting, design, construction, operation, and closure of low-level radioactive waste disposal sites in States under NRC jurisdiction
- certifying the design, construction, and operation of commercial transportation casks
- licensing the design, construction, and operation of spent fuel storage casks and interim storage facilities for spent fuel and high-level waste
- licensing nuclear reactor operators
- certifying gaseous diffusion enrichment facilities and licensing other enrichment facilities
- conducting research to develop regulations and anticipate potential reactor and other nuclear facilities safety issues
- collecting, analyzing, and disseminating information about the safe operation of commercial nuclear power reactors and certain nonreactor activities
- issuing safety and security regulations, policies, goals, and orders that govern nuclear activities
- interacting with other Federal agencies, foreign governments, and international organizations on safety and security issues
- investigating nuclear incidents and allegations concerning any matter regulated by the NRC
- inspecting NRC licensees to ensure adequate performance of safety and security programs
- enforcing NRC regulations and the conditions of NRC licenses and imposing, when necessary, civil sanctions and penalties
- conducting public hearings on nuclear and radiological safety and security, and environmental concerns



- implementing international legal commitments made by the U.S. Government in treaties and conventions
- developing effective working relationships with State and Tribal governments
- maintaining an effective incident-response program and overseeing required emergency response activities at NRC-licensed facilities
- implementing lessons learned from the March 11, 2011, nuclear accident in Japan to enhance safety at U.S. commercial nuclear facilities
- involving the public in the regulatory process through meetings, conferences, and workshops; providing opportunities for commenting on new regulations, petitions, guidance documents, and technical reports; providing ways to report safety concerns; and providing documents under the Freedom of Information Act and through the NRC's Web site
- participating in Open Government initiatives designed to make Government more transparent, accountable, and accessible
- engaging and informing the public through social media platforms and by providing interactive, high-value data sets (data in a form that allows members of the public to search, filter, or repackage information in a way that is most useful to them)



*The NRC headquarters complex, located in Rockville, MD.*



# FY 2012 Accomplishment Highlights

## Reactors

- completed all required inspection and assessment activities of the Reactor Oversight Process, including initiating 12 inspections in response to safety-significant events
- processed 1,448 reactor licensing tasks and activities
- received 18 National Fire Protection Association (NFPA) Standard 805 license amendment request submittals and completed 14 NFPA Standard 805 onsite audits
- collaborated with States, Federal agencies, and licensees in responding to natural events, such as tornadoes, floods, hurricanes, and earthquakes
- issued amendments to the certifications for the AP1000 and the Advanced Boiling Water Reactor (ABWR) designs
- issued the first two new reactor combined licenses for Vogtle Electric Generating Plant, Units 3 and 4 and for Virgil C. (V.C.) Summer Nuclear Generating Station, Units 2 and 3, and conducted the first midcycle assessments under the Construction Reactor Oversight Process pilot for Vogtle and V.C. Summer
- developed a comprehensive report to Congress identifying the NRC's overall strategy for preparing to license advanced reactors
- continued implementing the rulemaking initiative for emergency preparedness
- hosted an interagency workshop and Webinar on probabilistic flood hazard assessment
- hosted the first International Security Regulators Conference with more than 250 attendees
- published the national report on the safety of U.S. nuclear power plants titled, "United States Fifth National Report for the Convention on Nuclear Safety"
- issued a safety culture policy statement
- participated in 18 new international agreements, adding to the existing 100 active international agreements for cooperative research
- published extensive research results on a variety of topics to confirm the safety of operating facilities



## Materials and Waste

- supported hearings and issued two special nuclear material licenses for the AREVA Eagle Rock Enrichment Facility and the GE-Hitachi Global Laser Enrichment facility
- issued a source-material license to International Isotopes Fluorine Product for a first-of-a-kind commercial depleted-uranium deconversion facility
- renewed the license of Nuclear Fuel Services for 25 years
- oversaw the continued construction of the URENCO Louisiana Enrichment Services facility and the Mixed-Oxide Fuel Fabrication Facility
- completed post-Fukushima inspections at fuel cycle facilities to verify licensees are adequately prepared for the consequences of emergency events
- identified potential issues with Honeywell's emergency response capability and issued a confirmatory order to ensure Honeywell takes appropriate corrective actions before restart
- developed and began implementing the Revised Fuel Cycle Oversight Process (RFCOP) project plan
- issued the final policy statement on the protection of sealed radiation sources containing cesium-137 chloride

- enhanced coordination with the States through the Integrated Materials Performance Evaluation Program and the State liaison officers
- made substantial progress on rulemakings ranging from the standards for protection against radiation to the control and accounting of special nuclear material (see Appendix Z for specific NRC regulations.)

## Administration

- coordinated the move into the newly constructed Three White Flint North headquarters building
- held the 25th Annual Regulatory Information Conference, with more than 2,800 attendees
- continued to conduct agency outreach to audiences interested in NRC activities, including through the use of social media
- held 1,054 public meetings
- processed 293 Freedom of Information Act requests
- awarded \$12.4 million in grants to 91 minority-serving institutions of higher education
- piloted the use of tablet computers to assist construction inspectors



## Organizations and Functions

The NRC's Commission has five members nominated by the President and confirmed by the U.S. Senate for 5-year terms. The members' terms are staggered so one Commissioner's term expires on June 30 of every year. The President designates one member to serve as Chairman. The Chairman is the principal executive officer and spokesperson of the agency. No more than three Commissioners can belong to the same political party. The Commission as a whole formulates policies and regulations governing safety and security of nuclear reactors and materials, issues orders to licensees, and adjudicates legal matters brought before it. The Executive Director for Operations carries out the policies and decisions of the Commission and directs the activities of the program and regional offices. (See Figure 2: NRC Organizational Chart and Figure 3: NRC Regions.)

### Commissioner Term Expiration

Commissioner	Expiration of Term
<i>Allison M. Macfarlane, Chairman</i>	<i>June 30, 2018</i>
<i>Kristine L. Svinicki</i>	<i>June 30, 2017</i>
<i>George Apostolakis</i>	<i>June 30, 2014</i>
<i>William D. Magwood, IV</i>	<i>June 30, 2015</i>
<i>William C. Ostendorff</i>	<i>June 30, 2016</i>

\* Commissioners listed by seniority

The NRC is headquartered in Rockville, MD, and has four regional offices in King of Prussia, PA; Atlanta, GA; Lisle, IL; and Arlington, TX.

The major program offices within the NRC include the following:

The **Office of Nuclear Reactor Regulation**, which handles all licensing and inspection activities for existing nuclear power reactors and research and test reactors.

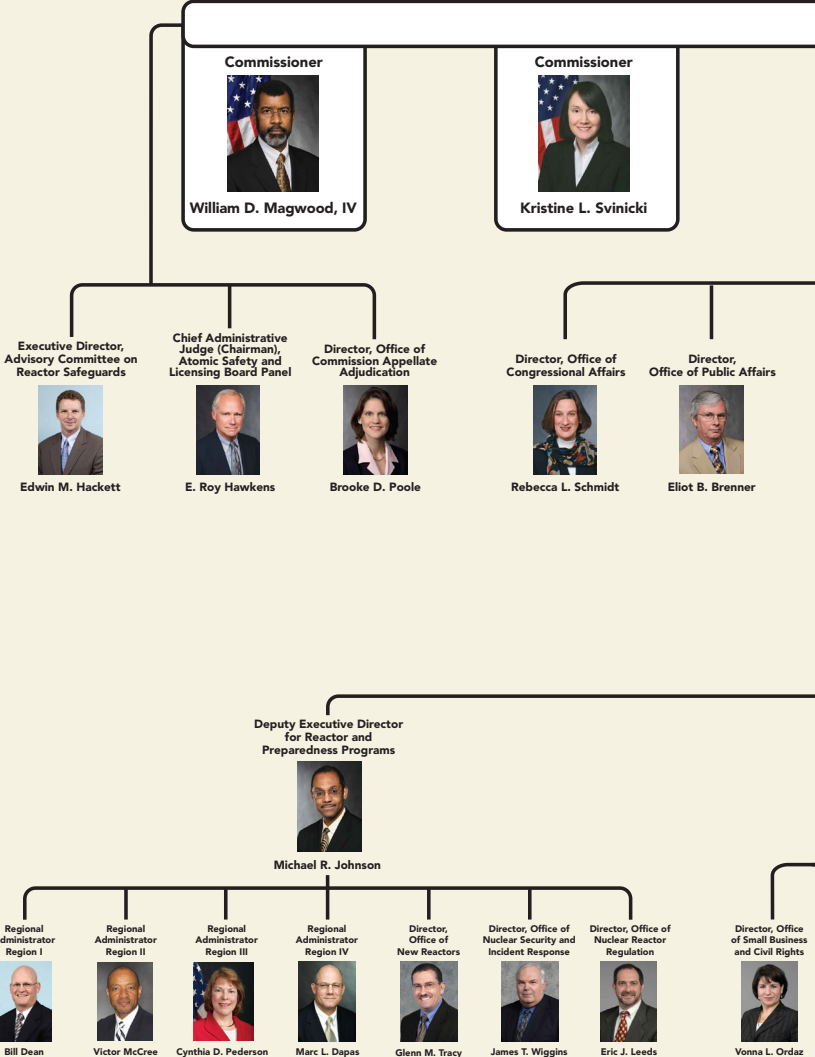
The **Office of New Reactors**, which oversees the design, siting, licensing, and construction of new commercial nuclear power reactors.

The **Office of Nuclear Material Safety and Safeguards**, which regulates activities to ensure the safe and secure production of commercial nuclear fuel; the safe storage, transportation, and disposal of high- and low-level radioactive waste and spent nuclear fuel; and the transportation of certain radioactive materials.



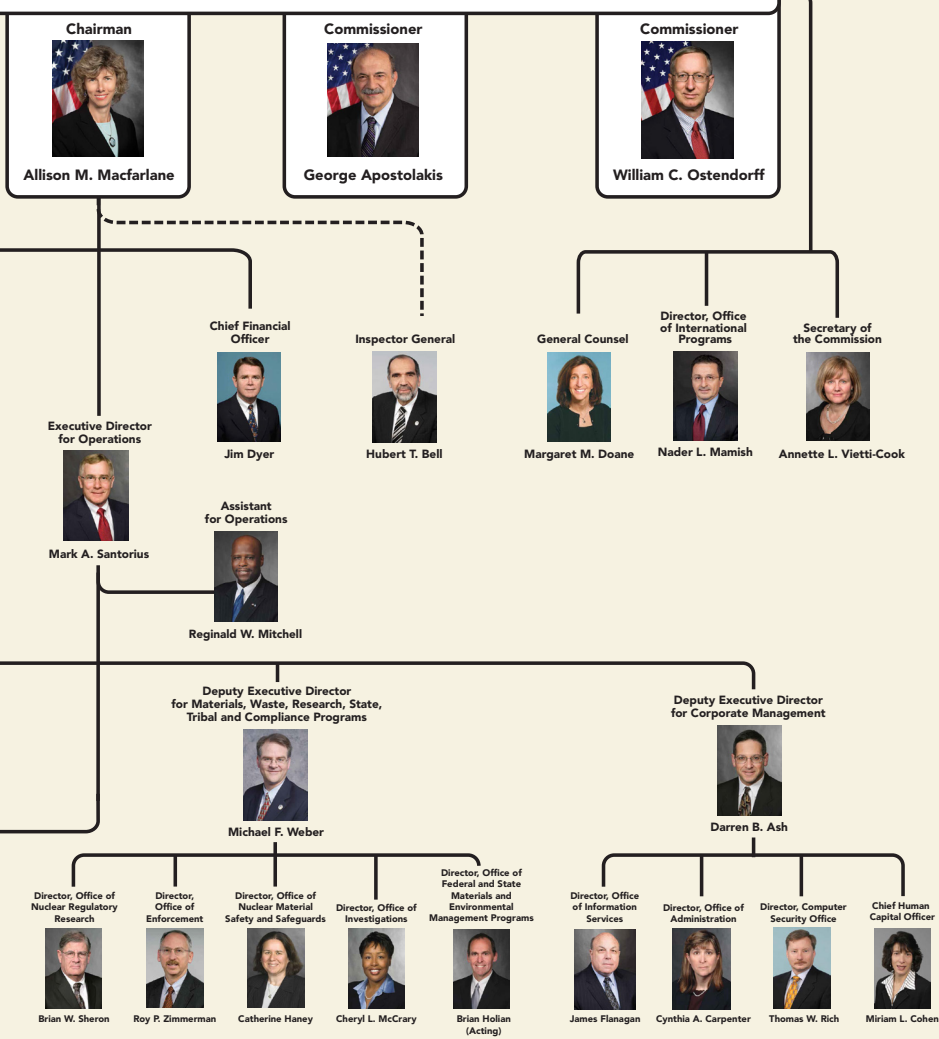
# Organizations and Functions

Figure 2. NRC Organizational Chart

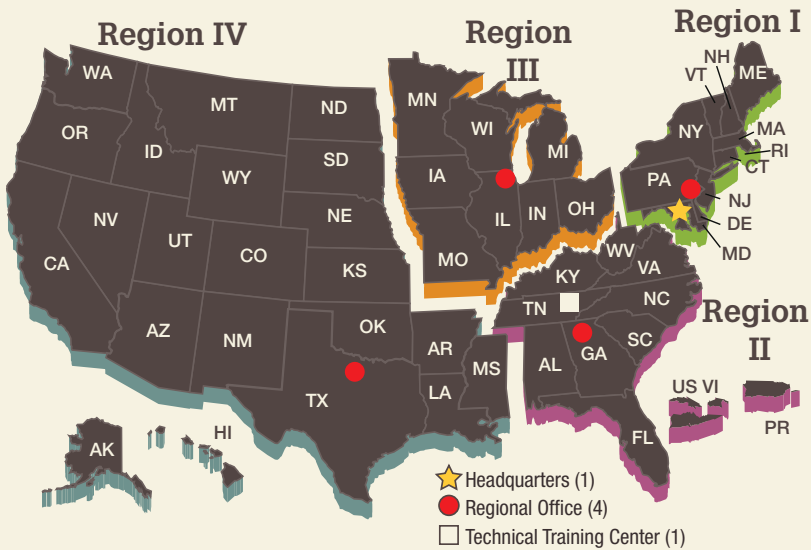




# The Commission



**Figure 3. NRC Regions**



**Nuclear Power Plants**

- Each regional office oversees the plants in its region except the Callaway plant in Missouri, which Region IV oversees.

**Materials Licensees**

- Region I oversees licensees and Federal facilities located geographically in Region I and Region II.
- Region III oversees licensees and Federal facilities located geographically in Region III.
- Region IV oversees licensees and Federal facilities located geographically in Region IV.

**Nuclear Fuel Processing Facilities**

- Region II oversees all the fuel processing facilities in the region and those in Illinois, New Mexico, and Washington.
- Region II also handles all construction inspectors' activities for new nuclear power plants and fuel cycle facilities in all regions.



The **Office of Federal and State Materials and Environmental Management Programs**, which develops and oversees the regulatory framework for the safe and secure use of nuclear material in medical, industrial, academic and commercial applications; uranium recovery activities; low-level radioactive waste sites; and the decommissioning of previously operating nuclear facilities. It works with Federal agencies, States, and Tribal and local governments on regulatory matters.

The **Office of Nuclear Regulatory Research**, which provides independent expertise and information for making timely regulatory judgments, anticipating problems of potential safety significance, and resolving safety issues. It helps develop technical regulations and standards and collects, analyzes, and disseminates information about the safety of commercial nuclear power plants and certain nuclear materials activities.

The **Office of Nuclear Security and Incident Response**, which initiates and oversees implementation of agency security policy for nuclear facilities and users of radioactive material, coordinates with other Federal agencies and international organizations on security issues, and maintains the agency's emergency preparedness and incident response program.

The **regional offices**, which conduct inspection, enforcement (in conjunction with the Office of Enforcement), investigation, licensing, and emergency response programs for nuclear reactors, fuel facilities, and materials licensees.

## Budget


For fiscal year (FY) 2013 (October 1, 2012 through September 30, 2013), the NRC's budget is \$985.6 million. The NRC's FY 2013 personnel ceiling is 3,931 full time equivalent (FTE) staff; this includes the Office of the Inspector General (see Figure 4: NRC Budget Authority and Personnel Ceiling, FYs 2003-2013). The Office of the Inspector General received its own appropriation of \$10.3 million. This amount is included in the total NRC budget. The breakdown of the budget is shown in Figure 5: NRC FY 2013 Distribution of Budget Authority and Staff; Recovery of Budget. By law, the NRC must recover, through fees billed to licensees, approximately 90 percent of its budget authority, less the amounts appropriated from general funds for waste-incidental-to-reprocessing activities and generic homeland security activities. The NRC collects fees each year by September 30 and transfers them to the U.S. Treasury. The total budget amount the NRC will recover in FY 2013 is approximately \$864.0 million. (See Figure 6: NRC Public Participation and Interaction.)



**Figure 4. NRC Budget Authority and Personnel Ceiling, FYs 2003–2013**

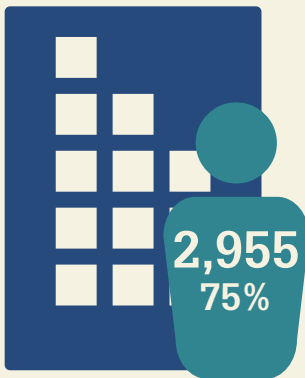


 Budget Authority  
Dollars in Millions

 Full-Time Equivalent (FTE) Staff

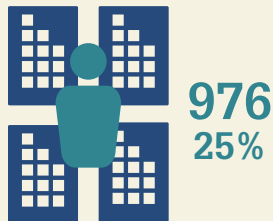
Note: Dollars are rounded to the nearest million.

### Headquarters

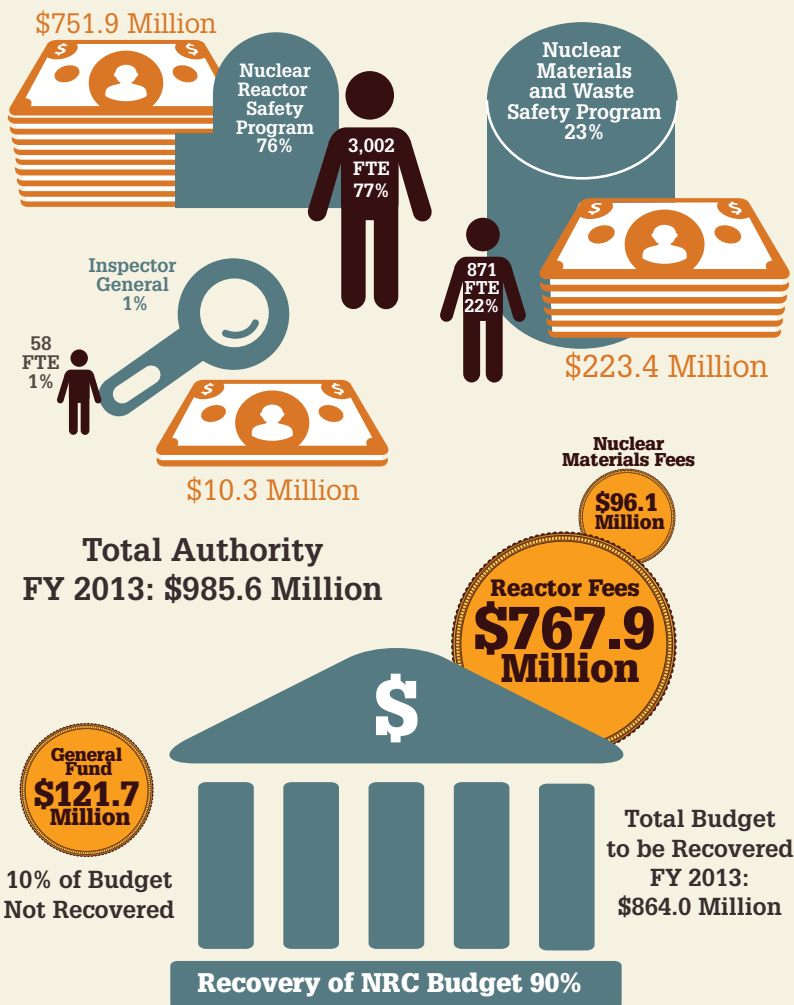


## FY 2013 Staff by Location Total FTE: 3,931

### Regions



**Figure 5. NRC FY 2013 Distribution of Budget Authority and Staff; Recovery of NRC Budget**



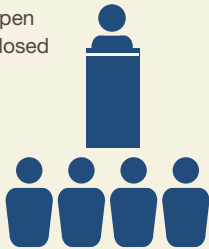
Note: The NRC incorporates corporate and administrative costs proportionately within programs.



**Figure 6. NRC Public Participation and Interaction**

**Public Meetings**

Open  
Closed



**General Inquiries**

Phone  
Mail  
E-mail  
In person



**Information Meetings**

Scoping  
Preliminary  
Counterpart  
Information  
Exchanges



**Resident Inspectors in the community**



**10 CFR 2.206 Petition**

Electronic or hard copy



**Advisory Committee Meetings**



**Public Document Room**

Phone  
E-mail  
In person



**Conferences**

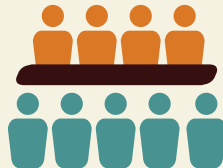
International  
Trade  
Industry



**Open Houses**



**Congressional Hearings**



## Education and Business Outreach

Minorities Groups  
Small Business  
Vendors/Contracts  
Recruitment



## Media Outreach

Press Conferences  
Press Releases  
Editorial Boards  
Interviews



## Public Comments

Regulations.gov  
Mail  
E-mail  
Fax  
Verbally at  
Public Meetings



# U.S. NRC

Regulatory Commission

and the Environment

## Web Site

[www.nrc.gov](http://www.nrc.gov)



## Adjudicatory Hearings



## Emergency Preparedness

Federal  
State  
Local



## Social Media

Blog  
Chat  
Twitter  
YouTube  
Flickr



## Visitors to the Agency



## Allegations



## Petitions for Rulemaking



## Federal Register Notices



# U.S. and Worldwide Nuclear Energy

Meetings Work Commission Organizations Electricity Generated  
Research  
Integrated Regulatory Review Service (IRRS) Programs Regulate Federal Assistance Ministry Import-Export Petitions Multinational Affairs Leadership





ide  
 Public Involvement  
 Cooperation  
 Staff  
 Agreements  
 Government  
 International  
 Nuclear  
 Mission  
 Nations  
 Waste  
 Inspectors  
 Commercial  
 U.S.  
 Foreign  
 Atomic  
 Regulatory  
 Congress  
 States  
 Energy  
 Reactor  
 NRC  
 Foreign  
 Nationals  
 International  
 Conference  
 Ruling  
 Detail  
 Legislations  
 Environment  
 Summit  
 Safety  
 Country  
 Orders  
 Policy  
 Major Activities  
 Radiation  
 Information  
 Protection  
 Nuclear-Materials  
 Functions  
 Power  
 Bilateral  
 NRC-Licensed



Nuclear science and technology are used worldwide for a variety of peaceful purposes:

- generating electricity through nuclear power reactors
- diagnosing and treating medical conditions
- making food safer and longer lasting through irradiation
- breeding new disease- and pest-resistant seed varieties with higher yields
- maintaining quality control in industry with nuclear gauges
- dating objects and identifying minerals

The NRC supports U.S. interests abroad in the safe and secure civilian use of nuclear materials, and in guarding against the misuse of these materials and technologies for nonpeaceful purposes.

## International Activities

Over time, the NRC has developed its international efforts to meet needs identified by the Commission. The Office of International Programs implements U.S. export and import regulations on nuclear materials and facilitates cooperation with other countries. Many NRC international activities are mandated by U.S. law or international treaties and conventions, while others are voluntary.

The NRC works with multilateral organizations, such as the International Atomic Energy Agency, and works directly with counterpart agencies in other countries through research and cooperation agreements. Through these activities, the NRC seeks to share and learn the best regulatory safety and security practices. Further, joint research gives the NRC access to research facilities not available in the United States.

## Conventions and Treaties

International conventions and treaties legally commit participating countries to maintaining a high level of nuclear safety by imposing international requirements on governments, regulatory bodies, and the civilian nuclear community. These commitments contribute to public assurance that safety is given proper attention.



The NRC, with many other U.S. agencies, assists in implementing the country's international nuclear policies and obligations. The NRC develops and implements rules, regulations, and policies that address issues including:

- nuclear nonproliferation
- export and import licensing
- safety
- international safeguards
- physical protection
- emergency notification and assistance
- spent fuel and waste management
- liability

In 2012, the NRC participated in international meetings related to two conventions:

- The Fourth Review Meeting of the Joint Convention on the Safety of Spent Fuel Management and on the Safety of Radioactive Waste Management
- An Extraordinary Meeting of the Convention on Nuclear Safety to address Fukushima-related issues

At each of these meetings, the U.S. Government provided national reports detailing how the United States met its obligations. Each report was peer reviewed by participating nations, with the goal of encouraging all countries to enhance their regulatory programs.



Photo courtesy of IAEA

*The NRC participates in the annual General International Conference for the International Atomic Energy Agency in Vienna, Austria.*

*See the list in Appendix AA of Conventions and Treaties.*



The NRC fulfills its obligation to share peaceful uses of nuclear technology internationally by providing technical and policy support to U.S. delegations abroad. The agency also shares information through international assistance and cooperative programs.

## Export and Import Licensing

The NRC uses export and import controls to help limit proliferation and to support safe and secure use of nuclear materials and technology. It continues to work with other countries on the effective implementation of the Code of Conduct on the Safety and Security of Radioactive Sources. (See Web Link Index for Code of Conduct) Meetings with foreign counterparts ensure consistency in global regulatory approaches. The NRC's export and import regulations are outlined in 10 CFR Part 110, "Export and Import of Nuclear Equipment and Material."

*See Appendix AA for a list of export and import licenses.*

## Bilateral Cooperation and Assistance

The NRC has bilateral programs of assistance or cooperation with 42 countries, Taiwan, and the European Atomic Energy Community. (See Figure 7: Bilateral Information Exchange and Cooperation Agreements with the NRC.)

### Cooperation

The NRC participates in a range of programs that enhance the safety and security of peaceful nuclear activities worldwide. Exchanges with countries that have mature nuclear power or radioactive materials programs focus on operational information and best practices. With other countries, the NRC's focus is on developing and improving that country's regulatory activities.

Some of the benefits of consulting with other countries include:

- awareness of new reactor-related activities useful in new reactor construction in the United States
- prompt notification of foreign partners about U.S. safety issues
- receipt of information about foreign safety issues that may affect the United States
- sharing of significant security information with selected countries



**Figure 7. Bilateral Information Exchange and Cooperation Agreements with the NRC**



**Agreement Country, Renewal Date**

Argentina, 2012	Germany, 2012	Poland, 2015
Armenia, 2012	Greece, 2013	Romania, 2016
Australia, 2013	Hungary, 2012	Russia*, 2001
Belgium, 2014	Indonesia, 2013	Slovakia, 2015
Brazil, 2014	Israel, 2016	Slovenia, 2015
Bulgaria*, 2011	Italy, 2015	South Africa, 2014
Canada, 2012	Japan, 2015	Spain, 2015
China, 2013	Kazakhstan, 2014	Sweden*, 2011
Croatia, 2013	Korea, Rep. of, 2015	Switzerland, 2012
Czech Republic, 2014	Lithuania, 2015	Thailand, 2012
Egypt, 1991	Mexico, 2012	Ukraine, 2016
EURATOM, 2014	Netherlands, 2013	United Arab Emirates, 2015
Finland*, 2011	Peru, Open-Ended	United Kingdom, 2013
France, 2013	Philippines, Open-Ended	Vietnam, 2013

Note: The country's short-form name is used. The NRC also provides support to the American Institute in Taiwan. Egypt's agreement has been deferred until its regulatory body requests reinstatement.

EURATOM—The European Atomic Energy Community

\* In negotiation



## Assistance

The NRC assists other countries through training, workshops, peer review of regulatory documents, working group meetings, and exchanges of technical information and specialists. The agency also responds to direct requests from countries to help improve their national controls over radioactive material. In the past year, the NRC has assisted countries in the Caucasus region of central Asia as well as in Latin America, Africa, and the Middle East.

The NRC's Advisory Committee on Reactor Safeguards (ACRS) cooperates with other international advisory committees to exchange information through annual working group meetings and plenary meetings that occur every 4 years.

## Foreign Assignee Program

Since 1975, the agency has hosted more than 350 foreign nationals in on-the-job training at NRC headquarters and the regional offices. The NRC's Foreign Assignee Program helps instill regulatory awareness, capabilities, and commitments in exchanges with assignees from other countries. It also helps enhance the regulatory expertise of both foreign assignees and NRC staff. Additionally, the program improves channels of communication through interaction with the international nuclear community and development of relationships with key officials in foreign regulatory agencies.



*NRC hosts a bilateral meeting at the International Regulators Conference on Nuclear Security in Rockville, MD.*



## Multilateral Organizations

Bilateral activities can help individual countries, but the NRC also uses opportunities within multilateral organizations to interact simultaneously with many countries with similar challenges or at similar stages of development in their national regulatory programs.

The NRC participates in the different programs and committee work of the International Atomic Energy Agency, the Organization for Economic Cooperation and Development's Nuclear Energy Agency, and other multilateral organizations on issues related to:

- safety research and regulatory matters
- radiation protection
- risk assessment
- emergency preparedness
- waste management
- transportation
- safeguards
- physical protection
- security
- standards development
- training
- technical assistance
- communications

*See Appendix AA for a list of NRC's Participation with Multilateral Organizations.*

In an effort to lead the support for the global improvement of nuclear safety, the NRC underwent an Integrated Regulatory Review Service (IRRS) mission sponsored by the IAEA in 2010. After the mission, the NRC hosted an IAEA lessons-learned workshop with countries that participated in different IRRS missions to share experiences and insights to strengthen this peer-evaluation process. Finally, the NRC plans to host a followup IRRS mission in 2014 to demonstrate NRC actions taken to address the IRRS mission recommendations and best practices. These activities demonstrate the openness of the U.S. regulatory system to international peer review and encourage other countries to accept these missions.



## International Cooperative Research

The NRC participates in international cooperative research programs to share U.S. operating experience and to learn from the experiences of other countries. Recent exchanges have focused on managing aging nuclear plants, fire risk in nuclear plants, and pressurized thermal shock in reactor vessels. The NRC also participates in international efforts to improve the security of radioactive materials and the management of radioactive wastes.

The NRC participates in cooperative research programs with 30 countries and Taiwan through approximately 100 multilateral agreements. This helps leverage access to foreign test facilities that are otherwise unavailable to the United States. Access to foreign test facilities expands the NRC's knowledge base and contributes to the best use of NRC resources.

## Worldwide Electricity Generated by Commercial Nuclear Power

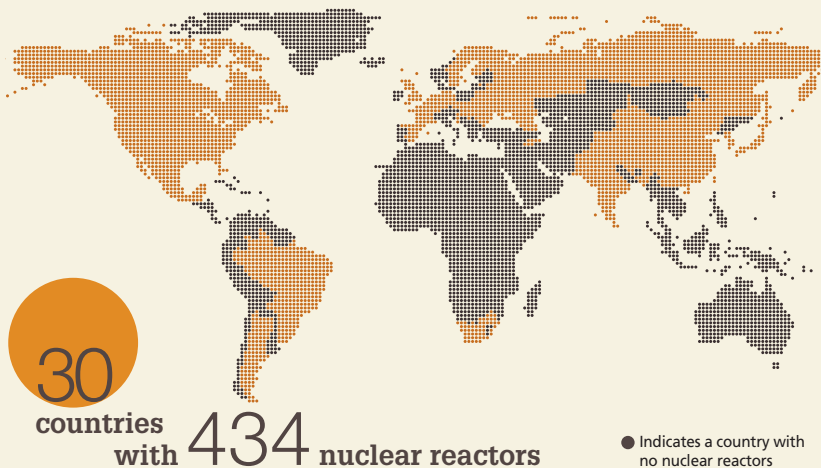
As of July 2013, there were 434 operating reactors in 31 countries with a total installed capacity of 370,543 megawatts electric (MWe). (See Figure 8: Operating Nuclear Power Plants Worldwide.) In addition, one nuclear power plant was in long-term shutdown, and 68 were under construction. Based on preliminary data from 2012, France had the highest portion (75 percent) of total domestic energy generated by nuclear power. (See Figure 9: Nuclear Share of Electricity Generated by Country.)

*See Appendix T for the number of nuclear power reactors by nation and Appendix U for nuclear power units by reactor type, worldwide.*



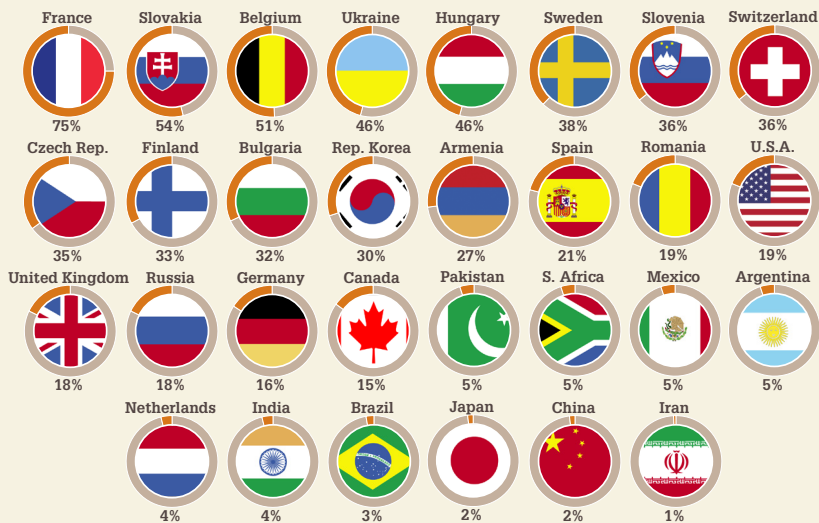


**Figure 8. Operating Nuclear Power Plants Worldwide**



Source: IAEA, Power Reactor Information System database, as of July 2013

**Figure 9. Nuclear Share of Electricity Generated by Country**



Note: The country's short-form name is used.

Source: IAEA, Power Reactor Information System database, as of May 2013

# Nuclear

Energy Safety Major Activities Nuclear Materials Plant Public Infrastructure  
Petitions Orders Protection Reviews Fuel Technical Nuclear  
Commercial New Reactor Protection Operators Designs Funding Important Activities  
Regulatory International Activities Steam Generators Enforcement  
Policy Staff NRC License Renewal  
Federal Public-Involvement



# Reactors

Advanced  
Research NRC-Licensed Reactor Affairs Technology Test Reactors  
Environment Inspectors Evaluation Construction  
Regulatory Information Performance Fuel Analyses  
Regulate Detail Fuel Power Stations Issues Organizations Important  
Nuclear Work Inspection Leadership Functions Reactor  
Radiation Atomic Inspection Oversight Requirements U.S. Protection  
Mission Protection Commercial  
Commission



## U.S. Electricity Generated by Commercial Nuclear Power

In 2012, NRC-licensed nuclear reactors accounted for about 20 percent of U.S. net electric generation, providing 770 billion kilowatt-hours of electricity. (See Figure 10: U.S. Net Electric Generation by Energy Source, 2012 and Figure 11: U.S. Net Electric Generation by Energy Source, 2003–2012.)

Thirty-one of the 50 States generate electricity from nuclear power plants. Of these states, four (New Hampshire, New Jersey, South Carolina and Vermont) generated more than 50 percent of their electricity from nuclear power last year. In addition, 12 States generated 25 to 50 percent of their electricity from nuclear power in 2012. The data cited reflect the percentages of the total net generation from nuclear sources in these States. (See Figure 12: Net Electricity Generated in Each State by Nuclear Power.)

Since the 1970s, the Nation's utilities have sought power uprates as a way to generate more electricity from existing nuclear plants. By January 2013, the NRC had approved 146 power uprates, resulting in a gain of approximately 6,823 megawatts electric (MWe) at existing plants. Collectively, these uprates have

added the equivalent of six new reactors' worth of electrical generation to the power grid (see the Glossary entry for "power grid").

Licensees responding to a December 2012 NRC survey indicated they plan to submit 10 power uprate applications in the next 5 years. If approved, the resulting uprates would add another 1,563 MWe to the Nation's generating capacity. (See Figure 13: Power Uprates: Past, Current, and Future.)

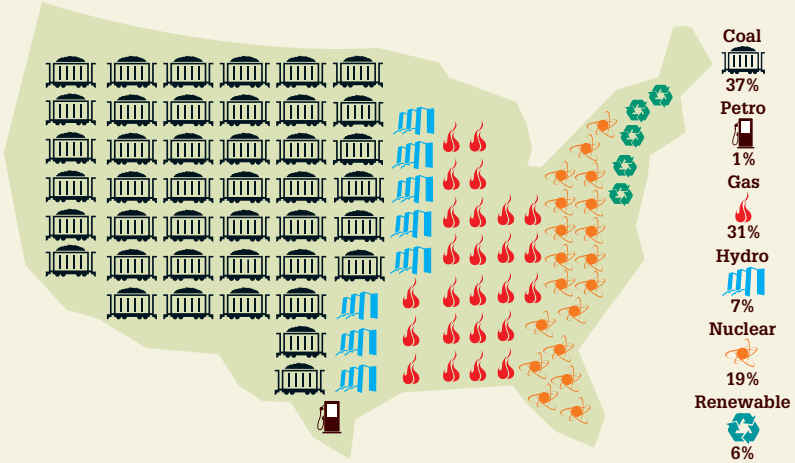
Photo courtesy of Entergy



*Waterford Steam Electric Station, Unit 1, located in Killona, LA*

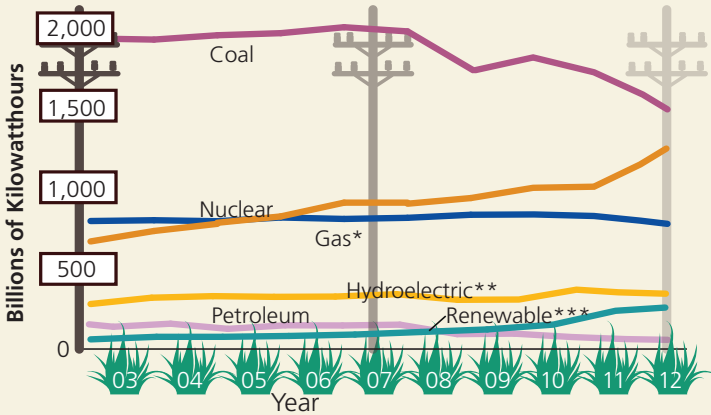


**Figure 10. U.S. Net Electric Generation by Energy Source, 2012**



Source: DOE/EIA, May 2013, [www.eia.doe.gov](http://www.eia.doe.gov) Note: Figures are rounded to the nearest whole digit.

**Figure 11. U.S. Net Electric Generation by Energy Source, 2003–2012**



\* Gas includes natural gas, blast furnace gas, propane gas, and other manufactured and waste gases derived from fossil fuel.

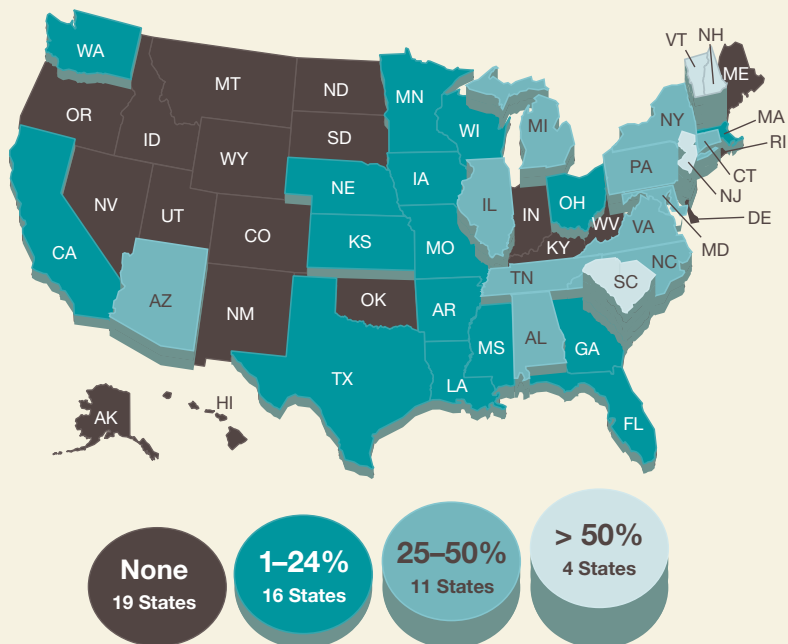
\*\* Hydroelectric includes conventional hydroelectric and hydroelectric pumped storage.

\*\*\* Renewable energy includes geothermal, wood and nonwood waste, wind, and solar energy.

Source: DOE/EIA, May 2013, [www.eia.doe.gov](http://www.eia.doe.gov)

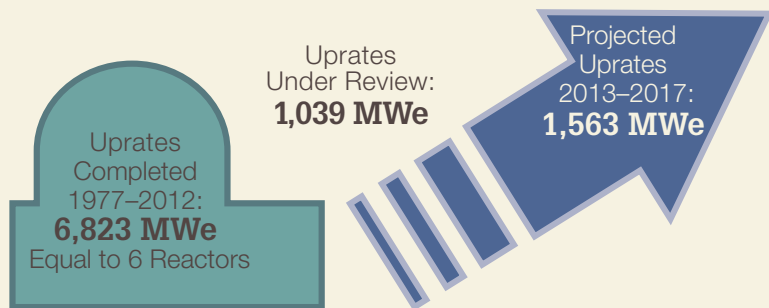


**Figure 12. Net Electricity Generated in Each State by Nuclear Power**



Source: DOE/EIA, "State Electricity Profiles," Data from May 2013, [www.eia.doe.gov](http://www.eia.doe.gov)

**Figure 13. Power Upgrades: Past, Current, and Future**



## U.S. Commercial Nuclear Power Reactors

During 2013, the Kewaunee, Crystal River, and San Onofre nuclear power reactors permanently shut down and entered the decommissioning process. So as of August 2013, the NRC oversees 100 licensed commercial nuclear power reactors operating at 62 sites in 31 States.

The Nation's 100 commercial power reactors fall into several categories:

- 4 different reactor vendors
- 25 operating companies
- about 80 different designs

*See Appendix A for a listing of reactors and their general licensing information and Appendix V for Native American Reservations and Trust lands near nuclear power plants.*

Although commercial U.S. reactors have many similarities, each one can be considered unique. Figure 14 shows a typical pressurized-water reactor (PWR) and Figure 15 shows a typical boiling-water reactor (BWR). Currently, the NRC oversees 35 BWRs and 65 PWRs.

### Resident Inspectors

At least two NRC inspectors work full time at each nuclear power plant site to ensure that the reactors are meeting NRC regulations. (See Figure 16: U.S. Operating Commercial Nuclear Power Reactors and Figure 17: Day in the Life of an NRC Resident Inspector.)



*An NRC inspector conducts routine inspections of plant equipment to ensure the plant is meeting NRC regulations.*



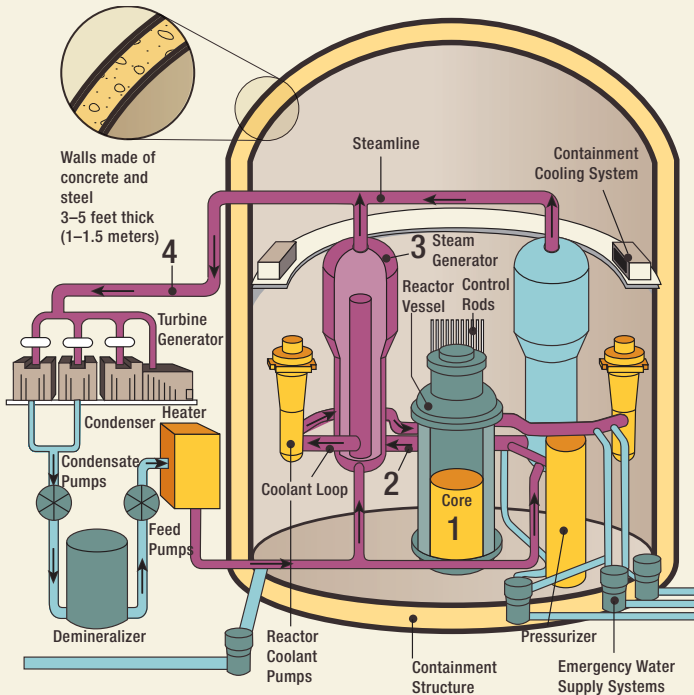
**Figure 14. Typical Pressurized-Water Reactor**

### How Nuclear Reactors Work

In a typical design concept of a commercial PWR, the following process occurs:

1. The core inside the reactor vessel creates heat.
2. Pressurized water in the primary coolant loop carries the heat to the steam generator.
3. Inside the steam generator, heat from the primary coolant loop vaporizes the water in a secondary loop, producing steam.
4. The steamline directs the steam to the main turbine, causing it to turn the turbine generator, which produces electricity.

The unused steam is exhausted to the condenser, where it is condensed into water. The resulting water is pumped out of the condenser with a series of pumps, reheated, and pumped back to the steam generator. The reactor's core contains fuel assemblies that are cooled by water circulated using electrically powered pumps. These pumps and other operating systems in the plant receive their power from the electrical grid. If offsite power is lost, emergency cooling water is supplied by other pumps, which can be powered by onsite diesel generators. Other safety systems, such as the containment cooling system, also need electric power. PWRs contain between 150–200 fuel assemblies.





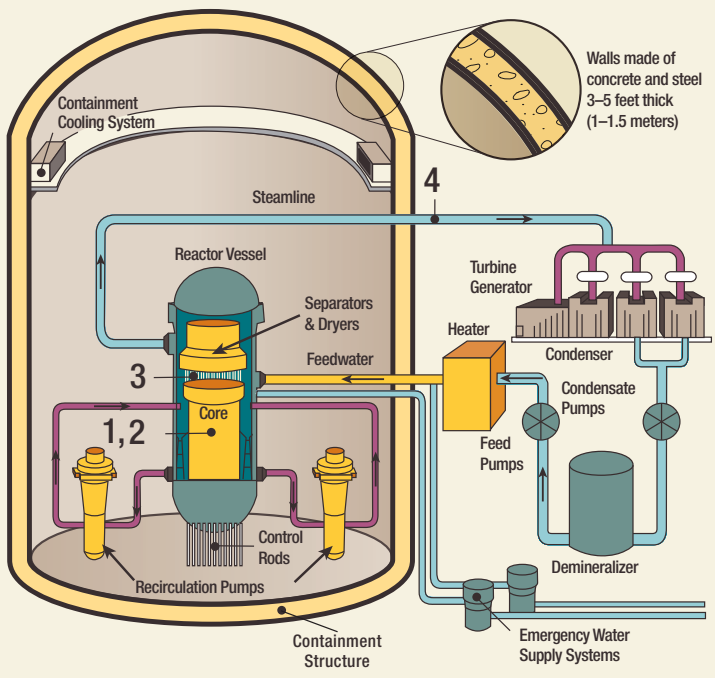
**Figure 15. Typical Boiling-Water Reactor**

**How Nuclear Reactors Work**

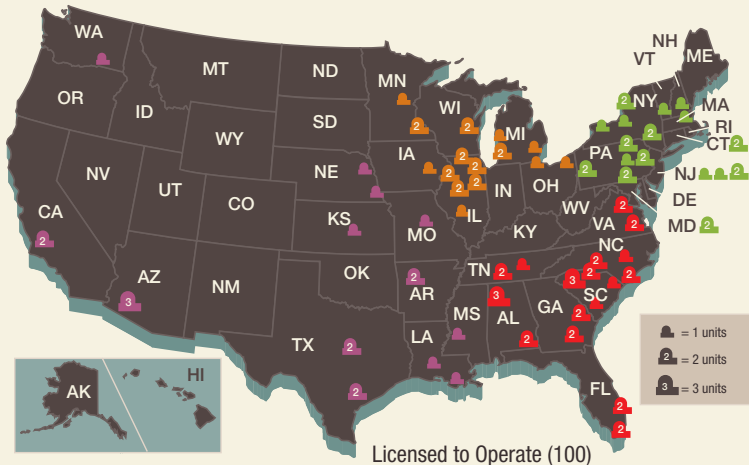
In a typical design concept of a commercial BWR, the following process occurs:

1. The core inside the reactor vessel creates heat.
2. A steam-water mixture is produced when very pure water (reactor coolant) moves upward through the core, absorbing heat.
3. The steam-water mixture leaves the top of the core and enters the two stages of moisture separation where water droplets are removed before the steam is allowed to enter the steamline.
4. The steamline directs the steam to the main turbine, causing it to turn the turbine generator, which produces electricity.

The unused steam is exhausted to the condenser, where it is condensed into water. The resulting water is pumped out of the condenser with a series of pumps, reheated, and pumped back to the reactor vessel. The reactor's core contains fuel assemblies that are cooled by water circulated using electrically powered pumps. These pumps and other operating systems in the plant receive their power from the electrical grid. If offsite power is lost, emergency cooling water is supplied by other pumps, which can be powered by onsite diesel generators. Other safety systems, such as the containment cooling system, also need electric power. BWRs contain between 370–800 fuel assemblies.



**Figure 16. U.S. Operating Commercial Nuclear Power Reactors**



Licensed to Operate (100)

**REGION I**

- CONNECTICUT
  - ▲ Millstone 2 and 3
- MARYLAND
  - ▲ Calvert Cliffs 1 and 2
- MASSACHUSETTS
  - ▲ Pilgrim
- NEW HAMPSHIRE
  - ▲ Seabrook
- NEW JERSEY
  - ▲ Hope Creek
  - ▲ Oyster Creek
  - ▲ Salem 1 and 2
- NEW YORK
  - ▲ FitzPatrick
  - ▲ Ginna
  - ▲ Indian Point 2 and 3
  - ▲ Nine Mile Point 1 and 2
- PENNSYLVANIA
  - ▲ Beaver Valley 1 and 2
  - ▲ Limerick 1 and 2
  - ▲ Peach Bottom 2 and 3
  - ▲ Susquehanna 1 and 2
  - ▲ Three Mile Island 1
- VERMONT
  - ▲ Vermont Yankee

**REGION II**

- ALABAMA
  - ▲ Browns Ferry 1, 2, and 3
  - ▲ Farley 1 and 2
- FLORIDA
  - ▲ St. Lucie 1 and 2
  - ▲ Turkey Point 3 and 4
- GEORGIA
  - ▲ Edwin I. Hatch 1 and 2
  - ▲ Vogtle 1 and 2
- NORTH CAROLINA
  - ▲ Brunswick 1 and 2
  - ▲ McGuire 1 and 2
  - ▲ Harris 1
- SOUTH CAROLINA
  - ▲ Catawba 1 and 2
  - ▲ Oconee 1, 2, and 3
  - ▲ Robinson 2
  - ▲ Summer
- TENNESSEE
  - ▲ Sequoyah 1 and 2
  - ▲ Watts Bar 1
- VIRGINIA
  - ▲ North Anna 1 and 2
  - ▲ Surry 1 and 2

**REGION III**

- ILLINOIS
  - ▲ Braidwood 1 and 2
  - ▲ Byron 1 and 2
  - ▲ Clinton
  - ▲ Dresden 2 and 3
  - ▲ LaSalle 1 and 2
  - ▲ Quad Cities 1 and 2
- IOWA
  - ▲ Duane Arnold
- MICHIGAN
  - ▲ Cook 1 and 2
  - ▲ Fermi 2
  - ▲ Palisades
- MINNESOTA
  - ▲ Monticello
  - ▲ Prairie Island 1 and 2
- OHIO
  - ▲ Davis-Besse
  - ▲ Perry
- WISCONSIN
  - ▲ Point Beach 1 and 2

**REGION IV**

- ARKANSAS
  - ▲ Arkansas Nuclear 1 and 2
- ARIZONA
  - ▲ Palo Verde 1, 2, and 3
- CALIFORNIA
  - ▲ Diablo Canyon 1 and 2
- KANSAS
  - ▲ Wolf Creek 1
- LOUISIANA
  - ▲ River Bend 1
  - ▲ Waterford 3
- MISSISSIPPI
  - ▲ Grand Gulf
- MISSOURI
  - ▲ Callaway
- NEBRASKA
  - ▲ Cooper
  - ▲ Fort Calhoun
- TEXAS
  - ▲ Comanche Peak 1 and 2
  - ▲ South Texas Project 1 and 2
- WASHINGTON
  - ▲ Columbia



**Figure 17. Day in the Life of an NRC Resident Inspector**



## Japan Lessons Learned Directorate

The Japan Lessons Learned Project Directorate, or JLD, leads the NRC's efforts to build upon and implement the recommendations issued in July 2011 by a task force convened shortly after the nuclear accident in Japan. The JLD's approximately 20 full-time employees work with NRC experts from across the agency to take action on what the agency learned from the events at Fukushima. The JLD is directed by a steering committee made up of NRC senior managers.

The JLD developed and issued three orders in March 2012, which required U.S. reactors to:

- Obtain and protect additional emergency equipment, such as pumps and generators, to support all reactors at a given site simultaneously following a natural disaster.
- Install enhanced equipment for monitoring water levels in each plant's spent fuel pool.
- Improve/install emergency venting systems that can relieve pressure in the event of a serious accident (only for reactors with designs similar to the Fukushima plant).

The JLD has also requested information from all U.S. reactors related to earthquake and flooding hazards. The JLD is also working on new or revised rules related to filtering radioactive material after an accident, maintaining key safety functions in an extended "black out" situation, and several aspects of emergency preparedness. (See Figure 18: NRC Post-Fukushima Safety Enhancements.)

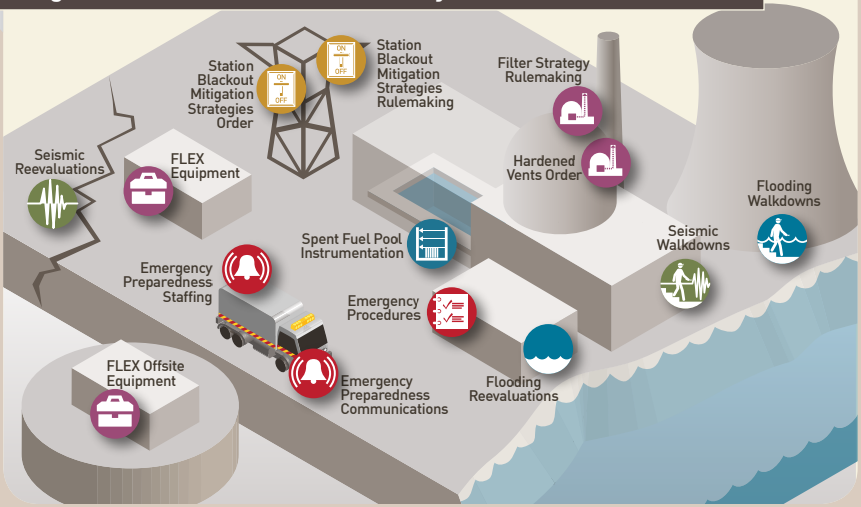
## Principal Licensing, Inspection, and Enforcement Activities

The NRC's commercial reactor licensing and inspection activities in 2012 included:

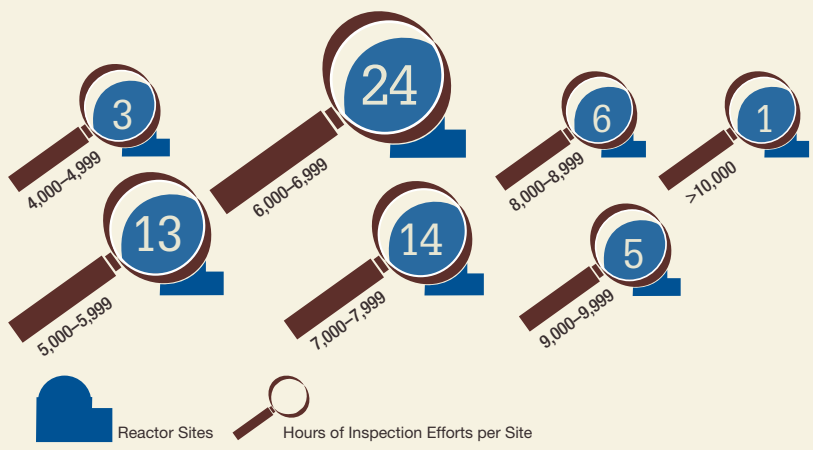
- Reviewing the Tennessee Valley Authority's operating license application for the Watts Bar Unit 2 reactor, now under construction near Spring City, TN.
- Reviewing an average of about 10 separate license change requests from each power reactor licensee each year. The NRC completed 770 separate reviews in FY 2012.



**Figure 18. NRC Post-Fukushima Safety Enhancements**

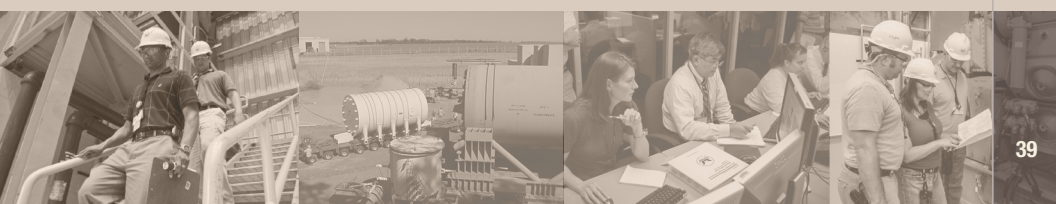


**Figure 19. NRC Inspection Effort at Operating Reactors, 2012**



Note: Data include calendar year (CY) 2012 hours for all activities related to baseline, plant-specific, generic safety issue, and allegation inspections.

\* 66 total sites (including Indian Point Units 2 and 3, which are treated as separate sites for inspection effort)



- Ensuring the qualifications of approximately 4,600 NRC-licensed reactor operators. Each operator must requalify every 2 years and ask the NRC to renew their license every 6 years.
- Spending an average of 6,600 hours performing inspection-related activities at each operating reactor site. (See Figure 19: NRC Inspection Effort at Operating Reactors, 2012.)
- Reviewing 10 applications for proposed 16 new reactors.
- Inspecting construction activities at three U.S. sites.
- Reviewing approximately 3,000 operating experience items each year and distributing lessons learned (in areas such as fire protection and access authorization) that could help licensed facilities operate more effectively.
- Issuing about 20 notices of violation, civil penalties, or orders to operating reactors for significant violations of NRC regulations regarding public health and safety.
- Investigating approximately 600 allegations of inadequacy or impropriety associated with NRC-regulated activities.
- Incorporating independent advice from the Advisory Committee on Reactor Safeguards (ACRS), a group of nuclear, engineering, and safety experts appointed by the Commission. The ACRS held 11 full Committee meetings and approximately 70 subcommittee meetings during FY 2012 to examine potential safety issues for existing or proposed reactors.

*See Appendix C for a list of permanently shut down and decommissioned reactors and Appendix X for a list of significant enforcement actions.*

## Oversight of U.S. Commercial Nuclear Power Reactors

The NRC establishes requirements for the design, construction, operation, and security of commercial nuclear power plants in the United States. The agency ensures the plants are operated safely and securely within these requirements by licensing the plants to operate, licensing control room personnel, establishing technical specifications for operating each plant, and inspecting plants daily.



## Reactor Oversight Process

The NRC's Reactor Oversight Process (ROP) verifies that U.S. reactors are operating in accordance with NRC rules, regulations, and license requirements. If they are not, the NRC has full authority to take actions ranging from conducting additional inspections to shutting a plant down in order to protect public health and the environment.

In general terms, the ROP combines NRC inspection findings and performance records of each reactor to assess the plants' safety performance and security measures. Every 3 months, through the ROP, the NRC places the plants in one of five categories ranging from "fully meeting all safety cornerstone objectives" to "unacceptable performance" (see Figure 20: Reactor Oversight Action Matrix Performance Indicator). The ROP works under the expectation that plants will effectively address all issues that arise, whether they are of low or high safety significance. NRC inspections start with detailed baseline-level activities for every plant. As the number of issues at a plant increases, the NRC's inspections increase. The agency's supplemental inspections and other actions (if needed) ensure that significant performance issues are promptly addressed. The latest plant-specific inspection findings and historical performance information can be found on the NRC's Web site (see the Web Link Index).

The ROP benefits from what the NRC has learned from 30 years of improvements in nuclear industry performance, as well as improved approaches to inspecting and evaluating the safety and security performance of NRC-licensed plants. More ROP information is available on the NRC's Web site and in NUREG-1649, Revision 4, "Reactor Oversight Process," issued December 2006. (See Figure 21: Reactor-Oversight Framework.)

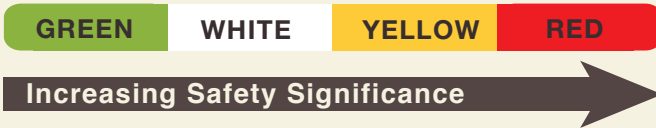
## Tracking Industry Performance

In addition to evaluating individual plant performance, the NRC compiles data on overall reactor industry performance using industry-level statistics. (See Figure 22: Industry Performance Indicators: Averages for FYs 2003–2012.)

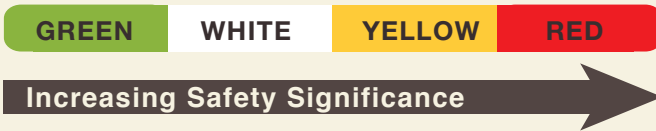


**Figure 20. Reactor Oversight Action Matrix Performance Indicators**

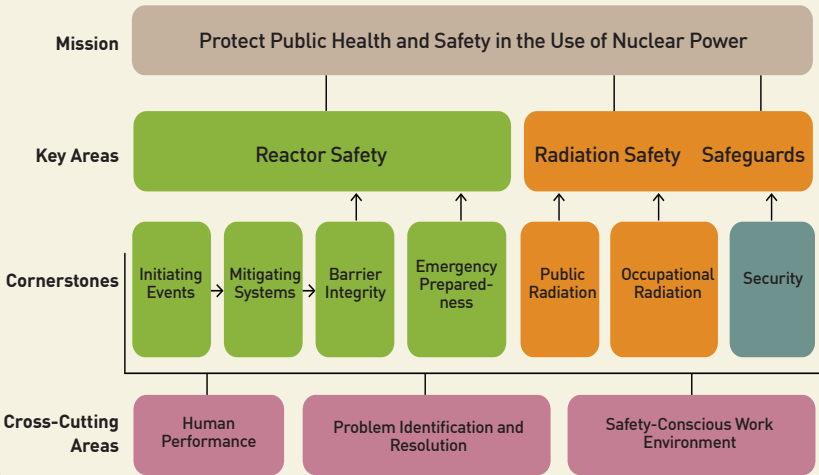
### Performance Indicators



### Inspection Findings

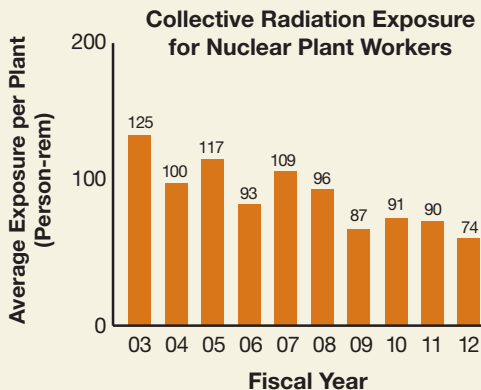


**Figure 21. Reactor Oversight Framework**





**Figure 22. Industry Performance Indicators: FYs 2003–2012 Averages**



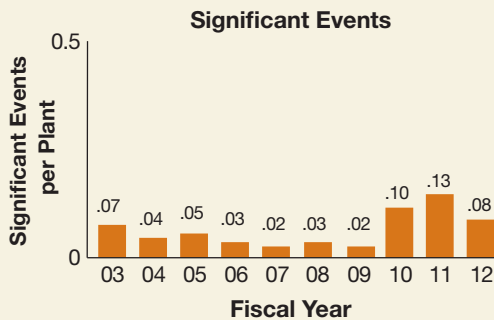
*This indicator monitors the total radiation dose accumulated by plant personnel.*

**Further Explanation:**

In 2012, those workers receiving a measurable dose of radiation received an average of about 0.1 rem. For comparison purposes, the average U.S. citizen receives 0.3 rem of radiation each year from natural sources (i.e., the everyday environment). See the definition of “exposure” in the Glossary.

Note: Data represent annual industry averages, with plants in extended shutdown excluded. Data are rounded for display purposes. These data may differ slightly from previously published data as a result of refinements in data quality. Source: Licensee data as compiled by the NRC

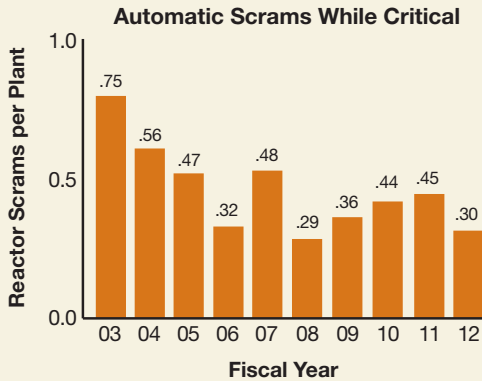
**Figure 22. Industry Performance Indicators: FYs 2003–2012 Averages (continued)**



*Significant events are events that meet specific NRC criteria, for example, degradation of safety equipment, a sudden reactor shutdown with complications, or an unexpected response to a sudden degradation of fuel or pressure boundaries. The NRC staff identifies significant events through detailed screening and evaluation of operating experience.*

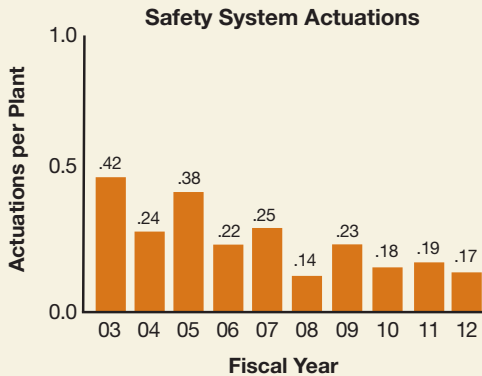


**Figure 22. Industry Performance Indicators:  
FYs 2003–2012 Averages (continued)**



A reactor is said to be “critical” when it achieves a self-sustaining nuclear chain reaction, such as when the reactor is operating. The sudden shutting down of a nuclear reactor by the rapid insertion of control rods, either automatically or manually by the reactor operator, is referred to as a “scram.” This indicator measures the number of unplanned automatic scrams that occurred while the reactor was critical.

**Figure 22. Industry Performance Indicators:  
FYs 2003–2012 Averages (continued)**



Safety system actuations are certain manual or automatic actions taken to start emergency core cooling systems or emergency power systems. These systems are specifically designed to either remove heat from the reactor fuel rods if the normal core cooling system fails or to provide emergency electrical power if the normal electrical systems fail.



## Reactor License Renewal

The Atomic Energy Act of 1954 (as amended) authorizes the NRC to issue 40-year initial licenses for commercial power reactors. The Act also allows for license renewal—under the NRC’s current regulations, the agency can renew reactor licenses for up to 20 years. Congressional consideration of economic and antitrust issues—as opposed to potential concerns over the limitations of nuclear technology—led to the original 40-year term for reactor licenses. Some parts of a reactor, however, may have been engineered based on an expected 40-year service life, so they need to be maintained and monitored during the additional period of operation.

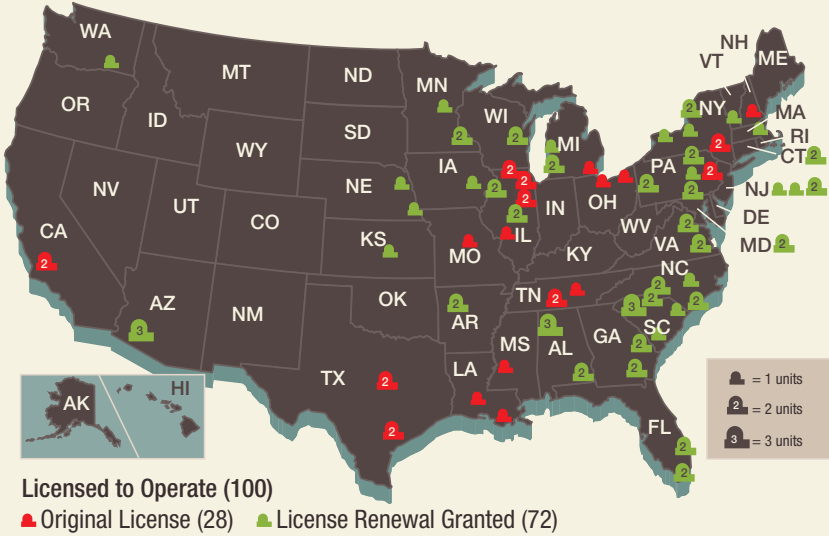
*See Appendix G and H for power reactors operating licenses by year issued and expired.*

As of June 2013, 72 operating reactors (at 43 sites) have received renewed licenses. (See Figure 23: License Renewals Granted for Operating Nuclear Power Reactors.) To see current reactors grouped by how long they have operated, please see Figure 24: U.S. Commercial Nuclear Power Reactors—Years of Operation by the End of 2013. To see reactors listed by license expiration dates, see Figure 25: U.S. Commercial Nuclear Power Reactor Operating License—Expiration by Year. Nuclear power plant owners typically base their decision to seek license renewal on a plant’s economic situation and on whether it can continue to meet NRC requirements in the future.

The NRC’s license renewal reviews determine whether a plant can continue to operate safely beyond 40 years. The NRC reviews renewal applications along two paths—one review examines safety issues and the other considers environmental issues (see Figure 26: License Renewal Process). A plant owner must give the NRC an evaluation that describes how the plant will address aging of plant systems not already covered by NRC inspection and maintenance rules. The plant owner must also report on the potential environmental impacts if the plant operates for up to an additional 20 years. The regulations are detailed in 10 CFR Part 54, “Requirements for Renewal of Operating Licenses for Nuclear Power Plants,” while the environmental protection requirements for license renewal are found in 10 CFR Part 51, “Environmental Protection Regulations for Domestic Licensing and Related Regulatory Functions.” If the NRC concludes a renewed license will be safe, the staff verifies that safety evaluation through onsite inspections as the plant continues to operate.

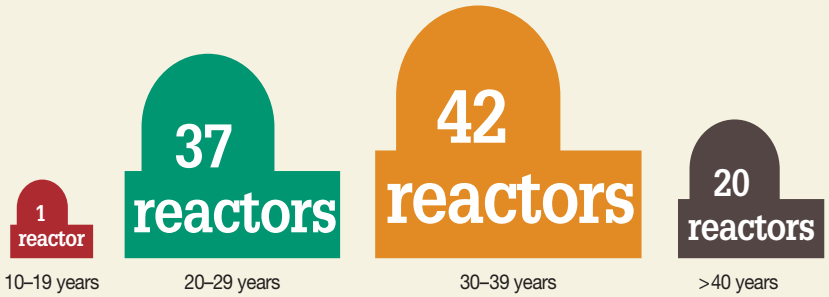


**Figure 23. License Renewals Granted for Operating Nuclear Power Reactors**



Kewaunee's license was renewed before the plant ceased operations on May 7, 2013.

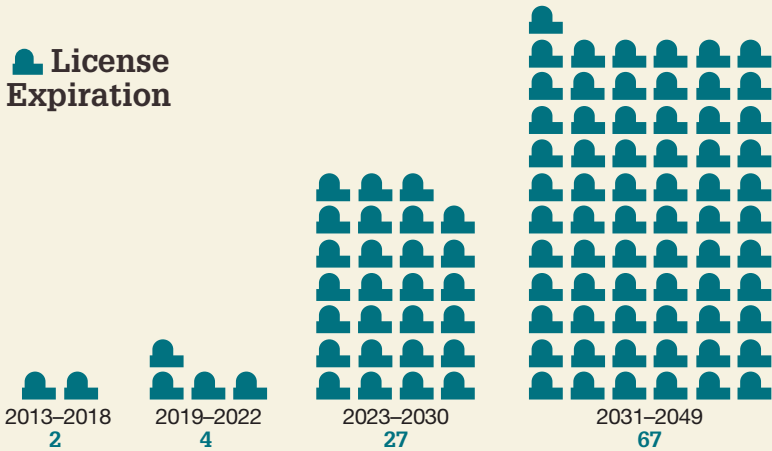
**Figure 24. U.S. Commercial Nuclear Power Reactors—Years of Operation by the End of 2013**



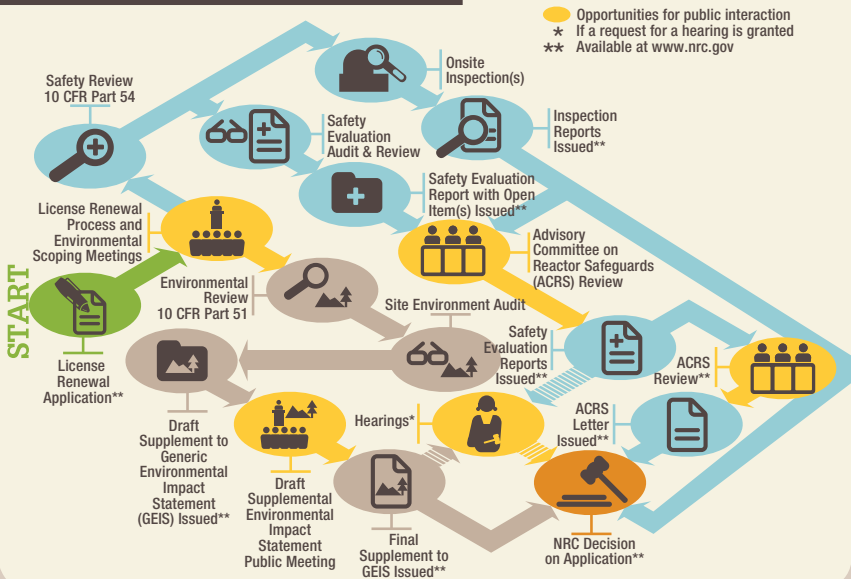
Note: Ages have been rounded up to the end of the year.



**Figure 25. U.S. Commercial Nuclear Power Reactor Operating Licenses—Expiration by Year**



**Figure 26. License Renewal Process**



Although the NRC continues to review license renewal applications, the Commission decided in August 2012 not to make final licensing decisions until the staff completes its waste confidence rule and environmental review. The NRC expects to finish its waste confidence work by September 2014 (see Waste Confidence, page 93).

## Public Involvement

The public plays an important role in the license renewal process. Members of the public have several opportunities to contribute to the environmental review and to discuss how aging will be managed if a plant operates beyond 40 years. The NRC shares information provided by the applicant and holds public meetings. The agency fully documents the results of its technical and environmental reviews and makes them publicly available. In addition, ACRS public meetings often discuss technical or safety issues related to plant designs or a particular plant or site. Individuals or groups can raise legal arguments against a license renewal application in an Atomic Safety and Licensing Board (ASLB) hearing if they would be affected by the renewal and meet basic requirements for requesting a hearing. For more information, visit the NRC's Web site (see the Web Link Index).

## Research and Test Reactors

Nuclear research and test reactors (RTRs) are designed and used for research, testing, and education in nuclear engineering, physics, chemistry, biology, anthropology, medicine, materials sciences, and related fields.

These reactors do not produce commercial electricity. The largest U.S. research and test reactor (which produces 20 megawatts thermal [MWt]) is 75 times smaller than the smallest U.S. commercial power nuclear reactor (which produces 1,500 MWt). There are 39 licensed research and test reactors:

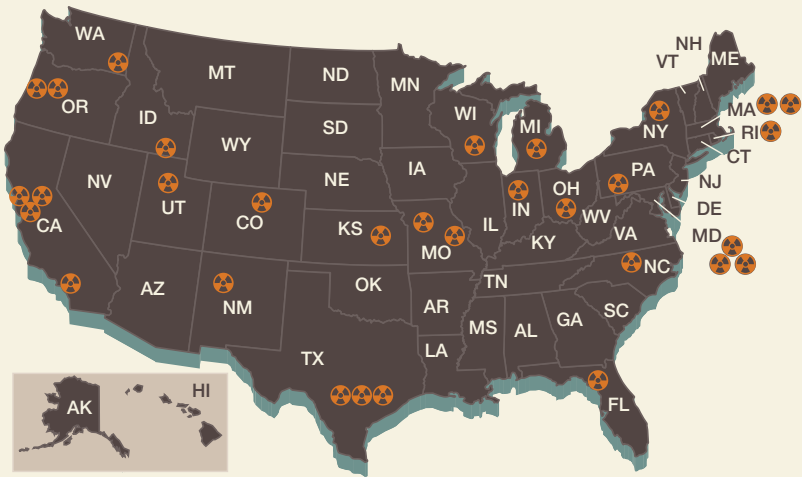
- 31 RTRs operating in 21 States (see Figure 27: U.S. Nuclear Research and Test Reactors)
- 8 RTRs shut down and in various stages of decommissioning

NRC inspectors visit each research and test reactor facility at least once a year to conduct varying levels of inspection. Research and test reactors licensed to produce

*See Appendix J for a list of the 31 operating RTRs regulated by the NRC and Appendix K for a list of the 8 RTRs regulated by the NRC that are in the process of decommissioning.*



**Figure 27. U.S. Nuclear Research and Test Reactors**



☢ RTRs Licensed/Currently Operating (31)

<p><b>1,500 MWt</b></p> <p><b>SMALLEST COMMERCIAL POWER REACTOR</b></p> <p><b>1,500 Megawatts thermal</b></p>	<p><b>20 MWt</b></p> <p><b>LARGEST RESEARCH &amp; TEST REACTOR</b></p> <p><b>75x Smaller</b></p> <p><b>20 Megawatts thermal</b></p>
---	---



2 MWt or more receive a full NRC inspection every year; research and test reactors licensed to produce less than 2 MWt receive a full inspection every 2 years. Since 1958, 83 licensed research and test reactors have been decommissioned.

## Principal Licensing and Inspection Activities

The NRC's research and test reactor licensing and inspection activities include:

- licensing the 31 operating sites, including license renewals and license amendments
- overseeing decommissioning
- licensing approximately 100 operators
- overseeing operator relicensing programs
- overseeing security programs
- conducting approximately 50 inspections each year, based on inspection frequency and procedures for operating RTRs

## New Commercial Nuclear Power Reactor Licensing

The NRC reviews license applications for new commercial power reactors using a revised process much improved over the process used through the 1990s (see Figure 28: New Reactor Licensing Process). In early 2012, the NRC issued the first combined construction and operating licenses (called a combined license or COL) under the new licensing process.

The NRC will continue reviewing 9 additional COL applications (which would authorize approximately 14 new reactors) over the next several years and has in place the infrastructure and staff to support the necessary technical work (see Figure 29: Locations of New Nuclear Power Reactor Applications and the Web Link Index). The NRC is including the lessons learned from the Fukushima accident in the agency's ongoing design certification, COL, and early site permit reviews.

Although the NRC continues to review new reactor license applications, the Commission decided in August 2012 not to make final licensing decisions until the staff completes its waste confidence rule and environmental review. The NRC expects to finish its waste confidence work in September 2014. (See Waste Confidence, page 93.)

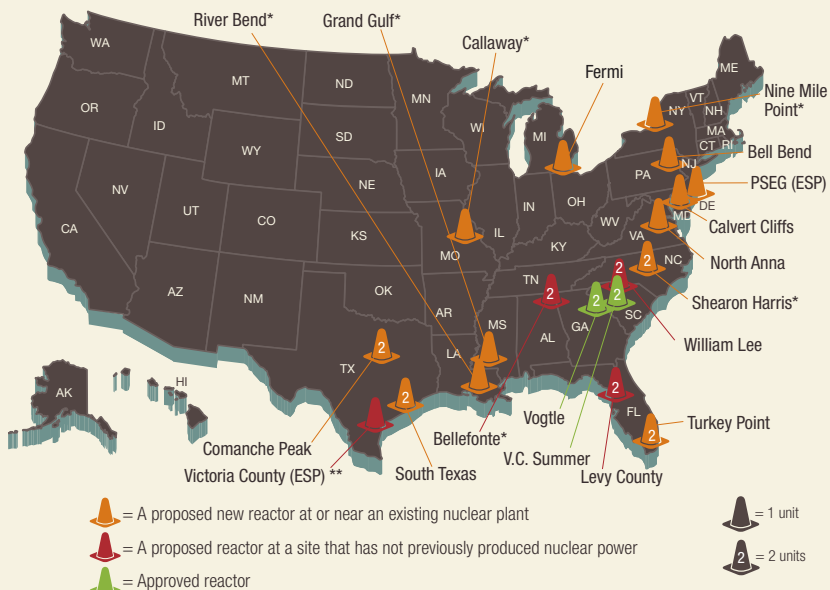




**Figure 28. New Reactor Licensing Process**



**Figure 29. Locations of New Nuclear Power Reactors Applications**



\* Review suspended \*\* COL application amended by applicant to ESP on March 25, 2010.  
 Note: Data is as of June 2013.

## Construction and Operating License Applications

Since June 2007, the NRC has received 18 COL applications for 28 new reactor units:

- Calvert Cliffs (MD)
- South Texas Project (TX)
- Bellefonte (AL)
- North Anna (VA)
- William States Lee III (SC)
- Shearon Harris (NC)
- Grand Gulf (MS)
- Vogtle (GA)
- V.C. Summer (SC)
- Callaway (MO)
- Levy County (FL)
- Victoria County Station (TX)
- Fermi (MI)
- Comanche Peak (TX)
- River Bend (LA)
- Nine Mile Point (NY)
- Bell Bend (PA)
- Turkey Point (FL)

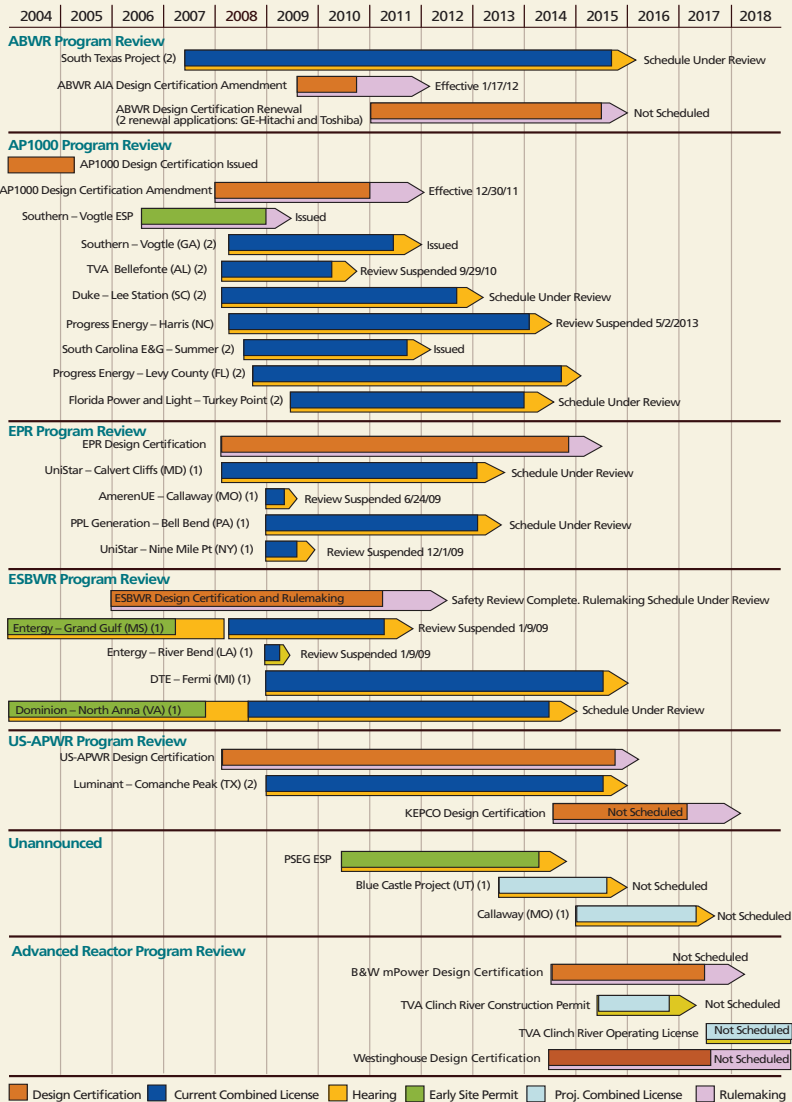
*See Appendix B: List of the U.S. New Nuclear Power Plant Applications.*

The NRC suspended or cancelled seven COL application reviews because of applicant business decisions (Grand Gulf, Callaway, Nine Mile Point, River Bend, Shearon Harris, Victoria County Station, and Bellefonte). Figure 30: New Reactor Licensing Schedule of Application by Design, shows the potential new reactor locations. For the current review schedule for reactor licensing applications, consult the NRC's public Web site (see the Web Link Index).



**Figure 30. New Reactor Licensing Schedule of Applications by Design**

Estimated Schedules by Calendar Year (as of July 1, 2013)



■ Design Certification 
 ■ Current Combined License 
 ■ Hearing 
 ■ Early Site Permit 
 ■ Proj. Combined License 
 ■ Rulemaking

Note: Lines depict approximate dates on schedule. Data on projected applications are based on information from potential applicants and are subject to change. Schedules depicted for future activities represent nominal assumed review durations based on submittal timeframes in letters of intent from prospective applicants. Numbers in ( ) next to the COL name indicate the number of units per site. The acceptance review is included at the beginning of the COL review. The rules in 10 CFR Part 2, "Rules of Practice for Domestic Licensing Proceedings and Issuance of Orders," govern hearings on COLs.

## Public Involvement

Even before the NRC receives an application, the agency holds a public meeting to talk to the community near the proposed reactor location, explaining how the NRC reviews an application and how the public may participate in the process. After the application is submitted, the NRC asks the public to comment on which factors should be considered in the agency's environmental review of the application. Later in the review, the NRC asks for public input on the agency's draft environmental evaluation, which it posts on the agency's Web site. There is no formal opportunity for public comment on the staff's safety evaluation, but members of the public are welcome to attend public meetings and make comments. Individuals or groups can raise legal arguments against a new reactor application in an ASLB hearing if they would be affected by the new reactor and meet basic requirements for requesting a hearing. The NRC announces opportunities to request these hearings in press releases, in the *Federal Register*, and on the NRC's Web site.

## Early Site Permits

An early site permit (ESP) review examines whether a piece of land can support a nuclear power plant in terms of site safety, environmental protection, and emergency preparedness. The ACRS reviews those portions of the ESP application that concern safety. As with COL reviews, the public participates in the environmental portion of the NRC's early site permit review and the public can challenge an application in a hearing. The NRC has issued early site permits to:

- System Energy Resources, Inc. (Entergy), for the Grand Gulf site in Mississippi
- Exelon Generation Company, LLC, for the Clinton site in Illinois
- Dominion Nuclear North Anna, LLC, for the North Anna site in Virginia
- Southern Nuclear Operating Company, for the Vogtle site in Georgia

The NRC is currently reviewing an ESP application submitted in May 2010 for a site located near the Hope Creek/Salem operating reactors in New Jersey. The NRC expects to receive one additional ESP application by the end of 2014.



## Design Certifications

The NRC issues design certifications for reactor designs that meet basic requirements for ensuring safe operation. Utilities can cite a certified design when applying for a nuclear power plant combined license. The certification is valid for 15 years from the date issued and can be renewed for an additional 15 years. The new reactor designs under review incorporate new elements such as passive safety systems and simplified system designs. The four certified designs are:

- General Electric-Hitachi Nuclear Energy's (GEH's) Advanced Boiling-Water Reactor (ABWR)
- Westinghouse's System 80+
- Westinghouse's AP600
- Westinghouse's amended AP1000

The NRC is reviewing design certification applications for:

- AREVA's U.S. Evolutionary Power Reactor (EPR)
- Mitsubishi Heavy Industries' U.S. Advanced Pressurized-Water Reactor (US-APWR)

The NRC completed the technical reviews on General Electric-Hitachi's Economic Simplified Boiling-Water Reactor (ESBWR) and the certification is in the rulemaking process.

In late 2011, the NRC approved STP Nuclear Operating Company's ABWR design certification amendment to address the agency's aircraft impact rule.

The NRC is performing preapplication activities with Korea Hydro Nuclear Power for the APR1400 design and expects to receive a design certification application in 2013.

## Design Certification Renewals

The NRC is reviewing two applications for design certification renewal for the ABWR from GEH and Toshiba; the companies submitted the applications in 2010.



## Advanced Reactor Designs

Several companies are considering advanced reactor designs and technologies and plan to submit the first of these applications to the NRC in 2014. These technologies include light-water reactors a fraction of the size of today's designs, as well as reactors cooled by liquid metals or high-temperature gas. The NRC's advanced reactor efforts will ensure the agency has the resources and expertise to address these new technologies. While developing the regulatory framework for advanced reactor licensing, the NRC is also examining policy issues in areas such as security and emergency preparedness.

## New Reactor Construction Inspections

The NRC monitors reactor-construction activity with inspectors based in the agency's Region II office in Atlanta, GA. These expert staff ensure licensee construction is carried out according to NRC license specifications and related regulations. The NRC staff examines the licensee's operational programs in areas such as security, radiation protection, and operator training and qualification. Inspections at a construction site verify a licensee has completed required inspections, tests, analyses, and other acceptance criteria.

In February 2012, the NRC issued COLs to Southern Nuclear Operating Company for Vogtle, Units 3 and 4. In March 2012, the NRC issued COLs to South Carolina Electric and Gas for V.C. Summer, Units 2 and 3. The NRC's resident construction inspectors at both Vogtle and V.C. Summer are onsite throughout construction, overseeing day-to-day licensee and contractor activities. In addition, specialists at the NRC Region II's Center for Construction Inspection conduct periodic inspections at the site to ensure the facilities are being constructed using the approved design.

The NRC assesses all of these activities through the Construction Reactor Oversight Process. Before the agency will allow a new reactor to start up, NRC inspectors must confirm the licensee has met all of the acceptance criteria in its COL.

The agency also inspects domestic and overseas factories and other vendor facilities to ensure new U.S. reactors receive high-quality products and services that meet the NRC's regulatory requirements. The NRC's Web site has more information on new reactor licensing activities (see the Web Link Index).



## Nuclear Regulatory Research

The NRC's research supports the agency's mission by providing technical advice, tools, methods, data, and information. This research can identify, explore, and resolve safety issues, as well as provide information supporting licensing decisions and new regulations and guidance. The NRC's research includes:

- independently confirming other parties' work through experiments and analyses
- developing technical support for agency safety decisions
- preparing for the future by evaluating the safety implications of new technologies and designs for nuclear reactors, materials, waste, and security

The research program focuses on the challenges of an evolving industry, as well as on retaining technical skills when experienced staff retires. The NRC's research covers the light-water reactor technology developed in the 1960s and 1970s, today's advanced light-water reactor designs, and fuel cycle facilities. Current interest in more exotic reactor concepts, cooled by high-temperature gases or liquid metals, has prompted the agency to consider longer-term research needs.

The NRC's research programs examine a broad range of subjects, such as:

- material performance (such as cracking of metal alloys, managing aging components and materials, boric-acid corrosion, alkali-silicate reaction in concretes, and metals becoming brittle during use in a reactor)
- new and evolving technologies (such as mixed uranium plutonium fuel performance, electrochemical reprocessing, computerized instrumentation and control, and safety critical software)
- experience gained from operating reactors
- enhanced risk-assessment methods, tools, and models to support the increased use of probabilistic risk assessment in regulatory applications
- earthquake and flooding hazards
- equipment performance under extreme conditions (e.g., heat, radiation, or humidity)
- ultrasound and other nondestructive means of assessing reactor-component degradation

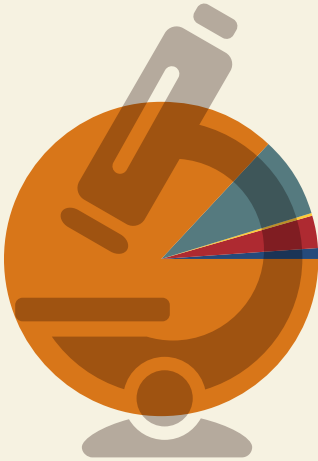


Photo courtesy: University of Wisconsin—Madison



*Universities and other academic institutions use nuclear materials in laboratory experiments while conducting health physics-related research.*

**Figure 31. NRC Research Funding, FY 2013**



**Total \$34.2 Million**

- Reactor Program—\$29.7 M
- New/Advanced Reactor Licensing—\$2.9 M
- Homeland Security—\$0.04 M
- Materials and Waste—\$1.2 M
- Infrastructure Support—\$0.3 M

Note: Totals may not equal sum of components because of independent rounding.





- the human side of reactor operations, including safety culture, and computerization and automation of control rooms

The research program also:

- Develops fire-safety research, including fire modeling, fire probabilistic risk assessment methods, and fire testing.
- Develops and improves computer codes as hardware becomes more powerful and additional information allows for more realistic simulations. These computer codes analyze severe reactor accidents, the movement of radioactive material through the environment, health effects of radioactive releases, fire conditions in nuclear facilities, reactor fuel performance, and nuclear power plant risk assessment.
- Evaluates potential security vulnerabilities and possible solutions.

The NRC's research program involves about 6 percent of the agency's personnel and uses about 11 percent of its contracting funds. The NRC's \$34.2 million research budget for FY 2013 includes contracts with national laboratories, universities, other Federal agencies (e.g., the National Institute of Standards and Technology, the U.S. Army Corps of Engineers, and the U.S. Geological Survey), and research organizations for greater expertise and access to research facilities. Figure 31: NRC Research Funding, FY 2013, illustrates the primary areas of research. The NRC directs more than 75 percent of the research program toward maintaining the safety of operating reactors. The remaining research budget supports regulating new and advanced reactors, nuclear fuel cycle and radioactive waste programs, and security. The infrastructure-support item in Figure 31: NRC Research Funding, FY2013 includes information technology and human resources funding for the research program.

The NRC's cooperative agreements with universities and nonprofit organizations focus research on the agency's specific interests. The NRC's agreement with the National Academy of Sciences, for example, will lead to pilot studies assessing cancer risk for populations around nuclear power facilities. The pilot work is based on an earlier phase of the project, which developed scientifically sound study methods.

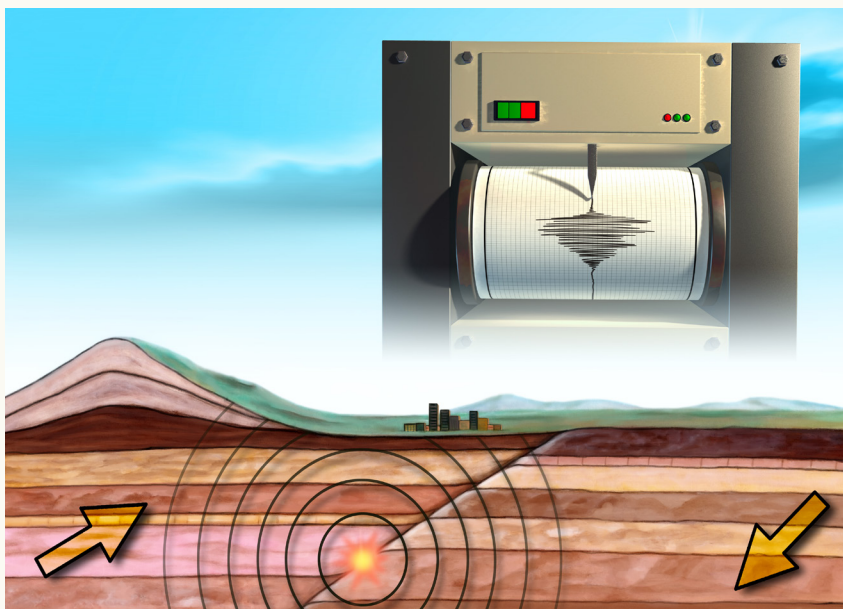
The NRC's multi-year cooperation with the U.S. Department of Energy (DOE) and the Electric Power Research Institute has significantly advanced the understanding of earthquake hazards for U.S. nuclear power plants. In 2012, this



collaboration led to a new seismic source characterization model and report for assessing seismic hazards at Central and Eastern U.S. nuclear facilities. The model replaces information developed in the late 1980s and can be used to calculate the likelihood of various levels of earthquake-caused ground motions. The new model will support new nuclear facility testing and will be used by reactors in that geographic area as part of the NRC's lessons learned from the 2011 Fukushima nuclear accident in Japan.

*See Appendix W for a list of the NRC's cooperative research agreements.*

NRC research also informs the public. The State-of-the-Art Reactor Consequence Analyses (SOARCA) project developed best estimates of possible public health consequences for potential severe accidents for two U.S. nuclear power plants:



*The NRC requires all of its licensees to take seismic activity into account when designing and maintaining its nuclear power plants. When new seismic hazard information becomes available, the NRC evaluates the new data and models and determines if any changes are needed at plants.*



the Peach Bottom Atomic Power Station (a boiling-water reactor near Delta, PA) and the Surry Power Station (a pressurized-water reactor near Surry, VA). The project, which began in 2007, combined up-to-date information about the plants' layout and operations with local population data and emergency preparedness plans. This information was then analyzed using state-of-the-art computer programs incorporating decades of research in severe reactor accidents. The project concluded the populations around the two plants would see only a very small increase in fatal cancer risk if the analyzed accidents occurred. In 2012, the NRC issued the final report in NUREG-1935, "State-of-the-Art Reactor Consequence Analyses Report." The NRC continues to use SOARCA's methods and models to inform other agency programs.

The NRC cooperates with international researchers, which leverages agency resources, facilitates work on advancing existing technologies, and determines any safety implications of new technologies. The NRC's leadership role in international organizations such as the IAEA and Europe's Nuclear Energy Agency helps guide the agency's collaborations.

The NRC's international cooperative research includes more than 100 agreements with more than two dozen foreign governments. This work covers technical areas from severe accident research and computer code development to materials degradation, nondestructive examination, fire risk, and human-factors research. Cooperation under these agreements is more efficient than conducting research independently. Examples of agreements include:

- the NRC's Program on Steam Generator Tube Integrity (renewed with five foreign counterparts for another 5 years)
- more than 25 agreements with foreign regulators and research organizations for participation in the NRC's Code Applications and Maintenance Program

See the Web link Index for more information on specific NRC research projects and activities.



# Nuclear M

Nuclear Materials

Extraction  
Gas Diffusion  
Devices  
Transportation  
Research  
Organizations  
Fabrication  
Safeguards  
Information  
International Activities  
Staff  
Nuclear Materials  
Environment  
Uranium  
Medical  
Public Inv  
Facilities  
Agreement  
Commission  
Detail  
Industrial  
NRC-Licensed Energy  
Reactor  
Affairs  
Inspect  
Important  
Recover



# Materials

Commercial Irradiator Academic  
Safety Recovery Fuel Cycle Nuclear Medicine  
Material Security Training Petitions  
Gauges Enrichment Protection Radiation Heap Leach Ruling  
Nuclear Major Activities Mission Security  
NRC Power Leadership Congress  
Regulate Commercial  
Federal Activities  
Atomic Public  
Monitoring Policy  
Work  
Federal  
Orders  
NRC  
Leadership  
Congress  
Monitoring  
Policy  
NRC  
Leadership  
Congress  
Monitoring  
Policy  
NRC  
Leadership  
Congress



The NRC regulates each phase of the nuclear fuel cycle—the steps needed to turn uranium ore into fuel for nuclear power plants. In some states, it also regulates nuclear materials used for medical, industrial, and academic purposes.

## Materials Licenses

States have the option to regulate certain radioactive materials themselves under agreements with the NRC. Thirty-seven states, called Agreement States, have taken on this responsibility. These states developed regulations and appointed officials to ensure nuclear materials are used safely and securely. Agreement States must adopt rules consistent with the NRC's. Only the NRC regulates nuclear reactors, fuel fabrication facilities, and certain amounts of what is called “special nuclear material”—that is, radioactive material that can fission or split apart.

The NRC and Agreement States have issued about 21,800 licenses to use nuclear materials (see Table 1: U.S. Materials Licenses by State):

- The NRC administers approximately 2,900 licenses.
- 37 Agreement States administer approximately 18,900 licenses.

Radioactive materials, or radionuclides, are used for many purposes. They can be produced in a reactor or an accelerator—a machine that propels charged particles. The NRC does not regulate accelerators but does license the use of radioactive materials produced in accelerators. Radionuclides are used in civilian and military industrial applications; basic and applied research; manufacture of consumer products; academic studies; and medical diagnosis, treatment, and research.

## Medical and Academic

The NRC and Agreement States review the facilities, personnel, program controls, and equipment involved in using radioactive materials in medical and academic settings. These reviews ensure the safety of the public, patients, and workers who might be exposed to radiation from those materials. The NRC regulates only the use of radioactive material, which is why the NRC does not regulate X-ray machines or other devices that produce radiation without using radioactive materials.


*See Appendix L for State Agreements map.*



**Table 1. U.S. Materials Licenses by State**

State	Number of Licenses	
	NRC	Agreement States
Alabama	18	439
Alaska	64	0
Arizona	12	366
Arkansas	5	213
California	57	1,852
Colorado	20	356
Connecticut	180	0
Delaware	52	0
District of Columbia	42	0
Florida	22	1,720
Georgia	17	520
Hawaii	60	0
Idaho	74	0
Illinois	32	711
Indiana	283	0
Iowa	3	170
Kansas	11	286
Kentucky	9	431
Louisiana	11	519
Maine	2	125
Maryland	84	598
Massachusetts	25	500
Michigan	501	0
Minnesota	12	177
Mississippi	6	331
Missouri	282	0

State	Number of Licenses	
	NRC	Agreement States
Montana	89	0
Nebraska	5	148
Nevada	3	237
New Hampshire	8	82
New Jersey	39	638
New Mexico	14	198
New York	22	1,403
North Carolina	17	760
North Dakota	8	83
Ohio	40	629
Oklahoma	17	233
Oregon	5	335
Pennsylvania	53	745
Rhode Island	1	49
South Carolina	15	414
South Dakota	41	0
Tennessee	22	589
Texas	49	1,665
Utah	10	197
Vermont	34	0
Virginia	59	426
Washington	15	405
West Virginia	176	0
Wisconsin	14	321
Wyoming	84	0
Others*	162	0
<b>Total</b>	<b>2,886</b>	<b>18,871</b>

 Agreement State

\* Others include major U.S. territories.

Note: The NRC and Agreement State data is as of June 2012. The NRC licenses Federal agencies in Agreement States.



## Medical

The NRC and Agreement States license hospitals and physicians to use radioactive materials in medical treatments. The NRC also develops guidance and regulations for licensees. These regulations require licensees to have experience and special training, focusing on operating equipment safely, controlling the radioactive material, and keeping accurate records.

To help the NRC stay current, the agency sponsors an Advisory Committee on the Medical Uses of Isotopes. This expert committee includes scientists, physicians, and other health care professionals.

### Nuclear Medicine

Doctors use radioactive materials to diagnose or treat about one-third of all patients admitted to hospitals. This branch of medicine is known as nuclear medicine, and the radioactive materials are called radiopharmaceuticals.

Two types of radiopharmaceutical tests can diagnose medical problems. In vivo tests (“within the living”) administer radiopharmaceuticals directly to patients. In vitro tests (“within the glass”) add radioactive materials to lab samples taken from patients.

### Radiation Therapy

Doctors also use nuclear materials and radiation-producing devices to treat medical conditions. They can treat hyperthyroidism and some cancers, for example, and can also ease the pain caused by bone cancer.

Radiation therapy aims to deliver an accurate radiation dose to a target site while protecting surrounding healthy tissue. To be most effective, treatments often require several exposures over a period of time. When used to treat malignant cancers, radiation therapy is often combined with surgery or chemotherapy.

There are three main categories of radiation therapy:

1. External beam therapy (also called teletherapy) is a beam of radiation directed to the target tissue. Several different types of machines provide external beam therapy. Treatment machines regulated by the NRC contain high-activity radioactive sources (usually cobalt-60) that emit photons to treat the target site.
2. Brachytherapy treatments use sealed radioactive sources placed near or even directly in cancerous tissue. The radiation dose is delivered at a distance of up to an inch (up to 2.54 centimeters) from the target area.





Photo courtesy: Sirtex



Vials containing millions of Yttrium-90 (Y-90) microspheres used to treat liver cancers.

Samples of two manufacturers of Y-90 SIR-Spheres® (left) TheraSphere® (below)

Photo courtesy: Biodex

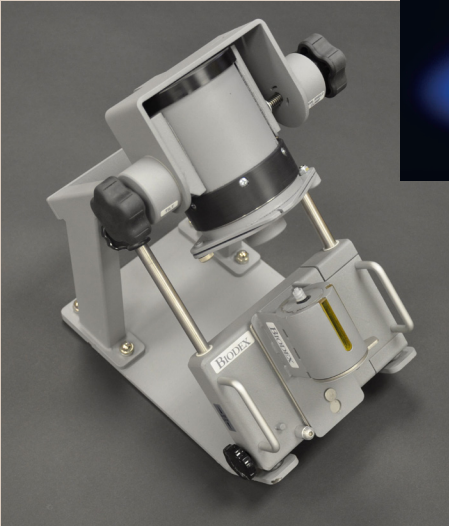


Photo courtesy: Nordion

Shielding and syringe holder used to protect medical workers as they load a syringe from a bulk vial of a radiopharmaceutical containing fluorine-18 (F-18). The F-18 produces gamma rays, which show up in a PET Scan, allowing the radiologist to see internal organs and the blood flowing to and from them. (left)



3. Therapeutic radiopharmaceuticals deliver a large radiation dose inside the body. Different radioactive materials can be given to patients and will concentrate in different regions or organ systems.

## Academic

The NRC issues licenses to academic institutions for education and research. For example, qualified instructors may use radioactive materials in classroom demonstrations and scientists in many disciplines use radioactive materials for laboratory research.

## Industrial

The NRC and Agreement States issue licenses that specify the type, quantity, and location of radioactive materials to be used. Radionuclides can be used in industrial radiography, gauges, well logging, and manufacturing. Radiography uses radiation sources to find structural defects in metal and welds. Gas chromatography uses low-energy radiation sources to identify the chemical elements in an unknown substance. This process can determine the components of complex mixtures, such as petroleum products, smog, and cigarette smoke. It can also be used in biological and medical research to identify the components of complex proteins and enzymes. Well-logging devices use radioactive sources and detection equipment to make a record of geological formations from inside a well. This process is used extensively for oil, gas, coal, and mineral exploration.

## Nuclear Gauges

Nuclear gauges are used to measure the physical properties of products and industrial processes nondestructively as a part of quality control. Gauges use radiation sources to determine the thickness of paper products, fluid levels in oil and chemical tanks, and the moisture and density of soils and material at construction sites. Gauges may be fixed or portable.

A fixed gauge has a radioactive source shielded in a container. When the user opens the container's shutter, a beam of radiation hits the material or product being processed or controlled. A detector mounted opposite the source measures the radiation passing through the product. The gauge readout or computer monitor shows the measurement. The material and process being monitored dictate the type, energy, and strength of radiation used.



Fixed fluid gauges are used by the beverage, food, plastics, and chemical industries. Installed on a pipe or the side of a tank, these gauges measure the densities, flow rates, levels, thicknesses, and weights of a variety of materials and surfaces.

A portable gauge uses both a shielded radioactive source and a detector. The gauge is placed on the object to be measured. Some gauges rely on radiation from the source to reflect back to the bottom of the gauge. Other gauges insert the source into the object. The detector in the gauge measures the radiation either directly from the inserted source or from the reflected radiation.

Figure 32: Moisture Density Gauge, shows a portable gauge that places a gamma source under the surface of the ground through a tube. Radiation is transmitted directly to the detector on the bottom of the gauge, allowing accurate measurements of compaction. Industry uses such gauges to monitor the structural integrity of roads, buildings, and bridges. Airport security uses nuclear gauges to detect explosives in luggage.

The radiation measurement indicates the thickness, density, moisture content, or some other property that is displayed on a gauge readout or on a computer monitor. The top of the gauge has sufficient shielding to protect the operator while the radioactive source is exposed. When the measuring process is completed, the radioactive source is retracted or a shutter closes, minimizing exposure from the source.

## Commercial Irradiators

Commercial irradiators expose products such as food, spices, medical supplies, and wood flooring to gamma radiation. This process can be used to eliminate harmful bacteria, germs, and insects or for hardening or other purposes (see Figure 33: Commercial Irradiator). The gamma radiation does not leave radioactive residue or make the treated products radioactive. That radiation can come from radioactive materials (e.g., cobalt-60), an X-ray tube, or an electron beam.

The NRC and Agreement States license about 50 commercial irradiators. The U.S. Food and Drug Administration and other agencies have approved the irradiation of food. Up to 10 million curies of radioactive material can be used in these types of irradiators. NRC regulations protect workers and the public from this radiation. Generally, two types of commercial irradiators are in operation in the United States: underwater and wet-source-storage panoramic models.



**Figure 32. Moisture Density Gauge**

**Direct Transmission**

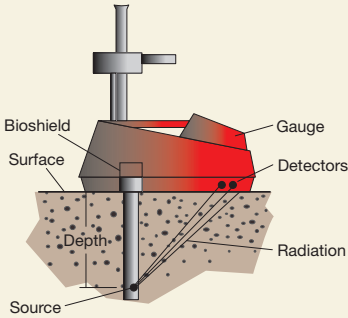


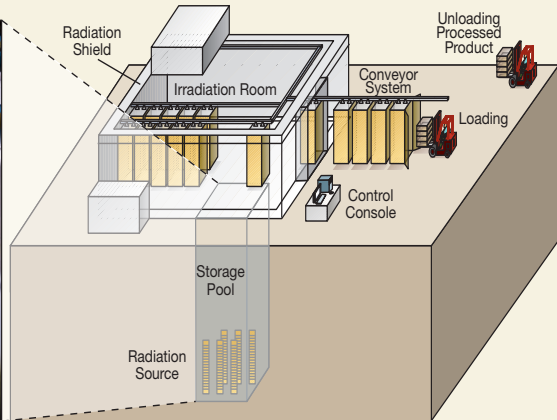
Photo courtesy: APNGA

*A moisture density gauge indicates whether a foundation is suitable for constructing a building or roadway.*

**Figure 33. Commercial Irradiator**



Photo courtesy: Nordion



Underwater irradiators use sealed sources (radioactive material encased inside a capsule) that remain in the water at all times, providing shielding for workers and the public. The product to be irradiated is placed in a watertight container, lowered into the pool, irradiated, and then removed.

Wet-source-storage panoramic irradiators also store radioactive sealed sources in water. But the sources are raised into the air to irradiate products that are automatically moved in and out of the room on a conveyor system. Sources are then lowered back into the pool. For this type of irradiator, thick concrete walls and ceilings or steel barriers protect workers and the public when the sources are lifted from the pool.

## Transportation

About 3 million packages of radioactive materials are shipped each year in the United States by road, rail, air, or water. This represents less than 1 percent of the Nation's yearly hazardous material shipments. The NRC and the U.S. Department of Transportation (DOT) share responsibility for regulating the safety of radioactive material shipments. The vast majority of these shipments consist of small amounts of radioactive materials used in industry, research, and medicine. The NRC requires such materials to be shipped in accordance with DOT's safety regulations.

## Material Security

To monitor the manufacture, distribution, and ownership of the most high-risk sources, the NRC set up a National Source Tracking System (NSTS) in January 2009. Licensees use this secure Web-based system to enter information on the receipt or transfer of tracked radioactive sources. (See Figure 34: Life-Cycle Approach to Source Security.) The NRC and the Agreement States use the system to monitor where high-risk sources are made, shipped, and used.

The NSTS tracks more than 80,000 sources held by about 1,400 NRC and Agreement State licensees. Of those sources, about 46 percent are Category 1 sources and 54 percent are Category 2. (See the Glossary for definitions of the categories of sources.) The majority are cobalt-60, the most widely used isotope in large sources.

Over the past several years, the NRC and the Agreement States have increased controls on the most sensitive radioactive materials. Stronger physical-security



requirements and stricter limits on who can access the materials give the NRC and the Agreement States added confidence in their security. The NRC has also joined with other Federal agencies, such as the U.S. Department of Homeland Security and the U.S. Department of Energy's National Nuclear Security Administration, to set up an additional layer of voluntary protection. Together, these activities help make potentially dangerous radioactive sources even more secure and less vulnerable to terrorists.

## Major Licensing and Inspection Activities

Each year, the NRC issues about 1,300 new licenses, renewals, or amendments for existing materials licenses. The NRC conducts around 1,000 health, safety, and security inspections of materials licensees each year.

## Nuclear Fuel Cycle

Figure 35: The Nuclear Fuel Cycle, illustrates the nuclear fuel cycle, including uranium recovery, conversion, enrichment, and fabrication to produce fuel for nuclear power plants. Uranium is recovered or extracted from ore, converted, and enriched. Then the enriched uranium is manufactured into pellets. These pellets are placed into fuel assemblies and ultimately into nuclear reactors.

### Uranium Recovery

The NRC does not regulate conventional mining, but does regulate the processing of uranium ore, known as uranium recovery. This processing can be done at three types of facilities: conventional mills, heap leach facilities, and in situ recovery (ISR) facilities. The NRC has a well-established regulatory framework for ensuring that uranium recovery facilities are licensed, operated, decommissioned, and monitored to protect the public and the environment.

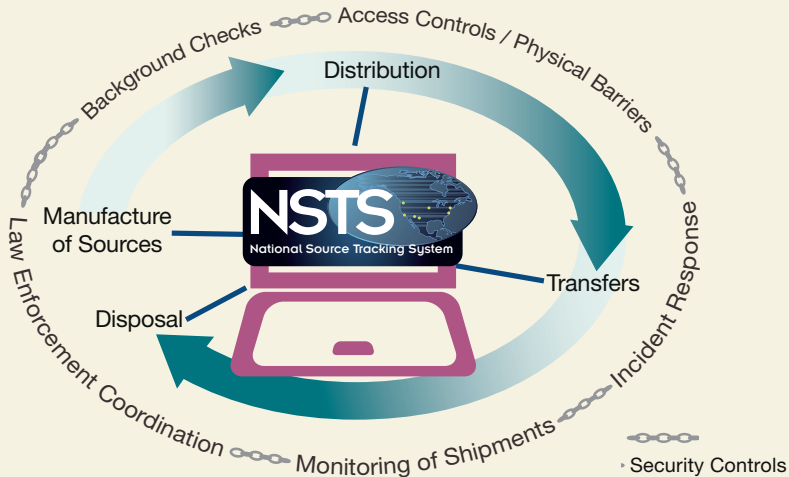
### Conventional Uranium Mill

A conventional uranium mill is a chemical plant that extracts uranium from ore. Most conventional mills are located away from population centers and within about 30 miles (50 kilometers) of a uranium mine.

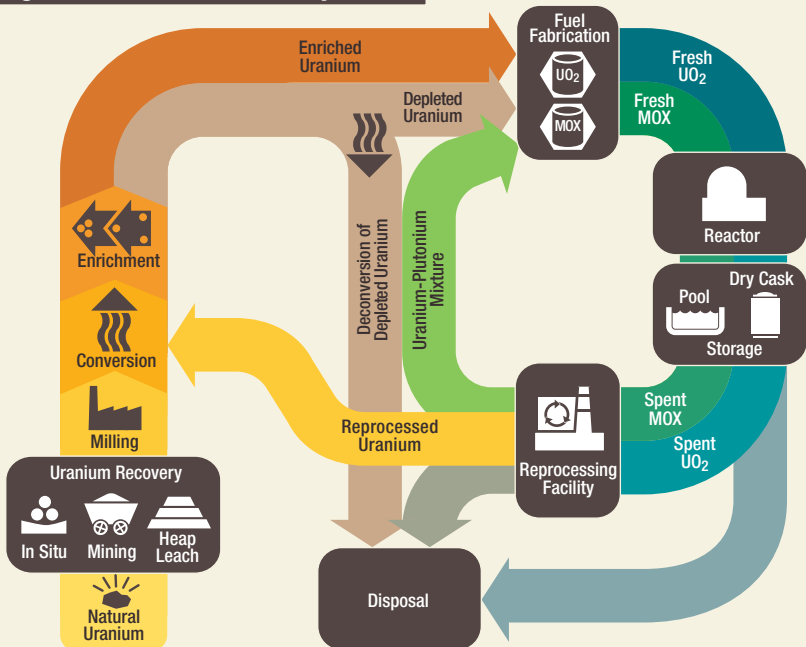
In a conventional uranium mill, the process of uranium extraction from ore begins when ore is hauled to the mill and crushed. Sulfuric acid dissolves and removes 90 to 95 percent of the uranium from the ore. The uranium is then separated from the solution, concentrated, and dried to form yellowcake. There are 18 uranium recovery



**Figure 34. Life-Cycle Approach to Source Security**



**Figure 35. The Nuclear Fuel Cycle**



sites licensed by the NRC—11 are conventional mills and seven are in situ recovery facilities. Of these 18 facilities, 10 are in various stages of decommissioning and one is in standby status with the potential to restart in the future.

## Heap Leach Facility

Heap leach facilities also extract uranium from ore. At these facilities, the ore is placed in piles or heaps on top of liners. The liners prevent uranium and other chemicals from moving into the ground. Sulfuric acid is dripped onto the heap and dissolves uranium as it moves through the ore. Uranium solution drains into collection basins, where it is piped to a processing plant. At the plant, uranium is extracted, concentrated, and dried to form yellowcake (see Figure 36: The Heap Leach Recovery Process). The NRC has not yet licensed any heap leach facilities but expects to receive applications for such facilities in the future.

## In Situ Recovery

In situ recover is another way to extract uranium—in this case, directly from underground ore. In situ recovery facilities recover uranium from ores that cannot be processed economically using other methods. In this process, a solution of native groundwater, typically mixed with oxygen or hydrogen peroxide and sodium bicarbonate or carbon dioxide, is injected into the ore to dissolve the uranium. The solution is then pumped out of the rock and the uranium separated to form yellowcake (see Figure 37: The In Situ Uranium Recovery Process). The United States has about 14 in situ recovery facilities. Of these facilities, the NRC licenses seven and Agreement States license the rest. (See Table 2: Locations of NRC-Licensed Uranium Recovery Facilities.)

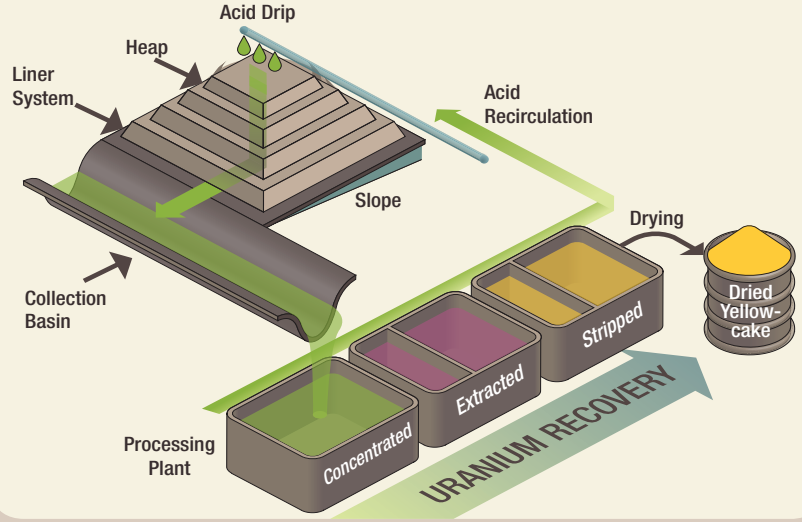
The NRC expects as many as 16 applications to build new uranium recovery facilities and to expand or restart existing facilities in the next few years. As of July 2013, the agency had received seven applications for new facilities and six applications to expand or restart an existing facility.

The current status of applications can be found on the NRC's Web site (see the Web Link Index). Existing facilities and new potential sites are located in Wyoming, New Mexico, Nebraska, South Dakota, and Oregon, and in the Agreement States of Texas, Colorado, and Utah. (See Figure 38: Locations of NRC-Licensed Uranium Recovery Facility Sites.)

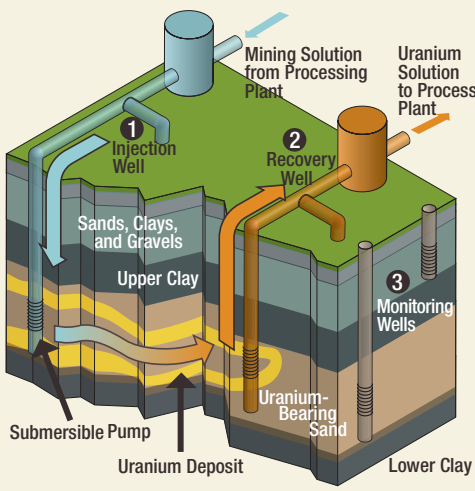




**Figure 36. The Heap Leach Recovery Process**



**Figure 37. The In Situ Uranium Recovery Process**



*Injection wells (1) pump a chemical solution—typically groundwater mixed with sodium bicarbonate, hydrogen peroxide, and oxygen—into the layer of earth containing uranium ore. The solution dissolves the uranium from the deposit in the ground and is then pumped back to the surface through recovery wells (2) and sent to the processing plant to be processed into uranium yellowcake. Monitoring wells (3) are checked regularly to ensure that uranium and chemicals are not escaping from the drilling area.*



The NRC works closely with stakeholders, including Native American Tribal governments, to address their concerns with licensing new uranium recovery facilities. The NRC is also responsible for these actions:

- inspecting and overseeing both active and inactive uranium recovery facilities
- ensuring the safe management of mill tailings (waste)—the NRC requires facilities to be located and designed to minimize radon release and disturbance by weather or seismic activity (see the entry for mill tailings in the Glossary)
- developing requirements to ensure cleanup of active and closed uranium recovery facilities
- formulating stringent financial requirements to ensure funds are available for decommissioning
- making sure licensees follow requirements for underground disposal of mill tailings and liners for tailings impoundments
- monitoring to prevent groundwater contamination
- monitoring and overseeing decommissioned facilities

## Fuel Cycle Facilities

The NRC licenses all commercial fuel cycle facilities involved in conversion, enrichment, and fuel fabrication. (See Figure 39: Location of Fuel Cycle Facilities; Figure 40: Enrichment Process; and Figure 41: Simplified Fuel Fabrication Process.) The NRC also routinely inspects their safety, safeguards, security, and environmental protection programs. On average, every year the NRC issues about 85 new licenses, license renewals, license amendments, and safety and safeguards reviews for fuel cycle facilities.

*See Appendix M for Major U.S. Fuel Cycle Facility Sites.*

These facilities turn the uranium that has been removed from ore (as yellowcake) into fuel for nuclear reactors. In this process, the conversion facility converts yellowcake into uranium hexafluoride ( $UF_6$ ). Next, an enrichment facility heats the solid  $UF_6$  enough to turn it into a gas, which is “enriched,” or processed to increase the concentration of the isotope uranium-235.



**Table 2. Locations of NRC-Licensed Uranium Recovery Facilities**

Licensee	Site Name, Location
<b>In Situ Recovery Facilities</b>	
Uranium One	Willow Creek, WY
Cameco Resources, Inc.	Crow Butte, NE*
Hydro Resources, Inc.°	Crownpoint, NM
Cameco Resources, Inc.	Smith Ranch and Highland, WY*
Uranium One	Moore Ranch, WY
Lost Creek ISR, Inc.	Lost Creek, WY
Uranerz Energy Corp.	Nichols Ranch, WY
<b>Conventional Uranium Mill Recovery Facilities</b>	
American Nuclear Corp.†	Gas Hills, WY
Bear Creek Uranium Co.†	Bear Creek, WY
Exxon Mobil Corp.†	Highlands, WY
Homestake Mining Co.†	Homestake, NM
Kennecott Uranium Corp.°	Sweetwater, WY
Pathfinder Mines Corp.†	Lucky Mc, WY
Pathfinder Mines Corp.†	Shirley Basin, WY
Rio Algom Mining, LLC†	Ambrosia Lake, NM
Umetco Minerals Corp.†	Gas Hills, WY
United Nuclear Corp.†	Church Rock, NM
Western Nuclear, Inc.†	Split Rock, WY

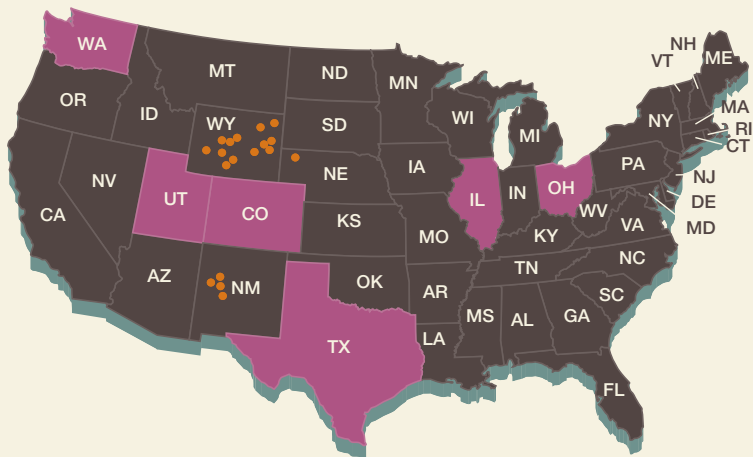
Note: For further details on NRC-related uranium recovery facility applications in review and applications, restarts, and expansions, see the Web Link Index. This table does not include uranium recovery facilities licensed by Agreement States.

\* Satellite facilities are located within the State.

† These sites are undergoing decommissioning.

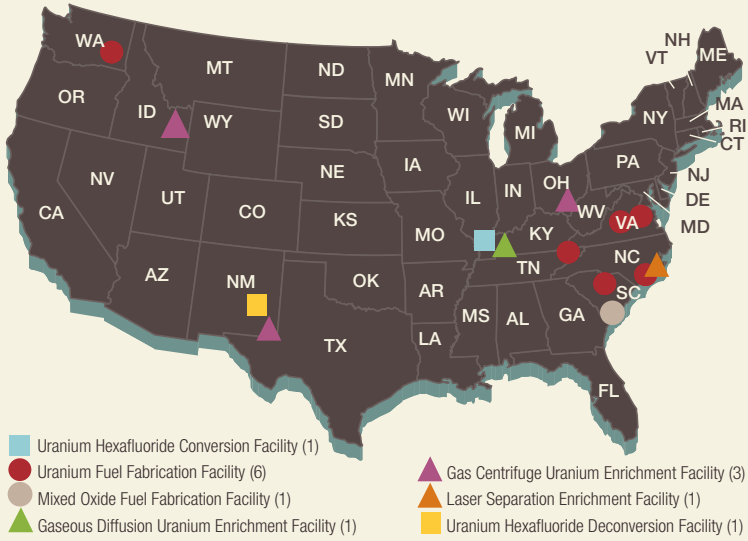
° Hydro Resource Inc. has an operating license, but the facility has not yet been constructed. Kennecott Uranium Company has an operating license but is in "standby" mode.

**Figure 38. Locations of NRC-Licensed Uranium Recovery Facility Sites**



- States with authority to license uranium recovery facility sites
- States where the NRC has retained authority to license uranium recovery facilities
- NRC-licensed uranium recovery facility sites (18)

**Figure 39. Locations of Fuel Cycle Facilities**



Note: There are no fuel cycle facilities in Alaska or Hawaii.



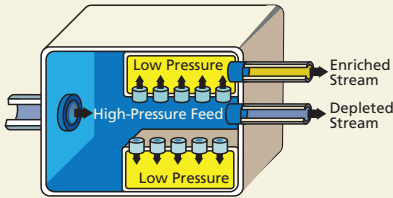
*URENCO USA gas centrifuge uranium enrichment facility in Eunice, NM.*

Photo courtesy: Louisiana Energy Services



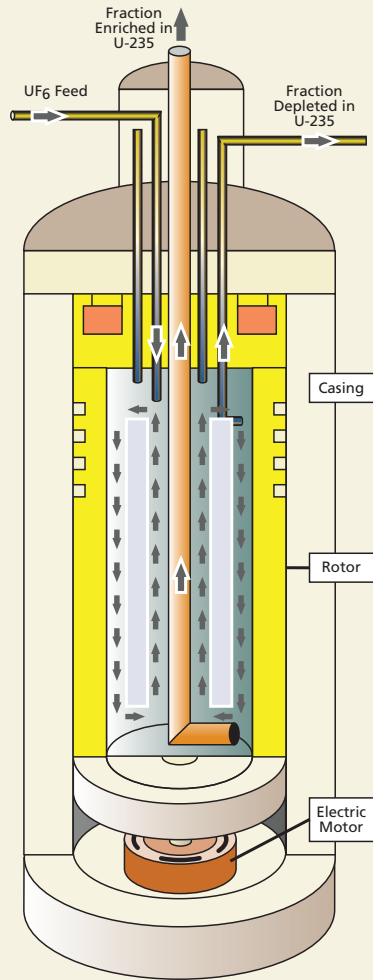
**Figure 40. Enrichment Processes**

**A. Gaseous Diffusion Process**



**A.** The gaseous diffusion process uses molecular diffusion to separate a gas from a two-gas mixture. The isotopic separation is accomplished by diffusing uranium, which has been combined with fluorine to form  $UF_6$  gas, through a porous membrane (barrier) and using the different molecular velocities of the two isotopes to achieve separation.

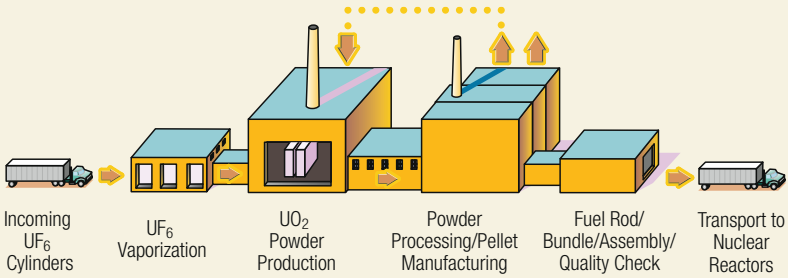
**B. Gas Centrifuge Process**



**B.** The gas centrifuge process uses a large number of rotating cylinders in series and parallel configurations. Gas is introduced and rotated at high speed, concentrating the component of higher molecular weight toward the outer wall of the cylinder and the component of lower molecular weight toward the center. The enriched and the depleted gases are removed by scoops.

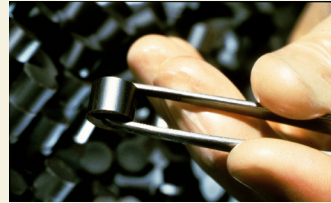


**Figure 41. Simplified Fuel Fabrication Process**

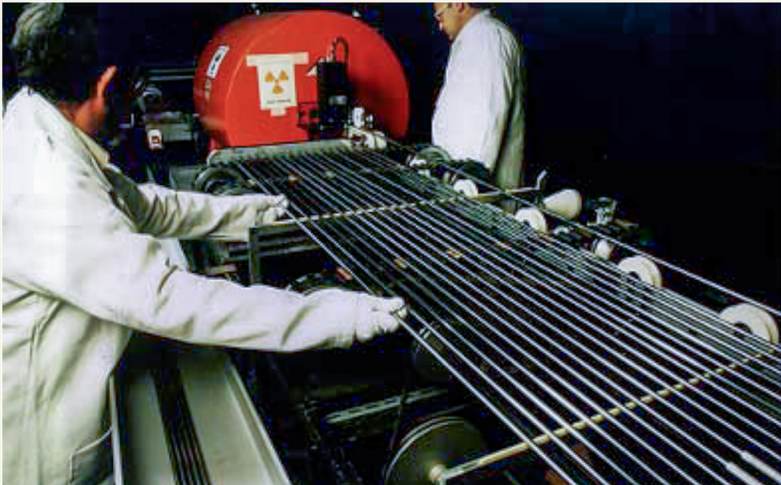


Fabrication of commercial light-water reactor fuel consists of the following three basic steps:

- (1) the chemical conversion of  $UF_6$  to  $UO_2$  powder
- (2) a ceramic process that converts  $UO_2$  powder to small ceramic pellets
- (3) a mechanical process that loads the fuel pellets into rods and constructs finished fuel assemblies



*Small ceramic fuel pellets.*



*Fuel pellets being assembled into fuel rods.*

The enriched uranium gas is mechanically and chemically processed back into a solid uranium dioxide (UO<sub>2</sub>) powder. The powder is blended, milled, pressed, and fused into ceramic fuel pellets about the size of a fingertip. The pellets are stacked into tubes or rods that are about 14 feet (4.3 meters) long and made of material such as zirconium alloys; this material is referred to as cladding. These fuel rods are made to maintain both their chemical and physical properties under the extreme conditions of heat and radiation present inside an operating reactor.

After careful inspection, the fuel rods are bundled into fuel assemblies for use in reactors. The assemblies are washed, inspected, and stored in a special rack until ready for shipment to a nuclear power plant. The NRC inspects this operation to ensure it is conducted safely.

### **Domestic Safeguards Program**

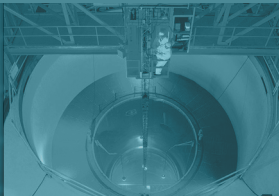
The NRC's domestic safeguards program for fuel cycle facilities and transportation is aimed at ensuring that special nuclear material (such as plutonium or enriched uranium) is not stolen and does not pose a risk to the public from sabotage or terrorism. Through licensing and inspections, the NRC verifies that licensees apply safeguards to protect special nuclear material.

The NRC and DOE developed the Nuclear Materials Management and Safeguards System (NMMSS) to track transfers and inventories of special nuclear material, source material from abroad, and other material. The NRC has issued licenses authorizing some 180 facilities to possess special nuclear material in quantities ranging from a single kilogram to multiple tons. These licensees verify and document their inventories in the NMMSS database.

The NRC or Agreement States license several hundred additional sites that possess special nuclear material in smaller quantities. Licensees possessing small amounts of special nuclear material must confirm their inventory annually in the NMMSS database. Previously, those licensees reported transfers of material but not annual inventories.



Inspectors U.S.  
Low Level Waste  
Principal Licensing  
Radioactive  
Nuclear Fuel Cycle  
Regulate Requirements Reactor  
Leadership  
Security  
Public Research  
Major-Activities  
Safety  
Nuclear  
International Activities  
Power Detail  
Orders  
Shipping  
Dry Cask  
Ruling Compacts  
Regional  
Energy  
Storage  
Federal ISFSI





ive Waste

Transportation

NRC

Commercial

Agreement States

Organizations

Decommissioning

High Level Waste

Functions

Mission Policy

Disposal

NRC-licensed

Congress

Energy

Protection

Spent Fuel

Commission

Public Involvement

Facilities

Atomic

Environment

Activities

Affairs

Inspection

Information

Important

Nuclear Materials

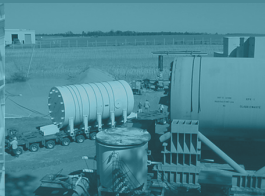
Class

Radiation

Staff

Petitions

Reprocessing



## Low-Level Radioactive Waste Disposal

Low-level radioactive waste (LLW) includes items contaminated with radioactive material or exposed to neutron radiation. This waste typically consists of contaminated protective shoe covers and clothing, wiping rags, mops, filters, reactor water treatment residues, equipment and tools, medical waste, and laboratory animal carcasses and tissue.

Low-level waste is not necessarily low in radioactivity. Much of it is indeed quite low—as low as just above background levels found in nature. Some licensees, notably hospitals, store some lower-level radioactive waste onsite until it has decayed and lost its radioactivity. Then it can be disposed of as ordinary trash. Other waste, such as parts of a reactor vessel from a nuclear power plant, is more radioactive and requires special handling. Waste that does not decay fairly quickly is stored until amounts are large enough for shipment to an LLW disposal site in containers approved by the Department of Transportation (DOT) and the NRC.

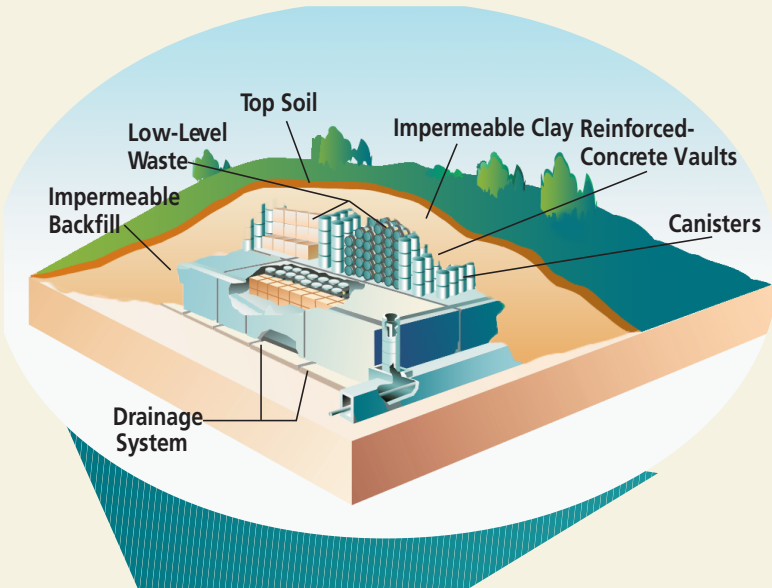
Commercial LLW can be disposed of in facilities licensed by either the NRC or Agreement States. The facilities are designed, constructed, and operated to meet NRC safety standards. The facility operator analyzes how the facility will perform in the future based on the environmental characteristics of the site. Current LLW disposal uses shallow land disposal sites with or without concrete vaults. (See Figure 42: Low-Level Waste Disposal.)

The NRC classifies low-level waste based on its potential hazards. It has specified disposal and waste requirements for each of the three classes of waste—Classes A, B, and C—with progressively higher concentrations of radioactive material. Class A waste, which is the least radioactive, accounts for approximately 96 percent of the total volume of LLW. Determination of the classification of waste is a complex process. A fourth class of LLW, called “greater-than-Class-C,” is not generally acceptable for near-surface, shallow-depth disposal. By law, DOE is responsible for disposal of greater-than-Class-C waste under an NRC license. Although it falls under DOE jurisdiction, it is not high-level waste.

The volume and radioactivity of waste vary from year to year. Waste volumes currently include several million cubic feet each year from reactor facilities undergoing decommissioning and from cleanup of contaminated sites.



**Figure 42. Low-Level Waste Disposal**



*This LLW disposal site accepts waste from States participating in a regional disposal agreement.*



The Low-Level Radioactive Waste Policy Amendments Act of 1985 gave the States responsibility for low-level waste disposal. The Act authorized States to:

- Form regional compacts, with each compact to provide for LLW disposal site access.
- Manage LLW import to, and export from, a compact.
- Exclude waste generated outside a compact.

The States have licensed four active LLW disposal facilities:

- EnergySolutions Barnwell facility, located in Barnwell, SC—Previously, Barnwell accepted waste from all U.S. generators of low-level waste. As of July 2008, Barnwell accepts waste only from the Atlantic Compact States of Connecticut, New Jersey, and South Carolina. The State of South Carolina licenses Barnwell to receive Classes A, B, and C waste.
- EnergySolutions Clive facility, located in Clive, UT—Clive accepts waste from all regions of the United States. The State of Utah licenses Clive for Class A waste only.
- US Ecology's Richland facility, located in Richland, WA, on the Hanford Nuclear Reservation—Richland accepts waste from the Northwest Compact States (Alaska, Hawaii, Idaho, Montana, Oregon, Utah, Washington, and Wyoming) and the Rocky Mountain Compact States (Colorado, Nevada, and New Mexico). The State of Washington licenses Richland to receive Classes A, B, and C waste.
- Waste Control Specialists Andrews facility, located in Andrews, TX—Andrews accepts waste from the Texas Compact, which consists of Texas and Vermont. It also accepts waste from out-of-the-compact generators on a case-by-case basis. Andrews began receiving waste in 2011. The State of Texas licensed Andrews to receive Classes A, B and C waste.

Closed low-level waste disposal facility sites licensed by the NRC or Agreement States include:

- Beatty, NV, closed 1993
- Sheffield, IL, closed 1978
- Maxey Flats, KY, closed 1977
- West Valley, NY, closed 1975

*See Appendix Q for  
Regional Compacts.*



# High-Level Radioactive Waste Management

## Spent Nuclear Fuel Storage

Commercial spent nuclear fuel, although highly radioactive, is stored safely and securely in 34 States. This includes 30 States with operating nuclear power reactors, where spent fuel is safely stored onsite in spent-fuel pools and in dry casks. The remaining four States—Colorado, Idaho, Maine, and Oregon—do not have operating power reactors but are safely storing spent fuel at storage facilities. Waste can be stored safely in pools or casks for 100 years or more.

As of December 2012, the amount of commercial spent fuel in safe storage at commercial nuclear power plants was an estimated 69,000 metric tons. The amount of spent fuel in storage at commercial nuclear power plants is expected to increase at a rate of approximately 2,400 metric tons each year. The NRC licenses and regulates the storage of spent fuel, both at commercial nuclear power plants and at separate storage facilities.

*See Appendices O and P for information about dry spent fuel storage and licensees.*

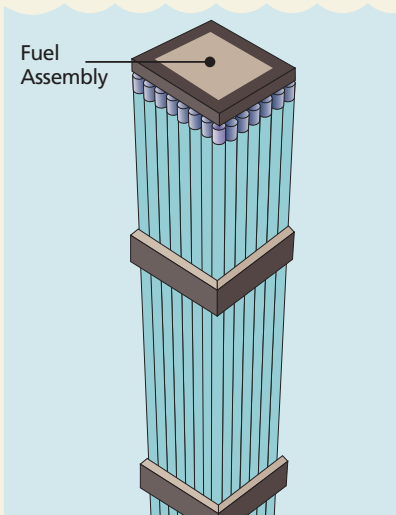
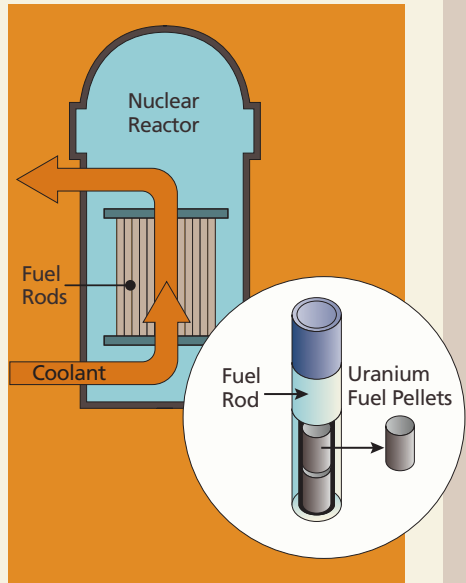
Most reactor facilities were not designed to store the full amount of spent fuel that the reactors would generate during their operational lives. Facilities originally planned to store spent fuel temporarily in deep pools of continuously circulating water, which cools the spent fuel assemblies. After a few years, the facilities were expected to send the spent fuel to a recycling plant. However, in 1977, the Government declared a moratorium on recycling spent fuel in the United States. Although the Government later lifted the restriction, recycling has not resumed in the United States (see the Glossary entries for “recycling” and “reprocessing”).

As a result, facilities expanded their storage capacity by using high-density storage racks in their spent fuel pools (see Figure 43: Spent Fuel Generation and Storage after Use). To provide supplemental storage, some older fuel assemblies are stored in dry casks on site. These facilities are called independent spent fuel storage installations (ISFSIs) and are licensed by the NRC. These large casks are typically made of leak-tight, welded, and bolted steel and concrete surrounded by another layer of steel or concrete. The spent fuel sits in the center of the nested canisters in an inert gas. Dry cask storage shields people and the environment from radiation and keeps the spent fuel inside dry and nonreactive (see Figure 44: Dry Storage of Spent Nuclear Fuel).

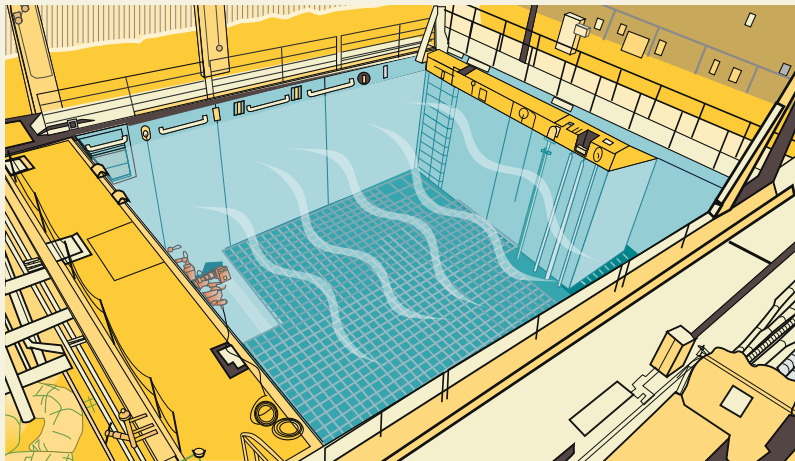


**Figure 43. Spent Fuel Generation and Storage after Use**

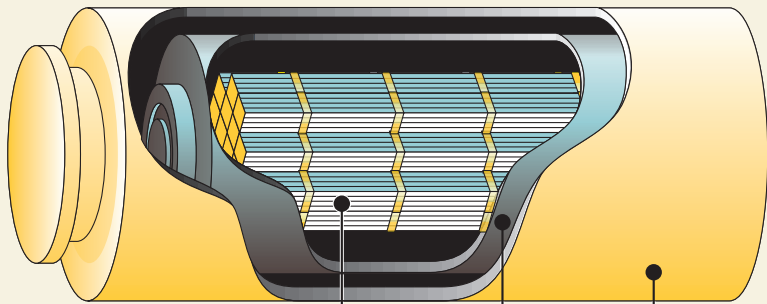
**1** A nuclear reactor is powered by enriched uranium-235 fuel. Fission (splitting of atoms) generates heat, which produces steam that turns turbines to produce electricity. A reactor rated at several hundred megawatts may contain 100 or more tons of fuel in the form of bullet-sized pellets loaded into long metal rods that are bundled together into fuel assemblies. PWRs contain between 150 and 200 fuel assemblies. BWRs contain between 370 and 800 fuel assemblies.



**2** After 5–6 years, spent fuel assemblies—typically 14 feet (4.3 meters) long and containing nearly 200 fuel rods for PWRs and 80–100 fuel rods for BWRs—are removed from the reactor and allowed to cool in storage pools for a few years. At this point, the 900-pound (409-kilogram) assemblies contain only about one-fifth the original amount of uranium-235.



**3** Commercial light-water nuclear reactors store spent radioactive fuel in a steel-lined, seismically designed concrete pool under about 40 feet (12.2 meters) of water that provides shielding from radiation. Water pumps supply continuously flowing water to cool the spent fuel. Extra water for the pool is provided by other pumps that can be powered from an onsite emergency diesel generator. Support features, such as water-level monitors and radiation detectors, are also in the pool. Spent fuel is stored in the pool until it can be transferred to dry casks onsite (as shown in Figure 42) or transported offsite to a high-level radioactive waste disposal site.



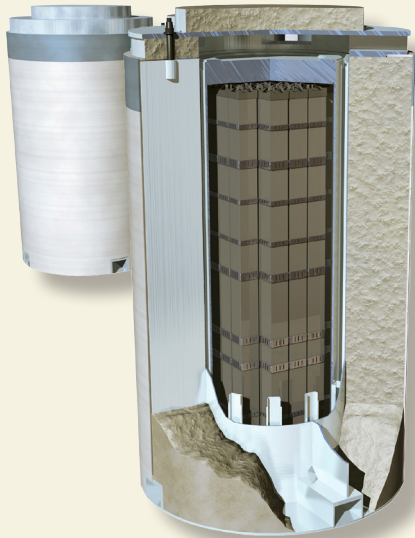
Bundle of Used Fuel Assemblies      Canister      Storage Cask

Source: DOE and the Nuclear Energy Institute

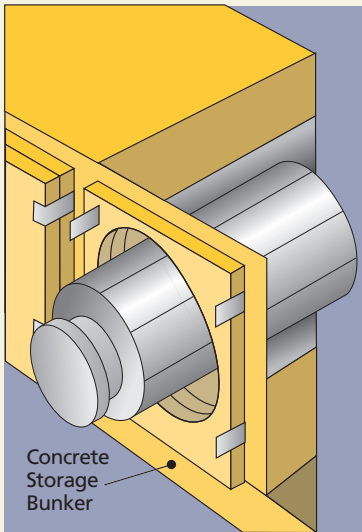
### Figure 44. Dry Storage of Spent Nuclear Fuel

*At some nuclear reactors across the country, spent fuel is kept onsite, typically above ground, in systems basically similar to the ones shown here.*

**1** Once the spent fuel has sufficiently cooled, it is loaded into special canisters that are designed to hold nuclear fuel assemblies. Water and air are removed. The canister is filled with inert gas, welded shut, and rigorously tested for leaks. It is then placed in a cask for storage or transportation. The NRC has approved the storage of up to 40 PWR assemblies and up to 68 BWR assemblies in each canister. The dry casks are then loaded onto concrete pads.



**2** The canisters can also be stored in above ground concrete bunkers, each of which is about the size of a one-car garage.





As of March 2013, there were 69 licensed ISFSIs in the United States. As of January 2013, NRC-licensed ISFSIs were storing spent fuel in more than 1,720 loaded dry casks (see Figure 45: Licensed and Operating Independent Spent Fuel Storage Installations by State). The NRC authorizes storage of spent fuel at an ISFSI by one of two licensing options: site-specific licensing and general licensing.

The NRC grants site-specific licenses after a safety review of the technical requirements and operating conditions for the ISFSI. The license term can be up to 40 years, and can be renewed for up to another 40 years. A general license from the NRC authorizes a nuclear power reactor licensee to store spent fuel onsite in dry storage casks. Under the general license, the authority to use a storage cask is tied to the cask's certificate of compliance term issued through a rulemaking. The NRC has issued certificates to several dry storage cask designs. The agency issues initial and renewed certificates for terms not to exceed 40 years.

## Public Involvement

The public can participate in decisions about spent fuel storage, as it can in many licensing and rulemaking decisions. The Atomic Energy Act of 1954, as amended, and the NRC's own regulations call for public hearings about site-specific licensing actions and allow the public to comment on certificate rulemakings. Members of the public may also file petitions for rulemaking. Additional information on ISFSIs is available on the NRC's Web site (see the Web Link Index).

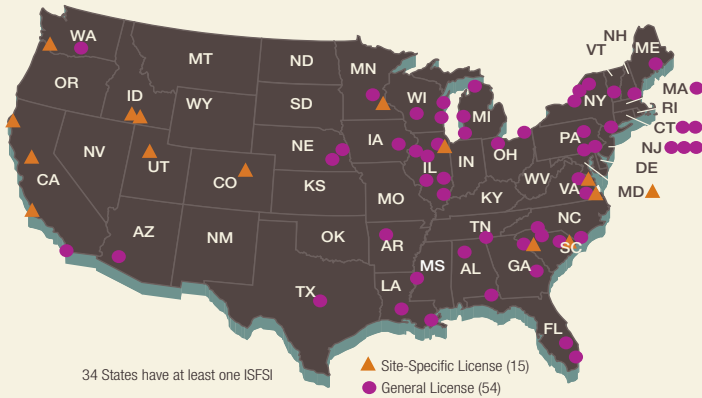
## Spent Nuclear Fuel Disposal

The current U.S. policy governing permanent disposal of high-level radioactive waste is defined by the Nuclear Waste Policy Act of 1982, as amended, and the Energy Policy Act of 1992. These acts specify that high-level radioactive waste will be disposed of underground in a deep geologic repository.

In January 2012, the Blue Ribbon Commission on America's Nuclear Future proposed establishing consolidated sites for interim storage of spent fuel until a repository is available. In January 2013, the U.S. Department of Energy issued a strategy for implementing those recommendations. The NRC will help ensure that any new policy direction is implemented safely.



**Figure 45. Licensed and Operating Independent Spent Fuel Storage Installations by State**



**ALABAMA**

- Browns Ferry
- Farley

**ARIZONA**

- Palo Verde

**ARKANSAS**

- Arkansas Nuclear

**CALIFORNIA**

- ▲ Diablo Canyon
- ▲ Rancho Seco
- San Onofre
- ▲ Humboldt Bay

**COLORADO**

- ▲ Fort St. Vrain

**CONNECTICUT**

- Haddam Neck
- Millstone

**FLORIDA**

- St. Lucie
- Turkey Point

**GEORGIA**

- Hatch

**IDAHO**

- ▲ DOE: TMI-2 (Fuel Debris)
- ▲ Idaho Spent Fuel Facility

**ILLINOIS**

- Braidwood
- Byron
- ▲ GE Morris (Wet)
- Dresden
- La Salle
- Quad Cities

**IOWA**

- Duane Arnold

**LOUISIANA**

- River Bend
- Waterford

**MAINE**

- Maine Yankee

**MARYLAND**

- ▲ Calvert Cliffs

**MASSACHUSETTS**

- Yankee Rowe

**MICHIGAN**

- Big Rock Point
- Palisades
- Cook

**MINNESOTA**

- Monticello
- ▲ Prairie Island

**MISSISSIPPI**

- Grand Gulf

**NEBRASKA**

- Cooper
- Ft. Calhoun

**NEW HAMPSHIRE**

- Seabrook

**NEW JERSEY**

- Hope Creek
- Salem
- Oyster Creek

**NEW YORK**

- Indian Point
- FitzPatrick
- Ginna
- Nine Mile Point

**NORTH CAROLINA**

- Brunswick
- McGuire

**OHIO**

- Davis-Besse
- Perry

**OREGON**

- ▲ Trojan

**PENNSYLVANIA**

- Limerick
- Susquehanna
- Peach Bottom

**SOUTH CAROLINA**

- Oconee
- ▲ Robinson
- Catawba

**TENNESSEE**

- Sequoyah

**TEXAS**

- Comanche Peak

**UTAH**

- ▲ Private Fuel Storage

**VERMONT**

- Vermont Yankee

**VIRGINIA**

- ▲ Surry
- ▲ North Anna

**WASHINGTON**

- Columbia

**WISCONSIN**

- Point Beach
- Kewaunee
- LaCrosse

## Waste Confidence

In June 2012, the U.S. Appeals Court for the District of Columbia Circuit struck down a provision in NRC regulations known as the “waste confidence rule.” Waste confidence is a generic finding that spent nuclear fuel can be stored safely for decades at reactor sites in either spent fuel pools or dry storage casks, and that a repository will be available for final disposal of the spent fuel. It does not authorize extended storage of spent fuel at reactor sites, but it allows the NRC to proceed with environmental reviews of new reactors or reactor license renewal without considering the site-specific effects of spent fuel storage in the environmental analysis.

Following the court ruling, the Commission directed the staff to develop a new rule and a generic environmental impact statement detailing the environmental impacts of extended storage of spent fuel, including a scenario in which a repository is never available. The rule and the report are due by September 2014. Meanwhile, the Commission said the NRC will make no final licensing decisions on new reactors or reactor license renewals until the agency finishes the waste confidence work.

## Transportation

The NRC is also involved in the transportation of spent nuclear fuel. The NRC establishes safety and security requirements in collaboration with the Department of Transportation, certifies transportation cask designs, and conducts inspections to ensure that requirements are being met.

Spent fuel transportation casks are designed to meet the following safety criteria under both normal and accident conditions:

- prevent the loss or dispersion of radioactive contents
- shield everything outside the cask from the radioactivity of the contents
- dissipate the heat from the contents
- prevent nuclear criticality (a self-sustaining nuclear chain reaction) from occurring inside the cask

Transportation casks must be designed to survive a sequence of tests, including a 30-foot (9-meter) drop onto an unyielding surface, a puncture test, a fully engulfing fire at 1,475 degrees Fahrenheit (802 degrees Celsius) for



30 minutes, and immersion under water. This very severe test sequence, akin to the cask striking a concrete pillar along a highway at high speed and being engulfed in a severe and long-lasting fire, simulates conditions more severe than 99 percent of vehicle accidents. (See Figure 46: Ensuring Safe Spent Fuel Shipping Containers.)

To ensure the safe transportation of spent fuel and other nuclear materials, each year the NRC:

- conducts about 1,000 transportation safety inspections of fuel, reactor, and materials licensees
- reviews, evaluates, and certifies approximately 70 new, renewed, or amended transport package design applications
- inspects more than 24 dry-storage and transport package licensees
- reviews and evaluates approximately 150 license applications for the export or import of nuclear materials

Additional information on materials transportation is available on the NRC's Web site (see the Web Link Index).

## Decommissioning

Decommissioning is the safe removal of a nuclear facility from service and the reduction of residual radioactivity to a level that permits release of the property and termination of the license. NRC rules establish site-release criteria and provide for unrestricted and (under certain conditions) restricted release of a site. There are three options for decommissioning:

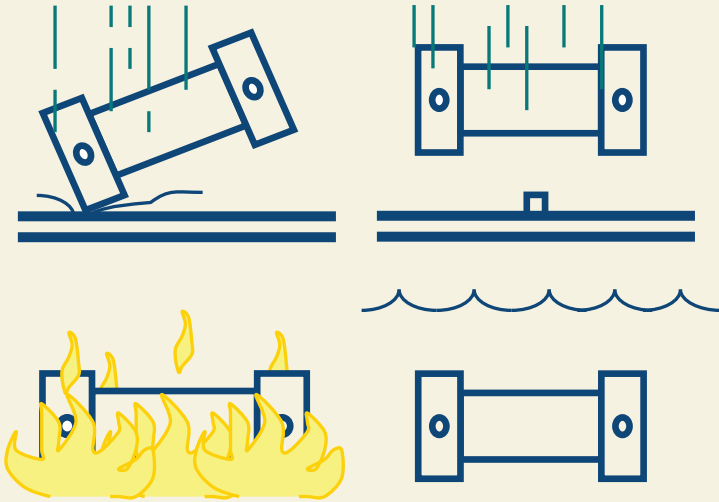
- immediate decommissioning (called DECON)
- letting the site sit unused so radiation can decay for 60 years (called SAFESTOR)
- surrounding the radioactive equipment with concrete (called ENTOMB)

The NRC rules also require all licensees to maintain financial assurance that funds will be available when needed for decommissioning.

The NRC regulates the decontamination and decommissioning of nuclear power



**Figure 46. Ensuring Safe Spent Fuel Shipping Containers**



*The impact (free drop and puncture), fire, and water immersion tests are considered in sequence to determine their cumulative effects on a given package.*



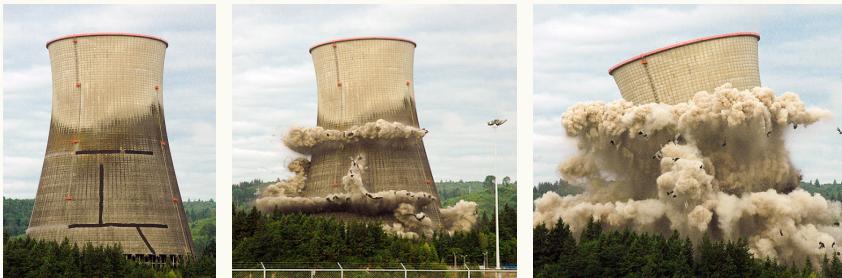
plants, materials and fuel cycle facilities, research and test reactors, and uranium-recovery facilities, with the ultimate goal of license termination. The NRC terminates approximately 150 materials licenses each year. Most of these license terminations are routine, and the sites require little or no remediation to meet the NRC's criteria for unrestricted access. The decommissioning program focuses on the termination of licenses for sites involving more complex decommissioning activities. (See Figure 47: Locations of NRC-Regulated Complex Material Sites Undergoing Decommissioning).

During 2013, the Kewaunee, Crystal River, and San Onofre nuclear power reactors permanently shut down and entered the decommissioning process. As of August 2013, these facilities were undergoing decommissioning under NRC jurisdiction. (See Figure 48: Facilities Undergoing Decommissioning under NRC Jurisdiction):

- 21 nuclear power and early demonstration reactors
- 18 complex material sites
- 8 research and test reactors
- 1 fuel cycle facility
- 11 uranium recovery facilities

*See Appendices C, K and S for licensees undergoing decommissioning.*

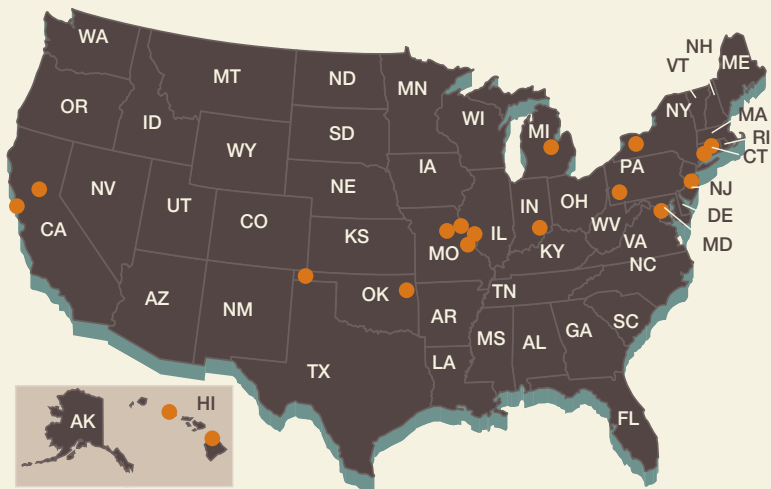
The "Status of the Decommissioning Program 2012 Annual Report" contains additional information on the decommissioning programs of the NRC and Agreement States. More information is on the NRC's Web site. (See the Web Link Index.)



*As part of the decommissioning process, the cooling tower of a nuclear power plant is imploded.*



**Figure 47. Locations of NRC-Regulated Complex Material Sites Undergoing Decommissioning**



● NRC-regulated complex material sites (18)

**Figure 48. Facilities Undergoing Decommissioning Under NRC Jurisdiction**



# Security and Emergency Preparedness

NRC  
Public Involvement  
Congress  
Unusual Events  
Alert  
Preparedness Program  
U.S. Protective  
International Activities  
Plant  
Potassium Iodine  
Work  
Research  
Federal  
Major Activities  
Protection  
Events  
Technical  
Energy  
Petitions  
Regulate  
Activities  
Reactor  
Sheltering  
Important  
Commission





ment Public Exercise  
 acuation Cyber Regulatory Information  
 vent NRC Licensed Leadership Nuclear Ruling  
 Significant Enforcement Zones NRC licensed Detail  
 protect Planning Operations Affairs Mission Construction  
 Actions Preparedness  
**cy Preparedness**  
 Safety Offsite Power Inter Agency Nuclear Materials  
 Atomic Functions Policy Orders  
 Organizations Information Inspectors Health Radiation  
 Environment Classifications



## Overview

Nuclear security is a high priority for the NRC. For decades, effective NRC regulation and strong partnerships with Federal, State, Tribal, and local authorities have ensured effective implementation of security programs at nuclear facilities and radioactive materials sites across the country. In fact, nuclear power plants are likely the best-protected, private sector facilities in the United States. However, given today's threat environment, the agency recognizes the need for continued vigilance and high levels of security.

In recent years, the NRC has made many enhancements to the security of nuclear power plants. Because nuclear power plants are inherently robust structures, these additional security upgrades (see Figure 49: Security Components) largely focus on:

- well-trained and armed security officers
- high-tech equipment and physical barriers
- greater standoff distances for vehicle checks
- intrusion detection and surveillance systems
- tested emergency preparedness and response plans
- restrictive site access control, including background checks and fingerprinting of workers

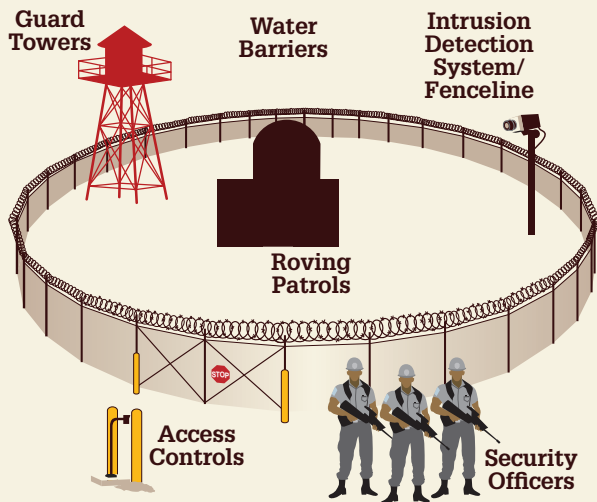
Security is further strengthened by coordinating and sharing threat information among the U.S. Department of Homeland Security, the FBI, intelligence agencies, the U.S. Department of Defense, and local law enforcement.

## Facility Security

Under NRC regulations, nuclear power plants and Category 1 fuel facilities that handle highly enriched uranium must be able to defend successfully against a set of hypothetical threats the agency calls the design-basis threat (DBT). This includes threats that challenge a plant's physical security, personnel security, and cyber security. The NRC does not make details of the DBT public because of security concerns. However, the agency continuously evaluates this set of hypothetical threats against real-world intelligence to ensure the DBT remains current. To test the adequacy of a nuclear power plant's or Category 1 facility's defenses against the DBT, the NRC conducts rigorous "force-on-force" inspections. (See the Glossary for definitions of the categories of fuel facilities.)



**Figure 49. Security Components**



*Protecting nuclear facilities requires all of the security features to come together and work as one.*



*Licensees are authorized to use deadly force while protecting nuclear facilities from intruders.*





*Access control security gates within a nuclear facility provide another layer of protection.*

During these inspections, a highly trained mock adversary force “attacks” a nuclear facility. Beginning in 2004, the NRC made these exercises more realistic, more challenging, and more frequent.

The NRC spends about 16,000 hours a year scrutinizing security at nuclear power plants and fuel fabrication facilities, including 8,000 hours of force-on-force inspections. Publicly available portions of security-related inspection reports are on the NRC’s Web site (see the Web Link Index). For security reasons, inspection reports are not available for the NRC-licensed fuel facilities that handle highly enriched uranium.

## Cyber Security

Nuclear facilities use digital and analog systems to monitor, control, and run various types of equipment, as well as to obtain and store vital information. Protecting these systems and the information they contain from sabotage or malicious use is called cyber security. The reactor control systems of nuclear plants are isolated from the Internet, but for added security, all nuclear power plants licensed by the NRC must have a cyber security program. In 2013, the



NRC began regular cyber security inspections of nuclear power plants under new regulations designed to guard against the cyber threat. The experience that the NRC gained in developing the cyber security requirements for nuclear power plants provided a basis for developing similar cyber security requirements for nonreactor licensees and nuclear facilities.

The NRC's cyber security team includes technology and threat experts who constantly evaluate and identify emerging cyber-related issues that could possibly endanger plant systems. This team also makes recommendations to other NRC offices and programs on cyber security issues.

## Materials Security

The security of radioactive materials is important to reduce the possibility that terrorists could use radioactive materials to make a radiological dispersal device, sometimes called an RDD or a dirty bomb. The NRC works with its Agreement States, other Federal agencies, the IAEA, and licensees to protect radioactive materials from theft or diversion. The agency has improved and upgraded the joint NRC–DOE database that tracks the movement and location of certain forms and quantities of special nuclear material. In early 2009, the NRC deployed its new National Source Tracking System, designed to track the most risk-sensitive radiation sources on a continuous basis. Other improvements allow U.S. Customs and Border Protection agents to promptly validate whether radioactive materials coming into the United States are properly licensed by the NRC.

## Emergency Preparedness

Operators of nuclear facilities are required to develop and maintain effective emergency plans and procedures. The NRC inspects licensees to ensure that they are prepared to deal with emergencies. In addition, the agency monitors

performance indicators related to emergency preparedness. (See Figure 50: Industry Performance Indicators FY 2003 through FY 2012 Average for 104 Plants—Alert and Notification System Reliability.)

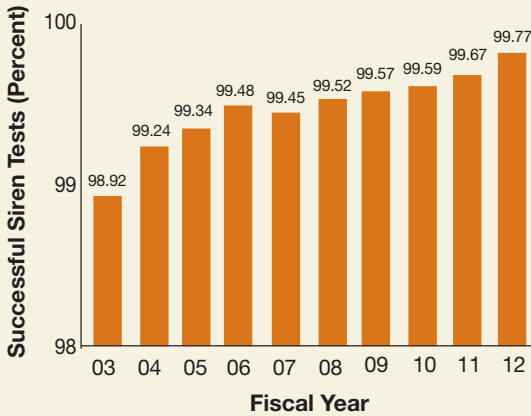
*See Appendix I for lists of industry performance indicators.*

Effective emergency preparedness plans ensure that a nuclear power plant operator can protect public health and safety in the unlikely event of an



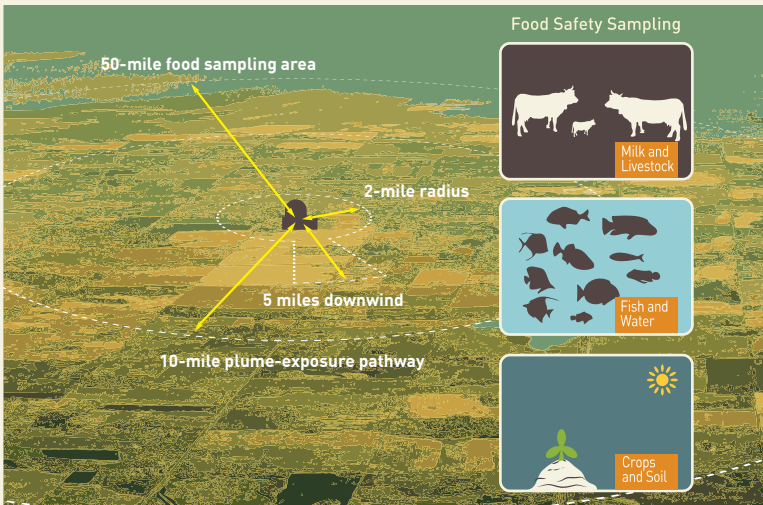
**Figure 50. Industry Performance Indicators: FYs 2003–2012 Averages for 104 Plants**

**Alert and Notification System (ANS) Reliability**



*This shows the percentage of ANS sirens that successfully operated during periodic tests in the previous year. The result is an indicator of the reliability of the ANS to alert the public in an emergency.*

**Figure 51. Emergency Planning Zones**



Note: A 2-mile ring around the plant is identified for evacuation, along with a 5-mile zone downwind of the projected release path.

emergency. The NRC staff participates in emergency preparedness exercises, some of which include security- and terrorism-based scenarios. Licensees, other Federal agencies, State, Tribal, and local officials, and first responders may participate to practice a coordinated emergency response.

Nuclear power plant operators must conduct full-scale exercises with the NRC, the Federal Emergency Management Agency, and State and local officials at least once every 2 years. These exercises test and maintain the skills of the emergency responders and identify any areas that need to be addressed. Nuclear power plant operators also conduct their own emergency response drills, which NRC inspectors evaluate. Emergency preparedness plans include public information, preparations for evacuation, instructions for sheltering, and other actions to protect the residents near nuclear power plants in the event of a serious incident.

## Emergency Planning Zones

The NRC defines two emergency planning zones (EPZs) around each nuclear power plant. The exact size and configuration of the zones vary from plant to plant based on local emergency response needs and capabilities, population, land characteristics, access routes, and jurisdictional boundaries. The zone boundaries are flexible, and the NRC may expand these zones during an emergency if circumstances warrant.

(See Figure 51: Emergency Planning Zones for a typical emergency planning zone around a nuclear plant.)

*See the Glossary for radiation sources.*

The two types of emergency planning zones are:

- The plume-exposure pathway. This zone extends outward from a plant to a radius of about 10 miles (16 kilometers) and is the area of greatest concern about the public's exposure to, and inhalation of, airborne radioactive contamination. Research has shown the most significant impacts of an accident would be expected in the immediate vicinity of a plant, and any initial protective actions, such as evacuations or sheltering in place, should be focused there.
- The ingestion-pathway, or food safety sampling area. This zone extends outward from a plant to a radius of about 50 miles (80 kilometers) and is the area of greatest concern about the ingestion of food and liquid contaminated by radioactivity.



## Protective Actions

During an actual nuclear power plant accident, the NRC would use radiation-dose projection models to predict the nature and extent of a radiation release. The dose calculations would also account for weather conditions to project what doses of radiation the nearby population would receive. The NRC would confer with appropriate State and county governments on its assessment results. Plant personnel would also provide assessments. State and local officials in communities within the emergency planning zone have detailed plans to protect the public during a radiation release. These officials make their protective action decisions, including decisions to order evacuations, based on these and other assessments.

## Evacuation, Sheltering, and the Use of Potassium Iodide

Protective actions considered for a radiological emergency include evacuation, sheltering, and the preventive use of potassium iodide (KI) supplements to protect the thyroid from radioactive iodine, which can cause thyroid cancer.

Under certain conditions, evacuation may be preferred to remove the public from further exposure to radioactive material. However, a complete evacuation of the 10-mile (16-kilometer) zone around a nuclear power plant is not likely to be needed in most cases. The release of radioactive material from a plant during a major incident would move with the wind, not in all directions surrounding the



*The NRC's upgraded Operations Center is located in the agency's new Three White Flint North headquarters building.*





plant. The release would also expand and become less concentrated as it travels away from a plant. For these reasons, evacuations can be planned based on the anticipated path of the release.

Under some conditions, people may be instructed to take shelter in their homes, schools, or office buildings. Sheltering is a protective action that keeps people indoors to reduce exposure to radioactive material. Depending on the type of structure, sheltering can significantly reduce someone's dose when compared to staying outside. In certain situations, KI may be used as a supplement to sheltering. It may be appropriate to shelter when the release of radioactive material is known to be short term or is controlled by the nuclear power plant operator.

Additional information on emergency preparedness is available on the NRC's Web site. (See Web Link Index).

## Incident Response

Quick communication among the NRC, other Federal and State agencies, and the nuclear industry is critical to responding promptly to any incident. The NRC staff supports several Federal incident-response centers where officials can coordinate assessments of event-related information. The NRC Headquarters Operations Center, located in the agency's Headquarters in Rockville, MD, is staffed around the clock to disseminate information and coordinate response activities. The NRC also constantly reviews intelligence reports and assesses suspicious activity to keep licensees and other agencies up to date on current threats.

The NRC works within the National Response Framework to respond to events. The framework guides the Nation in its response to complex events that might involve a variety of agencies and hazards. Under this framework, the NRC retains its independent authority and ability to respond to emergencies involving NRC-licensed facilities or materials. The NRC may request support from the Department of Homeland Security in responding to an emergency at an NRC-licensed facility or involving NRC-licensed materials. The Department of Homeland Security may lead and manage the overall Federal response to an event, according to Homeland Security Presidential Directive 5, "Management of Domestic Incidents." In this case, the NRC would provide technical expertise and help share information among the various organizations and licensees.





*During the first exercise in the agency's new Operations Center, NRC Protective Measures team members look at simulated projected doses to the public from radiation as part of the exercise scenario.*

In response to an incident involving possible radiation releases, the NRC activates its incident response program at its Headquarters Operations Center and one of its four Regional Incident Response Centers. Teams of specialists assemble at these centers to evaluate event information and independently assess the potential impact on public health and safety. The NRC staff provides expert consultation, support, and assistance to State and local public safety officials and keeps the public informed of agency actions. Scientists and engineers at these centers analyze the event and evaluate possible recovery strategies. Meanwhile, other NRC experts evaluate the effectiveness of protective actions the licensee has recommended to State and local officials. If needed, the NRC will dispatch a team of technical experts from the responsible regional office to the site. This team would augment the NRC's resident inspectors, who work at the plant. The Headquarters Operations Center would continue to provide around the clock communications, logistical support, and technical analysis throughout the response.



## Emergency Classifications

Emergencies at nuclear facilities are classified according to the risk being posed to the public. These classifications help guide first responders on the actions to take to protect the populations near the site.

Nuclear power plants use these four emergency classifications (see Figure 52: Emergency Classifications for Nuclear Reactor Events, 2012):

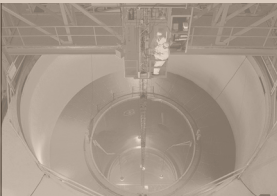
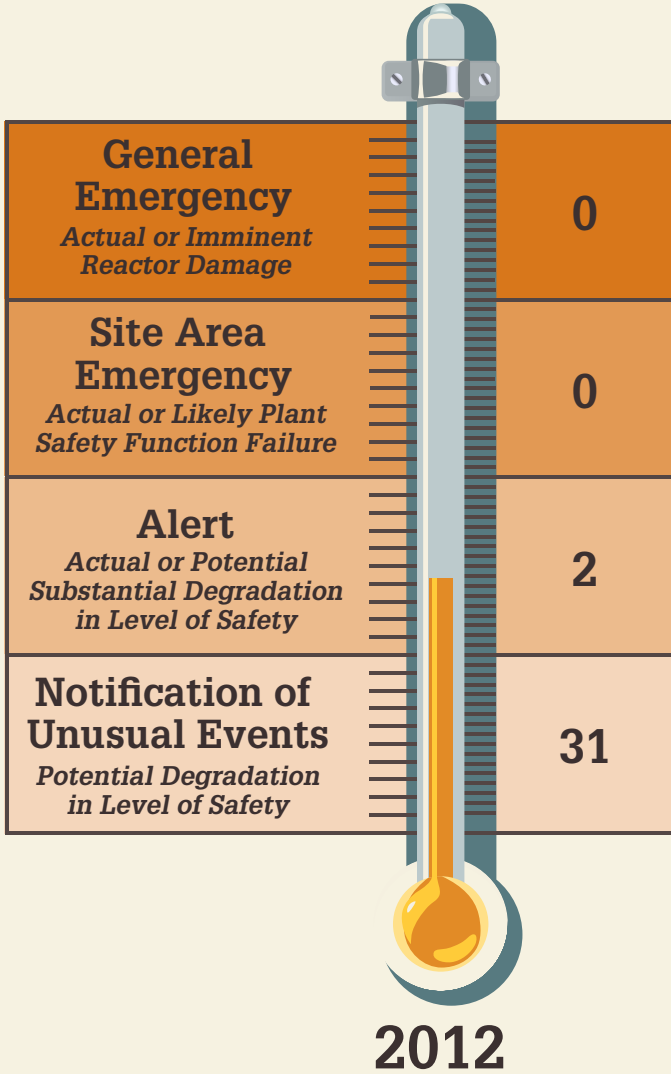
- **Notification of Unusual Event:** Events that indicate a potential degradation in the level of safety of the plant are in progress or have occurred. No release of radioactive material requiring offsite response or monitoring is expected unless further degradation occurs.
- **Alert:** Events that involve an actual or potential substantial degradation in the level of plant safety are in progress or have occurred. Any releases of radioactive material are expected to be limited to a small fraction of the limits set forth by the U.S. Environmental Protection Agency (EPA).
- **Site Area Emergency:** Events that may result in actual or likely major failures of plant functions needed to protect the public are in progress or have occurred. Any releases of radioactive material are not expected to exceed the limits set forth by the EPA except near the site boundary.
- **General Emergency:** Events that involve actual or imminent substantial core damage or melting of reactor fuel with the potential for loss of containment integrity are in progress or have occurred. Radioactive releases can be expected to exceed the limits set forth by the EPA for more than the immediate site area.

Nuclear materials and fuel cycle facility licensees use these emergency classifications:

- **Alert:** Events that could lead to a release of radioactive materials are in progress or have occurred. The release is not expected to require a response by an offsite response organization to protect citizens near the site.
- **Site Area Emergency:** Events that could lead to a significant release of radioactive materials are in progress or have occurred. The release could require a response by offsite response organizations to protect citizens near the site.



Figure 52. Emergency Classifications for Nuclear Reactor Events, 2012

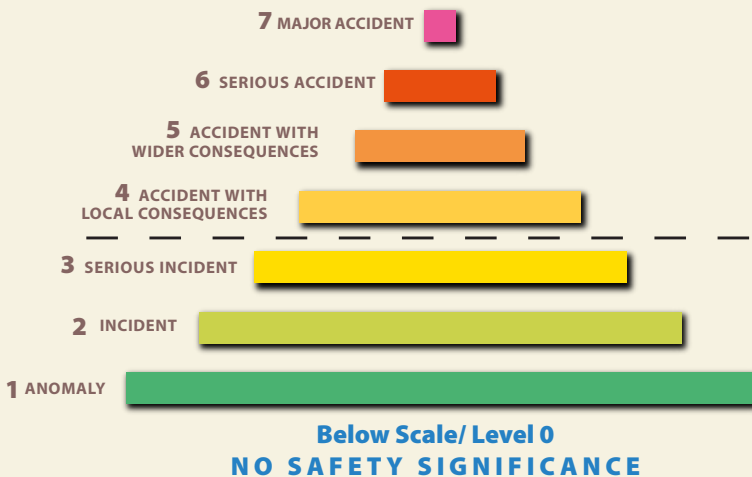


## International Emergency Classifications

The IAEA uses the International Nuclear and Radiological Event Scale (INES) as a tool for promptly and consistently communicating to the public the safety significance of reported nuclear and radiological incidents and accidents worldwide (see Figure 53: The International Nuclear and Radiological Event Scale).

The scale can be applied to any event associated with nuclear facilities, as well as the transport, storage, and use of radioactive material and radiation sources. Licensees are not required to classify events or provide offsite notifications using the INES scale. But the NRC has committed to transmit to the IAEA an INES-based rating for an applicable event occurring in the United States rated at Level 2 or above, or events attracting international public interest.

**Figure 53. The International Nuclear and Radiological Event Scale**



*INES events are classified on the scale at 7 levels. Levels 1–3 are called “incidents” and Levels 4–7 “accidents.” The scale is designed so that the severity of an event is about 10 times greater for each increase in level on the scale. Events without safety significance are called “deviations” and are classified as Below Scale or at Level 0.*



# Appendices

Congress Maps Nuclear Materials NRC Regulated Sites  
NRC Approved Ruling Independent Regulatory Agency Quick Reference  
Index Organizations Agreement States Regulatory  
Cooperative-Agreements Operating Reactors U.S. Information  
Acronyms Functions Affairs Important Safety Industry Performance  
Tables Important Agreement States State and Territory Staff Terms Defined Nuclear React  
Petitions Commercial Tables Appendix A Environment Grants Detail



Security and Emergency Preparedness  
 Terms Defined  
 Abbreviations  
 Organizations  
 Energy  
 Operating Reactors  
 Radioactive Waste  
 Leadership U.S.  
 Radiation  
 NRC Regulated Sites  
 NRC Approved  
 Industry Averages  
 Operating  
 Parent Company  
 International Activities  
 Worldwide Nuclear Energy  
 Security and Emergency Preparedness  
 Staff Orders  
 Acronyms  
 Parent Company  
 Industry Performance  
 Independent Regulatory Agency  
 Nuclear Materials  
 Affairs  
 State and Territory  
 Nuclear Materials  
 Inspectors  
 Policy  
 Information  
 Web Link  
 Reactor  
 Abbreviations  
 Grants  
 Nuclear Reactors  
 Public Involvement  
 Nuclear Materials  
 Information  
 Power  
 Reactor  
 Abbreviations  
 Grants  
 Regulate  
 Glossary  
 Worldwide Nuclear Energy  
 Public Involvement  
 State and Territory  
 Nuclear Materials  
 Atomic  
 Organizations  
 Power  
 Reactor  
 Abbreviations  
 Grants  
 Index  
 Mission  
 Quick Reference  
 Glossary  
 NRC  
 Protection  
 Worldwide Nuclear Energy  
 Federal  
 Public  
 Major Activities  
 Nuclear Source  
 Radioactive Waste



## Abbreviations

<b>ABWR</b>	advanced boiling-water reactor	<b>EPZ</b>	emergency planning zone
<b>AC</b>	Allis Chalmers	<b>ERO</b>	emergency response organization
<b>ACRS</b>	Advisory Committee on Reactor Safeguards	<b>ESP</b>	early site permit
<b>AE</b>	architect-engineer	<b>EVESR</b>	ESADA (Empire States Atomic Development Associates)
<b>AEC</b>	Atomic Energy Commission (U.S.)		Vallecitos Experimental Superheat Reactor
<b>AEP</b>	American Electric Power Company	<b>EXP. DATE</b>	expiration date of operating license
<b>AGN</b>	solid homogeneous core (Aerojet-General Nuclonics)	<b>FBI</b>	Federal Bureau of Investigation (U.S.)
<b>AI</b>	Atomics International	<b>FBR</b>	fast breeder reactor
<b>ANS</b>	American Nuclear Society	<b>FLUR</b>	Fluor Pioneer
<b>B&amp;R</b>	Burns & Roe	<b>FR</b>	<i>Federal Register</i>
<b>B&amp;W</b>	Babcock & Wilcox	<b>FW</b>	Foster Wheeler
<b>BALD</b>	Baldwin Associates	<b>FY</b>	fiscal year
<b>BECH</b>	Bechtel	<b>G&amp;H</b>	Gibbs & Hill
<b>BLH</b>	Baldwin Lima Hamilton	<b>GA</b>	General Atomic
<b>BRRT</b>	Brown & Root	<b>GCR</b>	gas-cooled reactor
<b>BWR</b>	boiling-water reactor	<b>GEH</b>	General Electric-Hitachi Nuclear Energy
<b>CE</b>	Combustion Engineering	<b>GEIS</b>	generic environmental impact statement
<b>CFR</b>	<i>Code of Federal Regulations</i>	<b>GETR</b>	General Electric Test Reactor
<b>CO</b>	Commission order	<b>GHDR</b>	Gibbs & Hill & Durham & Richardson
<b>Co</b>	company	<b>GIL</b>	Gilbert Associates
<b>CoC</b>	certificate of compliance	<b>GL</b>	general license
<b>COL</b>	combined license	<b>GPC</b>	Georgia Power Company
<b>COMM. OP.</b>	date of commercial operation	<b>GWe</b>	gigawatt(s) electrical
<b>CON TYPE</b>	containment type	<b>HTG</b>	high-temperature gas (reactor)
<b>DRYAMB</b>	dry, ambient pressure	<b>HWR</b>	heavy-water reactor
<b>DRYSUB</b>	dry, subatmospheric	<b>IAEA</b>	International Atomic Energy Agency
<b>ICECND</b>	wet, ice condenser	<b>INES</b>	International Nuclear Event Scale
<b>MARK 1</b>	wet, Mark I	<b>IRRS</b>	IAEA Integrated Regulatory Review Service
<b>MARK 2</b>	wet, Mark II	<b>ISFSI</b>	independent spent fuel storage installation
<b>MARK 3</b>	wet, Mark III	<b>JONES</b>	J.A. Jones
<b>CP</b>	construction permit	<b>KAIS</b>	Kaiser Engineers
<b>CP ISSUED</b>	date of construction permit issuance	<b>KI</b>	potassium iodide
<b>CVP</b>	civil penalties	<b>kW</b>	kilowatt(s)
<b>CVTR</b>	Carolinas-Virginia Tube Reactor	<b>LES</b>	Louisiana Energy Services
<b>CWE</b>	Commonwealth Edison Company	<b>LLP</b>	B&W lowered loop
<b>CY</b>	calendar year	<b>LMFB</b>	liquid metal fast breeder (reactor)
<b>DANI</b>	Daniel International	<b>LR ISSUED</b>	license renewal issued
<b>DBDB</b>	Duke & Bechtel	<b>LWGR</b>	light-water-cooled graphite moderated reactor
<b>DC</b>	design certification	<b>MW</b>	megawatt(s)
<b>DHS</b>	Department of Homeland Security (U.S.)	<b>MWe</b>	megawatt(s) electrical
<b>DOE</b>	Department of Energy (U.S.)	<b>MWh</b>	megawatt-hour(s)
<b>DOT</b>	Department of Transportation (U.S.)	<b>MWt</b>	megawatt(s) thermal
<b>DUKE</b>	Duke Power Company	<b>NIAG</b>	Niagara Mohawk Power Corporation
<b>EBSO</b>	Ebasco		
<b>EIA</b>	Energy Information Administration (DOE)		
<b>EIS</b>	environmental impact statement		
<b>EPA</b>	Environmental Protection Agency (U.S.)		
<b>EPR</b>	Evolutionary Power Reactor		





<b>NISA</b>	Japanese Nuclear and Industrial Safety Agency	<b>S&amp;W</b>	Stone & Webster
<b>NOV</b>	notices of violation	<b>SCF</b>	sodium-cooled fast (reactor)
<b>NOVF</b>	notices of violation associated with inspection findings	<b>SCGM</b>	sodium-cooled, graphite-moderated (reactor)
<b>NOVSL</b>	notices of violation for severity level	<b>SDP</b>	significance determination process
<b>NRC</b>	Nuclear Regulatory Commission (U.S.)	<b>SGEC</b>	architect for Vogtle
<b>NSP</b>	Northern States Power Company	<b>SI</b>	système internationale (d'unités) (International System of Units)
<b>NSSS</b>	nuclear steam system supplier and design type	<b>SL</b>	site licenses
<b>GE 2</b>	<i>GE Type 2</i>	<b>SOARCA</b>	State-of-the-Art Consequence Analysis
<b>GE 3</b>	<i>GE Type 3</i>	<b>SSI</b>	Southern Services Incorporated
<b>GE 4</b>	<i>GE Type 4</i>	<b>STARS</b>	Strategic Teaming and Resource Sharing Group
<b>GE 5</b>	<i>GE Type 5</i>	<b>STP</b>	South Texas Project
<b>GE 6</b>	<i>GE Type 6</i>	<b>TMI-2</b>	Three Mile Island Unit 2 reactor systems codes
<b>WEST 2LP</b>	<i>Westinghouse Two-Loop</i>	<b>TRACE</b>	Training Reactor and Isotopes Production, General Atomics
<b>WEST 3LP</b>	<i>Westinghouse Three-Loop</i>	<b>TRIGA</b>	Tennessee Valley Authority
<b>WEST 4LP</b>	<i>Westinghouse Four-Loop</i>	<b>UE&amp;C</b>	United Engineers & Constructors
<b>OCM</b>	organically cooled and moderated operating license	<b>USAID</b>	U.S. Agency for International Development
<b>OL</b>	operating license	<b>USEC</b>	U.S. Enrichment Corporation
<b>OL ISSUED</b>	date of latest full power operating license	<b>US-APWR</b>	United States [version of] Advanced Pressurized-Water Reactor
<b>PG&amp;E</b>	Pacific Gas & Electric Company	<b>VBWR</b>	Vallecitos Boiling-Water Reactor
<b>PHWR</b>	pressurized heavy-water-moderated and -cooled (reactor)	<b>WCS</b>	Waste Control Specialist
<b>PRA</b>	probabilistic risk assessment	<b>WDCO</b>	Westinghouse Development Corporation
<b>PSE</b>	Pioneer Services and Engineering	<b>WEST</b>	Westinghouse Electric
<b>PSEG</b>	Public Service Electric and Gas Company		
<b>PTHW</b>	pressure tube heavy water		
<b>PWR</b>	pressurized-water reactor		
<b>RTR</b>	research and test reactors		
<b>S&amp;L</b>	Sargent & Lundy		

### State and Territory Abbreviations

Alabama	AL	Kentucky	KY	Ohio	OH
Alaska	AK	Louisiana	LA	Oklahoma	OK
Arizona	AZ	Maine	ME	Oregon	OR
Arkansas	AR	Maryland	MD	Pennsylvania	PA
California	CA	Massachusetts	MA	Puerto Rico	PR
Colorado	CO	Michigan	MI	Rhode Island	RI
Connecticut	CT	Minnesota	MN	South Carolina	SC
Delaware	DE	Mississippi	MS	South Dakota	SD
District of Columbia	DC	Missouri	MO	Tennessee	TN
Florida	FL	Montana	MT	Texas	TX
Georgia	GA	Nebraska	NE	Utah	UT
Guam	GU	Nevada	NV	Vermont	VT
Hawaii	HI	New Hampshire	NH	Virgin Islands	VI
Idaho	ID	New Jersey	NJ	Virginia	VA
Illinois	IL	New Mexico	NM	Washington	WA
Indiana	IN	New York	NY	West Virginia	WV
Iowa	IA	North Carolina	NC	Wisconsin	WI
Kansas	KS	North Dakota	ND	Wyoming	WY

## APPENDIX A

### U.S. Commercial Nuclear Power Reactors Operating Reactors

Plant Name, Unit Number Licensee Location Docket Number NRC Web Page Address	NRC Region	Con Type NSSS Architect Engineer Constructor	Licensed MWt	CP Issued OL Issued Comm. Op. LR Issued Exp. Date	2007– 2012** Capacity Factor (Percent)
Arkansas Nuclear One, Unit 1 Entergy Operations, Inc. London, AR (6 miles NW of Russellville, AR) 05000313 <a href="http://www.nrc.gov/info-finder/reactor/ano1.html">www.nrc.gov/info-finder/reactor/ano1.html</a>	IV	PWR-DRYAMB B&W LLP BECH BECH	2,568	12/06/1968	94
				05/21/1974	83
				12/19/1974	99
				06/20/2001	90
				05/20/2034	87
102					
Arkansas Nuclear One, Unit 2 Entergy Operations, Inc. London, AR (6 miles NW of Russellville, AR) 05000368 <a href="http://www.nrc.gov/info-finder/reactor/ano2.html">www.nrc.gov/info-finder/reactor/ano2.html</a>	IV	PWR-DRYAMB CE BECH BECH	3,026	12/06/1972	99
				09/01/1978	91
				03/26/1980	90
				06/30/2005	97
				07/17/2038	90
93					
Beaver Valley Power Station, Unit 1 FirstEnergy Nuclear Operating Co. Shippingport, PA (17 miles W of McCandless, PA) 05000334 <a href="http://www.nrc.gov/info-finder/reactor/bv1.html">www.nrc.gov/info-finder/reactor/bv1.html</a>	I	PWR-DRYAMB WEST 3LP S&W S&W	2,900	06/26/1970	95
				07/02/1976	101
				10/01/1976	92
				11/05/2009	91
				01/29/2036	101
92					
Beaver Valley Power Station, Unit 2 FirstEnergy Nuclear Operating Co. Shippingport, PA (17 miles W of McCandless, PA) 05000412 <a href="http://www.nrc.gov/info-finder/reactor/bv2.html">www.nrc.gov/info-finder/reactor/bv2.html</a>	I	PWR-DRYAMB WEST 3LP S&W S&W	2,900	05/03/1974	87
				08/14/1987	103
				11/17/1987	87
				11/05/2009	84
				05/27/2047	102
91					
Braidwood Station, Unit 1 Exelon Generation Co., LLC Braceville, IL (20 miles SW of Joliet, IL) 05000456 <a href="http://www.nrc.gov/info-finder/reactor/brai1.html">www.nrc.gov/info-finder/reactor/brai1.html</a>	III	PWR-DRYAMB WEST 4LP S&L CWE	3,586.6	12/31/1975	92
				07/02/1987	101
				07/29/1988	95
				N/A	89
				10/17/2026	101
91					
Braidwood Station, Unit 2 Exelon Generation Co., LLC Braceville, IL (20 miles SW of Joliet, IL) 05000457 <a href="http://www.nrc.gov/info-finder/reactor/brai2.html">www.nrc.gov/info-finder/reactor/brai2.html</a>	III	PWR-DRYAMB WEST 4LP S&L CWE	3,586.6	12/31/1975	100
				05/20/1988	92
				10/17/1988	93
				N/A	99
				12/18/2027	93
93					
Browns Ferry Nuclear Plant, Unit 1 Tennessee Valley Authority Athens (Limestone County), AL (32 miles W of Huntsville, AL) 05000259 <a href="http://www.nrc.gov/info-finder/reactor/bf1.html">www.nrc.gov/info-finder/reactor/bf1.html</a>	II	BWR-MARK 1 GE 4 TVA TVA	3,458	05/10/1967	49
				12/20/1973	88
				08/01/1974	94
				05/04/2006	86
				12/20/2033	91
88					



## APPENDIX A

### U.S. Commercial Nuclear Power Reactors Operating Reactors (continued)

Plant Name, Unit Number Licensee Location Docket Number NRC Web Page Address	NRC Region	Con Type NSSS		Licensed MWt	CP Issued	2007–
		Architect	Engineer		OL Issued	2012**
		Constructor			Comm. Op.	Factor
					LR Issued Exp. Date	(Percent)
Browns Ferry Nuclear Plant, Unit 2 Tennessee Valley Authority Athens (Limestone County), AL (32 miles W of Huntsville, AL) 05000260 <a href="http://www.nrc.gov/info-finder/reactor/bf2.html">www.nrc.gov/info-finder/reactor/bf2.html</a>	II	BWR-MARK 1		3,458	05/10/1967	78
		GE 4			06/28/1974	98
		TVA			03/01/1975	94
		TVA			05/04/2006	91
						06/28/2034
Browns Ferry Nuclear Plant, Unit 3 Tennessee Valley Authority Athens (Limestone County), AL (32 miles W of Huntsville, AL) 05000296 <a href="http://www.nrc.gov/info-finder/reactor/bf3.html">www.nrc.gov/info-finder/reactor/bf3.html</a>	II	BWR-MARK 1		3,458	07/31/1968	93
		GE 4			07/02/1976	81
		TVA			03/01/1977	95
		TVA			05/04/2006	81
						07/02/2036
Brunswick Steam Electric Plant, Unit 1 Carolina Power & Light Co. Southport, NC (30 miles S of Wilmington, NC) 05000325 <a href="http://www.nrc.gov/info-finder/reactor/bru1.html">www.nrc.gov/info-finder/reactor/bru1.html</a>	II	BWR-MARK 1		2,923	02/07/1970	96
		GE 4			09/08/1976	85
		UE&C			03/18/1977	98
		BRRT			06/26/2006	83
						09/08/2036
Brunswick Steam Electric Plant, Unit 2 Carolina Power & Light Co. Southport, NC (30 miles S of Wilmington, NC) 05000324 <a href="http://www.nrc.gov/info-finder/reactor/bru2.html">www.nrc.gov/info-finder/reactor/bru2.html</a>	II	BWR-MARK 1		2,923	02/07/1970	87
		GE 4			12/27/1974	95
		UE&C			11/03/1975	80
		BRRT			06/26/2006	99
						12/27/2034
Byron Station, Unit 1 Exelon Generation Co., LLC Byron, IL (17 miles SW of Rockford, IL) 05000454 <a href="http://www.nrc.gov/info-finder/reactor/byro1.html">www.nrc.gov/info-finder/reactor/byro1.html</a>	III	PWR-DRYAMB		3,586.6	12/31/1975	98
		WEST 4LP			02/14/1985	95
		S&L			09/16/1985	94
		CWE			N/A	101
						10/31/2024
Byron Station, Unit 2 Exelon Generation Co., LLC Byron, IL (17 miles SW of Rockford, IL) 05000455 <a href="http://www.nrc.gov/info-finder/reactor/byro2.html">www.nrc.gov/info-finder/reactor/byro2.html</a>	III	PWR-DRYAMB		3,586.6	12/31/1975	89
		WEST 4LP			01/30/1987	96
		S&L			08/02/1987	102
		CWE			N/A	96
						11/06/2026
Callaway Plant Union Electric Co. Fulton, MO (25 miles NE of Jefferson City, MO) 05000483 <a href="http://www.nrc.gov/info-finder/reactor/call.html">www.nrc.gov/info-finder/reactor/call.html</a>	IV	PWR-DRYAMB		3,565	04/16/1976	90
		WEST 4LP			10/18/1984	90
		BECH			12/19/1984	98
		DANI			N/A	86
						10/18/2024
				103		



## APPENDIX A

### U.S. Commercial Nuclear Power Reactors Operating Reactors (continued)

Plant Name, Unit Number Licensee Location Docket Number NRC Web Page Address	NRC Region	Con Type NSSS		Licensed MwT	CP Issued	2007–
		Architect	Engineer		OL Issued	2012**
		Constructor			Comm. Op.	Capacity Factor (Percent)
Calvert Cliffs Nuclear Power Plant, Unit 1 Calvert Cliffs Nuclear Power Plant, LLC Lusby, MD (40 miles S of Annapolis, MD) 05000317 <a href="http://www.nrc.gov/info-finder/reactor/calv1.html">www.nrc.gov/info-finder/reactor/calv1.html</a>	I	PWR-DRYAMB		2,737	07/07/1969	99
		CE			07/31/1974	93
		BECH			05/08/1975	98
		BECH			03/23/2000	90
						07/31/2034
Calvert Cliffs Nuclear Power Plant, Unit 2 Calvert Cliffs Nuclear Power Plant, LLC Lusby, MD (40 miles S of Annapolis, MD) 05000318 <a href="http://www.nrc.gov/info-finder/reactor/calv2.html">www.nrc.gov/info-finder/reactor/calv2.html</a>	I	PWR-DRYAMB		2,737	07/07/1969	90
		CE			08/13/1976	99
		BECH			04/01/1977	93
		BECH			03/23/2000	97
						08/13/2036
Catawba Nuclear Station, Unit 1 Duke Energy Carolinas, LLC York, SC (18 miles S of Charlotte, NC) 05000413 <a href="http://www.nrc.gov/info-finder/reactor/cat1.html">www.nrc.gov/info-finder/reactor/cat1.html</a>	II	PWR-ICECND		3,411	08/07/1975	102
		WEST 4LP			01/17/1985	89
		DUKE			06/29/1985	91
		DUKE			12/05/2003	100
						12/05/2043
Catawba Nuclear Station, Unit 2 Duke Energy Carolinas, LLC York, SC (18 miles S of Charlotte, NC) 05000414 <a href="http://www.nrc.gov/info-finder/reactor/cat2.html">www.nrc.gov/info-finder/reactor/cat2.html</a>	II	PWR-ICECND		3,411	08/07/1975	84
		WEST 4LP			05/15/1986	103
		DUKE			08/19/1986	90
		DUKE			12/05/2003	92
						12/05/2043
Clinton Power Station, Unit 1 Exelon Generation Co., LLC Clinton, IL (23 miles SSE of Bloomington, IL) 05000461 <a href="http://www.nrc.gov/info-finder/reactor/clin.html">www.nrc.gov/info-finder/reactor/clin.html</a>	III	BWR-MARK 3		3,473	02/24/1976	101
		GE 6			04/17/1987	99
		S&L			11/24/1987	97
		BALD			N/A	92
						09/29/2026
Columbia Generating Station Energy Northwest Benton County, WA (12 miles NW of Richland, WA) 05000397 <a href="http://www.nrc.gov/info-finder/reactor/wash2.html">www.nrc.gov/info-finder/reactor/wash2.html</a>	IV	BWR-MARK 2		3,486	03/19/1973	82
		GE 5			04/13/1984	93
		B&R			12/13/1984	67
		BECH			05/22/2012	95
						12/20/2043
Comanche Peak Nuclear Power Plant, Unit 1 Luminant Generation Co., LLC Glen Rose, TX (40 miles SW of Fort Worth, TX) 05000445 <a href="http://www.nrc.gov/info-finder/reactor/cp1.html">www.nrc.gov/info-finder/reactor/cp1.html</a>	IV	PWR-DRYAMB		3,612	12/19/1974	85
		WEST 4LP			04/17/1990	96
		G&H			08/13/1990	100
		BRRT			N/A	91
						02/08/2030
				98		



## APPENDIX A

### U.S. Commercial Nuclear Power Reactors

#### Operating Reactors (continued)

Plant Name, Unit Number Licensee Location Docket Number NRC Web Page Address	NRC Region	Con Type NSSS		Licensed MwT	CP Issued	2007–
		Architect	Engineer		OL Issued	2012**
		Constructor			Comm. Op.	Factor
					LR Issued	(Percent)
					Exp. Date	
Comanche Peak Nuclear Power Plant, Unit 2 Luminant Generation Company, LLC Glen Rose, TX (40 miles SW of Fort Worth, TX) 05000446 www.nrc.gov/info-finder/reactor/cp2.html	IV	PWR-DRYAMB		3,612	12/19/1974	102
		WEST 4LP			04/06/1993	95
		BECH			08/03/1993	94
		BRRT			N/A	104
						02/02/2033
Cooper Nuclear Station Nebraska Public Power District Brownville, NE (23 miles S of Nebraska City, NE) 05000298 www.nrc.gov/info-finder/reactor/cns.html	IV	BWR-MARK 1		2,419	06/04/1968	100
		GE 4			01/18/1974	90
		B&R			07/01/1974	72
		B&R			11/29/2010	100
						01/18/2034
Davis-Besse Nuclear Power Station, Unit 1 FirstEnergy Nuclear Operating Co. Oak Harbor, OH (21 miles ESE of Toledo, OH) 05000346 www.nrc.gov/info-finder/reactor/davi.html	III	PWR-DRYAMB		2,817	03/24/1971	99
		B&W LLP			04/22/1977	97
		BECH			07/31/1978	99
		B&W			N/A	66
						04/22/2017
Diablo Canyon Nuclear Power Plant, Unit 1 Pacific Gas & Electric Co. Avila Beach, CA (12 miles SW of San Luis Obispo, CA) 05000275 www.nrc.gov/info-finder/reactor/diab1.html	IV	PWR-DRYAMB		3,411	4/23/1968	90
		WEST 4LP			11/02/1984	98
		PG&E			05/07/1985	84
		PG&E			N/A	88
						11/02/2024
Diablo Canyon Nuclear Power Plant, Unit 2 Pacific Gas & Electric Co. Avila Beach, CA (12 miles SW of San Luis Obispo, CA) 05000323 www.nrc.gov/info-finder/reactor/diab2.html	IV	PWR-DRYAMB		3,411	12/09/1970	99
		WEST 4LP			08/26/1985	74
		PG&E			03/13/1986	84
		PG&E			N/A	100
						08/26/2025
Donald C. Cook Nuclear Plant, Unit 1 Indiana Michigan Power Co. Bridgman, MI (13 miles S of Benton Harbor, MI) 05000315 www.nrc.gov/info-finder/reactor/cook1.html	III	PWR-ICECND		3,304	03/25/1969	103
		WEST 4LP			10/25/1974	64
		AEP			08/28/1975	3
		AEP			08/30/2005	88
						10/25/2034
Donald C. Cook Nuclear Plant, Unit 2 Indiana Michigan Power Co. Bridgman, MI (13 miles S of Benton Harbor, MI) 05000316 www.nrc.gov/info-finder/reactor/cook2.html	III	PWR-ICECND		3,468	03/25/1969	86
		WEST 4LP			12/23/1977	101
		AEP			07/01/1978	87
		AEP			08/30/2005	84
						12/23/2037
				91		



## APPENDIX A

### U.S. Commercial Nuclear Power Reactors Operating Reactors (continued)

Plant Name, Unit Number Licensee Location Docket Number NRC Web Page Address	NRC Region	Con Type NSSS		CP Issued OL Issued Comm. Op. LR Issued Exp. Date	2007– 2012** Capacity Factor (Percent)
		Architect Constructor	Engineer MWT		
Dresden Nuclear Power Station, Unit 2 Exelon Generation Co., LLC Morris, IL (25 miles SW of Joliet, IL) 05000237 www.nrc.gov/info-finder/reactor/dres2.html	III	BWR-MARK 1 GE 3 S&L UE&C	2,957	01/10/1966 02/20/1991 <sup>A</sup> 06/09/1970 10/28/2004 12/22/2029	92 98 91 102 95 104
Dresden Nuclear Power Station, Unit 3 Exelon Generation Co., LLC Morris, IL (25 miles SW of Joliet, IL) 05000249 www.nrc.gov/info-finder/reactor/dres3.html	III	BWR-MARK 1 GE 3 S&L UE&C	2,957	10/14/1966 01/12/1971 11/16/1971 10/28/2004 01/12/2031	100 93 97 90 99 91
Duane Arnold Energy Center NextEra Energy Duane Arnold, LLC Palo, IA (8 miles NW of Cedar Rapids, IA) 05000331 www.nrc.gov/info-finder/reactor/duan.html	III	BWR-MARK 1 GE 4 BECH BECH	1,912	06/22/1970 02/22/1974 02/01/1975 12/16/2010 02/21/2034	89 103 92 89 99 83
Edwin I. Hatch Nuclear Plant, Unit 1 Southern Nuclear Operating Co. Baxley, GA (20 miles S of Vidalia, GA) 05000321 www.nrc.gov/info-finder/reactor/hat1.html	II	BWR-MARK 1 GE 4 BECH GPC	2,804	09/30/1969 10/13/1974 12/31/1975 01/15/2002 08/06/2034	98 84 94 85 98 89
Edwin I. Hatch Nuclear Plant, Unit 2 Southern Nuclear Operating Co., Inc. Baxley, GA (20 miles S of Vidalia, GA) 05000366 www.nrc.gov/info-finder/reactor/hat2.html	II	BWR-MARK 1 GE 4 BECH GPC	2,804	12/27/1972 06/13/1978 09/05/1979 01/15/2002 06/13/2038	87 96 67 96 78 98
Fermi, Unit 2 DTE Electric Company Newport, MI (25 miles NE of Toledo, OH) 05000341 www.nrc.gov/info-finder/reactor/ferm2.html	III	BWR-MARK 1 GE 4 S&L DANI	3,430	09/26/1972 07/15/1985 01/23/1988 N/A 03/20/2025	85 98 75 80 94 54
Fort Calhoun Station, Unit 1 Omaha Public Power District Ft. Calhoun, NE (19 miles N of Omaha, NE) 05000285 www.nrc.gov/info-finder/reactor/fcs.html	IV	PWR-DRYAMB CE GHDR GHDR	1,500	06/07/1968 08/09/1973 09/26/1973 11/04/2003 08/09/2033	104 83 100 102 28 0

<sup>A</sup>: AEC issued a provisional OL on 12/22/1969, allowing commercial operation. The NRC issued a full-term OL on 02/20/1991.



## APPENDIX A

### U.S. Commercial Nuclear Power Reactors Operating Reactors (continued)

Plant Name, Unit Number Licensee Location Docket Number NRC Web Page Address	NRC Region	Con Type NSSS		CP Issued OL Issued Comm. Op. LR Issued Exp. Date	2007– 2012** Capacity Factor (Percent)
		Architect Constructor	Engineer MWT		
Grand Gulf Nuclear Station, Unit 1 Entergy Operations, Inc. Port Gibson, MS (20 miles S of Vicksburg, MS) 05000416 <a href="http://www.nrc.gov/info-finder/reactor/gg1.html">www.nrc.gov/info-finder/reactor/gg1.html</a>	IV	BWR-MARK 3	4,408	09/04/1974	84
		GE 6		11/01/1984	86
		BECH		07/01/1985	100
		BECH		N/A	88
				11/01/2024	94
					70
H.B. Robinson Steam Electric Plant, Unit 2 Carolina Power & Light Co. Hartsville, SC (26 miles NW of Florence, SC) 05000261 <a href="http://www.nrc.gov/info-finder/reactor/rob2.html">www.nrc.gov/info-finder/reactor/rob2.html</a>	II	PWR-DRYAMB	2,339	04/13/1967	92
		WEST 3LP		07/31/1970	87
		EBSO		03/07/1971	104
		EBSO		04/19/2004	57
				07/31/2030	100
					85
Hope Creek Generating Station, Unit 1 PSEG Nuclear, LLC Hancocks Bridge, NJ (18 miles SE of Wilmington, DE) 05000354 <a href="http://www.nrc.gov/info-finder/reactor/hope.html">www.nrc.gov/info-finder/reactor/hope.html</a>	I	BWR-MARK 1	3,840	11/04/1974	87
		GE 4		07/25/1986	108
		BECH		12/20/1986	95
		BECH		07/20/2011	93
				04/11/2046	103
					93
Indian Point Nuclear Generating, Unit 2 Entergy Nuclear Indian Point 2, LLC Buchanan, NY (24 miles N of New York, NY) 05000247 <a href="http://www.nrc.gov/info-finder/reactor/ip2.html">www.nrc.gov/info-finder/reactor/ip2.html</a>	I	PWR-DRYAMB	3,216	10/14/1966	99
		WEST 4LP		09/28/1973	91
		UE&C		08/01/1974	98
			WDCO	N/A	82
					09/28/2013
					90
Indian Point Nuclear Generating, Unit 3 Entergy Nuclear Indian Point 3, LLC Buchanan, NY (24 miles N of New York, NY) 05000286 <a href="http://www.nrc.gov/info-finder/reactor/ip3.html">www.nrc.gov/info-finder/reactor/ip3.html</a>	I	PWR-DRYAMB	3,216	08/13/1969	87
		WEST 4LP		12/12/1975	107
		UE&C		08/30/1976	85
			WDCO	N/A	99
					12/12/2015
					100
James A. FitzPatrick Nuclear Power Plant Entergy Nuclear FitzPatrick, LLC Scriba, NY (6 miles NE of Oswego, NY) 05000333 <a href="http://www.nrc.gov/info-finder/reactor/fitz.html">www.nrc.gov/info-finder/reactor/fitz.html</a>	I	BWR-MARK 1	2,536	05/20/1970	93
		GE 4		10/17/1974	89
		S&W		07/28/1975	99
		S&W		09/08/2008	85
				10/17/2034	97
					84
Joseph M. Farley Nuclear Plant, Unit 1 Southern Nuclear Operating Co. Columbia, AL (18 miles E of Dothan, AL) 05000348 <a href="http://www.nrc.gov/info-finder/reactor/far1.html">www.nrc.gov/info-finder/reactor/far1.html</a>	II	PWR-DRYAMB	2,775	08/16/1972	88
		WEST 3LP		06/25/1977	97
		SSI		12/01/1977	90
		DANI		05/12/2005	88
				06/25/2037	101
					91



## APPENDIX A

### U.S. Commercial Nuclear Power Reactors Operating Reactors (continued)

Plant Name, Unit Number Licensee Location Docket Number NRC Web Page Address	NRC Region	Con Type NSSS Architect Engineer Constructor	Licensed MWt	CP Issued OL Issued Comm. Op. LR Issued Exp. Date	2007– 2012** Capacity Factor (Percent)
Joseph M. Farley Nuclear Plant, Unit 2 Southern Nuclear Operating Co. Columbia, AL (18 miles E of Dothan, AL) 05000364 <a href="http://www.nrc.gov/info-finder/reactor/far2.html">www.nrc.gov/info-finder/reactor/far2.html</a>	II	PWR-DRYAMB WEST 3LP SSI BECH	2,775	08/16/1972	87
				03/31/1981	90
				07/30/1981	96
				05/12/2005	88
				03/31/2041	89
					104
LaSalle County Station, Unit 1 Exelon Generation Co., LLC Marseilles, IL (11 miles SE of Ottawa, IL) 05000373 <a href="http://www.nrc.gov/info-finder/reactor/lasa1.html">www.nrc.gov/info-finder/reactor/lasa1.html</a>	III	BWR-MARK 2 GE 5 S&L CWE	3,546	09/10/1973	99
				04/17/1982	100
				01/01/1984	99
				N/A	94
				04/17/2022	101
					97
LaSalle County Station, Unit 2 Exelon Generation Co., LLC Marseilles, IL (11 miles SE of Ottawa, IL) 05000374 <a href="http://www.nrc.gov/info-finder/reactor/lasa2.html">www.nrc.gov/info-finder/reactor/lasa2.html</a>	III	BWR-MARK 2 GE 5 S&L CWE	3,546	09/10/1973	95
				12/16/1983	94
				10/19/1984	93
				N/A	101
				12/16/2023	96
					103
Limerick Generating Station, Unit 1 Exelon Generation Co., LLC Limerick, PA (21 miles NW of Philadelphia, PA) 05000352 <a href="http://www.nrc.gov/info-finder/reactor/lim1.html">www.nrc.gov/info-finder/reactor/lim1.html</a>	I	BWR-MARK 2 GE 4 BECH BECH	3,515	06/19/1974	101
				08/08/1985	95
				02/01/1986	101
				N/A	91
				10/26/2024	96
					85
Limerick Generating Station, Unit 2 Exelon Generation Co., LLC Limerick, PA (21 miles NW of Philadelphia, PA) 05000353 <a href="http://www.nrc.gov/info-finder/reactor/lim2.html">www.nrc.gov/info-finder/reactor/lim2.html</a>	I	BWR-MARK 2 GE 4 BECH BECH	3,515	06/19/1974	91
				08/25/1989	101
				01/08/1990	94
				N/A	99
				06/22/2029	90
					95
McGuire Nuclear Station, Unit 1 Duke Energy Carolinas, LLC Huntersville, NC (17 miles N of Charlotte, NC) 05000369 <a href="http://www.nrc.gov/info-finder/reactor/mcg1.html">www.nrc.gov/info-finder/reactor/mcg1.html</a>	II	PWR-ICECND WEST 4LP DUKE DUKE	3,411	02/23/1973	79
				07/08/1981	87
				12/01/1981	104
				12/05/2003	92
				06/12/2041	94
					105
McGuire Nuclear Station, Unit 2 Duke Energy Carolinas, LLC Huntersville, NC (17 miles N of Charlotte, NC) 05000370 <a href="http://www.nrc.gov/info-finder/reactor/mcg2.html">www.nrc.gov/info-finder/reactor/mcg2.html</a>	II	PWR-ICECND WEST 4LP DUKE DUKE	3,411	02/23/1973	103
				05/27/1983	90
				03/01/1984	94
				12/05/2003	104
				03/03/2043	91
					82





## APPENDIX A

### U.S. Commercial Nuclear Power Reactors Operating Reactors (continued)

Plant Name, Unit Number Licensee Location Docket Number NRC Web Page Address	NRC Region	Con Type NSSS Architect Engineer Constructor	Licensed MWt	CP Issued OL Issued Comm. Op. LR Issued Exp. Date	2007– 2012** Capacity Factor (Percent)
Millstone Power Station, Unit 2 Dominion Nuclear Connecticut, Inc. Waterford, CT (3.2 miles SW of New London, CT) 05000336 www.nrc.gov/info-finder/reactor/mill2.html	I	PWR-DRYAMB	2,700	12/11/1970	100
		CE		09/26/1975	86
		BECH		12/26/1975	81
		BECH		11/28/2005	97
				07/31/2035	87
Millstone Power Station, Unit 3 Dominion Nuclear Connecticut, Inc. Waterford, CT (3.2 miles SW of New London, CT) 05000423 www.nrc.gov/info-finder/reactor/mill3.html	I	PWR-DRYSUB	3,650	08/09/1974	86
		WEST 4LP		01/31/1986	88
		S&W		04/23/1986	105
		S&W		11/28/2005	86
				11/25/2045	87
Monticello Nuclear Generating Plant, Unit 1 Northern States Power Company-Minnesota Monticello, MN (30 miles NW of Minneapolis, MN) 05000263 www.nrc.gov/info-finder/reactor/mont.html	III	BWR-MARK 1	1,775	06/19/1967	84
		GE 3		01/09/1981 <sup>B</sup>	97
		BECH		06/30/1971	83
		BECH		11/08/2006	94
				09/08/2030	69
Nine Mile Point Nuclear Station, Unit 1 Nine Mile Point Nuclear Station, LLC Scriba, NY (6 miles NE of Oswego, NY) 05000220 www.nrc.gov/info-finder/reactor/nmp1.html	I	BWR-MARK 1	1,850	04/12/1965	88
		GE 2		12/26/1974 <sup>C</sup>	98
		NIAG		12/01/1969	92
		S&W		10/31/2006	97
				08/22/2029	84
Nine Mile Point Nuclear Station, Unit 2 Nine Mile Point Nuclear Station, LLC Scriba, NY (6 miles NE of Oswego, NY) 05000410 www.nrc.gov/info-finder/reactor/nmp2.html	I	BWR-MARK 2	3,988	06/24/1974	92
		GE 5		07/02/1987	90
		S&W		03/11/1988	99
		S&W		10/31/2006	89
				10/31/2046	95
North Anna Power Station, Unit 1 Virginia Electric & Power Co. Mineral (Louisa County), VA (40 miles NW of Richmond, VA) 05000338 www.nrc.gov/info-finder/reactor/na1.html	II	PWR-DRYSUB	2,940	02/19/1971	89
		WEST 3LP		04/01/1978	101
		S&W		06/06/1978	92
		S&W		03/20/2003	86
				04/01/2038	78
				89	

B: AEC issued a provisional OL on 09/08/1970, allowing commercial operation. The NRC issued a full-term OL on 01/09/1981.

C: AEC issued a provisional OL on 08/22/1969, allowing commercial operation. The NRC issued a full-term OL on 12/26/1974.



## APPENDIX A

### U.S. Commercial Nuclear Power Reactors Operating Reactors (continued)

Plant Name, Unit Number Licensee Location Docket Number NRC Web Page Address	NRC Region	Con Type NSSS Architect Engineer Constructor	Licensed MWt	CP Issued OL Issued Comm. Op. LR Issued Exp. Date	2007– 2012** Capacity Factor (Percent)
North Anna Power Station, Unit 2 Virginia Electric & Power Co. Mineral (Louisa County), VA (40 miles NW of Richmond, VA) 05000339 www.nrc.gov/info-finder/reactor/na2.html	II	PWR-DRYSUB WEST 3LP S&W S&W	2,940	02/19/1971	85
				08/21/1980	82
				12/14/1980	100
				03/20/2003	100
				08/21/2040	76
99					
Oconee Nuclear Station, Unit 1 Duke Energy Carolinas, LLC Seneca, SC (30 miles W of Greenville, SC) 05000269 www.nrc.gov/info-finder/reactor/oco1.html	II	PWR-DRYAMB B&W LLP DBDB DUKE	2,568	11/06/1967	99
				02/06/1973	84
				07/15/1973	85
				05/23/2000	100
				02/06/2033	79
90					
Oconee Nuclear Station, Unit 2 Duke Energy Carolinas, LLC Seneca, SC (30 miles W of Greenville, SC) 05000270 www.nrc.gov/info-finder/reactor/oco2.html	II	PWR-DRYAMB B&W LLP DBDB DUKE	2,568	11/06/1967	91
				10/06/1973	86
				09/09/1974	103
				05/23/2000	91
				10/06/2033	93
102					
Oconee Nuclear Station, Unit 3 Duke Energy Carolinas, LLC Seneca, SC (30 miles W of Greenville, SC) 05000287 www.nrc.gov/info-finder/reactor/oco3.html	II	PWR-DRYAMB B&W LLP DBDB DUKE	2,568	11/06/1967	87
				07/19/1974	102
				12/16/1974	94
				05/23/2000	91
				07/19/2034	103
86					
Oyster Creek Nuclear Generating Station Exelon Generation Co., LLC Forked River, NJ (9 miles S of Toms River, NJ) 05000219 www.nrc.gov/info-finder/reactor/oc.html	I	BWR-MARK 1 GE 2 B&R B&R	1,930	12/15/1964	94
				07/02/1991 <sup>D</sup>	83
				12/23/1969	92
				04/08/2009	85
				04/09/2029	98
88					
Palisades Nuclear Plant Entergy Nuclear Operations, Inc. Covert, MI (5 miles S of South Haven, MI) 05000255 www.nrc.gov/info-finder/reactor/pali.html	III	PWR-DRYAMB CE BECH BECH	2,565.4	03/14/1967	86
				02/21/1991 <sup>E</sup>	99
				12/31/1971	90
				01/17/2007	92
				03/24/2031	96
74					
Palo Verde Nuclear Generating Station, Unit 1 Arizona Public Service Company Wintersburg, AZ (50 miles W of Phoenix, AZ) 05000528 www.nrc.gov/info-finder/reactor/palo1.html	IV	PWR-DRYAMB CE80-2L BECH BECH	3,990	05/25/1976	77
				06/01/1985	86
				01/28/1986	101
				04/21/2011	81
				06/01/2045	83
100					

D: AEC issued a provisional OL on 04/09/1969, allowing commercial operation. The NRC issued a full-term OL on 07/02/1991.  
E: AEC issued a provisional OL on 03/24/1971, allowing commercial operation. The NRC issued a full-term OL on 02/21/1991.



## APPENDIX A

### U.S. Commercial Nuclear Power Reactors Operating Reactors (continued)

Plant Name, Unit Number Licensee Location Docket Number NRC Web Page Address	NRC Region	Con Type NSSS Architect Engineer Constructor	Licensed MWt	CP Issued OL Issued Comm. Op. LR Issued Exp. Date	2007– 2012** Capacity Factor (Percent)
Palo Verde Nuclear Generating Station, Unit 2 Arizona Public Service Company Wintersburg, AZ (50 miles W of Phoenix, AZ) 05000529 www.nrc.gov/info-finder/reactor/palo2.html	IV	PWR-DRYAMB CE80-2L BECH BECH	3,990	05/25/1976	95
				04/24/1986	74
				09/19/1986	83
				04/21/2011	101
				04/24/2046	91
90					
Palo Verde Nuclear Generating Station, Unit 3 Arizona Public Service Company Wintersburg, AZ (50 miles W of Phoenix, AZ) 05000530 www.nrc.gov/info-finder/reactor/palo3.html	IV	PWR-DRYAMB CE80-2L BECH BECH	3,990	05/25/1976	64
				11/25/1987	97
				01/08/1988	83
				04/21/2011	89
				11/25/2047	97
88					
Peach Bottom Atomic Power Station, Unit 2 Exelon Generation Co., LLC Delta, PA (17.9 miles S of Lancaster, PA) 05000277 www.nrc.gov/info-finder/reactor/pb2.html	I	BWR-MARK 1 GE 4 BECH BECH	3,514	01/31/1968	101
				10/25/1973	89
				07/05/1974	102
				05/07/2003	92
				08/08/2033	101
88					
Peach Bottom Atomic Power Station, Unit 3 Exelon Generation Co., LLC Delta, PA (17.9 miles S of Lancaster, PA) 05000278 www.nrc.gov/info-finder/reactor/pb3.html	I	BWR-MARK 1 GE 4 BECH BECH	3,514	01/31/1968	93
				07/02/1974	99
				12/23/1974	89
				05/07/2003	100
				07/02/2034	90
103					
Perry Nuclear Power Plant, Unit 1 FirstEnergy Nuclear Operating Co. Perry, OH (35 miles NE of Cleveland, OH) 05000440 www.nrc.gov/info-finder/reactor/perr1.html	III	BWR-MARK 3 GE 6 GIL KAIS	3,758	05/03/1977	75
				11/13/1986	98
				11/18/1987	67
				N/A	98
				03/18/2026	79
92					
Pilgrim Nuclear Power Station Entergy Nuclear Operations, Inc. Plymouth, MA (38 miles SE of Boston, MA) 05000293 www.nrc.gov/info-finder/reactor/pilg.html	I	BWR-MARK 1 GE 3 BECH BECH	2,028	08/26/1968	85
				06/08/1972	97
				12/01/1972	90
				05/29/2012	99
				06/08/2032	85
98					
Point Beach Nuclear Plant, Unit 1 NextEra Energy Point Beach, LLC Two Rivers, WI (13 miles NW of Manitowoc, WI) 05000266 www.nrc.gov/info-finder/reactor/poin1.html	III	PWR-DRYAMB WEST 2LP BECH BECH	1,800	07/19/1967	85
				10/05/1970	87
				12/21/1970	98
				12/22/2005	88
				10/05/2030	79
100					



## APPENDIX A

### U.S. Commercial Nuclear Power Reactors Operating Reactors (continued)

Plant Name, Unit Number Licensee Location Docket Number NRC Web Page Address	NRC Region	Con Type NSSS		Licensed MwT	CP Issued	2007– 2012**
		Architect	Engineer		OL Issued Comm. Op.	Capacity Factor
		Constructor			LR Issued Exp. Date	(Percent)
Point Beach Nuclear Plant, Unit 2 NextEra Energy Point Beach, LLC Two Rivers, WI (13 miles NW of Manitowoc, WI) 05000301 <a href="http://www.nrc.gov/info-finder/reactor/poin2.html">www.nrc.gov/info-finder/reactor/poin2.html</a>	III	PWR-DRYAMB		1,800	07/25/1968	99
		WEST 2LP			03/08/1973 <sup>E</sup>	89
		BECH			10/01/1972	84
		BECH			12/22/2005	96
					03/08/2033	67
						89
Prairie Island Nuclear Generating Plant, Unit 1 Northern States Power Co.—Minnesota Welch, MN (28 miles SE of Minneapolis, MN) 05000282 <a href="http://www.nrc.gov/info-finder/reactor/prai1.html">www.nrc.gov/info-finder/reactor/prai1.html</a>	III	PWR-DRYAMB		1,677	06/25/1968	92
		WEST 2LP			04/05/1974 <sup>F</sup>	84
		FLUR			12/16/1973	97
		NSP			06/27/2011	96
					08/09/2033	91
						81
Prairie Island Nuclear Generating Plant, Unit 2 Northern States Power Co.—Minnesota Welch, MN (28 miles SE of Minneapolis, MN) 05000306 <a href="http://www.nrc.gov/info-finder/reactor/prai2.html">www.nrc.gov/info-finder/reactor/prai2.html</a>	III	PWR-DRYAMB		1,677	06/25/1968	93
		WEST 2LP			10/29/1974	85
		FLUR			12/21/1974	75
		NSP			06/27/2011	86
					10/29/2034	99
						74
Quad Cities Nuclear Power Station, Unit 1 Exelon Generation Co., LLC Cordova, IL (20 miles NE of Moline, IL) 05000254 <a href="http://www.nrc.gov/info-finder/reactor/quad1.html">www.nrc.gov/info-finder/reactor/quad1.html</a>	III	BWR-MARK 1		2,957	02/15/1967	92
		GE 3			12/14/1972	96
		S&L			02/18/1973	82
		UE&C			10/28/2004	99
					12/14/2032	92
						102
Quad Cities Nuclear Power Station, Unit 2 Exelon Generation Co., LLC Cordova, IL (20 miles NE of Moline, IL) 05000265 <a href="http://www.nrc.gov/info-finder/reactor/quad2.html">www.nrc.gov/info-finder/reactor/quad2.html</a>	III	BWR-MARK 1		2,957	02/15/1967	99
		GE 3			12/14/1972	86
		S&L			03/10/1973	91
		UE&C			10/28/2004	92
					12/14/2032	104
						92
River Bend Station, Unit 1 Entergy Operations, Inc. St. Francisville, LA (24 miles NW of Baton Rouge, LA) 05000458 <a href="http://www.nrc.gov/info-finder/reactor/rbs1.html">www.nrc.gov/info-finder/reactor/rbs1.html</a>	IV	BWR-MARK 3		3,091	03/25/1977	85
		GE 6			11/20/1985	82
		S&W			06/16/1986	113
		S&W			N/A	98
					08/29/2025	90
						91

E: AEC issued a provisional OL on 11/18/1971. The NRC issued a full-term OL on 03/08/1973.

F: AEC issued a provisional OL on 08/09/1973. The NRC issued a full-term OL on 04/05/1974.



## APPENDIX A

### U.S. Commercial Nuclear Power Reactors

#### Operating Reactors (continued)

Plant Name, Unit Number Licensee Location Docket Number NRC Web Page Address	NRC Region	Con Type NSSS		Licensed MwT	CP Issued	2007–
		Architect	Engineer		OL Issued	2012**
		Constructor			Comm. Op.	Factor
					LR Issued	(Percent)
					Exp. Date	
R.E. Ginna Nuclear Power Plant R.E. Ginna Nuclear Power Plant, LLC Ontario, NY (20 miles NE of Rochester, NY) 05000244 <a href="http://www.nrc.gov/info-finder/reactor/ginn.html">www.nrc.gov/info-finder/reactor/ginn.html</a>	I	PWR-DRYAMB	WEST 2LP	1,775	04/25/1966	113
		GIL			09/19/1969	109
		BECH			07/01/1970	91
					05/19/2004	97
					09/18/2029	84
						90
St. Lucie Plant, Unit 1 Florida Power & Light Co. Jensen Beach, FL (10 miles SE of Ft. Pierce, FL) 05000335 <a href="http://www.nrc.gov/info-finder/reactor/stl1.html">www.nrc.gov/info-finder/reactor/stl1.html</a>	II	PWR-DRYAMB	CE	3,020	07/01/1970	85
		EBSO			03/01/1976	91
		EBSO			12/21/1976	100
		EBSO			10/02/2003	72
					03/01/2036	85
						72
St. Lucie Plant, Unit 2 Florida Power & Light Co. Jensen Beach, FL (10 miles SE of Ft. Pierce, FL) 05000389 <a href="http://www.nrc.gov/info-finder/reactor/stl2.html">www.nrc.gov/info-finder/reactor/stl2.html</a>	II	PWR-DRYAMB	CE	3,020	05/02/1977	70
		EBSO			06/10/1983	99
		EBSO			08/08/1983	80
		EBSO			10/02/2003	100
					04/06/2043	66
						68
Salem Nuclear Generating Station, Unit 1 PSE&G Nuclear, LLC Hancocks Bridge, NJ (18 miles SE of Wilmington, DE) 05000272 <a href="http://www.nrc.gov/info-finder/reactor/salm1.html">www.nrc.gov/info-finder/reactor/salm1.html</a>	I	PWR-DRYAMB	WEST 4LP	3,459	09/25/1968	89
		PSEG			12/01/1976	91
		UE&C			06/30/1977	99
					06/30/2011	85
					08/13/2036	86
						97
Salem Nuclear Generating Station, Unit 2 PSE&G Nuclear, LLC Hancocks Bridge, NJ (18 miles SE of Wilmington, DE) 05000311 <a href="http://www.nrc.gov/info-finder/reactor/salm2.html">www.nrc.gov/info-finder/reactor/salm2.html</a>	I	PWR-DRYAMB	WEST 4LP	3,459	09/25/1968	98
		PSEG			05/20/1981	83
		UE&C			10/13/1981	93
					06/30/2011	98
					04/18/2040	89
						88
Seabrook Station, Unit 1 NextEra Energy Seabrook, LLC Seabrook, NH (13 miles S of Portsmouth, NH) 05000443 <a href="http://www.nrc.gov/info-finder/reactor/seab1.html">www.nrc.gov/info-finder/reactor/seab1.html</a>	I	PWR-DRYAMB	WEST 4LP	3,648	07/07/1976	99
		UE&C			03/15/1990	89
		UE&C			08/19/1990	81
					N/A	100
					03/15/2030	77
						75
Sequoyah Nuclear Plant, Unit 1 Tennessee Valley Authority Soddy-Daisy, TN (16 miles NE of Chattanooga, TN) 05000327 <a href="http://www.nrc.gov/info-finder/reactor/seq1.html">www.nrc.gov/info-finder/reactor/seq1.html</a>	II	PWR-ICECND	WEST 4LP	3,455	05/27/1970	87
		TVA			09/17/1980	101
		TVA			07/01/1981	89
					N/A	84
					09/17/2020	98
						89



## APPENDIX A

### U.S. Commercial Nuclear Power Reactors Operating Reactors (continued)

Plant Name, Unit Number Licensee Location Docket Number NRC Web Page Address	NRC Region	Con Type NSSS Architect Engineer Constructor	Licensed MВт	CP Issued OL Issued Comm. Op. LR Issued Exp. Date	2007– 2012** Capacity Factor (Percent)
Sequoyah Nuclear Plant, Unit 2 Tennessee Valley Authority Soddy-Daisy, TN (16 miles NE of Chattanooga, TN) 05000328 <a href="http://www.nrc.gov/info-finder/reactor/seq2.html">www.nrc.gov/info-finder/reactor/seq2.html</a>	II	PWR-ICECND WEST 4LP TVA TVA	3,455	05/27/1970	100
				09/15/1981	89
				06/01/1982	89
				N/A	97
				09/15/2021	89
77					
Shearon Harris Nuclear Power Plant, Unit 1 Carolina Power & Light Co. New Hill, NC (20 miles SW of Raleigh, NC) 05000400 <a href="http://www.nrc.gov/info-finder/reactor/har1.html">www.nrc.gov/info-finder/reactor/har1.html</a>	II	PWR-DRYAMB WEST 3LP EBSO DANI	2,900	01/27/1978	94
				10/24/1986	99
				05/02/1987	94
				12/17/2008	90
				10/24/2046	103
90					
South Texas Project, Unit 1 STP Nuclear Operating Co. Bay City, TX (90 miles SW of Houston, TX) 05000498 <a href="http://www.nrc.gov/info-finder/reactor/stp1.html">www.nrc.gov/info-finder/reactor/stp1.html</a>	IV	PWR-DRYAMB WEST 4LP BECH EBSO	3,853	12/22/1975	105
				03/22/1988	95
				08/25/1988	90
				N/A	101
				08/20/2027	94
93					
South Texas Project, Unit 2 STP Nuclear Operating Co. Bay City, TX (90 miles SW of Houston, TX) 05000499 <a href="http://www.nrc.gov/info-finder/reactor/stp2.html">www.nrc.gov/info-finder/reactor/stp2.html</a>	IV	PWR-DRYAMB WEST 4LP BECH EBSO	3,853	12/22/1975	93
				03/28/1989	95
				06/19/1989	101
				N/A	88
				12/15/2028	88
72					
Surry Power Station, Unit 1 Virginia Electric and Power Co. Surry, VA (17 miles NW of Newport News, VA) 05000280 <a href="http://www.nrc.gov/info-finder/reactor/sur1.html">www.nrc.gov/info-finder/reactor/sur1.html</a>	II	PWR-DRYSUB WEST 3LP S&W S&W	2,857	06/25/1968	89
				05/25/1972	98
				12/22/1972	94
				03/20/2003	89
				05/25/2032	101
92					
Surry Power Station, Unit 2 Virginia Electric and Power Co. Surry, VA (17 miles NW of Newport News, VA) 05000281 <a href="http://www.nrc.gov/info-finder/reactor/sur2.html">www.nrc.gov/info-finder/reactor/sur2.html</a>	II	PWR-DRYSUB WEST 3LP S&W S&W	2,857	06/25/1968	101
				01/29/1973	94
				05/01/1973	92
				03/20/2003	100
				01/29/2033	76
91					
Susquehanna Steam Electric Station, Unit 1 PPL Susquehanna, LLC Berwick (Luzerne County), PA (70 miles NE of Harrisburg, PA) 05000387 <a href="http://www.nrc.gov/info-finder/reactor/susq1.html">www.nrc.gov/info-finder/reactor/susq1.html</a>	I	BWR-MARK 2 GE 4 BECH BECH	3,952	11/03/1973	95
				07/17/1982	89
				06/08/1983	101
				11/24/2009	80
				07/17/2042	86
70					



## APPENDIX A

### U.S. Commercial Nuclear Power Reactors Operating Reactors (continued)

Plant Name, Unit Number Licensee Location Docket Number NRC Web Page Address	NRC Region	Con Type NSSS Architect Engineer Constructor	Licensed MWt	CP Issued OL Issued Comm. Op. LR Issued Exp. Date	2007– 2012** Capacity Factor (Percent)
Susquehanna Steam Electric Station, Unit 2 PPL Susquehanna, LLC Berwick (Luzerne County), PA (70 miles NE of Harrisburg, PA) 05000388 <a href="http://www.nrc.gov/info-finder/reactor/susq2.html">www.nrc.gov/info-finder/reactor/susq2.html</a>	I	BWR-MARK 2 GE 4 BECH BECH	3,952	11/03/1973	88
				03/23/1984	100
				02/12/1985	90
				11/24/2009	96
				03/23/2044	72
83					
Three Mile Island Nuclear Station, Unit 1 Exelon Generation Co., LLC Middletown, PA (10 miles SE of Harrisburg, PA) 05000289 <a href="http://www.nrc.gov/info-finder/reactor/tmi1.html">www.nrc.gov/info-finder/reactor/tmi1.html</a>	I	PWR-DRYAMB B&W LLP GIL UE&C	2,568	05/18/1968	97
				04/19/1974	107
				09/02/1974	86
				10/22/2009	94
				04/19/2034	92
100					
Turkey Point Nuclear Generating, Unit 3 Florida Power & Light Co. Homestead, FL (20 miles S of Miami, FL) 05000250 <a href="http://www.nrc.gov/info-finder/reactor/tp3.html">www.nrc.gov/info-finder/reactor/tp3.html</a>	II	PWR-DRYAMB WEST 3LP BECH BECH	2,644	04/27/1967	97
				07/19/1972	101
				12/14/1972	86
				06/06/2002	88
				07/19/2032	96
40					
Turkey Point Nuclear Generating, Unit 4 Florida Power & Light Co. Homestead, FL (20 miles S of Miami, FL) 05000251 <a href="http://www.nrc.gov/info-finder/reactor/tp4.html">www.nrc.gov/info-finder/reactor/tp4.html</a>	II	PWR-DRYAMB WEST 3LP BECH BECH	2,644	04/27/1967	86
				04/10/1973	89
				09/07/1973	99
				06/06/2002	98
				04/10/2033	84
85					
Vermont Yankee Nuclear Power Station Entergy Nuclear Operations, Inc. Vernon, VT (5 miles S of Brattleboro, VT) 05000271 <a href="http://www.nrc.gov/info-finder/reactor/vy.html">www.nrc.gov/info-finder/reactor/vy.html</a>	I	BWR-MARK 1 GE 4 EBSO EBSO	1,912	12/11/1967	87
				03/21/1972	89
				11/30/1972	99
				03/21/2011	88
				03/21/2032	90
92					
Virgil C. Summer Nuclear Station, Unit 1 South Carolina Electric & Gas Co. Jenkinsville, SC (26 miles NW of Columbia, SC) 05000395 <a href="http://www.nrc.gov/info-finder/reactor/sum.html">www.nrc.gov/info-finder/reactor/sum.html</a>	II	PWR-DRYAMB WEST 3LP GIL DANI	2,900	03/21/1973	85
				11/12/1982	87
				01/01/1984	81
				04/23/2004	100
				08/06/2042	88
86					
Vogtle Electric Generating Plant, Unit 1 Southern Nuclear Operating Co., Inc. Waynesboro, GA (26 miles SE of Augusta, GA) 05000424 <a href="http://www.nrc.gov/info-finder/reactor/vog1.html">www.nrc.gov/info-finder/reactor/vog1.html</a>	II	PWR-DRYAMB WEST 4LP SGEC GPC	3,625.6	06/28/1974	99
				03/16/1987	93
				06/01/1987	91
				06/03/2009	102
				01/16/2047	92
91					



**APPENDIX A**  
**U.S. Commercial Nuclear Power Reactors**  
**Operating Reactors (continued)**

Plant Name, Unit Number Licensee Location Docket Number NRC Web Page Address	NRC Region	Con Type NSSS Architect Engineer Constructor	Licensed MWt	CP Issued OL Issued Comm. Op. LR Issued Exp. Date	2007- 2012** Capacity Factor (Percent)
Vogtle Electric Generating Plant, Unit 2 Southern Nuclear Operating Co., Inc. Waynesboro, GA (26 miles SE of Augusta, GA) 05000425 www.nrc.gov/info-finder/reactor/vog2.html	II	PWR-DRYAMB WEST 4LP SBEC GPC	3,625.6	06/28/1974	83
				03/31/1989	88
				05/20/1989	101
				06/03/2009	93
				02/09/2049	94
102					
Waterford Steam Electric Station, Unit 3 Entergy Operations, Inc. Killona, LA (25 miles W of New Orleans, LA) 05000382 www.nrc.gov/info-finder/reactor/wat3.html	IV	PWR-DRYAMB COMB CE EBSO EBSO	3,716	11/14/1974	98
				03/16/1985	89
				09/24/1985	87
				N/A	100
				12/18/2024	82
77					
Watts Bar Nuclear Plant, Unit 1 Tennessee Valley Authority Spring City, TN (60 miles SW of Knoxville, TN) 05000390 www.nrc.gov/info-finder/reactor/wb1.html	II	PWR-ICECND WEST 4LP TVA TVA	3,459	01/23/1973	102
				02/07/1996	82
				05/27/1996	94
				N/A	99
				11/09/2035	84
87					
Wolf Creek Generating Station, Unit 1 Wolf Creek Nuclear Operating Corp. Burlington (Coffey County), KS (28 miles SE of Emporia, KS) 05000482 www.nrc.gov/info-finder/reactor/wc.html	IV	PWR-DRYAMB WEST 4LP BECH DANI	3,565	05/31/1977	102
				06/04/1985 <sup>H</sup>	83
				09/03/1985	86
				11/20/2008	86
				03/11/2045	72
80					

H: The original OL (NPF-32) was issued on 03/11/1985. The license was superceded by OL (NPF-42) issued on 06/04/1985.





## APPENDIX A

### U.S. Commercial Nuclear Power Reactors Operating Reactors (continued)

#### UNDER ACTIVE CONSTRUCTION OR DEFERRED POLICY

Plant Name, Unit Number Licensee Location Docket Number NRC Web Page Address	NRC Region	Con Type NSSS Architect Engineer Constructor	Licensed MWt	CP Issued OL Issued Comm. Op. LR Issued Exp. Date	2007- 2012** Capacity Factor (Percent)
Bellefonte Nuclear Power Station, Unit 1*** Tennessee Valley Authority (6 miles NE of Scottsboro, AL) 05000438	II	PWR-DRYAMB B&W 205 TVA TVA	3,763	12/24/1974	N/A
Bellefonte Nuclear Power Station, Unit 2*** Tennessee Valley Authority (6 miles NE of Scottsboro, AL) 05000439	II	PWR-DRYAMB B&W 205 TVA TVA	3,763	12/24/1974	N/A
Watts Bar Nuclear Plant, Unit 2**** Tennessee Valley Authority Spring City, TN (60 miles SW of Knoxville, TN) 05000391 <a href="http://www.nrc.gov/info-finder/reactor/wb/watts-bar.html">www.nrc.gov/info-finder/reactor/wb/watts-bar.html</a>	II	PWR-ICECND WEST 4LP TVA TVA	3,411	01/23/1973	N/A
Virgil C. Summer Nuclear Station, Unit 2 South Carolina Electric & Gas Co. South Carolina Public Service Auth. Jenkinsville (Fairfield County), SC (26 miles NW of Columbia, SC) NPF-93	II	PWR AP1000 WEST SHAW	3,400	03/30/2012	N/A
Virgil C. Summer Nuclear Station, Unit 3 South Carolina Electric & Gas Co. South Carolina Public Service Auth. Jenkinsville (Fairfield County), SC (26 miles NW of Columbia, SC) NPF-94	II	PWR AP1000 WEST SHAW	3,400	03/30/2012	N/A
Vogtle Electric Generating Plant, Unit 3 Southern Nuclear Operating Co., Inc. Waynesboro (Burke County), GA (26 miles SE of Augusta, GA) NPF-91	II	PWR AP1000 WEST SHAW	3,400	02/10/2012	N/A
Vogtle Electric Generating Plant, Unit 4 Southern Nuclear Operating Co., Inc. Waynesboro, (Burke County), GA (26 miles SE of Augusta, GA) NPF-92	II	PWR AP1000 WEST SHAW	3,400	02/10/2012	N/A

\* Note: Plant names are as identified on the license as of August 2013.

\*\* Average capacity factor is listed in year order starting with 2007.

\*\*\*Bellefonte Units 1 and 2 are under the Commission Policy Statement on Deferred Plants (62 FR 38077; October 14, 1997).

\*\*\*\*Watts Bar Unit 2 is currently under active construction.

Source: NRC, with some data compiled from EIA/DOE



## APPENDIX B

### U.S. New Nuclear Power Plant Applications

Company (Project/Docket #)	Date of Application	Design	Date Accepted	Site Under Consideration	State	Existing Plant
NRG Energy (52-012/013)	9/20/07	ABWR	11/29/07	South Texas Project (2 units)	TX	Y
NuStart Energy (52-014/015)	10/30/07	AP1000	01/18/08	Bellefonte (2 units)	AL	N
UNISTAR (52-016)	7/13/07 (Env.), 3/13/08 (Safety)	EPR	01/25/08  06/03/08	Calvert Cliffs (1 unit)	MD	Y
Dominion (52-017)*	11/27/07	ESBWR	01/28/08	North Anna (1 unit)	VA	Y
Duke (52-018/019)	12/13/07	AP1000	02/25/08	William Lee Nuclear Station (2 units)	SC	N
Progress Energy (52-022/023)	2/19/08	AP1000	04/17/08	Harris (2 units)	NC	Y
NuStart Energy (52-024)	2/27/08	ESBWR	04/17/08	Grand Gulf (1 unit)	MS	Y
Southern Nuclear Operating Co. (52-025/026)	3/31/08	AP1000	05/30/08	Vogtle (2 units)	GA	Y
South Carolina Electric & Gas (52-027/028)	3/31/08	AP1000	07/31/08	Summer (2 units)	SC	Y
Progress Energy (52-029/030)	7/30/08	AP1000	10/06/08	Levy County (2 units)	FL	N
Detroit Edison (52-033)	9/18/08	ESBWR	11/25/08	Fermi (1 unit)	MI	Y
Luminant Power (52-034/035)	9/19/08	US-APWR	12/02/08	Comanche Peak (2 units)	TX	Y
Entergy (52-036)	9/25/08	ESBWR	12/04/08	River Bend (1 unit)	LA	Y
AmerenUE (52-037)	7/24/08	EPR	12/12/08	Callaway (1 unit)	MO	Y
UNISTAR (52-038)	9/30/08	EPR	12/12/08	Nine Mile Point (1 unit)	NY	Y
PPL Generation (52-039)	10/10/08	EPR	12/19/08	Bell Bend (1 unit)	PA	Y
Florida Power & Light Co. (52-040/041)	6/30/09	AP1000	09/04/09	Turkey Point (2 units)	FL	Y
Blue Castle Project		TBD		Utah (1 unit)	UT	N
AmerenUE		TBD		Callaway (1 unit)	MO	Y

\* Design technology was changed by the applicant on April 25, 2013.

Note: Application updates in this table do not show all projects previously mentioned because of changes in intent status or conversion to an ESP from a COL application. Data are shown as of June 2013.



## APPENDIX C

### U.S. Commercial Nuclear Power Reactors Undergoing Decommissioning and Permanently Shut Down Formerly Licensed To Operate

Unit Location Docket Number	Reactor Type MWt	NSSS Vendor	OL Issued Shut Down OL Terminated	Decommissioning Alternative Selected Current Status
Big Rock Point Charlevoix, MI 05000155	BWR 240	GE	05/01/1964 08/29/1997	DECON DECON Completed
GE Bonus* Punta Higuera, PR	BWR 50	CE	04/02/1964 06/01/1968	ENTOMB ENTOMB
Crystal River 3 Crystal River, FL 05000302	PWR 2,609	B&W LLP	12/03/1976 02/20/2013	DECON SAFSTOR In Progress
CVTR** Parr, SC 05000144	PTHW 65	WEST	11/27/1962 01/01/1967	DECON DECON Completed
Dresden 1 Morris, IL 0500010	BWR 700	GE	09/28/1959 10/31/1978	SAFSTOR SAFSTOR
Elk River* Elk River, MN 05000115	BWR 58	AC/S&L	11/06/1962 02/01/1968	DECON DECON Completed
Fermi 1 Newport, MI 05000016	SCF 200	CE	05/10/1963 09/22/1972	DECON SAFSTOR
Fort St. Vrain Platteville, CO 05000267	HTG 842	GA	12/21/1973 08/18/1989	DECON DECON Completed
GE VBWR Sunol, CA 05000017	BWR 50	GE	08/31/1957 12/09/1963	SAFSTOR SAFSTOR
Haddam Neck Meriden, CT 05000213	PWR 1,825	WEST	12/27/1974 12/05/1996	DECON DECON Completed

\* Boiling Nuclear Superheater Power Station

\*\* Carolina Virginia Tube Reactor



## APPENDIX C

### U.S. Commercial Nuclear Power Reactors Undergoing Decommissioning and Permanently Shut Down Formerly Licensed To Operate (continued)

Unit Location Docket Number	Reactor Type MWt	NSSS Vendor	OL Issued Shut Down OL Terminated	Decommissioning Alternative Selected Current Status
Hallam* Hallam, NE	SCGM 256	BLH	01/02/1962 09/01/1964	ENTOMB ENTOMB
NS Savannah Baltimore, MD 05000238	PWR 74	B&W	08/1965 11/1970	SAFSTOR SAFSTOR
Humboldt Bay 3 Eureka, CA 05000133	BWR 200	GE	08/28/1962 07/02/1976	DECON DECON In Progress
Kewaunee Carlton, WI 05000305	PWR 1,772	WEST 2LP	12/21/1973 05/07/2013	DECON SAFSTOR In Progress
Indian Point 1 Buchanan, NY 05000003	PWR 615	B&W	03/26/1962 10/31/1974	SAFSTOR SAFSTOR
La Crosse Genoa, WI 05000409	BWR 165	AC	07/03/1967 04/30/1987	SAFSTOR DECON In Progress
Maine Yankee Wiscasset, ME 05000309	PWR 2,700	CE	06/29/1973 12/06/1996	DECON DECON Completed
Millstone 1 Waterford, CT 05000245	BWR 2,011	GE	10/31/1970 07/21/1998	SAFSTOR SAFSTOR
Pathfinder Sioux Falls, SD 05000130	BWR 190	AC	03/12/1964 09/16/1967	DECON DECON Completed
Peach Bottom 1 Delta, PA 05000171	HTG 115	GA	01/24/1966 10/31/1974	SAFSTOR SAFSTOR
Piqua* Piqua, OH	OCM 46	AI	08/23/1962 01/01/1966	ENTOMB ENTOMB



## APPENDIX C

### U.S. Commercial Nuclear Power Reactors Undergoing Decommissioning and Permanently Shut Down Formerly Licensed To Operate (continued)

Unit Location Docket Number	Reactor Type MwT	NSSS Vendor	OL Issued Shut Down OL Terminated	Decommissioning Alternative Selected Current Status
Rancho Seco*** Herald, CA 05000312	PWR 2,772	B&W	08/16/1974 06/07/1989	DECON DECON Completed
San Onofre 1**** San Clemente, CA 05000216	PWR 1,347	WEST	03/27/1967 11/30/1992	DECON SAFSTOR
San Onofre 2 San Clemente, CA 05000361	PWR CE 3,438	CE	02/16/1982 06/12/2013	DECON SAFSTOR In Progress
San Onofre 3 San Clemente, CA 05000362	PWR CE 3,438	CE	11/15/1982 06/12/2013	DECON SAFSTOR In Progress
Saxton Saxton, PA 05000146	PWR 23.5	WEST	11/15/1961 05/01/1972	DECON DECON Completed
Shippingport* Shippingport, PA	PWR 236	WEST	N/A 1982	DECON DECON Completed
Shoreham Wading River, NY 05000322	BWR 2,436	GE	04/21/1989 06/28/1989	DECON DECON Completed
Three Mile Island 2 Middletown, PA 05000320	PWR 2,770	B&W	02/08/1978 03/28/1979	(1)
Trojan Rainier, OR 05000344	PWR 3,411	WEST	11/21/1975 11/09/1992	DECON DECON Completed
Yankee-Rowe Rowe, MA 05000029	PWR 600	WEST	12/24/1963 10/01/1991	DECON DECON Completed



## APPENDIX C

### U.S. Commercial Nuclear Power Reactors Undergoing Decommissioning and Permanently Shut Down Formerly Licensed To Operate (continued)

Unit Location Docket Number	Reactor Type MВт	NSSS Vendor	OL Issued Shut Down OL Terminated	Decommissioning Alternative Selected Current Status
Zion 1 Zion, IL 05000295	PWR 3,250	WEST	10/19/1973 02/21/1997	DECON DECON In Progress
Zion 2 Zion, IL 05000304	PWR 3,250	WEST	11/14/1973 09/19/1996	DECON DECON In Progress

\* AEC/DOE owned; not regulated by the NRC.

\*\* Byproduct license from the State of South Carolina was terminated.

\*\*\* Low-Level radiation waste storage remains licensed by the NRC.

\*\*\*\* Site has been decommissioned with exception of reactor vessel in long-term storage.

Notes: See Glossary for definitions of decommissioning alternatives (DECON, ENTOMB, SAFSTOR).

(1) Three Mile Island Unit 2 has been placed in a postdefueling monitored storage mode until Unit 1 permanently ceases operation, at which time both units are planned to be decommissioned.

Source: DOE Integrated Database for 1990, "U.S. Spent Fuel and Radioactive Waste, Inventories, Projections, and Characteristics" (DOE/RW-0006, Rev. 6), and NRC, "Nuclear Power Plants in the World," Edition 6



## APPENDIX D

### Cancelled U.S. Commercial Nuclear Power Reactors

Unit Utility Location	Con Type MWe per Unit	Cancelled Date Status Docket Number
Allens Creek 1 Houston Lighting & Power Company 4 miles NW of Wallis, TX	BWR 1,150	1982 Under CP Review 05000466
Allens Creek 2 Houston Lighting & Power Company 4 miles NW of Wallis, TX	BWR 1,150	1976 Under CP Review 05000467
Atlantic 1 & 2 Public Service Electric & Gas Company Floating Plants off the Coast of NJ	PWR 1,150	1978 Under CP Review 05000477 & 478
Bailly 1 Northern Indiana Public Service Company 12 miles NNE of Gary, IN	BWR 645	1981 With CP 05000367
Barton 1 & 2 Alabama Power & Light 15 miles SE of Clanton, AL	BWR 1,159	1977 Under CP Review 05000524 & 525
Barton 3 & 4 Alabama Power & Light 15 miles SE of Clanton, AL	BWR 1,159	1975 Under CP Review 05000526 & 527
Black Fox 1 & 2 Public Service Company of Oklahoma 3.5 miles S of Inola, OK	BWR 1,150	1982 Under CP Review 05000556 & 557
Blue Hills 1 & 2 Gulf States Utilities Company SW tip of Toledo Bend Reservoir, TX	PWR 918	1978 Under CP Review 05000510 & 511
Callaway 2 Union Electric Company 25 miles ENE of Jefferson City, MO	PWR 1,150	1981 With CP 05000486
Cherokee 1 Duke Power Company 6 miles SSW of Blacksburg, SC	PWR 1,280	1983 With CP 05000491
Cherokee 2 & 3 Duke Power Company 6 miles SSW of Blacksburg, SC	PWR 1,280	1982 With CP 05000492 & 493
Clinch River Project Management Corp., DOE, TVA 23 miles W of Knoxville, in Oak Ridge, TN	LMFB 350	1983 Under CP Review 05000537



## APPENDIX D

### Cancelled U.S. Commercial Nuclear Power Reactors (continued)

Unit Utility Location	Con Type MWe per Unit	Cancelled Date Status Docket Number
Clinton 2 Illinois Power Company 6 miles E of Clinton, IL	BWR 933	1983 With CP 05000462
Davis-Besse 2 & 3 Toledo Edison Company 21 miles ESE of Toledo, OH	PWR 906	1981 Under CP Review 05000500 & 501
Douglas Point 1 & 2 Potomac Electric Power Company Charles County, MD	BWR 1,146	1977 Under CP Review 05000448 & 449
Erie 1 & 2 Ohio Edison Company Berlin, OH	PWR 1,260	1980 Under CP Review 05000580 & 581
Forked River 1 Jersey Central Power & Light Company 2 miles S of Forked River, NJ	PWR 1,070	1980 With CP 05000363
Fort Calhoun 2 Omaha Public Power District 19 miles N of Omaha, NE	PWR 1,136	1977 Under CP Review 05000548
Fulton 1 & 2 Philadelphia Electric Company 17 miles S of Lancaster, PA	HTG 1,160	1975 Under CP Review 05000463 & 464
Grand Gulf 2 Entergy Nuclear Operations, Inc. 20 miles SW of Vicksburg, MS	BWR 1,250	1990 With CP 05000417
Greene County Power Authority of the State of NY 20 miles N of Kingston, NY	PWR 1,191	1980 Under CP Review 05000549
Greenwood 2 & 3 Detroit Edison Company Greenwood Township, MI	PWR 1,200	1980 Under CP Review 05000452 & 453
Hartsville A1 & A2 Tennessee Valley Authority 5 miles SE of Hartsville, TN	BWR 1,233	1984 With CP 05000518 & 519
Hartsville B1 & B2 Tennessee Valley Authority 5 miles SE of Hartsville, TN	BWR 1,233	1982 With CP 05000520 & 521





## APPENDIX D

### Cancelled U.S. Commercial Nuclear Power Reactors (continued)

Unit Utility Location	Con Type MWe per Unit	Cancelled Date Status Docket Number
Haven 1 (formerly Koshkonong) Wisconsin Electric Power Company 4.2 miles SSW of Fort Atkinson, WI	PWR 900	1980 Under CP Review 05000502
Haven 2 (formerly Koshkonong) Wisconsin Electric Power Company 4.2 miles SSW of Fort Atkinson, WI	PWR 900	1978 Under CP Review 05000503
Hope Creek 2 Public Service Electric & Gas Company 18 miles SE of Wilmington, DE	BWR 1,067	1981 With CP 05000355
Jamesport 1 & 2 Long Island Lighting Company 65 miles E of New York City, NY	PWR 1,150	1980 With CP 05000516 & 517
Marble Hill 1 & 2 Public Service of Indiana 6 miles NE of New Washington, IN	PWR 1,130	1985 With CP 05000546 & 547
Midland 1 Consumers Power Company S of City of Midland, MI	PWR 492	1986 With CP 05000329
Midland 2 Consumers Power Company S of City of Midland, MI	PWR 818	1986 With CP 05000330
Montague 1 & 2 Northeast Nuclear Energy Company 1.2 miles SSE of Turners Falls, MA	BWR 1,150	1980 Under CP Review 05000496 & 497
New England 1 & 2 New England Power Company 8.5 miles E of Westerly, RI	PWR 1,194	1979 Under CP Review 05000568 & 569
New Haven 1 & 2 New York State Electric & Gas Corporation 3 miles NW of New Haven, NY	PWR 1,250	1980 Under CP Review 05000596 & 597
North Anna 3 Virginia Electric & Power Company 40 miles NW of Richmond, VA	PWR 907	1982 With CP 05000404
North Anna 4 Virginia Electric & Power Company 40 miles NW of Richmond, VA	PWR 907	1980 With CP 05000405



## APPENDIX D

### Cancelled U.S. Commercial Nuclear Power Reactors (continued)

Unit Utility Location	Con Type MWe per Unit	Cancelled Date Status Docket Number
North Coast 1 Puerto Rico Water Resources Authority 4.7 miles ESE of Salinas, PR	PWR 583	1978 Under CP Review 05000376
Palo Verde 4 & 5 Arizona Public Service Company 36 miles W of Phoenix, AZ	PWR 1,270	1979 Under CP Review 05000592 & 593
Pebble Springs 1 & 2 Portland General Electric Company 55 miles WSW of Tri Cities (Kenewick-Pasco-Richland, WA), OR	PWR 1,260	1982 Under CP Review 05000514 & 515
Perkins 1, 2, & 3 Duke Power Company 10 miles N of Salisbury, NC	PWR 1,280	1982 Under CP Review 05000488 & 489 & 490
Perry 2 Cleveland Electric Illuminating Co. 35 miles NE of Cleveland, OH	BWR 1,205	1994 Under CP Review 05000441
Phipps Bend 1 & 2 Tennessee Valley Authority 15 miles SW of Kingsport, TN	BWR 1,220	1982 With CP 05000553 & 554
Pilgrim 2 Boston Edison Company 4 miles SE of Plymouth, MA	PWR 1,180	1981 Under CP Review 05000471
Pilgrim 3 Boston Edison Company 4 miles SE of Plymouth, MA	PWR 1,180	1974 Under CP Review 05000472
Quanicassee 1 & 2 Consumers Power Company 6 miles E of Essexville, MI	PWR 1,150	1974 Under CP Review 05000475 & 476
River Bend 2 Gulf States Utilities Company 24 miles NNW of Baton Rouge, LA	BWR 934	1984 With CP 05000459
Seabrook 2 Public Service Co. of New Hampshire 13 miles S of Portsmouth, NH	PWR 1,198	1988 With CP 05000444
Shearon Harris 2 Carolina Power & Light Company 20 miles SW of Raleigh, NC	PWR 900	1983 With CP 05000401



## APPENDIX D

### Cancelled U.S. Commercial Nuclear Power Reactors (continued)

Unit Utility Location	Con Type MWe per Unit	Cancelled Date Status Docket Number
Shearon Harris 3 & 4 Carolina Power & Light Company 20 miles SW of Raleigh, NC	PWR 900	1981 With CP 05000402 & 403
Skagit/Hanford 1 & 2 Puget Sound Power & Light Company 23 miles SE of Bellingham, WA	PWR 1,277	1983 Under CP Review 05000522 & 523
Sterling Rochester Gas & Electric Corporation 50 miles E of Rochester, NY	PWR 1,150	1980 With CP 05000485
Summit 1 & 2 Delmarva Power & Light Company 15 miles SSW of Wilmington, DE	HTG 1,200	1975 Under CP Review 05000450 & 451
Sundesert 1 & 2 San Diego Gas & Electric Company 16 miles SW of Blythe, CA	PWR 974	1978 Under CP Review 05000582 & 583
Surry 3 & 4 Virginia Electric & Power Company 17 miles NW of Newport News, VA	PWR 882	1977 With CP 05000434 & 435
Tyrone 1 Northern States Power Company 8 miles NE of Durond, WI	PWR 1,150	1981 Under CP Review 05000484
Tyrone 2 Northern States Power Company 8 miles NE of Durond, WI	PWR 1,150	1974 With CP 05000487
Vogtle 3 & 4 Georgia Power Company 26 miles SE of Augusta, GA	PWR 1,113	1974 With CP 050000426 & 427
Washington Nuclear 1 (WPPSS) Energy Northwest 10 miles E of Aberdeen, WA	PWR 1,266	1995 With CP 05000460
Washington Nuclear 3 (WPPSS) Energy Northwest 16 miles E of Aberdeen, WA	PWR 1,242	1995 With CP 05000508
Washington Nuclear 4 (WPPSS) Energy Northwest 10 miles E of Aberdeen, WA	PWR 1,218	1982 With CP 05000513



## APPENDIX D

### Cancelled U.S. Commercial Nuclear Power Reactors (continued)

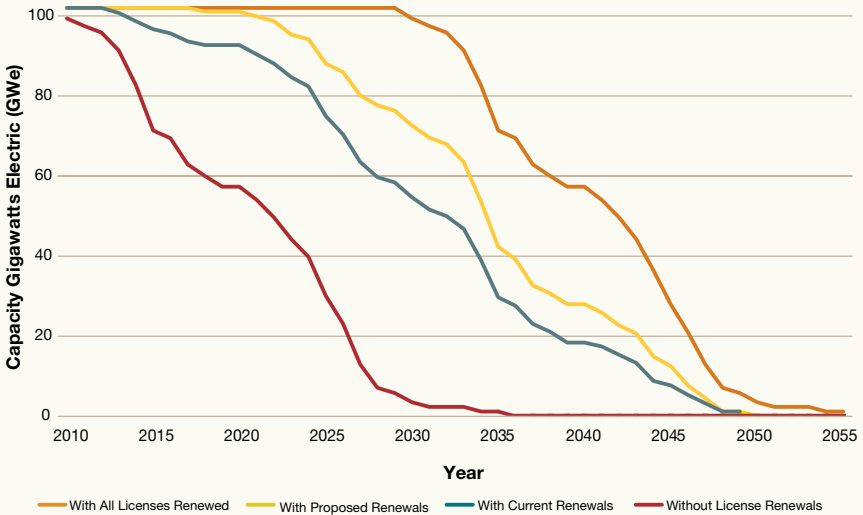
Unit Utility Location	Con Type MWe per Unit	Cancelled Date Status Docket Number
Washington Nuclear 5 (WPPSS) Energy Northwest 16 miles E of Aberdeen, WA	PWR 1,242	1982 With CP 05000509
Yellow Creek 1 & 2 Tennessee Valley Authority 15 miles E of Corinth, MS	BWR 1,285	1984 With CP 05000566 & 567
Zimmer 1 Cincinnati Gas & Electric Company 25 miles SE of Cincinnati, OH	BWR 810	1984 With CP 05000358

Note: Cancellation is defined as public announcement of cancellation or written notification to the NRC. Only NRC-docketed applications are included. Status is the status of the application at the time of cancellation.

Source: DOE/EIA Commercial Nuclear Power 1991 (DOE/EIA-0438), Appendix E (page 105), and the NRC

## APPENDIX E

### Projected Electric Capacity Dependent on License Renewals



## APPENDIX F

### U.S. Commercial Nuclear Power Reactors by Parent Company

Utility	NRC-Abbreviated Reactor Unit Name
AmerenUE <a href="http://www.ameren.com">www.ameren.com</a>	Callaway*
Arizona Public Service Company <a href="http://www.aps.com">www.aps.com</a>	Palo Verde 1, 2, & 3*
Constellation Energy <a href="http://www.constellation.com">www.constellation.com</a>	Calvert Cliffs 1 & 2 Ginna Nine Mile Point 1 & 2
DTE Electric Company (DTE) <a href="http://www.dteenergy.com">www.dteenergy.com</a>	Fermi 2
Dominion Generation <a href="http://www.dom.com">www.dom.com</a>	Kewaunee Millstone 2 & 3 North Anna 1 & 2 Surry 1 & 2
Duke Energy <a href="http://www.duke-energy.com">www.duke-energy.com</a>	Brunswick 1 & 2 Catawba 1 & 2 Crystal River 3 Harris 1 McGuire 1 & 2 Oconee 1, 2, & 3 Robinson 2
Energy Northwest <a href="http://www.energy-northwest.com">www.energy-northwest.com</a>	Columbia
Entergy Nuclear Operations, Inc. <a href="http://www.entergy-nuclear.com">www.entergy-nuclear.com</a>	Arkansas Nuclear One 1 & 2 FitzPatrick Grand Gulf 1 Indian Point 2 & 3 Palisades Pilgrim 1 River Bend 1 Vermont Yankee Waterford 3
Exelon Corporation, LLC <a href="http://www.exeloncorp.com">www.exeloncorp.com</a>	Braidwood 1 & 2 Byron 1 & 2 Clinton Dresden 2 & 3 LaSalle 1 & 2 Limerick 1 & 2 Oyster Creek Peach Bottom 2 & 3 Quad Cities 1 & 2 Three Mile Island 1



## APPENDIX F

### U.S. Commercial Nuclear Power Reactors by Parent Company (continued)

Utility	NRC-Abbreviated Reactor Unit Name
NextEra Energy, Inc. with principal subsidiaries Florida Power & Light Co. and NextEra Energy Resources, LLC <a href="http://www.firstenergycorp.com">www.firstenergycorp.com</a>	Beaver Valley 1 & 2 Davis-Besse Perry 1
FPL Group, Inc. <a href="http://www.fplgroup.com">www.fplgroup.com</a>	Duane Arnold Point Beach 1 & 2 Seabrook 1 St. Lucie 1 & 2 Turkey Point 3 & 4
Indiana Michigan Power Company <a href="http://www.indianamichiganpower.com">www.indianamichiganpower.com</a>	Cook 1 & 2
Luminant Generation Company, LLC <a href="http://www.luminant.com">www.luminant.com</a>	Comanche Peak 1 & 2*
Nebraska Public Power District <a href="http://www.nppd.com">www.nppd.com</a>	Cooper
Northern States Power, an Xcel Energy Operating Company <a href="http://www.xcelenergy.com">www.xcelenergy.com</a>	Monticello Prairie Island 1 & 2
Omaha Public Power District <a href="http://www.oppd.com">www.oppd.com</a>	Fort Calhoun
Pacific Gas & Electric Company <a href="http://www.pge.com">www.pge.com</a>	Diablo Canyon 1 & 2*
PPL Susquehanna, LLC <a href="http://www.pplweb.com">www.pplweb.com</a>	Susquehanna 1 & 2
PSEG Nuclear, LLC <a href="http://www.pseg.com">www.pseg.com</a>	Hope Creek 1 Salem 1 & 2
South Carolina Electric & Gas Company <a href="http://www.sceg.com">www.sceg.com</a>	Summer
Southern California Edison Company <a href="http://www.sce.com">www.sce.com</a>	San Onofre 2 & 3
Southern Nuclear Operating Company <a href="http://www.southerncompany.com">www.southerncompany.com</a>	Hatch 1 & 2 Farley 1 & 2 Vogtle 1 & 2
STP Nuclear Operating Company <a href="http://www.stpnoc.com">www.stpnoc.com</a>	South Texas Project 1 & 2*
Tennessee Valley Authority <a href="http://www.tva.gov">www.tva.gov</a>	Browns Ferry 1, 2, & 3 Sequoyah 1 & 2 Watts Bar 1
Wolf Creek Nuclear Operating Corporation <a href="http://www.wcnoc.com">www.wcnoc.com</a>	Wolf Creek 1*

\* These plants have a joint program called the Strategic Teaming and Resource Sharing (STARS) group. They share resources for refueling outages and develop some shared licensing applications.



## APPENDIX G

### U.S. Commercial Nuclear Power Reactor Operating Licenses— Issued by Year

<b>1969</b> Dresden 2 Ginna Nine Mile Point 1 Oyster Creek	Browns Ferry 2 Brunswick 2 Calvert Cliffs 1 Cooper	Hatch 2 North Anna 1	River Bend 1 Waterford 3 Wolf Creek 1
<b>1970</b> Point Beach 1 Robinson 2	Cook 1 Duane Arnold FitzPatrick Hatch 1	<b>1980</b> North Anna 2 Sequoyah 1	<b>1986</b> Catawba 2 Hope Creek 1 Millstone 3 Palo Verde 2 Perry 1
<b>1971</b> Dresden 3 Monticello	Oconee 3 Peach Bottom 3 Prairie Island 1 Prairie Island 2 Three Mile Island 1	<b>1981</b> Farley 2 McGuire 1 Salem 2 Sequoyah 2	<b>1987</b> Beaver Valley 2 Braidwood 1 Byron 2 Clinton Harris 1 Nine Mile Point 2 Palo Verde 3 Vogtle 1
<b>1972</b> Palisades Pilgrim Quad Cities 1 Quad Cities 2 Surry 1 Turkey Point 3 Vermont Yankee	<b>1975</b> Millstone 2 <b>1976</b> Beaver Valley 1 Browns Ferry 3 Brunswick 1 Calvert Cliffs 2 Indian Point 3 Salem 1 St. Lucie 1	<b>1982</b> LaSalle 1 Summer Susquehanna 1	<b>1988</b> Braidwood 2 South Texas Project 1
<b>1973</b> Browns Ferry 1 Fort Calhoun Indian Point 2 Oconee 1 Oconee 2 Peach Bottom 2 Point Beach 2 Surry 2 Turkey Point 4	<b>1977</b> Davis-Besse D.C. Cook 2 Farley 1 <b>1978</b> Arkansas Nuclear 2	<b>1983</b> McGuire 2 St. Lucie 2	<b>1989</b> Limerick 2 South Texas Project 2 Vogtle 2
<b>1974</b> Arkansas Nuclear 1		<b>1984</b> Callaway Columbia Diablo Canyon 1 Grand Gulf 1 LaSalle 2 Susquehanna 2	<b>1990</b> Comanche Peak 1 Seabrook 1
		<b>1985</b> Byron 1 Catawba 1 Diablo Canyon 2 Fermi 2 Limerick 1 Palo Verde 1	<b>1993</b> Comanche Peak 2 <b>1996</b> Watts Bar 1

Note: List is limited to reactors licensed to operate. Year is based on the date the initial full-power operating license was issued. NRC-abbreviated reactor names are listed.

## APPENDIX H

### U.S. Commercial Nuclear Power Reactor Operating Licenses— Expiration by Year, 2013–2049

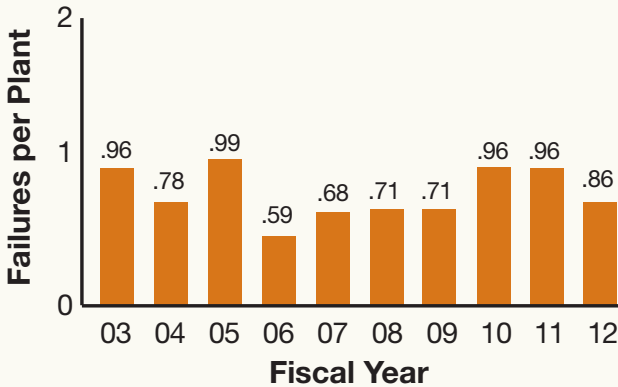
<b>2013</b> Indian Point 2	Limerick 2	<b>2034</b> Arkansas Nuclear 1	<b>2040</b> North Anna 2 Salem 2
<b>2015</b> Indian Point 3	Nine Mile Point 1	Browns Ferry 2	<b>2041</b> Farley 2 McGuire 1
<b>2016</b> Crystal River 3	Oyster Creek	Brunswick 2	<b>2042</b> Summer Susquehanna 1
<b>2017</b> Davis-Besse	<b>2030</b> Comanche Peak 1 Monticello	Calvert Cliffs 1 Cook 1 Cooper Duane Arnold Hatch 1 FitzPatrick Oconee 3	<b>2043</b> Catawba 1 Catawba 2 Columbia McGuire 2 St. Lucie 2
<b>2020</b> Sequoyah 1	Point Beach 1	Peach Bottom 3	<b>2044</b> Susquehanna 2
<b>2021</b> Sequoyah 2	Robinson 2	Prairie Island 2	<b>2045</b> Millstone 3 Palo Verde 1 Wolf Creek 1
<b>2022</b> LaSalle 1	Seabrook	Three Mile Island 1	<b>2046</b> Nine Mile Point 2 Harris 1 Hope Creek Palo Verde 2
<b>2023</b> LaSalle 2	<b>2031</b> Dresden 3 Palisades	<b>2035</b> Millstone 2 Watts Bar 1	<b>2047</b> Beaver Valley 2 Palo Verde 3 Vogtle 1
<b>2024</b> Byron 1	<b>2032</b> Pilgrim Quad Cities 1 Quad Cities 2 Surry 1 Turkey Point 3 Vermont Yankee	<b>2036</b> Beaver Valley 1 Browns Ferry 3 Brunswick 1 Calvert Cliffs 2 St. Lucie 1 Salem 1	<b>2049</b> Vogtle 2
Callaway Diablo Canyon 1 Grand Gulf 1 Limerick 1 Waterford 3	<b>2033</b> Browns Ferry 1 Comanche Peak 2 Fort Calhoun Kewaunee Oconee 1 Oconee 2 Peach Bottom 2 Point Beach 2 Prairie Island 1 Surry 2 Turkey Point 4	<b>2037</b> Cook 2 Farley 1	
<b>2025</b> Diablo Canyon 2 Fermi 2 River Bend 1		<b>2038</b> Arkansas Nuclear 2 Hatch 2 North Anna 1	
<b>2026</b> Braidwood 1 Byron 2 Clinton Pilgrim			
<b>2027</b> Braidwood 2 South Texas Project 1			
<b>2028</b> South Texas Project 2			
<b>2029</b> Dresden 2 Ginna			

Note: Limited to reactors licensed to operate. NRC-abbreviated reactor names listed. Data are as of June 2013.

**APPENDIX I**  
**Industry Performance Indicators:**  
**Annual Industry Averages, FYs 2003–2012**

Indicator	2003	2004	2005	2006	2007	2008	2009	2010	2011	2012
Automatic Scrams	0.75	0.56	0.47	0.32	0.48	0.29	0.36	0.44	0.45	0.30
Safety System Actuations	0.42	0.24	0.38	0.22	0.25	0.14	0.23	0.18	0.19	0.17
Significant Events	0.07	0.04	0.05	0.03	0.02	0.03	0.02	0.10	0.13	0.08
Safety System Failures	0.96	0.78	0.99	0.60	0.68	0.71	0.71	0.96	0.96	0.86
Forced Outage Rate	3.04	1.88	2.34	1.47	1.41	1.34	2.21	1.74	1.80	2.82
Equipment-Forced Outage Rate	0.16	0.15	0.13	0.10	0.11	0.08	0.09	0.10	0.09	0.09
Collective Radiation Exposure	125	100	117	93	109	96	87	91	90	74
Drill/Exercise Performance	95.73	95.64	95.85	96.03	96.17	96.25	97.06	96.85	97.29	97.54
ERO Drill Participation	99.74	97.87	98.19	97.96	97.58	98.14	98.64	98.77	99.42	99.38
Alert and Notification	99.92	99.24	99.34	99.48	99.45	99.52	99.57	99.59	99.67	99.77

**Safety System Failures**



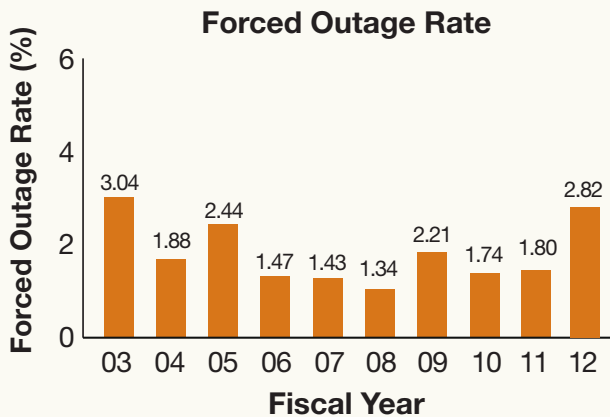
*Safety system failures are any actual failures, events, or conditions that could prevent a system from performing its required safety function.*



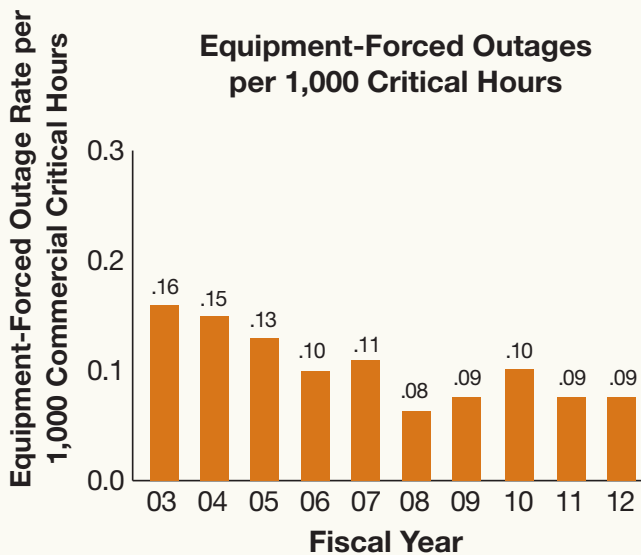


## APPENDIX I

### Industry Performance Indicators: Annual Industry Averages, FYs 2003–2012 (continued)



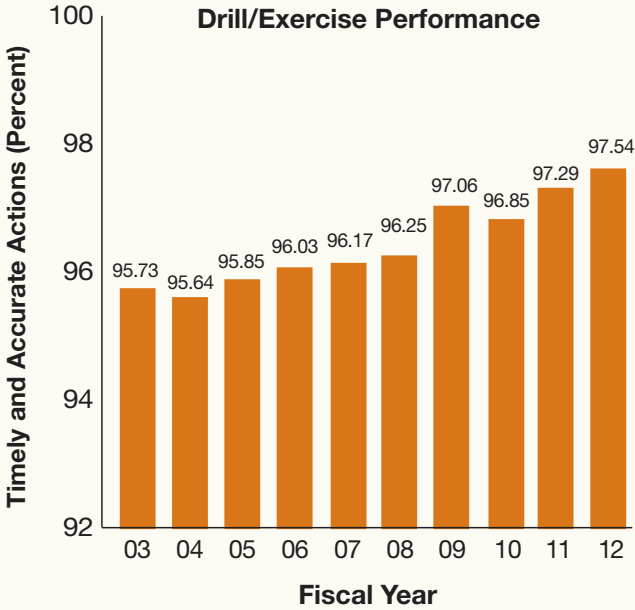
The forced outage rate is the number of hours that the plant is unable to operate (forced outage hours) divided by the sum of the hours that the plant is generating and transmitting electricity (unit service hours) and the hours that the plant is unable to operate (forced outage hours).



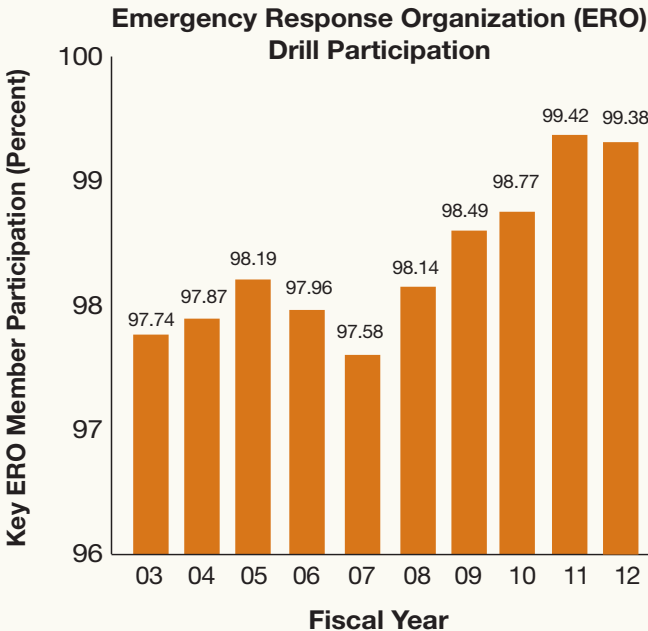
This indicator is the number of times the plant is forced to shut down because of equipment failures for every 1,000 hours that the plant is in operation and transmitting electricity.



**APPENDIX I**  
**Industry Performance Indicators:**  
**Annual Industry Averages, FYs 2003–2012 (continued)**



*The percentage of timely and accurate actions taken by plant personnel (emergency classifications, protective action recommendations, and notification to offsite authorities) in drills and actual events during the previous 2 years.*



*The percentage of participation by key plant personnel in drills or actual events in the previous 2 years, indicating proficiency and readiness to respond to emergencies.*



## APPENDIX J

### Operating U.S. Nuclear Research and Test Reactors Regulated by the NRC

Licensee Location	Reactor Type OL Issued	Power Level (kW)	Licensee Number Docket Number
Aerotest* San Ramon, CA	TRIGA (Indus) 07/02/1965	250	R-98 05000228
Armed Forces Radiobiology Research Institute Bethesda, MD	TRIGA 06/26/1962	1,100	R-84 05000170
Dow Chemical Company Midland, MI	TRIGA 07/03/1967	300	R-108 05000264
GE-Hitachi Sunol, CA	Tank 10/31/1957	100	R-33 05000073
Idaho State University Pocatello, ID	AGN-201 #103 10/11/1967	0.005	R-110 05000284
Kansas State University Manhattan, KS	TRIGA 10/16/1962	250	R-88 05000188
Massachusetts Institute of Technology Cambridge, MA	HWR Reflected 06/09/1958	6,000	R-37 05000020
Missouri University of Science and Technology Rolla, MO	Pool 11/21/1961	200	R-79 05000123
National Institute of Standards & Technology Gaithersburg, MD	Nuclear Test 05/21/1970	20,000	TR-5 05000184
North Carolina State University Raleigh, NC	Pulstar 08/25/1972	1,000	R-120 05000297
Ohio State University Columbus, OH	Pool 02/24/1961	500	R-75 05000150
Oregon State University Corvallis, OR	TRIGA Mark II 03/07/1967	1,100	R-106 05000243
Pennsylvania State University State College, PA	TRIGA 07/08/1955	1,100	R-2 05000005
Purdue University West Lafayette, IN	Lockheed 08/16/1962	1	R-87 05000182
Reed College Portland, OR	TRIGA Mark I 07/02/1968	250	R-112 05000288

\* Permanent shutdown ordered July 24, 2013.



## APPENDIX J

### Operating U.S. Nuclear Research and Test Reactors Regulated by the NRC (continued)

Licensee Location	Reactor Type OL Issued	Power Level (kW)	Licensee Number Docket Number
Rensselaer Polytechnic Institute Troy, NY	Critical Assembly 07/03/1964	0.1	CX-22 05000225
Rhode Island Atomic Energy Commission Narragansett, RI	GE Pool 07/23/1964	2,000	R-95 05000193
Texas A&M University College Station, TX	AGN-201M #106 08/26/1957	0.005	R-23 05000059
Texas A&M University College Station, TX	TRIGA 12/07/1961	1,000	R-83 05000128
U.S. Geological Survey Denver, CO	TRIGA Mark I 02/24/1969	1,000	R-113 05000274
University of California/Davis Sacramento, CA	TRIGA 08/13/1998	2,300	R-130 05000607
University of California/Irvine Irvine, CA	TRIGA Mark I 11/24/1969	250	R-116 05000326
University of Florida Gainesville, FL	Argonaut 05/21/1959	100	R-56 05000083
University of Maryland College Park, MD	TRIGA 10/14/1960	250	R-70 05000166
University of Massachusetts/Lowell Lowell, MA	GE Pool 12/24/1974	1,000	R-125 05000223
University of Missouri/Columbia Columbia, MO	Tank 10/11/1966	10,000	R-103 05000186
University of New Mexico Albuquerque, NM	AGN-201M #112 09/17/1966	0.005	R-102 05000252
University of Texas Austin, TX	TRIGA Mark II 01/17/1992	1,100	R-129 05000602
University of Utah Salt Lake City, UT	TRIGA Mark I 09/30/1975	100	R-126 05000407
University of Wisconsin Madison, WI	TRIGA 11/23/1960	1,000	R-74 05000156
Washington State University Pullman, WA	TRIGA 03/06/1961	1,000	R-76 05000027



## APPENDIX K

### U.S. Nuclear Research and Test Reactors under Decommissioning Regulated by the NRC

Licensee Location	Reactor Type Power Level (kW)	OL Issued Shutdown	Decommissioning Alternative Selected Current Status
General Atomics San Diego, CA	TRIGA Mark F 1,500	07/01/60 09/07/94	DECON SAFSTOR
General Atomics San Diego, CA	TRIGA Mark I 250	05/03/58 12/17/96	DECON SAFSTOR
General Electric Company Sunol, CA	GETR (Tank) 50,000	01/07/59 06/26/85	SAFSTOR SAFSTOR
General Electric Company* Sunol, CA	EVESR 17,000	11/12/63 02/01/67	SAFSTOR SAFSTOR
University of Buffalo Buffalo, NY	Pulstar 2,000	03/24/61 07/23/96	DECON DECON In Progress
University of Michigan Ann Arbor, MI	Pool 2,000	09/13/57 01/29/04	DECON DECON In Progress
Veterans Administration Omaha, NE	TRIGA 20	06/26/59 11/05/01	DECON SAFSTOR
Worcester Polytechnic Institute Worcester, MA	GE 10	12/16/59 06/30/07	DECON DECON In Progress

\* Originally licensed as a demonstration reactor.





## APPENDIX N

### Major U.S. Fuel Cycle Facility Sites

Licensor	Location	Status	Docket #
<b>Uranium Hexafluoride Conversion Facility</b>			
Honeywell International, Inc.	Metropolis, IL	active	04003392
<b>Uranium Fuel Fabrication Facilities</b>			
Global Nuclear Fuel-Americas, LLC	Wilmington, NC	active	07001139
Westinghouse Electric Company, LLC Columbia Fuel Fabrication Facility	Columbia, SC	active	07109239
Nuclear Fuel Services, Inc.	Erwin, TN	active	07000143
AREVA NP, Inc. Mt. Athos Road Facility	Lynchburg, VA	inactive, license termination pending	07001201
Babcock & Wilcox Nuclear Operations Group	Lynchburg, VA	active	07000027
AREVA NP, Inc.	Richland, WA	active	07001257
<b>Mixed Oxide Fuel Fabrication Facility</b>			
Shaw AREVA MOX Services, LLC	Aiken, SC	under construction (operating license under review)	07003098
<b>Gaseous Diffusion Uranium Enrichment Facilities</b>			
USEC Inc.	Paducah, KY	scheduled shutdown	07007001
<b>Gas Centrifuge Uranium Enrichment Facilities</b>			
American Centrifuge Plant, LLC (USEC)	Piketon, OH	license issued, construction halted	07007003
Louisiana Energy Services (URENCO-USA)	Eunice, NM	active*	07003103
AREVA Enrichment Services, LLC Eagle Rock Enrichment Facilities	Idaho Falls, ID	license issued, construction not started	07007015
<b>Laser Separation Enrichment Facility</b>			
GE-Hitachi	Wilmington, NC	license issued, construction not started	07007016
<b>Uranium Hexafluoride Deconversion Facility</b>			
International Isotopes	Hobbs, NM (Lea County)	license issued, construction not started	04009086

\* Partially operating and producing enriched uranium while undergoing further phases of construction.

Note: The NRC regulates nine other facilities that possess significant quantities of special nuclear material (other than reactors) or process source material (other than uranium recovery facilities).

Data are as of July 2013.



**APPENDIX O**  
**Dry Spent Fuel Storage Designs:**  
**NRC-Approved for Use by General Licensees**

<b>Vendor</b>	<b>Docket #</b>	<b>Storage Design Model</b>
General Nuclear Systems, Inc.	720001000	CASTOR V/21
NAC International, Inc.	720001002	NAC S/T
	720001003	NAC-C28 S/T
	720001015	NAC-UMS
	720001025	NAC-MPC
	720001031	Magnastor
Holtec International	720001008	HI-STAR 100
	720001014	HI-STORM 100
	720001032	HI-STORM FW
Energy Solutions, Inc.	720001007	VSC-24
	720001026	Fuel Solutions™ (WSNF-220, -221, -223) W-150 Storage Cask W-100 Transfer Cask W-21, W-74 Canisters
Transnuclear, Inc.	720001005	TN-24
	720001027	TN-68
	720001021	TN-32, 32A, 32B
	720001004	Standardized NUHOMS®-24P, -24PHB, -24PTH, -32PT, -32PTH1, -52B, -61BT, -61BTH
	720001029	Standardized Advanced NUHOMS®-24PT1, -24PT4
	720001030	NUHOMS® HD-32PTH

Data are as of June 2013 (See latest list on the NRC Web site at [www.nrc.gov/waste/spent-fuel-storage/designs.html](http://www.nrc.gov/waste/spent-fuel-storage/designs.html))





## APPENDIX P

### Dry Cask Spent Fuel Storage Licensees

Name Licensee	License Type	Date Issued	Vendor	Storage Model	Docket Number
Surry Virginia Electric & Power Company (Dominion Gen.)	SL	07/02/1986	General Nuclear Systems, Inc.	CASTOR V/21 TN-32	07200002
	GL	08/06/2007	Transnuclear, Inc. Westinghouse, Inc.	NAC-128 CASTOR X/33 MC-10 NUHOMS®-HD	07200055
H.B. Robinson Carolina Power & Light Company	SL	08/13/1986	Transnuclear, Inc.	NUHOMS®-7P	07200003
	GL	09/06/2005	Transnuclear, Inc.	NUHOMS®-24P	07200060
Oconee Duke Energy Company	SL	01/29/1990	Transnuclear, Inc.	NUHOMS®-24P	07200004
	GL	03/05/1999	Transnuclear, Inc.	NUHOMS®-24P	07200040
Fort St. Vrain* U.S. Department of Energy	SL	11/04/1991	FW Energy Applications, Inc.	Modular Vault Dry Store	07200009
	SL	11/25/1992	Transnuclear, Inc.	NUHOMS®-24P NUHOMS®-32P	07200008
Palisades Entergy Nuclear Operations, Inc.	GL	05/11/1993	Energy Solutions, Inc.	VSC-24 NUHOMS®-32PT	07200007
Prairie Island Northern States Power Co., a Minnesota Corp.	SL	10/19/1993	Transnuclear, Inc.	TN-40 HT TN-40	07200010
	GL	05/26/1996	Energy Solutions, Inc.	VSC-24 NUHOMS®-32PT	07200005
Davis-Besse FirstEnergy Nuclear Operating Company	GL	01/01/1996	Transnuclear, Inc.	NUHOMS®-24P	07200014
Arkansas Nuclear Entergy Nuclear Operations, Inc.	GL	12/17/1996	Energy Solutions, Inc. Holtec International	VSC-24 HI-STORM 100	07200013
North Anna Virginia Electric & Power Company (Dominion Gen.)	SL	06/30/1998	Transnuclear, Inc.	TN-32	07200016
	GL	03/10/2008	Transnuclear, Inc.	NUHOMS®-HD	07200056
Trojan Portland General Electric Corp.	SL	03/31/1999	Holtec International	HI-STORM 100	07200017
Idaho National Lab TMI-2 Fuel Debris, U.S. Department of Energy	SL	03/19/1999	Transnuclear, Inc.	NUHOMS®-12T	07200020
Susquehanna PPL Susquehanna, LLC	GL	10/18/1999	Transnuclear, Inc.	NUHOMS®-52B NUHOMS®-61BT	07200028



**APPENDIX P**  
**Dry Cask Spent Fuel Storage Licensees (continued)**

Name Licensee	License Type	Date Issued	Vendor	Storage Model	Docket Number
Peach Bottom Exelon Generation Company, LLC	GL	06/12/2000	Transnuclear, Inc.	TN-68	07200029
Hatch Southern Nuclear Operating, Inc.	GL	07/06/2000	Holtec International	HI-STAR 100 HI-STORM 100	07200036
Dresden Exelon Generation Company, LLC	GL	07/10/2000	Holtec International	HI-STAR 100 HI-STORM 100	07200037
Rancho Seco Sacramento Municipal Utility District	SL	06/30/2000	Transnuclear, Inc.	NUHOMS®-24P	07200011
McGuire Duke Energy, LLC	GL	02/01/2001	Transnuclear, Inc.	TN-32	07200038
Big Rock Point Entergy Nuclear Operations, Inc.	GL	11/18/2002	Energy Solutions, Inc.	Fuel Solutions™ W74	07200043
James A. FitzPatrick Entergy Nuclear Operations, Inc.	GL	04/25/2002	Holtec International	HI-STORM 100	07200012
Maine Yankee Maine Yankee Atomic Power Company	GL	08/24/2002	NAC International, Inc.	NAC-UMS	07200030
Columbia Generating Station Energy Northwest	GL	09/02/2002	Holtec International	HI-STORM 100	07200035
Oyster Creek AmerGen Energy Company, LLC.	GL	04/11/2002	Transnuclear, Inc.	NUHOMS®-61BT	07200015
Yankee Rowe Yankee Atomic Electric	GL	06/26/2002	NAC International, Inc.	NAC-MPC	07200031
Duane Arnold Next Era Energy Duane Arnold, LLC.	GL	09/01/2003	Transnuclear, Inc.	NUHOMS®-61BT	07200032
Palo Verde Arizona Public Service Co.	GL	03/15/2003	NAC International, Inc.	NAC-UMS	07200044
San Onofre Southern California Edison Company	GL	10/03/2003	Transnuclear, Inc.	NUHOMS®-24PT	07200041
Diablo Canyon Pacific Gas & Electric Co.	SL	03/22/2004	Holtec International	HI-STORM 100	07200026
Haddam Neck CT Yankee Atomic Power	GL	05/21/2004	NAC International, Inc.	NAC-MPC	07200039



## APPENDIX P

### Dry Cask Spent Fuel Storage Licensees (continued)

Name Licensee	License Type	Date Issued	Vendor	Storage Model	Docket Number
Sequoyah Tennessee Valley Authority	GL	07/13/2004	Holtec International	HI-STORM 100	07200034
Idaho Spent Fuel Facility Environmental Corp.	SL	11/30/2004	Foster Wheeler	Concrete Vault	07200025
Humboldt Bay Pacific Gas & Electric Co.	SL	11/30/2005	Holtec International	HI-STORM 100HB	07200027
Private Fuel Storage Facility	SL	02/21/2006	Holtec International	HI-STORM 100	07200022
Browns Ferry Tennessee Valley Authority	GL	08/21/2005	Holtec International	HI-STORM 100S	07200052
Joseph M. Farley Southern Nuclear Operating Co.	GL	08/25/2005	Transnuclear, Inc.	NUHOMS®-32PT	07200042
Millstone Dominion Generation	GL	02/15/2005	Transnuclear, Inc.	NUHOMS®-32PT	07200047
Quad Cities Exelon Generation Company, LLC	GL	12/02/2005	Holtec International	HI-STORM 100S	07200053
River Bend Entergy Nuclear Operations, Inc.	GL	12/29/2005	Holtec International	HI-STORM 100S	07200049
Fort Calhoun Omaha Public Power District	GL	07/29/2006	Transnuclear, Inc.	NUHOMS®-32PT	07200054
Hope Creek/Salem PSEG, Nuclear, LLC	GL	11/10/2006	Holtec International	HI-STORM 100	07200048
Grand Gulf Entergy Nuclear Operations, Inc.	GL	11/18/2006	Holtec International	HI-STORM 100S	07200050
Catawba Duke Energy Carolinas, LLC	GL	07/30/2007	NAC International, Inc.	NAC-UMS	07200045
Perry FirstEnergy	GL	08/21/2007	Holtec International	HI-STORM	07200069
Indian Point Entergy Nuclear Operations, Inc.	GL	01/11/2008	Holtec International	HI-STORM 100	07200051
St. Lucie Florida Power and Light Company	GL	03/14/2008	Transnuclear, Inc.	NUHOMS®-HD	07200061
Vermont Yankee Entergy Nuclear Operations, Inc.	GL	05/25/2008	Holtec International	HI-STORM100	07200059
Limerick Exelon Generation Co., LLC	GL	08/01/2008	Transnuclear, Inc.	NUHOMS®-61BT	07200065



## APPENDIX P

### Dry Cask Spent Fuel Storage Licensees (continued)

Name Licensee	License Type	Date Issued	Vendor	Storage Model	Docket Number
Seabrook FPL Energy	GL	08/07/2008	Transnuclear, Inc.	NUHOMS®-HD3PTM	07200061
Monticello Northern States Power Co.	GL	09/17/2008	Transnuclear, Inc.	NUHOMS®-61BT	07200058
Kewaunee Northern States Power Co.	GL	09/11/2009	Transnuclear, Inc.	NUHOMS®-39PT	07200064
Ginna Constellation Energy	GL	03/11/2010	Transnuclear, Inc.	NUHOMS	07200067
Salem PSEG Nuclear	GL	05/12/2010	Holtec International	HI-STORM	07200048
Brunswick Carolina Power Co.	GL	06/16/2010	Transnuclear, Inc.	NUHOMS	07200006
Byron Exelon Generation Co., LLC	GL	09/09/2010	Holtec International	HI-STORM 100	07200068
Cooper Nuclear Station Nebraska Public Power District	GL	10/21/2010	Transnuclear, Inc.	NUHOMS-61BT	07200066
La Salle Exelon Generation Co., LLC	GL	11/01/2010	Holtec International	HI-STORM100	07200070
Turkey Point ISFSI Florida Power and Light Company	GL	07/29/2010	Transnuclear, Inc.	NUHOMS HD	07200062
Lacrosse Dairyland Power	GL	07/07/2011	NAC International, Inc	NAC-MPC	07200046
Waterford Steam Electric Station Entergy Nuclear Operations, Inc.	GL	11/08/2011	Holtec International	HI-STORM 100	07200075
Cook Indiana/Michigan Power	GL	11/17/2011	Holtec International	HI-STORM	07200072
Braidwood Exelon Generation Co., LLC	GL	11/23/2011	Holtec International	HI-STORM 100	07200073
Comanche Peak Luminant Generation Company, LLC	GL	2/28/2012	Holtec International	HI-STORM 100	07200074
Nine Mile Point Constellation Energy	GL	04/03/2012	Transnuclear, Inc	NUHOMS	07201036

\* Fort St. Vrain is undergoing decommissioning and was transferred to DOE on June 4, 1999.  
Note: NRC-abbreviated unit names.



## APPENDIX Q

### U.S. Low-Level Radioactive Waste Compacts

#### Appalachian

---

Delaware  
Maryland  
Pennsylvania  
West Virginia

#### Atlantic

---

Connecticut  
New Jersey  
South Carolina\*

#### Central

---

Arkansas  
Kansas  
Louisiana  
Oklahoma

#### Central Midwest

---

Illinois  
Kentucky

#### Midwest

---

Indiana  
Iowa  
Minnesota  
Missouri  
Ohio  
Wisconsin

#### Northwest

---

Alaska  
Hawaii  
Idaho  
Montana  
Oregon  
Utah\*  
Washington\*  
Wyoming

#### Rocky Mountain

---

Colorado  
Nevada  
New Mexico  
*(Northwest accepts Rocky Mountain waste as agreed between compacts)*

#### Southeast

---

Alabama  
Florida  
Georgia  
Mississippi  
Tennessee  
Virginia

#### Southwestern

---

Arizona  
California  
North Dakota  
South Dakota

#### Texas

---

Texas\*  
Vermont

#### Unaffiliated

---

District of Columbia  
Maine  
Massachusetts  
Michigan  
Nebraska  
New Hampshire  
New York  
North Carolina  
Puerto Rico  
Rhode Island

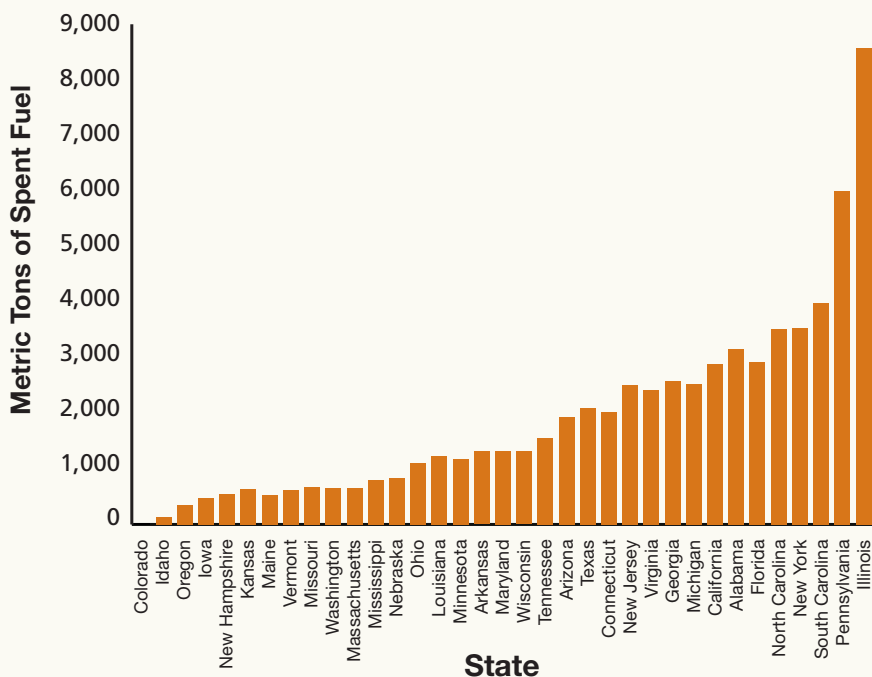
Note: Data are as of June 2013.

\* Site of an active LLW disposal facility.



## APPENDIX R

### Storage of Commercial Spent Fuel by State through 2012



Idaho is holding used fuel from Three Mile Island 2. The used Fuel Data are rounded up to the nearest 10 for CY 2011.

Source: Gutherman Technical Services and U.S. Department of Energy

Updated: April 2013.



## APPENDIX S

### NRC-Regulated Complex Material Sites Undergoing Decommissioning

Company	Location
AAR Manufacturing, Inc. (Brooks & Perkins)	Livonia, MI
ABB, Inc.	Windsor, CT
Analytical Bio-Chemistry Laboratories	Columbia, MO
Army, Department of, Jefferson Proving Ground	Madison, IN
Babcock & Wilcox SLDA	Vandergrift, PA
Beltsville Agricultural Research Center	Beltsville, MD
FMRI	Muskogee, OK
Hunter's Point Naval Shipyard	San Francisco, CA
Kerr-McGee	Cimarron, OK
Mallinckrodt Chemical, Inc.	St. Louis, MO
McClellan Air Force Base	Sacramento, CA
Pohakuloa Training Area	Kawaihe Harbor, HI
Schofield Army Barracks	Wahiawa, HI
Sigma Aldrich	Maryland Heights, MO
Stepan Chemical Corporation	Maywood, NJ
UNC Naval Products	New Haven, CT
West Valley Demonstration Project	West Valley, NY
Westinghouse Electric Corporation—Hematite	Festus, MO

Note: Data are as of June 2013.



## APPENDIX T

### Nuclear Power Units by Nation

Country	In Operation			Under Construction or on Order		Shutdown
	Nuclear Power Production GWh*	Number of Units	Capacity Net MWe	Number of Units	Capacity Net MWe	
Argentina	5,903	2	935	1	692	0
Armenia	2,124	1	375	0	0	1 <sup>P</sup>
Belgium	38,464	7	5,927	0	0	1 <sup>P</sup>
Brazil	15,170	2	1,884	1	1,245	0
Bulgaria	14,861	2	1,906	2	1,906	4 <sup>P</sup>
Canada	89,060	19	13,500	0	0	3 <sup>P</sup> & 6 <sup>L</sup>
China	92,652	18	13,860	28	27,844	0
Czech Republic	28,602	6	3,804	0	0	0
Finland	22,062	4	2,754	1	1,600	0
France	407,438	58	63,130	1	1,600	12 <sup>P</sup>
Germany	94,098	9	12,068	0	0	27 <sup>P</sup>
Hungary	14,763	4	1,889	0	0	0
India	29,665	20	4,391	7	4,824	0
Iran	1,328	1	915	0	0	0
Italy	0	0	0	0	0	4 <sup>P</sup>
Japan	17,238	50	44,215	2	2,650	9 <sup>P</sup> & 1 <sup>L</sup>
Kazakhstan	0	0	0	0	0	1 <sup>P</sup>
Rep. Korea	143,550	23	20,739	4	4,980	0
Lithuania	0	0	0	0	0	2 <sup>P</sup>
Mexico	8,412	2	1,530	0	0	0
Netherlands	3,707	1	482	0	0	1 <sup>P</sup>
Pakistan	5,271	3	725	2	630	0
Romania	10,564	2	1,300	0	0	0
Russia	166,293	33	23,643	11	9,297	5 <sup>P</sup>
Slovakia	14,411	4	1,816	2	880	3 <sup>P</sup>
Slovenia	5,244	1	688	0	0	0
South Africa	12,398	2	1,860	0	0	0
Spain	58,701	8	7,560	0	0	2 <sup>P</sup>
Sweden	61,474	10	9,408	0	0	3 <sup>P</sup>
Switzerland	24,425	5	3,308	0	0	1 <sup>P</sup>





## APPENDIX T

### Nuclear Power Units by Nation (continued)

Country	Nuclear Power Production GWh*	In Operation		Under Construction or on Order		Shutdown
		Number of Units	Capacity Net MWe	Number of Units	Capacity Net MWe	
Ukraine	84,886	15	13,107	2	1,900	4 <sup>P</sup>
United Arab Emirates	0	0	0	1	1,345	29 <sup>P</sup>
United Kingdom	63,964	16	9,938	0	0	29 <sup>P</sup>
United States	770,719	102	102,136	3	3,399	30 <sup>P</sup>
<b>Total</b>	<b>2,346,193</b>	<b>440</b>	<b>372,686</b>	<b>68</b>	<b>65,486</b>	<b>145<sup>P</sup> &amp; 1<sup>L</sup></b>

\* Annual electrical power production for 2011

P = Permanent Shutdown

L = Long-Term Shutdown

Note: Operable, under construction, or on order; country's short-form name used; rounded to the nearest whole number.

Sources: IAEA Power Reactor Information System Database; analysis compiled by the NRC, May 31, 2013

## APPENDIX U

### Nuclear Power Units by Reactor Type, Worldwide

Reactor Type	In Operation	
	Number of Units	Net MWe
Pressurized light-water reactors (PWR)	272	251,769
Boiling light-water reactors (BWR)	84	78,122
Heavy-water reactors, all types (HWR)	48	23,961
Light-water-cooled graphite-moderated reactor (LWGR)	15	10,219
Gas-cooled reactors, all types (GCR)	15	8,040
Liquid-metal-cooled fast-breeder reactors (FBR)	2	580
<b>Total</b>	<b>436</b>	<b>372,686</b>

Note: MWe values rounded to the nearest whole number.

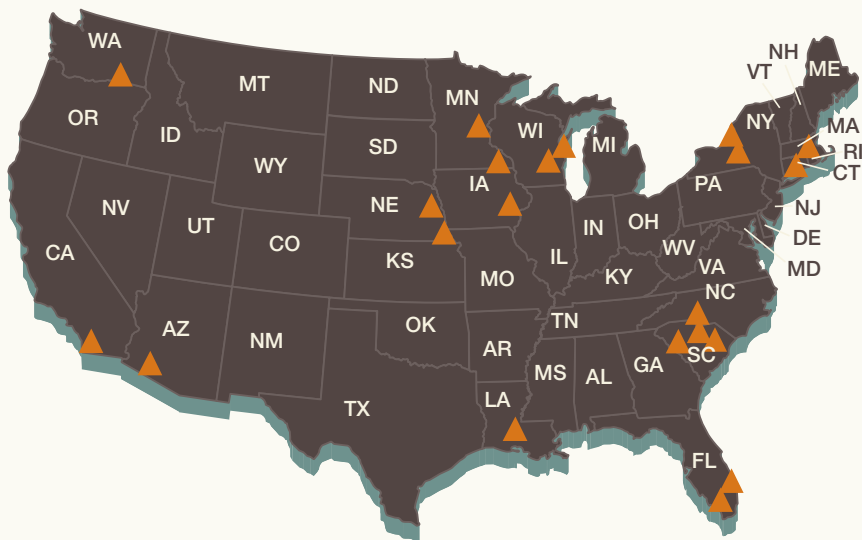
Source: IAEA Power Reactor Information System Database, [www.iaea.org](http://www.iaea.org)

Compiled by the NRC from data available as of May 31, 2013.



## APPENDIX V

### Native American Reservations and Trust Land within a 50-Mile Radius of a Nuclear Power Plant



#### ARIZONA

##### Palo Verde

Ak-Chin Indian Community  
Tohono O'odham  
Trust Land  
Gila River Reservation  
Maricopa Reserve

#### CALIFORNIA

##### San Onofre\*

Pechanga Reservation  
of Luiseño Indians  
Pala Reservation  
Pauma & Yuima Reserve  
Rincon Reservation  
San Pasqual Reservation  
La Jolla Reservation  
Cahuilla Reservation  
Soboba Reservation  
Santa Ysabel  
Mesa Grande Reservation  
Barona Reservation

#### CONNECTICUT

##### Millstone

Mohegan Reservation  
Mashantucket Pequot  
Reservation  
Narragansett  
Reservation

#### FLORIDA

##### St. Lucie

Brighton Reservation  
(Seminole Tribes  
of Florida)  
Fort Pierce Reservation

##### Turkey Point

Miccosukee  
Reservation  
Hollywood Reservation  
(Seminole Tribes  
of Florida)

#### IOWA

##### Duane Arnold

Sac & Fox Trust Land  
Sac & Fox Reserve

#### LOUISIANA

##### River Bend

Tunica-Biloxi Reservation

#### MASSACHUSETTS

##### Pilgrim

Wampanoag  
Tribe of Gay Head  
(Aquinnah)  
Trust Land

#### MINNESOTA

##### Monticello

Shakopee Community  
Shakopee Trust Land  
Mille Lacs Reservation

##### Prairie Island

Prairie Island Community  
Prairie Island Trust Land  
Shakopee Community  
Shakopee Trust Land

#### NEBRASKA

##### Cooper

Sac & Fox Trust Land  
Sac & Fox Reservation  
Kickapoo

##### Fort Calhoun

Winnnebago Trust Land  
Omaha Reservation  
Winnnebago Reservation

#### NEW YORK

##### FitzPatrick

Onondaga Reservation  
Onaida Reservation

##### Nine Mile Point

Onondaga Reservation  
Onaida Reservation

#### NORTH CAROLINA

##### McGuire

Catawba Reservation

#### SOUTH CAROLINA

##### Catawba

Catawba Reservation

##### Oconee

Eastern Cherokee  
Reservation

##### Summer

Catawba Reservation

#### WASHINGTON

##### Columbia

Yakama Reservation  
Yakama Trust

#### WISCONSIN

##### Kewaunee\*\*

Oneida Trust Land  
Oneida Reservation

##### Point Beach

Oneida Trust Land  
Oneida Reservation

Note: This table uses NRC-abbreviated reactor names and Native American Reservation and Trust land names.

\* The licensee has announced plant shut down in 2013.

\*\* Kewaunee ceased operations on May 7, 2013.



## APPENDIX W

### Regulatory Research Cooperative Agreements and Grants

<b>Electric Power Research Institute</b>	Research on irradiation-assisted stress-corrosion cracking
<b>Pennsylvania State University</b>	Assistance with cladding hydride reorientation and fracture behavior; TRACE development
<b>International Commission on Radiological Protection</b>	Research on radiological protection standards
<b>Oregon State University</b>	Research on high-temperature gas reactors
<b>University of Maryland</b>	Research on improved human reliability analysis methods and the cause-defense approach to common-cause failure modeling
<b>University of California-Berkeley</b>	Work on ground motion prediction models for central and eastern North America and postliquefaction residual strength
<b>University of South Carolina</b>	Research on aging electric cables and gas accumulation detection in nuclear power plants
<b>University of Wisconsin</b>	Research on advanced gas-cooled reactors
<b>Texas A&amp;M</b>	Research on bypass flow in prismatic reactor blocks and prolonged station blackout conditions
<b>American Nuclear Society</b>	Support for the development and maintenance of probabilistic risk assessment (PRA)-related standards
<b>ASME Standards Technology, LLC</b>	Support in the following areas: Committee on Nuclear Risk Management on PRA standards, nuclear risk management, code comparison for the Multinational Design Evaluation Program, and a nondestructive examination certification program
<b>National Academy of Sciences</b>	Support to the Committee on Geological and Geotechnical Engineering (COGGE), research to develop a consensus on the assessment of soil liquefaction potential and the related infrastructure consequences, and research on porous rocks. Phase 1 of the Cancer Study was completed in early FY 2013.
<b>University of Tennessee</b>	Research on seismic hazards and associated ground motion for the East Tennessee Seismic Zone
<b>Massachusetts Institute of Technology</b>	Research on incorporating a systems-based hazards analysis technique to support the review of digital safety systems
<b>University of Toronto, Ontario</b>	Research to develop a tool to confirm safety margins for modular steel-concrete composite constructions under seismic loads
<b>Ohio State University</b>	Design and development of an automated reliability prediction system
<b>University of Michigan</b>	Multiscale thermal hydraulic tool for nuclear power plant safety analyses



## APPENDIX X

### Significant Enforcement Actions Issued, 2012

Issued Significant Enforcement Actions, referred to as “escalated,” include notices of violation for severity level (NOV SL) I, II, or III violations; notices of violation (NOV) associated with inspection findings (NOVF) that the significance determination process (SDP) categorizes as white, yellow, or red; civil penalties (CVP); and Commission orders (CO). Escalated enforcement actions are issued to reactor, materials, and individual licensees; nonlicensees; and fuel cycle facility licensees.

Action #	Name	Type	Issue Date	Enforcement Action
EA-11-227	Entergy Nuclear Operations, Inc. (Palisades)	Reactor	01/03/12	NOV white SDP finding result of plant inspections
IA-11-032	Francis Guilbeau	Individual	01/05/12	CO
EA-11-159	Entergy Nuclear Operations, Inc. (River Bend)	Reactor	01/05/12	NOV SL III CVP - \$140,000
IA-11-039	Jeffery W. Coykendall	Individual	01/05/12	NOV SL III
IA-11-040	Anthony K. Linton	Individual	01/05/12	NOV SL III
IA-11-041	Eric L. Stone	Individual	01/05/12	NOV SL III
IA-11-055	Gerald Rinehart	Individual	01/06/12	NOV SL III
EA-11-228	Regents of the University of Michigan	Materials	01/06/12	NOV SL III
EA-11-222	Universal Products Concepts, Inc.	Materials	01/09/12	NOV SLIII CVP - \$7,000
EA-11-098	S&R Engineering S. E.	Materials	01/13/12	NOV SLIII CVP - \$14,000
EA-11-252	Tennessee Valley Authority (Browns Ferry)	Reactor	01/23/12	NOV SL III
EA-11-214	Entergy Nuclear Operations, Inc. (Palisades)	Reactor	01/25/12	CO result of an alternative dispute resolution mediation
IA-11-061	Edward G. Johnson	Individual	01/25/12	CO result of an alternative dispute resolution mediation
EA-10-090, EA-10-248, & EA-11-06	Entergy Nuclear Operations, Inc. (Fitzpatrick)	Reactor	01/26/12	CO result of an alternative dispute resolution mediation and NOV SL III
EA-09-328	Roxar Flow Measurements, Inc.	Materials	02/02/12	NOV SL III
EA-11-233	Dakota Panel	Materials	02/07/12	NOV SL III
EA-11-241	Entergy Nuclear Operations, Inc. (Palisades)	Reactor	02/14/12	NOV white SDP finding result of plant inspections
EA-11-243	Entergy Nuclear Operations, Inc. (Palisades)	Reactor	02/14/12	NOV yellow SDP finding result of plant inspections
EA-11-138	Humboldt Scientific, Inc.	Materials	03/08/12	NOV SL III
EA-11-242	Instro Tek/CPN International, Inc.	Materials	03/30/12	NOV SL III
EA-12-014	Department of the Army (Redstone Arsenal)	Materials	04/05/12	NOV SL III
EA-12-001	Florida Power and Light Company (Turkey Point)	Reactor	04/09/12	NOV white SDP finding result of plant inspections and NOV SL III CVP - \$140,000
EA-11-270	Morpho Detection, Inc.	Materials	04/10/12	NOV SL III
EA-12-023	Omaha Public power District (Fort Calhoun)	Reactor	04/10/12	NOV red SDP finding result of plant inspections



## APPENDIX X

### Significant Enforcement Actions Issued, 2012 (continued)

Action #	Name	Type	Issue Date	Enforcement Action
IA-12-003	Jay T. Barnes	Individual	04/12/12	NOV SL III
EA-11-254	ABSG Consulting, Inc.	Nonlicensee	04/17/12	CO result of an alternative dispute resolution mediation
EA-11-276	Advanced Material Services	Materials	04/17/12	NOV SL III
EA-12-013	Global Nuclear Fuels - Americas, LLC	Fuel Cycle Facility	04/23/12	NOV SL III
EA-12-060	Flowserve Corporation	Materials	04/30/12	NOV SL III
EA-12-075	Pacific Gas and Electric Company (Diablo Canyon)	Reactor	05/04/12	NOV SL III
EA-12-033	Virginia Electric and power Company (North Anna)	Reactor	05/10/12	NOV white SDP finding result of plant inspections
EA-10-102	Texas Gamma Ray, LLC	Materials	05/15/12	CO result of an alternative dispute resolution mediation - \$7,000
IA-11-036	Jamie Sanchez	Individual	05/17/12	CO and NOV SL III
EA-12-071	Tennessee Valley Authority (Browns Ferry)	Reactor	05/18/12	CO
EA-12-064	MIT International of LA, INC.	Materials	06/08/12	NOV SL III
EA-12-068	neo-pet, LLC	Materials	06/13/12	NOV SL III
EA-12-021	Tennessee Valley Authority (Watts Bar)	Reactor	06/18/12	CO result of an alternative dispute resolution mediation
EA-12-008	JANX Integrity Group, Inc.	Materials	06/25/12	NOV SLIII CVP - \$49,000
IA-12-014	Timothy M. Goold	Individual	06/25/12	CO
EA-12-077	American Radiolabeled Chemicals	Materials	06/25/12	NOV SL III
EA-12-005	Indiana Michigan Power Company (D. C. Cook)	Reactor	06/28/12	CO
EA-12-031	U. S. Air Force (Wright Patterson Medical Center)	Materials	06/29/12	NOV SL III CVP - \$8,500
EA-12-088	Gamma Irradiator Services	Materials	07/11/12	NOV SL III
EA-12-106	NextEra Energy Point Beach, LLC (Point Beach)	Reactor	07/24/12	NOV white SDP finding result of plant inspections
EA-12-108	L.E. Gregg Associates	Materials	07/27/12	NOV SL III
EA-12-085	Medstar Georgetown Medical Center	Materials	08/3/12	NOV SL III
EA-12-093	NextEra Energy Point Beach, LLC (Seabrook)	Reactor	08/7/12	NOV white SDP finding result of plant inspections
EA-11-124	Quality Inspection & Testing	Materials	08/10/12	CO result of an alternative dispute resolution mediation - \$3,500
IA-12-029	Joseph Quintanilla	Individual	08/10/12	CO
IA-12-028	Bradley Berg	Individual	08/10/12	NOV SL III
EA-12-133	Tennessee Valley Authority (Browns Ferry)	Reactor	08/13/12	NOV white SDP finding result of plant inspections



## APPENDIX X

### Significant Enforcement Actions Issued, 2012 (continued)

Action #	Name	Type	Issue Date	Enforcement Action
EA-12-142	The Christ Hospital	Materials	08/28/12	NOV SL III
IA-12-009	James Chaisson	Individual	09/10/12	CO result of an alternative dispute resolution mediation
IA-12-037	Peter E. Reynolds	Individual	09/11/12	NOV SL III
IA-12-043	Rodger T. Devlin	Individual	09/20/12	NOV SL III
EA-12-152	Wolf Creek Nuclear Operating Corporation (Wolf Creek)	Reactor	09/21/12	NOV yellow SDP finding result of plant inspections
EA-12-090	Avera McKennan Hospital	Materials	10/03/12	NOV SL II CVP - \$11,200
EA-12-132	Carolina Power and Light Company (Shearon Harris)	Reactor	10/03/12	NOV white SDP finding result of plant inspections and NOV SL III
IA-12-036	Brian Kemp	Individual	10/10/12	NOV SL III
EA-12-058	DBI, Inc.	Materials	10/11/12	CO result of an alternative dispute resolution mediation - \$3,500
IA-12-033	Christopher Rhoads	Individual	10/11/12	NOV SL III
EA-12-107	Benefis Hospitals	Materials	10/11/12	NOV SL III
EA-12-153	Duke Energy Carolinas, LLC. (Catawba)	Reactor	10/11/12	NOV white SDP finding result of plant inspections
EA-12-157	Honeywell International, Inc.	Fuel Cycle Facility	10/15/12	CO
EA-12-172	St. John Maccomb-Oakland Hospital	Materials	10/16/12	NOV SL III
EA-12-181	Detector Electronics Corporation	Materials	10/19/12	NOV SL III
EA-12-092	Energy Northwest (Columbia)	Reactor	10/24/12	NOV white SDP finding result of plant inspections and NOV SL III
EA-12-177	Cambridge Isotope Laboratories, Inc.	Materials	10/31/12	NOV SL III
IA-12-044	Brandon D. Neff	Individual	11/06/12	CO
EA-12-202	Lakeland Medical Center	Materials	12/06/12	NOV SL III

Note: Reactor facilities in a decommissioning status are listed as materials licensees. The NRC report on Issued Significant Enforcement Actions can be found on the NRC Web site at [www.nrc.gov/about-nrc/regulatory/enforcement/current.html](http://www.nrc.gov/about-nrc/regulatory/enforcement/current.html).



## APPENDIX Y

### Quick-Reference Metric Conversion Tables

#### SPACE AND TIME

Quantity	From Inch-Pound Units	To Metric Units	Multiply by
Length	mi (statute)	km	1.609 347
	yd	m	*0.914 4
	ft (int)	m	*0.304 8
	in	cm	*2.54
Area	mi <sup>2</sup>	km <sup>2</sup>	2.589 998
	acre	m <sup>2</sup>	4 046.873
	yd <sup>2</sup>	m <sup>2</sup>	0.836 127 4
	ft <sup>2</sup>	m <sup>2</sup>	*0.092 903 04
Volume	in <sup>2</sup>	cm <sup>2</sup>	*6.451 6
	acre foot	m <sup>3</sup>	1 233.489
	yd <sup>3</sup>	m <sup>3</sup>	0.764 554 9
	ft <sup>3</sup>	m <sup>3</sup>	0.028 316 85
	gal	L	28.316 85
	fl oz	mL	29.573 53
Velocity	in <sup>3</sup>	cm <sup>3</sup>	16.387 06
	mi/h	km/h	1.609 347
Acceleration	ft/s	m/s	*0.304 8
	ft/s <sup>2</sup>	m/s <sup>2</sup>	*0.304 8

#### NUCLEAR REACTION AND IONIZING RADIATION

Quantity	From Inch-Pound Units	To Metric Units	Multiply by
Activity (of a radionuclide)	curie (Ci)	MBq	*37,000.0
	dpm	becquerel (Bq)	0.016 667
Absorbed dose	rad	gray (Gy)	*0.01
	rad	cGy	*1.0
Dose equivalent	rem	sievert (Sv)	*0.01
	rem	mSv	*10.0
	mrem	mSv	*0.01
	mrem	μSv	*10.0
Exposure (X-rays and gamma rays)	roentgen (R)	C/kg (coulomb)	0.000 258



## APPENDIX Y

### Quick-Reference Metric Conversion Tables (continued)

#### HEAT

Quantity	From Inch-Pound Units	To Metric Units	Multiply by
Thermodynamic temperature	°F	K	*K = (°F + 459.67)/1.8
Celsius temperature	°F	°C	*°C = (°F-32)/1.8
Linear expansion coefficient	1/°F	1/K or 1/°C	*1.8
Thermal conductivity	(Btu • in)/(ft <sup>2</sup> • h • °F)	W/(m • °C)	0.144 227 9
Coefficient of heat transfer	Btu / (ft <sup>2</sup> • h • °F)	W/(m <sup>2</sup> • °C)	5.678 263
Heat capacity	Btu/°F	kJ/°C	1.899 108
Specific heat capacity	Btu/(lb • °F)	kJ/(kg • °C)	*4.186 8
Entropy	Btu/°F	kJ/°C	1.899 108
Specific entropy	Btu/(lb • °F)	kJ/(kg • °C)	*4.186 8
Specific internal energy	Btu/lb	kJ/kg	*2.326

#### MECHANICS

Quantity	From Inch-Pound Units	To Metric Units	Multiply by
Mass (weight)	ton (short)	t (metric ton)	*0.907 184 74
	lb (avdp)	kg	*0.453 592 37
Moment of mass	lb • ft	kg • m	0.138 255
Density	ton (short)/yd <sup>3</sup>	t/m <sup>3</sup>	1.186 553
	lb/ft <sup>3</sup>	g/m <sup>3</sup>	16.018 46
Concentration (mass)	lb/gal	g/L	119.826 4
Momentum	lb • ft/s	kg • m/s	0.138 255
Angular momentum	lb • ft <sup>2</sup> /s	kg • m <sup>2</sup> /s	0.042 140 11
Moment of inertia	lb • ft <sup>2</sup>	kg • m <sup>2</sup>	0.042 140 11
Force	kip (kilopound)	kN (kilonewton)	4.448 222
	lbf	N (newton)	4.448 222
Moment of force, torque	lbf • ft	N • m	1.355 818
	lbf • in	N • m	0.122 984 8
Pressure	atm (std)	kPa (kilopascal)	*101.325
	bar	kPa	*100.0
	lbf/in <sup>2</sup> (formerly psi)	kPa	6.894 757
	inHg (32 °F)	kPa	3.386 38
	ftH <sub>2</sub> O (39.2 °F)	kPa	2.988 98
	inH <sub>2</sub> O (60 °F)	kPa	0.248 84
mmHg (0 °C)	kPa	0.133 322	





## APPENDIX Y

### Quick-Reference Metric Conversion Tables (continued)

MECHANICS (continued)			
Quantity	From Inch-Pound Units	To Metric Units	Multiply by
Stress	kip/in <sup>2</sup> (formerly ksi)	MPa	6.894 757
	lbf/in <sup>2</sup> (formerly psi)	MPa	0.006 894 757
	lbf/in <sup>2</sup> (formerly psi)	kPa	6.894 757
	lbf/ft <sup>2</sup>	kPa	0.047 880 26
Energy, work	kWh	MJ	*3.6
	cal <sup>th</sup>	J (joule)	*4.184
	Btu	kJ	1.055 056
	ft • lbf	J	1.355 818
	therm (US)	MJ	105.480 4
Power	Btu/s	kW	1.055 056
	hp (electric)	kW	*0.746
	Btu/h	W	0.293 071 1

Note: The information contained in this table is intended to provide familiarization with commonly used SI units and provide a quick reference to aid in the understanding of documents containing SI units. The conversion factors provided have not been approved as NRC guidelines for the development of licensing actions, regulations, or policy.

To convert from metric units to inch-pound units, divide the metric unit by the conversion factor.

\* Exact conversion factors

Sources: Federal Standard 376B (January 27, 1993), "Preferred Metric Units for General Use by the Federal Government," and International Commission on Radiation Units and Measurements, ICRU Report 33 (1980), "Radiation Quantities and Units"

## APPENDIX Z

### Progress List of 2012 Rulemaking for Nuclear Material and Waste

1. 10 CFR Part 20, "Standards for Protection Against Radiation"
2. 10 CFR Part 35, "Medical Use of Byproduct Material"
3. 10 CFR Part 37, "Physical Protection of Category 1 and Category 2 Quantities of Radioactive Material"
4. 10 CFR Part 40, "Domestic Licensing of Source Material"
5. 10 CFR Part 61, "Licensing Requirements for Land Disposal of Radioactive Waste"
6. 10 CFR Part 73, "Physical Protection of Plants and Materials"
7. 10 CFR Part 74, "Material Control and Accounting of Special Nuclear Material"



## APPENDIX AA

### International Activities

#### CONVENTIONS AND TREATIES

##### Nuclear Treaties—But Not Touching On Arms Control Agreements

1. Treaty on the Non-Proliferation of Nuclear Weapons, entry into force 5 March 1970, United States (U.S.) is a party
2. Treaty for the Prohibition of Nuclear Weapons in Latin America (Tlatelolco Treaty), entry into force for each government individually, U.S. is a party to the specific protocols appended to the Treaty
3. There are three to four other treaties specifying nuclear weapons free zones in Africa, the South Pacific (Rarotonga), and Southeast Asia, including one being negotiated on the Middle East; the U.S. is only bound by specific protocols

##### Safety and Security Treaties, Conventions and Agreements under IAEA Auspices

1. Convention on Early Notification of a Nuclear Accident, entry into force 27 October 1986, U.S. is a party
2. Convention on Assistance in the Case of a Nuclear Accident or Radiological Emergency, entry into force 26 February 1987, U.S. is a party
3. Convention on Nuclear Safety, entry into force 24 October 1996, U.S. is a party
4. Joint Convention on the Safety of Spent Fuel Management and on the Safety of Radioactive Waste Management, entry into force 18 June 2001, U.S. is a party
5. Convention on the Physical Protection of Nuclear Material (CPPNM), entry into force 8 February 1987, U.S. is a party
6. Convention on the Prevention of Marine Pollution by Dumping of Wastes and Other Matter, entry into force 30 August 1975, U.S. is a party (also to amendments in 1978 (incineration), 1978 (disputes), 1980 (list of substances), 1989 (procedures), 1993 (banning dumping into sea of low-level radioactive wastes), 1996 (protocol to replace the 1972 Convention with a more restrictive text regulating the use of the sea as a depository for waste materials).

##### Safeguards Treaties, Conventions and Agreements under IAEA Auspices

1. Model Protocol Additional to the Agreement Between State(s) and the IAEA for the Application of Safeguards, entry into force 6 April 1989, U.S. is a party



## APPENDIX AA

### International Activities (continued)

#### LIST OF EXPORT LICENSES ISSUED FOR 2012

License Number	Applicant	Docket Number
IW030	GE Hitachi Nuclear Energy, LLC	11005957
XB1327	Century Geophysical Corporation	11006008
XB1328	Humboldt Scientific, Inc.	11006050
XCOM1234	Sandvik Special Metals, LLC	11005961
XCOM1237	Mytech Corporation	11005975
XCOM1239	Louisiana Energy Services, LLC	11005981
XCOM1241	Westinghouse Electric Company LLC	11005984
XCOM1242	Materion Brush Inc.	11005991
XCOM1243	FirstEnergy Nuclear Operating Company	11005992
XCOM1245	Transco Products Inc.	11005999
XCOM1247	ATI Wah Chang	11006009
XCOM1248	ATI Wah Chang	11006010
XCOM1249	Westinghouse Electric Company LLC	11006014
XCOM1250	General Atomics	11006028
XCOM1252	Westinghouse Electric Company LLC	11006040
XCOM1254	GE Oil and Gas - Dresser, Inc.	11006048
XMAT414	Concert Pharmaceuticals, Inc.	11005905
XMAT417	Sigma-Aldrich Corporation	11005954
XMAT418	Sigma-Aldrich Corporation	11005977
XMAT419	Cambridge Isotope Laboratories, Inc.	11005993
XMAT420	Cambridge Isotope Laboratories, Inc.	11005994
XMAT422	Cambridge Isotope Laboratories, Inc.	11005997
XMAT423	Linde Electronics and Specialty Gases	11006029
XMAT425	Cambridge Isotope Laboratories, Inc.	11006062
XR174	Westinghouse Electric Company LLC	11005963
XSNM3633	Department of Energy - Oak Ridge	11005854
XSNM3680	Department of Energy - Oak Ridge	11005930
XSNM3702	Westinghouse Electric Company LLC	11005968
XSNM3704	Transport Logistics International, Inc.	11005970
XSNM3705	AREVA NP Inc.	11005971
XSNM3706	AREVA NP Inc.	11005972
XSNM3707	AREVA NP Inc.	11005973
XSNM3708	Department of Energy - Oak Ridge	11005974
XSNM3709	Edlow International Company	11005976



## APPENDIX AA

### International Activities (continued)

#### LIST OF EXPORT LICENSES ISSUED FOR 2012 (continued)

License Number	Applicant	Docket Number
XSNM3710	Transport Logistics Intl	11005979
XSNM3711	Mitsui & Co. (U.S.A.), Inc.	11005980
XSNM3712	AREVA NP Inc.	11005987
XSNM3713	Mitsui & Co. (U.S.A.), Inc.	11005988
XSNM3714	Idaho National Laboratory	11005989
XSNM3715	Department of Energy - Oak Ridge	11005990
XSNM3716	Mitsui & Co. (U.S.A.), Inc.	11005996
XSNM3717	AREVA NP Inc.	11006002
XSNM3718	Mitsui & Co. (U.S.A.), Inc.	11006005
XSNM3719	Transport Logistics International	11006007
XSNM3720	Transport Logistics International	11006013
XSNM3721	AREVA NP Inc.	11006018
XSNM3722	Transnuclear, Inc.	11006019
XSNM3723	Edlow International Company	11006023
XSNM3724	AREVA NP Inc.	11006030
XSNM3725	Department of Energy - Savannah River	11006035
XSNM3726	Department of Energy - Oak Ridge	11006037
XSNM3728	AREVA NP Inc.	11006052
XSNM3731	Mitsui & Co. (U.S.A.), Inc.	11006056
XSOU8828	Global Advanced Metals USA	11006003
XSOU8829	Materion Advanced Chemicals	11006017

#### Non Appendix P Components Guide

(XSNM) denotes export of special nuclear material (plutonium, uranium-233, or uranium enriched above 0.711 percent, by weight, in the isotope uranium-235).

(XCOM) denotes export of minor reactor COMponents or other nuclear facility (e.g., nuclear fabrication) components under NRC jurisdiction (refer to Title 10 of the Code of Federal Regulations Part 110, Appendix A, Items (5)–(9) for minor reactor components and Appendices B–K and N–O for other nuclear facility components).

(XSOU) denotes export of source material (natural or depleted uranium; thorium; a mixture of uranium and thorium other than special nuclear material; or certain ores [e.g., tantalum and niobium that contain, by weight, 0.05 percent or more of the aforementioned materials for non-nuclear end use]).

(XB) denotes export of byproduct material 10 CFR Part 110, Appendix L for an illustrative list of byproduct materials under NRC jurisdiction.

(XR) denotes export of reactor facilities 10 CFR Part 110, Appendix A, Items (1) – (4).

(IW) denotes import of radioactive waste.

(XW) denotes export of radioactive waste.



## APPENDIX AA

### International Activities (continued)

#### LIST OF IMPORT LICENSES ISSUED FOR 2012

License Number	Applicant	Docket Number
PXB151.00	Overlook Medical Center	no docket number
PXB152.00	Christiana Care Health Services, Inc.	no docket number
PXB153.00	Loyola University Medical Center	no docket number
PXB154.00	QSA Global, Inc.	11006000
PXB155.00	University of Iowa Environmental Health & Safety Office	no docket number
PXB156.00	Caritas St. Elizabeth's Medical Center of Boston Inc.	11006006
PXB157.00	Halliburton Energy Services, Inc.	11006020
PXB158.00	Halliburton Energy Services, Inc.	11006021
PXB159.00	Halliburton Energy Services, Inc.	11006025
PXB160.00	Ronan Engineering Company	11006031
PXB161.00	Hartford Hospital	11006038
PXB162.00	Halliburton Energy Services, Inc.	11006039
PXB163.00	Regeneron Pharmaceuticals Inc.	11006043
PXB164.00	BIOQUAL, Inc.	11006044
PXB165.00	Mayo Clinic Jacksonville	11006045
PXB166.00	Lenox Hill Hospital	11006047
PXB167.00	Rochester General Hospital	11006051
PXB168.00	Halliburton Energy Services	11006058
PXB169.00	Baker Hughes Oilfield Operations, Inc.	11006064

#### Appendix P to 10 CFR Part 110 Components Guide

Appendix P licenses support the use of radioactive sealed sources for a variety of medical, industrial, research and educational activities. Some applicants have previously obtained a combined export/import license to allow export or import, use, resale, and import or export back to the supplier for recycling. These combined licenses are no longer appropriate and can no longer be amended going forward given the authorization for imports of Appendix P materials under a general license (see 10 CFR Part 110.27, "General License for Import"). These combined import/export licenses needing amendment are converted to export-only licenses. The 2010 changes to 10 CFR Part 110 generally necessitate specific licenses for only Appendix P, Category 1 and 2 exports.



## APPENDIX AA

### International Activities (continued)

#### LIST OF NRC'S PARTICIPATION WITH MULTILATERAL ORGANIZATIONS

---

#### International Commission on Radiological Protection

---

##### International Atomic Energy Agency

- Commission on Safety Standards
    - Nuclear Safety Standards Committee
    - Radiation Safety Standards Committee
    - Transport Safety Standards Committee
    - Waste Safety Standards Committee
  - Nuclear Security Guidance Committee
- 

#### International Nuclear Regulators Association

---

#### Multinational Design Evaluation Program

---

##### Nuclear Energy Agency

- NEA Steering Committee for Nuclear Energy
- Committee on Nuclear Regulatory Activities
  - Working Group on Inspection Practices
  - Working Group on Operating Experience
  - Working Group on Public Communication of Nuclear Regulatory Organizations
  - Working Group on the Regulation of New Reactors
  - Safety of Research Reactors Task Group
  - Senior-Level Task Group on Impacts of the Fukushima Accident
  - Task Group of Nonconforming, Counterfeit, Fraudulent, and Suspect Items
  - Task Group on Accident Management
- Committee on Radiation Protection and Public Health
  - Expert Group on the Implications of ICRP Recommendations
  - Expert Group on Occupational Exposure
  - Expert Group on the Public Health Perspective in Radiological Protection
  - Expert Group on the Radiological Protection Aspects of the Fukushima Accident
  - Expert Group on Radiological Protection Sciences
  - Working Part on Nuclear Emergency Matters



## APPENDIX AA

### International Activities (continued)

#### LIST OF NRC'S PARTICIPATION WITH MULTILATERAL ORGANIZATIONS

---

- Committee on the Safety of Nuclear Installations
    - CSNI Program Review Group
    - Working Group on Integrity of Components and Structures
    - Working Group on Analysis and Management of Accidents
    - Working Group on Risk Assessment
    - Working Group on Human and Organizational Factors
    - Working Group on Fuel Safety
    - Working Group on Fuel Cycle Safety
  - Radioactive Waste Management Committee
    - Forum on Stakeholder Confidence
    - Integration Group for the Safety Case of Radioactive Waste Repositories
    - Regulators' Forum
    - Working Party on Decommissioning and Dismantling
- 

#### **United Nations Scientific Committee on the Effects of Atomic Radiation**



## Glossary (Abbreviations and Terms Defined)

### Agreement State

A State that has signed an agreement with the U.S. Nuclear Regulatory Commission (NRC) authorizing the State to regulate certain uses of radioactive materials within the State.

### Atomic energy

The energy that is released through a nuclear reaction or radioactive decay process. Of particular interest is the process known as fission, which occurs in a nuclear reactor and produces energy, usually in the form of heat. In a nuclear power plant, this heat is used to boil water to produce steam that can be used to drive large turbines. This, in turn, activates generators to produce electrical power. Atomic energy is more correctly called nuclear energy.

### Background radiation

The natural radiation that is always present in the environment. It includes cosmic radiation that comes from the sun and stars, terrestrial radiation that comes from the Earth, and internal radiation that exists in all living things. The typical average individual exposure in the United States from natural background sources is about 300 millirems per year.

### Boiling-water reactor (BWR)

A common nuclear power reactor design in which water flows upward through the core, where it is heated by fission and allowed to boil in the reactor vessel. The resulting steam then drives turbines, which activate generators to produce electrical power. BWRs operate similarly to electrical plants using fossil fuel, except that the BWRs are powered by 370–800 nuclear fuel assemblies in the reactor core.

### Brachytherapy

A nuclear medicine procedure during which a sealed radioactive source is implanted directly into a person being treated for cancer (usually of the mouth, breast, lung, prostate, ovaries, or uterus). The radioactive implant may be temporary or permanent, and the radiation attacks the tumor as long as the device remains in place. Brachytherapy uses radioisotopes, such as iridium-192 or iodine-125, which are regulated by the NRC and its Agreement States.

### Byproduct material

As defined by NRC regulations, byproduct material includes any radioactive material (except enriched uranium or plutonium) produced by a nuclear reactor. It also includes the tailings or wastes produced by the extraction or concentration of uranium or thorium or the fabrication of fuel for nuclear reactors. Additionally, it is any material that has been made radioactive through the use of a particle accelerator or any discrete source of radium-226 used for a commercial, medical, or research activity. In addition, the NRC, in consultation with the U.S. Environmental Protection Agency (EPA), U.S. Department of Energy (DOE), U.S. Department of Homeland Security (DHS), and others, can designate as byproduct material any source of naturally occurring radioactive material, other than source material, that it determines would pose a threat to public health and safety or the common defense and security of the United States.





## Canister

See *Dry cask storage*.

## Capability

The maximum load that a generating unit, generating station, or other electrical apparatus can carry under specified conditions for a given period of time without exceeding approved limits of temperature and stress.

## Capacity

The amount of electric power that a generating unit can produce. The amount of electric power that a generator, turbine transformer, transmission, circuit, or system is able to produce, as rated by the manufacturer.

## Capacity charge

One of two elements in a two-part pricing method used in capacity transactions (the other element is the energy charge). The capacity charge, sometimes called the demand charge, is assessed on the capacity (amount of electric power) being purchased.

## Capacity factor

The ratio of the available capacity (the amount of electrical power actually produced by a generating unit) to the theoretical capacity (the amount of electrical power that could theoretically have been produced if the generating unit had operated continuously at full power) during a given time period.

## Capacity utilization

A percentage representing the extent to which a generating unit fulfilled its capacity in generating electric power over a given time period. This percentage is defined as the margin between the unit's available capacity (the amount of electrical power the unit actually produced) and its theoretical capacity (the amount of electrical power that could have been produced if the unit had operated continuously at full power) during a certain time period. Capacity utilization is computed by dividing the amount actually produced by the theoretical capacity and multiplying by 100.

## Cask

A heavily shielded container used for the dry storage or shipment (or both) of radioactive materials such as spent nuclear fuel or other high-level radioactive waste (HLW). Casks are often made from lead, concrete, or steel. Casks must meet regulatory requirements and are not intended for long-term disposal in a repository.

## Classified information

Information that could be used by an adversary to harm the United States or its allies and thus must be protected. The NRC has two types of classified information. The first type, known as national security information, is information that is classified by an Executive order. Its release would damage national security to some degree. The second type, known as restricted data, is information that is classified by the Atomic Energy Act of 1954, as amended. It would assist individuals or organizations in designing, manufacturing, or using nuclear weapons. Access to both types of information is restricted to authorized persons who have been properly cleared and have a "need to know" the information for their official duties.



### **Combined license (COL)**

An NRC-issued license that authorizes a licensee to construct and (with certain specified conditions) operate a nuclear power plant at a specific site, in accordance with established laws and regulations. A COL is valid for 40 years (with the possibility of a 20-year renewal).

### **Commercial sector (energy users)**

Generally, nonmanufacturing business establishments, including hotels, motels, and restaurants; wholesalers and retail stores; and health, social, and educational institutions. However, utilities may categorize commercial service as all consumers whose demand or annual usage exceeds some specified limit that is categorized as residential service.

### **Compact**

A group of two or more States that have formed business alliances to dispose of low-level radioactive waste (LLW) on a regional basis.

### **Construction recapture**

The maximum number of years that could be added to a facility's license expiration date to recapture the period between the date the NRC issued the facility's construction permit and the date it granted an operating license. A licensee must submit an application to request this extension.

### **Containment structure**

A gas-tight shell or other enclosure around a nuclear reactor to confine fission products that otherwise might be released to the atmosphere in the event of an accident. Such enclosures are usually dome-shaped and made of steel-reinforced concrete.



## Contamination

Undesirable radiological, chemical, or biological material (with a potentially harmful effect) that is either airborne or deposited in (or on the surface of) structures, objects, soil, water, or living organisms in a concentration that makes the medium unfit for its next intended use.

## Criticality

The normal operating condition of a reactor, in which nuclear fuel sustains a fission chain reaction. A reactor achieves criticality (and is said to be critical) when each fission event releases a sufficient number of neutrons to sustain an ongoing series of reactions.

## Decommissioning

The process of safely closing a nuclear power plant (or other facility where nuclear materials are handled) to retire it from service after its useful life has ended. This process primarily involves decontaminating the facility to reduce residual radioactivity and then releasing the property for unrestricted or (under certain conditions) restricted use. This often includes dismantling the facility or dedicating it to other purposes. Decommissioning begins after the nuclear fuel, coolant, and radioactive waste are removed.

## DECON

A method of decommissioning, in which structures, systems, and components that contain radioactive contamination are removed from a site and safely disposed of at a commercially operated LLW disposal facility or decontaminated to a level that permits the site to be released for unrestricted use shortly after it ceases operation.

## Decontamination

A process used to reduce, remove, or neutralize radiological, chemical, or biological contamination to reduce the risk of exposure. Decontamination may be accomplished by cleaning or treating surfaces to reduce or remove the contamination; filtering contaminated air or water; subjecting contamination to evaporation and precipitation; or covering the contamination to shield or absorb the radiation. The process can also simply allow adequate time for natural radioactive decay to decrease the radioactivity.

## Defense in depth

An approach to designing and operating nuclear facilities that prevents and mitigates accidents that release radiation or hazardous materials. The key is creating multiple independent and redundant layers of defense to compensate for potential human and mechanical failures so that no single layer, no matter how robust, is exclusively relied upon. Defense in depth includes the use of access controls, physical barriers, redundant and diverse key safety functions, and emergency response measures.



### **Depleted uranium**

Uranium with a percentage of uranium-235 lower than the 0.7 percent (by mass) contained in natural uranium. (The normal residual uranium-235 content in depleted uranium is 0.2–0.3 percent, with uranium-238 comprising the remaining 98.7–98.8 percent.) Depleted uranium is the byproduct of the uranium enrichment process. Depleted uranium can be blended with highly enriched uranium, such as that from weapons, to make reactor fuel.

### **Design-basis threat (DBT)**

A profile of the type, composition, and capabilities of an adversary. The NRC uses the DBT as a basis for designing safeguards systems to protect against acts of radiological sabotage and to prevent the theft of special nuclear material. Nuclear facility licensees are expected to demonstrate that they can defend against the DBT.

### **Design certification**

Certification and approval by the NRC of a standard nuclear power plant design independent of a specific site or an application to construct or operate a plant. A design certification is valid for 15 years from the date of issuance but can be renewed for an additional 10 to 15 years.

### **Dry cask storage**

A method for storing spent nuclear fuel above ground in special containers known as casks. After fuel has been cooled in a spent fuel pool for at least 1 year, dry cask storage allows approximately one to six dozen spent fuel assemblies to be sealed in casks and surrounded by inert gas. The casks are large, rugged cylinders made of steel or steel-reinforced concrete (18 or more inches thick or 45.72 or more centimeters). They are welded or bolted closed, and each cask is surrounded by steel, concrete, lead, or other material to provide leak-tight containment and radiation shielding. The casks may be placed horizontally in aboveground concrete bunkers or vertically in concrete vaults or on concrete pads.

### **Early site permit (ESP)**

A permit through which the NRC resolves site safety, environmental protection, and emergency preparedness (EP) issues to approve one or more proposed sites for a nuclear power facility, independent of a specific nuclear plant design or an application for a construction permit or COL. An ESP is valid for 10 to 20 years but can be renewed for an additional 10 to 20 years.

### **Economic Simplified Boiling-Water Reactor (ESBWR)**

A 4,500-megawatts thermal nuclear reactor design, which has passive safety features and uses natural circulation (with no recirculation pumps or associated piping) for normal operation. GE-Hitachi Nuclear Energy (GEH) submitted an application for final design approval and standard design certification for the ESBWR on August 24, 2005.



## Efficiency, plant

The percentage of the total energy content of a power plant's fuel that is converted into electricity. The remaining energy is lost to the environment as heat.

## Electric power grid

A system of synchronized power providers and consumers, connected by transmission and distribution lines and operated by one or more control centers. In the continental United States, the electric power grid consists of three systems—the Eastern Interconnect, the Western Interconnect, and the Texas Interconnect. In Alaska and Hawaii, several systems encompass areas smaller than the State.

## Electric utility

A corporation, agency, authority, person, or other legal entity that owns or operates facilities within the United States, its territories, or Puerto Rico for the generation, transmission, distribution, or sale of electric power (primarily for use by the public). Facilities that qualify as cogenerators or small power producers under the Public Utility Regulatory Policies Act are not considered electric utilities.



## Emergency classifications

Sets of plant conditions that indicate various levels of risk to the public and that might require response by an offsite emergency response organization to protect citizens near the site.

## Emergency preparedness (EP)

The programs, plans, training, exercises, and resources necessary to prepare emergency personnel to rapidly identify, evaluate, and react to emergencies, including those arising from terrorism or natural events such as hurricanes. EP strives to ensure that operators of nuclear power plants and certain fuel cycle facilities can implement measures to protect public health and safety in the event of a radiological emergency. Plant operators, as a condition of their licenses, must develop and maintain EP plans that meet NRC requirements.



### **Energy Information Administration (EIA)**

The agency, within the U.S. Department of Energy, that provides policy-neutral statistical data, forecasts, and analyses to promote sound policymaking, efficient markets, and public understanding regarding energy and its interaction with the economy and the environment.

### **Enrichment**

See *Uranium enrichment*.

### **ENTOMB**

A method of decommissioning, in which radioactive contaminants are encased in a structurally long-lived material, such as concrete. The entombed structure is maintained and surveillance is continued until the radioactive waste decays to a level permitting termination of the license and unrestricted release of the property. During the entombment period, the licensee maintains the license previously issued by the NRC.

### **Event Notification System**

An automated event tracking system used internally by the NRC's Headquarters Operations Center to track incoming notifications of significant nuclear events with an actual or potential effect on the health and safety of the public and the environment. Significant events are reported to the Operations Center by the NRC's licensees, Agreement States, other Federal agencies, the public, and other stakeholders.

### **Exposure**

Absorption of ionizing radiation or ingestion of a radioisotope. Acute exposure is a large exposure received over a short period of time. Chronic exposure is exposure received over a long period of time, such as during a lifetime. The National Council on Radiation Protection and Measurements estimates that an average person in the United States receives a total annual dose of about 0.62 rem (620 millirem) from all radiation source, a level that has not been shown to cause humans any harm. Of this total, natural background sources of radiation—including radon and thoron gas, natural radiation from soil and rocks, radiation from space, and radiation sources that are found naturally within the human body—account for approximately 50 percent. Medical procedures such as computed tomography (CT scans) and nuclear medicine account for approximately another 48 percent. Other small contributors of exposure to the U.S. population include consumer products and activities, industrial and research uses, and occupational tasks. The maximum permissible yearly dose for a person working with or around nuclear material is 5 rem.

### **Federal Emergency Management Agency (FEMA)**

A component of DHS responsible for protecting the nation and reducing the loss of life and property from all hazards, such as natural disasters and acts of terrorism. FEMA leads and supports a risk-based, comprehensive emergency management system of preparedness, protection, response, recovery, and mitigation. FEMA also administers the National Flood Insurance Program.



## **Federal Energy Regulatory Commission (FERC)**

An independent agency that regulates the interstate transmission of electricity, natural gas, and oil. FERC also regulates and oversees hydropower projects and the construction of liquefied natural gas terminals and interstate natural gas pipelines. FERC protects the economic, environmental, and safety interests of the American public, while working to ensure abundant, reliable energy in a fair, competitive market.

## **Fiscal year (FY)**

The 12-month period from October 1 through September 30 used by the Federal Government for budget formulation and execution. The FY is designated by the calendar year in which it ends; for example, FY 2009 runs from October 1, 2008, through September 30, 2009.

## **Fissile material**

A nuclide that is capable of undergoing fission after capturing low-energy thermal (slow) neutrons. Although sometimes used as a synonym for fissionable material, this term has acquired its more restrictive interpretation with the limitation that the nuclide must be fissionable by thermal neutrons. With that interpretation, the three primary fissile materials are uranium-233, uranium-235, and plutonium-239. This definition excludes natural uranium and depleted uranium that have not been irradiated or have only been irradiated in thermal reactors.

## **Fission (fissioning)**

The splitting of an atom, which releases a considerable amount of energy (usually in the form of heat) that can be used to produce electricity. Fission may be spontaneous but is usually caused by the nucleus of an atom becoming unstable (or “heavy”) after capturing or absorbing a neutron. During fission, the heavy nucleus splits into roughly equal parts, producing the nuclei of at least two lighter elements. In addition to energy, this reaction usually releases gamma radiation and two or more daughter neutrons.

## **Force-on-force**

Inspections designed to evaluate and improve the effectiveness of a licensee’s security force and ability to defend a nuclear power plant and other nuclear facilities against a DBT. An essential part of the security program instituted by the NRC, a full force-on-force inspection spans 2 weeks and includes tabletop drills and multiple simulated combat exercises between a mock commando-type adversary and the plant’s security force.

## **Foreign Assignee Program**

An on-the-job training program, sponsored by the NRC for assignees from other countries, usually under bilateral information exchange arrangements with their respective regulatory organizations.



### Freedom of Information Act (FOIA)

A Federal law that requires Federal agencies to provide, upon written request, access to records or information. Some material is exempt from FOIA, and FOIA does not apply to records that are maintained by State and local governments, Federal contractors, grantees, or private organizations or businesses.

### Fuel assembly (fuel bundle, fuel element)

A structured group of fuel rods (long, slender, metal tubes containing pellets of fissionable material, which provide fuel for nuclear reactors). Depending on the design, each reactor vessel may have dozens of fuel assemblies (also known as fuel bundles), each of which may contain 200 or more fuel rods.

### Fuel cycle

The series of steps involved in supplying fuel for nuclear power reactors includes the following:

- uranium recovery to extract (or mine) uranium ore and concentrate (or mill) the ore to produce yellowcake
- conversion of yellowcake into uranium hexafluoride ( $UF_6$ )
- enrichment to increase the concentration of uranium-235 in  $UF_6$
- fuel fabrication to convert enriched  $UF_6$  into fuel for nuclear reactors
- use of the fuel in reactors (nuclear power, research, or naval propulsion)
- interim storage of spent nuclear fuel
- reprocessing of HLW to recover the fissionable material remaining in the spent fuel (currently not done in the United States)
- final disposition (disposal) of HLW

The NRC regulates these processes, as well as the fabrication of mixed oxide (MOX) nuclear fuel, which is a combination of uranium and plutonium oxides.

### Fuel reprocessing (recycling)

The processing of reactor fuel to separate the unused fissionable material from waste material. Reprocessing extracts isotopes from spent nuclear fuel so they can be used again as reactor fuel. Commercial reprocessing is not practiced in the United States, although it has been practiced in the past. However, the U.S. Department of Defense oversees reprocessing programs at DOE facilities such as in Hanford, WA, and Savannah River, SC. These wastes, as well as those wastes at a formerly operating commercial reprocessing facility at West Valley, NY, are not regulated by the NRC.

### Fuel rod

A long, slender, zirconium metal tube containing pellets of fissionable material, which provide fuel for nuclear reactors. Fuel rods are assembled into bundles called fuel assemblies, which are loaded individually into the reactor core.





### Full-time equivalent (FTE)

A human resources measurement equal to one staff person working full time for 1 year.

### Gas centrifuge

A uranium enrichment process used to prepare uranium for use in fabricating fuel for nuclear reactors by separating its isotopes (as gases) based on their slight difference in mass. This process uses a large number of interconnected centrifuge machines (rapidly spinning cylinders). URENCO operates a gas centrifuge enrichment facility in New Mexico, and USEC and AREVA have received licenses to construct and operate facilities in Ohio and Idaho, respectively.

### Gas chromatography

A way of separating chemical substances from a mixed sample by passing the sample, carried by a moving stream of gas, through a tube packed with a finely divided solid that may be coated with a liquid film. Gas chromatography devices are used to analyze air pollutants, blood alcohol content, essential oils, and food products.

### Gaseous diffusion

A uranium enrichment process used to prepare uranium for use in fabricating fuel for nuclear reactors by separating its isotopes (as gases) based on their slight difference in velocity. (Lighter isotopes diffuse faster through a porous membrane or vessel than do heavier isotopes.) This process involves filtering  $UF_6$  gas to separate uranium-234 and uranium-235 from uranium-238, increasing the percentage of uranium-235 from 1 to 3 percent. As of August 2013, the last remaining gaseous diffusion plant in operation in the United States in Paducah, KY, is scheduled to be shut down. A similar plant near Piketon, OH, was closed in March 2001. Both plants are leased by USEC from DOE and have been regulated by the NRC since March 4, 1997.

### Gauging devices

Devices used to measure, monitor, and control the thickness of sheet metal, textiles, paper napkins, newspaper, plastics, photographic film, and other products as they are manufactured. Gauges mounted in fixed locations are designed for measuring or controlling material density, flow, level, thickness, or weight. The gauges contain sealed sources that radiate through the substance being measured to a readout or controlling device. Portable gauging devices, such as moisture density gauges, are used at field locations. These gauges contain a gamma-emitting sealed source, usually cesium-137, or a sealed neutron source, usually americium-241 or beryllium.

### Generation (gross)

The total amount of electric energy produced by a generating station, as measured at the generator terminals.



### **Generation (net)**

The gross amount of electric energy produced by a generating station, minus the amount used to operate the station. Net generation is usually measured in wathhours.

### **Generator capacity**

The maximum amount of electric energy that a generator can produce (from the mechanical energy of the turbine), adjusted for ambient conditions. Generator capacity is commonly expressed in megawatts (MW).

### **Generator nameplate capacity**

The maximum amount of electric energy that a generator can produce under specific conditions, as rated by the manufacturer. Generator nameplate capacity is usually expressed in kilovolt-amperes and kilowatts (kW), as indicated on a nameplate that is physically attached to the generator.

### **Geological repository**

An excavated, underground facility that is designed, constructed, and operated for safe and secure permanent disposal of HLW. A geological repository uses an engineered barrier system and a portion of the site's natural geology, hydrology, and geochemical systems to isolate the radioactivity of the waste. The Nuclear Waste Policy Act of 1982, as amended, specified that this waste would be disposed of in a deep geologic repository, and that Yucca Mountain, NV, would be the single candidate site for such a repository. On June 3, 2008, DOE submitted a license application to the NRC seeking authorization to construct the Yucca Mountain repository. On January 29, 2010, the President created the Blue Ribbon Commission on America's Nuclear Future to reassess the national policy on HLW disposal.

### **Gigawatt (GW)**

A unit of power equivalent to one billion (1,000,000,000) watts.

### **Gigawatthour (GWh)**

One billion (1,000,000,000) wathhours.

### **Grid**

See *Electric power grid*.

### **Half-life (radiological)**

The time required for half the atoms of a particular radioisotope to decay into another isotope that has half the activity of the original radioisotope. A specific half-life is a characteristic property of each radioisotope. Measured half-lives range from millionths of a second to billions of years, depending on the stability of the nucleus. Radiological half-life is related to, but different from, the biological half-life and the effective half-life.

### **Health physics**

The science concerned with recognizing and evaluating the effects of ionizing radiation on the health and safety of people and the environment, monitoring radiation exposure, and controlling the associated health risks and environmental hazards to permit the safe use of technologies that produce ionizing radiation.



## High-level radioactive waste (HLW)

The highly radioactive materials produced as byproducts of fuel reprocessing or of the reactions that occur inside nuclear reactors. HLW includes the following:

- irradiated spent nuclear fuel discharged from commercial nuclear power reactors
- the highly radioactive liquid and solid materials resulting from the reprocessing of spent nuclear fuel, which contain fission products in concentration (this includes some reprocessed HLW from defense activities and a small quantity of reprocessed commercial HLW)
- other highly radioactive materials that the Commission may determine require permanent isolation

## Highly (or High-) enriched uranium

Uranium enriched to at least 20 percent uranium-235 (a higher concentration than exists in natural uranium ore).

## In situ recovery (ISR)

One of the two primary recovery methods that are currently used to extract uranium from ore bodies where they are normally found underground (in other words, in situ), without physical excavation. ISR is also known as “solution mining” or in situ leaching.

## Incident response

Activities that address the short-term, direct effects of a natural or human-caused event and require an emergency response to protect life or property.

## Independent spent fuel storage installation (ISFSI)

A complex designed and constructed for the interim storage of spent nuclear fuel; solid, reactor-related, greater than Class C waste; and other associated radioactive materials. A spent fuel storage facility may be considered independent, even if it is located on the site of another NRC-licensed facility.

## International Atomic Energy Agency (IAEA)

The IAEA is the world's center of cooperation in the nuclear field. It was set up in 1957 as the world's "Atoms for Peace" organization within the United Nations family. The agency works with its 154 member States and multiple partners worldwide to promote safe, secure, and peaceful nuclear technology.

## International Nuclear Regulators Association

An association established in January 1997 to give international nuclear regulators a forum to discuss nuclear safety. Countries represented include Canada, France, Japan, the Republic of South Korea, Spain, Sweden, the United Kingdom, and the United States.

## Irradiation

Exposure to ionizing radiation. Irradiation may be intentional, such as in cancer treatments or in sterilizing medical instruments. Irradiation may also be accidental, such as from exposure to an unshielded source. Irradiation does not usually result in radioactive contamination, but damage can occur, depending on the dose received.



## Isotope

Two or more forms (or atomic configurations) of a given element that have identical atomic numbers (the same number of protons in their nuclei) and the same or very similar chemical properties but different atomic masses (different numbers of neutrons in their nuclei) and distinct physical properties. Thus, carbon-12, carbon-13, and carbon-14 are isotopes of the element carbon, and the numbers denote the approximate atomic masses. Among their distinct physical properties, some isotopes (known as radioisotopes) are radioactive, because their nuclei emit radiation as they strive toward a more stable nuclear configuration. For example, carbon-12 and carbon-13 are stable, but carbon-14 is unstable and radioactive.

## Kilowatt (kW)

A unit of power equivalent to one thousand (1,000) watts.

## Licensed material

Source material, byproduct material, or special nuclear material that is received, possessed, used, transferred, or disposed of under a general or specific license issued by the NRC or Agreement States.

## Licensee

A company, organization, institution, or other entity to which the NRC has granted a general or specific license to construct or operate a nuclear facility, or to receive, possess, use, transfer, or dispose of source, byproduct, or special nuclear material.

## Licensing basis

The collection of documents or technical criteria that provides the basis upon which the NRC issues a license to construct or operate a nuclear facility; to conduct operations involving the emission of radiation; or to receive, possess, use, transfer, or dispose of source, byproduct, or special nuclear material.

## Light-water reactor

A term used to describe reactors using ordinary water as a coolant, including BWRs and pressurized-water reactors (PWRs), the most common types used in the United States.

## Low-level radioactive waste (LLW)

A general term for a wide range of items that have become contaminated with radioactive material or have become radioactive through exposure to neutron radiation. A variety of industries, hospitals and medical institutions, educational and research institutions, private or government laboratories, and nuclear fuel cycle facilities generate LLW as part of their day-to-day use of radioactive materials. Some examples include radioactively contaminated protective shoe covers and clothing; cleaning rags, mops, filters, and reactor water treatment residues; equipment and tools; medical tubes, swabs, and hypodermic syringes; and carcasses and tissues from laboratory animals. The radioactivity in these wastes can range from just above natural background levels to much higher levels, such as seen in parts from inside the reactor vessel in a nuclear power plant. LLW is typically stored on site by licensees, either until it has decayed away and can be disposed of as ordinary trash, or until the accumulated amount becomes large enough to warrant shipment to an LLW disposal site.



### **Maximum dependable capacity (gross)**

The maximum amount of electricity that the main generating unit of a nuclear power reactor can reliably produce during the summer or winter (usually summer, but whichever represents the most restrictive seasonal conditions, with the least electrical output). The dependable capacity varies during the year, because temperature variations in cooling water affect the unit's efficiency. Thus, this is the gross electrical output as measured (in watts unless otherwise noted) at the output terminals of the turbine generator.

### **Maximum dependable capacity (net)**

The gross maximum dependable capacity of the main generating unit in a nuclear power reactor, minus the amount used to operate the station. Net maximum dependable capacity is measured in watts unless otherwise noted.

### **Megawatt (MW)**

A unit of power equivalent to one million (1,000,000) watts.

### **Metric ton**

Approximately 2,200 pounds.

### **Mill tailings**

Primarily, the sandy process waste material from a conventional uranium recovery facility. This naturally radioactive ore residue contains the radioactive decay products from the uranium chains (mainly the uranium-238 chain) and heavy metals. Although the milling process recovers about 93 percent of the uranium, the residues (known as "tailings") contain several naturally occurring radioactive elements, including uranium, thorium, radium, polonium, and radon.

### **Mixed oxide (MOX) fuel**

A type of nuclear reactor fuel (often called "MOX") that contains plutonium oxide mixed with either natural or depleted uranium oxide, in ceramic pellet form. (This differs from conventional nuclear fuel, which is made of pure uranium oxide.) Using plutonium reduces the amount of highly enriched uranium needed to produce a controlled reaction in commercial light-water reactors. However, plutonium exists only in trace amounts in nature and, therefore, must be produced by neutron irradiation of uranium-238 or obtained from other manufactured sources. As directed by Congress, the NRC regulates the fabrication of MOX fuel by DOE, a program that is intended to dispose of plutonium from international nuclear disarmament agreements.

### **Monitoring of radiation**

Periodic or continuous determination of the amount of ionizing radiation or radioactive contamination in a region. Radiation monitoring is a safety measure to protect the health and safety of the public and the environment through the use of bioassay, alpha scans, and other radiological survey methods to monitor air, surface water and ground water, soil and sediment, equipment surfaces, and personnel.



## National Response Framework

The guiding principles, roles, and structures that enable all domestic incident response partners to prepare for and provide a unified national response to disasters and emergencies. It describes how the Federal Government, States, Tribes, communities, and the private sector work together to coordinate a national response. The framework, which became effective March 22, 2008, builds upon the National Incident Management System, which provides a template for managing incidents.

## National Source Tracking System (NSTS)

A secure, Web-based data system that helps the NRC and its Agreement States track and regulate the medical, industrial, and academic uses of certain nuclear materials, from the time they are manufactured or imported to the time of their disposal or exportation. This information enhances the ability of the NRC and Agreement States to conduct inspections and investigations, communicate information to other government agencies, and verify the ownership and use of nationally tracked sources.

## Natural uranium

Uranium containing the relative concentrations of isotopes found in nature (0.7 percent uranium-235, 99.3 percent uranium-238, and a trace amount of uranium-234 by mass). In terms of radioactivity, however, natural uranium contains approximately 2.2 percent uranium-235, 48.6 percent uranium-238, and 49.2 percent uranium-234. Natural uranium can be used as fuel in nuclear reactors.

## Net electric generation

The gross amount of electric energy produced by a generating station, minus the amount used to operate the station. Note: Electricity required for pumping at pumped-storage plants is regarded as electricity for station operation and is deducted from gross generation. Net electric generation is measured in watthours, except as otherwise noted.

## Net summer capacity

The steady hourly output that generating equipment is expected to supply to system load, exclusive of auxiliary power, as demonstrated by measurements at the time of peak demand (summer). Net summer capacity is measured in watts unless otherwise noted.

## Nonpower reactor (research and test reactor)

A nuclear reactor that is used for research, training, or development purposes (which may include producing radioisotopes for medical and industrial uses) but has no role in producing electrical power. These reactors, which are also known as research and test reactors, contribute to almost every field of science, including physics, chemistry, biology, medicine, geology, archeology, and ecology.



## **NRC Headquarters Operations Center**

The primary center of communication and coordination among the NRC, its licensees, State and Tribal agencies, and other Federal agencies regarding operating events involving nuclear reactors or materials. Located in Rockville, MD, the Headquarters Operations Center is staffed 24 hours a day by employees trained to receive and evaluate event reports and coordinate incident response activities.

## **Nuclear energy**

See *Atomic energy*.

## **Nuclear Energy Agency (NEA)**

A specialized agency within the Organization for Economic Cooperation and Development (OECD), which was created to assist its member countries in maintaining and further developing the scientific, technological, and legal bases for safe, environmentally friendly, and economical use of nuclear energy for peaceful purposes. The NEA's current membership consists of 30 countries in Europe, North America, and the Asia-Pacific region, which account for approximately 85 percent of the world's installed nuclear capacity.

## **Nuclear fuel**

Fissionable material that has been enriched to a composition that will support a self-sustaining fission chain reaction when used to fuel a nuclear reactor, thereby producing energy (usually in the form of heat or useful radiation) for use in other processes.

## **Nuclear materials**

See *Special nuclear material*, *Source material*, and *Byproduct material*.

## **Nuclear Material Management and Safeguards System (NMMSS)**

A centralized U.S. Government database used to track and account for source and special nuclear material and used to ensure that it has not been stolen or diverted to unauthorized users. The system contains current and historical data on the possession, use, and shipment of source and special nuclear material within the United States, as well as all exports and imports of such material. The database is jointly funded by the NRC and DOE and is operated under a DOE contract.

## **Nuclear poison (or neutron poison)**

In reactor physics, a substance (other than fissionable material) that has a large capacity for absorbing neutrons in the vicinity of the reactor core. This effect may be undesirable in some reactor applications because it may prevent or disrupt the fission chain reaction, thereby affecting normal operation. However, neutron-absorbing materials (commonly known as "poisons") are intentionally inserted into some types of reactors to decrease the reactivity of their initial fresh fuel load. (Adding poisons, such as control rods or boron, is described as adding "negative reactivity" to the reactor.)



## Nuclear power plant

A thermal power plant, in which the energy (heat) released by the fissioning of nuclear fuel is used to boil water to produce steam. The steam spins the propeller-like blades of a turbine that turns the shaft of a generator to produce electricity. Of the various nuclear power plant designs, PWRs and BWRs are in commercial operation in the United States. These facilities generate about 20 percent of U.S. electrical power.

## Nuclear and Radiological Incident Annex

An annex to the National Response Framework, which provides for a timely, coordinated response by Federal agencies to nuclear or radiological accidents or incidents within the United States. This annex covers radiological dispersal devices and improvised nuclear devices, as well as accidents involving commercial reactors or weapons production facilities, lost radioactive sources, transportation accidents involving radioactive material, and foreign accidents involving nuclear or radioactive material.

## Nuclear reactor

The heart of a nuclear power plant or nonpower reactor, in which nuclear fission may be initiated and controlled in a self-sustaining chain reaction to generate energy or produce useful radiation. Although there are many types of nuclear reactors, they all incorporate certain essential features, including the use of fissionable material as fuel, a moderator (such as water) to increase the likelihood of fission (unless reactor operation relies on fast neutrons), a reflector to conserve escaping neutrons, coolant provisions for heat removal, instruments for monitoring and controlling reactor operation, and protective devices (such as control rods and shielding).

## Nuclear waste

A subset of radioactive waste that includes unusable byproducts produced during the various stages of the nuclear fuel cycle, including extraction, conversion, and enrichment of uranium; fuel fabrication; and use of the fuel in nuclear reactors. Specifically, these stages produce a variety of nuclear waste materials, including uranium mill tailings, depleted uranium, and spent (depleted) fuel, all of which are regulated by the NRC. (By contrast, “radioactive waste” is a broader term, which includes all wastes that contain radioactivity, regardless of how they are produced. It is not considered “nuclear waste,” because it is not produced through the nuclear fuel cycle and is generally not regulated by the NRC.)

## Occupational dose

The internal and external dose of ionizing radiation received by workers in the course of employment in such areas as fuel cycle facilities, industrial radiography, nuclear medicine, and nuclear power plants. These workers are exposed to varying amounts of radiation, depending on their jobs and the sources with which they work. The NRC requires its licensees to limit occupational exposure to 5,000 mrem (50 millisievert) per year. Occupational dose does not include the dose received from natural background sources, doses received as a medical patient or participant in medical research programs, or “second-hand doses” to members of the public received through exposure to patients treated with radioactive materials.





## Organisation for Economic Co-operation and Development (OECD)

An intergovernmental organization (based in Paris, France) that provides a forum for discussion and cooperation among the governments of industrialized countries committed to democracy and the market economy. The primary goal of OECD and its member countries is to support sustainable economic growth, boost employment, raise living standards, maintain financial stability, assist other countries' economic development, and contribute to growth in world trade. In addition, OECD is a reliable source of comparable statistics and economic and social data. OECD also monitors trends, analyzes and forecasts economic developments, and researches social changes and evolving patterns in trade, environment, agriculture, technology, taxation, and other areas.

## Orphan sources (unwanted radioactive material)

Sealed sources of radioactive material contained in a small volume (but not radioactively contaminated soils and bulk metals) in any one or more of the following conditions:

- an uncontrolled condition that requires removal to protect public health and safety from a radiological threat
- a controlled or uncontrolled condition, for which a responsible party cannot be readily identified
- a controlled condition, compromised by an inability to ensure the continued safety of the material (e.g., the licensee may have few or no options to provide for safe disposition of the material)
- an uncontrolled condition, in which the material is in the possession of a person who did not seek, and is not licensed, to possess it
- an uncontrolled condition, in which the material is in the possession of a State radiological protection program solely to mitigate a radiological threat resulting from one of the above conditions, and for which the State does not have the necessary means to provide for the appropriate disposition of the material

## Outage

The period during which a generating unit, transmission line, or other facility is out of service. Outages may be forced or scheduled and full or partial.

## Outage (forced)

The shutdown of a generating unit, transmission line, or other facility for emergency reasons, or a condition in which the equipment is unavailable as a result of an unanticipated breakdown. An outage (whether full, partial, or attributable to a failed start) is considered "forced" if it could not reasonably be delayed beyond 48 hours from identification of the problem, if there had been a strong commercial desire to do so. In particular, the following problems may result in forced outages:

- any failure of mechanical, fuel handling, or electrical equipment or controls within the generator's ownership or direct responsibility (i.e., from the point the generator is responsible for the fuel through to the electrical connection point)



- a failure of a mine or fuel transport system dedicated to that power station with a resulting fuel shortage that cannot be economically managed
- inadvertent or operator error
- limitations caused by fuel quality

Forced outages do not include scheduled outages for inspection, maintenance, or refueling.

### **Outage (full forced)**

A forced outage that causes a generating unit to be removed from the committed state (when the unit is electrically connected and generating or pumping) or the available state (when the unit is available for dispatch as a generator or pump but is not electrically connected and not generating or pumping). Full-forced outages do not include failed starts.

### **Outage (scheduled)**

The shutdown of a generating unit, transmission line, or other facility for inspection, maintenance, or refueling, which is scheduled well in advance (even if the schedule changes). Scheduled outages do not include forced outages and could be deferred if there were a strong commercial reason to do so.

### **Pellet, fuel**

A thimble-sized ceramic cylinder (approximately 3/8-inch in diameter and 5/8-inch in length), consisting of uranium (typically uranium oxide), which has been enriched to increase the concentration of uranium-235 (U-235) to fuel a nuclear reactor. Modern reactor cores in PWRs and BWRs may contain up to 10 million pellets, stacked in the fuel rods that form fuel assemblies.

### **Performance-based regulation**

A regulatory approach that focuses on desired, measurable outcomes, rather than prescriptive processes, techniques, or procedures. Performance-based regulation leads to defined results without specific direction regarding how those results are to be obtained. At the NRC, performance-based regulatory actions focus on identifying performance measures that ensure an adequate safety margin and offer incentives for licensees to improve safety without formal regulatory intervention by the agency.

### **Performance indicator**

A quantitative measure of a particular attribute of licensee performance that shows how well a plant is performing when measured against established thresholds. Licensees submit their data quarterly; the NRC regularly conducts inspections to verify the submittals and then uses its own inspection data plus the licensees' submittals to assess each plant's performance.

### **Possession-only license**

A license, issued by the NRC, that authorizes the licensee to possess specific nuclear material but does not authorize its use or the operation of a nuclear facility.



## Power uprate

The process of increasing the maximum power level at which a commercial nuclear power plant may operate. This power level, regulated by the NRC, is included in the plant's operating license and technical specifications. A licensee may only change its maximum power output after the NRC approves an uprate application. The NRC analyses must demonstrate that the plant could continue to operate safely with its proposed new configuration. When all requisite conditions are fulfilled, the NRC may grant the power uprate by amending the plant's operating license and technical specifications.

## Pressurized-water reactor (PWR)

A common nuclear power reactor design in which very pure water is heated to a very high temperature by fission, kept under high pressure (to prevent it from boiling), and converted to steam by a steam generator (rather than by boiling, as in a BWR). The resulting steam is used to drive turbines, which activate generators to produce electrical power. A PWR essentially operates like a pressure cooker, where a lid is tightly placed over a pot of heated water, causing the pressure inside to increase as the temperature increases (because the steam cannot escape) but keeping the water from boiling at the usual 212 degrees Fahrenheit (100 degrees Celsius). About two-thirds of the operating nuclear reactor power plants in the United States are PWRs.

## Probabilistic risk assessment (PRA)

A systematic method for assessing three questions that the NRC uses to define "risk." These questions consider (1) what can go wrong, (2) how likely it is to happen, and (3) what the consequences might be. These questions allow the NRC to understand likely outcomes, sensitivities, areas of importance, system interactions, and areas of uncertainty, which the staff can use to identify risk-significant scenarios. The NRC uses PRA to determine a numeric estimate of risk to provide insights into the strengths and weaknesses of the design and operation of a nuclear power plant.

## Production expense

Production expense is one component of the cost of generating electric power, which includes costs associated with fuel, as well as plant operation and maintenance.

## Rad (radiation absorbed dose)

One of the two units used to measure the amount of radiation absorbed by an object or person, known as the "absorbed dose," which reflects the amount of energy that radioactive sources deposit in materials through which they pass. The radiation-absorbed dose (rad) is the amount of energy (from any type of ionizing radiation) deposited in any medium (e.g., water, tissue, air). An absorbed dose of 1 rad means that 1 gram of material absorbed 100 ergs of energy (a small but measurable amount) as a result of exposure to radiation. The related international system unit is the gray (Gy), where 1 Gy is equivalent to 100 rad.



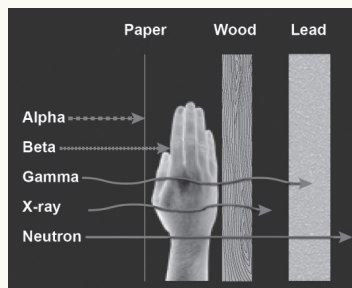
## Radiation, ionizing

A form of radiation, which includes alpha particles, beta particles, gamma rays and x-rays, neutrons, high-speed electrons, and high-speed protons. Compared to nonionizing radiation, such as found in ultraviolet light or microwaves, ionizing radiation is considerably more energetic. When ionizing radiation passes through material such as air, water, or living tissue, it deposits enough energy to break molecular bonds and displace (or remove) electrons. This electron displacement may lead to changes in living cells. Given this ability, ionizing radiation has a number of beneficial uses, including treating cancer or sterilizing medical equipment. However, ionizing radiation is potentially harmful if not used correctly, and high doses may result in severe skin or tissue damage. It is for this reason that the NRC strictly regulates commercial and institutional uses of the various types of ionizing radiation.

## Radiation, nuclear

Energy given off by matter in the form of tiny fast-moving particles (alpha particles, beta particles, and neutrons) or pulsating electromagnetic rays or waves (gamma rays) emitted from the nuclei of unstable radioactive atoms. All matter is composed of atoms, which are made up of various parts; the nucleus contains minute particles called protons and neutrons, and the atom's outer shell contains other particles called electrons.

The nucleus carries a positive electrical charge, while the electrons carry a negative electrical charge. These forces work toward a strong, stable balance by getting rid of excess atomic energy (radioactivity). In that process, unstable radioactive nuclei may emit energy, and this spontaneous emission is called nuclear radiation. All types of nuclear radiation are also ionizing radiation, but the reverse is not necessarily true; for example, x-rays are a type of ionizing radiation, but they are not nuclear radiation, because they do not originate from atomic nuclei. In addition, some elements are naturally radioactive, as their nuclei emit nuclear radiation as a result of radioactive decay, but others become radioactive by being irradiated in a reactor. Naturally occurring nuclear radiation is indistinguishable from induced radiation.



## Radiation source

A radioactive material or byproduct that is specifically manufactured or obtained for the purpose of using the emitted radiation. Such sources are commonly used in teletherapy or industrial radiography; in various types of industrial gauges, irradiators, and gamma knives; and as power sources for batteries (such as those used in spacecraft). These sources usually consist of a known quantity of radioactive material, which is encased in a manmade capsule, sealed between layers of nonradioactive material, or firmly bonded to a nonradioactive substrate to prevent radiation leakage. Other radiation sources include devices such as accelerators and x-ray generators.

## Radiation standards

Exposure limits; permissible concentrations; rules for safe handling; and regulations regarding receipt, possession, use, transportation, storage, disposal, and industrial control of radioactive material.



## Radiation therapy (radiotherapy)

The therapeutic use of ionizing radiation to treat disease in patients. Although most radiotherapy procedures are intended to kill cancerous tissue or reduce the size of a tumor, therapeutic doses may also be used to reduce pain or treat benign conditions. For example, intravascular brachytherapy uses radiation to treat clogged blood vessels. Other common radiotherapy procedures include gamma stereotactic radiosurgery (gamma knife), teletherapy, and iodine treatment to correct an overactive thyroid gland. These procedures use radiation sources, regulated by the NRC and its Agreement States, that may be applied either inside or outside the body. In either case, the goal of radiotherapy is to deliver the required therapeutic or pain-relieving dose of radiation with high precision and for the required length of time, while preserving the surrounding healthy tissue.

## Radiation warning symbol

An officially prescribed magenta or black trefoil on a yellow background, which must be displayed where certain quantities of radioactive materials are present or where certain doses of radiation could be received.



## Radioactive contamination

Undesirable radioactive material (with a potentially harmful effect) that is either airborne or deposited in (or on the surface of) structures, objects, soil, water, or living organisms (people, animals, or plants) in a concentration that may harm people, equipment, or the environment.

## Radioactive decay

The spontaneous transformation of one radioisotope into one or more different isotopes (known as “decay products” or “daughter products”), accompanied by a decrease in radioactivity (compared to the parent material). This transformation takes place over a defined period of time (known as a “half-life”), as a result of electron capture; fission; or the emission of alpha particles, beta particles, or photons (gamma radiation or x-rays) from the nucleus of an unstable atom. Each isotope in the sequence (known as a “decay chain”) decays to the next until it forms a stable, less energetic end product. In addition, radioactive decay may refer to gamma-ray and conversion electron emission, which only reduces the excitation energy of the nucleus.

## Radioactivity

The property possessed by some elements (such as uranium) of spontaneously emitting energy in the form of radiation as a result of the decay (or disintegration) of an unstable atom. Radioactivity is also the term used to describe the rate at which radioactive material emits radiation. Radioactivity is measured in units of becquerels or disintegrations per second.

## Radiography

The use of sealed sources of ionizing radiation for nondestructive examination of the structure of materials. When the radiation penetrates the material, it produces a shadow image by blackening a sheet of photographic film that has been placed behind the material, and the differences in blackening suggest flaws and unevenness in the material.

**Radioisotope (radionuclide)**

An unstable isotope of an element that decays or disintegrates spontaneously, thereby emitting radiation. Approximately 5,000 natural and artificial radioisotopes have been identified.

**Radiopharmaceutical**

A pharmaceutical drug that emits radiation and is used in diagnostic or therapeutic medical procedures. Radioisotopes that have short half-lives are generally preferred to minimize the radiation dose to the patient and the risk of prolonged exposure. In most cases, these short-lived radioisotopes decay to stable elements within minutes, hours, or days, allowing patients to be released from the hospital in a relatively short time.

**Reactor core**

The central portion of a nuclear reactor, which contains the fuel assemblies, water, and control mechanisms, as well as the supporting structure. The reactor core is where fission takes place.

**Reactor Oversight Process (ROP)**

The process by which the NRC monitors and evaluates the performance of commercial nuclear power plants. Designed to focus on those plant activities that are most important to safety, the ROP uses inspection findings and performance indicators to assess each plant's safety performance.

**Regulation**

The governmental function of controlling or directing economic entities through the process of rulemaking and adjudication.

**Regulatory Information Conference**

An annual NRC conference that brings together NRC staff, regulated utilities, materials users, and other interested stakeholders to discuss nuclear safety topics and significant and timely regulatory activities through informal dialogue to ensure an open regulatory process.

**Rem (roentgen equivalent man)**

One of the two standard units used to measure the dose equivalent (or effective dose), which combines the amount of energy (from any type of ionizing radiation) that is deposited in human tissue with the biological effects of the given type of radiation. For beta and gamma radiation, the dose equivalent is the same as the absorbed dose. By contrast, the dose equivalent is larger than the absorbed dose for alpha and neutron radiation, because these types of radiation are more damaging to the human body. Thus, the dose equivalent (in rems) is equal to the absorbed dose (in rads) multiplied by the quality factor of the type of radiation (Title 10 of the *Code of Federal Regulations* (10 CFR) 20.1004, "Units of Radiation Dose"). The related international system unit is the sievert (Sv), where 100 rem is equivalent to 1 Sv.



## Renewable resources

Natural, but limited, energy resources that can be replenished, including biomass, hydro, geothermal, solar, and wind. These resources are virtually inexhaustible but limited in the amount of energy that is available per unit of time. In the future, renewable resources could also include the use of ocean thermal, wave, and tidal action technologies. Utility renewable resource applications include bulk electricity generation, onsite electricity generation, distributed electricity generation, nongrid-connected generation, and demand-reduction (energy efficiency) technologies.

## Risk

The combined answer to three questions that consider (1) what can go wrong, (2) how likely it is to occur, and (3) what the consequences might be. These three questions allow the NRC to understand likely outcomes, sensitivities, areas of importance, system interactions, and areas of uncertainty, which can be used to identify risk-significant scenarios.

## Risk-based decisionmaking

An approach to regulatory decisionmaking that considers only the results of a probabilistic risk assessment.

## Risk-informed decisionmaking

An approach to regulatory decisionmaking, in which insights from probabilistic risk assessment are considered with other engineering insights.

## Risk-informed regulation

An approach to regulation taken by the NRC, which incorporates an assessment of safety significance or relative risk. This approach ensures that the regulatory burden imposed by an individual regulation or process is appropriate to its importance in protecting the health and safety of the public and the environment.

## Risk significant

“Risk significant” can refer to a facility’s system, structure, component, or accident sequence that exceeds a predetermined limit for contributing to the risk associated with the facility. The term also describes a level of risk exceeding a predetermined “significance” level.

## Safeguards

The use of material control and accounting programs to verify that all special nuclear material is properly controlled and accounted for, as well as the physical protection (or physical security) equipment and security forces. As used by IAEA, this term also means verifying that the peaceful use commitments made in binding nonproliferation agreements, both bilateral and multilateral, are honored.

## Safeguards Information

A special category of sensitive unclassified information that must be protected. Safeguards Information concerns the physical protection of operating power reactors, spent fuel shipments, strategic special nuclear material, or other radioactive material.



### **Safety-related**

In the regulatory arena, this term applies to systems, structures, components, procedures, and controls (of a facility or process) that are relied upon to remain functional during and following design-basis events. Their functionality ensures that key regulatory criteria, such as levels of radioactivity released, are met. Examples of safety-related functions include shutting down a nuclear reactor and maintaining it in a safe shutdown condition.

### **Safety significant**

When used to qualify an object, such as a system, structure, component, or accident sequence, this term identifies that object as having an impact on safety, whether determined through risk analysis or other means, that exceeds a predetermined significance criterion.

### **SAFSTOR**

A method of decommissioning in which a nuclear facility is placed and maintained in a condition that allows the facility to be safely stored and subsequently decontaminated (deferred decontamination) to levels that permit release for unrestricted use.

### **Scram**

The sudden shutting down of a nuclear reactor, usually by rapid insertion of control rods, either automatically or manually by the reactor operator (also known as a “reactor trip”).

### **Sensitive unclassified nonsafeguards information**

Information that is generally not publicly available and that encompasses a wide variety of categories, such as proprietary information, personal and private information, or information subject to attorney-client privilege.

### **Shutdown**

A decrease in the rate of fission (and heat or energy production) in a reactor (usually by the insertion of control rods into the core).

### **Source material**

Uranium or thorium, or any combination thereof, in any physical or chemical form, or ores that contain, by weight, 1/20 of 1 percent (0.05 percent) or more of (1) uranium, (2) thorium, or (3) any combination thereof. Source material does not include special nuclear material.

### **Special nuclear material**

Plutonium, uranium-233, or uranium enriched in the isotopes uranium-233 or uranium-235.

### **Spent fuel pool**

An underwater storage and cooling facility for spent (depleted) fuel assemblies that have been removed from a reactor.





## Spent (depleted or used) nuclear fuel

Nuclear reactor fuel that has been used to the extent that it can no longer effectively sustain a chain reaction.

## Subcriticality

The condition of a nuclear reactor system, in which nuclear fuel no longer sustains a fission chain reaction (that is, the reaction fails to initiate its own repetition, as it would in a reactor's normal operating condition). A reactor becomes subcritical when its fission events fail to release a sufficient number of neutrons to sustain an ongoing series of reactions, possibly as a result of increased neutron leakage or poisons.

## Teletherapy

Treatment in which the source of the therapeutic radiation is at a distance from the body. Because teletherapy is often used to treat malignant tumors deep within the body by bombarding them with a high-energy beam of gamma rays (from a radioisotope such as cobalt-60) projected from outside the body, it is often called “external beam radiotherapy.”

## Title 10 of the Code of Federal Regulations (10 CFR)

Four volumes of the *Code of Federal Regulations* (CFR) address energy-related topics. Parts 1 to 199 contain the regulations (or rules) established by the NRC. These regulations govern the transportation and storage of nuclear materials; use of radioactive materials at nuclear power plants, research and test reactors, uranium recovery facilities, fuel cycle facilities, waste repositories, and other nuclear facilities; and use of nuclear materials for medical, industrial, and academic purposes.

## Transient

A change in the reactor coolant system temperature, pressure, or both, attributed to a change in the reactor's power output. Transients can be caused by (1) adding or removing neutron poisons, (2) increasing or decreasing electrical load on the turbine generator, or (3) accident conditions.

## Transuranic waste

Material contaminated with transuranic elements—artificially made, radioactive elements, such as neptunium, plutonium, americium, and others—that have atomic numbers higher than uranium in the periodic table of elements. Transuranic waste is primarily produced from recycling spent fuel or using plutonium to fabricate nuclear weapons.

## Tritium

A radioactive isotope of hydrogen. Because it is chemically identical to natural hydrogen, tritium can easily be taken into the body by any ingestion path. It decays by emitting beta particles and has a half-life of about 12.5 years.

## Uprate

See *Power uprate*.



## Uranium

A radioactive element with the atomic number 92 and, as found in natural ores, an atomic weight of approximately 238. The two principal natural isotopes are uranium-235 (which comprises 0.7 percent of natural uranium), which is fissile, and uranium-238 (99.3 percent of natural uranium), which is fissionable by fast neutrons and is fertile, meaning that it becomes fissile after absorbing one neutron. Natural uranium also includes a minute amount of uranium-234.

## Uranium enrichment

The process of increasing the percentage of U235 from 0.7 percent in natural uranium to about 3-5 percent for use in fuel for nuclear reactors. Enrichment can be done through gaseous diffusion, gas centrifuges, or laser isotope separation.

## Uranium fuel fabrication facility

A facility that converts enriched  $UF_6$  into fuel for commercial light-water power reactors, research and test reactors, and other nuclear reactors. The  $UF_6$  in solid form in containers, is heated to a gaseous form and then chemically processed to form uranium dioxide ( $UO_2$ ) powder. This powder is then processed into ceramic pellets and loaded into metal tubes, which are subsequently bundled into fuel assemblies. Fabrication also can involve MOX fuel, which contains plutonium oxide mixed with either natural or depleted uranium oxide, in ceramic pellet form.

## Uranium hexafluoride production facility (or uranium conversion facility)

A facility that receives natural uranium in the form of ore concentrate (known as yellowcake) and converts it into  $UF_6$ , in preparation for fabricating fuel for nuclear reactors.

## U.S. Department of Energy (DOE)

The Federal agency established by Congress to advance the national, economic, and energy security of the United States, among other missions.

## U.S. Department of Homeland Security (DHS)

The Federal agency responsible for leading the unified national effort to secure the United States against those who seek to disrupt the American way of life. DHS is also responsible for preparing for and responding to all hazards and disasters and includes the formerly separate FEMA, the Coast Guard, and the Secret Service.

## U.S. Environmental Protection Agency (EPA)

The Federal agency responsible for protecting human health and safeguarding the environment. The EPA leads the Nation's environmental science, research, education, and assessment efforts to ensure that attempts to reduce environmental risk are based on the best available scientific information. The EPA also ensures that environmental protection is an integral consideration in U.S. policies.

## Viability assessment

A decisionmaking process used by DOE to assess the prospects for safe and secure permanent disposal of HLW in an excavated, underground facility, known as a geologic repository. This decisionmaking process is based on (1) specific design work on the critical elements of the repository and waste package, (2) a total system performance assessment that will describe the probable behavior of the repository, (3) a plan and cost estimate for the work required to complete the license application, and (4) an estimate of the costs to construct and operate the repository.



## Waste, radioactive

Radioactive materials at the end of their useful life or in a product that is no longer useful and requires proper disposal.

## Waste classification (classes of waste)

Classification of LLW according to its radiological hazard. The classes include Class A, B, and C, with Class A being the least hazardous and accounting for 96 percent of LLW. As the waste class and hazard increase, the regulations established by the NRC require progressively greater controls to protect the health and safety of the public and the environment.

## Watt

A unit of power (in the international system of units) defined as the consumption or conversion of 1 joule of energy per second. In electricity, a watt is equal to current (in amperes) multiplied by voltage (in volts).

## Watt-hour

An unit of energy equal to 1 watt of power steadily supplied to, or taken from, an electrical circuit for 1 hour (or exactly  $3.6 \times 10^3$  joules).

## Well logging

All operations involving the lowering and raising of measuring devices or tools that contain licensed nuclear material or are used to detect licensed nuclear materials in wells for the purpose of obtaining information about the well or adjacent formations that may be used in oil, gas, mineral, ground water, or geological exploration.

## Wheeling service

The movement of electricity from one system to another over transmission facilities of intervening systems. Wheeling service contracts can be established between two or more systems.

## Yellowcake

The solid form of mixed uranium oxide, which is produced from uranium ore in the uranium recovery (milling) process. The material is a mixture of uranium oxides, which can vary in proportion and color from yellow to orange to dark green (blackish) depending on the temperature at which the material is dried (which affects the level of hydration and impurities), with higher drying temperatures producing a darker and less soluble material. (The yellowcake produced by most modern mills is actually brown or black, rather than yellow, but the name comes from the color and texture of the concentrates produced by early milling operations.) Yellowcake is commonly referred to as  $U_3O_8$ , because that chemical compound comprises approximately 85 percent of the yellowcake produced by uranium recovery facilities, and that product is then transported to a uranium conversion facility, where it is transformed into  $UF_6$ , in preparation for fabricating fuel for nuclear reactors.

## Zirconium

A chemical element used (in the form of “Zircaloy” metals) in cladding for nuclear fuel rods. The thin zirconium tubes contain pellets of nuclear fuel and are bundled together into assemblies for use in a reactor.

# Web Link Index

## NRC: An Independent Regulatory Agency

### Mission, Goals, and Statutory Authority

Strategic Plan (NUREG-1614)  
[www.nrc.gov/reading-rm/doc-collections/nuregs/staff/sr1614](http://www.nrc.gov/reading-rm/doc-collections/nuregs/staff/sr1614)  
Statutory Authority  
[www.nrc.gov/about-nrc/governing-laws.html](http://www.nrc.gov/about-nrc/governing-laws.html)

### Major Activities

Public Involvement  
[www.nrc.gov/public-involve.html](http://www.nrc.gov/public-involve.html)  
Freedom of Information Act (FOIA)  
[www.nrc.gov/reading-rm/foia/foia-privacy.html](http://www.nrc.gov/reading-rm/foia/foia-privacy.html)  
Agency Rulemaking Actions  
[www.regulations.gov](http://www.regulations.gov)  
Significant Enforcement Actions  
[www.nrc.gov/reading-rm/doc-collections/enforcement/actions/](http://www.nrc.gov/reading-rm/doc-collections/enforcement/actions/)

### Organizations and Functions

Organization Chart  
[www.nrc.gov/about-nrc/organization/nrcorg.pdf](http://www.nrc.gov/about-nrc/organization/nrcorg.pdf)  
The Commission  
[www.nrc.gov/about-nrc/organization/commfuncdesc.html](http://www.nrc.gov/about-nrc/organization/commfuncdesc.html)  
Commission Direction-Setting and Policymaking Activities  
[www.nrc.gov/about-nrc/policymaking.html](http://www.nrc.gov/about-nrc/policymaking.html)  
NRC Regions  
[www.nrc.gov/about-nrc/locations.html](http://www.nrc.gov/about-nrc/locations.html)

### NRC Budget

Performance Budget: Fiscal Year 2012 (NUREG-1100)  
[www.nrc.gov/reading-rm/doc-collections/nuregs/staff/sr1100](http://www.nrc.gov/reading-rm/doc-collections/nuregs/staff/sr1100)

## U.S. and Worldwide Nuclear Energy

### U.S. Electricity

Energy Information Administration  
Official Energy Statistics from the U.S. Government  
[www.eia.doe.gov](http://www.eia.doe.gov)



## Worldwide Electricity Generated by Commercial Nuclear Power

International Atomic Energy Agency (IAEA)  
[www.iaea.org](http://www.iaea.org)

IAEA Power Reactor Information System (PRIS)  
[www.iaea.org/programmes/a2](http://www.iaea.org/programmes/a2)

Nuclear Energy Agency (NEA)  
[www.nea.fr/](http://www.nea.fr/)

World Nuclear Association (WNA)  
[www.world-nuclear.org/](http://www.world-nuclear.org/)

World Nuclear Power Reactors and Uranium Requirements  
[www.world-nuclear.org/info/reactors.html](http://www.world-nuclear.org/info/reactors.html)

WNA Reactor Database  
[www.world-nuclear.org/reference/default.aspx](http://www.world-nuclear.org/reference/default.aspx)

WNA Global Nuclear Reactors Map  
[www.wano.org.uk/WANO\\_Documents/WANO\\_Map/WANO\\_Map.pdf](http://www.wano.org.uk/WANO_Documents/WANO_Map/WANO_Map.pdf)

NRC Office of International Programs  
[www.nrc.gov/about-nrc/organization/oipfuncdesc.html](http://www.nrc.gov/about-nrc/organization/oipfuncdesc.html)

NRC Regulatory Information Conference (RIC)  
[www.nrc.gov/public-involve/conference-symposia/ric/index.html](http://www.nrc.gov/public-involve/conference-symposia/ric/index.html)

### International Activities

Treaties and Conventions  
[www.nrc.gov/about-nrc/ip/treaties-conventions.html](http://www.nrc.gov/about-nrc/ip/treaties-conventions.html)

### Operating Nuclear Reactors

#### U.S. Commercial Nuclear Power Reactors

Commercial Reactors  
[www.nrc.gov/info-finder/reactor/](http://www.nrc.gov/info-finder/reactor/)

#### Oversight of U.S. Commercial Nuclear Power Reactors

Reactor Oversight Process (ROP)  
[www.nrc.gov/NRR/OVERSIGHT/ASSESS/index.html](http://www.nrc.gov/NRR/OVERSIGHT/ASSESS/index.html)

NUREG-1649, "Reactor Oversight Process"  
[www.nrc.gov/reading-rm/doc-collections/nuregs/staff/sr1649](http://www.nrc.gov/reading-rm/doc-collections/nuregs/staff/sr1649)

ROP Performance Indicators Summary  
[www.nrc.gov/NRR/OVERSIGHT/ASSESS/pi\\_summary.html](http://www.nrc.gov/NRR/OVERSIGHT/ASSESS/pi_summary.html)

#### Future U.S. Commercial Nuclear Power Reactor Licensing

New Reactor License Process  
[www.nrc.gov/reactors/new-reactor-op-lic/licensing-process.html#licensing](http://www.nrc.gov/reactors/new-reactor-op-lic/licensing-process.html#licensing)



## **New Reactors**

New Reactor Licensing  
[www.nrc.gov/reactors/new-reactors.html](http://www.nrc.gov/reactors/new-reactors.html)

## **Reactor License Renewal**

Reactor License Renewal Process  
[www.nrc.gov/reactors/operating/licensing/renewal/process.html](http://www.nrc.gov/reactors/operating/licensing/renewal/process.html)

10 CFR Part 51, "Environmental Protection Regulations for Domestic Licensing and Related Regulatory Functions"  
[www.nrc.gov/reading-rm/doc-collections/cfr/part051/](http://www.nrc.gov/reading-rm/doc-collections/cfr/part051/)

10 CFR Part 54, "Requirements for Renewal of Operating Licenses for Nuclear Power Plants"  
[www.nrc.gov/reading-rm/doc-collections/cfr/part054/](http://www.nrc.gov/reading-rm/doc-collections/cfr/part054/)

Status of License Renewal Applications and Industry Activities  
[www.nrc.gov/reactors/operating/licensing/renewal/applications.html](http://www.nrc.gov/reactors/operating/licensing/renewal/applications.html)

## **U.S. Nuclear Research and Test Reactors**

Research and Test Reactors  
[www.nrc.gov/reactors/non-power.html](http://www.nrc.gov/reactors/non-power.html)

## **Nuclear Regulatory Research**

Nuclear Reactor Safety Research  
[www.nrc.gov/about-nrc/regulatory/research/reactor-rsch.html](http://www.nrc.gov/about-nrc/regulatory/research/reactor-rsch.html)

State-of-the-Art Reactor Consequence Analyses (SOARCA)  
[www.nrc.gov/about-nrc/regulatory/research/soar.html](http://www.nrc.gov/about-nrc/regulatory/research/soar.html)

Risk Assessment in Regulation  
[www.nrc.gov/about-nrc/regulatory/risk-informed.html](http://www.nrc.gov/about-nrc/regulatory/risk-informed.html)

Digital Instrumentation and Controls  
[www.nrc.gov/about-nrc/regulatory/research/digital.html](http://www.nrc.gov/about-nrc/regulatory/research/digital.html)

Computer Codes  
[www.nrc.gov/about-nrc/regulatory/research/comp-codes.html](http://www.nrc.gov/about-nrc/regulatory/research/comp-codes.html)

Generic Issues Program  
[www.nrc.gov/about-nrc/regulatory/gen-issues.html](http://www.nrc.gov/about-nrc/regulatory/gen-issues.html)

The Committee To Review Generic Requirements (CRGR)  
[www.nrc.gov/about-nrc/regulatory/crgr.html](http://www.nrc.gov/about-nrc/regulatory/crgr.html)

## **Nuclear Materials**

### **U.S. Fuel Cycle Facilities**

U.S. Fuel Cycle Facilities  
[www.nrc.gov/info-finder/materials/fuel-cycle/](http://www.nrc.gov/info-finder/materials/fuel-cycle/)



## Uranium Recovery

Uranium Milling/Recovery  
[www.nrc.gov/info-finder/materials/uranium/](http://www.nrc.gov/info-finder/materials/uranium/)

## U.S. Materials Licenses

Materials Licensees Toolkits  
[www.nrc.gov/materials/miau/mat-toolkits.html](http://www.nrc.gov/materials/miau/mat-toolkits.html)

## Medical Applications

Medical Applications  
[www.nrc.gov/materials/medical.html](http://www.nrc.gov/materials/medical.html)

## Medical Uses

Medical Uses  
[www.nrc.gov/materials/miau/med-use.html](http://www.nrc.gov/materials/miau/med-use.html)

## Nuclear Gauges and Commercial Product Irradiators

General Licenses Uses  
[www.nrc.gov/materials/miau/general-use.html](http://www.nrc.gov/materials/miau/general-use.html)

## Industrial Uses of Nuclear Material

Industrial Applications  
[www.nrc.gov/materials/miau/industrial.html](http://www.nrc.gov/materials/miau/industrial.html)  
Exempt Consumer Products  
[www.nrc.gov/materials/miau/consumer-pdts.html](http://www.nrc.gov/materials/miau/consumer-pdts.html)

## Radioactive Waste

### U.S. Low-Level Radioactive Waste Disposal

Low-Level Radioactive Waste  
[www.nrc.gov/waste/low-level-waste.html](http://www.nrc.gov/waste/low-level-waste.html)

### U.S. High-Level Radioactive Waste Management: Disposal and Storage

High-Level Radioactive Waste  
[www.nrc.gov/waste/high-level-waste.html](http://www.nrc.gov/waste/high-level-waste.html)

### Spent Nuclear Fuel Storage

Spent Nuclear Fuel Storage  
[www.nrc.gov/waste/spent-fuel-storage.html](http://www.nrc.gov/waste/spent-fuel-storage.html)

### U.S. Nuclear Materials Transportation

Nuclear Materials Transportation  
[www.nrc.gov/materials/transportation.html](http://www.nrc.gov/materials/transportation.html)

### Decommissioning

Decommissioning  
[www.nrc.gov/about-nrc/regulatory/decommissioning.html](http://www.nrc.gov/about-nrc/regulatory/decommissioning.html)



## **Nuclear Security and Emergency Preparedness**

Nuclear Security  
[www.nrc.gov/security.html](http://www.nrc.gov/security.html)

### **Domestic Safeguards**

Domestic Safeguards  
[www.nrc.gov/security/domestic.html](http://www.nrc.gov/security/domestic.html)

### **Information Security**

Information Security  
[www.nrc.gov/security/info-security.html](http://www.nrc.gov/security/info-security.html)

Ensuring the Security of Radioactive Material  
[www.nrc.gov/security/byproduct.html](http://www.nrc.gov/security/byproduct.html)

### **Emergency Preparedness and Response**

Emergency Preparedness and Response  
[www.nrc.gov/about-nrc/emerg-preparedness.html](http://www.nrc.gov/about-nrc/emerg-preparedness.html)

### **Research and Test Reactor Emergency Preparedness**

Research and Test Reactors  
[www.nrc.gov/reactors/non-power.html](http://www.nrc.gov/reactors/non-power.html)

### **Emergency Preparedness Stakeholder Meetings and Workshops**

[www.nrc.gov/public-involve/public-meetings/stakeholder-mtngs-wksp.html](http://www.nrc.gov/public-involve/public-meetings/stakeholder-mtngs-wksp.html)

### **Emergency Action Level Development**

[www.nrc.gov/about-nrc/emerg-preparedness/about-emerg-preparedness/emerg-action-level-dev.html](http://www.nrc.gov/about-nrc/emerg-preparedness/about-emerg-preparedness/emerg-action-level-dev.html)

### **Hostile-Action-Based Emergency Preparedness Drills**

[www.nrc.gov/about-nrc/emerg-preparedness/respond-to-emerg/hostile-action.html](http://www.nrc.gov/about-nrc/emerg-preparedness/respond-to-emerg/hostile-action.html)

### **Exercise Schedules**

NRC Participation Exercise Schedule  
[www.nrc.gov/about-nrc/emerg-preparedness/about-emerg-preparedness/exercise-schedules.html](http://www.nrc.gov/about-nrc/emerg-preparedness/about-emerg-preparedness/exercise-schedules.html)

## **Other Web Links**

### **Employment Opportunities**

NRC—*A Great Place to Work*  
[www.nrc.gov/about-nrc/employment.html](http://www.nrc.gov/about-nrc/employment.html)

### **Glossary**

NRC Basic References  
[www.nrc.gov/reading-rm/basic-ref/glossary/full-text.html](http://www.nrc.gov/reading-rm/basic-ref/glossary/full-text.html)





## Glossary of Electricity Terms

[www.eia.doe.gov/cneaf/electricity/epav1/glossary.html](http://www.eia.doe.gov/cneaf/electricity/epav1/glossary.html)

## Glossary of Security Terms

<https://hseep.dhs.gov/DHSResource/Glossary.aspx>

## Public Involvement

NRC Library

[www.nrc.gov/reading-rm.html](http://www.nrc.gov/reading-rm.html)

Freedom of Information and Privacy Acts

[www.nrc.gov/reading-rm/foia/foia-privacy.html](http://www.nrc.gov/reading-rm/foia/foia-privacy.html)

Agencywide Documents Access and Management System (ADAMS)

[www.nrc.gov/reading-rm/adams.html](http://www.nrc.gov/reading-rm/adams.html)

Public Document Room

[www.nrc.gov/reading-rm/pdr.html](http://www.nrc.gov/reading-rm/pdr.html)

Public Meeting Schedule

[www.nrc.gov/public-involve/public-meetings/index.cfm](http://www.nrc.gov/public-involve/public-meetings/index.cfm)

Documents for Comment

[www.nrc.gov/public-involve/doc-comment.html](http://www.nrc.gov/public-involve/doc-comment.html)

## Small Business and Civil Rights

Contracting Opportunities for Small Businesses

[www.nrc.gov/about-nrc/contracting/small-business.html](http://www.nrc.gov/about-nrc/contracting/small-business.html)

Workplace Diversity

[www.nrc.gov/about-nrc/employment/diversity.html](http://www.nrc.gov/about-nrc/employment/diversity.html)

Discrimination Complaint Activity

[www.nrc.gov/about-nrc/civil-rights.html](http://www.nrc.gov/about-nrc/civil-rights.html)

Equal Employment Opportunity Program

[www.nrc.gov/about-nrc/civil-rights/eo.html](http://www.nrc.gov/about-nrc/civil-rights/eo.html)

Limited English Proficiency

[www.nrc.gov/about-nrc/civil-rights/limited-english.html](http://www.nrc.gov/about-nrc/civil-rights/limited-english.html)

Minority Serving Institutions Program

[www.nrc.gov/about-nrc/grants.html#msip](http://www.nrc.gov/about-nrc/grants.html#msip)

NRC Comprehensive Diversity Management Plan brochure

[www.nrc.gov/reading-rm/doc-collections/nuregs/brochures/br0316](http://www.nrc.gov/reading-rm/doc-collections/nuregs/brochures/br0316)

## Social Media Platforms

NRC Blog: <http://public-blog.nrc-gateway.gov/>

NRC Chat: <http://chat.nrc-gateway.gov>

Twitter: <https://twitter.com/#!/nrcgov>

YouTube: <http://www.youtube.com/user/NRCgov>

Flickr: <http://www.flickr.com/photos/nrcgov>

GovDelivery: <http://www.nrc.gov/public-involve/listserver.htm#gov>

RSS: <http://www.nrc.gov/public-involve/listserver.htm#rss>



## Index

### A

Academic 2, 13, 58, 64, 68, 192, 203

Appropriation 13

Agreement 4, 7, 20, 22, 23, 26, 59,  
60, 61, 64, 65, 66, 68, 69, 71, 72,  
74, 77, 81, 84, 85, 86, 96, 103, 152,  
165, 172, 178, 184, 190, 191, 192,  
199, 201

Atomic Energy Act 4, 45, 91, 179

### B

Bilateral program 22

Boiling-water reactor 35, 55, 61, 114,  
115, 178, 182

Byproduct 136, 171, 174, 178, 182,  
189, 190, 193, 194, 198, 210

### C

Cask 5, 73, 87, 89, 90, 91, 93, 94,  
154, 155-158, 179, 182

### D

Decommissioning 3, 5, 13, 33, 48, 50,  
74, 76, 77, 84, 94, 96, 97, 133, 134,  
135, 136, 151, 158, 161, 168, 177,  
181, 184, 202, 209

Disposal 2, 5, 9, 73, 76, 84, 85, 86,  
89, 91, 93, 159, 171, 179, 181, 186,  
188, 190, 192, 198, 204, 205, 209

### E

Energy Reorganization Act 4,

Enrichment 5, 8, 72, 73, 76, 78, 79,  
115, 153, 182, 184, 186, 187, 194,  
204

Environmental issues 45

### F

Fabrication 8, 64, 72, 73, 76, 78, 80,  
102, 153, 174, 178, 186, 191, 194,  
204

Fuel facilities 13, 100, 102

Fuel rods 44, 80, 81, 88, 186, 196, 205

### G

Gaseous diffusion 5, 78, 79, 153, 187,  
204

Gauges 20, 68, 69, 187, 198, 209

### H

Heap Leach 72, 74, 75

Hexafluoride 76, 78, 153, 186, 204,

High-level radioactive waste 87, 89, 91,  
179, 189, 209

### I

Industrial 2, 13, 64, 68, 115, 175, 184,  
192, 194, 195, 198, 203, 209

In situ leach 73, 189

Inspection 3, 7, 8, 9, 11, 13, 33, 37,  
38, 39, 40, 41, 42, 45, 47, 48, 50, 56,  
72, 81, 93, 94, 100, 102, 103, 115,  
166-168, 176, 185, 192, 196, 200

International 5, 6, 7, 11, 13, 16, 20, 21,  
22, 24, 25, 26, 61, 111, 114, 115,  
153-158, 165-168, 171-177, 189,  
191, 197, 200, 205, 207

### J

Japan Lessons Learned 38

### L

Licensing 3, 5, 7, 9, 10, 13, 21, 22, 33,  
38, 40, 45, 48, 50, 51, 52, 53, 56, 57,  
58, 72, 76, 81, 91, 93, 144, 171, 190,  
207, 208

Low-level radioactive waste 4, 5, 9, 13,  
84, 86, 159, 172, 180, 190, 209

### M

Materials 2, 3, 4, 5, 8, 9, 11, 12, 13, 15,  
20, 22, 26, 48, 57, 58, 61, 64, 65, 66,  
68, 69, 70, 71, 72, 74, 76, 78, 80, 81,  
94, 96, 100, 103, 107, 109, 166, 167,  
168, 171, 172, 174, 175, 178, 179,  
181, 185, 189, 190, 192-194, 197,  
199, 200, 203, 205, 208, 209



Medical 2, 13, 20, 64, 66, 67, 68, 69, 84, 167, 168, 171, 175, 178, 184, 189, 190, 192, 194, 198, 200, 203, 209

Milling 73, 191, 205, 209

Mission 2, 25, 42, 57, 204, 206

Mixed oxide 8, 78, 153, 186, 191

## N

Nuclear Waste Policy Act 4, 91, 188

## O

Operating reactors 26, 39, 40, 45, 54, 57, 59, 116-131

## P

Pressurized-water reactor 33, 34, 55, 61, 115, 190, 197

Probabilistic risk assessment 57, 59, 115, 165, 197, 201

Public participation 13, 16

## R

Radiation exposure 2, 43, 188

Radioactive waste 4, 5, 9, 13, 21, 26, 59, 82, 84, 86-92, 136, 159, 171, 172, 174, 177, 179, 180, 181, 184, 189, 190, 194, 209

Radionuclide 64, 68, 169, 200

Reactor Oversight Process 7, 41, 56, 200, 207

Rulemaking 3, 7, 8, 17, 39, 53, 55, 91, 171, 200, 206

Rules 21, 37, 38, 41, 45, 53, 64, 94, 198, 203

## S

Safety 2, 4, 5, 6, 7, 9, 10, 13, 15, 20, 21, 22, 25, 34, 35, 37, 38, 39, 40, 41, 42, 43, 44, 45, 47, 48, 51, 53, 54, 55, 57, 59, 61, 64, 71, 72, 76, 84, 91, 93, 94, 103, 105, 108, 109, 110, 115, 132, 146, 165, 172, 175-178, 181, 182, 183, 184, 185, 188, 189, 191, 195, 196, 200, 201, 202, 205, 208, 211

Security 2, 5, 7, 9, 10, 11, 13, 20, 22, 24, 25, 26, 37, 40, 41, 42, 50, 56, 57, 58, 59, 69, 71, 72, 73, 76, 93, 98-110, 112-114, 172, 176, 178, 179, 185, 201, 204, 210, 211

Significant events 7, 43, 146, 184

Spent fuel 5, 21, 38, 39, 87, 88, 89, 90, 91, 92, 93, 94, 95, 114, 136, 154-158, 160, 172, 182, 186, 189, 201, 202, 203, 209

Statutory authority 4, 206

## U

Uranium 4, 8, 13, 57, 64, 72, 73, 74, 75, 76, 77, 78, 79, 81, 88, 96, 97, 100, 102, 153, 174, 178, 182, 184-187, 189, 191, 192, 194, 196, 199, 202, 203, 204, 205, 207, 209

## W

Waste 2, 4, 5, 7-9, 11, 13, 15, 21, 25, 26, 31, 48, 50, 57, 58, 59, 76, 82, 84-94, 96, 115, 136, 154, 159, 171, 172, 174, 176-178, 179, 180, 181, 184, 186, 188, 189, 190, 191, 194, 203, 204, 205, 209

Waste Confidence 48, 50, 93

## Y

Yellowcake 72, 74, 75, 76, 186, 204, 205



<b>NRC FORM 335</b> (2-89) NRCM 1102, 3201,3202		<b>U.S. NUCLEAR REGULATORY COMMISSION</b>		<b>1. REPORT NUMBER</b> (Assigned by NRC, Add Vol., Supp., Rev., and Addendum Numbers, if any.)  NUREG-1350, Vol. 25					
<b>BIBLIOGRAPHIC DATA SHEET</b> <i>(See instructions on the reverse)</i>									
<b>2. TITLE AND SUBTITLE</b>  U.S. Nuclear Regulatory Commission Information Digest 2013-2014			<b>3. DATE REPORT PUBLISHED</b> <table border="1"> <tr> <td>MONTH</td> <td>YEAR</td> </tr> <tr> <td>August</td> <td>2013</td> </tr> </table>			MONTH	YEAR	August	2013
MONTH	YEAR								
August	2013								
<b>5. AUTHOR(S)</b>  Ivonne Couret, et al.			<b>4. FIN OR GRANT NUMBER</b>  n/a						
<b>6. TYPE OF REPORT</b>  Annual			<b>7. PERIOD COVERED (Inclusive Dates)</b>  2013-2014						
<b>8. PERFORMING ORGANIZATION - NAME AND ADDRESS (If NRC, provide Division, Office or Region, U.S. Nuclear Regulatory Commission, and mailing address; if contractor, provide name and mailing address.)</b>  Public Affairs Staff Office of Public Affairs U.S. Nuclear Regulatory Commission Washington, DC 20555-0001									
<b>9. SPONSORING ORGANIZATION - NAME AND ADDRESS (If NRC, type "Same as above"; if contractor, provide NRC Division, Office or Region, U.S. Nuclear Regulatory Commission, and mailing address.)</b>  Same as 8, above									
<b>10. SUPPLEMENTARY NOTES</b> There may be a supplementary document produced with only the updated figures, tables, and/or appendices within the next 12 months.									
<b>11. ABSTRACT (200 words or less)</b>  The U.S. Nuclear Regulatory Commission (NRC) 2013–2014 Information Digest provides a summary of information about the NRC and the industries it regulates. It describes the agency's regulatory responsibilities and licensing activities, and provides general information on nuclear-related topics. It is updated annually. The Information Digest includes NRC and industry data in a quick-reference format for activities through 2012, or the most recent information available at manuscript completion. The Digest also includes information graphics to help explain the data and expand the agency's transparency and public-outreach. The Web Link Index provides Web addresses for more information on major topics. The Digest also includes the NRC Facts at a Glance tear-out reference sheet. The NRC reviewed information from industry and international sources but did not perform an independent verification. This edition contains adjustments to preliminary figures from the previous year. All information is final unless otherwise noted. The NRC is the source for all photographs, graphics, and tables unless otherwise noted. The agency welcomes comments or suggestions on the Information Digest. Please contact the Office of Public Affairs by mail at U.S. Nuclear Regulatory Commission, Washington, DC 20555-0001, by e-mail at <a href="mailto:OPA.Resource@nrc.gov">OPA.Resource@nrc.gov</a> , or post comments on the NRC Blog's Open Forum category at <a href="http://public-blog.nrc-gateway.gov/">http://public-blog.nrc-gateway.gov/</a> .									
<b>12. KEY WORDS/DESCRIPTORS (List words or phrases that will assist researchers in locating the report.)</b>  Information Digest 2013-2014 Edition NRC Facts Nuclear Regulatory Commission 10CFR				<b>13. AVAILABILITY STATEMENT</b>  unlimited					
				<b>14. SECURITY CLASSIFICATION</b> <i>(This Page)</i>  unclassified					
				<i>(This Report)</i>  unclassified					
				<b>15. NUMBER OF PAGES</b>  222					
				<b>16. PRICE</b>					

NRC FORM 335 (9-2004)

PRINTED ON RECYCLED PAPER



## AVAILABILITY OF REFERENCE MATERIALS IN NRC PUBLICATIONS

### NRC Reference Material

As of November 1999, you may electronically access NUREG-series publications and other NRC records at NRC's Public Electronic Reading Room at <http://www.nrc.gov/reading-rm.html>. Publicly released records include, to name a few, NUREG-series publications; *Federal Register* notices; applicant, licensee, and vendor documents and correspondence; NRC correspondence and internal memoranda; bulletins and information notices; inspection and investigative reports; licensee event reports; and Commission papers and their attachments.

NRC publications in the NUREG series, NRC regulations, and Title 10, "Energy," in the *Code of Federal Regulations* may also be purchased from one of these two sources.

1. The Superintendent of Documents  
U.S. Government Printing Office  
Mail Stop SSOP  
Washington, DC 20402-0001  
Internet: [bookstore.gpo.gov](http://bookstore.gpo.gov)  
Telephone: 202-512-1800  
Fax: 202-512-2250
2. The National Technical Information Service  
Springfield, VA 22161-0002  
[www.ntis.gov](http://www.ntis.gov)  
1-800-553-6847 or, locally, 703-605-6000

A single copy of each NRC draft report for comment is available free, to the extent of supply, upon written request as follows:

Address: U.S. Nuclear Regulatory Commission  
Office of Administration  
Publications Branch  
Washington, DC 20555-0001

E-mail: [DISTRIBUTIONRESOURCE@NRC.GOV](mailto:DISTRIBUTIONRESOURCE@NRC.GOV)  
Facsimile: 301-415-2289

Some publications in the NUREG series that are posted at NRC's Web site address <http://www.nrc.gov/reading-rm/doc-collections/nuregs> are updated periodically and may differ from the last printed version. Although references to material found on a Web site bear the date the material was accessed, the material available on the date cited may subsequently be removed from the site.

### Non-NRC Reference Material

Documents available from public and special technical libraries include all open literature items, such as books, journal articles, transactions, *Federal Register* notices, Federal and State legislation, and congressional reports. Such documents as theses, dissertations, foreign reports and translations, and non-NRC conference proceedings may be purchased from their sponsoring organization.

Copies of industry codes and standards used in a substantive manner in the NRC regulatory process are maintained at—

The NRC Technical Library  
Two White Flint North  
11545 Rockville Pike  
Rockville, MD 20852-2738

These standards are available in the library for reference use by the public. Codes and standards are usually copyrighted and may be purchased from the originating organization or, if they are American National Standards, from—

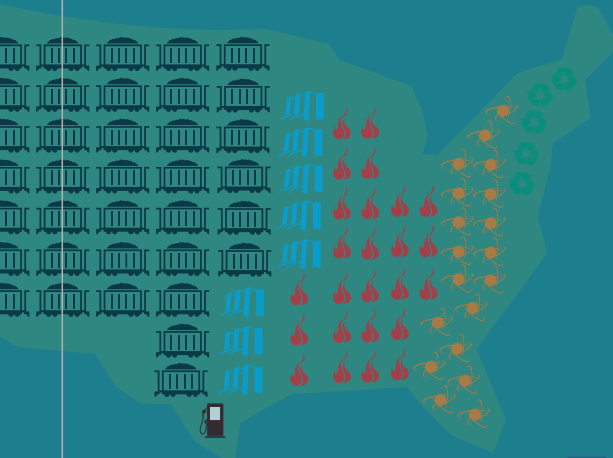
American National Standards Institute  
11 West 42<sup>nd</sup> Street  
New York, NY 10036-8002  
[www.ansi.org](http://www.ansi.org)  
212-642-4900

Legally binding regulatory requirements are stated only in laws; NRC regulations; licenses, including technical specifications; or orders, not in NUREG-series publications. The views expressed in contractor-prepared publications in this series are not necessarily those of the NRC.

The NUREG series comprises (1) technical and administrative reports and books prepared by the staff (NUREG-XXXX) or agency contractors (NUREG/CR-XXXX), (2) proceedings of conferences (NUREG/CP-XXXX), (3) reports resulting from international agreements (NUREG/IA-XXXX), (4) brochures (NUREG/BR-XXXX), and (5) compilations of legal decisions and orders of the Commission and Atomic and Safety Licensing Boards and of Directors' decisions under Section 2.206 of NRC's regulations (NUREG-0750).

**DISCLAIMER:** This report was prepared as an account of work sponsored by an agency of the U.S. Government. Neither the U.S. Government nor any agency thereof, nor any employee, makes any warranty, expressed or implied, or assumes any legal liability or responsibility for any third party's use, or the results of such use, of any information, apparatus, product, or process disclosed in this publication, or represents that its use by such third party would not infringe privately owned rights.





U.S. Nuclear Regulatory Commission  
 NUREG-1350, Volume 25  
 August 2013

