



NUREG/CR-7102
SAND2011-6548P

Kerite Analysis in Thermal Environment of FIRE (KATE-Fire): Test Results

Final Report

**AVAILABILITY OF REFERENCE MATERIALS
IN NRC PUBLICATIONS**

NRC Reference Material

As of November 1999, you may electronically access NUREG-series publications and other NRC records at NRC's Public Electronic Reading Room at <http://www.nrc.gov/reading-rm.html>. Publicly released records include, to name a few, NUREG-series publications; *Federal Register* notices; applicant, licensee, and vendor documents and correspondence; NRC correspondence and internal memoranda; bulletins and information notices; inspection and investigative reports; licensee event reports; and Commission papers and their attachments.

NRC publications in the NUREG series, NRC regulations, and *Title 10, Energy*, in the Code of *Federal Regulations* may also be purchased from one of these two sources.

1. The Superintendent of Documents
U.S. Government Printing Office
Mail Stop SSOP
Washington, DC 20402-0001
Internet: bookstore.gpo.gov
Telephone: 202-512-1800
Fax: 202-512-2250
2. The National Technical Information Service
Springfield, VA 22161-0002
www.ntis.gov
1-800-553-6847 or, locally, 703-605-6000

A single copy of each NRC draft report for comment is available free, to the extent of supply, upon written request as follows:

Address: U.S. Nuclear Regulatory Commission
Office of Administration
Publications Branch
Washington, DC 20555-0001
E-mail: DISTRIBUTION.RESOURCE@NRC.GOV
Facsimile: 301-415-2289

Some publications in the NUREG series that are posted at NRC's Web site address <http://www.nrc.gov/reading-rm/doc-collections/nuregs> are updated periodically and may differ from the last printed version. Although references to material found on a Web site bear the date the material was accessed, the material available on the date cited may subsequently be removed from the site.

Non-NRC Reference Material

Documents available from public and special technical libraries include all open literature items, such as books, journal articles, and transactions, *Federal Register* notices, Federal and State legislation, and congressional reports. Such documents as theses, dissertations, foreign reports and translations, and non-NRC conference proceedings may be purchased from their sponsoring organization.

Copies of industry codes and standards used in a substantive manner in the NRC regulatory process are maintained at—

The NRC Technical Library
Two White Flint North
11545 Rockville Pike
Rockville, MD 20852-2738

These standards are available in the library for reference use by the public. Codes and standards are usually copyrighted and may be purchased from the originating organization or, if they are American National Standards, from—

American National Standards Institute
11 West 42nd Street
New York, NY 10036-8002
www.ansi.org
212-642-4900

Legally binding regulatory requirements are stated only in laws; NRC regulations; licenses, including technical specifications; or orders, not in NUREG-series publications. The views expressed in contractor-prepared publications in this series are not necessarily those of the NRC.

The NUREG series comprises (1) technical and administrative reports and books prepared by the staff (NUREG-XXXX) or agency contractors (NUREG/CR-XXXX), (2) proceedings of conferences (NUREG/CP-XXXX), (3) reports resulting from international agreements (NUREG/IA-XXXX), (4) brochures (NUREG/BR-XXXX), and (5) compilations of legal decisions and orders of the Commission and Atomic and Safety Licensing Boards and of Directors' decisions under Section 2.206 of NRC's regulations (NUREG-0750).

DISCLAIMER: This report was prepared as an account of work sponsored by an agency of the U.S. Government. Neither the U.S. Government nor any agency thereof, nor any employee, makes any warranty, expressed or implied, or assumes any legal liability or responsibility for any third party's use, or the results of such use, of any information, apparatus, product, or process disclosed in this publication, or represents that its use by such third party would not infringe privately owned rights.

Kerite Analysis in Thermal Environment of FIRE (KATE-Fire): Test Results

Manuscript Completed: June 2011
Date Published: December 2011

Prepared by
S.P. Nowlen and J.W. Brown

Sandia National Laboratories
Risk and Reliability Analysis Dept. 6231
P.O. Box 5800
Albuquerque, NM 87185-0748

Gabriel Taylor, NRC Project Manager

NRC Job Code N6959

ABSTRACT

This report presents the results of cable functionality tests conducted on the cable product marketed under the trade name Kerite FR. Although Kerite FR is a thermoset polymer, reviews have identified prior tests that documented cable failure at relatively low temperatures compared to other known thermoset insulation materials. Other tests have indicated thermal performance limits consistent with other thermoset insulation materials. Hence, the actual high-temperature electrical performance limits of this material under fire exposure conditions were uncertain. New old stock samples of Kerite cables have been tested as a part of two recent programs. During some, but not all, of these tests, cable failures were observed at relatively low temperatures. Two separate phenomena working in concert, insulation cracking and production of a conductive liquid within the cable, are thought to be the mechanisms responsible for the observed cases of early degradation and failure. This report summarizes the previously available information for this cable product, presents all of the newly developed test data and provides an assessment of the material's fire-exposure electrical performance.

TABLE OF CONTENTS

| <u>Section</u> | <u>Page</u> |
|---|-------------|
| ABSTRACT..... | iii |
| TABLE OF CONTENTS..... | v |
| LIST OF FIGURES..... | ix |
| LIST OF TABLES..... | xiii |
| EXECUTIVE SUMMARY..... | xv |
| ACKNOWLEDGEMENTS..... | xix |
| ACRONYMS..... | xxi |
| | |
| 1 INTRODUCTION AND OBJECTIVES..... | 1-1 |
| | |
| 2 A SUMMARY OF PRIOR TESTING..... | 2-1 |
| 2.1 SNL – Severe Accident Equipment Qualification Testing..... | 2-1 |
| 2.2 South Carolina Electric & Gas – Kaowool Fire Barrier Testing..... | 2-2 |
| 2.3 Summary of Prior Knowledge Base and Guidance..... | 2-3 |
| | |
| 3 KERITE CABLE SAMPLES..... | 3-1 |
| 3.1 Overview..... | 3-1 |
| 3.2 Cable Descriptions..... | 3-1 |
| 3.3 Cable Sample Designations..... | 3-3 |
| | |
| 4 CABLE ELECTRICAL PERFORMANCE MONITORING UNITS..... | 4-1 |
| 4.1 Alternating Current (ac) Systems..... | 4-1 |
| 4.1.1 Surrogate Circuit Diagnostic Unit..... | 4-1 |
| 4.1.2 The Insulation Resistance Measurement System..... | 4-4 |
| 4.2 Direct Current System..... | 4-4 |
| 4.2.1 Direct Current Simulation Panels..... | 4-5 |
| 4.2.1.1 MOV1 and MOV2..... | 4-5 |
| 4.2.1.2 SOV1 and SOV2..... | 4-5 |

TABLE OF CONTENTS (Continued)

| <u>Section</u> | <u>Page</u> |
|---|-------------|
| 4.2.1.3 1-in. Valve | 4-5 |
| 4.2.1.4 Large Coil | 4-5 |
| 4.2.1.5 Switchgear | 4-6 |
| 4.2.2 The dc Battery Bank | 4-6 |
| | |
| 5 TEST CONDITIONS | 5-1 |
| 5.1 Small Scale Experiments..... | 5-1 |
| 5.2 Intermediate-Scale Experiments | 5-3 |
| | |
| 6 MATRIX OF KERITE TESTS | 6-1 |
| 6.1 DESIREE-Fire Small-Scale Experiments | 6-3 |
| 6.2 The Intermediate-Scale DESIREE-Fire Tests..... | 6-4 |
| 6.2.1 DESIREE-Fire Intermediate-Scale Test 9 | 6-4 |
| 6.2.2 DESIREE-Fire Intermediate-Scale Test 10 | 6-5 |
| 6.3 KATE-Fire Small-Scale Penlight Experiments..... | 6-7 |
| | |
| 7 OVERVIEW OF TESTING RESULTS..... | 7-1 |
| 7.1 Chapter Organization and Content..... | 7-1 |
| 7.2 Cable Item A: 2/C-12 AWG, FR..... | 7-1 |
| 7.3 Cable Item B: 2/C-10 AWG, FR-III..... | 7-3 |
| 7.4 Cable Item C: 4/C-10 AWG, FR-III..... | 7-5 |
| 7.5 Cable Item D: 5/C-12 AWG, FR (with zinc wrap) | 7-5 |
| 7.6 Cable Item E: 7/C-12 AWG, FR (with zinc wrap)..... | 7-10 |
| 7.7 Cable Item F: 9/C-14 AWG, FR | 7-15 |
| 7.8 Cable Item G: 10/C-16 AWG, FR-II..... | 7-17 |
| 7.9 Cable Item H: 10/C-12 AWG, FR (with zinc wrap) | 7-20 |
| 7.10 Cable Item I: 12/C-12 AWG, FR-III..... | 7-28 |
| 7.11 Cable Item J: 15/C-12 AWG, FR (with zinc wrap)..... | 7-30 |
| 7.12 Cable Item K: 3/C-6 AWG, HT | 7-34 |

TABLE OF CONTENTS
(Continued)

| <u>Section</u> | <u>Page</u> |
|---|--------------------|
| 8 SUMMARY OF TESTING RESULTS | 8-1 |
| 8.1 Kerite FR Test Results and Observations | 8-1 |
| 8.2 Summary of Test Results for FR-II, FR-III and HT | 8-7 |
| 9 CONCLUSIONS..... | 9-1 |
| 9.1 Conclusions Regarding Kerite FR-Insulated Cables..... | 9-1 |
| 9.2 Conclusions Regarding FR-II, FR-III and HT Insulations..... | 9-2 |
| 10 REFERENCES..... | 10-1 |
| APPENDIX A - TEST SUPPORT SYSTEMS..... | A-1 |
| APPENDIX B - TEST RESULTS | B-1 |

LIST OF FIGURES

| <u>Figure</u> | <u>Page</u> |
|----------------------|---|
| 4.1 | Circuit diagram for a generic SCDU including an active electrical interlock on the contactor pair..... 4-2 |
| 5.1 | The Penlight apparatus..... 5-1 |
| 5.2 | Thermocouple placement within a cable sample during KATE-Fire. 5-3 |
| 5.3 | Schematic representation of the DESIREE-Fire intermediate-scale test structure..... 5-4 |
| 5.4 | Schematic representation of the DESIREE-Fire intermediate-scale test structure located within the bunker facility. 5-5 |
| 5.5 | Photo of the sand diffusion burner..... 5-6 |
| 6.1 | Specialized tray B for the intermediate-scale tests. 6-5 |
| 6.2 | Specialized tray C for the intermediate-scale tests. 6-6 |
| 6.3 | Bundled tray A configuration for the intermediate-scale tests. 6-6 |
| 7.1 | Liquid observed during the testing of Item A..... 7-2 |
| 7.2 | Longitudinal cracking along the conductors of Item A. 7-2 |
| 7.3 | Circumferential cracking extending to the bare wire of Item A. 7-2 |
| 7.4 | IRMS data for Item A during test K16. 7-3 |
| 7.5 | Pre-test (left) and post-test (right) photos of liquid produced during Item B testing..... 7-4 |
| 7.6 | Conductors from the section of Item B located in the center of Penlight..... 7-4 |
| 7.7 | Close-up of the conductors from Item B..... 7-4 |
| 7.8 | Progression of liquid observed during the testing of Item C. 7-5 |
| 7.9 | Post-test analysis of conductors from Item C located in the center of Penlight during Test K10 – no insulation cracking evident. 7-5 |
| 7.10 | Item D target voltage increase during Test D13. 7-6 |
| 7.11 | A pre-test view of the test cables (left) and a photo taken during the Test 15 (right) showing liquid leaking from the cut ends of the both of the thermal response cables (the 10/C and 5/C cables)..... 7-6 |
| 7.12 | IRMS results from Test K8..... 7-7 |
| 7.13 | Oily residue found between the jacket and zinc wrap of Item D..... 7-8 |
| 7.14 | Two holes found on the zinc wrap during post-test investigation of Item D in Test K8..... 7-8 |
| 7.15 | Larger hole found during the post-test analysis of Item D in Test K8. 7-8 |

**LIST OF FIGURES
(CONTINUED)**

| <u>Figure</u> | <u>Page</u> |
|----------------------|--|
| 7.16 | Hole in the conductor insulation corresponding to the hole found in the zinc wrap..... 7-9 |
| 7.17 | Temperature and target voltage response of Item D during Test K5..... 7-9 |
| 7.18 | Liquid produced during testing being captured within a clean, glass jar..... 7-11 |
| 7.19 | Wire nuts containing liquid formed during testing. 7-11 |
| 7.20 | Dried liquid coming through the jacket material during post-test examination. 7-11 |
| 7.21 | Longitudinal cracking found along the conductors of Item E 7-12 |
| 7.22 | Temperature and voltage response of Item E from Test K1..... 7-12 |
| 7.23 | IRMS results from Test K6..... 7-13 |
| 7.24 | Zinc slag connecting conductors..... 7-13 |
| 7.25 | Cable temperature and electrical response of Item E during Test IS10..... 7-14 |
| 7.26 | Temperature and voltage observed during Test K2..... 7-15 |
| 7.27 | Insulation resistance data from Test K21..... 7-16 |
| 7.28 | Progression of the liquid residue leaking from the cut end of the thermocouple cable: pre-test on the left, and then progressively later in the test for the center and right photos..... 7-16 |
| 7.29 | Longitudinal cracking observed during post-test analysis of Item F..... 7-16 |
| 7.30 | Cable temperature and electrical response of Item F during Test IS10..... 7-17 |
| 7.31 | Post-test damage to Item G..... 7-18 |
| 7.32 | Close up view of the presumed failure point. 7-19 |
| 7.33 | Conductors of Item G spread apart after Test K3..... 7-19 |
| 7.34 | SCDU results from Test K3 for Item G..... 7-19 |
| 7.35 | Electrical and temperature data for Test 13-qual..... 7-20 |
| 7.36 | Oily residue found between the jacketing material and zinc wrap. 7-21 |
| 7.37 | Co-located circumferential cracks discovered in two adjacent conductors during post-test examination of the cable from Test D13-qual. 7-21 |
| 7.38 | Longitudinal cracking observed during the post-test analysis is visible as a dark line running along the right hand conductor near the center of the photo. 7-22 |
| 7.39 | Numbering scheme for Item H. 7-22 |
| 7.40 | Liquid observed from cut end of thermal response cable during Test K4..... 7-23 |

**LIST OF FIGURES
(CONTINUED)**

| <u>Figure</u> | <u>Page</u> |
|----------------------|--|
| 7.41 | Modified target voltages from Test K4..... 7-24 |
| 7.42 | Modified target currents from Test K4. 7-24 |
| 7.43 | Temperature and voltage response of Item H. 7-25 |
| 7.44 | Large hole uncovered during the removal of the jacketing material. 7-25 |
| 7.45 | Close-up image of the large hole formed in the zinc wrap. 7-26 |
| 7.46 | Jacketing material removed from the thermally exposed portion of the energized cable..... 7-26 |
| 7.47 | Removal of the zinc wrap and charred insulation material reveal the bare copper conductors. 7-26 |
| 7.48 | Post-test image of the conductors without insulation cracking for Item H..... 7-27 |
| 7.49 | Cable temperature and electrical response of Item H during Test IS10. 7-27 |
| 7.50 | Temperature and target voltage response of Item I during Test K19. 7-28 |
| 7.51 | Source voltage response during Test K19. 7-29 |
| 7.52 | Burned section of Item I. 7-29 |
| 7.53 | Unburned section of Item I next to the leading flame edge..... 7-29 |
| 7.54 | Opposite unburned section of Item I next to the leading flame edge. 7-30 |
| 7.55 | Liquid produced during Test K20..... 7-31 |
| 7.56 | Modified target voltages for Item J during Test K20. 7-31 |
| 7.57 | Modified target currents for Item J during Test K20..... 7-32 |
| 7.58 | Temperature and voltage response of Item J. 7-32 |
| 7.59 | Longitudinal cracking along the conductors outside the burned section of cable indicated by arrows..... 7-33 |
| 7.60 | Cable temperature and electrical response of Item J during Test IS10..... 7-33 |
| 7.61 | Test results for the HT insulated cable in Test 17-qual. 7-34 |

LIST OF TABLES

| <u>Table</u> | <u>Page</u> |
|--------------|--|
| 2.1 | Cable performance during superheated steam exposure testing (failure criterion IR < 1 kΩ-100 m). 2-1 |
| 2.2 | Cable performance during superheated steam exposure testing (failure criterion IR < 0.1 kΩ-100 m). 2-2 |
| 2.3 | South Carolina Electric & Gas 1999 Kaowool protected cables functionality test results..... 2-3 |
| 2.4 | Generic Criteria for the Assessment of the Ignition and Damage Potential of Electrical Cables under NUREG/CR-6850, EPRI 1011989, errata, 2006..... 2-3 |
| 3.1 | Kerite cable designation and images..... 3-4 |
| 3.2 | Kerite cable jacket markings as written on cable..... 3-7 |
| 4.1 | SCDU Target MOV Relays Pickup Voltages & Currents. 4-3 |
| 4.2 | Exide calcium flat plate battery cell specifications..... 4-7 |
| 5.1 | Relationship between shroud temperature and shroud 5-2 |
| 6.1 | The complete matrix of all Kerite experiments conducted during DESIREE-Fire and KATE-Fire..... 6-1 |
| 6.2 | Small scale experiments involving Kerite cable during DESIREE-Fire. 6-3 |
| 6.3 | Intermediate-scale experiments involving Kerite cable during DESIREE-Fire. 6-4 |
| 6.4 | Heat release rate for Test IS9..... 6-5 |
| 6.5 | Heat release rate for Intermediate-Scale Test 10. 6-7 |
| 6.6 | Penlight scale experiments from the KATE-Fire program. 6-8 |
| 7.1 | Conductor connection to SCDU for Test K4..... 7-23 |
| 8.1 | Summary of the Penlight results for tests involving FR-insulated cables (see notes below table for explanation of nomenclature)..... 8-2 |
| 8.2 | Summary of intermediate scale test results for FR insulated cables..... 8-5 |
| 8.3 | Summary of the Penlight test results for the other Kerite insulation formulations. 8-7 |

EXECUTIVE SUMMARY

Background

This report describes thermal damage tests of Kerite brand electrical cables sponsored by the U.S. Nuclear Regulatory Commission (NRC) Office of Nuclear Regulatory Research (RES). The Kerite Company marketed control cables to the nuclear power industry beginning in 1965. While Kerite continues to produce power cables today, its line of control cables was discontinued, apparently in the mid- to late-1980's. It is known that Kerite brand cables were installed in some U.S. commercial nuclear power plants, although the exact number of facilities with Kerite cables installed is unknown.

Over the course of production, Kerite control cables were available in at least four known insulation formulations; namely, FR, FR-II, FR-III, and HT (which is also referred to as HTK or HT-Kerite)². The exact distinctions between these products are unknown because the formulations themselves are manufacturer proprietary information. The primary focus of the tests reported here was the Kerite FR formulation, but all four of these formulations were tested.

Kerite cables were marketed as being based on thermoset material formulations. Thermoset insulation materials generally provide a higher degree of thermal resistance (i.e., higher thermal failure limits) than do thermoplastic materials. Thermoset materials are expected to provide adequate short-term electrical performance up to temperatures of at least 330°C and some common thermoset insulation materials have failure thresholds of 390°C or higher [4]. In contrast the lower bound failure temperature for thermoplastic insulated cables is approximately 205°C and some of the most common thermoplastic materials have failure thresholds in the 250-290°C range [4].

At least one prior fire barrier test program³ [2] reported Kerite FR cable failures at unexpectedly low temperatures (i.e., in comparison to typical thermoset insulation materials). Failures were reported during one test where the maximum temperature within the protected raceway envelope reached just 184°C. Another prior test series involving severe accident equipment qualification tests (superheated steam exposures) [3] indicated some degradation of the Kerite FR insulation at temperatures as low as 153-171°C, but no outright failures until cable temperatures had reached 372°C or higher. Overall, there was large uncertainty regarding the fire-induced thermal failure limits of, in particular, Kerite FR cables.

Based largely on evidence of fire damage at relatively low temperatures, the recommended current practice for fire Probabilistic Risk Assessment (PRA) applications [4], including the NRC's Significance Determination Process (SDP) [7], is to treat Kerite FR cables using the damage criteria associated with thermoplastic cables. Questions have been raised as to whether

² These formulations are all trademark product names of the Kerite Corporation.

³ The original source report for the fire barrier tests titled "KAOWOOL Triple Wrap Raceway Fire Barrier Test for Conduits and Cable Trays" dated May 5, 2000 was obtained by Salley in the cited Masters' Thesis. The original report is available through the NRC Agencywide Documents Access and Management System under accession number ML092080059.

this recommended treatment is overly conservative or truly reflective of the material behavior. The tests described here were undertaken in an effort to resolve this uncertainty.

Testing Overview

The cable samples used in testing were all new old stock (NOS) cables provided by the U.S. nuclear power industry through collaboration between RES and the Electric Power Research Institute (EPRI). The samples included cables based on all four of the material formulations noted above. Two scales of testing were pursued; namely, small-scale simulation tests using a facility called Penlight and intermediate-scale tests involving longer cable samples and actual fire exposure conditions.

One point of uncertainty that was resolved is whether the Kerite insulation formulations were thermoset or thermoplastic materials. Testing verified that each of the four Kerite insulation formulations tested is a thermoset material. There were no signs in any of the tests that the Kerite insulation or jacketing materials themselves were melting, which is one defining characteristic of thermoplastic polymers. That is, thermoplastic materials will melt on heating and re-solidify on cooling. Thermoset materials will not melt, but if heated to high enough temperatures, will instead char and burn. All four Kerite formulations behaved like a thermoset in this regard.

The tests did show uneven behavior of, in particular, the Kerite FR insulation. The tests clearly showed that Kerite FR insulated cables are subject to fire-induced insulation resistance degradation at relatively low temperatures for thermoset materials. Initial degradation was observed in the small-scale tests at temperatures as low as 247°C. Six test cases involved outright failure of the Kerite FR insulated cables at cable temperatures of 287-311°C. In other tests, the FR-insulated cables showed consistent substantive signs of electrical performance degradation at temperatures between 247-311°C but did not experience outright failures until much higher temperatures (i.e., 390°C or higher).

The other three Kerite insulation formulations, FR-II, FR-III and HT, did not show substantive signs of electrical degradation until they reached temperatures more typical of thermoset cable insulation performance limits. All three of the alternate formulations also displayed higher thermal damage limits than did the Kerite FR material. Of the three alternate formulations, the FR-II material showed the lowest damage threshold at about 341°C. This is consistent with the lower bound estimates of thermoset cable failure thresholds as noted above. Specific results for all formulations are provided in the body of this report. All of the test data and photos are available in electronic format in the companion CD-ROM provided with this publication.

Conclusions:

The tests described in this report do show that Kerite FR insulated cables may experience substantial electrical degradation at temperatures as low as 247°C. Overall, it is recommended that fire PRA applications assume a nominal fire-induced failure threshold for Kerite FR cables of 247°C. This recommendation includes consideration of the fact that actual fire exposure scenarios will involve longer lengths of the cable than did the small-scale test which form the

primary basis for the assessment. Longer cable exposure lengths could lead to higher levels of degradation, but should not impact temperature at which degradation is first observed.

A working hypothesis has been developed that explains the observed results. The low temperature failure mode in Kerite FR insulated cables likely results from two observed behaviors verified by direct observations:

- The first behavior of interest is the formation of cracks in the conductor insulation during the heating process. The presence of insulation cracks, both longitudinal and circumferential, in FR-insulated cable samples heated to no more than 320°C was verified during post-test examination of various cable samples through the course of the testing. Cracks were commonly observed that extended through the insulation exposing the bare copper wire. Longitudinal cracks extended as much as 5 cm (or more) along the length of the conductors.
- The second behavior of interest is the formation of a conductive liquid inside the cable during heating. That is, a liquid material was seen oozing from the cut ends of the cables during the heating process in all of the Kerite FR tests conducted. The exact source of the liquid was not determined, but it did not appear to be coming from the insulation and jacket materials themselves. The likely source of the conductive liquid is either the fibrous cable filler materials present in the cables or residual materials present that were used in the manufacturing process (e.g., lubricants that may have been used during manufacture of the cables). Samples of the liquid were collected during a number of tests, and in each case the material was found to be electrically conductive.

The postulated failure mode for Kerite FR is that short circuits (either conductor to conductor or conductor to ground) form when the conductive liquid fills cracks in the conductor insulation thereby creating a conduction path between adjacent conductors or between a conductor and ground (e.g., in the case of cables with a grounded shield wrap).

For those cases where some degree of lower-temperature insulation resistance degradation was noted (e.g., below 311°C) but outright failure (i.e., low impedance short circuits) was not observed until much higher temperatures, it is likely that cracks did form, but not close enough together to allow for low-resistance short circuits to form. That is, while the liquid was electrically conductive, it was not a particularly *good* conductor. It is likely that the relative proximity of the cracks plays a role in the faulting behavior by influencing the ‘quality’ of the short circuits that form. Poorer quality circuit shorting paths would be reflected by insulation resistance degradation but not by outright failure.

ACKNOWLEDGEMENTS

The authors gratefully acknowledge the efforts by Dan Funk, Harry Barrett, Jeffro Wagner, Michelle Kelly, Adam Stein, and Joelle DeJoseph who contributed insights on the testing of cables. We also thank Ken Canavan of EPRI for his relentless pursuit of the cable samples used in testing and those member utilities who actually provided the test samples. Finally, we once again thank Gabe Taylor and Mark Henry Salley, our sponsors at the U.S. NRC, for their continuing support of the fire programs.

ACRONYMS AND ABBREVIATIONS

| | |
|--------------|---|
| ac | alternating current |
| ADAMS | Agency-wide Documents Access and Management System |
| AOV | Air Operated Valve |
| ASTM | American Society of Testing and Materials |
| AWG | American Wire Gage |
| CAROLFIRE | the Cable Response to Live Fire project |
| CFR | Code of Federal Regulation |
| CPT | Control Power Transformer |
| dc | direct current |
| DCSim Panel | Direct Current Simulation Panels |
| DESIREE-Fire | the Direct Current Electrical Shorting in Response to Exposure Fire project |
| EPR | Ethylene Propylene Rubber |
| EPRI | Electric Power Research Institute |
| EQ | Equipment Qualification |
| FAQ | Frequently Asked Question |
| FB | Fuse Blow |
| HS | Hot Short |
| HT | A product trade name of the Kerite Corporation |
| IEEE | Institute of Electrical and Electronics Engineers |
| IR | Insulation Resistance |
| IRMS | Insulation Resistance Measurement System |
| IS | Intermediate-Scale |
| KATE-Fire | Kerite Analysis in Thermal Environment of Fire |
| FR | A product trade name of the Kerite Corporation |
| LOCA | Loss of Coolant Accident |
| MOU | Memorandum of Understanding |
| MOV | Motor Operated Valve |
| NA | Not Applicable |
| NEI | Nuclear Energy Institute |
| NFPA | National Fire Protection Agency |
| NOS | New Old Stock |
| NPP | Nuclear Power Plant |
| NRC | Nuclear Regulatory Commission |
| NRR | Nuclear Reactor Regulation |
| PORV | Power Operated Valve |
| PRA | Probabilistic Risk Assessment |
| RES | NRC Office of Nuclear Regulatory Research |
| SA | Spurious Actuation |
| SCDU | Surrogate Circuit Diagnostic Units |

| | |
|----------|------------------------------------|
| SCE&G | South Carolina Electric & Gas |
| SDP | Significance Determination Process |
| SNL | Sandia National Laboratories |
| SOV | Solenoid Operated Valve |
| SWGR-C/T | Switchgear Close/Trip Circuit |
| TC | Thermocouple |
| TSC | Technical Support Center |
| XLPO | Cross-Linked Polyolefin |

1 INTRODUCTION AND OBJECTIVES

This report presents the results of fire-induced thermal damage tests of Kerite brand electrical control cables focusing, in particular, on cables with Kerite FR insulation. Kerite FR is a trade name electrical cable product that is no longer available on the market, but that was used by some U.S. nuclear power plants (NPPs) during their original construction. According to the company's web site⁴, Kerite began marketing a control cable specifically aimed at the nuclear power industry in 1965. That cable was Kerite FR. The Kerite Company continued to produce control cables for the nuclear industry into the 1980's. While Kerite continues to produce power cables today, its line of control cables was discontinued, apparently in the mid- to late-1980's. It is known that Kerite brand cables were installed in some U.S. commercial NPPs, although the exact number of facilities with Kerite cables installed is unknown. Over the course of production, Kerite control cables were made available with a number of different insulation material formulations. Known formulations include FR, FR-II, FR-III, HT (also sometimes referred to as HTK or HT Kerite)⁵. The exact distinctions between these products are unknown because the formulations themselves are manufacturer proprietary information. While the primary focus of this study was the Kerite FR formulation, all four of these formulations were tested.

The Kerite cable thermal damage tests were completed as a part of two test programs sponsored by the U.S. Nuclear Regulatory Commission (NRC) Office of Nuclear Regulatory Research (RES). All tests were performed at Sandia National Laboratories (SNL) facilities in Albuquerque, NM. The first program was called the Direct Current Electrical Shorting in Response to Exposure Fire, or DESIREE-Fire, project [1] (reference NRC Job Code Number N6579). DESIREE-Fire focused on fire-induced cable failure modes and effects for dc-powered control circuits and did include a limited set of tests involving Kerite brand cables. The second program is the Kerite Analysis in Thermal Environment of Fire, or KATE-Fire, project (reference N6959). KATE-Fire was specifically aimed at resolving uncertainties regarding Kerite FR fire performance limits and involved a more extensive series of tests and a broader range of Kerite cable samples. The current report covers all of the Kerite cable tests performed under both programs.

The cable samples used in testing were all new old stock (NOS) cables provided by the U.S. nuclear power industry through collaboration under the terms of a Memorandum of Understanding (MOU) between RES and the Electric Power Research Institute (EPRI). Chapter 3 provides a detailed description of the cables used in testing. The FR formulation is identified by the manufacturer as an "extruded thermoset vulcanized flame retardant synthetic rubber" [2]. Testing has verified that Kerite FR is a thermoset material (as opposed to a thermoplastic) as are the other three insulation formulations noted above. There were no signs in any of the tests that the Kerite insulation or jacketing materials themselves were melting, which is one defining characteristic of thermoplastic polymers. That is, thermoplastic materials will melt on heating and re-solidify on cooling. Thermoset materials will not melt, but if heated to high enough

⁴ Based on: <http://www.kerite.com/about.asp>.

⁵ These formulations are all trademark product names of the Kerite Corporation.

temperatures, will instead char and burn. All four Kerite formulations behaved like a thermoset in this regard.

Thermoset cable insulation materials generally provide a higher degree of thermal resistance (i.e., higher thermal failure limits) than do thermoplastic materials. Thermoset insulation materials are expected to provide adequate short-term electrical performance up to temperatures of at least 330°C and many common thermoset materials have failure thresholds of 390°C or higher [4]. In contrast the lower bound failure temperature for thermoplastic insulated cables is approximately 205°C and many of the common thermoplastic materials have failure thresholds in the 250-290°C range [4].

At least one prior fire barrier test program⁶ [2] reported Kerite FR cable failures at unexpectedly low temperatures (i.e., in comparison to typical thermoset insulation materials). In one case Kerite FR insulated cables failed during a test where the maximum temperature recorded within the protected raceway was just 184°C. In a second case cable failures were recorded where the maximum temperature measured was 329°C. Another prior test series involving severe accident equipment qualification tests (superheated steam exposures) [3] indicated some degradation of the Kerite FR insulation at temperatures as low as 153-171°C, but no outright failures until cable temperatures had reached 372°C or higher. Chapter 2 of this report provides a more complete discussion of the pre-existing knowledge base on the high-temperature performance of Kerite FR cables.

Based largely on reference [2] and the cited evidence of fire damage at relatively low temperatures, the recommended current practice for fire Probabilistic Risk Assessment (PRA) applications [4], including the NRC's Significance Determination Process (SDP) [7], is to treat Kerite FR cables using the damage criteria associated with thermoplastic cables. Questions have been raised as to whether this recommended treatment is overly conservative or truly reflective of the material behavior. The tests described here were undertaken in an effort to resolve this uncertainty, in particular, for the Kerite FR insulated cables. As a part of testing, nominal failure thresholds for the other three Kerite insulation materials noted above have also been developed.

Note that in 2010 SNL published a preliminary report on Kerite cables that was based on a subset of the tests covered by this report [5]. The preliminary report covered only the small-scale fire tests performed as a part of the DESIREE-Fire project. These initial tests were not considered conclusive, but provided sufficient evidence to formulate a working hypothesis as to why the Kerite FR cables might experience cable failures at temperatures below 300°C. As discussed in Chapter 9 of this report, that hypothesis has been reinforced by the additional testing performed under KATE-Fire. The current report supersedes the preliminary report and covers the full set of all Kerite brand cable tests performed including those covered by the preliminary report. Given the much larger base of testing, the conclusions of the current report are considered definitive.

⁶ The original source report for the fire barrier tests titled "KAOWOOL Triple Wrap Raceway Fire Barrier Test for Conduits and Cable Trays" dated May 5, 2000 was obtained by Salley in the cited Masters' Thesis. The original report is available through the NRC Agencywide Documents Access and Management System under accession number ML092080059.

2 A SUMMARY OF PRIOR TESTING

2.1 SNL – Severe Accident Equipment Qualification Testing

As a part of the U.S. NRC-sponsored equipment aging research programs conducted at SNL [3], one test series was conducted involving Kerite FR cables. The objectives of this program were not specific to either fire or to the Kerite product, but rather, were to:

- determine the life extension potential of popular cable products used in U.S. NPPs; and,
- determine the potential of condition monitoring for residual life assessment.

This particular experimental program consisted of simultaneous thermal (~95°C) and radiation aging (~0.09 kGy/hr) followed by a simulated loss of coolant accident (LOCA) high temperature (superheated) steam exposure. During this program, two different samples of Kerite FR insulated, FR jacketed, 1/C-12 American Wire Gauge (AWG) cable were tested. The original test report presents results using four potential electrical failure thresholds all of which are based on the insulation resistance (IR) of the conductor insulation material expressed in units of resistance (Ω) over a specified length (100 m) of cable. This approach reflects the fact that the performance limits of a control cable may be a function of the circuit characteristics and its tolerance for leakage currents. A fully functional non-degraded cable would typically provide an IR in excess of 1000 k Ω -100 m. Lower IR values indicate higher levels of degradation. These equipment qualification (EQ) tests did observe signs of Kerite FR degradation at lower temperatures than were noted for the other tested materials, all of which were thermoset type materials. The results of these tests are presented in Table 4 of the original test report [3] and are summarized below in Table 2.1 and Table 2.2. Using a failure criterion of IR less than (<) 1 k Ω -100 m (the third of four progressively more severe degradation levels considered), the Kerite FR cable reached this level of degradation at temperatures significantly lower than did the other cables tested (i.e., 153–171°C for the Kerite FR samples versus 235°C or higher for the other cables). For the most severe degradation level considered, IR < 0.1 k Ω -100 m, the performance of the Kerite FR cable was broadly consistent with that of the other cables tested.

**Table 2.1: Cable performance during superheated steam exposure testing
(failure criterion IR < 1 k Ω -100 m).**

| Cable type | Cable samples | Temperature (°C) |
|-------------------------------------|---------------|------------------|
| XLPO ^a | 13 | 254 - 378 |
| EPR ^b | 16 | 235 - 400+ |
| Silicon Rubber | 2 | 396 - 400+ |
| Kerite FR | 2 | 153 - 171 |
| Polymide | 1 | 399 |
| {a} Cross-Linked Polyolefin (XLPO) | | |
| {b} Ethylene Propylene Rubber (EPR) | | |

Table 2.2: Cable performance during superheated steam exposure testing (failure criterion IR < 0.1 kΩ-100 m).

| Cable type | Cable samples | Temperature (°C) |
|----------------|---------------|------------------|
| XLPO | 13 | 299 - 388 |
| EPR | 16 | 370 - 400+ |
| Silicon Rubber | 2 | 396 - 400+ |
| Kerite FR | 2 | 372 - 382 |
| Polymide | 1 | 399 |

Around the time these tests were being conducted, SNL was also independently engaged in an effort to investigate the effects of fire on cable performance. Although the two types of exposures (i.e., superheated steam and a dry-air exposure) are different, Nowlen and Jacobus [6] argued that these thermal conditions are similar enough to allow for a comparison between results.

These authors noted that the most severe portions of the exposure profile in the EQ tests involved a superheated steam environment. Although these conditions were followed by a saturated steam environment, Nowlen and Jacobus [6] argued that the degradation of the cable resistance was caused by the elevated temperature and not water condensation because:

- there was little to no evidence of external cracking after the superheated steam exposure;
- no additional degradation in cable resistance was noted when saturated steam conditions were dominant; and,
- deionized and demineralized water was used in the steam system.

Based on this logic, the results of the superheated steam exposure tests are considered relevant to an overall understanding of the behavior of Kerite FR under fire exposure conditions.

2.2 South Carolina Electric & Gas – Kaowool Fire Barrier Testing

Subsequent fire testing involving Kerite FR samples at South Carolina Electric & Gas (SCE&G) showed cable failure again at lower than anticipated temperatures for a thermoset material. Kerite FR samples were used during the fire barrier testing of Kaowool (a trade name product of the 3M Corporation) ceramic fiber blanket thermal insulation [2]. Sample cables were placed within a tray alongside a single stranded, bare copper 8 AWG conductor instrumented with thermocouples every 15.24 cm along the entire conductor length (the instrumented bare conductor is a standardized approach to measuring temperatures interior to the fire barrier system during the fire exposure test). The tray was then wrapped with three layers of Kaowool material which nominally represented a 1-hour fire barrier. From this series of tests, Kerite FR cable failures were recorded at relatively low temperatures for a thermoset insulation material (i.e., at or below 184°C for one test sample and 329°C for another). The results from the SCE&G testing were summarized by Salley [2] and are summarized in Table 3.

Table 2.3: South Carolina Electric & Gas 1999 Kaowool protected cables functionality test results.

| Conductor Count/C-# AWG | Insulation / Jacket ^a | Post-test insulation resistance in (MΩ) | Maximum Temperature (°C) |
|--|----------------------------------|---|--------------------------|
| 2/C-9 AWG | FR/FR | Fail ^b | 609 |
| 4/C-12 AWG | FR/FR | 11 to 13 | 184 |
| 5/C-12 AWG | FR/FR | Fail ^b | 184 |
| 3/C-8 AWG | HTK/FR | ∞ | 184 |
| 5/C-12 AWG | FR/FR | Fail ^b | 329 |
| {a} Insulation/Jacket refer to the Kerite cable materials {b} Fail is defined as no resistance measured at the lowest scale (0.1 MΩ) with 1 kV applied. For test purposes, it's considered the conductor shorted. | | | |

2.3 Summary of Prior Knowledge Base and Guidance

Although limited, the experimental evidence suggested that Kerite FR insulated cables might be substantially more vulnerable to thermal damage than are other thermoset materials. Based on those results, NRC guidance documents [3,7] recommend that the cables insulated with Kerite FR should be analyzed using failure criteria typical of thermoplastic, rather than thermoset, materials. Table 2.4 shows the existing guidance for the treatment of Kerite FR cables as provided in an errata sheet⁽⁷⁾ to the existing fire PRA methodology guidance document [4].

Table 2.4: Generic Criteria for the Assessment of the Ignition and Damage Potential of Electrical Cables under NUREG/CR-6850, EPRI 1011989, errata, 2006.

| Cable Type | Radiant Heating Criteria | Temperature Criteria |
|-----------------------------------|--------------------------|----------------------|
| Thermoplastic <u>or</u> Kerite FR | 6 kW/m ² | 205°C |
| Thermoset | 11 kW/m ² | 330°C |

Some licensees are currently transitioning to National Fire Protection Association (NFPA) standard 805 per 10 CFR 50A8.c. As a part of this process, the Office of Nuclear Reactor Regulation (NRR) and industry manage a frequently asked question (FAQ) process through which licensees can seek to resolve technical and programmatic implementation questions. A FAQ related to the treatment of Kerite FR cable failure thresholds as used in fire PRA was submitted to this process⁸. The FAQ argued against using the sparse data described above as a basis for the thermal failure threshold. The FAQ argued that Kerite FR should be treated using the general guidance for thermoset insulation materials from the fire PRA guidance [4] for applications under NFPA 805. The proposed FAQ solution has never been approved by the NRC staff, and is awaiting the results of KATE-Fire for final resolution.

⁷ The errata sheet was distributed with the annual RES/EPRI Fire PRA training materials in 2006.

⁸ See unresolved FAQ #08-0053.

3 KERITE CABLE SAMPLES

3.1 Overview

As previously noted, it is no longer possible to procure Kerite FR cables from the manufacturer. However, the testing efforts were performed in collaboration with industry as represented by the EPRI and its member utilities. It was through this collaboration that samples were obtained for testing. It is common practice for U.S. NPPs to retain unused excess cable stocks left over from the original plant construction for use in ongoing plant maintenance activities (e.g., for new cable routings or as replacement cables in the event of some cable damage). Vintage unused (new old stock or NOS) cables originally procured in the late 1970's and early 1980's were provided for testing by three EPRI member utilities. The sections that follow describe each of the Kerite cables used in testing.

3.2 Cable Descriptions

Through the course of DESIREE-Fire and KATE-Fire, samples of 11 different Kerite cables were tested. The donated cables had varying conductor counts, wire gauges, shielding, fillers, and insulation materials. As noted above, Kerite FR is not the only cable insulation product produced by the manufacturer. The Kerite insulation materials tested were Kerite FR, FR-II, FR-III, and HT (also known as HTK or HT-Kerite). The concerns expressed in the prior guidance have focused on the Kerite FR formulation, but because samples of the other Kerite products were available, all four materials were evaluated in testing.

This section presents a description, organized by contributing company and in ascending order by conductor count, of the cables provided through the RES and EPRI MOU. The descriptions provided here include information taken directly from the cable data and information sheets as provided by the contributing companies.

- **2-conductor, 12 AWG (or 2/C-12 AWG) cable:** This cable is a Kerite FR insulated and FR jacketed light power cable. The jacket is approximately 1.6 mm thick with an adhered cloth wrap separating the jacket from the conductors. Jute filler material is used to fill gaps left from the 2-conductor geometry to make a rounded shape. The insulation is approximately 1.2 mm thick. The insulation on each conductor is gray with printed colors and numbers. The conductors are Class C concentric stranded (19 strands), tinned or lead alloy coated, annealed copper. The cable's outer diameter is 15 mm.
- **2/C-10 AWG cable:** This cable is a Kerite FR-III insulated and FR jacketed light power cable. The jacket is approximately 1.3 mm thick with an adhered cloth wrap separating the jacket from the conductors. Jute filler material is used to fill gaps left from the 2-conductor geometry to make a rounded shape. The insulation is approximately 1.0 mm thick. The insulation on each conductor is gray with printed colors and numbers. The conductors are Class C concentric stranded (19 strands), tinned or lead alloy coated, annealed copper. The cable's outer diameter is 14 mm.

- **3/C-6 AWG cable:** This cable is a Kerite HT insulated, Kerite FR jacketed light power cable. The jacket is approximately 2.0 mm thick. It has one wrap of fabric between the outer jacket and the insulated conductors. The Kerite HT conductor insulation was approximately 1.0 mm thick. Jute material was used to fill the gaps between conductors to make a circular geometry. The insulation on each conductor is gray with printed numbers and colors. The conductors are Class B stranded (7 strands) copper. The outer diameter of the cable is 22 mm.
- **4/C-10 AWG cable:** This cable is a Kerite FR-III insulated and FR jacketed light power cable. The jacket is approximately 1.7 mm thick with an adhered cloth wrap separating the jacket from the conductors. Jute filler material is used to fill the center of the cable and the gaps left from the 4-conductor geometry to make a rounded shape. The insulation is approximately 1.0 mm thick. The conductors are gray with printed colors and numbers. The conductors are Class C concentric stranded (19 strands), tinned or lead alloy coated, annealed copper. The cable's outer diameter is 18 mm.
- **5/C-12 AWG cable:** This cable is a Kerite FR insulated and jacketed control cable. The jacket that is approximately 1.7 mm thick. A zinc tape is spiral-wound directly beneath the jacketing material and two fabric wraps separate the insulated conductors from the zinc material. The five insulated conductors surround a central core of jute filler material. The conductor insulation is approximately 1.0 mm thick. The insulation on each conductor is gray with printed numbers and colors. The conductors are Class B stranding (7 strands), tin coated copper. The cable's outer diameter is 19 mm.
- **7/C-12 AWG cable:** This cable is a Kerite FR insulated and jacketed control cable. The jacket is approximately 1.7 mm thick with a black cloth tape adhered to the interior jacketing material. A zinc tape is spiral-wound directly beneath the jacketing material and two fabric wraps separate the insulated conductors from the zinc material. Six insulated conductors surround a central conductor. The Kerite FR conductor insulation material has an approximate thickness of 1.2 mm. The insulation on each conductor is gray with printed numbers and colors. The conductors are Class B stranding (7 strands), tin-coated copper. The cable's outer diameter is 20 mm.
- **9/C-14 AWG control cable:** This cable is a Kerite FR insulated and jacketed control cable. The jacket is approximately 1.7 mm thick and is red in color. Beneath this jacketing material is one layer of fabric wrap which surrounds the eight outermost conductors. There is one center conductor that is surrounded by filler jute material which stabilizes the circular pattern. The conductor insulation is approximately 1.3 mm thick. The insulation on each conductor is gray with printed colors and numbers. The conductors are Class B stranded (7 strands). The cables is rated 600V, FPD code EK19J, and certified to Franklin Institute Report #F-C4020-2, DTD 3/75. The cable's outer diameter is 22 mm.
- **10/C-16 AWG cable:** This cable is a Kerite FR-II insulated and FR jacketed control cable. The jacket is approximately 1.7 mm thick with an adhered cloth wrap separating the jacket from the conductors. The adhered cloth has a rubber-like material which stabilizes the outer eight conductors in place. The center two conductors are wrapped separately with a cloth tape and extra spaces are filled with jute material. The insulation is approximately 0.8 mm

thick. The insulation on each conductor is gray with printed colors and numbers. The conductors are Class C (19 strands) concentric stranded, tinned or lead alloy coated, annealed copper. The cable's outer diameter is 19 mm.

- **10/C-12 AWG cable:** This cable is a Kerite FR insulated and jacketed control cable. The jacket is approximately 2.0 mm thick with a spiral-wound zinc tape directly beneath the jacketing material. Two counter-wrapped spiral-wound fabric strips separate the insulated conductors from the zinc tape. Eight insulated conductors surround a center bundle of two conductors. Gaps created by this geometric configuration were filled with fabric wound bundles of stranded material. The center bundle is separated from the outer eight conductors by a single layer of fabric wrap. The conductor insulation is approximately 1.0 mm thick. Kerite FR insulated and jacketed control cable with shield wrap. The insulation on each conductor is gray with printed numbers and colors. The conductors are Class B stranded (7 strands), tin-coated copper. The cable's outer diameter is 27 mm.
- **12/C-12 AWG cable:** This cable is a Kerite FR-III insulated and FR jacketed control cable. The jacket is approximately 2.0 mm thick with an adhered cloth wrap separating the jacket from the conductors. The adhered cloth has a rubber-like material which stabilizes the outer eight conductors in place. The center three conductors are wrapped separately with a cloth tape and extra spaces are filled with jute material. The insulation is approximately 1.0 mm thick. The insulation on each conductor is gray with printed colors and numbers. The conductors are Class C concentric stranded (19 strands), tinned or lead alloy coated, annealed copper. The cable's outer diameter is 26 mm.
- **15/C-12 AWG cable:** This cable is a Kerite FR insulated and jacketed control cable. The jacket is approximately 2.0 mm thick with a black cloth tape adhered to the interior jacketing material. A zinc tape is spiral-wound directly beneath the jacketing material and two fabric wraps separate the insulated conductors from the zinc material. Ten insulated conductors surround a center bundle of five conductors, and fabric materials fill the gaps created by this geometric configuration. The center bundle consists of five conductors and filler materials all of which are secured within a fabric wrap. The Kerite FR conductor insulation material has an approximate thickness of 1.7 mm. The insulation on each conductor is gray with printed numbers and colors. The conductors are Class B stranded (7 strands), tin-coated copper. The cable's outer diameter is 30 mm.

3.3 Cable Sample Designations

Table 3.1 identifies all the cables tested. For each cable sample, an “item” identifier is defined using the letters A-K as designators (left-most column). These letter designations are used in the balance of this report to identify each cable sample (e.g., “Item A” will be used when referring to the 2/C, 12 AWG Kerite FR cable which is the first cable sample listed in Table 3.1). The cables are organized in ascending order by conductor count except for the 3-conductor HT-Kerite cable (Item K), which was only used during the DESIREE-Fire tests. Cross-section and exploded views (i.e., outer jacket removed to display the conductors, fillers, etc.) are presented along with a brief description and the designation. The jacket markings were noted and are presented in Table 3.2.

Table 3.1: Kerite cable designation and images.







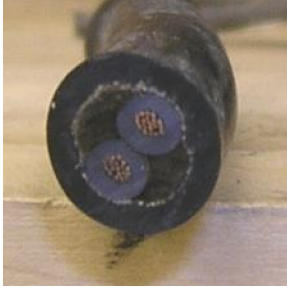

| Item | Description | Cross-section | Exploded view |
|------|--|---|---|
| A | 2/C-12 AWG FR insulated FR jacketed |  |  |
| B | 2/C-10 AWG FR III insulated, FR jacketed |  |  |
| C | 4/C-10 AWG FR-III insulated, FR jacketed |  |  |
| D | 5/C-12 AWG FR insulated FR jacketed |  |  |

Table 3.1: Kerite cable designation and images.

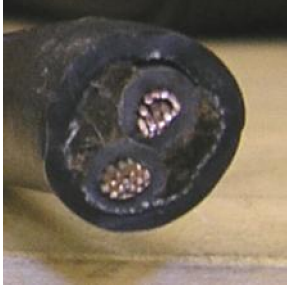





| Item | Description | Cross-section | Exploded view |
|------|--|---|---|
| E | 7/C-12 AWG FR insulated FR jacketed |  |  |
| F | 9/C-14 AWG FR insulated FR jacketed |  |  |
| G | 10/C-16 AWG FR-II insulated, FR jacketed |  |  |
| H | 10/C-12 AWG FR insulated FR jacketed |  |  |

Table 3.1: Kerite cable designation and images.





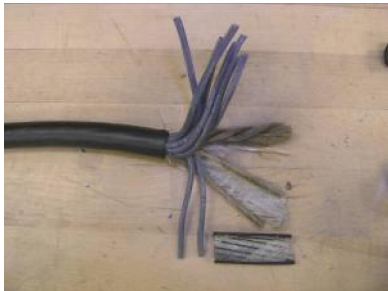

| Item | Description | Cross-section | Exploded view |
|------|---|---|---|
| I | 12/C-12 AWG FR-III insulated, FR jacketed |  |  |
| J | 15/C-12 AWG FR insulated FR jacketed |  |  |
| K | 3/C-6 AWG HT insulated, FR jacketed |  |  |

Table 3.2: Kerite cable jacket markings as written on cable.

| Item | Cable jacket markings |
|-------------|--|
| A | KERITE 1980 TYPE I 600V |
| B | KERITE 1984 2/C #10 AWG CU 600V FR3 90C D50-01 |
| C | KERITE 1984 4/C #10 AWG CU 600V FR3 90C D50-02 |
| D | KERITE 1981 5/C #12 AWG 600V EKB1K |
| E | KERITE 1976 7/C 600V #12 AWG EKB1L |
| F | NO MARKINGS, MODEL: EK-19J |
| G | KERITE 1981 10/C #16 AWG 600V CU FR II 90C D50-14 |
| H | KERITE 1978 10/C #12 AWG 600V EKB1M |
| I | KERITE 1982 12/C #12 AWG 600V CU FR-III 90C D50-10 GREEN |
| J | KERITE 1976 15/C 600V #12 AWG EKB1N |
| K | KERITE 1994 3/C #6 AWG CU 600V FR3 EKA3G |

4 CABLE ELECTRICAL PERFORMANCE MONITORING UNITS

4.1 Alternating Current (ac) Systems

SNL used two diagnostic systems which provide information on ac-powered electrical cable failure. These systems have been used in multiple programs to analyze the failure modes and effects of cables subjected to adverse thermal environments. The characteristics of these two diagnostic systems are described in the following subsections.

4.1.1 Surrogate Circuit Diagnostic Unit

The Surrogate Circuit Diagnostic Unit (SCDU) was developed for CAROLFIRE and is described in detail in NUREG/CR-6931 [8]. Each of the four SCDU systems provides the ability to simulate one ac control circuit. Figure 4.1 provides a general system schematic representative of each SCDU. For CAROLFIRE the units were generally deployed to simulate an ac-motor operated valve (MOV) control circuit. However, as described below, during the testing of the Kerite cables the SCDU was used in more generic configuration.

Each SCDU allows for the following circuit paths to be used:

- One, two or three (switch selectable) energized source circuit paths: These are generally referred to as 'S1' through 'S3' and are represented by the top three circuit paths in Figure 4.1.
- One passive target path: This target is a 1.8 k Ω resistor nominally simulating an indicator lamp and is represented by the fourth circuit path from the top in Figure 4.1. This circuit path is generally referred to as 'PT4' or more simply 'PT' (for the passive target on circuit path 4).
- Two active target circuit paths: These are the two motor contactors shown as 'K1' and 'K2' in the circuit diagram. These are typically referred to as 'AT5' and 'AT6' (for the active targets on circuit paths 5 and 6).
- One, two or three (switch selectable) circuit ground paths: These are represented by the bottom three circuit paths as shown in Figure 4.1. If one of these circuit paths is used in testing but with the selector switch open (not grounded) then the conductor on that circuit path would act as a monitored spare conductor (i.e., no circuit function but monitored for voltage and current).

The data graphs for each SCDU test as presented in the following chapters depict the electrical response for various circuit voltages and currents. A typical graph will identify a data trace as either "C# V#" or "C# A#". Using this nomenclature, the "C#" identifies the specific SCDU circuit and the "V#" or "A#" identify the voltage or current path being plotted. For example, a plot that shows "C1 V5" represents SCDU circuit 1 (SCDU1) voltage on circuit path 5 (an active

target). Similarly, "C2 A6" would indicate SCDU2 current on circuit path 6 (also an active target).

The four SCDU units each used a different size Control Power Transformer (CPT); namely, a 75 volt-ampere (VA) for SCDU4, 100 VA for SCDU1, 150 VA for SCDU2, and 200 VA for SCDU3.

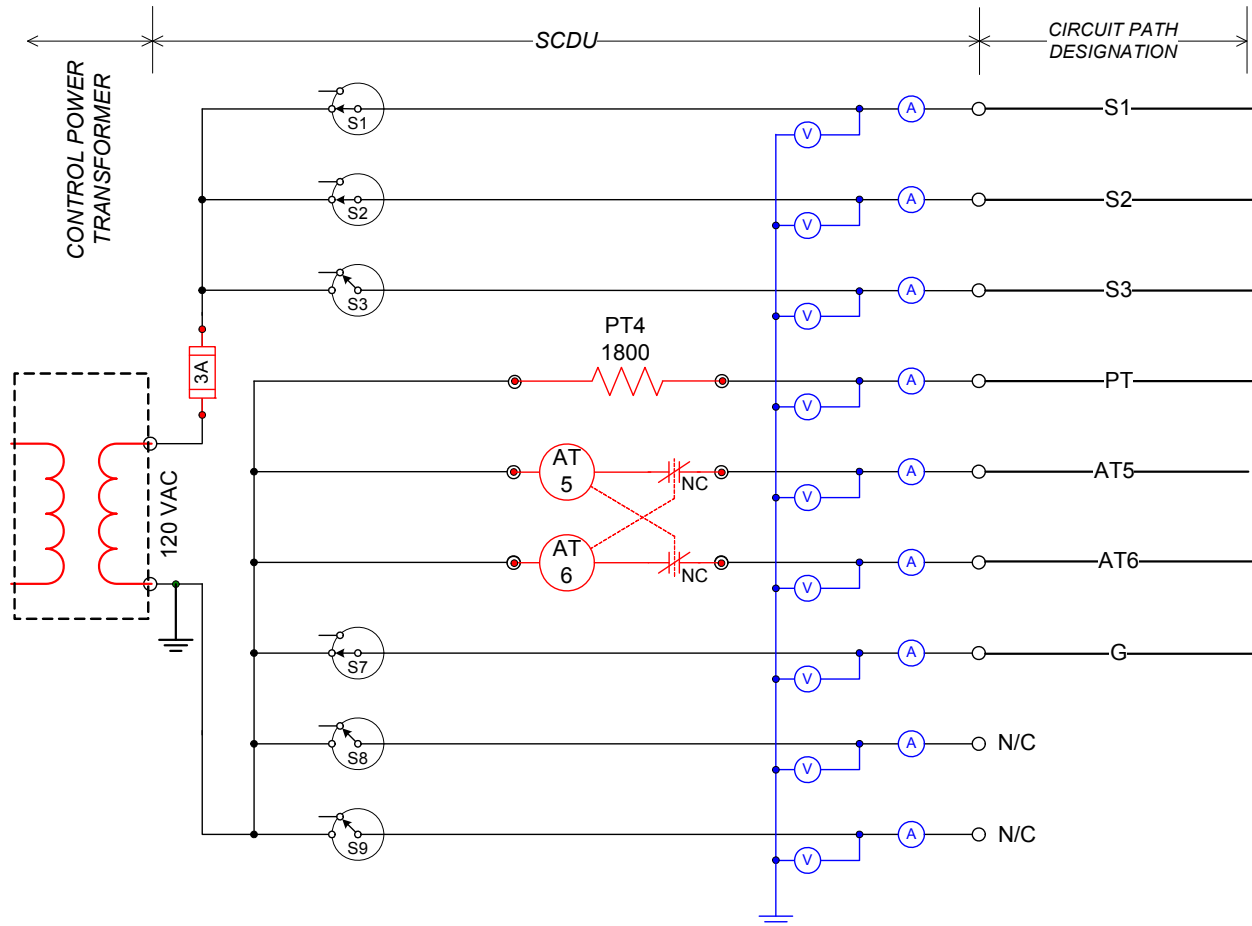

Figure 4.1: Circuit diagram for a generic SCDU including an active electrical interlock on the contactor pair.

One design change has been implemented relative to the SCDUs since CAROLFIRE; namely, replacement of the original motor starter contactor sets at the start of DESIREE-Fire. The original motor starter contactors were replaced by more representative Joslyn-Clark⁽⁹⁾ units of the same type used in the original EPRI/Nuclear Energy Institute (NEI) Fire Test Program [9]. The replacement contactors used on SCDU1, SCDU3 and SCDU4 included both mechanical and electrical interlocks while the replacement contactors used on SCDU2 only had the electrical interlocks.

⁹ Note that the EPRI test report (TR-1003326, page 4-13) cites "AO Smith (Clark Controls Division) Catalog #30U031" as the make and model of the motor starters used in that test program. AO Smith has since merged with Joslyn controls. The combined company is known as Joslyn-Clark Controls. The same model motor starter relays are sold under the Joslyn-Clark brand using essentially the same catalog number (T30U031).

The threshold pickup and dropout voltages and the holding currents of all the Joslyn-Clark contactors were measured for the DESIREE-Fire project and are presented in Table 4.1.

Table 4.1: SCDU Target MOV Relays Pickup Voltages & Currents.

| | MOV ID | Pickup voltage (Vac) | Holding current (A) | Dropout voltage (Vac) |
|--------------|---------------|-----------------------------|----------------------------|------------------------------|
| SCDU1 | AT5 | 93.9 | 0.07 | 71.7 |
| | AT6 | 80.5 | 0.08 | 67.1 |
| SCDU2 | AT5 | 81.1 | 0.08 | 60.1 |
| | AT6 | 79.7 | 0.08 | 69.5 |
| SCDU3 | AT5 | 82.3 | 0.09 | 64.6 |
| | AT6 | 83.2 | 0.08 | 57.5 |
| SCDU4 | AT5 | 85.1 | 0.08 | 59.7 |
| | AT6 | 85.0 | 0.08 | 57.2 |

For the Kerite tests, the SCDUs were not connected using the standard MOV wiring configuration as was applied in CAROLFIRE. The goal of the Kerite cable testing was to explore the cable's damage threshold rather than to explore cable/circuit failure modes and effects. Hence, the SCDUs were used in a more generic manner designed to maximize the potential for detection of conductor-to-conductor or conductor-to-ground short circuit interactions.

For the DESIREE-Fire tests, the test cable would generally be connected using either one or two energized source paths (S1 and/or S2) and both of the active target circuit paths (AT5 and AT6). The wiring configuration was adjusted depending on the number of conductors present, but in general, resulted in adjacent conductors alternating between an energized source and an active target. Given this configuration, conductor-to-conductor shorting between any adjacent conductor pair would activate the associated target motor contactor. Conductor-to-ground shorting for any of the energized conductors would result in a fuse blow failure. In some tests, one conductor was grounded. For these cases, a conductor-to-conductor short between an energized source and the grounded conductor would cause the circuit fuse to clear thus de-energizing the test circuit. This approach made detection of general insulation degradation possible, but not specific to a given conductor or conductor pair.

For the KATE-Fire tests, multiple SCDU circuits were used on a single cable sample to maximize the potential for detection of conductor interactions. In Table 6.6, these cases are labeled with "SCDU (M)". Again, the general wiring configuration set up adjacent conductors that were wired alternately as energized sources and active targets. The use of multiple SCDU circuits allowed for more specific detection of individual conductor or conductor pair interactions.

In all tests the cable tray and, if present, the zinc tape shield wrap (see cable descriptions above) were grounded to a common facility and instrumentation ground. Grounding of the zinc tape is consistent with plant practice for the contributing company and is considered general practice for cables of a similar construction (conductive shield wraps are generally grounded during

installation). These grounded elements provided additional mechanisms for fuse-blow failure to occur; namely, shorts between any energized conductor and either the external cable tray or the zinc wrap.

4.1.2 The Insulation Resistance Measurement System

The Insulation Resistance Measurement System (IRMS) was originally developed as a part of the RES collaboration on the 2001 EPRI/NEI Fire Test Program [9]. The system was also deployed during CAROLFIRE. IRMS uses 120 Vac (60 Hertz) line power as the energizing source potential. The design, operation, and data analysis associated with the IRMS remain as described in NUREG/CR-6931 [8]. In brief, the IRMS works by energizing one conductor at a time while monitoring for a return signal on each of the other conductors present. Any current flow from the energized conductor is an indication of insulation breakdown, and the IR values between conductor pairs (conductor-to-conductor or c-c resistance) and between conductors and ground (c-g resistance) can be calculated. A detailed description of the IRMS system may be found in NUREG/CR-6776 [10].

Although the IRMS was not used during DESIREE-Fire, results from the SCDU Kerite tests during DESIREE-Fire revealed degradation at relatively low temperatures for a thermoset material. Hence, the IRMS was utilized during KATE-Fire to help determine the severity of the early (lower temperature) degradation in the cable samples. In particular, the IRMS allows for a direct measurement of the minimum IR values over the course of the experiment.

The graphs for each IRMS test presented in the following chapters will depict the electrical response of the test cable based on either “c-c minimum” or “c-g minimum”. In these graphs, "c-c minimum" refers to the lowest conductor-to-conductor IR value measured among the various conductor pairs within a cable sample at each time step. Similarly, c-g minimum refers to the lowest conductor-to-ground IR value among the various conductors within a cable sample at each time step.

4.2 Direct Current System

The primary purpose of DESIREE-Fire was to investigate the fire-induced cable failure modes and effects of dc-powered control circuits. As a matter of opportunity Kerite cables were added to both the Penlight and intermediate-scale test matrices. Seven of the eight control circuits constructed for DESIREE-Fire were utilized for testing Kerite. Given the very limited lengths of donated cable samples, the inter-cable circuit configuration was excluded from the matrix. The circuit diagrams for each of the dc-powered control circuits used in testing may be found in Appendix A. Detailed descriptions are also provided in the DESIREE-Fire test plan which is available through the NRC website⁽¹⁰⁾. The subsections which follow provide a summary description of the dc test circuits.

¹⁰ ADAMS Accession No. ML082520518

4.2.1 Direct Current Simulation Panels

The Direct Current Simulation Panels (DCSim Panels) were constructed to simulate and monitor the performance of each of the following circuit types:

- dc reversing motor starters such as those used to control a motor operated valve (MOV)
- small (pilot) solenoid operated valve (SOV)
- medium sized (1-in. (25.4 mm) diameter) direct-acting vent-type SOV
- large (20.3 cm) direct acting valve coil
- large (15kV) switchgear breaker assembly

4.2.1.1 *MOV1 and MOV2*

Two separate dc-powered MOV circuits were used in testing. They are referred to as MOV1 and MOV2 in the balance of this report⁽¹¹⁾. Each MOV circuit was comprised of a matched pair of Joslyn-Clark-brand dc motor control contactors that were electrically and mechanically interlocked. One contactor is designated as the “open” contactor and the second as the “close” contactor (i.e., the contactors that, if energized, would cause the valve to open or close, respectively).

4.2.1.2 *SOV1 and SOV2*

Two separate small SOV circuits were also used in testing (referred to as SOV1 and SOV2). The two circuits each include a working solenoid valve of the type commonly used as a pilot control valve, for example, for a larger air-operated valve (AOV). The two small SOV circuits differed in that one circuit, SOV2, used a continuous duty “Class H” coil. SOV1 used a standard duty coil. Based on the manufacturer’s literature, the Class H coils will accommodate continuous duty over a wider voltage range; namely, 12% over normal and 28% under normal rated coil voltage. For a nominal 125 Vdc coil, this translates to a voltage range of 90 to 180 Vdc.

4.2.1.3 *1-in. Valve*

One test circuit was built around a relatively large, one inch (25 mm) SOV that was provided by the Target Rock Corporation through the EPRI collaboration. It is referred to as the “1-in. valve” throughout the remainder of this report. This was a normally open solenoid valve. The size (1-in.) refers to the nominal inlet and outlet pipe diameter. This was a fully functional valve and was similar to the type of valve that would be used as a head vent valve or in other safety relief applications (but smaller than a typical power operated relief valve (PORV)). The valve assembly included open and close indicator switches that were wired into the valve circuit.

4.2.1.4 *Large Coil*

One circuit was built around the coil assembly for a large, direct-acting SOV. In this case only the coil assembly itself was available (no valve mechanical elements present). Hence, the coil acted as a passive target for hot shorts. For a sense of scale, the coil assembly itself had a core diameter of approximately 200 mm and weighed approximately 114 kg. This coil was also

¹¹ The reader should note that the dc-powered MOV circuits are consistently referred to as MOV1 and MOV2. Although testing also involved a set of ac-powered MOV circuits, the ac-circuits are uniformly referred to as the SCUDU circuits or as SCUDU1 through SCUDU4. This convention is maintained throughout the report whenever the various test circuits are discussed.

provided by the Target Rock Corporation via the EPRI collaboration. Originally, one goal of the program was to include a representative PORV valve in the testing program, but EPRI was unable to obtain a suitable valve. When this valve coil became available, it was decided to include it in the testing program even though it was much larger than a typical PORV would be. Between the 1-in. valve and the large coil, the test circuits at the least bound a typical PORV.

4.2.1.5 Switchgear

One test circuit was built around an actual switchgear breaker unit. The unit used to test the Kerite samples was fully functional and would open (trip) and close in accordance with the control signals received. From the manufacturer's summary description, "the vacuum circuit breaker uses sealed vacuum power interrupters to establish and interrupt a primary circuit. Primary connections to the associated metal-clad switchgear are made by horizontal bars and disconnect fingers, electrically and mechanically connected to the vacuum interrupters." The operating mechanism provided direct motion at each phase location in order to move the movable contact of the vacuum interrupters from an open position to a spring-loaded closed position and then back to the open position on command. The primary interrupters were not energized during testing, although the 125 Vdc control circuit was fully functional (i.e., no primary power, control power only).

During a closing operation, the energy stored in the closing spring is used to close the vacuum interrupter contacts, compress the wipe springs that load the contacts, charge the opening spring, and overcome bearing and other friction forces. The energy then stored in the wipe springs and opening spring will open the contacts during an opening operation.

Closing and opening operations are controlled electrically by the metal-clad switchgear or remote relaying. Mechanical control is provided by manual close and trip buttons on the circuit breaker. The closing spring may be manually charged.

4.2.2 The dc Battery Bank

The battery set used in testing was made available through the RES and EPRI MOU. The set was comprised of 68 Exide model ES-13 calcium flat-plate, lead/acid battery cells that were being taken out of service from the North Anna Nuclear Station technical support center (TSC). The batteries had reached their nominal end of life and were being replaced as a matter of preventative maintenance. All of the cells were tested for serviceability by an independent electrical contractor before receipt at SNL and all the cells used in the program were certified as fully functional in accordance with Institute of Electrical and Electronics Engineers (IEEE) Standard 450-2002 [11].

The battery bank provided a nominal 125 Vdc power output, this having been identified by the industry representatives as typical of the dc-control circuit power supplies used in U.S. NPPs. A total of 60 battery cells, each approximately 2.2 Vdc, were used to construct the battery bank. For a sense of scale, each individual cell weighed about 36.7 kg, and together the 60-cell battery bank weighed approximately 2200 kg. Additional information on the battery specifications may be obtained from Table 4.2. The completed battery bank provided an estimated short-circuit output current at the main terminals of over 13,000 A.

Table 4.2: Exide calcium flat plate battery cell specifications.

| Model type | Overall dimensions (mm) | | | Weights (kg) | | Volume (liters) |
|-------------------|--------------------------------|--------------|---------------|---------------------|--------------------|-------------------------|
| | Length | Width | Height | Cell Only | Electrolyte | Electrolyte only |
| ES-13 | 124 | 274 | 475 | 36.7 | 9.1 | 7.6 |

5 TEST CONDITIONS

The equipment and physical test configurations used for the Kerite FR tests are essentially identical to those used during CAROLFIRE [8], an NRC-sponsored experimental program investigating ac-powered control circuits and their response to fire-induced cable failure. As in CAROLFIRE, two scales of testing were conducted. Volume 2 of the CAROLFIRE report [8] provides a detailed description of the small-scale and intermediate-scale tests facilities and the general test protocols applied.

The following two subsections provide a brief overview of the small-scale Penlight and intermediate-scale test facilities. The reader should refer to the CAROLFIRE report for more complete descriptions.

5.1 Small Scale Experiments

The small-scale tests were conducted at the Thermal Test Complex at SNL in Albuquerque, NM using a radiant heating apparatus known as “Penlight.” The Penlight apparatus is placed beneath a ventilation hood within the Adverse Thermal Environments Laboratory, as shown in Figure 5.1.



Figure 5.1: The Penlight apparatus.

Penlight uses computer-controlled, water-cooled quartz lamps to heat a stainless steel shroud. The shroud is painted flat-black and acts as a grey-body radiant heating source, re-radiating heat to a test sample located within the shroud. The exposure temperature is controlled and monitored based on thermocouples mounted on the inner surface of the shroud. Penlight creates a, primarily, radiant heating environment which is analogous to that seen by an object enveloped in a fire-induced hot gas layer. That is, the hot gas layer thermal exposure environment is dominated by radiant heat exchange between the hot, smoke-filled gases and any immersed objects. The hot, smoke-filled gases act largely as a gray-body radiator. Penlight simulates these conditions with the shroud temperature being analogous to the hot gas layer or smoke

temperature. The relationship between shroud temperature and shroud heat flux assuming an emissivity of 0.815 (which has been measured) may be found in Table 5.1.

Table 5.1: Relationship between shroud temperature and shroud heat flux assuming an emissivity of 0.815.

| Temperature (°C) | Heat flux (kW/m ²) |
|------------------|--------------------------------|
| 260 | 3.7 |
| 295 | 4.8 |
| 300 | 5 |
| 325 | 5.9 |
| 330 | 6.1 |
| 350 | 7 |
| 400 | 9.5 |
| 425 | 11 |
| 460 | 13.4 |
| 470 | 14.1 |
| 475 | 14.5 |
| 500 | 16.5 |
| 525 | 18.8 |
| 600 | 26.9 |
| 650 | 33.6 |
| 665 | 35.8 |
| 675 | 37.3 |
| 700 | 41.4 |
| 900 | 87.5 |

All of the small-scale Kerite tests were conducted on a 30 cm wide ladder-back style cable tray suspended through the center of the Penlight shroud. The cable trays and other physical test conditions are effectively identical to those used in CAROLFIRE. Each test generally used symmetrically paired cables, one electrically energized and a second identical cable monitored for thermal response. This cable pairing approach allows for a direct correlation of temperature response and electrical performance without compromising the electrical integrity of the energized cable. In the DESIREE-Fire program, the thermal response cables were instrumented sub-jacket with two type-K thermocouples located in the center of Penlight to provide redundant temperature data. During the KATE-Fire program, an additional thermocouple was added approximately 23 cm in each direction off center to provide a more complete thermal profile. Typical thermocouple placement for KATE-Fire is shown in Figure 5.2. This spacing allowed the thermocouple to be centered between the rungs of the cable tray. The entrance holes created by the incision into the jacket were covered with fiberglass tape.

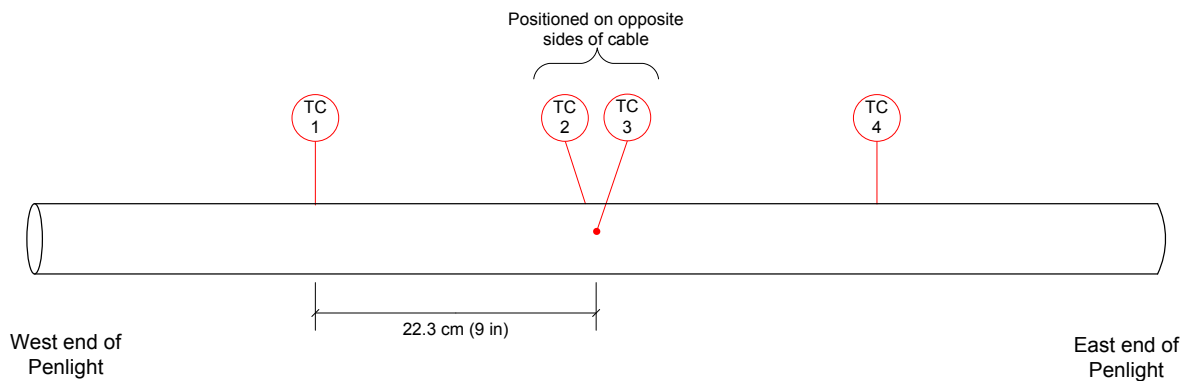

Figure 5.2: Thermocouple placement within a cable sample during KATE-Fire.

The exact heating protocol (i.e., the shroud set point temperature) varied from test to test depending on the specific test purpose (e.g., whether the test was conducted to investigate the low temperature failure mechanism or for performance under severe heating conditions). In some cases a specific set point value was established and maintained through the entire test. In other cases, the set point was varied through the course of the test. That is, a test would be started at a particular set point value, but that value would be increased as the measured cable temperature approached equilibrium. Step-wise increases were continued at, typically, 10 to 15-minute intervals until cable failure was observed. The actual test profile is unique for each DESIREE-Fire test; however, it became more standardized during KATE-Fire.

Since the potential for early (low temperature) failure was of primary interest, KATE-Fire began testing with a slow cable heating protocol. Based on the results of early testing, a nominal heating protocol started with an initial Penlight temperature of 325°C which was then increased by 10°C after 30 minutes. Successive temperature changes followed a stepwise pattern by increasing 10°C every 5 minutes until cable failure or test termination.

5.2 Intermediate-Scale Experiments

During DESIREE-Fire, a complementary test set was conducted at a scale more representative of in-plant conditions. These tests involved a more realistic open burn of larger arrays of cable under more varied and representative exposures. These tests were referred to as the intermediate-scale tests and represent an efficient method of evaluating the fire-induced circuit failure effects at actual scale without expending the time and effort full-scale testing would require. The intermediate-scale test approach is, again, identical to that used during the CAROLFIRE project with only slight modifications. This section provides a summary description of the test facility. For a more complete description, refer to the CAROLFIRE test report [8].

The intermediate-scale testing approach was developed during the CAROLFIRE project where a key goal of the research was to assess different exposure conditions, including cable failures due

to a hot gas layer exposure, flame impingement, and fire plume conditions. The design of the intermediate-scale test enclosure was based on the American Society of Testing and Materials (ASTM) standard test room specified in ASTM Standard E-603 [12], but is not a true room structure. Rather, it is a far more open configuration that did not restrict air flow to the fire (well-ventilated fire conditions). The test structure is arguably a good analog for a very common in-plant configuration; namely, a beam pocket within a larger room (i.e., a typical in-plant situation where the floor above is supported by massive steel and/or concrete beams creating isolated ceiling-level beam pockets).

The intermediate-scale test assembly is illustrated in Figure 5.3. Overall, the test structure measures approximately 2.4 m x 3.7 m x 3.0 m (W x L x H). The upper 1.2 m of the sides and the structure's top were covered with a 13 mm-thick "fireproof" wall board (trade name Durock)¹². This test structure acts to focus the fire's heat output initially to this confined volume, creating the desired hot gas layer exposure conditions. As the fire progresses the hot gas layer depth increases, and ultimately smoke and hot gasses spill out naturally from under the sides of the enclosed area. This again would be quite typical of the hot gas layer development behavior for a beam pocket configuration.

Conduits and trays could be routed in any manner desired. For DESIREE-Fire, all raceways were routed as a single straight section passing through the full width of the test structure (i.e., across the 2.4 m dimension). The raceways used are identical to those used in CAROLFIRE.

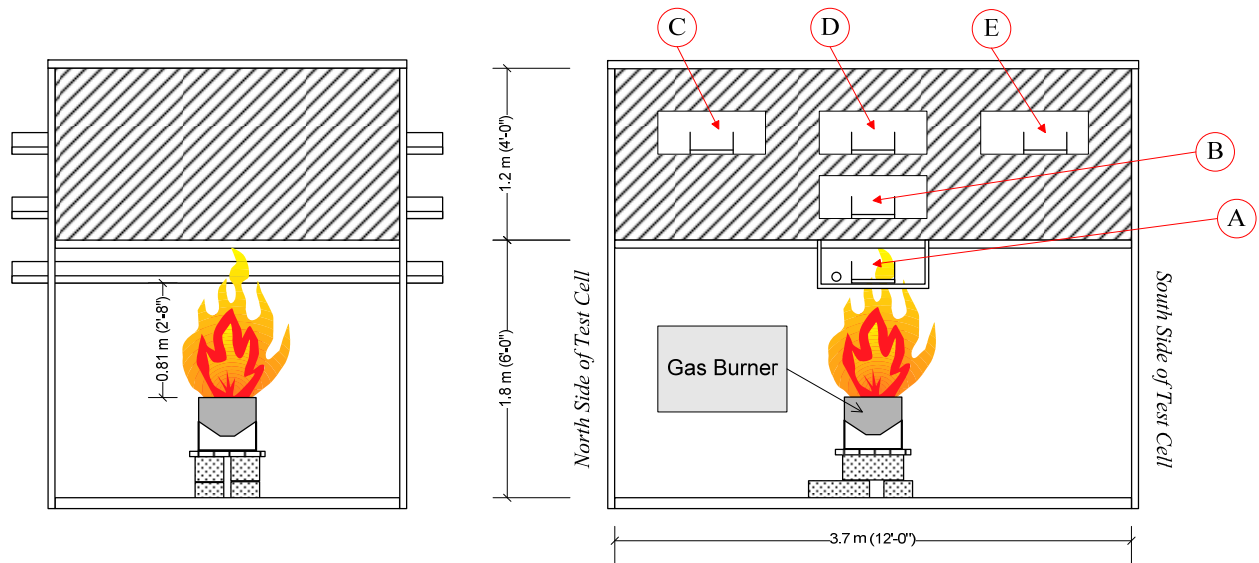

Figure 5.3: Schematic representation of the DESIREE-Fire intermediate-scale test structure.

During DESIREE-Fire, two intermediate-scale experiments involving Kerite cable were conducted. For convenience, a shorthand identifier is commonly used to identify the intermediate-scale tests, for example, "Test IS9" for intermediate-scale test number 9. The detailed test descriptions and test matrices identify cables by location consistent with the letter

¹² Durock[®] is a low-density concrete-based material with fiber-mesh reinforcement. The same material in smaller panels is commonly used as a "backer board" for tile installation.

designation labels found in Figure 5.3. Through-wall penetration holes were cut in the side panels to accommodate raceway routing and insulation was placed around the opening between the raceways and enclosure to maintain a hot gas layer within the enclosed portion of the test assembly.

The intermediate-scale test structure was positioned within a larger fire test facility. An existing SNL bunker facility served as the outer test structure. This isolated the test structure from the ambient environment (e.g., wind effects) and allowed for control of bulk air flow conditions through the facility to some extent. Figure 5.4 illustrates the placement of the test assembly within the larger facility and provides overall dimensions for the larger facility.

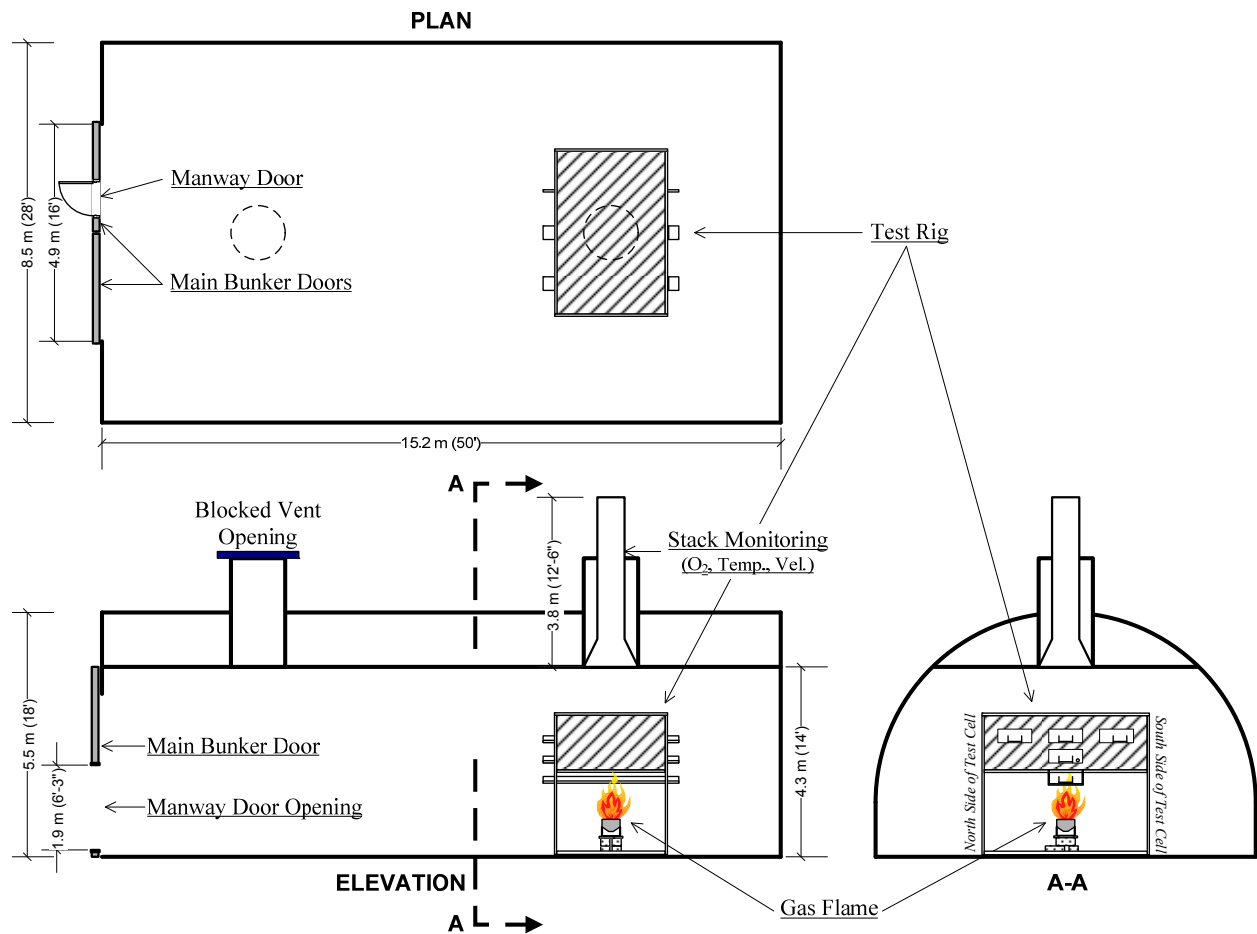

Figure 5.4: Schematic representation of the DESIREE-Fire intermediate-scale test structure located within the bunker facility.

The fires in all intermediate-scale tests were initiated using the same gas burner setup as was used in CAROLFIRE. The fuel in all cases was propene (propylene, C_3H_6). The burner used was a square “sand box” diffusion burner. Figure 5.5 provides a photograph of the burner. The top surface of the burner measured 40 cm on a side (outside dimensions).



Figure 5.5: Photo of the sand diffusion burner.

For testing, the burner's top surface was about 0.84 m above the floor of the enclosure. The burner was always placed in the center of the test structure and directly below cable raceway location A (as shown in Figure 5.3). The flow of gas to the burner was measured and controlled using the same electronic flow control valve as was used in CAROLFIRE [8]. In general, the initial heat release rate allowed for the flame to reach the bottom of the cable tray located in raceway position A. For the majority of the tests, this heat release rate was maintained for 15 to 20 minutes. The propene flow was subsequently increased every 10 to 30 minutes until the maximum flow rate, if necessary, was reached in order to cause the circuits in the wing positions (i.e., raceway positions C and E) to fail.

6 MATRIX OF KERITE TESTS

The Kerite cables were tested during two recent experimental series (i.e., DESIREE-Fire and KATE-Fire). DESIREE-Fire included a total of 11 small-scale Penlight tests and two intermediate scale tests involving Kerite cables. KATE-Fire included 24 small-scale Penlight tests, all involving the Kerite cables. Each program uses its own test numbering scheme so some confusion is possible especially with regard to the small-scale Penlight tests.

In order to maintain consistency with the DESIREE-Fire test report (publication pending), the DESIREE-Fire small-scale Penlight tests are cited based on the original test numbers used in that project. The only distinction made in this report is that the DESIREE-Fire small-scale tests are cited using a ‘D’ prefix (e.g., ‘Test D13’ would represent DESIREE-Fire Penlight Test 13). The intermediate scale tests are referred to using the prefix ‘IS’ and the original DESIREE-Fire test numbers (i.e., Tests IS9 and IS10). The KATE-Fire tests are cited using a ‘K’ prefix and are simply numbered K1-K24. Table 6.1 provides a complete matrix of the tests performed during both programs organized by test number. Note that the sections which follow will provide similar test matrices that have been re-organized by the cable item designators.

For each test the cable items tested are identified. Boxes containing “XX” indicates that two of the same cable type were included in the given test while rows containing X's in more than one column indicates that multiple cable types were tested. The subsections that follow provide a more detailed discussion of the tests performed.

Table 6.1: The complete matrix of all Kerite experiments conducted during DESIREE-Fire and KATE-Fire.

| Test Identifier | Tested cable(s) | | | | | | | | | | |
|-----------------|---------------------|-------------------------|-------------------------|---|---|---------------------|-------------------------|--|--------------------------|--|--------------------|
| | A - 2/C, 12 AWG, FR | B - 2/C, 10 AWG, FR-III | C - 4/C, 10 AWG, FR-III | D - 5/C, 12 AWG, FR (with zinc wrap) | E - 7/C, 12 AWG, FR (with zinc wrap) | F - 9/C, 14 AWG, FR | G - 10/C, 16 AWG, FR-II | H - 10/C, 12 AWG, FR (with zinc wrap) | I - 12/C, 12 AWG, FR-III | J - 15/C, 12 AWG, FR (with zinc wrap) | K - 3/C, 6 AWG, HT |
| D13-qual | | | | | | | | X | | | |
| D13 | | | | X | | | | X | | | |
| D14 | | | | X | | | | X | | | |
| D15 | | | | X | | | | X | | | |
| D16 | | | | X | | | | X | | | |
| D17-qual | | | | | | | | | | | X |
| D17 | | | | | | | | | | | XX |
| D18 | | | | | | | | | | | XX |
| D44 | | | | | | XX | | | | | |

Table 6.1: The complete matrix of all Kerite experiments conducted during DESIREE-Fire and KATE-Fire.

| Test Identifier | Tested cable(s) | | | | | | | | | | |
|-----------------|---------------------|-------------------------|-------------------------|---|---|---------------------|-------------------------|--|--------------------------|--|--------------------|
| | A - 2/C, 12 AWG, FR | B - 2/C, 10 AWG, FR-III | C - 4/C, 10 AWG, FR-III | D - 5/C, 12 AWG, FR (with zinc wrap) | E - 7/C, 12 AWG, FR (with zinc wrap) | F - 9/C, 14 AWG, FR | G - 10/C, 16 AWG, FR-II | H - 10/C, 12 AWG, FR (with zinc wrap) | I - 12/C, 12 AWG, FR-III | J - 15/C, 12 AWG, FR (with zinc wrap) | K - 3/C, 6 AWG, HT |
| D49 | | | | | | XX | | | | | |
| D50 | | | | | | XX | | | | | |
| IS9 | | | | | | | X | X | | | |
| IS10 | | | | | X | XX | X | X | X | X | |
| K1 | | | | | X | | | | | | |
| K2 | | | | | | X | | | | | |
| K3 | | | | | | | X | | | | |
| K4 | | | | | | | | X | | | |
| K5 | | | | X | | | | | | | |
| K6 | | | | | X | | | | | | |
| K7 | | | | | X | | | | | | |
| K8 | | | | X | | | | | | | |
| K9 | | | | X | | | | | | | |
| K10 | | | X | | | | | | | | |
| K11 | | | X | | | | | | | | |
| K12 | | X | | | | | | | | | |
| K13 | | X | | | | | | | | | |
| K14 | X | | | | | | | | | | |
| K15 | X | | | | | | | | | | |
| K16 | X | | | | | | | | | | |
| K17 | | X | | | | | | | | | |
| K18 | | | X | | | | | | | | |
| K19 | | | | | | | | X | | | |
| K20 | | | | | | | | | X | | |
| K21 | | | | | | X | | | | | |
| K22 | | | | | | | X | | | | |
| K23 | | | | | | X | | | | | |
| K24 | | | | | | | X | | | | |

6.1 DESIREE-Fire Small-Scale Experiments

Table 6.2 provides an alternate listing of the DESIREE-Fire small-scale Penlight tests. In this version, the tests have been grouped by cable type (i.e., the cable ‘Item’ designators A-K) rather than by test number. Also indicated is the test circuit applied to the electrically energized cables. Recall that the SCDU systems are ac-powered. All of the other systems used during DESIREE-Fire were dc-powered.

Table 6.2: Small scale experiments involving Kerite cable during DESIREE-Fire.

| Original test number | Tested cable | | | | | | | | | | Cable monitoring unit | |
|----------------------|---------------------|-------------------------|-------------------------|---|---|---------------------|-------------------------|--|--------------------------|--|-----------------------|--------------------|
| | A - 2/C, 12 AWG, FR | B - 2/C, 10 AWG, FR-III | C - 4/C, 10 AWG, FR-III | D - 5/C, 12 AWG, FR (with zinc wrap) | E - 7/C, 12 AWG, FR (with zinc wrap) | F - 9/C, 14 AWG, FR | G - 10/C, 16 AWG, FR-II | H - 10/C, 12 AWG, FR (with zinc wrap) | I - 12/C, 12 AWG, FR-III | J - 15/C, 12 AWG, FR (with zinc wrap) | | K - 3/C, 6 AWG, HT |
| D13 | | | | X | | | | | | | | SCDU1 |
| D14 | | | | X | | | | | | | | SCDU1 |
| D15 | | | | X | | | | | | | | SCDU1 |
| D16 | | | | X | | | | | | | | SCDU2 |
| D44 | | | | | | X | | | | | | MOV1 |
| D44 | | | | | | X | | | | | | MOV2 |
| D49 | | | | | | X | | | | | | MOV1 |
| D49 | | | | | | X | | | | | | MOV2 |
| D50 | | | | | | X | | | | | | MOV1 |
| D50 | | | | | | X | | | | | | MOV2 |
| D13-qual | | | | | | | | X | | | | SCDU2 |
| D13 | | | | | | | | X | | | | SCDU2 |
| D14 | | | | | | | | X | | | | SCDU2 |
| D15 | | | | | | | | X | | | | SCDU2 |
| D16 | | | | | | | | X | | | | SCDU1 |
| D17-qual | | | | | | | | | | | X | SCDU1 |
| D17 | | | | | | | | | | | X | SCDU1 |
| D17 | | | | | | | | | | | X | SCDU2 |
| D18 | | | | | | | | | | | X | SCDU1 |
| D18 | | | | | | | | | | | X | SCDU2 |

6.2 The Intermediate-Scale DESIREE-Fire Tests

Table 6.3 provides a more detailed matrix for the two intermediate-scale tests performed during DESIREE-Fire. Again, the test matrix is arranged primarily by cable type (i.e., by cable ‘Item’ designators A-K) and identifies the test circuits used for each cable tested. Note that cable Items A-D and K were not tested during the intermediate-scale tests. The specific test configurations for the intermediate-scale tests are described in greater detail in Sections 6.2.1 and 6.2.2.

Table 6.3: Intermediate-scale experiments involving Kerite cable during DESIREE-Fire.

| Original test number | Tested cable | | | | | | | | | | | Cable monitoring unit |
|----------------------|---------------------|-------------------------|-------------------------|---|---|---------------------|-------------------------|--|--------------------------|--|--------------------|-----------------------|
| | A - 2/C, 12 AWG, FR | B - 2/C, 10 AWG, FR-III | C - 4/C, 10 AWG, FR-III | D - 5/C, 12 AWG, FR (with zinc wrap) | E - 7/C, 12 AWG, FR (with zinc wrap) | F - 9/C, 14 AWG, FR | G - 10/C, 16 AWG, FR-II | H - 10/C, 12 AWG, FR (with zinc wrap) | I - 12/C, 12 AWG, FR-III | J - 15/C, 12 AWG, FR (with zinc wrap) | K - 3/C, 6 AWG, HT | |
| IS10 | | | | | X | | | | | | | 1-in. valve |
| IS10 | | | | | | X | | | | | | MOV1 |
| IS10 | | | | | | X | | | | | | Large Coil |
| IS9 | | | | | | | X | | | | | MOV1 |
| IS10 | | | | | | | X | | | | | SOV2 |
| IS9 | | | | | | | | X | | | | SOV1 |
| IS10 | | | | | | | | X | | | | MOV2 |
| IS10 | | | | | | | | | X | | | SOV1 |
| IS10 | | | | | | | | | | X | | SWGR-C/T |

6.2.1 DESIREE-Fire Intermediate-Scale Test 9

As shown in Table 6.3, two Kerite samples were tested in Test IS9; namely, Item G (connected to MOV1) and Item H (connected to SOV1). Both cables were located in Position B as shown in Figure 5.3 (second tray above the fire source). Figure 6.1 presents the cable bundling information; that is, the location of each monitored cable within the tray. As a matter of consistency between DESIREE-Fire and this report, the nomenclature used to distinguish the cable tray configurations during that test series was left the same. Cable Items G and H correspond to the numbers “3” and “4”, respectively, as shown in Figure 6.1. Next to each energized test cable is a cable labeled “TC”, which stands for ‘thermocouple’, and represents the location of the thermal response cable monitoring for that specific circuit. The thermal response cables were paired with the energized test cables in all tests. Cables 1 and 2 in this particular test were not Kerite brand cables and therefore are not discussed further in this report. The gray area in Figure 6.1 represents a random cable fill. Cables were stacked three deep (i.e., three rows) within the tray. As shown in the drawing, the two Kerite cables were located in the middle layer of cables. By configuring the cables in this manner, both samples were sheltered, at least

temporarily, from flames directly beneath the tray and from flames extending over the side rails of the cable tray. The heat release rate profile for Test IS9 may be found in Table 6.4.

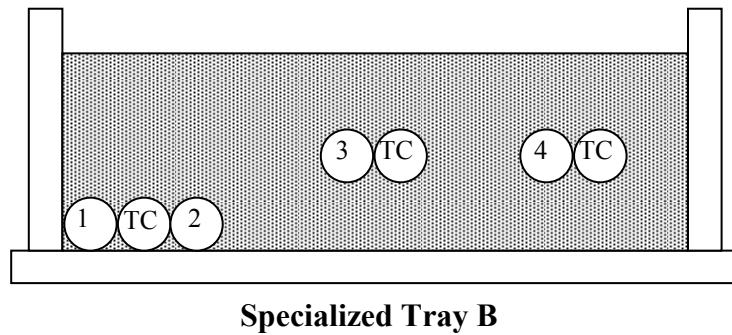

Figure 6.1: Specialized tray B for the intermediate-scale tests.

Table 6.4: Heat release rate for Test IS9.

| Time (minutes into test) | Burner flow (L/min) | Heat release rate (kW) |
|-----------------------------|------------------------|---------------------------|
| 0 | 148 | 173 |
| 15 | 180 | 210 |
| 29 | 213.6 | 250 |
| 39 | 241.2 | 282 |
| 55 | 0 | 0 |

6.2.2 DESIREE-Fire Intermediate-Scale Test 10

As shown in Table 6.3, five different Kerite cable items (a total of six Kerite cable samples) were tested during Test IS10. Position B as shown in Figure 5.3 (second tray above the fire source) contained three different Kerite samples; namely, Item G (connected to SOV2), Item H (connected to MOV2), and Item J (connected to both the trip and close circuit of the switchgear). Similar to the description in 6.2.1, the circuit cables are represented by a number and the corresponding thermal monitoring cable is labeled as “TC” in Figure 6.2. Item G is depicted as cable 3, Item H is depicted as cable 1, and Item J is depicted as cable 2. The gray area of this drawing represents the three layers of random cable fill.

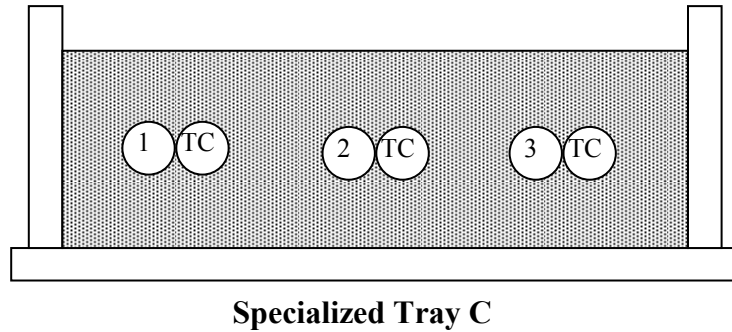

Figure 6.2: Specialized tray C for the intermediate-scale tests.

Position C as shown in Figure 5.3 (one of the side hot gas layer exposure locations) included two different Kerite samples; namely, Item F (connected to MOV1) and Item I (connected to SOV1). The specific tray configuration in this position is shown in Figure 6.3. Cable 1 represented Item I and cable 2 represented its corresponding thermal monitoring cable. Cable 3 represented Item F and cable 4 represented its corresponding thermal monitoring cable. The cables without numbers represent fill cables which were used primarily to isolate the energized cables from direct contact with the tray.

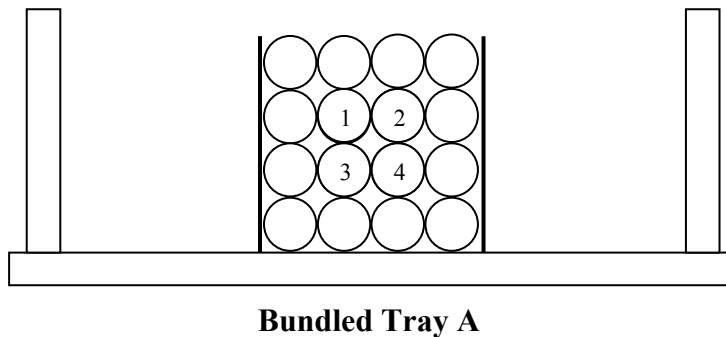

Figure 6.3: Bundled tray A configuration for the intermediate-scale tests.

Position D as shown in Figure 5.3 (third tray above the fire source) held two different Kerite samples; namely Item E (connected to the 1-in. valve) and Item F (connected to the Large Coil). Position D used the same tray configuration as shown in Figure 6.3. For Position D, Cable 1 represented Item E and cable 2 represented its corresponding thermal monitoring cable. Cable 3 represented Item F and cable 4 represented its corresponding thermal monitoring cable. Similar to Position C, the cables without numbers represent fill cables which were used primarily to isolate the energized cables from direct contact with the tray. The heat release rate for Test IS10 may be found in Table 6.5.

Table 6.5: Heat release rate for Intermediate-Scale Test 10.

| Time (minutes into test) | Burner flow (L/min) | Heat release rate (kW) |
|-------------------------------------|--------------------------------|-----------------------------------|
| 0 | 148 | 173 |
| 15 | 182.4 | 213 |
| 25 | 215.6 | 252 |
| 35 | 243.2 | 284 |
| 45 | 260.4 | 304 |
| 57 | 272 | 318 |
| 66 | 0 | 0 |

6.3 KATE-Fire Small-Scale Penlight Experiments

Table 6.6 shows the matrix of tests performed during KATE-Fire, all of which are small-scale Penlight tests. Again, the tests have been organized by cable item and the electrical performance monitoring system used in each test is indicated.

The KATE-Fire program involved two principal changes as compared to DESIREE-Fire. First, five additional cable samples were available for testing (Items A, B and C). Second, based on the initial analysis of the DESIREE-Fire data, it was determined that the new experimental series would include the IRMS in order to investigate the extent of cable insulation resistance degradation during the early stages of cable heating. Just over half of the experiments were conducted using the IRMS

In the case of the SCDU system, as described in Section 4.1.1, for KATE-Fire multiple SCDU systems were typically used to monitor each cable tested. This is indicated in the matrix by the designation ‘SCDU (M)’. Wiring configurations were customized to each cable type using a combination of energized sources, active targets, passive targets, and grounded conductors. Details of the wiring configurations for both the IRMS and SCDU as used in each test are provided in Appendix B.

Table 6.6: Penlight scale experiments from the KATE-Fire program.

| Test Identifier | Tested cable | | | | | | | | | | | Cable monitoring unit |
|-----------------|---------------------|-------------------------|-------------------------|---|---|---------------------|-------------------------|--|--------------------------|--|--------------------|-----------------------|
| | A - 2/C, 12 AWG, FR | B - 2/C, 10 AWG, FR-III | C - 4/C, 10 AWG, FR-III | D - 5/C, 12 AWG, FR (with zinc wrap) | E - 7/C, 12 AWG, FR (with zinc wrap) | F - 9/C, 14 AWG, FR | G - 10/C, 16 AWG, FR-II | H - 10/C, 12 AWG, FR (with zinc wrap) | I - 12/C, 12 AWG, FR-III | J - 15/C, 12 AWG, FR (with zinc wrap) | K - 3/C, 6 AWG, HT | |
| K14 | X | | | | | | | | | | | IRMS |
| K15 | X | | | | | | | | | | | IRMS |
| K16 | X | | | | | | | | | | | IRMS |
| K12 | | X | | | | | | | | | | IRMS |
| K13 | | X | | | | | | | | | | IRMS |
| K17 | | X | | | | | | | | | | SCDU1 |
| K10 | | | X | | | | | | | | | IRMS |
| K11 | | | X | | | | | | | | | IRMS |
| K18 | | | X | | | | | | | | | SCDU (M) |
| K5 | | | | X | | | | | | | | SCDU (M) |
| K8 | | | | X | | | | | | | | IRMS |
| K9 | | | | X | | | | | | | | IRMS |
| K1 | | | | | X | | | | | | | SCDU (M) |
| K6 | | | | | X | | | | | | | IRMS |
| K7 | | | | | X | | | | | | | IRMS |
| K2 | | | | | | X | | | | | | SCDU (M) |
| K21 | | | | | | X | | | | | | IRMS |
| K23 | | | | | | X | | | | | | SCDU (M) |
| K3 | | | | | | | X | | | | | SCDU (M) |
| K22 | | | | | | | X | | | | | IRMS |
| K24 | | | | | | | X | | | | | SCDU (M) |
| K4 | | | | | | | | X | | | | SCDU (M) |
| K19 | | | | | | | | | X | | | SCDU (M) |
| K20 | | | | | | | | | | X | | SCDU (M) |

7 OVERVIEW OF TESTING RESULTS

7.1 Chapter Organization and Content

This section provides a broad overview of the testing results for each cable type tested with an emphasis on general observations and unique findings. Both the small- and intermediate-scale experiments will be discussed for each cable item if applicable. General points to note relative to the discussions that follow include the following:

- The term “very low temperature degradation” refers to electrical degradation when the cable temperature was between 170–250°C.
- The terms “early degradation” and “low temperature degradation” are used interchangeably and refer to electrical degradation observed when the cable’s temperature was 247–311°C. Early degradation may or may not be associated with an outright electrical failure.
- An outright electrical failure is defined by a spurious actuation, hot short, or fuse blow for the SCUDU and dc-powered systems. Degradation (short of outright failure) was defined as a persistent increase in the measured current on source conductors or in the measured voltage of target conductors. An estimated IR of less than 1000 Ω was also considered an outright electrical failure for SCUDU tests.
- For the IRMS, an IR of less than 1000 Ω was considered an outright electrical failure. An IR below $10^5 \Omega$, but above $10^3 \Omega$, would be considered degradation but not outright failure (the IRMS has an upper detection limit of approximately $10^5 \Omega$).
- If a failure occurred during the initial heating phase (i.e. before the cable temperature had exceeded 310°C), it was referred to as a “low temperature failure” or an “early failure”.
- In all cases, cable temperatures were obtained from sub-jacket thermocouples as depicted in Figure 5.2. As shown in this figure, the thermocouples are labeled as TC 1, TC 2, TC 3, and TC 4. In the graphs of the KATE-Fire tests, TC 1 is synonymous with Cable 1, TC 2 with Cable 2, TC 3 with Cable 3, and TC 4 with Cable 4.

Appendix B provides additional details for each test performed.

7.2 Cable Item A: 2/C-12 AWG, FR

Cable Item A was only tested during the KATE-Fire program. This cable was tested three times (i.e., Tests K14, K15, and K16), all tests using the IRMS. No early degradation was observed during these tests and the cable was only driven to failure during Test K16. The other two tests were concluded prior to failure to preserve the samples for post-test examination. It is worth noting that liquid appeared in each of the tests at observed temperatures ranging from 282–299°C as depicted in Figure 7.1.

In addition to the liquid being observed, both longitudinal and circumferential cracks in the conductor insulation were found during post-test cable dissection of the cable from Tests K14 and K15. In this case the maximum cable temperatures reached before the tests were stopped were 394°C and 406°C, respectively. Some of these cracks extended to the stranded copper wire. Photos from the post-test analysis may be seen in Figure 7.2 and Figure 7.3.

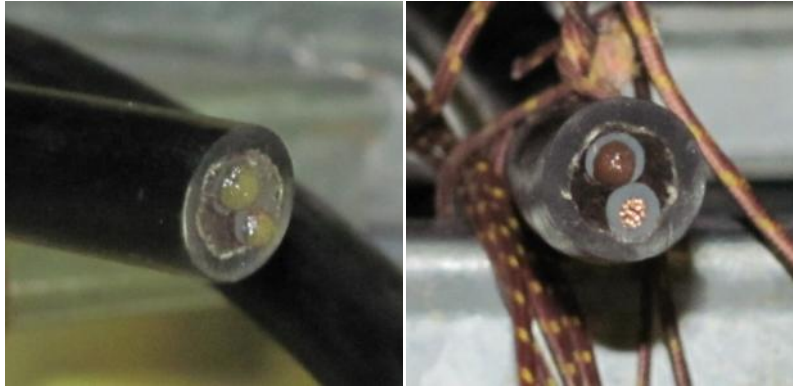

Figure 7.1: Liquid observed during the testing of Item A.

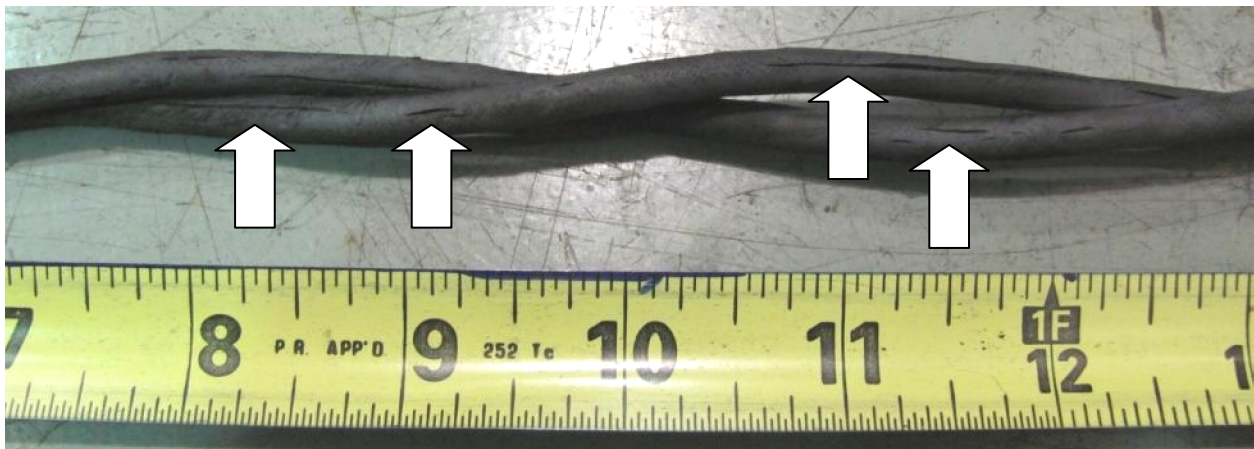

Figure 7.2: Longitudinal cracking along the conductors of Item A.



Figure 7.3: Circumferential cracking extending to the bare wire of Item A.

Figure 7.4 presents the failure of Item A during Test K16. Note that electrical failure occurred after ignition of the cable. The designation “c-c minimum” and “c-g minimum” represent conductor-to-conductor and conductor-to-ground IR values measured at each time step, respectively. The point of ignition is evident from the cable temperature plots based on the time (around 5600s) that these temperature traces suddenly depart from the general heating trend. From Figure 7.4, it is clear that the cable fails after ignition. Additional details from each of the Item A tests may be found in Appendix B.

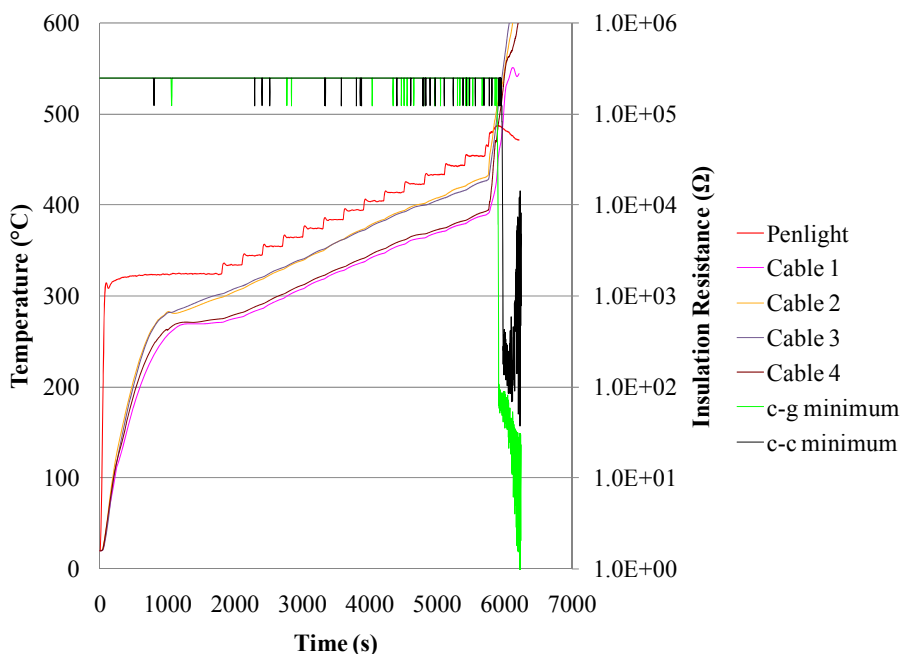

Figure 7.4: IRMS data for Item A during test K16.

Overall, Item A did not show measurable signs of electrical degradation during the early stages of heating (i.e., at temperatures from 250–310°C) as did the other FR-insulated cable samples (see Sections 7.4, 7.5, 7.6, 7.9 and 7.11). This assessment was based on three samples tested during KATE-Fire. The first two samples were driven to maximum cable temperatures of 394°C and 406°C, respectively, with no failures recorded. The cable was driven to failure in the third test, and in that case, failure occurred abruptly and slightly after the cable had ignited at an approximate cable temperature of 432°C. However, cracking, both longitudinal and circumferential, and production of a conductive liquid were observed between 282–299°C. No explanation for the unique behavior of this FR-insulated cable in comparison to the other FR-insulated cable samples has been developed. Given the presence of both the conductive liquid and apparent through-insulation cracks, degradation prior to outright failure would nominally have been anticipated, but none was detected.

7.3 Cable Item B: 2/C-10 AWG, FR-III

Cable Item B was only tested during the KATE-Fire program. This cable was tested three times, twice using the IRMS (Tests K12 and K13) and once with the SDCU (Test K17). No early degradation was observed during these tests. The cable was driven to failure in two tests (Tests K12 and K17) and in each case failure only occurred after cable ignition. It is worth noting that

liquid appeared during each of the Item B Penlight tests at temperatures ranging from 273–400°C as depicted in Figure 7.5. However, far less liquid was generated by this cable than seen with the FR cables.



Figure 7.5: Pre-test (left) and post-test (right) photos of liquid produced during Item B testing.

During Test K13, Penlight was increased to a maximum of 405°C. It was decided to conclude the test before cable ignition to preserve the cable sample for post-test examination. Upon investigation, insulation cracking was not observed along the conductors, as depicted in Figure 7.6 and Figure 7.7, despite cable temperatures as high as 384°C. Figure 7.7 is a close up of the conductors which were located at the center of Penlight.



Figure 7.6: Conductors from the section of Item B located in the center of Penlight.

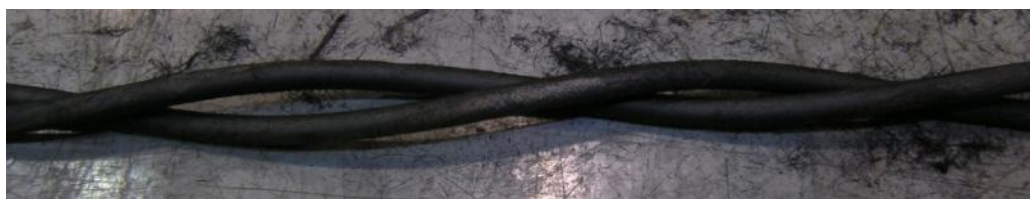

Figure 7.7: Close-up of the conductors from Item B.

Overall, Item B did not show measurable signs of electrical degradation during the early stages of heating (i.e., at temperatures from 250–310°C). This post-test inspection of the cable from Test K13 revealed no signs of insulation cracking despite having been heated to 384°C. A conductive liquid was observed out of the cut cable ends between 273–400°C but in relatively low volumes.

7.4 Cable Item C: 4/C-10 AWG, FR-III

Cable Item C was only tested during the KATE-Fire program. This cable was tested three times, twice using the IRMS (Tests K10 and K11) and once with the SDCU (Test K18). No early degradation was observed during the tests and the cable was driven to failure in two tests, (Tests K11 and K18). It is worth noting that liquid did appear in each one of the tests at observed temperatures ranging from 273–400°C as depicted in Figure 7.8.



Figure 7.8: Progression of liquid observed during the testing of Item C.

Test K10 was stopped prior to cable ignition in order to preserve the cables for post-test examination. Penlight had been increased to as high as 425°C and the cable had reached a maximum temperature of 393°C. The cable was dissected during post-test analysis and little to no cracking was observed. Additionally, the conductors' insulation was not brittle and was still flexible during investigation. Figure 7.9 displays a close-up of the conductors located at the center of Penlight. Details from each of the tests involving Item C may be found in Appendix B.



Figure 7.9: Post-test analysis of conductors from Item C located in the center of Penlight during Test K10 – no insulation cracking evident.

Overall, Item C did not show measurable signs of electrical degradation during the early stages of heating (i.e., at temperatures from 250–310°C). Post-test analysis revealed neither longitudinal nor circumferential cracking along the thermally exposed cable length despite heating to 393°C. During the three tests, liquid was observed out of the cut cable ends between 275–389°C.

7.5 Cable Item D: 5/C-12 AWG, FR (with zinc wrap)

Cable Item D was tested during both the DESIREE-Fire and KATE-Fire programs. This cable was tested seven times total between both programs: Tests D13, D14, D15, D16, K5, K8, and

K9. Two of the tests were conducted using the IRMS (Tests K8 and K9) and the remaining five tests utilized SCDU. This cable was not tested in the intermediate-scale experiments.

During DESIREE-Fire, this cable was noted for degradation behavior at a relatively low temperature which is illustrated in Figure 7.10. When the voltage on SCDU target conductor 5 (C1 V5) reached 2.5 Vac, based on field observations, liquid was first noticed coming out of the end of the cable instrumented for temperature response (the thermocouple cable). Post-test examination of a cable sample in subsequent tests revealed cracks forming along the conductor in this temperature range (i.e., 250–310°C). Given the formation of insulation cracks and conductive liquid, electrical degradation can be observed clearly during this test at lower temperatures than anticipated for a thermoset cable (in this case, 276°C).

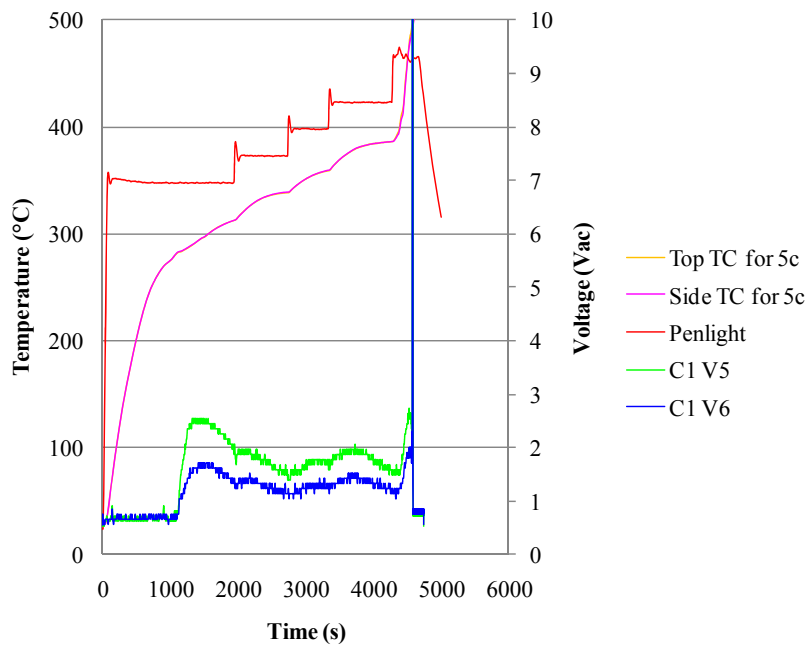

Figure 7.10: Item D target voltage increase during Test D13.

The voltage and current increases, as well as the production of the liquid (see Figure 7.11), during this initial test of Item D were observed in the other DESIREE-Fire tests of this cable as well.

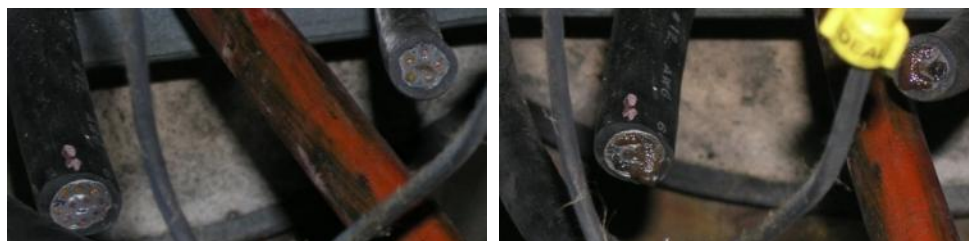

Figure 7.11: A pre-test view of the test cables (left) and a photo taken during the Test 15 (right) showing liquid leaking from the cut ends of the both of the thermal response cables (the 10/C and 5/C cables).

Three tests were conducted during KATE-Fire to gain additional insights on the failure behaviors for Item D. As previously mentioned, the IRMS system was utilized during two tests to investigate the extent of early cable degradation. Both of these tests revealed low impedance shorts (well below the nominal 1000 Ω criteria applied during CAROLFIRE) at relatively low temperatures. The results from Test K8, shown in Figure 7.12, indicate failure at 307°C. Results from Test K9, which failed at 311°C, may be found in Appendix B.

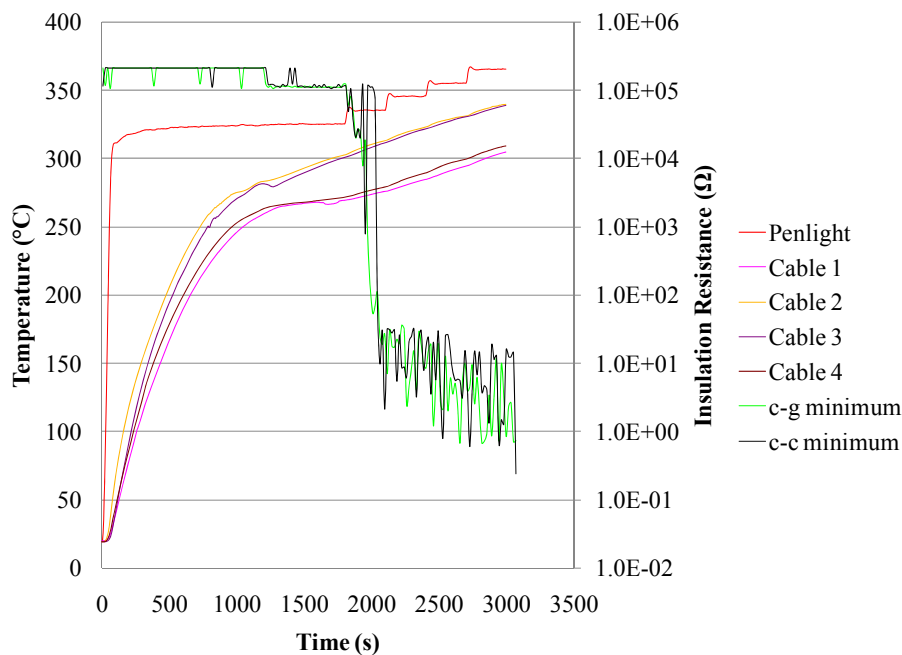

Figure 7.12: IRMS results from Test K8.

Cable dissection was conducted at the conclusion of Tests K8 and K9. Similar to the post-test analyses conducted during DESIREE-Fire, an oily residue was noticed between the zinc wrap and the jacketing material, as depicted in Figure 7.13.

After removing the jacketing material, holes in the zinc wrap were observed in multiple locations along the length of the thermally exposed portion of energized cable which may be seen in both Figure 7.14 and Figure 7.15. Beneath the holes in the zinc wrap were “soft spots” in the insulation material. These soft spots were comprised of charred insulation material held in place by the oily residue and extended to the bare copper wire. The insulation surrounding the charred holes was still relatively flexible and resilient to the applied pressure of investigative tools. The first failure mode of Item D during Test 8 was conductor-to-ground shorting. Given that the zinc shield wrap was grounded, this was almost certainly caused by shorting between the conductor and the wrap. This would also explain the holes found in the zinc wrap and the corresponding burn-through spots in the conductor insulation (i.e., arcing at the time of failure).



Figure 7.13: Oily residue found between the jacket and zinc wrap of Item D.

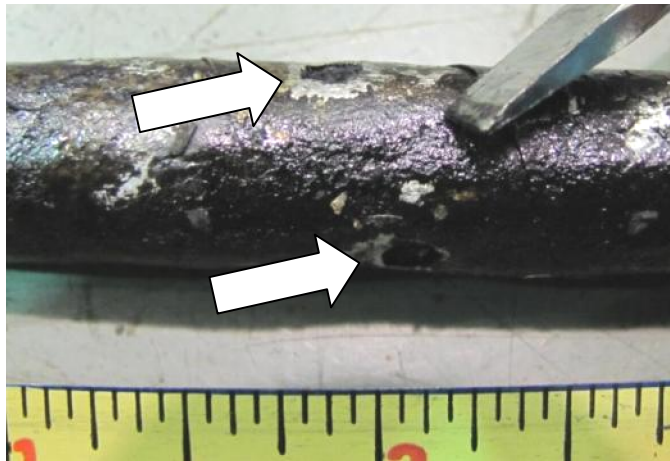

Figure 7.14: Two holes found on the zinc wrap during post-test investigation of Item D in Test K8.

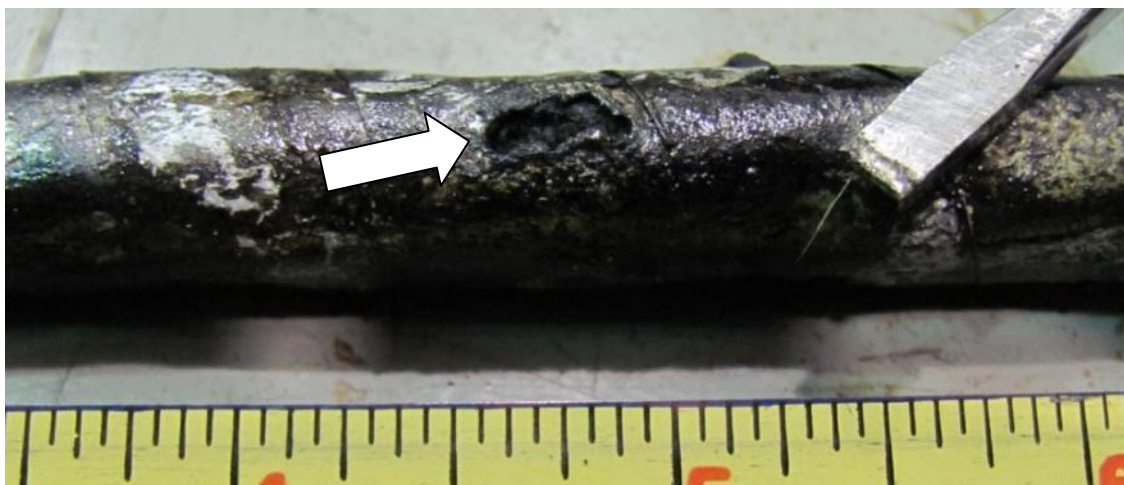

Figure 7.15: Larger hole found during the post-test analysis of Item D in Test K8.

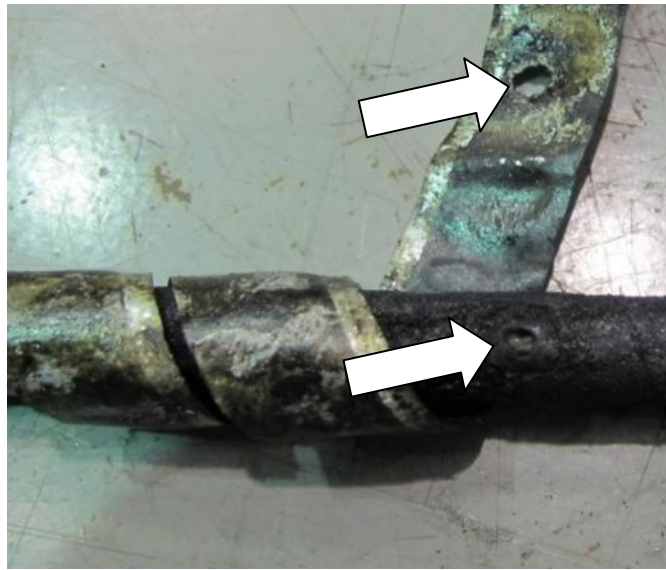

Figure 7.16: Hole in the conductor insulation corresponding to the hole found in the zinc wrap.

During Tests K8 and K9, low temperature degradation was not observed on the IRMS; however, both tests resulted in low temperature failures (i.e., low impedance shorting at less than 1000 Ω). Early degradation similar to that observed during DESIREE-Fire was captured during Test K5 as depicted in Figure 7.17. Since the cable ignited prior to the conclusion of the test, cable dissection and conductor investigation was not conducted.

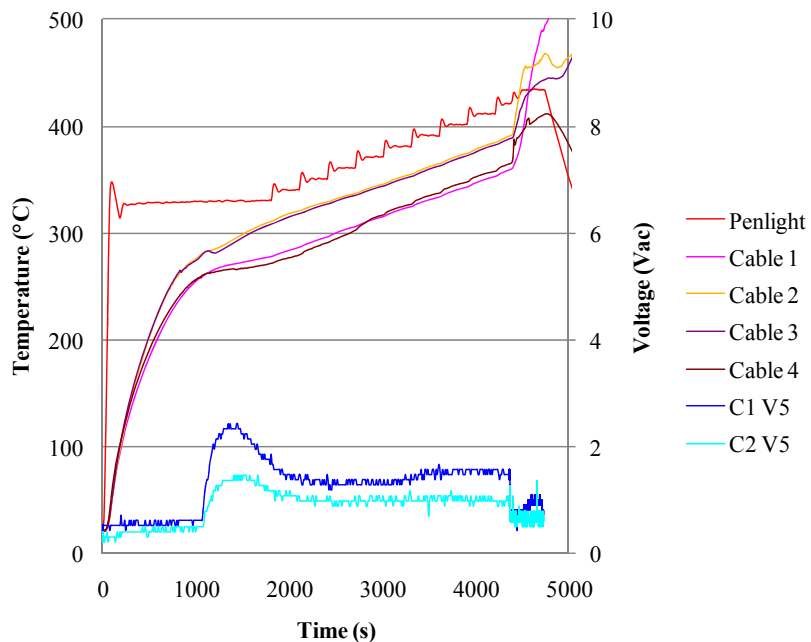

Figure 7.17: Temperature and target voltage response of Item D during Test K5.

For Item D, early degradation was observed on multiple tests throughout both DESIREE-Fire and KATE-Fire at temperatures between 257–303°C. During Test D14 Penlight was initially set to 450°C and in Test D16 Penlight was started at 470°C, both initial exposure temperatures causing the cable samples to ignite prior to early degradation and ultimate failure. Given the

initial elevated exposure temperatures for these two tests, the hypothesized early degradation mechanisms may not have time to develop before cable ignition. There was another test (Test K9) that experienced a low temperature failure at 311°C; however, this failure was rather abrupt and the cable did not show signs of substantial degradation prior to failure. Upon post-test inspection of the sample from Test K9, similar holes in the zinc wrap and conductors to those witnessed in Test K8 were observed.

Overall, Item D did display measurable signs of electrical degradation and failure during the early stages of heating (i.e., at temperatures from 250–310°C). Two cases of low temperature outright failures were observed. In both of these cases, the post-test analyses showed holes in the zinc wrap corresponding with holes in the conductor insulation which extended to the bare copper wire. Throughout the course of testing this cable, liquid was observed out of the cut cable ends between 258–284°C and post-test examination of pre-failure examples did reveal insulation cracking similar to other FR-insulated cables.

7.6 Cable Item E: 7/C-12 AWG, FR (with zinc wrap)

Cable Item E was initially tested during the intermediate-scale DESIREE-Fire series. For KATE-Fire, this cable was tested three times, twice on IRMS (Tests K6 and K7) and once on SCUDU (Test K1). Each of the Item E Penlight tests indicated low temperature insulation resistance degradation; however, outright failure was not observed during the initial heating phase.

For the IRMS tests, initial degradation was observed at temperatures ranging from 256–285°C and IR degradation to values in the 1105–2373 Ω range were observed during tests K6 and K7 (recall that an IR of less than 1000 Ω was considered indicative of outright failure). Liquid was observed at the cut ends of the thermocouple cable between 257–280°C.

The liquid was collected in the unused, clean glass jars attached to the cut ends of the thermally monitored cable; this may be seen in Figure 7.18. It would initially appear as a milky, yellow color before transitioning to a dark brown. The cut ends of the thermally monitored cable yielded a total of approximately 5 ml (for a sense of scale, approximately one teaspoon) of liquid. Item E produced the most liquid during the low and slow temperature heating phase of any cable tested. In comparison, other samples produced about 25% of this amount. After some of the tests, the wire nuts which capped the end of the electrically energized cable contained liquid produced during the thermal exposure, which may be observed in Figure 7.19. Also, as observed during the DESIREE-Fire tests, Item E provided indications of liquid seeping through the jacketing material before solidifying as observed in Figure 7.20. In general, the liquid had low viscosity, was oily to the touch, and possessed a harsh, chemical smell.

A Fluke multimeter was used to determine the conductivity of this liquid in the jars. Probes connected to the multimeter were spaced 1.27 cm (0.5 in) apart and were then submerged into the liquid until the readings stabilized. The probes were subsequently cleaned with water, dried off with terrycloth, and the process was repeated two more times. At this spacing, the liquid after each of the three tests of Item E had an averaged resistance ranging from approximately 62–246 Ω .



Figure 7.18: Liquid produced during testing being captured within a clean, glass jar.



Figure 7.19: Wire nuts containing liquid formed during testing.



Figure 7.20: Dried liquid coming through the jacket material during post-test examination.

Tests K1 and K6 were both ended prior to cable failure. At the time these two tests were ended, the cable temperatures were 298°C and 378°C, respectively. The samples were then subjected to post-test analysis and dissection. During the investigation longitudinal cracks were observed along the conductors although they did not appear to extend to the bare copper wire. The observed longitudinal cracking is depicted in Figure 7.21.

For the SCUDU tests, during Test K1, a voltage increase of approximately 5 Vac was observed on the active targets on SCUDU 1, 2, and 4 beginning at a cable temperature of 262°C, as see in Figure 7.22. Ultimate failure did not occur during this initial heating period and the test was concluded prior to ignition in order to preserve the sample for post-test examination.

Similar low temperature degradation was observed in Test K6 at a temperature of 271°C. The results from this test are shown in Figure 7.23.

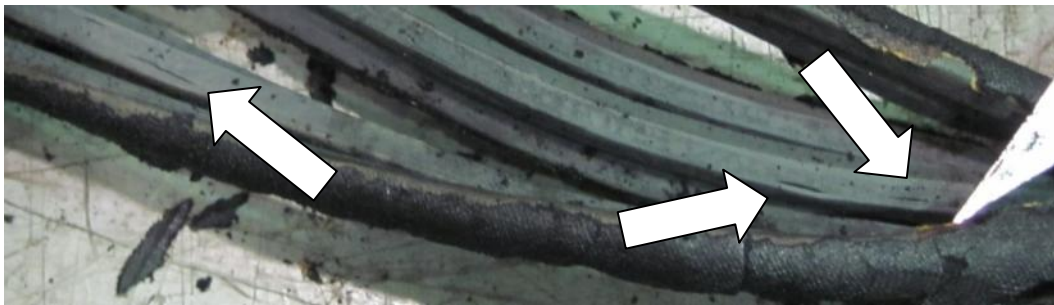

Figure 7.21: Longitudinal cracking found along the conductors of Item E

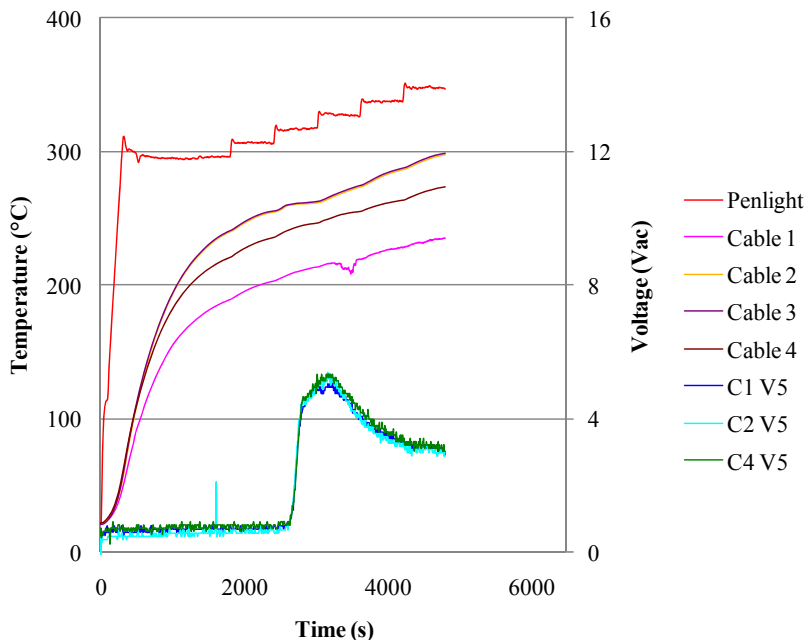

Figure 7.22: Temperature and voltage response of Item E from Test K1.

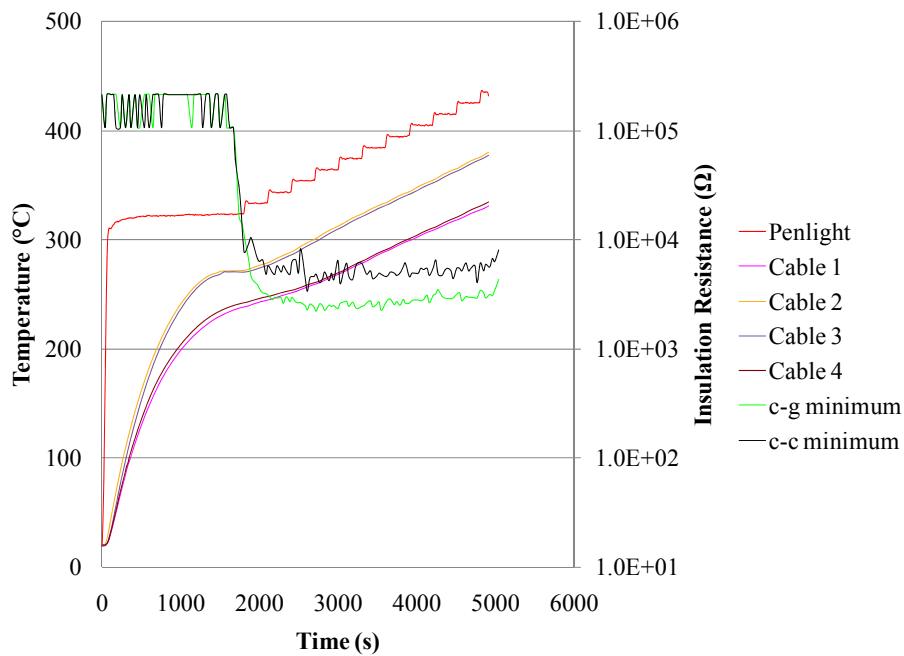

Figure 7.23: IRMS results from Test K6.

Similar low temperature degradation was observed in Test K7 beginning at a temperature of 285°C. The cable was taken to ignition and full failure. Ignition occurred at a cable temperature of roughly 417°C. The post-test cable analysis revealed zinc wrap slag adhered to the conductors as well as located at the bottom of Penlight, as illustrated in Figure 7.24. The zinc wrap welded multiple conductors together. It is not clear if this shielding occurred because of thermal influence or if it was related to electrical arcing. Zinc has a relatively low melting point at 419°C [13] and therefore it is entirely plausible that the heat produced by the ignition of the cable caused the wrap to melt onto the conductors. Low impedance shorting occurred abruptly and failures were detected shortly after ignition.

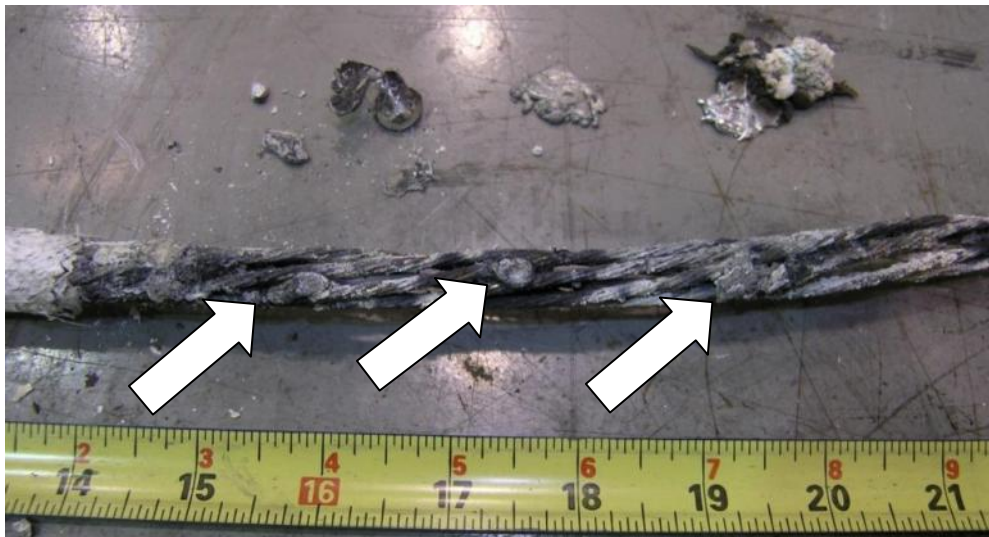

Figure 7.24: Zinc slag connecting conductors.

During the Test IS10, Item E was tested on the 1-in. valve circuit of the DCSim Panels. The cable was located in Position D. Low temperature degradation was observed beginning at a cable temperature of approximately 213°C which is lower than the observed cable temperatures from the Penlight series of tests. There is uncertainty associated with these temperature data. In the intermediate-scale tests an eight-foot length of cable is exposed. The thermocouples are concentrated in the central portion of the exposed samples. It is possible that the outer ends of the cable (i.e., those segments closer to the walls of the test cell) could experience higher temperatures than the center section. However, it is also possible that the longer exposure length led to a higher degree of 'net' degradation due to the formation of cracks along the entire exposure length. The most significant observation from this test, however, is the fact that early degradation may be observed during the more representative intermediate-scale experiments.

During Test IS10, the voltage increase detected on the target conductor is shown in Figure 7.25. The cable temperature is represented by a sub-jacket thermocouple located in the center of the thermally monitored cable. The as shown is the raw target voltage (i.e., V(S)) minus the negative battery reference voltage (i.e., V(Batt-)). This "corrected voltage" reflects the actual voltage applied across the valve coil. The voltage started increasing at approximately 1760 s to a maximum of 10 Vdc and then experienced an abrupt increase to about 25 Vdc at approximately 2400 s and a cable temperature of about 320°C. This cable ultimately experienced a hot short induced spurious actuation at about 2650 s.

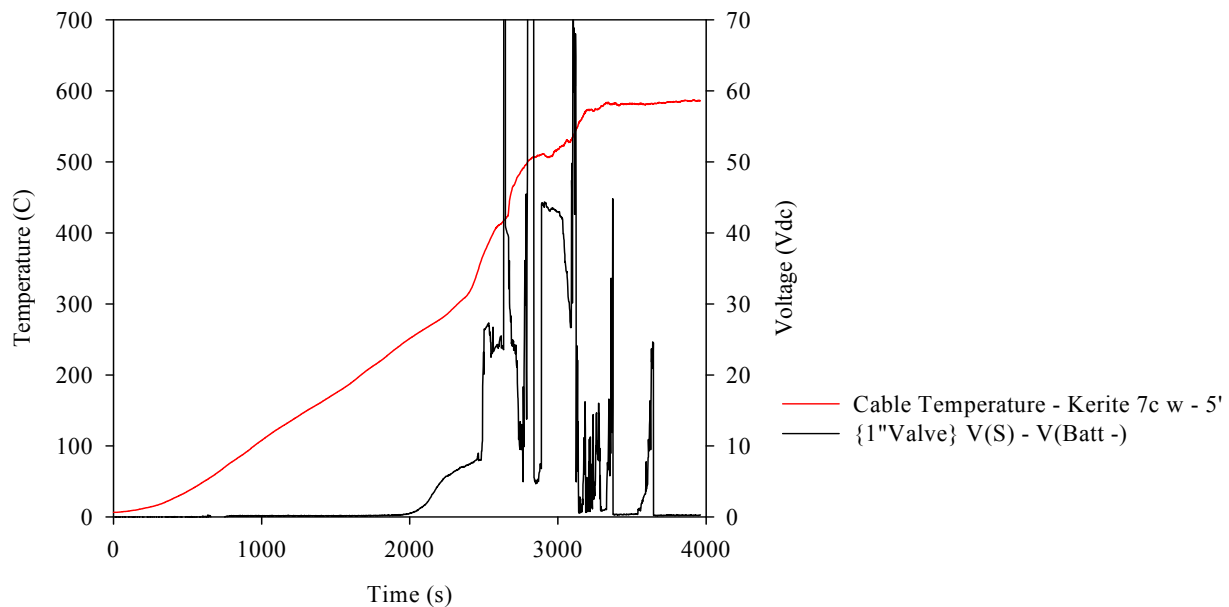

Figure 7.25: Cable temperature and electrical response of Item E during Test IS10.

Overall, Item E displayed measurable signs of electrical degradation during both the small- and intermediate-scale experiments in the very early to early stages of heating. Low temperature degradation occurred between 256–285°C and liquid was noticed at 257–280°C throughout the Penlight test series. During Test IS10, a voltage increase over the baseline was observed beginning at 1756 s and a cable temperature of 213°C.

More liquid was produced during the heating of this cable than any other sample. Extensive insulation cracking was also observed for this cable.

7.7 Cable Item F: 9/C-14 AWG, FR

Cable Item F was tested during both the DESIREE-Fire and KATE-Fire programs. This cable was tested three times during KATE-Fire; twice with SCDU (Tests K2 and K23) and once using the IRMS (Test K21). During DESIREE-Fire, Item F was tested using the MOV circuits in the DCSim Panels (Tests D49, D50 and IS10) and was also testing using the dc-powered large coil circuit in Test IS10. Each of the tests during the DESIREE-Fire Penlight series included two circuits with a thermally monitored cable in between the two electrically energized cables. These tests revealed discernable drifts in the ground fault detection [5] and the data from these specific tests may be found in Appendix B.

During the KATE-Fire tests, early degradation was observed during the SCDU tests but not during the IRMS test as depicted in Figure 7.26 and Figure 7.27, respectively. The initial temperature of Penlight during Test K2 was set to 350°C. Both Tests K21 and K23 were started with Penlight at 325°C. Ultimate failure of Item F did not occur prior to cable ignition in any of experiments from both test series. Ignition was primarily observed in a range from 411–454°C. During Test D50, Penlight was started at 450°C, a common set point for thermoset cable failure within a 10–30 minute timeframe. This caused ignition to occur at a cable temperature of 330°C.

Similar to the observations made during DESIREE-Fire, liquid was produced from the cut ends of the thermal response cable as shown in Figure 7.28. Liquid was observed at temperature range from 129–296°C; however, only a few drops were produced during each test. Initially, the liquid would start out as a clear green color before transitioning to dark brown. Test K2 was concluded prior to failure and ignition of the cable. The maximum cable temperature reached was 327°C. Post-test cable analysis revealed longitudinal cracking along the conductors which is illustrated in Figure 7.29.

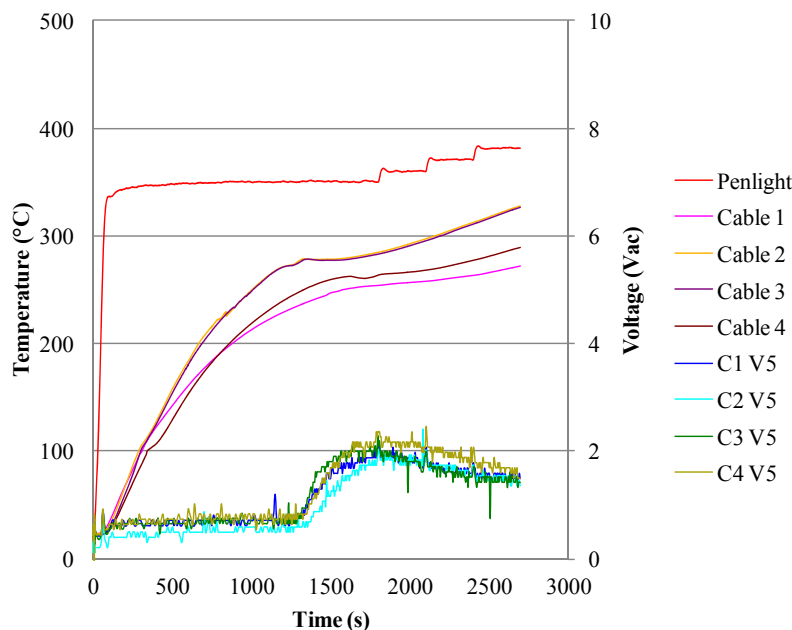

Figure 7.26: Temperature and voltage observed during Test K2.

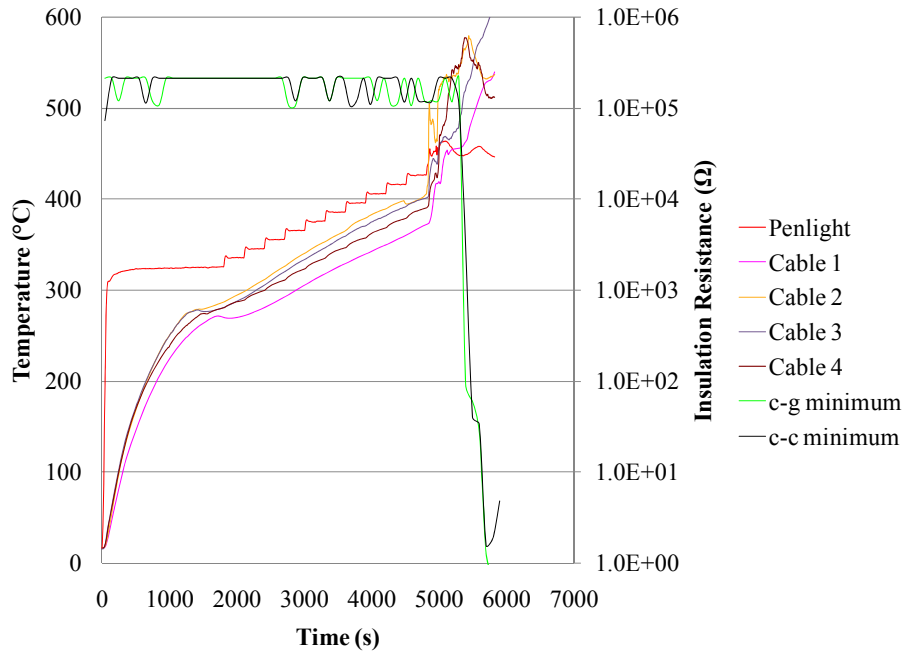

Figure 7.27: Insulation resistance data from Test K21.



Figure 7.28: Progression of the liquid residue leaking from the cut end of the thermocouple cable: pre-test on the left, and then progressively later in the test for the center and right photos.



Figure 7.29: Longitudinal cracking observed during post-test analysis of Item F.

During Test IS10, two circuits were tested using Item F; namely, MOV1 in Position C and the large coil in Position D. During these tests, very low temperature degradation was observed in both circuits beginning at cable temperatures of 172°C and 245°C for the MOV1 and large coil circuits, respectively. This is illustrated in Figure 7.30. Also note that several voltage spikes to the target conductors on the MOV1 circuit occurred while the cable was still below 300°C indicating a very precarious functional condition. Ultimately, circuit MOV1 experienced a spurious actuation. The large coil circuit experienced a fuse blow failure. The most significant observation from these tests is the fact that early degradation may be observed during the more representative intermediate-scale experiments, especially given the low temperature degradation noted for MOV1.

Based on the IRMS results, the early IR degradation ranged between 1383–9458 Ω given cable temperatures ranging from 267–303°C. Liquid was observed during all the tests between a temperature range of 129–296°C. Post-test analysis of the cable sample from Test K2, revealed longitudinal cracking along each of the conductors, some exceeding 5 cm in length.

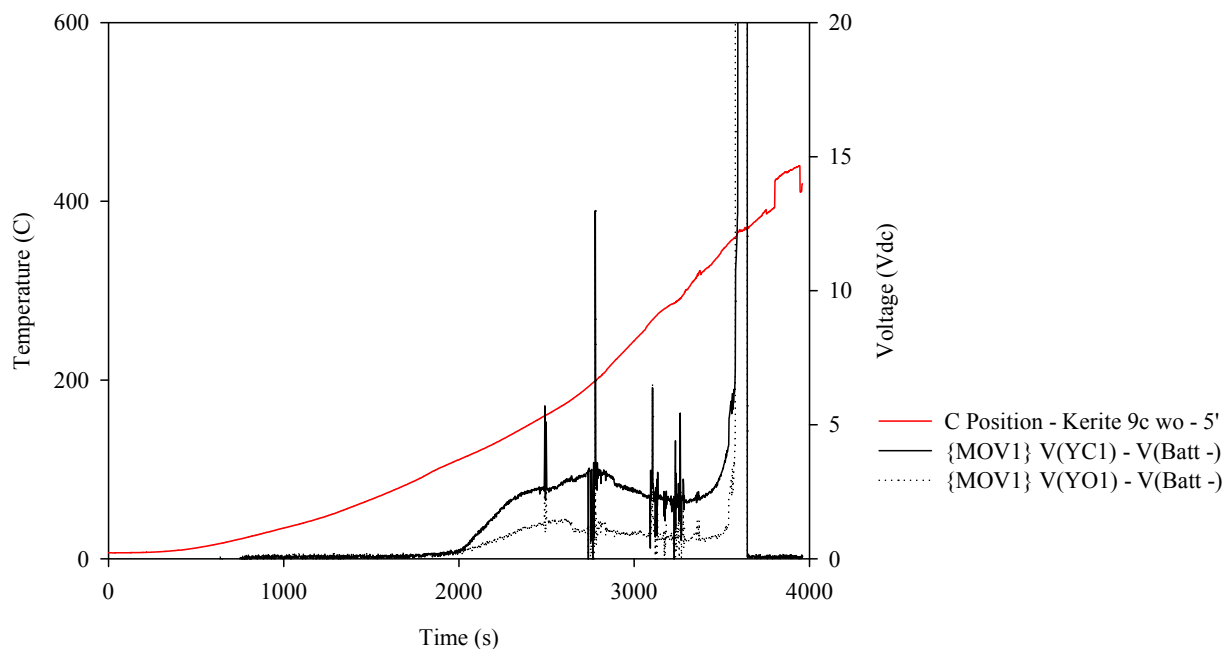

Figure 7.30: Cable temperature and electrical response of Item F during Test IS10.

7.8 Cable Item G: 10/C-16 AWG, FR-II

Cable Item G was the only Kerite FR-II insulated cable sample available for testing. This cable was tested during the intermediate-scale DESIREE-Fire experiments and KATE-Fire program. This cable was tested once using the IRMS unit (Test K22) and twice with SCDU (Tests K3 and K24). Item G was also tested during both Test IS9 and Test IS10. During Test IS9, Item G was connected to MOV1 and placed in Position B. For Test IS10, this cable was connected to the SOV2 circuit and was also placed in Position B.

The initial Penlight test of Item G (i.e., Test K3) was the only test ended prior to cable ignition. Inspection of the cable from this test revealed severe damage to the jacketing material as well as

the conductors. The maximum cable temperature for this test was 388°C. The damage is illustrated in Figure 7.31, Figure 7.32, and Figure 7.33. It is presumed that the white ash mark in Figure 7.32 is indicative of the failure point and may have resulted from arcing given that a hot-short induced spurious actuation occurred. The cable's electrical response to thermal exposure from this test is shown in Figure 7.34.

During the post-test analysis of the cable, jacketing material flaked off with little effort. Additionally, the conductor insulation was badly damaged and fell off while the jacket was removed. As a result, determining if the insulation experienced longitudinal and/or circumferential cracking in the section of cable located at the center of Penlight was not possible; however, cracking in the insulation was observed in the outermost regions of the cable (i.e., those portions located towards either end of the Penlight cylindrical exposure shroud). These cracks were less than 0.65 mm (0.25 in) in length and were not as deep or as prevalent as the cracking observed in the Kerite FR samples.

One particular item worthy of note was the fact that dried liquid was observed on the cut ends of the thermal response cable during the tests; however, it was not produced in great enough quantities to be collected in the attached glass jars. Field notes indicated that Item G cable temperatures would exceed 350°C before liquid was observed. Insulation resistance degradation was observed during the heating process; however, only at temperatures ranging from 341–388°C. Failures during each of the three Penlight tests ultimately occurred between 367–388°C.



Figure 7.31: Post-test damage to Item G.



Figure 7.32: Close up view of the presumed failure point.



Figure 7.33: Conductors of Item G spread apart after Test K3.

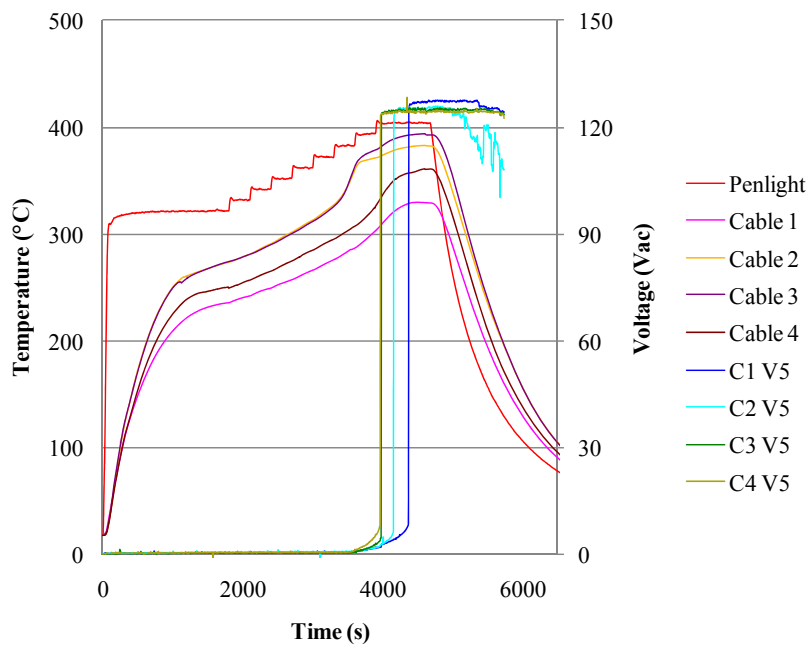

Figure 7.34: SCDU results from Test K3 for Item G.

During the intermediate-scale tests, this cable's failure range was approximately 374°C or higher. In one case the cable temperature at the time of failure was recorded as 484°C, but in this case the temperature is not considered reliable and likely indicates that the thermal response cable had already ignited.

In general, while Item G displayed IR degradation before outright failure; however, degradation did not occur at temperatures below 341°C. The lowest cable temperature at outright failure was 367°C (Test K24). Overall, limited amounts of liquid were produced but not until temperatures of greater than 350°C. Cracking along the insulation was observed during post-test analysis; however, these cracks were not as deep or as numerous as with the Kerite FR samples.

7.9 Cable Item H: 10/C-12 AWG, FR (with zinc wrap)

Cable Item H was tested during DESIREE-Fire Tests D13-qual, D13, D14, D15, D16 and during intermediate-scale tests IS9 and IS10. Only one test of this cable could be conducted during KATE-Fire before the supply was depleted (Test K4). The initial scoping test for Item H (i.e., Test D13-qual) was actually the first Kerite exposure test performed. The test produced a spurious actuation failure at a cable temperature of 287°C (see Figure 7.35). The cable did not ignite during this test, and post-test investigation revealed an oily residue between the jacketing material and the zinc wrap (see Figure 7.36). Inspection also revealed circumferential (see Figure 7.37) and longitudinal (see Figure 7.38) cracking. In particular, the inspection of the center section of the cable found two adjacent conductors that were initially adhered to each other and which had circumferential cracks at the same location extending fully through the conductor insulation. These cracks are highlighted in Figure 7.37. It is likely that this was, in fact, the point of failure.

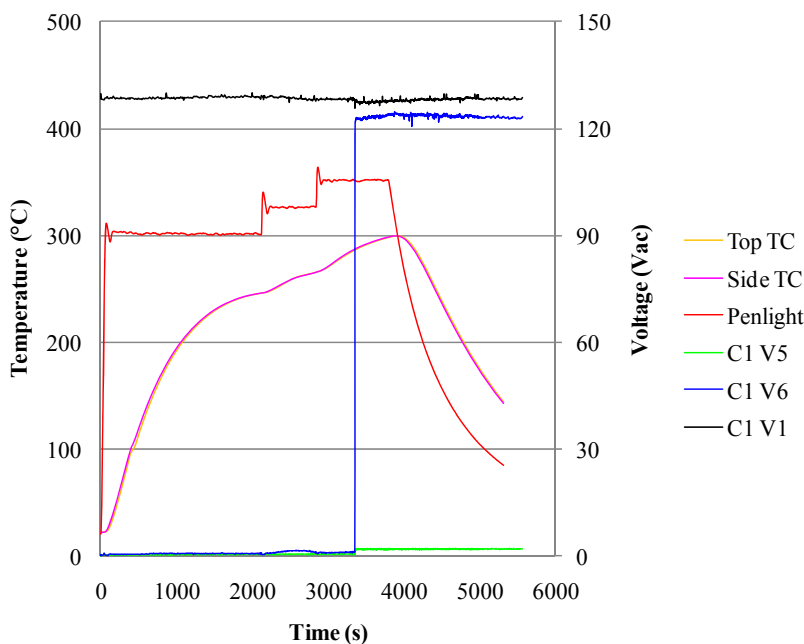

Figure 7.35: Electrical and temperature data for Test 13-qual.



Figure 7.36: Oily residue found between the jacketing material and zinc wrap.

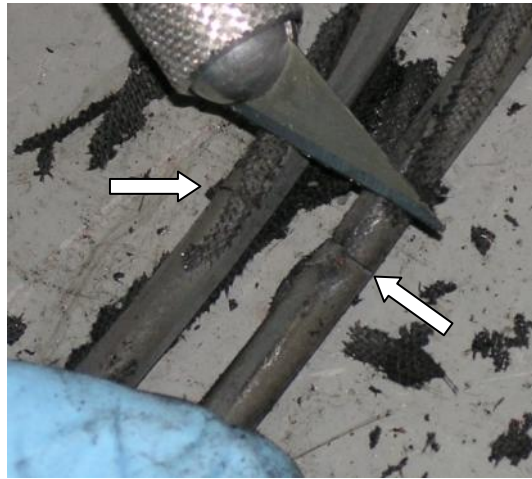
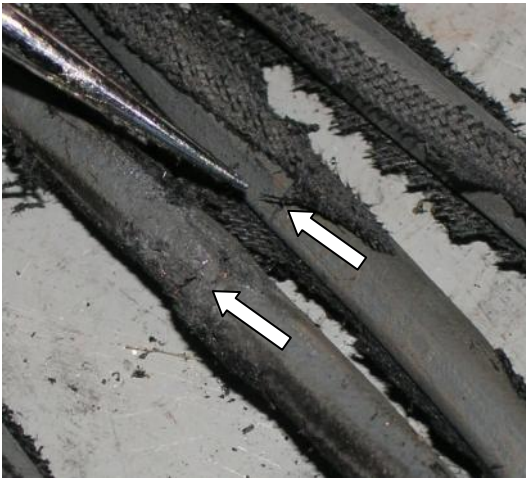

Figure 7.37: Co-located circumferential cracks discovered in two adjacent conductors during post-test examination of the cable from Test D13-qual.



Figure 7.38: Longitudinal cracking observed during the post-test analysis is visible as a dark line running along the right hand conductor near the center of the photo.

Subsequent Penlight tests of this cable during DESIREE-Fire did not result in any further outright failures at low temperatures (i.e., below 330°C); however, increased target voltages were observed during essentially all of the tests performed on this cable. As noted above, DESIREE-Fire did not apply the IRMS so the actual level of IR degradation for these tests was not measured. However, an analysis of the SCDU leakage current and voltage data from Tests D13 and D15 based on application of Ohm’s law estimated that the cable experienced IRs of less than 1000 Ω during the early low temperature degradation period. This is the failure criterion defined in NUREG/CR-6931 [8] for the interpretation of IRMS data. Hence, these cases would likely be considered outright failures during the low-temperature regime.

Given the remaining sample length of Item H, only one test could be run in Penlight during the KATE-Fire series (Test K4). The cable numbering scheme and SCDU wiring connections are shown in Figure 7.39 and Table 7.1, respectively. Note that the wiring configuration meant that adjacent conductors in the outer ring alternated between sources and targets. The two cables in the center were wired as source conductors but using a voltage divider circuit such that conductor 1 was at approximately 40 V and conductor 2 was at about 80 V. The initial Penlight set point temperature for Test K4 was 325°C.

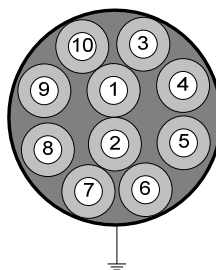

Figure 7.39: Numbering scheme for Item H.

Table 7.1: Conductor connection to SCDU for Test K4.

| Conductor number | Conductor color | SCDU circuit number | SCDU circuit path | Notes |
|------------------|-----------------|---------------------|-------------------|-------------------------------------|
| 1 | Black | 2 | SCDU2 S2 to T4 | Connected through a 3.6 kΩ resistor |
| 2 | White | 3 | SCDU3 S2 to T4 | Connected through a 0.9 kΩ resistor |
| 3 | Red | 1 | SCDU1-S1 | Source |
| 4 | Green | 1 | SCDU1-T5 | Target |
| 5 | Orange | 2 | SCDU2-S1 | Source |
| 6 | Blue | 2 | SCDU2-T5 | Target |
| 7 | White/Black | 3 | SCDU3-S1 | Source |
| 8 | Red/Black | 3 | SCDU3-T5 | Target |
| 9 | Green/Black | 4 | SCDU4-S1 | Source |
| 10 | Orange/Black | 4 | SCDU4-T5 | Target |
| Zinc Wrap | NA | NA | NA | Grounded to tray, but not monitored |

Initial degradation was observed approximately 1322 s into the test at a cable temperature of 266°C. The voltages increased steadily to about 4 Vac before starting to decline. At a cable temperature of 289°C and 1800 s into the test, liquid was observed coming from the cut end of the thermal response cable as shown in Figure 7.40. At approximately 1980 s into the test and at a cable temperature of 296°C, a short and spurious actuation occurred between conductors 4 and 5 (SCDU1-T5 and SCDU2-S1). The cable temperature reached a maximum of 326°C before the test was stopped (prior to ignition) so that the cable could be preserved for post-test cable examination. Figure 7.41, Figure 7.42, and Figure 7.43 illustrate the electrical failures.



Figure 7.40: Liquid observed from cut end of thermal response cable during Test K4.

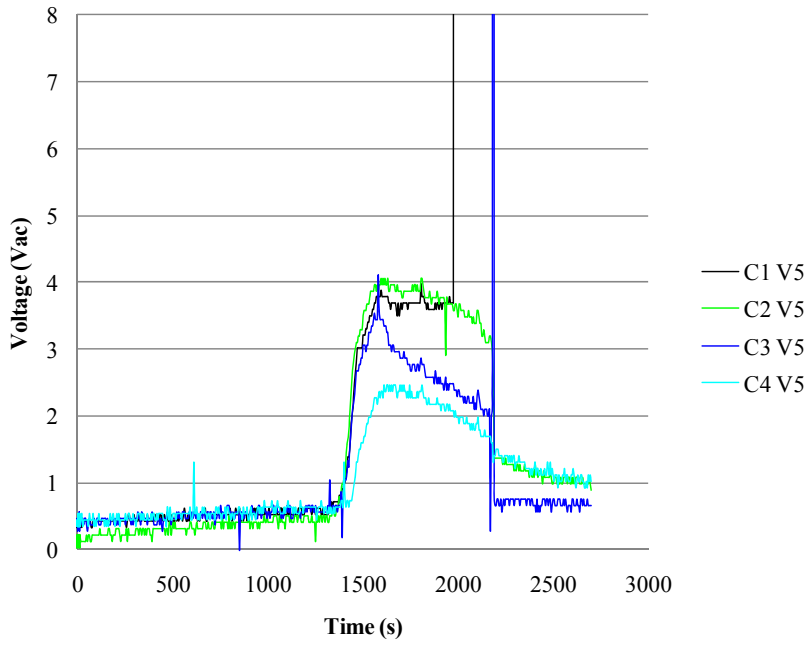

Figure 7.41: Modified target voltages from Test K4.

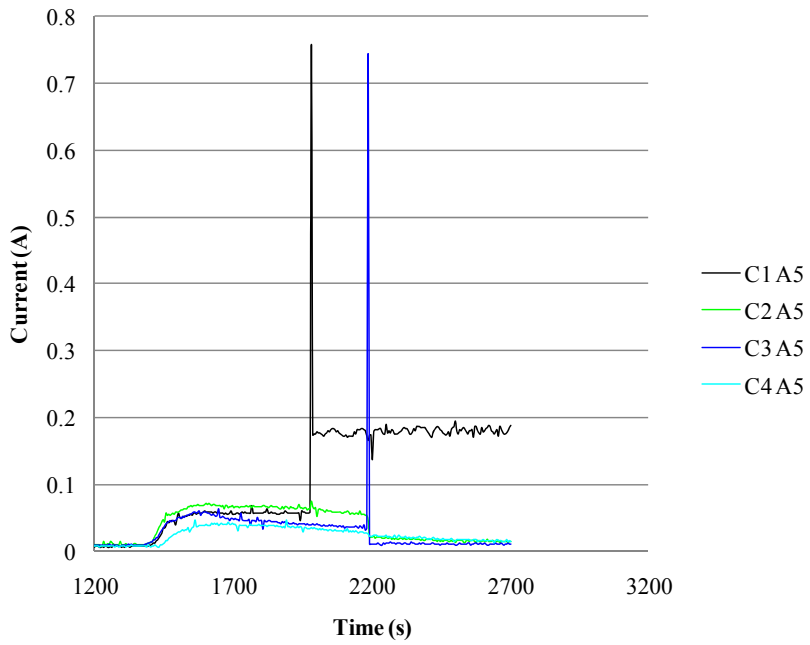

Figure 7.42: Modified target currents from Test K4.

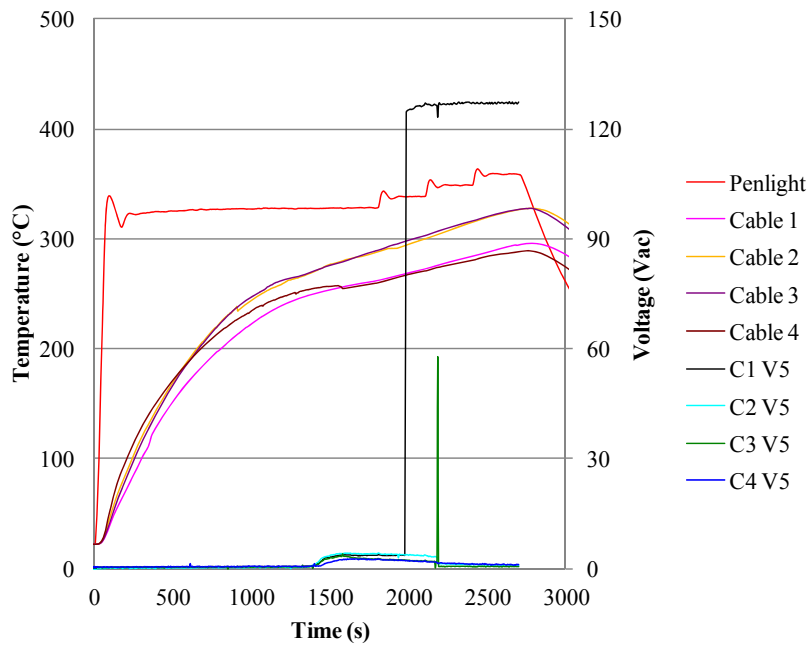

Figure 7.43: Temperature and voltage response of Item H.

During examination of the cable from Test K4, as the jacketing material was removed, similar to the DESIREE-Fire experiments, an oily residue was found between the jacket and zinc wrap. As more of the cable jacket was removed, a large hole in the zinc wrap was discovered. This is shown in Figure 7.44 and Figure 7.45. After the jacketing material was detached from the thermally exposed section of cable, the zinc wrap was carefully removed, as shown in Figure 7.46 and Figure 7.47. Directly beneath the hole in the zinc wrap was a “soft spot” in the insulation material, very similar to that observed during the testing of Item D. This soft spot was comprised of charred insulation material held in place by the oily residue and the charring extended to the copper wire. The insulation surrounding the charred hole was still relatively flexible and resilient to the applied pressure of investigative tools. Unlike Test D13-qual, longitudinal and circumferential cracking along the conductors was not prevalent. The general cable condition is shown in Figure 7.48.



Figure 7.44: Large hole uncovered during the removal of the jacketing material.



Figure 7.45: Close-up image of the large hole formed in the zinc wrap.



Figure 7.46: Jacketing material removed from the thermally exposed portion of the energized cable.



Figure 7.47: Removal of the zinc wrap and charred insulation material reveal the bare copper conductors.



Figure 7.48: Post-test image of the conductors without insulation cracking for Item H.

Item H was tested during both Test IS9 and Test IS10 of the DESIREE-Fire intermediate-scale experiments. For Test IS9, Item H was connected to the SOV1 circuit and located in Position B. In Test IS10, this cable sample was connected to MOV2 and again located in Position B. Early electrical degradation was observed in both Test IS9 and Test IS10 beginning at cable temperatures of 316°C and 251°C, respectively. These values are generally consistent with those observed during the Penlight tests. The ultimate failure mode during Test IS9 was a hot short to an indication lamp. The indicated cable temperature at the time of failure was in excess of 400°C. The results from Test IS10 are illustrated in Figure 7.49. During Test IS10, initial degradation was noted when the cable was at approximately 251°C and an outright failure (spurious actuation) occurred at a cable temperature of about 334°C.

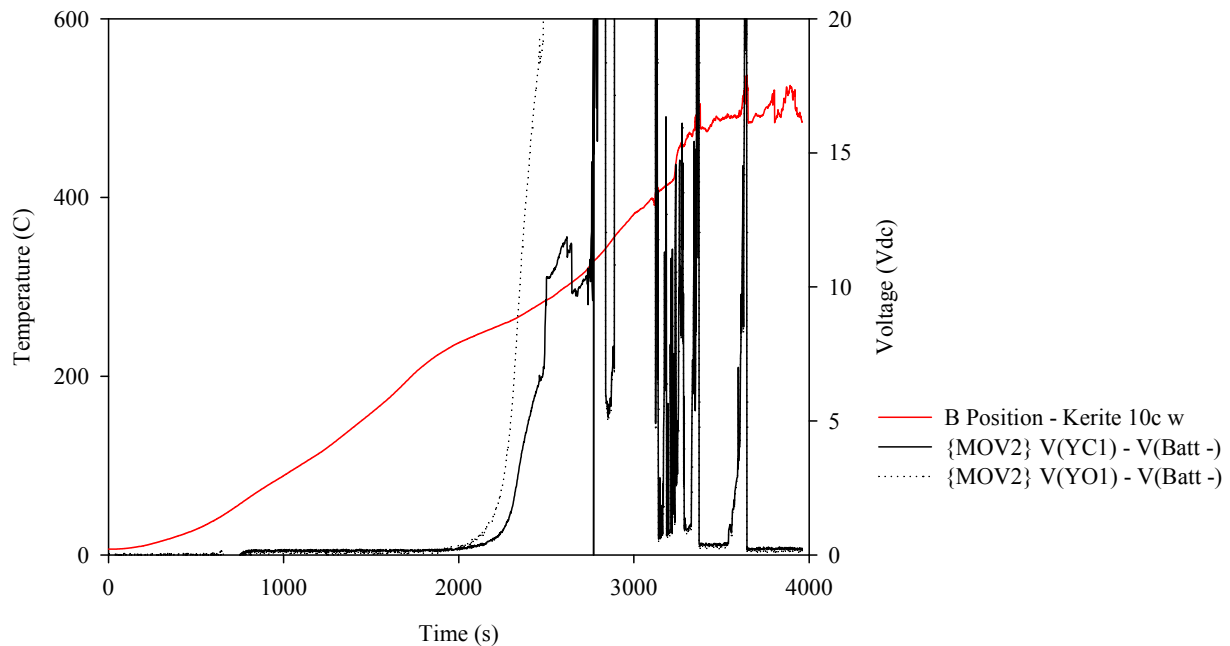

Figure 7.49: Cable temperature and electrical response of Item H during Test IS10.

Overall, Item H experienced spurious actuations at temperatures below 300°C during Tests D13-qual and K4. Other tests, such as Tests D13 and D15, displayed low temperature degradation but outright failure at much higher temperatures (i.e., in excess of 380°C). Low temperature degradation was also observed for this cable during both of the intermediate-scale experiments. Liquid was observed at temperatures ranging from 268–300°C. Post-test examinations of Item H revealed both longitudinal and circumferential cracking.

7.10 Cable Item I: 12/C-12 AWG, FR-III

Cable Item I was tested once during the intermediate-scale DESIREE-Fire experiments (test IS10) and once during the KATE-Fire program (Test K19). During Test IS10, this cable was tested on the SOV1 circuit and located in Position C. For test K19, the SCDU in multi-unit mode was used to monitor the sample’s electrical performance.

During the Penlight test K19, the exposure temperature was increased steadily, but Item I showed little signs of duress and electrical degradation until relatively high temperatures as indicated in Figure 7.50. At approximately 385°C cable temperature, liquid began to appear from the cut end of the thermal response cable; however, not in sufficient quantities to collect in the glass jars. The cable ignited at a Penlight exposure temperature of 430°C and a cable temperature of approximately 400°C. Three minutes after ignition, the SCDU fuses began to clear with all fuses clearing over a 180 s period as shown in Figure 7.51. No spurious actuations were observed.

Even though the cable ignited during the experiment, as seen in Figure 7.52, a post-test investigation was conducted for evidence of longitudinal and circumferential cracking on the cable regions just beyond the burned area. As shown in Figure 7.53 and Figure 7.54, no cracking was observed. Additionally, the insulation was not brittle outside of the immediate region burned during the test.

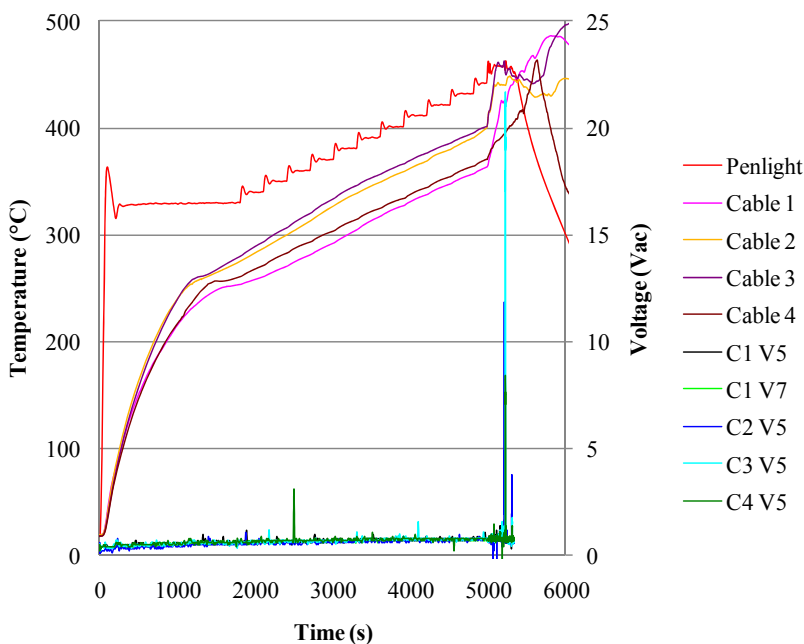

Figure 7.50: Temperature and target voltage response of Item I during Test K19.

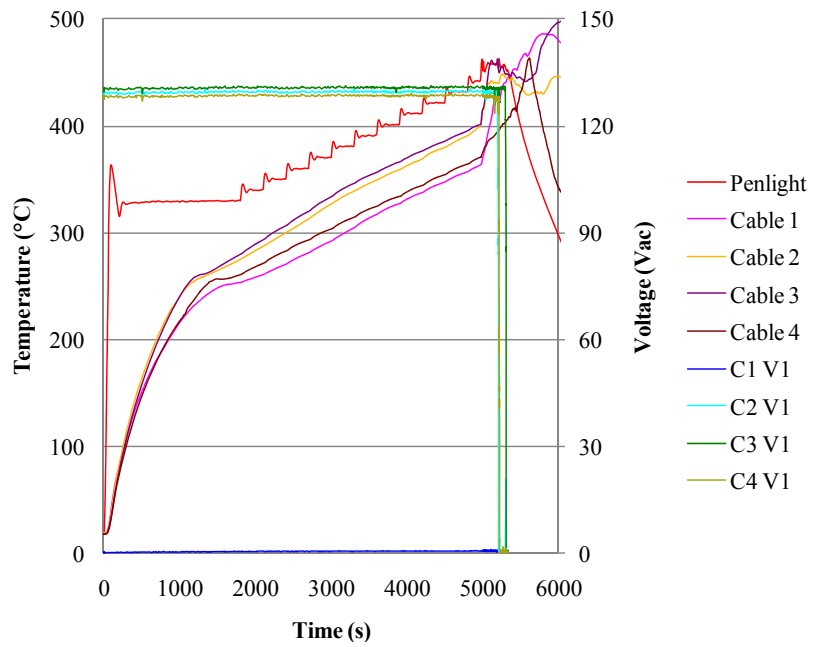

Figure 7.51: Source voltage response during Test K19.



Figure 7.52: Burned section of Item I.



Figure 7.53: Unburned section of Item I next to the leading flame edge.



Figure 7.54: Opposite unburned section of Item I next to the leading flame edge.

During the intermediate-scale experiment, Item I showed no signs of early electrical degradation although failure of the thermocouples during the test make the actual temperature response uncertain. Overall, Item I performed similarly to other Kerite FR-III insulated samples in that liquid was produced at higher temperatures and that the conductors displayed no indications of cracking outside the area of flame impact. No early or lower temperature electrical degradation was observed throughout the Penlight tests and failures only occurred after the cable had already ignited.

7.11 Cable Item J: 15/C-12 AWG, FR (with zinc wrap)

Cable Item J was tested once during the intermediate-scale DESIREE-Fire testing (test IS10) and once in Penlight during the KATE-Fire testing (test K20). During the intermediate-scale test, this cable sample was connected to the switchgear trip and close circuits, and was tested in Position B (second tray above the gas burner). During test K20, this cable was tested using SCDU.

During the test K20, liquid initially appeared at a cable temperature of 265°C, as shown in Figure 7.55. Shortly after the liquid was observed, at 1994 s and a cable temperature of 276°C, voltage and current increases were detected on the target conductors as shown in Figure 7.56, Figure 7.57, and Figure 7.58. A fuse blow occurred on SCDU2 prior to ignition at a cable temperature of 344°C. The test was continued until ignition occurred at a cable temperature of 361°C. Shortly after ignition, the remaining SCDU fuses began to clear.

The conductors immediately outside the burned region of the cable were closely studied for evidence of cracking after the test was concluded. Cracking was observed along with dried liquid residue present between the conductors. Figure 7.59 depicts the area of conductors outside the cable region exposed to fire. The red arrows point to cracks in the insulation material while the yellow arrows point to the dried liquid residue located between the conductors.

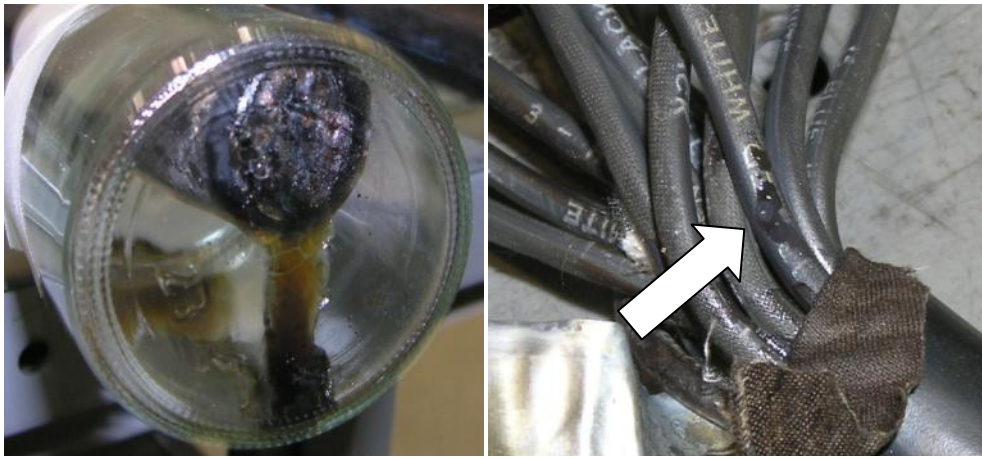

Figure 7.55: Liquid produced during Test K20.

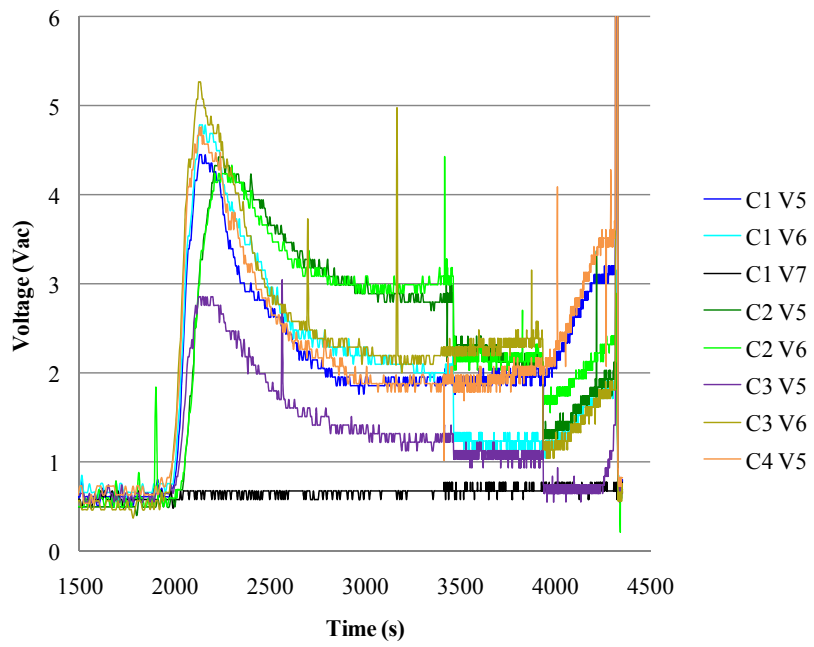

Figure 7.56: Modified target voltages for Item J during Test K20.

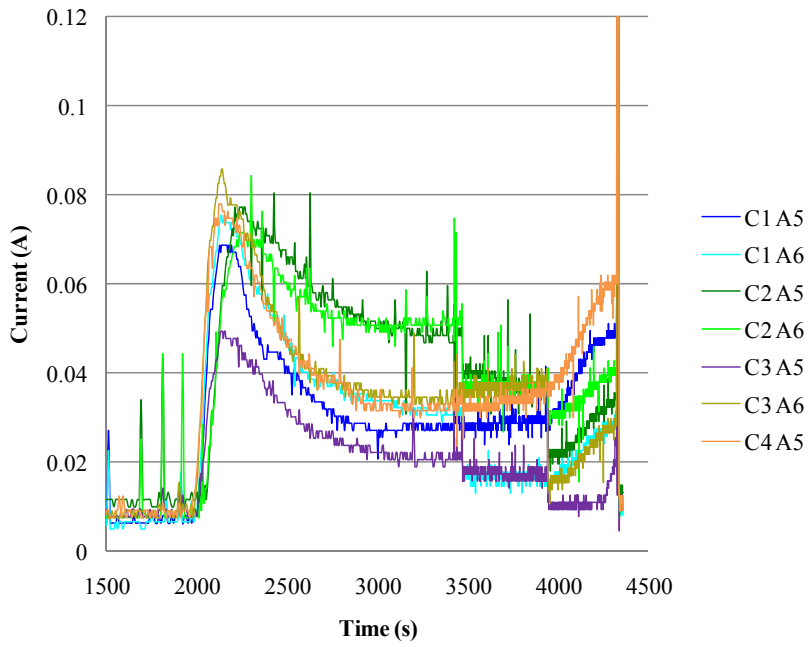

Figure 7.57: Modified target currents for Item J during Test K20.

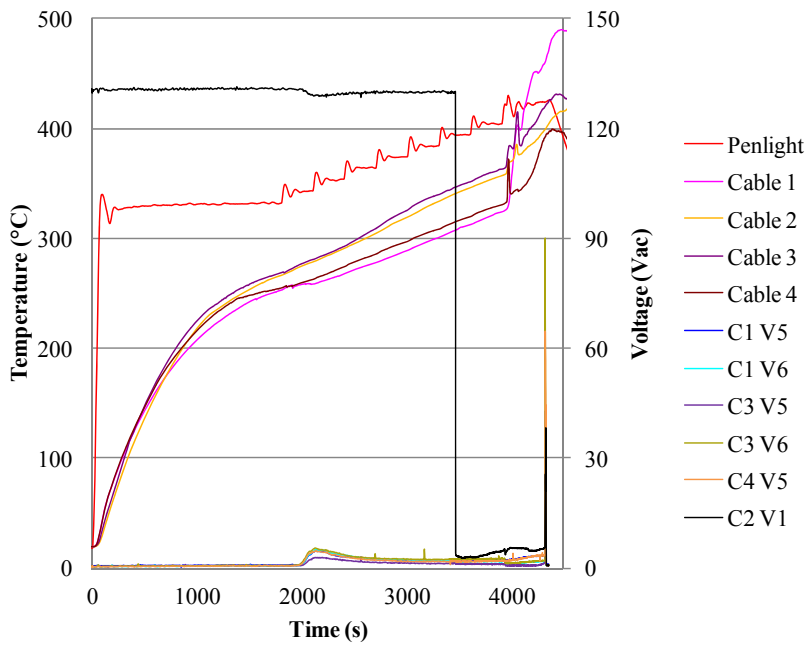

Figure 7.58: Temperature and voltage response of Item J.

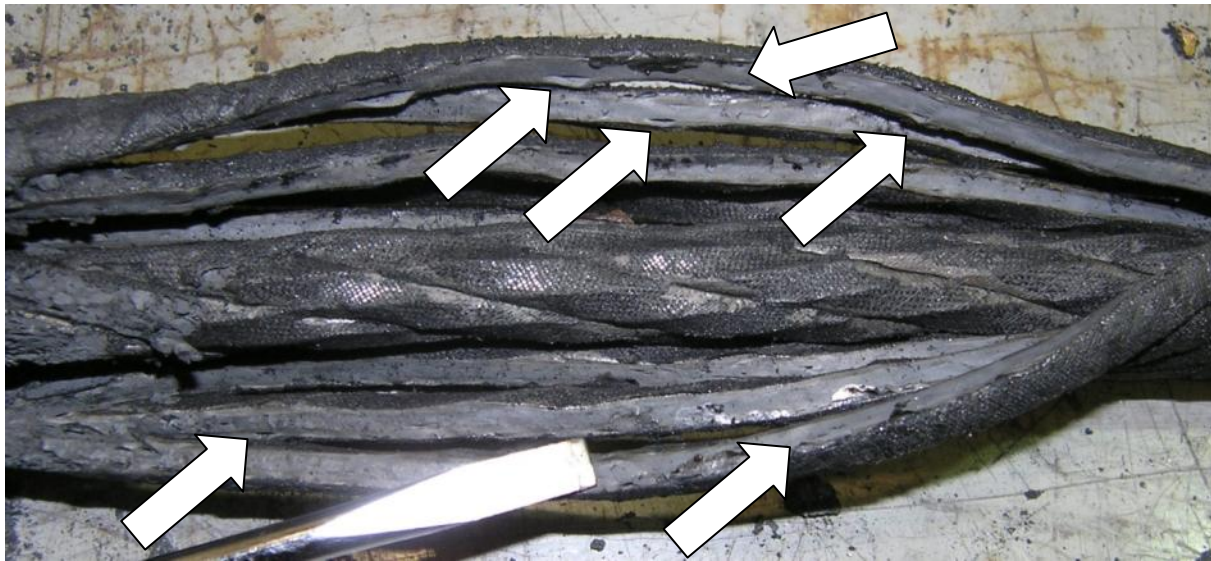

Figure 7.59: Longitudinal cracking along the conductors outside the burned section of cable indicated by arrows.

The results from the intermediate-scale tests were complimentary to the results obtained during the small scale experiments. Early degradation, in this case voltage leakage from the green indication lamp, was observed beginning at about 2646 s into the test and at a cable temperature of 261°C. Outright failure occurred at about 3108 s and at a cable temperature of about 337°C. This is shown in Figure 7.60 where the cable temperature shown in red and the voltage of conductor ‘G’ shown in black and the two arrows indicate the onset of initial degradation and outright failure.

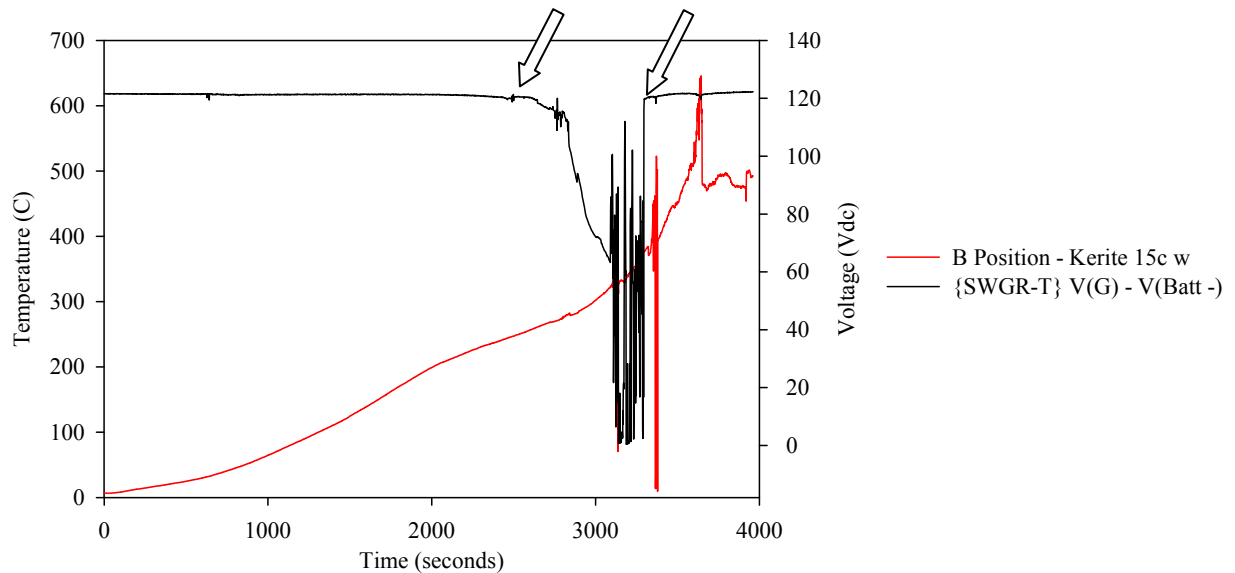

Figure 7.60: Cable temperature and electrical response of Item J during Test IS10

Overall, cable item J experienced IR degradation (as low as 1365 Ω) during the Penlight tests at a temperature as low as 276°C. Liquid was observed at a cable temperature of 265°C. Outright

failures (a fuse blow) occurred at a cable temperature of 344°C. Post-test analysis of the cable sample from Test K20 found longitudinal cracking along each of the conductors outside of the region impacted by flame.

7.12 Cable Item K: 3/C-6 AWG, HT

Cable Item K was only tested during the DESIREE-Fire program and in the small-scale Penlight apparatus. This was the only HT insulated cable tested. This cable was tested three times (Tests D17-qual, D17, and D18) all using the SCDU.

No liquid was observed during any of the tests. There were no indications of early cable degradation as were noted during the testing of the various FR insulated cables. Failures for this cable all occurred after cable ignition and cable ignition occurred at cable temperatures between 386–409°C. Although each test resulted in cable ignition, post-test analysis of the unburned regions of the cable revealed no cracking along the insulation. Typical test results are shown in Figure 7.61. Details are provided in Appendix B.

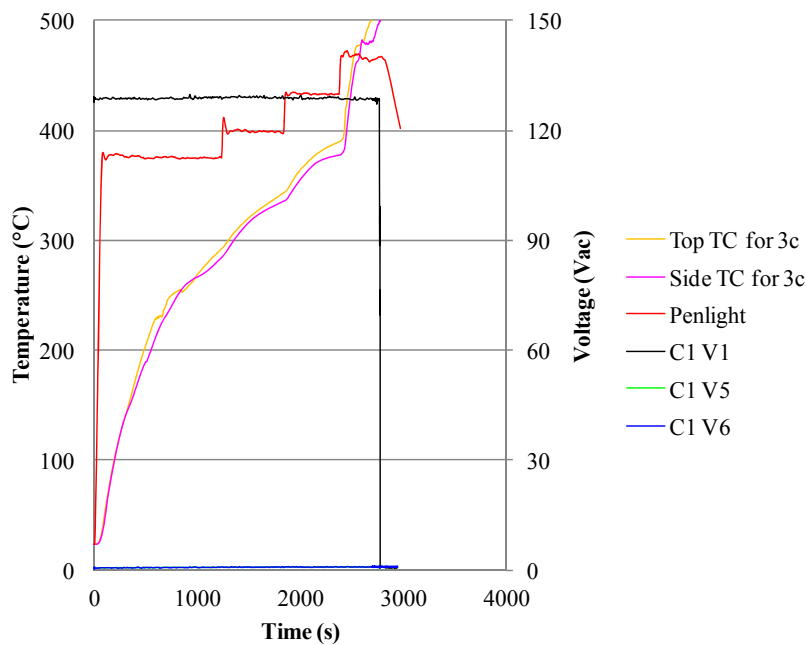

Figure 7.61: Test results for the HT insulated cable in Test 17-qual.

8 SUMMARY OF TESTING RESULTS

8.1 Kerite FR Test Results and Observations

Six different examples of Kerite FR insulated cables were tested (cable Items A, D, E, F, H, and J). A total of 29 small-scale Penlight exposure tests were performed involving these cables types, and the results of those tests are summarized in Table 8.1. Based on the Penlight results, there are two distinct failure modes active for the Kerite FR cables. With few exceptions, the Kerite-FR insulated cable samples showed similar behaviors during testing. The exceptions involve all three of the Cable Item A samples tested and four of the nine samples of Cable Item F tested. These exceptions will be discussed further below.

When interpreting the test results to determine the minimum threshold of thermal damage, certain tests in the series are discounted (not considered). In particular, some of the early DESIREE-Fire Penlight tests involved cable samples exposed to very high initial shroud temperatures (450-470°C). Under these extreme heating conditions the cable jacket will ignite while interior cable temperatures are still relatively low (as low as 202°C in one case). As noted in prior test reports (e.g., see Reference [8]) cable temperatures obtained after the sample ignites are considered unreliable because (1) the thermocouple tip may lose contact with the insulation and may even emerge from the jacket due to jacket swelling, cracking or blistering in which case measured temperatures may reflect air or even flame temperatures rather than insulation temperatures and (2) even if the thermocouple tip remains embedded within the cable, it may not capture the worst-case insulation conditions because the tip location may not coincide with localized insulation hot-spots which tend to drive overall cable electrical breakdown. As a result, those tests involving an initial Penlight shroud temperatures of 450-470°C and early cable ignition are discounted in the final assessment of minimum damage thresholds (i.e., the four test samples in tests D14 and D16). Note that for tests where cable failure occurs after ignition the data summaries will report that cable failure occurred at a temperature greater than the last reliable pre-ignition temperature measurements (e.g., ">289°C"). Some of these cases did involve less severe exposure conditions and substantially higher internal cable temperatures.

For the majority of the FR-insulated cables, a common pattern of degradation was observed. The first of the two active failure modes observed involved electrical degradation when the cable temperature was in the 247–317°C range (in the summary table this behavior is highlighted in the five columns grouped under the label “early degradation”). This early degradation behavior is evident in 18 of the 29 Penlight tests performed (the exceptions are clearly noted in the table). Of the 11 tests where this behavior was not observed, four involved early cable ignition so that any potential early degradation behavior would have been masked by the uncertain post-ignition cable temperatures, and the other seven represent the exception cases noted above and discussed further below.

Out of the 18 early degradation cases, four (D13-Qual, K4, K8 and K9) involved an outright electrical failure during the early degradation period (i.e., a fuse blow (FB) or spurious actuation (SA) failure for the SCDU and MOV circuits, or an IR value below 1000 Ω for the IRMS). Two additional SCDU tests (D13 and D15) resulted in estimated IR values of less than 1000 Ω during the early degradation period but not an outright FB or SA failure. Note that the estimated cable

IR for the SCDU system is based on a direct application of Ohm's Law using the measured leakage currents and known source voltages. These two tests would also be considered outright failures if the IRMS failure criteria are applied (i.e., IR of less than 1000 Ω).

Table 8.1: Summary of the Penlight results for tests involving FR-insulated cables (see notes below table for explanation of nomenclature).

| Test Setup | | Early Degradation | | | | | Outright Failure | | | Ignition | | Exposure condition |
|--|--|---------------------------------------|------------------------|-------------------------------------|------------------------|---|-----------------------------|------------------------|--------------------|----------|---|--|
| | | Onset of early degradation | | Maximum extent of early degradation | | | | | | | | |
| Test number | Electrical performance monitoring unit | Time (s) | Cable temperature (°C) | Time (s) | Cable temperature (°C) | Estimated minimum cable IR (Ω) | Time (s) | Cable temperature (°C) | First failure mode | Time (s) | Max. cable temperature reached or pre-ignition cable temperature (°C) | Penlight shroud temperature setting (°C) |
| Cable Item: A - 2/C, 12 AWG, FR | | | | | | | | | | | | |
| K14 | IRMS | No signs of early degradation | | | | | Test stopped ⁽¹⁾ | | | NA | 391 | 325-405 |
| K15 | IRMS | No signs of early degradation | | | | | Test stopped | | | NA | 406 | 325-425 |
| K16 | IRMS | No signs of early degradation | | | | | 5907 | >426 | C-G | 5760 | 432 | 325-465 |
| Cable Item: D - 5/C, 12 AWG, FR (with zinc wrap) | | | | | | | | | | | | |
| D13 | SCDU1 | 1123 | 283 | 1341 | 290 | 2173 | 4571 | >394 | SA | 4362 | 394 | 350-470 |
| D14 | SCDU1 | Cable ignited at 289°C ⁽²⁾ | | | | | 965 | >289 | FB | 600 | 289 | 450 |
| D15 | SCDU1 | 2308 | 257 | 2566 | 265 | 1578 | Test stopped | | | NA | 355 | 300-400 |
| D16 | SCDU2 | Cable ignited at 207°C | | | | | 753 | >207 | FB | 353 | 207 | 470 |
| K5 | SCDU(M) | 1065 | 281 | 1237 | 285 | 2233 | 4368 | >389 | FB | 4341 | 389 | 325-415 |
| K8 | IRMS | 1831 | 303 | 1943 | 307 | C-G | Early degradation failure | | | NA | 339 | 325-365 |
| K9 | IRMS | 2040 | 311 | 2040 | 311 | C-C | Early degradation failure | | | NA | 322 | 325-345 |
| Cable Item: E - 7/C, 12 AWG, FR (with zinc wrap) | | | | | | | | | | | | |
| K1 | SCDU(M) | 2465 | 256 | 2937 | 262 | 1105 | Test stopped | | | NA | 298 | 325-375 |
| K6 | IRMS | 1680 | 271 | 2700 | 299 | 2219 | Test stopped | | | NA | 378 | 325-435 |
| K7 | IRMS | 1395 | 285 | 1655 | 294 | 2373 | 5356 | >417 | C-G | 5332 | 417 | 325-445 |
| Cable Item: F - 9/C, 14 AWG, FR | | | | | | | | | | | | |
| D44 | MOV1 | 2148 | 267 | 3514 | 289 | NC | 9073 | ~443 | SA | 10277 | 454 | 325-485 |
| D44 | MOV2 | 2104 | 267 | 2705 | 268 | NC | 10043 | ~448 | SA | 10277 | 454 | 325-485 |
| D49 | MOV1 | 1149 | 303 | 1274 | 317 | NC | 4394 | >415 | SA | 4391 | 415 | 350-440 |
| D49 | MOV2 | No signs of early degradation | | | | | 4823 | >415 | SA | 4391 | 415 | 350-440 |
| D50 | MOV1 | No signs of early degradation | | | | | 1279 | >330 | HS | 822 | 330 | 450 |
| D50 | MOV2 | No signs of early degradation | | | | | 1164 | >330 | HS | 822 | 330 | 450 |
| K2 | SCDU(M) | 1295 | 275 | 2108 | 296 | 1383 | Test stopped | | | NA | 327 | 350-380 |
| K21 | IRMS | No signs of early degradation | | | | | 5465 | >414 | C-G | 4834 | 414 | 325-435 |
| K23 | SCDU(M) | 1200 | 281 | 1786 | 297 | 1600 | 5232 | >411 | FB | 4530 | 411 | 325-415 |
| Cable Item: H - 10/C, 12 AWG, FR (with zinc wrap) | | | | | | | | | | | | |
| D13-qual | SCDU2 | 2200 | 247 | 3363 | 287 | SA | Early degradation failure | | | NA | 298 | 300-350 |
| D13 | SCDU2 | 1240 | 260 | 1569 | 277 | 583 | 4590 | >374 | FB | 4362 | 374 | 350-470 |
| D14 | SCDU2 | Cable ignited at 229°C | | | | | 966 | Ind. | FB | 600 | 229 | 450 |
| D15 | SCDU2 | 2288 | 252 | 3031 | 274 | 500 | Test stopped | | | NA | 352 | 300-400 |
| D16 | SCDU1 | Cable ignited at 202°C | | | | | 834 | Ind. | FB | 353 | 202 | 470 |
| K4 | SCDU(M) | 1322 | 266 | 1980 | 296 | SA | Early degradation failure | | | NA | 326 | 325-355 |
| Cable Item: J - 15/C, 12 AWG, FR (with zinc wrap) | | | | | | | | | | | | |
| K20 | SCDU(M) | 1994 | 276 | 2084 | 279 | 1365 | 3468 | 344 | FB | 3933 | 361 | 325-405 |

Table 8.1 Notes:

- (1) "Test Stopped" indicates the test was ended prior to outright electrical failure. This was done to allow for post-test examination of a cable sample heated to at least 300°C (cable temperature) but that had not ignited and burned.
- (2) "Cable ignited at XXX°C" indicates that the intense heating from penlight (450°C or higher initial shroud temperature) caused an early cable ignition when the outer surface of the cable reached the auto-ignition temperature. The temperature indicated is the cable's sub-jacket temperature measured at the time of ignition. Post-ignition temperature data are considered unreliable.
- (3) General nomenclature:
 - FB = fuse blow failure;
 - SA = spurious actuation failure;
 - HS = hot short failure (conductor-to-conductor);
 - C-G = conductor to ground failure on the IRMS;
 - C-C = conductor-to-conductor failure on the IRMS;
 - NA = not applicable (i.e., the cable did not ignite during test);
 - NC = not calculated (i.e., cable IR has not been estimated for tests using dc-powered circuits);
 - Ind. = indeterminate (temperatures measured after cable ignition are not reliable indicators of actual cable temperature).

The second active failure mode is manifested at much higher cable temperatures. That is, if the particular sample did not experience an outright failure while passing through the early degradation stage, then an outright failure would occur at cable temperatures of 370°C or greater, and commonly after cable ignition. The typical behavior in these cases included recovery of some heightened electrical performance after passing through the early degradation stage. That is, once the cable temperature passed about 317°C, leakage currents from source conductors and voltages on target conductors would drop to near normal levels for the SCDU and MOV circuits. In the case of the IRMS test, the cable IR values would recover somewhat, typically not to pre-test values but to in excess of 10,000 Ω. This functional recover would then be followed by an outright failure at the higher cable temperatures.

The first exception to this general behavior is the Cable Item A samples (the 2/C-12AWG cable). This cable type was only tested three times, but did not show any signs of early degradation or failure. These particular cable samples failed abruptly and only when driven to temperatures in excess of 391°C. While the number of tests performed is relatively small, the behavior was consistent between tests and the data are considered reliable. No explanation for this unique behavior as compared to the other FR-insulated cables has been developed.

The second exception involves four of the nine tested samples of Cable Item F; namely, one of the two samples in Test D49, both samples in test D50, and the single sample in test K21. In these specific cases the cables showed no signs of early degradation behavior and failed abruptly at the higher temperatures and in all cases only after cable ignition. Again, no definitive explanation for these cases is possible, but they may be explained by the general hypothesis regarding the mechanisms associated with the FR-insulated cable's behavior as discussed further below.

Two factors were shown to correlate with the observed early degradation and failure behaviors:

- The first factor is a liquid material seen oozing from the cable ends during heating.
- The second factor is the formation of cracks in the cable insulation during heating.

The first key observation made during testing of the various Kerite FR samples (including Cable Items A and F) was the production of a liquid material during the heating process. The liquid was observed oozing out the ends of the exposed cables. The liquid first appeared when cable temperature ranged between about 250–280°C. As discussed in Chapter 7, the liquid would typically undergo a color change as the cable temperature increased, darkening from a cloudy yellow or clear green to dark brown by the end of the test.

Several samples of the liquid were captured in clean glass jars. The liquid was oily to the touch, had a strong chemical odor and remained liquid at room temperature. No chemical analysis was performed to determine the composition of the material, but the material was clearly not water (it would not evaporate over time) and was not melted thermoplastic material (it did not solidify on cooling). Each sample was tested for electrical resistance using a simple multi-meter. Probes connected to the multi-meter were spaced 1.27 cm apart and then submerged into the liquid. This process was repeated three times for each sample and the results were averaged. In all cases the material was found to be electrically conductive. Material gathered from the various samples of Kerite FR cable showed resistances ranging between 62–246 Ω .

The second behavior of interest is the formation of cracks in the cable insulation during the heating process. At least one (and typically more) samples of each cable item were inspected following heating in Penlight. The samples were either taken from tests terminated before cable ignition, in some cases after an outright failure was observed (these cases are noted in the summary table by an entry of “test stopped” in the columns grouped under the heading “outright failure”), or from the unburned sections of a cable sample that had ignited (i.e., segments of the cable away from the center where the heating was most intense). As discussed in Chapter 7, post-test examinations of Kerite FR cable samples, including the Cable Items A and F, revealed longitudinal and/or circumferential conductor insulation cracks. Many of these cracks extended to the bare copper stranded wire. Due to the limited quantity of cables available, no effort was made to systematically explore the onset-temperature for the cracking behavior; however, the samples inspected revealed cracks present in cables heated in one case to less than 300°C and in other cases to no more than 320°C.

One observation was that the samples of Cable Item A did show somewhat less cracking than did the other FR cables. There were typically fewer cracks in the insulation and the cracks that did form were typically shorter than those observed in other cable types. In the majority of cases, the cracks did appear to penetrate to the conductor itself. Additional information and illustrations are provided in Chapter 7. Cable Item F showed cracking behavior that was similar to the other FR-insulated cables.

Another unique observation made during KATE-Fire was the occurrence of holes in the zinc shield wrap used in some cable types. These holes in the shield wrap typically coincided (were co-located) with holes in the underlying conductor insulation that were in turn filled with charred material. Upon the removal of the charred material, it was observed that an oily, tacky residue was binding the charred materials between the bare stranded copper wire and the grounded zinc shield wrap. Based on these observations, it was inferred that cracks formed along the insulation material, conductive liquid filled the cracks and this led to shorting between the energized conductors and the grounded zinc shield wrap. The shorting was apparently sufficient to cause arcing between the conductor and shield wrap and charring of the cable insulation.

In summary, with the exception of the three samples of Cable Item A tested and four of the nine samples of Cable Item F tested, electrical degradation in Kerite FR insulated cables was consistently observed a cable temperatures in the 247–317°C range. In addition, four of 18 tests where the early degradation was observed resulted in outright failure generally when the cable reached temperatures from 287–311°C. Two additional tests saw estimated IR values using the SCUDU systems that would have been considered failures using the criteria applied when using the IRMS. These observations, as well as the post test forensics described above, support the hypothesis that the early degradation and failure cases result from the combination of insulation cracking and production of a conductive liquid within the cable during heating.

No explanation for the inconsistent behavior of cable Item A has been developed. Only three samples of this cable type were tested due to limited supplies of this cable type, and none showed signs of early electrical degradation. This cable did produce the conductive liquid and did experience insulation cracking. However, physical inspection of tested samples showed that this cable developed fewer, shorter, and generally shallower cracks.

In the case of Cable Item F, five of the nine samples behaved in a manner nominally consistent with other FR-insulated cables. The fact that four of the samples did not experience early degradation may be attributed to a lack of cracks in close proximity on adjacent conductors (i.e., it may be a matter of simple chance).

The intermediate scale tests were more limited in scope than the Penlight tests but do confirm the behaviors observed in Penlight. A total of six samples representing four examples of the FR-insulated cables (i.e., four cable items) were tested in DESIREE Fire Tests IS9 and IS10. The results are summarized in Table 8.2. The table indicates the time at which the first signs of cable degradation were observed and the corresponding cable temperature at that time. As with the Penlight tests, observations of initial cable degradation were based on voltage increases to various target conductors. The table also indicates the time when outright circuit failures were observed, the corresponding cable temperature at that time, and the mode of circuit failure observed.

Table 8.2: Summary of intermediate scale test results for FR insulated cables.

| DESIREE Fire test number | Cable Item number | Test position | Cable monitoring unit | Time of initial degradation (s) {1} | Cable temperature at time of initial degradation (°C) {2} | Air temperature near cable at time of initial degradation (°C) {2} | Time of first outright circuit failure (s) {3} | Cable temperature at time of outright failure (C) | First failure mode |
|---|-------------------|---------------|-----------------------|-------------------------------------|---|--|--|---|--------------------|
| Cable Item: E - 7/C, 12 AWG, FR (with zinc wrap) | | | | | | | | | |
| IS10 | E | D | 1-in. valve | 1756 | 213 | 465 | 2502 | 345-372 | HS |
| Cable Item: F - 9/C, 14 AWG, FR | | | | | | | | | |
| IS10 | F | C | MOV1 | 2312 | 172 | 421 | 3584 | 365-381 | SA |
| IS10 | F | D | Large Coil | 2006 | 245 | 474 | 2890 | >400 | FB |

| DESIREE Fire test number | Cable Item number | Test position | Cable monitoring unit | Time of initial degradation (s) {1} | Cable temperature at time of initial degradation (°C) {2} | Air temperature near cable at time of initial degradation (°C) {2} | Time of first outright circuit failure (s) {3} | Cable temperature at time of outright failure (C) | First failure mode |
|--|-------------------|---------------|-----------------------|-------------------------------------|---|--|--|---|--------------------|
| Cable Item: H - 10/C, 12 AWG, FR (with zinc wrap) | | | | | | | | | |
| IS9 | H | B | SOV1 | 2067 | 316 | 571 | 2429 | >400 | HS |
| IS10 | H | B | MOV2 | 2159 | 251 | 464 | 2798 | ~334 | SA |
| Cable Item: J - 15/C, 12 AWG, FR (with zinc wrap) | | | | | | | | | |
| IS10 | J | B | SWGR-C/T | 2646 | 261 | 616 | 3108 | ~337 | SA |

During Test IS10 in particular, the cables showed signs of early degradation at somewhat lower cable temperatures than were observed during the Penlight tests. In one case (IS10/MOV1) degradation was noted when the recorded cable temperature was just 172°C and in a second sample (IS10/1-in. valve) at 213°C. In both of these cases the cable temperature at the time of initial degradation is substantially lower than the worst-case behavior noted in Penlight. The other samples are more consistent with the penlight tests showing degradation at cable temperatures of 245°C or higher. Note that the intermediate scale cable temperature results hold considerable uncertainty due to the nature of the cable temperature measurements.

The intermediate scale tests include a higher degree of uncertainty regarding the test and cable conditions. Other than control over the rate of fuel flow to the gas burner, there is no control over the fire exposure conditions. Also, the cables cannot be observed during the tests due to the buildup of smoke in the test chamber. As a result, the timing of cable ignition and the extent of cable burning at any given time is largely unknown. Thermal response cable samples were included at each test location and adjacent to each cable sample monitored for electrical performance. However, the thermocouples are concentrated towards the center of the cable length and may not detect the actual maximum cable (or air) temperatures at any given time during the test. If, for example, a substantial wall plume was formed in the test cell, the cables could be hotter near the edges of the exposure cell than at the center. As a result, there is a much higher level of uncertainty regarding a cable's actual hot-spot temperature response during the tests. As a result, the temperature data may not have captured the cable's "hot spot" temperature and may therefore under-estimate the cables temperature conditions.

The intermediate scale results are generally consistent with those obtained during the Penlight tests. There was some speculation prior to testing that the longer exposure lengths used in the intermediate scale tests (e.g., approximately 2.4 m) could be more functionally challenging in comparison to the shorter cable exposure lengths tested in Penlight (approximately 0.5 m effective exposure length). It seems unlikely that the intermediate scale test conditions would substantively impact the temperatures at which insulation cracks first appear and production of the conductive liquid begins as compared to the Penlight tests. However, a longer exposure length would generally mean that a larger number of insulation cracks would form in the

exposed cable given the same cable temperatures. Second, the likelihood of insulation cracks in close proximity would increase given an increase in the overall number of cracks. With more cracks, the insulation resistance would be expected to degrade more quickly because each additional crack introduces a new possible electrical leakage pathway that would act in parallel with other leakage pathways (i.e., other cracks). As a result, one might anticipate a higher degree of electrical degradation given a longer cable exposure length and the same thermal conditions.

In the balance, the cable exposure length does not appear to have been a substantive factor in the actual test results. The levels of degradation observed in the intermediate scale tests during the early low temperature degradation phase appear roughly equivalent to those observed in the Penlight tests. It is also worth noting that two of the cases appear to have involved outright early degradation failures (IS10/MOV2 and IS10/SWGR) but there was no obvious increase in the relative number of early degradation failures observed.

8.2 Summary of Test Results for FR-II, FR-III and HT

The test results for the other three Kerite insulation formulations tested, FR-II, FR-III and HT, are summarized in Table 8.3. Note that none of these alternate formulations showed any signs of early degradation. The worst-case example was the FR-II formulation which showed the first signs of degradation as temperatures of 341°C or higher, which is nearly 100°C higher than the worst-case early degradation temperatures observed for the FR insulated cables.

Each of the cables does show different electrical failure thresholds with the HT insulation being the most resistant to thermally induced failure. For both the FR-III and HT cables, electrical failure was most typically observed only after the cable had ignited. Based on these results recommendations for electrical failure thresholds for each insulation type have been developed as discussed in Section 9.2 below.

Table 8.3: Summary of the Penlight test results for the other Kerite insulation formulations.

| Test number | Cable monitoring unit | Time of first failure (s) | Cable Temperature at time of first failure (°C) | Failure mode | Time of cable ignition (s) | Cable temperature at time of cable ignition or shutdown (°C) | Penlight shroud temperature setting (°C) |
|--|-----------------------|-----------------------------|---|--------------|----------------------------|--|--|
| Cable Item: B - 2/C, 10 AWG, FR-III | | | | | | | |
| K12 | IRMS | 5486 | >417 | C-C | 5217 | 435 | 325-445 |
| K13 | IRMS | Test ended prior to failure | | | N/A | N/A | 325-405 |
| K17 | SCDU(M) | 6317 | ~441 | SA | 6310 | 441 | 325-485 |
| Cable Item: C - 4/C, 10 AWG, FR-III | | | | | | | |
| K10 | IRMS | Test ended prior to failure | | | N/A | N/A | 325-425 |
| K11 | IRMS | 5580 | >422 | C-G | 5358 | 422 | 325-445 |
| K18 | SCDU(M) | 5259 | >416 | SA | 5149 | 416 | 325-445 |
| Cable Item: G - 10/C, 16 AWG, FR-II | | | | | | | |
| K3 | SCDU(M) | 3968 | 377 | SA | N/A | N/A | 325-405 |

| Test number | Cable monitoring unit | Time of first failure (s) | Cable Temperature at time of first failure (°C) | Failure mode | Time of cable ignition (s) | Cable temperature at time of cable ignition or shutdown (°C) | Penlight shroud temperature setting (°C) |
|--|-----------------------|---------------------------|---|--------------|----------------------------|--|--|
| K22 | IRMS | 4907 | 423 | C-G | 4921 | 424 | 325-435 |
| K24 | SCDU(M) | 3084 | Ind. | SA | 3084 | 367 | 325-375 |
| Cable Item: I - 12/C, 12 AWG, FR-III | | | | | | | |
| K19 | SCDU(M) | 5159 | Ind. | FB | 4974 | 400 | 325-435 |
| Cable Item: K - 3/C, 6 AWG, HT | | | | | | | |
| D17-qual | SCDU1 | 2777 | Ind. | FB | 2412 | 386 | 375-470 |
| D17 | SCDU1 | 1798 | Ind. | SA | 1740 | TC failure | 430 |
| D17 | SCDU2 | 1880 | Ind. | FB | 1740 | TC failure | 430 |
| D18 | SCDU1 | 5807 | Ind. | FB | 5665 | 409 | 420-450 |
| D18 | SCDU2 | 5665 | Ind. | SA | 5665 | 409 | 420-450 |
| <p>Table notes:</p> <ul style="list-style-type: none"> - “Ind.” indicates that electrical failure occurred after cable ignition and cable temperatures are indeterminate. The temperature reported at the time of ignition is considered the last reliable indication of cable temperature during the test. - “N/A” indicates that the cable sample did not ignite so entry is not applicable. - “TC failure” indicates that the thermocouples experienced a functional failure and cable temperatures are indeterminate. | | | | | | | |

9 CONCLUSIONS

9.1 Conclusions Regarding Kerite FR-Insulated Cables

As discussed in Chapter 8, two distinct failure modes are active for the Kerite FR-insulated cables. The first lower temperature mode is evident at cable temperatures of roughly 247–317°C and involves some degree of electrical insulation degradation up to and including outright circuit failures. This early degradation behavior was clearly evident in 18 of the 29 Penlight tests performed and in all six samples tested in the intermediate scale. These early degradations included four cases where an outright electrical failure occurred at cable temperatures of 287–311°C (tests D13-Qual, K4, K8 and K9) and two additional cases (test D13 and D15) where estimated IR values fell below 1000 Ω during the early degradation period (the failure criterion applied when analyzing the IRMS data).

The second active failure mode is manifested at much higher cable temperatures; namely, 370°C or greater, and commonly after cable ignition. That is, if the particular sample did not experience an outright failure while passing through the early degradation stage, then an outright failure would occur at these higher cable temperatures.

There were three general cases among the 11 Penlight tests where this pattern of behavior was not observed. These exceptions are summarized as follows:

- In four Penlight tests the initial shroud temperature set point was high enough that cable ignition occurred very quickly (within 2-3 minutes). As a result the cable temperatures at the time of failure are unknown.
- In all three trials of Cable Item A, no evidence of early lower temperature degradation was observed and all three samples failed at the higher temperature range (370°C or higher). No explanation for the apparently anomalous behavior of this one example cable has been developed.
- In four of the nine trials of Cable Item F, no evidence of the early lower temperature degradation was observed. However, the other five trials of Cable Item F did show evidence of early degradation.

A working hypothesis to explain this pattern of behavior has been developed. Namely, the early degradation may be explained by the combination of the conductive liquid produced in the cable during heating and the cracking of the conductor insulation. Taken together, these two effects provide a potential short circuit path between conductors (or between a conductor and ground) at the location(s) of the cracked insulation; namely, the filling of insulation cracks with conductive liquid during early stage heating. Some additional observations relative to this hypothesis are discussed in Chapter 8.

Given the relative consistency of the observed behavior, it is recommended that a temperature of 247°C be assumed as the minimum threshold of electrical failure for Kerite FR cables. This is the minimum temperature at which signs of electrical degradation were detected during the Penlight tests.

This recommendation may appear somewhat conservative given the Penlight data, but it allows for the known uncertainty associated with the short cable exposure lengths used in the Penlight tests. That is, the minimum cable temperature at which an outright FR insulated cable failure was observed in Penlight was 287°C. However, given the working hypothesis described above, it is likely that electrical failures will occur more readily at lower cable temperatures given a longer cable exposure length. For real fire scenarios the cable exposure length would generally be longer than that used in the Penlight tests. With a longer cable exposure length it would be expected that a more insulation cracks would form which would have two effects on cable performance. First, the likelihood that two cracks might form in close proximity on adjacent conductors would increase. Second, cable electrical performance would be degraded more severely due to the cumulative effect of multiple parallel conductor-to-conductor or conductor-to-ground shorting paths. These observations do appear consistent with the intermediate scale tests although those tests have high uncertainty relative to the cable temperatures as discussed in Chapter 8. Hence, the recommended value for the electrical failure threshold is based on the minimum cable temperature at which substantive degradation was observed and should bound the effects of longer cable lengths exposed to fire.

9.2 Conclusions Regarding FR-II, FR-III and HT Insulations

All three of the other Kerite cable insulation formulations, FR-II, FR-II and HT, tested performed substantially better than did the FR insulation. None of these alternate formulations showed signs of the low-temperature degradation typical of the FR insulated cables. The test results and conclusions are summarized as follows:

- Only one example of an FR-II insulated cable was available for testing (Cable Item G). Testing included three trials of that cable. The FR-II cable samples showed detectable signs of electrical degradation only at temperatures of 341°C or higher. However, the initial degradation was relatively minor and no failures were observed until cable temperatures exceeded 374°C (or higher). On this basis, a failure threshold of 374°C is recommended for FR-II insulated cables.
- Three examples of an FR-III insulated cable were available for testing (Cable Items B, C and I), and all three examples performed quite consistently. The FR-III insulated cables showed no signs of early or low temperature degradation, failed consistently at temperatures of 384°C or higher, and often failed only after cable ignition had occurred. For the FR-III insulated cables, an electrical failure threshold of 384°C is recommended.
- Only one example of an HT insulated cable was available for testing (Cable Item K). Over the course of five trials of that cable, no signs of early or low-temperature degradation were observed. The cable performed quite similar to the FR-III insulated

cables. Electrical failures occurred abruptly at temperatures of 386°C or higher and often only after cable ignition had occurred. For the HT insulated cables, an electrical failure threshold of 386°C is recommended.

10 REFERENCES

1. **U.S. Nuclear Regulatory Commission**, Nowlen, S.P., Brown, J.W., Wyant, F.J., “Direct Current Electrical Shorting in Response to Exposure Fire (DESIREE-Fire): Test Results,” draft report, U.S. NRC, ADAMS Accession No. ML103230105, (2010).
2. Salley, M.H., “An Examination of the Methods and Data Used to Determine Functionality of Electrical Cables when Exposed to Elevated Temperatures as a Result of a Fire in a Nuclear Power Plant,” University of Maryland, MS Thesis, 2000.
3. **NUREG/CR-5655**, Jacobus, M.J., Fuehrer, G.F., *Submergence and High Temperature Steam Testing of Class 1E Electrical Cables*, May 1991.
4. **NUREG/CR-6850**, Nowlen, S.P., Najafi, B., et.al., *EPRI/NRC-RES Fire PRA Methodology for Nuclear Power Facilities*, a joint NRC – EPRI publication, , EPRI TR 1011989, Washington DC and Palo Alto CA, September 2005.
5. **SAND2010-4936**, Nowlen, S.P., and Brown, J., *A Preliminary Look at the Fire-Induced Electrical Failure Behavior of Kerite FR Insulated Electrical Cables - A Letter Report to the U.S. NRC/RES*, Sandia National Laboratories, Albuquerque, NM, July 2010.
6. **SAND92-1404C**, Nowlen, S.P. and M.J. Jacobus, *The Estimation of Electrical Cable Fire-Induced Damage Limits*, presented at Fire and Materials 1st International Conference and Exhibition, Sept. 24-25, 1992, Washington, DC.
7. **Inspection Manual Chapter**, IMC 0308, Attachment 3, Appendix F, Technical Basis for Fire Protection Significance Determination Process (IMC 0609, Appendix F) at Power Operations, CN Number 05-007, February 25, 2005.
8. **NUREG/CR-6931**, Nowlen, S. P., Wyant, F. J., *Cable Response to Live Fire (CAROLFIRE) Volume 1: Test Descriptions and Analysis of Circuit Response Data*, , Vol. 1, April 2008.
9. **EPRI TR 1003326**, *Characterization of Fire-Induced Circuit Faults – Results of Cable Fire Testing*, EPRI, Palo Alto, CA, Dec. 2002.
10. **NUREG/CR-6776**, Wyant, F.J., Nowlen, S.P., *Cable Insulation Resistance Measurements Made During Cable Fire Tests*, SAND2002-0447P, U.S. NRC, Washington DC, June 2002.
11. **IEEE Standard 450-2002**, *IEEE Recommended Practice for Maintenance, Testing, and Replacement of Vented Lead-Acid Batteries for Stationary Applications*, 2003.
12. **ASTM Standard E603-06**, *Standard Guide for Room Fire Experiments*, American Society of Testing and Materials, 100 Barr Harbor Drive, P.O. Box C700, West Conshohocken, PA 19428-2959, 2006.
13. Zumdahl, S.S., Zumdahl, S.A., *Chemistry*, Boston, Houghton Mifflin Company, 2000.

APPENDIX A: TEST SUPPORT SYSTEMS

A.1 Introduction

The appendix on test support systems provides the critical information necessary to conduct the experiments during both the DESIREE-Fire and KATE-Fire series. Included in the discussion are details on the cable monitoring equipment, circuits, data acquisition, data processing, and additional support systems. Since the KATE-Fire test series uses equipment from previously existing programs and published works (e.g., CAROLFIRE, DESIREE-Fire), this appendix seeks to summarize and incorporate the relevant main points found in previously published works without going into the same level of detail.

A.2 Direct Current Simulation Panels

The DCSim Panels were created for the DESIREE-Fire program in order to investigate the electrical performance of dc-powered circuits when their control cables are subjected to elevated thermal environments. This project provided a target opportunity to test in both the Penlight and intermediate-scale configurations. The circuits created for this testing includes:

- Two MOV
- Two SOV
- One large coil
- One 1-in. valve
- One Switchgear trip and close
- Intercable configuration

These circuits were housed within three separate metal chassis and all were commonly grounded for each test. Nearly all the dc-circuits were used to investigate the failure modes and effects of Kerite; however, since there was a limited amount of the donated cable the intercable configuration circuit was not used. What follows is a brief description of the circuits used to investigate the performance of Kerite. Additional detail on each dc-circuit and the battery bank may be found in NUREG/CR-7100 [1]¹³.

A.2.1 Direct Current (dc)-Powered Motor Operated Valve (MOV) Circuits

The line drawing for the dc MOV control circuit may be found in Figure A.1. From this figure, the positive (P) and the green lamp (G) conductors are connected to the positive side of the battery. The negative (N) conductor is connected to the G and red lamp (R) conductors through individual 1800 Ω resistors. The auxiliary contacts for the open (YO1) and close (YC1) coil conductors on the motor controllers are normally closed. Upon actuation of YC1, the contact for YO1 will open and the G and R conductors will remain in the same state, namely, closed and open, respectively. If YO1 actuates, contact for YC1 opens, the R closes, and the G opens. Table A.1 identifies the conductor-to-conductor interactions required to occur within a cable sample to cause a specific circuit malfunction, including spurious opening of the valve.

¹³ At the time of the printing of this document, NUREG/CR-7100 on DESIREE-Fire is pending publication.

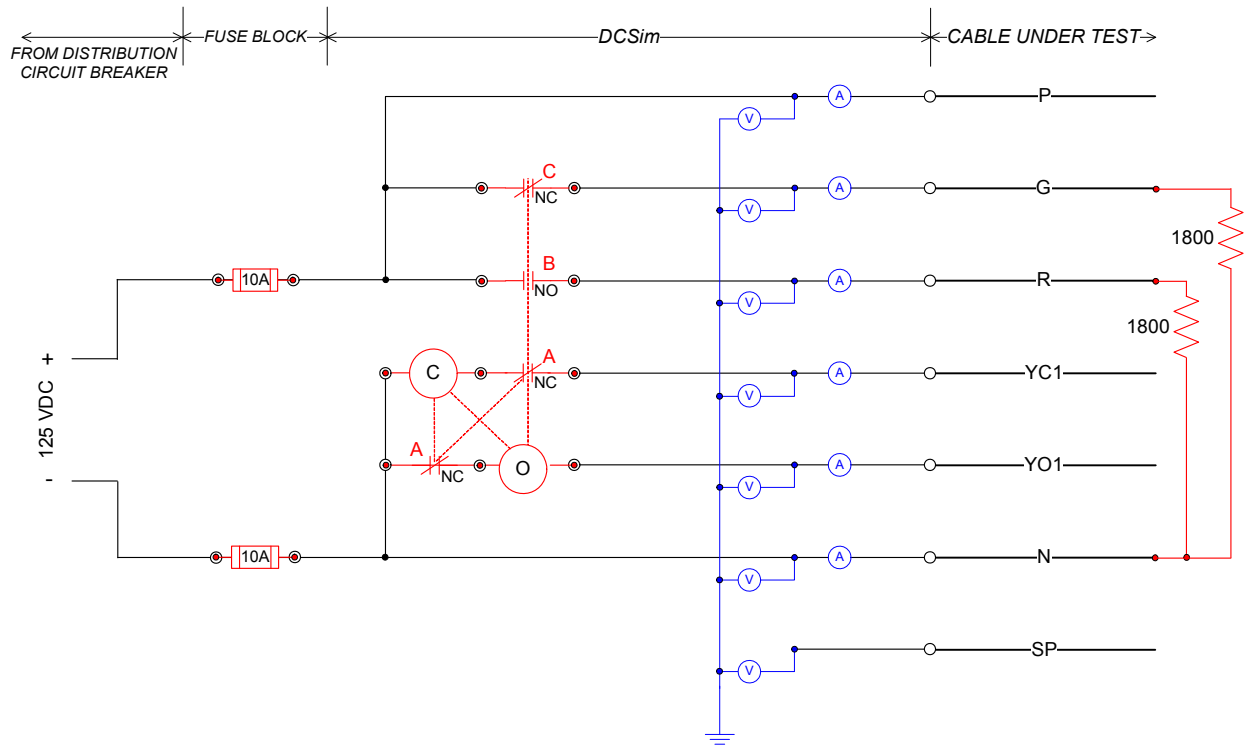

Figure A.1: DCSim panel layout for the control circuit on a dc MOV.

Table A.1: Identification of specific intracable induced circuit failure modes for the dc MOV.

| Circuit Failure Effect | Will occur if any of these conductors... | Come into contact with any of these conductors... | Notes |
|--|--|---|---|
| Valve spuriously opens | P, G | YO1 | |
| Loss of valve control | N | YO1, R | Circuit fuse(s) will blow if an attempt is made to open the valve while this internal short condition exists. |
| Loss of circuit power (blown fuse(s)) | P, G | N | |
| Erroneous/spurious valve position indication | P, G | R | |
| Loss of valve position indication | — | — | Open circuit failure of conductor G or N. |

It is also worthwhile noting that no immediate discernible effect occurs if conductors P, YO1, YC1, or R experience an open circuit failure (conductor break) as the initial failure mode.

The motor starters for MOV circuits were procured through Joslyn Clark¹⁴ and the details, including model numbers and description, may be found in Table A.2.

Table A.2: Description of the motor controller from Joslyn Clark, 250 Volts DC Max.

| <u>NEMA Size</u> | <u>Description</u> | <u>Reference No.</u> |
|------------------|-------------------------------|----------------------|
| 1 | Open Type dc Coil 2 Pole N.O. | 7401-1020-12 |
| 1 | N.O. & N.C. Aux | 5M65 |
| 1 | Mechanical Interlock | 5999-4737 |
| 1 | Reversing Base Plate | 23082.79-1 |

To confirm proper circuit wiring, a procedure was followed to verify current and voltage readings for both circuits. The results of the testing were as anticipated; however, they did not reveal a defect with one of the connected motor controllers. This defect was not observed until a subsequent equipment analysis.

As a part of post-test data analysis, pick-up and drop-out voltage tests were conducted for each of the four individual relay contactor units and the results are summarized in Table A.3. This was not performed before testing because the relay contactor units were delivered by Joslyn-Clark nearly three months late. By the time the units arrived, construction of the entire set of dc surrogate circuits had been completed (with the exception of these relays), and all preparations for testing had been completed. A decision was made to measure the coil resistance for each unit, but to defer the pick-up and drop-out testing and proceed with testing.

Table A.3: Coil characterizations for dc MOV.

| Device | Cold Coil Resistance | Average Pickup Voltage (Vdc) | Average Pickup Current (A) | Average Dropout Voltage (Vdc) | Average Dropout Current (A) |
|--------------|----------------------|------------------------------|----------------------------|-------------------------------|-----------------------------|
| MOV1 (open) | 154.9 | 29.0 | 0.1785 | 26.6 | 0.1625 |
| MOV1 (close) | 154.6 | 89.3 | 0.4873 | 4.8 | 0.0263 |
| MOV2 (open) | 155.3 | 50.7 | 0.2867 | 7.3 | 0.0420 |
| MOV2 (close) | 155.3 | N/A | N/A | N/A | N/A |

The close contactor unit for MOV2 was found to not have a metal slug as part of its movable core assembly. Thus it was incapable of operating when the coil was energized.

During the post-test examination, three of the four in-service relay contactor units tested out as expected, but the fourth unit, the “close” unit in circuit MOV2, failed to pick up (close) despite

¹⁴ Additional information may be ascertained from the Joslyn Clark catalogue which is available at <http://www.joslynclark.com/downloads.htm>.

application of up to 170 Vdc. An external physical inspection revealed no obvious flaw and the contactor could be closed manually. Also, the voltage and current observed during the pick-up test indicated that the relay coil was in place and operating as expected. A coil resistance measurement also yielded a value that was consistent with pre-test readings.

At this point a decision was made to disassemble the non-functional unit. A second working unit was also disassembled for comparison. This inspection revealed that the moving core was missing from the non-functional unit. Figure A.2 shows the functional unit with the moving core in place and Figure A.3 shows the non-functional unit with the moving core absent. Figure A.4 shows the two units side by side. The relay was received from the manufacturer without the moving core. An inspection was also performed for a fifth (spare) relay contactor unit, and it was found that the spare contactor was also missing the moving core. Hence, two of five relay contactor units obtained directly from Joslyn-Clark were non-functional.

The implications for the data analysis are summarized as follows:

- Circuit MOV1 is not effected in any way.
- For circuit MOV2, the “open” contactor was fully functional but the “close” contactor was a non-functional passive coil target only. The “close” contactor was present as an inductive load on the circuit, but the relay would never have closed during testing.
- The data can still be analyzed and interpreted, including for spurious actuations, but the following cases need to be considered:
 - Given an initial hot short to the close coil, the electrical and mechanical interlocks will not engage. A subsequent hot short to the open coil would cause the open coil to close and would trip the close coil out of the circuit via the electrical interlock.
 - Given an initial hot short to the open coil, the open contactor would close, triggering both the mechanical and electrical interlocks. A subsequent hot short to the close coil would behave exactly as if the close contactor was fully functional (i.e., there would be an indication of voltage applied to that circuit path but no current flow).
 - Overall, it was not possible to electrically engage (i.e., induce current flow) in both the open and close coils simultaneously despite the non-functional close contactor unit.

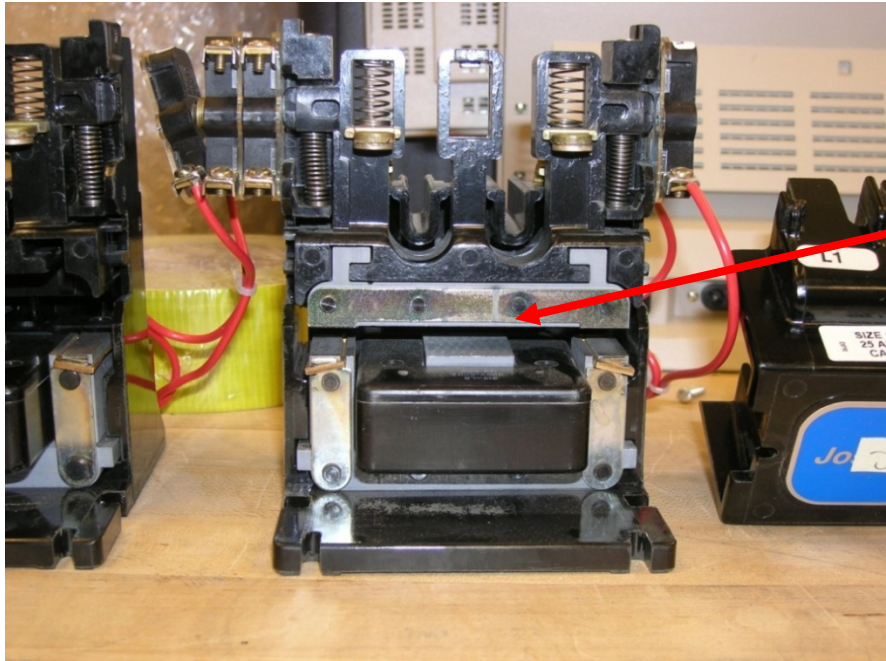

Moving core present
in operational motor
control contactor
unit

Figure A.2: Open motor controller with functional moving core for the MOV2 circuit.

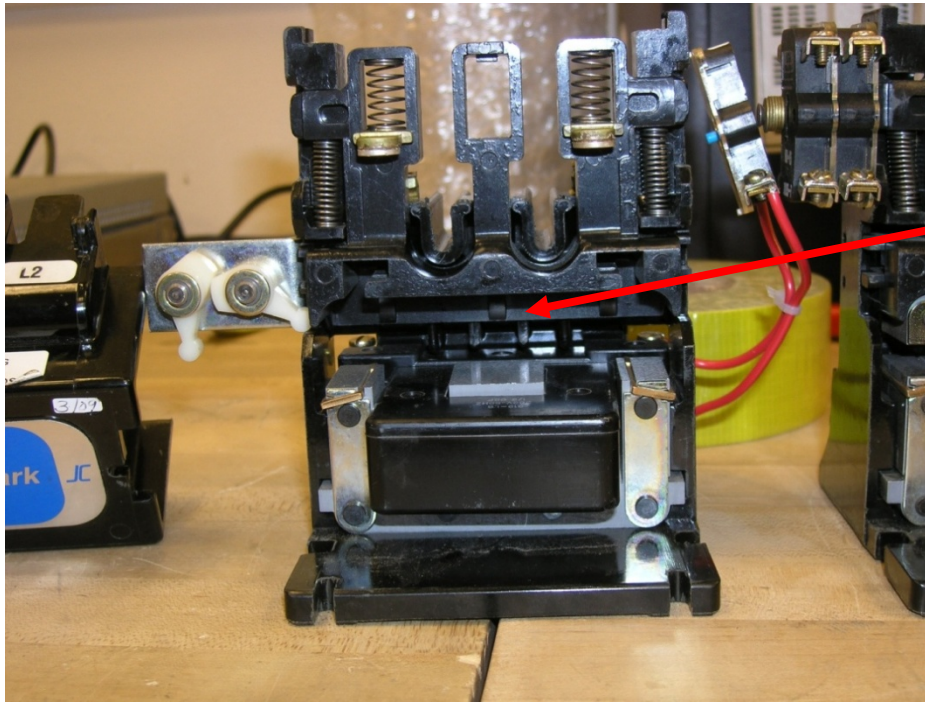

Moving core absent
from non- operational
motor control contactor
unit

Figure A.3: Close motor controller missing the metal driver for the moving core for the MOV2 circuit.

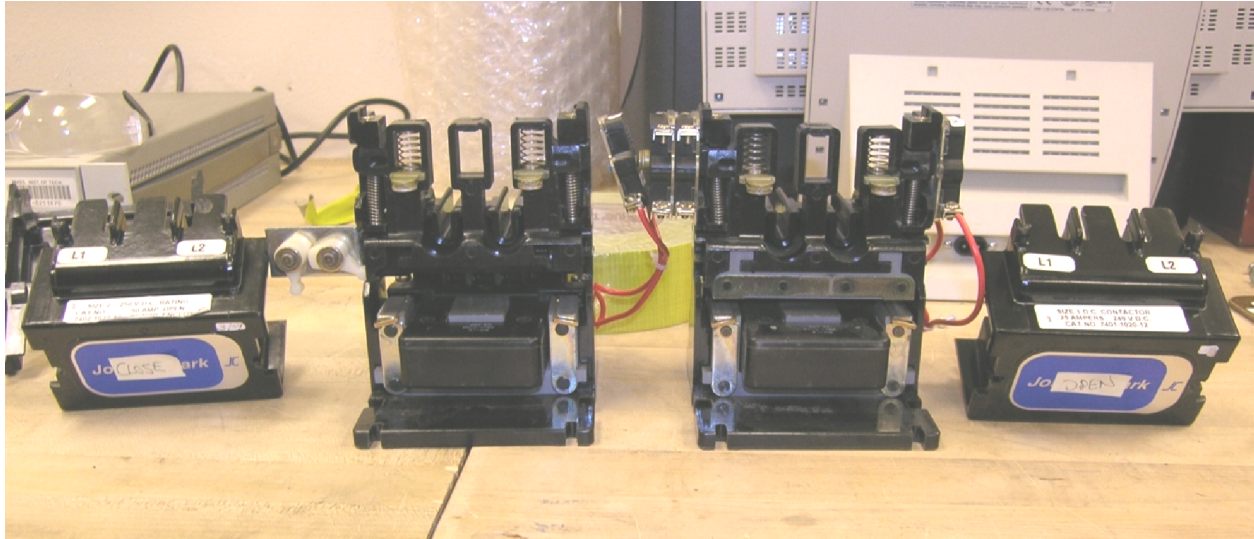

Figure A.4: Side-by-side comparison of the open and closed motor contactors for the MOV2 circuit.

A.2.2 dc-Powered Solenoid-Operated Valve (SOV) Circuits

The line drawing for the dc SOV control circuit may be found in Figure A.5. From this figure, the positive (P), source (S1), and the green lamp (G) conductors are connected to the positive side of the battery. The negative (N) conductor is connected to the G and red lamp (R) conductors through individual 1800 Ω resistors. If the conductors connected to the positive side of the battery bank short to the solenoid (S2) conductor, a spurious operation may occur.

The small solenoid valve is shown in its normally closed position. Table A.4 identifies the conductor-to-conductor interactions required to occur within test cable to cause a specific circuit failure mode, including spurious opening of the valve. It is also worthwhile noting that no immediate discernible effect occurs if conductors P, N, S1, S2, or R experience an open circuit failure (conductor break) as the initial failure mode.

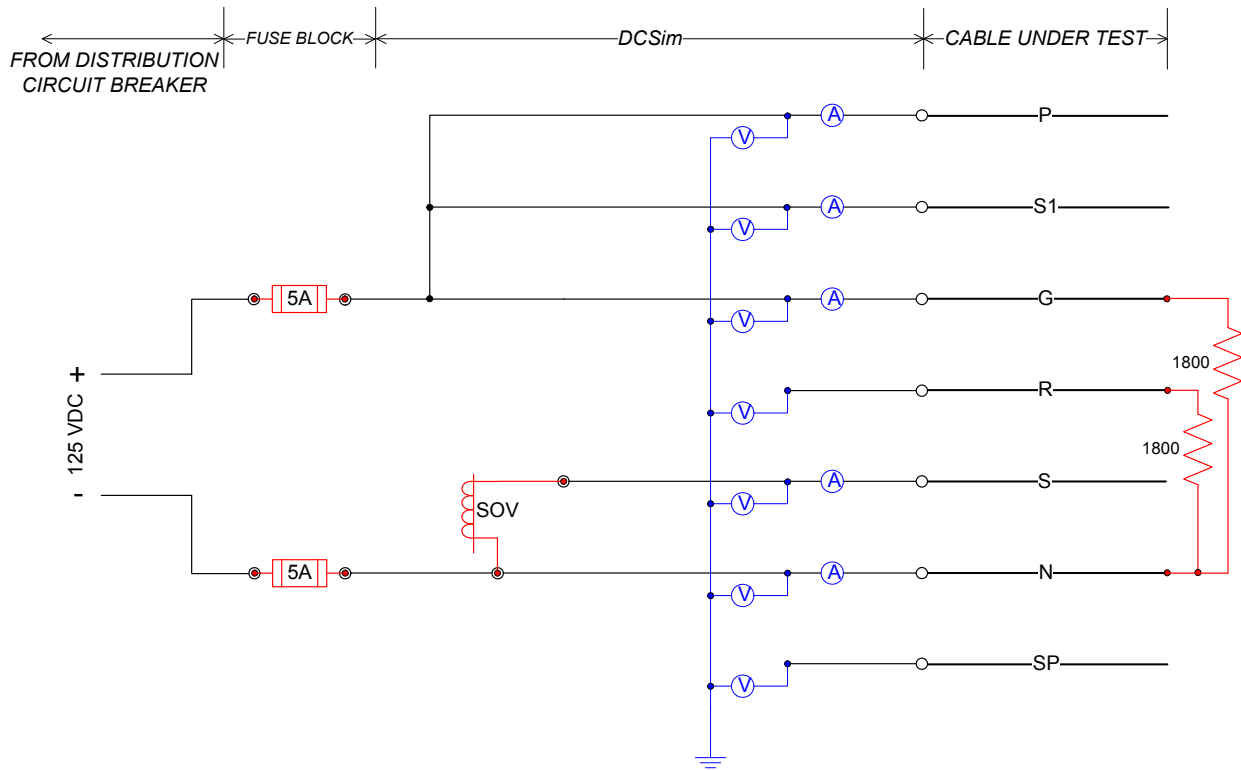

Figure A.5: DCSim panel layout for a small SOV dc circuit.

Table A.4: Identification of specific intracable induced circuit failure modes for the small SOV.

| Circuit Failure Effect | Will occur if any of these conductors... | Come into contact with any of these conductors... | Notes |
|--|--|---|---|
| Valve spuriously opens | P, S1, G | S2 | |
| Loss of valve control | N | S2, R | Circuit fuse(s) will blow if an attempt is made to open the valve while this internal short condition exists. |
| Loss of circuit power (blown fuse(s)) | P, S1, G | N | |
| Erroneous/spurious valve position indication | P, S1, G | R | |
| Loss of valve position indication | — | — | Open circuit failure of conductor G. |

The SOV circuits utilized two ASCO RedHat¹⁵ general service solenoid valves throughout the testing program. Information for these two solenoids may be found in Table A.5.

Based on recommendations from the peer review committee, SOV2 used a continuous-duty Class H coil. Continuous-duty Class H coils are required for battery-charging circuits where wider voltage ranges are typically encountered. Based on the manufacturer’s literature, the Class H coils will accommodate continuous duty over a wider voltage range; namely, 12% over normal and 28% under normal rated coil voltage. For a nominal 125-Vdc coil, this translates to a voltage range of 90 to 180 Vdc.

Table A.5: Description of the RedHat SOV.

| Circuit | Item | Series | Part Order Number |
|---------|---|-------------------------|-------------------|
| SOV1 | Solenoid Operated Valve | ASCO RedHat Series 8320 | 8320G172 |
| SOV2 | Solenoid Operated Valve with Class H Coil | ASCO RedHat Series 8320 | EFHT8320G172 |

Also note that the wiring of the dc SOVs was not polarity-specific. That is, the two lead wires to the solenoid coil could be connected without consideration of the power source polarity. A member of the peer team clarified that dc solenoids are often configured with an integral (internal) rectifier, so that they will operate correctly regardless of whether the source applied is alternating current (ac) or dc, and regardless of the dc polarity applied. The SOVs used in DESIREE-Fire appear to be of this type (internally rectified). Hence, a “reverse polarity” dc hot short on an SOV such as those tested here would still cause a spurious operation. A reverse polarity short on a dc solenoid without the internal rectifier would not cause a spurious operation.

Note that the test data has been reviewed for this effect, and no cases were observed that appeared to involve a reverse polarity short to the SOVs. Given the test configurations, a reverse polarity short would require, at a minimum, the following events to occur:

- A positive source conductor must short to the (nominally) negative side of the valve coil. That is, a positive source must short to either conductor N or G as shown in the circuit schematic, thereby “back-feeding” a positive potential to the nominally negative side of the coil. Further, this short circuit must result in clearing of the negative fuse for this circuit (i.e., instead of the positive fuse). Note that the positive source could come from intracable shorting (i.e., with conductor S1) or from intercable shorting to a second cable.

¹⁵ Additional information may be ascertained from the ASCO catalogue, which is available at <http://www.ascovalvet.com/AscoValvet/Applications/LiteratureRequest/PublicSite/LRPublicWeb.aspx?action=add>.

- Because the negative fuse must clear, an independent negative energizing source would need to come into contact with the (nominally) positive side of the valve coil (conductor S2). Given the test configuration, this would require either an intercable hot sort or multiple shorts to ground on the negative battery potential that included conductor S2.

The SOV solenoids were electrically characterized following the intermediate scale tests in order to determine their actual pick-up and drop-out voltage and current thresholds. Table A.6 provides a summary of each SOV’s electrical characteristics. Note that the two valves have essentially identical electrical characteristics; that is, the Class H coil appears to have no impact on pick-up voltage, pick-up current, or drop-out voltage.

Table A.6: Coil characterizations for small dc SOV devices.

| Device | Cold Coil Resistance | Average Pick-up Voltage (Vdc) | Average Pick-up Current (A) | Average Dropout Voltage (Vdc) | Average Dropout Current (A) |
|--------|----------------------|-------------------------------|-----------------------------|-------------------------------|-----------------------------|
| SOV1 | 1280 | 56.9 | 0.042 | 43.8 | 0.033 |
| SOV2 | 1270 | 55.2 | 0.042 | 43.8 | 0.033 |

A.2.3 dc-Powered 1-in. Valve and Large Coil

Two valves were obtained for the purposes of DESIREE–Fire, namely a “1-in. valve” and a “Large Coil.” The line illustrations providing the overall description of the 1-in. valve circuit may be found in Figure A.6. From this figure, the positive (P) and the green lamp (G) conductors are connected to the positive side of the battery. The negative (N2) conductor is connected to the G and red lamp (R) conductors through individual 1800 Ω resistors. Although this drawing is pictured with the open and close contacts, during one of the DESIREE-Fire tests the R contact fused closed effectively modifying it to be a positive source. If the conductors connected to the positive side of the battery bank short to the solenoid (S) conductor, a spurious operation may occur.

The 1-in. valve is shown in its normally closed position. Table A.7 identifies the conductor-to-conductor interactions required to occur within test cable to cause a specific circuit failure mode, including spurious opening of the valve. It is also worthwhile noting that no immediate discernible effect occurs if conductors P, N1, N2, or R experience an open circuit failure (conductor break) as the initial failure mode.

The line drawing for the Large Coil control circuit may be found in Figure A.7. From this figure, the positive (P) and the green lamp (G) conductors are connected to the positive side of the battery. The negative (N2) conductor is connected to the G and red lamp (R) conductors through individual 1800 Ω resistors. If the conductors connected to the positive side of the battery bank short to the solenoid (S) conductor, a spurious operation may occur.

The Large Coil is shown in its normally closed position. Table A.8 identifies the conductor-to-conductor interactions required to occur within test cable to cause a specific circuit failure mode, including spurious opening of the valve. It is also worthwhile noting that no immediate discernible effect occurs if conductors P, N1, N2, or R experience an open circuit failure (conductor break) as the initial failure mode.

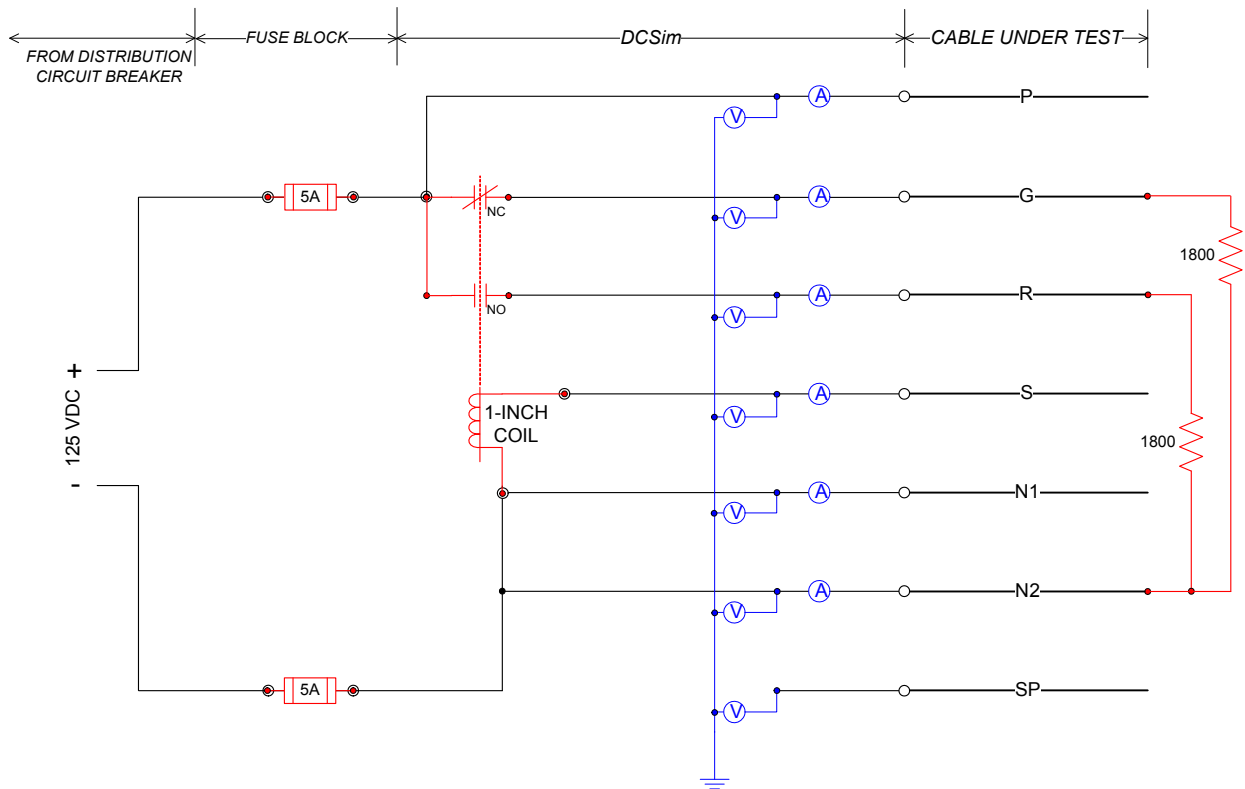

Figure A.6: Line drawing of the DCSim panel layout for a 1-in. valve circuit.

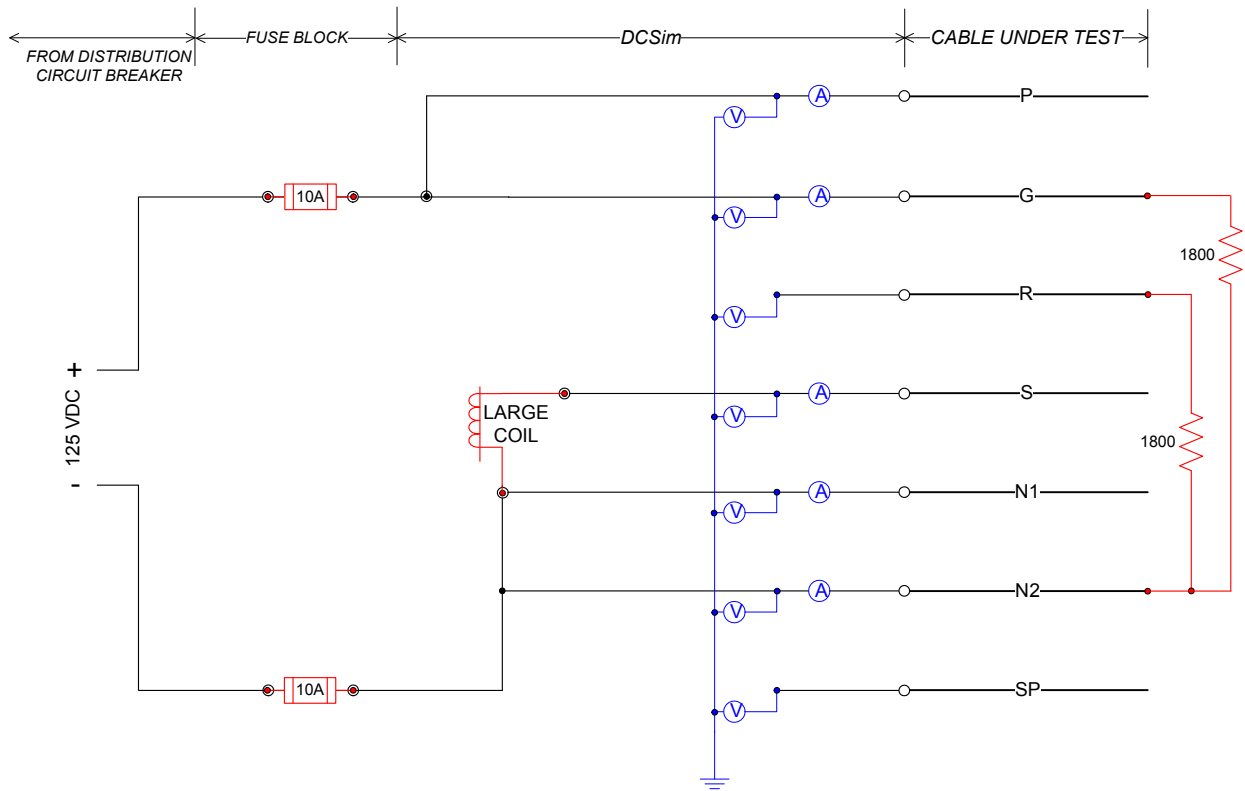

Figure A.7: Line drawing for the dc large coil circuit.

Table A.7: Identification of specific intracable induced circuit failure modes for the 1-in. valve.

| Circuit Failure Effect | Will occur if any of these conductors... | Come into contact with any of these conductors... | Notes |
|--|--|---|---|
| Valve spuriously opens | P, G, R | S | |
| Loss of valve control | N1, N2 | S, R | Circuit fuse(s) will blow if an attempt is made to open the valve while this internal short condition exists. |
| Loss of circuit power (blown fuse(s)) | P, G, R | N1, N2 | |
| Erroneous/spurious valve position indication | P, G, R | R | |
| Loss of valve position indication | — | — | Open circuit failure of conductor G. |

Table A.8: Identification of specific intracable induced circuit failure modes for the Large Coil.

| Circuit Failure Effect | Will occur if any of these conductors... | Come into contact with any of these conductors... | Notes |
|--|--|---|---|
| Valve spuriously opens | P, G, R | S | |
| Loss of valve control | N1, N2 | S, R | Circuit fuse(s) will blow if an attempt is made to open the valve while this internal short condition exists. |
| Loss of circuit power (blown fuse(s)) | P, G, R | N1, N2 | |
| Erroneous/spurious valve position indication | P, G, R | R | |
| Loss of valve position indication | — | — | Open circuit failure of conductor G. |

The 1-in. valve solenoid was electrically characterized following the intermediate-scale tests in order to determine its actual pick-up and drop-out voltage and current thresholds. Table A.9 provides a summary of the SOV's electrical characteristics. Since it has no moving parts to determine when pick-up or drop-out occurs, the large coil was not characterized electrically.

Table A.9: 1-in. valve solenoid and Large Coil characterizations.

| Device | Cold Coil Resistance | Average Pick-up Voltage (Vdc) | Average Pick-up Current (A) | Average Dropout Voltage (Vdc) | Average Dropout Current (A) |
|------------|----------------------|-------------------------------|-----------------------------|-------------------------------|-----------------------------|
| 1-in. coil | 158.8 | 47.9 | 0.30 | 17.2 | 0.11 |
| Large Coil | 36 | N/A | N/A | N/A | N/A |

A.2.4 4.16 kV GE PowerVac® Breaker

A refurbished medium voltage circuit breaker configured with a 125-VDC control circuit that uses 20-A and 35-A fuses for the close and trip circuits was donated through the EPRI

collaboration. The breaker was a 5 kV class GE PowerVac[®], Model VB1-4.16-250, 1200 A, 4.16 kV.

From the manufacturer's summary description, the vacuum circuit breaker uses sealed vacuum power interrupters to establish and interrupt a primary circuit. Primary connections to the associated metalclad switchgear are made by horizontal bars and disconnect fingers, electrically and mechanically connected to the vacuum interrupters. The operating mechanism provides direct motion at each phase location in order to move the movable contact of the vacuum interrupters from an open position to a spring-loaded closed position and then back to the open position on command.

The ML-18 and ML-18H mechanisms are of the stored-energy type and use a gear motor to charge a closing spring. During a closing operation, the energy stored in the closing spring is used to close the vacuum interrupter contacts, compress the wipe springs that load the contacts, charge the opening spring, and overcome bearing and other friction forces. The energy then stored in the wipe springs and opening spring will open the contacts during an opening operation.

Closing and opening operations are controlled electrically by the metalclad switchgear or remote relaying. Mechanical control is provided by manual close and trip buttons on the circuit breaker. The closing spring may be manually charged.

Figure A.8, Figure A.9, and Figure A.10 provide representative drawings for the new switchgear.

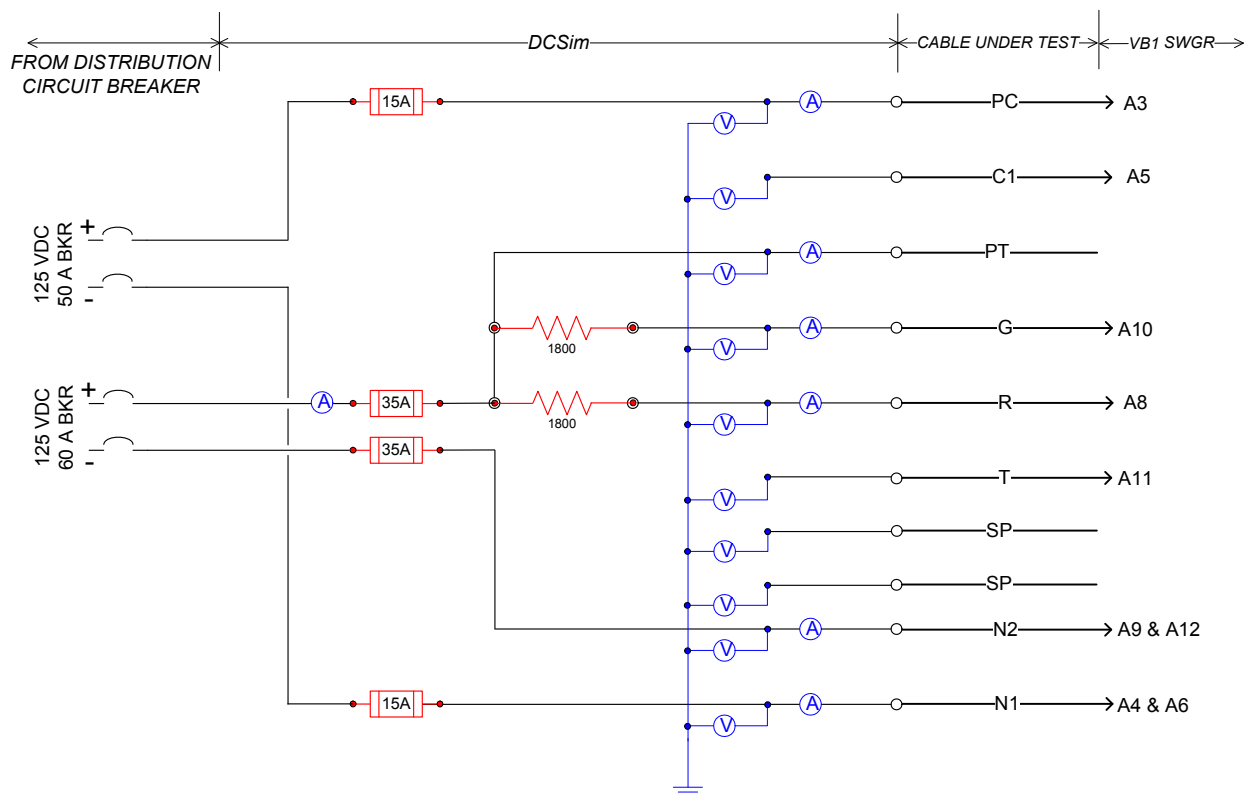

Figure A.8: DCSim panel layout for the control circuit on the GE VB1 switchgear dc control circuit.

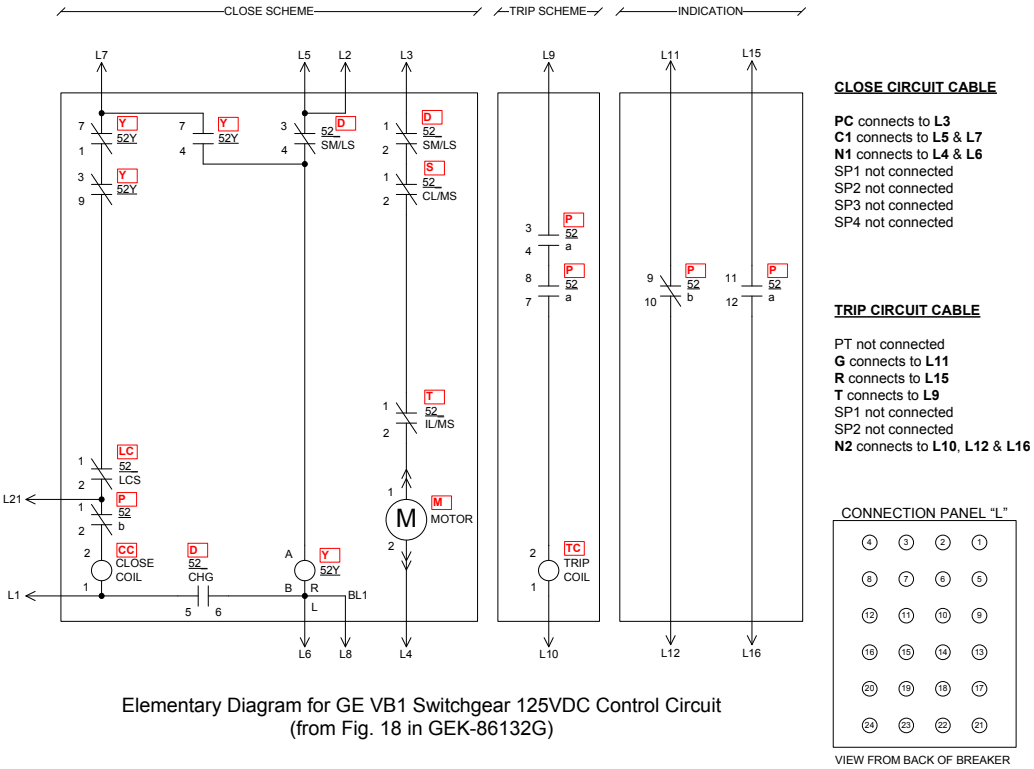

Figure A.9: GE VB1 4.16 kV circuit breaker elementary diagram.

CLOSE CIRCUIT CABLE

PC connects to L3
C1 connects to L5 & L7
N1 connects to L4 & L6
SP1 not connected
SP2 not connected
SP3 not connected
SP4 not connected

TRIP CIRCUIT CABLE

PT not connected
G connects to L11
R connects to L15
T connects to L9
SP1 not connected
SP2 not connected
N2 connects to L10, L12 & L16

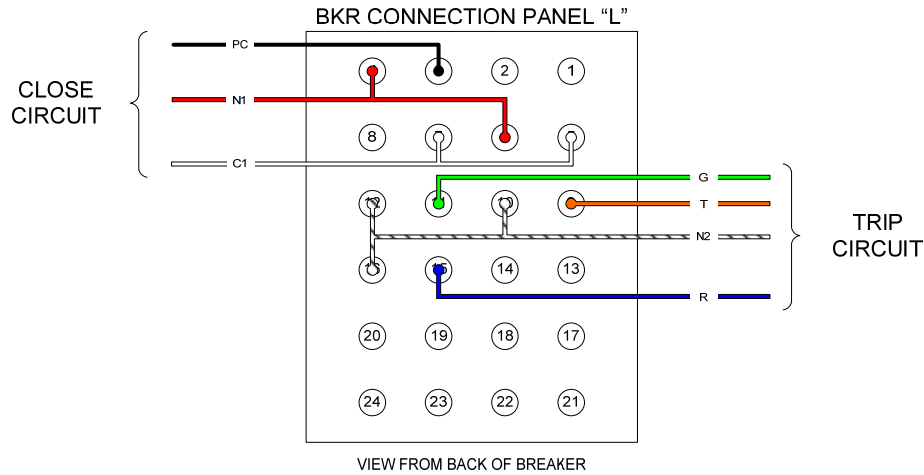

Figure A.10: GE VB1 4.16 kV circuit breaker connection diagram.

A.2.5 The Battery Bank and Power Distribution System

A.2.5.1 Overview

The battery bank was built to supply a nominal 125-Vdc power source. The batteries were obtained through the EPRI memorandum of understanding (MOU) and were being taken out of service from the North Anna Nuclear Station Technical Support Center as a part of preventative maintenance. The battery cells had reached their nominal end-of-life conditions, but were still in serviceable condition and were transported to Sandia National Laboratories (SNL) for use in this test project.

A.2.5.2 Basic Design Parameters

The dc power supply battery bank was constructed using a set of Exide model ES-13 calcium alloy flat plate, wet-acid, nominal 2.1-Vdc uninterruptible power supply (UPS) battery cells. Each cell contains approximately 9.1 liters (2 gallons) of sulfuric acid as the electrolyte. A total of 60 cells were used in the main battery bank and were connected intercell in series using lead-plated copper bars. Eight spare cells were also available, but were not used in the program as no cell failures occurred during testing.

Before installation, all of the individual battery cells were tested by an independent testing laboratory using IEEE Standard 450-1995 [2]. All of the cells used in testing, including the spare cells, were certified as being in good working condition.

Cell handling was performed in accordance with IEEE Standard 484-2002 [3]. Load/capacity calculations were performed in accordance with IEEE Standard 485-1997 [4].

The basic design parameters of the battery bank are summarized as follows:

- Cell type: Exide ES-13, calcium alloy acid-filled cells
- Nominal open circuit voltage: 2.06 V
- Nominal cell float voltage: 2.17–2.26 V
- Total cell count in main battery bank: 60
- Nominal bank float voltage: 125 V
- Available short circuit current at the battery terminals: approximately 13,680 A
- Cell-to-cell connections: Exide lead-plated copper bars and bolts

Table A.10 provides additional physical information for the individual battery cells as provided by Exide.

Table A.10: Exide battery cell description from the manufacturer's literature.

| Model type | Overall dimensions (mm) | | | Weights (kg) | | Volume (liters) |
|------------|-------------------------|-------|--------|--------------|-------------|------------------|
| | Length | Width | Height | Cell Only | Electrolyte | Electrolyte only |
| ES-13 | 124 | 274 | 475 | 36.7 | 9.1 | 7.6 |

A.2.5.3 Battery Banking Housing and Connections

The battery cells were installed in a portable transportainer providing personnel protection, spill containment (in the event of a cell leak or rupture), environmental protection to the cells, and the ability to transport the cells between testing sites. The transportainer was provided with both heating and cooling to ensure that the cells did not deviate from the manufacturer-specified operating or storage conditions. Figure A.11 provides a nominal schematic of the battery cell layout within the transportainer.

Intercell connections were removed during transport. Once in place on site, the intercell connection plates were installed in accordance with manufacturer specifications. The connections were also tested for continuity using a micro-ohm meter and in accordance with manufacturer specifications. Any out of compliance connections were reworked to ensure an acceptable level of terminal-to-terminal resistance and consistency between connections. Figure A.12 provides a photograph of the battery cells during work to install the cell-to-cell connector plates.

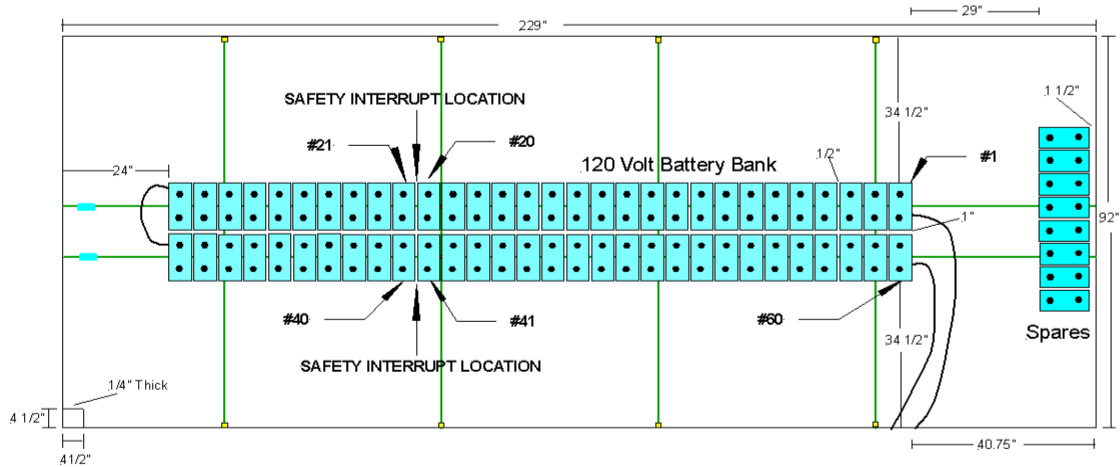

Figure A.11: Battery enclosure layout.



Figure A.12: Photo of the battery assembly.

An automatic charging system capable of recharging the cells over night was also installed. The charger was capable of providing both a freshening charge and float charging. All cells received a freshening charge when they arrived at SNL. Once installed, the battery bank also received a freshening charge. The bank was then recharged periodically throughout the course of testing. In general, the bank would be recharged at least weekly during the small-scale tests where the loads on the cells were relatively modest. During the larger-scale tests, the cells would be charged as a minimum after completion of two tests. The charger was secured and disconnected from the battery bank during testing.

The battery bank was ungrounded, although ground faults during testing were expected and a ground-fault monitoring circuit was included in the test design and monitored during testing.

A.2.5.4 Power Distribution

The battery bank was connected to the DCSim panels via a series of fuses and breakers. The power distribution system is illustrated schematically in Figure A.13. In order, progressing from the battery cells to the DCSim panels, were the following electrical features:

- The main terminal of the battery bank was connected to the power distribution system via two single-conductor 4/0 power cables (the battery bank was ungrounded).
- A primary disconnect switch.
 - 250 - 125 Vdc bus - 200-A contacts.
- 200-A fuse on each of the main output cables.
 - Two each Littelfuse fuse, part number JTD-200ID.
- A dc breaker panel with separate breakers for each test branch circuit.
 - Two-pole dc circuit breakers rated at 250 Vdc.
 - Circuit breaker capacities range from 30 A to 60 A depending on the specific circuit.
- 3/C, 8 AWG power cables connecting the dc breaker panel to the DCSim panels (each test circuit was serviced by an individual cable).
- A fuse on each incoming power feed cable to the DCSim panel.
 - Fuse sizes are specific to each test circuit. Refer to the corresponding circuit descriptions for details.
- 12 AWG cables connecting the DCSim panels to the test cables.

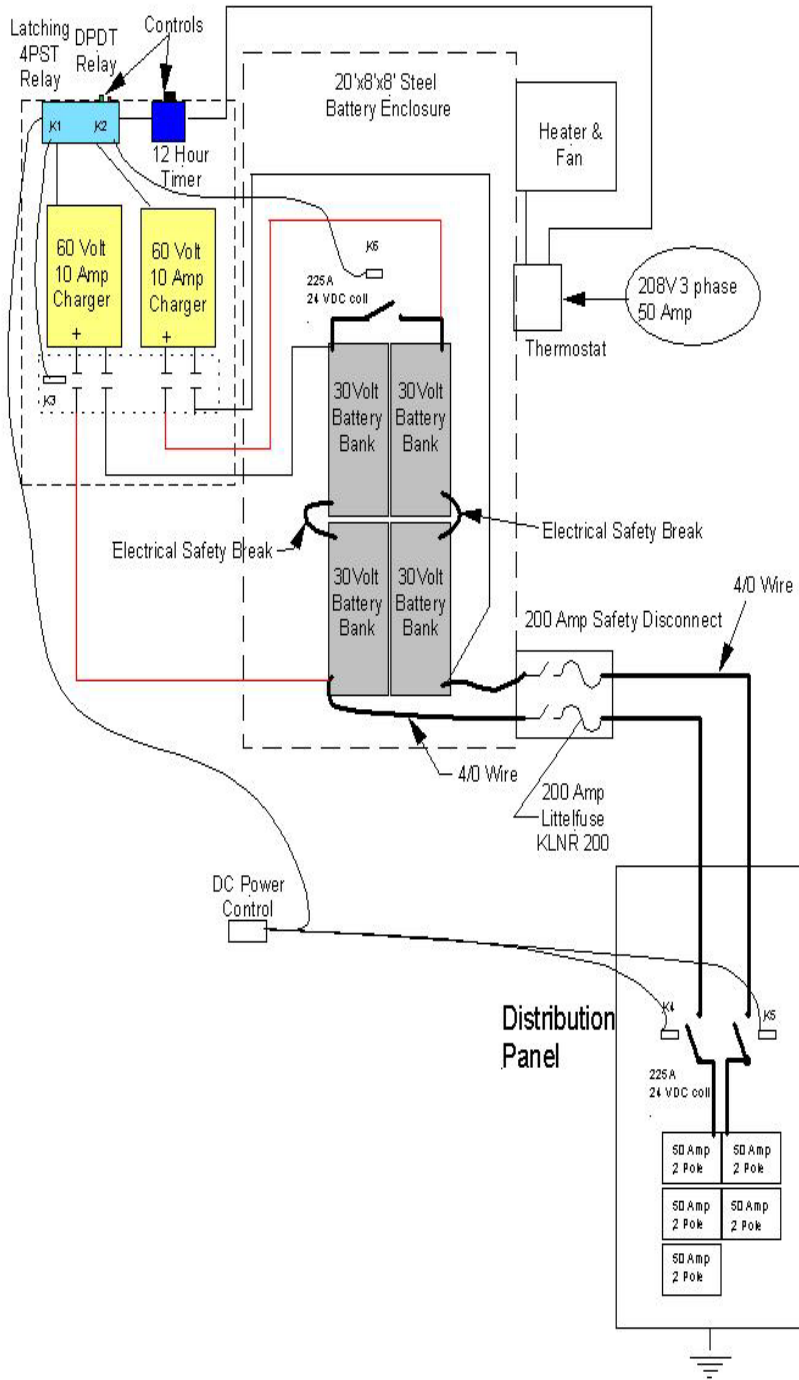
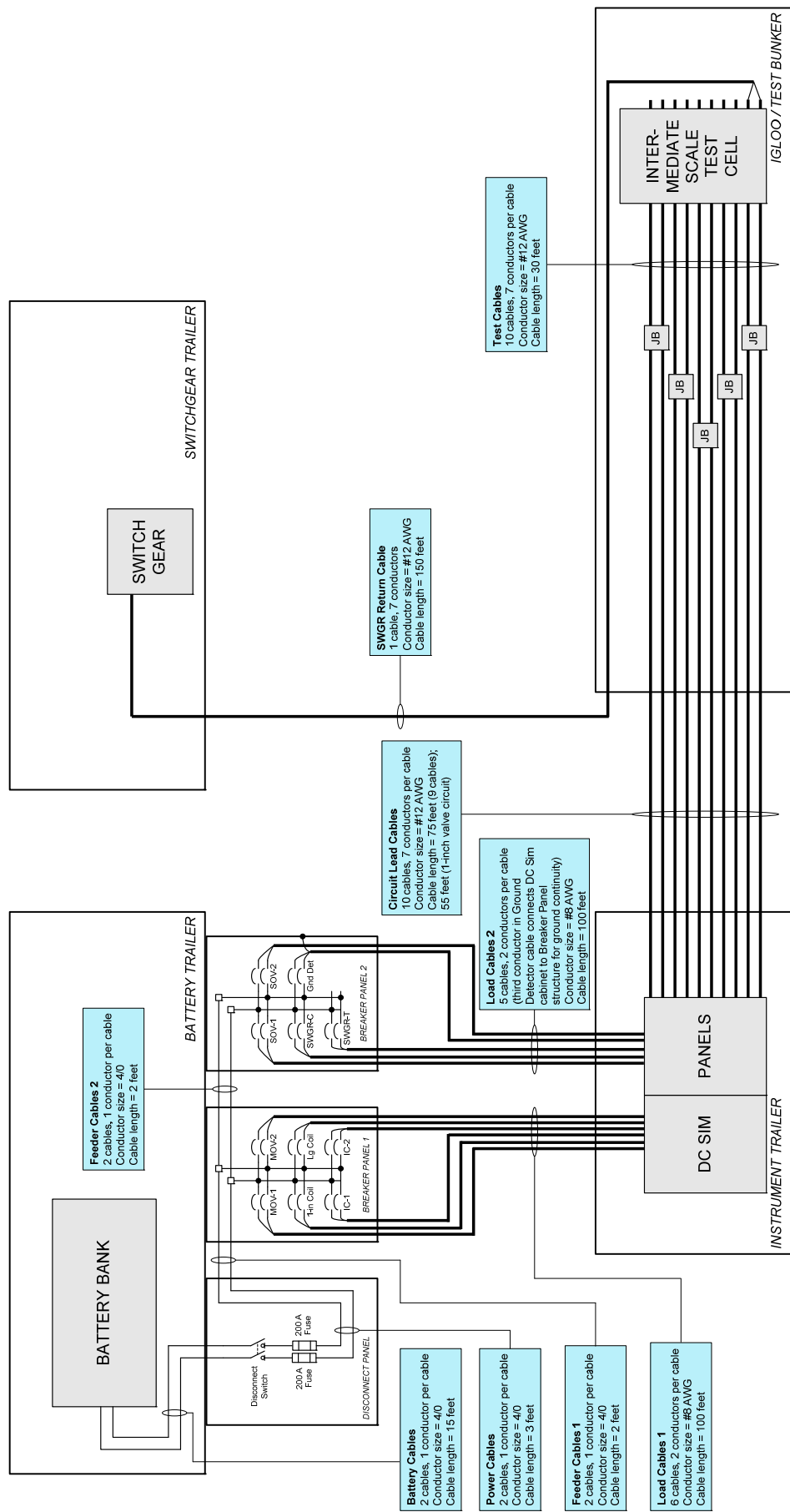

Figure A.13: Power skid schematic for the dc battery bank.



11/23/2009

Figure A.14: Battery bank power connection layout for the intermediate-scale tests.

Figure A.14 provides a second schematic of the connections and cable lengths for each connection from the battery to the DCSim panels and to the test cables, including the lead cable to the switchgear unit itself. This figure includes specification of each cable's wire gauge and length (e.g., for use in calculating voltage drops).

It should be noted that for each of the test circuits, the primary circuit protection is provided by the individual circuit fuses. These fuses are intended to represent typical plant practices. The other circuit protection features (i.e., the breakers, 200-A main output fuses, and primary disconnect switch) are all provided for personnel protection and safety. These additional protective devices were selected to provide appropriate breaker-fuse coordination, but are not intended to represent in-plant practice.

A.2.5.5 Battery Bank Ground Fault Detection Circuit

The dc battery bank was nominally an ungrounded power supply system. A ground fault detection circuit provided the opportunity to monitor for shorts between the battery bank and ground (ground faults). Figure A.15 illustrates the line drawing for this circuit.

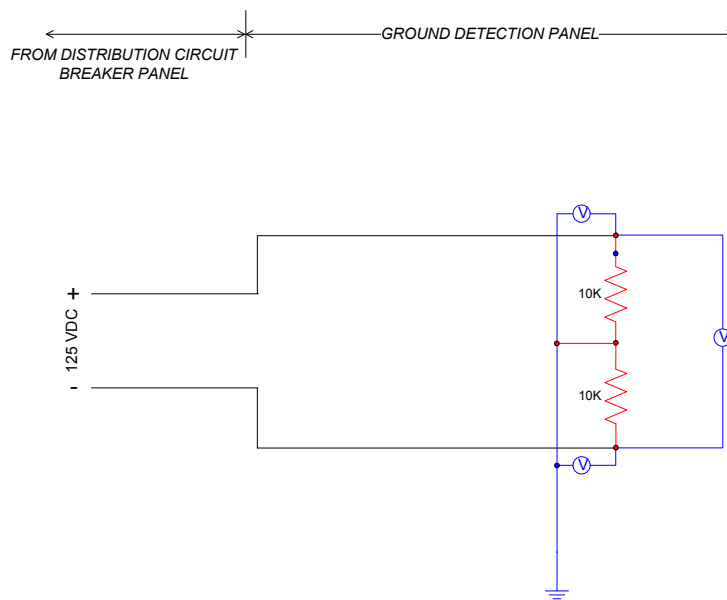

Figure A.15: Line drawing for the dc ground detection circuit

In practice, the ground detection circuit provides a monitored high-resistance (10,000 Ω) path between each side of the battery bank and the local ground plane. Under normal conditions (i.e., no ground faults present) the voltage monitor on the far right will read the full 125 Vdc battery voltage, and each of the other two voltage transducers, those measuring across the two ballast resistors, will read exactly one-half that value. Should a ground fault occur on either side of the battery bank, the overall bank voltage will not change; however, the voltages across the ballast resistors will both change. If, for example, there is a ground fault on the positive leg of the battery bank, the voltage across the positive-side ballast resistor will drop to zero, and that across the resistor on the negative side will rise to the full battery bank potential of 125 Vdc.

To ensure proper operation, all experimental systems and equipment were connected to a common ground plane (e.g., facility ground). The voltage transducers for the various dc circuit simulator panels measured circuit path voltages relative to this same common ground plane.

A.3 Alternating Current (ac) Powered Surrogate Circuit Diagnostic Unit

Figure A.16 shows the simulated MOV control circuit that was employed during the CAROLFIRE tests. An ac power source, an 1800 Ω resistor representing an indicator lamp, and two relay coil targets are connected to the simulated circuit. A seven-conductor cable connected to the Surrogate Circuit Diagnostic Unit (SCDU) is the device under test. Although it is possible to encounter a circuit in a NPP that is supplied with power directly for a power source, typically a CPT is used. In the SCDU chassis, four different circuits are used to monitor a cable's performance throughout fire exposure. The primary difference between each circuit is the CPT size. SCDU1 uses a 100 VA CPT, SCDU2 uses a 150 VA CPT, SCDU3 uses a 200 VA CPT, and SCDU4 uses a 75 VA CPT. All CPTs are grounded. Additional information may be found in NUREG/CR-6931 [5].

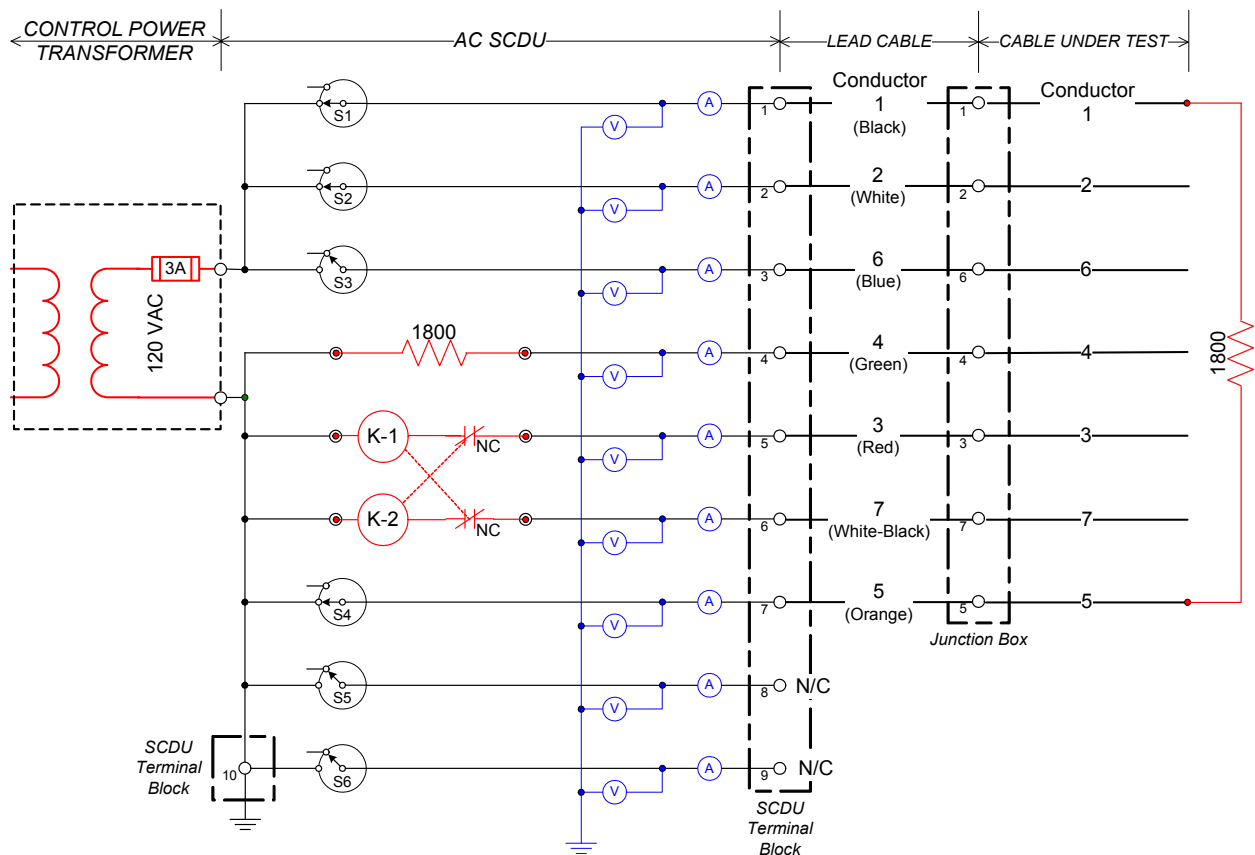

Figure A.16: Simulated ac MOV control circuit, with CPT, for typical cable tests.

The motor starters used during CAROLFIRE were, in hindsight, found to require far less motive power to lock in and hold a spurious actuation signal than anticipated. The intent in CAROLFIRE had been to obtain motor starters that required a nominal 100 VAC of power to

lock in a relay actuation. In practice, while the relays obtained were cited as 100 Vac relays, it actually took a much smaller power level to lock in an actuation (on the order of 60 Vac). As a result, CAROLFIRE was unable to resolve one of the original Regulatory Information Summary (RIS) 2004-03, “Risk-Informed Approach for Post-Fire Safe-Shutdown Circuit Inspections,” unresolved issues; namely, that item related to how CPT size relative to the nominal circuit required power would impact spurious actuation likelihood. The CPT units used in CAROLFIRE were sized against the anticipated 100-Vac power requirement for the relays. Given the actual power requirement of the relays, the CPTs were, in effect, over-sized. As a result, the CAROLFIRE tests did not experience the same type of CPT power drawdown observed in the original NEI/EPRI testing program.

The existing motor starter relays were replaced with Joslyn-Clark¹⁶ (current part number is T30U031) for the DESIREE-FIRE test series. SCDU1 and SCDU2 were replaced with the original motor starter sets used during the NEI tests while SCDU3 and SCDU4 were replaced with newly purchased, identical sets of these controllers. All of the sets of motor starters included the mechanical interlock devices except SCDU2, which was used as shipped by EPRI. These interlocks more realistically represented the actual plant circuit implementation and provided a new aspect to the test data not previously explored.

The MOV contactors were electrically characterized following the intermediate-scale tests in order to determine their actual pick-up and drop-out voltage and current thresholds. Table A.11 provides a summary of each MOV contactor’s electrical characteristics.

Table A.11: ac MOV contactor coil pick-up and drop-out characteristics.

| Device | Average Pick-up Voltage (Vdc) | Average Pick-up Current (A) | Average Drop-out Voltage (Vdc) | Average Drop-out Current (A) |
|---------------|--------------------------------------|------------------------------------|---------------------------------------|-------------------------------------|
| SCDU1 (T5) | 93.9 | 0.07 | 71.7 | N/A |
| SCDU1 (T6) | 80.5 | 0.08 | 67.1 | N/A |
| | | | | |
| SCDU2 (T5) | 81.1 | 0.08 | 60.1 | N/A |
| SCDU2 (T6) | 79.7 | 0.08 | 69.5 | N/A |
| | | | | |
| SCDU3 (T5) | 82.3 | 0.09 | 64.6 | N/A |
| SCDU3 (T6) | 83.2 | 0.08 | 57.5 | N/A |
| | | | | |
| SCDU4 (T5) | 85.1 | 0.08 | 59.7 | N/A |
| SCDU4 (T6) | 85.0 | 0.08 | 57.2 | N/A |

¹⁶ Note that the EPRI test report (TR-1003326, page 4-13) cites “AO Smith (Clark Controls Division) Catalog #30U031” as the make and model of the motor starters used in that test program. AO Smith has since merged with Joslyn controls. The combined company is known as Joslyn-Clark Controls. The same model motor starter relays are sold under the Joslyn-Clark brand using essentially the same catalog number (T30U031).

A.3.1 Multiple SCDU Configuration

In general, all the SCDU circuits are wired identically with the only differences being the CPT size and motor controller condition (i.e., new or from the NEI tests). For the KATE-Fire series of tests, multiple SCDU circuits were used on one cable sample. In Appendix B, tests utilizing this multiple SCDU configuration are identified by “SCDU (M)” in the table for test parameters.

The use of multiple SCDU circuits was intended to maximize the potential source to target combinations and to aid in identifying the precise source and target interactions. For some of the tests, specifically those involving cables with higher conductor counts (i.e., seven conductors or greater), modified voltage sources were used to further identify source-to-target interactions as well as source-to-source interactions. Within the SCDU chassis at the terminal block, a resistor was placed between a source (e.g., terminal two) and passive target (i.e., terminal four). A conductor was connected to the passive target was then monitored for performance. This is depicted in Figure A.17.

The remaining conductors within the test cable were connected to other SCDU circuits. In Appendix B, the conductor designation was presented by the test cable conductor number, conductor color, SCDU circuit number, SCDU circuit pathway, and notes. An example of conductor designation table may be found in Table A.12 which was taken from Test K1. As previously noted, Conductor 1 is a source conductor which was modified to provide 60 V.

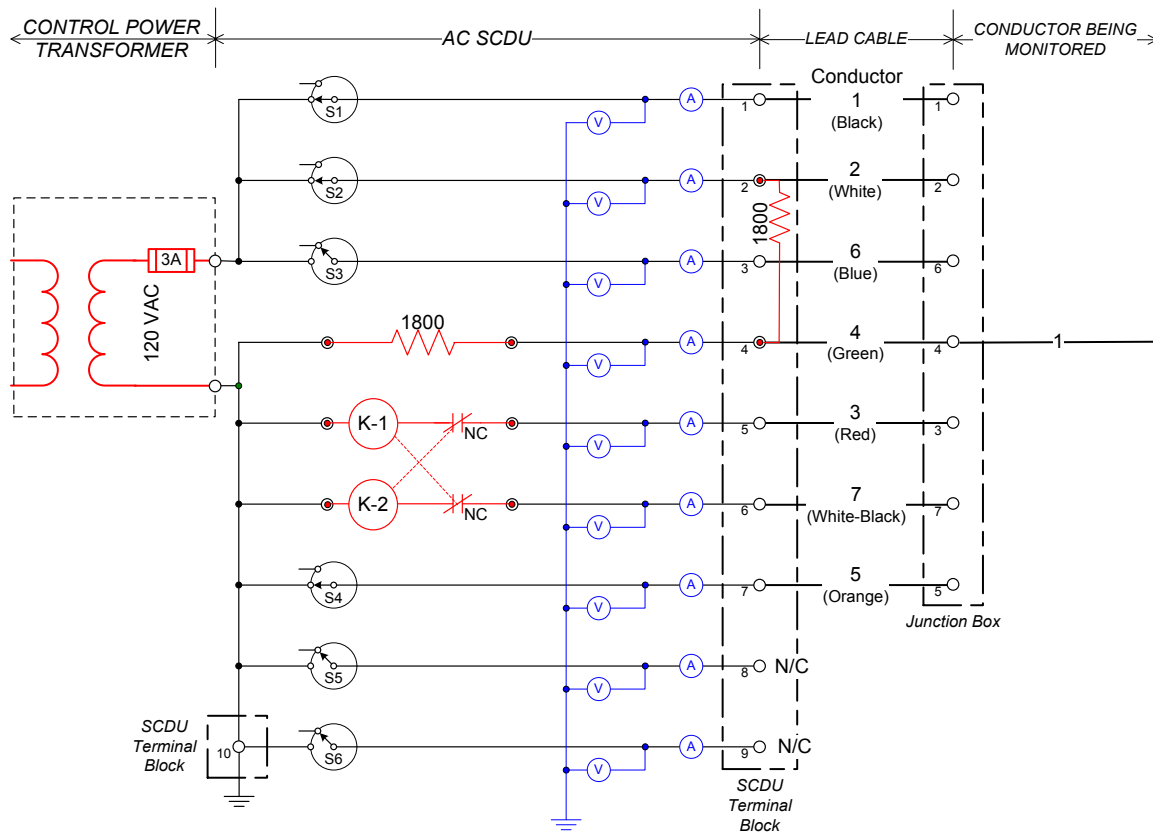

Figure A.17: Modified SCDU circuit with a resistor between a source conductor and the passive target.

Table A.12: Conductor designation for Item E, Test K1

| Kerite 7/C, 12 AWG, FR, zinc wrap. Black cable, gray conductors with white print | | | | |
|--|-----------------|---------------------|-------------------|---|
| Conductor Number | Conductor Color | SCDU Circuit Number | SCDU Circuit Path | Notes |
| 1 | Black | 3 | S2/T4 | Adjusted source conductor which was connected through 1.8 k Ω resistor. By doing this, the output source voltage was reduced to 60 V – SCDU3 Voltage = C3 V4; current = C3 I4 |
| 2 | White | 1 | S1 | Energized source conductor for SCDU1– Voltage = C1 V1; current = C1 I1 |
| 3 | Red | 1 | T5 | Active target conductor for SCDU1 – Voltage = C1 V5; current = C1 I5 |
| 4 | Green | 2 | S1 | Energized source conductor for SCDU2– Voltage = C2 V1; current = C2 I1 |
| 5 | Orange | 2 | T5 | Active target conductor for SCDU2 – Voltage = C2 V5; current = C2 I5 |
| 6 | Blue | 4 | S1 | Energized source conductor for SCDU4– Voltage = C4 V1; current = C4 I1 |
| 7 | White/Black | 4 | T5 | Active target conductor for SCDU4 – Voltage = C4 V5; current = C4 I5 |
| Zinc Wrap | NA | 3 | G7 | Grounded to tray, but not monitored |

A.4 Insulation Resistance Measurement System

The Sandia National Laboratories (SNL) Insulation Resistance Measurement System (IRMS) is a patented system that enables the real-time monitoring of insulation resistance in a cable or cable bundle by sequentially energizing conductor pairs and observing the voltage states. Through easily developed mathematical relations, one can then calculate the corresponding resistances. The resulting time series of resistances thereby allow identification of adverse developments in the cable bundle at certain instances in time. Additional information may be found in NUREG/CR-6776 [6].

A.4.1 Theory of Operation

The concept is based on the assumption that if one were to impress a unique signature voltage on each conductor in a cable (or cable bundle) then by systematically allowing for and monitoring known current leakage paths it should be possible to determine if leakage from one conductor to another, or to ground, is in fact occurring. That is, part of or the entire voltage signature may be

detected on any of the other conductors in the cable (or in an adjacent cable) or may leak to ground directly.

To illustrate, consider a three-conductor (3/C) cable as shown in Figure A.18 (for now we will neglect leakage directly to ground). If a known voltage is applied to conductor 1, then the degree of isolation of conductors 2 and 3 from conductor 1 can be determined by systematically opening a potential conductor-to-conductor current leakage path and then logging the voltages of each conductor in turn while conductor 1 is energized. Determining the insulation resistance between conductors 1 and 2 (R_{1-2}) at the time of voltage measurement on conductor 2 (V_2) is a simple calculation employing Ohm's law:

$$I_{1-2} = V_2 / R$$

and

$$R_{1-2} = (V_1 / I_{1-2}) - R$$

where I_{1-2} is the measured current flow between the conductors and R is the known value of the ballast resistors built into the system. In the same way, the insulation resistance existing between conductors 1 and 3 at the time V_3 is measured can be determined. Continuously switching between the two conductors and recording the voltage drop across the ballast resistor R at each switch position yields a time-dependent history of R_{1-2} and R_{1-3} . (Of course an alternate method would be to connect a resistor/voltmeter assembly to both conductors 2 and 3 simultaneously and keep a continuous record of the two voltages. This approach quickly becomes unwieldy as the number of conductors increases.)

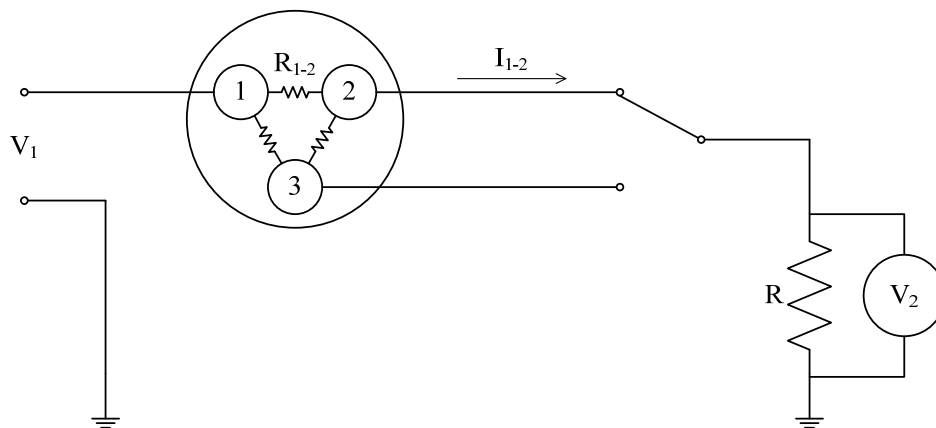

Figure A.18: Simple insulation resistance measuring circuit.

The above method alone does not describe the isolation existing between conductors 2 and 3 (because conductor 1 is always the energized conductor). However, by sequentially energizing each conductor and reading the impressed voltages on the remaining conductors one can determine the relative resistance existing between any conductor pair (see Figure A.19).

This concept evolved to include the two sets of controlled switches, one set on the input side (i) and one on the output side (j) of the circuit. One switch on the voltage input side is closed (thereby energizing one conductor) followed by the sequential closing-measurement-opening of

each measurement side switch. Each sequential switching configuration measures leakage currents between one energized “source” conductor and one non-energized “target” conductor, and the various pairs are systematically evaluated in sequence.

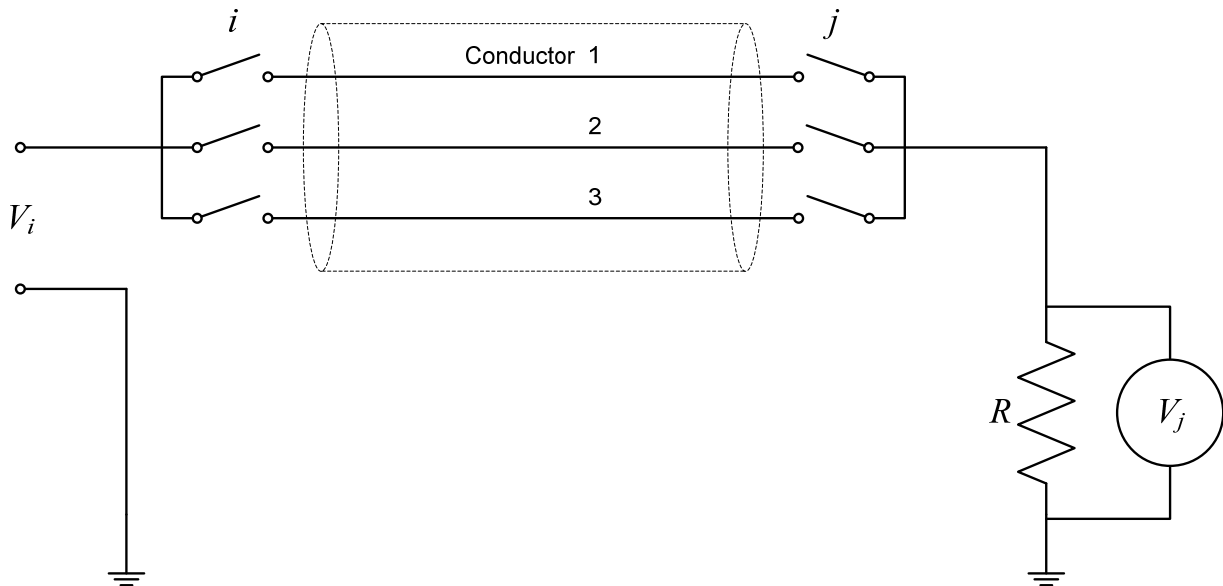

Figure A.19: Circuit for measuring insulation resistance between any conductor pair in a cable.

The insulation resistance between pairs of conductors can be determined in the same way as discussed above. Note that when the input and measurement side switches are connected to the same conductor ($i = j$), the full input voltage will be measured across R . Since this provides no useful information about the isolation existing between any of the conductor pairs, these measurements can be ignored for the purpose of determining IR. (The presence of the full voltage, $V_j = V_i$, does however indicate conductor continuity and otherwise could be useful in identifying an open circuit condition.)

This approach is fine as long as the cable can be kept electrically isolated from ground. If that is not possible (or not desirable, e.g., because short to ground failures are of interest) then changes to the design (simple ones) and resistance calculations (significant) are required.

Figure A.20 shows how the number of possible leakage paths for each of the three conductors in the previous example changes when a ground path is considered. By adding a path to ground for each conductor, the complexity of determining the insulation resistance between pairs of conductors has grown from one resistance determination to now having to determine three resistances for each pair of conductors. A circuit change is required to enhance the number of independent measurements so as to retain a solvable problem. The revised circuit is shown in Figure A.21, and includes a ballast/load resistor on the input side in addition to the output side ballast/load resistor.

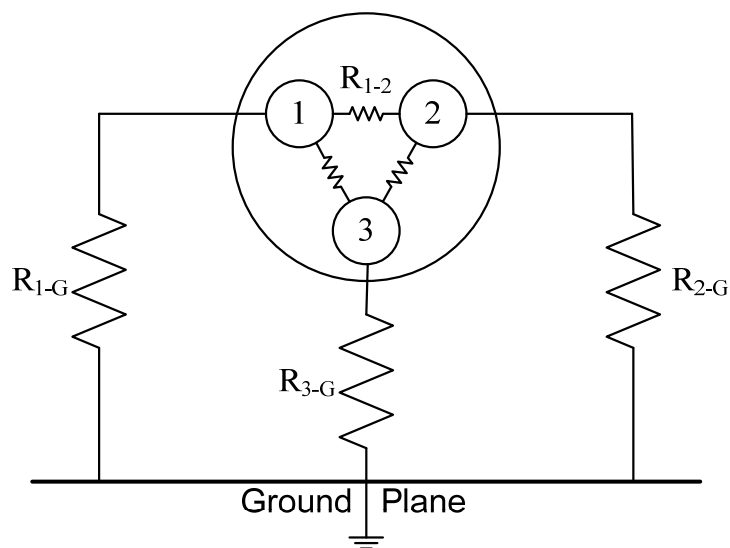

Figure A.20: Resistive leakage paths for each conductor with a ground present.

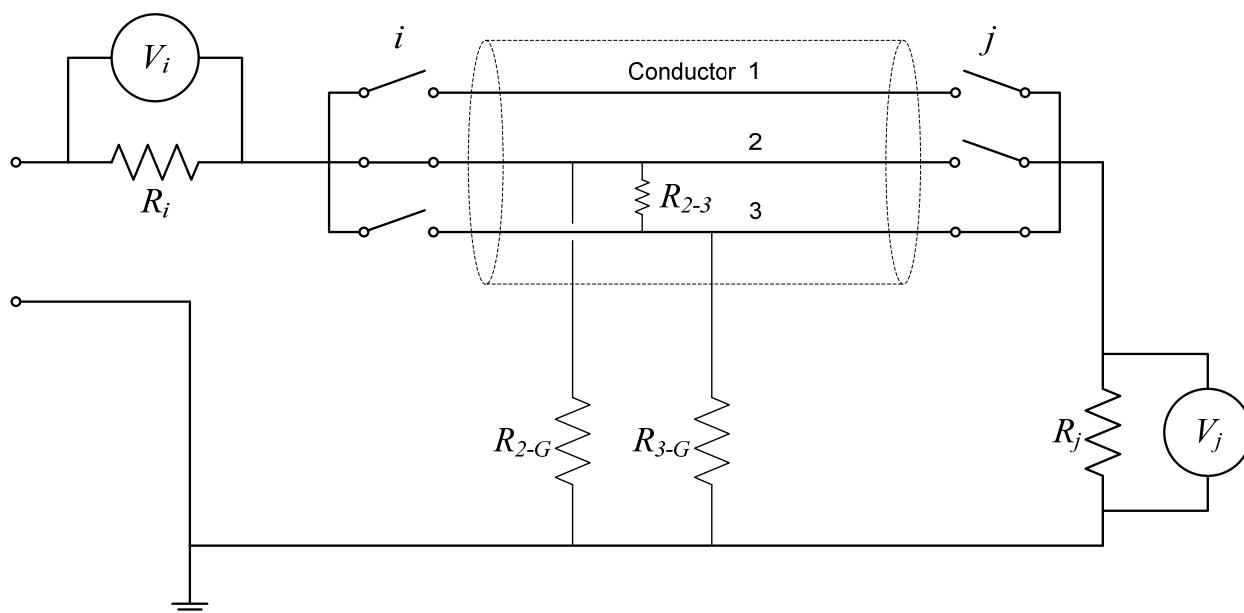

Figure A.21: Insulation resistance measuring circuit with ground paths.

The calculation of the three resistances for each conductor pair (one conductor-to-conductor path and each of the two conductor-to-ground paths) requires the measured voltages (V_i and V_j) for two complementary switching configurations. For example, the complement for the case illustrated in Figure A.21 is shown in Figure A.22. As illustrated in Figure A.21, conductor 2 is connected to the input side and conductor 3 is connected to the measurement side. The complementary case shows conductor 3 on the input side and conductor 2 on the measurement

side (shown in Figure A.22). This complementary pair provides four separate voltage readings that can be used to determine the three resistance paths affecting these two conductors; namely, R_{2-3} , R_{2-G} , and R_{3-G} .

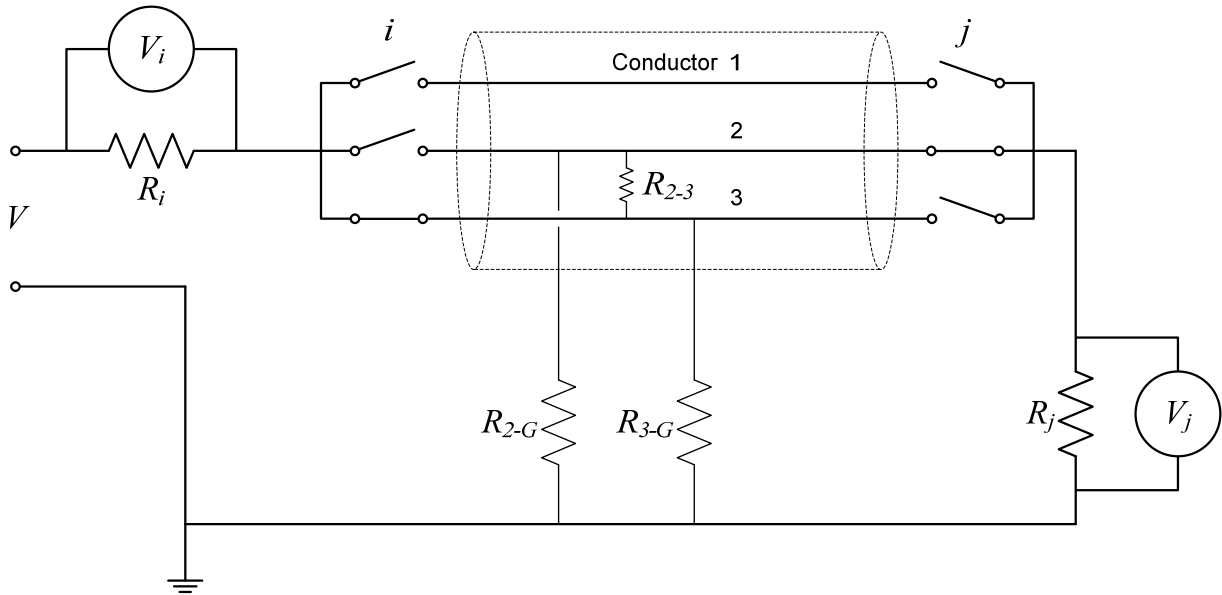

Figure A.22: Complementary IR measuring circuit with respect to the circuit shown in Figure 4.

The equations for determining the three resistances for this case are as follows:

$$R_{2-G} = [V_{j2}V_{j3} - (V - V_{i2})(V - V_{i3})] / [(V_{i3} / R_i - V_{j2} / R_j)V_{j3} - (V_{i2} / R_i - V_{j3} / R_j)(V - V_{i3})]$$

$$R_{3-G} = V_{j3} / [(V_{i2} / R_i - V_{j3} / R_j) - (V - V_{i2}) / R_{2-G}]$$

$$R_{2-3} = [(V - V_{i2}) - V_{i3}] / [(V_{j3} / R_{3-G}) + (V_{j3} / R_j)]$$

This concept is scalable for virtually any number of conductors in a cable or bundle of cables. Another advantage is that only the two voltage measurements for each switching configuration need to be recorded in real time; determination of the resistances can be deferred until after the test has been completed. This is the basic concept utilized in the design and application of the IR Measurement System.

A.4.2 Design Features

As configured for CAROLFIRE, each IRMS can monitor the insulation resistance of up to fourteen separate conductors. The limit of fourteen conductors was based on the capacity of the internal memory of the programmable logic control (PLC) units. In practice the system was typically run with fewer active channels. This is because the total cycle time increases exponentially as the number of monitored conductors increases. The goal was to keep cycle times as short a practical. A schematic diagram of the complete system is provided in Figure A.23.

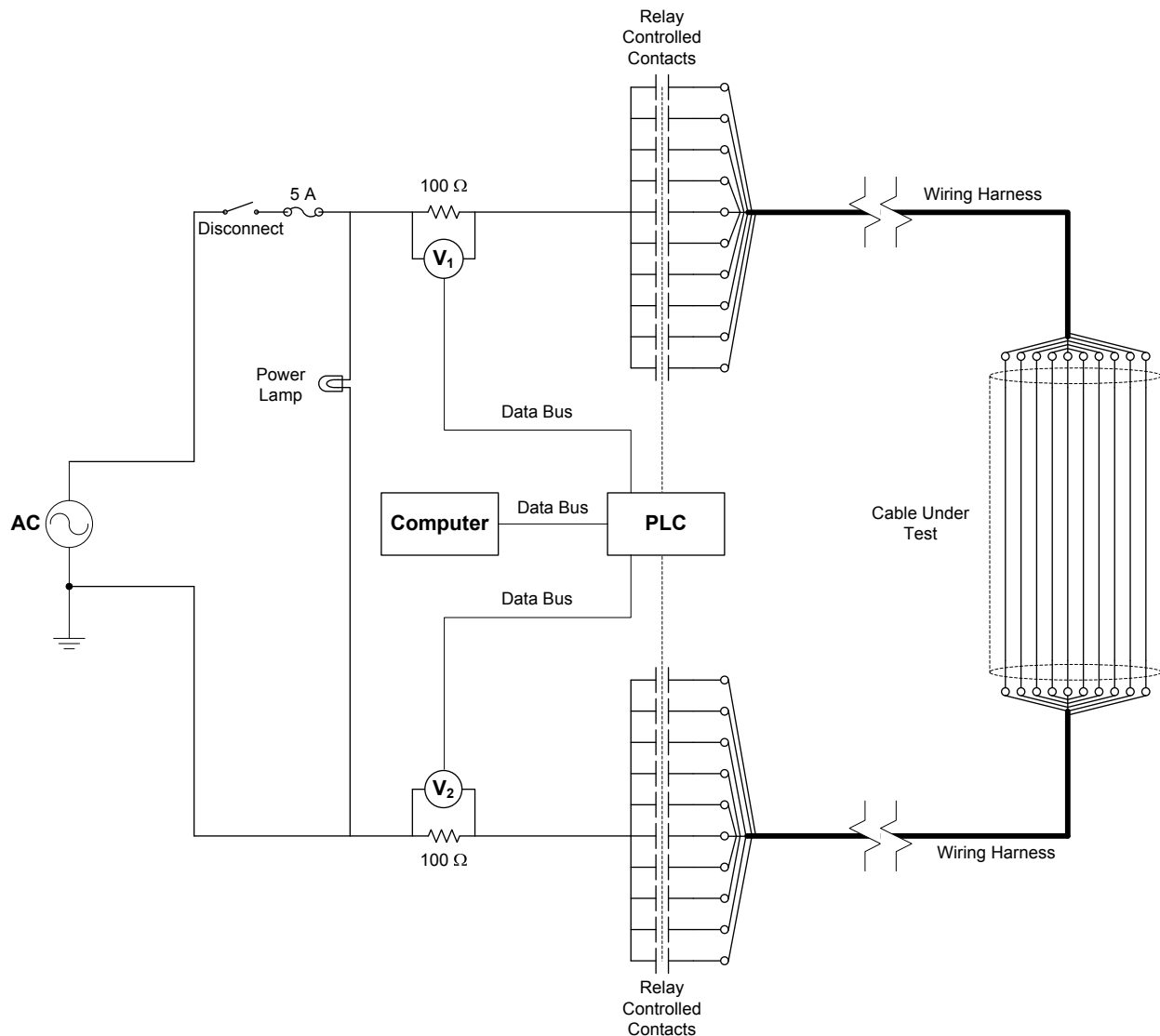

Figure A.23: Schematic diagram of the IR Measurement System.

A.4.3 Operation

Operation of the SNL IR Measurement System is a relatively simple matter of connecting the two wiring harnesses to each end of the test cable bundle, turning on power to the main control cabinet, starting up the control software on the computer, and starting the IR measurement program by pushing the “Run” button.

Connection of the wiring harnesses to the test cable during the KATE-Fire tests was accomplished using commercially available wire nuts. It is important that each end of a specific conductor in the test cable be connected to the corresponding conductors in both wiring harnesses. For example, the conductors marked “1” in each wiring harness needed to be connected to the ends of the same conductor in the test cable. This also applied to the conductors marked “2” through “N” in the harnesses, where N is the total number of conductors being

monitored during a given test. Proper connections are checked by performing a continuity check of the pairs of harness conductors at the patch panel ends of the wiring harnesses.

A.4.4 Data Recording, Analysis, and Uncertainty

Raw data is written initially to a simple text file in a specific format and order. The raw data files are preserved for archival purpose. For purposes of analysis, data from the raw files are imported into an Excel™ spreadsheet and the necessary IR calculations are performed to determine the IRs as part of the post-test data analysis. The resulting IR data can then be used to determine the nature (e.g., conductor-to-conductor versus conductor-to-ground) and order (i.e., which conductors shorted and when) of any short-circuit failures observed. The data analysis can also include the generation of IR versus time plots for each conductor in each test.

Some notes regarding IRMS sensitivity and uncertainty are also in order. The IRMS as configured for CAROLFIRE was intended to focus on lower IR values at the cost of sensitivity to high IR values. The maximum IR that will be recorded by the IRMS as configured for CAROLFIRE is approximately $3 \times 10^5 \Omega$ regardless of the actual IR value. In reality, cable IR values for an undamaged cable are typically much higher than this. This should be noted when reviewing the test results.

In terms of general system accuracy, a comprehensive assessment of the overall uncertainty associated with the new IR system has not been undertaken. The sources of uncertainty would primarily be associated with the voltage monitoring equipment that measures the voltage drop across the two ballast resistors in the system. A general assessment of system accuracy was made as a part of the system “proof of operation” testing during CAROLFIRE. This involved the use of known-value resistors inserted across specific conductor/circuit paths with the IRMS then measuring the resulting ‘IR’ value. The focus of CAROLFIRE testing was on lower IR values (those associated with cable failure); hence, resistors ranging from 10 to 5000 Ω were used in this assessment. In all cases the IRMS reproduced the known resistance values to within $\pm 3\%$.

A second point to note is the fact that IR estimates are based on the manipulation of corresponding data pairs and this introduces an additional source of measurement uncertainty that is particularly relevant to periods of rapid change in the cable IR. That is, for any given pair of conductors (say C1 and C2), the IR for C1-to-ground, C2-to-ground, and C1-to-C2 are estimated based on the analysis of two measured data points – a complimentary pair of data points. The first of this complementary pair monitors current leakage given that C1 is energized and C2 is connected to the system return path. The second of the complimentary pair monitors leakage currents given that C2 is energized and C1 is connected to the system return path. These two data points must be taken at separate points in time because the two conductors must be separately and individually energized to obtain the needed leakage current data. This time separation is the source of the potential added uncertainty.

In practice, the system control software collects the complimentary pair data points in immediate sequence for all conductor pairings. None the less, the two data points will still be separated in time, typically by 3 - 10 seconds depending on the system cycle time. This separation leads to an added level of measurement uncertainty that is most pronounced in cases where the IR is

changing quickly (e.g., as a cable is cascading to failure). The magnitude of the error cannot be estimated generically because it depends entirely on how large an IR change occurs between the times that the first data point is taken and when the second data point is taken.

Overall, this source of uncertainty is not seen as significant in the context of CAROLFIRE because the focus here is placed on the gross failure behavior and mode of failure. These behaviors would not be masked by the added uncertainty associated with the separation of the complimentary data point pairs in time. However, the exact IR values during times of rapid IR transition do contain an inherently higher level of uncertainty than do those values measured during times of relative IR stability.

A.5 Other Systems and Additional Information

This section of the appendix is dedicated to the other support systems that were necessary for the successful implementation and completion of the experimental series.

A.5.1 Transducers

A.5.1.1 Current Transducers

A note should be made regarding the current transducers¹⁷ used for monitoring the dc-powered test circuits. The transducers were based on Hall-effect current probes. Hall-effect probes were selected mainly because they are non-intrusive. Duke Energy had used current shunts in its testing. Shunts are low-resistance devices inserted into a circuit path that induce a small voltage drop proportional to current flow. Measuring the voltage drop provides a measure of current flow. In the Duke Energy tests these shunts proved problematic, in some cases failing due to sustained short-circuit currents. The EPRI peer team also expressed concern that the presence of shunts in the various circuit paths could act to limit short-circuit currents, potentially compromising or altering the fuse-blow behavior for the circuits.

The current transducers were selected in two sizes. Most had a range of +/- 35 Adc (Ohio Semitronics Model CTL-51/35, signal conditioner Model CTA201RX5), but the main input power leads to each circuit were also equipped with larger +/- 500 A transducers (Ohio Semitronics Model CTL-601/500, signal conditioner Model CTA201X5). The intent was for the smaller transducers to pick up the smaller currents associated with normal circuit operation and early faulting behavior, and the larger transducers would pick up the higher-current behavior anticipated as gross cable failures occurred. Through the course of testing, three separate issues arose that impact the analysis and interpretation of the test data.

The first issue encountered was an apparent drift in the zero-point offset of the transducers between the beginning and the end of a given test, and between the end of one test and the beginning of the next test. This problem was observed early during the Penlight test series. The

¹⁷ All transducers were procured through Ohio Semitronics. Additional information may be ascertained from their catalog found on their website: <https://www.ohiosemitronics.com/>.

supplier's technical support was contacted and the source of the problem was identified. The Hall-effect sensors are basically magnetic coils that react to the fields created by the flow of electrical current producing a proportional voltage signal. When these devices are subjected to dc current flows, they will retain a certain degree of residual magnetism that is reflected as a non-zero voltage output. The magnetism will fade over time, and can be reversed by sending a reverse current signal through the pick-up core, but is an inevitable, but unadvertised, aspect of the devices when used for dc circuits. A separate drift existed during the first few minutes that instrument power (i.e., 120 VAC to turn on the equipment) was applied. These two unique occurrences prevented the uniform application of a zero-point offset.

These issues were discussed among the full peer team and potential options were explored. One option was to replace the Hall-effect transducers with shunts, but this was rejected for the same reasons that Hall-effect transducers were selected in the first place (as described above). Instead, a decision was made to continue the test program using the Hall-effect transducers and to deal with the offset issue in data analysis. To support the required data analysis adjustments, the testing protocol was modified in two ways. First, the transducers were energized up to 30 minutes before the beginning of a test to ensure that they were fully "warmed up" before testing. Second, data logging was initiated before energizing the test circuits and a set of baseline test data without any current flow was collected. Third, once the test circuits were energized (i.e., the connections to the battery bank were closed) an additional period of baseline data logging was allowed. Finally, after the completion of a given test, a period of post-test data was gathered with the battery engaged and continuing until after the battery bank was disconnected from the circuits.

The analysis of test data has "corrected" the current transducer data by subtracting out the pre-test, pre-battery initiation, zero current offset value for each transducer. That is, the pre-test zero condition data are used to calculate an average zero-point offset for each current transducer and that value is subtracted from all test readings. Note that this approach provides a nominal correction but is imperfect. This is because, as noted, the zero-point offset drifts through the course of a test depending on the current flow experienced by the transducer. No attempts were made to correct the data beyond reflecting the pre-test offset. The result is that the current measurements at the end of the test may indicate a small current flow even after the circuits are fully de-energized.

The second issue identified was related to transducer sensitivity. The 35-A transducers were chosen at the outset because the peer team was interested in the characteristics of the short circuit currents, which were expected to be much larger than the normal circuit operating currents. However, this meant that the transducers were not especially sensitive to the normal circuit operating currents (typically 1 A or less). The early tests also showed that the transient short circuit current pulses were simply too fast for the data logging system to fully catch (i.e., the transducers would "see" the fault, but there was no assurance that the true peak current was being captured). After discussion with the peer team, a decision was made to increase the sensitivity of the current transducers by looping the conductors repeatedly through the Hall-effect sensor coils. That is, by looping a conductor through the transducer five times, the signal strength sensed by the transducer is multiplied by five. In this manner, all of the 35-A transducers were amplified by a factor of five (five loops) and the 500-A transducers by a factor of two (two loops). This amplification effect was reversed during data processing so that the

processed data files and all of the plots presented in this report show the corrected data and the actual (corrected) current values.

The final issue that was identified for the current transducers impacted the larger 500-A transducers only. The data from early tests showed that these transducers did not appear to be picking up the current signals at all. Diagnosis of the installed transducers showed that they were properly wired and that they could detect a steady current flow as expected. However, even after amplification of the signal by a factor of two, the transducers still appeared insensitive to the current transients. That is, even when a 35-A transducer (effectively reduced to +/-7 A transducers by the amplification) saturated, the 500-A transducers will not show a corresponding current flow. Several measures were taken in an attempt to address this issue. The final measure taken was to shift all of the 500-A transducers to a data logging system capable of much higher logging speeds (100 Hz). The system used for monitoring the high-ranged current transducers was, in fact, the system normally used to record data from the SCUDU circuits. Even this change did not yield the desired result. Again, operability of the revised data logging system was verified, but still the 500-A transducers were not providing meaningful data signals when the transient short circuits were observed. The root cause of this issue has not been traced. It is thought that the larger Hall-effect coils may simply not be fast enough to respond to the transient faulting behaviors that seem to be manifested in tenths of a second. Overall, the 500-A transducers provided little or no data of value.

A.5.1.2 Voltage Transducers

Two types of voltage transducers were used for each circuit. When directly fed from a pole off the battery, a unidirectional transducer (Ohio Semitronics Model VTU-005X5) was used for monitoring the voltage. Typically, as an example, positive and negative source conductors were monitored using these types of transducers.

When a conductor was not tied to a specific battery terminal, such as a spare, a bi-direction transducer (Ohio Semitronics Model VT7-005X5-11) was used to monitor the voltage. This provided an opportunity to learn how the conductor was being affected by the other failing conductors.

A.5.2 Fuses, Fuse Holders, and Terminal Blocks

The fuses for the dc circuits were ordered through Ferraz-Shawmut.¹⁸ The MOV circuits were fused with 10-A, fast-acting, midget fuses (Model Number ATM10) and connected with a two-pole fuse block (Model Number 30352). The SOV circuits were typically fused with 5-A, fast-acting, midget fuses (Model Number ATM5). The 1-in. valve and the switchgear close circuits were fused at 15 A using the ATM15, fast-acting, midget fuses. The large coil was fused with 25-A, fast-acting, midget fuses. The switchgear trip circuit was fused at 35 A, Model Number FRZ A2Y35-1.

¹⁸ Additional information on the Ferraz-Shawmut fuses may be ascertained from their website at <http://us.ferrazshawmut.com/>.

Except for the 35-A fuses on the switchgear circuit, the fuses were housed within two-pole fuse blocks (Model Number 30352). The 35-A fuses were connected by two-pole fuse blocks, Model Number 20606.

The terminal blocks (Buchanan Model 223) used in each circuit were rated for up to 600 VDC.

A.5.3 Thermocouples

This test series provided additional cable thermal response data for the fire model improvement effort started in the CAROLFIRE test program.¹⁹ In this particular program, providing cable thermal response data was a secondary objective. However, measurements of the cable thermal response are important to characterize the environmental conditions leading to the failure, and additional data in this regards is considered quite valuable. As a “target of opportunity,” cable thermal response data was gathered during the tests in a manner similar to that employed in CAROLFIRE, albeit with somewhat less instrument density.

As noted for CAROLFIRE, it is not appropriate to instrument any single cable for both thermal and electrical response. This is because installation of a thermocouple on, or within, a cable could impact the electrical failure behavior. Instead, the approach to be applied involves mirroring a cable being monitored for electrical performance with a second cable (in an adjacent or symmetric location) that will be monitored for thermal response. Figure A.24 provides a graphical depiction of this dual-cable setup. In the majority of the small-scale tests, however, the orientation more often resembled Figure A.25.

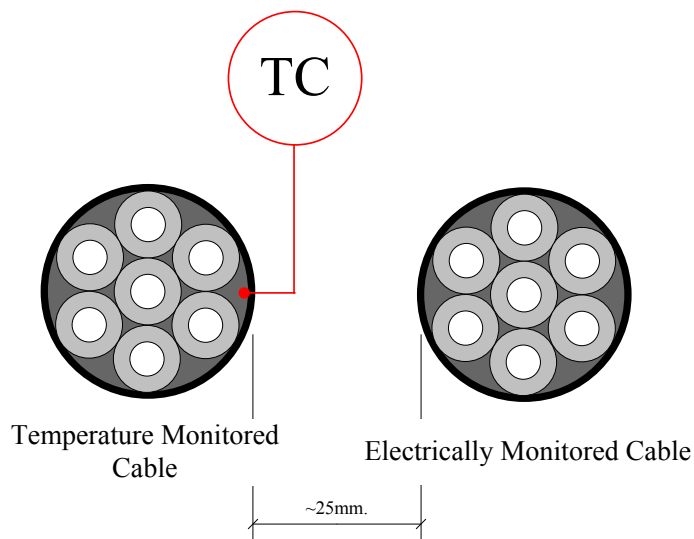

Figure A.24: Example thermocouple arrangement for temperature monitoring of seven-conductor cable located near the electrically monitored cable in tray. Cables will be in contact during conduit tests.

¹⁹ CAROLFIRE Final Report, 2007.

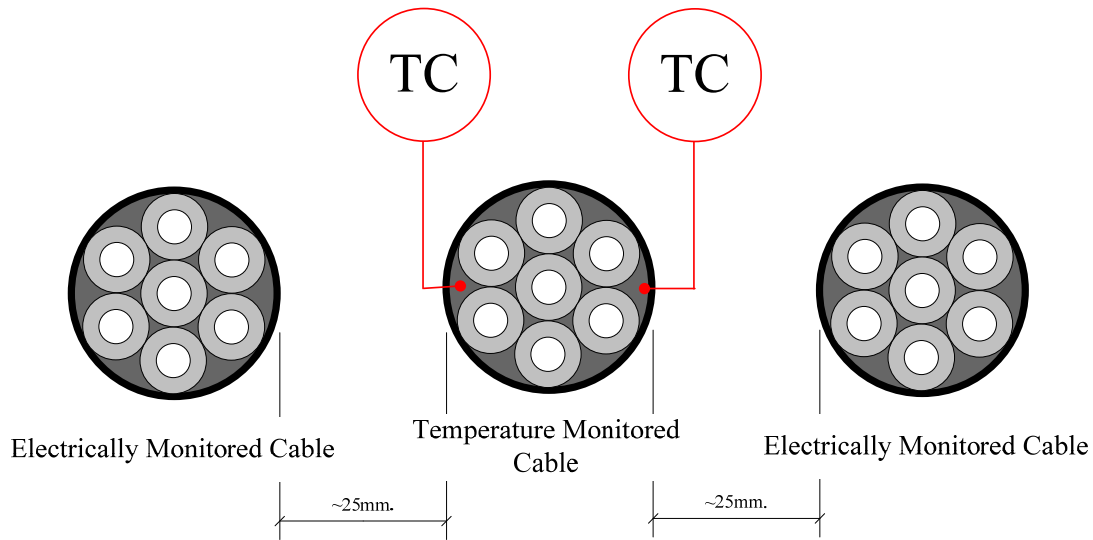

Figure A.25: Alternative orientation for the two electrically monitored cables and the thermally monitored cable.

Thermocouples measured the thermal response of cables upon heating. In Penlight, Type K thermocouples placed just below the outer cable jacket were used for cable thermal response monitoring, a technique proven during the CAROLFIRE tests. In this process, a small slit is cut in the jacket, allowing insertion of the thermocouple bead. The bead itself can typically be inserted to a distance of approximately 2.5 to 10 cm along the length of the cable, placing it well away from the cut in the outer jacket. Placement distance does vary depending on the cable type. The slit was then closed and secured with a single layer of fiberglass tape.

For the armored cables, a pilot hole was drilled through the armor to allow for the insertion of a thermocouple next to the conductors. After the hole was drilled, a probe was used to further widen the gap for the thermocouple. In similar fashion, the bead was inserted approximately 1 to 4 in. and the pilot hole was sealed with fiberglass tape.

Where it was necessary to do so, such as in the Kerite[®] tests, the configurations of the thermocouple-instrumented cables/bundles exactly mimicked the configurations employed by the electrically monitored cables/bundles. The principal exceptions to this approach were those cases where three-cable bundles were run through a conduit. Here only a single thermocouple-instrumented cable was included with the bundle due to space constraints within the conduit.

Thermocouples were also widely used throughout the intermediate-scale experiments; however, because of the extensive effort expelled on circuit preparation, thermally monitored cables were not as prevalent. Instead, air temperatures were gathered at each test position. In Position A and Position B, the middle of the tray was assumed to be the hottest exposure area for the involved circuits and, as such, only the air temperatures at the center of the tray were monitored. In the three remaining positions, air temperatures were captured at 3 feet, the middle, and 7 feet of the 10-foot tray. The only tests that contained thermocouple instrumented cables were ISTest9 and ISTest10, the Kerite[®] and armored cable tests, respectively.

During the course of testing, there were instances when the recorded thermocouple data yielded erratic results, such as pronounced increases and/or decreases in temperature. An example of this may be observed in the air temperature for B-Position in ISTest10 at approximately 2800 seconds. Possible causes of this behavior may include failure at the junction point between the thermocouple connector and the thermocouple lead (e.g., debris interference, thermal impact) or interaction with electrical arcing; however, subsequent investigation of the off-normal readings did not occur upon the conclusion of this test or others with similar results. The data from the effected thermocouple should be discarded after the gross failure.

A.5.4 Data Acquisition and Processing

The dc circuits were connected to a National Instruments screw terminal block (Model Number SCXI-1300), 32-channel amplifier (Model Number SCXI-1102), and 12-slot chassis (Model Number SCXI-1001). The temperature data was collected by a similar system; however, it used a 4-slot chassis (Model Number SCXI-1000) rather than the 12-slot. The SCDU circuits, and later the CT500 current transducers, were monitored on a National Instruments SCB-100.

These systems interfaced were controlled by LabView Developer Suite, a software program developed by National Instruments.

A.5.4.1 Computers/Software

Individual computers were connected to the data acquisition systems for the dc circuits, ac circuits, and temperature data. This was to prevent data loss in the event of a system or power failure.

The dc system was connected to a Hewlett-Packard desktop, Workstation XW4100 with a Pentium 4 Processor.

The ac system was connected to a Dell desktop, Precision 350 with a Pentium 4 Processor.

The temperature data acquisition system was connected to a Hewlett Packard laptop, Compaq nc6230 with an Intel Centrino Processor.

All three systems were operated on Windows XP.

A.5.4.2 Data Files

A list of the data files for each test may be found in Table A.13.

Table A.13 Matrix of the raw Penlight and intermediate-scale test data files.

| | | | |
|------------|----------------|-------------|-----------|
| Burn Test* | Raw Data Files | | Test Date |
| | Circuit | Temperature | |

Table A.13 Matrix of the raw Penlight and intermediate-scale test data files.

| Burn Test* | Raw Data Files | | Test Date |
|------------|-------------------------------------|---|--------------------|
| | Circuit | Temperature | |
| D13_qual | Test-13-qualification_SCDU-1 | 7-27-09-1410.csv | July 27, 2009 |
| D13 | Test-13_SCDU-1-2 | 7-27-09-1708.csv | July 27, 2009 |
| D14 | Test-14_SCDU-1-2 | 7-28-09-1000.csv | July 28, 2009 |
| D15 | Test-15_SCDU-1-2 | 7-28-09-1416.csv | July 28, 2009 |
| D16 | Test-16_SCDU-1-2 | 7-28-09-1750.csv | July 28, 2009 |
| D17_qual | Test-17-qual_SCDU-1-2 | 7-30-09-1041.csv | July 30, 2009 |
| D17 | Test-17_SCDU-1-2 | 7-31-09-0815.csv | July 31, 2009 |
| D18 | Test-18_SCDU-1-2 | 7-31-09-1107.csv | July 31, 2009 |
| D44 | Oct-5-09_MOV1_MOV2_Test-44.csv | 10-05-09_0138.csv | October 5, 2009 |
| D49 | Oct-9-09_MOV1_MOV2_Test-49.csv | 10-09-09_1310.csv | October 9, 2009 |
| D50 | Oct-12-09_MOV1_MOV2_Test-50.csv | 10-12-09_1251.csv | October 12, 2009 |
| IS9 | 03-17-2010_Test-9_Burnsite.csv | 3-17-10_.csv | March 17, 2010 |
| IS10 | 03-25-2010_Test-10_Burnsite.csv | 3-25-10_1040.csv | March 25, 2010 |
| K1 | Test1_9-22-10_Kerite7c-w | 9-22-10_ATE_AC-Circuit-Fires_Test1.csv | September 22, 2010 |
| K2 | Test2_9-23-10_Kerite9c-wo | 9-23-10_ATE_Penlight_AC-Circuit-Fires_Test2.csv | September 23, 2010 |
| K3 | Test3_9-24-10_Kerite10c-wo | 9-24-10_ATE_AC-Circuit-Fires_Test3.csv | September 24, 2010 |
| K4 | Test4_11-08-10_Kerite10c-w | Test4-ac-circuitfire-11-8-10-1425.csv | November 8, 2010 |
| K5 | Test5_11-09-10_Kerite5c-w | Test5-ac-circuitfire-11-9-10-1536.csv | November 9, 2010 |
| K6 | Test6_9-28-10_Kerite7c-w.csv | 9-28-10-ate-ac-circuit-fires-test-6.csv | September 28, 2010 |
| K7 | Test7_10-28-10_Kerite7c-w.csv | test7fr-circuitfire-10-28-10-1148.csv | October 28, 2010 |
| K8 | Test8_10-25-10_Kerite5c_w.csv | 8-10-25-10-kerite-2cfr1-1600.csv | October 25, 2010 |
| K9 | Test9_11-04-10_Kerite5c_FR-w.csv | Test-9-ac-circuitfire-11-4-10-1600.csv | November 4, 2010 |
| K10 | Test10_10-27-10_Kerite4c_wo.csv | test10fr3-circuitfire-10-27-10-1546.csv | October 27, 2010 |
| K11 | Test11_11-01-10_Kerite4c_FR3-wo.csv | 11-ac-circuitfire-11-1-10-1355.csv | November 1, 2010 |
| K12 | Test12_11-04-10_Kerite2c_FR3-wo.csv | test-12-ac-circuitfire-11-4-10-903.csv | November 4, 2010 |
| K13 | Test13_11-04-10_Kerite2c_FR3-wo.csv | test13-circuitfire-11-4-10-1318.csv | November 4, 2010 |

Table A.13 Matrix of the raw Penlight and intermediate-scale test data files.

| Burn Test* | Raw Data Files | | Test Date |
|--|-------------------------------------|---|-------------------|
| | Circuit | Temperature | |
| K14 | Test14_10-25-10_Kerite2c_FR1-wo.csv | 14-10-25-10-kerite-2cfr1-1132.csv | October 25, 2010 |
| K15 | Test15_11-01-10_Kerite2c_FR1-wo.csv | 15-ac-circuitfire-11-1-10-1608.csv | November 1, 2010 |
| K16 | Test16_11-02-10_Kerite2c_FR1-wo.csv | 16-ac-circuitfire-11-2-10-930.csv | November 2, 2010 |
| K17 | Test17_11-09-10_Kerite2c-wo | Test17-ac-circuitfire-11-9-10-818.csv | November 9, 2010 |
| K18 | Test18_11-09-10_Kerite4c-wo | test18-ac-circuitfire-11-9-10-1250.csv | November 9, 2010 |
| K19 | Test19_11-10-10_Kerite12c-wo | Test19-ac-circuitfire-12c-11-10-10-1513.csv | November 10, 2010 |
| K20 | Test20_11-11-10_Kerite15c-w | Test20-ac-circuitfire-11-11-10-1025.csv | November 11, 2010 |
| K21 | Test21_10-27-10_Kerite9c_wo | test21fr-circuitfire-10-27-10-1055.csv | October 27, 2010 |
| K22 | Test22_10-26-10_Kerite10c_wo.csv | kerite22-circuitfire-10cfr2-10-26-10-1340.csv | October 26, 2010 |
| K23 | Test23_11-10-10_Kerite9c-wo.csv | Test23-ac-circuitfire-9c-11-10-10-1100.csv | November 10, 2010 |
| K24 | Test24_11-05-10_Kerite10c-wo | test24-ac-circuitfire-11-5-10-1530.csv | November 5, 2010 |
| * It should be noted that the D indicates that the test was conducted during the DESIREE-Fire test series. The IS indicates that the test is an intermediate-scale test which was conducted during DESIREE-Fire. The K indicates that the test was conducted during the KATE-Fire test series. | | | |

A.5.4.3 Data Processing and Analysis

Both the Penlight and intermediate-scale experiments have associated circuit files that contain the date and test number. The temperature data files contain the date and nominal test start time of each test. This data may be found in the associated software included with this report.

The AC files are analyzed in similar fashion to the CAROLFIRE SCDU files. Essentially, a Microsoft Excel[®] template was created and may be populated with the relevant data captured from the SCDU system through the “Import Raw Data.” As with SCDU files from CAROLFIRE, specific test information had to be included on the Test Conditions sheet in order to correctly synchronize the circuit and fire data start times. Graphs located on separate sheets populate automatically.

The data processing was significantly more complicated on the dc circuit systems. For each pair of circuits (i.e., MOV1 and MOV2, SOV1 and SOV2, etc), there was a separate Excel[®] template and graphing template developed to aid in data analysis. Similar to the SCDU template, a Test

Conditions page with specific information, such as circuit data acquisition and fire start times, must be filled out for each experiment. Once this information is entered, the circuit offset, fire offset, and the test duration are calculated and displayed. Time, circuit, and ground data from the raw circuit file may then be copied and pasted into the Raw Data sheet. As described in previous sections, the current offset must be adjusted for each test. Typically, the last 100 seconds before the battery was turned on was averaged and used as the offset. The Processed Data worksheet was used for data manipulation, such as incorporating the current offset information, adjusting the negative voltages monitored on the unidirectional transducers, and the filtering of the ground fault activity. In order to clearly interpret the data, it is important to filter out the ground fault behavior. Figure A.26, Figure A.28, and Figure A.29 display the progression of data analysis beginning with the raw positive, negative, and coil voltage and extending through the filtering of the ground detection circuit. The spurious actuation may be clearly observed in the final graph.

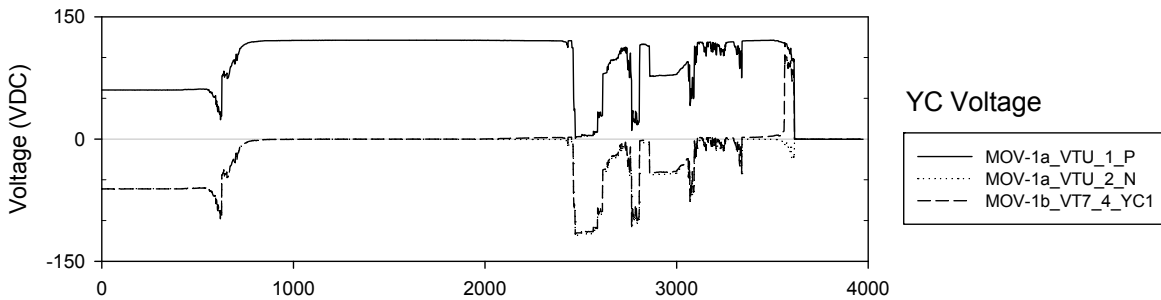

Figure A.26: Unedited voltage data including the positive and negative sources.

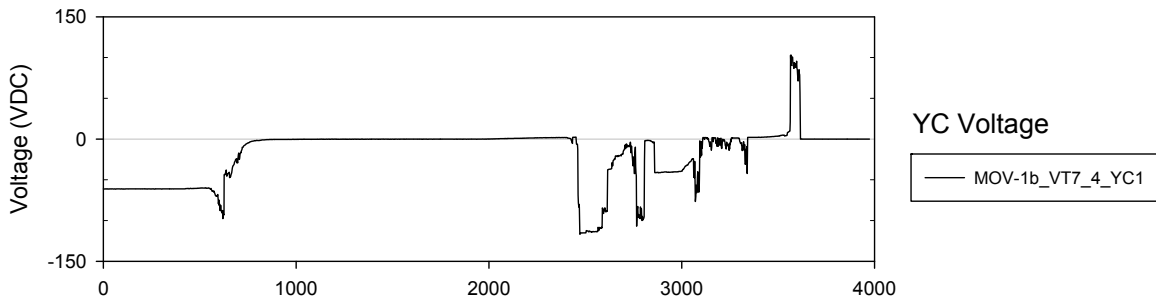

Figure A.27: Raw voltage plot for the MOV1 close coil.

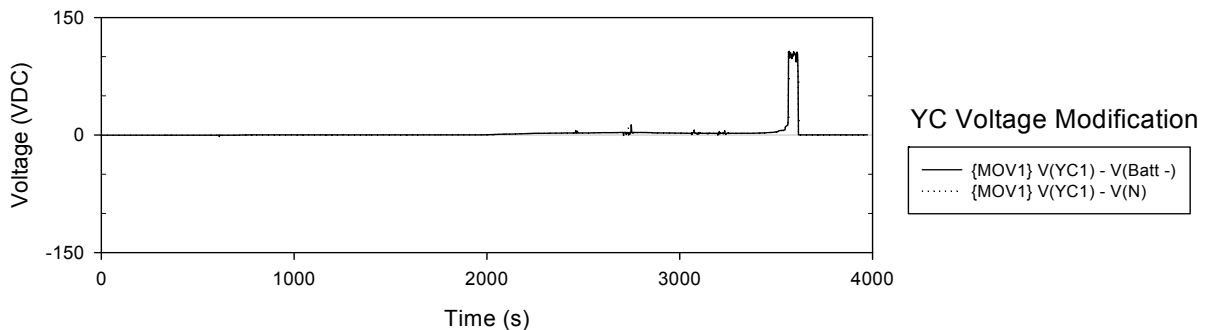

Figure A.28: Voltage with the ground filtered out.

The specific ground, current, and voltage information may be copied and pasted into the Final Data worksheet. This worksheet is then used to populate the graphing templates.

SigmaPlot[®] 11 was used to create the graphs for each circuit, excluding the SCDU. Each circuit pair had a separate graphing template developed to facilitate the analysis process. Each template contains graphs that may be edited to narrow in on failure behavior. In the subsequent appendices for each circuit pair, voltages are primarily displayed with the ground filtered out. In the caption for these graphs, the word “Modified” is displayed to differentiate between the original and modified data.

A.6 Intermediate-Scale Tests

Cable grouping and bundling was widely used for the circuit cables throughout the intermediate scale tests. When looking at the test data in subsequent sections, the orientation (e.g., in direct contact the tray, on top of fuel cables) of the cable bundle within the tray is important to note. The loaded cable tray orientation diagrams represents trays filled with 30 to 40 filler cables used to facilitate hot gas production. The bundled cable tray orientation diagrams illustrate trays that were modified with brackets to contain small bundles of fuel cables as well as the circuits. The specialized cable tray orientation defines the circuit location for two tests, ISTest9 and ISTest10. In both tests, Kerite was tested and specific orientations were necessary for the test conditions. These tests included thermally monitored cables as well as air temperature data.

In all three tray conditions, the gray background represents filler cables and the white circles represent the circuit cables. For each test, the filler cables surrounding the circuit cables were of similar type. In other words, thermoset circuit cables were grouped with the thermoset filler cables. The only exception to this was the cable trays containing only filler cable. In these trays, it was most common to have similar cable types, but a limited amount of dissimilar cables were added if deemed necessary. As the data is presented in subsequent sections, Figure A.29 illustrates the location of the circuit cables within the filler cables.

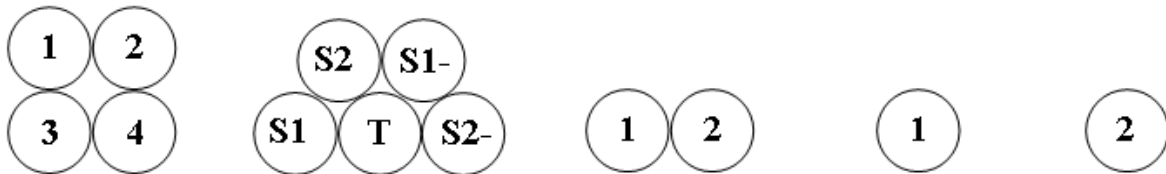
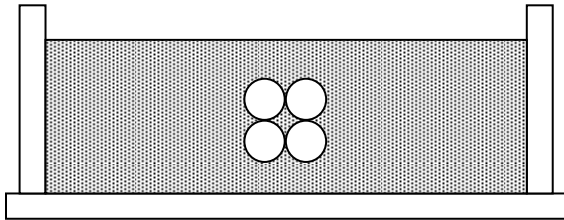

Figure A.29: Circuit cable orientation within the cable trays.

A.6.1 Loaded Cable Tray Orientation

During the intermediate-scale tests, the cable trays located in Position A and B were typically loaded with circuits and filler cables. The filler cables were included to provide fuel for the fire. The following diagrams display the location of the sample cables within the loaded tray.



Fill Tray A

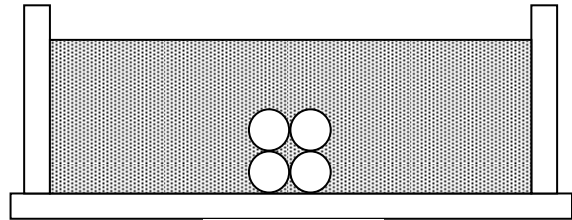

Fill Tray B

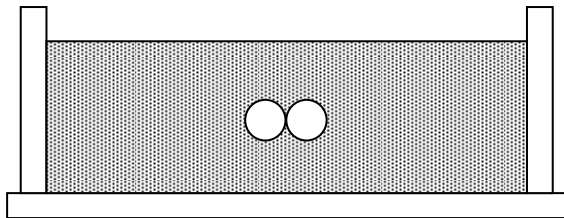

Fill Tray C

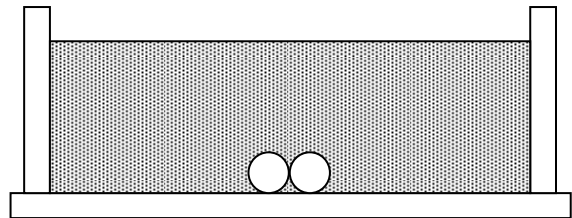

Fill Tray D

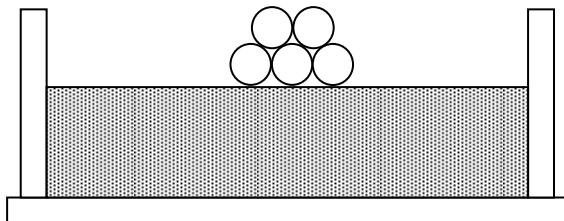

Fill Tray E

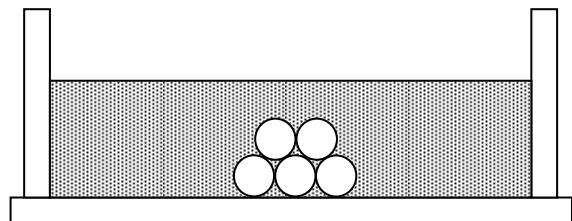

Fill Tray F

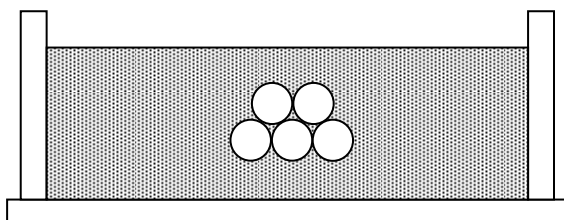

Fill Tray G

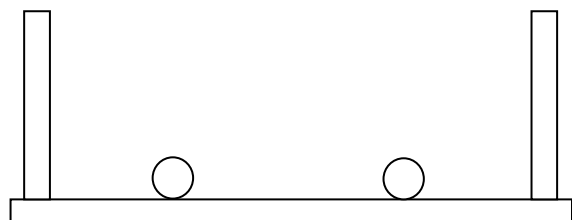

Fill Tray H

A.6.2 Bundled Cable Tray Orientation

During the intermediate-scale tests, the cable trays located in Position C, D, and E were typically loaded with circuits and filler cables. The filler cables were included to simulate loaded cable tray scenarios by orienting them in a 4 by 4 matrix and the following diagrams display the location of the sample cables within the matrix.

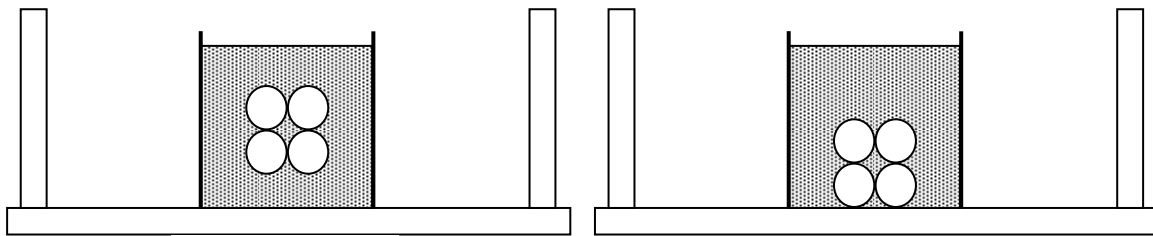

Bundled Tray A

Bundled Tray B

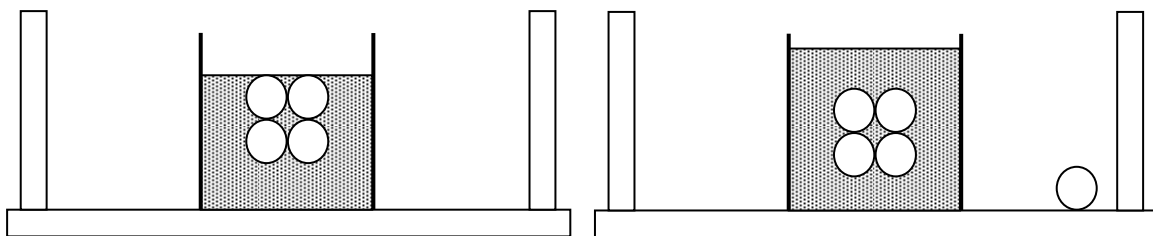

Bundled Tray C

Bundled Tray D

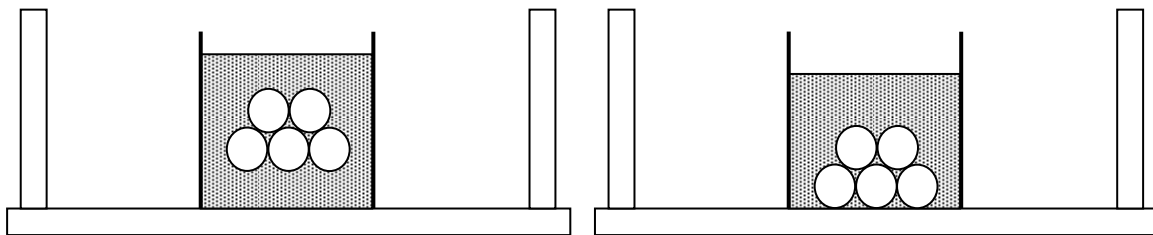

Bundled Tray E

Bundled Tray F

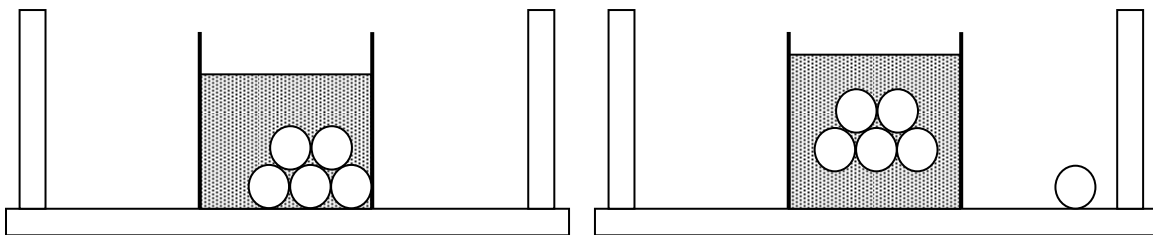

Bundled Tray G

Bundled Tray H

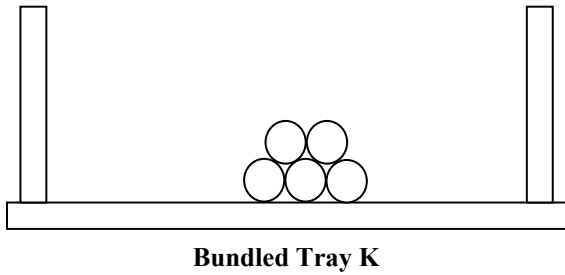
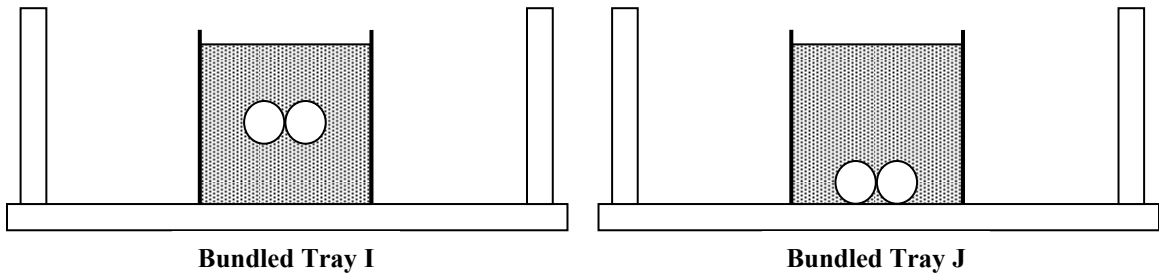

A.6.3 Specialized Cable Tray Orientation

For IS9 and IS10, specific cable orientations were used to investigate particular failure conditions for Kerite and Armored cables. The following diagrams display the location of the sample cables within the specialized tray orientation.

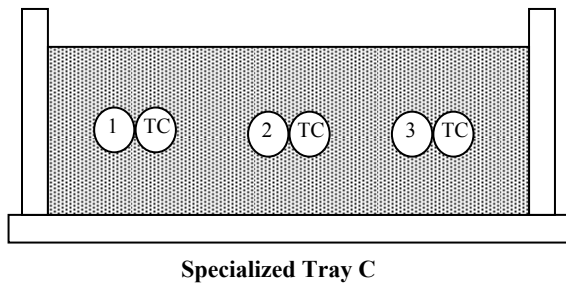
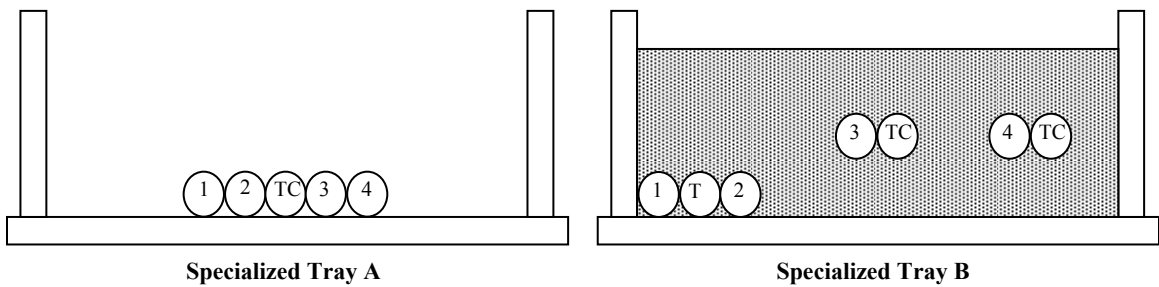

A.6.4 Intermediate-Scale Burner System

Nearly identical to the propylene pressure system used in CAROLFIRE, the propylene pressure system was used to feed the gas from externally secured tanks to the sand burner within the bunker facility (Figure A.30). The sand burner was identical to the one used during this previous testing program. Typically, six bottles of propene were connected to 100-psig regulators attached to stainless steel flex line. This line connected to Swagelok® fittings and was piped through a ventilation valve, an isolation valve, and pressure gauge before penetrating a through-way into the bunker. The line was connected to an Omega Mass Flow Controller,²⁰ which regulated the flow of propylene to the sand burner. The digital readout was run from within the bunker to the instrumentation transportainer just outside the bunker.

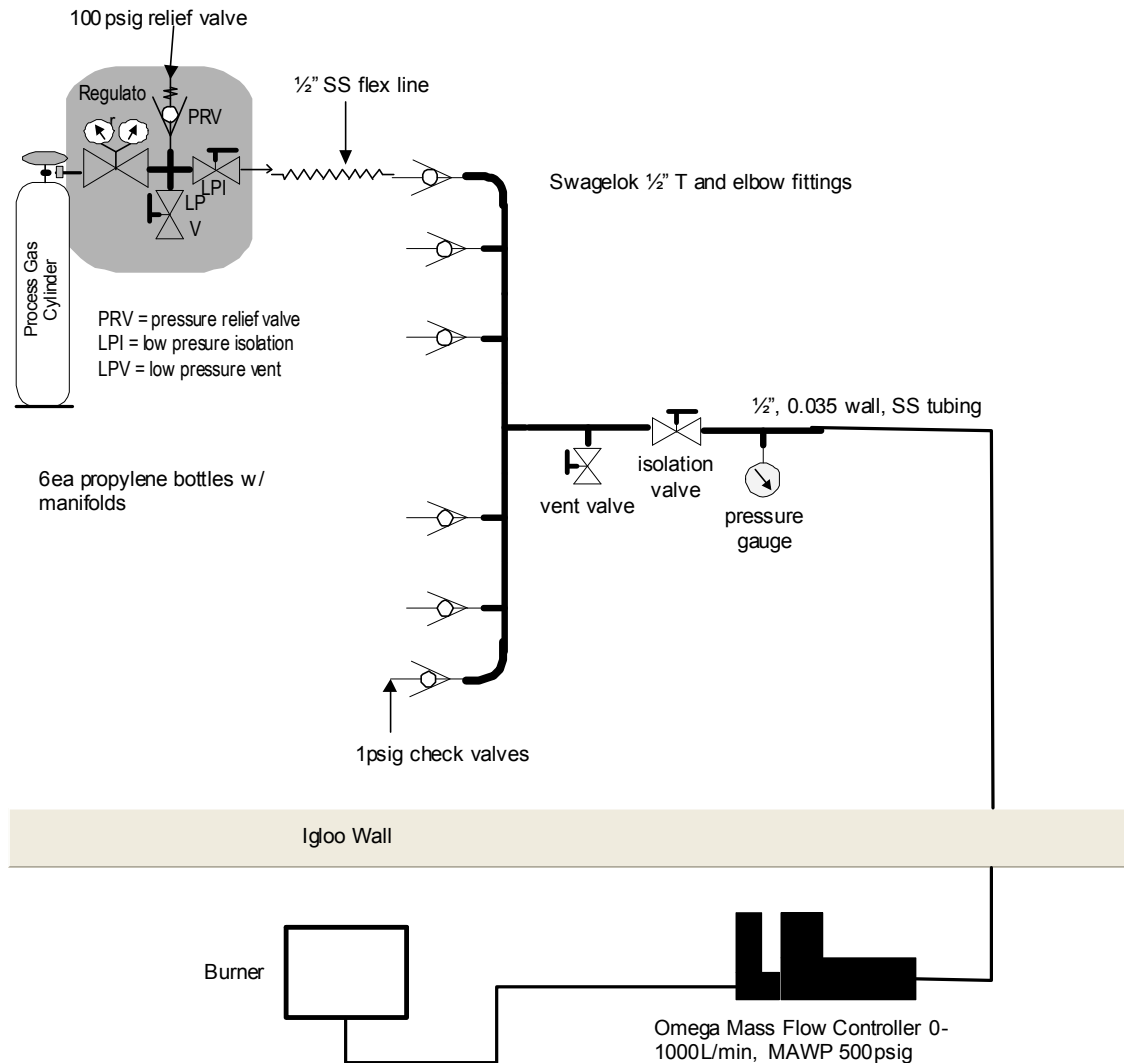

Figure A.30: Illustration of the propene pressure system for the intermediate-scale experiments

²⁰ Additional information may be ascertained from Omega’s product literature found on the following website <http://www.omega.com/manuals/index.html?s=all>.

The top surface of the burner measured 400 mm on a side (outside dimensions). A metal lip around the upper edge of the burner was turned to the inside of the burner on all sides and measures 12 mm wide (a piece of standard mild steel angle iron was used to form the top rail of the burner). The sand box burner is illustrated in Figure A.31.

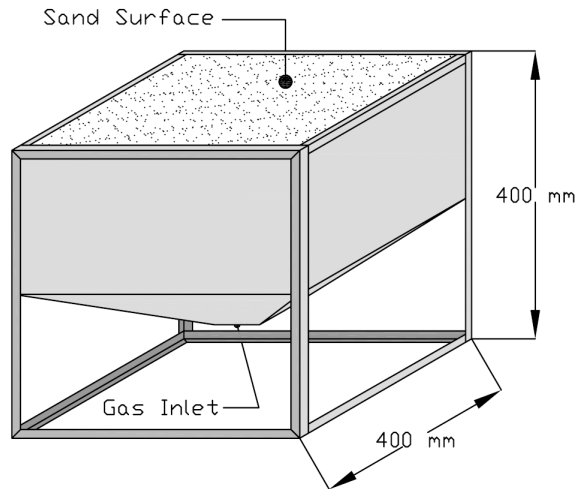

Figure A.31: Illustration of the sand box burner.

By itself, the burner stood a total of 400 mm high (a nominal cube). The lower half of the burner was an open support framework, while the upper half was an enclosed box section. That is, the upper 200 mm of each side of the support framework was enclosed with thin steel sheet panels welded and sealed with high-temperature caulk. Below this upper section a four-sided funnel shaped section was welded below the side panels. The lower funnel section acted as a plenum for gas entering the burner. A coarse copper screen was placed at the top of the funnel section and was supported by an X-shaped metal framework at the interface between the funnel section and the upper section side panels. A layer of 6 to 9 mm gravel was placed on top of the first screen filling the lower two-thirds of the upper box section. A second (finer) screen was placed on top of the gravel and a layer of course sand filled the upper one-third of the upper box section flush to the top lip of the burner. Gas flowed into the bottom of the sand box, percolated up through the gravel, through the sand, and then burned as a diffusion flame above the sand surface.

For testing, the burner was elevated above the floor of the test enclosure. The top surface of the burner was about 840 mm above the floor of the enclosure. The burner was always placed in the center of the test structure and directly below cable raceway Location A. The flow of gas to the burner was measured and controlled by an electronic flow control valve.²¹

The single largest source of uncertainty associated with the intermediate-scale test conditions was that associated with conversion of the gas burner measure flow rate into an effective HRR. That is, while the gas flow rate was monitored in all tests, the HRR must be calculated and

²¹ The flow controller used was from Omega Controls and is electronic flow controller model FMA5545.

specific assumptions must be made with respects to combustion efficiency. The HRR (MW) can be estimated based on the measure fuel flow rate as follows:

$$HRR = \eta \cdot V_g \cdot \rho \cdot H_c,$$

where η is the combustion efficiency, H_c is the heat of complete combustion (45.79 MJ/kg), ρ is the fuel gas density as standard conditions (1.802 kg/m³), and V_g is the measured fuel gas volume flow rate (m³/s). All but one of these parameters was either well known or directly measured, the exception being the combustion efficiency. The intent had been to estimate the burner efficiency based on cross-calculation of the HRR based on both the fuel flow rate and oxygen consumption calorimetry based on stack measurements. This proved to be impractical given the extremely long residence times for combustion products in the outer test cell that led to an untenably long delay between gas burner changes and the achievement of steady-state conditions at the stack.

Typical values for this parameter for a sand burner and a fuel such as propene will generally range from 0.8 to 0.9. *Note that throughout this report, whenever a value or plot of the nominal gas burner HRR has been cited, the calculation has assumed a combustion efficiency of 0.85 (85%).* The relatively low combustion efficiency reflects two factors. First, the sand burner creates a diffusion flame that is less efficient than a pre-mixed gas-air flame. Second, propene was chosen as the fuel gas specifically because under diffusion flame burning conditions propene burns with a luminous, sooty flame. However, such burning behavior is also indicative of a less complete, hence less efficient, combustion process than would be obtained with a cleaner-burning fuel gas such as propane. Based on these conditions, 0.85 is considered a reasonable estimate of the overall combustion efficiency of the propene sand burner. Given the range of typically measured sand burner efficiencies, the resulting HRR calculations are estimated to have a nominal uncertainty of $\pm 5\%$.

Gas flow to the gas burner was provided through a set-point flow control valve. The flow rate was recorded in standard liters per minute of gas. In practical application, the volume flow rate of the gas as reported by the mass flow meter must be multiplied by a constant “correction factor.” The correction factor was specified by the flow controller’s manufacturer and corrects for the flow of propene gas as compared to the flow of nitrogen gas against which the valve was calibrated. Hence, Equation A-2 is modified in application as follows:

$$HRR = \eta \cdot 0.4 \cdot V_{g\text{-reported}} \cdot \rho \cdot H_c$$

where 0.4 is the calibration correction factor and $V_{g\text{-reported}}$ is the measured fuel gas volume flow rate as reported by the flow meter.

A.6.4.1 Intermediate-Scale Test Burner Settings

The calculation inputs for the HRR is described in Table A.14. Table A.15 presents the flow and corresponding heat release rate for IS9. Table A.16 presents the flow and corresponding heat release rate for IS10. It should be noted that the flow rates did not stabilize on one value, but in fact fluctuated by approximately ± 3 liters per minute. Additionally, the ambient temperatures

(e.g., extreme colds of -25°C) impacted the performance of the pressure system. These conditions will be noted as appropriate.

Table A.14 Inputs for the heat release rate equation.

| <u>Condition</u> | <u>Symbol</u> | <u>Units</u> | <u>Value</u> |
|-----------------------|---------------|-------------------|--------------|
| Combustion Efficiency | η | | 0.85 |
| Heat of Combustion | H_c | MJ/kg | 45.79 |
| Fuel Gas Density | ρ | kg/m ³ | 1.802 |
| Correction Factor | | | 0.4 |

Table A.15: Heat release rate for Intermediate-Scale Test 9.

| Time (minutes into test) | Burner Flow (L/min) | Heat Release Rate (kW) |
|--------------------------|---------------------|------------------------|
| 0 | 148 | 173 |
| 15 | 180 | 210 |
| 29 | 213.6 | 250 |
| 39 | 241.2 | 282 |
| 55 | 0 | 0 |

Table A.16: Heat release rate for Intermediate-Scale Test 10.

| Time (minutes into test) | Burner Flow (L/min) | Heat Release Rate (kW) |
|--------------------------|---------------------|------------------------|
| 0 | 148 | 173 |
| 15 | 182.4 | 213 |
| 25 | 215.6 | 252 |
| 35 | 243.2 | 284 |
| 45 | 260.4 | 304 |
| 57 | 272 | 318 |
| 66 | 0 | 0 |

A.7 References

- [1] **NUREG/CR-7100**, “Direct Current Electrical Shorting in Response to Exposure Fire (DESIREE-Fire),” Draft Document, U.S. Nuclear Regulatory Commission, Washington DC, September 2010.
- [2] **Standard 450-1995**, “IEEE Recommended Practice for Maintenance, Testing and Replacement of Vented Lead-Acid Batteries for Stationary Applications,” Published by The Institute of Electrical and Electronics Engineers, 3 Park Avenue, New York, NY 10016-5997, June 1995.
- [3] **Standard 484-2002**, “IEEE Recommended Practice for Installation Design and Implementation of Vented Lead-Acid Batteries for Stationary Applications,” Published by The Institute of Electrical and Electronics Engineers, 3 Park Avenue, New York, NY 10016-5997, September 2002.
- [4] **Standard 485-1997**, “IEEE Recommended Practice for Sizing Lead-Acid Batteries for Stationary Applications,” Published by The Institute of Electrical and Electronics Engineering, 3 Park Avenue, New York, NY 10016-5997, May 1997.
- [5] **NUREG/CR-6931**, “Cable Response to Live Fire (CAROLFIRE),” U.S. Nuclear Regulatory Commission, Washington DC, April 2006.
- [6] **NUREG/CR-6776**, “Cable Insulation Resistance Measurements Made During Cable Fire Tests,” U.S. Nuclear Regulatory Commission, Washington DC, June 2002.

APPENDIX B: TEST RESULTS

B.1 Introduction

The following sections provide the experimental data and test results for each cable item. The tests are first separated by cable identification, then test program (i.e., DESIREE-Fire or KATE-Fire), testing scale (i.e., small- or intermediate-scale), and finally original test number. Illustrations are provided at the cable item level to reflect the conductor numbering scheme. When looking at the diagram of the test cable, the dark gray region represents the jacketing material while the lighter gray region represents the insulation surrounding the wire. Each wire is white with a number representing the specific conductor within the cable. Some of the cable samples contained a zinc tape wrap for grounding. This zinc tape is represented by the ground symbol.

At the test level, parameters are provided to identify specific details of the test including the date the experiment was conducted, cable monitoring unit utilized, and initial heating conditions. After the test parameters, a table containing wiring information for the sample cable to specific cable monitoring unit is presented. A time-line of the experimental including key results and graphs of the electrical data are then provided for each test.

The thermocouple placement information for each test series and scale is provided in Figure B.1 through Figure B.6. In all of the data plots, cable temperature are identified as “cable n” where ‘n’ indicates the specific thermocouple (TC) and its corresponding placement in the thermal response cable. For the Penlight tests performed under DESIREE-Fire, two TCs were used as illustrated in Figures B.1 and B.2. Both TCs are located below the cable jacket at the longitudinal center of the exposed cable segment (i.e., relative to the Penlight shroud). The cable is placed in Penlight for testing such that TC2 is at the top of the cable and TC1 is on the side of the cable facing the center of the tray. In the Kate-Fire Penlight tests an additional two thermocouples were used each place at an “outboard” location as shown in Figures B.5 and B.6. The specific arrangement for a given Penlight test is therefore defined by whether there were two or four thermocouples present. In the case of the DESIREE-Fire intermediate scale tests, three thermocouples were used for each thermal response cable as illustrated in Figures B.3 and B.4. It should be noted that for the intermediate-scale experiments and for cables located in Position B (second tray directly above the burner), only the data for TC2 is reported. For this test location, the cable center heated much more quickly than did the outboard locations because the center section was generally in the burner’s flame zone. During the intermediate-scale experiments, air temperatures were measured approximately 5 cm above the cable location. There were cases during the intermediate scale tests where thermocouples failed during testing. The data for such cases have not been reported here but are retained in the raw data files.

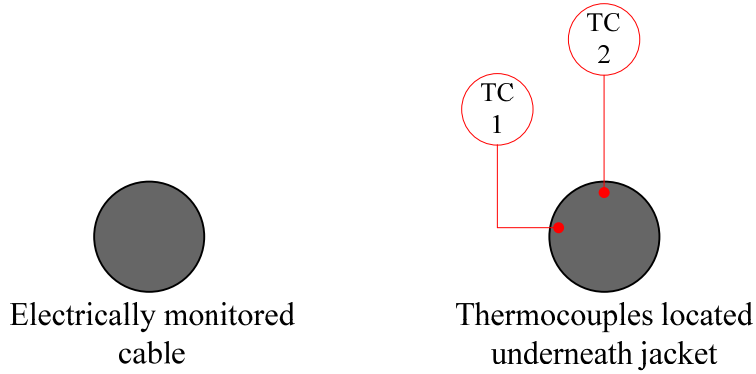

Figure B.1: Illustration of the thermally monitored cable with circumferential thermocouple placement for Penlight DESIREE-Fire tests.

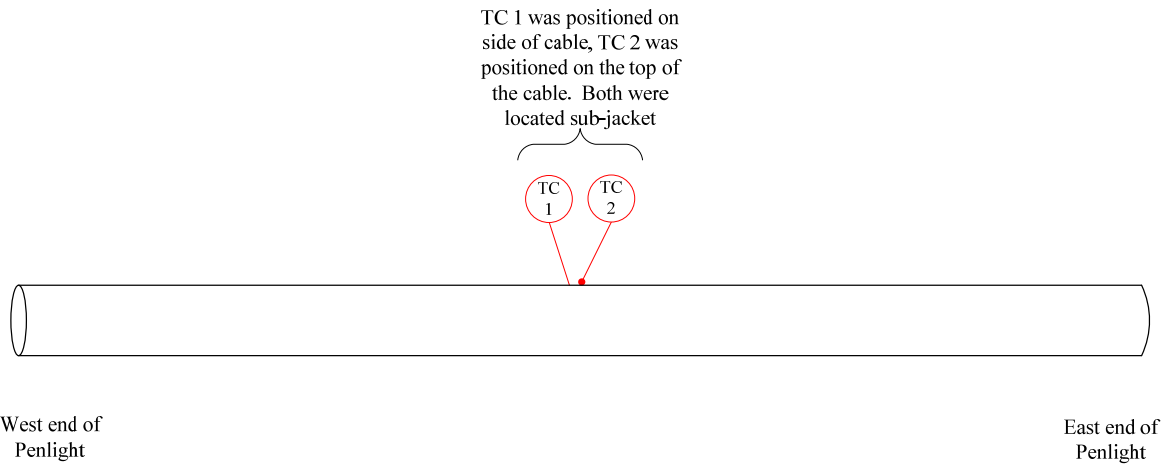

Figure B.2: Illustration of the thermally monitored cable with longitudinal thermocouple placement for Penlight DESIREE-Fire tests.

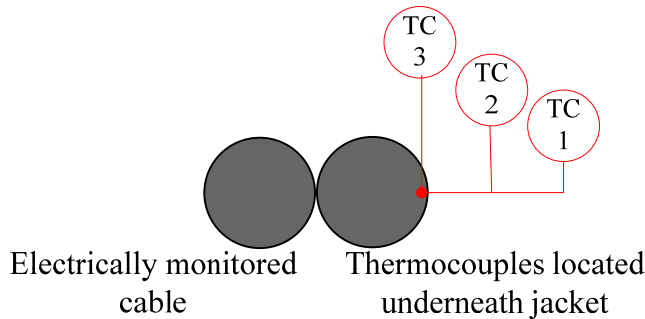

Figure B.3: Illustration of the thermally monitored cable with circumferential thermocouple placement for intermediate-scale DESIREE-Fire tests.

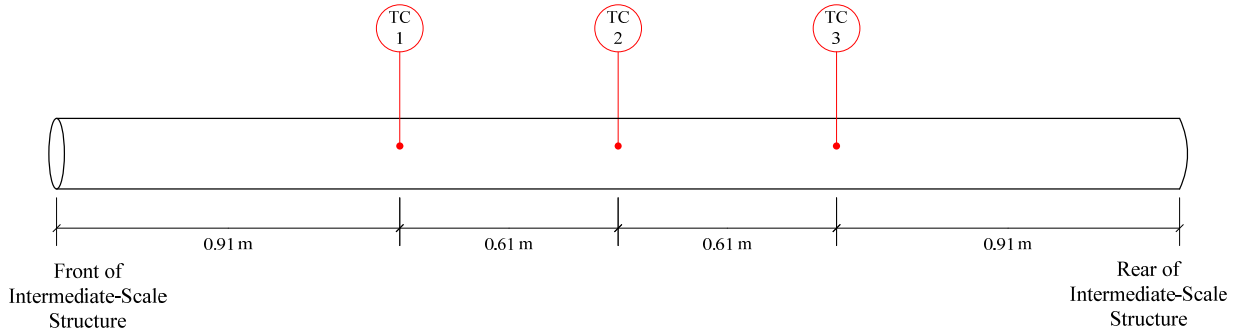

Figure B.4: Illustration of the thermally monitored cable with longitudinal thermocouple placement for intermediate-scale DESIREE-Fire tests.

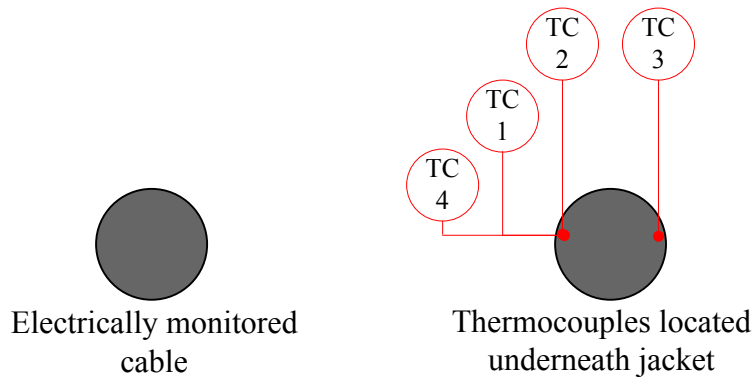

Figure B.5: Illustration of the thermally monitored cable with circumferential thermocouple placement for KATE-Fire Penlight tests.

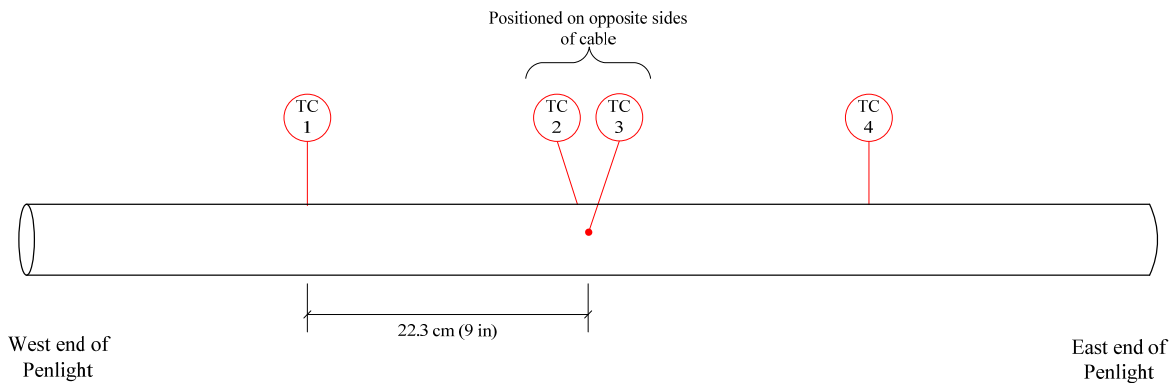

Figure B.6: Illustration of the thermally monitored cable with longitudinal thermocouple placement for KATE-Fire tests.

B.2 Cable Item A: 2/C-12 AWG, FR

Cable Item A is a 2/C-12 AWG cable with FR insulation, according to the bill of materials provided by the donating company, and the conductors are numbered as depicted in Figure B.7. The cable was tested three times during the KATE-Fire test series, all on IRMS. The following sections detail the test parameters, conductor paths, circuit data, and test summary for each test.

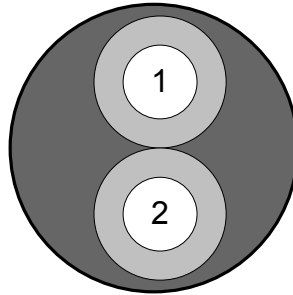

Figure B.7: Illustration of Cable Item A.

B.2.1 Test K14

Test K14 utilized the IRMS to monitor the electrical performance of the cable throughout the thermal exposure. The test parameters may be found in Table B.1. The conductor pathway for the cable monitoring unit may be found in Table B.2. Electrical performance of the cable may be found in Figure B.8. From this graph, the green and black lines display the conductor-to-ground and conductor-to-conductor minimum resistances, respectively. Throughout the thermal exposure, the insulation resistance did not degrade to the point of current leakage during the extended low temperature exposure at 325°C and gradual stepwise increase to 405°C. A summary of the test may be found in Table B.3.

Table B.1: Test parameters for Test K14.

| | |
|--------------------------------|-----------------------|
| Test Series | KATE-FIRE |
| Test Name | Test 14 |
| Test Date | 10/25/2010 |
| Cable 1 | Kerite 2/C-12 AWG, FR |
| Cable Monitoring Unit Utilized | IRMS |
| Cable 2 | NA |
| Cable Monitoring Unit Utilized | NA |
| Penlight Starting Temperature | 325°C |
| Penlight Final Temperature | 405°C |

Table B.2: Conductor designation for Item A, Test K14.

| Kerite 2/C-12 AWG, FR. Black cable, gray conductors with white print | | | |
|--|-----------------|---------------------|-------|
| Conductor Number | Conductor Color | IRMS Circuit Number | Notes |
| 1 | Black | 1 | |
| 2 | White | 2 | |

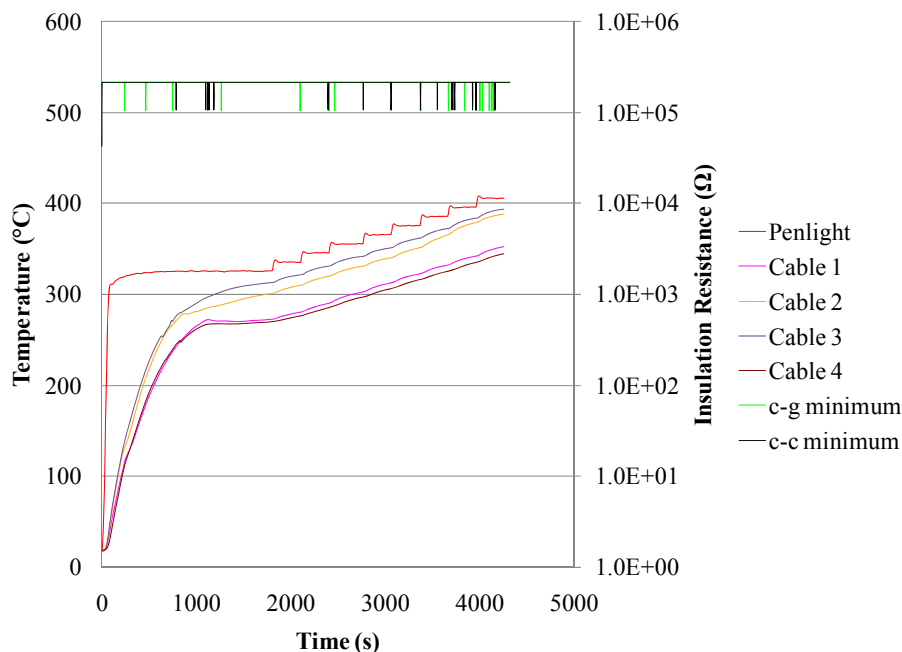

Figure B.8: Penlight shroud temperature, cable temperatures, and electrical performance data for Test K14.

Table B.3: Summary of observed faulting behavior for Test K14.

| Time (s) | Event | Comments |
|-----------|---|---|
| 0 | Penlight On; set at 325°C (5.92 kW/m ²) | The initial Penlight set point temperature was maintained for approximately 30 minutes before being increased. |
| 1800-4260 | Penlight set point temperature increased stepwise | During this time span, the temperature was increased stepwise by 10°C every five minutes until the test was concluded. The final set point temperature of Penlight was 405°C. |
| 4260 | Penlight shutdown | No electrical failures were detected. Penlight was shut down for cable dissection and analysis. Cables reached approximately 391°C at a Penlight set point of 405°C before the test was concluded. The cables did not ignite. |

B.2.2 Test K15

Test K15 utilized the IRMS to monitor the electrical performance of the cable throughout the thermal exposure. The test parameters may be found in Table B.4. The conductor pathway for the cable monitoring unit may be found in Table B.5. Electrical performance of the cable may be found in Figure B.9. From this graph, the green and black lines display the conductor-to-ground and conductor-to-conductor minimum resistances, respectively. Throughout the thermal exposure, the insulation resistance did not degrade to the point of current leakage during the extended low temperature exposure at 325°C and gradual stepwise increase to 425°C. A summary of the test may be found in Table B.6.

Table B.4: Test parameters for Test K15.

| | |
|--------------------------------|-----------------------|
| Test Series | KATE-FIRE |
| Test Name | Test 15 |
| Test Date | 11/1/2010 |
| Cable 1 | Kerite 2/C-12 AWG, FR |
| Cable Monitoring Unit Utilized | IRMS |
| Cable 2 | NA |
| Cable Monitoring Unit Utilized | NA |
| Penlight Starting Temperature | 325°C |
| Penlight Final Temperature | 425°C |

Table B.5: Conductor designation for Item A, Test K15.

| Kerite 2/C-12 AWG, FR. Black cable, gray conductors with white print | | | |
|--|-----------------|---------------------|-------|
| Conductor Number | Conductor Color | IRMS Circuit Number | Notes |
| 1 | Black | 1 | |
| 2 | White | 2 | |

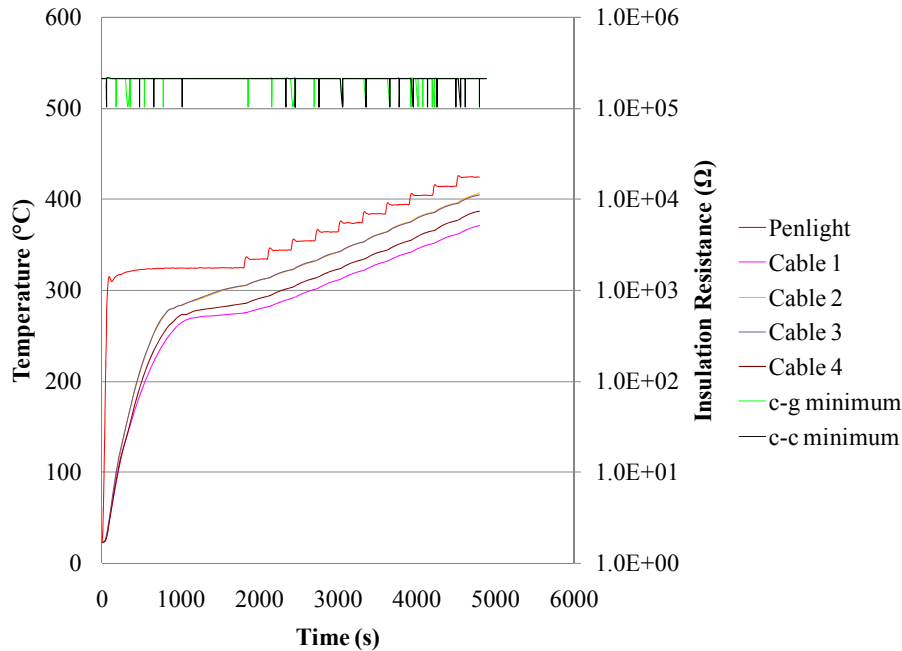

Figure B.9: Penlight shroud temperature, cable temperatures, and electrical performance data for Test K15.

Table B.6: Summary of observed faulting behavior for Test K15.

| Time (s) | Event | Comments |
|-----------|---|--|
| 0 | Penlight On; set at 325°C (5.92 kW/m ²) | The initial Penlight set point temperature was maintained for approximately 30 minutes before being increased. |
| 1800-4800 | Penlight set point temperature increased stepwise | During this time span, the temperature was increased stepwise by 10°C every five minutes until the test was concluded. The final set point temperature of Penlight was 425°C. |
| 4800 | Penlight shutdown | No electrical failures were detected. Penlight was shut down for cable dissection and analysis. Cables reached approximately 406°C before the test was concluded. The cables did not ignite. |

B.2.3 Test K16

Test K16 utilized the IRMS to monitor the electrical performance of the cable throughout the thermal exposure. The test parameters may be found in Table B.7. The conductor pathway for the cable monitoring unit may be found in Table B.8. Electrical performance of the cable may be found in Figure B.10. From this graph, the green and black lines display the conductor-to-ground and conductor-to-conductor minimum resistances, respectively. The insulation resistance did not degrade to the point of current leakage during the extended low temperature exposure at

325°C. Since the previous two tests were concluded for post-test cable inspection prior to failure, Penlight temperatures for Test K16 were gradually increased stepwise until ignition. The cable ignited after the Penlight set point temperature was increased to 465°C and at a cable temperature of approximately 430°C. Shortly after ignition, initial electrical failure below 1000 Ω was detected between conductor 2 and ground. A summary of the test may be found in Table B.9.

Table B.7: Test parameters for Test K16.

| | |
|--------------------------------|-----------------------|
| Test Series | KATE-FIRE |
| Test Name | Test 16 |
| Test Date | 11/2/2010 |
| Cable 1 | Kerite 2/C-12 AWG, FR |
| Cable Monitoring Unit Utilized | IRMS |
| Cable 2 | NA |
| Cable Monitoring Unit Utilized | NA |
| Penlight Starting Temperature | 325°C |
| Penlight Final Temperature | 465°C |

Table B.8: Conductor designation for Item A, Test K16.

| Kerite 2/C-12 AWG, FR. Black cable, gray conductors with white print | | | |
|--|-----------------|---------------------|-------|
| Conductor Number | Conductor Color | IRMS Circuit Number | Notes |
| 1 | Black | 1 | |
| 2 | White | 2 | |

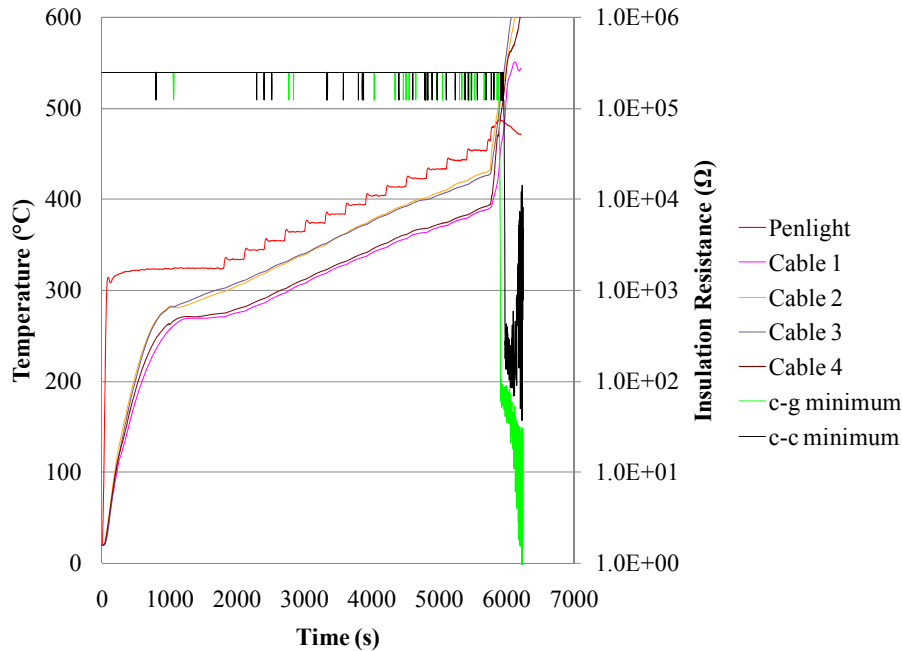

Figure B.10: Penlight shroud temperature, cable temperatures, and electrical performance data for Test K16.

Table B.9: Summary of observed faulting behavior for Test K16.

| Time (s) | Event | Comments |
|-----------|--|--|
| 0 | Penlight On; set at 325°C (5.92 kW/m ²) | The initial Penlight set point temperature was maintained for approximately 30 minutes before being increased. |
| 1800-5400 | Penlight set point temperature increased stepwise | During this time span, the temperature was increased stepwise by 10°C every five minutes until the test was concluded. The final set point temperature of Penlight was 465°C. |
| ~5670 | Ignition | The cable temperature was approximately 433°C before ignition. The approximate time was obtained from the field notes and then compared again the temperature plot for consistency. The observed ignition time corresponds reasonably well with the data. The Penlight set point temperature was not increased after ignition. |
| 5887-5907 | Conductor 2 displaying initial signs of current leakage to ground. | |
| 5907-5909 | Conductor 2 shorts to ground and at less than 1000 Ω | |
| 5909-6210 | Conductor 2 shorts to ground and at less than 100 Ω | |
| 5957-5970 | Conductor 1 displaying initial signs of current leakage to ground. | |

Table B.9: Summary of observed faulting behavior for Test K16.

| Time (s) | Event | Comments |
|-----------------|---|-----------------|
| 5957-5972 | Conductor 1 displaying initial signs of current leakage to Conductor 2. | |
| 5970-5975 | Conductor 1 shorts to ground and at less than 1000 Ω | |
| 5972-6053 | Conductor 1 shorts to Conductor 2 and at less than 1000 Ω | |
| 5975-6210 | Conductor 1 shorts to ground and at less than 100 Ω | |
| 6053-6210 | Conductor 1 shorts to Conductor 2 and at less than 100 Ω | |
| 6210 | Penlight shutdown | |

B.3 Cable Item B: 2/C-10 AWG, FR-III

Cable Item B is a 2/C-10 AWG cable with FR-III insulation, according to the bill of materials provided by the donating company, and the conductors are numbered as depicted in Figure B.11. The cable was tested three times during the KATE-Fire test series, twice on IRMS and once on SCDU. The following sections detail the test parameters, conductor paths, circuit data, and test summary for each test.

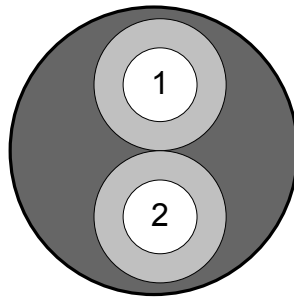

Figure B.11: Illustration of Cable Item B.

B.3.1 Test K12

Test K12 utilized the IRMS to monitor the electrical performance of the cable throughout the thermal exposure. The test parameters may be found in Table B.10. The conductor pathway for the cable monitoring unit may be found in Table B.11. Electrical performance of the cable may be found in Figure B.12. From this graph, the green and black lines display the conductor-to-ground and conductor-to-conductor minimum resistances, respectively. The insulation resistance did not degrade to the point of current leakage during the extended low temperature exposure at 325°C. Penlight temperatures for Test K12 were gradually increased stepwise until ignition.

The cable ignited after the Penlight set point temperature was increased to 445°C and at a cable temperature of approximately 416°C. Shortly after ignition, initial electrical failure below 1000 Ω was detected between conductors 1 and 2. A summary of the test may be found in Table B.12.

Table B.10: Test parameters for Test K12.

| | |
|--------------------------------|---------------------------|
| Test Series | KATE-FIRE |
| Test Name | Test 12 |
| Test Date | 11/4/2010 |
| Cable 1 | Kerite 2/C-10 AWG, FR-III |
| Cable Monitoring Unit Utilized | IRMS |
| Cable 2 | NA |
| Cable Monitoring Unit Utilized | NA |
| Penlight Starting Temperature | 325°C |
| Penlight Final Temperature | 445°C |

Table B.11: Conductor designation for Item B, Test K12.

| Kerite 2/C-10 AWG, FR-III. Black cable, gray conductors with white print | | | |
|--|-----------------|---------------------|-------|
| Conductor Number | Conductor Color | IRMS Circuit Number | Notes |
| 1 | Black | 1 | |
| 2 | White | 2 | |

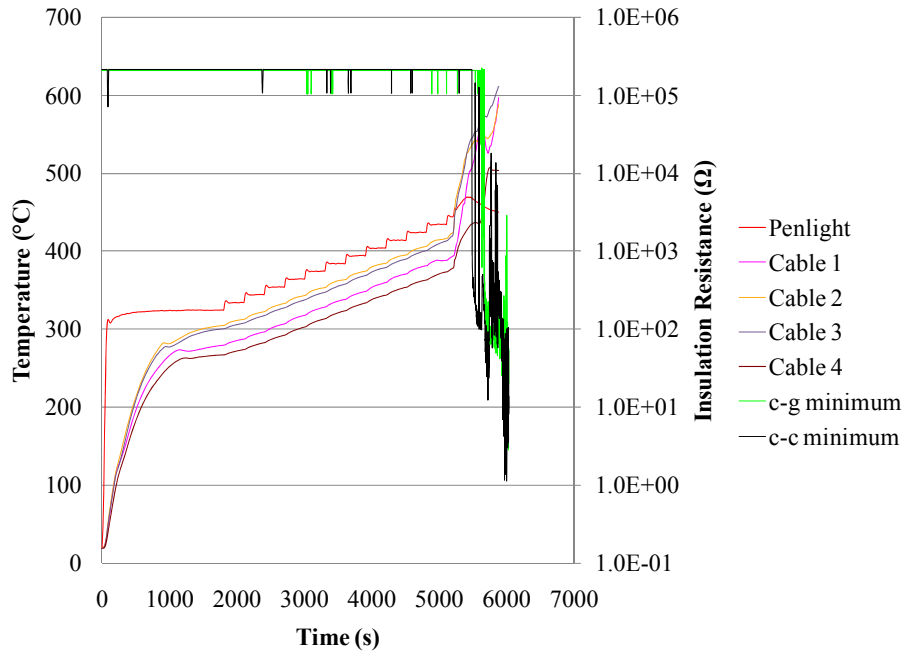

Figure B.12: Penlight shroud temperature, cable temperatures, and electrical performance data for Test K12.

Table B.12: Summary of observed faulting behavior for Test K12.

| Time (s) | Event | Comments |
|-----------|---|---|
| 0 | Penlight On; set at 325°C (5.92 kW/m ²) | The initial Penlight set point temperature was maintained for approximately 30 minutes before being increased. |
| 1800-5100 | Penlight set point temperature increased stepwise | During this time span, the temperature was increased stepwise by 10°C every five minutes until the test was concluded. The final Penlight set point temperature of Penlight was 445°C. |
| ~5217 | Ignition | The cable temperature was approximately 416°C before ignition. The approximate time was obtained from the field notes and then compared again the temperature plot for consistency. The observed ignition time corresponds reasonably well with the data. |
| 5486-5621 | Conductor 1 shorts to Conductor 2 and at less than 1000 Ω | |
| 5486-5624 | Conductor 1 shorts to ground and at less than 1000 Ω | |
| 5621-5880 | Conductor 1 shorts to Conductor 2 and at less than 100 Ω | |
| 5624-5880 | Conductor 1 shorts to ground and at less than 100 Ω | |

Table B.12: Summary of observed faulting behavior for Test K12.

| Time (s) | Event | Comments |
|-----------|---|----------|
| 5669-5689 | Conductor 2 shorts to ground and at less than 1000 Ω | |
| 5689-5880 | Conductor 2 shorts to ground and at less than 100 Ω | |
| 5880 | Penlight shutdown | |

B.3.2 Test K13

Test K13 utilized the IRMS to monitor the electrical performance of the cable throughout the thermal exposure. The test parameters may be found in Table B.13. The conductor pathway for the cable monitoring unit may be found in Table B.14. Electrical performance of the cable may be found in Figure B.13. From this graph, the green and black lines display the conductor-to-ground and conductor-to-conductor minimum resistances, respectively. Throughout the thermal exposure, the insulation resistance did not degrade to the point of current leakage during the extended low temperature exposure at 325°C and gradual stepwise increase to 405°C. A summary of the test may be found in Table B.15.

Table B.13: Test parameters for Test K13.

| | |
|--------------------------------|---------------------------|
| Test Series | KATE-FIRE |
| Test Name | Test 13 |
| Test Date | 11/4/2010 |
| Cable 1 | Kerite 2/C-10 AWG, FR-III |
| Cable Monitoring Unit Utilized | IRMS |
| Cable 2 | NA |
| Cable Monitoring Unit Utilized | NA |
| Penlight Starting Temperature | 325°C |
| Penlight Final Temperature | 405°C |

Table B.14: Conductor designation for Item B, Test K13.

| Kerite 2/C-10 AWG, FR-III. Black cable, gray conductors with white print | | | |
|--|-----------------|---------------------|-------|
| Conductor Number | Conductor Color | IRMS Circuit Number | Notes |
| 1 | Black | 1 | |
| 2 | White | 2 | |

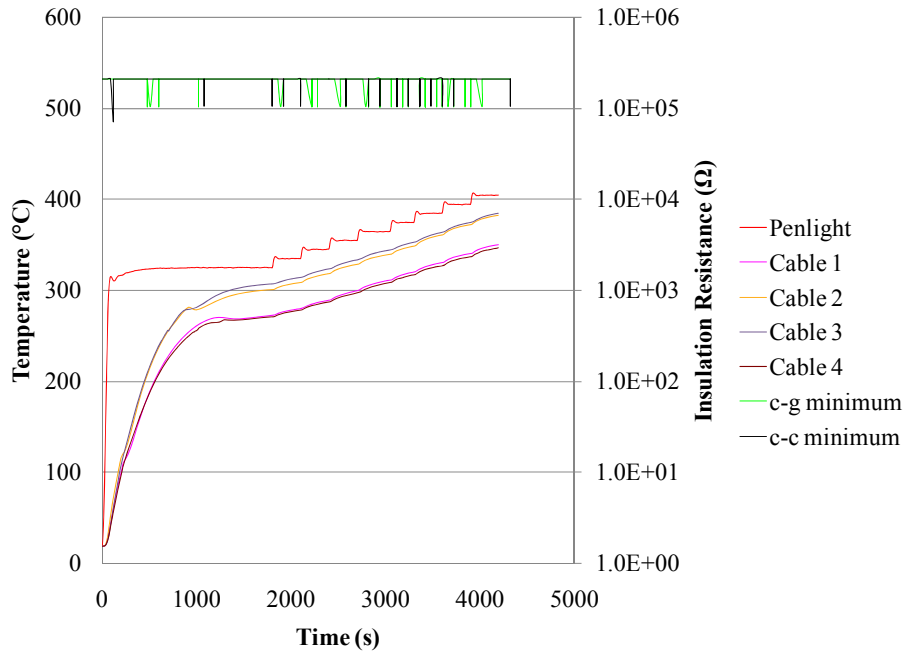

Figure B.13: Penlight shroud temperature, cable temperatures, and electrical performance data for Test K13.

Table B.15: Summary of observed faulting behavior for Test K13.

| Time (s) | Event | Comments |
|-----------|---|--|
| 0 | Penlight On; set at 325°C (5.92 kW/m ²) | The initial Penlight set point temperature was maintained for approximately 30 minutes before being increased. |
| 1800-4200 | Penlight set point temperature increased stepwise | During this time span, the temperature was increased stepwise by 10°C every five minutes until the test was concluded. The final Penlight set point temperature of Penlight was 405°C. |
| 4200 | Penlight shutdown | No electrical failures were detected. Penlight was shut down for cable dissection and analysis. Cables reached approximately 384°C before the test was concluded. The cables did not ignite. |

B.3.3 Test K17

Test K17 utilized the SCDU to monitor the electrical performance of the cable throughout the thermal exposure. The test parameters may be found in Table B.16. The conductor pathway for the cable monitoring unit may be found in Table B.17. Electrical performance of the cable may be found in Figure B.14. From this graph, the dark blue and light blue lines display the source and target voltages, respectively. The cable did not degrade electrically during the extended low

temperature exposure at 325°C; however, electrical degradation on the target conductor occurred at approximately 6000 s into the test during the gradual stepwise increase. At this time, Penlight and cable temperatures were 455°C and 428°C, respectively. At approximately 6310 s, the cables ignited at around 441°C. Shortly after ignition, there was a spurious operation on the active target for SCDU1. The actuation lasted for about 15 s before the fuse cleared. Penlight was shutdown 15 s after the fuse blow. A summary of the test may be found in Table B.18.

Table B.16: Test parameters for Test K17.

| | |
|--------------------------------|---------------------------|
| Test Series | KATE-FIRE |
| Test Name | Test 17 |
| Test Date | 11/9/2010 |
| Cable 1 | Kerite 2/C-10 AWG, FR-III |
| Cable Monitoring Unit Utilized | SCDU1 |
| Cable 2 | NA |
| Cable Monitoring Unit Utilized | NA |
| Penlight Starting Temperature | 325°C |
| Penlight Final Temperature | 485°C |

Table B.17: Conductor designation for Item B, Test K17.

| Kerite 2/C-10 AWG, FR-III. Black cable, gray conductors with white print | | | | |
|--|-----------------|---------------------|-------------------|---|
| Conductor Number | Conductor Color | SCDU Circuit Number | SCDU Circuit Path | Notes |
| 1 | Black | 1 | S1 | Energized source conductor for SCDU1 – Voltage = C1 V1; current = C1 I1 |
| 2 | White | 1 | T5 | Active target conductor for SCDU1 – Voltage = C1 V5; current = C1 I5 |

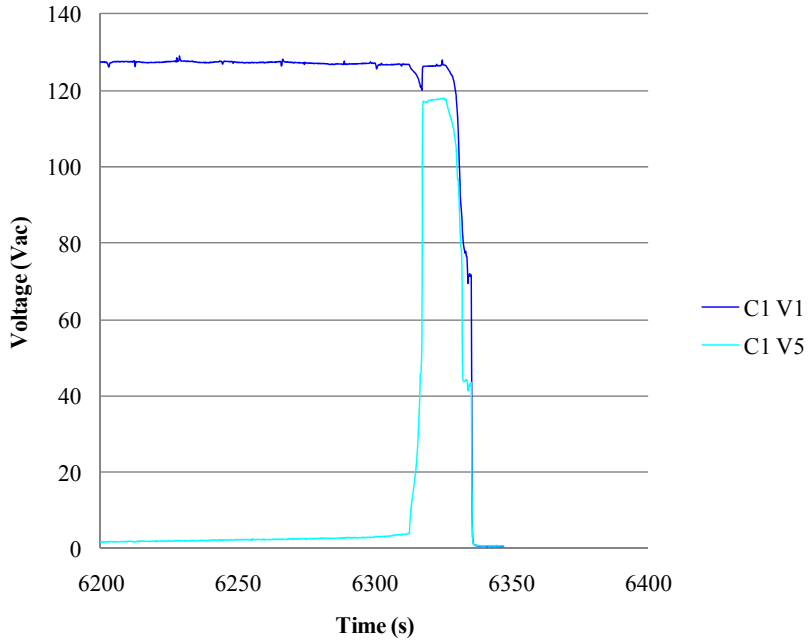

Figure B.14: Conductor voltages for Test K17 showing spurious actuation of T5 lasting approximately 15 s followed by fuse blow.

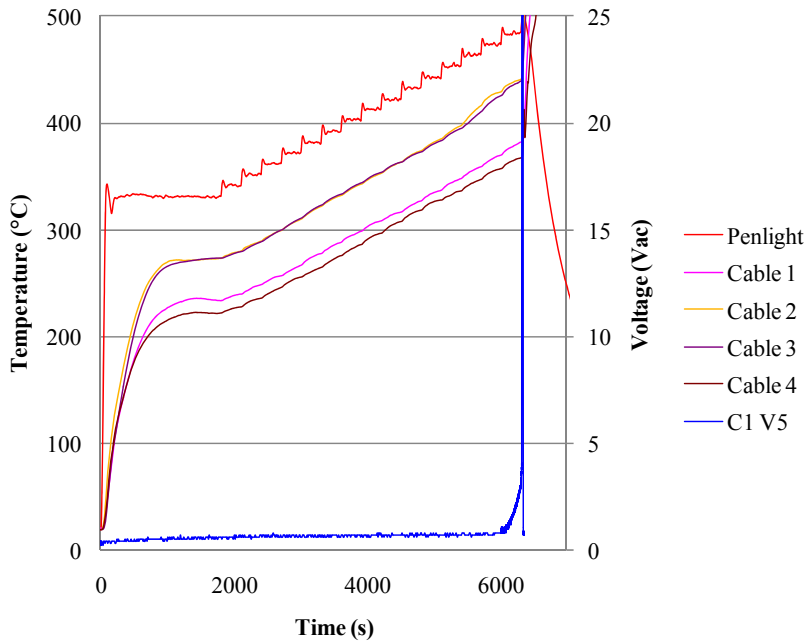

Figure B.15: Penlight shroud temperature, cable temperatures, and target conductor voltage for Test K17.

Table B.18: Summary of observed faulting behavior for Test K17.

| Time (s) | Event | Discussion |
|-----------------|---|--|
| 0 | Penlight On; set at 325°C (5.92 kW/m ²) | The initial Penlight set point temperature was maintained for approximately 30 minutes before being increased. |
| 1800-6300 | Penlight set point temperature increased stepwise | During this time span, the temperature was increased stepwise by 10°C every five minutes until the test was concluded. The final Penlight set point temperature of Penlight was 485°C. |
| 6000-6317 | Voltage increase on the active target | During this time period, the voltage increased from less than 1 V to approximately 4 V before spuriously actuating. The temperature at the initial point of voltage increase was approximately 428° B. |
| ~6310 | Ignition | The time denoted was approximated from the field notes; however, the time appears reasonable given the data. The cable temperature at ignition was approximately 441°C. |
| 6317-6332 | Spurious actuation of active target on SCDU1 | The active target on SCDU1 spuriously actuated and remained engaged for approximately 15s before the fuse cleared. |
| 6332 | Fuse clear on SCDU1 | |
| 6347 | Test concluded, Penlight shutdown | |

B.4 Cable Item C: 4/C-10 AWG, FR-III

Cable Item C is a 4/C-10 AWG cable with FR-III insulation, according to the bill of materials provided by the donating company, and the conductors are numbered as depicted in Figure B.16. The cable was tested three times during the KATE-Fire test series, twice on IRMS and once on SCDU. The following sections detail the test parameters, conductor paths, circuit data, and test summary for each test.

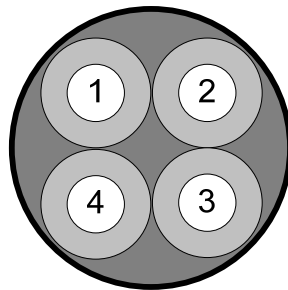

Figure B.16: Illustration of Cable Item B.

B.4.1 Test K10

Test K10 utilized the IRMS to monitor the electrical performance of the cable throughout the thermal exposure. The test parameters may be found in Table B.19. The conductor pathway for the cable monitoring unit may be found in Table B.20. Electrical performance of the cable may be found in Figure B.17. From this graph, the green and black lines display the conductor-to-ground and conductor-to-conductor minimum resistances, respectively. Throughout the thermal exposure, the insulation resistance did not degrade to the point of current leakage during the extended low temperature exposure at 325°C and gradual stepwise increase to 425°C. The final cable temperature was approximately 393°C. A summary of the test may be found in Table B.21.

Table B.19: Test parameters for Test K10.

| | |
|--------------------------------|---------------------------|
| Test Series | KATE-FIRE |
| Test Name | Test 10 |
| Test Date | 10/27/2010 |
| Cable 1 | Kerite 4/C-10 AWG, FR-III |
| Cable Monitoring Unit Utilized | IRMS |
| Cable 2 | NA |
| Cable Monitoring Unit Utilized | NA |
| Penlight Starting Temperature | 325°C |
| Penlight Final Temperature | 425°C |

Table B.20: Conductor designation for Item C, Test K10.

| Kerite 4/C-10 AWG, FR-III. Black cable, gray conductors with white print | | | |
|--|-----------------|---------------------|-------|
| Conductor Number | Conductor Color | IRMS Circuit Number | Notes |
| 1 | Black | 1 | |
| 2 | White | 2 | |
| 3 | Red | 3 | |
| 4 | Green | 4 | |

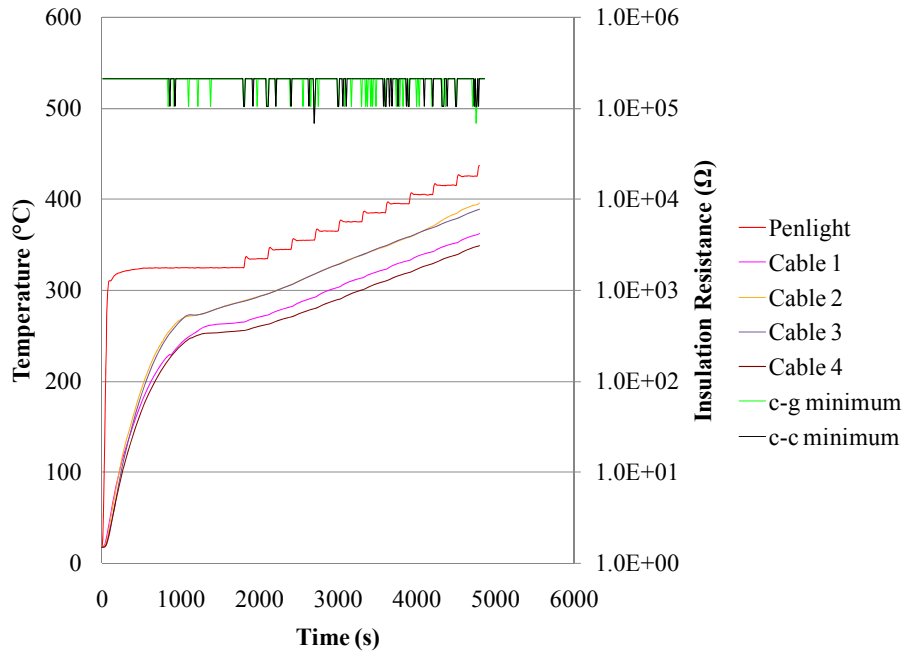

Figure B.17: Penlight shroud temperature, cable temperatures, and electrical performance data for Test K10.

Table B.21: Summary of observed faulting behavior for Test K10.

| Time (s) | Event | Comments |
|-----------|---|--|
| 0 | Penlight On; set at 325°C (5.92 kW/m ²) | The initial Penlight set point temperature was maintained for approximately 30 minutes before being increased. |
| 1800-4800 | Penlight set point temperature increased stepwise | During this time span, the temperature was increased stepwise by 10°C every five minutes until the test was concluded. The final set point temperature of Penlight was 425°C. |
| 4800 | Penlight shutdown | No electrical failures were detected. Penlight was shut down for cable dissection and analysis. Cables reached approximately 393°C before the test was concluded. The cables did not ignite. |

B.4.2 Test K11

Test K11 utilized the IRMS to monitor the electrical performance of the cable throughout the thermal exposure. The test parameters may be found in Table B.22. The conductor pathway for the cable monitoring unit may be found in Table B.23. Electrical performance of the cable may be found in Figure B.18. From this graph, the green and black lines display the conductor-to-ground and conductor-to-conductor minimum resistances, respectively. The insulation resistance did not degrade to the point of current leakage during the extended low temperature exposure at

325°C. Penlight temperatures for Test K11 were gradually increased stepwise until ignition. The cable ignited after the Penlight set point temperature was increased to 445°C and at a cable temperature of approximately 422°C. Soon after ignition, initial electrical failure below 1000 Ω was detected between conductors 4 and ground. A summary of the test may be found in Table B.24.

Table B.22: Test parameters for Test K11.

| | |
|--------------------------------|---------------------------|
| Test Series | KATE-FIRE |
| Test Name | Test 11 |
| Test Date | 11/1/2010 |
| Cable 1 | Kerite 4/C-10 AWG, FR-III |
| Cable Monitoring Unit Utilized | IRMS |
| Cable 2 | NA |
| Cable Monitoring Unit Utilized | NA |
| Penlight Starting Temperature | 325°C |
| Penlight Final Temperature | 445°C |

Table B.23: Conductor designation for Item C, Test K11.

| Kerite 4/C-10 AWG, FR-III. Black cable, gray conductors with white print | | | |
|--|-----------------|---------------------|-------|
| Conductor Number | Conductor Color | IRMS Circuit Number | Notes |
| 1 | Black | 1 | |
| 2 | White | 2 | |
| 3 | Red | 3 | |
| 4 | Green | 4 | |

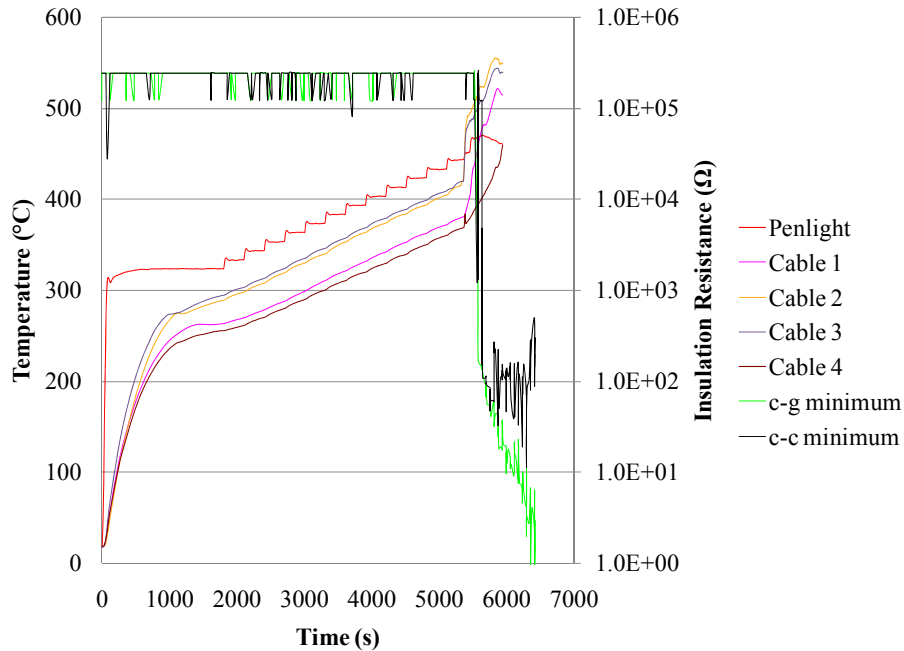

Figure B.18: Penlight shroud temperature, cable temperatures, and electrical performance data for Test K11.

Table B.24: Summary of observed faulting behavior for Test K11.

| Time (s) | Event | Comments |
|-----------|---|---|
| 0 | Penlight On; set at 325°C (5.92 kW/m ²) | The initial Penlight set point temperature was maintained for approximately 30 minutes before being increased. |
| 1800-5100 | Penlight set point temperature increased stepwise | During this time span, the temperature was increased stepwise by 10°C every five minutes until the test was concluded. The final set point temperature of Penlight was 445°C. |
| ~5358 | Ignition | The cable temperature was approximately 422°C before ignition. The approximate time was obtained from the field notes and then compared again the temperature plot for consistency. The observed ignition time corresponds reasonably well with the data. |
| 5580-5730 | Conductor 4 shorts to ground at less than 1000 Ω | Shorting path may be through ground (tray) |
| 5640-5670 | Conductor 3 shorts to ground at less than 1000 Ω | |
| 5670-6300 | Conductors 3 and 4 short to ground at less than 100 Ω | |
| 5670-5730 | Conductor 2 shorts to ground at less than 1000 Ω | |
| 5700-6300 | Conductor 3 shorts to Conductor 4 at less than 100 Ω | |

Table B.24: Summary of observed faulting behavior for Test K11.

| Time (s) | Event | Comments |
|-----------------|--|-----------------|
| 5700-5730 | Conductor 2 shorts to Conductor 4 at less than 1000 Ω | |
| 5700-5760 | Conductor 1 shorts to ground and also shorts to Conductor 4 at less than 1000 Ω | |
| 5700-5790 | Conductor 1 shorts to ground and also shorts to Conductor 2 at less than 1000 Ω | |
| 5730-6300 | Conductor 4 shorts to ground at less than 100 Ω | |
| 5730-6300 | Conductor 2 shorts to ground and also shorts to Conductor 4 at less than 100 Ω | |
| 5730-6000 | Conductor 1 shorts to Conductor 3 at less than 1000 Ω | |
| 5760-6300 | Conductor 1 shorts to ground and also shorts to Conductor 4 at less than 100 Ω | |
| 5790-6300 | Conductor 1 shorts to ground and also shorts to Conductor 2 at less than 100 Ω | |
| 5880-6120 | Conductor 2 shorts to Conductor 3 at less than 1000 Ω | |
| 6000-6300 | Conductor 1 shorts to Conductor 3 at less than 100 Ω | |
| 6120-6300 | Conductor 2 shorts to Conductor 3 at less than 100 Ω | |
| 6300 | Penlight shutdown | |

B.4.3 Test K18

Test K18 utilized the SCDU to monitor the electrical performance of the cable throughout the thermal exposure. The test parameters may be found in Table B.25. The conductor pathway for the cable monitoring unit may be found in Table B.26. Electrical performance of the cable may be found in Figure B.19. From this graph, the dark blue and light blue lines display the source and target voltages for SCDU circuit 1, respectively. The light green and dark green lines display the source and target voltages for SCDU circuit 2, respectively. Throughout the thermal exposure, the insulation resistance did not degrade to the point of current leakage during the extended low temperature exposure at 325°C and gradual stepwise increase to 455°C. At approximately 5149 s into the test, the cables ignited at a nominal 416°C. Nearly two minutes later, the active target on SCDU2 spuriously operated and remained engaged for about 9 s before the fuse for SCDU1 cleared. This would indicate that the source from SCDU1 shorted to the active target in SCDU2. At 5374 s into the test, there was voltage increase on the active target

for SCDU2 until the fuse ultimately cleared 9 s later. Penlight was subsequently shutdown and the test was concluded. The temperature profile and electrical response may be found in Figure B.20. A summary of the test may be found in Table B.27.

Table B.25: Test parameters for Test K18.

| | |
|--------------------------------|---------------------------|
| Test Series | KATE-FIRE |
| Test Name | Test 18 |
| Test Date | 11/9/2010 |
| Cable 1 | Kerite 4/C-10 AWG, FR-III |
| Cable Monitoring Unit Utilized | SCDU (M) |
| Cable 2 | NA |
| Cable Monitoring Unit Utilized | NA |
| Penlight Starting Temperature | 325°C |
| Penlight Final Temperature | 455°C |

Table B.26: Conductor designation for Item C, Test K18.

| Kerite 4/C-10 AWG, FR-III. Black cable, gray conductors with white print | | | | |
|--|-----------------|---------------------|-------------------|---|
| Conductor Number | Conductor Color | SCDU Circuit Number | SCDU Circuit Path | Notes |
| 1 | Black | 1 | S1 | Energized source conductor for SCDU1 – Voltage = C1 V1; current = C1 I1 |
| 2 | White | 1 | T5 | Active target conductor for SCDU1 Voltage = C1 V5; current = C1 I5 |
| 3 | Red | 2 | S1 | Energized source conductor for SCDU2 – Voltage = C2 V1; current = C2 I1 |
| 4 | Green | 2 | T5 | Active target conductor for SCDU2 Voltage = C2 V5; current = C2 I5 |

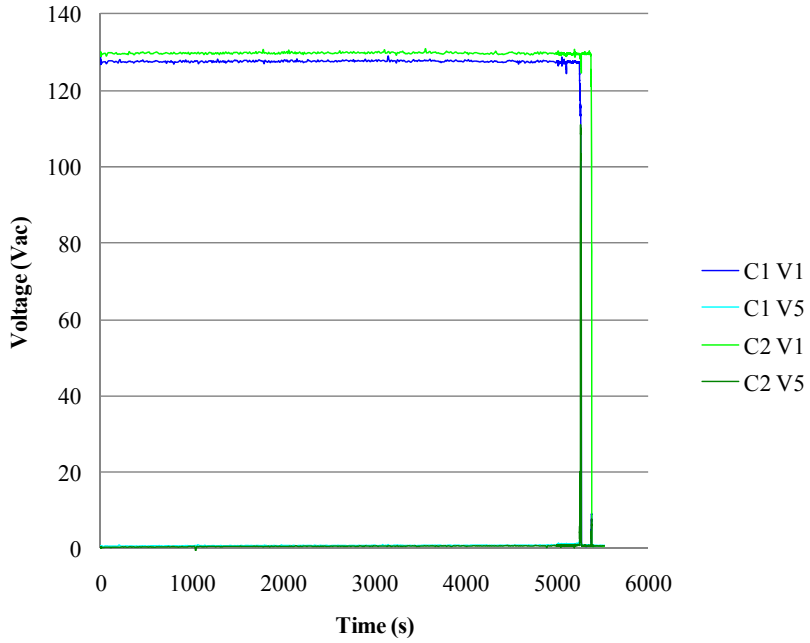

Figure B.19: Conductor voltage for Test K18 showing the clearing of fuses in SCDU1 and SCDU2.

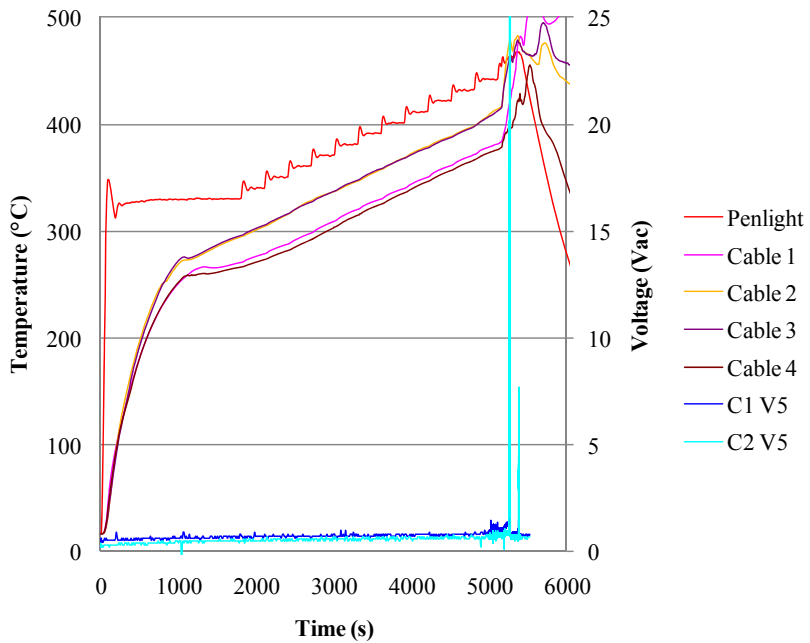

Figure B.20: Penlight shroud temperature, cable temperature, and target conductor voltages for Test K18.

Table B.27: Summary of observed faulting behavior for Test K18.

| Time (s) | Event | Discussion |
|-----------------|---|--|
| 0 | Penlight On; set at 325°C (5.92 kW/m ²) | The initial Penlight set point temperature was maintained for approximately 30 minutes before being increased. |
| 1800-5100 | Penlight set point temperature increased stepwise | During this time span, the temperature was increased stepwise by 10°C every five minutes until the test was concluded. The final set point temperature of Penlight was 455°C. |
| ~5149 | Ignition | The time denoted was approximated from the field notes; however, the time appears reasonable given the data. The cable temperature at ignition was approximately 416°C. |
| 5259-5268 | Spurious actuation on active target on SCDU2 | The spurious actuation occurred on SCDU2 active target through the SCDU1 source conductor. During this time span, the temperature was approximately 415°C. It should be noted that the cable ignited nearly two minutes prior to the spurious actuation. |
| 5269 | Fuse clear SCDU1 | Temperature at the time the fuse cleared was approximately 415°C. |
| 5374-5383 | Voltage increase on active target on SCDU2 | A voltage increase on the SCDU2 active target was detected during this time span. The voltage went from less than 1 V to approximately 7.7 V before the fuse cleared. At the time of the fuse clear, the temperatures were approximately 421°C. |
| 5383 | Fuse clear SCDU2 | |
| 5520 | Test concluded, Penlight shutdown | |

B.5 Cable Item D: 5/C-12 AWG, FR, zinc wrap

Cable Item D is a 5/C-12 AWG cable with FR insulation, according to the bill of materials provided by the donating company, and the conductors are numbered as depicted in Figure B.21. Surrounding the conductors is a zinc tape wrap which was grounded during each test based on typical plant practice as specified by the donating company. The cable was tested four times during DESIREE-Fire, all on the SCDU, and three times during the KATE-Fire tests, twice on IRMS and once on SCDU. The following sections detail the test parameters, conductor paths, circuit data, and test summary for each test.

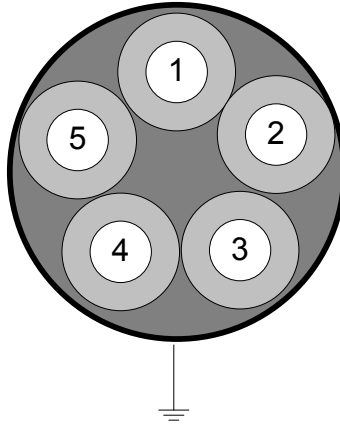

Figure B.21: Illustration of Cable Item D.

B.5.1 Test D13

Test D13 utilized the SCDU to monitor the electrical performance of the cable throughout the thermal exposure. The test parameters may be found in Table B.28. The conductor pathway for the cable monitoring unit may be found in Table B.29. Electrical performance of the cable may be found in Figure B.22. From this graph, the dark blue and light blue lines display the source and target voltages, the orange and dark green represent active targets, and the light green line represents the conductor monitoring ground.

Penlight was initially set to 350°C for approximately 32 minutes. During this stabilized heating period, electrical degradation could be observed for the active target conductors and the grounded conductor as voltages and currents increased, as observed in Figure B.22. Smoke was observed about 10 minutes into the test and at around 200°C on the cable thermocouples, cable jacket popping and crackling was heard and liquid was later seen bubbling out of the temperature monitoring cables. After this initial heating period, Penlight was increased to 375°C for 13 minutes. Penlight was then increased to 400°C for 10 minutes. The Penlight set point was increased to 425°C for 16 minutes before being increased to 470°C. Ignition occurred shortly after the increase at a cable temperature of 394°C. Slight voltage increases were detected at approximately 1129 s and 283°C. Target 6 actuated after ignition and persisted for approximately 8 s until the fuse cleared as shown in Figure B.23. The electrical response of the cable to temperature may be found in Figure B.24. A summary of the test results may be found in Table B.30.

Table B.28: Test parameters for Test D13, Circuit.

| | |
|-----------------------|----------------------------------|
| Test Series | DESIREE-FIRE |
| Test Name | Test 13 |
| Test Date | 7/27/2010 |
| Cable 1 | Kerite 5/C-12 AWG, FR, zinc wrap |
| Cable Monitoring Unit | SCDU1 |

Table B.28: Test parameters for Test D13, Circuit.

| | |
|---------------------------------|-----------------------------------|
| Utilized | |
| Cable 2* | Kerite 10/C-12 AWG, FR, zinc wrap |
| Cable Monitoring Unit Utilized | SCDU2 |
| Penlight Starting Temperature | 350 °C |
| Penlight Final Temperature | 470°C |
| * See section B.9.2 for results | |

Table B.29: Conductor designation for Item D, Test D13, Circuit 1.

| Kerite 5/C-12 AWG, FR, zinc wrap. Black cable, gray conductors with white print | | | | |
|---|-----------------|---------------------|-------------------|---|
| Conductor Number | Conductor Color | SCDU Circuit Number | SCDU Circuit Path | Notes |
| 1 | Black | 1 | S1 | Energized source conductor for SCDU1– Voltage = C1 V1; current = C1 I1 |
| 2 | White | 1 | T5 | Active target conductor for SCDU1 – Voltage = C1 V5; current = C1 I5 |
| 3 | Red | 1 | S2 | Energized source conductor for SCDU1– Voltage = C1 V2; current = C1 I2 |
| 4 | Green | 1 | T6 | Active target conductor for SCDU1 – Voltage = C1 V6; current = C1 I6 |
| 5 | Orange | 1 | G | Grounded source conductor for SCDU1– Voltage = C1 V7; current = C1 I7 |
| Zinc Wrap | NA | | | Grounded to tray |

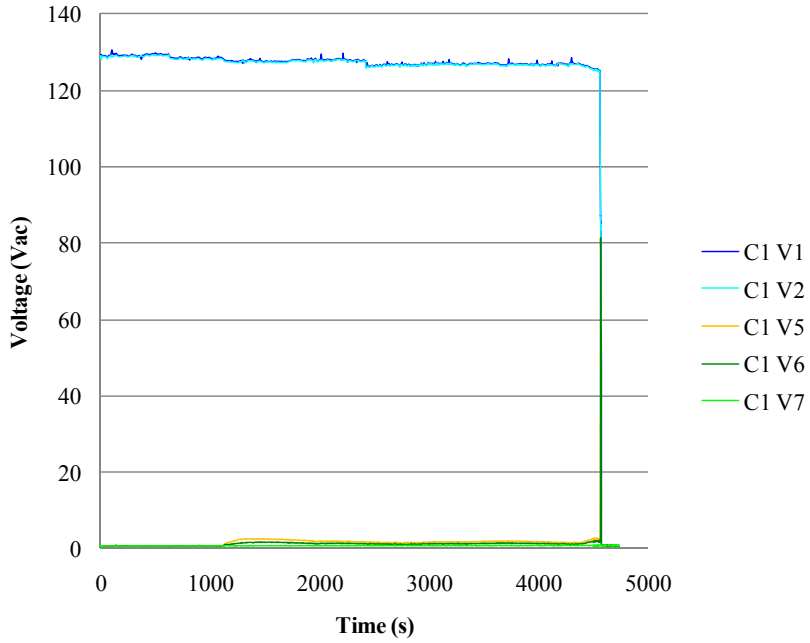

Figure B.22: Voltages for Test D13 showing increases on target conductors.

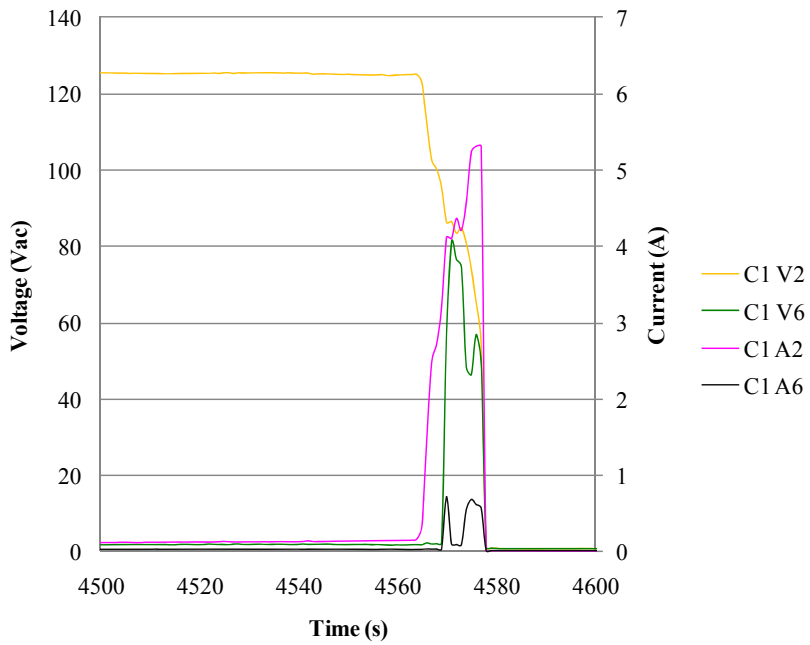

Figure B.23: Overlay of target and source conductor currents and voltages for Test D13.

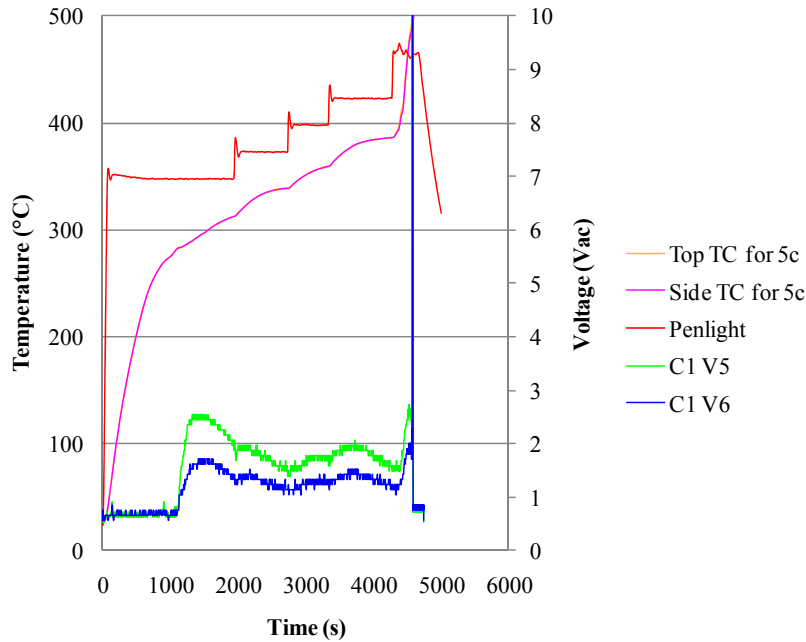

Figure B.24: Penlight shroud temperature and target conductor voltages for Test D13.

Table B.30: Summary of Observed Faulting Behavior for Test D13, Circuit 1.

| Time (s) | Event | Discussion |
|-----------|---|--|
| 0 | Penlight On; set at 350°C (6.97 kW/m ²) | |
| 1129-1342 | Increase in voltage observed on active target 5 | At 1129 s, the cable temperature reached about 283°C. The voltage on Target 5 increased to just over 2.5 V. |
| 1342-2695 | Decrease in voltage observed on active target 5 | At 1342 s, voltage on Target 5 decreased to just a low of approximately 1.14 V. |
| 1920 | Penlight increased to 375°C | |
| 2695-3791 | Increase in voltage observed on active target 5 | At 2695 s, the cable temperature reached about 339°C. The voltage on Target 5 increased to just over 2 V. |
| 2700 | Penlight increased to 400°C | |
| 3300 | Penlight increased to 425°C | |
| 3791-4362 | Decrease in voltage observed on active target 5 | At 3791 s, voltage on Target 5 decreased to just a low of approximately 1.14 V. The temperature was approximately 381°C. |

Table B.30: Summary of Observed Faulting Behavior for Test D13, Circuit 1.

| Time (s) | Event | Discussion |
|-----------------|---------------------------------------|---|
| 4260 | Penlight increased to 470°C | |
| 4362 | Ignition | Cables ignited at a cable temperature of 394°C and an exposure of 470°C. |
| 4570-4578 | Spurious actuation on active target 6 | The spurious operation occurred between source 2 and the active target resulting in actuation that persisted for approximately 8 s. |
| 4578 | Fuse clear | |
| 4662 | Test concluded, Penlight shutdown | |

B.5.2 Test D14

One of the objectives of Test D14 was to investigate how the cable sample would perform electrically under a higher initial temperature than Test D13. Test D14 utilized the SCDU to monitor the electrical performance of the cable throughout the thermal exposure. The test parameters may be found in Table B.31. The conductor pathway for the cable monitoring unit may be found in Table B.32. Penlight was initially set to 450°C and blistering and popping of the jacketing material was observed approximately six minutes into the test. At the initial exposure condition, ignition occurred approximately 10 minutes into the test at a cable temperature of approximately 288°C. Electrical performance of the cable may be observed in Figure B.25. From this figure, the target voltages in did not experience electrical degradation during the initial heating phase as was observed in previous tests (e.g., Test D13). The fuse would clear approximately 6 minutes after ignition. The electrical response of the cable to temperature may be found in Figure B.26. A summary of the test results may be found in Table B.33.

Table B.31: Test parameters for Test D14, Circuit 1.

| | |
|--------------------------------|-----------------------------------|
| Test Series | DESIREE-FIRE |
| Test Name | Test 14 |
| Test Date | 7/28/2010 |
| Cable 1 | Kerite 5/C-12 AWG, FR, zinc wrap |
| Cable Monitoring Unit Utilized | SCDU1 |
| Cable 2* | Kerite 10/C-12 AWG, FR, zinc wrap |
| Cable Monitoring Unit Utilized | SCDU2 |
| Penlight Starting Temperature | 450°C |
| Penlight Final Temperature | 450°C |

Table B.31: Test parameters for Test D14, Circuit 1.

* See section B.9.3 for results

Table B.32: Conductor designation for Item D, Test D14, Circuit 1.

| Kerite 5/C-12 AWG, FR, zinc wrap. Black cable, gray conductors with white print | | | | |
|---|-----------------|---------------------|-------------------|---|
| Conductor Number | Conductor Color | SCDU Circuit Number | SCDU Circuit Path | Notes |
| 1 | Black | 1 | S1 | Energized source conductor for SCDU1– Voltage = C1 V1; current = C1 I1 |
| 2 | White | 1 | T5 | Active target conductor for SCDU1 – Voltage = C1 V5; current = C1 I5 |
| 3 | Red | 1 | S2 | Energized source conductor for SCDU1– Voltage = C1 V2; current = C1 I2 |
| 4 | Green | 1 | T6 | Active target conductor for SCDU1 – Voltage = C1 V6; current = C1 I6 |
| 5 | Orange | 1 | G | Grounded source conductor for SCDU1– Voltage = C1 V7; current = C1 I7 |
| Zinc Wrap | NA | | | Grounded to tray |

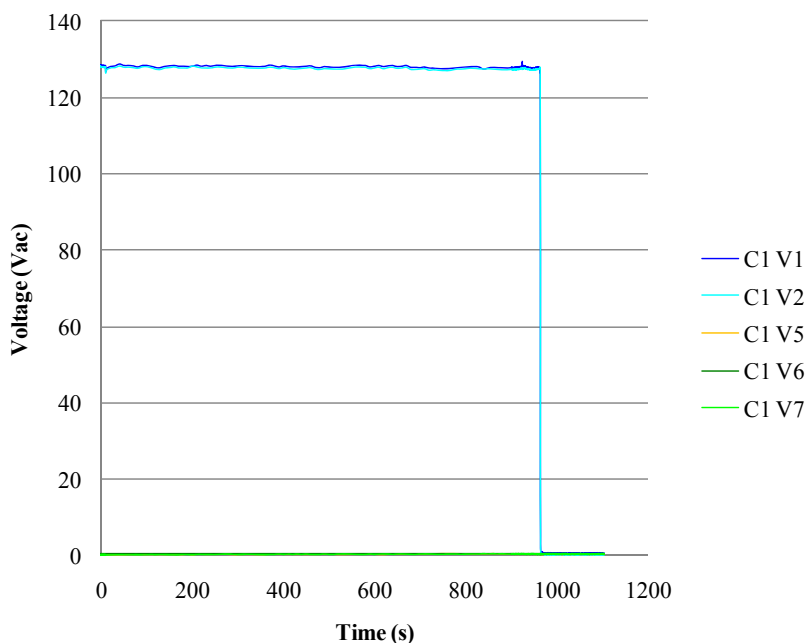

Figure B.25: All source and target voltages for Test D14, Circuit 1.

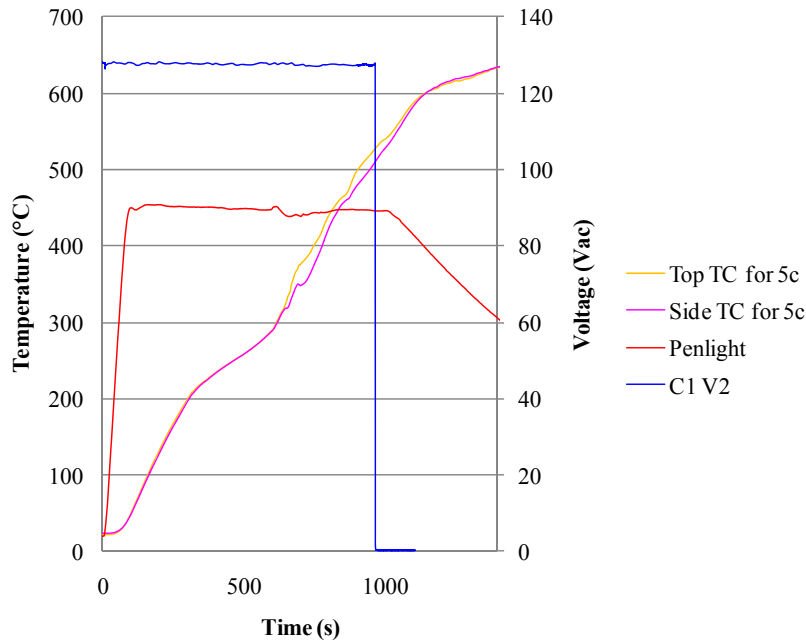

Figure B.26: Penlight shroud temperature and conductor voltage for Test D14 displaying the fuse clear.

Table B.33: Summary of Observed Faulting Behavior for Test D14, Circuit 1.

| Time (s) | Event | Discussion |
|----------|--|---|
| 0 | Penlight On; set at 450°C (12.64 kW/m ²) | |
| 600 | Ignition | The cable temperature was approximately 288°C. |
| 965 | Fuse clear | At this time, a short to ground occurred causing the fuse to clear. No components were activated. |
| 1006 | Test concluded, Penlight shutdown | |

B.5.3 Test D15

Test D15 was conducted to replicate the heating protocol of DESIREE-Fire Test 13, qualification in which a low temperature failure was observed in Item H. SCDU was utilized to monitor the electrical performance of the cable throughout the thermal exposure. The test parameters may be found in Table B.34. The conductor pathway for the cable monitoring unit may be found in Table B.35. Electrical performance of the cable may be found in Figure B.27. From this graph, the dark blue and light blue lines display the source and target voltages, the orange and dark green represent active targets, and the light green line represents the conductor monitoring ground.

Penlight was initially set to 300°C for approximately 37 minutes. During this stabilized heating period, electrical degradation could be observed on the active target conductors and the grounded conductor as voltages and currents increased, which may be observed in Figure B.28 and Figure B.29. Smoke was observed approximately 15 minutes into the test at an approximate cable temperature of 215°C. Soon after smoke was noticed, jacket swelling and popping was observed and liquid was seen bubbling out of the temperature monitoring cables. After the initial heating period, the Penlight set point temperature would be increased to 325°C for 12 minutes. Concurrently, voltages were increasing to approximately 3.25 V on Target 6. Penlight was then increased to 350°C for 15 minutes. The temperature was then increased to 375°C for approximately 15 minutes before a final increase to 400°C for the remainder of the test (16 minutes). The test was concluded prior to ultimate electrical failure (i.e., fuse clear or spurious operation) and ignition to inspect the conductor integrity after the exposure. Although ultimate circuit failure did not occur during this test, electrical degradation was observed during the low temperature heating phase. The temperature protocol and electrical response may be found in Figure B.30. A summary of the test results may be found in Table B.36.

Table B.34: Test parameters for Test D15, Circuit 1.

| | |
|---------------------------------|-----------------------------------|
| Test Series | DESIREE-FIRE |
| Test Name | Test 15 |
| Test Date | 7/28/2010 |
| Cable 1 | Kerite 5/C-12 AWG, FR, zinc wrap |
| Cable Monitoring Unit Utilized | SCDU1 |
| Cable 2* | Kerite 10/C-12 AWG, FR, zinc wrap |
| Cable Monitoring Unit Utilized | SCDU2 |
| Penlight Starting Temperature | 300°C |
| Penlight Final Temperature | 400°C |
| * See section B.9.4 for results | |

Table B.35: Conductor designation for Item D, Test D15, Circuit 1.

| Kerite 5/C-12 AWG, FR, zinc wrap. Black cable, gray conductors with white print | | | | |
|---|-----------------|---------------------|-------------------|--|
| Conductor Number | Conductor Color | SCDU Circuit Number | SCDU Circuit Path | Notes |
| 1 | Black | 1 | S1 | Energized source conductor for SCDU1– Voltage = C1 V1; current = C1 I1 |
| 2 | White | 1 | T5 | Active target conductor for SCDU1 – Voltage = C1 V5; current = C1 I5 |
| 3 | Red | 1 | S2 | Energized source conductor for SCDU1– Voltage = C1 V2; current = C1 I2 |
| 4 | Green | 1 | T6 | Active target conductor for SCDU1 – |

Table B.35: Conductor designation for Item D, Test D15, Circuit 1.

| Kerite 5/C-12 AWG, FR, zinc wrap. Black cable, gray conductors with white print | | | | |
|---|-----------------|---------------------|-------------------|--|
| Conductor Number | Conductor Color | SCDU Circuit Number | SCDU Circuit Path | Notes |
| | | | | Voltage = C1 V6; current = C1 I6 |
| 5 | Orange | 1 | G | Grounded source conductor for SCDU1- Voltage = C1 V7; current = C1 I7 |
| Zinc Wrap | NA | | | Grounded to tray |

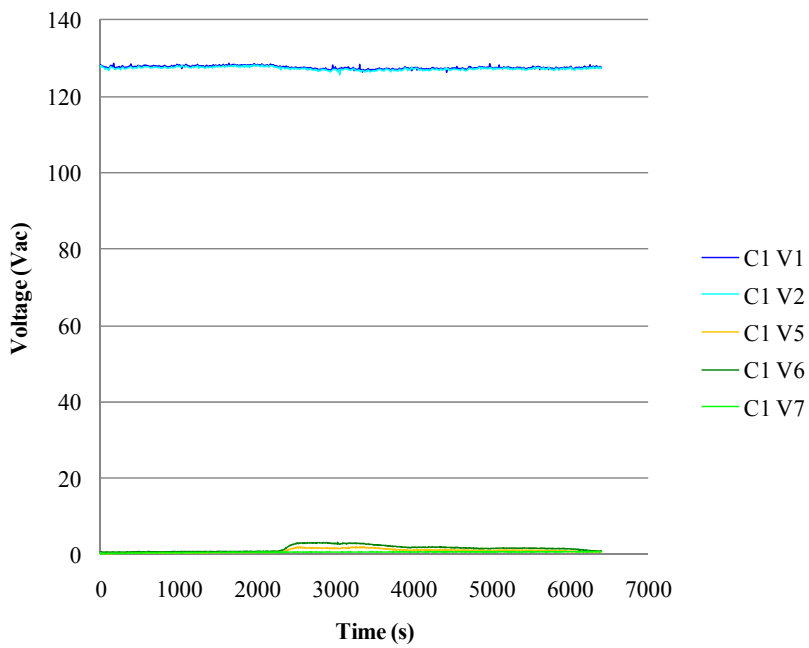

Figure B.27: All source and target conductor voltages for Test D15 displaying early degradation.

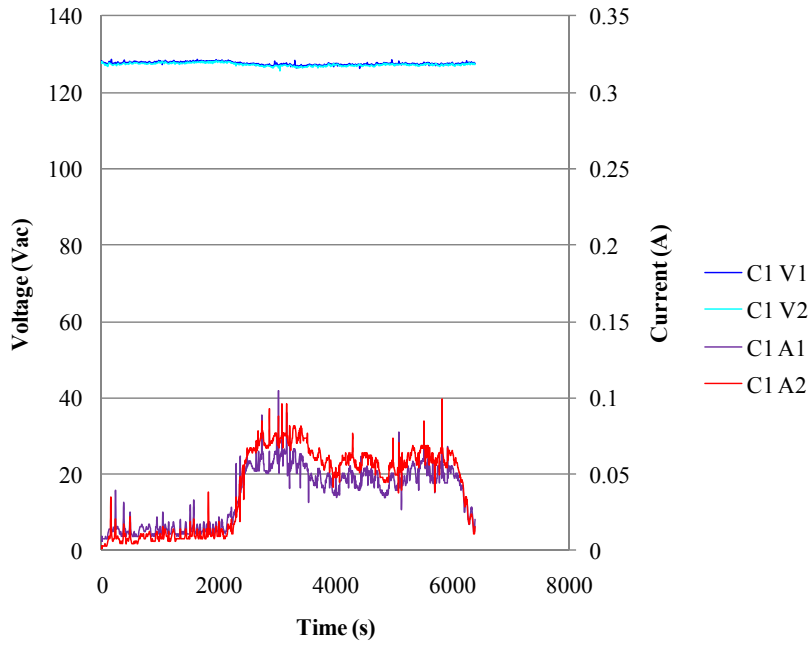

Figure B.28: Source conductors display early degradation as currents increase for Test D15.

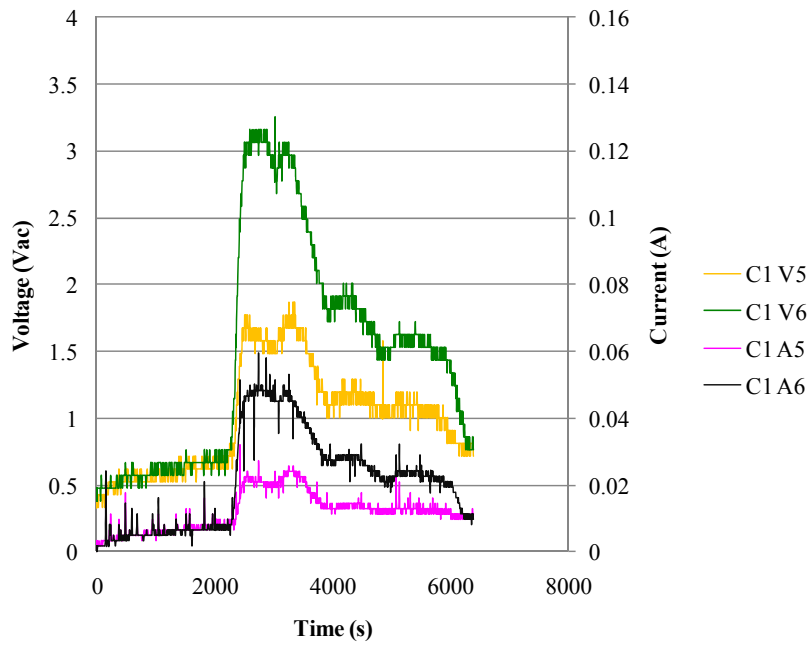

Figure B.29: Target conductors display early degradation as currents and voltages increase during Test D15.

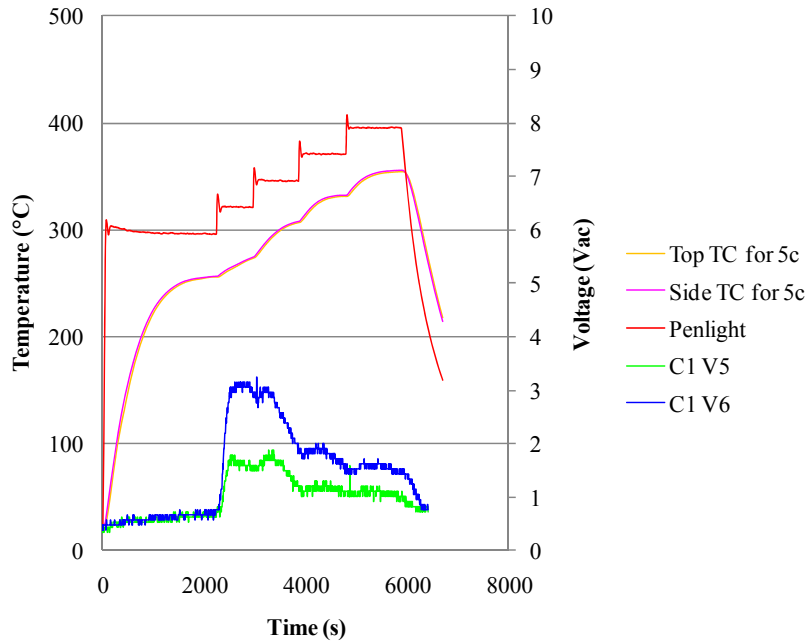

Figure B.30: Penlight shroud temperature and target conductor voltages for Test D15.

Table B.36: Summary of Observed Faulting Behavior for Test D15, Circuit 1.

| Time (s) | Event | Discussion |
|-----------|---|---|
| 0 | Penlight On; set at 300°C (4.99 kW/m ²) | The initial Penlight set point temperature and the subsequent heating protocol was to resemble the heating protocol for Test D13, qualification in which an ultimate failure was observed at lower than anticipated temperatures. |
| 2240 | Penlight temperature increased to 325° | |
| 2960 | Penlight temperature increased to 350°C | |
| 2308-3033 | Voltage increase on Target 6. | Target 6 increased to 3.25 V during this period of time. The cable temperature was approximately 257°C. |
| 3033-5885 | Voltage decrease on Target 6. | Over this time span, the voltage gradually decreased to the conclusion of the test. |
| 3860 | Penlight temperature increased to 375°C | |
| 4790 | Penlight temperature increased to 400°C | |
| 5885 | Test concluded, Penlight shutdown | The test was concluded prior to ultimate electrical failure and ignition in order to preserve the specimen for physical inspection and analysis. |

B.5.4 Test D16

One of the objectives of Test D16 was to investigate how the cable sample would perform electrically under a typical Penlight set point value for thermoset materials. Test D16 utilized the SCDU to monitor the electrical performance of the cable throughout the thermal exposure. The test parameters may be found in Table B.37. The conductor pathway for the cable monitoring unit may be found in Table B.38. Electrical performance of the cable may be observed in Figure B.31 and Figure B.32. From these figures, the target voltages in Figure B.25 did not experience electrical degradation during the initial heating phase as was observed in previous tests (e.g., Test D13). In this graph, the orange and dark green represent active targets, and the light green line represents the conductor monitoring ground.

Penlight was initially set to 470°C and blistering and popping of the jacketing material was observed approximately five minutes into the test and ignition occurred shortly after at a cable temperature of approximately 210°C. The fuse would clear approximately seven minutes after ignition and spurious operation was not observed. The electrical response of the cable to temperature may be found in Figure B.33. A summary of the test results may be found in Table B.39.

Table B.37: Test parameters for Test D16, Circuit 2.

| | |
|---------------------------------|-----------------------------------|
| Test Series | DESIREE-FIRE |
| Test Name | Test 16 |
| Test Date | 7/28/2010 |
| Cable 1* | Kerite 10/C-12 AWG, FR, zinc wrap |
| Cable Monitoring Unit Utilized | SCDU1 |
| Cable 2 | Kerite 5/C-12 AWG, FR, zinc wrap |
| Cable Monitoring Unit Utilized | SCDU2 |
| Penlight Starting Temperature | 470°C |
| Penlight Final Temperature | 470°C |
| * See section B.9.5 for results | |

Table B.38: Conductor designation for Item D, Test D16, Circuit 2.

| Kerite 5/C-12 AWG, FR, zinc wrap. Black cable, gray conductors with white print | | | | |
|---|-----------------|---------------------|-------------------|--|
| Conductor Number | Conductor Color | SCDU Circuit Number | SCDU Circuit Path | Notes |
| 1 | Black | 2 | S1 | Energized source conductor for SCDU2– Voltage = C2 V1; current = C2 I1 |
| 2 | White | 2 | T5 | Active target conductor for SCDU2 – Voltage = C2 V5; current = C2 I5 |
| 3 | Red | 2 | S2 | Energized source conductor for SCDU2– |

Table B.38: Conductor designation for Item D, Test D16, Circuit 2.

| Kerite 5/C-12 AWG, FR, zinc wrap. Black cable, gray conductors with white print | | | | |
|---|-----------------|---------------------|-------------------|---|
| Conductor Number | Conductor Color | SCDU Circuit Number | SCDU Circuit Path | Notes |
| | | | | Voltage = C2 V2; current = C2 I2 |
| 4 | Green | 2 | T6 | Active target conductor for SCDU2 – Voltage = C2 V6; current = C2 I6 |
| 5 | Orange | 2 | G | Grounded source conductor for SCDU2– Voltage = C2 V7; current = C2 I7 |
| Zinc Wrap | NA | | | Grounded to tray |

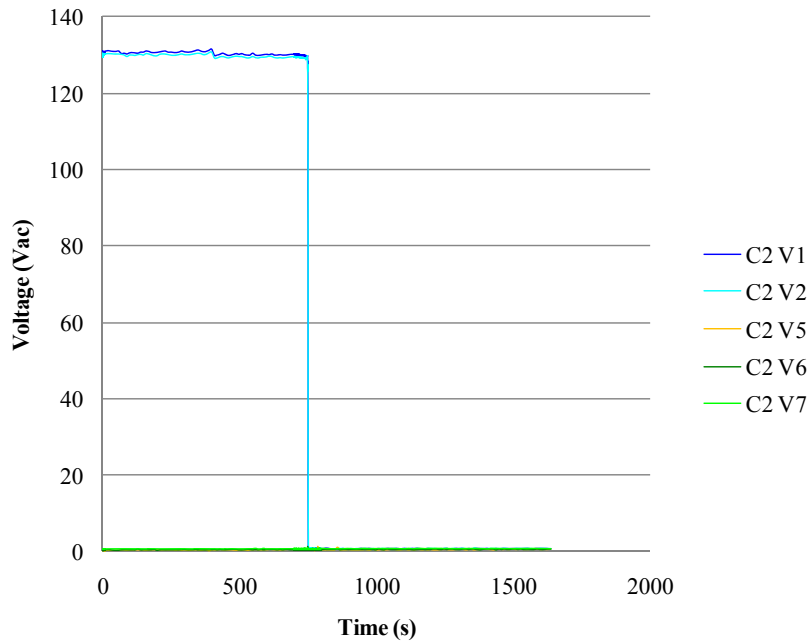

Figure B.31: Voltages for Test D16 showing a fuse clear.

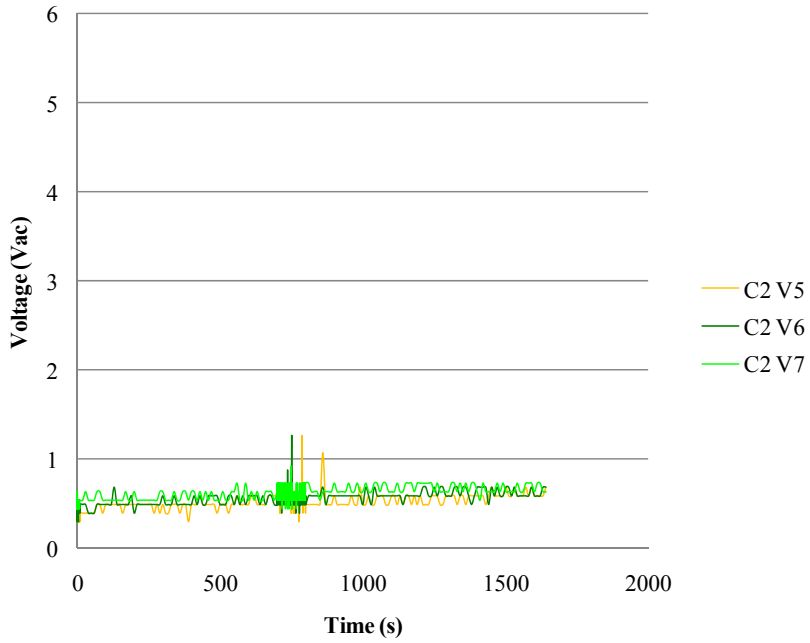

Figure B.32: Target voltages for Test D16 without degradation.

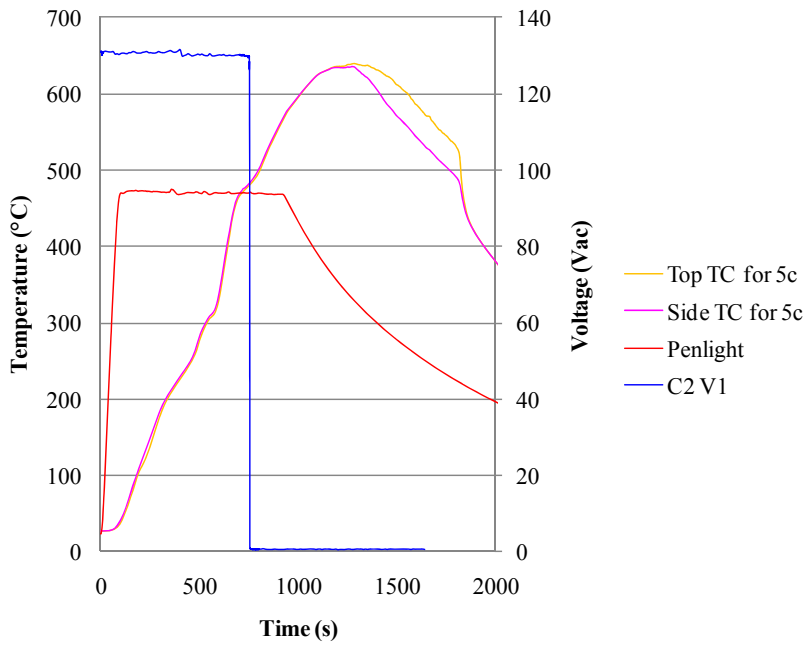

Figure B.33: Penlight shroud temperature and target conductor voltages for Test D16.

Table B.39: Summary of Observed Faulting Behavior for Test D16, Circuit 2.

| Time (s) | Event | Discussion |
|----------|--|---|
| 0 | Penlight On; set at 470°C (14.09 kW/m ²) | The initial Penlight set point temperature is a typical value for testing thermoset cables. |
| 353 | Ignition | The cable temperature was approximately 210°C. |
| 750 | Fuse clear | There were no indications of voltage increase on the Targets of Circuit 2. |
| 922 | Test concluded, Penlight shutdown | |

B.5.5 Test K5

Test K5 utilized the multiple SCDU configuration detailed in Appendix A to monitor the electrical performance of the cable throughout the thermal exposure. The test parameters may be found in Table B.40. The conductor pathway for the cable monitoring unit may be found in Table B.41. Overall electrical performance of the cable may be found in Figure B.34. From this graph, the dark blue and light blue lines display the source and target voltages for SCDU circuit 1, respectively. The light green and dark green lines display the source and target voltages for SCDU circuit 2, respectively. Electrical degradation on the target conductors occurred at approximately 1065 s into the test at a Penlight and cable temperature of 325°C and 281°C, respectively. The active targets increased to approximately 2.5 V and 1.5 V. The early degradation may be found in Figure B.35. This was the only electrical activity before the cables ignited at approximately 4341 s into the test and at a temperature of 389°C. Shortly after ignition, the fuse for SCDU2 cleared. At 4709 s, the fuse on SCDU1 cleared. The test was subsequently concluded and Penlight was shutdown. An overlapping graph depicting the overall electrical performance for a given temperature exposure may be found in Figure B.36. A summary of the test may be found in Table B.42.

Table B.40: Test parameters for Test K5.

| | |
|--------------------------------|----------------------------------|
| Test Series | KATE-FIRE |
| Test Name | Test 5 |
| Test Date | 11/9/2010 |
| Cable 1 | Kerite 5/C-12 AWG, FR, zinc wrap |
| Cable Monitoring Unit Utilized | SCDU (M) |
| Cable 2 | NA |
| Cable Monitoring Unit Utilized | NA |
| Penlight Starting Temperature | 325°C |
| Penlight Final Temperature | 425°C |

Table B.41: Conductor designation for Item D, Test K5.

| Kerite 5/C-12 AWG, FR, zinc wrap. Black cable, gray conductors with white print | | | | |
|---|-----------------|---------------------|-------------------|--|
| Conductor Number | Conductor Color | SCDU Circuit Number | SCDU Circuit Path | Notes |
| 1 | Black | 1 | S1 | Energized source conductor for SCDU1– Voltage = C1 V1; current = C1 I1 |
| 2 | White | 1 | T5 | Active target conductor for SCDU1 – Voltage = C1 V5; current = C1 I5 |
| 3 | Red | 2 | S1 | Energized source conductor for SCDU2– Voltage = C2 V1; current = C2 I1 |
| 4 | Green | 2 | T5 | Active target conductor for SCDU2 – Voltage = C2 V5; current = C2 I5 |
| 5 | Orange | 2 | S2/T4 | Adjusted source conductor which was connected through 3.6 kΩ resistor. By doing this, the output source voltage was reduced to 40 V – SCDU2 Voltage = C2 V4; current = C2 I4 |
| Zinc Wrap | NA | NA | NA | Grounded to tray, but not monitored |

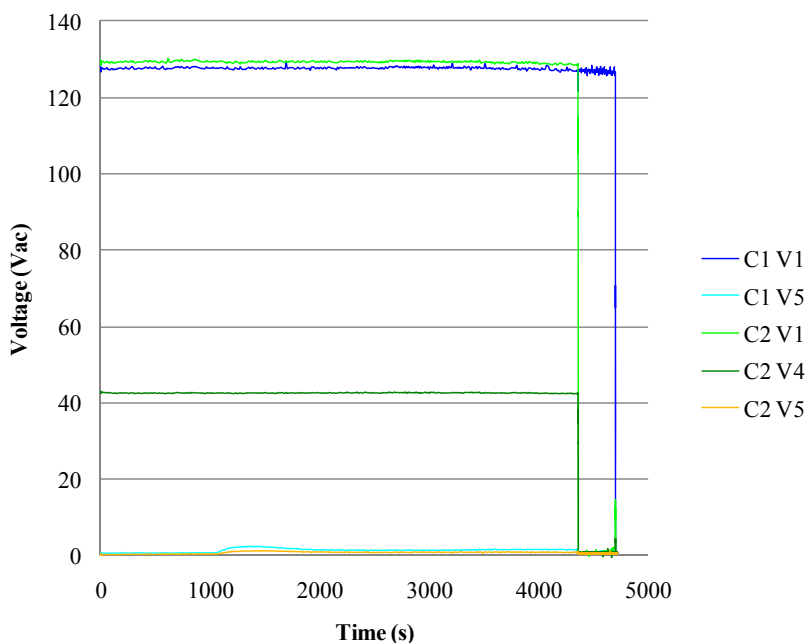

Figure B.34: Voltages for Test K5 showing increases on target conductors followed by fuse clears.

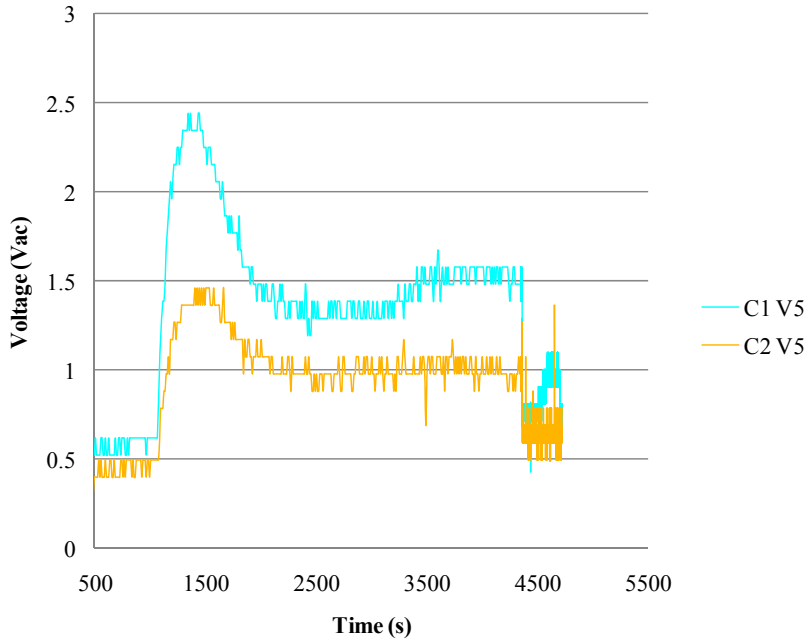

Figure B.35: Target conductor voltages for Test K5 showing early degradation.

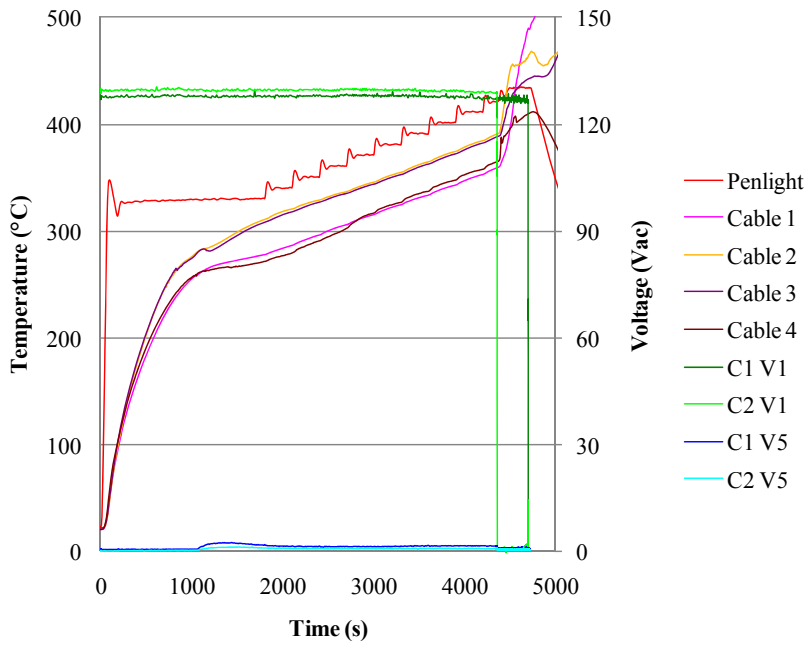

Figure B.36: Penlight shroud temperature, cable temperatures, and target conductor voltages for Test K5.

Table B.42: Summary of observed faulting behavior for Test K5.

| Time (s) | Event | Discussion |
|-----------|---|---|
| 0 | Penlight On; set at 325°C (5.92 kW/m ²) | |
| 1065-1400 | Voltage increase on active targets in SCDU1 and SCDU2 | The voltage and current increase in active targets for SCDU1 and 2 reached a maximum of approximately 2.5 V and 1.5 V as well as 0.038 A and 0.022 A, respectively. For the remainder of the test, both the voltages and currents declined until the fuses cleared on each unit. The temperature at the initial increase was approximately 281°C. |
| 1800-4200 | Penlight set point temperature increased step wise | Penlight temperature was increased stepwise by 10°C every 5 minutes during this time period until ignition. Upon ignition, the Penlight set point temperature remained constant until the conclusion of the test. The final Penlight set point was 415°C. |
| ~4341 | Ignition | The time denoted was approximated from the field notes; however, the time appears reasonable given the data. The cable temperature at ignition was approximately 389°C. |
| 4368 | Fuse clear on SCDU2 | |
| 4709 | Fuse clear on SCDU1 | |
| 4726 | Test concluded, Penlight shutdown | |

B.5.6 Test K8

Test K8 utilized the IRMS to monitor the electrical performance of the cable throughout the thermal exposure. The test parameters may be found in Table B.43. The conductor pathway for the cable monitoring unit may be found in Table B.44. Electrical performance of the cable may be found in Figure B.37. From this graph, the green and black lines display the conductor-to-ground and conductor-to-conductor minimum resistances, respectively. It should be noted that the insulation resistance between conductor 4 and ground degraded to less than 1000 Ω at an internal temperature of 307°C and exposure temperature of 335°C. Conductor 4 most likely shorted to the grounded zinc tape which was located just beneath the jacketing material. Approximately one minute later, conductor 4 would short to ground at less than 100 Ω. The Penlight set point temperature was increased step wise to 365°C, at which the test was intentionally concluded for post-test analysis. A summary of the test may be found in Table B.45.

Table B.43: Test parameters for Test K8.

| | |
|--------------------------------|----------------------------------|
| Test Series | KATE-FIRE |
| Test Name | Test 8 |
| Test Date | 10/25/2010 |
| Cable 1 | Kerite 5/C-12 AWG, FR, zinc wrap |
| Cable Monitoring Unit Utilized | IRMS |
| Cable 2 | NA |
| Cable Monitoring Unit Utilized | NA |
| Penlight Starting Temperature | 325°C |
| Penlight Final Temperature | 365°C |

Table B.44: Conductor designation for Item D, Test K8.

| Kerite 5/C-12 AWG, FR, zinc wrap. Black cable, gray conductors with white print | | | |
|---|-----------------|---------------------|-------|
| Conductor Number | Conductor Color | IRMS Circuit Number | Notes |
| 1 | Black | 1 | |
| 2 | White | 2 | |
| 3 | Red | 3 | |
| 4 | Green | 4 | |
| 5 | Orange | 5 | |
| Zinc Wrap | NA | NA | |

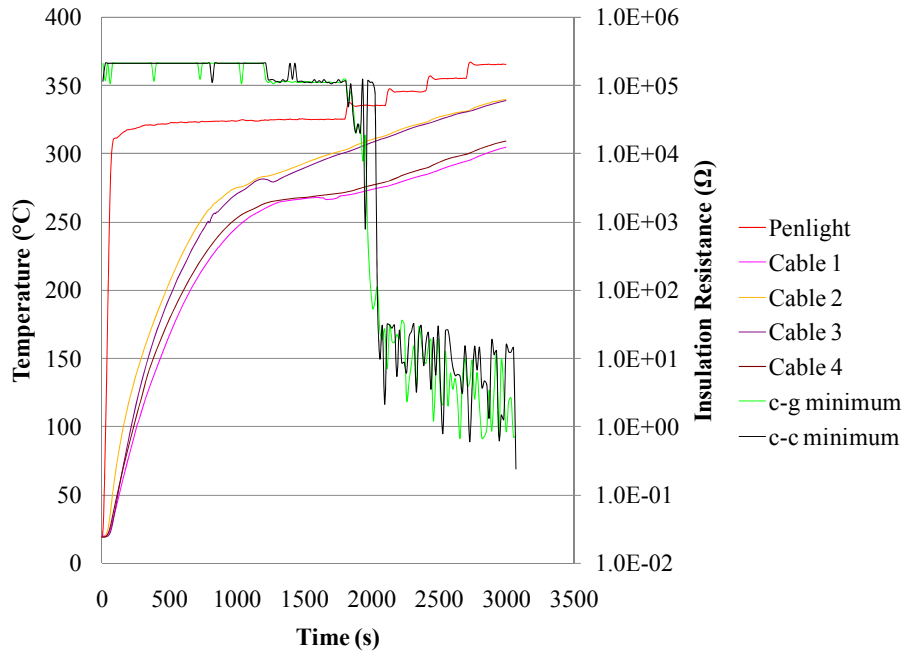

Figure B.37: Penlight shroud temperature, cable temperatures, and electrical performance data for Test K8.

Table B.45: Summary of observed faulting behavior for Test K8.

| Time (s) | Event | Comments |
|-----------|---|--|
| 0 | Penlight On; set at 325°C (5.92 kW/m ²) | |
| 1800-3000 | Penlight set point temperature increased step wise | Penlight temperature was increased stepwise by 10°C every 5 minutes during this time period until the conclusion of the test. The final Penlight set point was 365°C, at which the test was concluded for analysis. |
| 1831 | Conductor 3 and 4 begin to short to ground. | At a cable temperature of 303°C, conductors display onset degradation. Conductors 3 and 4 begin to short to ground. The conductors may be shorting to the zinc wrap directly or through a conductor that is previously grounded. |
| 1932 | Conductor 5 begins to short to ground | Shorting path may be to the zinc wrap |
| 1943-2011 | Conductor 4 shorts to ground at less than 1000 Ω | Shorting path may be to the zinc wrap. Cable temperature was 307°C |
| 2011-3000 | Conductor 4 shorts to ground at less than 100 Ω | Shorting path may be to the zinc wrap. Cable temperature was 309°C |
| 2430-2527 | Conductor 2 begins to short to ground. | |

Table B.45: Summary of observed faulting behavior for Test K8.

| Time (s) | Event | Comments |
|-----------|--|---|
| 2527-2531 | Conductor 2 shorts to ground, Conductor 2 shorts to Conductor 3 at less than 1000 Ω | These two conductors are adjacent to one another. |
| 2531-3000 | Conductor 2 shorts to Conductor 5 at less than 100 Ω | These two conductors are adjacent to one another. |
| 2545-3000 | Conductor 2 shorts to ground, Conductor 2 shorts to Conductor 3 at less than 100 Ω | |
| 2549-3000 | Conductor 5 shorts to ground at less than 100 Ω | Conductor 5 may be shorting to the zinc wrap directly or through a conductor that is previously grounded. |
| 3000 | Penlight shutdown | |

B.5.7 Test K9

Test K9 utilized the IRMS to monitor the electrical performance of the cable throughout the thermal exposure. The test parameters may be found in Table B.46. The conductor pathway for the cable monitoring unit may be found in Table B.47. Electrical performance of the cable may be found in Figure B.38. From this graph, the green and black lines display the conductor-to-ground and conductor-to-conductor minimum resistances, respectively. It should be noted that the insulation resistances between conductor 4 and ground and between conductor 4 and conductor 5 degraded to less than 1000 Ω at an internal temperature of 311°C and exposure temperature of 345°C. Conductor 4 most likely shorted to the grounded zinc tape which was located just beneath the jacketing material. Approximately one minute later, conductor 4 would short to both ground and conductor 5 at less than 100 Ω . The Penlight set point temperature was increased step wise to 345°C, at which the test was intentionally concluded for post-test analysis. A summary of the test may be found in Table B.48.

Table B.46: Test parameters for Test K9.

| | |
|--------------------------------|----------------------------------|
| Test Series | KATE-FIRE |
| Test Name | Test 9 |
| Test Date | 11/4/2010 |
| Cable 1 | Kerite 5/C-12 AWG, FR, zinc wrap |
| Cable Monitoring Unit Utilized | IRMS |
| Cable 2 | NA |
| Cable Monitoring Unit Utilized | NA |
| Penlight Starting Temperature | 325°C |

Table B.46: Test parameters for Test K9.

| | |
|----------------------------|-------|
| Penlight Final Temperature | 345°C |
|----------------------------|-------|

Table B.47: Conductor designation for Item D, Test K9.

| Kerite 5/C-12 AWG, FR, zinc wrap. Black cable, gray conductors with white print | | | |
|---|-----------------|---------------------|-------|
| Conductor Number | Conductor Color | IRMS Circuit Number | Notes |
| 1 | Black | 1 | |
| 2 | White | 2 | |
| 3 | Red | 3 | |
| 4 | Green | 4 | |
| 5 | Orange | 5 | |
| Zinc Wrap | NA | NA | |

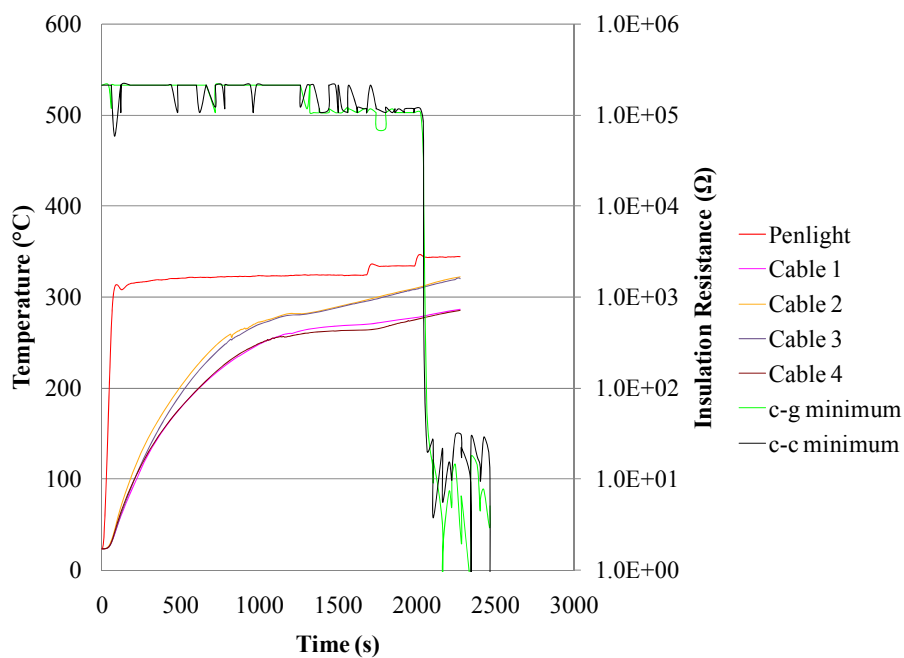

Figure B.38: Penlight shroud temperature, cable temperatures, and electrical performance data for Test K9.

Table B.48: Summary of observed faulting behavior for Test K9.

| Time (s) | Event | Comments |
|-----------|---|--|
| 0 | Penlight On; set at 325°C (5.92 kW/m ²) | |
| 1680-2280 | Penlight set point temperature increased step wise | Penlight temperature was increased stepwise by 10°C every 5 minutes during this time period until the conclusion of the test. The final Penlight set point was 345°C, at which point the test was concluded for examination. |
| 2040-2100 | Conductor 4 shorts to ground and also shorts to 5 at less than 1000 Ω | The cable temperature at this time is 311°C |
| 2100-2280 | Conductor 4 shorts to ground and also shorts to 5 at less than 100 Ω | The cable temperature at this time is 314°C |
| 2280 | Penlight shutdown | |

B.6 Cable Item E: 7/C-12 AWG, FR, zinc wrap

Cable Item E is a 7/C-12 AWG cable with FR insulation, according to the bill of materials provided by the donating company, and the conductors are numbered as depicted in Figure B.39. Surrounding the conductors is a zinc tape wrap which was grounded during each test based on typical plant practice as specified by the donating company. The cable was tested once during the DESIREE-Fire intermediate-scale series on the dc powered 1-in. valve circuit and three times during the KATE-Fire tests, twice on IRMS and once on SCDU. The following sections detail the test parameters, conductor paths, circuit data, and test summary for each test.

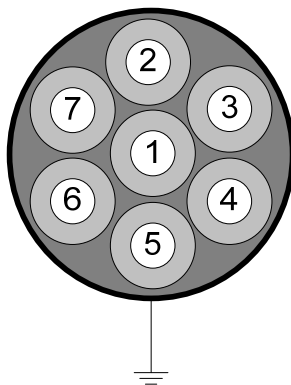

Figure B.39: Illustration of Cable Item E.

B.6.1 Test IS10

The intermediate-scale test series conducted during DESIREE-Fire was a target opportunity to investigate the performance of Kerite cable in a more representative fire environment. During

Test IS10, Item E was connected to the dc-powered 1-in. valve and situated in Position D. The test parameters may be found in Table B.49. The conductor pathway for the cable monitoring unit may be found in Table B.50. Electrical performance of the cable may be found in Figure B.40 and Figure B.41. In the former graph, the positive and negative sources as well as the energized green lamp conductor were graphed with the coil voltage. The latter graph displays the voltage of the lamps through the test. From these two graphs, it should be noted that there is a voltage increase at approximately 2055 s which corresponds to a cable temperature of 258°C. False indication of the red lamp occurred at 2502 s for approximately 32 s before a spurious operation occurred on the 1-in. valve. The actuation continued for approximately 9 s until the negative fuse cleared. The temperature profile and voltage response may be found in Figure B.42. In this figure, the air temperature is listed as the location of the cable and the length along the tray while the sub-jacket temperature is listed with the location of the cable, cable type, and length along the sample. A summary of the test results may be found in Table B.51.

Table B.49: Test parameters for Test IS10, Item E.

| | |
|------------------------------|------------------------------------|
| Test Name | Test IS10 |
| Test Date | 3/25/2010 |
| Cable Type for 1-in. Valve | Kerite, 7/C-12 AWG, FR, zinc wrap |
| 1-in. Valve Position | Position D |
| Cable Fill Type | Bundled Tray A, Cable 1 |
| Cables Co-Located in Raceway | Cable 2 - TC Cable for 1-in. Valve |
| | Cable 3 - Large Coil |
| | Cable 4 - TC Cable for Large Coil |
| Battery Voltage (Pre-test) | 121.96 Vdc |
| Battery Voltage (Post-test) | 122.21 Vdc |

Table B.50: Conductor designation for Item E, Test IS10.

| Test IS10, 1-in. valve, 7/C-12 AWG, zinc wrap | | | | | |
|---|----------------------------|--|---------------------------------------|-----------------------------|----------------------------|
| Lead Cable Conductor number | Lead cable conductor color | Terminal block location in DCSim Panel | Terminal block circuit identification | Test Cable conductor number | Test cable conductor color |
| 1 | Black | TB 2 | P | 1 | Black |
| 2 | White | TB 5 | R | 2 | White |
| 3 | Red | TB 3 | G | 3 | Red |
| 4 | Green | TB 6 | SP | 4 | Green |
| 5 | Orange | TB 9 | N1 | 5 | Orange |
| 6 | Blue | TB 7 | N2 | 6 | Blue |
| 7 | White/Black | TB 8 | SP | 7 | White/Black |

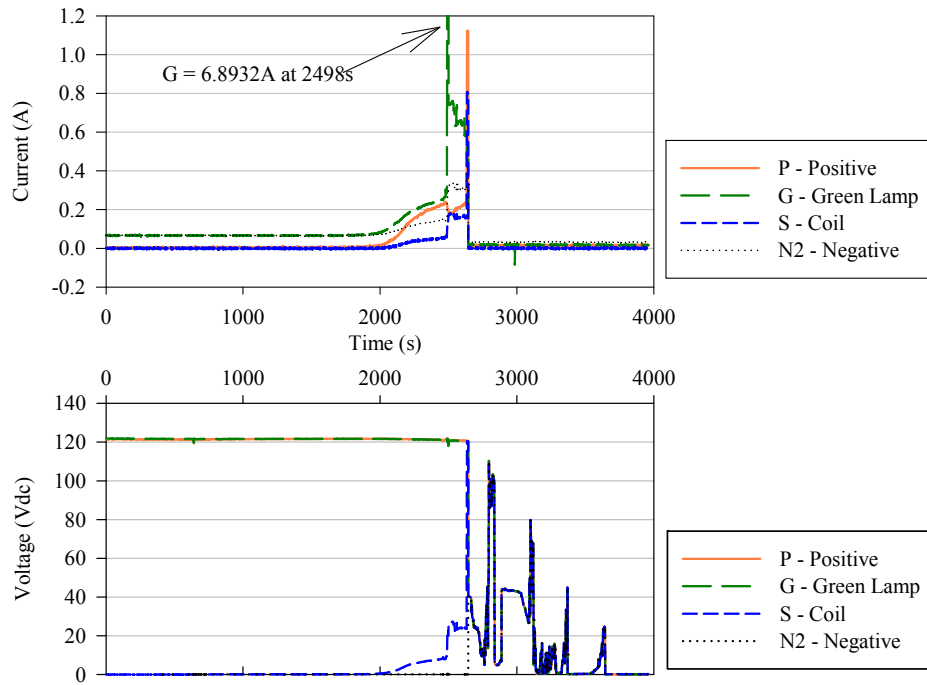

Figure B.40: Voltage and current response of the coil connected to Item E during Test IS10.

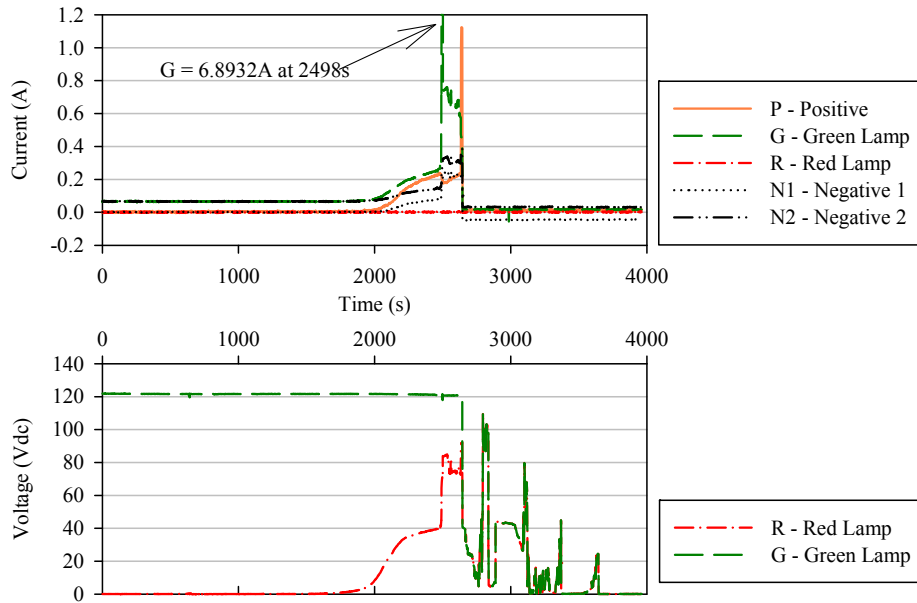

Figure B.41: Voltage and current response of the lamps connected to Item E during Test IS10.

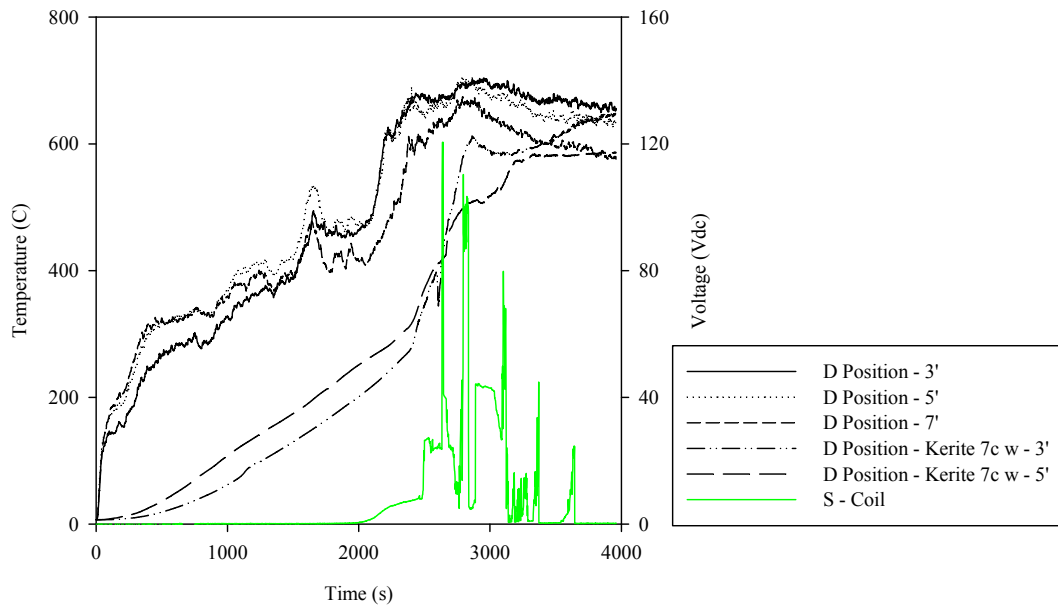

Figure B.42: Temperature profile of Test IS10 and the voltage response of the 1-in. valve coil.

Table B.51: Summary of observed faulting behavior for Test IS10, Item E.

| Time (s) | Event | Discussion |
|-----------|-----------------------------------|--|
| 0 | Fire Initiated | |
| 2055 | Voltage increase detected on coil | The voltage begins to increase on the coil conductor. At this time, the corresponding cable temperature is approximately 258°C |
| 2502-2535 | False Indication Red Light ON | |
| 2635-2644 | Spurious Actuation | The current at this time is 0.7131 A. |
| 2646 | Negative Fuse Clear | |
| 3646 | Positive Fuse Clear | |
| 3960 | Fire Off | |

B.6.2 Test K1

Test K1 utilized the multiple SCUDU configuration detailed in Appendix A to monitor the electrical performance of the cable throughout the thermal exposure. The test parameters may be found in Table B.52. The conductor pathway for the cable monitoring unit may be found in Table B.53. Overall electrical performance of the cable may be found in Figure B.43. The electrical performance of the 120 V sources and the targets may be observed in Figure B.44 and Figure B.45, respectively.

The initial Penlight set point temperature was 325°C. From this graph, approximately 7 minutes into the test, the switch was closed for SCDU3, Circuit Path 2 energizing the center conductor bringing the voltage from 0 V to approximately 62 V for the remainder of the test. Electrical degradation on the source and target conductors may be observed at approximately 2600 s into the test at a Penlight set point and cable temperature of 325°C and 256°C, respectively. At nearly 41 minutes into the test, a current increase was observed on the grounded zinc wrap. About three minutes later and continuing for 10 minutes, voltage and current increased on the three active targets to a maximum of 5.34 V and 0.11 A. Just over 53 minutes into the test, the voltage and current for each of the active targets slowly decreased to 3 V and 0.05 A at the conclusion of the test. The final Penlight temperature was 375°C and the maximum cable temperature was just under 300°C. There were no spurious actuations, fuses were not cleared, and the cable did not ignite. Penlight was shutdown and the test was subsequently concluded for post-test examination of the cable specimen. Upon preliminary data analysis of the test temperatures, it was discovered that the incorrect TC was monitoring the Penlight set point temperature. This ultimately resulted in lower than anticipated exposure temperatures; however, the cable temperature data was found to be wired correctly. An overlapping graph depicting the overall electrical performance for a given temperature exposure may be found in Figure B.46. A summary of the test may be found in Table B.54.

Table B.52: Test parameters for Test K1.

| | |
|--------------------------------|----------------------------------|
| Test Series | KATE-FIRE |
| Test Name | Test 1 |
| Test Date | 9/22/2010 |
| Cable 1 | Kerite 7/C-12 AWG, FR, zinc wrap |
| Cable Monitoring Unit Utilized | SCDU (M) |
| Cable 2 | NA |
| Cable Monitoring Unit Utilized | NA |
| Penlight Starting Temperature | 325°C |
| Penlight Final Temperature | 375°C |

Table B.53: Conductor designation for Item E, Test K1.

| Kerite 7/C-12 AWG, FR, zinc wrap. Black cable, gray conductors with white print | | | | |
|---|-----------------|---------------------|-------------------|---|
| Conductor Number | Conductor Color | SCDU Circuit Number | SCDU Circuit Path | Notes |
| 1 | Black | 3 | S2/T4 | Adjusted source conductor which was connected through 1.8 kΩ resistor. By doing this, the output source voltage was reduced to 60 V – SCDU3 Voltage = C3 V4; current = C3 I4 |

Table B.53: Conductor designation for Item E, Test K1.

| Kerite 7/C-12 AWG, FR, zinc wrap. Black cable, gray conductors with white print | | | | |
|---|-----------------|---------------------|-------------------|---|
| Conductor Number | Conductor Color | SCDU Circuit Number | SCDU Circuit Path | Notes |
| 2 | White | 1 | S1 | Energized source conductor for SCDU1– Voltage = C1 V1; current = C1 I1 |
| 3 | Red | 1 | T5 | Active target conductor for SCDU1 – Voltage = C1 V5; current = C1 I5 |
| 4 | Green | 2 | S1 | Energized source conductor for SCDU2– Voltage = C2 V1; current = C2 I1 |
| 5 | Orange | 2 | T5 | Active target conductor for SCDU2 – Voltage = C2 V5; current = C2 I5 |
| 6 | Blue | 4 | S1 | Energized source conductor for SCDU4– Voltage = C4 V1; current = C4 I1 |
| 7 | White/Black | 4 | T5 | Active target conductor for SCDU4 – Voltage = C4 V5; current = C4 I5 |
| Zinc Wrap | NA | 3 | G7 | Grounded to tray, but not monitored |

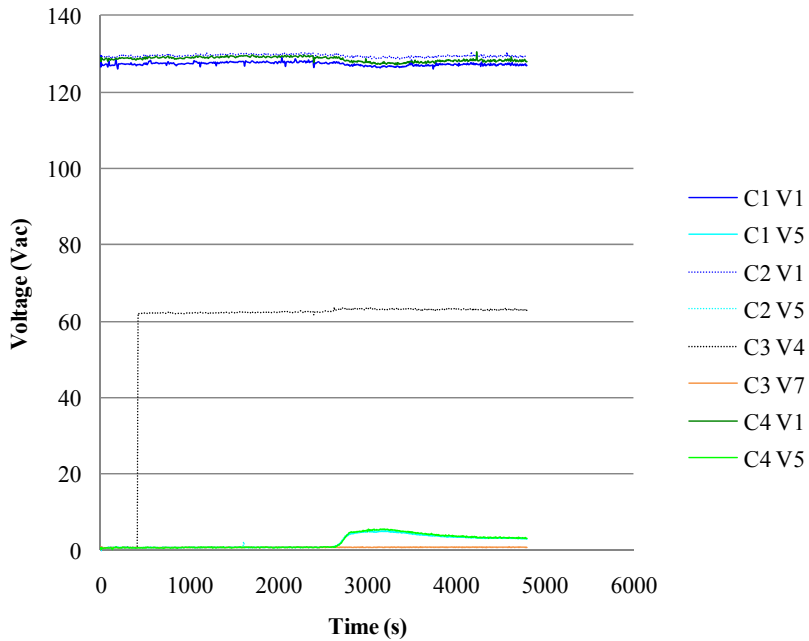

Figure B.43: All conductor voltages for Test K1 showing a decrease in 120V sources and increase on the target voltages.

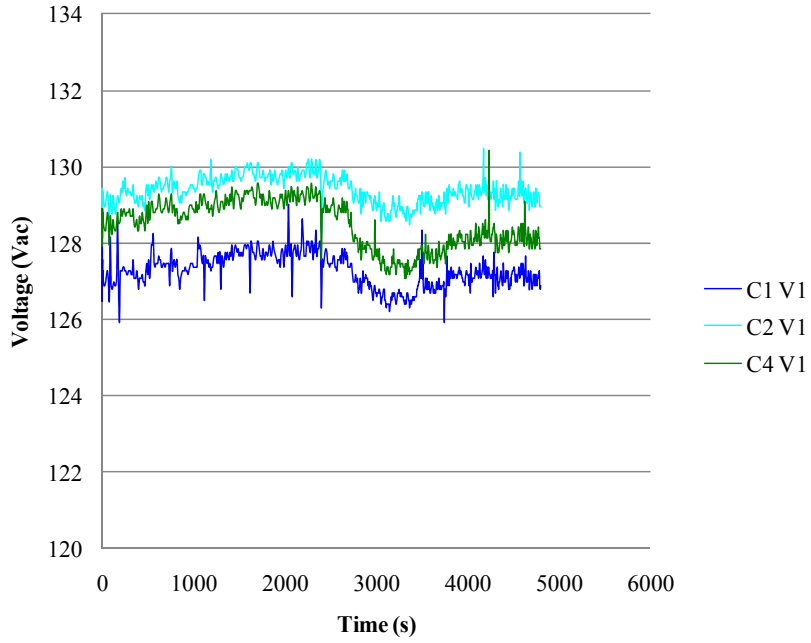

Figure B.44: All 120 V source conductor voltages for Test K1 displaying a voltage drop.

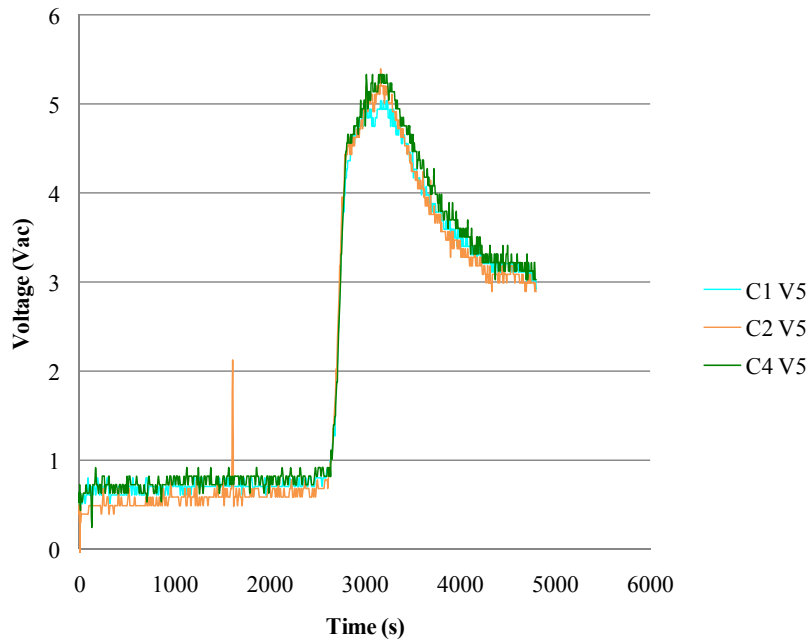

Figure B.45: All target conductor voltages for Test K1 showing a voltage increase.

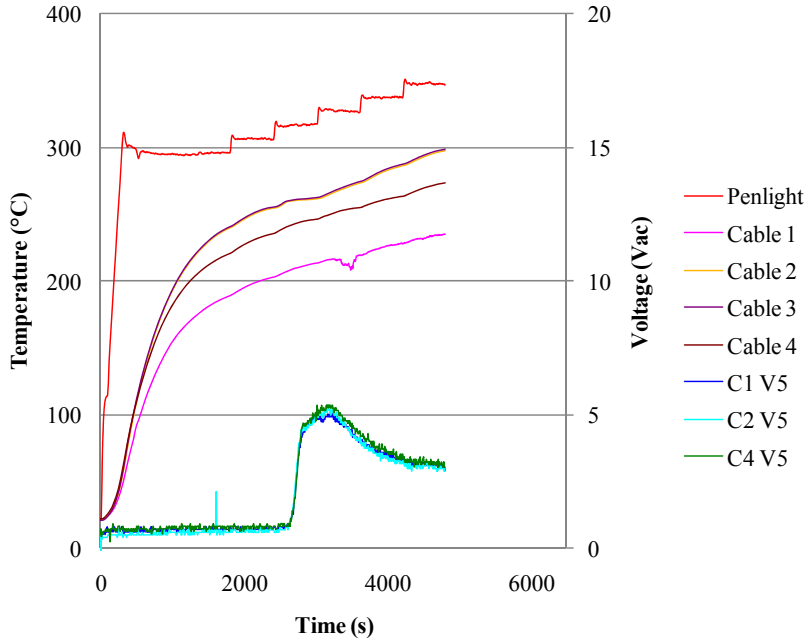

Figure B.46: Penlight shroud temperature, cable temperatures, and target conductor voltages for Test K1.

Table B.54: Summary of observed faulting behavior for Test K1.

| Time (s) | Event | Discussion |
|-----------|--|---|
| 0 | Penlight On; set at 325°C (5.92 kW/m ²) | |
| 417 | Switch was closed to energize the conductor 1 with the burden resistor | Before this time, conductor 1 was not energized. Upon being energized, the conductor voltage increased to approximately 62 V as was intended given the circuit configuration. |
| 1800-4800 | Penlight set point temperature increased step wise | Penlight temperature was increased stepwise by 10°C every 10 minutes during this time period until ignition. Upon ignition, the Penlight set point temperature remained constant until the conclusion of the test. The final Penlight set point was 375°C. |
| 2465-2700 | Ground experiences leakage current | Ground is the first to noticeably see current leakage, starting at a nominal 0.013 A to 0.036 A, compared to the other target conductors. The cable temperature is about 256°C. At approximately 2700 s, the current experienced on the other target conductors is about equal to that on ground. |

Table B.54: Summary of observed faulting behavior for Test K1.

| Time (s) | Event | Discussion |
|-----------------|--|---|
| 2600-3200 | Voltage and current increases on all active targets | The increases in both voltages and currents occur simultaneously on each of the active target conductors. During this span, the voltage ranges from 1 to approximately 5.34 V while the current increased from 0.01 to 0.11 A. Cable temperature at the onset of voltage and current increase was 260°C. According to the field notes, liquid was observed out of the cut thermocouple cable end. |
| 3072 | Insulation resistance on SCUDU2, Target 5 decreases below 1000 Ω | The cable temperature was approximately 263°C. |
| 3200-4800 | Voltage and current decreases on all targets | Voltages and currents on all active targets steadily declined until the conclusion of the test. The voltages on the active targets stabilized at just over 3 V. Correspondingly, the currents were maintained at approximately 0.05 A. |
| 4800 | Test concluded, Penlight shutdown | |

B.6.3 Test K6

Test K6 utilized the IRMS to monitor the electrical performance of the cable throughout the thermal exposure. The test parameters may be found in Table B.55. The conductor pathway for the cable monitoring unit may be found in Table B.56. Electrical performance of the cable may be found in Figure B.47. From this graph, the green and black lines display the conductor-to-ground and conductor-to-conductor minimum resistances, respectively. It should be noted that initial degradation occurred at approximately 1680 s. Although conductor-to-conductor current leakage was detected, conductor-to-ground shorting was more severe. The established failure threshold of 1000 Ω was not breached throughout the step wise increases in temperature and the test was concluded prior to ignition to preserve the sample for examination. The maximum Penlight set point and cable temperatures were 435°C and 378°C and the associated electrical response may be observed in Figure B.47. A summary of the test may be found in Table B.57.

Table B.55: Test parameters for Test K6.

| | |
|-----------------------|----------------------------------|
| Test Series | KATE-FIRE |
| Test Name | Test 6 |
| Test Date | 9/28/2010 |
| Cable 1 | Kerite 7/C-12 AWG, FR, zinc wrap |
| Cable Monitoring Unit | IRMS |

Table B.55: Test parameters for Test K6.

| | |
|--------------------------------|-------|
| Utilized | |
| Cable 2 | NA |
| Cable Monitoring Unit Utilized | NA |
| Penlight Starting Temperature | 325°C |
| Penlight Final Temperature | 435°C |

Table B.56: Conductor designation for Item E, Test K6.

| Kerite 7/C-12 AWG, FR, zinc wrap. Black cable, gray conductors with white print | | | |
|---|-----------------|---------------------|--|
| Conductor Number | Conductor Color | IRMS Circuit Number | Notes |
| 1 | Black | 1 | |
| 2 | White | 2 | |
| 3 | Red | 3 | |
| 4 | Green | 4 | |
| 5 | Orange | 5 | |
| 6 | Blue | 6 | |
| 7 | White/Black | 7 | |
| Zinc Wrap | NA | NA | The zinc wrap was grounded for the test; however, it was not electrically monitored. |

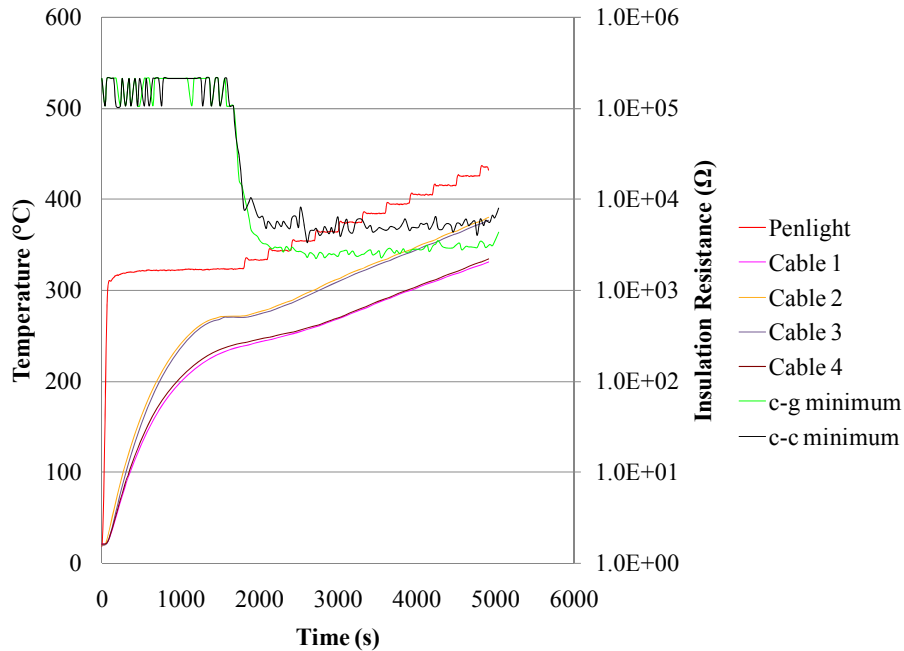

Figure B.47: Penlight shroud temperature, cable temperatures, and electrical performance data for Test K6.

Table B.57: Summary of observed faulting behavior for Test K6.

| Time (s) | Event | Comments |
|-----------|--|---|
| 0 | Penlight On; set at 325°C (5.92 kW/m ²) | |
| 1680-1860 | Initial degradation of Conductor 3 and Conductor 6 to ground. | The cable temperature at this time was approximately 271°C. |
| 1740-1860 | Initial degradation of Conductor 1, Conductor 2, Conductor 4, and Conductor 5 to ground. | The cable temperature at this time was approximately 271°C. |
| 1800-4920 | Conductor 2 shorts to ground and Conductor 4 at less than 10 kΩ | The cable temperature at this time was approximately 271°C. It is likely that the conductors are shorting to the zinc wrap which is grounded. |
| 1800 | Conductor 1 shorts to Conductor 6 and Conductor 7 at less than 10 kΩ | |

Table B.57: Summary of observed faulting behavior for Test K6.

| Time (s) | Event | Comments |
|-----------------|---|--|
| 1860-4920 | Conductor 1, Conductor 3, Conductor 4, and Conductor 5 fail to ground at less than 10 k Ω . Conductor 3 shorts to Conductor 4 at less than 10 k Ω , possibly through ground. Conductor 6 shorts to Conductor 7 at less than 10 k Ω , possibly through ground. | The cable temperature at this time was approximately 280°C. |
| 1920 | Conductor 4 shorts to Conductor 6 at less than 10 k Ω . Conductor 5 shorts to Conductor 7 at less than 10 k Ω . | |
| 1980 | Conductor 2 and Conductor 3 short to Conductor 5 at less than 10 k Ω . Conductor 3 shorts to Conductor 7 at less than 10 k Ω . Conductor 4 shorts to Conductor 7 at less than 10 k Ω . | |
| 2010 | Conductor 2 shorts to Conductor 6 at less than 10 k Ω . | |
| 2040 | Conductor 3 shorts to Conductor 6 at less than 10 k Ω . | |
| 2220-4920 | Conductor 1 shorts to ground between 1622-2917 Ω . Conductor 3 shorts to ground between 2417-8352 Ω . Conductor 4 shorts to ground between 2336-8027 Ω . Conductor 5 shorts to ground between 2219-8352 Ω . Conductor 6 shorts to ground between 2420-9087 Ω . | The average ohm reading for Conductor 1 between this time period was 2120 Ω . Conductor 1 shorted to ground at 1622 Ω at 3300 s and 322°C. The average ohm reading for Conductor 3 between this time period was 4604 Ω . Conductor 3 shorted to ground at 2415 Ω at 2700 s and 299°C. The average ohm reading for Conductor 4 between this time period was 4041 Ω . Conductor 4 shorted to ground at 2336 Ω at 3270 s and 321°C. The average ohm reading for Conductor 5 between this time period was 3921 Ω . Conductor 5 shorted to ground at 2219 Ω at 2700 s and 299 B. The average ohm reading for Conductor 6 between this time period was 4549 Ω . Conductor 6 shorted to ground at 2420 Ω at 2700 s and 299°C. |
| 2340 | Conductor 1 shorts to Conductor 5 at less than 10 k Ω . | |

Table B.57: Summary of observed faulting behavior for Test K6.

| Time (s) | Event | Comments |
|-----------|---|---|
| 2400-4920 | Conductor 2 shorts to ground between 1697-8704 Ω . Conductor 7 shorts to ground between 2518.9087 Ω . | The average ohm reading for Conductor 2 between this time period was 4050 Ω . Conductor 2 shorted to ground at 1697 Ω at 3720 s and 337°C. The average ohm reading for Conductor 7 between this time period was 4887 Ω . Conductor 7 shorted to ground at 2518 Ω at 2700 s and 299°C. |
| 2760 | Conductor 1 shorts to Conductor 4 at less than 10 k Ω . | |
| 2790 | Conductor 1 shorts to Conductor 3 at less than 10 k Ω . | |
| 2820 | Conductor 1 shorts to Conductor 2 at less than 10 k Ω . | |
| 4920 | Penlight shutdown | The side panel on Penlight opened causing the test to automatically shutdown. The final Penlight and corresponding cable temperatures were 435°C and 378°C, respectively. Ignition did not occur. |

B.6.4 Test K7

Test K7 utilized the IRMS to monitor the electrical performance of the cable throughout the thermal exposure. The test parameters may be found in Table B.58. The conductor pathway for the cable monitoring unit may be found in Table B.59. Electrical performance of the cable may be found in Figure B.48. From this graph, the green and black lines display the conductor-to-ground and conductor-to-conductor minimum resistances, respectively. It should be noted that initial degradation occurred at approximately 1395 s. All conductors appear to have shorting to ground. The established failure threshold of 1000 Ω or 100 Ω were not breached throughout the step wise increases in temperature; however, immediately upon ignition the cable experienced shorting to ground at less than 100 Ω . The maximum Penlight set point and cable temperatures were 445°C and 417°C and the associated electrical response may be observed in Figure B.48. A summary of the test may be found in Table B.60.

Table B.58: Test parameters for Test K7.

| | |
|--------------------------------|----------------------------------|
| Test Series | KATE-FIRE |
| Test Name | Test 7 |
| Test Date | 10/28/2010 |
| Cable 1 | Kerite 7/C-12 AWG, FR, zinc wrap |
| Cable Monitoring Unit Utilized | IRMS |

Table B.58: Test parameters for Test K7.

| | |
|--------------------------------|-------|
| Cable 2 | NA |
| Cable Monitoring Unit Utilized | NA |
| Penlight Starting Temperature | 325°C |
| Penlight Final Temperature | 445°C |

Table B.59: Conductor designation for Item E, Test K7.

| Kerite 7/C-12 AWG, FR, zinc wrap. Black cable, gray conductors with white print | | | |
|---|-----------------|---------------------|--|
| Conductor Number | Conductor Color | IRMS Circuit Number | Notes |
| 1 | Black | 1 | |
| 2 | White | 2 | |
| 3 | Red | 3 | |
| 4 | Green | 4 | |
| 5 | Orange | 5 | |
| 6 | Blue | 6 | |
| 7 | White/Black | 7 | |
| Zinc Wrap | NA | NA | The zinc wrap was grounded for the test; however, it was not electrically monitored. |

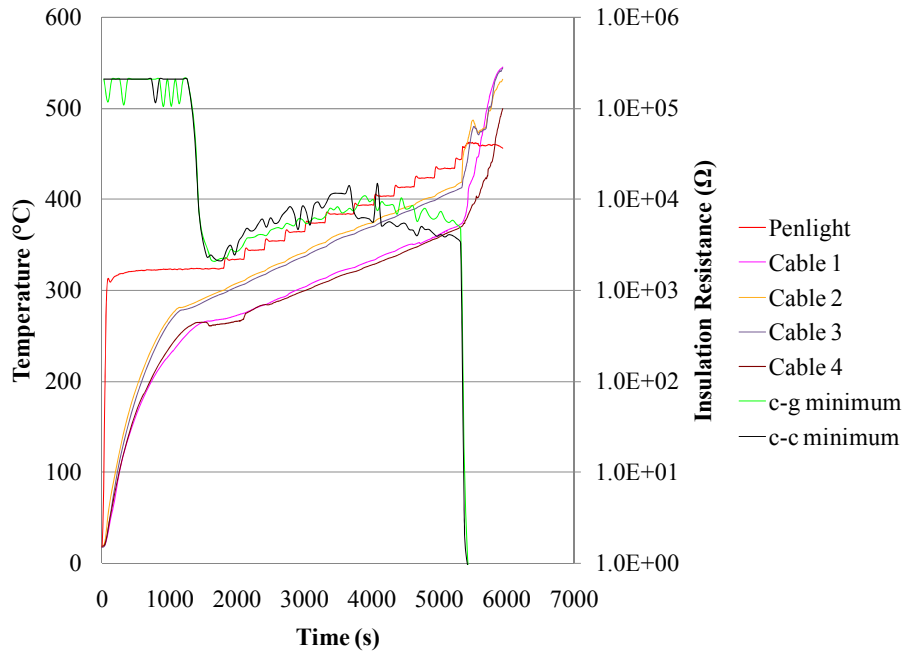

Figure B.48: Penlight shroud temperature, cable temperatures, and electrical performance data for Test K7.

Table B.60: Summary of observed faulting behavior for Test K7.

| Time (s) | Event | Comments |
|-----------|---|---|
| 0 | Penlight On; set at 325°C (5.92 kW/m ²) | |
| 1395-1476 | All conductors begin to short to ground. | The cable temperature was at 285°C. The short to ground is most likely to the zinc wrap surrounding the bundle of seven conductors. |
| 1461-5332 | Conductor 6 shorts to ground at less than 10 kΩ. | The cable temperature was 287°C at 1461 s. From 1540-2069 s, Conductor 6 shorts to ground ranging from 2647-6901 Ω and at an average of 3964 Ω. From 2069-5332 s, Conductor 6 shorts to ground ranging from 4429-47288 Ω and at an average of 16358 Ω. This behavior is indicative of a potential early failure mechanism followed by a recovery. It is also worth noting that at 1576 s, Conductor 6 shorted to Conductor 5 at 2692 Ω. |

Table B.60: Summary of observed faulting behavior for Test K7.

| Time (s) | Event | Comments |
|-----------|---|---|
| 1462-5332 | Conductor 5 shorts to ground at less than 10 k Ω . | The cable temperature was 287°C at 1462 s. From 1537-2067 s, Conductor 5 shorts to ground ranging from 2373-6440 Ω and at an average of 3825 Ω . From 2067-5332 s, Conductor 5 shorts to ground ranging from 4650-46988 Ω and at an average of 16100 Ω . This behavior is indicative of a potential early failure mechanism followed by a recovery. It is also worth noting that at 1714 s, Conductor 5 shorted to Conductor 1 at 2453 Ω . |
| 1467-5332 | Conductor 7 shorts to ground at less than 10 k Ω . | The cable temperature was 288°C at 1467 s. From 1543-2072 s, Conductor 7 shorts to ground ranging from 2574-7850 Ω and at an average of 4128 Ω . From 2072-5332 s, Conductor 7 shorts to ground ranging from 4139-49188 Ω and at an average of 18859 Ω . This behavior is indicative of a potential early failure mechanism followed by a recovery. It is also worth noting that at 1703 s, Conductor 7 shorted to Conductor 6 at 2716 Ω . |
| 1470-5332 | Conductor 2 shorts to ground at less than 10 k Ω . | The cable temperature was 288°C at 1470 s. From 1588-1999 s, Conductor 2 shorts to ground ranging from 2493.5851 Ω and at an average of 3589 Ω . From 1999-5332 s, Conductor 2 shorts to ground ranging from 2742-79279 Ω and at an average of 19628 Ω . This behavior is indicative of a potential early failure mechanism followed by a recovery. It is also worth noting that at 1666 s, Conductor 2 shorted to Conductor 4 at 2493 Ω . |
| 1473-5332 | Conductor 1 shorts to ground at less than 10 k Ω . | The cable temperature was 288°C at 1473 s. From 1588-2335 s, Conductor 1 shorts to ground ranging from 2356-3963 Ω and at an average of 3098 Ω . From 2335-5332 s, Conductor 1 shorts to ground ranging from 3153-7875 Ω and at an average of 5343 Ω . This behavior is indicative of a potential early failure mechanism followed by a recovery. It is also worth noting that at 1770 s, Conductor 1 shorted to Conductor 4 at 2450 Ω . |

Table B.60: Summary of observed faulting behavior for Test K7.

| Time (s) | Event | Comments |
|-----------------|---|---|
| 1473-5332 | Conductor 3 shorts to ground at less than 10 k Ω . | The cable temperature was 288°C at 1473 s. From 1532-2061 s, Conductor 3 shorts to ground ranging from 2558-6825 Ω and at an average of 4086 Ω . From 2061-5332 s, Conductor 3 shorts to ground ranging from 4592-78924 Ω and at an average of 23472 Ω . This behavior is indicative of a potential early failure mechanism followed by a recovery. It is also worth noting that at 1795 s, Conductor 3 shorted to Conductor 4 at 2753 Ω . |
| 1476-5332 | Conductor 4 shorts to ground at less than 10 k Ω . | The cable temperature was 288°C at 1476 s. From 1593-2064 s, Conductor 4 shorts to ground ranging from 2529-8115 Ω and at an average of 3930 Ω . From 2064-5332 s, Conductor 4 shorts to ground ranging from 4077-49192 Ω and at an average of 16701 Ω . This behavior is indicative of a potential early failure mechanism followed by a recovery. It is also worth noting that at 1770 s, Conductor 4 shorted to Conductor 1 at 2450 Ω . |
| ~5332 | Ignition | The ignition time was compared to the observed time in the notes and there appears to be a reasonable correspondence. The cable ignited at approximately 417°C. |
| 5356 | Conductor 4 shorts to ground at less than 1000 Ω . | |
| 5381 | Conductor 4 shorts to ground at less than 100 Ω . | |
| 5393-5398 | Conductor 4 shorts to Conductor 5, Conductor 6, and Conductor 7 at less than 100 Ω . | |
| 5440-5449 | Conductor 3 shorts to ground, Conductor 6, and Conductor 7 at less than 100 Ω . | |
| 5465 | Conductor 6 shorts to ground and Conductor 7 at less than 1000 Ω . | |
| 5479 | Conductor 6 shorts to ground at less than 100 Ω . | |
| 5482 | Conductor 7 shorts to ground at less than 100 Ω . | |
| 5490-5502 | Conductor 5 shorts to ground and Conductor 3 at less than 100 Ω . | |
| 5519-5524 | Conductor 5, Conductor 6, and Conductor 7 short together at less than 100 Ω . | |

Table B.60: Summary of observed faulting behavior for Test K7.

| Time (s) | Event | Comments |
|-----------------|--|-----------------|
| 5558 | Conductor 3 shorts to Conductor 4 at less than 100 Ω . | |
| 5600 | Conductor 1 shorts to Conductor 7 at less than 1000 Ω . | |
| 5603-5614 | Conductor 2 shorts to ground, Conductor 3, Conductor 4, Conductor 5, Conductor 6, and Conductor 7 at less than 1000 Ω . | |
| 5645 | Conductor 1 shorts to Conductor 2 at less than 100 Ω . | |
| 5647-5656 | Conductor 1 shorts to ground, Conductor 3, Conductor 4, Conductor 5, and Conductor 6 at less than 1000 Ω . | |
| 5661-5664 | Conductor 2 shorts to ground, Conductor 3, and Conductor 4 at less than 100 Ω . | |
| 5703-5709 | Conductor 1 shorts to ground, Conductor 3, Conductor 4 at less than 100 Ω . | |
| 5835 | Conductor 1 shorts to Conductor 7 at less than 100 Ω . | |
| 5843-5849 | Conductor 2 shorts to Conductor 5 and Conductor 7 at less than 100 Ω . | |
| 5888 | Conductor 1 shorts to Conductor 5 at less than 100 Ω . | |
| 5940 | Penlight shutdown | |

B.7 Cable Item F: 9/C-14 AWG, FR

Cable Item F is a 9/C-14 AWG cable with FR insulation, according to the bill of materials provided by the donating company, and the conductors are numbered as depicted in Figure B.49. The cable was tested four times during the DESIREE-Fire series, three for Penlight and once for intermediate-scale. The three Penlight tests were conducted on the MOV circuits. During the intermediate-scale test, it was tested on the 1-in. valve circuit. The cable was also tested three times during the KATE-Fire tests, once on IRMS and twice on SCDU. The following sections detail the test parameters, conductor paths, circuit data, and test summary for each test.

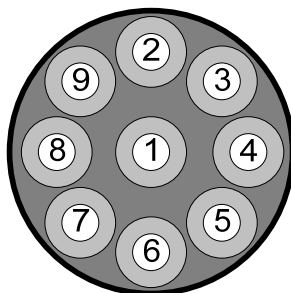

Figure B.49: Illustration of Cable Item F.

B.7.1 Test D44

DESIREE-Fire provided a target opportunity to preliminarily investigate the performance of Kerite cable under thermal duress. During Test D44, Item F was connected to each of the dc-powered MOV circuits. The test parameters may be found in Table B.61. The conductor pathway for the cable monitoring unit may be found in Table B.62. Electrical performance of the cable may be found in the following two sections, namely Circuit 1 and Circuit 2.

Table B.61: Test parameters for Test D44.

| | |
|--------------------------------|-----------------------|
| Test Series | DESIREE-FIRE |
| Test Name | Test 44 |
| Test Date | 10/5/2010 |
| Cable 1 | Kerite 9/C-14 AWG, FR |
| Cable Monitoring Unit Utilized | MOV1 |
| Cable 2 | Kerite 9/C-14 AWG, FR |
| Cable Monitoring Unit Utilized | MOV2 |
| Penlight Starting Temperature | 325°C |
| Penlight Final Temperature | 485°C |

Table B.62: Conductor designation for Item F, Test D44, Circuit 1 and Circuit 2.

| DCSim MOV, 9/C-14 AWG, FR | | | | | |
|-----------------------------|----------------------------|--|---------------------------------------|-----------------------------|----------------------------|
| Lead Cable Conductor number | Lead cable conductor color | Terminal block location in DCSim Panel | Terminal block circuit identification | Test Cable conductor number | Test cable conductor color |
| 1 | Black | TB 3i | P | 3 | Red |
| 2 | White | TB 3/C | G | 4 | Green |
| 3 | Red | TB 7/C | YC1 | 5 | Orange |
| 4 | Green | TB 4/C | R | 6 | Blue |
| 5 | Orange | TB 6i | SP | 7 | White/Black |

Table B.62: Conductor designation for Item F, Test D44, Circuit 1 and Circuit 2.

| DCSim MOV, 9/C-14 AWG, FR | | | | | |
|-----------------------------|----------------------------|--|---------------------------------------|-----------------------------|----------------------------|
| Lead Cable Conductor number | Lead cable conductor color | Terminal block location in DCSim Panel | Terminal block circuit identification | Test Cable conductor number | Test cable conductor color |
| 6 | Blue | TB 5i | N | 8 | Red/Black |
| 7 | White/Black | TB 6c | YO1 | 9 | Green/Black |
| 8 | Red/Black | Not Connected | Not Connected | Not Connected | Not Connected |
| 9 | Green/Black | Not Connected | Not Connected | Not Connected | Not Connected |

B.7.1.1 Circuit 1

The electrical performance of this circuit may be found in Figure B.50 and Figure B.51. In the former figure, the positive and negative sources are graphed with the open and close coil targets. The latter graph displays the energized green lamp conductor were graphed with the positive and negative sources. At approximately 9073 s and a cable temperature of 435°C, the close coil spuriously actuated for approximately 20 minutes. False indication of the red lamp occurred at 11204 s for approximately 60 s before a fuse clear. It should be noted that the auxiliary contacts were not performing as anticipated throughout the test. At the conclusion of the test, the auxiliary contact was inspected and it was discovered that the metal contacts were not making complete connections upon actuation. This would reflect the lack of when the red lamp was actuated upon the spurious operation of the close coil. The temperature profile and voltage response may be found in Figure B.52 and a modified plot displaying low temperature degradation can be observed in Figure B.53. A summary of the test results may be found in Table B.63.

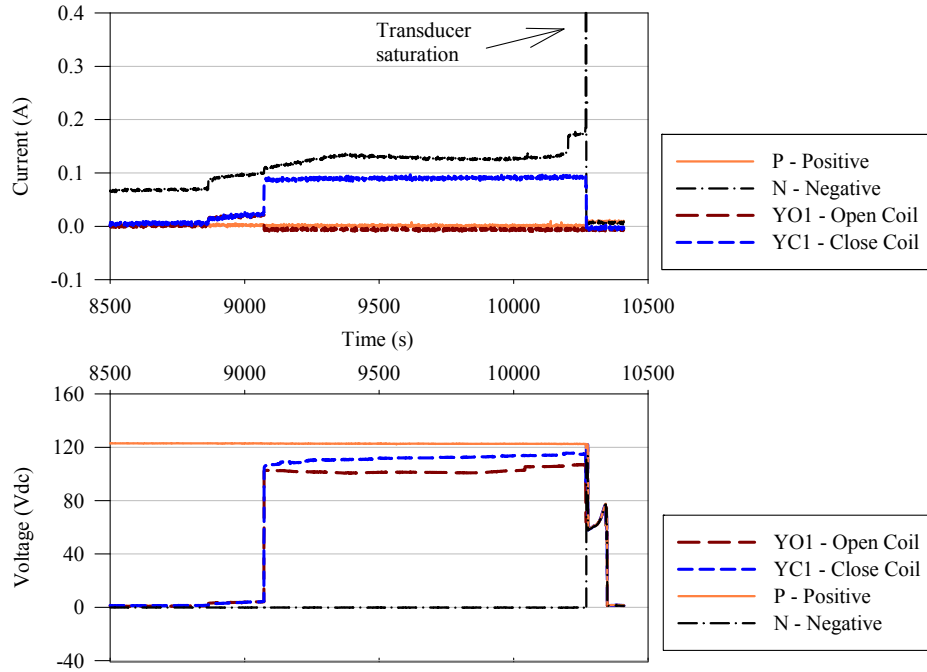

Figure B.50: Voltage and current response for the active target in Test D44, Circuit 1.

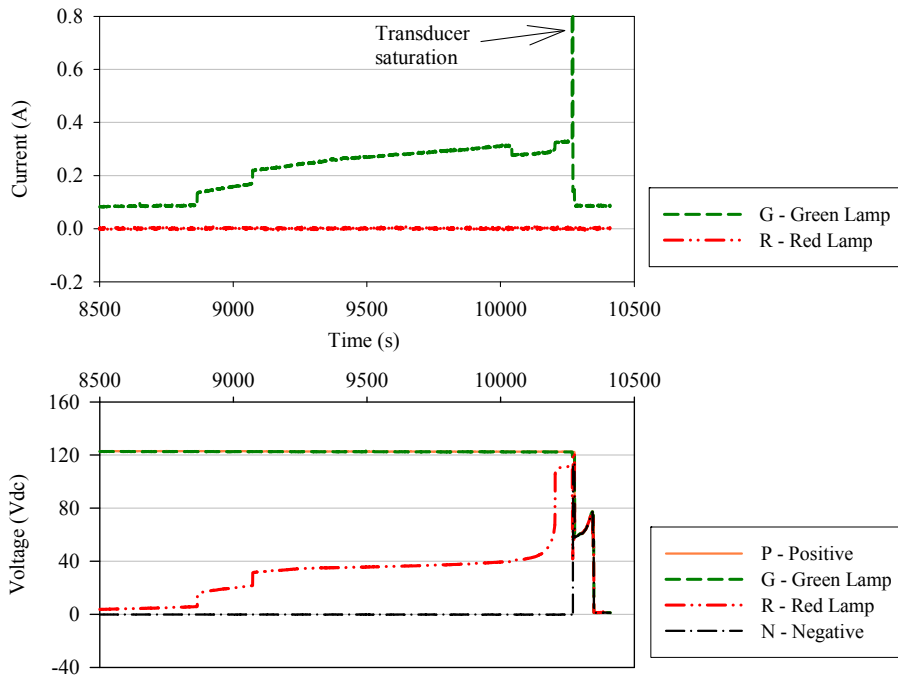

Figure B.51: Voltage and current response for the lamps in Test D44, Circuit 1.

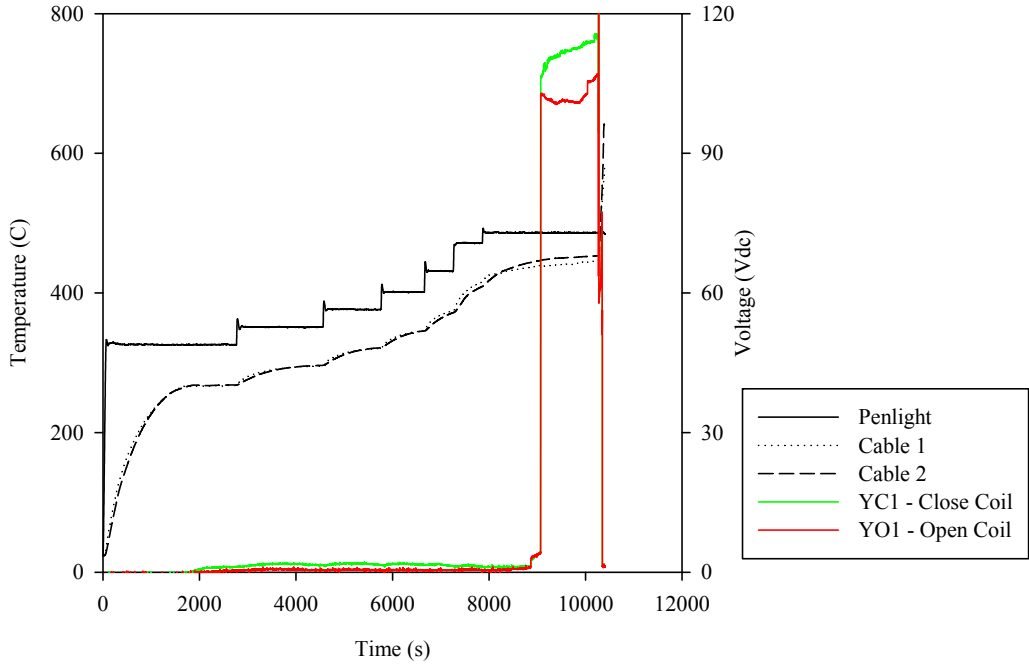

Figure B.52: Temperature profile and electrical response for Test D44, Circuit 1.

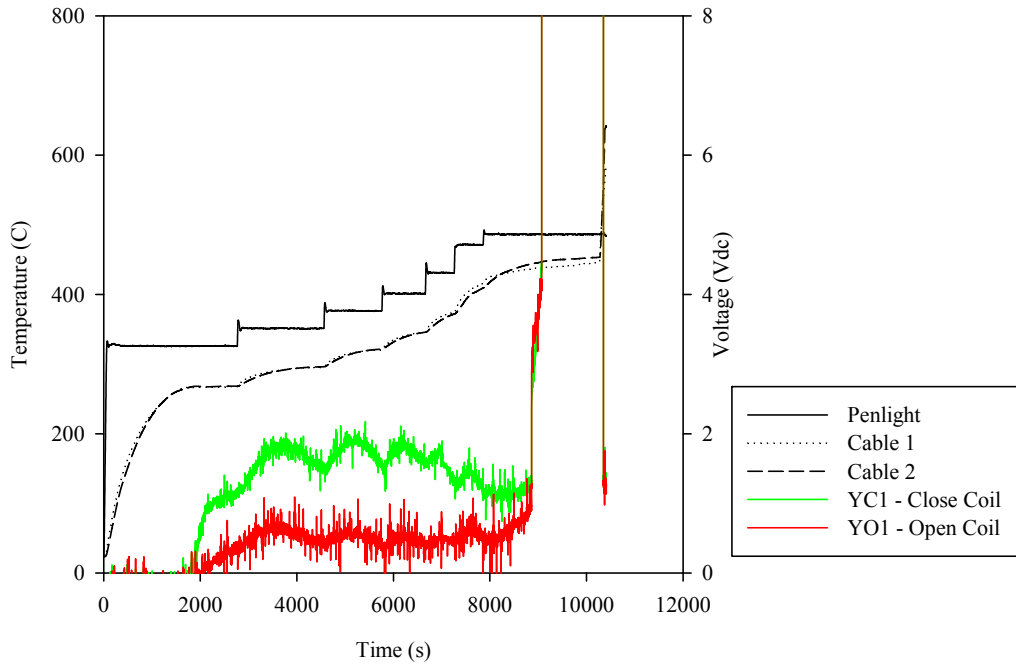

Figure B.53: Modified temperature profile and electrical response for Test D44, Circuit 1 showing the early degradation.

Table B.63: Summary of observed faulting behavior for Test D44, Circuit 1.

| Time (s) | Event | Discussion |
|-----------------|---|---|
| 0 | Penlight On; set at 325°C (5.92 kW/m ²) | |
| 396 | Liquid observed exiting end of TC cable | Cable temperature at approximately 129°C |
| 821 | Smoke observed | |
| 1993 | Increased flow of liquid exiting TC cable | |
| 2760 | Penlight set point temperature increased | Penlight set point increased to 350°C |
| 4560 | Penlight set point temperature increased | Penlight set point increased to 375°C |
| 5760 | Penlight set point temperature increased | Penlight set point increased to 400°C |
| 6660 | Penlight set point temperature increased | Penlight set point increased to 430°C |
| 7260 | Penlight set point temperature increased | Penlight set point increased to 470°C |
| 7860 | Penlight set point temperature increased | Penlight set point increased to 485°C |
| 9073-10276 | Spurious Actuation Close Coil | At this time, the current was approximately 0.9 A and the cable temperature was approximately 435°C |
| 10204-10276 | False Indication Red Lamp ON | It should be noted that the auxiliary contacts are not functioning as anticipated. |
| 10277 | Negative Fuse Clear – MOV1 | At this time, the cable arced and caused ignition. |
| 10277 | Ignition | Ignition occurred as a result of electrical arcing |
| 10349 | Positive Fuse Clear – MOV1 | |
| 10950 | Penlight off | |

B.7.1.2 Circuit 2

The electrical performance of this circuit may be found in Figure B.54 and Figure B.55. In the former figure, the positive and negative sources are graphed with the open and close coil targets. The latter graph displays the energized green lamp conductor were graphed with the positive and negative sources. At approximately 10043 s and a cable temperature of 435°C, the open coil spuriously actuated for approximately 5 minutes. The temperature profile and voltage response may be found in Figure B.56 and a modified plot displaying low temperature degradation can be observed in Figure B.53. A summary of the test results may be found in Table B.64.

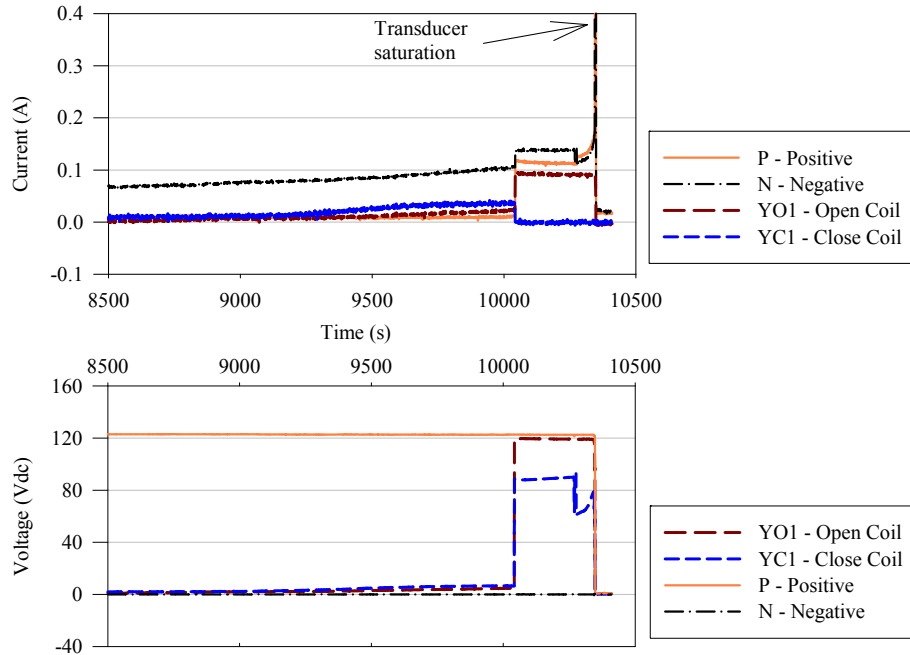

Figure B.54: Voltage and current response for the active target in Test D44, Circuit 2.

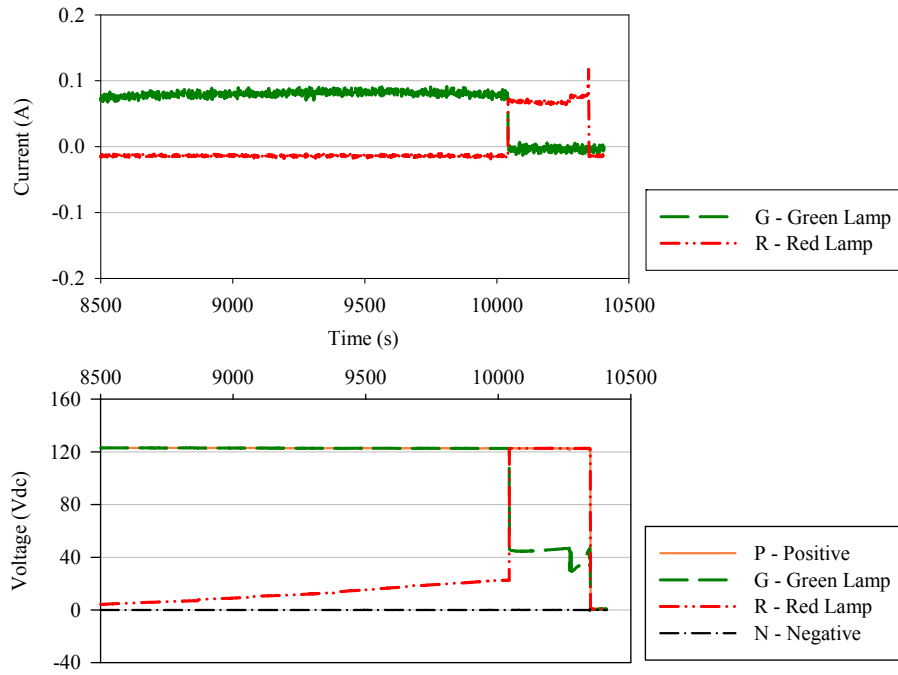

Figure B.55: Voltage and current response for the lamps in Test D44, Circuit 2.

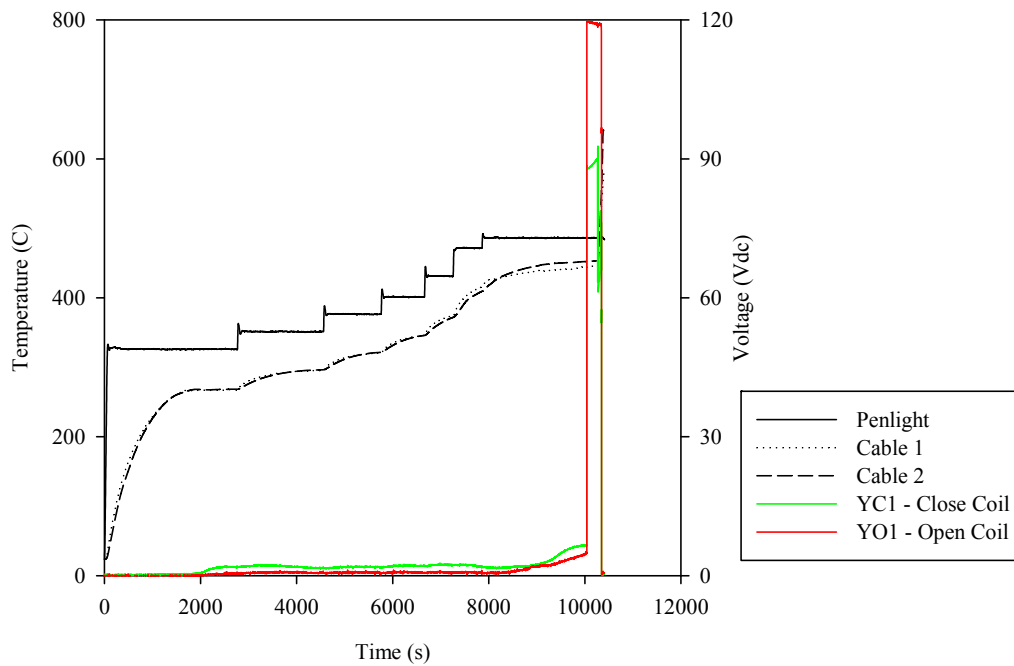

Figure B.56: Temperature profile and electrical response for Test D44, Circuit 2.

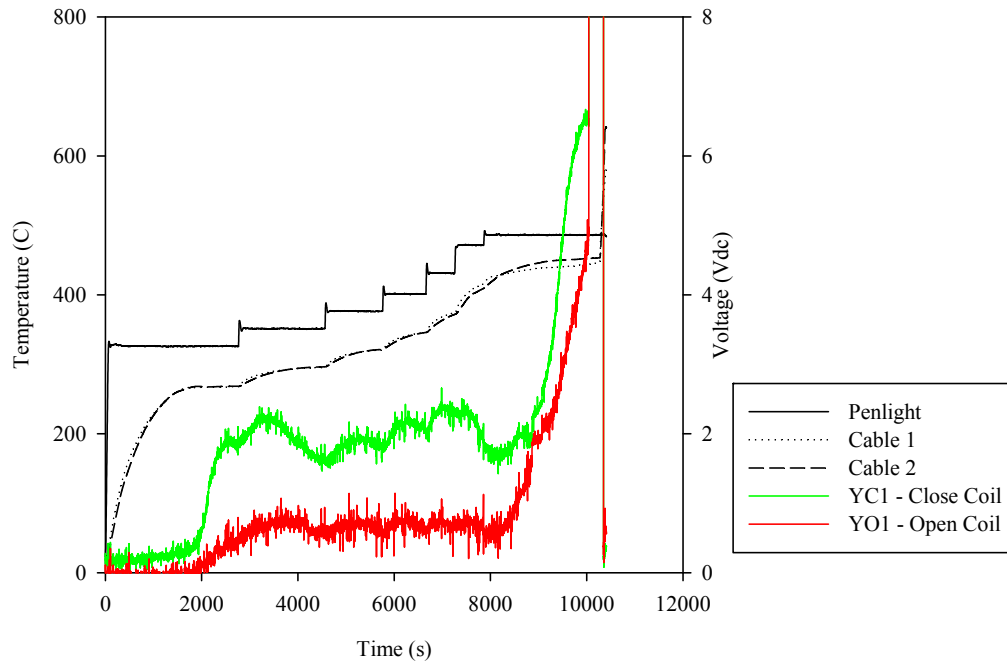

Figure B.57: Modified temperature profile and electrical response for Test D44, Circuit 2 showing the early degradation.

Table B.64: Summary of observed faulting behavior for Test D44, Circuit 2.

| Time (s) | Event | Discussion |
|----------|---|--|
| 0 | Penlight On; set at 325°C (5.92 kW/m ²) | |
| 396 | Liquid observe exiting end of TC cable | Cable temperature at approximately 129°C |
| 821 | Smoke observed | |
| 1993 | Increased flow of liquid exiting TC cable | |
| 2760 | Penlight set point temperature increased | Penlight set point increased to 350°C |
| 4560 | Penlight set point temperature increased | Penlight set point increased to 375°C |
| 5760 | Penlight set point temperature increased | Penlight set point increased to 400°C |

Table B.64: Summary of observed faulting behavior for Test D44, Circuit 2.

| Time (s) | Event | Discussion |
|-----------------|--|---|
| 6660 | Penlight set point temperature increased | Penlight set point increased to 430°C |
| 7260 | Penlight set point temperature increased | Penlight set point increased to 470°C |
| 7860 | Penlight set point temperature increased | Penlight set point increased to 485°C |
| 10043-10349 | Spurious Actuation Open Coil | At this time, there was a hot short on the Open Coil for MOV2 |
| 10277 | Arcing – Cable Ignition | There was an arc in one of the cables that lead to the ignition of each sample cable. |
| 10349 | Positive Fuse Clear – MOV2 | |
| 10950 | Penlight off | |

B.7.2 Test D49

DESIREE-Fire provided a target opportunity to preliminarily investigate the performance of Kerite cable under thermal duress. Similar to Test D44, Test D49 was connected to each of the dc-powered MOV circuits. During this test, however, the Penlight set point was set to 400°C to investigate the performance of the cable under greater initial temperatures. The test parameters may be found in Table B.61. The conductor pathway for the cable monitoring unit may be found in Table B.62. Electrical performance of the cable may be found in the following two sections, namely Circuit 1 and Circuit 2.

Table B.65: Test parameters for Test D49.

| | |
|--------------------------------|-----------------------|
| Test Series | DESIREE-FIRE |
| Test Name | Test 49 |
| Test Date | 10/9/2010 |
| Cable 1 | Kerite 9/C-14 AWG, FR |
| Cable Monitoring Unit Utilized | MOV1 |
| Cable 2 | Kerite 9/C-14 AWG, FR |
| Cable Monitoring Unit Utilized | MOV2 |
| Penlight Starting Temperature | 400°C |
| Penlight Final Temperature | 440°C |

Table B.66: Conductor designation for Item F, Test D49, Circuit 1 and Circuit 2.

| DCSim MOV1, 9/C-14 AWG, FR | | | | | |
|-----------------------------|----------------------------|--|---------------------------------------|-----------------------------|----------------------------|
| Lead Cable Conductor number | Lead cable conductor color | Terminal block location in DCSim Panel | Terminal block circuit identification | Test Cable conductor number | Test cable conductor color |
| 1 | Black | TB 3i | P | 3 | Red |
| 2 | White | TB 3/C | G | 4 | Green |
| 3 | Red | TB 7/C | YC1 | 5 | Orange |
| 4 | Green | TB 4/C | R | 6 | Blue |
| 5 | Orange | TB 6i | SP | 7 | White/Black |
| 6 | Blue | TB 5i | N | 8 | Red/Black |
| 7 | White/Black | TB 6c | YO1 | 9 | Green/Black |
| 8 | Red/Black | Not Connected | Not Connected | Not Connected | Not Connected |
| 9 | Green/Black | Not Connected | Not Connected | Not Connected | Not Connected |

B.7.2.1 Circuit 1

The electrical performance of this circuit may be found in Figure B.58 and Figure B.59. In the former figure, the positive and negative sources are graphed with the open and close coil targets. The latter graph displays the energized green lamp conductor were graphed with the positive and negative sources. At approximately 4394 s and a cable temperature of 405°C, the close coil spuriously actuated for approximately 7 s before a fuse clear. The temperature profile and voltage response may be found in Figure B.60. Similar to Test D44, there was early degradation observed during this test which may be seen in Figure B.61. A summary of the test results may be found in Table B.68.

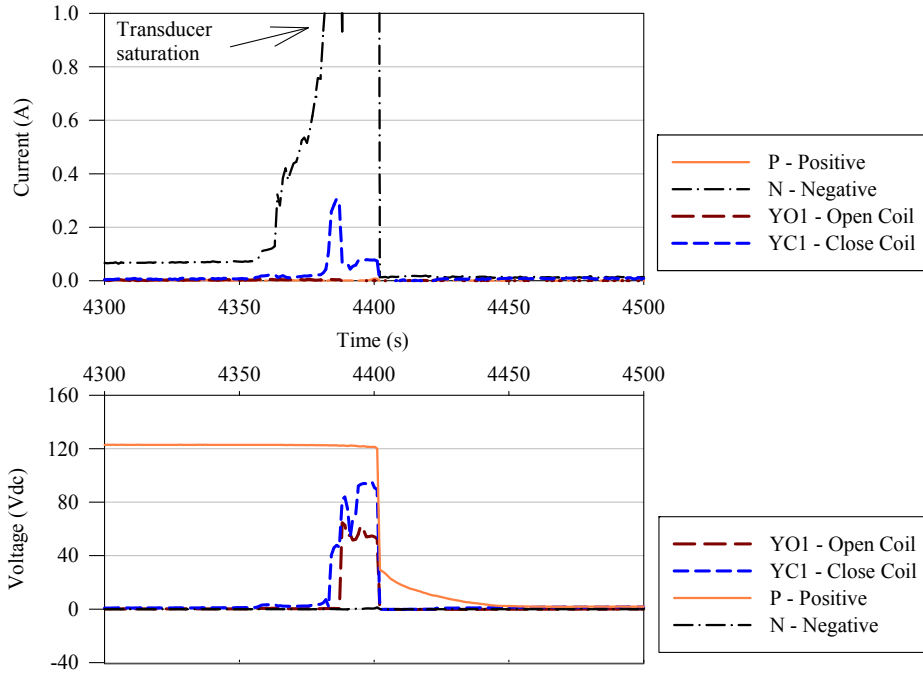

Figure B.58: Voltage and current response for the active target in Test D49, Circuit 1.

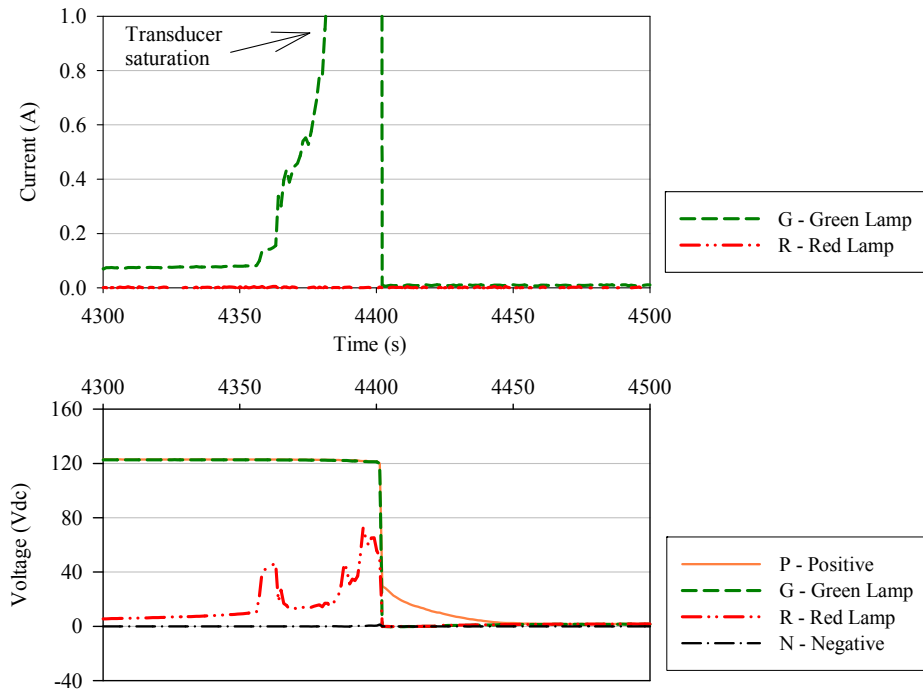

Figure B.59: Voltage and current response for the lamps in Test D49, Circuit 1.

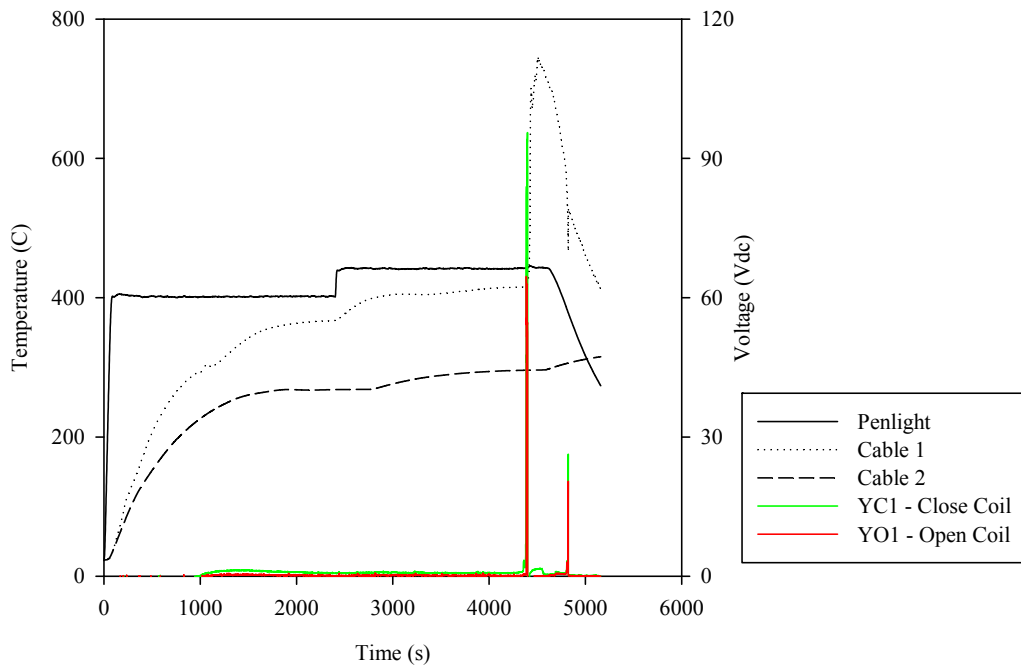

Figure B.60: Temperature profile and electrical response for Test D49, Circuit 1

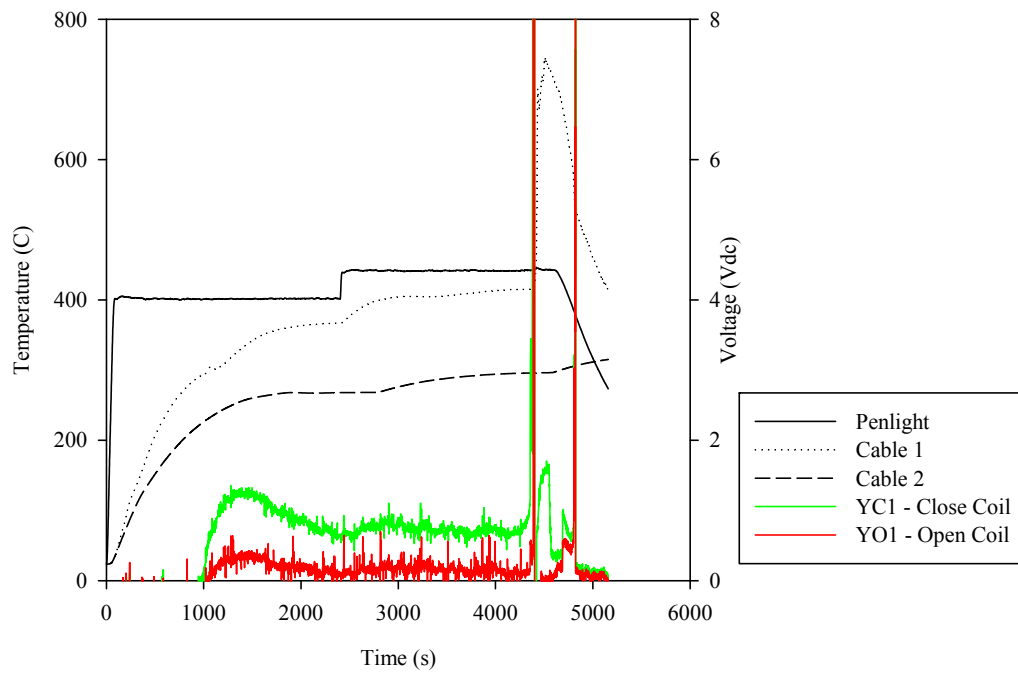

Figure B.61: Modified temperature profile and electrical response for Test D49, Circuit 1 showing the early degradation.

Table B.67: Summary of observed faulting behavior for Test D49, Circuit 1.

| Time (s) | Event | Discussion |
|-----------------|---|--|
| 0 | Penlight On; set at 400°C (9.49 kW/m ²) | |
| 755 | Liquid exiting TC cable | Cable temperature at approximately 265°C |
| 2400 | Penlight increased to 440°C | |
| 4394-4401 | Spurious Actuation Close Coil | |
| 4394 | Ignition | The cables ignited upon electrical arcing occurring from the spurious actuation. |
| 4402 | MOV1 Fuse Clear | |
| 4402-4824 | Battery Negative shorts to ground | |
| 4620 | Penlight off | |
| ~4820 | Interactions between MOV1 and MOV2 circuits | This was based on field notes and validated with the data during post-test analysis. |

B.7.2.2 Circuit 2

The electrical performance of this circuit may be found in Figure B.62 and Figure B.63. In the former figure, the positive and negative sources are graphed with the open and close coil targets. The latter graph displays the energized green lamp conductor were graphed with the positive and negative sources. At approximately 4620 s, Penlight was shutdown. At 4823 s, the open coil spuriously actuated for approximately 1 s before a fuse clear. The temperature profile and voltage response may be found in Figure B.64. Unlike Circuit 1, early degradation was not observed for this circuit. A summary of the test results may be found in Table B.68.

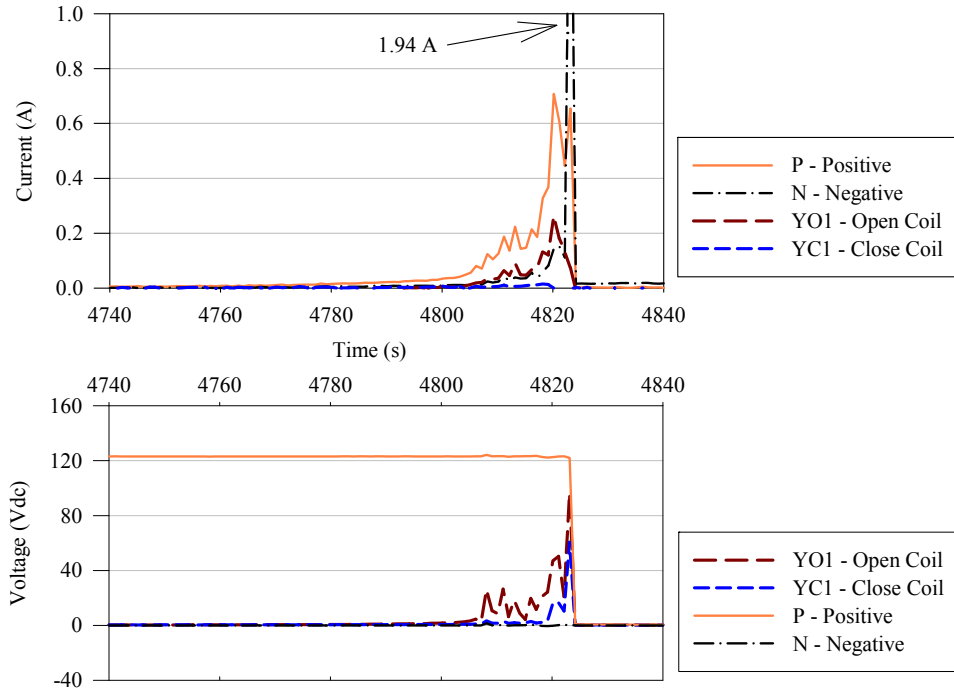

Figure B.62: Voltage and current response for the active target in Test D49, Circuit 2.

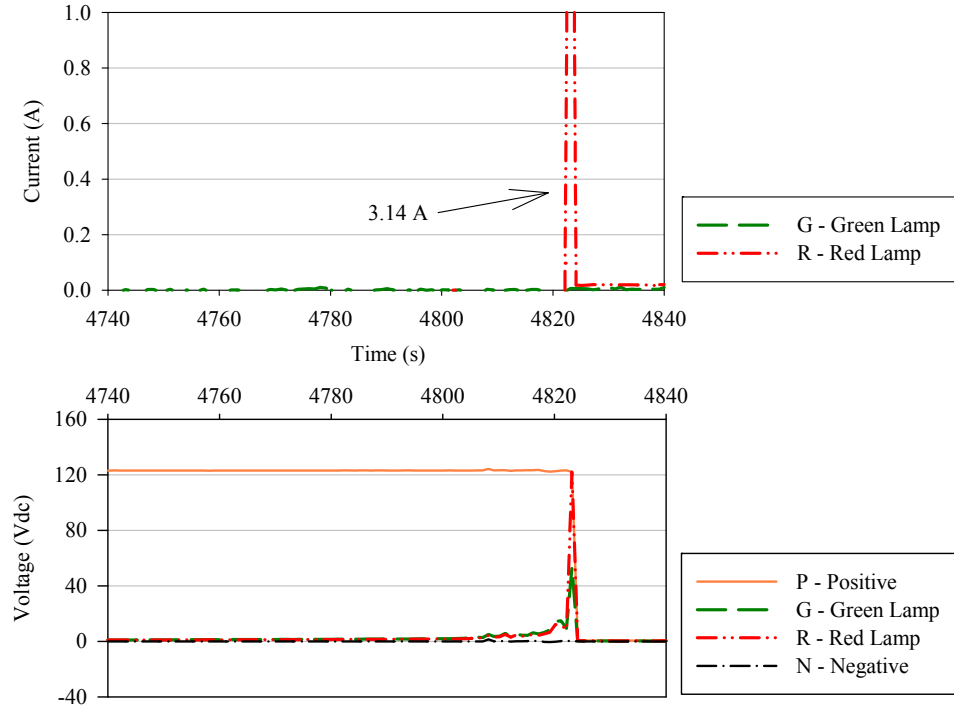

Figure B.63: Voltage and current response for the lamps in Test 49, Circuit 2.

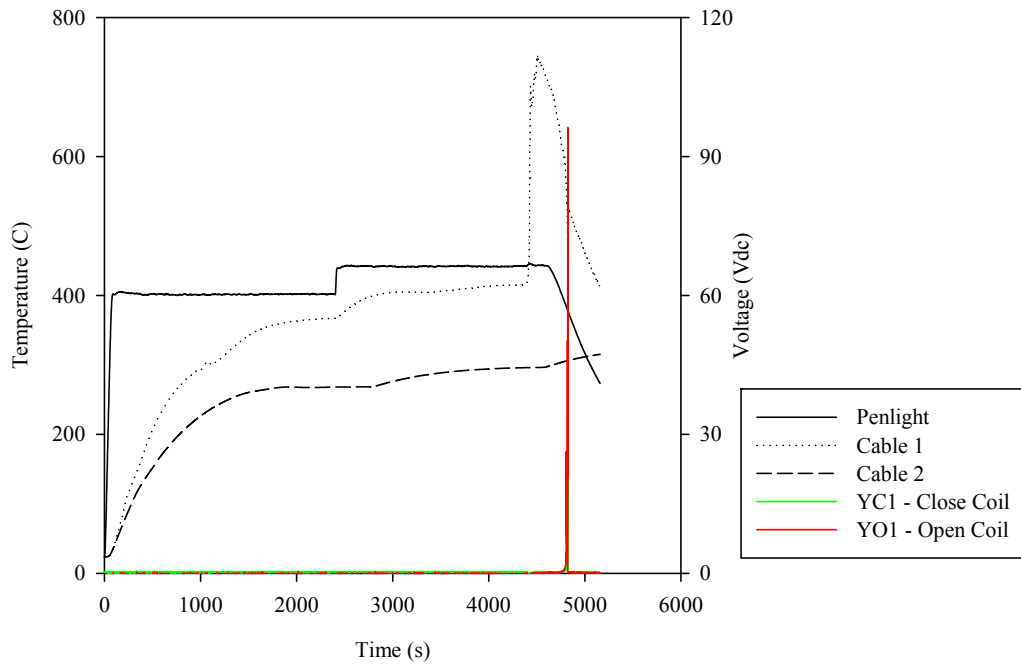

Figure B.64: Temperature profile and electrical response for Test D49, Circuit 2.

Table B.68: Summary of observed faulting behavior for Test D49, Circuit 2.

| Time (s) | Event | Discussion |
|-----------|---|---|
| 0 | Penlight On; set at 400°C (9.49 kW/m ²) | |
| 755 | Liquid exiting TC cable | |
| 2400 | Penlight increased to 440°C | |
| 4402-4824 | Battery Negative shorts to ground | |
| 4620 | Penlight off | |
| ~4820 | Interactions between MOV1 and MOV2 circuits | |
| 4823 | Spurious Actuation Open Coil | The duration of the spurious actuation was approximately 1 s. |
| 4824 | MOV2 Fuse Clear | |

B.7.3 Test D50

This was the final Penlight test for Item F during the DESIREE-Fire series. The Penlight set point temperature was set to 450°C. There were no temperature increases during this test since the cables ignited approximately 14 minutes into the test. Similar to the previous two tests, Test D50 was connected to each of the dc-powered MOV circuits. The test parameters may be found in Table B.69. The conductor pathway for the cable monitoring unit may be found in Table B.70. Electrical performance of the cable may be found in the following two sections, namely Circuit 1 and Circuit 2.

Table B.69: Test parameters for Test D50.

| | |
|--------------------------------|-----------------------|
| Test Series | DESIREE-FIRE |
| Test Name | Test 50 |
| Test Date | 10/12/2010 |
| Cable 1 | Kerite 9/C-14 AWG, FR |
| Cable Monitoring Unit Utilized | MOV1 |
| Cable 2 | Kerite 9/C-14 AWG, FR |
| Cable Monitoring Unit Utilized | MOV2 |
| Penlight Starting Temperature | 450°C |
| Penlight Final Temperature | 450°C |

Table B.70: Conductor designation for Item F, Test D50, Circuit 1 and Circuit 2.

| DCSim MOV, 9/C-14 AWG, FR | | | | | |
|-----------------------------|----------------------------|--|---------------------------------------|-----------------------------|----------------------------|
| Lead Cable Conductor number | Lead cable conductor color | Terminal block location in DCSim Panel | Terminal block circuit identification | Test Cable conductor number | Test cable conductor color |
| 1 | Black | TB 3i | P | 3 | Red |
| 2 | White | TB 3/C | G | 4 | Green |
| 3 | Red | TB 7/C | YC1 | 5 | Orange |
| 4 | Green | TB 4/C | R | 6 | Blue |
| 5 | Orange | TB 6i | SP | 7 | White/Black |
| 6 | Blue | TB 5i | N | 8 | Red/Black |
| 7 | White/Black | TB 6c | YO1 | 9 | Green/Black |
| 8 | Red/Black | Not Connected | Not Connected | Not Connected | Not Connected |
| 9 | Green/Black | Not Connected | Not Connected | Not Connected | Not Connected |

B.7.3.1 Circuit 1

The electrical performance of this circuit may be found in Figure B.65 and Figure B.66. In the former figure, the positive and negative sources are graphed with the open and close coil targets. The latter graph displays the energized green lamp conductor were graphed with the positive and negative sources. At approximately 1279 s, there was a false actuation of the red lamp for 21 s before a fuse clear. There were no spurious operations observed on Circuit 1 during the test. The temperature profile and voltage response may be found in Figure B.67. Early degradation was not observed for this circuit. A summary of the test results may be found in Table B.71.

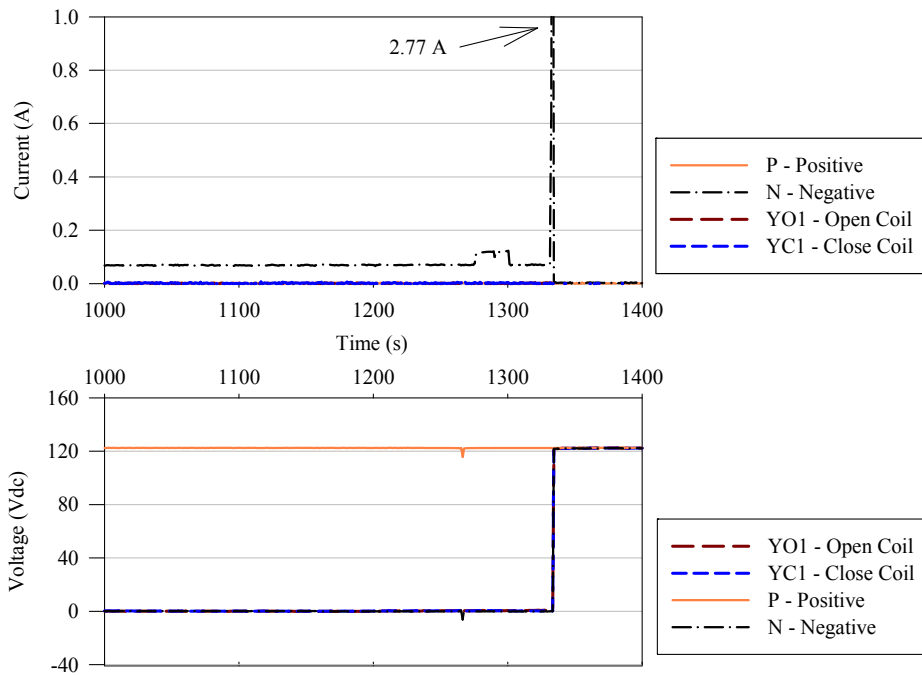

Figure B.65: Voltage and current response for the active target in Test D50, Circuit 1.

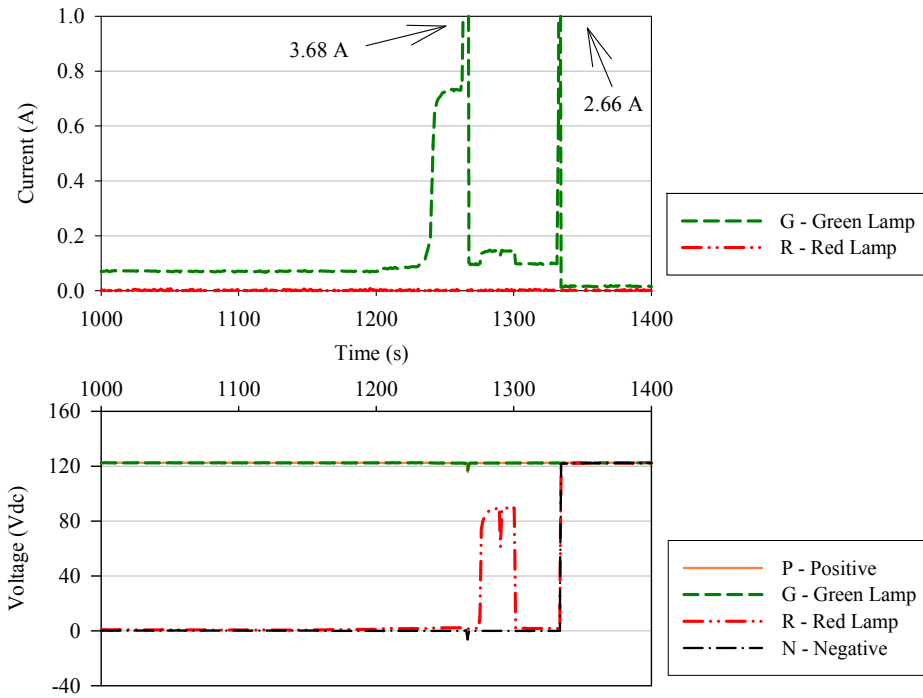

Figure B.66: Voltage and current response for the lamps in Test D50, Circuit 1.

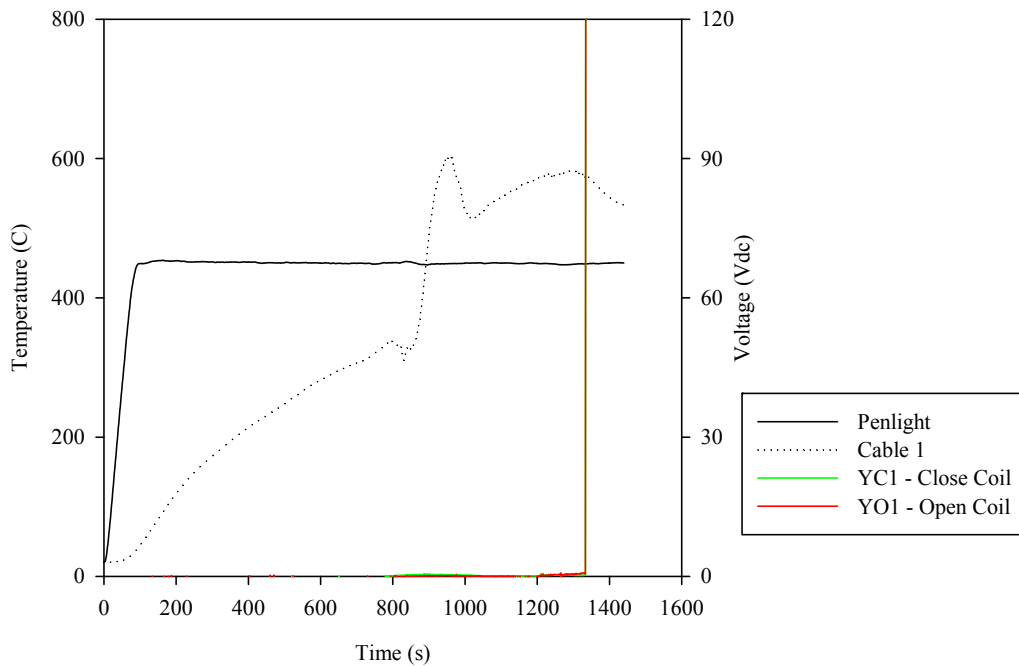

Figure B.67: Temperature profile and electrical response for Test D50, Circuit 1.

Table B.71: Summary of observed faulting behavior for Test D50, Circuit 1.

| Time (s) | Event | Discussion |
|-----------------|--|-------------------|
| 0 | Penlight On; set at 450°C (12.64 kW/m ²) | |
| 420 | Liquid exiting end of TC cable | |
| 822 | Cable Ignition | |
| 1242-1334 | Battery Positive shorts to ground | |
| 1279-1300 | False Indication – Red lamp ON | |
| 1334 | Negative Fuse Clear MOV1 | |
| 1440 | Penlight off | |

B.7.3.2 Circuit 2

The electrical performance of this circuit may be found in Figure B.68 and Figure B.69. In the former figure, the positive and negative sources are graphed with the open and close coil targets. The latter graph displays the energized green lamp conductor were graphed with the positive and negative sources. At approximately 1164 s, there was a false actuation of the red lamp for 17 s. There was a spurious operation observed at 1242 s on Circuit 2 close coil during the test. The duration was approximately 22 s before the negative fuse cleared. The temperature profile and voltage response may be found in Figure B.70. Early degradation was not observed during this test. A summary of the test results may be found in Table B.72.

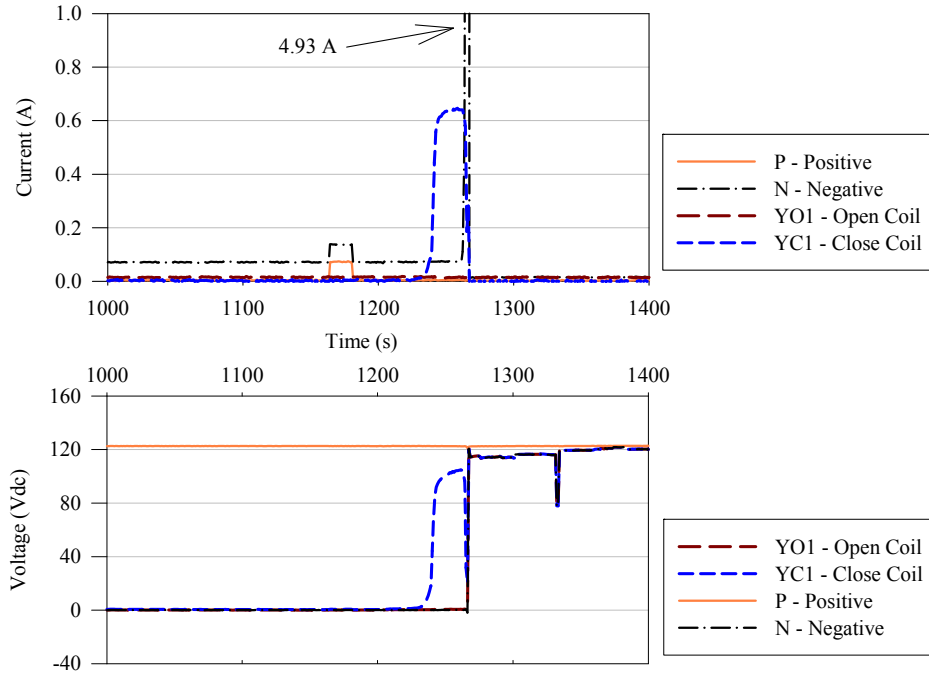

Figure B.68: Voltage and current response for the active target in Test D50, Circuit 2.

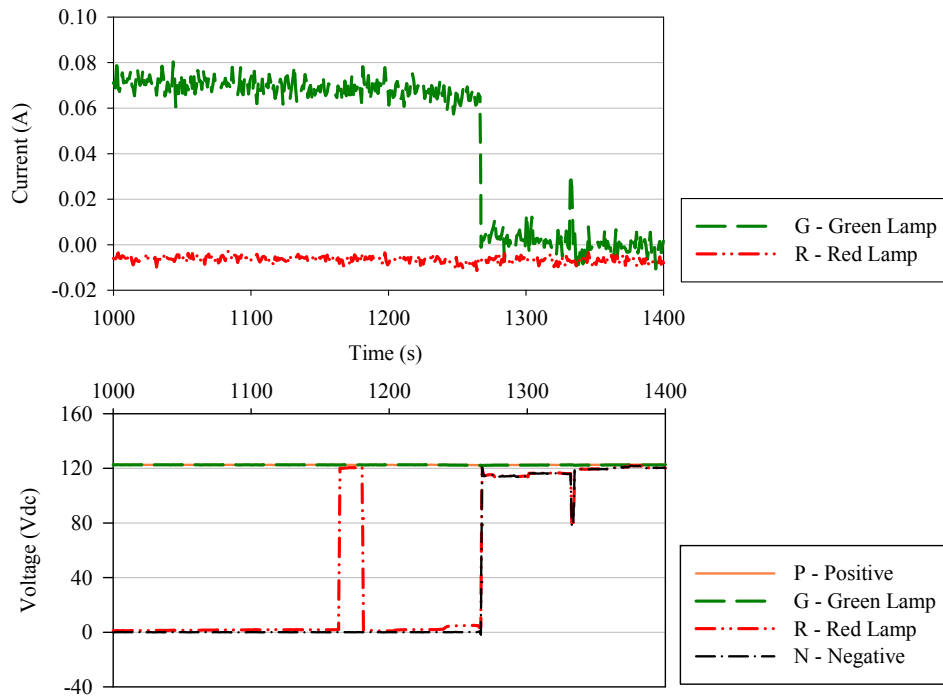

Figure B.69: Voltage and current response for the lamps in Test D50, Circuit 2.

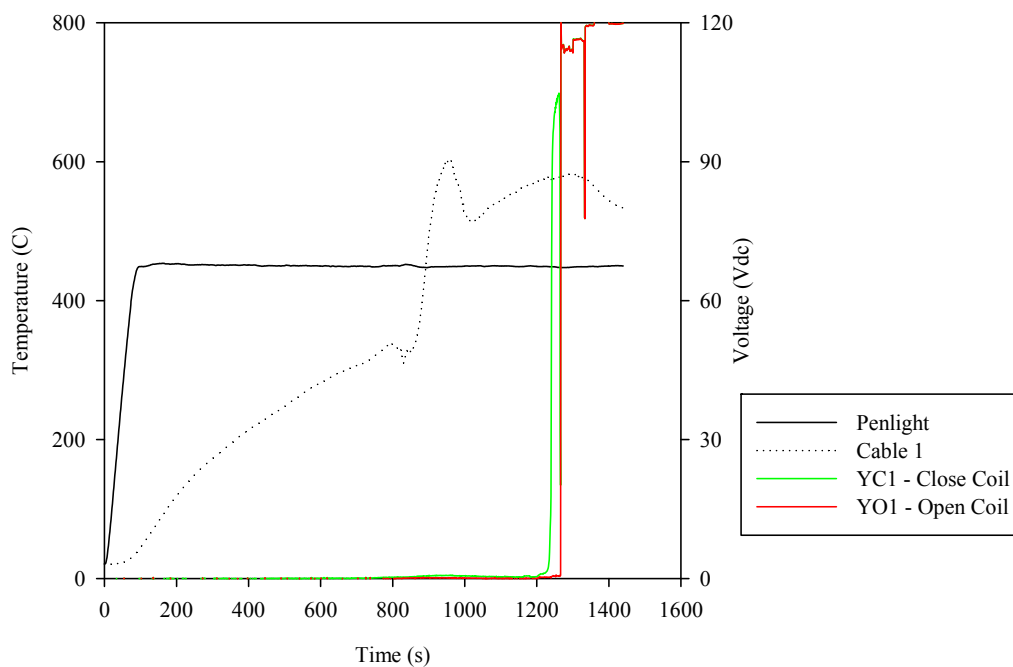

Figure B.70: Temperature profile and electrical response for Test D50, Circuit 2.

Table B.72: Summary of observed faulting behavior for Test D50, Circuit 2.

| Time (s) | Event | Discussion |
|-----------|--|--|
| 0 | Penlight On; set at 450°C (12.64 kW/m ²) | |
| 420 | Liquid exiting end of TC cable | |
| 822 | Cable Ignition | |
| 1164-1181 | False Indication MOV2 – Red lamp ON | |
| 1242-1334 | Battery Positive shorts to ground | |
| 1242-1264 | Spurious Actuation Close Coil | The duration of the spurious actuation was approximately 22 s. |
| 1267 | Negative Fuse Clear MOV2 | |
| 1440 | Penlight off | |

B.7.4 Test IS10

The intermediate-scale test series conducted during DESIREE-Fire was a target opportunity to investigate the performance of Kerite cable in a more representative fire environment. Item F was tested on two different dc-circuits and exposure locations, namely the Large Coil (Position D) and MOV1 (Position C). The performance of these circuits will be described in the following two sections.

B.7.4.1 Circuit 1

During Test IS10, Item F was connected to the dc-powered Large Coil and situated in Position D. The test parameters may be found in Table B.73. The conductor pathway for the cable monitoring unit may be found in Table B.74. Electrical performance of the cable may be found in Figure B.71 and Figure B.72. In the former graph, the positive and negative sources as well as the energized green lamp conductor were graphed with the coil voltage. The latter graph displays the voltage of the lamps through the test. From these two graphs, it should be noted that there is a voltage increase at approximately 2055 s which corresponds to a cable temperature of 258°C. False indication of the red lamp occurred at 2502 s for approximately 32 s before a spurious operation occurred on the 1-in. 1-in. valve. The actuation continued for approximately 9 s until the negative fuse cleared. The temperature profile and voltage response may be found in Figure B.73. In this figure, the air temperature is listed as the location of the cable and the length along the tray while the sub-jacket temperature is listed with the location of the cable, cable type, and length along the sample. A summary of the test results may be found in Table B.75.

Table B.73: Test parameters for Test IS10, Large Coil.

| | |
|------------------------------|------------------------------------|
| Test Name | Test IS10 |
| Test Date | 3/25/2010 |
| Cable Type for Large Coil | Kerite, 9/C-14 AWG, FR |
| Large Coil Position | Position D |
| Cable Fill Type | Bundled Tray A, Cable 1 |
| Cables Co-Located in Raceway | Cable 1 - 1-in. Valve |
| | Cable 2 - TC Cable for 1-in. Valve |
| | Cable 4 - TC Cable for Large Coil |
| Battery Voltage (Pre-test) | 121.96 Vdc |
| Battery Voltage (Post-test) | 122.21 Vdc |

Table B.74: Conductor designation for Item F, Test IS10, Large Coil.

| Test IS10, Large Coil, 9/C-14 AWG | | | | | |
|-----------------------------------|----------------------------|--|---------------------------------------|-----------------------------|----------------------------|
| Lead Cable Conductor number | Lead cable conductor color | Terminal block location in DCSim Panel | Terminal block circuit identification | Test Cable conductor number | Test cable conductor color |
| 1 | Black | TB 2 | P | 1 | Black |
| 2 | White | TB 5 | R | 2 | White |
| 3 | Red | TB 3 | G | 3 | Red |
| 4 | Green | TB 6 | SP | 4 | Green |
| 5 | Orange | TB 9 | N1 | 5 | Orange |
| 6 | Blue | TB 7 | N2 | 6 | Blue |
| 7 | White/Black | TB 8 | SP | 7 | White/Black |

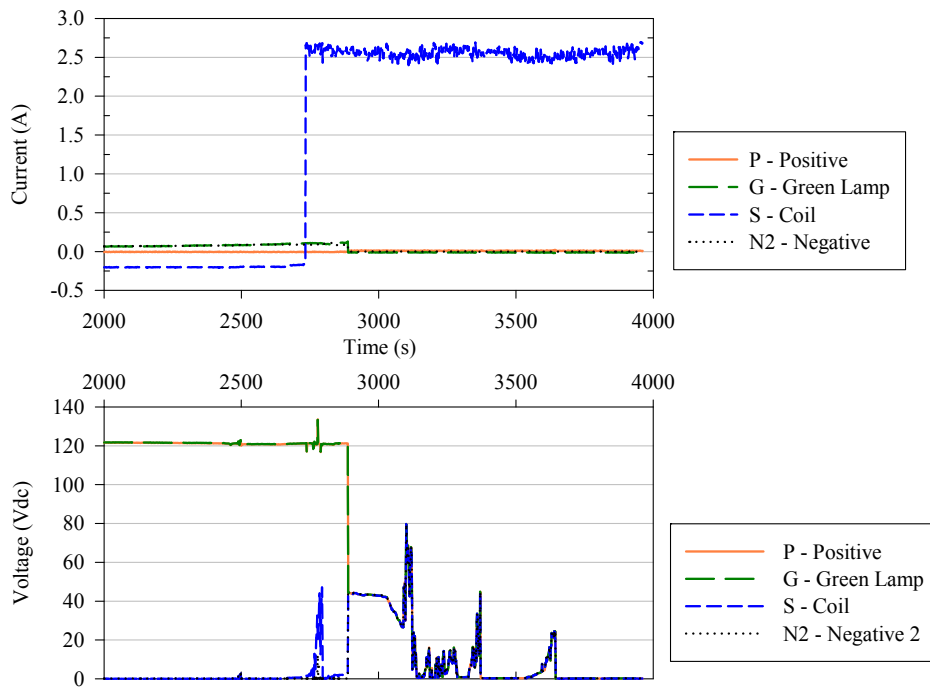

Figure B.71: Voltage and current response for the active target in Test IS10, Large Coil.

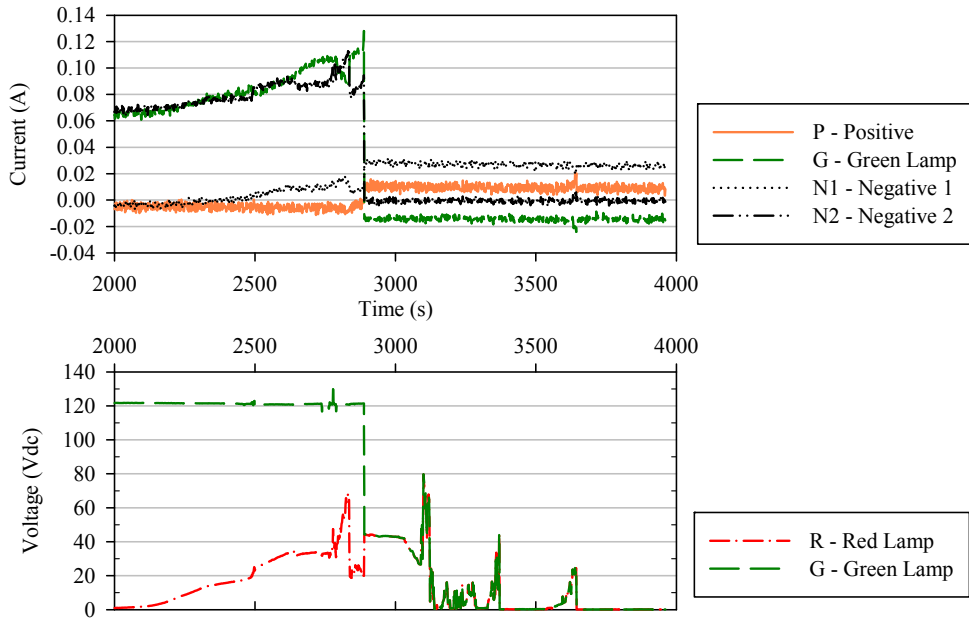

Figure B.72: Voltage and current response for the lamps in Test IS10, Large Coil.

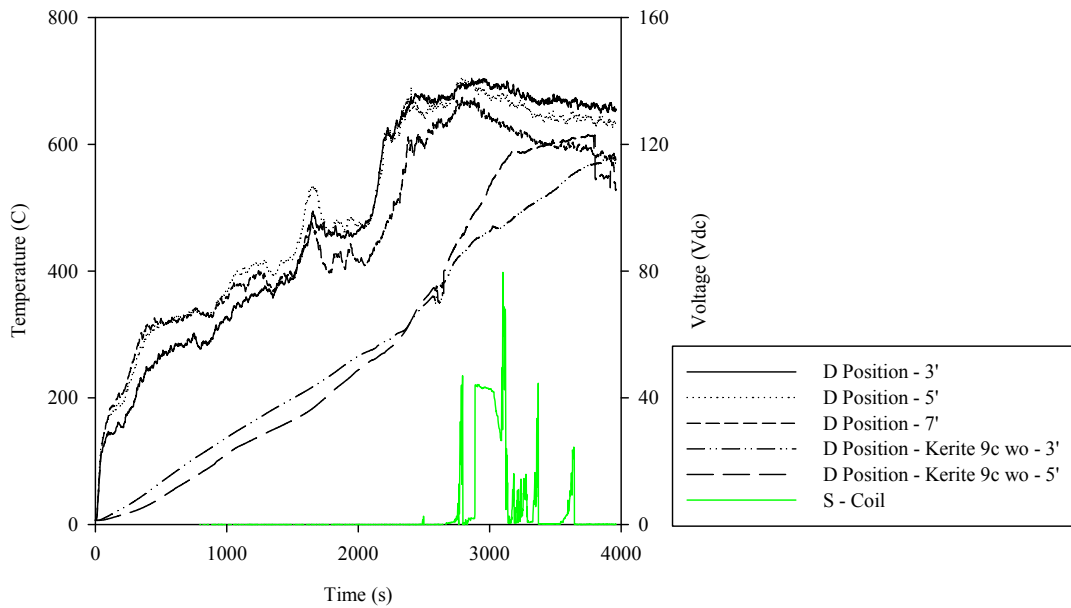

Figure B.73: Temperature profile and electrical response for Test IS10, Large Coil.

Table B.75: Summary of observed faulting behavior for Test IS10, Large Coil.

| Time (s) | Event | Discussion |
|-----------------|--|---|
| 0 | Fire initiated | |
| 2735 | Current increase on the coil conductor | The current increased to approximately 2.65 A for the remainder of the test. Although the fuses cleared, the transducer indicated the same nominal 2.65 A which most likely represents a failure with that particular transducer. This increase in current corresponds to the increase in voltage. The shorting is most likely the cause of transducer failure. |
| 2735-2795 | Voltage increase to approximately 47 V | |
| 2890 | Positive and negative fuses clear | The displayed voltages are referenced to ground. Since multiple circuits are connected to the same dc power supply, the graphed voltages will drift with the reference as other fuses throughout the test clear. |
| 3960 | Fire Off | |

B.7.4.2 Circuit 2

During Test IS10, Item F was connected to the dc-powered MOV1 circuit and situated in Position B. The test parameters may be found in Table B.76. The conductor pathway for the cable monitoring unit may be found in Table B.77. Electrical performance of the cable may be found in Figure B.74 and Figure B.75. In the former graph, the positive and negative sources were graphed with the coil voltage. The latter graph displays the voltage of the lamps through the test. It should be noted that the positive current transducer displayed signs of failure during the course of this test starting at 1650 s. The current on this transducer eventually saturates and is therefore not seen on in the figure.

From these two graphs, it should be noted that there is a voltage increase at approximately 2109 s which corresponds to a cable temperature of 152°C. At this point, the temperature corresponding to the electrical response appears to be lower than anticipated; however, given the nature of the intermediate-scale experiments, it is plausible that the hottest point of the cable was not captured by the sub-jacket TCs. The initial spurious actuation occurred on the open coil at 3579 s and continued for approximately 7 s. Seconds later, the close coil spurious actuated and continued for approximately 52 s before the positive fuse cleared. The temperature profile and corresponding voltage response may be observed in Figure B.76. In this figure, the air temperature is listed as the location of the cable and the length along the tray while the sub-jacket temperature is listed with the location of the cable, cable type, and length along the sample. A modified graph of the temperature profile and voltage response may be found in Figure B.77 which displays the early degradation of the cable sample. A summary of the test results may be found in Table B.78.

Table B.76: Test parameters for Test IS10, MOV1.

| | |
|------------------------------|----------------------------------|
| Test Name | Test IS10 |
| Test Date | 3/25/2010 |
| Cable Type for MOV1 | Kerite 9/C-14 AWG, FR, zinc wrap |
| MOV1 Position | Position C |
| Cable Fill Type | Bundled Tray A, Cable 3 |
| Cables Co-Located in Raceway | Cable 1 - SOV1 |
| | Cable 2 - TC Cable for SOV1 |
| | Cable 4 - TC Cable for MOV1 |
| Battery Voltage (Pre-test) | 121.96 Vdc |
| Battery Voltage (Post-test) | 122.21 Vdc |

Table B.77: Conductor designation for Item F, Test IS10, MOV1.

| Test IS10, MOV 1, 9/C-14 AWG | | | | | |
|------------------------------|----------------------------|--|---------------------------------------|-----------------------------|----------------------------|
| Lead Cable Conductor number | Lead cable conductor color | Terminal block location in DCSim Panel | Terminal block circuit identification | Test Cable conductor number | Test cable conductor color |
| 1 | Black | TB 3i | P | 1 | Black |
| 2 | White | TB 3/C | G | 2 | White |
| 3 | Red | TB 7/C | YC1 | 3 | Red |
| 4 | Green | TB 4/C | R | 4 | Green |
| 5 | Orange | TB 6i | SP | 5 | Orange |
| 6 | Blue | TB 5i | N | 6 | Blue |
| 7 | White/Black | TB 6c | YO1 | 7 | White/Black |

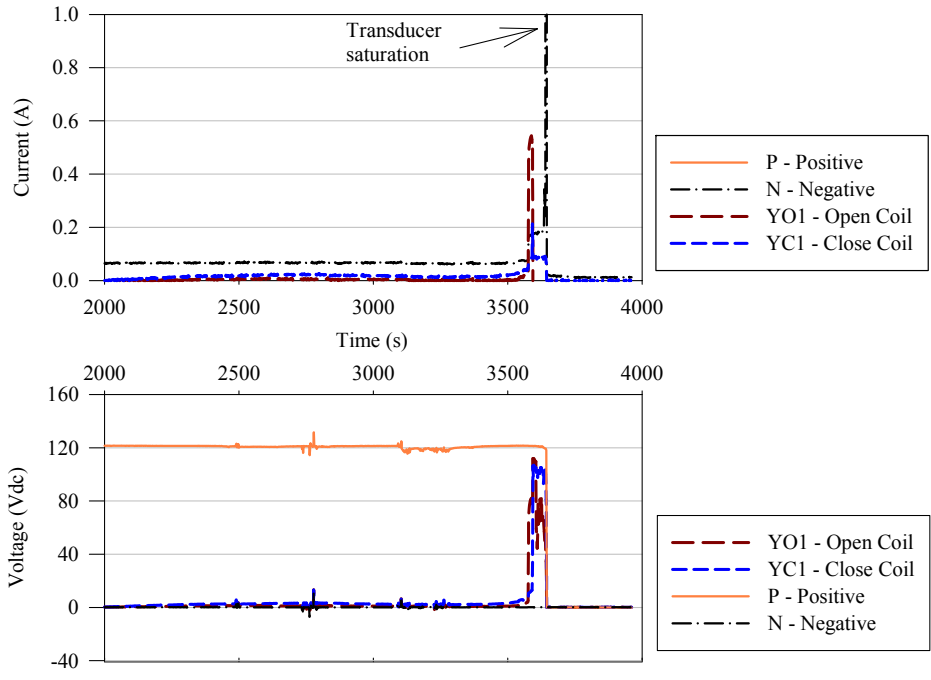

Figure B.74: Voltage and current response for the active target in Test IS10, MOV1.

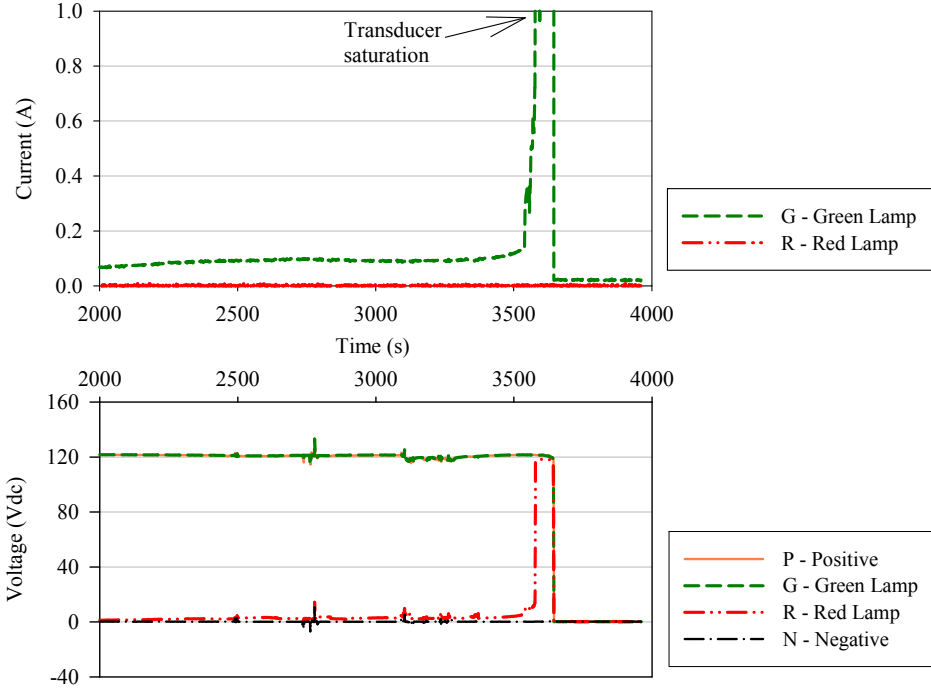

Figure B.75: Voltage and current response for the lamps in Test IS10, MOV1.

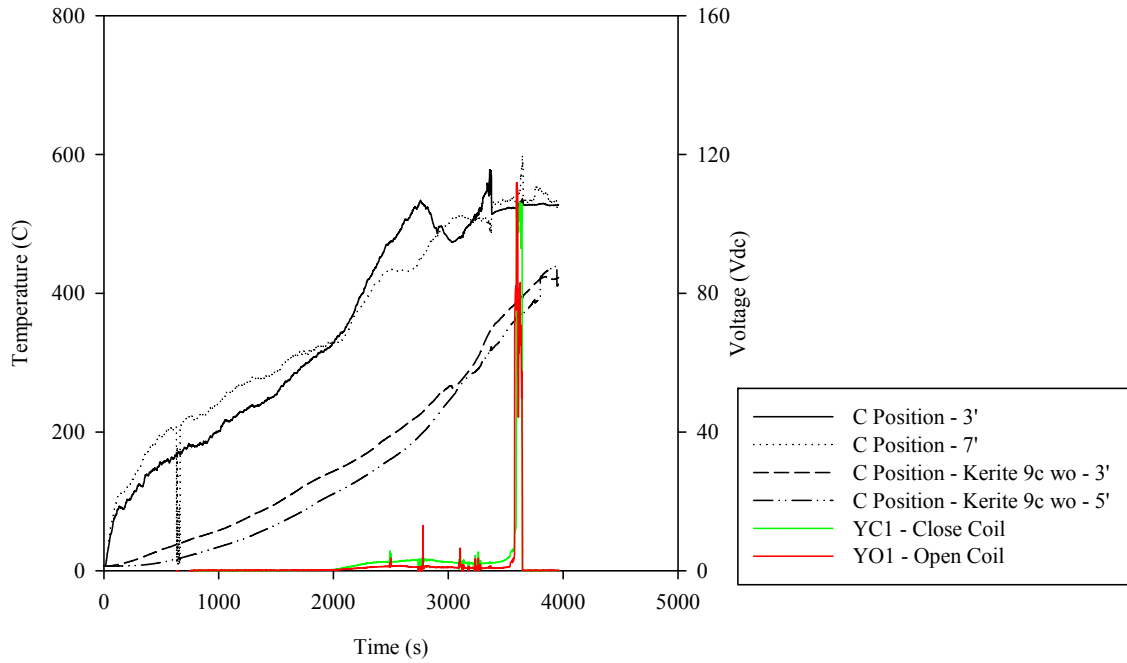

Figure B.76: Temperature profile and electrical response for Test IS10, MOV1.

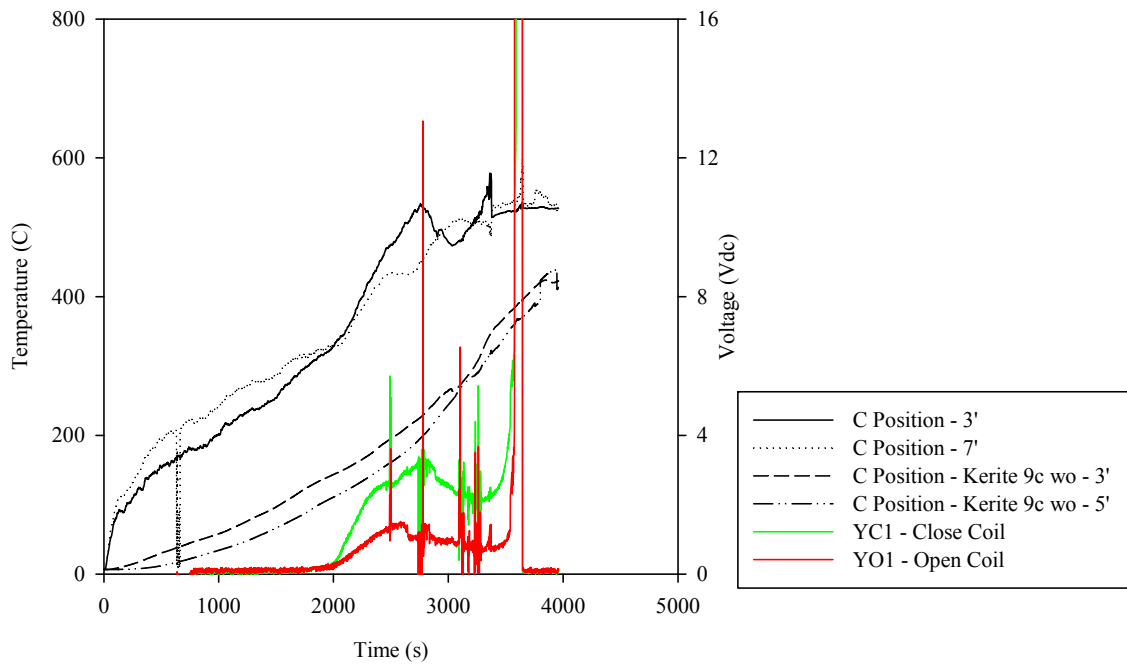

Figure B.77: Modified temperature profile and electrical response for Test IS10, MOV1 which more clearly illustrates the early degradation.

Table B.78: Summary of observed faulting behavior for Test IS10, MOV1.

| Time (s) | Event | Discussion |
|-----------|-------------------------------------|--|
| 0 | Fire initiated | |
| 1650 | Positive current transducer failure | The current transducer monitoring the positive conductor begins to display signs of failure. The current rises steadily and then peaks at a saturation point for the remainder of the test and after the battery bank system is isolated from the circuit. |
| 3541-3647 | Current increase on green | Green current transducer saturates for the final 12s before the fuse clears |
| 3579-3646 | Voltage increase on red | |
| 3584-3591 | Spurious actuation on open coil | The current was approximately 0.5303 A at the time of operation. |
| 3594-3646 | Spurious actuation on close coil | The current was approximately 0.0912 A at the time of operation. |
| 3594-3605 | Hot short open coil | |
| 3646 | Positive fuse clears | |
| 3960 | Fire off | |

B.7.5 Test K2

Test K2 utilized the multiple SCUDU configuration detailed in Appendix A to monitor the electrical performance of the cable throughout the thermal exposure. The test parameters may be found in Table B.79. The conductor pathway for the cable monitoring unit may be found in Table B.80. Overall electrical performance of the cable may be found in Figure B.78. A graph displaying the target behavior may be observed in Figure B.79.

Penlight was initially set to 350°C. Approximately 21 minutes into the test, at a cable temperature of approximately 275°C, the voltage and current began to increase on the conductors connected to the active targets. This increase persisted gradually for about 10.5 minutes before steadily declining. After the initial half hour heating period, the Penlight control temperature was increased by 10°C every 5 minutes until reaching a maximum of 380°C. The maximum cable temperature reached approximately 327°C before the heating apparatus was shut down for post-test examination of the conductors. The cable did not ignite, the fuses did not clear, and there were no spurious actuations. The electrical performance for the temperature exposure may be found in Figure B.80. A summary of the electrical performance of the cable may be found in Table B.81.

Table B.79: Test parameters for Test K2.

| | |
|--------------------------------|-----------------------|
| Test Series | KATE-FIRE |
| Test Name | Test 2 |
| Test Date | 9/23/2010 |
| Cable 1 | Kerite 9/C-14 AWG, FR |
| Cable Monitoring Unit Utilized | SCDU (M) |
| Cable 2 | NA |
| Cable Monitoring Unit Utilized | NA |
| Penlight Starting Temperature | 350°C |
| Penlight Final Temperature | 380°C |

Table B.80: Conductor designation for Item F, Test K2.

| Kerite 9/C-14 AWG, FR. Red cable, gray conductors with white print | | | | |
|--|-----------------|---------------------|-------------------|---|
| Conductor Number | Conductor Color | SCDU Circuit Number | SCDU Circuit Path | Notes |
| 1 | Black | 3 | S2/T4 | Adjusted source conductor which was connected through 1.8 kΩ resistor. By doing this, the output source voltage was reduced to 60 V – SCDU3 Voltage = C3 V4; current = C3 I4 |
| 2 | White | 1 | S1 | Energized source conductor for SCDU1– Voltage = C1 V1; current = C1 I1 |
| 3 | Red | 1 | T5 | Active target conductor for SCDU1 – Voltage = C1 V5; current = C1 I5 |
| 4 | Green | 2 | S1 | Energized source conductor for SCDU2– Voltage = C2 V1; current = C2 I1 |
| 5 | Orange | 2 | T5 | Active target conductor for SCDU2 – Voltage = C2 V5; current = C2 I5 |
| 6 | Blue | 3 | S1 | Energized source conductor for SCDU3– Voltage = C3 V1; current = C3 I1 |
| 7 | White/Black | 3 | T5 | Active target conductor for SCDU3 – Voltage = C3 V5; current = C3 I5 |
| 8 | Red/Black | 4 | S1 | Energized source conductor for SCDU4– Voltage = C4 V1; current = C4 I1 |
| 9 | Green/Black | 4 | T5 | Active target conductor for SCDU4 – Voltage = C4 V5; current = C4 I5 |

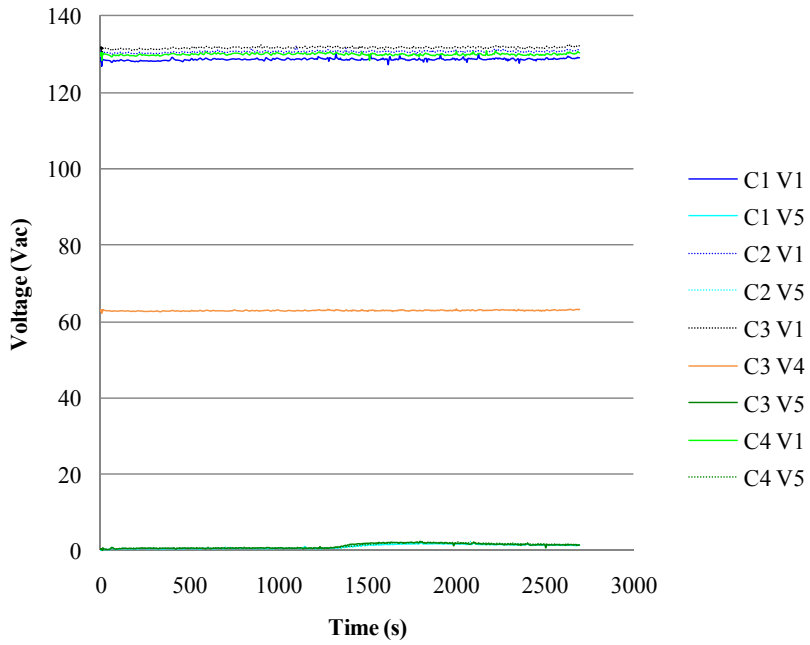

Figure B.78: All conductor voltages for Test K2 showing an increase on the target voltages.

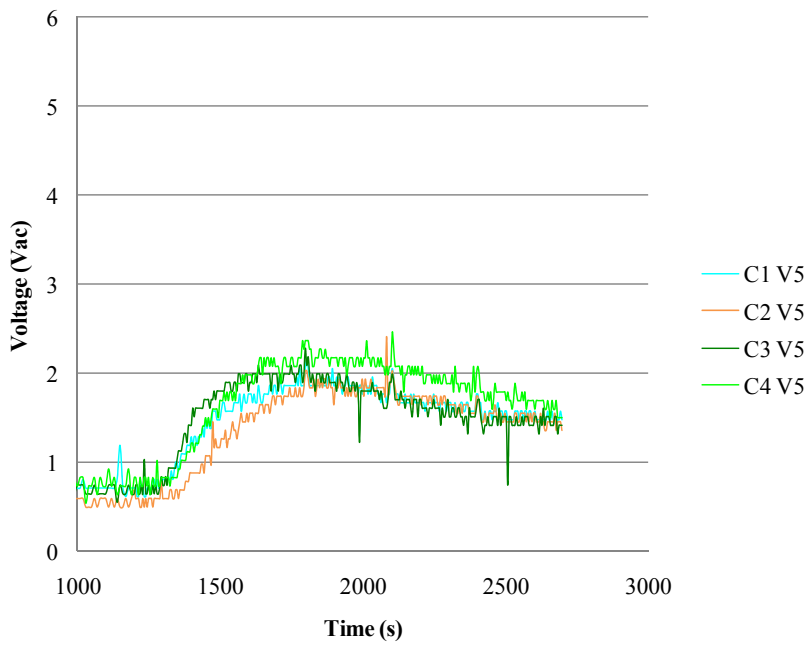

Figure B.79: All target conductor voltages for Test K2 showing a voltage increase.

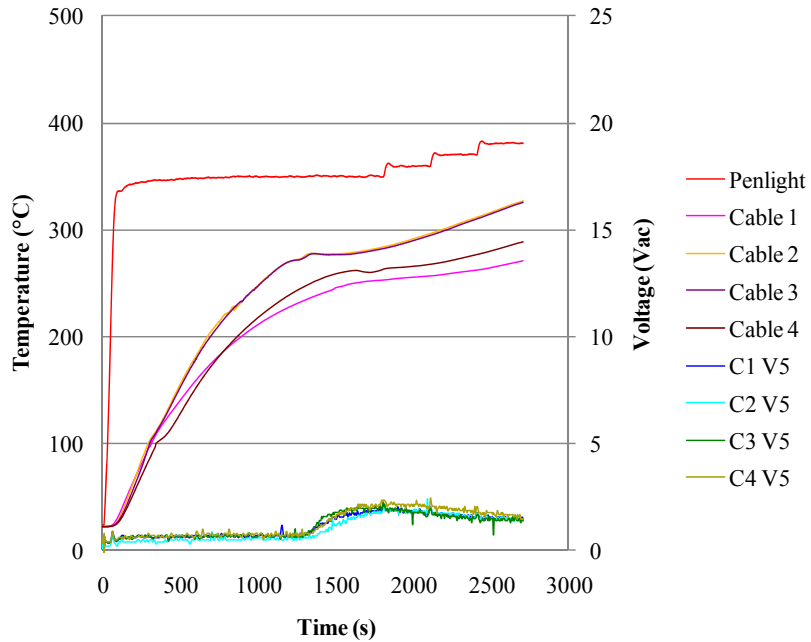

Figure B.80: Penlight shroud temperature, cable temperatures, and target conductor voltages for Test K2.

Table B.81: Summary of observed faulting behavior for Test K2.

| Time (s) | Event | Discussion |
|-----------|--|---|
| 0 | Penlight On; set at 350°C (6.97 kW/m ²) | |
| 1295-1920 | Voltage and current increases on all active targets | During this time, the voltage and current for each active target increases from less than 1 V to approximately 2.3 V and 0.0075 A to 0.035 A, respectively. During the initial phases of voltage and current increase, the cable temperature was approximately 275°C. |
| 1489 | Insulation resistance on SCDU4, Target 5 decreases to 1795 Ω | The cable temperature was approximately 278°C. |
| 1548 | Insulation resistance on SCDU3, Target 5 decreases to 1692 Ω | The cable temperature was approximately 278°C. |
| 1775 | Insulation resistance on SCDU2, Target 5 decreases to 1812 Ω | The cable temperature was approximately 283°C. |
| 1800-2700 | Penlight temperature increased by 10°C every 5 minutes | Penlight temperature was increased stepwise by 10°C every 5 minutes during this time period. The final Penlight set point was 380°C. |

Table B.81: Summary of observed faulting behavior for Test K2.

| Time (s) | Event | Discussion |
|-----------------|---|---|
| 1920-2700 | Voltage and current decreases on all active targets | The voltage and current for the active targets declined for the remainder of the test to approximately 1.5 V and 0.025 A, respectively. |
| 1927 | Insulation resistance on SCDU1, Target 5 decreases to 1977 Ω | The cable temperature was approximately 288°C. |
| 2108 | Insulation resistance on SCDU1, Target 5 decreases to 1383 Ω | The cable temperature was approximately 296°C. |
| 2700 | Test concluded, Penlight shutdown | The test was concluded prior to failure in order to preserve the cable sample for post-test analysis. |

B.7.6 Test K21

Test K21 utilized the IRMS to monitor the electrical performance of the cable throughout the thermal exposure. The test parameters may be found in Table B.82. The conductor pathway for the cable monitoring unit may be found in Table B.83. Electrical performance of the cable may be found in Figure B.81. From this graph, the green and black lines display the conductor-to-ground and conductor-to-conductor minimum resistances, respectively. It should be noted that electrical degradation did not occur prior to ignition. Shortly after ignition, the cable experienced electrical shorting to less than 1000 Ω . The maximum Penlight set point and cable temperatures were 435°C and 400°C and the associated electrical response may be observed in Figure B.81. A summary of the test may be found in Table B.84.

Table B.82: Test parameters for Test K21.

| | |
|--------------------------------|-----------------------|
| Test Series | KATE-FIRE |
| Test Name | Test 21 |
| Test Date | 10/27/2010 |
| Cable 1 | Kerite 9/C-14 AWG, FR |
| Cable Monitoring Unit Utilized | IRMS |
| Cable 2 | NA |
| Cable Monitoring Unit Utilized | NA |
| Penlight Starting Temperature | 325°C |
| Penlight Final Temperature | 435°C |

Table B.83: Conductor designation for Item F, Test K21.

| Kerite 9/C-14 AWG, FR. Red cable, gray conductors with white print | | | |
|--|-----------------|---------------------|-------|
| Conductor Number | Conductor Color | IRMS Circuit Number | Notes |
| 1 | Black | 1 | |
| 2 | White | 2 | |
| 3 | Red | 3 | |
| 4 | Green | 4 | |
| 5 | Orange | 5 | |
| 6 | Blue | 6 | |
| 7 | White/Black | 7 | |
| 8 | Red/Black | 8 | |
| 9 | Green/Black | 9 | |

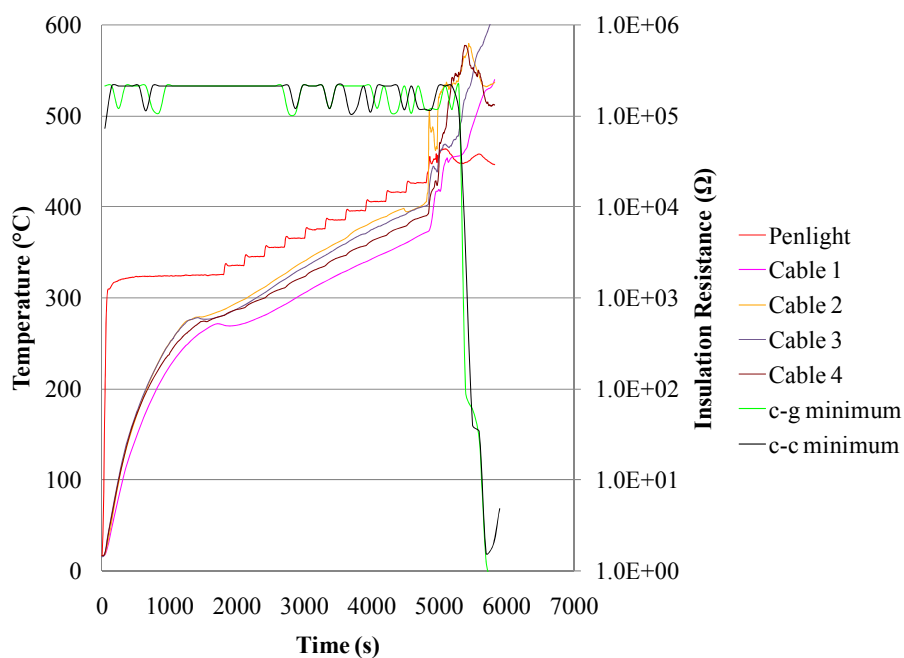

Figure B.81: Penlight shroud temperature, cable temperatures, and electrical performance data for Test K21.

Table B.84: Summary of observed faulting behavior for Test K21.

| Time (s) | Event | Comments |
|----------|---|----------|
| 0 | Penlight On; set at 325°C (5.92 kW/m ²) | |

Table B.84: Summary of observed faulting behavior for Test K21.

| Time (s) | Event | Comments |
|-----------------|--|---|
| 1800-4834 | Penlight temperature increased stepwise by 10°C every 5 minutes | Penlight temperature was increased stepwise by 10°C every 5 minutes during this time period until ignition. Upon ignition, the Penlight set point temperature remained constant until the conclusion of the test. The final Penlight set point was 435°C. |
| ~4834 | Ignition | The cable temperature was approximately 414°C before ignition. The approximate time was obtained from the field notes and then compared again the temperature plot for consistency. The observed ignition time corresponds reasonably well with the data. |
| 5378-5460 | Conductor 8 and Conductor 3 begin to display signs of leakage to one another and ground. | Shortly thereafter, Conductors 4, 5, 6, 7, and 9 also displayed signs of initial degradation by shorting together and to ground. |
| 5443-5465 | Conductor 2 displays signs of insulation degradation | |
| 5465-5586 | Conductor 2 shorts to ground at less than 1000 Ω | Conductors 3, 4, 5, 6, 7, 8, and 9 short to ground at less than 1000 Ω at this time. |
| 5507-5820 | Conductor 4 shorts to ground at less than 100 Ω | Conductors 5 and 7 short to ground at less than 100 Ω at this time. |
| 5513-5820 | Conductor 9 shorts to Conductor 4 at less than 100 Ω | |
| 5545-5644 | Conductor 1 shorts to ground at less than 1000 Ω | |
| 5569-5820 | Conductor 2 shorts to ground at less than 100 Ω | |
| 5574-5820 | Conductor 6 and 8 shorts to ground at less than 100 Ω | |
| 5586-5820 | Conductor 3 shorts to ground at less than 100 Ω | |
| 5644-5820 | Conductor 1 shorts to ground at less than 100 Ω | |
| 5820 | Penlight shutdown | |

B.7.7 Test K23

Test K23 utilized the multiple SCDU configuration detailed in Appendix A to monitor the electrical performance of the cable throughout the thermal exposure. The test parameters may be found in Table B.85. The conductor pathway for the cable monitoring unit may be found in Table B.86. Overall electrical performance of the cable may be found in Figure B.82. A time modified graph of the source voltages may be observed in Figure B.83. This was included to

illustrate the clearing of the fuses throughout the test. A graph displaying the target behavior may be observed in Figure B.84.

The penlight was initially set to 325°C and increased 10°C after a 30 minute heating period. After the first increase, the heating apparatus was increased 10°C every 5 minutes. Electrical degradation on the target conductors occurred at approximately 1200 s into the test at a Penlight and cable temperature of 335°C and 281°C, respectively. At approximately 4530 s, the cables ignited around 411°C. The fuses for both SCDU1 and 4 cleared at 5232 s after high current shorting to ground. The source conductor on SCDU2 hot shorted to the source conductors on SCDU1 and 4 before the fuse cleared at 5325 s. At 5346 s, a spurious operating lasting for approximately 1 s occurred on SCDU3 and then cleared the fuse. Penlight was shut down shortly after the fuse blow on SCDU3. The electrical performance throughout the thermal exposure may be found in Figure B.85.

Table B.85: Test parameters for Test K23.

| | |
|--------------------------------|-----------------------|
| Test Series | KATE-FIRE |
| Test Name | Test 23 |
| Test Date | 11/10/2010 |
| Cable 1 | Kerite 9/C-14 AWG, FR |
| Cable Monitoring Unit Utilized | SCDU (M) |
| Cable 2 | NA |
| Cable Monitoring Unit Utilized | NA |
| Penlight Starting Temperature | 325°C |
| Penlight Final Temperature | 455°C |

Table B.86: Conductor designation for Item F, Test K23.

| Kerite 9/C-14 AWG, FR. Red cable, gray conductors with white print | | | | |
|--|-----------------|---------------------|-------------------|---|
| Conductor Number | Conductor Color | SCDU Circuit Number | SCDU Circuit Path | Notes |
| 1 | Black | 3 | S2/T4 | Adjusted source conductor which was connected through 1.8 kΩ resistor. By doing this, the output source voltage was reduced to 60 V – SCDU3 Voltage = C3 V4; current = C3 I4 |
| 2 | White | 1 | S1 | Energized source conductor for SCDU1– Voltage = C1 V1; current = C1 I1 |
| 3 | Red | 1 | T5 | Active target conductor for SCDU1 – Voltage = C1 V5; current = C1 I5 |
| 4 | Green | 2 | S1 | Energized source conductor for SCDU2– Voltage = C2 V1; current = C2 I1 |
| 5 | Orange | 2 | T5 | Active target conductor for SCDU2 – Voltage = C2 V5; current = C2 I5 |

Table B.86: Conductor designation for Item F, Test K23.

| Kerite 9/C-14 AWG, FR. Red cable, gray conductors with white print | | | | |
|--|-----------------|---------------------|-------------------|---|
| Conductor Number | Conductor Color | SCDU Circuit Number | SCDU Circuit Path | Notes |
| 6 | Blue | 3 | S1 | Energized source conductor for SCDU3– Voltage = C3 V1; current = C3 I1 |
| 7 | White/Black | 3 | T5 | Active target conductor for SCDU3 – Voltage = C3 V5; current = C3 I5 |
| 8 | Red/Black | 4 | S1 | Energized source conductor for SCDU4– Voltage = C4 V1; current = C4 I1 |
| 9 | Green/Black | 4 | T5 | Active target conductor for SCDU4 – Voltage = C4 V5; current = C4 I5 |

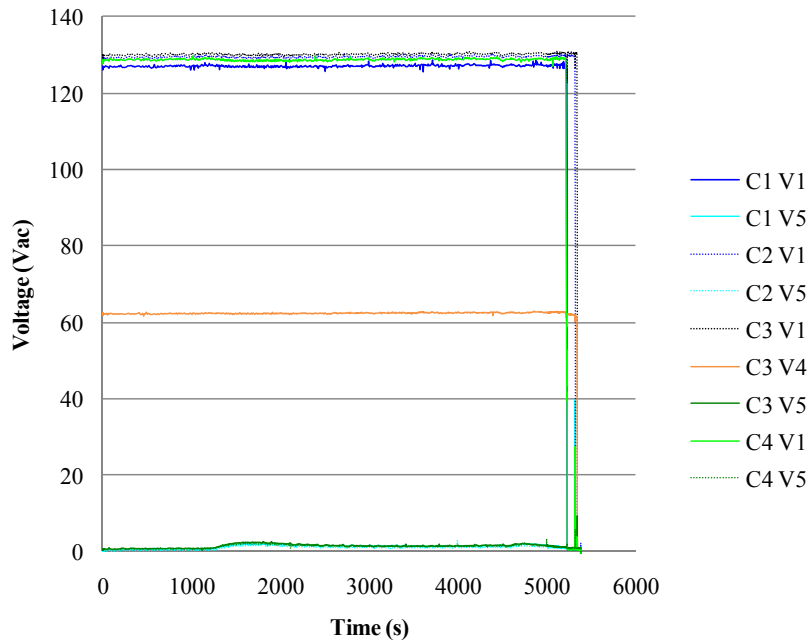

Figure B.82: All conductor voltages for Test K23 showing an increase on the target voltages.

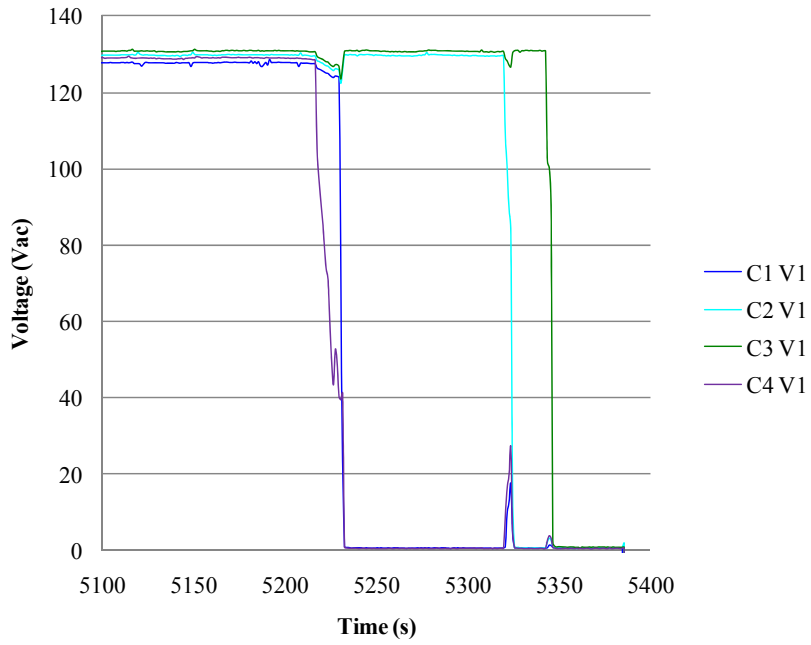

Figure B.83: All 120 V source conductor voltages for Test K23 showing when each fuse cleared.

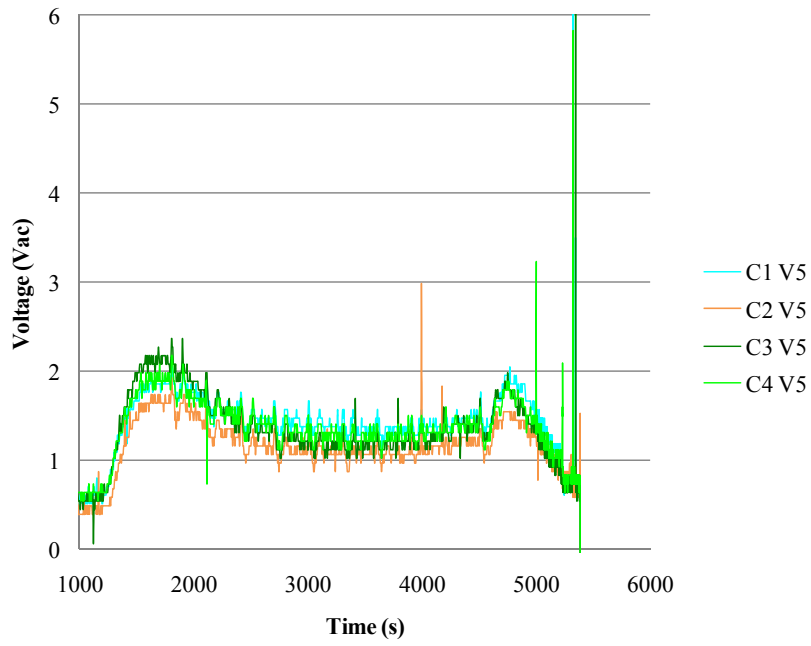

Figure B.84: All target conductor voltages for Test K23 showing a voltage increase.

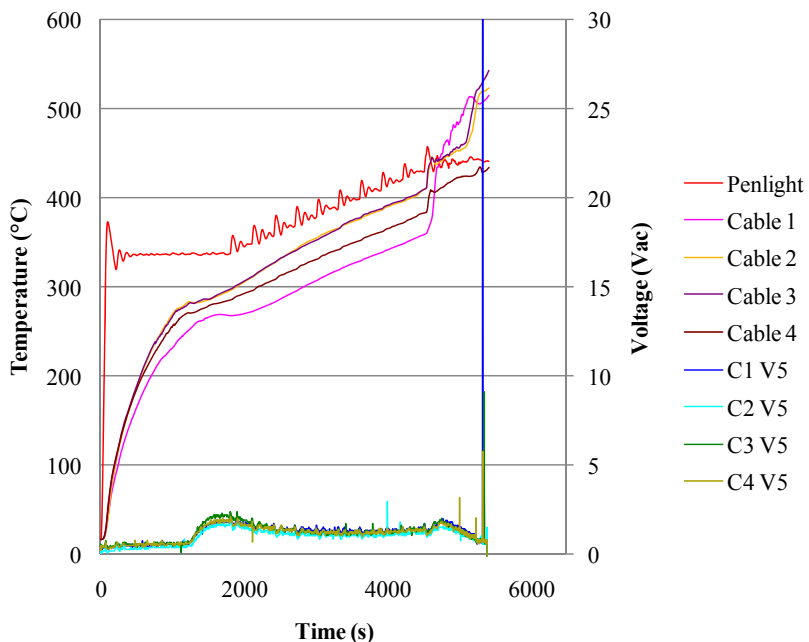

Figure B.85: Penlight shroud temperature, cable temperatures, and target conductor voltages for Test K23.

Table B.87: Summary of observed faulting behavior for Test K23.

| Time (s) | Event | Discussion |
|-----------|---|---|
| 0 | Penlight On; set at 325°C (5.92 kW/m ²) | |
| 1200-1800 | Voltage increase on the active targets | Voltage increases from less than 1 V to 2 V on the active targets during this time span. The cable temperature was approximately 281°C. |
| 1800-4530 | Penlight temperature increased stepwise by 10°C every 5 minutes | Penlight temperature was increased stepwise by 10°C every 5 minutes during this time period until ignition. Upon ignition, the Penlight set point temperature remained constant until the conclusion of the test. The final Penlight set point was 455°C. |
| 1800-5410 | Voltage decreases and stabilizes on the active targets at approximately 1 V | After reaching approximately 2 V, the voltage stabilizes to 1.5 V for the remainder of the test. |
| ~4530 | Ignition | The time denoted was approximated from the field notes; however, the time appears reasonable given the data. The cable temperature at ignition was approximately 411°C. |
| 5218-5232 | High current short to ground on source conductor for SCDU4 | During this period of time, the voltage gradually declines from 128 V until the fuse clear and the current is maintained from less than 1 A initially to over 5 A. |

Table B.87: Summary of observed faulting behavior for Test K23.

| Time (s) | Event | Discussion |
|-----------------|--|--|
| 5231-5232 | High current short to ground on source conductor for SCDU1 | During this period of time, the voltage gradually declines from 128 V until the fuse cleared and the current is maintained from less than 1 A initially to over 5 A. |
| 5232 | Fuse clear SCDU1 and SCDU4 | |
| 5321-5325 | Hot short between source conductors on SCDU2 and SCDU1 and 4 | |
| 5325 | Fuse clear SCDU2 | |
| 5346-5347 | Spurious actuation on SCDU3 | |
| 5347 | Fuse clear on SCDU3 | |
| 5410 | Test concluded, Penlight shutdown | |

B.8 Cable Item G: 10/C-16 AWG, FR-II

Cable Item G is a 10/C-16 AWG cable with FR-II insulation, according to the bill of materials provided by the donating company, and the conductors are numbered as depicted in Figure B.86. The cable was tested during the DESIREE-Fire series intermediate-scale tests 9 and 10. In Test IS9, the cable was tested on MOV1. During Test IS10, the cable was tested on SOV2. It was tested three times during the KATE-Fire tests, once on IRMS and twice on SCDU. The following sections detail the test parameters, conductor paths, circuit data, and test summary for each test.

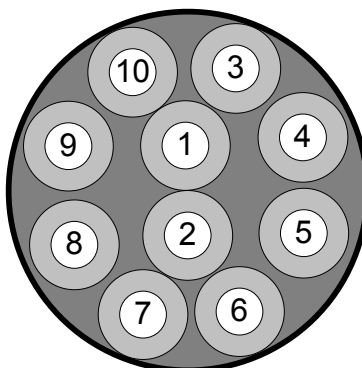

Figure B.86: Illustration of Cable Item G.

B.8.1 Test IS9

The intermediate-scale test series conducted during DESIREE-Fire provided a target opportunity to investigate the performance of Kerite cable in a more representative fire environment. During Test IS9, Item G was connected to the dc-powered MOV1 circuit and situated in Position B. The test parameters may be found in Table B.88. The conductor pathway for the cable monitoring unit may be found in Table B.89. Electrical performance of the cable may be found in Figure B.87 and Figure B.88. In the former graph, the positive and negative sources were graphed with the coil voltage. From here, a spurious actuation occurs at 2613 s and continues for approximately 21 s before a subsequent fuse clear. The latter graph displays the voltage of the lamps throughout the test. When looking at the graphs, it should be noted that the voltages are referenced to ground. Since the other fused circuits are connected to the same dc power supply, the ground continues to drift after the negative fuse clears on MOV1. The temperature profile and voltage response may be found in Figure B.89. In this figure, the air temperature is listed as the location of the cable and the length along the tray while the sub-jacket temperature is listed with the location of the cable, cable type, and length along the sample. A summary of the test results may be found in Table B.90.

Table B.88: Test parameters for Test IS9.

| | |
|------------------------------|----------------------------|
| Test Name | Test IS9 |
| Test Date | 3/17/2010 |
| Cable Type for MOV1 | Kerite, 10/C-16 AWG, FR-II |
| MOV1 Position | Position B |
| Cable Fill Type | Fill Tray C, Circuit 1 |
| Cables Co-Located in Raceway | Cable 1 - 1-in. Valve |
| | Cable 2 - Large Coil |
| | Cable 4 - SOV1 |
| Battery Voltage (Pre-test) | 122.15 Vdc |
| Battery Voltage (Post-test) | 122.41 Vdc |

Table B.89: Conductor designation for Item G, Test IS9.

| Test IS9, MOV1, 10/C-16 AWG | | | | | |
|-----------------------------|----------------------------|--|---------------------------------------|-----------------------------|----------------------------|
| Lead Cable Conductor number | Lead cable conductor color | Terminal block location in DCSim Panel | Terminal block circuit identification | Test Cable conductor number | Test cable conductor color |
| 1 | Black | TB 3i | P | 3 | Red |
| 2 | White | TB 3/C | G | 4 | Green |
| 3 | Red | TB 7/C | YC1 | 5 | Orange |
| 4 | Green | TB 4/C | R | 6 | Blue |
| 5 | Orange | TB 6i | SP | 7 | White/Black |

Table B.89: Conductor designation for Item G, Test IS9.

| Test IS9, MOV1, 10/C-16 AWG | | | | | |
|-----------------------------|----------------------------|--|---------------------------------------|-----------------------------|----------------------------|
| Lead Cable Conductor number | Lead cable conductor color | Terminal block location in DCSim Panel | Terminal block circuit identification | Test Cable conductor number | Test cable conductor color |
| 6 | Blue | TB 5i | N | 8 | Red/Black |
| 7 | White/Black | TB 6c | YO1 | 9 | Green/Black |

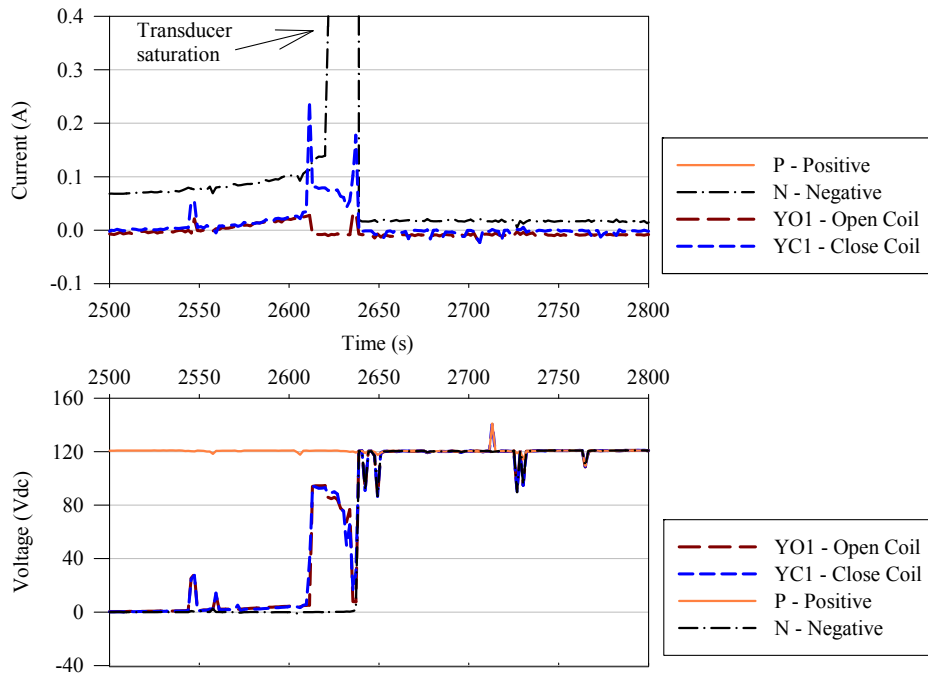

Figure B.87: Voltage and current response for the active target in Test IS9, MOV1.

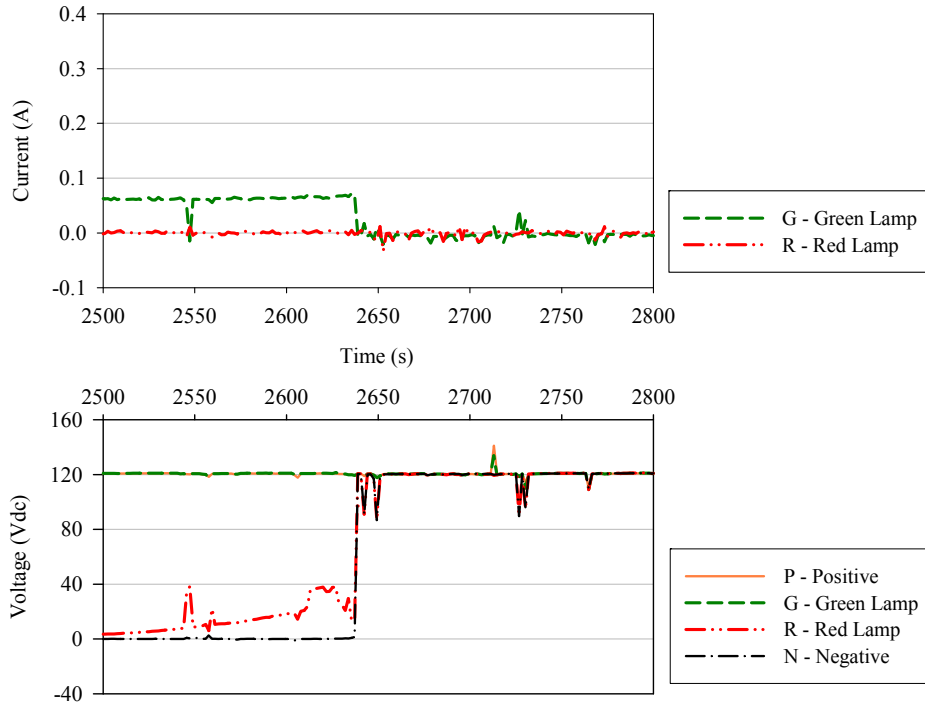

Figure B.88: Voltage and current response for the lamps in Test IS9, MOV1.

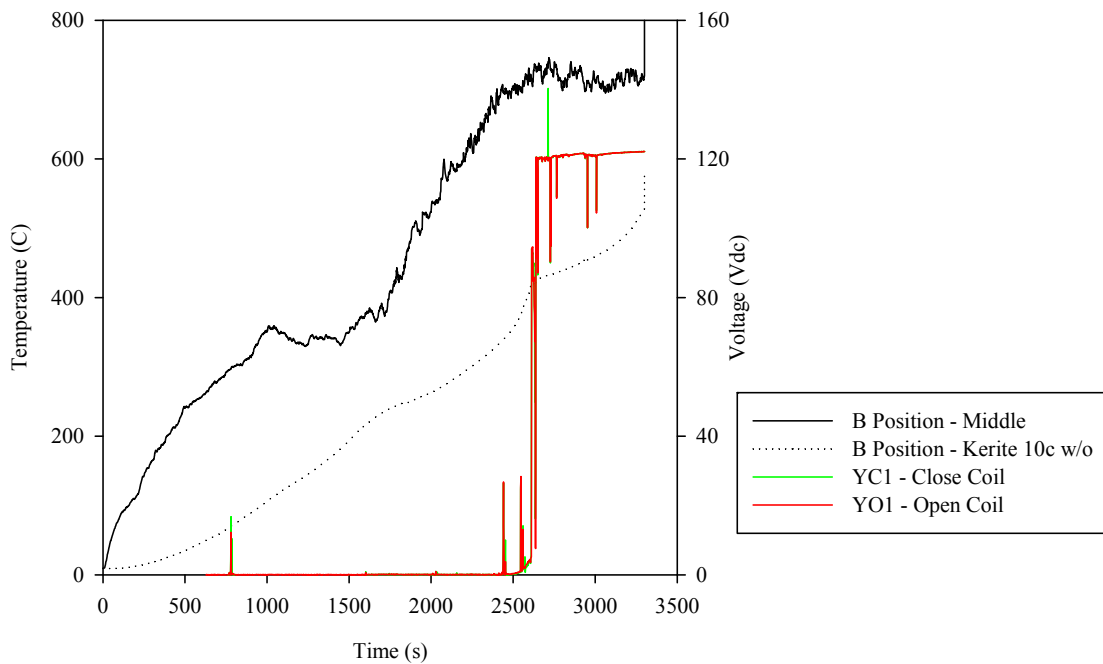

Figure B.89: Temperature profile and electrical response for Test IS9, MOV1.

Table B.90: Summary of observed faulting behavior for Test IS9, Item G.

| Time (s) | Event | Discussion |
|-----------|---|--|
| 0 | Fire initiated | |
| 2613-2634 | Spurious actuation close coil (0.2410A) | Target 6 was actuated and maintained actuation for approximately 21 s. |
| 2638 | Negative Fuse Clears | The main battery bank is used to power all the dc circuits during the intermediate-scale experiments. Since the graphed voltage is referenced to the common ground and not all circuit fuses clear at the same time, some graphs may indicate that electrical activity is occurring after this noted time. |
| 3300 | Fire Off | |

B.8.2 Test IS10

Item G was tested a second time during the intermediate-scale test series. In this second test, the cable sample was connected to the dc-powered SOV2 circuit and situated in Position B. The test parameters may be found in Table B.91. The conductor pathway for the cable monitoring unit may be found in Table B.92. Electrical performance of the cable may be found in Figure B.90 and Figure B.91. In the former graph, the positive and negative sources are graphed with the coil voltage. From here, a gradual voltage increase may be seen on the solenoid conductor; however, there was not sufficient enough voltage to cause spurious actuation before a subsequent fuse clear. The latter graph displays the voltage of the lamps throughout the test. The voltage reaches a point where false indication of the red light is observed. When looking at the graphs, it should be noted that the voltages are referenced to ground. Since the other fused circuits are connected to the same dc power supply, the ground continues to drift after the negative fuse clears on SOV2. The temperature profile and voltage response may be found in Figure B.92. In this figure, the air temperature is listed as the location of the cable and the length along the tray while the sub-jacket temperature is listed with the location of the cable, cable type, and length along the sample. A summary of the test results may be found in Table B.93.

Table B.91: Test parameters for Test IS10, Item G.

| | |
|------------------------------|-------------------------------|
| Test Name | Test IS10 |
| Test Date | 3/25/2010 |
| Cable Type for SOV2 | Kerite, 10/C-16 AWG, FR-II |
| SOV2 Position | Position B |
| Cable Fill Type | Specialized Tray C, Cable 3 |
| Cables Co-Located in Raceway | Cable 1 - MOV2 |
| | Cable 2 - SWGR Close and Trip |

Table B.91: Test parameters for Test IS10, Item G.

| | |
|-----------------------------|------------|
| Battery Voltage (Pre-test) | 121.96 Vdc |
| Battery Voltage (Post-test) | 122.21 Vdc |

Table B.92: Conductor designation for Test IS10, Item G.

| Test IS10, SOV2, 10/C-16 AWG | | | | | |
|------------------------------|----------------------------|--|---------------------------------------|-----------------------------|----------------------------|
| Lead Cable Conductor number | Lead cable conductor color | Terminal block location in DCSim Panel | Terminal block circuit identification | Test Cable conductor number | Test cable conductor color |
| 1 | Black | TB2 | P | 3 | Red |
| 2 | White | TB4 | G | 4 | Green |
| 3 | Red | TB3 | S1 | 5 | Orange |
| 4 | Green | TB6 | R | 6 | Blue |
| 5 | Orange | TB9 | N | 7 | White/Black |
| 6 | Blue | TB7 | SP | 8 | Red/Black |
| 7 | White/Black | TB8 | S2 | 9 | Green/Black |

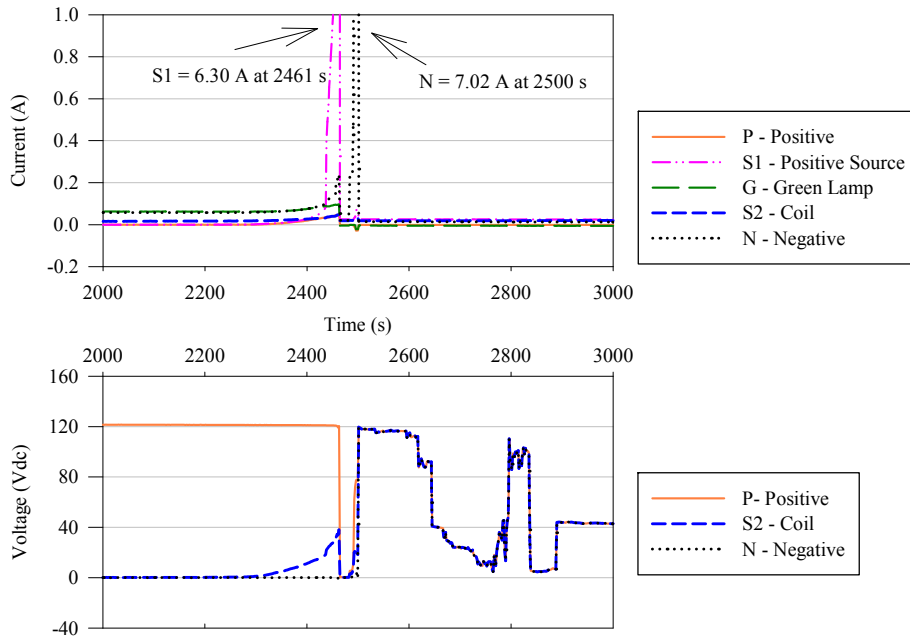

Figure B.90: Voltage and current response for the active target in Test IS10, SOV2.

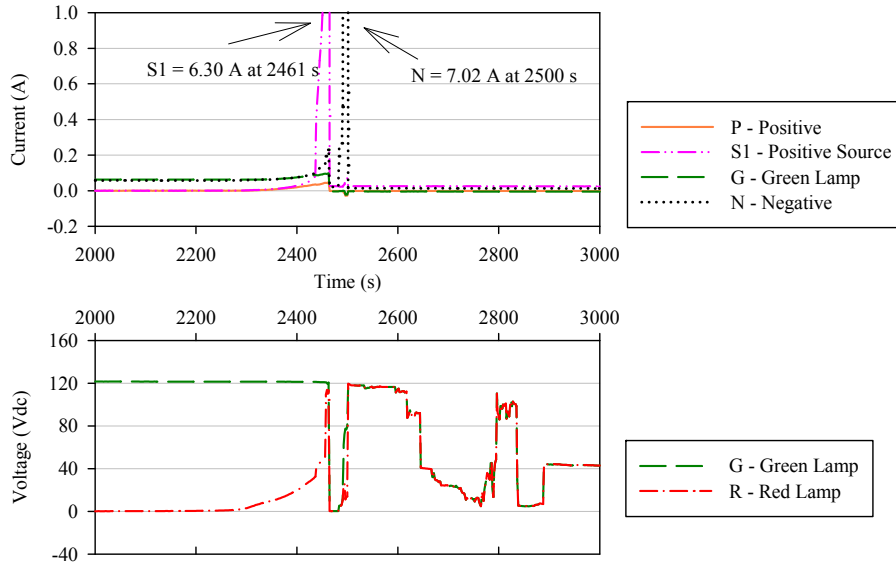

Figure B.91: Voltage and current response for the lamps in Test IS10, SOV2.

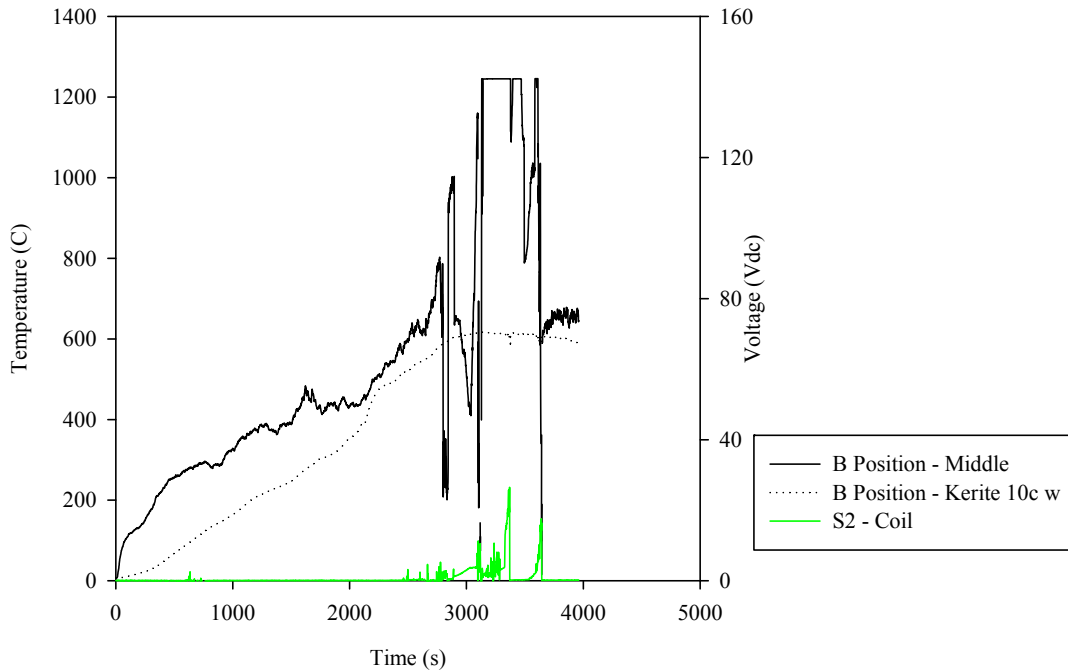

Figure B.92: Temperature profile and electrical response for Test IS10, SOV2.

Table B.93: Summary of observed faulting behavior for Test IS10, Item G.

| Time (s) | Event | Discussion |
|----------|----------------|------------|
| 0 | Fire initiated | |

Table B.93: Summary of observed faulting behavior for Test IS10, Item G.

| Time (s) | Event | Discussion |
|-----------|--|--|
| 2298-2463 | Voltage increase from 1.06V to 38V on solenoid | The voltage never reaches the point to which actuation occurred. |
| 2458-2463 | False indication red light on | |
| 2465 | Positive fuse clears | The main battery bank is used to power all the dc circuits during the intermediate-scale experiments. Since the graphed voltage is referenced to the common ground and not all circuit fuses clear at the same time, some graphs may indicate that electrical activity is occurring after this noted time. |
| 2502 | Negative fuse clears | |
| 3960 | Fire off | |

B.8.3 Test K3

Test K3 utilized the multiple SCDU configuration detailed in Appendix A to monitor the electrical performance of the cable throughout the thermal exposure. The test parameters may be found in Table B.94. Penlight was initially set to 325°C for a half hour before the temperature was increased 10°C every five minutes. The final Penlight set point temperature was 385°C. Electrical degradation on the target conductors occurred at approximately 3498 s into the test at a Penlight and cable temperature of 385°C and 345°C, respectively. A spurious actuation on the active target for SCDU4 occurred at approximately 3968 s and a temperature of 377°C. About 15 s later, there was a spurious actuation on the active target for SCDU3. Three minutes later, the active target for SCDU2 operated at 384°C. The active target on SCDU1 actuated approximately three and a half minutes later at 4373 s into the test and 387°C. All spurious actuations continued until Penlight was shutdown at 4680 s; ignition did not occur. During the cool down, SCDU2 engaged and disengaged on two different occasions. All fuses remained intact until the cable monitoring unit was ultimately terminated. The electrical performance for the temperature exposure may be found in Figure B.95. The conductor pathway for the cable monitoring unit may be found in Table B.95. Overall electrical performance of the cable may be found in Figure B.93. A graph displaying the target behavior may be observed in Figure B.94. A summary of the electrical performance of the cable may be found in Table B.96.

Table B.94: Test parameters for Test K3.

| | |
|--------------------------------|---------------------------|
| Test Series | KATE-FIRE |
| Test Name | Test 3 |
| Test Date | 9/24/2010 |
| Cable 1 | Kerite 10/C-16 AWG, FR-II |
| Cable Monitoring Unit Utilized | SCDU (M) |

Table B.94: Test parameters for Test K3.

| | |
|--------------------------------|-------|
| Cable 2 | NA |
| Cable Monitoring Unit Utilized | NA |
| Penlight Starting Temperature | 325°C |
| Penlight Final Temperature | 400°C |

Table B.95: Conductor designation for Item G, Test K3.

| Kerite 10/C-16 AWG, FR-II. Black cable, gray conductors with white print | | | | |
|--|-----------------|---------------------|-------------------|---|
| Conductor Number | Conductor Color | SCDU Circuit Number | SCDU Circuit Path | Notes |
| 1 | Black | 2 | S2/T4 | Adjusted source conductor which was connected through 3.6 kΩ resistor. By doing this, the output source voltage was reduced to 40 V – SCDU2 Voltage = C2 V4; current = C2 I4 |
| 2 | White | 3 | S2/T4 | Adjusted source conductor which was connected through 0.9 kΩ resistor. By doing this, the output source voltage was reduced to 80 V – SCDU3 Voltage = C3 V4; current = C3 I4 |
| 3 | Red | 1 | S1 | Energized source conductor for SCDU1 – Voltage = C1 V1; current = C1 I1 |
| 4 | Green | 1 | T5 | Active target conductor for SCDU1 – Voltage = C1 V5; current = C1 I5 |
| 5 | Orange | 2 | S1 | Energized source conductor for SCDU2 – Voltage = C2 V1; current = C2 I1 |
| 6 | Blue | 2 | T5 | Active target conductor for SCDU2 – Voltage = C2 V5; current = C2 I5 |
| 7 | White/Black | 3 | S1 | Energized source conductor for SCDU3 – Voltage = C3 V1; current = C3 I1 |
| 8 | Red/Black | 3 | T5 | Active target conductor for SCDU3 – Voltage = C3 V5; current = C3 I5 |
| 9 | Green/Black | 4 | S1 | Energized source conductor for SCDU4 – Voltage = C4 V1; current = C4 I1 |
| 10 | Orange/Black | 4 | T5 | Active target conductor for SCDU4 – Voltage = C4 V5; current = C4 I5 |

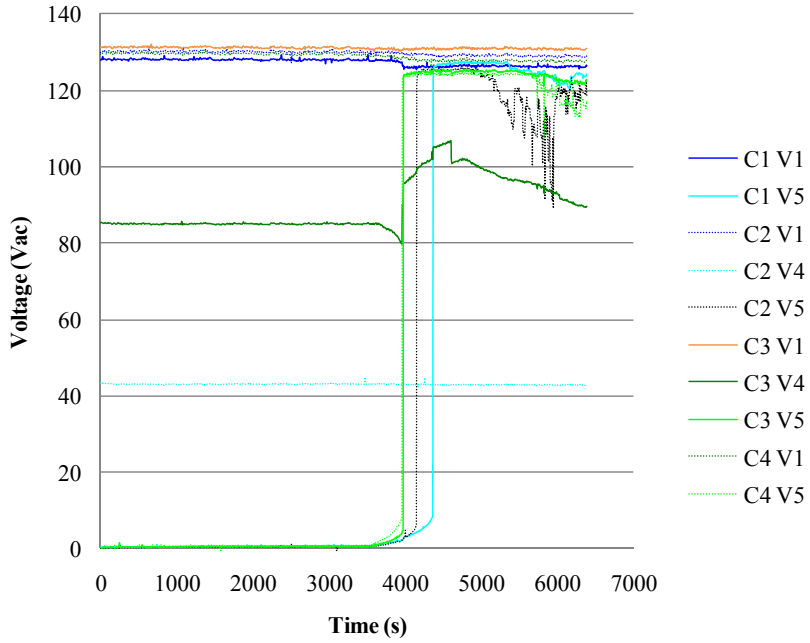

Figure B.93: All conductor voltages for Test K3.

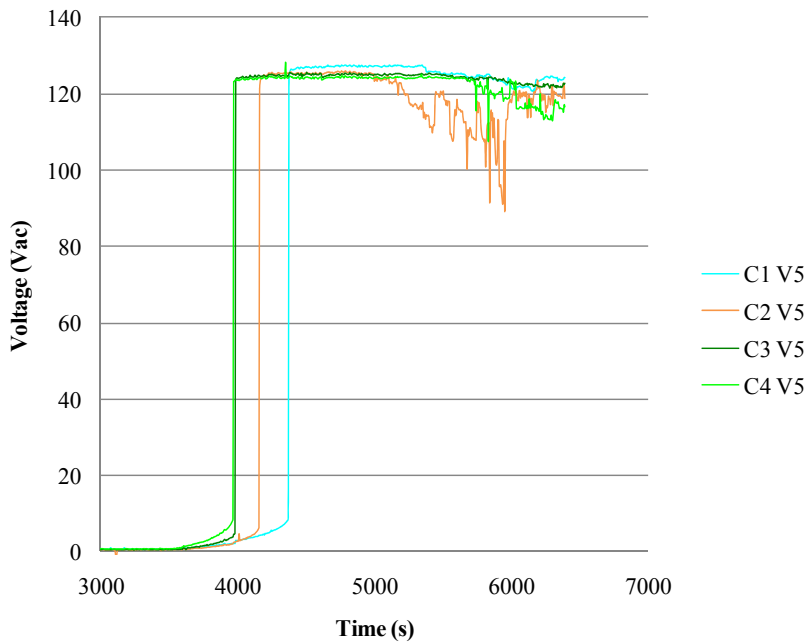

Figure B.94: Modified target conductor voltages for Test K3 displaying spurious actuation on each of the active targets.

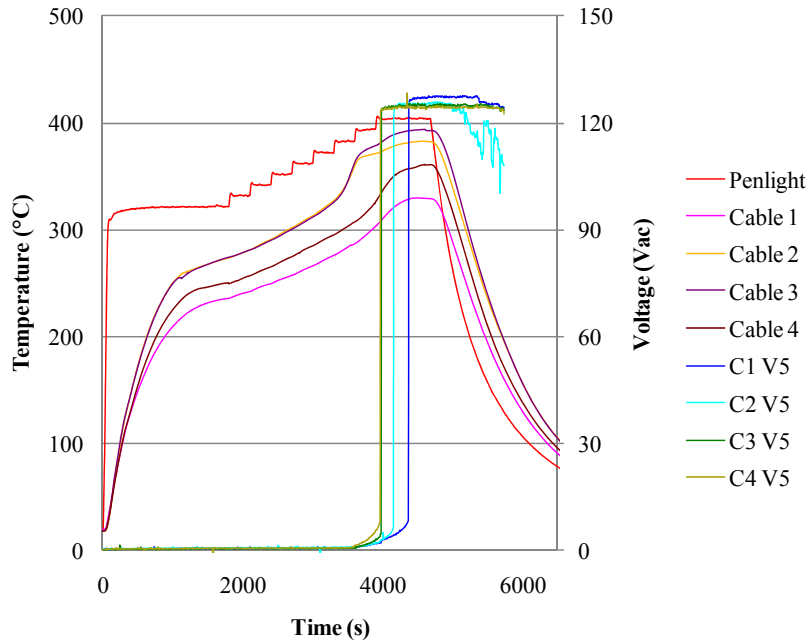

Figure B.95: Penlight shroud temperature, cable temperatures, and target conductor voltages for Test K3.

Table B.96: Summary of observed faulting behavior for Test K3.

| Time (s) | Event | Discussion |
|-----------|---|--|
| 0 | Penlight On; set at 325°C (5.92 kW/m ²) | |
| 1800 | Penlight temperature raised 10°C | |
| 1800-4680 | Penlight temperature raised 10°C every 5 minutes | Penlight temperature was increased stepwise by 10°C every 5 minutes during this time period until the conclusion of the test. The final Penlight set point was 385°C. |
| 3498-3968 | Voltage and current increase on active target for SCDU4 | Active target for SCDU4 experiences a voltage increase from a nominal 0 V to 9 V and a rise in current from approximately 0 A to 0.15 A before a spurious actuation occurs. Penlight was set 385°C and the cable temperature was approximately 345°C at the onset of electrical degradation. |
| 3498-3983 | Voltage and current increase on active target for SCDU3 | Active target for SCDU3 experiences a voltage increase from a nominal 0 V to 5 V and a rise in current from approximately 0 A to 0.09 A before a spurious actuation occurs. Penlight was set 385°C and the cable temperature was approximately 345°C at the onset of electrical degradation. |

Table B.96: Summary of observed faulting behavior for Test K3.

| Time (s) | Event | Discussion |
|-----------------|---|--|
| 3498-4160 | Voltage and current increase on active target for SCDU2 | Active target for SCDU2 experiences a voltage increase from a nominal 0 V to 8 V and a rise in current from approximately 0 A to 0.14 A before a spurious actuation occurs. Penlight was set 385°C and the cable temperature was approximately 345°C at the onset of electrical degradation. |
| 3498-4373 | Voltage and current increase on active target for SCDU1 | Active target for SCDU1 experiences a voltage increase from a nominal 0 V to 10 V and a rise in current from approximately 0 A to 0.15 A before a spurious actuation occurs. Penlight was set 385°C and the cable temperature was approximately 345°C at the onset of electrical degradation. |
| 3968-4680 | Spurious actuation on active target for SCDU4 | Spurious actuation on active target for SCDU4 at a voltage and current of 121 V and 0.16 A, respectively. At this time, the voltage on the 80 V center conductor increases to 90 V. The cable temperature was approximately 377°C. |
| 3983-4680 | Spurious actuation on active target 3 | Spurious actuation on active target 3 at a voltage and current of 122 V and 0.17 A, respectively. At this time, the voltage on the 90 V center conductor increases to 95 V. The voltage on this center conductor gradually increases to a maximum of 106 V by the time Penlight was shutdown. The cable temperature was approximately 378°C. |
| 4160-4680 | Spurious actuation on active target for SCDU2 | Spurious actuation on active target for SCDU2 at a voltage and current of 121 V and 0.17 A, respectively. The cable temperature was approximately 384°C. |
| 4373-4680 | Spurious actuation on active target for SCDU1 | Spurious actuation on active target for SCDU4 at a voltage and current of 121 V and 0.18 A, respectively. The cable temperature was approximately 387°C. |
| 4680 | Penlight was shutdown | The heating apparatus was set as high as 405°C before being shutdown. The temperature recorded at the center of the cable was at an average of 388°C. SCDU was kept running during the cooling phase. |
| 5676-5682 | Locking in and out on active target for SCDU2 | The cable temperature was 207°C. |
| 5914-5959 | Locking in and out heard on active target for SCDU2 | The cable temperature was 169°C. |
| 6480 | SCDU Shutdown | |

B.8.4 Test K22

Test K22 utilized the IRMS to monitor the electrical performance of the cable throughout the thermal exposure. The test parameters may be found in Table B.97. The conductor pathway for the cable monitoring unit may be found in Table B.98. It should be noted that Conductors 8, 9, and 10 were not monitored during the test. Electrical performance of the cable may be found in Figure B.96. From this graph, the green and black lines display the conductor-to-ground and conductor-to-conductor minimum resistances, respectively. It should be noted that insulation degradation occurred prior to ignition at a temperature of approximately 388°C. At 4907 s, the cable experienced electrical shorting to less than 100 Ω between Conductor 3 and ground. Shortly after this electrical shorting, the cables ignited. The maximum Penlight set point and cable temperatures were 435°C and 400°C, respectively, and the associated electrical response may be observed in Figure B.96. A summary of the test may be found in Table B.99.

Table B.97: Test parameters for Test K22.

| | |
|--------------------------------|---------------------------|
| Test Series | KATE-FIRE |
| Test Name | Test 22 |
| Test Date | 10/26/2010 |
| Cable 1 | Kerite 10/C-16 AWG, FR-II |
| Cable Monitoring Unit Utilized | IRMS |
| Cable 2 | NA |
| Cable Monitoring Unit Utilized | NA |
| Penlight Starting Temperature | 325°C |
| Penlight Final Temperature | 435°C |

Table B.98: Conductor designation for Item G, Test K22.

| Kerite 10/C-16 AWG, FR-II. Black cable, gray conductors with white print | | | |
|--|-----------------|---------------------|-------|
| Conductor Number | Conductor Color | IRMS Circuit Number | Notes |
| 1 | Black | 1 | |
| 2 | White | 2 | |
| 3 | Red | 3 | |
| 4 | Green | 4 | |
| 5 | Orange | 5 | |
| 6 | Blue | 6 | |
| 7 | White/Black | 7 | |
| 8 | Red/Black | Not Connected | |
| 9 | Green/Black | Not Connected | |
| 10 | Orange/Black | Not | |

Table B.98: Conductor designation for Item G, Test K22.

| Kerite 10/C-16 AWG, FR-II. Black cable, gray conductors with white print | | | |
|--|-----------------|---------------------|-------|
| Conductor Number | Conductor Color | IRMS Circuit Number | Notes |
| | | Connected | |

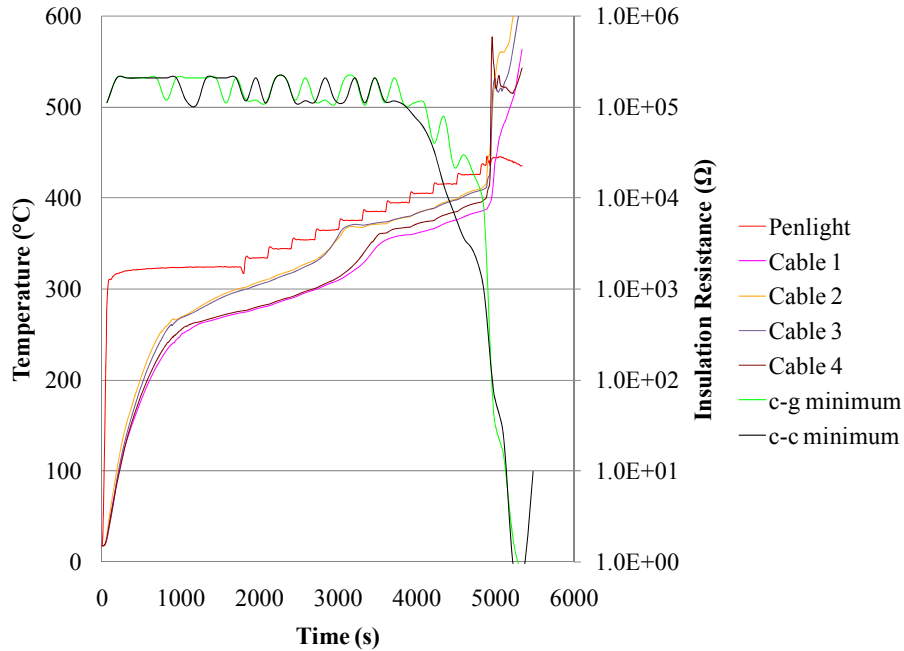

Figure B.96: Penlight shroud temperature, cable temperatures, and electrical performance data for Test K22.

Table B.99: Summary of observed faulting behavior for Test K22.

| Time (s) | Event | Comments |
|-----------|---|---|
| 0 | Penlight On; set at 325°C (5.92 kW/m ²) | Conductors 8, 9, and 10 were not monitored during Test 22. |
| 1800-5340 | Penlight temperature increased stepwise by 10°C every 5 minutes | Penlight temperature was increased stepwise by 10°C every 5 minutes during this time period until ignition. Upon ignition, the Penlight set point temperature remained constant until the conclusion of the test. The final Penlight set point was 435°C. |

Table B.99: Summary of observed faulting behavior for Test K22.

| Time (s) | Event | Comments |
|-----------------|--|---|
| 4158-4940 | Initial degradation is observed during this time period. | Conductor 1 displays current leakage to Conductor 2 at 4158 s. The cable temperature was approximately 388°C. Shortly thereafter, both Conductor 2 and Conductor 7 begin to short to ground at 4194 s. The remaining conductors subsequently displayed similar degradation. |
| 4907 | Conductor 3 shorts to ground at less than 100 Ω. | Cable temperature was 423°C. |
| ~4921 | Ignition | The cable temperature was approximately 436°C before ignition. The approximate time was obtained from the field notes and then compared again the temperature plot for consistency. The observed ignition time corresponds reasonably well with the data. |
| 4940-5340 | Conductor 5 shorts to ground at less than 100 Ω. | During this time span, the other conductors begin shorting together and also to ground. |
| 4942-4980 | Conductor 4 shorts to ground at less than 1000 Ω. | |
| 4942-5040 | Conductor 2 shorts to ground at less than 1000 Ω. | |
| 4947-4984 | Conductor 6 shorts to ground at less than 1000 Ω. | |
| 4950-4986 | Conductor 7 shorts to ground at less than 1000 Ω. | |
| 4950-5191 | Conductor 2 shorts to Conductor 7 at less than 1000 Ω. | |
| 4961-5213 | Conductor 3 shorts to Conductor 4 at less than 1000 Ω. | |
| 4980-5340 | Conductor 4 shorts to ground at less than 100 Ω. | Conductor 6 and 7 also short to ground at less than 100 Ω at 4984 s and 4986 s, respectively. |
| 4981-5233 | Conductor 4 shorts to Conductor 5 at less than 1000 Ω. | Conductor 4 also shorts at less than 1000 Ω to Conductor 6 and 7 at 4984 s and 4986 s, respectively. |
| 4998-5124 | Conductor 5 shorts to Conductor 6 and Conductor 7 at less than 1000 Ω. | |
| 5012-5264 | Conductor 6 shorts to Conductor 7 at less than 1000 Ω. | |
| 5033-5159 | Conductor 3 shorts to Conductor 7 at less than 1000 Ω. | |
| 5040-5045 | Conductor 1 shorts to ground at less than 1000 Ω. | |
| 5040-5166 | Conductor 1 shorts to Conductor 2 at less than 1000 Ω. | |

Table B.99: Summary of observed faulting behavior for Test K22.

| Time (s) | Event | Comments |
|-----------------|--|---|
| 5040-5340 | Conductor 2 shorts to ground at less than 100 Ω . | |
| 5045-5340 | Conductor 1 shorts to ground at less than 100 Ω . | Conductor 1 also shorts at less than 100 Ω to Conductor 6 and 7 at 5051 s and 5054 s, respectively. |
| 5065-5191 | Conductor 2 shorts to Conductor 3 at less than 1000 Ω . | Shortly thereafter, Conductor 2 also shorts at less than 1000 Ω to Conductor 4 (5068 s), Conductor 5 (5071 s), and Conductor 6 (5073 s). |
| 5076-5340 | Conductor 2 shorts to Conductor 7 at less than 100 Ω . | Shortly thereafter, Conductor 2 also shorts at less than 100 Ω to Conductor 3 (5191 s), Conductor 4 (5193 s), and Conductor 6 (5199 s). |
| 5090-5216 | Conductor 3 shorts to Conductor 5 at less than 1000 Ω . | Conductor 3 also shorts at less than 1000 Ω to Conductor 6 at 5093 s. |
| 5110-5340 | Conductor 4 shorts to Conductor 5 and Conductor 6 at less than 100 Ω . | |
| 5124-5340 | Conductor 5 shorts to Conductor 6 and Conductor 7 at less than 100 Ω . | |
| 5166-5340 | Conductor 1 shorts to Conductor 2 at less than 100 Ω . | |
| 5168-5340 | Conductor 1 shorts to Conductor 3 at less than 100 Ω . | |
| 5159-5340 | Conductor 3 shorts to Conductor 7 at less than 100 Ω . | |
| 5171-5340 | Conductor 1 shorts to Conductor 4 and Conductor 5 at less than 1000 Ω . | |
| 5213-5340 | Conductor 3 shorts to Conductor 4 and Conductor 5 at less than 100 Ω . | |
| 5233-5340 | Conductor 4 shorts to Conductor 5 at less than 100 Ω . | |
| 5264-5340 | Conductor 6 shorts to Conductor 7 at less than 1000 Ω . | |
| 5300-5340 | Conductor 1 shorts to Conductor 5 at less than 100 Ω . | |
| 5340 | Penlight shutdown | |

B.8.5 Test K24

Test K24 utilized the multiple SCDU configuration detailed in Appendix A to monitor the electrical performance of the cable throughout the thermal exposure. The test parameters may be found in Table B.100. The conductor pathway for the cable monitoring unit may be found in Table B.101. Overall electrical performance of the cable may be found in Figure B.97. A time modified graph of the source voltages may be observed in Figure B.98. The altered source voltage performance may be found in Figure B.99. The target performance may be observed in Figure B.100. These graphs were included to illustrate the cable degradation over temperature exposure, altered source performance, and spurious actuations throughout the test. The electrical performance for the temperature exposure may be found in Figure B.101.

Penlight was initially set to 325°C for a half hour before the temperature was increased 10°C every five minutes. The final Penlight set point temperature was 375°C. Electrical degradation on the target conductors occurred at approximately 2870 s into the test at a Penlight and cable temperature of 365°C and 341°C, respectively. At approximately 3084 s, the cables ignited at a sub-jacket temperature of 367°C. Shortly after ignition, there was a spurious operation on the active target for all SCDU units, first on 3 (duration of 118 s), then 2 (duration of 115 s), followed by 4 (duration of 111 s), and finally 1 (duration of 25 s). Both of the modified sources (i.e., 80V and 40V) shorted to the 120 V sources. The each spurious actuation was concluded upon the respective unit's fuse clearing. Penlight was shutdown 59 s after the fuse blow on SCDU1. A summary of the electrical performance of the cable may be found in Table B.102.

Table B.100: Test parameters for Test K24.

| | |
|--------------------------------|---------------------------|
| Test Series | KATE-FIRE |
| Test Name | Test 24 |
| Test Date | 11/5/2010 |
| Cable 1 | Kerite 10/C-16 AWG, FR-II |
| Cable Monitoring Unit Utilized | SCDU (M) |
| Cable 2 | NA |
| Cable Monitoring Unit Utilized | NA |
| Penlight Starting Temperature | 325°C |
| Penlight Final Temperature | 375°C |

Table B.101: Conductor designation for Item G, Test K24.

| Kerite 10/C-16 AWG, FR-II. Black cable, gray conductors with white print | | | | |
|--|-----------------|---------------------|-------------------|---|
| Conductor Number | Conductor Color | SCDU Circuit Number | SCDU Circuit Path | Notes |
| 1 | Black | 2 | S2/T4 | Adjusted source conductor which was connected through 3.6 kΩ resistor. By doing this, the output source voltage was |

Table B.101: Conductor designation for Item G, Test K24.

| Kerite 10/C-16 AWG, FR-II. Black cable, gray conductors with white print | | | | |
|--|-----------------|---------------------|-------------------|---|
| Conductor Number | Conductor Color | SCDU Circuit Number | SCDU Circuit Path | Notes |
| | | | | reduced to 40 V – SCDU2 Voltage = C2 V4; current = C2 I4 |
| 2 | White | 3 | S2/T4 | Adjusted source conductor which was connected through 0.9 kΩ resistor. By doing this, the output source voltage was reduced to 80 V – SCDU3 Voltage = C3 V4; current = C3 I4 |
| 3 | Red | 1 | S1 | Energized source conductor for SCDU1– Voltage = C1 V1; current = C1 I1 |
| 4 | Green | 1 | T5 | Active target conductor for SCDU1 – Voltage = C1 V5; current = C1 I5 |
| 5 | Orange | 2 | S1 | Energized source conductor for SCDU2– Voltage = C2 V1; current = C2 I1 |
| 6 | Blue | 2 | T5 | Active target conductor for SCDU2 – Voltage = C2 V5; current = C2 I5 |
| 7 | White/Black | 3 | S1 | Energized source conductor for SCDU3– Voltage = C3 V1; current = C3 I1 |
| 8 | Red/Black | 3 | T5 | Active target conductor for SCDU3 – Voltage = C3 V5; current = C3 I5 |
| 9 | Green/Black | 4 | S1 | Energized source conductor for SCDU4– Voltage = C4 V1; current = C4 I1 |
| 10 | Orange/Black | 4 | T5 | Active target conductor for SCDU4 – Voltage = C4 V5; current = C4 I5 |

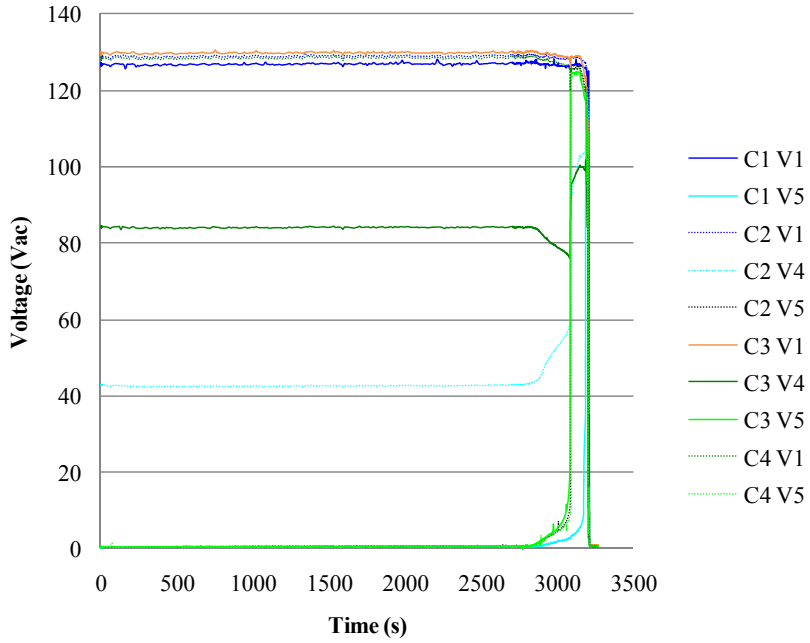

Figure B.97: All conductor voltages for Test K24.

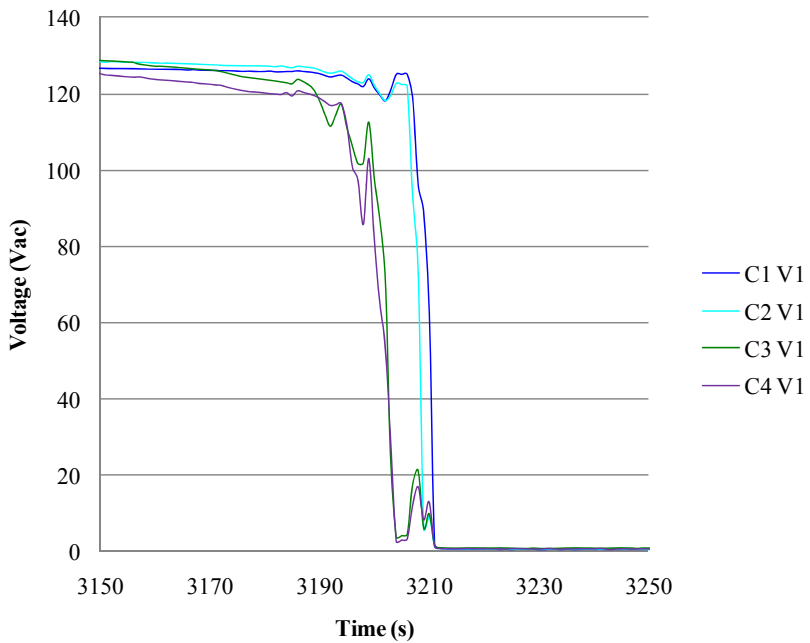

Figure B.98: Modified source conductor voltages for Test K24 displaying the fuse clears.

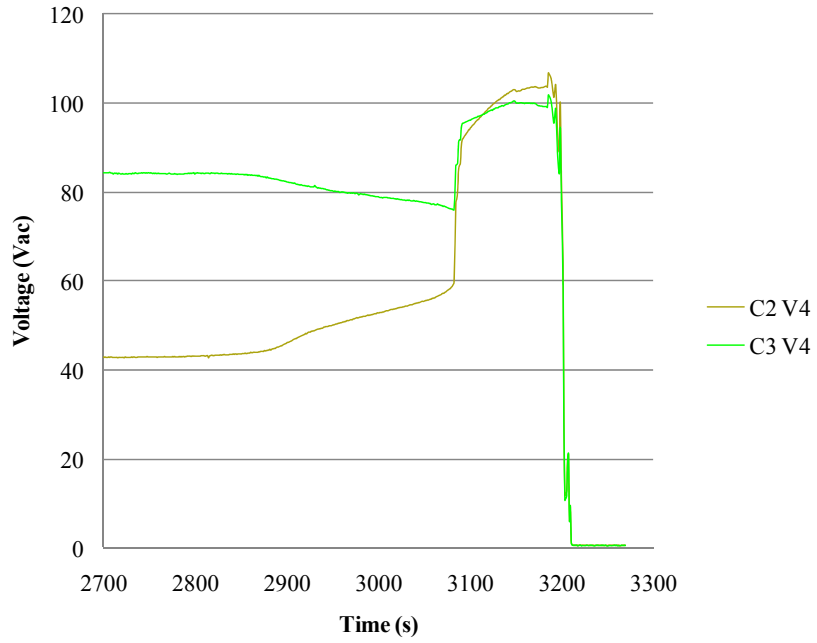

Figure B.99: Modified altered source conductor voltages for Test K24.

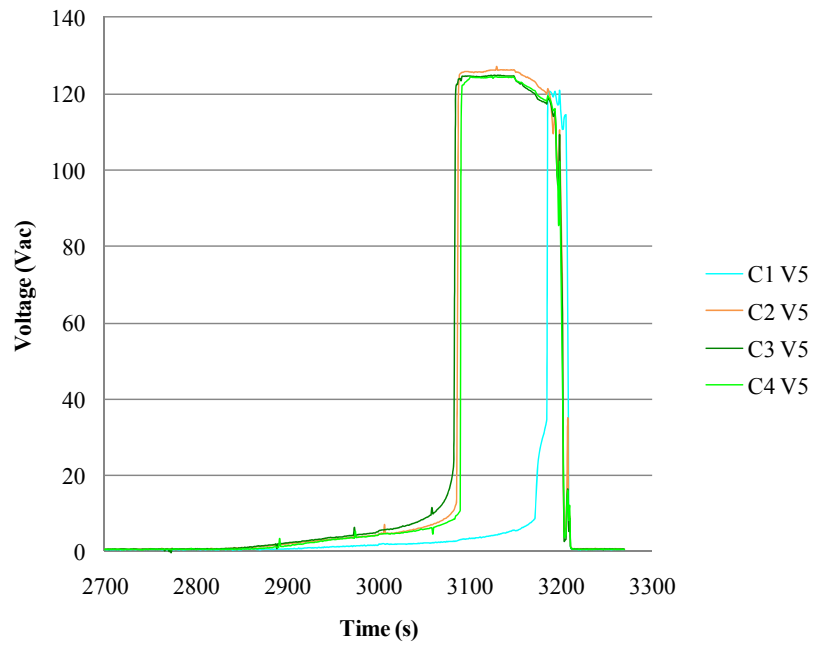

Figure B.100: Modified target conductor voltages for Test K24 displaying actuation.

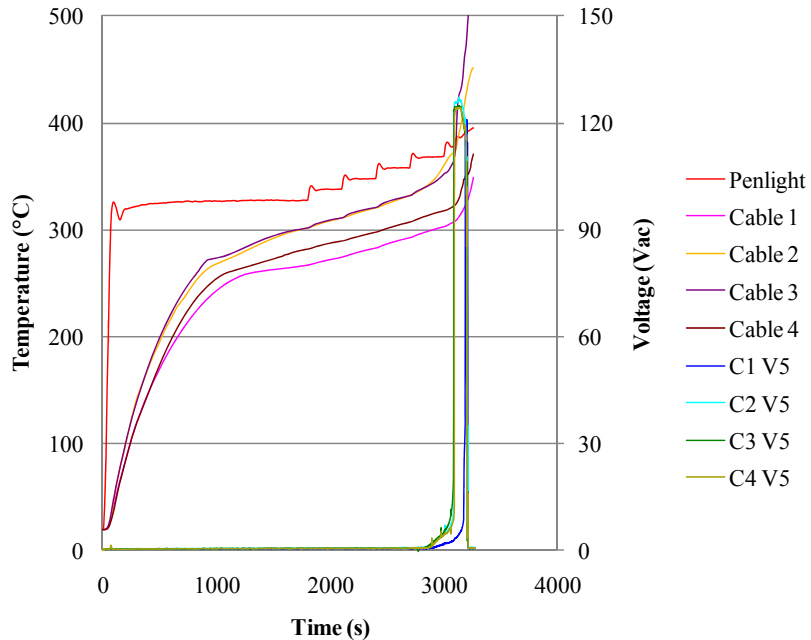

Figure B.101: Penlight shroud temperature, cable temperatures, and target conductor voltages for Test K24.

Table B.102: Summary of observed faulting behavior for Test K24.

| Time (s) | Event | Discussion |
|-----------|---|---|
| 0 | Penlight On; set at 325°C (5.92 kW/m ²) | |
| 1800-3084 | Penlight temperature increased 10°C every 5 minutes | Penlight temperature was increased stepwise by 10°C every 5 minutes during this time period until ignition. Upon ignition, the Penlight set point temperature remained constant until the conclusion of the test. The final Penlight set point was 375°C. |
| 2870-3082 | Voltage increase on the nominal 40 V conductor | During this time span, the voltage on the nominal 40 V conductor (reading 43 V) increased to approximately 58 V. The temperature at the initial increase was approximately 341°C. |
| 2870-3082 | Voltage decrease on the nominal 80 V conductor | During this time span, the voltage on the nominal 80 V conductor (reading 85 V) decreased to approximately 77 V. |
| 2870-3084 | Voltage increase on the active target on SCDU3 | The voltage increased from 1 V to 76 V on the active target for SCDU3 before actuating. |
| 2870-3087 | Voltage increase on the active target on SCDU2 | The voltage increased from 1 V to 55 V on the active target for SCDU2 before actuating. |
| 2870-3091 | Voltage increase on the active target on SCDU4 | The voltage increased from 1 V to 64 V on the active target for SCDU4 before actuating. |

Table B.102: Summary of observed faulting behavior for Test K24.

| Time (s) | Event | Discussion |
|-----------------|--|--|
| 2870-3186 | Voltage increase on the active target on SCDU1 | The voltage increased from 1 V to 66 V on the active target for SCDU4 before actuating. |
| ~3084 | Ignition | It is not clear whether ignition occurred before or after the spurious actuation. The cable temperature at this time was approximately 367°C. |
| 3084-3202 | Spurious actuation on active target for SCDU3 | |
| 3087-3202 | Spurious actuation on active target for SCDU2 | |
| 3091-3202 | Spurious actuation on active target for SCDU4 | |
| 3186-3211 | Spurious actuation on active target for SCDU1 | |
| 3194-3202 | High current short on source conductor for SCDU3 | During this period of time, the voltage gradually declines from 128 V until the fuse clear and the current is maintained from less than 2 A initially to over 5 A. |
| 3197-3203 | High current short on source conductor for SCDU4 | During this period of time, the voltage gradually declines from 128 V until the fuse clear and the current is maintained from less than 2 A initially to over 5 A. |
| 3203 | Fuse clear SCDU3 | Upon the fuse clearing, SCDU3 continued to see voltage on the source and active target indicating that these two conductors had shorted to another energized source. |
| 3204 | Fuse clear SCDU4 | Upon the fuse clearing, SCDU4 continued to see voltage on the source and active target indicating that these two conductors had shorted to another energized source. |
| 3206-3208 | High current short on source conductor for SCDU2 | During this period of time, the voltage gradually declines from 128 V until the fuse clear and the current is maintained from less than 1 A initially to over 5 A. |
| 3208 | Fuse clear on SCDU2 | Upon the fuse clearing, SCDU2 continued to see voltage on the source and active target indicating that these two conductors had shorted to another energized source. |
| 3207-3211 | High current short on source conductor for SCDU1 | During this period of time, the voltage gradually declines from 128 V until the fuse clear and the current is maintained from less than 1 A initially to over 5 A. |
| 3211 | Fuse clear on SCDU1 | Upon the fuse clearing, all remaining voltages on various active target and source conductors dropped to a nominal 0 V. |
| 3270 | Test concluded, Penlight shutdown | |

B.9 Cable Item H: 10/C-12 AWG, FR, zinc wrap

Cable Item H is a 10/C-12 AWG cable with FR insulation, according to the bill of materials provided by the donating company, and the conductors are numbered as depicted in Figure B.102. Surrounding the conductors is a zinc tape wrap which was grounded during each test, as is typical with plant practices. The cable was tested eight times during DESIREE-Fire; all five Penlight scale tests were on the SCDU and the intermediate-scale tests were conducted on the dc MOV and dc SOV circuits. It was tested once during the KATE-Fire tests on a modified SCDU. The following sections detail the test parameters, conductor paths, circuit data, and test summary for each test.

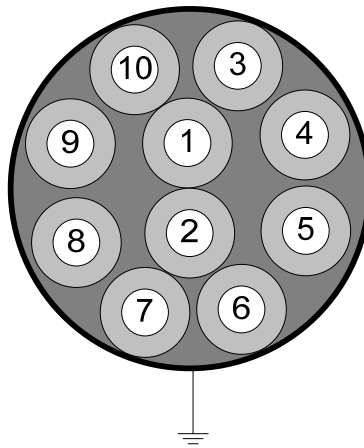

Figure B.102: Illustration of Cable Item H.

B.9.1 Test D13-Qualification

Test 13-qualification (shorthand Test D13, qual) was the first test of Cable Item H. This test was the initial investigation on the failure mechanisms and electrical response to thermal stresses on Kerite FR cable. Test D13, qual utilized the SCDU cable monitoring unit to monitor the electrical performance of the cable throughout the heat exposure. The test parameters may be found in Table B.103. The conductors were grouped together to provide a simplistic, initial assessment of the cable performance. The outer most alternating conductors were ganged and between source and target pathways while one center conductor was connected to a separate source and target. The conductor pathway for the cable monitoring unit may be found in Table B.104.

Penlight was initially set to 300°C for approximately 35 minutes. After 35 minutes, Penlight was increased to 325°C. Twelve minutes later, the Penlight set point temperature was increased to 350°C for the remainder of the test. At a cable temperature of 200°C, the jacket was observed to be popping and liquid was later seen out of the temperature monitoring cable. Blistering and swelling of the cable jacket was noticed at an approximate cable temperature of 250°C. When the cable temperature reached 287°C, Target 6, located on the ganged outer ring, was actuated and Penlight temperature was maintained for over 7 minutes before being shutdown. Ignition

did not occur during the test and the cable remained energized during the cool down period. Electrical performance of the cable may be found in Figure B.22. The electrical response of the cable to temperature may be found in Figure B.104. A summary of the test results may be found in Table B.105.

Table B.103: Test parameters for Test D13, Qual.

| | |
|--------------------------------|-----------------------------------|
| Test Series | DESIREE-FIRE |
| Test Name | Test D13-Qualification |
| Test Date | 7/27/2010 |
| Cable 1 | Kerite 10/C-12 AWG, FR, zinc wrap |
| Cable Monitoring Unit Utilized | SCDU1 |
| Cable 2 | NA |
| Cable Monitoring Unit Utilized | NA |
| Penlight Starting Temperature | 300°C |
| Penlight Final Temperature | 350°C |

Table B.104: Conductor designation for Item H, Test D13, Qual.

| Kerite 10/C-12 AWG, FR, zinc wrap. Black cable, gray conductors with white print | | | | |
|--|-----------------|---------------------|-------------------|---|
| Conductor Number | Conductor Color | SCDU Circuit Number | SCDU Circuit Path | Notes |
| 1 | Black | 1 | S1 | Energized source conductor for SCDU1– Voltage = C1 V1; current = C1 I1 |
| 2 | White | 1 | T5 | Active target conductor for SCDU1 – Voltage = C1 V5; current = C1 I5 |
| 3 | Red | 1 | S2 | Energized source conductor for SCDU1– Voltage = C1 V2; current = C1 I2 |
| 4 | Green | 1 | T6 | Active target conductor for SCDU1 – Voltage = C1 V6; current = C1 I6 |
| 5 | Orange | 1 | S2 | Energized source conductor for SCDU1– Voltage = C1 V2; current = C1 I2 |
| 6 | Blue | 1 | T6 | Active target conductor for SCDU1 – Voltage = C1 V6; current = C1 I6 |
| 7 | White/Black | 1 | S2 | Energized source conductor for SCDU1– Voltage = C1 V2; current = C1 I2 |
| 8 | Red/Black | 1 | T6 | Active target conductor for SCDU1 – Voltage = C1 V6; current = C1 I6 |
| 9 | Green/Black | 1 | S2 | Energized source conductor for SCDU1– Voltage = C1 V2; current = C1 I2 |
| 10 | Orange/Black | 1 | T6 | Active target conductor for SCDU1 – Voltage = C1 V6; current = C1 I6 |
| Zinc Wrap | NA | | | Grounded to tray |

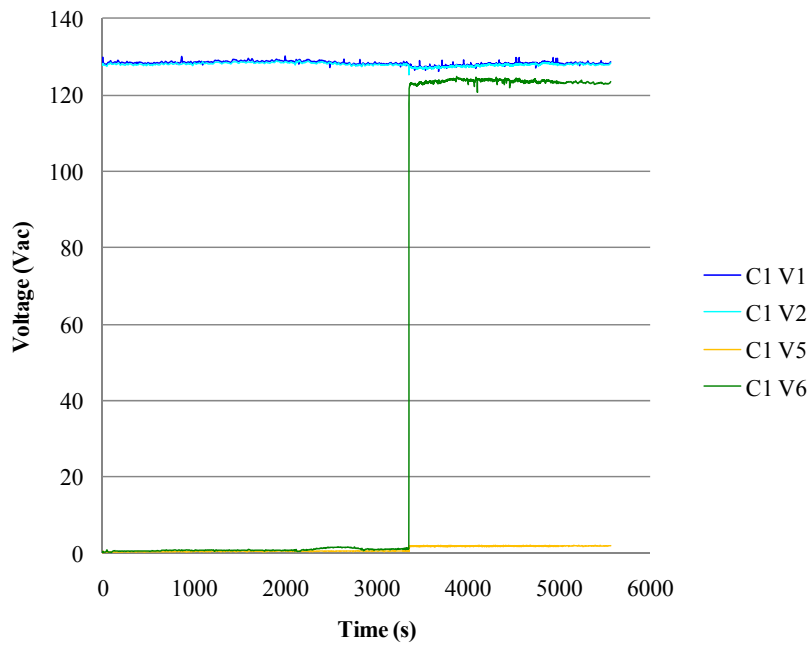

Figure B.103: All conductor voltages for Test D13, Qual.

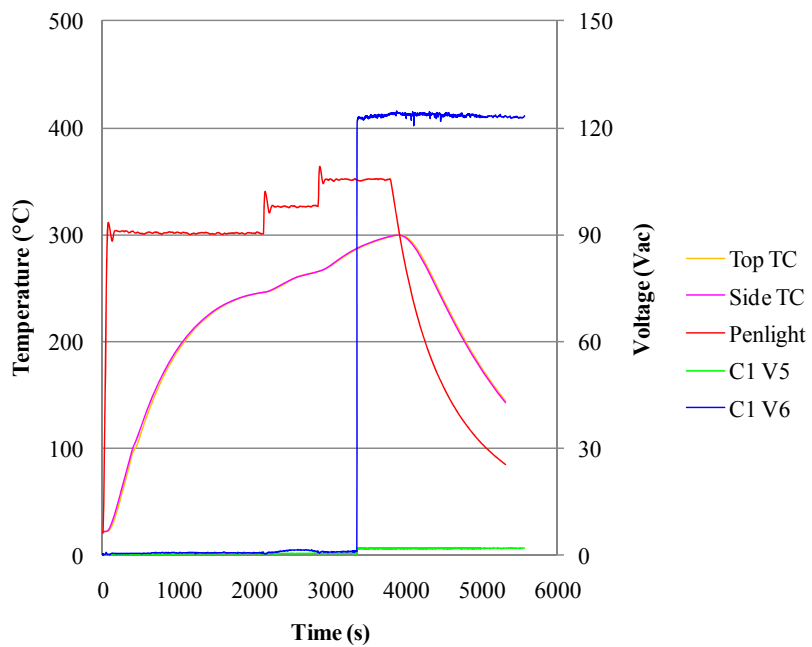

Figure B.104: Penlight shroud temperature and target conductor voltages for Test D13, Qual.

Table B.105: Summary of observed faulting behavior for Test D13, Qual, Circuit 1.

| Time (s) | Event | Discussion |
|-----------------|---|---|
| 0 | Penlight On; set at 300°C (4.99 kW/m ²) | |
| 2100 | Penlight temperature increased to 325°C. | |
| 2195-2857 | Increase in voltage observed on active target 6 | Voltage begins to increase to a maximum of approximately 2V. This correlated with the increase in Penlight temperature from 300°C to 325°C. |
| 2820 | Penlight temperature increased to 350°C | |
| 3360-5579 | Target conductor 6 was actuated | Target 6 was actuated and maintained actuation for the duration of the experiment. The cable temperature was approximately 287°C. |
| 3804 | Test concluded, Penlight shutdown | |
| 5579 | SCDU deenergized | |

B.9.2 Test D13

Test D13 utilized the SCDU to monitor the electrical performance of the cable throughout the thermal exposure. The test parameters may be found in Table B.106. The conductor pathway for the cable monitoring unit may be found in Table B.107. Electrical performance of the cable may be found in Figure B.105. From this graph, the dark blue and light blue lines display the source and target voltages, the orange and dark green represent active targets, and the light green line represents the conductor monitoring ground.

Penlight was initially set to 350°C for approximately 32 minutes. During this stabilized heating period, electrical degradation could be observed for the active target conductors as voltages and currents increased, as observed in Figure B.105. Just over twenty minutes into the test, voltages increased on both Target 5 and Target 6 to about 4 V and 12 V, respectively. These voltages stabilized until ignition. Smoke was noticed at 10 minutes into the test and at 200°C on the cable thermocouples, cable jacket popping and crackling was heard and liquid was later seen bubbling out of the temperature monitoring cables. After this initial heating period, Penlight was increased to 375°C for 13 minutes. Penlight was then increased to 400°C for 10 minutes. The Penlight set point was increased to 425°C for 16 minutes before being increased to 470°C. Ignition occurred shortly after the increase at a cable temperature of 374°C. Both Target 5 and 6 did not actuate before the fuse was tripped; however, voltages on Target 6 increased to 47 V. The electrical response of the cable to temperature may be found in Figure B.106. A summary of the test results may be found in Table B.108.

Table B.106: Test parameters for Test D13, Circuit 2.

| | |
|---------------------------------|-----------------------------------|
| Test Series | DESIREE-FIRE |
| Test Name | Test D13 |
| Test Date | 7/27/2010 |
| Cable 1* | Kerite 5/C-12 AWG, FR, zinc wrap |
| Cable Monitoring Unit Utilized | SCDU1 |
| Cable 2 | Kerite 10/C-12 AWG, FR, zinc wrap |
| Cable Monitoring Unit Utilized | SCDU2 |
| Penlight Starting Temperature | 350°C |
| Penlight Final Temperature | 470°C |
| * See section B.5.1 for results | |

Table B.107: Conductor designation for Item H, Test D13.

| Kerite 10/C-12 AWG, FR, zinc wrap. Black cable, gray conductors with white print | | | | |
|--|-----------------|---------------------|-------------------|---|
| Conductor Number | Conductor Color | SCDU Circuit Number | SCDU Circuit Path | Notes |
| 1 | Black | 2 | S1 | Energized source conductor for SCDU2– Voltage = C2 V1; current = C2 I1 |
| 2 | White | 2 | T5 | Active target conductor for SCDU2 – Voltage = C2 V5; current = C2 I5 |
| 3 | Red | 2 | S2 | Energized source conductor for SCDU2– Voltage = C2 V2; current = C2 I2 |
| 4 | Green | 2 | T6 | Active target conductor for SCDU2 – Voltage = C2 V6; current = C2 I6 |
| 5 | Orange | 2 | S2 | Energized source conductor for SCDU2– Voltage = C2 V2; current = C2 I2 |
| 6 | Blue | 2 | T6 | Active target conductor for SCDU2 – Voltage = C2 V6; current = C2 I6 |
| 7 | White/Black | 2 | S2 | Energized source conductor for SCDU2– Voltage = C2 V2; current = C2 I2 |
| 8 | Red/Black | 2 | T6 | Active target conductor for SCDU2 – Voltage = C2 V6; current = C2 I6 |
| 9 | Green/Black | 2 | S2 | Energized source conductor for SCDU2– Voltage = C2 V2; current = C2 I2 |
| 10 | Orange/Black | 2 | T6 | Active target conductor for SCDU2 – Voltage = C2 V6; current = C2 I6 |
| Zinc Wrap | NA | | | Grounded to tray |

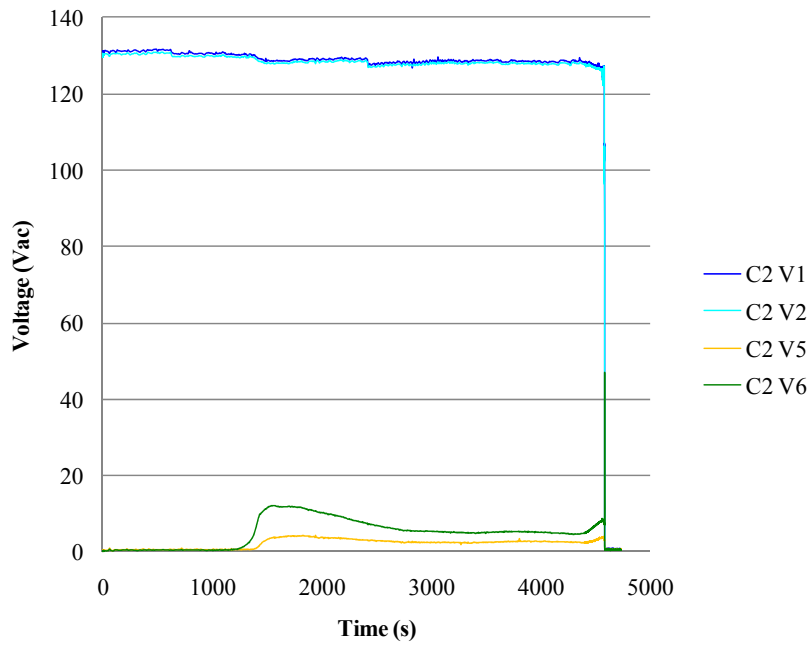

Figure B.105: Voltages for Test D13 showing increases on target conductors.

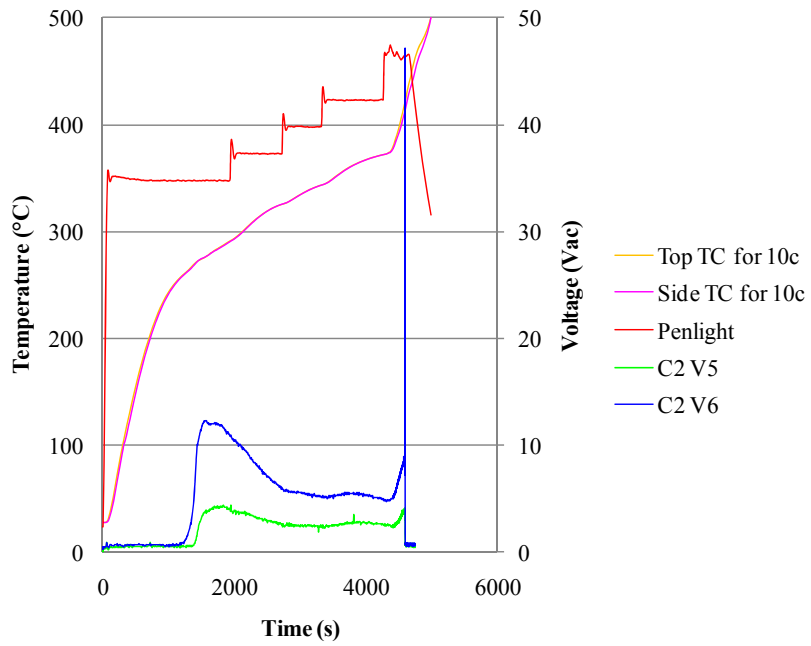

Figure B.106: Penlight shroud temperature and target conductor voltages for Test D13.

Table B.108: Summary of observed faulting behavior for Test D13, Circuit 2.

| Time (s) | Event | Discussion |
|-----------------|--|---|
| 0 | Penlight On; set at 350°C (6.97 kW/m ²) | |
| 1260-1768 | Increasing voltage occurs on Target 5 and Target 6 | Increased voltages were being detected on both Target 5 and Target 6 when the cable temperatures were approximately 261°C. Target 5 hovered at 4 V while Target 6 reached just over 12 V. |
| 1768-2790 | Voltages stabilize on both Target 5 and Target 6 | The voltage increase on Target 5 stabilized at around 2.5 V until 4450 s. Target 6 stabilized at approximately 5.7 V until roughly the same time as Target 5. |
| 1920 | Penlight increased to 375°C | |
| 2700 | Penlight increased to 400°C | |
| 3300 | Penlight increased to 425°C | |
| 4260 | Penlight increased to 470°C | |
| 4362 | Ignition | Cables ignited at a cable temperature of 374°C and an exposure of 470°C. |
| 4450 | Target 5 and 6 experienced an increase in voltages | At this approximate time, the cables within Penlight ignited. Voltages steadily increased on both Target 5 and 6 until the ultimate failure at 4590. Target 5 edged to around 3 V while Target 6 reached 8 V. |
| 4590 | Target 6 experienced a voltage increase and subsequently tripped the 3 A fuse. | Upon ignition, the cable experienced degradation which ultimately lead to shorting behavior that tripped the fuse. Though Target 6 did not actuate, there was an increase in voltage to approximately 47 V. |
| 4662 | Test concluded, Penlight shutdown | |

B.9.3 Test D14

One of the objectives of Test D14 was to investigate how the cable sample would perform electrically under a higher initial temperature than Test D13. Test D14 utilized the SCDU to monitor the electrical performance of the cable throughout the thermal exposure. The test parameters may be found in Table B.109. The conductor pathway for the cable monitoring unit may be found in Table B.110. Penlight was initially set to 450°C and blistering and popping of the jacketing material was observed approximately six minutes into the test. At the initial exposure condition, ignition occurred approximately 10 minutes into the test at a cable temperature of approximately 288°C. Electrical performance of the cable may be observed in Figure B.107. From this figure, the target voltages in did not experience electrical degradation during the initial heating phase as was observed in previous tests (e.g., Test D13). Upon ignition, the cable displayed signs of degradation prior to ultimate failure (fuse clear). The fuse would clear approximately 6 minutes after ignition. The electrical response of the cable to

temperature may be found in Figure B.108. A summary of the test results may be found in Table B.111.

Table B.109: Test parameters for Test D14, Circuit 2.

| | |
|---------------------------------|-----------------------------------|
| Test Series | DESIREE-FIRE |
| Test Name | Test D14 |
| Test Date | 7/28/2010 |
| Cable 1* | Kerite 5/C-12 AWG, FR, zinc wrap |
| Cable Monitoring Unit Utilized | SCDU1 |
| Cable 2 | Kerite 10/C-12 AWG, FR, zinc wrap |
| Cable Monitoring Unit Utilized | SCDU2 |
| Penlight Starting Temperature | 450°C |
| Penlight Final Temperature | 450°C |
| * See section B.5.2 for results | |

Table B.110: Conductor designation for Item H, Test D14, Circuit 2.

| Kerite 10/C-12 AWG, FR, zinc wrap. Black cable, gray conductors with white print | | | | |
|--|-----------------|---------------------|-------------------|---|
| Conductor Number | Conductor Color | SCDU Circuit Number | SCDU Circuit Path | Notes |
| 1 | Black | 2 | S1 | Energized source conductor for SCDU2– Voltage = C2 V1; current = C2 I1 |
| 2 | White | 2 | T5 | Active target conductor for SCDU2 – Voltage = C2 V5; current = C2 I5 |
| 3 | Red | 2 | S2 | Energized source conductor for SCDU2– Voltage = C2 V2; current = C2 I2 |
| 4 | Green | 2 | T6 | Active target conductor for SCDU2 – Voltage = C2 V6; current = C2 I6 |
| 5 | Orange | 2 | S2 | Energized source conductor for SCDU2– Voltage = C2 V2; current = C2 I2 |
| 6 | Blue | 2 | T6 | Active target conductor for SCDU2 – Voltage = C2 V6; current = C2 I6 |
| 7 | White/Black | 2 | S2 | Energized source conductor for SCDU2– Voltage = C2 V2; current = C2 I2 |
| 8 | Red/Black | 2 | T6 | Active target conductor for SCDU2 – Voltage = C2 V6; current = C2 I6 |
| 9 | Green/Black | 2 | S2 | Energized source conductor for SCDU2– Voltage = C2 V2; current = C2 I2 |
| 10 | Orange/Black | 2 | T6 | Active target conductor for SCDU2 – Voltage = C2 V6; current = C2 I6 |
| Zinc Wrap | NA | | | Grounded to tray |

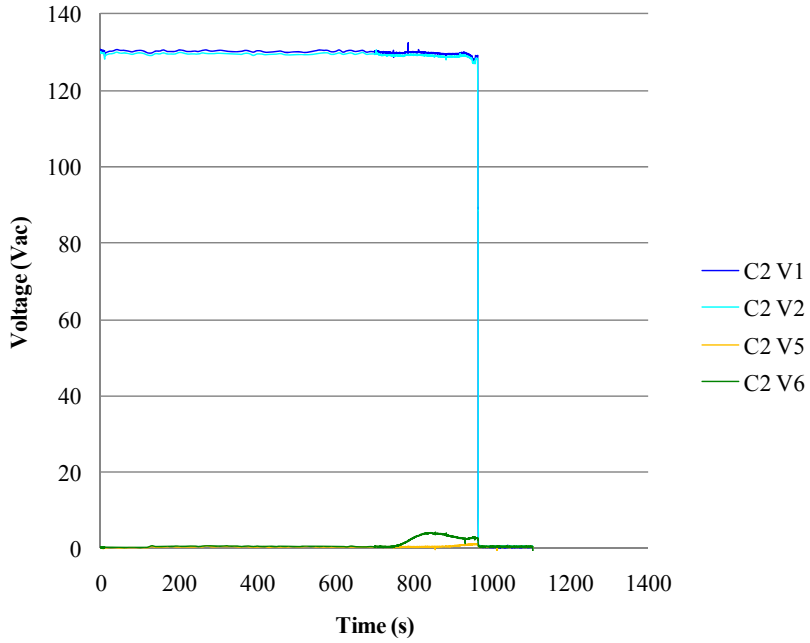

Figure B.107: All conductor voltages for Test D14 displaying the target voltage increase followed by fuse clear.

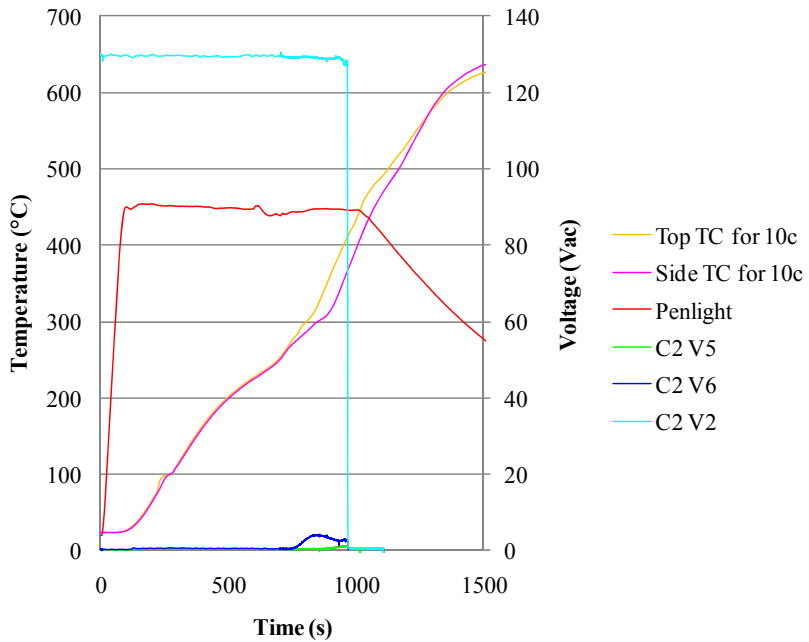

Figure B.108: Penlight shroud temperature and target conductor voltages for Test D14 displaying the slight voltage increase prior to fuse clear.

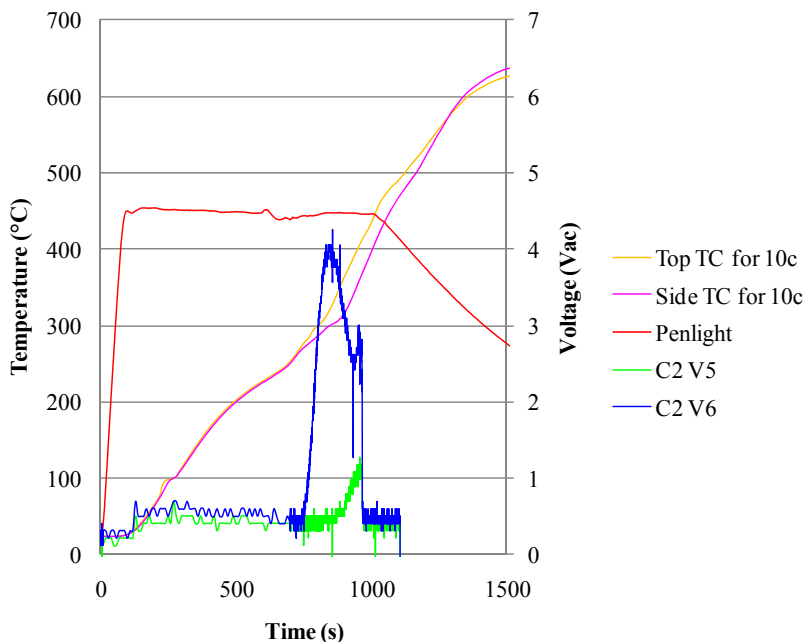

Figure B.109: Modified target conductor voltages and Penlight shroud temperature for Test D14 displaying the slight voltage increase on the target voltages prior to fuse clear.

Table B.111: Summary of observed faulting behavior for Test D14, Circuit 2.

| Time (s) | Event | Discussion |
|----------|--|---|
| 0 | Penlight On; set at 450°C (12.64 kW/m ²) | |
| 600 | Ignition | The cable temperature was approximately 226°C. |
| 760 | Voltage increase on Target 6 | At this time, the voltage steadily increased to approximately 4V. The voltage decreased to about 2V over the span of about three minutes. |
| 966 | Fuse clear | No components were activated. |
| 1006 | Test concluded, Penlight shutdown | |

B.9.4 Test D15

Test D15 was conducted to replicate the heating protocol of DESIREE-Fire Test 13, qualification in which a low temperature failure was observed. SCDU was utilized to monitor the electrical performance of the cable throughout the thermal exposure. The test parameters may be found in Table B.112. The conductor pathway for the cable monitoring unit may be found in Table B.113. Electrical performance of the cable may be found in Figure B.110.

Penlight was initially set to 300°C for approximately 37 minutes. During this stabilized heating period, electrical degradation could be observed on the active target conductors and the grounded

conductor as voltages and currents increased, which may be observed in Figure B.111 and Figure B.112. Smoke was observed approximately 15 minutes into the test at an approximate cable temperature of 215°C. Soon after smoke was noticed, jacket swelling and popping was observed and liquid was seen bubbling out of the thermal monitoring cables at a cable temperature of 253°C. After the initial heating period, the Penlight set point temperature would be increased to 325°C for 12 minutes. Concurrently, voltages were increasing on both Target 5 and Target 6 to approximately 12 V and 4 V, respectively. Penlight was then increased to 350°C for 15 minutes. The temperature was then increased to 375°C for approximately 15 minutes before a final increase to 400°C for the remainder of the test (16 minutes). The test was concluded prior to ultimate electrical failure (i.e., fuse clear or spurious operation) and ignition to inspect the conductor integrity after the exposure. Although ultimate circuit failure did not occur during this test, electrical degradation was observed during the low temperature heating phase. The temperature protocol and electrical response may be found in Figure B.113. A summary of the test results may be found in Table B.114.

Table B.112: Test parameters for Test D15.

| | |
|---------------------------------|-----------------------------------|
| Test Series | DESIREE-FIRE |
| Test Name | Test D15 |
| Test Date | 7/28/2010 |
| Cable 1* | Kerite 5/C-12 AWG, FR, zinc wrap |
| Cable Monitoring Unit Utilized | SCDU1 |
| Cable 2 | Kerite 10/C-12 AWG, FR, zinc wrap |
| Cable Monitoring Unit Utilized | SCDU2 |
| Penlight Starting Temperature | 300°C |
| Penlight Final Temperature | 400°C |
| * See section B.5.3 for results | |

Table B.113: Conductor designation for Item H, Test D15, Circuit 2.

| Kerite 10/C-12 AWG, FR, zinc wrap. Black cable, gray conductors with white print | | | | |
|--|-----------------|---------------------|-------------------|--|
| Conductor Number | Conductor Color | SCDU Circuit Number | SCDU Circuit Path | Notes |
| 1 | Black | 2 | S2 | Energized source conductor for SCDU2– Voltage = C2 V2; current = C2 I2 |
| 2 | White | 2 | T6 | Active target conductor for SCDU2 – Voltage = C2 V6; current = C2 I6 |
| 3 | Red | 2 | S1 | Energized source conductor for SCDU2– Voltage = C2 V1; current = C2 I1 |
| 4 | Green | 2 | T5 | Active target conductor for SCDU2 – Voltage = C2 V5; current = C2 I5 |
| 5 | Orange | 2 | S1 | Energized source conductor for SCDU2– |

Table B.113: Conductor designation for Item H, Test D15, Circuit 2.

| Kerite 10/C-12 AWG, FR, zinc wrap. Black cable, gray conductors with white print | | | | |
|--|-----------------|---------------------|-------------------|--|
| Conductor Number | Conductor Color | SCDU Circuit Number | SCDU Circuit Path | Notes |
| | | | | Voltage = C2 V1; current = C2 I1 |
| 6 | Blue | 2 | T5 | Active target conductor for SCDU2 – Voltage = C2 V5; current = C2 I5 |
| 7 | White/Black | 2 | S1 | Energized source conductor for SCDU2– Voltage = C2 V1; current = C2 I1 |
| 8 | Red/Black | 2 | T5 | Active target conductor for SCDU2 – Voltage = C2 V5; current = C2 I5 |
| 9 | Green/Black | 2 | S1 | Energized source conductor for SCDU2– Voltage = C2 V1; current = C2 I1 |
| 10 | Orange/Black | 2 | T5 | Active target conductor for SCDU2 – Voltage = C2 V5; current = C2 I5 |
| Zinc Wrap | NA | | | Grounded to tray |

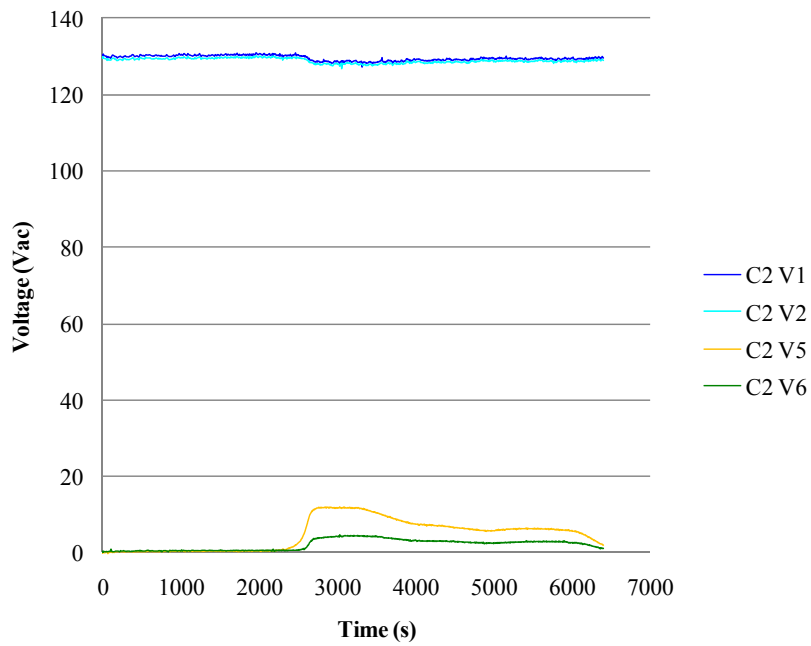

Figure B.110: All source and target conductor voltages for Test D15 displaying early degradation.

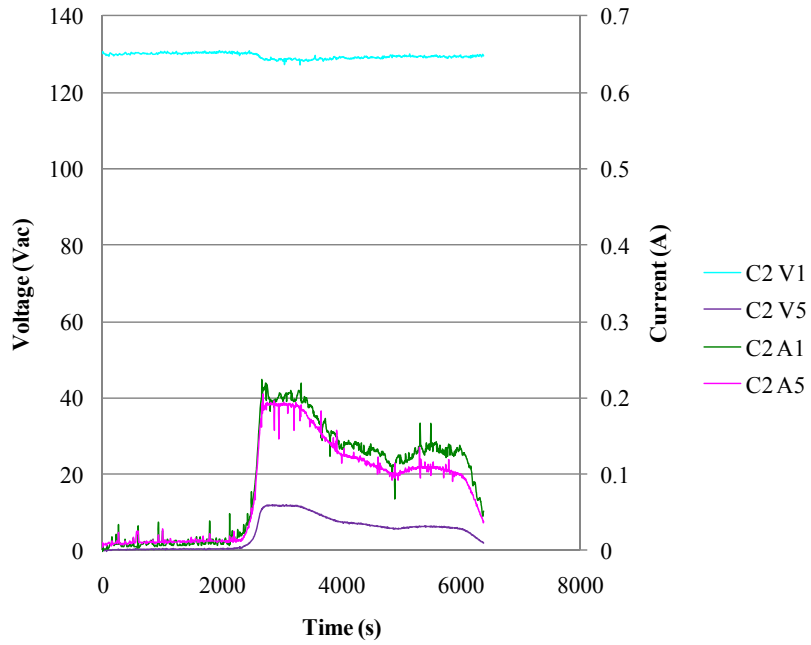

Figure B.111: Source and target conductors located on the outer ring display early degradation as currents and voltages increase for Test D15.

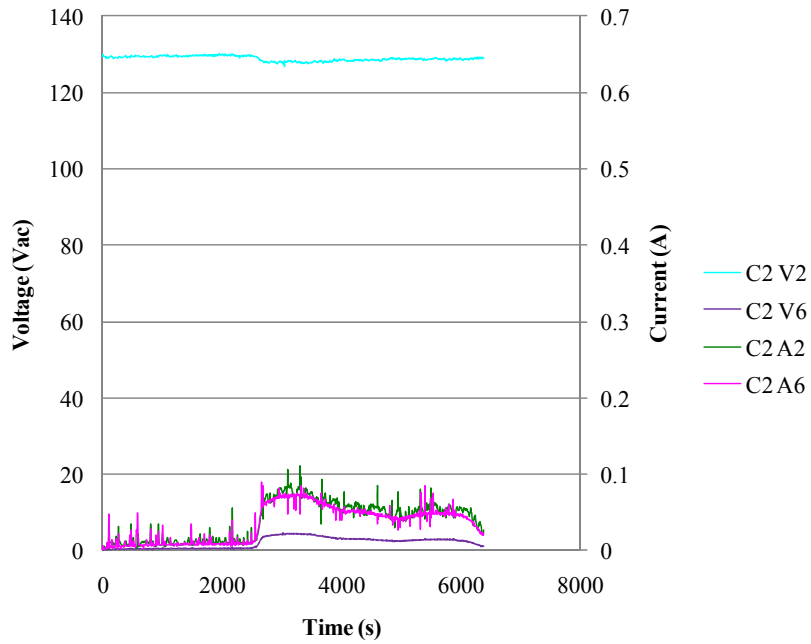

Figure B.112: Source and target conductors located in the inner core display early degradation as currents and voltages increase for Test D15.

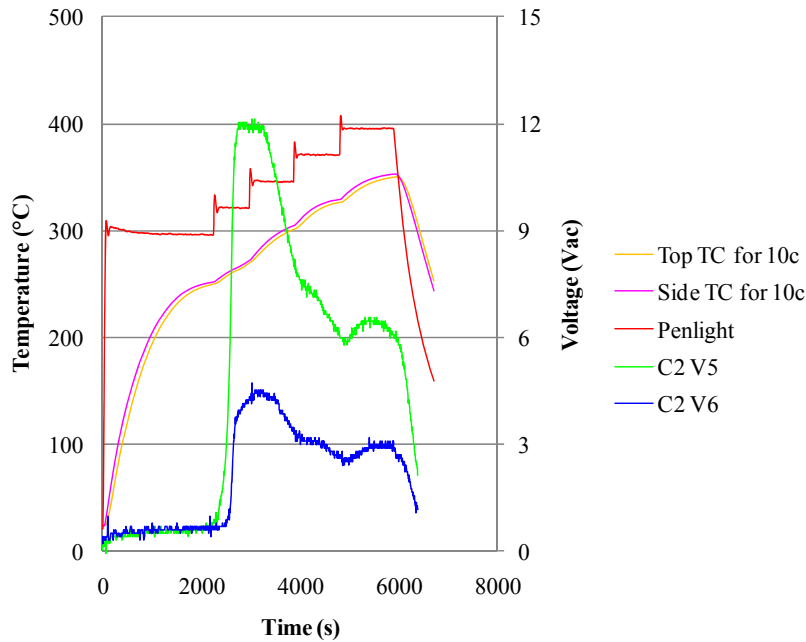

Figure B.113: Penlight shroud temperature and target conductor voltages for Test D15.

Table B.114: Summary of observed faulting behavior for Test D15, Circuit 2.

| Time (s) | Event | Discussion |
|-----------|---|--|
| 0 | Penlight On; set at 300°C (4.99 kW/m ²) | |
| 2240 | Penlight temperature increased to 325°C | |
| 2308-3258 | Voltage increase on Target 5 and Target 6 | Target 5 experienced an increase of 12 V while Target 6 experienced about 4 V. The cable temperature at this initial time was approximately 253°C. |
| 2960 | Penlight temperature increased to 350°C | |
| 3258-4820 | Voltage decrease on Target 5 and Target 6 | Over this time span, the voltage gradually decreases before stabilizing. The cable temperature at this initial time was approximately 285°C. |
| 3860 | Penlight temperature increased to 375°C | |
| 4790 | Penlight temperature increased to | |

Table B.114: Summary of observed faulting behavior for Test D15, Circuit 2.

| Time (s) | Event | Discussion |
|-----------------|-----------------------------------|---|
| | 400°C | |
| 4820-5885 | Targets 5 and 6 stabilize | Targets 5 and 6 stabilize to about 7 V and 3 V, respectively, for the duration of the test. The cable temperature at this initial time was approximately 328°C. |
| 5885 | Test concluded, Penlight shutdown | |

B.9.5 Test D16

One of the objectives of Test D16 was to investigate how the cable sample would perform electrically under a typical Penlight set point value for thermoset materials. Test D16 utilized the SCDU to monitor the electrical performance of the cable throughout the thermal exposure. The test parameters may be found in Table B.115. The conductor pathway for the cable monitoring unit may be found in Table B.116. Penlight was initially set to 470°C and blistering and popping of the jacketing material was observed approximately five minutes into the test and ignition occurred shortly after at a cable temperature of approximately 210°C. Electrical performance of the cable may be observed in Figure B.114. From this figure, the target voltages experienced slight electrical degradation as voltage increased to approximately 2 V on Target 6 before the fuse cleared. Spurious actuation did not occur during this test. The electrical response of the cable to temperature may be found in Figure B.115. A summary of the test results may be found in Table B.117.

Table B.115: Test parameters for Test D16.

| | |
|---------------------------------|-----------------------------------|
| Test Series | DESIREE-FIRE |
| Test Name | Test D16 |
| Test Date | 7/28/2010 |
| Cable 1 | Kerite 10/C-12 AWG, FR, zinc wrap |
| Cable Monitoring Unit Utilized | SCDU1 |
| Cable 2* | Kerite 5/C-12 AWG, FR, zinc wrap |
| Cable Monitoring Unit Utilized | SCDU2 |
| Penlight Starting Temperature | 470°C |
| Penlight Final Temperature | 470°C |
| * See section B.5.4 for results | |

Table B.116: Conductor designation for Item H, Test D16, Circuit 1.

| Kerite 10/C-12 AWG, FR, zinc wrap. Black cable, gray conductors with white print | | | | |
|--|-----------------|---------------------|-------------------|---|
| Conductor Number | Conductor Color | SCDU Circuit Number | SCDU Circuit Path | Notes |
| 1 | Black | 1 | S1 | Energized source conductor for SCDU1 – Voltage = C1 V1; current = C1 I1 |
| 2 | White | 1 | T5 | Active target conductor for SCDU1 – Voltage = C1 V5; current = C1 I5 |
| 3 | Red | 1 | S2 | Energized source conductor for SCDU1 – Voltage = C1 V2; current = C1 I2 |
| 4 | Green | 1 | T6 | Active target conductor for SCDU1 – Voltage = C1 V6; current = C1 I6 |
| 5 | Orange | 1 | S2 | Energized source conductor for SCDU1 – Voltage = C1 V2; current = C1 I2 |
| 6 | Blue | 1 | T6 | Active target conductor for SCDU1 – Voltage = C1 V6; current = C1 I6 |
| 7 | White/Black | 1 | S2 | Energized source conductor for SCDU1 – Voltage = C1 V2; current = C1 I2 |
| 8 | Red/Black | 1 | T6 | Active target conductor for SCDU1 – Voltage = C1 V6; current = C1 I6 |
| 9 | Green/Black | 1 | S2 | Energized source conductor for SCDU1 – Voltage = C1 V2; current = C1 I2 |
| 10 | Orange/Black | 1 | T6 | Active target conductor for SCDU1 – Voltage = C1 V6; current = C1 I6 |
| Zinc Wrap | NA | | | Grounded to tray |

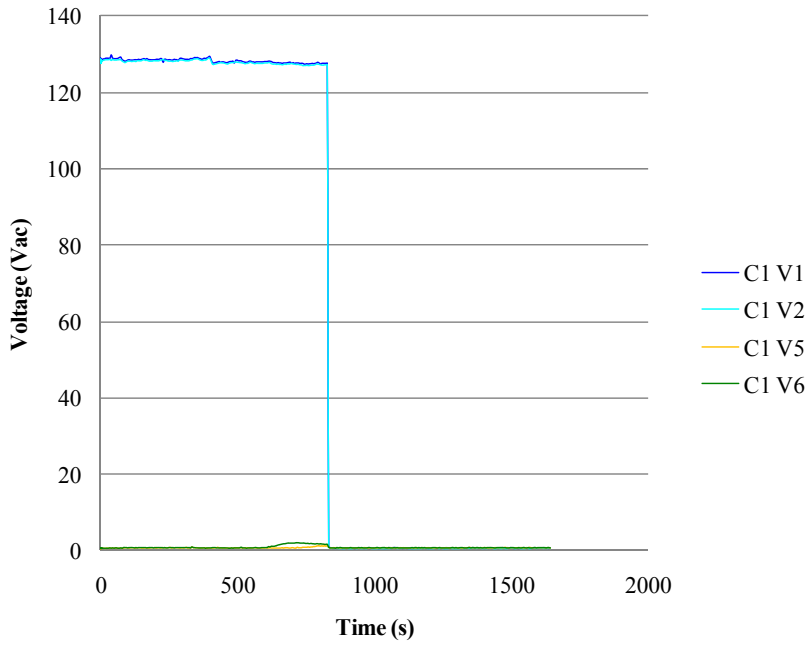

Figure B.114: Conductor voltages for Test D16 showing a fuse clear.

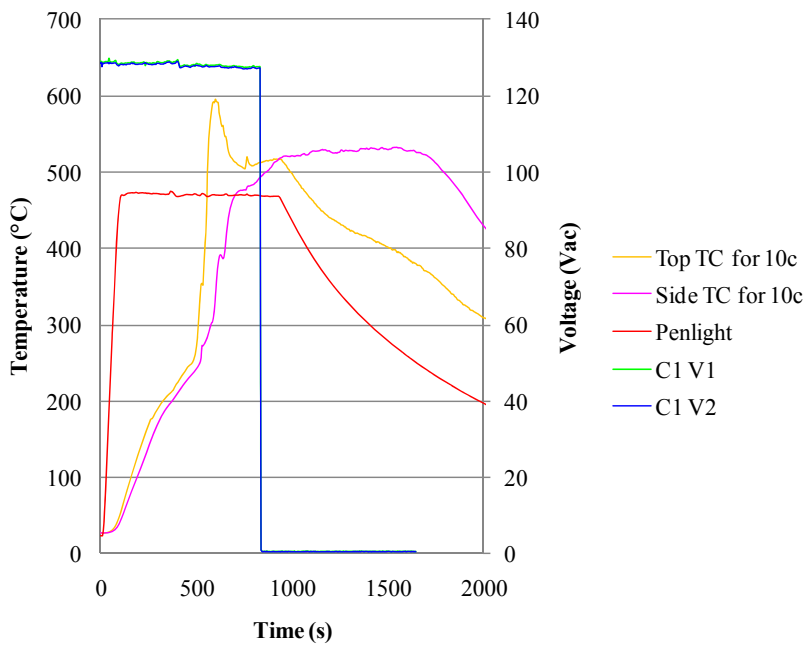

Figure B.115: Penlight shroud temperature and conductor voltages for Test D16.

Table B.117: Summary of Observed Faulting Behavior for Test D16, Circuit 1.

| Time (s) | Event | Discussion |
|----------|--|--|
| 0 | Penlight On; set at 470°C (14.09 kW/m ²) | |
| 353 | Ignition | The cable temperature was approximately 202°C. |
| 630 | Voltage increase on Target 6 | Voltages remained around 2V until the ultimate fuse clear. |
| 834 | Fuse clear | |
| 922 | Test concluded, Penlight shutdown | |

B.9.6 Test IS9

The intermediate-scale test series conducted during DESIREE-Fire provided a target opportunity to investigate the performance of Kerite cable in a more representative fire environment. During Test IS9, Item H was connected to the dc-powered SOV1 circuit and situated in Position B. The test parameters may be found in Table B.118. The conductor pathway for the cable monitoring unit may be found in Table B.119. Electrical performance of the cable may be found in Figure B.116 and Figure B.117. In the former graph, the positive and negative sources were graphed with the coil voltage. From here, a spurious actuation occurs at 2584 s and continues for approximately 112 s before a subsequent fuse clear. The latter graph displays the voltage of the lamps throughout the test. From this graph, two separate hot shorts occurred causing a false indication on the red indication lamp. When looking both figures, it should be noted that the voltages are referenced to ground. Since the other fused circuits are connected to the same dc power supply, the ground continues to drift after the fuses clear on SOV1. The temperature profile and voltage response may be found in Figure B.118. In this figure, the air temperature is listed as the location of the cable and the length along the tray while the sub-jacket temperature is listed with the location of the cable, cable type, and length along the sample. A summary of the test results may be found in Table B.120.

Table B.118: Test parameters for Test IS9.

| | |
|------------------------------|------------------------------------|
| Test Name | Test IS9 |
| Test Date | 3/17/2010 |
| Cable Type for SOV1 | Kerite, 10/C-12 AWG, FR, zinc wrap |
| SOV1 Position | Position B |
| Cable Fill Type | Specialized Tray B, Cable 4 |
| Cables Co-Located in Raceway | Cable 1 - 1-in. Valve |
| | Cable 2 - Large Coil |
| | Cable 3 - MOV1 |

Table B.118: Test parameters for Test IS9.

| | |
|-----------------------------|------------|
| Battery Voltage (Pre-test) | 122.15 Vdc |
| Battery Voltage (Post-test) | 122.41 Vdc |

Table B.119: Conductor designation for Item H, Test IS9.

| Test IS9, SOV 1, 10/C-12 AWG, zinc wrap | | | | | |
|---|----------------------------|--|---------------------------------------|-----------------------------|----------------------------|
| Lead Cable Conductor number | Lead cable conductor color | Terminal block location in DCSim Panel | Terminal block circuit identification | Test Cable conductor number | Test cable conductor color |
| 1 | Black | TB2 | P | 3 | Red |
| 2 | White | TB4 | G | 4 | Green |
| 3 | Red | TB3 | S1 | 5 | Orange |
| 4 | Green | TB6 | R | 6 | Blue |
| 5 | Orange | TB9 | N | 7 | White/Black |
| 6 | Blue | TB7 | SP | 8 | Red/Black |
| 7 | White/Black | TB8 | S2 | 9 | Green/Black |

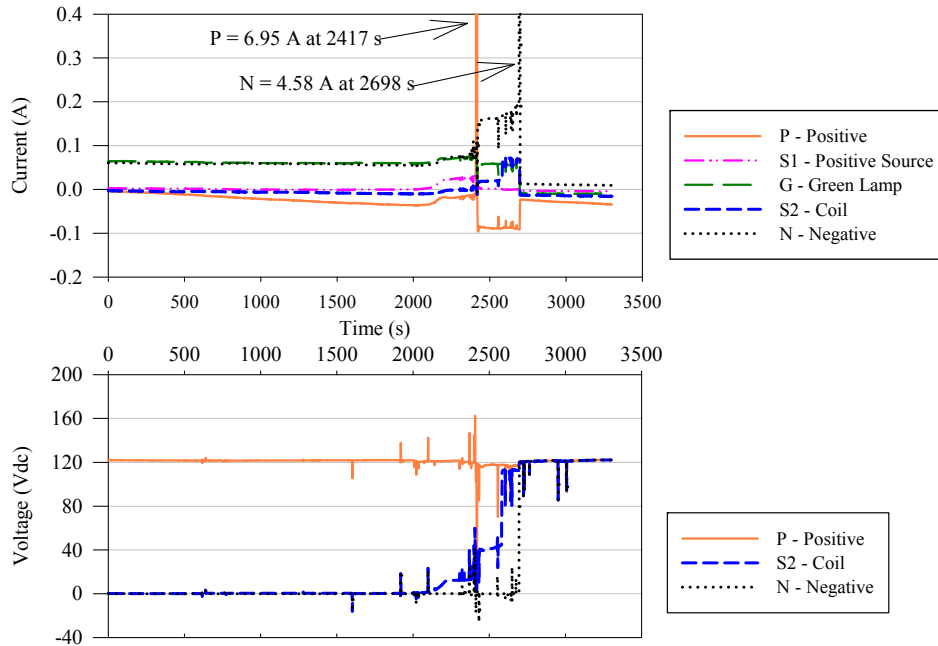

Figure B.116: Voltage and current response for the active target in Test IS9, SOV1.

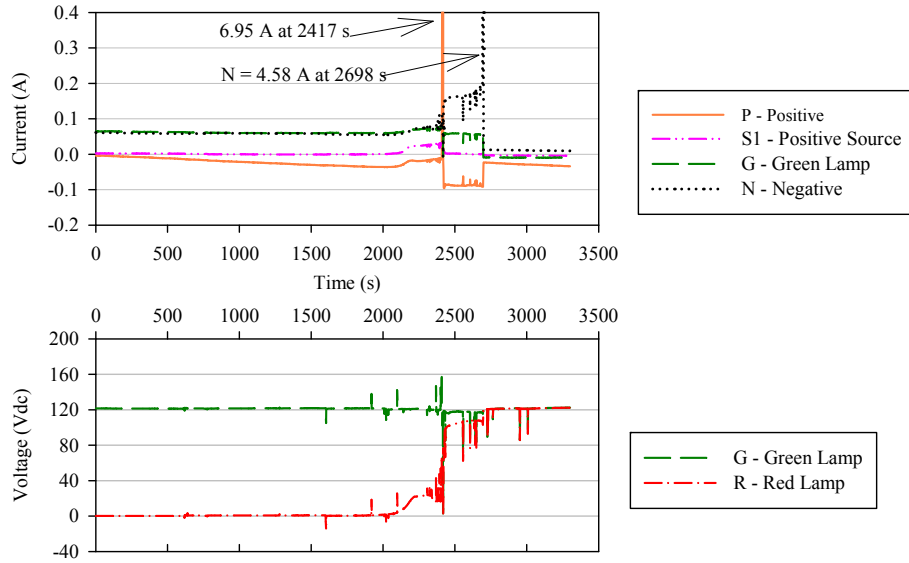

Figure B.117: Voltage and current response for the lamps in Test IS9, SOV1.

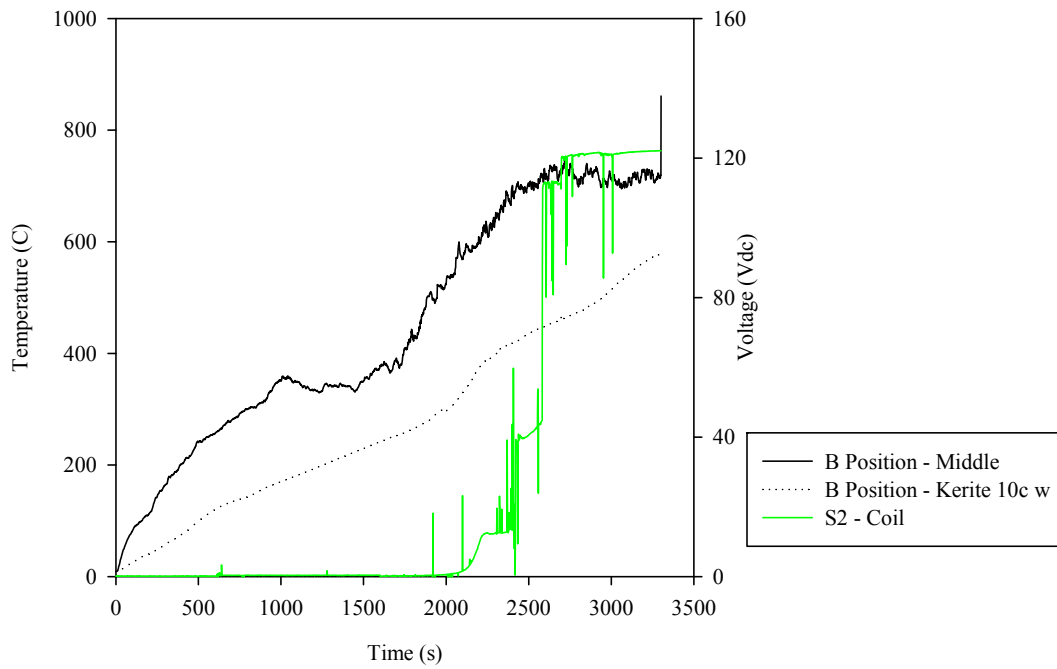

Figure B.118: Temperature profile and electrical response for Test IS9, SOV1.

Table B.120: Summary of observed faulting behavior for Test IS9, Item H.

| Time (s) | Event | Discussion |
|----------|----------------|------------|
| 0 | Fire initiated | |

Table B.120: Summary of observed faulting behavior for Test IS9, Item H.

| Time (s) | Event | Discussion |
|-----------------|---|--|
| 2101-2225 | Voltage increase from 1.58V to 12.05V on solenoid | |
| 2227-2418 | Voltage on Solenoid Nominally Steady from 12.14V | |
| 2421-2582 | Voltage on Solenoid Nominally Steady from 39.45V | |
| 2429-2432 | False indication red light | |
| 2435-2584 | False indication red light | The red lamp experienced a short at this time. |
| 2584-2696 | Spurious actuation on solenoid | The spurious actuation continued for approximately 112 s. |
| 2699 | Positive and negative fuses clear | The main battery bank is used to power all the dc circuits during the intermediate-scale experiments. Since the graphed voltage is referenced to the common ground and not all circuit fuses clear at the same time, some graphs may indicate that electrical activity is occurring after this noted time. |
| 3300 | Fire Off | |

B.9.7 Test IS10

During Test IS10, Item H was connected to the dc-powered MOV2 circuit and situated in Position B. The test parameters may be found in Table B.121. The conductor pathway for the cable monitoring unit may be found in Table B.122. Electrical performance of the cable may be found in Figure B.119 and Figure B.120. In the former graph, the positive and negative sources were graphed with the coil voltage. From here, a spurious actuation occurs at 2798 s and continues for approximately 37 s before a subsequent fuse clear. The latter graph displays the voltage of the lamps throughout the test. When looking at the graphs, it should be noted that the voltages are referenced to ground. Since the other fused circuits are connected to the same dc power supply, the ground continues to drift after the negative fuse clears on MOV2. The temperature profile and voltage response may be found in Figure B.121. In this figure, the air

temperature is listed as the location of the cable and the length along the tray while the sub-jacket temperature is listed with the location of the cable, cable type, and length along the sample. A summary of the test results may be found in Table B.123.

Table B.121: Test parameters for Test IS10.

| | |
|------------------------------|------------------------------------|
| Test Name | Test IS10 |
| Test Date | 3/25/2010 |
| Cable Type for MOV2 | Kerite, 10/C-12 AWG, FR, zinc wrap |
| MOV2 Position | Position B, Cable 1 |
| Cable Fill Type | Fill Tray |
| Cables Co-Located in Raceway | Cable 2 - SWGR Close and Trip |
| | Cable 3 - SOV2 |
| Battery Voltage (Pre-test) | 121.96 Vdc |
| Battery Voltage (Post-test) | 122.21 Vdc |

Table B.122: Conductor designation for Item H, Test IS10.

| Test IS10, MOV2, 10/C-12 AWG, zinc wrap | | | | | |
|---|----------------------------|--|---------------------------------------|-----------------------------|----------------------------|
| Lead Cable Conductor number | Lead cable conductor color | Terminal block location in DCSim Panel | Terminal block circuit identification | Test Cable conductor number | Test cable conductor color |
| 1 | Black | TB 3i | P | 3 | Red |
| 2 | White | TB 3/C | G | 4 | Green |
| 3 | Red | TB 7/C | YC1 | 5 | Orange |
| 4 | Green | TB 4/C | R | 6 | Blue |
| 5 | Orange | TB 6i | SP | 7 | White/Black |
| 6 | Blue | TB 5i | N | 8 | Red/Black |
| 7 | White/Black | TB 6c | YO1 | 9 | Green/Black |

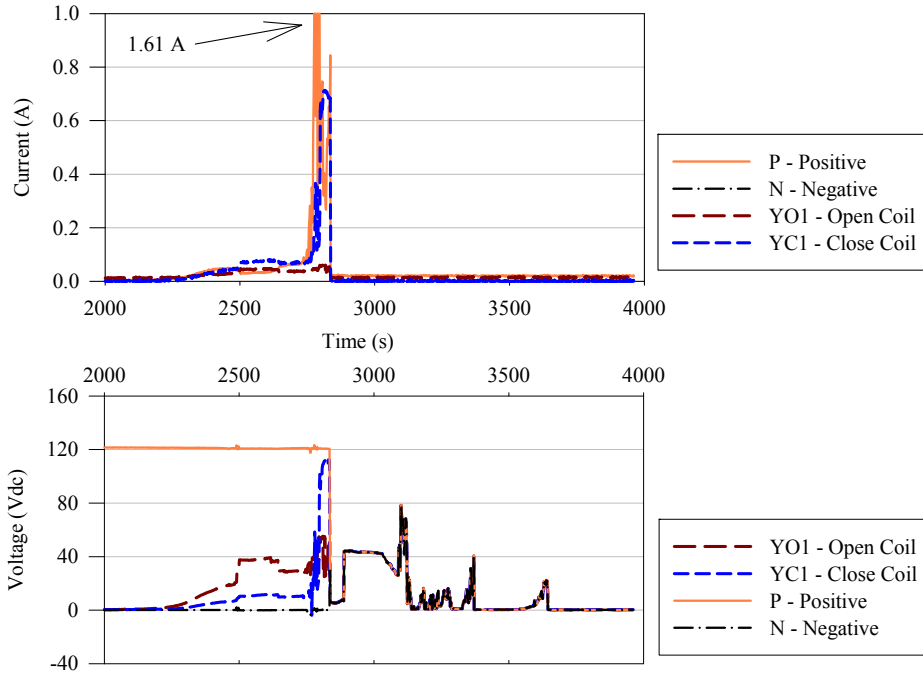

Figure B.119: Voltage and current response for the active target in Test IS10, MOV2.

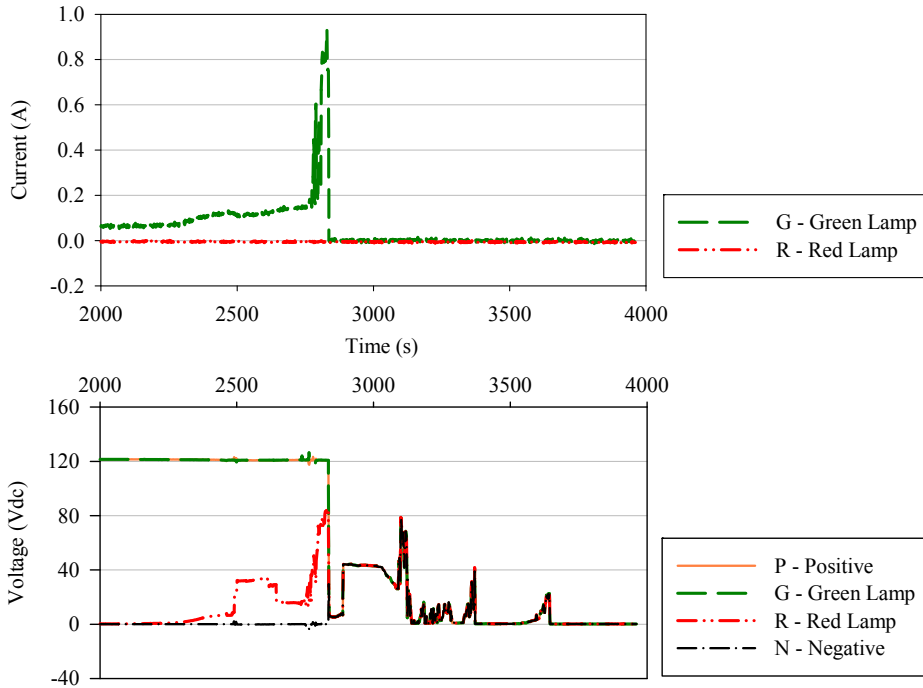

Figure B.120: Voltage and current response for the lamps in Test IS10, MOV2.

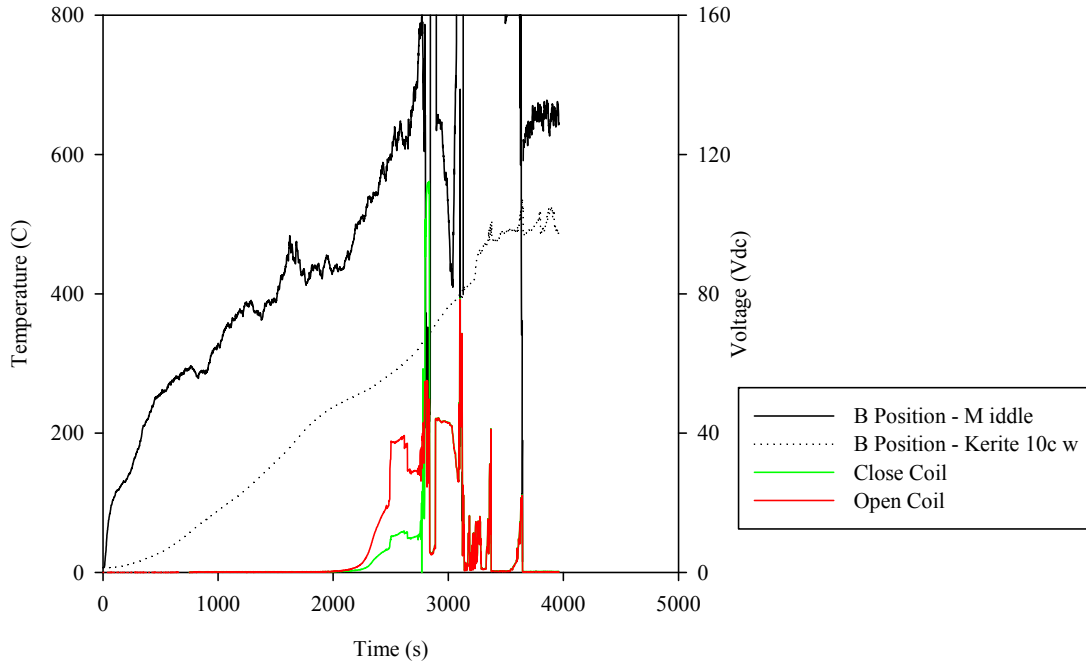

Figure B.121: Temperature profile and electrical response for Test IS10, MOV2.

Table B.123: Summary of observed faulting behavior for Test IS10, Item H.

| Time (s) | Event | Discussion |
|-----------|-----------------------------------|--|
| 0 | Fire initiated | |
| 2159 | Voltage increase on the open coil | The temperature of the cable at this time was approximately 251°C |
| 2764-2836 | Current increase on green light | |
| 2798-2835 | Spurious actuation close coil | At this time, the current was 0.63347 A. The spurious actuation continued for 37 s. |
| 2802 | Air TC failure | The air TC located in the middle of the tray during this test displayed failure after this point. Temperatures were erratic and jumped between uncharacteristically high and low readings. |
| 2836 | Positive and negative fuses clear | |
| 3960 | Fire off | |

B.9.8 Test K4

Test K4 utilized the multiple SCDU configuration detailed in Appendix A to monitor the electrical performance of the cable throughout the thermal exposure. The test parameters may be

found in Table B.124. The conductor pathway for the cable monitoring unit may be found in Table B.125. Penlight was initially set to 325°C for a half hour before the temperature was increased 10°C every five minutes. The final Penlight set point temperature was 365°C. Electrical degradation on the altered source conductors occurred at approximately 1322 s into the test at a Penlight and cable temperature of 325°C and 270°C, respectively. The degradation was initially observed on the two center conductors with an increase of 17 V on the nominal 40 V conductor and a decrease of 8 V on the nominal 80 V conductor. At the onset of this voltage change, each of the active targets experienced a voltage increase. The degradation on the target conductors occurred at approximately 1392 s into the test at a Penlight and cable temperature of 335°C and 266°C, respectively. At 1980 s, there was a spurious actuation on the active target for SCDU1 from the source conductor from SCDU2. The cable temperature was 296°C at the time of actuation. The spurious operation continued for approximately 12 minutes. At 2184 s, the active target for SCDU3 increased to approximately 60 V and 0.74 A before the fuse cleared. At 2700 s, Penlight was shut down prior to ignition in order to preserve the sample for post-test examination. Only the fuse in SCDU3 cleared. In Figure B.122, all the test conductor voltages are graphed displaying the overall performance of the cable during thermal exposure. All 120 V source voltages were graphed in Figure B.123 to display the fuse clear at 2184 s. The 80 V and 40 V conductor voltages were graphed in Figure B.124 to display the early degradation at 1322 s. The target voltages were displayed in Figure B.125 which displays the early degradation and the spurious actuation at 1980 s. The overall temperature profile and electrical response may be found in Figure B.126. A summary of the electrical performance of the cable may be found in Table B.126.

Table B.124: Test parameters for Test K4.

| | |
|--------------------------------|-----------------------------------|
| Test Series | KATE-FIRE |
| Test Name | Test K4 |
| Test Date | 11/8/2010 |
| Cable 1 | Kerite 10/C-12 AWG, FR, zinc wrap |
| Cable Monitoring Unit Utilized | SCDU (M) |
| Cable 2 | NA |
| Cable Monitoring Unit Utilized | NA |
| Penlight Starting Temperature | 325°C |
| Penlight Final Temperature | 365°C |

Table B.125: Conductor designation for Item H, Test K4.

| Kerite 10/C-12 AWG, FR, zinc wrap. Black cable, gray conductors with white print | | | | |
|--|-----------------|---------------------|-------------------|---|
| Conductor Number | Conductor Color | SCDU Circuit Number | SCDU Circuit Path | Notes |
| 1 | Black | 2 | S2/T4 | Adjusted source conductor which was connected through 3.6 k Ω resistor. By doing this, the output source voltage was reduced to 40 V – SCDU2 Voltage = C2 V4; current = C2 I4 |
| 2 | White | 3 | S2/T4 | Adjusted source conductor which was connected through 0.9 k Ω resistor. By doing this, the output source voltage was reduced to 80 V – SCDU3 Voltage = C3 V4; current = C3 I4 |
| 3 | Red | 1 | S1 | Energized source conductor for SCDU1– Voltage = C1 V1; current = C1 I1 |
| 4 | Green | 1 | T5 | Active target conductor for SCDU1 – Voltage = C1 V5; current = C1 I5 |
| 5 | Orange | 2 | S1 | Energized source conductor for SCDU2– Voltage = C2 V1; current = C2 I1 |
| 6 | Blue | 2 | T5 | Active target conductor for SCDU2 – Voltage = C2 V5; current = C2 I5 |
| 7 | White/Black | 3 | S1 | Energized source conductor for SCDU3– Voltage = C3 V1; current = C3 I1 |
| 8 | Red/Black | 3 | T5 | Active target conductor for SCDU3 – Voltage = C3 V5; current = C3 I5 |
| 9 | Green/Black | 4 | S1 | Energized source conductor for SCDU4– Voltage = C4 V1; current = C4 I1 |
| 10 | Orange/Black | 4 | T5 | Active target conductor for SCDU4 – Voltage = C4 V5; current = C4 I5 |
| Zinc Wrap | NA | NA | NA | Grounded to tray, but not monitored |

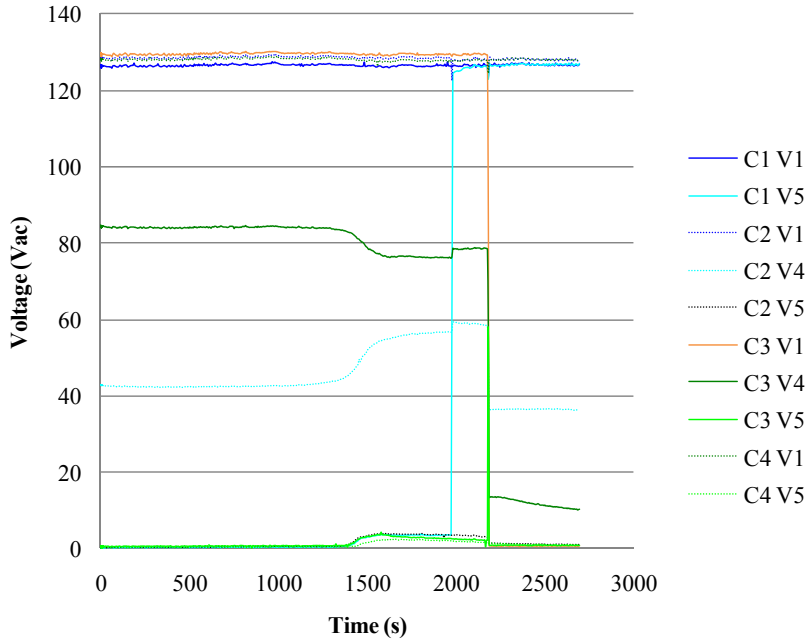

Figure B.122: All conductor voltages for Test K4 displaying early degradation on the target and modified source voltages.

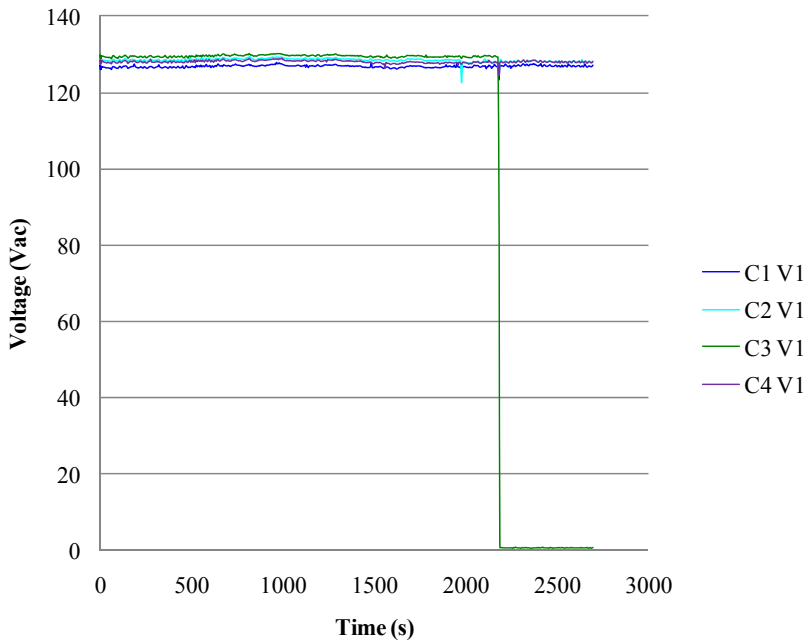

Figure B.123: All 120 V source conductor voltages for Test K4 displaying a fuse clear at 2187 s.

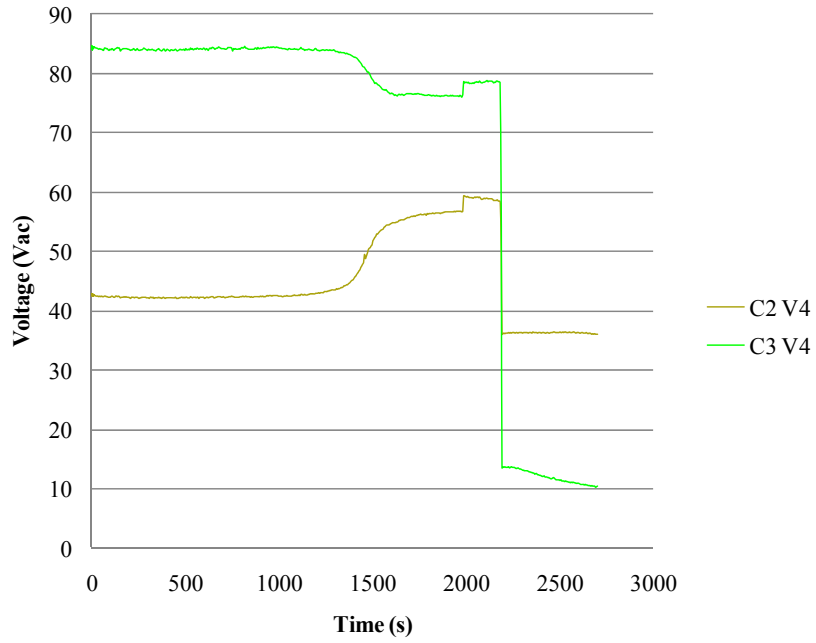

Figure B.124: Altered source conductor voltages for Test K4 displaying degradation.

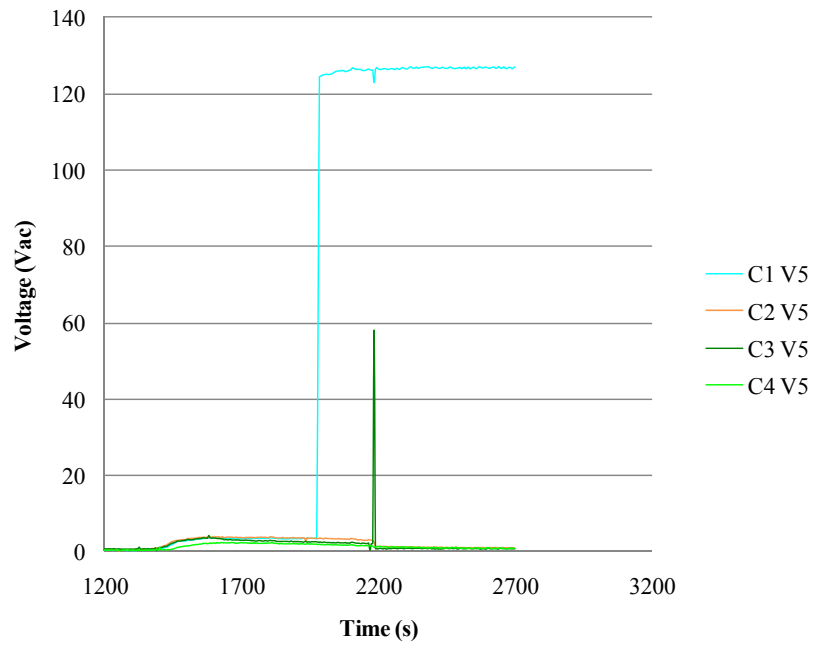

Figure B.125: All target conductor voltages for Test K4 displaying a spurious actuation.

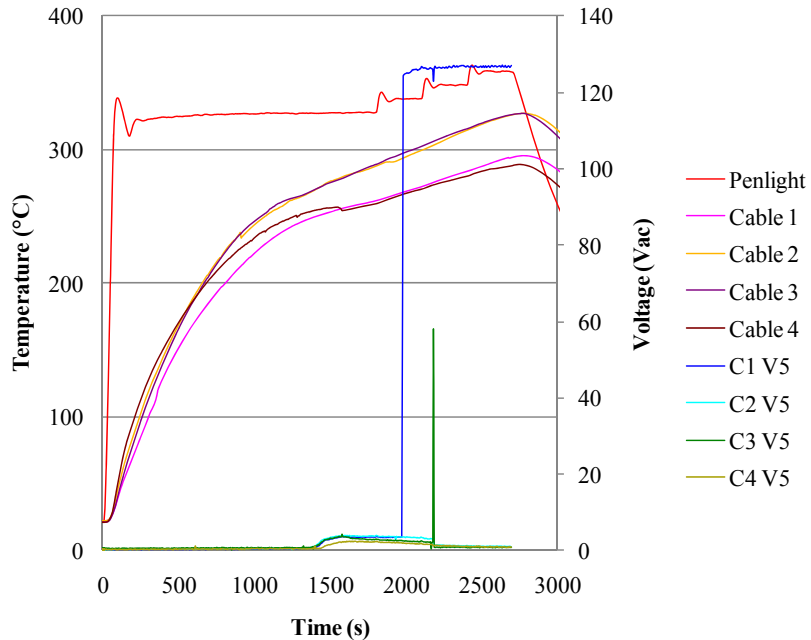

Figure B.126: Penlight shroud temperature, cable temperatures, and target conductor voltages for Test K4.

Table B.126: Summary of observed faulting behavior for Test K4.

| Time (s) | Event | Discussion |
|-----------|--|--|
| 0 | Penlight On; set at 325°C (5.92 kW/m ²) | |
| 1322-1980 | Voltage increase on 40 V conductor, voltage decrease on 80 V conductor | The voltages began to converge indicating incipient leakage to one another. The voltage on the 40 V conductor (stable at 43 V prior to leakage) increased to nominally 57 V while the 80 V (stable at 84 V prior to leakage) conductor decreased to 76 V. At the initial time, the temperature is approximately 266°C. |
| 1392-1980 | Voltage increase on active target for SCDU1 | The voltage on the active target for SCDU1 increased steadily to 8 V until locking in. The temperature of the cable was approximately 270°C at the initial time of increase. |
| 1392-2187 | Voltage increase on active targets for SCDU2, 3, and 4 | The voltage on active targets for SCDU2, 3, and 4 continued until the fuse clear on SCDU3. The maximum voltage on SCDU2, 3, and 4 were approximately 4 V, 3.8 V, and 2.5 V, respectively. |
| 1800-2700 | Penlight temperature increased by 10°C every 5 minutes | The Penlight set point temperature at the conclusion of the test was 365°C. |

Table B.126: Summary of observed faulting behavior for Test K4.

| Time (s) | Event | Discussion |
|-----------------|---|--|
| 1980-2700 | Spurious actuation on active target for SCDU1 | During this time period, the active target for SCDU1 spuriously actuated and continued for the duration of the test. The locked in voltage and current were approximately 124 V and 0.17 A. When looking at the data, the 120 V source conductor for SCDU2 was the major contributor to the actuation. The cable temperature at actuation was 296°C. |
| 2184-2187 | Active target for SCDU3 experienced voltage and current leakage | The active target for SCDU3 experienced a maximum of nearly 60 V and 0.74 A during this time period before the fuse cleared. |
| 2187 | Fuse clears for SCDU3 | Although the fuse clears on SCDU3, the 80 V conductor continued to see 10.13 V from another conductor while the nominal 40V conductor declined to approximately 37V. |
| 2700 | Test concluded, Penlight shutdown | Penlight was shut down before the cables could ignite. The cable temperatures reached 326°C before the test was concluded. |

B.10 Cable Item I: 12/C-12 AWG, FR-III

Cable Item I is a 12/C-12 AWG cable with FR-III insulation, according to the bill of materials provided by the donating company, and the conductors are numbered as depicted in Figure B.127. The cable was tested once during the DESIREE-Fire series intermediate-scale tests on the dc powered SOV1 circuit. It was tested once during the KATE-Fire tests on the modified SCDU circuit. The following sections detail the test parameters, conductor paths, circuit data, and test summary for each test.

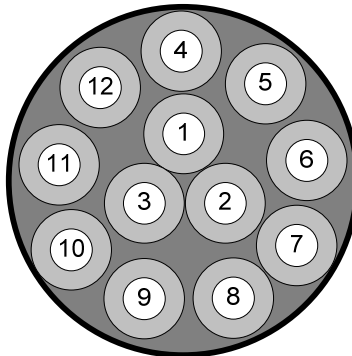

Figure B.127: Illustration of Cable Item I.

B.10.1 Test IS10

The intermediate-scale test series conducted during DESIREE-Fire provided a target opportunity to investigate the performance of Kerite cable in a more representative fire environment. During Test IS10, Item I was connected to the dc-powered SOV1 circuit and situated in Position B. The test parameters may be found in Table B.127. The conductor pathway for the cable monitoring unit may be found in Table B.128. Electrical performance of the cable may be found in Figure B.128 and Figure B.129. In the former graph, the positive and negative sources are graphed with the coil voltage. From here, a gradual voltage increase may be seen on the solenoid conductor; however, there was not sufficient enough voltage to cause spurious actuation before a subsequent fuse clear. The latter graph displays the voltage of the lamps throughout the test. The voltage reaches a point where false indication of the red light is observed. When looking at the graphs, it should be noted that the voltages are referenced to ground. Since the other fused circuits are connected to the same dc power supply, the ground continues to drift after the negative fuse clears on SOV1. The temperature profile and voltage response may be found in Figure B.130. In this figure, the air temperature is listed as the location of the cable and the length along the tray while the sub-jacket temperature is listed with the location of the cable, cable type, and length along the sample. A summary of the test results may be found in Table B.129.

Table B.127: Test parameters for Test IS10.

| | |
|------------------------------|-----------------------------|
| Test Name | Test IS10 |
| Test Date | 3/25/2010 |
| Cable Type for SOV1 | Kerite 12/C-12 AWG, FR-III |
| SOV1 Position | Position C |
| Cable Fill Type | Bundle Tray A, Cable 1 |
| Cables Co-Located in Raceway | Cable 2 - TC Cable for SOV1 |
| | Cable 3 - MOV1 |
| | Cable 4 - TC Cable for MOV1 |
| Battery Voltage (Pre-test) | 121.96 Vdc |
| Battery Voltage (Post-test) | 122.21 Vdc |

Table B.128: Conductor designation for Item I, Test IS10.

| Test IS10, SOV1, 12/C-12 AWG | | | | | |
|------------------------------|----------------------------|--|---------------------------------------|-----------------------------|----------------------------|
| Lead Cable Conductor number | Lead cable conductor color | Terminal block location in DCSim Panel | Terminal block circuit identification | Test Cable conductor number | Test cable conductor color |
| 1 | Black | TB2 | P | 4 | Green |
| 2 | White | TB4 | G | 5 | Orange |
| 3 | Red | TB3 | S1 | 6 | Blue |
| 4 | Green | TB6 | R | 7 | White/Black |

Table B.128: Conductor designation for Item I, Test IS10.

| Test IS10, SOV1, 12/C-12 AWG | | | | | |
|------------------------------|----------------------------|--|---------------------------------------|-----------------------------|----------------------------|
| Lead Cable Conductor number | Lead cable conductor color | Terminal block location in DCSim Panel | Terminal block circuit identification | Test Cable conductor number | Test cable conductor color |
| 5 | Orange | TB9 | N | 8 | Red/Black |
| 6 | Blue | TB7 | SP | 9 | Green/Black |
| 7 | White/Black | TB8 | S2 | 10 | Orange/Black |

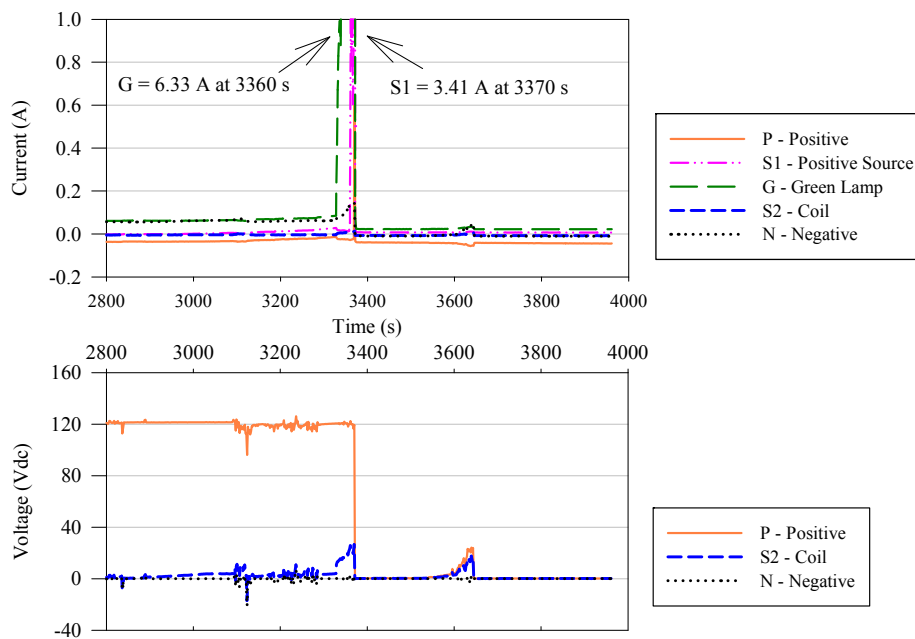

Figure B.128: Voltage and current response for the active target in Test IS10, SOV1.

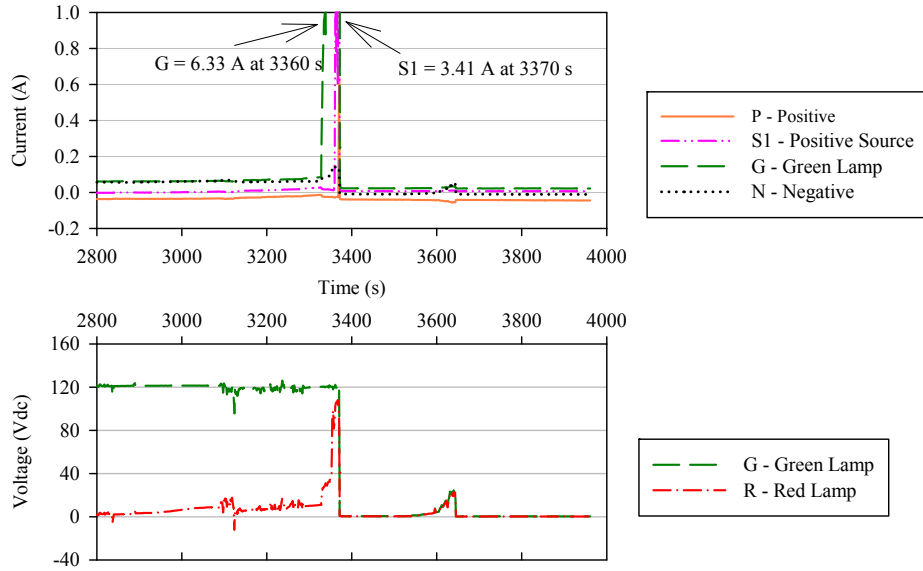

Figure B.129: Voltage and current response for the lamps in Test IS10, SOV1.

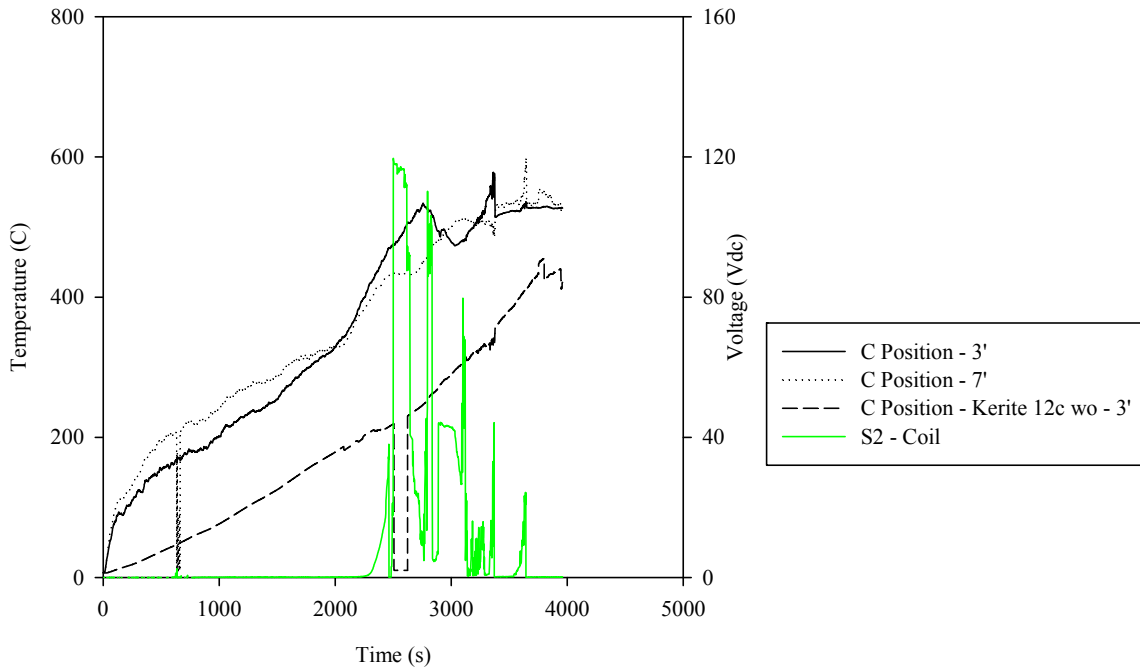

Figure B.130: Temperature profile and electrical response for Test IS10, SOV1.

Table B.129: Summary of observed faulting behavior for Test IS10, Item I.

| Time (s) | Event | Discussion |
|----------|----------------|------------|
| 0 | Fire initiated | |

Table B.129: Summary of observed faulting behavior for Test IS10, Item I.

| Time (s) | Event | Discussion |
|-----------|--|--|
| 2298-2463 | Voltage increase from 1.06V to 38V on Solenoid | |
| 2458-2463 | False indication red light | |
| 3372 | Positive fuse clears | The main battery bank is used to power all the dc circuits during the intermediate-scale experiments. Since the graphed voltage is referenced to the common ground and not all circuit fuses clear at the same time, some graphs may indicate that electrical activity is occurring after this noted time. |
| 3960 | Fire off | |

B.10.2 Test K19

Test K19 utilized the multiple SCDU configuration detailed in Appendix A to monitor the electrical performance of the cable throughout the thermal exposure. The test parameters may be found in Table B.130. Penlight was initially set to 325°C for a half hour before the temperature was increased 10°C every five minutes. The final Penlight set point temperature was 445°C. At 3000 s into the test and a cable temperature of 330 °C, the voltage on the 40 V center conductor increased from 43 V to 47 V over a 37 minute time span. At approximately 4974 s into the test, the cables ignited at a Penlight and cable temperature of 435 °C and 400 °C, respectively. The fuse for SCDU1 cleared approximately 3 minutes later. At 5210 s, the fuse on SCDU2 cleared. About 9 s later, there was a voltage increase of less than 1 V to 21 V over a 5 s span on the active target for SCDU3 before the fuse on SCDU4 cleared. The final fuse cleared at 5311 s and the test was subsequently concluded. The conductor pathway for the cable monitoring unit may be found in Table B.131. Overall electrical performance of the cable may be found in Figure B.131. A graph displaying the target behavior may be observed in Figure B.133. A graph displaying the fuse clears may be found in Figure B.132. The electrical performance for the temperature exposure may be found in Figure B.134. A summary of the electrical performance of the cable may be found in Table B.132.

Table B.130: Test parameters for Test K19.

| | |
|--------------------------------|----------------------------|
| Test Series | KATE-FIRE |
| Test Name | Test 19 |
| Test Date | 11/10/2010 |
| Cable 1 | Kerite 12/C-12 AWG, FR-III |
| Cable Monitoring Unit Utilized | SCDU (M) |
| Cable 2 | NA |
| Cable Monitoring Unit Utilized | NA |

Table B.130: Test parameters for Test K19.

| | |
|-------------------------------|--------|
| Penlight Starting Temperature | 325 °C |
| Penlight Final Temperature | 445 °C |

Table B.131: Conductor designation for Item I, Test K19.

| Kerite 12/C-12 AWG, FR-III. Black cable, gray conductors with white print | | | | |
|---|-----------------|---------------------|-------------------|---|
| Conductor Number | Conductor Color | SCDU Circuit Number | SCDU Circuit Path | Notes |
| 1 | Black | 2 | S2/T4 | Adjusted source conductor which was connected through 3.6 kΩ resistor. By doing this, the output source voltage was reduced to 40 V – SCDU2 Voltage = C2 V4; current = C2 I4 |
| 2 | White | 3 | S2/T4 | Adjusted source conductor which was connected through 1.8 kΩ resistor. By doing this, the output source voltage was reduced to 60 V – SCDU3 Voltage = C3 V4; current = C3 I4 |
| 3 | Red | 4 | S2/T4 | Adjusted source conductor which was connected through 0.9 kΩ resistor. By doing this, the output source voltage was reduced to 80 V – SCDU3 Voltage = C3 V4; current = C3 I4 |
| 4 | Green | 1 | G7 | Grounded conductor for SCDU1– Voltage = C1 V7; current = C1 I7 |
| 5 | Orange | 1 | S1 | Energized source conductor for SCDU1– Voltage = C1 V1; current = C1 I1 |
| 6 | Blue | 1 | T5 | Active target conductor for SCDU1 – Voltage = C1 V5; current = C1 I5 |
| 7 | White/Black | 2 | S1 | Energized source conductor for SCDU2– Voltage = C2 V1; current = C2 I1 |
| 8 | Red/Black | 2 | T5 | Active target conductor for SCDU2 – Voltage = C2 V5; current = C2 I5 |
| 9 | Green/Black | 3 | S1 | Energized source conductor for SCDU3– Voltage = C3 V1; current = C3 I1 |
| 10 | Orange/Black | 3 | T5 | Active target conductor for SCDU3 – Voltage = C3 V5; current = C3 I5 |
| 11 | Blue/Black | 4 | S1 | Energized source conductor for SCDU4– Voltage = C4 V1; current = C4 I1 |
| 12 | Black/White | 4 | T5 | Active target conductor for SCDU4 – Voltage = C4 V5; current = C4 I5 |

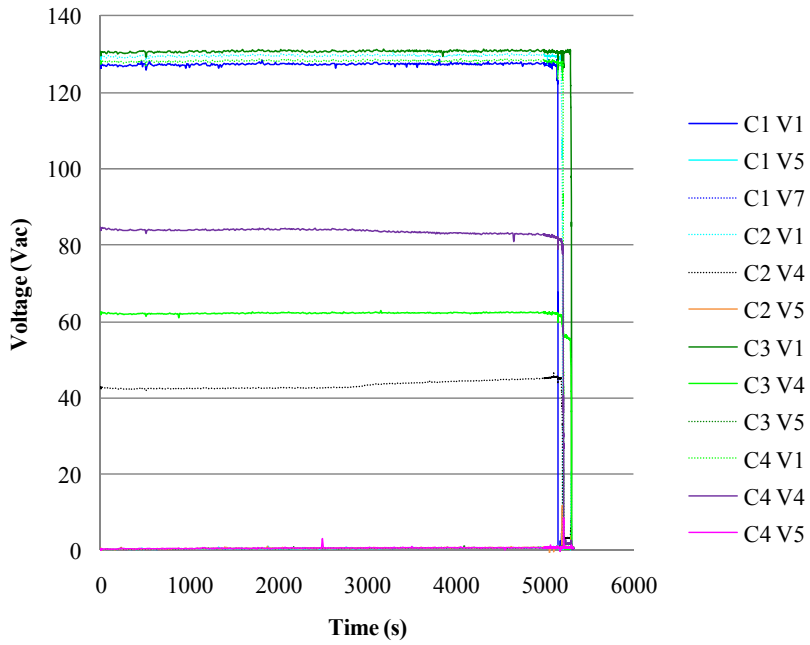

Figure B.131: All conductor voltages for Test K19.

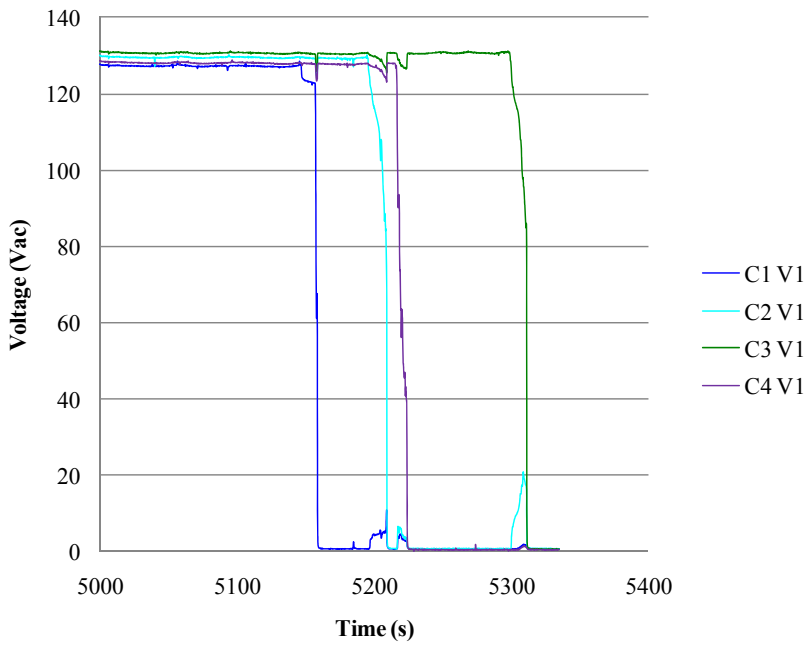

Figure B.132: All 120 V source conductor voltages for Test K19 displaying fuse clears.

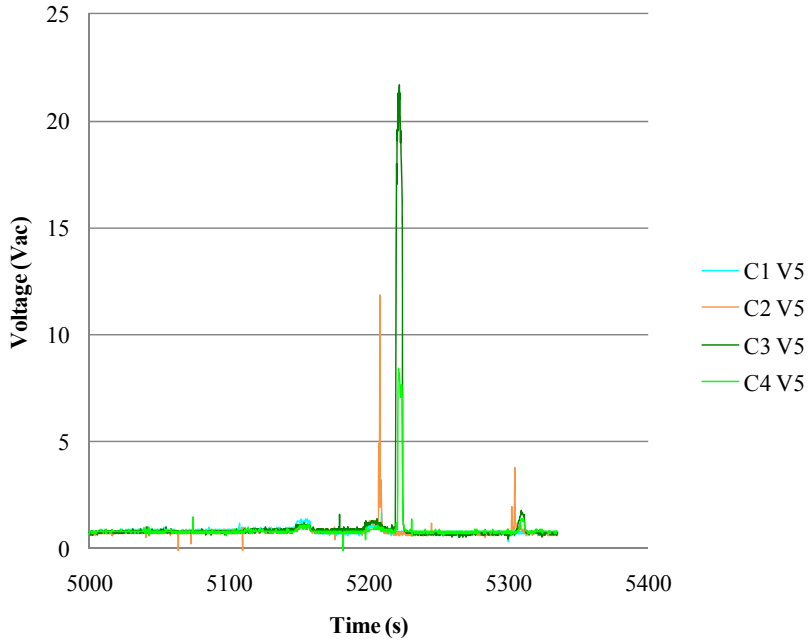

Figure B.133: All target conductor voltages for Test K19 displaying voltage increase, but did not result in actuation.

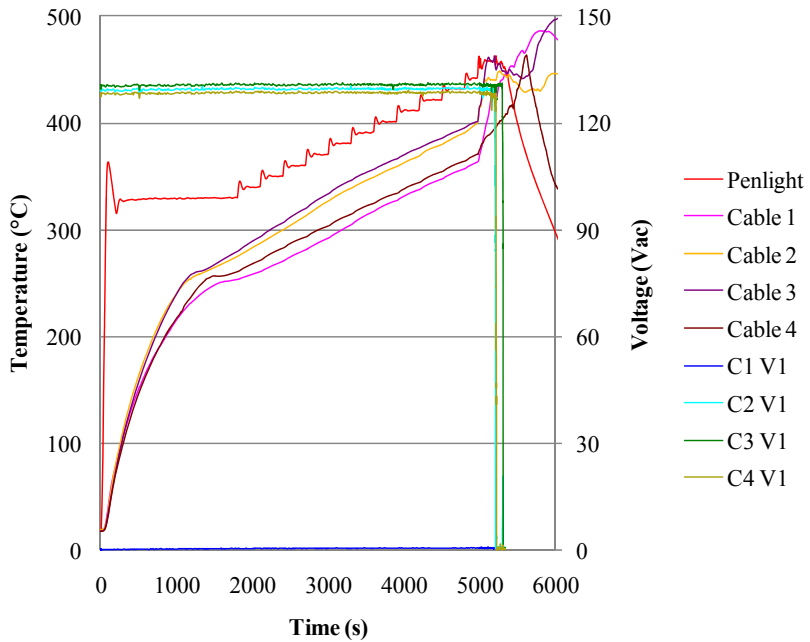

Figure B.134: Penlight shroud temperature, cable temperatures, and conductor voltages for Test K19.

Table B.132: Summary of observed faulting behavior for Test K19.

| Time (s) | Event | Discussion |
|-----------------|--|---|
| 0 | Penlight On; set at 325°C (5.92 kW/m ²) | |
| 1800-5335 | Penlight temperature increased by 10°C every 5 minutes | Penlight temperature was increased stepwise by 10°C every 5 minutes during this time period until ignition. Upon ignition, the Penlight set point temperature remained constant until the conclusion of the test. The final Penlight set point was 445°C. |
| 3000-5219 | Voltage increase on the 40 V center conductor | During this time span, the voltage increased on the nominal 40 V conductor (reading approximately 43 V throughout the first part of the test) to a maximum of 47 V. The temperature at the initial voltage increase was approximately 330 °C. |
| ~4974 | Ignition | The time denoted was approximated from the field notes; however, the time appears reasonable given the data. The cable temperature at ignition was approximately 400 °C. |
| 5159 | Fuse clear SCDU1 | |
| 5210 | Fuse clear SCDU2 | |
| 5219-5224 | Voltage increase on the active target of SCDU3 | The voltage increased from 1 V to a maximum of 21 V on the active target of SCDU3 before the SCDU4 fuse cleared. During this period of time, the current increased from approximately 0.04 A to 0.33 A. There was no actuation. |
| 5224 | Fuse clear SCDU4 | |
| 5311 | Fuse clear SCDU3 | Although the fuses on SCDU1, 2, and 4 cleared earlier than SCDU3, the 60 V conductor continued to provide up to 9 V and 4 V on the 40 and 80 V conductors, respectively, until the ultimate fuse clear. |
| 5335 | Test concluded, Penlight shutdown | |

B.11 Cable Item J: 15/C-12 AWG, FR, zinc wrap

Cable Item J is a 15/C-12 AWG cable with FR insulation, according to the bill of materials provided by the donating company, and the conductors are numbered as depicted in Figure B.135. Surrounding the conductors is a zinc tape wrap which was grounded during each test based on typical plant practices as specified by the donating company. The cable was tested once during DESIREE-Fire using the switchgear trip and close circuits. It was tested once during KATE-Fire on a modified SCDU. The following sections detail the test parameters, conductor paths, circuit data, and test summary for each test.

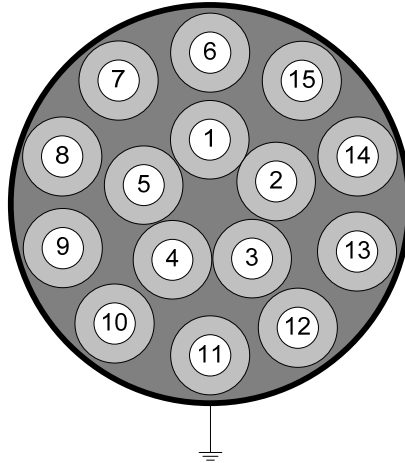

Figure B.135: Illustration of Cable Item J.

B.11.1 Test IS10

The intermediate-scale test series conducted during DESIREE-Fire provided a target opportunity to investigate the performance of Kerite cable in a more representative fire environment. During Test IS10, Item J was connected to the dc-powered switchgear trip and close circuit and situated in Position B. The test parameters may be found in Table B.133. The conductor pathway for the cable monitoring unit may be found in Table B.134. From here, it may be discerned that the inner core of conductors were connected to the close coil circuit and the outer core conductors were connected to the trip circuit. The electrical performance of the cable may be found in Figure B.136, Figure B.137, and Figure B.138 which represents the close coil, trip coil, and indication lamps during the thermal exposure. At 2644 s and a cable temperature of 261°C, voltage on the green conductor began to decrease. At 2802 s, the TC monitoring the air temperature started to display erratic behavior, fluctuating between 0 and 1400°C for the remainder of the test. At 3108 s and a cable temperature of 331°C, the trip coil actuated. The temperature profile and voltage response may be found in Figure B.139. In this figure, the air temperature is listed as the location of the cable and the length along the tray while the sub-jacket temperature is listed with the location of the cable, cable type, and length along the sample. A summary of the test results may be found in Table B.135.

Table B.133: Test parameters for Test IS10.

| | |
|------------------------------|------------------------------------|
| Test Name | Test IS10 |
| Test Date | 3/25/2010 |
| Cable Type for SWGR T/C | Kerite, 15/C-12 AWG, FR, zinc wrap |
| SWGR T/C Position | Position B |
| Cable Fill Type | Specialized Tray C, Cable 2 |
| Cables Co-Located in Raceway | Cable 1 - MOV2 |
| | Cable 3 - SOV2 |
| Battery Voltage (Pre-test) | 121.96 Vdc |

Table B.133: Test parameters for Test IS10.

| | |
|-----------------------------|------------|
| Battery Voltage (Post-test) | 122.21 Vdc |
|-----------------------------|------------|

Table B.134: Conductor designation for Item J, Test IS10.

| Test IS10, Switchgear, 15/C-12 AWG, zinc wrap | | | | | |
|---|----------------------------|--|---------------------------------------|-----------------------------|----------------------------|
| Lead Cable Conductor number | Lead cable conductor color | Terminal block location in DCSim Panel | Terminal block circuit identification | Test Cable conductor number | Test cable conductor color |
| 1a | Black | TB 2 | PC | 1 | Black |
| 2a | White | n/a | n/a | 2 | White |
| 3a | Red | TB 3 | C1 | 3 | Red |
| 4a | Green | n/a | n/a | 4 | Green |
| 5a | Orange | TB 5 | N1 | 5 | Orange |
| 6a | Blue | n/a | n/a | 6 | Blue |
| 7a | White/Black | n/a | n/a | 7 | White/Black |
| 1b | Black | TB2 | PT | 8 | Red/Black |
| 2b | White | TB3 | G | 9 | Green/Black |
| 3b | Red | TB6 | T | 10 | Orange/Black |
| 4b | Green | TB4 | R | 11 | Blue/Black |
| 5b | Orange | TB9 | N2 | 12 | Black/White |
| 6b | Blue | TB8 | SP | 13 | Red/White |
| 7b | White/Black | TB7 | SP | 14 | Green/White |
| NA | NA | NA | NA | 15 | Orange/White |

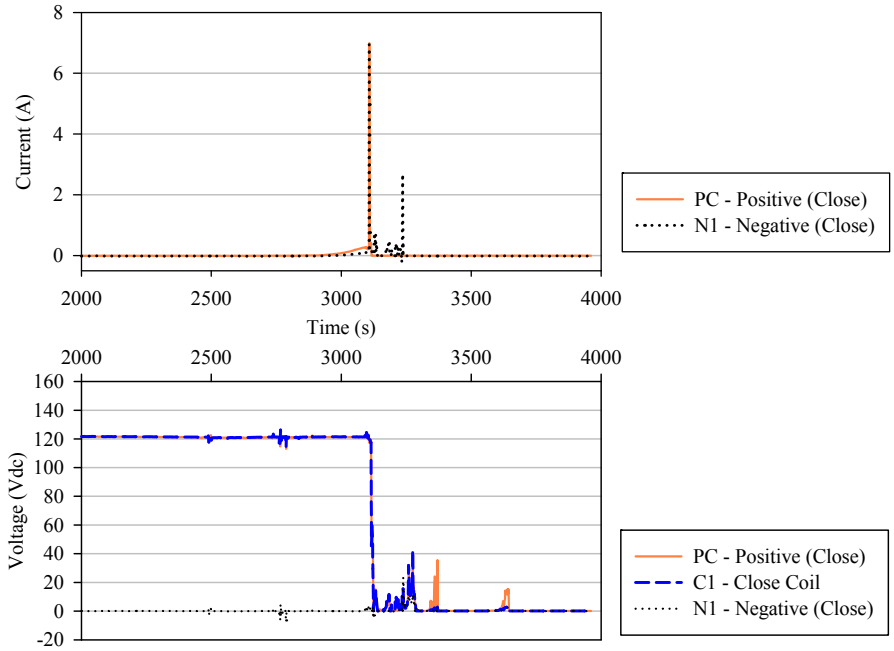

Figure B.136: Voltage and current response for the close coil in Test IS10, SWGR.

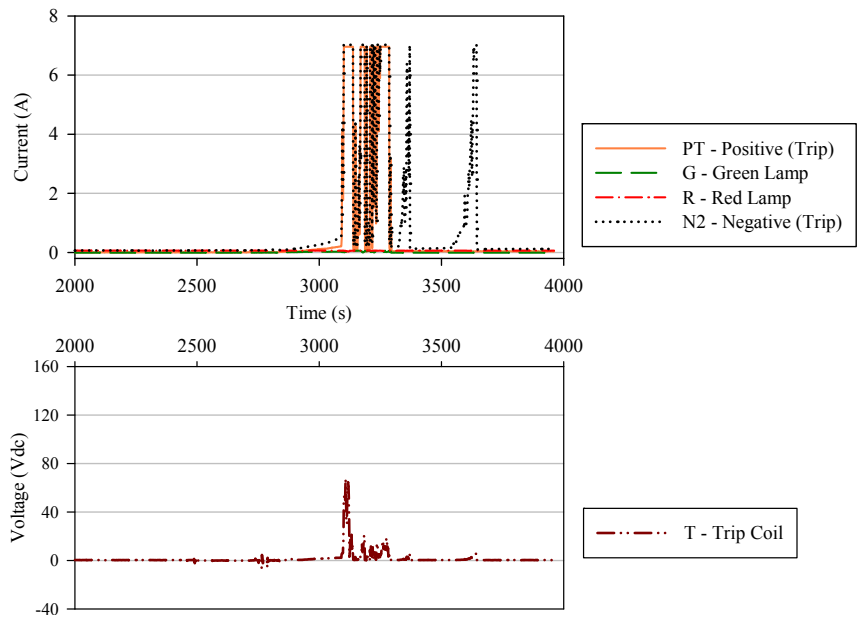

Figure B.137: Voltage and current response for the trip coil in Test IS10, SWGR.

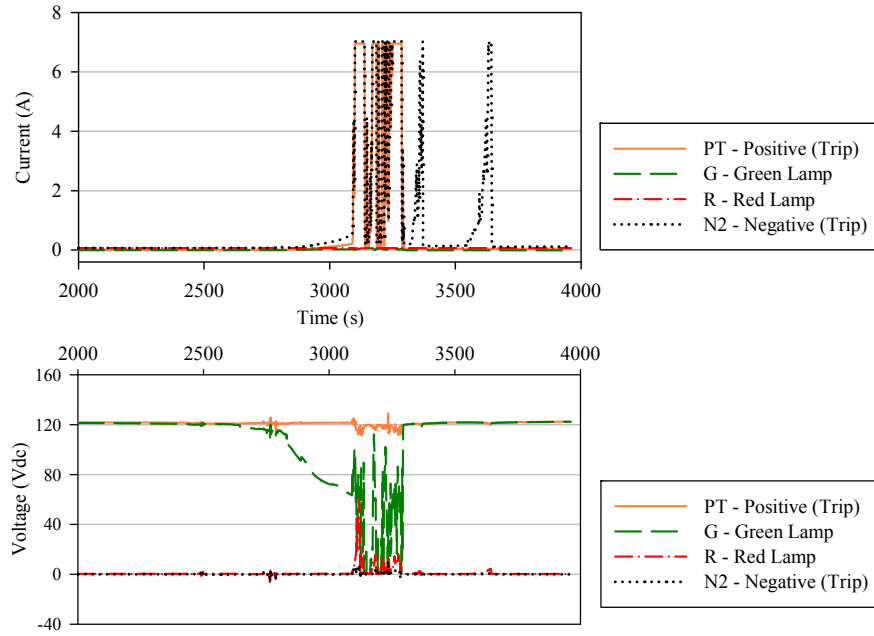

Figure B.138: Voltage and current response for the lamps in Test IS10, SWGR.

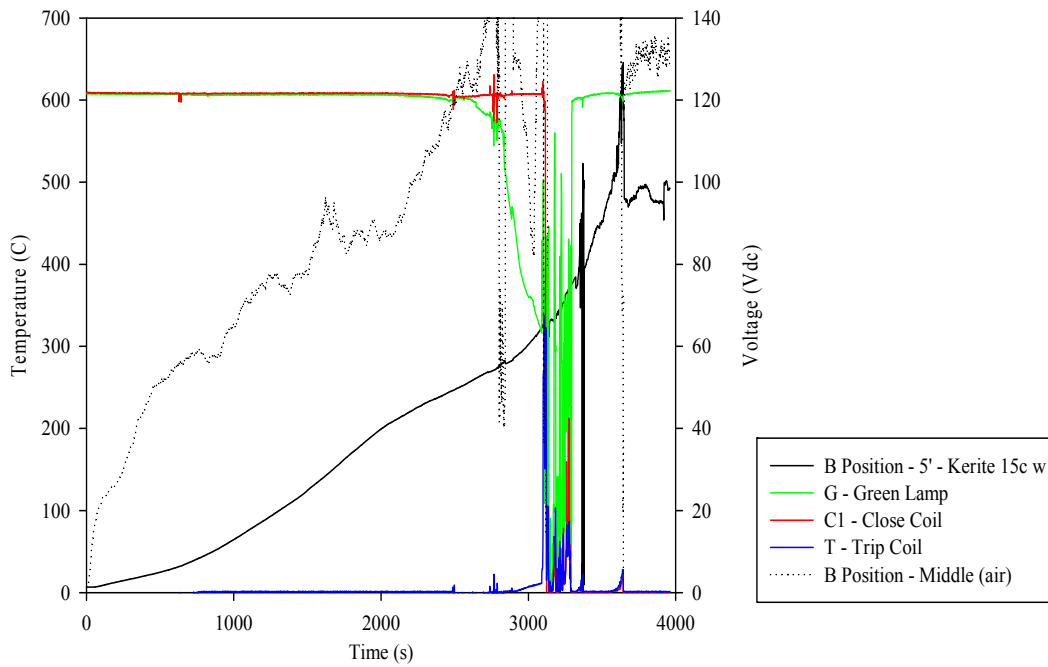

Figure B.139: Temperature profile and electrical response for Test IS10, SWGR.

Table B.135: Summary of observed faulting behavior for Test IS10.

| Time (s) | Event | Discussion |
|-----------------|---|--|
| 0 | Fire Initiated | Breaker is closed, there is a jumper installed between C1 and PB. |
| 657- 968 | Negative going to ground potential | |
| 968-2484 | Negative shorted to ground | |
| 2644-3090 | SWGR-T: Voltage on G decreasing slowly | The cable temperature was approximately 261°C when the voltage began decreasing. |
| 2802 | Air TC not functioning properly | The air temperatures recorded by the TC fluctuated between 0 and 1400°C erratically. |
| 3108 | SWGR-T: Spurious actuation on trip coil (T) | Breaker is open. At this time, the cable temperature was approximately 338°C. |
| 3177 | SWGR-C: Positive fuse clears | |
| 3236 | SWGR-C: Negative fuse clears | |
| 3960 | Fire off | |

B.11.2 Test K20

Test K20 utilized the multiple SCDU configuration detailed in Appendix A to monitor the electrical performance of the cable throughout the thermal exposure. The test parameters may be found in Table B.136. Penlight was initially set to 325°C for a half hour before the temperature was increased 10°C every five minutes. The final Penlight set point temperature was 415°C. Starting at 1994 s and 276°C, the voltages increased from less than 1 V to more than 5 V on the active targets in the inner and outer core over nearly a 7 minute time span. Additionally, during this period, the energized center conductors experienced voltage changes, the most dramatic was the 15 V drop in the nominal 80 V conductor. At 2400 s, the voltages steadily declined until the fuse on SCDU2 cleared at 3468 s. Ignition occurred at approximately 3933 s at a temperature of 361°C. Shortly after ignition, the fuse on SCDU3 cleared. At 4321 s, a voltage increase from 5 V to 39 V was detected on the source conductor for SCDU2 indicating shorting behavior from an

energized source, most likely from SCUD4, to that conductor. A spurious actuation was witnessed on the active target 6 for SCUD3 which persisted for 3 s. A high current short was observed on the SCUD1 and SCUD4 source until the fuses cleared at 4332 s. The test was subsequently concluded 25 s after these fuses cleared. The conductor pathway for the cable monitoring unit may be found in Table B.137. Overall electrical performance of the cable may be found in Figure B.140. A graph displaying the fuse clears may be found in Figure B.141. A graph displaying the target behavior may be observed in Figure B.142. The altered source conductors (i.e., the 40, 60, and 80 V) may be found in Figure B.143. These altered conductors were located in the center bundle of conductors along with two targets from SCUD2. The target performance from the center bundle may be found in Figure B.144. The electrical performance for the temperature exposure may be found in Figure B.145. A summary of the electrical performance of the cable may be found in Table B.138.

Table B.136: Test parameters for Test K20.

| | |
|--------------------------------|-----------------------------------|
| Test Series | KATE-FIRE |
| Test Name | Test 20 |
| Test Date | 11/11/2010 |
| Cable 1 | Kerite 15/C-12 AWG, FR, zinc wrap |
| Cable Monitoring Unit Utilized | SCDU (M) |
| Cable 2 | NA |
| Cable Monitoring Unit Utilized | NA |
| Penlight Starting Temperature | 325°C |
| Penlight Final Temperature | 415°C |

Table B.137: Conductor designation for Item J, Test K20.

| Kerite 15/C-12 AWG, FR, zinc wrap. Black cable, gray conductors with white print | | | | |
|--|-----------------|---------------------|-------------------|---|
| Conductor Number | Conductor Color | SCDU Circuit Number | SCDU Circuit Path | Notes |
| 1 | Black | 2 | S2/T4 | Adjusted source conductor which was connected through 3.6 kΩ resistor. By doing this, the output source voltage was reduced to 40 V – SCUD2 Voltage = C2 V4; current = C2 I4 |
| 2 | White | 3 | S2/T4 | Adjusted source conductor which was connected through 1.8 kΩ resistor. By doing this, the output source voltage was reduced to 60 V – SCUD3 Voltage = C3 V4; current = C3 I4 |
| 3 | Red | 2 | T5 | Active target conductor for SCUD2 – Voltage = C2 V5; current = C2 I5 |

Table B.137: Conductor designation for Item J, Test K20.

| Kerite 15/C-12 AWG, FR, zinc wrap. Black cable, gray conductors with white print | | | | |
|--|-----------------|---------------------|-------------------|---|
| Conductor Number | Conductor Color | SCDU Circuit Number | SCDU Circuit Path | Notes |
| 4 | Green | 4 | S2/T4 | Adjusted source conductor which was connected through 0.9 kΩ resistor. By doing this, the output source voltage was reduced to 80 V – SCDU3 Voltage = C3 V4; current = C3 I4 |
| 5 | Orange | 2 | T6 | Active target conductor for SCDU2 – Voltage = C2 V6; current = C2 I6 |
| 6 | Blue | 1 | S1 | Energized source conductor for SCDU1– Voltage = C1 V1; current = C1 I1 |
| 7 | White/Black | 1 | T5 | Active target conductor for SCDU1 – Voltage = C1 V5; current = C1 I5 |
| 8 | Red/Black | 1 | S2 | Energized source conductor for SCDU1– Voltage = C1 V2; current = C1 I2 |
| 9 | Green/Black | 1 | T6 | Active target conductor for SCDU1 – Voltage = C1 V6; current = C1 I6 |
| 10 | Orange/Black | 2 | S1 | Energized source conductor for SCDU2– Voltage = C2 V1; current = C2 I1 |
| 11 | Blue/Black | 3 | T5 | Active target conductor for SCDU3 – Voltage = C3 V5; current = C3 I5 |
| 12 | Black/White | 3 | S1 | Energized source conductor for SCDU3– Voltage = C3 V1; current = C3 I1 |
| 13 | Red/White | 3 | T6 | Active target conductor for SCDU3 – Voltage = C3 V6; current = C3 I6 |
| 14 | Green/White | 4 | S1 | Energized source conductor for SCDU4– Voltage = C4 V1; current = C4 I1 |
| 15 | Blue/White | 4 | T5 | Active target conductor for SCDU4 – Voltage = C4 V5; current = C4 I5 |
| Zinc Wrap | NA | 1 | G7 | Grounded conductor for SCDU1– Voltage = C1 V7; current = C1 I7 |

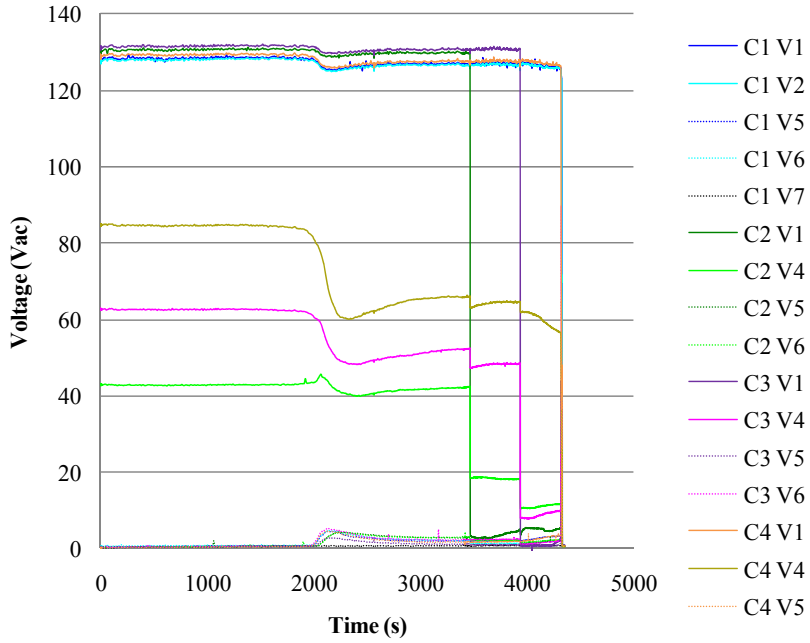

Figure B.140: All conductor voltages for Test K20 displaying early degradation and ultimate fuse clears.

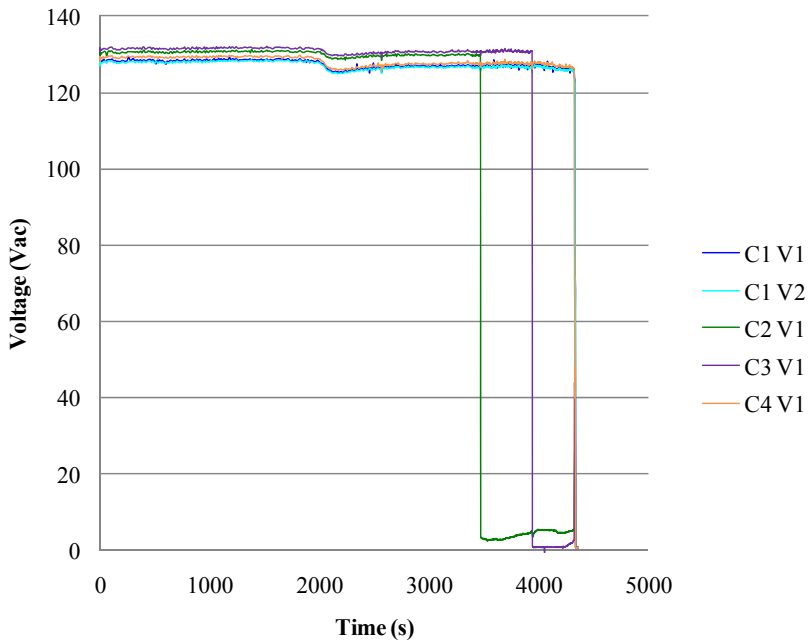

Figure B.141: All 120 V source conductor voltages for Test K20 displaying fuse clears.

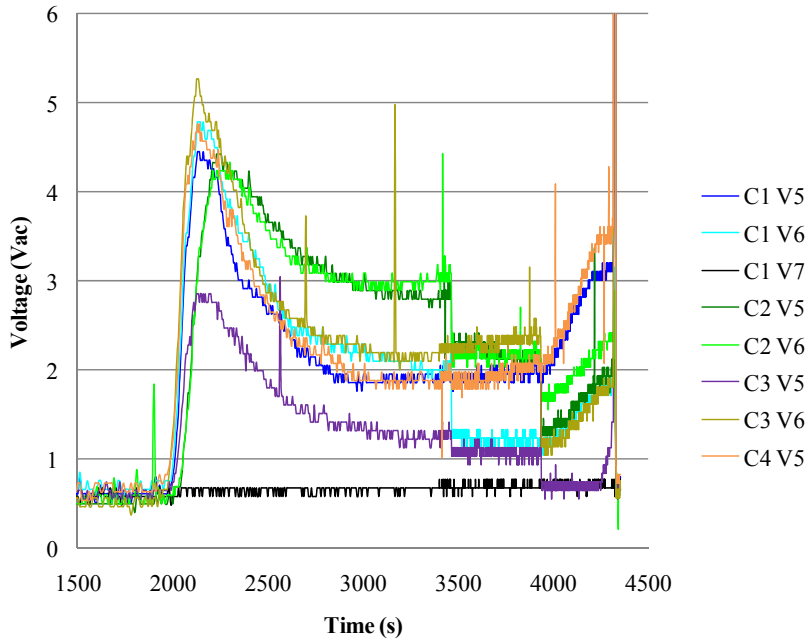

Figure B.142: All target conductor voltages for Test K20 displaying early degradation.

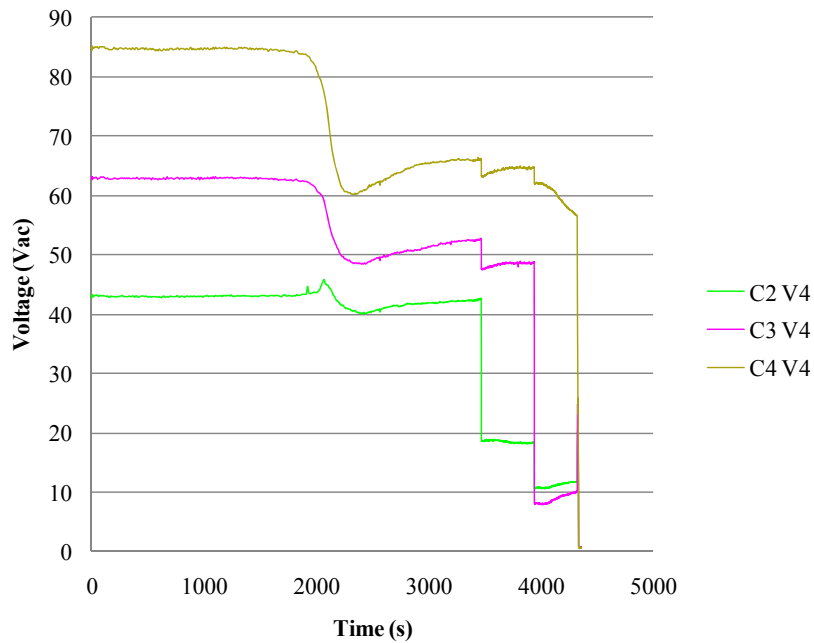

Figure B.143: All the altered conductor voltages for Test K20 displaying the early degradation and fuse clears.

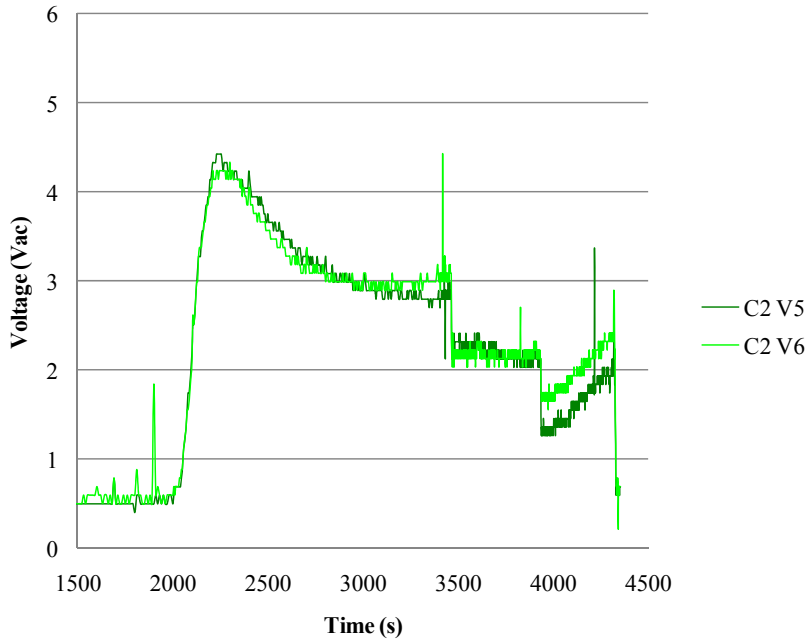

Figure B.144: Target conductor voltages within the center bundle of conductors for Test K20.

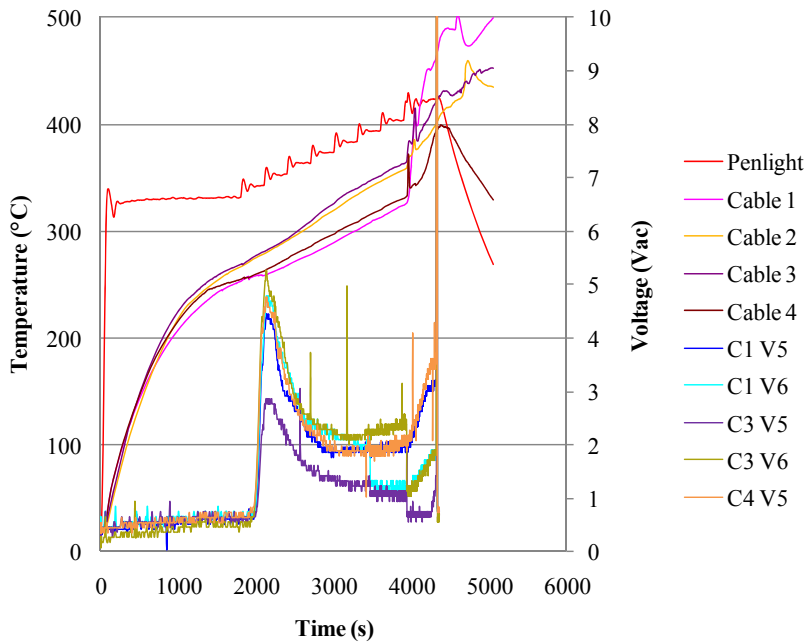

Figure B.145: Penlight shroud temperature, cable temperatures, and target conductor voltages for Test K20.

Table B.138: Summary of observed faulting behavior for Test K20.

| Time (s) | Event | Discussion |
|-----------------|---|--|
| 0 | Penlight On; set at 325°C (5.92 kW/m ²) | |
| 1800-4357 | Penlight temperature increased by 10°C every 5 minutes | Penlight temperature was increased stepwise by 10°C every 5 minutes during this time period until ignition. Upon ignition, the Penlight set point temperature remained constant until the conclusion of the test. The final Penlight set point was 415°C. |
| 1994-2400 | Voltage increase on the active targets | The active targets in the inner and outer core grouping of conductors all experienced an increase in voltage during this time span. The inner and outer core of active target conductors increased from less than 1 V to approximately 5 V. The temperature at the initial voltage increase was approximately 276°C. After this period of voltage increase, the voltages all declined until the fuses subsequently cleared. The energized sources in the center core of conductors experienced the most dramatic change in voltage as the nominal 80 V conductor (reading 85 V) dropped to approximately 60 V, the nominal 60 V conductor (reading 63 V) dropped to approximately 50 V, and the nominal 40 V conductor (reading 43 V) dropped to 40 V. |
| 2083-2229 | Period of insulation resistance degradation | From 2083-2229 s, the average IR on SCDU1, Target 5 was approximately 1840 Ω. From 2083-2229 s, the average IR on SCDU1, Target 6 was approximately 1691 Ω. From 2083-2229 s, the average IR on SCDU3, Target 5 was approximately 2756 Ω. From 2083-2229 s, the average IR on SCDU3, Target 6 was approximately 1580 Ω with a low of 1365 at 2084 s. From 2083-2229 s, the average IR on SCDU4, Target 5 was approximately 1640 Ω with a low of 1527 Ω at 2129 s. The cable temperature was approximately 279°C at 2083 s. |
| 3468 | Fuse clear on SCDU2 | The cable temperature was approximately 344°C. |
| ~3933 | Ignition | The time denoted was approximated from the field notes; however, the time appears reasonable given the data. The cable temperature at ignition was approximately 361°C. |
| 3939 | Fuse clear on SCDU3 | |
| 4321-4332 | Voltage increase on SCDU2 and 3 source conductors and voltage decrease on SCDU4 | During this time span, the voltage on the source conductor for SCDU2 increased from 5 V to 39 V and the source on SCDU3 increased from approximately 2.5 V to 45 V. Meanwhile, the voltage on the source conductor for SCDU4 decreased gradually from 126 V to less than 1 V and the current increased from less than 1 A to approximately 5.3 A indicating a high current short to ground |

Table B.138: Summary of observed faulting behavior for Test K20.

| Time (s) | Event | Discussion |
|-----------------|-----------------------------------|---|
| 4322-4325 | Spurious actuation on SCDU3 | A spurious actuation occurred on the active target 6 on SCDU3. |
| 4332 | Fuse clear on SCDU1 and on SCDU4 | Upon the fuse clearing, as expected, all other test conductors declined to less than 1 V. |
| 4357 | Test concluded, Penlight shutdown | |

B.12 Cable Item K: 3/C-6 AWG, HT

Cable Item K is a 3/C-6 AWG cable with HT insulation, according to the bill of materials provided by the donating company, and the conductors are numbered as depicted in Figure B.146. The cable was tested three times during the DESIREE-Fire test series, all on SCDU. The following sections detail the test parameters, conductor paths, circuit data, and test summary. During Test D17 and D18, two different SCDU circuits were tested in each experiment.

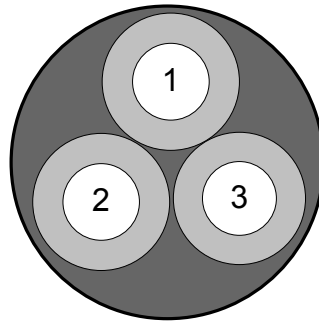

Figure B.146: Illustration of Cable Item K.

B.12.1 Test D17, Qualification

Test D17, Qualification (i.e., Test D17, Qual) was the first test of this cable sample. The purpose of this test was to quantify the failure mechanisms and possible failure temperature threshold. This test utilized the SCDU to monitor the electrical performance of the cable throughout the thermal exposure. The test parameters may be found in Table B.139. The conductor pathway for the cable monitoring unit may be found in Table B.140. Electrical performance of the cable may be found in Figure B.147 and Figure B.148. The cable did not degrade electrically prior to ignition. The first Penlight set point was 375°C for 20 minutes, then 400°C for 10 minutes, then 435°C for 10 minutes, and then to a maximum of 470°C before the cables ignited. The approximate cable temperature was 387°C prior to ignition. Shortly after ignition, there was a fuse clear on SCDU1 and Penlight was subsequently shutdown. There were no spurious actuations. A graph displaying the electrical response over the thermal exposure may be found in Figure B.149. A summary of the test results may be found in Table B.141.

Table B.139: Test parameters for D17, Qual.

| | |
|--------------------------------|------------------------|
| Test Series | DESIREE-FIRE |
| Test Name | Test 17, Qualification |
| Test Date | 7/30/2010 |
| Cable 1 | Kerite 3/C-6 AWG, HTK |
| Cable Monitoring Unit Utilized | SCDU1 |
| Cable 2 | NA |
| Cable Monitoring Unit Utilized | NA |
| Penlight Starting Temperature | 375°C |
| Penlight Final Temperature | 470°C |

Table B.140: Conductor designation for Item K, Test D17, Qual.

| Kerite 3/C-6 AWG, HTK. Black cable, tan conductors with white print | | | | |
|---|-----------------|---------------------|-------------------|---|
| Conductor Number | Conductor Color | SCDU Circuit Number | SCDU Circuit Path | Notes |
| 1 | Black | 1 | S1 | Energized source conductor for SCDU1 – Voltage = C1 V1; current = C1 I1 |
| 2 | White | 1 | T5 | Active target conductor for SCDU1 – Voltage = C1 V5; current = C1 I5 |
| 3 | Red | 1 | T6 | Active target conductor for SCDU1 – Voltage = C1 V6; current = C1 I6 |

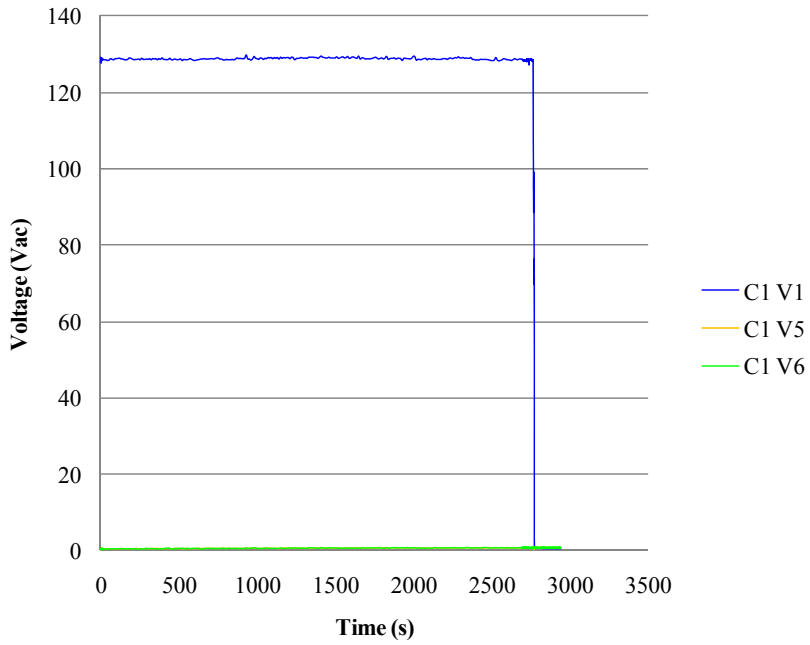

Figure B.147: All conductor voltages for Test D17, Qual indicating a fuse clear.

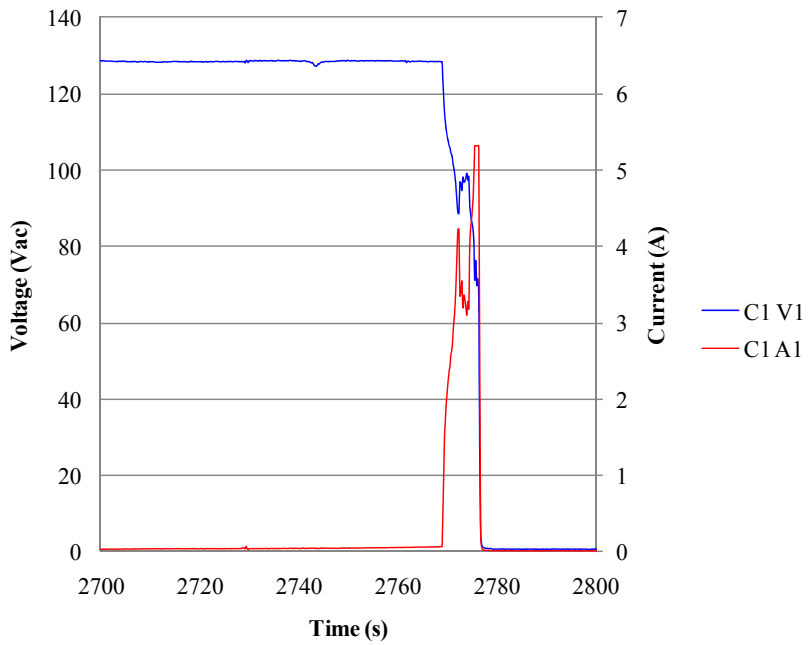

Figure B.148: Modified course conductor currents and voltages for Test D17, Qual.

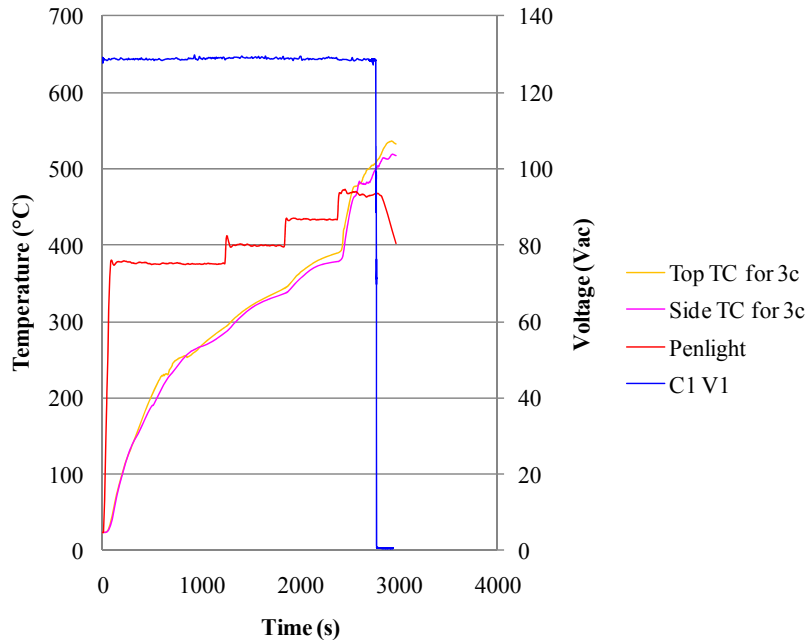

Figure B.149: Penlight shroud temperature and source conductor voltages for Test D17, Qual.

Table B.141: Summary of observed faulting behavior for D17, Qual, Circuit 1.

| Time (s) | Event | Discussion |
|----------|---|---|
| 0 | Penlight On; set at 375°C (8.16 kW/m ²) | |
| 1235 | Penlight set point temperature increased | The Penlight set point temperature was increased to 400°C |
| 1835 | Penlight set point temperature increased | The Penlight set point temperature was increased to 435°C |
| 2375 | Penlight set point temperature increased | The Penlight set point temperature was increased to 470°C |
| 2412 | Ignition | The cable ignited at a temperature of 386°C and an exposure of 470°C. |
| 2769 | Fuse clear | |
| 2817 | Test concluded, Penlight shutdown | |

B.12.2 Test D17

Given the results of the previous test, Test D17 provided the opportunity to further investigate the failure mechanism and threshold temperatures. Two SCDU units (i.e., Circuit 1 and Circuit

2) were utilized to monitor the electrical performance of the cable samples throughout the thermal exposure. The test parameters may be found in Table B.142. The conductor pathway for the both cable monitoring units may be found in Table B.143. Electrical performance of the cable samples may be found in the following two sections, namely Circuit 1 and Circuit 2.

Table B.142: Test parameters for Test D17.

| | |
|--------------------------------|-----------------------|
| Test Series | DESIREE-FIRE |
| Test Name | Test 17 |
| Test Date | 7/31/2010 |
| Cable 1 | Kerite 3/C-6 AWG, HTK |
| Cable Monitoring Unit Utilized | SCDU1 |
| Cable 2 | Kerite 3/C-6 AWG, HTK |
| Cable Monitoring Unit Utilized | SCDU2 |
| Penlight Starting Temperature | 430°C |
| Penlight Final Temperature | 430°C |

Table B.143: Conductor designation for Item K, Test D17, Circuit 1 and Circuit 2.

| Kerite 3/C-6 AWG, HTK. Black cable, tan conductors with white print | | | | |
|---|-----------------|---------------------|-------------------|--|
| Conductor Number | Conductor Color | SCDU Circuit Number | SCDU Circuit Path | Notes |
| 1 | Black | 1 and 2 | S1 | Energized source conductor for SCDU1 – Voltage = C1 V1; current = C1 I1 Energized source conductor for SCDU2 – Voltage = C2 V1; current = C2 I1 |
| 2 | White | 1 and 2 | T5 | Active target conductor for SCDU1 – Voltage = C1 V5; current = C1 I5 Active target conductor for SCDU2 – Voltage = C2 V5; current = C2 I5 |
| 3 | Red | 1 and 2 | T6 | Active target conductor for SCDU1 – Voltage = C1 V6; current = C1 I6 Active target conductor for SCDU2 – Voltage = C2 V6; current = C2 I6 |

B.12.2.1 Circuit 1

The Penlight temperature was set to 430°C for the entire test. Approximately 8 minutes into the test, swelling of the jacketing material and light smoke was observed from the test cables. Smoldering of the cable jacket was noticed about 4 minutes later; however, ignition would not occur until 29 minutes into the test. Two minutes after ignition, Targets 5 and 6 experienced electrical interactions which lead to alternating spurious actuation activity over a 60 s period at which point the fuse cleared. The cable did not degrade electrically prior to ignition. Electrical performance of the cable may be found in Figure B.150 and Figure B.151. The latter graph

displays the electrical activity on a smaller time scale which provides greater detail into the failure behavior. A graph displaying the electrical response over the thermal exposure may be found in Figure B.152. A summary of the test results may be found in Table B.144.

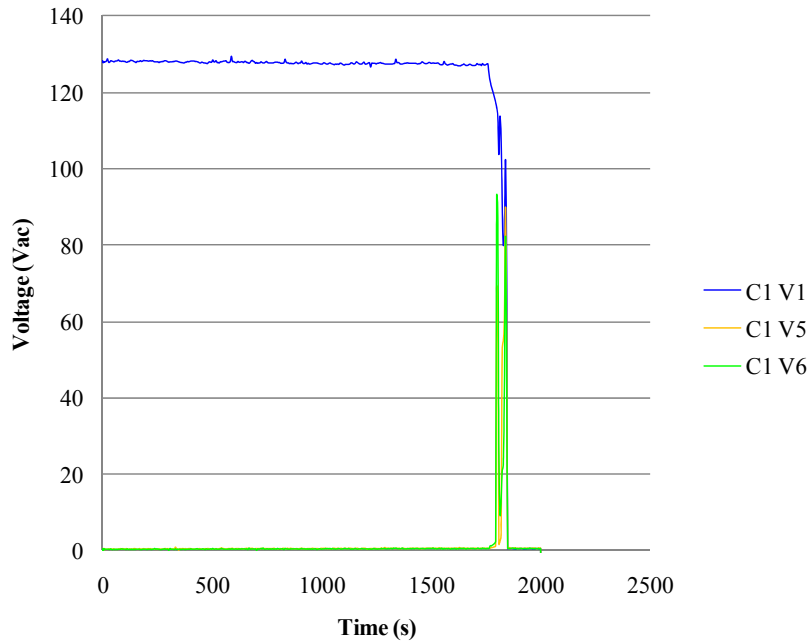

Figure B.150: All conductor voltages for Test D17, Circuit 1 showing target actuation and fuse clear.

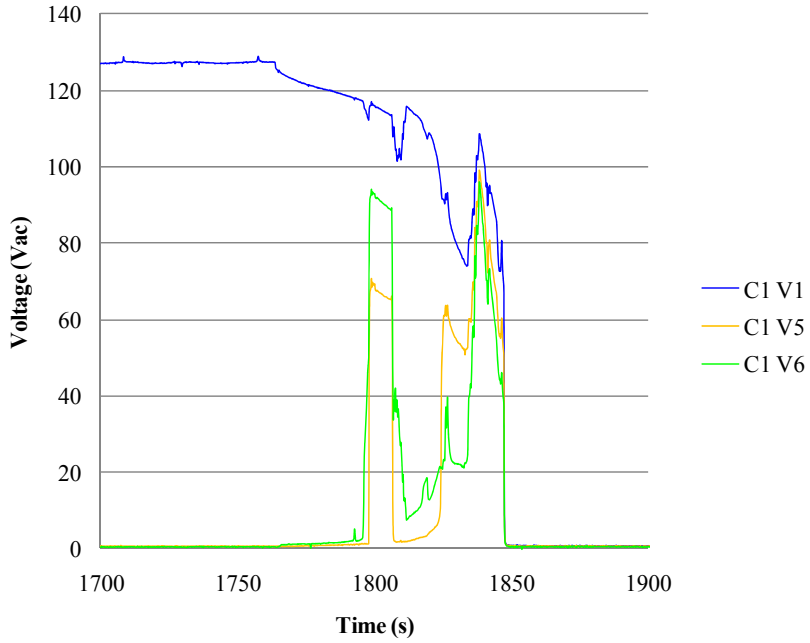

Figure B.151: Modified conductor voltages for Test D17, Circuit 1 providing more detail on the shorting and failure behavior of the cable sample.

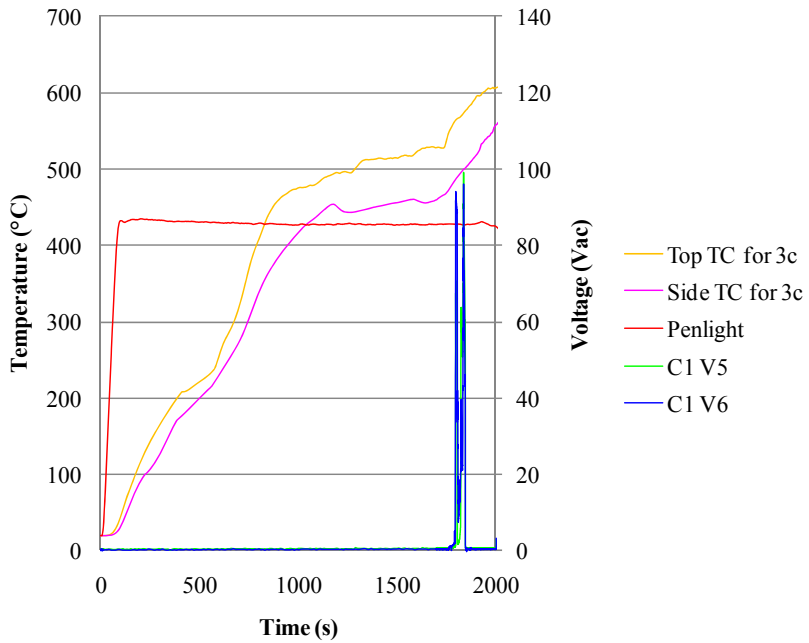

Figure B.152: Penlight shroud temperature and target conductor voltages for Test D17, Circuit 1.

Table B.144: Summary of observed faulting behavior for Test D17, Circuit 1.

| Time (s) | Event | Discussion |
|-----------------|---|--|
| 0 | Penlight On; set at 430°C (11.3 kW/m ²) | |
| 1740 | Ignition | Cable TCs most likely popped out of cable jacket since the temperatures were reading higher than anticipated temperatures. |
| 1764-1848 | Shorting behavior between source and targets | At this time, spurious actuations were observed between Target 5 and Target 6 until the fuse cleared. |
| 1848 | Fuse clear | The activity on Targets 5 and 6 ceased as the fuse for Circuit 1 tripped. |
| 1984 | Test concluded, Penlight shutdown | |

B.12.2.2 Circuit 2

The Penlight temperature was set to 430°C for the entire test. Approximately 8 minutes into the test, swelling of the jacketing material and light smoke was observed from the test cables. Smoldering of the cable jacket was noticed about 4 minutes later; however, ignition would not occur until 29 minutes into the test. Shortly after ignition, the source conductor experienced electrical degradation until initially shorting to Target 6 prior to the fuse clear. The shorting was not sufficiently strong enough to result in spurious actuation. The cable did not degrade electrically prior to ignition. Electrical performance of the cable may be found in Figure B.153. A graph displaying the electrical response over the thermal exposure may be found in Figure B.154. A summary of the test results may be found in Table B.145.

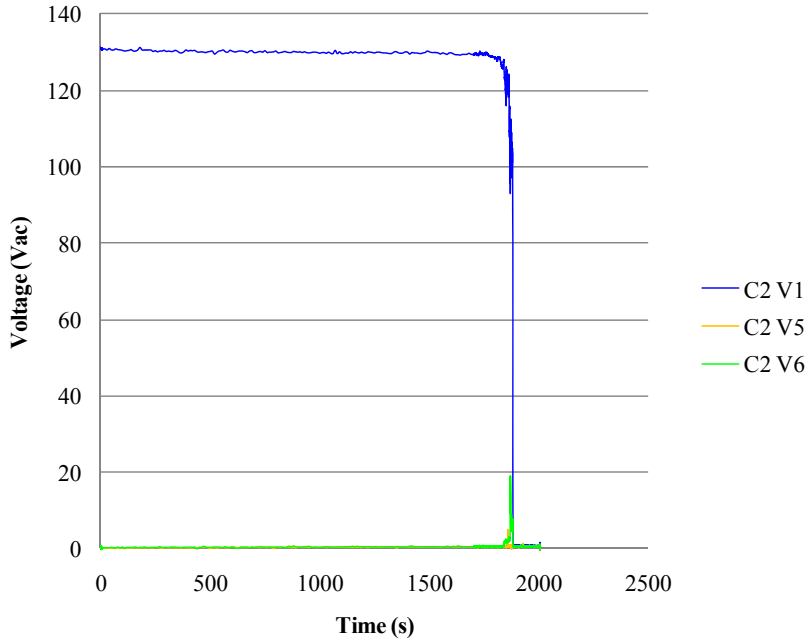

Figure B.153: All conductor voltages for Test D17, Circuit 2 displaying the fuse clear.

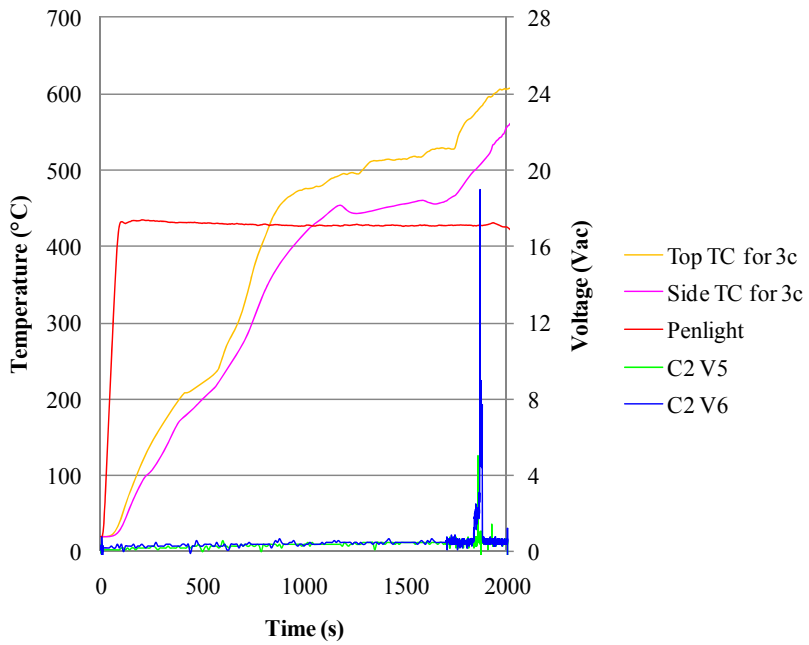

Figure B.154: Penlight shroud temperature and target conductor voltages for Test D17, Circuit 2.

Table B.145: Summary of observed faulting behavior for Test D17, Circuit 2.

| Time (s) | Event | Discussion |
|----------|---|--|
| 0 | Penlight On; set at 430°C (11.3 kW/m ²) | |
| 1740 | Ignition | Cable TCs most likely popped out of cable jacket. |
| 1785 | Voltage degradation on the source conductor | At this time, the voltage on the source conductor began to degrade. This degradation lasted approximately 115 s before the fuse tripped. |
| 1900 | Fuse clear | |
| 1984 | Test concluded, Penlight shutdown | |

B.12.3 Test D18

Test D18 was the final test for this cable sample. Two SCDU units (i.e., Circuit 1 and Circuit 2) were utilized to monitor the electrical performance of the cable samples throughout the thermal exposure. The test parameters may be found in Table B.146. The conductor pathway for the both cable monitoring units may be found in Table B.147. Electrical performance of the cable samples may be found in the following two sections, namely Circuit 1 and Circuit 2.

Table B.146: Test parameters for Test D18.

| | |
|--------------------------------|-----------------------|
| Test Series | DESIREE-FIRE |
| Test Name | Test 18 |
| Test Date | 7/31/2010 |
| Cable 1 | Kerite 3/C-6 AWG, HTK |
| Cable Monitoring Unit Utilized | SCDU1 |
| Cable 2 | Kerite 3/C-6 AWG, HTK |
| Cable Monitoring Unit Utilized | SCDU2 |
| Penlight Starting Temperature | 420°C |
| Penlight Final Temperature | 450°C |

Table B.147: Conductor designation for Item K, Test D18, Circuit 1 and Circuit 2.

| Kerite 3/C-6 AWG, HTK. Black cable, tan conductors with white print | | | | |
|---|-----------------|---------------------|-------------------|---------------------------------------|
| Conductor Number | Conductor Color | SCDU Circuit Number | SCDU Circuit Path | Notes |
| 1 | Black | 1 and 2 | S1 | Energized source conductor for SCDU1– |

Table B.147: Conductor designation for Item K, Test D18, Circuit 1 and Circuit 2.

| Kerite 3/C-6 AWG, HTK. Black cable, tan conductors with white print | | | | |
|---|-----------------|---------------------|-------------------|--|
| Conductor Number | Conductor Color | SCDU Circuit Number | SCDU Circuit Path | Notes |
| | | | | Voltage = C1 V1; current = C1 I1 Energized source conductor for SCDU2– Voltage = C2 V1; current = C2 I1 |
| 2 | White | 1 and 2 | T5 | Active target conductor for SCDU1 – Voltage = C1 V5; current = C1 I5 Active target conductor for SCDU2 – Voltage = C2 V5; current = C2 I5 |
| 3 | Red | 1 and 2 | T6 | Active target conductor for SCDU1 – Voltage = C1 V6; current = C1 I6 Active target conductor for SCDU2 – Voltage = C2 V6; current = C2 I6 |

B.12.3.1 Circuit 1

The initial Penlight temperature was set to 420°C and increased to 450°C after 42 minutes. Approximately 9 minutes into the test, swelling of the jacketing material and light smoke was observed from the test cables. Smoldering of the cable jacket was observed during the test prior to ignition. Ignition most likely occurred as a result of shorting in Circuit 2; however, the flames self-extinguished within 15 s according to the field notes. Approximately 90 s later, the cables would ignite again most likely due to the fuse clear for SCDU1. The cable did not degrade electrically prior to ignition. Electrical performance of the cable may be found in Figure B.155. A graph displaying the electrical response over the thermal exposure may be found in Figure B.156. A summary of the test results may be found in Table B.148.

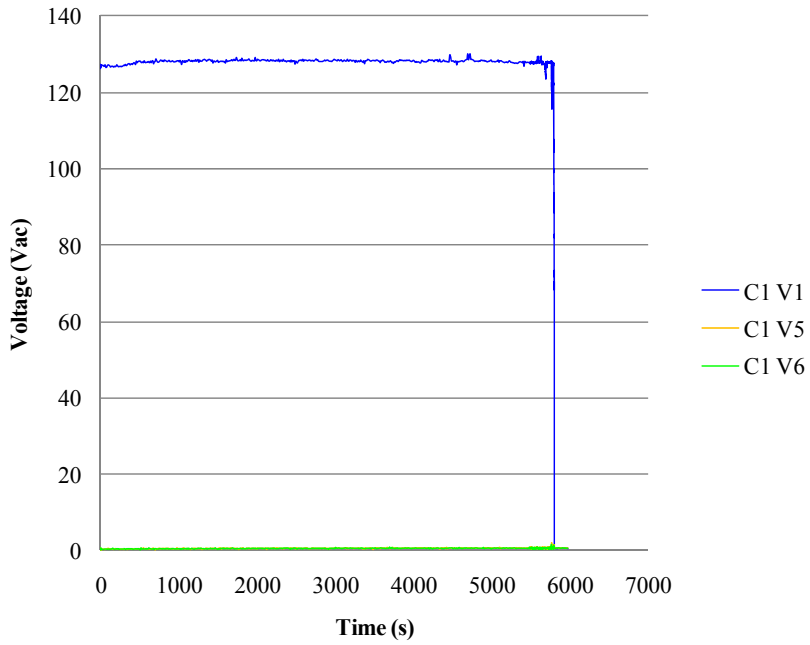

Figure B.155: All conductor voltages for Test D18, Circuit 1 showing a fuse clear.

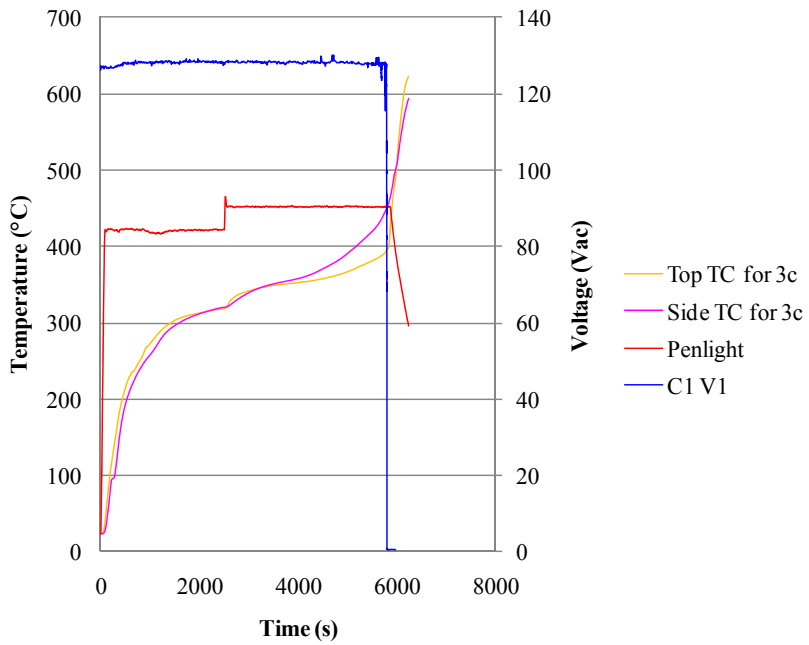

Figure B.156: Penlight shroud temperature and conductor voltages for Test D18, Circuit 1.

Table B.148: Summary of Observed Faulting Behavior for Test D18, Circuit 1.

| Time (s) | Event | Discussion |
|-----------------|--|---|
| 0 | Penlight On; set at 420°C (10.67 kW/m ²) | |
| 2510 | Penlight set point increased | Penlight temperature was increased to 450°C. |
| 5685 | Ignition | Cable temperature was approximately 410°C at an exposure temperature of 450°C. Ignition most likely occurred due to shorting behavior in Circuit 2. |
| 5701 | Flame self-extinguishes | |
| 5807 | Fuse cleared | |
| 5807 | Ignition | |
| 5877 | Test concluded, Penlight shutdown | |

B.12.3.2 Circuit 2

The initial Penlight temperature was set to 420°C and increased to 450°C after 42 minutes. Approximately 9 minutes into the test, swelling of the jacketing material and light smoke was observed from the test cables. Smoldering of the cable jacket was observed during the test prior to ignition. Ignition most likely occurred as a result of shorting and spurious actuation of Target 6 for Circuit 2; however, the flames self-extinguished within 15 s just as the fuse cleared in accordance with the field notes and electrical data. Approximately 90 s later, the cables would ignite again most likely due to the fuse clear for SCDU1. The cable did not degrade electrically prior to ignition. Electrical performance of the cable may be found in Figure B.157 and Figure B.158. The latter graph provides more detail into how the cable fails electrically over a shorter time span. A graph displaying the electrical response over the thermal exposure may be found in Figure B.159. A summary of the test results may be found in Table B.149.

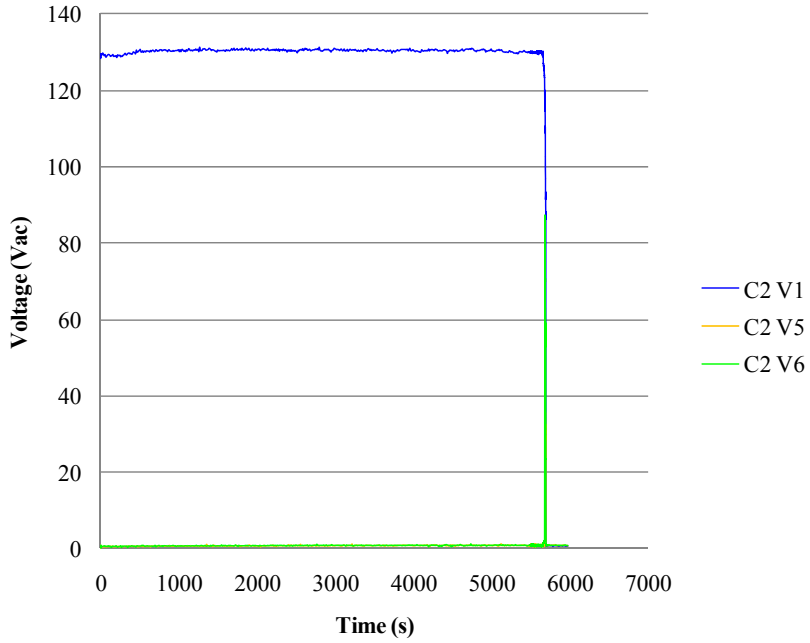

Figure B.157: All conductor voltages for Test D18, Circuit 2 illustrating the spurious actuation and fuse clear.

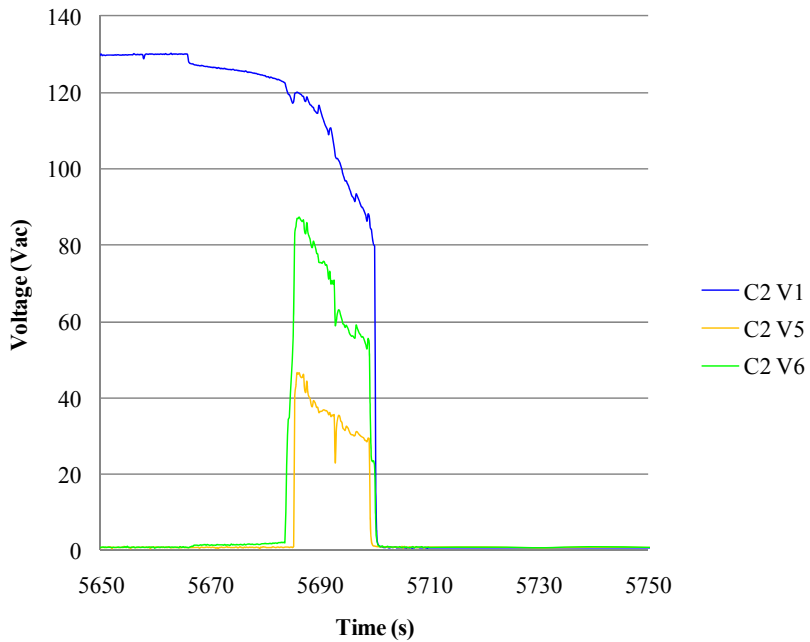

Figure B.158: Modified voltages for the source and target conductors in Test D18, Circuit 2.

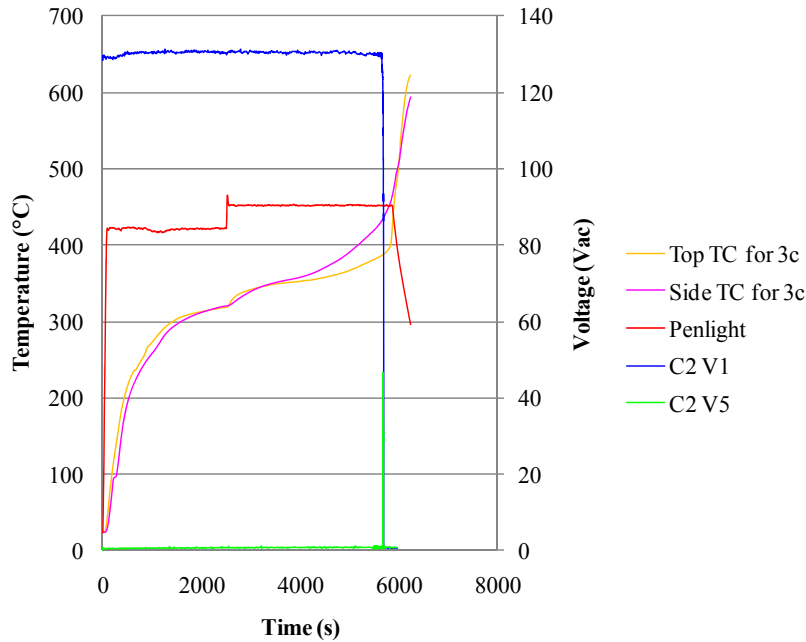

Figure B.159: Penlight shroud temperature and conductor voltages for Test D18, Circuit 2.

Table B.149: Summary of Observed Faulting Behavior for Test D18, Circuit 2.

| Time (s) | Event | Discussion |
|-----------|--|---|
| 0 | Penlight On; set at 420°C (10.67 kW/m ²) | |
| 2520 | Penlight set point increased | Penlight temperature increased to 450°C |
| 5685-5700 | Target 6 actuated | Target 6 was actuated and Target 5 displayed signs of voltage increase. |
| 5685 | Ignition | Ignition most likely occurred as a result of the shorting behavior. |
| 5700 | Fuse clear | |
| 5701 | Flame self-extinguishes | |
| 5807 | Ignition | Ignition most likely occurred due to shorting behavior in Circuit 1. |
| 5877 | Test concluded, Penlight shutdown | |

BIBLIOGRAPHIC DATA SHEET

(See instructions on the reverse)

NUREG/CR-7102
SAND2011-6548P

2. TITLE AND SUBTITLE

Kerite Analysis in Thermal Environment of FIRE (KATE-Fire): Test Results

3. DATE REPORT PUBLISHED

MONTH

YEAR

December

2011

4. FIN OR GRANT NUMBER

USNRC JCN N6959

5. AUTHOR(S)

S.P.Nowlen and J.W.Brown

6. TYPE OF REPORT

Technical

7. PERIOD COVERED (Inclusive Dates)

2/26-2010 - 10/5/2011

8. PERFORMING ORGANIZATION - NAME AND ADDRESS (If NRC, provide Division, Office or Region, U.S. Nuclear Regulatory Commission, and mailing address; if contractor, provide name and mailing address.)

Sandia National Laboratories
Risk and Reliability Analysis Dept. 6231
P.O. Box 5800
Albuquerque, NM 87185-0748

9. SPONSORING ORGANIZATION - NAME AND ADDRESS (If NRC, type "Same as above"; if contractor, provide NRC Division, Office or Region, U.S. Nuclear Regulatory Commission, and mailing address.)

Division of Risk Analysis
Office of Nuclear Regulatory Research
U.S. Nuclear Regulatory Commission
Washington, DC 20555-0001

10. SUPPLEMENTARY NOTES

G. Taylor, NRC Project Manager

11. ABSTRACT (200 words or less)

This report presents the results of cable functionality tests conducted on the cable product marketed under the trade name Kerite FR. Although Kerite FR is a thermoset polymer, reviews have identified prior tests that documented cable failure at relatively low temperatures compared to other known thermoset insulation materials. Other tests have indicated thermal performance limits consistent with other thermoset insulation materials. Hence, the actual high-temperature electrical performance limits of this material under fire exposure conditions were uncertain. New old stock samples of Kerite cables have been tested as a part of two recent programs. During some, but not all of these tests, cable failures were observed at relatively low temperatures. Two separate phenomena working in concert, insulation cracking and production of a conductive liquid within the cable are thought to be the mechanisms responsible for the observed cases of early degradation and failure. This report summarizes the previously available information for this cable product, presents all of the newly developed test data and provides an assessment of the materials fire-exposure electrical performance.

12. KEY WORDS/DESCRIPTORS (List words or phrases that will assist researchers in locating the report.)

Electric cables, cables, fire, cable failure, fire risk, fire PRA, fire PSA, post-fire safe shutdown, spurious actuation, spurious operation, hot short

13. AVAILABILITY STATEMENT

unlimited

14. SECURITY CLASSIFICATION

(This Page)

unclassified

(This Report)

unclassified

15. NUMBER OF PAGES

16. PRICE



Federal Recycling Program



**UNITED STATES
NUCLEAR REGULATORY COMMISSION**
WASHINGTON, DC 20555-0001

OFFICIAL BUSINESS

NUREG/CR-7102

Kerite Analysis in Thermal Environment of FIRE (KATE-Fire): Test Results

December 2011