



**U.S. Nuclear Regulatory
Commission**

Vol. 1, Rev. 4

RTM-96

**Response
Technical
Manual**

**Incident Response
Division
Office for Analysis and
Evaluation of Operational
Data**

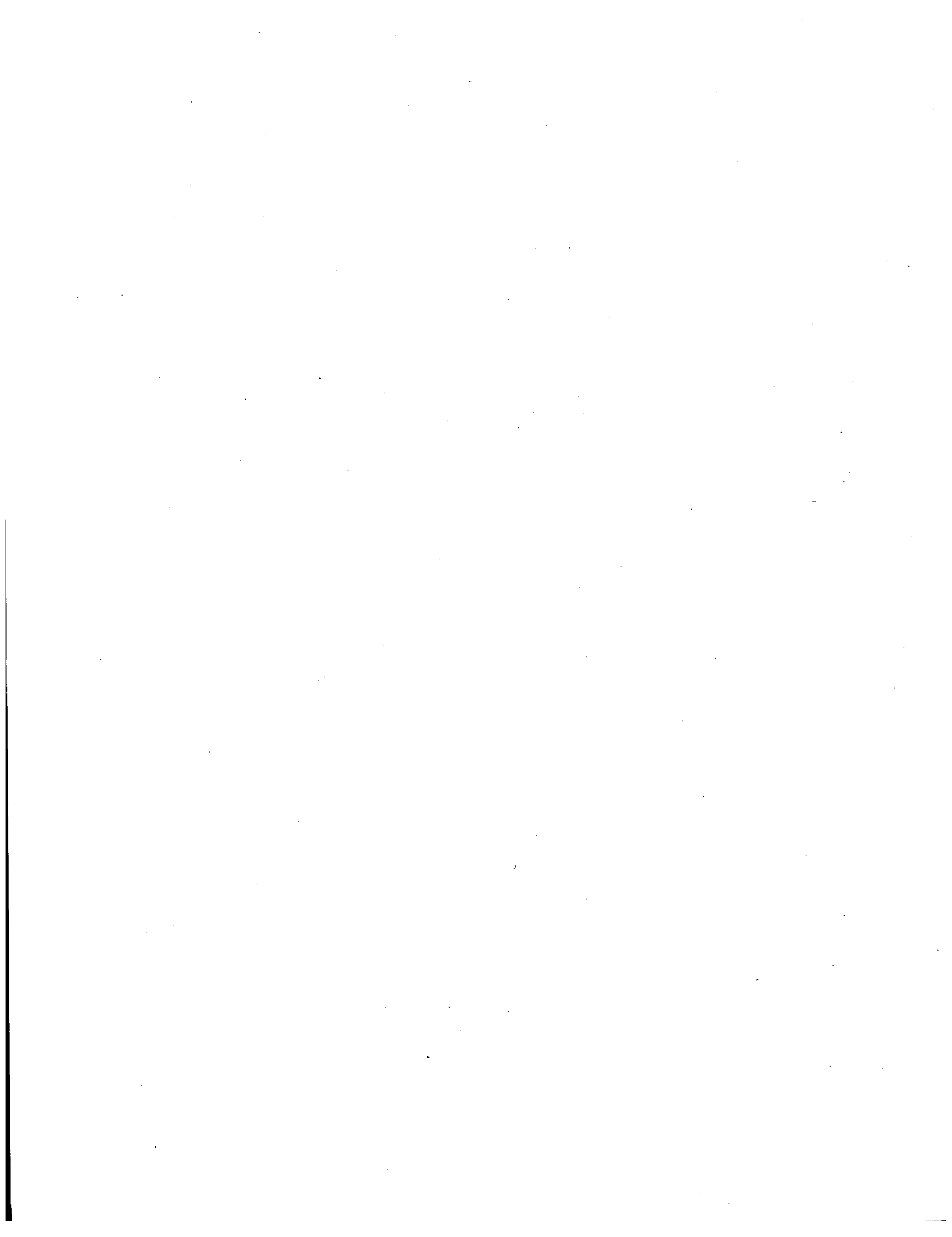



NUREG/BR-0150, Vol. 1, Rev. 4

U.S. Nuclear Regulatory Commission

RTM-96

Response Technical Manual

March 1996

T. McKenna, J. Trefethen,
K. Gant (ORNL), J. Jolicoeur,
G. Kuzo, G. Athey

**Incident Response Division
Office for Analysis and Evaluation
of Operational Data**

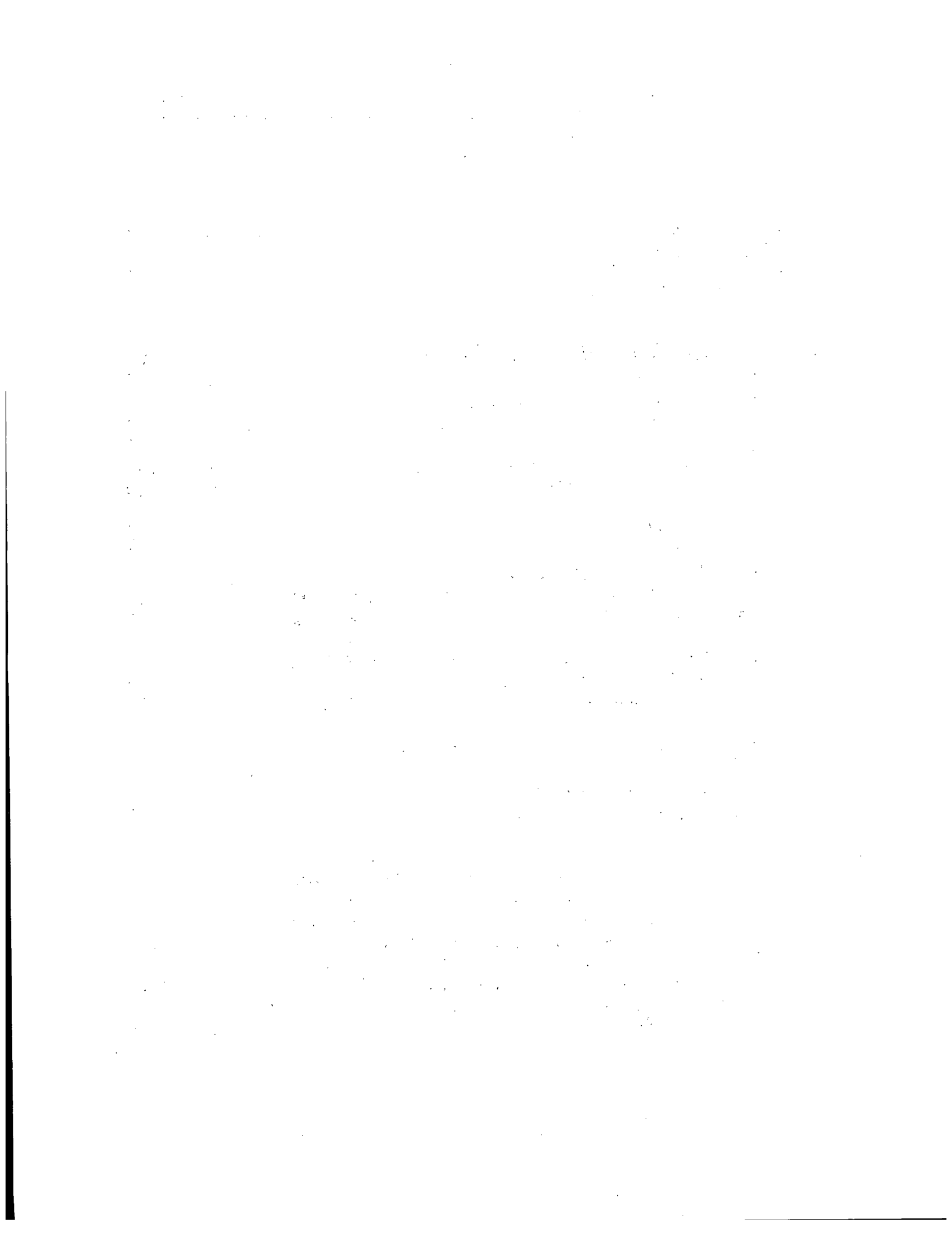

CONTENTS

LIST OF TABLES	v
LIST OF FIGURES	vii
LIST OF WORKSHEETS	ix
ACKNOWLEDGEMENTS	xi
INTRODUCTION	xiii
A. REACTOR CORE DAMAGE ASSESSMENT	A-3
A.1 Evaluation of Water Injection	A-7
A.2 Evaluation of Sub-Cooling Margin	A-9
A.3 Evaluation of Core Once Uncovered	A-11
A.4 Evaluation of Containment Radiation	A-13
A.4 Evaluation of Coolant Concentrations	A-17
A.5 Evaluation of Containment Hydrogen	A-19
B. CLASSIFICATION ASSESSMENT	B-3
B.1 NUREG-0654 Quick Assessment Chart	B-5
B.1 NUREG-0654 Full Guidance	B-7
B.3 NUMARC/NESP-007 Emergency Action Level Guidance	B-23
B.4 Fuel Cycle and Material Facilities Classification Guidance	B-25
C. REACTOR ACCIDENT CONSEQUENCE ASSESSMENT BASED ON PLANT CONDITIONS	C-3
C.1 Reactor Consequence Assessment Using Event Trees	C-5
D. SPENT FUEL POOL DAMAGE AND CONSEQUENCE ASSESSMENT	D-3
D.1 Spent Fuel Pool Accident Consequence Assessment Using Event Trees	D-5
E. URANIUM HEXAFLUORIDE RELEASE ASSESSMENT	E-3
E.1 Estimation of Inhaled Soluble Uranium Intake and Hydrogen Fluoride Concentration After a Liquid UF ₆ Release	E-7
E.2 Calculation of Inhaled Soluble Uranium Intake and Hydrogen Fluoride Concentration After UF ₆ Release	E-9
E.3 Estimation of Committed Effective Dose Equivalent Resulting From Inhaled Uranium After a Liquid UF ₆ Release	E-13
E.4 Calculation of Committed Effective Dose Equivalent Resulting From Inhaled Uranium After a UF ₆ Release	E-15

F.	EARLY PHASE DOSE PROJECTIONS	F-3
F.1	Calculation of Activity Based on Weight	F-5
F.2	Estimation of the Activity Released by a Fire	F-7
F.3	Downwind Dose Projection Based on Estimated Activity Released	F-9
F.4	Estimation of Dose and Exposure Rate from Point Source	F-15
F.5	Adjusting 1-Mile Dose to Consider Distance, Elevation, and Rain	F-19
F.6	Quick Long-Range Estimation	F-21
G.	EARLY PHASE PROTECTIVE ACTION ASSESSMENT	G-3
H.	INTERMEDIATE PHASE PROTECTIVE ACTION ASSESSMENT	H-3
I.	INGESTION PATHWAY PROTECTIVE ACTION ASSESSMENT	I-3
J.	USE OF POTASSIUM IODIDE AND THYROID MONITORING	J-3
K.	EXTRAORDINARY NUCLEAR OCCURRENCE	K-3
L.	USE OF RASCAL	L-3
	Description	L-3
	RASCAL Worksheets	L-6
M.	RADIOACTIVE HALF-LIVES AND DECAY DATA	M-3
	Half-life Values	M-3
	Decay Diagrams	M-3
N.	EXPONENTS, SI UNITS, AND CONVERSIONS	N-3
	Exponents	N-3
	SI Units	N-4
	Conversion Factors	N-4
O.	PUTTING RADIATION IN PERSPECTIVE FOR THE PUBLIC	O-3
	Radiation Dose	O-3
	Radiation Releases	O-3
P.	SUMMARY OF ASSUMPTIONS	P-3
Q.	GLOSSARY	Q-3
R.	ACRONYMS AND ABBREVIATIONS	R-3
S.	REFERENCES	S-3
	INDEX	Index-1

LIST OF TABLES

A-1	Saturation table	A-21
A-2	Core damage vs. time that reactor core is uncovered	A-23
A-3	PWR baseline coolant concentration	A-24
A-4	BWR baseline coolant concentration	A-24
B-1	NUREG-0654 quick assessment chart	B-27
B-2	Recognition Category A: Abnormal rad levels/radiological effluent initiating condition matrix	B-32
B-3	Recognition Category H: Hazards and other conditions affecting plant safety initiating condition matrix	B-33
B-4	Recognition Category S: System malfunction initiating condition matrix	B-34
B-5	Recognition Category F: Fission product barrier degradation initiating condition matrix	B-36
B-6	BWR emergency action level fission product barrier reference table thresholds for loss or potential loss of barriers	B-37
B-7	PWR emergency action level fission product barrier reference table thresholds for loss or potential loss of barriers	B-41
B-8	Event classification for fuel cycle and material facilities	B-46
C-1	Possible offsite consequences within a few hours after the start of a release	C-15
C-2	PWR coolant concentrations	C-16
C-3	BWR coolant concentrations	C-17
C-4	Core release fractions (CRF)	C-18
C-5	Reduction factors (RDF)	C-19
C-6	Escape fractions (EF)	C-20
C-7	Fission and activation product inventory (FPI) in LWR core about 30 min after shutdown	C-21
D-1	Heatup and boil-dry times for a typical spent fuel pool	D-9
E-1	UF ₆ cylinder data	E-19
E-2	Health effects of uranium intake	E-20
E-3	Health effects of hydrogen fluoride exposure	E-20
E-4	Radioactive half-life and specific activity for selected uranium isotopes	E-21
E-5	Isotopic abundance and specific activity for different enrichment levels	E-21
E-6	Adult dose conversion factors for committed effective dose equivalent from inhalation of soluble uranium isotopes	E-22
F-1	Specific activity	F-25
F-2	Fire release fraction by compound form	F-31
F-3	Fire release fraction by isotope	F-32

F-4	Release conversion factor, RCF, in mrem/ μ Ci, ≤ 0.25 mile from source for 1- μ Ci release	F-37
F-5	Release conversion factor, RCF, in mrem/ μ Ci, at 1 mile downwind for 1- μ Ci release	F-43
F-6	Early phase deposition and air immersion dose conversion factors	F-49
F-7	Early phase inhalation dose conversion factors in (mrem/h)/(μ Ci/m ³)	F-55
F-8	Stability class description and relationship to standard deviation of wind direction and lapse rate	F-62
F-9	Relationship of stability class to weather conditions	F-62
F-10	Dilution factors, $(\chi\bar{U})/Q$, in m ⁻²	F-63
F-11	Ground concentration factors	F-63
F-12	Point source dose rate and exposure rate factors at 1 m from source	F-64
F-13	Half-value layer for selected materials	F-70
G-1	Early phase Protective Action Guides (PAGs)	G-7
G-2	Early health effects of exposure to radiation	G-8
H-1	Relocation Protective Action Guides (PAGs)	H-7
H-2	Long term objectives for intermediate phase	H-7
H-3	Recommended surface contamination screening levels for emergency screening of persons and other surfaces at screening or monitoring stations in high background radiation areas (0.1–5 mR/h)	H-8
H-4	Recommended surface contamination screening levels for persons and other surfaces at monitoring stations in low background radiation areas (< 0.1 mR/h)	H-9
I-1	Ingestion Protective Action Guides	I-5
I-2	Ingestion pathway protective actions	I-6
J-1	Approximate response to radioiodine in the thyroid for different detectors	J-5
K-1	Total projected radiation doses for extraordinary nuclear occurrence	K-5
K-2	Total surface contamination levels for extraordinary nuclear occurrence	K-5
M-1	Element names, atomic numbers, and half-lives for selected radioisotopes	M-5
N-1	Base and supplementary SI units	N-5
N-2	Derived SI units with special names	N-5
N-3	SI prefixes	N-6
N-4	Conversion to SI units	N-7
N-5	Other conversion factors	N-10
N-6	Number of hours to add or subtract when converting times	N-11
O-1	Radiation releases in perspective	O-5

LIST OF FIGURES

A-1	Injection required to replace water lost by boiling resulting from decay heat for a 3000 MW(t) plant (0.5-24 h after shutdown)	A-25
A-2	Injection required to replace water lost by boiling resulting from decay heat for a 3000 MW(t) plant (1-30 days after shutdown)	A-25
A-3	Areas assumed to be monitored in PWR containment	A-26
A-4	Areas assumed to be monitored in BWR containment	A-27
A-5	PWR containment monitor response (sprays on)	A-28
A-6	PWR containment monitor response (sprays off)	A-28
A-7	BWR Mark I & II drywell containment monitor response (sprays on)	A-29
A-8	BWR Mark I & II drywell containment monitor response (sprays off)	A-29
A-9	BWR Mark I & II wetwell containment monitor response	A-30
A-10	BWR Mark III drywell containment monitor response (sprays on)	A-30
A-11	BWR Mark III drywell containment monitor response (sprays off)	A-31
A-12	BWR Mark III wetwell containment monitor response	A-31
A-13	Percentage of H ₂ in containment relative to core damage	A-32
C-1	PWR dry containment simplified release pathways	C-23
C-2	PWR ice condenser containment simplified release pathways	C-24
C-3	BWR Mark I simplified release pathways	C-25
C-4	BWR Mark II simplified release pathways	C-26
C-5	BWR Mark III simplified release pathways	C-27
C-6	Dose for PWR large dry or subatmospheric containment release for a gap release	C-28
C-7	Dose for PWR large dry or subatmospheric containment release for an in-vessel core melt release	C-29
C-8	Dose for PWR ice condenser containment release for a gap release	C-30
C-9	Dose for PWR ice condenser containment release for an in-vessel core melt release	C-31
C-10	Dose for PWR steam generator tube rupture with a release of normal coolant	C-32
C-11	Dose for PWR steam generator tube rupture with a release of spiked coolant (non-noble spike 100 × normal)	C-33
C-12	Dose for PWR steam generator tube rupture with a release of coolant contaminated due to a gap release from the core	C-34
C-13	Dose for PWR steam generator tube rupture with a release of coolant contaminated due to in-vessel core melt	C-35
C-14	Dose for BWR containment drywell release for a gap release	C-36
C-15	Dose for BWR containment drywell release for an in-vessel core melt release	C-37
C-16	Dose for BWR containment wetwell release for a gap release	C-38
C-17	Dose for BWR containment wetwell release for an in-vessel core melt release	C-39

C-18	Dose for BWR/PWR containment bypass release for a gap release	C-40
C-19	Dose for BWR/PWR containment bypass release for an in-vessel core melt release	C-41
C-20	Shutdown time correction factors for total acute bone dose (TABD) after gap release	C-42
C-21	Shutdown time correction factors for total acute bone dose (TABD) after in-vessel core melt release	C-43
C-22	Shutdown time correction factors for thyroid dose after release (all core conditions)	C-44
D-1	Whole body gamma ground level dose rate from drained spent fuel pool	D-10
D-2	BWR/PWR spent fuel pool release event tree for a Zircaloy fire in one 3-month-old batch of fuel	D-11
D-3	BWR/PWR spent fuel pool release event tree for a gap release from one 3-month-old batch of fuel	D-12
D-4	BWR/PWR spent fuel pool release event tree for a gap release from 15 1-year-old batches of fuel	D-13
E-1	Distance downwind at which early health effects from HF exposure might occur or EPA PAGs could be exceeded	E-23
E-2	Adult uranium intake resulting from release of 1 metric ton of UF ₆	E-24
E-3	Air concentrations of hydrogen fluoride from release of 1 metric ton of UF ₆	E-24
E-4	Committed effective dose equivalent for adult downwind from release of 1 metric ton liquid UF ₆	E-25
F-1	Conversion factors needed to adjust total acute bone dose (TABD) or total effective dose equivalent (TEDE) at 1 mile for other distances and other release conditions	F-76
F-2	Conversion factors needed to adjust thyroid dose at 1 mile resulting from inhalation of plume for other distances and other release conditions.	F-77
F-3	Normalized peak concentrations as a function of downwind travel time for a near-ground and elevated release	F-78
G-1	Protective actions in the event of severe core damage or loss of control of facility	G-9
J-1	Percentage of thyroid blocking by 130 mg of KI	J-6
L-1	Identification of appropriate RASCAL tool	L-5
M-1	Decay diagrams for selected radioisotopes	M-10
N-1	Equivalences (temperature, activity, and dose equivalent)	N-12
O-1	Radiation doses in perspective	O-6

LIST OF WORKSHEETS

F-1	Isotopic contributions to dose components (Method F.3, Step 1, quick estimate method)	F-79
F-2	Isotopic contributions to dose components (Method F.3, Step 1, full calculation method)	F-80
F-3	Summation of dose components (Method F.3, Step 2)	F-81
F-4	Adjusting TABD for distance, elevation, and rain (Method F.5, Step 2)	F-82
F-5	Adjusting thyroid dose for distance, elevation, and rain (Method F.5, Step 2)	F-83
L-1	RASCAL ST-DOSE weather data worksheet	L-6
L-2	RASCAL ST-DOSE data worksheet	L-7
L-3	RASCAL ST-DOSE source term worksheet	L-9
L-4	RASCAL FM-DOSE model worksheet	L-13
L-5	NRC consequence analysis summary	L-14
L-6	NRC consequence analysis log	L-15

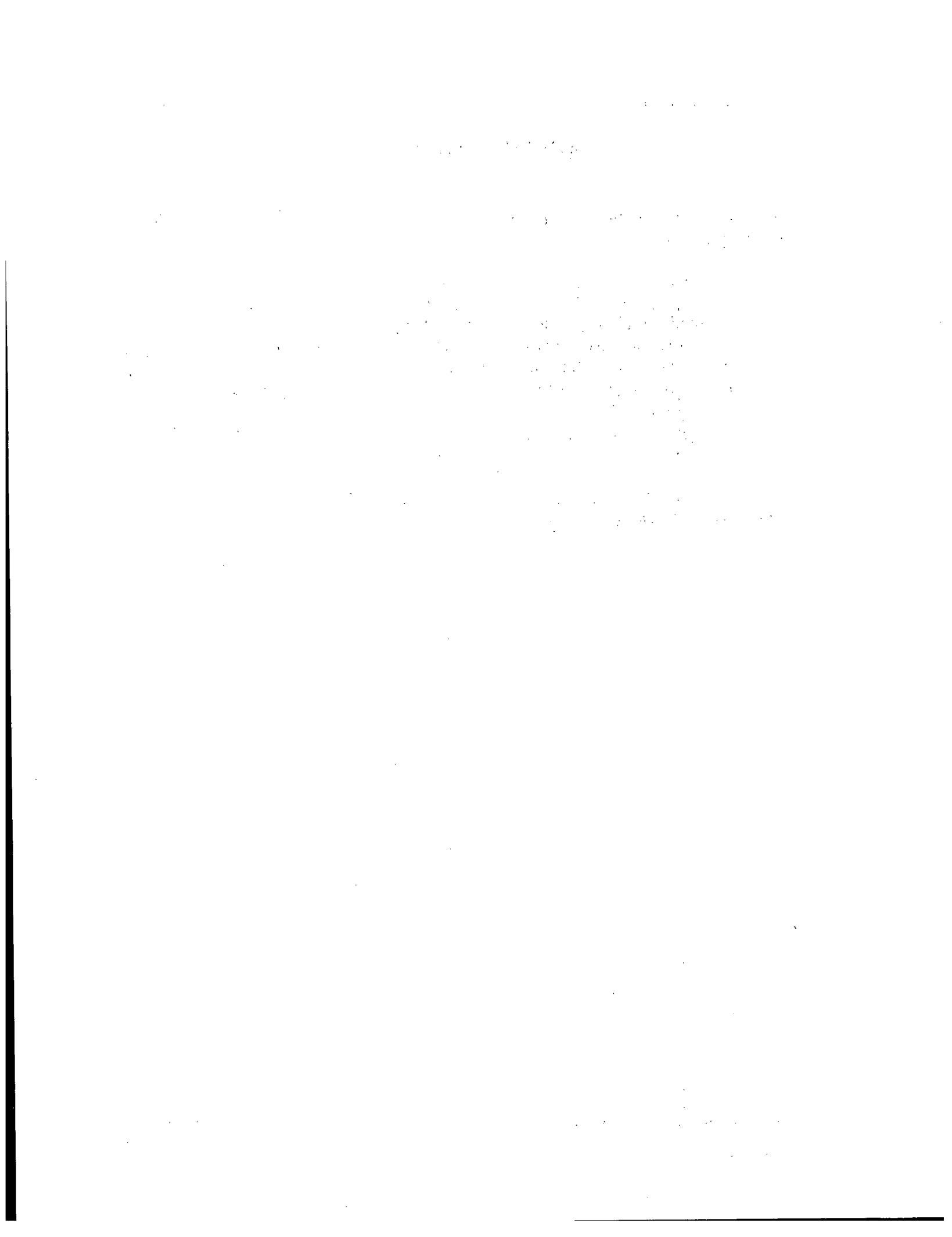

ACKNOWLEDGEMENTS

The authors acknowledge and appreciate the contributions to this document from the following people:

Oscar Aguilar-Torres (CNSNS-Mexico)
Roland Draxler and Glenn Rolph, National Oceanic and Atmospheric
Administration, Air Resources Laboratory
Emilio Garcia, NRC Field Office, Walnut Creek, California
Larry Grove, Ohio Emergency Management Agency
Joseph Himes, NRC Headquarters, Office for Analysis and Evaluation of
Operational Data
Karen Jackson, NRC Headquarters, Office for Analysis and Evaluation of
Operational Data

Editorial, design, and graphics assistance were provided by Charles Hagan and Karen Bowman, Oak Ridge National Laboratory.

Before You Begin

This manual contains simple methods for estimating the possible consequences of different kinds of radiological accidents. The resulting estimates will help officials determine or confirm where to recommend protective actions to the public. These methods should be used only by trained personnel who can interpret the calculations, table, and figures in this document.

There are two objectives for the use of this manual:

- To prevent early health effects (deaths and injuries) by
 - taking action before or shortly after a major (core damage) release from a light water reactor or nuclear material accident and
 - keeping the acute dose equivalent (due to both external exposure and inhalation) below the early health effects thresholds.
- To reduce the risk of delayed effects on health (primarily cancer and genetic effects) by implementing protective actions in accordance with EPA
 - early phase Protective Action Guides (PAGs) and
 - intermediate phase PAGs (both ingestion and relocation concerns).

This manual contains methods (procedures) used to perform the assessments necessary to meet the public protection objectives. The methods are in the approximate order that assessments will be performed and are located at the front of the manual. Later sections contain the tables, figures, worksheets, and reference material that are necessary or useful in performing the procedures.

Each assessment section contains at least one stand-alone procedure. The more complicated assessments involve the use of more than one method (a separate procedure) to complete the assessment. Each method is organized into purpose, discussion, and steps. The discussion may provide a summary of the steps, assumptions, cautions, and other relevant information. Method steps provide the instructions for the procedure.

This manual is conservative; that is, the results should overestimate the dose or result in actions at levels below those recommended in the guidance. *Do not add additional conservatism* (e.g., do not divide a guideline by 10 just to be safe). Adding additional conservatism will cause confusion and will make it difficult to compare the risk of the action to the risk avoided.

This manual is intended to be consistent with the guidance in the U.S. Environmental Protection Agency's May 1992 *Manual of Protective Action Guides and Protective Actions For Nuclear Incidents* (EPA 400-R-92-001).

The following suggestions will help in getting the best use of this manual.

- Use one of the charts in the following overview to guide the initial assessment.
- Read the remainder of this introduction and the discussion at the beginning of each section before performing assessments.
- Read each method completely before applying it.

Overview of Assessment Process

The following discussion and flow charts present an overview of the basic tasks in assessing a light water reactor (LWR) accident or a generic non-LWR accident. These charts can provide a starting point for the assessment.

LWR Accident Assessment

LWR accidents posing the greatest risk involve core damage and a prompt (within 24 h) release. Releases that pose the greatest risk will most likely be those that occur through an unmonitored pathway. The most effective protective action for a core damage accident is to evacuate near the plant (2-5 miles) before or shortly after the start of a release. Protective actions should be taken based on core conditions. Do not wait until a release is confirmed. The status of the containment is not normally considered because containment failure (leakage) is unpredictable under severe core damage conditions.

The basic assessment strategy for a severe (core damage) LWR accident is divided into three nonexclusive time periods:

Immediate and ongoing actions

If there is actual or projected severe core damage, recommend protective actions close to the site. The goal is to take protective actions before or shortly after the start of a release.

In plume (during a release)

Adjust the protective actions taken based on plant conditions and any results from monitoring in the plume. Estimate the inhalation dose to the public and emergency workers in the plume using dose rates and inhalation dose to dose-rate ratios. Note

that the thyroid dose from inhalation can be a hundred or more times higher than the dose from external exposure.

After plume passage

- Locate and evacuate areas with high deposition dose rates [hot spots, > 500 mrem/h (early health effects) and > 10 mrem/h (evacuation PAGs)]. The principal source of early and late phase dose after plume passage will be from the external exposure to material deposited on the ground. Inhalation dose from resuspension should not be a concern for LWR accidents.
- Locate areas where deposition dose rates will result in doses in excess of the intermediate phase relocation PAGs and relocate the people in those areas.
- Identify areas, based on deposition exposure rates and isotope concentrations, where ingestion may be a concern. Confirm where ingestion is of concern based on analysis of food, water and milk from the suspect areas.

Chart 1 shows the order in which the assessment should be performed for a LWR accident.

Generic Accident Assessment (for Non-LWR Accidents)

For an accident involving contamination (dispersion of radioactive material), the isotopic "mix" or composition of the definition must be identified in order to determine appropriate protective actions, establish emergency worker turn back limits, or assess environmental data. For some isotopes (e.g., Pu), inhalation doses (plume and resuspension of deposited material) could pose a threat of early health effects, even though the external exposure rates may be very low.

Chart 2 shows the order in which the assessment should be performed for a non-LWR accident.

Chart 1. LWR accident assessment tasks

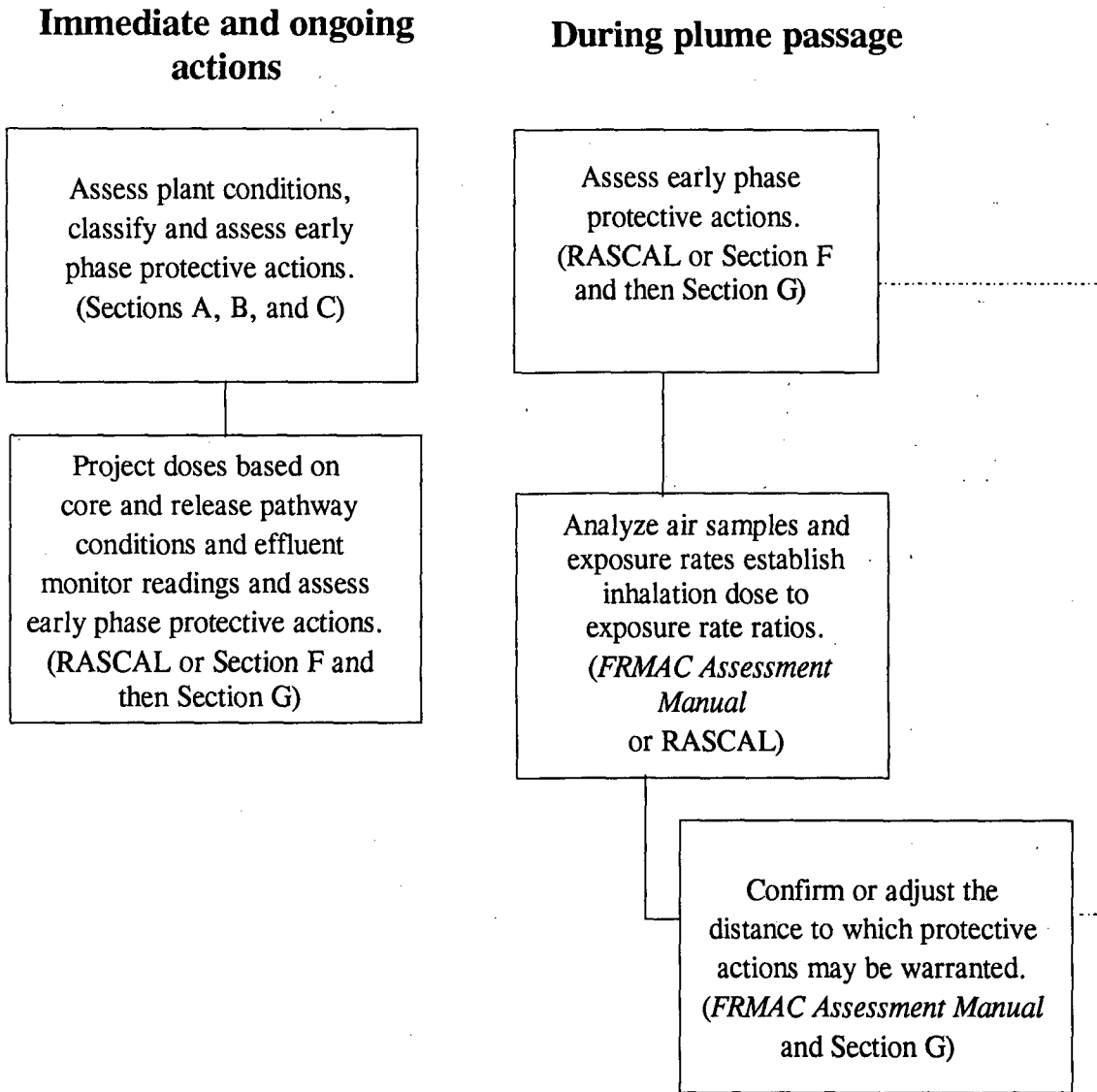

Chart 1. LWR accident assessment tasks (continued)

After plume passage

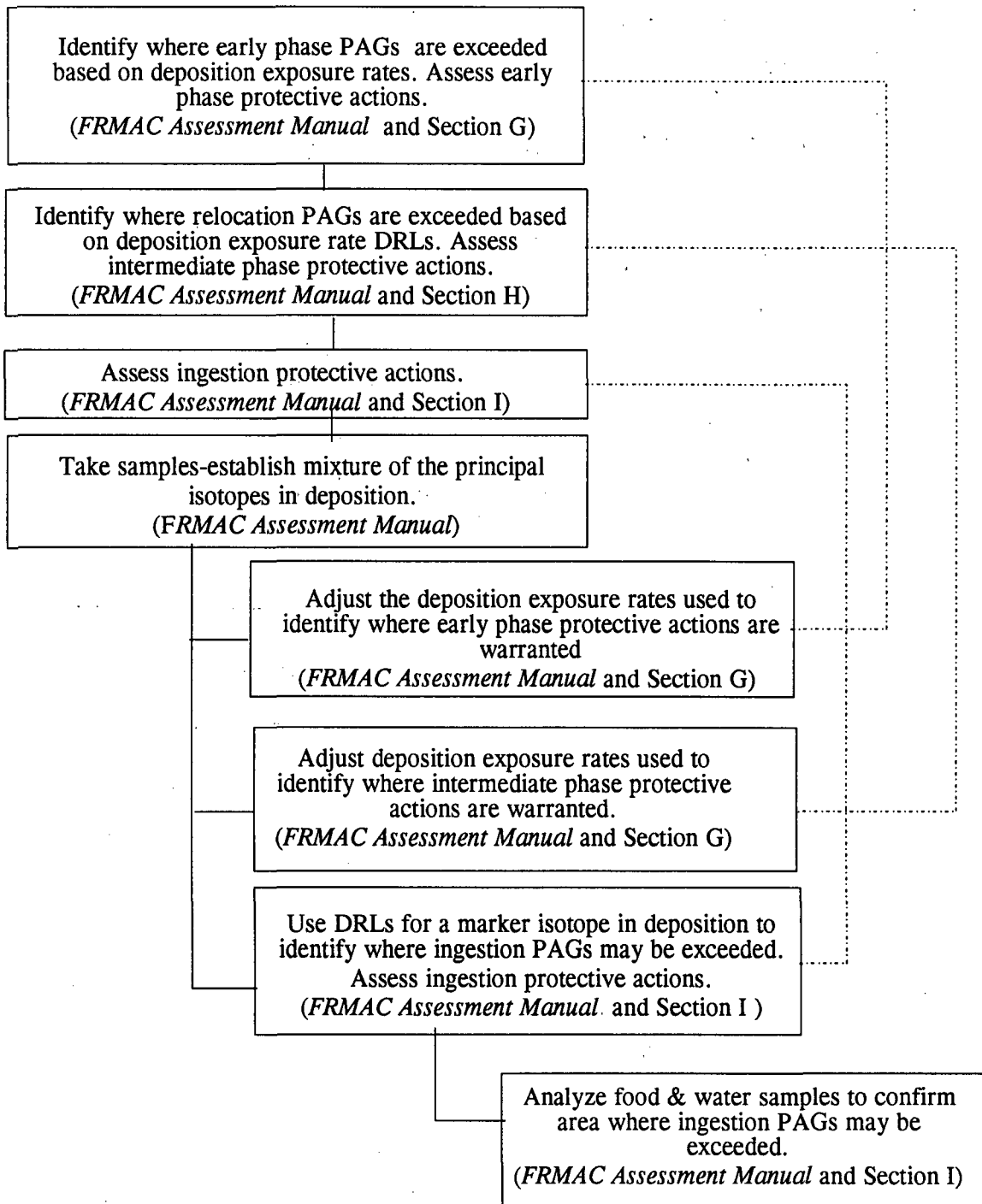

Chart 2. Generic accident assessment tasks (non-LWR accident)

Immediate and ongoing actions

During plume passage or near source

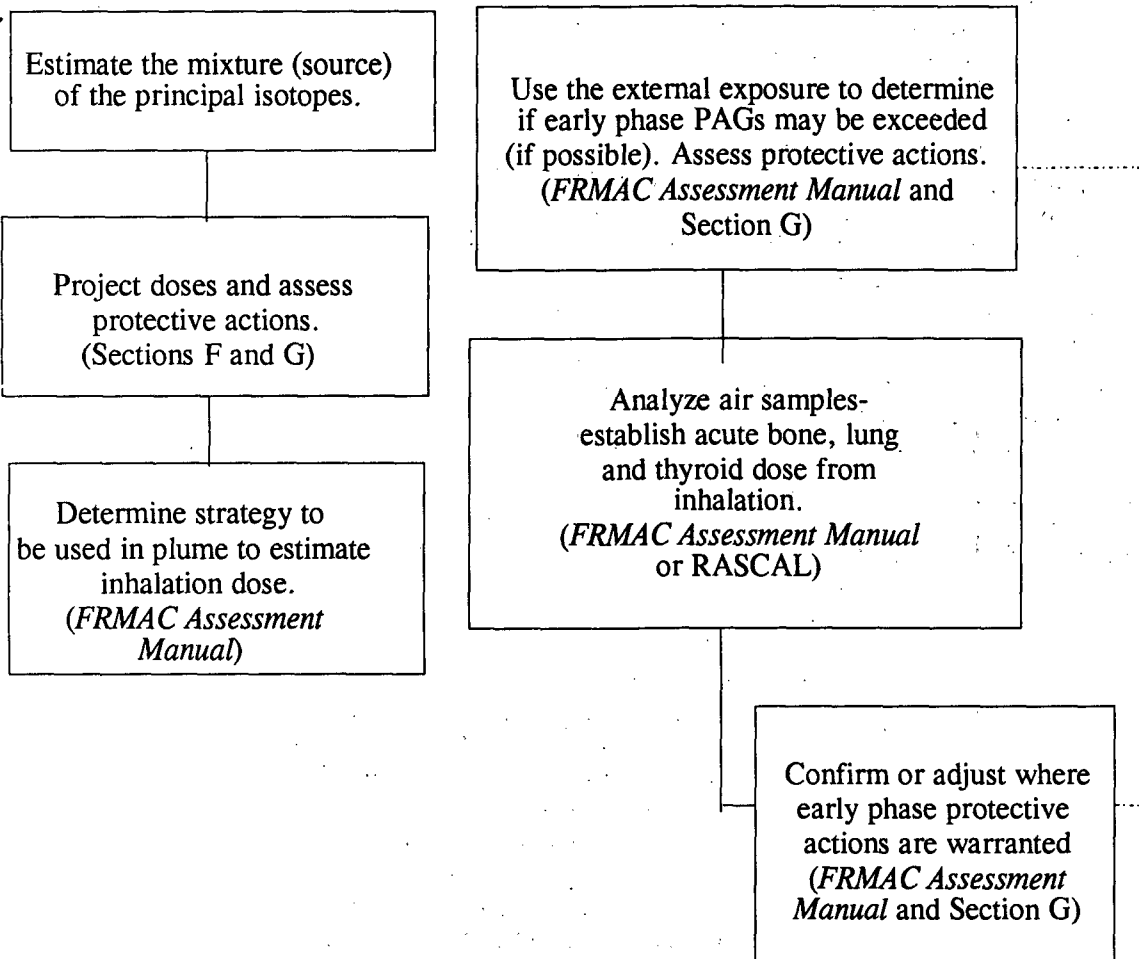
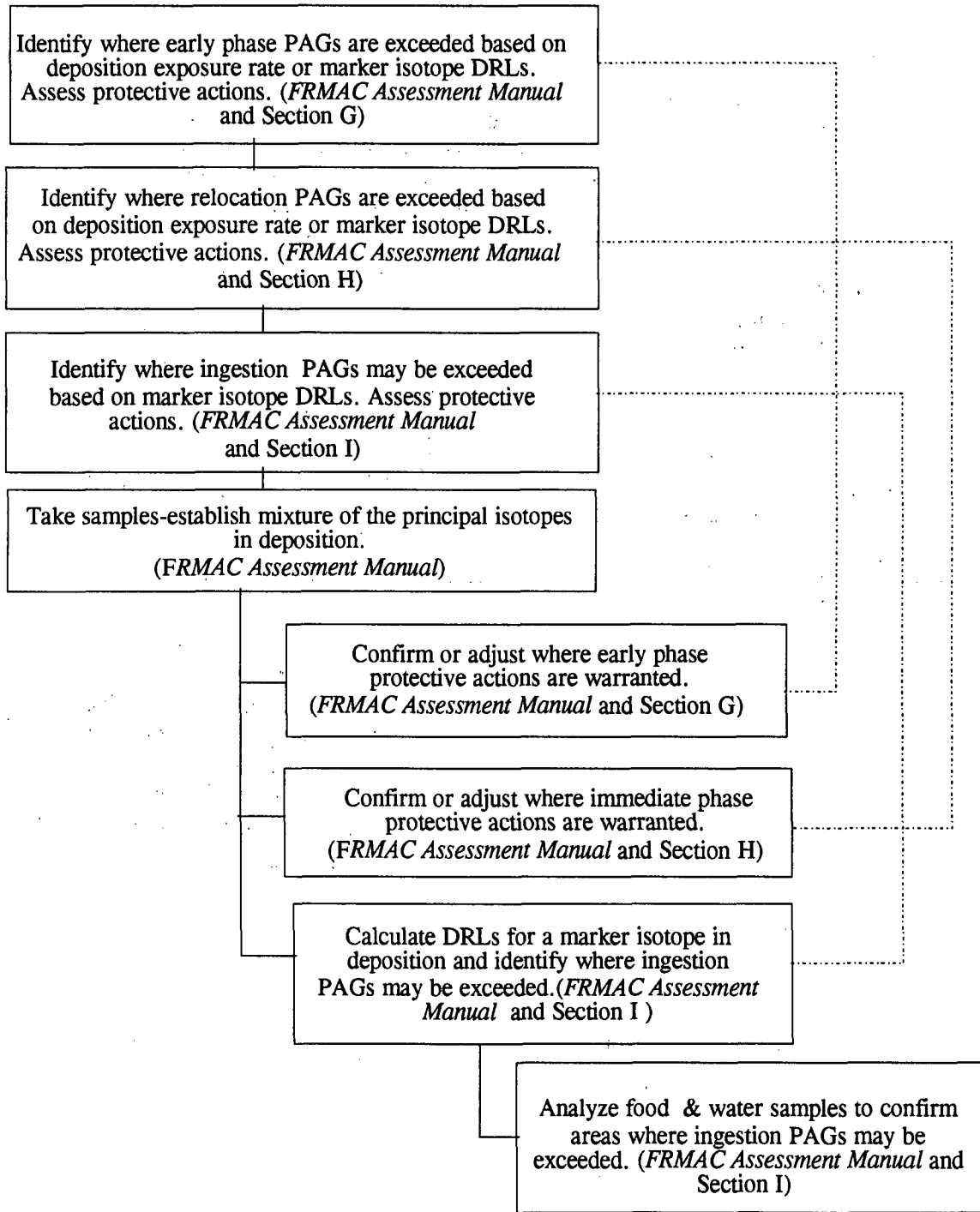
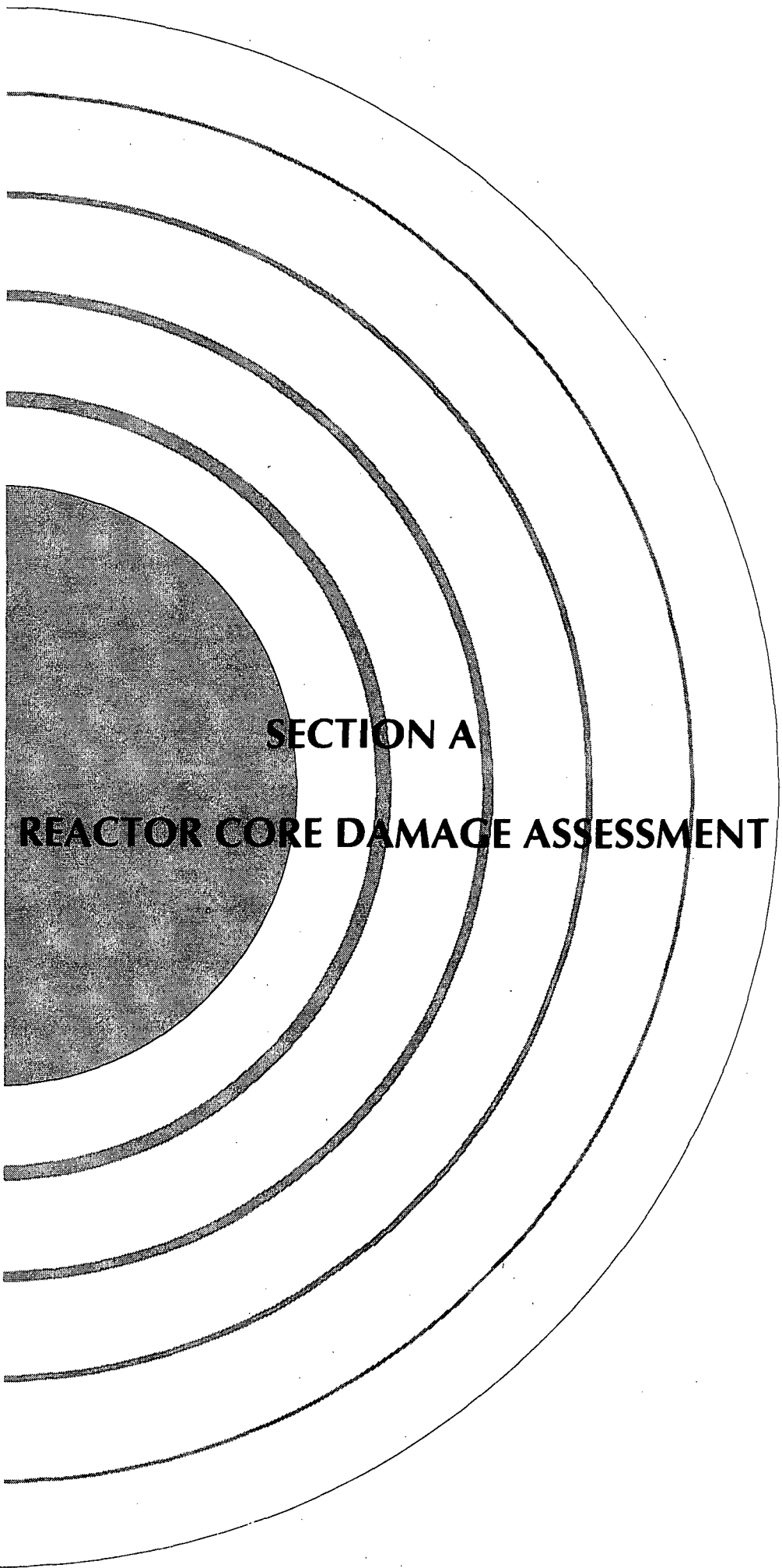

Chart 2. Generic accident assessment tasks (non-LWR accident) (continued)

After plume passage



A



SECTION A
REACTOR CORE DAMAGE ASSESSMENT

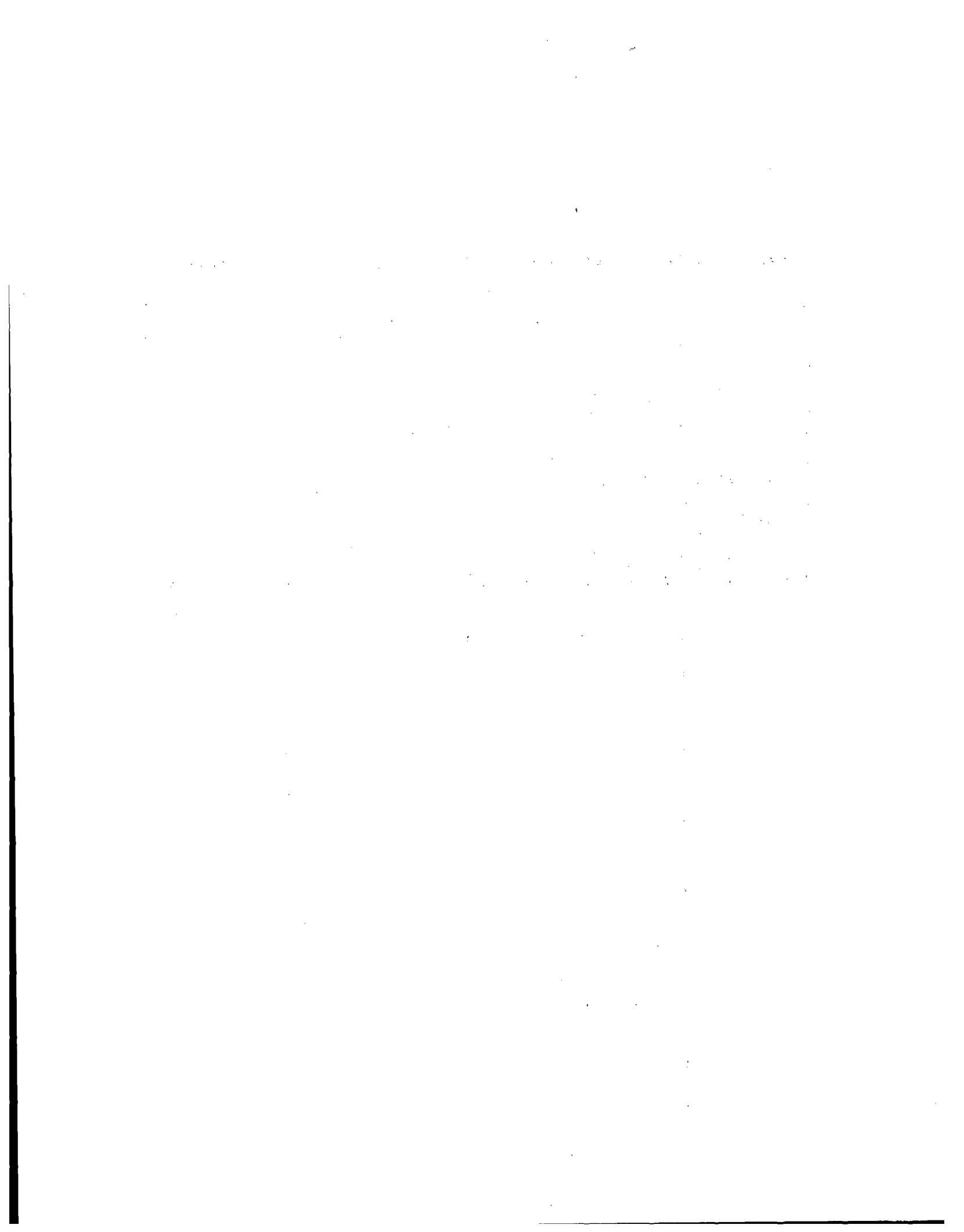

Section A
Quick Reference Guide

	<i>Page</i>
Reactor core damage assessment	A-3
Evaluation of water injection	A-7
Evaluation of sub-cooling margin (saturation table)	A-9
Evaluation of core once uncovered	A-11
Evaluation of containment radiation	A-13
Evaluation of coolant concentrations	A-17
Evaluation of containment hydrogen	A-19
Section A tables	A-21
Section A figures	A-25

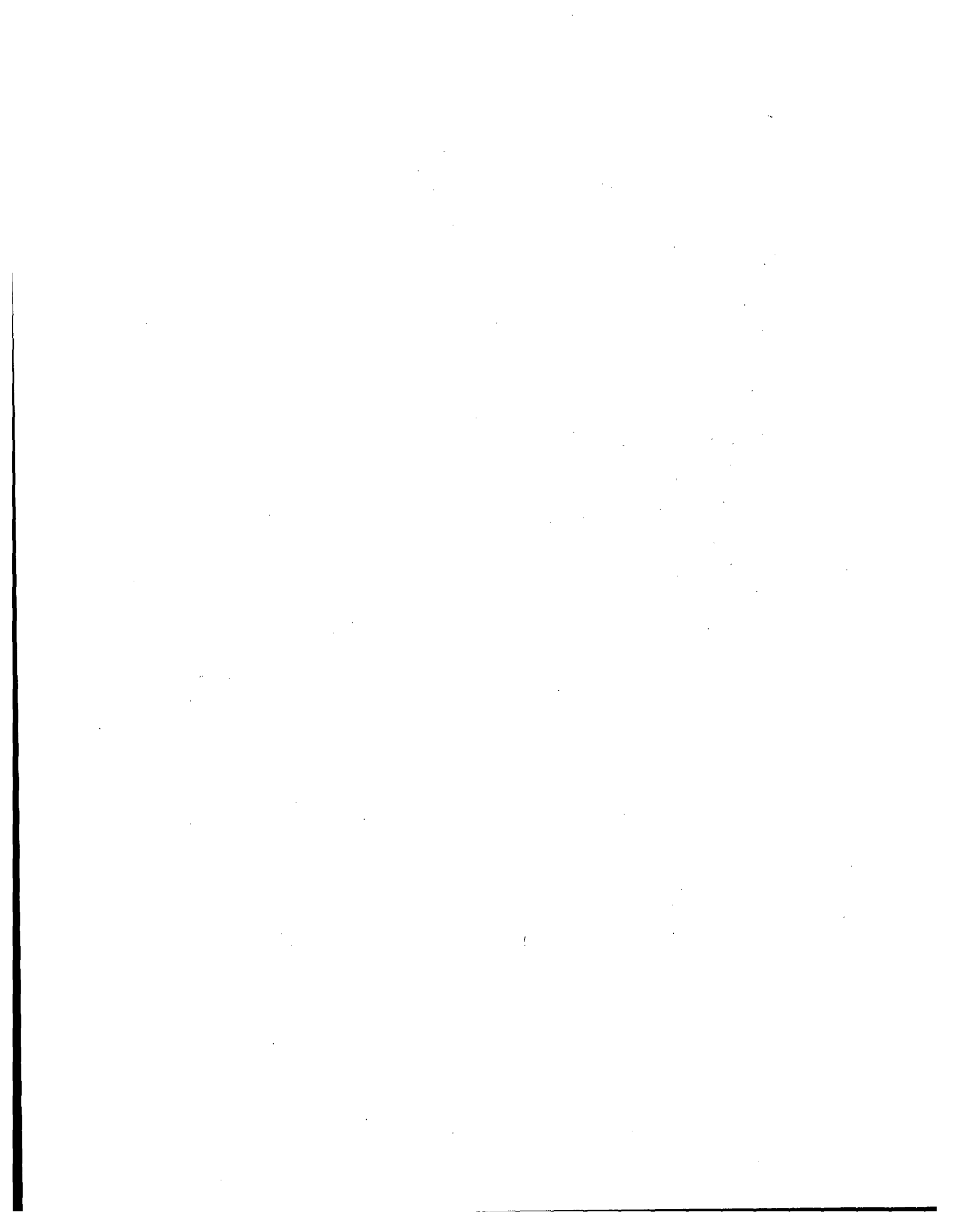

Section A Reactor Core Damage Assessment

Purpose

To assess the condition of a light water reactor core for use in classifying an accident (Section B), projecting possible consequences (Section C), and determining early phase protective actions (Section G).

Discussion

In assessing core conditions, do not lose sight of the big picture! Never use just one instrument as the basis for your assessment.

Core damage assessment is a continual process. The steps in this process are listed below in the approximate order that the needed information might be available. After completing any method in this section, the assessor must continue to monitor the core status for changes and must update core damage assessments for others performing related assessments.

The steps in this assessment are summarized below:

- | | |
|--------|---|
| Step 1 | Assess the status of critical safety functions for indications that the core may already be uncovered. |
| Step 2 | Monitor for indications that the core may soon become uncovered. |
| Step 3 | Project core damage if uncovered and inform those assessing consequences, classification, and protective actions. |
| Step 4 | Monitor radiation levels to confirm and assess core damage. |
| Step 5 | Continue to assess core damage. |

Step 1

Assess the current status of the critical safety functions by answering the following questions. If any of the critical safety functions are not being met or are degraded, estimate when the core may be uncovered. If the core is projected to be uncovered, perform Steps 2 and 3.

- Is the plant subcritical (shutdown)? How is this confirmed?
- Is the core covered now and will it be in the long term? How is this confirmed?

- Is the amount of water being injected into the primary or secondary system sufficient to remove the decay heat? Use Method A.1 to confirm that there is sufficient injection of water.
- Is decay heat being removed to the environment? How is this confirmed?
- What is the status of the vital auxiliaries? DC power? AC power?

Step 2

Monitor the following indications for detecting imminent uncovering of the reactor core. Consider the reliability of the indications or instrument readings during accident conditions as discussed below.

For PWR

Core exit thermocouple (CET) readings and primary cooling system pressure can be used to evaluate whether the core will be uncovered. A loss of sub-cooling margin (Method A.2) indicates that sufficient water injection is not being provided to keep the core covered. If the core is uncovered, the CET readings will continue to rise but will be considerably lower than the actual average and maximum core temperatures. CET readings are not accurate after core damage.

In-vessel water level indication system can also be used as an indicator of potential uncovering of the core. Decreasing water levels can confirm that there is insufficient water injection to keep the core covered. Water level indications should be used only to detect trends because of the considerable (up to 30%) uncertainties in the measurements during accident conditions. This system is not reliable after core damage.

For BWR

Water level can be used under some accident conditions to confirm that insufficient water is being injected to protect the core and to estimate the time at which the core will be uncovered.

Consider the following limitations:

- The lower limit of the water measurement system is at or above the level at which core heat-up begins (20% uncovered).
- High drywell temperature (e.g., LOCA) can cause the BWR reactor water level to read erroneously high.

- During low pressure accidents, the BWR water level can read erroneously high.
- Mechanical Yarway instruments may indicate a false on-scale water level at about 1 ft above the top of core if the actual water level fell below the lower end of the instrument range.

If there are indications of imminent uncovering of the core, go to **Step 3**. If not, provide an assessment of critical safety functions and core status to those assessing the emergency classification (Section B), assessing early phase protective actions (Section G), or projecting consequences (Section C). Continue to monitor plant indicators (**Step 1** and **Step 2**).

Step 3

If core is projected to be uncovered (Step 1) or there are indications that this is imminent (Step 2), use Method A.3 to determine projected times for the following core damage states:

Time to gap release from fuel: _____ h

Time to in-vessel core melt: _____ h

and

provide an assessment of the critical safety functions and core status to those assessing the emergency classification (Section B), assess early phase protective actions (Section G), or project consequences (Section C). If actual or projected core damage is detected, the accident should be classified as a General Emergency and protective actions should be considered in accordance with Section G of this manual. *Do not wait* for core damage to be confirmed.

Step 4

Monitor the radiation levels to attempt initial confirmation of core damage. Detection of very large increases (orders of magnitude) in radiation levels by radiation monitors (e.g., containment) can confirm actual core damage. If the release is into the containment, use Method A.4 to assess the level of damage. Compare with core damage estimate from **Step 3**. The following possibilities should be considered:

- The release may bypass the monitor.
- Monitors may be influenced by a source not intended to be monitored.
- Areas monitored may not be representative of the entire containment.

- Calibration assumptions may not match accident conditions.
- Shielding or other design factors may have been incorrectly considered.
- Monitor may show high, low, or center range if it fails.
- Monitor may be read incorrectly.

Reassess the emergency classification (Section B), early phase protective actions (Section G), or consequences (Section C). If actual or projected core damage is detected, the accident should be classified as a General Emergency and protective actions should be considered in accordance with Section G.

Step 5

After the core is uncovered, continue to evaluate the amount of core damage using the available information. The following methods may be used:

Evaluate core once uncovered	Method A.3
Evaluate containment radiation	Method A.4
Evaluate coolant concentrations	Method A.5
Evaluate containment hydrogen	Method A.6

Reassess the emergency classification (Section B), early phase protective actions (Section G), or consequences (Section C). If actual or projected core damage is detected, the accident should be classified as a General Emergency and protective actions should be considered in accordance with Section G. Note that these methods for estimating core damage can be time-consuming and may be unreliable. *Do not delay protective actions* by waiting for confirmation of core damage.

END

Source: NUREG-1228

Method A.1 Evaluation of Water Injection

Purpose

To determine the amount of water that must be injected into a LWR core to replace the water lost by boiling resulting from decay heat.

Discussion

This method provides curves of the water injection rates required to remove decay heat *by boiling*. These curves are based on a 3000-MW(t) plant operated at a constant power for an infinite period and then shut down instantaneously. The decay heat power is based on ANSI/ANS-5.1. If the injected water is about 80°F (27°C), the curves are within 5% for pressures 14–2500 psia (0.1–17.2 MPa). The curves are valid within 20% for injected water temperatures up to 212°F (100°C).

If there is a break in a pipe requiring make-up water, more water than indicated here will be required to keep the core covered and cooled. If the core has been uncovered for an extended time (e.g., > 15–30 min), the fuel temperatures will have already increased significantly. In this case, additional injection water will be required to accommodate the heat from the Zr-H₂O reaction and allow the heat transfer necessary to return the fuel to equilibrium temperatures.

Step 1

Use Figs. A-1 and A-2 to determine the minimum amount of water that must be injected to replace water lost by boiling (resulting from decay heat) for a 3000-MW(t) plant based on the time since shutdown.

Time since reactor shutdown: _____ h or _____ days

Minimum required water injection: _____ gal/min

Step 2

Adjust this injection rate for the size of the plant using

$$inject_{plant} = inject_{3000} \times \frac{MW(t)_{plant}}{3000}$$

$$(\text{ gal/min}) = (\text{ gal/min}) \times \frac{[MW(t)]}{3000 MW(t)}$$

where:

- $inject_{3000}$ = amount of injected water for 3000-MW(t) plant (from Fig. A-1 or A-2),
- $MW(t)_{plant}$ = size of plant in MW(t) [$MW(t) \cong 3 \times MW(e)$],
- $inject_{plant}$ = amount of injected water needed for this plant.

Step 3

If the core has been uncovered for 15-30 min or longer, increase the amount of water required to cool core by a factor of two to three.

END

Method A.2 Evaluation of Sub-Cooling Margin (Saturation Table)

Purpose

To determine if water at a given pressure and temperature is boiling and to calculate the sub-cooling margin. (This method is only useful for a PWR with primary system pressure and temperature instruments.)

Discussion

The sub-cooling margin can be approximated by subtracting the coolant temperature from the saturation temperature for the given primary system pressure. A coolant temperature taken from the core exit thermocouple reading greater than the saturation temperature indicates that the water in the core is boiling.

Step 1

Record the primary system pressure.

_____ psia or _____ MPa

Step 2

Record the primary coolant temperature ($temp_{PWR}$) from the core exit thermocouple.

_____ °F or _____ °C

Step 3

Using Table A-1, determine the saturation temperature ($temp_{sat}$) for the primary system pressure recorded above.

_____ °F or _____ °C

Step 4

Determine the sub-cooling margin using the following equation:

$$\text{sub-cooling margin} = \text{temp}_{\text{sat}} - \text{temp}_{\text{PWR}}$$

A negative sub-cooling margin in a PWR indicates that water is boiling in the reactor vessel and that the core may be uncovered.

END

Method A.3 Evaluation of Core Once Uncovered

Purpose

To estimate LWR core temperature and damage progression once the core is uncovered.

Discussion

A severely damaged core may not be in a coolable state, even if it is re-covered with water. Core temperature (core exit thermocouple) and primary system water temperature (ΔT) indications cannot confirm a coolable core.

It can be assumed that the fuel in the core will heat up at $1-2^{\circ}\text{F/s}$ ($0.5-1.0^{\circ}\text{C/s}$) immediately after the top of an active core of a PWR is uncovered or 5-10 min after the top of an active core of a BWR is uncovered. These fuel heatup estimates are reasonable within a factor of two if the core is uncovered within a few hours of shutdown (including failure to scram) for a boil-down case (without injection). If there is injection, core heatup may be stopped or slowed because of steam cooling. However, steam cooling may not prevent core damage under accident conditions.

Step 1

Use Table A-2 to estimate or project the level of core damage based on the time the core is uncovered. Estimate average fuel temperature by assuming an increase of $1-2^{\circ}\text{F/s}$ ($0.5-1^{\circ}\text{C/s}$) once the core is uncovered.

END

1. The first part of the document discusses the importance of maintaining accurate records of all transactions and activities. It emphasizes that this is essential for ensuring transparency and accountability in the organization's operations.

2. The second part of the document outlines the various methods and tools used to collect and analyze data. It highlights the need for consistent and reliable data collection processes to support effective decision-making.

3. The third part of the document focuses on the role of technology in data management and analysis. It discusses how modern software solutions can streamline data collection, storage, and reporting, thereby improving efficiency and accuracy.

4. The fourth part of the document addresses the challenges associated with data management, such as data quality, security, and privacy. It provides strategies to mitigate these risks and ensure that data is used responsibly and ethically.

5. The fifth part of the document discusses the importance of data governance and the establishment of clear policies and procedures. It stresses that a strong data governance framework is necessary to ensure that data is managed in a consistent and compliant manner.

6. The sixth part of the document explores the role of data in strategic planning and performance management. It explains how data-driven insights can help organizations identify trends, opportunities, and areas for improvement.

7. The seventh part of the document discusses the importance of data literacy and training for all employees. It emphasizes that having a data-literate workforce is crucial for maximizing the value of data and driving organizational success.

8. The eighth part of the document provides a summary of the key points discussed and offers recommendations for implementing the best practices outlined. It encourages organizations to regularly review and update their data management strategies to stay current in a rapidly changing environment.

9. The ninth part of the document discusses the future of data management and the emerging trends that will shape the industry. It highlights the growing importance of artificial intelligence, machine learning, and cloud-based data solutions.

10. The final part of the document concludes with a call to action, urging organizations to embrace a data-driven culture and take the necessary steps to ensure their data is managed effectively and securely.

Method A.4 Evaluation of Containment Radiation

Purpose

To assess the core damage based on the containment radiation monitor readings.

Discussion

This method uses containment radiation monitor readings to assess core damage; however, containment radiation monitor readings *cannot* confirm core damage in all cases. The release may bypass the containment, be retained in the primary system, be released over a long period of time, or not be uniformly mixed. Therefore, a low containment radiation reading does not guarantee a lack of core damage.

Confirm that the containment radiation monitor "sees" more than 50% of the shaded area shown in either Fig. A-3 (PWR) or Fig. A-4 (BWR). If not, this method should not be used to assess core damage.

These calculations should provide the maximum reading expected under the conditions stated. The calculations assume (1) a prompt release to containment of all the fission products in the coolant, spike, gap, or from in-vessel core melt; (2) uniform mixing in the containment; and (3) an unshielded monitor that can see most of the area shown in Fig. A-3 or Fig. A-4. Because the mix is most likely different from that assumed in the calibration of the monitor, the actual reading at the upper end of the scale could differ by a factor of 10-100 if a shielded detector is used for the higher radiation measurements.

The levels of damage indicated on Figs. A-5-A-12 should be considered minimum levels unless there are inconsistent monitor readings. Inconsistent readings may be caused by the uneven mixing in containment [e.g., steam rising to top of dome, not enough time for uniform mixing to occur (it may take hours)]. The values in the figures were generated using CONDOS II (NUREG/CR-2068).

Four types of releases are considered:

In-vessel core melt release—the release into containment of all the fission products expected to be released from a core that is partially melted (see Table C-4) after being uncovered for 30 min or more.

Gap release—the release into containment of all the fission products in the fuel pin gap (see Table C-4) after the fuel cladding has failed from being uncovered for more than 15 min.

Spiked coolant release—the release into containment of 100 times the non-noble gas fission products normally found in the coolant.

Typical (normal) coolant release—the release into containment of the fission products normally found in the coolant (see Tables C-2 and C-3).

Step 1

Record the following readings:

Normal radiation monitor reading: _____ R/h

Unshielded monitor reading: _____ R/h

Time of reading after release into containment: _____ h

Sprays: _____ on or _____ off

Step 2

Determine the absolute containment radiation rate by subtracting the radiation monitor reading during normal operations from the unshielded monitor reading after the accident.

absolute radiation rate = unshielded monitor reading - normal radiation monitor reading

$$(\quad \text{R/h}) = (\quad \text{R/h}) - (\quad \text{R/h})$$

Step 3

Estimate the core damage based on the absolute containment radiation rate calculated above, using the appropriate figure from the following list. The figures show the range of containment monitor readings assuming that the fission products associated with 1-100% of the level of core damage stated. It is assumed the release from the core is uniformly mixed in the containment and that the monitor is unshielded. Sprays are assumed to remove non-nobles to a location where the monitor cannot see them.

PWR (sprays on)	Fig. A-5
PWR (sprays off)	Fig. A-6
BWR Mark I & II dry well (sprays on)	Fig. A-7
BWR Mark I & II dry well (sprays off)	Fig. A-8
BWR Mark I & II wet well	Fig. A-9
BWR Mark III dry well (sprays on)	Fig. A-10
BWR Mark III dry well (sprays off)	Fig. A-11
BWR Mark III wet well	Fig. A-12

END

Source: NUREG/CR-5157 was used to confirm the core melt numbers.

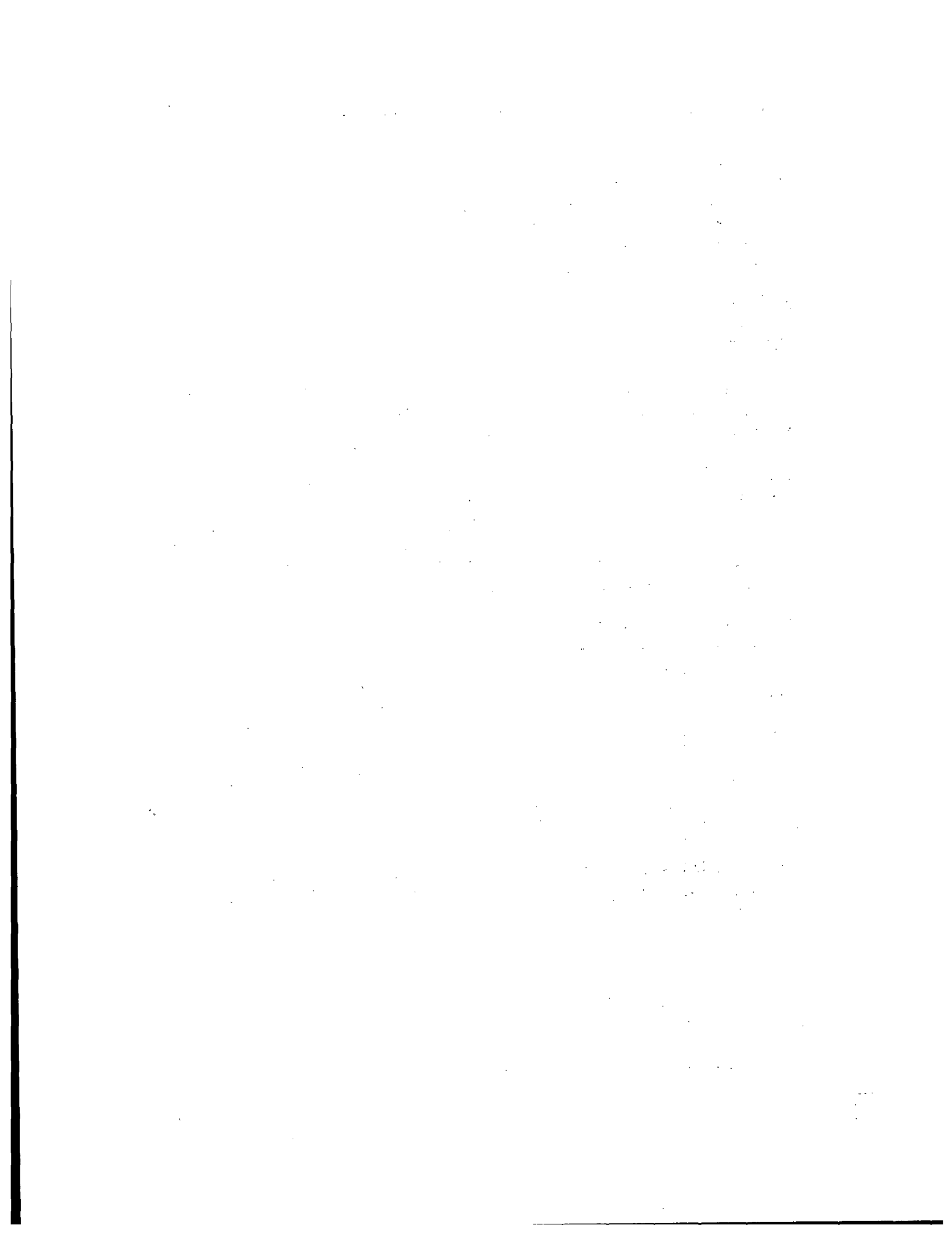

Method A.5 Evaluation of Coolant Concentrations

Purpose

To assess the LWR core damage based on a coolant sample.

Discussion

Coolant concentrations should not be required to confirm core damage because they may take hours to draw and analyze and may not be representative of primary system concentrations (e.g., no flow through sample line).

This method of confirming core damage assumes that releases from the core are uniformly mixed in the coolant and that there is no dilution from injection. The baseline coolant concentrations are for 0.5 h after shutdown of a core that has been through at least one refueling cycle. The half-life of the fission products should be considered in analyzing samples. The plant-specific coolant system volume does not have a major influence on coolant concentrations (<20%).

For a BWR, it is assumed that the release from the core is uniformly mixed in the reactor coolant system and suppression pool. If most of the core release is confined to the reactor coolant system, the concentrations in the coolant could be up to 10 times higher.

Step 1

For PWRs and BWRs, compare the reported coolant concentrations with the baseline coolant concentrations in Table A-3 or Table A-4. These tables will overestimate the concentrations for the long-lived fission products (Cs and Sr) in a *new* core.

For other LWRs that have primary system coolant inventories considerably different than those assumed in Table A-3 (2.5×10^5 kg), adjust the Table A-3 baseline concentrations by multiplying each value by

$$\frac{2.5 \times 10^5 \text{ kg}}{\text{reactor coolant inventory (kg)}}$$

END

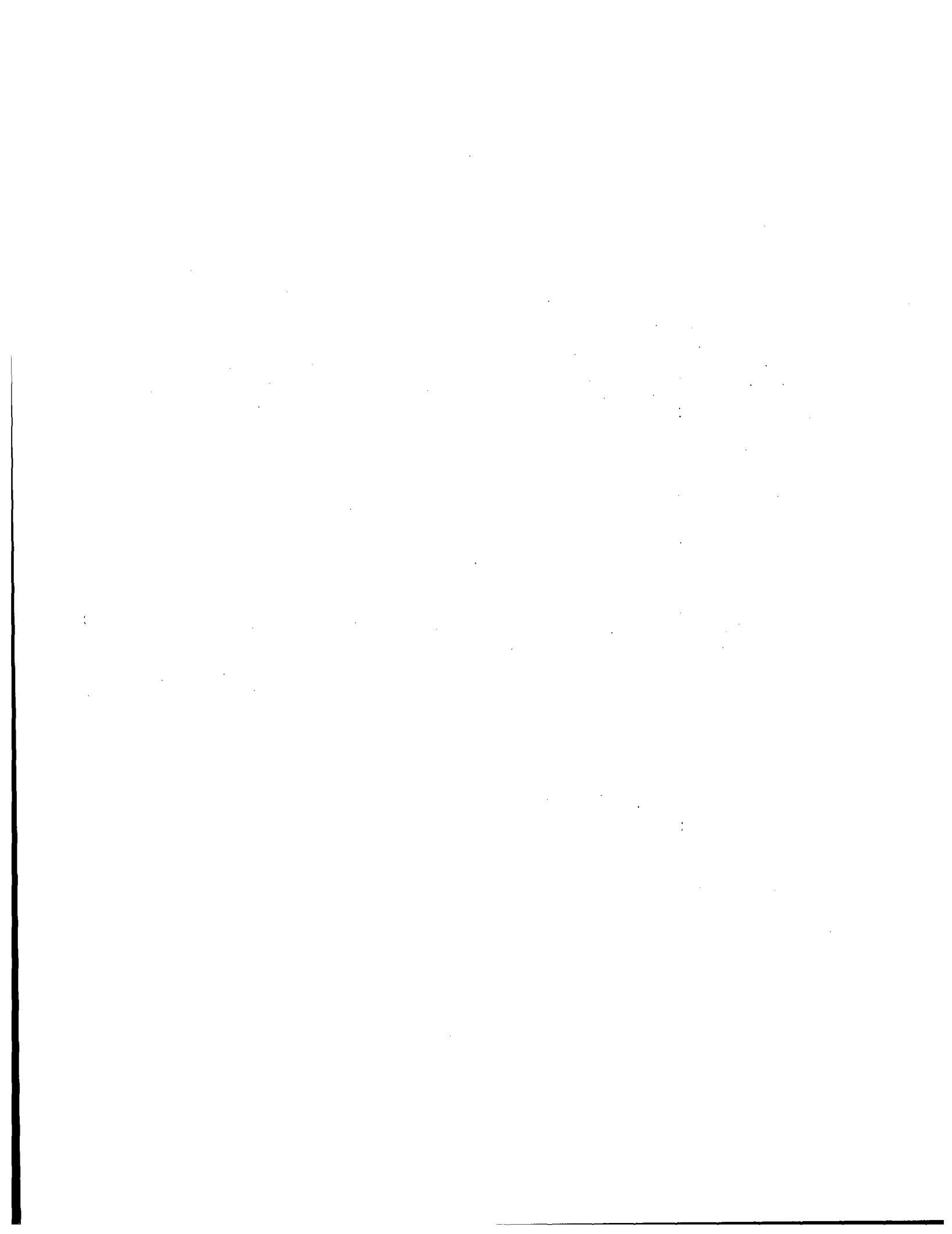

Method A.6 Evaluation of Containment Hydrogen

Purpose

To assess the core damage based on hydrogen concentrations in containment samples.

This method may be used to assess the core damage based on hydrogen concentrations in samples of the containment atmosphere. Hydrogen concentrations should not be relied upon to confirm core damage in all cases. Containment samples may require hours to collect and analyze and may not be representative of the total hydrogen generated in the core because of incomplete mixing in the containment or containment bypass.

Discussion

The hydrogen concentrations used in this method are for wet samples; however, most hydrogen samples are dry (steam removed). If a dry sample concentration is used, one may overestimate considerably the level of core damage. This method assumes that all hydrogen is released to the containment and is completely mixed in the containment atmosphere. The curves in Fig. A-13 are a function of containment size. The results of severe accident research (research supporting NUREG-1150) were examined to identify the least percentage of metal-water reaction associated with each core damage state. Higher percentages of metal-water reaction are possible for some accident sequences (e.g., Three Mile Island).

Step 1

Obtain an estimate from the facility of the average hydrogen wet sample concentration in the containment.

Hydrogen percentage: _____ %

Step 2

Use the hydrogen percentage and Fig. A-13 to estimate the percentage of metal-water reaction and possible levels of core damage for the appropriate reactor containment

type. Any of the core conditions shown on the y-axis below this percentage may be possible.

Percentage metal-water reaction: _____ %

Possible levels of core damage:

END

Table A-1. Saturation table

Absolute pressure		Saturation temperature	
(psia)	(MPa)	(°F)	(°C)
14.70	0.10	212.0	100.00
15	0.10	213.0	100.57
20	0.14	228.0	108.87
30	0.21	250.3	121.30
40	0.28	267.3	130.69
50	0.34	281.0	138.34
60	0.41	292.7	144.84
70	0.48	302.9	150.52
80	0.55	312.0	155.58
90	0.62	320.3	160.16
100	0.69	327.8	164.34
110	0.76	334.8	168.22
120	0.83	341.3	171.82
130	0.90	347.3	175.18
140	0.97	353.0	178.36
150	1.03	358.4	181.35
160	1.10	363.6	184.19
170	1.17	368.4	186.90
180	1.24	373.1	189.49
190	1.31	377.5	191.96
200	1.38	381.8	194.33
210	1.45	385.9	196.62
220	1.52	389.9	198.82
230	1.59	393.7	200.94
240	1.65	397.4	202.99
250	1.72	401.0	204.98
260	1.79	404.4	206.91
270	1.86	407.8	208.78
280	1.93	411.1	210.59
290	2.00	414.3	212.36
300	2.07	417.4	214.08
350	2.41	431.7	222.07
400	2.76	444.6	229.22
450	3.10	456.3	235.71
500	3.45	467.0	241.67

Table A-1. Saturation table (continued)

Absolute pressure		Saturation temperature	
(psia)	(MPa)	(°F)	(°C)
550	3.79	476.9	247.19
600	4.14	486.2	252.33
650	4.48	494.9	257.16
700	4.83	503.1	261.71
750	5.17	510.8	266.02
800	5.52	518.2	270.12
850	5.86	525.2	274.02
900	6.21	532.0	277.75
950	6.55	538.4	281.33
1000	6.89	544.6	284.77
1050	7.24	550.5	288.07
1100	7.58	556.3	291.27
1150	7.93	561.8	294.34
1200	8.27	567.2	297.33
1250	8.62	572.4	300.21
1300	8.96	577.4	303.01
1350	9.31	582.3	305.73
1400	9.65	587.1	308.37
1450	10.00	591.7	310.94
1500	10.34	596.2	313.44
1550	10.69	600.6	315.88
1600	11.03	604.9	318.26
1650	11.38	609.1	320.58
1700	11.72	613.1	322.85
1750	12.07	617.1	325.07
1800	12.41	621.0	327.23
1850	12.76	624.8	329.35
1900	13.10	628.6	331.42
1950	13.44	632.2	333.46
2000	13.79	635.8	335.44
2100	14.48	642.8	339.31
2200	15.17	649.5	343.03
2300	15.86	655.9	346.61
2400	16.55	662.1	350.06
2500	17.24	668.1	353.39

Table A-1: Saturation table (continued)

Absolute pressure		Saturation temperature	
(psia)	(MPa)	(°F)	(°C)
2600	17.93	673.9	356.62
2700	18.62	679.5	359.74
2800	19.31	685.0	362.76
2900	19.99	690.2	365.68
3000	20.68	695.3	368.52
3100	21.37	700.3	371.27
3200	22.06	705.1	373.93
3208.2 ^a	22.12 ^a	705.5	374.15

^aCritical temperature.

Source: ASME 1993, Table 2, pp. 187-193.

Table A-2. Core damage vs. time that reactor core is uncovered

Time PWR or 20% of BWR active core is uncovered (h)	Core temperature		Possible core damage
	(°F)	(°C)	
0	> 600	> 315	<ul style="list-style-type: none"> • None
0.5 to 0.75	1800-2400	980-1300	<ul style="list-style-type: none"> • Local fuel melting • Burning of cladding with steam production (exothermic Zr-H₂O reaction with rapid H₂ generation) • Rapid fuel cladding failure (gap release from the core^a)
0.5 to 1.5	2400-4200	1300-2300	<ul style="list-style-type: none"> • Rapid release of volatile fission products (in-vessel severe core damage release from core^a) • Possible relocation (slump) of molten core • Possible uncoolable core
1 to 3+	> 4200	> 2300	<ul style="list-style-type: none"> • Melt-through of vessel with possible containment failure and release of additional less-volatile fission products

^aTable C-4 contains the assumed core release fractions for this release.

Sources: NUREG/CR-4245, NUREG/CR-4624, NUREG/CR-4629, NUREG/CR-5374, NUREG-0900, NUREG-0956, NUREG-1150, and NUREG-1465.

Table A-3. PWR baseline coolant concentration

Nuclide	Normal concentration ($\mu\text{Ci/g}$)	Concentration after gap release ($\mu\text{Ci/g}$)	Concentration after in-vessel melt ($\mu\text{Ci/g}$)	TMI concentration + 48 h ($\mu\text{Ci/g}$) ^a
¹³¹ I	4×10^{-2}	2×10^4	1×10^5	1.3×10^4
¹³³ I	1×10^{-1}	3×10^4	2×10^5	6.5×10^3
¹³⁵ I	2×10^{-1}	3×10^4	2×10^5	-
¹³⁴ Cs	7×10^{-3}	2×10^3	8×10^3	6.3×10^1
¹³⁷ Cs	9×10^{-3}	9×10^2	5×10^3	2.8×10^2
¹⁴⁰ Ba	NC ^b	NC	3×10^4	-
⁹⁰ Sr	1×10^{-5}	NC	1×10^4	5.3×10^0

^aTMI coolant concentrations 48 h after the accident.

^bNC = not calculated (data not available).

Source: (Normal coolant) ANSI/ANS 18.1, 1984, confirmed by NUREG/CR-4397, Table 2.1; (TMI) NUREG-600.

Table A-4. BWR baseline coolant concentration

Nuclide	Normal concentration ($\mu\text{Ci/g}$)	Concentration after gap release ($\mu\text{Ci/g}$) ^a	Concentration after in-vessel melt ($\mu\text{Ci/g}$) ^a
¹³¹ I	2×10^{-3}	1×10^3	1×10^4
¹³³ I	1×10^{-2}	3×10^3	2×10^4
¹³⁵ I	2×10^{-2}	2×10^3	2×10^4
¹³⁴ Cs	3×10^{-5}	1×10^2	6×10^2
¹³⁷ Cs	8×10^{-5}	8×10^1	4×10^2
¹⁴⁰ Ba	NC ^b	NC	2×10^3
⁹⁰ Sr	7×10^{-6}	NC	1×10^3

^aIn the reactor coolant system and suppression pool.

^bNC = not calculated (data not available).

Source: (Normal coolant) ANSI/ANS 18.1, 1984, confirmed by NUREG/CR-4245, Table 3.2.

Fig. A-1
Injection required to replace water lost by boiling resulting from decay heat for a 3000 MW(t) plant (0.5–24 h after shutdown).

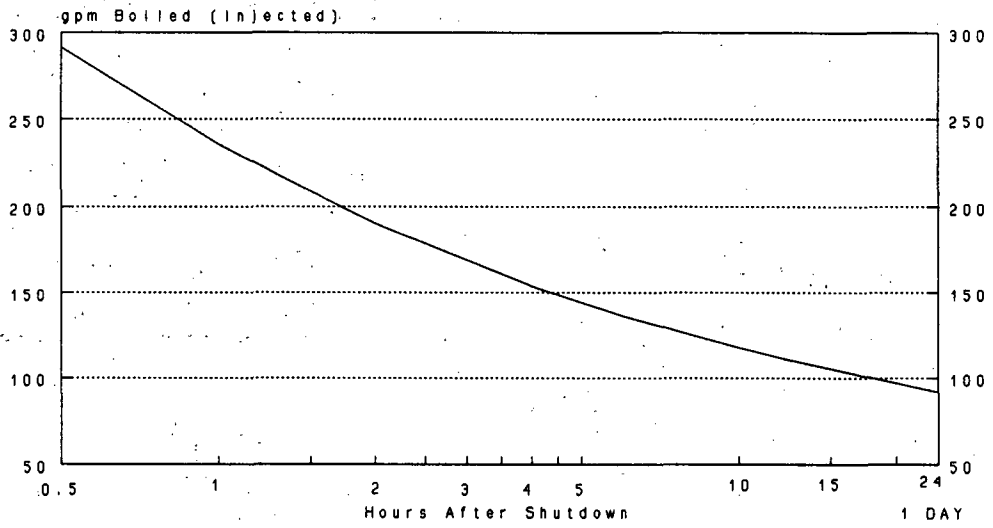

Fig. A-2
Injection required to replace water lost by boiling resulting from decay heat for a 3000 MW(t) plant (1–30 days after shutdown).

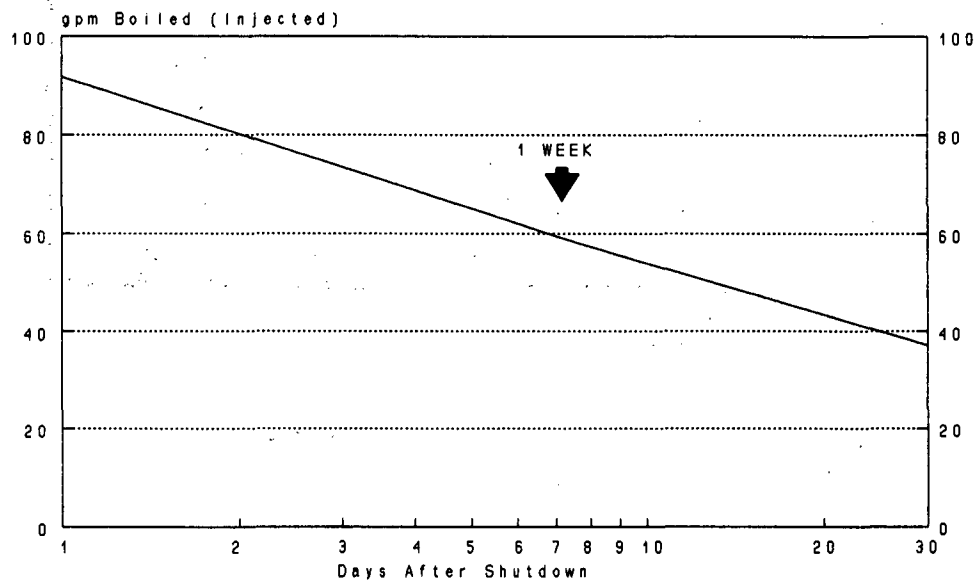

Fig. A-3
Areas assumed to be monitored in PWR containment.

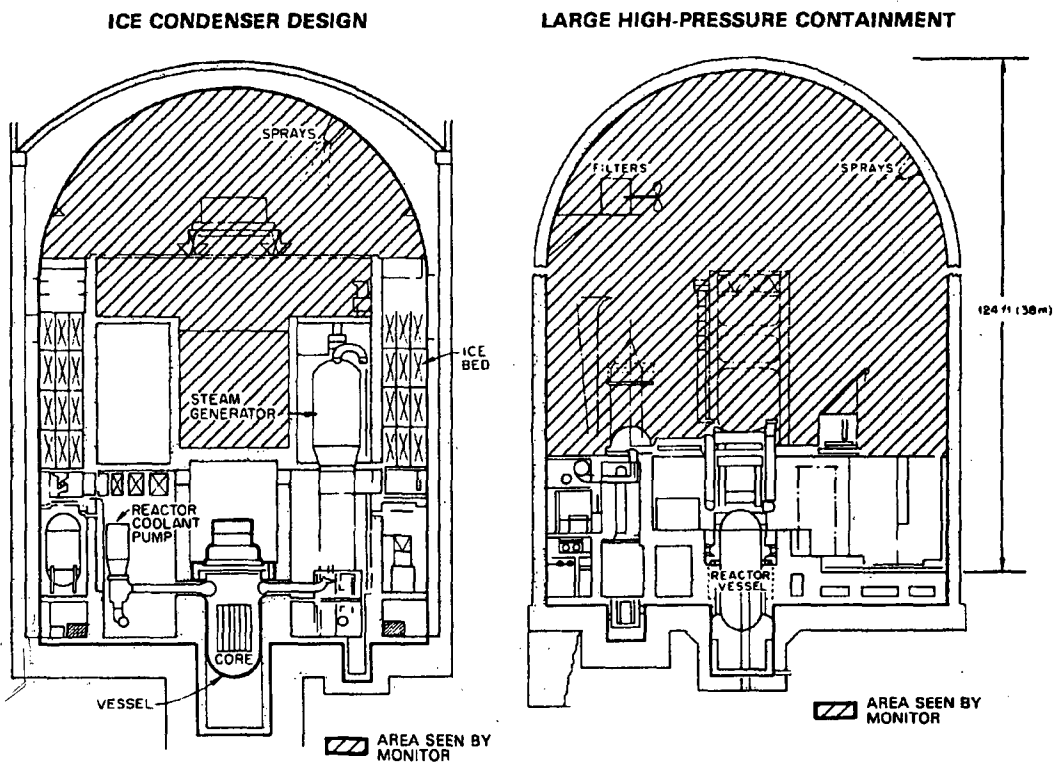

Fig. A-4
Areas assumed to be monitored in BWR containment.

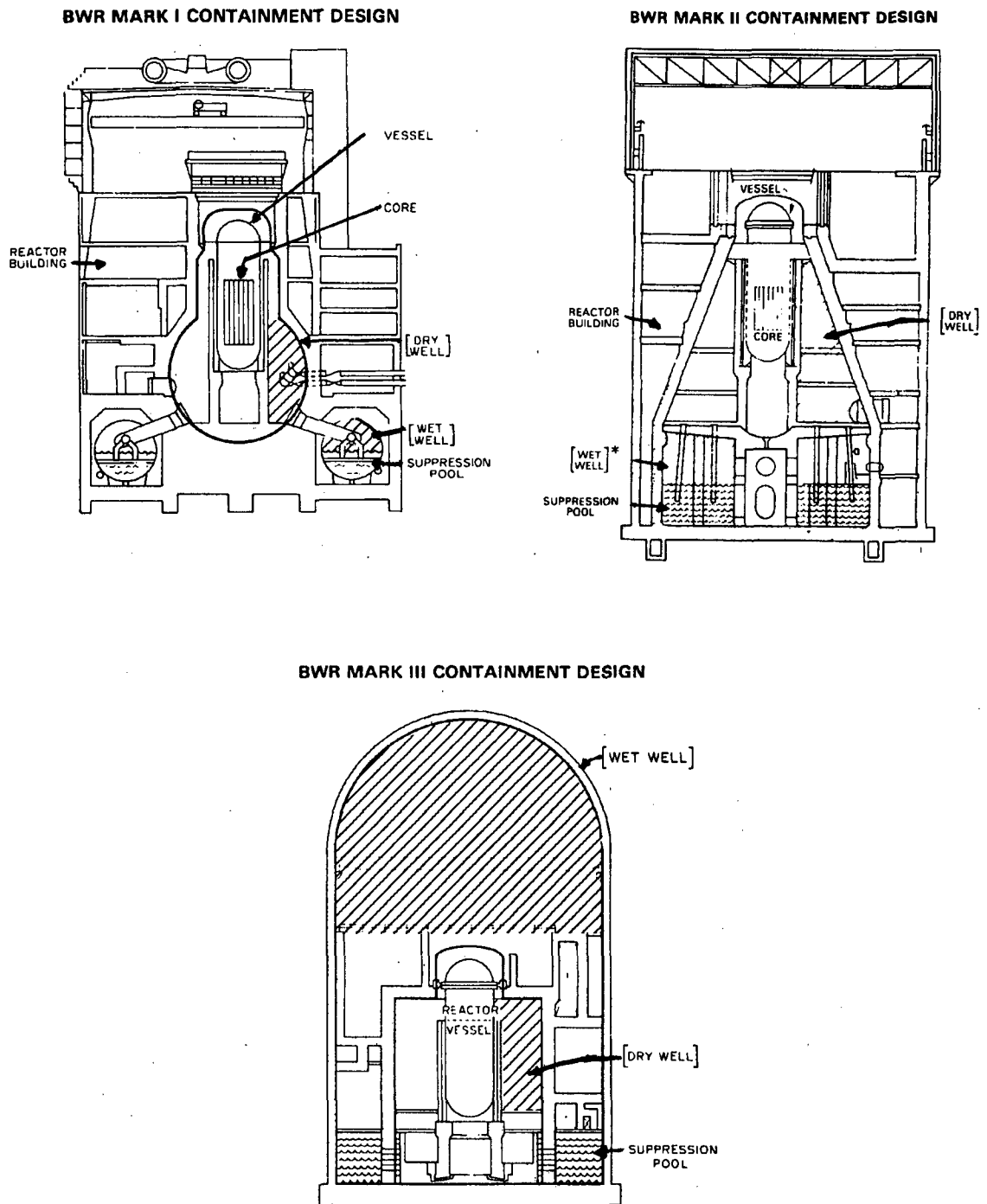

Fig. A-5
PWR containment monitor response (sprays on).

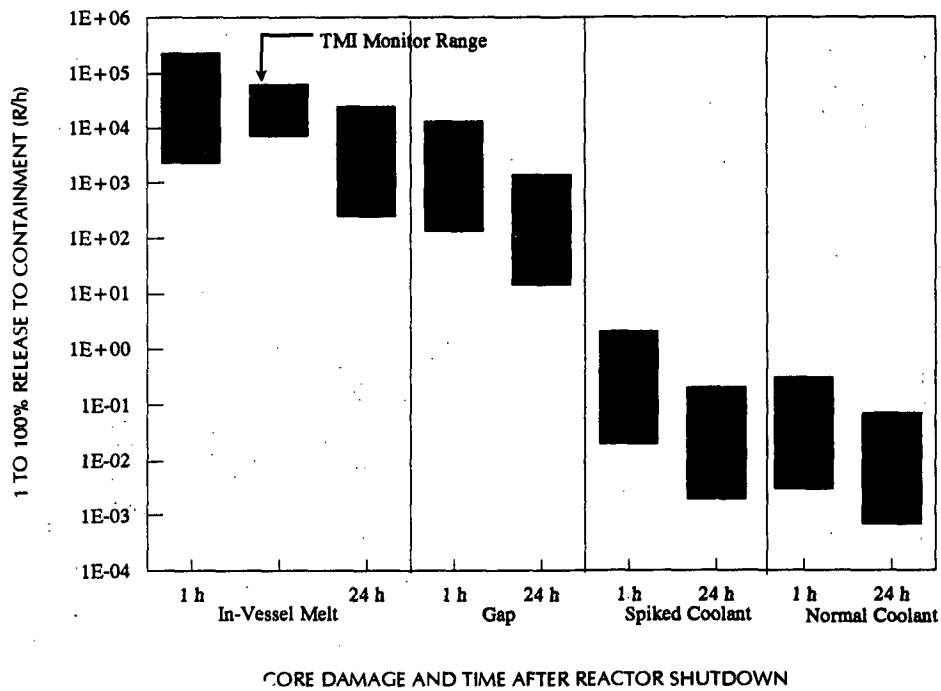

Fig. A-6
PWR containment monitor response (sprays off).

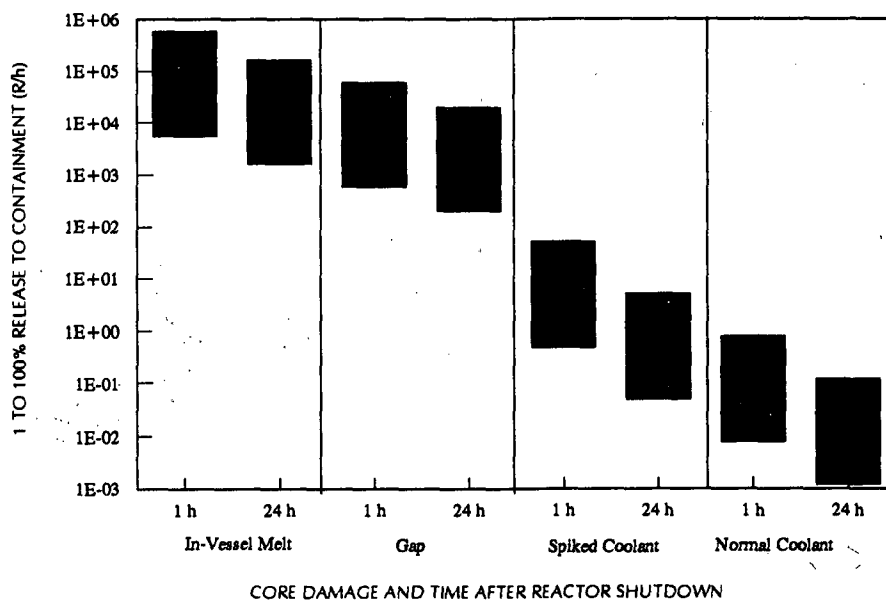

Fig. A-7
BWR Mark I & II drywell containment monitor response (sprays on).

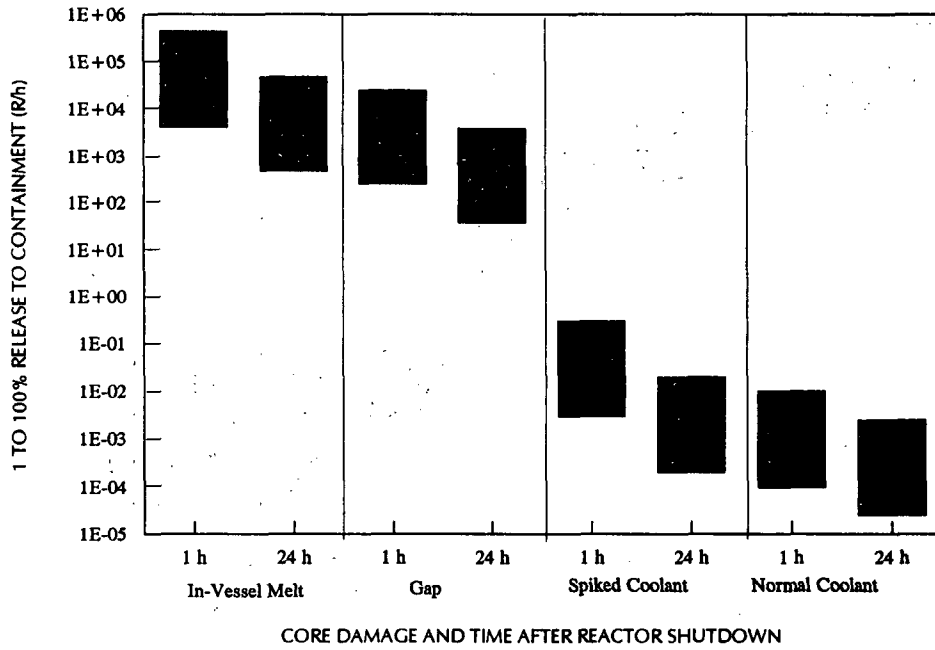

Fig. A-8
BWR Mark I & II drywell containment monitor response (sprays off).

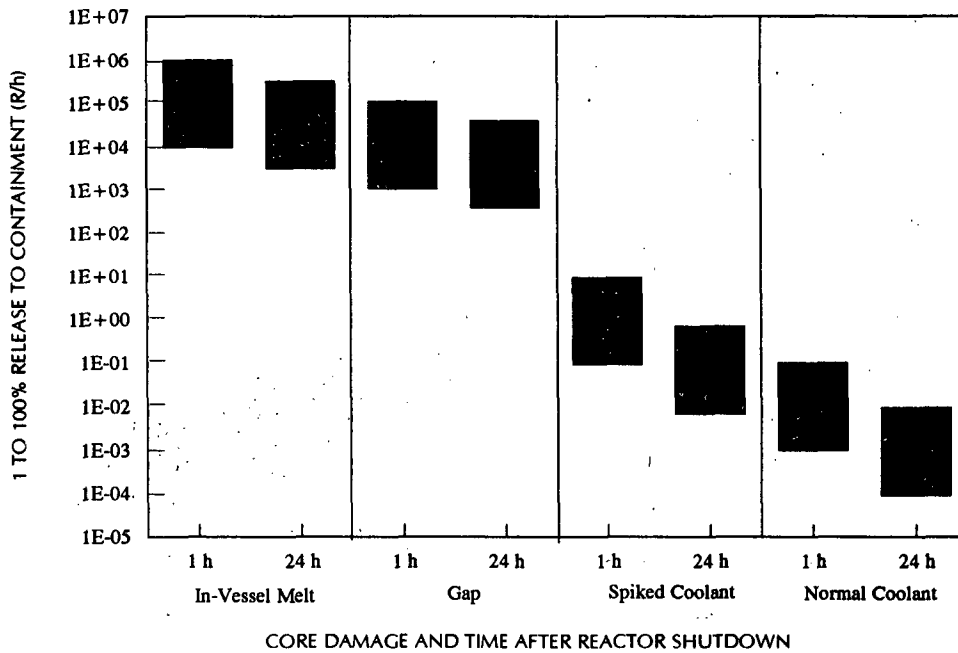

Fig. A-9
BWR Mark I & II wetwell containment monitor response.

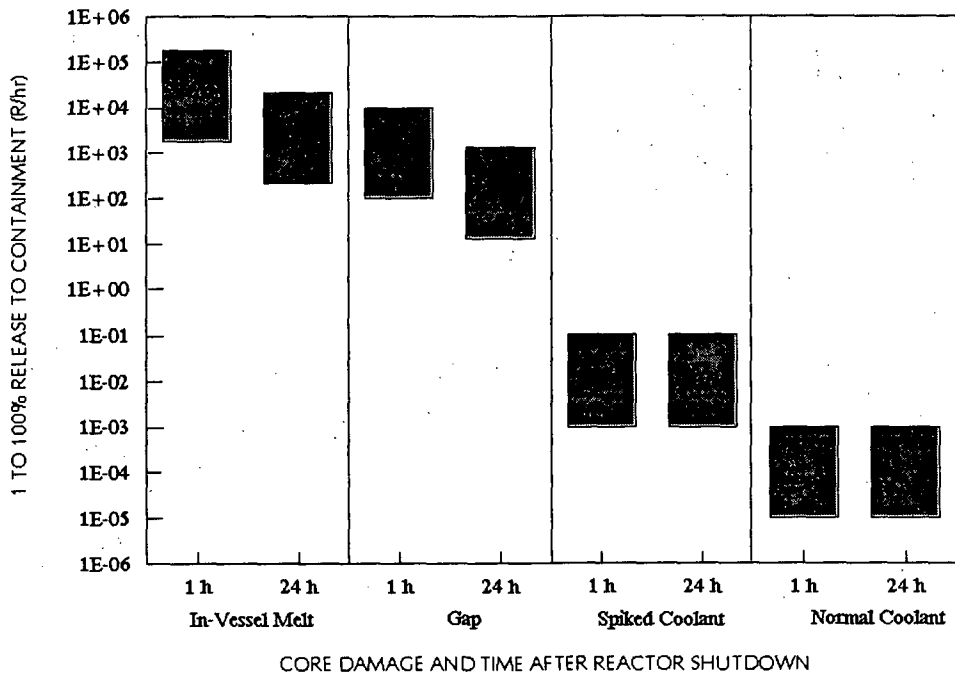

Fig. A-10
BWR Mark III drywell containment monitor response (sprays on).

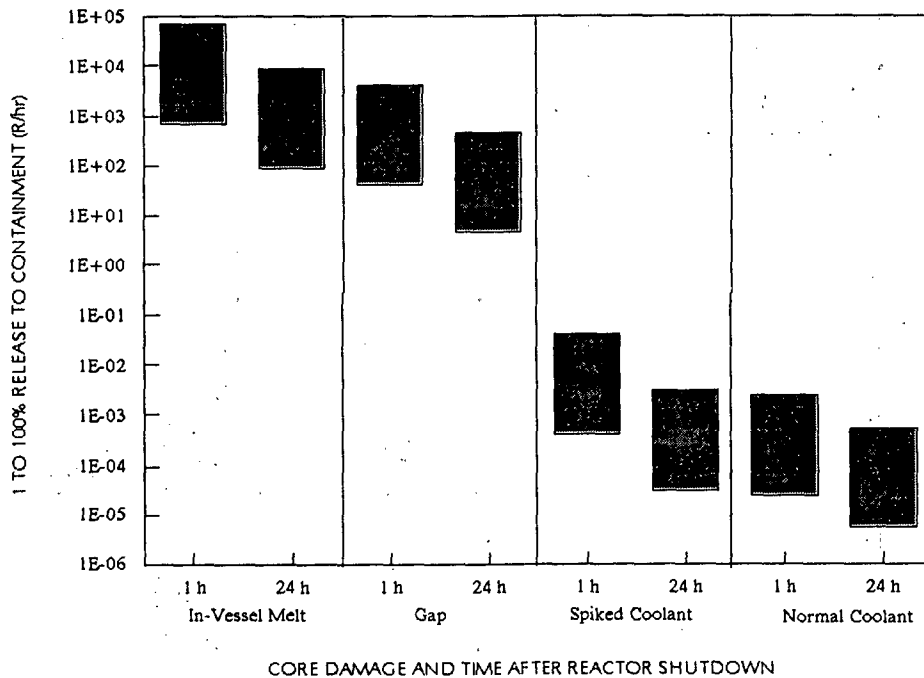

Fig. A-11
BWR Mark III drywell containment monitor response (sprays off).

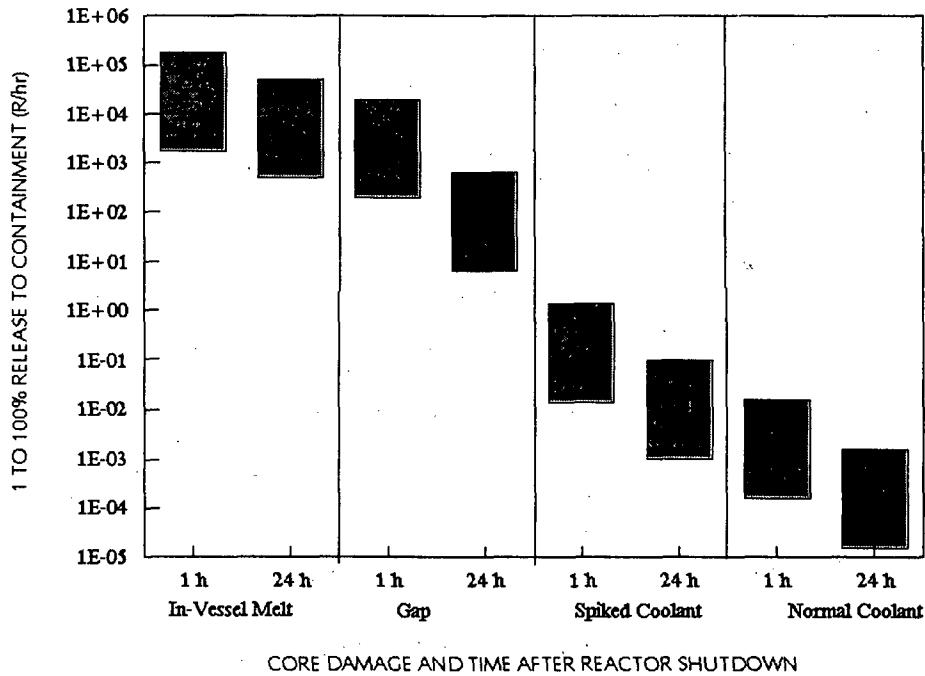
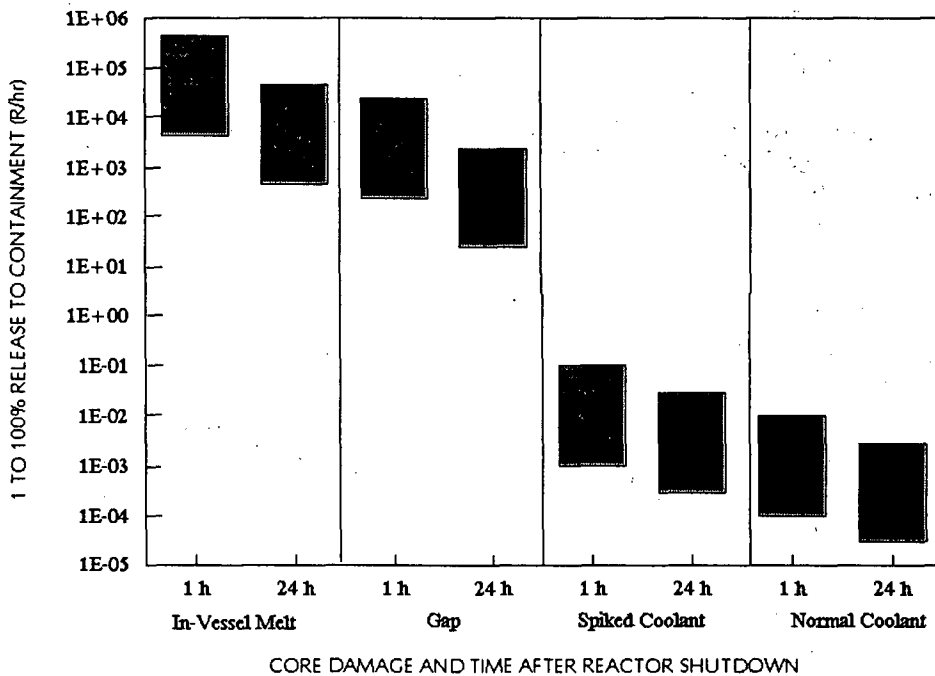
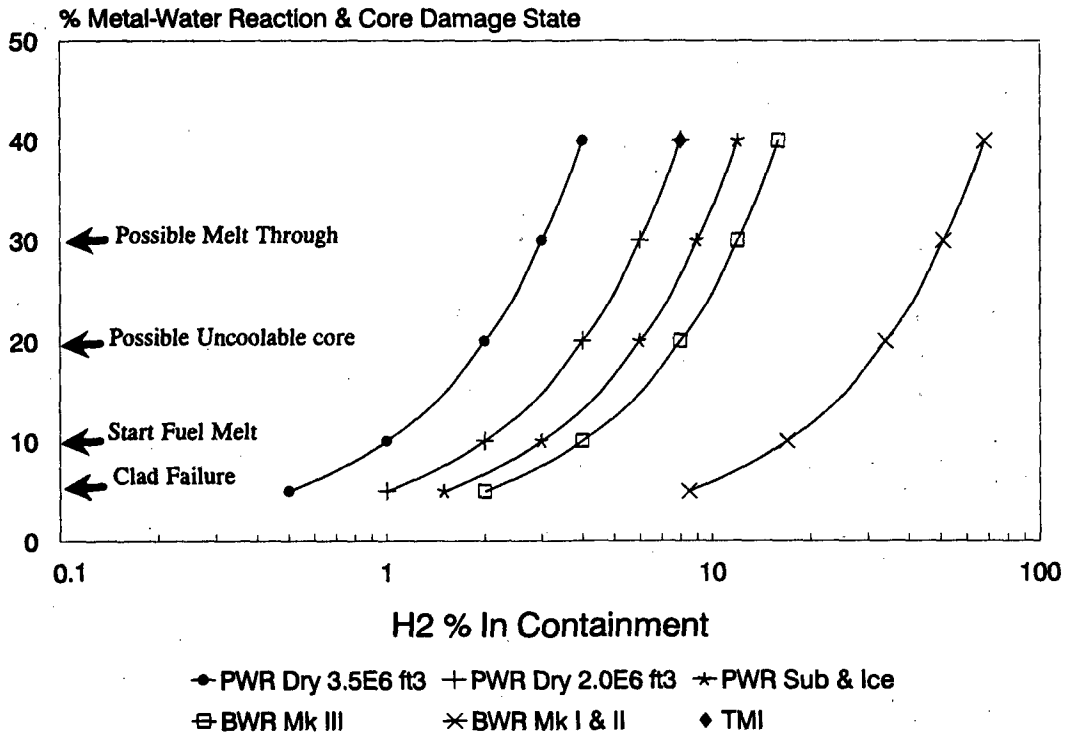

Fig. A-12
BWR Mark III wetwell containment monitor response.



B

Fig. A-13
Percentage of H₂ in containment relative to core damage.



Sources: NUREG/CR-2726, p. 4-3; damage states, NUREG-4524, Vol. 5.;
 TMI percentage, NUREG-1370; NUREG/CR-4041; NUREG/CR-5567, Table 4.9, p. 71,
 confirms "dry" volume.

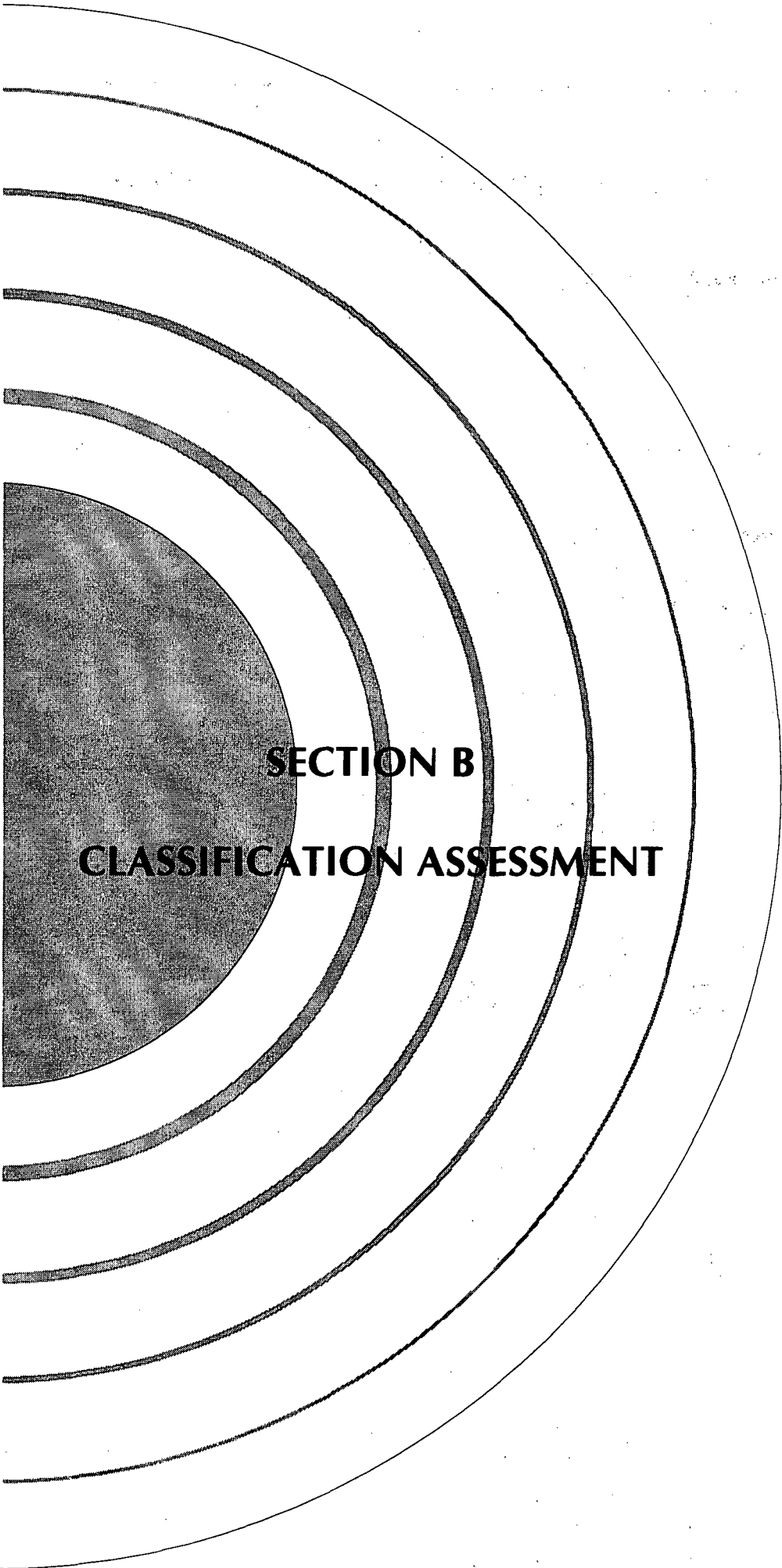

SECTION B
CLASSIFICATION ASSESSMENT

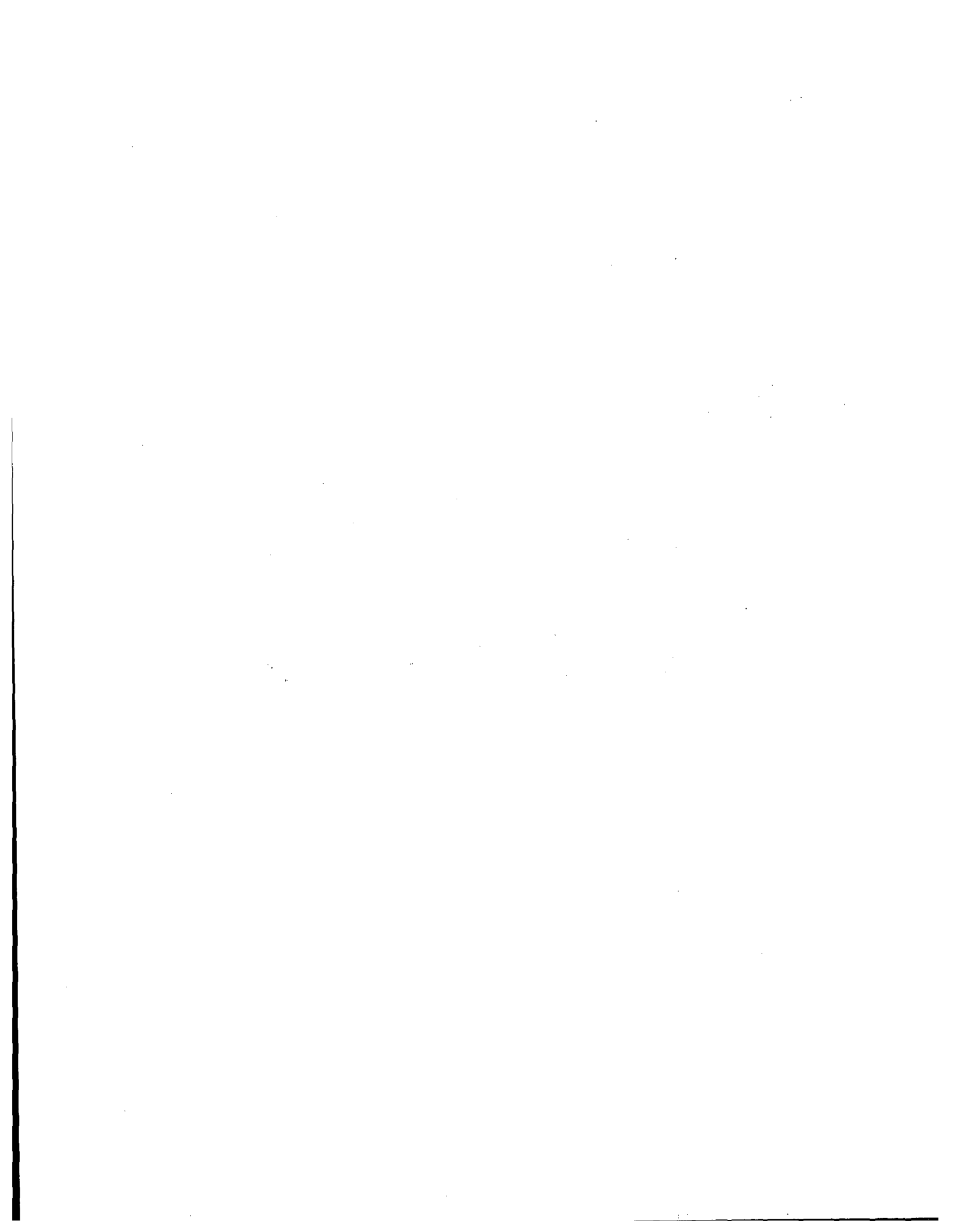

Section B
Quick Reference Guide

	<i>Page</i>
Classification assessment	B-3
NUREG-0654 quick assessment chart	B-5
NUREG-0654 full guidance	B-7
NUMARC/NESP-007 emergency action level guidance	B-23
Fuel cycle and material facilities classification guidance	B-25
Section B tables	B-27

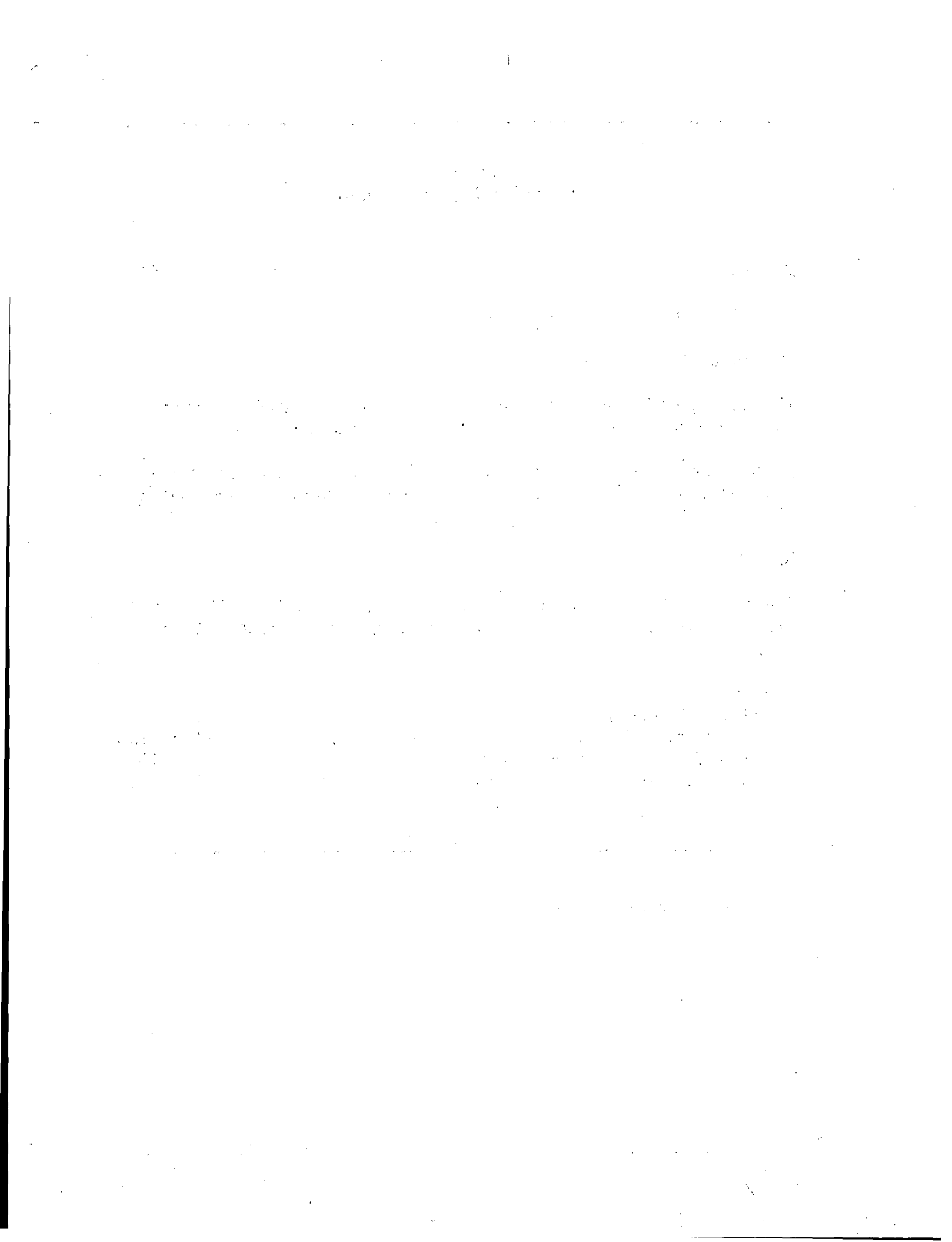

Section B Classification Assessment

Purpose

To verify the licensee's classification of the accident.

Discussion

This section provides methods for determining the appropriate classification of an accident at a nuclear power reactor or at a fuel cycle or material facility.

Differences in classification should be discussed with the licensee only if there is a clear conflict in classification. Questioning the licensee in other cases could slow the accident response.

Step 1

Assess the classification of the accident using one of the methods below. The method chosen will depend on the type of facility and the classification method the facility uses.

Reactor accident

NUREG-0654 quick assessment	Method B.1
NUREG-0654 full guidance	Method B.2
NUMARC/NESP-007 assessment (barrier approach)	Method B.3
Fuel cycle and material facilities accident	Method B.4

END

Sources: NUREG-0654, NUMARC/NESP-007

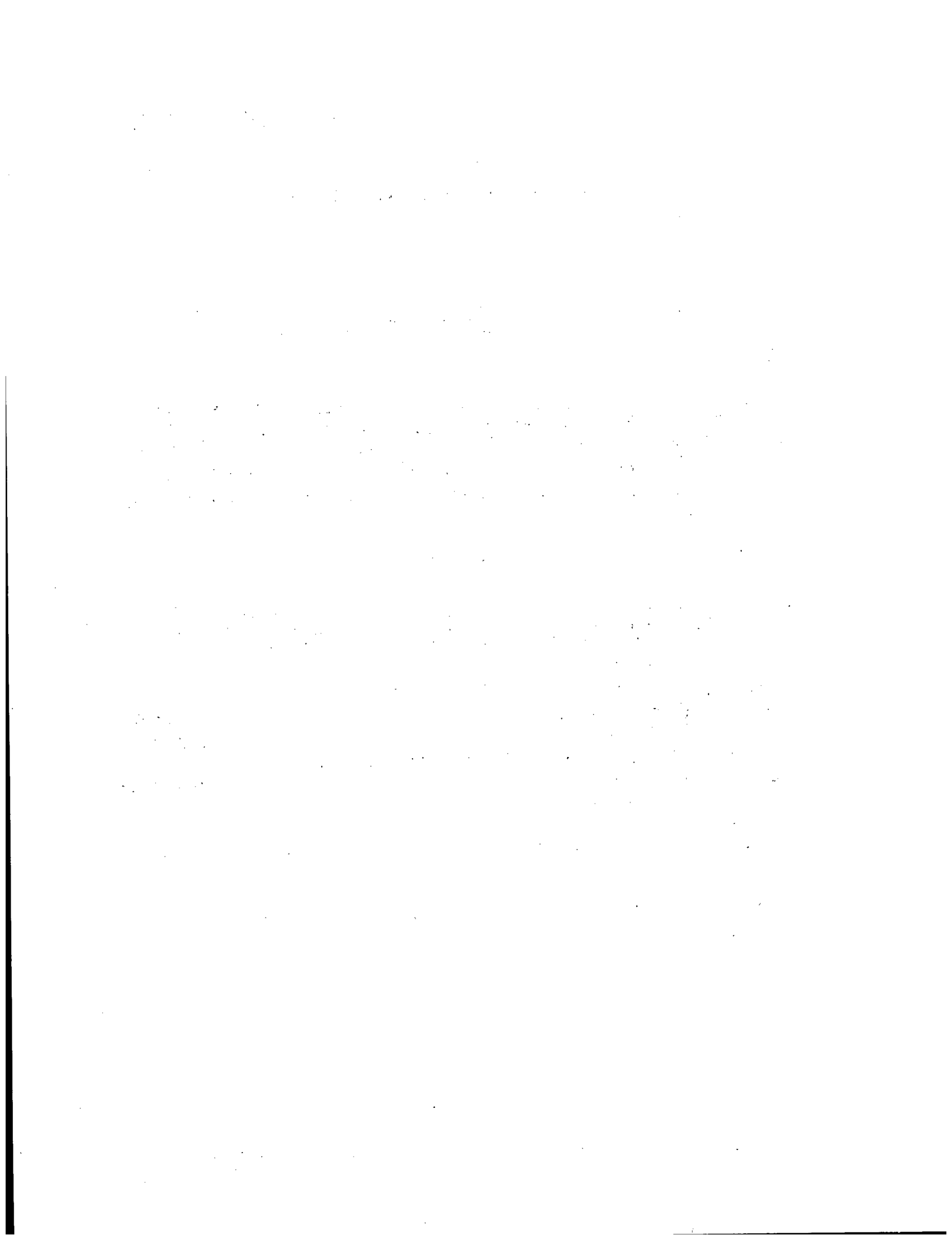

Method B.1 NUREG-0654 Quick Assessment Chart

Purpose

To assess the classification of the accident when the facility uses a classification system based on the initiating conditions (IC) contained in NUREG-0654.

Discussion

This method uses a quick assessment chart containing the NUREG-0654 initiating conditions sorted by the critical safety function, fission product barriers, radiological releases, and other events for easy comparison with the accident condition.

Step 1

Use Table B-1 to determine the emergency classification.

Step 2

Compare the classification with the licensee's classification. If the licensee's classification does not appear to be correct, review the licensee's classification procedure before discussing your finding with the licensee. Resolve any differences in the interpretation of the plant conditions.

Step 3

If, after attempts to resolve any differences, it appears that the licensee is potentially underclassifying a General Emergency, ask the licensee to reevaluate.

Step 4

If the classification is determined to be General Emergency, assess protective actions using Section G.

END

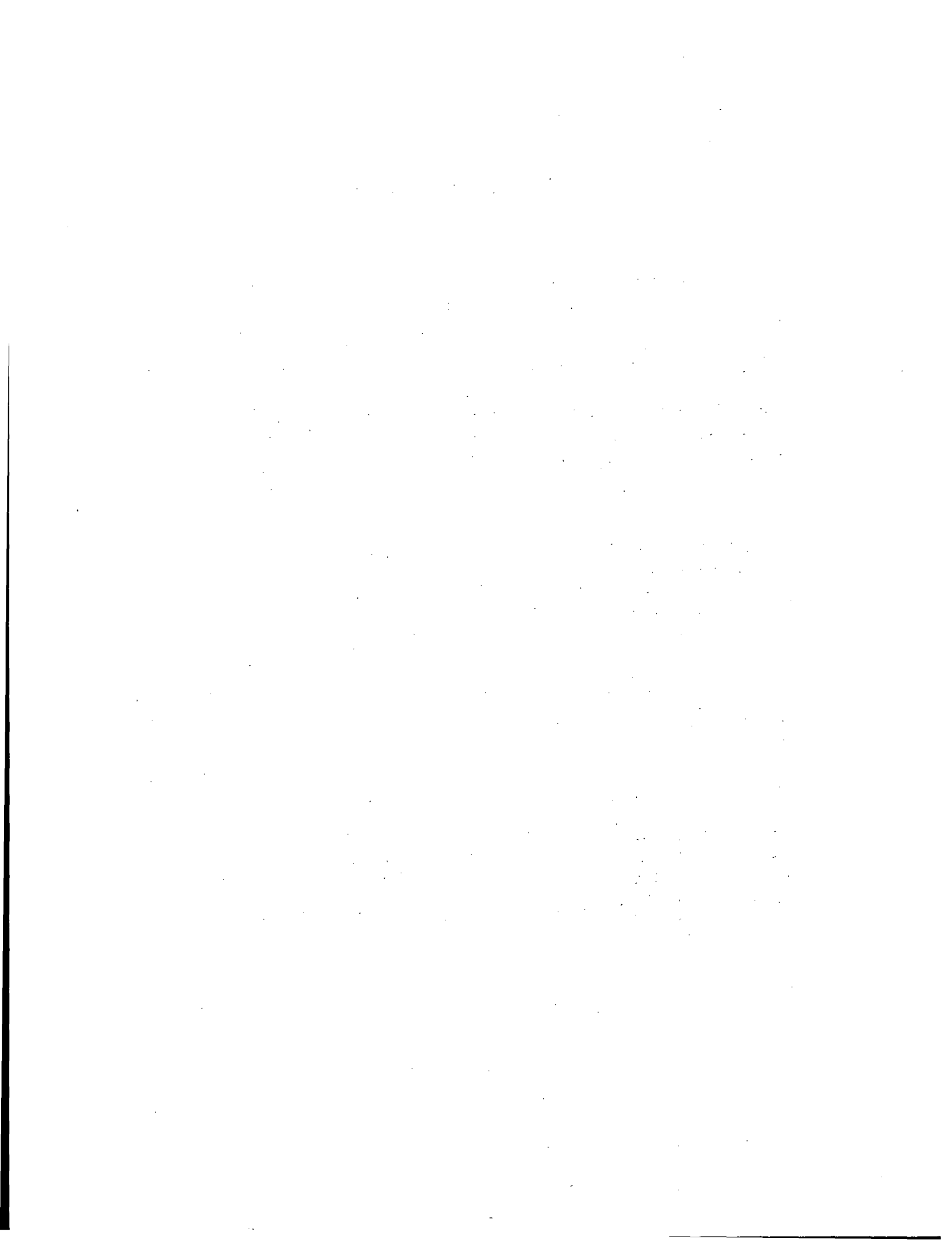

Method B.2 NUREG-0654 Full Guidance

Purpose

To assess the classification of the accident using the NUREG-0654 guidance.

Discussion

This method is used to assess the classification of the accident when the facility uses a classification system based on the initiating conditions contained in NUREG-0654. It provides the complete description, as contained in NUREG-0654, of the initiating conditions that correspond to each of the emergency classes. This method should be used only if you are very familiar with NUREG-0654.

Step 1

Determine the emergency classification of the accident by locating the appropriate example initiating conditions that are listed for each of the emergency classes. (The appropriate appendix from NUREG-0654 is reprinted beginning on p. B-9. An index to the excerpted material appears below.)

	<i>Page</i>
Notification of Unusual Event	B-10
Alert	B-13
Site Area Emergency	B-16
General Emergency	B-19

Step 2

Compare the classification with the licensee's classification. If the licensee's classification does not appear to be correct, review the licensee's classification procedure before discussing your finding with the licensee. Resolve any differences in the interpretation of the plant conditions.

Step 3

If, after attempts to resolve any differences, it appears that the licensee is potentially underclassifying a General Emergency, ask the licensee to reevaluate.

Step 4

If the classification is determined to be General Emergency, assess protective actions using Section G.

END

NUREG-0654 Appendix 1

BASIS FOR EMERGENCY ACTION LEVELS FOR NUCLEAR POWER FACILITIES

Four classes of Emergency Action Levels are established which replace the classes in Regulatory Guide 1.101, each with associated examples of initiating conditions. The classes are:

Notification of Unusual Event

Alert

Site Area Emergency

General Emergency

The rationale for the notification and alert classes is to provide early and prompt notification of minor events which could lead to more serious consequences given operator error or equipment failure or which might be indicative of more serious conditions which are not yet fully realized. A gradation is provided to assure fuller response preparations for more serious indicators. The site area emergency class reflects conditions where some significant releases are likely or are occurring but where a core melt situation is not indicated based on current information. In this situation full mobilization of emergency personnel in the near site environs is indicated as well as dispatch of monitoring teams and associated communications. The general emergency class involves actual or imminent substantial core degradation or melting with the potential for loss of containment. ~~The immediate action for this class is sheltering (staying inside) rather than evacuation until an assessment can be made that (1) an evacuation is indicated and (2) an evacuation, if indicated, can be completed prior to significant release and transport of radioactive material to the affected areas.~~

The example initiating conditions listed after the immediate actions for each class are to form the basis for establishment by each licensee of the specific plant instrumentation readings (as applicable) which, if exceeded, will initiate the emergency class.

Potential NRC actions during various emergency classes are given in NUREG-0728, Report to Congress: NRC Incident Response Plan. The NRC response to any notification from a licensee will be related to, but not limited by, the licensee estimate of severity; NRC will consider such other factors as the degree of uncertainty and the lead times required to position NRC response personnel should something more serious develop.

Prompt notification of offsite authorities is intended to indicate within about 15 minutes for the unusual event class and sooner (consistent with the need for other emergency actions) for other classes. The time is measured from the time at which operators recognize that events have occurred which make declaration of an emergency class appropriate.

<u>Class</u>	<u>Licensee Actions</u>	<u>State and/or Local Offsite Authority Actions</u>
NOTIFICATION OF UNUSUAL EVENT	<ol style="list-style-type: none"> 1. Promptly inform State and/or local offsite authorities of nature of unusual condition as soon as discovered 2. Augment on-shift resources as needed 3. Assess and respond 4. Escalate to a more severe class, if appropriate 	<ol style="list-style-type: none"> 1. Provide fire or security assistance if requested 2. Escalate to a more severe class, if appropriate 3. Stand by until verbal closeout
<u>Class Description</u>	<u>or</u>	
<p>Unusual events are in process or have occurred which indicate a potential degradation of the level of safety of the plant. No releases of radioactive material requiring offsite response or monitoring are expected unless further degradation of safety systems occurs.</p>	<ol style="list-style-type: none"> 5. Close out with verbal summary to offsite authorities; followed by written summary within 24 hours 	
<u>Purpose</u>		
<p>Purpose of offsite notification is to (1) assure that the first step in any response later found to be necessary has been carried out, (2) bring the operating staff to a state of readiness, and (3) provide systematic handling of unusual events information and decisionmaking.</p>		

EXAMPLE INITIATING CONDITIONS: NOTIFICATION OF UNUSUAL EVENT

1. Emergency Core Cooling System (ECCS) initiated and discharge to vessel
2. Radiological effluent technical specification limits exceeded
3. Fuel damage indication. Examples:
 - a. High offgas at BWR air ejector monitor (greater than 500,000 $\mu\text{Ci}/\text{sec}$; corresponding to 16 isotopes decayed to 30 minutes; or an increase of 100,000 $\mu\text{Ci}/\text{sec}$ within a 30 minute time period)
 - b. High coolant activity sample (e.g., exceeding coolant technical specifications for iodine spike)
 - c. Failed fuel monitor (PWR) indicates increase greater than 0.1% equivalent fuel failures within 30 minutes
4. Abnormal coolant temperature and/or pressure or abnormal fuel temperatures outside of technical specification limits
5. Exceeding either primary/secondary leak rate technical specification or primary system leak rate technical specification
6. Failure of a safety or relief valve in a safety related system to close following reduction of applicable pressure
7. Loss of offsite power or loss of onsite AC power capability
8. Loss of containment integrity requiring shutdown by technical specifications
9. Loss of engineered safety feature or fire protection system function requiring shutdown by technical specifications (e.g., because of malfunction, personnel error or procedural inadequacy)
10. Fire within the plant lasting more than 10 minutes
11. Indications or alarms on process or effluent parameters not functional in control room to an extent requiring plant shutdown or other significant loss of assessment or communication capability (e.g., plant computer, Safety Parameter Display System, all meteorological instrumentation)
12. Security threat or attempted entry or attempted sabotage
13. Natural phenomenon being experienced or projected beyond usual levels
 - a. Any earthquake felt in-plant or detected on station seismic instrumentation
 - b. 50 year floor or low water, tsunami, hurricane surge, seiche
 - c. Any tornado on site
 - d. Any hurricane

14. Other hazards being experienced or projected
 - a. Aircraft crash on-site or unusual aircraft activity over facility
 - b. Train derailment on-site
 - c. Near or onsite explosion
 - d. Near or onsite toxic or flammable gas release
 - e. Turbine rotating component failure causing rapid plant shutdown
15. Other plant conditions exist that warrant increased awareness on the part of a plant operating staff or State and/or local offsite authorities or require plant shutdown under technical specification requirements or involve other than normal controlled shutdown (e.g., cooldown rate exceeding technical specification limits, pipe cracking found during operation)
16. Transportation of contaminated injured individual from site to offsite hospital
17. Rapid depressurization of PWR secondary side.

<u>Class</u>	<u>Licensee Actions</u>	<u>State and/or Local Offsite Authority Actions</u>
<p>ALERT</p> <p><u>Class Description</u></p> <p>Events are in process or have occurred which involve an actual or potential substantial degradation of the level of safety of the plant. Any releases expected to be limited to small fractions of the EPA Protective Action Guideline exposure levels.</p> <p><u>Purpose</u></p> <p>Purpose of offsite alert is to (1) assure that emergency personnel are readily available to respond if situation becomes more serious or to perform confirmatory radiation monitoring if required, and (2) provide offsite authorities current status information.</p>	<ol style="list-style-type: none"> 1. Promptly inform State and/or local authorities of alert status and reason for alert as soon as discovered 2. Augment resources and activate on-site Technical Support Center and on-site operational support center. Bring Emergency Operations Facility (EOF) and other key emergency personnel to standby status 3. Assess and respond 4. Dispatch on-site monitoring teams and associated communications 5. Provide periodic plant status updates to offsite authorities (at least every 15 minutes) 6. Provide periodic meteorological assessments to offsite authorities and, if any releases are occurring, dose estimates for actual releases 7. Escalate to a more severe class, if appropriate 8. Close out or recommend reduction in emergency class by verbal summary to offsite authorities followed by written summary within 8 hours of closeout or class reduction 	<ol style="list-style-type: none"> 1. Provide fire or security assistance if requested 2. Augment resources and bring primary response centers and EBS to standby status 3. Alert to standby status key emergency personnel including monitoring teams and associated communications 4. Provide confirmatory offsite radiation monitoring and ingestion pathway dose projections if actual releases substantially exceed technical specification limits 5. Escalate to a more severe class, if appropriate 6. Maintain alert status until verbal closeout or reduction of emergency class

EXAMPLE INITIATING CONDITIONS: ALERT

1. Severe loss of fuel cladding
 - a. High offgas at BWR air ejector monitor (greater than 5 ci/sec; corresponding to 16 isotopes decayed 30 minutes)
 - b. Very high coolant activity sample (e.g., 300 μ ci/cc equivalent of I-131)
 - c. Failed fuel monitor (PWR) indicates increase greater than 1% fuel failures within 30 minutes or 5% total fuel failures.
2. Rapid gross failure of one steam generator tube with loss of offsite power
3. Rapid failure of steam generator tubes (e.g., several hundred gpm primary to secondary leak rate)
4. Steam line break with significant (e.g., greater than 10 gpm) primary to secondary leak rate (PWR) or MSIV malfunction causing leakage (BWR)
5. Primary coolant leak rate greater than 50 gpm
6. Radiation levels or airborne contamination which indicate a severe degradation in the control of radioactive materials (e.g., increase of factor of 1000 in direct radiation readings within facility)
7. Loss of offsite power and loss of all onsite AC power (see Site Area Emergency for extended loss)
8. Loss of all onsite DC power (See Site Area Emergency for extended loss)
9. Coolant pump seizure leading to fuel failure
10. Complete loss of any function needed for plant cold shutdown
11. Failure of the reactor protection system to initiate and complete a scram which brings the reactor subcritical
12. Fuel damage accident with release of radioactivity to containment or fuel handling building
13. Fire potentially affecting safety systems
14. Most or all alarms (annunciators) lost
15. Radiological effluents greater than 10 times technical specification instantaneous limits (an instantaneous rate which, if continued over 2 hours, would result in about 1 mr at the site boundary under average meteorological conditions)
16. Ongoing security compromise

17. Severe natural phenomena being experienced or projected
 - a. Earthquake greater than OBE levels
 - b. Flood, low water, tsunami, hurricane surge, seiche near design levels
 - c. Any tornado striking facility
 - d. Hurricane winds near design basis level
18. Other hazards being experienced or projected
 - a. Aircraft crash on facility
 - b. Missile impacts from whatever source on facility
 - c. Known explosion damage to facility affecting plant operation
 - d. Entry into facility environs of uncontrolled toxic or flammable gases
 - e. Turbine failure causing casing penetration
19. Other plant conditions exist that warrant precautionary activation of technical support center and placing near-site Emergency Operations Facility and other key emergency personnel on standby
20. Evacuation of control room anticipated or required with control of shutdown systems established from local stations

<u>Class</u>	<u>Licensee Actions</u>	<u>State and/or Local Offsite Authority Actions</u>
SITE AREA EMERGENCY		
<u>Class Description</u>		
Events are in process or have occurred which involve actual or likely major failures of plant functions needed for protection of the public. Any releases not expected to exceed EPA Protective Action Guideline exposure levels except near site boundary.		
<u>Purpose</u>		
Purpose of the site area emergency declaration is to (1) assure that response centers are manned, (2) assure that monitoring teams are dispatched, (3) assure that personnel required for evacuation of near-site areas are at duty stations if situation becomes more serious, (4) provide consultation with offsite authorities, and (5) provide updates for the public through offsite authorities.	<ol style="list-style-type: none"> 1. Promptly inform State and/or local offsite authorities of site area emergency status and reason for emergency as soon as discovered 2. Augment resources by activating on-site Technical Support Center, on-site operational support center and near-site Emergency Operations Facility (EOF) 3. Assess and respond 4. Dispatch on-site and offsite monitoring teams and associated communications 5. Dedicate an individual for plant status updates to offsite authorities and periodic pressure briefings (perhaps joint with offsite authorities) 6. Make senior technical and management staff onsite available for consultation with NRC and State on a periodic basis 7. Provide meteorological and dose estimates to offsite authorities for actual releases via a dedicated individual or automated data transmission 8. Provide release and dose projections based on available plant condition information and foreseeable contingencies 9. Escalate to <u>general emergency class</u>, if appropriate <p style="text-align: center;">or</p> <ol style="list-style-type: none"> 10. Close out or recommend reduction in emergency class by briefing of offsite authorities at EOF and by phone followed by written summary within 8 hours of closeout or class reduction 	<ol style="list-style-type: none"> 1. Provide any assistance requested 2. If sheltering near the site is desirable, activate public notification system within at least two miles of the plant 3. Provide public within at least about 10 miles periodic updates on emergency status 4. Augment resources by activating primary response centers 5. Dispatch key emergency personnel including monitoring teams and associated communications 6. Alert to standby status other emergency personnel (e.g., those needed for evacuation) and dispatch personnel to near-site duty stations 7. Provide offsite monitoring results to licensee, DOE and others and jointly assess them 8. Continuously assess information from licensee and offsite monitoring with regard to changes to protective actions already initiated for public and mobilizing evacuation resources 9. Recommend placing milk animals within 2 miles on stored feed and assess need to extend distance 10. Provide press briefings, perhaps with licensee 11. Escalate to <u>general emergency class</u>, if appropriate 12. Maintain site area emergency status until closeout or reduction of emergency class

EXAMPLE INITIATING CONDITIONS: SITE AREA EMERGENCY

1. Known loss of coolant accident greater than makeup pump capacity
2. Degraded core with possible loss of coolable geometry (indicators should include instrumentation to detect inadequate core cooling, coolant activity and/or containment radioactivity levels)
3. Rapid failure of steam generator tubes (several hundred gpm leakage) with loss of offsite power
4. BWR steam line break outside containment without isolation
5. PWR steam line break with greater than 50 gpm primary to secondary leakage and indication of fuel damage
6. Loss of offsite power and loss of onsite AC power for more than 15 minutes
7. Loss of all vital onsite DC power for more than 15 minutes
8. Complete loss of any function needed for plant hot shutdown
9. Transient requiring operation of shutdown systems with failure to scram (continued power generation but no core damage immediately evident)
10. Major damage to spent fuel in containment or fuel handling building (e.g., large object damages fuel or water loss below fuel level)
11. Fire compromising the functions of safety systems
12. Most or all alarms (annunciators) lost and plant transient initiated or in progress
13.
 - a. Effluent monitors detect levels corresponding to greater than 50 mr/hr for 1/2 hour or greater than 500 mr/hr W.B. for two minutes (or five times these levels to the thyroid) at the site boundary for adverse meteorology
 - b. These dose rates are projected based on other plant parameters (e.g., radiation level in containment with leak rate appropriate for existing containment pressure) or are measured in the environs
 - c. EPA Protective Action Guidelines are projected to be exceeded outside the site boundary
14. Imminent loss of physical control of the plant
15. Severe natural phenomena being experienced or projected with plant not in cold shutdown
 - a. Earthquake greater than SSE levels

- b. Flood, low water, tsunami, hurricane surge, seiche greater than design levels or failure of protection of vital equipment at lower levels
 - c. Sustained winds or tornadoes in excess of design levels
16. Other hazards being experienced or projected with plant not in cold shutdown
- a. Aircraft crash affecting vital structures by impact or fire
 - b. Severe damage to safe shutdown equipment from missiles or explosion
 - c. Entry of uncontrolled flammable gases into vital areas. Entry of uncontrolled toxic gases into vital areas where lack of access to the area constitutes a safety problem
17. Other plant conditions exist that warrant activation of emergency centers and monitoring teams or a precautionary notification to the public near the site
18. Evacuation of control room and control of shutdown systems not established from local stations in 15 minutes

<u>Class</u>	<u>Licensee Actions</u>	<u>State and/or Local Offsite Authority Actions</u>
GENERAL EMERGENCY		
<u>Class Description</u>		
Events are in process or have occurred which involve actual or imminent substantial core degradation or melting with potential for loss of containment integrity. Releases can be reasonably expected to exceed EPA Protective Action Guideline exposure levels offsite for more than the immediate site area.		
<u>Purpose</u>		
Purpose of the general emergency declaration is to (1) initiate predetermined protective actions for the public, (2) provide continuous assessment of information from licensee and offsite organization measurements, (3) initiate additional measures as indicated by actual or potential releases, (4) provide consultation with offsite authorities and (5) provide updates for the public through offsite authorities.	<ol style="list-style-type: none"> 1. Promptly inform State and local offsite authorities of general emergency status and reason for emergency as soon as discovered (Parallel notification of State/local) 2. Augment resources by activating on-site Technical Support Center, on-site operational support center and near-site Emergency Operations Facility (EOF) 3. Assess and respond 4. Dispatch on-site and offsite monitoring teams and associated communications 5. Dedicate an individual for plant status updates to offsite authorities and periodic press briefings (perhaps joint with offsite authorities) 6. Make senior technical and management staff onsite available for consultation with NRC and State on a periodic basis 7. Provide meteorological and dose estimates to offsite authorities for actual releases via a dedicated individual or automated data transmission 8. Provide release and dose projections based on available plant condition information and foreseeable contingencies 9. Close out or recommend reduction of emergency class by briefing of offsite authorities at EOF and by phone followed by written summary within 8 hours of closeout or class reduction 	<ol style="list-style-type: none"> 1. Provide any assistance requested 2. Activate immediate public notification of emergency status and provide public periodic updates 3. Recommend sheltering for 2 mile radius and 5 miles downwind and assess need to extend distances. Consider advisability of evacuation (projected time available vs. estimated evacuation times) 4. Augment resources by activating primary response centers 5. Dispatch key emergency personnel including monitoring teams and associated communications 6. Dispatch other emergency personnel to duty stations within 5 mile radius and alert all others to standby status 7. Provide offsite monitoring results to licensee, DOE and others and jointly assess them 8. Continuously assess information from licensee and offsite monitoring with regard to changes to protective actions already initiated for public and mobilizing evacuation resources 9. Recommend placing milk animals within 10 miles on stored feed and assess need to extend distance 10. Provide press briefings, perhaps with licensee 11. Maintain general emergency status until closeout or reduction of emergency class

EXAMPLE INITIATING CONDITIONS: GENERAL EMERGENCY

1. a. Effluent monitors detect levels corresponding to 1 rem/hr W.B. or 5 rem/hr thyroid at the site boundary under actual meteorological conditions
- b. These dose rates are projected based on other plant parameters (e.g., radiation levels in containment with leak rate appropriate for existing containment pressure with some confirmation from effluent monitors) or are measured in the environs

~~Note: Consider evacuation only within about 2 miles of the site boundary unless these site boundary levels are exceeded by a factor of 10 or projected to continue for 10 hours or EPA Protective Action Guideline exposure levels are predicted to be exceeded at longer distances~~

2. Loss of 2 of 3 fission product barriers with a potential loss of 3rd barrier, (e.g., loss of primary coolant boundary, clad failure, and high potential for loss of containment)

3. Loss of physical control of the facility

~~Note: Consider 2 mile precautionary evacuation~~

4. Other plant conditions exist, from whatever source, that make release of large amounts of radioactivity in a short time period possible, e.g., any core melt situation. See the specific PWR and BWR sequences below.

~~Notes: a. For core melt sequences where significant releases from containment are not yet taking place and large amounts of fission products are not yet in the containment atmosphere, consider 2 mile precautionary evacuation. Consider 5 mile downwind evacuation (450 to 900 sector) if large amounts of fission products (greater than gap activity) are in the containment atmosphere. Recommend sheltering in other parts of the plume exposure emergency planning zone under this circumstance.~~

~~b. For core melt sequences where significant releases from containment are not yet taking place and containment failure leading to a direct atmospheric release is likely in the sequence but not imminent and large amounts of fission products in addition to noble gases are in the containment atmosphere, consider precautionary evacuation to 5 miles and 10 mile downwind evacuation (450 to 900 sector).~~

~~c. For core melt sequences where large amounts of fission products other than noble gases are in the containment atmosphere and containment failure is judged imminent, recommend shelter for those areas where evacuation cannot be completed before transport of activity to that location.~~

~~d. As release information becomes available adjust these actions in accordance with dose projections, time available to evacuate and estimated evacuation times given current conditions.~~

5. Example PWR Sequences

- a. Small and large LOCA's with failure of ECCS to perform leading to severe core degradation or melt in from minutes to hours. Ultimate failure of containment likely for melt sequences. (Several hours likely to be available to complete protective actions unless containment is not isolated)
- b. Transient initiated by loss of feedwater and condensate systems (principal heat removal system) followed by failure of emergency feedwater system for extended period. Core melting possible in several hours. Ultimate failure of containment likely if core melts.
- c. Transient requiring operation of shutdown systems with failure to scram which results in core damage or additional failure of core cooling and makeup systems (which could lead to core melt)
- d. Failure of offsite and onsite power along with total loss of emergency feedwater makeup capability for several hours. Would lead to eventual core melt and likely failure of containment.
- e. Small LOCA and initially successful ECCS. Subsequent failure of containment heat removal systems over several hours could lead to core melt and likely failure of containment.

NOTE: Most likely containment failure mode is melt-through with release of gases only for dry containment; quicker and larger releases likely for ice condenser containment for melt sequences. Quicker releases expected for failure of containment isolation system for any PWR.

6. Example BWR Sequences

- a. Transient (e.g., loss of offsite power) plus failure of requisite core shut down systems (e.g., scram). Could lead to core melt in several hours with containment failure likely. More severe consequences if pumps trip does not function.
- b. Small or large LOCA's with failure of ECCS to perform leading to core melt degradation or melt in minutes to hours. Loss of containment integrity may be imminent.
- c. Small or large LOCA occurs and containment performance is unsuccessful affecting longer term success of the ECCS. Could lead to core degradation or melt in several hours without containment boundary.

- d. Shutdown occurs but requisite decay heat removal systems (e.g., RHR) or non-safety systems heat removal means are rendered unavailable. Core degradation or melt could occur in about ten hours with subsequent containment failure.
- 7. Any major internal or external events (e.g., fires, earthquakes, substantially beyond design basis) which could cause massive common damage to plant systems resulting in any of the above.

Method B.3 NUMARC/NESP-007 Emergency Action Level Guidance

Purpose

To assess the classification of an accident when the facility uses a classification system based on NUMARC/NESP-007 methodology (barrier approach).

Discussion

The Nuclear Energy Institute [formerly the Nuclear Management and Resources Council, Inc. (NUMARC)] methodology is contained in NUMARC/NESP-007, *Methodology for Development of Emergency Action Levels*. The emergency action level (EAL) methodology is generic and was intended to provide the logic for developing site-specific EALs. As a result, the utilities' EALs may reference site-specific procedures, indications, values, etc.

This methodology uses Recognition Categories for classifying the accident. For each of the Recognition Categories, a matrix is provided showing initiating conditions (ICs) and the corresponding emergency class. The IC matrices apply to both PWRs and BWRs. Refer to NUMARC/NESP-007 for specific examples of EALs.

All cases of severe core damage (loss of fuel cladding barrier) should be classified as a General Emergency.

Step 1

Determine the Recognition Category (A, H, S, or F, as shown below) that matches the existing plant condition.

Abnormal radiation levels/radiological effluent	A
Hazards and other conditions affecting plant safety	H
System malfunction	S
Fission product barrier degradation	F

Step 3

If the Recognition Category is F, go to Step 4.

If the Recognition Category is **A**, **H**, or **S**, use the applicable IC matrix for the Recognition Category to determine the IC and the corresponding emergency class. Then go to **Step 5**.

Category A	Table B-2
Category H	Table B-3
Category S	Table B-4

Step 4

If the Recognition Category is **F**, then use the fission product barrier degradation IC matrix (Table B-5) to determine the IC and the emergency class. To determine if the fission product barrier(s) is/are lost or potentially lost, refer to the barrier-based emergency action levels (EALs) listed in Table B-6 for BWRs and Table B-7 for PWRs. Match the observed plant parameters affecting each of the fuel, RCS, and containment fission product barriers to the EALs that are listed in these tables, and note whether each barrier is lost or potentially lost. Then return to Table B-5 and determine the classification from the listed barrier conditions.

Step 5

Compare the classification with the licensee's classification. If the licensee's classification does not appear to be correct, review the licensee's classification procedure before discussing your finding with the licensee. Resolve any differences in the interpretation of the plant conditions.

Step 6

If, after attempts to resolve any differences, it appears that the licensee is potentially underclassifying a General Emergency, ask the licensee to reevaluate.

Step 7

If the classification is determined to be General Emergency, assess protective actions using Section G.

END

Method B.4

Fuel Cycle and Material Facilities Classification Guidance

Purpose

This method is used to assess the classification of an accident at a fuel cycle or material facility.

Discussion

Emergency plans for fuel cycle and material facilities are not yet standardized. As licenses are renewed at facilities requiring emergency plans, a standardized classification system will be adopted. Some facilities do not have emergency plans because of the small quantity of material they handle. These classification descriptions would not apply to the facilities that do not have emergency plans.

Step 1

Use the classification descriptions in Table B-8 to determine the emergency classification of the accident. Note that there are no Unusual Event or General Emergency classifications for non-reactor facilities.

Step 2

Compare the classification with the licensee's classification. If the licensee's classification does not appear to be correct, review the licensee's classification procedure before discussing your finding with the licensee. Resolve any differences in the interpretation of the plant conditions.

Step 3

If, after attempts to resolve any differences, it appears that the licensee is potentially underclassifying a General Emergency, ask the licensee to reevaluate.

Step 4

If the classification is determined to be General Emergency, assess protective actions using Section G.

END

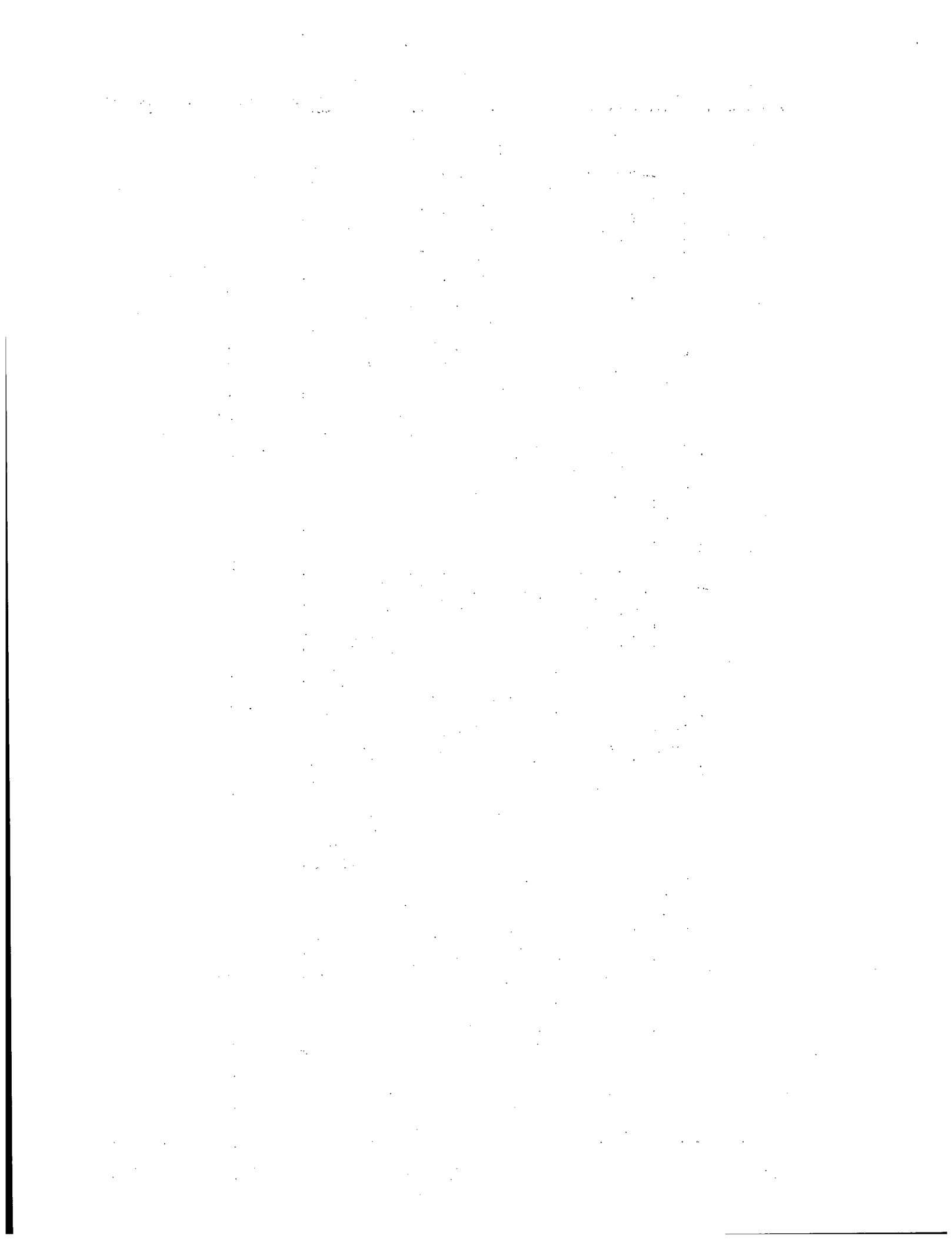

Table B-1. NUREG-0654 quick assessment chart

Type	Unusual Event	Alert	Site Area	General
Reactivity control loss		Failure to completely shut down the reactor	Transient requiring shutdown <i>and</i> failure to shutdown	Transient requiring shutdown, failure to shut down, <i>and</i> - failure of ECCS <i>or</i> - indication of core damage
Inventory control loss	ECCS starts and injects water into reactor	Primary system leak rate > 50 gal/min	Primary system leak > makeup capacity	Primary coolant system leak (LOCA) <i>and</i> failure of ECCS Any event leading to prolonged uncover of core
Heat removal loss	Outside Tech Specs: - coolant temperature - coolant pressure - fuel temperature Loss of engineered safety feature system requiring shutdown by Tech Specs	Complete loss of function required for cold shutdown RC pump seizure leading to fuel cladding failure	Complete loss of function needed for hot shutdown	Decay heat removal systems (primary coolant or containment) failure for extended period PWR loss of main and auxiliary feedwater for an extended period

Table B-1. NUREG-0654 quick assessment chart (continued)

Type	Unusual Event	Alert	Site Area	General
Vital auxiliaries loss Power	AC loss onsite or offsite	AC loss onsite and offsite Vital DC loss onsite PWR loss of offsite power <i>and</i> rapid steam generator tube rupture	AC loss > 15 min onsite and offsite Vital DC loss onsite > 15 min PWR loss of offsite power <i>and</i> > 300 gal/min steam generator tube rupture	PWR AC loss onsite and offsite <i>and</i> loss of auxiliary feedwater for several hours BWR loss of onsite and offsite power <i>and</i> reactor not shut down
Control room		Evacuation of control room <i>and</i> control of shutdown system established	Evacuation of control room <i>and</i> control of shutdown system not established within 15 min Loss of most control room alarms <i>and</i> transient in progress	Loss of control of the facility
Instruments & alarms	Loss of instruments and alarms requiring shutdown by Tech Specs Significant loss of assessment capability	Loss of most control room alarms		
Fuel cladding loss	>0.1% clad failure in 30 min BWR high radioactivity in offgas or reactor coolant Coolant activity > Tech Spec	>1.0% cladding failure in 30 min <i>or</i> 5% total clad failure BWR very high radioactivity in offgas (>5 Ci/s). Reactor coolant (>300 μ Ci/cc)	Degraded core with possible loss of coolable geometry	Actual or projected >100% cladding failure equivalent Any sequence that could lead to severe heatup of core

Table B-1. NUREG-0654 quick assessment chart (continued)

Type	Unusual Event	Alert	Site Area	General
Primary system breaks & leaks	Primary system leak > Tech Spec	Primary system leak rate > 50 gal/min	Primary system leak > makeup system capability (LOCA)	Primary system leak > makeup <i>and</i> failure of ECCS
	PWR steam generator tube leak > Tech Specs	PWR rapid steam generator tube rupture(s) <i>and</i> - loss of offsite power	PWR rapid steam generator tube rupture > 300 gal/min & loss of offsite power	Events leading to prolonged core uncover
	PWR rapid loss of secondary side pressure	<i>or</i> - leak > 300 gal/min	PWR steam line break & steam generator tube rupture leak > 50 gal/min <i>and</i> cladding failure	Loss of two of three fission product barriers <i>and</i> potential loss of the third barrier
	Stuck open code safety or power operated relief valves	PWR steam line break <i>and</i> steam generator tube leak > 10 gal/min BWR steam line break inside containment without MSIV closure	BWR steam line break outside containment without MSIV closure	
Containment loss	Loss of containment integrity requiring shutdown by Tech Specs	BWR steam line break inside containment without MSIV closure	BWR steam line break outside containment without MSIV closure	Loss of any two of three fission product barriers <i>and</i> potential loss of the third barrier BWR primary system leak <i>and</i> loss of containment integrity affecting success of ECCS
Radiological release	Effluent radiation release > Tech Specs	Offsite radiation release > 10 × instantaneous limits In-plant radiation levels > 1000 × normal	Whole body dose projection assuming adverse meteorological conditions indicate > 50 mR/h for 30 min <i>or</i> 500 mR/h for 2 min at site boundary	Actual measurements or dose projections under actual meteorological conditions indicate EPA PAGs will be exceeded at the site boundary Possible release of large amounts of radioactivity offsite

Table B-1. NUREG-0654 quick assessment chart (continued)

Type	Unusual Event	Alert	Site Area	General
Spent fuel accident		Spent fuel damage with radiation release in plant	Major damage to spent fuel Spent fuel pool water level below top of spent fuel	Dose projections or measurements indicate EPA PAGs will be exceeded at site boundary
Fire	Plant fire lasting > 10 min Loss of fire protection system requiring shutdown by Tech Specs	Fire potentially affecting safety systems	Fire compromising the functions of safety systems	Major fire that could cause massive common damage to plant systems leading to core melt
Security	Security threat Attempted entry Attempted sabotage	Ongoing security compromise	Imminent loss of control of the plant	Loss of control of the plant
Other hazards	Actual or projected hazards - earthquakes - floods - hurricanes - tornados - explosions - gas releases - aircraft crashes - derailment	Actual or projected severe hazards	Severe natural phenomena or hazard <i>and</i> plant not in cold shutdown - any event greater than design - damage to safety systems - flammable gas in vital areas	Major event which could cause massive common damage to plant systems resulting in core melt

Table B-1. NUREG-0654 quick assessment chart (continued)

Type	Unusual Event	Alert	Site Area	General
Activation of centers	Conditions warrant increased awareness	Conditions warrant activation of TSC	Conditions warrant activation of TSC or EOF	
Public notification			Conditions warrant notification of the public	
Medical	Transport of contaminated injured person to hospital			

Source: Adapted from NUREG-0654.

Table B-2. Recognition Category A: Abnormal rad levels/radiological effluent initiating condition matrix

Unusual Event		Alert		Site Area Emergency		General Emergency	
AU1	Any unplanned release of gaseous or liquid radioactivity to the environment that exceeds two times the radiological technical specifications for 60 min or longer. Op. modes: All	AA1	Any unplanned release of gaseous or liquid radioactivity to the environment that exceeds 200 times the radiological technical specifications for 15 min or longer. Op. modes: All	AS1	Site boundary dose resulting from an actual or imminent release of gaseous radioactivity that exceeds 100 mR whole body or 500 mR child thyroid for the actual or projected duration of the release. Op. modes: All	AG1	Site boundary dose resulting from an actual or imminent release of gaseous radioactivity that exceeds 1000 mR whole body or 5000 mR child thyroid for the actual or projected duration of the release using actual meteorology. Op. modes: All
AU2	Unexpected increase in plant radiation levels or airborne concentration. Op. modes: All	AA2	Major damage to irradiated fuel or loss of water level that has or will result in the uncovering of irradiated fuel outside the reactor vessel. Op. modes: All				
		AA3	Release of radioactive material or increases in radiation levels within the facility that impedes operation of systems required to maintain safe operations or to establish or maintain cold shutdown. Op. modes: All				

Source: NUMARC/NESP-007, p. 5-3.

Table B-3. Recognition Category H: Hazards and other conditions affecting plant safety initiating condition matrix

Unusual Event	Alert	Site Area Emergency	General Emergency
HU1 Natural and destructive phenomena occurring within the protected area. Op. modes: All	HA1 Natural and destructive phenomena occurring within the plant vital area. Op. modes: All	HS1 Security event in plant vital area. Op. modes: All	HG1 Security event resulting in loss of ability to reach and maintain cold shutdown. Op. modes: All
HU2 Fire within protected area boundary not extinguished within 15 min of detection. Op. modes: All	HA2 Fire affecting the operability of plant safety systems required for the current operating mode. Op. modes: All	HS2 Control room evacuation has been initiated and plant control cannot be established. Op. modes: All	HG2 Other conditions existing which, in the judgement of the Emergency Director, warrant declaration of a General Emergency. Op. modes: All
HU3 Release of toxic or flammable gases deemed detrimental to safe operation of the plant. Op. modes: All	HA3 Release of toxic or flammable gases within a facility structure which jeopardizes operation of systems required to establish or maintain cold shutdown. Op. modes: All	HS3 Other conditions existing which, in the judgement of the Emergency Director, warrant declaration of a Site Area Emergency. Op. modes: All	
HU4 Confirmed security event which indicates a potential degradation in the level of safety of the plant. Op. modes: All	HA4 Security event in a plant protected area. Op. modes: All		
HU5 Other conditions existing which, in the judgement of the Emergency Director, warrant declaration of an Unusual Event. Op. modes: All	HA5 Control room evacuation has been initiated. Op. modes: All		
	HA6 Other conditions existing which, in the judgement of the Emergency Director, warrant declaration of an Alert. Op. modes: All		

Source: NUMARC/NESP-007, p. 5-35.

Table B-4. Recognition Category S: System malfunction initiating condition matrix

Unusual Event	Alert	Site Area Emergency	General Emergency
SU1 Loss of all offsite power to essential buses for greater than 15 min. Op. modes: All	SA1 Loss of all offsite power and loss of all onsite AC power to essential buses during cold shutdown or refueling mode. Op. modes: Cold shutdown, refueling, defueled	SS1 Loss of all offsite power and loss of all onsite AC power. Op. modes: Power operation, hot standby, hot shutdown	SG1 Prolonged loss of all offsite power and prolonged loss of all onsite AC power. Op. modes: Power operation, hot standby, hot shutdown
SU2 Inability to reach required shutdown within technical specification limits. Op. modes: Power operation, hot standby, hot shutdown	SA2 Failure of reactor protection system instrumentation to complete or initiate an automatic reactor scram once a reactor protection system setpoint has been exceeded and manual scram was successful. Op. modes: Power operation, hot standby	SS2 Failure of reactor protection system instrumentation to complete or initiate an automatic reactor scram once a reactor protection system setpoint has been exceeded and manual scram was NOT successful. Op. mode: Power operation.	SG2 Failure of the reactor protection system to complete an automatic scram and manual scram was NOT successful AND there is indication of an extreme challenge to the ability to cool the core. Op. mode: Power operation
SU3 Unplanned loss of most or all safety system annunciators for greater than 15 min. Op. modes: Power operation, hot standby, hot shutdown	SA3 Inability to maintain plant in cold shutdown. Op. modes: Cold shutdown, refueling	SS3 Loss of all vital DC power. Op. modes: Power operation, hot standby, hot shutdown	
SU4 Fuel clad degradation. Op. modes: All	SA4 Unplanned loss of all safety annunciators with transient in progress. Op. modes: Power operation, hot standby, hot shutdown	SS4 Complete loss of function needed to achieve or maintain hot shutdown. Op. modes: Power operation, hot standby, hot shutdown	
SU5 RCS leakage. Op. modes: Power operation, hot standby, hot shutdown, cold shutdown		SS5 Loss of water level that has or will uncover fuel in the reactor vessel. Op. modes: Cold shutdown, refueling	

Table B-4. Recognition Category S: System malfunction initiating condition matrix (continued)

Unusual Event	Alert	Site Area Emergency	General Emergency
<p>SU6 Unplanned loss of all onsite or offsite communication capabilities. Op. modes: All</p> <p>SU7 Unplanned loss of required DC power during cold shutdown or refueling for greater than 15 min. Op. modes: Cold shutdown, refueling</p>	<p>SA5 AC power capability to essential buses reduced to a single power source for greater than 15 min such that any additional single failure would result in station blackout. Op. modes: Power operation, hot standby, hot shutdown</p>	<p>SS6 Inability to monitor a significant transient in progress. Op. modes: Power operation, hot standby, hot shutdown</p>	

Source: NUMARC/NESP-007, p. 5-54.

Table B-5. Recognition Category F: Fission product barrier degradation initiating condition matrix^{a,b}
(See Table B-6 for BWR example EALs and Table B-7 for PWR example EALs.)

Unusual Event	Alert	Site Area Emergency	General Emergency
FU1 ANY loss or ANY potential loss of containment. Op. modes: Power operation, hot standby/startup (BWR), hot shutdown	FA1 ANY loss or ANY potential loss of EITHER fuel clad OR RCS. Op. modes: Power operation, hot standby/startup (BWR), hot shutdown	FS1 Loss of BOTH fuel clad AND RCS OR Potential loss of BOTH fuel clad AND RCS OR Potential loss of EITHER fuel clad OR RCS, and loss of ANY additional barrier Op. modes: Power operation, hot standby/startup (BWR), hot shutdown	FG1 Loss of ANY two barriers AND Potential loss of third barrier. Op. modes: Power operation, hot standby/startup (BWR), hot shutdown

^aAlthough the logic used for these initiating conditions appears overly complex, it is necessary to reflect the following considerations:

- The fuel clad barrier and the RCS barrier are weighted more heavily than the containment barrier (see Sections 3.4 and 3.8 of NUMARC/NESP-007 for more information on this point). Unusual Event ICs associated with RCS and fuel clad barriers are addressed under system malfunction ICs.
- At the Site Area Emergency level, there must be some ability to dynamically assess how far present conditions are from a General Emergency. For example, if fuel clad barrier and RCS barrier "loss" EALs existed, this would indicate to the Emergency Director that, in addition to offsite dose assessments, continual assessments of radioactive inventory and containment integrity must be focused on. If, on the other hand, both fuel clad barrier and RCS barrier "potential loss" EALs existed, the Emergency Director would have more assurance that there was no immediate need to escalate to a General Emergency.
- The ability to escalate to higher emergency classes as an event gets worse must be maintained. For example, steadily increasing RCS leakage would represent an increasing risk to public health and safety.

^bBe capable of addressing event dynamics. Thus, the EAL reference tables (Figs. B-6 and B-7) state that imminent (i.e., within 1 to 3 h) loss or potential loss should result in a classification as if the affected threshold(s) are already exceeded, particularly for the higher emergency classes.

Source: NUMARC/NESP-007, p. 5-17.

Table B-6. BWR emergency action level fission product barrier reference table thresholds for loss or potential loss of barriers

Determine which combination of the three barriers is lost or has a potential loss and use the following key to classify the event. Also, an event or multiple events could occur, which result in the conclusion that exceeding the loss or potential loss thresholds is IMMEDIATE (i.e., within 1 to 3 h). In this IMMEDIATE LOSS situation, use judgement and classify as if the thresholds are exceeded.

UNUSUAL EVENT		ALERT		SITE AREA EMERGENCY		GENERAL EMERGENCY	
ANY loss or ANY potential loss of containment		ANY loss or ANY potential loss of EITHER fuel clad OR RCS		Loss of BOTH fuel clad AND RCS, OR potential loss of BOTH fuel clad AND RCS, OR potential loss of EITHER fuel clad OR RCS AND loss of ANY additional barrier		Loss of ANY two barriers AND potential loss of third barrier	
FUEL CLAD BARRIER EXAMPLE EALS		RCS BARRIER EXAMPLE EALS		PRIMARY CONTAINMENT BARRIER EXAMPLE EALS			
LOSS	POTENTIAL LOSS	LOSS	POTENTIAL LOSS	LOSS	POTENTIAL LOSS		
<u>1. Primary coolant activity levels</u>		<u>1. RCS leak rate</u>		<u>1. Drywell pressure</u>			
Coolant activity GREATER THAN (site-specific) value	Not applicable	(Site-specific) indication of main steamline break	RCS leakage GREATER THAN 50 gal/min inside the drywell OR Unisolable primary system leakage outside drywell as indicated by area temp or area rad alarm	Rapid unexplained decrease following initial increase OR Drywell pressure response not consistent with LOCA conditions	(Site-specific) psig and increasing OR Explosive mixture exists	OR	
OR		OR		OR			

Table B-6. BWR emergency action level fission product barrier reference table thresholds for loss or potential loss of barriers (continued)

UNUSUAL EVENT		ALERT		SITE AREA EMERGENCY		GENERAL EMERGENCY	
ANY loss or ANY potential loss of containment		ANY loss or ANY potential loss of EITHER fuel clad OR RCS		Loss of BOTH fuel clad AND RCS, OR potential loss of BOTH fuel clad AND RCS, OR potential loss of EITHER fuel clad OR RCS AND loss of ANY additional barrier		Loss of ANY two barriers AND potential loss of third barrier	
FUEL CLAD BARRIER EXAMPLE EALS		RCS BARRIER EXAMPLE EALS		PRIMARY CONTAINMENT BARRIER EXAMPLE EALS			
LOSS	POTENTIAL LOSS	LOSS	POTENTIAL LOSS	LOSS	POTENTIAL LOSS		
<u>2. Reactor vessel water level</u>		<u>2. Drywell pressure</u>		<u>2. Containment isolation valve after containment isolation</u>			
Level LESS THAN (site-specific) value	Level LESS THAN (site-specific) value	Pressure GREATER THAN (site-specific) psig	Not applicable	Failure of both valves in any one line to close AND downstream pathway to the environmental exists	Not applicable		
OR		OR		Intentional venting per EOPs	Not applicable		
				Unisolable primary system leakage outside dry well as indicated by area temp or area rad alarm			
						OR	

Table B-6. BWR emergency action level fission product barrier reference table thresholds for loss or potential loss of barriers (continued)

UNUSUAL EVENT		ALERT		SITE AREA EMERGENCY		GENERAL EMERGENCY	
ANY loss or ANY potential loss of containment		ANY loss or ANY potential loss of EITHER fuel clad OR RCS		Loss of BOTH fuel clad and RCS, OR potential loss of BOTH fuel clad AND RCS, OR potential loss of EITHER fuel clad OR RCS and loss of ANY additional barrier		Loss of ANY two barriers AND potential loss of third barrier	
FUEL CLAD BARRIER EXAMPLE EALS		RCS BARRIER EXAMPLE EALS		PRIMARY CONTAINMENT BARRIER EXAMPLE EALS			
LOSS	POTENTIAL LOSS	LOSS	POTENTIAL LOSS	LOSS	POTENTIAL LOSS		
<u>3. Drywell radiation monitoring</u>		<u>3. Drywell radiation monitoring</u>		<u>3. Significant radioactive inventory in containment</u>			
Drywell radiation monitor reading GREATER THAN (site-specific) R/h	Not applicable	Drywell radiation monitor reading GREATER THAN (site specific) R/h	Not applicable	Not applicable	Containment radiation monitor reading GREATER THAN (site-specific) R/h		
<u>4. Other (site-specific) indications</u>		<u>4. Reactor vessel water level</u>		<u>4. Reactor vessel water level</u>			
(Site-specific) as applicable	(Site-specific) as applicable	Level LESS THAN (site-specific) value	Not applicable	Not applicable	Reactor vessel water level LESS THAN (site-specific) value and the maximum core uncover time limit is in the UNSAFE region		
OR		OR		OR			

Table B-6. BWR emergency action level fission product barrier reference table thresholds for loss or potential loss of barriers (continued)

UNUSUAL EVENT		ALERT		SITE AREA EMERGENCY		GENERAL EMERGENCY	
ANY loss or ANY potential loss of containment		ANY loss or ANY potential loss of EITHER fuel clad OR RCS		Loss of BOTH fuel clad and RCS, OR potential loss of BOTH fuel clad AND RCS, OR potential loss of EITHER fuel clad OR RCS and loss of ANY additional barrier		Loss of ANY two barriers AND potential loss of third barrier	
FUEL CLAD BARRIER EXAMPLE EALS		RCS BARRIER EXAMPLE EALS		PRIMARY CONTAINMENT BARRIER EXAMPLE EALS			
LOSS	POTENTIAL LOSS	LOSS	POTENTIAL LOSS	LOSS	POTENTIAL LOSS		
<u>5. Emergency Director judgement</u>		<u>5. Other (site-specific) indications</u>		<u>5. Other (site-specific) indications</u>			
Any condition in the judgement of the Emergency Director that indicates loss or potential loss of the FUEL CLAD barrier.		(Site-specific) as applicable	(Site-specific) as applicable	(Site-specific) as applicable	(Site-specific) as applicable		
		OR		OR			
		<u>6. Emergency Director judgement</u>		<u>6. Emergency Director judgement</u>			
		Any condition in the judgement of the Emergency Director that indicates loss or potential loss of the RCS barrier.		Any condition in the judgement of the Emergency Director that indicates loss or potential loss of the CONTAINMENT barrier.			

Source: NUMARC/NESP-007, pp. 5-18, 5-19.

Table B-7. PWR emergency action level fission product barrier reference table thresholds for loss or potential loss of barriers (continued)

Determine which combination of the three barriers is lost or has a potential loss and use the following key to classify the event. Also, an event or multiple events could occur, resulting in the conclusion that exceeding the loss or potential loss thresholds is IMMIDENT (i.e., within 1 to 3 h). In this IMMIDENT LOSS situation, use judgement and classify as if the thresholds are exceeded.

UNUSUAL EVENT		ALERT		SITE AREA EMERGENCY		GENERAL EMERGENCY	
ANY loss or ANY potential loss of containment		ANY loss or ANY potential loss of EITHER fuel clad or RCS		Loss of BOTH fuel clad AND RCS, OR potential loss of BOTH fuel clad AND RCS, OR potential loss of EITHER fuel clad OR RCS AND loss of ANY additional barrier		Loss of ANY two barriers AND potential loss of third barrier	
FUEL CLAD BARRIER EXAMPLE EALS		RCS BARRIER EXAMPLE EALS		CONTAINMENT BARRIER EXAMPLE EALS			
LOSS	POTENTIAL LOSS	LOSS	POTENTIAL LOSS	LOSS	POTENTIAL LOSS		
<u>1. Critical safety function status</u>		<u>1. Critical safety function status</u>		<u>1. Critical safety function status</u>			
Core-cooling-red	Core cooling-orange OR Heat sink-red	Not applicable	RCS integrity-red OR Heat sink-red	Not applicable	Containment-red	OR	
OR		OR					

Table B-7. PWR emergency action level fission product barrier reference table thresholds for loss or potential loss of barriers (continued)

UNUSUAL EVENT		ALERT		SITE AREA EMERGENCY		GENERAL EMERGENCY	
ANY loss or ANY potential loss of containment		ANY loss or ANY potential loss of EITHER fuel clad or RCS		Loss of BOTH fuel clad AND RCS, OR potential loss of BOTH fuel clad AND RCS, OR potential loss of EITHER fuel clad OR RCS AND loss of ANY additional barrier		Loss of ANY two barriers AND potential loss of third barrier	
FUEL CLAD BARRIER EXAMPLE EALS		RCS BARRIER EXAMPLE EALS		CONTAINMENT BARRIER EXAMPLE EALS			
LOSS	POTENTIAL LOSS	LOSS	POTENTIAL LOSS	LOSS	POTENTIAL LOSS		
<u>2. Primary coolant activity level</u>		<u>2. RCS leak rate</u>		<u>2. Containment pressure</u>			
Coolant activity GREATER THAN (site-specific) value	Not applicable	GREATER THAN available makeup capacity as indicated by a loss of RCS subcooling	Unisolable leak exceeding the capacity of one charging pump in the normal charging mode	Rapid unexplained decrease following initial increase	(Site-specific) psig and increasing		
OR		OR		OR	OR		
				Containment pressure or sump level response not consistent with LOCA conditions	Explosive mixture exists		
					OR		
					Containment pressure GREATER THAN containment depressurization system setpoint with less than one full train of depressurization equipment operating		
					OR		

Table B-7. PWR emergency action level fission product barrier reference table thresholds for loss or potential loss of barriers (continued)

UNUSUAL EVENT		ALERT		SITE AREA EMERGENCY		GENERAL EMERGENCY	
ANY loss or ANY potential loss of containment		ANY loss or ANY potential loss of EITHER fuel clad OR RCS		Loss of BOTH fuel clad AND RCS, OR potential loss of BOTH fuel clad AND RCS, OR potential loss of EITHER fuel clad OR RCS AND loss of ANY additional barrier		Loss of ANY two barriers AND potential loss of third barrier	
FUEL CLAD BARRIER EXAMPLE EALS		RCS BARRIER EXAMPLE EALS		CONTAINMENT BARRIER EXAMPLE EALS			
LOSS	POTENTIAL LOSS	LOSS	POTENTIAL LOSS	LOSS	POTENTIAL LOSS		
<u>3. Core exit thermocouple readings</u>		<u>3. SG tube rupture</u>		<u>3. Containment isolation valves status after containment isolation</u>			
GREATER THAN (site-specific) degree F	GREATER THAN (site-specific) degree F	(Site-specific) indication that a SG is ruptured and has non-insoluble secondary line break OR (Site-specific) indication that a SG is ruptured and a prolonged release of contaminated secondary coolant is occurring from the affected SG to the environment	(Site-specific) indication that a SG is ruptured and the primary-to-secondary leak rate exceeds the capacity of one charging pump in the normal charging mode.	Valve(s) not closed AND Downstream pathway to the environment exists	Not applicable		
	OR				OR		
<u>4. Reactor vessel water level</u>		<u>4. Containment radiation monitoring</u>		<u>4. SG secondary side release with primary-to-secondary leakage</u>			
Not applicable	Level LESS THAN (site-specific) value	Containment radiation monitor reading GREATER THAN (site-specific) R/h	Not applicable	Release of secondary side to atmosphere with primary-to-secondary leakage GREATER THAN tech spec allowable	Not applicable		
	OR				OR		

Table B-7. PWR emergency action level fission product barrier reference table thresholds for loss or potential loss of barriers (continued)

UNUSUAL EVENT		ALERT		SITE AREA EMERGENCY		GENERAL EMERGENCY	
ANY loss or ANY potential loss of containment		ANY loss or ANY potential loss of EITHER fuel clad OR RCS		Loss of BOTH fuel clad AND RCS, OR potential loss of BOTH fuel clad AND RCS, OR potential loss of EITHER fuel clad OR RCS AND loss of ANY additional barrier		Loss of ANY two barriers AND potential loss of third barrier	
FUEL CLAD BARRIER EXAMPLE EALS		RCS BARRIER EXAMPLE EALS		CONTAINMENT BARRIER EXAMPLE EALS			
LOSS	POTENTIAL LOSS	LOSS	POTENTIAL LOSS	LOSS	POTENTIAL LOSS		
<u>5. Containment radiation monitoring</u>		<u>5. Other (site-specific)</u>		<u>5. Significant radioactive inventory in containment</u>			
Containment radiation monitor reading GREATER THAN (site-specific) R/h	Not applicable	(Site-specific) as applicable	(Site-specific) as applicable	Not applicable	Containment radiation monitor reading GREATER THAN (site-specific) R/h		
	OR		OR		OR		
<u>6. Other (site-specific) indications</u>		<u>6. Emergency Director judgement</u>		<u>6. Core exit thermocouple reading</u>			
(Site-specific) as applicable	(Site-specific) as applicable	Any condition in the judgement of the Emergency Director that indicates loss or potential loss of the RCS barrier		Not applicable	Core exit thermocouples in excess of 1200°F AND restoration procedures not effective within 15 min		
	OR				OR		
					Core exit thermocouples in excess of 700°F with reactor vessel level below top of active fuel and restoration procedures not effective within 15 min.		
					OR		

Table B-7. PWR emergency action level fission product barrier reference table thresholds for loss or potential loss of barriers (continued)

UNUSUAL EVENT	ALERT	SITE AREA EMERGENCY	GENERAL EMERGENCY																								
ANY loss or ANY potential loss of containment	ANY loss or ANY potential loss of EITHER fuel clad OR RCS	Loss of BOTH fuel clad AND RCS, OR potential loss of BOTH fuel clad AND RCS, OR potential loss of EITHER fuel clad OR RCS AND loss of ANY additional barrier	Loss of ANY two barriers AND potential loss of third barrier																								
<p style="text-align: center;">FUEL CLAD BARRIER EXAMPLE EALS</p> <table border="0" style="width: 100%;"> <tr> <td style="width: 50%; text-align: center;">LOSS</td> <td style="width: 50%; text-align: center;">POTENTIAL LOSS</td> </tr> <tr> <td colspan="2"> </td> </tr> <tr> <td colspan="2"><u>7. Emergency Director judgement</u></td> </tr> <tr> <td colspan="2">Any condition in the judgement of the Emergency Director that indicates loss or potential loss of FUEL CLAD barrier</td> </tr> </table>		LOSS	POTENTIAL LOSS	 		<u>7. Emergency Director judgement</u>		Any condition in the judgement of the Emergency Director that indicates loss or potential loss of FUEL CLAD barrier		<table border="0" style="width: 100%;"> <tr> <td colspan="2" style="text-align: center;">RCS BARRIER EXAMPLE EALS</td> </tr> <tr> <td style="width: 50%; text-align: center;">LOSS</td> <td style="width: 50%; text-align: center;">POTENTIAL LOSS</td> </tr> <tr> <td colspan="2"> </td> </tr> <tr> <td colspan="2"><u>7. Other (site-specific) indications</u></td> </tr> <tr> <td style="text-align: center;">(Site-specific) as applicable</td> <td style="text-align: center;">(Site-specific) as applicable</td> </tr> <tr> <td colspan="2" style="text-align: center;">OR</td> </tr> <tr> <td colspan="2"><u>8. Emergency Director judgement</u></td> </tr> <tr> <td colspan="2">Any condition in the judgement of the Emergency Director that indicates loss or potential loss of the CONTAINMENT barrier</td> </tr> </table>		RCS BARRIER EXAMPLE EALS		LOSS	POTENTIAL LOSS	 		<u>7. Other (site-specific) indications</u>		(Site-specific) as applicable	(Site-specific) as applicable	OR		<u>8. Emergency Director judgement</u>		Any condition in the judgement of the Emergency Director that indicates loss or potential loss of the CONTAINMENT barrier	
LOSS	POTENTIAL LOSS																										
<u>7. Emergency Director judgement</u>																											
Any condition in the judgement of the Emergency Director that indicates loss or potential loss of FUEL CLAD barrier																											
RCS BARRIER EXAMPLE EALS																											
LOSS	POTENTIAL LOSS																										
<u>7. Other (site-specific) indications</u>																											
(Site-specific) as applicable	(Site-specific) as applicable																										
OR																											
<u>8. Emergency Director judgement</u>																											
Any condition in the judgement of the Emergency Director that indicates loss or potential loss of the CONTAINMENT barrier																											

Source: NUMARC/NESP-007, pp. 5-25-5-27.

Table B-8. Event classification for fuel cycle and material facilities

Class/Description	Offsite Consequences	Anticipated Responses
<p>Alert</p> <p>Events may occur, are in progress, or have occurred that could lead to a release of radioactive material but the release is not expected to require a response by offsite response organizations to protect persons offsite.</p>	<p>Possible minor releases well below EPA PAG exposure levels. Environmental sampling and some offsite monitoring may be required.</p>	<p>Licensee emergency response personnel secure operations, stop any releases and perform monitoring.</p> <p>State and local organizations notified, inspectors dispatched.</p> <p>Fire department, ambulance and law enforcement respond as required to support onsite response.</p> <p>NRC notified, Regional Operations Center activated and inspectors or site team dispatched. HQ may activate Operations Center.</p> <p>DOE medical support and/or monitoring may be requested.</p>
<p>Site Area Emergency</p> <p>Events may occur, are in progress, or have occurred that could lead to a significant release of radioactive material and could require a response by offsite response organizations to protect persons offsite.</p>	<p>Significant release possibly approaching EPA PAG exposure levels. Radiation and contamination levels may require restricting areas offsite. Environmental sampling and offsite monitoring required.</p>	<p>Licensee emergency response personnel secure operations, stop the release, perform monitoring and regain control of radioactive material.</p> <p>State and local organizations notified, emergency personnel respond to site, assess situation, assist monitoring activities and advise the public as required.</p> <p>Fire department, ambulance and law enforcement personnel respond to mitigate consequences, restrict public access to affected areas and support onsite response as required.</p> <p>NRC notified, Operations Center activated and site team dispatched.</p> <p>DOE monitoring support requested. DOE medical support may be requested if required.</p>



SECTION C

**REACTOR CONSEQUENCE ASSESSMENT
BASED ON PLANT CONDITIONS**

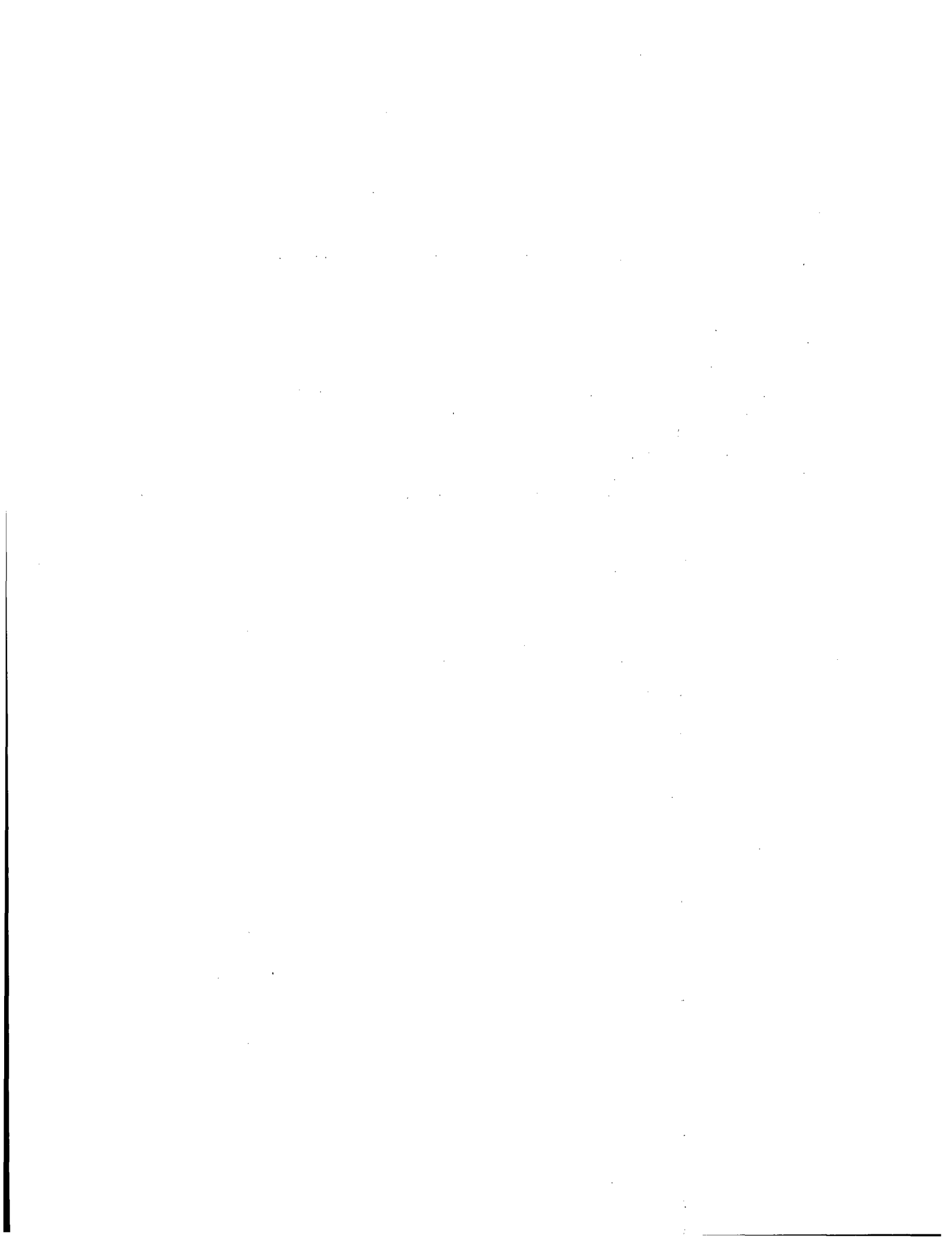

Section C
Quick Reference Guide

	<i>Page</i>
Reactor accident consequence assessment based on plant conditions	C-3
Reactor accident consequence assessment using event trees	C-5
Assumptions for reactor accident consequence event trees	C-11
Section C tables	C-15
Section C figures	C-23

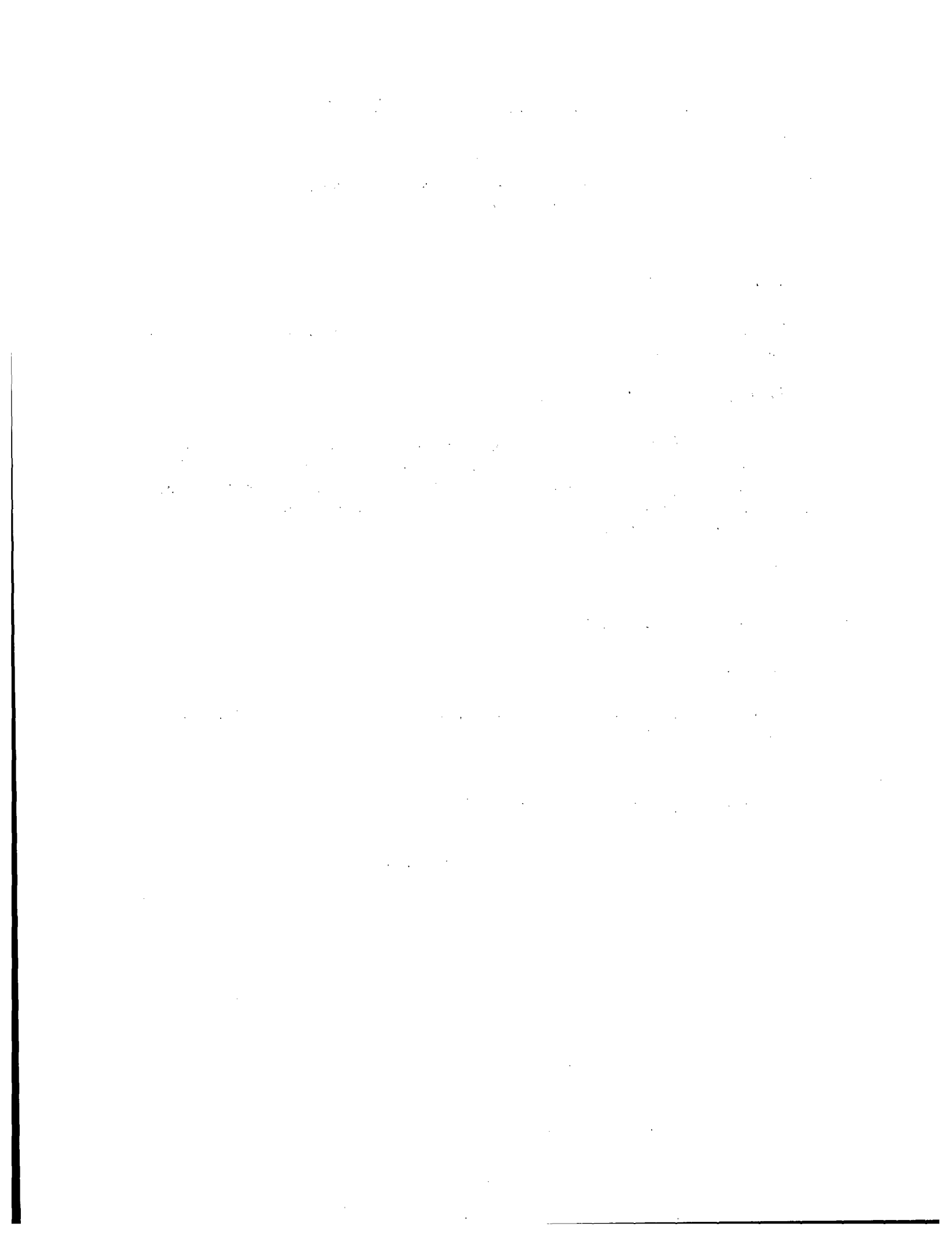

Section C

Reactor Accident Consequence Assessment Based on Plant Conditions

Purpose

To estimate offsite consequences based on the status of the reactor core and release pathway conditions.

Discussion

This procedure allows projection of selected radiation doses from reactor accidents before the release of radioactive material or when the release occurs through an unmonitored pathway. These estimates can be used to confirm or modify protective action recommendations. Table C-1 provides a quick summary of the offsite consequences for various reactor conditions.

Step 1

Use Method C.1 to assess the consequences of the accident.

Step 2

Report your assessment of the possible consequences of the reactor accident and the assumptions behind the assessment.

END

Source: NUREG-1228. Some values in this document have been revised to conform to NUREG-1150 findings.

THE UNIVERSITY OF CHICAGO

PHYSICS DEPARTMENT

1964

PHYSICS 551

LECTURE NOTES

BY

ROBERT H. DICKINSON

PHYSICS DEPARTMENT

UNIVERSITY OF CHICAGO

CHICAGO, ILLINOIS

1964

PHYSICS 551

LECTURE NOTES

BY

ROBERT H. DICKINSON

PHYSICS DEPARTMENT

UNIVERSITY OF CHICAGO

CHICAGO, ILLINOIS

1964

PHYSICS 551

Method C.1 Reactor Accident Consequence Assessment Using Event Trees

Purpose

To estimate offsite consequences based on the status of the reactor core and on release pathway conditions.

Discussion

This method uses event trees containing precalculated dose estimates to determine the offsite consequences of a reactor accident. This method is designed to provide a best estimate of the dose when the source term is not known (before a release or for a release through an unmonitored pathway). These calculations consider only the plant, release, and atmospheric conditions that have a major (greater than a factor of 10) impact on dose.

Consequence assessments in this method are based on a best estimate of the maximum total acute bone marrow dose (TABD) and maximum thyroid dose (plume center line) to an individual, assuming average weather conditions, a 1-h release, and no sheltering or protection. TABD is considered the most sensitive indication for the onset of early non-thyroid health effects. Thyroid dose is calculated because it provides an indication of the distances at which the EPA early phase PAGs may be exceeded.

Doses include the external and inhalation dose from the passing plume and the dose from exposure to contaminated ground for 24 h. The plant conditions and release conditions having the greatest impact on dose are considered. The dose estimates should be within a factor of 10–100 *if* the plant, release height, and rain conditions are accurately represented.

The steps in this assessment are summarized below:

Step 1	Review assumptions and select release pathway.
Step 2	Locate event tree and determine projected dose.
Step 3	Record doses from event tree.
Step 4	Adjust doses for reactor size.
Step 5	Adjust doses for release duration.
Step 6	Correct doses for reactor shutdown time.
Step 7	Correct dose estimate for distance, release elevation, and rain.
Step 8	Determine distance at which selected consequences are possible.
Step 9	Combine consequence projection and release description for presentation.

Step 1

Review the event tree assumptions, p. C-11, and select the potential release pathway to be considered. Identify the release pathway on the appropriate figure.

PWR dry containment	Fig. C-1
PWR ice condenser containment	Fig. C-2
BWR Mark I containment	Fig. C-3
BWR Mark II containment	Fig. C-4
BWR Mark III containment	Fig. C-5

Step 2

Select the appropriate type of release. Once the release type has been selected, locate the corresponding event tree, select appropriate plant conditions, and determine the projected doses.

PWR large dry or subatmospheric containment release	
Gap release	Fig. C-6
In-vessel core melt	Fig. C-7
PWR ice condenser containment release	
(If the ice condenser is bypassed or the the ice is exhausted before the release from the core, treat the event as a PWR large dry containment release.)	
Gap release	Fig. C-8
In-vessel core melt	Fig. C-9

PWR steam generator tube rupture (SGTR) release

(If the primary and secondary release pathway are dry, treat the event as a PWR/BWR containment bypass release.)

Normal coolant	Fig. C-10
Spiked coolant, 100 × non-nobles	Fig. C-11
Gap release	Fig. C-12
In-vessel core melt	Fig. C-13

BWR containment drywell release

Gap release	Fig. C-14
In-vessel core melt	Fig. C-15

BWR containment wetwell release

(If the suppression pool is bypassed or if more heat than decay heat is released to the pool or if the suppression pool is actively boiling, treat the event as a BWR containment drywell release.)

Gap release	Fig. C-16
In-vessel core melt	Fig. C-17

BWR/PWR containment bypass release

Gap release	Fig. C-18
In-vessel core melt	Fig. C-19

Step 3

Record the following doses for a 1-h release from a 1000-MW(e) reactor from the appropriate event tree:

TABD @ 1 mile: _____ rem
 Thyroid dose @ 1 mile: _____ rem

Step 4

Adjust doses for reactor size.

Size of reactor: _____ MW(e)

$$(TABD @ 1 mile)_{reactor} = (TABD @ 1 mile)_{1000 MW(e)} \times (reactor size)/1000$$

$$(\quad rem) = (\quad rem) \times [\quad MW(e)]/[1000 MW(e)]$$

$$(thyroid dose @ 1 mile)_{reactor} = (thyroid dose @ 1 mile)_{1000 MW(e)} \times (reactor size)/1000$$

$$(\quad rem) = (\quad rem) \times [\quad MW(e)]/[1000 MW(e)]$$

Step 5

Adjust the doses for different release durations by multiplying the dose by the release duration in hours. (Do not assume more than a 1-h release for the 100%/h release cases; 1 h is the the maximum possible release time for these cases.)

$$(TABD @ 1 \text{ mile}) = (TABD @ 1 \text{ mile for 1-h release}) \times \text{release duration}$$

$$(\text{ rem}) = (\text{ rem/h}) \times (\text{ h})$$

$$(\text{thyroid dose @ 1 mile}) = (\text{thyroid dose @ 1 mile for 1 h release}) \times \text{release duration}$$

$$(\text{ rem}) = (\text{ rem/h}) \times (\text{ h})$$

Step 6

If the reactor has been shutdown 1 day or more, use the shutdown time correction factors to reduce the adjusted dose. Choose the appropriate factor from the identified graphs, choosing the curve corresponding to the holdup time.

- Acute bone dose after gap release Fig. C-20
- Acute bone dose after in-vessel severe core damage release Fig. C-21
- Thyroid dose after release (all core conditions) Fig. C-22

TABD shutdown correction factor: _____

Thyroid dose shutdown correction factor: _____

$$(TABD @ 1 \text{ mile})_{\text{corrected}} = (TABD @ 1 \text{ mile}) \times \text{shutdown correction factor}$$

$$(\text{ rem})_{\text{corrected}} = (\text{ rem}) \times (\text{ })$$

$$(\text{thyroid dose @ 1 mile})_{\text{corrected}} = (\text{thyroid dose @ 1 mile}) \times \text{shutdown correction factor}$$

$$(\text{ rem})_{\text{corrected}} = (\text{ rem}) \times (\text{ })$$

Step 7

Estimate the dose at other distances and adjust dose if there has been rain or the release was elevated. Doses at 1, 2, 5, 10, and 25 miles for these conditions can be projected using Method F.5, "Adjusting Dose Projections to Consider Distance, Elevation, and Rain."

Step 8

Because of the great uncertainty in these dose projections, do not use dose values when presenting results. Instead, use the results of Step 7 to identify the distances to which certain consequences might be possible and fill in the blanks below. (When dealing with elevated releases under these assumptions, the maximum dose will occur more than 1 mile downwind from the plant.)

Distance to which early deaths are possible

(TABD > 220 rem) _____ mile

Distance to which vomiting and diarrhea are possible

(TABD > 50 rem) _____ mile

Distance to which EPA early phase PAG may be exceeded

(thyroid dose > 5 rem) _____ mile

Step 9

Combine this assessment with the general description of the release, information on plant conditions, and a markup of one of the reactor diagrams (Figs. C-1-C-5) showing assumed release pathway(s).

END

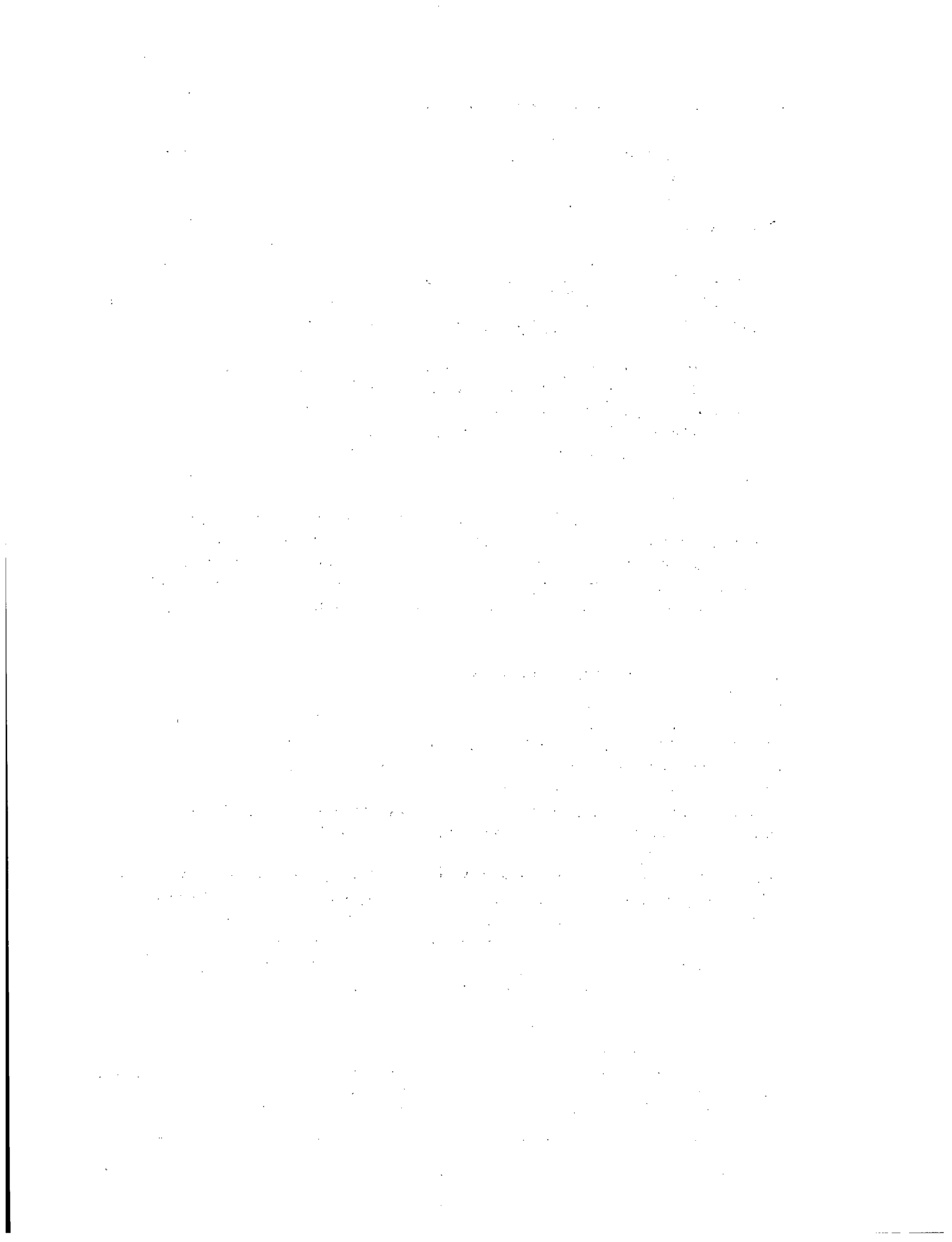

Assumptions for Reactor Accident Consequence Event Trees

Core Conditions

Four different core conditions can be assumed. These conditions span the entire range of possible core damage states. The amount of fission products assumed to be released is approximately the mean value calculated for a range of core damage accidents.

The first two core conditions, (1) normal coolant leakage and (2) spiked coolant leakage, are used for steam generator tube rupture (SGTR) accidents that do not involve core damage. Normal coolant concentrations are based on an ANSI standard and are shown in Tables C-2 and C-3. Spiked coolant assumes all the non-nobles in the normal coolant increase by a factor of 100 to estimate the maximum spiking sometimes seen with rapid shutdown or depressurization of the primary system.

The two remaining core conditions are based on the amount of core damage: (3) A gap release assumes that all fuel pins have failed, releasing the gaseous fission products contained in the fuel pin gap; and (4) in-vessel core melt assumes that the entire core has melted, releasing a mixture of isotopes believed to be representative for most core melt accidents.¹ The assumed core release fractions are shown in Table C-4.

Release Pathways and Conditions

Figures C-1-C-5 show the simplified release pathways for PWR large dry, PWR ice condenser, BWR Mark I, BWR Mark II, and BWR Mark III containments. For each containment release pathway, the mechanisms that will substantially reduce the release are considered (e.g., containment sprays). The effectiveness of the reduction mechanism used is representative for a range of assumptions. The reduction factors assumed for each reduction mechanism are listed in Table C-5.

A **PWR dry containment release** and **BWR drywell containment release** assume a release into the containment which in turn leaks to the atmosphere. The effectiveness of sprays or natural processes (plate-out) can be considered. For the BWR drywell containment release, it is assumed that the majority of the release bypasses the suppression pool. In this containment, the amount of released material may be reduced if it passes through the standby gas treatment system filters.

¹Previous editions of the *Response Technical Manual* included a fifth case, vessel melt-through. Although vessel melt-through would release additional fission products and increase the projected doses, the protective action recommendations resulting from this situation would be the same as those from the in-vessel core melt case.

A **PWR ice condenser containment release** assumes either a single pass through the ice (because of fan failure or major containment failure) or recirculation through the ice. Credit for sprays and natural processes can also be taken. If the ice is depleted before core damage occurs, then the PWR dry containment release pathway should be used.

A **BWR wetwell containment release** assumes a release through the suppression pool. If the release bypasses the suppression pool, then the BWR drywell release pathway should be used. Credit may be taken for a release through the standby gas treatment system filters.

A **PWR SGTR release** assumes contaminated coolant leaks through the rupture. Steam generator partitioning can be considered as a reduction mechanism. The effectiveness of the condenser may also be considered for releases out of the steam-jet air ejector. If the primary system is dry, then the containment bypass release pathway should be used.

A **PWR/BWR containment bypass release** assumes a release through a dry pathway from the primary system out of the containment. Only plateout on pipes and filtering (if established) in the release pathway can be considered.

Release Rates

The release rates were chosen to provide estimates for the total range of possible rates. The assumed release rates and resulting escape fractions are listed in Table C-6.

Containment leakage rates include (1) catastrophic failure, releasing most of the fission products promptly (in about 1 h for a 1 ft² hole at design pressure), (2) 100%/day, which is a traditional assumption for a failure to isolate containment, and (3) design leakage.

The SGTR leakage rates are for failure of one tube at full pressure (500 gal/min) and for the failure of one tube at low-pressure with coolant being pushed out of the break by one charging pump (50 gal/min).

Dose Calculation

Doses at 1 mile are calculated with RASCAL 2.1 assuming a 1-h ground level release, building wake, and average meteorological conditions (4 mph, no rain, and D stability). Total acute bone dose (TABD) includes 1 h of cloudshine, acute (30-day committed) inhalation dose, and 24 h of groundshine. Radioactive decay and in-growth are included. Thyroid doses are for adults from inhalation only.

Basic Source Term Calculation Method

The following is a summary of the method used to approximate severe accident source terms; see NUREG-1228 for a full description.

- (1) Estimate the amount of fission products in the core.
- (2) Estimate the fraction of the fission product inventory released from the core for a normal coolant, spiked coolant, gap release, or in-vessel core melt.
- (3) Estimate the fraction of the fission product inventory released from the core that is removed on the way to the environment.
- (4) Estimate the fraction of the available fission product inventory actually released to the environment.

Source estimation for the event trees calculations was done using the following formula:

$$\text{Source Term}_i = FPI_i \times CRF_i \times \prod_{j=1}^n RDF_{(i,j)} \times EF_i$$

for radionuclide i and n reduction mechanisms.

$$FPI_i \text{ (Tables C-2, C-3, C-7) = Isotope inventory (coolant, core)}$$

$$RDF_{ij} \text{ (Table C-5) = } \frac{\text{Ci available for release following reduction mechanism } j}{\text{Ci before reduction mechanism } j}$$

$$CRF_i \text{ (Table C-4) = } \frac{\text{Amount of isotope } i \text{ released out of core}}{\text{Core inventory of isotope } i}$$

$$EF_i \text{ (Table C-6) = } \frac{\text{Ci released to environment}}{\text{Ci available for release}}$$

[The maximum reduction allowed (minimum value of IRDF) is 0.001.]

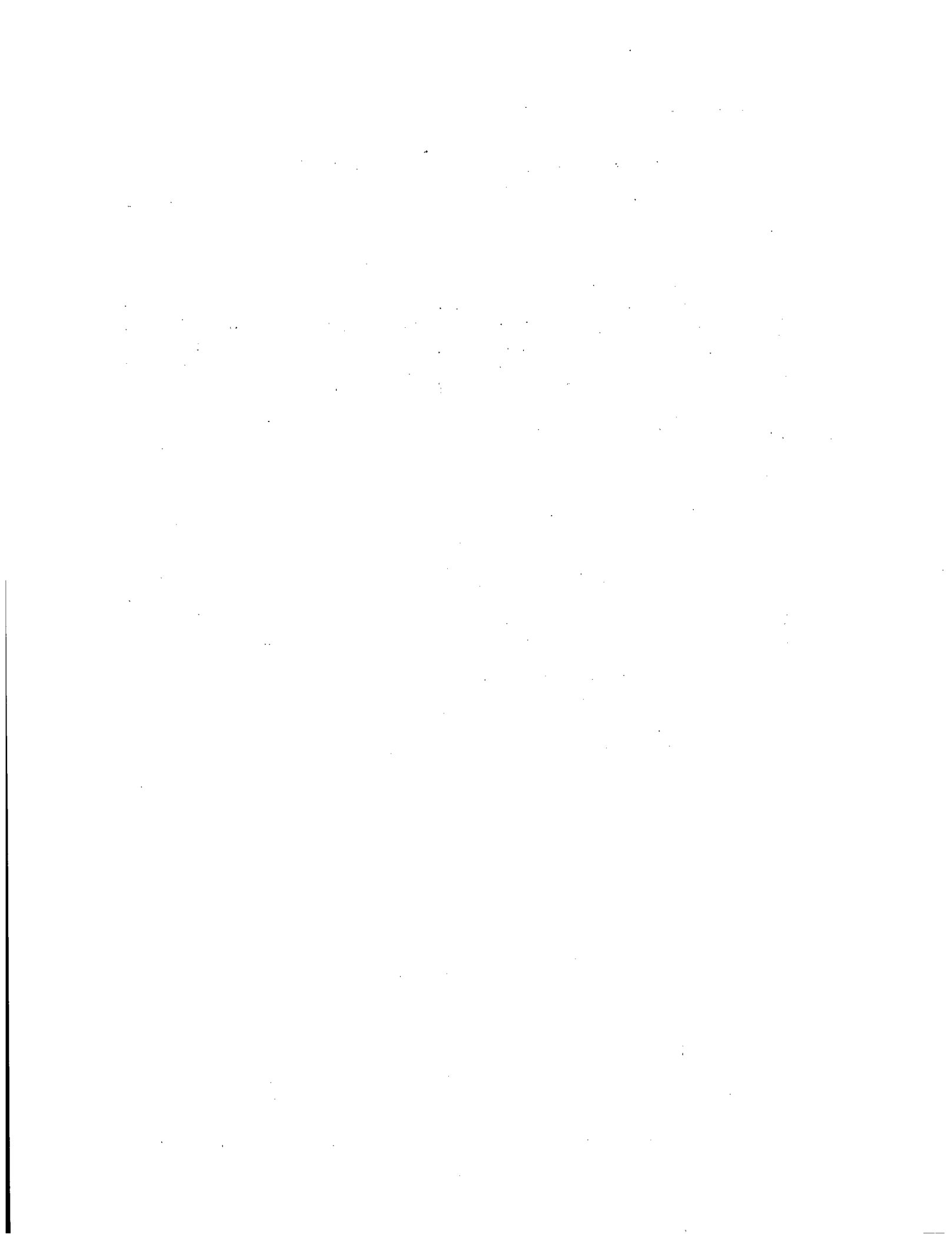

Table C-1. Possible offsite consequences within a few hours after the start of a release

Conditions		Results		
Core	Release	Distance at which EPA early phase PAGs exceeded (miles)	Threshold for acute health effects ^a exceeded	
Spikes or no damage	• Lesser coolant release (50 gal/min)	None	None	
	• Major coolant release (> 500 gal/min)	<2	None	
Gap release (uncovered 15-30 min)	• Design leak in containment	None	None	
	• Major leak in containment	<5	None	
	• Total failure of containment	>10	Thyroid effects	
Melted or severely heated (uncovered >30 min)	• Design leak in containment	<2	None	
	• Major leak in containment	>10	Thyroid effects	
	Total containment failure >2 h after release from vessel	Mitigated ^b or unmitigated	>10	Radiation sickness
	Total containment failure <2 h after release from vessel	Mitigated ^b	>10	Radiation sickness
		Unmitigated	>10	Deaths

^aEffects from high dose rates delivered over a short period of exposure (see Table G-2) at the site boundary.

^bMitigated by sprays, filters and/or through pool. Releases with hold-up times >2 h are assumed to be mitigated by plateout in containment.

Table C-2. PWR coolant concentrations

Nuclide	Normal concentration (Ci/g)
³ H	1.0E-06
⁵⁴ Mn	1.6E-09
⁵⁸ Co	4.6E-09
⁶⁰ Co	5.3E-10
⁸⁵ Kr	4.3E-07
^{85m} Kr	9.6E-10
⁸⁷ Kr	5.2E-12
⁸⁸ Kr	6.4E-09
⁸⁹ Sr	4.7E-09
⁹⁰ Sr	7.5E-09
⁹¹ Sr	1.6E-07
⁹¹ Y	1.5E-07
⁹⁹ Mo	2.8E-07
⁹⁹ Tc	1.4E-10
¹⁰³ Ru	1.2E-11
¹⁰⁶ Ru	9.6E-08
^{129m} Te	1.9E-10
^{131m} Te	1.5E-09
¹³² Te	1.7E-09
¹²⁷ Sb	0
¹²⁹ Sb	0
¹³¹ I	4.5E-08
¹³² I	2.1E-07
¹³³ I	1.4E-07
¹³⁴ I	3.4E-07
¹³⁵ I	2.6E-07
^{131m} Xe	7.3E-07
¹³³ Xe	2.6E-06
^{133m} Xe	7.0E-08
¹³⁵ Xe	8.5E-07
¹³⁸ Xe	1.2E-07
¹³⁴ Cs	7.1E-09
¹³⁶ Cs	8.7E-10
¹³⁷ Cs	9.4E-09
¹⁴⁰ Ba	1.3E-08
¹⁴⁰ La	2.5E-08
¹⁴⁴ Ce	4.0E-09
²³⁹ Np	2.2E-09

Source: ANSI/ANS 18.1, 1984.

Table C-3. BWR coolant concentrations

Nuclide	Normal concentration (Ci/g)
³ H	1.0E-08
⁵⁴ Mn	7.0E-11
⁵⁸ Co	2.0E-10
⁶⁰ Co	4.0E-10
⁸⁵ Kr	0
^{85m} Kr	0
⁸⁷ Kr	0
⁸⁸ Kr	0
⁸⁹ Sr	1.0E-10
⁹⁰ Sr	7.0E-12
⁹¹ Sr	4.0E-09
⁹¹ Y	4.0E-11
⁹⁹ Mo	2.0E-09
⁹⁹ Tc	2.0E-09
¹⁰³ Ru	2.0E-11
¹⁰⁶ Ru	3.0E-12
^{129m} Te	4.0E-11
^{131m} Te	1.0E-10
¹³² Te	1.0E-11
¹²⁷ Sb	0
¹²⁹ Sb	0
¹³¹ I	2.2E-09
¹³² I	2.2E-08
¹³³ I	1.5E-08
¹³⁴ I	4.3E-08
¹³⁵ I	2.2E-08
^{131m} Xe	0
¹³³ Xe	0
^{133m} Xe	0
¹³⁵ Xe	0
¹³⁸ Xe	0
¹³⁴ Cs	3.0E-11
¹³⁶ Cs	2.0E-11
¹³⁷ Cs	8.0E-11
¹⁴⁰ Ba	4.0E-11
¹⁴⁰ La	4.0E-10
¹⁴⁴ Ce	3.0E-12
²³⁹ Np	8.0E-09

Source: ANSI/ANS 18.1, 1984.

Table C-4. Core release fractions (CRF)^a

Core condition	Fuel cladding temperature (°F)	Element	Core release fraction
Fuel pin cladding intact (normal leakage)	600		Normal coolant ^b
Spikes resulting from rapid shutdown or depressurization (core remains covered)	600		100 × normal coolant ^c
Gap release (cladding failure, core uncovered 15-30 min)	1300-2100	Xe, Kr	0.05
		I	0.05
		Cs	0.05
In-vessel severe core damage (core uncovered >30 min)	>3000	Xe, Kr	0.95
		I, Br	0.35
		Cs	0.25
		Te, Sb, Se	0.15
		Ba	0.04
		Sr	0.03
		Ce, Np, Pu	0.01
		Ru, Mo, Tc, Rh, Pd	0.008
		La, Y, Pm, Zr, Nd, Eu, Nb, Pr, Sm	0.002
		Vessel melt through ^d	>3000
I, Br	0.64		
Cs	0.64		
Te, Sb, Se	0.44		
Ba	0.14		
Sr	0.15		
Ce, Np, Pu	0.03		
Ru, Mo, Tc, Rh, Pd	0.012		
La, Y, Pm, Zr, Nd, Eu, Nb, Pr, Sm	0.017		

^aThe core release fraction is the fraction of each element that is assumed to be released from the core for different core damage states [CRF = (Ci released from core)/(Ci in core)]. It is assumed that the entire core is in one state. The fractions are mean estimates for the range of core damage accidents.

^bCoolant concentration assuming the core remains covered. See Tables C-2 and C-3 for normal concentrations. Normal concentration is based on ANSI/ANS-18:1, 1984.

^cSpikes assume that all the non-noble concentrations are 100 times higher than normal. A 100 times increase is a reasonable upper bound if the core remains covered.

^dAssume that the core melts through the vessel before the start of the release.

Source: NUREG-1465, Table 3.12.

Table C-5. Reduction factors (RDF)

Reduction mechanism	Reduction factor ^a
Standby gas treatment system filters	
Dry-low pressure flow	0.01
Wet-high pressure flow (blowout)	1.00
Other filters	
Dry-low pressure flow	0.01
Wet-high pressure flow (blowout)	1.00
Suppression pool scrubbing	
Slow steady flow (decay heat)	0.01
Pool subcooled	0.05
Pool saturated	1.00
Pool bypass	
Removal of suspended aerosols and particulates	
Natural processes (no sprays)	0.75 ^b
< 1 h holdup time	0.36 ^b
2- to 12-h holdup time	0.03 ^b
24-h holdup time	
Sprays on	0.03
< 1 h holdup time	0.02
2 to 12-h holdup time	0.01 ^b
24-h holdup time	
Ice condenser	
One pass through condenser (no recirculation)	0.50
Continual recirculation through condenser (1 h or more)	0.25
Ice bed exhausted before core damage	1.00
Primary system retention (plateout)	
Bypass accidents only	0.20 ^b
Steam generator partitioning (liquid release from reactor cooling system)	
Partitioned	0.02
Not partitioned	0.50
Air ejector	0.02

^aThis list contains representative reduction factors [RDF = (C_i available for release after reduction mechanism)/(C_i available for release before reduction mechanism)] for the mechanisms that should have the greatest impact on fission products traveling from the core to the environment. These RDFs are for fission products carried by a dry gas stream (gas or steam) except for SGTR partitioning. *These mechanisms apply only to non-noble gases.* The total reduction can be estimated by multiplying the RDFs together. However, the minimum RDF allowed is 0.001.

^bValues adjusted to be representative of NUREG-1150.

Source: NUREG-1228, except values noted by *b*.

Table C-6. Escape fractions (EF)

Release pathway	Escape fraction ^a
Primary containment failure leakage	
Typical design leakage at design pressure	
PWR—large dry (0.1%/day)	4E-05
PWR—subatmospheric (0.1%/day)	4E-05
PWR—ice condenser (0.25%/day)	1E-04
BWRs (0.5%/day)	2E-04
Failure to isolate (100%/day)	
Failure of isolation valve seal	0.04
Catastrophic failures	
1-h puff release	1.00
Steam generator tube rupture	
1 tube at full pressure (coolant leak 500 gal/min)	0.35
1 tube at low-pressure, single charging pump flow (coolant leak 50 gal/min)	0.03

^aFraction of containment volume or primary system coolant inventory released in 1 h.

Source: NUREG-1228, p. 4-37.

Table C-7. Fission and activation product inventory (FPI)
in LWR core about 30 min after shutdown^a

Fission product	Inventory [Ci/MW(e)]	Inventory [Ci/1000 MW(e)]
⁸⁵ Kr ^b	5.6E+02	5.6E+05
^{85m} Kr ^b	2.4E+04	2.4E+07
⁸⁷ Kr ^b	4.7E+04	4.7E+07
⁸⁸ Kr ^b	6.8E+04	6.8E+07
⁸⁶ Rb	2.6E+01	2.6E+04
⁸⁹ Sr ^b	9.4E+04	9.4E+07
⁹⁰ Sr ^b	3.7E+03	3.7E+06
⁹¹ Sr ^b	1.1E+05	1.1E+08
⁹⁰ Y	3.9E+03	3.9E+06
⁹¹ Y ^b	1.2E+05	1.2E+08
⁹⁵ Zr	1.5E+05	1.5E+08
⁹⁷ Zr	1.5E+05	1.5E+08
⁹⁵ Nb	1.5E+05	1.5E+08
⁹⁹ Mo ^b	1.6E+05	1.6E+08
^{99m} Tc	1.4E+05	1.4E+08
¹⁰³ Ru ^b	1.1E+05	1.1E+08
¹⁰⁵ Ru	7.2E+04	7.2E+07
¹⁰⁶ Ru	2.5E+04	2.5E+07
¹⁰⁵ Rh	4.9E+04	4.9E+07
¹²⁷ Te	5.9E+03	5.9E+06
^{127m} Te	1.1E+03	1.1E+06
¹²⁹ Te	3.1E+04	3.1E+07
^{129m} Te ^b	5.3E+03	5.3E+06
^{131m} Te ^b	1.3E+04	1.3E+07
¹³² Te ^b	1.2E+05	1.2E+08
¹²⁷ Sb ^b	6.1E+03	6.1E+06
¹²⁹ Sb ^b	3.3E+04	3.3E+07
¹³¹ I ^b	8.5E+04	8.5E+07
¹³² I ^b	1.2E+05	1.2E+08
¹³³ I ^b	1.7E+05	1.7E+08
¹³⁴ I ^b	1.9E+05	1.9E+08
¹³⁵ I ^b	1.5E+05	1.5E+08
^{131m} Xe ^b	1.0E+03	1.0E+06
¹³³ Xe ^b	1.7E+05	1.7E+08
^{133m} Xe ^b	6.0E+03	6.0E+06

**Table C-7. Fission and activation product inventory (FPI)
in LWR core about 30 min after shutdown (continued)**

Fission product	Inventory [Ci/MW(e)]	Inventory [Ci/1000 MW(e)]
¹³⁵ Xe ^b	3.4E+04	3.4E+07
¹³⁸ Xe ^b	1.7E+05	1.7E+08
¹³⁴ Cs ^b	7.5E+03	7.5E+06
¹³⁶ Cs ^b	3.0E+03	3.0E+06
¹³⁷ Cs ^b	4.7E+03	4.7E+06
¹⁴⁰ Ba ^b	1.6E+05	1.6E+08
¹⁴⁰ La ^b	1.6E+05	1.6E+08
¹⁴¹ Ce	1.5E+05	1.5E+08
¹⁴³ Ce	1.3E+05	1.3E+08
¹⁴⁴ Ce ^b	8.5E+04	8.5E+07
¹⁴³ Pr	1.3E+05	1.3E+08
¹³⁷ Nd	6.0E+04	6.0E+07
²³⁹ Np ^b	1.6E+06	1.6E+09
²³⁸ Pu	5.7E+01	5.7E+04
²³⁹ Pu	2.1E+01	2.1E+04
²⁴⁰ Pu	2.1E+01	2.1E+04
²⁴¹ Pu	3.4E+03	3.4E+06
²⁴¹ Am	1.7E+00	1.7E+03
²⁴² Cm	5.0E+02	5.0E+05
²⁴⁴ Cm	2.3E+01	2.3E+04

^aIt is assumed that the core is at equilibrium [i.e., has been operating for at least one fueling cycle (18 months)]. This assumption could overestimate the inventory of long-lived fission products for a new core. Only the fission products with half-lives greater than 30 min are considered.

^bFission products that should be considered in assessments because they are either a major contributor to early phase dose or they are likely to be released (noble gases).

Source: WASH-1400, Table VI-3-1.

Fig. C-1
PWR dry containment simplified release pathways.

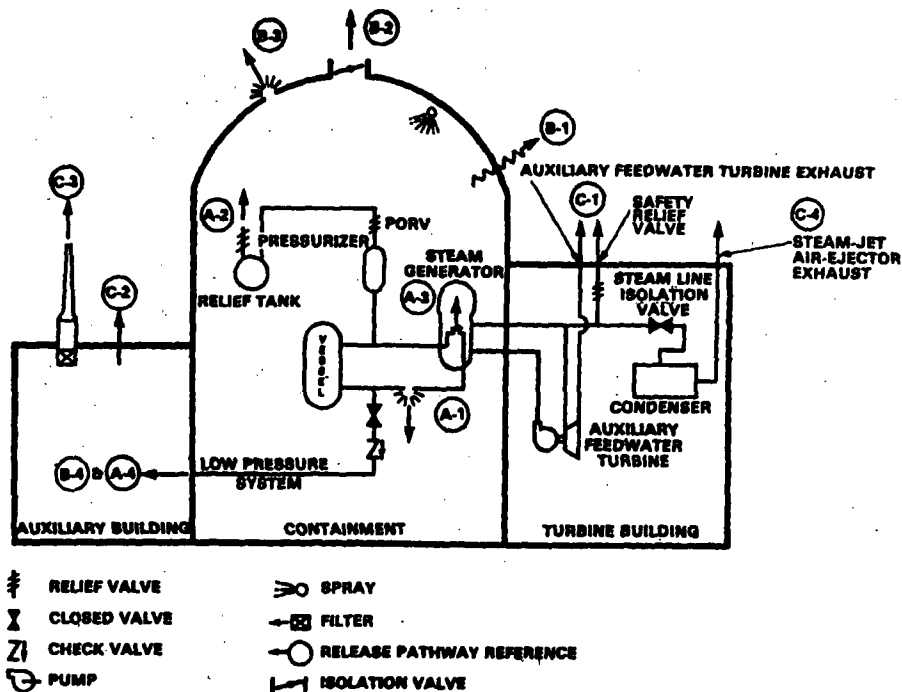

Figure key:

- A Reactor coolant system
 - A-1 Breaks and leaks
 - A-2 Power-operated relief valves (PORVs)
 - A-3 Steam generator tube rupture
 - A-4 Bypass (failure into low-pressure steam)

- B Containment
 - B-1 Design leakage
 - B-2 Small isolation valve seal failure
 - B-3 Catastrophic (> 1 ft²)
 - B-4 Bypass

- C Other
 - C-1 Secondary side relief/safety valve or turbine exhaust
 - C-2 Building leakage—unfiltered
 - C-3 Building leakage—filtered
 - C-4 Condenser steam-jet air-ejector

Fig. C-2
PWR ice condenser containment simplified release pathways.

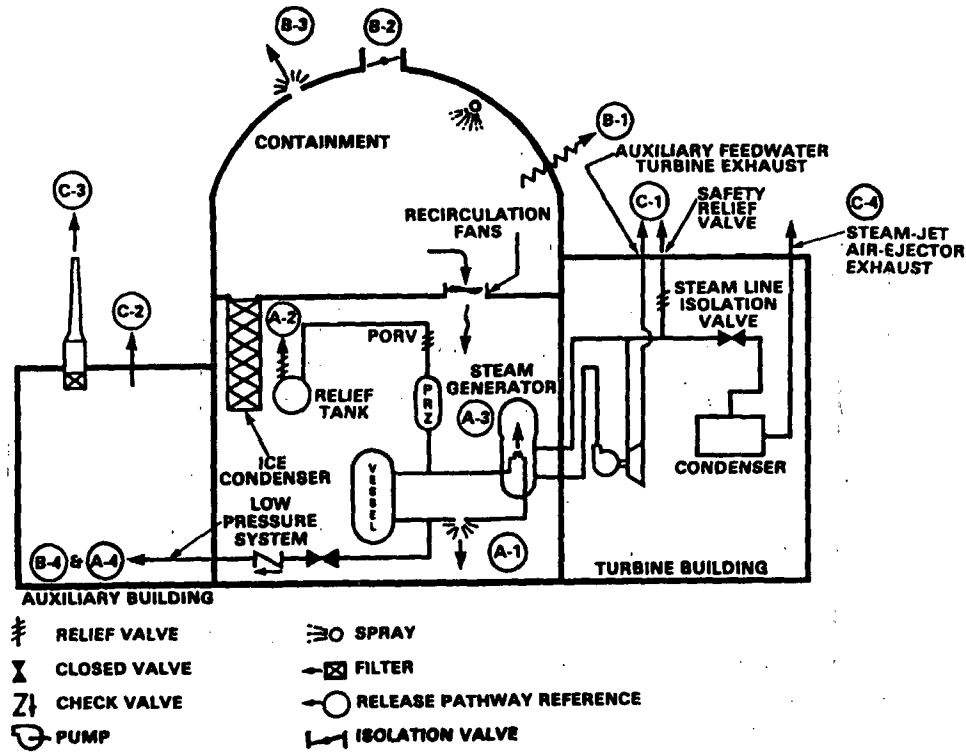

Fig. C-3
BWR Mark I simplified release pathways.

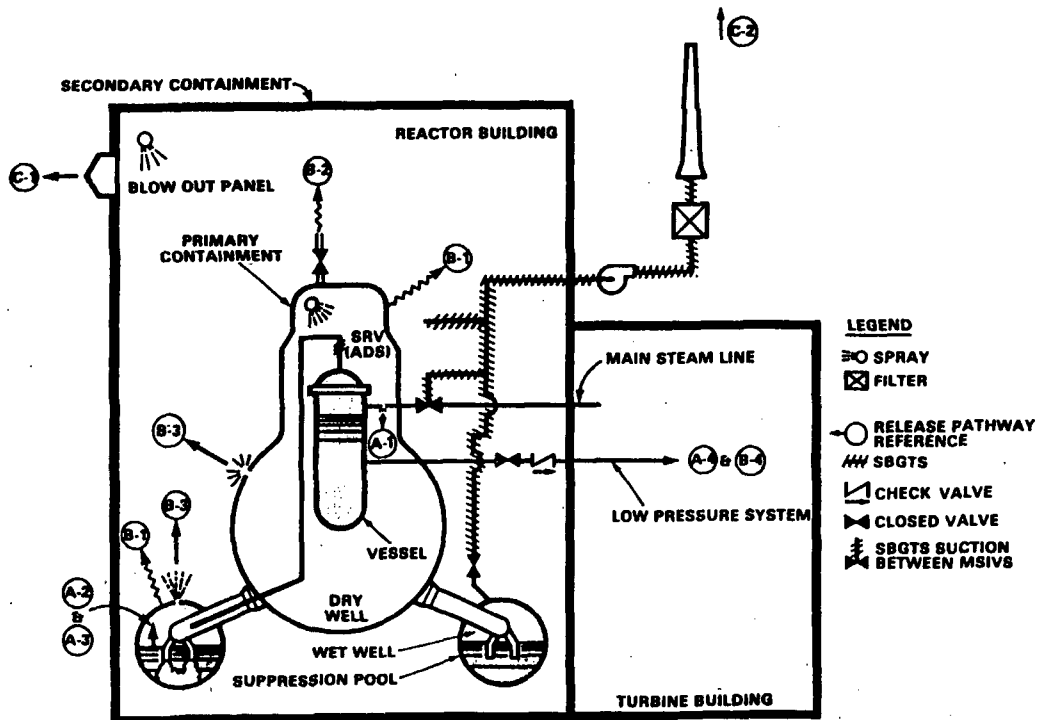

Figure key:

- A Reactor coolant system**
 - A-1 Breaks and leaks bypassing suppression pool
 - A-2 Breaks and leaks through suppression pool
 - A-3 Automatic depressurization system (ADS) and safety relief valves (SRV)
 - A-4 Bypass (interface LOCA)
- B Containment**
 - B-1 Design leakage
 - B-2 Small isolation valve seal failure
 - B-3 Catastrophic
 - B-4 Bypass
- C Other**
 - C-1 Building leakage—unfiltered
 - C-2 Standby gas treatment system (SBGTS)

Fig. C-4
BWR Mark II simplified release pathways.

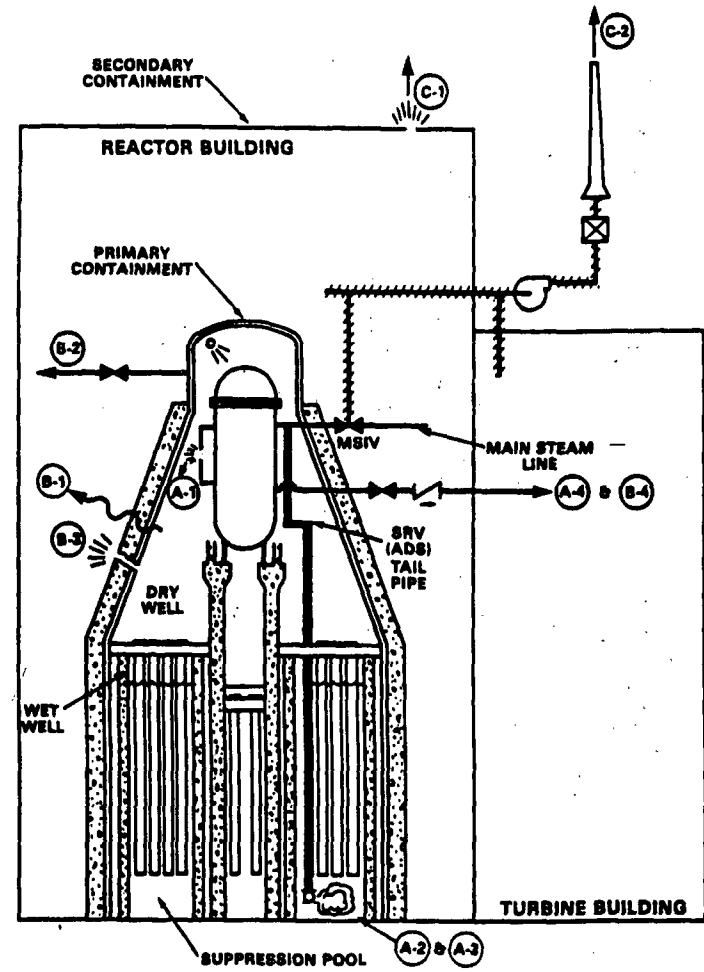

Figure key:

- A Reactor coolant system
 - A-1 Breaks and leaks bypassing suppression pool
 - A-2 Breaks and leaks through suppression pool
 - A-3 Automatic depressurization system (ADS) and safety relief valves (SRV)
 - A-4 Bypass (interface LOCA)
- B Containment
 - B-1 Design leakage
 - B-2 Small isolation valve seal failure
 - B-3 Catastrophic
 - B-4 Bypass
- C Other
 - C-1 Building leakage—unfiltered
 - C-2 Standby gas treatment system (SBGTS)

LEGEND

SPRAY	SBGTS	CHECK VALVE
FILTER	CLOSED VALVE	MSIV MAIN STEAM LINE ISOLATION VALVE
RELEASE PATHWAY REFERENCE	SBGTS SUCTION BETWEEN MSIVS	

Fig. C-5
BWR Mark III simplified release pathways.

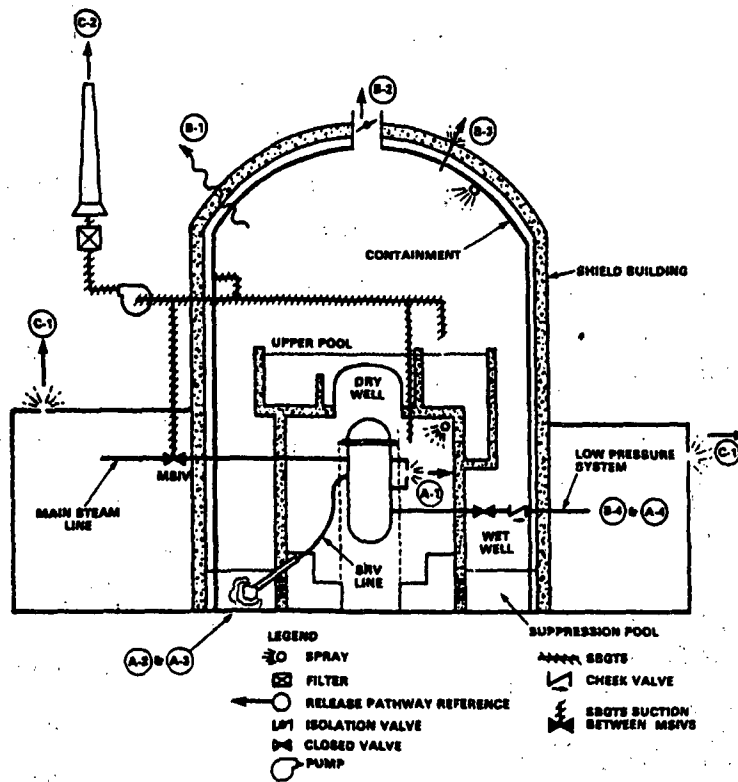

Figure key:

- A Reactor coolant system
 - A-1 Breaks and leaks bypassing suppression pool
 - A-2 Breaks and leaks through suppression pool
 - A-3 Automatic depressurization system (ADS) and safety relief valves (SRV)
 - A-4 Bypass (interface LOCA)
- B Containment
 - B-1 Design leakage
 - B-2 Small isolation valve seal failure
 - B-3 Catastrophic
 - B-4 Bypass
- C Other
 - C-1 Building leakage—unfiltered
 - C-2 Standby gas treatment system (SBGTS)

Fig. C-6
Dose for PWR large dry or subatmospheric containment release for a gap release.

Core	Containment			Dose ^a at 1 mile (rem)	
	Condition	Conditions	Holdup time	Leak rate	TABD
gap release (uncovered 15-30 min)	spray off	≤ 1 h	100%/h	2E+02	1E+04
			100%/h	6E+01	5E+03
		2-12 h	100%/day	2E+00	2E+02
			design rate	2E-03	2E-01
			100%/h	4E+00	4E+02
		> 12 h	100%/day	1E-01	1E+01
	design rate		< 1E-03	1E-02	
	100%/h		2E+01	4E+02	
	spray on	≤ 1 h	100%/h	7E+00	3E+02
			100%/day	3E-01	1E+01
		2-12 h	design rate	< 1E-03	1E-02
			100%/h	2E+00	1E+02
			100%/day	6E-02	5E+00
		> 12 h	design rate	< 1E-03	5E-03

^aDose calculations reflect a 1-h ground level release with average meteorological conditions (D stability, 4 mph, no rain) and the effect of building wake. The acute bone dose includes 1 h of inhalation, 1 h of cloudshine, and 24 h of groundshine to an adult performing normal activities. The thyroid dose includes 1 h of inhalation exposure to an adult.

Fig. C-7
Dose for PWR large dry or subatmospheric containment release
for an in-vessel core melt release.

Core Condition	Containment			Dose ^a at 1 mile (rem)	
	Condition	Holdup time	Leak rate	TABD	Thyroid
in-vessel core melt (uncovered > 30 min)	spray off	≤ 1 h	100%/h	2E+03	9E+04
		2-12 h	100%/h	6E+02	4E+04
			100%/day	2E+01	2E+03
			design rate	2E-02	2E+00
		> 12 h	100%/h	4E+01	3E+03
			100%/day	2E+00	1E+02
	design rate		2E-03	1E-01	
	spray on	≤ 1 h	100%/h	3E+02	3E+03
		2-12 h	100%/h	1E+02	2E+03
			100%/day	4E+00	9E+01
			design rate	4E-03	9E-02
		> 12 h	100%/h	2E+01	9E+02
100%/day			8E-01	4E+01	
design rate	< 1E-03		4E-02		

^aDose calculations reflect a 1-h ground level release with average meteorological conditions (D stability, 4 mph, no rain) and the effect of building wake. The total acute bone dose (TABD) includes 1 h of inhalation, 1 h of cloudshine, and 24 h of groundshine to an adult performing normal activities. The thyroid dose includes 1 h of inhalation exposure to an adult.

Fig. C-8
Dose for PWR ice condenser containment release for a gap release.

Core	Containment			Dose ^a at 1 mile (rem)			
				Once through ice (fans off)		With recir. (fans on)	
Condition	Conditions	Holdup time	Leak rate	TABD	Thyroid	TABD	Thyroid
gap release (uncovered 15-30 min)	sprays off	≤ 1 h	100%/h	1E+02	6E+03	<i>b</i>	<i>b</i>
		2-12 h	100%/h	3E+01	3E+03	<i>b</i>	<i>b</i>
			100%/day	1E+00	1E+02	7E-01	5E+01
			design rate	1E-03	1E+01	<1E-03	5E-02
		12 h	100%/h	2E+00	2E+02	<i>b</i>	<i>b</i>
			100%/day	8E-02	7E+00	5E-02	4E+00
	design rate		<1E-03	7E-03	<1E-03	4E-03	
	sprays on	≤ 1 h	100%/h	2E+01	2E+02	<i>b</i>	<i>b</i>
		2-12 h	100%/h	6E+00	1E+02	<i>b</i>	<i>b</i>
			100%/day	2E-01	6E+00	2E-01	3E+00
			design rate	<1E-03	6E-03	<1E-03	3E-03
		> 12 h	100%/h	1E+00	6E+01	<i>b</i>	<i>b</i>
			100%/day	4E-02	2E+00	3E-02	1E+00
			design rate	<1E-03	2E-03	<1E-03	1E-03

^aDose calculations reflect a 1-h ground level release with average meteorological conditions (D stability, 4 mph, no rain) and the effect of building wake. The total acute bone dose (TABD) includes 1 h of inhalation, 1 h of cloudshine, and 24 h of groundshine to an adult performing normal activities. The thyroid dose includes 1 h of inhalation exposure to an adult.

^bBecause of the high release rate, it is assumed that there is no recirculation through ice.

Fig. C-9
Dose for PWR ice condenser containment release
for an in-vessel core melt release.

Core	Containment			Dose ^a at 1 mile (rem)				
				Once through ice (fans off)		With recir. (fans on)		
Condition	Conditions	Holdup time	Leak rate	TABD	Thyroid	TABD	Thyroid	
in-vessel core melt (uncovered > 30 min)	sprays off	≤ 1 h	100%/h	1E+03	4E+04	<i>b</i>	<i>b</i>	
			100%/h	3E+02	2E+04	<i>b</i>	<i>b</i>	
		2-12 h	100%/day	1E+01	8E+02	8E+00	4E+02	
			design rate	1E-02	8E-01	8E-03	4E-01	
			100%/h	2E+01	1E+03	<i>b</i>	<i>b</i>	
		> 12 h	100%/day	9E-01	5E+01	7E-01	3E+01	
			design rate	< 1E-03	6E-02	< 1E-03	3E-02	
			100%/h	3E+02	2E+03	<i>b</i>	<i>b</i>	
		sprays on	≤ 1 h	100%/h	9E+01	1E+03	<i>b</i>	<i>b</i>
				100%/h	4E+00	4E+01	3E+00	2E+01
			2-12 h	100%/day	4E+00	4E+01	3E+00	2E+01
				design rate	4E-03	4E-02	3E-03	2E-02
				100%/h	1E+01	5E+02	<i>b</i>	<i>b</i>
			> 12 h	100%/day	6E-01	2E+01	5E-01	9E+00
design rate	< 1E-03			2E-02	< 1E-03	1E-02		

^aDose calculations reflect a 1-h ground level release with average meteorological conditions (D stability, 4 mph, no rain) and the effect of building wake. The acute bone dose includes 1 h of inhalation, 1 h of cloudshine, and 24 h of groundshine to an adult performing normal activities. The thyroid dose includes 1 h of inhalation exposure to an adult.

^bBecause of the high release rate, it is assumed that there is no recirculation through ice.

Fig. C-10
Dose for PWR steam generator tube rupture with a release of normal coolant.

Core/coolant	Steam generator		Dose ^a at 1 mile (rem)			
			Safety valve		Steam jet air ejector	
Conditions	Leak rate	Conditions	TABD	Thyroid	TABD	Thyroid
no core damage, normal coolant	1 tube fails at full pressure (500 gal/min)	not partitioned	<1E-03	9E-03	<1E-03	<1E-03
		partitioned	<1E-03	<1E-03	<1E-03	<1E-03
		not partitioned	<1E-03	<1E-03	<1E-03	<1E-03
		partitioned	<1E-03	<1E-03	<1E-03	<1E-03
	1 pump fails at low pressure (50 gal/min)	not partitioned	<1E-03	<1E-03	<1E-03	<1E-03
		partitioned	<1E-03	<1E-03	<1E-03	<1E-03
		not partitioned	<1E-03	<1E-03	<1E-03	<1E-03
		partitioned	<1E-03	<1E-03	<1E-03	<1E-03

^aDose calculations reflect a 1-h ground level release with average meteorological conditions (D stability, 4 mph, no rain) and the effect of building wake. The total acute bone dose (TABD) includes 1 h of inhalation, 1 h of cloudshine, and 24 h of groundshine to an adult performing normal activities. The thyroid dose includes 1 h of inhalation exposure to an adult.

Fig. C-11
Dose for PWR steam generator tube rupture with a release
of spiked coolant (non-noble spike 100 × normal).

Core/coolant	Steam generator		Dose ^a at 1 mile (rem)			
			Safety valve		Steam jet air ejector	
Condition	Leak rate	Conditions	TABD	Thyroid	TABD	Thyroid
no core damage, coolant 100 × normal non-noble spike	1 tube fails at full pressure (500 gal/min)	not partitioned	6E-02	9E-01	1E-03	2E-02
		partitioned	2E-03	4E-02	< 1E-03	2E-03
	1 pump injects at low pressure (50 gal/min)	not partitioned	5E-03	8E-02	< 1E-03	2E-03
		partitioned	< 1E-03	3E-03	< 1E-03	< 1E-03

^aDose calculations reflect a 1-h ground level release with average meteorological conditions (D stability, 4 mph, no rain) and the effect of building wake. The total acute bone dose (TABD) includes 1 h of inhalation, 1 h of cloudshine, and 24 h of groundshine to an adult performing normal activities. The thyroid dose includes 1 h of inhalation exposure to an adult.

Fig. C-12
Dose for PWR steam generator tube rupture with a release of
coolant contaminated due to a gap release from the core.

Core/coolant	Steam generator		Dose ^a at 1 mile (rem)			
			Safety valve		Steam jet air ejector	
			Condition	Leak rate	Conditions	TABD
gap release concentration (uncovered 15-30 min)	1 tube fails at full pressure (500 gal/min)	not partitioned	6E+01	3E+03	8E+00	5E+01
		partitioned	9E+00	1E+02	7E+00	5E+00
	1 pump injects at low pressure (50 gal/min)	not partitioned	5E+00	2E+02	7E-01	5E+00
		partitioned	8E-01	9E+00	6E-01	5E-01

^aDose calculations reflect a 1-h ground level release with average meteorological conditions (D stability, 4 mph, no rain) and the effect of building wake. The total acute bone dose (TABD) includes 1 h of inhalation, 1 h of cloudshine, and 24 h of groundshine to an adult performing normal activities. The thyroid dose includes 1 h of inhalation exposure to an adult.

Fig. C-13
Dose for PWR steam generator tube rupture with a release of
coolant contaminated due to in-vessel core melt.

Core/coolant	Steam generator		Dose ^a at 1 mile (rem)			
			Safety valve		Steam jet air ejector	
Condition	Leak rate	Conditions	TABD	Thyroid	TABD	Thyroid
in-vessel core melt release concentration (uncovered > 30 min)	1 tube fails at full pressure (500 gal/min)	not partitioned	6E+02	2E+04	1E+02	4E+02
		partitioned	2E+02	8E+02	1E+02	4E+01
	1 pump injects at low pressure (50 gal/min)	not partitioned	5E+01	2E+03	1E+01	3E+01
		partitioned	1E+01	7E+01	1E+01	4E+00

^aDose calculations reflect a 1-h ground level release with average meteorological conditions (D stability, 4 mph, no rain) and the effect of building wake. The total acute bone dose (TABD) includes 1 h of inhalation, 1 h of cloudshine, and 24 h of groundshine to an adult performing normal activities. The thyroid dose includes 1 h of inhalation exposure to an adult.

Fig. C-14
Dose for BWR containment drywell release for a gap release.

Core	Containment			Dose ^a at 1 mile (rem)				
				Not filtered		Filtered		
Condition	Conditions	Holdup time	Leak rate	TABD	Thyroid	TABD	Thyroid	
gap release (uncovered 15-30 min)	sprays off	≤ 1 h	100%/h	2E+02	1E+04	<i>b</i>	<i>b</i>	
		2-12 h	100%/h	6E+01	5E+03	<i>b</i>	<i>b</i>	
			100%/day	2E+00	2E+02	2E-01	2E+00	
			design rate	2E-03	2E-01	< 1E-03	2E-03	
		> 12 h	100%/h	4E+00	4E+02	<i>b</i>	<i>b</i>	
			100%/day	1E-01	1E+01	2E-02	1E-01	
			design rate	< 1E-03	1E-02	< 1E-03	< 1E-03	
		sprays on	≤ 1 h	100%/h	2E+01	4E+02	<i>b</i>	<i>b</i>
			2-12 h	100%/h	7E+00	3E+02	<i>b</i>	<i>b</i>
	100%/day			3E-01	1E+01	2E-01	1E-01	
	design rate			< 1E-03	1E-02	< 1E-03	< 1E-03	
	> 12 h		100%/h	2E+00	1E+02	<i>b</i>	<i>b</i>	
			100%/day	6E-02	5E+00	2E-02	5E-02	
		design rate	< 1E-03	5E-03	< 1E-03	< 1E-03		

^aDose calculations reflect a 1-h ground level release with average meteorological conditions (D stability, 4 mph, no rain) and the effect of building wake. The total acute bone dose (TABD) includes 1 h of inhalation, 1 h of cloudshine, and 24 h of groundshine to an adult performing normal activities. The thyroid dose includes 1 h of inhalation exposure to an adult.

^bNo filtering; filters are assumed to blow out.

Fig. C-15
Dose for BWR containment drywell release for an in-vessel core melt release.

Core	Containment			Dose ^a at 1 mile (rem)				
				Not filtered		Filtered		
Condition	Conditions	Holdup time	Leak rate	TABD	Thyroid	TABD	Thyroid	
in-vessel core melt (uncovered > 30 min)	sprays off	≤ 1 h	100%/h	2E+03	9E+04	<i>b</i>	<i>b</i>	
			2-12 h	100%/h	6E+02	4E+04	<i>b</i>	<i>b</i>
				100%/day	2E+01	2E+03	3E+00	2E+01
		> 12 h	design rate	2E-02	2E+00	3E-03	2E-02	
			100%/h	4E+01	3E+03	<i>b</i>	<i>b</i>	
			100%/day	2E+00	1E+02	4E-01	1E+00	
		> 12 h	design rate	2E-03	1E-01	<1E-03	1E-03	
			≤ 1 h	100%/h	3E+02	3E+03	<i>b</i>	<i>b</i>
				2-12 h	100%/h	1E+02	2E+03	<i>b</i>
		100%/day			4E+00	9E+01	3E+00	9E-01
		> 12 h	design rate	4E-03	9E-02	3E-03	<1E-03	
			100%/h	2E+01	9E+02	<i>b</i>	<i>b</i>	
			100%/day	7E-01	4E+01	4E-01	4E-01	
		> 12 h	design rate	<1E-03	4E-02	<1E-03	<1E-03	

^aDose calculations reflect a 1-h ground level release with average meteorological conditions (D stability, 4 mph, no rain) and the effect of building wake. The total acute bone dose (TABD) includes 1 h of inhalation, 1 h of cloudshine, and 24 h of groundshine to an adult performing normal activities. The thyroid dose includes 1 h of inhalation exposure to an adult.

^bNo filtering; filters are assumed to blow out.

Fig. C-16
Dose for BWR containment wetwell release for a gap release.

Core	Containment			Dose ^a at 1 mile (rem)			
				Not filtered		Filtered	
Condition	Suppression pool conditions	Holdup time in dry/wet well	Wet well leak rate	TABD	Thyroid	TABD	Thyroid
gap release (uncovered 15-30 min)	saturated (no sprays)	≤ 1 h	100%/h	2E+01	6E+02	<i>b</i>	<i>b</i>
			100%/h	7E+00	3E+02	<i>b</i>	<i>b</i>
		2-12 h	100%/day	3E-01	1E+01	2E-01	1E-01
			design rate	<1E-03	1E-02	<1E-03	<1E-03
		> 12 h	100%/h	6E-01	2E+01	<i>b</i>	<i>b</i>
			100%/day	3E-02	7E-01	2E-02	7E-03
	design rate	<1E-03	<1E-03	<1E-03	<1E-03		
	subcooled (no sprays)	≤ 1 h	100%/h	1E+01	1E+02	<i>b</i>	<i>b</i>
			100%/h	5E+00	5E+01	<i>b</i>	<i>b</i>
		2-12 h	100%/day	2E-01	2E+00	2E-01	2E-02
			design rate	<1E-03	2E-03	<1E-03	<1E-03
		> 12 h	100%/h	6E-01	1E+01	<i>b</i>	<i>b</i>
			100%/day	2E-02	5E-01	2E-02	5E-03
	design rate	<1E-03	<1E-03	<1E-03	<1E-03		

^aDose calculations reflect a 1-h ground level release with average meteorological conditions (D stability, 4 mph, no rain) and the effect of building wake. The total acute bone dose (TABD) includes 1 h of inhalation, 1 h of cloudshine, and 24 h of groundshine to an adult performing normal activities. The thyroid dose includes 1 h of inhalation exposure to an adult.

^bNo filtering; filters are assumed to blow out.

Fig. C-17
Dose for BWR containment wetwell release
for an in-vessel core melt release.

Core	Containment			Dose ^a at 1 mile (rem)			
				Not filtered		Filtered	
Condition	Suppression pool conditions	Holdup time in dry/wet well	Wet well leak rate	TABD	Thyroid	TABD	Thyroid
in-vessel core melt (uncovered > 30 min)	saturated (no sprays)	≤ 1 h	100%/h	3E+02	4E+03	<i>b</i>	<i>b</i>
			100%/h	1E+02	2E+03	<i>b</i>	<i>b</i>
		2-12 h	100%/day	4E+00	8E+01	3E+00	8E-01
			design rate	4E-03	8E-02	3E-03	<1E-03
		> 12 h	100%/h	1E+01	1E+02	<i>b</i>	<i>b</i>
			100%/day	4E-01	5E+00	4E-01	6E-02
	subcooled (no sprays)	≤ 1 h	100%/h	2E+02	9E+02	<i>b</i>	<i>b</i>
			100%/h	8E+01	4E+02	<i>b</i>	<i>b</i>
		2-12 h	100%/day	3E+00	2E+01	3E+00	2E-01
			design rate	3E-03	2E-02	3E-03	<1E-03
		> 12 h	100%/h	1E+01	9E+01	<i>b</i>	<i>b</i>
			100%/day	4E-01	4E+00	4E-01	5E-02
		design rate	<1E-03	4E-03	<1E-03	<1E-03	<1E-03

^aDose calculations reflect a 1-h ground level release with average meteorological conditions (D stability, 4 mph, no rain) and the effect of building wake. The total acute bone dose (TABD) includes 1 h of inhalation, 1 h of cloudshine, and 24 h of groundshine to an adult performing normal activities. The thyroid dose includes 1 h of inhalation exposure to an adult.

^bNo filtering; filters are assumed to blow out.

Fig. C-18
Dose for BWR/PWR containment bypass release for a gap release.

Core Condition	Containment		Dose ^a at 1 mile (rem)	
	Release conditions	Release rate	TABD	Thyroid
gap release (uncovered 15-30 min)	not filtered	100%/h	8E+01	3E+03
		100%/day	3E+00	1E+02
		0.1%/day	3E-03	1E-01
	filtered	100%/h	<i>b</i>	<i>b</i>
		100%/day	8E-01	1E+00
		0.1%/day	<1E-03	1E-03

^aDose calculations reflect a 1-h ground level release with average meteorological conditions (D stability, 4 mph, no rain) and the effect of building wake. The total acute bone dose (TABD) includes 1 h of inhalation, 1 h of cloudshine, and 24 h of groundshine to an adult performing normal activities. The thyroid dose includes 1 h of inhalation exposure to an adult.

^bNo filtering; filters are assumed to blow out.

Fig. C-19
Dose for BWR/PWR containment bypass release
for an in-vessel core melt release.

Core	Containment		Bone dose ^a at 1 mile (rem)	
	Release conditions	Release rate	TABD	Thyroid
in-vessel core melt (uncovered > 30 min)	not filtered	100%/h	9E+02	2E+04
		100%/day	4E+01	9E+02
		0.1%/day	4E-02	1E+00
		100%/h	<i>b</i>	<i>b</i>
	filtered	100%/day	2E+01	9E+00
		0.1%/day	2E-02	1E-02

^aDose calculations reflect a 1-h ground level release with average meteorological conditions (D stability, 4 mph, no rain) and the effect of building wake. The total acute bone dose (TABD) includes 1 h of inhalation, 1 h of cloudshine, and 24 h of groundshine to an adult performing normal activities. The thyroid dose includes 1 h of inhalation exposure to an adult.

^bNo filtering; filters are assumed to blow out.

Fig. C-20
Shutdown time correction factors for total acute bone dose (TABD)
after gap release.

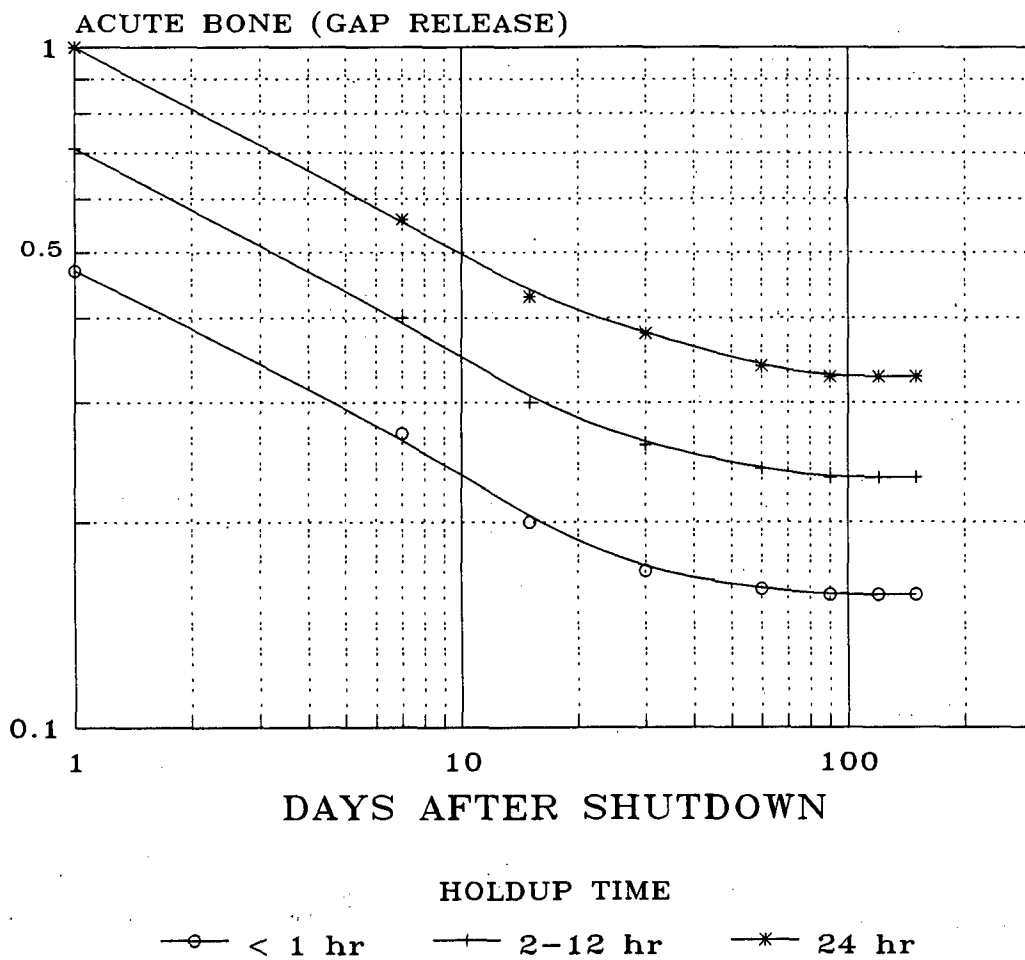

Fig. C-21
Shutdown time correction factors for total acute bone dose (TABD)
after in-vessel core melt release.

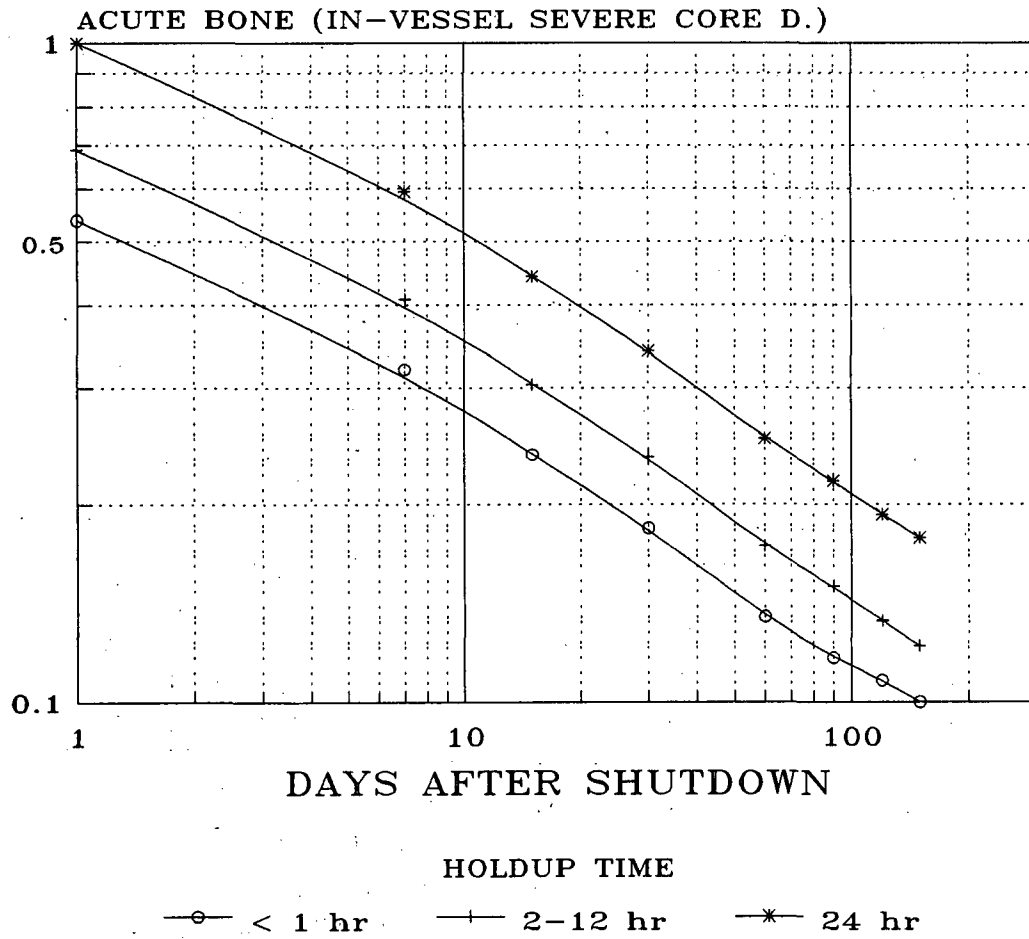
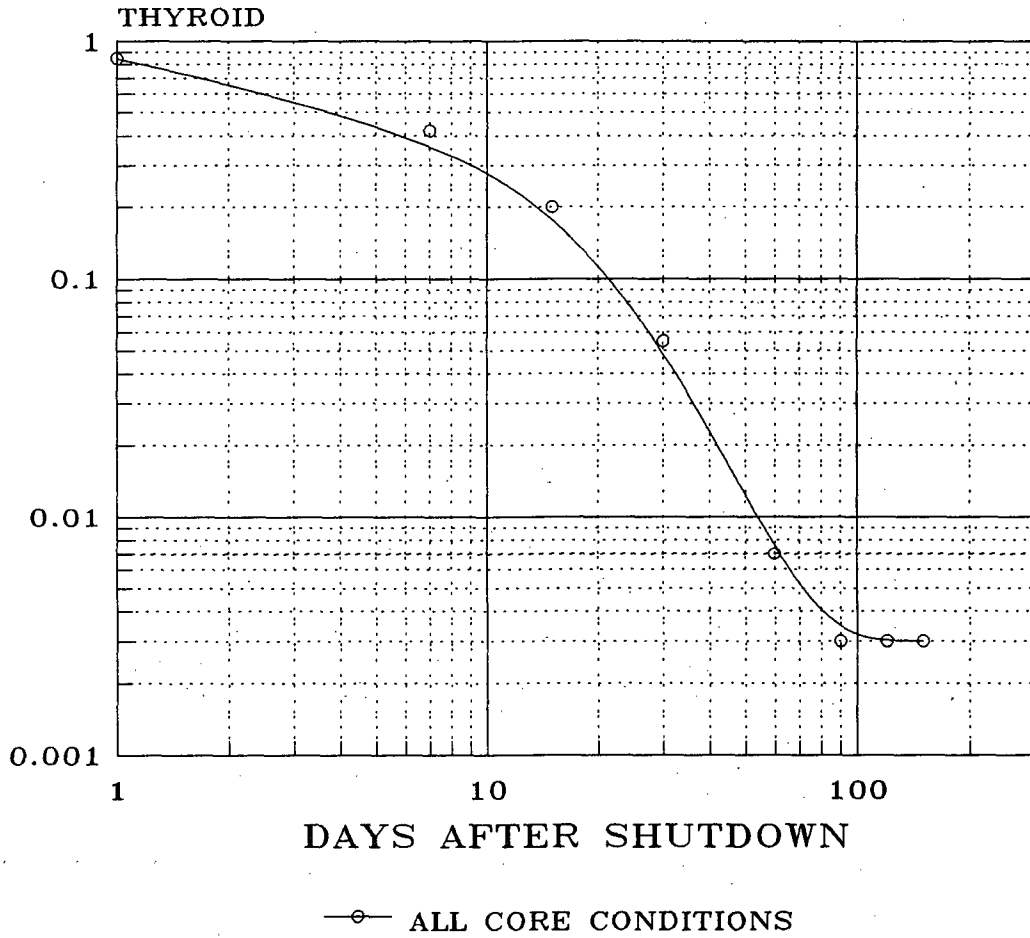
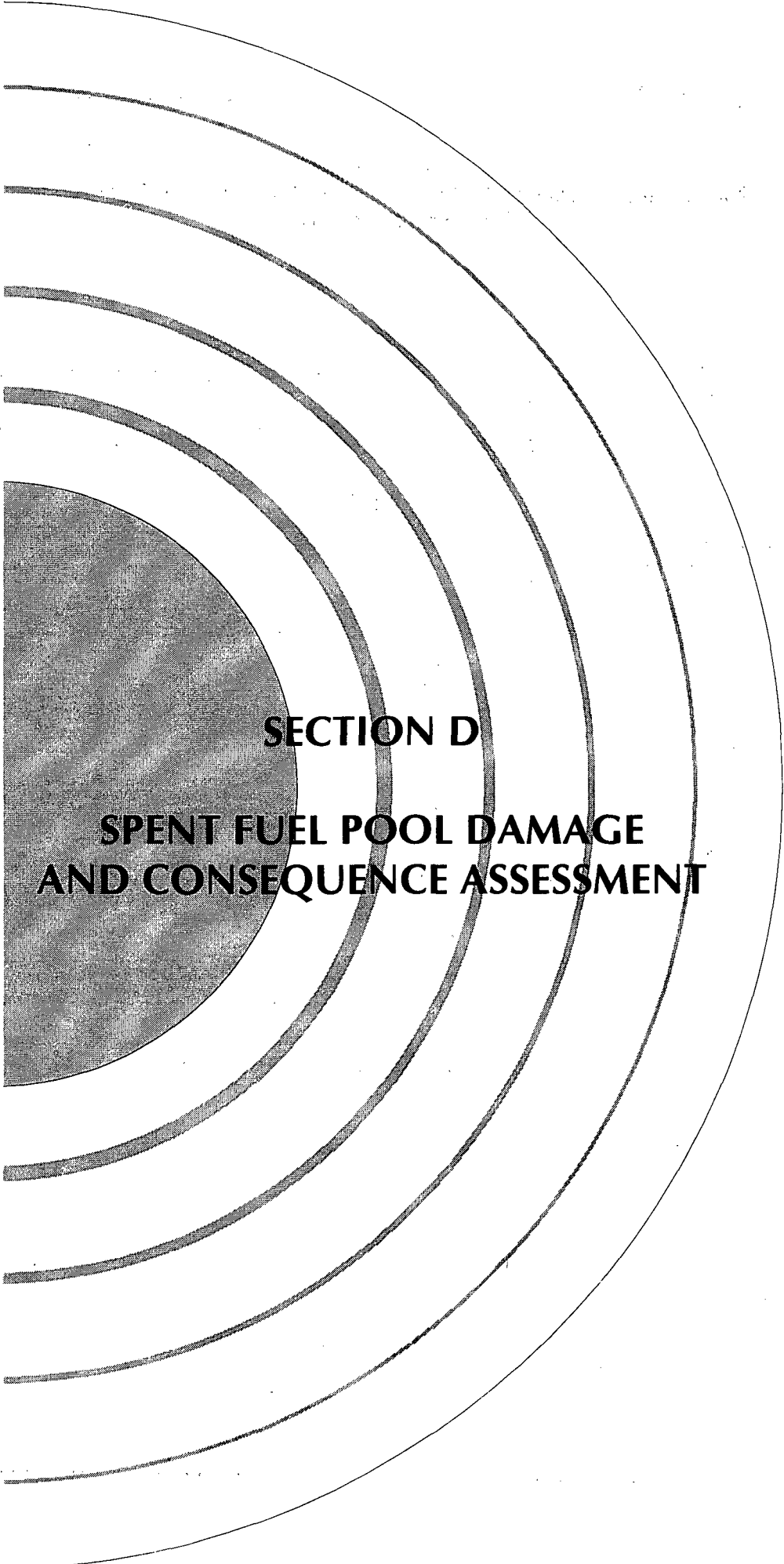
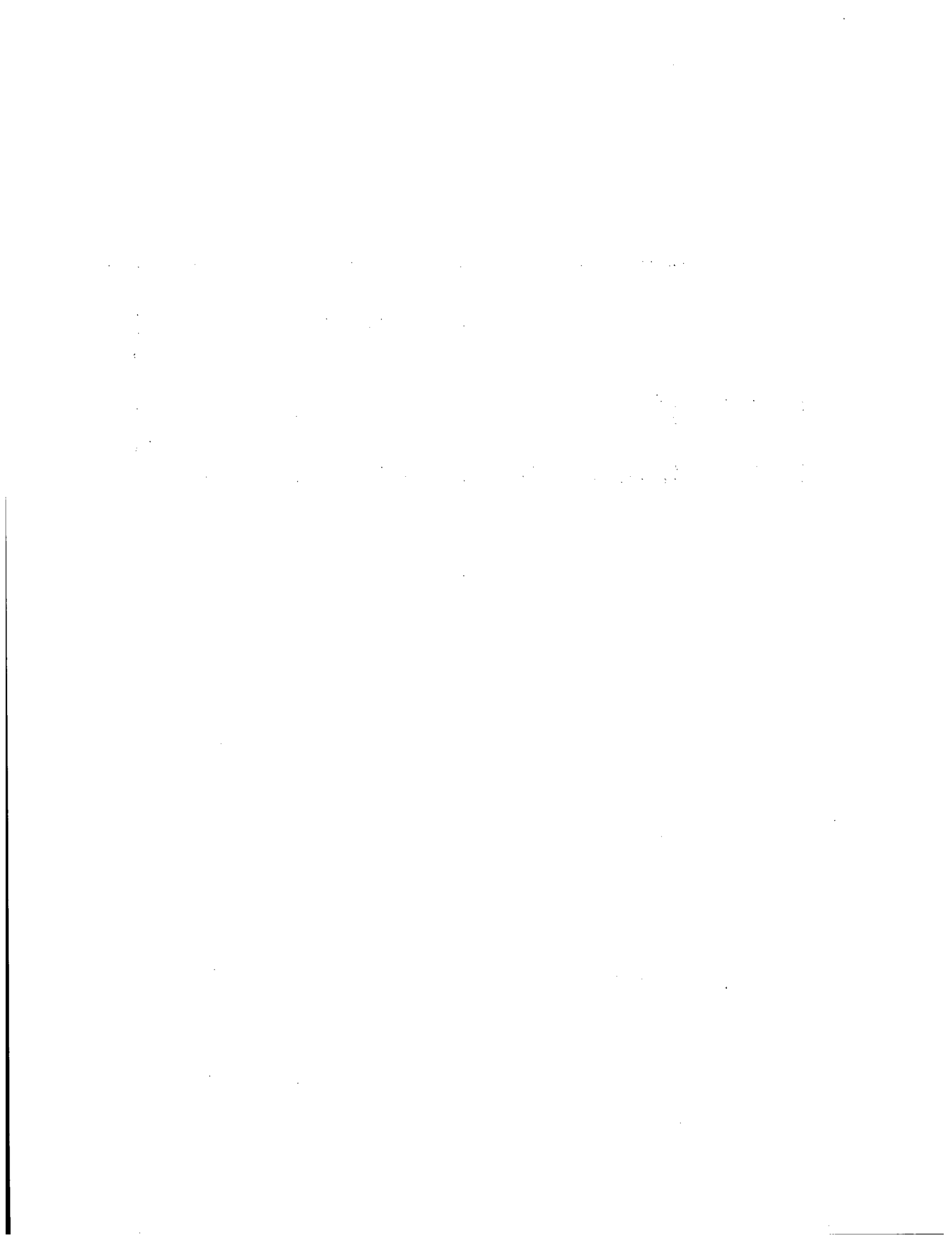

Fig. C-22
Shutdown time correction factors for thyroid dose after release
(all core conditions).





SECTION D
**SPENT FUEL POOL DAMAGE
AND CONSEQUENCE ASSESSMENT**



Section D
Quick Reference Guide

	<i>Page</i>
Spent fuel pool damage and consequence assessment	A-3
Spent fuel pool accident consequence assessment using event trees	A-5
Section D table	A-9
Section D figures	A-10

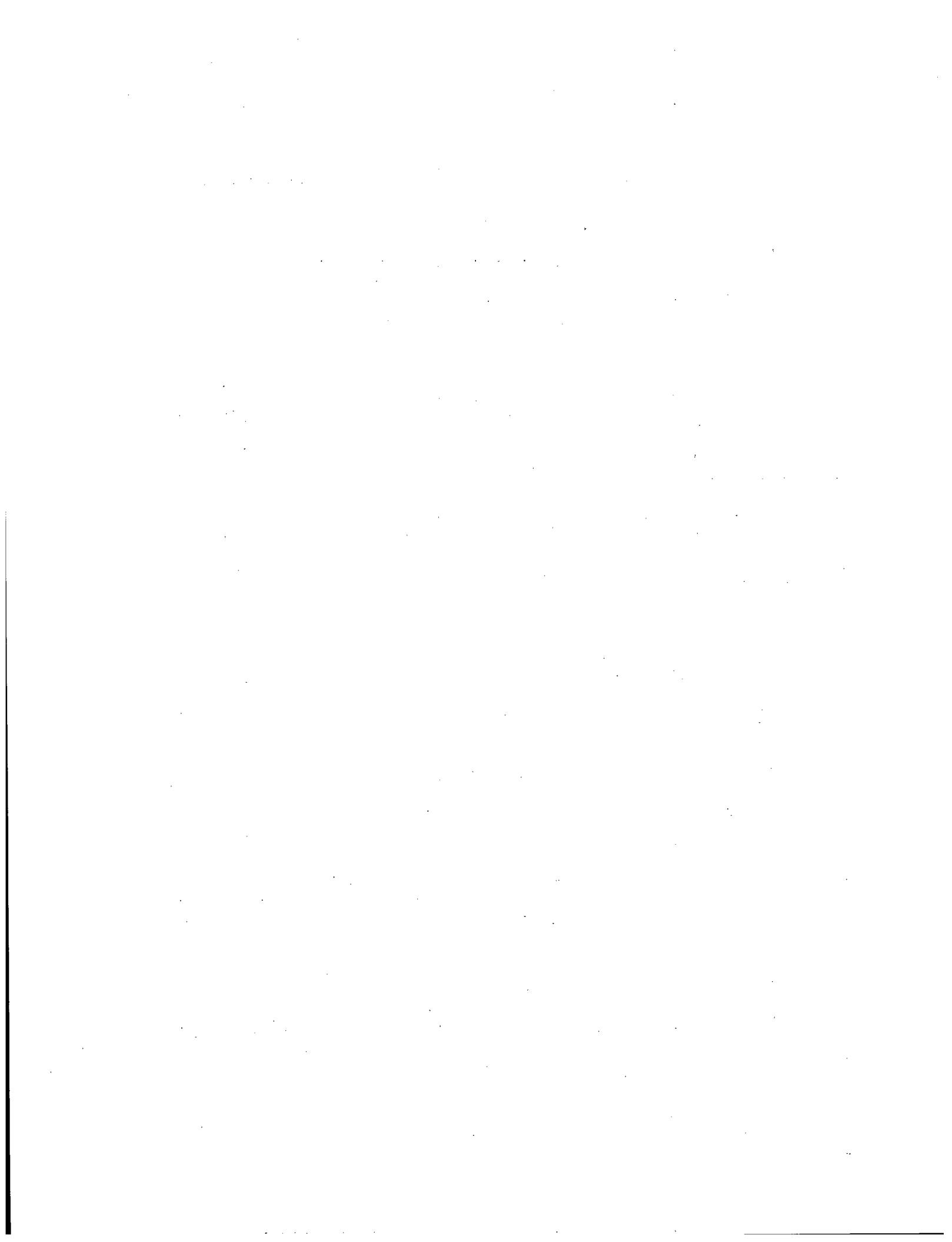

Section D

Spent Fuel Pool Damage and Consequence Assessment

Purpose

To assess accidents involving loss of coolant to a spent fuel pool.

Discussion

Accidents involving the loss of coolant in the spent fuel pool may have offsite consequences because of damage to the fuel from overheating. Two types of damage may occur: (1) a Zircaloy cladding fire resulting in substantial release of fission products from recently discharged fuel and (2) cladding failure with release of the fission products in the fuel pin gap.

Fuel damage may be prevented if 100–250 gal/min of water can be sprayed on the pool, beginning within 1 h of draining the pool. This flow rate can be achieved with fire hoses. Use Fig. D-1 to estimate the dose from direct radiation from a drained pool (this estimate may be needed to protect those responding near the pool).

Step 1

Estimate the time to drain the pool (or boil off the water) using Table D-1.

Step 2

Estimate potential spent fuel damage. Consider the following:

- The spent fuel pool must be virtually drained for substantial damage to occur. Pools are considered coolable as long as 20% of the fuel is covered.
- Cladding failure with release of the fission products in the fuel pin gap is possible within 2 h to several days after the pool is drained. It is assumed that the pin will heat up before failure, releasing about 5% of the volatile fission products (i.e., typical gap release fractions).
- After the pool has been drained, a Zircaloy cladding fire resulting in release of a substantial amount of the volatile fission products (in-vessel core melt release fraction—i.e., 25% of cesium) is possible in BWR fuel for 30–250 days after shutdown (30–180 days for PWR). A Zircaloy cladding fire is likely to propagate to adjacent fuel bundles discharged within the last 2 years.

Step 3

Estimate potential offsite consequences using Method D.1.

Step 4

Report your assessment of the possible consequences of the reactor accident and the assumptions behind the assessment.

END

Sources: NUREG/CR-0649, NUREG-1353.

Method D.1

Spent Fuel Pool Accident Consequence Assessment Using Event Trees

Purpose

To estimate offsite consequences based on the status and age of the fuel in the spent fuel pool and on release pathway conditions.

Discussion

This method uses event trees containing precalculated dose estimates to determine the offsite consequences of a release from damaged fuel in a spent fuel pool. This method is designed to provide a best estimate of the dose when the source term is not known (before a release or for a release through an unmonitored pathway, such as a building pressure valve). These calculations consider only the fuel conditions, release, and atmospheric conditions that have a major (greater than a factor of 10) impact on dose.

Consequence assessments in this method are based on a best estimate of the maximum total acute bone marrow dose (TABD) and maximum thyroid dose (plume center line) to an individual, assuming average weather conditions, a 1-h release, and no sheltering or protection. TABD is considered the most sensitive indication for the onset of early non-thyroid health effects. Thyroid dose is calculated because it provides an indication of the distances at which the EPA early phase PAGs may be exceeded.

Doses were calculated using RASCAL 2.1 and include the external and inhalation dose from the passing plume and the dose from exposure to contaminated ground for 24 h. The dose estimates should be within a factor of 10-100 if the spent fuel pool and rain conditions are accurately represented.

The steps in this assessment are summarized below:

- | | |
|--------|--|
| Step 1 | Locate event tree and determine projected dose. |
| Step 2 | Record doses from event tree. |
| Step 3 | Adjust doses for number of batches if necessary. |
| Step 4 | Adjust doses for release duration. |
| Step 5 | Correct dose estimate for distance, release elevation, and rain. |
| Step 6 | Determine distance at which selected consequences are possible. |
| Step 7 | Combine consequence projection and release description for presentation. |

Step 1

Select the type of release to be considered, locate the corresponding event tree, select appropriate pool and release conditions, and determine the projected doses. Doses can be adjusted later for the number of batches.

Zircaloy fire from one 3-month-old batch	Fig. D-2
Gap release from one 3-month-old batch	Fig. D-3
Gap release from 15 1-year-old batches	Fig. D-4

Step 2

Record the following doses for a 1-h release from the appropriate event tree:

TABD at 1 mile: _____ rem
 Thyroid dose at 1 mile: _____ rem

Step 3

Adjust doses for the number of batches in pool. Multiply the TABD at 1 mile and the thyroid dose at 1 mile from Fig. D-2 and Fig. D-3 by the number of batches (reloads) in pool. (A batch is one-third of the core, the amount typically removed during refueling.) Note that the calculation in Fig. D-4 is for 15 batches, instead of a single batch. In that case, this step may not be needed.

$$(TABD \text{ at 1 mile}) = (TABD \text{ at 1 mile for 1 batch}) \times \text{number of batches in pool}$$

$$(\quad \text{rem}) = (\quad \text{rem}) \times (\quad)$$

$$(\text{thyroid dose at 1 mile}) = (\text{thyroid dose at 1 mile for 1 batch}) \times \text{number of batches in pool}$$

$$(\quad \text{rem}) = (\quad \text{rem}) \times (\quad)$$

Step 4

Adjust the doses for different release durations by multiplying the dose by the release duration in hours. (Do not assume more than a 1-h release for the 100%/h release cases; 1 h is the maximum possible release time for these cases.)

$$(TABD \text{ at 1 mile}) = (TABD \text{ at 1 mile for 1-h release}) \times \text{release duration}$$

$$(\quad \text{rem}) = (\quad \text{rem/h}) \times (\quad \text{h})$$

(thyroid dose at 1 mile) = (thyroid dose at 1 mile for 1-h release) × release duration

$$(\text{ rem}) = (\text{ rem/h}) \times (\text{ h})$$

Step 5

Estimate the dose at 1, 2, 5, 10, and 25 miles for a ground level or elevated release with or without rain, as appropriate, using Method F.5, "Adjusting Dose Projections to Consider Distance, Elevation, and Rain."

Step 6

Because of the great uncertainty, do not use dose numbers when presenting results. Instead, use the results of Step 5 to identify the distances to which certain consequences might be possible and fill in the blanks below. (When dealing with elevated releases under these assumptions, the maximum dose will be further than 1 mile away from the plant.)

Distance to which early deaths are possible

(TABD > 220 rem): _____ miles

Distance to which vomiting and diarrhea are possible

(TABD > 50 rem): _____ miles

Distance to which EPA early phase PAG may be exceeded

(thyroid dose > 5 rem) _____ miles

Step 7

Combine this assessment with the general description of the release.

END

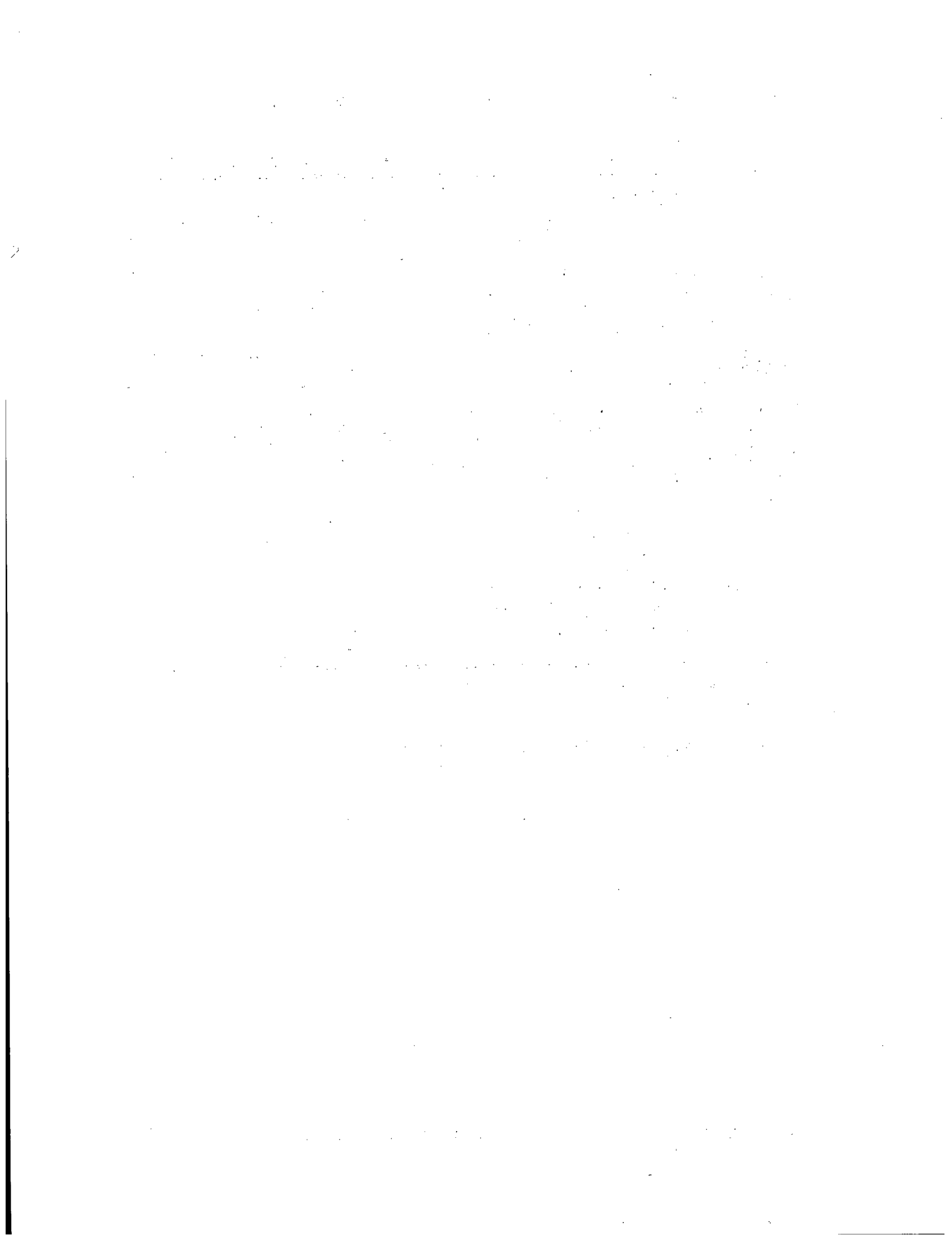

Table D-1. Heatup and boil-dry times for a typical spent fuel pool

Days after shutdown ^a	One-third of core recently discharged + 20 years of accumulated discharges			Full core recently discharged + 20 years of accumulated discharges		
	Time to heat from 125°F to 212°F ^b (h)	Time to boil off water ^c (h)	Water to make up boil-off (gal/min)	Time to heat from 150°F to 212°F ^b (h)	Time to boil off water ^c (h)	Water to make up boil-off (gal/min)
5	11.2	125.0	31.9	3.1	49.3	81.0
10	13.9	154.9	25.8	4.1	63.8	62.6
30	19.0	212.2	18.8	6.1	95.8	41.7
45	21.8	242.8	16.4	7.4	115.5	34.5
65	24.3	270.4	14.8	8.6	135.2	29.5
100	27.5	306.5	13.0	10.5	164.2	24.3
150	32.0	357.1	11.2	13.6	212.6	18.8
200	35.1	391.2	10.2	16.1	251.9	15.8
250	37.2	414.5	9.6	18.1	282.6	14.1
300	38.4	428.3	9.3	19.3	302.4	13.2
350	39.2	437.5	9.1	20.2	316.6	12.6
365	39.3	438.6	9.1	20.4	318.4	12.5

^aDays after shutdown of core recently discharged.

^b52°C to 100°C.

^cTo drain the pool.

Source: NUREG-1353.

Fig. D-1
Whole body gamma ground level dose rate from drained spent fuel pool.^a

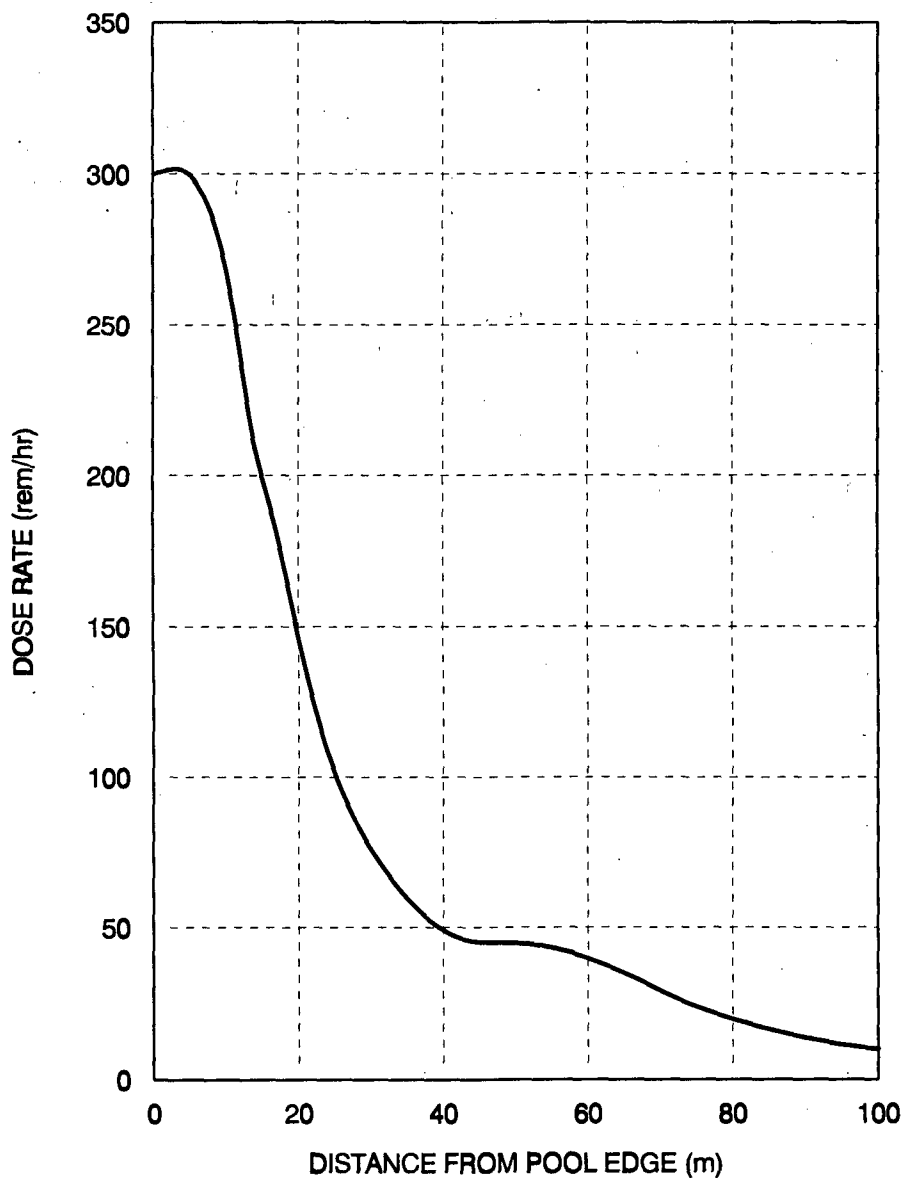

^a30 days after one fuel core discharged. Rest of material is 1, 2, or 3 years after discharge.

Source: NUREG/CR-0649.

Fig. D-2
BWR/PWR spent fuel pool release event tree for a Zircaloy fire
in one 3-month-old batch of fuel.

Fuel	Release			Dose ^a at 1 mile (rem)				
				Not filtered		Filtered		
Conditions	Pool condition	Holdup time	Leak rate	TABD	Thyroid	TABD	Thyroid	
Zircaloy fire from one 3-month-old batch	sprays off	≤1 h	100%/h	3E+01	8E+01	<i>b</i>	<i>b</i>	
			100%/day	1E+00	3E+00	1E-02	3E-02	
		2-12 h	100%/h	1E+01	4E+01	<i>b</i>	<i>b</i>	
			100%/day	5E-01	2E+00	5E-03	2E-02	
		sprays on	≤1 h	100%/h	1E+00	3E+00	<i>b</i>	<i>b</i>
				100%/day	4E-02	1E-01	<1E-03	1E-03
	2-12 h		100%/h	7E-01	2E+00	<i>b</i>	<i>b</i>	
			100%/day	3E-02	8E-02	<1E-03	<1E-03	

^aDose calculations reflect a 1-h ground level release with average meteorological conditions (D stability, 4 mph, no rain) and the effect of building wake. The acute bone dose includes 1 h of inhalation, 1 h of cloudshine, and 24 h of groundshine to an adult performing normal activities. The thyroid dose includes 1 h of inhalation exposure to an adult.

^bNo filtering is assumed at this leak rate.

Fig. D-3
BWR/PWR spent fuel pool release event tree
for a gap release from one 3-month-old batch of fuel.

Fuel	Release			Dose ^a at 1 mile (rem)				
				Not filtered		Filtered		
Condition	Pool conditions	Holdup time	Leak rate	TABD	Thyroid	TABD	Thyroid	
gap release from one 3-month- old batch	sprays off	≤1 h	100%/h	3E+00	1E+01	<i>b</i>	<i>b</i>	
			100%/day	1E-01	5E-01	1E-03	5E-03	
		2-12 h	100%/h	2E+00	6E+00	<i>b</i>	<i>b</i>	
			100%/day	6E-02	3E-01	<1E-03	3E-03	
		sprays on	≤1 h	100%/h	1E-01	5E-01	<i>b</i>	<i>b</i>
				100%/day	5E-03	2E-02	<1E-03	<1E-03
	2-12 h		100%/h	9E-02	4E-01	<i>b</i>	<i>b</i>	
			100%/day	4E-03	1E-02	<1E-03	<1E-03	

^aDose calculations reflect a 1-h ground level release with average meteorological conditions (D stability, 4 mph, no rain) and the effect of building wake. The acute bone dose includes 1 h of inhalation, 1 h of cloudshine, and 24 h of groundshine to an adult performing normal activities. The thyroid dose includes 1 h of inhalation exposure to an adult.

^bNo filtering is assumed at this leak rate.

Fig. D-4
BWR/PWR spent fuel pool release event tree
for a gap release from 15 1-year-old batches of fuel.

Fuel	Release			Dose ^a at 1 mile (rem)			
				Not filtered		Filtered	
Condition	Pool conditions	Holdup time	Leak rate	TABD	Thyroid	TABD	Thyroid
gap release from 15 1-year-old batches	sprays off	≤1 h	100%/h	3E+01	1E+02	^b	^b
			100%/day	1E+00	4E+00	1E-02	4E-02
		2-12 h	100%/h	1E+01	5E+01	^b	^b
			100%/day	5E-01	2E+00	5E-03	2E-02
	sprays on	≤1 h	100%/h	1E+00	4E+00	^b	^b
			100%/day	4E-02	2E-01	<1E-03	2E-03
		2-12 h	100%/h	7E-01	3E+00	^b	^b
			100%/day	3E-02	1E-01	<1E-03	1E-03

^aDose calculations reflect a 1-h ground level release with average meteorological conditions (D stability, 4 mph, no rain) and the effect of building wake. The acute bone dose includes 1 h of inhalation, 1 h of cloudshine, and 24 h of groundshine to an adult performing normal activities. The thyroid dose includes 1 h of inhalation exposure to an adult.

^bNo filtering is assumed at this leak rate.

E

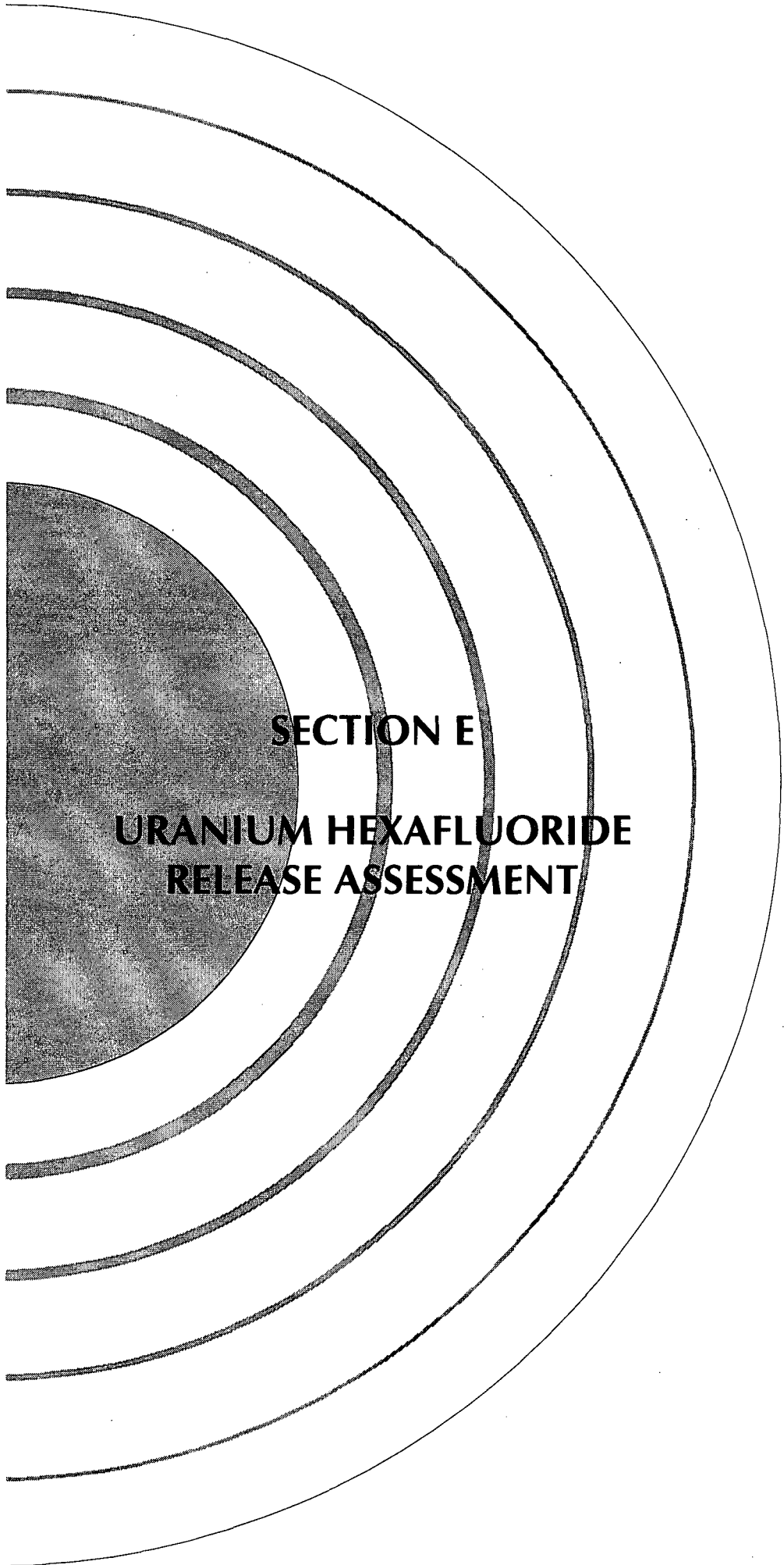

SECTION E
URANIUM HEXAFLUORIDE
RELEASE ASSESSMENT

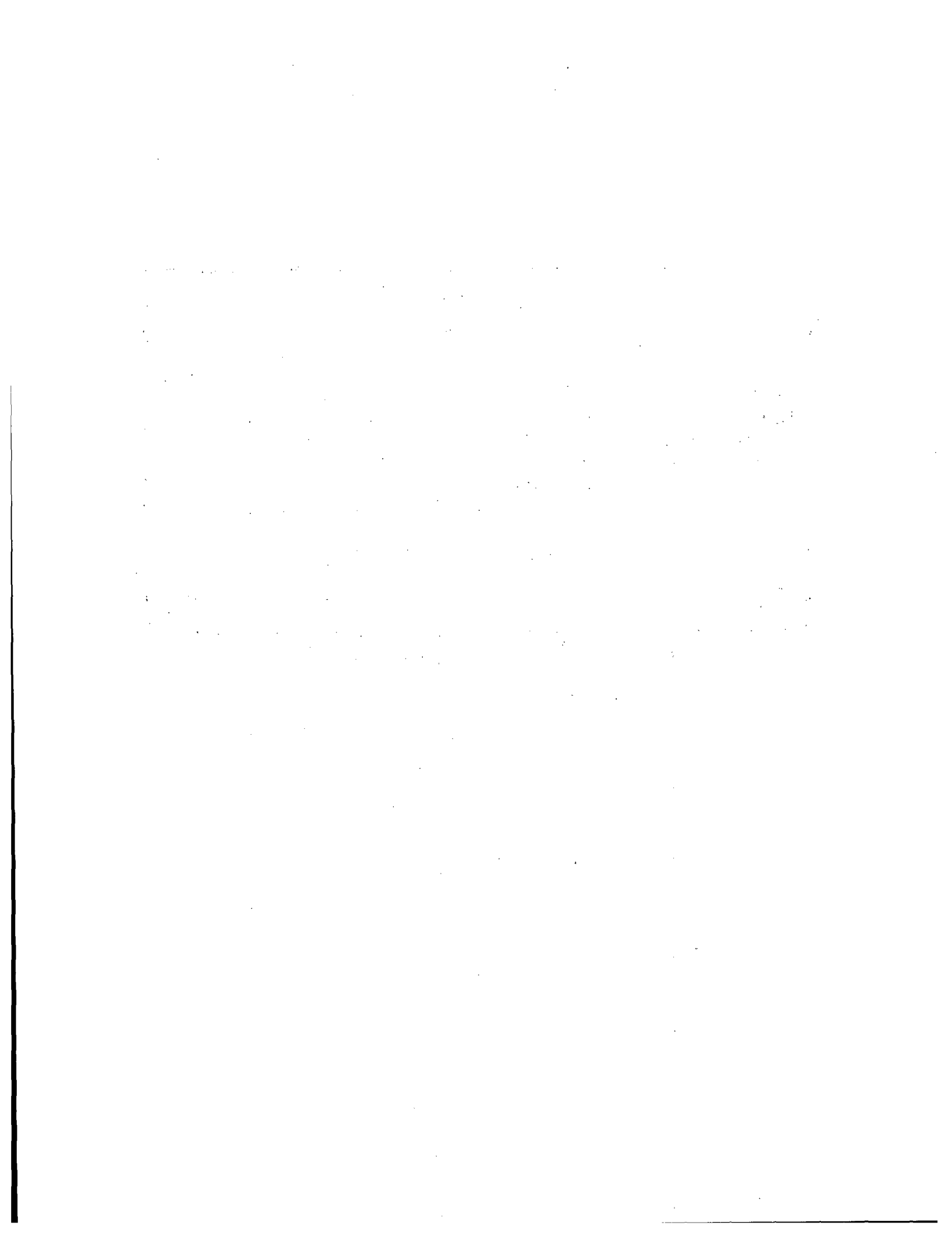

Section E
Quick Reference Guide

	<i>Page</i>
Uranium hexafluoride release assessment	E-3
Estimation of inhaled soluble uranium intake and hydrogen fluoride concentration after a liquid UF ₆ release	E-7
Calculation of inhaled soluble uranium intake and hydrogen fluoride concentration after a UF ₆ release	E-9
Estimation of committed effective dose equivalent resulting from inhaled uranium after a liquid UF ₆ release	E-13
Calculation of committed effective dose equivalent resulting from inhaled uranium after a UF ₆ release	E-15
Section E tables	E-19
Section E figures	E-23

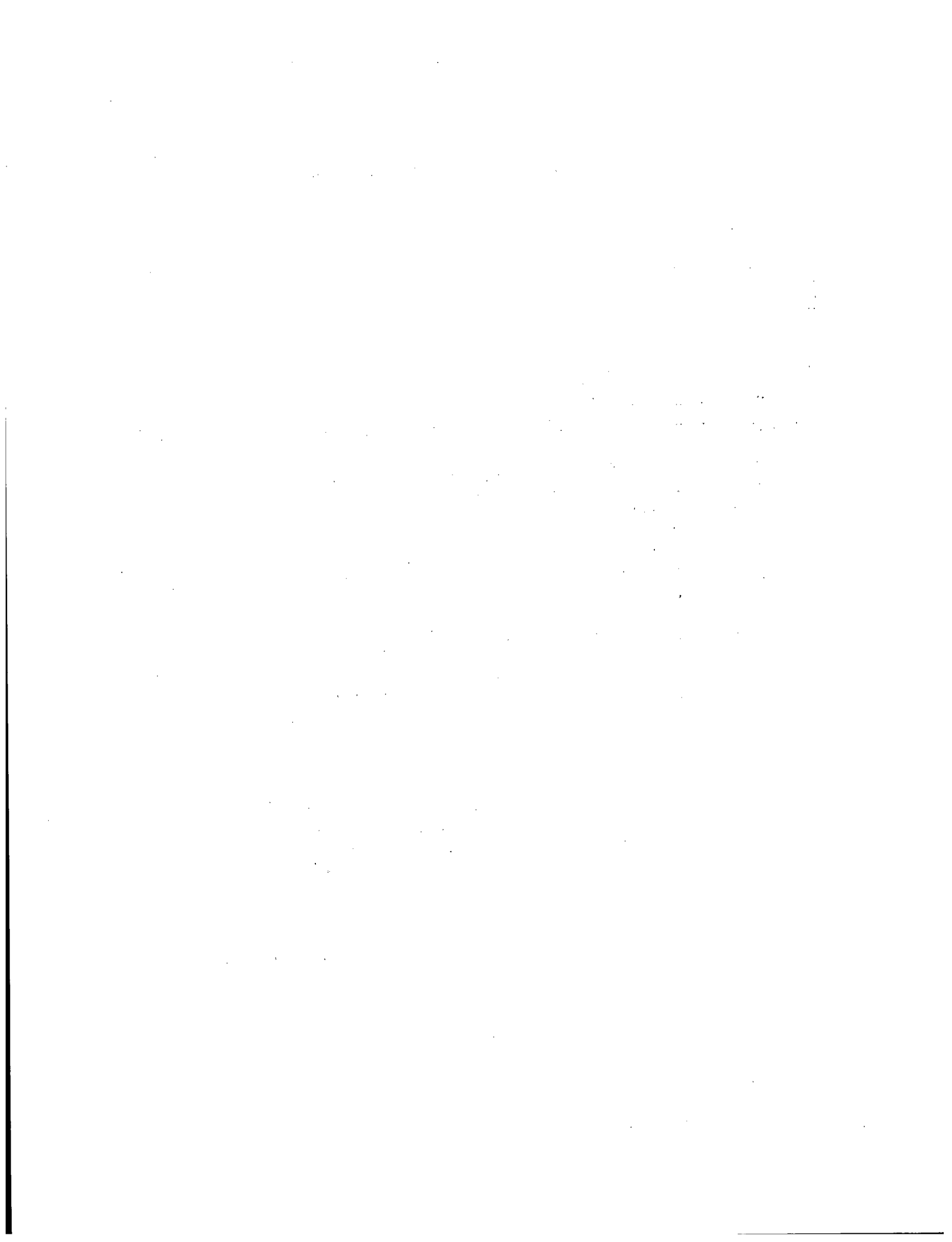

Section E

Uranium Hexafluoride Release Assessment

Purpose

To assess the possible consequences of a uranium hexafluoride (UF_6) release and determine the need for protective actions.

Discussion

UF_6 is a readily dispersible form of uranium that is produced in uranium conversion plants, shipped to uranium enrichment plants, enriched in the ^{235}U isotope, and then shipped to fuel fabrication plants to be processed into nuclear fuel. A large accidental release is most likely when large, hot cylinders of UF_6 are handled at a processing facility or a large cylinder is involved in a fire.

Released UF_6 gas reacts vigorously with water vapor in the air, producing uranyl fluoride (UO_2F_2), hydrogen fluoride (HF), and excess heat. If there is sufficient humidity, the reaction products may be hydrates of UO_2F_2 and HF- H_2O fog, which are seen as a white cloud. The chemical toxicity of a UF_6 release dominates the radiological risks. The permissible exposure levels for soluble uranium compounds are based on chemical toxicity. UO_2F_2 is a particulate that is very soluble in the lungs, and the uranium acts as a heavy metal poison that can affect the kidneys. The hydrogen fluoride is an acid vapor that can cause acid burns on the skin or lungs if it is concentrated. Toxic levels can be reached in minutes, so immediate protective actions should be taken when a release is possible. Do not let your assessment impede ongoing protective actions at the site.

Chemically lethal or toxic airborne releases of natural and low-enriched soluble uranium would not produce enough radiation to exceed the PAGs beyond the area where there is a chemical hazard. After making any immediate protective action recommendations, estimate consequences attributable to chemical toxicity before considering any radiological threat.

If the release is underway, avoid contact with the plume consisting of UF_6 and its reaction products. A highly concentrated plume of UF_6 may be visible and immediately irritating to the lungs. Stay out of low areas. Evacuation out of the plume and/or sheltering may be appropriate. Cooling the source of the leak and misting the plume with water will significantly reduce the amount of material that becomes airborne.

The reaction of the UF_6 with water vapor produces HF, which is an extremely corrosive acid. Inhaling less than 1 gram of soluble uranium may be fatal, and contact of HF with the skin may cause burns. Anyone who contacts the plume should be examined for HF burns and low-level radioactive contamination and observed for several days following the accident for any delayed health effects resulting from renal uptake of soluble uranium.

The steps in this procedure are summarized below:

- | | |
|--------|---|
| Step 1 | Determine the amount and form of UF_6 available for release. |
| Step 2 | Assess the need for immediate protective actions. |
| Step 3 | Project the uranium intake and HF concentration downwind. |
| Step 4 | Evaluate the potential health effects attributable to chemical toxicity and determine protective actions. |
| Step 5 | Project the committed effective dose equivalent downwind. |
| Step 6 | Compare committed effective dose equivalent to EPA PAGs. |
| Step 7 | Recommend or adjust protective action recommendations. |

Step 1

Determine the amount and physical form (gas or liquid) of UF_6 available for release, using information from the licensee or by checking the cylinder type in Table E-1. Liquid UF_6 will vaporize, but not all of the UF_6 will become airborne. UF_6 gas may be found in heated cylinders, releases in fires, or when the gas is being transferred.

Step 2

Assess the need for immediate protective actions. If the amount of UF_6 available for release is less than 0.5 metric ton (500 kg), recommend protective actions up to 0.5 mile (800 m). For a larger quantity of UF_6 , recommend protective actions up to 1.0 mile (1600 m).¹ If the release has occurred, is occurring, or seems immediately imminent, sheltering may be an appropriate initial action until responders determine when and where evacuation is appropriate.

Step 3

Estimate the potential toxic effects of the incident, based on projected integrated intake of soluble uranium (IU_{sol}) and the projected HF concentration (χ_{HF}) at downwind distances of interest. Roughly estimate the uranium intake and HF

¹NUREG-1140 considers the rupture outdoors of a heated "14-ton" UF_6 cylinder, releasing 9,500 kg UF_6 , to be the maximum credible accident and finds a 1-mile evacuation appropriate to prevent fatalities and permanent injuries. Values for 0.5 ton were taken from Fig. E-2 for HF concentrations in the 16-24 mg/m³ range.

concentration from a liquid UF_6 release using default parameters in Method E.1. To calculate projected values for a UF_6 gas release or for a liquid release using incident-specific information or other meteorological conditions, use Method E.2.

Step 4

Compare the projected integrated intake of soluble uranium (IU_{sol}) and the projected HF concentration (χ_{HF}) with the health effects values indicated in Table E-2 and Table E-3, respectively. Evaluate the potential health effects. Consider the duration of the HF exposure. If the duration of the exposure is short with low concentrations, there may be no significant effects. If the exposure is such that there may be significant health effects, recommend protective measures and postpone the evaluation of any radiological impact.

Figure E-1 (based on the same assumptions as those in Method E.1) provides an indication of the distance downwind to which the Immediately Dangerous to Life and Health (IDLH) concentration of HF might be reached. The distance at which the PAGs might be exceeded for *highly enriched* uranium are also indicated.

Step 5

Estimate the committed effective dose equivalent ($H_{E,50}$) for the desired downwind distance. Use Method E.3 to estimate this value for the desired distance and enrichment level under default assumptions for a liquid UF_6 release, or use Method E.4 to project the dose for a UF_6 gas release or to consider incident-specific parameters or other meteorology for a liquid release.

Step 6

Compare the committed effective dose equivalent ($H_{E,50}$) to the EPA early phase PAGs in Table G-1 (or to any State-specific PAGs).

Step 7

Recommend appropriate protective actions or adjust protective action recommendations based on comparisons in Step 4 and Step 6. Discuss these recommendations with licensee. Consult with other Federal agencies (EPA, HHS, and USDA and DOE for gaseous diffusion plants) if time permits.

END

Sources: NUREG-1140, NUREG-1391, DOT P 5800.5, ORO-651.

[The following text is extremely faint and largely illegible. It appears to be a multi-paragraph document, possibly a letter or report, with a header and a footer. The content is mostly lost to the quality of the scan.]

Method E.1

Estimation of Inhaled Soluble Uranium Intake and Hydrogen Fluoride Concentration After a Liquid UF₆ Release

Purpose

To estimate the soluble uranium uptake and the HF concentration at a given downwind distance from a liquid UF₆ release using default release and meteorological parameters.

Discussion

The estimations in this method are based on the following assumptions: average meteorological conditions [D stability, 4 mph (1.8 m/s) wind speed, and no rain]. Release of 1 kg of liquid UF₆ combining with 0.1 kg of water results in the release of 0.88 kg of UO₂F₂ (containing 0.68 kg of uranium) and 0.23 kg of HF (NUREG-1140, p. 28). Fifty percent of the released uranium is assumed to become airborne, producing a release fraction of 0.34 of the total liquid UF₆ release (NUREG-1140, p. 32). Fifty percent of the HF formed is assumed to become airborne, producing a release fraction of 0.12 of the total liquid UF₆ release. A release time of 15 min (NUREG-1140, p. 35) and breathing rate of 3.3×10^{-4} m³/s, equivalent to adult light activity (EPA-520/1-88-020, p. 10) were used. A Gaussian plume model is assumed to approximate the distribution of the airborne fraction downwind.

Step 1

Estimate the amount of UF₆ released in metric tons (1 metric ton = 1000 kg). Obtain an estimate from the licensee or check the cylinder type in Table E-1.

Amount of UF₆ released or available for release _____ (metric ton)

Step 2

Estimate the amount of inhaled soluble uranium. Consult Fig. E-2 to estimate the intake of soluble uranium (IU_{sol}) in grams for the downwind distances of interest from a release of 1 metric ton of UF₆. Multiply the IU_{sol} value from the graph by the number of metric tons of UF₆ released.

$$\text{_____ } IU_{sol} \times \text{_____ tons UF}_6 \text{ released} = \text{_____ g}$$

Step 3

Estimate HF concentration, χ_{HF} . Use Fig. E-3 to estimate the concentration of HF (g/m^3) in the air downwind resulting from a release of 1 metric ton (1000 kg) of UF_6 . Multiply the value from the graph by the number of metric tons of UF_6 released.

$$\underline{\hspace{2cm}} \chi_{HF} \times \underline{\hspace{2cm}} \text{tons } \text{UF}_6 \text{ released} = \underline{\hspace{2cm}} \text{g}/\text{m}^3$$

END

Method E.2 Calculation of Inhaled Soluble Uranium Intake and Hydrogen Fluoride Concentration After a UF₆ Release

Purpose

To project the soluble uranium uptake and the HF concentration at a given downwind distance from a UF₆ release using incident-specific parameters and meteorology.

Discussion

When specific information is known about the accident conditions, the soluble uranium uptake and HF concentration at a distance downwind can be calculated. A Gaussian plume model is assumed to approximate the distribution of the airborne fraction downwind. This method allows the values of parameters in the formula to be varied.

If gaseous UF₆ is released, then the assumption that 100% of the UF₆ becomes airborne and is incorporated in the plume is appropriate for the purposes of performing a rough bounding calculation. Under this assumption, the release fractions would be 0.68 for uranium and 0.23 for HF.

Calculation of inhaled soluble uranium is covered in Steps 3 and 4. Steps 5 and 6 deal with calculation of the HF air concentration.

Step 1

Estimate the amount of UF₆ released in grams (1 metric ton = 10³ kg = 10⁶ g). Obtain an estimate from the licensee or check the cylinder type in Table E-1.

Amount of UF₆ released or available for release (Q_{UF_6}) _____ g

Step 2

Determine the meteorological parameters. Dispersion close to the source (≤ 0.25 mile) is dominated by building and source wake; the dilution factor is the same for all stability classes.

Stability class (see Table F-8 or F-9) _____
Wind speed (\bar{U}) _____ m/s
Distance downwind (d) _____ m
Dilution factor (see Table F-10) (DF_d) _____ m⁻²

Step 3

Estimate the release fraction for soluble uranium ($RF_{U_{sol}}$). The release fraction is the fraction (by weight) of the uranium that is incorporated in the plume relative to the weight of the total UF_6 inventory available for release. Use licensee estimates if available or assume a release fraction of 0.34 for liquid UF_6 (see discussion in Method E.1) or 0.68 for UF_6 gas for bounding calculation.

Release fraction for soluble uranium ($RF_{U_{sol}}$) _____

Step 4

Calculate the amount of soluble uranium inhaled (IU_{sol}), over the entire duration of plume passage, at a given downwind distance.

$$IU_{sol} = \frac{Q_{UF_6} \times RF_{U_{sol}} \times DF_d \times BR}{\bar{U}}$$

$$\left(\quad \right) \text{ g} = \frac{\left(\quad \right) \text{ g} \times \left(\quad \right) \times \left(\quad \right) \text{ m}^{-2} \times \left(\quad \right) \text{ m}^3/\text{s}}{\left(\quad \right) \text{ m/s}}$$

where

- IU_{sol} = total integrated inhaled intake of soluble uranium (g)
- Q_{UF_6} = UF_6 inventory in process or container available for release (g)
- $RF_{U_{sol}}$ = uranium release fraction (default value 0.34 for liquid UF_6 , 0.68 for gas)
- DF_d = dilution factor (m^{-2}) at distance, d , from release for appropriate stability class (Table F-10)
- BR = breathing rate (m^3/s) (default value $3.3 \times 10^{-4} \text{ m}^3/\text{s}$ from EPA-520/1-88-020, p. 10)
- \bar{U} = average wind speed (m/s) (default value 4 mph = 1.8 m/s)

Step 5

Estimate the release fraction for HF. The release fraction is the fraction (by weight) of the total UF₆ inventory available for release that is released as HF. Use the licensee estimates if available or assume a release fraction of 0.12 for liquid UF₆ (see discussion in Method E.1) or 0.23 for gas for bounding calculation.

Release fraction for hydrogen fluoride (RF_{HF}) _____

Step 6

Calculate the HF concentration at this downwind distance.

$$\chi_{HF} = \frac{Q_{UF_6} \times RF_{HF} \times DF_d}{t_r \times \bar{U}}$$

$$\left(\quad \text{g} \right) = \frac{\left(\quad \text{g} \right) \times \left(\quad \right) \times \left(\quad \text{m}^{-2} \right)}{\left(\quad \text{s} \right) \times \left(\quad \text{m/s} \right)}$$

where

- χ_{HF} = HF concentration (g/m³) at distance d from the release
- Q_{UF_6} = UF₆ inventory available for release (g)
- RF_{HF} = HF release fraction (default value 0.12 for liquid UF₆, 0.23 for gas)
- DF_d = dilution factor (m⁻²) at distance, d, from release for appropriate stability class (Table F-10)
- \bar{U} = average wind speed (m/s) (default value 1.8 m/s)
- t_r = UF₆ release duration (s) [default value 900 s (15 min) from NUREG-1140, p. 35]

END

1. The first part of the document discusses the importance of maintaining accurate records of all transactions.

2. It is essential to ensure that all entries are supported by appropriate documentation.

3. Regular audits should be conducted to verify the accuracy of the records.

4. The second part of the document outlines the procedures for handling discrepancies.

5. Any errors identified during the audit process should be promptly investigated.

6. The findings of the audit should be reported to the appropriate authorities.

7. The third part of the document provides guidelines for the management of funds.

8. Funds should be allocated based on the needs of the organization.

9. It is important to maintain a clear and concise budget.

10. The fourth part of the document discusses the role of the board of directors.

11. The board is responsible for overseeing the operations of the organization.

12. They should ensure that the organization is operating in the best interests of its members.

13. The fifth part of the document concludes with a summary of the key points.

14. It is hoped that these guidelines will help to improve the financial management of the organization.

15. The document is intended to serve as a reference for all members of the organization.

16. Thank you for your attention and cooperation.

17. Sincerely,
[Signature]

Method E.3

Estimation of Committed Effective Dose Equivalent Resulting From Inhaled Uranium After a Liquid UF₆ Release

Purpose

To estimate the radiological dose (committed effective dose equivalent) from inhaled uranium at a given distance downwind from a release of liquid UF₆ using default release and meteorological parameters.

Discussion

The calculations in this method assume the following: average meteorological conditions [D stability, 4 mph (1.8 m/s) wind speed, and no rain]. Release of 1 kg of UF₆ combining with 0.1 kg of water results in the release of 0.88 kg of UO₂F₂ (containing 0.68 kg of uranium) and 0.23 kg of HF (NUREG-1140, p. 28). Fifty percent of the released uranium is assumed to become airborne, producing a release fraction of 0.34 of the total UF₆ release. A release time of 15 min (NUREG-1140, p. 35) and breathing rate of 3.3×10^{-4} m³/s, equivalent to adult light activity (EPA 520/1-88-020, p. 10) were used. A Gaussian plume model is assumed to approximate the distribution of the airborne fraction downwind.

Step 1

Estimate the amount of UF₆ released in metric tons (1 metric ton = 1000 kg). Gain information from the licensee or check the process inventory or cylinder type in Table E-1.

Amount of UF₆ released or available for release _____ (metric ton)

Step 2

Estimate the committed effective dose equivalent (CEDE). Consult Fig. E-4 to estimate the CEDE in rem for the downwind distances of interest from a release of 1 metric ton of liquid UF₆. The four curves correspond to different enrichment levels (the percentage by weight of the ²³⁵U isotope). Multiply the value from the graph by the number of metric tons of UF₆ released.

_____ CEDE × _____ tons UF₆ released = _____ rem

_____ END _____

... ..
... ..
... ..

... ..
... ..
... ..

... ..
... ..
... ..

... ..
... ..
... ..

... ..
... ..
... ..

... ..
... ..
... ..

... ..
... ..
... ..

... ..
... ..
... ..

... ..
... ..
... ..

... ..
... ..
... ..

... ..
... ..
... ..

... ..
... ..
... ..

Method E.4

Calculation of Committed Effective Dose Equivalent Resulting From Inhaled Uranium After a UF_6 Release

Purpose

To project the committed effective dose equivalent (CEDE) from the inhalation of uranium at a given distance downwind after a UF_6 (gas or liquid) release using incident-specific parameters and meteorology.

Discussion

A Gaussian plume model is assumed to approximate the distribution of the airborne fraction downwind. This method allows the values of parameters in the formula to be varied.

If gaseous UF_6 is released, then the assumption that 100% of the UF_6 becomes airborne and is incorporated in the plume is appropriate for the purposes of performing a rough bounding calculation. Under this assumption, the release fractions would be 0.68 for uranium and 0.23 for HF.

Step 1

If you used Method E.2 to calculate soluble uranium intake, refer to the values calculated in that method and skip to Step 5 (next page).

Estimate the amount of UF_6 released in grams (1 metric ton = 10^3 kg = 10^6 g).

Amount of UF_6 released or available for release (Q_{UF_6}) _____ g

Step 2

Determine the meteorological parameters. Dispersion close to the source (≤ 0.25 mile) is dominated by building and source wake; the dilution factor is the same for all stability classes.

Stability class (see Table F-8 or F-9) _____
Wind speed (\bar{U}) _____ m/sec
Distance downwind (d) _____ m
Dilution factor (see Table F-10) (DF_d) _____ m^{-2}

Step 3

Estimate the release fraction for soluble uranium ($RF_{U_{sol}}$). The release fraction is the fraction (by weight) of the uranium that is incorporated in the plume relative to the weight of the total UF_6 inventory available for release. Use licensee estimates if available or assume a release fraction of 0.34 for soluble uranium from a liquid UF_6 release (see discussion in Method E.3) or 0.68 for release of UF_6 gas for bounding calculation.

Release fraction for soluble uranium ($RF_{U_{sol}}$) _____

Step 4

Calculate the amount of soluble uranium inhaled (IU_{sol}) at this downwind distance.

$$IU_{sol} = \frac{Q_{UF_6} \times RF_{U_{sol}} \times DF_d \times BR}{\bar{U}}$$

$$\left(\text{g} \right) = \frac{\left(\text{g} \right) \times \left(\right) \times \left(\text{m}^{-2} \right) \times \left(\text{m}^3/\text{s} \right)}{\left(\text{m/s} \right)}$$

where

- IU_{sol} = total integrated inhaled intake of soluble uranium
- Q_{UF_6} = UF_6 inventory available for release in process or cylinder (grams)
- $RF_{U_{sol}}$ = uranium release fraction (default value 0.34 for liquid UF_6 release, 0.68 for gas)
- DF_d = dilution factor (m^{-2}) at distance, d , from release for appropriate stability class (Table F-10)
- BR = breathing rate (default value $3.3 \times 10^{-4} \text{ m}^3/\text{s}$ from EPA-520/1-88-020, p. 10)
- \bar{U} = average wind speed (m/s) (default value 4 mph = 1.8 m/s)

Step 5

Determine the specific activity (SpA) of the uranium. Use licensee data or see Table E-4 for single isotopes or Table E-5 for different enrichment levels. ^{234}U is the major contributor to specific activity of enriched UF_6 . If a specific activity cannot be

obtained, using the specific activity for ^{234}U ($6.19 \times 10^3 \mu\text{Ci/g}$) will provide an overestimate of CEDE.

$$SpA_{U_{sol}} = \text{_____ } \mu\text{Ci/g}$$

Step 6

Determine the dose conversion factor. Dose conversion factors, $DCF_{E,50}$, for the CEDE resulting from inhalation of soluble uranium isotopes are found in Table E-6. Use the dose conversion factor given for ^{234}U to approximate that for all isotopic mixes.

$$DCF_{E,50} \text{ _____ rem}/\mu\text{Ci}$$

Step 7

Calculate the CEDE at this downwind distance.

$$H_{E,50} = I_{U_{sol}} \times SpA \times DCF_{E,50}$$

$$(\text{rem}) = (\text{g}) \times (\mu\text{Ci/g}) \times (\text{rem}/\mu\text{Ci})$$

where

- $H_{E,50}$ = committed effective dose equivalent (CEDE) (rem)
- $I_{U_{sol}}$ = total integrated inhaled intake of soluble uranium (g)
- SpA = specific activity of uranium (Table E-4 or Table E-5).
- $DCF_{E,50}$ = dose conversion factor for CEDE resulting from inhalation of soluble ^{234}U (Table E-6).

END

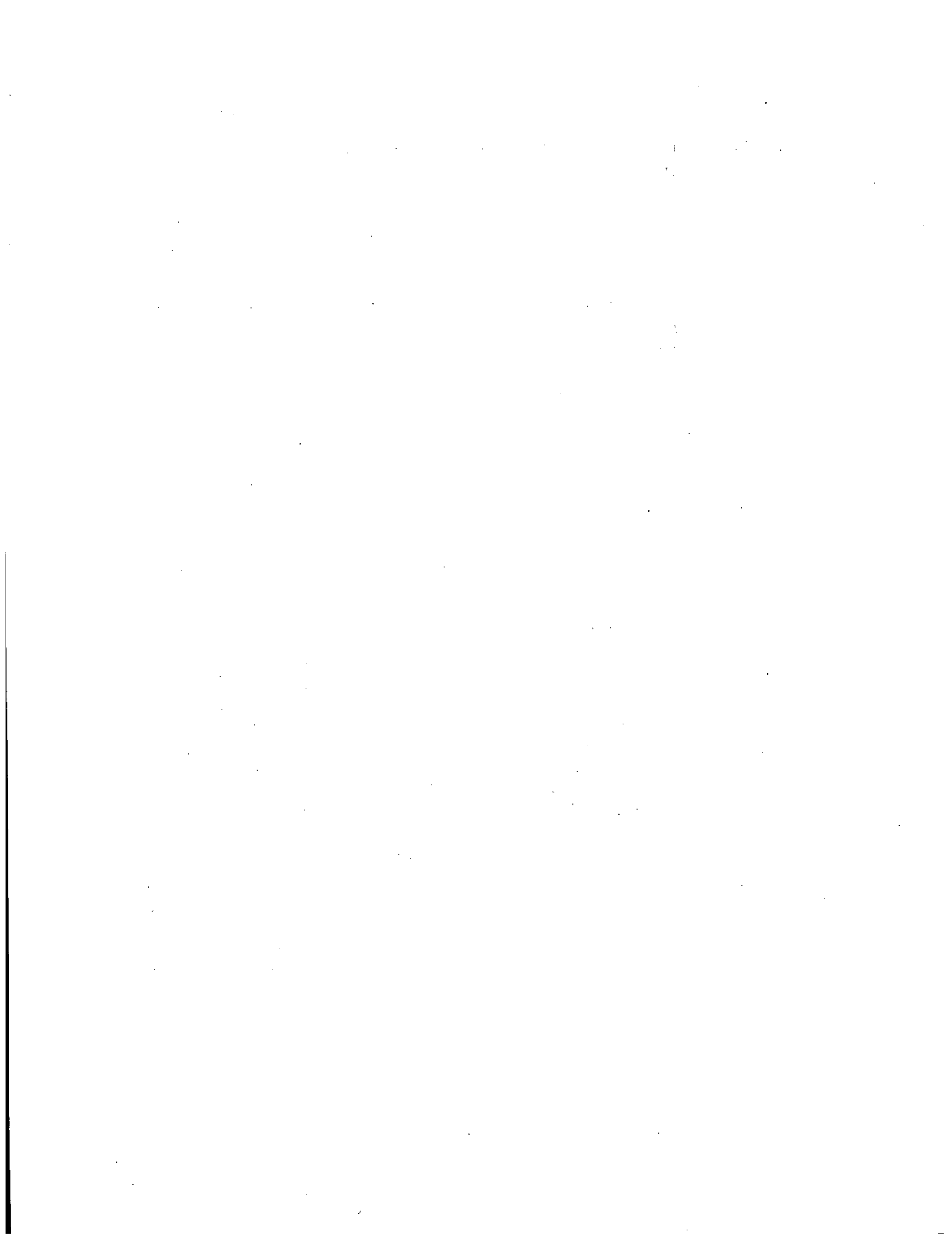

Table E-1. UF₆ cylinder data

Cylinder model	Nominal diameter (in.)	Minimum wall thickness (in.)	Approximate tare weight without valve protector		Maximum enrichment (percent by weight ²³⁵ U)	Shipping limit ^a (maximum UF ₆)	
			(lb)	(metric ton ^b)		(lb)	(metric ton ^b)
1S	1.5	1/16	1.75	7.9E-04	100.0	1.0	4.5E-04
2S	3.5	1/16	4.2	1.9E-03	100.0	4.9	2.2E-03
5A, 5B	5	7/64	55	2.5E-02	100.0	55	2.5E-02
8A	8	1/8	120	5.4E-02	12.5	255	1.2E-01
12A, 12B	12	3/16	185	8.4E-02	5.0	460	2.1E-01
30B ^c	30	5/16	1,400	6.4E-01	5.0 ^d	5,020	2.3E+00
48A, 48X ^e	48	1/2	4,500	2.0E+00	4.5 ^{d,f}	21,030	9.5E+00
48F	48	1/2	5,200	2.4E+00	4.5 ^d	27,030	1.2E+01
48G	48	1/4	2,600	1.2E+00	1.0 ^g	26,840 ^h	1.2E+01 ^h
48Y ^e	48	1/2	5,200	2.4E+00	4.5 ^d	27,560	1.3E+01
48H, 48HX	48	1/4	3,170	1.4E+00	1.0 ^g	27,030	1.2E+01
48OM	48	1/4	3,050	1.4E+00	1.0 ^g	27,030	1.2E+01

^aShipping limits are based on 250°F (121°C) maximum UF₆ temperature (203.3 lb UF₆/ft³), certified minimum internal volumes for all cylinders, which provides a 5% ullage for safety. The operating limits apply to UF₆ with a minimum purity of 99.5%. More restrictive measures are required if additional impurities are present. The maximum UF₆ temperature must not be exceeded.

^b1 metric ton = 1000 kg = 1.0E+06 g = 2205 lb.

^cThis cylinder replaces the Model 30A cylinder.

^dMaximum enrichments indicated require moderation control equivalent to a UF₆ purity of 99.5%. Without moderation control, the maximum permissible enrichment is 1.0% by weight ²³⁵U.

^eModels 48X and 48Y replace Models 48A and 48F whose volumes have not been certified.

^fIn Model 48X, enrichment to 5.0% UF₆ by weight is safe with moderation control equivalent to UF₆ purity of 99.5%, but limited to 4.5% by weight ²³⁵U for shipment.

^gEnrichment to 4.5% by weight is safe with moderation control equivalent to a UF₆ purity of 99.5%, but limited to 1.0% by weight ²³⁵U for shipment.

^hFor depleted uranium with UF₆ purity in excess of 99.5%, the shipping limit is 28,000 lb for cylinders with 8,800-lb water capacity or greater.

Source: Adapted from ORO-651, pp. 6, 25.

Table E-2. Health effects of uranium intake

Soluble uranium intake, IU_{sol} (g)	Health effect
<0.005	None
0.008	Threshold for transient renal damage
0.050	Threshold for permanent renal damage
0.230	50% will die

Source: Adapted from NUREG-1391, p. 3.

Table E-3. Health effects of hydrogen fluoride exposure

Airborne hydrogen fluoride concentration, χ_{HF} (g/m ³) ^a	Exposure time (min)	Health effect
0.0025	—	Detectable odor, but no health effect
0.004	60	Emergency Response Planning Guideline-1 ^b
0.013	15	Irritation
0.016	60	Emergency Response Planning Guideline-2 ^c
0.024	30	Immediately Dangerous to Life and Health ^d
0.408	60	Emergency Response Planning Guideline-3 ^e
0.100	1	Unbearable for 1 min
3.500	15	Lethal

^ag/m³ = (ppm/1000) × (molecular weight/24.5).

^bEmergency Response Planning Guideline (ERPG)-1 (5 ppm) is the maximum airborne concentration below which it is believed that nearly all individuals could be exposed for up to 1 h without experiencing other than mild, transient adverse health effects or without perceiving a clearly defined objectionable odor.

^cERPG-2 (20 ppm) is the maximum airborne concentration below which it is believed that nearly all individuals could be exposed for up to 1 h without experiencing or developing irreversible or other serious health effects or symptoms which could impair an individual's ability to take protective actions.

^dThe Immediately Dangerous to Life and Health (IDLH) (30 ppm) was developed for respirator use. It is the maximum concentration from which, in the event of respirator failure, one could escape within 30 min without a respirator and without experiencing any escape-impairing (e.g., severe eye irritation) or irreversible health effects.

^eERPG-3 (50 ppm) is the maximum airborne concentration below which it is believed that nearly all individuals could be exposed for up to 1 h without experiencing or developing life-threatening health effects.

Sources: Adapted from NUREG-1140, p. 39. IDLH value from NIOSH, p. 126. ERPG values from AIHA.

Table E-4. Radioactive half-life and specific activity for selected uranium isotopes

Isotope	Radioactive half-life (years)	Specific activity ($\mu\text{Ci/g}$)
^{234}U	2.48E+5	6.19E+3
^{235}U	7.13E+8	2.14E+0
^{236}U	2.39E+7	6.34E+1
^{238}U	4.51E+9	3.33E-1

Table E-5. Isotopic abundance and specific activity for different enrichment levels

Enrichment (% ^{235}U by weight)	Specific activity ^a ($\mu\text{Ci/g}$)	Percentage abundance			
		^{234}U	^{235}U	^{236}U	^{238}U
Depleted	0.4	0.0005	0.25		99.75
Natural	0.67	0.0006	0.72		99.27
4.0	2.4	0.032	4.0	0.025	95.94
20.0	9.4		20.0		
93.0	~110	>2.0	>93.0	<0.05	<5.0

^aThe specific activity of enriched uranium may depend somewhat on the history of the material and the method of enrichment. As material is enriched in ^{235}U by gaseous diffusion, the ^{234}U concentration increases faster than the ^{235}U concentration. ^{234}U is major contributor to the specific activity.

Sources: Sources of specific activities are EGG-2530, p. 2-8, for depleted; ORO-651, p. 31, for natural; and calculations from relative abundance and Table E-4 for 4%. Specific alpha activity for 20% enrichment was calculated using $\text{SpA} = 0.4 + 0.38\epsilon + 0.0034\epsilon^2$ ($\mu\text{Ci/g}$), where ϵ is percentage ^{235}U by weight (equation from ORO-651, p. 31). Values given for 93% enrichment are noted in RTM-93 as measured. Relative isotopic abundance for depleted and natural uranium from EGG-2530, p. 2-2.

Table E-6. Adult dose conversion factors for committed effective dose equivalent from inhalation of soluble uranium isotopes

Isotope	Dose conversion factor for committed effective dose equivalent ($DCF_{E,50}$) ^{a,b}	
	(rem/ μ Ci)	(Sv/Bq)
²³⁴ U	2.7	7.4E-7
²³⁵ U	2.3	6.8E-7
²³⁶ U	2.6	7.0E-7
²³⁷ U	2.4	6.6E-7

^aCommitted effective dose equivalent (CEDE or $H_{E,50}$) is the sum of the effective dose equivalent over a 50-year period following intake.

^bLung clearance class (solubility class) is D.

Source: EPA-520/1-88-020, pp. 150-151.

Fig. E-1
Distance downwind at which early health effects from HF exposure
might occur or EPA PAGs could be exceeded.

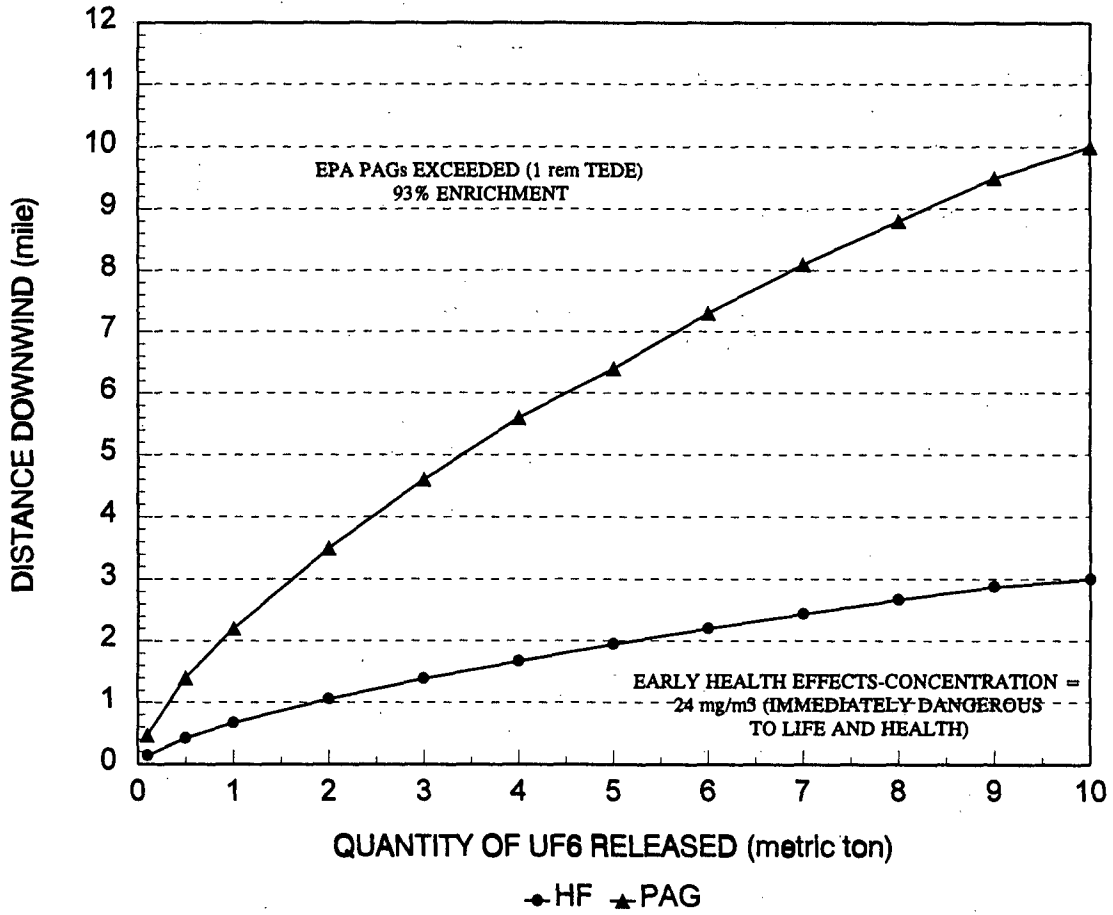
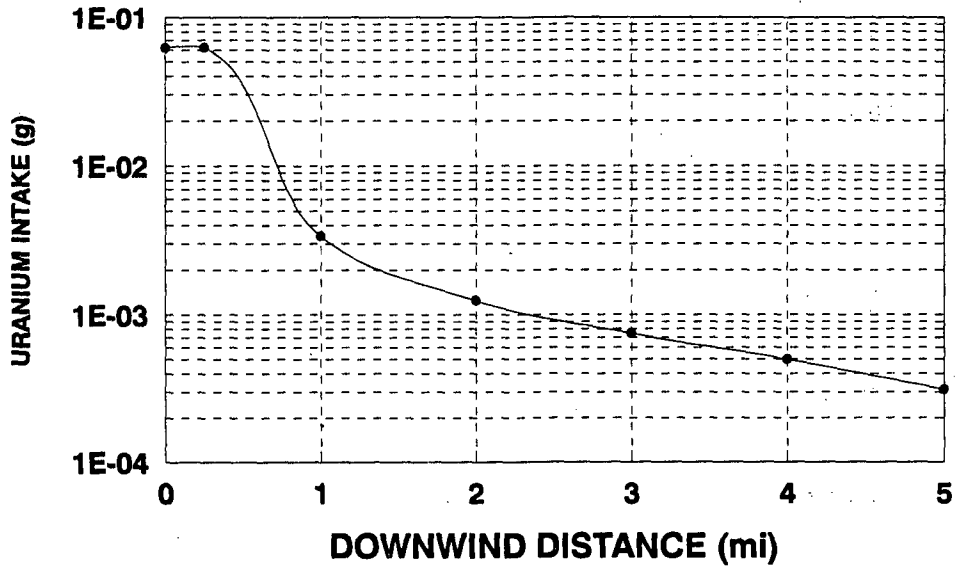
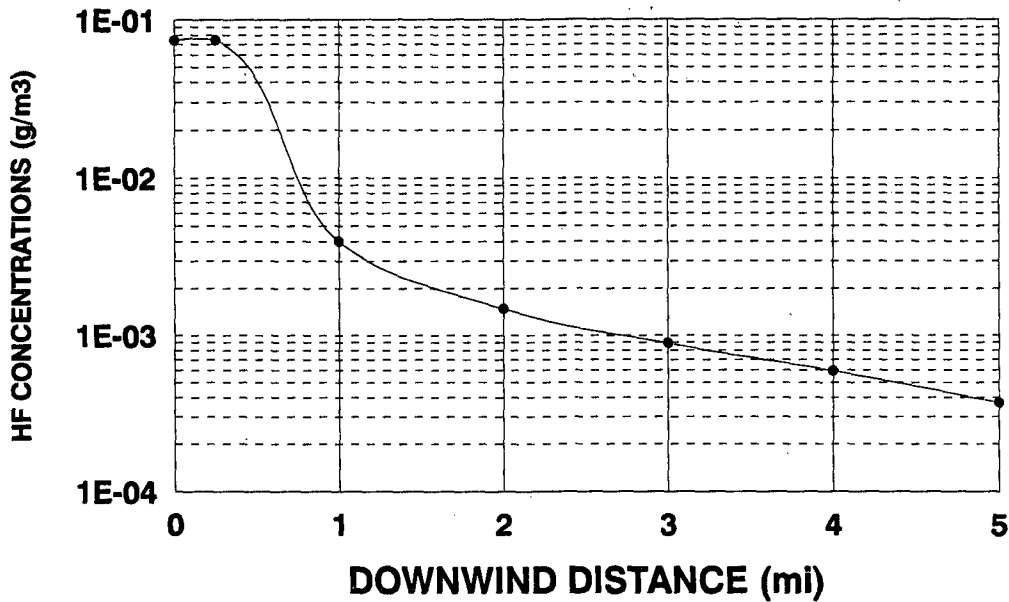

Fig. E-2
Adult uranium intake resulting from release
of 1 metric ton of liquid UF₆.^a



^aAssumptions and default values are discussed in Method E.1.

Fig. E-3
Air concentrations of hydrogen fluoride from release
of 1 metric ton of liquid UF₆.^a



^aAssumptions and default values are discussed in Method E.1.

Fig. E-4
Committed effective dose equivalent for adult downwind
from release of 1 metric ton liquid UF₆.^a

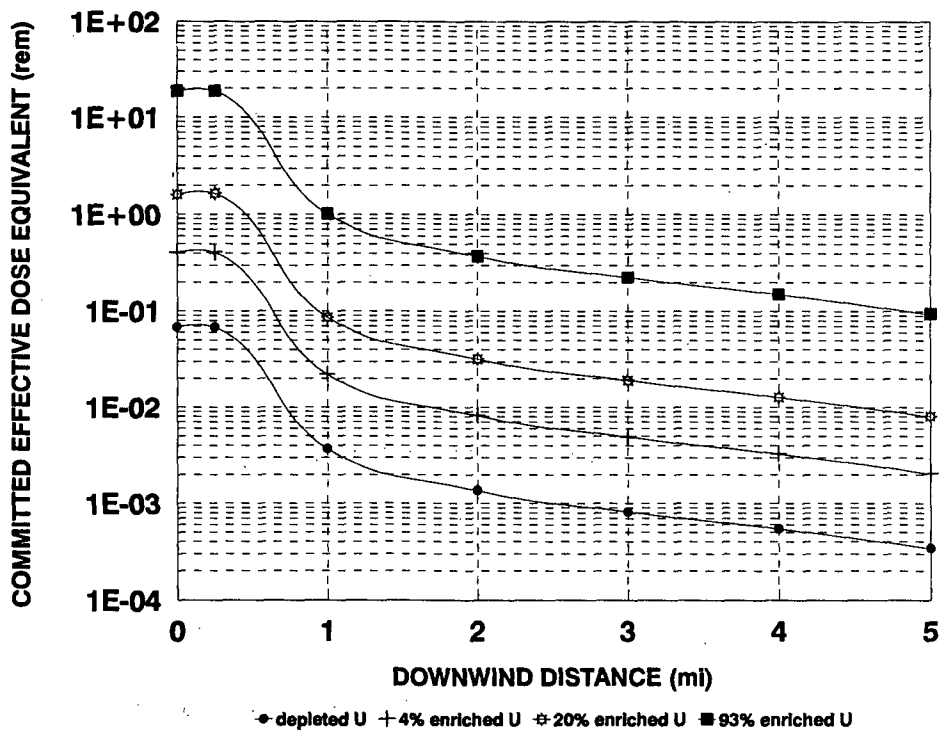

^aAssumptions and default values are discussed in Method E.3.

F

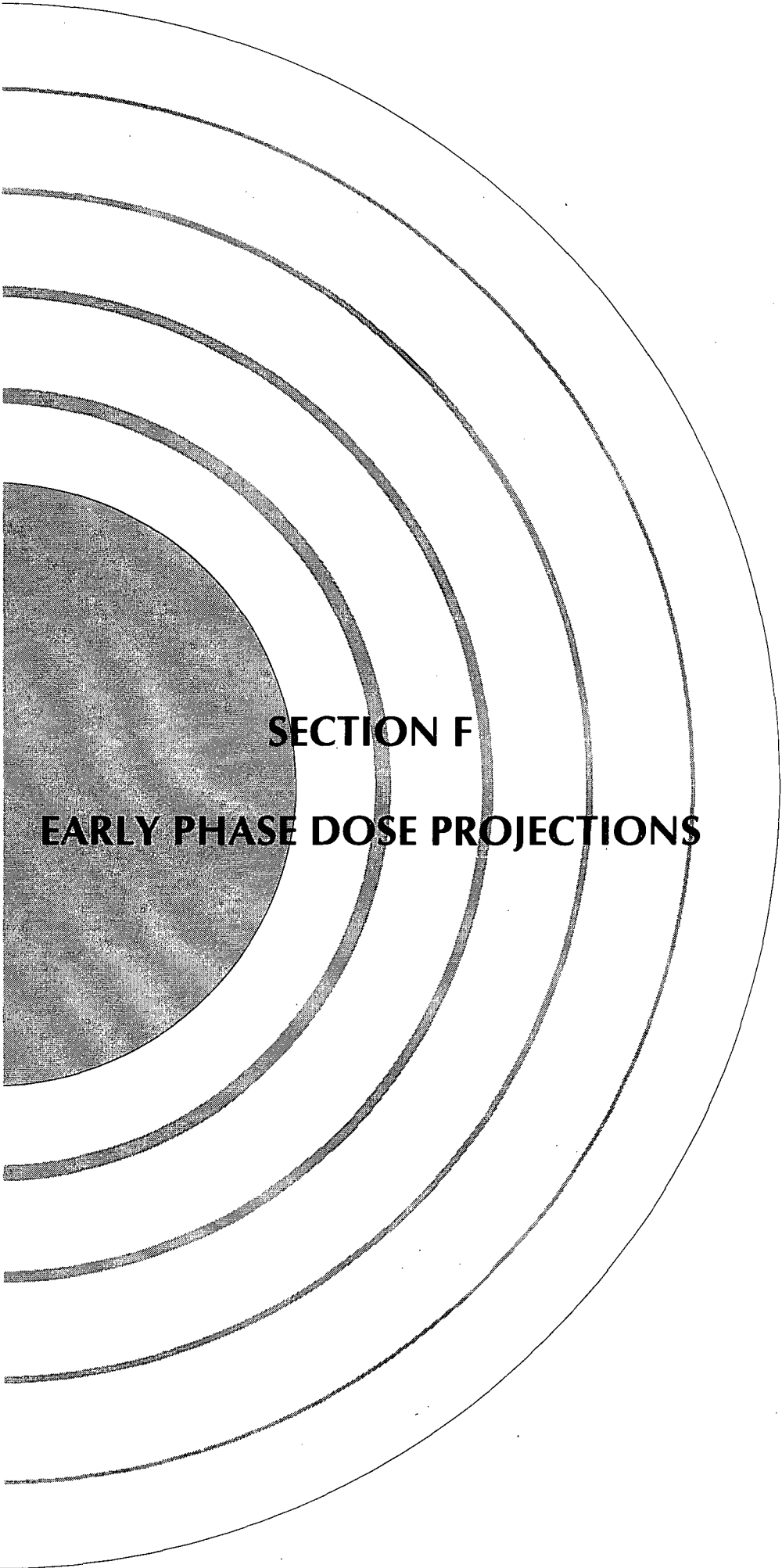

SECTION F

EARLY PHASE DOSE PROJECTIONS

THE UNIVERSITY OF CHICAGO
DIVISION OF THE PHYSICAL SCIENCES
DEPARTMENT OF CHEMISTRY

REPORT OF THE RESEARCH GROUP ON THE CHEMISTRY OF
THE SOLID STATE

BY
ROBERT H. EMMETT
AND
JAMES H. DEWITT

RESEARCH REPORT NO. 10
MAY 1954

THE UNIVERSITY OF CHICAGO
DIVISION OF THE PHYSICAL SCIENCES
DEPARTMENT OF CHEMISTRY
5708 S. UNIVERSITY AVENUE
CHICAGO, ILLINOIS

Section F
Quick Reference Guide

	<i>Page</i>
Early phase dose projections	F-3
Calculation of activity based on weight	F-5
Estimation of the activity released by a fire	F-7
Downwind dose projection based on estimated activity released	F-9
Estimation of dose and exposure rate from point source	F-15
Adjusting 1-mile dose to consider distance, elevation, and rain	F-19
Quick long-range estimation	F-21
Section F tables	F-25
Section F figures	F-76
Section F worksheets	F-79

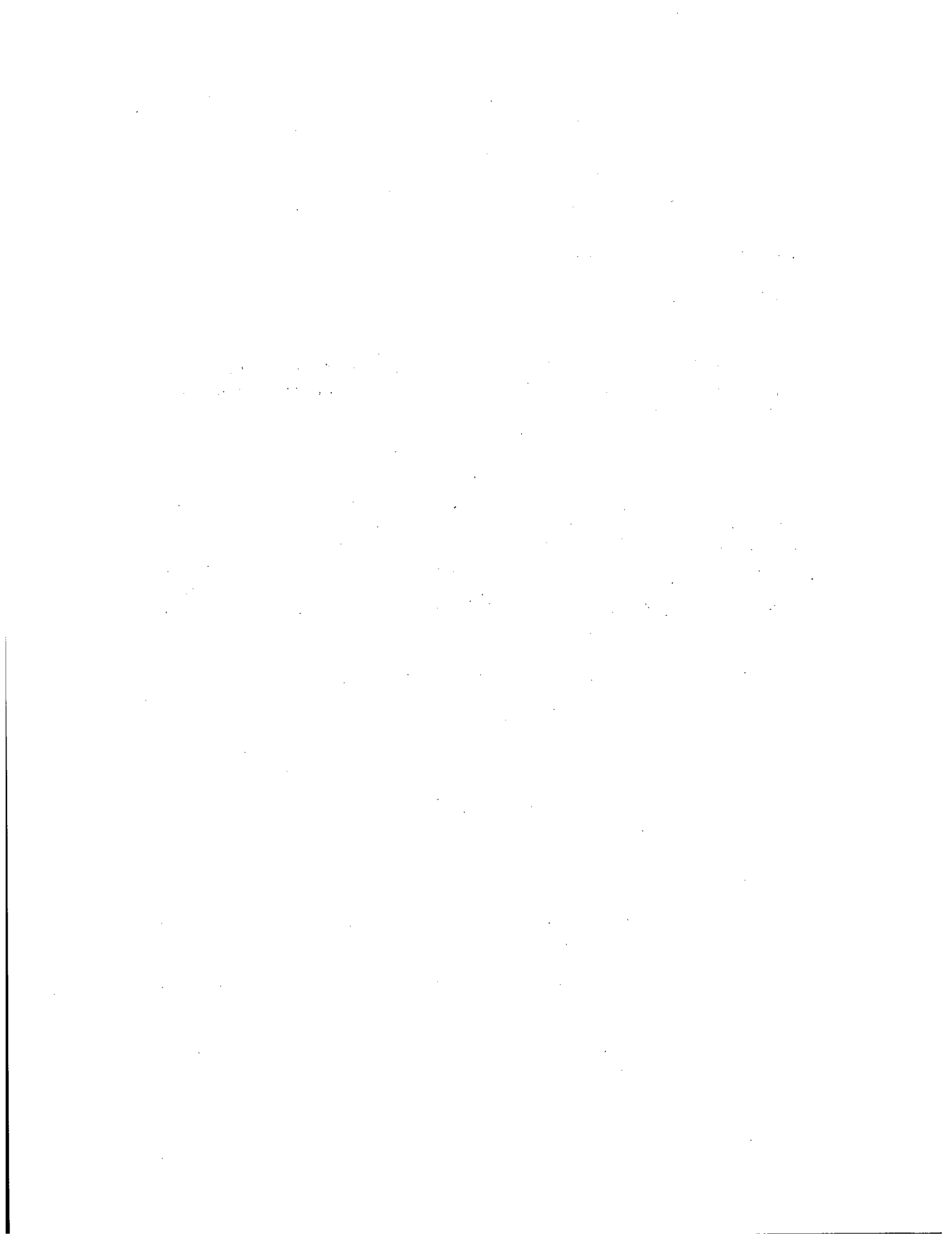

Section F

Early Phase Dose Projections

Purpose

To provide methods to project the dose and assess the need to take urgent protective action during the early phase. Methods are provided to project doses and evaluate their potential for early health effects using (1) activity based on weight (mass), (2) releases from an accident (i.e., fire), (3) dose from point sources, and (4) doses for isotopic releases. Use Section E for assessment of a UF_6 release and Section C for assessment of LWR accidents.

Discussion

The early phase of an accident extends from the identification of a release threat until the release (or threat of the release) has ended and any areas of major contamination have been identified. The early phase normally includes up to 4 days (100 h) of exposure to deposition. To project the potential consequences from a radiological accident the following steps must be performed: (1) estimate the amount of activity released, (2) estimate the downwind dose from this material, and (3) determine the impact of this dose in terms of health effects and PAGs.

This section provides methods for performing these steps for accidents involving release of a simple isotopic mixture or exposure to a radioactive source. For complex mixtures (e.g., reactor accidents), other methods such as those in Section C or the RASCAL model (Section L) should be used. Remember that there are great uncertainties associated with these methods or any dose projection code.

This manual does not provide methods to assess environmental measurements; these methods can be found in the *FRMAC Assessment Manual*.

Step 1

Estimate the activity in a point source or the activity released or that may be released. The following methods may be useful:

- If one knows the mass of the radioactive material involved but not the activity, use Method F.1.
- To estimate the potential releases from isotopes involved in a fire (typically the worst case), use Method F.2.

Step 2

Estimate the dose from the source or release using one of the following:

- To project the dose 0.25 mile and 1 mile downwind based on the estimated activity released, use Method F.3.
- To estimate dose and exposure rates from a point source, use Method F.4.

Step 3

If needed, the dose at 1 mile can be adjusted for longer distances or to consider elevation or rain using Method F.5. Method F.6 can provide a quick estimate of the maximum air concentrations or ground deposition at much greater distances from the release.

Step 4

Assess the potential for early health effects and for projected doses exceeding early phase PAGs using Section G.

END

Method F.1 Calculation of Activity Based On Weight

Purpose

To determine the activity in microcuries of the radioactive material from the weight.

Discussion

The quantity of material involved in an accident may be specified by weight (mass). The activity (rate of radioactive disintegration) is needed for dose calculation. The total activity of an isotope is the product of the mass and the specific activity for that isotope. (Method F.3 can be used to estimate dose.)

Step 1

Calculate the activity using the following equation:

$$A_i = Wt \times SpA$$

$$(\quad \mu\text{Ci}) = (\quad \text{g}) \times (\quad \mu\text{Ci/g})$$

where

- A_i = Activity (μCi) of isotope i available
- Wt = Weight (g)
- SpA = Specific activity ($\mu\text{Ci/g}$) from Table F-1 or the formulas below

The specific activity is defined as activity per unit mass (e.g., Ci/g , $\mu\text{Ci/g}$) of material and can be calculated by one of the following equations depending on the units in which the radiological half-life ($T_{1/2}$) is given.

$$SpA\left(\frac{\mu\text{Ci}}{\text{g}}\right) = \frac{3.134 \times 10^{15}}{T_{1/2}(\text{h}) \times AMN}$$

or

$$SpA\left(\frac{\mu\text{Ci}}{\text{g}}\right) = \frac{1.306 \times 10^{14}}{T_{1/2}(\text{days}) \times AMN}$$

or

$$SpA\left(\frac{\mu\text{Ci}}{\text{g}}\right) = \frac{3.578 \times 10^{11}}{T_{1/2}(\text{years}) \times AMN}$$

where

AMN = Atomic mass number (the number of protons plus the number of neutrons in the isotope); for example, for ^{131}I , the AMN is 131.

$T_{1/2}$ = radioactive half-life in hours, days or years, respectively

END

Source: PB-230 846, p. 103.

Method F.2 Estimation of the Activity Released by a Fire

Purpose

To estimate the quantity of radioactive material released from a fire and the rate of release when the total activity is known.

Discussion

Filtering, plateout, or other mechanisms that can reduce the release of non-nobles are not considered in this calculation. Therefore, this method should provide a reasonable upper bound for most accidents involving radioactive material. This method is *not* valid for reactor accidents. (To calculate the activity of the material from the weight, use Method F.1. Method F.3 can be used to estimate the dose.)

Step 1

Estimate the total activity or release rate using the following equations:

Total activity (μCi) released

$$Q_T = A_i \times FRF_i$$

$$(\quad \mu\text{Ci}) = (\quad \mu\text{Ci}) \times (\quad)$$

Release rate ($\mu\text{Ci/s}$)

$$Q_i = \frac{A_i \times FRF_i}{T_{rd}}$$

$$(\quad \mu\text{Ci/s}) = \frac{(\quad \mu\text{Ci}) \times (\quad)}{(\quad \text{s})}$$

where

- A_i = Activity (μCi) of isotope i available (in fire)
- FRF_i = Fire release fraction for isotope i , from Table F-2 if the compound form is known or Table F-3 if the compound form is unknown
- T_{rd} = Release duration (s)
- Q_i = Release rate ($\mu\text{Ci/s}$) for isotope i
- Q_{Ti} = Total activity (μCi) of isotope i released

END

Method F.3 Downwind Dose Projection Based on Estimated Activity Released

Purpose

To estimate doses from a release where the isotopic composition is known.

Discussion

Two alternative approaches to calculate the downwind components of the acute dose equivalent and total effective dose equivalent (TEDE) are provided: quick estimate or full calculation. The quick method is used to predict doses for ground-level releases under average or unknown meteorological conditions. The full calculation method is used when the meteorological conditions are fully understood or for isotopes not in the tables.

Once the dose components are calculated, they are summed to obtain the desired projected doses. These projected doses can then be compared to the thresholds for early health effects and to the early phase PAGs (Section G). For UF_6 accidents, chemical toxicity will dominate the risk; those accidents should be assessed using Section E.

Step 1

Quick estimate method

This method uses precalculated doses at 0.25 and 1 mile from a 1 μCi release. A ground-level release and average meteorological conditions (D stability, 4 mph wind speed, and no rain) were assumed in calculating these doses. The doses represent the maximum expected because the exposed individual is assumed to be at the centerline of the plume without protection for the entire release. Initial calculations can be adjusted to consider an elevated release and rain. The projections should be within a factor of 10 for a reasonable range of stability classes and wind speeds.

Calculate the following doses for isotopes in the release: organ dose from inhalation (D_T) (acute bone, acute lung, and thyroid); committed effective dose equivalent from inhalation (CEDE, $H_{e,50}$); effective dose equivalent from external radiation from immersion in plume (H_a); and early phase (4-day) dose equivalent from exposure to ground deposition (D_{EPg}) using Worksheet F-1 and the following equations:

$$Dose_{ij} = Q_{Ti} \times RCF_{ij}$$

$$\left(\text{mrem} \right) = \left(\mu\text{Ci} \right) \times \left(\frac{\text{mrem}}{\mu\text{Ci}} \right)$$

where

- $Dose_{ij}$ = Total dose equivalent (mrem) type j at specified distance from release of isotope i
 Q_{Ti} = Total activity (μCi) of isotope i released
 RCF_{ij} = Release conversion factor (mrem/ μCi) from Table F-4 (0.25 mile) or Table F-5 (1 mile) for 1 μCi of isotope i and dose type j

Go to **Step 2** to sum the dose components.

Full Calculation Method

Calculate the following doses for isotopes in the release: dose equivalent to organ from inhalation (D_T) (acute bone, acute lung, and thyroid); committed effective dose equivalent from inhalation (CEDE, $H_{e,50}$); effective dose equivalent from external radiation from immersion in plume (H_a); and early phase (4-day) dose equivalent from exposure to ground deposition (D_{EPg}) using Worksheet F-2 and the following equations:

Air immersion: H_{ai}

$$H_{ai} = \frac{Q_i \times DF \times DCF_{ai} \times T_{ed}}{\bar{U}}$$

$$\left(\text{mrem} \right) = \frac{\left(\mu\text{Ci/s} \right) \times \left(\text{m}^{-2} \right) \times \left(\frac{\text{mrem/h}}{\mu\text{Ci/m}^3} \right) \times \left(\text{h} \right)}{\left(\text{m/s} \right)}$$

Inhalation: CEDE ($H_{e,50i}$), organ dose (D_{Ti})—acute bone, acute lung, and thyroid

$$H_{e,50i} = \frac{Q_i \times DF \times DCF_{e,50i} \times T_{ed}}{\bar{U}}$$

$$D_{Ti} = \frac{Q_i \times DF \times DCF_{Ti} \times T_{ed}}{\bar{U}}$$

$$\left(\text{mrem} \right) = \frac{\left(\mu\text{Ci/s} \right) \times \left(\text{m}^{-2} \right) \times \left(\frac{\text{mrem/h}}{\mu\text{Ci/m}^3} \right) \times \left(\text{h} \right)}{\left(\text{m/s} \right)}$$

Early phase ground: D_{EPgi} , from groundshine and resuspension for 4 days exposure

$$D_{EPgi} = Q_{Ti} \times GCF \times DCF_{EPgi}$$

$$\left(\text{mrem} \right) = \left(\mu\text{Ci} \right) \times \left(\text{m}^{-2} \right) \times \left(\frac{\text{mrem}}{\mu\text{Ci/m}^2} \right)$$

where

- DCF_{ai} = Effective air immersion dose conversion factor [(mrem/h)/($\mu\text{Ci/m}^3$)] from Table F-6
- $DCF_{e,50i}$ = CEDE dose conversion factor [(mrem/h)/($\mu\text{Ci/m}^3$)] for isotope i from Table F-7
- DCF_{EPgi} = Dose conversion factor [(mrem)/($\mu\text{Ci/m}^2$)] for ground surface deposition during the early phase (4 days) including resuspension from Table F-6
- DCF_{Ti} = Dose conversion factor [(mrem/h)/($\mu\text{Ci/m}^3$)] for inhalation dose for various organs (acute bone, acute lung, and thyroid) and commitment periods, from Table F-7
- DF = Dilution factor (m^{-2}) from Table F-10 for projected distance from source (Table F-8 or F-9 can be used to determine the stability class)
- GCF = Ground concentration factor from Table F-11
- H_{ai} = Effective external dose (mrem) from isotope i from air immersion
- Q_i = Release rate (source term) ($\mu\text{Ci/s}$) of isotope i
- Q_{Ti} = Total activity (μCi) of isotope i released
- T_{ed} = Exposure duration (assume release duration)(h)
- \bar{U} = Average wind speed (m/s)

Step 2

Calculate the total acute bone dose (TABD), total acute lung dose (TALD), and total effective dose equivalent (TEDE) by summing the contributing doses calculated with either of the methods in Step 1 and using Worksheet F-3 and the equations below. The acute thyroid dose is the committed dose equivalent to the thyroid from inhalation.

Total Acute Bone Dose (TABD)

$$TABD = \sum_i^n [H_{ai} + D_{EPgi} + D_{Ti}(\text{bone})]$$

Total Acute Lung Dose (TALD)

$$TALD = \sum_i^n [H_{ai} + D_{EPgi} + D_{Ti}(\text{lung})]$$

Total Effective Dose Equivalent (TEDE)

$$TEDE = \sum_i^n (H_{ai} + D_{EPgi} + H_{e,50i})$$

$$(\quad \text{mrem}) = \sum_i^n [(\quad \text{mrem}) + (\quad \text{mrem}) + (\quad \text{mrem})]$$

Acute Thyroid Dose [$D_{Ti}(\text{thyroid})$]

$$D_{Ti}(\text{thyroid}) = \underline{\hspace{2cm}} \text{ mrem (from Step 1)}$$

where

- D_{EPgi} = Early phase dose equivalent from 4 days exposure to groundshine and resuspension of isotope i (calculated in Step 1)
- $D_{Ti}(\text{organ})$ = Committed effective dose equivalent to organ (bone, lung, and thyroid) from inhalation of isotope i in plume (calculated in Step 1)
- H_{ai} = Effective external dose equivalent (mrem) from isotope i due to air immersion (calculated in Step 1)

Step 3

Use Method F.5 to estimate the downwind dose or to consider rain or an elevated release.

Step 4

Determine consequences.

- Is the *projected* TABD or TALD greater than or equal to the thresholds in Table G-2? If yes, inform management immediately that early health effects are possible.
- Is either the *projected* committed dose equivalent to thyroid greater than or equal to early phase thyroid PAG or *projected* TEDE greater than or equal to the TEDE early phase PAG? If yes, inform management immediately that early phase PAGs may be exceeded. (See Table G-1 for EPA early phase PAGs. Some States may use State-specific PAGs; in these cases, use the State-specified values for comparison.)

END

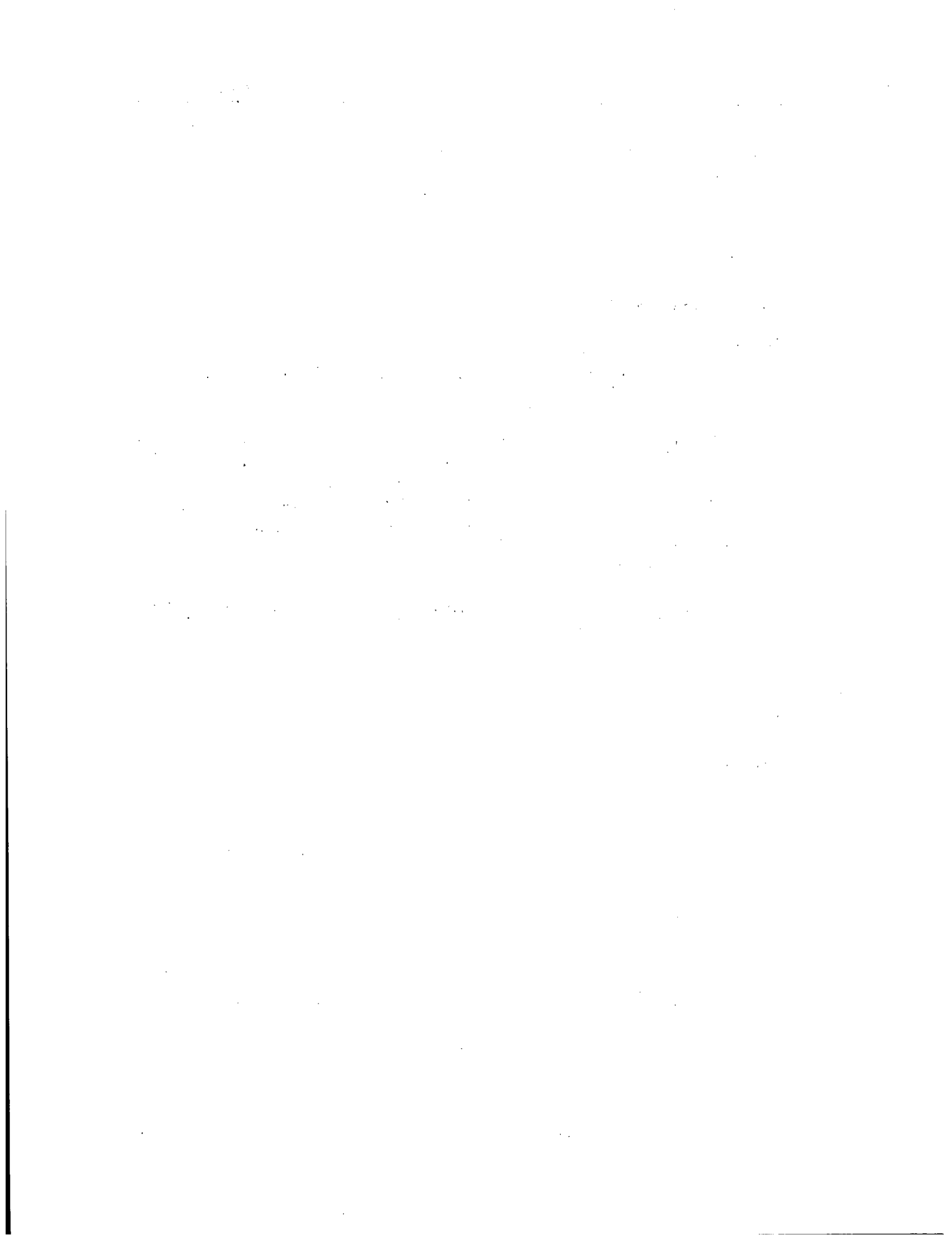

Method F.4

Estimation of Dose and Exposure Rate from Point Source

Purpose

To estimate the exposure and dose from a point source.

Discussion

This method uses dose and exposure rates that have been precalculated at 1 m, assuming no shielding, to estimate the dose at various distances. It can be used to project doses to the public or emergency workers or to estimate instrument readings (e.g., when searching for a source). Shielding can be considered, but the calculation does not include build-up. Therefore if shielding is included, the result should be considered the *lower bound*.

Two equations are given. The first is used to estimate the dose for comparison to health effects thresholds and EPA PAGs. For contact dose (e.g., source in a pocket), assume a distance (*Dis*) from the source of 10^{-2} m (1 cm) (NUREG/BR-0024, p. 157). The second equation, for exposure intensity, can be used to estimate the instrument reading in a gamma field.

Step 1

Calculate the effective dose or exposure intensity using the following equations:

Effective Dose

$$H_p = \frac{A_i \times DCF_p \times T_{ed} \times (0.5)^{\frac{ST}{HVL}}}{\left(\frac{Dis}{DCF \text{ Distance}}\right)^2}$$

$$\left(\text{mrem} \right) = \frac{\left(\mu\text{Ci} \right) \times \left(\frac{\text{mrem/h}}{\mu\text{Ci}} \right) \times \left(\text{h} \right) \times \left(0.5^{\left(\frac{\text{cm}}{\text{cm}} \right)} \right)}{\left(\frac{\left(\text{m} \right)}{1 \text{ m}} \right)^2}$$

where

- A_i = Activity (μCi) of isotope i
- DCF_p = Point source dose conversion factor ($\text{mrem}/\mu\text{Ci}$) from Table F-12
- Dis = Distance (m) from source
- HVL = Half-value layer (cm) from Table F-13
- H_p = Effective dose equivalent (mrem) from point source
- T_{ed} = Exposure duration (h)
- ST = Shielding thickness (cm)

Exposure Intensity

$$I = \frac{A_i \times ECF_p \times \left(0.5^{\frac{ST}{HVL}}\right)}{\left(\frac{Dis}{ECF \text{ distance}}\right)^2}$$

$$\left(\text{mR/h} \right) = \frac{\left(\mu\text{Ci} \right) \times \left(\frac{\text{mrem/h}}{\mu\text{Ci}} \right) \times \left(0.5^{\left(\frac{\text{cm}}{\text{cm}} \right)} \right)}{\left(\frac{\text{m}}{1 \text{ m}} \right)^2}$$

where

- A_i = Activity (μCi) of isotope i
- Dis = Distance (m) from source
- ECF_p = Point source exposure conversion factor ($\text{mR}/\mu\text{Ci}$) from Table F-12
- HVL = Half-value layer (cm) from Table F-13
- I = Exposure intensity ($\text{mR}/\mu\text{Ci}$)
- ST = Shielding thickness (cm)

Step 2

Determine consequences.

- Is the *projected* effective dose equivalent greater than or equal to the early effects thresholds in Table G-2? If yes, inform management immediately that early health effects are possible.
- Is the *projected* effective dose equivalent greater than or equal to State early phase PAGs? If yes, inform management immediately that early phase PAGs may be exceeded. (See Table G-1 for EPA early phase PAGs. Some States may use State-specific PAGs; in these cases, use the State-specified values for comparison.)

END

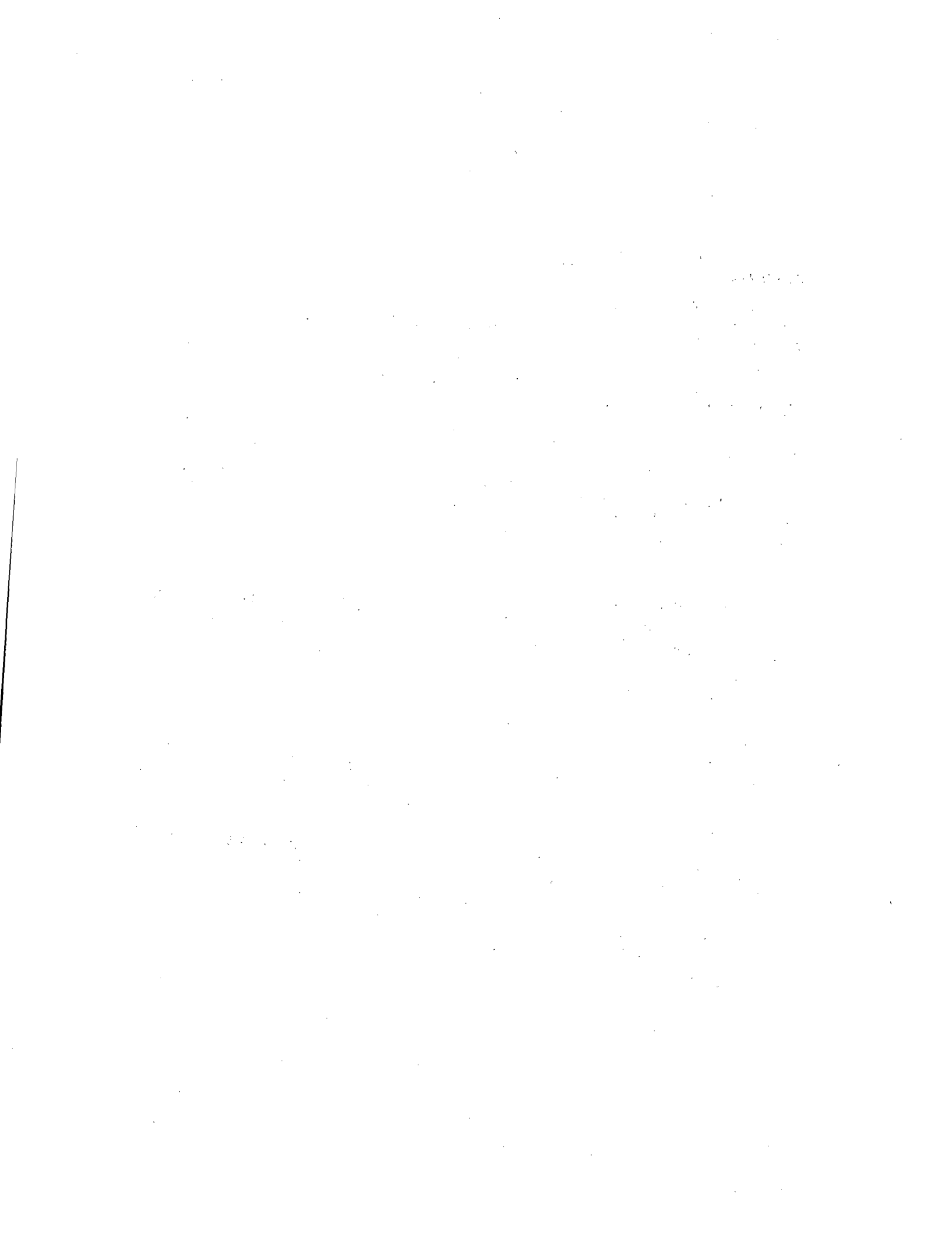

Method F.5

Adjusting 1-Mile Dose to Consider Distance, Elevation, and Rain

Purpose

To adjust the estimated total acute bone and thyroid dose for longer distances downwind and can also be used to determine the effect of rain and release elevation on the doses.

Discussion

This method requires an estimate of the dose at 1 mile from a ground-level release under average meteorological conditions (D stability, 4 mph wind speed, and no rain). Doses should be for the distances the plume has traveled, not the distance from the release source. The estimates assume a constant wind direction and should represent the maximum dose within a factor of 10 for a range of stability classes and wind speeds.

Estimates of the acute bone dose or thyroid dose at 1 mile from a ground-level release and no rain can be obtained using one of these suggested methods. The acute bone and inhalation doses (acute lung or thyroid dose) at 1 mile can be found for reactor accidents using the event trees in Section C, for spent fuel pool accidents using Section D, or for isotopic releases using Method F.3.

Acute bone doses used as input should represent dose equivalent from cloudshine and acute dose equivalent from inhalation and approximately 24 h of the resulting groundshine to an adult performing normal activities with no sheltering or protection (these are the assumptions used in Sections C and D and Method F.3). The thyroid dose should be from inhalation of the plume alone.

Assume a ground-level release unless the release is from an isolated stack more than 2.5 times higher than nearby structures or if observation indicates that it has an effective release height of 200 m or more. The elevated release height is assumed in this case to be 200 m. NOAA recommends that the maximum effective release height of a plume be assumed to be one-half of the mixing level. The assumed 200 m is one-half of the typical nighttime mixing level.

Step 1

Select the appropriate release conditions:

- ground-level release without rain
- ground-level release with rain
- elevated release without rain
- elevated release with rain

Step 2

Estimate the downwind acute bone and thyroid doses at 1, 2, 5, 10 and 25 miles using Worksheets F-4 and F-5, respectively. Each worksheet has conversion factors that represent each of the four release conditions shown above. Figures F-1 and F-2 show the dose conversion factors for different release conditions as a function of distance for acute bone marrow and thyroid doses, respectively.

END

Method F.6 Quick Long-Range Estimation

Purpose

To produce a quick estimate of the maximum ground-level air concentrations and deposition that can be expected for a given release amount at downwind distances after travel times of 1-5 days after release.

Discussion

Because dose is a function of air and ground concentration, these concentrations can also be used to estimate dose at great distances. The procedure used is a result of analytical and experimental studies which are summarized in a simple nomogram giving the normalized concentration as a function of travel time for a release within the atmospheric boundary layer and for a release above the boundary layer.

A long-range non-depositing tracer experiment conducted from January through March of 1987 showed that the maximum concentrations measured (Draxler et al. 1991, Fig. 10) during any 24 h sampling period followed the simple Gaussian model form for an instantaneous release (AP-26, Eq. 5.21),

$$\chi/Q = [0.5(2\pi)^{3/2} \sigma_x \sigma_y \sigma_z]^{-1}$$

where it is assumed that $\sigma_z = (2Kt)^{1/2}$ and that the vertical mixing coefficient K has an average value of 5 m²/s in the atmospheric boundary layer (near the ground) and about 1 m²/s in the upper regions of the atmosphere (Machta 1966). The along-wind and crosswind dispersion coefficients are assumed both to be equal to 0.5 times the downwind travel time in seconds (Heffter 1965). The equation in this form has each exponential term for the along-wind, crosswind, and vertical offset set to one to yield the maximum ground-level concentration.

If the release occurs above the boundary layer, a correction of the form

$$\exp[-0.5(H/\sigma_z)^{1/2}]$$

is applied to the normalized concentration to obtain an estimate of the ground-level concentration.

An estimate of the maximum deposition can be obtained from Fig. F-3 by multiplying the air concentration by the vertical dispersion parameter. This result would then assume that all the material in the air is removed at that time.

Step 1

Determine if the release is at ground level or elevated. An elevated release may occur when there is a large thermal source or explosion, resulting in most of the material being ejected above the boundary layer. The calculations in this method assume an average elevated release to be about 1500 m above ground. Normal stack emissions are to be considered as a ground-level release.

Step 2

Determine the time in days after the accidental release for which the estimate is desired. Assume 4-mph wind speed if the average wind speed is not known. Other analysis methods must be employed to determine the location of this estimate. For instance, a simple trajectory or projection based upon wind speed might be sufficient, depending upon the circumstances.

Step 3

Estimate air concentration and deposition based on total release

- Use Fig. F-3. Find the desired downwind travel time on the horizontal axis and read the normalized concentration from the appropriate release height curve. The concentration is in units of m^{-3} .

Downwind travel time _____ days
Normalized concentration (from Fig. F-3) _____ m^{-3}

- Determine the total amount of material emitted (in mass or activity units) and multiply this by the normalized concentration. Do not use a release rate (mass/time or activity/time) because the values in Fig. F-3 are based upon the total emission. If the total release was given in Ci, the result is now Ci/m^{-3} .

$$\text{peak air concentration} = \text{total release} \times \text{normalized concentration}$$

- The dashed line on Fig. F-3 gives an estimate of the deposition (use the same values on the vertical axis but units are m^{-2}). It is assumed that all the airborne material is available for ground deposit at each downwind time. Fractional removal requires subsequent deposition and air concentrations to be adjusted accordingly.

Normalized maximum deposition (from Fig. F-3) _____ m^{-2}

$$\text{maximum deposition} = \text{total release} \times \text{normalized maximum deposition}$$

Estimate deposition or concentration based on near field measurements or model projections

- Find the downwind travel times on the horizontal axis of Fig. F-3 corresponding to the location of the near field and the long distance concentrations, depositions, or doses of interest. Read the normalized concentration from the appropriate release curve.

Downwind travel time to near field point _____ days
 Normalized concentration at near field point, C_1 (from Fig. F-3) _____ m^{-3}
 Downwind travel time to distant point _____ days
 Normalized concentration at distant point, C_2 (from Fig. F-3) _____ m^{-3}

- To estimate the long distance dose or concentration (V_2), multiply the dose or concentration at the near field location by the ratio of the long distance to near field dose or concentrations.

Measured or calculated near field value, V_1 _____ m^{-3}

$$V_2 = V_1 \times \frac{C_2}{C_1}$$

Similar ratios can be used to estimate maximum deposition or dose (proportional to deposition or concentration) at longer travel times when a near field value is known.

Step 4

Ensure that the user understands the limitations of this method. It should be clear from Fig. F-3 that there can be large variations in the estimate if the height of release is incorrect. These calculations assume a non-depositing material. With a non-depositing material, ground-level estimates will always be the more conservative and should be used. It should be noted that elevated releases of depositing material can show much higher concentrations downwind than ground-level releases because of their initial lack of deposition.

The estimates from Fig. F-3 are much more appropriate at longer downwind distances, when the spreading of the material is comparable to the 24-h sampling time that was used to verify this approach. At travel times less than 1 day, the average dispersion parameters that were used are difficult to justify.

END

The first part of the report deals with the general situation in the country. It is noted that the economy is still in a state of depression, and that the government has been unable to carry out its program of reconstruction. The report then goes on to discuss the various causes of this situation, including the effects of the war, the lack of investment, and the corruption of the government.

In the second part of the report, the author discusses the political situation. It is noted that the government is still dominated by the military, and that there is a lack of political freedom. The author also discusses the role of the press and the judiciary, and the state of the labor movement.

The third part of the report deals with the social situation. It is noted that there is a high level of unemployment, and that the standard of living is very low. The author also discusses the state of the education system, and the role of the church in society.

In the final part of the report, the author offers some suggestions for reform. It is suggested that the government should carry out a program of economic reconstruction, and that there should be a change in the political system. The author also suggests that there should be a reform of the judiciary, and that there should be a strengthening of the labor movement.

Table F-1. Specific activity

Isotope	Half-life, $T_{1/2}$ (h)	Specific activity, SpA ^a ($\mu\text{Ci/g}$)
³ H	1.1E+05	9.7E+09
¹⁴ C	5.0E+07	4.5E+06
²² Na	2.3E+04	6.3E+09
²⁴ Na	1.5E+01	8.7E+12
³² P	3.4E+02	2.9E+11
³³ P	6.1E+02	1.6E+11
³⁵ S	2.1E+03	4.3E+10
³⁶ Cl	2.6E+09	3.3E+04
⁴⁰ K	1.1E+13	7.0E+00
⁴² K	1.2E+01	6.0E+12
⁴⁵ Ca	3.9E+03	1.8E+10
⁴⁶ Sc	2.0E+03	3.4E+10
⁴⁴ Ti	4.1E+05	1.7E+08
⁴⁸ V	3.9E+02	1.7E+11
⁵¹ Cr	6.6E+02	9.2E+10
⁵⁴ Mn	7.5E+03	7.7E+09
⁵⁶ Mn	2.6E+00	2.2E+13
⁵⁵ Fe	2.4E+04	2.4E+09
⁵⁹ Fe	1.1E+03	5.0E+10
⁵⁸ Co	1.7E+03	3.2E+10
⁶⁰ Co	4.6E+04	1.1E+09
⁶³ Ni	8.4E+05	5.9E+07
⁶⁴ Cu	1.3E+01	3.9E+12
⁶⁵ Zn	5.9E+03	8.2E+09
⁶⁸ Ga	1.1E+00	4.1E+13
⁶⁸ Ge	6.9E+03	6.7E+09
⁷⁵ Se	2.9E+03	1.5E+10

Table F-1. Specific activity (continued)

Isotope	Half-life, $T_{1/2}$ (h)	Specific activity, SpA ^a ($\mu\text{Ci/g}$)
⁸⁵ Kr	9.4E+04	3.9E+08
^{85m} Kr	4.5E+00	8.2E+12
⁸⁷ Kr	1.3E+00	2.8E+13
⁸⁸ Kr	2.8E+00	1.3E+13
⁸⁶ Rb	4.5E+02	8.1E+10
⁸⁷ Rb	4.1E+14	8.7E-02
⁸⁸ Rb	3.0E-01	1.2E+14
⁸⁹ Sr	1.2E+03	2.9E+10
⁹⁰ Sr	2.6E+05	1.4E+08
⁹¹ Sr	9.5E+00	3.6E+12
⁹⁰ Y	6.4E+01	5.4E+11
⁹¹ Y	1.4E+03	2.5E+10
^{91m} Y	8.3E-01	4.2E+13
⁹³ Zr	1.3E+10	2.5E+03
⁹⁵ Zr	1.5E+03	2.1E+10
⁹⁴ Nb	1.8E+08	1.9E+05
⁹⁵ Nb	8.4E+02	3.9E+10
⁹⁹ Mo	6.6E+01	4.8E+11
⁹⁹ Tc	1.9E+09	1.7E+04
^{99m} Tc	6.0E+00	5.3E+12
¹⁰³ Ru	9.4E+02	3.2E+10
¹⁰⁵ Ru	4.4E+00	6.7E+12
¹⁰⁶ Ru	8.8E+03	3.3E+09
¹⁰⁶ Rh	8.3E-03	3.6E+15
¹⁰⁹ Cd	1.1E+04	2.6E+09
^{113m} Cd	1.2E+05	2.3E+08
^{110m} Ag	6.0E+03	4.8E+09
^{114m} In	1.2E+03	2.3E+10
¹¹³ Sn	2.8E+03	1.0E+10
¹²³ Sn	3.1E+03	8.2E+09
¹²⁶ Sn	8.8E+08	2.8E+04

Table F-1. Specific activity (continued)

Isotope	Half-life, $T_{1/2}$ (h)	Specific activity, SpA ^a ($\mu\text{Ci/g}$)
¹²⁴ Sb	1.4E+03	1.7E+10
¹²⁶ Sb	3.0E+02	8.4E+10
^{126m} Sb	3.2E-01	7.9E+13
¹²⁷ Sb	9.2E+01	2.7E+11
¹²⁹ Sb	4.3E+00	5.6E+12
¹²⁷ Te	9.4E+00	2.6E+12
^{127m} Te	2.6E+03	9.4E+09
¹²⁹ Te	1.2E+00	2.1E+13
^{129m} Te	8.1E+02	3.0E+10
¹³¹ Te	4.2E-01	5.7E+13
^{131m} Te	3.0E+01	8.0E+11
¹³² Te	7.8E+01	3.0E+11
¹²⁵ I	1.4E+03	1.7E+10
¹²⁹ I	1.4E+11	1.8E+02
¹³¹ I	1.9E+02	1.2E+11
¹³² I	2.3E+00	1.0E+13
¹³³ I	2.1E+01	1.1E+12
¹³⁴ I	8.8E-01	2.7E+13
¹³⁵ I	6.6E+00	3.5E+12
^{131m} Xe	2.9E+02	8.4E+10
¹³³ Xe	1.3E+02	1.9E+11
^{133m} Xe	5.3E+01	4.5E+11
¹³⁵ Xe	9.1E+00	2.6E+12
^{135m} Xe	2.5E-01	9.1E+13
¹³⁸ Xe	2.4E-01	9.6E+13
¹³⁴ Cs	1.8E+04	1.3E+09
¹³⁵ Cs	2.0E+10	1.2E+03
¹³⁶ Cs	3.1E+02	7.3E+10
¹³⁷ Cs	2.6E+05	8.7E+07
¹³⁸ Cs	5.4E-01	4.2E+13
¹³³ Ba	9.4E+04	2.5E+08
^{137m} Ba	4.3E-02	5.4E+14
¹⁴⁰ Ba	3.1E+02	7.3E+10
¹⁴⁰ La	4.0E+01	5.6E+11

Table F-1. Specific activity (continued)

Isotope	Half-life, $T_{1/2}$ (h)	Specific activity, SpA ^a ($\mu\text{Ci/g}$)
¹⁴¹ Ce	7.8E+02	2.8E+10
¹⁴⁴ Ce	6.8E+03	3.2E+09
¹⁴⁴ Pr	2.9E-01	7.6E+13
^{144m} Pr	1.2E-01	1.8E+14
¹⁴⁵ Pm	1.6E+05	1.4E+08
¹⁴⁷ Pm	2.3E+04	9.3E+08
¹⁴⁷ Sm	9.3E+14	2.3E-02
¹⁵¹ Sm	7.9E+05	2.6E+07
¹⁵² Eu	1.2E+05	1.8E+08
¹⁵⁴ Eu	7.7E+04	2.6E+08
¹⁵⁵ Eu	4.3E+04	4.7E+08
¹⁵³ Gd	5.8E+03	3.5E+09
¹⁶⁰ Tb	1.7E+03	1.1E+10
^{166m} Ho	1.1E+07	1.8E+06
¹⁷⁰ Tm	3.1E+03	6.0E+09
¹⁶⁹ Yb	7.7E+02	2.4E+10
¹⁷² Hf	1.6E+04	1.1E+09
¹⁸¹ Hf	1.0E+03	1.7E+10
¹⁸² Ta	2.8E+03	6.3E+09
¹⁸⁷ W	2.4E+01	7.0E+11
¹⁹² Ir	1.8E+03	9.2E+09
¹⁹⁸ Au	6.5E+01	2.4E+11
²⁰³ Hg	1.1E+03	1.4E+10
²⁰⁴ Tl	3.3E+04	4.6E+08
²¹⁰ Pb	1.9E+05	7.7E+07
²⁰⁷ Bi	3.3E+05	4.5E+07
²¹⁰ Bi	1.2E+02	1.2E+11

Table F-1. Specific activity (continued)

	Half-life, $T_{1/2}$ (h)	Specific activity, SpA ^a (μ Ci/g)
²¹⁰ Po	3.3E+03	4.5E+09
²²⁶ Ra	1.4E+07	9.9E+05
²²⁷ Ac	1.9E+05	7.2E+07
²²⁸ Ac	6.1E+00	2.2E+12
²²⁷ Th	4.5E+02	3.1E+10
²²⁸ Th	1.7E+04	8.2E+08
²³⁰ Th	6.7E+08	2.0E+04
²³¹ Th	2.6E+01	5.3E+11
²³² Th	1.2E+14	1.1E-01
²³¹ Pa	2.9E+08	4.7E+04
²³³ Pa	6.5E+02	2.1E+10
U-depleted ^b		3.6E+01 ^c
U-natural ^b		6.8E+01 ^c
U-enr (4% ²³⁵ U) ^b		2.4E+00 ^c
U-enr (20% ²³⁵ U) ^b		9.4E+00 ^c
U-enr (93% ²³⁵ U) ^b		1.1E+02 ^c
²³² U ^b	6.3E+05	2.1E+07
²³³ U ^b	1.4E+09	9.7E+03
²³⁴ U ^b	2.1E+09	6.3E+03
²³⁵ U ^b	6.2E+12	2.2E+00
²³⁶ U ^b	2.0E+11	6.5E+01
²³⁸ U ^b	3.9E+13	3.4E-01
²³⁷ Np	1.9E+10	7.1E+02
²³⁹ Np	5.7E+01	2.3E+11
²³⁶ Pu	2.5E+04	5.3E+08
²³⁸ Pu	7.7E+05	1.7E+07
²³⁹ Pu	2.1E+08	6.2E+04
²⁴⁰ Pu	5.7E+07	2.3E+05
²⁴¹ Pu	1.3E+05	1.0E+08
²⁴² Pu	3.3E+09	3.9E+03
²⁴¹ Am	3.8E+06	3.4E+06
^{242m} Am	1.3E+06	9.7E+06
²⁴³ Am	6.5E+07	2.0E+05

Table F-1. Specific activity (continued)

	Half-life, $T_{1/2}$ (h)	Specific activity, SpA ^a (μ Ci/g)
²⁴² Cm	3.9E+03	3.3E+09
²⁴³ Cm	2.5E+05	5.2E+07
²⁴⁴ Cm	1.6E+05	8.1E+07
²⁴⁵ Cm	7.4E+07	1.7E+05
²⁵² Cf	2.3E+04	5.4E+08

^aExcept where noted SpA (μ Ci/g) = $3.134E+15/[T_{1/2}(h) \times \text{atomic mass number}]$ from PB-230 846, p. 103.

^bCaution: The chemical toxicity of uranium will be a problem before there are radiological concerns.

^cThe specific activity of natural and depleted uranium is based on 10 CFR 20 App. B, confirmed by calculations. For enriched uranium, SpA is dominated by the concentration of ²³⁴U because the ²³⁴U concentration increases with ²³⁵U enrichment and ²³⁴U has a relatively high SpA. The ²³⁴U concentration relative to the ²³⁵U enrichment is assumed to be 4% enrichment, 0.032% ²³⁴U; 20% enrichment, 0.15% ²³⁴U; and 93% enrichment, 2% ²³⁴U.

Table F-2. Fire release fraction by compound form

Form of compound in fire ^a	Fire release fraction, <i>FRF</i> ^b
Noble gas	1.0
Very mobile form (i.e., particle attached to flammable trash in a fire)	1.0
Volatile and combustible compounds	0.5
Carbon	0.01
Semi-volatile compounds	0.01
Non-volatile compounds	0.001
Uranium and plutonium metal	0.001
Non-volatile in flammable liquids	0.005
Non-volatile in non-flammable liquids	0.001
Non-volatile solids	0.0001

^aIf the compound form is not known, use the fire release fractions in Table F-3.

^bThe fire release fraction is the fraction of the isotope released when the material is involved in a fire, $FRF = [\text{total activity released } (\mu\text{Ci})]/[\text{activity involved in fire } (\mu\text{Ci})]$.

Source: NUREG-1140.

Table F-3. Fire release fraction by isotope

Isotope ^a	Fire release fraction, FRF ^b
³ H(gas)	5.00E-01
¹⁴ C	1.00E-02
²² Na	1.00E-02
²⁴ Na	1.00E-02
³² P	5.00E-01
³³ P	5.00E-01
³⁵ S	5.00E-01
³⁶ Cl	5.00E-01
⁴⁰ K	5.00E-01
⁴² K	1.00E-02
⁴⁵ Ca	1.00E-02
⁴⁶ Sc	1.00E-02
⁴⁴ Ti	1.00E-02
⁴⁸ V	1.00E-02
⁵¹ Cr	1.00E-02
⁵⁴ Mn	1.00E-02
⁵⁶ Mn	1.00E-02
⁵⁵ Fe	1.00E-02
⁵⁹ Fe	1.00E-02
⁵⁸ Co	1.00E-03
⁶⁰ Co	1.00E-03
⁶³ Ni	1.00E-02
⁶⁴ Cu	1.00E-02
⁶⁵ Zn	1.00E-02
⁶⁸ Ga	NC
⁶⁸ Ge	1.00E-02
⁷⁵ Se	1.00E-02
⁸⁵ Kr	1.00E+00
^{85m} Kr	1.00E+00
⁸⁷ Kr	1.00E+00
⁸⁸ Kr	1.00E+00

Table F-3. Fire release fraction by isotope (continued)

Isotope ^a	Fire release fraction, FRF ^b
⁸⁶ Rb	1.00E-02
⁸⁷ Rb	1.00E-02
⁸⁸ Rb	1.00E-02
⁸⁹ Sr	1.00E-02
⁹⁰ Sr	1.00E-02
⁹¹ Sr	1.00E-02
⁹⁰ Y	1.00E-02
⁹¹ Y	1.00E-02
^{91m} Y	1.00E-02
⁹³ Zr	1.00E-02
⁹⁵ Zr	1.00E-02
⁹⁴ Nb	1.00E-02
⁹⁵ Nb	1.00E-02
⁹⁹ Mo	1.00E-02
⁹⁹ Tc	1.00E-02
^{99m} Tc	1.00E-02
¹⁰³ Ru	1.00E-02
¹⁰⁵ Ru	1.00E-02
¹⁰⁶ Ru	1.00E-02
¹⁰⁶ Rh	1.00E-02
^{110m} Ag	1.00E-02
¹⁰⁹ Cd	1.00E-02
^{113m} Cd	1.00E-02
^{114m} In	1.00E-02
¹¹³ Sn	1.00E-02
¹²³ Sn	1.00E-02
¹²⁶ Sn	1.00E-02
¹²⁴ Sb	1.00E-02
¹²⁶ Sb	1.00E-02
^{126m} Sb	1.00E-02
¹²⁷ Sb	1.00E-02
¹²⁹ Sb	1.00E-02

Table F-3. Fire release fraction by isotope (continued)

Isotope ^a	Fire release fraction, FRF ^b
¹²⁷ Te	1.00E-02
^{127m} Te	1.00E-02
¹²⁹ Te	1.00E-02
^{129m} Te	1.00E-02
¹³¹ Te	1.00E-02
^{131m} Te	1.00E-02
¹³² Te	1.00E-02
¹²⁵ I	5.00E-01
¹²⁹ I	5.00E-01
¹³¹ I	5.00E-01
¹³² I	5.00E-01
¹³³ I	5.00E-01
¹³⁴ I	5.00E-01
¹³⁵ I	5.00E-01
^{131m} Xe	1.00E+00
¹³³ Xe	1.00E+00
^{133m} Xe	1.00E+00
¹³⁵ Xe	1.00E+00
^{135m} Xe	1.00E+00
¹³⁸ Xe	1.00E+00
¹³⁴ Cs	1.00E-02
¹³⁵ Cs	1.00E-02
¹³⁶ Cs	1.00E-02
¹³⁷ Cs	1.00E-02
¹³⁸ Cs	1.00E-02
¹³³ Ba	1.00E-02
^{137m} Ba	1.00E-02
¹⁴⁰ Ba	1.00E-02
¹⁴⁰ La	1.00E-02
¹⁴¹ Ce	1.00E-02
¹⁴⁴ Ce	1.00E-02
¹⁴⁴ Pr	1.00E-02
^{144m} Pr	1.00E-02
¹⁴⁵ Pm	1.00E-02
¹⁴⁷ Pm	1.00E-02
¹⁴⁷ Sm	1.00E-02
¹⁵¹ Sm	1.00E-02

Table F-3. Fire release fraction by isotope (continued)

Isotope ^a	Fire release fraction, FRF ^b
¹⁵² Eu	1.00E-02
¹⁵⁴ Eu	1.00E-02
¹⁵⁵ Eu	1.00E-02
¹⁵³ Gd	1.00E-02
¹⁶⁰ Tb	1.00E-02
^{166m} Ho	1.00E-02
¹⁷⁰ Tm	1.00E-02
¹⁶⁹ Yb	1.00E-02
¹⁷² Hf	1.00E-02
¹⁸¹ Hf	1.00E-02
¹⁸² Ta	1.00E-03
¹⁸⁷ W	1.00E-02
¹⁹² Ir	1.00E-03
¹⁹⁸ Au	1.00E-02
²⁰³ Hg	1.00E-02
²⁰⁴ Tl	1.00E-02
²¹⁰ Pb	1.00E-02
²⁰⁷ Bi	1.00E-02
²¹⁰ Bi	1.00E-02
²¹⁰ Po	1.00E-02
²²⁶ Ra	1.00E-03
²²⁷ Ac	1.00E-03
²²⁸ Ac	1.00E-03
²²⁷ Th	1.00E-03
²²⁸ Th	1.00E-03
²³⁰ Th	1.00E-03
²³¹ Th	1.00E-03
²³² Th	1.00E-03
²³¹ Pa	1.00E-03
²³³ Pa	1.00E-03

Table F-3. Fire release fraction by isotope (continued)

Isotope ^a	Fire release fraction, FRF ^b
²³² U	1.00E-03
²³³ U	1.00E-03
²³⁴ U	1.00E-03
²³⁵ U	1.00E-03
²³⁶ U	1.00E-03
²³⁸ U	1.00E-03
²³⁷ Np	1.00E-03
²³⁹ Np	1.00E-03
²³⁶ Pu	1.00E-03
²³⁸ Pu	1.00E-03
²³⁹ Pu	1.00E-03
²⁴⁰ Pu	1.00E-03
²⁴¹ Pu	1.00E-03
²⁴² Pu	1.00E-03
²⁴¹ Am	1.00E-03
^{242m} Am	1.00E-03
²⁴³ Am	1.00E-03

^aIf the specific compound form of the isotope is known, use Table F-2.

^bThe fire release fraction is the fraction of the isotope released when the material is involved in a fire, $FRF = [\text{total activity released } (\mu\text{Ci})] / [\text{activity involved in fire } (\mu\text{Ci})]$.

Sources: NUREG-1140, relationship to isotopes not listed in NUREG-1140 from NUREG-1465, Table 3.7, p.12.

Table F-4. Release conversion factor, RCF, in mrem/ μ Ci,
 ≤ 0.25 mile from source for 1- μ Ci release^a

Isotope	Inhalation ^b				Air immersion ^c	Ground ^d
	Acute bone	Acute lung	Thyroid	CEDE		
³ H	1E-08	1E-08	NC	2E-08 ^e	7E-13	6E-13
¹⁴ C	2E-07	2E-07	NC	4E-07	5E-13	1E-11
²² Na	NC	NC	NC	1E-06	2E-07	8E-08
²⁴ Na	1E-07	8E-07	NC	2E-07	5E-07	3E-08
³² P	3E-06	2E-05	NC	3E-06	2E-10	2E-10
³³ P	NC	NC	NC	4E-07	2E-12	1E-11
³⁵ S	3E-08	2E-06	NC	5E-07	5E-13	1E-11
³⁶ Cl	NC	NC	NC	4E-06	5E-11	1E-10
⁴⁰ K	NC	NC	NC	2E-06	2E-08	5E-09
⁴² K	NC	NC	NC	3E-07	3E-08	2E-09
⁴⁵ Ca	NC	NC	NC	1E-06	2E-12	3E-11
⁴⁶ Sc	NC	NC	NC	6E-06	2E-07	7E-08
⁴⁴ Ti + ⁴⁴ Sc	NC	NC	NC	2E-04	2E-07	8E-08
⁴⁸ V	NC	NC	NC	2E-06	3E-07	9E-08
⁵¹ Cr	1E-08	2E-07	NC	6E-08	3E-09	1E-09
⁵⁴ Mn	5E-07	2E-06	NC	1E-06	8E-08	3E-08
⁵⁶ Mn	NC	NC	NC	7E-08	2E-07	2E-09
⁵⁵ Fe	1E-08	2E-07	NC	5E-07	0	1E-11
⁵⁹ Fe	8E-07	5E-06	NC	3E-06	1E-07	4E-08
⁵⁸ Co	2E-07	3E-06	NC	2E-06	1E-07	3E-08
⁶⁰ Co	6E-07	9E-06	NC	4E-05	3E-07	9E-08
⁶³ Ni	2E-08	6E-07	NC	6E-07	0	1E-11
⁶⁴ Cu	NC	NC	NC	5E-08	2E-08	1E-09
⁶⁵ Zn	3E-07	2E-06	NC	4E-06	6E-08	2E-08
⁶⁸ Ga	NC	1E-07	NC	3E-08	1E-07	6E-10
⁶⁸ Ge + ⁶⁸ Ga	NC	1E-07	NC	1E-05	1E-07	3E-08
⁷⁵ Se	4E-07	2E-06	NC	2E-06	4E-08	1E-08

**Table F-4. Release conversion factor, RCF, in mrem/ μ Ci,
 ≤ 0.25 mile from source for 1- μ Ci release (continued)**

Isotope	Inhalation ^b				Air immersion ^c	Ground ^d
	Acute bone	Acute lung	Thyroid	CEDE		
⁸⁶ Rb	1E-06	2E-06	NC	1E-06	1E-08	3E-09
⁸⁷ Rb	NC	NC	NC	6E-07	4E-12	2E-11
⁸⁸ Rb	NC	NC	NC	2E-08	7E-08	9E-11
⁸⁹ Sr	2E-06	2E-05	NC	8E-06	2E-10	3E-10
⁹⁰ Sr	3E-06	4E-05	NC	2E-04	2E-11	6E-09
⁹¹ Sr	NC	NC	NC	3E-07	7E-08	3E-09
⁹⁰ Y	2E-07	6E-06	NC	2E-06	4E-10	1E-10
⁹¹ Y	9E-07	2E-05	NC	9E-06	5E-10	4E-10
^{91m} Y	NC	NC	NC	7E-09	5E-08	2E-10
⁹³ Zr	NC	NC	NC	6E-05	0	1E-09
⁹⁵ Zr	2E-06	7E-06	NC	4E-06	7E-08	3E-08
⁹⁴ Nb	NC	NC	NC	8E-05	2E-07	6E-08
⁹⁵ Nb	3E-07	3E-06	NC	1E-06	8E-08	3E-08
⁹⁹ Mo + ^{99m} Tc	3E-07	3E-06	NC	7E-07	3E-08	6E-09
⁹⁹ Tc	3E-08	4E-06	NC	2E-06	3E-12	4E-11
^{99m} Tc	2E-09	2E-08	NC	6E-09	1E-08	4E-10
¹⁰³ Ru	3E-07	5E-06	NC	2E-06	5E-08	2E-08
¹⁰⁵ Ru	NC	NC	NC	9E-08	8E-08	2E-09
¹⁰⁶ Ru + ¹⁰⁶ Rh	2E-06	6E-05	NC	9E-05	2E-08	1E-08
¹⁰⁶ Rh	NC	NC	NC	NC	2E-08	9E-13
^{110m} Ag	1E-06	9E-06	NC	2E-05	3E-07	1E-07
¹⁰⁹ Cd + ^{109m} Ag	NC	NC	NC	2E-05	1E-09	2E-09
^{113m} Cd	NC	NC	NC	3E-04	1E-11	7E-09
^{114m} In	NC	NC	NC	2E-05	9E-09	4E-09
¹¹³ Sn + ^{113m} In	NC	NC	NC	2E-06	3E-08	1E-08
¹²³ Sn	NC	NC	NC	6E-06	8E-10	5E-10
¹²⁶ Sn + ^{126m} Sb	NC	NC	NC	2E-05	6E-09	5E-08
¹²⁴ Sb	9E-07	2E-05	NC	5E-06	2E-07	6E-08
¹²⁶ Sb	NC	NC	NC	2E-06	3E-07	9E-08
^{126m} Sb	NC	NC	NC	6E-09	2E-07	3E-10
¹²⁷ Sb	NC	NC	NC	1E-06	7E-08	2E-08
¹²⁹ Sb	NC	NC	NC	1E-07	1E-07	3E-09

Table F-4. Release conversion factor, RCF, in mrem/ μ Ci,
 ≤ 0.25 mile from source for 1- μ Ci release (continued)

Isotope	Inhalation ^b				Air immersion ^c	Ground ^d
	Acute bone	Acute lung	Thyroid	CEDE		
¹²⁷ Te	NC	NC	NC	6E-08	5E-10	3E-11
^{127m} Te	2E-06	1E-05	NC	4E-06	3E-10	5E-10
¹²⁹ Te	NC	NC	NC	2E-08	6E-09	4E-11
^{129m} Te	3E-06	2E-05	NC	4E-06	3E-09	1E-09
¹³¹ Te	NC	NC	2E-06	9E-08	4E-08	9E-11
^{131m} Te	2E-07	2E-06	3E-05	1E-06	1E-07	2E-08
¹³² Te	2E-07	1E-06	4E-05	2E-06	2E-08	6E-09
¹²⁵ I	1E-08	2E-07	1E-04	5E-06	1E-09	2E-09
¹²⁹ I	1E-08	2E-07	1E-03	3E-05	8E-10	2E-09
¹³¹ I	4E-08	5E-07	2E-04	6E-06	4E-08	1E-08
¹³² I	1E-08	2E-07	1E-06	7E-08	2E-07	3E-09
¹³³ I	2E-08	6E-07	3E-05	1E-06	6E-08	6E-09
¹³⁴ I	4E-09	1E-07	2E-07	2E-08	3E-07	1E-09
¹³⁵ I + ^{135m} Xe	2E-08	3E-07	6E-06	2E-07	2E-08	5E-09
^{131m} Xe	NC	NC	NC	NC	8E-10	7E-10
¹³³ Xe	NC	NC	NC	NC	3E-09	1E-09
^{133m} Xe	NC	NC	NC	NC	3E-09	8E-10
¹³⁵ Xe	NC	NC	NC	NC	2E-08	1E-09
^{135m} Xe	NC	NC	NC	NC	4E-08	6E-11
¹³⁸ Xe	NC	NC	NC	NC	1E-07	1E-10
¹³⁴ Cs	2E-06	2E-06	NC	9E-06	2E-07	6E-08
¹³⁵ Cs	1E-07	3E-07	NC	9E-07	1E-12	2E-11
¹³⁶ Cs	1E-06	1E-06	NC	1E-06	2E-07	7E-08
¹³⁷ Cs + ^{137m} Ba	1E-06	2E-06	NC	6E-06	6E-08	2E-08
¹³⁸ Cs	NC	NC	NC	2E-08	3E-07	6E-10
¹³³ Ba	NC	NC	NC	1E-06	4E-08	1E-08
^{137m} Ba	NC	NC	NC	NC	6E-08	1E-11
¹⁴⁰ Ba	7E-07	1E-06	NC	7E-07	2E-08	6E-09
¹⁴⁰ La	3E-07	3E-06	NC	9E-07	2E-07	4E-08
¹⁴¹ Ce	1E-07	6E-06	NC	2E-06	7E-09	3E-09
¹⁴⁴ Ce + ^{144m} Pr	1E-06	6E-05	NC	7E-05	2E-09	4E-09
¹⁴⁴ Pr	NC	NC	NC	8E-09	4E-09	6E-12
^{144m} Pr	NC	NC	NC	NC	6E-10	8E-13
¹⁴⁵ Pm	NC	NC	NC	6E-06	1E-09	1E-09
¹⁴⁷ Pm	1E-07	3E-06	NC	7E-06	1E-12	2E-10

Table F-4. Release conversion factor, RCF, in mrem/ μ Ci,
 ≤ 0.25 mile from source for 1- μ Ci release (continued)

Isotope	Inhalation ^b				Air immersion ^c	Ground ^d
	Acute bone	Acute lung	Thyroid	CEDE		
¹⁴⁷ Sm	NC	NC	NC	1E-02	0	3E-07
¹⁵¹ Sm	3E-08	8E-07	NC	6E-06	8E-14	1E-10
¹⁵² Eu	6E-07	8E-06	NC	4E-05	1E-07	4E-08
¹⁵⁴ Eu	8E-07	1E-05	NC	5E-05	1E-07	4E-08
¹⁵⁵ Eu	1E-07	3E-06	NC	8E-06	5E-09	2E-09
¹⁵³ Gd	NC	NC	NC	4E-06	8E-09	4E-09
¹⁶⁰ Tb	NC	NC	NC	5E-06	1E-07	4E-08
^{166m} Ho	NC	NC	NC	1E-04	2E-07	7E-08
¹⁷⁰ Tm	NC	NC	NC	5E-06	5e-10	3E-10
¹⁶⁹ Yb	3E-07	5E-06	NC	2E-06	3E-08	1E-08
¹⁷² Hf	NC	NC	NC	6E-05	8E-09	6E-09
¹⁸¹ Hf	NC	NC	NC	3E-06	5E-08	2E-08
¹⁸² Ta	NC	NC	NC	8E-06	1E-07	4E-08
¹⁸⁷ W	NC	NC	NC	1E-07	5E-08	6E-09
¹⁹² Ir	6E-07	1E-05	NC	5E-06	8E-08	3E-08
¹⁹⁸ Au	NC	NC	NC	6E-07	4E-08	9E-09
²⁰³ Hg	NC	NC	NC	1E-06	2E-08	8E-09
²⁰⁴ Tl	NC	NC	NC	5E-07	1E-10	6E-11
²¹⁰ Pb	2E-06	7E-07	NC	3E-03	1E-10	6E-08
²⁰⁷ Bi	NC	NC	NC	4E-06	2E-07	5E-08
²¹⁰ Bi	NC	NC	NC	4E-05	7E-11	7E-10
²¹⁰ Po	6E-05	2E-03	NC	2E-03	9E-13	4E-08
²²⁶ Ra	7E-06	2E-03	NC	2E-03	7E-10	4E-08
²²⁷ Ac	NC	NC	NC	1E+00	1E-11	3E-05
²²⁸ Ac	NC	NC	NC	6E-05	1E-07	3E-09

Table F-4. Release conversion factor, RCF, in mrem/ μ Ci,
 ≤ 0.25 mile from source for 1- μ Ci release (continued)

Isotope	Inhalation ^b				Air immersion ^c	Ground ^d
	Acute bone	Acute lung	Thyroid	CEDE		
²²⁷ Th	3E-04	6E-03	NC	3E-03	1E-08	7E-08
²²⁸ Th	7E-04	1E-02	NC	6E-02	2E-10	2E-06
²³⁰ Th	1E-04	2E-03	NC	6E-02	4E-11	2E-06
²³¹ Th	NC	NC	NC	2E-07	1E-09	2E-10
²³² Th	1E-04	2E-03	NC	3E-01	2E-11	8E-06
²³¹ Pa	8E-05	2E-03	NC	2E-01	4E-09	6E-06
²³³ Pa	NC	NC	NC	2E-06	2E-08	7E-09
U-dep&nat ^{f,g}	1E-05	2E-03	NC	2E-02	7E-12	6E-07
U-enric ^{f,g}	1E-05	2E-03	NC	2E-02	2E-11	6E-07
U-soluble ^{f,g,h} (UF ₆)	1E-05	1E-04	NC	5E-04	2E-11	1E-08
²³² U ^g	1E-05	2E-03	NC	1E-01	3E-11	3E-06
²³³ U ^g	NC	NC	NC	3E-02	3E-11	6E-07
²³⁴ U ^g	1E-05	2E-03	NC	2E-02	2E-11	6E-07
²³⁵ U ^g	1E-05	2E-03	NC	2E-02	1E-08	6E-07
²³⁶ U ^g	1E-05	2E-03	NC	2E-02	1E-11	6E-07
²³⁸ U ^g	1E-05	2E-03	NC	2E-02	7E-12	6E-07
²³⁷ Np	8E-05	2E-03	NC	1E-01	2E-09	3E-06
²³⁹ Np	6E-08	2E-06	NC	5E-07	2E-08	3E-09
²³⁶ Pu	NC	NC	NC	3E-02	1E-11	7E-07
²³⁸ Pu	9E-05	2E-03	NC	7E-02	1E-11	2E-06
²³⁹ Pu	8E-05	2E-03	NC	8E-02	9E-12	2E-06
²⁴⁰ Pu	8E-05	2E-03	NC	8E-02	1E-11	2E-06
²⁴¹ Pu	2E-08	4E-07	NC	2E-03	2E-13	4E-08
²⁴² Pu	8E-05	2E-03	NC	8E-02	8E-12	2E-06
²⁴¹ Am	9E-05	2E-03	NC	8E-02	2E-09	2E-06
^{242m} Am	NC	NC	NC	8E-02	7E-11	2E-06
²⁴³ Am	9E-05	2E-03	NC	8E-02	5E-09	2E-06
²⁴² Cm	1E-04	2E-03	NC	3E-03	1E-11	8E-08
²⁴³ Cm	1E-04	2E-03	NC	6E-02	1E-08	1E-06
²⁴⁴ Cm	1E-04	2E-03	NC	5E-02	1E-11	1E-06
²⁴⁵ Cm	NC	NC	NC	9E-02	8E-09	2E-06
²⁵² Cf	NC	NC	NC	3E-02	1E-11	7E-07

^aRelease conversion factors (RCFs), when multiplied by the activity released (μCi), will give a dose estimate for a ground-level release with no rain close to the source (<0.25 mile). The RCFs assume that the exposed individual is at the center of the plume for the entire duration of the release. The daughters are included in all the inhalation doses and in the external doses where noted (e.g., $^{44}\text{Ti}+^{44}\text{Sc}$). These RCFs should provide an upper bound of the dose from ground-level releases *not* involving rain and a range of stability classes and wind speeds. (The derivation of the RCFs is shown below.)

^bInhalation doses include daughters and are, as recommended by EPA, for an adult performing light activity. The RCFs given are the (1) organ dose [(D_T) for bone, lung, and thyroid] and (2) CEDE ($H_{E,50}$) from inhalation. Entries marked "NC" were not calculated.

^cThe air immersion dose equivalent is for a semi-infinite plume, thus maximizing the dose from cloudshine.

^dThe ground exposure is for the early phase and includes external dose equivalent from groundshine and CEDE from resuspension (non-arid area, $R_s = 1\text{E}-6$) from remaining on contaminated ground for 4 days. The groundshine doses were corrected for ground roughness.

^eCEDE from inhalation was doubled to account for skin absorption.

^fFor natural and depleted uranium, it is assumed all the release is ^{238}U , and for enriched uranium it is assumed all of the release is ^{234}U . The specific activity of natural and depleted uranium is dominated by the concentration of ^{238}U , and enriched uranium is dominated by the concentration of ^{234}U (because of its high specific activity). While releases of natural and enriched uranium will be composed principally of a mixture of ^{234}U , ^{235}U , and ^{238}U , the dose factors for ^{234}U , ^{235}U , and ^{238}U are within 10%, so it is reasonable to use a single dose factor.

^gCaution: For uranium, the chemical toxicity is always more important than the radiation dose.

^hInhalation dose for the soluble form of ^{234}U , which is the likely form in UF_6 .

Calculation of Release Conversion Factors

$$\text{RCF for acute bone marrow dose: } RCF(\text{bone}) = DCF_{ab} \times CF$$

$$\text{RCF for acute lung dose: } RCF(\text{lung}) = DCF_{al} \times CF$$

$$\text{RCF for thyroid dose: } RCF(\text{thyroid}) = DCF_{thy} \times CF$$

$$\text{RCF for CEDE dose: } RCF(\text{CEDE}) = DCF_{E,50} \times CF$$

$$\text{RCF for air immersion dose: } RCF(\text{air}) = DCF_a \times CF$$

RCF for ground exposure dose for early phase:

$$RCF(\text{early phase ground}) = DCF_{EPg} \times GCF \times T_{ed}$$

where

CF = Conversion factor = $1.56\text{E}-7$ from $CF = (Q \times DF \times T_{rd})/\bar{U}$, based on Method F.3

DCF = Dose conversion factors from Tables F-6 and F-7

DF = Dilution factor = $1\text{E}-3 \text{ m}^{-2}$ for 0.25 mile from Table F-10

GCF = Ground concentration factor = $3.9\text{E}-8$ for 0.25 mile from Table F-11

Q = Release rate = $2.8\text{E}-4 \mu\text{Ci/s}$ ($1 \mu\text{Ci/h}$)

T_{ed} = Exposure duration = 100 h (4 days) for D_{EPg}

T_{rd} = Release duration = 1 h

\bar{U} = Average wind speed = 1.8 m/s (4 mph)

Table F-5. Release conversion factor, RCF, in mrem/ μ Ci,
at 1 mile downwind for 1- μ Ci release^a

Isotope	Inhalation ^b				Air immersion ^c	Ground ^d
	Acute bone	Acute lung	Thyroid	CEDE		
³ H	6E-10	6E-10	NC	1E-09 ^e	4E-14	3E-13
¹⁴ C	9E-09	9E-09	NC	2E-08	3E-14	6E-12
²² Na	NC	NC	NC	8E-08	1E-08	4E-08
²⁴ Na	8E-09	4E-08	NC	1E-08	2E-08	2E-08
³² P	2E-07	8E-07	NC	2E-07	1E-11	9E-11
³³ P	NC	NC	NC	2E-08	9E-14	6E-12
³⁵ S	1E-09	9E-08	NC	2E-08	3E-14	6E-12
³⁶ Cl	NC	NC	NC	2E-07	2E-12	7E-11
⁴⁰ K	NC	NC	NC	1E-07	9E-10	3E-09
⁴² K	NC	NC	NC	1E-08	2E-09	9E-10
⁴⁵ Ca	NC	NC	NC	7E-08	1E-13	2E-11
⁴⁶ Sc	NC	NC	NC	3E-07	1E-08	4E-08
⁴⁴ Ti + ⁴⁴ Sc	NC	NC	NC	1E-05	1E-08	5E-08
⁴⁸ V	NC	NC	NC	1E-07	2E-08	5E-08
⁵¹ Cr	7E-10	1E-08	NC	3E-09	2E-10	6E-10
⁵⁴ Mn	3E-08	9E-08	NC	7E-08	5E-09	2E-08
⁵⁶ Mn	NC	NC	NC	4E-09	1E-08	1E-09
⁵⁵ Fe	6E-10	1E-08	NC	3E-08	0	7E-12
⁵⁹ Fe	4E-08	3E-07	NC	1E-07	7E-09	2E-08
⁵⁸ Co	1E-08	2E-07	NC	1E-07	5E-09	2E-08
⁶⁰ Co	3E-08	5E-07	NC	2E-06	1E-08	5E-08
⁶³ Ni	1E-09	3E-08	NC	3E-08	0	8E-12
⁶⁴ Cu	NC	NC	NC	3E-09	1E-09	7E-10
⁶⁵ Zn	2E-08	9E-08	NC	2E-07	3E-09	1E-08
⁶⁸ Ga	NC	8E-09	NC	1E-09	5E-09	3E-10
⁶⁸ Ge + ⁶⁸ Ga	NC	8E-09	NC	5E-07	5E-09	2E-08
⁷⁵ Se	2E-08	8E-08	NC	9E-08	2E-09	7E-09

Table F-5. Release conversion factor, RCF, in mrem/ μ Ci,
at 1 mile downwind for 1- μ Ci release (continued)

Isotope	Inhalation ^b				Air immersion ^c	Ground ^d
	Acute bone	Acute lung	Thyroid	CEDE		
⁸⁵ Kr	NC	NC	NC	NC	1E-11	5E-11
^{85m} Kr	NC	NC	NC	NC	8E-10	2E-10
⁸⁷ Kr	NC	NC	NC	NC	5E-09	3E-10
⁸⁸ Kr + ⁸⁸ Rb	NC	NC	NC	NC	2E-08	2E-09
⁸⁶ Rb	7E-08	1E-07	NC	7E-08	5E-10	2E-09
⁸⁷ Rb	NC	NC	NC	3E-08	2E-13	1E-11
⁸⁸ Rb	NC	NC	NC	8E-10	4E-09	5E-11
⁸⁹ Sr	9E-08	1E-06	NC	4E-07	9E-12	1E-10
⁹⁰ Sr	2E-07	2E-06	NC	1E-05	8E-13	3E-09
⁹¹ Sr	NC	NC	NC	2E-08	4E-09	2E-09
⁹⁰ Y	1E-08	3E-07	NC	9E-08	2E-11	8E-11
⁹¹ Y	5E-08	1E-06	NC	5E-07	3E-11	2E-10
^{91m} Y	NC	NC	NC	4E-10	3E-09	1E-10
⁹³ Zr	NC	NC	NC	3E-06	0	8E-10
⁹⁵ Zr	1E-07	4E-07	NC	2E-07	4E-09	1E-08
⁹⁴ Nb	NC	NC	NC	4E-06	9E-09	3E-08
⁹⁵ Nb	1E-08	1E-07	NC	6E-08	4E-09	1E-08
⁹⁹ Mo + ^{99m} Tc	1E-08	2E-07	NC	4E-08	1E-09	3E-09
⁹⁹ Tc	1E-09	2E-07	NC	8E-08	2E-13	2E-11
^{99m} Tc	1E-10	1E-09	NC	3E-10	7E-10	2E-10
¹⁰³ Ru	1E-08	3E-07	NC	9E-08	3E-09	9E-09
¹⁰⁵ Ru	NC	NC	NC	5E-09	4E-09	1E-09
¹⁰⁶ Ru + ¹⁰⁶ Rh	9E-08	3E-06	NC	5E-06	1E-09	5E-09
¹⁰⁶ Rh	NC	NC	NC	NC	1E-09	5E-13
^{110m} Ag	6E-08	5E-07	NC	8E-07	2E-08	5E-08
¹⁰⁹ Cd + ^{109m} Ag	NC	NC	NC	1E-06	5E-11	9E-10
^{113m} Cd	NC	NC	NC	2E-05	8E-13	4E-09
^{114m} In	NC	NC	NC	9E-07	5E-10	2E-09
¹¹³ Sn + ^{113m} In	NC	NC	NC	1E-07	1E-09	5E-09
¹²³ Sn	NC	NC	NC	3E-07	5E-11	2E-10
¹²⁶ Sn + ^{126m} Sb	NC	NC	NC	1E-06	3E-10	3E-08

Table F-5. Release conversion factor, RCF, in mrem/ μ Ci,
at 1 mile downwind for 1- μ Ci release (continued)

Isotope	Inhalation ^b				Air immersion ^c	Ground ^d
	Acute bone	Acute lung	Thyroid	CEDE		
¹²⁴ Sb	5E-08	8E-07	NC	3E-07	1E-08	3E-08
¹²⁶ Sb	NC	NC	NC	1E-07	2E-08	5E-08
^{126m} Sb	NC	NC	NC	3E-10	8E-09	1E-10
¹²⁷ Sb	NC	NC	NC	6E-08	4E-09	9E-09
¹²⁹ Sb	NC	NC	NC	6E-09	8E-09	2E-09
¹²⁷ Te	NC	NC	NC	3E-09	3E-11	1E-11
^{127m} Te	9E-08	6E-07	NC	2E-07	2E-11	3E-10
¹²⁹ Te	NC	NC	NC	9E-10	3E-10	2E-11
^{129m} Te	2E-07	1E-06	NC	2E-07	2E-10	8E-10
¹³¹ Te	NC	NC	1E-07	5E-09	2E-09	5E-11
^{131m} Te	9E-09	8E-08	1E-06	6E-08	8E-09	1E-08
¹³² Te	1E-08	5E-08	2E-06	1E-07	1E-09	3E-09
¹²⁵ I	6E-10	8E-09	8E-06	2E-07	6E-11	9E-10
¹²⁹ I	7E-10	8E-09	6E-05	2E-06	4E-11	9E-10
¹³¹ I	2E-09	2E-08	1E-05	3E-07	2E-09	6E-09
¹³² I	5E-10	1E-08	6E-08	4E-09	1E-08	1E-09
¹³³ I	1E-09	3E-08	2E-06	6E-08	3E-09	3E-09
¹³⁴ I	2E-10	5E-09	1E-08	1E-09	1E-08	6E-10
¹³⁵ I + ^{135m} Xe	8E-10	2E-08	3E-07	1E-08	1E-09	3E-09
^{131m} Xe	NC	NC	NC	NC	4E-11	4E-10
¹³³ Xe	NC	NC	NC	NC	2E-10	7E-10
^{133m} Xe	NC	NC	NC	NC	2E-10	4E-10
¹³⁵ Xe	NC	NC	NC	NC	1E-09	6E-10
^{135m} Xe	NC	NC	NC	NC	2E-09	3E-11
¹³⁸ Xe	NC	NC	NC	NC	6E-09	7E-11
¹³⁴ Cs	9E-08	1E-07	NC	5E-07	8E-09	3E-08
¹³⁵ Cs	8E-09	2E-08	NC	5E-08	6E-14	1E-11
¹³⁶ Cs	6E-08	7E-08	NC	7E-08	1E-08	4E-08
¹³⁷ Cs + ^{137m} Ba	5E-08	8E-08	NC	3E-07	3E-09	1E-08
¹³⁸ Cs	NC	NC	NC	1E-09	1E-08	3E-10
¹³³ Ba	NC	NC	NC	8E-08	2E-09	8E-09
^{137m} Ba	NC	NC	NC	NC	3E-09	7E-12
¹⁴⁰ Ba	4E-08	6E-08	NC	4E-08	1E-09	3E-09
¹⁴⁰ La	2E-08	2E-07	NC	5E-08	1E-08	2E-08
¹⁴¹ Ce	7E-09	3E-07	NC	9E-08	4E-10	1E-09
¹⁴⁴ Ce + ^{144m} Pr	5E-08	3E-06	NC	4E-06	1E-10	2E-09

Table F-5. Release conversion factor, RCF, in mrem/ μ Ci, at 1 mile downwind for 1- μ Ci release (continued)

Isotope	Inhalation ^b				Air immersion ^c	Ground ^d
	Acute bone	Acute lung	Thyroid	CEDE		
¹⁴⁴ Pr	NC	NC	NC	4E-10	2E-10	3E-12
^{144m} Pr	NC	NC	NC	NC	3E-11	4E-13
¹⁴⁵ Pm	NC	NC	NC	3E-07	8E-11	7E-10
¹⁴⁷ Pm	6E-09	1E-07	NC	4E-07	8E-14	1E-10
¹⁴⁷ Sm	NC	NC	NC	8E-04	0	2E-07
¹⁵¹ Sm	2E-09	4E-08	NC	3E-07	4E-15	8E-11
¹⁵² Eu	3E-08	4E-07	NC	2E-06	6E-09	2E-08
¹⁵⁴ Eu	4E-08	7E-07	NC	3E-06	7E-09	2E-08
¹⁵⁵ Eu	8E-09	1E-07	NC	4E-07	3E-10	1E-09
¹⁵³ Gd	NC	NC	NC	2E-07	4E-10	2E-09
¹⁶⁰ Tb	NC	NC	NC	3E-07	6E-09	2E-08
^{166m} Ho	NC	NC	NC	8E-06	9E-09	4E-08
¹⁷⁰ Tm	NC	NC	NC	3E-07	2E-11	2E-10
¹⁶⁹ Yb	2E-08	3E-07	NC	8E-08	1E-09	6E-09
¹⁷² Hf	NC	NC	NC	3E-06	5E-10	3E-09
¹⁸¹ Hf	NC	NC	NC	2E-07	3E-09	1E-08
¹⁸² Ta	NC	NC	NC	5E-07	7E-09	2E-08
¹⁸⁷ W	NC	NC	NC	6E-09	3E-09	3E-09
¹⁹² Ir	3E-08	6E-07	NC	3E-07	4E-09	2E-08
¹⁹⁸ Au	NC	NC	NC	3E-08	2E-09	5E-09
²⁰³ Hg	NC	NC	NC	7E-08	1E-09	4E-09
²⁰⁴ Tl	NC	NC	NC	2E-08	6E-12	3E-11
²¹⁰ Pb	1E-07	4E-08	NC	1E-04	6E-12	3E-08
²⁰⁷ Bi	NC	NC	NC	2E-07	8E-09	3E-08
²¹⁰ Bi	NC	NC	NC	2E-06	4E-12	4E-10
²¹⁰ Po	3E-06	1E-04	NC	9E-05	5E-14	2E-08
²²⁶ Ra	4E-07	1E-04	NC	9E-05	4E-11	2E-08
²²⁷ Ac	NC	NC	NC	7E-02	7E-13	2E-05
²²⁸ Ac	NC	NC	NC	3E-06	5E-09	2E-09

Table F-5. Release conversion factor, RCF, in mrem/ μ Ci, at 1 mile downwind for 1- μ Ci release (continued)

Isotope	Inhalation ^b				Air immersion ^c	Ground ^d
	Acute bone	Acute lung	Thyroid	CEDE		
²²⁷ Th	2E-05	3E-04	NC	2E-04	5E-10	4E-08
²²⁸ Th	4E-05	6E-04	NC	3E-03	1E-11	9E-07
²³⁰ Th	6E-06	1E-04	NC	3E-03	2E-12	8E-07
²³¹ Th	NC	NC	NC	9E-09	6E-11	1E-10
²³² Th	6E-06	1E-04	NC	2E-02	1E-12	4E-06
²³¹ Pa	4E-06	1E-04	NC	1E-02	2E-10	3E-06
²³³ Pa	NC	NC	NC	1E-07	1E-09	4E-09
U-dep&nat ^{f,g}	NC	1E-04	NC	1E-03	4E-13	3E-07
U-enric ^{f,g}	6E-07	1E-04	NC	1E-03	9E-13	3E-07
U-sol/UF ₆ ^{f,g,h}	6E-07	6E-06	NC	3E-05	9E-13	7E-09
²³² U _g	7E-07	1E-04	NC	7E-03	2E-12	2E-06
²³³ U _g	NC	NC	NC	1E-03	2E-12	3E-07
²³⁴ U _g	6E-07	1E-04	NC	1E-03	9E-13	3E-07
²³⁵ U _g	5E-07	1E-04	NC	1E-03	8E-10	3E-07
²³⁶ U _g	6E-07	1E-04	NC	1E-03	6E-13	3E-07
²³⁸ U _g	5E-07	1E-04	NC	1E-03	4E-13	3E-07
²³⁷ Np	4E-06	1E-04	NC	5E-03	1E-10	1E-06
²³⁹ Np	3E-09	9E-08	NC	3E-08	9E-10	2E-09
²³⁶ Pu	NC	NC	NC	1E-03	7E-13	4E-07
²³⁸ Pu	5E-06	1E-04	NC	4E-03	5E-13	1E-06
²³⁹ Pu	4E-06	1E-04	NC	4E-03	5E-13	1E-06
²⁴⁰ Pu	4E-06	1E-04	NC	4E-03	5E-13	1E-06
²⁴¹ Pu	9E-10	2E-08	NC	8E-05	8E-15	2E-08
²⁴² Pu	4E-06	1E-04	NC	4E-03	4E-13	1E-06
²⁴¹ Am	5E-06	1E-04	NC	4E-03	9E-11	1E-06
^{242m} Am	NC	NC	NC	4E-03	4E-12	1E-06
²⁴³ Am	5E-06	1E-04	NC	4E-03	2E-10	1E-06
²⁴² Cm	5E-06	1E-04	NC	2E-04	6E-13	4E-08
²⁴³ Cm	5E-06	1E-04	NC	3E-03	7E-10	8E-07
²⁴⁴ Cm	5E-06	1E-04	NC	2E-03	5E-13	6E-07
²⁴⁵ Cm	NC	NC	NC	5E-03	4E-10	1E-06
²⁵² Cf	NC	NC	NC	2E-03	6E-13	4E-07

^aRelease conversion factors (RCFs), when multiplied by the activity released (μCi), will give a dose estimate for a ground-level release with no rain at 1 mile downwind from the source. The RCFs assume that the exposed individual is at the center of the plume for the entire duration of the release. The daughters are included in all the inhalation doses and in the external doses where noted (e.g., $^{44}\text{Ti} + ^{44}\text{Sc}$). These RCFs should provide an upper bound of the dose from ground-level releases *not* involving rain and a range of stability classes and wind speeds. (The derivation of the RCFs is shown below.)

^bInhalation doses include daughters and are, as recommended by EPA, for an adult performing light activity. The RCFs are for the (1) organ dose [(D_T) for bone, lung, and thyroid] and (2) CEDE ($H_{E,50}$) from inhalation. Entries marked "NC" were not calculated.

^cThe air immersion dose equivalent is for a semi-infinite plume, thus maximizing the dose from cloudshine.

^dThe ground exposure is for the early phase and includes external dose equivalent from groundshine and CEDE from resuspension (non-arid area, $R_s = 1\text{E}-6$) from remaining on contaminated ground for 4 days. The groundshine doses were corrected for ground roughness.

^eCEDE from inhalation was doubled to account for skin absorption.

^fFor natural and depleted uranium, it is assumed all the release is ^{238}U , and for enriched uranium it is assumed all of the release is ^{234}U . The specific activity of natural and depleted uranium is dominated by the concentration of ^{238}U , and enriched uranium is dominated by the concentration of ^{234}U (because of its high specific activity). While releases of natural and enriched uranium will be composed principally of a mixture of ^{234}U , ^{235}U , and ^{238}U , the dose factors for ^{234}U , ^{235}U , and ^{238}U are within 10%, so it is reasonable to use a single dose factor.

^gCaution: For uranium, the chemical toxicity is always more important than the radiation dose.

^hInhalation dose for the soluble form of ^{234}U , which is the likely form in UF_6 .

Calculation of Release Conversion Factors

$$\text{RCF for acute bone marrow dose: } RCF(\text{bone}) = DCF_{ab} \times CF$$

$$\text{RCF for acute lung dose: } RCF(\text{lung}) = DCF_{al} \times CF$$

$$\text{RCF for thyroid dose: } RCF(\text{thyroid}) = DCF_{thy} \times CF$$

$$\text{RCF for CEDE dose: } RCF(\text{CEDE}) = DCF_{E,50} \times CF$$

$$\text{RCF for air immersion dose: } RCF(\text{air}) = DCF_a \times CF$$

RCF for ground exposure dose for early phase:

$$RCF(\text{early phase ground}) = DCF_{epg} \times GCF \times T_{ed}$$

where

CF = Conversion factor = $1.56\text{E}-7$ from $CF = (Q \times DF \times T_{rd})/\bar{U}$, based on Method F.3

DCF = Dose conversion factors from Tables F-6 and F-7

DF = Dilution factor = $5.4\text{E}-5 \text{ m}^{-2}$ for 1 mile from Table F-11

GCF = Ground concentration factor = $2.1\text{E}-8$ for 1 mile from Table F-11

Q = Release rate = $2.8\text{E}-4 \mu\text{Ci/s}$ ($1 \mu\text{Ci/h}$)

T_{ed} = Exposure duration = 100 h (4 days) for D_{EPg}

T_{rd} = Release duration = 1 h

\bar{U} = Average wind speed = 1.8 m/s (4 mph)

Table F-6. Early phase deposition and air immersion dose conversion factors

Isotope	External exposure rate from deposition ^{b,c} , ECF_{gi}	External EDE rate from deposition ^{b,d} , DCF_{gi}	4-day EDE from deposition ^{a,b} , DCF_{EPgi}		External EDE rate from air immersion ^{b,e} , DCF_{ai}
	$\left(\frac{\text{mR/h}}{\mu\text{Ci/m}^2}\right)$	$\left(\frac{\text{mrem/h}}{\mu\text{Ci/m}^2}\right)$	Non-arid resuspension ($R_s = 1\text{E}-6$) $\left(\frac{\text{mrem}}{\mu\text{Ci/m}^2}\right)$	Arid resuspension ($R_s = 1\text{E}-4$) $\left(\frac{\text{mrem}}{\mu\text{Ci/m}^2}\right)$	$\left(\frac{\text{mrem/h}}{\mu\text{Ci/m}^3}\right)$
³ H	0	0	1.5E-05	1.5E-03	4.4E-06
¹⁴ C	2.1E-07	1.5E-07	2.6E-04	2.5E-02	3.0E-06
²² Na	2.7E-02	2.0E-02	1.9E+00	2.0E+00	1.4E+00
²⁴ Na	4.7E-02	3.4E-02	7.2E-01	7.2E-01	2.9E+00
³² P	3.8E-05	2.7E-05	4.1E-03	1.7E-01	1.3E-03
³³ P	5.8E-07	4.2E-07	3.0E-04	2.6E-02	1.1E-05
³⁵ S	2.2E-07	1.6E-07	3.1E-04	2.9E-02	3.2E-06
³⁶ Cl	8.8E-06	6.3E-06	3.3E-03	2.6E-01	3.0E-04
⁴⁰ K	1.9E-03	1.4E-03	1.4E-01	2.8E-01	1.1E-01
⁴² K	3.5E-03	2.5E-03	4.4E-02	4.7E-02	1.9E-01
⁴⁵ Ca	6.0E-07	4.3E-07	8.3E-04	7.9E-02	1.1E-05
⁴⁶ Sc	2.5E-02	1.8E-02	1.8E+00	2.1E+00	1.3E+00
⁴⁴ Ti + ⁴⁴ Sc	2.9E-02	2.1E-02	2.2E+00	1.4E+01	1.5E+00
⁴⁸ V	3.6E-02	2.6E-02	2.4E+00	2.5E+00	1.9E+00
⁵¹ Cr	4.0E-04	2.9E-04	2.7E-02	3.1E-02	2.0E-02
⁵⁴ Mn	1.1E-02	7.6E-03	7.5E-01	8.3E-01	5.4E-01
⁵⁶ Mn	2.1E-02	1.5E-02	5.5E-02	5.5E-02	1.1E+00
⁵⁵ Fe	0	0	3.2E-04	3.2E-02	0
⁵⁹ Fe	1.5E-02	1.0E-02	1.0E+00	1.2E+00	7.9E-01
⁵⁸ Co	1.2E-02	8.9E-03	8.7E-01	9.9E-01	6.3E-01
⁶⁰ Co	3.1E-02	2.2E-02	2.2E+00	4.8E+00	1.7E+00
⁶³ Ni	0	0	3.7E-04	3.7E-02	0
⁶⁴ Cu	2.4E-03	1.7E-03	3.2E-02	3.2E-02	1.2E-01
⁶⁵ Zn	7.2E-03	5.2E-03	5.1E-01	7.5E-01	3.9E-01
⁶⁸ Ga	1.2E-02	8.8E-03	1.4E-02	1.4E-02	6.1E-01
⁶⁸ Ge + ⁶⁸ Ga	1.2E-02	8.8E-03	8.8E-01	1.5E+00	6.1E-01
⁷⁵ Se	4.9E-03	3.5E-03	3.5E-01	4.5E-01	2.5E-01
⁸⁵ Kr	3.4E-05	2.5E-05	2.5E-03	2.5E-03	1.6E-03
^{85m} Kr	2.0E-03	1.4E-03	9.1E-03	9.1E-03	9.9E-02
⁸⁷ Kr	9.6E-03	6.8E-03	1.2E-02	1.2E-02	5.5E-01
⁸⁸ Kr + ⁸⁸ Rb	3.0E-02	2.2E-02	8.9E-02	8.9E-02	1.8E+00
⁸⁶ Rb	1.2E-03	8.7E-04	8.1E-02	1.5E-01	6.4E-02
⁸⁷ Rb	1.1E-06	8.2E-07	4.7E-04	3.9E-02	2.4E-05
⁸⁸ Rb	7.8E-03	5.5E-03	2.4E-03	2.4E-03	4.5E-01

Table F-6. Early phase deposition and air immersion dose conversion factors (continued)

Isotope	External exposure rate	External EDE rate	4-day EDE from deposition ^{a,b} , DCF_{EPgi}		External EDE rate from air immersion ^{b,e} , DCF_{ai}
	from deposition ^{b,c} , ECF_{gi}	from deposition ^{b,d} , DCF_{gi}	Non-arid resuspension ($R_s = 1E-6$)	Arid resuspension ($R_s = 1E-4$)	
	($\frac{mR/h}{\mu Ci/m^2}$)	($\frac{mrem/h}{\mu Ci/m^2}$)	($\frac{mrem}{\mu Ci/m^2}$)	($\frac{mrem}{\mu Ci/m^2}$)	($\frac{mrem/h}{\mu Ci/m^2}$)
⁸⁹ Sr	3.0E-05	2.1E-05	6.9E-03	4.8E-01	1.0E-03
⁹⁰ Sr	3.7E-06	2.6E-06	1.6E-01	1.6E+01	1.0E-04
⁹¹ Sr	8.8E-03	6.3E-03	1.3E-01	1.3E-01	4.6E-01
⁹⁰ Y	6.9E-05	5.0E-05	3.6E-03	6.5E-02	2.5E-03
⁹¹ Y	7.5E-05	5.4E-05	1.1E-02	5.8E-01	3.5E-03
^{91m} Y	6.8E-03	4.9E-03	5.8E-03	5.8E-03	3.4E-01
⁹³ Zr	0	0	3.8E-02	3.8E+00	0
⁹⁵ Zr	9.4E-03	6.7E-03	6.6E-01	9.3E-01	4.8E-01
⁹⁴ Nb	2.0E-02	1.4E-02	1.5E+00	6.4E+00	1.0E+00
⁹⁵ Nb	9.8E-03	7.0E-03	6.7E-01	7.4E-01	5.0E-01
⁹⁹ Mo + ^{99m} Tc	3.5E-03	2.5E-03	1.6E-01	1.8E-01	1.8E-01
⁹⁹ Tc	1.0E-06	7.3E-07	1.1E-03	1.0E-01	2.2E-05
^{99m} Tc	1.6E-03	1.1E-03	9.8E-03	9.8E-03	7.8E-02
¹⁰³ Ru	6.0E-03	4.3E-03	4.2E-01	5.2E-01	3.0E-01
¹⁰⁵ Ru	1.0E-02	7.2E-03	4.6E-02	4.6E-02	5.1E-01
¹⁰⁶ Ru + ¹⁰⁶ Rh	2.8E-03	2.0E-03	2.5E-01	5.9E+00	1.4E-01
¹⁰⁶ Rh	2.8E-03	2.0E-03	2.4E-05	2.4E-05	1.4E-01
^{110m} Ag	3.5E-02	2.5E-02	2.5E+00	3.4E+00	1.8E+00
¹⁰⁹ Cd + ^{109m} Ag	4.2E-04	3.0E-04	4.4E-02	1.4E+00	6.5E-03
^{113m} Cd	3.4E-06	2.5E-06	1.8E-01	1.8E+01	9.2E-05
^{114m} In	1.2E-03	8.5E-04	9.3E-02	1.1E+00	5.6E-02
¹¹³ Sn + ^{113m} In	3.7E-03	2.6E-03	2.6E-01	3.8E-01	1.7E-01
¹²³ Sn	1.1E-04	7.8E-05	1.2E-02	3.9E-01	5.4E-03
¹²⁶ Sn + ^{126m} Sb	2.0E-02	4.1E-02	1.4E+00	2.6E+00	2.9E+00
¹²⁴ Sb	2.2E-02	1.6E-02	1.6E+00	1.8E+00	1.2E+00
¹²⁶ Sb	3.6E-02	2.6E-02	2.3E+00	2.4E+00	1.8E+00
^{126m} Sb	2.0E-02	1.4E-02	6.5E-03	6.5E-03	1.0E+00
¹²⁷ Sb	8.8E-03	6.3E-03	4.4E-01	4.9E-01	4.4E-01
¹²⁹ Sb	1.8E-02	1.3E-02	8.5E-02	8.5E-02	9.5E-01
¹²⁷ Te	6.8E-05	4.8E-05	6.6E-04	1.2E-03	3.2E-03
^{127m} Te	1.5E-04	1.1E-04	1.3E-02	2.6E-01	2.0E-03
¹²⁹ Te	7.8E-04	5.6E-04	9.4E-04	9.5E-04	3.7E-02
^{129m} Te	4.9E-04	9.1E-04	6.7E-02	3.3E-01	5.8E-02
¹³¹ Te	5.4E-03	3.8E-03	2.3E-03	2.3E-03	2.7E-01
^{131m} Te	1.8E-02	1.3E-02	5.5E-01	5.9E-01	9.3E-01
¹³² Te	3.0E-03	2.1E-03	1.4E+00	1.5E+00	1.4E-01

Table F-6. Early phase deposition and air immersion dose conversion factors (continued)

Isotope	External exposure rate from deposition ^{b,c} , ECF_{gi} ($\frac{\text{mR/h}}{\mu\text{Ci/m}^2}$)	External EDE rate from deposition ^{b,d} , DCF_{gi} ($\frac{\text{mrem/h}}{\mu\text{Ci/m}^2}$)	4-day EDE from deposition ^{a,b} , DCF_{EPgi}		External EDE rate from air immersion ^{b,e} , DCF_{ai} ($\frac{\text{mrem/h}}{\mu\text{Ci/m}^2}$)
			Non-arid resuspension ($R_s = 1\text{E}-6$)	Arid resuspension ($R_s = 1\text{E}-4$)	
			($\frac{\text{mrem}}{\mu\text{Ci/m}^2}$)	($\frac{\text{mrem}}{\mu\text{Ci/m}^2}$)	
¹²⁵ I	5.6E-04	4.0E-04	4.2E-02	3.2E-01	6.9E-03
¹²⁹ I	3.4E-04	2.4E-04	4.5E-02	2.1E+00	5.1E-03
¹³¹ I	4.9E-03	3.5E-03	3.0E-01	6.2E-01	2.4E-01
¹³² I	2.9E-02	2.1E-02	6.8E-02	6.8E-02	1.5E+00
¹³³ I	7.8E-03	5.6E-03	1.6E-01	1.8E-01	3.9E-01
¹³⁴ I	3.3E-02	2.4E-02	3.0E-02	3.0E-02	1.7E+00
¹³⁵ I + ^{135m} Xe	2.0E-02	1.4E-02	1.4E-01	1.4E-01	1.1E+00
^{131m} Xe	2.7E-04	1.9E-04	1.7E-02	1.7E-02	5.2E-03
¹³³ Xe	6.0E-04	4.3E-04	3.3E-02	3.3E-02	2.1E-02
^{133m} Xe	5.3E-04	3.8E-04	2.1E-02	2.1E-02	1.8E-02
¹³⁵ Xe	3.2E-03	2.3E-03	3.0E-02	3.0E-02	1.6E-01
^{135m} Xe	5.5E-03	4.0E-03	1.5E-03	1.5E-03	2.7E-01
¹³⁸ Xe	1.3E-02	9.6E-03	3.3E-03	3.3E-03	7.7E-01
¹³⁴ Cs	2.0E-02	1.4E-02	1.4E+00	2.0E+00	1.0E+00
¹³⁵ Cs	4.3E-07	3.1E-07	5.8E-04	5.5E-02	7.5E-06
¹³⁶ Cs	2.7E-02	1.9E-02	1.7E+00	1.8E+00	1.4E+00
¹³⁷ Cs + ^{137m} Ba	7.6E-03	5.5E-03	5.5E-01	9.3E-01	3.8E-01
¹³⁸ Cs	2.9E-02	2.0E-02	1.6E-02	1.6E-02	1.6E+00
¹³³ Ba	5.2E-03	3.7E-03	3.7E-01	4.6E-01	2.4E-01
^{137m} Ba	7.6E-03	5.5E-03	3.3E-04	3.3E-04	3.8E-01
¹⁴⁰ Ba	2.3E-03	1.7E-03	1.1E+00	1.1E+00	1.1E-01
¹⁴⁰ La	2.8E-02	2.0E-02	9.6E-01	9.9E-01	1.6E+00
¹⁴¹ Ce	9.6E-04	6.9E-04	6.7E-02	1.7E-01	4.6E-02
¹⁴⁴ Ce + ¹⁴⁴ Pr	7.4E-04	6.7E-04	9.7E-02	4.5E+00	4.1E-02
¹⁴⁴ Pr	4.9E-04	3.5E-04	1.5E-04	1.5E-04	2.6E-02
^{144m} Pr	1.7E-04	1.2E-04	2.1E-05	2.1E-05	3.7E-03
¹⁴⁵ Pm	4.3E-04	3.0E-04	3.4E-02	3.9E-01	9.4E-03
¹⁴⁷ Pm	4.4E-07	3.2E-07	4.7E-03	4.7E-01	9.2E-06
¹⁴⁷ Sm	0	0	9.0E+00	9.0E+02	0
¹⁵¹ Sm	6.6E-08	4.7E-08	3.6E-03	3.6E-01	4.8E-07
¹⁵² Eu	1.4E-02	1.0E-02	1.0E+00	3.7E+00	7.5E-01
¹⁵⁴ Eu	1.6E-02	1.1E-02	1.1E+00	4.5E+00	8.2E-01
¹⁵⁵ Eu	7.7E-04	5.5E-04	6.0E-02	5.5E-01	3.3E-02
¹⁵³ Gd	1.4E-03	9.9E-04	1.0E-01	3.8E-01	4.9E-02
¹⁶⁰ Tb	1.4E-02	1.0E-02	9.9E-01	1.3E+00	7.4E-01
^{166m} Ho	2.2E-02	1.6E-02	1.7E+00	1.1E+01	1.1E+00

Table F-6. Early phase deposition and air immersion dose conversion factors (continued)

Isotope	External exposure rate	External EDE rate	4-day EDE from deposition ^{a,b} , DCF_{EPgi}		External EDE rate from air immersion ^{b,e} , DCF_{ai}
	from deposition ^{b,c} , ECF_{gi}	from deposition ^{b,d} , DCF_{gi}	Non-arid resuspension ($R_s = 1E-6$)	Arid resuspension ($R_s = 1E-4$)	
	$\left(\frac{\text{mR/h}}{\mu\text{Ci/m}^2}\right)$	$\left(\frac{\text{mrem/h}}{\mu\text{Ci/m}^2}\right)$	$\left(\frac{\text{mrem}}{\mu\text{Ci/m}^2}\right)$	$\left(\frac{\text{mrem}}{\mu\text{Ci/m}^2}\right)$	$\left(\frac{\text{mrem/h}}{\mu\text{Ci/m}^3}\right)$
¹⁷⁰ Tm	7.7E-05	5.5E-05	8.6E-03	3.2E-01	3.0E-03
¹⁶⁹ Yb	4.0E-03	2.8E-03	2.7E-01	3.6E-01	1.7E-01
¹⁷² Hf	1.5E-03	1.1E-03	1.4E-01	3.9E+00	5.4E-02
¹⁸¹ Hf	7.1E-03	5.1E-03	4.9E-01	6.7E-01	3.5E-01
¹⁸² Ta	1.6E-02	1.1E-02	1.1E+00	1.7E+00	8.5E-01
¹⁸⁷ W	6.1E-03	4.4E-03	1.4E-01	1.4E-01	3.0E-01
¹⁹² Ir	1.0E-02	7.5E-03	7.4E-01	1.1E+00	5.2E-01
¹⁹⁸ Au	5.2E-03	3.7E-03	2.3E-01	2.5E-01	2.6E-01
²⁰³ Hg	3.0E-03	2.2E-03	2.1E-01	2.9E-01	1.5E-01
²⁰⁴ Tl	1.9E-05	1.4E-05	1.7E-03	3.0E-02	7.4E-04
²¹⁰ Pb	3.2E-05	2.3E-05	1.6E+00	1.6E+02	7.5E-04
²⁰⁷ Bi	1.9E-02	1.4E-02	1.4E+00	1.6E+00	1.0E+00
²¹⁰ Bi	1.4E-05	9.8E-06	1.9E-02	1.8E+00	4.4E-04
²¹⁰ Po	1.1E-07	7.7E-08	1.1E+00	1.1E+02	5.5E-06
²²⁶ Ra	8.4E-05	6.0E-05	1.4E+00	1.0E+02	4.2E-03
²²⁷ Ac	2.0E-06	1.5E-06	8.0E+02	8.0E+04	7.7E-05
²²⁸ Ac	1.2E-02	8.7E-03	8.0E-02	4.0E-01	6.4E-01
²²⁷ Th	1.4E-03	9.7E-04	1.9E+00	1.8E+02	6.5E-02
²²⁸ Th	3.1E-05	2.2E-05	4.1E+01	4.1E+03	1.2E-03
²³⁰ Th	9.8E-06	7.0E-06	3.9E+01	3.9E+03	2.3E-04
²³¹ Th	2.4E-04	1.7E-04	6.0E-03	9.5E-03	6.9E-03
²³² Th	7.2E-06	5.1E-06	2.0E+02	2.0E+04	1.2E-04
²³¹ Pa	5.3E-04	3.8E-04	1.5E+02	1.5E+04	2.3E-02
²³³ Pa	2.5E-03	1.8E-03	1.7E-01	2.8E-01	1.2E-01
²³² Uf	1.3E-05	9.4E-06	7.9E+01	7.9E+03	1.9E-04
²³³ Uf	9.3E-06	6.7E-06	1.6E+01	1.6E+03	2.2E-04
²³⁴ Uf	9.8E-06	7.0E-06	1.6E+01	1.6E+03	1.0E-04
²³⁵ Uf	1.9E-03	1.4E-03	1.5E+01	1.5E+03	9.6E-02
²³⁶ Uf	8.5E-06	6.1E-06	1.5E+01	1.5E+03	6.7E-05
²³⁸ Uf	7.2E-06	5.1E-06	1.4E+01	1.4E+03	4.5E-05
U-dep&nat ^{f,g}	7.2E-06	5.1E-06	1.4E+01	1.4E+03	4.5E-05
U-enrich ^{f,g}	9.8E-06	7.0E-06	1.6E+01	1.6E+03	1.0E-04
²³⁴ U-sol/UF ₆ ^{f,g,h}	9.8E-06	7.0E-06	3.2E-01	3.2E+01	1.0E-04

Table F-6. Early phase deposition and air immersion dose conversion factors (continued)

Isotope	External exposure rate from deposition ^{b,c} , ECF_{gi} ($\frac{\text{mR/h}}{\mu\text{Ci/m}^2}$)	External EDE rate from deposition ^{b,d} , DCF_{gi} ($\frac{\text{mrem/h}}{\mu\text{Ci/m}^2}$)	4-day EDE from deposition ^{a,b} , DCF_{EPgi}		External EDE rate from air immersion ^{b,e} , DCF_{ai} ($\frac{\text{mrem/h}}{\mu\text{Ci/m}^3}$)
			Non-arid resuspension ($R_s = 1\text{E}-6$)	Arid resuspension ($R_s = 1\text{E}-4$)	
			($\frac{\text{mrem}}{\mu\text{Ci/m}^2}$)	($\frac{\text{mrem}}{\mu\text{Ci/m}^2}$)	
²³⁷ Np	3.7E-04	2.7E-04	6.5E+01	6.5E+03	1.4E-02
²³⁹ Np	2.1E-03	1.5E-03	8.8E-02	1.0E-01	1.0E-01
²³⁶ Pu	1.3E-05	9.1E-06	1.7E+01	1.7E+03	8.4E-05
²³⁸ Pu	1.1E-05	7.8E-06	4.7E+01	4.7E+03	6.5E-05
²³⁹ Pu	4.8E-06	3.4E-06	5.1E+01	5.1E+03	5.6E-05
²⁴⁰ Pu	1.0E-05	7.5E-06	5.1E+01	5.1E+03	6.3E-05
²⁴¹ Pu	2.5E-08	1.8E-08	9.9E-01	9.9E+01	9.6E-07
²⁴² Pu	8.7E-06	6.2E-06	4.9E+01	4.9E+03	5.3E-05
²⁴¹ Am	3.6E-04	2.6E-04	5.3E+01	5.3E+03	1.1E-02
^{242m} Am	3.9E-05	2.8E-05	5.1E+01	5.1E+03	4.2E-04
²⁴³ Am	7.0E-04	5.0E-04	5.3E+01	5.3E+03	2.9E-02
²⁴² Cm	1.2E-05	8.9E-06	2.1E+00	2.1E+02	7.6E-05
²⁴³ Cm	1.6E-03	1.2E-03	3.7E+01	3.7E+03	7.8E-02
²⁴⁴ Cm	1.1E-05	8.2E-06	3.0E+01	3.0E+03	6.5E-05
²⁴⁵ Cm	1.1E-03	8.1E-04	5.5E+01	5.5E+03	5.3E-02
²⁵² Cf	9.4E-06	6.7E-06	1.9E+01	1.9E+03	6.7E-05

^aExternal dose equivalent from deposition and CEDE from inhaled resuspension from remaining on contaminated ground for 4 days. The dose is calculated for two different resuspension factors. Daughters are included in inhalation doses and in external doses as indicated.

^bExternal doses from deposition are corrected by a factor of 0.7 for ground roughness. Contribution of daughters is included in external doses where noted (e.g., ⁴⁴Ti + ⁴⁴Sc).

^cExposure rate at 1 m above ground from a 1- $\mu\text{Ci/m}^2$ deposition of given isotope.

^dEffective dose equivalent rate at 1 m above ground level from a 1- $\mu\text{Ci/m}^2$ deposition of given isotope.

^eEffective dose equivalent from immersion in a semi-infinite cloud of uniform given isotope concentration. Contribution of daughters included where indicated.

^fCaution: The chemical toxicity of uranium is more important in producing early health effects than radiation dose.

^gFor natural and depleted uranium it is assumed all the release is ²³⁸U, and for enriched uranium it is assumed all of the release is ²³⁴U. The activity of enriched uranium is dominated by the concentration of ²³⁴U (because of its high SpA). While releases of natural and enriched uranium will be composed principally of a mixture of ²³⁴U, ²³⁵U, and ²³⁸U, the dose factors are all within 10% so it is reasonable to use a single factor.

^hThe D (day) lung clearance class was used in estimating early-phase inhalation dose because the uranium in UF₆ is in a soluble form.

Calculation of Exposure and Dose Conversion Factors

Exposure conversion factor from groundshine:

$$ECF_g = DCECSD \times SiCF \times GRCF \times 1.4$$

(EDE is multiplied by 1.4 to estimate external exposure rate as recommended by EPA 400-R-92-001. Early phase assessment methods in the *FRMAC Assessment Manual* can be used to calculate ECF_g for other isotopes or for different assumptions.)

Dose conversion factor from groundshine: $DCF_g = DCECGS \times SiCF \times GRCF$

(Early phase assessment methods in the *FRMAC Assessment Manual* can be used to calculate DCF_g for other isotopes or for different assumptions.)

Dose conversion factor for early phase (4 days) from deposition:

$$DCF_{EPg} = DCF_g + CEDE \text{ (from resuspension)}$$

The *FRMAC Assessment Manual* contains a full description of how DCF_{EPg} is calculated and early phase assessment methods to calculate DCF_{EPg} for other isotopes or other resuspension factors.)

Dose conversion factor air: $DCF_a = DCAS \times SiCF$

(Early phase assessment methods in the *FRMAC Assessment Manual* can be used to calculate DCF_a for isotopes not listed or for different assumptions.)

where

$DCAS$ = dose coefficients for air immersion from EPA-402-R-93-081, Table III.1, pp. 51-73

$DCECGS$ = dose conversion for exposure to contaminated ground surface factor from EPA-402-R-93-081, Table III.3, pp. 93-109

$GRCF$ = ground roughness correction factor, 0.7

$SiCF$ = conversion factor from SI units, see below

$$SiCF = \frac{\text{Sv/s}}{\text{Bq/m}^2} \times \frac{3.6 \times 10^5 \text{ s}}{\text{h}} \times \frac{10^5 \text{ mrem}}{\text{Sv}} \times \frac{\text{Bq}}{2.7 \times 10^{-5} \text{ } \mu\text{Ci}} = \frac{1.33 \times 10^{13} \text{ mrem}}{\mu\text{Ci/m}^2}$$

Table F-7. Early phase inhalation dose conversion factors in (mrem/h)/($\mu\text{Ci}/\text{m}^3$)^a

Isotope	$DCF_{e,50i}$ ^b	DCF_{Ti}		
		Acute bone ^c	Acute lung ^c	Thyroid CDE ^d
³ H	1.53E-01 ^e	7.10E-02	7.10E-02	NC ^f
¹⁴ C	2.50E+00	1.02E+00	1.02E+00	NC
²² Na	9.19E+00	NC	NC	NC
²⁴ Na	1.45E+00	9.32E-01	5.33E+00	NC
³² P	1.86E+01	2.04E+01	9.77E+01	NC
³³ P	2.78E+00	NC	NC	NC
³⁵ S	2.97E+00	1.78E-01	1.07E+01	NC
³⁶ Cl	2.63E+01	NC	NC	NC
⁴⁰ K	1.48E+01	NC	NC	NC
⁴² K	1.63E+00	NC	NC	NC
⁴⁵ Ca	7.95E+00	NC	NC	NC
⁴⁶ Sc	3.56E+01	NC	NC	NC
⁴⁴ Ti	1.22E+03	NC	NC	NC
⁴⁸ V	1.23E+01	NC	NC	NC
⁵¹ Cr	4.01E-01	7.99E-02	1.33E+00	NC
⁵⁴ Mn	8.04E+00	3.42E+00	1.07E+01	NC
⁵⁶ Mn	4.53E-01	NC	NC	NC
⁵⁵ Fe	3.22E+00	7.10E-02	1.33E+00	NC
⁵⁹ Fe	1.78E+01	5.33E+00	3.51E+01	NC
⁵⁸ Co	1.31E+01	1.51E+00	2.00E+01	NC
⁶⁰ Co	2.62E+02	3.91E+00	5.77E+01	NC
⁶³ Ni	3.73E+00	1.38E-01	4.13E+00	NC
⁶⁴ Cu	3.32E-01	NC	NC	NC
⁶⁵ Zn	2.45E+01	2.09E+00	1.07E+01	NC
⁶⁸ Ga	1.66E-01	NC	9.32E-01	NC
⁶⁸ Ge	6.22E+01	NC	9.32E-01	NC
⁷⁵ Se	1.02E+01	2.26E+00	9.77E+00	NC

Table F-7. Early phase inhalation dose conversion factors
in (mrem/h)/($\mu\text{Ci}/\text{m}^3$) (continued)

Isotope	$DCF_{e,50i}^a$	DCF_T		
		Acute bone ^c	Acute lung ^c	Thyroid CDE ^d
⁸⁵ Kr	7.32E-04	7.32E-04	NC	NC
^{85m} Kr	4.68E-04	4.68E-04	NC	NC
⁸⁷ Kr	1.56E-03	1.56E-03	NC	NC
⁸⁸ Kr	3.72E-03	3.72E-03	NC	NC
⁸⁶ Rb	7.95E+00	7.99E+00	1.33E+01	NC
⁸⁷ Rb	3.88E+00	NC	NC	NC
⁸⁸ Rb	1.00E-01	NC	NC	NC
⁸⁹ Sr	4.97E+01	1.02E+01	1.38E+02	NC
⁹⁰ Sr	1.56E+03	2.09E+01	2.80E+02	NC
⁹¹ Sr	1.99E+00	2.76E-01	NC	NC
⁹⁰ Y	1.01E+01	1.25E+00	4.13E+01	NC
⁹¹ Y	5.86E+01	5.77E+00	1.47E+02	NC
^{91m} Y	4.36E-02	NC	NC	NC
⁹³ Zr	3.85E+02	NC	NC	NC
⁹⁵ Zr	2.80E+01	1.20E+01	4.17E+01	NC
⁹⁴ Nb	4.97E+02	NC	NC	NC
⁹⁵ Nb	6.97E+00	1.78E+00	1.78E+01	NC
⁹⁹ Mo	4.75E+00	1.69E+00	1.91E+01	NC
⁹⁹ Tc	9.99E+00	1.73E-01	2.44E+01	NC
^{99m} Tc	3.91E-02	1.38E-02	1.38E-01	NC
¹⁰³ Ru	1.07E+01	1.78E+00	3.06E+01	NC
¹⁰⁵ Ru	5.46E-01	NC	NC	NC
¹⁰⁶ Rh	NC	NC	NC	NC
¹⁰⁶ Ru	5.73E+02	1.02E+01	3.95E+02	NC
^{110m} Ag	9.63E+01	7.10E+00	5.77E+01	NC
¹⁰⁹ Cd	1.37E+02	NC	NC	NC
^{113m} Cd	1.83E+03	NC	NC	NC
^{114m} In	1.07E+02	NC	NC	NC
¹¹³ Sn	1.28E+01	NC	NC	NC
¹²³ Sn	3.90E+01	NC	NC	NC
¹²⁶ Sn	1.19E+02	NC	NC	NC

Table F-7. Early phase inhalation dose conversion factors
in (mrem/h)/($\mu\text{Ci}/\text{m}^3$) (continued)

Isotope	$DCF_{e,50i}^b$	DCF_T		
		Acute bone ^c	Acute lung ^c	Thyroid CDE ^d
¹²⁴ Sb	3.02E+01	5.77E+00	9.77E+01	NC
¹²⁶ Sb	1.41E+01	NC	NC	NC
^{126m} Sb	4.07E-02	NC	NC	NC
¹²⁷ Sb	7.24E+00	3.96E-01	NC	NC
¹²⁹ Sb	7.73E-01	5.52E-02	NC	NC
¹²⁷ Te	3.82E-01	4.68E-03	NC	NC
^{127m} Te	2.58E+01	1.07E+01	6.66E+01	NC
¹²⁹ Te	1.07E-01	1.33E-02	NC	NC
^{129m} Te	2.87E+01	1.82E+01	1.15E+02	NC
¹³¹ Te	5.73E-01	NC	NC	1.17E+01
^{131m} Te	7.68E+00	1.02E+00	9.77E+00	1.60E+02
¹³² Te	1.13E+01	1.24E+00	6.22E+00	2.79E+02
¹²⁵ I	2.90E+01	7.55E-02	4.44E-01	9.59E+02
¹²⁹ I	2.08E+02	8.44E-02	9.77E-01	6.93E+03
¹³¹ I	3.95E+01	2.40E-01	2.89E+00	1.30E+03
¹³² I	4.57E-01	6.22E-02	1.20E+00	7.73E+00
¹³³ I	7.02E+00	1.20E-01	3.64E+00	2.16E+02
¹³⁴ I	1.58E-01	2.71E-02	6.22E-01	1.28E+00
¹³⁵ I	1.47E+00	9.77E-02	1.95E+00	3.76E+01
^{131m} Xe	NC	NC	NC	NC
¹³³ Xe	1.92E-03	1.92E-03	NC	NC
^{133m} Xe	NC	NC	NC	NC
¹³⁵ Xe	2.52E-03	2.52E-03	NC	NC
^{135m} Xe	NC	NC	NC	NC
¹³⁸ Xe	NC	NC	NC	NC
¹³⁴ Cs	5.55E+01	1.02E+01	1.24E+01	NC
¹³⁵ Cs	5.46E+00	9.32E-01	1.82E+00	NC
¹³⁶ Cs	8.79E+00	6.66E+00	8.88E+00	NC
¹³⁷ Cs	3.83E+01	6.22E+00	9.77E+00	NC
¹³⁸ Cs	1.22E-01	NC	NC	NC
¹³³ Ba	9.37E+00	NC	NC	NC
^{137m} Ba	NC	NC	NC	NC
¹⁴⁰ Ba	4.48E+00	4.44E+00	7.10E+00	NC
¹⁴⁰ La	5.82E+00	2.04E+00	1.86E+01	NC
¹⁴¹ Ce	1.07E+01	8.44E-01	3.73E+01	NC
¹⁴⁴ Ce	4.48E+02	6.22E+00	3.60E+02	NC

Table F-7. Early phase inhalation dose conversion factors
in (mrem/h)/($\mu\text{Ci}/\text{m}^3$) (continued)

Isotope	$DCF_{e,50i}^b$	DCF_T		
		Acute bone ^c	Acute lung ^c	Thyroid CDE ^d
¹⁴⁴ Pr	5.19E-02	NC	NC	NC
^{144m} Pr	NC	NC	NC	NC
¹⁴⁵ Pm	3.65E+01	NC	NC	NC
¹⁴⁷ Pm	4.71E+01	6.66E-01	1.73E+01	NC
¹⁴⁷ Sm	8.97E+04	NC	NC	NC
¹⁵¹ Sm	3.60E+01	2.09E-01	4.88E+00	NC
¹⁵² Eu	2.65E+02	4.04E+00	4.88E+01	NC
¹⁵⁴ Eu	3.43E+02	5.33E+00	8.44E+01	NC
¹⁵⁵ Eu	4.97E+01	9.32E-01	1.64E+01	NC
¹⁵³ Gd	2.85E+01	NC	NC	NC
¹⁶⁰ Tb	3.00E+01	NC	NC	NC
^{166m} Ho	9.28E+02	NC	NC	NC
¹⁷⁰ Tm	3.16E+01	NC	NC	NC
¹⁶⁹ Yb	9.68E+00	2.22E+00	3.11E+01	NC
¹⁷² Hf	3.82E+02	NC	NC	NC
¹⁸¹ Hf	1.85E+01	NC	NC	NC
¹⁸² Ta	5.37E+01	NC	NC	NC
¹⁸⁷ W	7.41E-01	NC	NC	NC
¹⁹² Ir	3.38E+01	3.64E+00	6.66E+01	NC
¹⁹⁸ Au	3.94E+00	NC	NC	NC
²⁰³ Hg	8.79E+00	NC	NC	NC
²⁰⁴ Tl	2.89E+00	NC	NC	NC
²¹⁰ Pb	1.63E+04	1.33E+01	4.80E+00	NC
²⁰⁷ Bi	2.40E+01	NC	NC	NC
²¹⁰ Bi	2.35E+02	NC	NC	NC
²¹⁰ Po	1.13E+04	3.77E+02	1.20E+04	NC
²²⁶ Ra	1.03E+04	4.44E+01	1.15E+04	NC
²²⁷ Ac	8.04E+06	NC	NC	NC
²²⁸ Ac	3.70E+02	NC	NC	NC

Table F-7. Early phase inhalation dose conversion factors
in (mrem/h)/($\mu\text{Ci}/\text{m}^3$) (continued)

Isotope	$DCF_{e,50i}^b$	DCF_T		
		Acute bone ^c	Acute lung ^c	Thyroid CDE ^d
²²⁷ Th	1.94E+04	2.23E+03	3.70E+04	NC
²²⁸ Th	4.10E+05	4.45E+03	7.57E+04	NC
²³⁰ Th	3.91E+05	7.55E+02	1.33E+04	NC
²³¹ Th	1.05E+00	NC	NC	NC
²³² Th	1.97E+06	6.66E+02	1.15E+04	NC
²³¹ Pa	1.54E+06	4.89E+02	1.42E+04	NC
²³³ Pa	1.15E+01	NC	NC	NC
²³² U ^g	7.90E+05	8.01E+01	1.60E+04	NC
²³³ U ^g	1.63E+05	NC	NC	NC
²³⁴ U ^g	1.59E+05	7.11E+01	1.33E+04	NC
²³⁵ U ^g	1.47E+05	6.41E+01	1.25E+04	NC
²³⁶ U ^g	1.51E+05	6.67E+01	1.29E+04	NC
²³⁸ U ^g	1.42E+05	6.39E+01	1.21E+04	NC
U dep & nat ^{g,h}	1.42E+05	6.39E+01	1.21E+04	NC
U enrich ^{g,h}	1.59E+05	7.11E+01	1.33E+04	NC
²³⁴ U sol (UF ₆) ^{g,h,i}	3.20E+03	7.11E+01	6.7E+02	NC
²³⁷ Np	6.48E+05	4.90E+02	1.16E+04	NC
²³⁹ Np	3.01E+00	4.00E-01	1.07E+01	NC
²³⁶ Pu	1.74E+05	NC	NC	NC
²³⁸ Pu	4.71E+05	5.77E+02	1.55E+04	NC
²³⁹ Pu	5.15E+05	5.33E+02	1.47E+04	NC
²⁴⁰ Pu	5.15E+05	5.33E+02	1.47E+04	NC
²⁴¹ Pu	9.90E+03	1.07E-01	2.84E+00	NC
²⁴² Pu	4.93E+05	5.33E+02	1.38E+04	NC
²⁴¹ Am	5.33E+05	5.78E+02	1.33E+04	NC
^{242m} Am	5.11E+05	NC	NC	NC
²⁴³ Am	5.28E+05	5.81E+02	1.29E+04	NC
²⁴² Cm	2.07E+04	6.22E+02	1.38E+04	NC
²⁴³ Cm	3.69E+05	6.24E+02	1.42E+04	NC
²⁴⁴ Cm	2.97E+05	6.22E+02	1.42E+04	NC
²⁴⁵ Cm	5.46E+05	NC	NC	NC
²⁵² Cf	1.88E+05	1.15E+04	NC	NC

^aDose conversion factors are provided in terms of mrem acquired in 1 h breathing an air concentration of $1\mu\text{Ci}/\text{m}^3$. To arrive at these DCFs, the breathing rate of an adult performing light activity ($1.2\text{ m}^3/\text{h}$) was assumed. Contribution from daughters is included in all the inhalation doses. The lung class giving the highest dose was assumed except for UF_6 .

^bCommitted effective dose equivalent (CEDE) dose factor, $\text{DCF}_{e,50}$, is the committed dose equivalent for 50 years.

^cAbsorbed dose for 30 days after the isotope has been inhaled.

^dCommitted dose equivalent to thyroid from radioiodine.

^eCEDE dose factor from inhalation was doubled to account for skin absorption.

^fNot calculated.

^gCaution: For uranium, chemical toxicity is always more important than the dose for early health effects.

^hFor natural and depleted uranium it is assumed all the release is ^{238}U , and for enriched uranium it is assumed all of the release is ^{234}U . The specific activity of enriched uranium is dominated by the concentration of ^{234}U (because of its high SpA). While releases of natural and enriched uranium will be composed principally of a mixture of ^{234}U , ^{235}U , and ^{238}U , the dose factors are all within 10% so it is reasonable to use a single factor.

ⁱThe day lung clearance class (soluble) was assumed because the uranium in UF_6 is in a soluble form.

Calculation of Dose Conversion Factors

Committed dose equivalent conversion factor: $DCF_{e,50} = EDCF_{e,50} \times BR \times CF$

Acute bone marrow dose conversion factor:

$$DCF_T(\text{bone}) = [ABM-AD_{(H)} \times QF + ABM-AD_{(L)}] \times BR \times CF$$

Acute lung dose conversion factor:

$$DCF_T(\text{lung}) = [AL-AD_{(H)} \times QF + AL-AD_{(L)}] \times BR \times CF$$

Thyroid committed dose equivalent: $DCF_T(\text{thyroid}) = EDCF_T \times BR \times CF$

where

$ABM-AD$ = Acute bone marrow absorbed dose (high or low LET) in Gy/Bq (adult, 30 day) from NRPB-R162, Table A:4, p. 40. Most conservative lung clearance class was used.

$AL-AD$ = Acute lung absorbed dose (high or low LET) in Gy/Bq (adult, 30 day) from NRPB-R162, Table A:5, p. 43. Most conservative lung clearance class was used.

BR = Breathing rate for an adult performing light activity, $0.020 \text{ m}^3/\text{min} \times 60 \text{ min/h} = 1.2 \text{ m}^3/\text{h}$, from EPA 520/1-88-020, p. 10. This breathing rate overestimates the average daily rate (see Table 3.10).

$EDCF_{e,50}$ = Exposure to committed effective dose equivalent conversion factor, from EPA-520/1-88-020, Table 2.1, "effective" column, pp. 121-153.

$EDCF_T$ = Exposure to committed dose equivalent conversion factor for thyroid, from EPA-520/1-88-020, Table 2.1, "thyroid" column, pp. 121-153.

QF = Quality factor. The dose equivalent was computed using a quality factor of 10 to better represent the acute dose.

CF = Conversion factor for units, given below.

$$\frac{\text{Sv}}{\text{Bq}} \times \frac{10^5 \text{ mrem}}{\text{Sv}} \times \frac{\text{Bq}}{2.7 \times 10^{-5} \mu\text{Ci}} = \frac{3.7 \times 10^9 \text{ mrem}}{\mu\text{Ci}/\text{m}^2}$$

Early phase assessment methods in the *FRMAC Assessment Manual* can be used to calculate DCFs for isotopes not listed or for different assumptions.

Table F-8. Stability class description and relationship to standard deviation of wind direction and lapse rate

Class ^a	Description	Standard deviation of horizontal wind direction, σ_θ , at 10 m	Lapse rate, Δt ($\frac{^\circ\text{C}}{100 \text{ m}}$)
A	Extremely unstable conditions	25°	< -0.19
B	Moderately unstable conditions	20°	-1.9 to -1.7
C	Slightly unstable conditions	15°	-1.7 to -1.5
D	Neutral conditions	10°	-1.5 to -0.5
E	Slightly stable conditions	5°	-0.5 to 1.5
F	Moderately stable conditions	2.5°	1.5 to 4.0

^aPasquill turbulence types.

Source: DOE/TIC-27601, p. 591.

Table F-9. Relationship of stability class to weather conditions

Surface wind speed (m/s)	Daytime insolation (solar radiation)			Nighttime conditions ^a		Day or night
	Strong	Moderate	Slight	Thin overcast or >4/8 cloudiness	≤3/8 cloudiness	Heavy overcast
<2	A	A-B	B	—	—	D
2	A-B	B	C	E	F	D
4	B	B-C	C	D	E	D
6	C	C-D	D	D	D	D
>6	C	D	D	D	D	D

^aThe degree of cloudiness is defined as that fraction of the sky above the local apparent horizon that is covered by clouds.

Source: DOE/TIC-27601, p. 591.

Table F-10. Dilution factors, $(\chi\bar{U})/Q$, in m^{-2}

Distance ^b (mile)	Stability class ^a					
	A	B	C	D	E	F
≤0.25 ^c	1.0E-3	1.0E-3	1.0E-3	1.0E-3	1.0E-3	1.0E-3
1	1.0E-6	6.0E-6	1.7E-5	5.4E-5	1.1E-4	2.5E-4
2	7.0E-7	1.5E-6	5.0E-6	2.0E-5	4.0E-5	1.0E-4
3	4.5E-7	6.5E-7	2.2E-6	1.2E-5	2.5E-5	6.0E-5
4	3.5E-7	4.5E-7	1.2E-6	8.0E-6	1.6E-5	4.0E-5
5	3.0E-7	4.0E-7	9.5E-7	5.0E-6	1.1E-5	3.0E-5
10	1.7E-7	2.2E-7	3.0E-7	2.0E-6	5.0E-6	1.2E-5
15	1.2E-7	1.5E-7	2.0E-7	1.0E-6	2.6E-6	7.0E-6
20	9.5E-8	1.1E-7	1.7E-7	7.0E-7	2.0E-6	5.0E-6
25	8.0E-8	9.0E-8	1.3E-7	4.5E-7	1.4E-6	4.0E-6

^aPasquill turbulence types. Dilution factors are for center line of ground-level release at a vertical dispersion limit of 1000 m.

^bDistance downwind of source on center line of plume.

^cThese factors are dominated by building wake; in this table they are assumed to be constant and independent of stability class.

Sources: Values for 0.25 mi are based on interpretation of NUREG/CR-5055, Figs. 5-7, pp. 25-27; others, AP-26, Figs. 3-5a-3-5f.

Table F-11. Ground concentration factors

Distance (mile)	Ground concentration factor ^a , <i>GCF</i> (m^{-2})
0.25 ^b	3.9E-08
1.0	2.1E-08
2.0	1.4E-08
5.0	6.3E-09
10.0	2.8E-09

^aGCFs provide an estimate of the activity deposited as a function of distance from a ground-level release ($\mu\text{Ci}/m^2$ per μCi released). Factors were based on RASCAL calculations and consider building wake effects. Average meteorological conditions (D stability) were assumed. The deposition velocity assumed was 0.3 cm/s. This is considered reasonable for dry deposition for most depositing isotopes. A higher deposition velocity is often assumed for iodine, but for most accidents the majority of the iodine is assumed to be bound to a particle so the 0.3-cm/s deposition velocity should provide a reasonable estimate for iodine also.

^b $GCF(0.25 \text{ mile}) = GCF(1 \text{ mile}) \times [DF(0.25 \text{ mile})/DF(1 \text{ mile})]$ where DF is dilution factor from Table F-10.

**Table F-12. Point source dose rate and exposure rate factors
at 1 m from source**

Isotope	Exposure conversion rate factor, ECF_p $\left(\frac{\text{mR/h}}{\mu\text{Ci}}\right)$	Effective dose equiv. rate conversion factor, DCF_p $\left(\frac{\text{mrem/h}}{\mu\text{Ci}}\right)$	Bone dose equiv. rate conversion factor, DCF_{pab} $\left(\frac{\text{mrem/h}}{\mu\text{Ci}}\right)$
^3H	0	0	0
^{14}C	0	0	0
^{22}Na	1E-03	8E-04	7E-04
^{24}Na	2E-03	1E-03	1E-03
^{32}P	0	0	0
^{33}P	0	0	0
^{35}S	0	0	0
^{36}Cl	8E-08	1E-09	2E-11
^{40}K	8E-05	6E-05	5E-05
^{42}K	1E-04	1E-04	9E-05
^{45}Ca	2E-11	3E-13	6E-15
^{46}Sc	1E-03	8E-04	7E-04
^{44}Ti	1E-04	4E-05	2E-05
^{48}V	2E-03	1E-03	1E-03
^{51}Cr	7E-05	1E-05	1E-05
^{54}Mn	6E-04	3E-04	3E-04
^{56}Mn	9E-04	6E-04	6E-04
^{55}Fe	8E-05	1E-06	2E-08
^{59}Fe	7E-04	4E-04	4E-04
^{58}Co	6E-04	4E-04	3E-04
^{60}Co	1E-03	9E-04	8E-04
^{63}Ni	0	0	0
^{64}Cu	2E-04	7E-05	6E-05
^{65}Zn	5E-04	2E-04	2E-04
^{68}Ga	6E-04	4E-04	3E-04

Table F-12. Point source dose rate and exposure rate factors
at 1 m from source (continued)

Isotope	Exposure conversion rate factor, ECF_p $\left(\frac{\text{mR/h}}{\mu\text{Ci}}\right)$	Effective dose equiv. rate conversion factor, DCF_p $\left(\frac{\text{mrem/h}}{\mu\text{Ci}}\right)$	Bone dose equiv. rate conversion factor, DCF_{pab} $\left(\frac{\text{mrem/h}}{\mu\text{Ci}}\right)$
$^{68}\text{Ge} + ^{68}\text{Ga}$	8E-04	4E-04	3E-04
^{75}Se	5E-04	1E-04	1E-04
^{85}Kr	1E-06	8E-07	8E-07
$^{85\text{m}}\text{Kr}$	1E-04	6E-05	4E-05
^{87}Kr	4E-04	3E-04	3E-04
$^{88}\text{Kr} + ^{88}\text{Rb}$	1E-03	9E-04	7E-04
^{86}Rb	5E-05	4E-05	3E-05
^{87}Rb	0	0	0
^{88}Rb	2E-04	2E-04	2E-04
^{89}Sr	8E-08	5E-08	5E-08
^{90}Sr	0	0	0
^{91}Sr	4E-04	3E-04	2E-04
^{90}Y	0	0	0
^{91}Y	2E-06	1E-06	1E-06
$^{91\text{m}}\text{Y}$	3E-04	2E-04	2E-04
^{93}Zr	0	0	0
^{95}Zr	4E-04	3E-04	3E-04
^{94}Nb	9E-04	6E-04	5E-04
^{95}Nb	4E-04	3E-04	3E-04
^{99}Mo	1E-04	6E-05	5E-05
^{99}Tc	2E-10	2E-10	9E-11
$^{99\text{m}}\text{Tc}$	8E-05	4E-05	3E-05
^{103}Rh	1E-04	8E-05	7E-05
^{103}Ru	3E-04	2E-04	2E-04
^{105}Ru	5E-04	3E-04	3E-04
^{106}Ru	3E-05	5E-06	1E-06
$^{106}\text{Ru} + ^{106}\text{Rh}$	3E-05	5E-06	1E-06
$^{110\text{m}}\text{Ag}$	2E-03	1E-03	9E-04

Table F-12. Point source dose rate and exposure rate factors
at 1 m from source (continued)

Isotope	Exposure conversion rate factor, ECF_p $\left(\frac{\text{mR/h}}{\mu\text{Ci}}\right)$	Effective dose equiv. rate conversion factor, DCF_p $\left(\frac{\text{mrem/h}}{\mu\text{Ci}}\right)$	Bone dose equiv. rate conversion factor, DCF_{pab} $\left(\frac{\text{mrem/h}}{\mu\text{Ci}}\right)$
$^{109}\text{Cd} + ^{109m}\text{Ag}$	1E-03	6E-04	5E-04
^{113m}Cd	0	0	0
^{114m}In	1E-04	4E-05	3E-05
^{113}Sn	2E-04	1E-05	3E-06
^{123}Sn	4E-06	3E-06	2E-06
$^{126}\text{Sn} + ^{126m}\text{Sb}$	8E-05	2E-05	1E-05
^{124}Sb	1E-03	7E-04	6E-04
^{126}Sb	2E-03	1E-03	9E-04
^{126m}Sb	3E-06	2E-06	2E-06
^{127}Sb	4E-04	3E-04	2E-04
^{129}Sb	8E-04	5E-04	5E-04
^{127}Te	4E-05	2E-05	2E-05
^{127m}Te	4E-05	6E-06	1E-06
^{129}Te	2E-04	2E-04	1E-04
$^{129m}\text{Te} + ^{129}\text{Te}$	3E-04	2E-04	1E-04
^{131}Te	3E-04	2E-04	1E-04
^{131m}Te	8E-04	5E-04	5E-04
^{132}Te	2E-04	8E-05	6E-05
^{125}I	1E-04	2E-05	4E-06
^{129}I	8E-05	1E-05	2E-06
^{131}I	2E-04	1E-04	1E-04
^{132}I	1E-03	9E-04	8E-04
^{133}I	4E-04	2E-04	2E-04
^{134}I	2E-03	1E-03	9E-04
$^{135}\text{I} + ^{135}\text{Xe}$	2E-03	1E-03	1E-03
^{131m}Xe	6E-05	1E-05	2E-06
^{133}Xe	7E-05	2E-05	6E-06
^{133m}Xe	8E-05	2E-05	9E-06
^{135}Xe	1E-04	9E-05	7E-05
^{138}Xe	6E-04	4E-04	4E-04

Table F-12. Point source dose rate and exposure rate factors
at 1 m from source (continued)

Isotope	Exposure conversion rate factor, ECF_p $\left(\frac{\text{mR/h}}{\mu\text{Ci}}\right)$	Effective dose equiv. rate conversion factor, DCF_p $\left(\frac{\text{mrem/h}}{\mu\text{Ci}}\right)$	Bone dose equiv. rate conversion factor, DCF_{pab} $\left(\frac{\text{mrem/h}}{\mu\text{Ci}}\right)$
^{134}Cs	9E-04	6E-04	5E-04
^{136}Cs	1E-03	8E-04	7E-04
$^{137}\text{Cs} + ^{137m}\text{Ba}$	4E-04	2E-04	2E-04
^{138}Cs	2E-05	1E-05	1E-05
^{133}Ba	3E-04	2E-04	1E-04
^{137m}Ba	4E-04	2E-04	2E-04
^{140}Ba	2E-04	7E-05	6E-05
^{140}La	1E-03	9E-04	8E-04
^{141}Ce	5E-05	3E-05	2E-05
$^{144}\text{Ce} + ^{144}\text{Pr}$	4E-05	1E-05	6E-06
^{144m}Pr	1E-04	1E-05	3E-06
^{144}Pr	2E-05	5E-06	1E-06
^{145}Pm	7E-05	1E-05	3E-06
^{147}Pm	2E-09	1E-09	7E-10
^{151}Sm	4E-07	8E-09	4E-10
^{152}Eu	7E-04	4E-04	4E-04
^{154}Eu	7E-04	5E-04	4E-04
^{155}Eu	6E-05	2E-05	1E-05
^{153}Gd	2E-04	4E-05	2E-05
^{160}Tb	7E-04	4E-04	4E-04
^{166m}Ho	1E-03	6E-04	5E-04
^{170}Tm	2E-05	2E-06	7E-07
^{169}Yb	4E-04	1E-04	7E-05
^{172}Hf	2E-04	8E-05	7E-05
^{181}Hf	4E-04	2E-04	2E-04
^{182}Ta	8E-04	5E-04	4E-04
^{187}W	3E-04	2E-04	2E-04
^{192}Ir	5E-04	3E-04	3E-04

**Table F-12. Point source dose rate and exposure rate factors
at 1 m from source (continued)**

Isotope	Exposure conversion rate factor, ECF_p $\left(\frac{\text{mR/h}}{\mu\text{Ci}}\right)$	Effective dose equiv. rate conversion factor, DCF_p $\left(\frac{\text{mrem/h}}{\mu\text{Ci}}\right)$	Bone dose equiv. rate conversion factor, DCF_{pob} $\left(\frac{\text{mrem/h}}{\mu\text{Ci}}\right)$
^{198}Au	2E-04	2E-04	1E-04
^{203}Hg	2E-04	8E-05	7E-05
^{204}Ti	4E-06	4E-07	2E-07
^{210}Pb	1E-04	3E-06	3E-07
^{207}Bi	1E-03	6E-04	5E-04
^{210}Bi	0	0	0
^{210}Po	5E-09	3E-09	3E-09
^{226}Ra	8E-06	2E-06	2E-06
^{227}Ac	8E-06	1E-07	2E-08
^{228}Ac	8E-04	4E-04	3E-04
^{227}Th	3E-04	4E-05	3E-05
^{228}Th	6E-05	1E-06	4E-07
^{230}Th	5E-05	9E-07	8E-08
^{231}Th	3E-05	9E-07	6E-08
^{232}Th	5E-05	8E-07	4E-08
^{231}Pa	3E-04	2E-05	9E-06
^{233}Pa	2E-04	6E-05	5E-05
U-dep & nat ^a	6E-05	8E-07	2E-08
U-enrich ^a	7E-05	1E-06	4E-08
^{232}U	8E-05	1E-06	6E-08
^{233}U	3E-05	4E-07	5E-08
^{234}U	7E-05	1E-06	4E-08
^{235}U	3E-04	5E-05	4E-05
^{236}U	0	0	0
^{238}U	6E-05	8E-07	2E-08
^{237}Np	2E-04	1E-05	5E-06
^{239}Np	0	0	0

Table F-12. Point source dose rate and exposure rate factors at 1 m from source (continued)

Isotope	Exposure conversion rate factor, ECF_p $\left(\frac{\text{mR/h}}{\mu\text{Ci}}\right)$	Effective dose equiv. rate conversion factor, DCF_p $\left(\frac{\text{mrem/h}}{\mu\text{Ci}}\right)$	Bone dose equiv. rate conversion factor, DCF_{pob} $\left(\frac{\text{mrem/h}}{\mu\text{Ci}}\right)$
^{236}Pu	4E-05	1E-06	7E-08
^{238}Pu	3E-05	1E-06	6E-08
^{239}Pu	1E-05	4E-07	3E-08
^{240}Pu	3E-05	1E-06	6E-08
^{241}Pu	0	0	0
^{242}Pu	3E-05	9E-07	5E-08
^{241}Am	1E-04	1E-05	3E-06
^{242}Am	9E-05	3E-06	2E-07
^{243}Am	1E-04	2E-05	8E-06
^{242}Cm	3E-05	1E-06	6E-08
^{243}Cm	2E-04	5E-05	3E-05
^{244}Cm	3E-05	1E-06	5E-08

^aFor natural and depleted uranium it is assumed all the material is ^{238}U , and for enriched uranium it is assumed all of the material is ^{234}U . The specific activity of enriched uranium is dominated by the concentration of ^{234}U (because of its high SpA). While releases from natural and enriched uranium will be composed principally of a mixture of ^{234}U , ^{235}U , and ^{238}U , the dose factors are all within 10% so it is reasonable to use a single factor.

Source: Calculated using CONDOS II program at 1 m with no shielding.

Table F-13. Half-value layer for selected materials

Isotope	Half-value layer ^a , HVL (cm)					
	Lead ^b	Iron ^b	Aluminum ^b	Water ^b	Air ^c	Concrete ^b
³ H	0	0	0	0	0	0
¹⁴ C	0	0	0	0	0	0
²² Na	0.67	1.38	3.85	9.4	7,940	4.35
²⁴ Na	1.32	2.14	6.22	14.75	12,678	6.88
³² P	0	0	0	0	0	0
³³ P	0	0	0	0	0	0
³⁵ S	0	0	0	0	0	0
³⁶ Cl	0	0.01	0.02	0.04	39	0.02
⁴⁰ K	1.15	1.8	4.99	11.97	10,192	5.63
⁴² K	1.18	1.84	5.1	12.21	10,414	5.75
⁴⁵ Ca	0.01	0.03	0.1	0.24	212	0.11
⁴⁶ Sc	0.82	1.48	4.2	9.84	8,472	4.66
⁴⁴ Ti	0.04	0.21	0.6	1.41	1,247	0.67
⁴⁸ V	0.8	1.48	4.18	9.95	8,503	4.67
⁵¹ Cr	0.17	0.82	2.38	5.69	4,980	2.68
⁵⁴ Mn	0.68	1.33	3.8	9	7,703	4.22
⁵⁶ Mn	0.94	1.65	4.78	11.13	9,664	5.27
⁵⁵ Fe	0	0.02	0.05	0.12	102	0.05
⁵⁹ Fe	0.94	1.59	4.51	10.58	9,097	5.02
⁶⁰ Co	1	1.66	4.65	10.99	9,421	5.2
⁶³ Ni	0	0	0	0	0	0
⁶⁴ Cu	0.41	1.08	3.01	7.61	6,320	3.43
⁶⁵ Zn	0.87	1.53	4.34	10.15	8,740	4.81
⁶⁸ Ga	0.42	1.09	3.04	7.67	6,376	3.47
⁶⁸ Ge + ⁶⁸ Ga ^d	0.42	1.09	3.04	7.67	6,376	3.47
⁶⁸ Ge	0.01	0.03	0.08	0.18	160	0.09
⁷⁵ Se	0.12	0.62	1.79	4.26	3,742	2.01

Table F-13. Half-value layer for selected materials (continued)

Isotope	Half-value layer ^a , HVL (cm)					
	Lead ^b	Iron ^b	Al ^b	Water ^b	Air ^c	Concrete ^b
⁸⁵ Kr	0.41	1.07	3	7.59	6,305	3.43
^{85m} Kr	0.1	0.5	1.46	3.46	3,046	1.64
⁸⁷ Kr	0.83	1.67	4.84	11.46	9,922	5.36
⁸⁸ Kr + ⁸⁸ Rb ^d	1.17	1.89	5.51	12.74	11,132	6.05
⁸⁸ Kr	1.20	1.95	5.71	13.2	11,575	6.25
⁸⁶ Rb	0.87	1.53	4.35	10.13	8,741	4.81
⁸⁸ Rb	1.17	1.89	5.51	12.74	11,132	6.05
⁸⁹ Sr	0.74	1.4	4	9.35	8,050	4.42
⁹⁰ Sr	0	0	0	0	0	0
⁹¹ Sr	0.71	1.38	3.94	9.31	7,980	4.38
⁹¹ Y	0.96	1.62	4.57	10.74	9,226	5.09
⁹³ Zr	0	0	0	0	0	0
⁹⁵ Zr	0.6	1.26	3.58	8.61	7,314	4
⁹⁴ Nb	0.64	1.30	3.70	8.84	7,538	4.13
⁹⁵ Nb	0.62	1.28	3.63	8.72	7,416	4.06
⁹⁹ Mo + ^{99m} Tc ^d	0.49	1.11	3.16	7.6	6,483	3.54
⁹⁹ Mo	0.49	1.11	3.16	7.6	6,483	3.54
⁹⁹ Tc	0.05	0.25	0.73	1.73	1,529	0.82
^{99m} Tc	0.07	0.39	1.13	2.68	2,367	1.27
¹⁰³ Ru	0.4	1.06	2.97	7.53	6,253	3.4
¹⁰⁵ Ru	0.48	1.16	3.28	7.98	6,774	3.69
¹⁰⁶ Ru	0	0	0	0	0	0
¹⁰⁶ Ru + ¹⁰⁶ Rh ^d	0.49	1.17	3.29	8.16	6,837	3.73
¹⁰⁶ Rh	0.49	1.17	3.29	8.16	6,837	3.73
^{110m} Ag	0.71	1.38	3.91	9.36	7,979	4.38
¹⁰⁹ Cd	0.01	0.06	0.18	0.43	380	0.2
^{113m} Cd	0	0	0	0	0	0
^{114m} In	0.23	0.75	2.14	5.18	4,447	2.41

Table F-13. Half-value layer for selected materials (continued)

Isotope	Half-value layer ^a , HVL (cm)					
	Lead ^b	Iron ^b	Al ^b	Water ^b	Air ^c	Concrete ^b
¹¹³ Sn	0.02	0.09	0.27	0.65	571	0.31
¹²³ Sn	0.88	1.53	4.36	10.16	8,767	4.83
¹²⁶ Sn + ^{126m} Sb ^d	0.48	1.15	3.27	7.99	6,755	3.68
¹²⁶ Sn	0.04	0.19	0.55	1.3	1,148	0.62
¹²⁴ Sb	0.83	1.55	4.39	10.49	8,979	4.9
¹²⁶ Sb	0.52	1.19	3.37	8.21	6,951	3.79
^{126m} Sb	0.48	1.15	3.27	7.99	6,755	3.68
¹²⁷ Sb	0.47	1.14	3.24	7.92	6,695	3.65
¹²⁹ Sb	0.72	1.4	3.98	9.45	8,092	4.43
^{127m} Te	0.01	0.08	0.23	0.54	476	0.26
¹²⁹ Te	0.33	0.93	2.63	6.53	5,504	2.99
^{129m} Te	0.38	0.82	2.33	5.65	4,785	2.61
^{131m} Te	0.65	1.31	3.74	8.88	7,612	4.17
¹³² Te	0.1	0.53	1.5	3.66	3,223	1.73
¹²⁵ I	0.01	0.08	0.23	0.54	477	0.26
¹²⁹ I	0.02	0.09	0.25	0.6	526	0.28
¹³¹ I	0.25	0.93	2.67	6.5	5,587	3.02
¹³² I	0.63	1.31	3.7	8.91	7,574	4.14
¹³³ I	0.47	1.15	3.23	8.05	6,735	3.67
¹³⁴ I	0.72	1.4	3.98	9.43	8,081	4.43
¹³⁵ I	0.98	1.66	4.7	11.06	9,526	5.23
¹³⁵ I + ^{135m} Xe ^d	0.98	1.66	4.7	11.06	9,526	5.23
^{131m} Xe	0.02	0.1	0.29	0.7	616	0.33
¹³³ Xe	0.03	0.16	0.47	1.11	980	0.53
^{133m} Xe	0.05	0.25	0.73	1.72	1,519	0.82
¹³⁵ Xe	0.14	0.72	2.1	4.99	4,380	2.36
^{135m} Xe	0.41	1.07	2.99	7.54	6,271	3.41
¹³⁸ Xe	0.9	1.64	4.79	11.09	9,723	5.26
¹³⁴ Cs	0.57	1.24	3.5	8.5	7,186	3.93
¹³⁶ Cs	0.65	1.32	3.76	8.86	7,623	4.18
¹³⁷ Cs	0	0	0	0	0	0
¹³⁷ Cs + ^{137m} Ba ^d	0.53	1.19	3.35	8.2	6,916	3.77

Table F-13. Half-value layer for selected materials (continued)

Isotope	Half-value layer ^a , HVL (cm)					
	Lead ^b	Iron ^b	Al ^b	Water ^b	Air ^c	Concrete ^b
¹³³ Ba	0.16	0.67	1.92	4.63	4,023	2.17
^{137m} Ba	0.53	1.19	3.35	8.2	6,916	3.77
¹⁴⁰ Ba	0.33	0.96	2.69	6.72	5,645	3.06
¹⁴⁰ La	0.93	1.64	4.63	11.04	9,468	5.19
¹⁴¹ Ce	0.07	0.37	1.07	2.52	2,225	1.2
¹⁴⁴ Ce + ^{144m} Pr ^d	0.05	0.28	0.82	1.95	1,722	0.93
¹⁴⁴ Pr						
^{144m} Pr	0.02	0.1	0.28	0.67	588	0.32
¹⁴⁵ Pm	0.02	0.11	0.31	0.74	656	0.35
¹⁴⁷ Pm	0.06	0.34	0.99	2.35	2,075	1.12
¹⁴⁷ Sm						
¹⁵¹ Sm	0.01	0.03	0.09	0.21	182	0.1
¹⁵² Eu	0.66	1.32	3.73	8.84	7,592	4.17
¹⁵⁴ Eu	0.74	1.38	3.91	9.24	7,924	4.35
¹⁵⁵ Eu	0.04	0.23	0.66	1.56	1,373	0.74
¹⁵³ Gd	0.03	0.18	0.51	1.21	1,065	0.57
¹⁶⁰ Tb	0.68	1.35	3.84	9.01	7,770	4.26
^{166m} Ho	0.45	1.09	3.1	7.46	6,374	3.48
¹⁷⁰ Tm	0.03	0.18	0.51	1.21	1,064	0.57
¹⁶⁹ Yb	0.06	0.3	0.87	2.05	1,808	0.97
¹⁸¹ Hf	0.27	0.86	2.41	6.02	5,074	2.75
¹⁸² Ta	0.8	1.39	3.94	9.26	7,972	4.39
¹⁸⁷ W	0.43	1.03	2.91	7.17	6,038	3.29
¹⁹² Ir	0.24	0.92	2.64	6.42	5,521	2.98
¹⁹⁸ Au	0.29	0.97	2.74	6.77	5,746	3.11
²⁰³ Hg	0.14	0.73	2.13	5.04	4,443	2.39

Table F-13. Half-value layer for selected materials (continued)

Isotope	Half-value layer ^a , HVL (cm)					
	Lead ^b	Iron ^b	Al ^b	Water ^b	Air ^c	Concrete ^b
²⁰⁴ Tl	0.03	0.18	0.53	1.27	1,117	0.6
²¹⁰ Pb	0.01	0.05	0.15	0.35	311	0.17
²⁰⁷ Bi	0.65	1.3	3.68	8.79	7,503	4.11
²¹⁰ Bi	0	0	0	0	0	0
²¹⁰ Po	0.65	1.31	3.73	8.88	7,581	4.15
²²⁶ Ra	0.09	0.48	1.4	3.32	2,930	1.58
²²⁷ Ac	0.01	0.08	0.22	0.52	457	0.25
²²⁸ Ac	0.67	1.35	3.84	9.05	7,786	4.27
²²⁷ Th	0.11	0.58	1.69	4.01	3,525	1.9
²²⁸ Th	0.02	0.13	0.37	0.88	773	0.42
²³⁰ Th	0.01	0.05	0.14	0.34	302	0.16
²³² Th	0.01	0.04	0.12	0.28	248	0.13
²³¹ Pa	0.09	0.46	1.35	3.2	2,816	1.51
²³² U	0.01	0.04	0.12	0.29	259	0.14
²³³ U	0.01	0.06	0.16	0.39	344	0.18
²³⁴ U	0.01	0.04	0.12	0.28	242	0.13
²³⁵ U	0.09	0.46	1.35	3.19	2,814	1.51
²³⁸ U	0.01	0.04	0.11	0.27	236	0.13
²³⁷ Np	0.03	0.12	0.41	0.98	862	0.46
²³⁶ Pu	0.01	0.04	0.11	0.27	239	0.13
²³⁸ Pu	0.01	0.04	0.11	0.27	237	0.13
²³⁹ Pu	0.01	0.04	0.12	0.29	258	0.14
²⁴⁰ Pu	0.01	0.04	0.11	0.27	237	0.13
²⁴¹ Pu	0	0	0	0	0	0
²⁴² Pu	0.01	0.04	0.11	0.27	237	0.13
²⁴¹ Am	0.02	0.12	0.35	0.82	727	0.39
^{242m} Am	0.01	0.04	0.13	0.3	267	0.14
²⁴³ Am	0.03	0.18	0.52	1.24	1,090	0.59

Table F-13. Half-value layer for selected materials (continued)

Isotope	Half-value layer ^a , HVL (cm)					
	Lead ^b	Iron ^b	Al ^b	Water ^b	Air ^c	Concrete ^b
²⁴² Cm	0.01	0.04	0.12	0.28	248	0.13
²⁴³ Cm	0.08	0.43	1.26	2.98	2,626	1.41
²⁴⁴ Cm	0.01	0.04	0.12	0.28	247	0.13
²⁴⁵ Cm	0.05	0.27	0.79	1.86	1,643	0.88
²⁵² Cf	0.01	0.04	0.12	0.3	261	0.14

^aThe HVL is the thickness of a substance, which when introduced in the path of a beam of radiation, reduces the exposure rate by one-half. Values are given for "good geometry" where build-up of secondary radiation is not important.

^bValues less than 0.01 were set equal to zero.

^cValues less than 0.99 were set equal to zero.

^dValues given are the higher of the two.

Source: Values calculated with CONDOS II with no build-up.

Fig. F-1
Conversion factors needed to adjust total acute bone dose (TABD)
or total effective dose equivalent (TEDE) at 1 mile
for other distances and other release conditions.

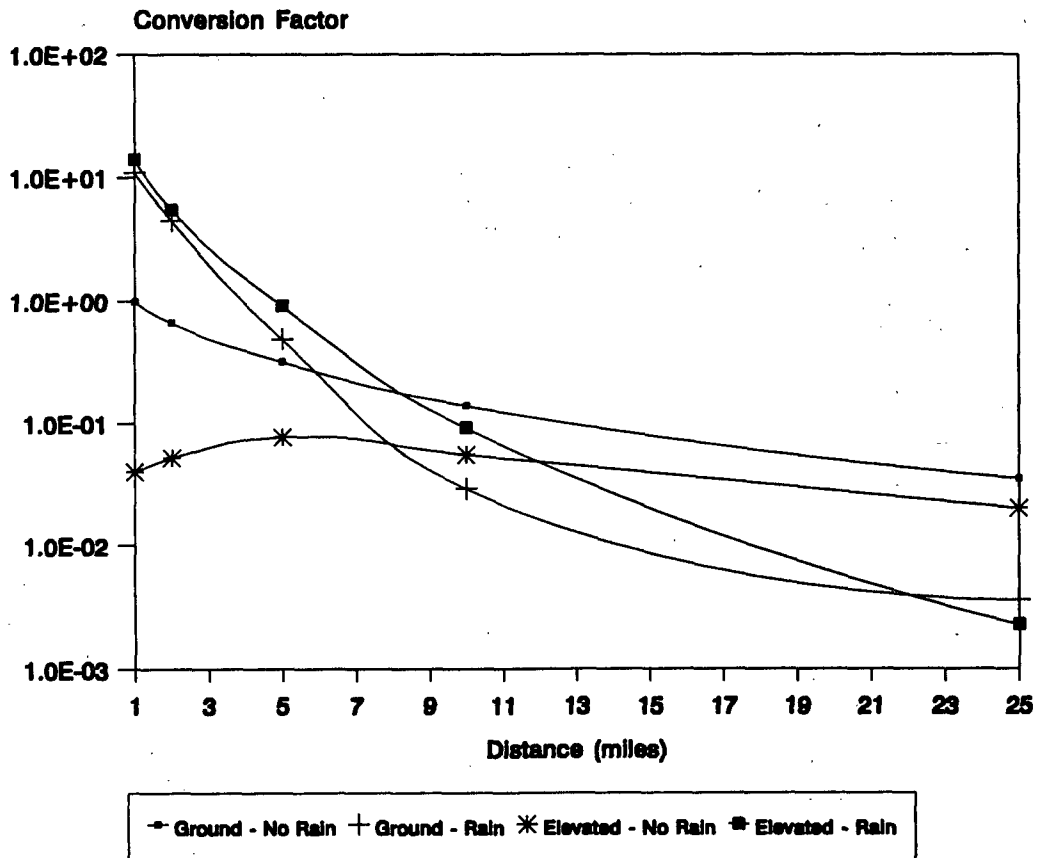

Fig. F-2
Conversion factors needed to adjust thyroid dose at 1 mile resulting from inhalation of plume for other distances and other release conditions.

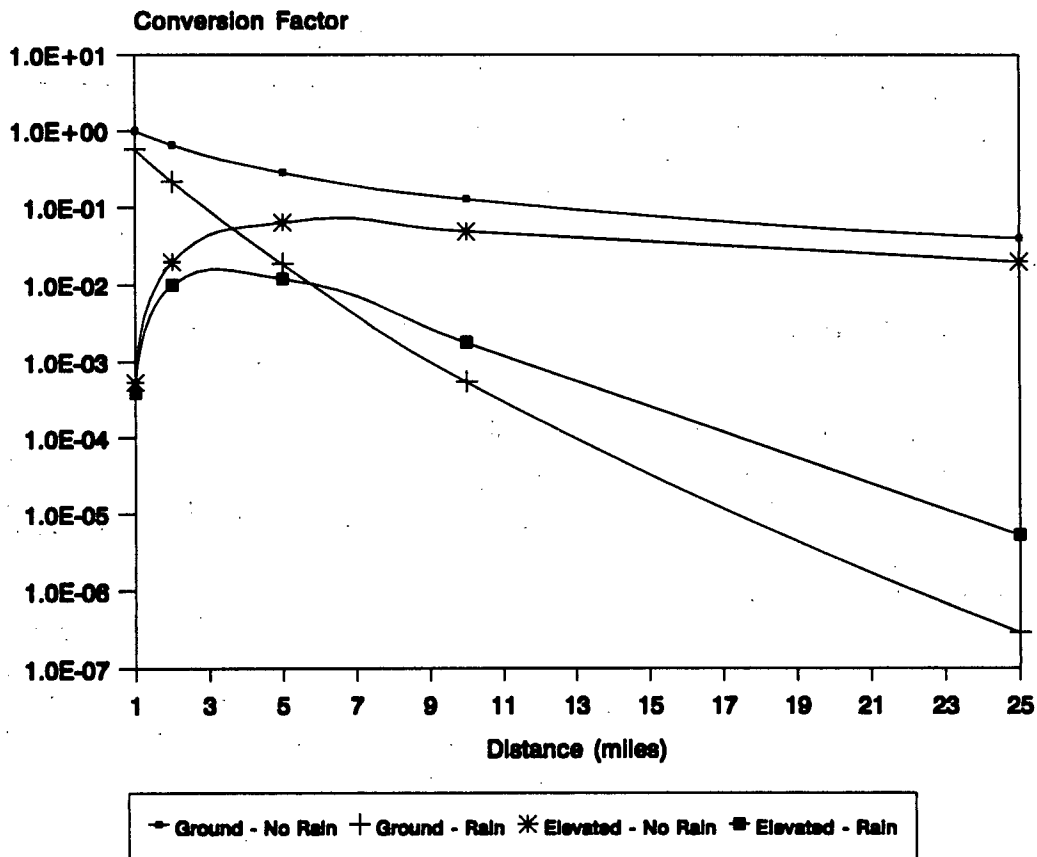
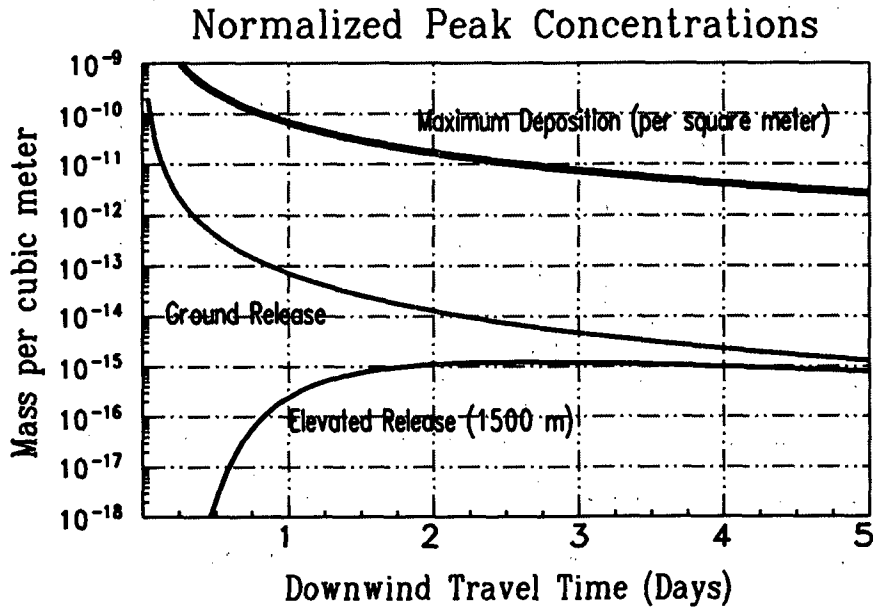

Fig. F-3
Normalized peak concentrations as a function of downwind travel time
for a near-ground and elevated release.



**Worksheet F-1. Isotopic contributions to dose components
(Method F.3, Step 1, quick estimate method).**

Number: _____		Date: _____		Time _____	
Analyst: _____		Sample location: _____			
Step 1					
Isotope <i>i</i>	<i>Column A</i>	×	<i>Column B</i>	=	<i>Column D</i>
	Q_{Ti} (μCi)		RCF_{ij} (mrem/ μCi)		Dose (mrem)
		×		=	
		×		=	
		×		=	
		×		=	
		×		=	
		×		=	
		×		=	
		×		=	
		×		=	
		×		=	
		×		=	
Notes:			<i>Column C (sum)</i>		

**Worksheet F-2. Isotopic contributions to dose components
(Method F.3, Step 1, full calculation method).**

Number: _____ Analyst: _____ Date: _____ Time: _____ Sample location: _____	Isotope <i>i</i> : _____
--	-----------------------------

Air Immersion H_{ai}

$$H_{ai} = \frac{Q_i \times DF \times DCF_{ai} \times T_{ed}}{\bar{U}}$$

$$\left(\text{mrem} \right) = \frac{\left(\frac{\mu\text{Ci}}{\text{s}} \right) \times \left(\text{m}^{-2} \right) \times \left(\frac{\text{mrem/h}}{\mu\text{Ci/m}^3} \right) \times \left(\text{h} \right)}{\left(\frac{\text{m}}{\text{s}} \right)}$$

Inhalation D_{Ti} or $H_{e,50i}$

$$H_{e,50i} = \frac{Q_i \times DF \times DCF_{e,50i} \times T_{ed}}{\bar{U}}$$

$$D_{Ti} = \frac{Q_i \times DF \times DCF_{Ti} \times T_{ed}}{\bar{U}}$$

$$\left(\text{mrem} \right) = \frac{\left(\frac{\mu\text{Ci}}{\text{s}} \right) \times \left(\text{m}^{-2} \right) \times \left(\frac{\text{mrem/h}}{\mu\text{Ci/m}^3} \right) \times \left(\text{h} \right)}{\left(\frac{\text{m}}{\text{s}} \right)}$$

Ground D_{EPgi}

$$D_{EPgi} = Q_{Ti} \times GCF \times DCF_{EPgi}$$

$$\left(\text{mrem} \right) = \left(\mu\text{Ci} \right) \times \left(\frac{\mu\text{Ci/m}^2}{\mu\text{Ci}} \right) \times \left(\frac{\text{mrem}}{\mu\text{Ci/m}^2} \right)$$

Worksheet F-3. Summation of dose components (Method F.3, Step 2).

Number: _____		Date: _____		Time: _____			
Analyst: _____		Sample location: _____					
Step 2							
Isotope <i>i</i>	Column A		Column B		Column C		Column D
	H_{ai} (rem)		$D_{Ti}(\text{bone})$ or $D_{Ti}(\text{lung})$ or $H_{e,50i}$ (rem)		D_{EPgi} (rem)		TABD or TALD or TEDE (rem)
		+		+		=	
		+		+		=	
		+		+		=	
		+		+		=	
		+		+		=	
		+		+		=	
		+		+		=	
		+		+		=	
		+		+		=	
		+		+		=	
		+		+		=	
Notes:					<i>Column C</i> (sum)		

**Worksheet F-4. Adjusting TABD for distance, elevation,
and rain (Method F.5, Step 2).**

Ground-level release without rain

Dose at 1 mile		Conversion factor		Doses at...
	×	1.0E+00	=	1 mile
	×	6.7E-01	=	2 miles
	×	3.2E-01	=	5 miles
	×	1.4E-01	=	10 miles
	×	3.5E-02	=	25 miles

Ground-level release with rain

Dose at 1 mile		Conversion factor		Doses at...
	×	1.1E+01	=	1 mile
	×	4.5E+00	=	2 miles
	×	4.9E-01	=	5 miles
	×	2.9E-02	=	10 miles
	×	3.6E-03	=	25 miles

Elevated release without rain

Dose at 1 mile		Conversion factor		Doses at...
	×	4.0E-02	=	1 mile
	×	5.2E-02	=	2 miles
	×	7.7E-02	=	5 miles
	×	5.5E-02	=	10 miles
	×	2.0E-02	=	25 miles

Elevated release with rain

Dose at 1 mile		Conversion factor		Doses at...
	×	1.4E+01	=	1 mile
	×	5.5E+00	=	2 miles
	×	9.2E-01	=	5 miles
	×	9.2E-02	=	10 miles
	×	2.3E-03	=	25 miles

Worksheet F-5. Adjusting thyroid dose for distance, elevation, and rain (Method F.5, Step 2).

Ground-level release without rain

Dose at 1 mile		Conversion factor		Doses at...
	×	1.0E+00	=	1 mile
	×	6.6E-01	=	2 miles
	×	2.9E-01	=	5 miles
	×	1.3E-01	=	10 miles
	×	4.0E-02	=	25 miles

Ground-level release with rain

Dose at 1 mile		Conversion factor		Doses at...
	×	5.8E+01	=	1 mile
	×	2.2E-01	=	2 miles
	×	1.9E-02	=	5 miles
	×	5.5E-04	=	10 miles
	×	2.9E-07	=	25 miles

Elevated release without rain

Dose at 1 mile		Conversion factor		Doses at...
	×	5.4E-04	=	1 mile
	×	2.0E-02	=	2 miles
	×	6.4E-02	=	5 miles
	×	4.9E-02	=	10 miles
	×	2.0E-02	=	25 miles

Elevated release with rain

Dose at 1 mile		Conversion factor		Doses at...
	×	3.9E-04	=	1 mile
	×	1.0E-02	=	2 miles
	×	1.2E-02	=	5 miles
	×	1.8E-03	=	10 miles
	×	5.3E-06	=	25 miles

G

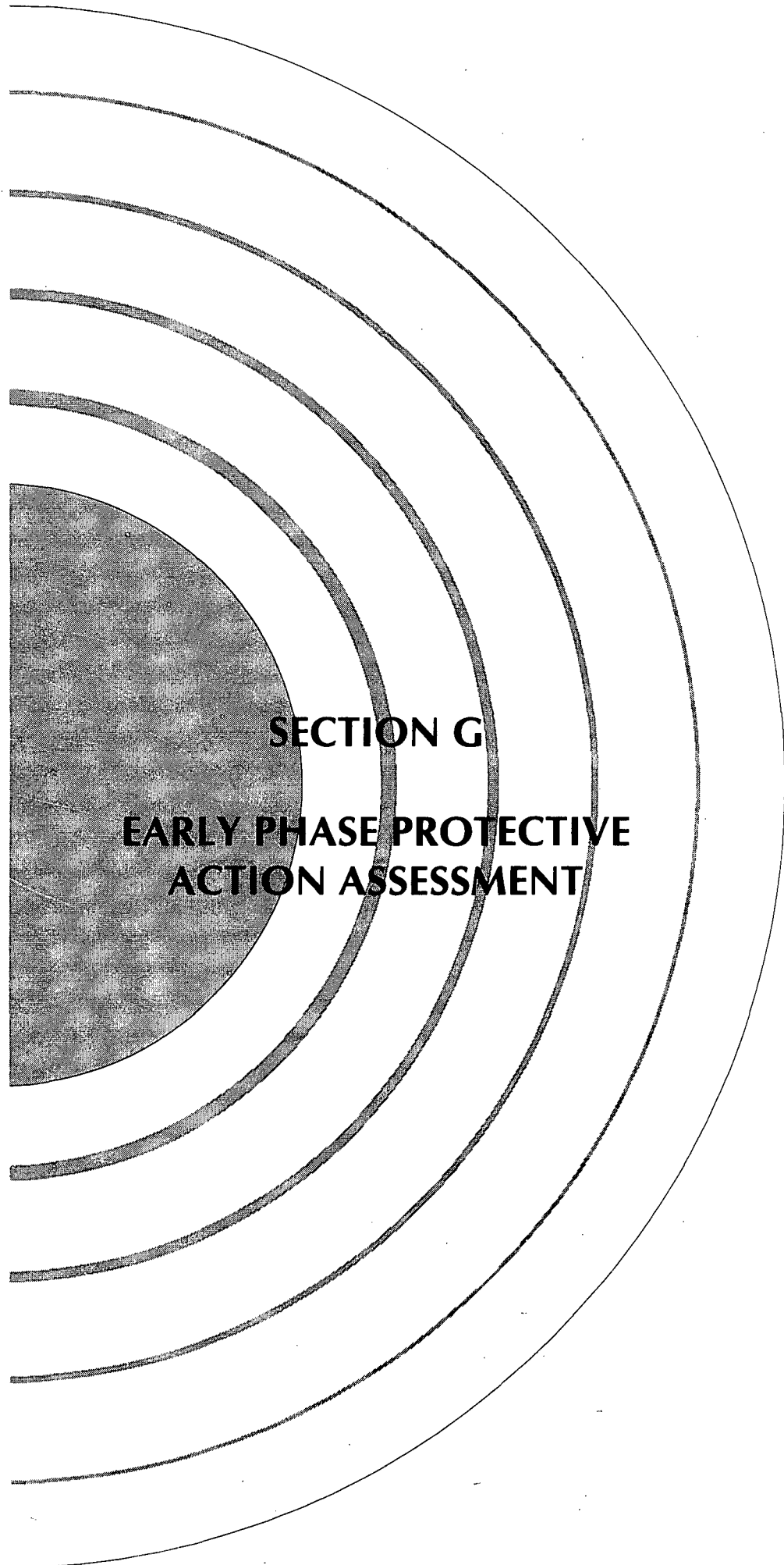

SECTION G
**EARLY PHASE PROTECTIVE
ACTION ASSESSMENT**

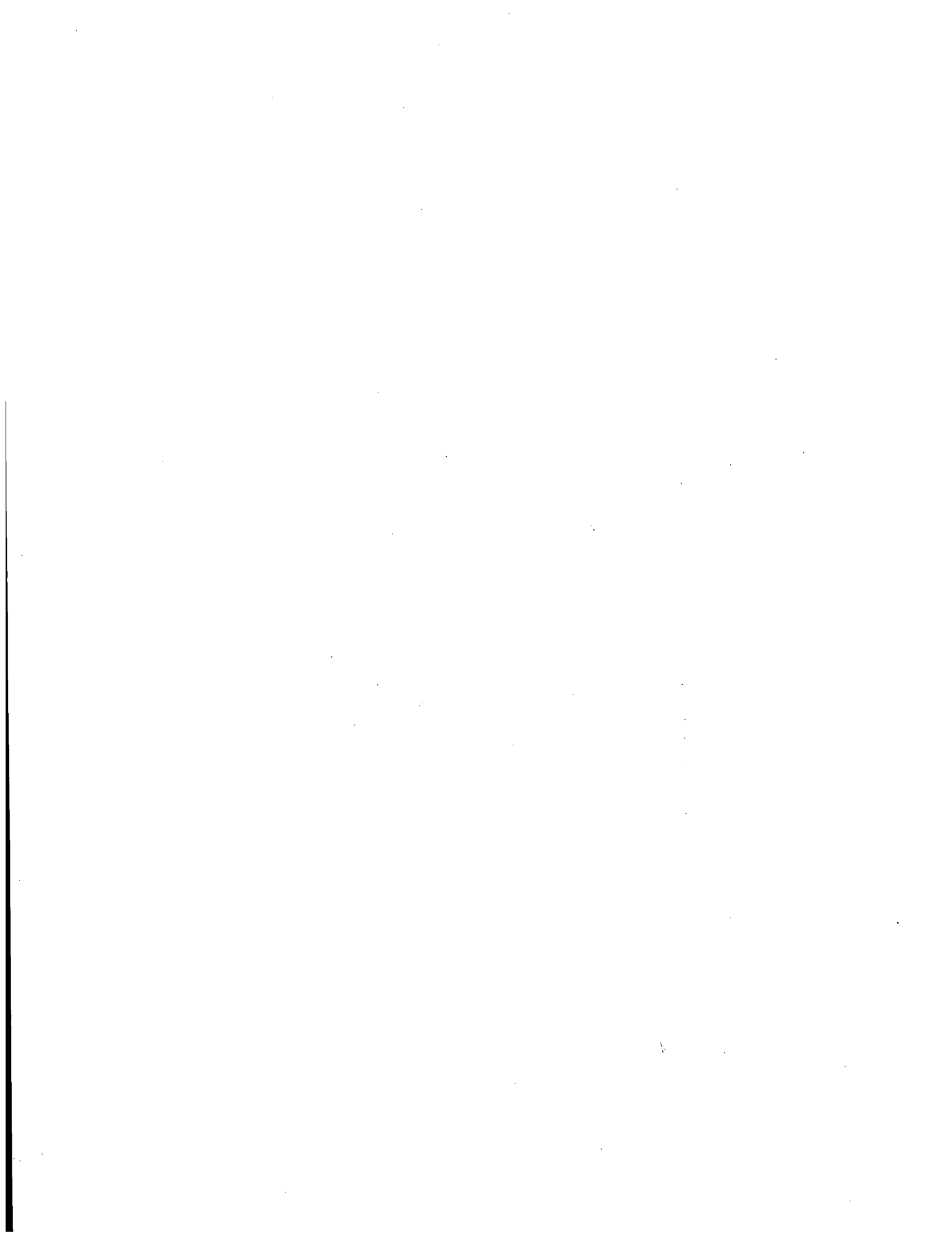

Section G
Quick Reference Guide

	<i>Page</i>
Early phase protective action assessment	G-3
Section G tables	G-7
Section G figure	G-9

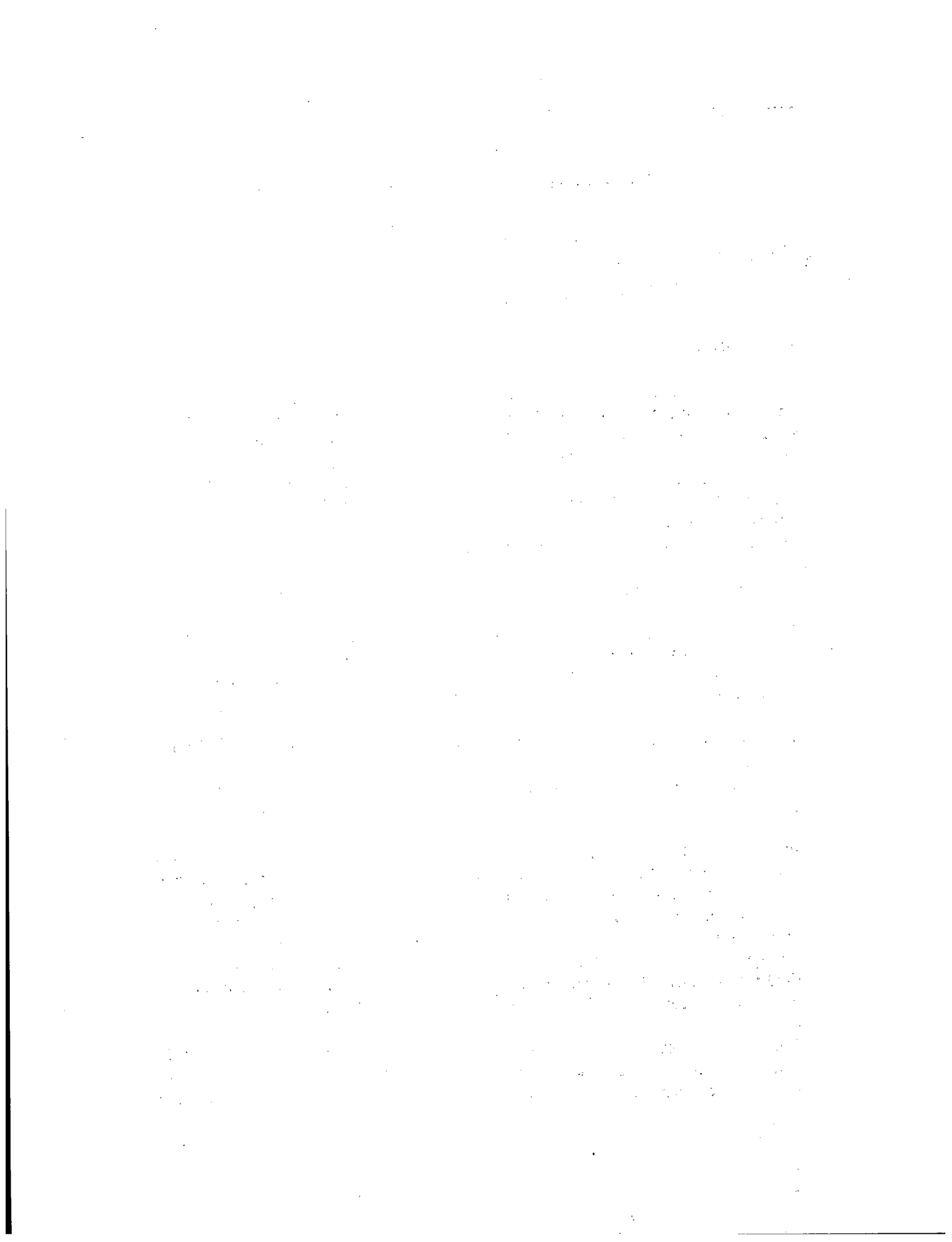

Section G

Early Phase Protective Action Assessment

Purpose

To assess public (offsite) protective actions in support of the State.

Discussion

The early phase is the period at the beginning of a nuclear incident when immediate decisions for effective use of protective actions are required and must therefore usually be based primarily on the status of the nuclear facility (or other incident site) and the prognosis for worsening conditions. This phase may last from hours to days. For the purpose of dose projection, it is assumed to last for 4 days. Radiation doses may accrue from both airborne and deposited materials. Early phase dose calculations normally include the dose from any airborne plume and up to 4 days (~100 h) of exposure to deposited radioactive material.

Protective actions must be taken during the early phase of an emergency to

- prevent early health effects (deaths and injuries) by keeping the short-term external dose equivalent below 50 rem and keeping the acute inhalation dose equivalent below the early health effects thresholds for the thyroid, lung, and bone marrow and
- reduce the risk of delayed health effects (primarily cancer and genetic effects)

by implementing protective actions in accordance with EPA Protective Action Guides (PAGs).

For reactor accidents it may be necessary to take actions based on plant conditions before or shortly after a release to meet these goals. Meeting these protective action goals during or after a major release may require prompt field monitoring to identify areas of high exposure rates and sources of high inhalation dose. For some accidents (e.g., dispersion of plutonium), it may be very difficult to measure the inhalation dose promptly. In these cases, estimates of the isotopic mix should be used to relate the field measurements to the inhalation dose. Methods for assessing environmental measurements can be found in the *FRMAC Assessment Manual*.

Federal recommendations should be made *only* if there is a major concern or if the State has requested Federal assistance. Do not allow offsite officials to wait for a Federal assessment before taking action. Do not do anything to interfere with ongoing

implementation of protective actions. In commercial reactor accidents, licensees recommend actions and the offsite officials make decisions based on these recommendations. Mechanisms are already in place for prompt decision making and for warning the public 24 h per day. Revising the preplanned actions may delay the response. Federal recommendations to extend the area for protective actions can be made after the initial protective actions have been started. (The emergency plans at most fuel conversion/fabrication facilities consider the need for protective actions, but they do not specify predetermined protective actions.)

Step 1

Review the protective action criteria in the licensee and State or local emergency plans and procedures.

Step 2

Assess the protective actions based on the accident type. Consult with representatives from HHS, USDA, and EPA, if possible.

- **Severe LWR core damage or loss of control of plant.** If the event is a reactor accident involving severe core damage or loss of control, use Fig. G-1 to make the initial assessment.
- **Release of radioactive material or after the initial assessment of protective actions for an LWR accident.** If the event involves release of radiological material, use the EPA early phase PAGs in Table G-1. Give priority to areas where early health effects are possible (Table G-2). (For most reactor accidents, the distance to which PAGs are exceeded will be determined by the thyroid dose.)

Note that some States may use their own PAGs. If this is the case, the State PAGs should be considered in the assessment.

- **Uranium hexafluoride (UF₆) release.** Use Section E, Uranium Hexafluoride Release Assessment. Evaluate the chemical hazards of uranium hexafluoride before estimating the effects of exposure to the radioactive uranium in the uranium hexafluoride.

Step 3

If your assessment agrees with the licensee's recommendations and the State and local actions, go to **Step 5**. If there is disagreement, continue with **Step 4**.

Step 4

Discuss assessment differences with licensee and/or offsite technical contacts and determine the basis for their protective action recommendations. Do not do anything to interfere with ongoing implementation of protective actions. If offsite technical contacts cannot be contacted within a reasonable period of time, move on to Step 5.

Step 5

Prepare a briefing for the Executive Team (ET) or Director of Site Operations (DSO) using the following checklist:

- _____ A comparison of the recommendations or actions of the licensee, offsite officials and your assessment.
- _____ The results of your discussions with licensee and offsite officials (or the fact that these parties could not be contacted).
- _____ The title, name, and phone number of the licensee and offsite protective action decision-makers.
- _____ The existing emergency plan predetermined protective action decision-making criteria.
- _____ The offsite radiological conditions, if known.
- _____ Any local conditions that affected decisions (i.e., local weather or impediments on evacuation routes).
- _____ Any consultation with the Advisory Team for Environment, Food, and Health (Advisory Team) during assessment. (Advisory Team members include EPA, HHS/FDA, and USDA, at a minimum).

Step 6

Provide verbal assessment to the ET Director and DSO immediately. Follow with a written assessment.

Step 7

Consult with and brief the representatives of other appropriate Federal agencies, such as DOE and FEMA, as time permits.

Step 8

Continue to reassess plant and radiological conditions until the situation stabilizes. If there has been a release, consider the need for intermediate phase protective actions (Section H) or protective measures for the ingestion pathway (Section I).

The magnitude of protective actions and the geographic areas affected can always be expanded and/or adjusted. Do not recommend that protective actions be relaxed until the threat of a release is over and any ground contamination has been characterized and thoroughly discussed with State officials.

END

Source: EPA 400-R-92-001.

Table G-1. Early phase Protective Action Guides (PAGs)

Protective action	PAG (projected dose)	Comments
Evacuation (or sheltering) ^a	1-5 rem ^b	Evacuation (or for some situations, sheltering) ^a should normally be initiated at 1 rem.
Administration of stable iodine	25 rem thyroid ^c	Requires approval of State medical officials.

^aSheltering may be the preferred protective action when it will provide protection equal to or greater than evacuation, based on consideration of factors such as source term characteristics, and temporal or other site-specific conditions. For further guidance, see EPA 400-92-001, Sect. 2.3.1.

^bThe sum of the effective dose equivalent (EDE) resulting from exposure to external sources and the committed effective dose equivalent (CEDE) incurred from all significant inhalation pathways during the early phase. Committed dose equivalents to the thyroid and to the skin may be 5 and 50 times larger, respectively.

^cCommitted dose equivalent (CDE) to the thyroid from radioiodine.

Source: Adapted from EPA 400-R-92-001, p. 2-6.

Table G-2. Early health effects of exposure to radiation

Organ ^a	Dose rate (rad/h)	Dose ^b (rad)	Acute health effects ^c	Onset ^d
Whole body (external effective dose)	>6	50	Threshold for vomiting and diarrhea	3 h (100-200 rem) 2 h (200-600 rem)
	>6	200	50% have vomiting and diarrhea	1 h (600-1000 rem)
Thyroid		20,000	Threshold for acute radiation thyroiditis	Within 2 weeks
		120,000	50% have acute radiation thyroiditis	
Lung	1000	700	Threshold for deaths ^e	
	100	2000	Threshold for deaths	
	50	4000	Threshold for deaths	
Marrow (WB)	≥ 1000	150 (230) ^f	Threshold for deaths ^g	Within 2 months (200-1000 rem)
	5	220 (330)	Threshold for deaths	Within 2 weeks
	5	440 (660)	50% deaths	(1000-5000 rem)
	1	500 (750)	Threshold for deaths	
Skin	>6	300 ^h	Threshold for erythema	Erythema in 2-6 days
	>6	1000	Threshold for transepithelial injury or moist desquamation ⁱ	(2000-3000 rad, single dose); in 12-17 days (1000-2000 rad, single dose, or 2000-4000 rad @200 rad/day). Moist desquamation that heals in 30-50 days (2000-2400 rad, single dose, or 4500-5000 rad @200 rad/day).

^aEffective dose equivalent from external sources (cloud and ground shine) is approximately equal to bone marrow and whole body (WB) dose.

^bThyroid doses are due to ¹³¹I. Others are external doses.

^cA threshold is the lowest dose at which an effect might occur. Occurrences at this level are unlikely. Thresholds are dose-rate dependent.

^dOnsets are generally dose and dose rate dependent. (One rem dose equivalent corresponds to a 1 rad absorbed dose for β and γ radiation.)

^eDeaths due to pulmonary syndrome.

^fThe first values represent minimal treatment (first aid in a clean environment). The second values are appropriate when there is supportive medical treatment (normal hospital care without heroic treatment, such as bone marrow transplants or use of colony stimulating factors).

^gDeaths due to marrow syndrome.

^hLow LET irradiation of 50-100 cm² area.

ⁱMoist shedding of outer layers of skin in scales or small sheets equivalent to second degree thermal burn in which blisters form in the epidermis.

Sources: NUREG/CR-4214, Rev. 1, Part II (external effective, p. II-21; thyroid, p. II-61; lung, p. 55; marrow, pp. II-38, II-39; skin, pp. II-67, II-68); IAEA Tech. Rep. #152 (onset of vomiting and diarrhea and onset of deaths from whole body exposure, p. 45).

Fig. G-1
Protective actions in the event of severe core damage or loss of control of facility.

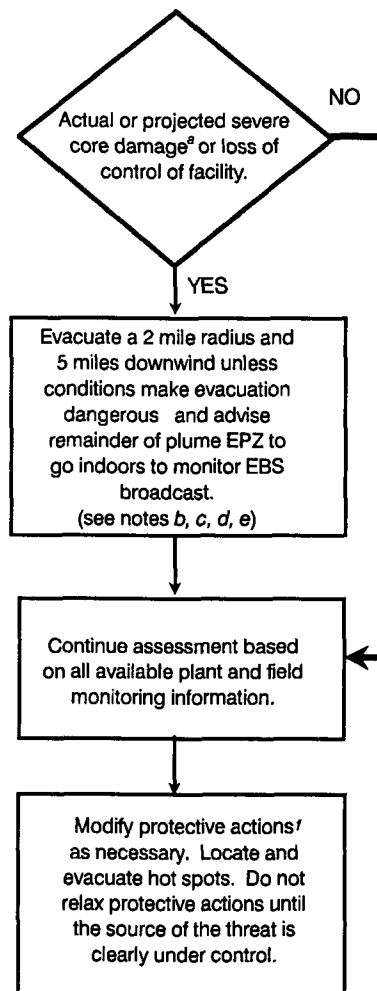

^aSevere core damage is indicated by (1) loss of critical functions required for core protection (e.g., loss of injection combined with loss of cooling accident); (2) high core temperatures (PWR) or partially uncovered core (BWR); or (3) very high radiation levels in area or process monitors.

^bDistances are approximate—actual distances will be determined by the size of the preplanned sub-areas, which are based on geopolitical boundaries.

^cIf there are very dangerous travel conditions, initially shelter rather than evacuate the population until conditions improve.

^dTransit-dependent persons should be advised to remain indoors until transportation resources arrive, if possible.

^eShelter may be the appropriate action for controlled releases of radioactive material from the containment if there is assurance that the release is short term (puff release) and the area near the plant cannot be evacuated before plume arrives.

^fConsider EPA PAGs (Table G-1) in modifying initial protective actions.

Source: NUREG-0654, Suppl. 3.

H

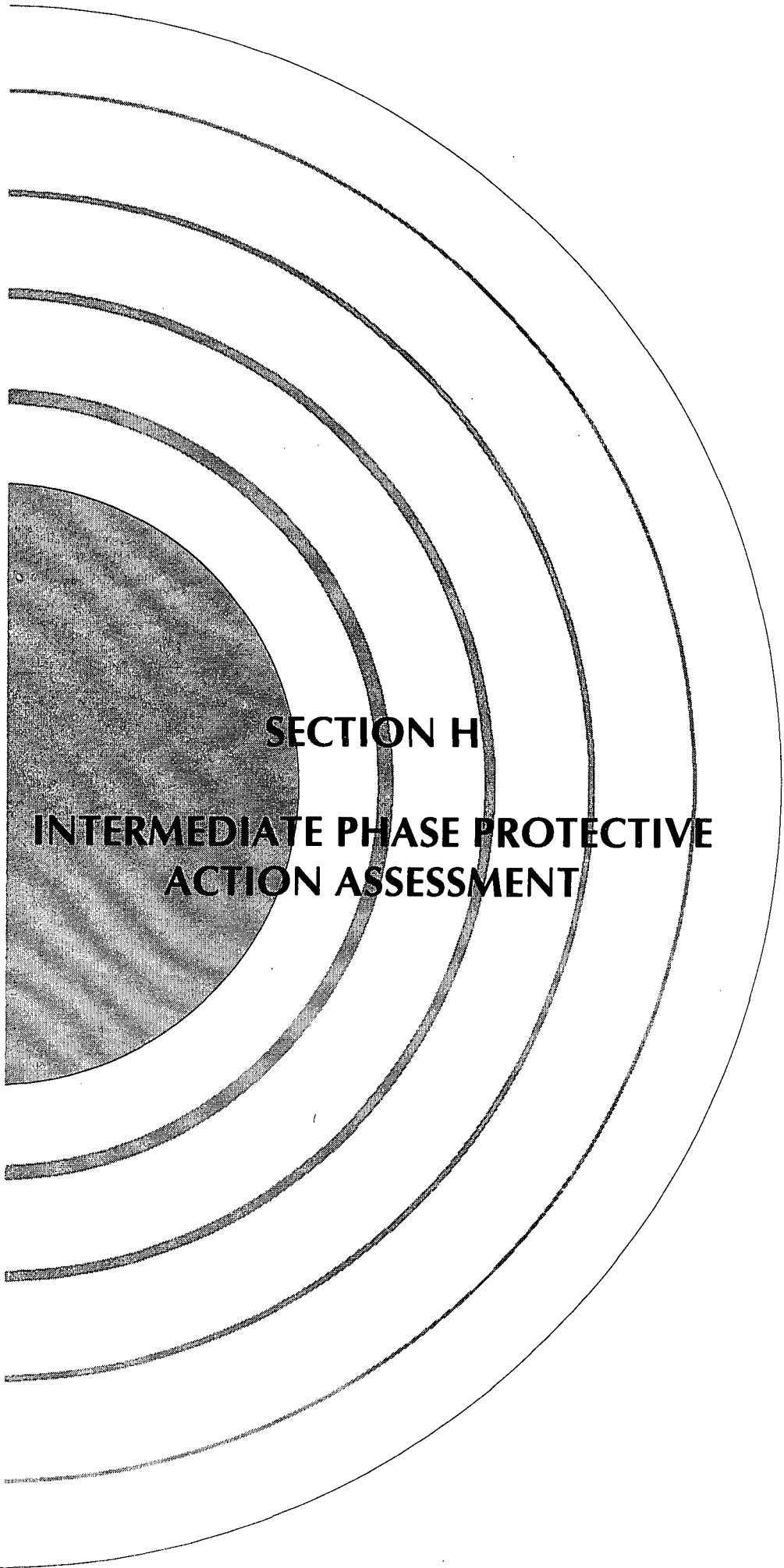

SECTION H
INTERMEDIATE PHASE PROTECTIVE
ACTION ASSESSMENT

THE UNIVERSITY OF CHICAGO
DEPARTMENT OF CHEMISTRY
5800 S. UNIVERSITY AVENUE
CHICAGO, ILLINOIS 60637
TEL: 773-936-3700
FAX: 773-936-3701
WWW: WWW.CHEM.UCHICAGO.EDU

Section H
Quick Reference Guide

	<i>Page</i>
Intermediate phase protective action assessment	H-3
Section H tables	H-7

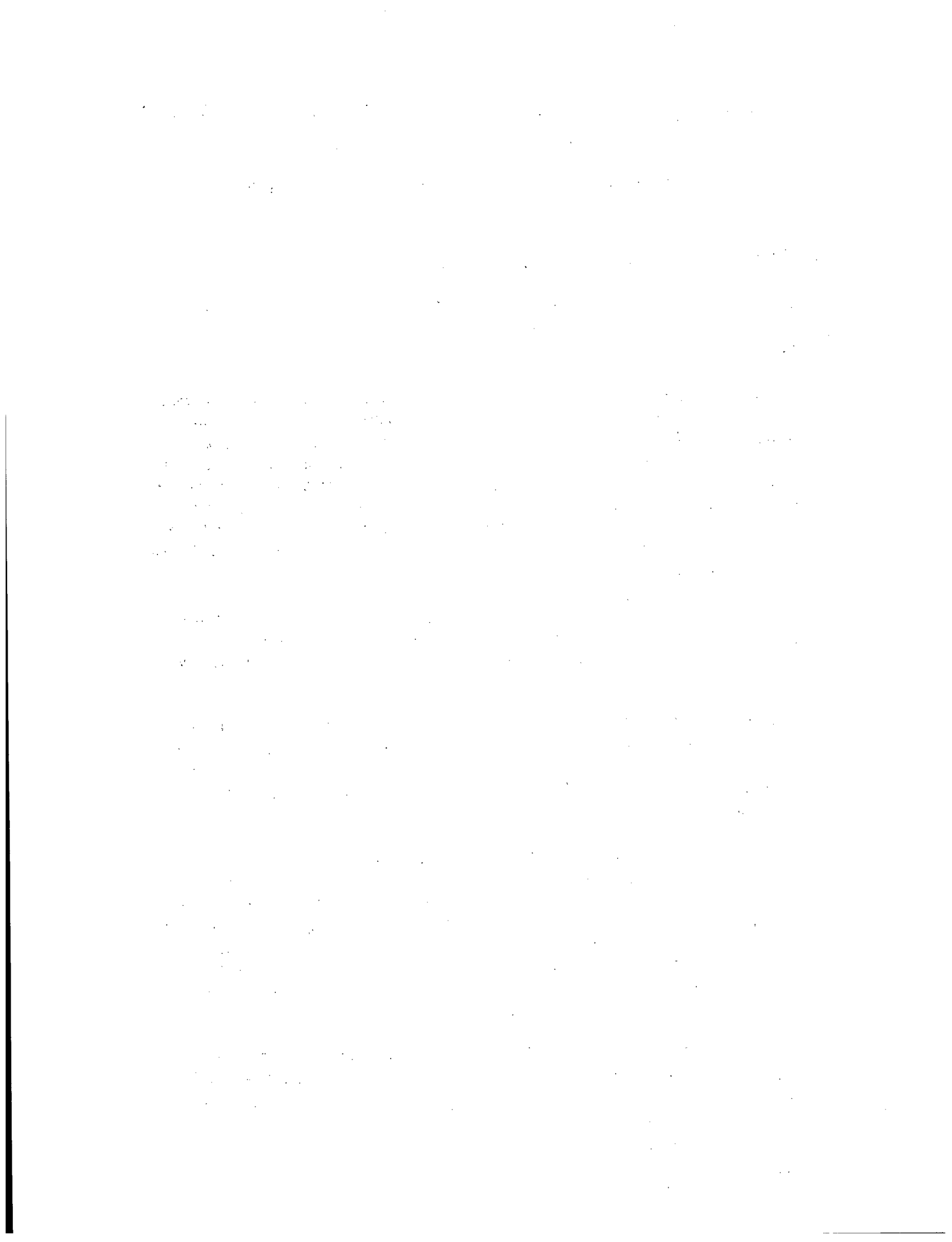

Section H Intermediate Phase Protective Action Assessment

Purpose

To provide guidance on the assessment of intermediate phase protective actions.

Discussion

The intermediate phase is the period beginning after the incident source and releases have been brought under control and reliable environmental measurements are available for use as a basis for decisions on additional protective actions and extending until these protective actions are terminated. This phase may overlap the early and late phases and may last from weeks to many months. For the purpose of dose projection, the intermediate phase is assumed to last for 1 year. In some accidents (e.g., a reactor core damage accident) there may be ongoing small releases even after the threat of a major release has passed. These small releases should not delay the intermediate phase assessments.

Two radiation exposure pathways are of primary concern during the intermediate phase: (1) exposure to deposited material (direct exposure and inhalation of resuspended material) and (2) ingestion. The evaluation of the ingestion pathway is discussed in Section I.

EPA has published PAGs for relocation of the general population to avoid exposure to deposited material. Areas where projected doses are equal to or greater than the intermediate (relocation) PAGs are called restricted zones. There are two aspects to intermediate phase assessment: (1) relocation PAGs for the first year (Table H-1) and (2) long-term dose objectives (Table H-2).

Identification of areas where the PAGs may be exceeded can be difficult. Field and aerial radiation measurements can help identify such areas (see the *FRMAC Assessment Manual*), but resuspension and drifting of radioactive material, complex deposition patterns, and unidentified hot spots may produce higher radiation levels in small portions of the surrounding area. The restricted area identified should be expanded to include a buffer zone until the radiological situation is evaluated and confirmed. The relocation zone may also be adjusted by State or local officials so that local terrain features and landmarks define the area to be investigated.

The EPA PAG manual recommends unrestricted return of evacuees when external radiation levels do not exceed twice background, but areas meeting this criterion may be hard to identify. If, however, the inhalation dose from resuspension is not the

principal exposure pathway, as is likely the case for reactor accidents, a 0.1-mR/h exposure rate will result in less than one-half of the relocation PAG (2 rem the first year), even if no decay or weathering is assumed. An exposure rate of less than 0.1 mR/h is recommended as an area suitable for "low background" screening of evacuees. Persons working in areas inside the restricted zone should operate under the controlled conditions normally established for occupational exposure.

If there is a shortage of food or water and contaminated food and/or water cannot be completely eliminated from the diet, the committed effective dose equivalent from ingestion of this food and water should be added to the projected dose from other exposure pathways for decisions on relocation.

Step 1

Evaluate whether the intermediate phase has begun by determining if a subsequent major release is possible. Consider the following:

- Is there radioactive material inventory capable of being released and causing offsite consequences?
- Are the barriers to a release threatened by
 - fire,
 - facility under control of others,
 - hydrogen or other explosive gas,
 - reactor core melt with possible containment failure at the time the vessel melts through,
 - pressure build-up (loss of decay heat removal), or
 - isolation failure.
- Is the reactor shutdown (subcritical) and can it go critical?
- Is the reactor core being cooled? Is decay heat removal threatened?

If the threat of a major release has passed, continue with the intermediate phase assessment.

Step 2

Determine the exposure rate at 3 ft (1 m) above ground level, the isotopic mixture (relative abundance) of the ground surface deposition, and air concentrations.

Step 3

Using the intermediate phase assessment methods in the *FRMAC Assessment Manual* or similar methods, identify the areas where the relocation PAGs may be exceeded (restricted zone). Recommend relocation of population in the restricted zone, with priority given to those in the areas with the highest exposure rates. Access to the restricted zone should be controlled. Monitoring and decontamination stations should be established at the boundaries of the zone to check any people, material, or agricultural products coming out of the restricted zone.

Step 4

In general, after reactor accidents, people who were initially evacuated may be able to return if exposure rates are less than 0.1 mR/h. However, if inhalation of resuspended activity is important or deposited material could drift into reoccupied or still-occupied areas, occupancy should be restricted until the situation is analyzed and dose projections are confirmed.

Step 5

Evaluate the second-year and 50-year dose (use the intermediate phase methods in the *FRMAC Assessment Manual* or RASCAL "Field Measurements to Dose" option). Evaluate the effectiveness of simple decontamination techniques and of sheltering (due to partial occupancy of residences and work places) in reducing the expected dose. Persons evacuated from higher dose rate areas may return once field measurements confirm that the objectives of the intermediate phase PAGs will be met. If it is impractical to meet the long-term objectives of the Intermediate PAG (Table H-2) through decontamination, consideration should be given to relocation at a lower projected first-year dose than that specified by the intermediate (relocation) PAG.

Step 6

Data should be gathered to establish long-term radiation protection criteria for recovery and to determine the effectiveness of various decontamination or other recovery techniques. Operations to recover contaminated property in the restricted zone should begin. Contamination screening levels are listed in Tables H-3 and H-4.

END

Source: EPA 400-R-92-001.

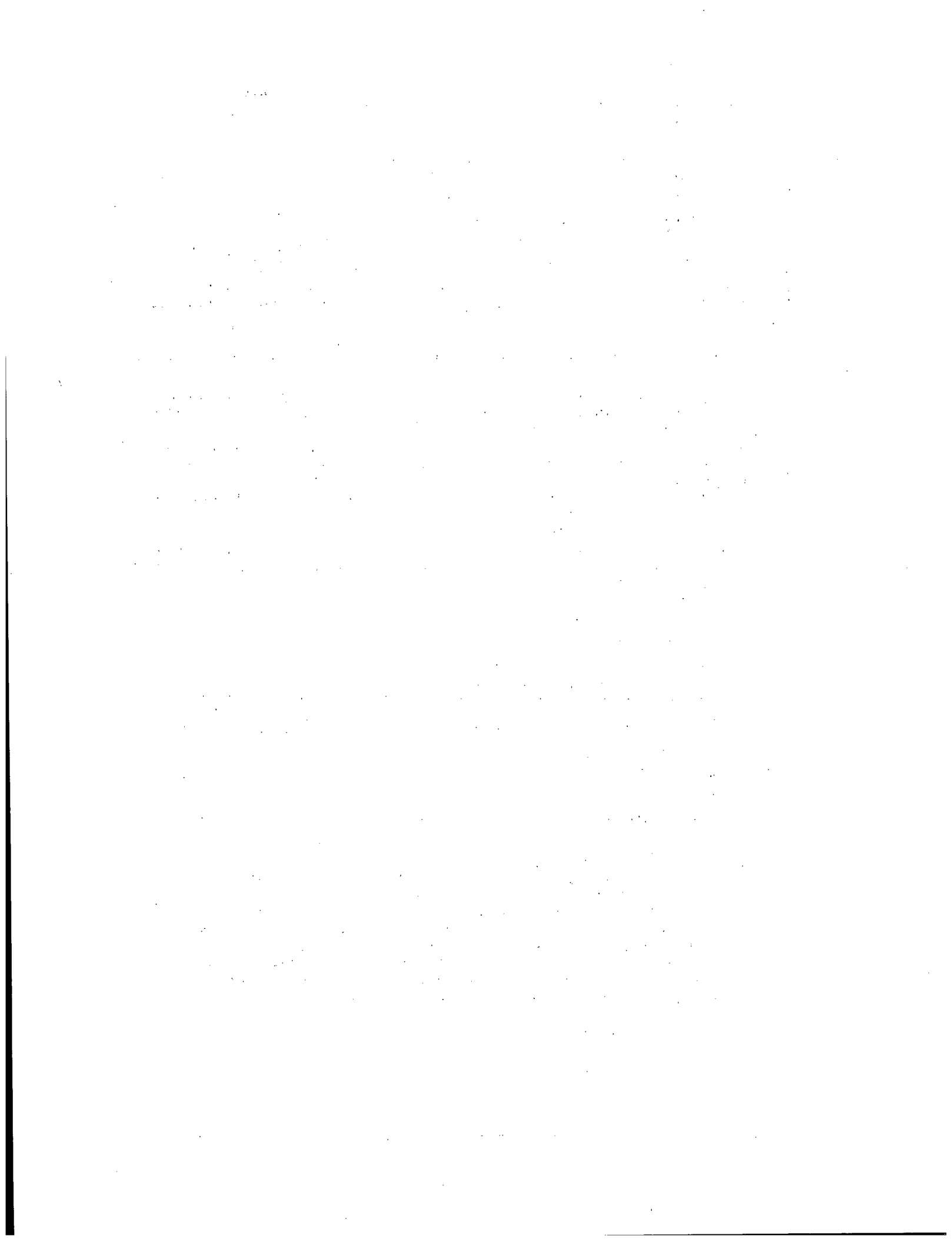

Table H-1. Relocation Protective Action Guides (PAGs)^a

Protective action	Protective Action Guide (projected first-year dose) ^b	Comments
Relocate the general population. ^c	$\geq 2,000$ mrem	Beta dose to skin may be up to 50 times higher.
Apply simple dose reduction techniques. ^d	$< 2,000$ mrem	These protective actions should be taken to reduce doses to as low as practicable levels.

^aPAGs for exposure to deposited radioactivity during the intermediate phase of a nuclear incident.

^bThe projected sum of effective dose equivalent from external gamma radiation and committed effective dose equivalent from inhalation of resuspended materials, from exposure or intake during the first year. Projected dose refers to the dose that would be received in the absence of shielding from structures or the application of dose reduction techniques. These PAGs may not provide adequate protection from some long-lived radionuclides; see Table H-2 or EPA 400-R-92-001, Sect. 4.2.1, for further restrictions.

^cPersons previously evacuated from areas outside the relocation zone defined by this PAG may return to occupy their residences. Cases involving relocation of persons at high risk from such action (e.g., patients under intensive care) should be evaluated individually.

^dSimple dose reduction techniques include scrubbing and/or flushing hard surfaces, soaking or plowing soil, minor removal of soil from spots where radioactive materials have concentrated, and spending more time than usual indoors or in other low exposure rate areas.

Source: Adapted from EPA 400-R-92-001, Table 4.1, p. 4-4.

Table H-2. Long term objectives for intermediate phase^a

Time period	Objective ^b
Second year (or any succeeding year)	≤ 500 mrem
50 years	≤ 5000 mrem

^aFor reactor incidents, if the PAG of 2,000 mrem is met in the first year, the long-term objectives should be met through radioactive decay, weathering, and normal part-time occupancy of structures. If the release consists primarily of long-lived radionuclides, decontamination may be required during the first year in areas *outside* the restricted area. If decontamination is not practical in these situations, relocation at a lower first-year projected dose than 2,000 mrem should be considered.

^bThe projected sum of effective dose equivalent from external gamma radiation and committed effective dose equivalent from inhalation of resuspended materials, from exposure or intake during the indicated time period.

Source: EPA 400-R-92-001, p. 4-4.

Table H-3. Recommended surface contamination screening levels for emergency screening of persons and other surfaces at screening or monitoring stations in high background radiation areas (0.1–5 mR/h)^a

Condition	Geiger-counter shielded-window reading	Recommended action
Before decontamination	<ul style="list-style-type: none"> • $< 2 \times$ background <i>and</i> < 0.5 mR/h above background 	Unconditional release.
	<ul style="list-style-type: none"> • $> 2 \times$ background <i>or</i> > 0.5 mR/h above background 	Decontaminate. Equipment may be stored or disposed of as appropriate.
After decontamination	<ul style="list-style-type: none"> • $< 2 \times$ background <i>and</i> < 0.5 mR/h above background 	Unconditional release.
	<ul style="list-style-type: none"> • $> 2 \times$ background <i>or</i> > 0.5 mR/h above background 	Continue to decontaminate or refer to low background monitoring and decontamination station. Equipment may also be stored for decay or disposed of as appropriate.

^aMonitoring stations in these high exposure rate areas are for use only during the early phase of an incident involving major atmospheric releases of particulates. In other cases, use Table H-4.

Source: Adapted from EPA 400-R-92-001, Table 7-6, p. 7-23.

Table H-4. Recommended surface contamination screening levels for persons and other surfaces at monitoring stations in low background radiation areas (< 0.1 mR/h)

Condition	Geiger counter thin-window ^a reading	Recommended action
Before decontamination	• < 2 × background	Unconditional release.
	• > 2 × background	Decontaminate.
After simple decontamination ^b effort	• < 2 × background	Unconditional release.
	• > 2 × background	Full decontamination ^c
After full decontamination ^c effort	• < 2 × background	Unconditional release.
	• > 2 × background	Continue to decontaminate persons.
	• < 0.5 mR/h ^d	Release animals and equipment.
After additional full decontamination effort	• < 2 × background	Unconditional full release.
	• > 2 × background	Send persons for special evaluation.
	• < 0.5 mR/h ^d	Release animals and equipment.
	• > 0.5 mR/h ^d	Refer, or use informed judgement on further control of animals and equipment.

^aWindow thickness of approximately 30 mg/cm² is acceptable. Recommended limits for open window readings are expressed as twice the existing background (including background) in the area where measurements are being made. Corresponding levels, expressed in units related to instrument designations, may be adopted for convenience. Levels higher than twice background (not to exceed the meter reading corresponding to 0.1 mR/h) may be used to speed the monitoring of evacuees in very low background areas.

^bFlushing with water and wiping is an example of a simple decontamination effort.

^cWashing or scrubbing with soap or solvent followed by flushing is an example of a full decontamination effort.

^dClosed shield reading including background.

Source: Adapted from EPA-400-R-92-001, Table 7-7, p. 7-24.

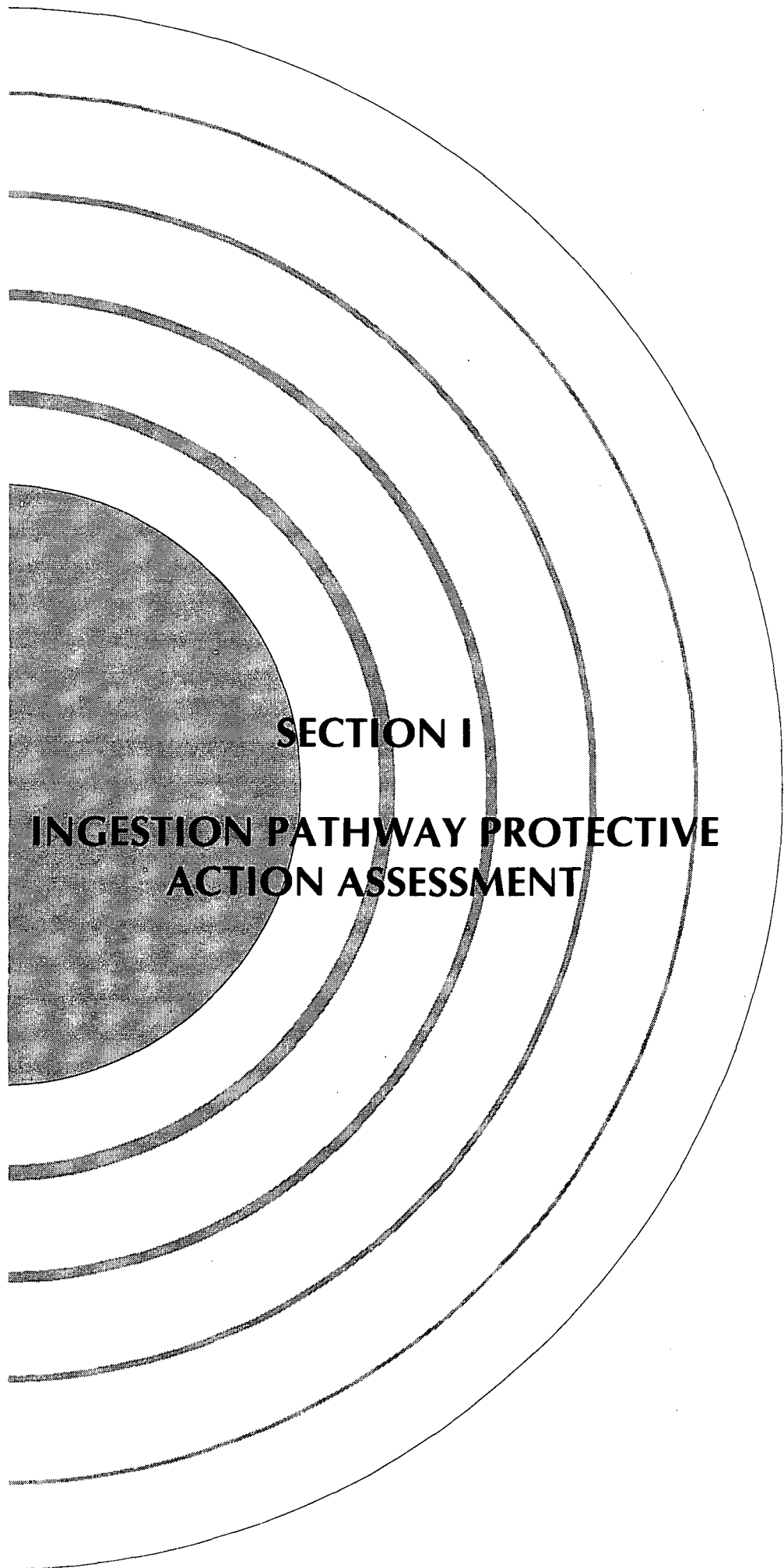

SECTION I

**INGESTION PATHWAY PROTECTIVE
ACTION ASSESSMENT**

AS

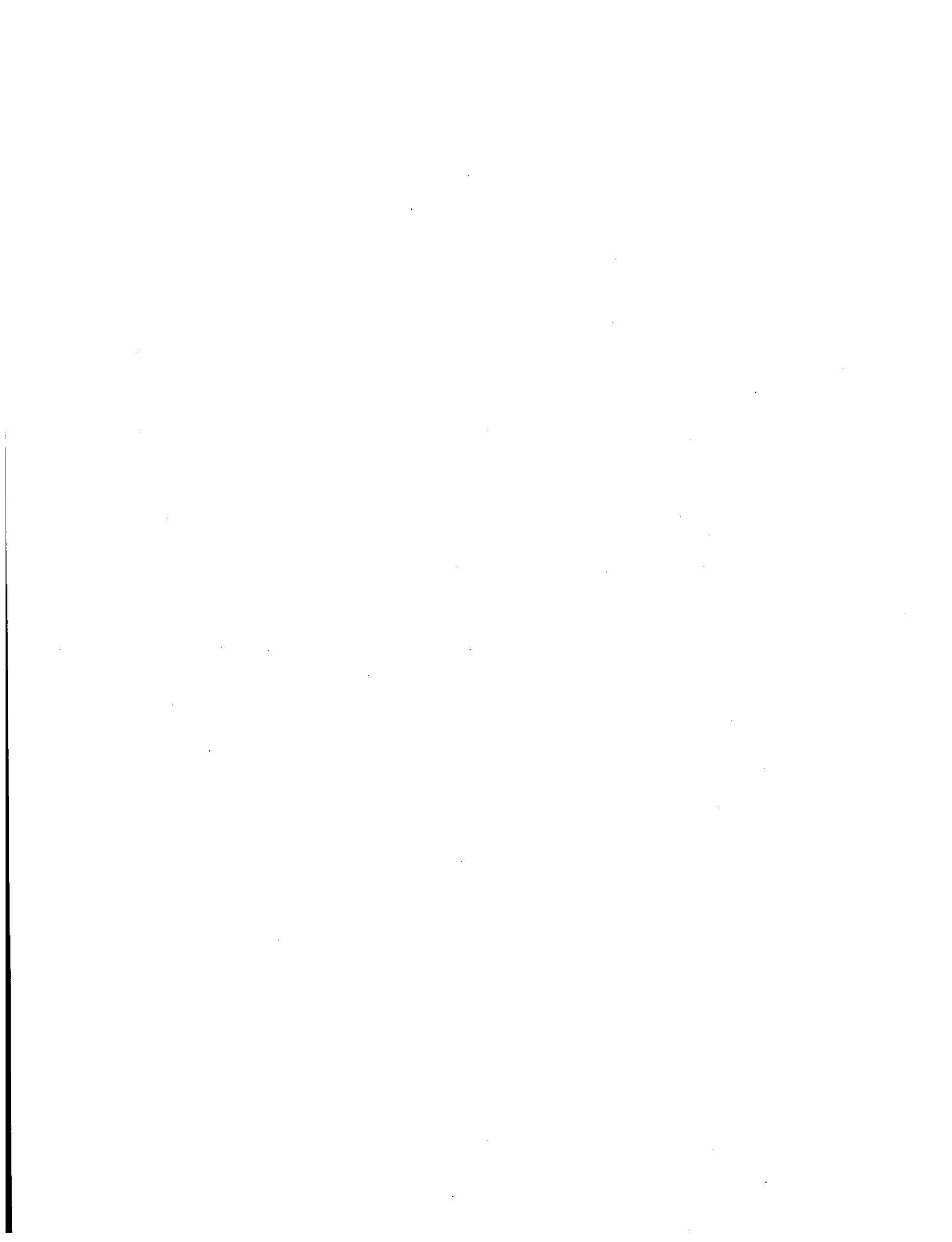

Section I
Quick Reference Guide

	<i>Page</i>
Ingestion pathway protective action assessment	I-3
Section I tables	I-5

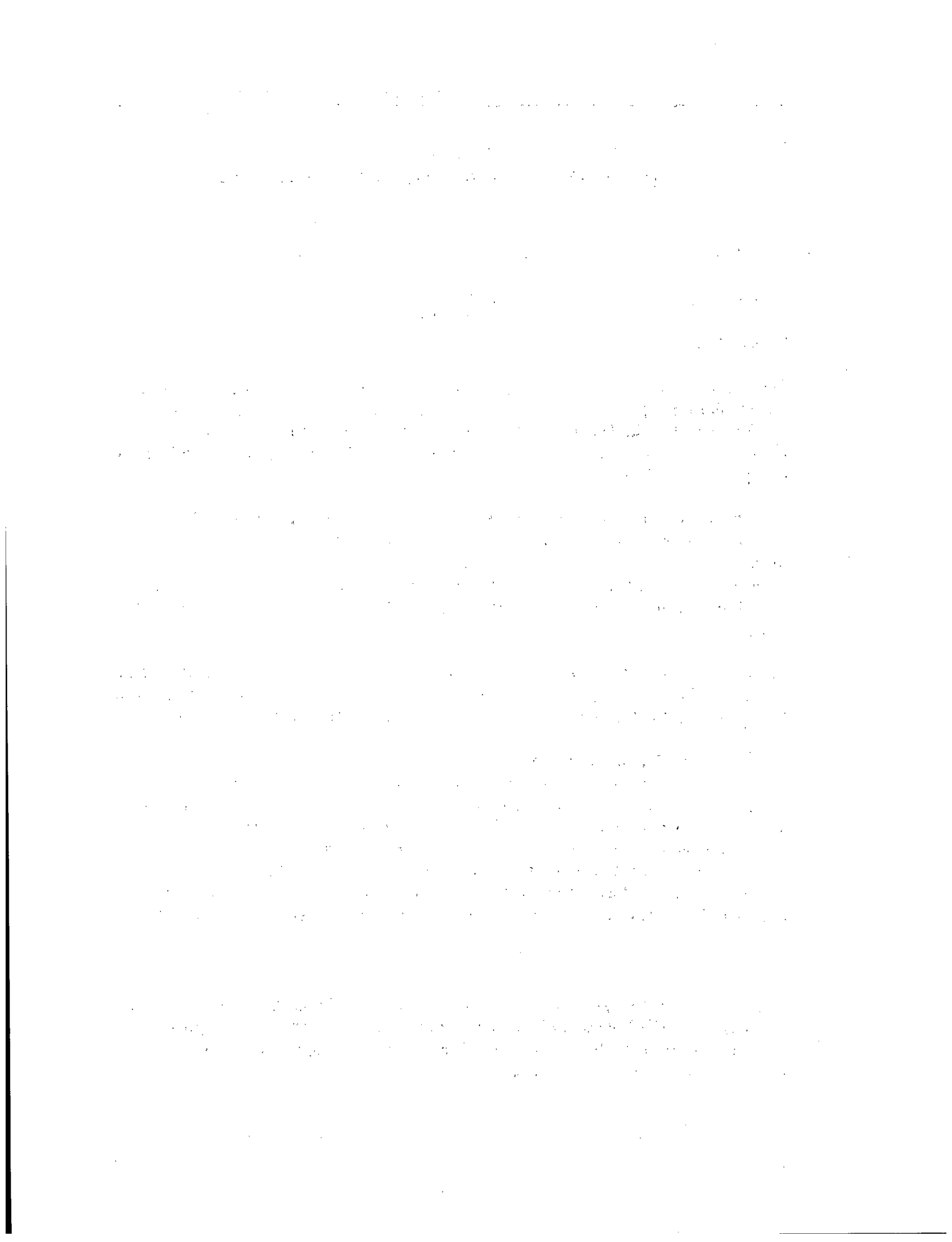

Section I Ingestion Pathway Protective Action Assessment

Purpose

To assess ingestion pathway protective actions.

Discussion

This section is used only to determine if protective actions are warranted to protect the public from ingestion of food, milk, and water that have been contaminated as a result of an accident. This procedure should be performed by the Advisory Team for Environment, Food, and Health (composed of EPA, HHS, and USDA, at a minimum) in support of the State.

The assessments are based on the HHS guidance for ingestion in EPA 400-R-92-001. Two levels of PAGs are provided: emergency and preventive (Table I-1). Recommended protective actions for each PAG level are shown in Table I-2. For large reactor releases involving core damage, milk-producing animals within 10 miles should immediately be sheltered, if possible, and placed on stored feed and protected water.

The PAGs apply only to *short-term* exposure from consumption of contaminated food and milk. They do not apply to the consumption of water; however, because guidance for water is still under development, the HHS PAGs are also being used for water.

The ingestion PAGs are intended to assess concentrations measured in food. However, it will be virtually impossible to analyze all potentially contaminated food. The goal, therefore, is to identify an *area* where the levels of radioactivity in food could exceed HHS PAGs. This identification must be made on the basis of readily measured quantities (e.g., exposure rate or surface deposition). Analysis of food samples will be used to confirm the areas of concern. The *FRMAC Assessment Manual* provides methods for evaluating environmental data to identify where the ingestion PAGs may be exceeded and for analyzing food, water, and milk samples.

Step 1

Using the methods in the *FRMAC Assessment Manual* or similar methods, determine the area where HHS ingestion PAGs may be exceeded based on either (1) gross gamma measurements (for a reactor accident before the isotopic contamination mixture is known) or (2) ground surface deposition.

Step 2

Obtain the analyses of food, water, and milk samples from the area where results from Step 1 indicate that the ingestion PAGs may be exceeded. Other areas of suspected contamination should also be sampled.

Step 3

Recommend protective actions in accordance with State or Federal guidance. (Federal guidance is summarized in Tables I-1 and I-2.) Results from samples taken around the perimeter of the identified areas may indicate whether the area of analysis needs to be expanded, reduced, or shifted.

Step 4

Coordinate a working group to develop guidance and a program for long-term ingestion controls to protect the public from ingestion of contaminated foods.

END

Source: EPA 400-R-92-001.

Table I-1. Ingestion Protective Action Guides

Protective action	Organ of interest	Projected dose commitment (mrem)
Preventive ^a (Lower impact)	• Whole body, bone marrow, or any other organ	500
	• Thyroid	1,500
Emergency ^b	• Whole body, bone marrow, or any other organ	5,000
	• Thyroid	15,000

^aPreventive PAGs are applicable to situations where protective actions causing minimal impact on the food supply are appropriate. A preventive PAG establishes a level at which responsible officials should take protective actions having minimal impact to prevent or reduce the concentration of radioactivity in food or animal feed.

^bEmergency PAGs are applicable to incidents where protective actions of great impact on the food supply are justified because of the projected health hazards. An emergency PAG establishes a level at which responsible officials should isolate food containing radioactivity to prevent its introduction into commerce, and at which the responsible officials must determine whether condemnation or another disposition is appropriate.

Source: 47 FR 47073, p. 47081, as incorporated into EPA 400-R-92-001, Chapter 3.

Table I-2. Ingestion pathway protective actions^a

Contaminated item	Protective action
At preventive PAG	
Pasture	<ul style="list-style-type: none"> • Remove lactating (milk-producing) dairy animals from pasture and substitute uncontaminated feed. • Substitute uncontaminated water.
Milk	<ul style="list-style-type: none"> • Withhold contaminated milk from market to allow decay of short-lived radionuclides. • Divert fluid milk to production of dry whole milk, non-fat dry milk, butter, cheese or evaporated milk.
Fruits and vegetables	<ul style="list-style-type: none"> • Wash, brush, scrub, or peel to remove surface contamination. • Preserve by canning, freezing, dehydration, or storage to permit decay of short-lived radionuclides.
Grains	<ul style="list-style-type: none"> • Mill • Polish
Other foods	<ul style="list-style-type: none"> • Process to remove surface contamination.
At emergency PAG	
All food	<ul style="list-style-type: none"> • Isolate food to prevent introduction into commerce and determine whether condemnation or other disposition is appropriate.
Before taking action consider the following:	<ul style="list-style-type: none"> • Availability of other possible protective actions. • Relative proportion of contaminated food in total diet by weight. • Importance of the food in nutrition and availability of uncontaminated substitutes. • Contribution of other foods and other radioisotopes to total projected dose. • Time and effort required to implement corrective action. • Exposure of food processing workers.

^aHHS has published guidance on the protective actions that should be considered if the ingestion of contaminated food may produce doses that exceed the PAGs. This guidance is summarized here.

Source: 47 FR 47073, p. 47083, as incorporated into EPA 400-R-92-001, Chapter 3.

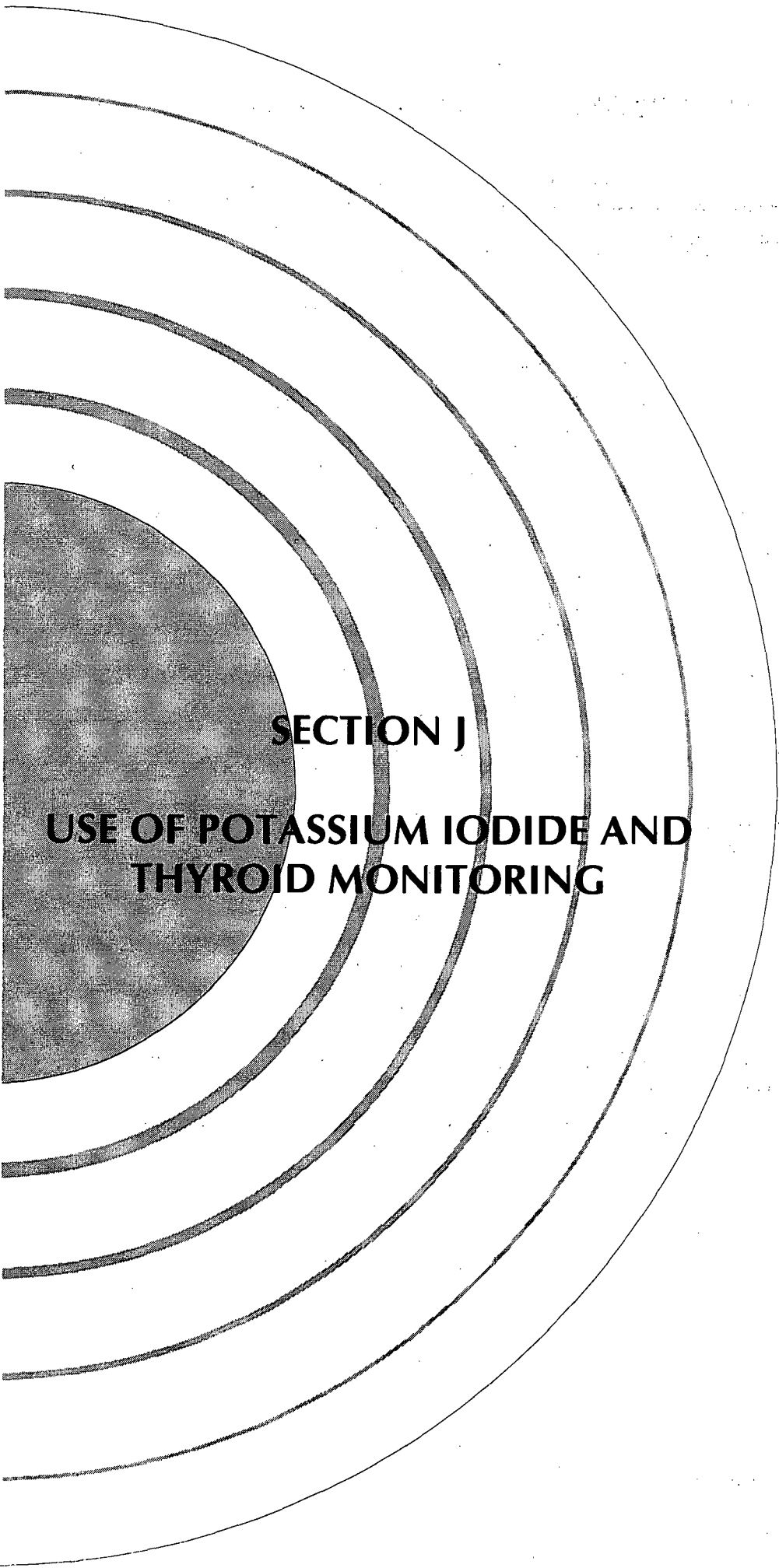

SECTION J

**USE OF POTASSIUM IODIDE AND
THYROID MONITORING**

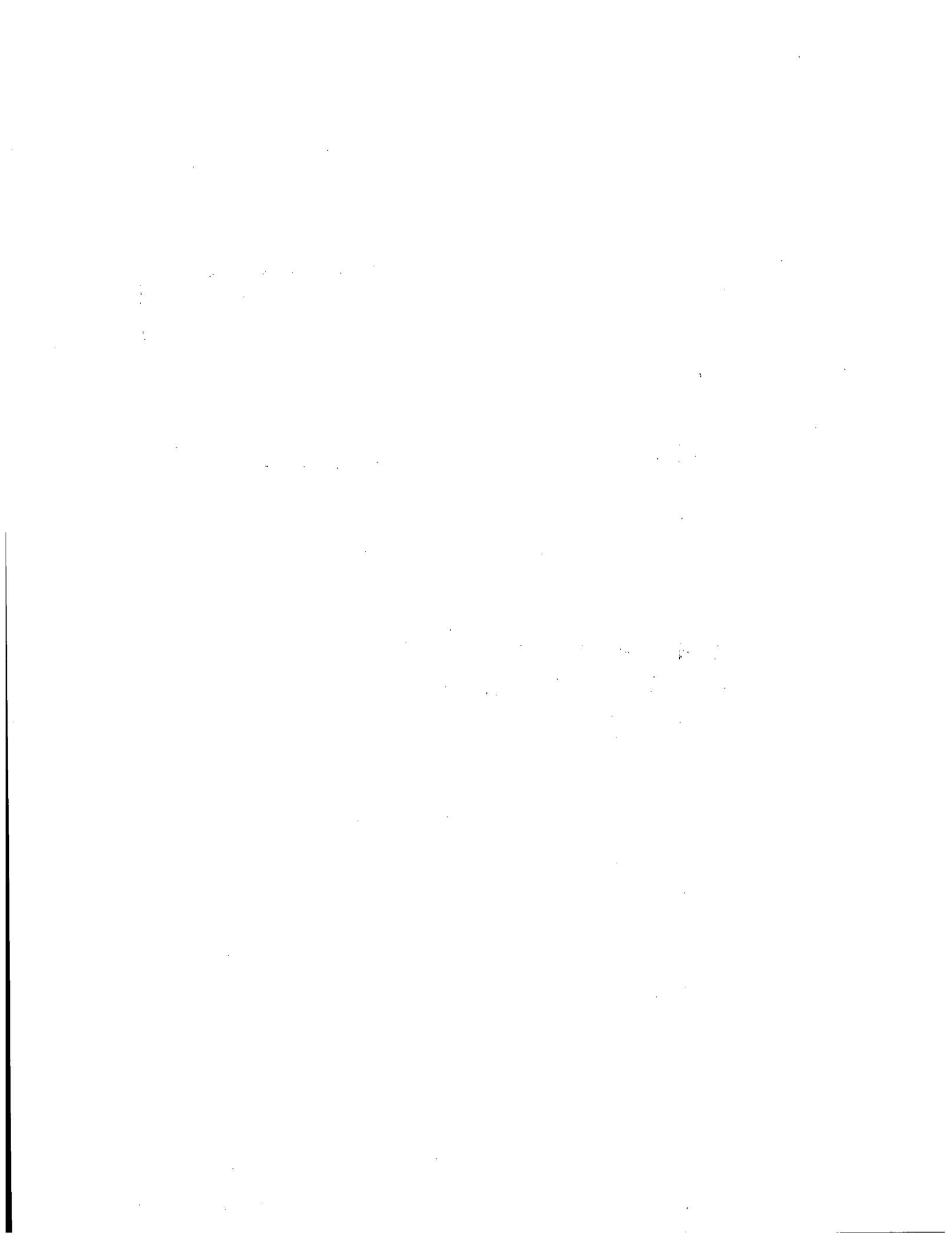

Section J
Quick Reference Guide

	<i>Page</i>
Use of potassium iodide and thyroid monitoring	J-3
Section J table	J-5
Section J figure	J-6

1. The first part of the document discusses the importance of maintaining accurate records of all transactions.

2. It then goes on to describe the various methods used to collect and analyze data.

3. The next section details the results of the study, including the identification of key trends and patterns.

4. Finally, the document concludes with a series of recommendations for future research and practice.

5. The following table provides a summary of the data collected during the study.

6. It is important to note that the data presented here is preliminary and subject to change.

7. The authors would like to thank the following individuals for their assistance and support:

8. This research was supported by a grant from the National Science Foundation.

9. The authors have no conflicts of interest to disclose.

10. The data for this study was collected over a period of six months.

11. The results of the study are consistent with previous research in this area.

12. The authors plan to publish their findings in a peer-reviewed journal.

13. The document is available for free download at the following URL:

Section J

Use of Potassium Iodide and Thyroid Monitoring

Purpose

To provide information on the use of potassium iodide (KI) to protect the thyroid from radioactive iodine intake.

Discussion

KI, administered orally, can be used effectively as a thyroid blocking agent to reduce the accumulation of radioiodine in the thyroid gland. The radioiodine enters the body through inhalation or ingestion. KI is not an adequate substitute for prompt evacuation or sheltering of the general population near a plant for a severe reactor accident. The decision to use KI to protect the public rests with the State and local health authorities. EPA early phase PAGs recommend evacuation or sheltering to avoid a total effective dose equivalent of 1-5 rem and administration of KI to avoid a committed dose equivalent from radioiodine to the adult thyroid of 25 rem (Table G-1).

Step 1

Consult with the representatives of involved State(s) and other Federal agencies (FEMA, HHS, EPA) before making any recommendations.

Step 2

Refer to the following information to answer questions:

Federal Position. The Food and Drug Administration (FDA) has evaluated the medical and radiological risks of administering KI for thyroid blocking under nuclear emergency conditions. FDA guidance states that risks from the short-term use of relatively low doses of KI for thyroid blocking in a radiation emergency are lower than the risk of radioiodine-induced thyroid nodules or cancer at a projected committed dose equivalent to the thyroid gland of 25 rem or more. FDA has approved the over-the-counter sale of the drug for this purpose.

Federal policy recommends the stockpiling or distribution of KI during emergencies for emergency workers and institutionalized persons but does not recommend requiring predistribution or stockpiling for the general public.

Effectiveness. The effectiveness of KI in blocking uptake of radioiodine by the thyroid depends strongly on the timing of the dose of KI relative to the exposure to radioactive iodine. KI is most effective when taken just before or within 1–2 h after exposure to radioiodine. Taking the recommended dosages of KI just before or at the time of exposure can provide greater than 90% blocking of radioactive iodine uptake by the thyroid (Fig. J-1). If KI is taken approximately 3–4 h after acute exposure, about 50% blocking could still occur. Once radioactive iodine has concentrated in the thyroid, KI is not effective at removing it.

Dosage. The FDA recommended dosage of KI is 130 mg/day for adults and children above 1 year, and 65 mg/day for children below 1 year of age (130 mg of KI contains 100 mg of stable iodine) given shortly before or just after the intake of radioactive iodine. KI should be administered for at least 3 days after an acute exposure because it takes approximately 48 h for most of the radioiodine to be excreted in the urine.

Thyroid Monitoring. Thyroid dose resulting from ^{131}I can be estimated by taking a measurement with a gamma radiation detector held horizontally next to the thyroid (immediately below the Adam's apple). From the count rate, an approximation of the thyroid uptake can be obtained. Several detectors have been evaluated using this technique; the average count rate per μCi of ^{131}I in the thyroid is given in Table J-1. The projected dose to the thyroid (in rem) is found by multiplying the estimated ^{131}I uptake in μCi by the appropriate dose conversion factor: adult (6.50 rem/ μCi), 5-year-old child (19.1 rem/ μCi), or 2-year-old child (36.0 rem/ μCi).

The minimum detectable thyroid dose commitment, assuming all the radioiodine has reached the thyroid, ranges from 0.01 rem (adult thyroid, scintillation counter) to 4.3 rem (2-year-old child thyroid, GM detector). This thyroid screening procedure is recommended only for emergency personnel at completion of their final mission involving direct exposure to a plume or for evacuees who were exposed to the plume for a significant time before evacuation. If this procedure suggests a projected thyroid dose greater than 10 rem, the individual should be sent to a hospital or laboratory for a more accurate determination of radioiodine uptake.

END

Sources: 50 FR 30258; 47 FR 28158; FDA 83-8211; (dose estimation) FEMA-REP-2, Sect. 5.6.

Table J-1. Approximate response to radioiodine in the thyroid for different detectors

Thyroid model	Detector response ^a (net cpm per $\mu\text{Ci } ^{131}\text{I}$ in thyroid)							
	D-103 ^b #1	D-103 #2	6306 ^c #1	6306 #2	489-4 ^d	489-55 ^e	SPA-3 ^f	RD-22 ^g
ANSI standard adult	152 ± 33	151 ± 26	1,149 ± 77	1,232 ± 159	258 ± 117	75,780 $\pm 6,244$	53,570 $\pm 2,950$	54,970 $\pm 1,324$
Adult	124 ± 23	123 ± 14	668 ± 51	682 ± 110	149 ± 31	45,840 $\pm 2,056$	32,490 ± 173	30,270 ± 996
5-year-old child	224 ± 52	231 ± 20	1,390 ± 61	1,580 ± 53	321 ± 79	18,140 $\pm 3,060$	58,100 $\pm 4,917$	56,830 $\pm 2,521$
2-year-old child	227 ± 53	274 ± 46	1,640 ± 234	1,910 ± 115	381 ± 79	102,120 $\pm 5,428$	72,980 $\pm 3,791$	73,020 $\pm 3,830$

^aThe first number for each instrument is the average of a series of 10 tests; the second is the standard deviation.

^bCivil defense model OCD-D-103 GM detector.

^cVictoreen model 6306 GM detector (organic quench gas, bismuth cathode, and special lead and copper shield).

^dVictoreen model 489-4 GM detector (organically quenched).

^eVictoreen model 489-55, 3.2 \times 3.8 cm NaI(Tl) crystal.

^fEberline model SPA-3, 5 \times 5 cm NaI(Tl) crystal.

^gEberline model RD-22, 5 \times 5 cm NaI(Tl) crystal (with ²⁴¹Am check source for use with stabilized assay meter).

Source: FEMA-REP-2, p. 5-16.

Fig. J-1
Percentage of thyroid blocking by 130 mg of KI.

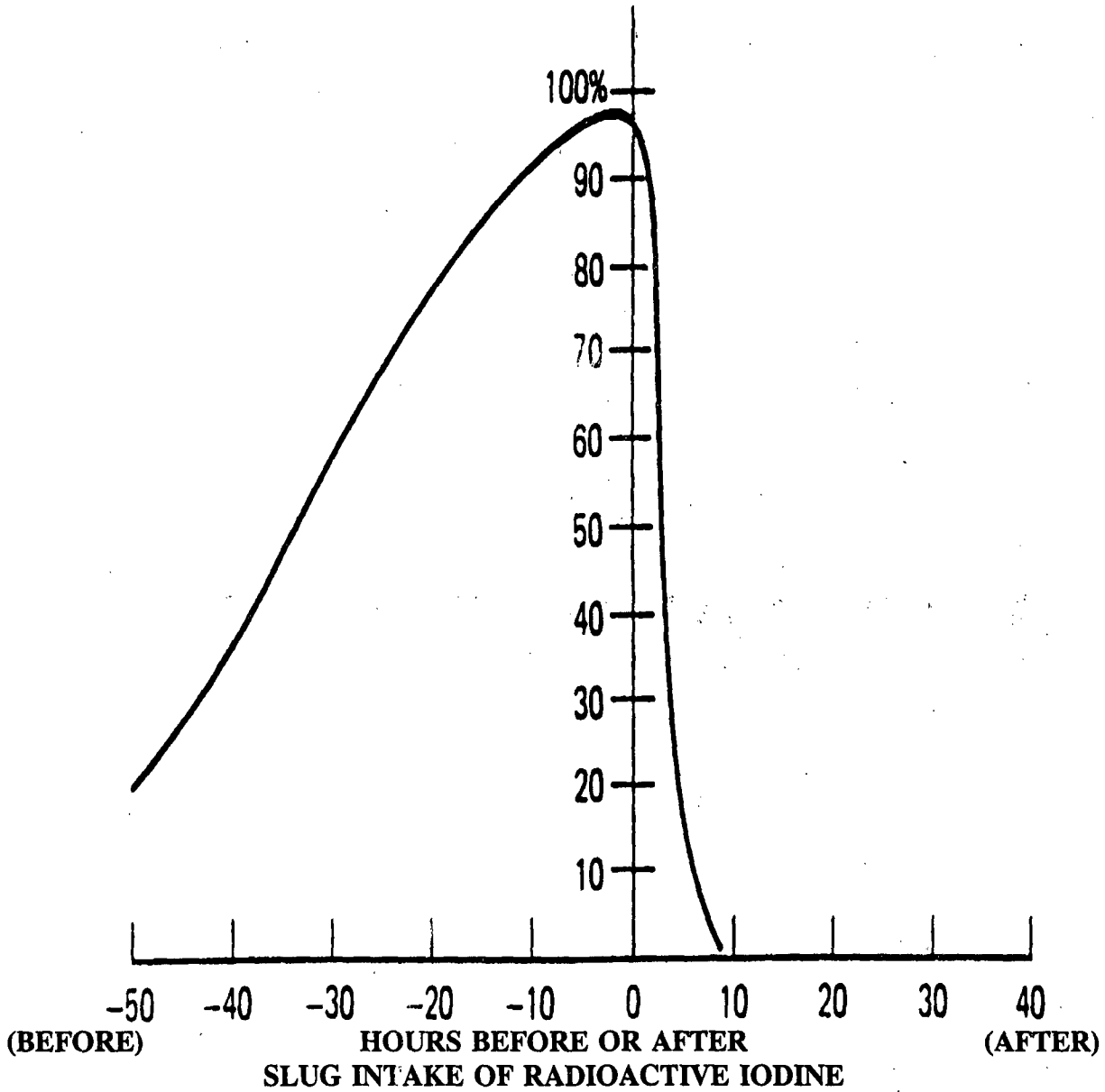

Source: AEC-tr-7536, p. 224.

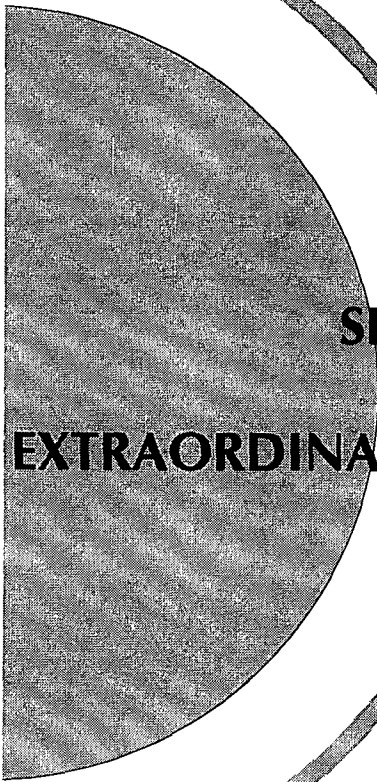

SECTION K

EXTRAORDINARY NUCLEAR OCCURRENCE

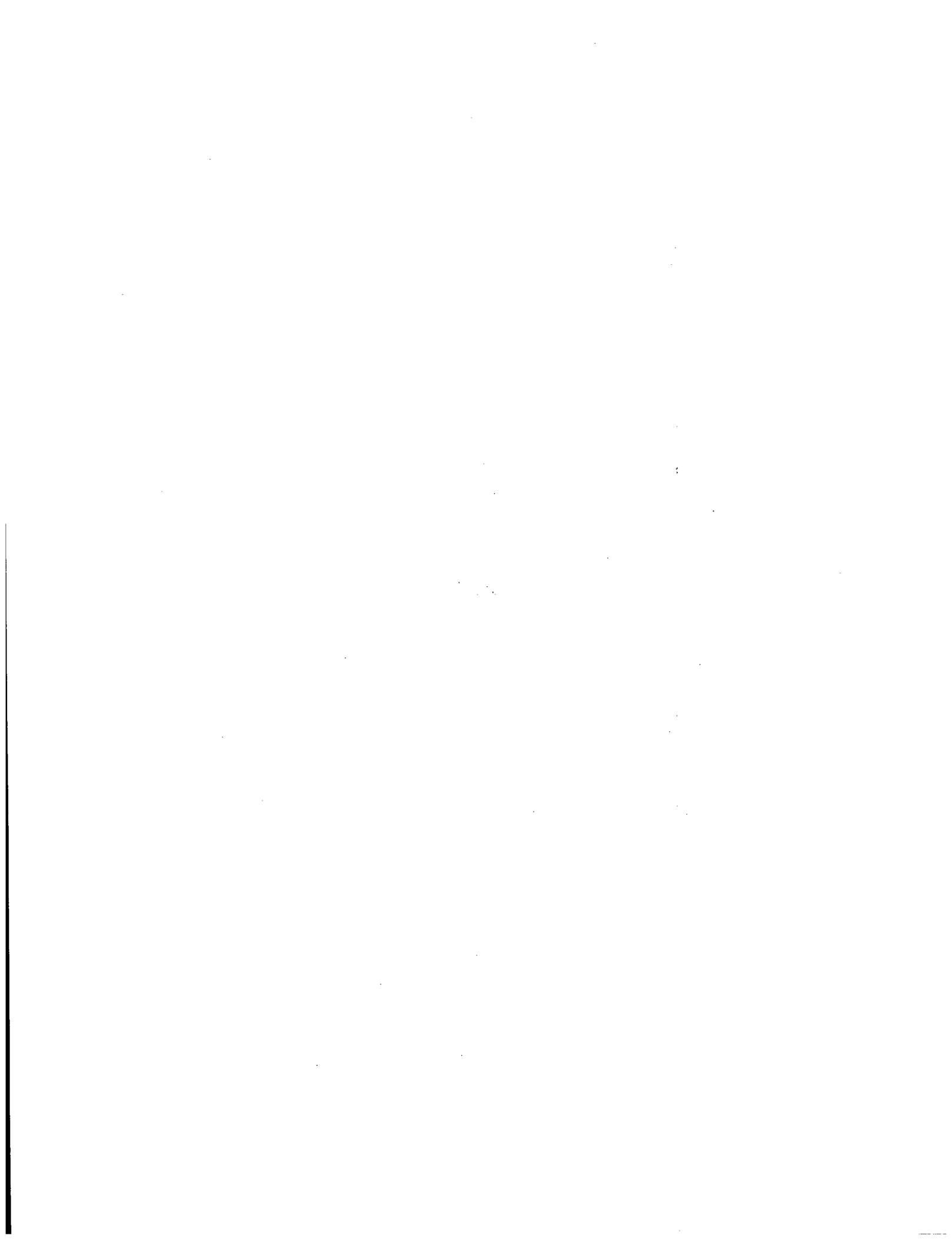

Section K
Quick Reference Guide

	<i>Page</i>
Extraordinary nuclear occurrence	K-3
Section K tables	K-5

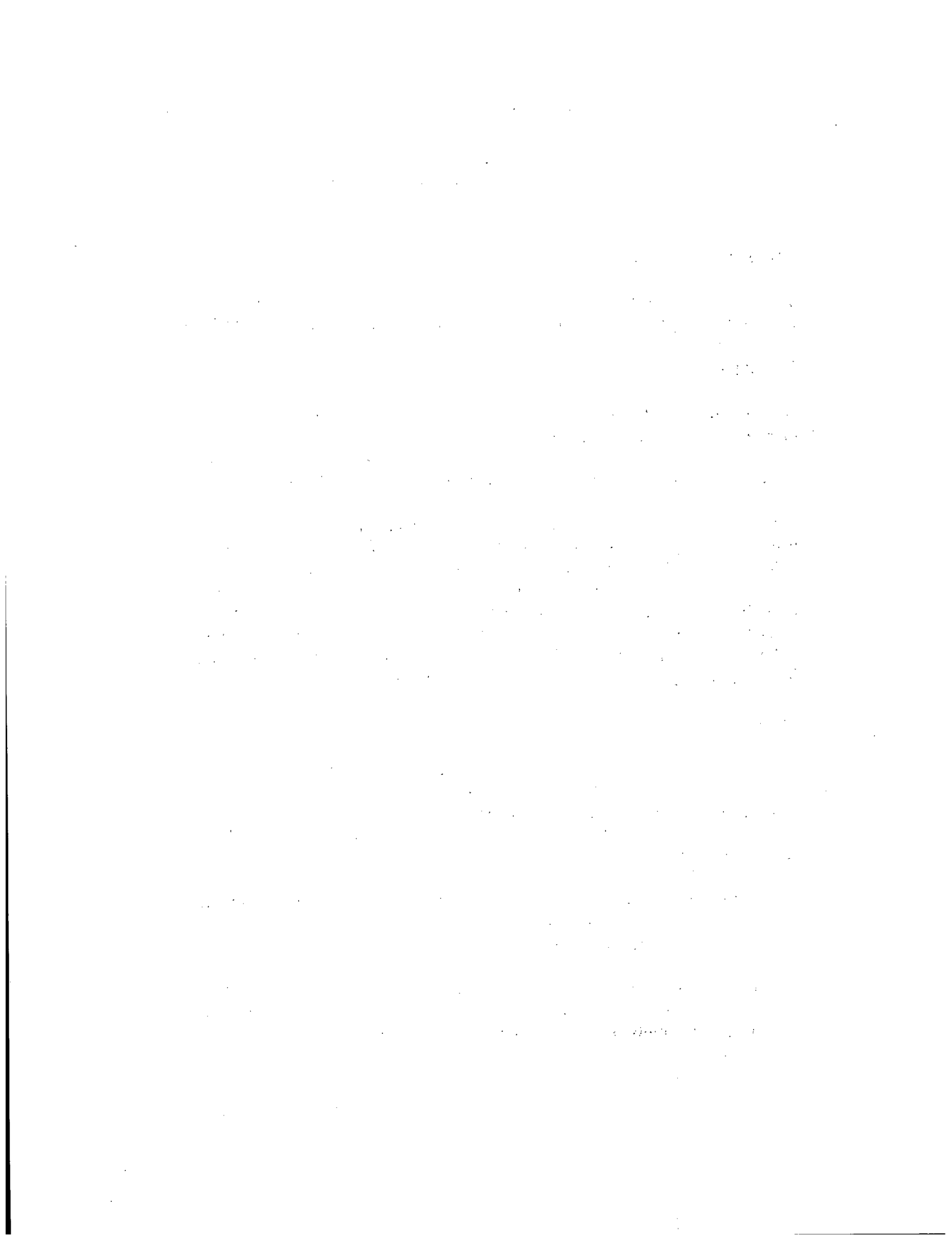

Section K Extraordinary Nuclear Occurrence

Purpose

To provide the Commission with an assessment of whether an event is an extraordinary nuclear occurrence in accordance with 10 CFR 140.81-140.85.

Discussion

An extraordinary nuclear occurrence determination does not mean that a particular claimant will recover on a claim. If there has been an extraordinary nuclear occurrence determination, the claimant must still proceed (in the absence of settlement) with a tort action, but the claimant's burden is substantially eased.

Any affected person, licensee, person with whom an indemnity agreement is executed, or a person providing financial protection may petition the Commission for a determination for whether or not there has been an extraordinary nuclear occurrence. If within 7 days of the event's occurrence the Commission does not have enough information to make a determination, it will publish a *Federal Register* notice requesting persons to submit information concerning the event. If the Commission publishes a notice in the *Federal Register* and does not make a determination within 90 days, the alleged event will not be deemed an extraordinary event.

Step 1

Determine if there has been a substantial release of radioactive material and/or substantial radiation levels offsite. There has been a substantial release if, as a result of an event of one or more related happenings, radioactive material is released from its intended place of confinement or radiation levels occur offsite *and* either criterion A *or* B are met:

- A. One or more persons offsite were, could have been, or might be exposed to radiation or to radioactive material resulting in a dose or a projected dose exceeding one of the levels in Table K-1.
- B. Surface contamination of at least a total of any 100 m² of offsite property has occurred as the result of a release of radioactive material from a production or utilization facility in levels exceeding one of the values in Column 1 or Column 2 of Table K-2.

or

Surface contamination of any offsite property has occurred as the result of a release of radioactive material in the course of transportation in levels exceeding one of the values in Column 2 of Table K-2.

Step 2

If the conditions in Step 1 are not met, no extraordinary nuclear occurrence has occurred; go to Step 3. If the conditions in Step 1 were met, continue with Step 2.

Determine if the event has resulted or will probably result in substantial damages to persons offsite or property offsite. This is indicated if either criterion C or D below is met.

- C. Death or hospitalization, within 30 days of the event, of five or more people located offsite showing objective clinical evidence of physical injury from exposure to the radioactive, toxic, explosive, or other hazardous properties of source, special nuclear, or byproduct material.
- D. Any of the following offsite damages has been or will probably be sustained:
 - 1. \$2,500,000 or more by any one person;
 - 2. \$5 million or more in the aggregate; or
 - 3. \$5,000 or more by each of 50 or more persons, resulting in \$1 million or more in the aggregate.

Damages shall be based upon estimates of the following: (1) total cost to put affected property back into use; (2) loss of use of affected property; (3) value of affected property where not practical to restore to use; (4) financial loss resulting from protective action appropriate to reduce or avoid exposure to radiation or radioactive materials.

Step 3

Prepare a report for the Commission based on your findings in Steps 1 and 2. The Commission can find that an extraordinary nuclear occurrence exists if the criteria in Step 1 and Step 2 are met.

END

Source: 10 CFR 140.81-140.85.

Table K-1. Total projected radiation doses for extraordinary nuclear occurrence

Critical organ	Dose ^a (rems)
Thyroid	30
Whole body	20
Bone marrow	20
Skin	60
Other organs or tissues	30

^aDoses from the following types of radiation sources are included: (1) radiation sources external to the body and (2) radioactive material that may be taken into the body through its occurrence in air, water, or food or on terrestrial surfaces.

Source: 10 CFR 140.84.

Table K-2. Total surface contamination levels for extraordinary nuclear occurrence^a

Type of emitter	Column 1 ^b	Column 2 ^c
Alpha emission from transuranic isotopes	3.5 $\mu\text{Ci}/\text{m}^2$	0.35 $\mu\text{Ci}/\text{m}^2$
Alpha emission from isotopes other than transuranic isotopes	35 $\mu\text{Ci}/\text{m}^2$	3.4 $\mu\text{Ci}/\text{m}^2$
Beta or gamma emission	40 mrad/h at 1 cm ^d	4 mrad/h at 1 cm ^d

^aThe maximum levels (above background), observed or projected, 8 h or more after initial deposition.

^bOffsite property, contiguous to site, owned or leased by person with whom an indemnity agreement is executed.

^cOther offsite property.

^dMeasured through not more than 7 mg/cm² of total absorber.

Source: 10 CFR 140.84.

L



SECTION L
USE OF RASCAL

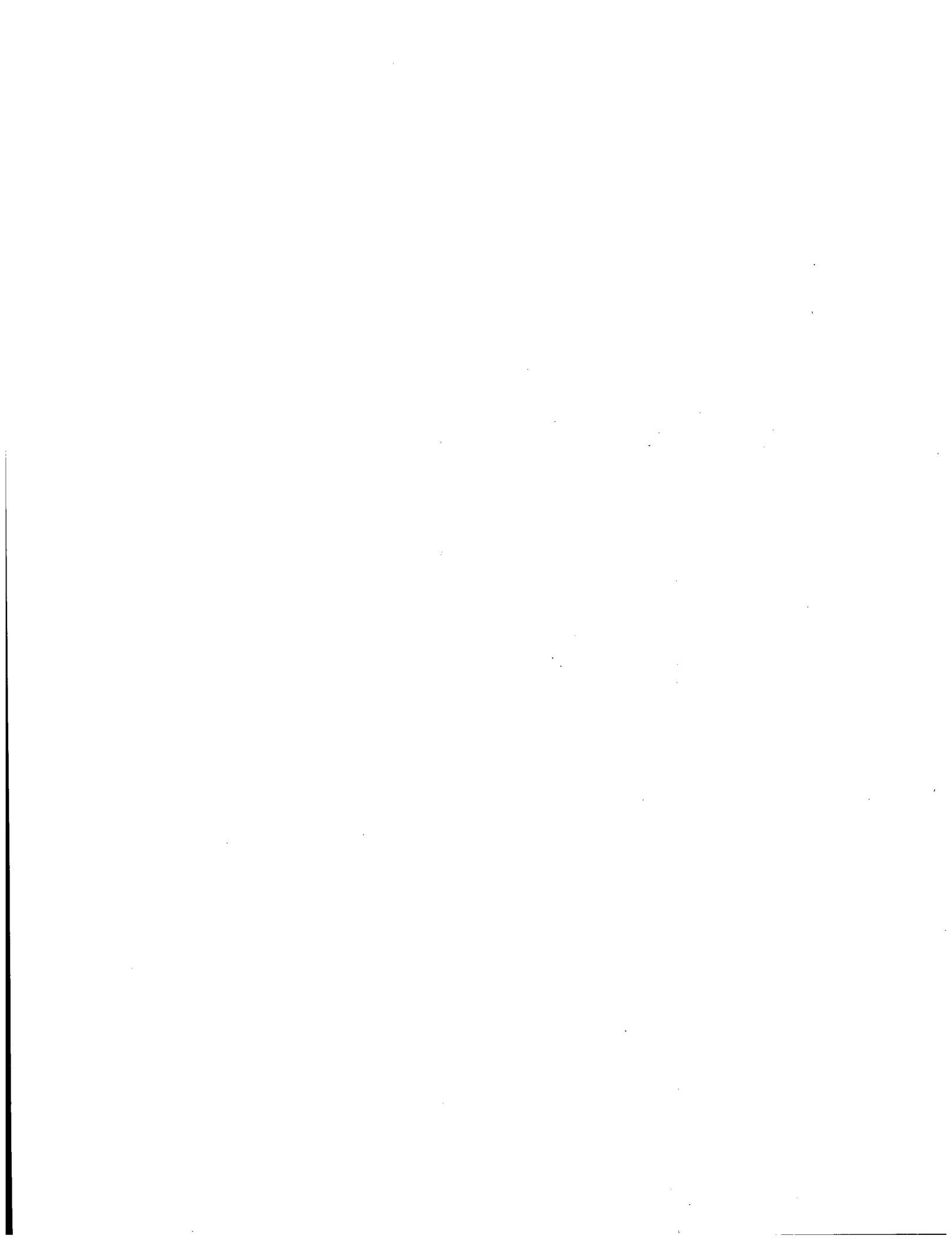

Section L
Quick Reference Guide

	<i>Page</i>
Use of RASCAL	L-3
Description	L-3
Section L figure	L-5
Section L worksheets	L-6

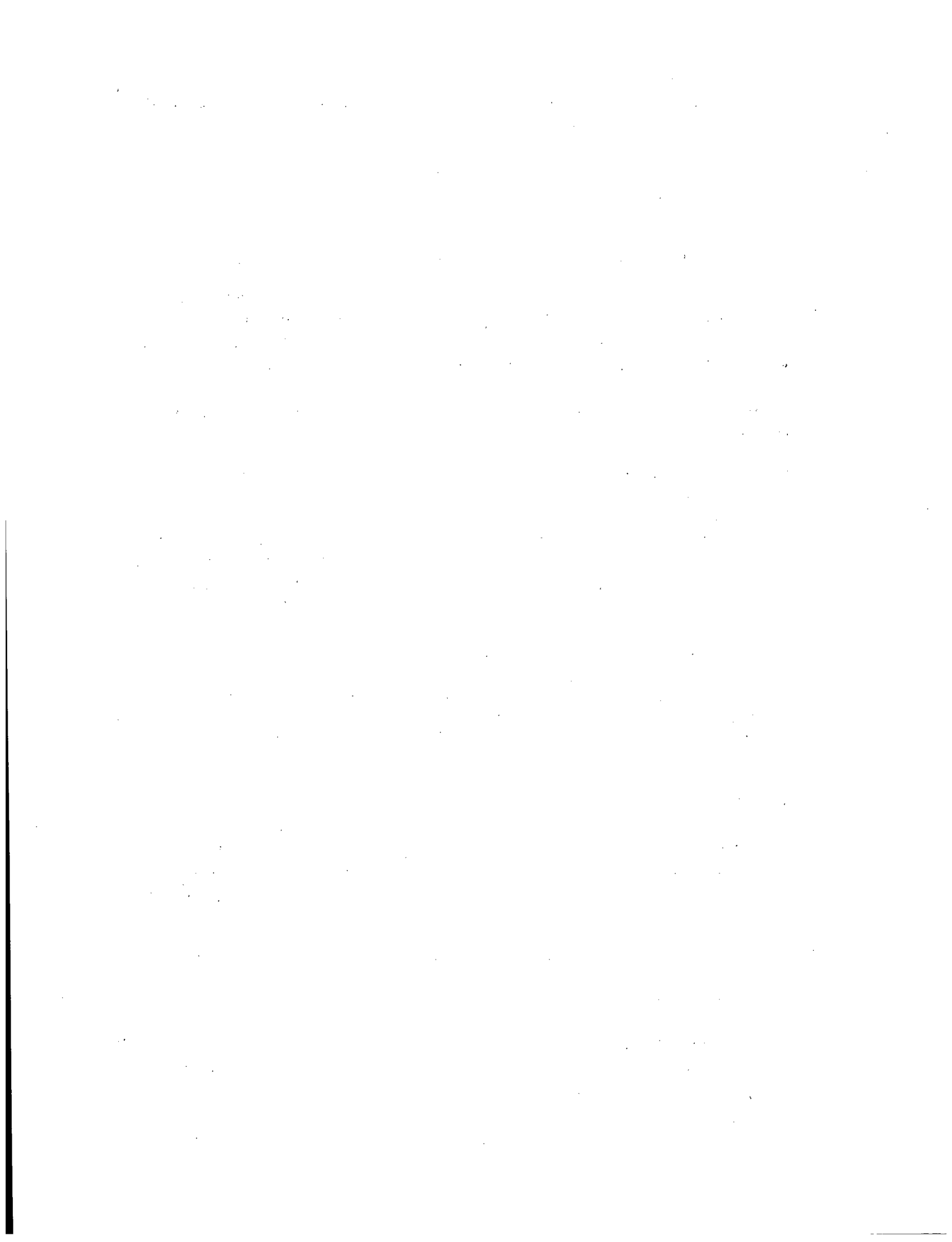

Section L Use of RASCAL

Description

The following material is included to provide information on the capabilities and availability of the tools in the Radiological Assessment System for Consequence Analysis software (RASCAL Version 2.1) and to provide some of the flowcharts and worksheets to facilitate the use of the tools.

RASCAL contains three basic tools to assist in consequence assessment. Figure L-1 can assist in determining the appropriate tool.

- ST-DOSE model (Source Term to Dose)

ST-DOSE computes doses starting with a source term. It allows you to estimate doses resulting from accidents at nuclear facilities. The doses are based on your specification of a source term and meteorological conditions. The plant condition source-term option performs the calculations used in Section C. The program (1) computes source terms from plant conditions, if necessary, (2) predicts radionuclide concentrations in the atmosphere and on the ground, and (3) calculates doses from the predicted concentrations.

This program should not be used to estimate doses based on radioisotope concentrations measured in the environment. If you have concentrations measured in the environment, you should use the FM-DOSE (Field Measurement to Dose) program.

- FM-DOSE model (Field Measurement to Dose)

FM-DOSE computes doses starting from isotopic concentrations measured in the air or on the ground. Groundshine, cloud immersion, and inhalation doses are computed. The overhead cloudshine dose is not computed. The computed doses may be viewed on the screen or printed.

The dose computations and dose factors used in FM-DOSE are the same as those used in ST-DOSE except that the ingrowth of radioactive decay products is included in more detail in FM-DOSE.

This program should not be used to estimate doses based on reactor conditions. If you have information about reactor conditions, you should use the ST-DOSE program.

- DECAF model

DECAF computes the activities of radionuclides after an input time for radioactive decay and buildup. It also computes the integrated activities over that time. It uses the same algorithm as in FM-DOSE and ST-DOSE. It does not compute doses.

The use of these tools is discussed in the following documents:

- *RASCAL Version 2.1 User's Guide*, by A. L. Sjoreen, G. F. Athey, J. V. Ramsdell and T. J. McKenna, NUREG/CR-5247, Vol. 1, Rev. 2, December 1994.
- *RASCAL Version 2.1 Workbook*, by G. F. Athey, A. L. Sjoreen and T. J. McKenna, NUREG/CR-5247, Vol. 2, Rev. 2, December 1994.
- *Operations Center Information Management System (OCIMS) Operations Manual*, by HFS Inc. (This document is primarily for NRC internal use.)

The RASCAL Version 2.1 software is available from

Energy, Science and Technology Software Center
P. O. Box 1020
Oak Ridge, TN 37831-1020
Phone: (423) 576-2606
FAX: (423) 576-2865
Internet: estsc@adonis.osti.gov

RASCAL Worksheets

The following worksheets are provided for use in collecting the information needed to run RASCAL and for summarizing results of the analyses.

	<i>Page</i>
L-1 ST-DOSE weather data	L-6
L-2 ST-DOSE data	L-7
L-3 ST-DOSE source term	L-9
L-4 FM-DOSE model	L-13
L-5 NRC consequence analysis summary	L-14
L-6 NRC consequence analysis log	L-15

Fig. L-1
Identification of appropriate RASCAL tool.

Which RASCAL tool to use?

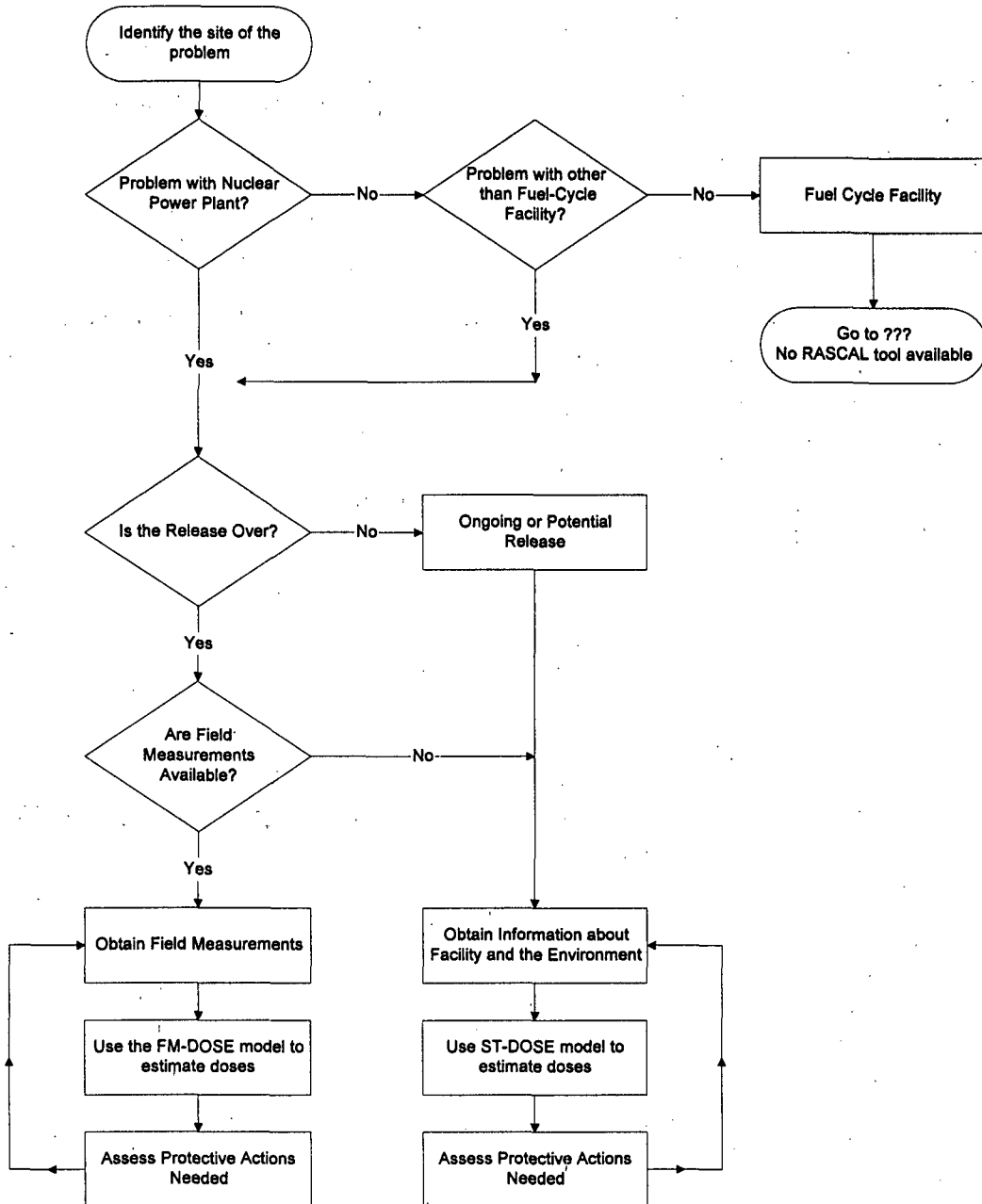

Worksheet L-1. RASCAL ST-DOSE weather data worksheet.

Site Name: _____

Site Code: _____

Time of Release: _____

Time Zone: _____

Part 1: Current Observations						
Time	Wind Speed / Units	Wind Direction	Stability Class	WX (Weather)	Data Source	
					NWS	Site

Part 2: Forecast						
Time	Wind Speed / Units	Wind Direction	Stability Class	Precipitation	Data Source	
					Worded	Computer

Part 3: Input for the ST-DOSE model					
Time	Wind Speed / Units	Wind Direction	Stability Class	Mixing Layer Height	Precipitation Codes

Worksheet L-2. RASCAL ST-DOSE data worksheet.

Analyst(s) _____ **Date/Time** _____

Description (Case Title, Site Name, etc.)

Default Units: Ci (output will be in rem) *or* Bq (output will be in Sv)

Data Source: Projected *or* Actual

Effective Release Height: _____ ft *or* m

Source Term

See the data sheet provided by the Source Term Analyst

Sequence of Events (dates and times)

	Reactor Shutdown	Start of Release to Containment	Start of Release to Environment	End of Release	End of Exposure
Date					
Time					

Meteorological Data

See the data sheet provided by the Dispersion Analyst

Calculation Options:

Model: Plume *or* Puff

Calculate Building Wake Effects: YES *or* NO

Calculation Radius: 0-10 miles *or* 0-25 miles

Worksheet L-2. RASCAL ST-DOSE data worksheet (continued).

Guidance on which results to examine first

For these conditions:	Look at these doses first:
Reactor accidents	TEDE and Thyroid for comparison with EPA PAGs
To compare with field monitoring external dose measurements	Cloud shine dose
For accidents where inhalation lung dose may dominate (e.g. Pu)	Acute Lung Dose

Check the results of most interest

- Total Acute Bone
- Acute Lung
- Total Effective Dose Equivalent
- Thyroid
- Cloudshine
- Initial Groundshine
- 4-day Groundshine
- Acute Bone Inhalation
- Inhalation Dose CEDE
- Deposition

Worksheet L-3. RASCAL ST-DOSE source term worksheet.

Case Name _____

A. User Specified Source Term—Isotopic Release Rates

Release Rate Units: _____ [Ci, Bq]/[sec, min, h]
prefix

Prefixes

Isotope	Release Rate	Isotope	Release Rate	
_____	_____	_____	_____	tera
_____	_____	_____	_____	giga
_____	_____	_____	_____	mega
_____	_____	_____	_____	kilo
_____	_____	_____	_____	centi
_____	_____	_____	_____	milli
_____	_____	_____	_____	micro
_____	_____	_____	_____	nano
_____	_____	_____	_____	pico

B. User Specified Source Term—Isotopic Concentrations

Release Rate: _____ [cc, ft³, L, g]/[sec, min, h]

Concentration Units: _____ [Ci, Bq]/[cc, ft³, L, g]
prefix

Input from DECAY Calculator: No or Yes

Prefixes

Isotope	Concentration	Isotope	Concentration	
_____	_____	_____	_____	tera
_____	_____	_____	_____	giga
_____	_____	_____	_____	mega
_____	_____	_____	_____	kilo
_____	_____	_____	_____	centi
_____	_____	_____	_____	milli
_____	_____	_____	_____	micro
_____	_____	_____	_____	nano
_____	_____	_____	_____	pico

C. Gross Reactor Release—Mix Specified By Analyst

Gross Release Rate: _____ Ci/sec or Bq/sec

Percentage of Release:

Kr, Xe: _____ %	Te, Sb: _____ %	La, Y, Ce, Np: _____ %
I: _____ %	Ba, Sr: _____ %	
Cs: _____ %	Ru, Mo: _____ %	

Worksheet L-3. RASCAL ST-DOSE source term worksheet (continued).

**D. Reactor Accident, Based on Plant Conditions
(six release pathways available)**

Large Dry, or Subatmospheric Containment Leakage/Failure

Core Condition: GAP RELEASE (core uncovered 15-30 min)
IN-VESSEL SEVERE CORE DAMAGE (uncovered > 30 min)
VESSEL MELT-THROUGH

Reactor Power: _____ MW(t) or Full Power

Containment Sprays: ON or OFF Release path: FILTERED or UNFILTERED

Containment Leak Rate:	100%/h	4%/h (100%/day)	design pressure
	50%/h	1%/h	½ design pressure
	10%/h	0.5%/h	

Steam Generator Tube Rupture (Coolant)

Coolant Concentration: GAP RELEASE (core uncovered 15-30 min)
IN-VESSEL SEVERE CORE DAMAGE (uncovered > 30 min)
TYPICAL COOLANT
COOLANT WITH 100x NORMAL NON-NOBLES

SG Conditions: PARTITIONED or NOT PARTITIONED

Release Rate:	1 TUBE 35%/h; 500 gal/min	1 PUMP 3%/h; 50 gal/min
	2 TUBES 70%/h; 1000 gal/min	2 PUMPS 6%/h; 100 gal/min
		3 PUMPS 9%/h; 150 gal/min

Release is from: STEAM JET AIR EJECTOR or SAFETY VALVE

Ice Condenser Containment Leakage/Failure

Core Condition: GAP RELEASE (core uncovered 15-30 min)
IN-VESSEL SEVERE CORE DAMAGE (uncovered > 30 min)
VESSEL MELT-THROUGH

Reactor Power: _____ MW(t) or Full Power Recirculation Fans: ON or OFF

Release Path: FILTERED or UNFILTERED Containment Sprays: ON or OFF

Ice Bed Condition

Before Core Damage: EXHAUSTED or NOT EXHAUSTED

Containment Leak Rate:	100%/h	4%/h (100%/day)	design pressure
	50%/h	1%/h	½ design pressure
	10%/h	0.5%/h	

Worksheet L-3. RASCAL ST-DOSE source term worksheet (continued).
Dry Well Leakage/Failure; BWR Containment

Core Condition: GAP RELEASE (core uncovered 15–30 min)
 IN-VESSEL SEVERE CORE DAMAGE (uncovered > 30 min)
 VESSEL MELT-THROUGH

Reactor Power: _____ MW(t) or Full Power

Release Path: FILTERED or UNFILTERED Containment Sprays: ON or OFF

Dry Well Leak Rate:	100%/h	1%/h
	50%/h	0.5%/h
	10%/h	design pressure
	4%/h (100%/day)	½ design pressure

Wet Well Leakage/Failure; BWR Containment

Core Condition: GAP RELEASE (core uncovered 15–30 min)
 IN-VESSEL SEVERE CORE DAMAGE (uncovered > 30 min)
 VESSEL MELT-THROUGH

Reactor Power: _____ MW(t) or Full Power

Wet Well: SATURATED or SUBCOOLED

Release Path: FILTERED or UNFILTERED

Wet Well Leak Rate:	100%/h	1%/h
	50%/h	0.5%/h
	10%/h	design pressure
	4%/h (100%/day)	½ design pressure

Containment Bypass (Event V)

Core Condition: GAP RELEASE (core uncovered 15–30 min)
 IN-VESSEL SEVERE CORE DAMAGE (uncovered > 30 min)
 VESSEL MELT-THROUGH

Reactor Power: _____ MW(t) or Full Power

Release Path: FILTERED or UNFILTERED

Leak Rate:	100%/h	1%/h
	50%/h	0.5%/h
	10%/h	design pressure
	4%/h (100%/day)	½ design pressure

Worksheet L-3. RASCAL ST-DOSE source term worksheet (continued).

E. Containment Monitor Reading

Location of Monitor: PWR
BWR Mark I Wet Well or Dry Well
BWR Mark II Wet Well or Dry Well
BWR Mark II Wet Well or Dry Well

Reactor Power: _____ MW(t) or Full Power

Monitor Reading: _____ R/h

Containment Sprays: ON or OFF

Release Path: FILTERED or UNFILTERED

Leak Rate:	100%/h	1%/h
	50%/h	0.5%/h
	10%/h	design pressure
	4%/h (100%/day)	½ design pressure

F. Spent Fuel / Spent Fuel Pool Accident

Fuel Condition: Zircalloy File—New Batch Only
Fuel Cladding Failure—Gap Release

Reactor Power: _____ MW(t) or Full Power

Last batch put in pool: _____ (date and time)

Number of batches: _____

Sprays: ON or OFF

Release Path: UNFILTERED or FILTERED

Leak Rate:	100%/h	1%/h
	50%/h	0.5%/h
	10%/h	0.1%/h
	4%/h (100%/day)	

Worksheet L-4. RASCAL FM-DOSE model worksheet.

Case Title: _____

Sample Collection
Date/Time: _____

Input Units for Ground Concentrations		Input Units for Air Concentrations	
tera	m ²	tera	m ³
giga	cm ²	giga	cm ³
mega	ft ²	mega	L
kilo		kilo	ft ³
centi		centi	
milli		milli	
micro		micro	
nano		nano	
pico		pico	

Output Units for Dose	
tera	rem
giga	Sv
mega	
kilo	
centi	
milli	
micro	
nano	
pico	

<input type="checkbox"/> Use Ground Concentrations in Calculations		<input type="checkbox"/> Use Air Concentrations in Calculations	
Ground Surface Correction Factor: _____		Exposure Time (h): _____	
Exposure Time (h): _____			
Resuspension Rate: _____			
Reentry Delay (days): _____			
<u>Nuclide</u>	<u>Concentration</u>	<u>Nuclide</u>	<u>Concentration</u>
_____	_____	_____	_____
_____	_____	_____	_____
_____	_____	_____	_____
_____	_____	_____	_____
_____	_____	_____	_____
_____	_____	_____	_____
_____	_____	_____	_____
_____	_____	_____	_____
_____	_____	_____	_____
_____	_____	_____	_____

Worksheet L-5. NRC consequence analysis summary.

Case Title: _____

Analyst(s): _____

Date/Time: _____
(when the analysis was done)

Summary of Results:

Attach the following as needed:

ST-DOSE Model

Model Worksheet
Source Term Worksheet
Weather Worksheet
Maximum Value Report
Model Input Summary
Computed Source Term
Graphics

FM-DOSE Model

FM-DOSE Worksheet
Model Input Summary
Early Phase Dose Report
Intermediate Phase Dose Report

Worksheet L-6. NRC consequence analysis log.

Case Title	Date/Time	Current Conditions	Analysis Requested	Comments and Results

M

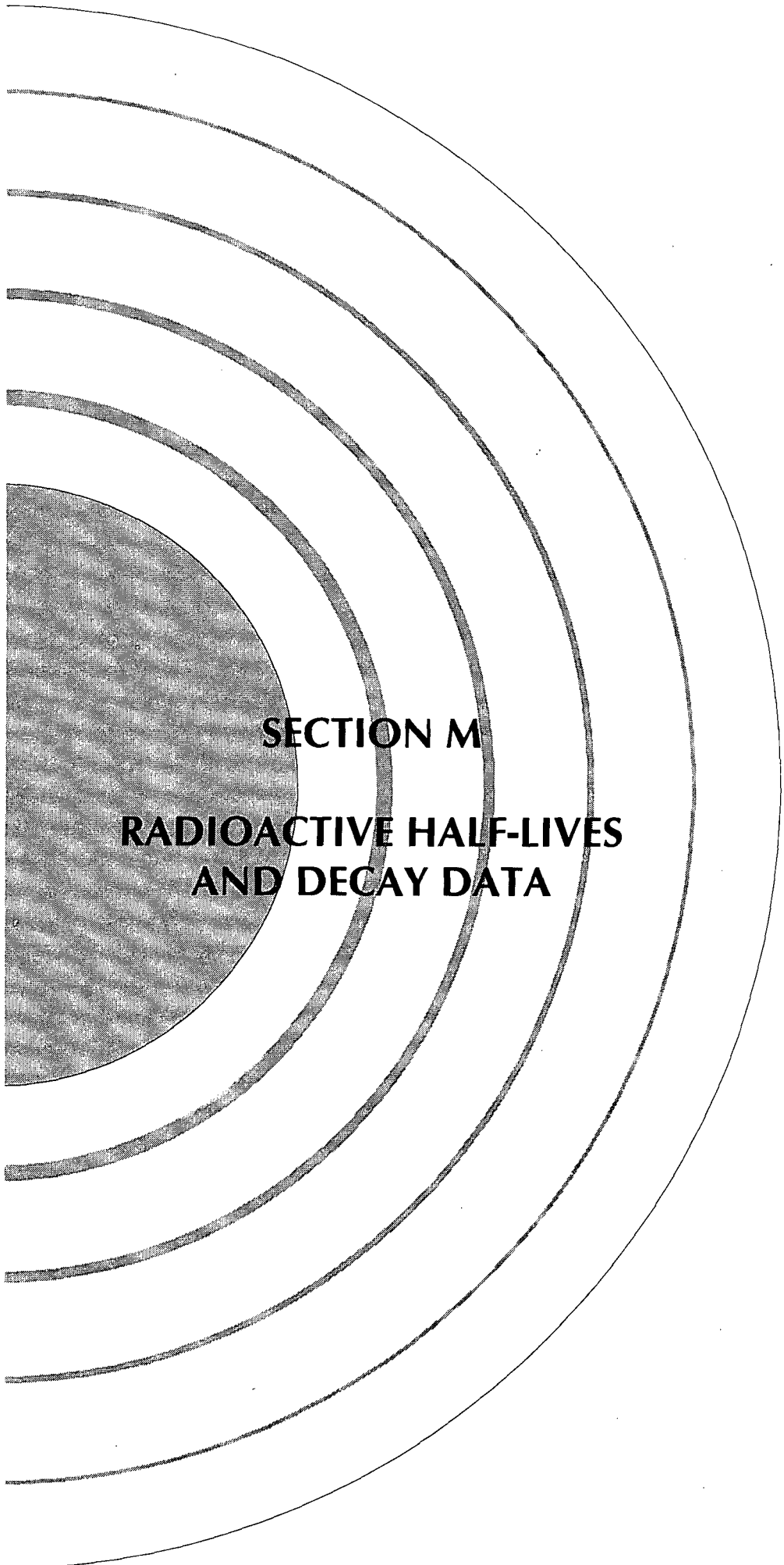

SECTION M
RADIOACTIVE HALF-LIVES
AND DECAY DATA

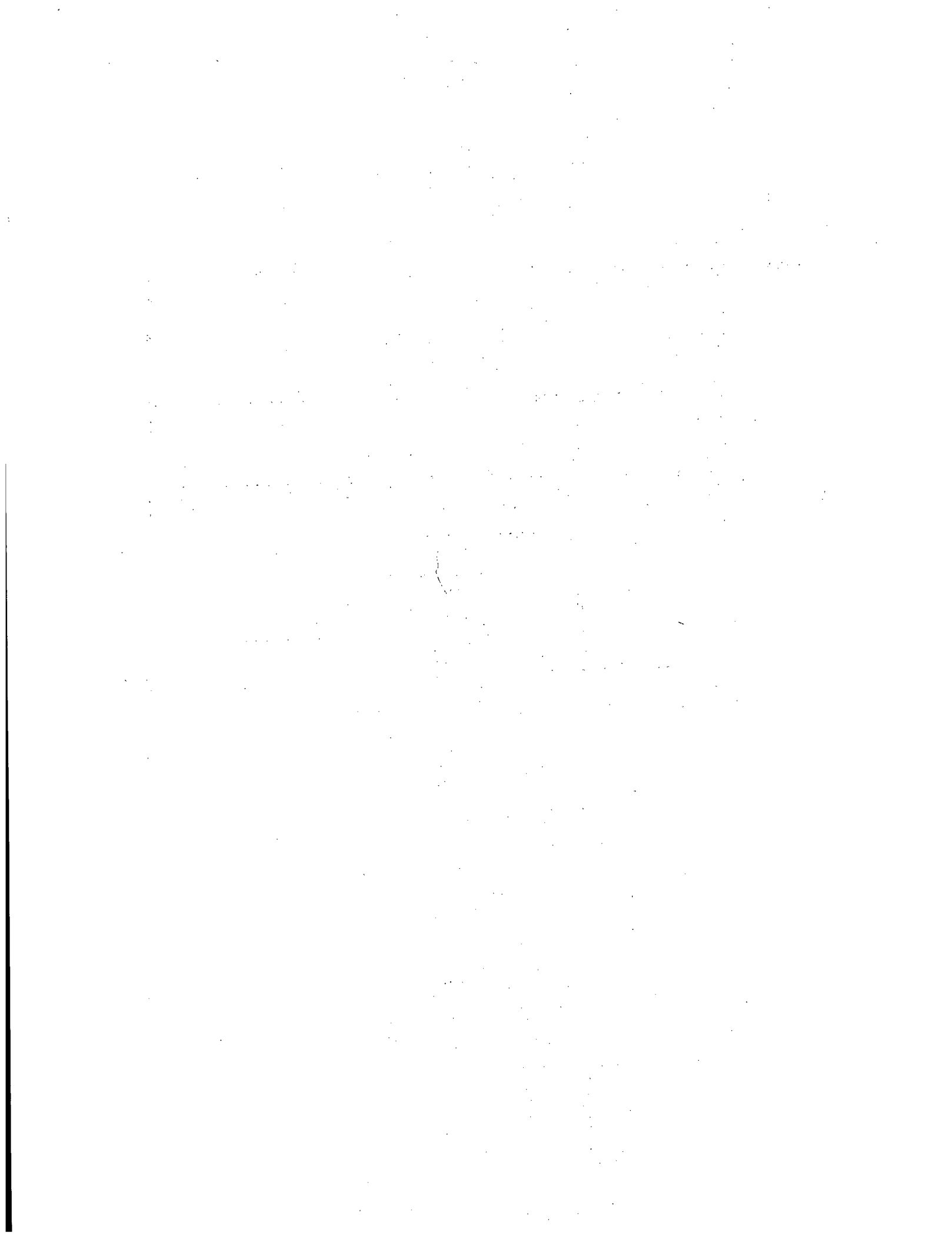

Section M
Quick Reference Guide

	<i>Page</i>
Radioactive half-lives and decay data	M-3
Half-life values	M-3
Decay diagrams	M-3
Section M table	M-5
Section M figure	M-10

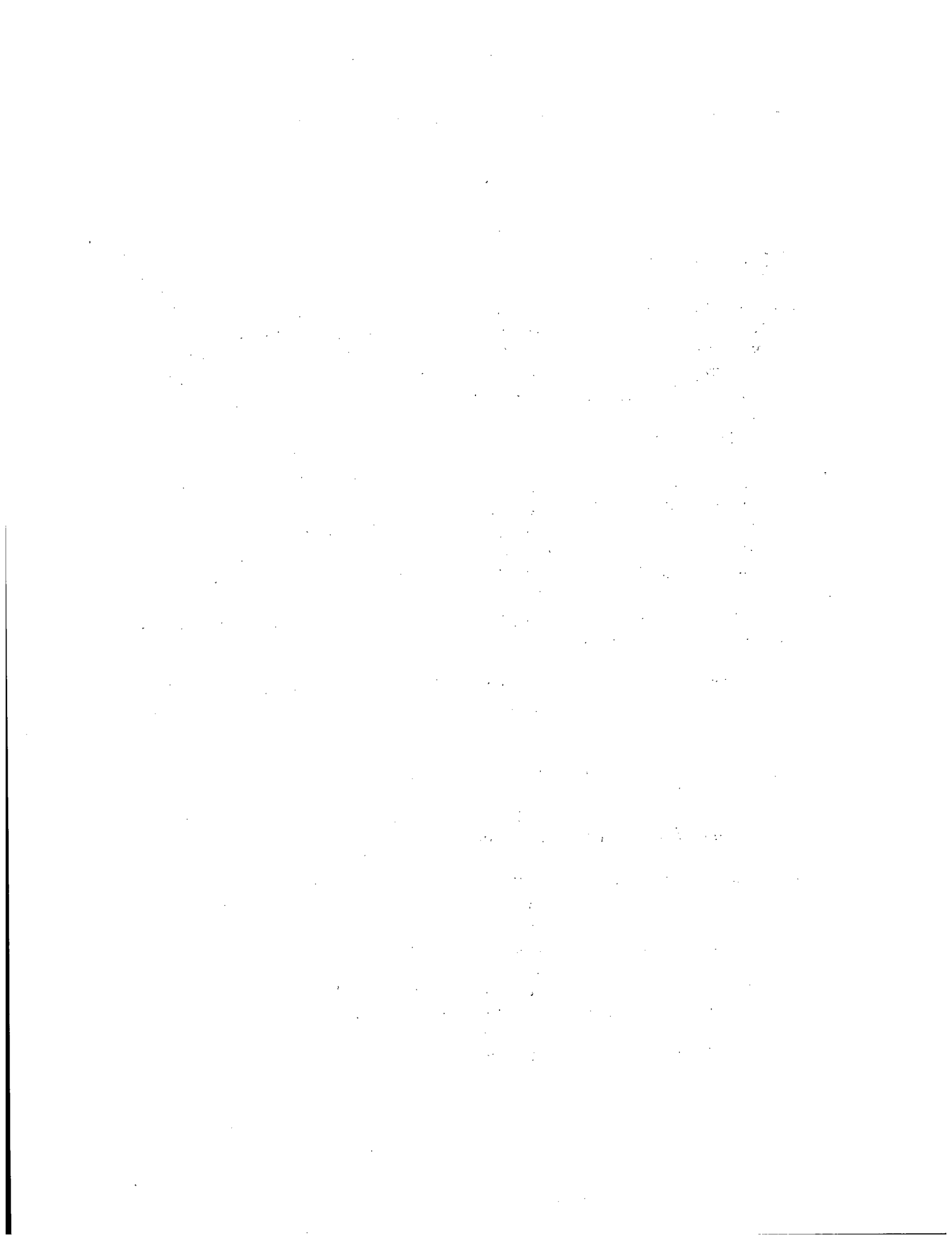

Section M

Radioactive Half-Lives and Decay Data

Half-Life Values

Table M-1 contains element names, chemical symbols, atomic numbers (Z), and radioactive half-lives for some selected radioisotopes. The atomic number is the number of protons in the nucleus of the atom; the number of protons defines the chemical properties of the element and thus defines the element. Radioactive half-life is the time required for one-half of the nuclei of a radioactive species to decay.

Decay Diagrams

Radioactive decay diagrams for many isotopes are shown in Fig. M-1. The isotopes are indicated in the form ${}^A\text{X}$, where X is the symbol for the element and A is the atomic mass number (the number of protons plus the number of neutrons).

Spontaneous fission is not indicated on the charts, although it may be the most important decay mode in terms of total energy releases for some transuranics.

Decay processes indicated on the diagrams are described below. Some relatively rare processes have been omitted.

α (alpha decay)—An atom with an atomic number Z and atomic mass number A emits an alpha particle (a ${}^4\text{He}$ nucleus with Z=2 and A=4), producing a daughter atom with atomic number Z-2 and mass number A-4.

β^- (β^- decay)—One of the beta decay processes in which a negative electron (β^-) and an antineutrino ($\bar{\nu}$) are emitted from the nucleus as a result of the transformation of a neutron into a proton, $n \rightarrow p + \beta^- + \bar{\nu}$. The atomic number Z increases by one, while the mass number A remains the same.

β^+ (β^+ decay)—One of the beta decay processes in which a positron (β^+) and a neutrino (ν) are emitted from the nucleus as a result of the transformation of a proton into a neutron, $p \rightarrow n + \beta^+ + \nu$. The atomic number Z decreases by one, while the mass number A remains the same.

EC (electron capture)—One of the beta decay processes in which an atomic electron is captured by the nucleus. This transforms a proton into a neutron and a neutrino is emitted, $p + e^- \rightarrow n + \nu$. As in β^+ decay, the atomic number Z decreases by one, and the mass number A remains the same.

IT (isomeric transition)—The decay of long-lived excited states of a nucleus (metastable states) to states of lower energy in the same nucleus (same atomic number and same mass number), usually accompanied by the emission of a gamma ray (γ) or an internal conversion electron. A gamma ray is composed of electromagnetic energy, roughly equal in energy to the energy difference in the two nuclear levels. In internal conversion, the energy difference between the two nuclear levels is transferred to a bound atomic electron, which is then ejected from the atom.

**Table M-1. Element names, atomic numbers,
and half-lives for selected radioisotopes**

Element name	Symbol	Atomic number	Radioisotope ^a	Half-life ^b
Hydrogen	H	1	³ H	12.28 yr
Carbon	C	6	¹⁴ C	5.73 × 10 ³ yr
Sodium	Na	11	²² Na	2.602 yr
			²⁴ Na	15.00 h
Phosphorus	P	15	³² P	14.29 d
			³³ P	25.4 d
Sulfur	S	16	³⁵ S	87.44 d
Chlorine	Cl	17	³⁶ Cl	3.01 × 10 ⁵ yr
Potassium	K	19	⁴⁰ K	1.277 × 10 ⁹ yr
			⁴² K	12.36 h
Calcium	Ca	20	⁴⁵ Ca	162.7 d
Scandium	Sc	21	⁴⁶ Sc	83.80 d
Titanium	Ti	22	⁴⁴ Ti	47.3 yr
Vanadium	V	23	⁴⁸ V	15.971 d
Chromium	Cr	24	⁵¹ Cr	27.704 d
Manganese	Mn	25	⁵⁴ Mn	312.7 d
			⁵⁶ Mn	2.5785 h
Iron	Fe	26	⁵⁵ Fe	2.7 yr
			⁵⁹ Fe	44.63 d
Cobalt	Co	27	⁵⁸ Co	70.80 d
			⁶⁰ Co	5.271 yr
Nickel	Ni	28	⁶³ Ni	100.1 yr
Copper	Cu	29	⁶⁴ Cu	12.701 h
Zinc	Zn	30	⁶⁵ Zn	244.4 d
Gallium	Ga	31	⁶⁸ Ga	68.0 m
Germanium	Ge	32	⁶⁸ Ge	288 d
Selenium	Se	34	⁷⁵ Se	119.78 d
Krypton	Kr	36	⁸⁵ Kr	10.72 yr
			^{85m} Kr	4.48 h
			⁸⁷ Kr	76.3 m
			⁸⁸ Kr	2.84 h

Table M-1. Element names, atomic numbers, and half-lives for selected radioisotopes (continued)

Element name	Symbol	Atomic number	Radioisotope ^a	Half-life ^b
Rubidium	Rb	37	⁸⁶ Rb	18.66 d
			⁸⁷ Rb	4.73×10^{10} yr
			⁸⁸ Rb	17.8 m
			⁸⁹ Rb	15.44 m
Strontium	Sr	38	⁸⁹ Sr	50.55 d
			⁹⁰ Sr	28.6 yr
			⁹¹ Sr	9.5 h
Yttrium	Y	39	⁹⁰ Y	64.1 h
			^{90m} Y	3.19 h
			⁹¹ Y	58.51 d
			^{91m} Y	49.71 m
Zirconium	Zr	40	⁹³ Zr	1.53×10^6 yr
			⁹⁵ Zr	64.02 d
			⁹⁷ Zr	16.90 h
Niobium	Nb	41	⁹⁴ Nb	2.03×10^4 yr
			^{94m} Nb	6.26 m
			⁹⁵ Nb	35.06 d
Molybdenum	Mo	42	⁹⁹ Mo	66.02 h
Technetium	Tc	43	⁹⁹ Tc	2.13×10^5 yr
			^{99m} Tc	6.02 h
Ruthenium	Ru	44	¹⁰³ Ru	39.35 d
			¹⁰⁵ Ru	4.44 h
			¹⁰⁶ Ru	368.2 d
Rhodium	Rh	45	^{103m} Rh	56.119 m
			¹⁰⁵ Rh	35.36 h
			^{105m} Rh	45 s
			¹⁰⁶ Rh	29.92 s
Silver	Ag	47	^{109m} Ag	39.6 s
			¹¹⁰ Ag	24.57 s
			^{110m} Ag	249.85 d
Cadmium	Cd	48	¹⁰⁹ Cd	464 d
			¹¹³ Cd	9.3×10^{15} yr
			^{113m} Cd	13.7 yr
Indium	In	49	¹¹⁴ In	71.9 s
			^{114m} In	49.51 d
Tin	Sn	50	¹¹³ Sn	115.1 d
			¹²³ Sn	129.2 d
			¹²⁶ Sn	1.0×10^5 yr

Table M-1. Element names, atomic numbers, and half-lives for selected radioisotopes (continued)

Element name	Symbol	Atomic number	Radioisotope ^a	Half-life ^b
Antimony	Sb	51	¹²⁴ Sb	60.20 d
			¹²⁶ Sb	12.4 d
			^{126m} Sb	19.0 m
			¹²⁷ Sb	3.85 d
			¹²⁹ Sb	4.40 h
Tellurium	Te	52	¹²⁷ Te	9.35 h
			^{127m} Te	109 d
			¹²⁹ Te	69.6 m
			^{129m} Te	33.6 d
			¹³¹ Te	25.0 m
			^{131m} Te	30 h
Iodine	I	53	¹²⁵ I	60.14 d
			¹²⁹ I	1.57 × 10 ⁷ yr
			¹³¹ I	8.040 d
			¹³² I	2.30 h
			¹³³ I	20.8 h
			¹³⁴ I	52.6 m
			¹³⁵ I	6.61 h
			Xenon	Xe
¹³³ Xe	5.245 d			
^{133m} Xe	2.19 d			
¹³⁵ Xe	9.11 h			
^{135m} Xe	15.36 m			
¹³⁸ Xe	14.13 m			
Cesium	Cs	55	¹³⁴ Cs	2.062 yr
			¹³⁵ Cs	2.3 × 10 ⁶ yr
			¹³⁶ Cs	13.16 d
			¹³⁷ Cs	30.17 yr
			¹³⁸ Cs	32.2 m
Barium	Ba	56	¹³³ Ba	10.5 yr
			^{135m} Ba	28.7 h
			^{137m} Ba	2.552 m
			¹⁴⁰ Ba	12.789 d
Lanthanum	La	57	¹⁴⁰ La	40.22 h
Cerium	Ce	58	¹⁴¹ Ce	32.50 d
			¹⁴³ Ce	33.0 h
			¹⁴⁴ Ce	284.3 d

**Table M-1. Element names, atomic numbers, and half-lives
for selected radioisotopes (continued)**

Element name	Symbol	Atomic number	Radioisotope ^a	Half-life ^b
Praseodymium	Pr	59	¹⁴³ Pr	13.56 d
			¹⁴⁴ Pr	17.28 m
			^{144m} Pr	7.2 m
Neodymium	Nd	60	¹⁴⁷ Nd	10.98 d
Promethium	Pm	61	¹⁴⁵ Pm	17.7 yr
			¹⁴⁷ Pm	2.6234 yr
Samarium	Sm	62	¹⁴⁷ Sm	1.069 × 10 ¹¹ yr
			¹⁵¹ Sm	90 yr
Europium	Eu	63	¹⁵² Eu	13.6 yr
			^{152m} Eu	9.32 h
			¹⁵⁴ Eu	8.8 yr
			¹⁵⁵ Eu	4.96 yr
Gadolinium	Gd	64	¹⁵³ Gd	241.6 d
Terbium	Tb	65	¹⁶⁰ Tb	72.3 d
Holmium	Ho	67	¹⁶⁶ Ho	26.80 h
			^{166m} Ho	1.20 × 10 ³ yr
Thulium	Tm	69	¹⁷⁰ Tm	128.6 d
Ytterbium	Yb	70	¹⁶⁹ Yb	31.97 d
Hafnium	Hf	72	¹⁸¹ Hf	42.39 d
Tantalum	Ta	73	¹⁸² Ta	114.74 d
Tungsten	W	74	¹⁸⁷ W	23.83 h
Iridium	Ir	77	¹⁹² Ir	74.02 d
Gold	Au	79	¹⁹⁸ Au	2.696 d
Mercury	Hg	80	²⁰³ Hg	46.60 d
Thallium	Tl	81	²⁰⁴ Tl	3.779 yr
Lead	Pb	82	²¹⁰ Pb	22.26 yr
			²⁰⁷ Pb	33.4 yr
Bismuth	Bi	83	²⁰⁷ Bi	33.4 yr
			²¹⁰ Bi	5.013 d
Polonium	Po	84	²¹⁰ Po	138.378 d
Francium	Fr	87	²²³ Fr	21.8 m

Table M-1. Element names, atomic numbers, and half-lives for selected radioisotopes (continued)

	Symbol	Atomic number	Radioisotope ^a	Half-life ^b
Radon	Rn	86	²¹⁸ Rn	0.035 s
			²¹⁹ Rn	3.96 s
			²²⁰ Rn	55.61 s
			²²² Rn	3.8235 d
Radium	Ra	88	²²⁶ Ra	1600 yr
			²²⁷ Ra	42.2 m
Actinium	Ac	89	²²⁷ Ac	21.773 yr
			²²⁸ Ac	6.13 h
Thorium	Th	90	²²⁷ Th	18.718 d
			²²⁸ Th	1.9132 yr
			²³⁰ Th	7.7×10^4 yr
			²³¹ Th	25.52 h
			²³² Th	1.405×10^{10} yr
Protactinium	Pa	91	²³¹ Pa	3.276×10^4 yr
			²³³ Pa	27.0 d
Uranium	U	92	²³² U	72 yr
			²³³ U	1.592×10^5 yr
			²³⁴ U	2.445×10^5 yr
			²³⁵ U	7.038×10^8 yr
			²³⁶ U	2.3415×10^7 yr
			²³⁸ U	4.468×10^9 yr
Neptunium	Np	93	²³⁷ Np	2.14×10^6 yr
			²³⁹ Np	2.355 d
Curium	Cm	96	²⁴² Cm	163.2 d
			²⁴³ Cm	28.5 yr
			²⁴⁴ Cm	18.11 yr
			²⁴⁵ Cm	8.5×10^3 yr
Californium	Cf	98	²⁵² Cf	2.639 yr

^aThe radioisotopes are listed in the form ^AX, where X is the symbol for the element and A is the atomic mass number. When the atomic mass number is followed by an "m," it indicates that the radioisotope is "metastable." Metastable states are excited nuclear states that have a half-life long enough to be observed.

^bIn this column, s = second, m = minute, d = day, h = hour, and yr = year.

Sources: Turner (1986), DOE/TIC-11026.

Fig. M-1
Decay diagrams for selected radioisotopes.

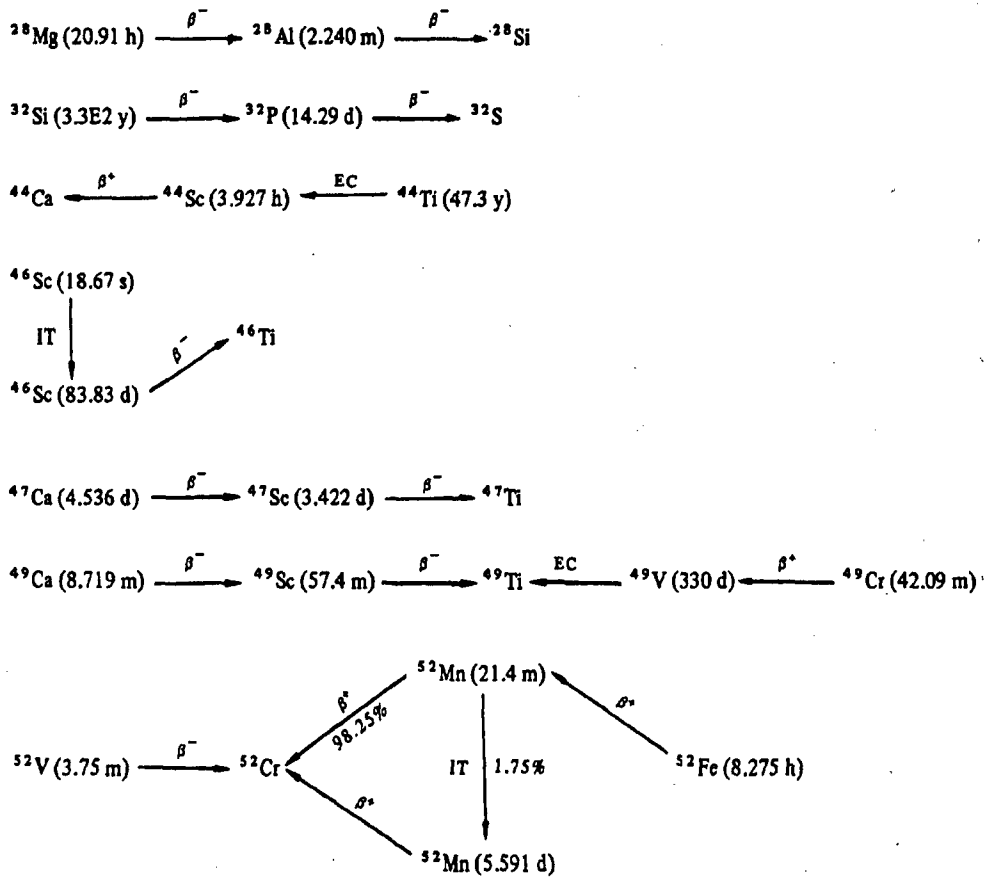

Fig. M-1
Decay diagrams for selected radioisotopes (continued).

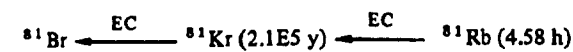
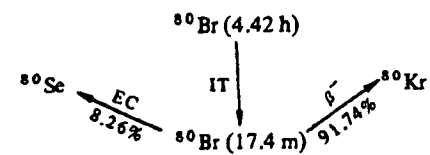
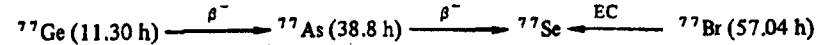
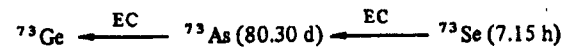
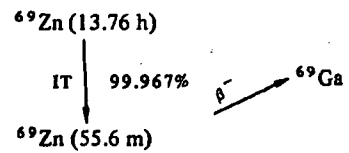
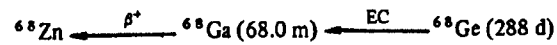
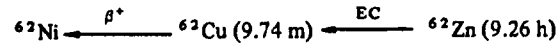
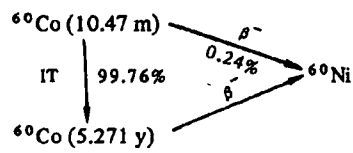
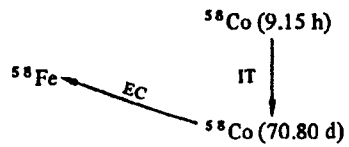
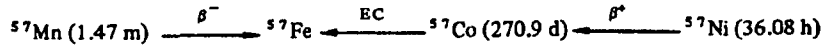
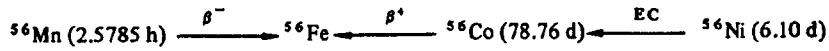

Fig. M-1
Decay diagrams for selected radioisotopes (continued).

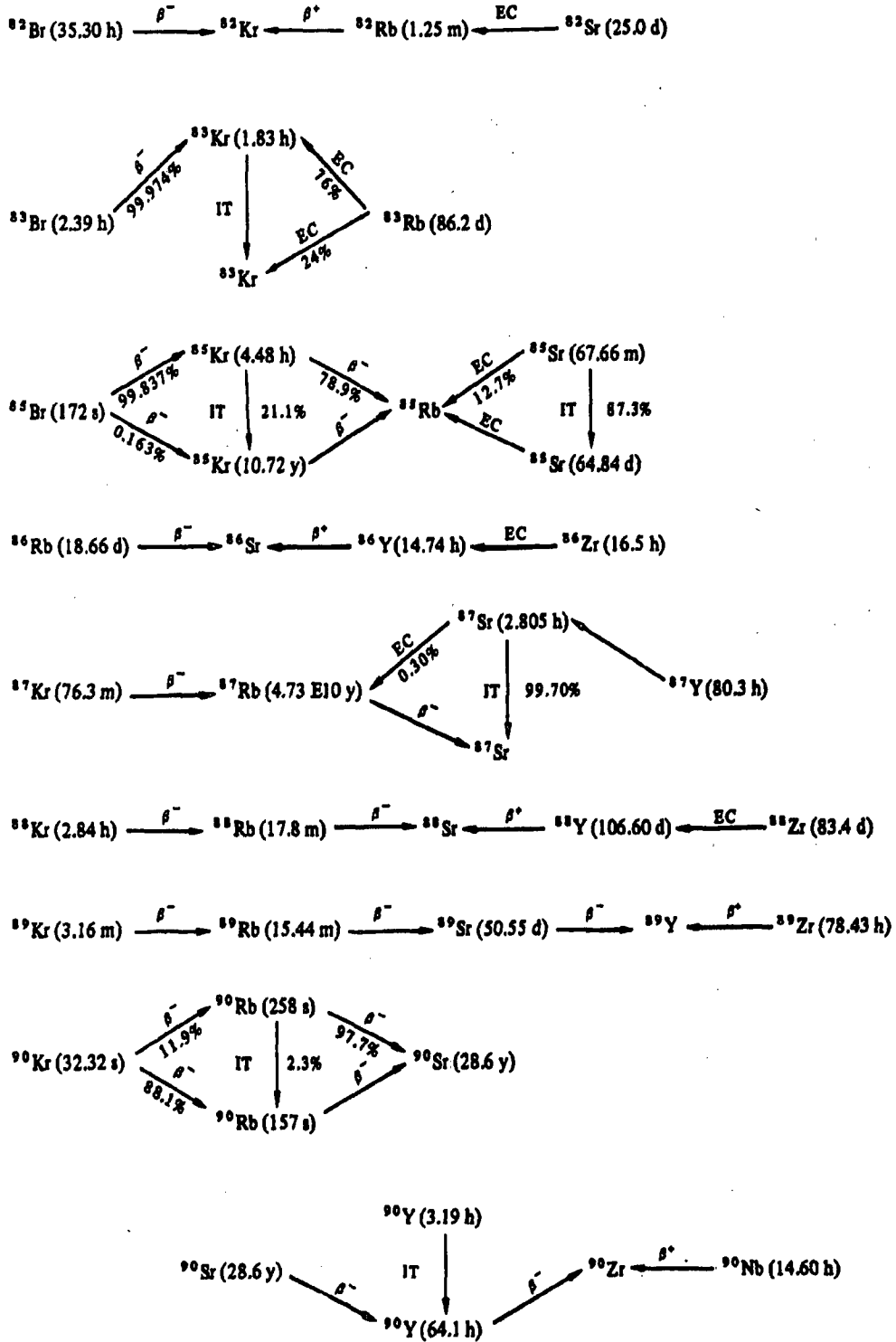

Fig. M-1
Decay diagrams for selected radioisotopes (continued).

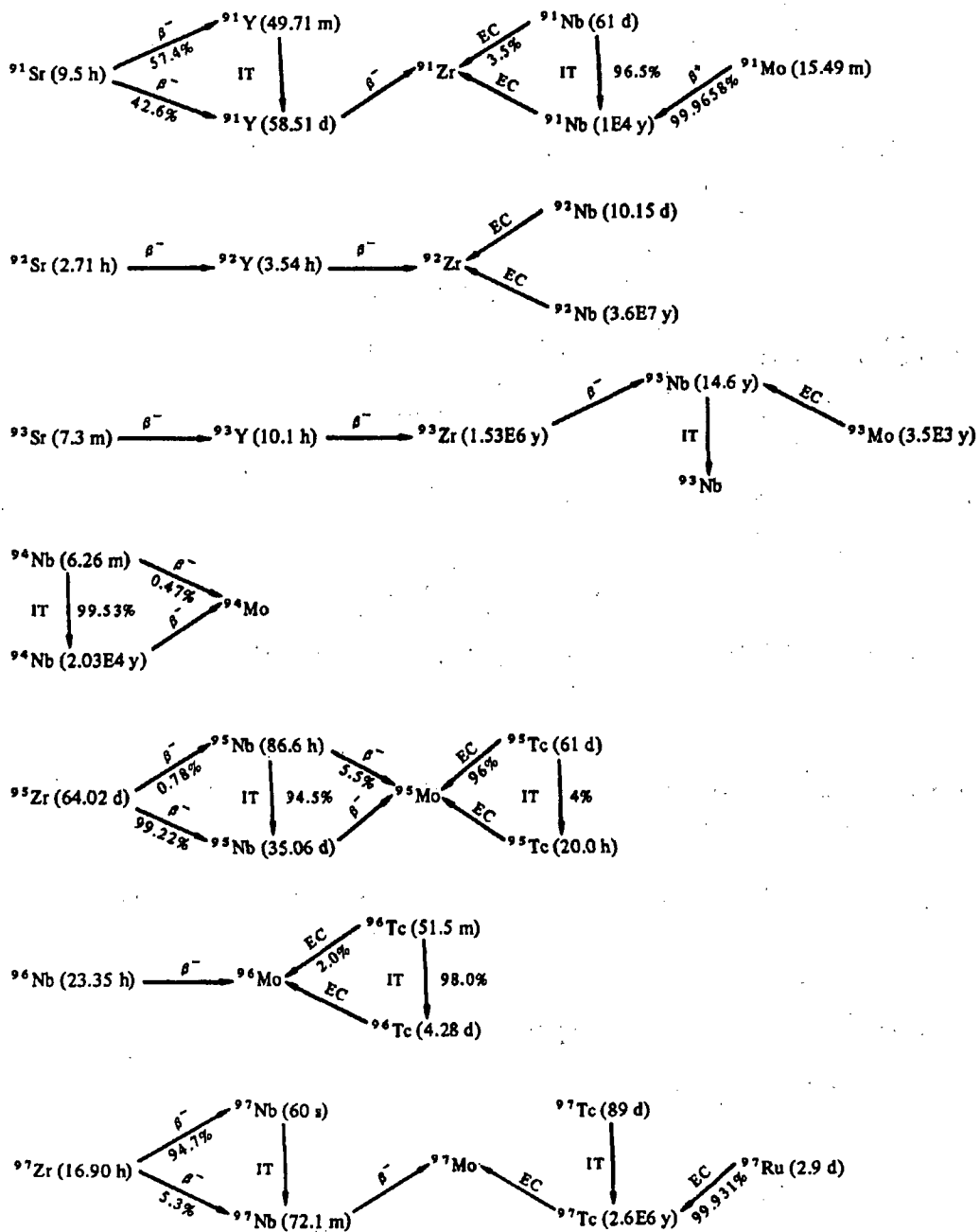

Fig. M-1
Decay diagrams for selected radioisotopes (continued).

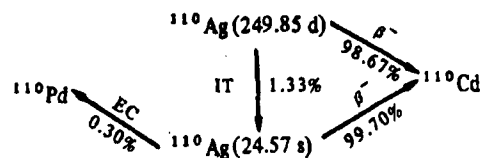
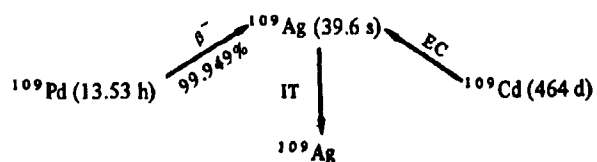
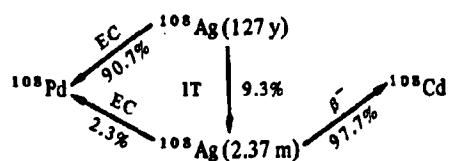
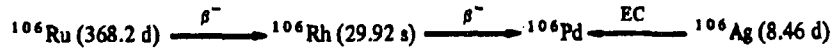
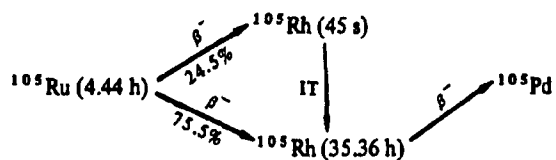
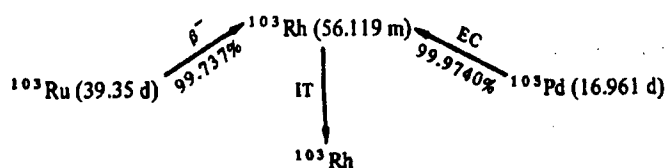
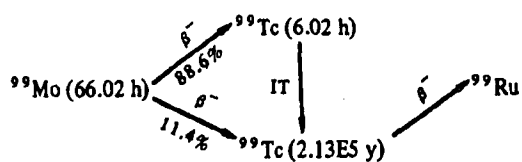

Fig. M-1
Decay diagrams for selected radioisotopes (continued).

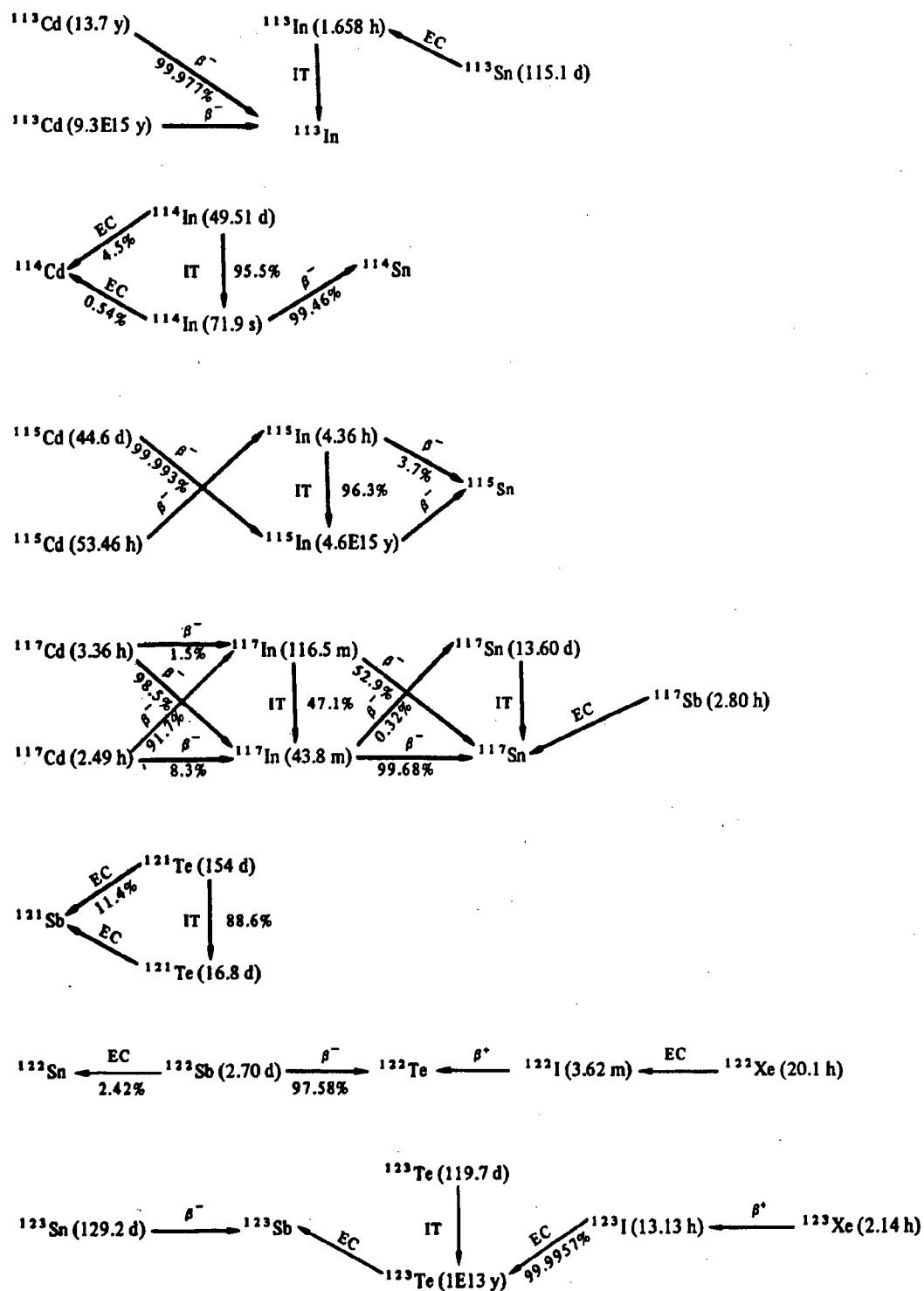

Fig. M-1
Decay diagrams for selected radioisotopes (continued).

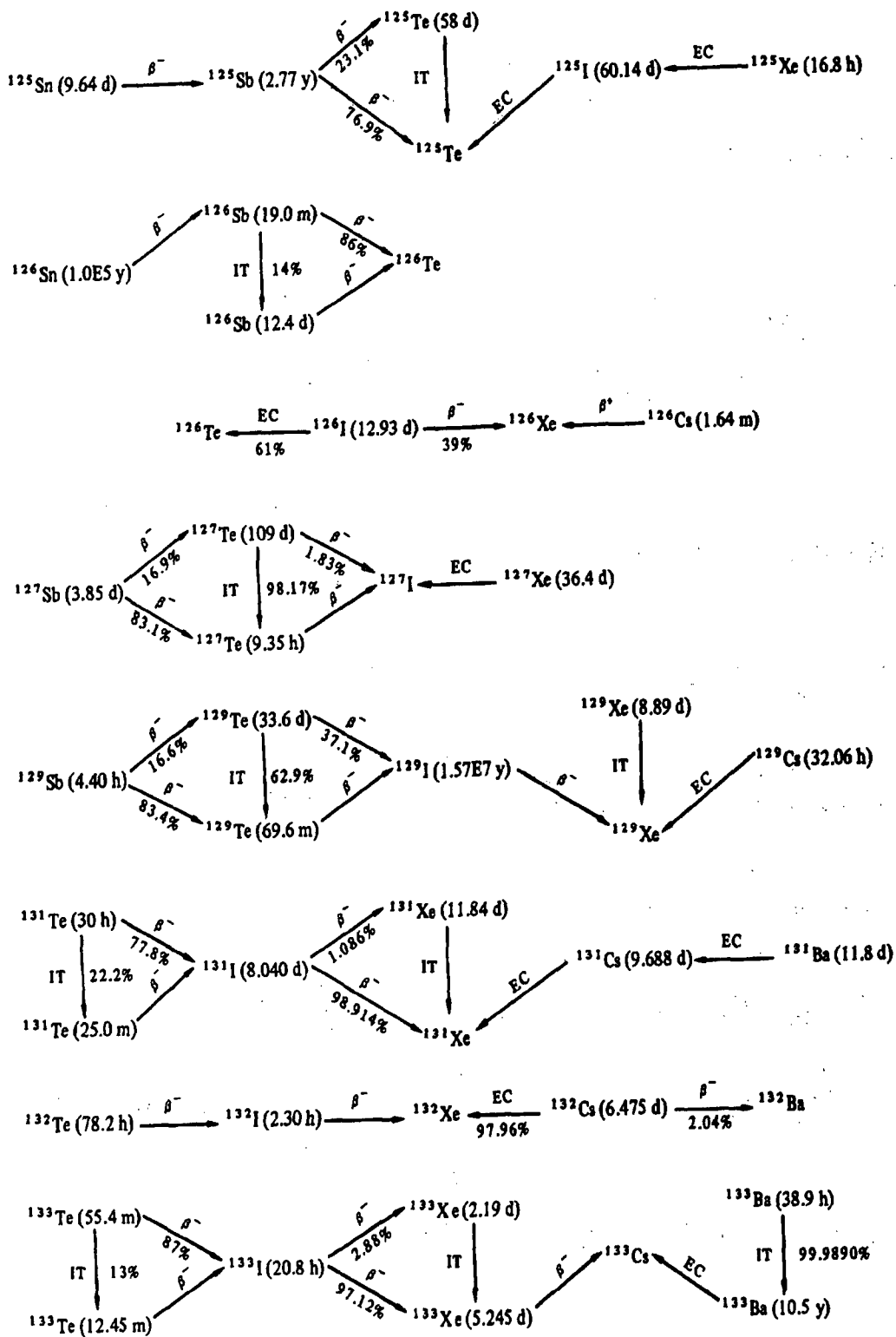

Fig. M-1
Decay diagrams for selected radioisotopes (continued).

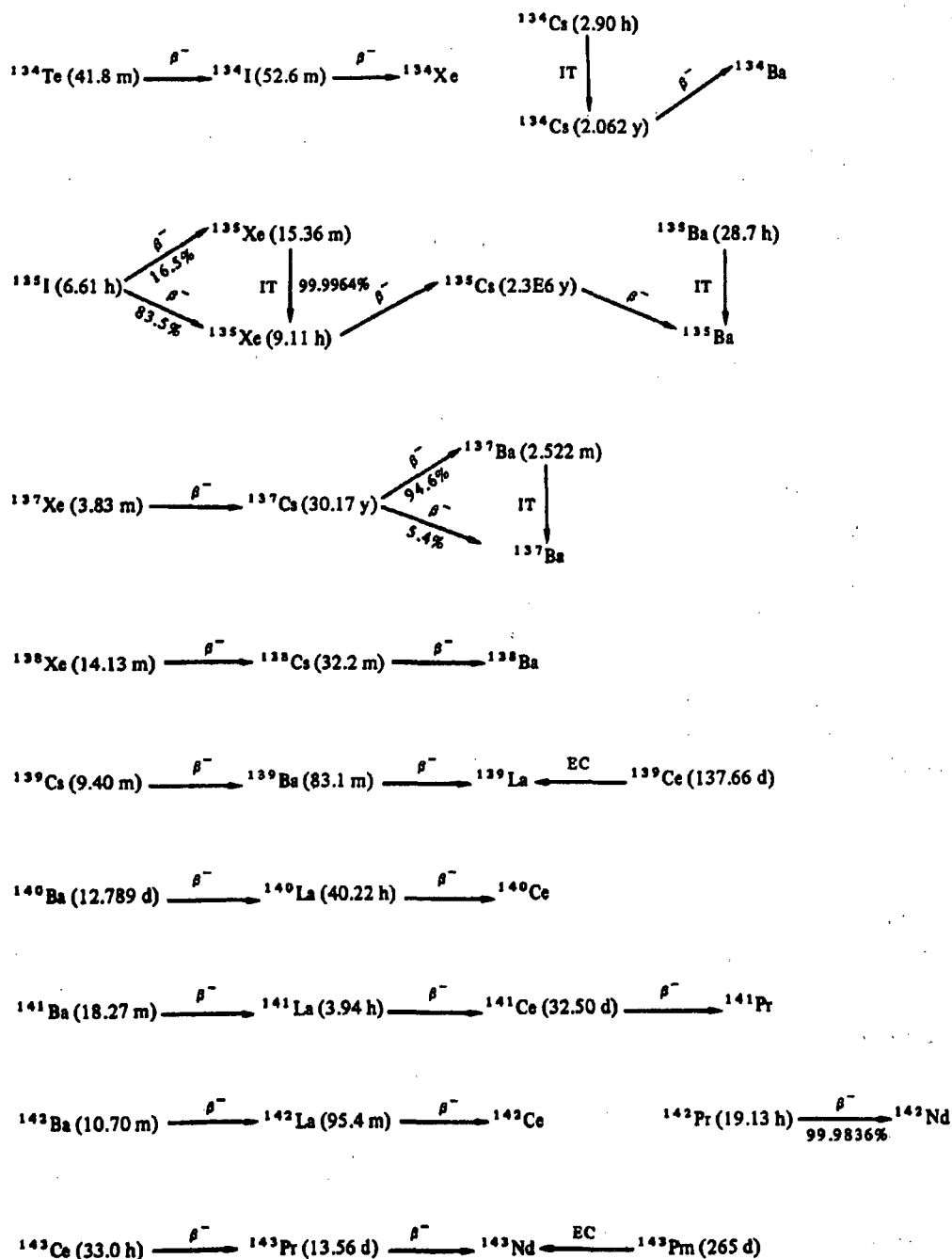

Fig. M-1
Decay diagrams for selected radioisotopes (continued).

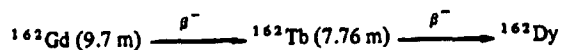
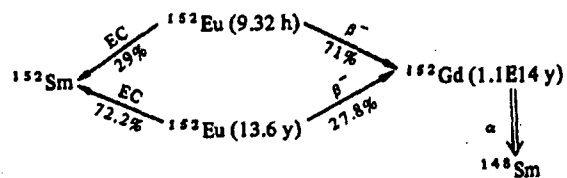
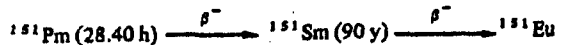
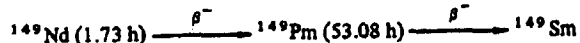
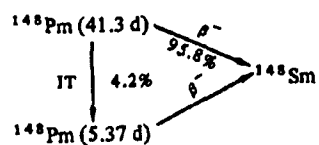
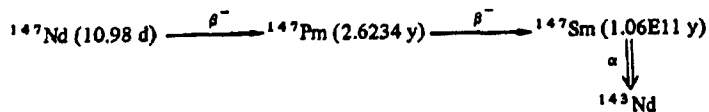
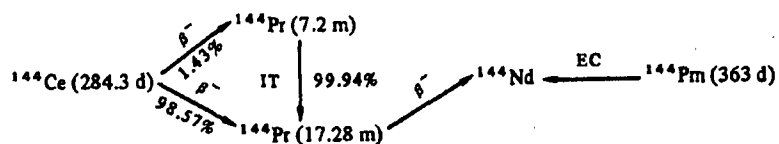

Fig. M-1
Decay diagrams for selected radioisotopes (continued).

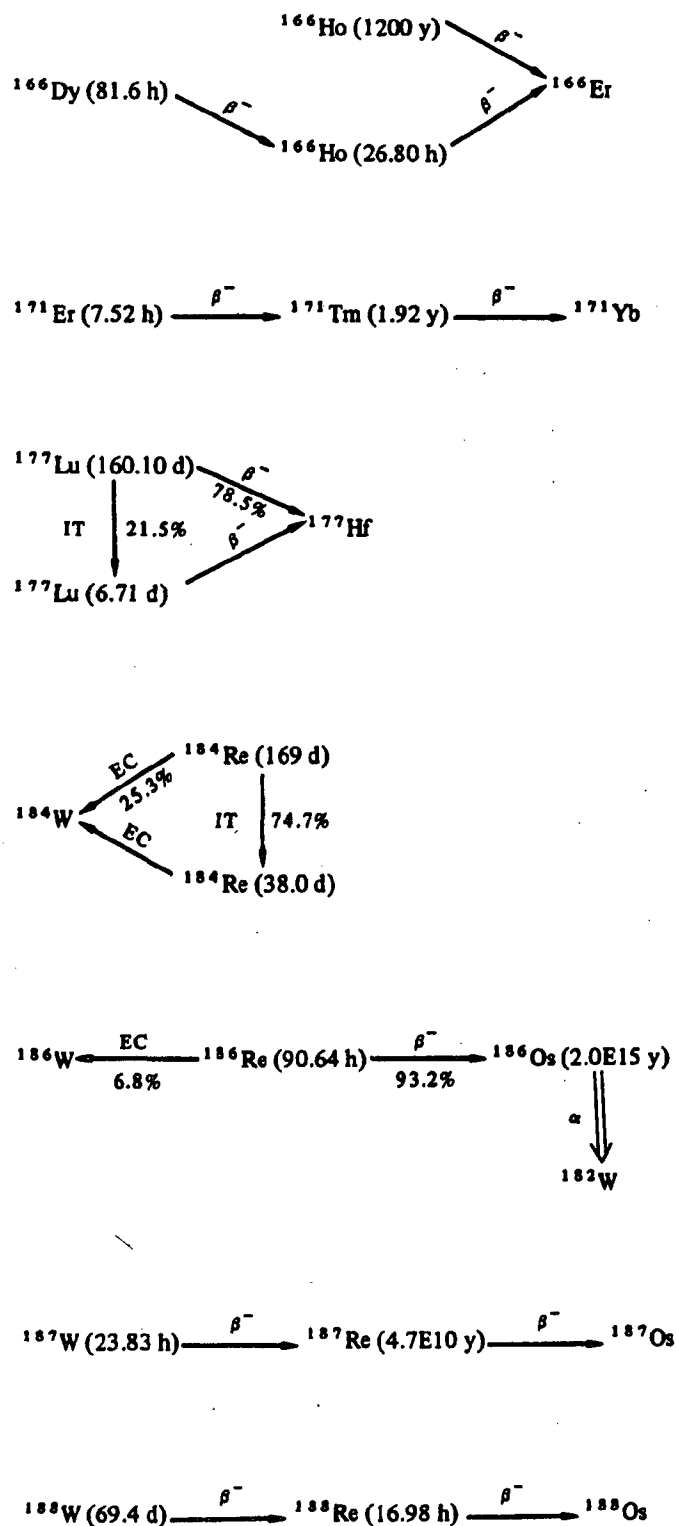

Fig. M-1
Decay diagrams for selected radioisotopes (continued).

Neptunium Series

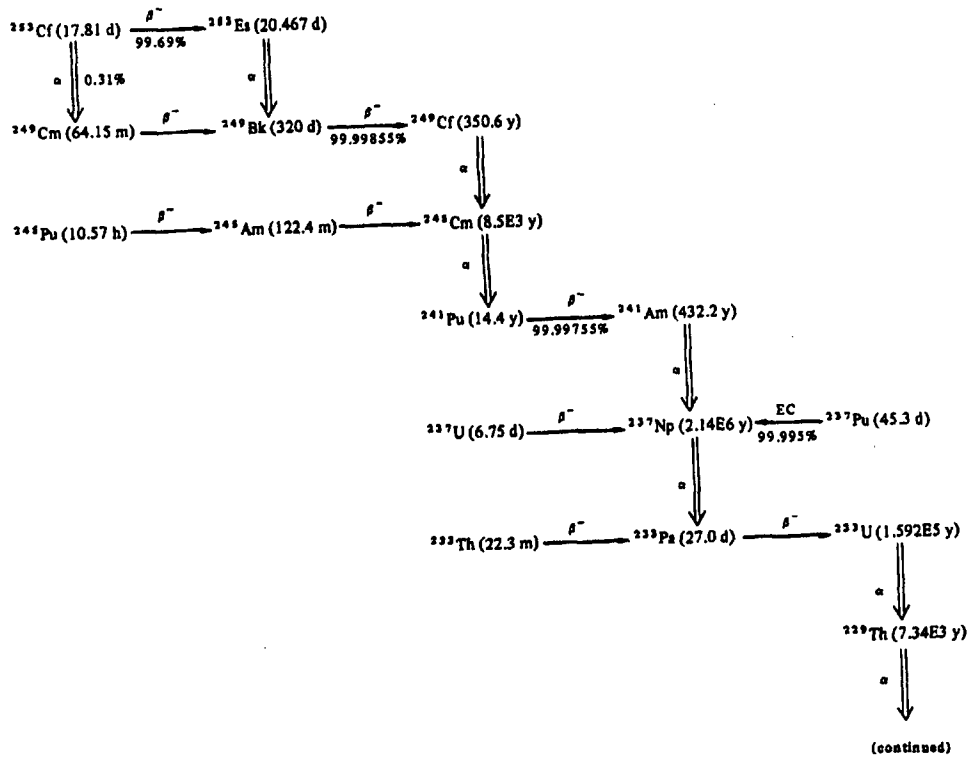

Fig. M-1
Decay diagrams for selected radioisotopes (continued).

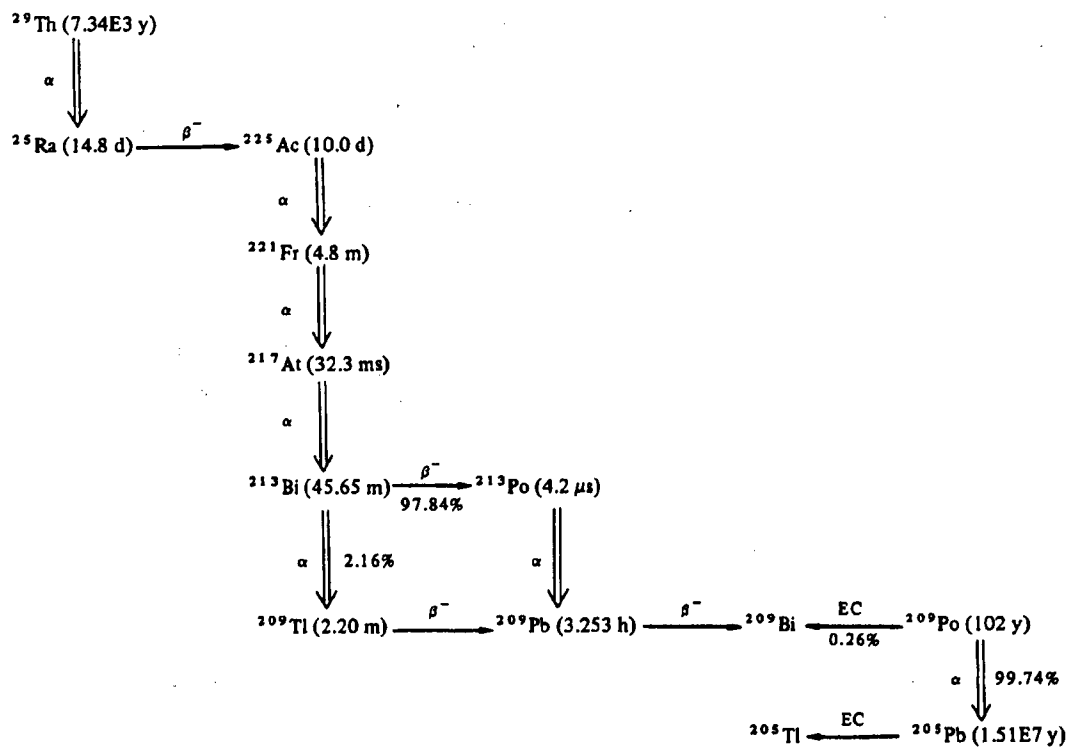
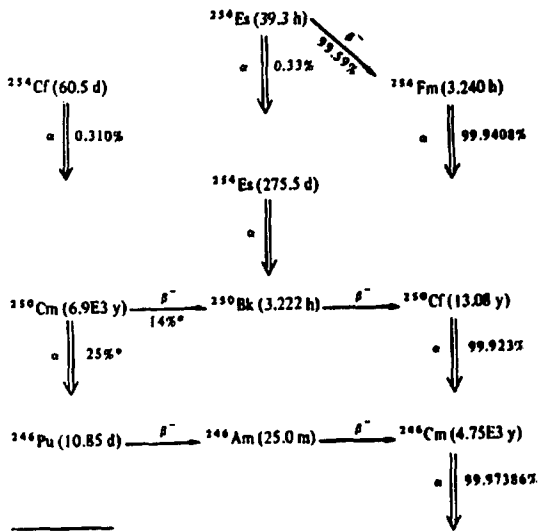

Fig. M-1
Decay diagrams for selected radioisotopes (continued).

Uranium Series



*Branching ratio based on systematics; decay has not been derived.

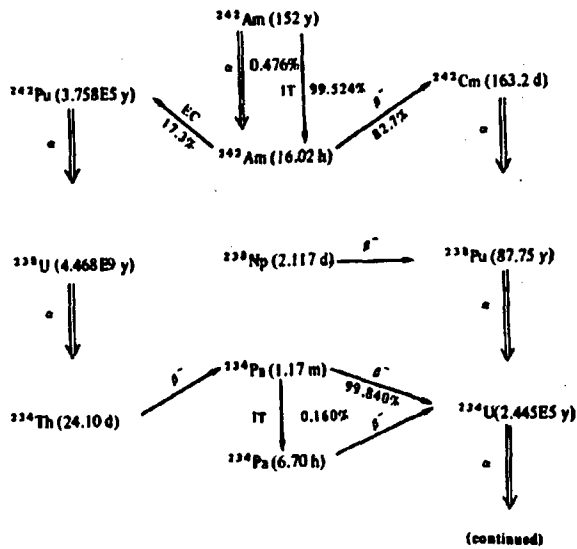

Fig. M-1
Decay diagrams for selected radioisotopes (continued).

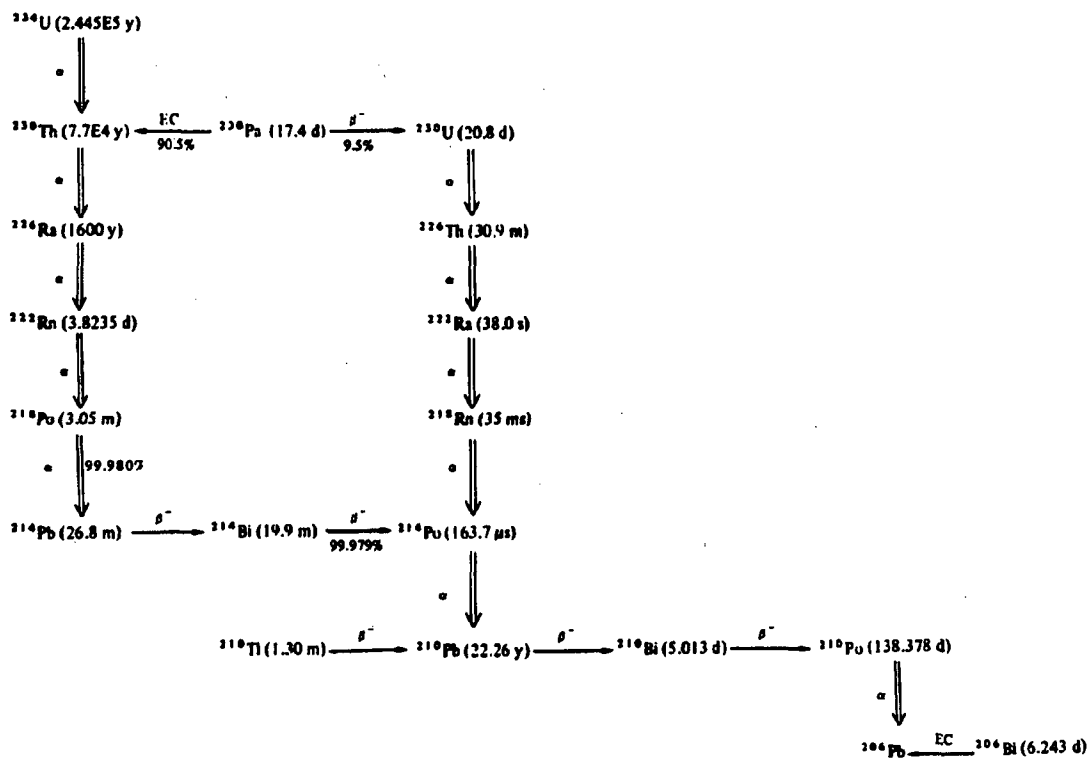

Fig. M-1
Decay diagrams for selected radioisotopes (continued).

Actinium Series

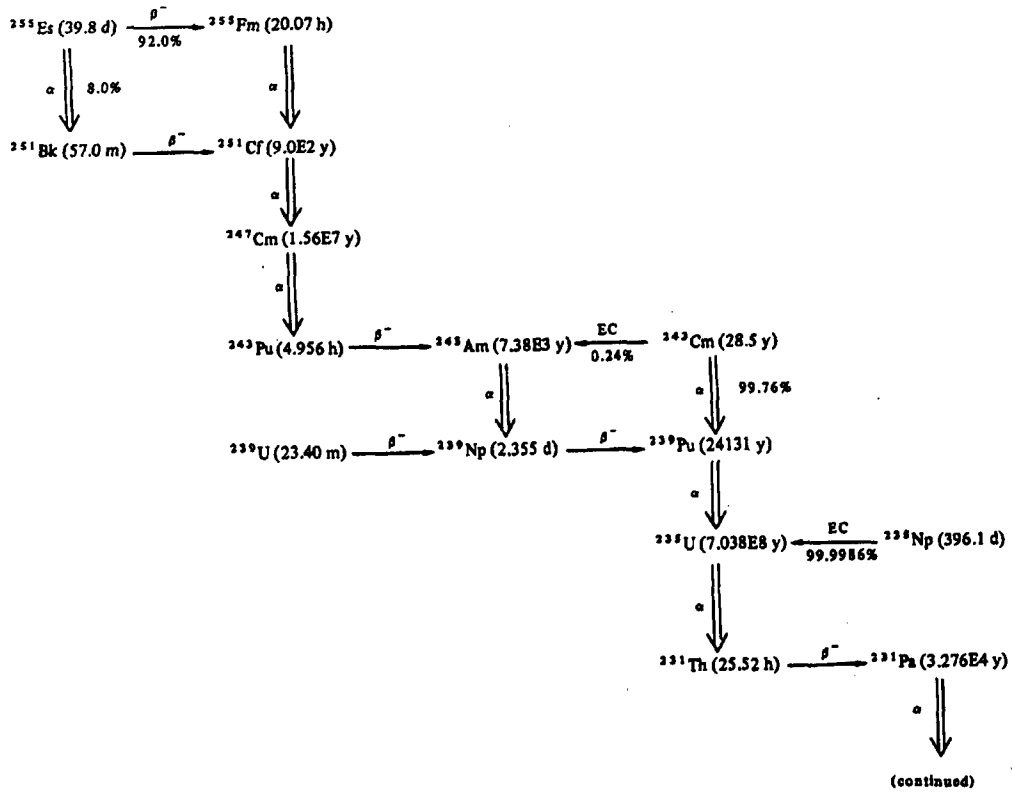

Fig. M-1
Decay diagrams for selected radioisotopes (continued).

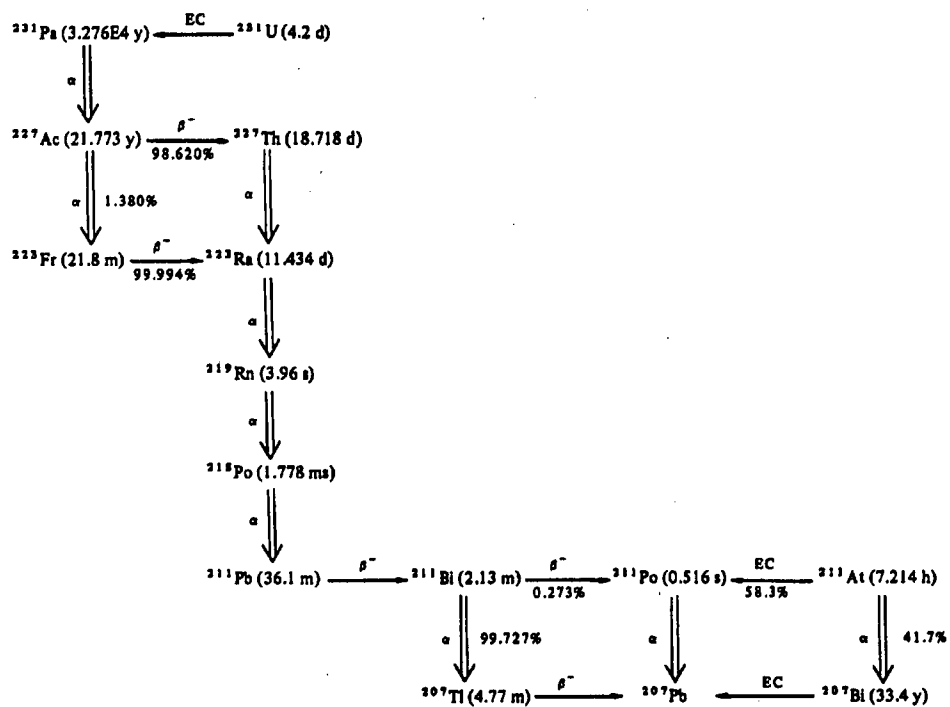
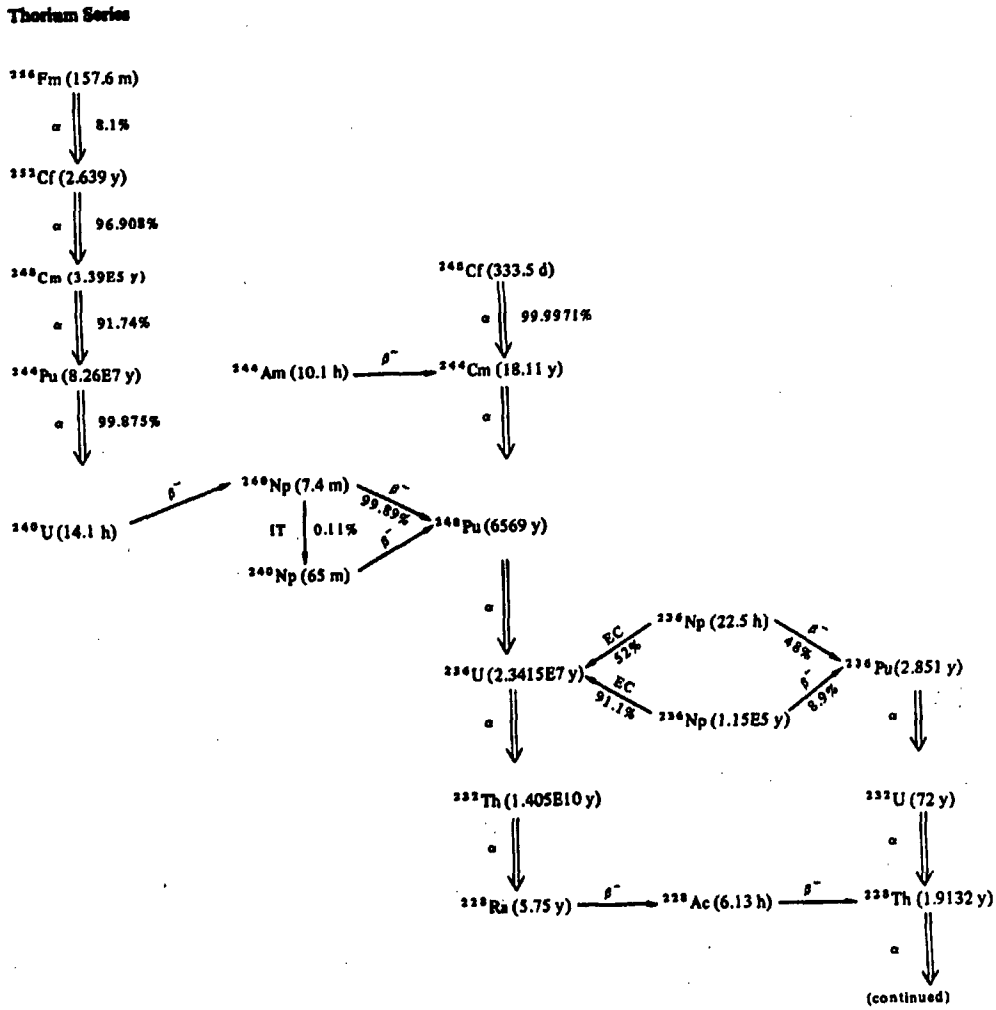
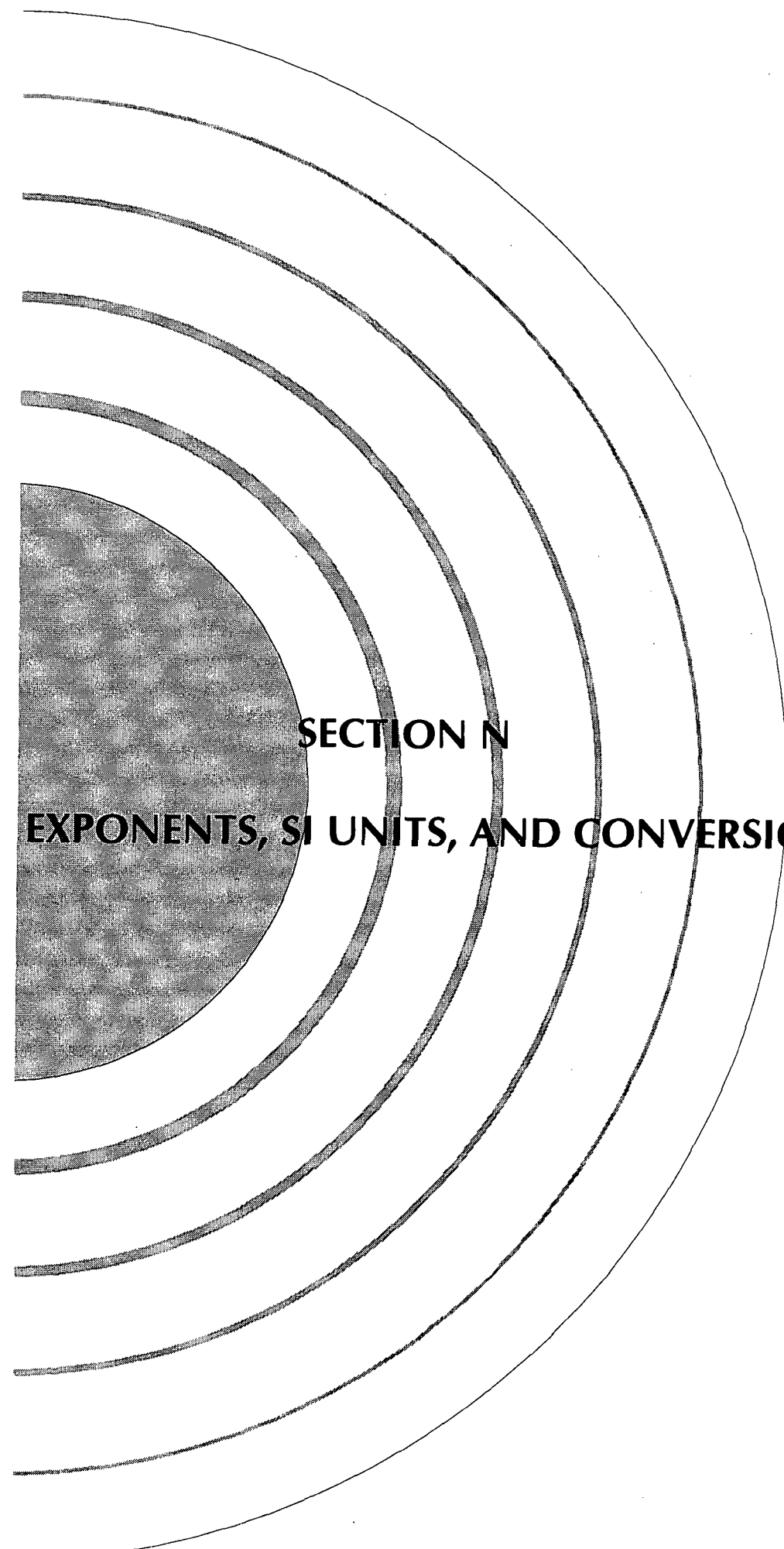

Fig. M-1
Decay diagrams for selected radioisotopes (continued).



N



SECTION N
EXPONENTS, SI UNITS, AND CONVERSIONS

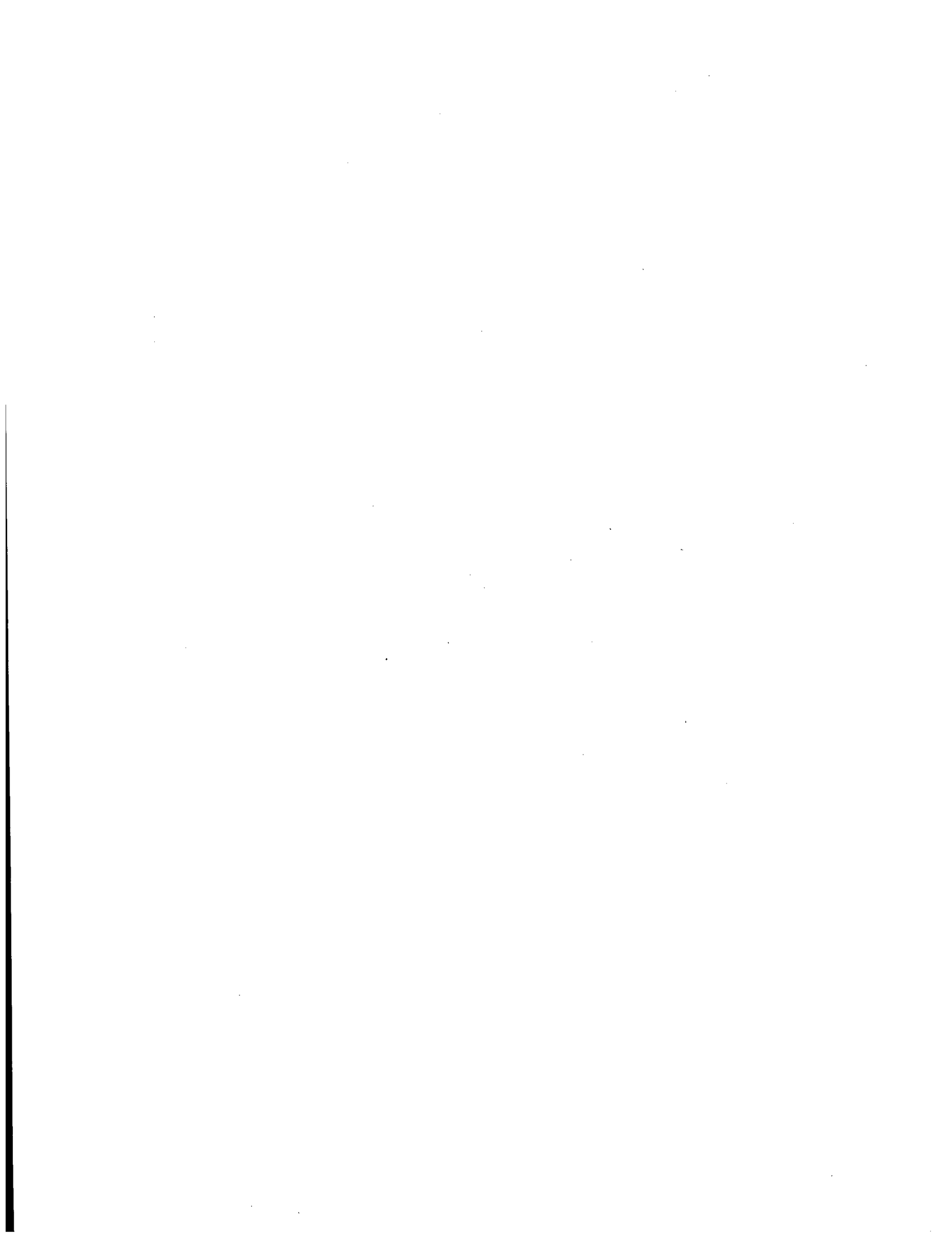

Section N
Quick Reference Guide

	<i>Page</i>
Exponents, SI units, and conversions	N-3
Exponents	N-3
SI units	N-4
Conversion factors	N-4
Section N tables	N-5
Section N figure	N-12

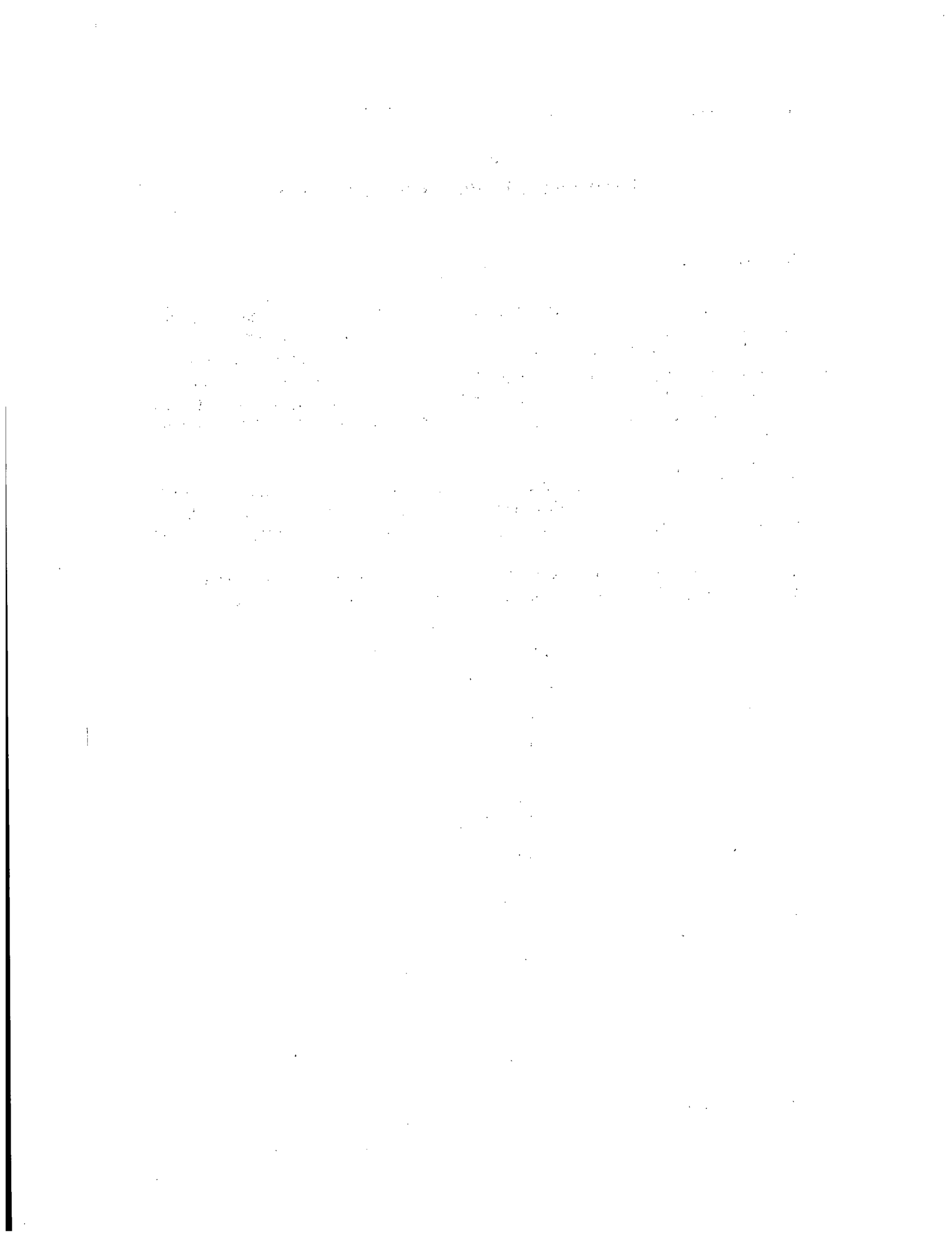

Section N

Exponents, SI Units, and Conversions

Exponents

An exponent is a symbol or number, usually written to the right of and above another symbol or number, that indicates how many times the latter number should be multiplied by itself. Exponents allow very large or very small numbers to be expressed compactly. Scientific notation is a mathematical notation in which the number is expressed as a number between 1 and 10 multiplied by a power of 10. For example, 750,000,000,000 can be written 7.5×10^{11} and 0.0000000123 is written 1.23×10^{-8} .

An alternate way of expressing the exponent, more convenient for data processing, uses the letter "E" to indicate that the number following is the exponent of 10. Using this system, 7.5×10^{11} is written 7.5E+11 and 1.23×10^{-8} is written 1.23E-08.

Operations with exponents of 10 follow the general rules for operations with exponents (a and b are positive, non-zero integers and x and y are not zero):

$$x^a x^b = x^{a+b}$$

$$(x^a)^b = x^{ab}$$

$$(xy)^a = x^a y^a$$

$$\frac{x^a}{x^b} = x^{a-b} \text{ if } a > b$$

$$\frac{x^a}{x^b} = \frac{1}{x^{b-a}} \text{ if } a < b$$

$$a^0 = 1$$

$$x^{-a} = \frac{1}{x^a}$$

$$x^{\frac{a}{b}} = \sqrt[b]{x^a}$$

(Examples: $10^2 10^3 = 10^5$, $(10^2)^3 = 10^6$, $(2 \cdot 10)^2 = 2^2 \cdot 10^2 = 4 \cdot 10^2 = 400$, $\frac{10^4}{10^2} = 10^2$,

$$\frac{10^2}{10^4} = \frac{1}{10^2}, 10^0 = 1, 10^{\frac{2}{3}} = \sqrt[3]{10^2}.)$$

SI Units

The International System of Units (*Le Système International d'Unités* or SI) is a rationalized selection of units from the metric system. SI is a coherent system with seven base units and two supplementary units for which names, symbols, and precise definitions have been established (Table N-1). There is only one unit for each physical quantity. Other units are derived from these units by multiplication and division with no numerical factors other than unity. Some derived units have been given special names (Table N-2).

In general, SI prefixes should be used to indicate orders of magnitude, eliminating nonsignificant digits and leading zeros. This convention provides a convenient alternative to the power-of-ten notation. The prefix should generally be chosen so that the numerical value is between 0.1 and 1000. The prefix should normally be attached to the unit in the numerator, except when kilogram occurs in the denominator. Compound prefixes, juxtaposing two SI prefixes, should not be used (1 nm instead of 1 m μ m). SI prefixes are found in Table N-3. (In pronunciation, the first syllable of the SI prefix is accented.)

Conversion Factors

Table N-4 contains selected conversion factors for converting from conventional to SI units. Table N-5 contains other useful conversion and equivalence factors. Equivalences between celsius and fahrenheit temperatures, activity in curies and becquerels, and dose equivalent in rem and sievert are displayed graphically in Fig. N-1. Conversions between time zones are shown in Table N-6.

Source: ASTM E 380-93.

Table N-1. Base and supplementary SI units

Base SI units			Supplementary SI units		
Quantity	Unit	Symbol	Quantity	Unit	Symbol
length	meter	m	plane		
mass	kilogram	kg	angle	radian	rad
time	second	s	solid		
electric current	ampere	A	angle	steradian	sr
thermodynamic temperature	kelvin	K			
amount of substance	mole	mol			
luminous intensity	candela	cd			

Source: ASTM E 380-93, Tables 1 and 2, p. 2.

Table N-2. Derived SI units with special names

Quantity	Unit	Symbol	Formula
frequency (of a periodic phenomenon)	hertz	Hz	1/s
force	newton	N	kg·m/s ²
pressure, stress	pascal	Pa	N/m ²
energy, work, quantity of heat	joule	J	N·m
power, radiant flux	watt	W	J/s
quantity of electricity, electrical charge	coulomb	C	A·s
electric potential, potential difference, electromotive force	volt	V	W/A
electrical capacitance	farad	F	C/V
electrical resistance	ohm	Ω	V/A
electrical conductance	siemens	S	A/V
magnetic flux	weber	Wb	V·s
magnetic flux density	tesla	T	Wb/m ²
inductance	henry	H	Wb/A
Celsius temperature	degree Celsius	°C	°K - 274.15
luminous flux	lumen	lm	cd·sr
illuminance	lux	lx	lm/m ²
activity (of a radionuclide)	becquerel	Bq	1/s
absorbed dose	gray	Gy	J/kg
dose equivalent	sievert	Sv	J/kg

Source: ASTM E 380-93, Table 3, p. 3.

Table N-3. SI prefixes

Multiplication factor	Prefix	Symbol
1 000 000 000 000 000 000 000 000 = 10^{24}	yotta	Y
1 000 000 000 000 000 000 000 = 10^{21}	zetta	Z
1 000 000 000 000 000 000 = 10^{18}	exa	E
1 000 000 000 000 000 = 10^{15}	peta	P
1 000 000 000 000 = 10^{12}	tera	T
1 000 000 000 = 10^9	giga	G
1 000 000 = 10^6	mega	M
1 000 = 10^3	kilo	k
100 = 10^2	hecto ^a	h
10 = 10^1	deka ^a	da
0.1 = 10^{-1}	deci ^a	d
0.01 = 10^{-2}	centi ^a	c
0.001 = 10^{-3}	milli	m
0.000 001 = 10^{-6}	micro	μ
0.000 000 001 = 10^{-9}	nano	n
0.000 000 000 001 = 10^{-12}	pico	p
0.000 000 000 000 001 = 10^{-15}	femto	f
0.000 000 000 000 000 001 = 10^{-18}	atto	a
0.000 000 000 000 000 000 001 = 10^{-21}	zepto	z
0.000 000 000 000 000 000 000 001 = 10^{-24}	yocto	y

^aUse to be avoided where practical.

Source: ASTM E 380-93, Table 5, p. 4, and NRPB 155.

Table N-4. Conversion to SI units

To convert from	Into	Multiply by
Angle		
degree	radian (rad)	1.745329 E-02
minute	radian (rad)	2.908882 E-04
second	radian (rad)	4.848137 E-06
Area		
acre	square meter (m ²)	4.046873 E+03
ft ²	square meter (m ²)	9.290304 E-02
hectare	square meter (m ²)	1.000000 E+04
in ²	square meter (m ²)	6.451600 E-04
mi ² (international)	square meter (m ²)	2.589988 E+06
mi ² (U.S. statute)	square meter (m ²)	2.589998 E+06
yd ²	square meter (m ²)	8.361274 E-01
Energy (includes work)		
British thermal unit (Int. table)	joule (J)	1.055056 E+03
British thermal unit (mean)	joule (J)	1.05587 E+03
calorie (International table)	joule (J)	4.186800 E+00
calorie (mean)	joule (J)	4.19002 E+00
electronvolt	joule (J)	1.60219 E-19
ft · lbf	joule (J)	1.355818 E+00
kW · h	joule (J)	3.600000 E+06
therm (European Community)	joule (J)	1.05506 E+08
therm (U.S.)	joule (J)	1.054804 E+08
ton (energy equivalent-TNT)	joule (J)	4.184 E+09
W · h	joule (J)	3.600000 E+03
W · s	joule (J)	1.000000 E+00
Force per unit length		
lbf/ft	newton per meter (N/m)	1.459390 E+01
lbf/in	newton per meter (N/m)	1.751268 E+02
Length		
foot	meter (m)	3.048000 E-01
inch	meter (m)	2.540000 E-02
mile (international nautical)	meter (m)	1.852000 E+03
mile (U.S. nautical)	meter (m)	1.852000 E+03
mile (international)	meter (m)	1.609344 E+03
mile (U.S. statute)	meter (m)	1.609347 E+03
yard	meter (m)	9.144000 E-01
Mass		
gram	kilogram (kg)	1.000000 E-03
ounce (avoirdupois)	kilogram (kg)	2.834952 E-02
ounce (troy or apothecary)	kilogram (kg)	3.110348 E-02
pound (lb avoirdupois)	kilogram (kg)	4.535924 E-01
pound (troy or apothecary)	kilogram (kg)	3.732417 E-01
ton (long, 2240 lb)	kilogram (kg)	1.016047 E+03
ton (metric)	kilogram (kg)	1.000000 E+03
ton (short, 2000 lb)	kilogram (kg)	9.071847 E+02
tonne	kilogram (kg)	1.000000 E+03

Table N-4. Conversion to SI units (continued)

To convert from	Into	Multiply by
Mass per unit area		
oz/ft ²	kilogram per sq meter (kg/m ²)	3.051517 E-01
lb/ft ²	kilogram per sq meter (kg/m ²)	4.882428 E+00
Mass per unit length		
lb/ft	kilogram per meter (kg/m)	1.488164 E+00
lb/in	kilogram per meter (kg/m)	1.785797 E+01
lb/yd	kilogram per meter (kg/m)	4.960546 E-02
Mass per unit volume (includes density and mass capacity)		
g/cm ³	kilogram per cubic meter (kg/m ³)	1.000000 E+03
oz (avoirdupois)/gal (U.K. liquid)	kilogram per cubic meter (kg/m ³)	6.236023 E+00
oz (avoirdupois)/gal (U.S. liquid)	kilogram per cubic meter (kg/m ³)	7.489152 E+00
lb/ft ³	kilogram per cubic meter (kg/m ³)	1.601846 E+01
lb/in ³	kilogram per cubic meter (kg/m ³)	2.767990 E+04
lb/gal (U.K. liquid)	kilogram per cubic meter (kg/m ³)	9.977637 E+01
lb/gal (U.S. liquid)	kilogram per cubic meter (kg/m ³)	1.198264 E+02
Power		
Btu (International table)/h	watt (W)	2.930711 E-01
Btu (International table)/s	watt (W)	1.055056 E+03
erg/s	watt (W)	1.000000 E-07
Pressure or stress (force per unit area)		
atmosphere, standard	pascal (Pa)	1.013250 E+05
atmosphere, technical	pascal (Pa)	9.806650 E+04
bar (meteorological atmos.)	pascal (Pa)	1.000000 E+05
foot of water (39.2°F)	pascal (Pa)	2.98898 E+03
psi	pascal (Pa)	6.894757 E+03
Radiation units		
curie	becquerel (Bq)	3.700000 E+10
rad	gray (Gy)	1.000000 E-02
rem	sievert (Sv)	1.000000 E-02
roentgen	coulomb per kilogram (C/kg)	2.580000 E-04
Temperature		
degree Celsius	kelvin (K)	$T_K = t_C + 273.15$
degree Fahrenheit	degree Celsius (°C)	$t_C = (t_F - 32)/1.8$
degree Fahrenheit	kelvin (K)	$T_K = (t_F + 459.67)/1.8$
degree Rankine	kelvin (K)	$T_K = T_R/1.8$
kelvin	degree Celsius (°C)	$t_C = T_K - 273.15$
Time		
day	second (s)	8.640000 E+04
hour	second (s)	3.600000 E+03
minute	second (s)	6.000000 E+01
year (365 days)	second (s)	3.153600 E+07

Table N-4. Conversion to SI units (continued)

To convert from	Into	Multiply by
Velocity (includes speed)		
ft/h	meter per second (m/s)	8.466667 E-05
ft/min	meter per second (m/s)	5.080000 E-03
ft/s	meter per second (m/s)	3.048000 E-01
in/s	meter per second (m/s)	2.540000 E-02
km/h	meter per second (m/s)	2.777778 E-01
knot (international)	meter per second (m/s)	5.144444 E-01
mi/h (international)	meter per second (m/s)	4.470400 E-01
mi/h (international)	kilometer per hour (km/h)	1.609344 E+00
rpm (r/min)	radian per second (rad/s)	1.047198 E-01
Volume (includes capacity)		
acre-foot	cubic meter (m ³)	1.233489 E+03
bushel (U.S.)	cubic meter (m ³)	3.523907 E-02
ft ³	cubic meter (m ³)	2.831685 E-02
gallon (Canadian liquid)	cubic meter (m ³)	4.546090 E-03
gallon (U.K. liquid)	cubic meter (m ³)	4.546092 E-03
gallon (U.S. dry)	cubic meter (m ³)	4.404884 E-03
gallon (U.S. liquid)	cubic meter (m ³)	3.785412 E-03
in ³	cubic meter (m ³)	1.638706 E-05
liter	cubic meter (m ³)	1.000000 E-03
ounce (U.K. fluid)	cubic meter (m ³)	2.841306 E-05
ounce (U.S. fluid)	cubic meter (m ³)	2.957353 E-05
peck (U.S.)	cubic meter (m ³)	8.809768 E-03
pint (U.S. dry)	cubic meter (m ³)	5.506105 E-04
pint (U.S. liquid)	cubic meter (m ³)	4.731765 E-04
quart (U.S. dry)	cubic meter (m ³)	1.101221 E-03
quart (U.S. liquid)	cubic meter (m ³)	9.463529 E-04
yd ³	cubic meter (m ³)	7.645549 E-01
Volume per unit time (includes flow)		
ft ³ /min	cubic meter per second (m ³ /s)	4.719474 E-04
ft ³ /s	cubic meter per second (m ³ /s)	2.831685 E-02
yd ³ /min	cubic meter per second (m ³ /s)	1.274258 E-02
gallon (U.S. liquid) per day	cubic meter per second (m ³ /s)	4.381264 E-08
gallon (U.S. liquid) per minute	cubic meter per second (m ³ /s)	6.309020 E-05

Source: ASTM E380-93, pp. 31-38.

Table N-5. Other conversion factors

To convert from	Into	Multiply by
centimeters	inches	0.39
feet	centimeters	30.48
feet	kilometers	$3.05E-04$
inches	centimeters	2.54
meters	centimeters	100.00
meters	feet	3.28
meters	miles (statute)	$6.21E-04$
meters per seconds	miles per hour	2.24
acres	square miles	$1.562E-03$
square centimeters	square inches	0.15
square feet	square centimeters	929.00
square feet	square meters	~ 11
square inches	square centimeters	6.45
square kilometers	square centimeters	$1.0E10$
square kilometers	square miles	0.39
square kilometers	square meters	10^6
cubic centimeters	milliliter	1.00
cubic centimeter water	gram	~ 1
cubic feet	gallons (U.S. liquid)	7.48
cubic feet	quarts (U.S. liquid)	29.92
cubic feet	pounds	62.4
gallons (U.S. liquid)	cubic centimeters	3785
gallons	cubic feet	0.13
gallons	liters	3.78
gallons of water ^a	pounds	8.33
gallons per minute	cubic feet per hour	8.02
liters	cubic centimeters	1,000.00
liters	cubic feet	0.035
liters	gallons (U.S. liquid)	0.26
cubic meters	liters	1,000
pounds of water (14.7 psi, 80°F)	cubic feet	0.016
pounds of water (14.7 psi, 80°F)	cubic inches	27.68
pounds of water (14.7 psi, 80°F)	gallons	0.12
quarts (liquid)	gallons	0.25
days	seconds	86,400.00
kilograms	pounds	2.20
tons (metric)	pounds	2,205.00
kilowatts	Btu per minute	56.92
kilowatt-hours	Btu	3,413.00
pounds per square inch	megapascals	145
pounds per square inch	pascals	~ 7000
degrees celsius	degrees fahrenheit	$t_F = 1.8(t_C) + 32$
becquerels	curies	2.7×10^{-11}
megabecquerels	millicuries	0.027
megabecquerels	microcuries	27
millicuries	megabecquerels	37
grays	rads	100
microsieverts (μ Sv)	millirem (mrem)	0.1
milligrays (mGy)	millirads (mrad)	100
millirads	milligrays	100
millirems	microsieverts	0.01
milliroentgens	microcoulombs/kilogram	10
microcoulombs/kilogram	milliroentgens	0.258
(rem/hour)/(curie/meter ²)	(millirem/year)/(microcurie/meter ²)	3.88
rem/curie	sievert/ becquerel	0.014
		3.7×10^{-12}

Table N-6. Number of hours to add or subtract when converting times^a

From	To							
	UTC/Z	Atlantic	Eastern	Central	Mountain	Pacific	Alaska	Hawaiian -Aleutian
UTC/Z ^b	0	-4	-5	-6	-7	-8	-9	-10
Atlantic	+4	0	-1	-2	-3	-4	-5	-6
Eastern	+5	+1	0	-1	-2	-3	-4	-5
Central	+6	+2	+1	0	-1	-2	-3	-4
Mountain	+7	+3	+2	+1	0	-1	-2	-3
Pacific	+8	+4	+3	+2	+1	0	-1	-2
Alaska	+9	+5	+4	+3	+2	+1	0	-1
Hawaiian- Aleutian	+10	+6	+5	+4	+3	+2	+1	0

^aDaylight saving time (DST) status must be same at both locations. To convert from UTC to DST in any zone, subtract one less hour than indicated (assuming DST is 1 h ahead of standard time). Add one less hour to convert local DST to UTC.

^bUniversal Time Coordinated (UTC) replaced Z or Greenwich Mean Time (GMT).

Fig. N-1
Equivalences (temperature, activity, and dose equivalent)

TEMPERATURE		ACTIVITY		DOSE EQUIVALENT	
<u>celsius</u>	<u>fahrenheit</u>	<u>curie</u>	<u>becquerel</u>	<u>rem</u>	<u>sievert</u>
3000°C	5432°F	1 pCi	37 MBq	0.1 mrem	1 μSv
2500°C	4532°F	27 pCi	1 Bq	1 mrem	10 μSv
2000°C	3632°F	1 nCi	37 Bq	10 mrem	100 μSv
1500°C	2732°F	27 nCi	1 kBq	100 mrem	1 mSv
1000°C	1832°F	1 μCi	37 kBq	500 mrem	5 mSv
800°C	1472°F	27 μCi	1 Mbq	1 rem	10 mSv
600°C	1112°F	1 mCi	37 MBq	5 rem	50 mSv
400°C	752°F	27 mCi	1 GBq	10 rem	100 mSv
200°C	392°F	1 Ci	37 GBq	25 rem	250 mSv
100°C	212°F	27 Ci	1 TBq	50 rem	500 mSv
50°C	122°F	1 kCi	37 TBq	100 rem	1 Sv
0°C	32°F	27 kCi	1 PBq	500 rem	5 mSv
-17.8°C	0°F	1 MCi	37 PBq	1000 rem	10 Sv

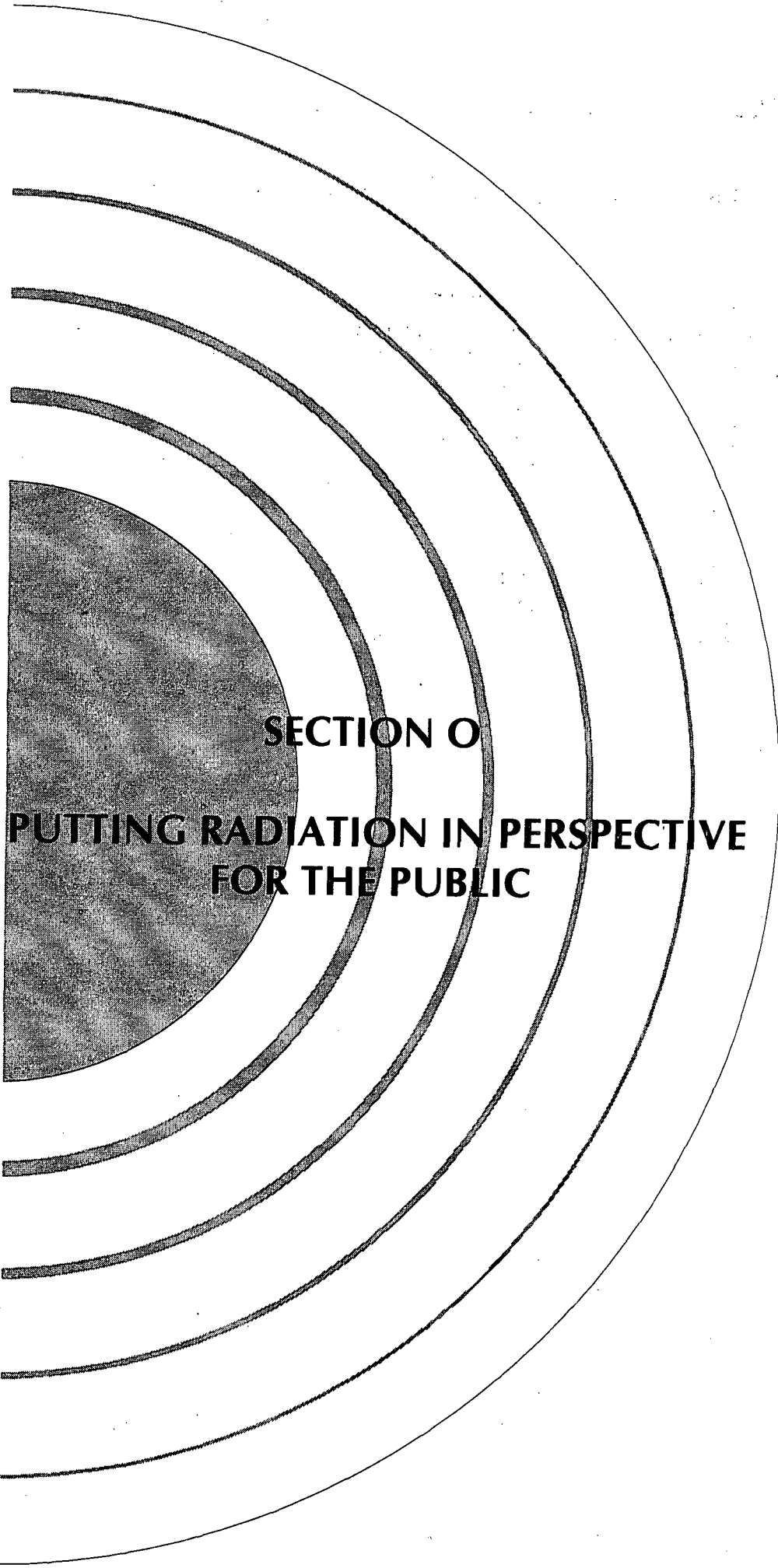

SECTION O
PUTTING RADIATION IN PERSPECTIVE
FOR THE PUBLIC

THE UNIVERSITY OF CHICAGO
DIVISION OF THE PHYSICAL SCIENCES
DEPARTMENT OF CHEMISTRY
5708 SOUTH CAMPUS DRIVE
CHICAGO, ILLINOIS 60637

Section O
Quick Reference Guide

	<i>Page</i>
Putting radiation in perspective for the public	O-3
Radiation doses	O-3
Radiation releases	O-3
Section O table	O-5
Section O figure	O-6

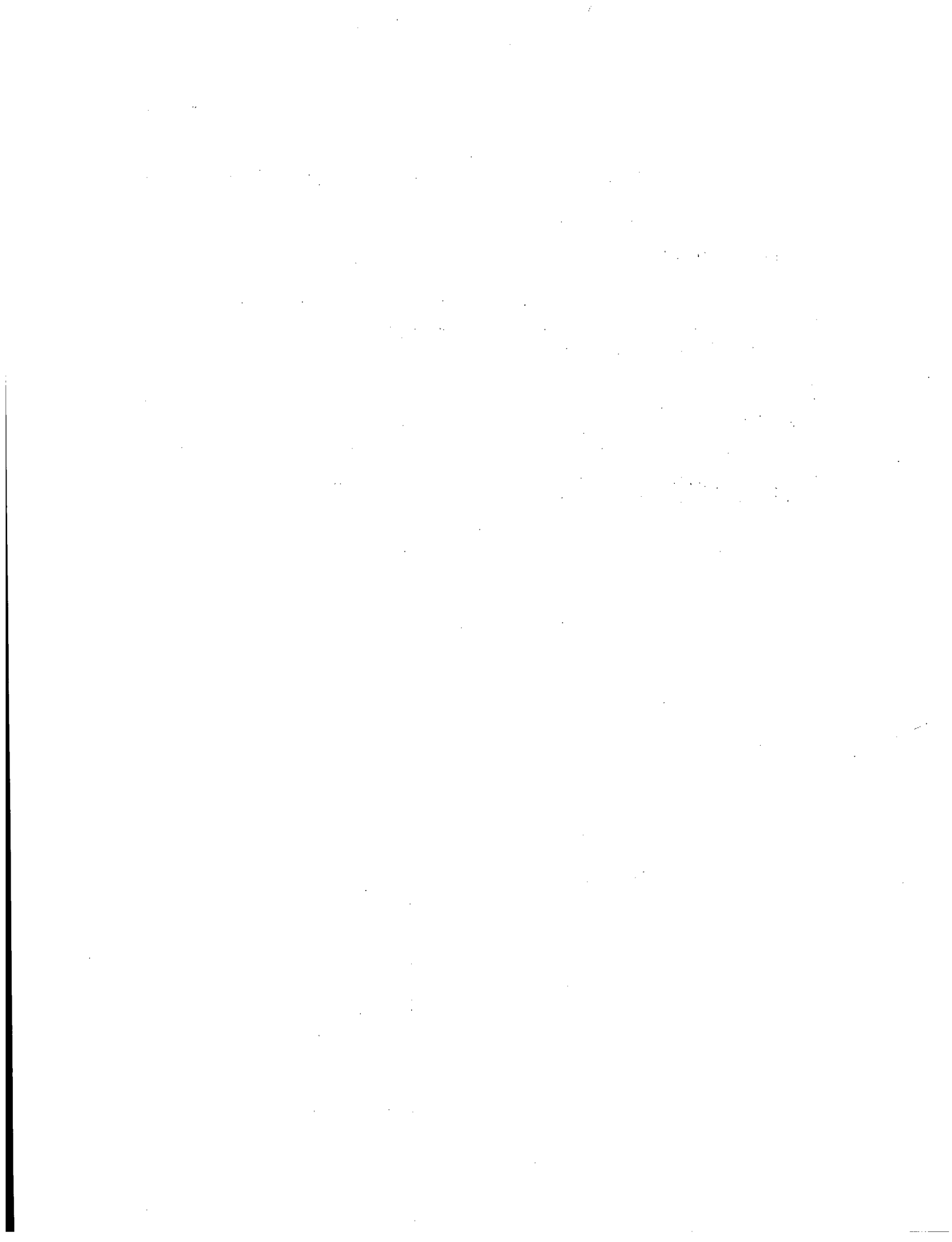

Section O

Putting Radiation in Perspective for the Public

Radiation Doses

Figure O-1 displays the effective dose equivalent associated with various activities, thresholds, and standards. Effective dose equivalents in the 0.1 mrem to 800,000 mrem (800 rem) range are included. Notes and sources for Fig. O-1 follow the figure.

Radiation Releases

Radioactivity (in curies) released during normal reactor operation is compared to releases during the Three Mile Island and Chernobyl accidents in Table O-1.

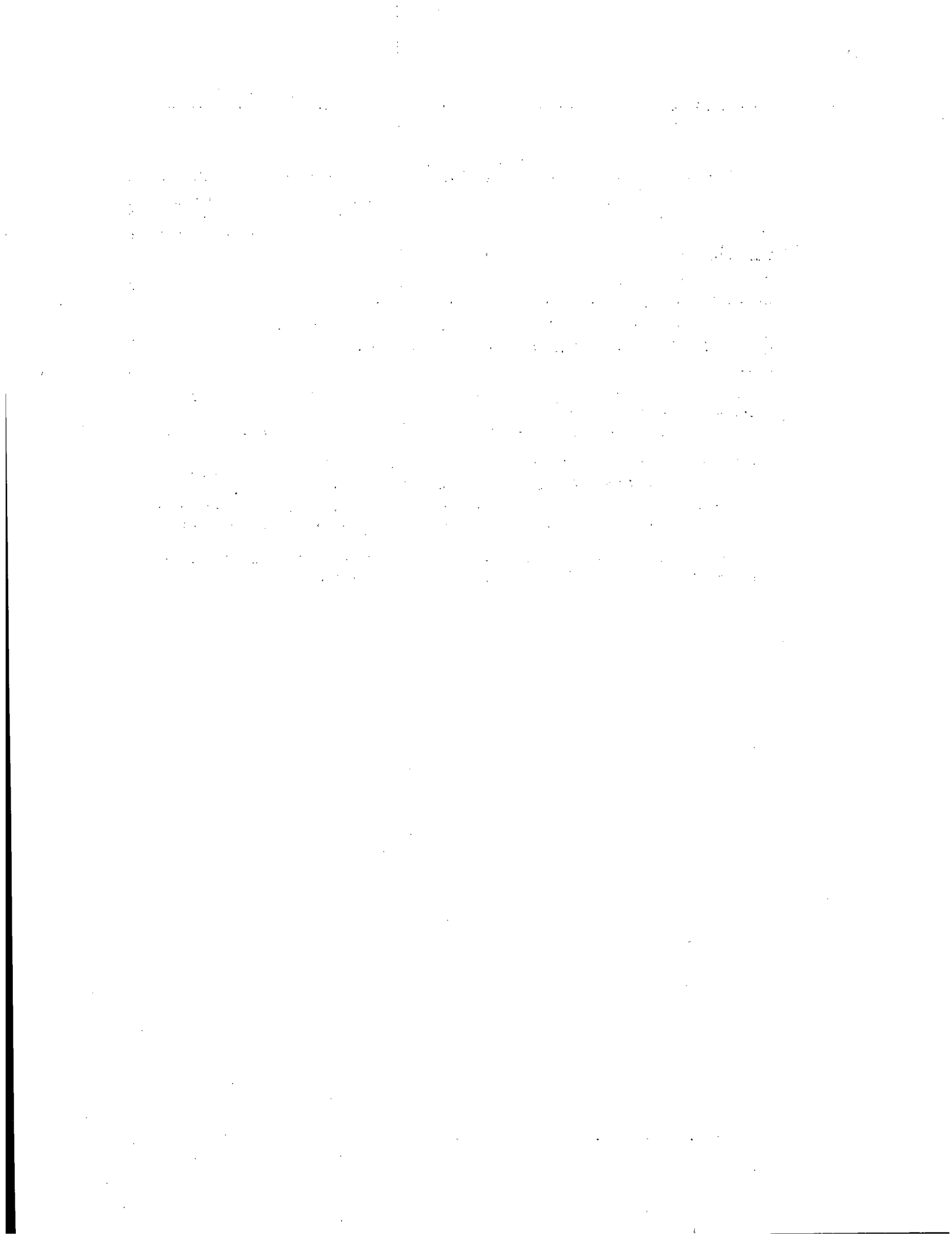

Table O-1. Radiation releases in perspective

Release	Noble gas ^a (Ci)	Iodine (Ci)	Particulate (Ci)
Average annual reactor release (1975-1979)	1,100	0.13	
Three Mile Island reactor release (1979)	2,500,000	15	
Chernobyl accident, USSR (April 1986) ^b	260,000,000	40,000,000	60,000,000

^aIodine and particulate releases pose a much greater risk to the public than noble gas releases.

^bThe estimates in the USSR reports and reports based on the USSR reports consider decay from April 26 to May 6 and thus exclude the short-lived fission products. The estimates shown here include the short-lived fission products expected to be released considering the power history of the plant.

Sources: (Aver. annual) UNSCEAR, (noble gases) p. 286, (iodine) p. 295, (particulates) p. 298 ; (Three Mile Island) Rogovin (1980), p. 344; (Chernobyl) USSR, Appendix 4, p. 21.

Fig. O-1
Radiation doses in perspective.

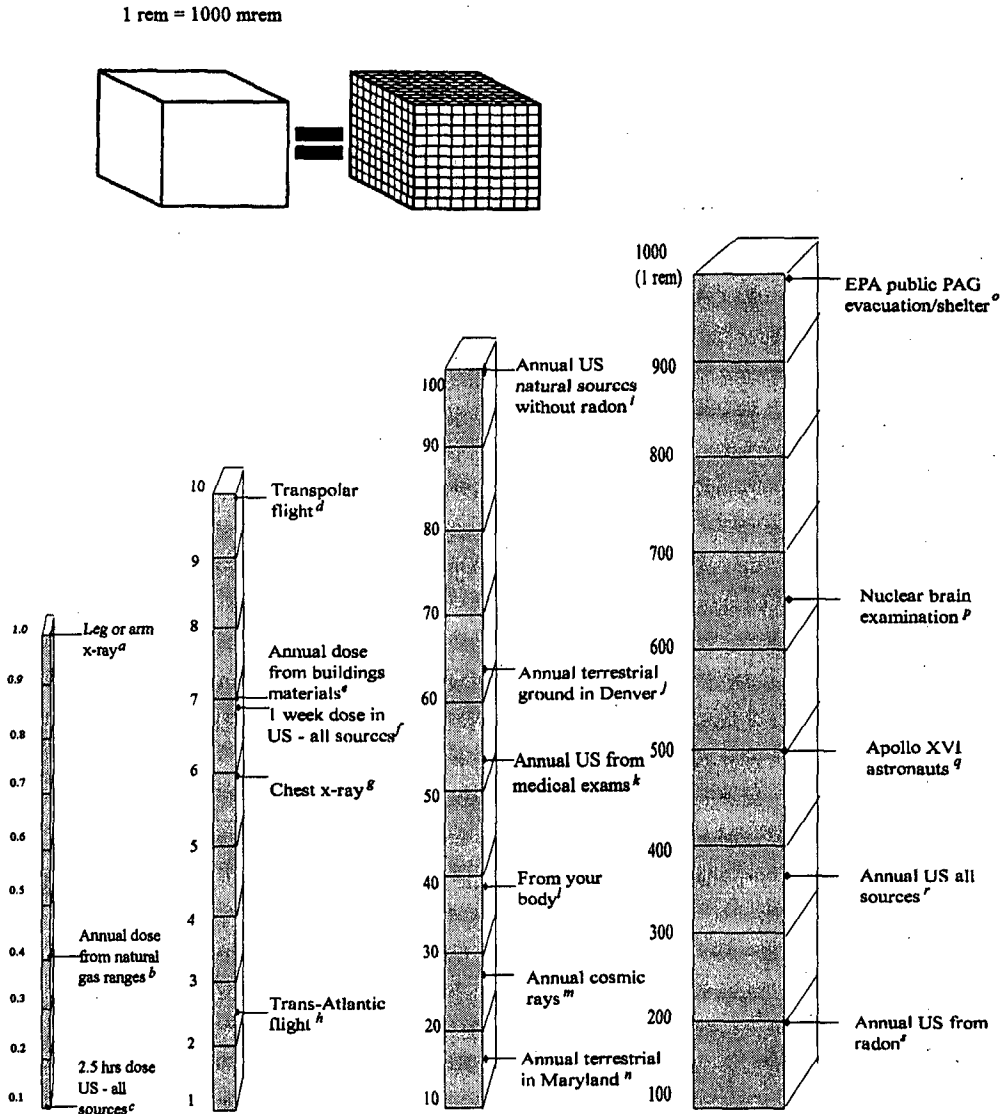
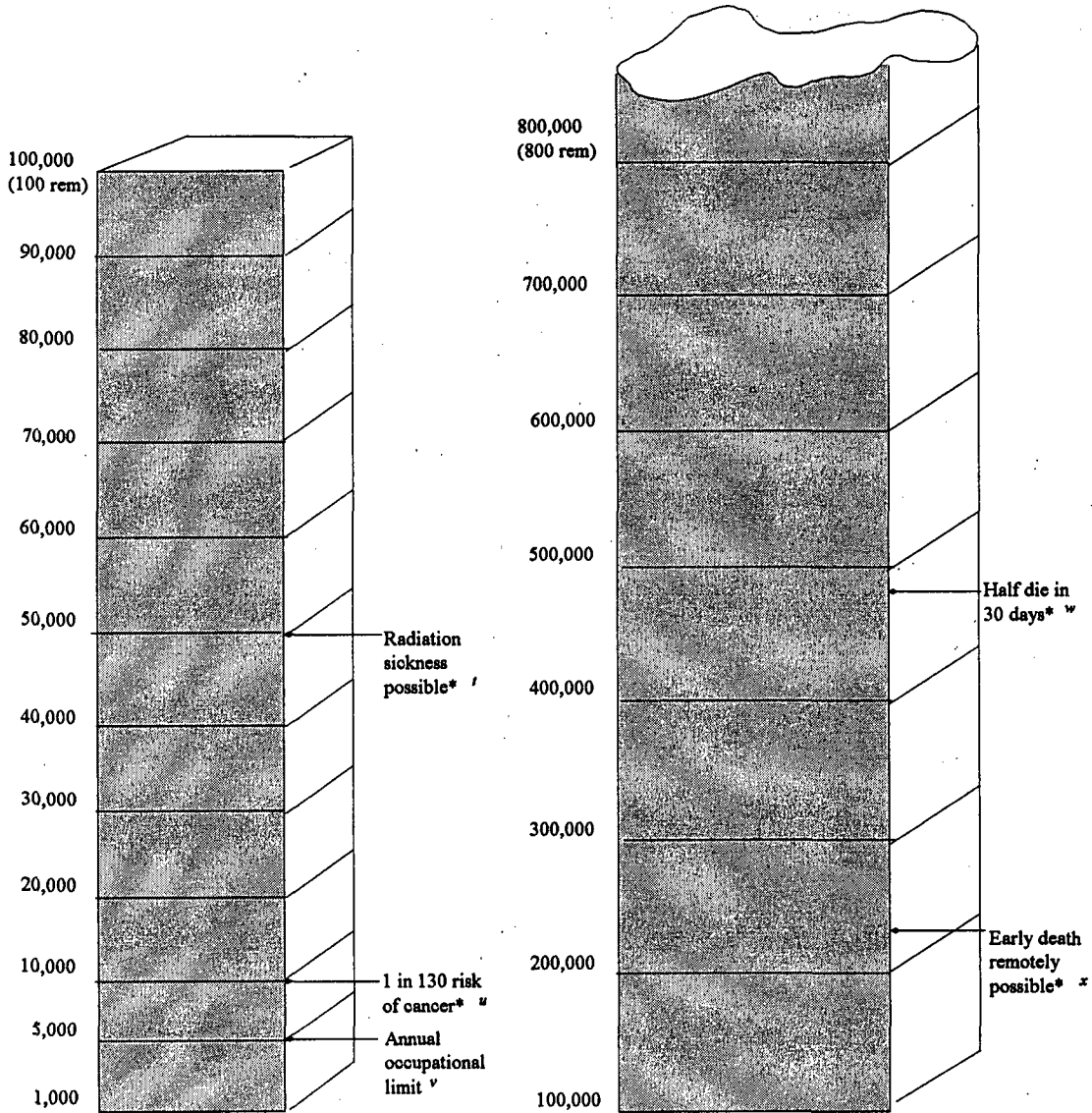

Fig. O-1
Radiation doses in perspective (continued).



* Doses received over a short time period (hours - days) at high dose rates (acute doses)

Notes for Fig. O-1.

^aAverage effective dose equivalent per diagnostic medical X-ray of extremity in 1980. *Source:* NCRP 93, p. 45.

^bAverage annual effective dose equivalent to exposed population. Average annual effective dose equivalent in U.S. population is 0.2 mrem. *Source:* NCRP 93, p. 31.

^cAverage effective dose equivalent in U.S. population in 2.5 h, derived from average annual effective dose equivalent of 360 mrem. *Source:* NCRP 93, p. 53.

^dCalculated dose equivalent resulting from cosmic radiation during a 10-h polar flight from California to Europe. *Source:* NCRP 94, p. 21.

^eAverage annual dose equivalent to exposed population from building materials. Average annual effective dose equivalent in U.S. population is 3.6 mrem. *Source:* NCRP 93, p. 31.

^fAverage effective dose equivalent in U.S. population in 1 week, derived from average annual effective dose equivalent of 360 mrem. *Source:* NCRP 93, p. 53.

^gAverage effective dose equivalent per diagnostic medical chest X-ray in 1980. *Source:* NCRP 93, p. 45.

^hCalculated dose equivalent due to cosmic rays from transcontinental or transatlantic flight of 5 h at 12 km altitude and mid-latitudes. *Source:* NCRP 94, p. 21.

ⁱAverage annual effective dose equivalent in U.S. population from natural sources, excluding radon (circa 1980-1982). *Source:* NCRP 93, p. 53.

^jAverage annual dose equivalent in Denver area from terrestrial sources. *Source:* NCRP 94, p. 89.

^kAverage annual effective dose equivalent in the U.S. population from medical examinations. Value includes 39 mrem from diagnostic X-rays (1980) and 12 mrem from nuclear medicine (1982). *Source:* NCRP 93, p. 47.

^lEstimated average annual effective dose equivalent to member of U.S. population from natural radioactive materials in the body. *Source:* NCRP 93, p. 15.

^mEstimated average annual effective dose equivalent to member of U.S. population from cosmic rays. *Source:* NCRP 93, p. 15.

ⁿAverage annual dose equivalent in Atlantic and Gulf Coast Plain from terrestrial sources. *Source:* NCRP 94, p. 89.

^oEPA Protective Action Guide for general public. *Source:* EPA 400-R-92-001, p. 2-6.

^pAverage effective dose equivalent per diagnostic nuclear medicine brain examination in U.S. in 1982. *Source:* NCRP 93, p. 46.

^q*Source:* UNSCEAR, p. 135.

⁷Average annual effective dose equivalent from all sources in U.S. population (circa 1980-1982). *Source: NCRP 93, p. 53.*

⁸Average annual effective dose equivalent in U.S. population as a result of natural radon (circa 1980-1982). *Source: NCRP 93, p. 53.*

⁹Estimated threshold dose equivalent to produce vomiting after total body irradiation for brief period of time (dose rate ≥ 6 rad/h). *Source: NUREG/CR-4214, Rev. 1, Part II, p. II-21.*

¹⁰An instantaneous dose of 10 rad to all body organs for an average population of 100,000 men is estimated to result in an average of 770 cancers. There would be about 15,000 cancers normally expected from other causes in this group of men. The same dose is estimated to result in an average of 810 cancers in an average population of 100,000 women. There would be about 18,000 cancers from other causes normally expected in this group. [Normal cancer estimates from *Health Physics* 63(3), September 1992, p. 279.] *Source: BEIR V, p. 172.*

¹¹10 CFR 20.1201.

¹²Calculated mean lethal bone marrow dose equivalent for 50% mortality for brief exposure (dose rate ≥ 100 rad/h) with supportive medical treatment. *Source: NUREG/CR-4214, Rev. 1, Part II, p. II-39.*

¹³Calculated mean threshold lethal bone marrow dose equivalent for brief exposure (dose rate $\geq 1,000$ rad/h) with supportive medical treatment. *Source: NUREG/CR-4214, Rev. 1, Part II, p. II-39.*

P

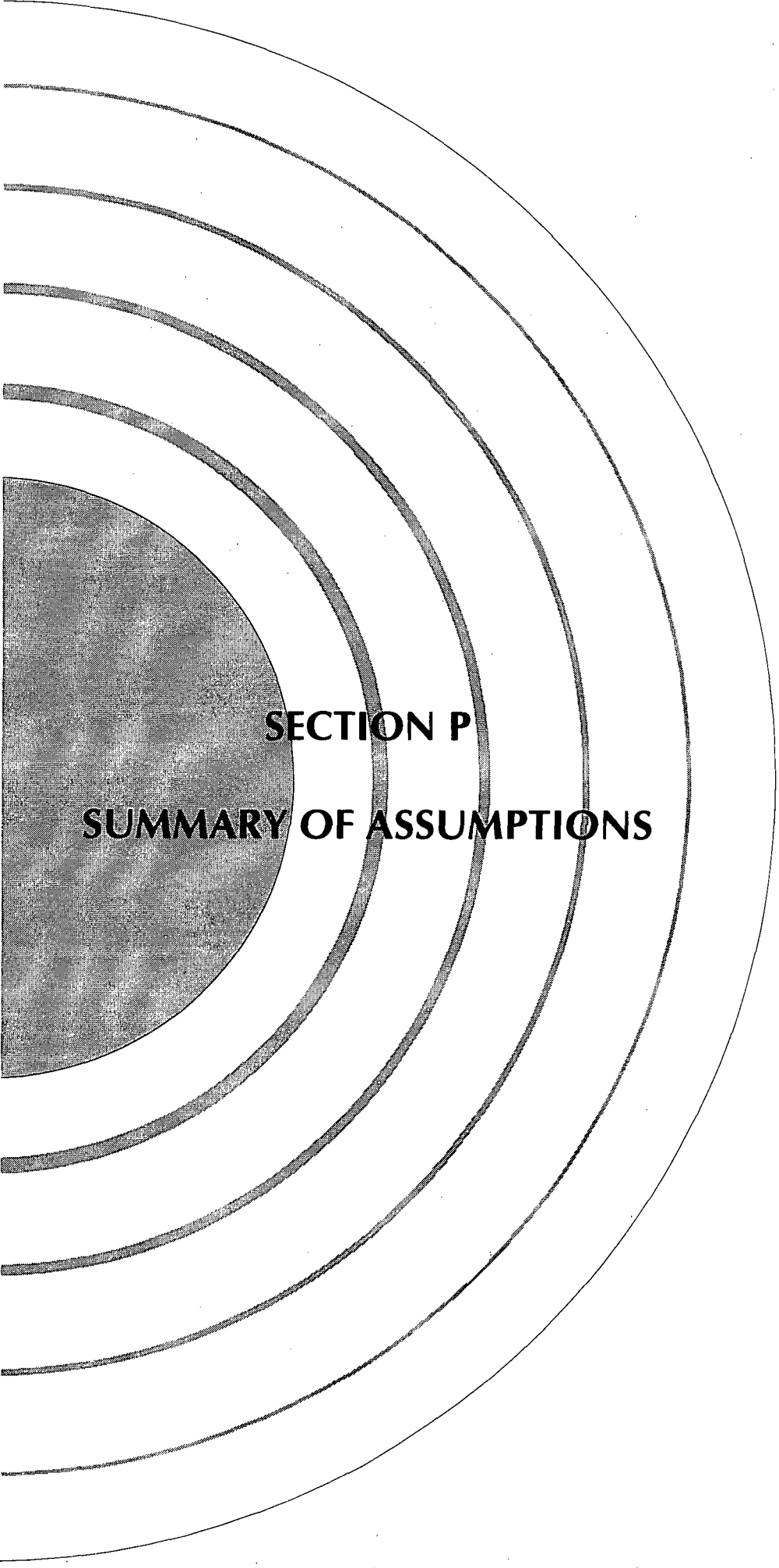

SECTION P
SUMMARY OF ASSUMPTIONS

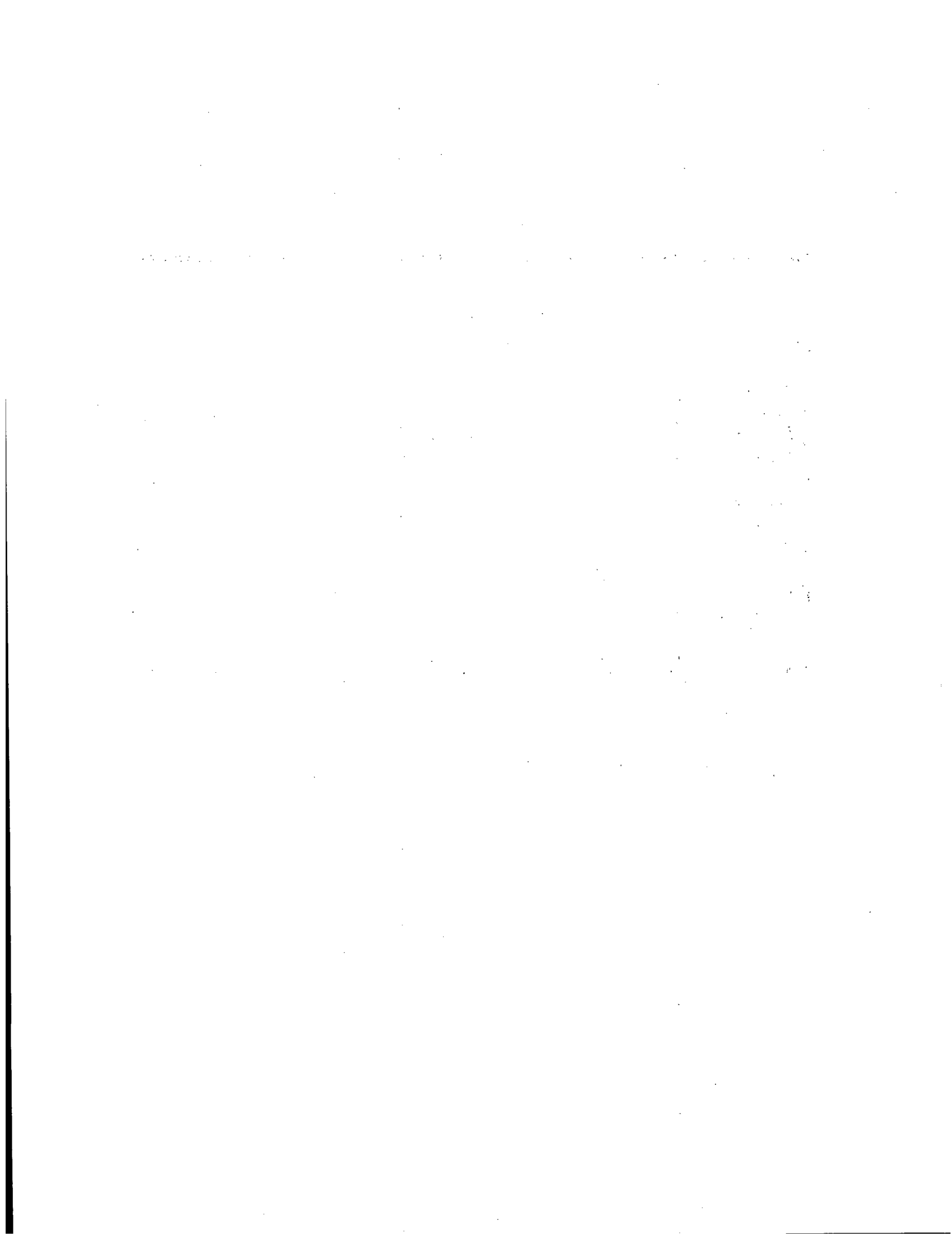

Section P
Quick Reference Guide

	<i>Page</i>
Assumptions	P-3
Introduction	P-3
Section A	P-3
Section B	P-5
Section C	P-5
Section D	P-7
Section E	P-8
Section F	P-9
Section G	P-15
Section H	P-15
Section I	P-15
Section J	P-15
Section K	P-15

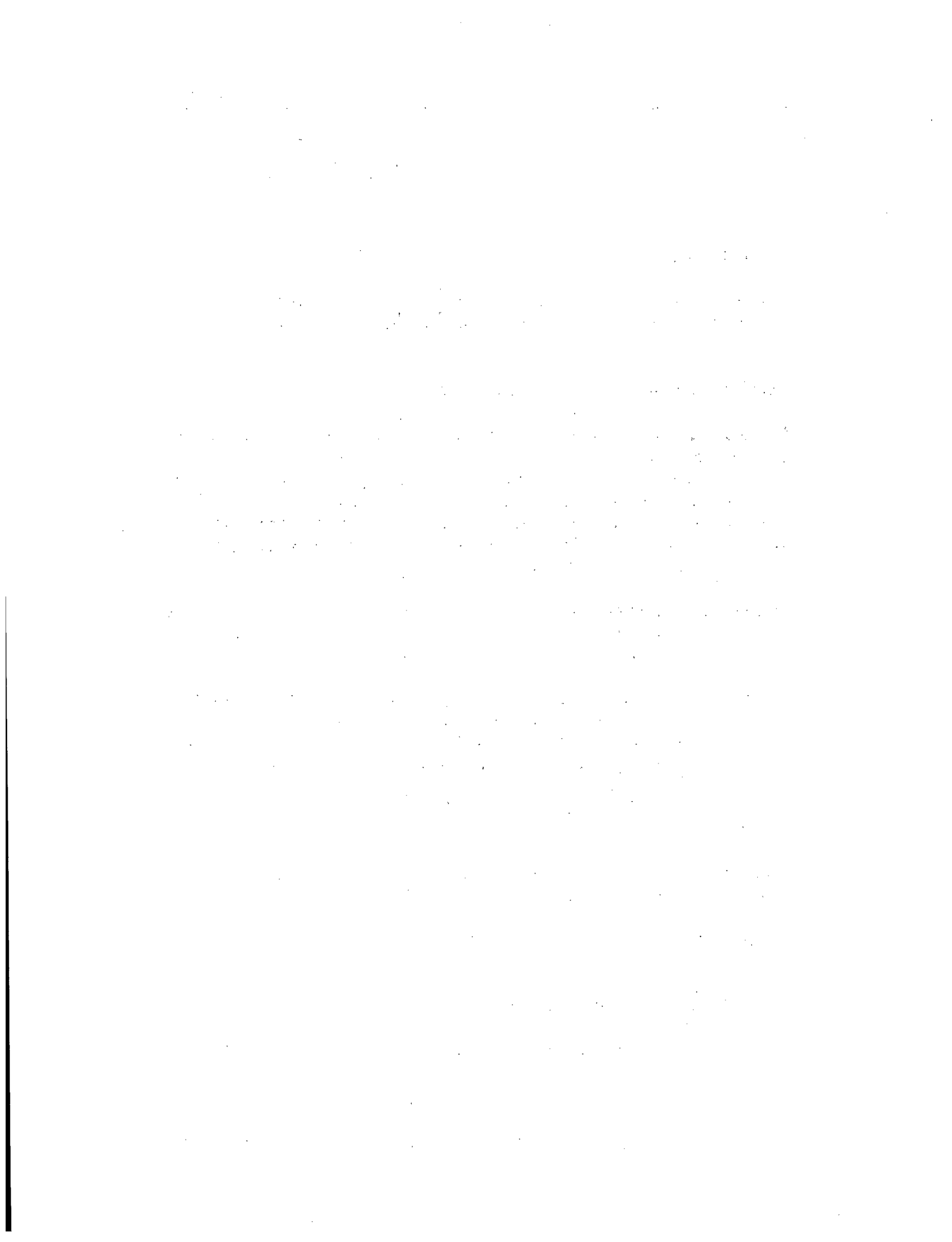

Section P Assumptions

Introduction

This section describes the assumptions used in the methods in Sections A–K. Most of this information is also found in the text or footnotes, but this section compiles and summarizes the information.

Section A: Core Damage Consequence Assessment

Method A.1: Evaluation of Water Injection. Figures A-1 and A-2 show the amount of water that must be injected to remove decay heat by boiling. The curves are based on a 3000-MW(t) nuclear power plant that has been operated at constant power and then shut down instantaneously. Decay heat data are based on ANSI/ANS-5.1. If the injected water is about 80°F (27°C), the curves are within 5% for pressures 14–2500 psia (0.1–17.2 MPa). The curves are valid within 20% for injected water temperatures up to 212°F (100°C).

Method A.2: Evaluate Sub-Cooling Margin (Saturation Table). Evaluation of whether water in core is boiling using the sub-cooling margin is appropriate only in PWRs.

Method A.3: Evaluate Core Once Uncovered. Estimation of LWR core temperature is based on the assumption that the fuel in the core will heat up at 1–2°F/s (0.5–1.0°C/s) immediately after the top of an active core of a PWR is uncovered or 5–10 min after the top of an active core of a BWR is uncovered. These fuel heatup estimates are reasonable within a factor of two if the core is uncovered within a few hours of shutdown (including failure to scram) for a boil-down case (without injection).

Method A.4: Evaluate Containment Radiation. Figures A-5 through A-12 provide probable maximum readings for the containment monitors assuming

- prompt release of all the fission products in the coolant, spike, gap, or from in-vessel core melt;
- uniform mixing in the containment; and
- an unshielded monitor that can "see" most of the area shown in Fig. A-3 or A-4.

Because the mix is most likely different from that assumed in the calibration of the monitor, the actual reading at the upper end of the scale could differ by a factor of 10-100 if a shielded detector is used for the higher radiation measurements.

The action of the emergency core cooling system sprays can affect the reading on the monitors. If the sprays were on for 1-2 h, the particulates and aerosols in the containment will be washed down where the monitors cannot see them. If the sprays were off, some of the material will plateout inside containment. Although the material that plates out is not available for release, it may be seen by the monitor and result in higher readings.

The levels of damage indicated on the charts should be considered minimum levels unless there are inconsistent monitor readings. Inconsistent readings may be caused by uneven mixing in containment [e.g., steam rising to top of dome, not enough time for uniform mixing to occur (it may take hours)]. The calculations were performed using CONDOS II (NUREG/CR-2068).

Method A.5: Evaluate Coolant Concentrations. This evaluation of fission products in the coolant assumes that

- releases from the core are uniformly mixed in the coolant and
- there is no dilution from injection.

The baseline coolant concentrations are for 0.5 h after shutdown of a core that has been through at least one refueling cycle.

For a BWR, it is assumed that the release from the core is uniformly mixed in the reactor coolant system and suppression pool. If most of the core release is confined to the reactor coolant system, the concentrations in the coolant could be up to 10 times higher.

Method A.6: Evaluate Containment Hydrogen. This method uses hydrogen percentages in wet samples. If a dry (steam removed) sample concentration is used, this method may overestimate considerably the level of core damage.

This method assumes that all hydrogen is released to the containment and is completely mixed in the containment atmosphere. The curves are a function of containment size. The results of severe accident research (research supporting NUREG-1150) were examined to identify the *least* percentage of metal-water reaction associated with each core damage state. Higher percentages of metal-water reaction are possible for some accident sequences.

Section B: Classification Assessment

Method B.2: NUREG-0654 Full Guidance. Use of this method requires the assessor to have a thorough knowledge of NUREG-0654.

Section C: Reactor Accident Consequence Assessment Based on Plant Conditions

These calculations consider only the plant, release, and atmospheric conditions that have a major (greater than a factor of 10) impact on dose.

Core Conditions. Four different core conditions can be assumed. These conditions span the entire range of possible core damage states. The amount of fission products assumed to be released is approximately the mean value calculated for a range of core damage accidents. Assumed core release fractions are shown in Table C-4.

- **Leakage of normal coolant** following a steam generator tube rupture (SGTR) accident that does not involve core damage. Normal coolant concentrations in Tables C-2 and C-3 are based on an ANSI standard.
- **Leakage of spiked coolant** following an SGTR accident that does not involve core damage. Spiked coolant assumes all the non-nobles in the normal coolant increase by a factor of 100 to estimate the maximum spiking sometimes seen with rapid shutdown or depressurization of the primary system.
- **A gap release** assumes that the core is damaged and all fuel pins have failed, releasing the gaseous fission products contained in the fuel pin gap.
- **An in-vessel core melt release** assumes that the entire core has melted, releasing a mixture of isotopes believed to be representative for most core melt accidents.

Release Pathways and Conditions. Six simplified release pathways and conditions are used for two PWR containments and three BWR containments. For each containment release pathway, the mechanisms that will substantially reduce the release are considered (e.g., containment sprays). The effectiveness of the reduction mechanism used is representative for a range of assumptions. The reduction factors assumed for each reduction mechanism are listed in Table C-5. Case-specific assumptions about reduction mechanisms are located in the notes to each event tree.

- **A PWR dry containment release** assumes a release into the containment which leaks to the atmosphere. The effectiveness of sprays or natural processes (plate-out) can be considered.

- A **BWR drywell containment release** assumes a release into the containment which leaks to the atmosphere. The effectiveness of sprays or natural processes (plateout) can be considered. The majority of the release bypasses the suppression pool. In this containment, the amount of released material may be reduced if it passes through the standby gas treatment system filters.
- A **PWR ice condenser containment release** assumes either a single pass through the ice (because of fan failure or major containment failure) or recirculation through the ice. Credit for sprays and natural processes can also be taken. If the ice is depleted before core damage occurs, then the PWR dry containment release pathway should be used.
- A **BWR wetwell containment release** assumes a release through the suppression pool. If the release bypasses the suppression pool, then the BWR drywell release pathway should be used. Credit may be taken for a release through the standby gas treatment system filters.
- A **PWR SGTR release** assumes contaminated coolant leaks through the rupture. Steam generator partitioning can be considered as a reduction mechanism. The effectiveness of the condenser may also be considered for releases out of the steam-jet air ejector. If the primary system is dry, then the containment bypass release pathway should be used.
- A **PWR/BWR containment bypass release** assumes a release through a dry pathway from the primary system out of the containment. Only plateout on pipes and filtering (if established) in the release pathway can be considered.

Release Rates. The assumed release rates and resulting escape fractions are listed in Table C-6. Containment leakage rates include

- catastrophic failure (100%/h),
- failure to isolate containment (100%/day), and
- design leakage (0.5%/day).

The SGTR leakage rates used are

- failure of one tube at full pressure (500 gal/min) and
- failure of one tube at low-pressure with coolant being pushed out of the break by one charging pump (50 gal/min).

Source Term. The method for calculating the source term is summarized on p. C-13. Release reduction mechanisms are included in the calculation. NUREG-1228 contains a full description of the method. Source term assumptions in RASCAL are discussed in Appendix C of *RASCAL Version 2.1 User's Guide*, NUREG/CR-5247.

Dose Calculation. Doses at 1 mile are calculated with RASCAL 2.1 with the following assumptions:

- a ground-level release of 1-h duration,
- building wake, and
- average meteorological conditions (4 mph or 1.8 m/s, no rain, and D stability).

Transport and diffusion assumptions in the RASCAL code are discussed in Appendix D of NUREG/CR-5247.

Doses are a best estimate of the maximum total acute bone marrow dose and maximum thyroid dose (plume center line) to an individual who stayed unsheltered and unprotected at a point along the centerline of the plume for 24 h. External dose factors are from EPA-402-R-93-081. Inhalation dose factors are from NRPB-R162 and WASH-1400. Dose factors used in RASCAL are found in Appendix K of NUREG/CR-5247.

- Total acute bone dose includes 1 h of cloudshine (external exposure from immersion in passing radioactive plume), acute inhalation dose (30-day dose commitment), and 24 h of groundshine (external exposure to deposited radioactive material). Radioactive decay and in-growth are included.
- Thyroid doses are for adults from inhalation of the passing plume only.

The dose estimates should be within a factor of 10-100 if the plant, release height, and rain conditions are accurately represented.

Section D: Fuel Pool Damage and Consequence Assessment

These calculations consider only the fuel conditions, release, and atmospheric conditions that have a major (greater than a factor of 10) impact on dose.

Two types of damage from overheating of fuel resulting from loss of coolant in the spent fuel pool were assumed:

- Zircaloy cladding fire in recently discharged fuel and

- cladding failure with release of the fission products in the fuel pin gap (gap release). This may occur from <2 h to several days after the pool is drained. The pin is assumed to heat up before failure, releasing about 5% of the volatile fission products.

Dose Calculation. Doses at 1 mile are calculated with RASCAL 2.1 using the following assumptions:

- a ground-level release of 1-h duration,
- building wake, and
- average meteorological conditions (4 mph, no rain, and D stability).

Doses are a best estimate of the maximum total acute bone marrow dose and maximum thyroid dose to an individual who stayed unsheltered at a point along the centerline of the plume for 24 h. External dose factors are from EPA-402-R-93-081. Inhalation dose factors are from NRPB-R162 and WASH-1400. A discussion of the dose factors used in RASCAL is found in Appendix K of *RASCAL Version 2.1 User's Guide*, NUREG/CR-5247.

- Total acute bone dose includes 1 h of cloudshine (external exposure to passing radioactive plume), acute inhalation dose (30-day dose commitment), and 24 h of groundshine (external exposure to deposited radioactive material). Radioactive decay and in-growth is included.
- Thyroid doses are for adults from inhalation of the passing plume only.

The dose estimates should be within a factor of 10–100 if the spent fuel pool and rain conditions are accurately represented.

Section E: Uranium Hexafluoride Release Assessment

The values shown in Fig. E-1 were calculated using the default assumptions described below under Method E.1.

Method E.1: Estimation of Inhaled Soluble Uranium Intake and Hydrogen Fluoride Concentration After a Liquid UF₆ Release. The estimations in this method use the following default assumptions:

- use of a Gaussian atmospheric dispersion model for the airborne fraction;
- average meteorological conditions (D stability, 4 mph or 1.8 m/s wind speed, and no rain);

- release fractions (percentage of liquid UF₆ by weight that becomes airborne as soluble uranium or HF) of 0.34 for soluble uranium and 0.12 for HF (NUREG-1140, pp. 32, 35);
- release time (duration) of 15 min (900 s) (NUREG-1140, p. 35); and
- breathing rate of 3.3×10^{-4} m³/s, equivalent to adult light activity (EPA-520/1-88-020, p. 10).

Method E.2: Calculation of Inhaled Soluble Uranium Intake and Hydrogen Fluoride Concentration After a UF₆ Release. A Gaussian plume model is assumed to approximate the distribution of the airborne fraction downwind. If gaseous UF₆ is released, then the assumption that 100% of the UF₆ becomes airborne and is incorporated in the plume is appropriate for the purposes of performing a rough bounding calculation. Under this assumption, the release fractions would be 0.68 for uranium and 0.23 for HF.

Method E.3: Estimation of Committed Effective Dose Equivalent Resulting From Inhaled Uranium After a Liquid UF₆ Release. The default assumptions for Method E.1 were also used in this calculation to find the intake of soluble uranium. The specific activity used for each enrichment is given in Table E-5. The specific activity of enriched uranium may depend somewhat on the history of the material and the method of enrichment. The dose conversion factor for ²³⁴U (2.7 rem/μCi) was used to give a conservative dose for the mixture:

Method E.4: Calculation of Committed Effective Dose Equivalent Resulting From Inhaled Uranium After a UF₆ Release. The assumptions used in Method E.2 were used in the calculation of the intake of soluble uranium. ²³⁴U is the major contributor to specific activity of enriched UF₆. The specific activity of enriched uranium may depend somewhat on the history of the material and the method of enrichment. If a specific activity cannot be obtained, using the specific activity for ²³⁴U (6.19×10^3 μCi/g) will provide an overestimate of the committed effective dose equivalent (CEDE). The dose conversion factor given for ²³⁴U is used to approximate that for all isotopic mixes.

Section F: Early Phase Dose Projections

The early phase of an accident extends from the identification of a release threat until the release (or threat of the release) has ended and any areas of major contamination have been identified. The early phase normally includes up to 4 days (100 h) of exposure to deposition.

Method F.1: Calculation of Activity Based On Mass. Specific activities of isotopes are in Table F-1. In this table, the specific activity of natural and depleted uranium is

based on 10 CFR 20 App. B, confirmed by calculations. For enriched uranium, the specific activity of the material is dominated by the concentration of ^{234}U because the ^{234}U concentration increases with ^{235}U enrichment and ^{234}U has a relatively high specific activity. The ^{234}U concentration relative to the ^{235}U enrichment is assumed to be 4% enrichment, 0.032% ^{234}U ; 20% enrichment, 0.15% ^{234}U ; and 93% enrichment, 2% ^{234}U .

Method F.2: Estimation of Activity Released by a Fire. Filtering, plateout, or other mechanisms that can reduce the release of non-nobles are *not* considered in this calculation; this method should provide a reasonable upper bound for most accidents involving radioactive material. This method is *not* valid for reactor accidents.

Method F.3: Downwind Dose Projection Based on Estimated Activity Released. Estimates and calculations in this method assume a Gaussian atmospheric dispersion model.

Dilution factors (Table F-10) are on the center line of ground-level release with a vertical dispersion limit of 1000 m; dilution factors at 0.25 mile are assumed to be dominated by building wake and are constant across all Pasquill turbulence types.

Ground concentration factors used in calculating deposition (Table F-11) were based on RASCAL calculations and include building wake. D stability was assumed. The average deposition velocity was 0.3 cm/s.

The total doses using either the quick estimate or full calculational method are assumed to be calculated as follows:

- The total acute bone dose is assumed to be the sum of the contribution of each isotope to the air immersion effective dose equivalent, the dose from 4 days exposure to deposition (including inhalation of resuspended materials), and the inhalation committed dose equivalent to the bone.
- The total acute lung dose is assumed to be the sum of the contribution of each isotope to the air immersion effective dose equivalent, the dose from 4 days exposure to deposition (including inhalation of resuspended materials), and the inhalation committed dose equivalent to the lung.
- The total effective dose equivalent is assumed to be the sum of the contribution of each isotope to the air immersion effective dose equivalent, the dose from 4 days exposure to deposition (including inhalation of resuspended materials), and the inhalation committed effective dose equivalent (CEDE).
- The thyroid dose is the committed dose equivalent to the thyroid from inhalation of the plume.

Quick estimate method. Precalculated doses from a 1- μ Ci release (release conversion factors) are provided for a variety of isotopes at distances of 0.25 (Table F.4) and 1 mile (Table F.5). Initial calculations can be adjusted to consider an elevated release and rain (Method F.5). The dose projections should be within a factor of 10 for a reasonable range of stability classes and wind speeds. Calculation of the release conversion factors is illustrated in the notes following Tables F-4 and F-5.

The following assumptions were used in calculating the release conversion factors:

- ground level release.
- average meteorological conditions (D stability, 4 mph or 1.8 m/s wind speed, and no rain).
- dose calculation is maximized by assuming the exposed individual remains unsheltered and unprotected at the centerline of plume pathway for the plume passage and remainder of 4-days (100 h).
- inhalation dose contribution
 - acute bone marrow and acute lung doses are from inhalation of 1- μ m activity mean aerodynamic diameter aerosol with a 30-day dose commitment;
 - CEDE and thyroid dose equivalent are 50-year dose commitment using dose conversion factors from EPA-520/1-88-020;
 - inhalation doses include contributions from daughter isotopes;
 - breathing rate is for an adult performing light activity as recommended by EPA-520/1-88-020, p. 10 (breathing rate = 3.3×10^{-4} m³/s);
 - the lung clearance class giving the highest dose was used, except for UF₆, where the D clearance class for soluble uranium was used; and
 - CEDE from inhalation of tritium was doubled to account for skin absorption.
- cloudshine dose contribution
 - air immersion dose equivalent is for a semi-infinite cloud, maximizing the dose from cloudshine; and
 - contributions from daughter isotopes are included in external doses only where noted in the tables.

- ground exposure dose contribution
 - daughters are included in external doses only where noted in the tables;
 - groundshine dose contribution includes external dose equivalent from groundshine for 4 days (1 m above ground level) and CEDE from resuspension ($R_s = 10^{-6}$, appropriate for non-arid areas) from remaining on contaminated ground for 4 days;
 - ground concentration factors (Table F-11) were $3.9 \times 10^{-8} \text{ m}^{-2}$ for 0.25 mile and $2.1 \times 10^{-8} \text{ m}^{-2}$ for 1 mile; and
 - the groundshine doses were corrected for ground roughness (ground roughness correction factor = 0.7).
- for natural and depleted uranium, it is assumed all the release is ^{238}U , and for enriched uranium it is assumed all the release is ^{234}U .

Full Calculation Method. The doses are calculated using dose conversion factors in Tables F-6 and F-7. Table F-6 also contains an exposure conversion factor to approximate a radiation meter reading at 1 m above the ground. The following assumptions were used in calculating the dose conversion factors (these calculations are shown in the notes following Tables F-6 and F-7):

- ground level release.
- no rain.
- dose calculation is maximized by assuming the exposed individual remains unsheltered and unprotected at the centerline of plume pathway for the plume passage and remainder of 4-days (100 h).
- inhalation dose contribution
 - acute bone marrow and acute lung doses are from inhalation of $1 \mu\text{m}$ activity mean aerodynamic diameter aerosol with a 30-day dose commitment
 - CEDE and thyroid dose are 50-year dose commitment using dose conversion factors from EPA-520/1-88-020;
 - inhalation doses include contributions from daughter isotopes;

- inhalation dose conversion factors (Table F-7) provide mrem acquired from 1 h of breathing an air concentration of $1 \mu\text{Ci}/\text{m}^3$ at a breathing rate of $1.2 \text{ m}^3/\text{h}$ or $3.3 \times 10^{-4} \text{ m}^3/\text{s}$ (breathing rate for an adult performing light activity as recommended by EPA-520/1-88-020, p. 10);
- the lung clearance class giving the highest dose was used, except for UF_6 , where the D clearance class for soluble uranium was used; and
- CEDE dose conversion factor for tritium was doubled to account for skin absorption.
- cloudshine dose contribution
 - daughters are included only where noted in the tables; and
 - assumes immersion in a semi-infinite cloud, maximizing the dose from cloudshine.
- ground exposure dose contribution
 - daughters are included only where noted in the tables;
 - ground exposure includes external dose equivalent from groundshine for 4 days and CEDE from resuspension from remaining on contaminated ground for 4 days;
 - two values are assumed for the resuspension factor, $R_s = 10^{-6}$ for non-arid areas and $R_s = 10^{-4}$ for arid areas;
 - groundshine doses were corrected for ground roughness (ground roughness correction factor = 0.7); and
 - external exposure rate is 1.4 times the effective dose equivalent rate from deposition.
- for natural and depleted uranium, it is assumed all the release is ^{238}U , and for enriched uranium it is assumed all the release is ^{234}U .

Method F.4: Estimation of Dose and Exposure Rate from Point Source. Dose rate and exposure rate conversion factors have been calculated using CONDOS II for various isotopes at 1 m from a point source (Table F-6). For natural and depleted uranium it is assumed all the material is ^{238}U , and for enriched uranium it is assumed all the material is ^{234}U .

The conversion factors assume no shielding. The calculations do not include build-up, so if shielding is added to the calculation, the result should be considered the *lower bound*. Half-value layers in Table F-13 are for "good geometry" where build-up is not important.

Method F.5: Adjusting 1-Mile Dose to Consider Distance, Elevation and Rain.

This method requires an estimate of the total acute bone dose or inhalation thyroid dose at 1 mile from a ground-level release under average meteorological conditions (D stability, 4 mph wind speed, and no rain). Doses should be for the distances the plume has traveled, not the distance from the release source. The estimates assume a constant wind direction and should represent the maximum dose within a factor of 10 for a range of stability classes and wind speeds.

Total acute bone doses used as input should represent dose equivalent from cloudshine and acute dose equivalent from inhalation and approximately 24 h of the resulting groundshine to an adult performing normal activities with no sheltering (these are the assumptions used in Sections C and D and Method F.3). The thyroid dose should be from inhalation of the plume alone.

A ground-level release should be used unless the release is from an isolated stack more than 2.5 times higher than nearby structures or if observation indicates that it has an effective release height of 200 m or more. The elevated release case is assumed here to be 200 m or one-half of the typical nighttime mixing level.

Method F.6: Quick Long-Range Estimation. The usefulness of this method is limited. The method assumes a simple Gaussian model for an instantaneous release. There can be large variations in the estimate if the height of release is incorrect. These calculations assume a non-depositing material. With a non-depositing material, ground-level estimates will always be the more conservative and should be used.

The estimates from Fig. F-3 are much more appropriate at longer downwind distances, when the spreading of the material is comparable to the 24-h sampling time that was used to verify this approach. At plume travel times less than 1 day, the average dispersion parameters that were used are difficult to justify.

The calculations in this method assume an average elevated release to be about 1500 m above ground. Normal stack emissions are to be considered as ground-level releases.

The estimate of the maximum deposition assumes that all the material in the air is removed at that time. It is assumed that all the airborne material is available for ground deposit at each downwind time. Fractional removal requires subsequent deposition and air concentrations to be adjusted accordingly.

Section G: Early Phase Protective Action Assessment

For dose projection purposes, the early phase is assumed to last for 4 days (100 h). Doses normally include contributions from the airborne plume and from 4 days exposure to material deposited on the ground.

Section H: Intermediate Phase Protective Action Assessment

For dose projection purposes, the intermediate phase is assumed to last for 1 year.

The *FRMAC Assessment Manual* and RASCAL can be used to evaluate the projected doses needed for assessment.

Section I: Ingestion Pathway Protective Action Assessment

The HHS Protective Action Guides apply to short-term exposure from consumption of contaminated food and milk. These guides are assumed to apply to water, for which there is no guidance.

The *FRMAC Assessment Manual* can be used to evaluate the areas in which the radiological contamination levels in food need to be evaluated and to analyze food, water, and milk samples.

Section J: Use of Potassium Iodide and Thyroid Monitoring

The minimum detectable dose commitment calculated from Table J-1 assumes that all the radioiodine has reached the thyroid.

Section K: Extraordinary Nuclear Occurrence

Projected doses required for an extraordinary nuclear occurrence (Table K-1) include radiation doses from external sources as well as from radioactive material that has been taken into the body (e.g., ingestion or inhalation).

Surface contamination levels required for an extraordinary nuclear occurrence (Table K-1) are maximum levels (observed or projected) above background 8 h or more after initial deposition. Beta or gamma dose rates must be measured through no more than 7 mg/cm² of total absorber.

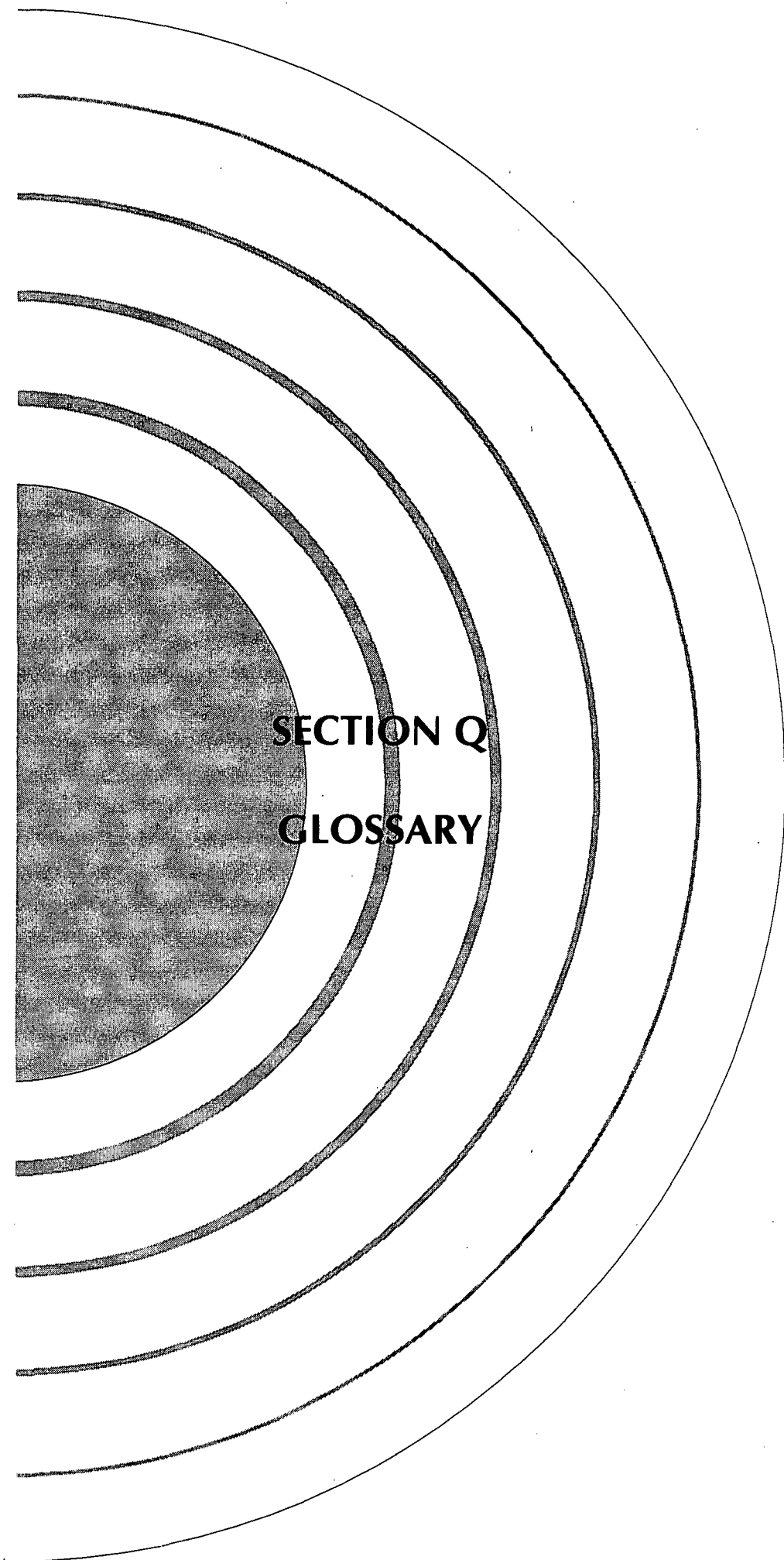

SECTION Q
GLOSSARY

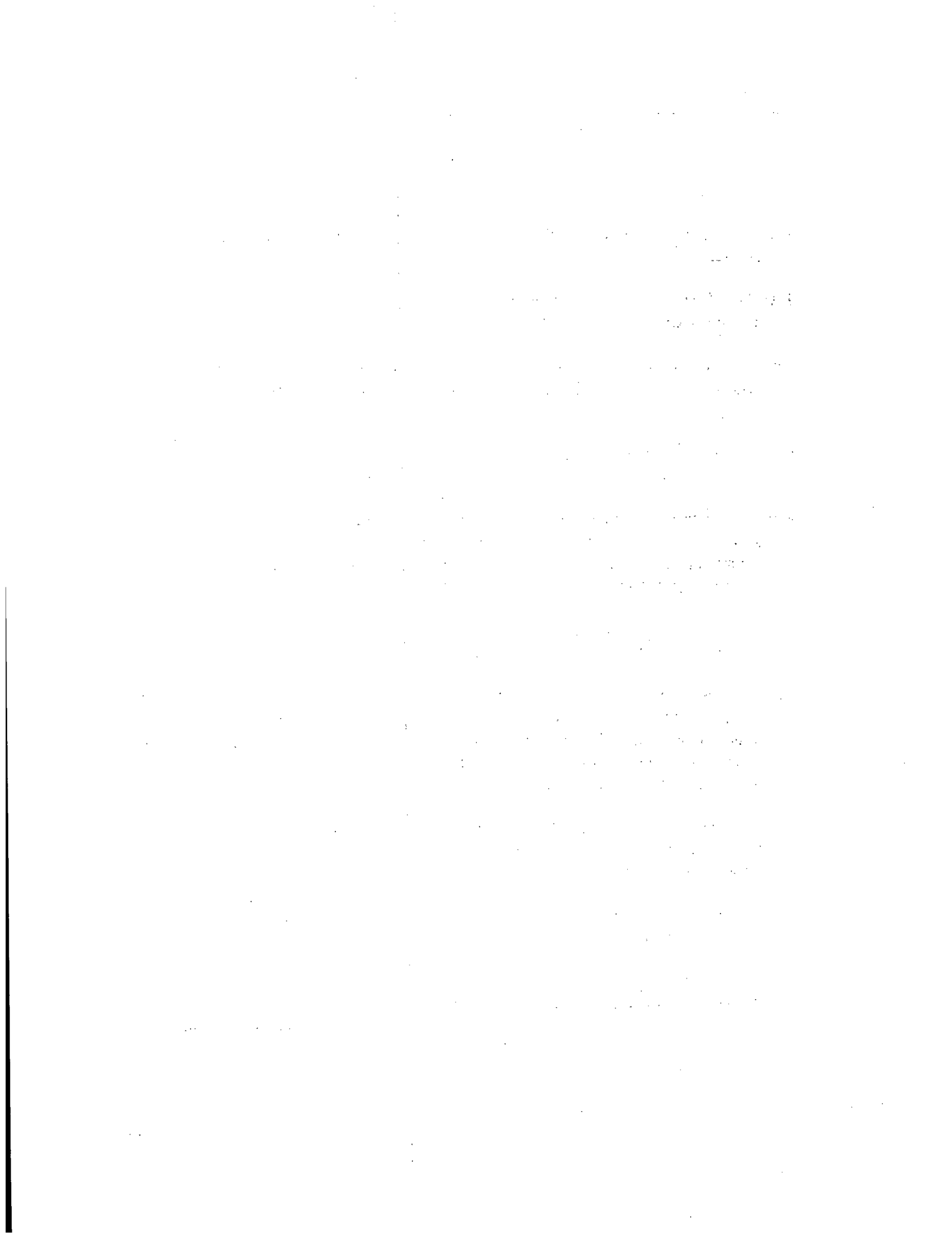

GLOSSARY

Absolute pressure. The total pressure of a gas system measured with respect to zero pressure.

Absorbed dose. A measure of energy deposition in any medium by all types of ionizing radiation (unit is usually rad or gray).

Activity. The number of nuclear disintegrations occurring in a given quantity of material per unit time. Becquerel and curie are the usual units for expressing activity.

Acute dose/dose equivalent. Radiation dose/dose equivalent received over a short period of time (hours-weeks), as opposed to a chronic dose.

Advisory Team for Environment, Food, and Health. A multi-agency team formed during a response to assist the NRC in preparing coordinated Federal recommendations on protective actions. The Advisory Team contains, at a minimum, representation from EPA, HHS, and USDA.

Aerosol. The suspension of very fine particles of a solid or droplets of a liquid in a gaseous medium.

Alert. The third most serious of the four NRC emergency classes. Classification as an "Alert" indicates that events are in progress or have occurred which involve an actual or potential substantial degradation of the level of safety of the plant. Any releases are expected to be limited to small fractions of the EPA Protective Action Guide exposure levels.

Alpha decay. A form of radioactive decay in which an alpha particle is emitted from the nucleus of an atom with atomic number Z and atomic mass A , leaving a daughter atom with atomic number $Z-2$ and mass number $A-4$.

Alpha particle (α). A particle consisting of two protons and two neutrons (a ${}^4\text{He}$ nucleus) emitted from the nucleus of an atom.

Alternating current (AC). An electric current that reverses direction in a circuit at regular intervals (e.g., normal household electrical service in U.S.). Alternating current is necessary to run such reactor components of the emergency core cooling system such as pumps and motor-operated valves.

Antineutrino ($\bar{\nu}$). A weakly interacting particle, with no rest mass and no charge, emitted along with an electron in β^- decay. An antineutrino is the antiparticle to the neutrino.

Atmospheric boundary layer. The lowest part of the earth's atmosphere in which considerable mixing occurs, extending from the earth's atmosphere to about 1 km (also called the mixing layer).

Atom. The smallest amount of an element retaining the characteristics of that element.

Atomic mass number (A). The sum of the number of protons plus the number of neutrons in the atom.

Atomic number (Z). The number of protons in an atom. The number of protons defines the chemical properties of the element and thus defines the element.

Atto (a). SI prefix corresponding to multiplication by 10^{-18} .

Automatic depressurization system. A system for rapidly relieving primary system pressure by dumping steam to the suppression pool in a boiling water reactor containment.

Background (radiation). Ionizing radiation normally present in the region of interest and coming from sources other than that of primary concern.

Basemat. The concrete base under the reactor containment structure.

Batch. Portion of nuclear material handled as a unit for accounting purposes. A batch of reactor fuel is usually one-third of the reactor fuel in the core, the amount typically used during refueling.

Beta decay. A family of radioactive decay processes including β^- decay, β^+ decay, and electron capture.

β^- decay. One of the beta decay processes in which an electron and an antineutrino are emitted from the nucleus as a result of the transformation of a neutron into a proton. The atomic number Z increases by one, while the mass number A remains the same.

β^+ decay. One of the beta decay processes in which a positron and a neutrino are emitted from the nucleus as a result of the transformation of a proton into a neutron. The atomic number Z decreases by one, while the mass number A remains the same.

Beta particle (β). An electron or positron emitted from the nucleus during beta decay.

Beta skin dose. Radiation dose to the skin from beta-emitters, usually from contamination on the surface of the skin or on clothing.

Boiling water reactor (BWR). A light-water reactor in which water, used as both coolant and moderator, and allowed to boil under pressure in the core to steam, which drives the turbine directly.

Bone marrow. Soft material that fills the cavity in most bones; it manufactures most of the formed elements of the blood.

British Thermal Unit (BTU). The amount of heat required to raise the temperature of 1 lb of water by 1°F.

Building wake. Distortions in the wind patterns which are caused by a building. This effect, which is most pronounced immediately downwind of a building, alters the distribution of material within an atmospheric plume released from a source at or near the building.

BWR containment drywell release. See *drywell release*.

BWR containment wetwell release. See *wetwell release*.

BWR/PWR containment bypass release. See *containment bypass release*.

Catastrophic failure. Failure of the reactor containment in a manner that releases most of the fission products in the containment into the environment in a short time.

Centerline (plume). An imaginary line drawn in the middle of the plume along its downwind travel direction with a straight-line Gaussian approximation model. The plume concentrations and deposition are assumed to be the highest along the centerline.

Centi (c). SI prefix corresponding to multiplication by 10^{-2} .

Chemical toxicity. The degree to which a material is poisonous or harmful because of its chemical nature (not because of radioactivity).

Chronic dose. Radiation dose received over a long period of time (years).

Cladding. The outer coating (usually zirconium alloy, aluminum, or stainless steel) which covers the nuclear fuel elements to prevent corrosion of the fuel and the release of fission products into the coolant.

Cloudshine. Gamma radiation from the radioactive materials in an airborne plume. In this document, the dose from cloudshine is the dose from immersion in the plume, assumed to be a semi-infinite cloud.

Coherent system of units. A system of units of measurement in which a small number of base units, defined as dimensionally independent, are used to derive all other units in the system by rules of multiplication and division with no numerical factors other than unity.

Cold leg. In a pressurized water reactor, the part of the reactor coolant system from the exit of the steam generator to the reactor vessel; in a boiling water reactor, the reactor coolant system from the feedwater containment penetration to the reactor vessel.

Combustion. A rapid chemical reaction accompanied by the evolution of light and the rapid production of heat.

Committed dose. The radiation dose resulting from radionuclides in the body over a time period following their inhalation or ingestion.

Committed dose equivalent. The total dose equivalent (averaged over a particular tissue) deposited over a time period following the intake of a radionuclide.

Committed effective dose equivalent (CEDE). The effective dose equivalent resulting from radionuclides in the body over a time period (50 years in this document) following their inhalation or ingestion.

Compound. Two or more elements chemically linked in definite proportions.

Condenser. A large heat exchanger designed to cool exhaust steam from a turbine so that it can be returned to the heat source as water. In a pressurized water reactor, the water is returned to the steam generator. In a boiling water reactor, it returns to the reactor vessel. The heat removed from the system by the condenser is transferred to a circulating water system and is exhausted to the environment, either through a cooling tower or directly into a body of water.

CONDOS II. A computer program used to compute doses from consumer products. It computes doses from radioactive objects of various geometries, including the effects of up to five layers of different shielding materials.

Containment. A gas-tight shell or other enclosure around a reactor to confine fission products that otherwise might be released to the environment.

Containment bypass release. A release from a boiling water reactor or pressurized water reactor through a dry pathway from the primary system to the outside of the containment.

Containment spray. The water system inside containment used to relieve pressure and temperature buildup by steam released (loss of coolant accident, main steam line rupture, or feedwater line rupture) in the containment structure.

Coolant. The medium, often water, used to remove heat from the reactor core to the heat sink.

Core. See reactor core.

Core release fraction. The fraction of each isotope in the core inventory that is assumed to be released from the core under given core conditions.

Criticality (critical). A condition in which the number of neutrons released by fission is exactly balanced by the neutrons being absorbed (by the fuel and poisons) and escaping the reactor core. A reactor is said to be "critical" when it achieves a self-sustaining nuclear chain reaction.

Critical organ. For a specific radionuclide, solubility class, and mode of intake, the organ that limited the maximum permissible concentration in air or water.

Critical pressure. The pressure of a substance at its critical temperature.

Critical safety function. Functions that must be performed during normal reactor operations and following an accident to protect the integrity of the fission product barriers and prevent the release of radioactive materials into the environment.

Critical temperature. The temperature above which a substance has no transition from the liquid to the gaseous phase; i.e., the highest pressure at which the gas can be liquified regardless of the pressure applied.

Curie (Ci). A unit of radioactivity equal to 3.7×10^{10} disintegrations per second.

Daughter isotope. Isotopes that are formed by the radioactive decay of some other isotope.

Daughter, radioactive. A radioactive isotope formed by radioactive decay.

Daylight Saving Time (DST). Time during which clocks are set ahead of standard time (usually by 1 h) to provide more daylight at the end of the working day during the late spring, summer, and early fall.

Decay, radioactive. See *radioactive decay*.

Decay heat. The heat produced by the decay of radioactive fission products after the reactor has been shut down or in spent fuel that has been removed from the reactor.

DECAY model. One of the tools in the RASCAL software that allows the user to compute the activities of radionuclides at a given time, allowing for radioactive decay and ingrowth.

Decay product(s). A radionuclide or a series of radionuclides formed by the nuclear transformation of another radionuclide which, in this context, is referred to as the parent.

Deci (d). SI prefix corresponding to multiplication by 10^{-1} .

Decontamination. The reduction or removal of radioactive contamination from a structure, area, object, or person. Decontamination may be accomplished by (1) treating the surface to remove or decrease the contamination, (2) letting the material stand so that the radioactivity is decreased as a result of natural decay, and (3) covering the contamination to shield or attenuate the radiation emitted.

Deka (da). SI prefix corresponding to multiplication by 10^1 .

Delayed health effects. Radiation effects which appear long after the relevant exposure. The vast majority are stochastic, that is, the severity is independent of the dose and the probability is assumed to be proportional to the dose, without threshold.

Delta T. The difference in temperatures between the hot and cold legs of the reactor cooling system. "Delta T" is also used to denote temperature difference in atmospheric mixing.

Depleted uranium. Uranium from which part of the ^{235}U has been removed by the enrichment process.

Depletion. Reduction of the concentration of one or more specified isotopes in a material or one of its constituents.

Deposition. The material, such as radioactive material, deposited on the ground and other surfaces when an atmospheric plume passes over them.

Derived response level (DRL). A level of radioactivity in an environmental medium that would be expected to produce a dose equivalent equal to its corresponding Protective Action Guide.

Direct current (DC). An electric current that flows in one direction only. Direct current is used to operate essential reactor safety systems such as circuit breakers, solenoid-operated valves, and instruments and permits control of many components from remote locations.

Disintegration, radioactive. A spontaneous nuclear transformation characterized by the emission of energy and/or mass from the nucleus.

Dose commitment. See *committed dose*.

Dose conversion factor (DCF). A number that relates a dose equivalent or dose equivalent rate from a given isotope under a particular set of assumptions to an environmental measurement (the concentration of that isotope in air or to the amount of that isotope deposited on the ground). With a point source, this number represents the dose equivalent from a unit source with no shielding at 1 m distance.

Dose equivalent. The product of the absorbed dose (in rad or gray), a quality factor related to the biological effectiveness of the radiation involved and any other modifying factors. The unit of dose equivalent is rem or sievert.

Drywell. The primary containment structure in a BWR system. The drywell houses the reactor and the recirculating loop.

Drywell release. A release from the core of a boiling water reactor that enters the containment and then leaks to the environment.

Early health effects. Prompt radiation effects (observable within a short period of time) for which the severity of the effect varies with the dose and for which practical thresholds exist.

Early phase. The period at the beginning of a nuclear incident when immediate decisions for effective use of protective actions are required, and must therefore usually be based primarily on the status of the nuclear facility (or other incident site) and the prognosis for worsening conditions. This phase may last from hours to days. For the purpose of dose projection in this document, it is assumed to last for 4 days.

Effective dose equivalent (EDE). The sum of the products of the dose equivalent (H) to each organ or tissue (T) and a weighting factor (w) (i.e., $H_E = \sum w_T H_T$), where the weighting factor is the ratio of the risk of mortality from delayed health effects arising from irradiation of a particular organ or tissue to the total risk of mortality from delayed health effects when the whole body is irradiated uniformly to the same dose.

Effective dose equivalent conversion factor. The committed effective dose equivalent per unit intake of radionuclide.

Electron. A fundamental particle from which an atom is constructed, with a single negative electrical charge and a mass of 1/1840 atomic mass units (usually neglected in determining the mass of the atom). An electron is the antiparticle to the positron.

Electron capture. One of the beta decay processes in which an atomic electron is captured by the nucleus. This transforms a proton into a neutron and a neutrino is emitted. Like β^+ decay, the atomic number Z decreases by one, and the mass number A remains the same.

Element. A substance which cannot be broken down by ordinary chemical processes into simpler substances.

Elevated release. A release of materials to the atmosphere through a stack or opening well above ground level.

Emergency. Any unplanned situation that results in or may result in substantial injury or harm to the population or substantial damage to or loss of property.

Emergency Action Level (EAL). Observable indicators, such as instrument readings, which if exceeded initiate classification of an event and appropriate response actions.

Emergency Broadcast System (EBS). Broadcasting facilities that have been authorized by the Federal Communications Commission to operate in a controlled manner during a war, state of public peril or disaster, or other national emergency as provided by the EBS plan (will be replaced by the Emergency Alert System).

Emergency core cooling system (ECCS). An emergency system that provides for removal of residual heat from a reactor following loss of normal heat removal capability or a loss of coolant accident.

Emergency Operations Facility (EOF). A licensee facility, usually established within about 20 miles of a reactor site, to manage the licensee emergency response.

Emergency Planning Zone (EPZ). An area defined around a nuclear or other facility to facilitate offsite planning and develop a significant response base. EPZs are defined around power reactors for both the plume and ingestion exposure pathways.

Emergency Protective Action Guide. The projected dose commitment value at which responsible officials should isolate food containing radioactivity to prevent its introduction into commerce and at which the responsible officials should determine whether condemnation or another disposition is appropriate. At the emergency PAG, higher impact actions are justified because of the projected health hazards.

Emergency Response Planning Guideline-1 (ERPG-1). The maximum airborne concentration below which it is believed that nearly all individuals could be exposed for up to 1 h without experiencing other than mild, transient adverse health effects or without perceiving a clearly defined objectionable odor.

Emergency Response Planning Guideline-2 (ERPG-2). The maximum airborne concentration below which it is believed that nearly all individuals could be exposed for up to 1 h without experiencing or developing irreversible or other serious health effects or symptoms which could impair an individual's ability to take protective actions.

Emergency Response Planning Guideline-3 (ERPG-3). The maximum airborne concentration below which it is believed that nearly all individuals could be exposed for up to 1 h without experiencing or developing life-threatening health effects.

Emergency worker. A person who performs emergency services and may be unavoidably exposed to radiation under emergency conditions (e.g., law enforcement, fire fighting, health services, animal care).

Erythema. Redness of the skin.

Escape fraction. Fraction of reactor containment volume or primary system coolant released in 1 h during an accident.

Evacuation. The urgent removal of people from an area to avoid or reduce high-level, short-term exposure to a hazard. Evacuation may be a preemptive action taken in response to a facility condition or a probably release of a hazardous material rather than an actual release.

Exa (E). SI prefix corresponding to multiplication by 10^{18} .

Executive Team (ET). The NRC headquarters team, led by the chairman or another commissioner, that directs the agency's response to significant events from the Operations Center. The Executive Team is supported by the Reactor Safety, Safeguards, Operations Support, Liaison, and Protective Measures teams.

Exposure. A measure of the ionization produced in air by X-rays or gamma radiation. It is the sum of the electrical charges on all of the ions of one sign produced in air when all electrons liberated by photons in a volume element of air are completely stopped in the air, divided by the mass of the air in the volume element. The special unit of exposure is the roentgen. In SI units, exposure is given in coulombs per kilogram (C/kg).

Exposure conversion factor. A number that relates the external exposure rate (instrument reading) in a gamma or X-ray field from a given isotope under a particular set of assumptions to the concentration of that isotope in air or to the amount of that isotope deposited on the ground. With a point source, this number represents the exposure rate from a unit source with no shielding at 1 m distance.

Exposure rate. The exposure per unit time.

Exponent. A symbol or number, usually written to the right of and above another symbol or number, that indicates how many times the latter number should be multiplied by itself.

External dose. The radiation dose resulting from radioactive materials outside the body (radiation must penetrate the skin).

External radiation. Radiation incident on a body from an external source.

Extraordinary nuclear occurrence. A radiological event which the Nuclear Regulatory Commission has determined to be an extraordinary nuclear event as defined in the Atomic Energy Act of 1954, as amended (10 CFR 140, Subpart E).

Federal Radiological Monitoring and Assessment Center (FRMAC). An operating center usually established near the scene of a radiological emergency from which the Federal field monitoring and assessment assistance is directed and coordinated.

Femto (f). SI prefix corresponding to multiplication by 10^{-15} .

Field measurement to dose model (FM-DOSE). One of the tools in the RASCAL software that allows the user to estimate doses based on isotopic concentrations of radionuclides on the ground or in the air.

Filtering. Passing a liquid or a gas through porous substance to remove constituents such as suspended matter.

Fissile. Capable of undergoing fission by interaction with thermal neutrons.

Fission. The splitting of the nucleus into at least two other nuclei and the release of a relatively large amount of energy. Two or three neutrons (and gamma rays) are usually released during this type of transformation.

Fission products. The nuclei (fission fragments) formed by the fission of heavy elements or by subsequent radioactive decay of the fission fragments.

Fissionable. Capable of undergoing fission by any process.

Flammability. Ability to be ignited and propagate a flame.

Fuel cladding. See *cladding*.

Fuel rod (fuel pin). A long, slender tube that holds fissionable material (fuel) for nuclear reactor use. Fuel rods are assembled into bundles called fuel elements or fuel assemblies, which are loaded individually into the reactor core.

Fuel cycle. The steps involved in supplying fuel for nuclear power reactors. It can include mining, milling, isotopic enrichment, fabrication of fuel elements, use in a reactor, chemical reprocessing to recover the fissionable material remaining in the spent fuel, reenrichment of the fuel material, refabrication into new fuel elements, and waste disposal.

Fuel reprocessing. The processing of reactor fuel to recover the unused fissionable material from the fission products.

Gamma (γ). Electromagnetic radiation emitted from the nucleus of the atom in gamma decay.

Gamma decay. Radioactive decay by the emission of a energetic photon (electromagnetic radiation).

Gap. The space inside a reactor fuel rod that exists between the fuel pellet and the fuel rod cladding.

Gap release. The release into containment of all the fission products in the fuel pin gap.

Gaussian plume dispersion model. A plume model based on the assumption that the concentration profiles in the crosswind direction (horizontal and vertical) are characterized by a Gaussian or normal distribution. Gaussian plume models have some important limitations: they do not deal well with complex terrain, light or calm winds, heavier-than-air gases, or materials that began as heavier-than-air and transform into neutrally buoyant gases, such as some cryogenically-stored materials.

General Emergency. The most serious of the four NRC emergency classes. Classification as a "General Emergency" indicates that events are in progress or have occurred which involve actual or imminent substantial core degradation or melting with potential for loss of containment integrity. Releases can be reasonably expected to exceed EPA Protective Action Guide exposure levels offsite for more than the immediate site area.

Genetic effect. An effect in a descendent resulting from the modification of genetic material in a parent.

Giga (G). SI prefix corresponding to multiplication by 10^9 .

Ground concentration factor. An estimate of the activity deposited as a function of distance downwind on the centerline from a ground level release. Calculation of ground concentration factors requires assumptions in meteorology and deposition velocity.

Ground level release. A release of materials to the atmosphere from a source or opening near ground level.

Ground roughness correction factor. A factor (assumed to be 0.7) in this document used to reduce the estimated dose because the radioactive material has been deposited on a rough surface which provides some shielding instead of a smooth plane.

Groundshine. Gamma radiation from radioactive materials deposited on the ground.

Half-life, biological. The time for the activity of radionuclide to diminish by a factor of a half because of biological elimination of the material.

Half-life, effective. The time for the activity of radionuclide to diminish by a factor of a half because of a combination of nuclear decay events and biological elimination of the radionuclide.

Half-life, radiological. The time for the activity of radionuclide to diminish by a factor of a half because of nuclear decay events.

Hecto (h). SI prefix corresponding to multiplication by 10^2 .

Hold-up time. The time that a release of radioactive material is held in the containment structure of the reactor before it is released to the environment.

Hot. A colloquial term meaning highly radioactive.

Hot leg. In a PWR, the reactor coolant system from the reactor vessel, past the pressurizer to the entrance of the steam generator; in a BWR, the reactor coolant system from the reactor vessel to the penetration exiting containment.

Hot spot. The region in a radiation or contamination area in which the level of radiation or contamination is noticeably greater than in neighboring regions in the area.

Ice bed. Part of the passive containment system for some pressurized water reactors. During an accident, steam is directed through the ice bed to a containment compartment. The ice cools and condenses the steam, decreasing the volume and thus limiting the maximum containment pressure.

Ice condenser. See *ice bed*.

Ice condenser containment release. A release from the core of a pressurized water reactor that passes through an ice bed one or more times before leaking to the environment.

Immediately Dangerous to Life and Health (IDLH). The maximum concentration from which, in the event of respirator failure, one could escape within 30 min without a respirator and without experiencing any escape-impairing (e.g., severe eye irritation) or irreversible health effects.

Immersion. The condition of being covered completely by a liquid or a gas.

Inadequate core cooling. A condition which may occur during a reactor cooling system failure that results in a heat buildup in the core. Indications of inadequate core cooling include the first indication of saturation, core uncover, and increase in fuel cladding temperature, finally exceeding the maximum value for normal recovery from a small loss-of-cooling accident.

Incident phase. EPA protective action guidance distinguishes three phases of an incident or accident: (1) *early phase*, (2) *intermediate phase*, and (3) *late phase*.

Indemnity agreement. A legal exception from liability damage.

Ingestion. Entry of a material (e.g., radioactive material) into the body through the mouth.

Ingrowth, radioactive. The increase in activity of a daughter radioactive isotope over time (when its half-life is longer than that of the parent).

Inhalation. The process of breathing in. Radioactive contamination in the atmosphere may enter the body by being breathed into the lungs. Some of the material will remain in the lung; some will pass into the blood stream; some will leave the lungs and be swallowed; and the remainder will be exhaled.

Inhalation dose. The committed dose (or committed dose equivalent) resulting from inhalation of radioactive materials and subsequent deposition of these radioisotopes in body tissues.

Inhalation organ dose. The committed dose equivalent to a particular organ as a result of breathing in radioactive material.

Initiating Condition (IC). A symptom or event that indicates actual or potential safety problems with a reactor, used in emergency classification systems.

Intensity. Amount of energy per unit time passing through a unit area perpendicular to the line of propagation at the point in question.

Intermediate phase. The period beginning after the incident source and releases have been brought under control and reliable environmental measurements are available for use as a basis for decisions on additional protective actions and extending until these protective actions are terminated. This phase may overlap the early and late phases and may last from weeks to many months. For the purpose of dose projection, it is assumed to last for 1 year.

Internal radiation. Radiation emitted from nuclides distributed within the body.

International System of Units (SI). Officially Le Système International d'Unités, a rationalized selection of units from the metric system. SI is a coherent system with seven base units and two supplementary units for which names, symbols, and precise definitions have been established.

In-vessel core melt. A condition during a reactor accident in which some of the cladding or reactor fuel melts as a result of overheating the fuel and remains inside the reactor vessel.

In-vessel core melt release. A release into containment from the reactor vessel which assumes the entire core has melted, releasing a representative mixture of radioisotopes.

Isobars. Nuclides which have the same atomic mass number but different atomic numbers (different elements).

Isolation failure. Failure to isolate fission products within the containment; as a result, leakage of fission products to the environment occurs.

Isomeric transition. Radioactive decay of long-lived excited states of a nucleus to states of lower energy in the same nucleus (same atomic number and same mass number), usually accompanied by the emission of a gamma ray or an internal conversion electron.

Isotopes. Nuclides of a particular element that contain the same number of protons but different numbers of neutrons.

Isotopic composition. The composition of a material in terms of the amounts of different isotopes present.

Kilo (k). SI prefix corresponding to multiplication by 10^3 .

Large, dry containment release. A release from the core of a pressurized water reactor that passes into the containment before leaking to the environment.

Late phase. The period beginning when recovery actions designed to reduce radiation levels in the environment to permanently acceptable levels are commenced, and ending when all recovery actions have been completed. This period may extend from months to years (also referred to as the recovery phase.)

Light water reactor (LWR). A nuclear reactor using slightly enriched uranium as fuel and water as both moderator and coolant.

Linear energy transfer (LET). Average energy lost by ionizing radiation per unit distance of its travel through a medium. High LET is generally associated with protons, alpha particles, and neutrons, while low LET is associated with X-rays, electrons, and gamma rays.

Loss of coolant accident (LOCA). Accidents that would result in a loss of reactor coolant at a rate in excess of the capability of the reactor makeup system. The coolant losses are from breaks in the reactor coolant pressure boundary, up to and including a break equivalent in size to the double-ended rupture of the largest pipe of the reactor coolant system.

Lung clearance class (D, W, or Y). A classification scheme for inhaled material according to its clearance half-time, on the order of days, weeks, or years, from the pulmonary region of the lung to the blood and the gastrointestinal tract.

Main steam isolation valve (MSIV). The valve that closes the main steam line where it penetrates the reactor containment.

MARK I, II, III. Three different containment designs used with boiling water reactors. (Fig. A-4 contains sketches of these designs.)

Mega (M). SI prefix corresponding to multiplication by 10^6 .

Metastable state. An excited nuclear state that has a half-life long enough to be observed.

Meteorology. The science dealing with the phenomena of the atmosphere, especially weather and weather conditions.

Micro (μ). SI prefix corresponding to multiplication by 10^{-6} .

Milli (m). SI prefix corresponding to multiplication by 10^{-3} .

Mitigation. A safety system or action that reduces the consequences of an event.

Mix. See *relative abundance*.

Mixing level. The height of the atmospheric boundary layer.

Model. A simplified representation of natural processes used to project expected outcomes of a set of conditions.

Moderation control (UF₆). A hydrogen-to-uranium atomic ratio of less than 0.088, which is equivalent to the purity specification of 99.5% for UF₆.

Moderator. A material used to slow neutrons in a reactor (by neutron scattering without appreciable neutron capture.)

Molecular weight. The weight of one molecule of a material, obtained by summing the atomic weights of the atoms in the molecule.

Monitoring (radiation). Periodic or continuous determination of the amount of ionizing radiation or radioactive contamination present in an occupied region, as a safety measure, for the purpose of health protection.

Nano (n). SI prefix corresponding to multiplication by 10⁻⁹.

Neutron. A close combination of a proton and electron, usually treated as a single fundamental particle. A neutron is electrically neutral and has a mass of approximately one atomic mass unit.

Neutrino (ν). A weakly-interacting particle, with no rest mass and no charge, emitted along with the positron in β^+ decay or emitted as a result of electron capture. A neutrino is the antiparticle to the antineutrino.

Noble gas. A gas that is unreactive (inert) or reactive only to a limited extent with other elements (i.e., helium, neon, argon, krypton, xenon, and radon).

Nomogram. A chart representing numerical relationships.

Non-isolable. Unable to be isolated.

Non-stochastic effects. Health effects for which the severity of the effect in affected individuals varies with the dose, and for which a threshold is assumed to exist, e.g., radiation-induced cataracts or nausea.

Normal coolant release. The release into containment of the fission products found in the reactor coolant system under normal operating conditions.

Nuclear incident. An event or series of events, either deliberate or accidental, leading to the release, or potential release, into the environment of radioactive materials in sufficient quantity to warrant consideration of protective actions.

Nucleus. The central core of the atom, around which the electrons rotate in various orbits.

Nuclide. Any isotope of an atom, a nuclear species.

Offsite. The area outside the boundary of the onsite area. For emergencies at a fixed nuclear facility, "offsite" generally refers to the area beyond the facility boundary. For emergencies that do not occur at fixed nuclear facilities and for which no physical boundary exists, the circumstances of the emergency will dictate the boundary of the offsite area.

Onsite. The area within (a) the boundary established by the owner or operator of a fixed nuclear facility, (b) the area established as a National Defense Area or National Security Area, (c) the area established around a downed/ditched U.S. spacecraft, or (d) the boundary established at the time of the emergency by the State or local government with jurisdiction for a transportation accident not occurring at a fixed nuclear facility and not involving nuclear weapons.

Operating basis earthquake (OBE). The earthquake that could reasonably be expected to affect a nuclear power plant site during the operating life of the plant; it is the earthquake that produces the vibratory ground motion for which those features of the plant necessary for continued operations without undue risk to the health and safety of the public are designed to remain functional.

Parent isotope. A radioisotope, that upon nuclear disintegration, yields a specified isotope, the daughter, either directly or as a later member of a radioactive series.

Partial occupancy. The use of a building or structure for part of the period in question.

Partitioning. See *steam generator partitioning*.

Particulate. Material composed of separate and distinct particles.

Peta (P). SI prefix corresponding to multiplication by 10^{15} .

Pico (p). SI prefix corresponding to multiplication by 10^{-12} .

Plateout. Deposition of some isotopes on solid surfaces before they reach the environment.

Plume, atmospheric. The airborne "cloud" of material released to the environment, which may contain radioactive materials and may or may not be invisible. In a plume release (as opposed to a "puff release"), the release and sampling times are long compared with travel time from the source.

Poison, nuclear. A substance which, because of its ability to absorb neutrons, can reduce the ability to sustain a nuclear reaction.

Positron. A particle having the same mass as an electron with one unit of positive charge. A positron is the antiparticle to the electron.

Power-operated relief valve (PORV). A valve placed on a tank that is operated electrically, hydraulically, or pneumatically to relieve a pressure buildup inside the tank. The relief valves are set to open before the self-actuating safety valves in the tank.

Pressure vessel. See reactor vessel.

Pressurized water reactor (PWR). A light water reactor, in which the uranium fuel elements are cooled and moderated by water under pressure to keep it from boiling. Water heated in the reactor vessel is pumped to the steam generators to provide the heat for production of steam to drive the turbines.

Pressurizer. A tank or vessel that acts as a head tank (or surge volume) to control the pressure in a pressurized water reactor.

Preventive Protective Action Guide. The projected dose commitment value at which responsible officials should take protective actions having minimal impact to prevent or reduce the radioactive contamination of human food or animal feeds.

Projected dose. Future dose calculated for a specified time period on the basis of estimated or measured initial concentrations of radionuclides or exposure rates and in the absence of protective actions.

Projected dose commitment. The dose commitment that would be received in the future by individuals in the population group from the contaminating event if no protective action were taken.

Protective action. An activity conducted in response to an incident or potential incident to avoid or reduce radiation dose to members of the population (sometimes called a protective measure).

Protective action (ingestion). An action or measure taken to avoid most of the radiation dose that would occur from future ingestion of foods contaminated with radioactive materials.

Protective Action Guide (PAG). The projected dose commitment to individuals in the general population that warrants protective action following a release of radioactive material. Protective action would be warranted if the expected individual dose reduction is not offset by negative social, economic, or health effects. The PAG does not include the dose that has unavoidably occurred before the assessment.

Protective measure. See *protective action*.

Proton. A fundamental particle found in the nucleus or central core of the atom. The proton has a single positive charge and a mass of approximately one atomic mass unit.

PWR large, dry containment release. See *large, dry containment release*.

PWR subatmospheric containment release. See *subatmospheric containment release*.

PWR ice condenser containment release. See *ice condenser containment release*.

PWR steam generator tube rupture release. See *steam generator tube rupture release*.

Quality factor. A factor (Q) used in the determination of the radiation dose equivalent that reflects the ability of a particular type of radiation to cause radiation damage. Usual values for Q include 1 for X-rays, gamma rays, and electrons; 2.3 for thermal neutrons; 10 for fast neutrons and protons; and 20 for alpha particles.

Rad. A unit of absorbed dose that is equivalent to an energy deposition of 0.01 J/kg.

Radiation, internal. Radiation emitted from radionuclides distributed within the body.

Radiation, ionizing. Any radiation capable of displacing electrons from atoms or molecules, thereby producing ions.

Radiation, external. Radiation incident upon the body from an external source.

Radiation sickness. Nausea and vomiting that occur within a few hours after a person receives a large acute radiation dose (usually greater than 100 rem).

Radioactive decay. Transformation of an unstable substance into a more stable form, usually accompanied by the emission of charged particles and gamma rays.

Radioiodine. One or more of the radioactive isotopes of iodine.

Radioisotope. A radioactive isotope of a specific element.

Radiological Assessment System for Consequence Analysis (RASCAL). An NRC software package containing a calculational model used to assist in estimating radiological doses from reactor or fuel cycle facility accidents based on source term information or assumptions or field measurements.

Reactor (nuclear). A device in which nuclear fission may be sustained and controlled in a self-supporting nuclear reaction. The varieties are many, but all incorporate certain features, including fissionable material or fuel, a moderating material (unless the reactor is operated on fast neutrons), a reflector to conserve escaping neutrons, provisions for heat removal, measuring and controlling instruments, and protective devices.

Reactor coolant pump. One of the pumps that circulate water through the reactor core and the rest of the primary coolant system.

Reactor coolant system (RCS). The system within a nuclear reactor containing coolant material for cooling the reactor core by the transfer of heat.

Reactor core. The central portion of a nuclear reactor containing the fuel elements, moderator, neutron poison, and support structures.

Reactor vessel. A strong metal container that contains the reactor core and reactor coolant under pressure (in LWRs).

Recognition Categories. Categories of events or symptoms used to develop Emergency Action Levels in the NUMARC/NESP-007 emergency classification system. The four recognition categories are A, Abnormal Rad Levels/Radiological Effluent; F, Fission Product Barrier Degradation; H, Hazards and Other Conditions Affecting Plant Safety, and S, System Malfunction.

Reduction factor (source term). The ratio of the radioactivity available for release after reduction mechanism is considered to the radioactivity available for release before the reduction mechanism.

Reduction mechanisms. Chemical or physical mechanisms that act to reduce the amount of radioactive material that escapes to the environment during an accident.

Reentry. Temporary entry into a restricted zone under controlled conditions.

Relative abundance. The isotopic ratio of the radionuclides in a sample or deposited on the ground.

Release conversion factor (RCF). A number that relates a dose equivalent from a given isotope under a particular set of assumptions to the amount (activity) of that isotope released.

Release fraction. See *core release fraction*.

Release rate. The rate (e.g., Ci/s) at which radioactive isotopes are released.

Release pathway. A mechanism or pathway through which radioactive materials are released to the environment.

Rem. A unit of dose equivalent. The dose equivalent in rem is numerically equal to the absorbed dose in rad multiplied by the quality factor, the distribution factor, and any other necessary modifying factors.

Restricted zone. An area with controlled access from which the population has been relocated.

Reprocessing. See *fuel reprocessing*.

Resuspension. Reintroduction into the atmosphere of material originally deposited on the ground or other surfaces.

Roentgen (R). The unit of exposure which corresponds to the production of ions (of one sign) carrying a charge of 2.58×10^{-4} coulombs per kilogram (C/kg) of air.

Safe shutdown earthquake (SSE). The earthquake that is based on an evaluation of the maximum earthquake potential considering regional and local geology and seismology and specific characteristics of local subsurface material. It is the earthquake that produces the maximum vibratory ground motion for which certain structures, systems, and components of a nuclear power plant are designed to remain functional so that the plant can be brought to a safe shutdown.

Safety relief valve. A valve in a pressurized tank that opens automatically to relieve the pressure before it reaches a dangerous level.

Saturated vapor. Vapor that is sufficiently concentrated to be able to exist in equilibrium with the liquid form of the same substance.

Saturation. A condition in the atmosphere corresponding to 100% relative humidity.

Saturation temperature. The temperature at which the liquid and vapor phases are in equilibrium at some given pressure.

Scientific notation. A form of mathematical notation in which the number is expressed as a number between 1 and 10 multiplied by a power of 10.

Screening level. An exposure, dose, or contamination level, below which no further scrutiny is required.

Sheltering. An immediate protective action where people go indoors, close all doors and windows, turn off all sources of outside air, listen to radio or television for information, and remain indoors until officially notified that it is safe to go out.

Shield building. A structure surrounding the containment that provides an additional barrier against the escape of radioactive material.

Shielding. Material intended to reduce the intensity of radiation entering an area.

Short-lived daughters. Radioactive progeny of radioactive isotopes that have half-lives on the order of a few hours or less.

Shutdown time. Amount of time since the reactor has been shut down.

Site Area Emergency. The second most serious of the four NRC emergency classes. Classification as a "Site Area Emergency" indicates that events are in progress or have occurred which involve actual or likely major failures of plant functions needed for protection of the public. Any releases are not expected to exceed EPA Protective Action Guide exposure levels, except near the site boundary.

Slump. Relocation of molten reactor core during an accident.

Source term. The amount and isotopic composition of material released or the release rate, used in modeling releases of material to the environment.

Source term to dose model (ST-DOSE). One of the tools in the RASCAL software that allows the user to estimate doses based on source terms and meteorological conditions.

Specific activity. The activity per unit weight of a sample of radioactive material.

Spent fuel. Reactor fuel removed from a reactor following irradiation, or which is no longer usable because of depletion of fissile material, poison buildup, or radiation damage.

Spent fuel pool. A large pool of water used to store and cool spent fuel and other radioactive elements before they are shipped for storage or disposal.

Spent fuel pool release (BWR/PWR). Release from fuel in storage in a spent fuel pool from either a Zircoloy fire or a gap release from ruptured cladding when fuel heats up.

Spiked coolant. Reactor coolant containing increased concentrations of non-noble isotopes, sometimes seen with rapid shutdown or depressurization of primary system.

Spiked coolant release. The release into containment of 100 times the non-noble gas fission products found in the coolant.

Spontaneous fission. Radioactive decay by fission that is not induced by the addition of energy, such as bombardment with neutrons.

Spray. See *containment spray*.

Stability class. One of several atmospheric turbulence types determined by meteorological conditions such as wind speed, time of day, and amount of sunlight (e.g., Pasquill stability classes, Tables F-8 and F-9) used to indicate the intensity of mixing in the atmosphere.

Standby gas treatment system (SGTS). A system to filter and remove particulates from the air in the containment before it is released to the environment.

Steam generator. The heat exchanger used in some reactor designs to transfer heat from the primary (reactor coolant) system to the secondary (steam) system. This design permits heat exchange with little or no contamination of the secondary system equipment.

Steam generator partitioning. The presence of a water-steam interface in the steam generator. When the steam generator is partitioned, particulates are retained in the steam generator water and are not released.

Steam generator tube rupture (SGTR) release. A release from a ruptured steam generator tube releasing radioisotopes characteristic of normal (typical) coolant, spiked (non-noble fission products increased by factor of 100) coolant, or coolant contaminated by a gap release from the core or an in-vessel core melt.

Steam jet air ejector. A system in a reactor to remove noncondensable gases from the main condenser and vent them to the offgas system.

Stochastic effects. Health effects for which the probability of the effect varies with dose (e.g., radiation-induced cancer). It is generally assumed that there is no threshold below which stochastic effects do not occur.

Subatmospheric containment release. A release into a pressurized water reactor containment (normally maintained at subatmospheric pressure) that leaks to the atmosphere.

Sub-cooling margin. The amount (in a PWR) by which the saturation temperature at the given primary system pressure exceeds the coolant temperature. When the coolant temperature exceeds the saturation temperature (negative sub-cooling margin), the coolant water is boiling.

Subcritical. The reactor condition when the number of neutrons released by fission is not sufficient to achieve a self-sustaining nuclear chain reaction.

Suppression pool. A pool of water in the wet well of a BWR containment that is designed to condense steam. Steam vents to the wet well after a loss of coolant accident. Condensing the steam reduces the pressure inside the containment after an accident.

Tera (T). SI prefix corresponding to multiplication by 10^{12} .

Thermocouple. A temperature-measuring device consisting of two different metals joined together at both ends. The temperature difference across the two metals produces a thermoelectric current proportional to the difference.

Thyroid blocking. The use of stable iodine (usually in the form of potassium iodide) to block the uptake of radioactive iodine by the thyroid.

Tort. Any wrongful act, damage, or injury done willfully, negligently, or in circumstances involving strict liability, but not involving breach of contract, for which a civil suit can be brought.

Total acute bone dose (TABD). The dose to the bone marrow received in the first 24 h after the release. TABD includes the dose from immersion in the plume during plume passage, the groundshine from deposition to an adult outside, and the committed effective dose equivalent from inhalation of plume.

Total effective dose equivalent (TEDE). The sum of the effective dose equivalent from external radiation while immersed in the plume, the effective dose equivalent from 4-days exposure to deposition, the committed effective dose equivalent from inhalation for 4 days of resuspended material that was deposited on the ground, and the committed effective dose equivalent from inhalation of the material in the plume.

Transuranic elements. Artificially produced elements with atomic numbers greater than that of uranium (92).

Turbulence. Atmospheric turbulence is essentially the motion of the wind over the time scales smaller than the averaging time used to determine the mean wind. Turbulence consists of circular whirls or eddies of all possible orientations.

Ullage. The gas volume above the liquid in a container, e.g., a UF₆ cylinder.

Universal Time Coordinated (UTC). Mean solar time for the meridian at Greenwich, England, formerly known as Greenwich Mean Time (GMT) or Z time. (Eastern Standard Time is 5 hours behind UTC; Eastern Daylight Time is 4 hours behind UTC.)

Unusual Event. The least serious of the four NRC emergency classes. This classification indicates that unusual events are in progress or have occurred which indicate a potential degradation of the level of safety of the plant. No releases of radioactive material requiring offsite response or monitoring are expected unless further degradation of safety systems occurs.

Vessel melt-through release. A reactor release which assumes that the melted core melts through the reactor vessel, releasing additional fission products as the core interacts with the containment basemat concrete.

Volatile. Readily vaporizable at a relatively low temperature.

Volatile fission products. Isotopes resulting from nuclear fission that are gaseous or can easily be vaporized.

Weathering. The reduction of the amount of deposited radioactive material in the environment resulting from exposure to weather.

Weathering factor. The fraction of radioactivity remaining after being affected by average weather conditions for a specified period of time.

Wetwell. The volume of a BWR containment that holds the suppression pool.

Wetwell release. Release from a boiling water reactor that passes through a suppression pool in containment before leaking to the environment.

Yarway instrument. An instrument for water level indication that uses differential pressure through the use of an external-to-vessel variable leg and an adjacent reference leg. The term "Yarway" implies a mechanical transducer with local level readouts or transmission by capillary pressure to a remote reading, requiring no electrical power for operation.

Yocto (y). SI prefix corresponding to multiplication by 10^{-24} .

Yotta (Y). SI prefix corresponding to multiplication by 10^{24} .

Zepto (z). SI prefix corresponding to multiplication by 10^{-21} .

Zetta (Z). SI prefix corresponding to multiplication by 10^{21} .

Zircaloy. An alloy consisting of approximately 98% zirconium that is used in the cladding of fuel for light-water power reactors.

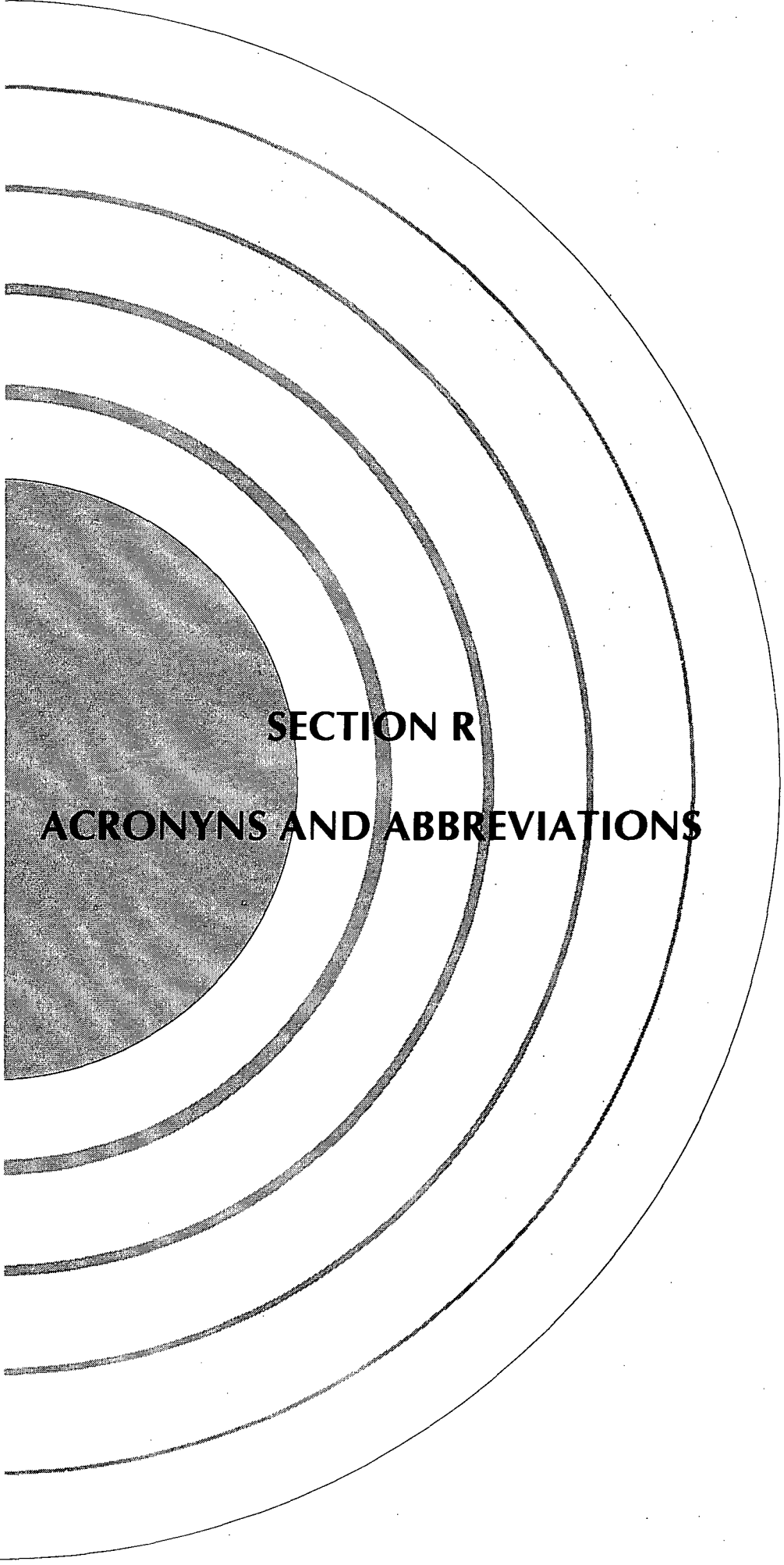

SECTION R
ACRONYNS AND ABBREVIATIONS

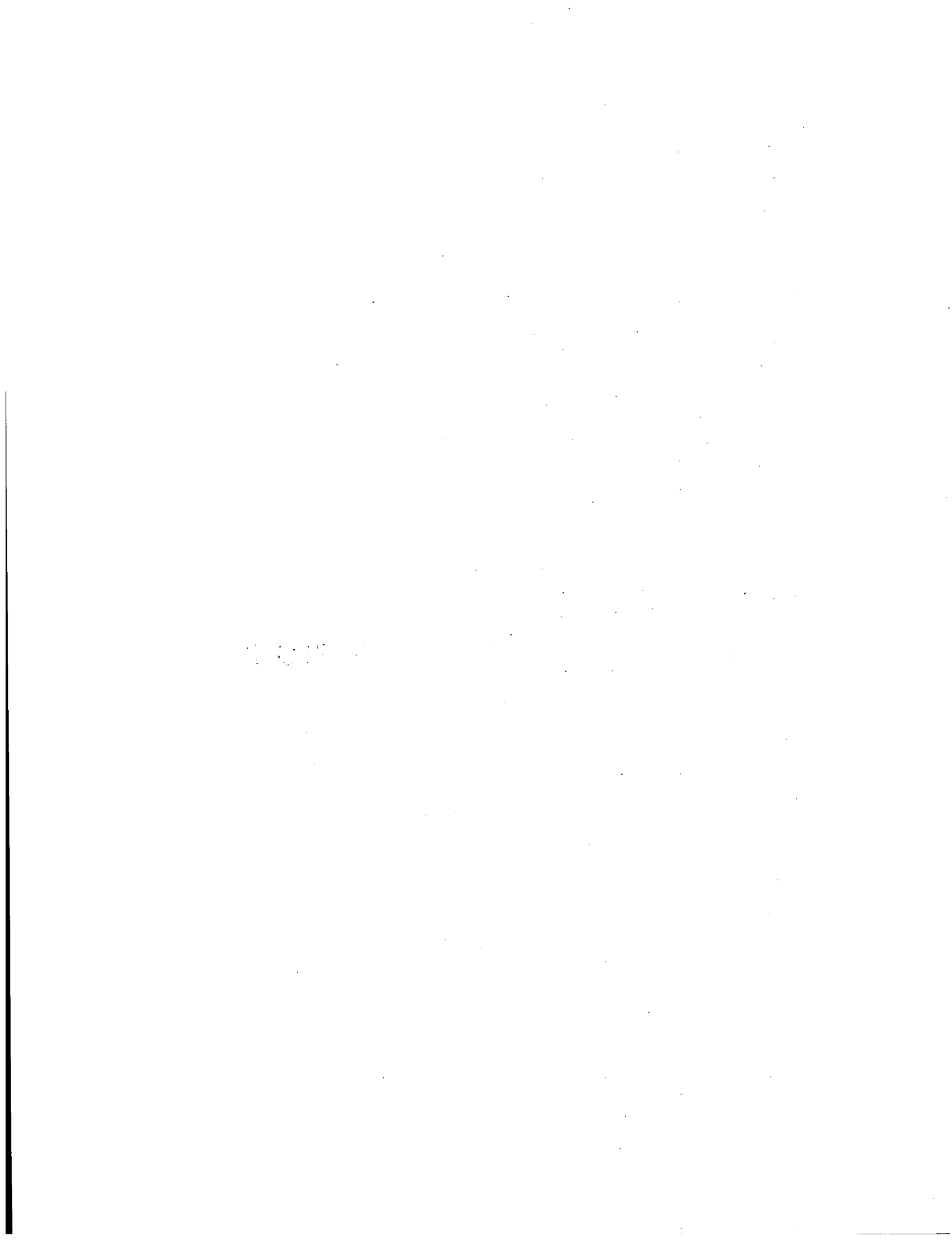

Section R

Acronyms and Abbreviations

A	atomic mass
A	ampere
A	activity of isotope
a	atto (SI prefix 10^{-18})
AC	alternating current
AIHA	American Industrial Hygiene Association
ADS	automatic depressurization system
AMN	atomic mass number
ANS	American Nuclear Society
ANSI	American National Standards Institute
ASME	American Society of Mechanical Engineers
α	alpha particle
@	at
Ba	barium
BEIR	Biological Effects of Ionizing Radiation
Btu	British thermal unit
Bq	becquerel
BR	breathing rate
BWR	boiling water reactor
β^+	β^+ particle (positron)
β^-	β^- particle (electron)
C	coulomb
c	centi (SI prefix 10^{-2})
$^{\circ}\text{C}$	degrees Celsius
cc	cubic centimeter
cd	candela
CDE	committed dose equivalent
CEDE	committed effective dose equivalent
CET	core exit thermocouple
CFR	<i>Code of Federal Regulations</i>
Ci	curie
cm	centimeter
cpm	counts per minute
CR	contractor report
CRF	core release fraction
Cs	cesium

cu	cubic
X_{HF}	hydrogen fluoride concentration
d	deci (SI prefix 10^{-1})
d	distance downwind
D_{EPg}	early phase dose equivalent from groundshine and resuspension
D_T	dose equivalent to an organ
da	deka (SI prefix 10^1)
DECAY	radioactive decay model
DC	direct current
DCF	dose conversion factor
$DCF_{E,50}$	dose conversion factor for CEDE
DCF_{IP}	dose conversion factor for immediate phase
DF	dilution factor
DF_d	dilution factor at distance, d
Dis	distance
DOC	U.S. Department of Commerce
DOE	U.S. Department of Energy
DOT	U.S. Department of Transportation
DSO	Director of Site Operations (NRC)
E	exa (SI prefix 10^{18})
EAL	Emergency Action Level
EBS	Emergency Broadcast System
EC	electron capture
ECCS	emergency core cooling system
EDE	effective dose equivalent
EF	escape factor
EOF	Emergency Operations Facility
EPA	U.S. Environmental Protection Agency
EPZ	Emergency Planning Zone
ERPG	Emergency Response Planning Guideline
ET	Executive Team (NRC)
F	farad
f	femto (SI prefix 10^{-15})
$^{\circ}F$	degrees Fahrenheit
FDA	Food and Drug Administration
FEMA	Federal Emergency Management Agency
FM-DOSE	field measurement to dose
FR	<i>Federal Register</i>

FRF	fire release fraction
FRMAC	Federal Radiological Monitoring and Assessment Center
FPI	fission product inventory
ft	foot/feet
G	giga (SI prefix 10^9)
g	gram
gal	gallon
GCF	ground concentration factor
GM	Geiger-Mueller
GMT	Greenwich Mean Time
Gy	gray
γ	gamma ray
H	henry
h	hecto (SI prefix 10^3)
h	hour
H_a	dose equivalent due to immersion
$H_{e,50}$	committed effective dose equivalent
H_p	effective dose equivalent from point source
H_2	hydrogen (molecular)
HF	hydrogen fluoride
H_2O	water
HHS	U.S. Department of Health and Human Services
HQ	headquarters
HVL	half value layer
Hz	hertz
I	iodine
I	exposure intensity
IAEA	International Atomic Energy Agency
IC	initiating condition
Ice	ice bed
IDLH	Immediately Dangerous to Life and Health
in.	inch
IT	isomeric transition
IU_{sol}	intake of soluble uranium
J	joule

K	kelvin
K	vertical mixing coefficient
k	kilo (SI prefix 10^3)
kg	kilogram
KI	potassium iodide
km	kilometer
lb	pound
lbf	pound force
LET	linear energy transfer
LOCA	loss of coolant accident
lm	lumen
LWR	light water reactor
lx	lux
M	mega (SI prefix 10^6)
m	milli (SI prefix 10^{-3})
m	meter
m	metastable
m ²	square meter
mg	milligram
mi	mile
min	minute
Mk	Mark
mL	milliliter
mol	mole
mph	miles per hour
mR	milliroentgen
mrad	millirad
mrem	millirem
MSIV	main steam isolation valve
MW(e)	megawatt (electric)
MW(t)	megawatt (thermal)
μ	micro (SI prefix 10^{-6})
μ Ci	microcurie
N	newton
n	neutron
n	nano (SI prefix 10^{-9})
NaI(Tl)	sodium iodide doped with thallium (scintillator)
NC	not calculated

NCRP	National Council on Radiation Protection and Measurements
NESP	National Environmental Studies Project (NUMARC)
NIOSH	National Institute for Occupational Safety and Health
NOAA	National Oceanic and Atmospheric Administration (DOC)
NRC	Nuclear Regulatory Commission
NUMARC	Nuclear Management and Resources Council, Inc.
NUREG	Nuclear Regulatory Commission report
NUREG/CR	U.S. Nuclear Regulatory Commission contractor report
$\bar{\nu}$	neutrino
ν	antineutrino
OBE	operating basis earthquake
OCIMS	Operations Center Information Management System (NRC)
Op	operating
ORNL	Oak Ridge National Laboratory
oz	ounce
Ω	ohm
P	pressure
P	peta (SI prefix 10^{15})
p	proton
p	pico (SI prefix 10^{-12})
Pa	pascal
PAG	Protective Action Guide
PORV	power-operated relief valve
ppm	parts per million
psi	pounds per square inch
psia	pounds per square inch absolute
psig	pounds per square inch gage
PWR	pressurized water reactor
Q	release rate of activity
Q_i	isotopic release rate
Q_T	total activity released
Q_{UF_6}	uranium hexafluoride inventory
R	roentgen
rad	radian
RASCAL	Radiological Assessment System for Consequence Analysis
RC	reactor coolant

RCF	release conversion factor
RCS	reactor coolant system
RDF	reduction factor
RF _{HF}	hydrogen fluoride release fraction
RF _{U_{sol}}	soluble uranium release fraction
rpm	revolutions per minute
S	siemens
s	second
SBGTS	standby gas treatment system
SGTR	steam generator tube rupture
SI	International System of Units (Le Système International d'Unités)
SpA	specific activity
sq	square
Sr	strontium
SRV	safety relief valve
SSE	safe shutdown earthquake
ST	shielding thickness
st	steradian
ST-DOSE	source term to dose
Sv	sievert
T	tesla
T	temperature
T	tera (SI prefix 10 ¹²)
T _{ed}	exposure duration
T _{rd}	release duration
T _{1/2}	radiological half-life
t _r	release duration
TABD	total acute bone (marrow) dose
TALD	total acute lung dose
Tech Specs	technical specifications
TEDE	total effective dose equivalent
TMI	Three Mile Island
TSC	Technical Support Center
U	uranium
Ū	average wind speed
UF ₆	uranium hexafluoride
UO ₂ F ₂	uranium fluoride

USDA	U.S. Department of Agriculture
UTC	Universal Time Coordinated
V	volt
W	watt
WB	whole body
Wb	weber
Wt	weight
Y	yotta (SI prefix 10^{24})
y	yocto (SI prefix 10^{-24})
yd	yard
yr	year
Z	atomic number
Z	Zulu (UTC)
Z	zetta (SI prefix 10^{21})
z	zepto (SI prefix 10^{-21})
Zr	zirconium



SECTION 5
REFERENCES

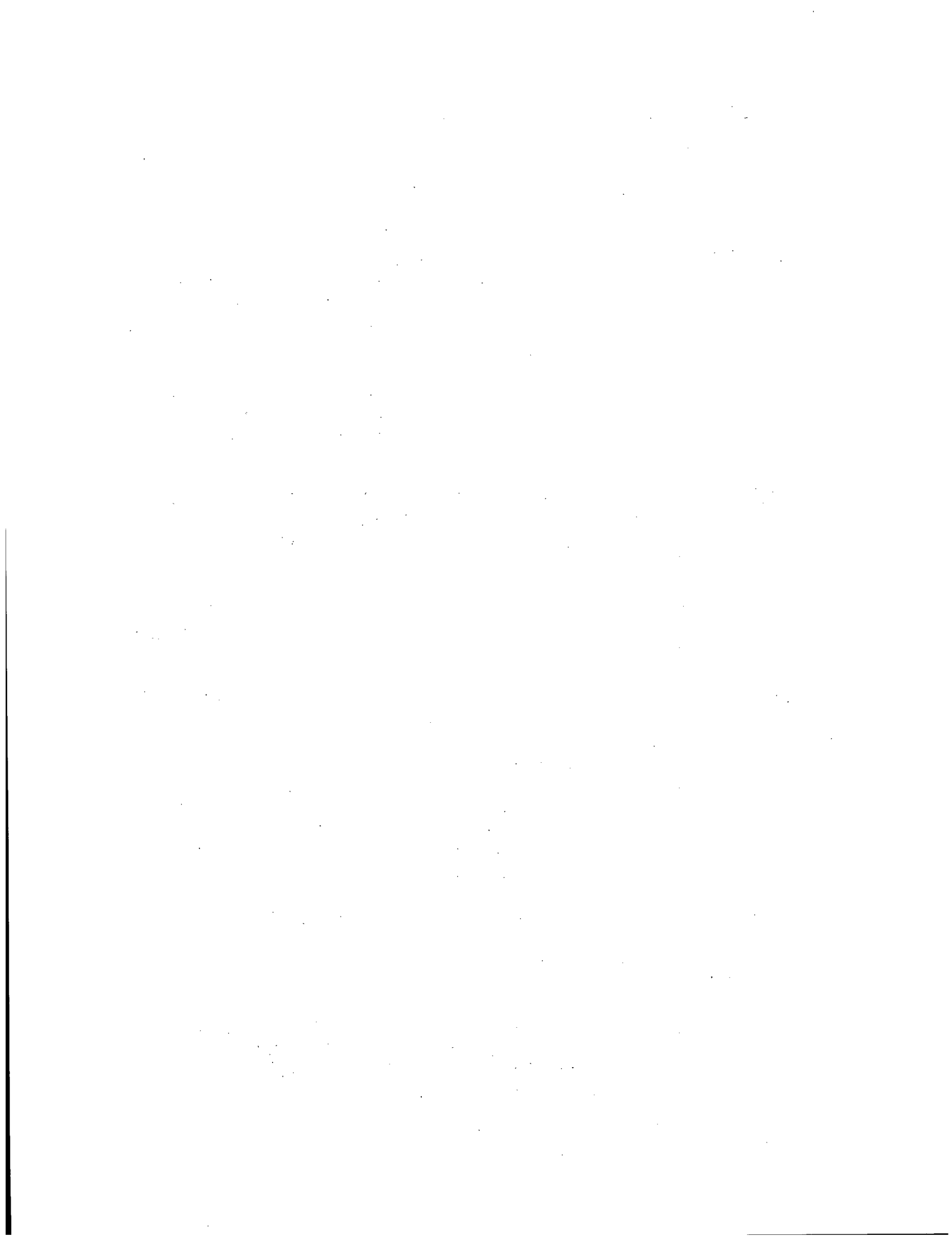

Section S References

- AEC-tr-7536 L. A. Il'in, et al., *Radioactive Iodine in the Problem of Radiation Safety*, AEC-tr-7536, U.S. Atomic Energy Commission, June 1974 (translation of Russian book, *Radioaktivnyi iod u probleme radiatsionnoi bezopasnosti*, Atomizdat, Moscow, 1972).
- AIHA American Industrial Hygiene Association, "Hydrogen Fluoride," *Emergency Response Planning Guidelines*, American Industrial Hygiene Association, Akron, Ohio, October 1988.
- ANS-9 The American Nuclear Society Standards Subcommittee on Nuclear Terminology and Units, *Glossary of Terms in Nuclear Science and Technology*, ANS-9, American Nuclear Society, La Grange Park, Illinois, 1986.
- ANSI/ANS-5.1 *American National Standard for Decay Heat Power in Light Water Reactors*, ANSI/ANS-5.1, American Nuclear Society, La Grange Park, Illinois, 1979.
- ANSI/ANS-18.1-1984 *American National Standard Radioactive Source Term for Normal Operation of Light-Water Reactors*, ANSI/ANS 18.1-1984, American Nuclear Society, La Grange Park, Illinois, December 1984.
- AP-26 D. B. Turner, *Workbook of Atmospheric Dispersion Estimates*, AP-26, Office of Air Programs, U.S. Environmental Protection Agency, Research Triangle Park, North Carolina, 1970.
- ASME 1993 C. A. Meyer, et al., *ASME Steam Tables: Thermodynamic and Transport Properties of Steam*, 6th ed., American Society of Mechanical Engineers Press, New York, 1993.
- ASTM E 380-93 *Standard Practice for Use of the International System of Units (SI) (The Modernized Metric System)*, ASTM E 380-93, American Society for Testing and Materials, Philadelphia, Pennsylvania, November 1993.

- BEIR V *Health Effects of Exposure to Low Levels of Ionizing Radiation*, BEIR V, National Academy of Sciences, Committee on the Biological Effects of Ionizing Radiation, Washington, D.C., 1990.
- 10 CFR 20.1201 *Code of Federal Regulations*, U.S. Nuclear Regulatory Commission, Part 20 (Standards for Protection Against Radiation), Subpart C (Occupational Dose Limits), 10 CFR 20.1201.
- 10 CFR 20, App. B “Annual Limits on Intake (ALIs) and Derived Air Concentrations (DACs) of Radionuclides for Occupational Exposure; Effluent Concentrations; Concentrations for Release to Sewerage,” Appendix B to 10 CFR 20, U.S. Nuclear Regulatory Commission, Standards for Protection Against Radiation, January 1, 1993.
- 10 CFR 140.81-85 “Financial Protection Requirements and Indemnity Agreements, Subpart E: Extraordinary Nuclear Occurrence,” 10 CFR 140.81-85.
- DOE/TIC-11026 D. C. Kocher, *Radioactive Decay Data Tables: A Handbook of Decay Data for Application to Radiation Dosimetry and Radiological Assessments*, DOE/TIC-11026, U.S. Department of Energy, Oak Ridge, Tennessee, 1981.
- DOE/TIC-11223 S. R. Hanna, G. A. Briggs, and R. P. Hosker, Jr., *Handbook on Atmospheric Diffusion*, DOE/TIC-11223, U.S. Department of Energy, Washington, D.C., 1982.
- DOE/TIC-27601 D. Randerson, ed., *Atmospheric Science and Power Production*, DOE/TIC-27601 (DE84005177), U.S. Department of Energy, Oak Ridge, Tennessee, 1984.
- DOT P 5800.5 *1990 Emergency Response Guidebook*, DOT P 5800.5, U.S. Department of Transportation, Washington, D.C., March 31, 1990.

- Draxler 1991 R. R. Draxler, et al., "Across North America Tracer Experiment (ANATEX): Sampling and Analysis," *Atm. Environ.* **25A**:2815-36, 1991.
- EGG-2530 B. L. Rich, et al., *Health Physics Manual of Good Practices for Uranium Facilities*, EGG-2530, EG&G Idaho, Inc., Idaho Falls, Idaho, June 1988.
- EPA 400-R-92-001 *Manual of Protective Action Guides and Protective Actions for Nuclear Incidents*, EPA 400-R-92-001, U.S. Environmental Protection Agency, Washington, D.C., May 1992.
- EPA-402-R-93-081 *External Exposure to Radionuclides in Air, Water, and Soil*, Federal Guidance Report No. 12, EPA-402-R-93-081, U.S. Environmental Protection Agency, Washington, D.C., September 1993.
- EPA 520/1-88-020 K. F. Eckerman, A. B. Wolbarst, and A. C. B. Richardson, *Limiting Values of Radionuclide Intake and Air Concentration and Dose Conversion Factors for Inhalation, Submersion, and Ingestion*, Federal Guidance Report 11, EPA-520/1-88-020, U.S. Environmental Protection Agency, Washington, D.C., September 1988.
- FDA 83-8211 B. Shleien, *Preparedness and Response in Radiation Accidents*, FDA 83-8211, Food and Drug Administration, U.S. Department of Health and Human Services, Rockville, Maryland, August 1983.
- FEMA-REP-2 *Guidance on Offsite Emergency Radiation Measurement Systems, Phase 1-Airborne Release*, FEMA-REP-2, rev. 2, Federal Emergency Management Agency, Washington, D.C., June 1990.
- 47 FR 28158 Food and Drug Administration, "Potassium Iodide as a Thyroid-Blocking Agent in a Radiation Emergency: Final Recommendations for Use," *Federal Register* **47**(125), 28158-59, June 29, 1982.

- 47 FR 47073 U.S. Department of Health and Human Services, "Accidental Radioactive Contamination of Human Food and Animal Feeds; Recommendations for State and Local Agencies," *Federal Register* 47(205), 47073-83, October 22, 1982.
- 50 FR 30258 Federal Emergency Management Agency, "Federal Policy on Distribution of Potassium Iodide Around Nuclear Power Sites for Use as a Thyroidal Blocking Agent," *Federal Register* 50(142), 30258-59, July 24, 1985.
- FRMAC Manual *FRMAC Assessment Manual*, vol. 1, *Methods*, and vol. 2, *Tables, Charts, Worksheets, Glossary, Reference, Index*, interim version, U.S. Department of Energy, Washington, D.C., July 1995.
- Glasstone 1980 S. Glasstone and W. H. Jordon, *Nuclear Power and its Environmental Effects*, American Nuclear Society, La Grange Park, Illinois, 1980.
- Heffter 1965 J. L. Heffter, "The Variation of Horizontal Diffusion Parameters with Time for Travel Periods of One Hour or Longer," *J. Appl. Met.* 4:153-6, 1965.
- HFS *Operations Center Information Management System (OCIMS) Operations Manual*, HFS, Inc.
- IAEA 152 E. J. Vallario, *Evaluation of Radiation Emergencies and Accidents: Selected Criteria and Data*, Technical Reports Series 152, International Atomic Energy Agency, Vienna, Austria, 1974.
- Machta 1996 L. Machta, "Some Aspects of Simulating Large Scale Atmospheric Mixing," *Tellus* 18:355-62, 1966.
- Martin 1979 A. Martin and S. A. Harbison, *Introduction to Radiation Protection*, 2nd ed., Chapman and Hall, New York, 1979.
- Morris 1992 C. Morris, ed., *Academic Press Dictionary of Science and Technology*, Academic Press, New York, 1992.

- NCRP 93 *Ionizing Radiation Exposure of the Populations of the United States*, NCRP Report No. 93, National Council on Radiation Protection and Measurements, Bethesda, Maryland, September 1, 1987.
- NCRP 94 *Exposure of the Population in the United States and Canada from Natural Background Radiation*, NCRP Report No. 94, National Council on Radiation Protection and Measurements, Bethesda, Maryland, December 30, 1987.
- NIOSH *NIOSH Pocket Guide to Chemical Hazards*, Pub. No. 90-117, National Institute for Occupational Safety and Health, U.S. Department of Health and Human Services, Washington, D.C., June 1990.
- NRPB-R162 J. R. Greenhalgh, T. P. Fell, and N. Adams, *Doses from Intakes of Radionuclides by Adults and Young People*, NRPB-R162, National Radiological Protection Board, Chilton, Didcot, Oxon, England, April 1985.
- NRPB 155 NRPB Radiological Protection Bulletin 155, as cited in *Health Physics Society Newsletter*, October 1994.
- NUMARC/NESP-007 *Methodology for Development of Emergency Action Levels*, NUMARC/NESP-007, rev. 2, Nuclear Management and Resources Council, Inc., Washington, D.C., January 1992.
- NUREG-600 *Investigation Into the March 28, 1979, Three Mile Island Accident by the Office of Inspection and Enforcement*, NUREG-600, U.S. Nuclear Regulatory Commission, Washington, D.C., August 1979.
- NUREG-0654 *Criteria for Preparation and Evaluation of Radiological Emergency Response Plans and Preparedness in Support of Nuclear Power Plants*, NUREG-0654 (FEMA-REP-1), rev. 1, U.S. Nuclear Regulatory Commission and Federal Emergency Management Agency, Washington, D.C., November 1980.

- NUREG-0900 J. T. Larkins and M. A. Cunningham, *Nuclear-Power-Plant-Severe-Accident Research Plan*, NUREG-0900, U.S. Nuclear Regulatory Commission, Washington, D.C., January 1983.
- NUREG-0956 M. Silberberg, et al., *Reassessment of Technical Bases for Estimating Source Terms*, NUREG-0956, U.S. Nuclear Regulatory Commission, Washington, D.C., July 1986.
- NUREG-1140 S. A. McGuire, *A Regulatory Analysis on Emergency Preparedness for Fuel Cycle and Other Radioactive Material Licensees (Final Report)*, NUREG-1140, U.S. Nuclear Regulatory Commission, Washington, D.C., January 1988.
- NUREG-1150 *Severe Accident Risks: An Assessment for Five U.S. Nuclear Power Plants*, NUREG-1150, vol. 1, U.S. Nuclear Regulatory Commission, Washington, D.C., December 1990.
- NUREG-1228 T. J. McKenna and J. G. Giitter, *Source Term Estimation During Incident Response to Severe Nuclear Power Plant Accidents*, NUREG-1228, U.S. Nuclear Regulatory Commission, Washington, D.C., October 1988.
- NUREG-1353 E. D. Thom, *Regulatory Analysis for the Resolution of Generic Issue 82, Beyond Design Basis Accidents in Spent Fuel Pools*, NUREG-1353, U.S. Nuclear Regulatory Commission, Washington, D.C., April 1989.
- NUREG-1370 C. M. Ferrell and L. Soffer, *Resolution of Unresolved Safety Issue A-48, Hydrogen Control Measures and Effects of Hydrogen Burns on Safety Equipment*, NUREG-1370, U.S. Nuclear Regulatory Commission, Washington, D.C., September 1979.
- NUREG-1391 S. A. McGuire, *Chemical Toxicity of Uranium Hexafluoride Compared to Acute Effects of Radiation*, NUREG-1391, U.S. Nuclear Regulatory Commission, Washington, D.C., January 1991.

- NUREG-1465 L. Soffer, et al., *Accident Source Terms for Light-Water Nuclear Power Plants*, NUREG-1465, U.S. Nuclear Regulatory Commission, Washington, D.C., June 1992.
- NUREG/BR-0024 S. McGuire, *Working Safely in Gamma Radiography: A Training Manual for the Industrial Radiographer*, NUREG/BR-0024, U.S. Nuclear Regulatory Commission, Washington, D.C., September 1982.
- NUREG/CR-0649 A. S. Benjamin, et al., *Spent Fuel Heatup Following Loss of Water During Storage*, NUREG/CR-0649 (SAND77-1371, R-3), Sandia Laboratories, Albuquerque, New Mexico, March 1979.
- NUREG/CR-2068 F. R. O'Donnell, et al., *CONDOS II—A Tool for Estimating Radiation Doses from Radionuclide-Containing Consumer Products*, NUREG/CR-2068 (ORNL/NUREG/TM-454), Oak Ridge National Laboratory, Oak Ridge, Tennessee, November 1981.
- NUREG/CR-2726 A. L. Camp, et al., *Light Water Reactor Hydrogen Manual*, NUREG/CR-2726 (SAND82-1137, R3), U.S. Nuclear Regulatory Commission, Washington, D.C., June 1983.
- NUREG/CR-4041 J. R. Larson, *System Analysis Handbook*, NUREG/CR-4041 (EGG-2354), EG&G Idaho, Inc., Idaho Falls, Idaho, December 1984.
- NUREG/CR-4214 S. Abrahamson, et al., *Health Effects Models for Nuclear Power Plant Accident Consequence Analysis (Low LET Radiation), Part II: Scientific Bases for Health Effects Models*, rev. 1, NUREG/CR-4214 (SAND85-7185), U.S. Nuclear Regulatory Commission, Washington, D.C., May 1989.
- NUREG/CR-4245 S. W. Duce, et al., *In-Plant Source Term Measurements at Brunswick Steam Electric Station*, NUREG/CR-4245 (EGG-2392), U.S. Nuclear Regulatory Commission, Washington, D.C., June 1985.

- NUREG/CR-4397 J. W. Mandler, et al., *In-Plant Source Term Measurements at Prairie Island Nuclear Generating Station*, NUREG/CR-4397 (EGG-2420, RR), U.S. Nuclear Regulatory Commission, Washington, D.C., September 1985.
- NUREG/CR-4524 W. J. Foley, R. S. Dean, and A. Hennick, *Closeout of IE Bulletin 80-24: Prevention of Damage Due to Water Leakage Inside Containment (October 17, 1980 Indian Point Event)*, NUREG/CR-4524 (PARAMETER IE-154), PARAMETER, Elm Grove, Wisconsin, March 1987.
- NUREG/CR-4624 R. S. Denning, et al., *Radionuclide Release Calculations for Selected Severe Accident Scenarios*; vol. 1, BWR, Mark I Design; vol. 2, PWR, Ice Condenser Design; vol. 3, PWR, Subatmospheric Containment Design; vol. 4, BWR, Mark III Design; vol. 5, PWR, Large Dry Containment Design; and vol. 6, *Radionuclide Release Calculations for Severe Accident Scenarios*; NUREG/CR-4624 (BMI-2139), U.S. Nuclear Regulatory Commission, Washington, D.C., July 1986 (vols. 1-5), August 1990 (vol. 6).
- NUREG/CR-4629 E. Cazzoli, et al., *Independent Verification of Radionuclide Calculations for Selected Accident Scenarios*, NUREG/CR-4629 (BNL-NUREG-51998), U.S. Nuclear Regulatory Commission, Washington, D.C., July 1986.
- NUREG/CR-5055 J. V. Ramsdell, *Atmospheric Diffusion for Control Room Habitability Assessments*, NUREG/CR-5055 (PNL-6391), Pacific Northwest Laboratory, Richland, Washington, May 1988.
- NUREG/CR-5157 S. H. Kim, et al., *The Development of "APRIL.MOD2" —A Computer Code for Core Meltdown Analysis of Boiling Water Nuclear Reactors*, NUREG/CR-5157 (ORNL/Sub/81-9089/3), Oak Ridge National Laboratory, Oak Ridge, Tennessee, July 1988.
-

- NUREG/CR-5247 A. L. Sjoreen, et al., *RASCAL Version 2.1 User's Guide*, NUREG/CR-5247, vol. 1, rev. 2, and G. F. Athey, A. L. Sjoreen, and T. J. McKenna, *RASCAL Version 2.1 Workbook*, NUREG/CR-5247, vol. 2, rev. 2, December 1994.
- NUREG/CR-5374 J. L. Anderson, E. W. Hagen, and T. C. Morelock, *Summary of Inadequate Core Cooling Instrumentation for U.S. Nuclear Power Plants*, NUREG/CR-5374 (ORNL/TM-11200), U.S. Nuclear Regulatory Commission, Washington, D.C., July 1990.
- NUREG/CR-5567 J. W. Yang, *PWR Dry Containment Issue Characterization*, NUREG/CR-5567 (BNL-NUREG-52234), U.S. Nuclear Regulatory Commission, Washington, D.C., August 1990.
- NWS WR-214 P. Mueller and J. Galt, *Emergency Operational Meteorological Considerations During an Accidental Release of Hazardous Chemicals*, NOAA Tech. Memorandum NWS WR-214, U.S. Department of Commerce, Washington, D.C., August 1991.
- ORO-651 *Uranium Hexafluoride: A Manual of Good Handling Practices*, ORO-651, rev. 6, U.S. Department of Energy Field Office, Oak Ridge, Tennessee, October 1991.
- PB-230 846 *Radiological Health Handbook*, PB-230 846, rev. ed., U.S. Department of Health, Education, and Welfare, Public Health Service, Rockville, Maryland, January 1970.
- Rogovin 1980 M. Rogovin, *Three Mile Island, A Report to the Commissioners and the Public*, U.S. Nuclear Regulatory Commission, Washington, D.C., January 1980.
- RTM-93 T. McKenna, et al., *Response Technical Manual*, NUREG/BR-0150, vol. 1, rev. 3, U.S. Nuclear Regulatory Commission, Washington, D.C., November 1993.

- Turner 1986 J. E. Turner, *Atoms, Radiation, and Radiation Protection*, Pergamon Press, New York, 1986.
- Turner 1994 D. B. Turner, *Workbook of Atmospheric Dispersion Estimates: An Introduction to Dispersion Modeling*, 2nd ed., Lewis Publishers, Boca Raton, Florida, 1994.
- UNSCEAR *Ionizing Radiation and Biological Effects, United Nations Scientific Committee on the Effects of Atomic Radiation 1982 Report to the General Assembly*, United Nations, New York, 1982.
- USAS N1.1-1967 Subcommittee N2-4 of the USA Standards Committee on General and Administrative Standards for Nuclear Energy, *USA Standard Glossary of Terms in Nuclear Science and Technology*, USAS N1.1-1967, USA Standards Institute, New York, 1967.
- USSR State Committee for Using Atomic Energy of USSR, *The Accident at the Chernobyl Nuclear Power Plant and Its Consequences* (Data prepared for IAEA Expert Conference, August 25-29, 1989, Vienna, Austria), U.S. Department of Energy, Washington, D.C., August 1986.
- WASH-1400 *Reactor Safety Study: An Assessment of Accident Risks in U.S. Commercial Nuclear Power Plants*, Executive Summary, WASH-1400 (NUREG 75/014), U.S. Nuclear Regulatory Commission, Washington, D.C., October 1975.

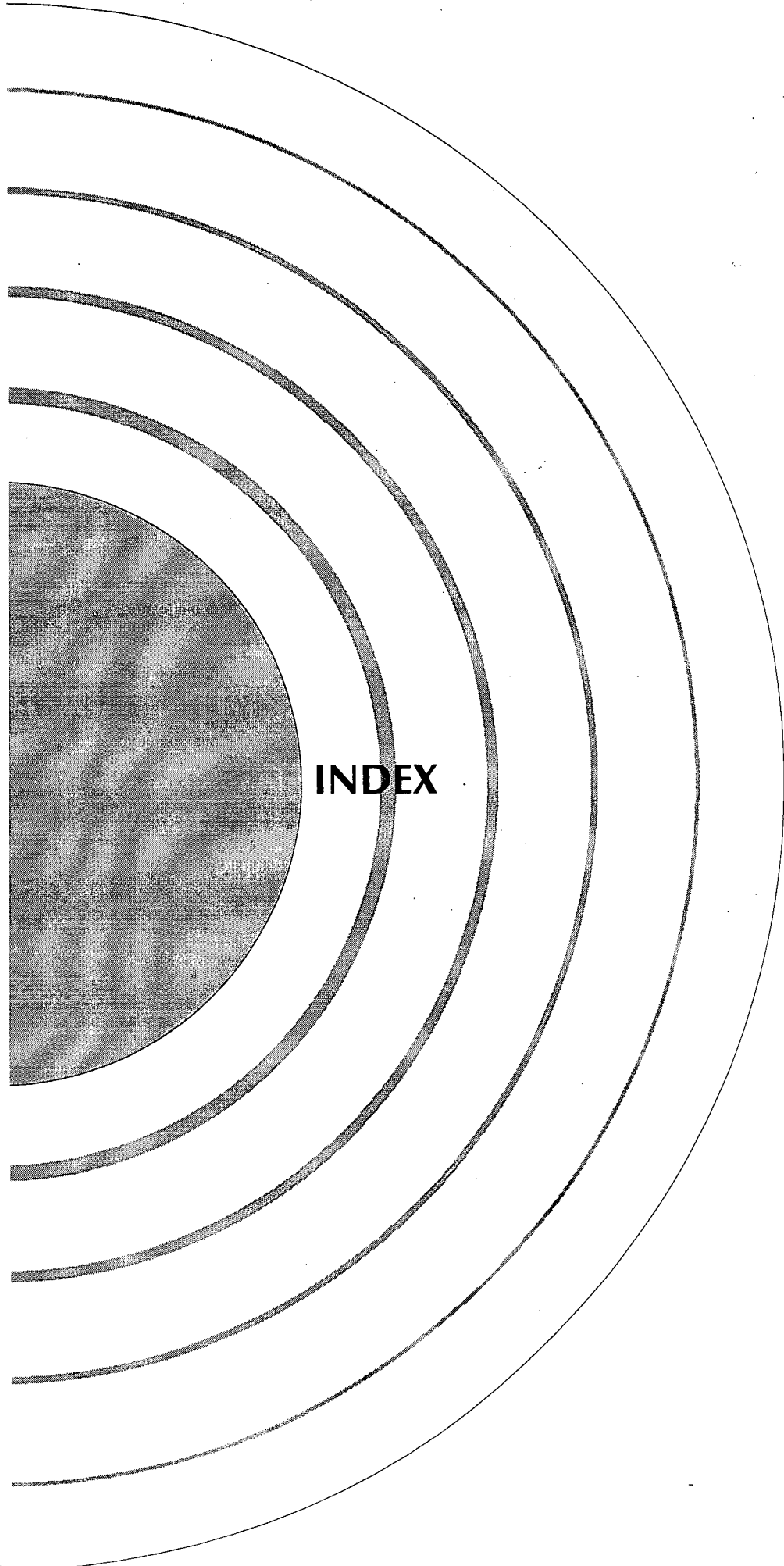

INDEX



INDEX

AC loss	B-11, 14, 17, 21, 28, 34-35
Actinium decay series	M-24-25
Activation of centers, classification	B-31
Activity, radiological	F-5-8, P-9-10
fraction released in fire	F-7-8, 31, 32-36, P-10
Acute health effects	G-8
Advisory Team	G-5
Air concentration	
dose from cloudshine	F-19-13, P-10-13
dose conversion factors	F-49-54
dose from to inhalation	F-9-13, P-10-13
dose conversion factors	F-55-61
projected maximum concentration at long distances	F-21-23, P-14
Air immersion dose (see <i>cloudshine</i>)	
Alpha decay	M-3
Atomic mass number	F-5-6
Atomic number	M-3, 5-9
table of elements	M-5-9
Beta decay	M-3
Bone dose	
based on estimated activity released	F-9-13
assumptions	F-9, P-10-13
based on spent fuel pool conditions	D-3-13
assumptions	D-5, P-7-8
Zircaloy fire, one 3-month-old batch	D-5-7, 11
gap release, one 3-month-old batch	D-5-7, 12
gap release, 15 1-month-old batches	D-5-7, 13
based on plant conditions	C-3-44
assumptions	C-11-13, P-5-7
BWR containment bypass release	C-7, 40-41
BWR containment drywell release	C-7, 36-37
BWR containment wetwell release	C-7, 38-39
PWR ice condenser containment release	C-6, 30-31
PWR large dry or subatmospheric containment release	C-6, 28-29
PWR steam generator tube rupture (SGTR) release	C-7, 32-35
early health effects	G-8
from point source (at 1 m)	F-64-69, P-13-14
ingestion PAG	I-5
Breathing rate	E-10, 16, F-60-61, P-11, 13
Building wake	C-12, F-63
Build-up of radiation	F-15, 75, P-14
Bypass release, projected consequences	C-5-9, 40-41
Catastrophic failure (containment), definition	C-12
Chemical elements (table)	M-5-9

Chemical hazard, uranium hexafluoride	E-3-5, 20
Chemical symbols (table)	M-5-9
Chernobyl accident, radiation released	O-5
Classification of emergency	
classification assessment	B-3-46
NUREG-0654 quick assessment chart	B-5, 27-31
NUREG-0654 full guidance	B-7, 9-22, P-5
NUMARC/NESP-007 emergency action level guidance	B-23-24, 32-45
Fuel cycle/materials facilities guidance	B-25, 46
Recognition categories	B-23-24, 32-36
Cloudshine (air immersion)	
dose	C-12, D-5
dose contribution from	F-9-10, P-10-13
dose rate conversion factors	F-49-54
release conversion factors	F-37-42, 43-48
Commission, Nuclear Regulatory	K-3-4
Committed effective dose equivalent (CEDE)	
from inhalation of soluble uranium	E-15, 25, P-13-14
from isotopic release	F-9-13, P-10-13
dose conversion factors, inhalation of soluble uranium	E-17, 22
Consequence assessment overview	
isotopic release	F-3-83, P-10-13
exposure to point source	F-15-17, P-13-14
reactor accident	C-3-44, P-5-7
spent fuel pool accident	D-3-13, P-7-8
uranium hexafluoride release	E-3-25, P-8-9
Containment radiation	
BWR monitor response	A-29, 30, 31
PWR monitor response	A-28
TMI monitor response	A-29
use in assessing core damage	A-13-15, 28-32, P-3-4
Containment release, projected consequences	C-3-44, P-5-7
BWR containment bypass release	C-7, 40-41
BWR drywell containment	C-7, 36-37
BWR wetwell containment	C-7, 38-39
PWR ice condenser containment	C-6, 30-31
PWR large dry or subatmospheric containment	C-6, 28-29
Contaminated property recovery	H-5, 8-9
Contamination control	
intermediate phase	H-3-5
surface contamination screening levels	H-8-9
Conversion factors	
conventional units to SI units	N-7-9
miscellaneous	N-10
time zones	N-11
Coolant concentrations (baseline)	
adjustment for different coolant inventory	A-17

Coolant concentrations (baseline) (<i>continued</i>)	
BWR	A-24
PWR	A-24
spiked	A-14
TMI	A-24
use in assessing core damage	A-17, P-4
Coolant fission product concentration	
BWR normal coolant	C-17
PWR normal coolant	C-16
Spikes, definition	C-11
Core conditions, definitions	C-11
Core damage assessment	
assessment overview	A-3-32
by evaluation of containment hydrogen	A-19-20, 32, P-6
by evaluation of containment radiation	A-13-15, 28-31, P-3-4
by evaluation of coolant concentrations	A-17, 24, P-4
by evaluation of sub-cooling margin	A-9-10, 21-23, P-3
by evaluation of temperature of uncovered core	A-11, 23, P-3
by evaluation of water injection	A-7-8, 25, P-3
consequence assessment	C-3-44, P-5-7
Core fission product inventory	C-13, 21-22
Core heatup	A-11, 23, P-3
Core release fractions	C-13, 18
Core exit thermocouple (CET)	A-4, 9, 11
Correction factor for ground roughness	F-42, 48, 55, P-12-13
Cylinder, uranium hexafluoride	E-3-4, 7, 13, 19
DC loss	B-28, 34-35
Decay, radioactive (<i>see radioactive decay</i>)	
DECAY model in RASCAL	L-4
Decontamination	
surface contamination screening levels	H-8-9
to reduce expected dose	H-5, 8-9
Delta T/ Δt	A-11, F-62
Deposition	
projected dose due to deposition based on estimated activity released	F-9-13, P-10-13
projected maximum at long distances	F-21-23, P-14
velocity	F-63
Dilution factor	F-11, 63
Director of Site Operations	G-5
Dose, radiation	
adjusting 1-mile dose for	
distance	F-19-20, 76-77, 82-83, P-14
elevation	C-8, D-7, F-19-20, P-14
number of batches in spent fuel pool	D-6
rain	C-8, D-7, F-19-20, P-14
reactor size	C-7
release duration	C-8

Dose, radiation

adjusting 1-mile dose for (<i>continued</i>)	
shutdown time	C-8, C-42-44
committed effective dose equivalent, based on activity released	F-9-13, P-10-13
external dose from point source	F-15-17, P-13-14
from deposition, based on activity released	F-9-13, P-10-13
from immersion in plume, based on activity released	F-9-13, P-10-13
from inhalation, based on activity released	F-9-13, P-10-13
put into perspective	O-3, O-6-7
to bone (see <i>bone dose</i>)	
to lung (see <i>lung dose</i>)	
to skin (see <i>skin dose</i>)	
to tissue, early health effects	G-8
to thyroid (see <i>thyroid dose</i>)	
Dose/dose rate conversion factors	
dose equivalent to bone from point source at 1 m	F-64-69
early phase acute bone dose from inhalation	F-56-61
early phase acute lung dose from inhalation	F-56-61
early phase committed dose equivalent to thyroid from inhalation	F-56-61
early phase committed effective dose equivalent from inhalation	F-56-61
early phase dose equivalent from deposition	F-49-55
from inhalation of soluble uranium	E-17, 22
effective external dose equivalent rate from deposition	F-49-55
effective external dose equivalent rate from air immersion	F-49-55
effective external dose equivalent from point source at 1 m	F-64-69
Early health effects	G-8
Early phase	
definition	G-3, P-15
dose from deposition based on estimated activity released	F-9-13
dose based on plant conditions	C-3-44
dose based on spent fuel pool conditions	D-3-13
dose from isotopic releases	F-3-83
protective action assessment	G-3-9
Effective dose equivalent, conversion to exposure for gamma field	F-55
Electron capture	M-3
Element symbols	M-5-9
Elevated release	F-19-20, 21-22
Emergency action level	
classification by	B-23, 24
examples	B-32-45
Emergency classes	B-9
Alert	B-13-15, 27-31, 46
definition	B-13
General Emergency	B-7-8, 27-31
definition	B-27
Notification of Unusual Event	B-10-12, 27-31
definition	B-10

Emergency classes (<i>continued</i>)	
Site Area Emergency	B-16-22, 27-31, B-46
definition	B-16
EPA Protective Action Guides	
early phase	G-7
intermediate phase	H-7
long-term objectives	H-7
relocation	H-7
Equivalence diagrams—temperature, activity, and dose units	N-12
Escape fractions	C-13, 19
Evacuation	
radiological criteria	G-3-4, 7
uranium hexafluoride release	E-3-5, 23
Executive Team	G-5
Exponents	N-3
Exposure control, uranium hexafluoride	E-3
Exposure rate conversion factors	
external exposure from deposition	F-49-55
from effective dose equivalent rate for gamma field	F-55
point source at 1 m	F-64-69
Extraordinary nuclear occurrence	
damage criteria	K-3-5
determination of	K-3-5
radiological criteria	K-3-5, P-15
Filter effectiveness	C-19
Fire	
accident classification	B-11, 14, 17, 20, 30
activity released in	F-7-8, 31-36, P-10
Zircaloy cladding in spent fuel pool	
consequence assessment	D-3-13, P-7-8
projected doses, one 3-month-old batch	D-6, 11
Fire release fraction	
by compound form	F-31
by isotope	F-32-36
Fission product inventory	
core	C-13, 21
normal coolant	C-16-17
spikes, definition	C-11
FM-DOSE model in RASCAL	L-3
<i>FRMAC Assessment Manual</i>	F-3, 55, 61, G-3, H-3-5, I-3
Fuel cycle facility	
accident classification	B-25, 45
uranium hexafluoride release assessment	E-3-25, P-8-9
Fuel heatup	A-11, 23, P-3
Gamma decay	M-4
Gap release	
coolant concentrations	A-24

Gap release (<i>continued</i>)	
definition	A-14, C-11, D-3
doses based on plant conditions	C-3-44, P-5-7
BWR containment drywell release	C-3-9, 36
BWR containment wetwell release	C-3-9, 38
BWR/PWR containment bypass release	C-3-9, 40
PWR large dry or subatmospheric containment release	C-3-9, 28
PWR ice condenser containment release	C-3-9, 30
doses based on spent fuel pool conditions	D-3-13, P-7-8
one 3-month-old batch	D-5-7, 12
15 1-month-old batches	D-5-7, 13
General Emergency	A-6
Ground concentration factor	F-42, 48, 63, P-12
Ground roughness correction	F-42, 48, 55, P-12-13
Groundshine	
dose contribution from	F-11, P-10-13
dose rate conversion factors	F-49-55
exposure rate conversion factors	F-49-55
release conversion factors	F-37-42, 43-48
Groundshine dose	C-12, D-5
Half-life, radioactive (<i>see radioactive half-life</i>)	
Half-value layer	F-15-16, 70-75, P-13-14
Health effects	
hydrogen fluoride	E-3-5, 7-8, 9-11, 20
radiation (early effects)	G-8
soluble uranium intake	E-3-5, 7, 9-10, 20
uranium hexafluoride	E-3-5
HHS ingestion Protective Action Guides	I-3-6
emergency	I-5
preventative	I-5
Hydrogen	
in containment	A-19, 32, P-4
production temperatures	A-23
sampling in containment	A-19
TMI percentage in containment	A-32
Hydrogen fluoride	
from uranium hexafluoride	E-3-5, 7-8, 9-11, 24, P-8-9
health effects	E-3-5, 7-8, 9-11, 20
Ice condenser containment (PWR) release, projected consequences	C-6, 30-31, P-5-7
Ice condenser, reduction in release due to	C-19
Ingestion	
protective action assessment	I-3
Protective Action Guides	I-3-6
radiation exposure pathway	H-3
Initiating conditions	
Alarms loss	B-11, 14, 17, 21, 28, 34, 35
Fire	B-11, 14, 17, 20, 30

Initiating conditions (*continued*)

Fuel cladding loss	11, 14, 17, 20-22, 28, 34, 37-45
Heat removal loss	B-14, 21, 27
Communications loss	B-35
Containment loss	B-11, 14, 21, 29, 36-39, 41-45
Control room loss	B-28
Inventory control loss	B-17, 27
Medical	B-31
Natural/technological hazards	B-11, 17, 22, 30, 33
Power loss	B-11, 14, 17, 21, 28, 34, 35
Primary coolant system breaks/leaks	B-11, 14, 17, 21, 29, 34, 36-41
Public notification	B-32
Radiological release	B-11, 14, 17, 20, 29, 32, 39-40, 42, 44, 46
Reactivity control loss	B-27
Safety system activation/loss	B-11, 14, 21, 34
Sabotage/security	B-11, 14, 17, 20, 30
Spent fuel accident	B-11, 14, 30, 46
Instrument reading	
exposure rate from deposition	F-49-54
in gamma field from point source	F-15, 17, 65-69
Intake of soluble uranium	E-3-5, 7, 9-10, 20, 24
Intermediate phase	
definition	H-3, P-15
doses	H-4-5
identification	H-4
ingestion protective action assessment	I-3-6, P-15
protective action assessment	H-3-9
radiation exposure pathways	H-3
Internal conversion	M-4
International system of units (<i>see SI units</i>)	
In-vessel core melt release	
coolant concentrations	A-24
definition	A-13, C-11
doses based on plant conditions	C-3-44, P-5-7
BWR containment drywell release	C-5-9, 37
BWR containment wetwell release	C-5-9, 39
BWR/PWR containment bypass release	C-5-9, 41
PWR large dry or subatmospheric containment release	C-5-9, 29
PWR ice condenser containment release	C-5-9, 31
Iodine, radioactive	
dose estimation	J-4-5, P-15
protection against	J-3-6
released in accidents	O-5
Isomeric transition	M-4
KI (<i>see potassium iodide</i>)	
Liability	K-3-4
Loss of coolant in spent fuel pool, consequence assessment	D-3, P-7-8

Lung dose	
based on estimated activity released	F-9-13
assumptions	F-9, P-10-13
early health effects	G-8
Materials facility	
accident classification	B-25, 45
uranium hexafluoride release assessment	E-3-25, P-13-14
Monitoring	
at boundaries to restricted zone	H-5
expected instrument reading	
from deposition	F-49-54
from point source	F-15-17, 65-69
thyroid screening	J-4-5, P-15
Neptunium decay series	M-20-21
Normal coolant release	
definition	A-14
NUMARC/NESP-007 classification	B-23
NUREG-0654	
classification	B-5, 7
Appendix 1 excerpted	B-9-22
Partitioning, reduction in release due to	C-19
Plateout, reduction in release due to	C-19
Plume phase (<i>see early phase</i>)	
Point source	
dose and exposure rate conversion factors at 1 m	F-64-69
dose rate and exposure rate	F-15-17, P-13-14
Potassium iodide	
dosage	J-4
effectiveness as thyroid block	J-4, 6
Federal position on use	J-3
Protective Action Guides	G-7, J-3
timing of dose	J-4, 6
use in thyroid blocking	J-3-4
Property damage from accident	K-3-5
Protective action	
early phase assessment	G-3-9
EPA Protective Action Guides	G-7
goal of	G-3
ingestion pathway actions	I-6
ingestion pathway assessment	I-3
intermediate pathway assessment	H-3
Protective Action Guides	
early phase	G-7, P-15
ingestion	I-3-6, P-15
emergency	I-5
preventative	I-5
water	I-3

Protective Action Guides (<i>continued</i>)	
intermediate phase	H-4-5, 7, P-15
long-term objectives	H-5, 7
non-emergency worker	H-4
relocation	H-7
thyroid protection/blocking	J-3
Radiation	
average annual doses	O-6-7
containment (see <i>containment radiation</i>)	
doses from various sources	O-6-7
dose projection (see <i>dose</i>)	
early health effects from	G-8
exposure pathways	
ingestion	H-3, I-3-6
intermediate phase	H-3
thyroid uptake of radioiodine	J-3-4
monitors (in containment)	
BWR monitor locations	A-27
PWR monitor locations	A-26
BWR monitor response	A-13-15, 29-30, 31
PWR monitor response	A-13-15, 28
releases	O-5
sickness	G-8
uranium hexafluoride	E-3-5, 13, 15-17, 21-22, 25, P-8-9
Radiation in perspective O-3-9	
radiation doses	O-3, 6-9
radiation releases	O-3, 5
Radioactive decay	
DECAY model in RASCAL	L-4
decay processes	M-3-4
decay series	
actinium series	M-24-25
neptunium series	M-20-21
thorium series	M-26-27
uranium series	M-22-23
diagrams	M-6-28
Radioactive half-life	
relationship to specific activity	F-5-6, P-9-10
table	F-25-30, M-5-9
Radioiodine (see <i>iodine, radioactive</i>)	
Release of radioactive material, put in perspective O-3, 5	
Relocation	
as protective action	H-5-7
Protective Action Guides	H-7
Restricted zone	
definition	H-3
radiological monitoring at boundaries	H-5

Restricted zone (<i>continued</i>)	
surface contamination screening levels	H-8-9
Resuspension	F-11-12, 48-54, H-3, P-12, 13
RASCAL	
calculations	
based on plant conditions	C-12, 28-41, D-5, 11-13, L-3
based on source term	L-3
DECAY model	L-4
description	L-3
documentation	L-4
how to obtain model	L-4
how to use	L-3-4
identification of appropriate tool	L-5
FM-DOSE model	H-5, L-3
source for obtaining software	L-4
ST-DOSE model	L-3
worksheets	L-6-15
Reactor	
accident consequence assesment	C-1-44, P-5-7
core fission product inventory	C-21
core release fractions	C-13, 18
normal coolant fission product concentraton	C-16-17
size, adjusting projected dose for reactor size	C-7
Recognition categories	B-23
A (abnormal radiation levels/radiological effluent)	B-23, 32
H (hazards and other conditions affecting safety)	B-23, 33
S (system malfunction)	B-23, 34-35
F (fission product barrier degradation)	B-23, 36
Reduction mechanisms, factors	C-13, C-19
Release	
duration	F-7-8
fraction released in fire	F-31, F-32-36, P-10
isotopic assessment	F-3-13, P-10-13
uranium hexafluoride	E-3-25, P-8-10
Release pathways	C-6-7, 11-12, P-5-6
BWR Mark I containment	C-25
BWR Mark II containment	C-26
BWR Mark III containment	C-27
PWR dry containment	C-23
PWR ice condenser containment	C-24
spent fuel pool	D-5
Release (reactor) rates, definitions	C-12
Resuspension	
contribution to dose	F-11, 42, 48, 49-55, P-10
resuspension factors	F-49-55, P-12-13
Samples—food, milk, and water	I-3-4
Saturation table	A-21, P-3

Sheltering	
in uranium hexafluoride release	E-3-4
radiological criteria	G-3-4, 7
to reduce expected dose	H-5
Shielding	
ground roughness	F-42, 48, 55, P-12-13
half-value layer	F-15-16, 70-75, P-14
Shutdown correction factors	C-8
thyroid dose	C-44
total acute bone dose	C-42-43
SI units	
base and supplementary units	N-5
definition	N-4
derived units	N-5
conversion to	N-7-9
prefixes	N-6
Skin dose	
early health effects	G-8
Protective Action Guide (early phase)	G-7
Specific activity	
relationship to half-life	F-5-6, P-9-10
table of values	F-25-30
uranium isotopes	E-21, F-29
Spiked coolant release	
definition	A-14, P-5
Sprays, reduction in release due to	C-19
ST-DOSE model in RASCAL	L-3
Stability class	
relative to weather conditions	F-62
dilution factors	F-63
Standby gas treatment system, reduction in release due to	C-19
Steam generator tube rupture release	
definition	C-11, P-6
doses based on plant conditions	
assumptions	C-11-13, P-5-7
PWR, normal coolant release	C-5-9, 32
PWR, spiked coolant release	C-5-9, 33
PWR, coolant contaminated by gap release	C-5-9, 34
PWR, coolant contaminated by in-vessel core melt	C-5-9, 35
release reduction due to partitioning	C-19
Sub-cooling margin	A-9, P-3
Suppression pool scrubbing, reduction in release due to	C-19
Surface contamination screening levels	
high background areas	H-8
low background areas	H-9
<i>Système International d'Unités</i> (see <i>SI units</i>)	
Tank, uranium hexafluoride	E-3-4, 7, 13, 19

Temperature rise in uncovered core	A-11, 23, P-3
Thorium decay series	M-26-27
Three Mile Island (TMI) accident	
radiation released	O-5
containment monitor response	A-29
coolant concentrations	A-24
hydrogen percentage in containment	A-32
Thyroid	
emergency monitoring	J-4-5, P-15
radioiodine blocking	J-3-6
potassium iodide	J-3-6
Thyroid dose	
based on estimated activity released	F-9-13, 37-48, 55-61
assumptions	F-9, P-10-13
based on plant conditions	C-3-44, P-5-7
assumptions	C-10-13, P-5-7
BWR containment bypass release	C-5-9, 40-41
BWR containment drywell release	C-5-9, 36-37
BWR containment wetwell release	C-5-9, 38-39
PWR ice condenser containment release	C-5-9, 30-31
PWR large dry or subatmospheric containment release	C-5-9, 28-29
PWR steam generator tube rupture (SGTR) release	C-5-9, 32-35
based on spent fuel pool conditions	D-3-13
assumptions	D-5, P-7-9
Zircaloy fire, one 3-month-old batch	D-5-7, 11
gap release, one 3-month-old batch	D-5-7, 12
gap release, 15 1-month-old batches	D-5-7, 13
early health effects	G-8
ingestion PAG	I-3
Protective Action Guide (early phase)	G-7
reduction with potassium iodide	J-3-6
Time to drain spent fuel pool	D-3, 10
Time zone conversions	N-11
Tissue dose, early health effects	G-8
Total acute bone dose (TABD) (see also <i>bone dose</i>)	
based on plant conditions	C-3-44
assumptions	C-10-13, P-5-7
based on spent fuel pool conditions	D-3-13
assumptions	D-5, P-7-9
definition	F-12, P-10
from isotopic release	F-9-13
Total acute lung dose (TALD)	
definition	F-12, P-10
isotopic release	F-9-13
Total effective dose equivalent (TEDE)	
definition	F-12, P-10
from isotopic release	F-12

Total effective dose equivalent (TEDE) (<i>continued</i>)	
Protective Action Guide (early phase)	G-7
Typical coolant release, definition	A-14, P-5
Unit conversion	
conventional to SI units	N-7-9
miscellaneous	N-10
time zones	N-11
Uranium	
decay series	M-22-23
enriched	E-3-5, 13, 15-17, 21, 25
isotopic abundance	E-21
specific activity	E-21, F-29
health effects	E-3-5, 7, 9-10, 13, 15-17, 20
specific activity	E-21, F-29
Uranium hexafluoride	
chemical hazard	E-3
committed effective dose equivalent	E-3-5, 13, 15-17, 25
consequence assessment overview	E-3-25, P-8-9
cylinders/tanks	E-3-4, 7, 13, 19
health effects	E-3-5, 7-8, 9-11, 20
dose conversion factors from inhalation of soluble uranium	E-17, 22
protective actions	E-3-5
release assessment	E-3-25, P-8-9
release description	E-3-4
Uranyl fluoride	E-3
Water	
injection	A-7, 25, P-3
required to cool core	A-7, 25
Water level indication system	A-4, 5
Wetwell (BWR) leakage	C-7, 12, 38-39
Whole body dose (<i>see total effective dose equivalent</i>)	
Yarway instruments	A-5
Zircaloy fire, consequence assessment	D-5-7, 11, P-7-8

