

2008  
Annual Radiological Environmental  
Operating Report

including the  
Radiological Effluent  
Release Report



Davis-Besse Nuclear Power Station

---

**ANNUAL RADIOLOGICAL  
ENVIRONMENTAL OPERATING  
REPORT**

---

**Davis-Besse Nuclear Power Station  
January 1, 2008 through December 31, 2008**

**Davis-Besse Nuclear Power Station**

**April 2009**

---

# TABLE OF CONTENTS

---

<u>Title</u>	<u>Page</u>
<b>List of Tables</b>	iv
<b>List of Figures</b>	vi
<b>Executive Summary</b>	viii
<b>INTRODUCTION</b>	
Fundamentals	1
Radiation and Radioactivity	2
Interaction with Matter	3
Quantities and Units of Measurement	5
Sources of Radiation	7
Health Effects of Radiation	9
Health Risks	10
Benefits of Nuclear Power	11
Nuclear Power Production	11
Station Systems	16
Reactor Safety and Summary	19
Radioactive Waste	19
Description of the Davis-Besse Site	22
References	24
<b>RADIOLOGICAL ENVIRONMENTAL MONITORING PROGRAM</b>	
Introduction	26
Pre-Operational Surveillance Program	26
Operational Surveillance Program Objectives	27
Quality Assurance	27
Program Description	28
Sample Analysis	32
Sample History Comparison	34

<u>Title</u>	<u>Page</u>
<b>RADIOLOGICAL ENVIRONMENTAL MONITORING PROGRAM (continued)</b>	
2008 Program Anomalies	36
Atmospheric Monitoring	36
Terrestrial Monitoring	43
Aquatic Monitoring	55
Direct Radiation Monitoring	67
Conclusion	78
References	78
<b>RADIOACTIVE EFFLUENT RELEASE REPORT</b>	
Protection Standards	81
Sources of Radioactivity Released	81
Processing and Monitoring	82
Exposure Pathways	83
Dose Assessment	84
Results	85
Regulatory Limits	86
Effluent Concentration Limits	87
Average Energy	87
Measurements of Total Activity	87
Batch Releases	88
Abnormal Releases	88
Percent of ODCM Limits	88
Sources of Input Data	89
Doses to Public Due to Activities Inside the Site Boundary	89
Inoperable Radioactive Effluent Monitoring Equipment	90
Changes to The ODCM and PCP	90
Borated Water Storage Tank Radionuclide Concentrations	90
Groundwater Monitoring	106
<b>LAND USE CENSUS</b>	
Program Design	112
Methodology	112
Results	113



<u>Title</u>	<u>Page</u>
<b>NON-RADIOLOGICAL ENVIRONMENTAL PROGRAMS</b>	
Meteorological Monitoring	118
On-Site Meteorological Monitoring	119
Land and Wetlands Management	134
Water Treatment Plant Operation	135
Chemical Waste Management	138
Other Environmental Regulating Acts	139
Other Environmental Programs	141
<b>APPENDICES</b>	
<b>Appendix A: Interlaboratory Comparison Program Results</b>	142
<b>Appendix B: Data Reporting Conventions</b>	161
<b>Appendix C: Maximum Permissible Concentrations of Radioactivity in Air and Water Above Background in Unrestricted Areas</b>	163
<b>Appendix D: REMP Sampling Summary</b>	165

---

## List of Tables

---

<u>Title</u>	<u>Table Number</u>	<u>Page Number</u>
Risk Factors: Estimated Decrease in Average Life Expectancy	1	10
Sample Codes and Collection Frequencies	2	30
Sample Collection Summary	3	31
Radiochemical Analyses Performed on REMP Samples	4	33
Air Monitoring Stations	5	39
Milk Monitoring Location	6	44
Groundwater Monitoring Locations	7	46
Broadleaf Vegetation and Fruit Locations	8	47
Animal/Wildlife Feed Locations	9	48
Wild Meat Locations	10	49
Soil Locations	11	51
Treated Surface Water Locations	12	57
Untreated Surface Water Locations	13	60
Shoreline Sediment Locations	14	61
Fish Locations	15	63
Thermoluminescent Dosimeter Locations	16	69
Gaseous Effluents – Summation of All Releases	17	91
Gaseous Effluents – Ground Level Releases – Batch Mode	18	92
Gaseous Effluents – Ground Level Releases - Continuous Mode	18	93
Ground Level Releases – LLDs for Continuous and Batch Mode	18	94
Gaseous Effluents – Mixed Mode Releases –Batch Mode	19	95
Gaseous Effluents – Mixed Mode Releases – Continuous Mode	19	96
LLDs for Gaseous Effluents – Mixed Mode Releases	19	97
Liquid Effluents – Summation of All Releases	20	98
Liquid Effluents – Nuclides Released in Batch Releases	21	99
Liquid Effluents - Nuclides Released Batch Releases	21	101

<b><u>Title</u></b>	<b><u>Table Number</u></b>	<b><u>Page Number</u></b>
Liquid Effluents – Nuclides Released Continuous Releases	21	101
Liquid Effluents – LLDs for Nuclides Released	21	102
Liquid Effluents – LLDs for Nuclides Released Solid Waste and Irradiated Fuel Shipments	22	103
Groundwater Monitoring Wells Sampled in 2008	23	106
Groundwater Results Following 3” Condensate Line Leak	24	108
Doses Due to Gaseous Releases for January through December 2008	25	109
Doses Due to Liquid Releases for January through December 2008	26	110
Annual Dose to the Most Exposed (from all pathways) Member of the Public 2008	27	111
Closest Exposure Pathways Present in 2008	28	115
Pathway Locations and Corresponding Atmospheric Dispersion (X/Q) and Deposition (D/Q) Parameters	29	117
Summary of Meteorological Data Recovery for 2008	30	123
Summary of Meteorological Data Measured for 2008	31	124
Joint Frequency Distribution by Stability Class	32	129

---

## List of Figures

---

<u>Description</u>	<u>Figure Number</u>	<u>Page Number</u>
The Atom	1	1
Principal Decay Scheme of the Uranium Series	2	3
Range and Shielding of Radiation	3	4
Sources of Exposure to the Public	4	8
Fission Diagram	5	12
Fuel Rod, Fuel Assembly, Reactor Vessel	6	13
Station Systems	7	15
Dry Fuel Storage Module Arrangement	8	21
Map of Area Surrounding Davis-Besse	9	22
2008 Airborne Particulate Gross Beta	10	38
Air Sample Site Map	11	40
Air Samples 5-mile Map	12	41
Air Sample 25-mile Map	13	42
Gross Beta Groundwater 1982-2008	14	45
Cs-137 in Soil 1972-2008	15	50
Terrestrial Site Map	16	52
Terrestrial 5-mile Map	17	53
Terrestrial 25-mile Map	18	54
Gross Beta in Treated Surface Water 1972-2008	19	56
Gross Beta Concentration in Untreated Surface Water 1977-2008	20	59
Gross Beta Fish 1972-2008	21	62
Aquatic Site Map	22	64
Aquatic 5-mile Map	23	65
Aquatic 25-mile Map	24	66
Gamma Dose for Environmental TLDs 1973 – 2008	25	68
TLD Site Map	26	75
TLD 5-mile Map	27	76
TLD 25-mile Map	28	77
Exposure Pathways	29	84

<b><u>Description</u></b>	<b><u>Figure Number</u></b>	<b><u>Page Number</u></b>
Land Use Census Map	30	114
Wind Rose Annual Average 100M	31	126
Wind Rose Annual Average 75M	32	127
Wind Rose Annual Average 10M	33	128

## Executive Summary

---

The Annual Radiological Environmental Operating Report (AREOR) is a detailed report on the Environmental Monitoring Programs conducted at the Davis-Besse Nuclear Power Station from January 1 through December 31, 2008. This report meets all of the requirements in Regulatory Guide 4.8, Section 5.6 of Davis-Besse Improved Standard Technical Specifications, and Davis-Besse Offsite Dose Calculation Manual (ODCM) Section 7.1. Reports included are the Radiological Environmental Monitoring Program, Radiological Effluents Release Report, Land Use Census, Groundwater Monitoring, and the Non-Radiological Environmental Programs, which consist of Meteorological Monitoring, Land and Wetland Management, Water Treatment, Chemical Waste Management, and Waste Minimization and Recycling. This report also includes the Radiological Effluent Release Report for the reporting period of January 1 through December 31, 2008.

### Radiological Environmental Monitoring Program

The Radiological Environmental Monitoring Program (REMP) is established to monitor the radiological condition of the environment around Davis-Besse. The REMP is conducted in accordance with Regulatory Guide 4.8, Davis-Besse Improved Technical Specifications, and the Davis-Besse ODCM Section 6.0. This program includes the sampling and analysis of environmental samples and evaluating the effects of releases of radioactivity on the environment.

Radiation levels and radioactivity have been monitored within a 25-mile radius around Davis-Besse since 1972. The REMP was established at Davis-Besse about five years before the Station became operational. This pre-operational sampling and analysis program provided data on radiation and radioactivity normally present in the area as natural background. Davis-Besse has continued to monitor the environment by sampling air, groundwater, milk, wild meat, fruit and vegetables, wild animal feed, drinking water, surface water, fish, shoreline sediment, and by direct measurement of radiation.

Samples are collected from Indicator and Control locations. Indicator locations are within approximately 5 miles of the site and are expected to show naturally occurring radioactivity plus any increases of radioactivity that might occur due to the operation of Davis-Besse. Control locations are farther away from the Station and are expected to indicate the presence of only naturally occurring radioactivity. The results obtained from the samples collected from indicator locations are compared with the results from those collected from control locations and with the concentrations present in the environment before Davis-Besse became operational. This allows for the assessment of any impact the operation of Davis-Besse might have had on the surrounding environment.

Over 2,000 radiological environmental samples were collected and analyzed in 2008. An explanation for the sample anomalies for this reporting period is provided on page 36.

The results of the REMP indicate that Davis-Besse continues to be operated safely in accordance with applicable federal regulations. No significant increase above background radiation or radioactivity is attributed to the operation of Davis-Besse.

The sampling results are divided into four sections: atmospheric monitoring, terrestrial monitoring, aquatic monitoring and direct radiation monitoring.

Air samples are continuously monitored at ten locations. Four samples are collected onsite. The other six are located between one-half and twenty-two miles away. Particulate filters and iodine cartridges are collected weekly. The 2008 indicator results were in close agreement with the samples collected at control locations.

Terrestrial monitoring includes analysis of milk, groundwater, meat, fruits, vegetables, animal feed, and soil samples. Samples are collected onsite and up to twenty-five miles away, depending on the type of sample. Results of terrestrial sample analyses indicate concentrations of radioactivity similar to previous years and indicate no build-up of radioactivity due to the operation of Davis-Besse.

Aquatic monitoring includes the collection and analysis of drinking water, untreated surface water, fish and shoreline sediments from onsite and the vicinity of Lake Erie. All samples of untreated surface water contained tritium at concentrations <330 pCi/liter, well below the 20,000 pCi/liter EPA drinking water limit for tritium. The 2008 results of analysis for fish, drinking water and shoreline sediment indicate normal background concentration of radionuclides and show no increase or build-up of radioactivity due to the operation of Davis-Besse.

The operation of Davis-Besse in 2008 caused no detected increase in the concentrations of radionuclides or adverse effects on the quality of the environment surrounding the plant. Radioactivity released in the Station's effluents was well below the applicable federal regulatory limits. The estimated radiation dose to the general public due to the operation of Davis-Besse in 2008 was well below all applicable regulatory limits.

In order to estimate radiation dose to the public, the pathways through which public exposure can occur must be known. To identify these exposure pathways, an Annual Land Use Census is performed as part of the REMP. During the census, Station personnel travel every public road within a radius of five miles of Davis-Besse to locate radiological exposure pathways (e.g., residences, vegetable gardens, milk cows/goats, etc.). The most important pathway is the one that, for a specific radionuclide, provides the greatest dose to a sector of the population. This is called the critical pathway. The critical pathway for 2008 was a garden in the West sector 1,560 meters from Davis-Besse, and is unchanged from 2007.

## Radiological Effluent Release Report

The Radiological Effluent Release Report (RERR) is a detailed listing of radioactivity released from the Davis-Besse Nuclear Power Station during the period January 1 through December 31, 2008. The doses due to radioactivity released during this period were only a fraction of what is allowed by our operating license:

The Total Body doses to an individual and population in an unrestricted area due to direct radiation from Davis-Besse is not distinguishable from background. These doses represent an extremely small fraction of the limits set by the NRC or the limits set in the ODCM.

One unplanned gaseous release occurred during plant startup on March 7, when High Pressure Feedwater Heater relief valves lifted. The steam released contained 1.08 E-03 curies of Tritium and had a calculated whole body dose of 1.44E-07 millirem.

There were no abnormal liquid releases during 2008.

There was one revision of the Process Control Program (PCP) and one revision of the Offsite Dose Calculation Manual (ODCM) during 2008.

## Groundwater Monitoring

As a result of a 2007 Nuclear Energy Institute initiative, Davis-Besse began monitoring groundwater wells near the plant in order to determine whether there have been any inadvertent releases of radioactivity that have impacted groundwater or could potentially affect local water supplies. The water was sampled from both pre-construction era wells and from 16 monitoring wells drilled in 2007. In 2008, tritium values in these wells ranged from <140 to 1,477 pCi/liter. There is no indication that the contaminated groundwater is moving offsite. These wells are not used for drinking water purposes, and the tritium concentrations found were all below the 20,000 pCi/liter EPA drinking water limit. Sampling of these wells is performed on a semi-annual basis.

On October 22, a leak was discovered in an underground 3 inch condensate line, which carries low-level tritiated water to an approved radioactive effluent discharge point. The line was immediately isolated and repaired, and several wells surrounding the line break were sampled. All wells showed tritium concentrations at less than the courtesy notification level of 2,000 pCi/liter. No gamma or hard-to-detect radionuclides (Strontium 89/90, Fe-55, Ni-63) were present in these samples. Follow-up sampling of these wells will occur in spring of 2009. Notifications were made to the NRC, State of Ohio, and Lucas and Ottawa County officials on October 23, 2008.

## Non-Radiological Environmental Programs

### Meteorological Monitoring

The Meteorological Monitoring Program at Davis-Besse is part of a program for evaluating the radiological effects of the routine operation of Davis-Besse on the surrounding environment. Meteorological monitoring began in October of 1968.

Meteorological data recorded at Davis-Besse include wind speed, wind direction, sigma theta (standard deviation of wind direction), ambient temperature, differential temperature, dew point and precipitation. Two instrument-equipped meteorological towers are used to collect data. Data recovery for the five instruments that are operationally required by Davis-Besse Technical Requirements Manual was 99.09%.

### Marsh Management

FirstEnergy owns the Navarre Marsh. It is leased to the U.S. Fish and Wildlife Service, who manage it as part of the Ottawa National Wildlife Refuge.

The Davis-Besse site currently has two active American Bald Eagle nests on the property. A total of seventeen healthy eaglets have fledged from Davis-Besse nests since 1995.



## Water and Wastewater Treatment

Davis-Besse withdraws water from Lake Erie and processes it through a vendor-supplied water treatment process to produce the high-purity water used in the Station's cooling systems.

Since December 1, 1998, the Carroll Township Water Treatment Plant has provided for domestic water needs at Davis-Besse.

Sewage is treated at the Davis-Besse Wastewater Treatment Plant (WWTP) and its effluent is pumped to a settling basin. Following a retention period, this water is discharged with other Station liquid effluents back to Lake Erie.

## Chemical Waste Management

The Chemical Waste Management Program at Davis-Besse was developed to ensure that the off-site disposal of non-radioactive hazardous and nonhazardous chemical wastes is performed in accordance with all applicable state and federal regulations. Chemical waste disposal vendors contracted by Davis-Besse use advanced technology for offsite disposal, including recycling of chemical wastes, in order to protect human health and the environment.

In 2008, the Davis-Besse Nuclear Power Station generated approximately 7,350 pounds of hazardous waste. Non-hazardous wastes generated include 9,540 gallons of used oil, latex paints, caulks and grout.

As required by Superfund Amendment and Reauthorization Act (SARA), Davis-Besse reported hazardous products and chemicals to local fire departments and local and state planning commissions. As part of the program to remove PCB fluid from Davis-Besse, all electrical transformers have been retrofilled and reclassified as non-PCB transformers.

## Waste Minimization and Recycling

The Waste Minimization and Recycling Program at Davis-Besse began in 1991 with the collection and recycling of paper. This program was expanded and reinforced during 1993 to include the recycling of paper, aluminum cans, cardboard, and metal. Paper and cardboard recycling typically exceeds 50 tons annually. The scrap metal collected onsite is sold to scrap companies.

## Appendices

Appendix A contains results from the Interlaboratory Comparison Program required by Davis-Besse Technical Specifications. Samples with known concentrations of radioisotopes are prepared by the Environmental Resources Associates (ERA), and then sent (with information on sample type and date of collection only) to the laboratory contracted by the Davis-Besse Nuclear Power Station to analyze its REMP samples. The Environmental Resources Associates (ERA) compares results to known standards.

Appendix B contains data reporting conversions used in the REMP at Davis-Besse. The appendix provides an explanation of the format and computational methods used in reporting REMP data. Information on counting uncertainties and the calculations of averages and standard devia-

tions are also provided.

Appendix C lists the effluent concentration limits for alpha and beta-emitting radioisotopes and for certain other radioisotopes in air and water samples. These concentrations are taken directly from the Code of Federal Regulations, and provide comparison values for actual REMP sampling results for 2008.

Appendix D provides a REMP sampling summary from 2008. The appendix provides a listing of the following for each sample type:

- number and types of analyses performed
- lower limit of detection for each analysis
- mean and range of results for control and indicator locations
- mean, range, and description of location with highest annual mean
- number of non-routine results

For detailed studies, Appendix D provides more specific information than that listed in this report. The information presented in Appendices A through D was provided by Environmental, Inc. Midwest Laboratory in their Final Progress Report to Davis-Besse (February, 2009).



## Introduction

---

# Introduction

---

Coal, oil, natural gas and hydropower are used to run this nation's electric generating stations; however, each method has its drawbacks. Coal-fired power can affect the environment through mining, acid rain and air pollution. Oil and natural gas are in limited supply and are, therefore, costly. Hydropower is limited due to the environmental impact of damming our waterways and the scarcity of suitable sites.

Nuclear power provides a readily available source of energy. The operation of nuclear power stations has a very small impact on the environment. In fact, the Davis-Besse Nuclear Power Station is surrounded by hundreds of acres of marshland, which make up part of the Ottawa National Wildlife Refuge. In order to provide better understanding of this unique source of energy, background information on basic radiation characteristics, risk assessment, reactor operation and effluent control is provided in this section.

## Fundamentals

### The Atom

All matter consists of **atoms**. Simply described, atoms are made up of positively and negatively charged particles, and particles which are neutral. These particles are called **protons**, **electrons**, and **neutrons**, respectively (Figure 1). The relatively large protons and neutrons are packed tightly together in a cluster at the center of the atom called the **nucleus**. Orbiting around the nucleus are one or more smaller electrons. In an electrically neutral atom the negative charges of the electrons are balanced by the positive charges of the protons. Due to their dissimilar charges, the protons and electrons have a strong attraction for each other. This holds the atom together. Other attractive forces between the protons and neutrons keep the densely packed protons from repelling each other, and prevent the nucleus from breaking apart.

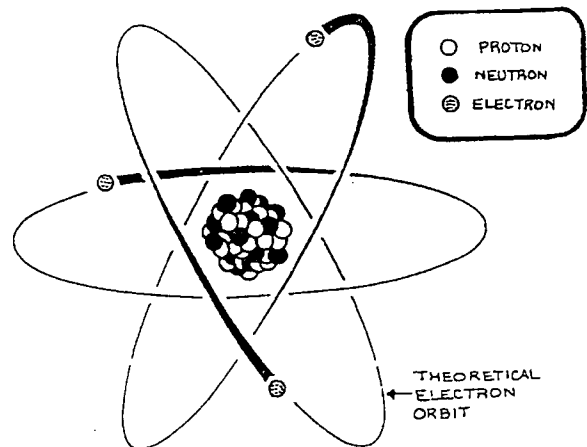

Figure 1: An atom consists of two parts: a nucleus containing positively charged protons and electrically neutral neutrons and one or more negatively charged electrons orbiting the nucleus. Protons and neutrons are nearly identical in size and weight, while each is about 2000 times heavier than an electron.

# Radiation and Radioactivity

## Isotopes and Radionuclides

A group of identical atoms containing the same number of protons make up an **element**. In fact, the number of protons an atom contains determines its chemical identity. For instance, all atoms with one proton are hydrogen atoms, and all atoms with eight protons are oxygen atoms. However, the number of neutrons in the nucleus of an element may vary. Atoms with the same number of protons but different numbers of neutrons are called **isotopes**. Different isotopes of the same element have the same chemical properties, and many are stable or nonradioactive. An unstable or radioactive isotope of an element is called a **radioisotope, a radioactive atom, or a radionuclide**. Radionuclides usually contain an excess amount of energy in the nucleus. The excess energy is usually due to a surplus or deficit in the number of neutrons in the nucleus. Radionuclides such as Uranium-238, Beryllium-7 and Potassium-40 occur naturally. Others are man-made, such as Iodine-131, Cesium-137, and Cobalt-60.

## Radiation

**Radiation** is simply the conveyance of energy through space. For instance, heat emanating from a stove is a form of radiation, as are light rays, microwaves, and radio waves. **Ionizing radiation** is another type of radiation and has similar properties to those of the examples listed above. Ionizing radiation consists of both **electromagnetic radiation** and **particulate radiation**. Electromagnetic radiation is energy with no measurable mass that travels with a wave-like motion through space. Included in this category are **gamma rays** and **X-rays**. Particulate radiation consists of tiny, fast moving particles which, if unhindered, travel in a straight line through space. The three types of particulate radiation of concern to us are **alpha particles**, which are made up of 2 protons and 2 neutrons; **beta particles**, which are essentially free electrons; and **neutrons**. The properties of these types of radiation will be described more fully in the Range and Shielding section.

## Radioactive Decay

Radioactive atoms, over time, will reach a stable, non-radioactive state through a process known as **radioactive decay**. Radioactive decay is the release of energy from an atom through the emission of ionizing radiation. Radioactive atoms may decay directly to a stable state or may go through a series of decay stages, called a **radioactive decay series**, and produce several **daughter products** that eventually result in a stable atom. The loss of energy and/or matter through radioactive decay may transform the atom into a chemically different element. For example, when Uranium-238 decays, it emits an alpha particle and, as a result, the atom loses 2 protons and 2 neutrons. As discussed previously, the number of protons in the nucleus of an atom determines its chemical identity. Therefore, when the Uranium-238 atom loses the 2 protons and 2 neutrons, it is transformed into an atom of Thorium-234. Thorium-234 is one of the 14 successive daughter products of Uranium-238. Radon is another daughter product, and the series ends with stable Lead-206.

This example is part of a known radioactive decay series, called the Uranium series, which begins with Uranium-238 and ends with Lead-206 (Figure 2).

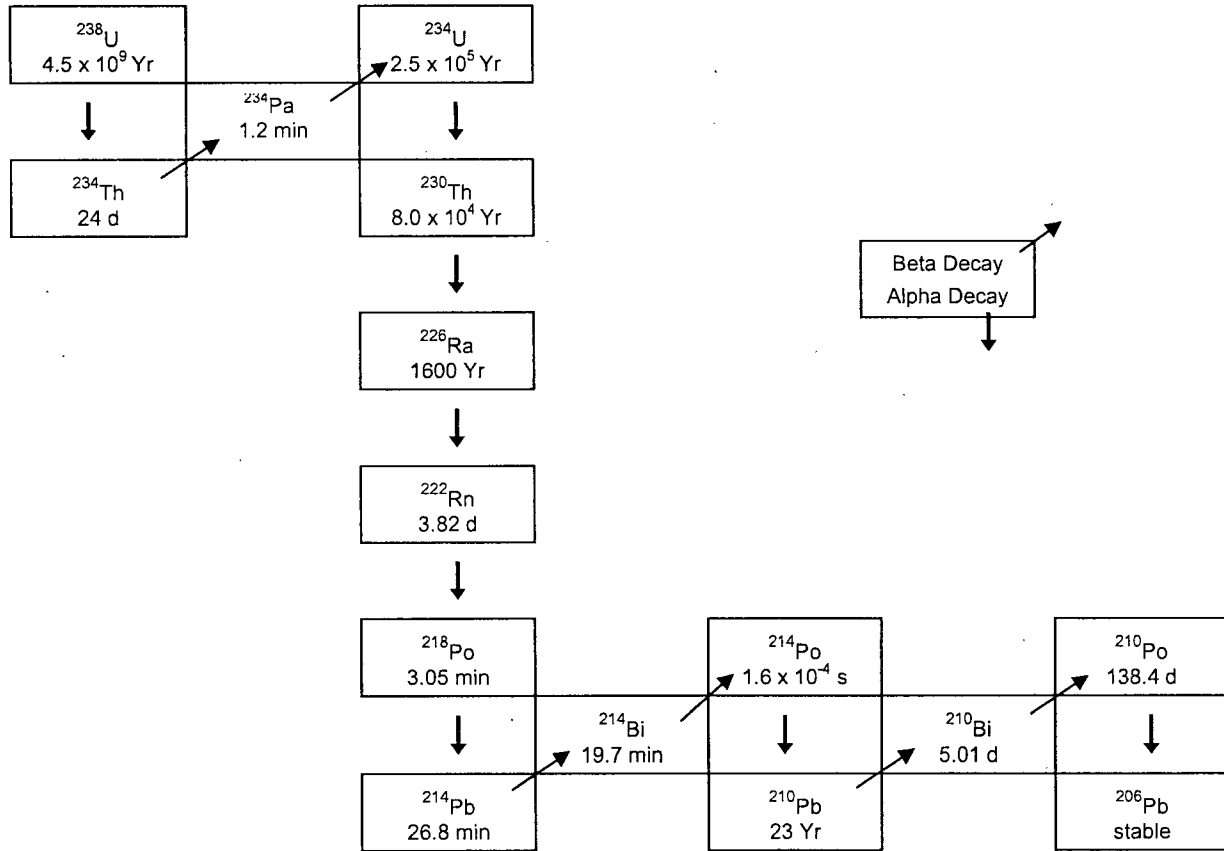

Figure 2: Principal Decay Scheme of the Uranium Series.

## Half-life

Most radionuclides vary greatly in the frequency with which their atoms release radiation. Some radioactive materials, in which there are only infrequent emissions, tend to have a very long half-lives. Those radioactive materials that are very active, emitting radiation more frequently, tend to have comparably shorter half-lives. The length of time an atom remains radioactive is defined in terms of **half-lives**. Half-life is the amount of time required for a radioactive substance to lose half of its activity through the process of radioactive decay. Half-lives vary from millionths of a second to millions of years.

## Interaction with Matter

### Ionization

Through interactions with atoms, alpha, beta, and gamma radiation lose their energy. When these forms of radiation interact with any form of material, the energy they impart may cause

atoms in that material to become **ions**, or charged particles. Normally, an atom has the same number of protons as electrons. Thus, the positive and negative charges cancel, and the atom is electrically neutral. When one or more electrons are removed an ion is formed. Ionization is one of the processes that may result in damage to biological systems.

## Range and Shielding

Particulate and electromagnetic radiation each travel through matter differently because of their different properties. Alpha particles contain 2 protons and 2 neutrons, are relatively large, and carry an electrical charge of +2. Alpha particles are ejected from the nucleus of a radioactive atom at speeds ranging from 2,000 to 20,000 miles per second. However, due to its comparatively large size, an alpha particle usually does not travel very far before it loses most of its energy through collisions and interactions with other atoms. As a result, a sheet of paper or a few centimeters of air can easily stop alpha particles (Figure 3).

Beta particles are very small, and comparatively fast particles, traveling at speeds near the speed of light (186,000 miles per second). Beta particles have an electrical charge of either +1 or -1. Because they are so small and have a low charge, they do not collide and interact as often as alpha particles, so they can travel farther. Beta particles can usually travel through several meters of air, but may be stopped by a thin piece of metal or wood.

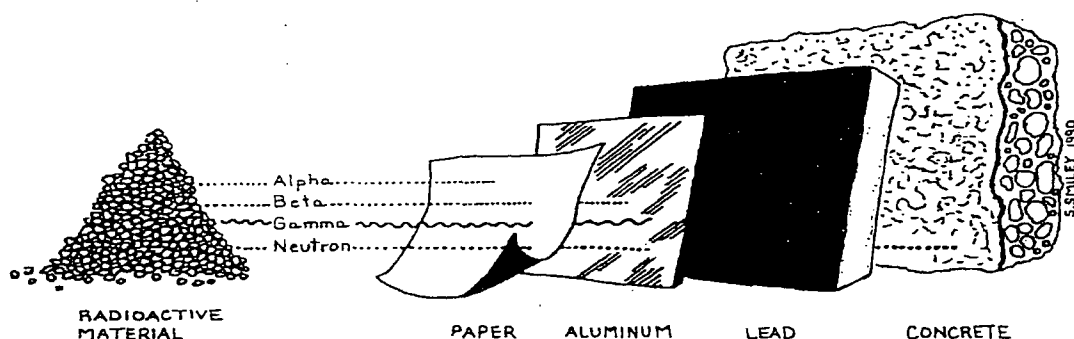

Figure 3: As radiation travels, it collides and interacts with other atoms and loses energy. Alpha particles can be stopped by a sheet of paper, and beta particles by a thin sheet of aluminum. Gamma radiation is shielded by highly dense materials such as lead, while hydrogenous materials (those containing hydrogen atoms), such as water and concrete, are used to stop neutrons.

Gamma rays are pure energy and travel at the speed of light. They have no measurable charge or mass, and generally travel much farther than alpha or beta particles before being absorbed. After repeated interactions, the gamma ray finally loses all of its energy and vanishes. The range of a gamma ray in air varies, depending on the ray's energy and interactions. Very high-energy gamma radiation can travel a considerable distance, whereas low energy gamma radiation may travel only a few feet in air. Lead is used as shielding material for gamma radiation because of its density. Several inches of Lead or concrete may be needed to effectively shield gamma rays.

Neutrons come from several sources, including the interactions of cosmic radiation with the earth's atmosphere and nuclear reactions within operating nuclear power reactors. However, neutrons are not of environmental concern since the neutron source at nuclear power stations is sealed within the containment building.

Because neutrons have no charge, they are able to pass very close to the nuclei of the material through which they are traveling. As a result, neutrons may be captured by one of these nuclei or they may be deflected. When deflected, the neutron loses some of its energy. After a series of these deflections, the neutron has lost most of its energy. At this point, the neutron moves about as slowly as the atoms of the material through which it is traveling, and is called a **thermal neutron**. In comparison, fast neutrons are much more energetic than thermal neutrons and have greater potential for causing damage to the material through which they travel. Fast neutrons can have from 200 thousand to 200 million times the energy of thermal neutrons.

Neutron shielding is designed to slow fast neutrons and absorb thermal neutrons. Neutron shielding materials commonly used to slow neutrons down are water or polyethylene. The shield is then completed with a material such as Cadmium, to absorb the now thermal neutrons. At Davis-Besse, concrete is used to form an effective neutron shield because it contains water molecules and can be easily molded around odd shapes.

## Quantities and Units of Measurement

There are several quantities and units of measurement used to describe radioactivity and its effects. Three terms of particular usefulness are **activity**, **absorbed dose**, and **dose equivalent**.

### Activity: Curie

**Activity** is the number of atoms in a sample that disintegrate (decay) per unit of time. Each time an atom disintegrates, radiation is emitted. The **curie** (Ci) is the unit used to describe the activity of a material and indicates the rate at which the atoms of a radioactive substance are decaying. One curie indicates the disintegration of 37 billion atoms per second.

A curie is a unit of activity, not a quantity of material. Thus, the amount of material required to produce one curie varies. For example, one gram (1/28th of an ounce) of radium-226 is the equivalent of one curie of activity, but it would take 9,170,000 grams (about 10 tons) of thorium-232 to equal one curie.

Smaller units of the curie are often used, especially when discussing the low concentrations of radioactivity detected in environmental samples. For instance, the microcurie (uCi) is equal to one millionth of a curie, while the picocurie (pCi) represents one trillionth of a curie.



## Absorbed Dose: Rad

**Absorbed dose** is a term used to describe the radiation energy absorbed by any material exposed to ionizing radiation, and can be used for both particulate and electromagnetic radiation. The **Rad (radiation absorbed dose)** is the unit used to measure the absorbed dose. It is defined as the energy of ionizing radiation deposited per gram of absorbing material (1 Rad = 100 erg/gm). The rate of absorbed dose is usually given in Rad/hr.

If the biological effect of radiation is directly proportional to the energy deposited by radiation in an organism, the Rad would be a suitable measurement of the biological effect. However, biological effects depend not only on the total energy deposited per gram of tissue, but on how this energy is distributed along its path. Experiments have shown that certain types of radiation are more damaging per unit path of travel than are others. Thus, another unit is needed to quantify the biological damage caused by ionizing radiation.

## Dose Equivalent: Rem

Biological damage due to alpha, beta, gamma and neutron radiation may result from the ionization caused by this radiation. Some types of radiation, especially alpha particles which cause dense local ionization, can result in up to 20 times the amount of biological damage for the same energy imparted as do gamma or X-rays. Therefore, a **quality factor** must be applied to account for the different ionizing capabilities of various types of ionizing radiation. When the quality factor is multiplied by the absorbed dose, the result is the **dose equivalent**, which is an estimate of the possible biological damage resulting from exposure to a particular type of ionizing radiation. The dose equivalent is measured in **rem (radiation equivalent man)**.

An example of this conversion from absorbed dose to dose equivalent uses the quality factor for alpha radiation, which is equal to 20. Thus, 1 Rad of alpha radiation is approximately equal to 20 rem. Beta and gamma radiation each have a quality factor of 1, therefore one Rad of either beta or gamma radiation is approximately equal to one rem. Neutrons have a quality factor ranging from 2 to 10. One rem produces the same amount of biological damage, regardless of the source. In terms of radiation, the rem is a relatively large unit. Therefore, a smaller unit, the **millirem**, is often used. One millirem (mrem) is equal to 1/1,000 of a rem.

## Deep Dose Equivalent (DDE)

Deep dose equivalent is the measurement of dose within the body, from sources of radiation that are external to the body. It is what is measured and recorded on thermoluminescent dosimeters (TLDs), film badges or other dosimeters. For example, at Davis-Besse or at any hospital that has x-ray equipment, you will see people wearing these devices. These instruments are worn to measure DDE.

## Committed Effective Dose Equivalent (CEDE)

Committed effective dose equivalent is a measure of the dose received from any radioactive material taken into the body. It is calculated from the sum of the products of the committed dose

equivalent to the organ or tissue multiplied by the organ or tissue-weighting factor. CEDE accounts for all the dose delivered during the entire time the radioactive material is in the body.

## Total Effective Dose Equivalent (TEDE)

Total effective dose equivalent is the sum of the deep dose equivalent (for dose from sources external to the body) and the committed effective dose equivalent (for internal dose). Since they are both doses to the body, they are not tracked separately. The NRC limits occupational dose to a radiation worker to five rem (5,000 mrem) TEDE per year.

## Sources of Radiation

### Background Radiation

Radiation did not begin with the nuclear power industry, and occurs naturally on earth. It is probably the most "natural" thing in nature. Mankind has always lived with radiation and probably always will. In fact, during every second of life, over 7,000 atoms undergo radioactive decay "naturally" in the body of the average adult. In addition, radioactive decay occurs naturally in soil, water, air and space. All these common sources of radiation contribute to the natural background radiation to which we are all exposed.

The earth is being showered by a steady stream of high-energy gamma rays and particulate radiation that come from space known as cosmic radiation. The atmosphere shields us from most of this radiation, but everyone still receives about 20 to 50 mrem each year from this source. The thinner air at higher altitudes provides less protection against cosmic radiation. People living at higher altitudes or flying in an airplane are exposed to even higher levels cosmic radiation. Radionuclides commonly found in the atmosphere as a result of cosmic ray interactions include Beryllium-7, Carbon-14, tritium (H-3), and Sodium-22.

Another common naturally occurring radionuclide is Potassium-40. About one-third of the external and internal dose from naturally occurring background radiation is attributed to this radioactive isotope of potassium.

The major source of background radiation is Radon, a colorless, odorless, radioactive gas that results from the decay of Radium-226, a member of the Uranium-238 decay series. Since Uranium occurs naturally in all soils and rocks, everyone is continuously exposed to Radon and its daughter products. Radon is not considered to pose a health hazard unless it is concentrated in a confined area, such as buildings, basements or underground mines. Radon-related health concerns stem from the exposure of the lungs to this radioactive gas. Radon emits alpha radiation when it decays, which can cause damage to internal tissues when inhaled. As a result, exposure to the lungs is a concern, since the only recognized health effect associated with exposure to Radon is an increased risk of lung cancer. This effect has been seen when Radon is present at levels common in uranium mines. According to the National Council on Radiation Protection and Measurement (NCRP), more than half of the radiation dose the average American receives is attributed to Radon.

## SOURCES OF EXPOSURE TO THE PUBLIC

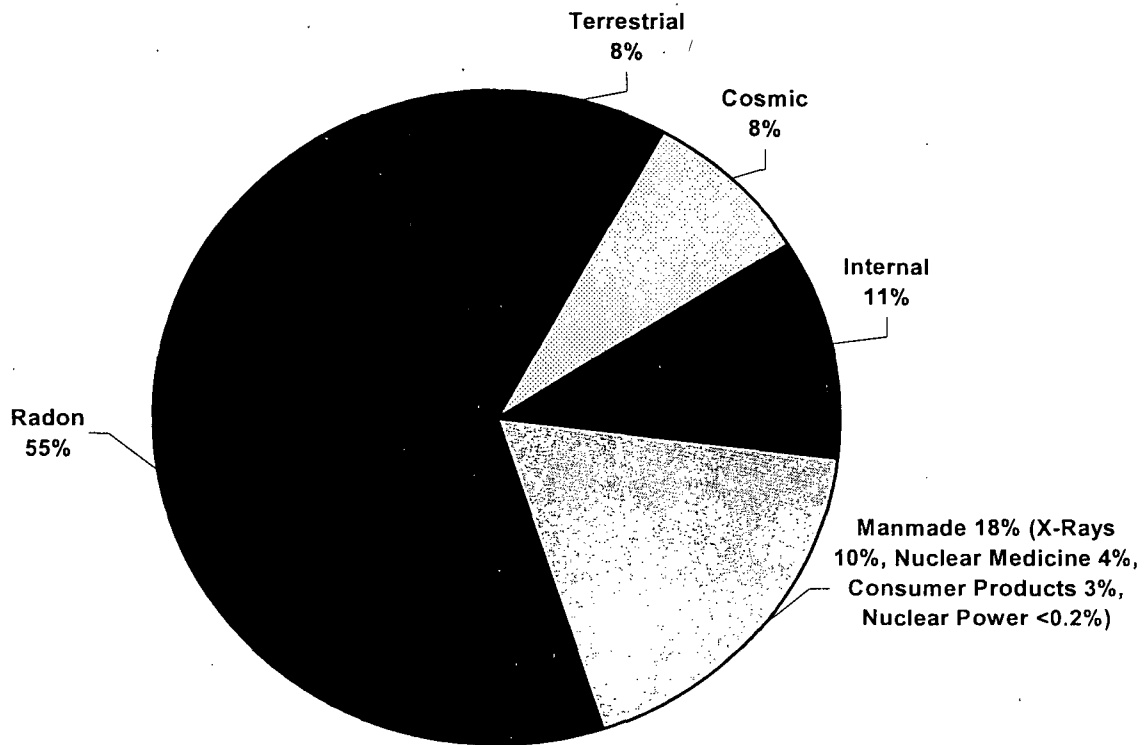

Figure 4: The most significant annual dose received by an individual of the public is that received from naturally occurring radon. A very small annual dose to the public results from producing electricity by nuclear power.

Further information on Radon, its measurement, and actions to reduce the Radon concentration in buildings can be obtained by contacting the state Radon program office at the following address:

Ohio Department of Health, Bureau of Radiation Protection  
P.O. Box 118, 35 East Chestnut Building 7<sup>th</sup> Floor  
Columbus, Ohio 43216-0118  
614) 481-5800  
(800) 523-4439 (in Ohio Only)

The approximate average background radiation in this area (see Figure 4) is 300 mrem/year.

### Man-made Radiation

In addition to naturally occurring cosmic radiation and radiation from naturally occurring radioactivity, people are also exposed to man-made radiation. The largest sources of exposure include

medical x-rays and radioactive pharmaceuticals. Small doses are also received from consumer products such as televisions, smoke detectors, and fertilizers. Fallout from nuclear weapons tests is another source of man-made exposure. Fallout radionuclides include Strontium-90, Cesium-137, and tritium. Less than one percent of the annual dose a member of the public receives is a result of having electricity generated by nuclear power.

## Health Effects of Radiation

The effects of ionizing radiation on human health have been under study for more than ninety years. Scientists have obtained valuable knowledge through the study of laboratory animals that were exposed to radiation under extremely controlled conditions. However, it has been difficult to relate the biological effects of irradiated laboratory animals to the potential health effects on humans.

The effects of radiation on humans can be divided into two categories, somatic and genetic. Somatic effects are those which develop in the directly exposed individual, including an unborn child. Genetic effects are those which are observed in the offspring of the exposed individual.

Somatic effects can be divided further into acute and chronic effects. Acute effects develop shortly after exposure to large amount of radiation. Much study has been done with human populations that were exposed to ionizing radiation under various circumstances. These groups include the survivors of the atomic bomb, persons undergoing medical radiation treatment, and early radiologists, who accumulated large doses of radiation, unaware of the potential hazards.

Chronic effects are a result of exposure to radiation over an extended period of time. Examples of such groups are clock dial painters, who ingested large amounts of Radium by "tipping" the paint brushes with their lips, and Uranium miners, who inhaled large amounts of radioactive dust while mining pitchblende (Uranium ore). The studies performed on these groups have increased our knowledge of the health effects from comparatively very large doses of radiation received over long periods of time.

Continuous exposure to low levels of radiation may produce somatic changes over an extended period of time. For example, someone may develop cancer from man-made radiation, background radiation, or some other source not related to radiation. Because all illnesses caused by low level radiation can also be caused by other factors, it is virtually impossible to determine individual health effects of low level radiation. Even though no effects have been observed at doses less than 50 rem, we assume the health effects resulting from low doses of radiation occur proportionally to those observed following large doses of radiation. Most radiation scientists agree that this assumption over-estimates the risks associated with a low-level radiation exposure. The effects predicted in this manner have never been actually observed in any individuals exposed to low level radiation. Therefore, the most likely somatic effect of low level radiation is believed to be a small increased risk of cancer. Genetic effects could occur as a result of ionizing radiation interacting with the genes in the human cells. Radiation (as well as common chemicals) can cause physical changes or mutations in the genes. Chromosome fibers can break and rearrange, causing interference with the normal cell division of the chromosome by affecting their number and structure. A cell is able to rejoin the ends of a broken chromosome, but if there are two breaks close enough together in space and time, the broken ends from one break could

join incorrectly with those from another. This could cause translocations, inversions, rings, and other types of structural rearrangements. When this happens, new mutated genes are created. Radiation is not the only mechanism by which such changes can occur. Spontaneous mutations and chemically induced mutations also have been observed. These mutated genes may be passed from parent to offspring. Viable mutations due to low level, low dose radiation have not been observed in humans.

## Health Risks

While people may accept the risks inherent in their personal activities, such as smoking and driving to work each day, they are less inclined to accept the risk inherent in producing electricity. As with any industrial environment, it is not possible to guarantee a risk free environment. Thus, attention should be focused on taking steps to safeguard the public, on developing a realistic assessment of the risks, and on placing these risks in perspective. The perceptions of risk associated with exposure to radiation may have the greatest misunderstanding. Because people do not understand ionizing radiation and its associated risks, many fear it. This fear is compounded by the fact that we cannot hear, smell, taste or feel ionizing radiation.

We do not fear other potentially hazardous things for which we have the same lack of sensory perception, such as radio waves, carbon monoxide, and small concentrations of numerous cancer-causing substances. These risks are larger and measurable compared to those presumed to be associated with exposure to low level, low dose radiation. Most of these risks are with us throughout our lives, and can be added up over a lifetime to obtain a total effect. Table 1 shows a number of different factors that decrease the average life expectancy of individuals in the United States.

---

**Table 1: Risk Factors: Estimated Decrease in Average Life Expectancy**

---

Overweight by 30%:		3.6 years
Cigarette smoking:	1 pack/day	7.0 years
	2 packs/day	10.0 years
Heart Disease:		5.8 years
Cancer:		2.7 years
City Living (non-rural):		5.0 years
All operating commercial nuclear power plants totaled:		less than 12 minutes

## Benefits of Nuclear Power

Nuclear power plays an important part in meeting today's electricity needs, and will continue to serve as an important source of electric energy well into the future. Today more than twenty percent of the electricity produced in the United States is from nuclear powered electrical generating stations.

Nuclear power offers several advantages over alternative sources of electric energy:

- Nuclear power has an excellent safety record dating back to 1957, when the first commercial nuclear power station began operating,
- Uranium, the fuel for nuclear power stations, is a relatively inexpensive fuel that is readily available in the United States,
- Nuclear power is the cleanest energy source for power stations that use steam to produce electricity. There are no greenhouse gases or acid gases produced when using nuclear fuel.

The following sections provide information on the fundamentals of how Davis-Besse uses nuclear fuel and the fission process to produce electricity.

## Nuclear Power Production

Electricity is produced in a nuclear power station in the same way as in a fossil-fueled station with the exception of the source of heat. Heat changes water to steam that turns a turbine. In a fossil-fueled station, the fuel is burned in a furnace, which is also a boiler. Inside the boiler, water is turned into steam. In a nuclear station, a reactor that contains a core of nuclear fuel, primarily uranium, replaces the furnace. Heat is produced when the atoms of Uranium are split, or fissioned, inside the reactor.

### What is Fission?

A special force called the binding force holds the protons and neutrons together in the nucleus of the atom. The strength of this binding force varies from atom to atom. If the bond is weak enough, the nucleus can be split when bombarded by a free neutron (Figure 5). This causes the entire atom to split, producing smaller atoms, more free neutrons, and heat. In a nuclear reactor, a chain reaction of fission events provides the heat necessary to boil the water to produce steam.

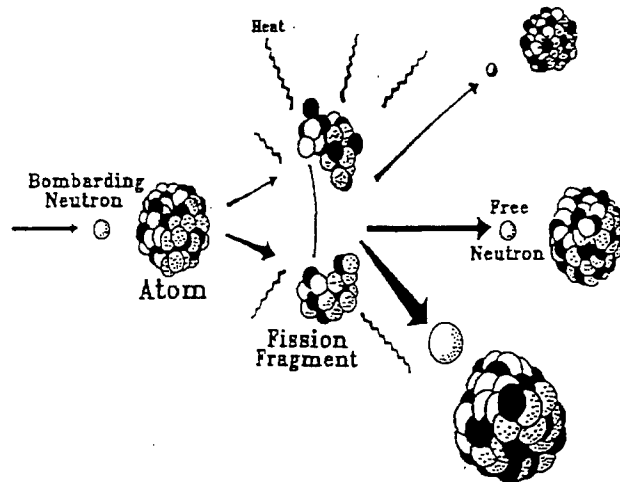

Figure 5: When a heavy atom, such as uranium-235 is split or fissioned, heat, free neutrons, and fission fragments result. The free neutrons can then strike neighboring atoms causing them to fission also. In the proper environment, this process can continue indefinitely in a chain reaction.

## Nuclear Fuel

The fissioning of one Uranium atom releases approximately 50 million times more energy than the combustion of a single Carbon atom common to all fossil fuels. Since a single small reactor fuel pellet contains trillions of atoms, each pellet can release an extremely large amount of energy. The amount of electricity that can be generated from three small fuel pellets would require about 3.5 tons of coal or 12 barrels of oil to generate.

Nuclear fission occurs spontaneously in nature, but these natural occurrences cannot sustain themselves because the freed neutrons either are absorbed by non-fissionable atoms or quickly **decay**. In contrast, a nuclear reactor minimizes neutron losses, thus sustaining the fission process by several means:

- using fuel that is free of impurities that might absorb the free neutrons,
- enriching the concentration of the rarer fissionable isotope of Uranium (U-235) relative to the concentration of U-238, a more common isotope that does not fission easily,
- slowing down neutron by providing a "moderator" such as water to increase the probability of fission.

Natural Uranium contains less than one percent U-235 compared to the more abundant U-238 when it's mined. Before it can be economically used in a reactor, it is enriched to three to five percent U-235, in contrast to nuclear material used in nuclear weapons which is enriched to over 97 percent. Because of the low levels of U-235 in nuclear fuel, a nuclear power station **cannot** explode like a bomb.

After the Uranium ore is separated from the earth and rock, it is concentrated in a milling process. After milling the ore to a granular form and dissolving out the Uranium with acid, the Uranium is converted to **Uranium hexafluoride (UF<sub>6</sub>)**. UF<sub>6</sub> is a chemical form of Uranium that exists as a gas at temperatures slightly above room temperature. The UF<sub>6</sub> is then highly purified and shipped to an enrichment facility where **gaseous diffusion converters** increase the concentration of U-235. The enriched gaseous UF<sub>6</sub> is then converted into powdered **Uranium dioxide (UO<sub>2</sub>)**, a highly stable ceramic material. The UO<sub>2</sub> powder is put under high pressure to form **fuel pellets**, each about 5/8 inch long and 3/8 inch in diameter. Approximately five pounds of these pellets are placed into a 12-foot long metal tube made of Zirconium alloy. The tubes constitute the **fuel cladding**. The fuel cladding is highly resistant to heat, radiation, and corrosion. When the tubes are filled with fuel pellets, they are called **fuel rods**.

## The Reactor Core

Two hundred eight fuel rods comprise a single **fuel assembly**. The **Reactor core** at Davis-Besse contains 177 of these fuel assemblies, each approximately 14 feet tall and 2,000 pounds in weight. In addition to the fuel rods, the fuel assembly also contains 16 vacant holes for the insertion of **control rods**, and one vacant hole for an **incore-monitoring probe**. This probe monitors temperature and neutron levels in the fuel assembly. The Davis-Besse reactor vessel, which contains all the fuel assemblies, weighs 838,000 pounds, has a diameter of 14 feet, is 39 feet high, and has steel walls that are 8 ½ inches thick.

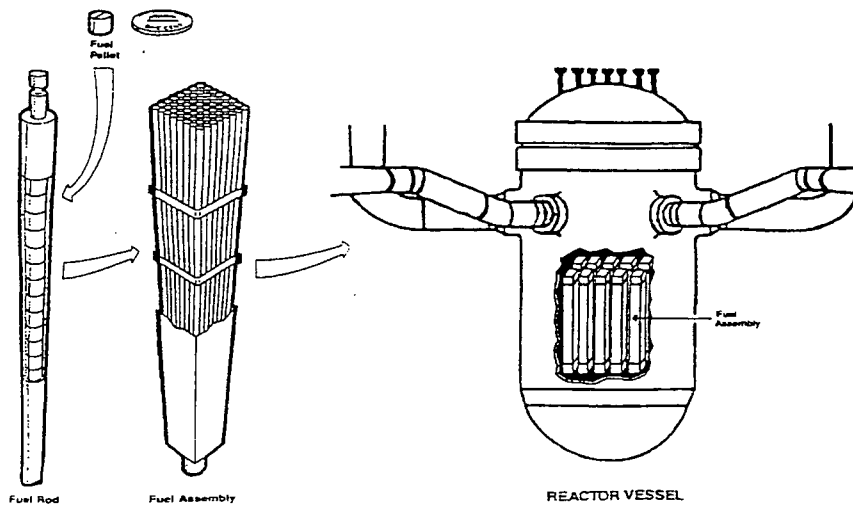

Figure 6: The reactor core at Davis-Besse contains 177 fuel assemblies. Each assembly contains 208 fuel rods. Each fuel rod is filled with approximately five pounds of fuel pellets, each pellet is approximately 3/8 inch diameter and 5/8 inch long.



## Fission Control

Raising or lowering control rod assemblies into the reactor core controls the fission rate. Each assembly consists of "fingers" containing Silver, Indium, and Cadmium metals that absorb free neutrons, thus disrupting the fission chain reaction. When control rod assemblies are slowly withdrawn from the core, fissioning begins and heat is produced. If the control rod assemblies are inserted rapidly into the reactor core, as during a plant "trip", the chain reaction ceases. A slower acting (but more evenly distributed) method of fission control is achieved by the addition of a **neutron poison** to the reactor coolant water. At Davis-Besse, high-purity boric acid is concentrated or diluted in the coolant to achieve the desired level of fission. Boron-10 readily absorbs free neutrons, forming Boron-11, removing the absorbed neutrons from the chain reaction.

## Reactor Types

Virtually all of the commercial reactors in this country are either **boiling water reactors (BWRs)** or **pressurized water reactors (PWRs)**. Both types are also called **light water reactors (LWRs)** because their coolant, or medium to transfer heat, is ordinary water, which contains the light isotope of Hydrogen. Some reactors use the heavy isotope of Hydrogen (deuterium) in the reactor coolant. Such reactors are called **heavy water reactors (HWRs)**.

In BWRs, water passes through the core and boils into steam. The steam passes through separators, which remove water droplets. The steam then travels to dryers before entering the turbine. After passing through the turbine the steam is condensed back into water and returns to the core to repeat the cycle.

In PWRs, the reactor water or coolant is pressurized to prevent it from boiling. The reactor water is then pumped to a **steam generator** (heat exchanger) where its heat is transferred to a secondary water supply. The secondary water inside the generator boils into steam, which is then used to turn the turbine. This steam is then condensed back into water and returned to the steam generator. Davis-Besse uses a PWR design.

The following paragraphs describe the various systems illustrated in Figure 7. Major systems in the Davis-Besse Station are assigned a different color in the figure.

# Davis-Besse Nuclear Power Station Unit No. 1

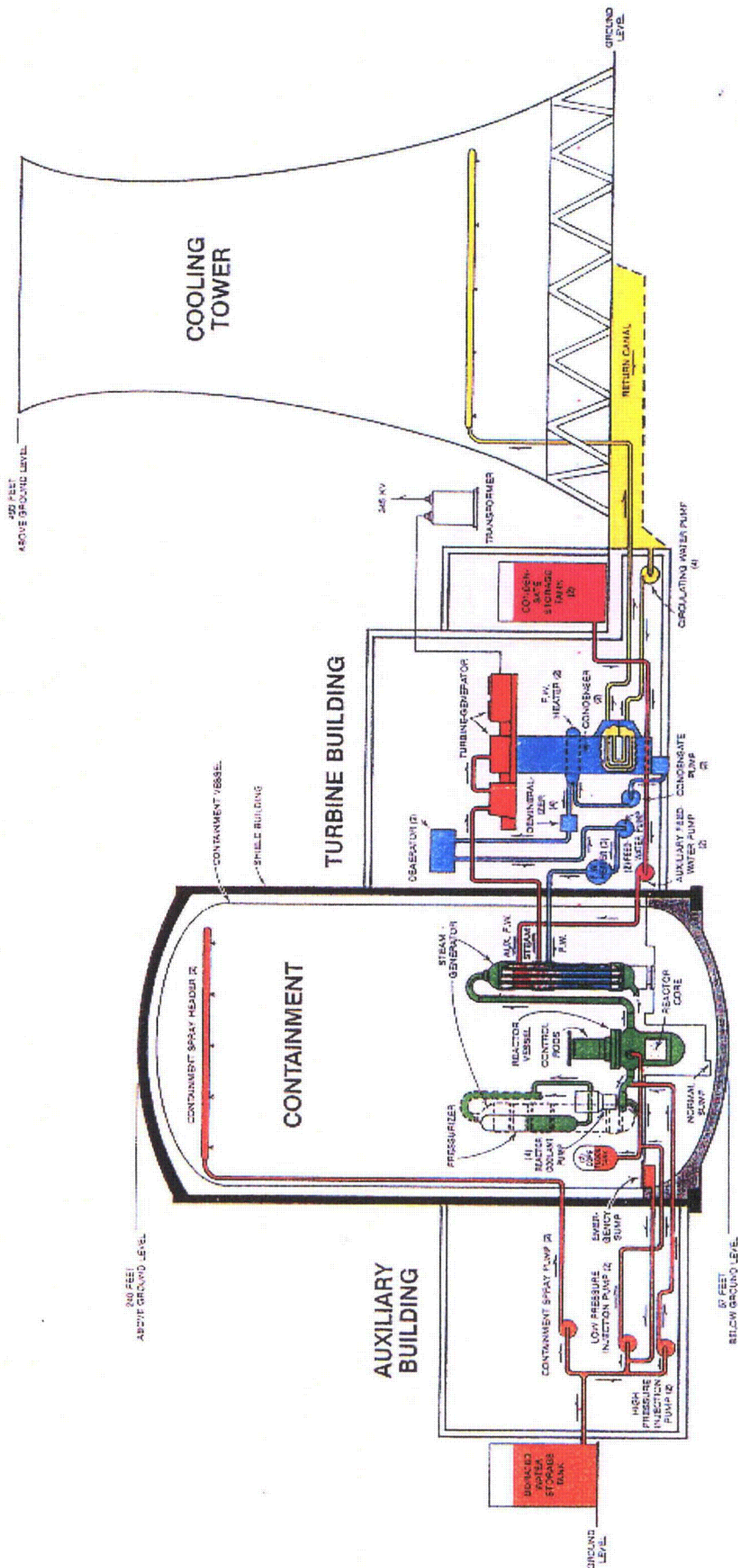

Figure 7: Station Systems

## Station Systems

### Containment Building and Fission Product Release Barriers

The **Containment building** houses the reactor vessel, the pressurizer, two steam generators, the Reactor Coolant Pumps and Reactor Coolant System piping. The building is constructed of an inner 1 -1/2 inch thick steel liner or **Containment vessel**, and the **Shield Building** with steel-reinforced concrete walls 2 feet thick. The shield building protects the containment vessel from a variety of environmental factors and provides an area for a **negative pressure boundary** around the steel Containment vessel. In the event that the integrity of the Containment vessel is compromised (e.g., a crack develops), this negative pressure boundary ensures that any airborne radioactive contamination present in the containment vessel is prevented from leaking out into the environment. This is accomplished by maintaining the pressure inside the Shield Building lower than that outdoors, thus forcing clean outside air to leak in, while making it impossible for the contaminated air between the Containment vessel and the Shield Building to leak out. The Containment vessel is the third in a **series of barriers** that prevent the release of fission products in the unlikely event of an accident. The first barrier to the release of fission products is the fuel cladding itself. The second barrier is the walls of the primary system, i.e. the reactor vessel, steam generator and associated piping.

### The Steam Generators

The **steam generators** perform the same function as a boiler at a fossil-fueled power station. The steam generator uses the heat of the primary coolant inside the steam generator tubes to boil the secondary side **feedwater** (secondary coolant). Fission heat from the reactor core is transferred to the steam generator in order to provide the steam necessary to drive the turbine. However, heat must also be removed from the core even after reactor shutdown in order to prevent damage to the fuel cladding. Therefore, pumps maintain a continuous flow of coolant through the reactor and steam generator. **Primary loop water** (green in Figure 7) exits the reactor at approximately 606°F, passes through the steam generator, transferring some of its heat energy to the **Secondary loop water** (blue in Figure 7) without actually coming in contact with it. Primary coolant water exits the steam generator at approximately 558°F to be circulated back into the reactor where it is again heated to 606°F as it passes up through the fuel assemblies. Under ordinary conditions, water inside the primary system would boil long before it reached such temperatures. However, it is kept under a pressure of approximately 2,200 pounds-per-square-inch (psi) at all times. This prevents the water from boiling and is the reason the reactor at Davis-Besse is called a Pressurized Water Reactor. Secondary loop water enters the base of the steam generator at approximately 450°F and under 1,100 psi pressure. At this pressure, the water can easily boil into steam as it passes over the tubes containing the primary coolant water.

Both the primary and the secondary coolant water are considered **closed loop systems**. This means that they are designed not to come in physical contact with one another. Rather, the cooling water in each loop transfers heat energy by **convection**. Convection is a method of **heat transfer** that can occur between two fluid media. It is the same process by which radiators are used to heat homes. The water circulating inside the radiator is separated from the air (a "fluid" medium) by the metal piping.

## The Turbine Generator

The turbine, main generator, and the condenser are all housed in what is commonly referred to as the **Turbine Building**. The purpose of the **turbine** is to convert the **thermal energy** of the steam produced in the steam generator (referred to as **main steam**, red in Figure 7) to **rotational energy** of the turbine generator shaft. The turbine at Davis-Besse is actually composed of one six-stage high-pressure turbine and two seven-stage low-pressure turbines aligned on a common shaft. A **turbine stage** refers to a set of blades. Steam enters at the center of each turbine and moves outward along the shaft in opposite directions through each successive stage of blading. As the steam passes over the turbine blades, it loses pressure. Thus, the blades must be proportionally larger in successive stages to extract enough energy from the steam to rotate the shaft at the correct speed.

The purpose of the **main generator** is to convert the rotational energy of the shaft to **electrical energy** for commercial usage and support of station systems. The main generator is composed of two parts, a stationary **stator** that contains coils of copper conductors, and a **rotor** that supplies a rotating magnetic field within the coils of the stator. Electrical current is generated in the stator portion of the main generator. From this point, the electric current passes through a series of **transformers** for transmission and use throughout northern Ohio.

## The Condenser

After the spent steam in the secondary loop (blue in Figure 7) passes through the High and Low Pressure Turbines, it is collected in the **condenser, which is** several stories tall and contains more than 70,000 small tubes. **Circulating Water** (yellow in Figure 7) goes to the **Cooling Tower** after passing through the tubes inside the Condenser. As the steam from the Low Pressure Turbines passes over these tubes, it is cooled and condensed. The condensed water is then purified and reheated before being circulated back into the steam generator again in a closed loop system. Circulating water forms the third (or **tertiary**) and final loop of cooling water used at the Davis-Besse Station.

Similar to the primary to secondary interface, the secondary-to-tertiary interface is based on a closed-loop design. The Circulating Water, which is pumped through the tubes in the Water Box, is able to cool the water in the Condenser by the processes of conduction and convection. Even in the event of a primary-to-secondary leak, the water vapor exiting the Davis-Besse Cooling Tower would remain non-radioactive. Closed loops are an integral part of the design of any nuclear facility. This feature greatly reduces the chance of environmental impact from Station operation.

## The Cooling Tower

The Cooling Tower at Davis-Besse is easily the most noticeable feature of the plant. The tower stands 493 feet high and the diameter of the base is 411 feet. Two nine-foot diameter pipes circulate 480,000 gallons of water per minute to the tower. Its purpose is to recycle water from the Condenser by cooling and returning it.

After passing through the Condenser, the Circulating Water has warmed to approximately 100°F. In order to cool the water back down to 70°F, the Circulating Water enters the Cooling Tower forty feet above the ground. It is then sprayed evenly over a series of baffles called fill sheets, which are suspended vertically in the base of the tower. A natural draft of air is swept upward through these baffles and cools the water by evaporation. The evaporated water exits the top of the Cooling Tower as water vapor.

As much as 10,000 gallons of water per minute are lost to the atmosphere via the **Cooling Tower**. Even so, approximately 98 percent of the water drawn from Lake Erie for station operation can be recycled through the Cooling Tower for reuse. A small portion of the Circulating Water is discharged back to Lake Erie at essentially the same temperature it was withdrawn earlier. The slightly warmer water has no adverse environmental impact on the area of lake surrounding the discharge point.

## Miscellaneous Station Safety Systems

The orange system in Figure 7 is part of the **Emergency Core Cooling System (ECCS)** housed in the **Auxiliary Building** of the station. The ECCS consists of three overlapping means of keeping the reactor core covered with water, in the unlikely event of a Loss-of-Coolant Accident (LOCA), thereby protecting the fuel cladding barrier against high-temperature failure. Depending on the severity of the loss of pressure inside the Primary System, the ECCS will automatically channel borated water into the Reactor by using **High Pressure Injection Pumps**, a **Core Flood Tank**, or **Low Pressure Injection Pumps**. Borated water can also be sprayed from the ceiling of the Containment Vessel to cool and condense any steam that escapes the Primary System.

The violet system illustrated in Figure 7 is responsible for maintaining the Primary Coolant water in a liquid state. It accomplishes this by adjusting the pressure inside the Primary System. Heaters inside the **Pressurizer** turn water into steam. This steam takes up more space inside the Pressurizer, thereby increasing the overall pressure inside the Primary System. The Pressurizer is equipped with spray heads that shower cool water over the steam in the unit. In this case, the steam condenses and the overall pressure inside the Primary System drops. The **Quench Tank** pictured in Figure 8 is simply where excess steam is directed and condensed for storage.

The scarlet system in Figure 7 is part of the **Auxiliary Feedwater System**, a key safety system in event the main feedwater supply (blue in Figure 7) to the Steam Generator is lost. Following a reactor shutdown, the Auxiliary Feedwater System can supply water to the Steam Generators from the **Condensate Storage Tanks**. The Auxiliary Feedwater System is housed in the Turbine Building along with the Turbine, Main Generator, and the Condenser.

## Reactor Safety and Summary

Nuclear power plants are inherently safe, not only by the laws of physics, but by design. Nuclear power plants cannot explode like a bomb, because the concentration of fissionable material is far less than is necessary for such a nuclear explosion. Also, many safety features are equipped with several backup systems to ensure that any possible accident would be prevented from causing a serious health or safety threat to the public, or serious impact on the local environment. Davis-Besse, like all U.S. nuclear units, has many overlapping, or redundant safety features. If one system should fail, there are still back-up systems to assure the safe operation of the Station. During normal operation, the **Reactor Control System** regulates the power output by adjusting the position of the control rods. The Reactor can be automatically shut down by a separate **Reactor Protection System**, which causes all the control rod assemblies to be quickly and completely inserted into the Reactor core, stopping the chain reaction. To guard against the possibility of a Loss of Coolant Accident, the Emergency Core Cooling System is designed to pump reserve water into the reactor automatically if the reactor coolant pressure drops below a predetermined level.

The Davis-Besse Nuclear Power Station was designed, constructed, and operates to produce a reliable, safe, and environmentally sound source of electricity.

## Radioactive Waste

Many of the activities we depend on in our everyday lives produce radioactive waste by-products. Nuclear energy, industrial processes, and medical treatments are some of these activities. These by-products are managed and disposed of under strict requirements set by the federal government. With the exception of used nuclear fuel assemblies, these by-products produced at commercial power plants are referred to as low level radioactive waste.

### Low Level Radioactive Waste

Low level radioactive waste consists mainly of ordinary trash and other items that have become contaminated with radioactive materials. It includes plastic gloves and other protective clothing, machine parts and tools, medical and laboratory equipment, filters, resins, and general scrap.

The radioactive material in low level radioactive waste emits the same types of radiation that naturally occurring radioactive materials tend to emit. Most low level activity in radioactive waste decay to background levels within months or years. Nearly all activity diminishes to stable materials in less than 300 years.

Davis-Besse currently ships low-level radioactive waste to facilities in South Carolina and Tennessee for waste minimization processing prior to disposal. Davis-Besse has the capacity to store low-level waste produced on site for several years in the Low Level Radioactive Waste Storage Facility (LLRWSF), should these facilities close.

## High Level Nuclear Waste

Like any industrial or scientific process, nuclear energy does produce waste. The most radioactive is defined as "high-level" waste (because it has high levels of radioactivity). Ninety-nine percent of high-level waste from nuclear plants is used nuclear fuel. The fuel undergoes certain changes during fission. Most of the fragments of fission, pieces that are left over after the atom is split, are radioactive. After a period of time, the fission fragments trapped in the fuel assemblies reduce the efficiency of the chain reaction. The oldest fuel assemblies are removed from the reactor and replaced with fresh fuel at 18-24 month intervals.

High-level nuclear waste volumes are small. Davis-Besse produces about 30 tons of used fuel every 24 months. All the used fuel produced by all America's nuclear energy plants since the first plant started operating over 30 years ago would cover an area the size of a football field about five yards deep. All of America's nuclear plants combined produce only 3,000 tons of used fuel each year. By contrast, the U.S. produces about 300,000,000 tons of chemical waste annually. Also, nuclear waste slowly loses its radioactivity, but some chemical waste remains hazardous indefinitely.

Davis-Besse presently stores most of its used fuel in a steel-lined water-filled concrete vault inside the plant. The Department of Energy is charged with constructing a permanent high-level waste repository for all of the nation's nuclear plants. By law, the Department of Energy was required to accept fuel from utilities by the end of 1998. Currently, Yucca Mountain, Nevada, is being considered as a possible site. Until the permanent DOE site is developed, nuclear plants will be responsible for the continued safe storage of high-level waste. At Davis-Besse, the fuel pool reached its capacity in 1996. At the end of 1996, Davis-Besse began the process of moving the older fuel assemblies that no longer require water cooling to air-cooled concrete shielded canisters. These will remain onsite until the Department of Energy facilities are ready to receive them. Dry fuel storage is already used in many countries, including Canada, and in the U.S. at nuclear plants in Arkansas, Colorado, Maryland, Michigan, Minnesota, Virginia, Wisconsin and South Carolina. Figure 8 illustrates the Dry Fuel Storage module arrangement at Davis-Besse.

In 2001, work was performed to increase the storage capacity of the Spent Fuel Pool. The pool remains the same size, however, removing old storage racks and replacing them with new ones changed the configuration of storage, and allows the site to safely hold all the fuel used during its 40 years of expected life. This modification was completed in April of 2002.

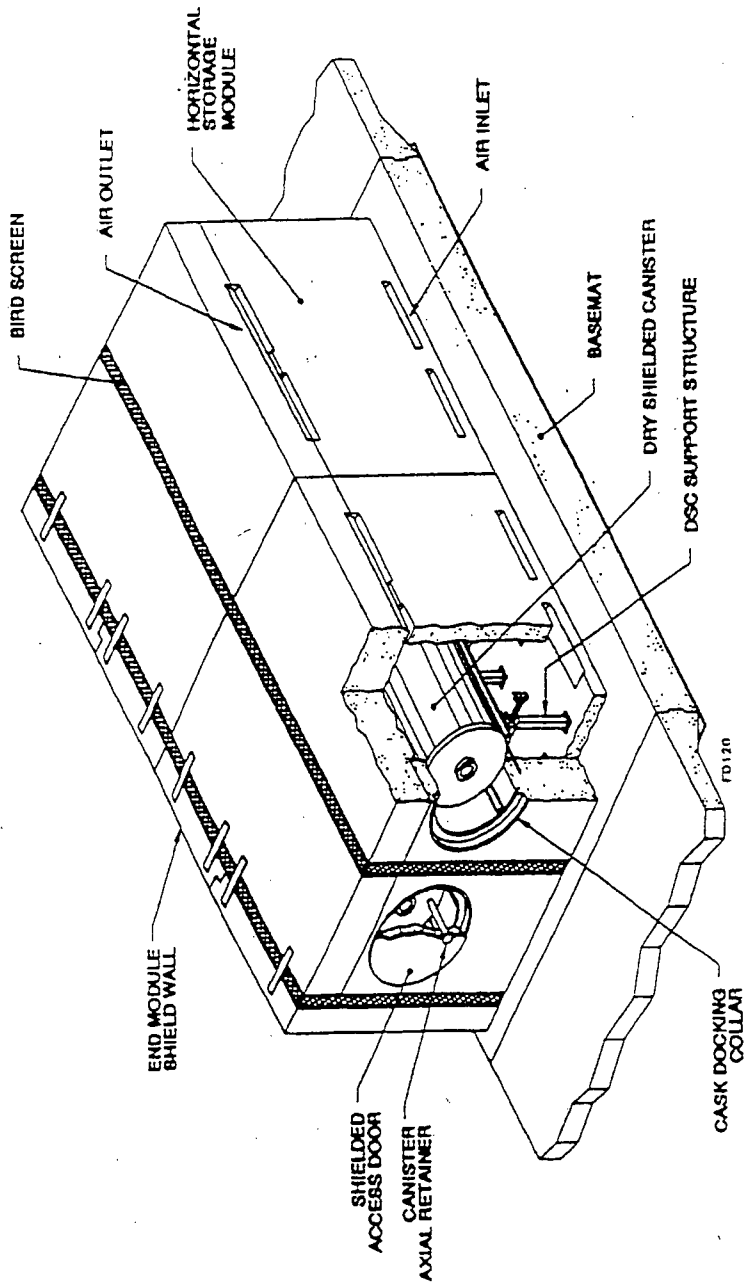

Figure 8: Dry Fuel Storage Module Arrangement



## Description of the Davis-Besse Site

The Davis-Besse site is located in Carroll Township of Ottawa County, Ohio. It is on the southwestern shore of Lake Erie, just north of the Toussaint River. The site lies north and east of Ohio State Route 2, approximately 10 miles northwest of Port Clinton, 7 miles north of Oak Harbor, and 25 miles east of Toledo, Ohio (Figure 9).

This section of Ohio is flat and marshy, with maximum elevations of only a few feet above the level of Lake Erie. The area originally consisted of swamp forest and marshland, rich in wildlife but unsuitable for settlement and farming. During the nineteenth century, the land was cleared and drained, and has been farmed successfully since. Today, the terrain consists of farmland with marshes extending in some places for up to two miles inland from the Sandusky Lake Shore Ridge.

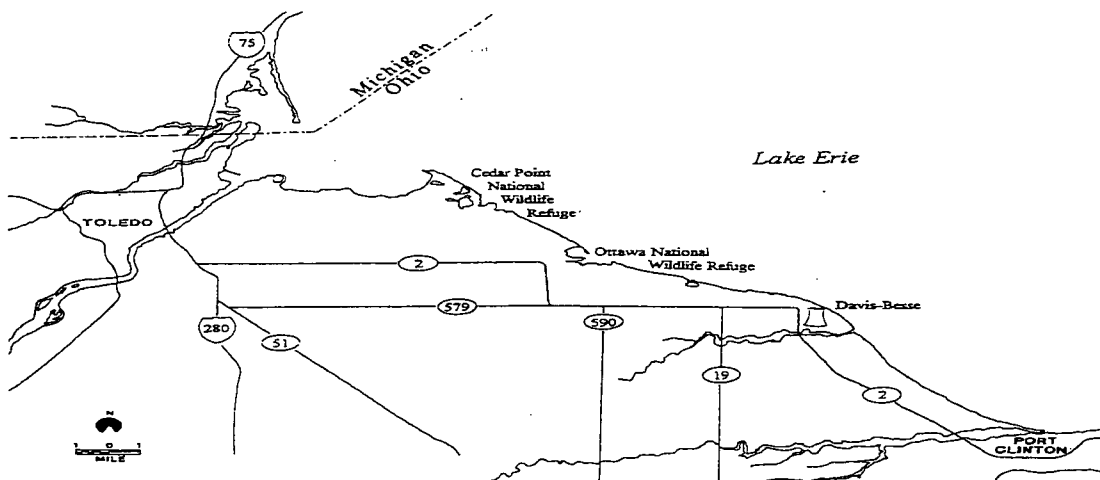

Figure 9: Davis-Besse is near Oak Harbor, Port Clinton, and the Ottawa National Wildlife Refuge.

The Davis-Besse site is mainly comprised of marshland, with a small portion consisting of farmland. The marshes are part of a valuable ecological resource, providing a breeding ground for a variety of wildlife, and a refuge for migratory birds. The site includes a tract known as Navarre Marsh, which was acquired from the U.S. Bureau of Sport Fisheries and Wildlife, Department of the Interior. In 1971, Toledo Edison purchased the 188-acre Toussaint River Marsh. The Toussaint River Marsh is contiguous with the 610-acre Navarre Marsh section of the Ottawa National Wildlife Refuge.

The immediate area near Davis-Besse is sparsely populated. The year 2000 Census listed the population of Ottawa County at 40,985. The incorporated communities nearest to Davis-Besse are:

- Port Clinton - 10 miles southeast, population 6,391
- Oak Harbor - 7 miles south, population 2,841
- Rocky Ridge - 7 miles west southwest, population 389
- Toledo (nearest major city) - 25 miles west, population 313,619

There are some residences along the lakeshore used mainly as summer homes. However, the major resort area of the county is farther east, around Port Clinton, Lakeside, and the Bass Islands.

The majority of non-marsh areas around the Davis-Besse site are used for farming. The major crops include soybeans, corn, wheat, oats, hay, fruits and vegetables. Meat and dairy animals are not major sources of income in the area. The main industries within five miles of the site are located in Erie Industrial Park, about four miles southeast of the station.

Most of the remaining marshes in the area have been maintained by private hunting clubs, the U.S. Fish and Wildlife Service, and the Ohio Department of Natural Resources, Division of Wildlife. The State of Ohio Department of Natural Resources operates many wildlife and recreational areas within 10 miles of the Station. These include Magee Marsh, Turtle Creek, Crane Creek State Park, and the Ottawa National Wildlife Refuge. Magee Marsh and Turtle Creek lie between three and six miles WNW of the Station. Magee Marsh is a wildlife preserve that allows public fishing, nature study, and a controlled hunting season. Turtle Creek, a wooded area at the southern end of Magee Marsh, offers boating and fishing. Crane Creek State Park is adjacent to Magee Marsh, and is a popular birding and hunting area. The Ottawa National Wildlife Refuge lies four to nine miles WNW of the Site, immediately west of Magee Marsh.

## References

1. "Basic Radiation Protection Criteria," Report No. 39, National Council on Radiation Protection and Measurement, Washington, D.C. (January 1971).
2. "Cesium-137 from the Environment to Man: Metabolism and Dose," Report No. 52, National Council on Radiation Protection and Measurements, Washington, D.C. (January 1977).
3. Deutch, R., "Nuclear Power, A Rational Approach," Fourth edition, GP Courseware, Inc., Columbia, MD. (1987).
4. Eisenbud, M., "Environmental Radioactivity," Academic Press, Inc., Orlando, FL. (1987).
5. "Environmental Radiation Measurements," Report No. 50, National Council on Radiation Protection and Measurements, Washington, D.C. (December 1976).
6. "Exposure of the Population in the United States and Canada from Natural Background Radiation," Report No. 94, National Council on Radiation Protection and Measurements, Washington, D.C. (December 1987).
7. "Health Effects of Exposure to Low Levels of Ionizing Radiation: BEIR V," Committee on the Biological Effects of Ionizing Radiations, Board on Radiation Effects Research Commission on Life Sciences, National Research Council, National Academy Press, Washington, D.C. (1990).
8. Hendee, William R., and Doege, Theodore C., "Origin and Health Risks of Indoor Radon," Seminars in Nuclear Medicine, Vol. XVIII, No. 1, American Medical Association, Chicago, IL. (January 1987).
9. Hurley, P., "Living with Nuclear Radiation," University of Michigan Press, Ann Arbor, MI. (1982).
10. "Indoor Air Quality Environmental Information Handbook: Radon," prepared for the United States Department of Energy, Assistant Secretary for Environment, Safety and Health, by Mueller Associated, Inc., Baltimore, MD. (January 1986).
11. Introduction to Davis-Besse Nuclear Power Station Plant Technology, July 1992, Rev. 4, Pg.2-9.
12. "Ionizing Radiation Exposure of the Population of the United States," Report No. 93, National Council on Radiation Protection and Measurements, Washington, D.C. (September 1987).
13. "Natural Background Radiation in the United States," Report No. 45, National Council on Radiation Protection and Measurements, Washington, D.C. (November 1975).

14. "Nuclear Energy Emerges from 1980's Poised for New Growth," U.S. Council for Energy Awareness, Washington, D.C. (1989).
15. "Nuclear Power: Answers to Your Questions," Edison Electric Institute, Washington, D.C. (1987).
16. "Public Radiation Exposure from Nuclear Power Generation in the United States," Report No. 92, National Council on Radiation Protection and Measurement, Washington, D.C. (December 1987).
17. "Radiation Protection Standards," Department of Environmental Sciences and Physiology and the Office of Continuing Education, Harvard School Of Public Health, Boston, MA. (July 1989).
18. "Radiological Environmental Monitoring Report for Three Mile Island Station," GPU Nuclear Corporation, Middletown, PA. (1985).
19. "Sources, Effects and Risk of Ionizing Radiation," United Nations Scientific Committee on the Effects of Atomic Radiation, 1988 Report to the General Assembly, United Nations, New York (1988).
20. "Standards for Protection Against Radiation," Title 10, Part 20, Code of Federal Regulation, Washington, D.C. (1988).
21. "Domestic Licensing of Production and Utilization Facilities," Title 10, Part 50, Code of Federal Regulations, Washington, D.C. (1988).
22. "Environmental Radiation Protection Standard for Nuclear Power Operations," Title 40, Part 190, Code of Federal Regulations, Washington, D.C. (1988).
23. "Tritium in the Environment," Report No. 62, National Council on Radiation Protection and Measurement, Washington, D.C. (March 1979).
24. Site Environmental Report, Fernald Environmental Management Project, United States Department of Energy (June 1993).
25. "Exposure from the Uranium Series with Emphasis on Radon and its Daughters" Report No. 77, National Council on Radiation Protection and Measurements, Washington, D.C. (1984).
26. "Evaluation of Occupational and Environmental Exposures to Radon and Radon daughter in the United States," Report No. 78, National Council on Radiation Protection and Measurements, Washington, D.C. (1984).



## Radiological Environmental Monitoring Program

# Radiological Environmental Monitoring Program

---

## Introduction

The **Radiological Environmental Monitoring Program (REMP)** was established at Davis-Besse for several reasons: to provide a supplementary check on the adequacy of containment and effluent controls, to assess the radiological impact of the Station's operation on the surrounding area, and to determine compliance with applicable radiation protection guides and standards. The REMP was established in 1972, five years before the Station became operational. This **pre-operational surveillance program** was established to describe and quantify the radioactivity, and its variability, in the area prior to the operation of Davis-Besse. After Davis-Besse became operational in 1977, the **operational surveillance program** continued to measure radiation and radioactivity in the surrounding areas.

A variety of environmental samples are collected as part of the REMP at Davis-Besse. The selection of sample types is based on the established critical pathways for the transfer of radionuclides through the environment to humans. The selection of sampling locations is based on sample availability, local meteorological and hydrological characteristics, local population characteristics, and land usage in the area of interest. The selection of sampling frequencies for the various environmental media is based on the radionuclides of interest, their respective half-lives, and their effect in both biological and physical environments.

A description of the REMP at Davis-Besse is provided in the following section. In addition, a brief history of analytical results for each sample type collected since 1972, and a more detailed summary of the analyses performed during this reporting period, is also provided.

## Pre-operational Surveillance Program

The federal government requires nuclear facilities to conduct radiological environmental monitoring prior to constructing the facility. This pre-operational surveillance program is for the collection of data needed to identify critical pathways, including selection of radioisotope and sample media combinations for the surveillance conducted after facility operations begin. Radiochemical analyses performed on samples should include nuclides that are expected to be released during normal facility operations, as well as typical fallout radionuclides and natural background radioactivity. All environmental media with a potential to be affected by facility operation, as well as those media directly in the critical pathways, should be sampled during the pre-operational phase of the environmental surveillance program.

The pre-operational surveillance design, including nuclide/media combinations, sampling frequencies and locations, collection techniques, and radiochemical analyses performed, should be carefully considered and incorporated in the design of the operational surveillance program. In

this manner, data can be compared in a variety of ways (for example: from year to year, location to location, etc.) in order to detect any radiological impact the facility has on the surrounding environment. Data collection during the pre-operational phase should be planned to provide a comprehensive database for evaluating any future changes in the environment surrounding the nuclear facility.

Davis-Besse began its pre-operational environmental surveillance program five years before the Station began producing power for commercial use in 1977. Data accumulated during that time provides an extensive database from which Station personnel are able to identify trends in the radiological characteristics of the local environment. The environmental surveillance program at Davis-Besse will continue after the Station has reached the end of its economically useful life and decommissioning has begun.

## Operational Surveillance Program Objectives

The operational phase of the environmental surveillance program at Davis-Besse was designed with the following objectives in mind:

- to fulfill the obligations of the radiological surveillance sections of the Station's Technical Specifications and Offsite Dose Calculation Manual
- to determine whether any significant increase in the concentration of radionuclides in critical pathways occurs
- to identify and evaluate the buildup, if any, of radionuclides in the local environment, or any changes in normal background radiation levels
- to verify the adequacy of Station controls for the release of radioactive materials

## Quality Assurance

An important part of the environmental monitoring program at Davis-Besse is the **Quality Assurance (QA) Program**, which is conducted in accordance with the guidelines specified in NRC Regulatory Guide 4.15, "Quality Assurance for Radiological Monitoring Programs". The QA Program is designed to identify possible deficiencies in the REMP so that corrective actions can be initiated promptly. Davis-Besse's Quality Assurance program also provides confidence in the results of the REMP through:

- performing regular audits (investigations) of the REMP, including a careful examination of sample collection techniques and record keeping
- performing audits of contractor laboratories which analyze the environmental samples
- requiring analytical contractor laboratories to participate in the United States Environmental Protection Agency Cross Check Program
- requiring analytical contractor laboratories to split samples for separate analysis followed by a comparison of results
- splitting samples prior to analysis by independent laboratories, and then comparing the results for agreement

- requiring analytical contractor laboratories to perform in-house spiked sample analyses

Quality Assessment audits and inspections of the Davis-Besse REMP are performed by the FirstEnergy Nuclear Operating Company QA Department and the NRC. In addition, the Ohio Department of Health (ODH) also performs independent environmental monitoring in the vicinity of Davis-Besse. The types of samples collected and list of sampling locations used by the ODH was incorporated in Davis-Besse's REMP, and the analytical results from their program can be compared to Davis-Besse's. This practice of comparing results from identical samples, which are collected and analyzed by different parties, provides a valuable tool to verify the quality of the laboratories' analytical procedures and data generated.

In 1987, environmental sampling personnel at Davis-Besse incorporated their own QA program into the REMP. Duplicate samples, called quality control samples, were collected at several locations. These duplicate samples were assigned different identification numbers than the numbers assigned to the routine samples. This ensured that the analytical laboratory would not know the samples were identical. The laboratory results from analysis of the quality control samples and the routine samples could then be compared for agreement. Quality control sampling has been integrated into the program and has become an important part of the REMP since 1987. Quality control sampling locations are changed frequently in order to duplicate as many sampling locations as possible, and to ensure the contractor laboratory has no way of correctly pairing a quality control sample with its routine sample counterpart.

## Program Description

The Radiological Environmental Monitoring Program (REMP) at Davis-Besse is conducted in accordance with Title 10, Code of Federal Regulations, Part 50; Regulatory Guide 4.8; the Davis-Besse Nuclear Power Station Operating License, Sections 5.6.1 and 5.6.2 of Davis-Besse Improved Standard Technical Specifications, the Davis-Besse Offsite Dose Calculation Manual (ODCM) and Station Operating Procedures. Samples are collected weekly, monthly, quarterly, semiannually, or annually, depending upon the sample type and nature of the radionuclides of interest. Environmental samples collected by Davis-Besse personnel are divided into four general types:

- **atmospheric** -- including samples of airborne particulate and airborne radio-iodine
- **terrestrial** -- including samples of milk, groundwater, broad leaf vegetation, fruits, animal/wildlife feed, soil, and wild and domestic meat
- **aquatic** -- including samples of treated and untreated surface water, fish, and shoreline sediments
- **direct radiation** -- measured by thermoluminescent dosimeters

All environmental samples are labeled using a sampling code. Table 2 provides the sample codes and collection frequency for each sample type.

REMP samples are collected onsite and offsite up to 25 miles away from the Station. Sampling locations may be divided into two general categories: indicator and control. Indicator locations are those which would be most likely to display the effects caused by the operation of Davis-



Besse, and are located within five miles of the station. Control locations are those which should be unaffected by Station operations, and are more than five miles from the Station. Data from indicator locations are compared with data from the control locations. This comparison allows REMP personnel to take into account naturally-occurring background radiation or fallout from weapons testing in evaluating any radiological impact Davis-Besse has on the surrounding environment. Data from indicator and control locations are also compared with pre-operational data to determine whether significant variations or trends exist.

Since 1987 the REMP has been reviewed and modified to develop a comprehensive sampling program adjusted to the current needs of the utility. Modifications have included additions of sampling locations above the minimum amount required in the ODCM and increasing the number of analyses performed on each sample. Besides adding new locations, duplicate or Quality Control (QC) sample collection was initiated to verify the accuracy of the lab analyzing the environmental samples. These additional samples are referred to as the REMP Enhancement Samples. Approximately 2,000 samples were collected and over 2,300 analyses were performed during 2008. In addition, 15% of the sampling locations were quality control sampling locations. Table 3 shows the number of the sampling location and number collected for each type.

Table 2: Sample Codes and Collection Frequencies

Sample Type	Sample Code	Collection Frequency
Airborne Particulate	AP	Weekly
Airborne Iodine	AI	Weekly
Thermoluminescent Dosimeter	TLD	Quarterly, Annually
Milk	MIL	Monthly (semi-monthly during grazing season)
Groundwater	WW	Quarterly
Broadleaf Vegetation	BLV	Monthly (when available)
Surface Water - Treated	SWT	Weekly
Surface Water - Untreated	SWU	Weekly
Fish	FIS	Annually
Shoreline Sediment	SED	Semiannually
Soil	SOI	Annually
Wildlife Feed	WFE	Annually
Meat-Wild	WME	Annually
Fruit	FRU	Annually

Table 3: Sample Collection Summary

Sample Type (Remarks)	Collection Type*/ Frequency**	Number of Locations	Number of Samples Collected	Number of Samples Missed
Atmospheric				
Airborne Particulates	C/W	10	519	1
Airborne Radioiodine	C/W	10	519	1
Terrestrial				
Milk (Jan.-Dec.)	G/M	1	12	0
Groundwater	G/Q**	3	9	0
Wild Meat	G/A	2	2	0
Broadleaf				
Vegetation	G/M	3	9	0
Fruit	G/A	3	3	0
Soil	G/A	10	10	0
Animal/Wildlife Feed	G/A	3	3	0
Aquatic				
Treated	Comp/WM	4	208	0
Surface Water	G/WM***	1	52	0
Untreated	G/WM***	3	156	0
Surface Water	Comp/WM	3	156	0
Fish (2 species)	G/A	2	6	0
Shoreline Sediments	G/SA	5	10	0
Direct Radiation				
Thermoluminescent	C/Q***	88	352	0
Dosimeters (TLD)	C/A***	88	88	0

\* Type of Collection: C = Continuous; G = Grab; Comp = Composite

\*\* Frequency of Collection: WM = Weekly composite Monthly; W = Weekly, M = Monthly; Q = Quarterly when available; SA = Semiannually; A = Annually

\*\*\* Includes quality control location. SWU and SWT QC included in weekly grab sample/composited monthly

## Sample Analysis

When environmental samples are analyzed, several types of measurements may be performed to provide information about the radionuclides present. The major analyses that are performed on environmental samples collected for the Davis-Besse REMP include:

**Gross beta analysis** measures the total amount of beta emitting radioactive material present in a sample. Beta radiation may be released by many different radionuclides. Since beta decay gives a continuous energy spectrum rather than the discrete lines or "peaks" associated with gamma radiation, identification of specific beta emitting nuclides is much more difficult. Therefore, gross beta analysis only indicates whether the sample contains normal or abnormal concentrations of beta emitting radionuclides; it does not identify specific radionuclides. Gross beta analysis merely acts as a tool to identify samples that may require further analysis.

**Gamma spectral analysis** provides more specific information than does gross beta analysis. Gamma spectral analysis identifies each gamma emitting radionuclide present in the sample, and the amount of each nuclide present. Each radionuclide has a very specific "fingerprint" that allows for swift and accurate identification. For example, gamma spectral analysis can be used to identify the presence and amount of Iodine-131 in a sample. Iodine-131 is a man-made radioactive isotope of Iodine that may be present in the environment as a result of fallout from nuclear weapons testing, routine medical uses in diagnostic tests, and routine releases from nuclear power stations.

**Tritium analysis** indicates whether a sample contains the radionuclide tritium (H-3) and the amount present. As discussed in the Introduction section, tritium is an isotope of Hydrogen that emits low energy beta particles.

**Strontium analysis** identifies the presence and amount of Strontium-89 and Strontium-90 in a sample. These man-made radionuclides are found in the environment as a result of fallout from nuclear weapons testing. Strontium is usually incorporated into the pool of the biosphere. In other words, it accumulates in living organisms, where it is stored in the bone tissue. The principal Strontium exposure pathway is via milk produced by cattle grazed on pastures exposed to deposition from airborne releases.

**Gamma Doses** measured by thermoluminescent dosimeters while in the field are determined by a special laboratory procedure. Table 4 provides a list of the analyses performed on environmental samples collected for the Davis-Besse REMP.

Often samples will contain little radioactivity, and may be below the lower limit of detection for the particular type of analysis used. The lower limit of detection (LLD) is the smallest amount of sample activity that can be detected with a reasonable degree of confidence at a predetermined level. When a measurement of radioactivity is reported as less than LLD (<LLD), it means that the radioactivity is so low that it cannot be accurately measured with any degree of confidence by a particular method for an individual analysis.

Table 4: Radiochemical Analyses Performed on REMP Samples

<b>Sample Type</b>	<b>Analyses Performed</b>
<b>Atmospheric Monitoring</b>	
Airborne Particulate	Gross Beta Gamma Spectroscopy Strontium-89 Strontium-90
Airborne Radioiodine	Iodine-131
<b>Terrestrial Monitoring</b>	
Milk	Gamma Spectroscopy Iodine-131 Strontium-89 Strontium-90 Stable Calcium Stable Potassium
Groundwater	Gross Beta Gamma Spectroscopy Tritium Strontium-89 Strontium-90
Broadleaf Vegetation and Fruits	Gamma Spectroscopy Iodine-131 Strontium-89 Strontium-90
Wildlife Feed	Gamma Spectroscopy
Soil	Gamma Spectroscopy
Wild Animal Meat	Gamma Spectroscopy

---

**Table 4: Radiochemical Analyses Performed on REMP Samples  
(continued)**

---

<b>Sample Type</b>	<b>Analyses Performed</b>
<b>Aquatic monitoring</b>	
Untreated Surface Water	Gross Beta Gamma Spectroscopy Tritium Strontium-89 Strontium-90
Treated Surface Water	Gross Beta Gamma Spectroscopy Tritium Strontium-89 Strontium-90 Iodine-131
Fish	Gross Beta Gamma Spectroscopy
Shoreline Sediment	Gamma Spectroscopy
<b>Direct Radiation Monitoring</b>	
Thermoluminescent Dosimeters	Gamma Dose

## Sample History Comparison

The measurement of radioactive materials present in the environment will depend on factors such as weather or variations in sample collection techniques or sample analysis. This is one reason why the results of sample analyses are compared with results from other locations and from earlier years. Generally, the results of sample analyses are compared with pre-operational and operational data. Additionally, the results of indicator and control locations are also compared. This allows REMP personnel to track and trend the radionuclides present in the environment, to assess whether a buildup of radionuclides is occurring and to determine the effects, if any, the operation of Davis-Besse is having on the environment. If any unusual activity is detected, it is investigated to determine whether it is attributable to the operation of Davis-Besse, or to some other source such as nuclear weapons testing.

## Atmospheric Monitoring

- **Airborne Particulates:** No radioactive particulates have been detected as a result of Davis-Besse's operation. Only natural and fallout radioactivity from nuclear weapons testing and the 1986 nuclear accident at Chernobyl have been detected.
- **Airborne Radioiodine:** Radioactive Iodine-131 fallout was detected in 1976, 1977, and 1978 from nuclear weapons testing, and in 1986 (0.12 to 1.2 picocuries per cubic meter) from the nuclear accident at Chernobyl.

## Terrestrial Monitoring:

- **Groundwater:** Tritium was not detected above the lower limit of detection during 2008 in any REMP samples.
- **Milk:** Iodine-131 from nuclear weapons testing fallout was detected in 1976 and 1977 at concentrations of 1.36 and 23.9 picocuries/liter respectively. In 1986, concentrations of 8.5 picocuries/liter were detected from the nuclear accident at Chernobyl. No Iodine-131 detected has been attributable to the operation of Davis-Besse.
- **Wild Meat:** Only naturally-occurring Potassium-40 and very low Cesium-137 from fallout activity has been detected in meat samples. Potassium-40 has ranged from 1.1 to 4.6 picocuries/gram weight (wet). Cesium-137 was detected in 1974, 1975, and 1981 due to fallout from nuclear weapons testing.
- **Broadleaf Vegetation and Fruits:** Only naturally-occurring radioactive material and material from nuclear weapons testing have been detected.
- **Soil:** Only natural background and material from nuclear weapons testing and the 1986 nuclear accident at Chernobyl have been detected.
- **Animal/Wildlife Feed:** Only natural background and material from weapons testing have been detected.

## Aquatic Monitoring

- **Surface Water (Treated and Untreated):** Historically, tritium has been detected sporadically at low levels in treated and untreated surface water at both Control and Indicator locations. During 2008 there were no samples of either Treated or Untreated Water that showed detectable tritium.
- **Fish:** Only natural background radioactive material and material from nuclear testing have been detected.
- **Shoreline Sediments:** Only natural background radiation, material from nuclear testing and the 1986 nuclear accident at Chernobyl have been detected.

## Direct Radiation Monitoring

- **Thermoluminescent Dosimeters (TLDs):** The annual gamma dose rates for the current reporting period recorded by TLDs averaged 65.8 millirem/year at Control locations, and 59.4 millirem/year at Indicator locations. No increase above natural

background radiation attributable to the operation of Davis-Besse has been observed.

## 2008 Program Anomalies

All ODCM-required samples were collected during 2008. Provided below is a description of sample collection irregularities:

- On March 10, ODCM-required air samplers T-1, T-2, and T-3 were without power for 8 hours due to scheduled maintenance. There were no radioactive gaseous batch releases or abnormal gaseous releases during the time the samplers were without power.
- On April 29, the air iodine/particulate sample at location T-7 (ODCM required) was missed due to an equipment malfunction. Enhancement sample T-9 was substituted in its place to fulfill the intent of the ODCM. Therefore, this is not considered a missed ODCM sample.

All other samples were collected as scheduled.

## Atmospheric Monitoring

### Air Samples

Environmental air sampling is conducted to detect any increase in the concentration of airborne radionuclides that may be inhaled by humans or serve as an external radiation source. Inhaled radionuclides may be absorbed from the lungs, gastrointestinal tract, or from the skin. Air samples collected by the Davis-Besse REMP include **airborne particulate** and **airborne radioiodine**.

Samples are collected weekly with low volume vacuum pumps, which draw a continuous sample through a glass fiber filter and charcoal cartridge at a rate of approximately one cubic foot per minute. Airborne particulate samples are collected on 47mm diameter filters. Charcoal cartridges are installed downstream of the particulate filters to sample for the airborne radioiodine.

The airborne samples are sent to an offsite contract laboratory for analysis. At the laboratory, the airborne particulate filters are stored for 72 hours before they are analyzed to allow for the decay of naturally-occurring short-lived radionuclides. However, due to the short half-life of iodine-131 (approximately eight days), the airborne radioiodine cartridges are analyzed upon receipt by the contract laboratory.



## Airborne Particulate

Davis-Besse has ten continuous air samplers that monitor for air particulate and iodine. There are six indicator locations including four around the site boundary (T-1, T-2, T-3, and T-4), one at Sand Beach (T-7), and another at a local farm (T-8). There are four control locations, Oak Harbor (T-9), Port Clinton (T-11), Toledo (T-12) and Crane Creek (T-27). Gross beta analysis is performed on each of the weekly samples.

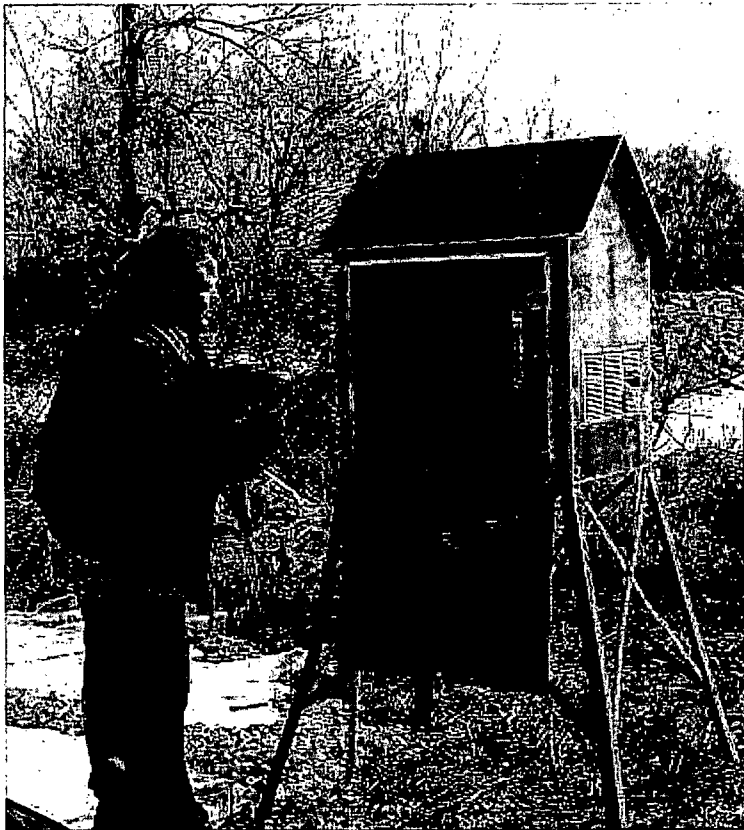

Each quarter, the filters from each location are combined (composite) and analyzed for gamma-emitting radionuclides, Strontium-89 and Strontium-90. Beta-emitting radionuclides were detected at both the indicator and control locations at average concentrations of  $0.026 \text{ pCi/m}^3$ . Beryllium-7 was the only gamma-emitting radionuclide detected by the gamma spectroscopic analysis of the quarterly composites.

Beryllium-7 is a naturally-occurring radionuclide produced in the upper atmosphere by cosmic radiation. No other gamma-emitting radionuclides were detected above their respective LLDs. Strontium-89 and Strontium-90 were not detected above their LLDs. These results show no adverse change in radioactivity in air samples attributable to the operation of the Davis-Besse Nuclear Power Station in 2008.

## Airborne Iodine-131

Airborne iodine-131 samples are collected at the same ten locations as the airborne particulate samples. Charcoal cartridges are placed downstream of the particulate filters. These cartridges are collected weekly, sealed in separate collection bags and sent to the laboratory for gamma analysis. There was no detectable iodine-131 above the LLD of 0.07 pCi/m<sup>3</sup>.

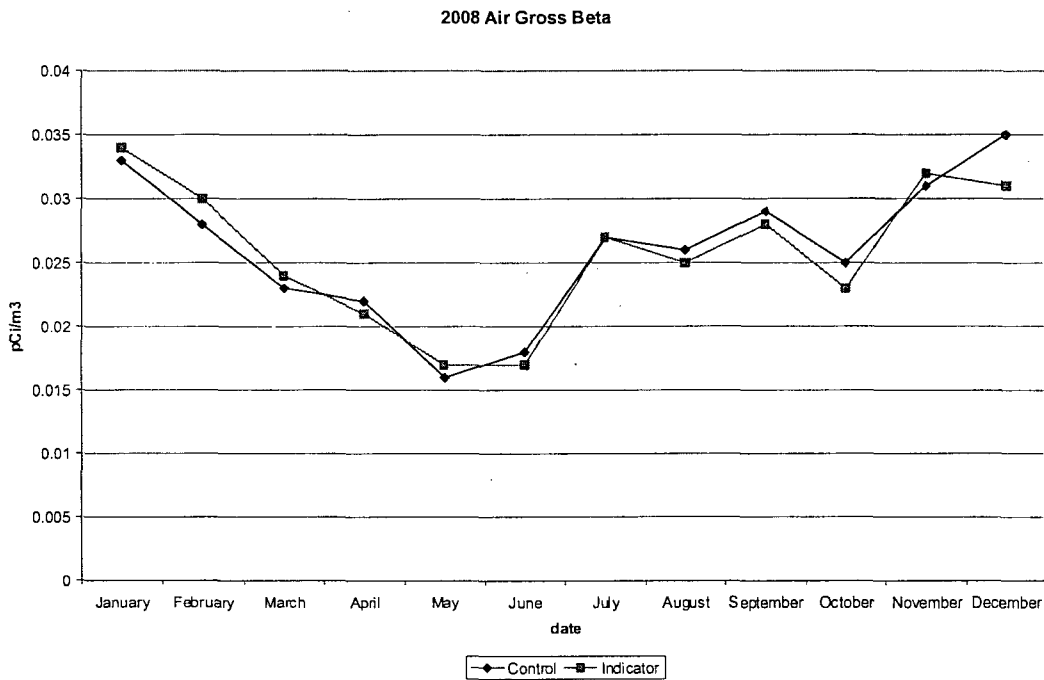

Figure 10. Concentrations of beta-emitting radionuclides in airborne particulate samples were nearly identical at indicator and control locations.

Table 5: Air Monitoring Locations

---

<b>Sample Location Number</b>	<b>Type of Location</b>	<b>Location Description</b>
T-1	I	Site boundary, 0.6 miles ENE of Station
T-2	I	Site boundary, 0.9 miles E of Station
T-3	I	Site boundary, 1.4 miles ESE of Station
T-4	I	Site boundary, 0.8 miles S of Station
T-7	I	Sand Beach, main entrance, 0.9 miles NW of Station
T-8	I	Earl Moore Farm, 2.7 miles WSW of Station
T-9	C	Oak Harbor Substation, 6.8 miles SW of Station
T-11	C	Port Clinton Water Treatment Plant, 9.5 miles SE of Station
T-12	C	Toledo Water Treatment Plant, 20.7 miles WNW of Station
T-27	C	Crane Creek State Park, 5.3 miles WNW of Station

---

I = Indicator C = Control

DAVIS-BESSE NUCLEAR POWER STATION RADIOLOGICAL ENVIRONMENTAL MONITORING PROGRAM  
AIR SAMPLES: SITE

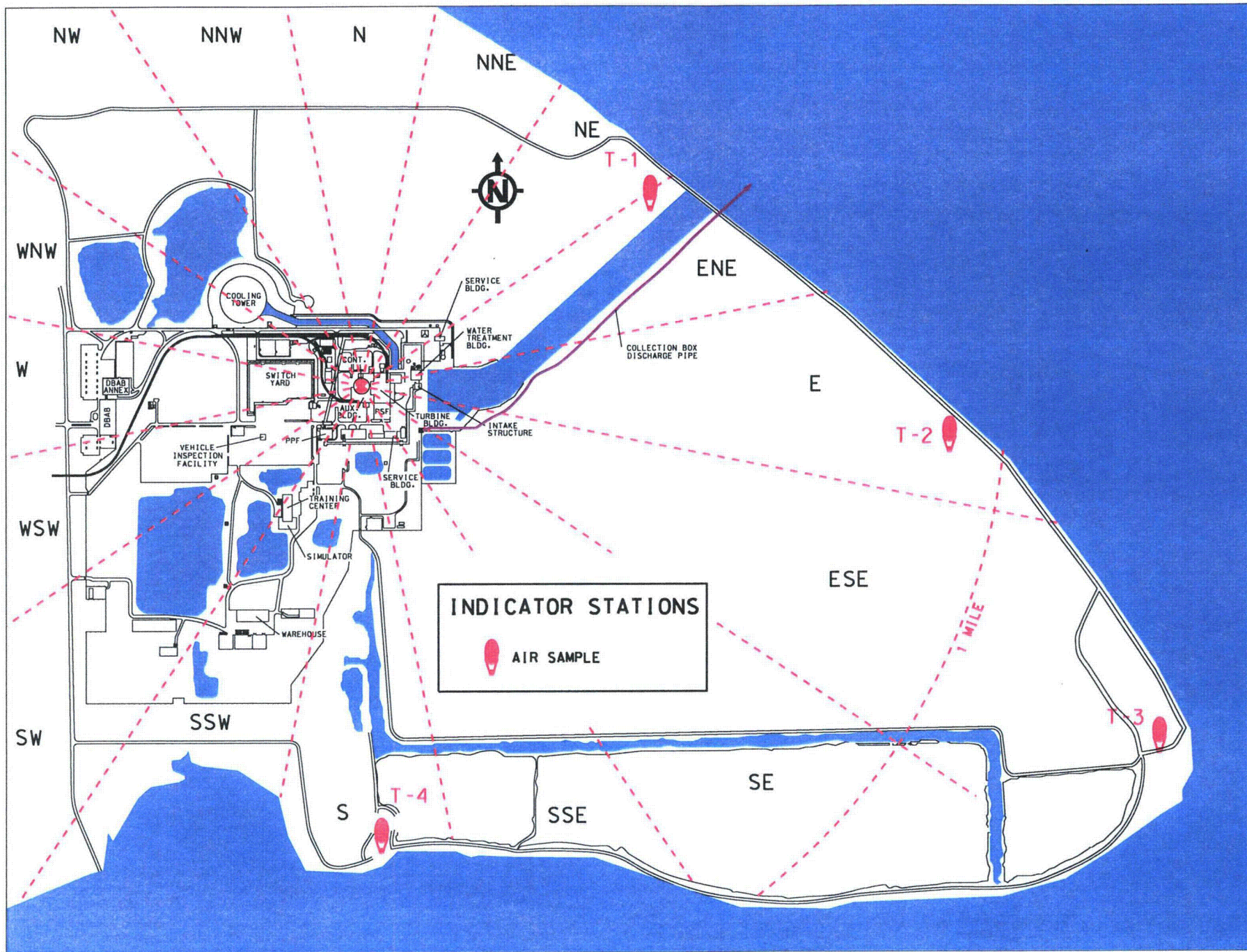
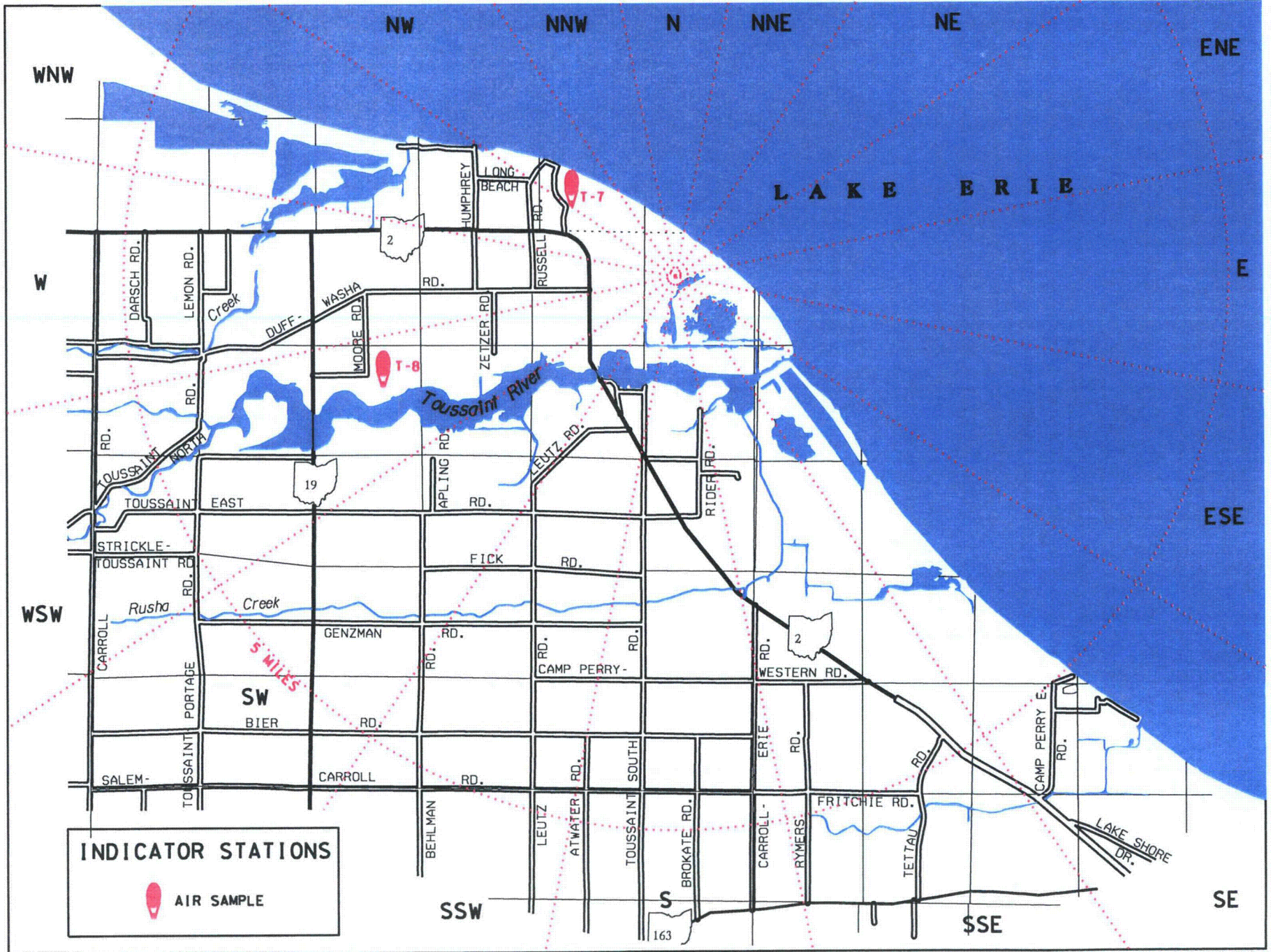

Figure 11: Air Sample Site Map



DAVIS-BESSE NUCLEAR POWER STATION RADIOLOGICAL ENVIRONMENTAL MONITORING PROGRAM  
 AIR SAMPLES: 5 MILE RADIUS



Davis-Besse Nuclear Power Station 2008 Annual Radiological Environmental Operating Report

Figure 12: Air Samples 5-mile Map



# DAVIS-BESSE NUCLEAR POWER STATION RADIOLOGICAL ENVIRONMENTAL MONITORING PROGRAM

AIR SAMPLES: 5-25 MILE RADIUS

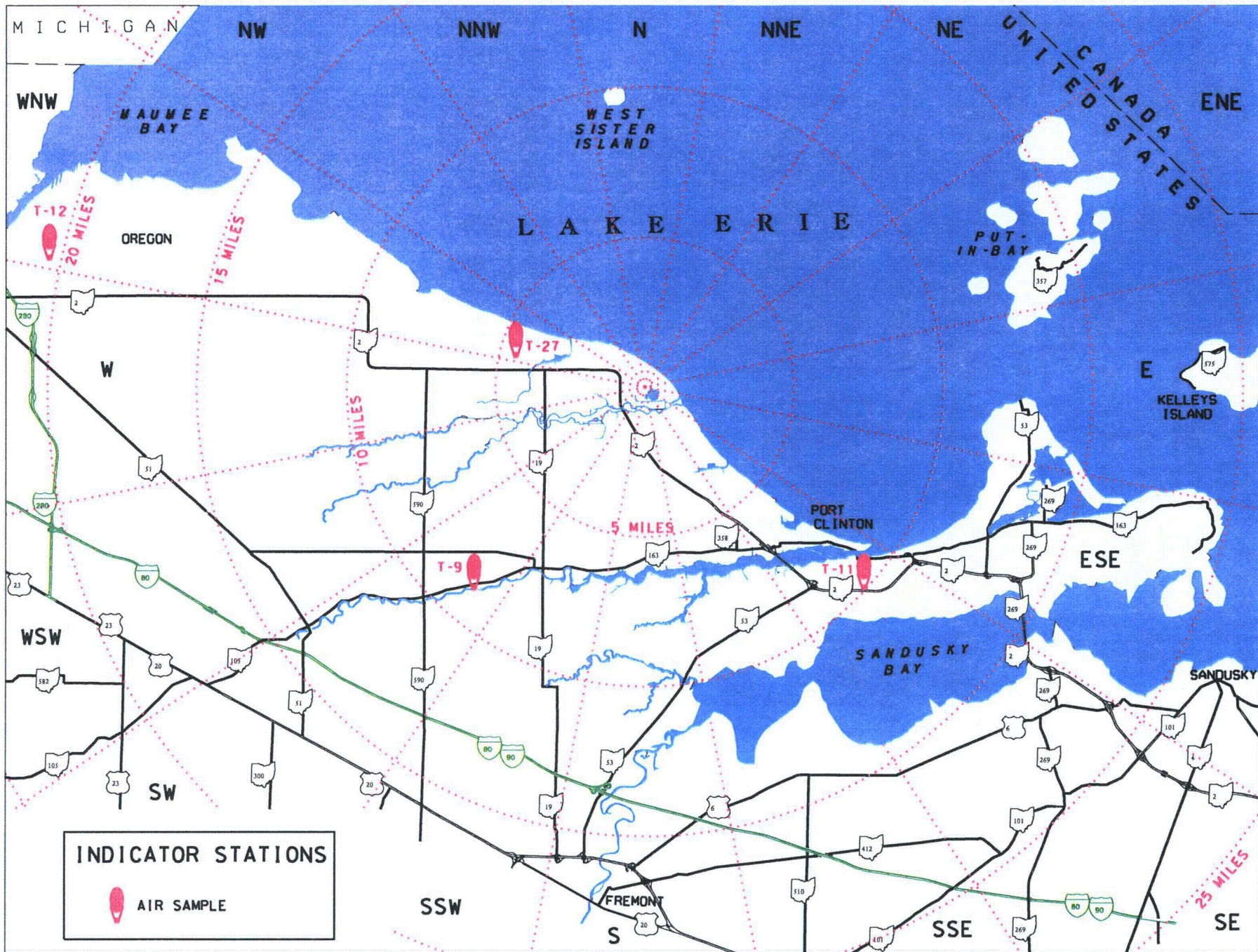

Figure 13: Air Sample 25-mile Map

## Terrestrial Monitoring

The collection and analysis of groundwater, milk, meat, fruits and broad leaf vegetation provides data to assess the buildup of radionuclides that may be ingested by humans. Animal and wildlife feed samples provide additional information on radionuclides that may be present in the food chain. The data from soil sampling provides information on the deposition of radionuclides from the atmosphere.

Many radionuclides are present in the environment due to sources such as cosmic radiation and fallout from nuclear weapons testing. Some of the radionuclides present are:

- **tritium**, present as a result of the interaction of cosmic radiation with the upper atmosphere and as a result of routine release from nuclear facilities
- **Beryllium-7**, present as a result of the interaction of cosmic radiation with the upper atmosphere
- **Cesium-137**, a manmade radionuclide which has been deposited in the environment, (for example, in surface soils) as a result of fallout from nuclear weapons testing and routine releases from nuclear facilities
- **Potassium-40**, a naturally occurring radionuclide normally found throughout the environment (including in the human body)
- **Fallout radionuclides** from nuclear weapons testing, including Strontium-89, Strontium-90, Cesium-137, Cerium-141, Cerium-144, and Ruthenium-106. These radionuclides may also be released in minute amounts from nuclear facilities

The radionuclides listed above are expected to be present in many of the environmental samples collected in the vicinity of the Davis-Besse Station. The contribution of radionuclides from the operation of Davis-Besse is assessed by comparing sample results with pre-operational data, operational data from previous years, control location data, and the types and amounts of radioactivity normally released from the Station in liquid and gaseous effluents.

### Milk Samples

Milk sampling is a valuable tool in environmental surveillance because it provides a direct basis for assessing the build up of radionuclides in the environment that may be ingested by humans. Milk is collected and analyzed because it is one of the few foods commonly consumed soon after production. The milk pathway involves the deposition of radionuclides from atmospheric releases onto forage consumed by cows. The radionuclides present in the forage-eating cow become incorporated into the milk, which is then consumed by humans.

When available, milk samples are collected at indicator and control locations once a month from November through April, and twice a month between May and October. Sampling is increased in the summer when the herds are usually outside on pasture and not on stored feed. In December of 1993, indicator location T-8 was eliminated from the sampling program, and no other indicator milk site has existed since that time. The control location will continue to be sampled



monthly in order to gather additional baseline data. If any dairy animals are discovered within five miles of the station, efforts will be made to include them in the milk-sampling program as indicator sites.

The 2008 milk samples were analyzed for Strontium-89, Strontium-90, Iodine-131, other gamma-emitting radionuclides, stable Calcium and Potassium. A total of 12 milk samples were collected in 2008. Strontium-89 was not detected above its LLD of 1.0 pCi/l. The annual average concentration of Strontium-90 was 1.0 pCi/l. For all sample sites, the annual average concentration was similar to those measured in the previous years.

Iodine-131 was not detected in any of the milk samples above the LLD of 0.5 pCi/l. The concentrations of Barium-140 and Cesium-137 were below their respective LLDs in all samples collected.

Since the chemistries of Calcium and Strontium are similar, as are Potassium and Cesium, organisms tend to deposit Cesium radioisotopes in muscle tissue and Strontium radioisotopes in bones. In order to detect the potential environmental accumulation of these radionuclides, the ratios of the Strontium radioactivity (pCi/l) to the concentration of Calcium (g/l), and the Cesium radioactivity (pCi/l) compared to the concentration of Potassium (g/l) were monitored in milk. These ratios are compared to standard values to determine if buildup is occurring. No statistically significant variations in the ratios were observed.

---

**Table 6: Milk Monitoring Location**

---

<b>Sample Location Number</b>	<b>Type of Location</b>	<b>Location Description</b>
T-24	C	Toft Dairy, Sandusky, 21.0 miles SE of Station

---

C = Control

### **Groundwater Samples**

Soil acts as a filter and an ion exchange medium for most radionuclides. However, tritium and other radionuclides such as Ruthenium-106 have a potential to seep through the soil and could reach groundwater. Davis-Besse does not discharge its liquid effluents directly to the ground. In the past, REMP personnel sampled local wells on a quarterly basis to ensure early detection of any adverse impact on the local groundwater supplies due to Station operation. In addition, a quality control sample was collected at one of the wells each quarter. The groundwater samples were analyzed for beta-emitting radionuclides, tritium, Strontium-89, Strontium-90 and gamma-emitting radionuclides.

During the fall of 1998, the Carroll Township Water Plant began operation and offered residents a reliable source of high-quality, inexpensive drinking water. This facility has replaced all of the



drinking water wells near Davis-Besse, as verified by the Ottawa County Health Department, and the indicator groundwater sampling was discontinued for a year. Since that time, two beach wells were located within five miles of the Station. Although the residents are seasonal and only use the township system for their drinking water needs, these wells were added to our sampling program as Indicator locations. The gross beta averaged 2.1 pCi/l at Indicator site. The Control location is sampled as available at T-27, and the gross beta averaged 2.7 pCi/l gross beta for the year 2008. REMP Groundwater samples did not appear to be affected by the operation of the Davis-Besse Nuclear Power Station.

Gross Beta Ground Water 1982-2008

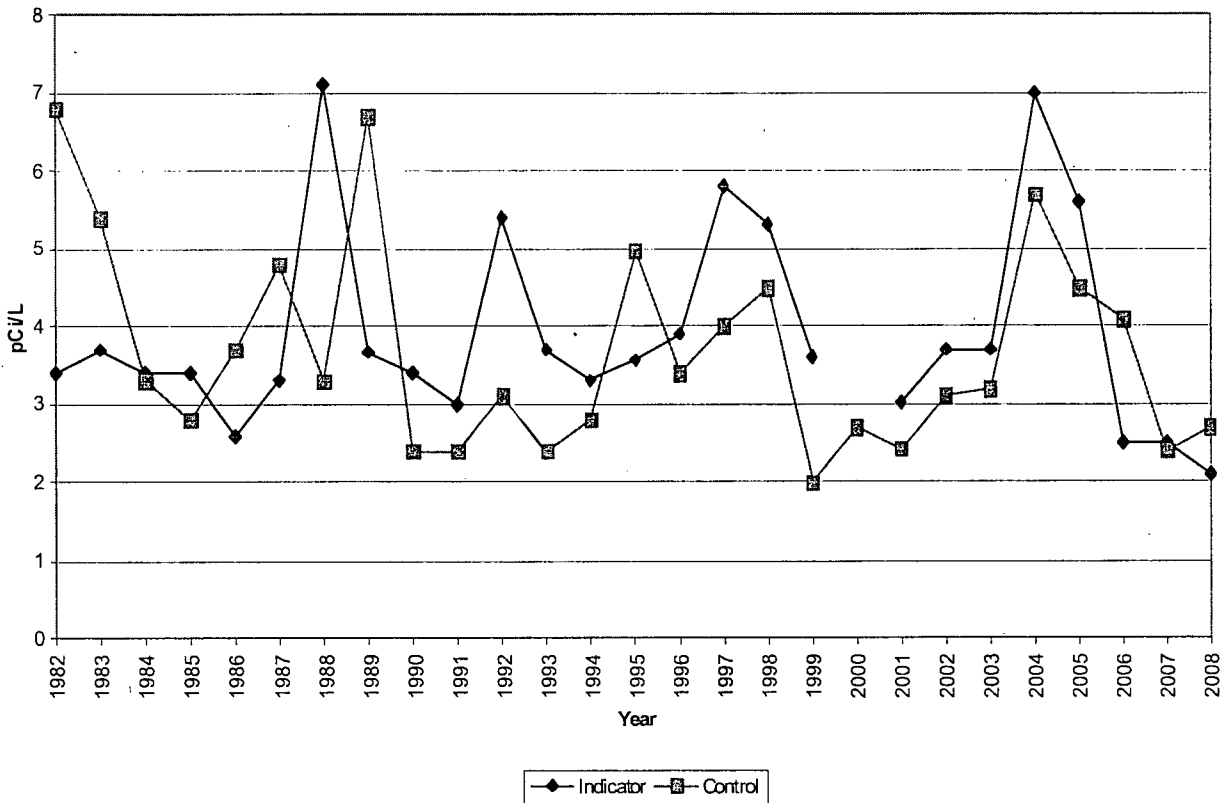

Figure 14: Shown above are the annual averages for gross beta in groundwater from 1982-2008. There were no known indicator samples available in 2000.

Table 7: Groundwater Monitoring Locations

Sample Location Number	Type of Location	Location Description
T-27	C	Crane Creek State Park, 5.3 miles WNW of Station
T-226	I	Allen residence, 1.6 miles NW of Station

C = control I = indicator

### Broadleaf Vegetation and Fruit Samples

Fruits and broadleaf vegetation also represent a direct pathway to humans. Fruits and broadleaf vegetation may become contaminated by deposition of airborne radioactivity (nuclear weapons fallout or airborne releases from nuclear facilities), or from irrigation water drawn from lake water which receives liquid effluents (hospitals, nuclear facilities, etc.). Radionuclides from the soil may be absorbed by the roots of the plants and become incorporated into the edible portions. During the growing season, edible broadleaf vegetation samples, such as kale and cabbage, are collected from gardens and farms in the vicinity of the Station. Fruit, such as apples, is collected from orchards in the vicinity of Davis-Besse.

In 2008, broadleaf vegetation samples were collected at two indicator locations (T-227 and T-19) and one control location (T-37). Fruit samples were collected at two indicator locations (T-8 and T-25) and one control location (T-209). Broadleaf vegetation was collected once per month during the growing season and consisted of cabbage. The fruit that was collected was apples. All samples were analyzed for gamma-emitting radionuclides, Strontium-89, Strontium-90, and Iodine-131.

Iodine-131 was not detected above the LLD of 0.022 pCi/g (wet) in any broadleaf vegetation nor above the LLD of 0.032 pCi/g (wet) in fruit samples. The only gamma-emitting radionuclide detected in the fruit and broadleaf vegetation samples was Potassium-40, which is naturally occurring. Results of broadleaf vegetation and fruit samples were similar to results observed in previous years. Neither Strontium 89 and Strontium 90 were detected in broadleaf or in apple samples. Operation of Davis-Besse had no observable adverse radiological effect on the surrounding environment in 2008.

Table 8: Broadleaf Vegetation and Fruit Locations

Sample Location Number	Type of Location	Location Description
T-8	I	Moore Farm, 2.7 miles WSW of Station
T-19	I	L. Bowyer Jr., 1.0 mile W of Station
T-25	I	Witt Farm, 1.6 miles S of Station
T-37	C	Bench Farm, 13.0 miles SW of Station
T-209	C	Roving Control Fruit location
T-227	I	Roving BLV location

I = indicator, C = control

#### Animal/Wildlife Feed Samples

Vegetation consumed by wildlife can provide an indication of airborne radionuclides deposited in the vicinity of the Station. Analyses of wildlife feed samples can also provide data for determining radionuclide concentration in the food chain. Wildlife feed samples are collected from the Navarre Marsh and from a local marsh within five miles of the Station. As in all terrestrial samples, naturally occurring Potassium-40, cosmic ray-produced radionuclides such as Beryllium-7, and fallout radionuclides such as Strontium 89 and Strontium 90 from nuclear weapons testing may be present in the feed samples.

Wildlife feed was collected at three locations (T-31, T-32 and T-198), and consisted of the edible portions of cattails. Samples were analyzed for gamma-emitting radionuclides. Naturally occurring Potassium-40 was detected in all samples. Beryllium-7 was detected at indicator location T-31 at 0.72 pCi/g (wet), and 0.27 pCi/g (wet) at the control location. All other radionuclides were below their respective LLDs. These samples indicate that the operation of Davis-Besse had no observable adverse effects on the surrounding environment.

Table 9: Animal/Wildlife Feed Locations

Sample Location Number	Type of Location	Location Description
T-31	I	Davis-Besse Navarre Marsh
T-32	C	Roving offsite location, 7.0 miles W of station in 2008
T-198	I	Toussaint Creek Wildlife Area, 4.0 miles WSW of the Station

I = indicator

C = control

### Wild Meat Samples

Sampling of wild meat provides information on environmental radionuclide concentrations that humans may be exposed to through an ingestion pathway. The principle pathways for radionuclide contamination of meat animals include deposition of airborne radioactivity in their food and drinking water and contamination of their drinking water from radionuclides released in liquid effluents.

The REMP generally collects wild meat on an annual basis. Wild animals commonly consumed by residents in the vicinity of Davis-Besse include waterfowl, deer, rabbits and muskrats. Analyses from these animals provide general information on radionuclide concentration in the food chain. When evaluating the results from analyses performed on meat animals, it is important to consider the age, diet and mobility of the animal before drawing conclusions from radionuclide concentrations in the local environment or in a species as a whole.

Meat samples were taken in 2008 as follows:

- Wild Meat: Muskrat samples were collected on Station property in Navarre Marsh and at a control location west of Crane Creek. The samples showed only naturally-occurring activity.

Table 10: Wild Meat Locations

Sample Location Number	Type of Location	Location Description
T-31	I	Onsite roving location
T-210	C	Roving offsite location (7.0 mi. W of the Station in 2008)

I = indicator C = control

### Soil Samples

Soil samples are generally collected once a year adjacent to our ten continuous air samplers. Only the top layer of soil is sampled in an effort to identify possible trends in the local environmental nuclide concentration caused by atmospheric deposition of fallout and station-released radionuclides. Generally, the sites are relatively undisturbed, so that the sample will be representative of the actual deposition in the area. Ideally, there should be little or no vegetation present, because the vegetation could affect the results of analyses. Approximately five pounds of soil are taken from the top two inches at each site. Many naturally occurring radionuclides such as Beryllium-7 (Be-7), Potassium-40 (K-40) and fallout radionuclides from nuclear weapons testing are detected. Fallout radionuclides that are often detected include Strontium-90 (Sr-90) and Cesium-137 (Cs-137).

Soil was collected at ten sites in 2008. The indicator locations included T-1, T-2, T-3, T-4, T-7, and T-8. The control locations were T-9, T-11, T-12, and T-27. All soil samples were analyzed for gamma-emitting radionuclides. The only gamma emitter detected (in addition to naturally occurring Be-7 and K-40) was Cs-137. Cs-137 was found in Indicator and Control locations at average concentrations of 0.13 pCi/g (dry) and 0.12 pCi/g (dry), respectively. The concentrations were similar to that observed in previous years (Figure 15).

Cs-137 in Soil 1972-2008

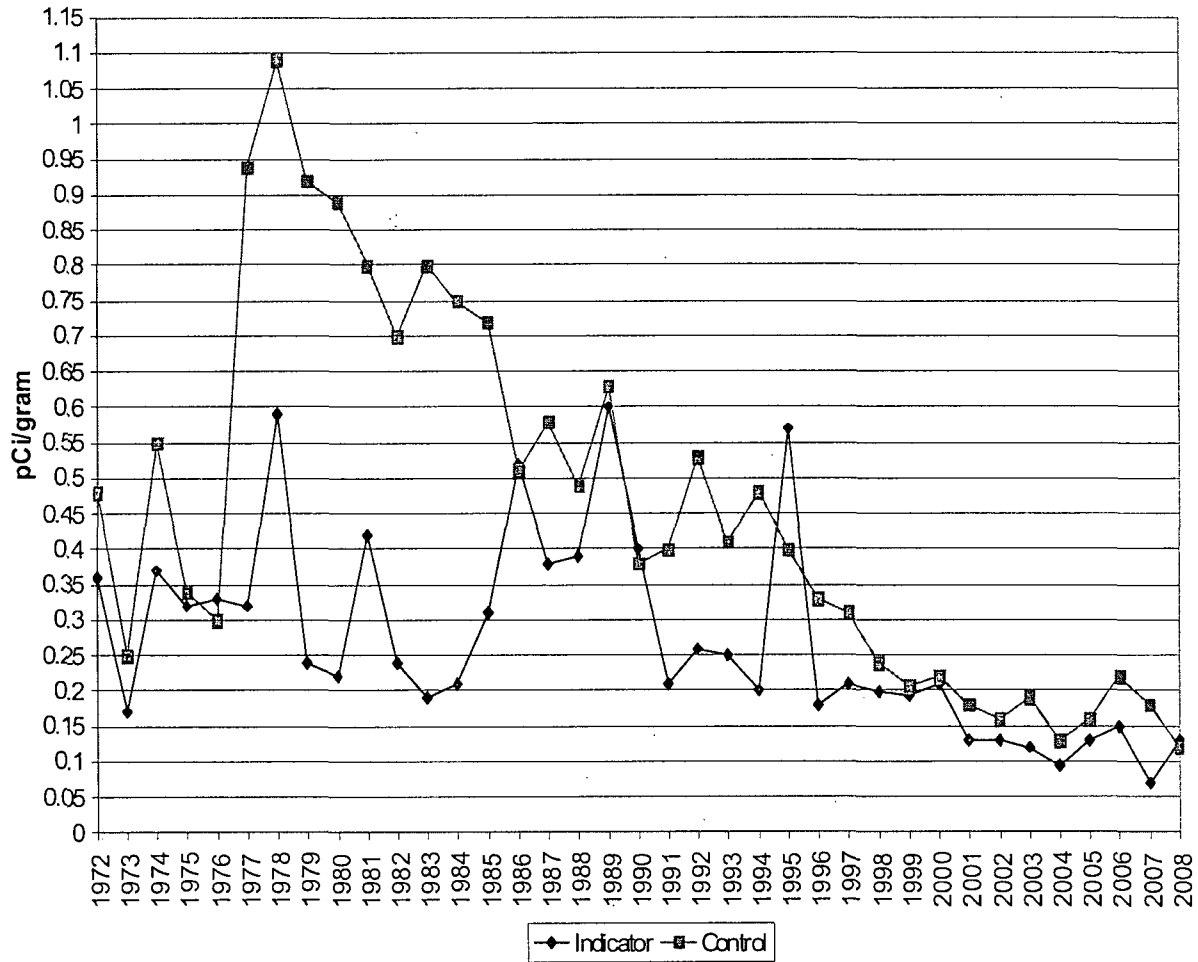

Figure 15: The concentration of Cesium-137 in soil has steadily declined in recent years. The peak seen in 1978 was due to fallout from nuclear weapons testing.

Table 11: Soil Locations

<b>Sample Location Number</b>	<b>Type of Location</b>	<b>Location Description</b>
T-1	I	Site boundary, 0.6 miles ENE of Station
T-2	I	Site boundary, 0.9 miles E of Station
T-3	I	Site boundary 1.4 miles ESE of Station
T-4	I	Site boundary 0.8 miles S of Station
T-7	I	Sand Beach, main entrance, 0.9 miles NW of Station
T-8	I	Moore Farm, 2.7 miles WSW of Station
T-9	C	Oak Harbor Substation, 6.8 miles SW of Station
T-11	C	Port Clinton Water Treatment Plant, 9.5 miles SE of Station
T-12	C	Toledo Water Treatment Plant, 20.7 miles WNW of Station
T-27	C	Crane Creek State Park, 5.3 miles WNW of Station

I = indicator C = control



DAVIS-BESSE NUCLEAR POWER STATION RADIOLOGICAL ENVIRONMENTAL MONITORING PROGRAM  
 TERRESTRIAL SAMPLES: SITE

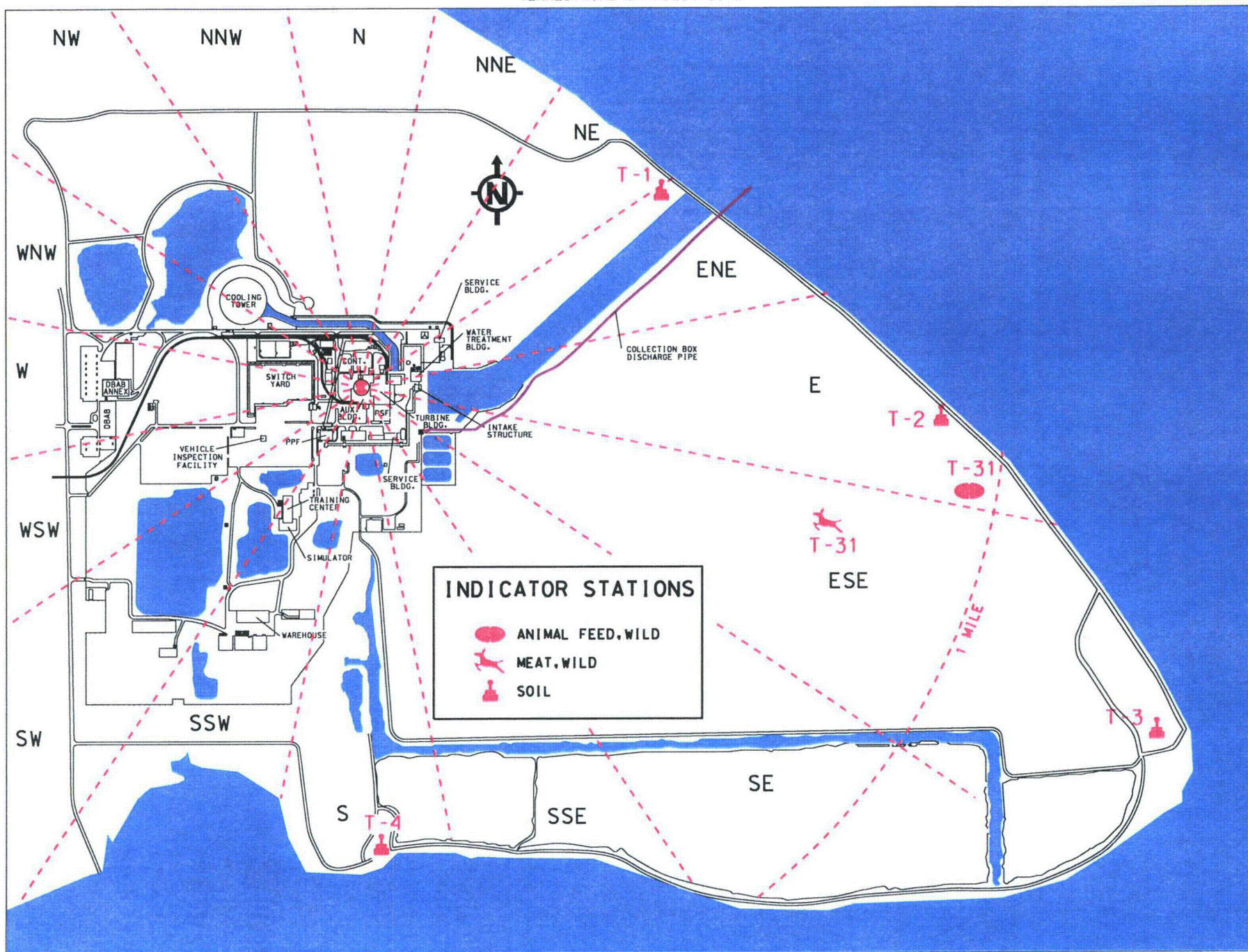

Figure 16: Terrestrial Site Map



DAVIS-BESSE NUCLEAR POWER STATION RADIOLOGICAL ENVIRONMENTAL MONITORING PROGRAM  
 TERRESTRIAL SAMPLES: 5 MILE RADIUS

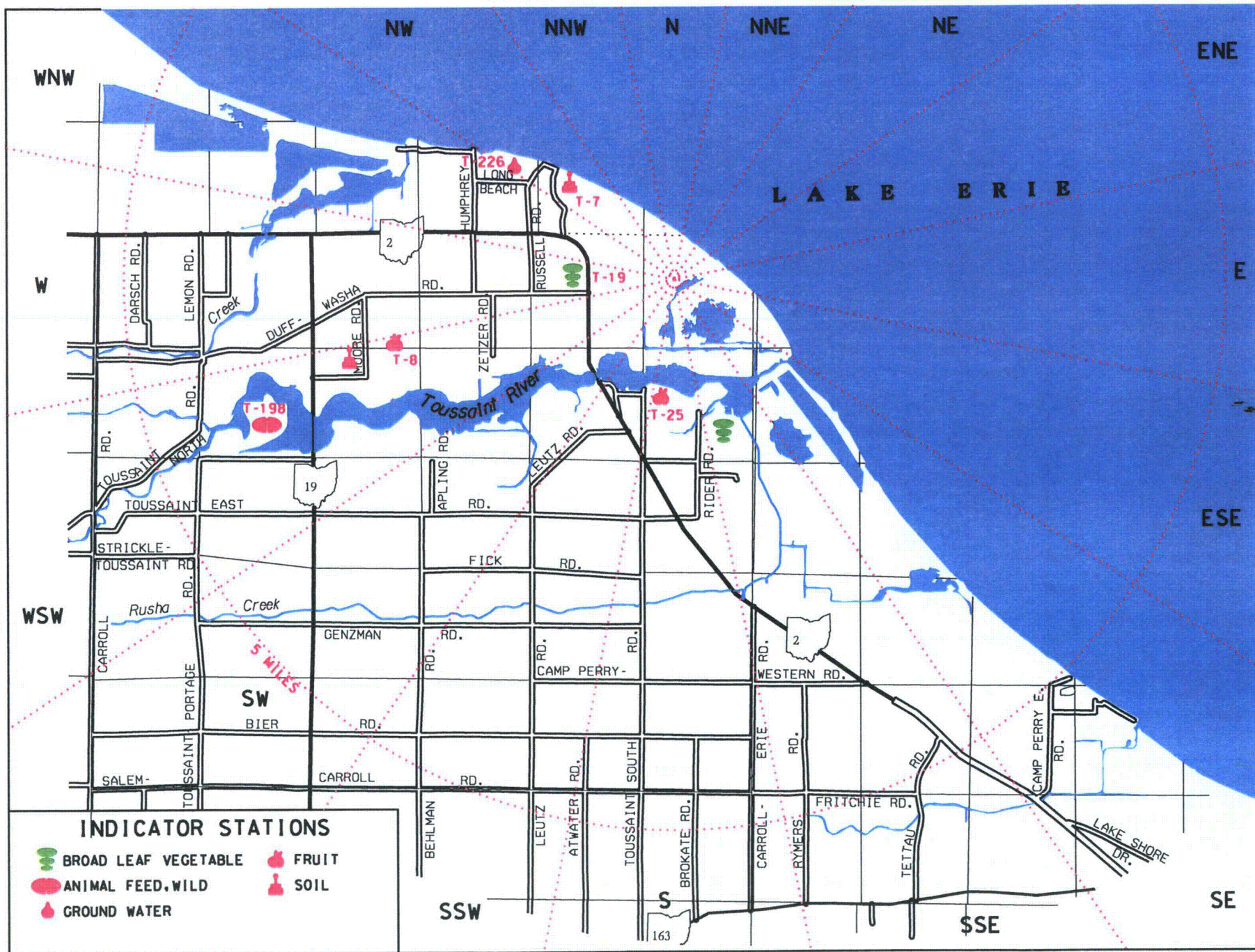

Figure 17: Terrestrial 5-mile Map



DAVIS-BESSE NUCLEAR POWER STATION RADIOLOGICAL ENVIRONMENTAL MONITORING PROGRAM  
 TERRESTRIAL SAMPLES: 5-25 MILE RADIUS

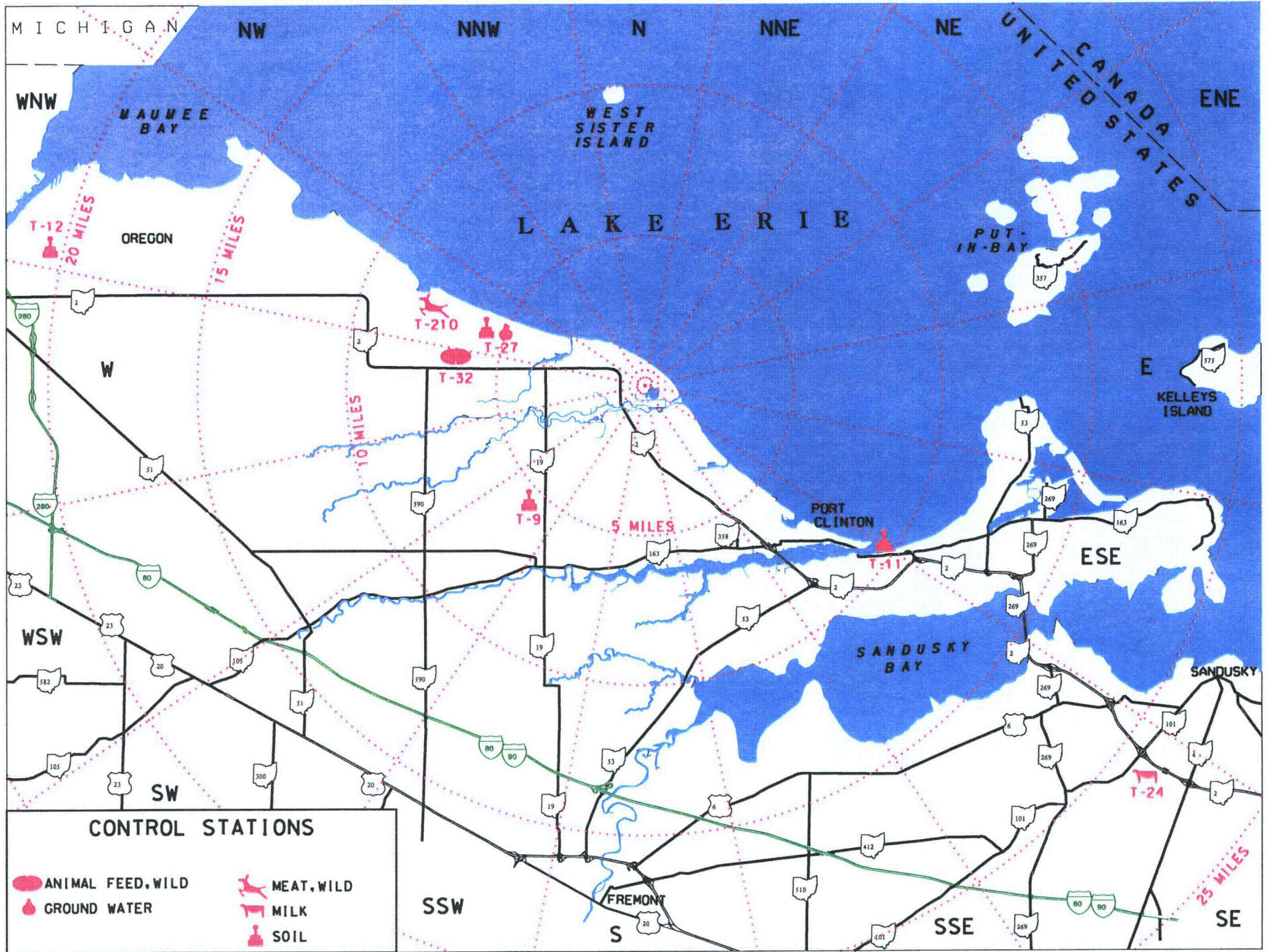
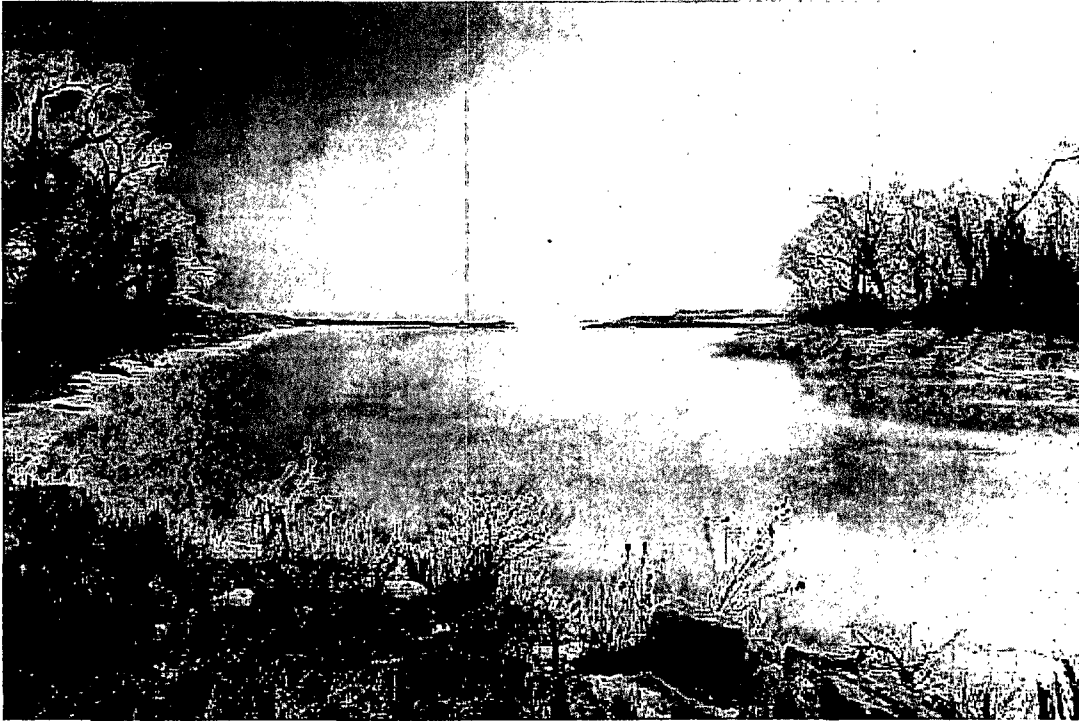

Figure 18: Terrestrial 25-mile Map



## Aquatic Monitoring



Radionuclides may be present in Lake Erie from many sources including atmospheric deposition, run-off/soil erosion, and releases of radioactive material in liquid effluents from hospitals or nuclear facilities. These sources provide two forms of potential exposure to radiation, external and internal. External exposure can occur from the surface of the water, shoreline sediments and from immersion (swimming) in the water. Internal exposure can occur from ingestion of radionuclides, either directly from drinking water, or as a result of the transfer of radionuclides through the aquatic food chain with eventual consumption of aquatic organisms, such as fish. To monitor these pathways, Davis-Besse samples treated surface water (drinking water), untreated surface water (lake or river water), fish, and shoreline sediments.

### Treated Surface Water

Treated surface water is water from Lake Erie, which has been processed for human consumption. Radiochemical analysis of this processed water provides a direct basis for assessing the dose to humans from ingestion of drinking water.

Samples of treated surface water were collected from two indicators (T-22B and T-50) and two control locations (T-11 and T-12). These locations include the water treatment facilities for Carroll Township, Erie Industrial Park, Port Clinton and Toledo. Samples were collected weekly and composited monthly. The monthly composites were analyzed for beta-emitting radionuclides. The samples were also composited in a quarterly sample and analyzed for Strontium-89, Strontium-90, gamma-emitting radionuclides, and tritium. One QC sample was collected from a routine location, which was changed each month.

The annual average of beta-emitting radionuclides for indicator and control locations was 2.1 and 1.9 pCi/l, respectively. These results are similar to previous years shown in Figure 19. Tritium

Davis-Besse Nuclear Power Station 2008 Annual Radiological Environmental Operating Report

was not detected above the LLD of 330 pCi/l during 2008. Strontium-89 was not detected above the LLD of 1.1 pCi/l. Strontium-90 activity was not detected above its LLD of 0.6 pCi/l. These results are similar to those of previous years and indicate no adverse impact on the environment resulting from the operation of Davis-Besse during 2008.

Each month, weekly quality control samples were collected at different locations. The results of the analyses from the quality control samples were in agreement with the routine samples. The average concentration of beta-emitting radionuclides detected at the QC locations was 3.2 pCi/l.

Gross Beta in Treated Surface Water 1972-2008

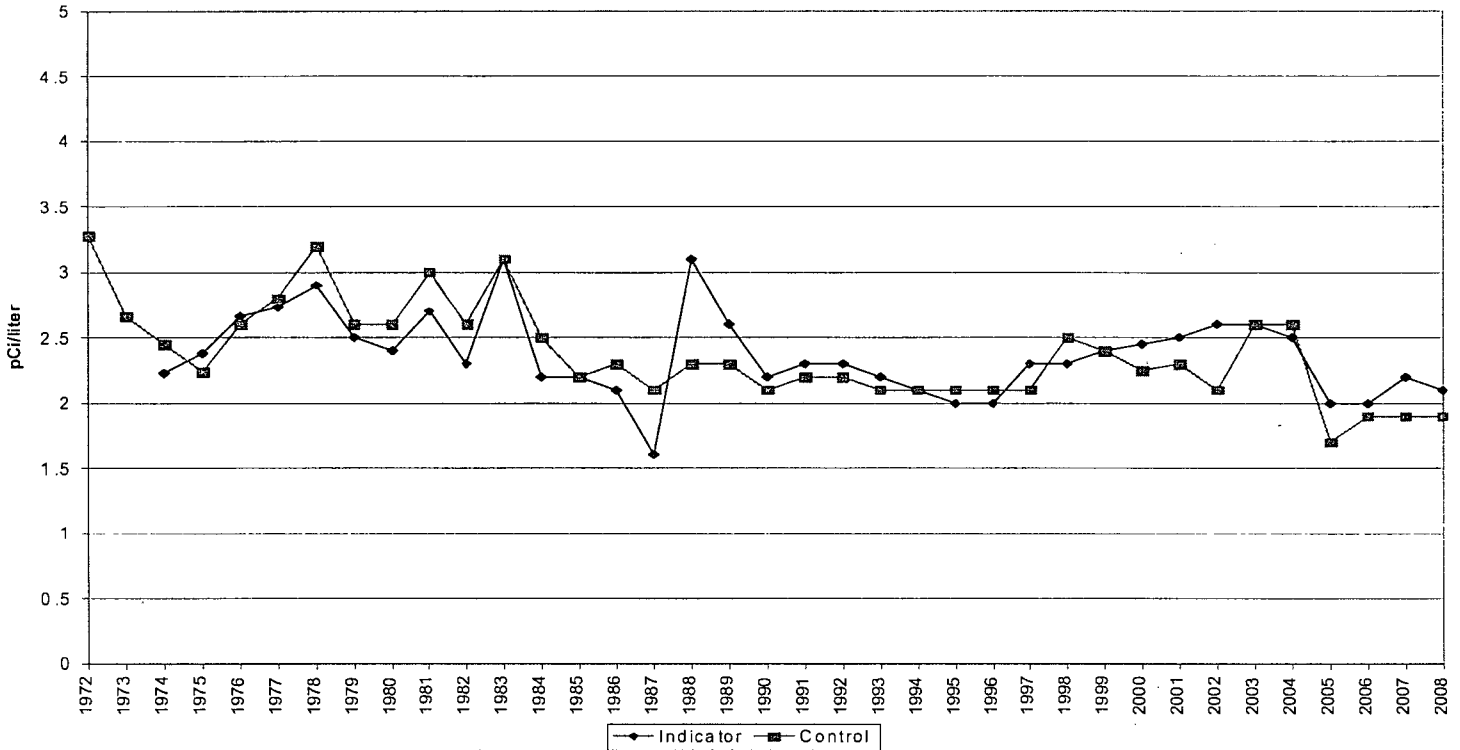

Figure 19: Since 1974, the annual concentrations of beta emitting radionuclides in treated surface water samples collected from indicator locations have been consistent with those from control locations. Davis-Besse has had no measurable radiological impact on surface water used to make drinking water.

Table 12: Treated Surface Water Locations

<b>Sample Location Number</b>	<b>Type of Location</b>	<b>Location Description</b>
T-11	C	Port Clinton Water Treatment Plant, 9.5 miles SE of Station
T-12	C	Toledo Water Treatment Plant, 20.7 miles WNW of Station
T-22B	I	Carroll Township Water Treatment Plant, sampled at Davis-Besse REMP lab
T-50	I	Erie Industrial Park, Port Clinton, 4.5 miles SE of Station
T-143	QC	Quality Control Site

I = indicator  
C = control  
QC = quality control

## Untreated Surface Water

Sampling and analysis of untreated surface water provides a method of assessing the dose to humans from external exposure from the lake surface as well as from immersion in the water. It also provides information on the radionuclides present, which may affect drinking water, fish, and irrigated crops.



## Routine Program

The routine program is the basic sampling program that is performed year round. Untreated water samples are collected from water intakes used by nearby water treatment plants. Routine samples are collected at Port Clinton, Toledo, Carroll Township and Erie Industrial Park. A sample is also collected from Lake Erie at the mouth of the Toussaint River. These samples are collected weekly and composited monthly. The monthly composite is analyzed for beta-emitting radionuclides, tritium, and gamma-emitting radionuclides. The samples are also composited quarterly and analyzed for Strontium-89 and Strontium-90. A QC sample is also collected weekly, with the location changing each month.

## Sample Results

For the routine untreated surface water samples that are composited weekly, the beta emitting radionuclides had an average concentration of 2.2 pCi/L at indicator locations during 2008. Control locations averaged 1.9 pCi/L during this period.

Tritium was not detected at untreated surface water indicator or control sites above the LLD of 330 pCi/ L during 2008. The EPA drinking water limit for tritium is 20,000 pCi/l.

Each month, weekly composited quality control samples were analyzed from different locations. The results of the analyses from the quality control samples were consistent with the routine samples, and averaged 1.8 pCi/L of beta emitting radionuclides.

Gross Beta Concentration in Untreated Surface Water 1977-2008

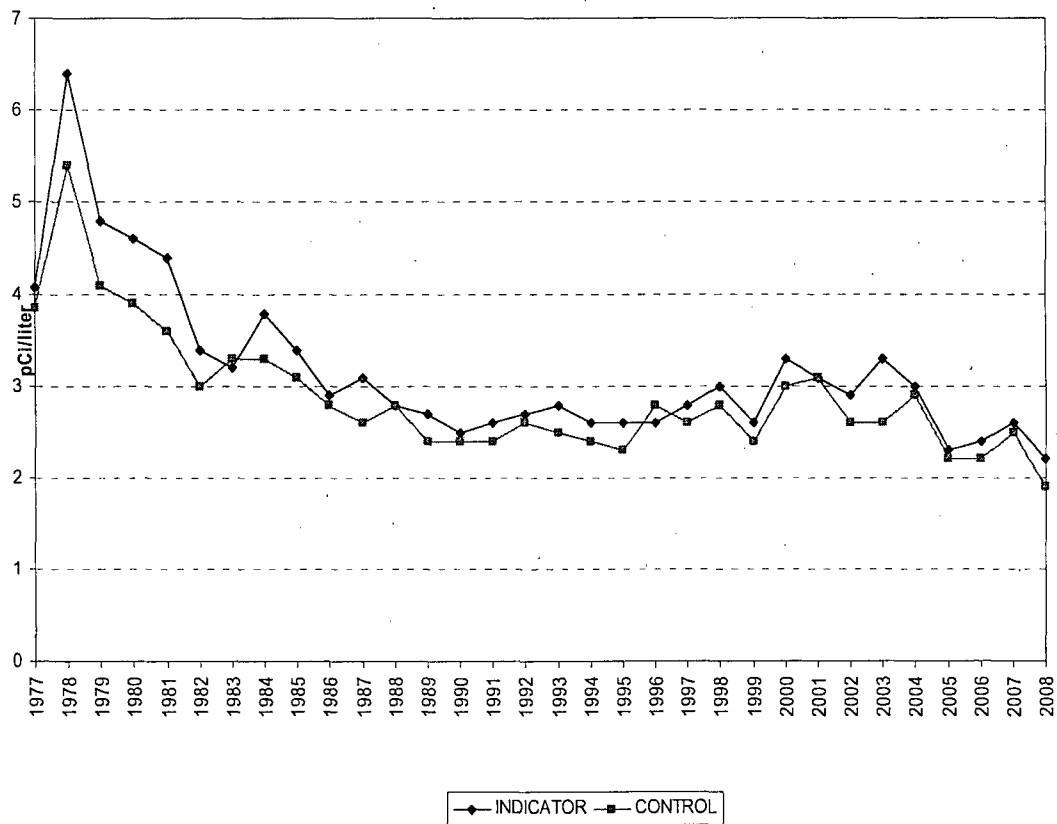

Figure 20: The average concentration of beta-emitting radionuclides in untreated water was similar between control and indicator locations. This demonstrates that Davis-Besse had no significant radiological impact on the surrounding environment.

Table 13: Untreated Surface Water Locations

<b>Sample Location Number</b>	<b>Type of Location</b>	<b>Location Description</b>
T-3	I	Site boundary, 1.4 miles ESE of Station
T-11	C	Port Clinton Water Treatment Plant, 9.5 miles SE of Station
T-12	C	Toledo Water Treatment Plant, sample taken from intake crib, 12.6 miles NW of Station
T-22A	I	Carroll Township Water Plant, State Route 2, 2.1 miles NW of Station
T-50	I	Erie Industrial Park, Port Clinton, 4.5 miles SE of Station
T-145	QC	Roving Quality Control Site

---

I = indicator, C = control



## Shoreline Sediment

The sampling of shoreline sediments can provide an indication of the accumulation of insoluble radionuclides which could lead to internal exposure to humans through the ingestion of fish, through re-suspension into drinking water supplies, or as an external radiation source from shoreline exposure to fishermen and swimmers.

Samples of deposited sediments in water along the shore were collected at various times from three indicator sites (T-3, T-4, and T-132) and one control location (T-27), and were analyzed for gamma-emitting radionuclides. Naturally occurring Potassium-40 was detected at both control and indicator locations. These results are similar to previous years.

---

**Table 14: Shoreline Sediment Locations**

---

<b>Sample Location Number</b>	<b>Type of Location</b>	<b>Location Description</b>
T-3	I	Site boundary, 1.4 miles ESE of Station
T-4	I	Site boundary, 0.8 miles S of Station
T-27	C	Crane Creek State Park, 5.3 miles WNW of Station
T-132	I	Lake Erie, 1.0 miles E of Station

---

I = indicator C = control

## Fish Sample

Fish are analyzed primarily to quantify the dietary radionuclide intake by humans, and secondarily to serve as indicators of radioactivity in the aquatic ecosystem. The principal nuclides that may be detected in fish include naturally occurring Potassium-40, as well as Cesium-137, and Strontium-90. Depending upon the feeding habit of the species (e.g., bottom-feeder versus predator), results from sample analyses may vary.

Davis-Besse routinely collects three species of fish once per year from sampling locations near the Station's liquid discharge point and more than ten miles away from the Station where fish populations would not be expected to be impacted by the Station operation. Walleye are collected because of being a popular sport fish and white perch or white bass are collected because their importance as a commercial fish. Carp are collected because they are bottom feeders where contaminants may settle.

The average concentration of beta-emitting radionuclides in fish was similar for indicator and control locations (4.12 pCi/g and 4.10 pCi/g wet weight, respectively). No other gamma emitters were detected above their respective LLDs.

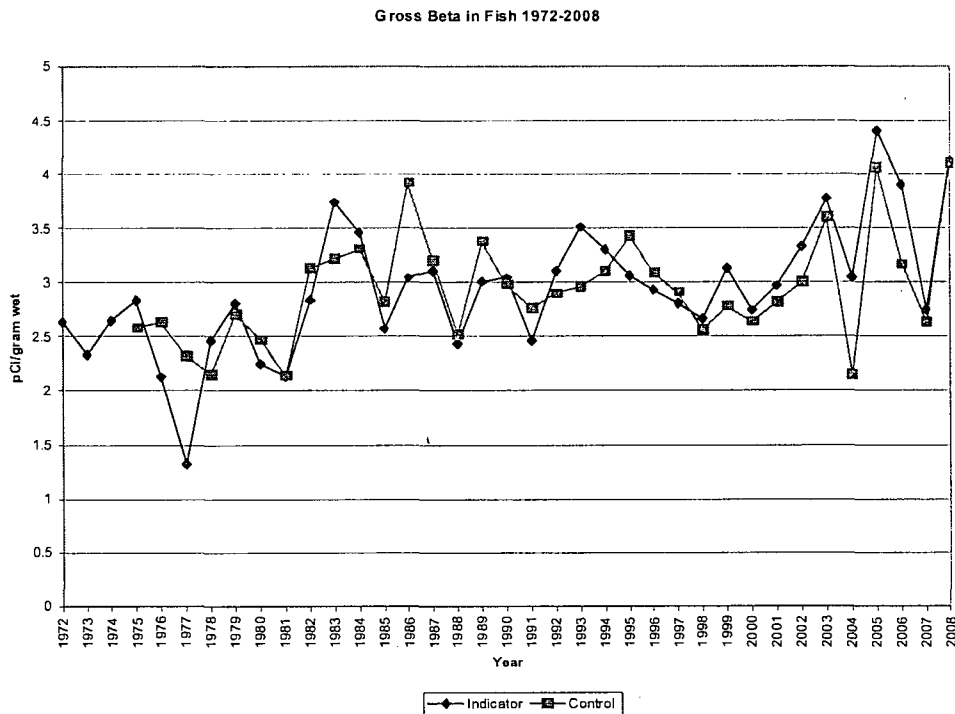

Figure 21: Average concentrations of beta-emitting radionuclides in fish samples were similar at indicator and control locations, and were within the range of results of previous years.

---

**Table 15: Fish Locations**

---

<b>Sample Location Number</b>	<b>Type of Location</b>	<b>Location Description</b>
T-33	I	Lake Erie, within 5 miles radius of Station
T-35	C	Lake Erie, greater than 10 mile radius of Station

---

I = indicator C= control

# DAVIS-BESSE NUCLEAR POWER STATION RADIOLOGICAL ENVIRONMENTAL MONITORING PROGRAM

AQUATIC SAMPLES: SITE

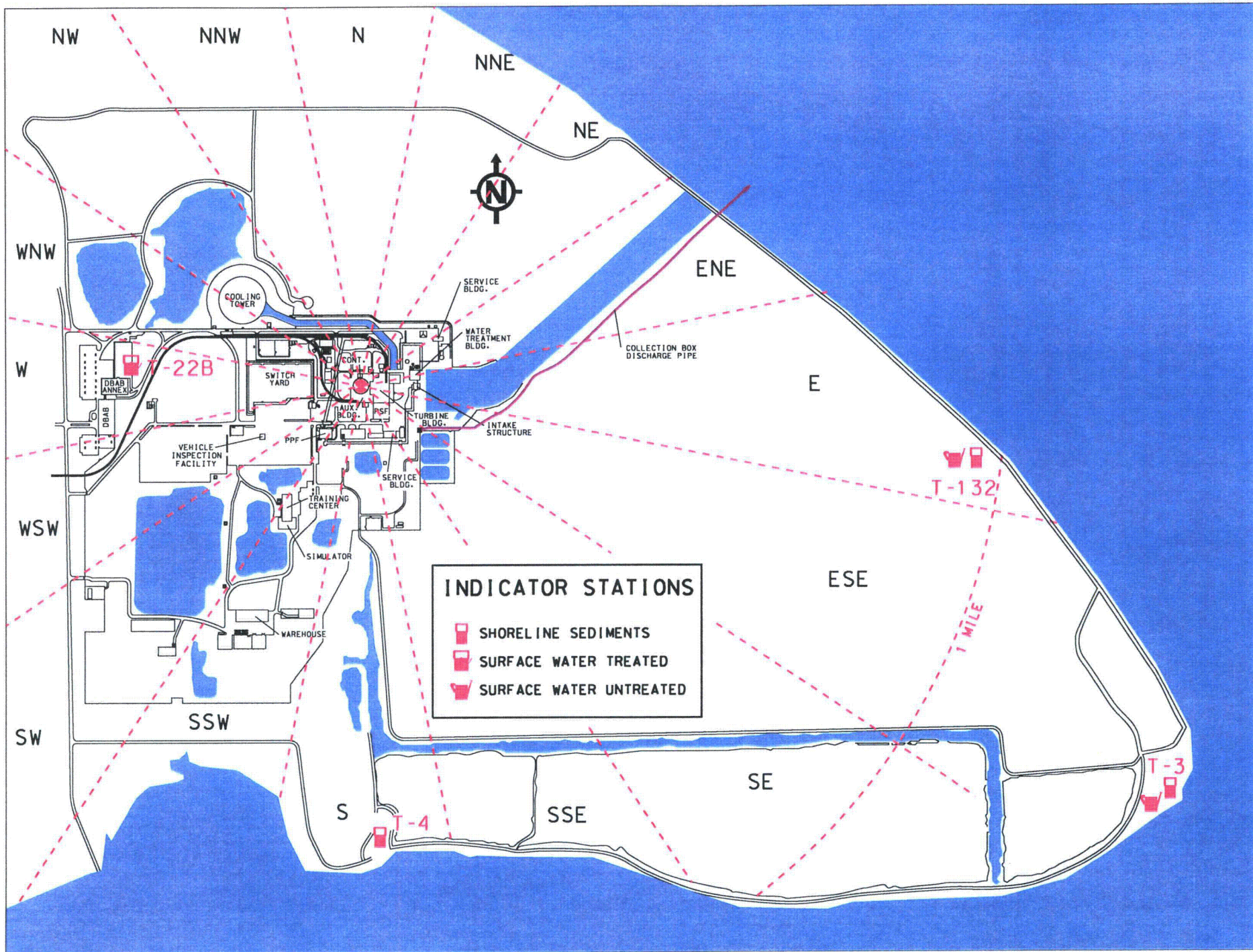

Figure 22: Aquatic Site Map  
64



# DAVIS-BESSE NUCLEAR POWER STATION RADIOLOGICAL ENVIRONMENTAL MONITORING PROGRAM

AQUATIC SAMPLES: 5 MILE RADIUS



Figure 23: Aquatic 5-mile Map



# DAVIS-BESSE NUCLEAR POWER STATION RADIOLOGICAL ENVIRONMENTAL MONITORING PROGRAM

AQUATIC SAMPLES: 5-25 MILE RADIUS

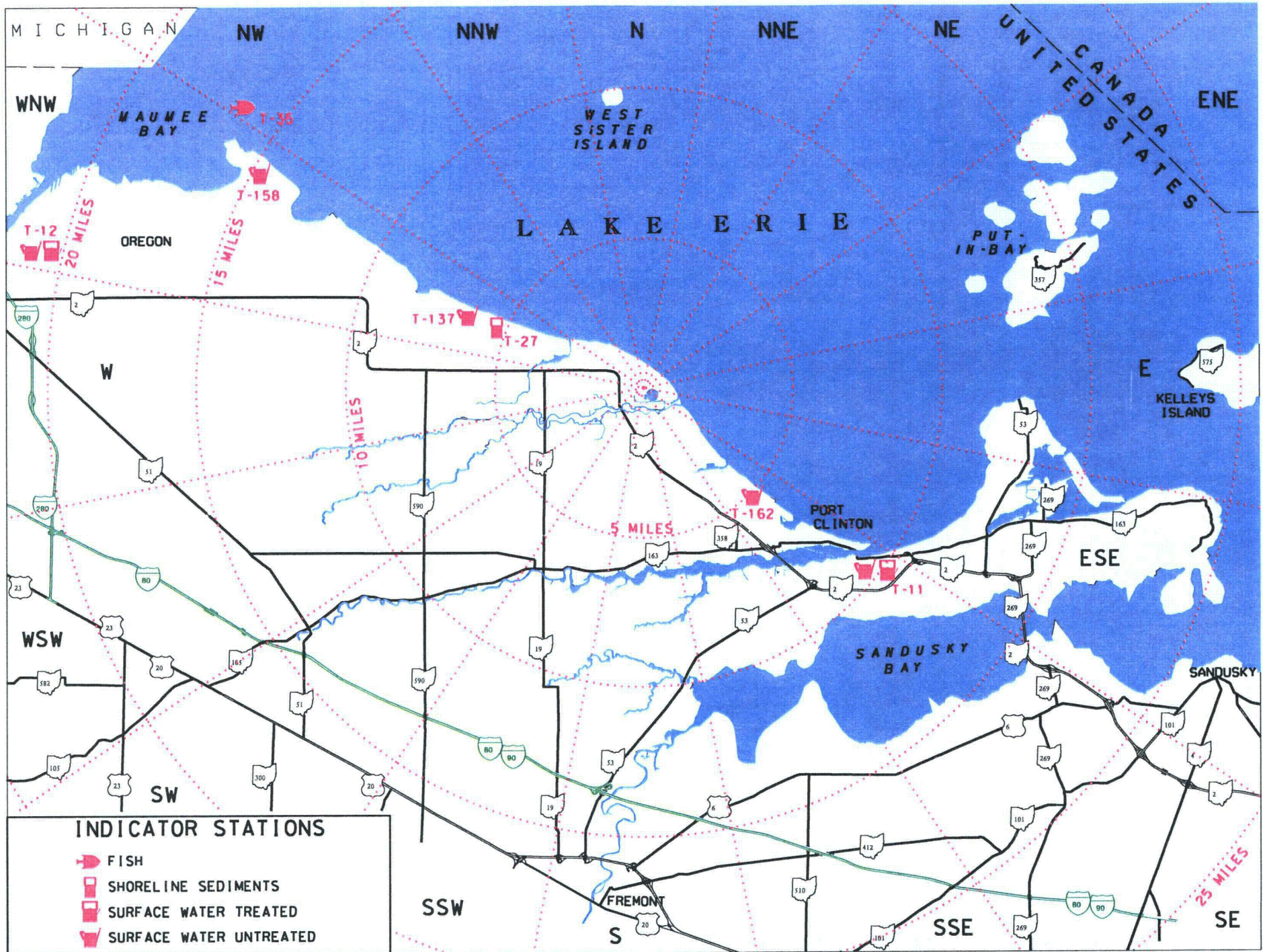

Figure 24: Aquatic 25-mile Map

## Direct Radiation Monitoring

### Thermoluminescent Dosimeters

Radionuclides present in the air and deposited on the ground may directly irradiate individuals. Direct radiation levels at and around Davis-Besse are constantly monitored by thermoluminescent dosimeters (TLDs). TLDs are small devices which store radiation dose information. The TLDs used at Davis-Besse contain a Sulfate:Dysprosium ( $\text{CaSO}_4:\text{Dy}$ ) card with four main readout areas. Multiple readout areas are used to ensure the precision of the measurements.

Thermoluminescence is a process in which ionizing radiation interacts with phosphor, which is the sensitive material in the TLD. Energy is trapped in the TLD material and can be stored for several months or years. This provides an excellent method to measure the dose received over long periods of time. The energy that was stored in the TLD as a result of interaction with radiation is released and measured by a controlled heating process in a calibrated reading system. As the TLD is heated, the phosphor releases the stored energy in the form of light. The amount of light detected is directly proportional to the amount of radiation to which the TLD was exposed. The reading process re-zeroes the TLD and prepares it for reuse.

### TLD Collection

Davis-Besse has 88 TLD locations (77 indicator and 11 control locations). TLDs are collected and replaced on a quarterly and annual basis. Nineteen QC TLDs are also collected on this schedule. There are a total of 214 TLDs in the environment surrounding Davis-Besse. By collecting them on a quarterly and annual basis from a single site, each measurement serves as a quality control check on the other. All quarterly and annual TLDs placed in the field were retrieved and evaluated during the current reporting period.

In 2008, the average dose equivalent for quarterly TLDs at indicator locations was 16.5 mrem/91 days, and for control locations was 17.5 mrem/91 days. The average dose equivalent for annual TLDs in 2008 was 59.4 mrem/365 days at indicator locations and 65.8 mrem/365 days for control locations.

### Quality Control TLDs

Duplicate TLDs have been placed at 18 sites. These TLDs are placed in the field at the same time and location as some of the routine TLDs, but are assigned quality control site numbers. This allows us to take several measurements at the location without the laboratory being aware that they are the same. A comparison of the quality control and routine results provides a method to check the accuracy of the measurements. The average dose equivalent of indicator quality control TLDs averaged 14.5 mrem/91 days while the quality control TLDs at control locations yielded an average dose equivalent of 16.6 mrem/91 days.



# Direct Radiation Monitoring

Gamma Dose for Environmental TLDs 1973-2008

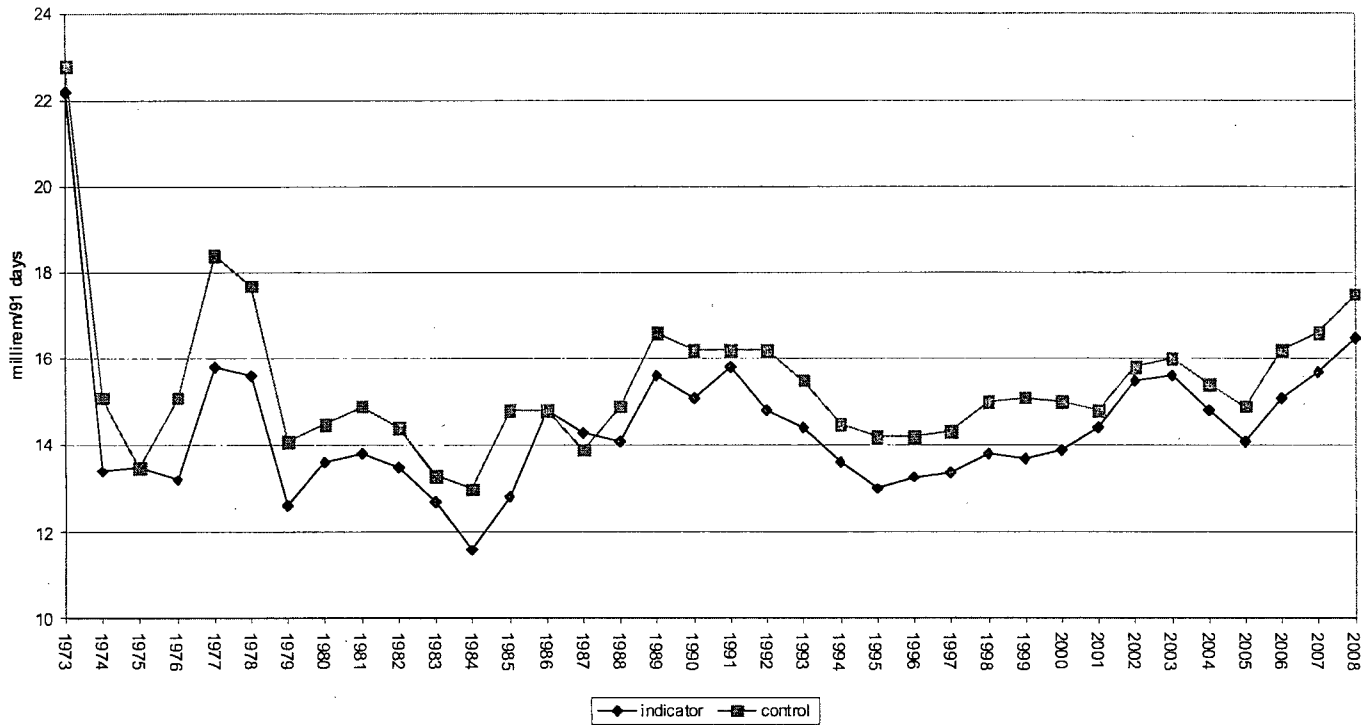

Figure 25: The similarity between indicator and control results demonstrates that the operation of Davis-Besse has not caused any abnormal gamma dose.



Table 16: Thermoluminescent Dosimeter Locations

<b>Sample Location Number</b>	<b>Type of Location</b>	<b>Location Description</b>
T-1	I	Site boundary, 0.6 miles ENE of Station
T-2	I	Site boundary, 0.9 miles E of Station
T-3	I	Site boundary, 1.4 miles ESE of Station
T-4	I	Site boundary, 0.8 miles S of Station
T-5	I	Site boundary, 0.5 miles W of Station
T-6	I	Site boundary, 0.5 miles NNE of Station
T-7	I	Sand Beach entrance, 0.9 miles NW of Station
T-8	I	Earl Moore Farm, 2.7 miles WSW of Station
T-9	C	Oak Harbor Substation, 6.8 miles SW of Station
T-10	I	Site boundary, 0.5 miles SSW of Station near warehouse
T-11	C	Port Clinton Water Treatment Plant, 9.5 miles SE of Station
T-12	C	Toledo Water Treatment Plant, 20.7 miles WNW of Station
T-24	C	Sandusky, 21.0 miles SE of Station
T-27	C	Crane Creek State Park, 5.3 miles WNW of Station
T-38	I	Site boundary, 0.6 miles ENE of Station
T-39	I	Site boundary 1.2 miles ENE of Station
T-40	I	Site boundary, 0.7 miles SE of Station
T-41	I	Site boundary, 0.6 miles SSE of Station
T-42	I	Site boundary, 0.8 miles SW of Station

Table 16: Thermoluminescent Dosimeter Locations (continued)

<b>Sample Location Number</b>	<b>Type of Location</b>	<b>Location Description</b>
T-43	I	Site boundary, 0.5 miles SW of Station
T-44	I	Site boundary, 0.5 miles WSW of Station
T-45	I	Site boundary, 0.5 miles WNW of Station
T-46	I	Site boundary, 0.5 miles NW of Station
T-47	I	Site boundary, 0.5 miles N of Station
T-48	I	Site boundary, 0.5 miles NE of Station
T-49	I	Site boundary, 0.5 miles NE of Station
T-50	I	Erie Industrial Park, Port Clinton, 4.5 miles SE of Station
T-51	C	on Siren Pole, 5.5 miles SSE of Station
T-52	I	Miller Farm, 3.7 miles S of Station
T-53	I	Nixon Farm, 4.5 miles S of Station
T-54	I	McNutt residence, 4.8 miles SW of Station
T-55	I	King Farm, 4.5 miles W of Station
T-60	I	Site boundary, 0.3 miles S of Station
T-62	I	Site boundary, 1.0 mile SE of Station
T-65	I	Site boundary, 0.3 miles E of Station
T-66	I	Site boundary, 0.3 miles ENE of Station
T-67	I	Site boundary, 0.3 miles NNW of Station
T-68	I	Site boundary, 0.5 miles WNW of Station
T-69	I	Site boundary, 0.4 miles W of Station

Table 16: Thermoluminescent Dosimeter Locations (continued)

<b>Sample Location Number</b>	<b>Type of Location</b>	<b>Location Description</b>
T-71	I	Site boundary, 0.1 mile NNW of Station
T-73	I	Site boundary, 0.1 mile WSW of Station
T-74	I	Site boundary, 0.1 mile SSW of Station
T-75	I	Site boundary, 0.2 mile SSE of Station
T-76	I	Site boundary, 0.1 mile SE of Station
T-80	QC	Quality Control Site
T-81	QC	Quality Control Site
T-82	QC	Quality Control Site
T-83	QC	Quality Control Site
T-84	QC	Quality Control Site
T-85	QC	Quality Control Site
T-86	QC	Quality Control Site
T-88	QC	Quality Control Site
T-87	QC	Quality Control in lead pig DBAB Annex
T-89	QC	Quality Control Site
T-90	I	Site Personnel Processing Facility
T-91	I	State Route 2 and Rankie Road, 2.5 miles SSE
T-92	I	Locust Point Road, 2.7 miles WNW of Station
T-93	I	Twelfth Street, Sand Beach, 0.6 miles NNE of Station
T-94	I	State Route 2, 1.8 miles WNW of Station
T-95	C	State Route 579, 9.3 miles W of Station

Table 16: Thermoluminescent Dosimeter Locations (continued)

<b>Sample Location Number</b>	<b>Type of Location</b>	<b>Location Description</b>
T-100	C	Ottawa County Highway Garage, Oak Harbor, 6.0 miles S of Station
T-111	C	Toussaint North Road, 8.3 miles WSW of Station
T-112	I	Thompson Road, 1.5 miles SSW of Station
T-113	QC	Quality Control Site
T-114	QC	Quality Control Site
T-115	QC	Quality Control Site
T-116	QC	Quality Control Site
T-117	QC	Quality Control Site
T-118	QC	Quality Control Site
T-119	QC	Quality Control Site
T-120	QC	Quality Control Site
T-121	I	State Route 19, 2.0 miles W of Station
T-122	I	Duff Washa and Humphrey Road, 1.7 miles W of Station
T-123	I	Zetzer Road, 1.6 miles WSW of Station
T-124	C	Church and Walnut Street, Oak Harbor, 6.5 miles SSW of Station
T-125	I	Behlman and Bier Roads, 4.4 miles SSW of Station
T-126	I	Camp Perry Western and Toussaint South Road, 3.7 miles S of Station
T-127	I	Camp Perry Western and Rymers Road, 4.0 miles SSE of Station

Table 16: Thermoluminescent Dosimeter Locations (continued)

Sample Location Number	Type of Location	Location Description
T-128	I	Erie Industrial Park, Port Clinton Road, 4.0 miles SE of Station
T-142	I	Site Boundary, 0.8 miles SSE of Station
T-150	I	Humphrey and Hollywood Roads, 2.1 miles NW of Station
T-151	I	State Route 2 and Humphrey Road, 1.8 miles WNW of Station
T-153	I	Leutz Road, 1.4 miles SSW of Station
T-154	I	State Route 2, 0.7 miles SW of Station
T-155	C	Fourth and Madison Streets, Port Clinton, 9.5 miles SE of Station
T-200	QC	Quality Control Site
T-201	I	Sand Beach, 1.1 miles NNW of Station
T-202	I	Sand Beach, 0.8 miles NNW of Station
T-203	I	Sand Beach, 0.7 miles N of Station
T-204	I	Sand Beach, 0.7 miles N of Station
T-205	I	Sand Beach, 0.5 miles NNE of Station
T-206	I	Site Boundary, 0.6 miles NW of Station
T-207	I	Site Boundary, 0.5 miles N of Station
T-208	I	Site Boundary, 0.5 miles NNE of Station.

I = Indicator

C = Control

QC = Quality Control

Table 16: Thermoluminescent Dosimeter Locations (continued)

<b>Sample Location Number</b>	<b>Type of Location</b>	<b>Location Description</b>
T-211	I	Site boundary, 0.79 miles E of Station
T-212	I	Site boundary, 1.2 miles ESE of Station
T-213	I	Site boundary, 0.6 miles SSW of Station
T-214	I	Site boundary, 0.7 miles SW of Station
T-215	I	Site boundary, 0.5 miles W of Station
T-216	I	Site boundary, 0.7 miles NW of station
T-217	I	Salem-Carroll Rd., 4.7 miles SSW of Station
T-218	I	Toussaint East Rd., 4.0 miles WSW of Station
T-219	I	Toussaint Portage Rd., 4.8 miles WSW of Station
T-220	I	Duff-Washa Rd., 4.8 miles W of Station
T-221	C	Magee Marsh, 5.1 miles WNW of Station
T-222	I	Turtle Creek Access, 3.7 miles WNW of Station
T-223	I	Lawrence Rd., 5.0 miles SE of Station
T-224	I	Erie Industrial Park, 4.4 miles SE of Station



# DAVIS-BESSE NUCLEAR POWER STATION RADIOLOGICAL ENVIRONMENTAL MONITORING PROGRAM

TLD SAMPLES: SITE

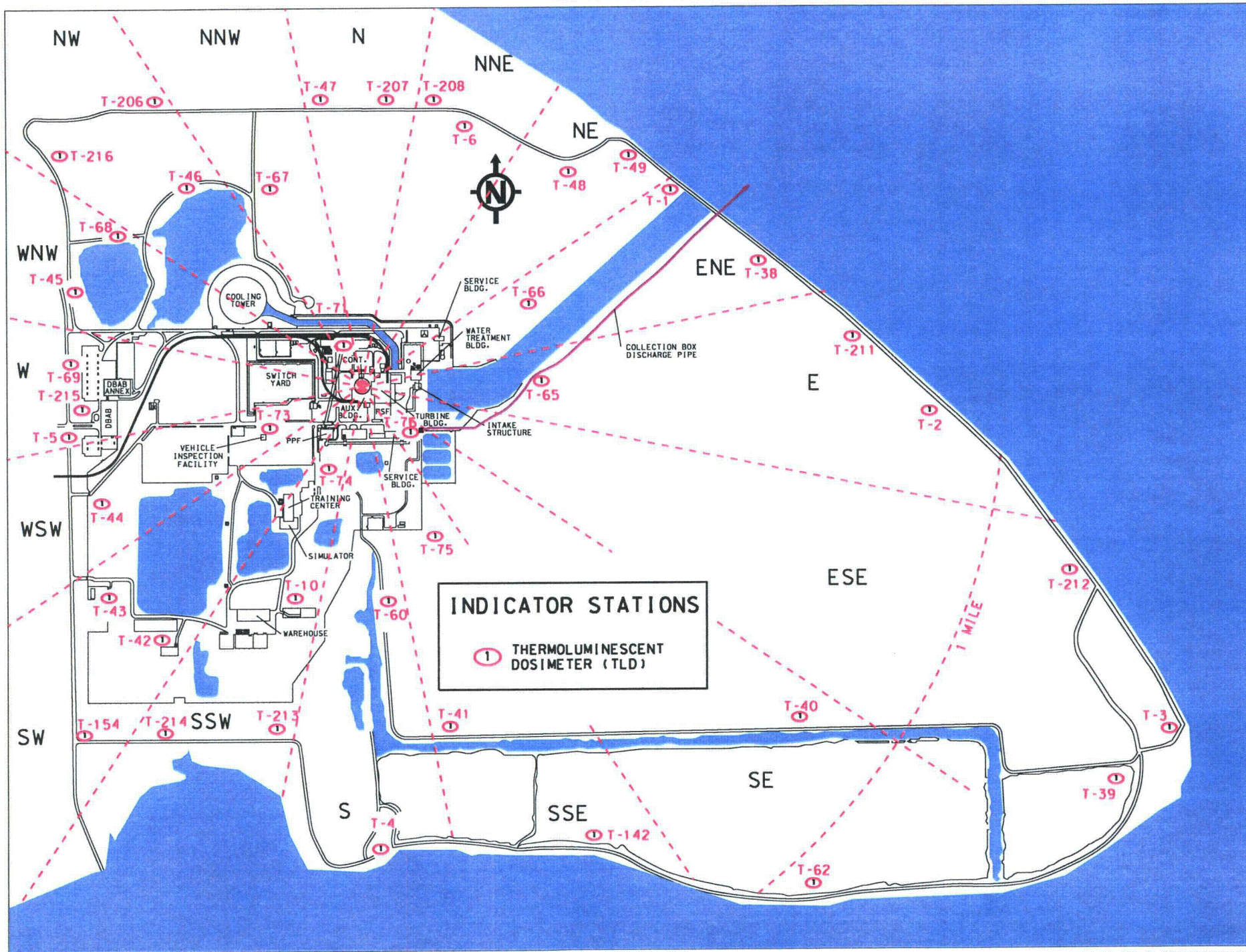

Figure 26: TLD Site Map



# DAVIS-BESSE NUCLEAR POWER STATION RADIOLOGICAL ENVIRONMENTAL MONITORING PROGRAM

TLD SAMPLES: 5 MILE RADIUS

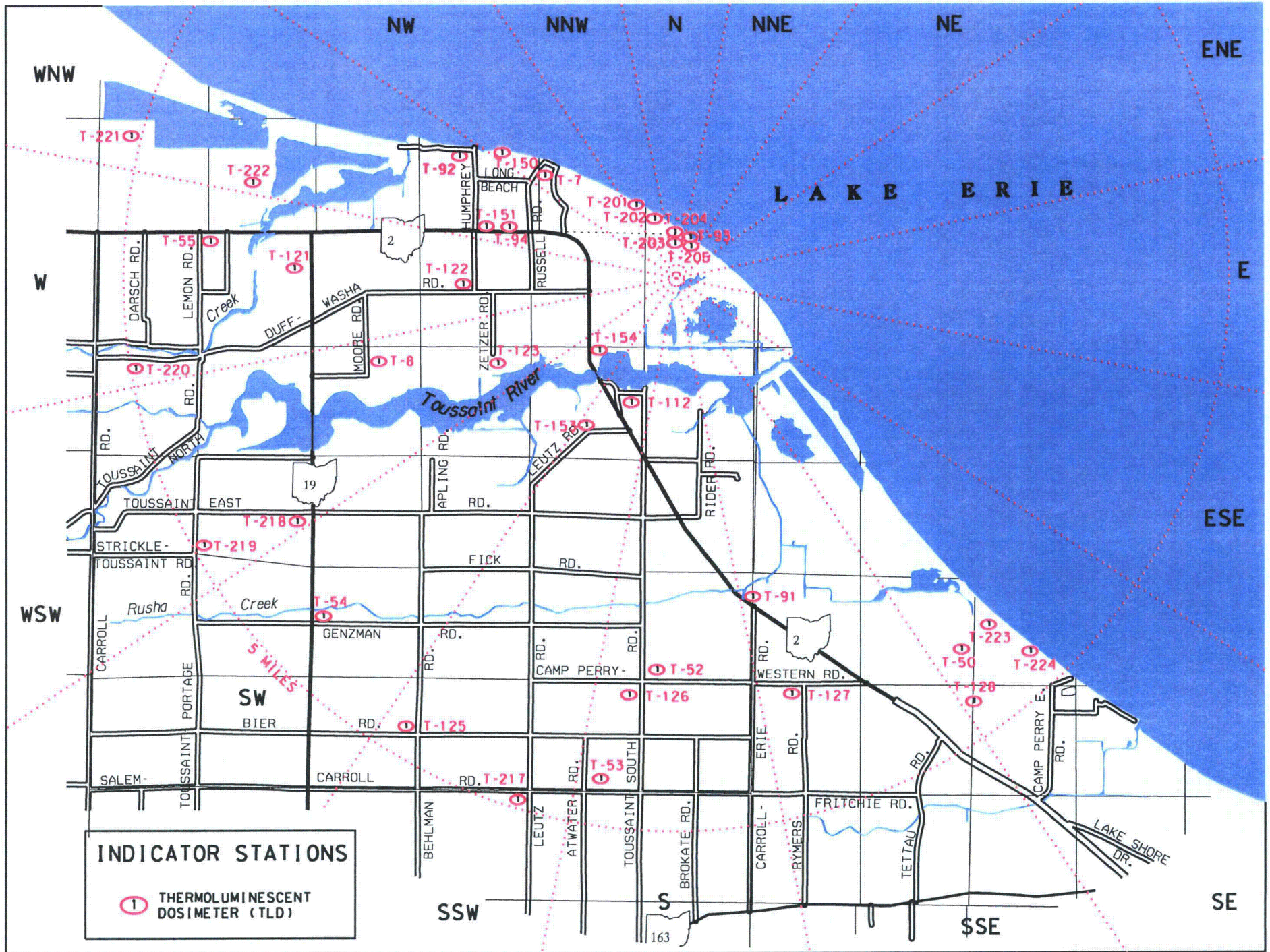

Figure 27: TLD 5-mile Map



# DAVIS-BESSE NUCLEAR POWER STATION RADIOLOGICAL ENVIRONMENTAL MONITORING PROGRAM

TLD SAMPLES: 5-25 MILE RADIUS

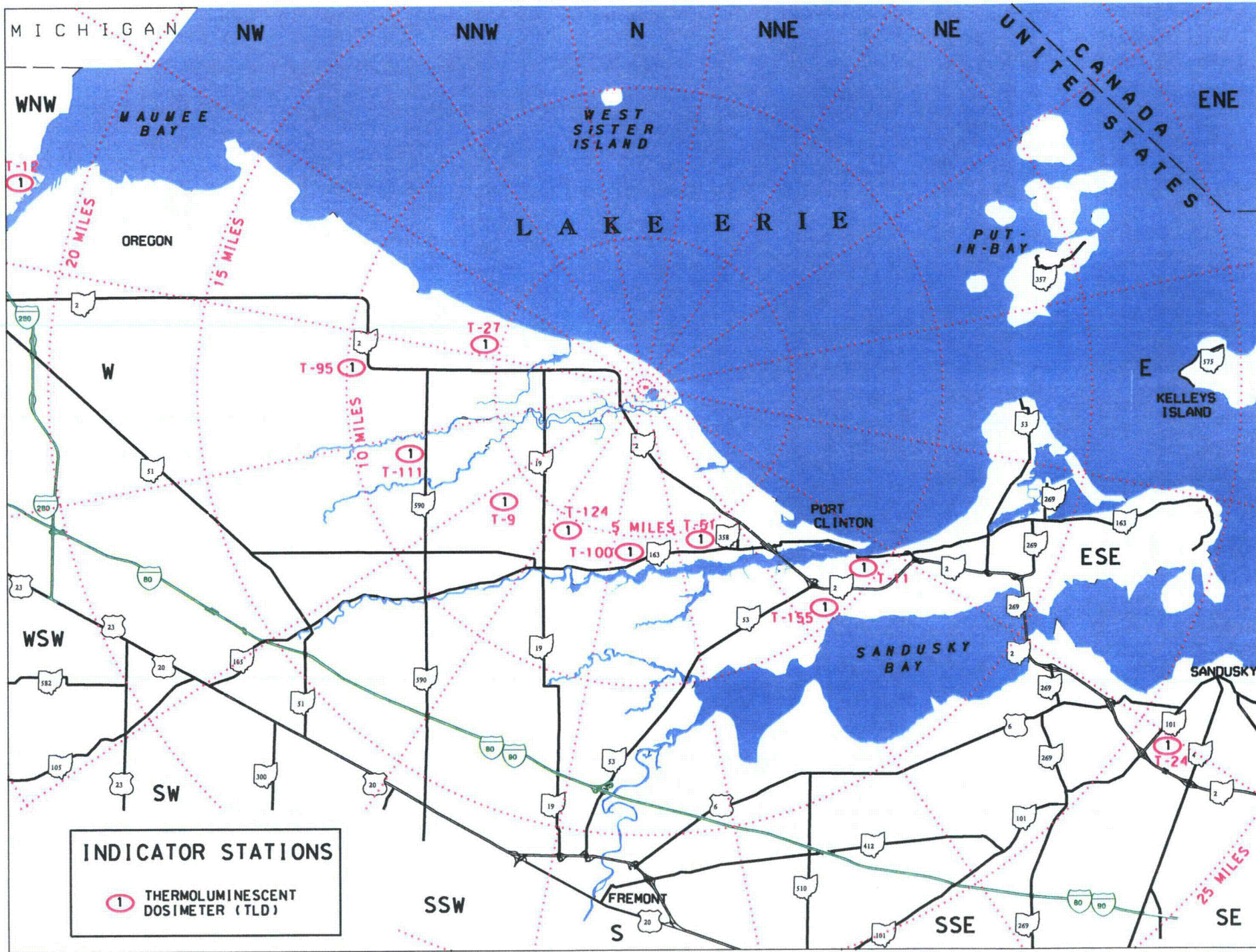

Figure 28: TLD 25-mile Map  
77



## Conclusion

The Radiological Environmental Monitoring Program at Davis-Besse is conducted to determine the radiological impact of the Station's operation on the environment. Radionuclide concentrations measured at indicator locations were compared with concentrations measured at control locations in previous operational studies and in the pre-operational surveillance program. These comparisons indicate normal concentrations of radioactivity in all environmental samples collected in 2008. Davis-Besse's operation in 2008 indicated no observable adverse radiological impact on the residents and environment surrounding the station. The results of the sample analyses performed during the period of January through December 2008 are summarized in Appendix D of this report.

## References

1. "Cesium-137 from the Environment to Man: Metabolism and Dose," Report No. 52, National Council on Radiation Protection and Measurement, Washington, D.C. (January 1977).
2. "Environmental Radiation Measurements," Report No. 50, National Council on Radiation Protection and Measurement, Washington, D.C. (December 1976).
3. "Exposure of the Population in the United States and Canada from Natural Background Radiation," Report No. 94, National Council on Radiation Protection and Measurement, Washington, D.C. (December 1987).
4. "A Guide for Environmental Radiological Surveillance at U.S. Department of Energy Installations," DOE/EP-0023, Department of Energy, Washington, D.C. (July 1981).
5. "Ionizing Radiation Exposure of the Population of the United States," Report No. 93, National Council on Radiation Protection and Measurement, Washington, D.C. (September 1987).
6. "Natural Background Radiation in the United States," Report No. 45, National Council on Radiation Protection and Measurement, Washington, D.C. (November 1975).
7. "Numerical Guides for Design Objectives and Limiting Conditions for Operation to meet the Criterion 'As Low As Reasonably Achievable' for Radioactive Material in Light Water Cooled Nuclear Power Reactor Effluents," Code of Federal Regulations, Title 10 Energy, Part 50 "Domestic Licensing of Production and Utilization Facilities," Appendix I (1988).
8. "Performance, Testing and Procedural Specifications for Thermoluminescent Dosimetry," American National Standards Institute, Inc., ANSI-N45-1975, New York, New York (1975).
9. "Public Radiation Exposure from Nuclear Power Generation in the United States," Report No. 92, National Council on Radiation Protection and Measurement, Washington, D.C. (December 1987).

10. "Radiological Assessment: Predicting the Transport, Bioaccumulation and Uptake by Man of Radionuclides Released to the Environment," Report No. 76, National Council on Radiation Protection and Measurement, Washington, D.C. (March 1984).
11. Regulatory Guide 4.1, "Programs for Monitoring Radioactivity in the Environs of Nuclear Power Plants," US NRC (April 1975).
12. Regulatory Guide 4.13, "Performance, Testing, and Procedural Specifications for Thermoluminescent Dosimetry: Environmental Applications," US NRC (July 1977).
13. Regulatory Guide 4.15, "Quality Assurance for Radiological Monitoring Programs (Normal Operations) - Effluent Streams and the Environment," US NRC (February 1979).
14. Regulatory Guide 0475, "Radiological Environmental Monitoring by NRC Licensees for Routine Operations of Nuclear Facilities," US NRC (September 1978).
15. "Standards for Protection Against Radiation," Code of Federal Regulations, Title 10, Energy, Part 20 (1993).
16. Teledyne Isotopes Midwest Laboratory, "Operational Radiological Monitoring for the Davis-Besse Nuclear Power Station Unit No.1, Oak Harbor, OH," Annual Report, Parts I and II (1977 through 1990).
17. Teledyne Isotopes Midwest Laboratory, "Final Monthly Progress Report to Toledo Edison Company", (1991-1999).
18. Environmental, Inc. Midwest Laboratory, "Final Report to FirstEnergy Corporation", (2000-2008)
19. Teledyne Isotopes Midwest Laboratory, "Pre-operational Environmental Radiological Monitoring for the Davis-Besse Power Station Unit No. 1", Oak Harbor, OH (1972-1977).
20. Toledo Edison Company, "Davis-Besse: Nuclear Energy for Northern Ohio."
21. Toledo Edison Company, Davis-Besse Nuclear Power Station, Unit No. 1, Radiological Effluent Technical Specifications", Volume 1, Appendix A to License No. NPF-3.
22. Toledo Edison Company, "Final Environmental Statement -Related to the Construction of Davis-Besse Nuclear Power Station," Docket #50-346 (1987).
23. Toledo Edison Company, "Performance Specifications for Radiological Environmental Monitoring Program," S-72N.
24. Davis-Besse Nuclear Power Station, "Radiological Environmental Monitoring Program," DB-CN-00015.

25. Davis-Besse Nuclear Power Station, "Radiological Environmental Monitoring Quarterly, Semiannual, and Annual Sampling", DB-CN-03004.
26. Davis-Besse Nuclear Power Station, "Radiological Monitoring Weekly, Semimonthly, and Monthly Sampling," DB-CN-03005.
27. Davis-Besse Nuclear Power Station, "REMP Enhancement Sampling", DB-CN-10101.
28. Toledo Edison Company, "Updated Safety Analysis for the Offsite Radiological Monitoring Program", USAR 11.6, Revision 14, (1992).
29. Davis-Besse Nuclear Power Station, "Annual Radiological Environmental Operating Report Preparation and Submittal", DB-CN-00014.
30. Davis-Besse Nuclear Power Station, "Preparation of Radioactive Effluent Release Report", DB-CN-00012.
31. Davis-Besse Nuclear Power Station, "Offsite Dose Calculation Manual".
32. "Tritium in the Environment", Report No. 62, National Council on Radiation Protection and Measurements, Washington, D.C. (March 1979).
33. NEI07-07, "Industry Ground Water Protection Initiative – Final Guidance Document", August, 2007.
34. "Groundwater Monitoring Well Installation & Monitoring Report Davis-Besse Nuclear Power Station Oak Harbor, Ohio", Environmental Resources Management, March 18, 2008.

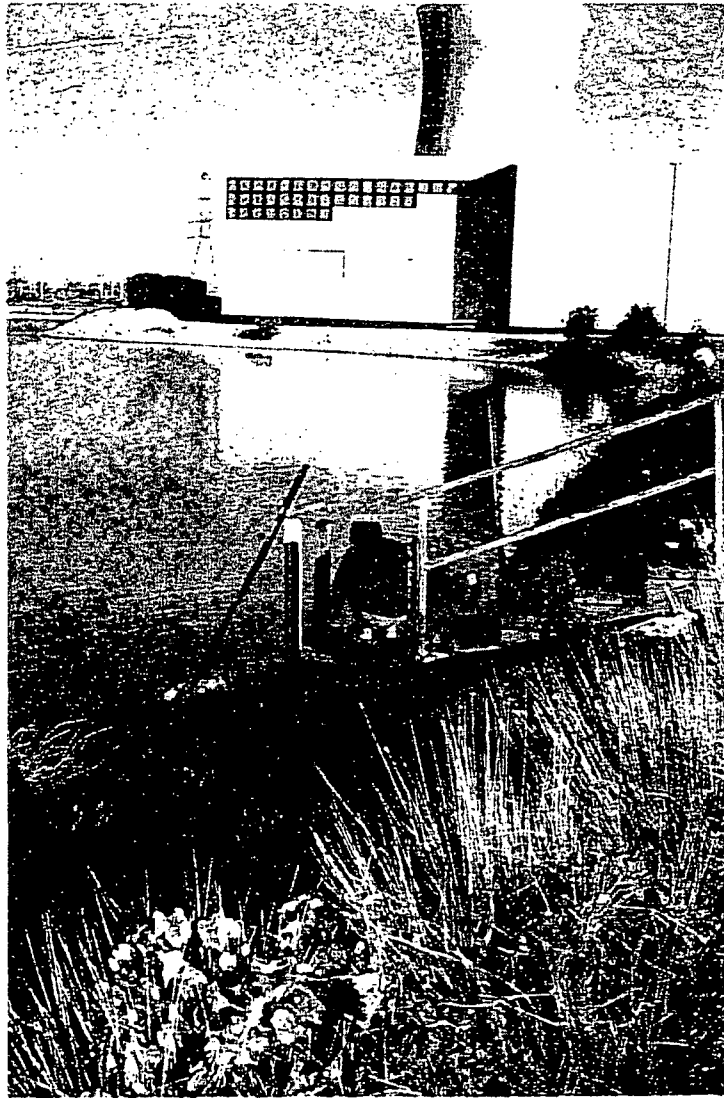

## Radioactive Effluent Release Report



# Radioactive Effluent Release Report

## January 1 through December 31, 2008

---

### Protection Standards

Soon after the discovery of x-rays in 1895 by Wilhelm Roentgen, the potential hazards of ionizing radiation were recognized and efforts were made to establish radiation protection standards. The primary source of recommendations for radiation protection standards within the United States is the National Council on Radiation Protection and Measurement (NCRP). Many of these recommendations have been given legislative authority by being published in the Code of Federal Regulations by the Nuclear Regulatory Commission.

The main objective in the control of radiation is to ensure that any dose is kept not only within regulatory limits, but kept as low as reasonably achievable (ALARA). The ALARA principle applies to reducing radiation dose both to the individual working at Davis-Besse and to the general public. "Reasonably achievable" means that exposure reduction is based on sound economic decisions and operating practices. By practicing ALARA, Davis-Besse minimizes health risk and environmental detriment and ensures that doses are maintained well below regulatory limits.

### Sources of Radioactivity Released

During the normal operation of a nuclear power station, most of the fission products are retained within the fuel and fuel cladding. However, small amounts of radioactive fission products and trace amounts of the component and structure surfaces, which have been activated, are present in the primary coolant water. The three types of radioactive material released are noble gases, iodine and particulates, and tritium.

The noble gas fission products in the primary coolant are given off as a gas when the coolant is depressurized. These gases are then collected by a system designed for gas collection and stored for radioactive decay prior to release.

Small releases of radioactivity in liquids may occur from valves, piping or equipment associated with the primary coolant system. These liquids are collected through a series of floor and equipment drains and sumps. All liquids of this nature are monitored and processed, if necessary, prior to release.

#### Noble Gas

Some of the fission products released in airborne effluents are radioactive isotopes of noble gases, such as Xenon (Xe) and Krypton (Kr). Noble gases are biologically and chemically inert. They do not concentrate in humans or other organisms. They contribute to human radiation dose by being an external source of radiation exposure to the body. Xe-133 and Xe-135, with half-lives of approximately five days and nine hours, respectively, are the major radioactive noble gases released. They are readily dispersed in the atmosphere.

## Iodine and Particulates

Annual releases of radioisotopes of Iodine, and those particulates with half-lives greater than 8 days, in gaseous and liquid effluents are small. Factors such as their high chemical reactivity and solubility in water, combined with the high efficiency of gaseous and liquid processing systems, minimize their discharge. The predominant radioiodine released is Iodine-131 with a half-life of approximately eight days. The main contribution of radioactive Iodine to human dose is to the thyroid gland, where the body concentrates Iodine.

The principal radioactive particulates released are fission products (e.g., Cesium-134 and Cesium-137) and activation products (e.g., Cobalt-58 and Cobalt-60). Radioactive Cesium and Cobalt contribute to internal radiation exposure of tissues such as muscle, liver, and the intestines. These particulates are also a source of external radiation exposure if deposited on the ground.

## Tritium

Tritium, a radioactive isotope of Hydrogen, is the predominant radionuclide in liquid effluents. It is also present in gaseous effluents. Tritium is produced in the reactor coolant as a result of neutron interaction with deuterium (also a Hydrogen isotope) present in the water and with the Boron in the primary coolant. When tritium, in the form of water or water vapor, is ingested or inhaled it is dispersed throughout the body until eliminated.

## Processing and Monitoring

Effluents are strictly controlled to ensure radioactivity released to the environment is minimal and does not exceed regulatory limits. Effluent control includes the operation of monitoring systems, in-plant and environmental sampling and analysis programs, quality assurance programs for effluent and environmental programs, and procedures covering all aspects of effluent and environmental monitoring.

The radioactive waste treatment systems at Davis-Besse are designed to collect and process the liquid and gaseous wastes that contain radioactivity. For example, the Waste Gas Decay Tanks allow radioactivity in gases to decay prior to release via the Station Vent.

Radioactivity monitoring systems are used to ensure that all releases are below regulatory limits. These instruments provide a continuous indication of the radioactivity present. Each instrument is equipped with alarms and indicators in the control room. The alarm setpoints are low enough to ensure the limits will not be exceeded. If a monitor alarms, a release from a tank is automatically stopped.

All wastes are sampled prior to release and analyzed to identify the specific concentrations of radionuclides. Sampling and analysis provides a more sensitive and precise method of determining effluent composition than can be accomplished with monitoring instruments.

A meteorological tower is located in the southwest sector of the Station which is linked to computers that record its data. Coupled with the effluent release data, the meteorological data are used to calculate the dose to the public.

Beyond the plant, devices maintained in conjunction with the Radiological Environmental Monitoring Program continuously sample the air in the surrounding environment. Frequent samples of other environmental media, such as water and vegetation, are taken to determine if buildup of deposited radioactive material has occurred in the area.

## Exposure Pathways

Radiological exposure pathways define the methods by which people may become exposed to radioactive material. The major pathways of concern are those which could cause the highest calculated radiation dose. These projected pathways are determined from the type and amount of radioactive material released, the environmental transport mechanism, and the use of the environment. The environmental transport mechanism includes consideration of physical factors, such as the hydrological (water) and meteorological (weather) characteristics of the area. An annual average of the water flow, wind speed, and wind direction are used to evaluate how the radionuclides will be distributed in an area for gaseous or liquid releases. An important factor in evaluating the exposure pathways is the use of the environment. Many factors are considered such as dietary intake of residents, recreational use of the area, and the locations of homes and farms in the area.

The external and internal exposure pathways considered are shown in Figure 29. The release of radioactive gaseous effluents involves pathways such as external whole body exposure, deposition of radioactive material on plants, deposition on soil, inhalation by animals destined for human consumption, and inhalation by humans. The release of radioactive material in liquid effluents involves pathways such as drinking water, fish consumption, and direct exposure from the lake at the shoreline while swimming.

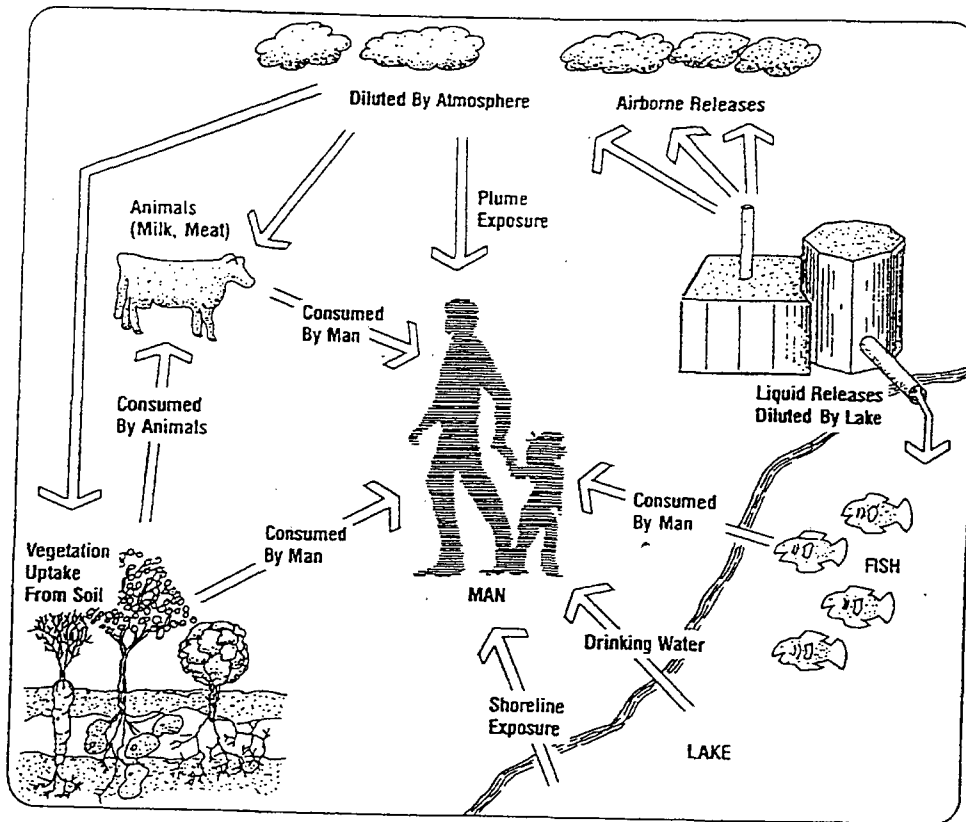

Figure 29: The exposure pathways shown here are monitored through the Radiological Environmental Monitoring Program (REMP) and are considered when calculating doses to the public.

Although radionuclides can reach humans by many different pathways, some result in more dose than others. The critical pathway is the exposure route that will provide, for a specific radionuclide, the greatest dose to a population, or to a specific group of the population called the critical group. The critical group may vary depending on the radionuclides involved, the age and diet of the group, or other cultural factors. The dose may be delivered to the whole body or to a specific organ. The organ receiving the greatest fraction of the dose is called the critical organ.

## Dose Assessment

Dose is the energy deposited by radiation in an exposed individual. Whole body exposure to radiation involves the exposure of all organs. Most background exposures are of this form. Both radioactive and non-radioactive elements can enter the body through inhalation or ingestion. When they do, they are usually not evenly distributed. For example, Iodine concentrates in the thyroid gland, Cesium collects in muscle and liver tissue, and Strontium collects in the bone.

The total dose to organs from a given radionuclide depends on the amount of radioactive material present in the organ and the length of time that the radionuclide remains there. Some radionuclides remain for short times due to their rapid radioactive decay and/or elimination rate from the body. Other radionuclides may remain in the body for longer periods of time.

The dose to the general public in the area surrounding Davis-Besse is calculated for each liquid or gaseous release. The dose due to radioactive material released in gaseous effluents is calculated using factors such as the amount of radioactive material released, the concentration beyond the site boundary, the average weather conditions at the time of the release, the locations of exposure pathways (cow milk, goat milk, vegetable gardens and residences), and usage factors (inhalation, food consumption). The dose due to radioactive material released in liquid effluents is calculated by using factors such as the total volume of the liquid released, the total volume of dilution water (near field dilution), and usage factors, such as water and fish consumption, and shoreline and swimming factors. These calculations produce a conservative estimation of the dose.

## Results

The Radioactive Effluent Release Report is a detailed listing of radioactivity released from the Davis-Besse Nuclear Power Station during the period from January 1 through December 31, 2008.

- Summation of the quantities of radioactive material released in gaseous and liquid effluents (Tables 17-23)
- Summation of the quantities of radioactive material contained in solid waste packaged and shipped for offsite disposal at federally approved sites (Table 24)
- A listing of all radioactive effluent monitoring instrumentation required by the Offsite Dose Calculation Manual, but which were inoperable for more than 30 days

A listing of all radioactive effluent monitoring instrumentation required by the Offsite Dose Calculation Manual, but which were inoperable for more than 30 days

During this reporting period, the estimated maximum individual offsite dose due to radioactivity released in effluent was:

### Liquid Effluents:

- 2.60E-03 mrem, maximum individual whole body
- 3.42E-03 mrem, maximum significant organ dose (liver)

### Gaseous Effluents:

#### Noble Gas:

- 4.30E-04 mrem, whole body
- 1.48E-03 mrem, skin

#### Iodine - 131, Tritium, and Particulates with Half-lives greater than 8 Days:

- 1.93E-03 mrem, whole body dose
- 2.21E-03 mrem, significant organ dose (thyroid)

These doses are a small fraction of the limits set by the NRC in the Davis-Besse ODCM.

Additional normal release pathways from the secondary system exist. For gaseous effluents, these pathways include the Auxiliary Feed Pump Turbines exhaust, the main steam safety valve system and the atmospheric vent valve system, steam packing exhaust and main feed water. For liquid effluents, the additional pathways include the Turbine Building drains via the settling basins. Releases via these pathways are included in the normal release tables in this report.

## Regulatory Limits

### Gaseous Effluents

In accordance with Offsite Dose Calculation Manual, dose rates due to radioactivity released in gaseous effluents from the site to areas at and beyond the site boundary shall be limited to the following:

Noble gases:

- Released at a rate equal to or less than 500 mrem TEDE per year.
- Released at a rate such that the total dose to the skin will be less than or equal to 3000 mrem in a year.

Iodine-131, tritium, and all radionuclides in particulate form with half-lives greater than 8 days:

- Released at a rate such that the total dose to any organ will be less than or equal to 1500 mrem in a year.

In accordance with 10CFR50, Appendix I, Sec. IIB. 1, air dose due to radioactivity released in gaseous effluents to areas at and beyond the site boundary shall be limited to the following:

- Less than or equal to 10 mrad total for gamma radiation and less than or equal to 20 mrad total for beta radiation in any calendar year.

In accordance with 10CFR50, Appendix I, Sec. IIC, dose to a member of the public from Iodine-131, tritium, and all radionuclides in particulate form with half-lives greater than 8 days in gaseous effluents released to areas at and beyond the site boundary shall be limited to the following:

- Less than or equal to 15 total mrem to any organ in any calendar year.

### Liquid Effluents

In accordance with 10CFR50, Appendix I, Sec IIA, the dose or dose commitment to a member of the public from radioactivity in liquid effluents released to unrestricted areas shall be limited to accumulated doses of:

- Less than or equal to 3 mrem to the total body and less than or equal to 10 mrem to any organ in any calendar year.



## Effluent Concentration Limits

The Effluent Concentration Limits (ECs) for gaseous and liquid effluents at and beyond the site boundary are listed in 10CFR20, Appendix B, Table II, Columns 1 and 2, with the most restrictive EC being used in all cases. For dissolved and entrained gases in liquids, the EC of 2.0E-04 uCi/ml is applied. This EC is based on the Xe-135 DAC of 1E-05 uCi/ml of air (submersion dose) converted to an equivalent concentration in water as discussed in the International Commission on Radiological Protection (ICRP), Publication 2.

## Average Energy

The Davis-Besse ODCM limits the dose equivalent rates due to the release of fission and activation products to less than or equal to 500 mrem per year to the total body and less than or equal to 3000 mrem per year to the skin. Therefore, the average beta and gamma energies (E) for gaseous effluents as described in Regulatory Guide 1.21, "Measuring, Evaluating, and Reporting Radioactivity in Solid Wastes and Releases of Radioactive Materials in Liquid and Gaseous Effluents from Light-Water-Cooled Nuclear Power Plants" are not applicable.

## Measurements of Total Activity

### Fission and Activation Gases:

These gases, excluding tritium, are collected in Marinelli beakers specially modified for gas sampling, in steel flasks, or in glass vials, and are counted on a Germanium detector for principal gamma emitters. Radionuclides detected are quantified via gamma spectroscopy.

Tritium gas is collected using a bubbler apparatus and counted by liquid scintillation.

### Iodine

Iodine is collected on a charcoal cartridge filter and counted on a germanium detector. Specific quantification of each iodine radionuclide is performed using gamma spectroscopy.

### Particulates

Particulates are collected on filter paper and counted on a Germanium detector. Specific quantification of each radionuclide present on the filter paper is performed by using gamma spectroscopy.

### Liquid Effluents

Liquid effluents are collected in a Marinelli beaker and counted on a germanium detector. Quantification of each gamma-emitting radionuclide present in liquid samples is via gamma spectroscopy. Tritium in the liquid effluent is quantified by counting an aliquot of a composite sample in a liquid scintillation counting system.

## Batch Releases

### Liquid from 1/1/08 through 12/31/08

1. Number of batch releases:	58
2. Total time period for the batch releases:	107.5 hours
3. Maximum time period for a batch release:	226 minutes
4. Minimum time period for a batch release:	80 minutes
5. Average time period for a batch release:	111 minutes

### Gaseous from 1/1/08 through 12/31/08

1. Number of batch releases:	6
2. Total time period for the batch releases:	51.2 hours
3. Maximum time period for a batch release:	1,718 minutes
4. Minimum time period for a batch release:	118 minutes
5. Average time period for batch release:	512 minutes

## Abnormal Releases

One abnormal gaseous release occurred during plant startup on March 7, when high pressure feed water heater relief valves lifted. The steam released contained 1.08 E-03 curies of Tritium and had a calculated whole body dose of 1.44E-07 millirem, which is well within regulatory limits.

There were no liquid abnormal releases of radioactivity during 2008.

## Percent of ODCM Release Limits

The following table presents the ODCM annual dose limits and the associated offsite dose to the public, in percent of limits, for January 1, 2008 through December 31, 2008.

SPECIFICATION	ANNUAL DOSE	LIMIT	PERCENT OF LIMIT
Report Period: January 1, 2008- December 31, 2008 (gaseous)			
Noble gases (gamma)	4.73E-04 mrad	10 mrad	4.73E-03
Noble gases (beta)	1.16E-03 mrad	20 mrad	5.80E-03
I-131, tritium and particulates	1.93E-03 mrem	15 mrem	1.29E-02
Report Period: January 1, 2008 - December 31, 2008 (liquid)			
Total body	2.60E-03 mrem	3 mrem	8.67E-02
Organ	3.42E-03 mrem	10 mrem	3.42E-02

## Sources of Input Data

- Water Usage: Survey of Water Treatment Plants (DSR-95-00347)
- 0-50 mile meat, milk, vegetable production, and population data was taken from 1982 Annual Environmental Operating Report entitled, "Evaluation of Compliance with Appendix I to 10CFR50: Updated Population, Agricultural, Meat - Animal, and Milk Production Data Tables for 1982". This evaluation was based on the 1980 Census, the Agricultural Ministry of Ontario 1980 report entitled "Agricultural Statistics and Livestock Marketing Account", the Agricultural Ministry of Ontario report entitled "Agricultural Statistics for Ontario, Publication 21, 1980", the Michigan Department of Agriculture report entitled "Michigan Agricultural Statistics, 1981", and the Ohio Crop Reporting Service report entitled "Ohio Agricultural Statistics, 1981".
- Gaseous and liquid source terms: Tables 17 through 21 of this report.
- Location of the nearest individuals and pathways by sector within 5 miles, see Land Use Census Section of the report.
- Population of the 50-mile Radius of Davis-Besse (DSR-95-00398).

## Dose to Public Due to Activities Inside the Site Boundary

In accordance with ODCM Section 7.2, the Radioactive Effluent Release Report includes an assessment of radiation doses from radioactivity released in liquid and gaseous effluents to members of the public from activities inside the site boundary.

The Wellness Center, Pavilion, Training Center pond and the intake forebay/canal area located inside DBNPS Owner Controlled Area are accessible to employees and their families. The Pavilion may be accessible to the public for certain social activities. The Training Center pond allows employees and their families to fish on site under a "catch-and-release" program; therefore the fish pathway is not considered applicable. Considering the frequency and duration of the visits, the resultant dose would be a small fraction of the calculated maximum site boundary dose. For purposes of assessing the dose to members of the public in accordance with ODCM Section 7.2, the following exposure assumptions are used:

- Exposure time for maximally-exposed visitors is 250 hours (1 hr/day, 5 day/ week, 50 wk/yr)
- Annual average meteorological dispersion (conservative, default use of maximum site boundary dispersion).
- For direct "shine" from the Independent Spent Fuel Storage Installation (ISFSI), default use of the maximum dose rate for a completed (full) ISFSI, and a distance of 950 feet.

The equations in the ODCM may be used for calculating the potential dose to a member of the public for activities inside the site boundary. Based on these assumptions, this dose would be at least a factor of 35 less than the maximum site boundary air dose, as calculated in the ODCM. Nowhere onsite are areas accessible to the public where exposure to liquid effluents could occur. Therefore, the modeling of the ODCM conservatively estimates the maximum potential dose to members of the public.

## Inoperable Radioactive Effluent Monitoring Equipment

There was no required radioactive effluent monitoring that was inoperable for more than 30 days during the reporting period.

## Changes to the Offsite Dose Calculation Manual (ODCM) and the Process Control Procedure (PCP)

There was one change to the ODCM and one change to the PCP during this reporting period.

## Borated Water Storage Tank Radionuclide Concentrations

During the reporting period of 2008, the Borated Water Storage Tank's (BWST) sum of limiting fractions of radionuclides concentration, (a unitless number between 0 and 1) exceeded the ODCM Section 2.2.4 limit of 1 on three occasions during 15RFO. The tank radioactivity was reduced by recirculation through the Spent Fuel Pool Demineralizer/filter on all three occasions. On each occasion, reduction to an acceptable level ( $<1$ ) was accomplished in between 32 and 48 hours.

Table 17  
Gaseous Effluents - Summation of All Releases

Type	Unit	1st Qtr 2008	2nd Qtr 2008	3rd Qtr 2008	4th Qtr 2008	Est. Total % Error
<b><u>Fission and Activation Gases</u></b>						
Total Release	Ci	1.85E+01	2.40E+00	1.88E+00	4.23E+00	2.5E+01
Average Release Rate for Period	µCi/sec	2.37E+00	3.05E-01	2.22E-01	5.37E-01	
Percent of ODCM Limits	See Supplemental Information in ODCM Release Limits Section 3.3, Gaseous Effluent Setpoint Determination					
<b><u>Iodines</u></b>						
Total Iodines (I-131)	Ci	8.19E-05	9.32E-05	1.52E-06	1.74E-06	2.5E+01
Average Release Rate for Period	µCi/sec	1.05E-05	1.18E-05	1.80E-07	2.21E-07	
Percent of ODCM Limits	See Supplemental Information in ODCM Release Limits Section 3.3, Gaseous Effluent Setpoint Determination					
<b><u>Particulates</u></b>						
Particulates with half-lives greater than 8 days	Ci	0.00E+00	0.00E+00	0.00E+00	0.00E+00	2.5E+01
Average Release Rate for Period	µCi/sec	0.00E+00	0.00E+00	0.00E+00	0.00E+00	
Percent of ODCM Limits	See Supplemental Information in ODCM Release Limits Section 3.3, Gaseous Effluent Setpoint Determination					
<b><u>Gross Alpha Activity</u></b>	Ci	0.00E+00	0.00E+00	0.00E+00	0.00E+00	2.5E+01
<b><u>Tritium</u></b>						
Total Release	Ci	1.91E+01	1.70E+01	1.52E+01	1.50E+01	2.5E+01
Average Release Rate for Period	µCi/sec	2.46E+00	2.16E+00	1.80E+00	1.91E+00	
Percent of ODCM Limits	See Supplemental Information in ODCM Release Limits Section 3.3, Gaseous Effluent Setpoint Determination					

Note: The average release rate is taken over the entire quarter, not over the time period of the releases.

Table 18  
Gaseous Effluents - Ground Level Releases - Batch Mode<sup>a</sup>

Nuclide	Unit	1st Qtr 2008	2nd Qtr 2008	3rd Qtr 2008	4th Qtr 2008
<b><u>Fission Gases</u></b>					
	Ci				
Kr-85		<LLD	<LLD	<LLD	<LLD
Kr-85m		<LLD	<LLD	<LLD	<LLD
Kr-87		<LLD	<LLD	<LLD	<LLD
Kr-88		<LLD	<LLD	<LLD	<LLD
Xe-133		<LLD	<LLD	<LLD	<LLD
Xe-135		<LLD	<LLD	<LLD	<LLD
Xe-135m		<LLD	<LLD	<LLD	<LLD
Xe-138		<LLD	<LLD	<LLD	<LLD
<b>Total for Period:</b>		N/A	N/A	N/A	N/A
<b><u>Iodines</u></b>					
	Ci				
I-131		<LLD	<LLD	<LLD	<LLD
I-133		<LLD	<LLD	<LLD	<LLD
I-135		<LLD	<LLD	<LLD	<LLD
<b>Total for Period:</b>		N/A	N/A	N/A	N/A
<b><u>Particulates and Tritium</u></b>					
	Ci				
H-3		5.09E-03	1.01E-02	1.07E-02	1.25E-02
Sr-89		<LLD	<LLD	<LLD	<LLD
Sr-90		<LLD	<LLD	<LLD	<LLD
Cs-134		<LLD	<LLD	<LLD	<LLD
Cs-137		<LLD	<LLD	<LLD	<LLD
Ba-La-140		<LLD	<LLD	<LLD	<LLD
<b>Total for Period:</b>		1.69E-03	1.01E-02	1.07E-02	1.25E-02



Table 18 (Continued)  
Gaseous Effluents - Ground Level Releases  
Continuous Mode<sup>b</sup>

Nuclide	Unit	1st Qtr 2008	2nd Qtr 2008	3rd Qtr 2008	4th Qtr 2008
<b><u>Fission Gases</u></b>					
	Ci				
Kr-85		<LLD	<LLD	<LLD	<LLD
Kr-85m		<LLD	<LLD	<LLD	<LLD
Kr-87		<LLD	<LLD	<LLD	<LLD
Kr-88		<LLD	<LLD	<LLD	<LLD
Xe-133		<LLD	<LLD	<LLD	<LLD
Xe-135		<LLD	<LLD	<LLD	<LLD
Xe-135m		<LLD	<LLD	<LLD	<LLD
Xe-138		<LLD	<LLD	<LLD	<LLD
<b>Total for Period:</b>		N/A	N/A	N/A	N/A
<b><u>Iodines</u></b>					
	Ci				
I-131		<LLD	<LLD	<LLD	<LLD
I-133		<LLD	<LLD	<LLD	<LLD
I-135		<LLD	<LLD	<LLD	<LLD
<b>Total for Period:</b>		N/A	N/A	N/A	N/A
<b><u>Particulates and Tritium</u></b>					
	Ci				
H-3		3.44E-03	2.77E-02	4.06E-02	3.34E-02
Sr-89		<LLD	<LLD	<LLD	<LLD
Sr-90		<LLD	<LLD	<LLD	<LLD
Cs-134		<LLD	<LLD	<LLD	<LLD
Cs-137		<LLD	<LLD	<LLD	<LLD
Ba-La-140		<LLD	<LLD	<LLD	<LLD
<b>Total for Period:</b>		3.44E-03	2.77E-02	4.06E-02	3.34E-02

Table 18 (Continued)  
Gaseous Effluents - Ground Level Releases  
LLDs for Continuous<sup>b</sup> and Batch<sup>a</sup> Mode

Kr-85	<2.3E-06	μCi/ml
Kr-85m	<9.0E-09	μCi/ml
Kr-87	<1.8E-08	μCi/ml
Kr-88	<2.9E-08	μCi/ml
Xe-133	<2.0E-08	μCi/ml
Xe-133m	<5.3E-08	μCi/ml
Xe-135	<7.1E-09	μCi/ml
Xe-135m	<2.1E-07	μCi/ml
Xe-138	<6.7E-07	μCi/ml
I-131	<1.3E-14	μCi/ml
I-133	<1.6E-14	μCi/ml
I-135	<8.1E-14	μCi/ml
Cs-134	<1.3E-14	μCi/ml
Cs-137	<1.1E-14	μCi/ml
Ba-140	<5.2E-14	μCi/ml
La-140	<7.0E-15	μCi/ml
Sr-89	<8.1E-16	μCi/ml
Sr-90	<2.8E-16	μCi/ml
Mn-54	<1.5E-14	μCi/ml
Fe-59	<2.3E-14	μCi/ml
Co-58	<1.7E-14	μCi/ml
Co-60	<1.9E-14	μCi/ml
Zn-65	<2.5E-14	μCi/ml
Mo-99	<1.8E-13	μCi/ml
Ce-141	<2.0E-14	μCi/ml

a Auxiliary Feed Pump Turbine Exhaust, Main Steam Safety Valves, and Auxiliary Boiler Outage Release are listed as batch releases.

b Atmospheric Vent Valve weepage and Steam Packing Exhaust are continuous releases.

Table 19  
Gaseous Effluents - Mixed Mode Releases  
Batch Mode

Nuclide	Unit	1st Qtr 2008	2nd Qtr 2008	3rd Qtr 2008	4th Qtr 2008
<b>Fission Gases</b>					
Ar-41	Ci	5.04E-04	<LLD	<LLD	<LLD
Kr-85	Ci	1.70E+00	1.73E-01	<LLD	<LLD
Kr-85m	Ci	<LLD	<LLD	<LLD	<LLD
Kr-87	Ci	<LLD	<LLD	<LLD	<LLD
Kr-88	Ci	<LLD	<LLD	<LLD	<LLD
Xe-131m	Ci	3.29E-02	<LLD	<LLD	<LLD
Xe-133	Ci	6.14E-01	<LLD	<LLD	<LLD
Xe-133m	Ci	<LLD	<LLD	<LLD	<LLD
Xe-135	Ci	<LLD	<LLD	<LLD	<LLD
Xe-135m	Ci	<LLD	<LLD	<LLD	<LLD
Xe-138	Ci	<LLD	<LLD	<LLD	<LLD
<b>Total for Period:</b>		2.35E+00	1.73E-01	0.00E+0	0.00E+00
<b>*Iodines</b>					
I-131	Ci	2.75E-07	<LLD	<LLD	<LLD
I-133	Ci	<LLD	<LLD	<LLD	<LLD
I-135	Ci	<LLD	<LLD	<LLD	<LLD
<b>Total for Period:</b>	Ci	N/A	N/A	N/A	N/A
<b>*Particulates &amp; Tritium</b>					
H-3	Ci	1.91E-02	1.71E-04	<LLD	<LLD
Sr-89	Ci	<LLD	<LLD	<LLD	<LLD
Sr-90	Ci	<LLD	<LLD	<LLD	<LLD
Cs-134	Ci	<LLD	<LLD	<LLD	<LLD
Cs-137	Ci	<LLD	<LLD	<LLD	<LLD
Ba-La-140	Ci	<LLD	<LLD	<LLD	<LLD
<b>Total for Period:</b>	Ci	5.85E-03	5.34E-03	0.00E+0	0.00E+00

\* Release of iodines and particulates are quantified in Mixed Mode Releases, Continuous Mode (Unit Station Vent)

Table 19 (Continued)  
Gaseous Effluents - Mixed Mode Releases  
Continuous Mode

Nuclide	Unit	1st Qtr 2008	2nd Qtr 2008	3rd Qtr 2008	4th Qtr 2008
<b>Fission Gases</b>					
Kr-85	Ci	<LLD	<LLD	<LLD	<LLD
Kr-85m	Ci	<LLD	<LLD	<LLD	<LLD
Kr-87	Ci	<LLD	<LLD	<LLD	<LLD
Kr-88	Ci	<LLD	<LLD	<LLD	<LLD
Xe-133	Ci	1.61E+01	2.23E+00	1.88E+00	4.23E+00
Xe-133m	Ci	<LLD	<LLD	<LLD	<LLD
Xe-135	Ci	<LLD	<LLD	<LLD	<LLD
Xe-135m	Ci	<LLD	<LLD	<LLD	<LLD
Xe-138	Ci	<LLD	<LLD	<LLD	<LLD
<b>Total for Period:</b>		1.61E+01	2.23E+00	1.88E+00	4.23E+00
<b>Iodines</b>					
I-131	Ci	6.50E-05	7.51E-05	1.52E-06	1.74E-06
I-132	Ci	<LLD	<LLD	<LLD	<LLD
I-133	Ci	1.66E-05	1.81E-05	<LLD	<LLD
I-135	Ci	<LLD	<LLD	<LLD	<LLD
<b>Total for Period:</b>		8.16E-05	9.32E-05	1.52E-06	1.74E-06
<b>Particulates and Tritium</b>					
Co-58	Ci	<LLD	<LLD	<LLD	<LLD
Sr-89	Ci	<LLD	<LLD	<LLD	<LLD
Sr-90	Ci	<LLD	<LLD	<LLD	<LLD
Cs-134	Ci	<LLD	<LLD	<LLD	<LLD
Cs-137	Ci	<LLD	<LLD	<LLD	<LLD
Ba-La-140	Ci	<LLD	<LLD	<LLD	<LLD
H-3	Ci	1.91E+01	1.70E+01	1.52E+01	1.50E+01
<b>Total for Period:</b>		1.91E+01	1.70E+01	1.52E+01	1.50E+01

Table 19 (Continued)

## LLDs for Gaseous Effluents - Mixed Mode Releases

Continuous Mode <sup>a</sup>		Batch Mode <sup>a</sup>	
Kr-85	<2.3E-06 μCi/ml	Ar-41	<2.2E-06 μCi/ml
Kr-85m	<9.0E-09 μCi/ml	Kr-85 <sup>b</sup>	<1.0E-04 μCi/ml
Kr-87	<1.8E-08 μCi/ml	Kr-85m	<1.4E-06 μCi/ml
Kr-88	<2.9E-08 μCi/ml	Kr-87	<4.6E-06 μCi/ml
Xe-133	<2.0E-08 μCi/ml	Kr-88	<5.0E-06 μCi/ml
Xe-133m	<5.3E-08 μCi/ml	Xe-133	<2.4E-06 uCi/ml
Xe-135	<7.1E-09 μCi/ml	Xe-133m	<8.6E-06 μCi/ml
Xe-135m	<2.1E-07 μCi/ml	Xe-135	<1.2E-06 μCi/ml
Xe-138	<6.7E-07 μCi/ml	Xe-135m	<7.7E-05 μCi/ml
I-131	<1.3E-14 μCi/ml	Xe-138	<1.8E-05 μCi/ml
I-133	<1.6E-14 μCi/ml	I-131	<1.2E-06 μCi/ml
I-135	<8.1E-14 μCi/ml	I-133	<1.1E-06 μCi/ml
Cs-134	<1.3E-14 μCi/ml	I-135	<4.9E-06 μCi/ml
Cs-137	<1.1E-14 μCi/ml	Sr-89	<8.1E-16 μCi/ml
Ba-140	<5.2E-14 μCi/ml	Sr-90	<2.8E-16 μCi/ml
La-140	<7.0E-15 μCi/ml	Cs-134	<1.2E-06 μCi/ml
Sr-89	<8.1E-16 μCi/ml	Cs-137	<1.8E-06 μCi/ml
Sr-90	<2.8E-16 μCi/ml	Ba-140	<4.5E-06 uCi/ml
Mn-54	<1.5E-14 μCi/ml	La-140	<1.4E-06 μCi/ml
Fe-59	<2.3E-14 μCi/ml		
Co-58	<1.7E-14 μCi/ml		
Co-60	<1.9E-14 μCi/ml		
Zn-65	<2.5E-14 μCi/ml		
Mo-99	<1.8E-13 μCi/ml		
Ce-141	<2.0E-14 μCi/ml		

a These radionuclides were not identified in every quarter in concentrations above the lower limit of detection (LLD).

b This nuclide was detected in all gaseous batch releases.

Table 20  
Liquid Effluents - Summation of All Releases

Type	Unit	1st Qtr 2008	2nd Qtr 2008	3rd Qtr 2008	4th Qtr 2008	Est. Total % Error
<b><u>Fission and Activation Products</u></b>						
Total Release (without Tritium, Gases, Alpha)	Ci	1.22E-02	2.10E-03	7.61E-04	1.13E-03	2.0E+01
Average Diluted Concentration During Period <sup>a</sup>	μCi/ml	1.34E-09	1.85E-10	5.47E-11	1.35E-10	
Percent of ODCM Limits	%	See Supplemental information in ODCM Section 2.3, Release Limits				
Percent of 10CFR20 Limit	%	6.87E-03	5.02E-04	2.51E-04	2.13E-04	
<b><u>Tritium</u></b>						
Total Release	Ci	2.64E+01	1.30E+02	4.22E+01	5.96E+01	2.0E+01
Average Diluted Concentration During Period <sup>a</sup>	μCi/ml	2.90E-06	1.15E-05	3.03E-06	7.12E-06	
Percent of 10CFR20 Limit	%	2.90E-01	1.15E+00	3.03E-01	7.12E-01	
<b><u>Dissolved and Entrained Gases</u></b>						
Total Release	Ci	6.30E-04	1.75E-02	1.64E-04	8.32E-06	2.0E+01
Average Diluted Concentration During Period <sup>a</sup>	μCi/ml	6.92E-11	1.54E-09	1.18E-11	9.93E-13	
Percent of 10CFR20 Limit	%	3.46E-05	7.69E-04	5.89E-06	4.97E-07	
<b><u>Gross Alpha</u></b>						
Total Release	Ci	0.00E+00	0.00E+00	0.00E+00	2.35E-04	2.0E+01
<b><u>Volume of Waste Released (prior to dilution)</u></b>						
Batch	liter	5.02E+05	5.39E+05	3.62E+05	3.64E+05	2.0E+01
Continuous	liter	1.08E+08	6.25E+07	6.04E+07	5.94E+07	2.0E+01
<b><u>Volume of Dilution Water</u></b>						
Batch	liter	1.45E+08	1.50E+08	1.14E+08	1.10E+08	2.0E+01
Continuous	liter	8.85E+09	1.11E+10	1.37E+10	8.21E+09	2.0E+01
<b><u>Total Volume of Water Released</u></b>	liter	9.11E+09	1.14E+10	1.39E+10	8.38E+09	

<sup>a</sup> Tritium and alpha are found in both continuous and batch releases. Average diluted concentrations are based on total volume of water released during the quarter. Fission and Activation products and Dissolved and Entrained Gases are normally only detected in batch releases.



Table 21  
Liquid Effluents - Nuclides Released  
In Batch Releases

Nuclide	Unit	1st Qtr 2008	2nd Qtr 2008	3rd Qtr 2008	4th Qtr 2008
<b>Fission and Activation Products</b>					
Cr-51	Ci	1.27E-04	<LLD	<LLD	<LLD
Mn-54	Ci	5.60E-05	<LLD	<LLD	<LLD
Fe-55 <sup>b</sup>	Ci	7.03E-03	8.62E-04	<LLD	<LLD
Co-57	Ci	3.22E-06	<LLD	<LLD	<LLD
Co-58	Ci	2.55E-03	1.54E-04	9.23E-05	2.42E-05
Fe-59	Ci	2.76E-06	<LLD	<LLD	<LLD
Co-60	Ci	9.53E-05	7.70E-06	7.77E-06	5.60E-07
Ni-63	Ci	1.36E-03	4.58E-04	1.34E-04	9.82E-04
Zn-65	Ci	<LLD	<LLD	<LLD	<LLD
Se75	Ci	<LLD	<LLD	<LLD	<LLD
Sr-89 <sup>b</sup>	Ci	<LLD	<LLD	<LLD	3.59E-05
Sr-90 <sup>b</sup>	Ci	1.06E-05	<LLD	<LLD	<LLD
Sr-92	Ci	<LLD	<LLD	<LLD	<LLD
Nb-95	Ci	2.22E-05	<LLD	<LLD	<LLD
Zr-95	Ci	1.50E-05	<LLD	<LLD	<LLD
Zr-97	Ci	<LLD	<LLD	<LLD	<LLD
Mo-99	Ci	<LLD	<LLD	<LLD	<LLD
Tc-99m	Ci	<LLD	<LLD	<LLD	<LLD
Ru-103	Ci	1.62E-06	<LLD	<LLD	<LLD
Ru-106	Ci	<LLD	<LLD	<LLD	<LLD
Ag-110m	Ci	2.25E-05	4.07E-05	5.22E-05	1.89E-05
Sb-122	Ci	<LLD	<LLD	<LLD	<LLD
Sb-124	Ci	1.04E-04	4.93E-5	1.73E-05	<LLD
Sb-125	Ci	4.62E-04	5.28E-04	4.57E-04	1.04E-04
I-131	Ci	2.13E-04	<LLD	<LLD	<LLD
I-132	Ci	<LLD	<LLD	<LLD	<LLD
Te-132	Ci	<LLD	<LLD	<LLD	<LLD
Cs-134	Ci	2.10E-05	<LLD	<LLD	<LLD
Cs-137	Ci	8.73E-05	2.09E-06	<LLD	<LLD
Ba-140	Ci	<LLD	<LLD	<LLD	<LLD
La-140	Ci	<LLD	<LLD	<LLD	<LLD
Ce-141	Ci	<LLD	<LLD	<LLD	<LLD
<b>Total for Period:</b>	Ci	1.22E-02	2.10E-03	7.61E-04	1.13E-03

Table 21 (continued)  
Liquid Effluents - Nuclides Released

Batch Releases

Nuclide	Unit	1st Qtr 2008	2nd Qtr 2008	3rd Qtr 2008	4th Qtr 2008
H-3	Ci	2.63E+01	1.30E+02	4.21E+01	5.94E+01
<b>Dissolved and Entrained Gases</b>					
Kr-85	Ci	<LLD	1.14E-02	1.52E-04	<LLD
Xe-131m	Ci	9.68E-05	4.74E-05	<LLD	<LLD
Xe-133	Ci	5.33E-04	5.95E-03	1.14E-05	8.32E-06
Xe-133m	Ci	<LLD	2.29E-05	<LLD	<LLD
Xe-135	Ci	<LLD	<LLD	<LLD	<LLD
<b>Total for Period:</b>	Ci	6.30E-04	1.75E-02	1.64E-04	8.32E-06

Table 21 (continued)  
Liquid Effluents – Nuclides<sup>a</sup> Released  
Continuous Releases

Nuclide	Unit	1st Qtr 2008	2nd Qtr 2008	3rd Qtr 2008	4th Qtr 2008
<b>Fission and Activation Products</b>					
Cr-51	Ci	<LLD	<LLD	<LLD	<LLD
Mn-54	Ci	<LLD	<LLD	<LLD	<LLD
Fe-59	Ci	<LLD	<LLD	<LLD	<LLD
Co-58	Ci	<LLD	<LLD	<LLD	<LLD
Co-60	Ci	<LLD	<LLD	<LLD	<LLD
Zn-65	Ci	<LLD	<LLD	<LLD	<LLD
Sr-89 <sup>b</sup>	Ci	<LLD	<LLD	<LLD	<LLD
Sr-90 <sup>b</sup>	Ci	<LLD	<LLD	<LLD	<LLD
Nb-95	Ci	<LLD	<LLD	<LLD	<LLD
Zr-95	Ci	<LLD	<LLD	<LLD	<LLD
Mo-99	Ci	<LLD	<LLD	<LLD	<LLD
Tc-99m	Ci	<LLD	<LLD	<LLD	<LLD
I-131	Ci	<LLD	<LLD	<LLD	<LLD
Cs-134	Ci	<LLD	<LLD	<LLD	<LLD
Cs-137	Ci	<LLD	<LLD	<LLD	<LLD
Ba/La-140	Ci	<LLD	<LLD	<LLD	<LLD
Ce-141	Ci	<LLD	<LLD	<LLD	<LLD
<b>Total for Period:</b>		0.00E+00	0.00E+00	6.02E-06	0.00E+00
<b>Tritium</b>	Ci	3.05E-02	5.45E-02	1.39E-01	2.38E-01
<b>Dissolved and Entrained Gases</b>					
Xe-133	Ci	<LLD	<LLD	<LLD	<LLD
Xe-135	Ci	<LLD	<LLD	<LLD	<LLD
<b>Total for Period:</b>	Ci	0.00E+00	0.00E+00	0.00E+00	0.00E+00

Table 21 (continued)

Liquid Effluents – LLDs for Nuclides Released<sup>a</sup>

Cr-51	<9.9E-8	μCi/ml	I-131	<1.0E-08	μCi/ml
Mn-54	<1.2E-08	μCi/ml	Xe-131m	<4.2E-07	μCi/ml
Fe-55 <sup>b</sup>	<8.7E-07	μCi/ml	Xe-133	<2.6E-08	μCi/ml
Co-57	<9.2E-09	μCi/ml	Xe-133m	<8.5E-08	μCi/ml
Co-58	<1.2E-08	μCi/ml	Cs-134	<1.3E-08	μCi/ml
Fe-59	<2.6E-08	μCi/ml	Xe-135	<9.3E-08	μCi/ml
Co-60	<8.1E-09	μCi/ml	Cs-137	<1.2E-08	μCi/ml
Zn-65	<3.1E-08	μCi/ml	Ba-140	<4.8E-08	μCi/ml
Kr-85	<3.4E-06	μCi/ml	La-140	<1.6E-08	μCi/ml
Sr-89 <sup>b</sup>	<3.4E-08	μCi/ml	Ce-141	<1.6E-08	μCi/ml
Sr-90 <sup>b</sup>	<7.9E-09	μCi/ml	Ce-144	<7.5E-08	μCi/ml
Sr-92	<2.5E-08	μCi/ml			
Zr-95	<1.5E-08	μCi/ml			
Zr-97	<1.5E-08	μCi/ml			
Nb-95	<1.2E-08	μCi/ml			
Tc-99m	<9.6E-09	μCi/ml			
Mo-99	<1.0E-07	μCi/ml			
Ru-103	<9.4E-09	μCi/ml			
Ru-106	<1.2E-07	μCi/ml			
Ag-110m	<1.2E-08	μCi/ml			
Sb-124	<1.1E-08	μCi/ml			
Sb-125	<2.9E-08	μCi/ml			

<sup>a</sup> These radionuclides were not identified every quarter in concentrations above the lower limit of detection (LLD). The largest LLD value is used for each radionuclide. LLDs are applicable to both batch and continuous modes due to identical sample and analysis methods.

<sup>b</sup> Quarterly composite sample

Table 22  
Solid Waste and Irradiated Fuel Shipments

A. SOLID WASTE SHIPPED OFFSITE FOR BURIAL OR DISPOSAL (Not irradiated fuel)

1. Type of Waste		Unit	12-month Period	Est. Total Error, %
a.	Spent resins, filter sludges, evaporator bottoms, etc.	m <sup>3</sup>	1.23E+01	2.5E+01
		Ci	2.21E-02	2.5E+01
b.	Dry compressible waste, contaminated equip., etc.	m <sup>3</sup>	4.33E+02	2.5E+01
		Ci	2.08E+00	2.5E+01
c.	Irradiated components, control rods, etc.	m <sup>3</sup>	N/A	N/A
		Ci		
d.	Others: Used oils	m <sup>3</sup>	1.78E+01	2.5E+01
		Ci	5.52E-06	2.5E+01
e.	Others: Spent Resin Storage Tank Liquor	m <sup>3</sup>	1.53E+01	2.5E+01
		Ci	5.48E+00	2.5E+01

2. Estimate of major nuclide composition (by type of waste)

	Type	Percent (%)	Est. Error, %
a. Spent Resins	Ni <sup>63</sup>	2.91E+01	2.50E+01
	Fe <sup>55</sup>	2.46E+01	2.50E+01
	Cs <sup>137</sup>	1.94E+01	2.50E+01
	Co <sup>60</sup>	1.14E+01	2.50E+01
	Co <sup>58</sup>	5.28E+00	2.50E+01
	Mn <sup>54</sup>	4.79E+00	2.50E+01
	Sb <sup>125</sup>	2.55E+00	2.50E+01
	C <sup>14</sup>	2.10E+00	2.50E+01
	Cs <sup>134</sup>	7.32E-01	2.50E+01
b. Dry compressible waste, contaminated equipment, etc.	Fe <sup>55</sup>	2.98E+01	2.50E+01
	Cs <sup>137</sup>	2.68E+01	2.50E+01
	H <sup>3</sup>	2.52E+01	2.50E+01
	Co <sup>58</sup>	7.08E+00	2.50E+01
	Co <sup>60</sup>	3.19E+00	2.50E+01
	Cs <sup>134</sup>	2.91E+00	2.50E+01
	Pu <sup>241</sup>	2.68E+00	2.50E+01
	Sb <sup>125</sup>	1.68E+00	2.50E+01
	C <sup>14</sup>	3.95E-01	2.50E+01
	Ag <sup>110m</sup>	1.65E-01	2.50E+01
c. None			

Table 22

Solid Waste and Irradiated Fuel Shipments (Continued)

	Type	Percent (%)	Est. Error, %
d. Others: Used Oils	Cs <sup>137</sup>	3.20E+01	2.50E+01
	Fe <sup>55</sup>	3.19E+01	2.50E+01
	H <sup>3</sup>	2.97E+01	2.50E+01
	Co <sup>60</sup>	3.63E+00	2.50E+01
	Zn <sup>65</sup>	1.49E+00	2.50E+01
	Pu <sup>241</sup>	7.92E-01	2.50E+01
	C <sup>14</sup>	4.79E-01	2.50E+01
	e. Others: Spent Resin Storage Tank Liquor	H <sup>3</sup>	8.44E+01
Ni <sup>63</sup>		6.63E+00	2.50E+01
Fe <sup>55</sup>		2.79E+00	2.50E+01
Co <sup>58</sup>		2.56E+00	2.50E+01
Cs <sup>137</sup>		1.08E+00	2.50E+01
Ag <sup>110m</sup>		1.01E+00	2.50E+01
Co <sup>60</sup>		7.83E-01	2.50E+01
Nb <sup>95</sup>		3.00E-01	2.50E+01
Zr <sup>95</sup>		1.33E-01	2.50E+01
C <sup>14</sup>		1.06E-01	2.50E+01

3. Solid Waste Disposition

Number of Shipments:	11
Mode of Transportation:	Truck
Destination:	Energy Solutions, Oak Ridge, TN for processing and disposal at Energy Solutions of Utah.
Type of Container (Container Volume):	Metal boxes (assorted sizes, 3.12-36.2 m <sup>3</sup> )
Volume shipped for processing	441.2 m <sup>3</sup>
Number of Shipments:	1
Mode of Transportation:	Truck
Destination:	Energy Solutions, Kingston, TN for processing and disposal at Energy Solutions of Utah
Type of Container (Container Volume):	High Integrity Container (6.1 m <sup>3</sup> )
Volume shipped for processing	3.8 m <sup>3</sup>



Table 22

Solid Waste and Irradiated Fuel Shipments (Continued)

---

Number of Shipments:	3
Mode of Transportation:	Truck
Destination:	Studsvik, Erwin, TN for processing and disposal at Energy Solutions of Utah
Type of Container (Container Volume):	High Integrity Container (6.1 m <sup>3</sup> )
Volume shipped for processing	15.3 m <sup>3</sup>

B. IRRADIATED FUEL SHIPMENTS

There were no shipments of irradiated fuel.

## Onsite Groundwater Monitoring

As a result of 2007 Nuclear Energy Institute initiative NEI 07-07, Davis-Besse began monitoring wells near the plant in order to evaluate whether there have been any inadvertent releases of radioactivity that have impacted groundwater and could potentially affect local water supplies. The groundwater samples were taken from pre-construction era wells and from 16 newly drilled wells surrounding the plant.

Tritium values in these wells ranged from <140 to 1,477 pCi/liter in 2008. There is no indication that the contaminated groundwater has moved offsite. These wells are not used for drinking water purposes, and the tritium concentrations found were all below the 20,000 pCi/liter EPA drinking water limit.

Results of this sampling are listed in Table 23 below:

**Table 23. Groundwater Monitoring Wells Sampled in 2008**

Well Designation	Sample Date	Tritium (pCi/L)	Well Designation	Sample Date	Tritium (pCi/L)
MW-100A	4/8/2008	<173	MW-100A	10/7/2008	405
MW-100B	4/9/2008	<173	MW-100B	10/7/2008	282
MW-100C	4/9/2008	<154	MW-100C	10/9/2008	<140
MW-101A	4/10/2008	203	MW-101A	10/13/2008	376
MW-101B	4/10/2008	<173	MW-101B	10/13/2008	257
MW-101C	4/10/2008	<173	MW-101C	10/13/2008	<141
MW-102A	4/15/2008	713	MW-102A	10/8/2008	458
MW-102B	4/15/2008	442	MW-102B	10/8/2008	531
MW-102C	4/15/2008	<143	MW-102C	10/8/2008	<141
MW-103A	4/14/2008	423	MW-103A	10/14/2008	326
MW-103B	4/14/2008	435	MW-103B	10/14/2008	365
MW-103C	4/14/2008	<156	MW-103C	10/14/2008	<140
MW-104A	4/16/2008	436 / 327*	MW-104A	10/9/2008	250
MW-104B	4/16/2008	230	MW-104B	10/9/2008	254
MW-104C	4/17/2008	<154	MW-104C	10/10/2008	<141
MW-105A	4/18/2008	1477	MW-105A	10/16/2008	1041 / 1054*
MW-18S	4/23/2008	436	MW-18S	10/16/2008	324
MW-20S	6/26/2008	380	MW-20S	10/15/2008	426
MW-37S	6/26/2008	596	MW-37S	10/15/2008	502 / 398*
MW-33S	4/23/2008	767	MW-33S	10/16/2008	212

\* Duplicate

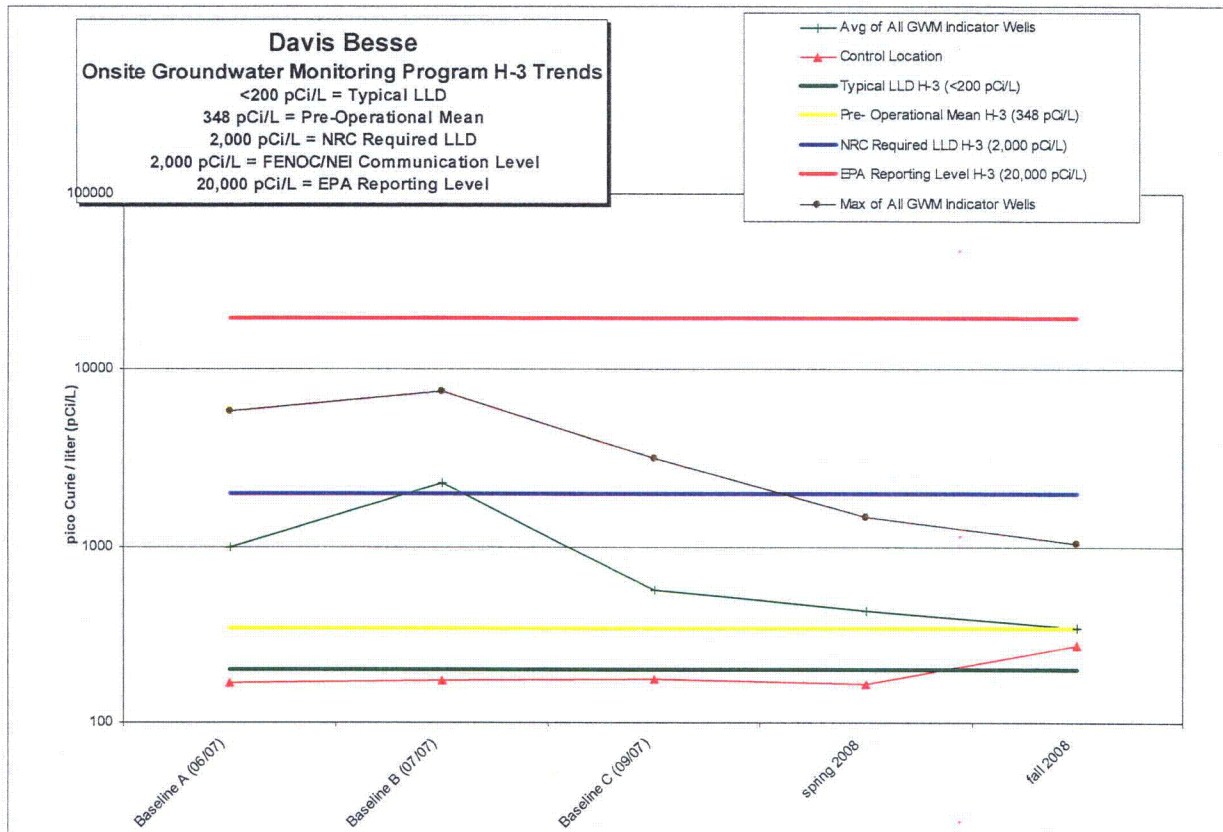

Figure 30. Davis-Besse Groundwater Monitoring through 2008

### Summary of Onsite Spills (>100 gallons)

On October 22, a leak was discovered in an underground 3 inch condensate line, which transports low-level tritiated water to an approved radioactive effluent discharge point. The line was immediately isolated and repaired, and several wells in the area surrounding the line break were sampled.

It was not possible to determine the volume of the leak. All wells showed tritium concentrations at less than the courtesy notification level of 2,000 pCi/liter. No gamma activity or hard-to-detect radionuclides (Sr-89, Sr-90, Fe-55, Ni-63) were present in the samples. Follow-up sampling of these wells will occur in spring of 2009. Notifications were made to the NRC, State of Ohio, and Lucas and Ottawa County officials on October 23, 2008.

Summary of Items Added to Decommissioning Files per 10CFR50.75(g)

Information regarding the leaking 3 inch condensate line was added to the 10CFR50.75(g) file. Results of well sampling following the leak are given in Table 24 below:

**Table 24. Groundwater Results Following 3" Condensate Line Leak**

Groundwater Well Sampling for Tritium			Additional Test Results					
Well Designation	Sample Date	Vendor Lab Tritium Analysis (pCi/L)	Gross Alpha	Gross Beta	Fe-55	Ni-63	Sr-89	Sr-90
MW-105A	10/27/2008	1183	14.4	<18.7	<776.5	<90.1	<0.6	<0.4
MW-31S	10/27/2008	1612	11.6	<16.9	<758.5	<92.7	<1.3	<1.0
MW-31D	10/27/2008	118						
MW-32S	10/29/2008	1383	5.4	10.2	<737.5	<94.2	<1.2	<0.5
MW-32D	10/29/2008	654	<19.1	222.2	<746.8	<119.6	<1.0	<0.5
MW-33S	10/28/2008	581	<11.8	<18.4	<771.4	<106.1	<0.7	<0.5
MW-33D	10/28/2008	1538	<5.2	88.6	<785.3	<109.8	<1.2	<0.9
MW-34S	10/28/2008	695	12.4	10.8	<771.4	<99.5	<0.6	<0.4
MW-34D	10/29/2008	1212	<19.3	135.4	<742.1	<82.0	<2.0	<0.9
MW-12S	10/30/2008	1219	5.1	9.0	<765.7	<104.4	<0.9	<0.4
MW-12D	10/30/2008	689	<4.1	52.8	<693.6	<103.6	<1.2	<0.5

Table 25

Doses Due to Gaseous Releases  
for January through December 2008

**Maximum Individual Dose Due to I-131, H-3 and Particulates with Half-Lives Greater than 8 days.**

Whole Body Dose	1.93E-03 mrem
Significant Organ Dose (thyroid)	2.21E-03 mrem

**Maximum Individual Dose Due to Noble Gas**

Whole Body Dose	4.30E-04 mrem
Skin Dose	1.48E-03 mrem

**Population Dose Due to I-131, H-3 and Particulates with Half-Lives Greater than 8 days.**

Total Integrated Population Dose	1.33E-02 person-rem
Average Dose to Individual in Population	6.09E-06 mrem

**Population Dose Due to Noble Gas**

Total Integrated Population Dose	6.03E-04 person-rem
Average Dose to Individual in Population	2.76E-07 mrem

Table 26  
Doses Due to Liquid Releases  
for January through December 2008

---

Maximum Individual Whole Body Dose	2.60E-03 mrem
Maximum Individual Significant Organ Dose (bone)	3.42E-03 mrem
Population Dose	
Total Integrated Population Dose	3.29E-01 person-rem
Average Dose to Individual	1.51E-04 mrem

Table 27

## Annual Dose to The Most Exposed (from all pathways) Member of the Public 2008

	ANNUAL DOSE (mrem)	40CFR190 LIMIT (mrem)	PERCENT OF LIMIT
<b>Whole Body Dose*</b>			
Noble Gas	4.30E-04		
Iodine, Tritium, Particulates	1.93E-03		
Liquid	2.60E-03		
Total Whole Body Dose	4.96E-03	25	1.99E-02
<b>Thyroid Dose</b>			
Iodine, Tritium, Particulates	4.03E-03	75	5.38E-03
<b>Skin Dose</b>			
Noble Gas	1.48E-03	25	5.92E-03
<b>Significant Organ Dose (liver)</b>	5.13E-03	25	2.05E-02

## Meteorological Data

Meteorological data, stored on a compact disk for January through December 31, 2008, has been submitted with this document to the U. S. Nuclear Regulatory Commission, Document Control Desk, Washington, D.C. 20555.

\*Direct radiation from the facility is not distinguishable from natural background and is, therefore, not included in this compilation.



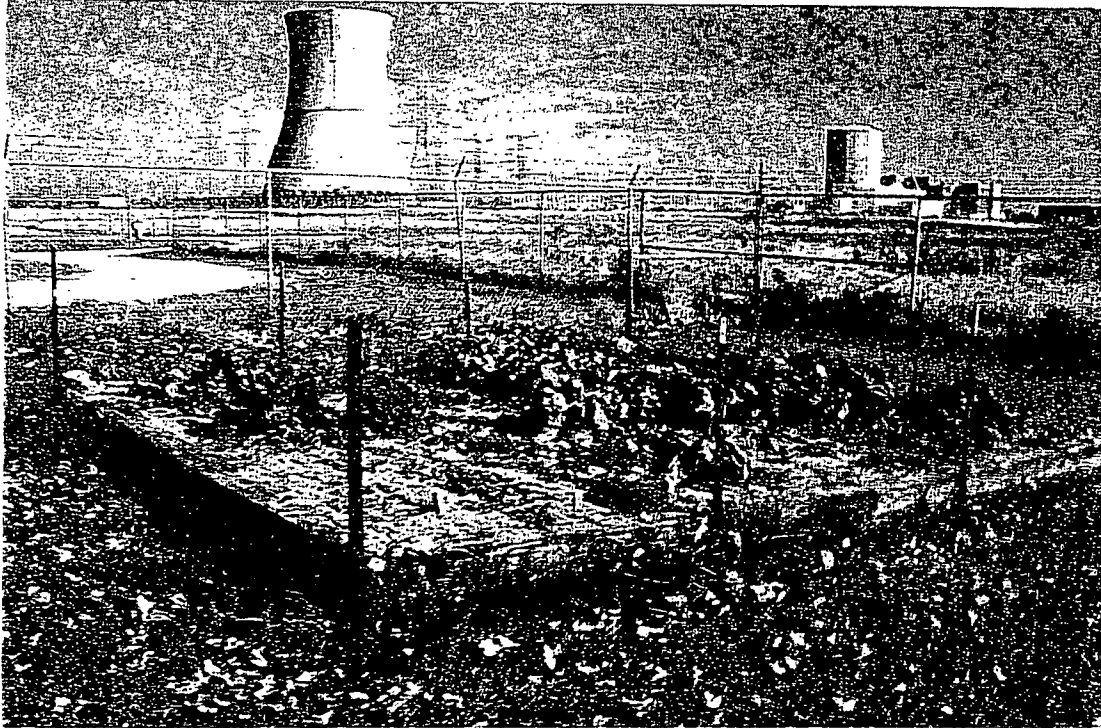

## Land Use Census

# Land Use Census

---

## Program Design

Each year a Land Use Census is conducted by Davis-Besse in order to update information necessary to estimate radiation dose to the general public and to determine if any modifications are necessary to the Radiological Environmental Monitoring Program (REMP). The Land Use Census is required by Title 10 of the Code of Federal Regulations, Part 50, Appendix I and Davis-Besse Nuclear Power Station Offsite Dose Calculation Manual, Section 5, Assessment of Land Use Census Data. The Land Use Census identifies gaseous pathways by which radioactive material may reach the general population around Davis-Besse. The information gathered during the Land Use Census for dose assessment and input into the REMP ensure these programs are as current as possible. The pathways of concern are listed below:

- **Inhalation Pathway** - Internal exposure as a result of breathing radionuclides carried in the air.
- **Ground Exposure Pathway** - External exposure from radionuclides deposited on the ground
- **Plume Exposure Pathway** - External exposure directly from a plume or cloud of radioactive material.
- **Vegetation Pathway** - Internal exposure as a result of eating vegetables, fruit, etc. which have a build up of deposited radioactive material or which have absorbed radionuclides through the soil.
- **Milk Pathway** - Internal exposure as a result of drinking milk, which may contain radioactive material as a result of a cow or goat grazing on a pasture contaminated by radionuclides.

## Methodology

The Land Use Census consists of recording and mapping the locations of the closest residences, dairy cattle and goats, and broad leaf vegetable gardens (greater than 500 square feet) in each meteorological sector within a five mile radius of Davis-Besse.

The surveillance portion of the 2008 Land Use Census was performed during the month of August. In order to gather as much information as possible, the locations of residences, dairy cows, dairy goats, and vegetable gardens were recorded. The residences, vegetable gardens, and milk animals are used in the dose assessment program. The gardens must be at least 500 square feet in size, with at least 20% of the vegetables being broadleaf plants (such as lettuce and cabbage).

Each residence is tabulated as being an inhalation pathway, as well as ground and plume exposure pathways. Each garden is tabulated as a vegetation pathway.

All of the locations identified are plotted on a map (based on the U.S. Geological Survey 7.5 minute series of the relevant quadrangles) which has been divided into 16 equal sectors corresponding to the 16 cardinal compass points (Figure 30). If available, the closest residence, milk animal, and vegetable garden in each sector are determined by measuring the distance from each to the Station Vent at Davis-Besse.

## Results

The following changes in the pathways were recorded in the 2008 census:

SSE Sector – a garden was added at 7,725 meters.

SW Sector – a garden was added at 5,580 meters.

S Sector – a garden was added at 6,035 meters.

**The critical receptor is a garden in the W sector at 1,560 meters from Davis-Besse, and is unchanged from 2007.**

The detailed list in Table 28 was used to update the database of the effluent dispersion model used in dose calculations. Table 28 is divided by sectors and lists the distance (in meters) of the closest pathway in each.

Table 29 provided information on pathways, critical age group, atmospheric dispersion (X/Q) and deposition (D/Q) parameters for each sector. This information is used to update the Offsite Dose Calculation Manual (ODCM). The ODCM describes the methodology and parameters used in calculating offsite doses from radioactivity released in liquid and gaseous effluents and in calculating liquid and gaseous effluent monitoring instrumentation alarm/trip setpoints.



DAVIS-BESSE NUCLEAR POWER STATION RADIOLOGICAL ENVIRONMENTAL MONITORING PROGRAM  
 PRIMARY PATHWAYS WITHIN A 5 MILE RADIUS

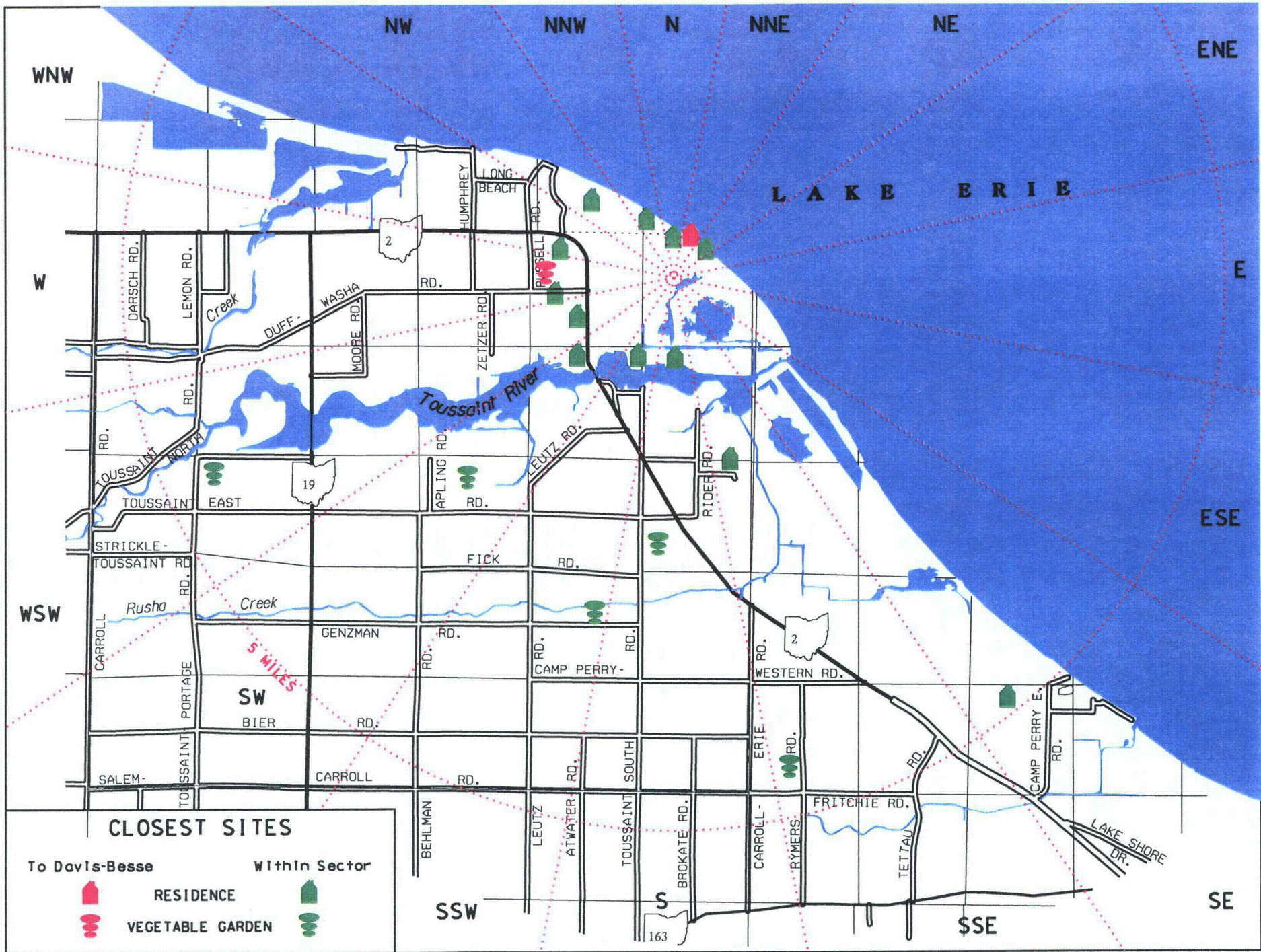

**CLOSEST SITES**

To Davis-Besse

Within Sector



RESIDENCE



VEGETABLE GARDEN

Figure 30: Land Use Census Map

Table 28  
Closest Exposure Pathways Present in 2008

<u>Sector</u>	<u>Distance from Station (meters)</u>	<u>Closest Pathways</u>
N	880	Inhalation Ground Exposure Plume Exposure
NNE	880	Inhalation Ground Exposure Plume Exposure
NE	900	Inhalation Ground Exposure Plume Exposure
ENE, E, ESE	N/A	Located over Lake Erie
SE	8,000	Inhalation Ground Exposure Plume Exposure
SSE	7,725	Vegetation
SSE	1,500	Inhalation Ground Exposure Plume Exposure
S	6,035	Vegetation
S	1,090	Inhalation Ground Exposure Plume Exposure
SSW	4,280	Vegetation
SSW	980	Inhalation Ground Exposure Plume Exposure
SW	1,070	Inhalation Ground Exposure Plume Exposure

Table 28  
Closest Exposure Pathways Present in 2008

<u>Sector</u>	<u>Distance from Station (meters)</u>	<u>Closest Pathways</u>
SW	5,580	Vegetation
WSW	1,540	Inhalation Ground Exposure Plume Exposure
WSW	6,450	Vegetation
W	980	Inhalation Ground Exposure Plume Exposure
W	1,560	Vegetation
WNW	1,520	Inhalation Ground Exposure Plume Exposure
NW	2,250	Vegetation
NW	1,490	Inhalation Ground Exposure Plume Exposure
NNW	1,290	Inhalation Ground Exposure Plume Exposure



**Table 29**  
**Pathway Locations and Corresponding**  
**Atmospheric Dispersion (X/Q) and Deposition (D/Q)**  
**Parameters**

<b>SECTOR</b>	<b>METERS</b>	<b>CRITICAL PATHWAY</b>	<b>AGE GROUP</b>	<b>X/Q (SEC/M<sup>3</sup>)</b>	<b>D/Q (M<sup>-2</sup>)</b>
N	880	Inhalation	Child	9.15E-07	8.40E-09
NNE	880	Inhalation	Child	1.24E-06	1.44E-08
NE	900	Inhalation	Child	1.26E-06	1.58E-08
ENE*	---	---	---	---	---
E*	---	---	---	---	---
ESE*	---	---	---	---	---
SE	8,000	Inhalation	Child	3.43E-08	1.45E-10
SSE**	7,725	Vegetation	Child	2.75E-08	1.18E-10
S**	6,035	Vegetation	Child	2.82E-08	1.56E-10
SSW	4,280	Vegetation	Child	3.31E-08	3.43E-10
SW**	5,580	Vegetation	Child	3.59E-08	2.94E-10
WSW	6,450	Vegetation	Child	3.89E-08	2.39E-10
W	1,560	Vegetation	Child	2.94E-07	4.67E-09
WNW	1,520	Inhalation	Child	1.89E-07	2.27E-09
NW	1,490	Vegetation	Child	7.19E-08	6.04E-10
NNW	1,290	Inhalation	Child	2.31E-07	1.67E-09

\* Since these sectors are located over marsh areas and Lake Erie, no ingestion pathways are present.





## Non-Radiological Environmental Programs

# Non-Radiological Environmental Programs

---

## Meteorological Monitoring<sup>1</sup>

The Meteorological Monitoring Program at Davis-Besse is required by the Nuclear Regulatory Commission (NRC) as part of the program for evaluating the effects of routine operation of nuclear power stations on the surrounding environment. Both NRC regulations and the Davis-Besse Technical Requirements Manual provide guidelines for the Meteorological Monitoring Program. These guidelines ensure that Davis-Besse has the proper equipment, in good working order, to support the many programs utilizing meteorological data.

Meteorological observations at Davis-Besse began in October 1968. The Meteorological Monitoring Program at Davis-Besse has an extensive record of data with which to perform climate studies which are used to determine whether Davis-Besse has had any impact upon the local climate. After extensive statistical comparative research the meteorological personnel have found no impact upon local climate or short-term weather patterns.

The Meteorological Monitoring Program also provides data that can be used by many other groups and programs such as the Radiological Environmental Monitoring Program, the Emergency Preparedness Program, Site Chemistry, Plant Operations, Nuclear Security, Materials Management and Industrial Safety, as well as other plant personnel and members of the surrounding community.

The Radiological Environmental Monitoring Program uses meteorological data to aid in evaluating the radiological impact, if any, of radioactivity released in Station effluents. The meteorological data is used to evaluate radiological environmental monitoring sites to assure the program is as current as possible. The Emergency Preparedness Program uses meteorological data to calculate emergency dose scenarios for emergency drills and exercises and uses weather data to plan evacuations or station isolation during adverse weather. The Chemistry Unit uses meteorological data for chemical spill response activities, marsh management studies, and wastewater discharge flow calculations. Plant Operations uses meteorological data for cooling tower efficiency calculations, Forebay water level availability and plant work which needs certain environmental conditions to be met before work begins. Plant Security utilizes weather data in their routine planning and activities. Materials Management plans certain Plant shipments around adverse weather conditions to avoid high winds and precipitation, which would cause delays in material deliveries and safety concerns. Industrial Safety uses weather and climate data to advise personnel of unsafe working conditions due to environmental conditions, providing a safer place to work. Regulatory Affairs uses climate data for their investigation into adverse weather accidents in relation to the Plant and personnel.

1. More detailed weather information is available upon request.

## On-site Meteorological Monitoring

### System Description

At Davis-Besse there are two meteorological systems, a primary and a backup. Both are housed in separate environmentally controlled buildings with independent power supplies. Both primary and backup systems have been analyzed to be statistically identical, so that if a redundant system in one unit fails, the other system can take its place. The instrumentation of each system follows:

<u>PRIMARY</u>	<u>BACKUP</u>
100 Meter Wind Speed	100 Meter Wind Speed
75 Meter Wind Speed	75 Meter Wind Speed
10 Meter Wind Speed	10 Meter Wind Speed
100 Meter Wind Direction	100 Meter Wind Direction
75 Meter Wind Direction	75 Meter Wind Direction
10 Meter Wind Direction	10 Meter Wind Direction
100 Meter Delta Temperature	100 Meter Delta Temperature
75 Meter Delta Temperature	75 Meter Delta Temperature
10 Meter Ambient Temperature	10 Meter Ambient Temperature
10 Meter Dew Point	10 Meter Solar Incidence
Precipitation	

### Meteorological Instrumentation

The meteorological system consists of one monitoring site located at an elevation of 577 feet above mean sea level (IGLD 1955)\*. It contains a 100m free-standing tower located about 3,000 feet SSW of the Cooling Tower and a 10m auxiliary tower located 100 feet west of the 100 m tower. Both are used to gather the meteorological data. The 100m tower has primary and backup instruments for wind speed and wind direction at 100m and 75m. The 100m tower also measures differential temperature (delta Ts): 100-10m and 75-10m. The 10m tower has instruments for wind speed and wind direction. Precipitation is measured by a tipping bucket rain gauge located near the base of the 10m tower.

According to the Davis-Besse Nuclear Power Station Technical Requirements Manual, a minimum of five instruments are required to be operable at the two lower levels (75m and 10m) to measure temperature, wind speed, and wind direction. During 2008, average annual data recoveries for all required instruments were 99.09 percent. Minor losses of data occurred during routine instrument maintenance, calibration, and data validation.

Personnel at Davis-Besse inspect the meteorological site and instrumentation regularly. Data is reviewed daily to ensure that all communication pathways, data availability and data reliability are working as required. Tower instrumentation maintenance and semiannual calibrations are performed by in-house facilities and by an outside consulting firm. These instruments are wind tunnel tested to assure compliance with applicable regulations and plant specifications.

\* International Great Lakes Data - 1955

## Meteorological Data Handling and Reduction

Each meteorological system, primary and backup, have two Campbell Scientific Data-loggers (model 21XL) assigned to them. The primary system has a first data logger to communicate 900 second averages to the control room via a Digital Alpha computer system. This is a dedicated line. If a failure occurs at any point between the primary meteorological system and the control room the control room can utilize the second data logger in the primary shelter. Each data logger has its own dedicated communication link with battery backup. The backup meteorological system is designed the same as the primary; so to lose all meteorological data the primary and backup meteorological systems would have to lose all four data loggers. However, this would be difficult since each is powered by a different power supply and equipped with lightning and surge protection, plus four independent communication lines and data logger battery backup.

The data from the primary and backup meteorological systems are stored in a 30-day circular storage module with permanent storage held by the Digital Alpha computer. Data goes back to 1988 in this format and to 1968 in both digital and hardcopy formats. All data points are scrutinized every 900 seconds by meteorological statistics programs running continuously. These are then reviewed by meteorological personnel daily for validity based on actual weather conditions. A monthly review is performed using 21 NRC computer codes, which statistically analyze all data points for their availability and validity. If questionable data on the primary system can not be corroborated by the backup system, the data in question is eliminated and not incorporated into the final database. All validated data is then documented and stored on hard copy and in digital format for a permanent record of meteorological conditions.

## Meteorological Data Summaries

This section contains Tables 30-32, which summarize meteorological data collected from the on-site monitoring program in 2008.

### Wind Speed and Wind Direction

Wind sector graphics represent the frequency of wind direction by sector and the wind speed in mph by sector. This data is used by the NRC to better understand local wind patterns as they relate to defined past climatological wind patterns reported in Davis-Besse's Updated Safety Analysis Report. The maximum measured sustained wind speeds for 2008 occurred on January 30, when they were measured at 48.56 mph at the 100m level, 53.79 mph at the 75m level, and 44.66 mph at the 10m level.

Figures 31-34 give an annual sector graphic of average wind speed and percent frequency by direction measured at the three monitoring levels. Each wind sector graphic has two radial bars. The darker bar represents the percent of time the wind blew from that direction. The hatched bar represents the average wind speed from that direction. Wind direction sectors are classified using Pasquill Stabilities. Percent calms (less than or equal to 1.0 mph) are shown in the middle of the wind sector graphic.

## Ambient and Differential Temperatures

Monthly average, minimum and maximum ambient temperatures for 2008 are given in Table 31. These data are measured at the 10m level; with differential temperatures taken from 100 meter and 75 meter levels. The yearly average ambient temperature was 50.21°F. The maximum temperature was 99.9°F on September 13 with a minimum temperature of -0.76°F on December 21. Yearly average differential temperatures were -0.227°F (100 meter), and -0.235°F (75 meter). Maximum differential temperatures for 100 meter and 75 meter levels were 7.99°F on November 6, (100 meter), and 7.99°F (75 meter), also on November 6. Minimum differential temperatures for 100m and 75m levels were -4.00°F on October 25 (100 meter) and -4.00°F on October 25 (75 meter). Differential temperatures are a measurement of atmospheric stability and used to calculate radioactive plume dispersions based on Gaussian Plume Models of continuous effluent releases.

## Dew Point Temperatures and Relative Humidity

Monthly average and extreme dew point temperatures for 2008 are provided in Table 31. These data are measured at the 10m level. The average dew point temperature was 22.38°F with a maximum dew point temperature of 52.68°F on September 13. Please note that dew point temperatures above 75°F are highly suspect and are possibly due to calm winds and high solar heating allowing the aspirated dew point processor to retain heat. The minimum dew point (dew point under 32°F is frost point) temperature was -22.94 on December 21. It is possible to have relative humidity above 100 percent, which is known as supersaturation. Conditions for supersaturation have been met a few times at Davis-Besse due to its close proximity to Lake Erie, and the evaporative pool of moisture available from such a large body of water.

## Precipitation

Monthly totals and extremes of precipitation at Davis-Besse for 2008 are given in Table 31. Total precipitation for the year was 27.88 inches. The maximum daily precipitation total was 1.18 inches on June 23. There were many days on which no precipitation was recorded. It is likely that precipitation totals recorded in colder months are somewhat less than actual due to snow/sleet blowing across the collection unit rather than accumulating in the gauge.

## Lake Breeze and Lake Level Monitoring

Lake Breeze is monitored at Davis-Besse because of its potential to cause major atmospheric/dispersion problems during an unlikely radioactive release. A lake breeze event occurs during the daytime, usually during the summer, where the land surface heats up faster than the water, and therefore reaches higher temperatures than the water. The warmer air above the land rises faster because it is less dense than the cooler air over the lake. This leads to rising air currents over the land with descending denser air over the lake. This starts a wind circulation, which draws air from the water to the land during the daytime, creating a "Lake Breeze" effect. This event could be problematic if a release were to occur because diffusion would be slow thus creating an adverse atmosphere to the surrounding site.

Lake and forebay levels are monitored at Davis-Besse to observe, evaluate, predict and disseminate high or low lake level information. This data is critical in the running of the plant due to the large amounts of water needed to cool plant components. If water levels get too low the plant operators can take measures for the safe shutdown of the plant. Since Lake Erie is the shallowest of the Great Lakes, it is not uncommon for five feet lake level fluctuation to occur within an eight to ten hour period (plus or minus). High water levels also affect the plant due to emergency transportation and evacuation pathways.

Table 30  
Summary of Meteorological Data Recovery For The  
**Davis-Besse Nuclear Power Station**

January 1, 2008 through December 31, 2008

	JAN	FEB	MAR	APR	MAY	JUN	JUL	AUG	SEP	OCT	NOV	DEC	2008
100m Wind Speed	100	100	92.47	89.17	99.60	100	100	100	100	100	100	100	98.44
100M Wind Direction	100	100	100	100	100	100	100	100	100	100	100	100	100
75M Wind Speed	100	100	93.55	95.56	100	100	100	100	100	100	100	100	99.09
75M Wind Direction	100	100	100	100	100	100	100	100	100	100	100	100	100
10M Wind Speed	100	100	97.31	94.58	100	100	100	100	100	100	100	100	99.33
10M Wind Direction	100	100	100	100	100	100	100	100	100	100	100	100	100
10M Ambient Air Temp	100	100	99.87	99.72	100	100	100	100	100	100	100	100	99.97
10M Dew Point Temp	100	100	99.87	99.72	100	99.86	100	100	100	100	100	100	99.95
Delta T (100M-10M)	100	100	99.87	99.72	100	100	100	100	100	100	100	100	99.97
Delta T (75M-10M)	100	100	99.87	99.72	100	100	100	100	100	100	100	100	99.97
Joint 100M Winds and Delta T (100M-10M)	100	100	92.47	89.17	99.60	100	100	100	100	100	100	100	98.44
Joint 75M Winds and Delta T (100M-10M)	100	100	93.55	95.56	100	100	100	100	100	100	100	100	99.09
Joint 10M Winds and Delta T (75M-10M)	100	100	97.31	94.58	100	100	100	100	100	100	100	100	99.33

\*all data for individual months expressed as percent of time instrument was operable during the month, divided by the maximum number of hours in that month that the instrument could be operable. Values for annual data recoveries equals the percent of time instrument was operable during the year, divided by the number of hours in the year that the instrument was operable.



Table 31  
 Summary of Meteorological Data Measured at  
 Davis-Besse Nuclear Power Station  
 January 1, 2008 through December 31, 2008

	JAN	FEB	MAR	APR	MAY	JUN	JUL	AUG	SEP	OCT	NOV	DEC	2008
<b>100M WIND</b>													
Max Speed (mph)	48.56	43.97	36.59	40.03	38.65	34.79	28.01	28.64	44.54	34.12	39.77	48.45	48.56
Date of Max Speed	01/30	02/18	03/03	04/01	05/31	06/21	07/02	08/10	09/14	10/26	11/15	12/28	01/30
Min Speed (mph)	0.70	1.51	0.00	0.00	0.01	0.02	2.56	1.45	2.04	1.01	3.06	1.35	0.00
Date of Min Speed	01/30	02/21	03/27	04/03	05/22	06/14	07/06	08/12	09/02	10/04	11/01	12/11	04/03
Ave Wind Speed	20.27	17.31	15.73	8.76	8.26	14.84	13.67	13.18	13.74	16.18	17.83	17.67	16.41
<b>75M WIND</b>													
Max Speed (mph)	53.79	40.95	37.48	40.91	35.0079	32.34	26.22	27.34	42.65	32.98	36.17	45.97	53.79
Date of Max Speed	01/30	02/18	03/25	04/01	05/31	06/09	07/02	08/10	09/14	10/26	11/15	12/28	01/30
Min Speed (mph)	2.15	1.20	0.21	2.57	0.86	1.84	1.87	1.70	1.42	1.05	2.18	1.27	0.21
Date of Min Speed	01/31	02/21	03/04	04/15	05/21	06/05	07/06	08/30	09/28	10/04	11/01	12/11	03/04
Ave Wind Speed	18.31	15.58	14.69	14.47	16.82	13.99	12.15	11.73	12.15	14.62	16.14	16.35	14.75
<b>10M WIND</b>													
Max Speed (mph)	44.66	33.05	29.27	32.03	23.90	22.56	18.84	19.25	28.27	25.70	28.74	34.26	44.66
Date of Max Speed	01/30	02/18	03/25	04/01	05/31	06/09	07/02	08/10	09/14	10/26	11/15	12/28	01/30
Min Speed (mph)	2.39	1.43	0.12	1.86	1.06	1.99	0.99	1.07	1.15	1.17	1.65	1.06	0.12
Date of Min Speed	01/27	02/01	03/04	04/15	05/13	06/04	07/05	08/29	09/03	10/15	11/15	12/11	03/04
Ave Wind Speed	12.10	10.29	9.90	9.25	9.59	8.34	7.43	7.58	7.68	8.85	9.65	11.57	9.35

Table 31 (continued)  
 Summary of Meteorological Data Measured at  
 Davis-Besse Nuclear Power Station  
 January 1, 2008 through December 31, 2008

	JAN	FEB	MAR	APR	MAY	JUN	JUL	AUG	SEP	OCT	NOV	DEC	2008
<b>10M AMBIENT TEMP</b>													
Max (F)	66.08	54.30	60.51	80.73	81.27	90.80	88.10	90.03	99.90	79.30	71.80	65.11	99.90
Date of Max	01/07	02/05	03/31	04/25	05/26	06/06	07/17	08/23	09/13	10/13	11/04	12/27	09/13
Min (F)	2.46	4.17	13.69	32.54	42.59	52.99	57.50	56.72	51.61	29.22	19.11	-0.76	-0.76
Date of Min	01/25	02/11	03/09	04/02	05/13	06/19	07/01	08/10	09/13	10/30	11/23	12/21	12/21
Ave Temp	29.13	26.12	34.05	52.62	57.14	70.58	73.51	71.34	67.00	52.47	40.15	28.47	50.21
<b>10M DEW POINT TEMP</b>													
Mean (F)	8.23	5.20	10.79	23.31	27.08	39.46	41.07	39.21	35.88	22.15	12.70	3.31	22.38
Max (F)	40.37	33.11	33.81	41.07	44.59	50.93	50.33	49.53	52.68	41.53	33.85	34.50	52.68
Date of Max	01/07	02/05	03/31	04/25	05/26	06/05	07/20	08/05	09/13	10/15	11/03	12/27	09/13
Min (F)	-16.34	-16.95	-7.58	3.24	14.79	27.46	29.55	29.99	25.40	5.66	-5.01	-22.94	-22.94
Date of Min	01/25	02/10	03/09	04/02	05/19	06/17	07/02	08/10	09/10	10/30	11/22	12/21	12/21
<b>PRECIPITATION</b>													
Total (inches)	1.34	3.51	3.19	1.47	2.28	5.55	2.35	0.35	1.54	0.99	2.51	2.80	27.88
Max. in One Day	0.17	0.29	0.45	0.17	0.39	1.18	0.32	0.13	0.24	0.27	0.22	0.15	1.18
Date	01/08	02/17	03/28	04/04	05/02	06/23	07/10	08/01	09/13	10/15	11/15	12/24	06/23

Figure 31  
Wind Rose Annual Average 100M

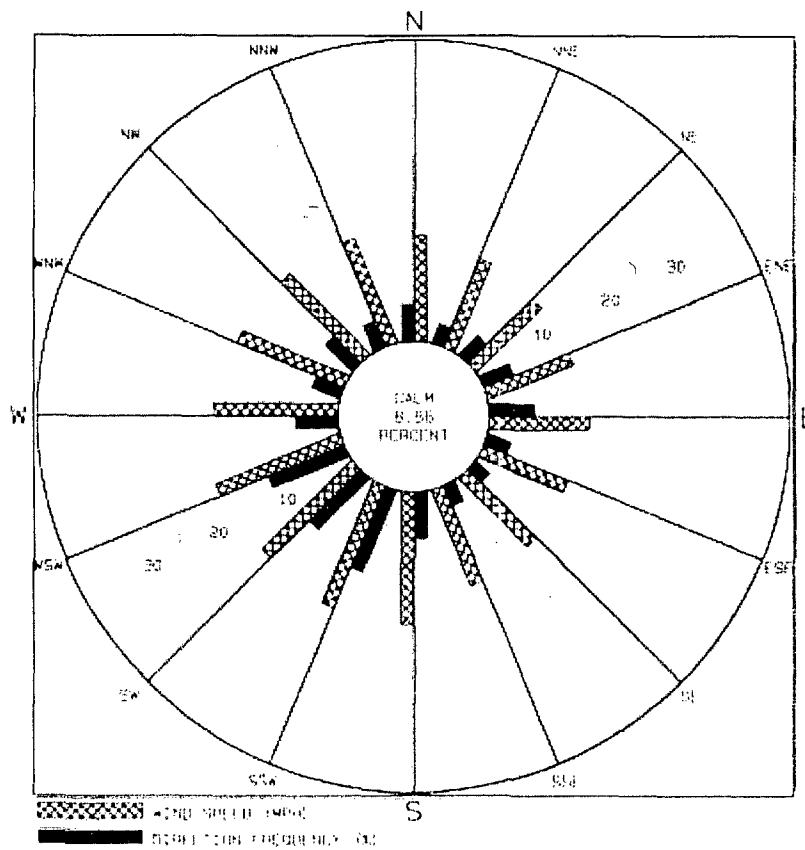

DAVIS-BESSE  
ANNUAL 2008  
100M LEVEL

Figure 32  
Wind Rose Annual Average 75M

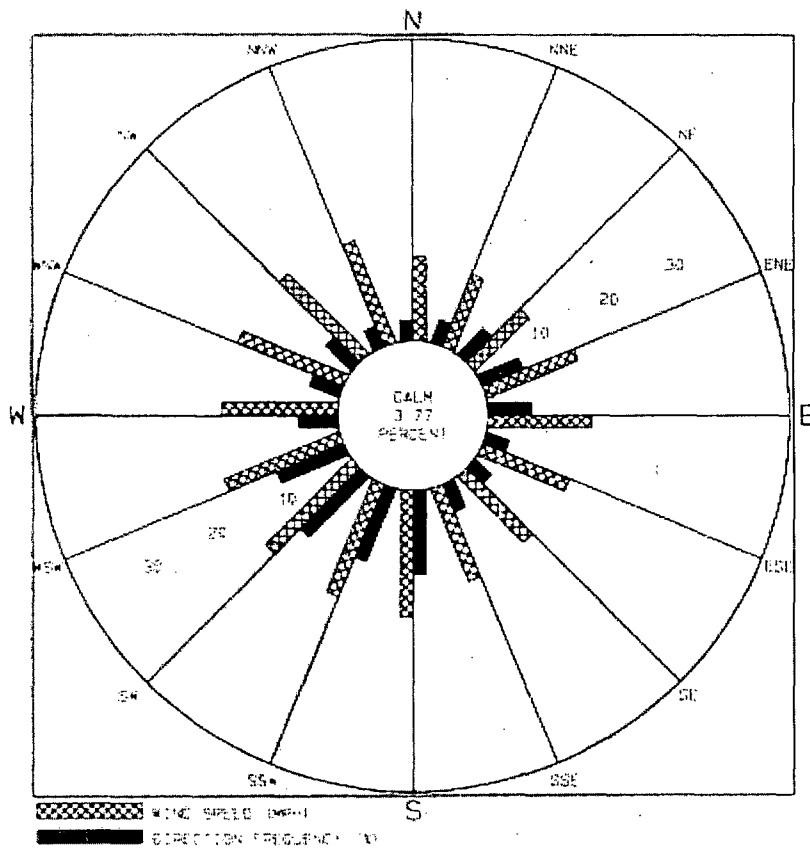

DAVIS-BESSE  
ANNUAL 2008  
75M LEVEL

Figure 33  
Wind Rose Annual Average 10M

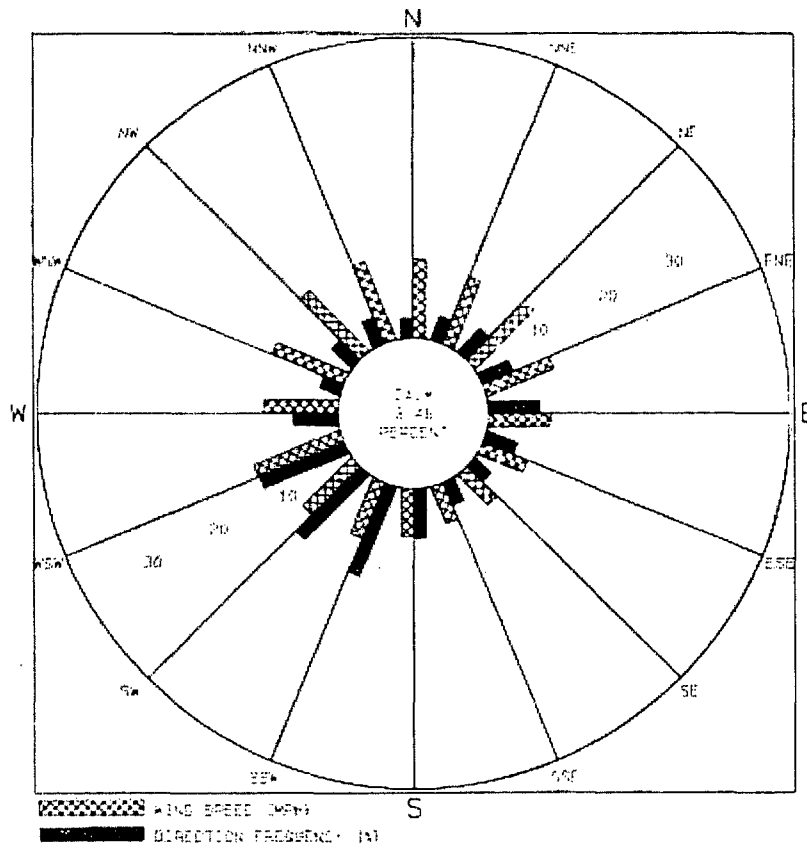

DAVIS-BESSE  
ANNUAL 2008  
10M LEVEL

## Table 32 Joint Frequency Distribution by Stability Class

DAVIS-BESSE ENVIRONMENTAL COMPLIANCE UNIT

12-Mar-09

PAGE 01

TIME OF DAY: 10:56:33

PROGRAM: JFD VERSION: F77-1.0

DAVIS-BESSE 75-10 DT, NO BACKUP

SITE IDENTIFIER: 8

DATA PERIOD EXAMINED: 01/01/2008 - 12/31/2008

\*\*\* ANNUAL \*\*\*

### STABILITY CLASS A BETWEEN 250.0 AND 35.0 FEET

STABILITY BASED ON: DELTA T

WIND MEASURED AT: 35.0 FEET

WIND THRESHOLD AT: 1.00 MPH

JOINT FREQUENCY DISTRIBUTION OF WIND SPEED AND DIRECTION IN HOURS AT 35.00 FEET

SPEED (MPH)	N	NNE	NE	ENE	E	ESE	SE	SSE	S	SSW	SW	WSW	W	WNW	NW	NNW	TOTAL
CALM																	0
1.01 - 3.49	0	2	0	0	0	0	0	0	0	0	0	0	0	0	0	0	2
3.50 - 7.49	7	8	0	0	0	0	1	0	6	5	0	0	1	1	6	8	43
7.50 - 12.49	7	2	1	0	1	0	0	2	1	2	1	6	5	4	9	16	57
12.50 - 18.49	0	0	0	4	3	2	0	0	0	0	1	1	0	2	15	13	41
18.50 - 24.49	0	0	0	0	0	0	0	0	0	0	0	3	0	0	2	2	7
>24.49	0	0	0	0	0	0	0	0	0	0	0	0	0	0	0	0	0
<b>TOTAL</b>	<b>14</b>	<b>12</b>	<b>1</b>	<b>4</b>	<b>4</b>	<b>2</b>	<b>1</b>	<b>2</b>	<b>7</b>	<b>7</b>	<b>2</b>	<b>10</b>	<b>6</b>	<b>7</b>	<b>32</b>	<b>39</b>	<b>150</b>

### STABILITY CLASS B BETWEEN 250.0 AND 35.0 FEET

STABILITY BASED ON: DELTA T

WIND MEASURED AT: 35.0 FEET

WIND THRESHOLD AT: 1.00 MPH

JOINT FREQUENCY DISTRIBUTION OF WIND SPEED AND DIRECTION IN HOURS AT 35.00 FEET

SPEED (MPH)	N	NNE	NE	ENE	E	ESE	SE	SSE	S	SSW	SW	WSW	W	WNW	NW	NNW	TOTAL
CALM																	0
1.01 - 3.49	0	0	0	0	0	0	0	0	0	0	0	0	0	0	0	0	0
3.50 - 7.49	6	10	2	0	0	0	0	0	1	7	3	2	0	1	4	9	45
7.50 - 12.49	6	10	5	2	9	4	0	0	0	1	9	15	5	3	11	12	92
12.50 - 18.49	1	0	2	4	3	1	0	0	0	0	6	9	1	5	4	9	45
18.50 - 24.49	0	0	0	0	0	0	0	0	0	0	0	3	0	0	1	0	4
>24.49	0	0	0	0	0	0	0	0	0	0	0	2	0	0	0	0	2
<b>TOTAL</b>	<b>13</b>	<b>20</b>	<b>9</b>	<b>6</b>	<b>12</b>	<b>5</b>	<b>0</b>	<b>0</b>	<b>1</b>	<b>8</b>	<b>18</b>	<b>31</b>	<b>6</b>	<b>9</b>	<b>20</b>	<b>30</b>	<b>188</b>

## Table 32 (continued) Joint Frequency Distribution by Stability Class

DAVIS-BESSE ENVIRONMENTAL COMPLIANCE UNIT

12-Mar-09 PAGE 02

TIME OF DAY: 10:56:33

PROGRAM: JFD VERSION: F77-1.0

DAVIS-BESSE 75-10 DT, NO BACKUP

SITE IDENTIFIER: 8

DATA PERIOD EXAMINED: 01/01/2008 - 12/31/2008

\*\*\* ANNUAL \*\*\*

### STABILITY CLASS C BETWEEN 250.0 AND 35.0 FEET

STABILITY BASED ON: DELTA T

WIND MEASURED AT: 35.0 FEET

WIND THRESHOLD AT: 1.00 MPH

JOINT FREQUENCY DISTRIBUTION OF WIND SPEED AND DIRECTION IN HOURS AT 35.00 FEET

SPEED (MPH)	N	NNE	NE	ENE	E	ESE	SE	SSE	S	SSW	SW	WSW	W	WNW	NW	NNW	TOTAL
CALM																	0
1.01 - 3.49	1	0	0	0	0	0	0	0	0	0	1	0	0	0	0	0	2
3.50 - 7.49	1	2	8	0	3	2	3	0	3	4	7	5	0	3	3	7	51
7.50 - 12.49	6	12	5	25	33	10	0	2	1	9	29	41	13	3	14	16	219
12.50 - 18.49	3	4	6	4	5	0	0	0	0	3	10	16	5	1	11	5	73
18.50 - 24.49	0	0	0	0	0	0	0	0	0	0	1	9	0	0	0	0	10
>24.49	0	0	0	0	0	0	0	0	0	0	0	2	2	0	0	0	4
<b>TOTAL</b>	<b>11</b>	<b>18</b>	<b>19</b>	<b>29</b>	<b>41</b>	<b>12</b>	<b>3</b>	<b>2</b>	<b>4</b>	<b>16</b>	<b>48</b>	<b>73</b>	<b>20</b>	<b>7</b>	<b>28</b>	<b>28</b>	<b>359</b>

### STABILITY CLASS D BETWEEN 250.0 AND 35.0 FEET

STABILITY BASED ON: DELTA T

WIND MEASURED AT: 35.0 FEET

WIND THRESHOLD AT: 1.00 MPH

JOINT FREQUENCY DISTRIBUTION OF WIND SPEED AND DIRECTION IN HOURS AT 35.00 FEET

SPEED (MPH)	N	NNE	NE	ENE	E	ESE	SE	SSE	S	SSW	SW	WSW	W	WNW	NW	NNW	TOTAL
CALM																	0
1.01 - 3.49	3	8	3	6	4	9	10	11	6	13	8	5	6	1	2	3	98
3.50 - 7.49	26	55	51	68	134	101	42	56	78	124	70	62	34	24	20	26	971
7.50 - 12.49	91	74	143	164	185	65	28	29	77	182	221	236	121	52	83	94	1845
12.50 - 18.49	49	63	101	60	48	5	0	0	11	99	141	276	91	57	79	70	1150
18.50 - 24.49	8	5	25	10	0	0	0	0	1	12	40	92	23	13	10	12	251
>24.49	4	2	0	0	0	0	0	0	0	0	1	39	7	2	0	4	59
<b>TOTAL</b>	<b>181</b>	<b>207</b>	<b>323</b>	<b>308</b>	<b>371</b>	<b>180</b>	<b>80</b>	<b>96</b>	<b>173</b>	<b>430</b>	<b>481</b>	<b>710</b>	<b>282</b>	<b>149</b>	<b>194</b>	<b>209</b>	<b>4374</b>



## Table 32 (continued) Joint Frequency Distribution by Stability Class

DAVIS-BESSE ENVIRONMENTAL COMPLIANCE UNIT

12-Mar-09

PAGE 03

TIME OF DAY: 10:56:33

PROGRAM: JFD VERSION: F77-1.0

DAVIS-BESSE 75-10 DT, NO BACKUP

SITE IDENTIFIER: 8

DATA PERIOD EXAMINED: 01/01/2008 - 12/31/2008

\*\*\* ANNUAL \*\*\*

### STABILITY CLASS E BETWEEN 250.0 AND 35.0 FEET

STABILITY BASED ON: DELTA T

WIND MEASURED AT: 35.0 FEET

WIND THRESHOLD AT: 1.00 MPH

JOINT FREQUENCY DISTRIBUTION OF WIND SPEED AND DIRECTION IN HOURS AT 35.00 FEET

SPEED (MPH)	N	NNE	NE	ENE	E	ESE	SE	SSE	S	SSW	SW	WSW	W	WNW	NW	NNW	TOTAL
CALM																	3
1.01 - 3.49	0	3	1	6	1	17	18	23	38	19	19	12	6	6	5	4	178
3.50 - 7.49	14	18	12	29	87	110	96	88	104	218	157	80	73	35	16	17	1154
7.50 - 12.49	6	19	14	33	54	37	26	17	55	164	100	81	77	38	32	19	772
12.50 - 18.49	2	4	1	1	9	0	0	3	26	71	44	37	14	15	13	1	241
18.50 - 24.49	0	0	0	0	0	0	0	0	2	13	7	7	3	3	0	1	36
>24.49	2	0	0	0	0	0	0	0	0	0	3	5	0	0	0	1	11
<b>TOTAL</b>	<b>24</b>	<b>44</b>	<b>28</b>	<b>69</b>	<b>151</b>	<b>164</b>	<b>140</b>	<b>131</b>	<b>225</b>	<b>485</b>	<b>330</b>	<b>222</b>	<b>173</b>	<b>97</b>	<b>66</b>	<b>43</b>	<b>2395</b>

### STABILITY CLASS F BETWEEN 250.0 AND 35.0 FEET

STABILITY BASED ON: DELTA T

WIND MEASURED AT: 35.0 FEET

WIND THRESHOLD AT: 1.00 MPH

JOINT FREQUENCY DISTRIBUTION OF WIND SPEED AND DIRECTION IN HOURS AT 35.00 FEET

SPEED (MPH)	N	NNE	NE	ENE	E	ESE	SE	SSE	S	SSW	SW	WSW	W	WNW	NW	NNW	TOTAL
CALM																	0
1.01 - 3.49	2	4	0	2	1	5	6	28	52	44	22	15	5	6	4	0	196
3.50 - 7.49	0	5	0	2	13	24	29	40	60	122	107	38	38	16	1	1	496
7.50 - 12.49	0	1	0	1	8	4	2	2	4	1	3	3	1	0	0	1	31
12.50 - 18.49	0	0	0	0	0	0	0	0	1	0	1	1	0	0	0	1	4
18.50 - 24.49	0	0	0	0	0	0	0	0	0	0	1	0	0	0	0	0	1
>24.49	0	0	0	0	0	0	0	0	0	0	0	0	0	0	0	0	0
<b>TOTAL</b>	<b>2</b>	<b>10</b>	<b>0</b>	<b>5</b>	<b>22</b>	<b>33</b>	<b>37</b>	<b>70</b>	<b>117</b>	<b>167</b>	<b>134</b>	<b>57</b>	<b>44</b>	<b>22</b>	<b>5</b>	<b>3</b>	<b>728</b>

**Table 32 (continued)**  
**Joint Frequency Distribution by Stability Class**

DAVIS-BESSE ENVIRONMENTAL COMPLIANCE UNIT

12-Mar-09

PAGE 04

TIME OF DAY:

10:56:33

PROGRAM: JFD VERSION: F77-1.0

DAVIS-BESSE 75-10 DT, NO BACKUP

SITE IDENTIFIER: 8

DATA PERIOD EXAMINED: 01/01/2008 - 12/31/2008

\*\*\* ANNUAL \*\*\*

**STABILITY CLASS G**  
 BETWEEN 250.0 AND 35.0 FEET

STABILITY BASED ON: DELTA T

WIND MEASURED AT: 35.0 FEET

WIND THRESHOLD AT: 1.00 MPH

JOINT FREQUENCY DISTRIBUTION OF WIND SPEED AND DIRECTION IN HOURS AT 35.00 FEET

SPEED (MPH)	N	NNE	NE	ENE	E	ESE	SE	SSE	S	SSW	SW	WSW	W	WNW	NW	NNW	TOTAL
CALM																	0
1.01 - 3.49	1	1	1	0	1	2	3	8	26	26	35	9	9	1	0	3	126
3.50 - 7.49	0	1	0	4	12	12	11	13	18	45	29	8	5	0	0	0	158
7.50 - 12.49	0	0	0	0	1	0	0	1	0	0	1	0	0	0	0	0	3
12.50 - 18.49	0	0	0	0	0	0	0	0	0	0	0	0	0	0	0	0	0
18.50 - 24.49	0	0	0	0	0	0	0	0	0	0	0	0	0	0	0	0	0
>24.49	0	0	0	0	0	0	0	0	0	0	0	0	0	0	0	0	0
<b>TOTAL</b>	<b>1</b>	<b>2</b>	<b>1</b>	<b>4</b>	<b>14</b>	<b>14</b>	<b>14</b>	<b>22</b>	<b>44</b>	<b>71</b>	<b>65</b>	<b>17</b>	<b>14</b>	<b>1</b>	<b>0</b>	<b>3</b>	<b>287</b>

**STABILITY CLASS ALL**  
 BETWEEN 250.0 AND 35.0 FEET

STABILITY BASED ON: DELTA T

WIND MEASURED AT: 35.0 FEET

WIND THRESHOLD AT: 1.00 MPH

JOINT FREQUENCY DISTRIBUTION OF WIND SPEED AND DIRECTION IN HOURS AT 35.00 FEET

SPEED (MPH)	N	NNE	NE	ENE	E	ESE	SE	SSE	S	SSW	SW	WSW	W	WNW	NW	NNW	TOTAL
CALM																	3
1.01 - 3.49	7	18	5	14	7	33	37	70	122	102	85	41	26	14	11	10	602
3.50 - 7.49	54	99	73	103	249	249	182	197	270	525	373	195	151	80	50	68	2918
7.50 - 12.49	116	118	168	225	291	120	56	53	138	359	364	382	222	100	149	158	3019
12.50 - 18.49	55	71	110	73	68	8	0	3	38	173	203	340	111	80	122	99	1554
18.50 - 24.49	8	5	25	10	0	0	0	0	3	25	49	114	26	16	13	15	309
>24.49	6	2	0	0	0	0	0	0	0	0	4	48	9	2	0	5	76
<b>TOTAL</b>	<b>246</b>	<b>313</b>	<b>381</b>	<b>425</b>	<b>615</b>	<b>410</b>	<b>275</b>	<b>323</b>	<b>571</b>	<b>1184</b>	<b>1078</b>	<b>1120</b>	<b>545</b>	<b>292</b>	<b>345</b>	<b>355</b>	<b>8481</b>

## Table 32 (continued) Joint Frequency Distribution by Stability Class

DAVIS-BESSE ENVIRONMENTAL COMPLIANCE UNIT 12-Mar-09 PAGE 05  
 TIME OF DAY: 10:56:33

PROGRAM: JFD VERSION: F77-1.0

DAVIS-BESSE 75-10 DT, NO BACKUP SITE IDENTIFIER: 8

DATA PERIOD EXAMINED: 01/01/2008 - 12/31/2008

\*\*\* ANNUAL \*\*\*

STABILITY BASED ON: DELTA T BETWEEN 250.0 AND 35.0 FEET  
 WIND MEASURED AT: 35.0 FEET  
 WIND THRESHOLD AT: 1.00 MPH

TOTAL NUMBER OF OBSERVATIONS: 8783  
 TOTAL NUMBER OF VALID OBSERVATIONS: 8481  
 TOTAL NUMBER OF MISSING OBSERVATIONS: 302  
 PERCENT DATA RECOVERY FOR THIS PERIOD: 96.6 %  
 MEAN WIND SPEED FOR THIS PERIOD: 9.4 MPH  
 TOTAL NUMBER OF OBSERVATIONS WITH BACKUP DATA: 0

### PERCENTAGE OCCURRENCE OF STABILITY CLASSES

A	B	C	D	E	F	G
1.77	2.22	4.23	51.57	28.24	8.58	3.38

### DISTRIBUTION OF WIND DIRECTION VS STABILITY

	N	NNE	NE	ENE	E	ESE	SE	SSE	S	SSW	SW	WSW	W	WNW	NW	NNW	CALM
A	14	12	1	4	4	2	1	2	7	7	2	10	6	7	32	39	0
B	13	20	9	6	12	5	0	0	1	8	18	31	6	9	20	30	0
C	11	18	19	29	41	12	3	2	4	16	48	73	20	7	28	28	0
D	181	207	323	308	371	180	80	96	173	430	481	710	282	149	194	209	0
E	24	44	28	69	151	164	140	131	225	485	330	222	173	97	66	43	3
F	2	10	0	5	22	33	37	70	117	167	134	57	44	22	5	3	0
G	1	2	1	4	14	14	14	22	44	71	65	17	14	1	0	3	0
<b>TOTAL</b>	<b>246</b>	<b>313</b>	<b>381</b>	<b>425</b>	<b>615</b>	<b>410</b>	<b>275</b>	<b>323</b>	<b>571</b>	<b>1184</b>	<b>1078</b>	<b>1120</b>	<b>545</b>	<b>292</b>	<b>345</b>	<b>355</b>	<b>3</b>

## Land and Wetlands Management

The Navarre Marsh, which is part of the Ottawa National Wildlife Refuge, makes up 733 acres of wetlands on the southwestern shore of Lake Erie and surrounds the Davis-Besse Nuclear Power Station. The marsh is owned by FirstEnergy and jointly managed by the U.S. Fish and Wildlife Service and FirstEnergy. Navarre Marsh is divided into three pools. The pools are separated from Lake Erie and each other by a series of dikes and revetments. Davis-Besse is responsible for the maintenance and repair of the dikes and controlling the water levels in each of the pools.

A revetment is a retaining structure designed to hold water back for the purposes of erosion control and beach formation. Revetments are built with a gradual slope, which causes waves to dissipate their energy when they strike their large surface area. Beach formation is encouraged through the passive deposition of sediment. A dike is a retaining structure designed to hold water for the purpose of flood control and to aid in the management of wetland habitat. When used as a marsh management tool, dikes help in controlling water levels in order to maintain desired vegetation and animal species. Manipulating water levels is one of the most important marsh management techniques used in the Navarre Marsh. Three major types of wetland communities exist in Navarre Marsh, the freshwater marsh, the swamp forest, and the wet meadow. Also, there exists a narrow dry beach ridge along the lakefront, with a sandbar extending out into Lake Erie. All these areas provide essential food, shelter and nesting habitat, as well as a resting area for migratory birds.

Davis-Besse personnel combine their efforts with a number of conservation agencies and organizations. The Ottawa National Wildlife Refuge, the Ohio Department of Natural Resources (ODNR), and the Black Swamp Bird Observatory work to preserve and enhance existing habitat. Knowledge is gained through research and is used to help educate the public about the importance of preserving wetlands.

With its location along two major migratory flyways, the Navarre Marsh serves as a refuge for a variety of birds in the spring and fall, giving them an area to rest and restore energy reserves before continuing their migration. The Black Swamp Bird Observatory, a volunteer research group, captures, bands, catalogues, and releases songbirds in the marsh during these periods.

Navarre Marsh is also home to wildlife that is typical of much of the marshland in this area, including deer, fox, coyote, muskrats, mink, rabbits, groundhogs, hawks, owls, ducks, geese, herons, snakes and turtles. For the first time in recent history, a pair of mature American Bald Eagles chose the Navarre Marsh as their nesting site in late 1994, and fledged a healthy eaglet in July 1995. A new nest was built in 1999-2000, from which a dozen eaglets were fledged. In the fall of 2005 two pairs of eagles built new nests on Davis-Besse property. One nest produced two eaglets, both of which successfully fledged bringing the total number of eagles fledged to seventeen since 1995. Ohio has gone from a low of 4 nesting eagle pairs statewide in 1978 to setting new hatch records every year for nearly three decades.

## Water Treatment Plant Operation

### Description

The Davis-Besse Nuclear Power Station draws water from Lake Erie for its water treatment plant. The lake water is treated with sodium hypochlorite and/or sodium hypo-bromite, coagulant aid, filtration, electrolysis and demineralization to produce high-purity water used in many of the Station's cooling systems.

Water from the Carroll Township Water Treatment Plant is used in Davis-Besse's Fire Protection System.

### Water Treatment System

Raw water from Lake Erie enters an intake structure, then passes through traveling screens which remove debris greater than one-half inch in size. The water is then pumped to chlorine detention tanks. Next, the water is sent to the pre-treatment system, which is comprised of coagulation and filtration to remove sediment, organic debris, and certain dissolved compounds from the raw water. The next step of the process is reverse osmosis, where pressure is used to remove certain impurities by passing the water through a selectively-permeable membrane. The water is then stripped of dissolved gases, softened, electrolytically deionized and finally, is routed through a polishing demineralization process before being sent to storage.

### Domestic Water

When Davis-Besse began operation over 30 years ago, all site domestic water was produced in the Water Treatment Facility. Operation of the domestic water treatment and distribution system, including the collection and analysis of daily samples, was reportable to the Ohio Environmental Protection Agency.

Since December of 1998, the Carroll Township Water Treatment Plant has supplied domestic water to Davis-Besse. Carroll Township Water and Wastewater District follow all applicable regulatory requirements for the sampling and analysis of Station drinking water.

### Zebra Mussel Control

With the exception of its domestic water, the Plant withdraws all of its water through an intake system from Lake Erie. Zebra mussels can severely impact the availability of water for Plant processes. *Dreissena polymorpha*, commonly known as the zebra mussel, is a native European bivalve that was introduced into the Great Lakes in 1986 and was discovered in Lake Erie in 1989. Zebra mussels are prolific breeders that rapidly colonize an area by forming byssal threads, which enable them to attach to solid surfaces and to each other. Because of their ability to attach in this manner, they may form layers several inches deep. This poses a problem to facilities that rely on water intakes from Lake Erie because mussels may attach to the intake structures and restrict water flow.

Zebra mussels have not caused any significant problems at Davis-Besse, but mussels have been found attached to the intake crib (the structure that allows water to be withdrawn from the lake) and the first section of the intake conduit (the pipe that connects the crib to the intake canal).

Mussels have also been found on the trash racks and on the walls of intake bay #3 prior to the traveling screens, and are periodically cleaned off by using high-pressure water. Davis-Besse uses continuous low level chlorination/bromination of the intake bays to control the mussels.

At present, the mussel population appears to be leveling off or declining. This is likely due to the increasing clarity of Lake Erie, since the mussels remove much of the algae. As the food source for the zebra mussel declines, mussel populations should continue to decline correspondingly.

### Wastewater Treatment Plant (WWTP) Operation

The WWTP operation is supervised by an Ohio licensed Wastewater Operator. Wastewater generated by site personnel is treated in an onsite extended aeration package treatment facility designed to accommodate up to 38,000 gallons per day. In the treatment process, wastewater from the various collection points around the site enters the facility through a grinder, from where it is distributed to the surge tanks of one or both of the treatment plants.

The wastewater is then pumped into aeration tanks, where it is digested by microorganisms. Oxygen is necessary for good sewage treatment, and is provided to the microbes by blowers and diffusers. The mixture of organics, microorganisms, and decomposed wastes is called activated sludge. The treated wastewater settles in a clarifier, and the clear liquid leaves the clarifier under a weir and exits the plant through an effluent trough. The activated sludge contains the organisms necessary for continued treatment, and is pumped back to the aeration tank to digest incoming wastewater. The effluent leaving the plant is drained to the wastewater basin (NPDES Outfall 601) where further treatment takes place.

### Summary of 2008 Wastewater Treatment Plant Operations

All wastewater parameters were within specifications during the year 2008.

### National Pollutant Discharge Elimination System (NPDES) Reporting

The Ohio Environmental Protection Agency (OEPA) has established limits on the amount of pollutants that Davis-Besse may discharge to the environment. These limits are regulated through the Station's National Pollutant Discharge Elimination System (NPDES) permit, number 2IB00011. Parameters such as chlorine, suspended solids and pH are monitored under the NPDES permit. Davis-Besse personnel prepare the NPDES Reports and submit them to the OEPA each month.

Davis-Besse has eight sampling points described in the NPDES permit. Seven of these locations are discharge points, or outfalls, and one is a temperature monitoring location. Descriptions of these sampling points follow:

**Outfall 001**

**Collection Box:** a point representative of discharge to Lake Erie

**Source of Wastes:** Low volume wastes (Outfalls 601 and 602), Circulating Water system blowdown and service water

**Outfall 002**

**Area Runoff:** Discharge to Toussaint River

**Source of Wastes:** Storm water runoff, Circulating Water pump house sumps

**Outfall 003**

**Screenwash Catch Basin:** Outfall to Navarre Marsh

**Source of Wastes:** Backwash water and debris from water intake screens

**Outfall 004**

**Cooling Tower Basin Ponds:** Outfall to State Route 2 Ditch

**Source of Wastes:** Circulating Water System drain (only during system outages)

**Outfall 588**

**Sludge Monitoring**

**Source of Wastes:** Wastewater Plant sludge shipped for offsite processing

**Outfall 601**

**Wastewater Plant Tertiary Treatment Basin:** Discharge from Wastewater Treatment Plant

**Sources of Wastes:** Wastewater Treatment Plant

**Outfall 602**

**Low volume wastes:** Discharge from settling basins

**Sources of wastes:** Water treatment residues, Condensate Polishing Holdup Tank decantation and Condensate Pit sumps

**Sampling Point 801**

**Intake Temperature:** Intake water prior to cooling operation

**2008 NPDES Summary**

During 2008, Davis-Besse Nuclear Power Station did not exceed any NPDES discharge limits.



## Chemical Waste Management

The Chemical Waste Management Program for hazardous and nonhazardous chemical wastes generated at the Davis-Besse Nuclear Power Station was developed to ensure wastes are managed and disposed of in accordance with all applicable state and federal regulations.

### Resource Conservation and Recovery Act

The Resource Conservation and Recovery Act (RCRA) is the statute which regulates solid hazardous waste. Solid waste is defined as a solid, liquid, semi-solid, or contained gaseous material. The major goals of RCRA are to establish a hazardous waste regulatory program to protect human health and the environment and to encourage the establishment of solid waste management, resource recovery, and resource conservation systems. The intent of the hazardous waste management program is to control hazardous wastes from the time they are generated until they are properly disposed of, commonly referred to as "cradle to grave" management. Anyone who generates, transports, stores, treats, or disposes of hazardous waste are subject to regulation under RCRA.

Under RCRA, there are essentially three categories of waste generators:

- Large quantity Generators - A facility which generates 1,000 kilograms/month (2,200 lbs./month) or more.
- Small quantity Generators - A facility which generates less than 1,000 kilograms/month (2,200 lbs./month).
- Conditionally Exempt Small Quantity Generators - A facility which generates 100 kilograms/month (220 lbs./month).

In 2008, the Davis-Besse Nuclear Power Station generated approximately 7,350 pounds of hazardous waste.

Non-hazardous waste generated in 2008 included 9,540 gallons of used oil and other nonhazardous wastes such as oil filters, latex paints and caulks.

RCRA mandates other requirements such as the use of proper storage and shipping containers, labels, manifests, reports, personnel training, a spill control plan and an accident contingency plan. These are part of the Chemical Management Program at Davis-Besse. The following are completed as part of the hazardous waste management program and RCRA regulations:

- Weekly Inspections of the Chemical Waste Accumulation Areas are designated throughout the site to ensure proper handling and disposal of chemical waste. These, along with the Chemical Waste Storage Area, are routinely patrolled by security personnel and inspected weekly by Environmental and Chemistry personnel. All areas used for storage or accumulation of hazardous waste are posted with warning signs and drums are color-coded for easy identification of waste categories.
- Waste Inventory Forms are placed on waste accumulation drums or provided in the accumulation area for employees to record the waste type and amount when chemicals are

added to the drum. This ensures that incompatible wastes are not mixed and also identifies the drum contents for proper disposal.

## Other Environmental Regulating Acts

### Comprehensive Environmental Response, Compensation and Liability Act

The Comprehensive Environmental Response, Compensation, and Liability Act (CERCLA, or Superfund) established a federal authority and source of funding for responding to spills and other releases of hazardous materials, pollutants and contaminants into the environment. Superfund establishes "reportable quantities" for several hundred hazardous materials and regulates the cleanup of abandoned hazardous waste disposal sites.

### Superfund Amendment and Reauthorization Act (SARA)

Superfund was amended in October 1986 to establish new reporting programs dealing with emergency preparedness and community right-to-know laws. As part of this program, CERCLA is enhanced by ensuring that the potential for release of hazardous substances is minimized, and that adequate and timely responses are made to protect surrounding populations.

Davis-Besse conducts site-wide inspections to identify and record all hazardous products and chemicals onsite as required by SARA. Determinations are made as to which products and chemicals are present in reportable quantities.

Annual SARA reports are submitted to local fire departments and state and local planning commissions by March 1 for the preceding calendar year.

### Toxic Substances Control Act (TSCA)

The Toxic Substance Control Act (TSCA) was enacted to provide the USEPA with the authority to require testing of new chemical substances for potential health effects before they are introduced into the environment, and to regulate them where necessary. This law would have little impact on utilities except for the fact that one family of chemicals, polychlorinated biphenyls (PCBs), has been singled out by TSCA. This has resulted in an extensive PCB management system, very similar to the hazardous waste management system established under RCRA.

In 1992, Davis-Besse completed an aggressive program that eliminated PCB transformers onsite. PCB transformers were either changed out with non-PCB fluid transformers or retrofilled with non-PCB liquid.

Retro-filling PCB transformers involves flushing the PCB fluid out of a transformer, refilling it with PCB-leaching solvents and allowing the solvent to circulate in the transformer during operation. The entire retro-fill process takes several years and will extract almost all of the PCB. In all, Davis-Besse performed retro-fill activities on eleven PCB transformers between 1987 and 1992. The only remaining PCB containing equipment onsite are a limited number of capacitors. These capacitors are being replaced and disposed of during scheduled maintenance activities.

## Clean Air Act

The Clean Air Act identifies substances that are considered air pollutants. Davis-Besse holds an OEPA permit to operate an Air Contaminant Source for the station Auxiliary Boiler. This boiler is used to heat the station and provide steam to plant systems when the reactor is not operating. A report detailing the Auxiliary Boiler operation is submitted annually.

The Ohio EPA has granted an exemption from permitting our six emergency diesel engines, including the Station Blackout Diesel Generator, the 2 Emergency Diesel Generators, the Emergency Response Facility Diesel Generator, the Miscellaneous Diesel, and the Fire Pump Diesel. These sources are operated infrequently to verify their reliability, and would only be used in the event of an emergency.

In response to recent "Clean Air Act Title V" legislation, an independent study identifying and quantifying all of the air pollution sources onsite was performed. Of particular significance is asbestos removal from renovation and demolition projects for which USEPA has outlined specific regulations concerning handling, removal, environmental protection, and disposal. Also, the Occupational Safety and Health Protection Administration (OSHA) strictly regulates asbestos with a concern for worker protection. Removal teams must meet medical surveillance, respirator fit tests, and training requirements prior to removing asbestos-containing material. Asbestos is not considered a hazardous waste by RCRA, but the EPA does require special handling and disposal of this waste under the Clean Air Act.

## Transportation Safety Act

The transportation of hazardous chemicals, including chemical waste, is regulated by the Transportation Safety Act of 1976. These regulations are enforced by the United States Department of Transportation (DOT) and cover all aspects of transporting hazardous materials, including packing, handling, labeling, marking, and placarding. Before any wastes are transported off site, Davis-Besse must ensure that the wastes are identified, labeled and marked according to DOT regulations, including verification that the vehicle has appropriate placards and it is in good operating condition.

## Other Environmental Programs

### Underground Storage Tanks

According to RCRA, facilities with Underground Storage Tanks (USTs) are required to notify the State. This regulation was implemented in order to provide protection from tank contents leaking and causing damage to the environment. Additional standards require leak detection systems and performance standards for new tanks. At Davis-Besse two 40,000 gallon and one 8,000 gallon diesel fuel storage tanks are registered USTs.

### Spill Kits

Spill control equipment is maintained throughout the Station at chemical storage areas and hazardous chemical and oil use areas. Equipment in the kits may include chemical-resistant coveralls, gloves, boots, decontamination agents, absorbent cloth, goggles and warning signs.

### Waste Minimization and Recycling

Municipal Solid Waste (MSW) is normal trash produced by individuals at home and by industries. In some communities, MSW is burned in specially designed incinerators to produce power or is separated into waste types (such as aluminum, glass, and paper) and recycled. The vast majority of MSW is sent to landfills for disposal. As the population increases and older landfills reach their capacity, MSW disposal becomes an important economic, health, and resource issue.

The State of Ohio has addressed the issue with the State Solid Waste Management Plan, otherwise known as Ohio House Bill 592. The intent of the bill is to extend the life of existing landfills by reducing the amount of MSW produced, by reusing certain waste material, and by recycling other wastes. This is frequently referred to as "**Reduce, Reuse, and Recycle.**"

Davis-Besse has implemented and participated in company wide programs that emphasize the reduction, reuse, recycle approach to MSW management. An active Investment Recovery Program has greatly contributed to the reduction of both hazardous and municipal waste generated by evaluating options for uses of surplus materials prior to the materials entering Davis-Besse's waste streams. Such programs include paper, cardboard, aluminum cans, used tires, and metals recycling or recovery. Paper and cardboard recycling is typically in excess of 50 tons annually. This represents a large volume of recyclable resources, which would have otherwise been placed in a landfill. Aluminum soft drink cans are collected for the Boy Scouts of America to recycle. Additionally, lead-acid batteries are recycled and tires are returned to the seller for proper disposal.

Although scrap metal is not usually considered part of the MSW stream, Davis-Besse collects and recycles scrap metals, which are sold at market price to a scrap dealer for resource recovery.

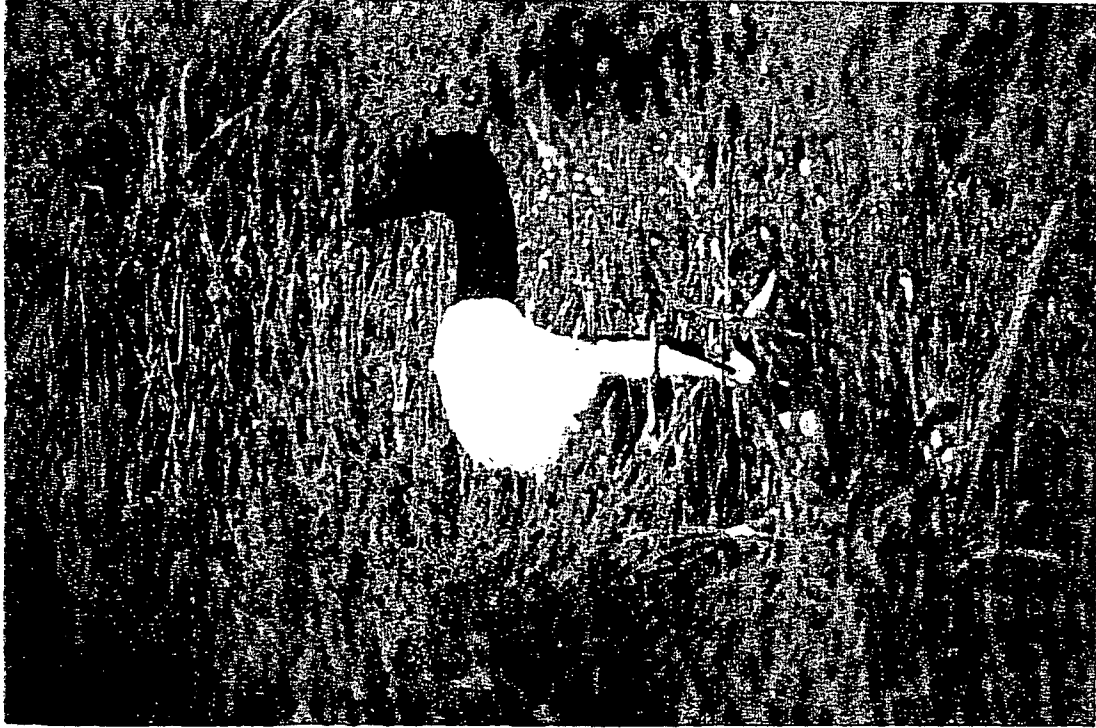

## Appendices

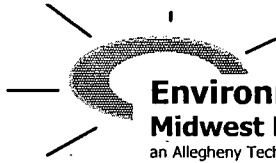

**Environmental, Inc.**  
**Midwest Laboratory**  
an Allegheny Technologies Co.

700 Landwehr Road • Northbrook, IL 60062-2310  
ph. (847) 564-0700 • fax (847) 564-4517

## APPENDIX A

### INTERLABORATORY COMPARISON PROGRAM RESULTS

**NOTE:** Environmental Inc., Midwest Laboratory participates in intercomparison studies administered by Environmental Resources Associates, and serves as a replacement for studies conducted previously by the U.S. EPA Environmental Monitoring Systems Laboratory, Las Vegas, Nevada. Results are reported in Appendix A. TLD Intercomparison results, in-house spikes, blanks, duplicates and mixed analyte performance evaluation program results are also reported. Appendix A is updated four times a year; the complete Appendix is included in March, June, September and December monthly progress reports only.

January, 2008 through December, 2008

## Appendix A

### Interlaboratory Comparison Program Results

Environmental, Inc., Midwest Laboratory has participated in interlaboratory comparison (crosscheck) programs since the formulation of its quality control program in December 1971. These programs are operated by agencies which supply environmental type samples containing concentrations of radionuclides known to the issuing agency but not to participant laboratories. The purpose of such a program is to provide an independent check on a laboratory's analytical procedures and to alert it of any possible problems.

Participant laboratories measure the concentration of specified radionuclides and report them to the issuing agency. Several months later, the agency reports the known values to the participant laboratories and specifies control limits. Results consistently higher or lower than the known values or outside the control limits indicate a need to check the instruments or procedures used.

Results in Table A-1 were obtained through participation in the environmental sample crosscheck program administered by Environmental Resources Associates, serving as a replacement for studies conducted previously by the U.S. EPA Environmental Monitoring Systems Laboratory, Las Vegas, Nevada.

The results in Table A-2 list results for thermoluminescent dosimeters (TLDs), via International Intercomparison of Environmental Dosimeters, when available, and internal laboratory testing.

Table A-3 lists results of the analyses on in-house "spiked" samples for the past twelve months. All samples are prepared using NIST traceable sources. Data for previous years available upon request.

Table A-4 lists results of the analyses on in-house "blank" samples for the past twelve months. Data for previous years available upon request.

Table A-5 lists REMP specific analytical results from the in-house "duplicate" program for the past twelve months. Acceptance is based on the difference of the results being less than the sum of the errors. Complete analytical data for duplicate analyses is available upon request.

The results in Table A-6 were obtained through participation in the Mixed Analyte Performance Evaluation Program.

Results in Table A-7 were obtained through participation in the environmental sample crosscheck program administered by Environmental Resources Associates, serving as a replacement for studies conducted previously by the Environmental Measurement Laboratory Quality Assessment Program (EML).

Attachment A lists the laboratory precision at the 1 sigma level for various analyses. The acceptance criteria in Table A-3 is set at  $\pm 2$  sigma.

Out-of-limit results are explained directly below the result.



Attachment A

## ACCEPTANCE CRITERIA FOR "SPIKED" SAMPLES

LABORATORY PRECISION: ONE STANDARD DEVIATION VALUES FOR VARIOUS ANALYSES<sup>a</sup>

Analysis	Level	One standard deviation for single determination
Gamma Emitters	5 to 100 pCi/liter or kg > 100 pCi/liter or kg	5.0 pCi/liter 5% of known value
Strontium-89 <sup>b</sup>	5 to 50 pCi/liter or kg > 50 pCi/liter or kg	5.0 pCi/liter 10% of known value
Strontium-90 <sup>b</sup>	2 to 30 pCi/liter or kg > 30 pCi/liter or kg	5.0 pCi/liter 10% of known value
Potassium-40	≥ 0.1 g/liter or kg	5% of known value
Gross alpha	≤ 20 pCi/liter > 20 pCi/liter	5.0 pCi/liter 25% of known value
Gross beta	≤ 100 pCi/liter > 100 pCi/liter	5.0 pCi/liter 5% of known value
Tritium	≤ 4,000 pCi/liter > 4,000 pCi/liter	± 1σ = 169.85 x (known) <sup>0.0933</sup> 10% of known value
Radium-226,-228	≥ 0.1 pCi/liter	15% of known value
Plutonium	≥ 0.1 pCi/liter, gram, or sample	10% of known value
Iodine-131, Iodine-129 <sup>b</sup>	≤ 55 pCi/liter > 55 pCi/liter	6 pCi/liter 10% of known value
Uranium-238, Nickel-63 <sup>b</sup> Technetium-99 <sup>b</sup>	≤ 35 pCi/liter > 35 pCi/liter	6 pCi/liter 15% of known value
Iron-55 <sup>b</sup>	50 to 100 pCi/liter > 100 pCi/liter	10 pCi/liter 10% of known value
Other Analyses <sup>b</sup>	---	20% of known value

<sup>a</sup> From EPA publication, "Environmental Radioactivity Laboratory Intercomparison Studies Program, Fiscal Year, 1981-1982, EPA-600/4-81-004.

<sup>b</sup> Laboratory limit.

TABLE A-1. Interlaboratory Comparison Crosscheck program, Environmental Resource Associates (ERA)<sup>a</sup>.

Lab Code	Date	Analysis	Concentration (pCi/L)				Acceptance
			Laboratory Result <sup>b</sup>	ERA Result <sup>c</sup>	Control Limits		
STW-1148	03/24/08	Sr-89	50.6 ± 2.4	60.4	48.6 - 68.2	Pass	
STW-1148	03/24/08	Sr-90	42.4 ± 1.4	39.2	28.8 - 45.1	Pass	
STW-1149	03/24/08	Ba-133	56.9 ± 5.4	58.3	48.3 - 64.3	Pass	
STW-1149	03/24/08	Co-60	73.9 ± 1.6	76.6	68.9 - 86.7	Pass	
STW-1149	03/24/08	Cs-134	50.2 ± 1.9	46.6	37.4 - 51.3	Pass	
STW-1149	03/24/08	Cs-137	97.7 ± 2.2	102.0	91.8 - 115.0	Pass	
STW-1149	03/24/08	Zn-65	109.9 ± 5.8	106.0	95.4 - 126.0	Pass	
STW-1150	03/24/08	Gr. Alpha	43.7 ± 7.5	50.8	26.5 - 63.7	Pass	
STW-1150	03/24/08	Gr. Beta	36.4 ± 1.8	51.4	35.0 - 58.4	Pass	
STW-1151	03/24/08	I-131	29.3 ± 1.4	28.7	23.9 - 33.6	Pass	
STW-1152	03/24/08	Ra-226	15.0 ± 1.1	15.3	11.4 - 17.6	Pass	
STW-1152	03/24/08	Ra-228	18.4 ± 1.8	17.0	11.4 - 20.4	Pass	
STW-1152	03/24/08	Uranium	23.4 ± 1.3	24.6	19.8 - 27.6	Pass	
STW-1153	03/24/08	H-3	12551.0 ± 207.0	12000.0	10400.0 - 13200.0	Pass	
STW-1154	07/07/08	Sr-89	24.9 ± 3.5	28.7	20.4 - 35.3	Pass	
STW-1154	07/07/08	Sr-90	39.7 ± 0.5	40.0	29.4 - 46.0	Pass	
STW-1155	07/07/08	Ba-133	45.0 ± 1.2	46.6	38.1 - 51.8	Pass	
STW-1155	07/07/08	Co-60	24.9 ± 3.0	25.7	22.3 - 31.0	Pass	
STW-1155	07/07/08	Cs-134	90.4 ± 5.3	93.2	76.6 - 102.0	Pass	
STW-1155	07/07/08	Cs-137	57.1 ± 2.8	54.6	49.1 - 62.9	Pass	
STW-1155	07/07/08	Zn-65	102.9 ± 7.3	98.8	88.9 - 118.0	Pass	
STW-1156	07/07/08	Gr. Alpha	24.8 ± 1.6	30.7	15.7 - 40.0	Pass	
STW-1156	07/07/08	Gr. Beta	23.9 ± 0.9	25.8	16.1 - 33.7	Pass	
STW-1157	07/07/08	Ra-226	8.0 ± 0.6	8.1	6.1 - 9.5	Pass	
STW-1157	07/07/08	Ra-228	7.7 ± 0.8	7.4	4.7 - 9.5	Pass	
STW-1157	07/07/08	Uranium	11.2 ± 0.3	11.3	8.9 - 13.0	Pass	
STW-1164	10/06/08	Sr-89	42.2 ± 3.2	48.7	38.2 - 56.1	Pass	
STW-1164	10/06/08	Sr-90	35.4 ± 1.2	33.6	24.6 - 38.8	Pass	
STW-1165	10/06/08	Ba-133	56.9 ± 1.0	63.5	52.8 - 69.9	Pass	
STW-1165	10/06/08	Co-60	47.6 ± 1.3	49.1	44.2 - 56.6	Pass	
STW-1165	10/06/08	Cs-134	26.4 ± 4.0	25.6	19.7 - 28.4	Pass	
STW-1165	10/06/08	Cs-137	24.3 ± 0.7	25.6	21.6 - 31.2	Pass	
STW-1165	10/06/08	Zn-65	72.0 ± 2.9	68.6	61.2 - 83.0	Pass	
STW-1166	10/06/08	Gr. Alpha	24.2 ± 4.8	26.9	13.6 - 35.5	Pass	
STW-1166	10/06/08	Gr. Beta	32.6 ± 1.0	38.0	25.1 - 45.5	Pass	
STW-1167	10/06/08	I-131	29.0 ± 0.3	28.1	23.4 - 33.0	Pass	
STW-1168	10/06/08	Ra-226	15.0 ± 1.0	16.1	12.0 - 18.4	Pass	
STW-1168	10/06/08	Ra-228	16.0 ± 1.0	14.1	9.4 - 17.1	Pass	
STW-1168	10/06/08	Uranium	47.8 ± 2.0	50.3	40.8 - 55.9	Pass	
STW-1169	10/06/08	H-3	2357.0 ± 66.0	2220.0	1830.0 - 2460.0	Pass	

<sup>a</sup> Results obtained by Environmental, Inc., Midwest Laboratory as a participant in the crosscheck program for proficiency testing in drinking water conducted by Environmental Resources Associates (ERA).

<sup>b</sup> Unless otherwise indicated, the laboratory result is given as the mean ± standard deviation for three determinations.

<sup>c</sup> Results are presented as the known values, expected laboratory precision (1 sigma, 1 determination) and control limits as provided by ERA.

TABLE A-2. Crosscheck program results; Thermoluminescent Dosimetry, (TLD, CaSO<sub>4</sub>: Dy Cards).

Lab Code	Date	Description	Known Value	mR		Control Limits	Acceptance
				Lab Result	± 2 sigma		
<u>Environmental, Inc.</u>							
2008-1	6/16/2008	40 cm.	30.23	33.87	± 1.17	21.16 - 39.30	Pass
2008-1	6/16/2008	50 cm.	19.35	23.13	± 0.57	13.55 - 25.16	Pass
2008-1	6/16/2008	60 cm.	13.44	16.25	± 1.10	9.41 - 17.47	Pass
2008-1	6/16/2008	70 cm.	9.87	10.39	± 0.52	6.91 - 12.83	Pass
2008-1	6/16/2008	80 cm.	7.56	7.44	± 0.51	5.29 - 9.83	Pass
2008-1	6/16/2008	90 cm.	5.97	5.80	± 1.04	4.18 - 7.76	Pass
2008-1	6/16/2008	100 cm.	4.84	4.32	± 0.43	3.39 - 6.29	Pass
2008-1	6/16/2008	120 cm.	3.36	2.69	± 0.15	2.35 - 4.37	Pass
2008-1	6/16/2008	150 cm.	2.15	2.05	± 0.69	1.51 - 2.80	Pass
2008-1	6/16/2008	180 cm.	1.49	1.23	± 0.80	1.04 - 1.94	Pass
<u>Environmental, Inc.</u>							
2008-2	11/17/2008	30 cm.	63.05	73.10	± 1.84	44.14 - 81.97	Pass
2008-2	11/17/2008	40 cm.	35.46	40.80	± 2.30	24.82 - 46.10	Pass
2008-2	11/17/2008	50 cm.	22.7	24.10	± 0.58	15.89 - 29.51	Pass
2008-2	11/17/2008	60 cm.	15.76	15.98	± 0.55	11.03 - 20.49	Pass
2008-2	11/17/2008	60 cm.	15.76	19.49	± 0.93	11.03 - 20.49	Pass
2008-2	11/17/2008	70 cm.	11.58	11.97	± 0.54	8.11 - 15.05	Pass
2008-2	11/17/2008	75 cm.	10.09	9.45	± 0.28	7.06 - 13.12	Pass
2008-2	11/17/2008	80 cm.	8.87	9.30	± 0.18	6.21 - 11.53	Pass
2008-2	11/17/2008	90 cm.	7.01	7.19	± 0.43	4.91 - 9.11	Pass
2008-2	11/17/2008	90 cm.	7.01	6.84	± 0.42	4.91 - 9.11	Pass
2008-2	11/17/2008	100 cm.	5.67	5.47	± 0.19	3.97 - 7.37	Pass
2008-2	11/17/2008	110 cm.	4.69	3.98	± 0.27	3.28 - 6.10	Pass
2008-2	11/17/2008	120 cm.	3.94	3.09	± 0.21	2.76 - 5.12	Pass
2008-2	11/17/2008	120 cm.	3.94	3.12	± 0.34	2.76 - 5.12	Pass
2008-2	11/17/2008	150 cm.	2.52	2.55	± 0.12	1.76 - 3.28	Pass
2008-2	11/17/2008	150 cm.	2.52	2.24	± 0.08	1.76 - 3.28	Pass
2008-2	11/17/2008	180 cm.	1.75	1.36	± 0.08	1.23 - 2.28	Pass

TABLE A-3. In-House "Spike" Samples

Lab Code <sup>b</sup>	Date	Analysis	Concentration (pCi/L) <sup>a</sup>			Acceptance
			Laboratory results 2s, n=1 <sup>c</sup>	Known Activity	Control Limits <sup>d</sup>	
SPW-111	1/14/2008	Tc-99	32.20 ± 0.85	32.34	20.34 - 44.34	Pass
SPW-298	1/31/2008	Ni-63	213.55 ± 3.07	212.58	148.81 - 276.35	Pass
W-11708	1/17/2008	Ra-226	11.34 ± 0.43	12.69	8.88 - 16.50	Pass
SPW-711	2/25/2008	U-238	33.56 ± 1.74	41.70	29.19 - 54.21	Pass
SPAP-881	3/11/2008	Cs-134	19.29 ± 1.53	20.09	10.09 - 30.09	Pass
SPAP-881	3/11/2008	Cs-137	114.04 ± 3.03	113.90	102.51 - 125.29	Pass
SPAP-883	3/11/2008	Gr. Beta <sup>e</sup>	54.56 ± 0.12	51.64	30.98 - 72.30	Pass
SPMI-885	3/11/2008	Sr-90	45.93 ± 1.60	45.13	36.10 - 54.16	Pass
SPW-887	3/11/2008	Sr-90	38.82 ± 1.60	45.13	36.10 - 54.16	Pass
SPW-889	3/11/2008	H-3	67325.00 ± 725.00	67384.00	53907.20 - 80860.80	Pass
W-31808	3/18/2008	Gr. Alpha	19.51 ± 0.40	20.08	10.04 - 30.12	Pass
W-31808	3/18/2008	Gr. Beta	47.20 ± 0.42	45.67	35.67 - 55.67	Pass
SPMI-885	3/24/2008	Cs-134	40.93 ± 1.55	39.69	29.69 - 49.69	Pass
SPMI-885	3/24/2008	Cs-137	61.36 ± 2.82	56.91	46.91 - 66.91	Pass
SPW-887	3/24/2008	Cs-134	40.68 ± 1.44	39.69	29.69 - 49.69	Pass
SPW-887	3/24/2008	Cs-137	58.52 ± 2.93	56.91	46.91 - 66.91	Pass
SPW-1282	4/2/2008	U-238	41.30 ± 1.78	41.70	29.19 - 54.21	Pass
W-40308	4/3/2008	Ra-226	15.17 ± 0.50	12.69	8.88 - 16.50	Pass
SPW-5580	4/7/2008	H-3	211.02 ± 7.71	240.00	0.00 - 806.46	Pass
SPW-1562	4/8/2008	Ra-228	28.93 ± 2.09	30.51	21.36 - 39.66	Pass
SPW-1560	4/10/2008	Tc-99	29.74 ± 0.84	32.34	20.34 - 44.34	Pass
SPW-1621	4/16/2008	Fe-55	27205.80 ± 982.90	28370.00	22696.00 - 34044.00	Pass
W-51508	5/15/2008	Gr. Alpha	24.01 ± 0.41	20.08	10.04 - 30.12	Pass
W-51508	5/15/2008	Gr. Beta	47.97 ± 0.41	45.68	35.68 - 55.68	Pass
SPAP-2673	6/2/2008	Cs-134	17.39 ± 1.32	18.60	8.60 - 28.60	Pass
SPAP-2673	6/2/2008	Cs-137	106.82 ± 3.42	113.30	101.97 - 124.63	Pass
SPAP-2674	6/2/2008	Gr. Beta <sup>e</sup>	53.57 ± 0.13	51.40	30.84 - 71.96	Pass
SPF-2745	6/2/2008	Cs-134	0.34 ± 0.02	0.37	0.22 - 0.52	Pass
SPF-2745	6/2/2008	Cs-137	2.06 ± 0.04	2.27	1.36 - 3.18	Pass
SPMI-2677	6/3/2008	Cs-137	53.99 ± 6.15	56.66	46.66 - 66.66	Pass
SPMI-2677A	6/3/2008	I-131	26.64 ± 0.59	28.58	16.58 - 40.58	Pass
SPW-2677	6/3/2008	Cs-134	40.30 ± 3.35	37.21	27.21 - 47.21	Pass
SPW-2677	6/3/2008	I-131(G)	25.92 ± 4.48	28.58	18.58 - 38.58	Pass
SPMI-2679	6/3/2008	Cs-134	35.02 ± 2.93	37.21	27.21 - 47.21	Pass
SPMI-2679	6/3/2008	Cs-137	58.49 ± 6.05	56.66	46.66 - 66.66	Pass
SPMI-2679	6/3/2008	I-131(G)	25.30 ± 4.97	28.58	18.58 - 38.58	Pass
SPMI-2679A	6/3/2008	I-131	30.37 ± 0.50	28.58	16.58 - 40.58	Pass
SPVE-2681	6/3/2008	I-131(G)	1.11 ± 0.06	0.95	0.57 - 1.33	Pass
SPW-2683	6/2/2008	Ni-63	2151.70 ± 10.22	2119.30	1483.51 - 2755.09	Pass
SPW-2685	6/2/2008	H-3	64927.20 ± 704.80	66540.80	53232.64 - 79848.96	Pass
SPW-2689	6/2/2008	C-14	4405.40 ± 15.21	4742.00	2845.20 - 6638.80	Pass

TABLE A-3. In-House "Spike" Samples

Lab Code <sup>b</sup>	Date	Analysis	Concentration (pCi/L) <sup>a</sup>			Acceptance
			Laboratory results 2s, n=1	Known Activity	Control Limits <sup>c</sup>	
W-81408	8/14/2008	Ra-226	12.98 ± 0.35	12.69	8.88 - 16.50	Pass
SPW-1562	8/14/2008	Ra-228	29.09 ± 2.46	30.51	21.36 - 39.66	Pass
SPW-81808	8/18/2008	U-238	42.59 ± 1.96	41.70	29.19 - 54.21	Pass
W-81808	8/18/2008	Gr. Alpha	21.36 ± 0.42	20.08	10.04 - 30.12	Pass
W-81808	8/18/2008	Gr. Beta	49.33 ± 1.01	45.68	35.68 - 55.68	Pass
W-112008	11/20/2008	Gr. Alpha	20.13 ± 0.40	20.08	10.04 - 30.12	Pass
W-112008	11/20/2008	Gr. Beta	48.28 ± 0.42	45.60	35.60 - 55.60	Pass
SPAP-6839	12/5/2008	Cs-134	15.39 ± 2.72	15.68	5.68 - 25.68	Pass
SPAP-6839	12/5/2008	Cs-137	111.45 ± 9.85	112.00	100.80 - 123.20	Pass
SPAP-6841	12/5/2008	Gr. Beta <sup>e</sup>	49.26 ± 0.12	50.72	30.43 - 71.01	Pass
SPW-6843	12/5/2008	C-14	19377.50 ± 55.27	23708.00	14224.80 - 33191.20	Pass
SPW-6845	12/5/2008	Fe-55	7068.30 ± 692.30	6028.00	4822.40 - 7233.60	Pass
SPW-6847	12/5/2008	Tc-99	37.71 ± 1.33	32.34	20.34 - 44.34	Pass
SPW-6849	12/5/2008	Ni-63	232.56 ± 3.26	211.34	147.94 - 274.74	Pass
SPW-6851	12/5/2008	H-3	63664.00 ± 8745.00	64674.00	51739.20 - 77608.80	Pass
SPF-6859	12/5/2008	Cs-134	0.63 ± 0.02	0.63	0.38 - 0.88	Pass
SPF-6859	12/5/2008	Cs-137	2.35 ± 0.01	2.24	1.34 - 3.14	Pass
SPW-7059	12/19/2008	Sr-90	49.19 ± 2.62	44.33	35.46 - 53.20	Pass
SPMI-7061	12/19/2008	Sr-90	39.39 ± 2.19	44.33	35.46 - 53.20	Pass

<sup>a</sup> Liquid sample results are reported in pCi/Liter, air filters( pCi/filter), charcoal (pCi/m<sup>3</sup>), and solid samples (pCi/g).

<sup>b</sup> Laboratory codes as follows: W (water), MI (milk), AP (air filter), SO (soil), VE (vegetation), CH (charcoal canister), F (fish).

<sup>c</sup> Results are based on single determinations.

<sup>d</sup> Control limits are established from the precision values listed in Attachment A of this report, adjusted to ± 2σ.

<sup>e</sup> Control limits based on the laboratory limit, Attachment A ("Other Analyses").

NOTE: For fish, Jello is used for the Spike matrix. For Vegetation, cabbage is used for the Spike matrix.

TABLE A-4. In-House "Blank" Samples

Lab Code	Sample Type	Date	Analysis <sup>b</sup>	Concentration (pCi/L) <sup>a</sup>		
				Laboratory results (4.66 $\sigma$ )		Acceptance Criteria (4.66 $\sigma$ )
				LLD	Activity <sup>c</sup>	
SPW-17	Water	1/3/2008	U-238	0.09	0.01 $\pm$ 0.07	1
SPW-112	Water	1/14/2008	Tc-99	4.70	-0.06 $\pm$ 2.85	10
W-11408	Water	1/14/2008	Ra-226	0.05	0.05 $\pm$ 0.04	1
SPAP-880	Air Filter	3/11/2008	Cs-134	0.91	-	100
SPAP-880	Air Filter	3/11/2008	Cs-137	1.13	-	100
SPW-888	Water	3/11/2008	H-3	159.99	-78.90 $\pm$ 80.40	200
W-31808	Water	3/18/2008	Gr. Alpha	0.42	-0.05 $\pm$ 0.29	1
W-31808	Water	3/18/2008	Gr. Beta	0.72	0.09 $\pm$ 0.51	3.2
SPMI-884	Milk	3/24/2008	Cs-134	2.79	-	10
SPMI-884	Milk	3/24/2008	Cs-137	3.36	-	10
W-40308	Water	4/3/2008	Ra-226	0.04	0.05 $\pm$ 0.03	1
SPW-1563	Water	4/8/2008	Ra-228	0.57	0.31 $\pm$ 0.30	2
SPW-1561	Water	4/10/2008	Tc-99	4.77	-3.42 $\pm$ 2.85	10
SPW-1621	Water	4/16/2008	Fe-55	668.50	-170.70 $\pm$ 397.20	1000
SPW-2451	Water	5/22/2008	U-238	0.21	0.35 $\pm$ 0.24	1
SPW-2676	Water	6/2/2008	Cs-134	2.03	-	10
SPW-2676	Water	6/2/2008	Cs-134	3.60	-	10
SPW-2676	Water	6/2/2008	Cs-137	2.38	-	10
SPW-2677	Water	6/2/2008	Cs-134	2.78	-	10
SPW-2677	Water	6/2/2008	I-131(G)	3.49	-	20
SPW-2677	Water	6/2/2008	I-131(G)	5.25	-	20
SPF-2744	Fish	6/2/2008	Cs-134	5.48	-	100
SPF-2744	Fish	6/2/2008	Cs-137	4.83	-	100
SPW-2676	Water	6/3/2008	I-131	0.18	0.01 $\pm$ 0.11	0.5
SPMI-2678	Milk	6/3/2008	I-131	0.22	0.12 $\pm$ 0.15	0.5
SPVE-2680	Vegetation	6/3/2008	I-131(G)	0.01	-	20
SPW-3581	Water	7/14/2008	U-238	0.10	0.13 $\pm$ 0.12	1
W-80708	Water	8/7/2008	Gr. Alpha	0.63	-0.02 $\pm$ 0.44	1
W-80708	Water	8/7/2008	Gr. Beta	1.43	-0.47 $\pm$ 0.99	3.2
W-81408	Water	8/14/2008	Ra-226	0.06	0.14 $\pm$ 0.04	1
SPW-1563	Water	8/14/2008	Ra-228	0.79	0.89 $\pm$ 0.47	2
SPW-81808	Water	8/18/2008	U-238	0.18	0.04 $\pm$ 0.13	1

TABLE A-4. In-House "Blank" Samples

Lab Code	Sample Type	Date	Analysis <sup>b</sup>	Concentration (pCi/L) <sup>a</sup>		
				Laboratory results (4.66 $\sigma$ )		Acceptance Criteria (4.66 $\sigma$ )
				LLD	Activity <sup>c</sup>	
W-112008	Water	11/20/2008	Gr. Alpha	0.40	0.02 $\pm$ 0.28	1
W-112008	Water	11/20/2008	Gr. Beta	0.75	-0.16 $\pm$ 0.52	3.2
SPAP-6838	Air Filter	12/5/2008	Cs-134	1.01	-	100
SPAP-6838	Air Filter	12/5/2008	Cs-137	0.95	-	100
SPAP-6840	Air Filter	12/5/2008	Gr. Beta	0.96	2.69 $\pm$ 0.64	3.2
SPW-6842	Water	12/5/2008	C-14	7.79	-3.04 $\pm$ 4.05	200
SPW-6844	Water	12/5/2008	Fe-55	715.10	21.70 $\pm$ 435.10	1000
SPW-6846	Water	12/5/2008	Tc-99	1.36	-0.47 $\pm$ 0.82	10
SPW-6848	Water	12/5/2008	Ni-63	1.94	3.08 $\pm$ 1.23	20
SPF-6858	Fish	12/5/2008	Cs-134	1.53	-	100
SPF-6858	Fish	12/5/2008	Cs-137	3.92	-	100
SPW-7058	Water	12/19/2008	Cs-134	2.62	-	10
SPW-7058	Water	12/19/2008	Cs-137	2.39	-	10
SPW-7058	Water	12/19/2008	Sr-90	0.65	-0.28 $\pm$ 0.26	1
SPMI-7060	Milk	12/19/2008	Cs-134	2.18	-	10
SPMI-7060	Milk	12/19/2008	Cs-137	3.87	-	10
SPMI-7060	Milk	12/19/2008	I-131(G)	2.80	-	20
SPMI-7060 <sup>d</sup>	Milk	12/19/2008	Sr-90	0.53	0.76 $\pm$ 0.34	1

<sup>a</sup> Liquid sample results are reported in pCi/Liter, air filters( pCi/filter), charcoal (pCi/charcoal canister), and solid samples (pCi/kg).

<sup>b</sup> I-131(G); iodine-131 as analyzed by gamma spectroscopy.

<sup>c</sup> Activity reported is a net activity result. For gamma spectroscopic analysis, activity detected below the LLD value is not reported.

<sup>d</sup> Low levels of Sr-90 are still detected in the environment. A concentration of (1-5 pCi/L) in milk is not unusual.

TABLE A-5. In-House "Duplicate" Samples

Lab Code	Date	Analysis	Concentration (pCi/L) <sup>a</sup>			Acceptance
			First Result	Second Result	Averaged Result	
AP-8809, 8810	1/2/2008	Be-7	0.06 ± 0.02	0.06 ± 0.01	0.06 ± 0.01	Pass
CF-42, 43	1/2/2008	Gr. Beta	8.88 ± 0.19	8.99 ± 0.19	8.94 ± 0.13	Pass
CF-42, 43	1/2/2008	K-40	5.08 ± 0.29	5.19 ± 0.30	5.14 ± 0.21	Pass
DW-80020, 80021	1/7/2008	Gr. Alpha	2.28 ± 0.84	1.98 ± 0.86	2.13 ± 0.60	Pass
U-169, 170	1/10/2008	Beta-K40	7.50 ± 5.50	11.70 ± 5.10	9.60 ± 3.75	Pass
SO-8836, 8837	1/14/2008	Cs-137	0.80 ± 0.05	0.75 ± 0.05	0.77 ± 0.03	Pass
SO-8836, 8837	1/14/2008	Gr. Alpha	13.30 ± 4.31	15.58 ± 4.10	14.44 ± 2.98	Pass
SO-8836, 8837	1/14/2008	Gr. Alpha	33.68 ± 3.73	29.21 ± 3.10	31.45 ± 2.43	Pass
SO-8836, 8837	1/14/2008	K-40	12.31 ± 0.74	12.96 ± 0.73	12.64 ± 0.52	Pass
DW-80045, 80046	1/15/2008	Gr. Alpha	2.94 ± 1.13	3.41 ± 1.04	3.17 ± 0.77	Pass
DW-80045, 80046	1/15/2008	Gr. Beta	1.86 ± 0.66	1.36 ± 0.63	1.61 ± 0.45	Pass
MI-138, 139	1/15/2008	K-40	1262.40 ± 81.70	1396.20 ± 154.20	1329.30 ± 87.25	Pass
LW-190, 191	1/16/2008	Gr. Beta	2.85 ± 1.07	1.64 ± 1.02	2.24 ± 0.74	Pass
DW-8008, 8009	1/16/2008	Ra-226	2.77 ± 0.20	3.11 ± 0.22	2.94 ± 0.15	Pass
DW-8008, 8009	1/16/2008	Ra-228	3.95 ± 0.74	3.96 ± 0.77	3.96 ± 0.53	Pass
DW-80057, 80058	1/21/2008	Gr. Alpha	6.77 ± 0.66	7.91 ± 1.73	7.34 ± 0.92	Pass
DW-80057, 80058	1/21/2008	Gr. Beta	13.83 ± 0.97	14.78 ± 1.01	14.31 ± 0.70	Pass
SWU-479, 480	1/29/2008	Gr. Beta	4.49 ± 1.13	3.13 ± 1.14	3.81 ± 0.80	Pass
W-920, 921	2/4/2008	Gr. Beta	4.20 ± 1.30	3.30 ± 1.30	3.75 ± 0.92	Pass
SW-540, 541	2/12/2008	Gr. Alpha	2.75 ± 1.16	4.01 ± 1.18	3.38 ± 0.83	Pass
SW-540, 541	2/12/2008	Gr. Beta	6.46 ± 1.11	6.71 ± 1.03	6.59 ± 0.76	Pass
DW-80155, 80156	2/12/2008	Ra-226	2.55 ± 0.22	2.01 ± 0.16	2.28 ± 0.14	Fail
DW-80155, 80156	2/12/2008	Ra-228	1.86 ± 0.70	1.53 ± 0.67	1.70 ± 0.48	Pass
DW-80165, 80166	2/20/2008	Gr. Alpha	1.51 ± 0.90	0.80 ± 1.05	1.16 ± 0.69	Pass
DW-80166, 80167	2/20/2008	Ra-226	0.40 ± 0.09	0.46 ± 0.09	0.43 ± 0.06	Pass
DW-80166, 80167	2/20/2008	Ra-228	1.44 ± 0.52	1.42 ± 0.57	1.43 ± 0.39	Pass
DW-80166, 80167	2/20/2008	Uranium	0.69 ± 0.25	0.69 ± 0.26	0.69 ± 0.18	Pass
W-1413, 1414	3/3/2008	Gr. Beta	7.50 ± 3.00	3.70 ± 2.60	5.60 ± 1.98	Pass
DW-80189, 80190	3/11/2008	Ra-226	4.41 ± 0.30	4.09 ± 0.25	4.25 ± 0.20	Pass
DW-80189, 80190	3/11/2008	Ra-228	1.99 ± 0.65	2.17 ± 0.66	2.08 ± 0.46	Pass
MI-1006, 1007	3/12/2008	K-40	1451.90 ± 112.80	1409.50 ± 111.40	1430.70 ± 79.27	Pass
MI-1006, 1007	3/12/2008	Sr-90	0.48 ± 0.31	0.97 ± 0.38	0.72 ± 0.24	Pass
DW-80205, 80206	3/14/2008	Gr. Alpha	3.64 ± 0.80	3.39 ± 0.82	3.52 ± 0.57	Pass
DW-80202, 80203	3/14/2008	Ra-226	3.16 ± 0.21	3.00 ± 0.19	3.08 ± 0.14	Pass
DW-80202, 80203	3/14/2008	Ra-228	2.40 ± 1.00	2.07 ± 0.69	2.24 ± 0.61	Pass
DW-80208, 80209	3/14/2008	U-233/4	1.32 ± 0.25	1.29 ± 0.36	1.31 ± 0.22	Pass
SG-1080, 1081	3/18/2008	Pb-214	3.99 ± 0.30	4.15 ± 0.29	4.07 ± 0.21	Pass
SO-1195, 1196	3/18/2008	U-233/4	0.14 ± 0.02	0.14 ± 0.02	0.14 ± 0.01	Pass
SO-1195, 1196	3/18/2008	U-238	0.13 ± 0.02	0.13 ± 0.02	0.13 ± 0.01	Pass
WW-1242, 1243	3/24/2008	Gr. Beta	10.36 ± 1.63	9.06 ± 1.55	9.71 ± 1.13	Pass
AP-1519, 1520	4/2/2008	Be-7	0.07 ± 0.01	0.08 ± 0.01	0.08 ± 0.01	Pass
W-1565, 1566	4/2/2008	Gr. Alpha	0.82 ± 0.64	1.58 ± 0.72	1.20 ± 0.48	Pass
W-1565, 1566	4/2/2008	Gr. Beta	3.73 ± 0.86	5.51 ± 1.09	4.62 ± 0.69	Pass



TABLE A-5. In-House "Duplicate" Samples

Lab Code	Date	Analysis	Concentration (pCi/L) <sup>a</sup>			Acceptance
			First Result	Second Result	Averaged Result	
DW-80255, 80256	4/8/2008	Ra-226	0.19 ± 0.08	0.28 ± 0.11	0.24 ± 0.07	Pass
DW-80255, 80256	4/8/2008	Ra-228	1.79 ± 0.57	1.32 ± 0.55	1.56 ± 0.40	Pass
DW-80259, 80260	4/8/2008	Gr. Alpha	3.39 ± 0.82	3.62 ± 0.82	3.51 ± 0.58	Pass
DW-80301, 80302	4/11/2008	Ra-226	0.47 ± 0.09	0.47 ± 0.09	0.47 ± 0.06	Pass
DW-80301, 80302	4/11/2008	Ra-228	1.02 ± 0.42	0.82 ± 0.45	0.92 ± 0.31	Pass
SO-1913, 1914	4/15/2008	K-40	12.79 ± 0.73	13.88 ± 0.85	13.34 ± 0.56	Pass
DW-80313, 80314	4/16/2008	Ra-226	3.39 ± 0.22	3.28 ± 0.21	3.34 ± 0.15	Pass
DW-80313, 80314	4/16/2008	Ra-228	4.27 ± 0.72	5.14 ± 0.77	4.71 ± 0.53	Pass
SWU-2087, 2088	4/29/2008	Gr. Beta	2.20 ± 0.60	3.50 ± 0.90	2.85 ± 0.54	Pass
LW-2297, 2298	4/30/2008	Gr. Beta	1.41 ± 0.43	1.02 ± 0.40	1.22 ± 0.30	Pass
LW-2321, 2322	4/30/2008	Gr. Beta	1.33 ± 0.54	1.23 ± 0.54	1.28 ± 0.38	Pass
BS-2063, 2064	5/1/2008	Gr. Beta	13.71 ± 2.06	17.60 ± 2.49	15.66 ± 1.62	Pass
SG-2229, 2230	5/5/2008	Ac-228	26.25 ± 2.70	24.90 ± 2.55	25.58 ± 1.86	Pass
W-2792, 2793	5/5/2008	Gr. Beta	7.20 ± 2.30	7.00 ± 2.50	7.10 ± 1.70	Pass
SG-2229, 2230	5/5/2008	Pb-214	23.28 ± 0.30	23.54 ± 0.33	23.41 ± 0.22	Pass
F-2850, 2851	5/7/2008	Cs-137	3.37 ± 0.21	3.16 ± 0.19	3.27 ± 0.14	Pass
DW-80376, 80377	5/9/2008	Ra-226	0.94 ± 0.13	1.07 ± 0.13	1.01 ± 0.09	Pass
DW-80376, 80377	5/9/2008	Ra-228	2.05 ± 0.57	1.40 ± 0.51	1.73 ± 0.38	Pass
MI-2363, 2364	5/14/2008	K-40	1335.40 ± 111.20	1510.70 ± 124.30	1423.05 ± 83.39	Pass
SG-2752, 2753	5/14/2008	Be-7	264.60 ± 83.90	222.80 ± 93.10	243.70 ± 62.66	Pass
SG-2752, 2753	5/14/2008	Cs-137	64.80 ± 6.00	68.90 ± 5.80	66.85 ± 4.17	Pass
SG-2752, 2753	5/14/2008	Gr. Alpha	19.35 ± 3.48	22.88 ± 4.04	21.12 ± 2.67	Pass
SG-2752, 2753	5/14/2008	Gr. Beta	30.53 ± 2.40	33.31 ± 2.71	31.92 ± 1.81	Pass
SG-2752, 2753	5/14/2008	K-40	9121.90 ± 191.80	9183.70 ± 194.20	9152.80 ± 136.47	Pass
DW-80389, 80390	5/14/2008	Ra-226	2.99 ± 0.36	2.58 ± 0.31	2.79 ± 0.24	Pass
DW-80389, 80390	5/14/2008	Ra-228	2.87 ± 0.68	1.73 ± 0.57	2.30 ± 0.44	Pass
DW-80392, 80393	5/14/2008	Gr. Alpha	19.94 ± 1.30	17.89 ± 1.26	18.92 ± 0.91	Pass
DW-80394, 80395	5/14/2008	U-233/4	2.03 ± 0.27	2.54 ± 0.39	2.29 ± 0.24	Pass
BS-2490, 2491	5/16/2008	Cs-137	6.81 ± 1.20	6.76 ± 1.23	6.78 ± 0.86	Pass
WW-2462, 2463	5/19/2008	H-3	158.61 ± 80.90	205.63 ± 83.06	182.12 ± 57.97	Pass
W-2826, 2827	5/27/2008	Gr. Alpha	3.47 ± 2.23	4.22 ± 2.20	3.84 ± 1.57	Pass
W-2826, 2827	5/27/2008	Gr. Beta	10.67 ± 1.92	9.43 ± 1.76	10.05 ± 1.30	Pass
SG-3378, 3379	6/2/2008	Gr. Alpha	6.51 ± 1.15	7.83 ± 1.32	7.17 ± 0.88	Pass
SG-3378, 3379	6/2/2008	Gr. Beta	16.23 ± 0.95	15.76 ± 1.06	16.00 ± 0.71	Pass
SG-3393, 3394	6/4/2008	Be-7	0.82 ± 0.23	0.66 ± 0.33	0.74 ± 0.20	Pass
SG-3393, 3394	6/4/2008	Cs-137	0.07 ± 0.01	0.07 ± 0.01	0.07 ± 0.01	Pass
SG-3393, 3394	6/4/2008	Gr. Alpha	18.96 ± 3.49	16.96 ± 3.34	17.96 ± 2.42	Pass
SG-3393, 3394	6/4/2008	Gr. Beta	30.01 ± 2.49	30.17 ± 2.56	30.09 ± 1.79	Pass
SG-3393, 3394	6/4/2008	K-40	9.78 ± 0.30	10.00 ± 0.28	9.89 ± 0.21	Pass
LW-2939, 2940	6/12/2008	Gr. Beta	1.46 ± 0.59	1.74 ± 0.59	1.60 ± 0.42	Pass
WW-3053, 3054	6/17/2008	Gr. Beta	4.28 ± 0.83	5.27 ± 0.91	4.77 ± 0.61	Pass
SW-3154, 3155	6/24/2008	Gr. Beta	2.15 ± 1.01	2.79 ± 0.97	2.47 ± 0.70	Pass

TABLE A-5. In-House "Duplicate" Samples

Lab Code	Date	Analysis	Concentration (pCi/L) <sup>a</sup>			Acceptance
			First Result	Second Result	Averaged Result	
BS-3245, 3246	6/27/2008	Co-60	108.84 ± 44.14	91.10 ± 22.32	99.97 ± 24.73	Pass
BS-3245, 3246	6/27/2008	Cs-137	952.18 ± 52.78	941.56 ± 13.61	946.87 ± 27.25	Pass
XW-1080, 1081	6/30/2008	Fe-55	2.96 ± 0.32	2.71 ± 0.30	2.84 ± 0.22	Pass
XW-3786, 3787	6/30/2008	Fe-55	2.96 ± 0.32	2.71 ± 0.30	2.84 ± 0.22	Pass
G-3274, 3275	7/1/2008	Gr. Beta	7.65 ± 0.24	7.44 ± 0.24	7.55 ± 0.17	Pass
SL-3295, 3296	7/1/2008	Gr. Beta	3.76 ± 0.24	3.64 ± 0.24	3.70 ± 0.17	Pass
AP-3531, 3532	7/1/2008	Be-7	0.10 ± 0.01	0.08 ± 0.01	0.09 ± 0.01	Pass
AP-3663, 3664	7/2/2008	Be-7	0.08 ± 0.01	0.08 ± 0.02	0.08 ± 0.01	Pass
AP-3690, 3691	7/2/2008	Be-7	0.07 ± 0.01	0.07 ± 0.01	0.07 ± 0.01	Pass
W-4333, 4334	7/7/2008	Gr. Beta	7.20 ± 1.90	7.70 ± 1.70	7.45 ± 1.27	Pass
W-4840, 4841	7/7/2008	Gr. Beta	6.70 ± 1.60	6.70 ± 1.80	6.70 ± 1.20	Pass
DW-80415, 80416	7/7/2008	Ra-226	2.81 ± 0.47	2.00 ± 0.34	2.41 ± 0.29	Pass
SG-3964, 3965	7/9/2008	Be-7	1.35 ± 0.23	1.51 ± 0.22	1.43 ± 0.16	Pass
SG-3964, 3965	7/9/2008	Cs-137	0.04 ± 0.01	0.04 ± 0.01	0.04 ± 0.00	Pass
SG-3964, 3965	7/9/2008	Gr. Alpha	23.17 ± 3.39	18.76 ± 3.24	20.97 ± 2.34	Pass
SG-3964, 3965	7/9/2008	Gr. Beta	28.99 ± 2.12	29.25 ± 2.31	29.12 ± 1.57	Pass
SG-3964, 3965	7/9/2008	K-40	6.86 ± 0.19	6.84 ± 0.17	6.85 ± 0.13	Pass
DW-80427, 80428	7/9/2008	Ra-226	3.25 ± 0.24	3.27 ± 0.20	3.26 ± 0.16	Pass
DW-80427, 80428	7/9/2008	Ra-228	2.65 ± 0.67	3.25 ± 0.72	2.95 ± 0.49	Pass
DW-80451, 80452	7/15/2008	Ra-226	1.02 ± 0.10	0.96 ± 0.12	0.99 ± 0.08	Pass
DW-80451, 80452	7/15/2008	Ra-228	1.09 ± 0.62	1.14 ± 0.60	1.12 ± 0.43	Pass
DW-80481, 80482	7/16/2008	Ra-226	1.20 ± 0.13	1.40 ± 0.14	1.30 ± 0.10	Pass
DW-80481, 80482	7/16/2008	Ra-228	1.69 ± 0.68	1.65 ± 0.77	1.67 ± 0.51	Pass
MI-3842, 3843	7/21/2008	K-40	1282.60 ± 108.30	1379.00 ± 111.40	1330.80 ± 77.68	Pass
MI-3892, 3893	7/28/2008	K-40	1371.50 ± 102.90	1501.20 ± 111.80	1436.35 ± 75.97	Pass
DW-4067, 4068	7/29/2008	Gr. Beta	10.46 ± 2.37	14.25 ± 2.78	12.36 ± 1.83	Pass
SWT-4158, 4159	7/29/2008	Gr. Beta	1.58 ± 0.45	1.80 ± 0.47	1.69 ± 0.33	Pass
LW-4221, 4222	7/31/2008	Gr. Beta	1.35 ± 0.56	0.91 ± 0.52	1.13 ± 0.38	Pass
LW-4242, 4243	7/31/2008	Gr. Beta	1.36 ± 0.56	1.18 ± 0.53	1.27 ± 0.38	Pass
VE-4046, 4047	8/4/2008	Be-7	0.77 ± 0.13	0.82 ± 0.19	0.80 ± 0.12	Pass
VE-4046, 4047	8/4/2008	Gr. Beta	8.81 ± 0.36	8.34 ± 0.31	8.58 ± 0.24	Pass
VE-4046, 4047	8/4/2008	K-40	5.17 ± 0.34	5.33 ± 0.42	5.25 ± 0.27	Pass
W-4821, 4822	8/4/2008	Gr. Alpha	1.70 ± 0.80	1.70 ± 0.90	1.70 ± 0.60	Pass
W-4821, 4822	8/4/2008	Gr. Beta	3.90 ± 0.80	3.70 ± 0.90	3.80 ± 0.60	Pass
W-4801, 4802	8/5/2008	Gr. Alpha	4.40 ± 2.40	4.80 ± 2.30	4.60 ± 1.66	Pass
W-4801, 4802	8/5/2008	Gr. Beta	13.20 ± 1.30	14.50 ± 1.40	13.85 ± 0.96	Pass
DW-80522, 80523	8/5/2008	Ra-226	0.50 ± 0.12	0.28 ± 0.12	0.39 ± 0.08	Pass
DW-80522, 80523	8/5/2008	Ra-228	1.23 ± 0.60	1.09 ± 0.57	1.16 ± 0.41	Pass

TABLE A-5. In-House "Duplicate" Samples

Lab Code	Date	Analysis	Concentration (pCi/L) <sup>a</sup>			Acceptance
			First Result	Second Result	Averaged Result	
DW-80531, 80532	8/5/2008	Gr. Alpha	18.90 ± 1.86	17.80 ± 1.96	18.35 ± 1.35	Pass
DW-80534, 80535	8/5/2008	Ra-226	3.01 ± 0.18	3.33 ± 0.18	3.17 ± 0.13	Pass
DW-80534, 80535	8/5/2008	Ra-228	2.24 ± 0.59	2.12 ± 0.59	2.18 ± 0.42	Pass
SG-4584, 4585	8/6/2008	Be-7	7.11 ± 0.20	7.44 ± 0.37	7.27 ± 0.21	Pass
SG-4584, 4585	8/6/2008	Cs-137	0.05 ± 0.01	0.04 ± 0.01	0.04 ± 0.00	Pass
SG-4584, 4585	8/6/2008	K-40	7.88 ± 10.18	8.02 ± 0.21	7.95 ± 5.09	Pass
SG-4584, 4585	8/6/2008	Ra-226	3.94 ± 0.18	3.74 ± 0.22	3.84 ± 0.14	Pass
SG-4573, 4574	8/13/2008	Gr. Alpha	240.72 ± 8.74	251.53 ± 9.56	246.13 ± 6.48	Pass
SG-4573, 4574	8/13/2008	Gr. Beta	201.60 ± 4.28	206.88 ± 4.71	204.24 ± 3.18	Pass
SG-4584, 4585	8/13/2008	Gr. Alpha	14.07 ± 3.10	12.97 ± 3.04	13.52 ± 2.17	Pass
SG-4584, 4585	8/13/2008	Gr. Beta	22.08 ± 2.36	23.02 ± 2.34	22.55 ± 1.66	Pass
DW-80547, 80548	8/13/2008	Gr. Alpha	3.33 ± 1.11	3.88 ± 1.07	3.61 ± 0.77	Pass
DW-80551, 80552	8/13/2008	U-233/4	2.57 ± 0.48	2.13 ± 0.46	2.35 ± 0.33	Pass
DW-80553, 80554	8/13/2008	Ra-226	0.92 ± 0.14	1.21 ± 0.17	1.07 ± 0.11	Pass
DW-80553, 80554	8/13/2008	Ra-228	2.20 ± 0.61	1.64 ± 0.56	1.92 ± 0.41	Pass
DW-80566, 80567	8/20/2008	Ra-226	1.10 ± 0.11	1.10 ± 0.10	1.10 ± 0.07	Pass
DW-80566, 80567	8/20/2008	Ra-228	2.01 ± 0.58	1.74 ± 0.58	1.88 ± 0.41	Pass
VE-4647, 4648	8/27/2008	K-40	1.97 ± 0.17	2.00 ± 0.21	1.99 ± 0.14	Pass
SL-4690, 4691	9/2/2008	Gr. Beta	2.28 ± 0.25	2.35 ± 0.24	2.32 ± 0.17	Pass
ME-4732, 4733	9/2/2008	Gr. Beta	2.86 ± 0.09	2.70 ± 0.09	2.78 ± 0.06	Pass
ME-4732, 4733	9/2/2008	K-40	2.44 ± 0.37	2.82 ± 0.51	2.63 ± 0.32	Pass
SG-5180, 5181	9/3/2008	Be-7	15.50 ± 0.43	15.54 ± 0.38	15.52 ± 0.29	Pass
SG-5180, 5181	9/3/2008	Cs-137	0.07 ± 0.01	0.07 ± 0.01	0.07 ± 0.01	Pass
SG-5180, 5181	9/3/2008	Gr. Alpha	18.74 ± 3.33	17.61 ± 3.15	18.18 ± 2.29	Pass
SG-5180, 5181	9/3/2008	Gr. Beta	29.19 ± 2.10	28.49 ± 2.15	28.84 ± 1.50	Pass
SG-5180, 5181	9/3/2008	K-40	8.55 ± 0.32	8.11 ± 0.27	8.33 ± 0.21	Pass
SG-5187, 5188	9/3/2008	Be-7	6.18 ± 0.54	5.90 ± 0.77	6.04 ± 0.47	Pass
SG-5187, 5188	9/3/2008	K-40	7.16 ± 0.60	7.29 ± 0.60	7.23 ± 0.42	Pass
SG-5193, 5194	9/3/2008	Gr. Alpha	5.80 ± 1.30	7.00 ± 1.50	6.40 ± 0.99	Pass
SG-5193, 5194	9/3/2008	Gr. Beta	15.60 ± 1.10	15.60 ± 1.10	15.60 ± 0.78	Pass
DW-4871, 4872	9/5/2008	I-131	1.15 ± 0.27	1.16 ± 0.31	1.16 ± 0.21	Pass
VE-5022, 5023	9/10/2008	K-40	1.27 ± 0.14	1.11 ± 0.06	1.19 ± 0.08	Pass
DW-5337, 5338	9/10/2008	Gr. Beta	3.00 ± 1.07	2.19 ± 1.05	2.60 ± 0.75	Pass
WW-4977, 4978	9/17/2008	Gr. Beta	3.71 ± 1.10	2.32 ± 1.11	3.01 ± 0.78	Pass
BS-5088, 5089	9/19/2008	K-40	10493 ± 607	10299 ± 470	10396 ± 384	Pass
DW-80584, 80585	9/19/2008	U-233/4	3.01 ± 0.52	2.44 ± 0.47	2.73 ± 0.35	Pass
DW-80584, 80585	9/19/2008	U-238	0.70 ± 0.25	0.27 ± 0.18	0.49 ± 0.15	Pass
DW-80579, 80580	9/25/2008	Gr. Alpha	10.69 ± 1.31	12.84 ± 1.51	11.77 ± 1.00	Pass
DW-80579, 80580	9/25/2008	Ra-226	3.13 ± 0.22	2.89 ± 0.21	3.01 ± 0.15	Pass
DW-80579, 80580	9/25/2008	Ra-228	3.03 ± 0.73	1.98 ± 0.69	2.51 ± 0.50	Pass
G-5389, 5390	10/1/2008	Be-7	1.49 ± 0.32	1.36 ± 0.28	1.43 ± 0.21	Pass
G-5389, 5390	10/1/2008	Gr. Beta	10.86 ± 0.24	11.18 ± 0.25	11.02 ± 0.17	Pass
G-5389, 5390	10/1/2008	K-40	7.42 ± 0.67	8.06 ± 0.63	7.74 ± 0.46	Pass

TABLE A-5. In-House "Duplicate" Samples

Lab Code	Date	Analysis	Concentration (pCi/L) <sup>a</sup>			Acceptance
			First Result	Second Result	Averaged Result	
AP-5814, 5815	10/1/2008	Be-7	0.08 ± 0.01	0.08 ± 0.01	0.08 ± 0.01	Pass
SG-6111, 6112	10/6/2008	Gr. Alpha	9.34 ± 1.82	8.95 ± 1.67	9.15 ± 1.24	Pass
SG-6111, 6112	10/6/2008	Gr. Beta	17.46 ± 1.46	18.86 ± 1.35	18.16 ± 0.99	Pass
DW-80592, 80593	10/7/2008	Gr. Alpha	2.30 ± 1.14	1.57 ± 0.88	1.94 ± 0.72	Pass
DW-80594, 80595	10/7/2008	Ra-228	1.41 ± 0.55	1.22 ± 0.50	1.32 ± 0.37	Pass
DW-80650, 80651	10/8/2008	Gr. Alpha	1.30 ± 0.86	0.12 ± 0.79	0.71 ± 0.58	Pass
DW-80650, 80651	10/8/2008	Gr. Beta	2.92 ± 0.69	3.03 ± 0.64	2.98 ± 0.47	Pass
DW-80629, 80630	10/13/2008	Ra-226	3.12 ± 0.18	2.87 ± 0.17	3.00 ± 0.12	Pass
DW-80629, 80630	10/13/2008	Ra-228	2.71 ± 0.80	3.28 ± 0.81	3.00 ± 0.57	Pass
DW-80663, 80664	10/13/2008	Gr. Alpha	5.91 ± 1.70	3.14 ± 1.44	4.53 ± 1.11	Pass
MI-5572, 5573	10/14/2008	K-40	1391.00 ± 97.39	1443.90 ± 110.60	1417.45 ± 73.68	Pass
MI-5603, 5604	10/14/2008	K-40	1412.80 ± 109.30	1413.80 ± 110.50	1413.30 ± 77.71	Pass
DW-80676, 80677	10/20/2008	Gr. Alpha	12.20 ± 1.48	11.87 ± 1.54	12.04 ± 1.07	Pass
DW-80676, 80677	10/20/2008	Ra-226	5.04 ± 0.25	5.10 ± 0.25	5.07 ± 0.18	Pass
DW-80676, 80677	10/20/2008	Ra-228	5.87 ± 0.86	6.98 ± 0.95	6.43 ± 0.64	Pass
SW-80687, 80688	10/22/2008	Gr. Alpha	3.42 ± 1.03	2.98 ± 1.01	3.20 ± 0.72	Pass
DW-80729, 80730	10/30/2008	Gr. Alpha	8.40 ± 1.45	7.76 ± 2.00	8.08 ± 1.24	Pass
DW-80729, 80730	10/30/2008	Gr. Beta	16.94 ± 1.45	15.41 ± 1.37	16.18 ± 1.00	Pass
DW-80738, 80739	10/31/2008	U-233/4	2.94 ± 0.50	3.06 ± 0.63	3.00 ± 0.40	Pass
DW-80747, 80748	10/31/2008	Ra-226	0.60 ± 0.09	0.50 ± 0.08	0.55 ± 0.06	Pass
DW-80747, 80748	10/31/2008	Ra-228	1.33 ± 0.59	1.38 ± 0.60	1.36 ± 0.42	Pass
BS-6271, 6272	11/3/2008	Gr. Beta	12.26 ± 1.69	13.78 ± 1.84	13.02 ± 1.25	Pass
SS-6593, 6594	11/19/2008	K-40	12.35 ± 0.57	13.10 ± 0.76	12.73 ± 0.48	Pass
MI-7046, 7047	12/16/2008	K-40	1380.10 ± 109.80	1477.30 ± 98.32	1428.70 ± 73.69	Pass
DW-80698, 80699	12/23/2008	Ra-226	3.13 ± 0.22	3.21 ± 0.23	3.17 ± 0.16	Pass
DW-80698, 80699	12/23/2008	Ra-228	5.48 ± 0.91	5.86 ± 0.93	5.67 ± 0.65	Pass
SW-7281, 7282	12/30/2008	Gr. Beta	0.87 ± 0.54	1.35 ± 0.54	1.11 ± 0.38	Pass

Note: Duplicate analyses are performed on every twentieth sample received in-house. Results are not listed for those analyses with activities that measure below the LLD.

<sup>a</sup> Results are reported in units of pCi/L, except for air filters (pCi/Filter), food products, vegetation, soil, sediment (pCi/g).

TABLE A-6. Department of Energy's Mixed Analyte Performance Evaluation Program (MAPEP)<sup>a</sup>.

Lab Code <sup>c</sup>	Date	Analysis	Concentration <sup>b</sup>		Control Limits <sup>d</sup>	Acceptance
			Laboratory result	Known Activity		
STW-1137	01/01/08	Am-241	1.27 ± 0.06	1.23	0.86 - 1.60	Pass
STW-1137	01/01/08	Co-57	23.80 ± 0.60	22.80	16.00 - 29.60	Pass
STW-1137	01/01/08	Co-60	8.60 ± 0.50	8.40	5.88 - 10.92	Pass
STW-1137 <sup>e</sup>	01/01/08	Cs-134	-0.021 ± 0.10	0.00	-1.00 - 1.00	Pass
STW-1137 <sup>e</sup>	01/01/08	Cs-137	0.00 ± 0.10	0.00	-1.00 - 1.00	Pass
STW-1137	01/01/08	Fe-55	32.60 ± 11.60	36.50	25.60 - 47.50	Pass
STW-1137	01/01/08	H-3	515.10 ± 12.70	472.00	330.00 - 614.00	Pass
STW-1137	01/01/08	Mn-54	12.90 ± 0.80	12.10	8.50 - 15.70	Pass
STW-1137	01/01/08	Ni-63	29.50 ± 2.30	30.70	21.50 - 39.90	Pass
STW-1137	01/01/08	Pu-238	0.60 ± 0.06	0.73	0.51 - 0.95	Pass
STW-1137	01/01/08	Pu-239/40	0.019 ± 0.015	0.01	0.00 - 1.00	Pass
STW-1137	01/01/08	Sr-90	12.00 ± 1.50	11.40	7.98 - 14.82	Pass
STW-1137	01/01/08	Tc-99	9.40 ± 1.70	11.20	7.80 - 14.60	Pass
STW-1137	01/01/08	U-233/4	3.37 ± 0.20	3.63	2.54 - 4.72	Pass
STW-1137	01/01/08	U-238	3.63 ± 0.21	3.74	2.62 - 4.86	Pass
STW-1137	01/01/08	Zn-65	16.90 ± 1.40	16.30	11.40 - 21.20	Pass
STW-1138	01/01/08	Gr. Alpha	0.96 ± 0.14	1.40	0.00 - 2.80	Pass
STW-1138	01/01/08	Gr. Beta	2.30 ± 0.15	2.43	1.22 - 3.65	Pass
STAP-1139	01/01/08	Co-57	3.90 ± 0.07	3.55	2.49 - 4.62	Pass
STAP-1139	01/01/08	Co-60	1.43 ± 0.07	1.31	0.92 - 1.70	Pass
STAP-1139	01/01/08	Cs-134	2.59 ± 0.16	2.52	1.76 - 3.28	Pass
STAP-1139	01/01/08	Cs-137	3.05 ± 0.12	2.70	1.89 - 3.51	Pass
STAP-1139	01/01/08	Mn-54	0.43 ± 0.58	0.00	0.00 - 1.00	Pass
STAP-1139	01/01/08	Pu-238	0.080 ± 0.016	0.11	0.07 - 0.14	Pass
STAP-1139	01/01/08	Pu-239/40	0.12 ± 0.02	0.11	0.08 - 0.15	Pass
STAP-1139	01/01/08	Sr-90	1.30 ± 0.27	1.55	1.08 - 2.01	Pass
STAP-1139 <sup>e</sup>	01/01/08	U-233/4	0.43 ± 0.03	0.22	0.15 - 0.28	Fail
STAP-1139 <sup>e</sup>	01/01/08	U-238	0.44 ± 0.03	0.23	0.16 - 0.29	Fail
STAP-1139	01/01/08	Zn-65	2.36 ± 0.18	2.04	1.43 - 2.65	Pass
STAP-1140	01/01/08	Gr. Alpha	0.11 ± 0.03	0.35	0.00 - 0.70	Pass
STAP-1140	01/01/08	Gr. Beta	0.34 ± 0.04	0.29	0.14 - 0.43	Pass
STVE-1141	01/01/08	Co-57	8.30 ± 0.18	6.89	4.82 - 8.96	Pass
STVE-1141	01/01/08	Co-60	3.03 ± 0.13	2.77	1.94 - 3.60	Pass
STVE-1141	01/01/08	Cs-134	6.53 ± 0.29	6.28	4.40 - 8.16	Pass
STVE-1141	01/01/08	Cs-137	3.90 ± 0.19	3.41	2.39 - 4.43	Pass
STVE-1141	01/01/08	Mn-54	5.43 ± 0.21	4.74	3.32 - 6.16	Pass
STVE-1141	01/01/08	Zn-65	0.033 ± 0.10	0.00	0.00 - 1.00	Pass

TABLE A-6. Department of Energy's Mixed Analyte Performance Evaluation Program (MAPEP)<sup>a</sup>.

Lab Code <sup>c</sup>	Date	Analysis	Concentration <sup>b</sup>			Acceptance
			Laboratory result	Known Activity	Control Limits <sup>d</sup>	
STSO-1142	01/01/08	Co-57	483.00 ± 3.00	421.00	295.00 - 547.00	Pass
STSO-1142	01/01/08	Co-60	3.00 ± 0.80	2.90	0.00 - 5.00	Pass
STSO-1142	01/01/08	Cs-134	896.50 ± 7.40	854.00	598.00 - 1110.00	Pass
STSO-1142	01/01/08	Cs-137	624.40 ± 4.10	545.00	382.00 - 709.00	Pass
STSO-1142	01/01/08	Mn-54	667.20 ± 3.80	570.00	399.00 - 741.00	Pass
STSO-1142	01/01/08	Ni-63	536.00 ± 15.50	640.00	448.00 - 832.00	Pass
STSO-1142	01/01/08	Pu-238	78.60 ± 4.80	72.80	51.00 - 94.60	Pass
STSO-1142	01/01/08	Pu-239/40	89.10 ± 4.50	90.10	63.10 - 117.10	Pass
STSO-1142	01/01/08	U-233/4	134.41 ± 5.40	142.00	99.00 - 185.00	Pass
STSO-1142	01/01/08	U-238	139.00 ± 5.50	148.00	104.00 - 192.00	Pass
STSO-1142	01/01/08	Zn-65	0.093 ± 0.91	0.00	0.00 - 1.00	Pass
STSO-1158	08/01/08	Am-241	57.73 ± 4.78	69.10	48.40 - 89.80	Pass
STSO-1158	08/01/08	Co-57	353.02 ± 2.01	333.00	233.00 - 433.00	Pass
STSO-1158	08/01/08	Co-60	151.99 ± 1.58	145.00	102.00 - 189.00	Pass
STSO-1158	08/01/08	Cs-134	499.72 ± 2.65	581.00	407.00 - 755.00	Pass
STSO-1158	08/01/08	Cs-137	2.54 ± 0.25	2.80	0.00 - 5.00	Pass
STSO-1158	08/01/08	K-40	643.94 ± 15.50	570.00	399.00 - 741.00	Pass
STSO-1158	08/01/08	Mn-54	452.14 ± 2.96	415.00	291.00 - 540.00	Pass
STSO-1158	08/01/08	Ni-63	803.09 ± 17.01	760.00	532.00 - 988.00	Pass
STSO-1158	08/01/08	Pu-238	0.12 ± 0.54	0.00	0.00 - 5.00	Pass
STSO-1158	08/01/08	Pu-239/40	60.88 ± 5.89	55.60	38.90 - 72.30	Pass
STSO-1158	08/01/08	Sr-90	1.95 ± 2.04	0.00	0.00 - 5.00	Pass
STSO-1158 <sup>f</sup>	08/01/08	Tc-99	337.00 ± 17.30	335.00	235.00 - 436.00	Pass
STSO-1158	08/01/08	U-238	315.67 ± 11.29	303.00	212.00 - 394.00	Pass
STSO-1158	08/01/08	Zn-65	0.10 ± 2.04	0.00	0.00 - 5.00	Pass
STVE-1159	08/01/08	Co-57	8.52 ± 0.23	7.10	5.00 - 9.20	Pass
STVE-1159	08/01/08	Co-60	5.08 ± 0.19	4.70	3.30 - 6.10	Pass
STVE-1159	08/01/08	Cs-134	5.26 ± 0.18	5.50	3.90 - 7.20	Pass
STVE-1159	08/01/08	Cs-137	0.01 ± 0.14	0.00	0.00 - 1.00	Pass
STVE-1159	08/01/08	Mn-54	6.39 ± 0.28	5.80	4.10 - 7.50	Pass
STVE-1159	08/01/08	Zn-65	7.73 ± 0.45	6.90	4.80 - 9.00	Pass

TABLE A-6. Department of Energy's Mixed Analyte Performance Evaluation Program (MAPEP)<sup>a</sup>.

Lab Code <sup>c</sup>	Date	Analysis	Concentration <sup>b</sup>			Acceptance
			Laboratory result	Known Activity	Control Limits <sup>d</sup>	
STW-1162 <sup>g</sup>	08/01/08	Am-241	0.20 ± 0.06	0.00	0.00 - 0.10	Fail
STW-1162	08/01/08	Co-57	0.03 ± 0.16	0.00	0.00 - 5.00	Pass
STW-1162	08/01/08	Co-60	11.27 ± 0.23	11.60	8.10 - 15.10	Pass
STW-1162	08/01/08	Cs-134	17.93 ± 0.52	19.50	13.70 - 25.40	Pass
STW-1162	08/01/08	Cs-137	23.72 ± 0.43	23.60	16.50 - 30.70	Pass
STW-1162	08/01/08	Fe-55	43.36 ± 16.81	46.20	32.30 - 60.10	Pass
STW-1162	08/01/08	H-3	385.15 ± 8.93	341.00	239.00 - 443.00	Pass
STW-1162	08/01/08	Mn-54	13.87 ± 0.37	13.70	9.60 - 17.80	Pass
STW-1162 <sup>h</sup>	08/01/08	Ni-63	10.77 ± 2.01	0.00	0.00 - 5.00	Fail
STW-1162 <sup>i</sup>	08/01/08	Pu-238	0.33 ± 0.06	0.50	0.40 - 0.70	Fail
STW-1162	08/01/08	Pu-239/40	0.14 ± 0.15	0.00	0.00 - 0.20	Pass
STW-1162	08/01/08	Sr-90	6.49 ± 1.12	6.45	4.52 - 8.39	Pass
STW-1162 <sup>j</sup>	08/01/08	Tc-99	1.80 ± 0.62	3.76	2.63 - 4.89	Fail
STW-1162	08/01/08	U-233/4	3.33 ± 0.18	3.44	2.41 - 4.47	Pass
STW-1162	08/01/08	U-238	3.38 ± 0.18	3.55	2.49 - 4.62	Pass
STW-1162	08/01/08	Zn-65	17.64 ± 0.61	17.10	12.00 - 22.20	Pass
STW-1163	08/01/08	Gr. Alpha	0.08 ± 0.04	0.00	0.00 - 0.56	Pass
STW-1163	08/01/08	Gr. Beta	0.12 ± 0.05	0.00	0.00 - 1.85	Pass

<sup>a</sup> Results obtained by Environmental, Inc., Midwest Laboratory as a participant in the Department of Energy's Mixed Analyte Performance Evaluation Program, Idaho Operations office, Idaho Falls, Idaho

<sup>b</sup> Results are reported in units of Bq/kg (soil), Bq/L (water) or Bq/total sample (filters, vegetation).

<sup>c</sup> Laboratory codes as follows: STW (water), STAP (air filter), STSO (soil), STVE (vegetation).

<sup>d</sup> MAPEP results are presented as the known values and expected laboratory precision (1 sigma, 1 determination) and control limits as defined by the MAPEP.

<sup>e</sup> The results of a repeat analysis were still unacceptable. A spiked air filter was prepared (known activity 4.17 pCi/filter) to verify the methodology; results of the spike analysis were acceptable, 4.64 pCi/filter.

<sup>f</sup> Corrected result. An error in calculation was found.

<sup>g</sup> Included in the testing series as a "false positive". Result of reanalysis, 0.04 ± 0.01 Bq/L.

<sup>h</sup> Included in the testing series as a "false positive". Result of reanalysis, 3.78 ± 2.03 Bq/L.

<sup>i</sup> The reason for the deviation is unknown. Result of the original sample recount: 0.47 ± 0.07 Bq/L.

The analysis was then repeated from the beginning. Result of reanalysis: 0.51 ± 0.07 Bq/L.

<sup>j</sup> The lower result was due to a higher than average background count used in the calculation. Average background result: 4.11 ± 0.66 Bq/L.

TABLE A-7. Interlaboratory Comparison Crosscheck program, Environmental Resource Associates (ERA)<sup>a</sup>.

Lab Code <sup>b</sup>	Date	Analysis	Concentration (pCi/L)		Control Limits	Acceptance
			Laboratory Result <sup>c</sup>	ERA Result <sup>d</sup>		
STAP-1143	03/24/08	Am-241	60.48 ± 3.52	50.1	29.3 - 68.7	Pass
STAP-1143	03/24/08	Co-60	650.72 ± 3.00	730.0	565.0 - 912.0	Pass
STAP-1143	03/24/08	Cs-134	467.50 ± 5.53	523.0	341.0 - 647.0	Pass
STAP-1143	03/24/08	Cs-137	1375.90 ± 25.41	1450.0	1090.0 - 1900.0	Pass
STAP-1143	03/24/08	Fe-55	145.60 ± 28.94	241.0	106.0 - 375.0	Pass
STAP-1143 <sup>e</sup>	03/24/08	Mn-54	0.00 ± 0.00	0.0	0.0 - 10.0	Pass
STAP-1143	03/24/08	Pu-238	53.65 ± 1.54	46.8	32.1 - 61.5	Pass
STAP-1143	03/24/08	Pu-239/40	70.44 ± 3.11	64.1	46.5 - 83.0	Pass
STAP-1143	03/24/08	Sr-90	157.60 ± 7.70	152.0	66.9 - 236.0	Pass
STAP-1143	03/24/08	U-233/4	62.15 ± 3.41	66.7	42.0 - 98.8	Pass
STAP-1143	03/24/08	U-238	64.11 ± 3.29	66.2	42.4 - 94.0	Pass
STAP-1143	03/24/08	Uranium	128.40 ± 3.29	136.0	69.5 - 216.0	Pass
STAP-1143	03/24/08	Zn-65	889.90 ± 15.90	872.0	604.0 - 1210.0	Pass
STAP-1144	03/24/08	Gr. Alpha	13.08 ± 1.09	8.8	4.56 - 13.2	Pass
STAP-1144	03/24/08	Gr. Beta	99.90 ± 3.09	92.2	56.80 - 135.0	Pass
STSO-1145	03/24/08	Ac-228	1269.02 ± 36.81	1180.0	757.0 - 1660.0	Pass
STSO-1145	03/24/08	Am-241	1268.50 ± 85.80	1230.0	735.0 - 1580.0	Pass
STSO-1145	03/24/08	Bi-212	1407.10 ± 56.64	1360.0	357.0 - 2030.0	Pass
STSO-1145	03/24/08	Bi-214	2145.50 ± 305.63	1790.0	1100.0 - 2570.0	Pass
STSO-1145	03/24/08	Co-60	5219.70 ± 90.30	5130.0	3730.0 - 6890.0	Pass
STSO-1145	03/24/08	Cs-134	5427.30 ± 102.94	5640.0	3630.0 - 6790.0	Pass
STSO-1145	03/24/08	Cs-137	6346.60 ± 201.80	6010.0	4600.0 - 7810.0	Pass
STSO-1145	03/24/08	K-40	11052.70 ± 181.80	11000.0	7980.0 - 14900.0	Pass
STSO-1145 <sup>e</sup>	03/24/08	Mn-54	0.00 ± 0.00	0.0	0.0 - 10.0	Pass
STSO-1145	03/24/08	Pb-212	1198.20 ± 96.58	1080.0	697.0 - 1520.0	Pass
STSO-1145	03/24/08	Pb-214	2253.30 ± 291.60	2020.0	1210.0 - 3010.0	Pass
STSO-1145	03/24/08	Sr-90	6407.00 ± 277.00	5360.0	1940.0 - 8750.0	Pass
STSO-1145	03/24/08	Th-234	2421.80 ± 321.00	2030.0	644.0 - 3870.0	Pass
STSO-1145 <sup>f</sup>	03/24/08	U-233/4	1227.93 ± 91.52	2050.0	1240.0 - 2580.0	Fail
STSO-1145	03/24/08	U-238	1319.90 ± 48.81	2030.0	1240.0 - 2580.0	Pass
STSO-1145	03/24/08	Uranium	2592.00 ± 140.50	4180.0	2380.0 - 5640.0	Pass
STSO-1145	03/24/08	Zn-65	2936.20 ± 73.50	2660.0	2110.0 - 3570.0	Pass



TABLE A-7. Interlaboratory Comparison Crosscheck program, Environmental Resource Associates (ERA)<sup>a</sup>.

Lab Code <sup>b</sup>	Date	Analysis	Concentration (pCi/L)			Acceptance
			Laboratory Result <sup>c</sup>	ERA Result <sup>d</sup>	Control Limits	
STVE-1146	03/24/08	Am-241	1261.50 ± 73.90	1260.0	718.0 - 1730.0	Pass
STVE-1146	03/24/08	Cm-244	1152.50 ± 57.44	1200.0	591.0 - 1870.0	Pass
STVE-1146	03/24/08	Co-60	912.41 ± 13.59	888.0	600.0 - 1280.0	Pass
STVE-1146	03/24/08	Cs-134	1547.70 ± 38.81	1540.0	882.0 - 2130.0	Pass
STVE-1146	03/24/08	Cs-137	1163.80 ± 20.62	1100.0	807.0 - 1530.0	Pass
STVE-1146	03/24/08	K-40	22186.00 ± 339.40	24600.0	17700.0 - 34800.0	Pass
STVE-1146 <sup>e</sup>	03/24/08	Mn-54	0.00 ± 0.00	0.0	0.0 - 10.0	Pass
STVE-1146	03/24/08	Sr-90	3825.90 ± 140.66	4130.0	2310.0 - 5480.0	Pass
STVE-1146	03/24/08	U-233/4	2753.30 ± 227.90	3070.0	2110.0 - 4070.0	Pass
STVE-1146	03/24/08	U-238	2697.10 ± 143.20	3050.0	2140.0 - 3850.0	Pass
STVE-1146	03/24/08	Uranium	5586.10 ± 455.20	6260.0	4300.0 - 8080.0	Pass
STVE-1146	03/24/08	Zn-65	1676.80 ± 43.00	1430.0	1030.0 - 1960.0	Pass
STW-1147	03/24/08	Am-241	97.56 ± 1.02	90.9	62.0 - 124.0	Pass
STW-1147	03/24/08	Co-60	1430.00 ± 33.33	1420.0	1240.0 - 1680.0	Pass
STW-1147	03/24/08	Cs-134	730.18 ± 33.39	751.0	555.0 - 862.0	Pass
STW-1147	03/24/08	Cs-137	1947.80 ± 13.80	1990.0	1690.0 - 2380.0	Pass
STW-1147	03/24/08	Fe-55	1422.70 ± 172.16	2080.0	1210.0 - 2780.0	Pass
STW-1147 <sup>e</sup>	03/24/08	Mn-54	0.00 ± 0.00	0.0	0.0 - 10.0	Pass
STW-1147	03/24/08	Pu-238	144.16 ± 4.54	135.0	102.0 - 168.0	Pass
STW-1147	03/24/08	Pu-239/40	82.16 ± 2.50	80.7	62.4 - 99.8	Pass
STW-1147	03/24/08	Sr-90	512.03 ± 43.37	512.0	325.0 - 684.0	Pass
STW-1147	03/24/08	U-233/4	74.40 ± 1.20	81.0	61.0 - 104.0	Pass
STW-1147	03/24/08	U-238	75.10 ± 1.35	80.3	61.3 - 99.5	Pass
STW-1147	03/24/08	Uranium	152.10 ± 2.55	165.0	119.0 - 220.0	Pass
STW-1147	03/24/08	Zn-65	708.90 ± 29.00	694.0	588.0 - 865.0	Pass
STW-1120	03/19/07	Uranium	339.60 ± 10.66	391.0	282.0 - 521.0	Pass
STW-1120	03/19/07	Zn-65	2009.00 ± 36.40	1910.0	1600.0 - 2410.0	Pass

<sup>a</sup> Results obtained by Environmental, Inc., Midwest Laboratory as a participant in the crosscheck program for proficiency testing administered by Environmental Resources Associates, serving as a replacement for studies conducted previously by the Environmental Measurements Laboratory Quality Assessment Program (EML).

<sup>b</sup> Laboratory codes as follows: STW (water), STAP (air filter), STSO (soil), STVE (vegetation).

<sup>c</sup> Unless otherwise indicated, the laboratory result is given as the mean ± standard deviation for three determinations.

<sup>d</sup> Results are presented as the known values, expected laboratory precision (1 sigma, 1 determination) and control limits as provided by ERA.

<sup>e</sup> Included in the testing series as a "false positive". No activity expected.

<sup>f</sup> The analysis was repeated by leaching and total dissolution methods. Total dissolution yielded results within expected range. Results of the reanalysis: U-233,4, 1655 ± 95 pCi/kg. U-238 1805 ± 97 pCi/kg.

APPENDIX B

DATA REPORTING CONVENTIONS

Data Reporting Conventions

1.0. All activities, except gross alpha and gross beta, are decay corrected to collection time or the end of the collection period.

2.0. Single Measurements

Each single measurement is reported as follows:  $x \pm s$

where:  $x$  = value of the measurement;  
 $s = 2s$  counting uncertainty (corresponding to the 95% confidence level).

In cases where the activity is less than the lower limit of detection  $L$ , it is reported as:  $<L$ ,  
 where  $L$  = the lower limit of detection based on 4.66s uncertainty for a background sample.

3.0. Duplicate analyses

3.1 Individual results: For two analysis results;  $x_1 \pm s_1$  and  $x_2 \pm s_2$

Reported result:  $x \pm s$ ; where  $x = (1/2)(x_1 + x_2)$  and  $s = (1/2)\sqrt{s_1^2 + s_2^2}$

3.2. Individual results:  $<L_1, <L_2$  Reported result:  $<L$ , where  $L$  = lower of  $L_1$  and  $L_2$

3.3. Individual results:  $x \pm s, <L$  Reported result:  $x \pm s$  if  $x \geq L$ ;  $<L$  otherwise.

4.0. Computation of Averages and Standard Deviations

4.1 Averages and standard deviations listed in the tables are computed from all of the individual measurements over the period averaged; for example, an annual standard deviation would not be the average of quarterly standard deviations. The average  $\bar{x}$  and standard deviation  $s$  of a set of  $n$  numbers  $x_1, x_2 \dots x_n$  are defined as follows:

$$\bar{x} = \frac{1}{n} \sum x \quad s = \sqrt{\frac{\sum (x - \bar{x})^2}{n - 1}}$$

4.2 Values below the highest lower limit of detection are not included in the average.

4.3 If all values in the averaging group are less than the highest LLD, the highest LLD is reported.

4.4 If all but one of the values are less than the highest LLD, the single value  $x$  and associated two sigma error is reported.

4.5 In rounding off, the following rules are followed:

4.5.1. If the number following those to be retained is less than 5, the number is dropped, and the retained numbers are kept unchanged. As an example, 11.443 is rounded off to 11.44.

4.5.2. If the number following those to be retained is equal to or greater than 5, the number is dropped and the last retained number is raised by 1. As an example, 11.445 is rounded off to 11.45.

**APPENDIX C**

**Maximum Permissible Concentrations  
of Radioactivity in Air and Water  
Above Background in Unrestricted Areas**

Table C-1. Maximum permissible concentrations of radioactivity in air and water above natural background in unrestricted areas<sup>a</sup>.

Air (pCi/m <sup>3</sup> )		Water (pCi/L)	
Gross alpha	1 x 10 <sup>-3</sup>	Strontium-89	8,000
Gross beta	1	Strontium-90	500
Iodine-131 <sup>b</sup>	2.8 x 10 <sup>-1</sup>	Cesium-137	1,000
		Barium-140	8,000
		Iodine-131	1,000
		Potassium-40 <sup>c</sup>	4,000
		Gross alpha	2
		Gross beta	10
		Tritium	1 x 10 <sup>6</sup>

<sup>a</sup> Taken from Table 2 of Appendix B to Code of Federal Regulations Title 10, Part 20, and appropriate footnotes. Concentrations may be averaged over a period not greater than one year.

<sup>b</sup> Value adjusted by a factor of 700 to reduce the dose resulting from the air-grass-cow-milk-child pathway.

<sup>c</sup> A natural radionuclide.

APPENDIX D  
REMP SAMPLING SUMMARY

Davis-Besse Nuclear Power Station 2008 Annual Radiological Environmental Operating Report

Table 4.5 Radiological Environmental Monitoring Program Summary

Name of Facility	<u>Davis-Besse Nuclear Power Station</u>	Docket No.	<u>50-346</u>
Location of Facility	<u>Ottawa, Ohio</u> ( County, State )	Reporting Period	<u>January-December, 2008</u>

Sample Type (Units)	Type and Number of Analyses <sup>a</sup>	LLD <sup>b</sup>	Indicator Locations Mean (F) <sup>c</sup> Range <sup>c</sup>	Location with Highest Annual Mean		Control Locations Mean (F) <sup>c</sup> Range <sup>c</sup>	Number Non-Routine Results <sup>d</sup>
				Location <sup>d</sup>	Mean (F) <sup>c</sup> Range <sup>c</sup>		
Airborne Particulates (pCi/m <sup>3</sup> )	GB 519	0.005	0.026 (311/311) (0.006-0.055)	T-4, Site Boundary 0.8 mi. S	0.027 (52/52) (0.009-0.045)	0.026 (208/208) (0.006-0.047)	0
	Sr-89 40	0.0009	< LLD	-	-	< LLD	0
	Sr-90 40	0.0005	< LLD	-	-	< LLD	0
	GS 40						
	Be-7	0.015	0.083 (24/24) (0.056-0.101)	T-11, Ottawa County WTP, 9.5 mi. SE	0.091 (4/4) (0.067-0.102)	0.085 (16/16) (0.059-0.102)	0
	K-40	0.031	< LLD	-	-	< LLD	0
	Nb-95	0.0013	< LLD	-	-	< LLD	0
	Zr-95	0.0020	< LLD	-	-	< LLD	0
	Ru-103	0.0014	< LLD	-	-	< LLD	0
	Ru-106	0.0087	< LLD	-	-	< LLD	0
	Cs-134	0.0011	< LLD	-	-	< LLD	0
	Cs-137	0.0011	< LLD	-	-	< LLD	0
	Ce-141	0.0020	< LLD	-	-	< LLD	0
Ce-144	0.0058	< LLD	-	-	< LLD	0	
Airborne Iodine (pCi/m <sup>3</sup> )	I-131 519	0.07	< LLD	-	-	< LLD	0
TLD (Quarterly) (mR/91 days)	Gamma 352	1.0	16.5 (308/308) ( 7.4-27.5)	T-8, Farm 2.7 mi. WSW	25.2 (4/4) (23.5-27.5)	17.5 (44/44) ( 12.8-25.1)	0
TLD (Quarterly) (mR/91 days) (Shield)	Gamma 4	1.0	8.2 (4/4) ( 7.2-9.4)	-	-	None	0
TLD (Annual) (mR/365 days)	Gamma 88	1.0	59.4 (77/77) ( 35.2-95.0)	T-8, Farm 2.7 mi. WSW	95.0 (1/1)	65.8 (11/11) ( 55.1-83.1)	0
TLD (Annual) (mR/365 days) (Shield)	Gamma 1	1.0	29.1 (1/1)	-	-	None	0

Davis-Besse Nuclear Power Station 2008 Annual Radiological Environmental Operating Report

Table 4.5 Radiological Environmental Monitoring Program Summary

Name of Facility	<u>Davis-Besse Nuclear Power Station</u>	Docket No.	<u>50-346</u>
Location of Facility	<u>Ottawa, Ohio</u> ( County, State )	Reporting Period	<u>January-December, 2008</u>

Sample Type (Units)	Type and Number of Analyses <sup>a</sup>	LLD <sup>b</sup>	Indicator Locations Mean (F) <sup>c</sup> Range <sup>c</sup>	Location with Highest Annual Mean		Control Locations Mean (F) <sup>c</sup> Range <sup>c</sup>	Number Non-Routine Results <sup>d</sup>		
				Location <sup>d</sup>	Mean (F) <sup>c</sup> Range <sup>c</sup>				
Milk (pCi/L)	I-131	12	0.5	none	-	-	< LLD	0	
	Sr-89	12	1.0	none	-	-	< LLD	0	
	Sr-90	12	0.8	none	T-24, Sandusky 21.0 mi. SE	1.0 (3/12) (0.8-1.3)	1.0 (3/12) (0.8-1.3)	0	
	GS	12							
	K-40		100	none	T-24, Sandusky 21.0 mi. SE	1390 (12/12) (1339-1466)	1390 (12/12) (1339-1466)	0	
	Cs-134		5.7	none	-	-	< LLD	0	
	Cs-137		5.0	none	-	-	< LLD	0	
	Ba-La-140		5.9	none	-	-	< LLD	0	
	(g/L)	Ca	12	0.50	none	T-24, Sandusky 21.0 mi. SE	1.25 (12/12) (1.11-1.51)	1.25 (12/12) (1.11-1.51)	0
	(g/L)	K (stable)	12		none	T-24, Sandusky 21.0 mi. SE	1.61 (12/12) (1.55-1.69)	1.61 (12/12) (1.55-1.69)	0
(pCi/g)	Sr-90/Ca	12		none	T-24, Sandusky 21.0 mi. SE	0.78 (3/12) (0.71-0.86)	0.78 (3/12) (0.71-0.86)	0	
(pCi/g)	Cs-137/K	12		none	-	-	< LLD	0	
Ground Water (pCi/L)	GB (TR)	9	0.9	2.1 (5/6) (1.6-2.7)	T-225, residence 1.55 mi. NW	2.1 (5/6) (1.6-2.7)	2.7 (3/3) (2.0-3.2)		
	H-3	9	330	< LLD	-	-	< LLD	0	
	Sr-89	9	1.4	< LLD	-	-	< LLD	0	
	Sr-90	9	0.7	< LLD	-	-	< LLD	0	
	GS								
	Mn-54		15	< LLD	-	-	< LLD	0	
	Fe-59		30	< LLD	-	-	< LLD	0	
	Co-58		15	< LLD	-	-	< LLD	0	
	Co-60		15	< LLD	-	-	< LLD	0	
	Zn-65		30	< LLD	-	-	< LLD	0	
	Zr-95		15	< LLD	-	-	< LLD	0	
	Cs-134		10	< LLD	-	-	< LLD	0	
	Cs-137		10	< LLD	-	-	< LLD	0	
Ba-La-140		15	< LLD	-	-	< LLD	0		



Davis-Besse Nuclear Power Station 2008 Annual Radiological Environmental Operating Report

Table 4.5 Radiological Environmental Monitoring Program Summary

Name of Facility	<u>Davis-Besse Nuclear Power Station</u>	Docket No.	<u>50-346</u>
Location of Facility	<u>Ottawa, Ohio</u> ( County, State )	Reporting Period	<u>January-December, 2008</u>

Sample Type (Units)	Type and Number of Analyses <sup>a</sup>	LLD <sup>b</sup>	Indicator Locations Mean (F) <sup>c</sup> Range <sup>c</sup>	Location with Highest Annual Mean		Control Locations Mean (F) <sup>c</sup> Range <sup>c</sup>	Number Non-Routine Results <sup>e</sup>
				Location <sup>d</sup>	Mean (F) <sup>c</sup> Range <sup>c</sup>		
Edible Meat (pCi/g wet)	GS 2	0.10	2.90 (1/1)	T-31, Onsite Roving location	2.90 (1/1)	2.34 (1/1)	0
	K-40						
	Nb-95						
	Zr-95						
	Ru-103						
	Ru-106						
	Cs-134						
	Cs-137						
	Ce-141						
Ce-144							
Fruits and Vegetables (pCi/g wet)	Sr-89 3	0.007	< LLD	-	-	< LLD	0
	Sr-90 3						
	I-131 3						
	GS 3						
	K-40						
	Nb-95						
	Zr-95						
	Cs-134						
	Cs-137						
	Ce-141						
	Ce-144						
Broad Leaf Vegetation (pCi/g wet)	Sr-89 9	0.004	< LLD	-	-	< LLD	0
	Sr-90 9						
	I-131 9						
	GS 9						
	K-40						
	Nb-95						
	Zr-95						
	Cs-134						
	Cs-137						
	Ce-141						
	Ce-144						

Davis-Besse Nuclear Power Station 2008 Annual Radiological Environmental Operating Report

Table 4.5 Radiological Environmental Monitoring Program Summary

Name of Facility	<u>Davis-Besse Nuclear Power Station</u>	Docket No.	<u>50-346</u>
Location of Facility	<u>Ottawa, Ohio</u> ( County, State )	Reporting Period	<u>January-December, 2008</u>

Sample Type (Units)	Type and Number of Analyses <sup>a</sup>	LLD <sup>b</sup>	Indicator Locations Mean (F) <sup>c</sup> Range <sup>c</sup>	Location with Highest Annual Mean		Control Locations Mean (F) <sup>c</sup> Range <sup>c</sup>	Number Non-Routine Results <sup>e</sup>
				Location <sup>d</sup>	Mean (F) <sup>c</sup> Range <sup>c</sup>		
Animal / Wildlife Feed (pCi/g wet)	GS 3						
	Be-7	0.19	0.72 (1/2)	T-31, Onsite Roving location	0.72 (1/1)	0.27 (1/1)	0
	K-40	0.10	3.08 (2/2) (2.40-3.76)	T-31, Onsite Roving location	3.76 (1/1)	2.13 (1/1)	0
	Nb-95	0.018	< LLD	-	-	< LLD	0
	Zr-95	0.023	< LLD	-	-	< LLD	0
	Ru-103	0.019	< LLD	-	-	< LLD	0
	Ru-106	0.14	< LLD	-	-	< LLD	0
	Cs-134	0.015	< LLD	-	-	< LLD	0
	Cs-137	0.016	< LLD	-	-	< LLD	0
	Ce-141	0.039	< LLD	-	-	< LLD	0
Ce-144	0.12	< LLD	-	-	< LLD	0	
Soil (pCi/g dry)	GS 10						
	Be-7	0.39	1.04 (4/6) (0.56-2.28)	T-8, Farm 2.7 mi. WSW	2.28 (1/1)	0.52 (1/4)	0
	K-40	0.10	12.82 (6/6) (5.33-19.92)	T-9, Oak Harbor 6.8 mi. SW	22.55 (1/1)	16.54 (4/4) (9.32-22.55)	0
	Nb-95	0.046	< LLD	-	-	< LLD	0
	Zr-95	0.061	< LLD	-	-	< LLD	0
	Ru-103	0.047	< LLD	-	-	< LLD	0
	Ru-106	0.22	< LLD	-	-	< LLD	0
	Cs-134	0.026	< LLD	-	-	< LLD	0
	Cs-137	0.022	0.13 (5/6) (0.048-0.27)	T-8, Farm 2.7 mi. WSW	0.27 (1/1)	0.12 (3/4) (0.070-0.15)	0
	Ce-141	0.084	< LLD	-	-	< LLD	0
Ce-144	0.17	< LLD	-	-	< LLD	0	

Davis-Besse Nuclear Power Station 2008 Annual Radiological Environmental Operating Report

Table 4.5 Radiological Environmental Monitoring Program Summary

Name of Facility	<u>Davis-Besse Nuclear Power Station</u>	Docket No.	<u>50-346</u>
Location of Facility	<u>Ottawa, Ohio</u>	Reporting Period	<u>January-December, 2008</u>
	( County, State )		

Sample Type (Units)	Type and Number of Analyses <sup>a</sup>	LLD <sup>b</sup>	Indicator Locations Mean (F) <sup>c</sup> Range <sup>c</sup>	Location with Highest Annual Mean		Control Locations Mean (F) <sup>c</sup> Range <sup>c</sup>	Number Non-Routine Results <sup>e</sup>
				Location <sup>d</sup>	Mean (F) <sup>c</sup> Range <sup>c</sup>		
Treated Surface Water (pCi/L)	GB (TR) 43	1.0	2.1 (23/24) (0.9-4.5)	T-22, Carroll Twp. WTP, 3.0 mi. NW	2.2 (12/12) (0.9-4.5)	1.9 (20/24) (1.0-3.1)	0
	H-3 16	330	< LLD	-	-	< LLD	0
	Sr-89 16	1.1	< LLD	-	-	< LLD	0
	Sr-90 16	0.6	< LLD	-	-	< LLD	0
	GS 16						
	Mn-54 15	15	< LLD	-	-	< LLD	0
	Fe-59 30	30	< LLD	-	-	< LLD	0
	Co-58 15	15	< LLD	-	-	< LLD	0
	Co-60 15	15	< LLD	-	-	< LLD	0
	Zn-65 30	30	< LLD	-	-	< LLD	0
	Zr-Nb-95 15	15	< LLD	-	-	< LLD	0
	Cs-134 10	10	< LLD	-	-	< LLD	0
	Cs-137 10	10	< LLD	-	-	< LLD	0
	Ba-La-140 15	15	< LLD	-	-	< LLD	0
Untreated Surface Water (pCi/L)	GB (TR) 60	1.0	2.2 (33/36) (0.9-4.5)	T-3, Site Boundary 1.4 mi. ESE	3.0 (12/12) (1.5-4.5)	1.9 (23/24) (0.9-3.5)	0
	H-3 60	330	< LLD	-	-	< LLD	0
	Sr-89 20	1.6	< LLD	-	-	< LLD	0
	Sr-90 20	0.9	< LLD	-	-	< LLD	0
	GS 60						
	Mn-54 15	15	< LLD	-	-	< LLD	0
	Fe-59 30	30	< LLD	-	-	< LLD	0
	Co-58 15	15	< LLD	-	-	< LLD	0
	Co-60 15	15	< LLD	-	-	< LLD	0
	Zn-65 30	30	< LLD	-	-	< LLD	0
	Zr-Nb-95 15	15	< LLD	-	-	< LLD	0
	Cs-134 10	10	< LLD	-	-	< LLD	0
	Cs-137 10	10	< LLD	-	-	< LLD	0
	Ba-La-140 15	15	< LLD	-	-	< LLD	0

Davis-Besse Nuclear Power Station 2008 Annual Radiological Environmental Operating Report

Table 4.5 Radiological Environmental Monitoring Program Summary

Name of Facility	<u>Davis-Besse Nuclear Power Station</u>	Docket No.	<u>50-346</u>
Location of Facility	<u>Ottawa, Ohio</u> ( County, State )	Reporting Period	<u>January-December, 2008</u>

Sample Type (Units)	Type and Number of Analyses <sup>a</sup>	LLD <sup>b</sup>	Indicator Locations Mean (F) <sup>c</sup> Range <sup>c</sup>	Location with Highest Annual Mean		Control Locations Mean (F) <sup>c</sup> Range <sup>c</sup>	Number Non-Routine Results <sup>e</sup>
				Location <sup>d</sup>	Mean (F) <sup>c</sup> Range <sup>c</sup>		
Fish (pCi/g wet)	GB 6	0.10	4.12 (3/3) (3.53-4.76)	T-33, Lake Erie 1.5 mi. NE	4.12 (3/3) (3.53-4.76)	4.10 (3/3) (3.37-5.32)	0
	GS 6						
	K-40	0.10	3.08 (3/3) (3.05-3.12)	T-33, Lake Erie 1.5 mi. NE	3.08 (3/3) (3.05-3.12)	2.88 (3/3) (2.56-3.22)	0
	Mn-54	0.024	< LLD	-	-	< LLD	0
	Fe-59	0.082	< LLD	-	-	< LLD	0
	Co-58	0.021	< LLD	-	-	< LLD	0
	Co-60	0.023	< LLD	-	-	< LLD	0
	Zn-65	0.043	< LLD	-	-	< LLD	0
	Cs-134	0.024	< LLD	-	-	< LLD	0
Cs-137	0.017	< LLD	-	-	< LLD	0	
Shoreline Sediments (pCi/g dry)	GS 8						
	K-40	0.10	12.85 (6/6) (10.12-19.69)	T-4, Site Boundary 0.8 mi. S	15.11 (2/2) (10.52-19.69)	10.87 (2/2) (9.89-11.85)	0
	Mn-54	0.038	< LLD	-	-	< LLD	0
	Co-58	0.039	< LLD	-	-	< LLD	0
	Co-60	0.02	< LLD	-	-	< LLD	0
	Cs-134	0.023	< LLD	-	-	< LLD	0
	Cs-137	0.025	< LLD	-	-	< LLD	0

<sup>a</sup> GB = gross beta, GS = gamma scan.

<sup>b</sup> LLD = nominal lower limit of detection based on a 4.66 sigma counting error for background sample.

<sup>c</sup> Mean and range are based on detectable measurements only (i.e., >LLD) Fraction of detectable measurements at specified locations is indicated in parentheses (F).

<sup>d</sup> Locations are specified by station code (Table 4.1) and distance (miles) and direction relative to reactor site.

<sup>e</sup> Non-routine results are those which exceed ten times the control station value.